

PHẦN III

**ĐƠN YÊU CẦU CẤP BẰNG ĐỘC QUYỀN KIỂU DÁNG CÔNG NGHIỆP**

(11) **6515**

(21) 3-2001-00610

(28) 01

(54) TAY CẦM BÀN CHẢI ĐÁNH RĂNG (51) **04-02**

(22) 09.07.2001

(43) 27.10.2003

(30) 29/135,311 09.01.2001 US

(71) COLGATE-PALMOLIVE COMPANY (US)

300 Park Avenue New York, New York 10022, United States of America

(72) Douglas Hohlbein (US)

(74) Văn phòng luật sư Phạm và Liên danh (PHAM & ASSOCIATES)

(55)

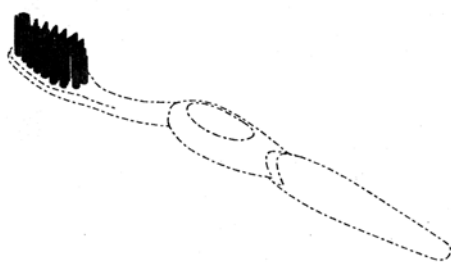

1.1



1.2



1.3



1.4



1.5



1.6

- (11) **6516**  
(21) 3-2001-00961 (28) 01  
(54) BAO GỐI BĂNG VỆ SINH (51) **09-05**  
(22) 30.11.2001 (43) 27.10.2003  
(71) KIMBERLY-CLARK CORPORATION (US)  
NEENAH, WISCONSIN, U.S.A.  
(72) Nhon Va Ma (VN)  
(74) Công ty TNHH Trần Hữu Nam và Đồng sự (TRAN H.N. & ASSOCIATES)  
(55)



1.1

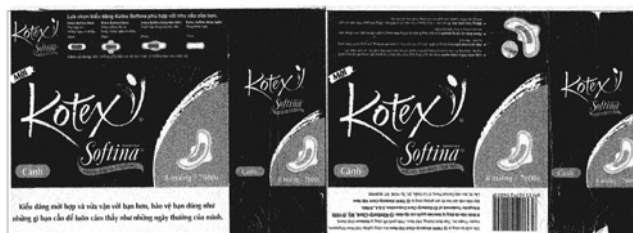

1.2

- (11) **6517**  
 (21) 3-2002-00289 (28) 02  
 (54) BÀN CHẢI ĐÁNH RĂNG (51) **04-02**  
 (22) 20.05.2002 (43) 27.10.2003  
 (30) 29/150,988 21.11.2001 US  
 (71) COLGATE-PALMOLIVE COMPANY (US)  
 300 Park Avenue, New York, New York 10022, United States of America  
 (72) Han Guo Ping (CN)  
 (74) Văn phòng luật sư Phạm và Liên danh (PHAM & ASSOCIATES)  
 (55)



1.1

1.2



1.3

1.4



1.5



1.6

1.7



2.1



2.2



2.3



2.4



2.5



2.6

2.7

(11) **6518**

(21) 3-2002-00563

(54) BỒN CẦU

(22) 06.09.2002

(30) 2002-06285 11.03.2002 JP

(71) TOTO LTD. (JP)

1-1, Nakashima 2 chome, Kokurakita-ku, Kitakyusyu, Fukuoka, 802-8601 Japan

(72) Ken IGARASHI (JP)

(74) Công ty Sở hữu công nghiệp (INVESTIP)

(55)

(28) 01

(51) **23-02**

(43) 27.10.2003

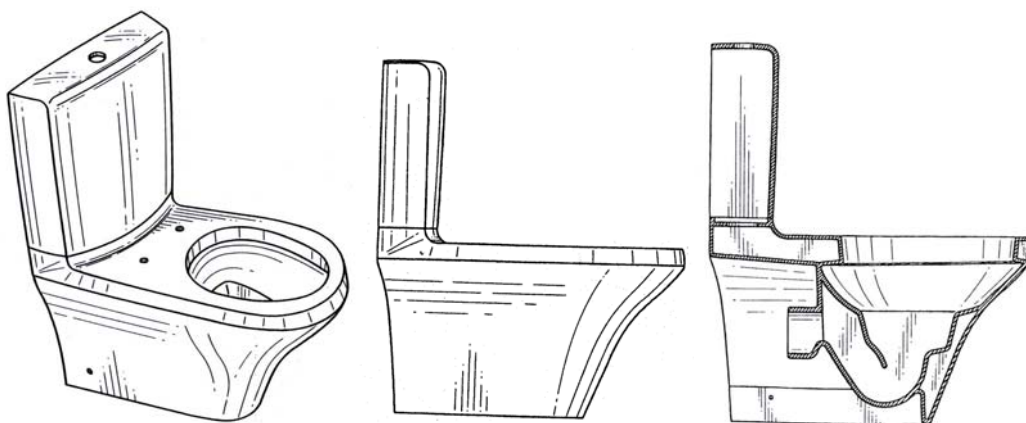

1.1

1.2

1.3

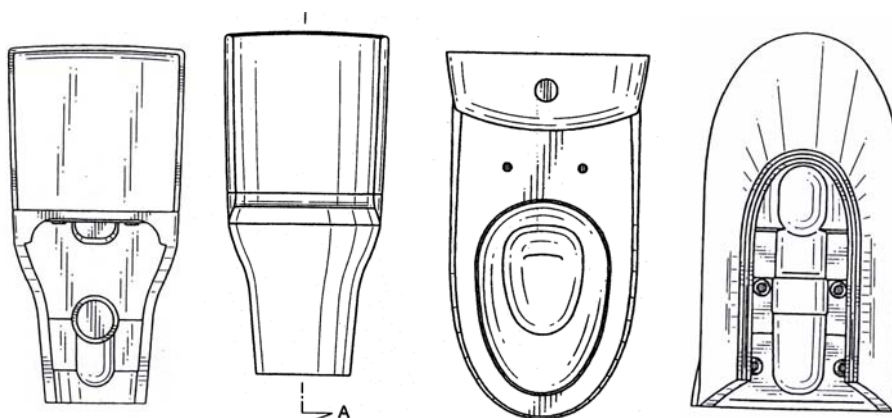

1.4

1.5

1.6

1.7

(11) **6519**

(21) 3-2002-00564

(54) BỒN CẦU

(22) 06.09.2002

(30) 2002-06286 11.03.2002 JP

(71) TOTO LTD. (JP)

1-1, Nakashima 2 chome, Kokurakita-ku, Kitakyusyu, Fukuoka, 802-8601 Japan

(72) Minoru TANI (JP)

(74) Công ty Sở hữu công nghiệp (INVESTIP)

(55)

(28) 01

(51) **23-02**

(43) 27.10.2003

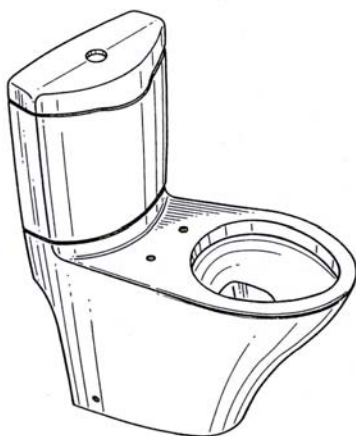

1.1

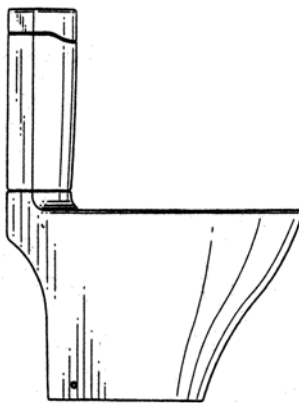

1.2

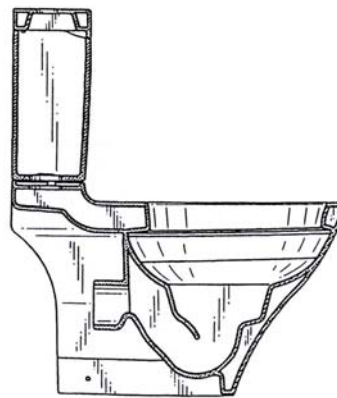

1.3



1.4

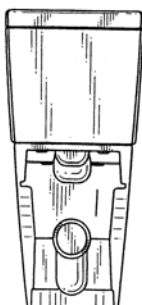

1.5



1.6

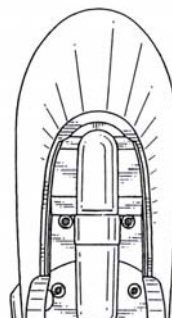

1.7

- (11) **6520**  
(21) 3-2002-00604 (28) 01  
(54) TAY CẦM BÀN CHẢI ĐÁNH RĂNG DÙNG ĐIỆN (51) **28-03**  
(22) 27.09.2002 (43) 27.10.2003  
(30) 3002547 28.03.2002 GB  
(71) UNILEVER N.V. (NL)  
Weena 455, 3013 AL Rotterdam, Netherlands  
(72) Olivier BREIT (DE)  
(74) Công ty TNHH Trần Hữu Nam và Đồng sự (TRAN H.N. & ASSOCIATES)  
(55)

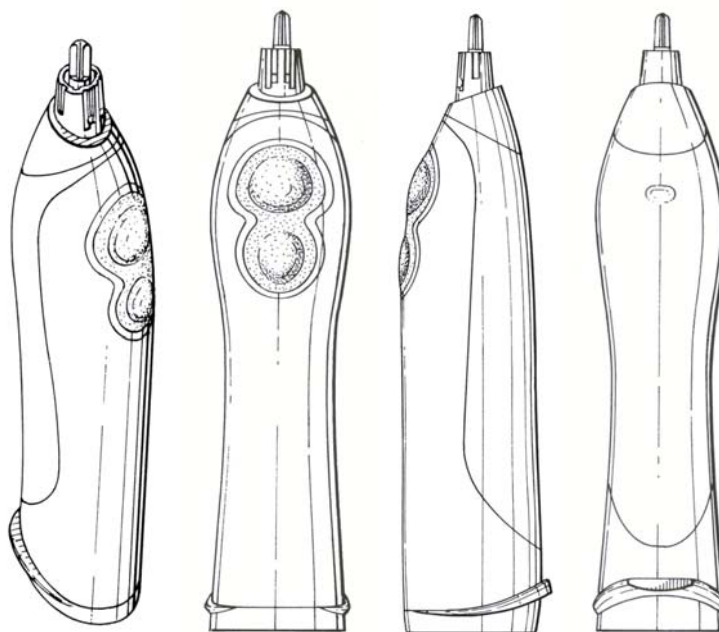

1.1

1.2

1.3

1.4

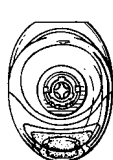

1.5

1.6

- (11) **6521**  
(21) 3-2002-00606 (28) 01  
(54) **ĐẦU BÀN CHẢI ĐÁNH RĂNG** (51) **04-02**  
(22) 27.09.2002 (43) 27.10.2003  
(30) 3002549 28.03.2002 GB  
(71) UNILEVER N.V. (NL)  
Weena 455, 3013 AL Rotterdam, Netherlands  
(72) Olivier BREIT (DE)  
(74) Công ty TNHH Trần Hữu Nam và Đồng sự (TRAN H.N. & ASSOCIATES)  
(55)

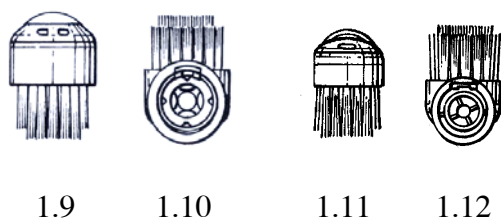
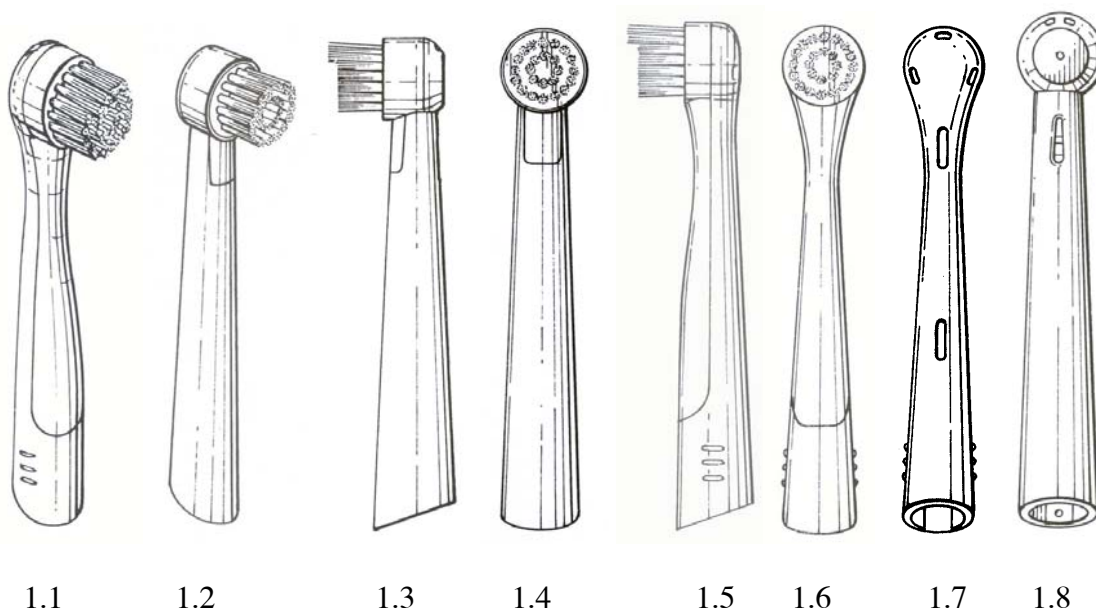

- (11) **6522**  
(21) 3-2002-00624 (28) 01  
(54) BAO GÓI CHAI NƯỚC HOA (51) **09-05**  
(22) 30.09.2002 (43) 27.10.2003  
(71) CÔNG TY CỔ PHẦN MỸ PHẨM SÀI GÒN (VN)  
1099 Trần Hưng Đạo, quận 5, Tp. Hồ Chí Minh  
(72) Nguyễn Kim Thoa (VN)  
(74) Công ty Sở hữu công nghiệp (INVESTIP)  
(55)

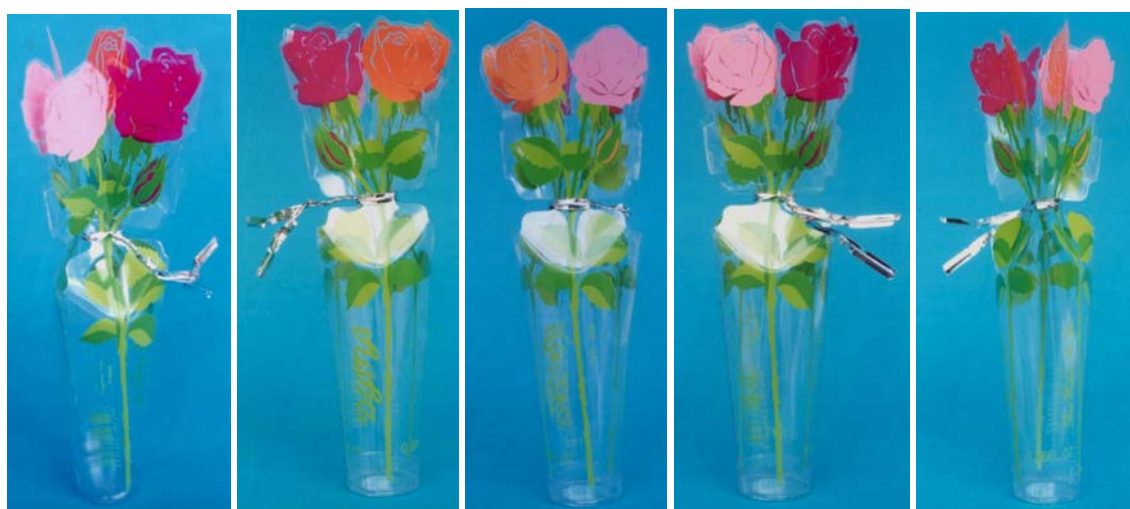

1.1

1.2

1.3

1.4

1.5

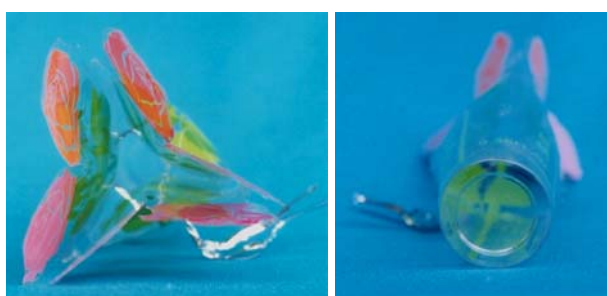

1.6

1.7



- (11) **6523**  
(21) 3-2002-00699  
(54) BÚT THỦY ĐIỆN  
(22) 25.10.2002  
(71) LÝ TUẤN DŨNG (VN)  
240 Lê Quang Sung, phường 6, quận 6, TP Hồ Chí Minh  
(72) Lý Tuấn Dũng (VN)  
(74) Văn phòng luật sư Phạm và Liên danh (PHAM & ASSOCIATES)  
(55)
- (28) 01  
(51) **10-04**  
(43) 27.10.2003



- (11) **6524**  
(21) 3-2002-00717 (28) 01  
(54) NHÃN SẢN PHẨM (51) **19-08**  
(22) 08.11.2002 (43) 27.10.2003  
(71) CƠ SỞ SẢN XUẤT NƯỚC MẮM HUỲNH THỊ CHI (VN)  
Tổ 1, thôn Tân Hải, Phú Hải, TP.Phan Thiết, tỉnh Bình Thuận  
(72) Huỳnh Thị Chi (VN)  
(55)





- (11) **6526**  
 (21) 3-2003-00035 (28) 01  
 (54) THÂN NẮP BÚT (51) **19-06**  
 (22) 21.01.2003 (43) 27.10.2003  
 (30) 40206098.9 22.07.2002 DE  
 (71) Merz & Krell GmbH & Co. KGaA (DE)  
 Bahnhofstrasse 76, 64401 Gross-Biebrach, DE (Germany)  
 (72) Volkmar ROMMEL (DE)  
 (74) Công ty TNHH Sở hữu trí tuệ Thảo Thọ Quyến (INVENCO)  
 (55)

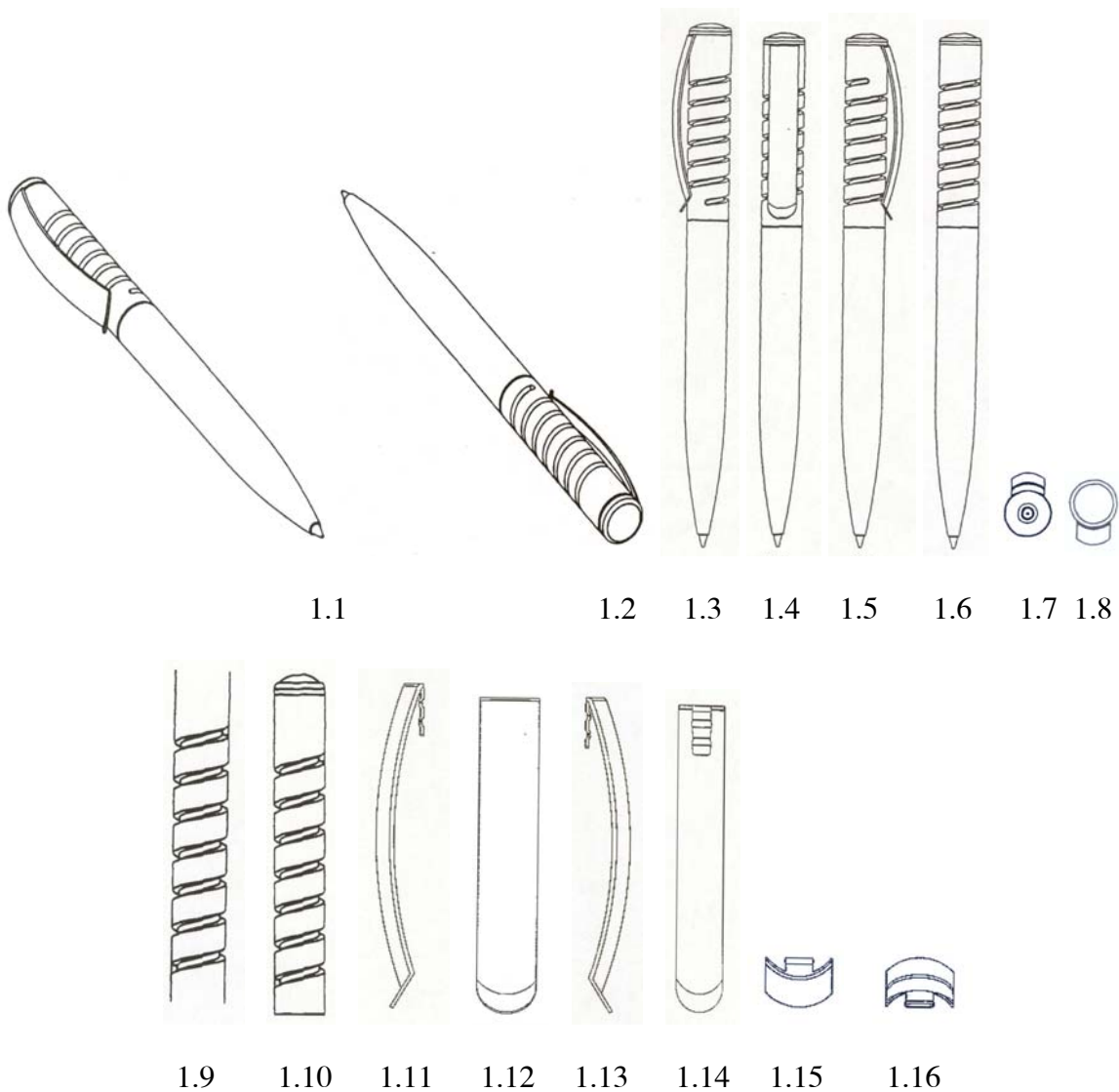

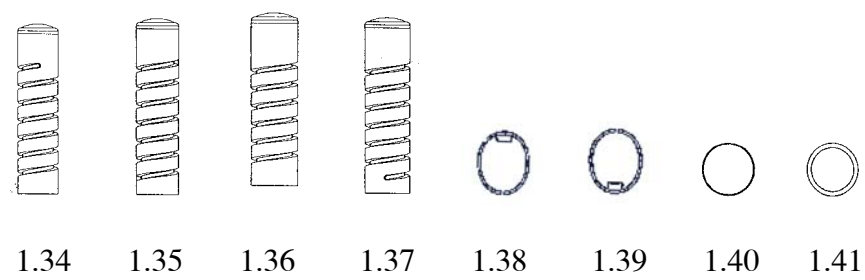
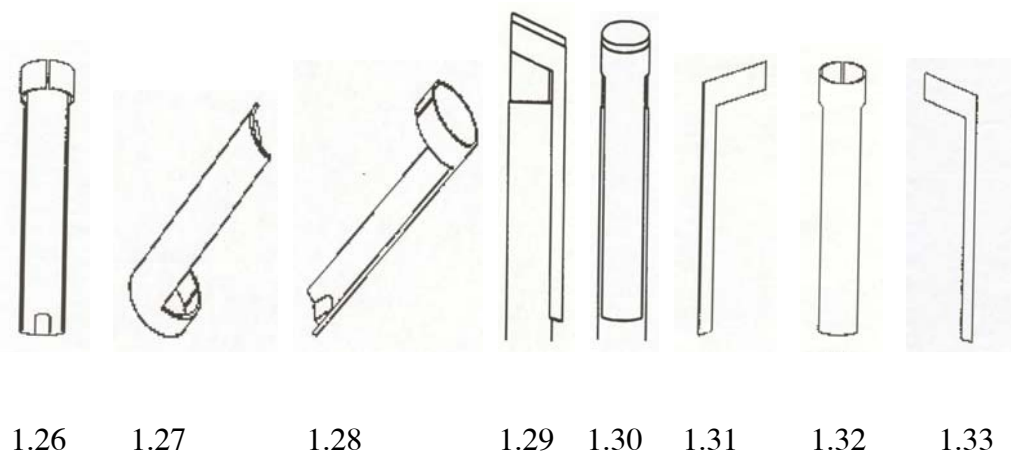
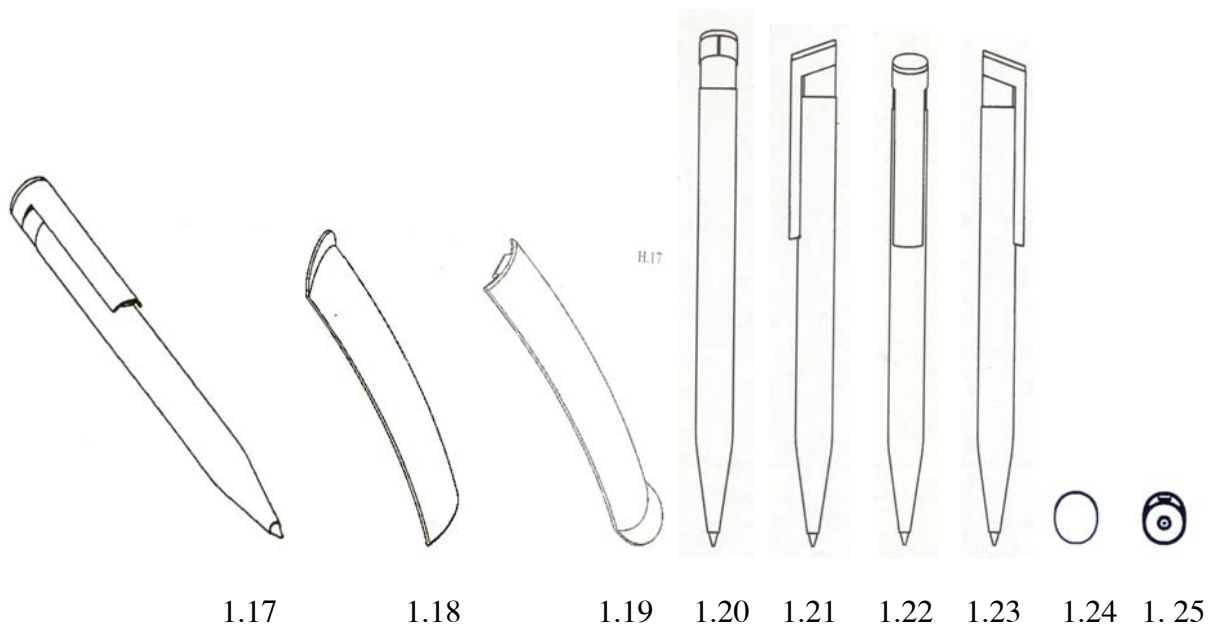

(11) **6527**

(21) 3-2003-00066

(54) BÌNH CHỨA

(22) 30.01.2003

(30) 024859 08.08.2002 FR

(71) UNILEVER N.V. (NL)

Weena 455, 3013 AL Rotterdam, Netherlands

(72) Francis John LOVELL (FR), Aurele HURTIS (FR), Valerie Julie Marie FAURE (FR),  
Theirry Michel MOLIERE (FR), Jorge Alberto SIRNA (AR)

(74) Công ty TNHH Trần Hữu Nam và Đồng sự (TRAN H.N. & ASSOCIATES)

(55)

(28) 01

(51) **09-01**

(43) 27.10.2003

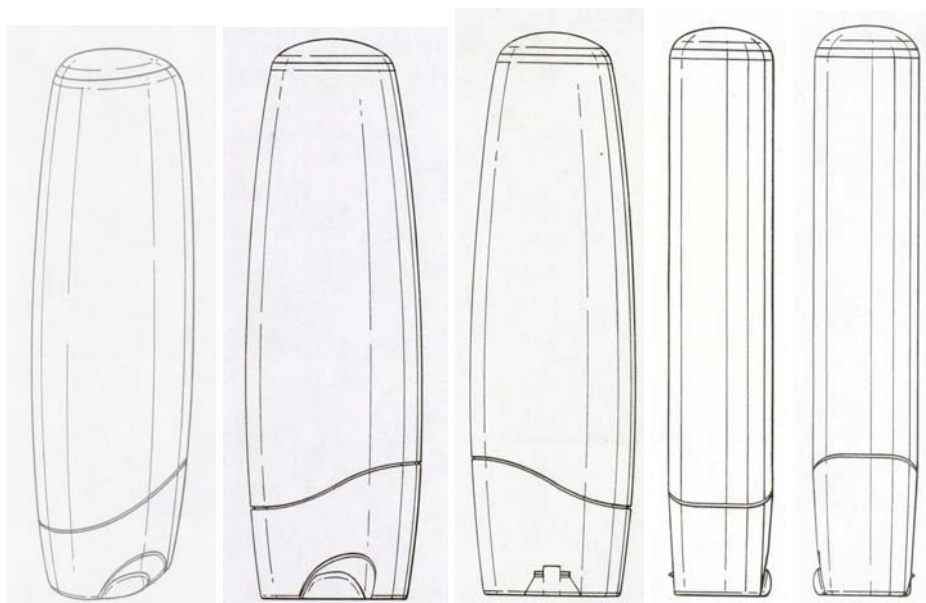

1.1

1.2

1.3

1.4

1.5

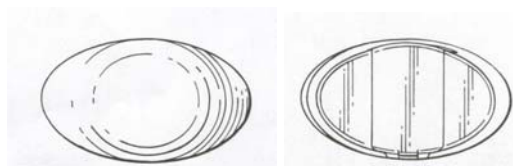

1.6

1.7

(11) **6528**

(21) 3-2003-00067

(54) BÌNH CHỨA

(22) 30.01.2003

(30) 024858 08.08.2002 FR

(71) UNILEVER N.V. (NL)

Weena 455, 3013 AL Rotterdam, Netherlands

(72) Francis John LOVELL (FR), Aurele HURTIS (FR), Valerie Julie Marie FAURE (FR),  
Theierry Michel MOLIERE (FR), Jorge Alberto SIRNA (AR)

(74) Công ty TNHH Trần Hữu Nam và Đồng sự (TRAN H.N. & ASSOCIATES)

(55)

(28) 01

(51) **09-01**

(43) 27.10.2003



1.1

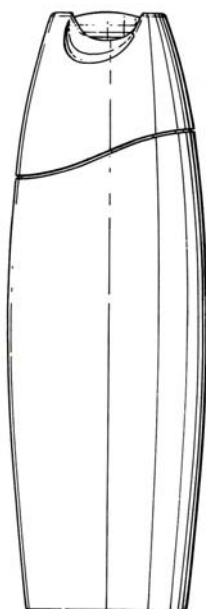

1.2

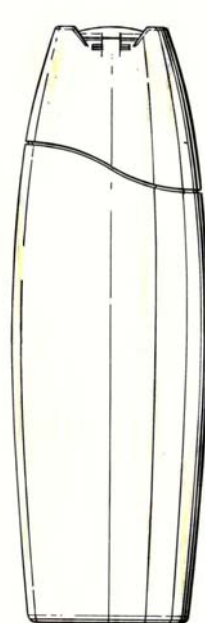

1.3



1.4



1.5



1.6

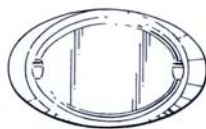

1.7

- (11) **6529**  
(21) 3-2003-00097 (28) 01  
(54) **ĐẦU BÀN CHẢI ĐÁNH RĂNG (51) 04-02**  
**DÙNG ĐIỆN**  
(22) 24.02.2003 (43) 27.10.2003  
(30) 3006464 28.08.2002 GB  
(71) UNILEVER N.V. (NL)  
Weena 455, 3013 AL Rotterdam, Netherlands  
(72) Rosario Donato De SALVO (IT)  
(74) Công ty TNHH Trần Hữu Nam và Đồng sự (TRAN H.N. & ASSOCIATES)  
(55)

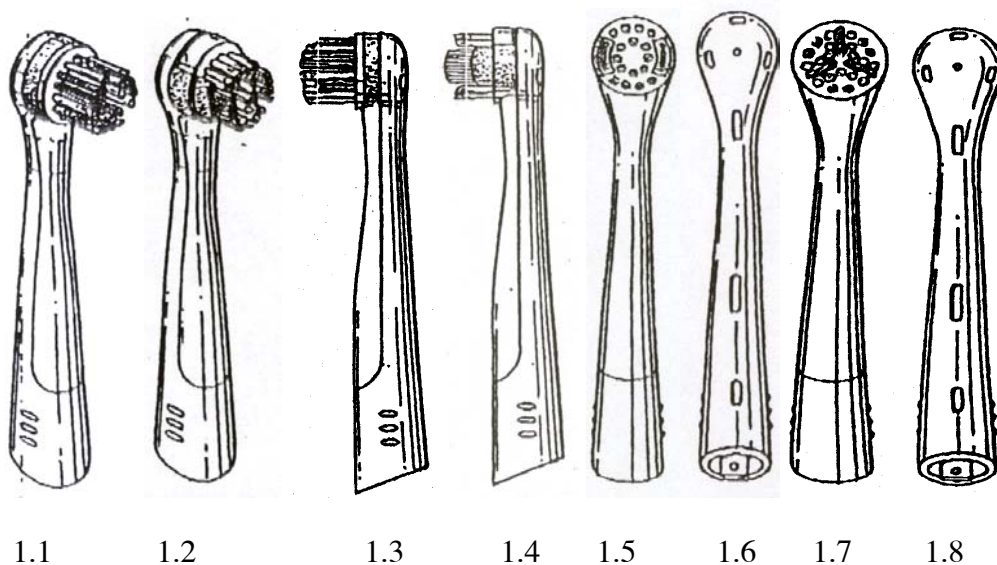

1.9



1.10



1.11



1.12



- (11) **6530**  
(21) 3-2003-00208 (28) 01  
(54) **VỎ HỘP XÍCH XE SCUTO** (51) **12-16**  
(22) 05.05.2003 (43) 27.10.2003  
(30) 2002-031366 14.11.2002 JP  
(71) HONDA GIKEN KOGYO KABUSHIKI KAISHA (JP)  
1-1 , Minami-Aoyama 2-chome, Minato-ku, Tokyo, Japan  
(72) Sanae Shimizu (JP), Tomotake Shimoji (JP)  
(74) Văn phòng luật sư Phạm và Liên danh (PHAM & ASSOCIATES)  
(55)



1.1

1.2

1.3



1.4

1.5

1.6



1.7

1.8

1.9 1.10

(11) **6531**

(21) 3-2003-00209

(28) 01

(54) CỤM ĐÈN SAU XE SCUTƠ

(51) **12-16**

(22) 05.05.2003

(43) 27.10.2003

(30) 2002-031356 14.11.2002 JP

(71) HONDA GIKEN KOGYO KABUSHIKI KAISHA (JP)

1-1, Minami-Aoyama 2-chome, Minato-ku, Tokyo, Japan

(72) Rika Mizuta (JP), Kiyoshi Takagi (JP)

(74) Văn phòng luật sư Phạm và Liên danh (PHAM & ASSOCIATES)

(55)



1.1



1.2



1.3



1.4



1.5

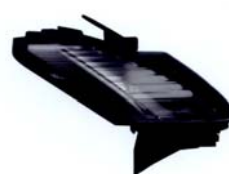

1.6



1.7



1.8



1.9



1.10



1.11



1.12

(11) **6532**

(21) 3-2003-00210

(28) 01

(54) **PHẦN VỎ CHE TAY LÁI VÀ ĐÈN** (51) **12-16**

TÍN HIỆU XE SCUTƠ

(22) 05.05.2003

(43) 27.10.2003

(30) 2002-031352 14.11.2002 JP

(71) HONDA GIKEN KOGYO KABUSHIKI KAISHA (JP)

1-1, Minami-Aoyama 2-chome, Minato-ku, Tokyo, Japan

(72) Rika Mizuta (JP), Kiyoshi Takagi (JP)

(74) Văn phòng luật sư Phạm và Liên danh (PHAM & ASSOCIATES)

(55)



1.1

1.2

1.3



1.4

1.5

1.6

1.7

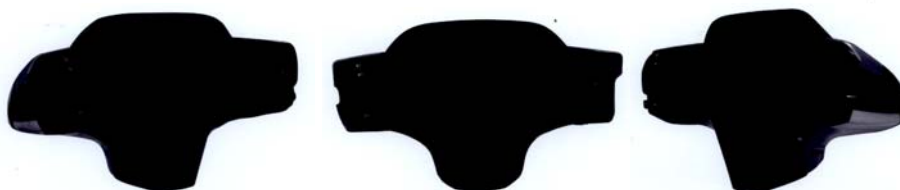

1.8

1.9

1.10



1.11



1.12

(11) **6533**

(21) 3-2003-00211

(54) XE SCUTƠ

(22) 05.05.2003

(30) 2002-031341 14.11.2002 JP

(71) Honda Giken Kogyo Kabushiki Kaisha (JP)

1-1 , Minami-Aoyama 2-chome, Minato-ku, Tokyo, Japan

(72) Rika Mizuta (JP), Yoshiharu Hashimoto (JP)

(74) Văn phòng luật sư Phạm và Liên danh (PHAM & ASSOCIATES)

(55)

(28) 01

(51) **12-11**

(43) 27.10.2003



1.1



1.2



1.3



1.4



1.5



1.6



1.7



1.8



1.9



1.10

- (11) **6534**  
(21) 3-2003-00212 (28) 01  
(54) XE SCUTƠ (51) **12-11**  
(22) 05.05.2003 (43) 27.10.2003  
(30) 2002-031343 14.11.2002 JP  
(71) Honda Giken Kogyo Kabushiki Kaisha (JP)  
1-1, Minami-Aoyama 2-chome, Minato-ku, Tokyo, Japan  
(72) Rika Mizuta (JP), Kiyoshi Takagi (JP)  
(74) Văn phòng luật sư Phạm và Liên danh (PHAM & ASSOCIATES)  
(55)



1.1



1.2



1.3



1.4



1.5



1.6



1.7

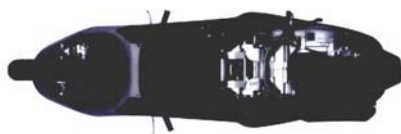

1.8

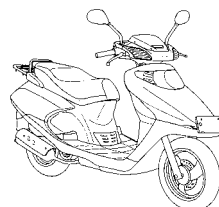

1.9

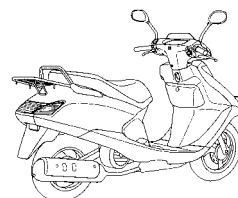

1.10

- (11) **6535**  
(21) 3-2003-00213 (28) 01  
(54) PHẦN VỎ CHE TAY LÁI VÀ ĐÈN (51) **12-16**  
TÍN HIỆU XE SCUTƠ  
(22) 05.05.2003 (43) 27.10.2003  
(30) 2002-031345 14.11.2002 JP  
(71) HONDA GIKEN KOGYO KABUSHIKI KAISHA (JP)  
1-1, Minami-Aoyama 2-chome, Minato-ku, Tokyo, Japan.  
(72) Rika Mizuta (JP), Yoshiharu Hashimoto (JP)  
(74) Văn phòng luật sư Phạm và Liên danh (PHAM & ASSOCIATES)  
(55)



1.1



1.2



1.3



1.4



1.5



1.6



1.7



1.8

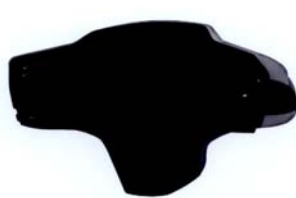

1.9



1.10

- (11) **6536**  
(21) 3-2003-00215 (28) 01  
(54) KHÓA VÒI NƯỚC (51) **23-01**  
(22) 07.05.2003 (43) 27.10.2003  
(30) 30-2002-003185 08.11.2002 KR  
(71) American Standard International Inc. (US)  
15 West 54th Street, New York, New York 10019, United States of America  
(72) Won Sub Lim (KR)  
(74) Công ty TNHH INVESTPRO và cộng sự (INVESTPRO & ASSOCIATES)  
(55)

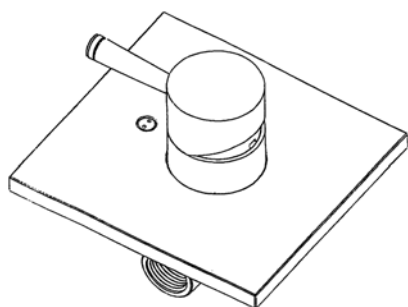

1.1

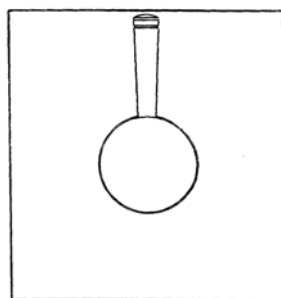

1.2

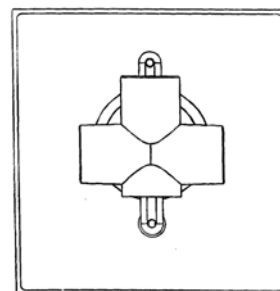

1.3

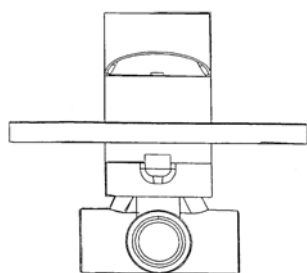

1.4

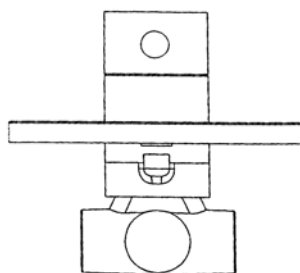

1.5

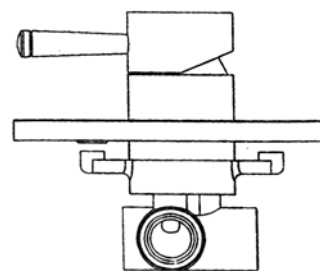

1.6

- (11) **6537**  
(21) 3-2003-00216 (28) 01  
(54) BỘ KHÓA VÒI NƯỚC (51) **23-01**  
(22) 07.05.2003 (43) 27.10.2003  
(30) 30-2002-003185 08.11.2002 KR  
(71) American Standard International Inc. (US)  
15 West 54th Street, New York, New York 10019, United States of America  
(72) Won Sub Lim (KR)  
(74) Công ty TNHH INVESTPRO và cộng sự (INVESTPRO & ASSOCIATES)  
(55)

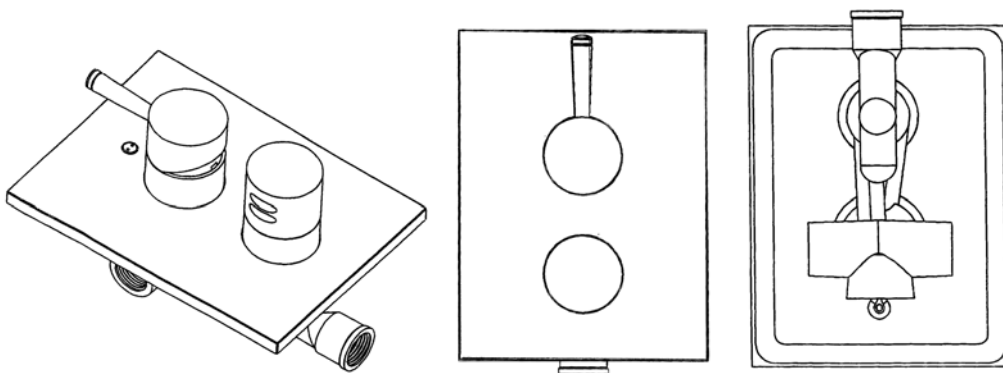

1.1

1.2

1.3

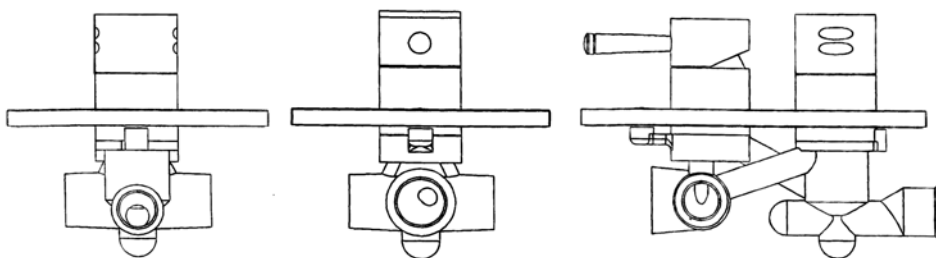

1.4

1.5

1.6



(11) **6538**

(21) 3-2003-00217

(54) ĐẦU PHUN SƯƠNG CẦM TAY

(22) 07.05.2003

(30) 30-2002-003185 08.11.2002 KR

(71) American Standard International Inc. (US)

15 West 54th Street, New York, New York 10019, United States of America

(72) Won Sub Lim (KR)

(74) Công ty TNHH INVESTPRO và cộng sự (INVESTPRO & ASSOCIATES)

(55)

(28) 01

(51) **23-02**

(43) 27.10.2003

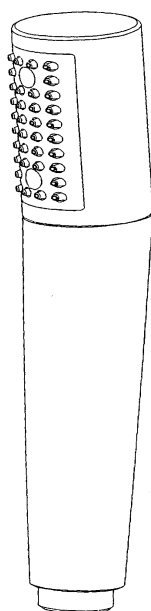

1.1

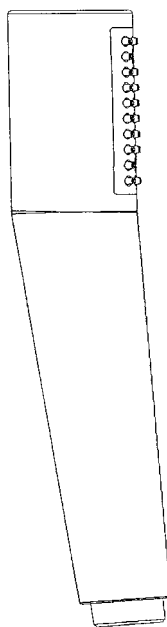

1.2

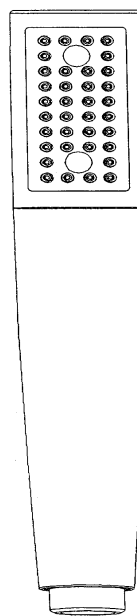

1.3



1.4



1.5



1.6

(11) **6539**

(21) 3-2003-00218

(54) ĐÀU VÒI SEN

(22) 07.05.2003

(30) 30-2002-003185 08.11.2002 KR

(71) American Standard International Inc. (US)

15 West 54th Street, New York, New York 10019, United States of America

(72) Won Sub Lim (KR)

(74) Công ty TNHH INVESTPRO và cộng sự (INVESTPRO & ASSOCIATES)

(55)

(28) 01

(51) **23-02**

(43) 27.10.2003

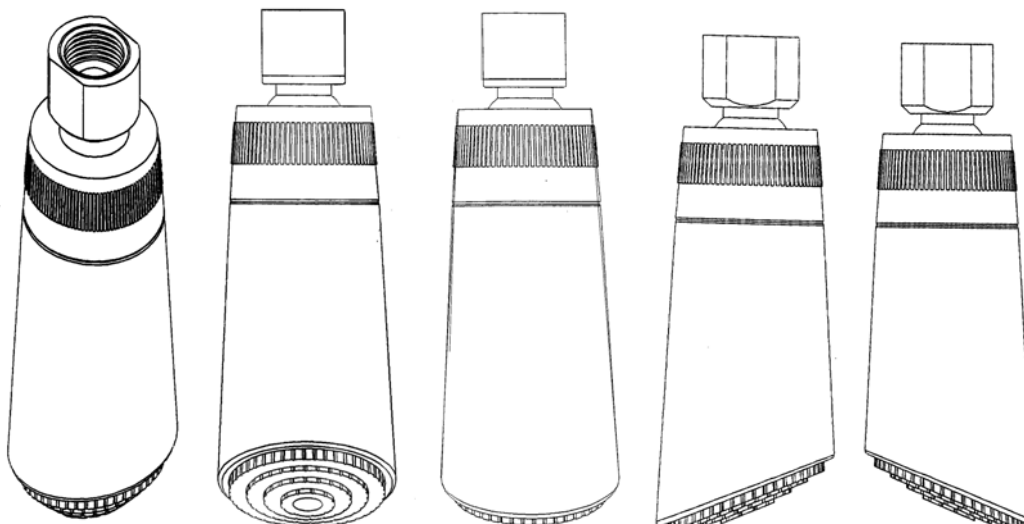

1.1

1.2

1.3

1.4

1.5

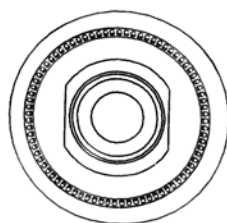

1.6

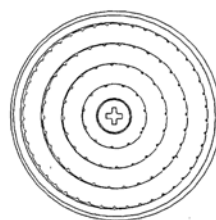

1.7

- (11) **6540**  
(21) 3-2003-00230 (28) 01  
(54) ĐÈN PHA DÙNG KHI SƯƠNG MÙ (51) **26-06**  
CHO XE CỘ  
(22) 12.05.2003 (43) 27.10.2003  
(30) 30-2002-003280 12.11.2002 KR  
(71) GM DAEWOO AUTO & TECHNOLOGY CO., LTD. (KR)  
199-1, Cheongcheon-Dong, Bupyeong-Gu, Incheon, Republic of Korea  
(72) Lee, Si-Il (KR), Oh, Hyeong-Jin (KR)  
(74) Văn phòng luật sư Phạm và Liên danh (PHAM & ASSOCIATES)  
(55)

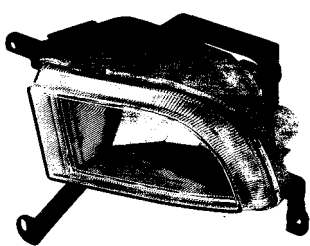

1.1

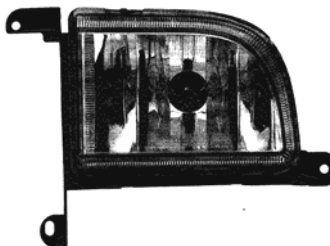

1.2

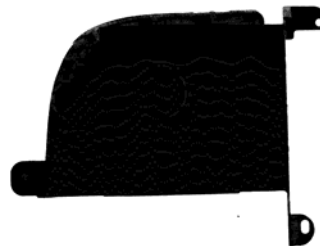

1.3

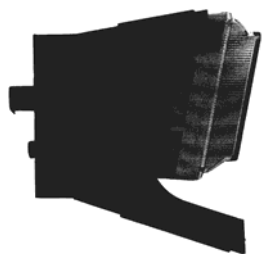

1.4

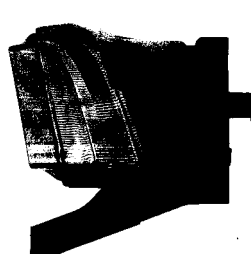

1.5

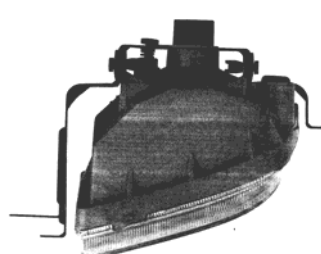

1.6

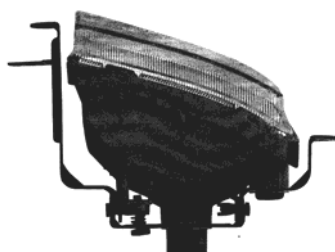

1.7



1.8

(11) **6541**

(21) 3-2003-00232

(28) 01

(54) GƯƠNG PHÍA NGOÀI CHO XE CỘ

(51) **12-16**

(22) 12.05.2003

(43) 27.10.2003

(30) 30-2002-003278 12.11.2002 KR

(71) GM DAEWOO AUTO & TECHNOLOGY CO., LTD. (KR)

199-1, Cheongcheon-Dong, Bupyung-Gu, Incheon, Republic of Korea

(72) Lee, Kyung-Rok (KR)

(74) Văn phòng luật sư Phạm và Liên danh (PHAM & ASSOCIATES)

(55)

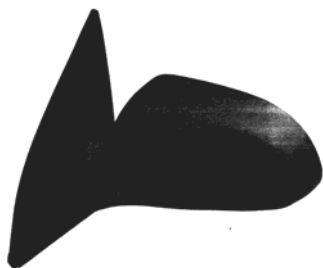

1.1



1.2

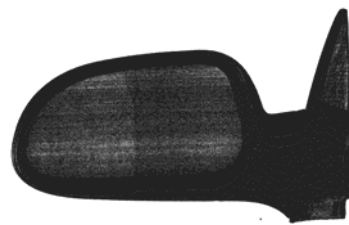

1.3



1.4

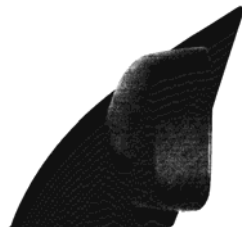

1.5

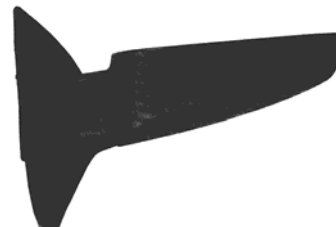

1.6



1.7



1.8

- (11) **6542**  
(21) 3-2003-00233 (28) 01  
(54) CỤM ĐÈN SAU CHO XE CỘ (51) **26-06**  
(22) 12.05.2003 (43) 27.10.2003  
(30) 30-2002-003280 12.11.2002 KR  
(71) GM DAEWOO AUTO & TECHNOLOGY CO., LTD. (KR)  
199-1, Cheongcheon-Dong, Bupyeong-Gu, Incheon, Republic of Korea  
(72) Lee Si-Il (KR), Kim Si-Hoon (KR)  
(74) Văn phòng luật sư Phạm và Liên danh (PHAM & ASSOCIATES)  
(55)



1.1

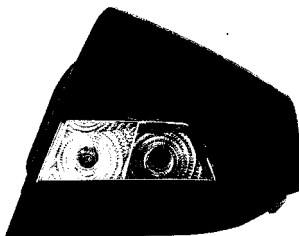

1.2

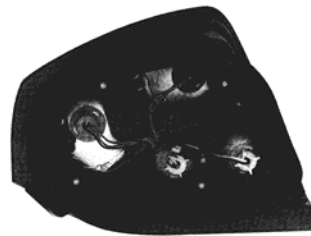

1.3

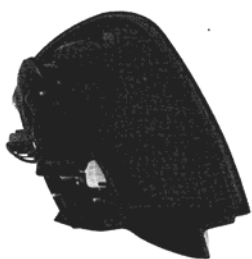

1.4



1.5

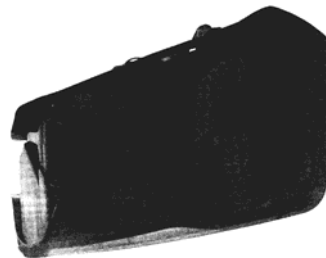

1.6

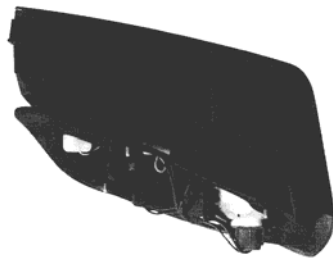

1.7



1.8



1.9

- (11) **6543**  
(21) 3-2003-00246 (28) 01  
(54) BỘ MÁNG ĐÔI ỐP TRẦN FRC (51) **26-05**  
40/36X2  
(22) 13.05.2003 (43) 27.10.2003  
(71) CÔNG TY BÓNG ĐÈN PHÍCH NƯỚC RẠNG ĐÔNG (VN)  
15 Hạ Đình, quận Thanh Xuân, Hà Nội  
(72) Lê Quốc Khánh (VN)  
(55)



1.1



1.2



1.3



1.4



1.5



1.6

- (11) **6544**  
(21) 3-2003-00247 (28) 01  
(54) BỘ MÁNG ĐƠN ỐP TƯỜNG FRW (51) **26-05**  
40/36X1  
(22) 13.05.2003 (43) 27.10.2003  
(71) CÔNG TY BÓNG ĐÈN PHÍCH NƯỚC RẠNG ĐÔNG (VN)  
15 Hạ Đình, quận Thanh Xuân, Hà Nội  
(72) Lê Quốc Khánh (VN)  
(55)



1.1



1.2



1.3



1.4



1.5



1.6

- (11) **6545**  
(21) 3-2003-00251 (28) 01  
(54) BỘ XÍ BỆT VT32 (51) **23-02**  
(22) 14.05.2003 (43) 27.10.2003  
(71) CÔNG TY SỨ VIỆT TRÌ (VN)  
Phố Hồng hà - Phường Tiên cát - Thành phố Việt trì, Phú thọ  
(72) Nguyễn Tiến Đỉnh (VN)  
(55)



1.1

1.2

1.3



1.4

1.5

1.6

1.7





1.8

1.9

1.10

1.11



1.12

1.13

1.14

(11) **6546**

(21) 3-2003-00252

(28) 01

(54) GIÁ NẮM TAY VÀ ĐÈO HÀNG XE (51) **12-16**

SCUTƠ

(22) 14.05.2003

(43) 27.10.2003

(30) 2002-031353 14.11.2002 JP

(71) HONDA GIKEN KOGYO KABUSHIKI KAISHA (JP)

1-1, Minami-Aoyama 2-chome, Minato-ku, Tokyo, Japan

(72) Rika Mizuta (JP), Tomotake Shimoji (JP)

(74) Văn phòng luật sư Phạm và Liên danh (PHAM & ASSOCIATES)

(55)

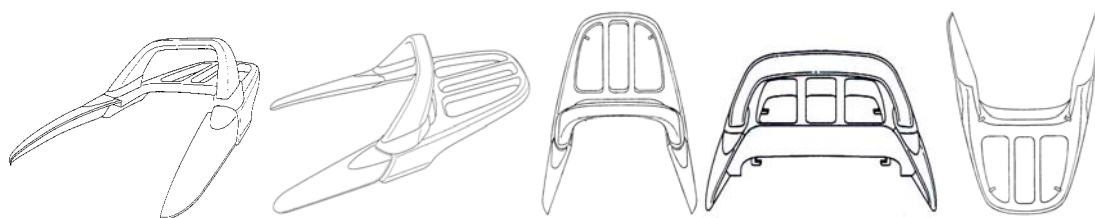

1.1

1.2

1.3

1.4

1.5

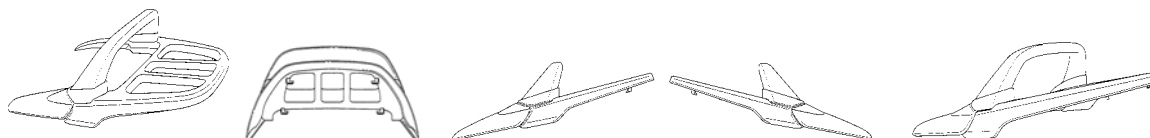

1.6

1.7

1.8

1.9

1.10

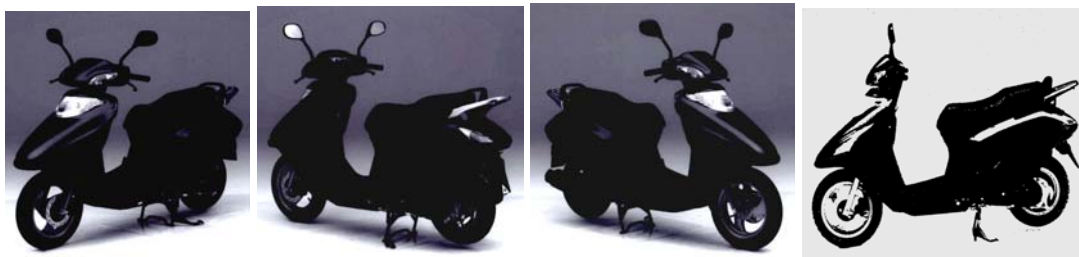

1.11

1.12

1.13

1.14

(11) **6547**

(21) 3-2003-00255

(28) 40

(54) ĐÀU GẬY GÔN

(51) **21-02**

(22) 15.05.2003

(43) 27.10.2003

(30) 29/171,005 15.11.2002 US

(71) Roger Cleveland Golf Company, Inc. (US)

5630 Cerritos Avenue, Cypress, California 90630, U.S.A.

(72) Douglas E. ROBERTS (US), Lionel POINCENOT (US), Jacques FAGOT (FR), Trent E. GARNER (US)

(74) Văn phòng luật sư Phạm và Liên danh (PHAM & ASSOCIATES)

(55)

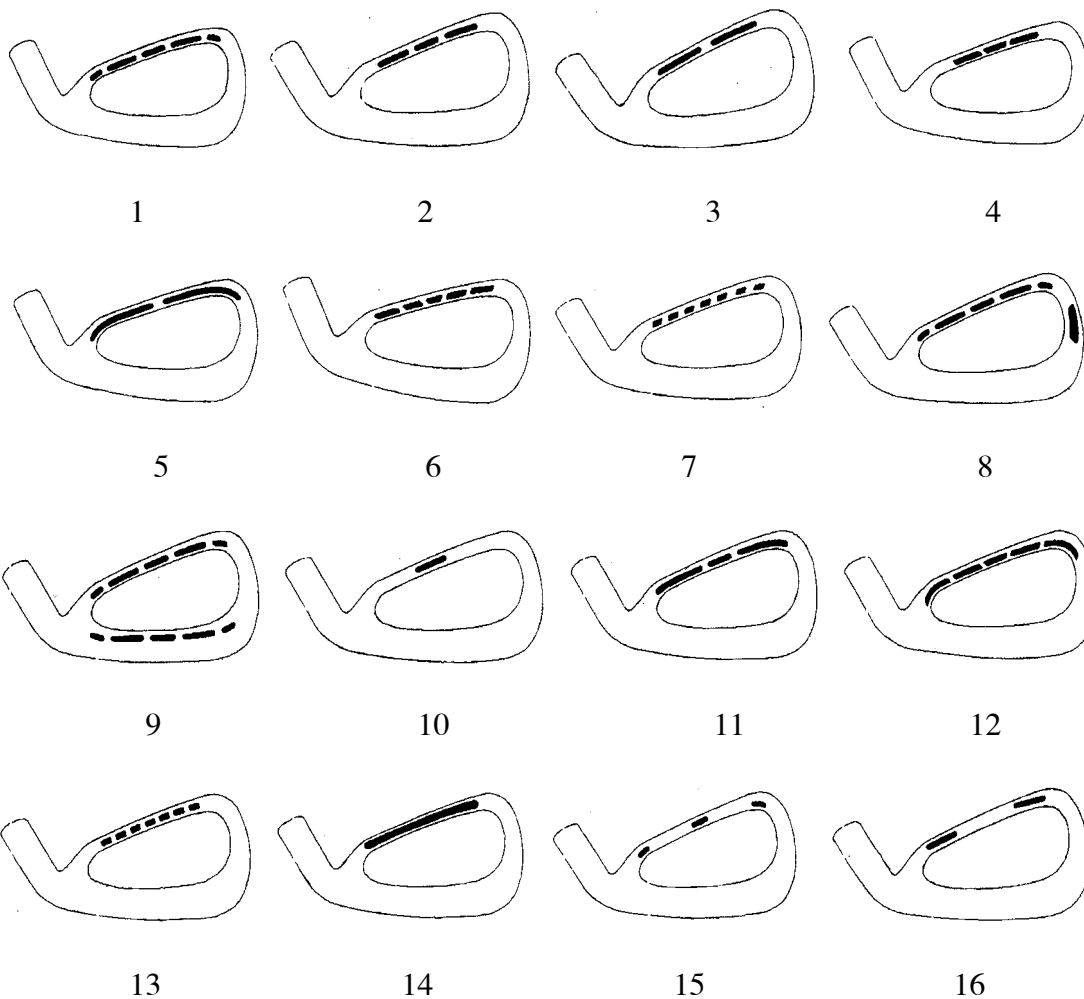

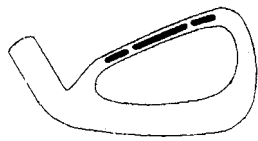

17

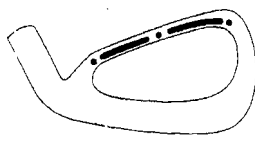

18

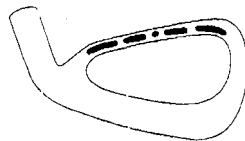

19

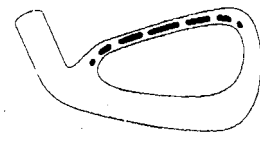

20

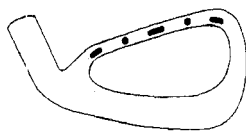

21

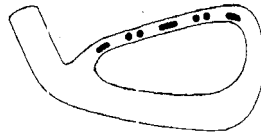

22

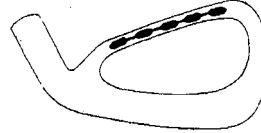

23



24



25



26

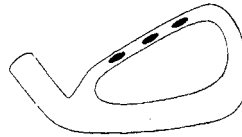

27

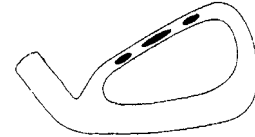

28



29



30

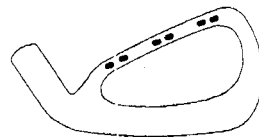

31

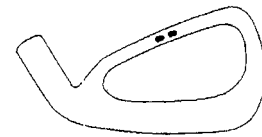

32

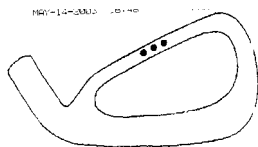

33

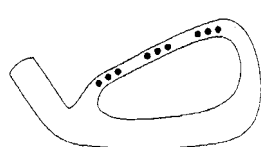

34

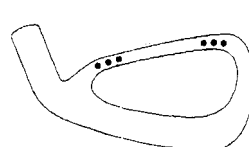

35

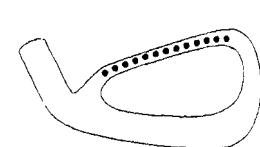

36



37

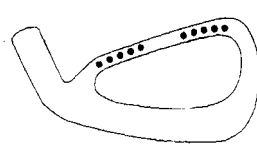

38

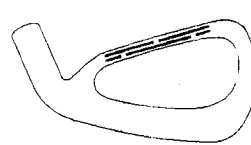

39



40

- (11) **6548**  
(21) 3-2003-00256 (28) 02  
(54) SỨC CÁCH ĐIỆN (51) **13-03**  
(22) 16.05.2003 (43) 27.10.2003  
(71) CÔNG TY TNHH SỨC KỸ THUẬT MINH LONG 2 (VN)  
Số 328, Quốc lộ 13, xã Hưng Định, huyện Thuận An, tỉnh Bình Dương  
(72) Dương Văn Long (VN)  
(74) Văn phòng luật sư Phạm và Liên danh (PHAM & ASSOCIATES)  
(55)

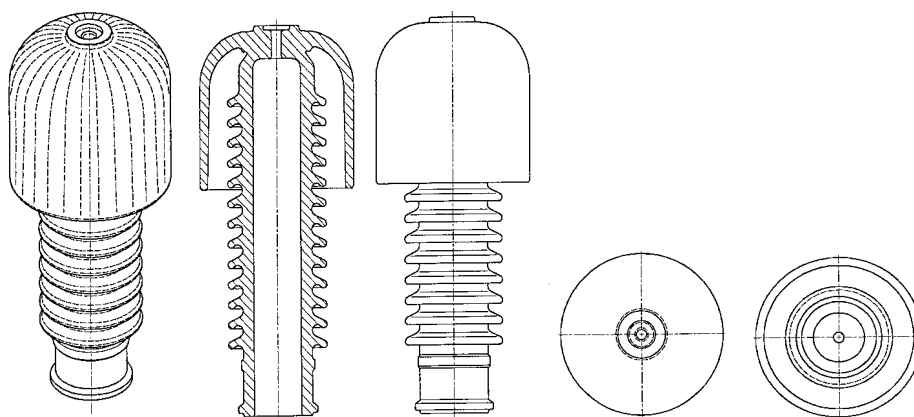

1.1 1.2 1.3 1.4 1.5

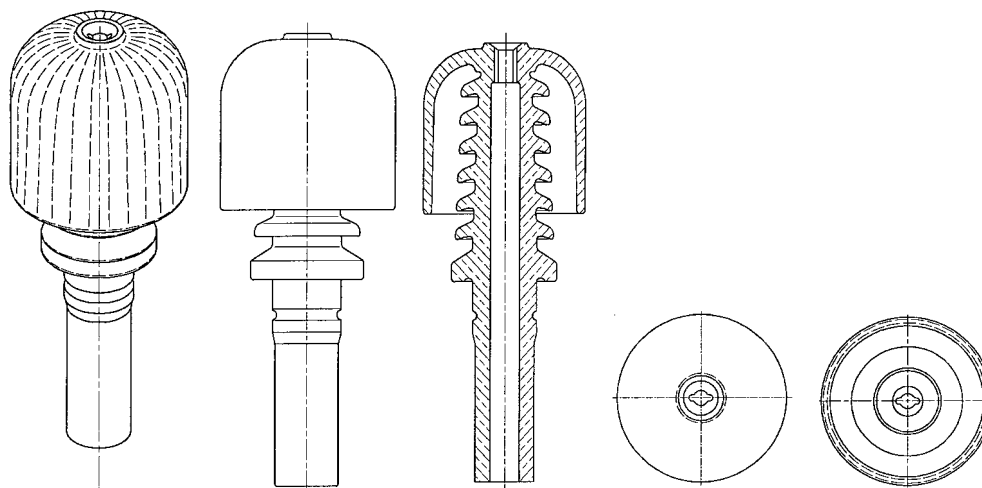

2.1 2.2 2.3 2.4 2.5

- (11) **6549**  
(21) 3-2003-00259 (28) 01  
(54) BÃNH XE MÁY (51) **12-11**  
(22) 19.05.2003 (43) 27.10.2003  
(30) 2003-009549 04.04.2003 JP  
(71) Yamaha Hatsudoki Kabushiki Kaisha (JP)  
2500 Shingai, Iwata-shi, Shizuoka-ken, Japan  
(72) Kiyotaka Kitagawa (JP)  
(74) Công ty Sở hữu công nghiệp (INVESTIP)  
(55)



1.1

1.2

1.3

1.4



1.5

1.6

1.7

1.8



1.9



1.10

- (11) **6550**  
(21) 3-2003-00260 (28) 01  
(54) BÁNH XE MÁY (51) **12-11**  
(22) 19.05.2003 (43) 27.10.2003  
(30) 2003-009548 04.04.2003 JP  
(71) Yamaha Hatsudoki Kabushiki Kaisha (JP)  
2500 Shingai, Iwata-shi, Shizuoka-ken, Japan  
(72) Kiyotaka Kitagawa (JP)  
(74) Công ty Sở hữu công nghiệp (INVESTIP)  
(55)



1.1

1.2

1.3

1.4



1.5

1.6

1.7

1.8



1.9

1.10

- (11) **6551**  
(21) 3-2003-00261  
(54) VẢI  
(22) 20.05.2003  
(71) LIN, KENNETH SUNCHWEN (TW)  
Số .110, TUNG PING RD., TAINAN CITY, TAIWAN  
(72) LIN, KENNETH SUNCHWEN (TW)  
(74) Công ty Tư vấn sở hữu công nghiệp và chuyển giao công nghệ (P & TB)  
(55)
- (28) 01  
(51) **05-05**  
(43) 27.10.2003

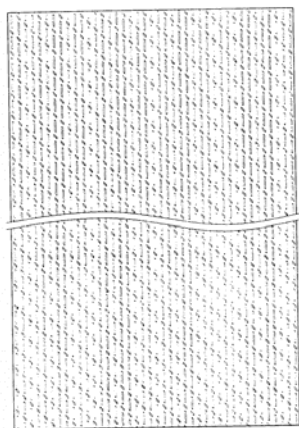

1.1



1.2

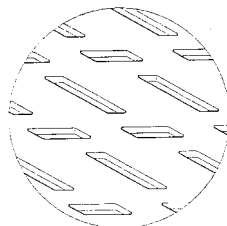

1.3



1.4



- (11) **6552**  
(21) 3-2003-00270 (28) 01  
(54) LỘ NƯỚC HOA (51) **09-01**  
(22) 28.05.2003 (43) 27.10.2003  
(30) FU2002O000090 11.12.2002 IT  
(71) SALVATORE FERRAGAMO ITALIA S.p.A (IT)  
2, Via Tornabuoni - 50123 - Florence - Italy  
(72) Serge Mansau (FR)  
(74) Công ty Sở hữu công nghiệp (INVESTIP)  
(55)

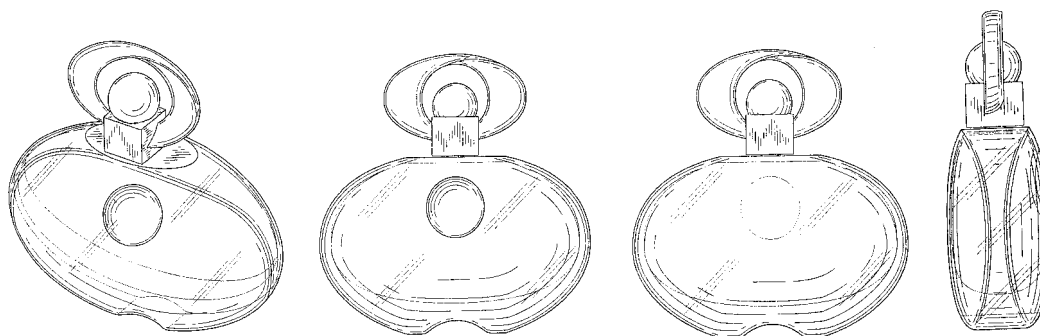

1.1

1.2

1.3

1.4

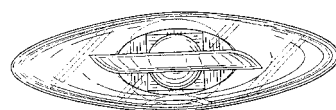

1.5

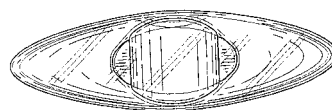

1.6

(11) **6553**

(21) 3-2003-00289

(54) HỘP ĐỰNG THỰC PHẨM

(22) 10.06.2003

(30) 29/172,417 11.12.2002 US

(71) Dart Industries Inc. (US)

14901 S. Orange Blossom Trail, Orlando, Florida 32837, U.S.A.

(72) Anita Suk Ping LIU (US)

(74) Công ty TNHH Dịch vụ Tâm nhìn và Liên danh (VISION & ASSOCIATES CO.LTD.)

(55)

(28) 03

(51) **09-03**

(43) 27.10.2003



1.1

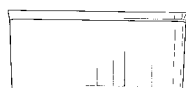

1.2

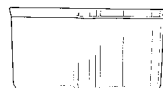

1.3

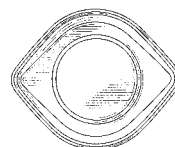

1.4

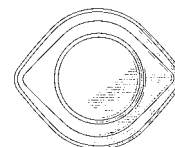

1.5

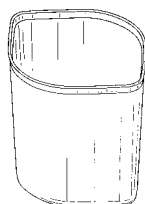

2.1

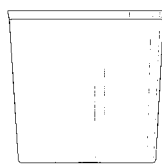

2.2

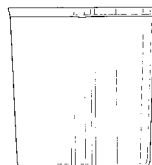

2.3



2.4

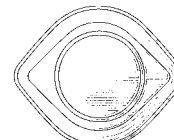

2.5

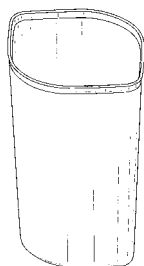

3.1



3.2

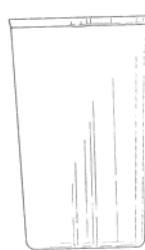

3.3

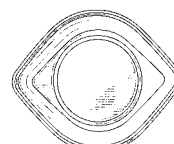

3.4



3.5

- (11) **6554**  
(21) 3-2003-00301 (28) 01  
(54) NHÃN SẢN PHẨM (51) **19-08**  
(22) 16.06.2003 (43) 27.10.2003  
(71) DNTN HẢI THÀNH (VN)  
đường Nguyễn Thông, phường Phú Hải, TP. Phan Thiết, tỉnh Bình Thuận  
(72) Nguyễn Thị Oanh (VN)  
(55)



- (11) **6555**  
(21) 3-2003-00337 (28) 01  
(54) LỘ ĐỤNG NƯỚC HOA (51) **09-01**  
(22) 30.06.2003 (43) 27.10.2003  
(30) 030633 31.01.2003 FR  
(71) BEAUTE PRESTIGE INTERNATIONAL (FR)  
28/32 Avenue Victor Hugo, 75116 Paris, FRANCE  
(72) Serge MANSOU (FR)  
(74) Công ty Tư vấn sở hữu công nghiệp và chuyển giao công nghệ (P & TB)  
(55)



1.1



1.2



1.3



1.4



1.5

- (11) **6556**  
(21) 3-2003-00338 (28) 01  
(54) LỘ ĐỤNG NƯỚC HOA (51) **09-01**  
(22) 30.06.2003 (43) 27.10.2003  
(30) 030633 31.01.2003 FR  
(71) BEAUTE PRESTIGE INTERNATIONAL (FR)  
28/32 Avenue Victor Hugo, 75116 Paris, FRANCE  
(72) Rémy GOMEZ (FR)  
(74) Công ty Tư vấn sở hữu công nghiệp và chuyển giao công nghệ (P & TB)  
(55)

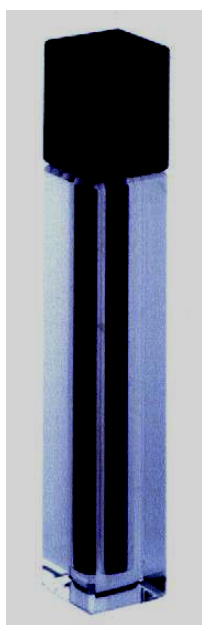

1.1

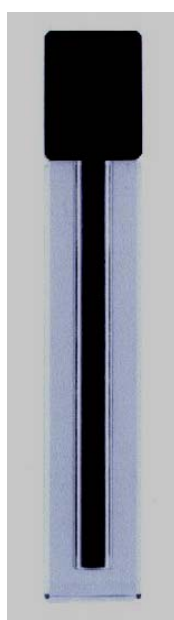

1.2

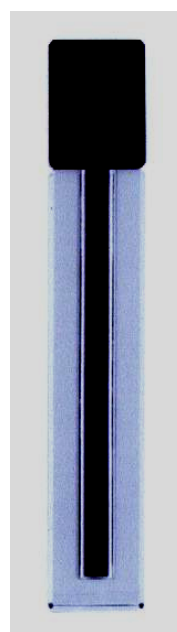

1.3



1.4



1.5

- (11) **6557**  
(21) 3-2003-00344 (28) 01  
(54) BAO GỐI BĂNG VỆ SINH (51) **09-05**  
(22) 02.07.2003 (43) 27.10.2003  
(71) Kimberly - Clark Worldwide, Inc. (US)  
Neenah, Wisconsin 54956, U.S.A.  
(72) Đặng Thanh Vân (VN)  
(74) Công ty TNHH Nghiên cứu và Tư vấn chuyển giao công nghệ và đầu tư (CONCETTI)  
(55)



1.1



1.2

- (11) **6558**  
(21) 3-2003-00349 (28) 01  
(54) BAO GỐI BÁNH (51) **09-05**  
(22) 03.07.2003 (43) 27.10.2003  
(71) CÔNG TY TNHH BÁNH KẸO THỰC PHẨM TÍCH SỸ GIAI (VN)  
Thôn Tân Văn, xã Tân Dĩnh, huyện Lạng Giang, tỉnh Bắc Giang  
(72) Trần Hán Vinh (VN)  
(74) Công ty TNHH Sở hữu trí tuệ WINCO (WINCO CO., LTD.)  
(55)



1.1



1.2

- (11) **6559**  
(21) 3-2003-00360 (28) 01  
(54) HỘP SỮA (51) **09-03**  
(22) 15.07.2003 (43) 27.10.2003  
(71) CƠ SỞ HÀ LAN (VN)  
9/36B Tự Do, Phường 16, Quận Tân Bình, Thành phố Hồ Chí Minh  
(72) Lê Huy Diễm Anh (VN)  
(74) Công ty TNHH Sở hữu trí tuệ Thảo Thọ Quyến (INVENCO)  
(55)

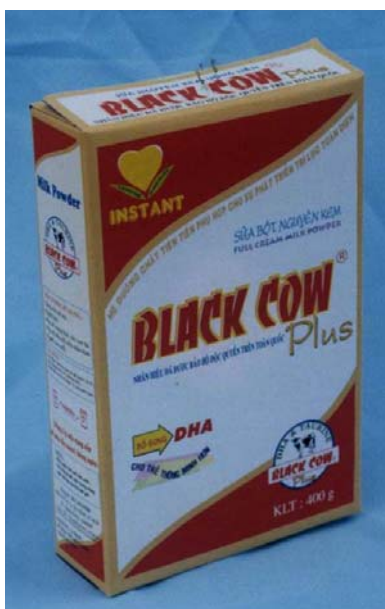

1.1



1.2



- (11) **6560**  
(21) 3-2003-00364  
(54) BAO GỐI MÌ  
(22) 16.07.2003  
(71) CÔNG TY LIÊN DOANH VIFON ACE-COOK (VN)  
6/1B Trường Chinh, phường 15, quận Tân Bình, thành phố Hồ Chí Minh.  
(72) Hoàng Cao Trí (VN)  
(74) Văn phòng luật sư Phạm và Liên danh (PHAM & ASSOCIATES)  
(55)
- (28) 02  
(51) **09-05**  
(43) 27.10.2003



1



2

- (11) **6561**  
(21) 3-2003-00366 (28) 01  
(54) HỘP ĐĨA QUANG (51) **09-03**  
(22) 18.07.2003 (43) 27.10.2003  
(30) 03304582.8 12.02.2003 CN  
(71) SONY KABUSHIKI KAISHA (also trading as SONY CORPORATION) (JP)  
7-35, Kitashinagawa 6-chome, Shinagawa-ku, Tokyo, Japan  
(72) Hiroki Oka (JP)  
(74) Công ty Tư vấn sở hữu công nghiệp và chuyển giao công nghệ (P & TB)  
(55)

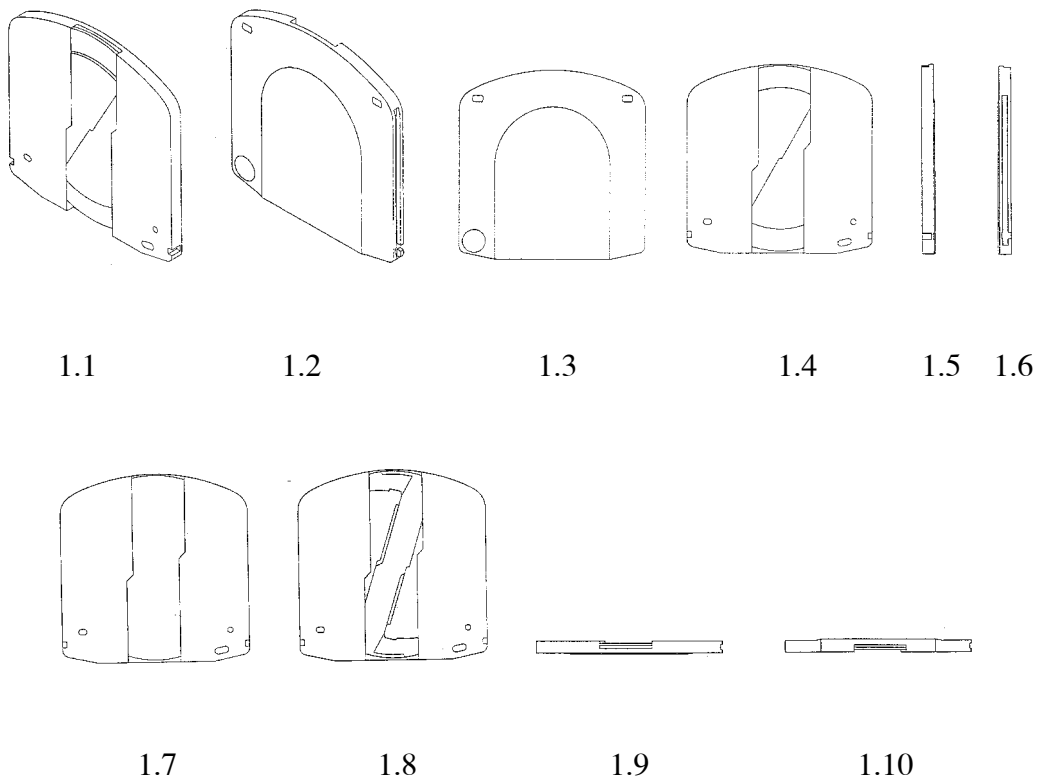

- (11) **6562**  
(21) 3-2003-00373 (28) 01  
(54) KẾT (51) **09-03**  
(22) 21.07.2003 (43) 27.10.2003  
(71) CÔNG TY TNHH NHỰA LONG THÀNH (VN)  
8 Kim Biên, phường 13, quận 5, thành phố Hồ Chí Minh  
(72) Phạm Văn Mười (VN)  
(74) Công ty Sở hữu công nghiệp (INVESTIP)  
(55)



1.1



1.2



1.3

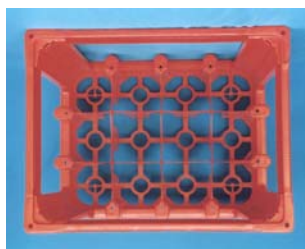

1.4



1.5

(11) **6563**

(21) 3-2003-00376

(54) NÚT ASEN

(22) 28.07.2003

(71) TRỊNH THỊ NHUNG (VN)

1A - Tràng Tiên, Hà Nội

(72) Trịnh Thị Nhung (VN)

(55)

(28) 01

(51) **09-07**

(43) 27.10.2003



1.1

1.2

1.3

1.4

- (11) **6564**  
(21) 3-2003-00377 (28) 01  
(54) CHAI (51) **09-01**  
(22) 28.07.2003 (43) 27.10.2003  
(71) XÍ NGHIỆP NƯỚC GIẢI KHÁT SUỐI XANH (VN)  
ấp Ngãi Lợi, xã Thân Cửu Nghĩa, huyện Châu Thành, tỉnh Tiền Giang  
(72) Huỳnh Hữu Hòa (VN)  
(74) Công ty Sở hữu công nghiệp (INVESTIP)  
(55)

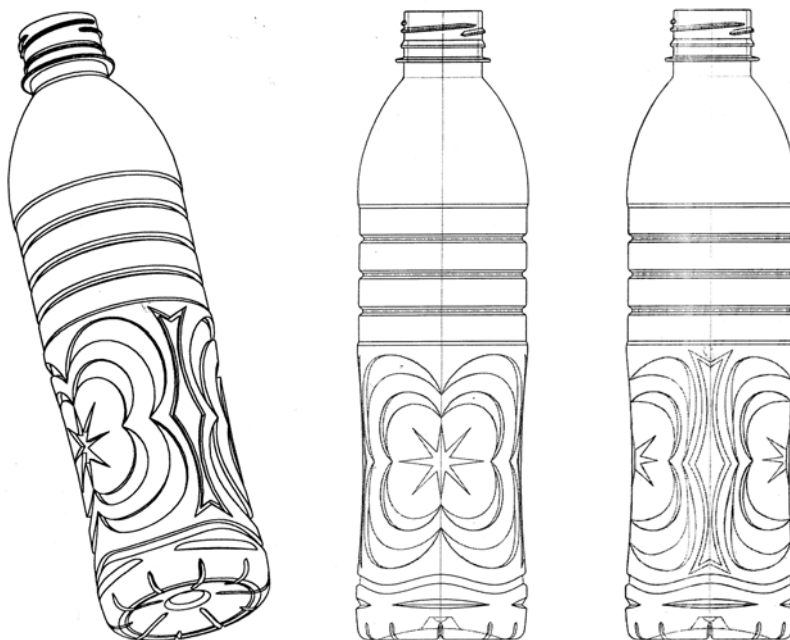

1.1

1.2

1.3

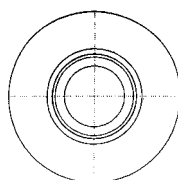

1.4

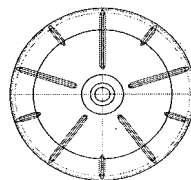

1.5

- (11) **6565**  
(21) 3-2003-00384 (28) 01  
(54) **GỐI ĐỖ ĐẦU** (51) **06-99**  
(22) 31.07.2003 (43) 27.10.2003  
(71) CÔNG TY TNHH SẢN XUẤT THƯƠNG MẠI PHỔ THIÊN (VN)  
D3/15T tỉnh lộ 10, ấp 4, xã Tân Tạo, huyện Bình Chánh, thành phố Hồ Chí Minh  
(72) Diệp Quốc Thái (VN)  
(74) Công ty Sở hữu công nghiệp (INVESTIP)  
(55)



1.1



1.2



1.3



1.4

- (11) **6566**  
(21) 3-2003-00450 (28) 01  
(54) THANH KIM LOẠI ĐỊNH HÌNH (51) **25-02**  
(22) 08.09.2003 (43) 27.10.2003  
(71) CÔNG TY TNHH XÂY DỰNG - THƯƠNG MẠI - SẢN XUẤT HOÀN THIỆN II (VN)  
179 đường Lý Thường Kiệt, phường 8, quận Tân Bình, thành phố Hồ Chí Minh  
(72) Đỗ Tiến Sĩ (VN)  
(55)

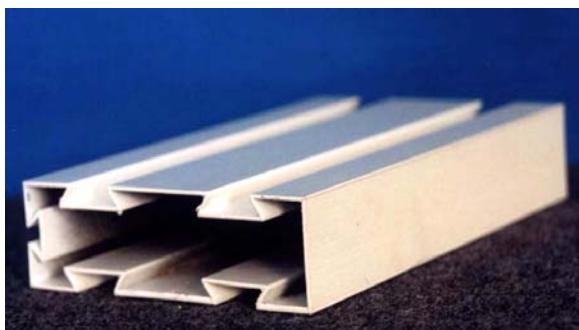

1.1

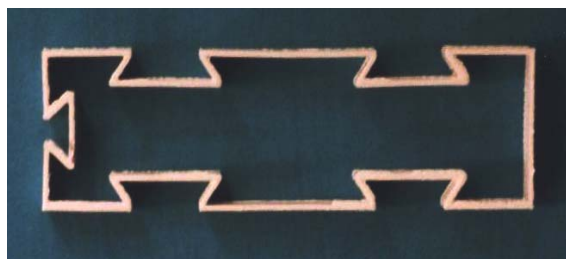

1.2