

PHẦN III

ĐƠN YÊU CẦU CẤP BẰNG ĐỘC QUYỀN KIỂU DÁNG CÔNG NGHIỆP

- (11) **13365**
(21) 3-2006-01242 (28) 01
(54) **THÙNG ĐỰNG RÁC** (51) **09-09**
(22) 24.10.2006 (43) 25.09.2008
(71) **CÔNG TY TNHH MẶT TRỜI VÀNG (VN)**
Số 132 phố Kim Mã, phường Kim Mã, quận Ba Đình, thành phố Hà Nội
(72) **Hoàng Hải Đường (VN)**
(55)

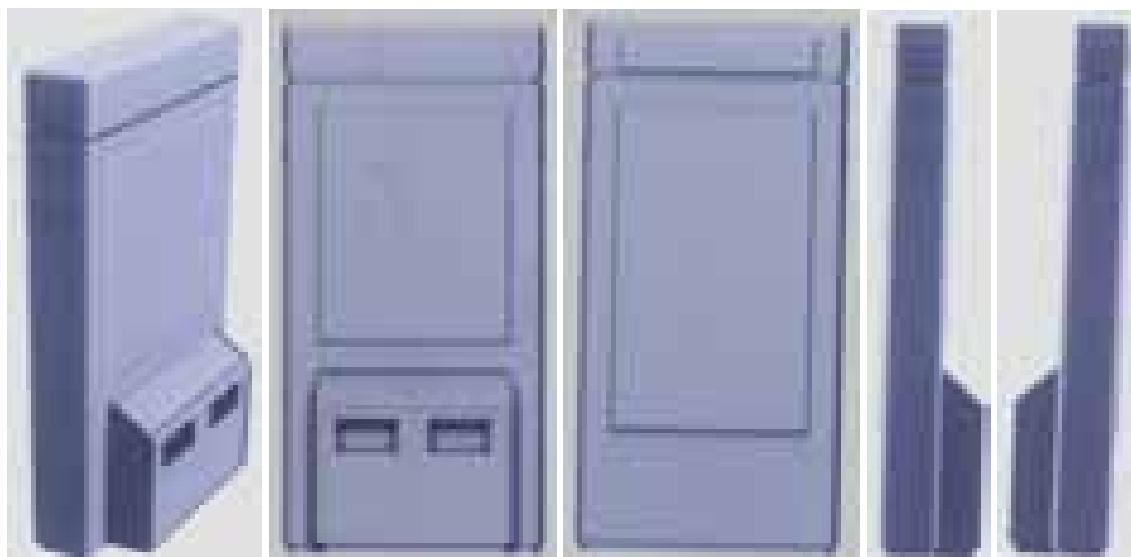

1.1

1.2

1.3

1.4

1.5

1.6

1.7

- (11) **13366**
(21) 3-2008-00013 (28) 01
(54) THIẾT BỊ MỞ HỐC BĂNG TẢI (51) **12-05**
(22) 03.01.2008 (43) 25.09.2008
(30) 07-00925-0101 03.07.2007 US
(71) 3M LNNOVATIVE PROPERTIES COMPANY (US)
3M Center, St. Paul, MN, 55133-3427, United States of America
(72) Shiow Shya Ling (SG), Kam Poi Chia (SG), Anthonius (ID)
(74) Công ty Tư vấn đầu tư và chuyển giao công nghệ (INVESTCONSULT)
(55)

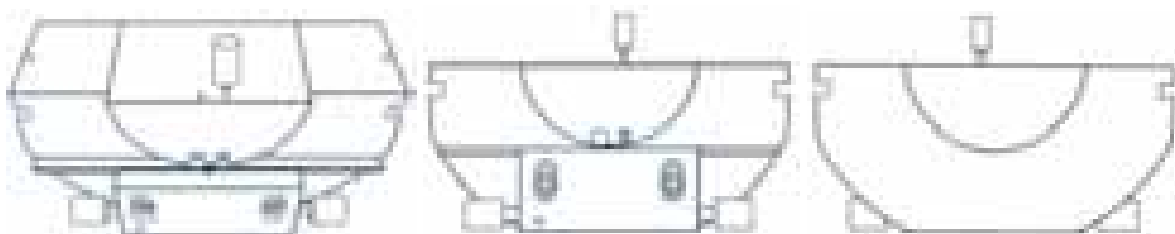

1.1

1.2

1.3



1.4

1.5

1.6

- (11) **13367**
(21) 3-2008-00370 (28) 01
(54) GHẾ (51) **06-01**
(22) 20.03.2008 (43) 25.09.2008
(30) 19888/2007 25.09.2007 AU
(71) SEBEL FURNITURE LIMITED (AU)
96 Canterbury Road, BANKSTOWN NSW 2200 AUSTRALIA
(72) Michael Fewchuk (AU)
(74) Công ty TNHH một thành viên Sở hữu trí tuệ VCCI (VCCI-IP CO.,LTD)
(55)

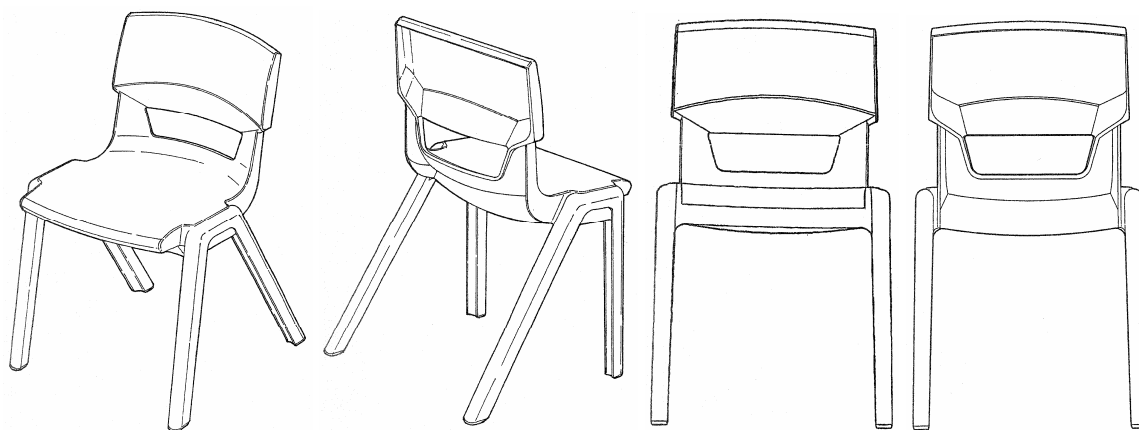

1.1

1.2

1.3

1.4

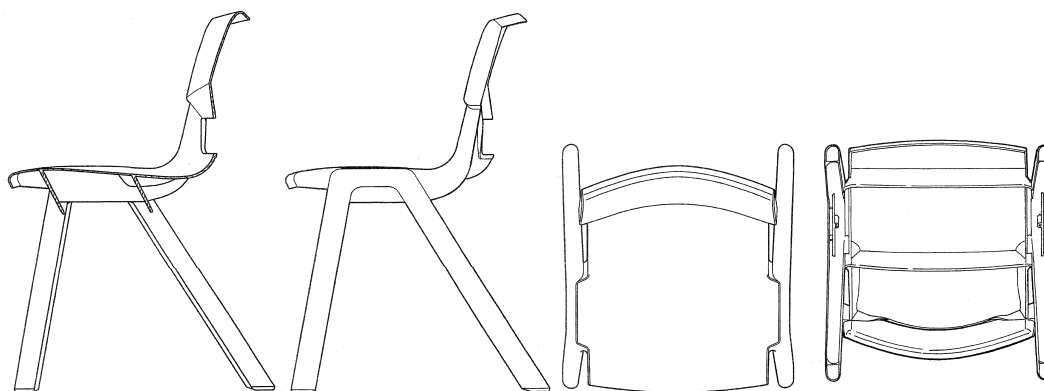

1.5

1.6

1.7

1.8

- (11) **13368**
(21) 3-2008-00373 (28) 01
(54) XE Ô TÔ (51) **12-08**
(22) 20.03.2008 (43) 25.09.2008
(71) TOYOTA JIDOSHA KABUSHIKI KAISHA (JP)
1, Toyota-cho, Toyota-shi, Aichi-ken 471-8571, Japan
(72) Masaki MOTOZAKI (JP), Yoshikazu HARADA (JP), Hiroshi TOMITA (JP)
(74) Công ty TNHH Quốc tế D & N (D&N INTERNATIONAL CO.,LTD.)
(55)



1.1

1.2



1.3

1.4

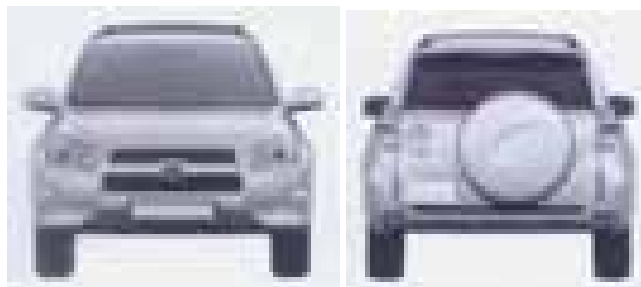

1.5

1.6

- (11) **13369**
(21) 3-2008-00374 (28) 01
(54) CỤM ĐÈN TRƯỚC CỦA XE Ô TÔ (51) **26-06**
(22) 20.03.2008 (43) 25.09.2008
(71) TOYOTA JIDOSHA KABUSHIKI KAISHA (JP)
1, Toyota-cho, Toyota-shi, Aichi-ken 471-8571, Japan
(72) Hiroyuki HATAKE (JP)
(74) Công ty TNHH Quốc tế D & N (D&N INTERNATIONAL CO.,LTD.)
(55)



1.1

1.2

1.3



1.4

1.5

1.6

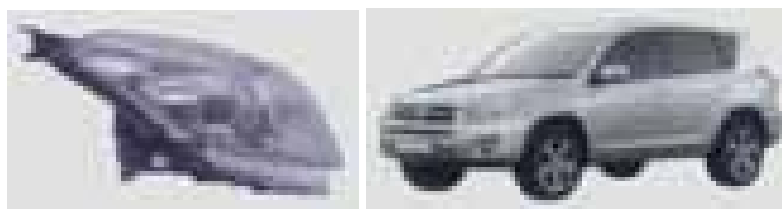

1.7

1.8

- (11) **13370**
(21) 3-2008-00375 (28) 01
(54) CỤM ĐÈN TRƯỚC CỦA XE Ô TÔ (51) **26-06**
(22) 20.03.2008 (43) 25.09.2008
(71) TOYOTA JIDOSHA KABUSHIKI KAISHA (JP)
1, Toyota-cho, Toyota-shi, Aichi-ken 471-8571, Japan
(72) Hiroyuki HATAKE (JP)
(74) Công ty TNHH Quốc tế D & N (D&N INTERNATIONAL CO.,LTD.)
(55)



1.1

1.2

1.3



1.4

1.5

1.6



1.7

1.8

- (11) **13371**
(21) 3-2008-00376 (28) 01
(54) CỤM ĐÈN HẬU XE Ô TÔ (51) **26-06**
(22) 20.03.2008 (43) 25.09.2008
(71) TOYOTA JIDOSHA KABUSHIKI KAISHA (JP)
1, Toyota-cho, Toyota-shi, Aichi-ken 471-8571, Japan
(72) Hiroyuki HATAKE (JP)
(74) Công ty TNHH Quốc tế D & N (D&N INTERNATIONAL CO.,LTD.)
(55)

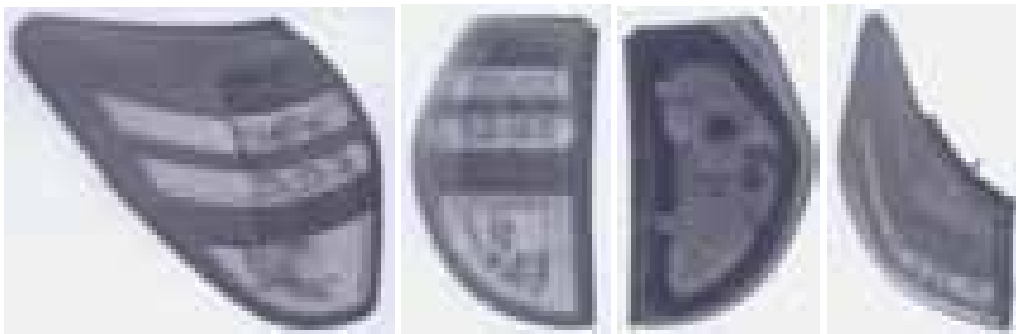

1.1

1.2

1.3

1.4

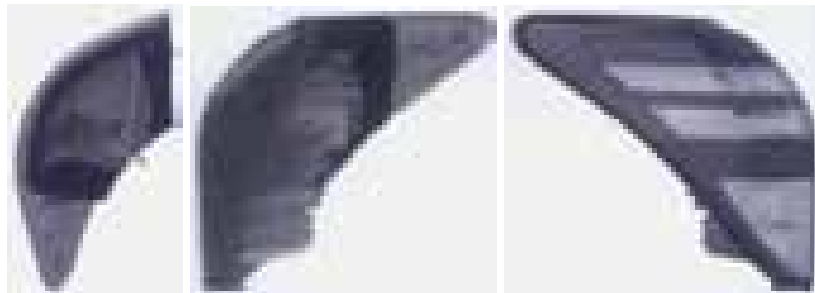

1.5

1.6

1.7



1.8

- (11) **13372**
(21) 3-2008-00377 (28) 01
(54) LƯỚI TẢN NHIỆT CỦA XE Ô TÔ (51) **12-16**
(22) 20.03.2008 (43) 25.09.2008
(71) TOYOTA JIDOSHA KABUSHIKI KAISHA (JP)
1, Toyota-cho, Toyota-shi, Aichi-ken 471-8571, Japan
(72) Ken NAGASAKA (JP), Yoshikazu HARADA (JP)
(74) Công ty TNHH Quốc tế D & N (D&N INTERNATIONAL CO.,LTD.)
(55)



1.1



1.2



1.3



1.4



1.5



1.6



1.7



1.8

- (11) **13373**
(21) 3-2008-00378 (28) 01
(54) TẮM CHẮN SAU XE Ô TÔ (51) **12-16**
(22) 20.03.2008 (43) 25.09.2008
(71) TOYOTA JIDOSHA KABUSHIKI KAISHA (JP)
1, Toyota-cho, Toyota-shi, Aichi-ken 471-8571, Japan
(72) Yutaka KUBOTA (JP), Hiroshi TOMITA (JP)
(74) Công ty TNHH Quốc tế D & N (D&N INTERNATIONAL CO.,LTD.)
(55)



1.1

1.2

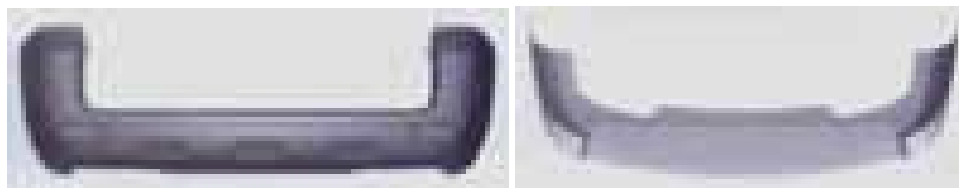

1.3

1.4

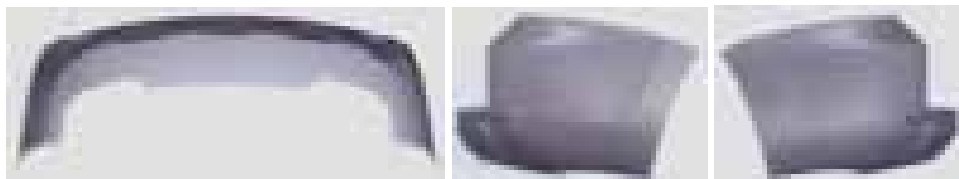

1.5

1.6

1.7



1.8

- (11) **13374**
(21) 3-2008-00379 (28) 01
(54) TẮM CHẮN TRƯỚC CỦA XE Ô TÔ (51) **12-16**
(22) 20.03.2008 (43) 25.09.2008
(71) TOYOTA JIDOSHA KABUSHIKI KAISHA (JP)
1, Toyota-cho, Toyota-shi, Aichi-ken 471-8571, Japan
(72) Kenta SHIMOGUCHI (JP), Kazuhiro SATO (JP)
(74) Công ty TNHH Quốc tế D & N (D&N INTERNATIONAL CO.,LTD.)
(55)



1.1

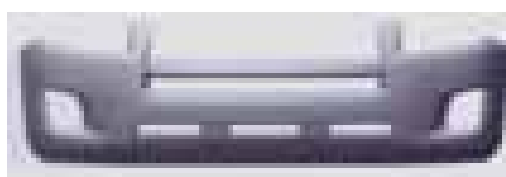

1.2



1.3

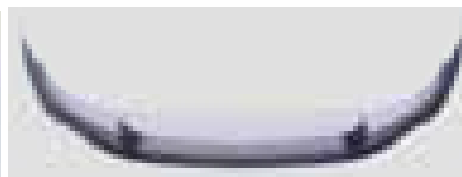

1.4

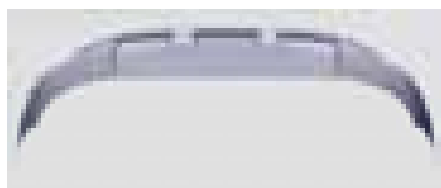

1.5



1.6



1.7



1.8

- (11) **13375**
(21) 3-2008-00380 (28) 01
(54) TẮM CHẮN TRƯỚC CỦA XE Ô TÔ (51) **12-16**
(22) 20.03.2008 (43) 25.09.2008
(71) TOYOTA JIDOSHA KABUSHIKI KAISHA (JP)
1, Toyota-cho, Toyota-shi, Aichi-ken 471-8571, Japan
(72) Hiroshi TOMITA (JP), Yutaka KUBOTA (JP)
(74) Công ty TNHH Quốc tế D & N (D&N INTERNATIONAL CO.,LTD.)
(55)



1.1

1.2

1.3



1.4

1.5



1.6

1.7

1.8

- (11) **13376**
(21) 3-2008-00416 (28) 01
(54) GHẾ GẤP (51) **06-01**
(22) 26.03.2008 (43) 25.09.2008
(71) NGUYỄN THANH HOÀN (VN)
Số 1A dãy thể dục thể thao An Dương, Yên Phụ Tây Hồ, thành phố Hà Nội
(72) Nguyễn Thanh Hoàn (VN)
(74) Công ty TNHH Sở hữu trí tuệ và Tư vấn đầu tư IPIC (IPIC CO.,LTD.)
(55)



1.1

1.2

1.3

1.4

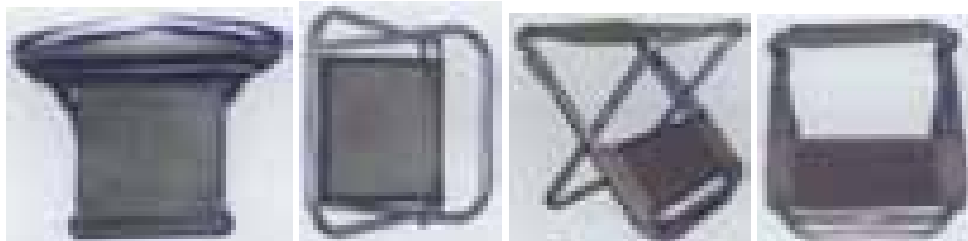

1.5

1.6

1.7

1.8

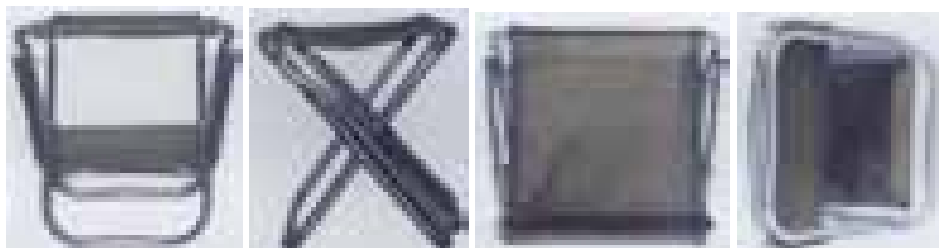

1.9

1.10

1.11

1.12

- (11) **13377**
(21) 3-2008-00446 (28) 01
(54) ĐÈN PHA Ô TÔ (51) **26-06**
(22) 31.03.2008 (43) 25.09.2008
(30) 2007-029055 23.10.2007 JP
(71) NISSAN JIDOSHA KABUSHIKI KAISHA (NISSAN MOTOR CO., LTD.) (JP)
No. 2, Takaracho, Kanagawa-ku, Yokohama-shi, Kanagawa-ken, Japan
(72) AKIO SHIMIZU (JP), HIDEO HAYASHI (JP)
(74) Công ty TNHH Sở hữu trí tuệ Thảo Thọ Quyển (INVENCO)
(55)



1.1

1.2

1.3

1.4



1.5

1.6

1.7



1.8

- (11) **13378**
(21) 3-2008-00447 (28) 01
(54) ĐÈN HẬU Ô TÔ (51) **26-06**
(22) 31.03.2008 (43) 25.09.2008
(30) 2007-029058 23.10.2007 JP
(71) NISSAN JIDOSHA KABUSHIKI KAISHA (NISSAN MOTOR CO., LTD.) (JP)
No. 2, Takaracho, Kanagawa-ku, Yokohama-shi, Kanagawa-ken, Japan
(72) HIDEO HAYASHI (JP), CHIN-HSUAN, CHEN (TW)
(74) Công ty TNHH Sở hữu trí tuệ Thảo Thọ Quyển (INVENCO)
(55)



1.1

1.2

1.3

1.4



1.5

1.6

1.7



1.8

- (11) **13379**
(21) 3-2008-00448 (28) 01
(54) CỬA LẤY GIÓ CHO BỘ TẢN (51) **12-16**
NHIỆT CỦA Ô TÔ
(22) 31.03.2008 (43) 25.09.2008
(30) 2007-029051 23.10.2007 JP
(71) NISSAN JIDOSHA KABUSHIKI KAISHA (NISSAN MOTOR CO., LTD.) (JP)
No. 2, Takaracho, Kanagawa-ku, Yokohama-shi, Kanagawa-ken, Japan
(72) HIDEO HAYASHI (JP), EN-HUNG LIU (TW)
(74) Công ty TNHH Sở hữu trí tuệ Thảo Thọ Quyến (INVENCO)
(55)

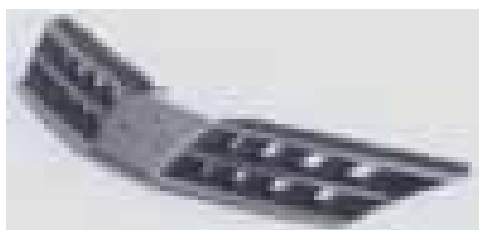

1.1

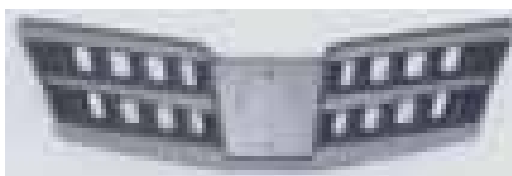

1.2

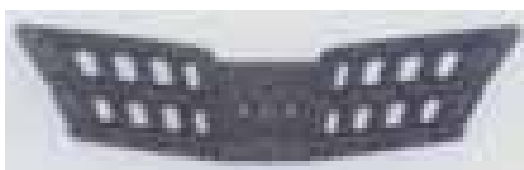

1.3



1.4



1.5



1.6



1.7

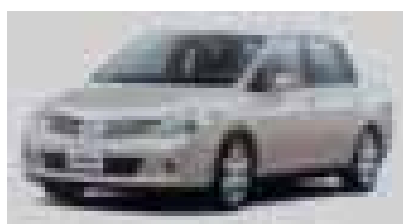

1.8

- (11) **13380**
(21) 3-2008-00449 (28) 01
(54) ĐÈN PHA Ô TÔ (51) **26-06**
(22) 31.03.2008 (43) 25.09.2008
(30) 2007-031103 09.11.2007 JP
(71) NISSAN JIDOSHA KABUSHIKI KAISHA (NISSAN MOTOR CO., LTD.) (JP)
No. 2, Takaracho, Kanagawa-ku, Yokohama-shi, Kanagawa-ken, Japan
(72) KAZUNORI MURABAYASHI (JP), CHISATO YAMAMOTO (JP)
(74) Công ty TNHH Sở hữu trí tuệ Thảo Thọ Quyển (INVENCO)
(55)

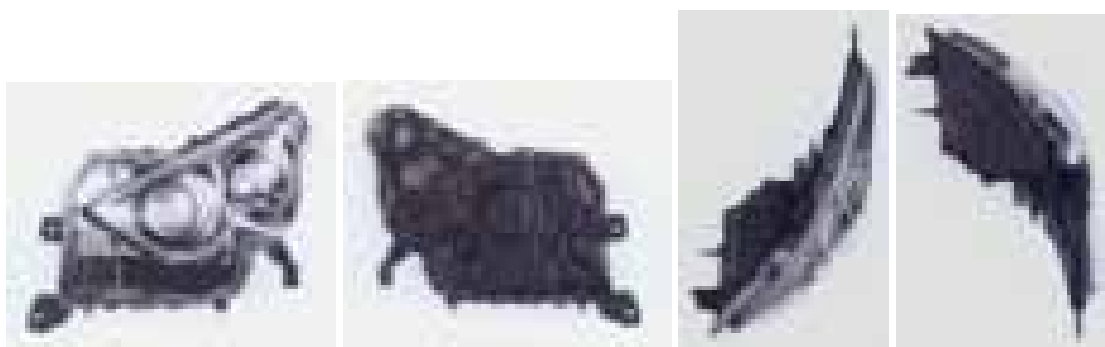

1.1

1.2

1.3

1.4



1.5

1.6

1.7



1.8

- (11) **13381**
(21) 3-2008-00450 (28) 01
(54) ĐÈN HẬU Ô TÔ (51) **26-06**
(22) 31.03.2008 (43) 25.09.2008
(30) 2007-029057 23.10.2007 JP
(71) NISSAN JIDOSHA KABUSHIKI KAISHA (NISSAN MOTOR CO., LTD.) (JP)
No. 2, Takaracho, Kanagawa-ku, Yokohama-shi, Kanagawa-ken, Japan
(72) HIDEO HAYASHI (JP), CHIN-HSUAN, CHEN (TW)
(74) Công ty TNHH Sở hữu trí tuệ Thảo Thọ Quyển (INVENCO)
(55)



1.1

1.2

1.3

1.4



1.5

1.6

1.7



1.8

- (11) **13382**
(21) 3-2008-00452 (28) 01
(54) TẤM BẢO HIỂM MŨI Ô TÔ (51) **12-16**
(22) 31.03.2008 (43) 25.09.2008
(30) 2007-029052 23.10.2007 JP
(71) NISSAN JIDOSHA KABUSHIKI KAISHA (NISSAN MOTOR CO., LTD.) (JP)
No. 2, Takaracho, Kanagawa-ku, Yokohama-shi, Kanagawa-ken, Japan
(72) HIDEO HAYASHI (JP), TE-TSUNG LIANG (TW)
(74) Công ty TNHH Sở hữu trí tuệ Thảo Thọ Quyển (INVENCO)
(55)



1.1



1.2



1.3



1.4



1.5



1.6

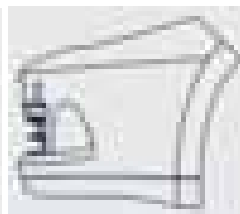

1.7



1.8

- (11) **13383**
(21) 3-2008-00453 (28) 01
(54) CỬA LẤY GIÓ CHO BỘ TẢN (51) **12-16**
NHIỆT CỦA Ô TÔ
(22) 31.03.2008 (43) 25.09.2008
(30) 2007-031098 09.11.2007 JP
(71) NISSAN JIDOSHA KABUSHIKI KAISHA (NISSAN MOTOR CO., LTD.) (JP)
No. 2, Takaracho, Kanagawa-ku, Yokohama-shi, Kanagawa-ken, Japan
(72) CHISATO YAMAMOTO (JP)
(74) Công ty TNHH Sở hữu trí tuệ Thảo Thọ Quyển (INVENCO)
(55)



1.1



1.2



1.3

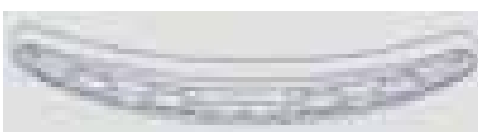

1.4



1.5

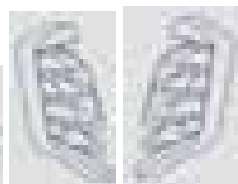

1.6

1.7



1.8

- (11) **13384**
(21) 3-2008-00454 (28) 01
(54) TẤM BẢO HIỂM ĐUÔI Ô TÔ (51) **12-16**
(22) 31.03.2008 (43) 25.09.2008
(30) 2007-029054 23.10.2007 JP
(71) NISSAN JIDOSHA KABUSHIKI KAISHA (NISSAN MOTOR CO., LTD.) (JP)
No. 2, Takaracho, Kanagawa-ku, Yokohama-shi, Kanagawa-ken, Japan
(72) HIDEO HAYASHI (JP), TE-TSUNG LIANG (TW)
(74) Công ty TNHH Sở hữu trí tuệ Thảo Thọ Quyển (INVENCO)
(55)



1.1

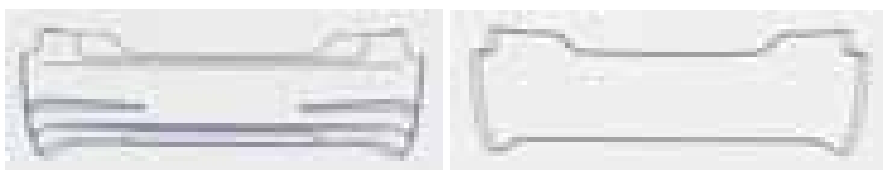

1.2

1.3



1.4

1.5

1.6

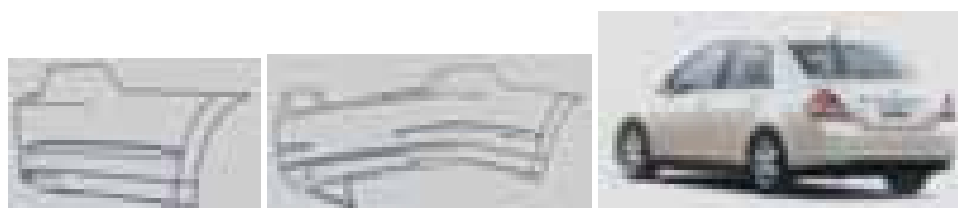

1.7

1.8

1.9

- (11) **13385**
(21) 3-2008-00455 (28) 01
(54) TẮM BẢO HIỂM MŨI Ô TÔ (51) **12-16**
(22) 31.03.2008 (43) 25.09.2008
(30) 2007-031100 09.11.2007 JP
(71) NISSAN JIDOSHA KABUSHIKI KAISHA (NISSAN MOTOR CO., LTD.) (JP)
No. 2, Takaracho, Kanagawa-ku, Yokohama-shi, Kanagawa-ken, Japan
(72) KAZUNORI MURABAYASHI (JP)
(74) Công ty TNHH Sở hữu trí tuệ Thảo Thọ Quyển (INVENCO)
(55)

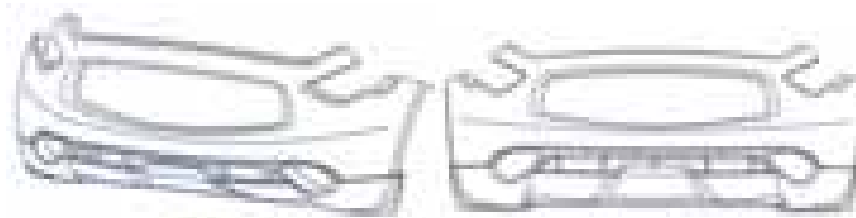

1.1

1.2



1.3

1.4

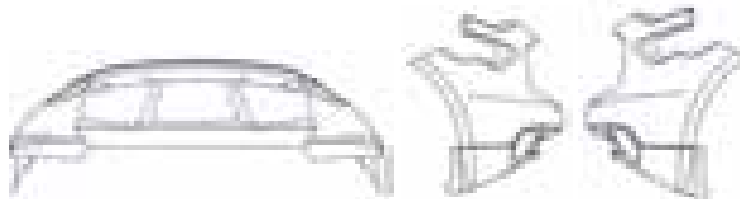

1.5

1.6

1.7



1.8

- (11) **13386**
(21) 3-2008-00472 (28) 01
(54) **VẬT BẢO VỆ GỐC CÂY BẰNG (51) 25-01**
GANG
(22) 02.04.2008 (43) 25.09.2008
(71) **CÔNG TY CỔ PHẦN DỰ ÁN CÔNG NGHỆ NHẬT HẢI (VN)**
Vila số 9-BT2, bán đảo Linh Đàm, quận Hoàng Mai, thành phố Hà Nội
(72) Lưu Hải Minh (VN)
(55)



1.1

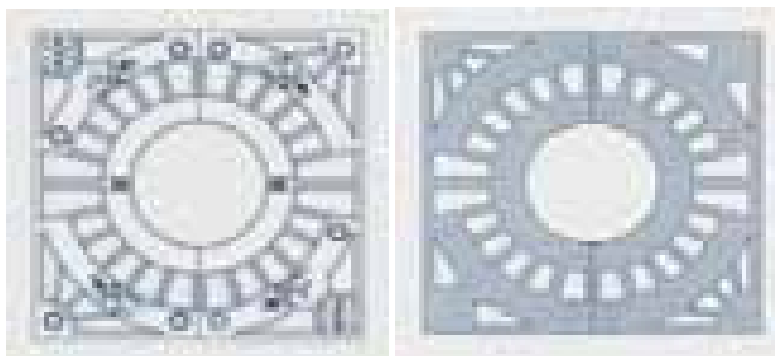

1.2

1.3



1.4

1.5

- (11) **13387**
(21) 3-2008-00510 (28) 01
(54) ĐUI BÓNG ĐIỆN (51) **26-05**
(22) 09.04.2008 (43) 25.09.2008
(30) 0702002771 15.10.2007 TH
(71) SOMJAI VIVATVANIT (TH)
200/12 Moonban Prinsiri, Navamin Road, Klongkum, Bungkum, Bangkok, Thailand
(72) Somjai Vivatvanit (TH)
(74) Công ty Hỗ trợ phát triển công nghệ (DETECH)
(55)

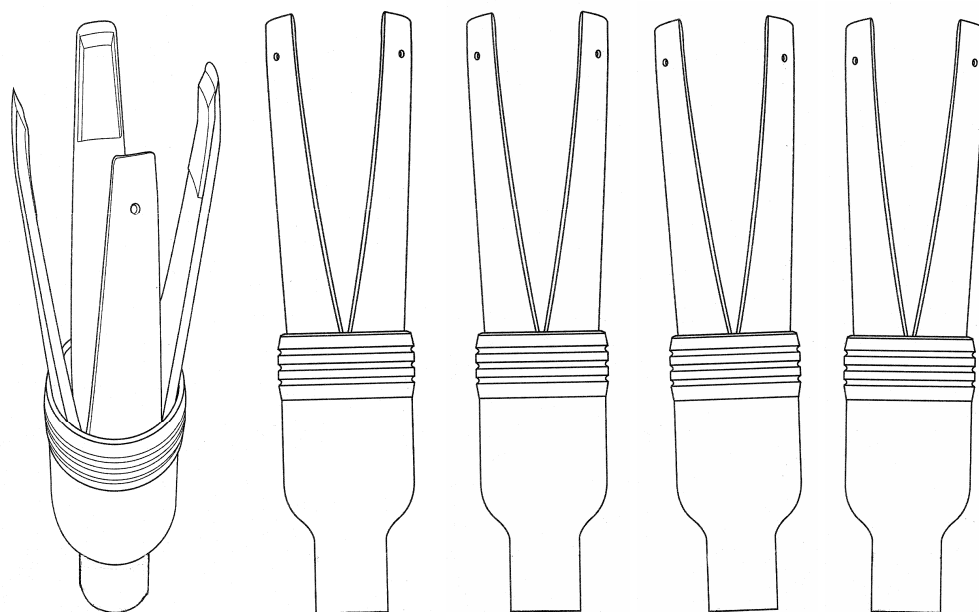

1.1

1.2

1.3

1.4

1.5

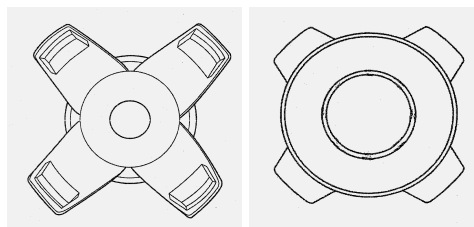

1.6

1.7

- (11) **13388**
(21) 3-2008-00540 (28) 01
(54) BÓNG ĐÈN (51) **26-04**
(22) 17.04.2008 (43) 25.09.2008
(30) 000812359-0001 19.10.2007 EM
(71) KONINKLIJKE PHILIPS ELECTRONICS N.V. (NL)
Groenewoudseweg 1, 5621 BA Eindhoven, The Netherlands
(72) Ernest Kin Man To (CN), Nan Zhao (CN)
(74) Công ty Cổ phần Sở hữu công nghiệp INVESTIP (INVESTIP)
(55)

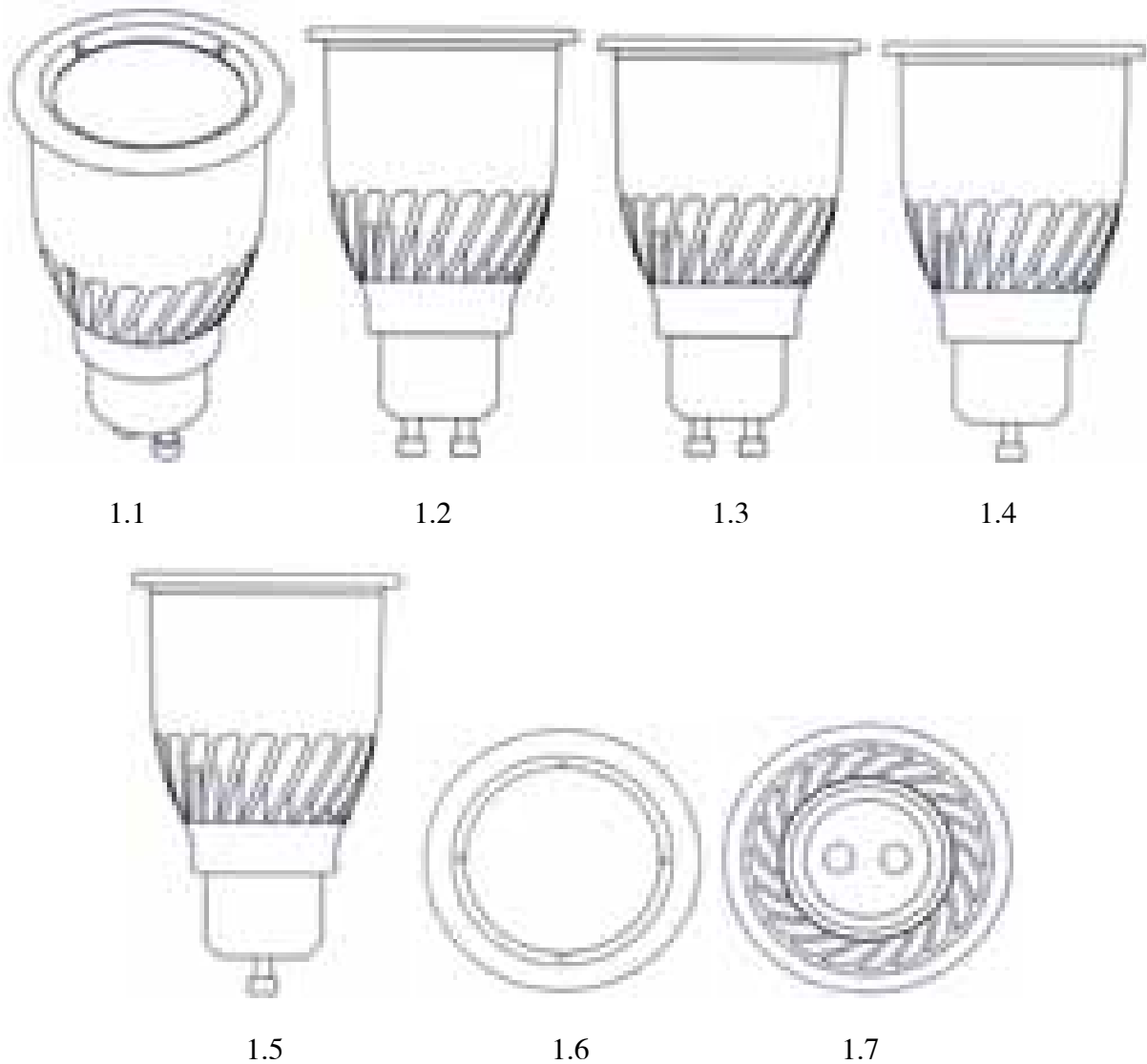

- (11) **13389**
(21) 3-2008-00542 (28) 01
(54) BÓNG ĐÈN (51) **26-04**
(22) 17.04.2008 (43) 25.09.2008
(30) 000812359-0003 19.10.2007 EM
(71) KONINKLIJKE PHILIPS ELECTRONICS N.V. (NL)
Groenewoudseweg 1, 5621 BA Eindhoven, The Netherlands
(72) Ernest Kin Man To (CN), Nan Zhao (CN)
(74) Công ty Cổ phần Sở hữu công nghiệp INVESTIP (INVESTIP)
(55)



1.1

1.2

1.3

1.4



1.5

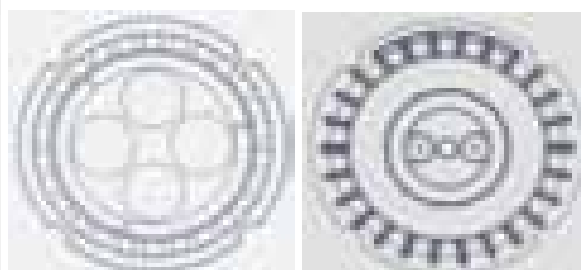

1.6

1.7

- (11) **13390**
(21) 3-2008-00549 (28) 01
(54) XE MÁY (51) **12-11**
(22) 21.04.2008 (43) 25.09.2008
(30) 000818299-0001 31.10.2007 EM
(71) PIAGGIO & C. S.P.A. (IT)
Viale Rinaldo Piaggio 25, 56025 PONTEDERA (Pisa), Italy
(72) Marco LAMBRI (IT)
(74) Công ty Cổ phần Sở hữu công nghiệp INVESTIP (INVESTIP)
(55)



1.1

1.2

1.3

1.4



1.5

1.6

1.7

1.8

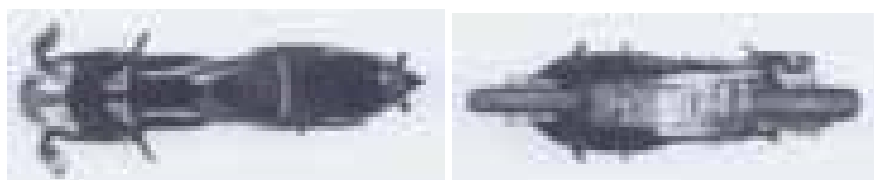

1.9

1.10

- (11) **13391**
(21) 3-2008-00559 (28) 01
(54) NỘI TRẺ EM DÙNG KHI ĐI (51) **06-02**
ĐƯỜNG
(22) 22.04.2008 (43) 25.09.2008
(30) 000812821 22.10.2007 EM
(71) MYKKO, NAAMLOZE VENOOTSCHAP (BE)
Lossingstraat 146, B-2900 Schoten, Belgium
(72) Daeseleire Bruno (BE)
(74) Văn phòng luật sư Phạm và Liên danh (PHAM & ASSOCIATES)
(55)



1.1

1.2

1.3



1.4

1.5

1.6

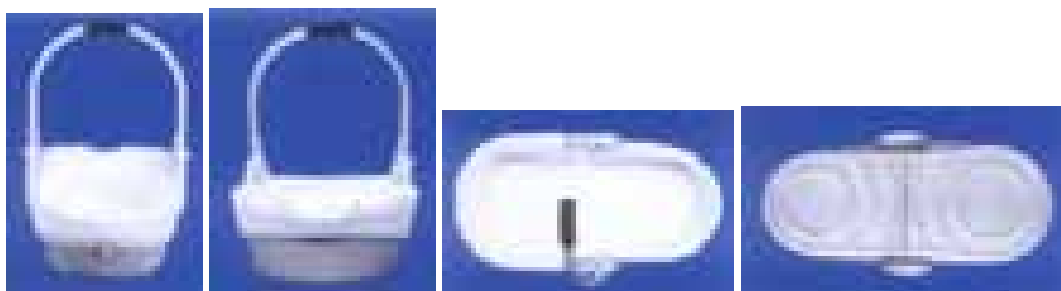

1.7

1.8

1.9

1.10

- (11) **13392**
(21) 3-2008-00560 (28) 01
(54) NỘI TRẺ EM DÙNG KHI ĐI (51) **06-02**
ĐƯỜNG
(22) 22.04.2008 (43) 25.09.2008
(30) 000812821 22.10.2007 EM
(71) MYKKO, NAAMLOZE VENOOTSCHAP (BE)
Lossingstraat 146, B-2900 Schoten, Belgium
(72) Daeseleire Bruno (BE)
(74) Văn phòng luật sư Phạm và Liên danh (PHAM & ASSOCIATES)
(55)

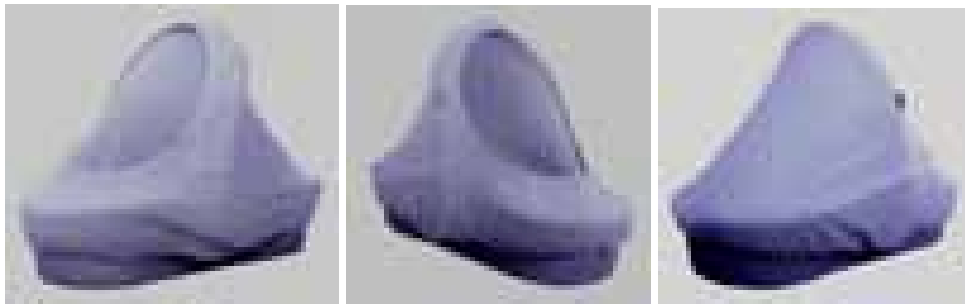

1.1

1.2

1.3



1.4

1.5

1.6



1.7

1.8

1.9

1.10

- (11) **13393**
(21) 3-2008-00574 (28) 01
(54) BAO GÓI BÁNH (51) **09-05**
(22) 23.04.2008 (43) 25.09.2008
(71) CÔNG TY TNHH BÁNH KẸO THỰC PHẨM TÍCH SỸ GIAI (VN)
Tân Dĩnh, Lạng Giang, tỉnh Bắc Giang
(72) Trần Hán Vinh (CN)
(55)



1.1



1.2

- (11) **13394**
(21) 3-2008-00575
(54) BAO GÓI BÁNH
(22) 23.04.2008
(71) CÔNG TY TNHH BÁNH KẸO THỰC PHẨM TÍCH SỸ GIAI (VN)
Tân Dĩnh, Lạng Giang, tỉnh Bắc Giang
(72) Trần Hán Vinh (CN)
(55)
(28) 01
(51) **09-05**
(43) 25.09.2008



1.1



1.2

- (11) **13395**
(21) 3-2008-00578 (28) 01
(54) HỘP ĐỰNG THUỐC (51) **09-03**
(22) 24.04.2008 (43) 25.09.2008
(71) CÔNG TY TNHH DƯỢC PHẨM HOA LAN (VN)
Phòng 205, 206 đơn nguyên A Tòa nhà RESCO B15 Đại Kim, phường Đại Kim, quận
Hoàng Mai, TP. Hà Nội
(72) Phạm Thị Như Hoa (VN)
(55)



1.1



1.2

- (11) **13396**
(21) 3-2008-00579 (28) 01
(54) XE MÁY (51) **12-11**
(22) 24.04.2008 (43) 25.09.2008
(71) CÔNG TY TRÁCH NHIỆM HỮU HẠN HỒNG ĐÀ (VN)
27 lô AA19, đường số 4, khu dân cư Bình Hưng, xã Bình Hưng, huyện Bình Chánh, TP.
Hồ Chí Minh
(72) Võ Thành Đạt (VN)
(74) Công ty TNHH Sở hữu trí tuệ và Công nghệ Thủ đô (CAPITAL IP&T CO.LTD.)
(55)



1.1

1.2

1.3

1.4

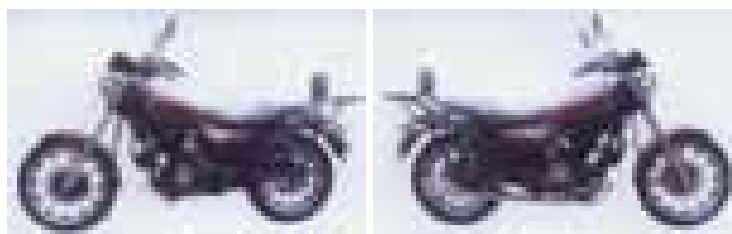

1.5

1.6



1.7

1.8

1.9

- (11) **13397**
(21) 3-2008-00614 (28) 01
(54) HỘP ĐUNG BĂNG VỆ SINH (51) **09-03**
(22) 07.05.2008 (43) 25.09.2008
(71) CÔNG TY TRÁCH NHIỆM HỮU HẠN MỘT THÀNH VIÊN MY LAN (VN)
Thôn Hoàng Xá, xã Kiêu Kỳ, huyện Gia Lâm, thành phố Hà Nội
(72) Nguyễn Thị Dung (VN)
(55)



1.1



1.2

- (11) **13398**
(21) 3-2008-00615 (28) 01
(54) HỘP ĐUNG BĂNG VỆ SINH (51) **09-03**
(22) 07.05.2008 (43) 25.09.2008
(71) CÔNG TY TRÁCH NHIỆM HỮU HẠN MỘT THÀNH VIÊN MY LAN (VN)
Thôn Hoàng Xá, xã Kiêu Kỳ, huyện Gia Lâm, thành phố Hà Nội
(72) Nguyễn Thị Dung (VN)
(55)



1.1

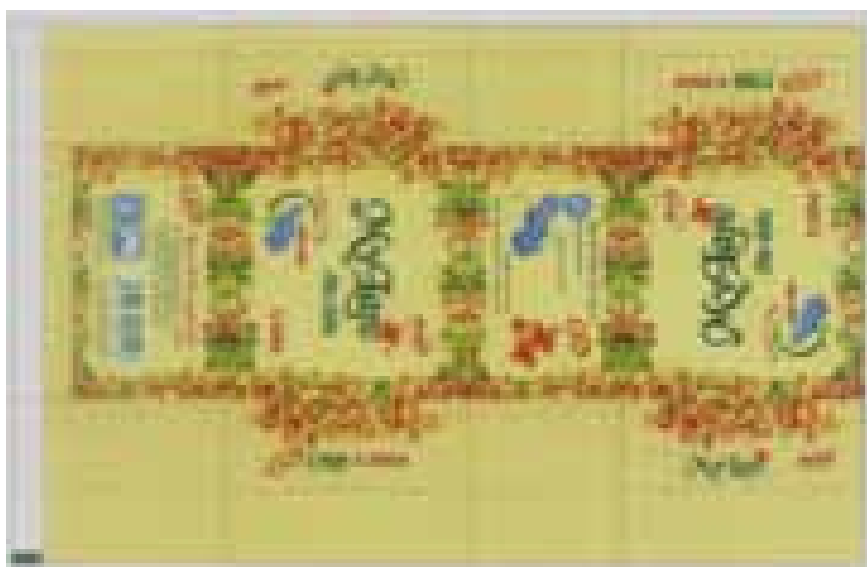

1.2

- (11) **13399**
(21) 3-2008-00616 (28) 01
(54) HỘP ĐUNG BĂNG VỆ SINH (51) **09-03**
(22) 07.05.2008 (43) 25.09.2008
(71) CÔNG TY TRÁCH NHIỆM HỮU HẠN MỘT THÀNH VIÊN MY LAN (VN)
Thôn Hoàng Xá, xã Kiêu Kỳ, huyện Gia Lâm, thành phố Hà Nội
(72) Nguyễn Thị Dung (VN)
(55)



1.1

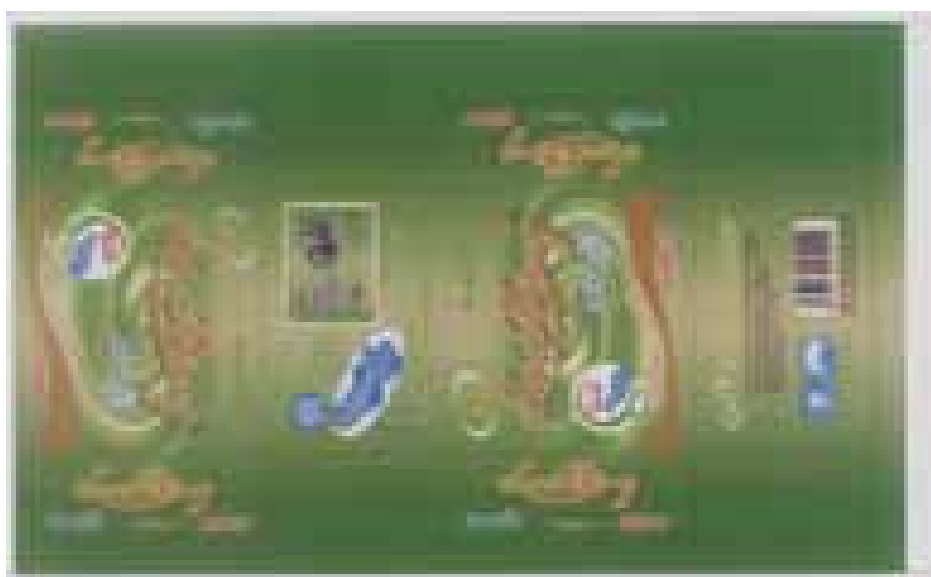

1.2

- (11) **13400**
(21) 3-2008-00617 (28) 01
(54) HỘP ĐUNG BĂNG VỆ SINH (51) **09-03**
(22) 07.05.2008 (43) 25.09.2008
(71) CÔNG TY TRÁCH NHIỆM HỮU HẠN MỘT THÀNH VIÊN MY LAN (VN)
Thôn Hoàng Xá, xã Kiêu Kỳ, huyện Gia Lâm, thành phố Hà Nội
(72) Nguyễn Thị Dung (VN)
(55)



1.1

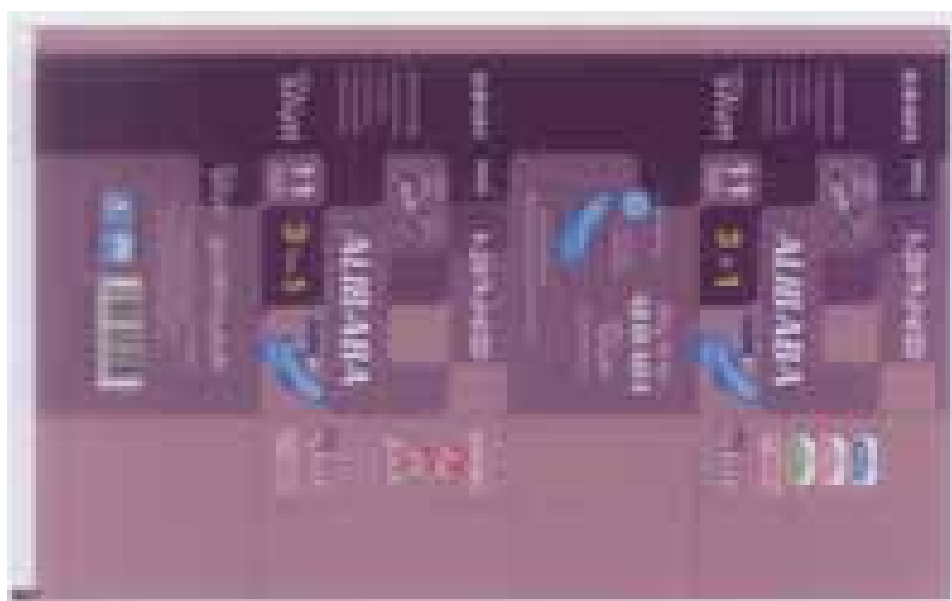

1.2

- (11) **13401**
(21) 3-2008-00618 (28) 01
(54) HỘP ĐỰNG KHĂN GIẤY (51) **09-03**
(22) 07.05.2008 (43) 25.09.2008
(71) CÔNG TY TRÁCH NHIỆM HỮU HẠN MỘT THÀNH VIÊN MY LAN (VN)
Thôn Hoàng Xá, xã Kiêu Kỳ, huyện Gia Lâm, thành phố Hà Nội
(72) Nguyễn Thị Dung (VN)
(55)



1.1



1.2

- (11) **13402**
(21) 3-2008-00619 (28) 04
(54) TÚI ĐỰNG GIẤY THƠM (51) **09-05**
(22) 07.05.2008 (43) 25.09.2008
(71) CÔNG TY TRÁCH NHIỆM HỮU HẠN MỘT THÀNH VIÊN MY LAN (VN)
Thôn Hoàng Xá, xã Kiêu Kỳ, huyện Gia Lâm, thành phố Hà Nội
(72) Nguyễn Thị Dung (VN)
(55)



1.1



1.2



2.1



2.2



3.1

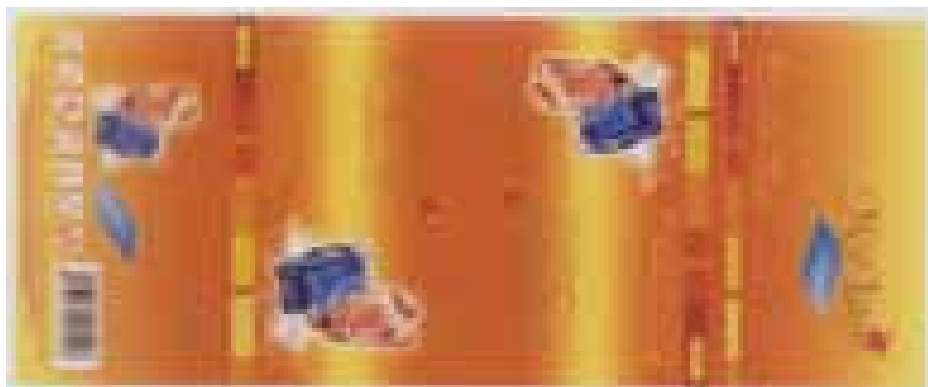

3.2



4.1



4.2

- (11) **13403**
(21) 3-2008-00668
(54) BÀN CHẢI
(22) 19.05.2008
(71) CƠ SỞ LƯU BẢO CHÂU (VN)
300 Gia Phú, phường 3, quận 6, TP. Hồ Chí Minh
(72) Lưu Cẩm Thành (VN)
(74) Công ty TNHH Sở hữu trí tuệ Thảo Thọ Quyến (INVENCO)
(55)
- (28) 01
(51) **04-01**
(43) 25.09.2008



1.1



1.2

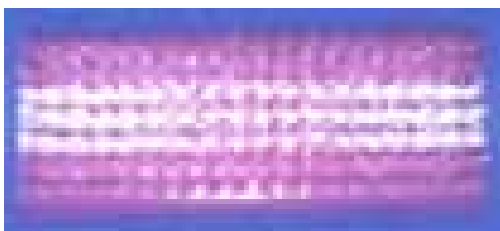

1.3

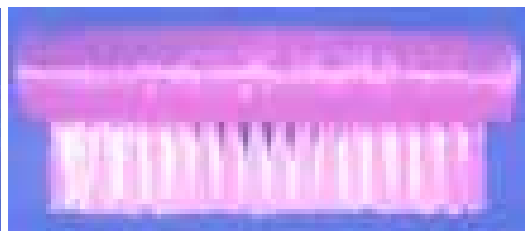

1.4

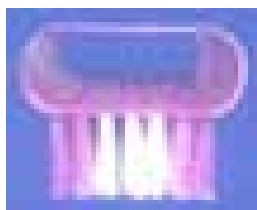

1.5

- (11) **13404**
(21) 3-2008-00673 (28) 01
(54) XE MÁY (51) **12-11**
(22) 19.05.2008 (43) 25.09.2008
(71) CÔNG TY CỔ PHẦN TẬP ĐOÀN T&T (VN)
18 Hàng Chuối, quận Hai Bà Trưng, thành phố Hà Nội
(72) Đỗ Quang Hiến (VN)
(55)



1.1

1.2

1.3

1.4



1.5

1.6

1.7

1.8



1.9

1.10

- (11) **13405**
(21) 3-2008-00688 (28) 01
(54) KÍNH QUAN SÁT BAN ĐÊM (51) **16-06**
(22) 21.05.2008 (43) 25.09.2008
(71) CÔNG TY CỔ PHẦN QUANG ĐIỆN TỬ VIỆT (VN)
Số 21, ngõ 24, đường Hoàng Quốc Việt, phường Nghĩa Đô, quận Cầu Giấy, thành phố Hà Nội
(72) Hoàng Ngọc Minh (VN)
(55)



1.1

1.2

1.3



1.4

1.5

1.6

1.7

- (11) **13406**
(21) 3-2008-00690 (28) 01
(54) KÍNH QUAN SÁT BAN ĐÊM (51) **16-06**
(22) 21.05.2008 (43) 25.09.2008
(71) CÔNG TY CỔ PHẦN QUANG ĐIỆN TỬ VIỆT (VN)
Số 21, ngõ 24, đường Hoàng Quốc Việt, phường Nghĩa Đô, quận Cầu Giấy, thành phố Hà Nội
(72) Hoàng Ngọc Minh (VN)
(55)



1.1

1.2

1.3

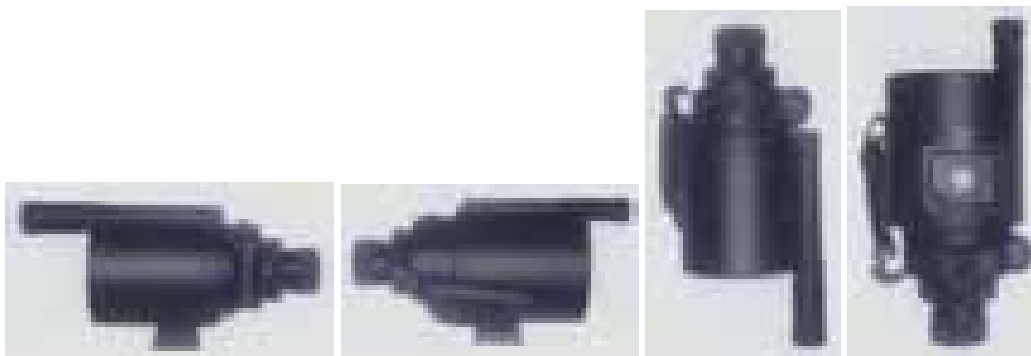

1.4

1.5

1.6

1.7

- (11) **13407**
(21) 3-2008-00697 (28) 01
(54) MÁY CHỤP ẢNH (51) **16-01**
(22) 26.05.2008 (43) 25.09.2008
(71) SONY COMPUTER ENTERTAINMENT INC. (JP)
2-6-21, Minami-Aoyama, Minato-ku, Tokyo 107-0062, Japan
(72) Takatoshi Nakamura (JP)
(74) Văn phòng luật sư Phạm và Liên danh (PHAM & ASSOCIATES)
(55)

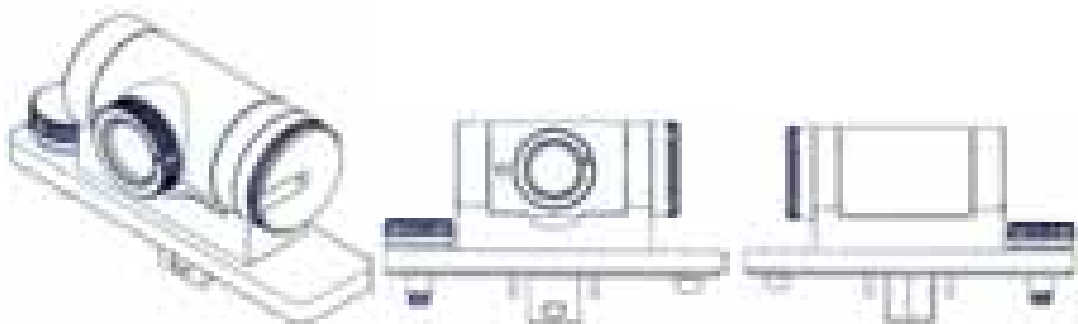

1.1

1.2

1.3



1.4

1.5

1.6

1.7

- (11) **13408**
(21) 3-2008-00698 (28) 01
(54) BỘ THU HỆ THỐNG ĐỊNH VỊ (51) **14-03**
TOÀN CẦU
(22) 26.05.2008 (43) 25.09.2008
(71) SONY COMPUTER ENTERTAINMENT INC. (JP)
2-6-21, Minami-Aoyama, Minato-ku, Tokyo 107-0062, Japan
(72) Takatoshi Nakamura (JP)
(74) Văn phòng luật sư Phạm và Liên danh (PHAM & ASSOCIATES)
(55)

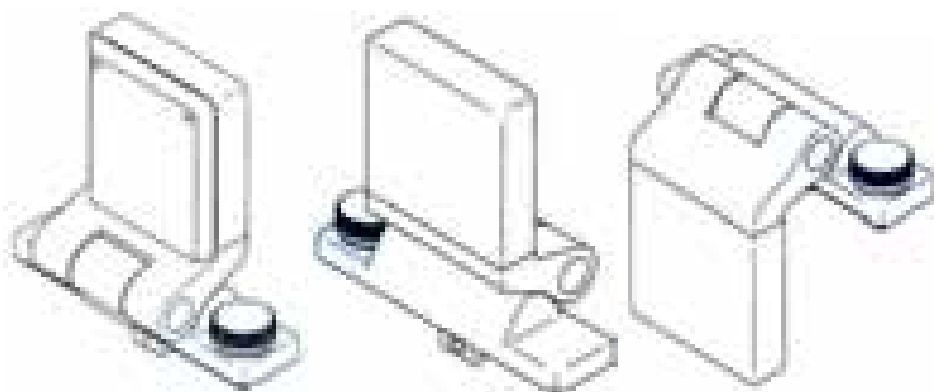

1.1

1.2

1.3

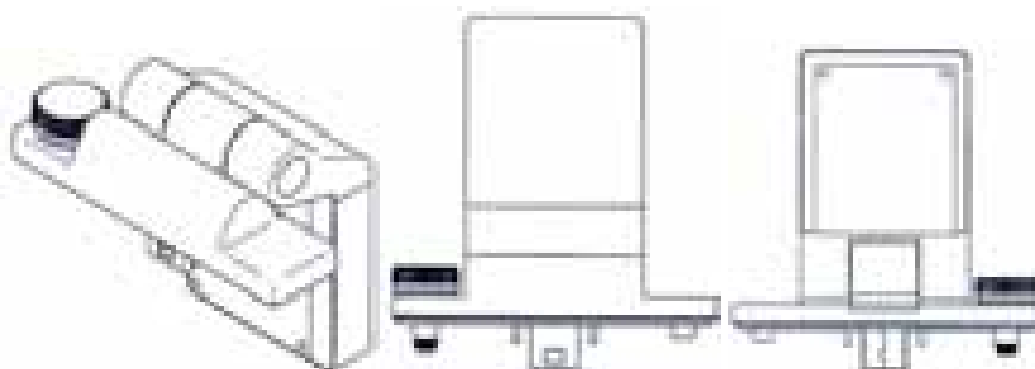

1.4

1.5

1.6

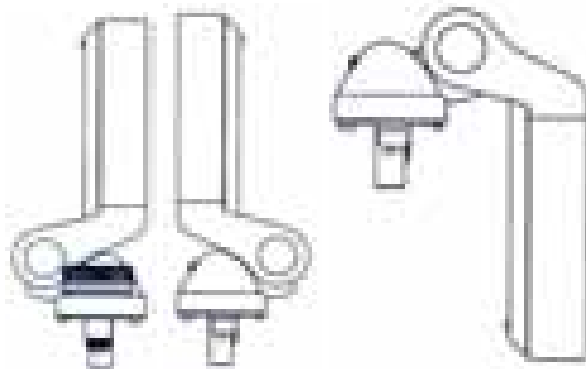

1.7

1.8

1.9

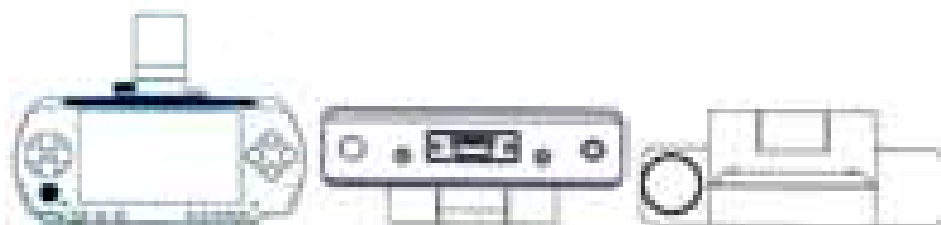

1.10

1.11

1.12

- (11) **13409**
(21) 3-2008-00699 (28) 01
(54) **HỆ THỐNG PHÁT NHẠC** (51) **14-01**
(22) 26.05.2008 (43) 25.09.2008
(30) 29/299161 20.12.2007 US
(71) BOSE CORPORATION (US)
The Mountain, Framingham, Massachusetts 01701-9168, United States of America
(72) John Arthur Lee Jr. (US), Stuart Raymond Jang (US)
(74) Văn phòng luật sư Phạm và Liên danh (PHAM & ASSOCIATES)
(55)



1.1



1.2



1.3

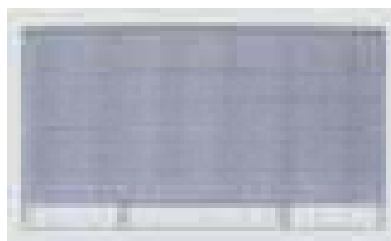

1.4

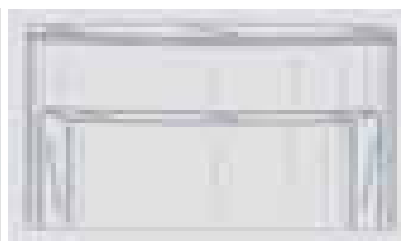

1.5



1.6

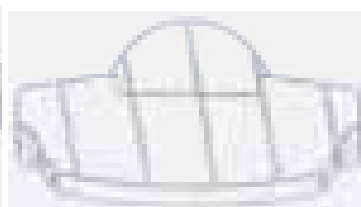

1.7

- (11) **13410**
(21) 3-2008-00700 (28) 01
(54) TẮM CHE PHÍA TRƯỚC XE MÁY (51) **12-16**
(22) 26.05.2008 (43) 25.09.2008
(30) 2007-032793 29.11.2007 JP
(71) HONDA MOTOR CO., LTD. (JP)
1-1, Minamiaoyama 2-chome, Minato-ku, Tokyo, Japan
(72) Masaharu Yoshimura (JP), Manit Phrammano (TH)
(74) Văn phòng luật sư Phạm và Liên danh (PHAM & ASSOCIATES)
(55)



1.1

1.2

1.3

1.4



1.5

1.6

1.7

1.8



1.9

1.10

1.11

- (11) **13411**
(21) 3-2008-00712 (28) 02
(54) CHAI (51) **09-01**
(22) 27.05.2008 (43) 25.09.2008
(30) 134642 09.01.2008 CH
(71) SOCIÉTÉ DES PRODUITS NESTLÉ S.A. (CH)
1800 Vevey, Switzerland
(72) Nicolas Dabrowski (FR)
(74) Công ty TNHH Ban Ca (BANCA)
(55)

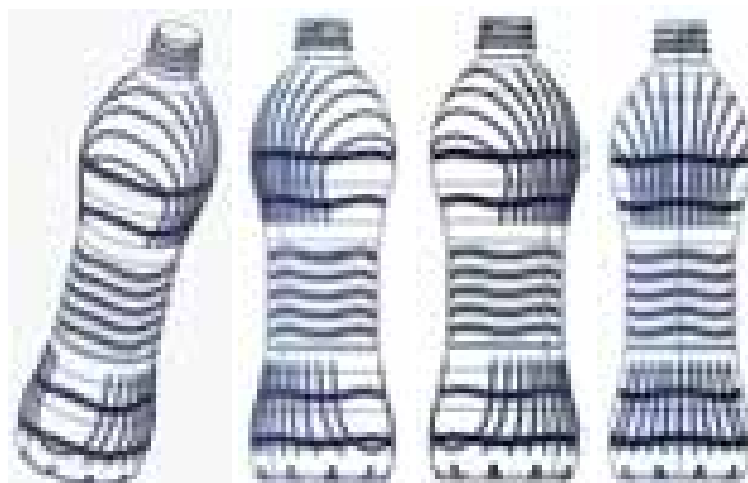

1.1

1.2

1.3

1.4



1.5

1.6

1.7

1.8

1.9



2.1

2.2

2.3

2.4

2.5

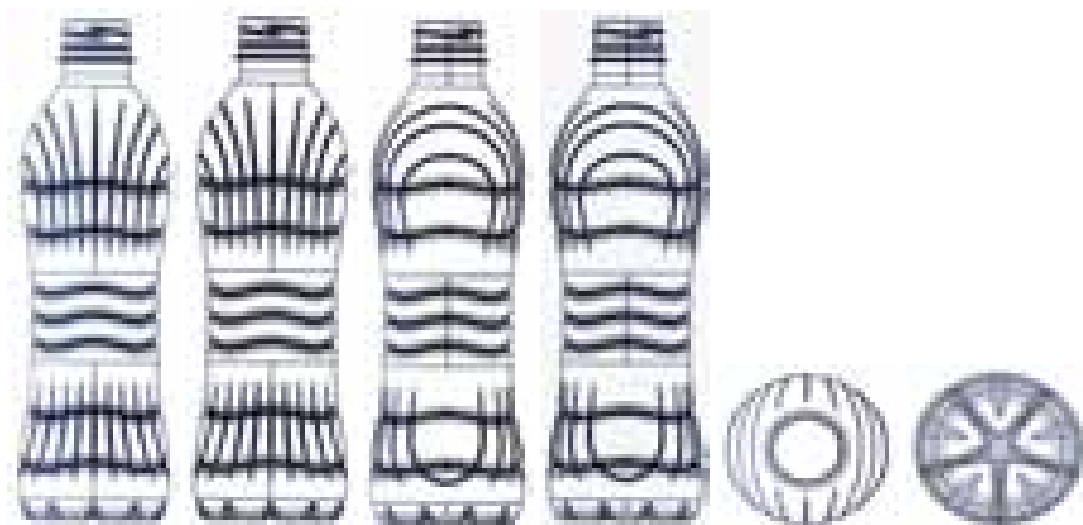

2.6

2.7

2.8

2.9

2.10

2.11

- (11) **13412**
(21) 3-2008-00734
(54) HỘP ĐỰNG MỰC IN
(22) 30.05.2008
(30) 2007-033061 30.11.2007 JP
(71) BROTHER INDUSTRIES, LTD. (JP)
15-1 Naeshiro-cho, Mizuho-ku, Nagoya-shi, Aichi-ken, Japan
(72) Shingo HATTORI (JP)
(74) Công ty TNHH Ban Ca (BANCA)
(55)
- (28) 01
(51) **18-02**
(43) 25.09.2008

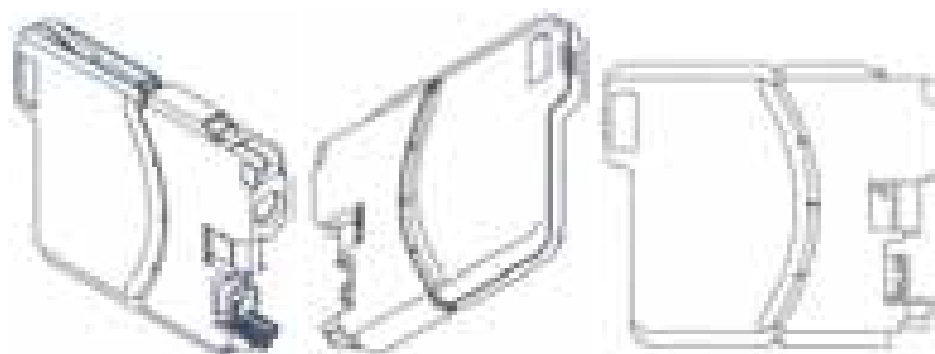

1.1

1.2

1.3

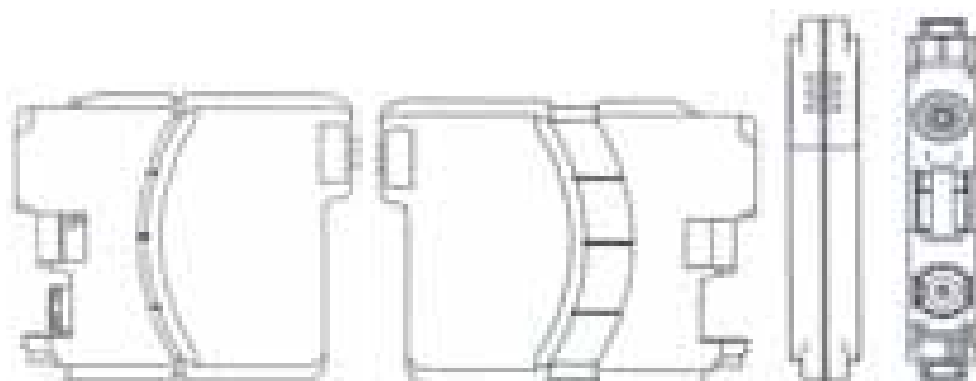

1.4

1.5

1.6

1.7



1.8

1.9

- (11) **13413**
(21) 3-2008-00735 (28) 01
(54) HỘP ĐUNG MỰC IN (51) **18-02**
(22) 30.05.2008 (43) 25.09.2008
(30) 2007-033062 30.11.2007 JP
(71) BROTHER INDUSTRIES, LTD. (JP)
15-1 Naeshiro-cho, Mizuho-ku, Nagoya-shi, Aichi-ken, Japan
(72) Shingo HATTORI (JP)
(74) Công ty TNHH Ban Ca (BANCA)
(55)



1.1

1.2

1.3



1.4

1.5

1.6

1.7



1.8

1.9

- (11) **13414**
(21) 3-2008-00736 (28) 01
(54) HỘP ĐUNG MỰC IN (51) **18-02**
(22) 30.05.2008 (43) 25.09.2008
(30) 2007-033063 30.11.2007 JP
(71) BROTHER INDUSTRIES, LTD. (JP)
15-1 Naeshiro-cho, Mizuho-ku, Nagoya-shi, Aichi-ken, Japan
(72) Shingo HATTORI (JP)
(74) Công ty TNHH Ban Ca (BANCA)
(55)

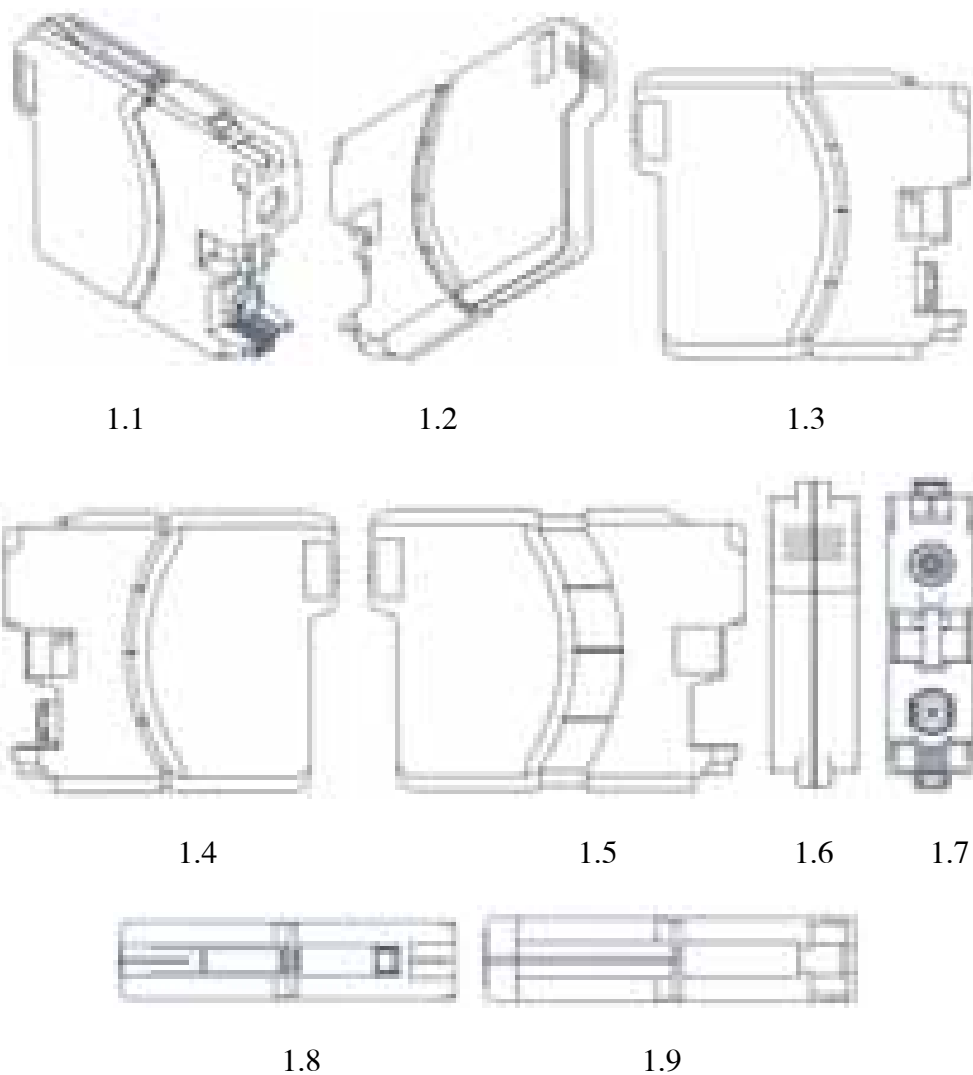

- (11) **13415**
(21) 3-2008-00751 (28) 01
(54) THANH KIM LOẠI ĐỊNH HÌNH (51) **25-01**
(22) 05.06.2008 (43) 25.09.2008
(71) CÔNG TY TNHH CỬA CUỐN ÚC VINH QUANG (VN)
Số 180 Tô Hiệu, phường Trại Cau, quận Lê Chân, thành phố Hải Phòng
(72) Lê Mạnh Đức (VN)
(74) Công ty TNHH Sở hữu trí tuệ HA VIP (HAVIP CO., LTD.)
(55)



1.1

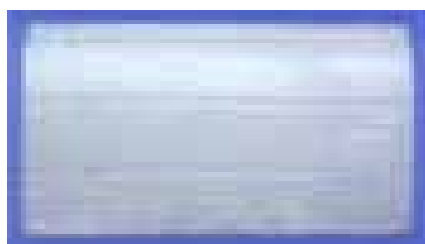

1.2

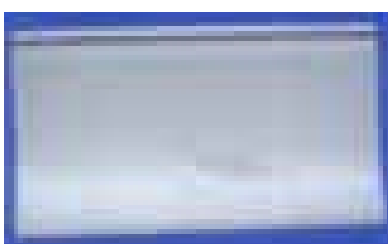

1.3



1.4



1.5

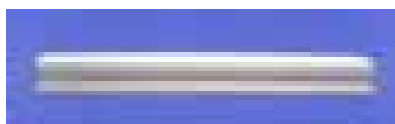

1.6

- (11) **13416**
(21) 3-2008-00752 (28) 02
(54) THANH KIM LOẠI ĐỊNH HÌNH (51) **25-01**
(22) 05.06.2008 (43) 25.09.2008
(71) CÔNG TY TNHH CỬA CUỐN ÚC VINH QUANG (VN)
Số 180 Tô Hiệu, phường Trại Cau, quận Lê Chân, thành phố Hải Phòng
(72) Lê Mạnh Đức (VN)
(74) Công ty TNHH Sở hữu trí tuệ HA VIP (HAVIP CO., LTD.)
(55)



1.1



1.2

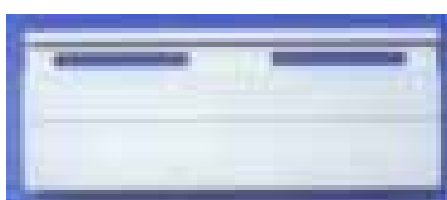

1.3



1.4



1.5

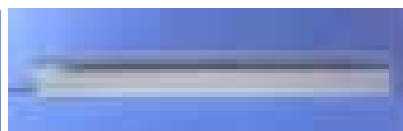

1.6



2.1



2.2



2.3



2.4



2.5

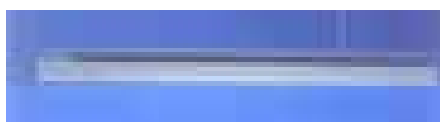

2.6

- (11) **13417**
(21) 3-2008-00769 (28) 01
(54) MÁY GIẶT (51) **15-05**
(22) 12.06.2008 (43) 25.09.2008
(71) MATSUSHITA ELECTRIC INDUSTRIAL CO., LTD. (JP)
No. 1006, Oaza Kadoma, Kadoma - shi, Osaka 571-8501, Japan
(72) MUNHEYUKI NAGAI (JP), KYOJI TAKAHASHI (JP)
(74) Công ty TNHH Sở hữu trí tuệ Thảo Thọ Quyển (INVENCO)
(55)



1.1

1.2

1.3

1.4



1.5

1.6

1.7

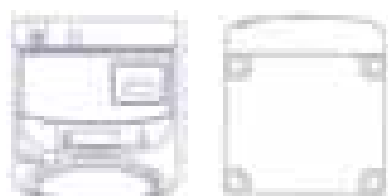

1.8

1.9

- (11) **13418**
(21) 3-2008-00772 (28) 02
(54) GHẾ (51) **06-01**
(22) 12.06.2008 (43) 25.09.2008
(71) DEDON GMBH (DE)
Zeppelinstrasse 22, 21337 Luneburg, Germany
(72) Massaud, Jean - Marie (FR)
(74) Văn phòng Luật sư A Hoà (AHOA LAW OFFICE)
(55)



1.1

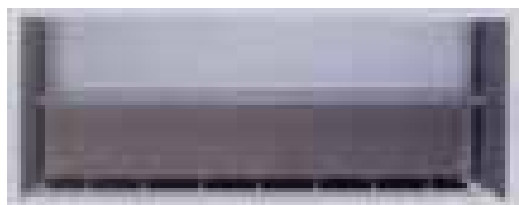

1.2



1.3



1.4

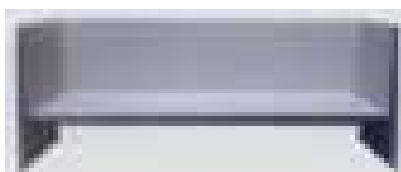

1.5



1.6



2.1

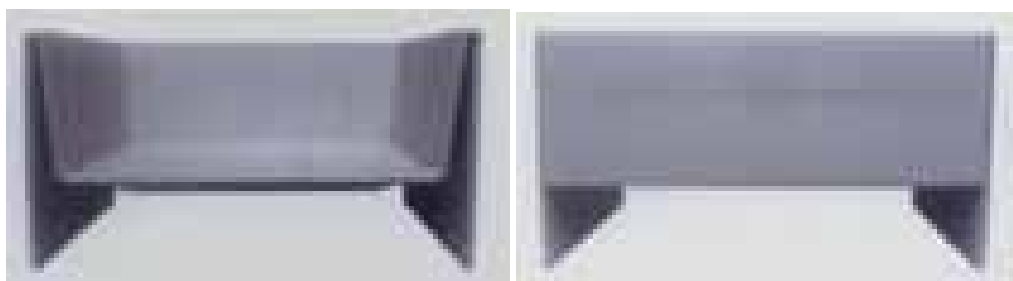

2.2

2.3



2.4

2.5

2.6

- (11) **13419**
(21) 3-2008-00774 (28) 01
(54) GHẾ (51) **06-01**
(22) 12.06.2008 (43) 25.09.2008
(71) DEDON GMBH (DE)
Zeppelinstrasse 22, 21337 Luneburg, Germany
(72) Massaud, Jean - Marie (FR)
(74) Văn phòng Luật sư A Hoà (AHOA LAW OFFICE)
(55)



1.1

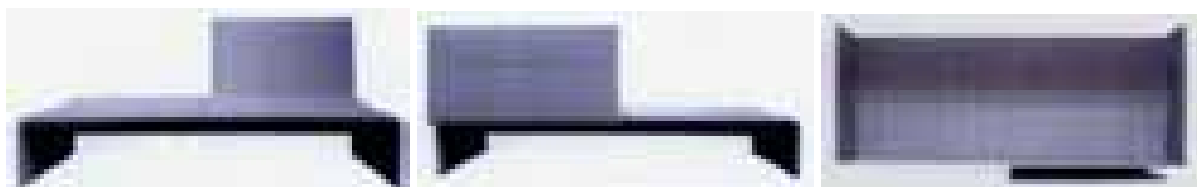

1.2

1.3

1.4

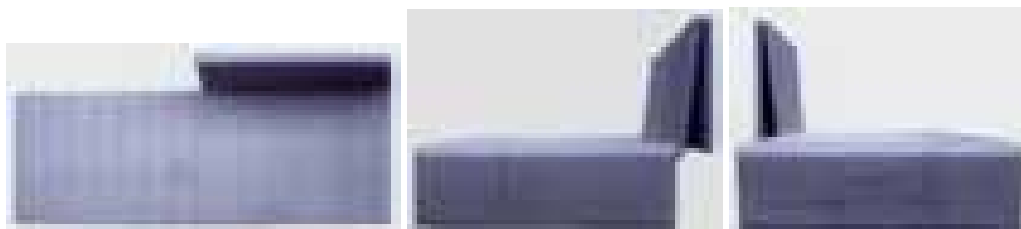

1.5

1.6

1.7

- (11) **13420**
(21) 3-2008-00776 (28) 01
(54) GHẾ (51) **06-01**
(22) 12.06.2008 (43) 25.09.2008
(71) DEDON GMBH (DE)
Zeppelinstrasse 22, 21337 Luneburg, Germany
(72) Massaud, Jean - Marie (FR)
(74) Văn phòng Luật sư A Hoà (AHOA LAW OFFICE)
(55)



1.1

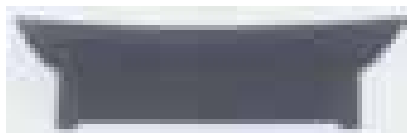

1.2



1.3



1.4



1.5



1.6

- (11) **13421**
(21) 3-2008-00778 (28) 01
(54) GHẾ (51) **06-01**
(22) 12.06.2008 (43) 25.09.2008
(71) DEDON GMBH (DE)
Zeppelinstrasse 22, 21337 Luneburg, Germany
(72) Mag. Art. Bergmann, Martin (AT), Mag. Art. Bohmann, Gernot (AT)
(74) Văn phòng Luật sư A Hoà (AHOA LAW OFFICE)
(55)



1.1

1.2

1.3



1.4

1.5

1.6

- (11) **13422**
(21) 3-2008-00779 (28) 01
(54) GHẾ (51) **06-01**
(22) 12.06.2008 (43) 25.09.2008
(71) DEDON GMBH (DE)
Zeppelinstrasse 22, 21337 Luneburg, Germany
(72) Mag. Art. Bergmann, Martin (AT), Mag. Art. Bohmann, Gernot (AT)
(74) Văn phòng Luật sư A Hoà (AHOA LAW OFFICE)
(55)



1.1



1.2

1.3

1.4

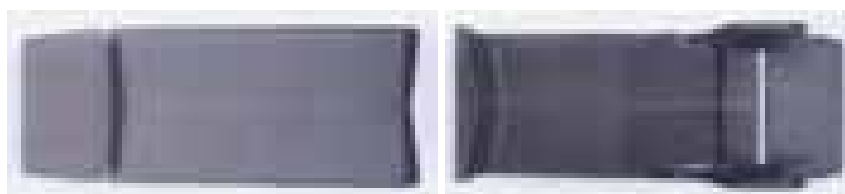

1.5

1.6

- (11) **13423**
(21) 3-2008-00780 (28) 01
(54) GHẾ (51) **06-01**
(22) 12.06.2008 (43) 25.09.2008
(71) DEDON GMBH (DE)
Zeppelinstrasse 22, 21337 Luneburg, Germany
(72) Mag. Art. Bergmann, Martin (AT), Mag. Art. Bohmann, Gernot (AT)
(74) Văn phòng Luật sư A Hoà (AHOA LAW OFFICE)
(55)



1.1

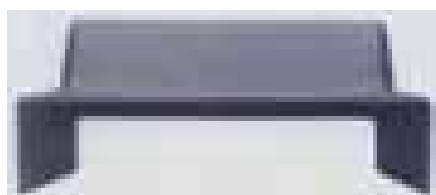

1.2

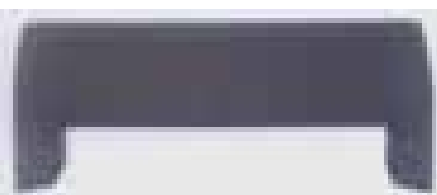

1.3



1.4

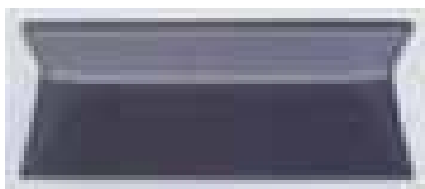

1.5

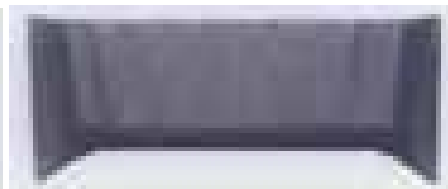

1.6

- (11) **13424**
(21) 3-2008-00782 (28) 01
(54) GHẾ (51) **06-01**
(22) 12.06.2008 (43) 25.09.2008
(71) DEDON GMBH (DE)
Zeppelinstrasse 22, 21337 Luneburg, Germany
(72) Mag. Art. Bergmann, Martin (AT), Mag. Art. Bohmann, Gernot (AT)
(74) Văn phòng Luật sư A Hoà (AHOA LAW OFFICE)
(55)



1.1

1.2

1.3



1.4

1.5

1.6

- (11) **13425**
(21) 3-2008-00783 (28) 01
(54) GHẾ (51) **06-01**
(22) 12.06.2008 (43) 25.09.2008
(71) DEDON GMBH (DE)
Zeppelinstrasse 22, 21337 Luneburg, Germany
(72) Mag. Art. Bergmann, Martin (AT), Mag. Art. Bohmann, Gernot (AT)
(74) Văn phòng Luật sư A Hoà (AHOA LAW OFFICE)
(55)



1.1

1.2

1.3



1.4

1.5

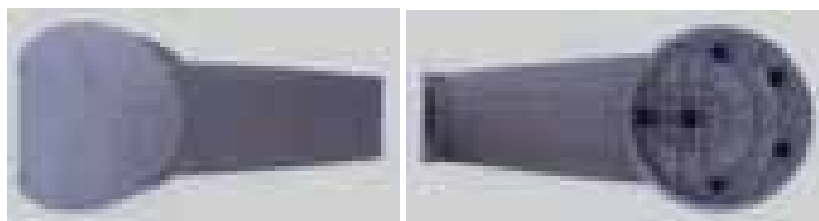

1.6

1.7

- (11) **13426**
(21) 3-2008-00802 (28) 01
(54) BAO GÓI MỠ (51) **09-05**
(22) 16.06.2008 (43) 25.09.2008
(71) CÔNG TY THỰC PHẨM MỠ HÀN QUỐC (VN)
Khu công nghiệp Đồng Lạng Tasco, xã Phù Ninh, huyện Phù Ninh, tỉnh Phú Thọ
(72) Chan Joon Park (KR)
(74) Công ty cổ phần Tư vấn đầu tư quốc tế G4 Việt Nam (G4 VIETNAM. CORP.)
(55)

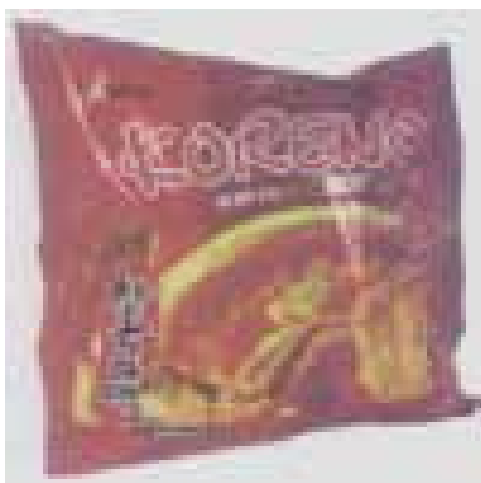

1.1



1.2

- (11) **13427**
(21) 3-2008-00806 (28) 01
(54) XE SCUTƠ (51) **12-11**
(22) 17.06.2008 (43) 25.09.2008
(30) 2008-193 09.01.2008 JP
(71) SUZUKI MOTOR CORPORATION (JP)
300 Takatsuka-cho, Minami-ku, Hamamatsu-shi, Shizuoka-Pref., Japan
(72) Kazuhiro Toyama (JP)
(74) Văn phòng luật sư Phạm và Liên danh (PHAM & ASSOCIATES)
(55)

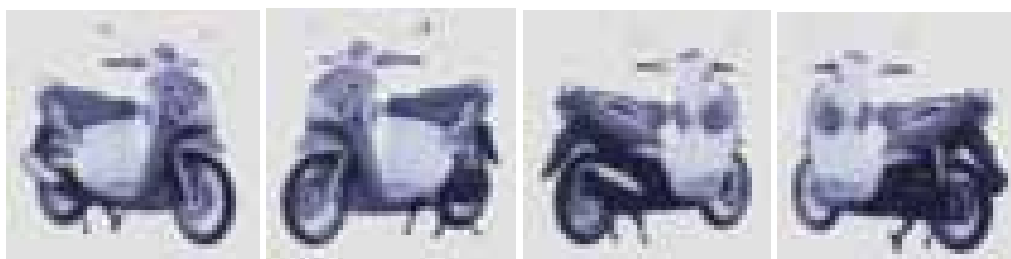

1.1

1.2

1.3

1.4

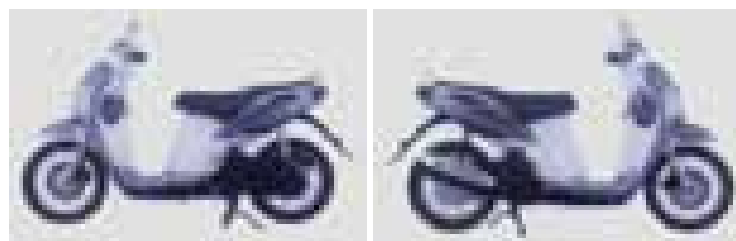

1.5

1.6

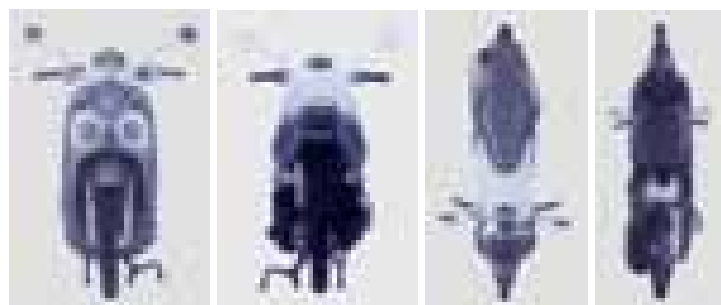

1.7

1.8

1.9

1.10

- (11) **13428**
(21) 3-2008-00807 (28) 01
(54) VẢI (51) **05-05**
(22) 17.06.2008 (43) 25.09.2008
(71) HWA FONG RUBBER IND. CO., LTD. (TW)
300, Sec. 2, Jhongshan Rd., Dacun Township, Changhua County, Taiwan
(72) Ching-Chuan Yu (TW)
(74) Công ty TNHH một thành viên Sở hữu trí tuệ VCCI (VCCI-IP CO.,LTD)
(55)



1.1

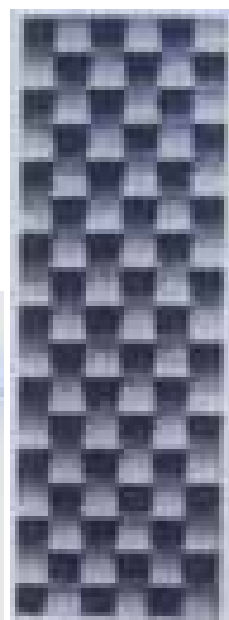

1.2

- (11) **13429**
(21) 3-2008-00825 (28) 02
(54) THANH NHÔM ĐỊNH HÌNH (51) **25-01**
(22) 19.06.2008 (43) 25.09.2008
(71) CÔNG TY TRÁCH NHIỆM HỮU HẠN CHOONG ANG VINA ALUMINIUM (VN)
009/02 ấp Tân Hội, xã Tân Hiệp, huyện Tân Uyên, tỉnh Bình Dương
(72) Oh Dae Kyun (KR)
(74) Công ty TNHH Tư vấn Sở hữu trí tuệ Á Đông (A ĐÔNG IP CONSULTANCY
CO.,LTD.)
(55)

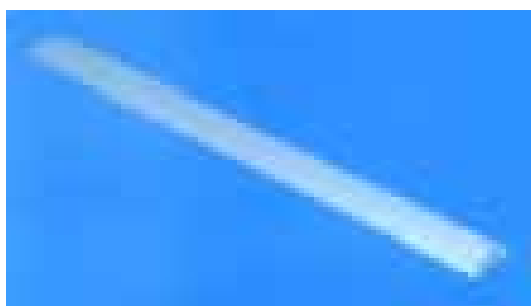

1.1



1.2

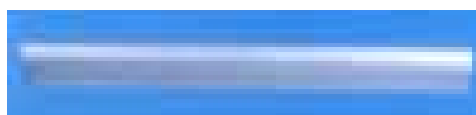

1.3

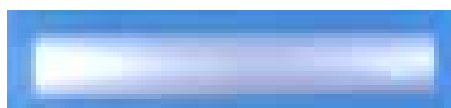

1.4

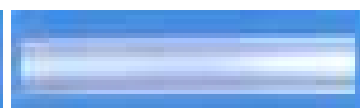

1.5

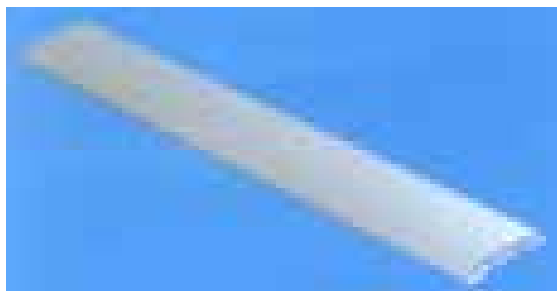

2.1



2.2

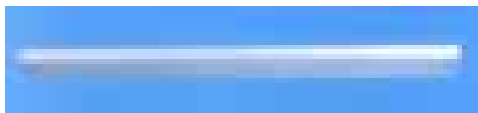

2.3



2.4



2.5

(11) **13430**

(21) 3-2008-00826

(28) 02

(54) XE MÔ TÔ

(51) **12-11**

(22) 19.06.2008

(43) 25.09.2008

(71) SANYANG INDUSTRY CO., LTD. (TW)

No. 184, Keng Tzu Kou, Shang Keng Village, Hsin Fong Shiang, Hsinchu, County 304, Taiwan

(72) Sheng-Hsiung CHENG (TW)

(74) Công ty TNHH Trường Xuân (AGELESS CO.,LTD.)

(55)



1.1

1.2

1.3



1.4

1.5

1.6



1.7

1.8

1.9



2.1



2.2



2.3



2.4



2.5



2.6



2.7



2.8



2.9

- (11) **13431**
(21) 3-2008-00832 (28) 01
(54) Ô TÔ ĐỒ CHƠI (51) **21-01**
(22) 20.06.2008 (43) 25.09.2008
(30) 000849153 21.12.2007 EM
(71) FERRARI S.p.A. (IT)
Via Emilia Est 1163, I-41100 MODENA
(72) Nikolaos TOMBAZIS (GR)
(74) Công ty TNHH một thành viên Sở hữu trí tuệ VCCI (VCCI-IP CO.,LTD)
(55)

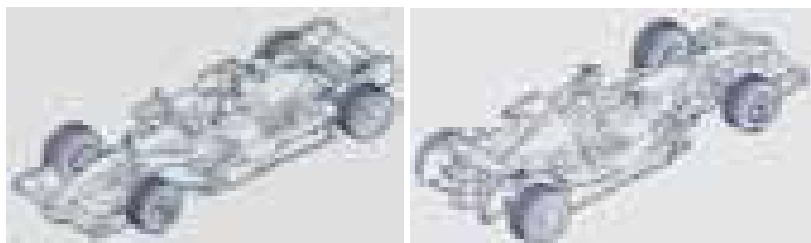

1.1

1.2

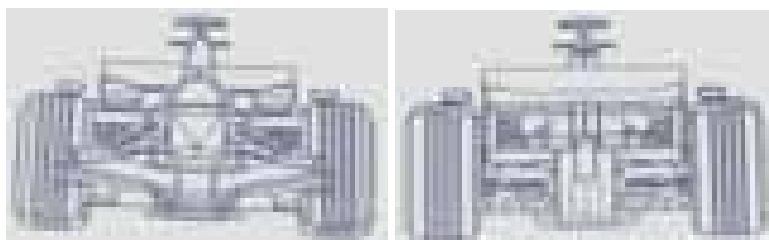

1.3

1.4



1.5

1.6



1.7

1.8

- (11) **13432**
(21) 3-2008-00833 (28) 01
(54) Ô TÔ (51) **12-08**
(22) 20.06.2008 (43) 25.09.2008
(30) 000849161 21.12.2007 EM
(71) FERRARI S.P.A. (IT)
Via Emilia Est 1163, I-41100 MODENA
(72) Nikolaos TOMBAZIS (GR)
(74) Công ty TNHH một thành viên Sở hữu trí tuệ VCCI (VCCI-IP CO.,LTD)
(55)



1.1



1.2

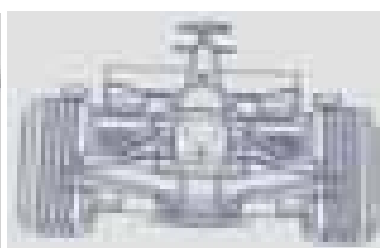

1.3

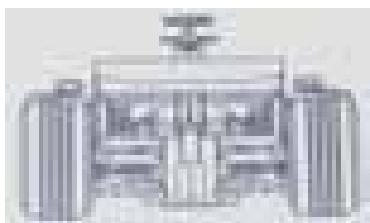

1.4



1.5



1.6



1.7

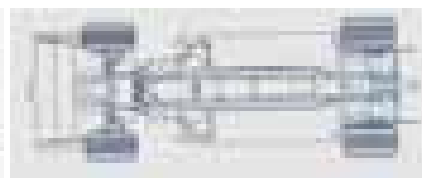

1.8

- (11) **13433**
(21) 3-2008-00836 (28) 01
(54) MŨ BẢO HIỂM (51) **02-03**
(22) 23.06.2008 (43) 25.09.2008
(71) CÔNG TY TNHH LONG HUEI (VN)
Số 23, đường 743, khu công nghiệp Sóng Thần II, huyện Dĩ An, tỉnh Bình Dương
(72) LI WEN CHIN (TW)
(74) Công ty TNHH Sở hữu trí tuệ Ngôi Sao chuyên nghiệp và liên danh (NOVAPRO & ASSOCIATES CO.,LTD.)
(55)



1.1

1.2

1.3

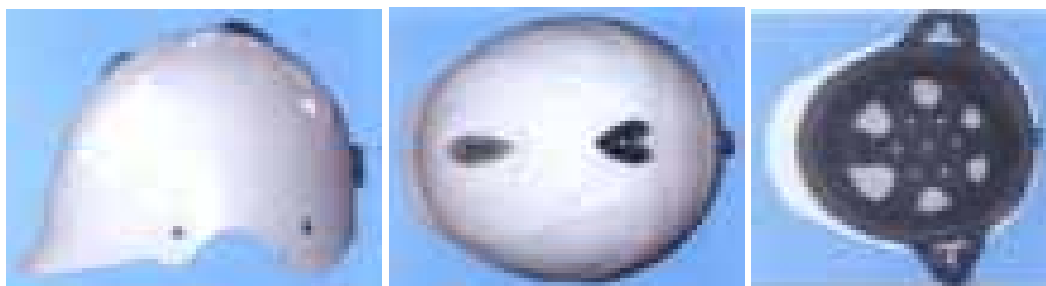

1.4

1.5

1.6

- (11) **13434**
(21) 3-2008-00837 (28) 01
(54) HỘP (51) **09-03**
(22) 23.06.2008 (43) 25.09.2008
(30) 000848494-0001 21.12.2007 EM
(71) SOCIÉTÉ JAS HENNESSY & CO. (FR)
1 Rue de la Richonne, 16100 Cognac, France
(72) Mrs. Inga Catherine Marie Sempé (FR)
(74) Văn phòng Luật sư Đoàn Hồng Sơn (VPLS DOANHONGSON)
(55)



1.1



1.2



1.3

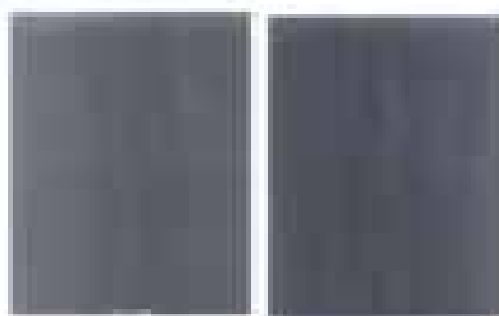

1.4

1.5



1.6



1.7

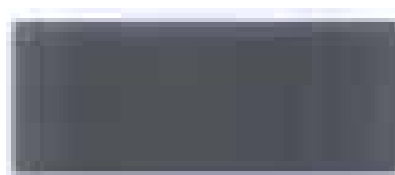

1.8

- (11) **13435**
(21) 3-2008-00839 (28) 01
(54) **ĐẦU GẬY CHƠI GÔN** (51) **21-02**
(22) 23.06.2008 (43) 25.09.2008
(30) 29/306075 01.04.2008 US
(71) **KARSTEN MANUFACTURING CORPORATION (US)**
2201 West Desert Cove, Phoenix, Arizona 85029, United States of America
(72) Bradley D. Schweigert (US), Xiaojian Chen (CN), Michael R. Nicolette (US)
(74) Công ty TNHH Sở hữu trí tuệ Vàng (GINTASSET CO., LTD.)
(55)

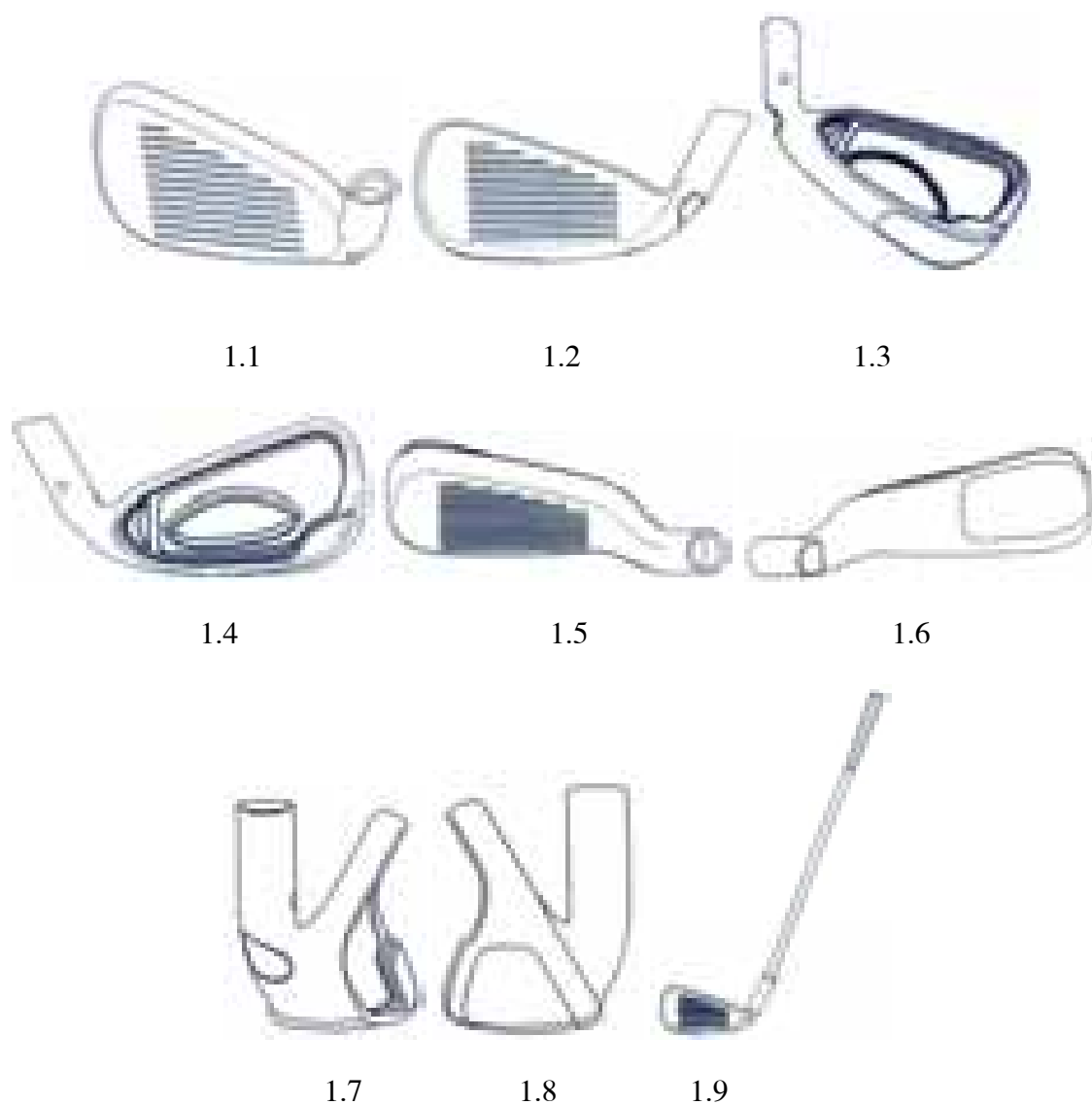

- (11) **13436**
(21) 3-2008-00841 (28) 01
(54) HỘP (51) **09-03**
(22) 24.06.2008 (43) 25.09.2008
(71) CÔNG TY TNHH SẢN XUẤT - THƯƠNG MẠI TBM - MINH PHÁT (VN)
141-143 Xóm Đất, phường 8, quận 11, TP. Hồ Chí Minh
(72) Dịp Văn Minh (VN)
(74) Văn phòng luật sư Phạm và Liên danh (PHAM & ASSOCIATES)
(55)



1.1

1.2

1.3



1.4

1.5

1.6

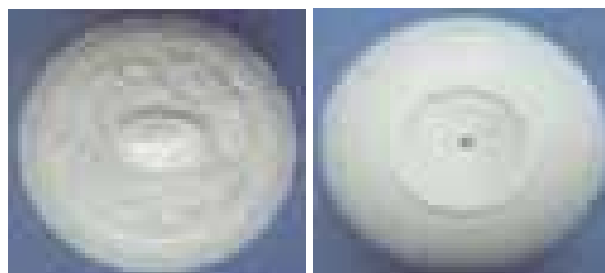

1.7

1.8

- (11) **13437**
(21) 3-2008-00846 (28) 02
(54) HỘP THUỐC (51) **09-03**
(22) 25.06.2008 (43) 25.09.2008
(71) CÔNG TY VACXIN VÀ SINH PHẨM SỐ 2 (VN)
26 Hàn Thuyên, thành phố Nha Trang, tỉnh Khánh Hòa
(72) Cao Quang Minh (VN)
(74) Công ty TNHH Sở hữu trí tuệ WINCO (WINCO CO., LTD.)
(55)



1.1



1.2



1.1



1.2

- (11) **13438**
(21) 3-2008-00848 (28) 01
(54) CÁI KHOÁ (51) **02-07**
(22) 25.06.2008 (43) 25.09.2008
(30) 2008-000175 09.01.2008 JP
(71) NIFCO INC. (JP)
184-1, Maioka-cho, Totsuka-ku, Yokohama-shi, Kanagawa-ken, 244-8522 Japan
(72) Manabu YOSHIGUCHI (JP)
(74) Công ty TNHH Sở hữu trí tuệ Thảo Thọ Quyển (INVENCO)
(55)

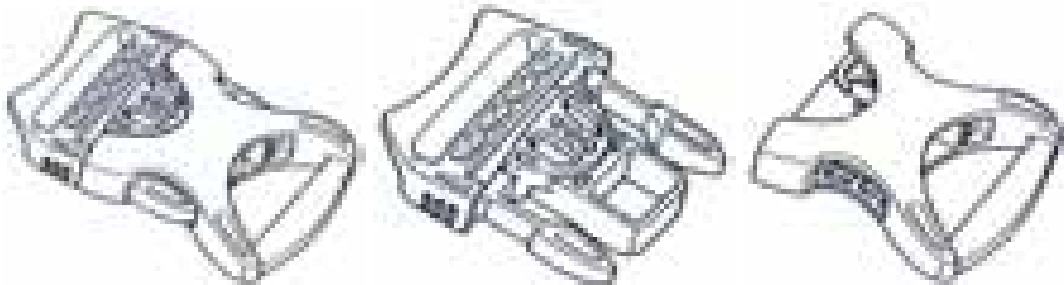

1.1

1.2

1.3



1.4

1.5

1.6

1.7



1.8

1.9

- (11) **13439**
(21) 3-2008-00855 (28) 01
(54) BAO GÓI ĐỰNG PHÂN BÓN (51) **09-05**
(22) 30.06.2008 (43) 25.09.2008
(71) CÔNG TY PHÂN BÓN MIỀN NAM - XÍ NGHIỆP PHÂN BÓN CHÁNH HUNG (VN)
Khu công nghiệp Long Định, xã Long Định, huyện Cần Đước, tỉnh Long An
(72) Trâm Phước Lợi (VN)
(74) DNTN Dịch vụ thương mại và sở hữu công nghiệp Song Ngọc (I.P.T.S.)
(55)



1.1

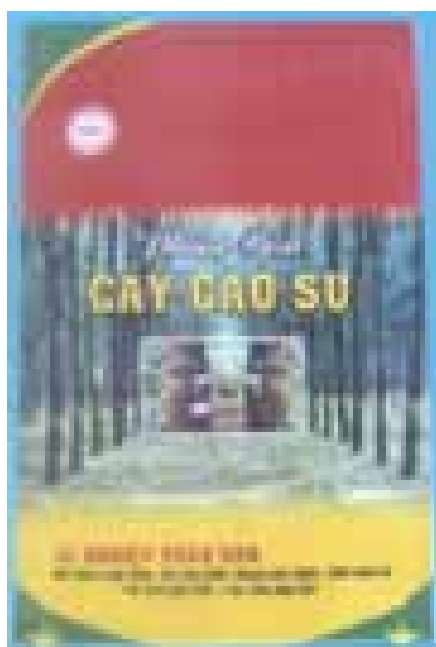

1.2

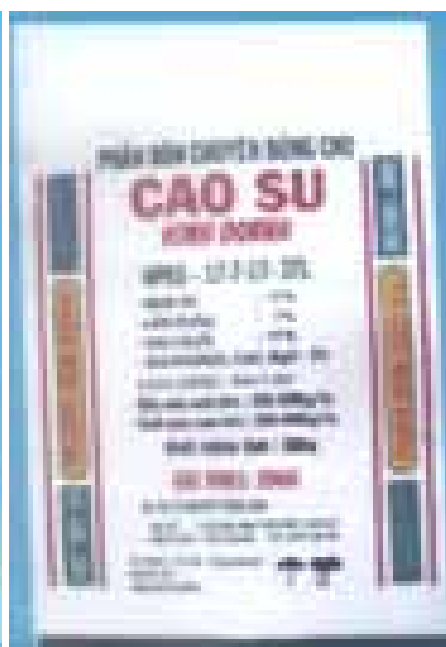

1.3

- (11) **13440**
(21) 3-2008-00856 (28) 01
(54) NHÃN SẢN PHẨM (51) **19-08**
(22) 30.06.2008 (43) 25.09.2008
(71) CÔNG TY TRÁCH NHIỆM HỮU HẠN THƯỜNG MẠI XÂY DỰNG DŨNG THÀNH (VN)
7 đường 52, cư xá Lữ Gia, phường 15, quận 11, TP. Hồ Chí Minh
(72) Lý Lương Thành (VN)
(74) Công ty TNHH Sở hữu trí tuệ Thảo Thọ Quyến (INVENCO)
(55)



1.1



1.2

- (11) **13441**
(21) 3-2008-00862 (28) 01
(54) BỘ ĐÈN NHÁY TRƯỚC XE MÁY (51) **26-06**
(22) 30.06.2008 (43) 25.09.2008
(71) YAMAHA HATSUDOKI KABUSHIKI KAISHA (JP)
2500 Shingai, Iwata-shi, Shizuoka-ken, Japan
(72) Takuya Nakamura (JP)
(74) Công ty TNHH Tư vấn - Đầu tư N.T.K. (N.T.K. CO., LTD.)
(55)



1.1

1.2

1.3



1.4

1.5

1.6



1.7

1.8

1.9



1.1.0



1.11

- (11) **13442**
(21) 3-2008-00863 (28) 02
(54) XE MÁY (51) **12-11**
(22) 30.06.2008 (43) 25.09.2008
(71) YAMAHA HATSUDOKI KABUSHIKI KAISHA (JP)
2500 Shingai, Iwata-shi, Shizuoka-ken, Japan
(72) Takuya Nakamura (JP)
(74) Công ty TNHH Tư vấn - Đầu tư N.T.K. (N.T.K. CO., LTD.)
(55)



1.1

1.2

1.3



1.4

1.5

1.6

1.7



1.8

1.9



2.1



2.2



2.3



2.4



2.5



2.6



2.7

- (11) **13443**
(21) 3-2008-00864
(54) BAO GÓI SẢN PHẨM
(22) 01.07.2008
(71) CÔNG TY TNHH NGỌC BÍCH (VN)
Khu công nghiệp Từ Sơn Bắc Ninh, số 8/2 đường Quang Trung, phường Trần Phú, thị xã Bắc Giang, tỉnh Bắc Giang
(72) Nguyễn Văn Thành (VN)
(74) Công ty TNHH Luật Gia Phạm (PHAM JURIST CO.,LTD.)
(55) (28) 01
(51) **09-05**
(43) 25.09.2008



1.1



1.2

- (11) **13444**
(21) 3-2008-00865 (28) 01
(54) BAO GÓI SẢN PHẨM (51) **09-05**
(22) 01.07.2008 (43) 25.09.2008
(71) CÔNG TY TNHH NGỌC BÍCH (VN)
Khu công nghiệp Từ Sơn Bắc Ninh, số 8/2 đường Quang Trung, phường Trần Phú, thị xã Bắc Giang, tỉnh Bắc Giang
(72) Nguyễn Văn Thành (VN)
(74) Công ty TNHH Luật Gia Phạm (PHAM JURIST CO.,LTD.)
(55)



1.1



1.2

- (11) **13445**
(21) 3-2008-00866 (28) 01
(54) BAO GÓI SẢN PHẨM (51) **09-05**
(22) 01.07.2008 (43) 25.09.2008
(71) CÔNG TY TNHH NGỌC BÍCH (VN)
Khu công nghiệp Từ Sơn Bắc Ninh, số 8/2 đường Quang Trung, phường Trần Phú, thị xã Bắc Giang, tỉnh Bắc Giang
(72) Nguyễn Văn Thành (VN)
(74) Công ty TNHH Luật Gia Phạm (PHAM JURIST CO.,LTD.)
(55)



1.1



1.2

- (11) **13446**
(21) 3-2008-00867 (28) 01
(54) BÚT VIẾT (51) **19-06**
(22) 01.07.2008 (43) 25.09.2008
(30) 40 2008 000107.9 03.01.2008 DE
(71) SENATOR GMBH & CO. KGAA (DE)
Bahnhofstrasse 57, 64401 Gross-Biebräu, Germany
(72) Volkmar ROMMEL (DE)
(74) Công ty TNHH Sở hữu trí tuệ Thảo Thọ Quyển (INVENCO)
(55)

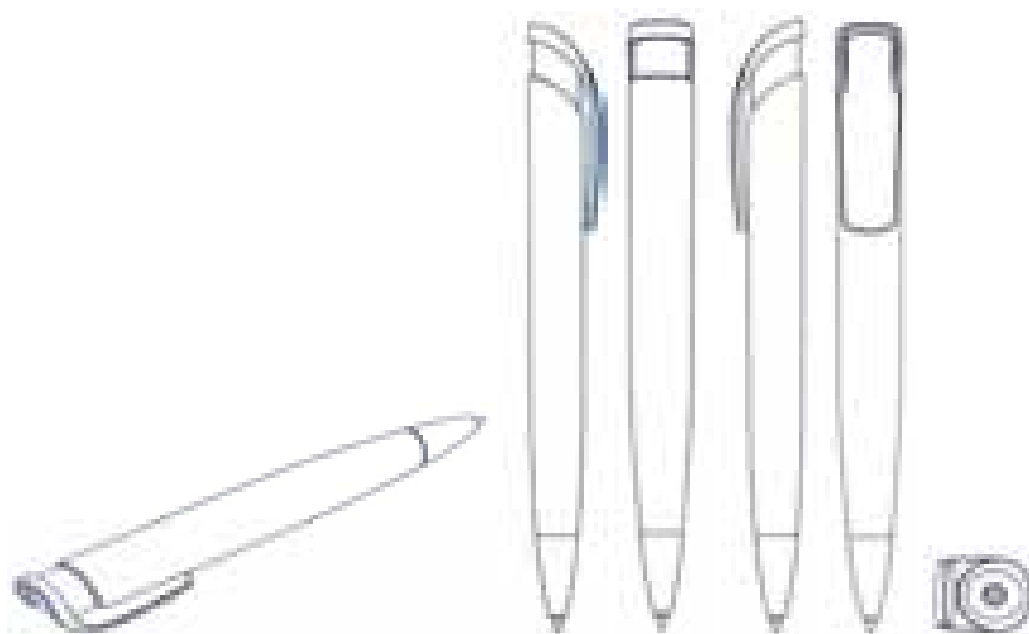

1.1

1.2

1.3

1.4

1.5

1.6

- (11) **13447**
(21) 3-2008-00868 (28) 02
(54) GHẾ (51) **06-01**
(22) 01.07.2008 (43) 25.09.2008
(71) CÔNG TY CỔ PHẦN CAO SU SÀI GÒN - KYMDAN (VN)
28 Bình Thới, phường 14, quận 11, TP. Hồ Chí Minh
(72) Nguyễn Hữu Trí (VN)
(74) Công ty TNHH Sở hữu trí tuệ Thảo Thọ Quyến (INVENCO)
(55)



1.1

1.2

1.3

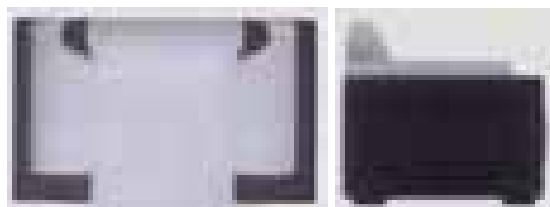

1.4

1.5

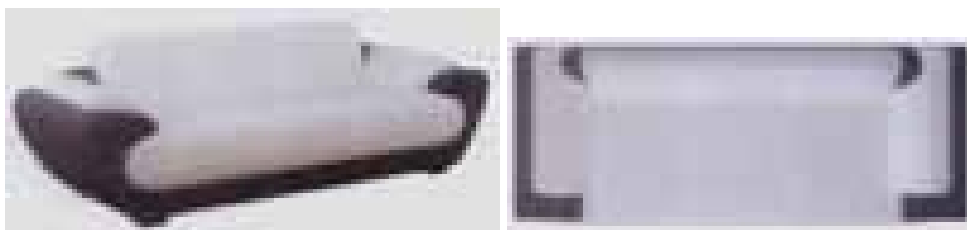

2.1

2.2



2.3



2.4



2.5

- (11) **13448**
(21) 3-2008-00869 (28) 01
(54) GIƯỜNG NGỦ (51) **06-02**
(22) 01.07.2008 (43) 25.09.2008
(71) CÔNG TY CỔ PHẦN CAO SU SÀI GÒN - KYMDAN (VN)
28 Bình Thới, phường 14, quận 11, TP. Hồ Chí Minh
(72) Nguyễn Hữu Trí (VN)
(74) Công ty TNHH Sở hữu trí tuệ Thảo Thọ Quyến (INVENCO)
(55)



1.1

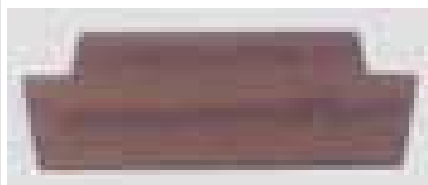

1.2

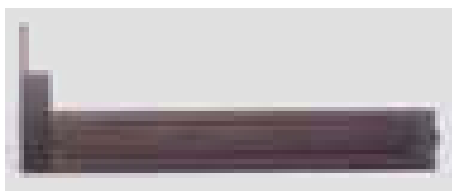

1.3

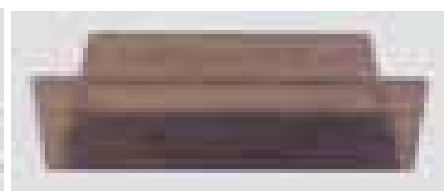

1.4



1.5



1.6

- (11) **13449**
(21) 3-2008-00870 (28) 01
(54) GIƯỜNG NGỦ (51) **06-02**
(22) 01.07.2008 (43) 25.09.2008
(71) CÔNG TY CỔ PHẦN CAO SU SÀI GÒN - KYMDAN (VN)
28 Bình Thới, phường 14, quận 11, TP. Hồ Chí Minh
(72) Nguyễn Hữu Trí (VN)
(74) Công ty TNHH Sở hữu trí tuệ Thảo Thọ Quyến (INVENCO)
(55)



1.1



1.2

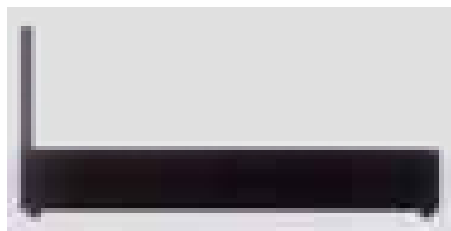

1.3



1.4

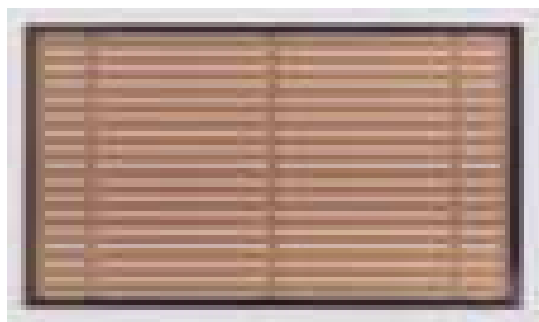

1.5

- (11) **13450**
(21) 3-2008-00871 (28) 01
(54) TỦ (51) **06-04**
(22) 01.07.2008 (43) 25.09.2008
(71) CÔNG TY CỔ PHẦN CAO SU SÀI GÒN - KYMDAN (VN)
28 Bình Thới, phường 14, quận 11, TP. Hồ Chí Minh
(72) Nguyễn Hữu Trí (VN)
(74) Công ty TNHH Sở hữu trí tuệ Thảo Thọ Quyến (INVENCO)
(55)

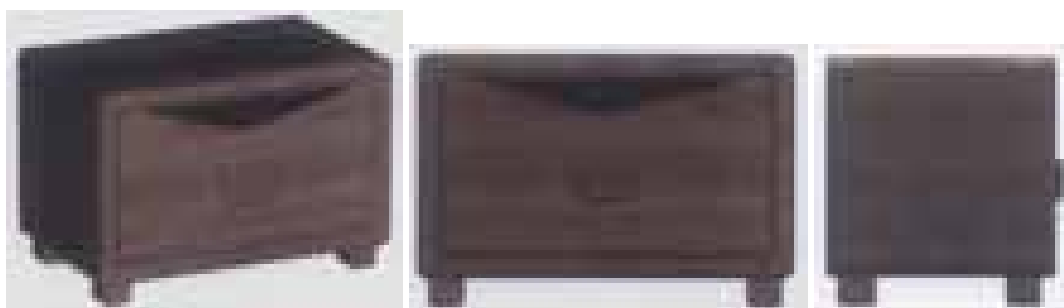

1.1

1.2

1.3

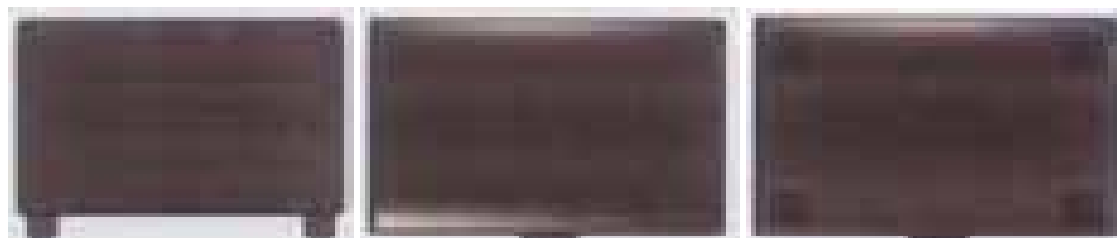

1.4

1.5

1.6

- (11) **13451**
(21) 3-2008-00872 (28) 01
(54) BÀN (51) **06-03**
(22) 01.07.2008 (43) 25.09.2008
(71) CÔNG TY CỔ PHẦN CAO SU SÀI GÒN - KYMDAN (VN)
28 Bình Thới, phường 14, quận 11, TP. Hồ Chí Minh
(72) Nguyễn Hữu Trí (VN)
(74) Công ty TNHH Sở hữu trí tuệ Thảo Thọ Quyến (INVENCO)
(55)



1.1



1.2

1.3



1.4

1.5

- (11) **13452**
(21) 3-2008-00875 (28) 02
(54) BỘ TIẾT KIỆM NHIÊN LIỆU CHO ĐỘNG CƠ (51) **15-01**
(22) 02.07.2008 (43) 25.09.2008
(71) ĐẶNG HOÀNG SƠN (VN)
93B Phạm Hùng, phường 9, thị xã Vĩnh Long, tỉnh Vĩnh Long
(72) Đặng Hoàng Sơn (VN)
(74) Công ty TNHH Tư vấn Sở hữu trí tuệ á Đông (A ĐÔNG IP CONSULTANCY CO.,LTD.)
(55)



1.1

1.2

1.3

1.4

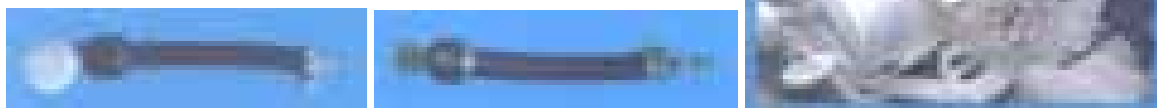

1.5

1.6

1.7

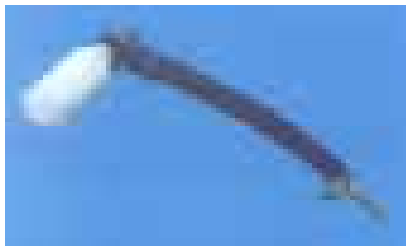

2.1

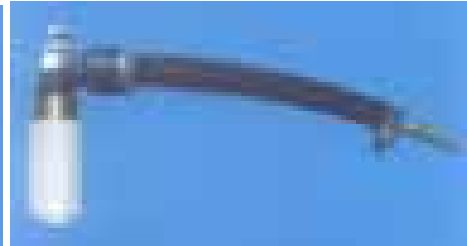

2.2

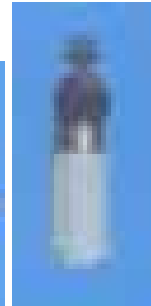

2.3



2.4



2.5

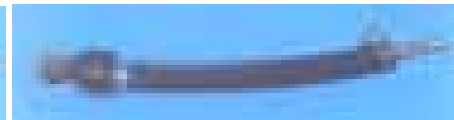

2.6



2.7

- (11) **13453**
(21) 3-2008-00877 (28) 01
(54) BỘ ẤM CHÉN (51) **07-01**
(22) 03.07.2008 (43) 25.09.2008
(71) CÔNG TY TRÁCH NHIỆM HỮU HẠN MINH LONG I (VN)
333 xã Hưng Định, huyện Thuận An, tỉnh Bình Dương
(72) Lý Ngọc Minh (VN)
(74) Công ty TNHH Lê & Lê (LE & LE)
(55)



1.1

1.2

1.3



1.4

1.5

1.6

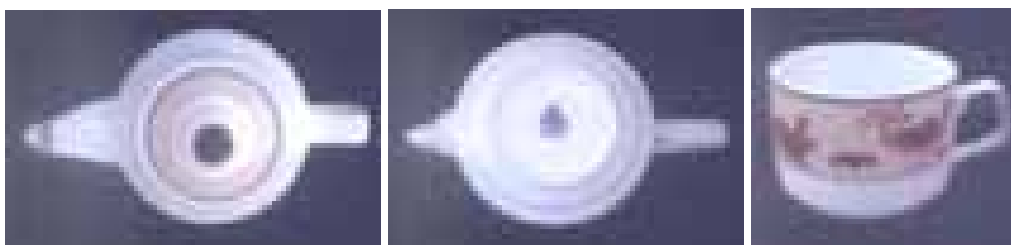

1.7

1.8

1.9



1.10

1.11

1.12



1.13

1.14

1.15



1.16

1.17

1.18



1.19

1.20

1.21

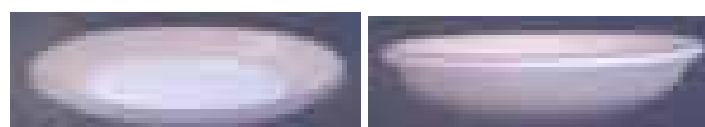

1.22

1.23

- (11) **13454**
(21) 3-2008-00878 (28) 03
(54) VÀNG MIẾNG (51) **99-00**
(22) 03.07.2008 (43) 25.09.2008
(71) CÔNG TY TRÁCH NHIỆM HỮU HẠN VÀNG BẠC ĐÁ QUÝ KIM TÍN (VN)
Số nhà 29 phố Kim Đồng, phường Hợp Giang, thị xã Cao Bằng, tỉnh Cao Bằng
(72) Cao Kim Trọng (VN)
(74) Công ty TNHH Sở hữu trí tuệ Vàng (GINTASSET CO., LTD.)
(55)



1.1

1.2

1.3

1.4

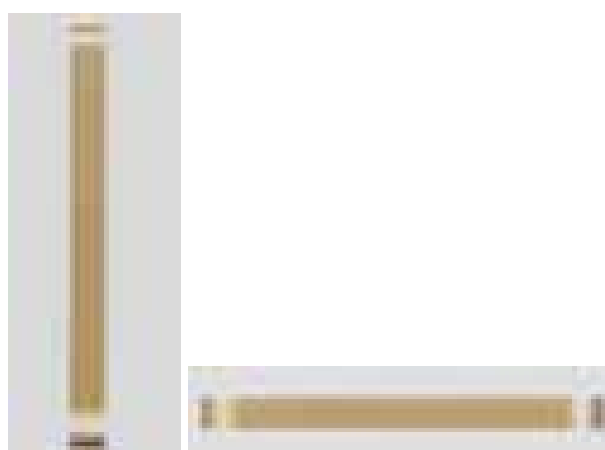

1.5

1.6



2.1

2.2

2.3

2.4



2.5

2.6



3.1

3.2

3.3

3.4

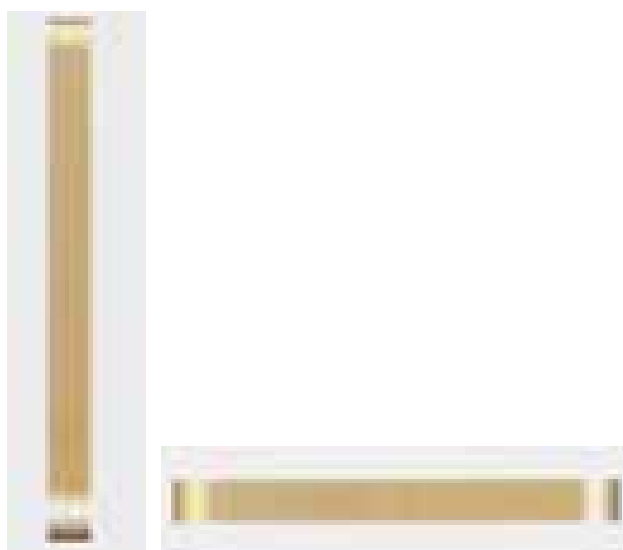

3.5

3.6

- (11) **13455**
(21) 3-2008-00879 (28) 01
(54) VÀNG MIẾNG (51) **99-00**
(22) 03.07.2008 (43) 25.09.2008
(71) CÔNG TY TRÁCH NHIỆM HỮU HẠN VÀNG BẠC ĐÁ QUÝ KIM TÍN (VN)
Số nhà 29 phố Kim Đồng, phường Hợp Giang, thị xã Cao Bằng, tỉnh Cao Bằng
(72) Cao Kim Trọng (VN)
(74) Công ty TNHH Sở hữu trí tuệ Vàng (GINTASSET CO., LTD.)
(55)



1.1

1.2

1.3

1.4

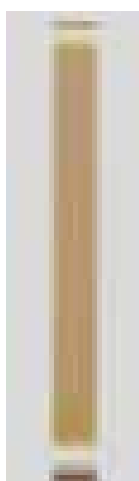

1.5



1.6

- (11) **13456**
(21) 3-2008-00883 (28) 01
(54) BAO ĐỰNG GẠO (51) **09-05**
(22) 04.07.2008 (43) 25.09.2008
(71) CÔNG TY TNHH AN ĐÌNH (VN)
Số nhà 39, ngách 34/156, phố Vĩnh Tuy, phường Vĩnh Tuy, quận Hai Bà Trưng, thành phố Hà Nội
(72) Nguyễn Thanh Nhị (VN)
(55)



1.1



1.2



1.3

- (11) **13457**
(21) 3-2008-00885 (28) 02
(54) **ĐẦU GẬY CHƠI GÔN** (51) **21-02**
(22) 08.07.2008 (43) 25.09.2008
(30) 29/306644 14.04.2008 US
29/306647 14.04.2008 US
(71) **KARSTEN MANUFACTURING CORPORATION (US)**
2201 West Desert Cove, Phoenix, Arizona 85029, United States of America
(72) David D. Jones (US), Xiaojian Chen (CN), Richard R. Sanchez (US)
(74) Công ty TNHH Sở hữu trí tuệ Vàng (GINTASSET CO., LTD.)
(55)

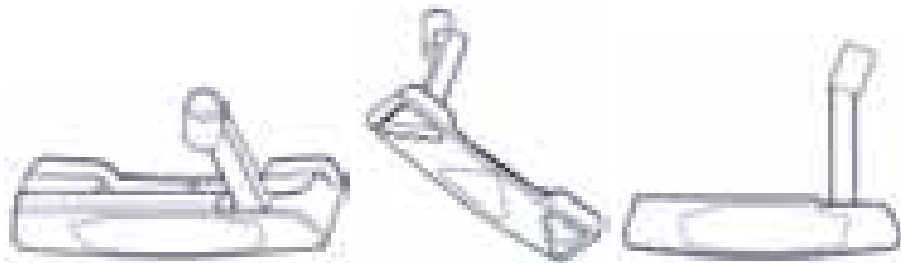

1.1

1.2

1.3

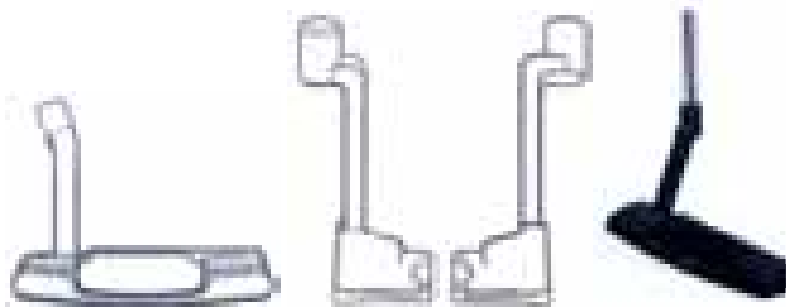

1.4

1.5

1.6

1.7



1.8

1.9

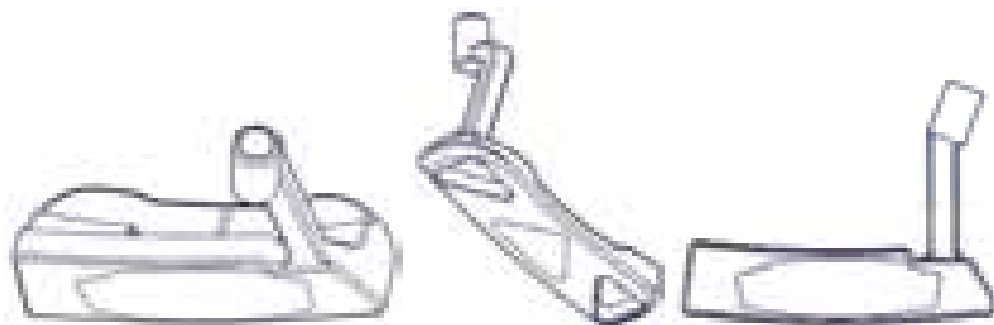

2.1

2.2

2.3



2.4

2.5

2.6

2.7



2.8

2.9

- (11) **13458**
(21) 3-2008-00886 (28) 01
(54) **ĐẦU GẬY CHƠI GÔN** (51) **21-02**
(22) 08.07.2008 (43) 25.09.2008
(30) 29/306652 14.04.2008 US
(71) KARSTEN MANUFACTURING CORPORATION (US)
2201 West Desert Cove, Phoenix, Arizona 85029, United States of America
(72) David D. Jones (US), Xiaojian Chen (CN), Richard R. Sanchez (US)
(74) Công ty TNHH Sở hữu trí tuệ Vàng (GINTASSET CO., LTD.)
(55)

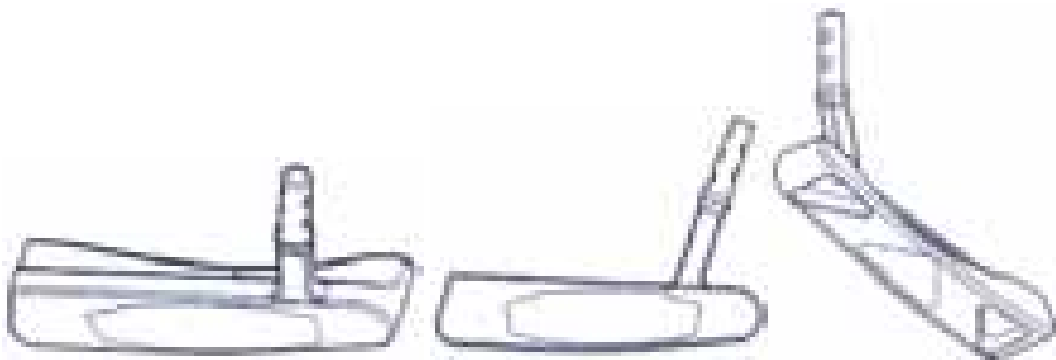

1.1

1.2

1.3

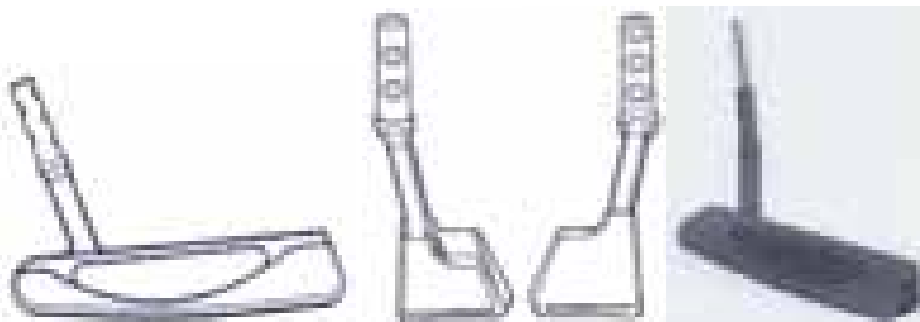

1.4

1.5

1.6

1.7



1.8

1.9

- (11) **13459**
(21) 3-2008-00887 (28) 01
(54) ĐẦU GẬY CHƠI GÔN (51) **21-02**
(22) 08.07.2008 (43) 25.09.2008
(30) 29/306646 14.04.2008 US
(71) KARSTEN MANUFACTURING CORPORATION (US)
2201 West Desert Cove, Phoenix, Arizona 85029, United States of America
(72) David D. Jones (US), Xiaojian Chen (CN), Richard R. Sanchez (US)
(74) Công ty TNHH Sở hữu trí tuệ Vàng (GINTASSET CO., LTD.)
(55)



1.1

1.2

1.3

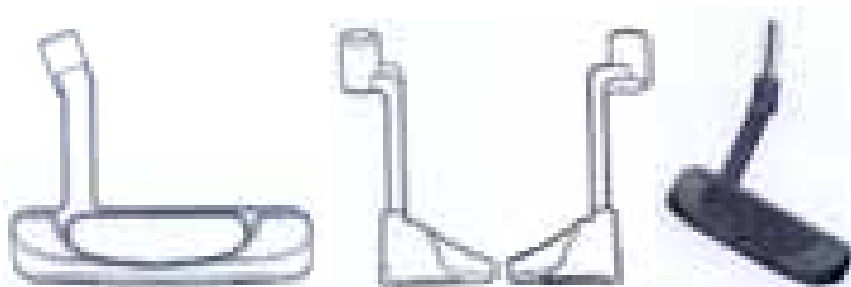

1.4

1.5

1.6

1.7



1.8

1.9

- (11) **13460**
(21) 3-2008-00888 (28) 01
(54) **ĐẦU GẬY CHƠI GÔN** (51) **21-02**
(22) 08.07.2008 (43) 25.09.2008
(30) 29/306649 14.04.2008 US
(71) KARSTEN MANUFACTURING CORPORATION (US)
2201 West Desert Cove, Phoenix, Arizona 85029, United States of America
(72) David D. Jones (US), Xiaojian Chen (CN), Richard R. Sanchez (US)
(74) Công ty TNHH Sở hữu trí tuệ Vàng (GINTASSET CO., LTD.)
(55)



1.1

1.2

1.3

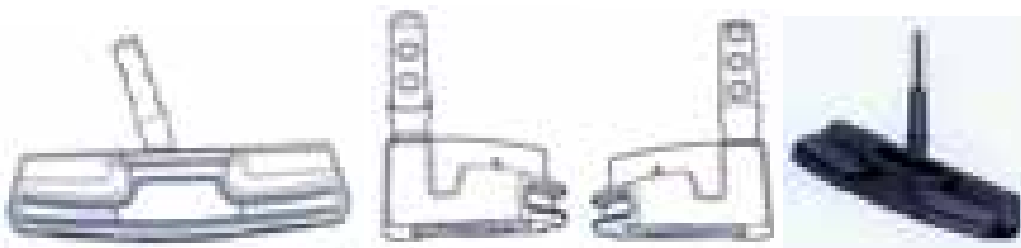

1.4

1.5

1.6

1.7



1.8

1.9

- (11) **13461**
(21) 3-2008-00889 (28) 01
(54) ĐẤU GẬY CHƠI GÔN (51) **21-02**
(22) 08.07.2008 (43) 25.09.2008
(30) 29/306655 14.04.2008 US
(71) KARSTEN MANUFACTURING CORPORATION (US)
2201 West Desert Cove, Phoenix, Arizona 85029, United States of America
(72) David D. Jones (US), Xiaojian Chen (CN), Richard R. Sanchez (US)
(74) Công ty TNHH Sở hữu trí tuệ Vàng (GINTASSET CO., LTD.)
(55)



1.1

1.2

1.3



1.4

1.5

1.6



1.7

1.8

1.9

- (11) **13462**
(21) 3-2008-00890 (28) 01
(54) HỘP MỸ PHẨM (51) **28-02**
(22) 08.07.2008 (43) 25.09.2008
(30) 30-2008-0004604 31.01.2008 KR
(71) LG HOUSEHOLD & HEALTH CARE LTD. (KR)
20, Yoido-dong, Youngdungpo-gu, Seoul, Korea
(72) Ryu Young-Bog (KR)
(74) Công ty TNHH Tầm nhìn và Liên danh (VISION & ASSOCIATES CO.LTD.)
(55)

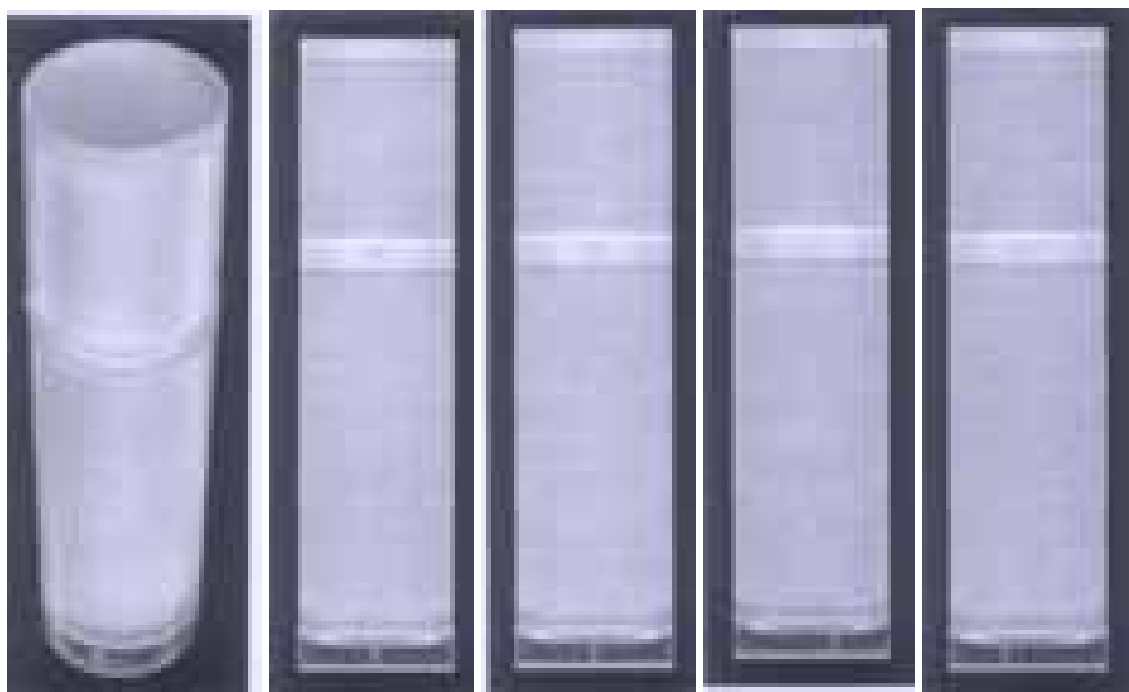

1.1

1.2

1.3

1.4

1.5



1.6

1.7

- (11) **13463**
(21) 3-2008-00891 (28) 02
(54) HỘP MỸ PHẨM (51) **09-03**
(22) 08.07.2008 (43) 25.09.2008
(30) 30-2008-0012870 25.03.2008 KR
(71) LG HOUSEHOLD & HEALTH CARE LTD. (KR)
20, Yoido-dong, Youngdungpo-gu, Seoul, Korea
(72) Ryu Young-Bog (KR)
(74) Công ty TNHH Tầm nhìn và Liên danh (VISION & ASSOCIATES CO.LTD.)
(55)

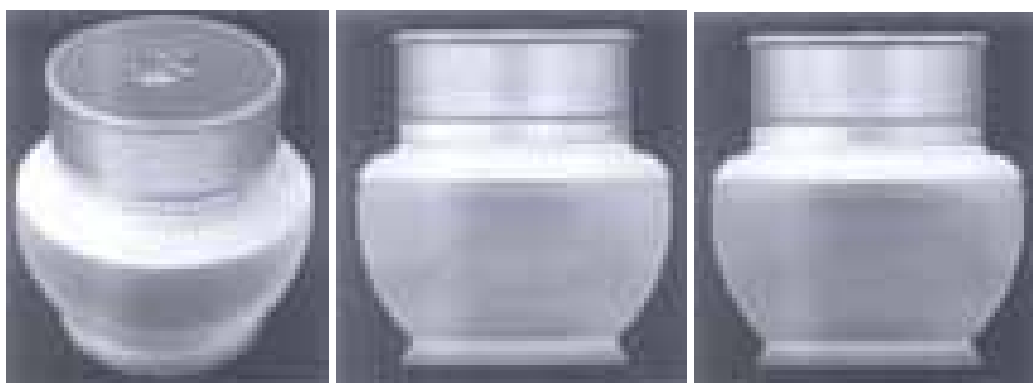

1.1

1.2

1.3

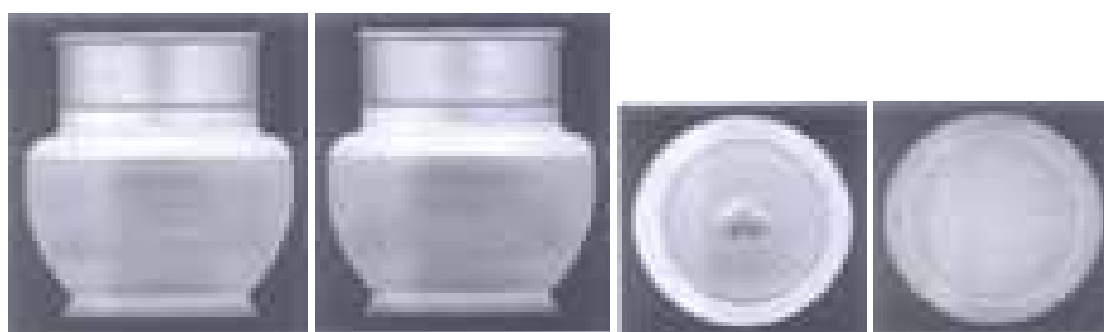

1.4

1.5

1.6

1.7



2.1

2.2

2.3

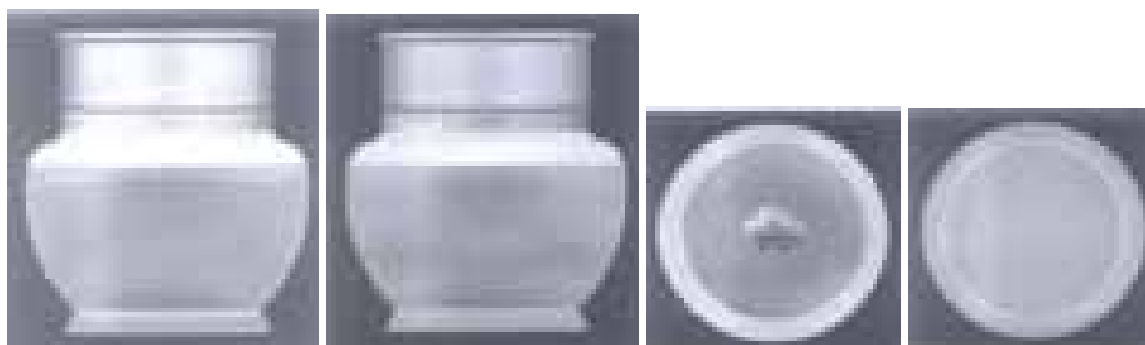

2.4

2.5

2.6

2.7

- (11) **13464**
(21) 3-2008-00892 (28) 01
(54) HỘP MỸ PHẨM (51) **09-03**
(22) 08.07.2008 (43) 25.09.2008
(30) 30-2008-0002066 16.01.2008 KR
(71) LG HOUSEHOLD & HEALTH CARE LTD. (KR)
20, Yoido-dong, Youngdungpo-gu, Seoul, Korea
(72) Ryu Young-Bog (KR)
(74) Công ty TNHH Tầm nhìn và Liên danh (VISION & ASSOCIATES CO.LTD.)
(55)

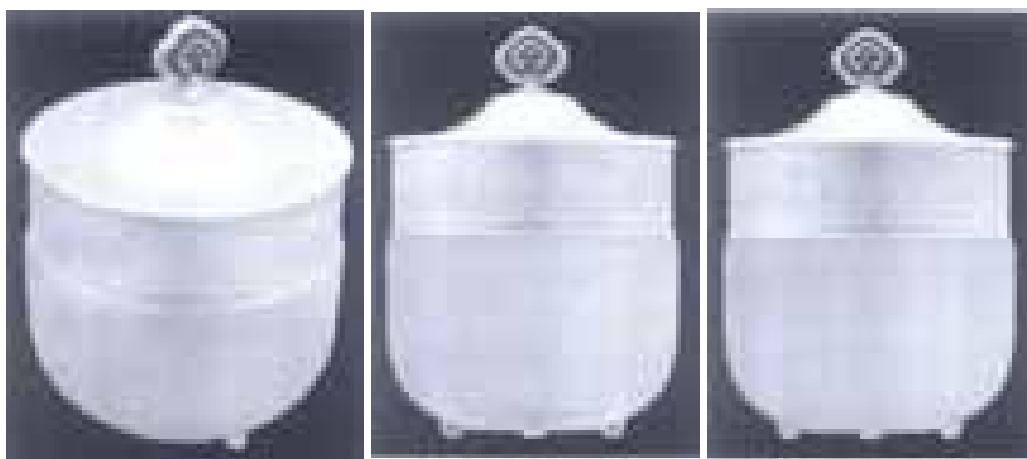

1.1

1.2

1.3

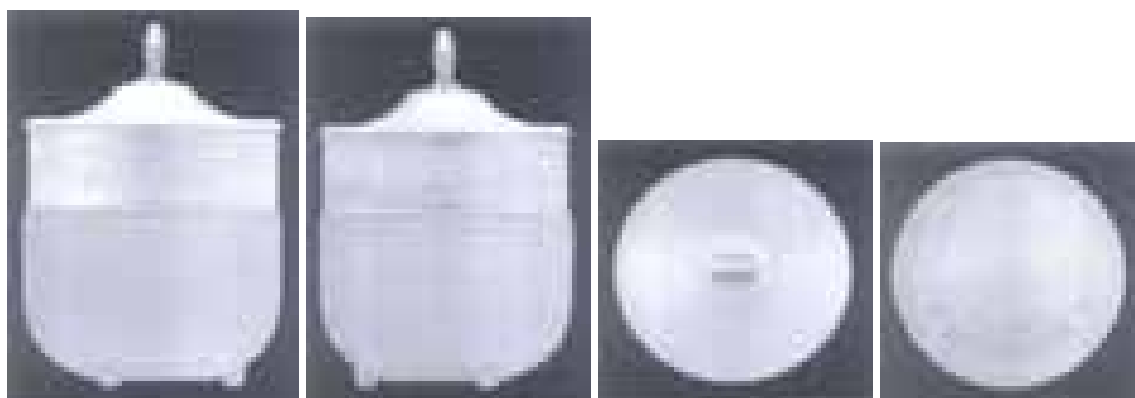

1.4

1.5

1.6

1.7

- (11) **13465**
(21) 3-2008-00893 (28) 01
(54) LỘ MỸ PHẨM (51) **09-01**
(22) 08.07.2008 (43) 25.09.2008
(30) 30-2008-0001816 15.01.2008 KR
(71) LG HOUSEHOLD & HEALTH CARE LTD. (KR)
20, Yoido-dong, Youngdungpo-gu, Seoul, Korea
(72) Ryu Young-Bog (KR)
(74) Công ty TNHH Tầm nhìn và Liên danh (VISION & ASSOCIATES CO.LTD.)
(55)



1.1

1.2

1.3

1.4



1.5



1.6



1.7

- (11) **13466**
(21) 3-2008-00894 (28) 01
(54) HỘP MỸ PHẨM (51) **09-03**
(22) 08.07.2008 (43) 25.09.2008
(30) 30-2008-0001834 15.01.2008 KR
(71) LG HOUSEHOLD & HEALTH CARE LTD. (KR)
20, Yoido-dong, Youngdungpo-gu, Seoul, Korea
(72) Ryu Young-Bog (KR)
(74) Công ty TNHH Tầm nhìn và Liên danh (VISION & ASSOCIATES CO.LTD.)
(55)



1.1

1.2

1.3

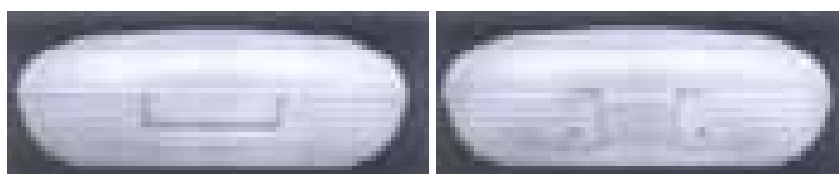

1.4

1.5

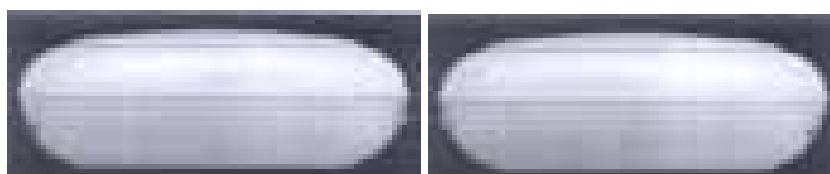

1.6

1.7

- (11) **13467**
(21) 3-2008-00895 (28) 01
(54) NHÃN SẢN PHẨM (51) **19-08**
(22) 08.07.2008 (43) 25.09.2008
(30) 30-2008-0008936 29.02.2008 KR
(71) LG HOUSEHOLD & HEALTH CARE LTD. (KR)
20, Yoido-dong, Youngdungpo-gu, Seoul, Korea
(72) Hwang Sung-Pil (KR)
(74) Công ty TNHH Tầm nhìn và Liên danh (VISION & ASSOCIATES CO.LTD.)
(55)



- (11) **13468**
(21) 3-2008-00897 (28) 01
(54) NHẢN SẢN PHẨM (51) **19-08**
(22) 08.07.2008 (43) 25.09.2008
(30) 30-2008-0010257 10.03.2008 KR
(71) LG HOUSEHOLD & HEALTH CARE LTD. (KR)
20, Yoido-dong, Youngdungpo-gu, Seoul, Korea
(72) Koo Seo-Young (KR)
(74) Công ty TNHH Tầm nhìn và Liên danh (VISION & ASSOCIATES CO.LTD.)
(55)



- (11) **13469**
(21) 3-2008-00898 (28) 01
(54) NHÃN SẢN PHẨM (51) **19-08**
(22) 08.07.2008 (43) 25.09.2008
(30) 30-2008-0008935 29.02.2008 KR
(71) LG HOUSEHOLD & HEALTH CARE LTD. (KR)
20, Yoido-dong, Youngdungpo-gu, Seoul, Korea
(72) Hwang Sung-Pil (KR)
(74) Công ty TNHH Tầm nhìn và Liên danh (VISION & ASSOCIATES CO.LTD.)
(55)



- (11) **13470**
(21) 3-2008-00899 (28) 01
(54) HỘP (51) **09-03**
(22) 08.07.2008 (43) 25.09.2008
(30) 30-2008-0011114 14.03.2008 KR
(71) LG HOUSEHOLD & HEALTH CARE LTD. (KR)
20, Yoido-dong, Youngdungpo-gu, Seoul, Korea
(72) An, Ja-Kyung (KR)
(74) Công ty TNHH Tâm nhìn và Liên danh (VISION & ASSOCIATES CO.LTD.)
(55)



1.1



1.2



1.3

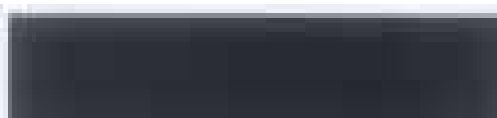

1.4



1.5

- (11) **13471**
(21) 3-2008-00900 (28) 01
(54) TẤM LỢP (51) **25-01**
(22) 08.07.2008 (43) 25.09.2008
(71) CÔNG TY CỔ PHẦN TÔN HIỆP HUNG (VN)
672 A quốc lộ 52, phường Phước Long B, quận 9, TP. Hồ Chí Minh
(72) Huỳnh Hòa Hiệp (VN)
(74) Công ty Cổ phần Sở hữu công nghiệp INVESTIP (INVESTIP)
(55)



1.1



1.2

1.3



1.4

1.5

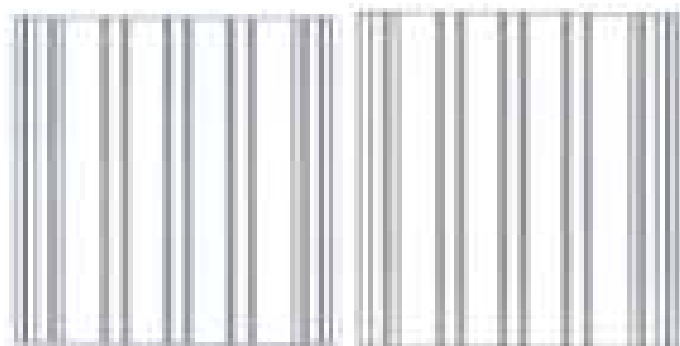

1.6

1.7

- (11) **13472**
(21) 3-2008-00901 (28) 01
(54) MẶT NẠ THÙNG LOA (51) **14-01**
(22) 08.07.2008 (43) 25.09.2008
(71) NGUYỄN ĐÌNH ĐỆ (VN)
20/D75 đường 3/2, phường 12, quận 10, TP. Hồ Chí Minh
(72) Nguyễn Đình Đệ (VN)
(74) Công ty TNHH Tư vấn Sở hữu trí tuệ Á Đông (A ĐÔNG IP CONSULTANCY CO.,LTD.)
(55)

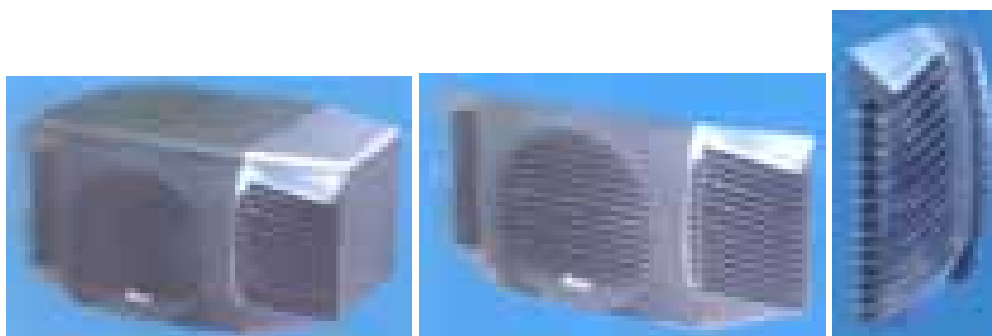

1.1

1.2

1.3

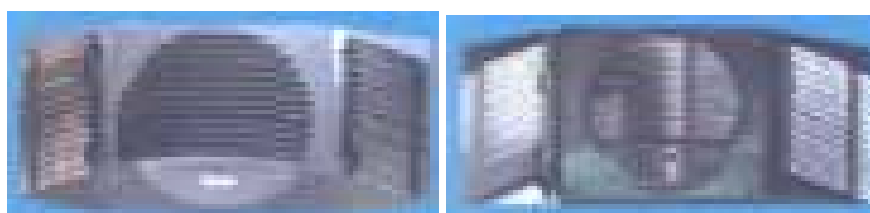

1.4

1.5



1.6

1.7

- (11) **13473**
(21) 3-2008-00902 (28) 01
(54) HỘP ĐỰNG THUỐC (51) **09-03**
(22) 08.07.2008 (43) 25.09.2008
(71) CÔNG TY CỔ PHẦN DỊCH VỤ THƯƠNG MẠI VÀ DƯỢC PHẨM HÀ NỘI (VN)
55A, ngõ 281 đường Trần Khát Chân, phường Thanh Nhân, quận Hai Bà Trưng, thành phố Hà Nội
(72) Đinh Quốc Tuấn (VN)
(74) Công ty TNHH Vĩnh Đạt (LACOM CO., LTD.)
(55)



1.1

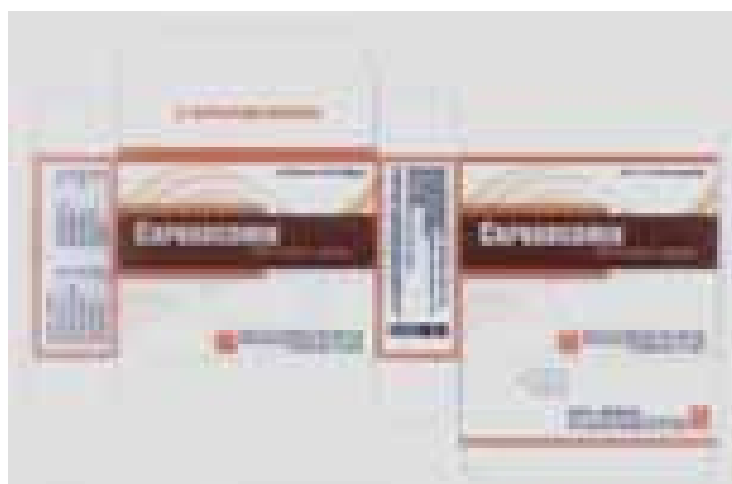

1.2

- (11) **13474**
(21) 3-2008-00903 (28) 01
(54) NHÃN SẢN PHẨM (51) **19-08**
(22) 09.07.2008 (43) 25.09.2008
(71) CÔNG TY CỔ PHẦN THƯƠNG MẠI SẢN XUẤT TÂN ÚC VIỆT (VN)
Lô 60, đường số 2, KCN Tân Tạo, phường Tân Tạo, quận Bình Tân, TP. Hồ Chí Minh
(72) Từ Đông Bảo (AU)
(74) Công ty TNHH Nam Việt và Liên danh (VIPCO)
(55)



1.1



1.2

- (11) **13475**
(21) 3-2008-00904 (28) 01
(54) HỘP (51) **09-03**
(22) 09.07.2008 (43) 25.09.2008
(71) CÔNG TY CỔ PHẦN THƯƠNG MẠI SẢN XUẤT TÂN ÚC VIỆT (VN)
Lô 60, đường số 2, KCN Tân Tạo, phường Tân Tạo, quận Bình Tân, TP. Hồ Chí Minh
(72) Từ Đông Bảo (AU)
(74) Công ty TNHH Nam Việt và Liên danh (VIPCO)
(55)



1.1



1.2

- (11) **13476**
(21) 3-2008-00905 (28) 01
(54) MÁY TÍNH (51) **18-01**
(22) 09.07.2008 (43) 25.09.2008
(71) CÔNG TY CỔ PHẦN ĐIỆN TỬ VIỆT NHẬT (VN)
518 Lạc Long Quân, phường 5, quận 11, TP. Hồ Chí Minh
(72) Nguyễn Đình Quý (VN)
(74) Văn phòng luật sư Phạm và Liên danh (PHAM & ASSOCIATES)
(55)



1.1

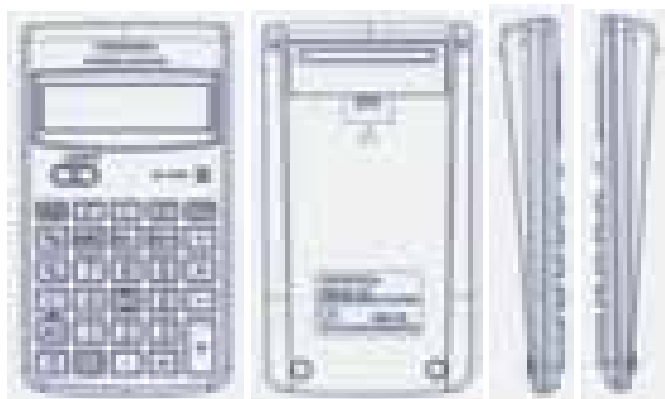

1.2

1.3

1.4

1.5



1.6



1.7

- (11) **13477**
(21) 3-2008-00910 (28) 01
(54) TẤM LỘP (51) **25-01**
(22) 09.07.2008 (43) 25.09.2008
(71) CÔNG TY CỔ PHẦN TÔN HIỆP HUNG (VN)
672 A quốc lộ 52, phường Phước Long B, quận 9, TP. Hồ Chí Minh
(72) Huỳnh Hoà Hiệp (VN)
(74) Công ty Cổ phần Sở hữu công nghiệp INVESTIP (INVESTIP)
(55)



1.1

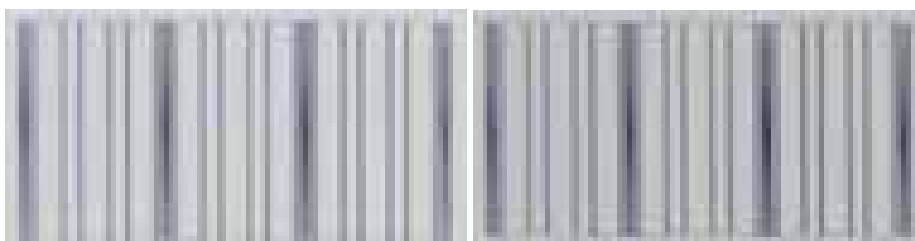

1.2

1.3



1.4

1.5



1.6

1.7

- (11) **13478**
(21) 3-2008-00912 (28) 01
(54) TAY CẦM GẬY CHƠI GÔN (51) **21-02**
(22) 10.07.2008 (43) 25.09.2008
(30) 29/294423 10.01.2008 US
(71) EATON CORPORATION (US)
Eaton Center, 1111 Superior Avenue, Cleveland, Ohio 44114-2584, U.S.A
(72) CHING CHI CHEN (TW)
(74) Công ty TNHH Trường Xuân (AGELESS CO.,LTD.)
(55)



1.1

1.2

1.3

1.4

1.5

1.6

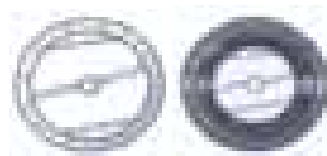

1.7

1.8

- (11) **13479**
(21) 3-2008-00914 (28) 01
(54) BÌNH SỨ ĐỰNG RƯỢU DẠNG DỆT (51) **09-01**
(22) 10.07.2008 (43) 25.09.2008
(71) CÔNG TY CỔ PHẦN ĂN UỐNG DẠ LAN (VN)
Số 1 Phan Chu Trinh, phường Điện Biên, thành phố Thanh Hoá, tỉnh Thanh Hoá
(72) Trịnh Thị Loan (VN)
(55)



1.1

1.2

1.3

1.4



1.5

1.6

- (11) **13480**
(21) 3-2008-00915 (28) 01
(54) HỘP (51) **09-03**
(22) 10.07.2008 (43) 25.09.2008
(71) CÔNG TY CỔ PHẦN HƯỚNG TƯƠNG LAI (VN)
284/9 Nguyễn Trọng Tuyển, phường 10, quận Phú Nhuận, TP. Hồ Chí Minh
(72) Nguyễn Thị Phi Vân (VN)
(74) Công ty TNHH Tư vấn sở hữu trí tuệ Việt (VIET IP CO.,LTD.)
(55)

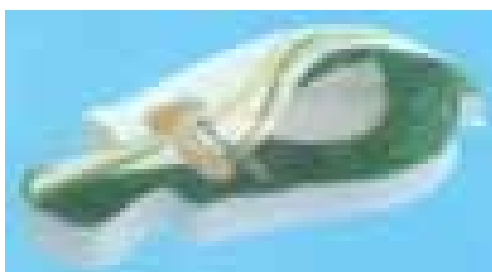

1.1



1.2



1.3

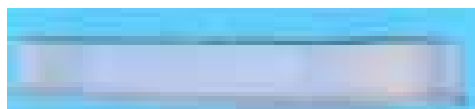

1.4



1.5

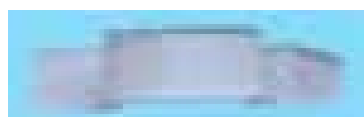

1.6

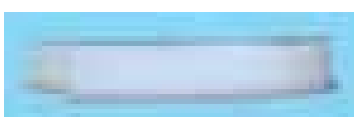

1.7

- (11) **13481**
(21) 3-2008-00916 (28) 01
(54) CHAI (51) **09-01**
(22) 11.07.2008 (43) 25.09.2008
(71) CÔNG TY TNHH SX & TM ÁNH DƯƠNG (VN)
271B/KV Lợi Dũ A, phường An Bình, quận Ninh Kiều, thành phố Cần Thơ
(72) Nguyễn Thanh Trình (VN)
(55)



1.1

1.2

1.3

1.4



1.5

1.6

- (11) **13482**
(21) 3-2008-00918 (28) 01
(54) HỘP THUỐC (51) **09-03**
(22) 11.07.2008 (43) 25.09.2008
(71) CÔNG TY CỔ PHẦN DƯỢC VẬT TUYỆT HẢI DƯƠNG (VN)
102, đường Chi Lăng, thành phố Hải Dương, tỉnh Hải Dương
(72) Đặng Văn Việt (VN)
(74) Công ty TNHH Sở hữu trí tuệ Đại Diện (IPACO.,LTD.)
(55)



1.1



1.2



1.3

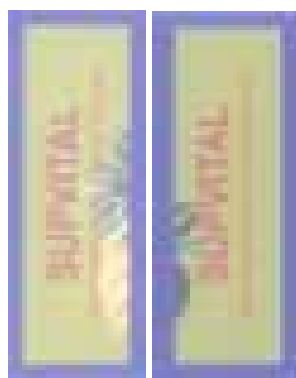

1.4

1.5



1.6

- (11) **13483**
(21) 3-2008-00921 (28) 01
(54) XE MÁY (51) **12-11**
(22) 11.07.2008 (43) 25.09.2008
(71) CÔNG TY TRÁCH NHIỆM HỮU HẠN HỒNG ĐÀ (VN)
27 lô AA19, đường số 4, khu dân cư Bình Hưng, xã Bình Hưng, huyện Bình Chánh, TP.
Hồ Chí Minh
(72) Võ Thành Đạt (VN)
(74) Công ty TNHH Sở hữu trí tuệ và Công nghệ Thủ đô (CAPITAL IP&T CO.LTD.)
(55)



1.1

1.2

1.3



1.4

1.5

1.6



1.7

1.8

1.9

- (11) **13484**
(21) 3-2008-00925 (28) 01
(54) Ô TÔ (51) **12-08**
(22) 14.07.2008 (43) 25.09.2008
(30) 2008-000794 18.01.2008 JP
(71) HONDA MOTOR CO., LTD. (JP)
1-1, Minamiaoyama 2-chome, Minato-ku, Tokyo, Japan
(72) Akihiko Ohhashi (JP), Masashi Shimada (JP)
(74) Văn phòng luật sư Phạm và Liên danh (PHAM & ASSOCIATES)
(55)



1.1

1.2



1.3

1.4

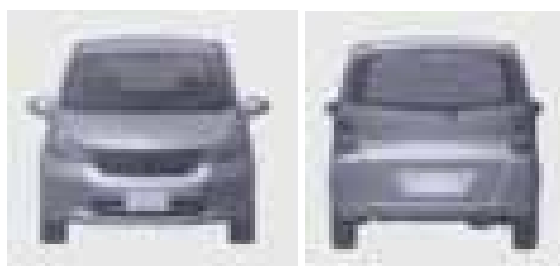

1.5

1.6

- (11) **13485**
(21) 3-2008-00926 (28) 01
(54) CỤM ĐÈN TRƯỚC DÙNG CHO Ô TÔ (51) **26-06**
TÔ
(22) 14.07.2008 (43) 25.09.2008
(30) 2008-000650 16.01.2008 JP
(71) HONDA MOTOR CO., LTD. (JP)
1-1, Minamiaoyama 2-chome, Minato-ku, Tokyo, Japan
(72) Keisuke Nakamura (JP)
(74) Văn phòng luật sư Phạm và Liên danh (PHAM & ASSOCIATES)
(55)



1.1

1.2

1.3



1.4

1.5

1.6

1.7



1.8

1.9

- (11) **13486**
(21) 3-2008-00927 (28) 01
(54) CỤM ĐÈN SAU DÙNG CHO Ô TÔ (51) **26-06**
(22) 14.07.2008 (43) 25.09.2008
(30) 2008-000651 16.01.2008 JP
(71) HONDA MOTOR CO., LTD. (JP)
1-1, Minamiaoyama 2-chome, Minato-ku, Tokyo, Japan
(72) Akihiko Ohhashi (JP)
(74) Văn phòng luật sư Phạm và Liên danh (PHAM & ASSOCIATES)
(55)



1.1

1.2

1.3

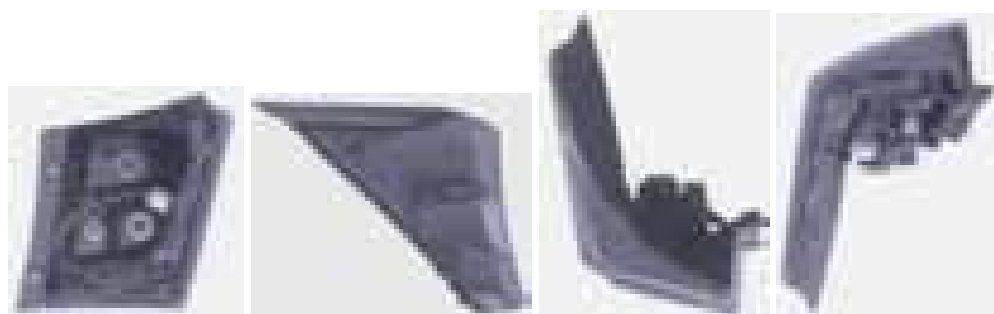

1.4

1.5

1.6

1.7

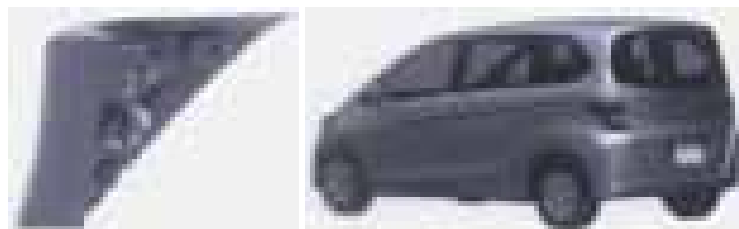

1.8

1.9

- (11) **13487**
(21) 3-2008-00928 (28) 01
(54) RƠ LE ĐIỀU CHỈNH MỨC CHẤT (51) **13-03**
LỎNG
(22) 14.07.2008 (43) 25.09.2008
(30) 2008-3575 19.02.2008 JP
(71) KASUGA DENKI KABUSHIKI KAISHA (also trading as KASUGA ELECTRIC WORKS, LTD.) (JP)
1-33, Shimorenjaku 6 Chome, Mitaka-Shi, Tokyo, Japan
(72) Kouji Nagase (JP), Naoki Shimoda (JP), Yoshiyuki Tomita (JP)
(74) Văn phòng luật sư Phạm và Liên danh (PHAM & ASSOCIATES)
(55)



1.1



1.2



1.3

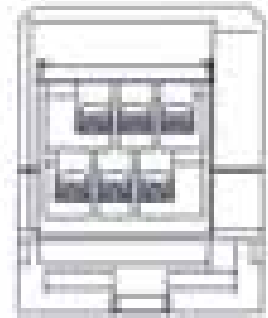

1.4

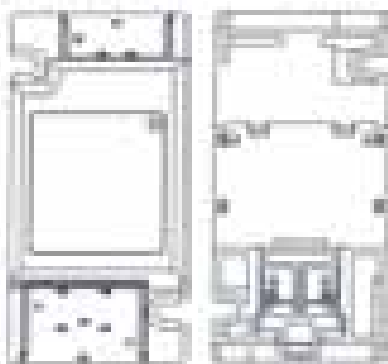

1.5

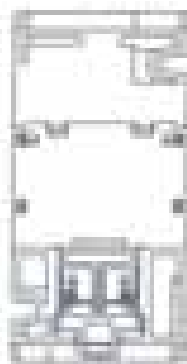

1.6

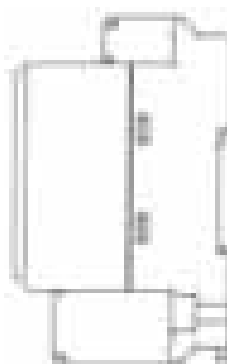

1.7

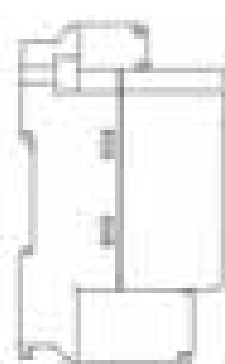

1.8

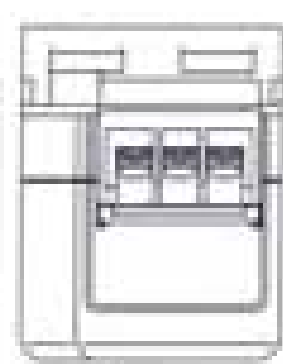

1.9

- (11) **13488**
(21) 3-2008-00936 (28) 01
(54) CHẬU RỬA (51) **23-02**
(22) 14.07.2008 (43) 25.09.2008
(71) CÔNG TY TNHH SỨ INAX VIỆT NAM (VINAX) (VN)
Đương Xá, Gia Lâm, thành phố Hà Nội
(72) KAZUYOSHI ISO (JP), Tô Ngọc Phương (VN), Phạm Văn Nam (VN)
(74) Công ty Luật TNHH AMBYS Hà Nội (AMBYS HANOI)
(55)



1.1

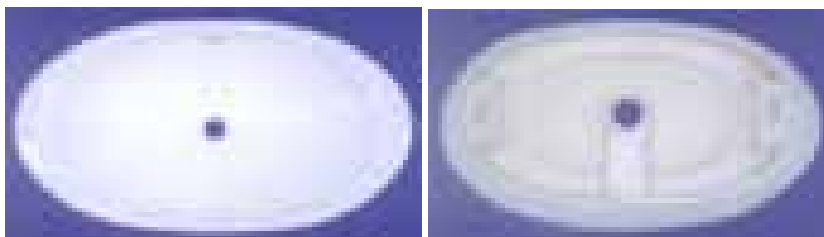

1.2

1.3



1.4

1.5

- (11) **13489**
(21) 3-2008-00937 (28) 01
(54) CHẬU RỬA (51) **23-02**
(22) 14.07.2008 (43) 25.09.2008
(71) CÔNG TY TNHH SỨ INAX VIỆT NAM (VINAX) (VN)
Dương Xá, Gia Lâm, thành phố Hà Nội
(72) KAZUYOSHI ISO (JP), Tô Ngọc Phương (VN), Phạm Văn Nam (VN)
(74) Công ty Luật TNHH AMBYS Hà Nội (AMBYS HANOI)
(55)



1.1

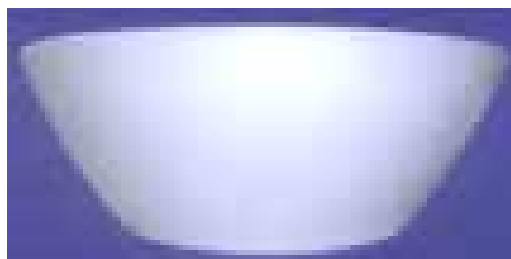

1.2



1.3



1.4

- (11) **13490**
(21) 3-2008-00939 (28) 01
(54) HỘP HIỂN THỊ SỐ CỦA MÁY (51) **19-02**
ĐẾM TIỀN
(22) 14.07.2008 (43) 25.09.2008
(71) CÔNG TY TNHH XIN DA (VN)
92 Bắc Hải, phường 6, quận Tân Bình, TP. Hồ Chí Minh
(72) Trần Thị Hà (VN)
(74) Công ty TNHH Sở hữu trí tuệ WINCO (WINCO CO., LTD.)
(55)



1.1



1.2



1.3

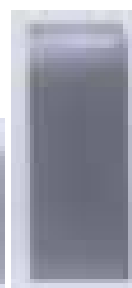

1.4



1.5

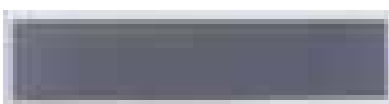

1.6

- (11) **13491**
(21) 3-2008-00940 (28) 02
(54) BAO GÓI ĐỰNG BĂNG VỆ SINH (51) **09-05**
PHỤ NỮ
(22) 14.07.2008 (43) 25.09.2008
(71) CÔNG TY CỔ PHẦN THƯƠNG MẠI CHIỀNG MAI (VN)
Thôn Vạn Khoảnh, xã Mỹ Phúc, huyện Mỹ Lộc, tỉnh Nam Định
(72) Hoàng Trọng Thứ (VN)
(74) Công ty TNHH Sở hữu trí tuệ HA VIP (HAVIP CO., LTD.)
(55)



1.1



1.2



2.1



2.2

- (11) **13492**
(21) 3-2008-00942 (28) 01
(54) GIƯỜNG XẾP (51) **06-02**
(22) 14.07.2008 (43) 25.09.2008
(71) CÔNG TY CỔ PHẦN NAM LIÊN (VN)
41/26 Phan Đình Phùng, phường Tân Thành, quận Tân Phú, TP. Hồ Chí Minh
(72) Nguyễn Hữu Phước (VN)
(74) DNTN Dịch vụ thương mại và sở hữu công nghiệp Song Ngọc (I.P.T.S.)
(55)

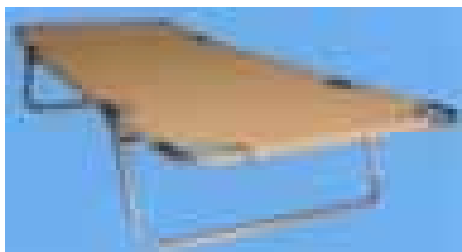

1.1

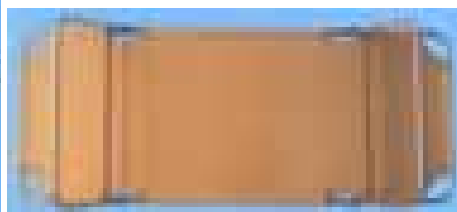

1.2

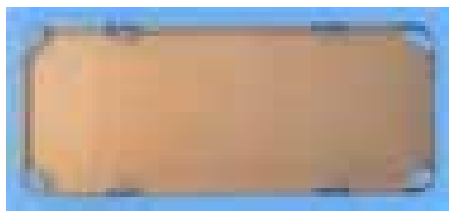

1.3

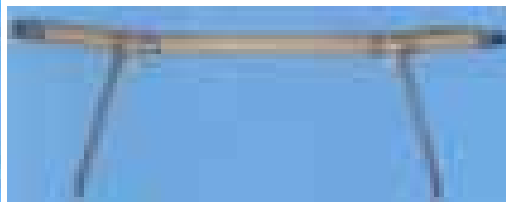

1.4

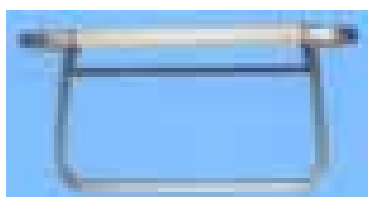

1.5

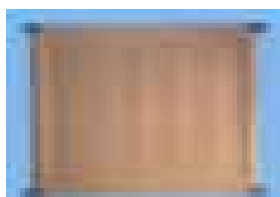

1.6



1.7



1.8

- (11) **13493**
(21) 3-2008-00943 (28) 01
(54) XE ĐẨY CHO TRẺ EM (51) 12-12
(22) 15.07.2008 (43) 25.09.2008
(71) CHEN, CHIEN-LUNG (TW)
No. 12-3, Lane 159, Section 1, Guo-Guang Rd., Da-Li City, Taichung Hsien, Taiwan
(72) Chen, Chien-Lung (TW)
(74) Văn phòng luật sư Phạm và Liên danh (PHAM & ASSOCIATES)
(55)

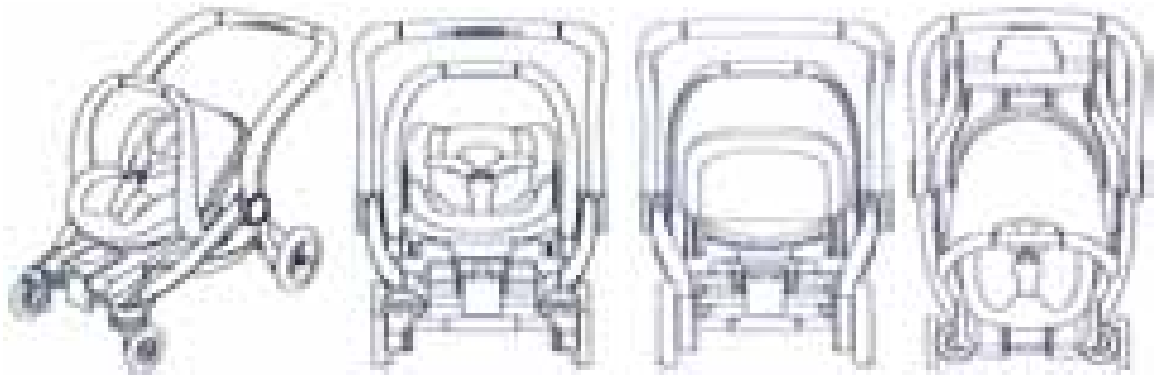

1.1

1.2

1.3

1.4



1.5

1.6

1.7

- (11) **13494**
(21) 3-2008-00944
(54) CHAI
(22) 15.07.2008
(71) CÔNG TY TNHH THỰC PHẨM THUYẾT SẢN ĐỨC TÍN (VN)
Số 1 tổ 27, phường Ngọc Lâm, quận Long Biên, thành phố Hà Nội
(72) Lê Đức Quỳnh (VN)
(55)
- (28) 01
(51) **09-01**
(43) 25.09.2008



1.1

1.2

1.3

1.4

1.5

- (11) **13495**
(21) 3-2008-00947 (28) 01
(54) HỘP ĐỰNG SẢN PHẨM (51) **09-03**
(22) 15.07.2008 (43) 25.09.2008
(71) CÔNG TY TNHH HOÀNG HƯƠNG (VN)
Số 6 ngõ 111 Láng Hạ, quận Đống Đa, thành phố Hà Nội
(72) Đinh Thị Chì (VN)
(74) Công ty TNHH Sở hữu trí tuệ WINCO (WINCO CO., LTD.)
(55)



1.1



1.2

- (11) **13496**
(21) 3-2008-00948 (28) 01
(54) BÀN NHỰA (51) **06-03**
(22) 15.07.2008 (43) 25.09.2008
(71) CÔNG TY CỔ PHẦN ĐẠI ĐỒNG TIẾN (VN)
216 Tân Thành, phường 15, quận 5, TP. Hồ Chí Minh
(72) Trịnh Đồng (VN)
(74) DNTN Dịch vụ thương mại và sở hữu công nghiệp Song Ngọc (I.P.T.S.)
(55)



1.1

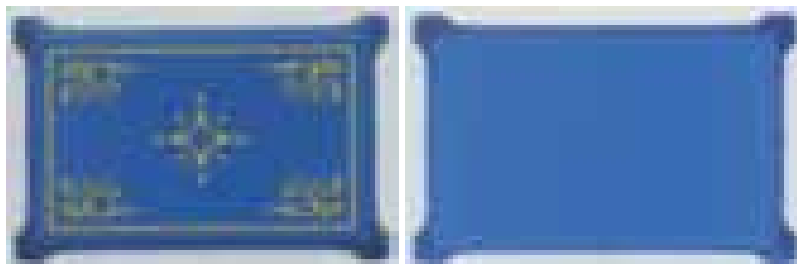

1.2

1.3

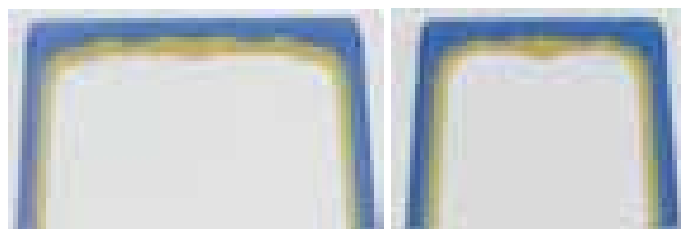

1.4

1.5

- (11) **13497**
(21) 3-2008-00949 (28) 01
(54) ĐỒ TRANG TRÍ (51) **11-02**
(22) 16.07.2008 (43) 25.09.2008
(71) CÔNG TY TNHH ĐỒ TRANG TRÍ PHAN (VN)
Số 53 Đức Giang, quận Long Biên, thành phố Hà Nội
(72) Chateignier Stephane (FR)
(74) Văn phòng luật sư Phạm và Liên danh (PHAM & ASSOCIATES)
(55)



1.1



1.2



1.3



1.4



1.5



1.6



1.7

- (11) **13498**
(21) 3-2008-00950 (28) 03
(54) NHÃN BỘT NĂNG (51) **19-08**
(22) 16.07.2008 (43) 25.09.2008
(71) CÔNG TY TNHH SẢN XUẤT THƯƠNG MẠI XUẤT NHẬP KHẨU VĨNH THUẬN (VN)
Lô số 54, đường số 03, KCN Tân Tạo, phường Tân Tạo A, quận Bình Tân, TP. Hồ Chí Minh
(72) Trần Kiên (VN)
(74) Trung tâm tư vấn phát triển Thương hiệu và Chất lượng (NATUSI)
(55)



1



2



- (11) **13499**
(21) 3-2008-00960 (28) 01
(54) NHÃN SẢN PHẨM (51) **19-08**
(22) 18.07.2008 (43) 25.09.2008
(71) CÔNG TY CỔ PHẦN KÍNH THUẬN THÀNH (VN)
304/55 Đào Duy Anh, phường 9, quận Phú Nhuận, TP. Hồ Chí Minh
(72) Phạm Thanh Tùng (VN)
(55)



- (11) **13500**
(21) 3-2008-00965 (28) 01
(54) BÚT BẮM (51) **19-06**
(22) 22.07.2008 (43) 25.09.2008
(71) CÔNG TY CỔ PHẦN TẬP ĐOÀN THIÊN LONG (VN)
Lô 6-8-10-12 đường số 3, khu công nghiệp Tân Tạo, quận Bình Tân, TP. Hồ Chí Minh
(72) Cô Gia Thọ (VN)
(74) Công ty TNHH Tư vấn sở hữu trí tuệ Việt (VIET IP CO.,LTD.)
(55)

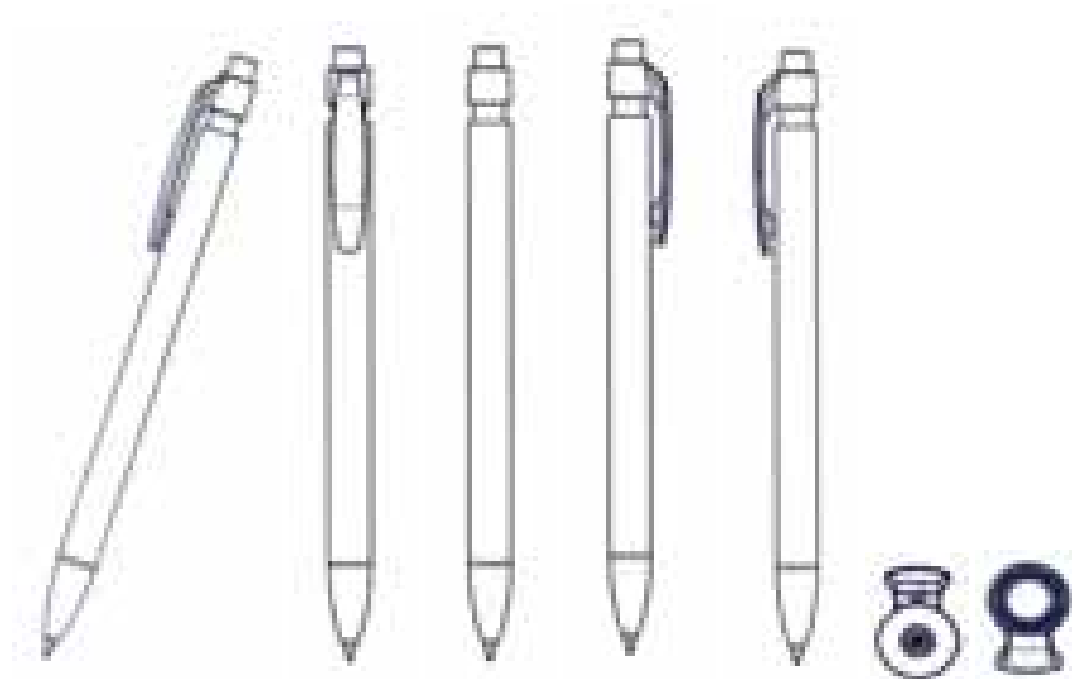

1.1

1.2

1.3

1.4

1.5

1.6

1.7

- (11) **13501**
(21) 3-2008-00966 (28) 01
(54) ĐIỆN THOẠI DI ĐỘNG (51) **14-03**
(22) 23.07.2008 (43) 25.09.2008
(30) 000871785-0001-0002 04.02.2008 EM
(71) SONY ERICSSON MOBILE COMMUNICATIONS AB (SE)
SE-221 88 Lund, Sweden
(72) HIRANO, Shimpei (JP)
(74) Công ty Cổ phần Sở hữu công nghiệp INVESTIP (INVESTIP)
(55)



1.1

1.2

1.3

1.4

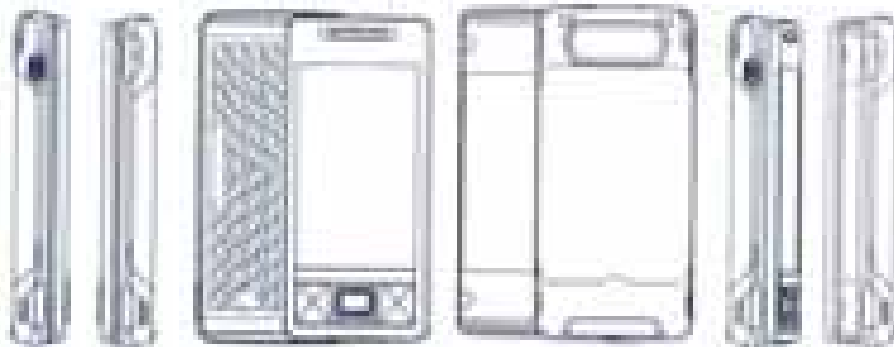

1.5

1.6

1.7

1.8

1.9

1.10



1.11

1.12

1.13

1.14

(11) **13502**

(21) 3-2008-00967

(28) 01

(54) XE MÔ TÔ

(51) **12-11**

(22) 23.07.2008

(43) 25.09.2008

(71) SANYANG INDUSTRY CO., LTD. (TW)

No. 184, Keng Tzu Kou, Shang Keng Village, Hsin Fong Shiang, Hsinchu, County 304, Taiwan

(72) Sheng-Hsiung CHENG (TW)

(74) Công ty TNHH Trường Xuân (AGELESS CO.,LTD.)

(55)



1.1



1.2



1.3



1.4



1.5



1.6



1.7



1.8



1.9

- (11) **13503**
(21) 3-2008-00968 (28) 01
(54) BAO GÓI TÃ GIẤY (51) **09-05**
(22) 23.07.2008 (43) 25.09.2008
(71) CÔNG TY CỔ PHẦN DIANA (VN)
Khu công nghiệp Vĩnh Tuy, đường Lĩnh Nam, phường Vĩnh Hưng, quận Hoàng Mai,
thành phố Hà Nội
(72) Đỗ Anh Tú (VN)
(74) Công ty TNHH Sở hữu trí tuệ và Công nghệ Thủ đô (CAPITAL IP&T CO.LTD.)
(55)



1.1

1.2



1.3

- (11) **13504**
(21) 3-2008-00969 (28) 01
(54) HỘP ĐỤNG THUỐC (51) **09-03**
(22) 23.07.2008 (43) 25.09.2008
(71) CÔNG TY CỔ PHẦN THƯƠNG MẠI VÀ DƯỢC PHẨM NGỌC THIỆN (VN)
Số 10, ngõ 3, đường Lý Bôn, thành phố Vinh Yên, tỉnh Vĩnh Phúc
(72) Nguyễn Thế Quyền (VN)
(74) Công ty TNHH Vĩnh Đạt (LACOM CO., LTD.)
(55)



1.1



1.2

- (11) **13505**
(21) 3-2008-00974 (28) 01
(54) ĐỒNG HỒ ĐO KHÍ (51) **10-04**
(22) 25.07.2008 (43) 25.09.2008
(71) TRUNG TÂM ĐO LƯỜNG VIỆT NAM (VN)
Số 8 Hoàng Quốc Việt, Cầu Giấy, thành phố Hà Nội
(72) Nguyễn Hồng Thái (VN)
(55)



1.1

1.2

1.3

1.4



1.5



1.6



1.7

- (11) **13506**
(21) 3-2008-00976 (28) 01
(54) LOA MÁY TÍNH (51) **14-01**
(22) 25.07.2008 (43) 25.09.2008
(30) 30-2008-0010504 11.03.2008 KR
(71) TRIGEM COMPUTER, INC. (KR)
of 1125-1, Singil-dong, Danwon-gu, Ansan-si, Gyeonggi-do, Korea
(72) Hyun-Saeng Ahn (KR)
(74) Công ty TNHH Tư vấn BIZCONSULT (BIZCONSULT CO., LTD.)
(55)

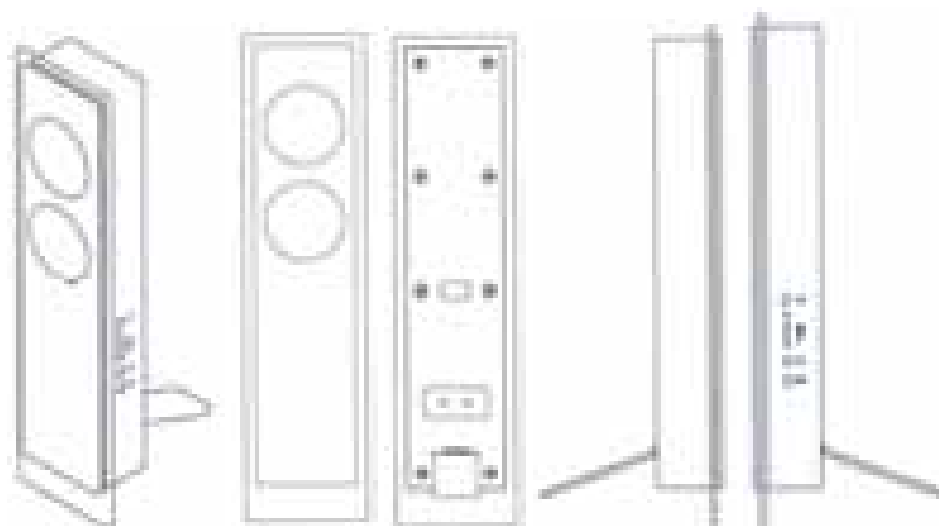

1.1

1.2

1.3

1.4

1.5

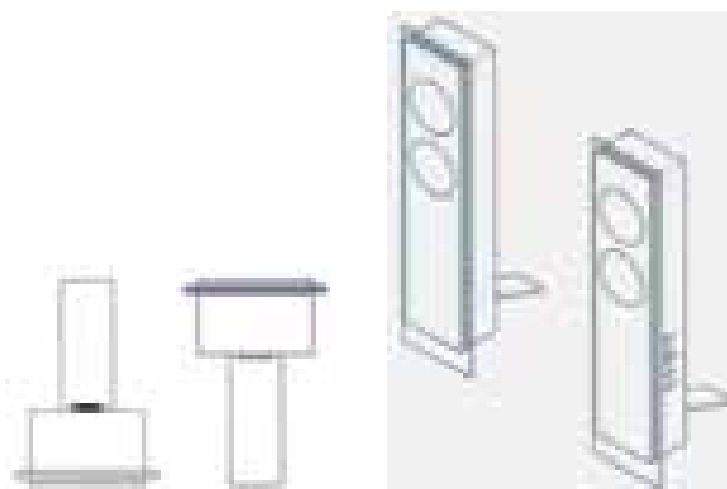

1.6

1.7

1.8

- (11) **13507**
(21) 3-2008-00979 (28) 01
(54) BAO GÓI ĐỰNG KẸO (51) **09-05**
(22) 28.07.2008 (43) 25.09.2008
(71) CÔNG TY TNHH THỰC PHẨM MINH THUẬN PHÁT (VN)
176/26 Hoà Bình, phường Tân Thới Hiệp, quận Tân Phú, TP. Hồ Chí Minh
(72) Trịnh Tỷ (VN)
(74) DNTN Dịch vụ thương mại và sở hữu công nghiệp Song Ngọc (I.P.T.S.)
(55)



1.1



1.2

1.3

- (11) **13508**
(21) 3-2008-00980 (28) 02
(54) NHÃN SẢN PHẨM (51) **19-08**
(22) 28.07.2008 (43) 25.09.2008
(71) CÔNG TY TNHH THƯƠNG MẠI TÂN BÌNH MINH (VN)
Số 8 lô 1C, khu đô thị mới Trung Yên, phường Trung Hòa, quận Cầu Giấy, thành phố Hà Nội
(72) Trương Khánh Tùng (VN)
(74) Công ty TNHH Sở hữu trí tuệ WINCO (WINCO CO., LTD.)
(55)



1



2

- (11) **13509**
(21) 3-2008-00981 (28) 01
(54) BAO BÌ (51) **09-05**
(22) 28.07.2008 (43) 25.09.2008
(71) TRƯƠNG LỆ HOA (VN)
426 Lê Hồng Phong, phường 1, quận 10, TP. Hồ Chí Minh
(72) Trương Lệ Hoa (VN)
(74) Công ty TNHH Sở hữu trí tuệ Thảo Thọ Quyến (INVENCO)
(55)



1.1



1.2

1.3

- (11) **13510**
(21) 3-2008-00983 (28) 01
(54) BÀN (51) **06-03**
(22) 28.07.2008 (43) 25.09.2008
(71) CÔNG TY CỔ PHẦN CAO SU SÀI GÒN - KYMDAN (VN)
28 Bình Thới, phường 14, quận 11, TP. Hồ Chí Minh
(72) Nguyễn Hữu Trí (VN)
(74) Công ty TNHH Sở hữu trí tuệ Thảo Thọ Quyến (INVENCO)
(55)



1.1

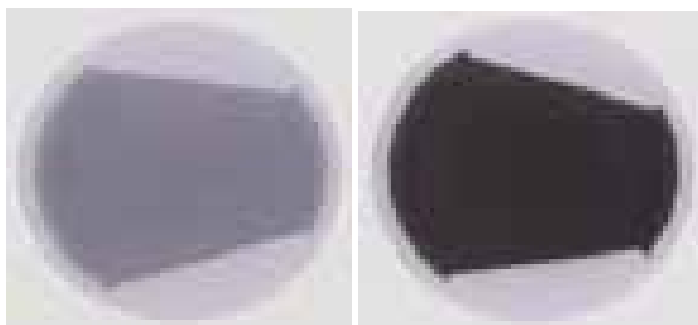

1.2

1.3

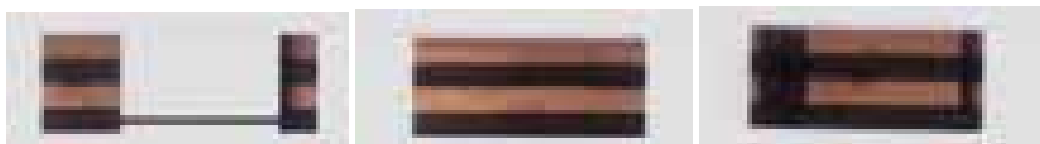

1.4

1.5

1.6

- (11) **13511**
(21) 3-2008-00984 (28) 02
(54) GHẾ (51) **06-01**
(22) 28.07.2008 (43) 25.09.2008
(71) CÔNG TY CỔ PHẦN CAO SU SÀI GÒN - KYMDAN (VN)
28 Bình Thới, phường 14, quận 11, TP. Hồ Chí Minh
(72) Nguyễn Hữu Trí (VN)
(74) Công ty TNHH Sở hữu trí tuệ Thảo Thọ Quyến (INVENCO)
(55)



1.1

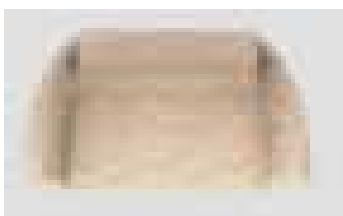

1.2

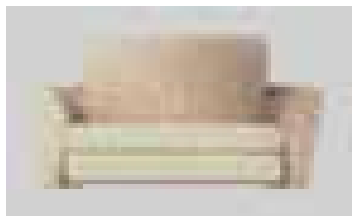

1.3

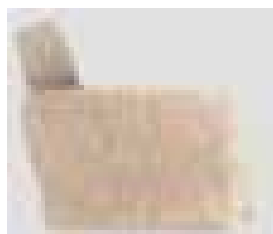

1.4

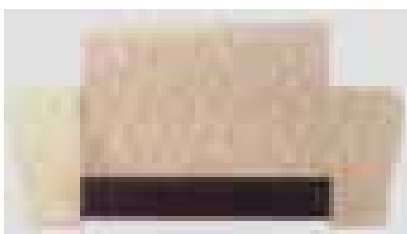

1.5



1.6

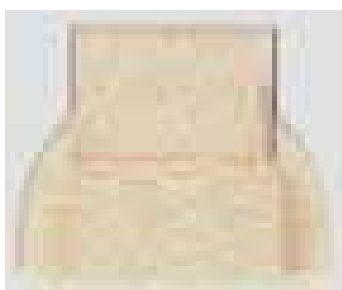

1.7

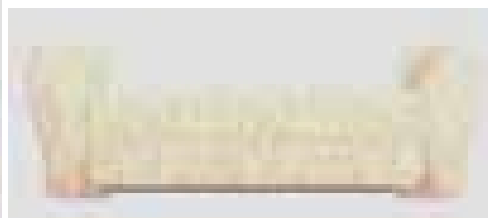

1.8

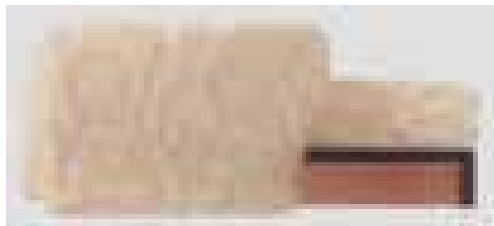

1.9

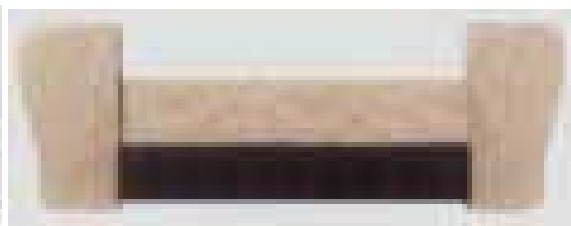

1.10



2.1



2.2



2.3

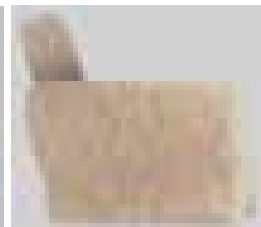

2.4



2.5

- (11) **13512**
(21) 3-2008-00991 (28) 01
(54) HỘP ĐỰNG THỰC PHẨM (51) **09-03**
(22) 29.07.2008 (43) 25.09.2008
(71) CÔNG TY TNHH MỘT THÀNH VIÊN CHẾ BIẾN THỰC PHẨM MINH CANG (VN)
102 Nguyễn Văn Sang, phường Tân Sơn Nhì, quận Tân Phú, TP. Hồ Chí Minh
(72) Lê Tấn Đợt (VN)
(74) Công ty Cổ phần Sở hữu công nghiệp INVESTIP (INVESTIP)
(55)



1.1



1.2