

PHẦN III

**ĐƠN YÊU CẦU CẤP BẰNG ĐỘC QUYỀN KIỂU DÁNG CÔNG NGHIỆP**

- (11) **12842**  
(21) 3-2007-00452 (28) 01  
(54) XE MÁY (51) **12-11**  
(22) 12.04.2007 (43) 26.05.2008  
(30) A00 2007 00024 04.01.2007 ID  
(71) PT. SEMESTA CITRA LNTAN (ID)  
Kantor Taman E3.3, Unit A6-A7, Jl. Mega Kuningan, Lot. 8.6-8.7 Kawasan Mega Kuningan, Jakarta 12950, Indonesia  
(72) Nono Sumarno (ID), Herwan (ID), Kaendah (ID), Eko Djuniedi (ID)  
(74) Công ty TNHH Sở hữu trí tuệ Gia Việt (GIAVIET CO., LTD.)  
(55)



1.1

1.2

1.3

1.4



1.5

1.6

1.7

1.8



1.9

1.10

- (11) **12843**  
(21) 3-2007-01176 (28) 01  
(54) ĐỂ GIÀY THỂ THAO (51) **02-04**  
(22) 07.09.2007 (43) 26.05.2008  
(30) 000684584-0001 08.03.2007 EM  
(71) 1. SOCIÉTÉ DE TECHNOLOGIE MLCHELLN (FR)  
23 rue Breschet, 63000 Clermont-Ferrand, FRANCE  
2. MICHELIN Recherche et Technique S.A. (CH)  
Route Louis Braille 10 et 12, 1763 Granges-Paccot, Switzerland  
(72) Arnaud LARREGAIN (FR), Adam JARA (AT), Frédéric PERRIN (FR)  
(74) Công ty TNHH Dịch vụ sở hữu trí tuệ ALPHA (ALPHA PLUS CO., LTD.)  
(55)



1.1



1.2

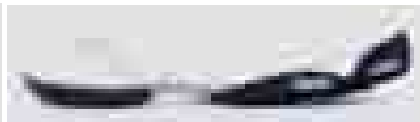

1.3



1.4



1.5



1.6



1.7

- (11) **12844**  
(21) 3-2007-01373  
(54) HỘP BÁNH  
(22) 05.10.2007  
(71) CÔNG TY CỔ PHẦN CHẾ BIẾN THỰC PHẨM THƯƠNG MẠI TAN TAN (VN)  
32C ấp Nội Hóa, xã Bình An, huyện Dĩ An, tỉnh Bình Dương  
(72) Trần Quốc Tân (VN)  
(74) Văn phòng luật sư Phạm và Liên danh (PHAM & ASSOCIATES)  
(55)
- (28) 01  
(51) **09-05**  
(43) 26.05.2008



1.1



1.2

- (11) **12845**  
(21) 3-2007-01663 (28) 01  
(54) BAO GÓI BỘT CANH (51) **09-05**  
(22) 28.11.2007 (43) 26.05.2008  
(71) CÔNG TY TRÁCH NHIỆM HỮU HẠN AN HẢI LIÊN (VN)  
Số 293 Trần Nguyên Hãn, phường Niệm Nghĩa, quận Lê Chân, thành phố Hải Phòng  
(72) Trần Thị Hiền Lương (VN)  
(74) Công ty TNHH Nghiên cứu và Tư vấn chuyển giao công nghệ và đầu tư (CONCETTI)  
(55)



1.1



1.2

- (11) **12846**  
(21) 3-2007-01664 (28) 01  
(54) ĐÈN (51) **26-05**  
(22) 28.11.2007 (43) 26.05.2008  
(30) 000732623-0001 31.05.2007 EM  
(71) KONINKLIJKE PHILIPS ELECTRONICS N.V. (NL)  
Groenewoudseweg 1, 5621 BA Eindhoven, The Netherlands  
(72) Helen Qi (CN)  
(74) Công ty Cổ phần Sở hữu công nghiệp INVESTIP (INVESTIP)  
(55)



1.1



1.2

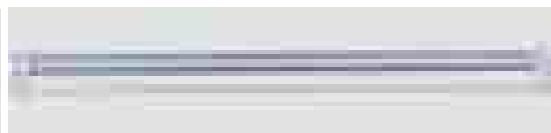

1.3



1.4

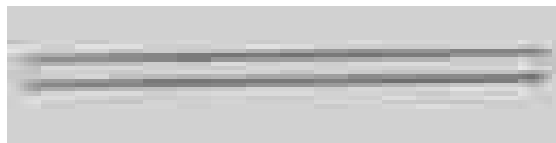

1.5



1.6

1.7

- (11) **12847**  
(21) 3-2007-01674  
(54) HỘP KEM  
(22) 30.11.2007  
(71) CÔNG TY CỔ PHẦN KINH ĐÔ (VN)  
6/134 quốc lộ 13, Thủ Đức, TP. Hồ Chí Minh  
(72) Trần Kim Thành (VN)  
(55)
- (28) 02  
(51) **09-03**  
(43) 26.05.2008



1.1

1.2

1.3

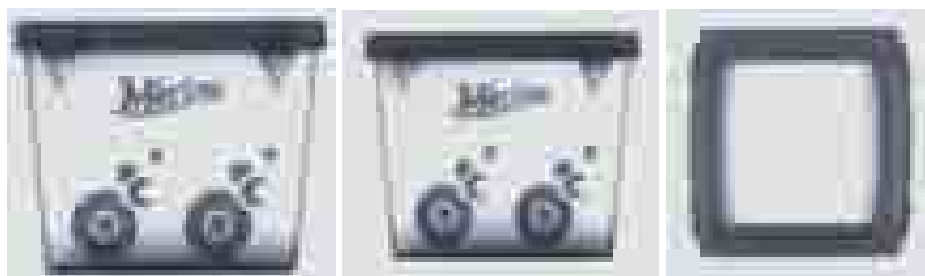

1.4

1.5

1.6

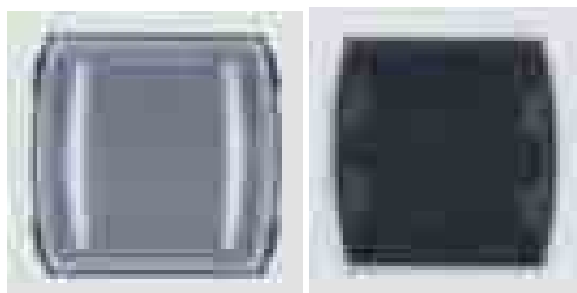

1.7

1.8



2.1



2.2



2.3



2.4



2.5

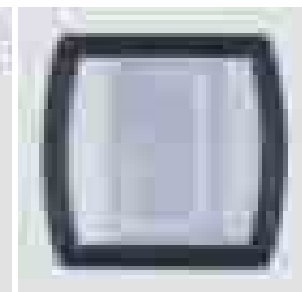

2.6



2.7

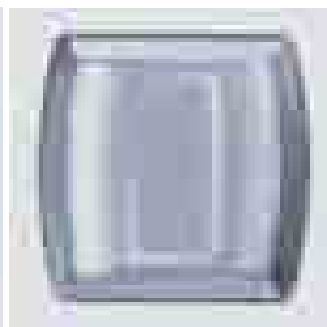

2.8

- (11) **12848**  
(21) 3-2007-01675  
(54) HỘP KEM  
(22) 30.11.2007  
(71) CÔNG TY CỔ PHẦN KINH ĐÔ (VN)  
6/134 quốc lộ 13, Thủ Đức, TP. Hồ Chí Minh  
(72) Trần Kim Thành (VN)  
(55)  
(28) 02  
(51) **09-03**  
(43) 26.05.2008

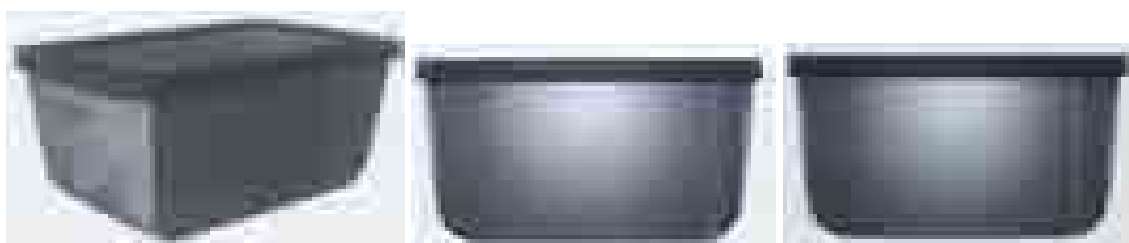

1.1

1.2

1.3

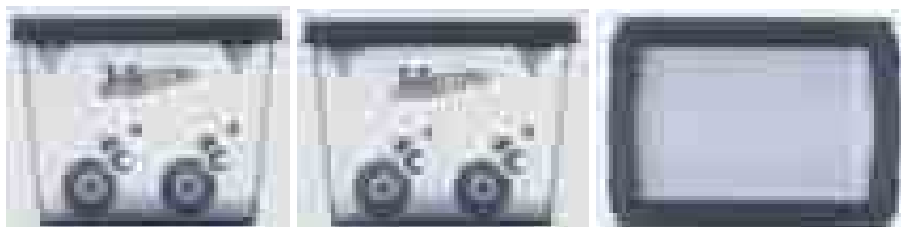

1.4

1.5

1.6

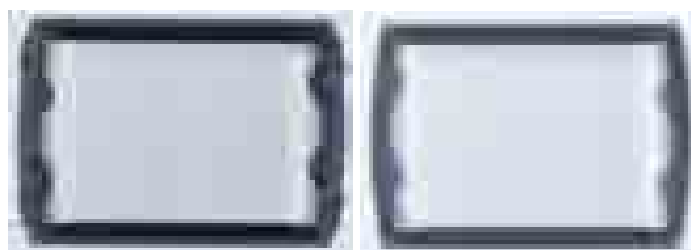

1.7

1.8





2.1



2.2

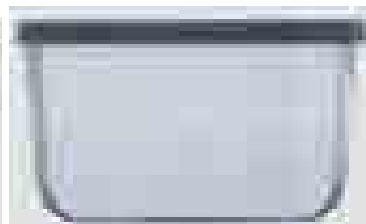

2.3



2.4



2.5

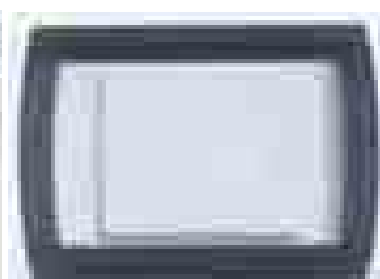

2.6

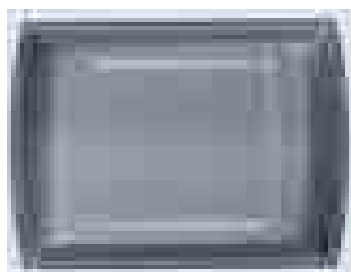

2.7

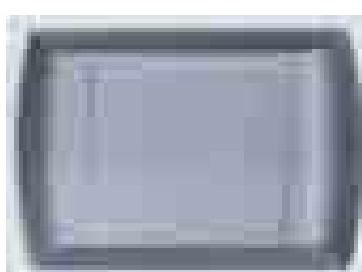

2.8

- (11) **12849**  
(21) 3-2007-01685  
(54) BAO GÓI KẸO  
(22) 04.12.2007  
(71) LÊ THỊ HỒNG ĐIỆP (VN)  
134 Đinh Bộ Lĩnh, phường 4, thị xã Cao Lãnh, tỉnh Đồng Tháp  
(72) Lê Thị Hồng Điệp (VN)  
(55)
- (28) 01  
(51) **09-05**  
(43) 26.05.2008

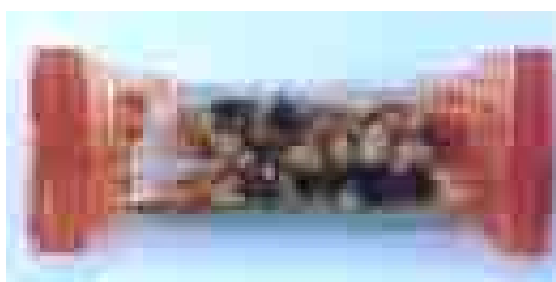

1.1

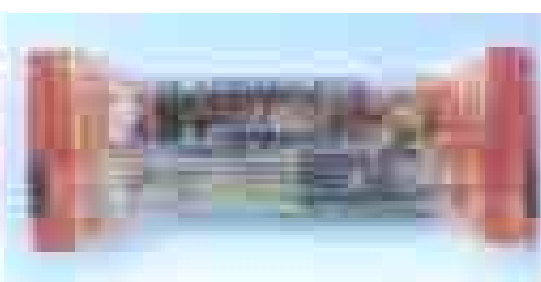

1.2



1.3

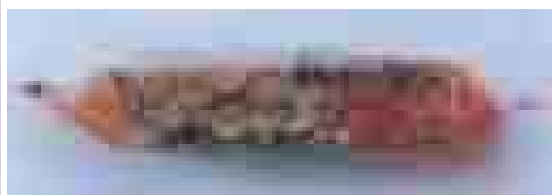

1.4

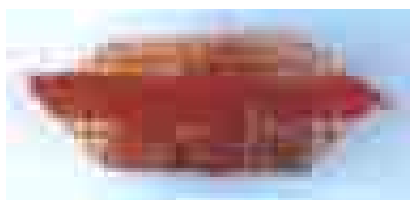

1.5

- (11) **12850**  
(21) 3-2007-01714 (28) 01  
(54) KHAY (51) **07-01**  
(22) 07.12.2007 (43) 26.05.2008  
(71) CÔNG TY TNHH SRITHAI (VIỆT NAM) (VN)  
Số 9, đường số 2, khu công nghiệp Sóng Thần 1, huyện Dĩ An, tỉnh Bình Dương  
(72) Karuna Srisawad (TH)  
(74) Công ty Cổ phần Sở hữu công nghiệp INVESTIP (INVESTIP)  
(55)



1.1

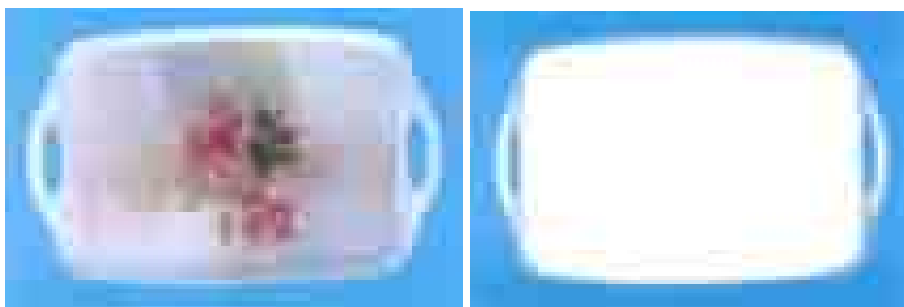

1.2

1.3

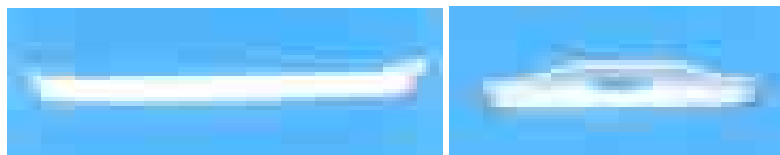

1.4

1.5

- (11) **12851**  
(21) 3-2007-01769 (28) 01  
(54) BAO GÓI KẸO (51) **09-05**  
(22) 18.12.2007 (43) 26.05.2008  
(71) CÔNG TY CỔ PHẦN CHẾ BIẾN THỰC PHẨM & BÁNH KẸO PHẠM NGUYỄN (VN)  
613 Trần Đại Nghĩa, phường Tân Tạo A, quận Bình Tân, TP. Hồ Chí Minh  
(72) Phạm Ngọc Thái (VN)  
(74) Văn phòng luật sư Phạm và Liên danh (PHAM & ASSOCIATES)  
(55)

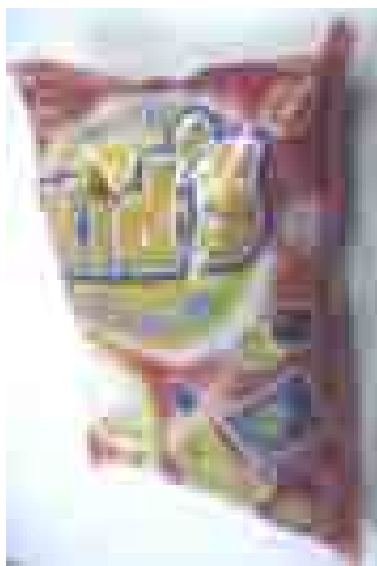

1.1



1.2

- (11) **12852**  
(21) 3-2007-01824 (28) 01  
(54) MÁY RỬA CÁC CHI TIẾT (51) **15-99**  
(22) 20.12.2007 (43) 26.05.2008  
(30) 29/281387 21.06.2007 US  
(71) SAFETY-KLEEN SYSTEMS, INC. (US)  
5400 Legacy Drive, Cluster II, Building 3, Plano, Texas 75024, Wisconsin, USA  
(72) Alex Richert (US), Rudy Publ (US), Sean Spaziani (US), Don Meisinger (US)  
(74) Công ty TNHH Quốc tế D & N (D&N INTERNATIONAL CO.,LTD.)  
(55)

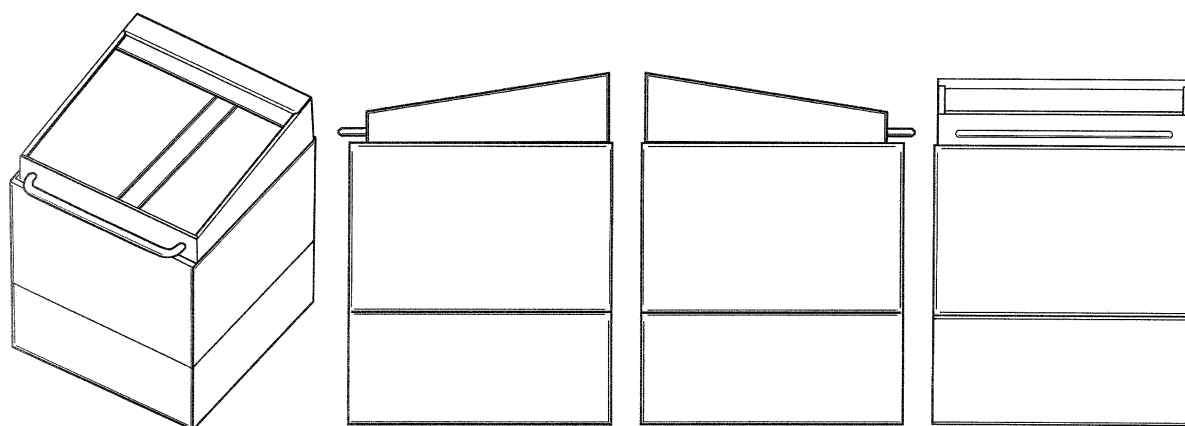

1.1

1.2

1.3

1.4

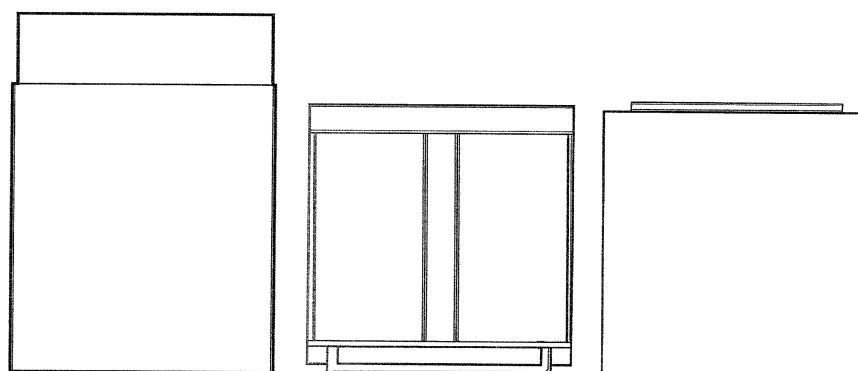

1.5

1.6

1.7

- (11) **12853**  
(21) 3-2007-01825 (28) 01  
(54) MÁY RỬA CÁC CHI TIẾT (51) **15-99**  
(22) 20.12.2007 (43) 26.05.2008  
(30) 29/281444 22.06.2007 US  
(71) SAFETY-KLEEN SYSTEMS, LNC. (US)  
5400 Legacy Drive, Cluster II, Building 3, Plano, Texas 75024, Wisconsin, USA  
(72) Colin Greenidge (CA), Klaus Trishcler (GE), Stephen H. Kaminski (US), Felix Nagelin (CH)  
(74) Công ty TNHH Quốc tế D & N (D&N INTERNATIONAL CO.,LTD.)  
(55)

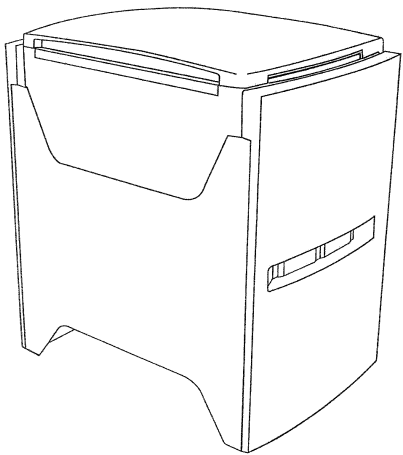

1.1

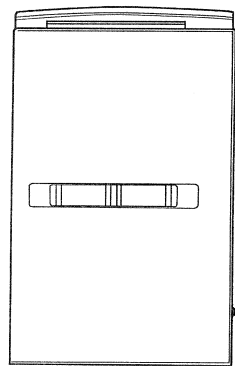

1.2

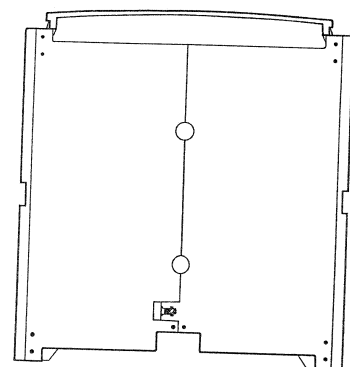

1.3

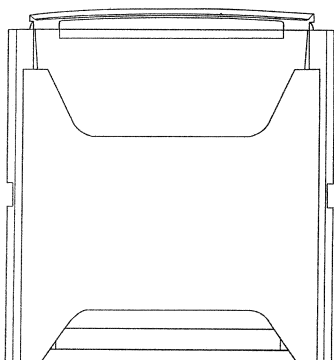

1.4

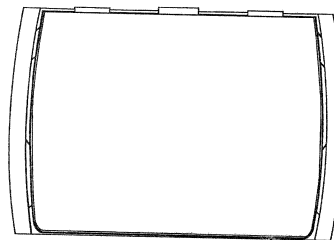

1.5

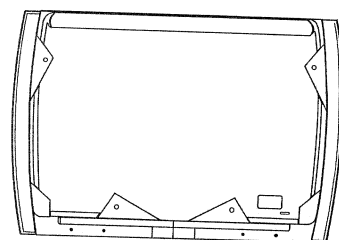

1.6

- (11) **12854**  
(21) 3-2007-01895 (28) 02  
(54) BỘ NHÃN SẢN PHẨM (51) **19-08**  
(22) 28.12.2007 (43) 26.05.2008  
(71) CÔNG TY CỔ PHẦN KIDO (VN)  
Khu công nghiệp Tây Bắc Củ Chi, ấp Cây Sộp, xã Tân An Hội, huyện Củ Chi, TP. Hồ Chí Minh  
(72) Huỳnh Trung Hiếu (VN)  
(74) Văn phòng luật sư Phạm và Liên danh (PHAM & ASSOCIATES)  
(55)



1.1



1.2

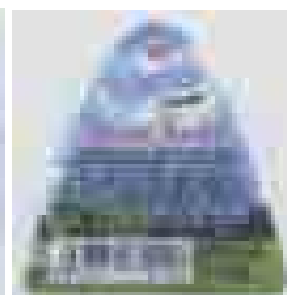

1.3



2.1



2.2



2.3

- (11) **12855**  
(21) 3-2008-00001 (28) 01  
(54) CHAI (51) **09-01**  
(22) 02.01.2008 (43) 26.05.2008  
(30) 2007-019063 12.07.2007 JP  
(71) KIRIN BEVERAGE KABUSHIKI KAISHA (ALSO TRADING AS KIRIN BEVERAGE CORPORATION) (JP)  
1, Kanda Izumi-Cho, Chiyoda-Ku, Tokyo, Japan  
(72) Hidenobu Hata (JP), Yukinobu Saito (JP)  
(74) Văn phòng luật sư Phạm và Liên danh (PHAM & ASSOCIATES)  
(55)



1.1

1.2

1.3

1.4



1.5

1.6

1.7

1.8

1.9



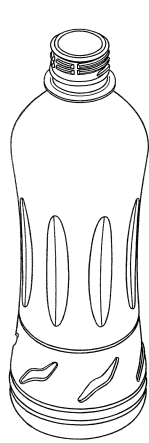

1.10

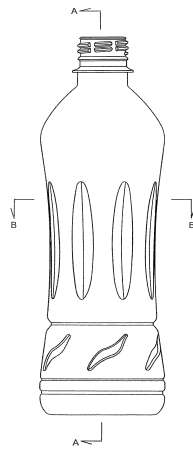

1.11

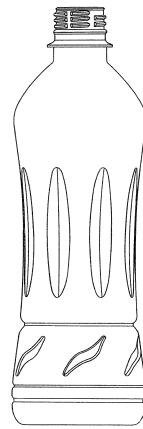

1.12

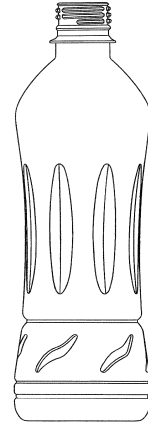

1.13

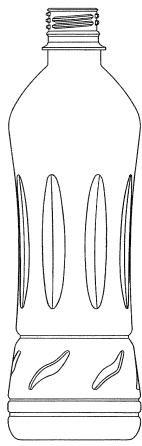

1.14

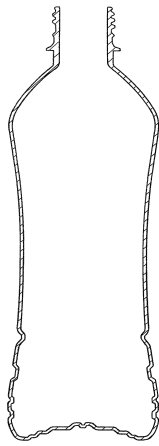

1.15

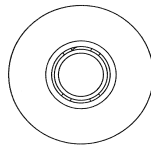

1.16

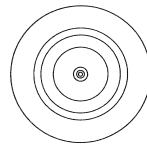

1.17

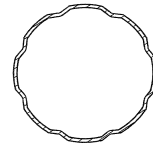

1.18

- (11) **12856**  
(21) 3-2008-00020 (28) 01  
(54) CHAI (51) **09-01**  
(22) 04.01.2008 (43) 26.05.2008  
(71) CÔNG TY CỔ PHẦN SONG HOA (VN)  
10/4 đường số 3, khu phố 4, phường Bình An, quận 2, TP. Hồ Chí Minh  
(72) Nguyễn Thị Đức Hạnh (VN)  
(74) Văn phòng luật sư Phạm và Liên danh (PHAM & ASSOCIATES)  
(55)

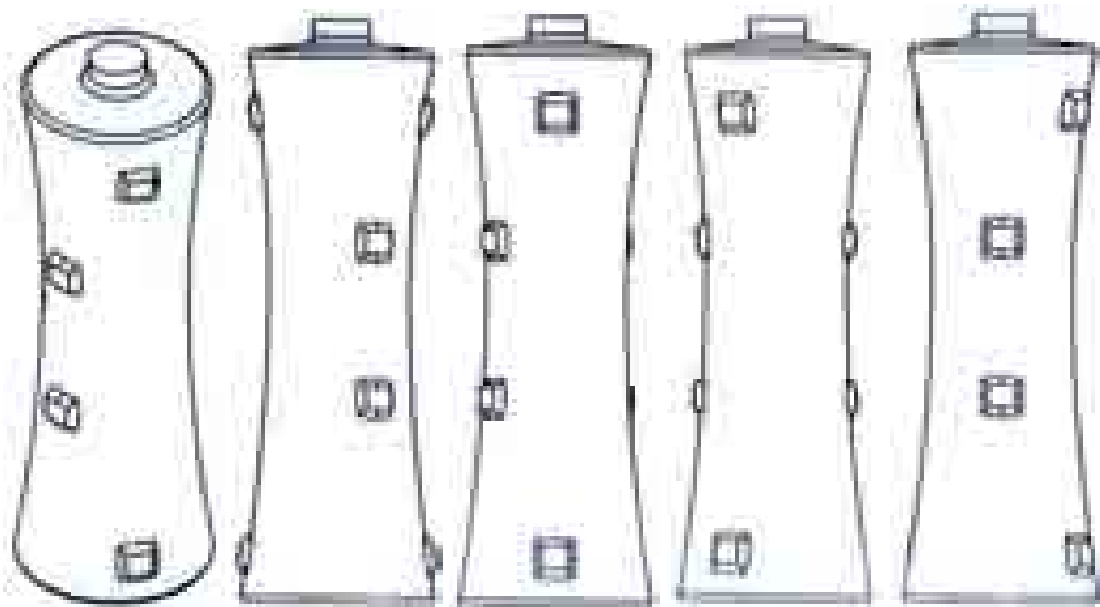

1.1

1.2

1.3

1.4

1.5

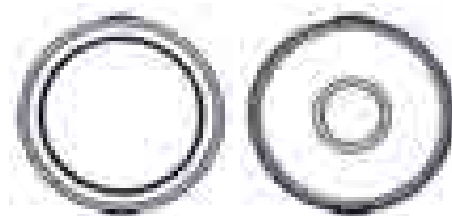

1.6

1.7

- (11) **12857**  
(21) 3-2008-00022 (28) 02  
(54) HỘP (51) **09-03**  
(22) 07.01.2008 (43) 26.05.2008  
(30) 000753157 05.07.2007 EM  
(71) TETRA LAVAL HOLDINGS & FINANCE S.A. (CH)  
Avenue Général-Guisan, 70 - PULLY 1009, Switzerland  
(72) Pietro MARTINI (IT)  
(74) Công ty TNHH Sở hữu trí tuệ Thảo Thọ Quyến (INVENCO)  
(55)

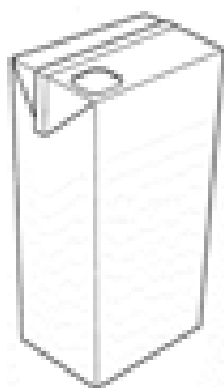

1.1

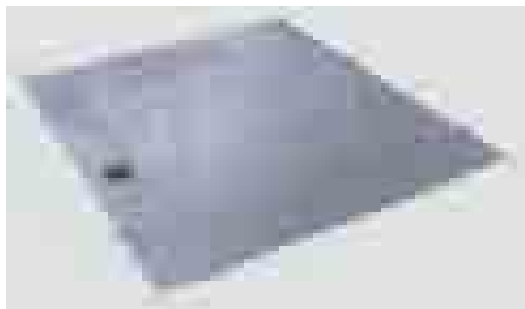

1.2



1.3

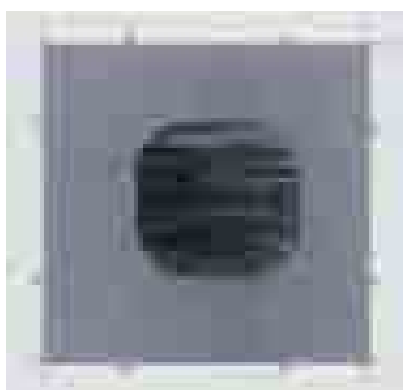

1.4



1.5

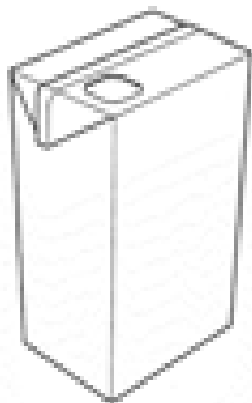

2.1

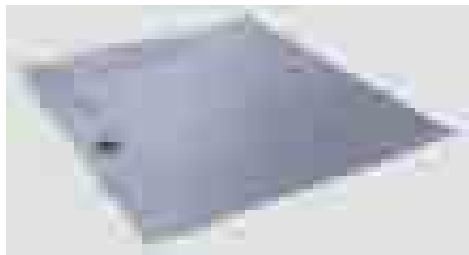

2.2

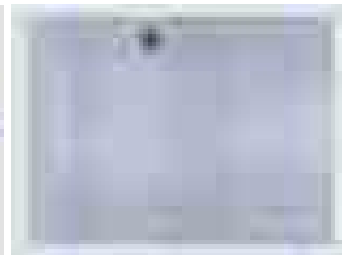

2.3

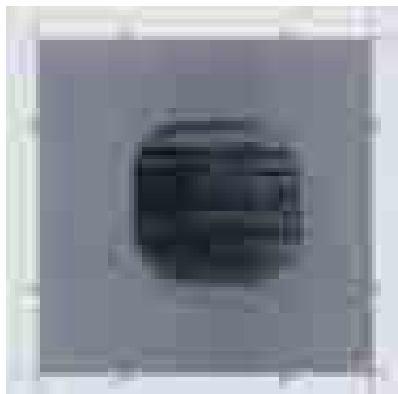

2.4



2.5

- (11) **12858**  
(21) 3-2008-00023 (28) 01  
(54) HỘP (51) **09-03**  
(22) 07.01.2008 (43) 26.05.2008  
(30) 000753157 05.07.2007 EM  
(71) TETRA LAVAL HOLDINGS & FINANCE S.A. (CH)  
Avenue Général-Guisan, 70 - PULLY 1009, Switzerland  
(72) Pietro MARTINI (IT)  
(74) Công ty TNHH Sở hữu trí tuệ Thảo Thọ Quyến (INVENCO)  
(55)

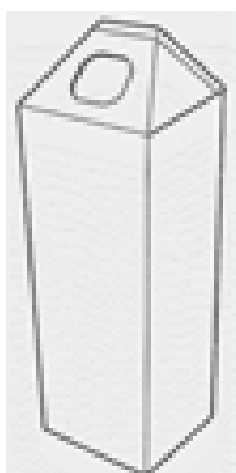

1.1



1.2

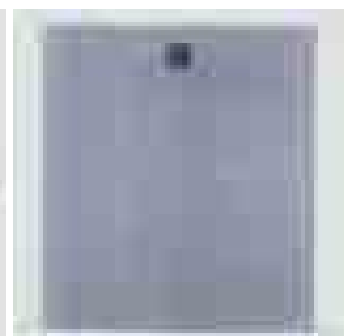

1.3

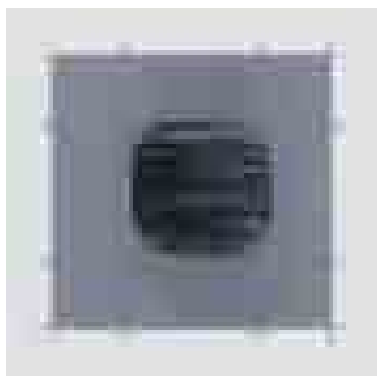

1.4



1.5

- (11) **12859**  
(21) 3-2008-00024 (28) 01  
(54) HỘP (51) **09-03**  
(22) 07.01.2008 (43) 26.05.2008  
(30) 000753157 05.07.2007 EM  
(71) TETRA LAVAL HOLDINGS & FINANCE S.A. (CH)  
Avenue Général-Guisan, 70 - PULLY 1009, Switzerland  
(72) Pietro MARTINI (IT)  
(74) Công ty TNHH Sở hữu trí tuệ Thảo Thọ Quyển (INVENCO)  
(55)

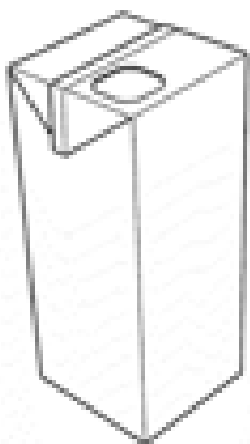

1.1



1.2



1.3



1.4

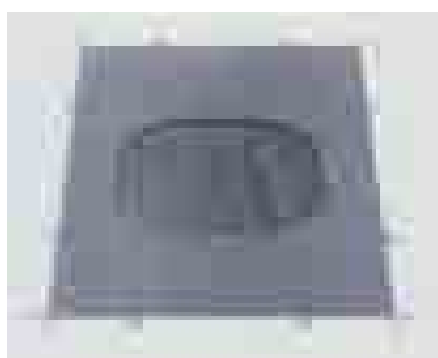

1.5

- (11) **12860**  
(21) 3-2008-00025 (28) 01  
(54) HỘP (51) **09-03**  
(22) 07.01.2008 (43) 26.05.2008  
(30) 000753157 05.07.2007 EM  
(71) TETRA LAVAL HOLDINGS & FINANCE S.A. (CH)  
Avenue Général-Guisan, 70 - PULLY 1009, Switzerland  
(72) Pietro MARTINI (IT)  
(74) Công ty TNHH Sở hữu trí tuệ Thảo Thọ Quyến (INVENCO)  
(55)

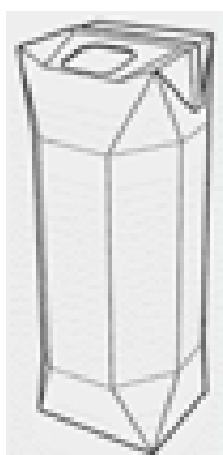

1.1

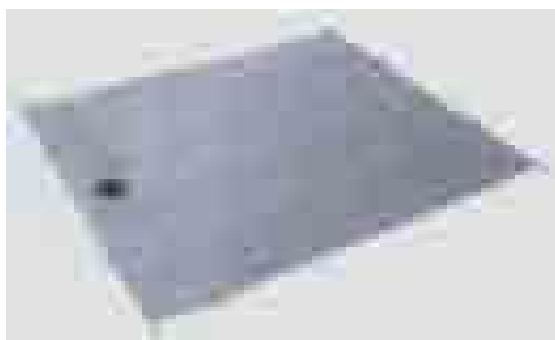

1.2



1.3

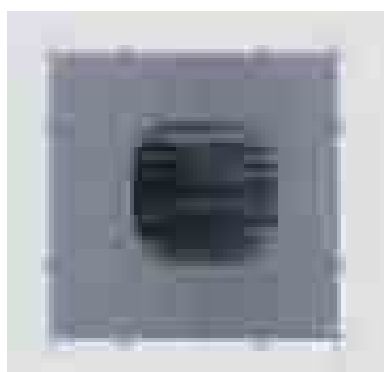

1.4

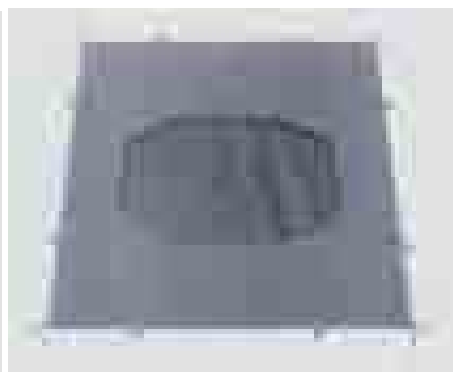

1.5

- (11) **12861**  
(21) 3-2008-00035 (28) 01  
(54) CHAI (51) **09-01**  
(22) 07.01.2008 (43) 26.05.2008  
(71) CÔNG TY TNHH MWAY (VN)  
Số 8, ngõ 470, đường Nguyễn Trãi, phường Thanh Xuân, quận Thanh Xuân, thành phố Hà Nội  
(72) Hoàng Vi Thuý (VN)  
(74) Công ty TNHH Vĩnh Đạt (LACOM CO., LTD.)  
(55)



1.1

1.2

1.3

1.4

1.5



1.6

1.7



- (11) **12862**  
(21) 3-2008-00061 (28) 01  
(54) **ĐỘNG CƠ GẮN NGOÀI TÀU (51) 15-01**  
THUYỀN  
(22) 09.01.2008 (43) 26.05.2008  
(30) 2007-019204 13.07.2007 JP  
(71) YAMAHA HATSUDOKI KABUSHIKI KAISHA (JP)  
2500, Shingai, Iwata-shi, Shizuoka-ken, Japan  
(72) Shinji MIYAKI (JP), Shigeyoshi IWATATE (JP)  
(74) Công ty Cổ phần Sở hữu công nghiệp INVESTIP (INVESTIP)  
(55)

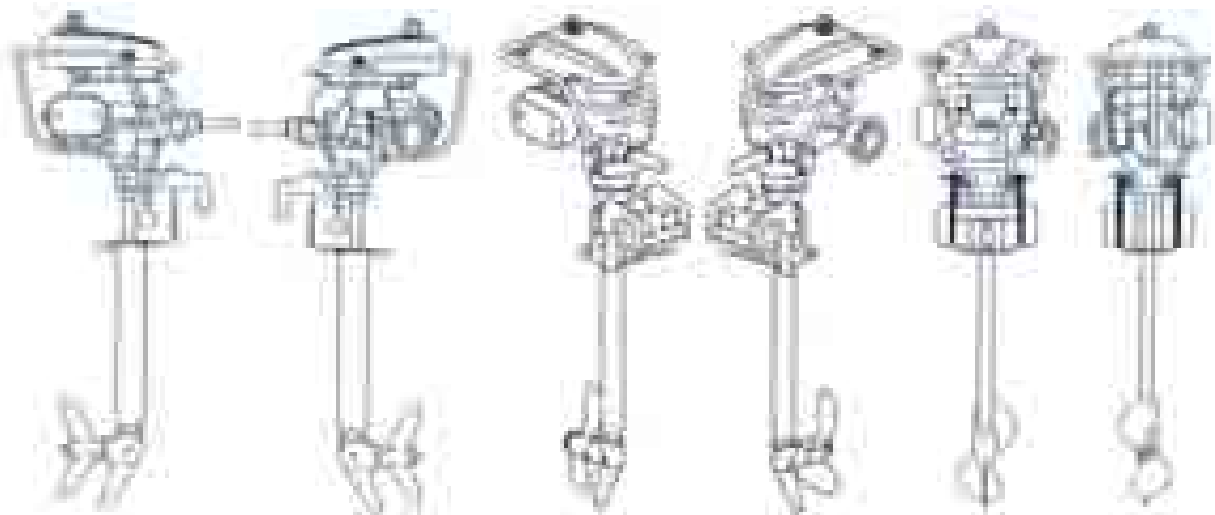

1.1

1.2

1.3

1.4

1.5

1.6

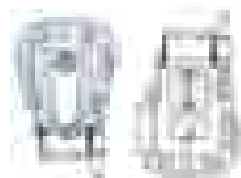

1.7

1.8

- (11) **12863**  
(21) 3-2008-00065 (28) 01  
(54) MÓC TREO ĐỒ CHO XE GẮN (51) **08-07**  
MÁY  
(22) 09.01.2008 (43) 26.05.2008  
(71) DOANH NGHIỆP TƯ NHÂN QUỲNH HIẾU (VN)  
311 Nguyễn Thị Nhỏ, phường 16, quận 11, TP. Hồ Chí Minh  
(72) Lưu Quỳnh (VN)  
(74) Công ty Cổ phần Sở hữu công nghiệp INVESTIP (INVESTIP)  
(55)



1.1



1.2



1.3

1.4

1.5

1.6

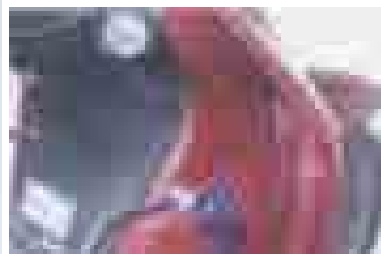

1.7

- (11) **12864**  
(21) 3-2008-00066 (28) 01  
(54) HỘP ĐỤNG BÁNH, KẸO (51) **09-03**  
(22) 10.01.2008 (43) 26.05.2008  
(71) CÔNG TY CỔ PHẦN THƯƠNG MẠI RỒNG VÀNG MINH NGỌC (VN)  
Khu 6, phường Cẩm Thượng, thành phố Hải Dương, tỉnh Hải Dương  
(72) Thái Thị Vân Anh (VN)  
(55)



1.1



1.2

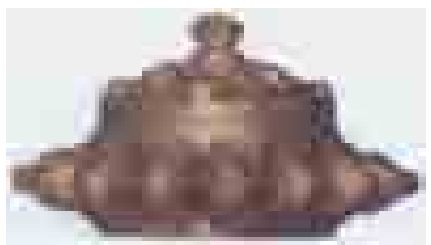

1.3

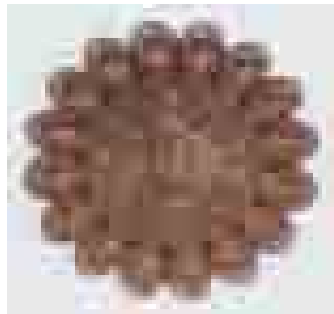

1.4

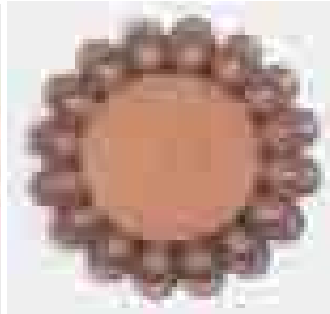

1.5

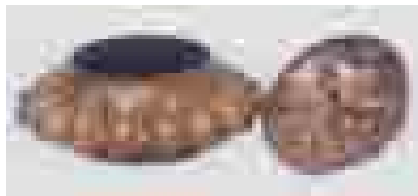

1.6

- (11) **12865**  
(21) 3-2008-00067 (28) 01  
(54) HỘP ĐỤNG THUỐC (51) **09-03**  
(22) 10.01.2008 (43) 26.05.2008  
(71) CÔNG TY TNHH DƯỢC PHẨM U.N.I VIỆT NAM (VN)  
Phòng 1216, toà nhà CT4C-X2, Bắc Linh Đàm, quận Hoàng Mai, thành phố Hà Nội  
(72) Nguyễn Minh Hải (VN)  
(74) Công ty TNHH Sở hữu trí tuệ Bình Minh (SUNRISE IP CO.,LTD.)  
(55)



1.1



1.2

- (11) **12866**  
(21) 3-2008-00072 (28) 01  
(54) MÓC TREO ĐỒ CHO XE GẮN (51) **08-07**  
MÁY  
(22) 10.01.2008 (43) 26.05.2008  
(71) DOANH NGHIỆP TƯ NHÂN QUỲNH HIẾU (VN)  
311 Nguyễn Thị Nhỏ, phường 16, quận 11, TP. Hồ Chí Minh  
(72) Lưu Quỳnh (VN)  
(74) Công ty Cổ phần Sở hữu công nghiệp INVESTIP (INVESTIP)  
(55)



1.1

1.2

1.3

1.4



1.5

1.6

1.7

- (11) **12867**  
(21) 3-2008-00073 (28) 01  
(54) MÓC TREO ĐỒ CHO XE GẮN MÁY (51) **08-07**  
(22) 10.01.2008 (43) 26.05.2008  
(71) DOANH NGHIỆP TƯ NHÂN QUỲNH HIẾU (VN)  
311 Nguyễn Thị Nhỏ, phường 16, quận 11, TP. Hồ Chí Minh  
(72) Lưu Quỳnh (VN)  
(74) Công ty Cổ phần Sở hữu công nghiệp INVESTIP (INVESTIP)  
(55)



1.1

1.2



1.3

1.4

1.5

1.6

1.7

- (11) **12868**  
(21) 3-2008-00076 (28) 01  
(54) HỘP ĐÈN TAXI (51) **20-03**  
(22) 11.01.2008 (43) 26.05.2008  
(71) CÔNG TY CỔ PHẦN TRUYỀN HÌNH CẤP TÂY NGUYÊN (VN)  
198 - Phan Đình Phùng, thị xã Kontum, tỉnh Kontum  
(72) Nguyễn Xuân Thành (VN)  
(74) Công ty TNHH Sở hữu trí tuệ PADEMARK (PADEMARK CO.,LTD.)  
(55)



1.1



1.2



1.3



1.4



1.5



1.6



1.7

- (11) **12869**  
(21) 3-2008-00092 (28) 01  
(54) **NẮP CHE KẸP QUAI** (51) **13-99**  
(22) 14.01.2008 (43) 26.05.2008  
(71) **CÔNG TY CỔ PHẦN PHÁT TRIỂN KỸ THUẬT KỸ NGUYÊN (VN)**  
29 đường số 3, phường 7, quận Gò Vấp, TP. Hồ Chí Minh  
(72) Nguyễn Trọng Hiếu (VN)  
(74) Công ty TNHH Sở hữu trí tuệ WINCO (WINCO CO., LTD.)  
(55)

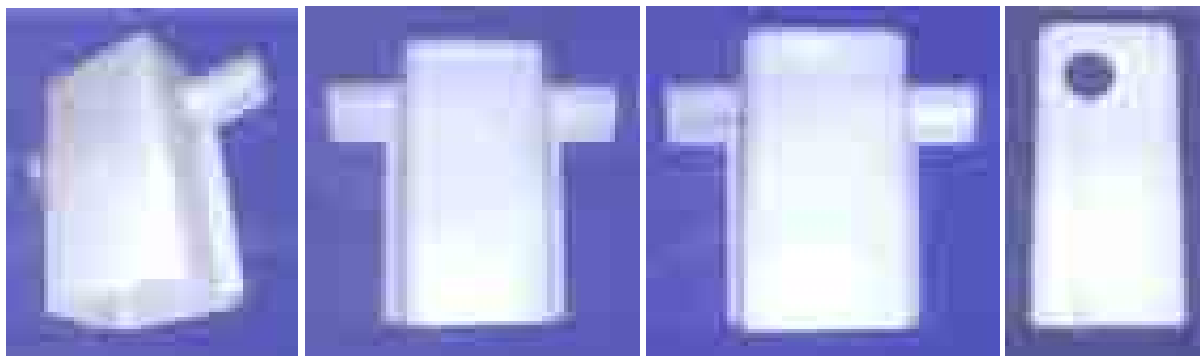

1.1

1.2

1.3

1.4

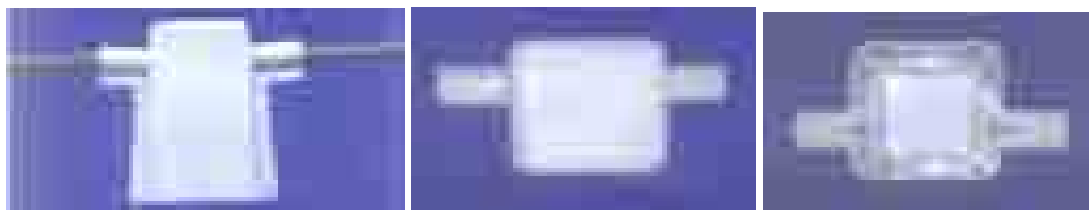

1.5

1.6

1.7



- (11) **12870**  
(21) 3-2008-00103 (28) 01  
(54) BÌNH LỌC NƯỚC (51) **23-01**  
(22) 16.01.2008 (43) 26.05.2008  
(30) 000760764 19.07.2007 EM  
(71) KONINKLIJKE PHILIPS ELECTRONICS N.V. (NL)  
Groenewoudseweg 1, 5621 BA Eindhoven, The Netherlands  
(72) Jamie Craig McCurrach (GB)  
(74) Công ty Cổ phần Sở hữu công nghiệp INVESTIP (INVESTIP)  
(55)

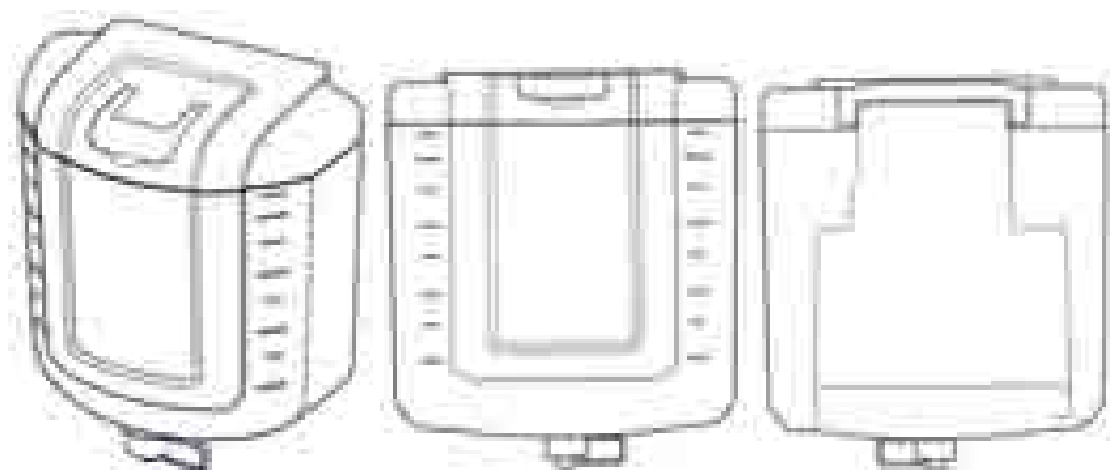

1.1

1.2

1.3

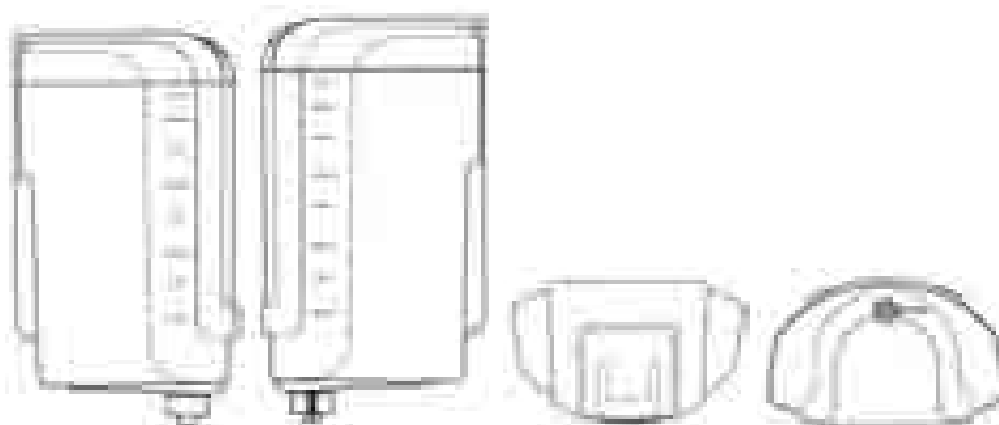

1.4

1.5

1.6

1.7

- (11) **12871**  
(21) 3-2008-00112 (28) 01  
(54) BÀN (51) **06-03**  
(22) 18.01.2008 (43) 26.05.2008  
(71) CÔNG TY TNHH MỘT THÀNH VIÊN THƯƠNG MẠI VIỆT ĐẠI THÀNH (VN)  
393, Xô Viết Nghệ Tĩnh, phường 24, quận Bình Thạnh, TP. Hồ Chí Minh  
(72) Julakid Rattanamastip (TH)  
(55)



1.1



1.2



1.3



1.4



1.5



1.6

- (11) **12872**  
(21) 3-2008-00113  
(54) GHẾ  
(22) 18.01.2008  
(71) CÔNG TY TNHH MỘT THÀNH VIÊN THƯƠNG MẠI VIỆT ĐẠI THÀNH (VN)  
393, Xô Viết Nghệ Tĩnh, phường 24, quận Bình Thạnh, TP. Hồ Chí Minh  
(72) Julakid Rattanmastip (TH)  
(55)
- (28) 01  
(51) **06-01**  
(43) 26.05.2008



1.1



1.2



1.3



1.4



1.5



1.6

- (11) **12873**  
(21) 3-2008-00114 (28) 01  
(54) HỘP ĐUNG MỰC IN (51) **18-02**  
(22) 18.01.2008 (43) 26.05.2008  
(30) 2007-022266 15.08.2007 JP  
(71) SEIKO EPSON CORPORATION (JP)  
4-1, Nishi-Shinjuku 2-chome, Shinjuku-ku, Tokyo 163-0811, Japan  
(72) Izumi NOZAWA (JP)  
(74) Công ty Tư vấn đầu tư và chuyển giao công nghệ (INVESTCONSULT)  
(55)

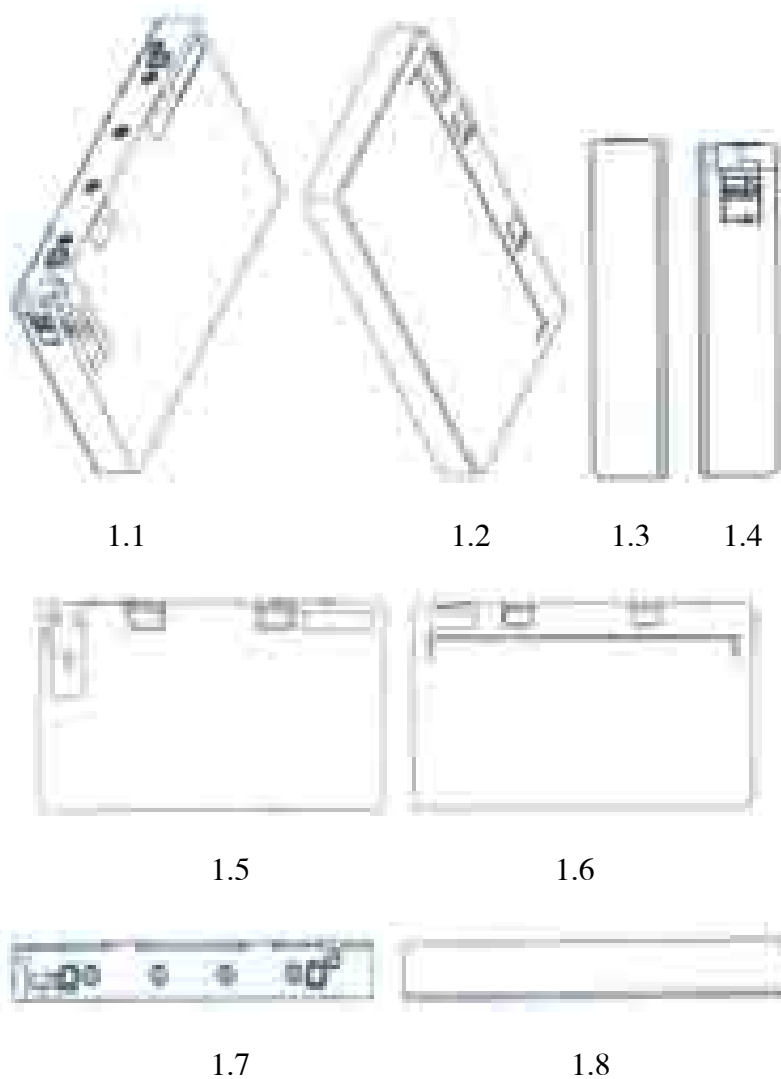

- (11) **12874**  
(21) 3-2008-00117 (28) 01  
(54) CHAI NHỰA (51) **09-01**  
(22) 18.01.2008 (43) 26.05.2008  
(71) CÔNG TY TRÁCH NHIỆM HỮU HẠN NHỰA DUY TÂN (VN)  
298 Hồ Học Lãm, phường An Lạc, quận Bình Tân, TP. Hồ Chí Minh  
(72) Trần Phước An (VN)  
(74) Công ty TNHH Sở hữu trí tuệ Thảo Thọ Quyến (INVENCO)  
(55)



1.1

1.2

1.3



1.4

1.5

- (11) **12875**  
(21) 3-2008-00124 (28) 01  
(54) CHAI (51) **09-01**  
(22) 18.01.2008 (43) 26.05.2008  
(30) 000760749-0001 19.07.2007 EM  
(71) CHIVAS BROTHERS PERNOD RICARD LTD. (GB)  
111 - 113 Renfrew Road, Paisley, PA3 4DY, Scotland  
(72) Simon Adamson (GB)  
(74) Công ty TNHH Tư vấn sở hữu trí tuệ Việt (VIET IP CO.,LTD.)  
(55)



1.1

1.2

1.3



1.4

1.5

- (11) **12876**  
(21) 3-2008-00151 (28) 01  
(54) CÔNG TẮC (51) **13-03**  
(22) 25.01.2008 (43) 26.05.2008  
(30) 2007-020261 26.07.2007 JP  
(71) MATSUSHITA ELECTRIC WORKS, LTD. (JP)  
1048, Oaza Kadoma, Kadoma-shi, OSAKA 571-8686, Japan  
(72) KATSUMI KIKUCHI (JP), ICHIRO SHIBAMURA (JP)  
(74) Công ty Luật TNHH AMBYS Hà Nội (AMBYS HANOI)  
(55)



1.1

1.2

1.3



1.4

1.5

1.6

1.7

- (11) **12877**  
(21) 3-2008-00152 (28) 01  
(54) CÔNG TẮC (51) **13-03**  
(22) 25.01.2008 (43) 26.05.2008  
(30) 2007-020260 26.07.2007 JP  
(71) MATSUSHITA ELECTRIC WORKS, LTD. (JP)  
1048, Oaza Kadoma, Kadoma-shi, OSAKA 571-8686, Japan  
(72) KATSUMI KIKUCHI (JP), ICHIRO SHIBAMURA (JP)  
(74) Công ty Luật TNHH AMBYS Hà Nội (AMBYS HANOI)  
(55)

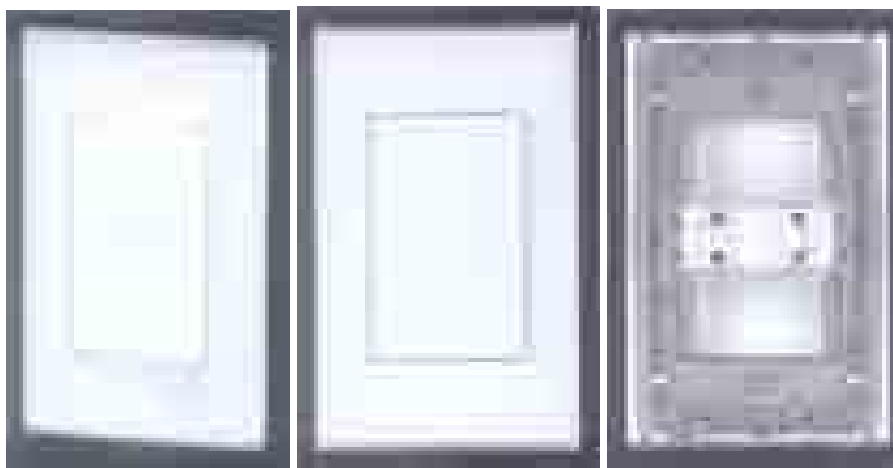

1.1

1.2

1.3

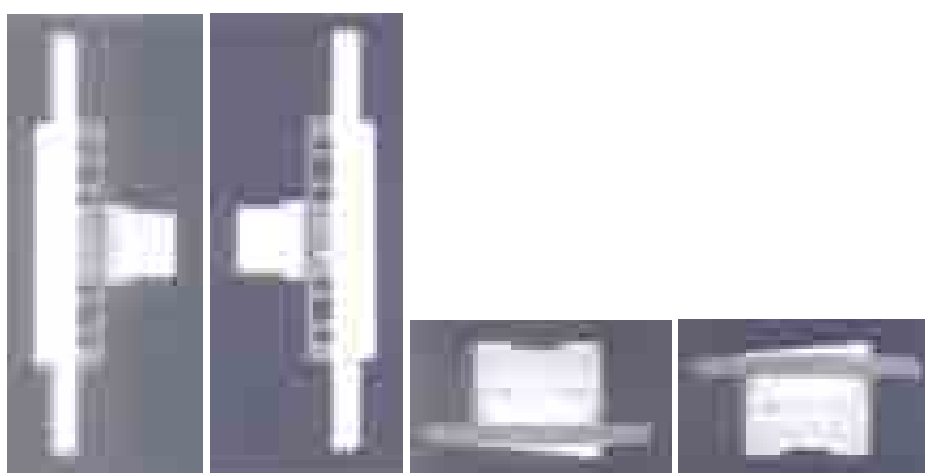

1.4

1.5

1.6

1.7



- (11) **12878**  
(21) 3-2008-00154 (28) 01  
(54) ĐIỀU KHIỂN TỪ XA (51) **14-03**  
(22) 25.01.2008 (43) 26.05.2008  
(71) CÔNG TY TNHH SẢN XUẤT VÀ THƯƠNG MẠI HUNG PHÁT (VN)  
Số 8 lô 13A, đô thị mới Trung Yên, phường Trung Hoà, quận Cầu Giấy, thành phố Hà Nội  
(72) Dương Quốc Tuấn (VN)  
(74) Công ty TNHH Sở hữu trí tuệ WINCO (WINCO CO., LTD.)  
(55)



1.1

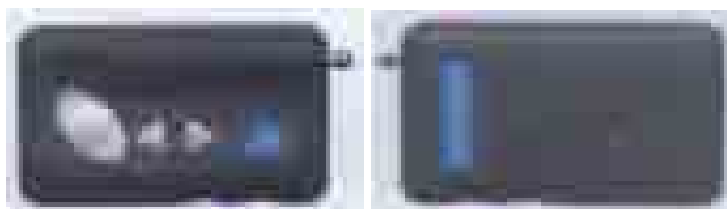

1.2

1.3



1.4

1.5

1.6

1.7

- (11) **12879**  
(21) 3-2008-00173 (28) 01  
(54) HỘP (51) **07-01**  
(22) 28.01.2008 (43) 26.05.2008  
(71) SUPON CHAISATAPORN (TH)  
99/99 Moo7, Sukhapibal 2 Road, Om-Noi, Krathumban, Samut Sakhon 74130, Thailand  
(72) Supon Chaisataporn (TH)  
(74) Công ty TNHH Tâm nhìn và Liên danh (VISION & ASSOCIATES CO.LTD.)  
(55)



1.1

1.2

1.3

1.4

1.5

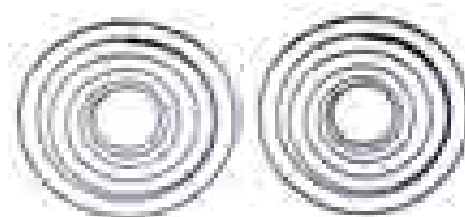

1.6

1.7

- (11) **12880**  
(21) 3-2008-00182 (28) 01  
(54) ĐÁY TÚI ĐỤNG GẬY CHƠI GÔN (51) **09-05**  
(22) 30.01.2008 (43) 26.05.2008  
(30) 29/283986 28.08.2007 US  
(71) KARSTEN MANUFACTURING CORPORATION (US)  
2201 West Desert Cove, Phoenix, Arizona 85029, United States of America  
(72) Douglas W. Anderson (US), Frank A. Quartarone (US)  
(74) Công ty TNHH Sở hữu trí tuệ Vàng (GINTASSET CO., LTD.)  
(55)



1.1



1.2

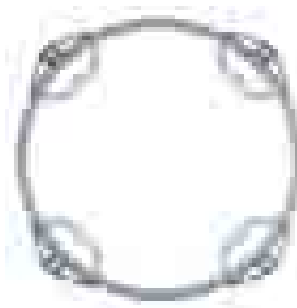

1.3

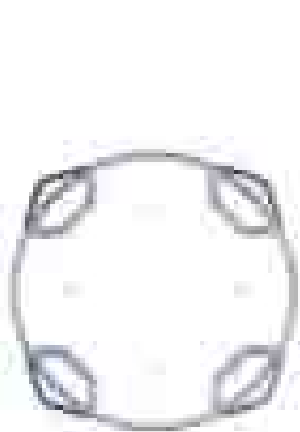

1.4

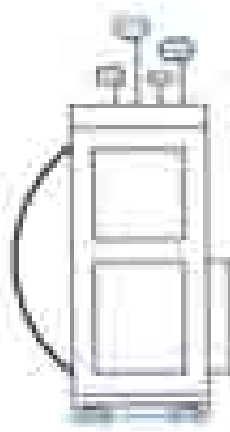

1.5



1.6

- (11) **12881**  
(21) 3-2008-00210 (28) 01  
(54) NHÃN SẢN PHẨM (51) **19-08**  
(22) 01.02.2008 (43) 26.05.2008  
(71) CÔNG TY CỔ PHẦN ĐƯỜNG BIÊN HOÀ (VN)  
Khu công nghiệp Biên Hòa 1, phường An Bình, thành phố Biên Hòa, tỉnh Đồng Nai  
(72) Lê Công Tạo (VN)  
(74) Công ty TNHH Luật Gia Phạm (PHAM JURIST CO.,LTD.)  
(55)



- (11) **12882**  
(21) 3-2008-00211 (28) 01  
(54) NHÃN SẢN PHẨM (51) **19-08**  
(22) 01.02.2008 (43) 26.05.2008  
(71) CÔNG TY CỔ PHẦN ĐƯỜNG BIÊN HOÀ (VN)  
Khu công nghiệp Biên Hòa 1, phường An Bình, thành phố Biên Hòa, tỉnh Đồng Nai  
(72) Lê Công Tạo (VN)  
(74) Công ty TNHH Luật Gia Phạm (PHAM JURIST CO.,LTD.)  
(55)



- (11) **12883**  
(21) 3-2008-00213 (28) 01  
(54) TAY CẦM XE MÁY (51) **12-16**  
(22) 01.02.2008 (43) 26.05.2008  
(71) CƠ SỞ NHẬT TIẾN (VN)  
D19/19C/23/19 Phan Anh, phường Bình Trị Đông, quận Bình Tân, TP. Hồ Chí Minh  
(72) Nguyễn Hùng Phú (VN)  
(74) DNTN Dịch vụ thương mại và sở hữu công nghiệp Song Ngọc (I.P.T.S.)  
(55)



1.1



1.2

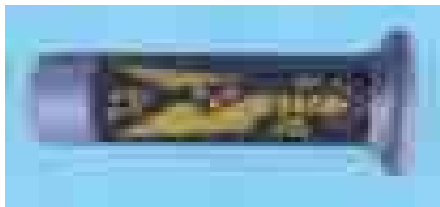

1.3

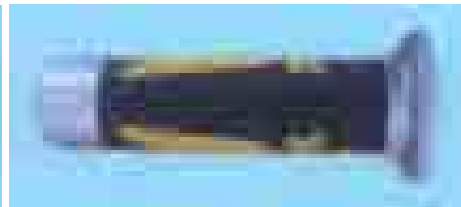

1.4



1.5

1.6

- (11) **12884**  
(21) 3-2008-00229 (28) 01  
(54) RỔ QUAY RAU (51) **07-07**  
(22) 12.02.2008 (43) 26.05.2008  
(71) CÔNG TY TRÁCH NHIỆM HỮU HẠN NHỰA DUY TÂN (VN)  
298 Hồ Học Lãm, phường An Lạc, quận Bình Tân, TP. Hồ Chí Minh  
(72) Trần Phước An (VN)  
(74) Công ty TNHH Sở hữu trí tuệ Thảo Thọ Quyến (INVENCO)  
(55)



1.1

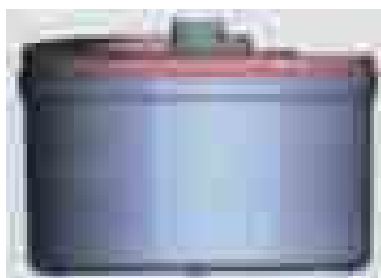

1.2

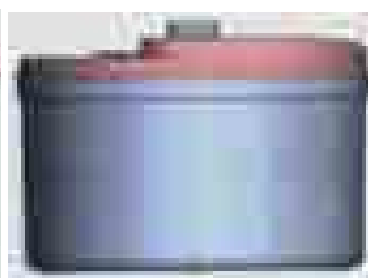

1.3

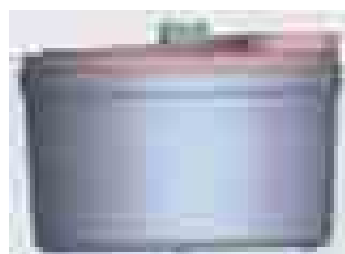

1.4

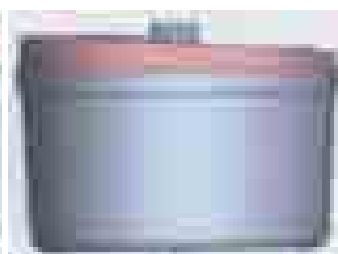

1.5



1.6

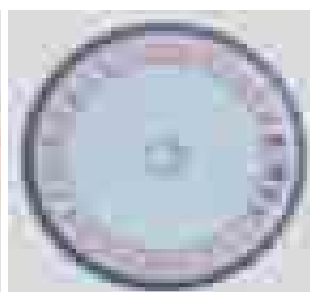

1.7

- (11) **12885**  
(21) 3-2008-00231 (28) 01  
(54) TẮM ỐP KHUNG CHÍNH DỪNG (51) **12-16**  
CHO XE MÁY  
(22) 12.02.2008 (43) 26.05.2008  
(30) 2007-021598 08.08.2007 JP  
(71) HONDA MOTOR CO., LTD. (JP)  
1-1, Minami-Aoyama 2-chome, Minato-ku, Tokyo, Japan  
(72) Witoon Rerksiriwan (TH), Yutapong Damroong (TH)  
(74) Văn phòng luật sư Phạm và Liên danh (PHAM & ASSOCIATES)  
(55)

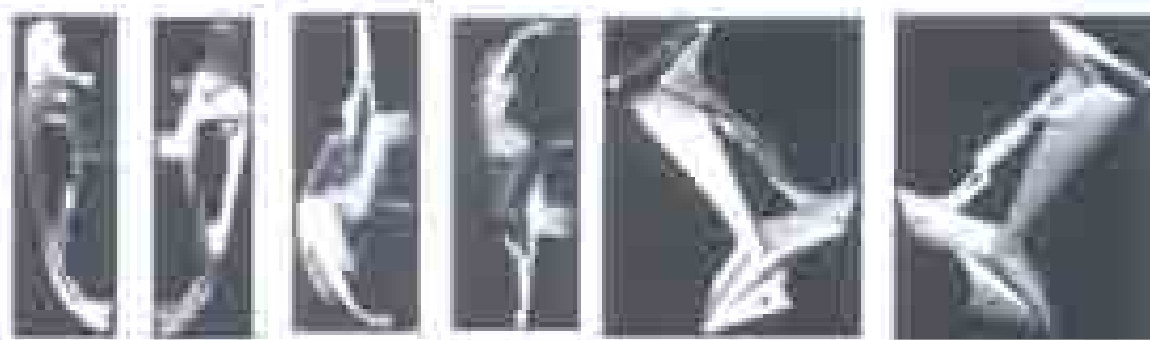

1.1

1.2

1.3

1.4

1.5

1.6

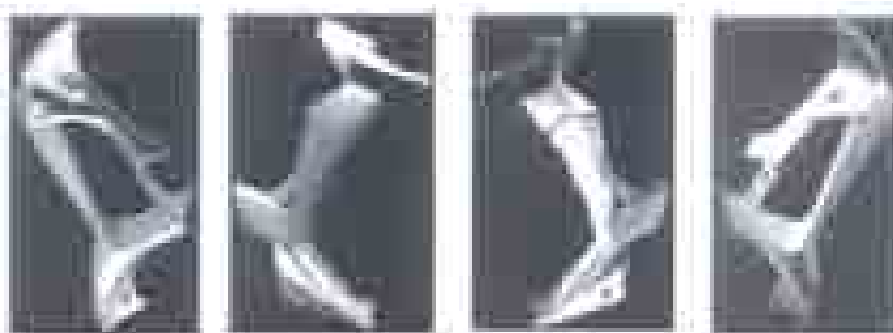

1.7

1.8

1.9

1.10





1.11

- (11) **12886**  
(21) 3-2008-00239 (28) 01  
(54) NHÃN SẢN PHẨM (51) **19-08**  
(22) 14.02.2008 (43) 26.05.2008  
(71) CÔNG TY CỔ PHẦN SƠN E.X.P.O.S.Y (VN)  
Thôn An Cường, xã Hiệp Sơn, huyện Kinh Môn, tỉnh Hải Dương  
(72) Nguyễn Văn Quyết (VN)  
(74) Công ty TNHH Sở hữu trí tuệ HA VIP (HAVIP CO., LTD.)  
(55)



- (11) **12887**  
(21) 3-2008-00246 (28) 01  
(54) XE SCUTƠ (51) **12-11**  
(22) 15.02.2008 (43) 26.05.2008  
(30) 2007-022250 15.08.2007 JP  
(71) HONDA MOTOR CO., LTD. (JP)  
1-1, Minami-Aoyama 2-chome, Minato-ku, Tokyo, Japan  
(72) Kiyoshi Katagiri (JP), Fujio Nakamura (JP)  
(74) Văn phòng luật sư Phạm và Liên danh (PHAM & ASSOCIATES)  
(55)



1.1

1.2

1.3



1.4

1.5

1.6

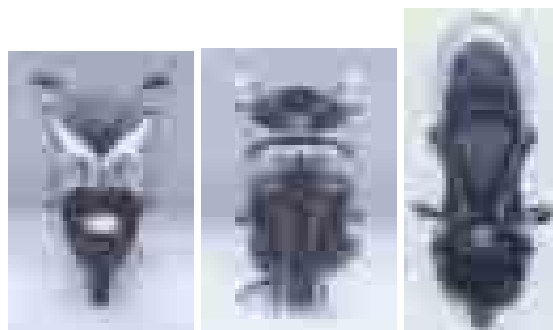

1.7

1.8

1.9

- (11) **12888**  
(21) 3-2008-00248 (28) 01  
(54) ĐÈN PHA DÙNG CHO XE SCUTƠ (51) **26-06**  
(22) 15.02.2008 (43) 26.05.2008  
(30) 2007-022253 15.08.2007 JP  
(71) HONDA MOTOR CO., LTD. (JP)  
1-1, Minami-Aoyama 2-chome, Minato-ku, Tokyo, Japan  
(72) Mamoru Ito (JP), Satoshi Kawawa (JP), Fujio Nakamura (JP)  
(74) Văn phòng luật sư Phạm và Liên danh (PHAM & ASSOCIATES)  
(55)



1.1

1.2

1.3

1.4



1.5

1.6

1.7

1.8



1.9

- (11) **12889**  
(21) 3-2008-00257 (28) 01  
(54) MÁY SẤY KHÔ TAY (51) **28-03**  
(22) 19.02.2008 (43) 26.05.2008  
(30) 2007-022467 20.08.2007 JP  
(71) MITSUBISHI ELECTRIC CORPORATION (JP)  
7-3, Marunouchi 2-Chome, Chiyoda-Ku, Tokyo, 100-8310 Japan  
(72) Hiroyuki KATO (JP), Kei KASUGA (JP)  
(74) Công ty Cổ phần Sở hữu công nghiệp INVESTIP (INVESTIP)  
(55)

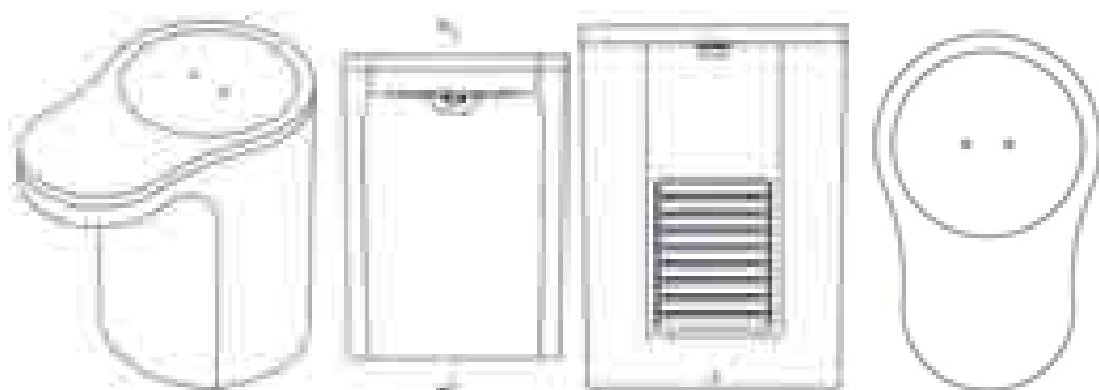

1.1

1.2

1.3

1.4

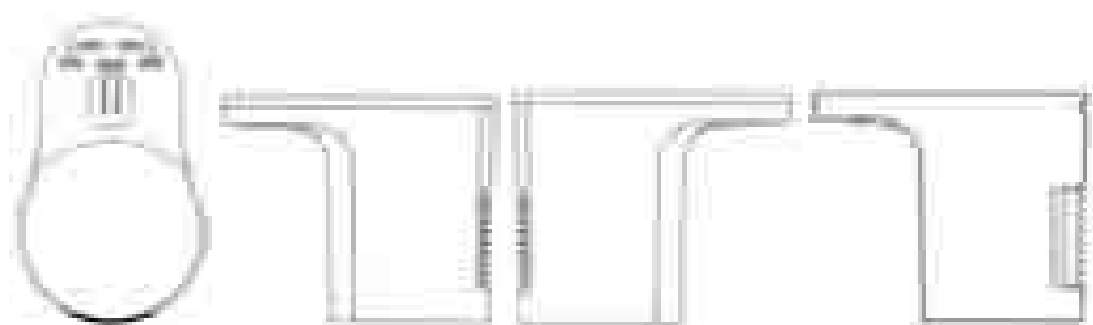

1.5

1.6

1.7

1.8

- (11) **12890**  
(21) 3-2008-00261 (28) 01  
(54) NHÃN SẢN PHẨM (51) **19-08**  
(22) 19.02.2008 (43) 26.05.2008  
(71) CÔNG TY CỔ PHẦN RƯỢU BÌNH TÂY (VN)  
621 Phạm Văn Chí, phường 7, quận 6, TP. Hồ Chí Minh  
(72) Phan Tâm Tình (VN)  
(74) Công ty TNHH Sở hữu trí tuệ Thảo Thọ Quyến (INVENCO)  
(55)



1.1



1.2

- (11) **12891**  
(21) 3-2008-00265 (28) 01  
(54) CHAI (51) **09-01**  
(22) 20.02.2008 (43) 26.05.2008  
(71) CÔNG TY TNHH NƯỚC GIẢI KHÁT VIỆT MỸ (VN)  
85 Trường Sơn, phường 2, quận Tân Bình, TP. Hồ Chí Minh  
(72) Trần Ngọc Lâm (VN)  
(74) Công ty TNHH Sở hữu trí tuệ WINCO (WINCO CO., LTD.)  
(55)



1.1

1.2

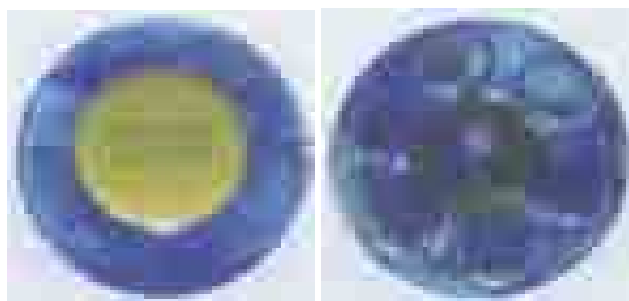

1.3

1.4

- (11) **12892**  
(21) 3-2008-00274 (28) 01  
(54) XE Ô TÔ (51) **12-08**  
(22) 21.02.2008 (43) 26.05.2008  
(30) 2007-022615 22.08.2007 JP  
(71) HONDA MOTOR CO., LTD. (JP)  
1-1, Minami-Aoyama 2-chome, Minato-ku, Tokyo, Japan  
(72) Toshiyuki Okumoto (JP), Tsutomu Fujita (JP)  
(74) Văn phòng luật sư Phạm và Liên danh (PHAM & ASSOCIATES)  
(55)



1.1



1.2



1.3



1.4



1.5

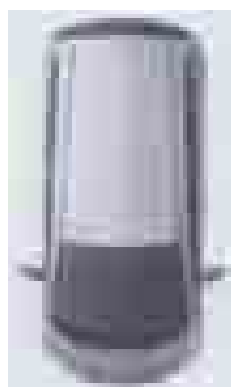

1.6



1.7



1.8



- (11) **12893**  
(21) 3-2008-00275 (28) 01  
(54) CỤM ĐÈN TRƯỚC DÙNG CHO XE (51) **26-06**  
Ô TÔ  
(22) 21.02.2008 (43) 26.05.2008  
(30) 2007-022681 22.08.2007 JP  
(71) HONDA MOTOR CO., LTD. (JP)  
1-1, Minami-Aoyama 2-chome, Minato-ku, Tokyo, Japan  
(72) Toshiyuki Okumoto (JP)  
(74) Văn phòng luật sư Phạm và Liên danh (PHAM & ASSOCIATES)  
(55)



1.1

1.2

1.3



1.4

1.5

1.6



1.7

1.8

1.9

- (11) **12894**  
(21) 3-2008-00276 (28) 01  
(54) CỤM ĐÈN SAU DÙNG CHO XE Ô TÔ (51) **26-06**  
TÔ  
(22) 21.02.2008 (43) 26.05.2008  
(30) 2007-022682 22.08.2007 JP  
(71) HONDA MOTOR CO., LTD. (JP)  
1-1, Minami-Aoyama 2-chome, Minato-ku, Tokyo, Japan  
(72) Yuji Terui (JP)  
(74) Văn phòng luật sư Phạm và Liên danh (PHAM & ASSOCIATES)  
(55)



1.1

1.2

1.3

1.4

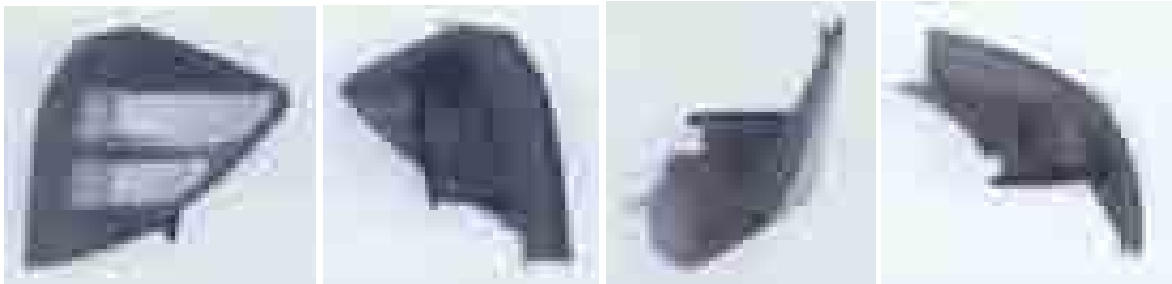

1.5

1.6

1.7

1.8



1.9

- (11) **12895**  
(21) 3-2008-00277 (28) 01  
(54) CỤM ĐÈN SAU DÙNG CHO XE Ô TÔ (51) **26-06**  
TÔ  
(22) 21.02.2008 (43) 26.05.2008  
(30) 2007-022683 22.08.2007 JP  
(71) HONDA MOTOR CO., LTD. (JP)  
1-1, Minami-Aoyama 2-chome, Minato-ku, Tokyo, Japan  
(72) Yuji Terui (JP)  
(74) Văn phòng luật sư Phạm và Liên danh (PHAM & ASSOCIATES)  
(55)

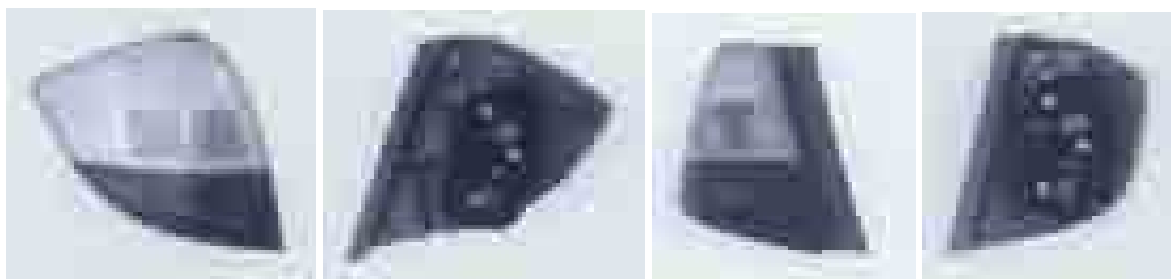

1.1

1.2

1.3

1.4

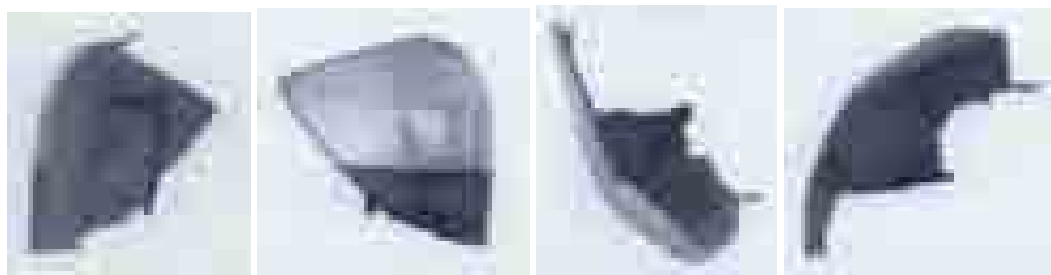

1.5

1.6

1.7

1.8



1.9

- (11) **12896**  
(21) 3-2008-00279 (28) 01  
(54) HỘP (51) **09-03**  
(22) 22.02.2008 (43) 26.05.2008  
(71) CÔNG TY TNHH THƯƠNG MẠI VÀ SẢN XUẤT KÍNH NGHỆ THUẬT (VN)  
Số 84 Phạm Ngọc Thạch, phường 6, quận 3, TP. Hồ Chí Minh  
(72) Bùi Chí Công (VN)  
(74) Công ty Luật Hợp danh Tư vấn Dương Đông I.C (INDOCHINE COUNSEL)  
(55)



1.1

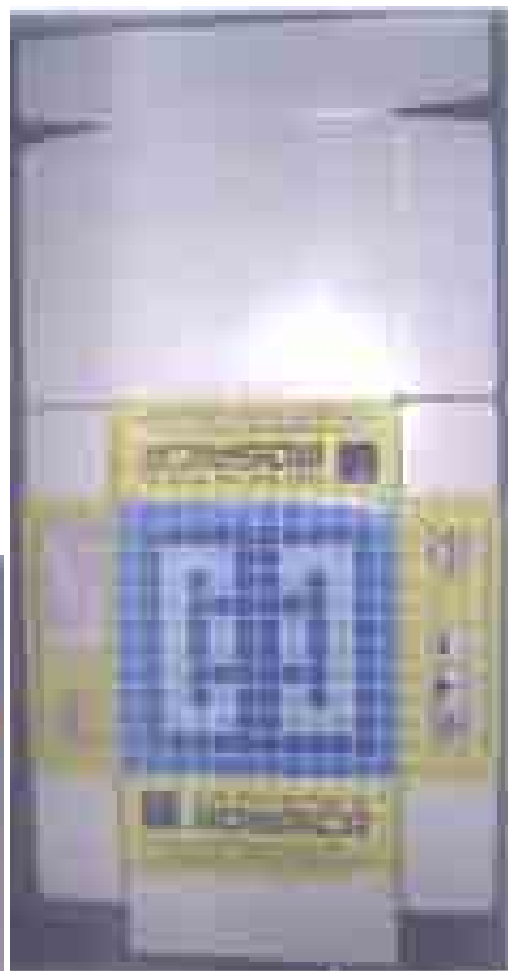

1.2

- (11) **12897**  
(21) 3-2008-00283 (28) 01  
(54) TỦ LẠNH (51) **15-07**  
(22) 22.02.2008 (43) 26.05.2008  
(30) 2007-026044 26.09.2007 JP  
(71) HAIER SANYO ELECTRIC CO., LTD. (JP)  
5-4, Takanawa, 1-chome, Minato-ku, Tokyo, Japan  
(72) Naoyuki FUKUDA (JP), Hidehiko SATOU (JP), Nobuhiko HOSHINO (JP)  
(74) Công ty TNHH Quốc tế D & N (D&N INTERNATIONAL CO.,LTD.)  
(55)

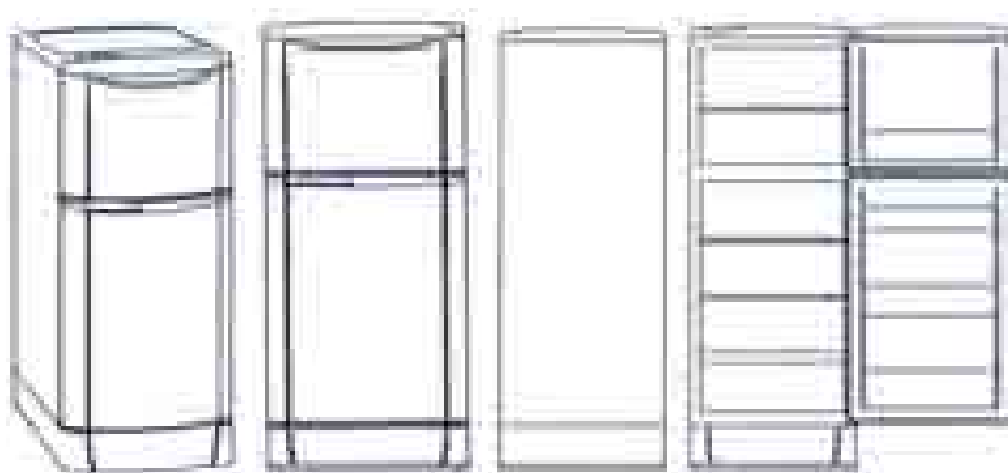

1.1

1.2

1.3

1.4



1.5

1.6

1.7

1.8

- (11) **12898**  
(21) 3-2008-00284 (28) 01  
(54) NHÃN SẢN PHẨM TRÀ BÍ ĐAO (51) **19-08**, 09-03  
(22) 25.02.2008 (43) 26.05.2008  
(71) CÔNG TY TRÁCH NHIỆM HỮU HẠN SẢN XUẤT - THƯƠNG MẠI HUỲNH VĨNH ĐỨC (VN)  
Lô số 09E, khu công nghiệp Tân Tạo, đường C, phường Tân Tạo A, quận Bình Tân, TP. Hồ Chí Minh  
(72) Huỳnh Vĩnh Đức (VN)  
(74) Công ty TNHH một thành viên Trường Luật (CÔNG TY TRUONG LUAT)  
(55)



1.1

1.2



1.3

- (11) **12899**  
(21) 3-2008-00286 (28) 01  
(54) CHAI NHỰA (51) **09-01**  
(22) 25.02.2008 (43) 26.05.2008  
(71) CÔNG TY TRÁCH NHIỆM HỮU HẠN SẢN XUẤT THƯƠNG MẠI ĐẠI VIỆT  
HƯƠNG (VN)  
111 Nguyễn Trãi, phường Bến Thành, quận 1, TP. Hồ Chí Minh  
(72) Ngô Trung Quân (VN)  
(74) Công ty TNHH Sở hữu trí tuệ Thảo Thọ Quyến (INVENCO)  
(55)



1.1

1.2

1.3

1.4

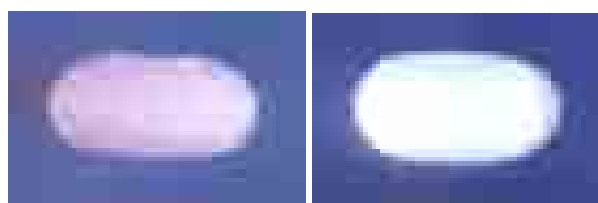

1.5

1.6

- (11) **12900**  
(21) 3-2008-00287 (28) 01  
(54) HỘP ĐUNG THỰC PHẨM (51) **09-03**  
(22) 25.02.2008 (43) 26.05.2008  
(30) 30-2007-0041403 05.10.2007 KR  
(71) KOREA ALPHALINE CO., LTD. (KR)  
435-5 Dunchon-dong, Kangdong-ku, Seoul 134-060 Republic of Korea  
(72) Wang, Soo Chang (KR)  
(74) Công ty TNHH INVESTPRO và cộng sự (INVESTPRO & ASSOCIATES)  
(55)



1.1

1.2

1.3

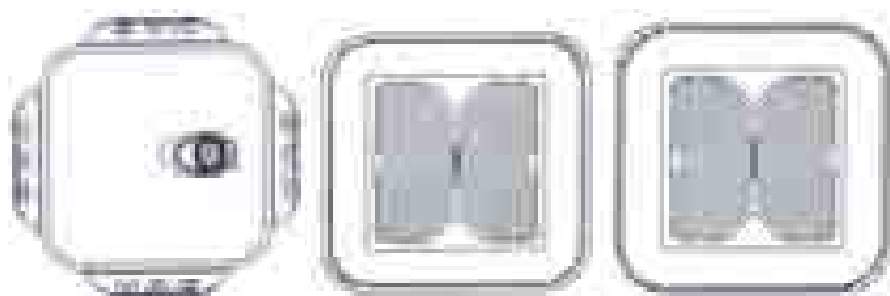

1.4

1.5

1.6

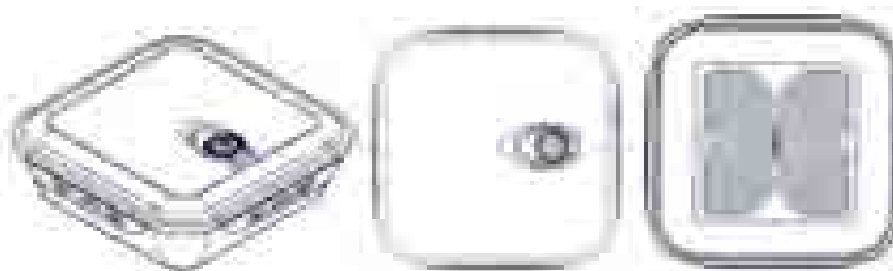

1.7

1.8

1.9





1.10

1.11

1.12

1.13



1.14

1.15

1.16

1.17



1.18

1.19

1.20



1.21

1.22

1.23

CÔNG BÁO SỞ HỮU CÔNG NGHIỆP SỐ 242 TẬP A (05.2008)

---

- (11) **12901**  
(21) 3-2008-00288 (28) 01  
(54) HỘP ĐUNG THỰC PHẨM (51) **09-03**  
(22) 25.02.2008 (43) 26.05.2008  
(30) 30-2007-0040245 21.09.2007 KR  
(71) KOREA ALPHALINE CO., LTD. (KR)  
435-5 Dunchon-dong, Kangdong-ku, Seoul 134-060 Republic of Korea  
(72) Wang, Soo Chang (KR)  
(74) Công ty TNHH INVESTPRO và cộng sự (INVESTPRO & ASSOCIATES)  
(55)

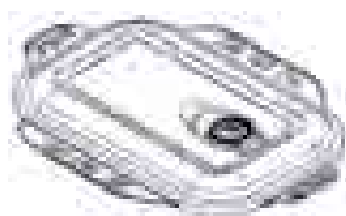

1.1

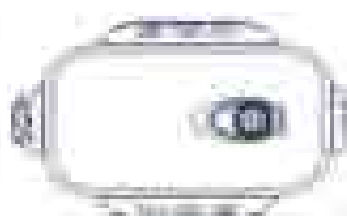

1.2



1.3



1.4



1.5

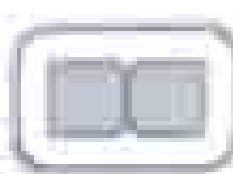

1.6

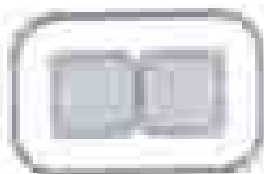

1.7



1.8



1.9



1.10



1.11



1.12

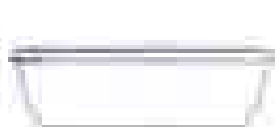

1.13



1.14



1.15



1.16

1.17

1.18

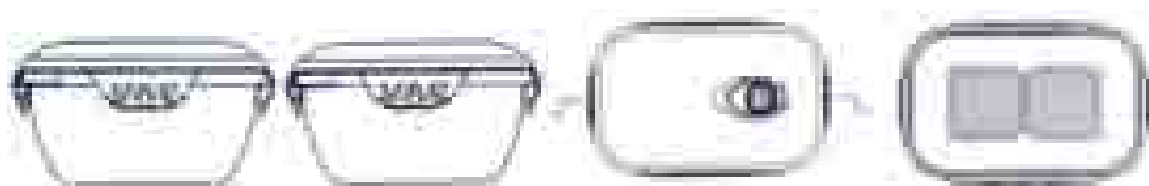

1.19

1.20

1.21

1.22



1.23

- (11) **12902**  
(21) 3-2008-00289 (28) 01  
(54) **HỘP ĐỰNG** (51) **09-03**  
(22) 25.02.2008 (43) 26.05.2008  
(30) 4004112 24.08.2007 GB  
(71) UNILEVER N.V. (NL)  
Weena 455, 3013 AL Rotterdam, Netherlands  
(72) Paolo PININFARINA (IT)  
(74) Công ty TNHH Trần Hữu Nam và Đồng sự (TRAN H.N & ASS.)  
(55)

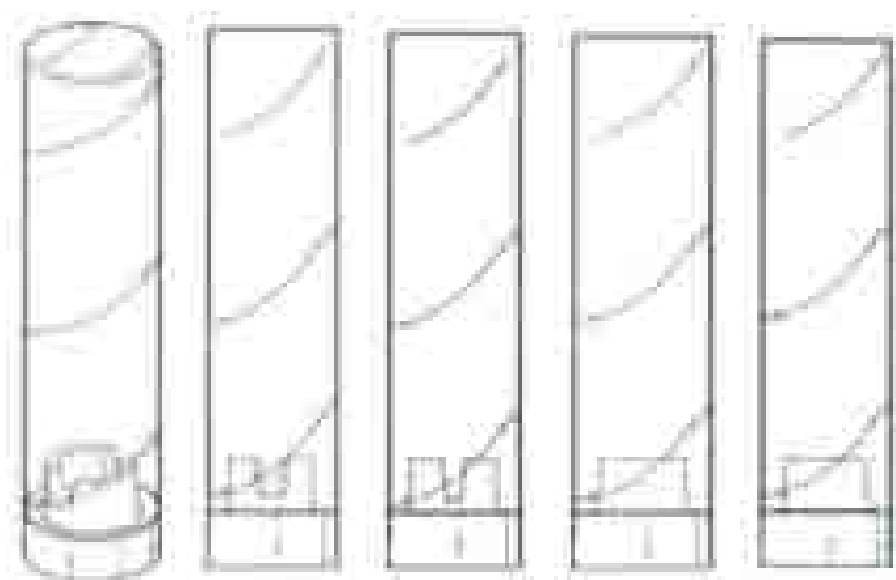

1.1

1.2

1.3

1.4

1.5

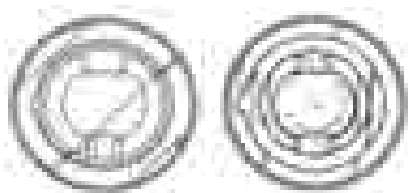

1.6

1.7

- (11) **12903**  
(21) 3-2008-00292 (28) 01  
(54) MẶT BÀN (51) **06-03**  
(22) 26.02.2008 (43) 26.05.2008  
(71) CÔNG TY TNHH SẢN XUẤT THƯƠNG MẠI CƠ KHÍ NAM TOÀN CẦU (VN)  
264A Lê Hồng Phong, phường 4, quận 5, TP. Hồ Chí Minh  
(72) Trương Minh Tuấn (VN)  
(74) Công ty TNHH Sở hữu trí tuệ WINCO (WINCO CO., LTD.)  
(55)



1.1

1.2



1.3

1.4

- (11) **12904**  
(21) 3-2008-00293 (28) 01  
(54) BÀN (51) **06-03**  
(22) 27.02.2008 (43) 26.05.2008  
(71) CÔNG TY CỔ PHẦN CAO SU SÀI GÒN - KYMDAN (VN)  
28 Bình Thới, phường 14, quận 11, TP. Hồ Chí Minh  
(72) Nguyễn Hữu Trí (VN)  
(74) Công ty TNHH Sở hữu trí tuệ Thảo Thọ Quyển (INVENCO)  
(55)



1.1

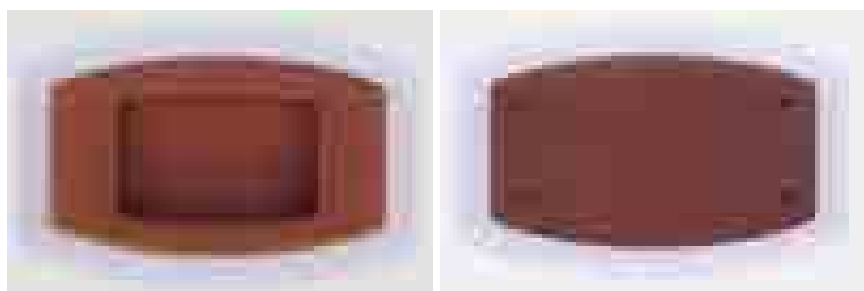

1.2

1.3



1.4

1.5

- (11) **12905**  
(21) 3-2008-00295 (28) 01  
(54) BAO GÓI SẢN PHẨM (51) **09-05**  
(22) 28.02.2008 (43) 26.05.2008  
(30) 2007-026815 31.08.2007 JP  
(71) GUNZE LIMITED (JP)  
1, Zeze, Aono-cho, Ayabe-shi, Kyoto 623-8511 Japan  
(72) Tatsuya Ban (JP), Aya Sacki (JP)  
(74) Văn phòng luật sư Phạm và Liên danh (PHAM & ASSOCIATES)  
(55)



1.1

1.2

1.3



1.4

1.5

1.6

1.7



1.8

1.9

- (11) **12906**  
(21) 3-2008-00296 (28) 01  
(54) LỌ ĐỰNG THUỐC (51) **09-01**  
(22) 28.02.2008 (43) 26.05.2008  
(71) OTSUKA PHARMACEUTICAL CO., LTD. (JP)  
2-9, Kanda-Tsukasamachi, Chiyoda-ku, Tokyo 101-8535, Japan  
(72) Takashi Fujimoto (JP), Shun-ichiro Sumida (JP)  
(74) Văn phòng luật sư Phạm và Liên danh (PHAM & ASSOCIATES)  
(55)

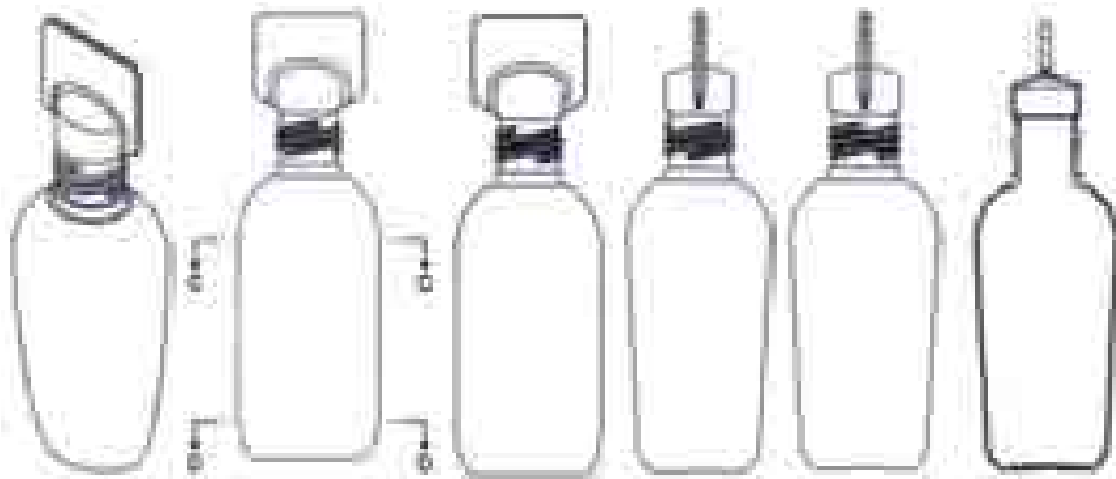

1.1

1.2

1.3

1.4

1.5

1.6



1.7

1.8

1.9

1.10

1.11

1.12



- (11) **12907**  
(21) 3-2008-00298 (28) 01  
(54) **LỌ ĐỰNG THUỐC** (51) **09-01**  
(22) 28.02.2008 (43) 26.05.2008  
(71) OTSUKA PHARMACEUTICAL CO., LTD. (JP)  
2-9, Kanda-Tsukasamachi, Chiyoda-ku, Tokyo 101-8535, Japan  
(72) Takashi Fujimoto (JP), Shun-ichiro Sumida (JP)  
(74) Văn phòng luật sư Phạm và Liên danh (PHAM & ASSOCIATES)  
(55)



1.1 1.2 1.3 1.4 1.5 1.6

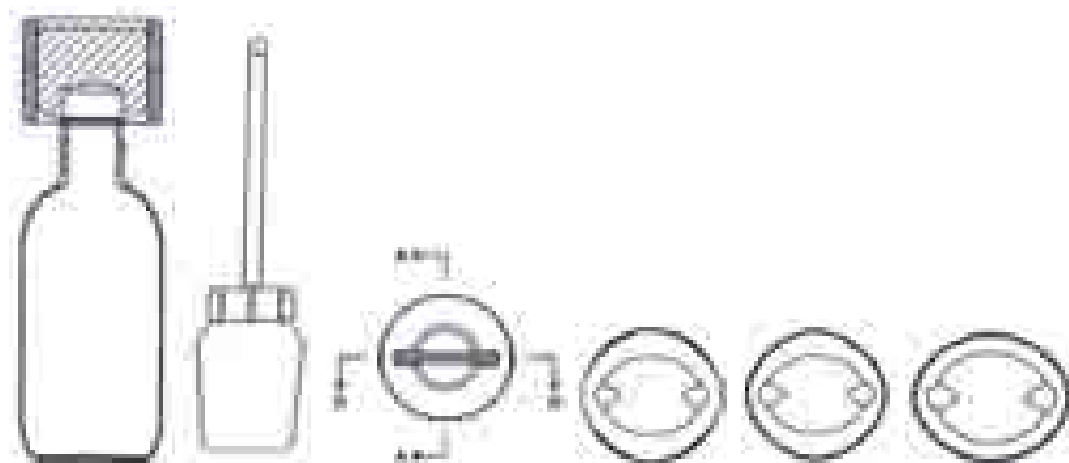

1.7 1.8 1.9 1.10 1.11 1.12

- (11) **12908**  
(21) 3-2008-00303 (28) 02  
(54) XE Ô TÔ (51) **12-08**  
(22) 28.02.2008 (43) 26.05.2008  
(30) 2007-023570 30.08.2007 JP  
2007-023569 30.08.2007 JP  
(71) TOYOTA JIDOSHA KABUSHIKI KAISHA (JP)  
1, Toyota-cho, Toyota-shi, Aichi-ken 471-8571, Japan  
(72) Kouichi SUGA (JP), Yahiko KUMAI (JP), Hiroyuki TADA (JP), Kenichi HIRAI (JP)  
(74) Công ty TNHH Quốc tế D & N (D&N INTERNATIONAL CO.,LTD.)  
(55)



1.1

1.2

1.3



1.4

1.5

1.6



2.1



2.2



2.3



2.4



2.5



2.6

- (11) **12909**  
(21) 3-2008-00307  
(54) MÓC TREO QUẦN ÁO  
(22) 29.02.2008  
(71) PHẠM THỊ HOA (VN)  
Phố 6, ấp 3, xã Phú Vinh, huyện Định Quán, tỉnh Đồng Nai  
(72) Phạm Thị Hoa (VN)  
(74) Công ty TNHH một thành viên Trường Luật (CÔNG TY TRUONG LUAT)  
(55)
- (28) 01  
(51) **06-08**  
(43) 26.05.2008

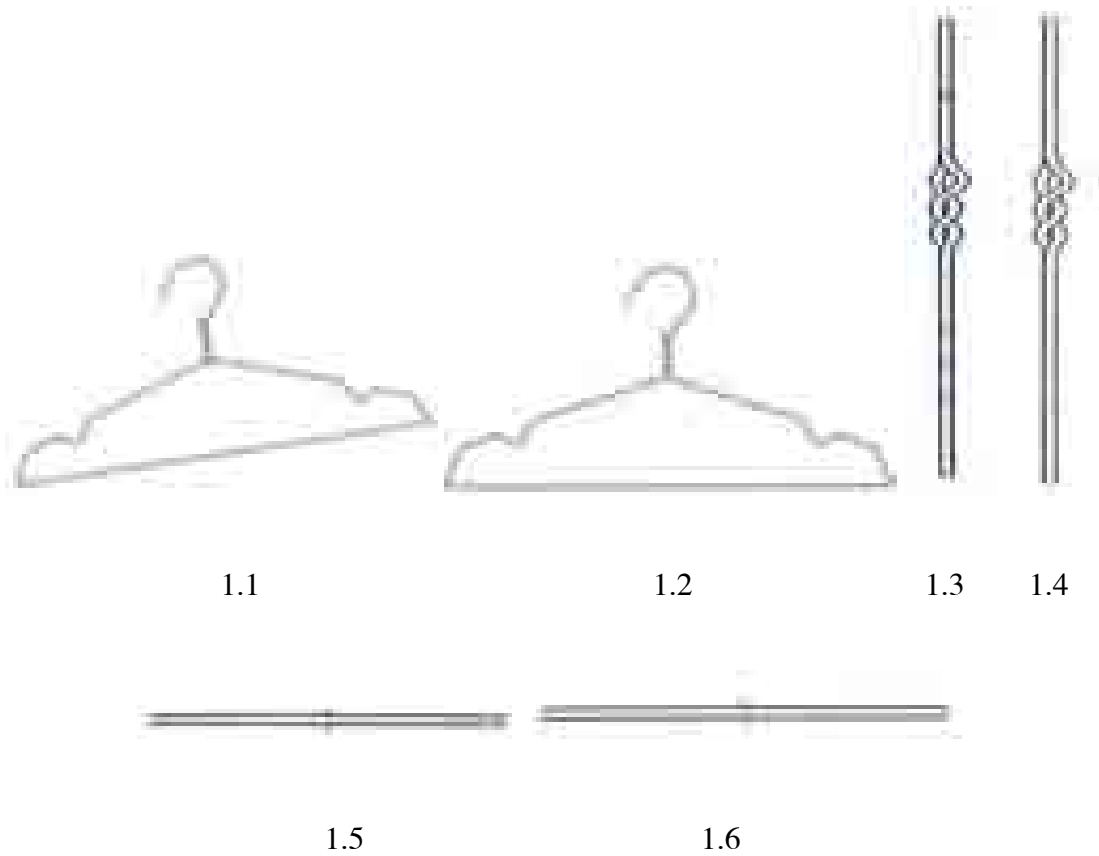

- (11) **12910**  
(21) 3-2008-00308 (28) 01  
(54) CHAI (51) **09-01**  
(22) 29.02.2008 (43) 26.05.2008  
(71) CÔNG TY CỔ PHẦN SONG HOA (VN)  
10/4 đường số 3, khu phố 4, phường Bình An, quận 2, TP. Hồ Chí Minh  
(72) Nguyễn Thị Đức Hạnh (VN)  
(74) Văn phòng luật sư Phạm và Liên danh (PHAM & ASSOCIATES)  
(55)

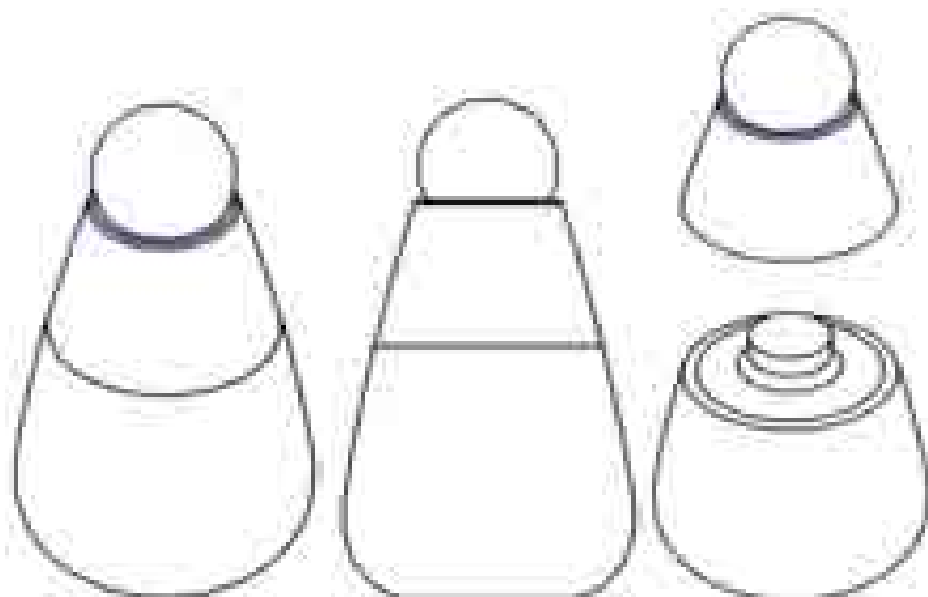

1.1

1.2

1.3

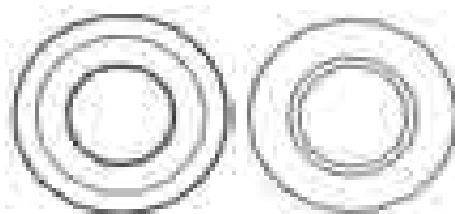

1.4

1.5

- (11) **12911**  
(21) 3-2008-00311 (28) 01  
(54) DÉP (51) **02-04**  
(22) 29.02.2008 (43) 26.05.2008  
(71) CƠ SỞ NGÂN PHONG (VN)  
200/27/7 Xóm Đất, phường 10, quận 11, TP. Hồ Chí Minh  
(72) Ngô Lệ Hương (VN)  
(74) Công ty TNHH Sở hữu trí tuệ WINCO (WINCO CO., LTD.)  
(55)



1.1

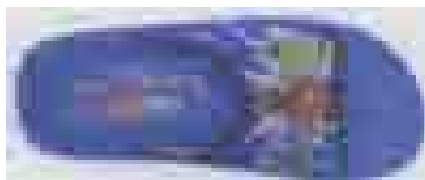

1.2

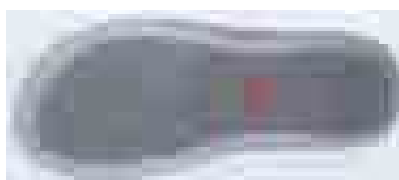

1.3



1.4

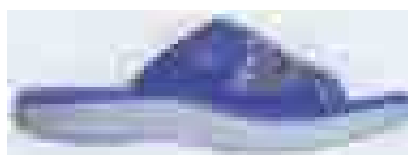

1.5



1.6



1.7

- (11) **12912**  
(21) 3-2008-00312 (28) 01  
(54) TỦ (51) **06-04**  
(22) 03.03.2008 (43) 26.05.2008  
(71) CÔNG TY TRÁCH NHIỆM HỮU HẠN NHỰA DUY TÂN (VN)  
298 Hồ Học Lãm, phường An Lạc, quận Bình Tân, TP. Hồ Chí Minh  
(72) Trần Phước An (VN)  
(74) Công ty TNHH Sở hữu trí tuệ Thảo Thọ Quyến (INVENCO)  
(55)

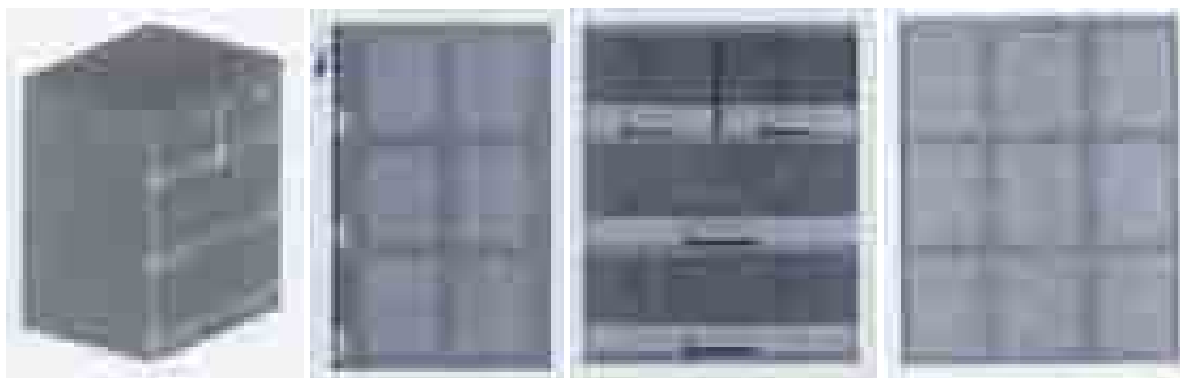

1.1

1.2

1.3

1.4

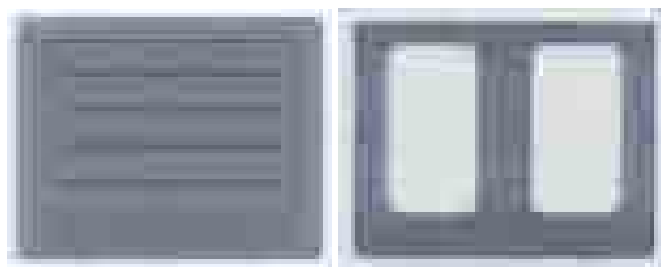

1.5

1.6

- (11) **12913**  
(21) 3-2008-00314 (28) 01  
(54) HỘP ĐỰNG (51) **09-03**  
(22) 03.03.2008 (43) 26.05.2008  
(71) CÔNG TY TNHH HIỆP PHONG (VN)  
Số 1, tập thể A37, tổ 110 Hoàng Cầu, phường Ô Chợ Dừa, quận Đống Đa, thành phố Hà Nội  
(72) Trần Minh Trung (VN)  
(74) Công ty TNHH Trường Xuân (AGELESS CO.,LTD.)  
(55)



1.1



1.2



- (11) **12914**  
(21) 3-2008-00316 (28) 04  
(54) ĐIỆN THOẠI DI ĐỘNG (51) **14-03**  
(22) 04.03.2008 (43) 26.05.2008  
(30) 200730288120.7 07.12.2007 CN  
200730288119.4 07.12.2007 CN  
200730288121.1 07.12.2007 CN  
200730287659.0 14.12.2007 CN  
(71) SHENZHEN SANG FEI CONSUMER COMMUNICATIONS CO., LTD. (CN)  
Sangda Industrial Building, Science & Technology Industrial Park Shenzhen,  
Guangdong Province, P.R. China  
(72) Charlie Bolton (GB), Russell Blanchard (US)  
(74) Công ty TNHH Sở hữu trí tuệ WINCO (WINCO CO., LTD.)  
(55)

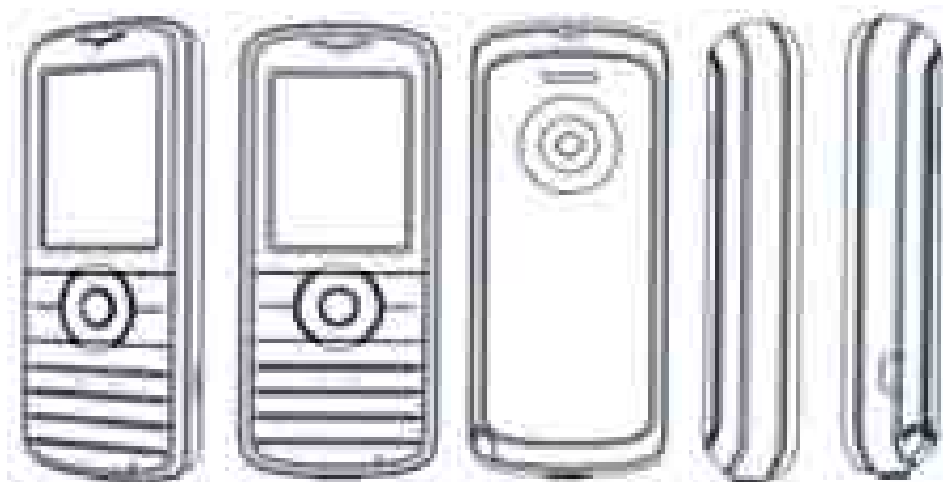

1.1

1.2

1.3

1.4

1.5



1.6

1.7



2.1

2.2

2.3

2.4

2.5



2.6

2.7

2.7



3.1

3.2

3.3

3.4

3.5



3.6

3.7



4.1

4.2

4.3

4.4

4.5



4.6

4.7

- (11) **12915**  
(21) 3-2008-00323 (28) 01  
(54) HỘP MỸ PHẨM (51) **28-02**  
(22) 05.03.2008 (43) 26.05.2008  
(30) 30-2007-0038100 06.09.2007 KR  
(71) LG HOUSEHOLD & HEALTH CARE LTD. (KR)  
20, Yoido-dong, Youngdungpo-gu, Seoul, Korea  
(72) Ryu, Young Bog (KR)  
(74) Công ty TNHH Tầm nhìn và Liên danh (VISION & ASSOCIATES CO.LTD.)  
(55)



1.1



1.2

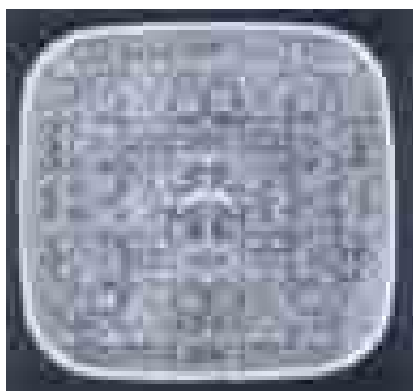

1.3

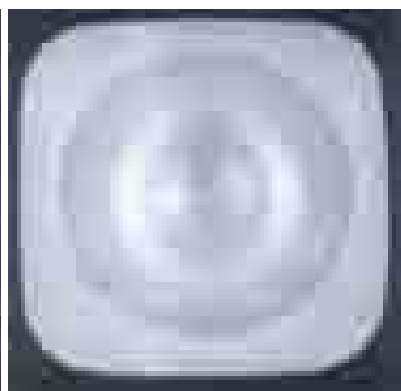

1.4

- (11) **12916**  
(21) 3-2008-00324 (28) 01  
(54) BỘ ĐỒ TRÀ (51) **07-01**  
(22) 05.03.2008 (43) 26.05.2008  
(71) CÔNG TY TRÁCH NHIỆM HỮU HẠN MINH LONG I (VN)  
333 xã Hưng Định, huyện Thuận An, tỉnh Bình Dương  
(72) Lý Ngọc Minh (VN)  
(74) Công ty TNHH Lê & Lê (LE & LE)  
(55)



1.1



1.2

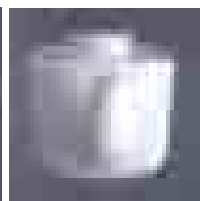

1.3

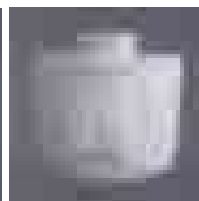

1.4



1.5



1.6



1.7

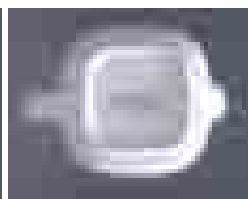

1.8



1.9



1.10



1.11



1.12



1.13



1.14

1.15

1.16

1.17

1.18

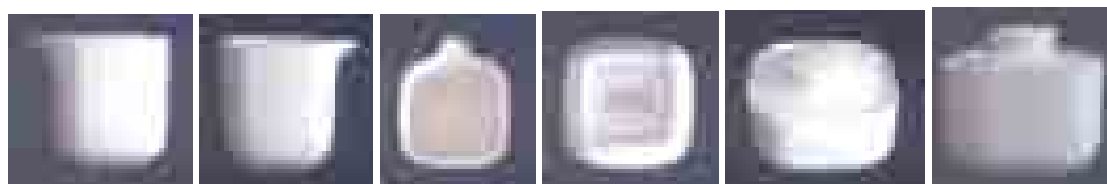

1.19

1.20

1.21

1.22

1.23

1.24



1.25

1.26

1.27

1.28

1.29

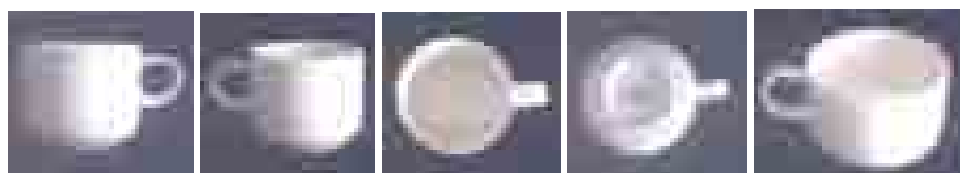

1.30

1.31

1.32

1.33

1.34



1.34

1.35

1.36

1.37

1.38



1.39

1.40

1.41

1.42

1.43

- (11) **12917**  
(21) 3-2008-00325 (28) 01  
(54) BAO ĐỰNG MÌ (51) **09-05**  
(22) 05.03.2008 (43) 26.05.2008  
(71) CÔNG TY CỔ PHẦN LƯƠNG THỰC THỰC PHẨM COLUSA - MILIKET (VN)  
1230 Kha Vạn Cân, phường Linh Trung, quận Thủ Đức, TP. Hồ Chí Minh  
(72) Võ Văn Út (VN)  
(74) Công ty Cổ phần Sở hữu công nghiệp INVESTIP (INVESTIP)  
(55)



1.1



1.2

(11) **12918**

(21) 3-2008-00326

(28) 02

(54) BỘ NHÃN SẢN PHẨM

(51) **19-08**

(22) 05.03.2008

(43) 26.05.2008

(71) CÔNG TY CỔ PHẦN KIDO (VN)

Khu công nghiệp Tây Bắc Củ Chi, ấp Cây Sộp, xã Tân An Hội, huyện Củ Chi, TP. Hồ Chí Minh

(72) Huỳnh Trung Hiếu (VN)

(74) Văn phòng luật sư Phạm và Liên danh (PHAM & ASSOCIATES)

(55)

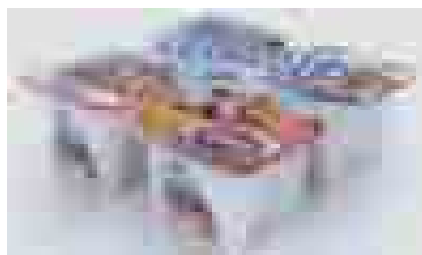

1.1



1.2

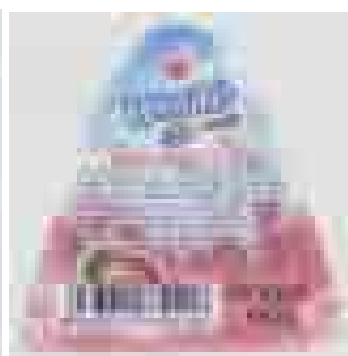

1.3

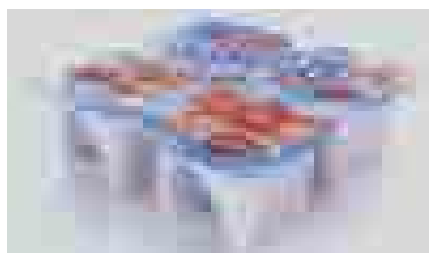

2.1



2.2



2.3



- (11) **12919**  
(21) 3-2008-00327 (28) 01  
(54) HỘP ĐỰNG BÁNH KẸO (51) **09-03**  
(22) 06.03.2008 (43) 26.05.2008  
(71) CÔNG TY CỔ PHẦN THƯƠNG MẠI RỒNG VÀNG MINH NGỌC (VN)  
Khu 6, phường Cẩm Thượng, thành phố Hải Dương, tỉnh Hải Dương  
(72) Thái Thị Vân Anh (VN)  
(55)



1.1



1.2



1.3



1.4

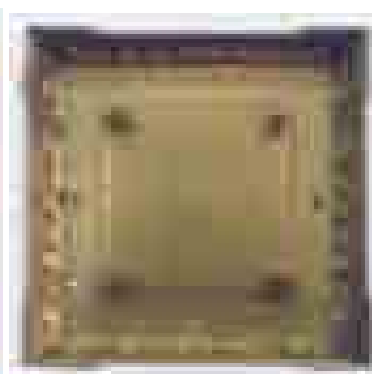

1.5

- (11) **12920**  
(21) 3-2008-00328 (28) 01  
(54) HỘP ĐỰNG BÁNH KẸO (51) **09-03**  
(22) 06.03.2008 (43) 26.05.2008  
(71) CÔNG TY CỔ PHẦN THƯƠNG MẠI RỒNG VÀNG MINH NGỌC (VN)  
Khu 6, phường Cẩm Thượng, thành phố Hải Dương, tỉnh Hải Dương  
(72) Thái Thị Vân Anh (VN)  
(55)



1.1

1.2

1.3

1.4



1.5

1.6

1.7

- (11) **12921**  
(21) 3-2008-00329 (28) 01  
(54) BAO GÓI KẸO ĐẬU PHỘNG (51) **09-05**  
(22) 06.03.2008 (43) 26.05.2008  
(71) CƠ SỞ BÁNH TÂN HOÀ (VN)  
83A đường 14/9, phường 5, thị xã Vĩnh Long, tỉnh Vĩnh Long  
(72) Trương Lan Anh (VN)  
(74) Công ty TNHH Sở hữu trí tuệ Thảo Thọ Quyến (INVENCO)  
(55)

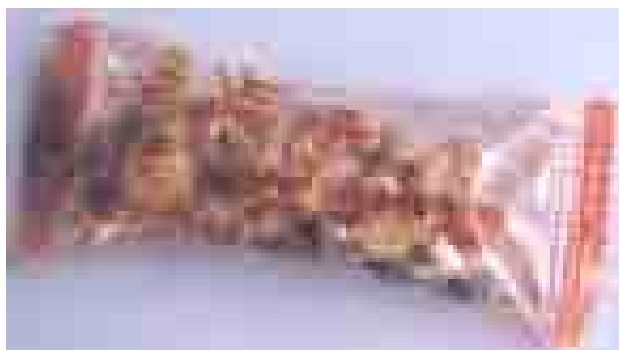

1.1



1.2

- (11) **12922**  
(21) 3-2008-00331 (28) 01  
(54) XE Ô TÔ (51) **12-08**  
(22) 06.03.2008 (43) 26.05.2008  
(30) 30-2008-0003261 23.01.2008 KR  
(71) GM DAEWOO AUTO & TECHNOLOGY COMPANY (KR)  
199-1, Cheongcheon-dong, Bupyeong-gu, Incheon 403-714, Republic of Korea  
(72) Ju-myoung JEON (KR)  
(74) Công ty TNHH Trường Xuân (AGELESS CO.,LTD.)  
(55)

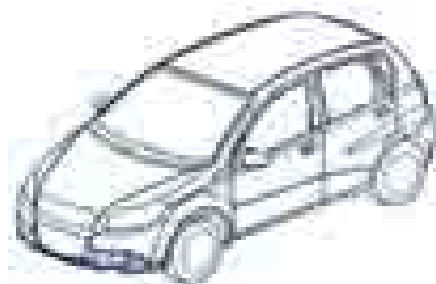

1.1



1.2

1.3

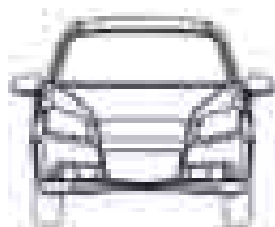

1.4



1.5

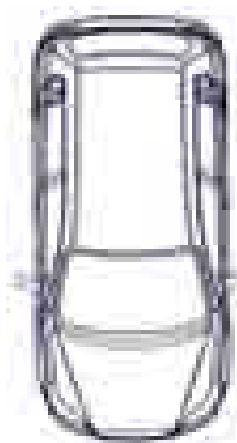

1.6

- (11) **12923**  
(21) 3-2008-00336 (28) 01  
(54) BAO ĐỰNG CHÁO (51) **09-05**  
(22) 06.03.2008 (43) 26.05.2008  
(71) CÔNG TY CỔ PHẦN LƯƠNG THỰC THỰC PHẨM COLUSA - MILIKET (VN)  
1230 Kha Vạn Cân, phường Linh Trung, quận Thủ Đức, TP. Hồ Chí Minh  
(72) Võ Văn út (VN)  
(74) Công ty Cổ phần Sở hữu công nghiệp INVESTIP (INVESTIP)  
(55)



1.1



1.2

- (11) **12924**  
(21) 3-2008-00337 (28) 01  
(54) BAO GÓI THUỐC (51) **09-05**  
(22) 07.03.2008 (43) 26.05.2008  
(71) CÔNG TY CỔ PHẦN THƯƠNG MẠI VÀ CHUYỂN GIAO CÔNG NGHỆ YCM (VN)  
Số 17, ngõ 61/67, đường Trần Duy Hưng, quận Cầu Giấy, thành phố Hà Nội  
(72) Lê Hải Nam (VN)  
(55)



1.1



1.2

- (11) **12925**  
(21) 3-2008-00338 (28) 01  
(54) HỘP ĐỤNG THUỐC (51) **09-03**  
(22) 07.03.2008 (43) 26.05.2008  
(71) CÔNG TY CỔ PHẦN THƯƠNG MẠI VÀ CHUYỂN GIAO CÔNG NGHỆ YCM (VN)  
Số 17, ngõ 61/67, đường Trần Duy Hưng, quận Cầu Giấy, thành phố Hà Nội  
(72) Lê Hải Nam (VN)  
(55)



1.1



1.2

- (11) **12926**  
(21) 3-2008-00339  
(54) NHÃN SẢN PHẨM  
(22) 07.03.2008  
(71) CÔNG TY TNHH VŨ THANH (VN)  
Hữu Bằng, Kiến Thụy, thành phố Hải Phòng  
(72) Đỗ Tuấn Nghĩa (VN)  
(55)
- (28) 01  
(51) **19-08**  
(43) 26.05.2008





- (11) **12927**  
(21) 3-2008-00342 (28) 01  
(54) BÀN (51) **06-03**  
(22) 10.03.2008 (43) 26.05.2008  
(71) NGUYỄN TRỌNG HIẾU (VN)  
595/21 Cách Mạng Tháng Tám, phường 15, quận 10, TP. Hồ Chí Minh  
(72) Nguyễn Trọng Hiếu (VN)  
(74) Công ty TNHH Sở hữu trí tuệ WINCO (WINCO CO., LTD.)  
(55)



1.1

1.2



1.3

1.4

1.5

1.6

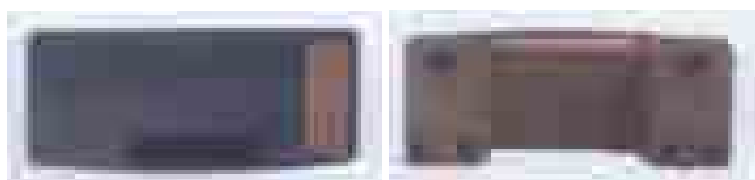

1.7

1.8

- (11) **12928**  
(21) 3-2008-00343 (28) 01  
(54) BÌNH NHỰA (51) **07-07**  
(22) 10.03.2008 (43) 26.05.2008  
(71) CÔNG TY CỔ PHẦN ĐẠI ĐỒNG TIẾN (VN)  
216 Tân Thành, phường 15, quận 5, TP. Hồ Chí Minh  
(72) Trịnh Đồng (VN)  
(74) DNTN Dịch vụ thương mại và sở hữu công nghiệp Song Ngọc (I.P.T.S.)  
(55)



1.1

1.2

1.3



1.4

1.5

1.6

- (11) **12929**  
(21) 3-2008-00349 (28) 01  
(54) GIÁ ĐỖ KHAY THỨC ĂN (51) **06-04**  
(22) 12.03.2008 (43) 26.05.2008  
(71) TRINH M. KAISLER (US)  
2264 Lion's Gate, Vista, California 92084, U.S.A.  
(72) Trinh M. Kaisler (US)  
(74) Văn phòng luật sư Phạm và Liên danh (PHAM & ASSOCIATES)  
(55)



1.1

1.2



1.3

1.4

1.5

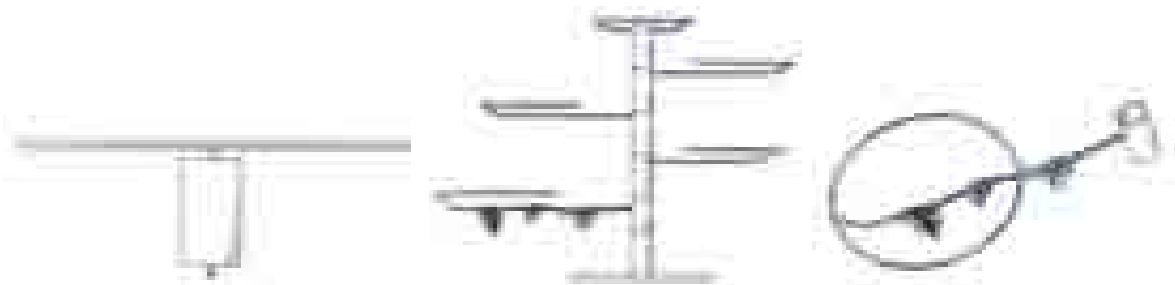

1.6

1.7

1.8

- (11) **12930**  
(21) 3-2008-00353 (28) 02  
(54) BAO BÌ (51) **09-05**  
(22) 13.03.2008 (43) 26.05.2008  
(71) HOÀNG THỊ LÊ (VN)  
Phòng 509-B1, Láng Hạ, quận Đống Đa, thành phố Hà Nội  
(72) Hoàng Thị Lê (VN)  
(74) Công ty TNHH Sở hữu trí tuệ HA VIP (HAVIP CO., LTD.)  
(55)



1.1



1.2



2.1



2.2

- (11) **12931**  
(21) 3-2008-00354 (28) 01  
(54) GIÁ ĐỖ NẾN (51) **26-01**  
(22) 14.03.2008 (43) 26.05.2008  
(71) CÔNG TY TRÁCH NHIỆM HỮU HẠN VINH KHÁNH (VN)  
Khu Cam Lộ, phường Hùng Vương, quận Hồng Bàng, thành phố Hải Phòng  
(72) Hoàng Li Wei (CN)  
(74) Công ty TNHH Nghiên cứu và Tư vấn chuyển giao công nghệ và đầu tư (CONCETTI)  
(55)



1.1

1.2

1.3



1.4

1.5

1.6

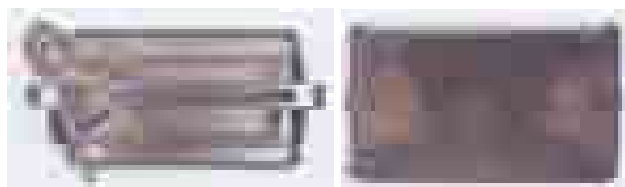

1.7

1.8

- (11) **12932**  
(21) 3-2008-00355 (28) 01  
(54) GIÁ ĐỖ NẾN (51) **26-01**  
(22) 14.03.2008 (43) 26.05.2008  
(71) CÔNG TY TRÁCH NHIỆM HỮU HẠN VINH KHÁNH (VN)  
Khu Cam Lộ, phường Hùng Vương, quận Hồng Bàng, thành phố Hải Phòng  
(72) Hoàng Li Wei (CN)  
(74) Công ty TNHH Nghiên cứu và Tư vấn chuyển giao công nghệ và đầu tư (CONCETTI)  
(55)



1.1

1.2

1.3

1.4



1.5

1.6

1.7

1.8

- (11) **12933**  
(21) 3-2008-00356 (28) 01  
(54) NÚM VẶN VÒI NƯỚC (51) **23-01**  
(22) 17.03.2008 (43) 26.05.2008  
(71) WATERTEC (MALAYSIA) SDN BHD (MY)  
Lot 6 Jalan Halba 16/16, Section 16, 40200 Shah Alam, Selangor, Malaysia  
(72) Mohd Nizam Bin Najmuddin (MY)  
(74) Công ty TNHH Tư vấn Phạm Anh Nguyên (ANPHAMCO CO.,LTD.)  
(55)

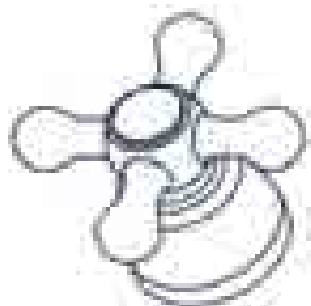

1.1

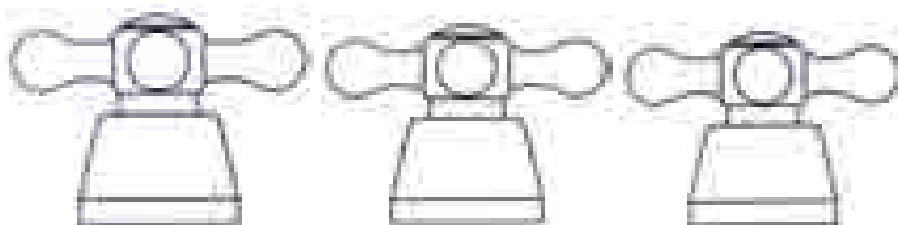

1.2

1.3

1.4

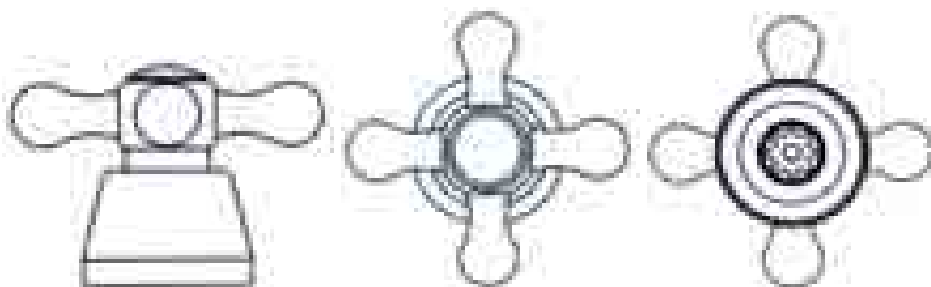

1.5

1.6

1.7

- (11) **12934**  
(21) 3-2008-00357 (28) 01  
(54) MŨ BẢO HIỂM (51) **02-03**  
(22) 17.03.2008 (43) 26.05.2008  
(71) CÔNG TY TNHH SẢN XUẤT - THƯƠNG MẠI - DỊCH VỤ SĨ TÂM (VN)  
16B Hàm Tử, phường 1, quận 5, TP. Hồ Chí Minh  
(72) Nguyễn Văn Sĩ (VN)  
(74) DNTN Dịch vụ thương mại và sở hữu công nghiệp Song Ngọc (I.P.T.S.)  
(55)



1.1



1.2

1.3



1.4

1.5

1.6



- (11) **12935**  
(21) 3-2008-00358 (28) 01  
(54) GHẾ (51) **06-01**  
(22) 18.03.2008 (43) 26.05.2008  
(71) CÔNG TY CỔ PHẦN CAO SU SÀI GÒN - KYMDAN (VN)  
28 Bình Thới, phường 14, quận 11, TP. Hồ Chí Minh  
(72) Nguyễn Hữu Trí (VN)  
(74) Công ty TNHH Sở hữu trí tuệ Thảo Thọ Quyến (INVENCO)  
(55)



1.1

1.2

1.3

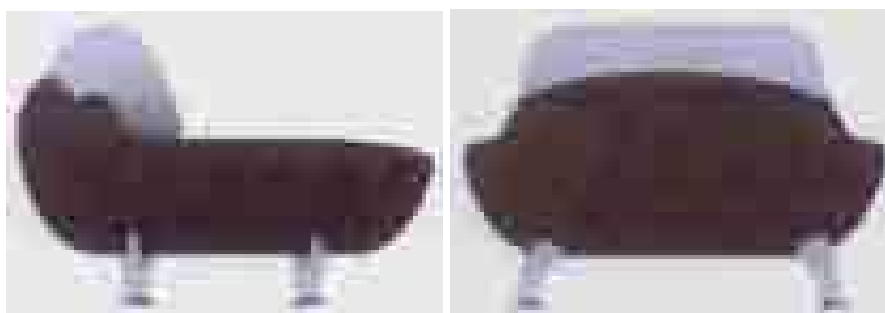

1.4

1.5

- (11) **12936**  
(21) 3-2008-00359 (28) 01  
(54) BÀN (51) **06-03**  
(22) 18.03.2008 (43) 26.05.2008  
(71) CÔNG TY CỔ PHẦN CAO SU SÀI GÒN - KYMDAN (VN)  
28 Bình Thới, phường 14, quận 11, TP. Hồ Chí Minh  
(72) Nguyễn Hữu Trí (VN)  
(74) Công ty TNHH Sở hữu trí tuệ Thảo Thọ Quyến (INVENCO)  
(55)

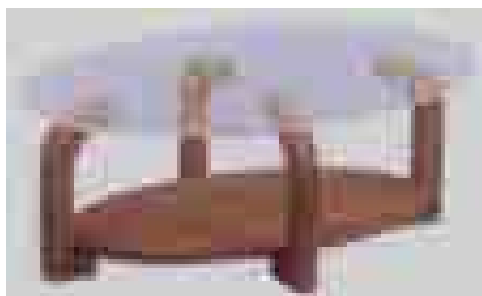

1.1



1.2

1.3

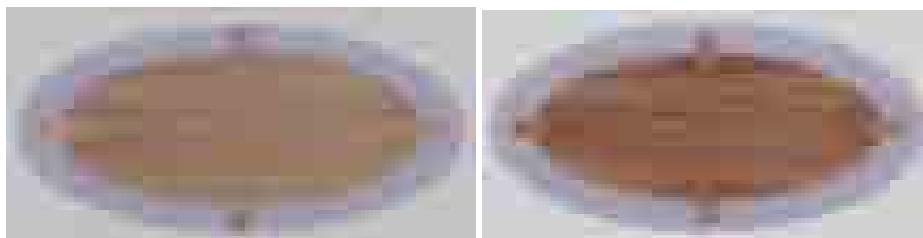

1.4

1.5

- (11) **12937**  
(21) 3-2008-00360 (28) 02  
(54) GHẾ (51) **06-01**  
(22) 18.03.2008 (43) 26.05.2008  
(71) CÔNG TY CỔ PHẦN CAO SU SÀI GÒN - KYMDAN (VN)  
28 Bình Thới, phường 14, quận 11, TP. Hồ Chí Minh  
(72) Nguyễn Hữu Trí (VN)  
(74) Công ty TNHH Sở hữu trí tuệ Thảo Thọ Quyến (INVENCO)  
(55)

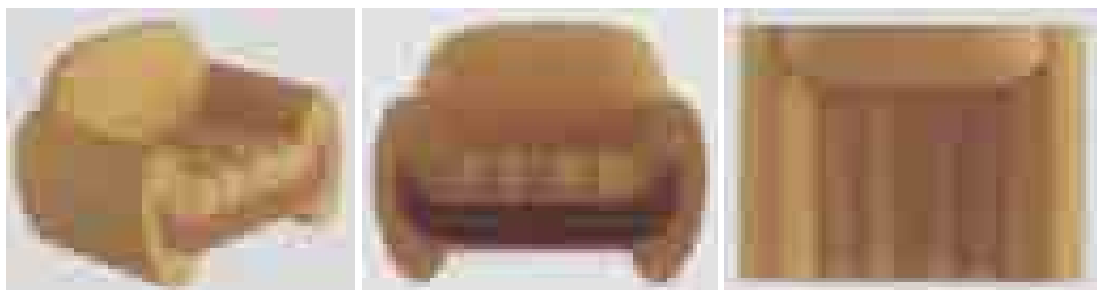

1.1

1.2

1.3

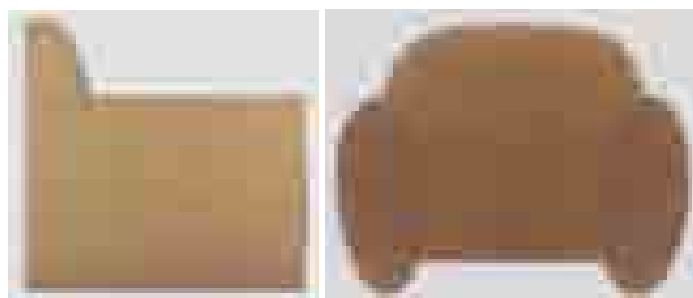

1.4

1.5



2.1

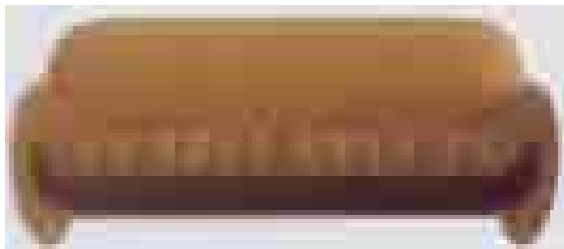

2.2

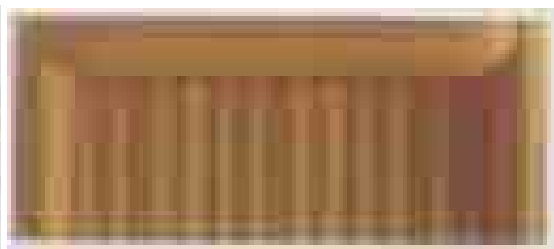

2.3



2.4

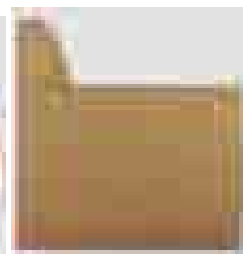

2.5

- (11) **12938**  
(21) 3-2008-00361 (28) 01  
(54) GHẾ (51) **06-01**  
(22) 18.03.2008 (43) 26.05.2008  
(71) CÔNG TY CỔ PHẦN CAO SU SÀI GÒN - KYMDAN (VN)  
28 Bình Thới, phường 14, quận 11, TP. Hồ Chí Minh  
(72) Nguyễn Hữu Trí (VN)  
(74) Công ty TNHH Sở hữu trí tuệ Thảo Thọ Quyển (INVENCO)  
(55)



1.1

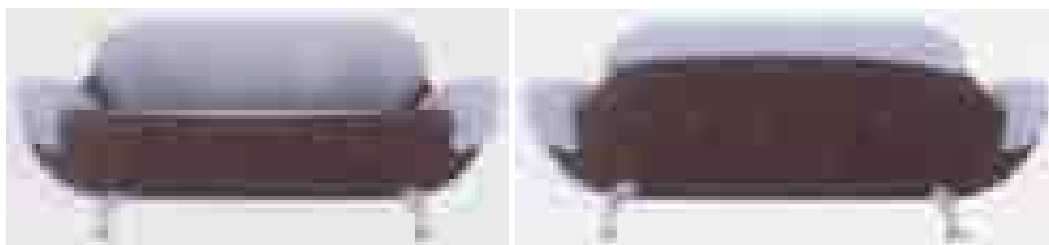

1.2

1.3

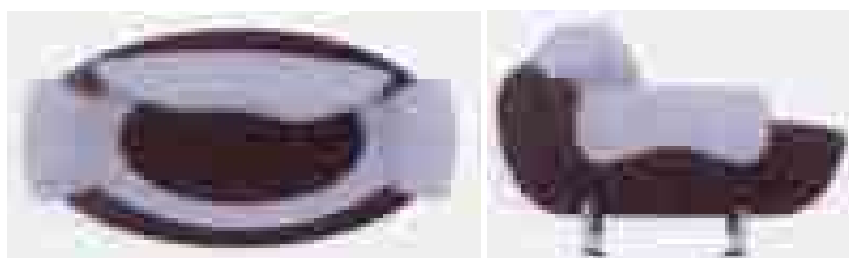

1.4

1.5

- (11) **12939**  
(21) 3-2008-00362 (28) 01  
(54) BÀN (51) **06-03**  
(22) 18.03.2008 (43) 26.05.2008  
(71) CÔNG TY CỔ PHẦN CAO SU SÀI GÒN - KYMDAN (VN)  
28 Bình Thới, phường 14, quận 11, TP. Hồ Chí Minh  
(72) Nguyễn Hữu Trí (VN)  
(74) Công ty TNHH Sở hữu trí tuệ Thảo Thọ Quyến (INVENCO)  
(55)



1.1

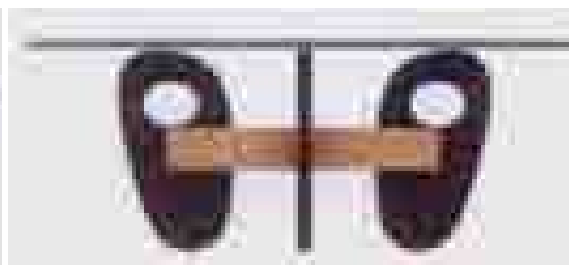

1.2

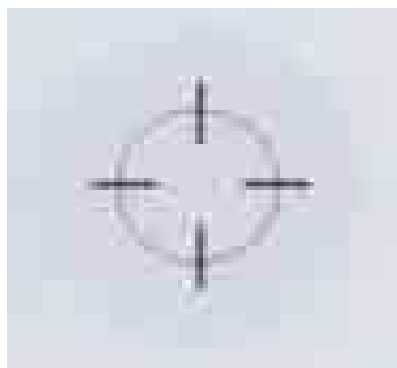

1.3

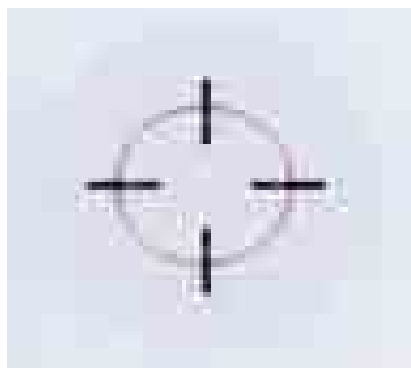

1.4

- (11) **12940**  
(21) 3-2008-00363 (28) 01  
(54) GIƯỜNG NGỦ (51) **06-02**  
(22) 18.03.2008 (43) 26.05.2008  
(71) CÔNG TY CỔ PHẦN CAO SU SÀI GÒN - KYMDAN (VN)  
28 Bình Thới, phường 14, quận 11, TP. Hồ Chí Minh  
(72) Nguyễn Hữu Trí (VN)  
(74) Công ty TNHH Sở hữu trí tuệ Thảo Thọ Quyến (INVENCO)  
(55)



1.1

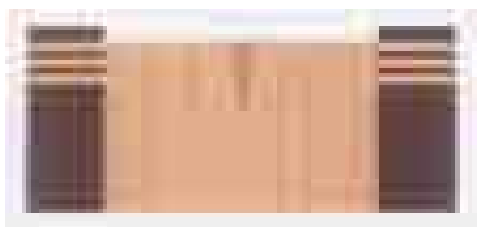

1.2

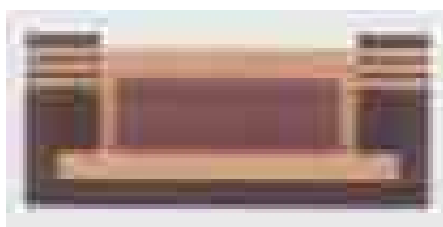

1.3

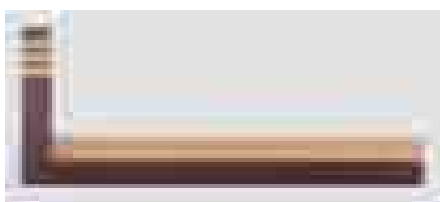

1.4



1.5

- (11) **12941**  
(21) 3-2008-00365 (28) 01  
(54) XE MÁY (51) **12-11**  
(22) 18.03.2008 (43) 26.05.2008  
(71) YAMAHA HATSUDOKI KABUSHIKI KAISHA (JP)  
2500, Shingai, Iwata-shi, Shizuoka-ken, Japan  
(72) Atsurou Takeno (JP)  
(74) Công ty Cổ phần Sở hữu công nghiệp INVESTIP (INVESTIP)  
(55)



1.1

1.2

1.3

1.4



1.5

1.6



1.7

1.8

1.9



- (11) **12942**  
(21) 3-2008-00366 (28) 01  
(54) XE CHỮA CHÁY KÍCH THƯỚC (51) **12-13**  
NHỎ  
(22) 18.03.2008 (43) 26.05.2008  
(71) CÔNG TY TNHH BỒ CÁT (VN)  
299L28 khu dân cư Sông Giồng, Nguyễn Thị Định, phường An Phú, quận 2, TP. Hồ  
Chí Minh  
(72) Giảng Thị Minh Châu (VN)  
(74) Công ty TNHH Tư vấn Sở hữu trí tuệ á Đông (A ĐÔNG IP CONSULTANCY  
CO.,LTD.)  
(55)



1.1

1.2

1.3

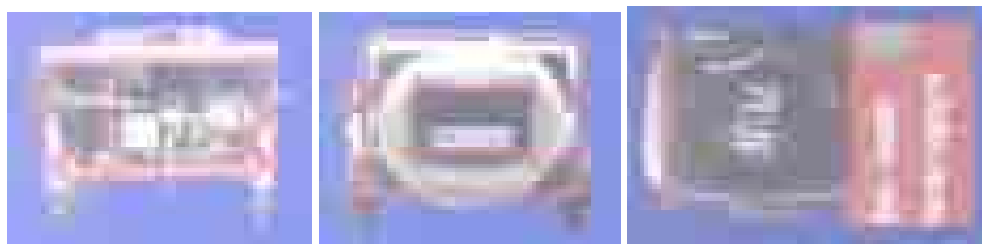

1.4

1.5

1.6

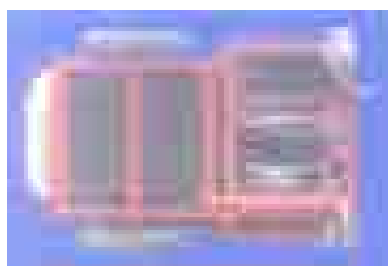

1.7

- (11) **12943**  
(21) 3-2008-00367 (28) 01  
(54) BẢNG QUY TẮC BÀN TAY TRÁI (51) **20-03**  
TÌM BẢN MẠNG  
(22) 18.03.2008 (43) 26.05.2008  
(71) NGUYỄN NGỌC THẠCH (VN)  
36/6 Điện Biên Phủ, phường 15, quận Bình Thạnh, TP. Hồ Chí Minh  
(72) Nguyễn Ngọc Thạch (VN)  
(74) Công ty Cổ phần Sở hữu công nghiệp INVESTIP (INVESTIP)  
(55)



1.1



1.2

- (11) **12944**  
(21) 3-2008-00368 (28) 01  
(54) HỘ ĐUNG THUỐC (51) **09-03**  
(22) 19.03.2008 (43) 26.05.2008  
(71) CÔNG TY CỔ PHẦN THƯƠNG MẠI VÀ DƯỢC PHẨM NGỌC THIÊN (VN)  
Số 10, ngõ 3, đường Lý Bôn, thành phố Vinh Yên, tỉnh Vĩnh Phúc  
(72) Nguyễn Thế Quyền (VN)  
(74) Công ty TNHH Vĩnh Đạt (LACOM CO., LTD.)  
(55)



1.1



1.2

- (11) **12945**  
(21) 3-2008-00369 (28) 02  
(54) NHÃN SẢN PHẨM (51) **19-08**  
(22) 19.03.2008 (43) 26.05.2008  
(71) CÔNG TY CỔ PHẦN Ô TÔ PHÚ ĐẠT (VN)  
B6/4E Trần Đại Nghĩa, xã Tân Kiên, huyện Bình Chánh, TP. Hồ Chí Minh  
(72) Lưu Bá Khanh (VN)  
(74) Công ty TNHH Sở hữu trí tuệ WINCO (WINCO CO., LTD.)  
(55)

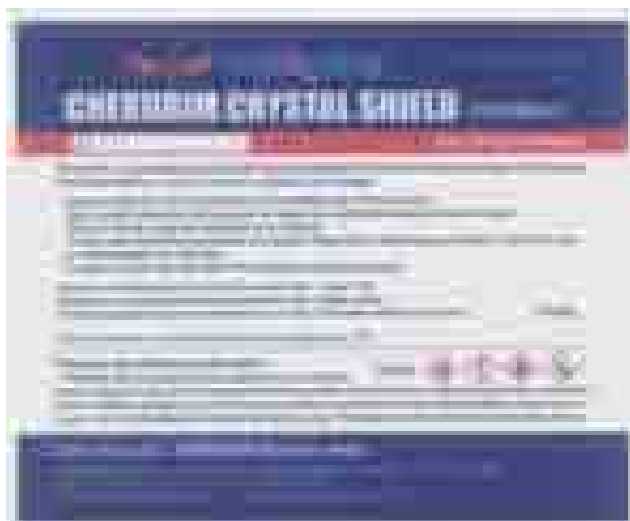

1



2

(11) **12946**

(21) 3-2008-00371

(54) KHẨU TRANG

(22) 20.03.2008

(71) NGUYỄN NHẬT HÀ (VN)

Số 21/36 đường Đặng Tiến Đông, phường Trung Liệt, quận Đống Đa, thành phố Hà Nội

(72) Nguyễn Nhật Hà (VN)

(55)

(28) 01

(51) **02-99**

(43) 26.05.2008



1.1



1.2



1.3



1.4



1.5



1.6

- (11) **12947**  
(21) 3-2008-00372 (28) 01  
(54) XE Ô TÔ (51) **12-08**  
(22) 20.03.2008 (43) 26.05.2008  
(71) TOYOTA JIDOSHA KABUSHIKI KAISHA (JP)  
1, Toyota-cho, Toyota-shi, Aichi-ken 471-8571, Japan  
(72) Masaki MOTOZAKI (JP), Yoshikazu HARADA (JP), KENTA SHIMOGUCHI (JP)  
(74) Công ty TNHH Quốc tế D & N (D&N INTERNATIONAL CO.,LTD.)  
(55)



1.1



1.2



1.3

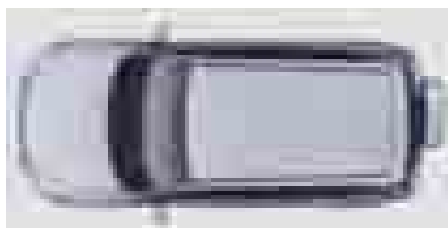

1.4



1.5

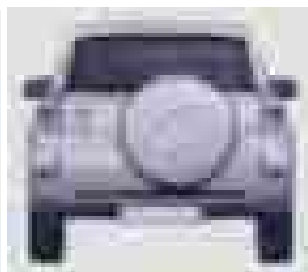

1.6

- (11) **12948**  
(21) 3-2008-00381 (28) 01  
(54) GHẾ (51) **06-01**  
(22) 20.03.2008 (43) 26.05.2008  
(71) CÔNG TY TRÁCH NHIỆM HỮU HẠN MỘT THÀNH VIÊN THƯƠNG MẠI VIỆT  
ĐẠI THÀNH (VN)  
393 Xô Viết Nghệ Tĩnh, phường 24, quận Bình Thạnh, TP. Hồ Chí Minh  
(72) Chokchai Charoenapornwatana (TH)  
(74) Công ty TNHH một thành viên Trường Luật (CÔNG TY TRUONG LUAT)  
(55)

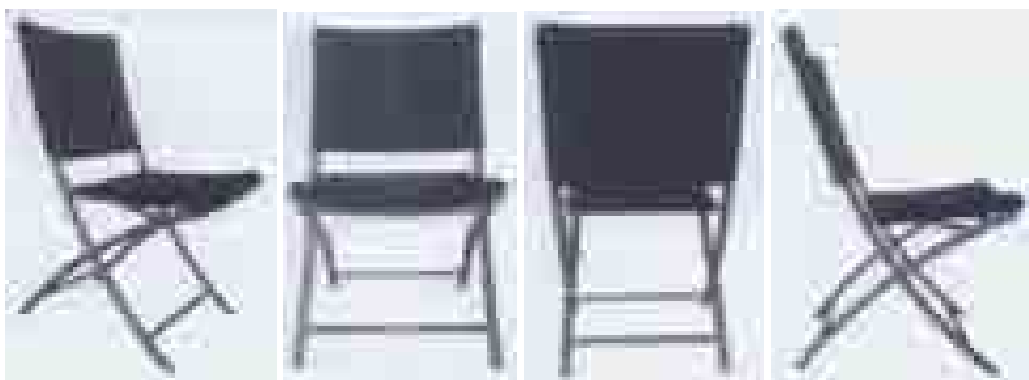

1.1

1.2

1.3

1.4

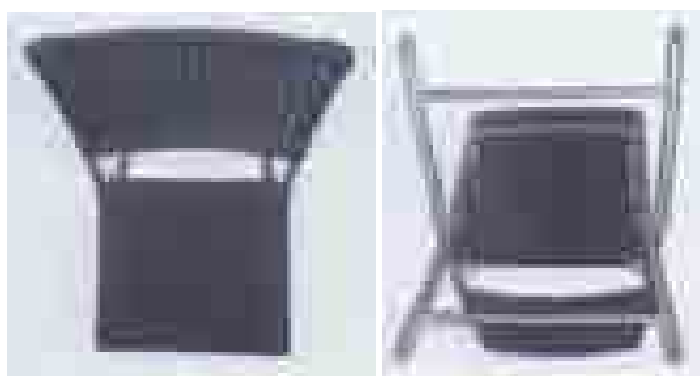

1.5

1.6

- (11) **12949**  
(21) 3-2008-00382 (28) 01  
(54) XE Ô TÔ (51) **12-08**  
(22) 21.03.2008 (43) 26.05.2008  
(30) 2007-025532 21.09.2007 JP  
(71) HONDA MOTOR CO., LTD. (JP)  
1-1, Minami-Aoyama 2-chome, Minato-ku, Tokyo, Japan  
(72) Tetsuji Morikawa (JP)  
(74) Văn phòng luật sư Phạm và Liên danh (PHAM & ASSOCIATES)  
(55)



1.1

1.2



1.3

1.4



1.5

1.6



- (11) **12950**  
(21) 3-2008-00383 (28) 01  
(54) HỘP GẮN ĐỒNG HỒ DÙNG CHO XE Ô TÔ (51) **12-16**  
(22) 21.03.2008 (43) 26.05.2008  
(30) 2007-025609 21.09.2007 JP  
(71) HONDA MOTOR CO., LTD. (JP)  
1-1, Minami-Aoyama 2-chome, Minato-ku, Tokyo, Japan  
(72) Yosuke Shimizu (JP)  
(74) Văn phòng luật sư Phạm và Liên danh (PHAM & ASSOCIATES)  
(55)



1.1



1.2



1.3



1.4



1.5



1.6

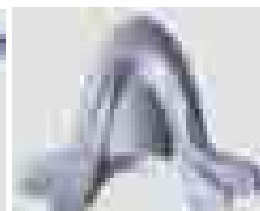

1.7



1.8



1.9



1.10

- (11) **12951**  
(21) 3-2008-00384 (28) 01  
(54) HỘP GẮN ĐỒNG HỒ DÙNG CHO (51) **12-16**  
XE Ô TÔ  
(22) 21.03.2008 (43) 26.05.2008  
(30) 2007-025625 21.09.2007 JP  
(71) HONDA MOTOR CO., LTD. (JP)  
1-1, Minami-Aoyama 2-chome, Minato-ku, Tokyo, Japan  
(72) Takuya Okita (JP)  
(74) Văn phòng luật sư Phạm và Liên danh (PHAM & ASSOCIATES)  
(55)



1.1

1.2

1.3



1.4

1.5

1.6



1.7

1.8

1.9

- (11) **12952**  
(21) 3-2008-00385 (28) 01  
(54) CHAI NHỰA (51) **09-01**  
(22) 21.03.2008 (43) 26.05.2008  
(71) CÔNG TY TRÁCH NHIỆM HỮU HẠN SẢN XUẤT THƯƠNG MẠI ĐẠI VIỆT  
HƯƠNG (VN)  
111 Nguyễn Trãi, phường Bến Thành, quận 1, TP. Hồ Chí Minh  
(72) Ngô Trung Quân (VN)  
(74) Công ty TNHH Sở hữu trí tuệ Thảo Thọ Quyển (INVENCO)  
(55)



1.1

1.2

1.3

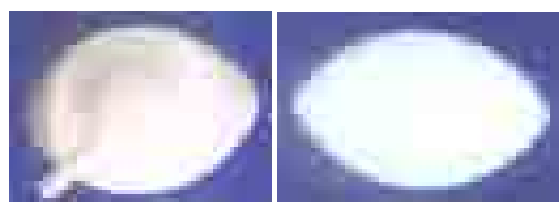

1.4

1.5

- (11) **12953**  
(21) 3-2008-00386 (28) 01  
(54) CHAI NHỰA (51) **09-01**  
(22) 21.03.2008 (43) 26.05.2008  
(71) CÔNG TY TRÁCH NHIỆM HỮU HẠN SẢN XUẤT THƯƠNG MẠI ĐẠI VIỆT  
HƯƠNG (VN)  
111 Nguyễn Trãi, phường Bến Thành, quận 1, TP. Hồ Chí Minh  
(72) Ngô Trung Quân (VN)  
(74) Công ty TNHH Sở hữu trí tuệ Thảo Thọ Quyển (INVENCO)  
(55)



1.1

1.2

1.3

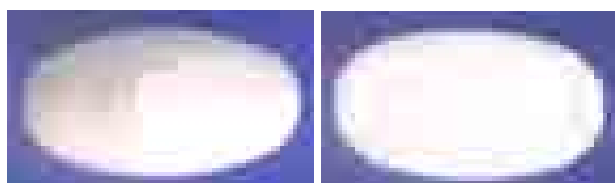

1.4

1.5

- (11) **12954**  
(21) 3-2008-00387 (28) 01  
(54) CHAI NHỰA (51) **09-01**  
(22) 21.03.2008 (43) 26.05.2008  
(71) CÔNG TY TRÁCH NHIỆM HỮU HẠN SẢN XUẤT THƯƠNG MẠI ĐẠI VIỆT  
HƯƠNG (VN)  
111 Nguyễn Trãi, phường Bến Thành, quận 1, TP. Hồ Chí Minh  
(72) Ngô Trung Quân (VN)  
(74) Công ty TNHH Sở hữu trí tuệ Thảo Thọ Quyến (INVENCO)  
(55)



1.1

1.2

1.3

1.4

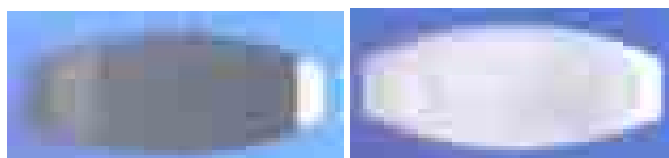

1.5

1.6

- (11) **12955**  
(21) 3-2008-00388 (28) 01  
(54) BÀN (51) **06-03**  
(22) 21.03.2008 (43) 26.05.2008  
(71) CÔNG TY CỔ PHẦN CAO SU SÀI GÒN - KYMDAN (VN)  
28 Bình Thới, phường 14, quận 11, TP. Hồ Chí Minh  
(72) Nguyễn Hữu Trí (VN)  
(74) Công ty TNHH Sở hữu trí tuệ Thảo Thọ Quyến (INVENCO)  
(55)



1.1



1.2

1.3



1.4

1.5

- (11) **12956**  
(21) 3-2008-00389 (28) 02  
(54) GHẾ (51) **06-01**  
(22) 21.03.2008 (43) 26.05.2008  
(71) CÔNG TY CỔ PHẦN CAO SU SÀI GÒN - KYMDAN (VN)  
28 Bình Thới, phường 14, quận 11, TP. Hồ Chí Minh  
(72) Nguyễn Hữu Trí (VN)  
(74) Công ty TNHH Sở hữu trí tuệ Thảo Thọ Quyến (INVENCO)  
(55)

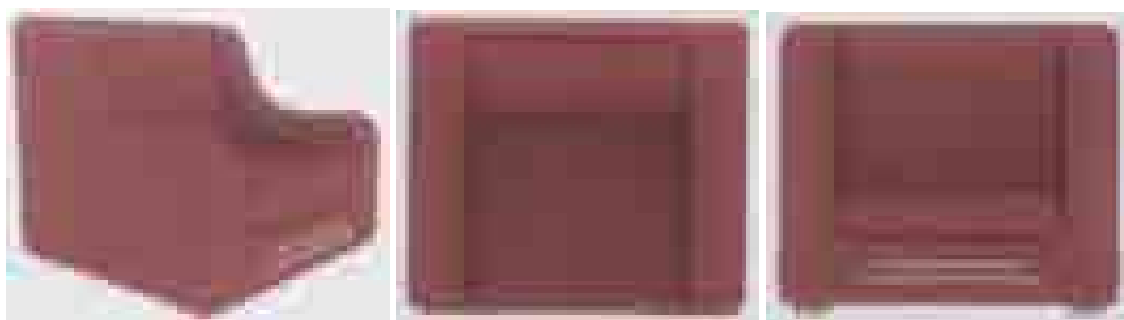

1.1

1.2

1.3

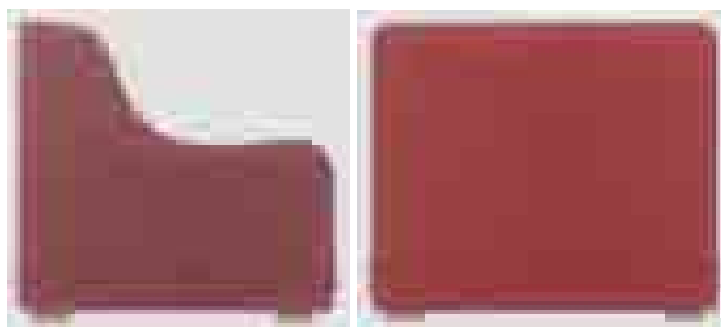

1.4

1.5



2.1



2.2

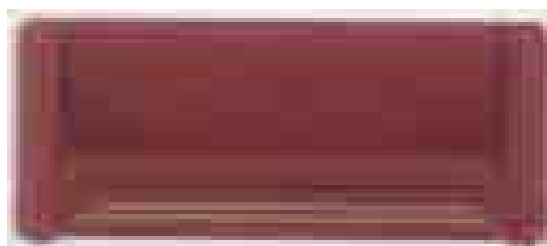

2.3



2.4



2.5



- (11) **12957**  
(21) 3-2008-00390  
(54) BÀN  
(22) 21.03.2008  
(71) CÔNG TY TNHH MỘT THÀNH VIÊN THƯƠNG MẠI VIỆT ĐẠI THÀNH (VN)  
393, Xô Viết Nghệ Tĩnh, phường 24, quận Bình Thạnh, TP. Hồ Chí Minh  
(72) Julakid Rattanamastip (TH)  
(55) (28) 01  
(51) **06-03**  
(43) 26.05.2008



1.1



1.2



1.3



1.4

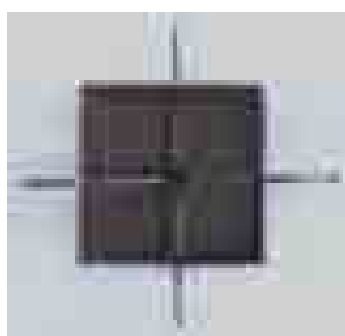

1.5

- (11) **12958**  
(21) 3-2008-00391 (28) 01  
(54) BỘ ĐỒ ĂN (51) **07-01**  
(22) 21.03.2008 (43) 26.05.2008  
(71) CÔNG TY TRÁCH NHIỆM HỮU HẠN MINH LONG I (VN)  
333 xã Hưng Định, huyện Thuận An, tỉnh Bình Dương  
(72) Lý Ngọc Minh (VN)  
(74) Công ty TNHH Lê & Lê (LE & LE)  
(55)



1.1

1.2

1.3

1.4

1.5



1.6

1.7

1.8

1.9

1.10



1.11

1.12

1.13

1.14

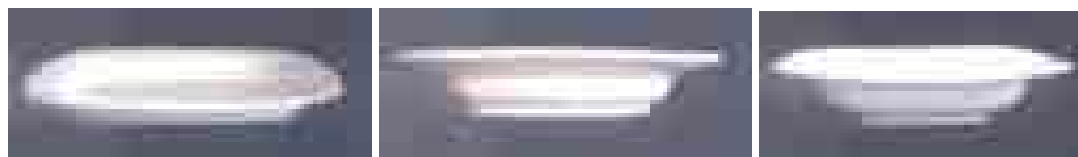

1.15

1.16

1.17

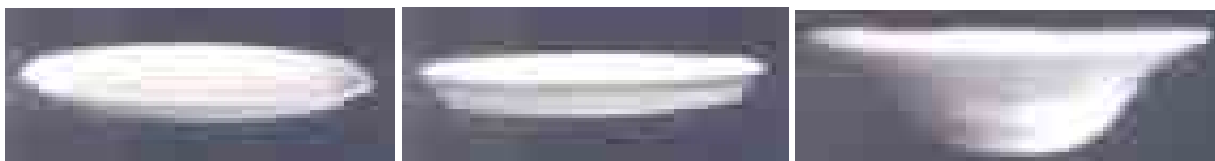

1.18

1.19

1.20

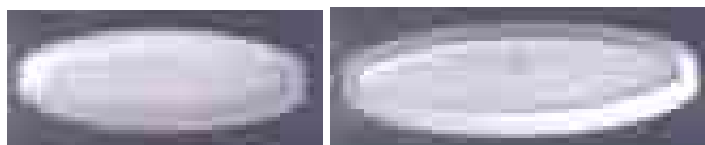

1.21

1.22

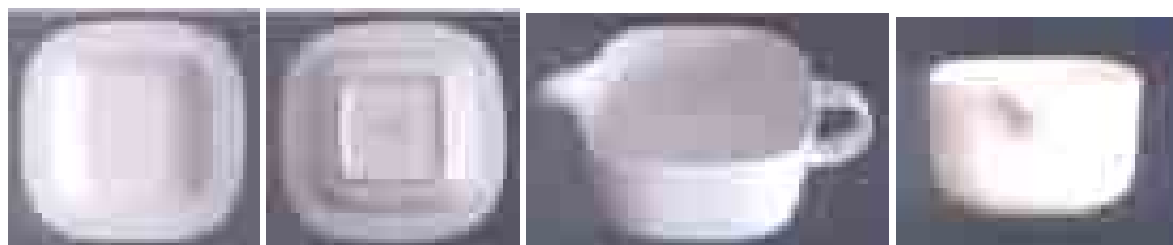

1.23

1.24

1.25

1.26



1.27

1.28

1.29

1.30

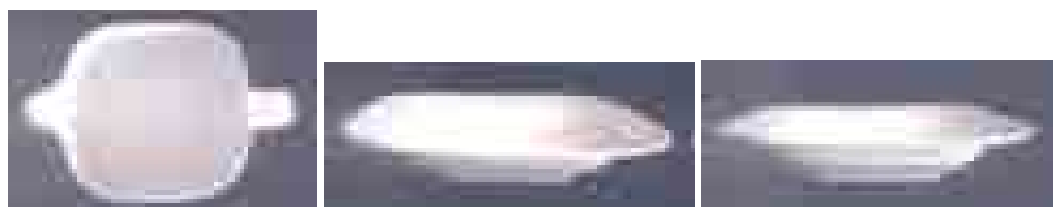

1.31

1.32

1.33



1.34

1.35

1.36

1.37

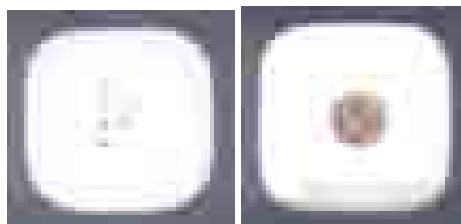

1.38

1.39

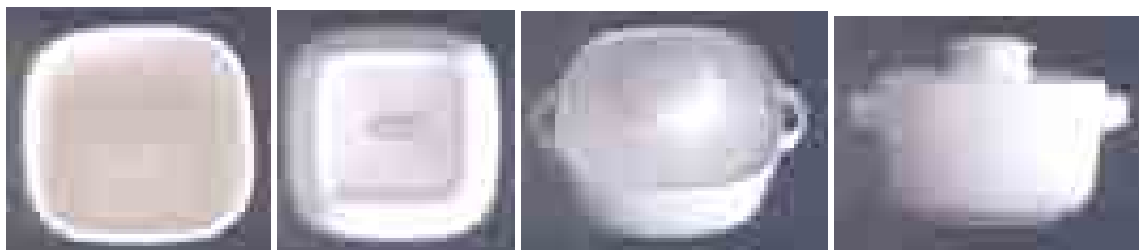

1.40

1.41

1.42

1.43

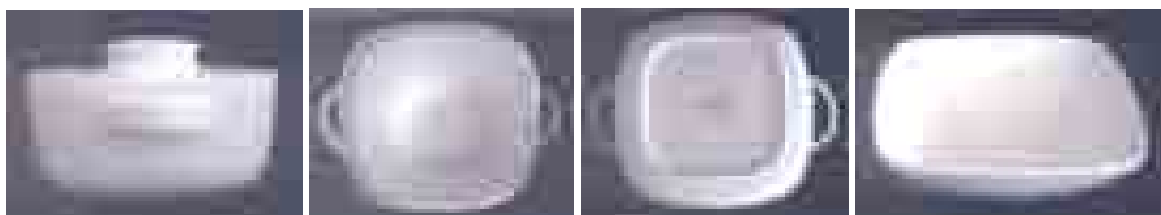

1.44

1.45

1.46

1.47

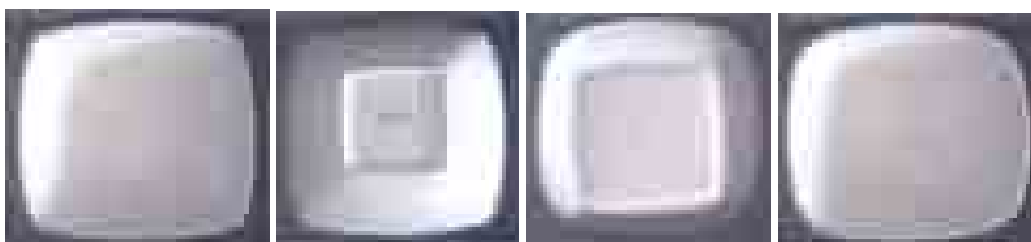

1.48

1.49

1.50

1.51



1.52

1.53

1.54



1.55

1.56

1.57

1.58



1.59

1.60

1.61



1.62

1.63

- (11) **12959**  
(21) 3-2008-00392 (28) 01  
(54) KHẨU TRANG (51) **02-99**  
(22) 21.03.2008 (43) 26.05.2008  
(71) CÔNG TY TRÁCH NHIỆM HỮU HẠN THƯƠNG MẠI SẢN XUẤT THẮNG LỢI (VN)  
Số 258, tổ 21, đường Cầu Giấy, phường Quan Hoa, quận Cầu Giấy, thành phố Hà Nội  
(72) Ngô Viết Thắng (VN)  
(55)



1.1

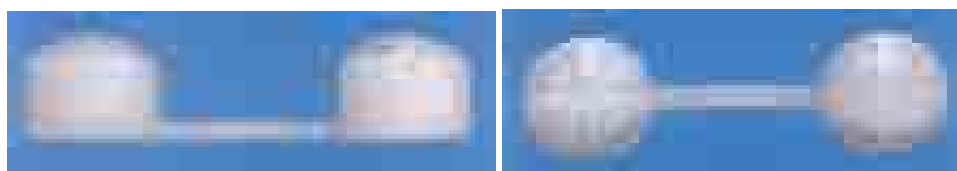

1.2

1.3

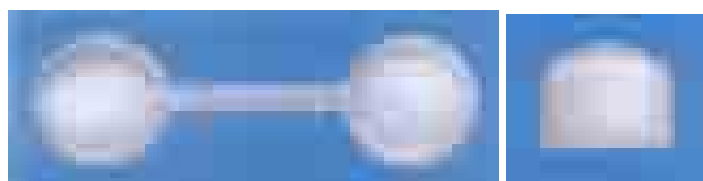

1.4

1.5

- (11) **12960**  
(21) 3-2008-00397 (28) 01  
(54) TÔ (51) **07-01**  
(22) 21.03.2008 (43) 26.05.2008  
(71) SRITHAI SUPERWARE PUBLIC COMPANY LIMITED (TH)  
355 Suksawat Rd., Soi 36 Rasburana Bangkok 10140, Thailand  
(72) SUPAP KITIPOON (TH)  
(74) Công ty Cổ phần Sở hữu công nghiệp INVESTIP (INVESTIP)  
(55)



1.1

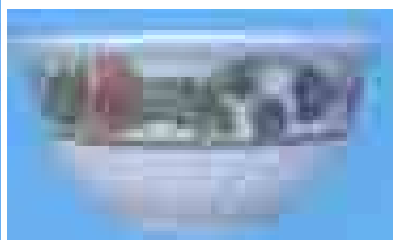

1.2

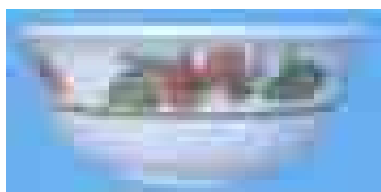

1.3

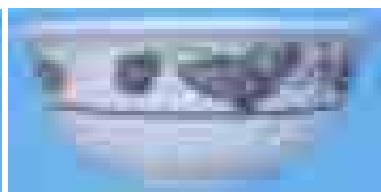

1.4

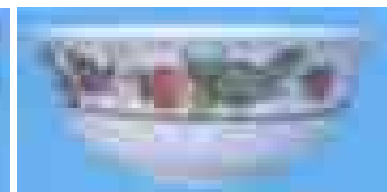

1.5



1.6



1.7

- (11) **12961**  
(21) 3-2008-00400 (28) 01  
(54) CÔNG TẮC BẮM (51) **13-03**  
(22) 24.03.2008 (43) 26.05.2008  
(30) 2007-027522 09.10.2007 JP  
(71) KASUGA DENKI KABUSHIKI KAISHA (ALSO TRADING AS KASUGA ELECTRIC WORKS, LTD.) (JP)  
1-33, Shimorenjaku 6 Chome, Mitaki-shi, Tokyo, Japan  
(72) Toshio Moriya (JP), Tetsuo Takahashi (JP)  
(74) Văn phòng luật sư Phạm và Liên danh (PHAM & ASSOCIATES)  
(55)

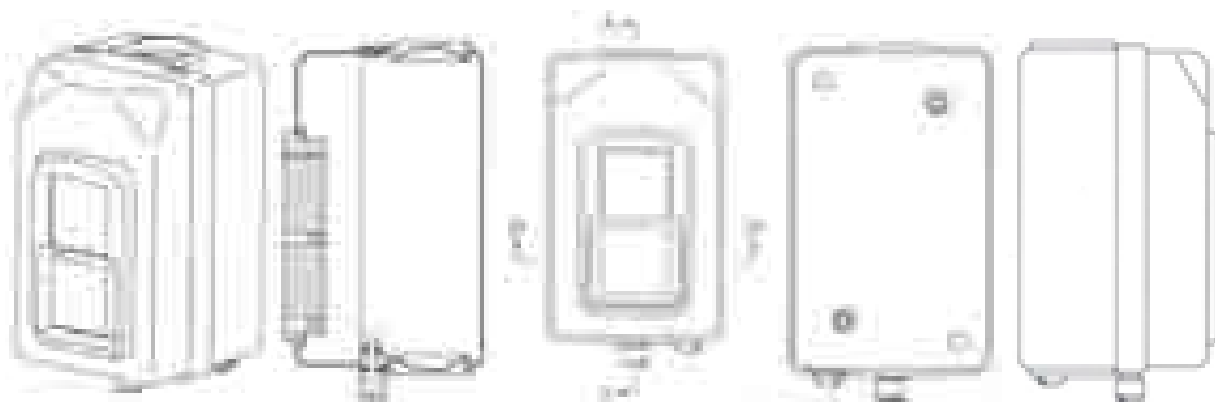

1.1

1.2

1.3

1.4

1.5



1.6

1.7

1.8

1.9

1.10



- (11) **12962**  
(21) 3-2008-00401 (28) 01  
(54) HỘP ĐỤNG THUỐC (51) **09-03**  
(22) 24.03.2008 (43) 26.05.2008  
(71) CÔNG TY TNHH CÔNG NGHỆ SINH HỌC XANH VIỆT NAM (VN)  
Số 1 ngõ 208 Đội Cấn, quận Ba Đình, thành phố Hà Nội  
(72) Trần Danh Thủy (VN)  
(74) Công ty TNHH Sở hữu trí tuệ PADEMARK (PADEMARK CO.,LTD.)  
(55)



1.1



1.2

- (11) **12963**  
(21) 3-2008-00403 (28) 01  
(54) CHAI (51) **09-01**  
(22) 24.03.2008 (43) 26.05.2008  
(71) CÔNG TY TNHH SẢN XUẤT VÀ THƯƠNG MẠI TÂN QUANG MINH (VN)  
Lô C21/I, đường 2F, khu công nghiệp Vĩnh Lộc, huyện Bình Chánh, TP. Hồ Chí Minh  
(72) Nguyễn Đăng Hiến (VN)  
(74) Công ty TNHH Sở hữu trí tuệ WINCO (WINCO CO., LTD.)  
(55)



1.1

1.2

1.3

1.4

- (11) **12964**  
(21) 3-2008-00425 (28) 01  
(54) NHÃN SẢN PHẨM (51) **19-08**  
(22) 27.03.2008 (43) 26.05.2008  
(71) CÔNG TY CỔ PHẦN SINH HÓA MINH ĐỨC (VN)  
Nội Bài, xã Phú Minh, huyện Sóc Sơn, thành phố Hà Nội  
(72) Nguyễn Thanh Đức (VN)  
(55)

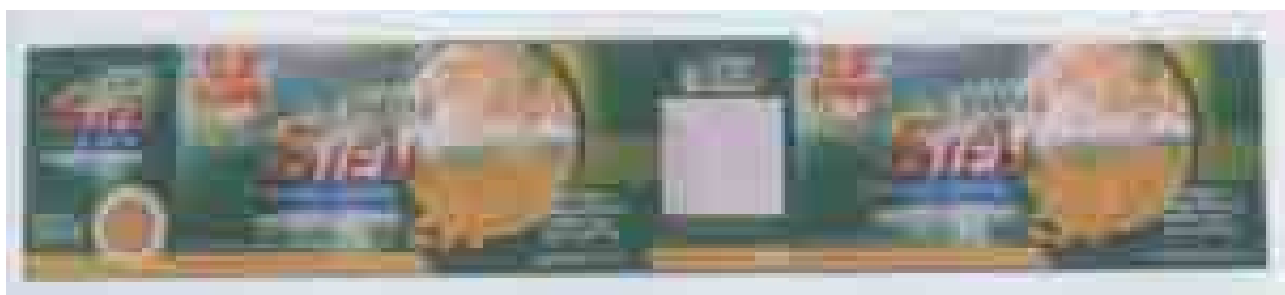

- (11) **12965**  
(21) 3-2008-00426 (28) 01  
(54) NHÃN SẢN PHẨM (51) **19-08**  
(22) 27.03.2008 (43) 26.05.2008  
(71) CÔNG TY CỔ PHẦN SINH HÓA MINH ĐỨC (VN)  
Nội Bài, xã Phú Minh, huyện Sóc Sơn, thành phố Hà Nội  
(72) Nguyễn Thanh Đức (VN)  
(55)

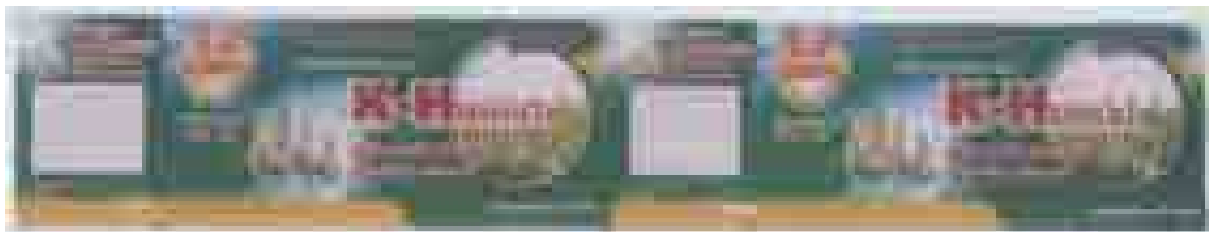

- (11) **12966**  
(21) 3-2008-00427 (28) 01  
(54) NHÃN SẢN PHẨM (51) **19-08**  
(22) 27.03.2008 (43) 26.05.2008  
(71) CÔNG TY CỔ PHẦN SINH HÓA MINH ĐỨC (VN)  
Nội Bài, xã Phú Minh, huyện Sóc Sơn, thành phố Hà Nội  
(72) Nguyễn Thanh Đức (VN)  
(55)



- (11) **12967**  
(21) 3-2008-00428 (28) 01  
(54) NHÃN SẢN PHẨM PHÂN BÓN (51) **19-08**  
(22) 27.03.2008 (43) 26.05.2008  
(71) CÔNG TY CỔ PHẦN SINH HÓA MINH ĐỨC (VN)  
Nội Bài, xã Phú Minh, huyện Sóc Sơn, thành phố Hà Nội  
(72) Nguyễn Thanh Đức (VN)  
(55)

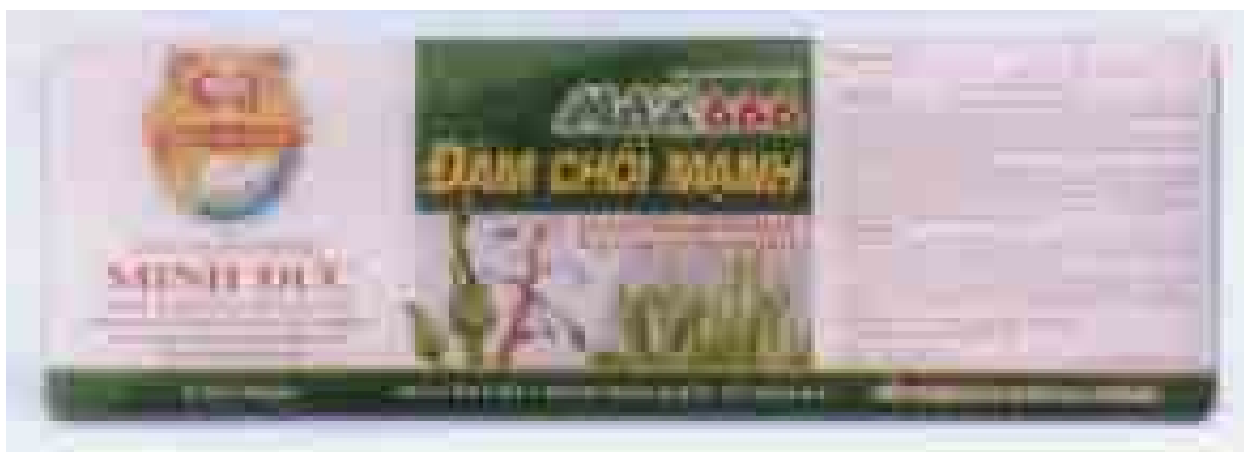

- (11) **12968**  
(21) 3-2008-00434 (28) 01  
(54) XE Ô TÔ (51) **12-08**  
(22) 28.03.2008 (43) 26.05.2008  
(30) 2007-026338 28.09.2007 JP  
(71) HONDA MOTOR CO., LTD. (JP)  
1-1, Minami-Aoyama 2-chome, Minato-ku, Tokyo, Japan  
(72) Masaru Hasegawa (JP), Toshihiko Shimizu (JP), Atsushi Murakawa (JP)  
(74) Văn phòng luật sư Phạm và Liên danh (PHAM & ASSOCIATES)  
(55)



1.1



1.2

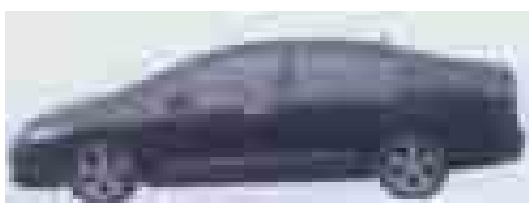

1.3



1.4



1.5



1.6

- (11) **12969**  
(21) 3-2008-00435 (28) 01  
(54) BỘ ĐÈN TRƯỚC DÙNG CHO XE Ô TÔ (51) **26-06**  
TÔ  
(22) 28.03.2008 (43) 26.05.2008  
(30) 2007-026339 28.09.2007 JP  
(71) HONDA MOTOR CO., LTD. (JP)  
1-1, Minami-Aoyama 2-chome, Minato-ku, Tokyo, Japan  
(72) Masaru Hasegawa (JP)  
(74) Văn phòng luật sư Phạm và Liên danh (PHAM & ASSOCIATES)  
(55)



1.1

1.2

1.3



1.4

1.5

1.6



1.7

1.8

1.9



- (11) **12970**  
(21) 3-2008-00436 (28) 01  
(54) BỘ ĐÈN SAU DÙNG CHO XE Ô TÔ (51) **26-06**  
TÔ  
(22) 28.03.2008 (43) 26.05.2008  
(30) 2007-026340 28.09.2007 JP  
(71) HONDA MOTOR CO., LTD. (JP)  
1-1, Minami-Aoyama 2-chome, Minato-ku, Tokyo, Japan  
(72) Hiroshi Matsunami (JP)  
(74) Văn phòng luật sư Phạm và Liên danh (PHAM & ASSOCIATES)  
(55)

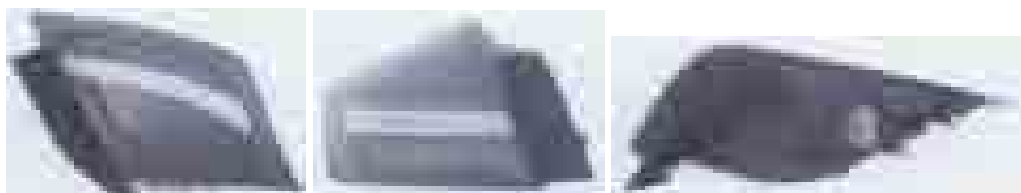

1.1

1.2

1.3



1.4

1.5

1.6

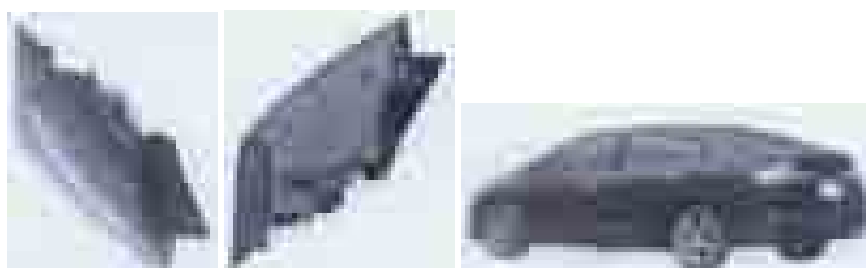

1.7

1.8

1.9

- (11) **12971**  
(21) 3-2008-00456 (28) 01  
(54) DÉP (51) **02-04**  
(22) 31.03.2008 (43) 26.05.2008  
(71) CƠ SỞ NGÂN PHONG (VN)  
200/27/7 Xóm Đất, phường 10, quận 11, TP. Hồ Chí Minh  
(72) Ngô Lệ Hương (VN)  
(74) Công ty TNHH Sở hữu trí tuệ WINCO (WINCO CO., LTD.)  
(55)



1.1

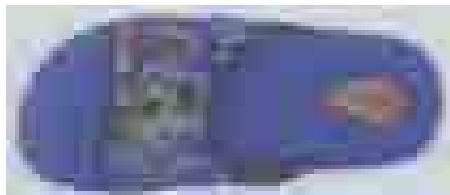

1.2

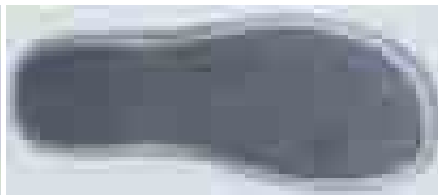

1.3



1.4

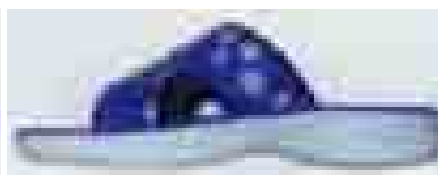

1.5



1.6



1.7

- (11) **12972**  
(21) 3-2008-00464 (28) 01  
(54) ĐẦU GẬY CHƠI GÔN (51) **21-02**  
(22) 01.04.2008 (43) 26.05.2008  
(30) 29/297903 21.11.2007 US  
(71) KARSTEN MANUFACTURING CORPORATION (US)  
2201 West Desert Cove, Phoenix, Arizona 85029, United States of America  
(72) Michael R. Nicolette (US), Bradley D. Schweigert (US), Marty R. Jertson (US), Richard  
R. Sanchez (US), Xiaojian Chen (CN), John A. Solheim (US)  
(74) Công ty TNHH Sở hữu trí tuệ Vàng (GINTASSET CO., LTD.)  
(55)

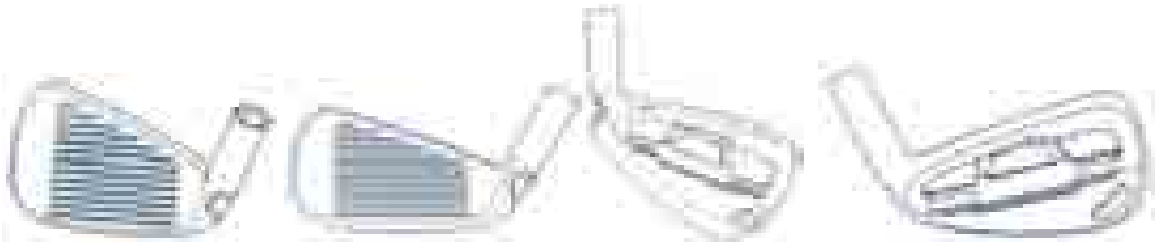

1.1

1.2

1.3

1.4



1.5

1.6

1.7

1.8



1.9

- (11) **12973**  
(21) 3-2008-00476 (28) 01  
(54) XE Ô TÔ (51) **12-08**  
(22) 04.04.2008 (43) 26.05.2008  
(30) 2007-027527 09.10.2007 JP  
(71) TOYOTA JIDOSHA KABUSHIKI KAISHA (JP)  
1-Toyota-cho, Toyota-shi, Aichi-ken 471-8571 Japan  
(72) Sou Tamiya (JP), Yoshitake Takaoka (JP), Tokuharu Mino (JP)  
(74) Công ty TNHH một thành viên Sở hữu trí tuệ VCCI (VCCI-IP CO.,LTD)  
(55)



1.1

1.2



1.3

1.4

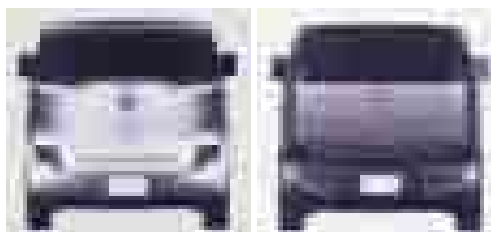

1.5

1.6

- (11) **12974**  
(21) 3-2008-00482 (28) 01  
(54) GẠCH XÂY (51) **25-01**  
(22) 04.04.2008 (43) 26.05.2008  
(71) CÔNG TY TNHH SÔNG CÁT (VN)  
33 Ngô Sĩ Liên, phường 14, quận 8, TP. Hồ Chí Minh  
(72) Lê Văn Kía (VN)  
(74) DNTN Dịch vụ thương mại và sở hữu công nghiệp Song Ngọc (I.P.T.S.)  
(55)



1.1



1.2

1.3



1.4

1.5