

CỘNG HÒA XÃ HỘI CHỦ NGHĨA VIỆT NAM  
BỘ KHOA HỌC VÀ CÔNG NGHỆ  
CỤC SỞ HỮU TRÍ TUỆ

---

**CÔNG BÁO**  
**SỞ HỮU CÔNG NGHIỆP**

TẬP A

**QUYỂN 2: KIỂU DÁNG CÔNG NGHIỆP**

10 - 2019

---

379

**CỘNG HOÀ XÃ HỘI CHỦ NGHĨA VIỆT NAM  
BỘ KHOA HỌC VÀ CÔNG NGHỆ  
CỤC SỞ HỮU TRÍ TUỆ**

---

**CÔNG BÁO  
SỞ HỮU CÔNG NGHIỆP  
TẬP A**

**QUYỂN 2: KIỂU DÁNG CÔNG NGHIỆP**

**10-2019**

---

**379**

---

**HÀ NỘI**

## MỤC LỤC

	Trang
<u>PHẦN I:</u> Đơn yêu cầu cấp Bằng độc quyền kiểu dáng công nghiệp	7
<u>PHẦN II:</u> Sửa đổi đơn	430
<u>PHẦN III:</u> Thay đổi chủ đơn	432

## CONTENTS

<u>PART I:</u> Applications for Industrial Design Patents	7
<u>PART II:</u> Amendment of Applications	430
<u>PART III:</u> Change of Applicants	432

---

**CÔNG BÁO SỞ HỮU CÔNG NGHIỆP SỐ 379 TẬP A - QUYỂN 2 (10.2019)**

**MÃ SỐ HAI CHỮ CÁI THỂ HIỆN TÊN NƯỚC VÀ CÁC THỰC THỂ KHÁC TRONG CÁC TƯ LIỆU SỞ HỮU CÔNG NGHIỆP THEO TIÊU CHUẨN ST3 CỦA WIPO**

AE	United Arab Emirates	CN	China	HK	Hong Kong
AF	Afganistan	CO	Colombia	HN	Honduras
AG	Antihua and Barbuda	CR	Costa Rica	HR	Croatia
AI	Anguilla	CU	Cuba	HT	Haiti
AL	Albania	CV	Cape Verde	HU	Hungary
AN	Netherlands Antilles	CY	Cyprus	ID	Indonesia
AO	Angola	CZ	Czech Republic	IE	Ireland
AR	Argentina	DE	Germany	IL	Israel
AT	Austria	DJ	Djibouti	IN	India
AU	Australia	DK	Denmark	IQ	Iraq
AW	Aruba	DM	Dominica	IR	Iran (Islamic Republic of)
BB	Barbados	DO	Dominican Republic	IS	Iceland
BD	Bangladesh	DZ	Algeria	IT	Italy
BE	Belgium	EC	Ecuador	JM	Jamaica
BF	Burkina Faso	EE	Estonia	JO	Jordan
BG	Bulgaria	EG	Egypt	JP	Japan
BH	Bahrain	ES	Spain	KE	Kenya
BI	Burundi	ET	Ethiopia	KH	Cambodia
BJ	Benin	FI	Finland	KI	Kiribati
BM	Bermuda	FJ	Fiji	KM	Comoros
BN	Brunei Darussalam	FK	Falkand Islands (Malvinas)	KN	Saint Kitts and Nevis
BO	Bolivia	FR	France	KP	Democratic People's Republic of Korea
BR	Brazil	GA	Gabon	KR	Republic of Korea
BS	Bahamas	GB	United Kingdom	KW	Kuwait
BT	Bhutan	GD	Grenada	KY	Cayman Islands
BW	Botswana	GE	Georgia	KZ	Kazakhstan
BY	Belarus	GH	Ghana	LA	Laos
BZ	Belize	GI	Gibraltar	LB	Lebanon
CA	Canada	GM	Gambia	LC	Saint Lucia
CF	Central African Republic	GN	Guinea	LI	Liechtenstein
CG	Congo	GQ	Equatorial Guinea	LK	SriLanka
CH	Switzerland	GR	Greece	LR	Liberia
CI	Côte d'Ivoire	GT	Guatemala	LS	Lesotho
CL	Chile	GW	Guinea-Bissau	LT	Lithuania
CM	Cameroon	GY	Guyana	TC	Turk and Caicos Islands
LU	Luxembourg	PA	Panama	TD	Chad
LV	Latvia	PE	Peru	TG	Togo
LY	Lybya	PG	Papua New Guinea	TH	Thailand
MA	Morocco	PH	Philippines	TN	Tunisia
MC	Monaco	PK	Pakistan	TO	Tonga
MD	Republic of Moldova	PL	Poland	TR	Turkey

**CÔNG BÁO SỞ HỮU CÔNG NGHIỆP SỐ 379 TẬP A - QUYỂN 2 (10.2019)**

MG	Madagascar	PT	Portugal	TT	Trinidad and Tobago
ML	Mali	PY	Paraguay	TV	Tuvalu
MM	Myanmar	QA	Qatar	TW	Taiwan, Province of China
MN	Mongolia	RO	Rumania	TZ	United Republic of Tanzania
MO	Macau	RU	Russian Federation	UA	Ukraine
MR	Mauritania	RW	Rwanda	UG	Uganda
MS	Montserrat	SA	Saudi Arabia	US	United States of America
MT	Malta	SB	Solomon Islands	UY	Uruguay
MU	Mauritius	SC	Seychelles	UZ	Uzbekistan
MV	Maldives	SD	Sudan	VA	Holy see
MW	Malawi	SE	Sweden	VC	Saint Vincent and the Grenadines
MX	Mexico	SG	Singapore	VE	Venezuela
MY	Malaysia	SH	Saint Helena	VG	Virgin Islands (British)
MZ	Mozambique	SL	Slovenia	VN	Vietnam
NA	Namibia	SK	Slovakia	VU	Vanuatu
NE	Niger	SL	Sierra Leone	WS	Samoa
NG	Nigeria	SM	San Marino	YE	Yemen
NJ	Nicaragua	SN	Senegal	YU	Yugoslavia
NL	Netherlands	SO	Somalia	ZA	South Africa
NO	Norway	SR	Suriname	ZM	Zambia
NP	Nepal	ST	Sao Tome and Principe	ZR	Zaire
NR	Nauru	SV	El Sanvador	ZW	Zimbabwe
NZ	New Zealand	SY	Syria		
OM	Oman	SZ	Swaziland		

**CÁC TỔ CHỨC QUỐC TẾ**

AO	African Intellectual Property Organization (OAPI)
AP	African Regional Industrial Property Organization (ARIPO)
BX	Benelux Trademark Office and Benelux Designs Office
EP	European Patent Office (EPO)
IB, WO	International Bureau of the World Intellectual Property Organization (WIPO)

**NHỮNG MÃ SỐ INID TRÍCH TỪ TIÊU CHUẨN ST80 CỦA TỔ CHỨC SỞ HỮU TRÍ TUỆ THẾ GIỚI (WIPO) ĐỂ NHẬN BIẾT CÁC DỮ LIỆU THƯ MỤC DÙNG CÔNG BỐ ĐƠN VÀ BẰNG ĐỘC QUYỀN KIỂU DÁNG CÔNG NGHIỆP**

- (11) Số bằng độc quyền kiểu dáng công nghiệp / Số công bố đơn
- (15) Ngày cấp
- (17) Ngày hết hạn hiệu lực của bằng độc quyền kiểu dáng công nghiệp
- (21) Số đơn
- (22) Ngày nộp đơn
- (23) Tên triển lãm, ngày và nơi triển lãm
- (28) Số phương án yêu cầu bảo hộ
- (30) Số đơn ưu tiên, ngày nộp đơn ưu tiên
- (43) Ngày công bố đơn
- (45) Ngày công bố bằng độc quyền kiểu dáng công nghiệp
- (51) Phân loại quốc tế kiểu dáng công nghiệp
- (54) Tên sản phẩm mang kiểu dáng công nghiệp
- (55) Ảnh chụp / hình vẽ kiểu dáng công nghiệp
- (57) Đặc điểm khác biệt yêu cầu bảo hộ của kiểu dáng công nghiệp
- (62) Số và ngày nộp đơn, số bằng độc quyền KDCN hoặc số công bố đơn liên quan đến tách đơn
- (71) Tên và địa chỉ của người nộp đơn
- (72) Tên của tác giả KDCN
- (73) Tên, địa chỉ của chủ bằng độc quyền KDCN
- (74) Tên của người đại diện SHCN

**PHẦN I**

**ĐƠN YÊU CẦU CẤP BẰNG ĐỘC QUYỀN KIỂU DÁNG CÔNG NGHIỆP**

- (11) **36628**  
(21) 3-2019-01401 (28) 1  
(54) **HỘP ĐỰNG BÚT** (51) **19-06**  
(22) 30/05/2019 (43) 25/10/2019  
(30) 2018-028439 26/12/2018 JP;  
KING JIM CO., LTD. (JP)  
(73) 10-18, Higashi-Kanda 2-chome, Chiyoda-ku, Tokyo, Japan  
1. KOUICHI TANIMOTO (JP)  
(72) 2. NAYUMI YAMADA (JP)  
3. MAIKO HARA (JP)  
(74) Công ty Luật TNHH AMBYS Hà Nội (AMBYS HANOI)  
(55)

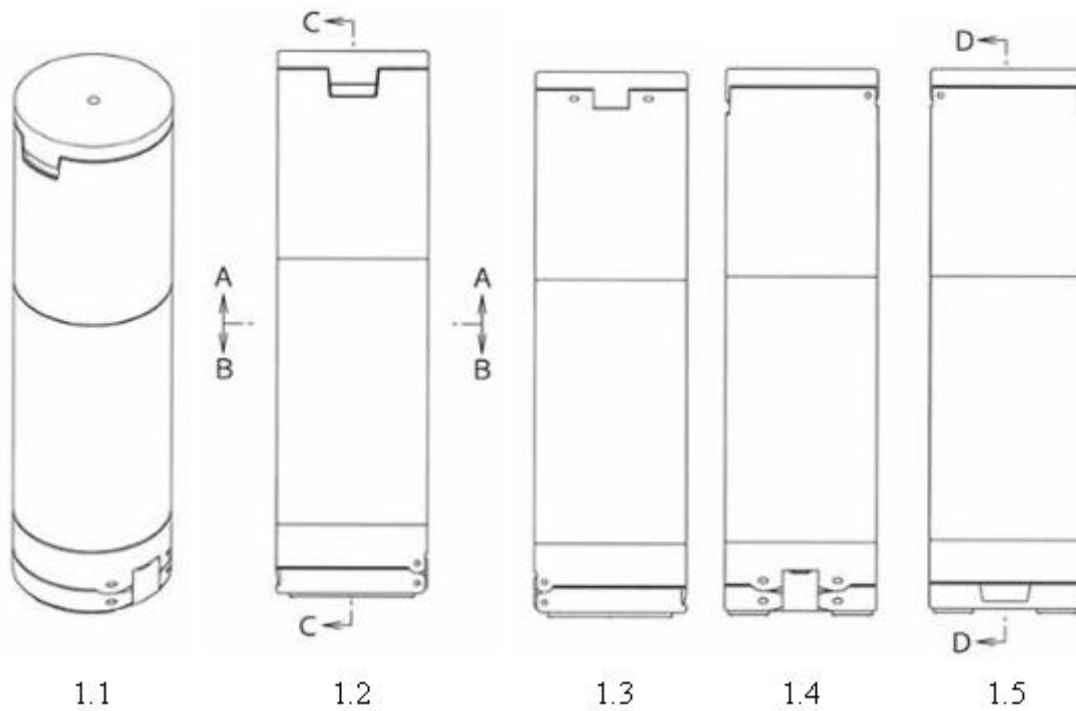

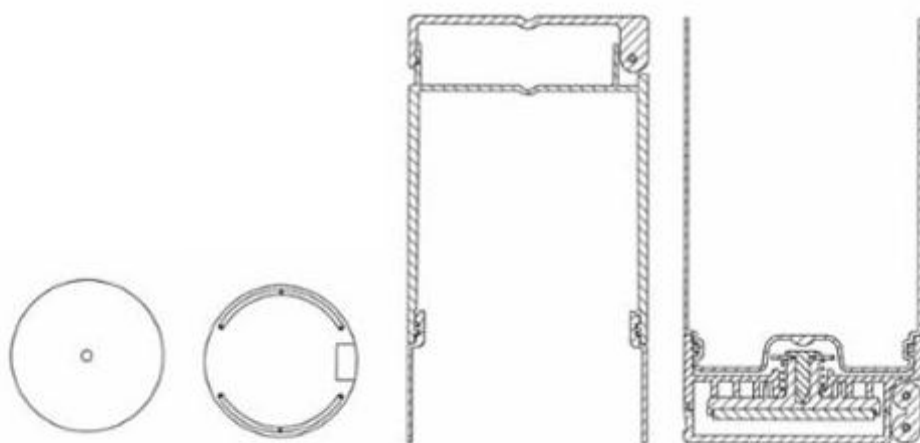

1.6

1.7

1.8

1.9

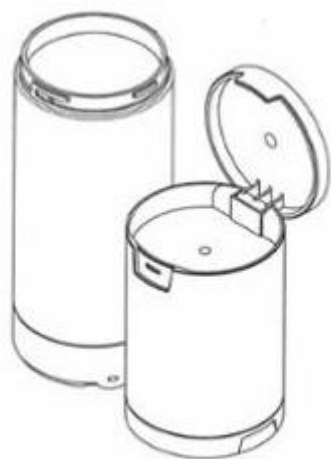

1.10



1.11

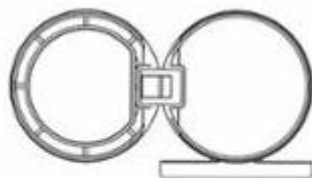

1.12



(11) **36629**

(21) 3-2019-01403

(54) **GIÁ ĐỒ**

(22) 30/05/2019

CÔNG TY CỔ PHẦN ĐẦU TƯ VÀ THƯƠNG MẠI KHÁNH NHẬT (VN)

(73) Số 12, ngõ 332/7 đường Hoàng Công Chất, phường Phú Diễn, quận Bắc Từ Liêm, thành phố Hà Nội

(72) Bùi Trung Dũng (VN)

(74) Công ty TNHH Tư vấn đầu tư và Sở hữu trí tuệ Hoàng Phi (HOANG PHI INVEST & I.P CO., LTD)

(55)

(28) 1

(51) **12-05**

(43) 25/10/2019

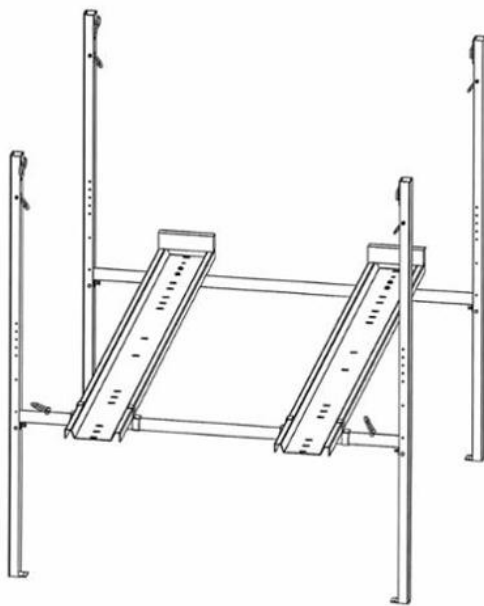

1.1

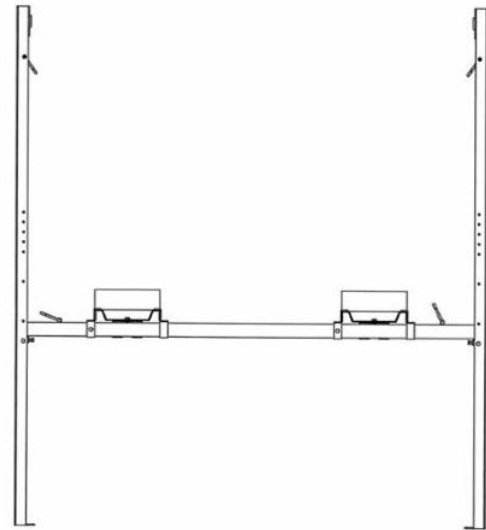

1.2

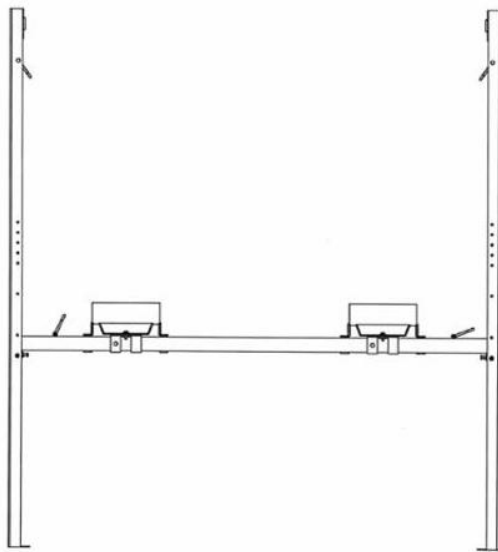

1.3

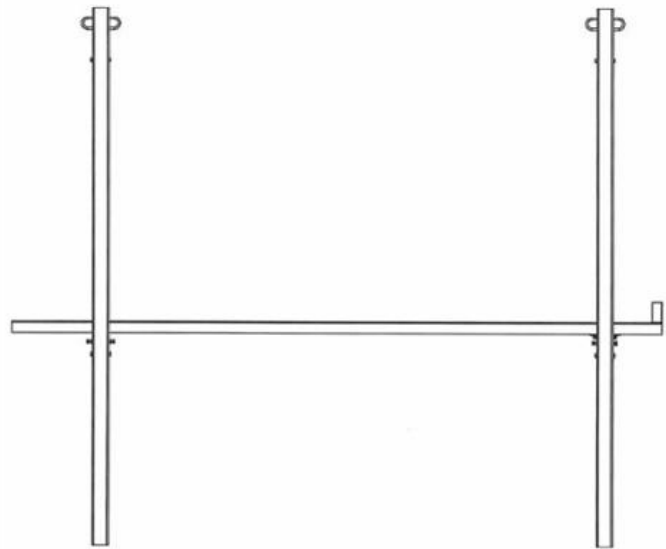

1.4

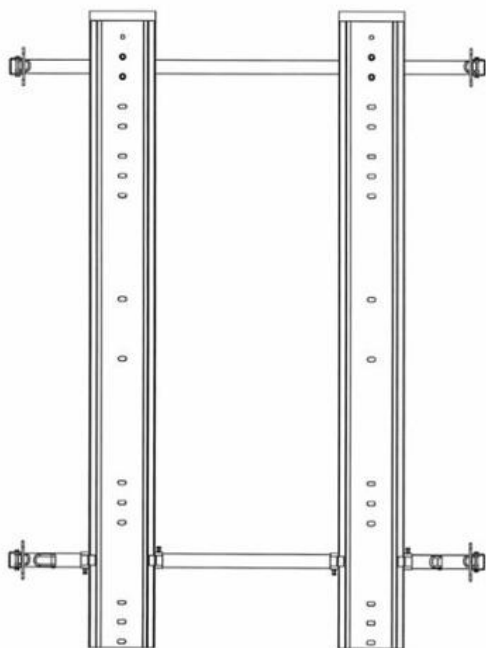

1.5

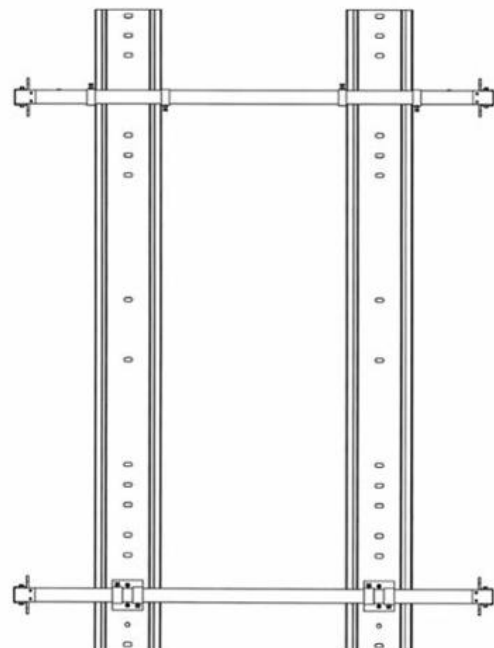

1.6

- (11) **36630**  
(21) 3-2019-01408 (28) 1  
(54) **QUẠT HƠI NƯỚC** (51) **23-04**  
(22) 31/05/2019 (43) 25/10/2019  
LEADER BRIGHT INDUSTRIES LIMITED (CN)  
(73) E2, 1/F., Tuen Mun Industrial Centre, Pui To Road, TMTL 76, Tuen Mun, New Territories, Hong Kong  
(72) 1. WON KWONG MING, ARTHUR (HK)  
2. LEUNG WING HONG (HK)  
(74) Công ty Cổ phần Sở hữu công nghiệp INVESTIP (INVESTIP)  
(55)

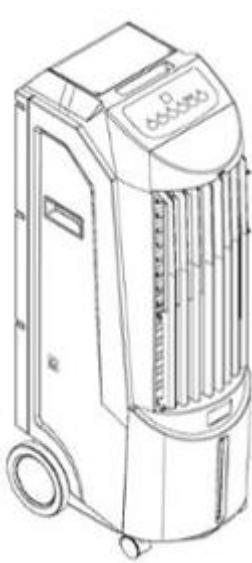

1.1

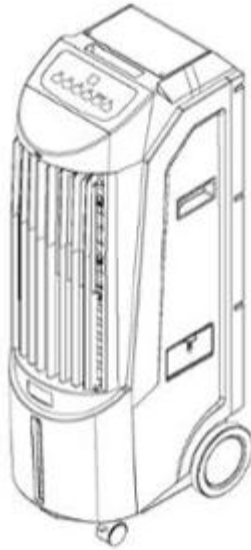

1.2



1.3



1.4

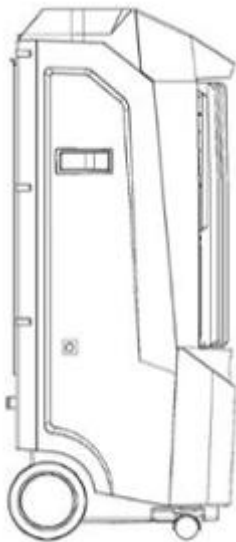

1.5

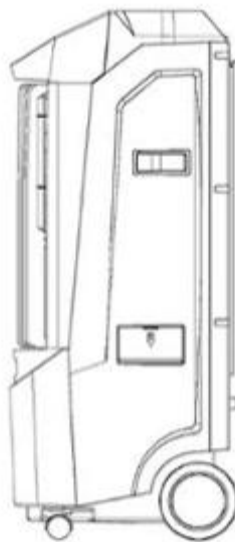

1.6



1.7

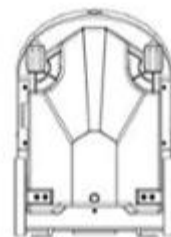

1.8

- (11) **36631**  
(21) 3-2019-01415 (28) 1  
(54) **LỌ ĐỰNG SON MÔI** (51) **28-02**  
(22) 03/06/2019 (43) 25/10/2019  
(30) 30-2019-0024691 24/05/2019 KR;  
LG HOUSEHOLD & HEALTH CARE LTD. (KR)  
(73) 58, Saemunan-ro, Jongno-gu, Seoul, Republic of Korea  
(72) PARK, Jin Won (KR)  
(74) Công ty TNHH Sở hữu trí tuệ Việt (VIET A IP CO.,LTD)  
(55)

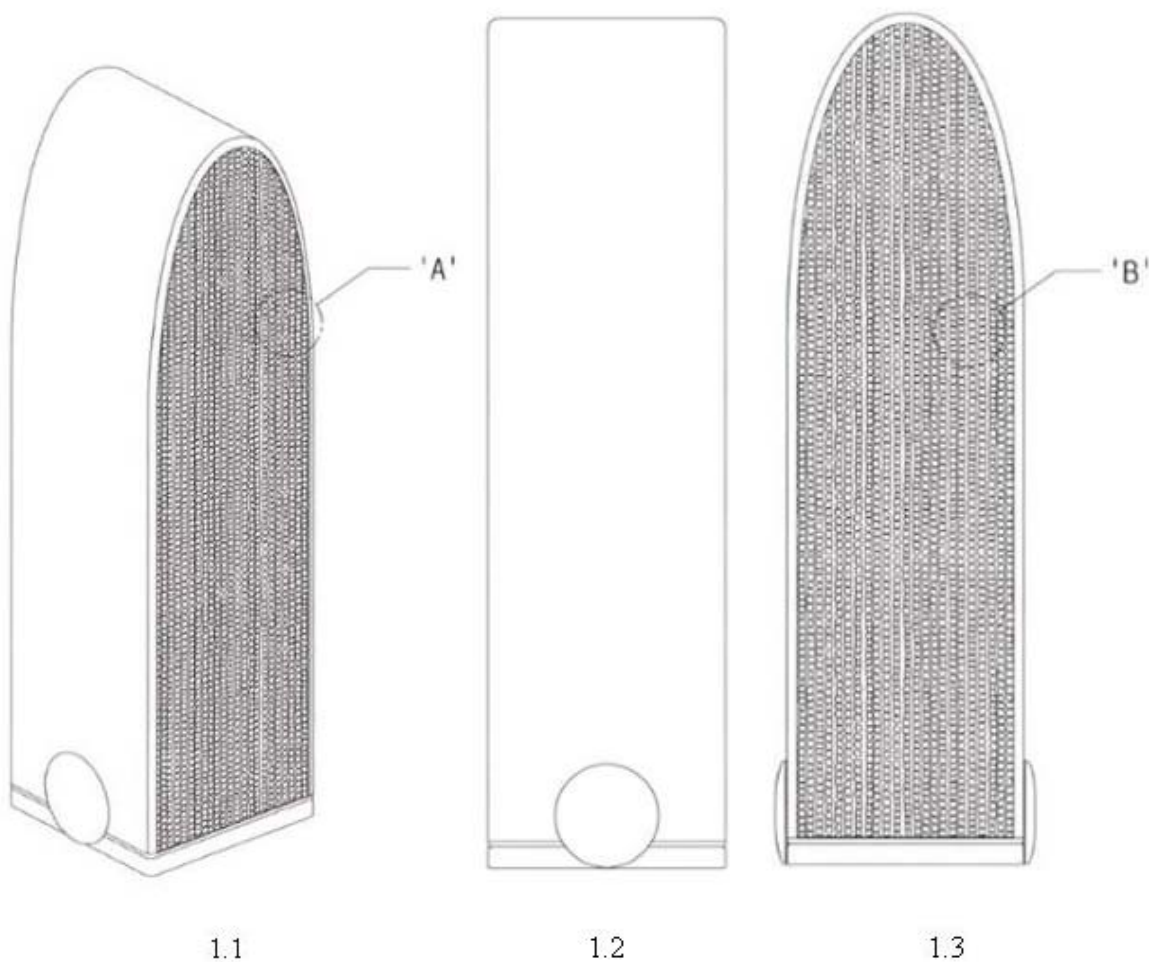



1.4

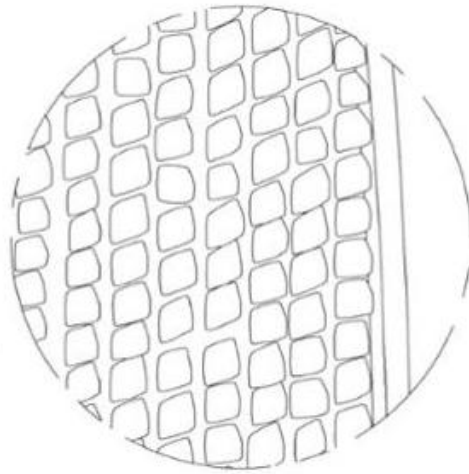

1.5

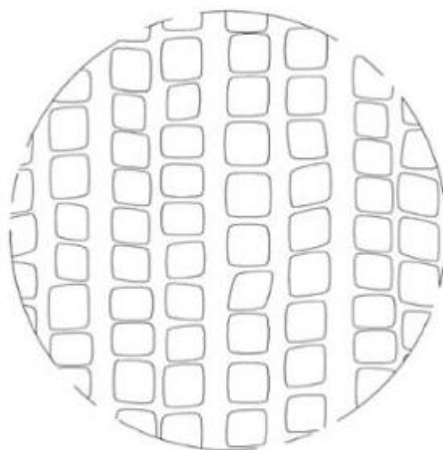
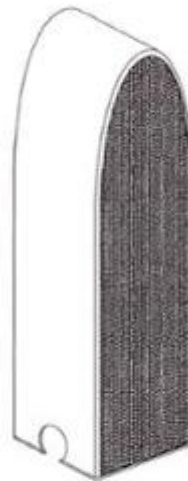

1.6

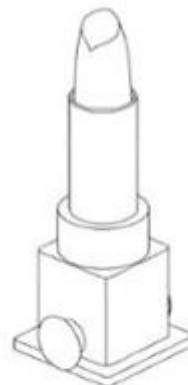

1.7

- (11) **36632**  
(21) 3-2019-01422 (28) 1  
(54) **VIÊN NANG ĐỰNG MỸ PHẨM** (51) **28-02**  
(22) 04/06/2019 (43) 25/10/2019  
(30) 30-2019-0025997 31/05/2019 KR;  
(73) LG HOUSEHOLD & HEALTH CARE LTD. (KR)  
(73) 58, Saemunan-ro, Jongno-gu, Seoul, Republic of Korea  
(72) LEE, Hye Jin (KR)  
(74) Công ty TNHH Sở hữu trí tuệ Việt Á (VIET A IP CO.,LTD)  
(55)

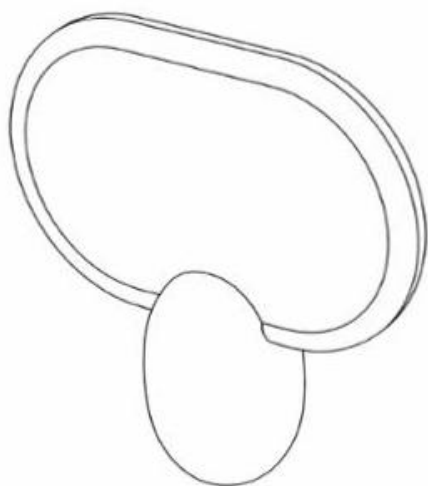

1.1

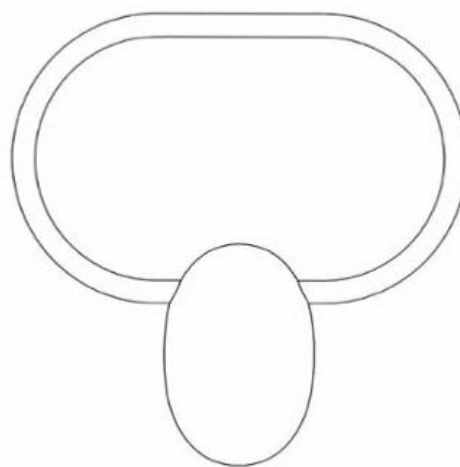

1.2

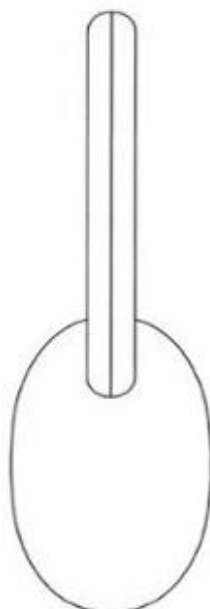

1.3

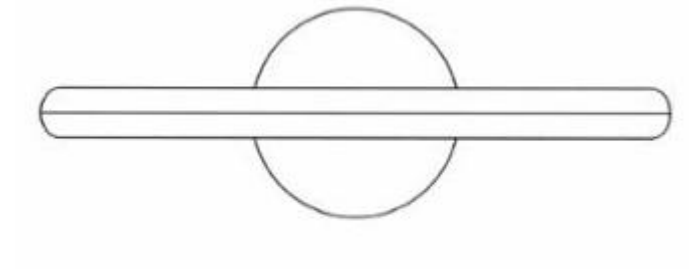

1.4

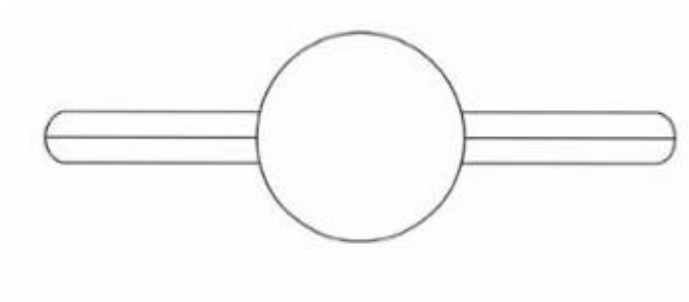

1.5

- (11) **36633**  
(21) 3-2019-01441 (28) 1  
(54) **CỐC** (51) **07-01**  
(22) 05/06/2019 (43) 25/10/2019  
(30) 29/672,428 05/12/2018 US;  
BALL CORPORATION (US)  
(73) 10 Longs Peak Drive, Broomfield, Colorado 80021 UNITED STATES  
(72) Anthony J. SCOTT (US)  
(74) Công ty TNHH Trường Xuân (AGELESS CO.,LTD.)  
(55)



1.1

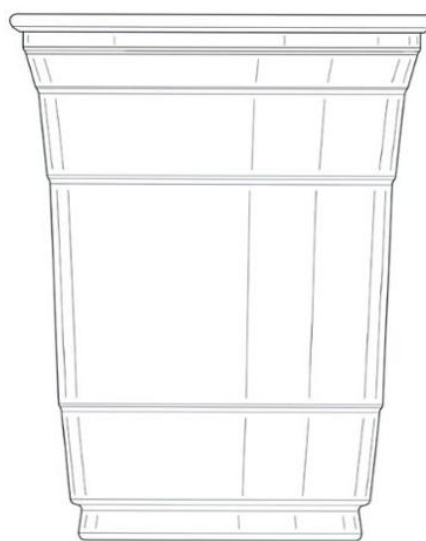

1.2

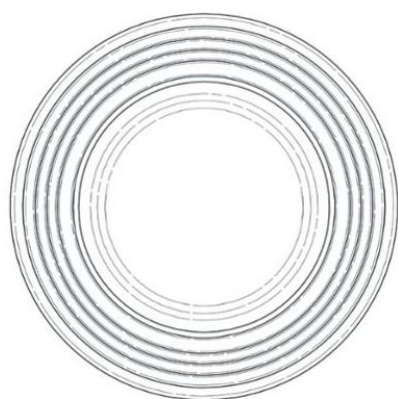

1.3

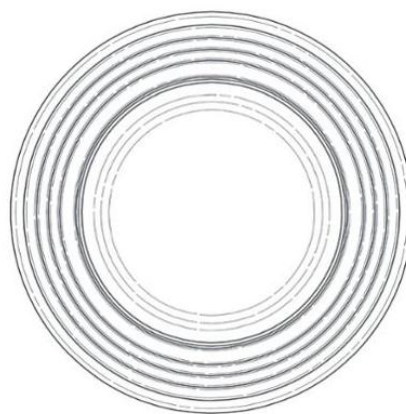

1.4



- (11) **36634**  
(21) 3-2019-01447 (28) 1  
(54) **VÀNH BÁNH XE MÁY** (51) **12-16**  
(22) 06/06/2019 (43) 25/10/2019  
(73) CÔNG TY TNHH QUỐC TẾ NAM VIỆT (VN)  
Số 28 đường Nguyễn Văn Linh, phường Liên Bảo, Vĩnh Yên, tỉnh Vĩnh Phúc  
(72) Nguyễn Thị Chính (VN)  
(74) Công ty Luật TNHH MINH KHUÊ (MK LAW FIRM)  
(55)



1.1



1.2



1.3



1.4



1.5



1.6



1.7

- (11) **36635**  
(21) 3-2019-01467 (28) 1  
(54) **LỚP XE** (51) **12-15**  
(22) 07/06/2019 (43) 25/10/2019  
KUMHO TIRE CO., INC. (KR)  
(73) (Sochon-dong) 658, Eodeung-daero, Gwangsan-gu, Gwangju 62392, Republic of Korea  
(72) In-Hee PARK (KR)  
(74) Công ty Cổ phần Sở hữu công nghiệp INVESTIP (INVESTIP)  
(55)



1.1



1.2



1.3



1.4



1.5



1.6



1.7

- (11) **36636**  
(21) 3-2019-01480 (28) 1  
(54) **MŨ BẢO HIỂM** (51) **02-03**  
(22) 10/06/2019 (43) 25/10/2019  
(30) 970011715 06/03/2019 WO;  
OGK KABUTO CO., LTD. (JP)  
(73) 3-4, Nagata-nishi 6-chome, Higashi-Osaka-shi, Osaka, Japan  
(72) Takeshi MURAKAMI (JP)  
(74) Công ty Luật TNHH Phạm và Liên danh (PHAM & ASSOCIATES)  
(55)



1.1



1.2



1.3



1.4



1.5



1.6



1.7



1.8



1.9



1.10



1.11

- (11) **36637**  
(21) 3-2019-01488 (28) 1  
(54) **ĐỒNG HỒ THÔNG MINH** (51) **10-02**  
(22) 10/06/2019 (43) 25/10/2019  
(30) 201830767455.5 28/12/2018 CN;  
BEIJING KINGSOFT INTERNET SECURITY SOFTWARE CO., LTD. (CN)  
(73) Eastern, 2nd Floor, No. 33 Xiao Ying Xi Road, Haidian District, Beijing 100085,  
P. R. China  
(72) WANG, Xin (CN)  
(74) Công ty TNHH Trường Xuân (AGELESS CO.,LTD.)  
(55)



1.1



1.2



1.3



1.4





1.5



1.6



1.7

- (11) **36638**  
(21) 3-2019-01491  
(54) **TƯỢNG TRANG TRÍ**  
(22) 11/06/2019  
(73) CÔNG TY TNHH MINH LONG I (VN)  
333 khu phố Hưng Lộc, phường Hưng Định, thị xã Thuận An, tỉnh Bình Dương  
(72) Lý Ngọc Minh (VN)  
(55)
- (28) 1  
(51) **11-02**  
(43) 25/10/2019



1.1



1.2



1.3



1.4



1.5



1.6



1.7



1.8

- (11) **36639**  
(21) 3-2019-01492  
(54) **TƯỢNG TRANG TRÍ**  
(22) 11/06/2019  
(73) CÔNG TY TNHH MINH LONG I (VN)  
333 khu phố Hưng Lộc, phường Hưng Định, thị xã Thuận An, tỉnh Bình Dương  
(72) Lý Ngọc Minh (VN)  
(55)
- (28) 1  
(51) **11-02**  
(43) 25/10/2019



1.1



1.2



1.3



1.4



1.5



1.6



1.7



1.8

- (11) **36640**  
(21) 3-2019-01493  
(54) **TƯỢNG TRANG TRÍ**  
(22) 11/06/2019  
(73) CÔNG TY TNHH MINH LONG I (VN)  
333 khu phố Hưng Lộc, phường Hưng Định, thị xã Thuận An, tỉnh Bình Dương  
(72) Lý Ngọc Minh (VN)  
(55)
- (28) 1  
(51) **11-02**  
(43) 25/10/2019



1.1



1.2



1.3



1.4





1.5



1.6



1.7



1.8

- (11) **36641**  
(21) 3-2019-01496 (28) 1  
(54) **NỒI CƠM ĐIỆN** (51) **07-02**  
(22) 11/06/2019 (43) 25/10/2019  
(30) 201830770624.0 29/12/2018 CN;  
ZHEJIANG SUPOR ELECTRICAL APPLIANCES MANUFACTURE CO.,  
LTD. (CN)  
(73) No. 501, Binan Road Binan, High-tech Zone (Binjiang), Hangzhou city, Zhejiang  
province, China  
(72) HUO, Lei (CN)  
(74) Công ty Luật TNHH quốc tế BMVN (BMVN INTERNATIONAL LLC)  
(55)



1.1



1.2



1.3



1.4



1.5



1.6



1.7

- (11) **36642**  
(21) 3-2019-01503 (28) 1  
(54) **MÁY LỌC NƯỚC NÓNG LẠNH** (51) **23-01**  
(22) 11/06/2019 (43) 25/10/2019  
(30) 30-2018-0061185 24/12/2018 KR;  
(73) CUCKOO HOMESYS CO., LTD. (KR)  
(73) 349, Emtibeuibuk-ro, Siheung-si, Gyeonggi-do, 15117, Republic of Korea  
(72) PARK, Seo Jun (KR)  
(74) Công ty TNHH Tâm nhìn và Liên danh (VISION & ASSOCIATES CO.LTD.)  
(55)

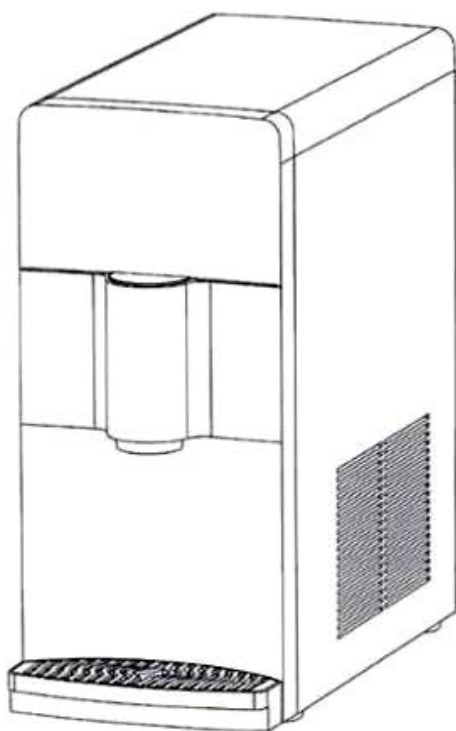

1.1

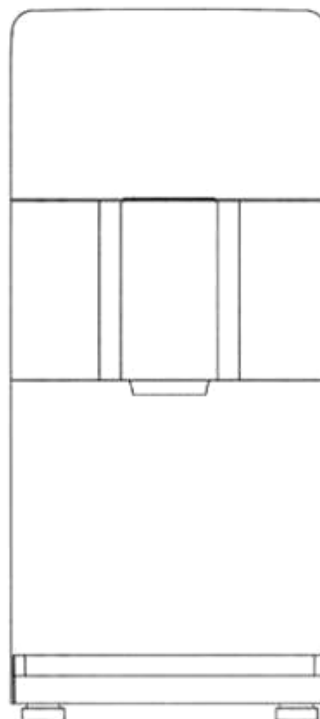

1.2



1.3

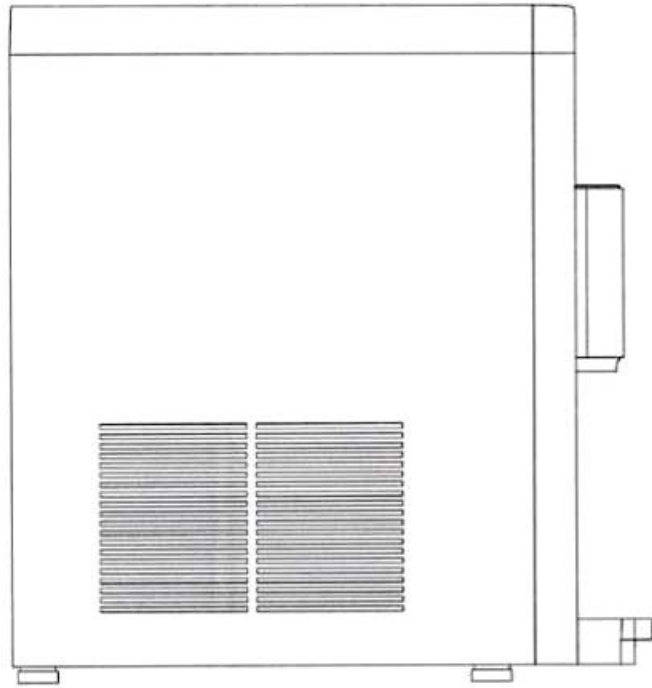

1.4

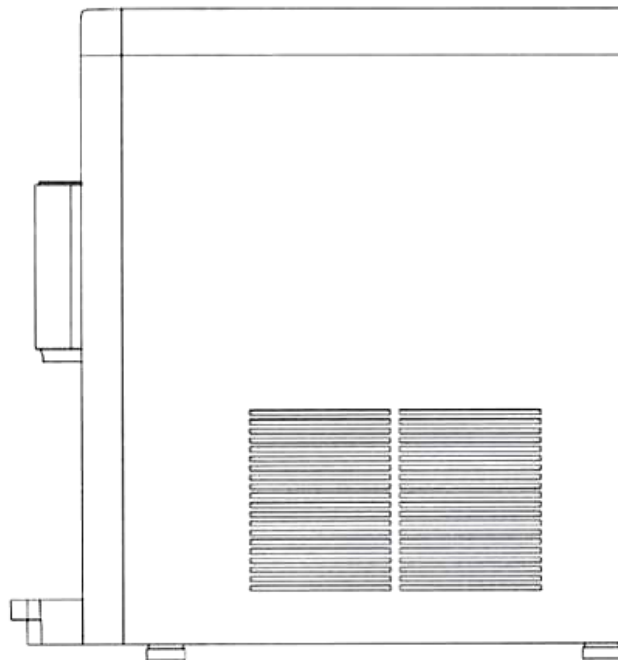

1.5

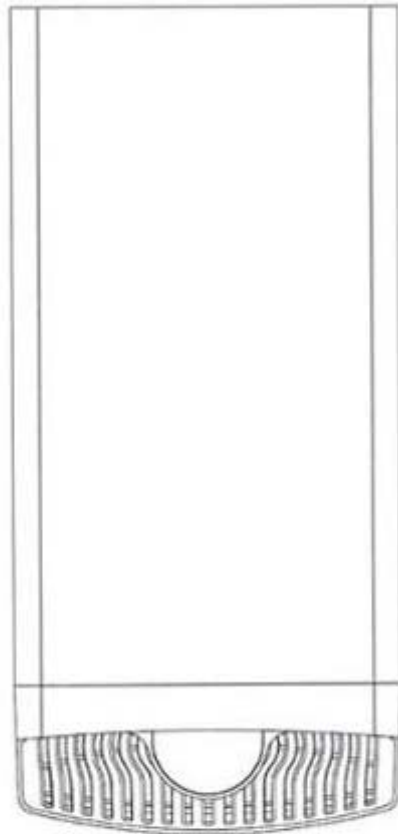

1.6

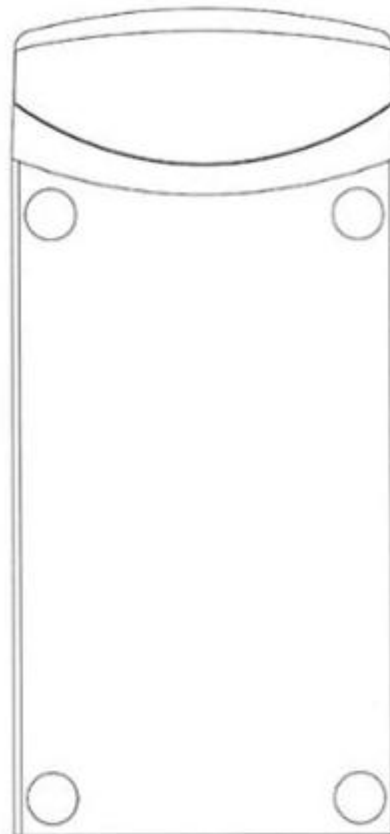

1.7

- (11) **36643**  
(21) 3-2019-01495 (28) 1  
(54) **QUẠT HỒI NƯỚC** (51) **23-04**  
(22) 11/06/2019 (43) 25/10/2019  
LEADER BRIGHT INDUSTRIES LIMITED (HK)  
(73) E2, 1/F., Tuen Mun Industrial Centre, Pui To Road, TMTL 76, Tuen Mun, New Territories, Hong Kong  
(72) 1. WON KWONG MING, ARTHUR (CN)  
2. LEUNG WING HONG (CN)  
(74) Công ty Cổ phần Sở hữu công nghiệp INVESTIP (INVESTIP)  
(55)

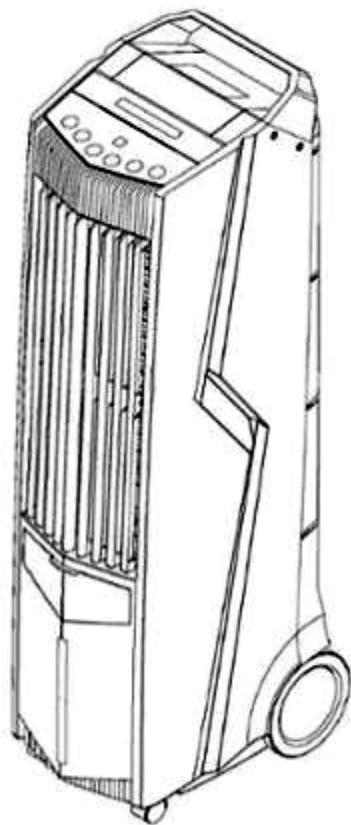

1.1

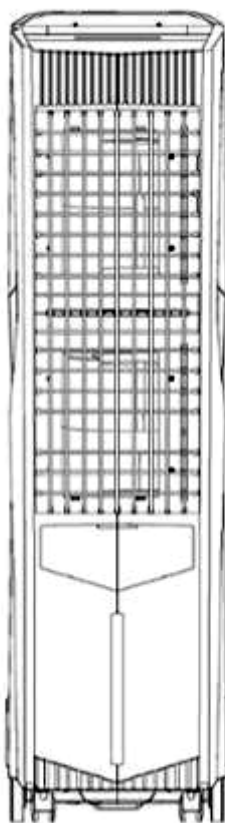

1.2



1.3

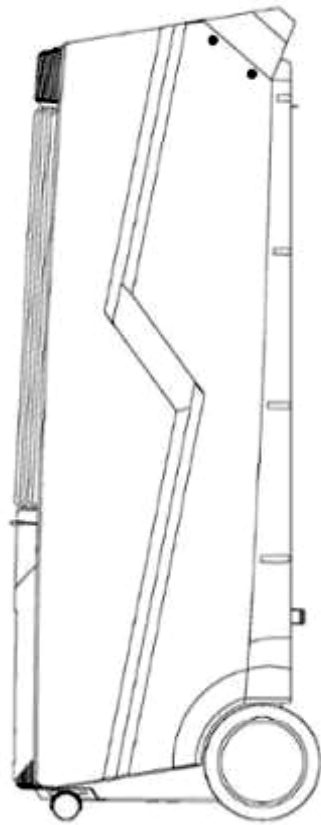

1.4

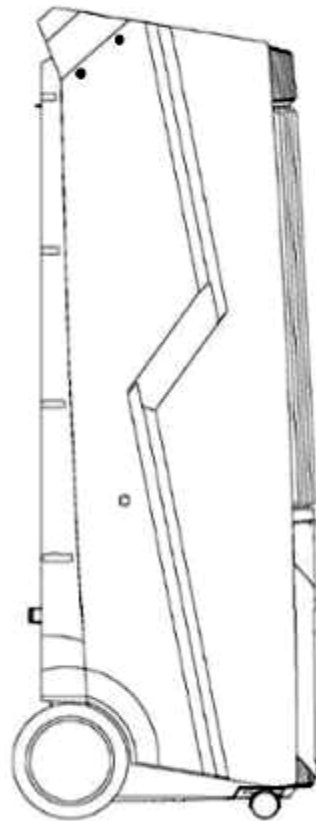

1.5

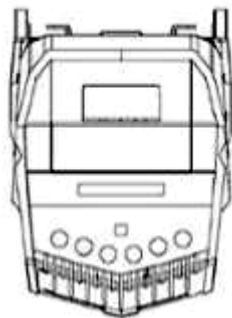

1.6

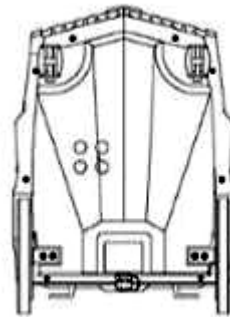

1.7



- |      |   |      |              |
|------|---|------|--------------|
| (11) | <b>36644</b>  |      |              |
| (21) | 3-2019-01521  | (28) | 1            |
| (54) | <b>HỘP</b>  | (51) | <b>09-03</b> |
| (22) | 13/06/2019  | (43) | 25/10/2019   |
| (73) | HỘ KINH DOANH NGỌC GIÀU (VN)                          |      |              |
|      | Ấp Tân Thành, xã Tân Tiến, huyện Đầm Dơi, tỉnh Cà Mau |      |              |
| (72) | Trương Ngọc Giàu (VN)                                 |      |              |
| (74) | Văn phòng Luật sư A Hoà (AHOA LAW OFFICE)             |      |              |
| (55) |   |      |              |



1.1

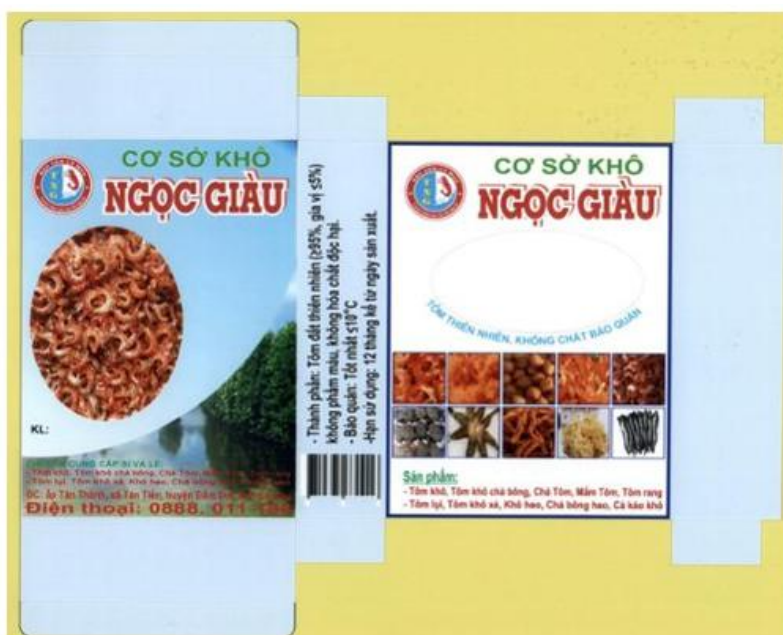

1.2

- (11) **36645**  
(21) 3-2019-01520 (28) 1  
(54) **LỘ ĐỤNG MỸ PHẨM** (51) **09-01**  
(22) 13/06/2019 (43) 25/10/2019  
(30) 30-2019-0026762 05/06/2019 KR;  
LG HOUSEHOLD & HEALTH CARE LTD. (KR)  
(73) 58, Saemunan-ro, Jongno-gu, Seoul, Republic of Korea  
(72) LEE, Hye Jin (KR)  
(74) Công ty TNHH Sở hữu trí tuệ Việt Á (VIET A IP CO.,LTD)  
(55)



1.1



1.2



1.3



1.4



1.5



1.6



1.7



1.8



1.9

- (11) **36646**  
(21) 3-2019-01518 (28) 1  
(54) **ĐIỆN THOẠI DI ĐỘNG** (51) **14-03**  
(22) 13/06/2019 (43) 25/10/2019  
(30) 201830728040.7 14/12/2018 CN;  
HUAWEI TECHNOLOGIES CO., LTD. (CN)  
(73) Huawei Administration Building, Bantian, Longgang, Shenzhen, Guangdong  
518129, China  
(72) 1. QIAN WANG (CN)  
2. XIAOYUAN WANG (CN)  
(74) Công ty Luật TNHH Phạm và Liên danh (PHAM & ASSOCIATES)  
(55)

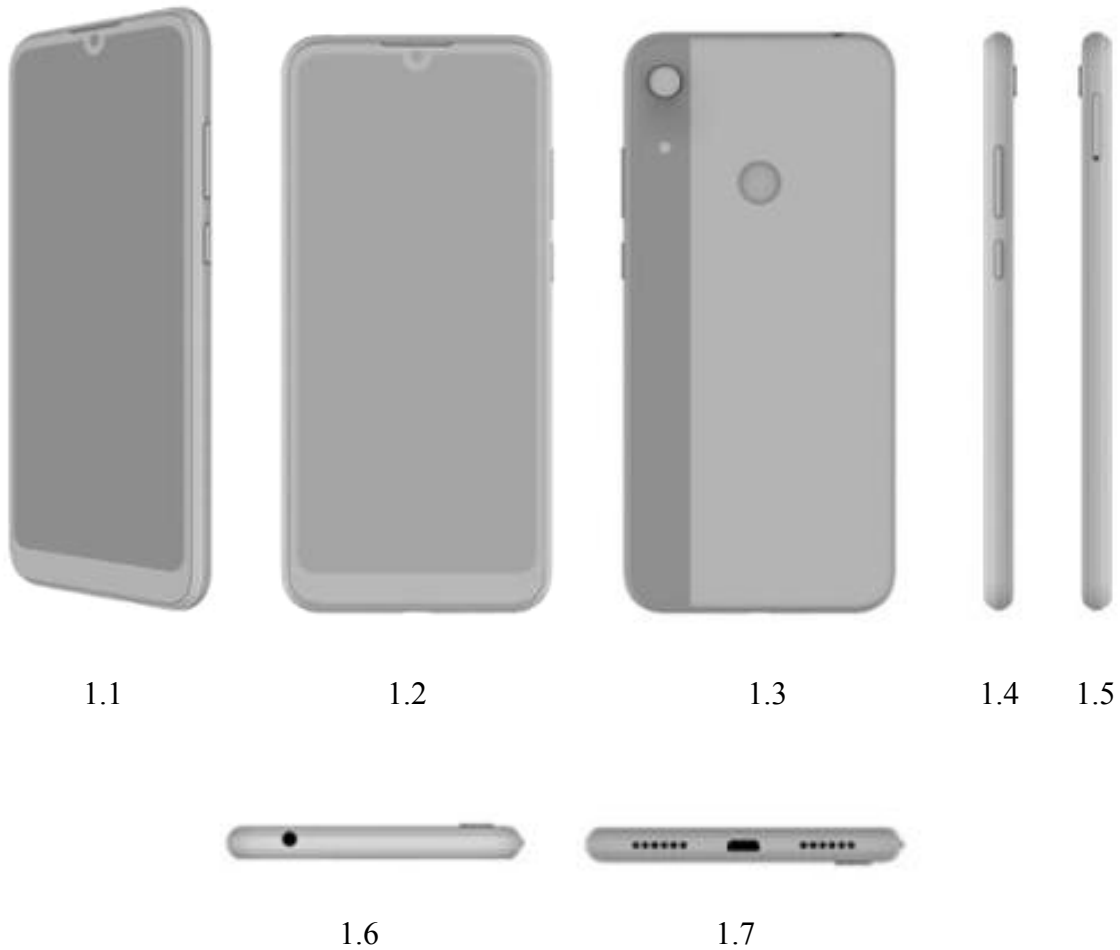

- (11) **36647**  
(21) 3-2019-01526 (28) 1  
(54) **THANH GHEP TRẦN VÀ TƯỜNG** (51) **25-01; 25-02**  
(22) 14/06/2019 (43) 25/10/2019  
(73) CÔNG TY TNHH KIẾN GIANG (VN)  
(72) SS10-SS11 Hồng Lĩnh, phường 15, quận 10, thành phố Hồ Chí Minh  
(55) Tống Phương Nam (VN)

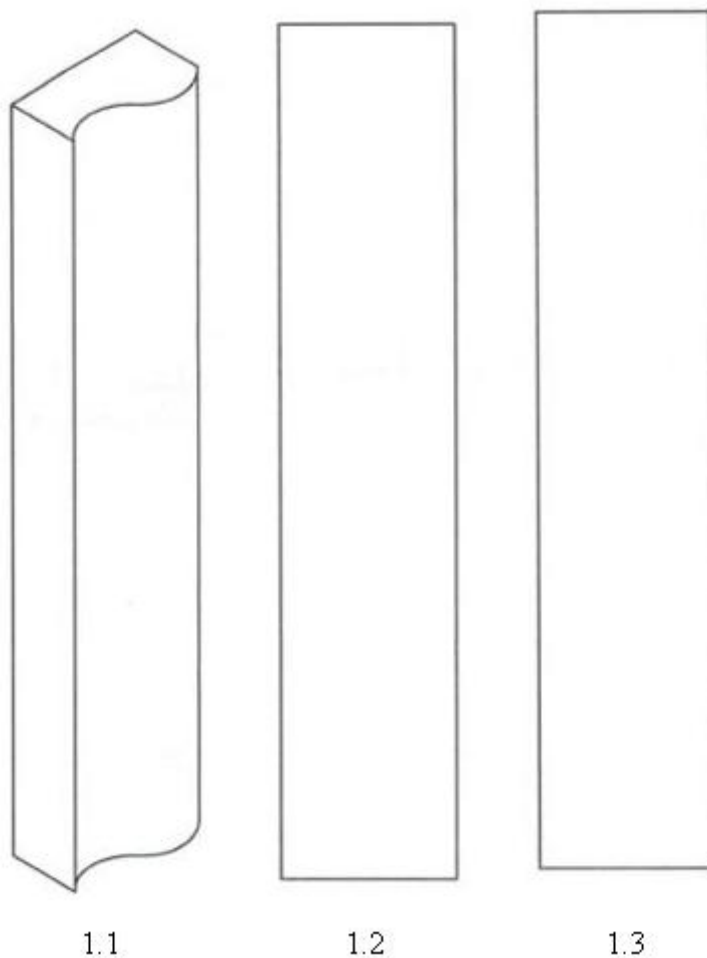

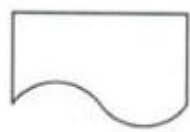

1.4

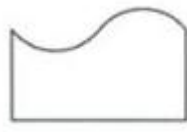

1.5



1.6



1.7



**CÔNG BÁO SỞ HỮU CÔNG NGHIỆP SỐ 379 TẬP A – QUYỀN 2 (10.2019)**

- (11) **36648**  
(21) 3-2019-01530 (28) 1  
(54) **CHAI** (51) **09-01**  
(22) 14/06/2019 (43) 25/10/2019  
CÔNG TY TNHH WATTANA VINA (VN)  
(73) Phòng 802, lầu 8, Vietnam Business Center, 57-59 Hồ Tùng Mậu, phường Bến  
Nghé, quận 1, thành phố Hồ Chí Minh  
(72) Lê Chí Cường (VN)  
(74) Công ty TNHH một thành viên Trường Luật (Trường Luật)  
(55)



1.1

1.2

1.3

1.4



1.5



1.6



1.7

- (11) **36649**  
(21) 3-2019-01529 (28) 1  
(54) **THIẾT BỊ CẢM BIẾN ÁNH SÁNG** (51) **10-05**  
(22) 14/06/2019 (43) 25/10/2019  
(30) 201830735500.9 18/12/2018 CN;  
BEIJING XIAOMI MOBILE SOFTWARE CO., LTD. (CN)  
(73) Room 01, Floor 9, Rainbow City Shopping Mall II of China Resources, NO. 68,  
Qinghe Middle Street, Haidian District, Beijing, 100085 China  
1. YINGCHUN XIE (CN)  
2. TAO WANG (CN)  
(72) 3. NINGNING LI (CN)  
4. MINZHEN JIANG (CN)  
5. JIA CHEN (CN)  
(74) Công ty TNHH Sở hữu trí tuệ Vàng (GINTASSET CO., LTD.)  
(55)



1.1



1.2

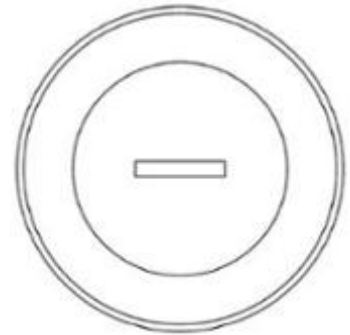

1.3

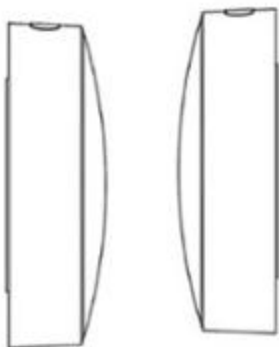

1.4

1.5

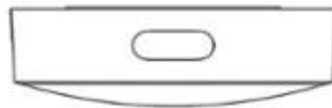

1.6



1.7



1.8

- (11) **36650**  
(21) 3-2019-01539 (28) 1  
(54) **PANEN TRANG TRÍ NỘI THẤT** (51) **06-99**  
(22) 17/06/2019 (43) 25/10/2019  
PARK MYUNG YUL (KR)  
(73) 54-97, Gomo-ro 134beon-gil, Jillye-myeon, Gimhae-si, Gyeongsangnam-do,  
Republic of Korea  
(72) PARK MYUNG YUL (KR)  
(74) Công ty TNHH Sở hữu công nghiệp Sao Bắc Đẩu (SAO BAC DAU IP CO.,LTD)  
(55)



1.1

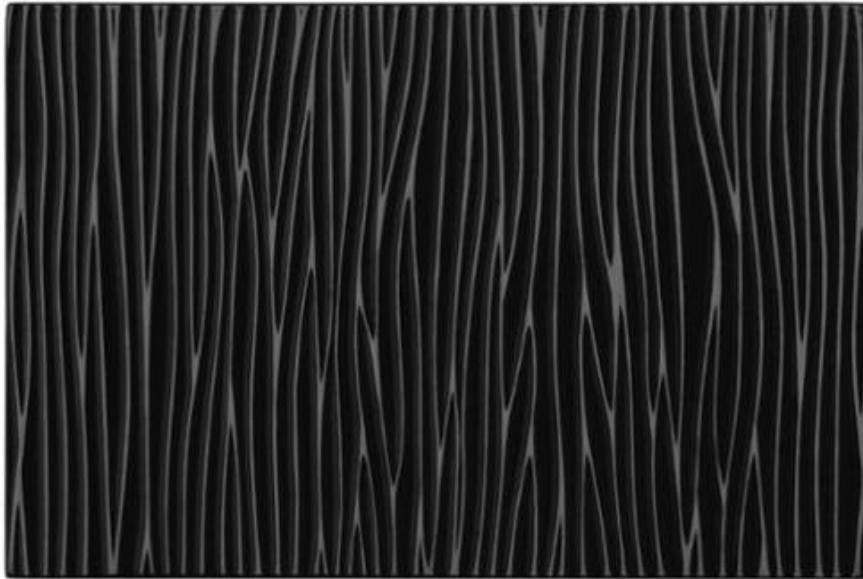

1.2



1.3



1.4

1.5



1.6



1.7

- (11) **36651**  
(21) 3-2019-01555 (28) 1  
(54) **KẾT ĐỰNG CHAI** (51) **09-04**  
(22) 18/06/2019 (43) 25/10/2019  
TỔNG CÔNG TY CỔ PHẦN BIA - RƯỢU - NƯỚC GIẢI KHÁT SÀI GÒN  
(73) (VN)  
187 Nguyễn Chí Thanh, phường 12, quận 5, thành phố Hồ Chí Minh  
(72) Neo Gim Siong Bennett (SG)  
(74) Công ty Luật TNHH Phạm và Liên danh (PHAM & ASSOCIATES)  
(55)



1.1



1.2



1.3

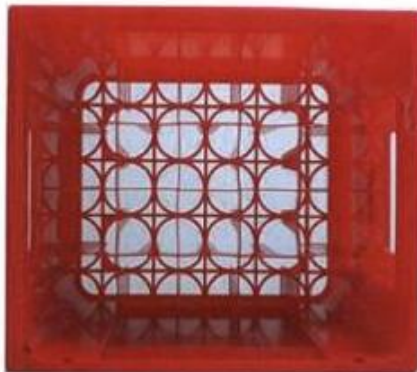

1.4



1.5



- (11) **36652**
  - (21) 3-2019-01556
  - (54) **THÙNG BIA**
  - (22) 18/06/2019
  - (73) (VN)  
187 Nguyễn Chí Thanh, phường 12, quận 5, thành phố Hồ Chí Minh
  - (72) Neo Gim Siong Bennett (SG)
  - (74) Công ty Luật TNHH Phạm và Liên danh (PHAM & ASSOCIATES)
  - (55)
  - (28) 1
  - (51) **09-03**
  - (43) 25/10/2019
- TỔNG CÔNG TY CỔ PHẦN BIA - RƯỢU - NƯỚC GIẢI KHÁT SÀI GÒN



1.1



1.2

**CÔNG BÁO SỞ HỮU CÔNG NGHIỆP SỐ 379 TẬP A – QUYỀN 2 (10.2019)**

- (11) **36653**  
(21) 3-2019-01557 (28) 1  
(54) **LỘC BIA** (51) **09-03**  
(22) 18/06/2019 (43) 25/10/2019  
TỔNG CÔNG TY CỔ PHẦN BIA - RƯỢU - NƯỚC GIẢI KHÁT SÀI GÒN  
(73) (VN)  
187 Nguyễn Chí Thanh, phường 12, quận 5, thành phố Hồ Chí Minh  
(72) Neo Gim Siong Bennett (SG)  
(74) Công ty Luật TNHH Phạm và Liên danh (PHAM & ASSOCIATES)  
(55)



1.1



1.2

- (11) **36654**  
(21) 3-2019-01558 (28) 1  
(54) **THÙNG BIA** (51) **09-03**  
(22) 18/06/2019 (43) 25/10/2019  
TỔNG CÔNG TY CỔ PHẦN BIA - RƯỢU - NƯỚC GIẢI KHÁT SÀI GÒN  
(73) (VN)  
187 Nguyễn Chí Thanh, phường 12, quận 5, thành phố Hồ Chí Minh  
(72) Neo Gim Siong Bennett (SG)  
(74) Công ty Luật TNHH Phạm và Liên danh (PHAM & ASSOCIATES)  
(55)



1.1



1.2

- (11) **36655**  
(21) 3-2019-01559 (28) 1  
(54) **LỘC BIA** (51) **09-03**  
(22) 18/06/2019 (43) 25/10/2019  
TỔNG CÔNG TY CỔ PHẦN BIA - RƯỢU - NƯỚC GIẢI KHÁT SÀI GÒN  
(73) (VN)  
187 Nguyễn Chí Thanh, phường 12, quận 5, thành phố Hồ Chí Minh  
(72) Neo Gim Siong Bennett (SG)  
(74) Công ty Luật TNHH Phạm và Liên danh (PHAM & ASSOCIATES)  
(55)



1.1



1.2

- (11) **36656**  
(21) 3-2019-01560 (28) 1  
(54) **THÙNG BIA** (51) **09-03**  
(22) 18/06/2019 (43) 25/10/2019  
TỔNG CÔNG TY CỔ PHẦN BIA - RƯỢU - NƯỚC GIẢI KHÁT SÀI GÒN  
(73) (VN)  
187 Nguyễn Chí Thanh, phường 12, quận 5, thành phố Hồ Chí Minh  
(72) Neo Gim Siong Bennett (SG)  
(74) Công ty Luật TNHH Phạm và Liên danh (PHAM & ASSOCIATES)  
(55)



1.1



1.2

**CÔNG BÁO SỞ HỮU CÔNG NGHIỆP SỐ 379 TẬP A – QUYỀN 2 (10.2019)**

- (11) **36657**  
(21) 3-2019-01561 (28) 1  
(54) **LỘC BIA** (51) **09-03**  
(22) 18/06/2019 (43) 25/10/2019  
TỔNG CÔNG TY CỔ PHẦN BIA - RƯỢU - NƯỚC GIẢI KHÁT SÀI GÒN  
(73) (VN)  
187 Nguyễn Chí Thanh, phường 12, quận 5, thành phố Hồ Chí Minh  
(72) Neo Gim Siong Bennett (SG)  
(74) Công ty Luật TNHH Phạm và Liên danh (PHAM & ASSOCIATES)  
(55)



1.1



1.2

- (11) **36658**  
(21) 3-2019-01545 (28) 1  
(54) **ĐIỆN THOẠI DI ĐỘNG** (51) **14-03**  
(22) 18/06/2019 (43) 25/10/2019  
(30) 201930010571.7 09/01/2019 CN;  
HUAWEI TECHNOLOGIES CO., LTD. (CN)  
(73) Huawei Administration Building, Bantian, Longgang District, Shenzhen,  
Guangdong 518129, China  
(72) 1. MINGHUI ZHAO (CN)  
2. ZE YUAN (CN)  
(74) Công ty TNHH một thành viên Sở hữu trí tuệ VCCI (VCCI-IP CO.,LTD.)  
(55)



1.1



1.2



1.3



1.4



1.5



1.6

1.7



1.8

1.9

1.10



- (11) **36659**  
(21) 3-2019-01565 (28) 1  
(54) **BAO GỐI** (51) **09-05**  
(22) 19/06/2019 (43) 25/10/2019  
(73) **CÔNG TY TRÁCH NHIỆM HỮU HẠN HẢI CHÂU (VN)**  
Tổ 1, ấp Bãi Giếng, xã Bình An, huyện Kiên Lương, tỉnh Kiên Giang  
(72) **Hồ Minh Huy (VN)**  
(55)



1.1



1.2

- (11) **36660**  
(21) 3-2019-01566 (28) 1  
(54) **MÁY BƠM XỊT RỬA ÁP LỰC** (51) **15-02**  
(22) 19/06/2019 (43) 25/10/2019  
(73) LÂM TƯ THANH (VN)  
(73) 136/1 Bình Thới, phường 14, quận 11, thành phố Hồ Chí Minh  
(72) Lâm Tư Thanh (VN)  
(55)



1.1



1.2



1.3



1.4



1.5



1.6



1.7

- (11) **36661**  
(21) 3-2019-01567 (28) 1  
(54) **MÁY BƠM XỊT RỬA ÁP LỰC** (51) **15-02**  
(22) 19/06/2019 (43) 25/10/2019  
(73) LÂM TƯ THANH (VN)  
(73) 136/1 Bình Thới, phường 14, quận 11, thành phố Hồ Chí Minh  
(72) Lâm Tư Thanh (VN)  
(55)



1.1



1.2



1.3



1.4



1.5



1.6



1.7

- (11) **36662**  
(21) 3-2019-01568 (28) 1  
(54) **MÁY BƠM XỊT RỬA ÁP LỰC** (51) **15-02**  
(22) 19/06/2019 (43) 25/10/2019  
(73) LÂM TƯ THANH (VN)  
(73) 136/1 Bình Thới, phường 14, quận 11, thành phố Hồ Chí Minh  
(72) Lâm Tư Thanh (VN)  
(55)



1.1



1.2



1.3





1.4



1.5



1.6



1.7

- (11) **36663**  
(21) 3-2019-01569 (28) 1  
(54) **MÁY BƠM XỊT RỬA ÁP LỰC** (51) **15-02**  
(22) 19/06/2019 (43) 25/10/2019  
(73) LÂM TƯ THANH (VN)  
(73) 136/1 Bình Thới, phường 14, quận 11, thành phố Hồ Chí Minh  
(72) Lâm Tư Thanh (VN)  
(55)



1.1



1.2



1.3



1.4



1.5



1.6



1.7

- (11) **36664**  
(21) 3-2019-01570 (28) 1  
(54) **MÁY BƠM XỊT RỬA ÁP LỰC** (51) **15-02**  
(22) 19/06/2019 (43) 25/10/2019  
(73) LÂM TƯ THANH (VN)  
(73) 136/1 Bình Thới, phường 14, quận 11, thành phố Hồ Chí Minh  
(72) Lâm Tư Thanh (VN)  
(55)



1.1



1.2



1.3



1.4



1.5



1.6



1.7



- (11) **36665**  
(21) 3-2019-01580 (28) 1  
(54) **MÁY BƠM XỊT RỬA ÁP LỰC** (51) **15-02**  
(22) 20/06/2019 (43) 25/10/2019  
(73) LÂM TƯ THANH (VN)  
(73) 136/1 Bình Thới, phường 14, quận 11, thành phố Hồ Chí Minh  
(72) Lâm Tư Thanh (VN)  
(55)



1.1



1.2



1.3



1.4



1.5



1.6



1.7

- (11) **36666**  
(21) 3-2019-01578 (28) 1  
(54) **LỘ ĐỤNG SON MÔI** (51) **28-02**  
(22) 20/06/2019 (43) 25/10/2019  
(30) 30-2019-0028657 17/06/2019 KR;  
(73) LG HOUSEHOLD & HEALTH CARE LTD. (KR)  
58, Saemunan-ro, Jongno-gu, Seoul, Republic of Korea  
(72) LEE, Henson (KR)  
(74) Công ty TNHH Sở hữu trí tuệ Việt Á (VIET A IP CO.,LTD)  
(55)



1.1



1.2



1.3



1.4



1.5



1.6

- (11) **36667**  
(21) 3-2019-01581 (28) 1  
(54) **ĐIỆN THOẠI DI ĐỘNG** (51) **14-03**  
(22) 20/06/2019 (43) 25/10/2019  
(73) SHARP KABUSHIKI KAISHA (JP)  
1 Takumi-cho, Sakai-ku, Sakai City, Osaka 590-8522, Japan  
(72) TAKUYA WAKE (JP)  
(74) Công ty TNHH một thành viên Sở hữu trí tuệ VCCI (VCCI-IP CO.,LTD.)  
(55)



1.1

1.2

1.3

1.4



1.5

1.6



1.7

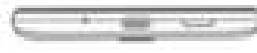

1.8

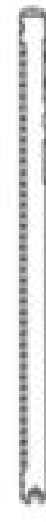

1.9



1.10



1.11

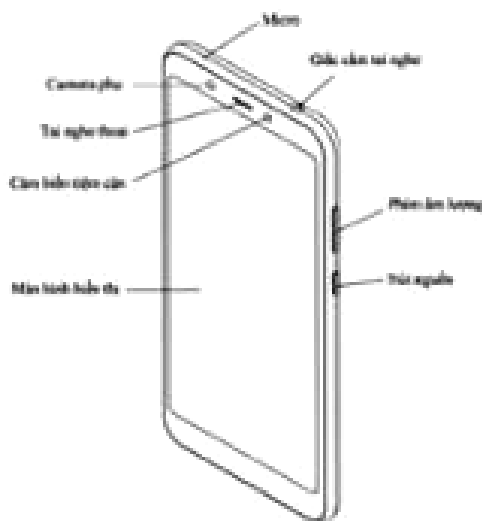

1.12

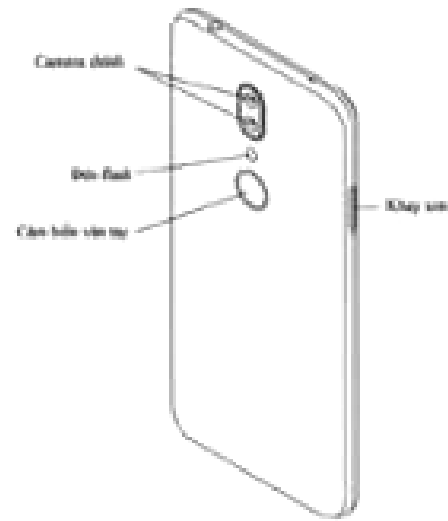

1.13

- (11) **36668**  
(21) 3-2019-01584 (28) 1  
(54) **LỚP XE** (51) **12-15**  
(22) 20/06/2019 (43) 25/10/2019  
(30) 29/674,546 21/12/2018 US;  
COOPER TIRE & RUBBER COMPANY (US)  
(73) 701 Lima Avenue, Findlay, Ohio, 45840, United States of America  
1. JEREMY J. JACOBS (US)  
(72) 2. TODD SCHIMMOELLER, JR. (US)  
(74) Công ty Luật TNHH AMBYS Hà Nội (AMBYS HANOI)  
(55)

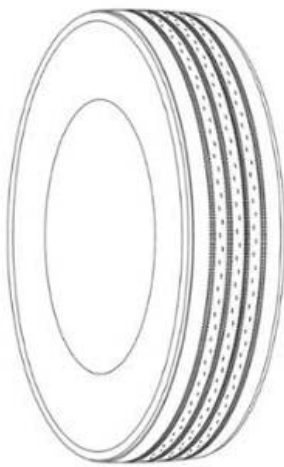

1.1

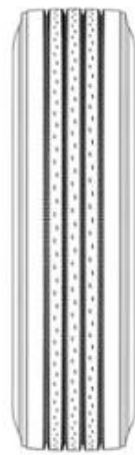

1.2

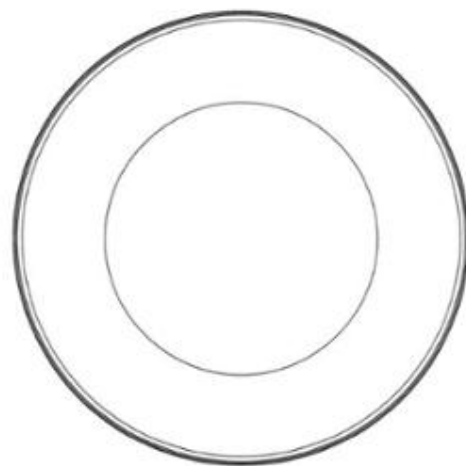

1.3

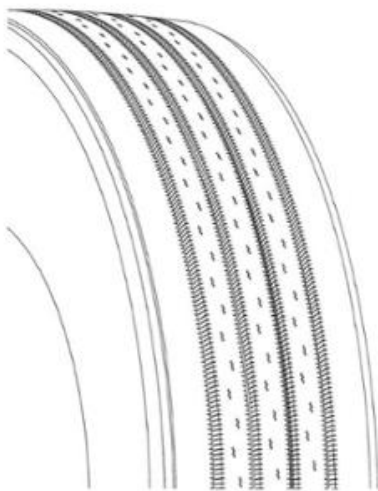

1.4

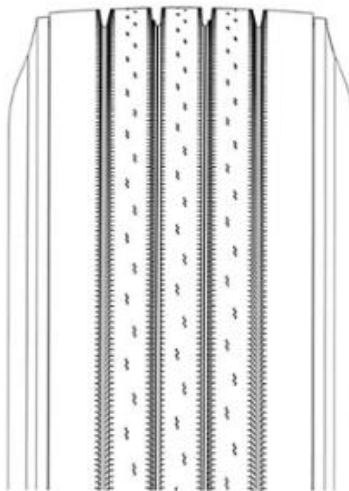

1.5

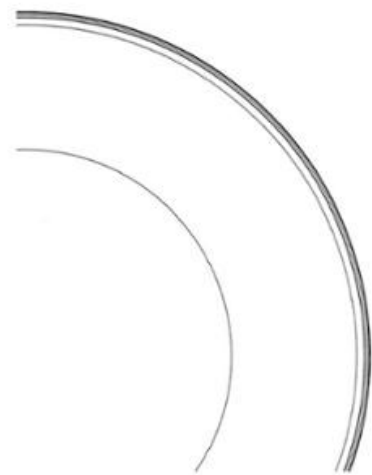

1.6

- (11) **36669**  
(21) 3-2019-01590 (28) 1  
(54) **THANH KIM LOẠI ĐỊNH HÌNH** (51) **25-01**  
(22) 20/06/2019 (43) 25/10/2019  
(73) CÔNG TY CỔ PHẦN CÔNG NGHIỆP G9 (VN)  
Thị tứ Quang Phục, xã Quang Phục, huyện Tứ Kỳ, tỉnh Hải Dương  
(72) Nguyễn Văn Điệp (VN)  
(74) Công ty TNHH Sở hữu trí tuệ PADEMARK (PADEMARK CO.,LTD.)  
(55)



1.1

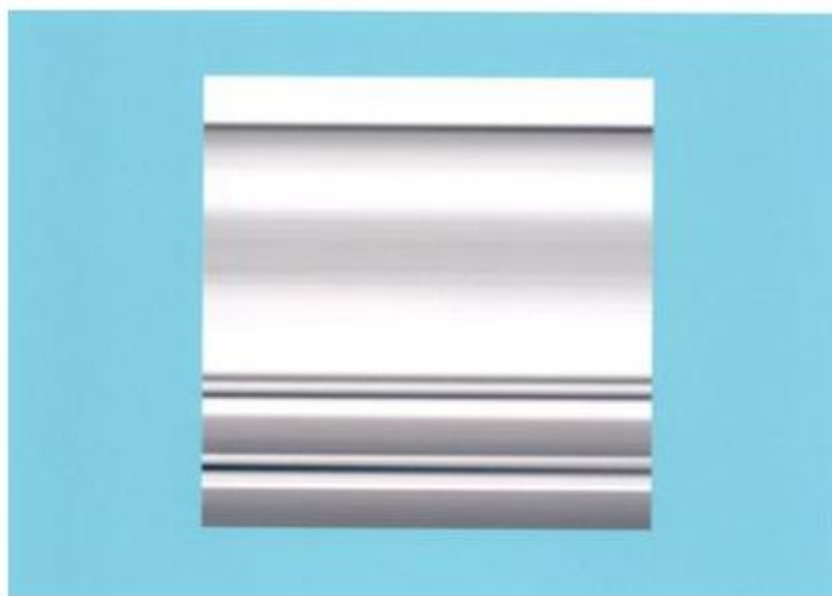

1.2





1.3



1.4

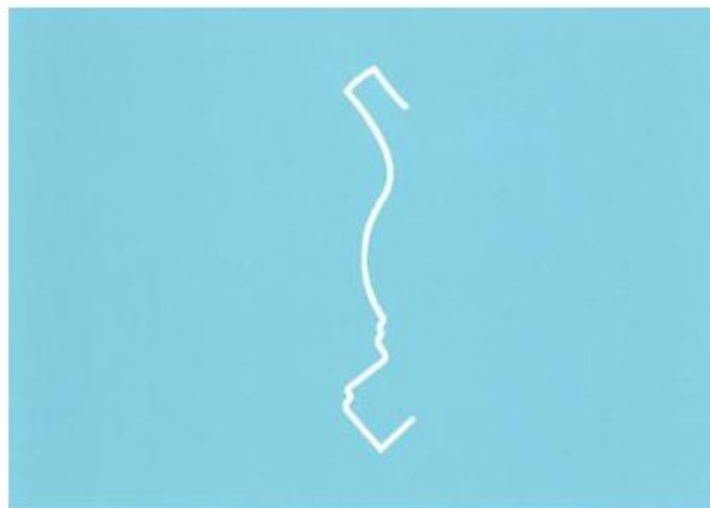

1.5



1.6



1.7

- (11) **36670**  
 (21) 3-2019-01593 (28) 1  
 (54) **NHÃN SẢN PHẨM** (51) **19-08**  
 (22) 21/06/2019 (43) 25/10/2019  
**HỘ KINH DOANH SỮA LONG THÀNH (VN)**  
 (73) Phùng Hưng, tổ 10B, ấp Long Đức 3, (tờ bản đồ số 73, thửa đất số 171) xã Tam Phước, thành phố Biên Hòa, tỉnh Đồng Nai  
 (72) Hoàng Công Mẫn (VN)  
 (55)

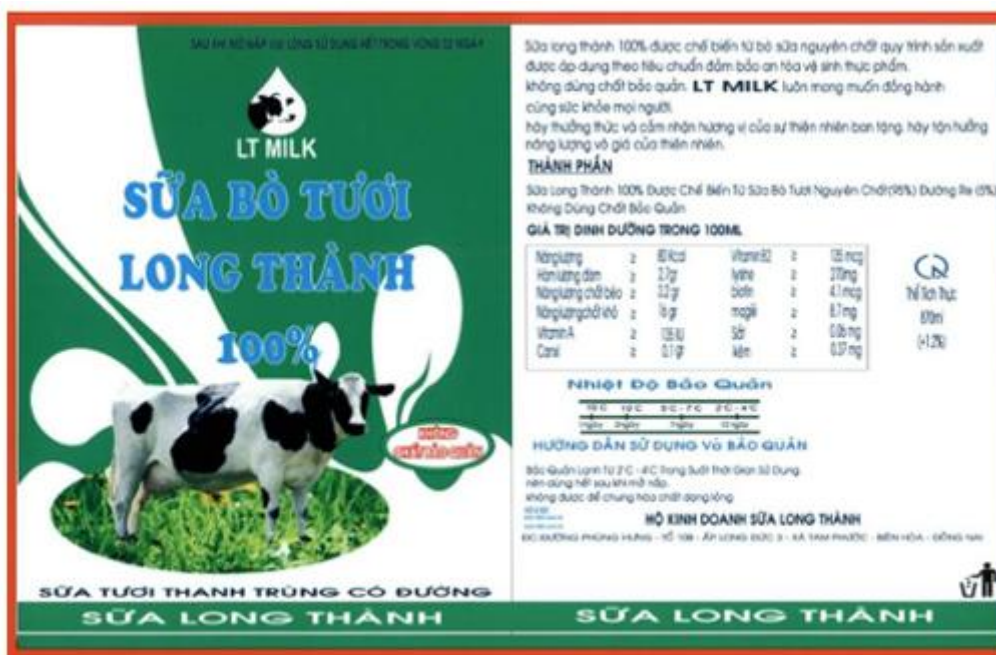

1.1

- (11) **36671**
- (21) 3-2019-01594 (28) 1
- (54) **NHÃN SẢN PHẨM** (51) **19-08**
- (22) 21/06/2019 (43) 25/10/2019
- HỘ KINH DOANH SỮA LONG THÀNH (VN)
- (73) Phùng Hưng, tổ 10B, ấp Long Đức 3, (tờ bản đồ số 73, thửa đất số 171) xã Tam Phước, thành phố Biên Hòa, tỉnh Đồng Nai
- (72) Hoàng Công Mẫn (VN)
- (55)

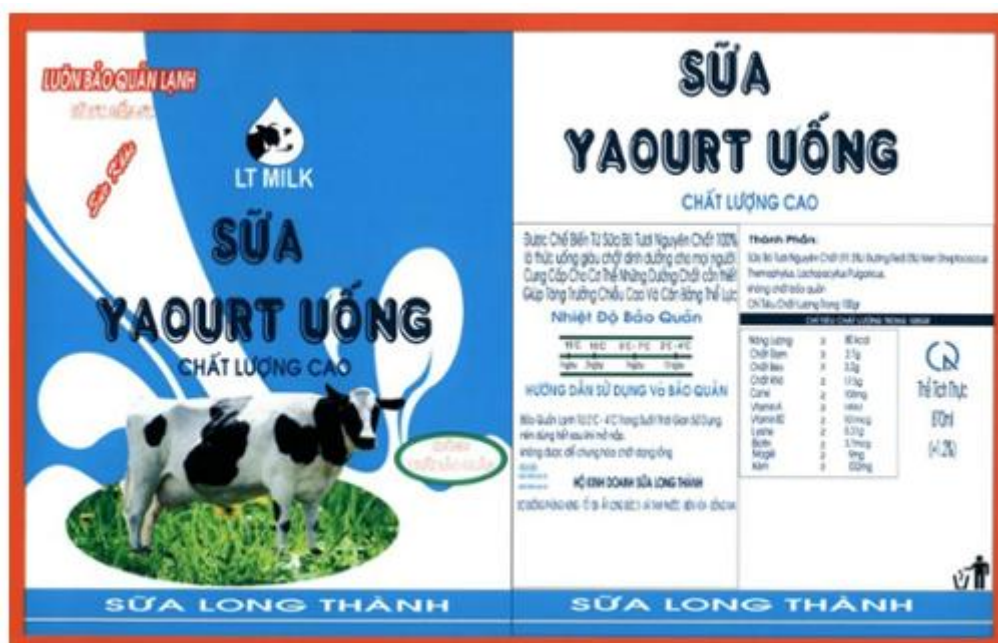

1.1

- (11) **36672**  
(21) 3-2019-01595 (28) 1  
(54) **GHẾ XÍCH ĐU** (51) **99-00**  
(22) 21/06/2019 (43) 25/10/2019  
(73) CÔNG TY TNHH JUMPER KIDS VIỆT NAM (VN)  
số 05, kiệt 30 Ngự Bình, phường An Cựu, thành phố Huế, tỉnh Thừa Thiên Huế  
(72) Cung Đình Đạt (VN)  
(55)



1.1

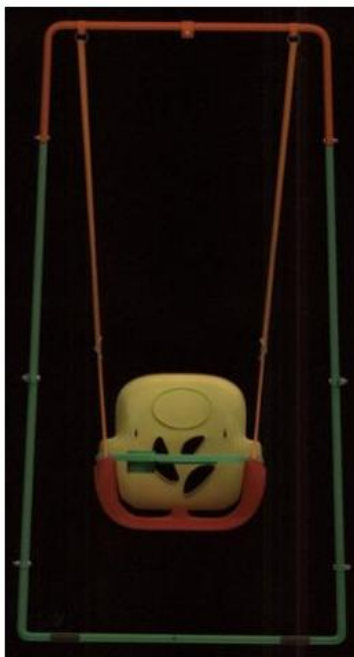

1.2

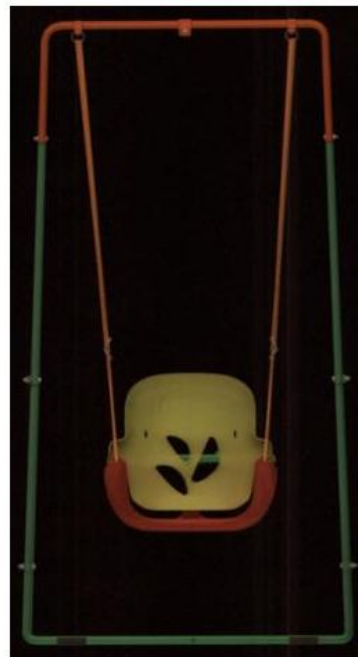

1.3

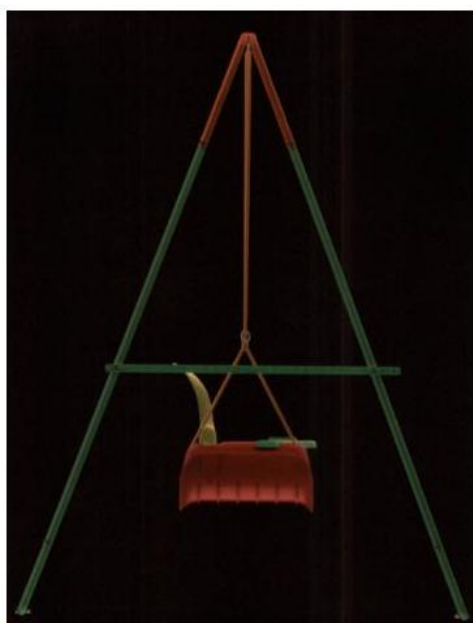

1.4



1.5

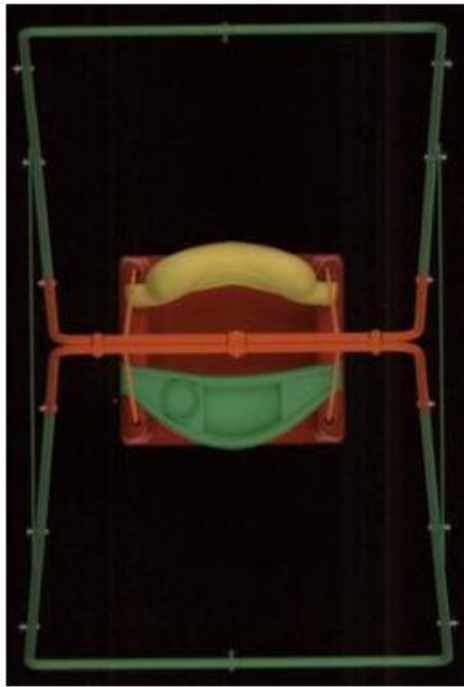

1.6

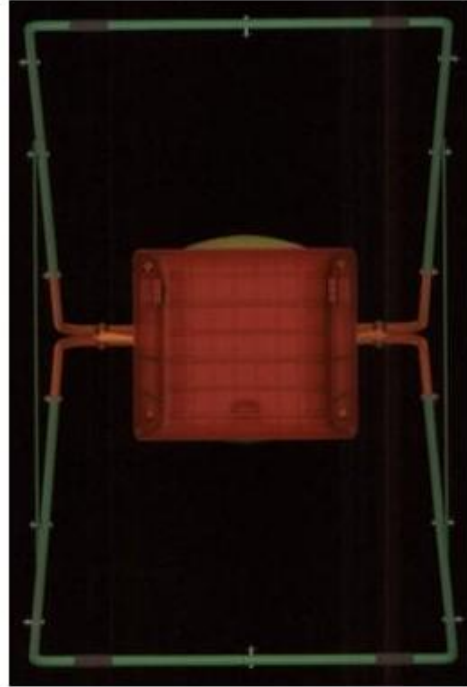

1.7

- (11) **36673**  
(21) 3-2019-01605 (28) 1  
(54) **DÉP** (51) **02-04**  
(22) 24/06/2019 (43) 25/10/2019  
(73) CÔNG TY TNHH BÌNH TIÊN ĐỒNG NAI (VN)  
1/1 Phạm Văn Thuận, phường Tam Hiệp, thành phố Biên Hoà, tỉnh Đồng Nai  
(72) Lai Khiêm (VN)  
(74) Công ty TNHH Tư vấn sở hữu trí tuệ Việt (VIET IP CO.,LTD.)  
(55)



1.1



1.2



1.3



1.4



1.5



1.6



1.7



- (11) **36674**  
(21) 3-2019-01598 (28) 1  
(54) **MÁY LỌC NƯỚC** (51) **23-01**  
(22) 24/06/2019 (43) 25/10/2019  
(30) 30-2018-0061553 26/12/2018 KR;  
BODYFRIEND CO., LTD. (KR)  
(73) 163, Yangjaecheon-ro, Gangnam-gu, Seoul, Republic of Korea  
1. ILSOO YEOM (KR)  
2. MYONGKYU KIM (KR)  
(72) 3. SOEUN CHOI (KR)  
4. HYUNWOO PARK (KR)  
(74) Công ty TNHH Sở hữu trí tuệ Thảo Thọ Quyên (INVENCO.,LTD)  
(55)

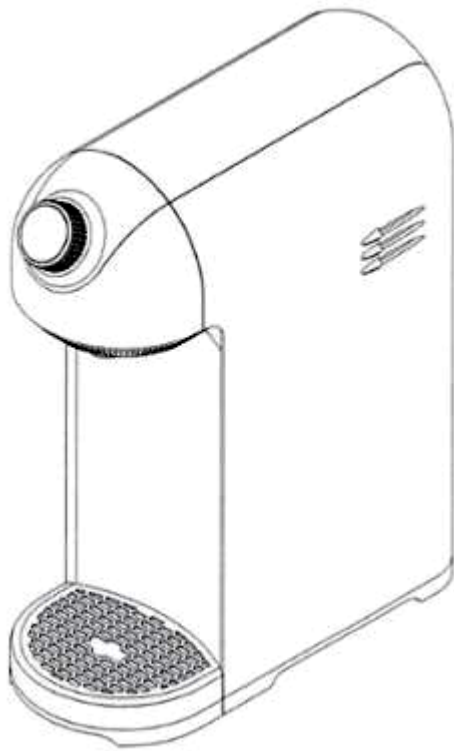

1.1

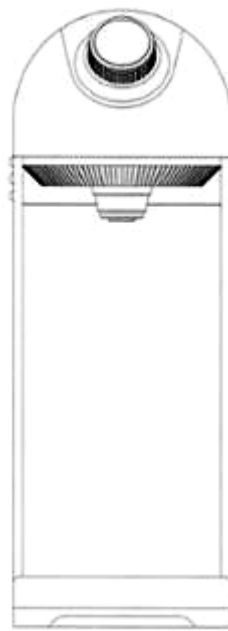

1.2

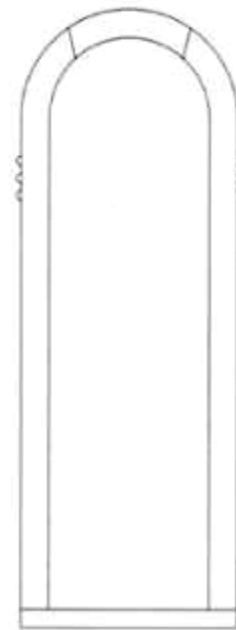

1.3



1.4

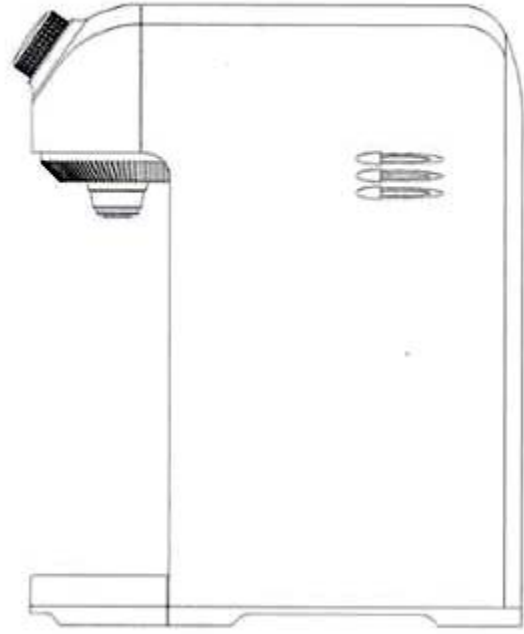

1.5



1.6

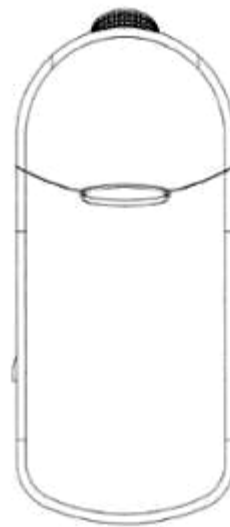

1.7

- (11) **36675**  
(21) 3-2019-01600 (28) 1  
(54) **BẦY CÔN TRỪNG** (51) **22-06**  
(22) 24/06/2019 (43) 25/10/2019  
(73) JEONG IL HEO (KR)  
Verville # 107, Hakdong-ro 30 gil 21, Kangnam-Gu, Seoul, Korea  
(72) JEONG IL HEO (KR)  
(74) Công ty TNHH Sáng chế ACTIP (ACTIP PATENT LIMITED)  
(55)

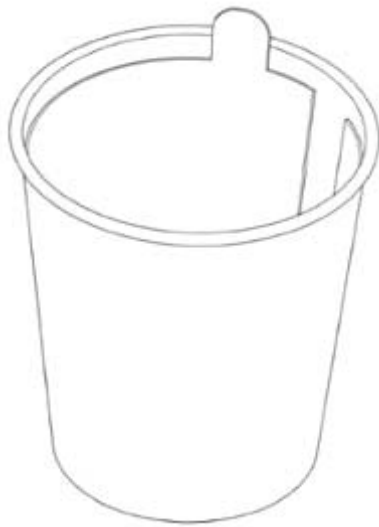

1.1

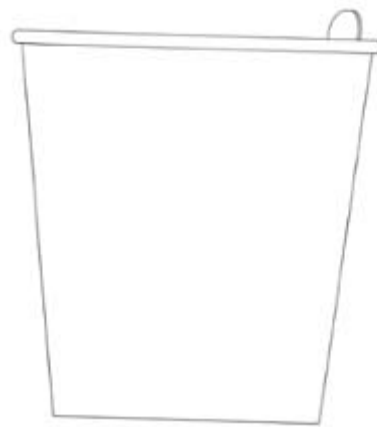

1.2

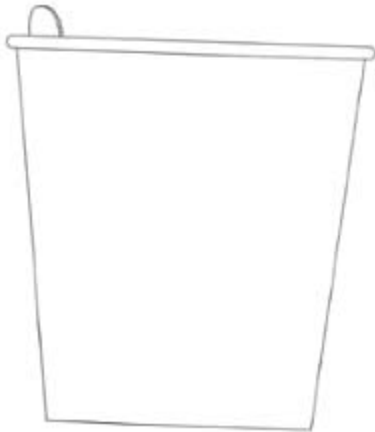

1.3

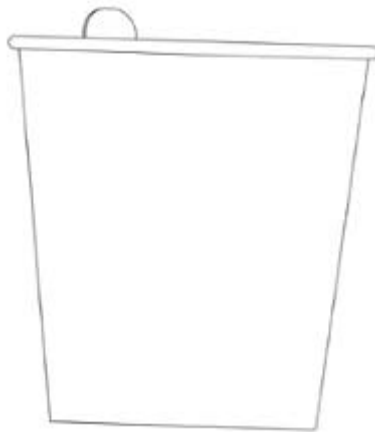

1.4

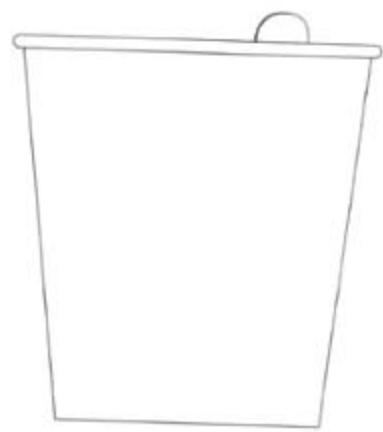

1.5



1.6

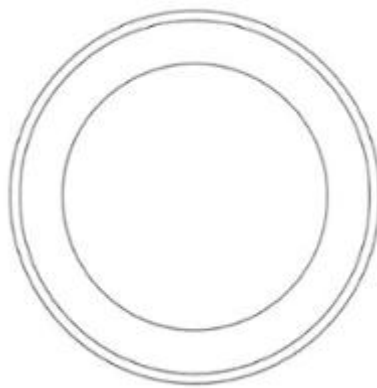

1.7

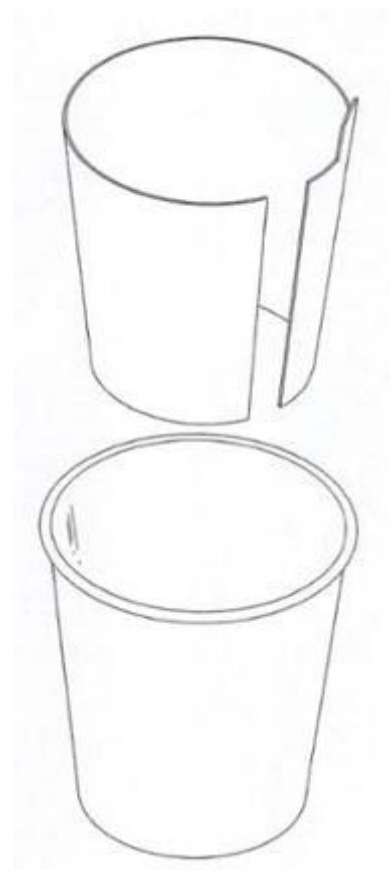

1.8

**CÔNG BÁO SỞ HỮU CÔNG NGHIỆP SỐ 379 TẬP A – QUYỀN 2 (10.2019)**

- (11) **36676**  
(21) 3-2019-01606 (28) 1  
(54) **BAO GỐI SẢN PHẨM** (51) **09-05**  
(22) 25/06/2019 (43) 25/10/2019  
(73) CÔNG TY TNHH UNIVERS FARM ORGANICS (VN)  
(72) Đồi Bạch Đàn, thôn Giãn Dân, xã Lạc Xuân, huyện Đơn Dương, tỉnh Lâm Đồng  
(55) Đào Vân Anh (VN)



1.1



1.2

- (11) 36677  
(21) 3-2019-01613  
(54) **DÉP**  
(22) 25/06/2019  
(73) CÔNG TY TNHH SẢN XUẤT THƯƠNG MẠI HÙ KIẾT (VN)  
Tỉnh lộ 830, ấp 8, xã Lương Hòa, huyện Bến Lức, tỉnh Long An  
(72) Gíp Cao Thanh (VN)  
(55)
- (28) 1  
(51) **02-04**  
(43) 25/10/2019



1.1



1.2



1.3



1.4



1.5



1.6



1.7

- (11) **36678**  
(21) 3-2019-01614  
(54) **DÉP**  
(22) 25/06/2019  
(73) CÔNG TY TNHH SẢN XUẤT THƯƠNG MẠI HÙ KIẾT (VN)  
Tỉnh lộ 830, ấp 8, xã Lương hòa, huyện Bến Lức, tỉnh Long An  
(72) Gíp Cao Thanh (VN)  
(55)
- (28) 1  
(51) **02-04**  
(43) 25/10/2019



1.1



1.2

1.3





1.4



1.5



1.6



1.7

- (11) **36679**  
(21) 3-2019-01615  
(54) **DÉP**  
(22) 25/06/2019  
(73) CÔNG TY TNHH SẢN XUẤT THƯƠNG MẠI HÙ KIẾT (VN)  
Tỉnh lộ 830, ấp 8, xã Lương hòa, huyện Bến Lức, tỉnh Long An  
(72) Gíp Cao Thanh (VN)  
(55)  
(28) 1  
(51) **02-04**  
(43) 25/10/2019



1.1



1.2



1.3



1.4



1.5



1.6



1.7

- (11) **36680**  
(21) 3-2019-01616  
(54) **DÉP**  
(22) 25/06/2019  
(73) CÔNG TY TNHH SẢN XUẤT THƯƠNG MẠI HÙ KIẾT (VN)  
Tỉnh lộ 830, ấp 8, xã Lương hòa, huyện Bến Lức, tỉnh Long An  
(72) Gíp Cao Thanh (VN)  
(55)  
(28) 1  
(51) **02-04**  
(43) 25/10/2019



1.1



1.2

1.3



1.4



1.5



1.6



1.7

- (11) **36681**  
(21) 3-2019-01622 (28) 1  
(54) **LON BIA** (51) **09-03**  
(22) 25/06/2019 (43) 25/10/2019  
TỔNG CÔNG TY CỔ PHẦN BIA - RƯỢU - NƯỚC GIẢI KHÁT SÀI GÒN  
(73) (VN)  
187 Nguyễn Chí Thanh, phường 12, quận 5, thành phố Hồ Chí Minh  
(72) Neo Gim Siong Bennett (SG)  
(74) Công ty Luật TNHH Phạm và Liên danh (PHAM & ASSOCIATES)  
(55)



1.1



1.2



1.3



1.4



1.5



1.6

1.7

- (11) **36682**  
(21) 3-2019-01624 (28) 1  
(54) **LON BIA** (51) **09-03**  
(22) 25/06/2019 (43) 25/10/2019  
TỔNG CÔNG TY CỔ PHẦN BIA - RƯỢU - NƯỚC GIẢI KHÁT SÀI GÒN  
(73) (VN)  
187 Nguyễn Chí Thanh, phường 12, quận 5, thành phố Hồ Chí Minh  
(72) Neo Gim Siong Bennett (SG)  
(74) Công ty Luật TNHH Phạm và Liên danh (PHAM & ASSOCIATES)  
(55)



1.1



1.2



1.3



1.4



1.5



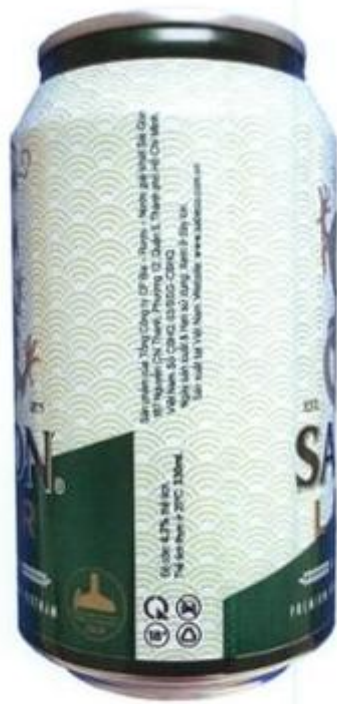

1.6



1.7

- (11) **36683**  
(21) 3-2019-01626 (28) 1  
(54) **LON BIA** (51) **09-03**  
(22) 25/06/2019 (43) 25/10/2019  
TỔNG CÔNG TY CỔ PHẦN BIA - RƯỢU - NƯỚC GIẢI KHÁT SÀI GÒN  
(73) (VN)  
187 Nguyễn Chí Thanh, phường 12, quận 5, thành phố Hồ Chí Minh  
(72) Neo Gim Siong Bennett (SG)  
(74) Công ty Luật TNHH Phạm và Liên danh (PHAM & ASSOCIATES)  
(55)



1.1



1.2



1.3



1.4



1.5

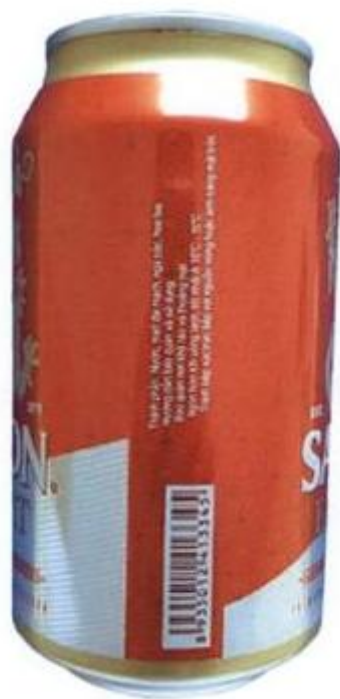

1.6



1.7

- (11) **36684**  
(21) 3-2019-01607 (28) 1  
(54) **CHUÔNG CỬA CAMERA** (51) **10-06**  
(22) 25/06/2019 (43) 25/10/2019  
CÔNG TY CỔ PHẦN BKAV (VN)  
(73) Tầng 2 tòa nhà HH1, khu đô thị Yên Hòa, phường Yên Hòa, quận Cầu Giấy,  
thành phố Hà Nội  
(72) 1. VŨ THANH THẮNG (VN)  
2. HOÀNG MẠNH CUỒNG (VN)  
(55)



1.1



1.2



1.3

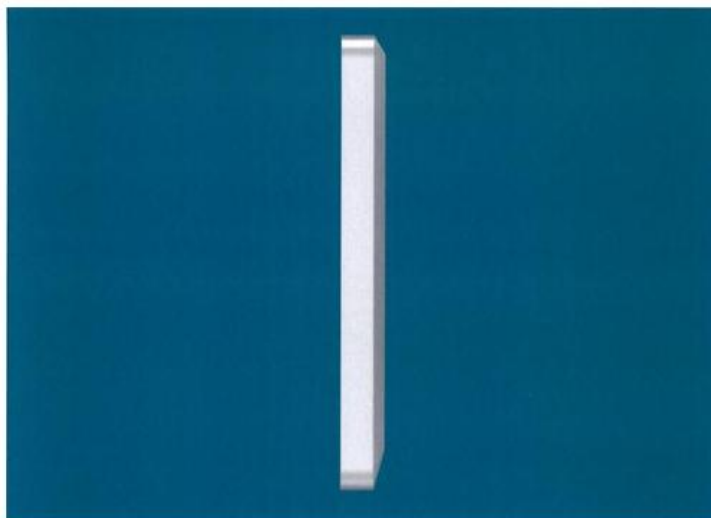

1.4

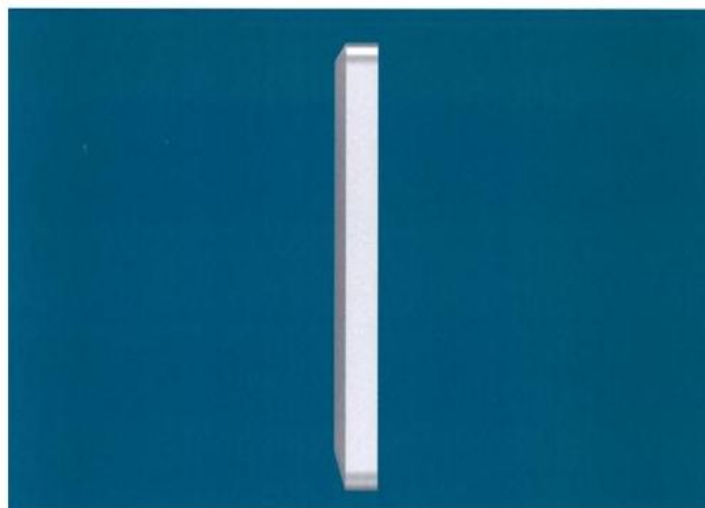

1.5

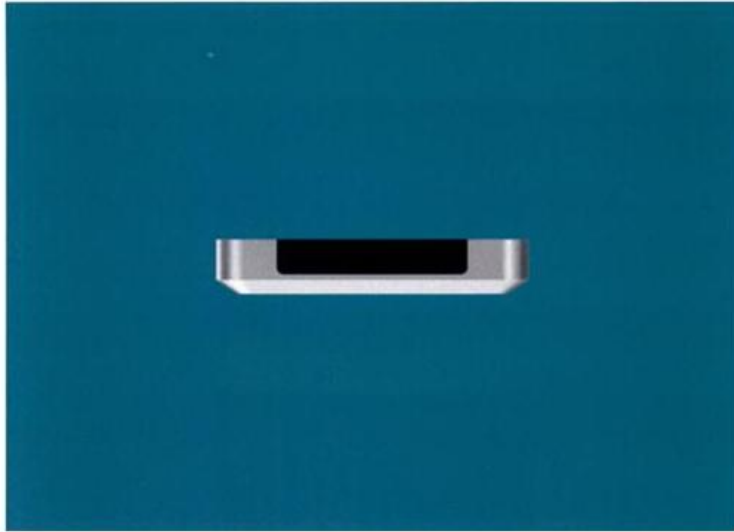

1.6



1.7

- (11) **36685**  
(21) 3-2019-01608 (28) 1  
(54) **LOA THÔNG MINH** (51) **14-01**  
(22) 25/06/2019 (43) 25/10/2019  
CÔNG TY CỔ PHẦN BKAV (VN)  
(73) Tầng 2 tòa nhà HH1, khu đô thị Yên Hòa, phường Yên Hòa, quận Cầu Giấy,  
thành phố Hà Nội  
(72) 1. VŨ THANH THẮNG (VN)  
2. HOÀNG MẠNH CUỒNG (VN)  
(55)



1.1



1.2



13



14



15



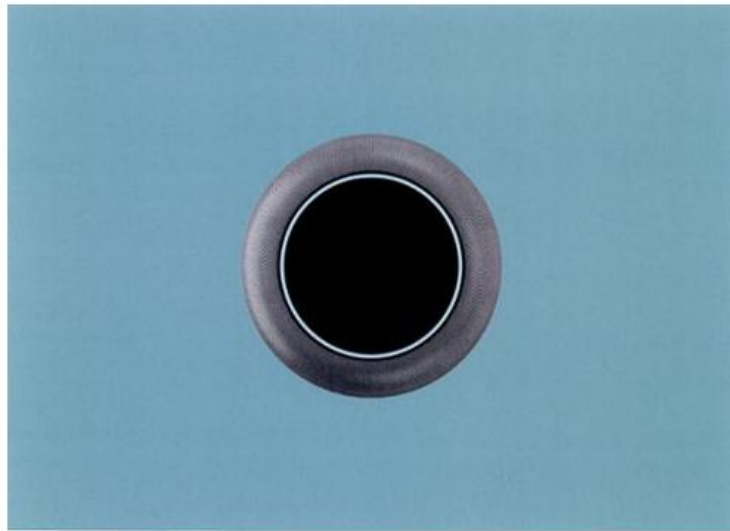

1.6

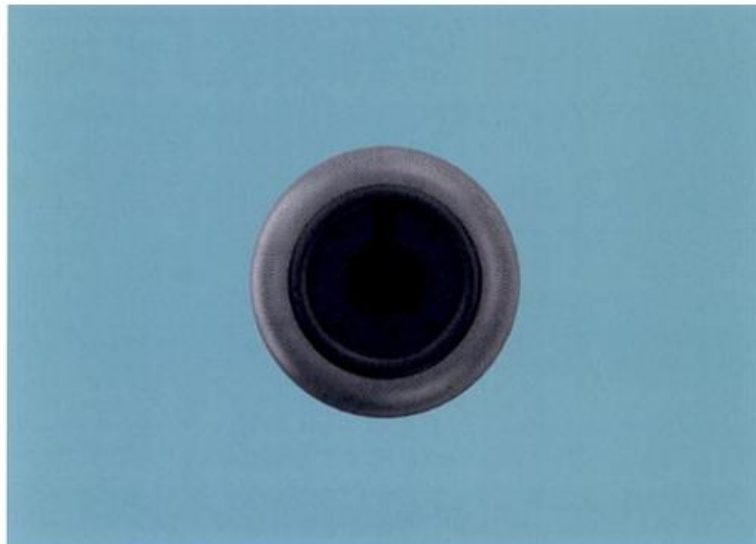

1.7

- (11) **36686**  
(21) 3-2019-01609 (28) 1  
(54) **CAMERA THÔNG MINH** (51) **16-01**  
(22) 25/06/2019 (43) 25/10/2019  
CÔNG TY CỔ PHẦN BKAV (VN)  
(73) Tầng 2 tòa nhà HH1, khu đô thị Yên Hòa, phường Yên Hòa, quận Cầu Giấy,  
thành phố Hà Nội  
(72) 1. VŨ THANH THẮNG (VN)  
2. HOÀNG MẠNH CUƯỜNG (VN)  
(55)



1.1



1.2



1.3



1.4

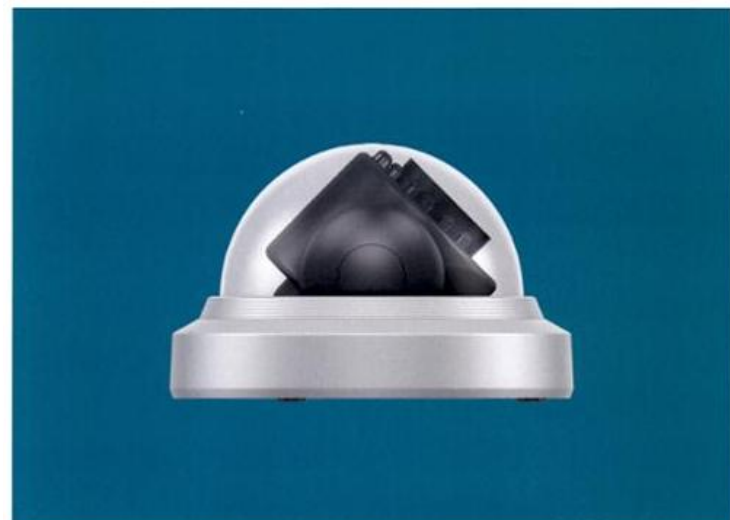

1.5



1.6

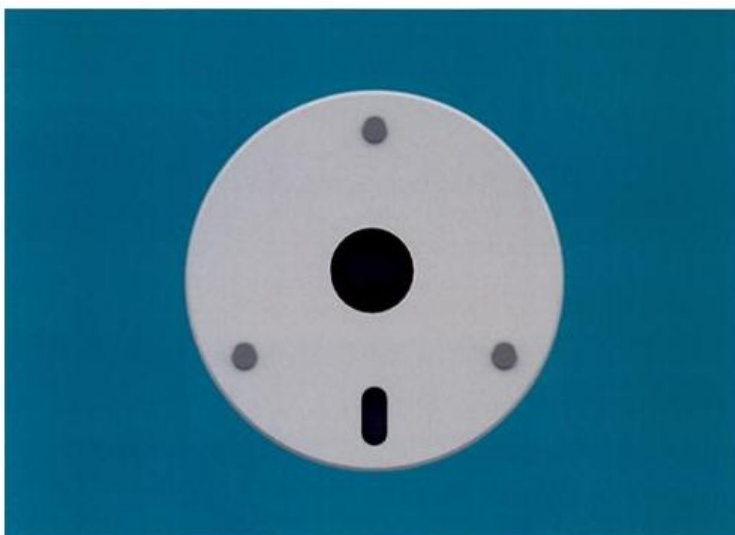

1.7

- (11) **36687**  
(21) 3-2019-01611 (28) 1  
(54) **MÁY LỌC NƯỚC NÓNG VÀ LẠNH** (51) **23-01**  
(22) 25/06/2019 (43) 25/10/2019  
(30) 30-2018-0061558 26/12/2018 KR;  
BODYFRIEND CO., LTD. (KR)  
(73) 163, Yangjaecheon-ro, Gangnam-gu, Seoul, Republic of Korea  
1. ILSOO YEOM (KR)  
2. MYONGKYU KIM (KR)  
(72) 3. SOEUN CHOI (KR)  
4. HYUNWOO PARK (KR)  
(74) Công ty TNHH Sở hữu trí tuệ Thảo Thọ Quyên (INVENCO.,LTD)  
(55)

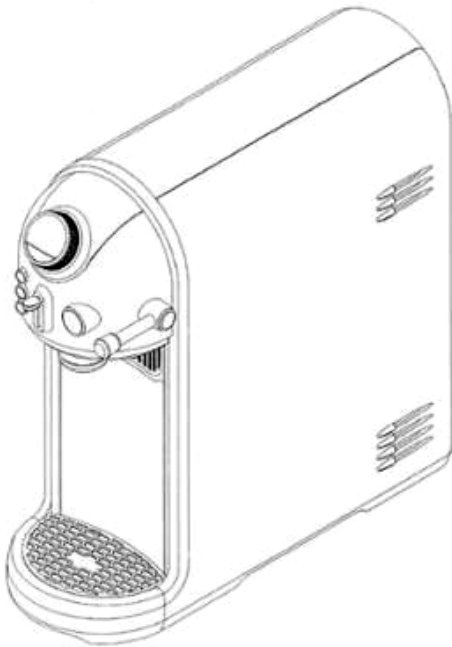

1.1



1.2

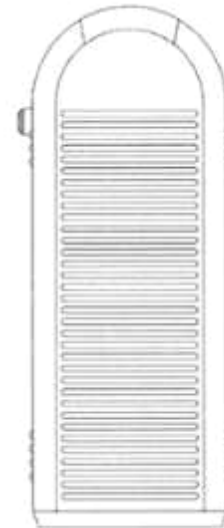

1.3

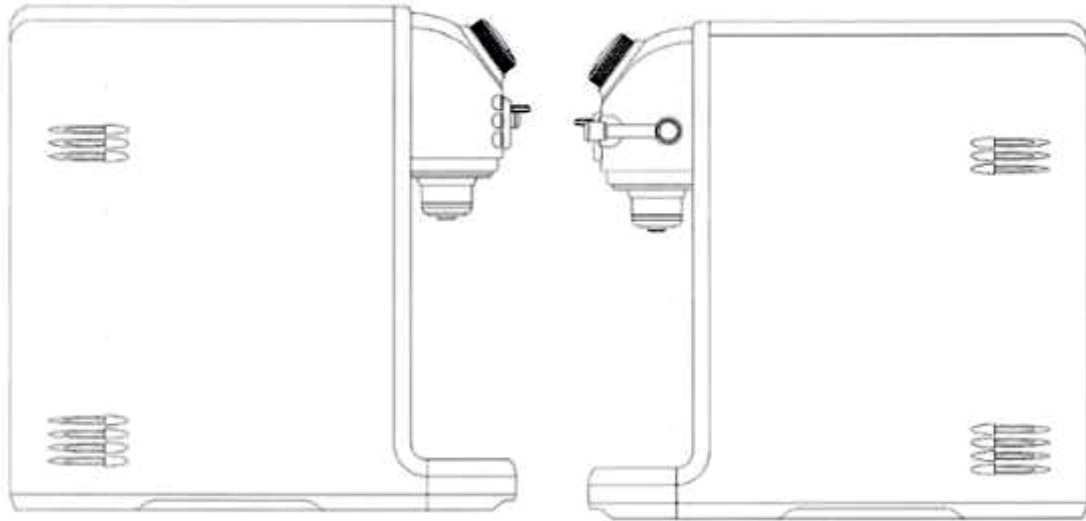

1.4

1.5

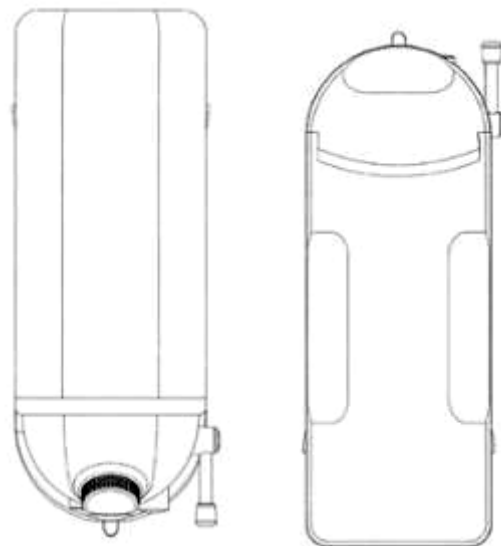

1.6

1.7

- (11) **36688**  
(21) 3-2019-01617 (28) 1  
(54) **LỘ ĐỪNG** (51) **09-01**  
(22) 25/06/2019 (43) 25/10/2019  
(73) LG HOUSEHOLD & HEALTH CARE LTD. (KR)  
58, Saemunan-ro, Jongno-gu, Seoul, Republic of Korea  
(72) PARK, Jin Won (KR)  
(74) Công ty TNHH Sở hữu trí tuệ Việt Á (VIET A IP CO.,LTD)  
(55)



1.1

1.2

1.3

1.4

1.5



1.6

1.7

- (11) **36689**  
(21) 3-2019-01618 (28) 1  
(54) **HỘP ĐỰNG** (51) **09-03**  
(22) 25/06/2019 (43) 25/10/2019  
(73) LG HOUSEHOLD & HEALTH CARE LTD. (KR)  
58, Saemunan-ro, Jongno-gu, Seoul, Republic of Korea  
(72) LEE, Ji Hee (KR)  
(74) Công ty TNHH Sở hữu trí tuệ Việt Á (VIET A IP CO.,LTD)  
(55)



1.1

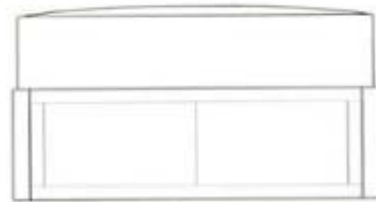

1.2



1.3

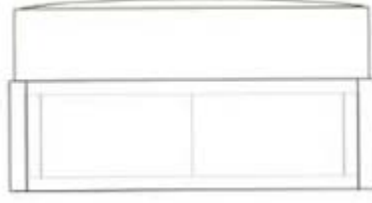

1.4

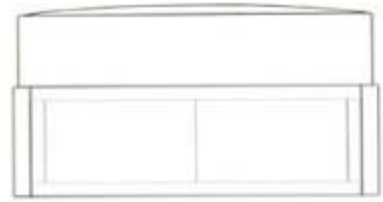

1.5

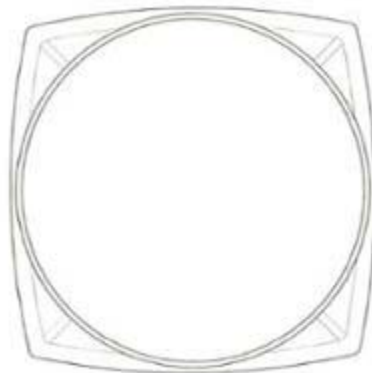

1.6

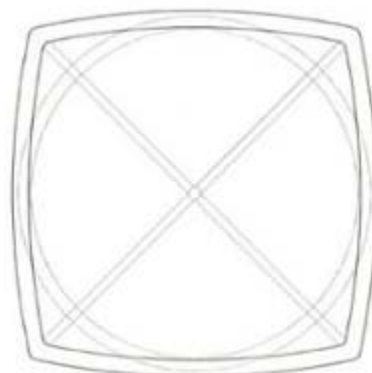

1.7



- (11) **36690**  
(21) 3-2019-01619 (28) 1  
(54) **HỘP ĐỰNG MỸ PHẨM** (51) **28-02**  
(22) 25/06/2019 (43) 25/10/2019  
(30) 30-2019-0029631 21/06/2019 KR;  
(73) LG HOUSEHOLD & HEALTH CARE LTD. (KR)  
58, Saemunan-ro, Jongno-gu, Seoul, Republic of Korea  
(72) LEE, Henson (KR)  
(74) Công ty TNHH Sở hữu trí tuệ Việt Á (VIET A IP CO.,LTD)  
(55)



1.1

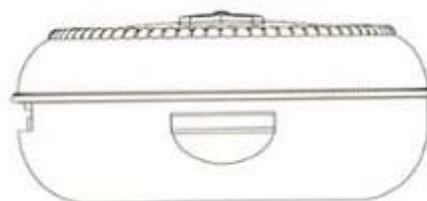

1.2

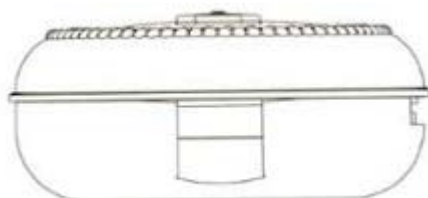

1.3

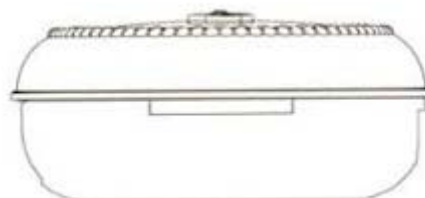

1.4



1.5



1.6



1.7

- (11) **36691**  
(21) 3-2019-01620  
(54) **BÌNH ĐUN NƯỚC NÓNG**  
(22) 25/06/2019  
(73) Số 124 đường Tôn Đức Thắng, phường Quốc Tử Giám, quận Đống Đa, thành phố Hà Nội  
(72) Nguyễn Duy Chính (VN)  
(55)
- (28) 1  
(51) **23-03**  
(43) 25/10/2019  
CÔNG TY CỔ PHẦN ĐẦU TƯ TẬP ĐOÀN TÂN Á ĐẠI THÀNH (VN)



1.1



1.2



1.3



1.4



1.5



1.6



1.7

- (11) **36692**  
(21) 3-2019-01628 (28) 1  
(54) **HỘP ĐỰNG** (51) **09-03**  
(22) 26/06/2019 (43) 25/10/2019  
(73) LG HOUSEHOLD & HEALTH CARE LTD. (KR)  
58, Saemunan-ro, Jongno-gu, Seoul, Republic of Korea  
(72) LEE, Hyun Seung (KR)  
(74) Công ty TNHH Sở hữu trí tuệ Việt Á (VIET A IP CO.,LTD)  
(55)



1.1



1.2



1.3



1.4



1.5



1.6



1.7

**CÔNG BÁO SỞ HỮU CÔNG NGHIỆP SỐ 379 TẬP A – QUYỀN 2 (10.2019)**

- (11) **36693**
- (21) 3-2019-01635 (28) 1
- (54) **NHÃN SẢN PHẨM** (51) **19-08**
- (22) 26/06/2019 (43) 25/10/2019
- CÔNG TY CỔ PHẦN DƯỢC PHẨM QUỐC GIA (VN)**
- (73) Số 57 đường Lạc Long Quân, phường Nghĩa Đô, quận cầu Giấy, thành phố Hà Nội
- (72) Nguyễn Lập Phương (VN)
- (74) Công ty TNHH Sở hữu trí tuệ và Công nghệ Thủ đô (CAPITAL IP&T CO.LTD.)
- (55)



- (11) **36694**  
(21) 3-2019-01636 (28) 1  
(54) **XE Ô TÔ** (51) **12-08**  
(22) 26/06/2019 (43) 25/10/2019  
(30) 2018-028603 27/12/2018 JP;  
NISSAN JIDOSHA KABUSHIKIKAISHA (ALSO TRADING AS NISSAN  
(73) MOTOR CO., LTD.) (JP)  
2, Takara-cho, Kanagawa-ku, Yokohama-shi, Kanagawa, Japan  
1. TAKASHI UTSUNOMIYA (JP)  
(72) 2. TSUYOSHI KAWASHIMA (JP)  
3. MARCUS QUACH (US)  
(74) Công ty Luật TNHH AMBYS Hà Nội (AMBYS HANOI)  
(55)



1.1



1.2



1.3



1.4



1.5





1.6



1.7



1.8

- (11) **36695**  
(21) 3-2019-01637 (28) 1  
(54) **TẮM HÃM XUNG PHÍA TRƯỚC CỦA Ô TÔ** (51) **12-16**  
(22) 26/06/2019 (43) 25/10/2019  
(30) 201817899 27/12/2018 AU;  
TOYOTA JIDOSHA KABUSHIKI KAISHA (JP)  
(73) 1, Toyota-cho, Toyota-shi, Aichi-ken, 471-8571 Japan  
1. HIROFUMI FUKUI (JP)  
(72) 2. HISATAKA TOKIZANE (JP)  
(74) Công ty TNHH một thành viên Sở hữu trí tuệ VCCI (VCCI-IP CO.,LTD.)  
(55)

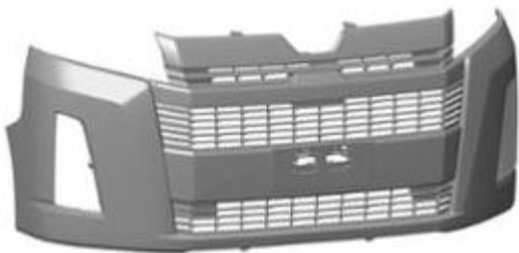

1.1

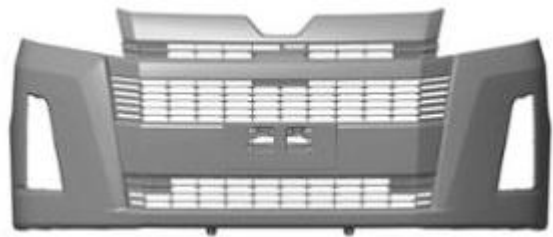

1.2

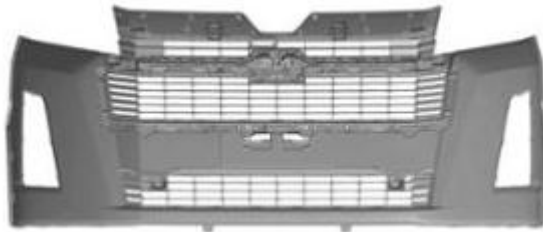

1.3



1.4



1.5



1.6



1.7



1.8

- (11) **36696**  
(21) 3-2019-01638 (28) 1  
(54) **BỘ ĐÈN PHÍA TRƯỚC CỦA Ô TÔ** (51) **26-06**  
(22) 26/06/2019 (43) 25/10/2019  
(30) 201817900 27/12/2018 AU;  
TOYOTA JIDOSHA KABUSHIKI KAISHA (JP)  
(73) 1, Toyota-cho, Toyota-shi, Aichi-ken, 471-8571 JAPAN  
1. HIROFUMI FUKUI (JP)  
(72) 2. HISATAKA TOKIZANE (JP)  
(74) Công ty TNHH một thành viên Sở hữu trí tuệ VCCI (VCCI-IP CO.,LTD.)  
(55)



HÌNH 1

1.1



HÌNH 2

1.2



HÌNH 3

1.3



HÌNH 4

1.4



HÌNH 5

1.5



HÌNH 6

1.6



HÌNH 7

1.7



HÌNH 8

1.8

- (11) **36697**  
(21) 3-2019-01639 (28) **2**  
(54) **Ô TÔ** (51) **12-08**  
(22) 26/06/2019 (43) 25/10/2019  
(30) 2018-028785 27/12/2018 JP; 2018-028784 27/12/2018 JP;  
TOYOTA JIDOSHA KABUSHIKI KAISHA (JP)  
(73) 1, Toyota-cho, Toyota-shi, Aichi-ken, 471-8571 JAPAN  
1. NAOYA SUZUKI (JP)  
(72) 2. HIROFUMI FUKUI (JP)  
3. SHO OKAZAKI (JP)  
(74) Công ty TNHH một thành viên Sở hữu trí tuệ VCCI (VCCI-IP CO.,LTD.)  
(55)



1.1



1.2



1.3



1.4



1.5



1.6



1.7



1.8



1.9



2.1



2.2



2.3



2.4



2.5



2.6



2.7



2.8



2.9



(11) **36698**

(21) 3-2019-01640

(54) **XE ĐIỆN**

(22) 26/06/2019

SANYANG MOTOR CO., LTD. (TW)

(73) No. 184, Keng Tzu Kou, Shang Keng Village, Hsin Fong Shiang, Hsinchu County  
304, TAIWAN

(72) Ching-Chung CHIU (TW)

(74) Công ty TNHH Trường Xuân (AGELESS CO.,LTD.)

(55)

(28) 1

(51) **12-11**

(43) 25/10/2019



1.1



1.2



1.3



1.4



1.5



1.6



1.7



1.8



1.9

- (11) **36699**  
(21) 3-2019-01645 (28) 1  
(54) **NẤP HỘP** (51) **09-07**  
(22) 27/06/2019 (43) 25/10/2019  
PUTIAN GOODWILL MACHINERY CO. LTD. (CN)  
(73) No.106, Dongang Street, Jiangkou Town, Hanjiang District, Putian, Fujian, China  
351115  
(72) CHU, JUI-LING (CN)  
(74) Công ty TNHH Trà và cộng sự (TRA & ASSOCIATES CO.,LTD)  
(55)

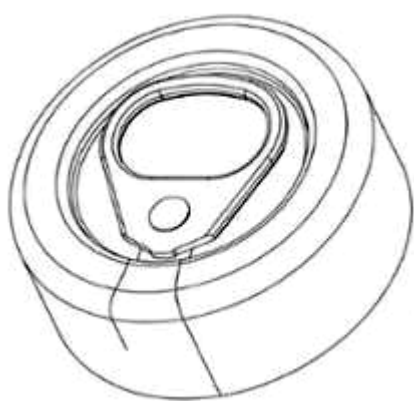

1.1

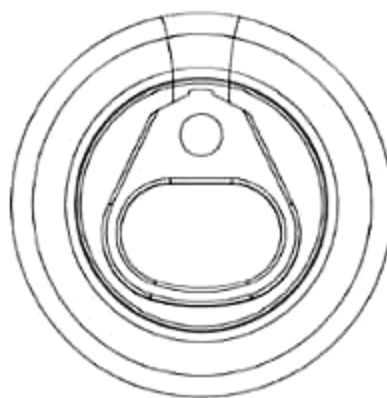

1.2

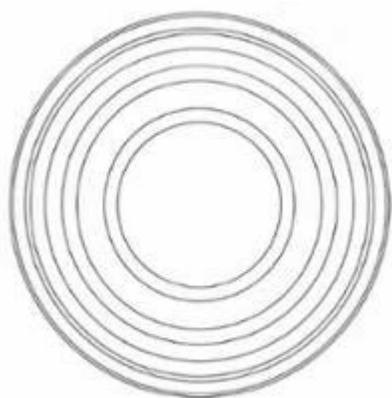

1.3

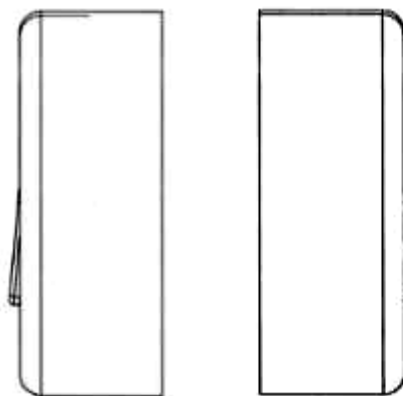

1.4

1.5

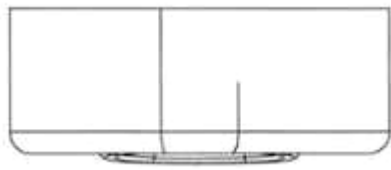

1.6



1.7

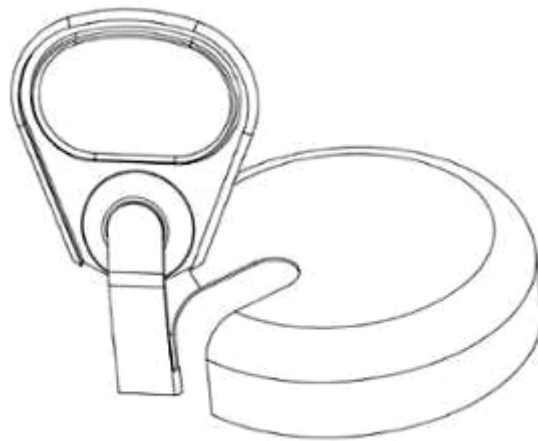

1.8

- (11) **36700**  
(21) 3-2019-01641 (28) 1  
(54) **GHẾ CHO TRẺ EM** (51) **06-09**  
(22) 27/06/2019 (43) 25/10/2019  
(30) 2019-002177 04/02/2019 JP;  
RICHELL CORPORATION (JP)  
(73) 136 Mizuhashi sakuragi, Toyama-shi, Toyama, Japan  
(72) Satoshi URABE (JP)  
(74) Công ty Luật TNHH Phạm và Liên danh (PHAM & ASSOCIATES)  
(55)



1.1



1.2



1.3



1.4



1.5



1.6



1.7

(11) **36701**

(21) 3-2019-01642

(28) 1

(54) **MŨ BẢO HIỂM**

(51) **02-03**

(22) 27/06/2019

(43) 25/10/2019

FOSHAN CITY NANHAI YONGHENG HELMET MANUFACTURING CO., LTD (CN)

(73) Yannan Industrial Area, Longgao Rd., Jiujiang, Nanhai, Foshan City, Guangdong, China

(72) CHEN YEQIANG (CN)

(74) Công ty Luật TNHH WINCO (WINCO LAW FIRM)

(55)



1.1



1.2



1.3

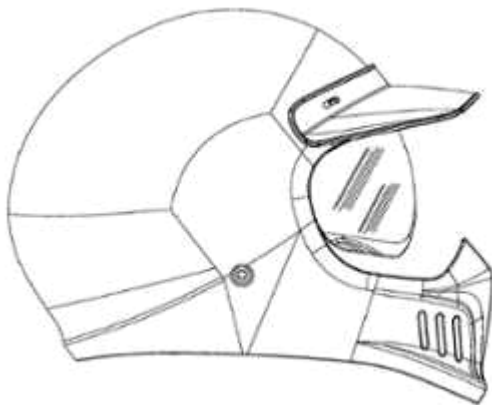

1.4

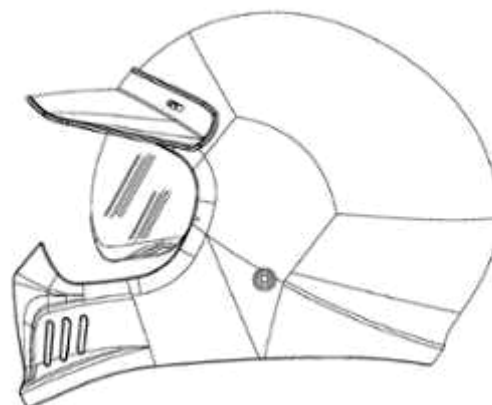

1.5





1.6

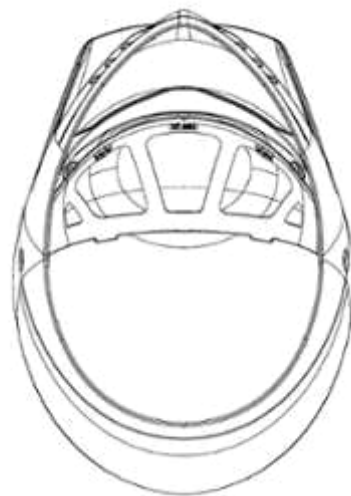

1.7

- (11) **36702**  
(21) 3-2019-01643 (28) 1  
(54) **MŨ BẢO HIỂM** (51) **02-03**  
(22) 27/06/2019 (43) 25/10/2019  
FOSHAN CITY NANHAI YONGHENG HELMET MANUFACTURING CO.,  
LTD (CN)  
(73) Yannan Industrial Area, Longgao Rd., Jiujiang, Nanhai, Foshan City, Guangdong,  
China  
(72) CHEN YEQIANG (CN)  
(74) Công ty Luật TNHH WINCO (WINCO LAW FIRM)  
(55)



1.1



1.2



1.3

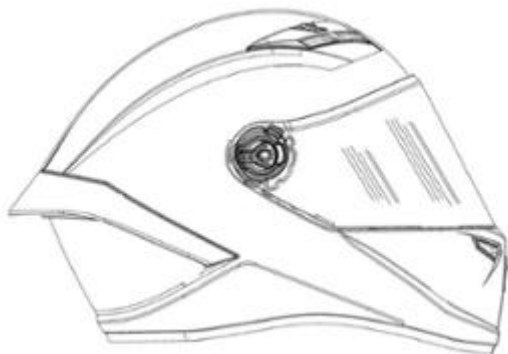

1.4



1.5



1.6



1.7

- (11) **36703**  
(21) 3-2019-01646 (28) 1  
(54) **THIẾT BỊ ĐIỀU KHIỂN** (51) **13-03; 14-02**  
(22) 28/06/2019 (43) 25/10/2019  
(73) **PHẠM CAO KỲ (VN)**  
(72) **Phạm Cao Kỳ (VN)**  
(55) 115/5/8/5 đường 11, phường Trường Thọ, quận Thủ Đức, thành phố Hồ Chí Minh

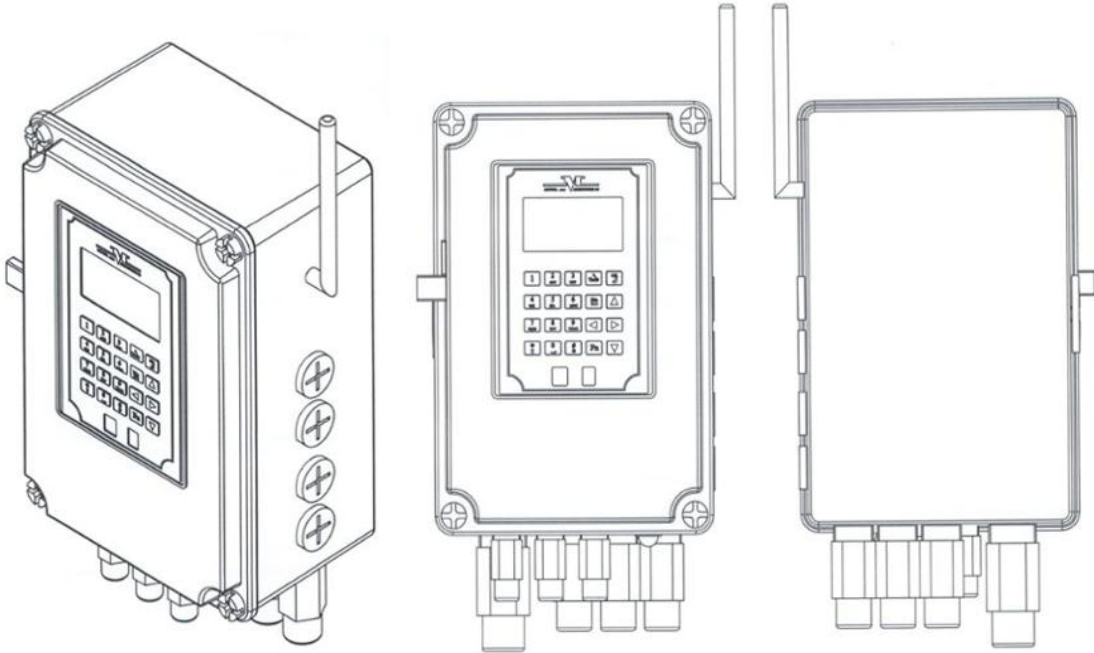

1.1

1.2

1.3

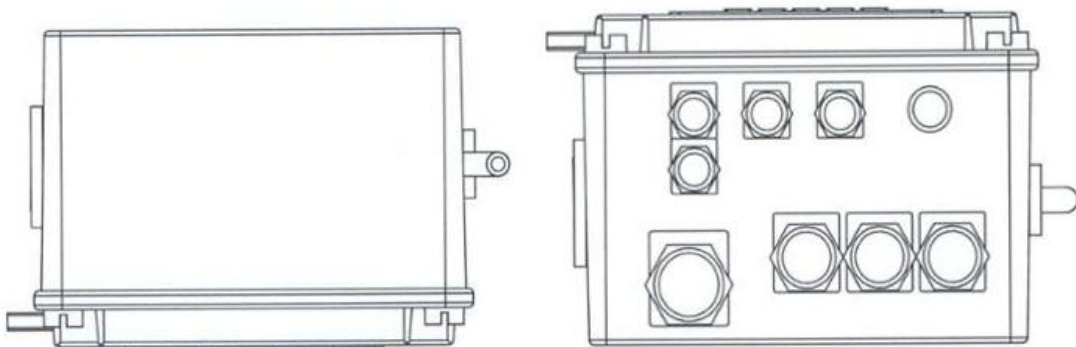

1.4

1.5



1.6



1.7

- (11) **36704**  
(21) 3-2019-01648 (28) 1  
(54) **HỘP ĐỰNG MỸ PHẨM** (51) **09-03**  
(22) 28/06/2019 (43) 25/10/2019  
CÔNG TY TNHH SẢN XUẤT THƯƠNG MẠI XUẤT NHẬP KHẨU THIÊN  
PHÚ TÀI (VN)  
(73) 222 Hiệp Bình, khu phố 7, phường Hiệp Bình Chánh, quận Thủ Đức, thành phố  
Hồ Chí Minh  
(72) Nguyễn Văn Tài (VN)  
(55)



1.1



1.2

- (11) **36705**  
(21) 3-2019-01649 (28) 1  
(54) **NHÃN SẢN PHẨM** (51) **19-08**  
(22) 28/06/2019 (43) 25/10/2019  
**CÔNG TY CỔ PHẦN DINH DƯỠNG KHÁNH HÒA (VN)**  
(73) 68 đường 17, KP3, phường Hiệp Bình Chánh, quận Thủ Đức, thành phố Hồ Chí Minh  
(72) Trần Văn Trung (VN)  
(55)



**CÔNG BÁO SỞ HỮU CÔNG NGHIỆP SỐ 379 TẬP A – QUYỀN 2 (10.2019)**

- (11) **36706**  
(21) 3-2019-01650 (28) 1  
(54) **NHÃN SẢN PHẨM** (51) **19-08**  
(22) 28/06/2019 (43) 25/10/2019  
CÔNG TY CỔ PHẦN DINH DƯỠNG KHÁNH HÒA (VN)  
(73) 68 đường 17, KP3, phường Hiệp Bình Chánh, quận Thủ Đức, thành phố Hồ Chí Minh  
(72) Trần Văn Trung (VN)  
(55)





- (11) **36707**  
(21) 3-2019-01651 (28) 1  
(54) **NHÃN SẢN PHẨM** (51) **19-08**  
(22) 28/06/2019 (43) 25/10/2019  
**CÔNG TY CỔ PHẦN DINH DƯỠNG KHÁNH HÒA (VN)**  
(73) 68 đường 17, KP3, phường Hiệp Bình Chánh, quận Thủ Đức, thành phố Hồ Chí Minh  
(72) Trần Văn Trung (VN)  
(55)



1.1

- (11) **36708**  
(21) 3-2019-01655 (28) 1  
(54) **THANH KIM LOẠI ĐỊNH HÌNH** (51) **25-01**  
(22) 28/06/2019 (43) 25/10/2019  
(73) CÔNG TY CỔ PHẦN CÔNG NGHIỆP G9 (VN)  
Thị tứ Quang Phục, xã Quang Phục, huyện Tứ Kỳ, tỉnh Hải Dương  
(72) Nguyễn Văn Điệp (VN)  
(74) Công ty TNHH Sở hữu trí tuệ PADEMARK (PADEMARK CO.,LTD.)  
(55)



1.1



1.2



1.3

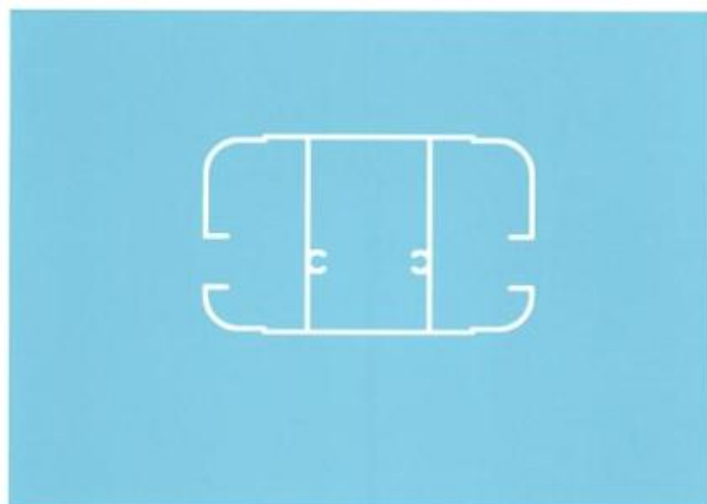

1.4

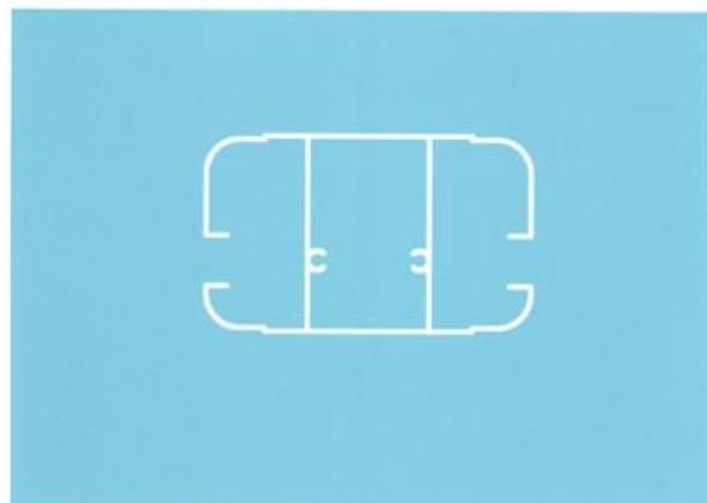

1.5



1.6



1.7

- (11) **36709**  
(21) 3-2019-01657 (28) 1  
(54) **HỘP ĐỰNG** (51) **09-03**  
(22) 01/07/2019 (43) 25/10/2019  
(73) LG HOUSEHOLD & HEALTH CARE LTD. (KR)  
58, Saemunan-ro, Jongno-gu, Seoul, Republic of Korea  
(72) LEE, Hye Jin (KR)  
(74) Công ty TNHH Sở hữu trí tuệ Việt Á (VIET A IP CO.,LTD)  
(55)



1.1



1.2



1.3



1.4



1.5



1.6



1.7

- (11) **36710**  
(21) 3-2019-01658 (28) 1  
(54) **HỘP ĐỰNG SẢN PHẨM** (51) **09-03**  
(22) 01/07/2019 (43) 25/10/2019  
(73) **CÔNG TY TNHH QUỐC TẾ LUXURY PHARMA (VN)**  
Đội 1, thôn Đoài Khê, xã Đan Phượng, huyện Đan Phượng, thành phố Hà Nội  
(72) Nguyễn Văn Duân (VN)  
(74) Công ty TNHH Sở hữu trí tuệ Bình Minh (SUNRISE IP CO.,LTD.)  
(55)



1.1



1.2

- (11) **36711**  
(21) 3-2019-01663 (28) 1  
(54) **BƠM NƯỚC** (51) **12-05**  
(22) 02/07/2019 (43) 25/10/2019  
(30) 201930002803.4 03/01/2019 CN;  
(73) XUZHOU NORTH PUMP CO., LTD. (CN)  
Tushang Town Industrial Park, Pizhou, Jiangsu, China  
(72) MA, Haitao (CN)  
(74) Công ty TNHH Sở hữu trí tuệ NTT (NTT IP CO.,LTD)  
(55)



1.1



1.2



1.3



1.4



1.5



1.6



1.7



1.8



1.9



1.10



**CÔNG BÁO SỞ HỮU CÔNG NGHIỆP SỐ 379 TẬP A – QUYỀN 2 (10.2019)**

- (11) **36712**  
(21) 3-2019-01664 (28) 1  
(54) **BẢNG ĐIỀU KHIỂN** (51) **24-01**  
(22) 02/07/2019 (43) 25/10/2019  
CÔNG TY CỔ PHẦN NỘI THẤT VÀ DỊCH VỤ PHÒNG THÍ NGHIỆM ĐÔNG  
DƯƠNG (VN)  
(73) Tầng 2, số 3 ngõ 117 phố Đặng Tiến Đông, phường Trung Liệt, quận Đống Đa,  
thành phố Hà Nội  
(72) Vương Sơn (VN)  
(55)



1.1



1.2



1.3



1.4



1.5

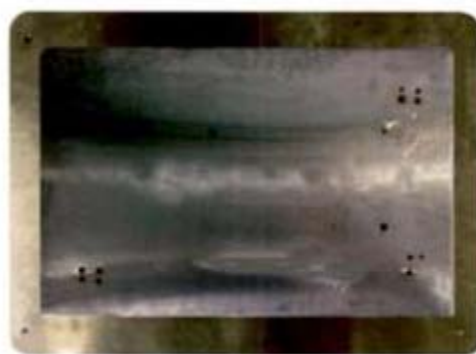

1.6

- (11) **36713**  
(21) 3-2019-01668 (28) 1  
(54) **NẤP HỘP ĐỰNG THỰC PHẨM** (51) **09-07**  
(22) 02/07/2019 (43) 25/10/2019  
(30) 30-2019-0001169 09/01/2019 KR;  
LOCK & LOCK COMPANY LIMITED (KR)  
(73) Lock & Lock Building, 1556-1, Seocho-3 Dong, Seocho-gu, Seoul, Korea  
(72) Kim Seonjeong (KR)  
(74) Công ty TNHH Tầm nhìn và Liên danh (VISION & ASSOCIATES CO.LTD.)  
(55)

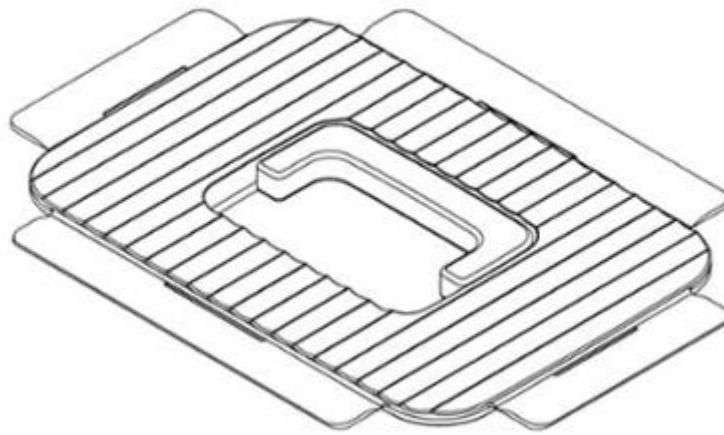

1.1



1.2



1.3



1.4



1.5

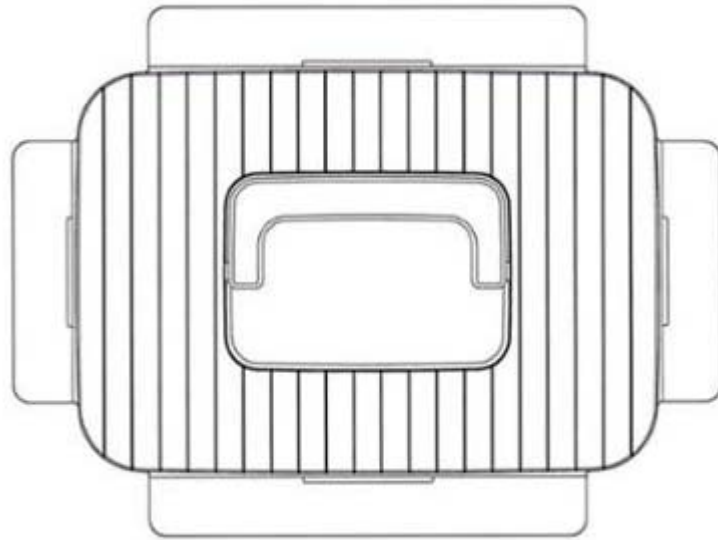

1.6



1.7

- (11) **36714**  
(21) 3-2019-01669 (28) 1  
(54) **NẤP HỘP ĐỰNG THỰC PHẨM** (51) **09-07**  
(22) 02/07/2019 (43) 25/10/2019  
(30) 30-2019-0001173 09/01/2019 KR;  
(73) LOCK & LOCK COMPANY LIMITED (KR)  
(73) Lock & Lock Building, 1556-1, Seocho-3 Dong, Seocho-gu, Seoul, Korea  
(72) Kim Seonjeong (KR)  
(74) Công ty TNHH Tầm nhìn và Liên danh (VISION & ASSOCIATES CO.LTD.)  
(55)

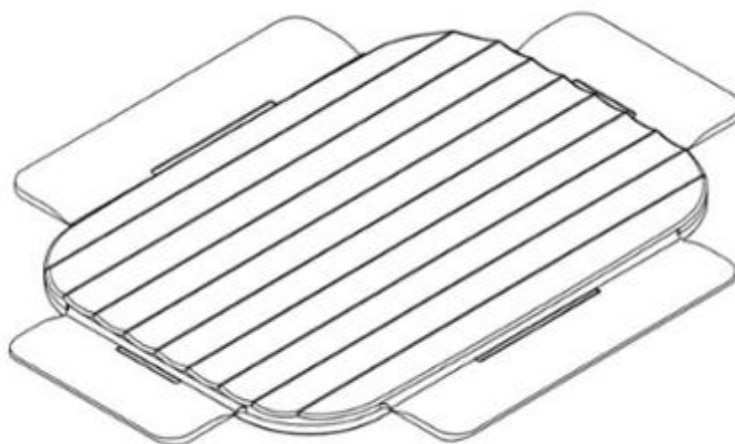

1.1



1.2



1.3



1.4



1.5



1.6



1.7

- (11) **36715**  
(21) 3-2019-01670 (28) 1  
(54) **NÁP HỘP ĐỰNG THỰC PHẨM** (51) **09-07**  
(22) 02/07/2019 (43) 25/10/2019  
(30) 30-2019-0001170 09/01/2019 KR;  
(73) LOCK & LOCK COMPANY LIMITED (KR)  
(73) Lock & Lock Building, 1556-1, Seocho-3 Dong, Seocho-gu, Seoul, Korea  
(72) Kim Seonjeong (KR)  
(74) Công ty TNHH Tầm nhìn và Liên danh (VISION & ASSOCIATES CO.LTD.)  
(55)

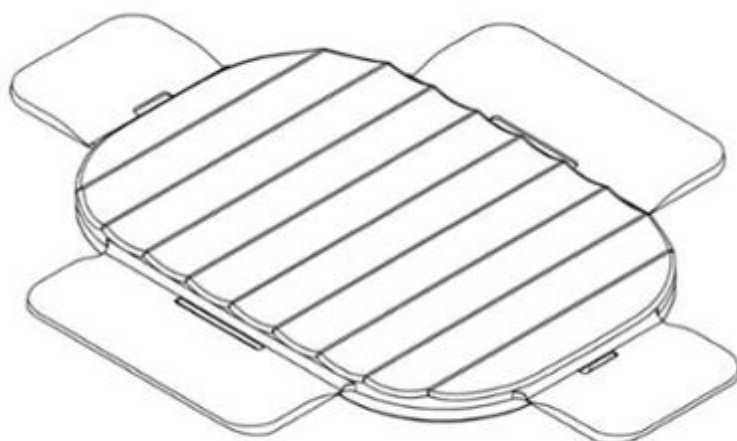

1.1



1.2



1.3



1.4



1.5

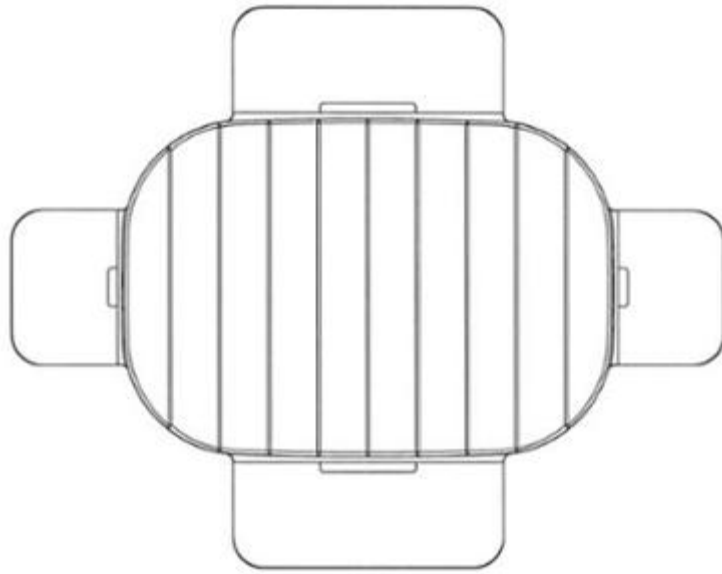

1.6

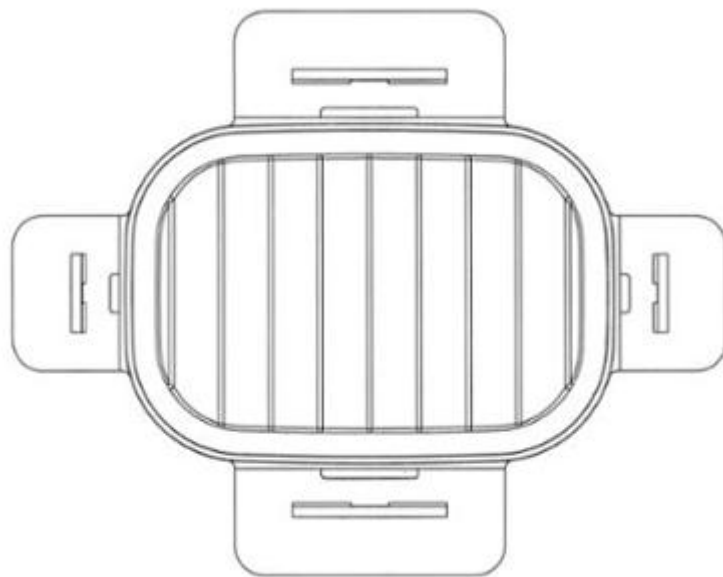

1.7

- (11) **36716**  
(21) 3-2019-01671 (28) 1  
(54) **HỘP ĐỰNG THỰC PHẨM** (51) **09-03**  
(22) 02/07/2019 (43) 25/10/2019  
(30) 30-2019-0001174 09/01/2019 KR;  
(73) LOCK & LOCK COMPANY LIMITED (KR)  
Lock & Lock Building, 1556-1, Seocho-3 Dong, Seocho-gu, Seoul, Korea  
(72) Kim Seonjeong (KR)  
(74) Công ty TNHH Tầm nhìn và Liên danh (VISION & ASSOCIATES CO.LTD.)  
(55)

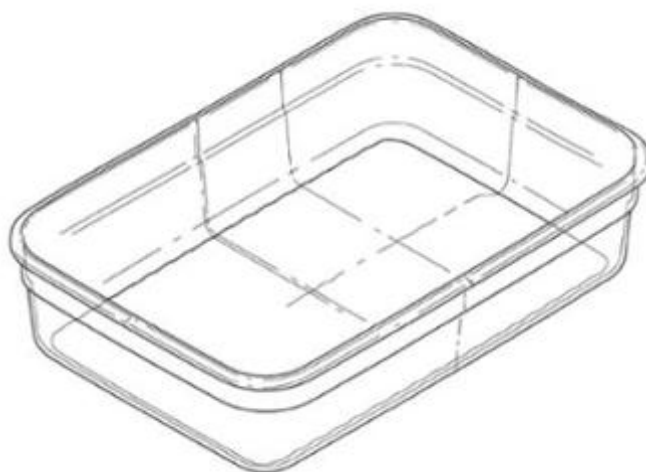

1.1



1.2



1.3



1.4



1.5



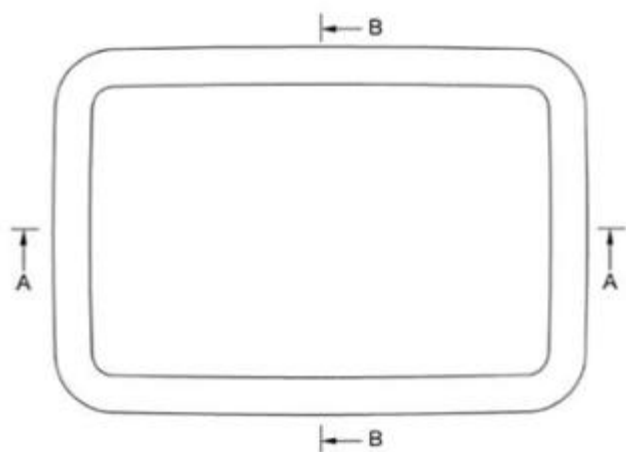

1.6

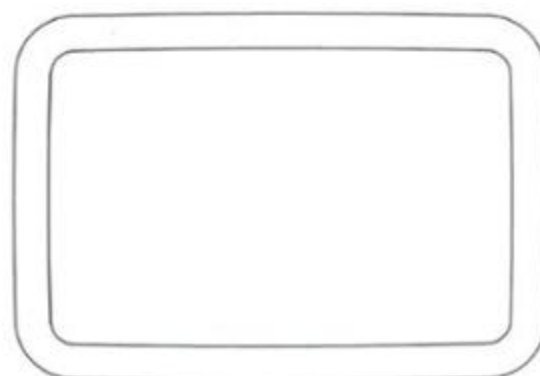

1.7



1.8

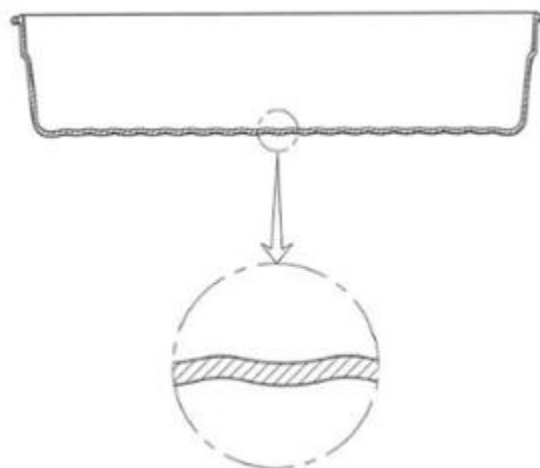

1.9

- (11) **36717**  
(21) 3-2019-01672 (28) 1  
(54) **HỘP ĐỰNG THỰC PHẨM** (51) **09-03**  
(22) 02/07/2019 (43) 25/10/2019  
(30) 30-2019-0001171 09/01/2019 KR;  
(73) LOCK & LOCK COMPANY LIMITED (KR)  
(73) Lock & Lock Building, 1556-1, Seocho-3 Dong, Seocho-gu, Seoul, Korea  
(72) Kim Seonjeong (KR)  
(74) Công ty TNHH Tầm nhìn và Liên danh (VISION & ASSOCIATES CO.LTD.)  
(55)



1.1

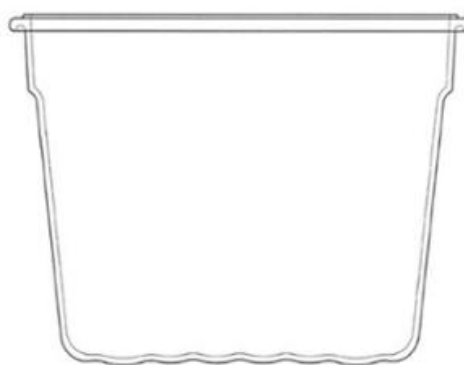

1.2

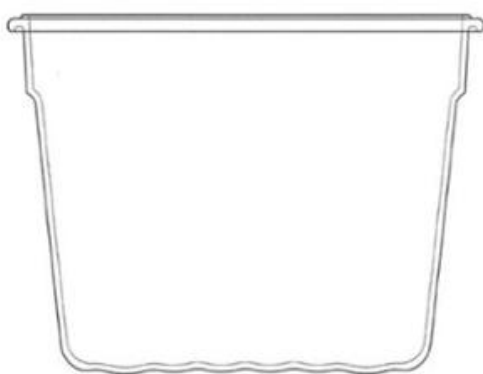

1.3

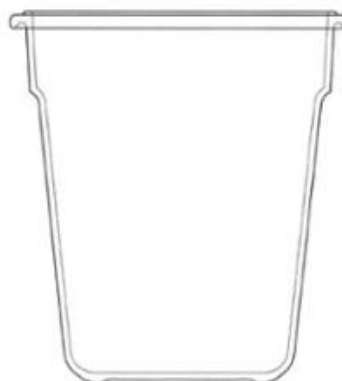

1.4



1.5

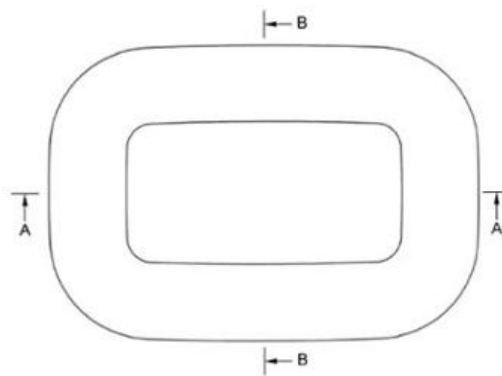

1.6

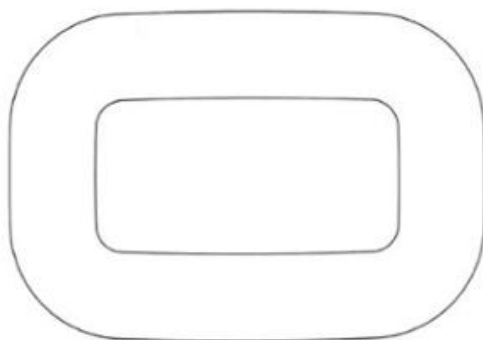

1.7

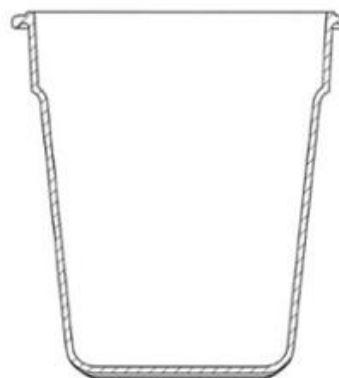

1.8

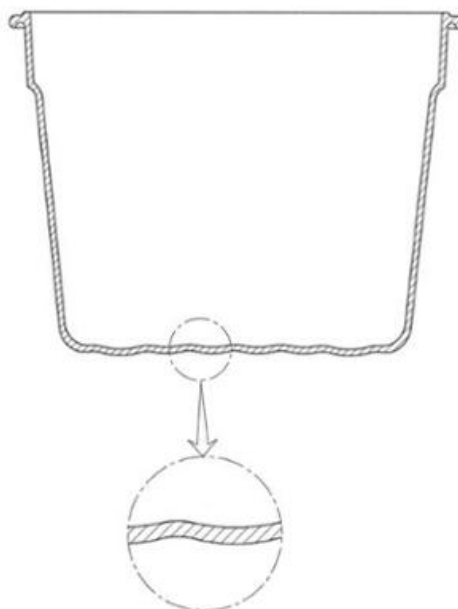

1.9

- (11) **36718**  
(21) 3-2019-01673 (28) 1  
(54) **NỒI CƠM ĐIỆN** (51) **07-02**  
(22) 03/07/2019 (43) 25/10/2019  
(30) 201930048739.3 28/01/2019 CN;  
FOSHAN SHUNDE MIDEA ELECTRICAL HEATING APPLIANCES  
(73) MANUFACTURING CO. LIMITED (CN)  
San Le Road #19, Beijiao, Shunde, Foshan, Guangdong Province 528311, China  
1. GUO, JIAJIA (CN)  
(72) 2. FENG, HONGTAO (CN)  
3. TAN, MAO (CN)  
4. HUANG, HENG (CN)  
(74) Công ty TNHH Dịch vụ Sở hữu trí tuệ KENFOX (KENFOX IP SERVICE  
CO.,LTD.)  
(55)

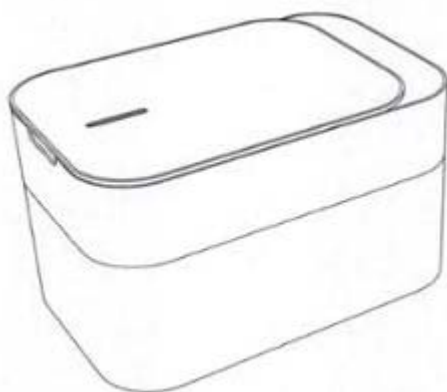

1.1

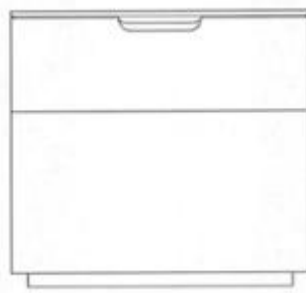

1.2



1.3

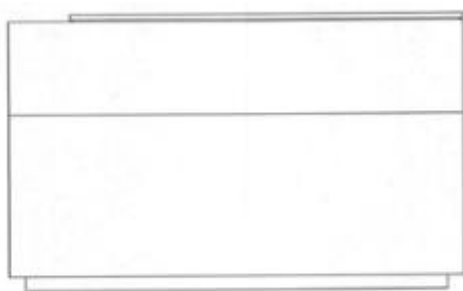

1.4

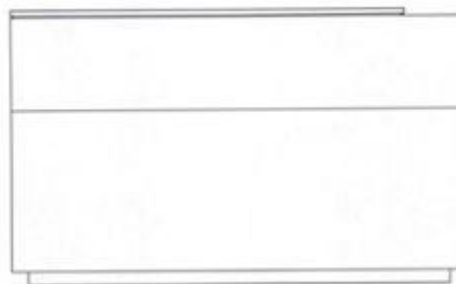

1.5



1.6



1.7

- (11) **36719**  
(21) 3-2019-01681 (28) 1  
(54) **CHAI ĐỰNG** (51) **09-01**  
(22) 03/07/2019 (43) 25/10/2019  
(73) CÔNG TY TNHH DẦU THỰC VẬT DABACO (VN)  
Cụm Công Nghiệp Tân Chi, Xã Tân Chi, Huyện Tiên Du, Tỉnh Bắc Ninh  
(72) Nguyễn Như So (VN)  
(55)



1.1

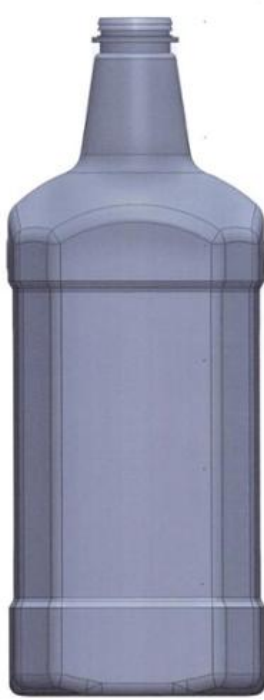

1.2

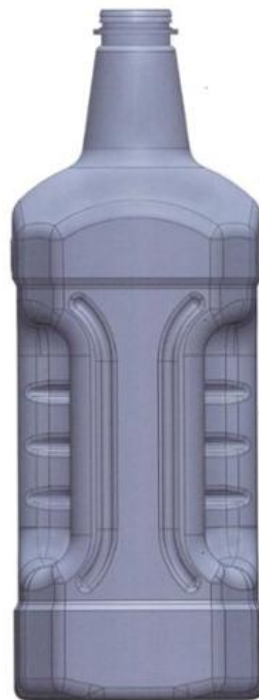

1.3



1.4



1.5



1.6

- (11) **36720**  
(21) 3-2019-01682 (28) 1  
(54) **NHÃN SẢN PHẨM** (51) **19-08**  
(22) 03/07/2019 (43) 25/10/2019  
(73) CÔNG TY TNHH THƯƠNG MẠI DỊCH VỤ KHÂM TÍN (VN)  
284/11 Cô Bắc, phường Cô Giang, quận 1, thành phố Hồ Chí Minh  
(72) Trần Văn Tường (VN)  
(74) Công ty Luật TNHH SIPCO (SIPCO LAWYERS & IP AGENTS)  
(55)



1.1



1.2

- (11) **36721**  
 (21) 3-2019-01683 (28) 1  
 (54) **NHÃN SẢN PHẨM** (51) **19-08**  
 (22) 03/07/2019 (43) 25/10/2019  
**CÔNG TY TNHH THƯƠNG MẠI DỊCH VỤ KHÂM TÍN**  
 (73) (VN)  
 284/11 Cô Bắc, phường Cô Giang, quận 1, thành phố Hồ Chí Minh  
 (72) Trần Văn Tường (VN)  
 (74) Công ty Luật TNHH SIPCO (SIPCO LAWYERS & IP AGENTS)  
 (55)



1.1



1.2



- (11) **36722**  
(21) 3-2019-01675 (28) 1  
(54) **THÙNG XE MÔ TÔ** (51) **09-02**  
(22) 03/07/2019 (43) 25/10/2019  
(73) GIVI SPA (IT)  
Via G. Ungaretti, 48 25020 Flero (BS) Italy  
(72) Visenzi Giuseppe (IT)  
(74) Công ty Cổ phần Sở hữu công nghiệp INVESTIP (INVESTIP)  
(55)



1.1



1.2



1.3



1.4



1.5



1.6

- (11) **36723**  
(21) 3-2019-01676 (28) 1  
(54) **THIẾT BỊ GIÁM SÁT HÀNH TRÌNH** (51) **14-03**  
(22) 03/07/2019 (43) 25/10/2019  
(73) TẬP ĐOÀN CÔNG NGHIỆP - VIỄN THÔNG QUÂN ĐỘI (VIETTEL) (VN)  
Số 1 Trần Hữu Dực, Mỹ Đình 2, Nam Từ Liêm, Hà Nội, Việt Nam  
1. TRẦN BÌNH MINH (VN)  
2. NGUYỄN MINH KHÁNH NGỌC (VN)  
(72) 3. NGUYỄN TUẤN PHƯỚC (VN)  
4. VŨ ĐỨC MINH (VN)  
5. NGUYỄN TIẾN TÙNG (VN)  
(74) Công ty Luật TNHH quốc tế BMVN (BMVN INTERNATIONAL LLC)  
(55)



1.1



1.2

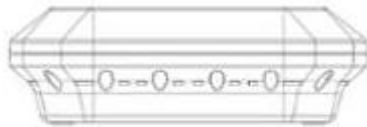

1.3



1.4



1.5

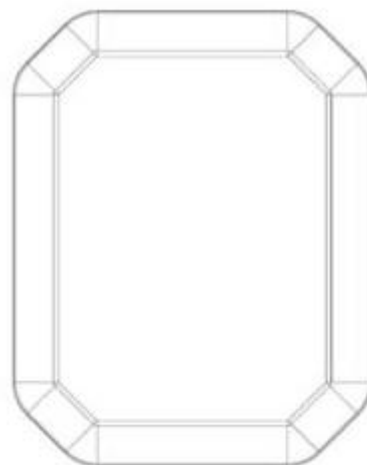

1.6

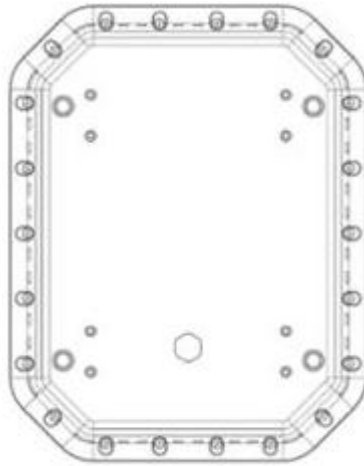

1.7

- (11) **36724**  
(21) 3-2019-01690 (28) 1  
(54) **THIẾT BỊ THU PHÁT SÓNG WIFI** (51) **14-03**  
(22) 04/07/2019 (43) 25/10/2019  
(73) TẬP ĐOÀN CÔNG NGHIỆP - VIỄN THÔNG QUÂN ĐỘI (VIETTEL) (VN)  
Số 1 Trần Hữu Dực, Mỹ Đình 2, Nam Từ Liêm, Hà Nội  
1. TRẦN BÌNH MINH (VN)  
(72) 2. VŨ ĐỨC MINH (VN)  
3. MAI TUẤN ANH (VN)  
4. BÙI TRUNG KHÁNH (VN)  
(74) Công ty Luật TNHH quốc tế BMVN (BMVN INTERNATIONAL LLC)  
(55)

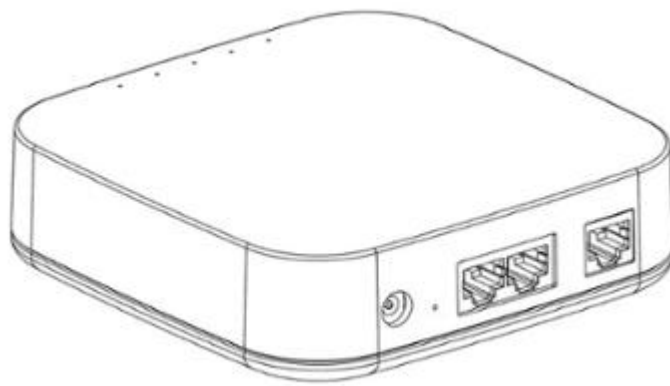

1.1

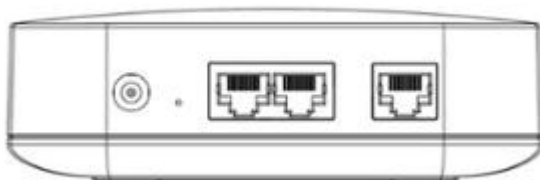

1.2



1.3



1.4



1.5



1.6

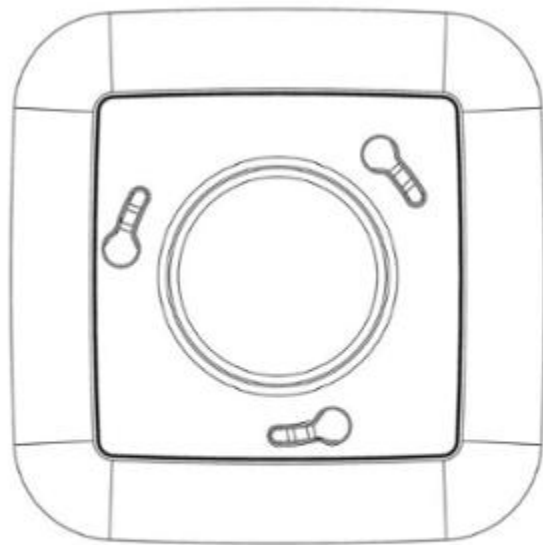

1.7

- (11) **36725**  
(21) 3-2019-01697 (28) 1  
(54) **LỘ ĐỪNG** (51) **09-01**  
(22) 05/07/2019 (43) 25/10/2019  
(73) LG HOUSEHOLD & HEALTH CARE LTD. (KR)  
58, Saemunan-ro, Jongno-gu, Seoul, Republic of Korea  
(72) PARK, Jin Won (KR)  
(74) Công ty TNHH Sở hữu trí tuệ Việt Á (VIET A IP CO.,LTD)  
(55)



1.1



1.2



1.3



1.4



1.5

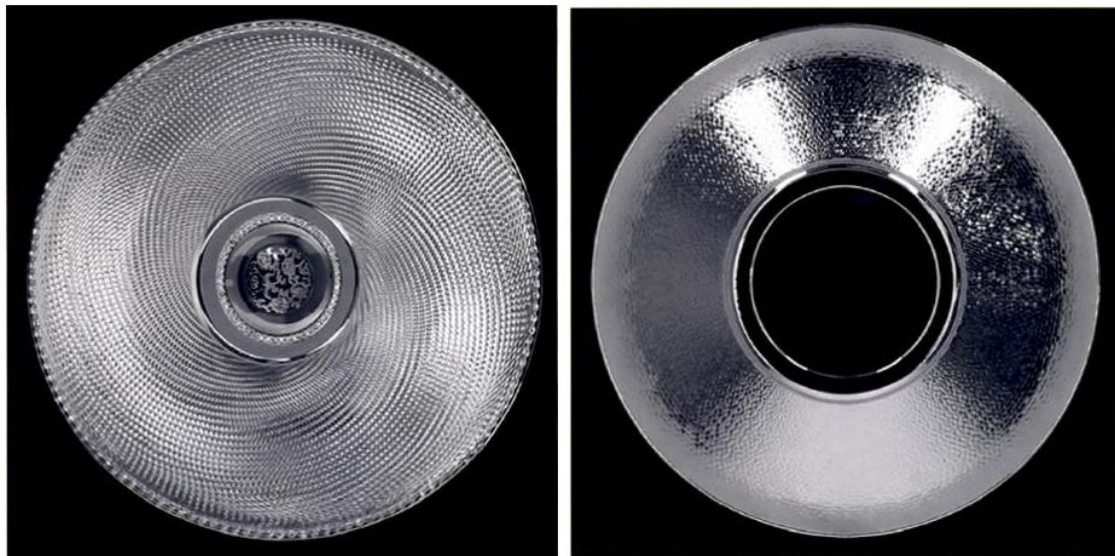

1.6

1.7



- (11) **36726**  
(21) 3-2019-01716 (28) 1  
(54) **LỚP XE** (51) **12-15**  
(22) 05/07/2019 (43) 25/10/2019  
(30) 2019-000265 09/01/2019 JP;  
THE YOKOHAMA RUBBER CO., LTD. (JP)  
(73) 36-11, Shimbashi 5-chome, Minato-ku, Tokyo 105-8685, Japan  
(72) Tomoyuki SHIBUYA (JP)  
(74) Công ty Luật TNHH AMBYS Hà Nội (AMBYS HANOI)  
(55)

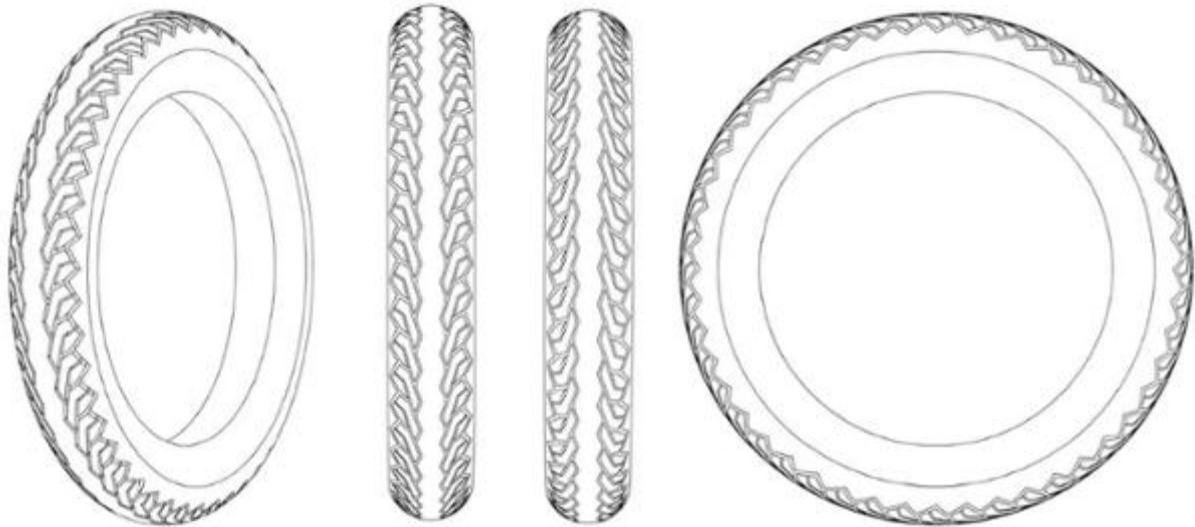

1.1

1.2

1.3

1.4

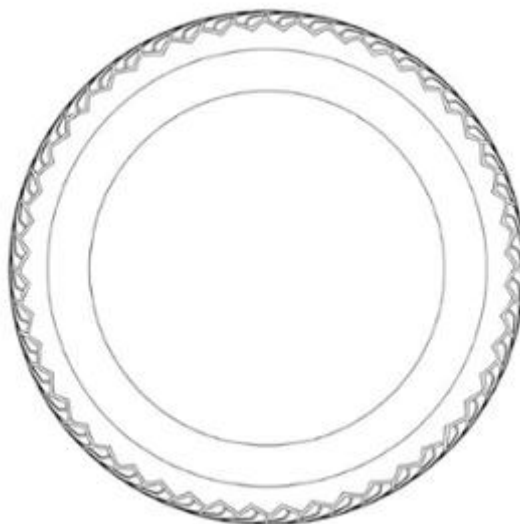

1.5

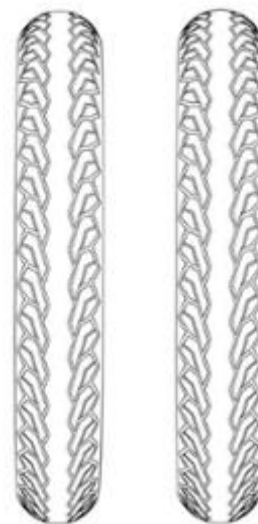

1.6

1.7

- (11) **36727**  
(21) 3-2019-01717 (28) 1  
(54) **LỚP XE** (51) **12-15**  
(22) 05/07/2019 (43) 25/10/2019  
(30) 2019-000264 09/01/2019 JP;  
THE YOKOHAMA RUBBER CO., LTD. (JP)  
(73) 36-11, Shimbashi 5-chome, Minato-ku, Tokyo 105-8685, Japan  
(72) Shoei KAKUTA (JP)  
(74) Công ty Luật TNHH AMBYS Hà Nội (AMBYS HANOI)  
(55)

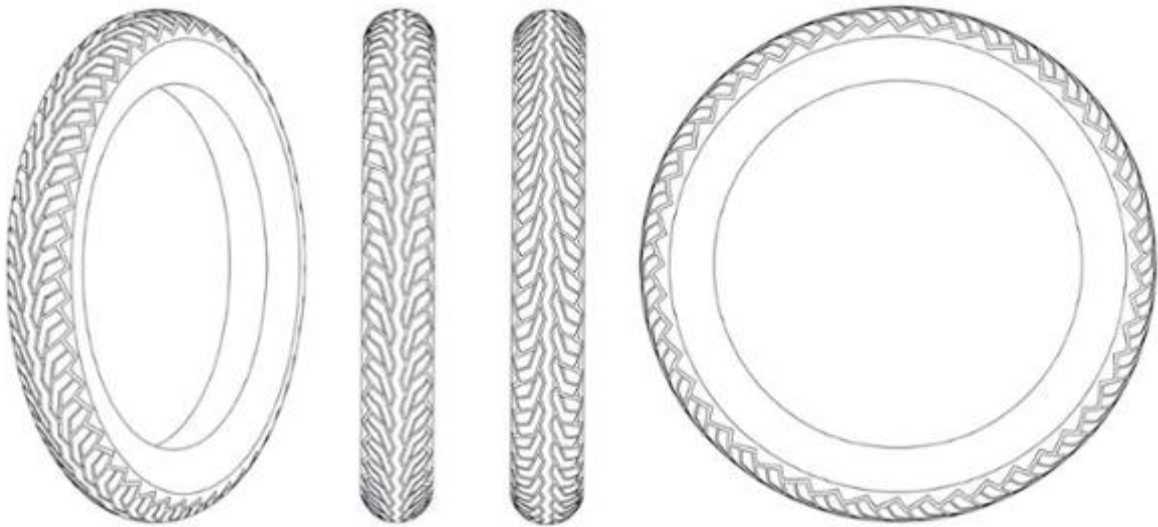

1.1

1.2

1.3

1.4



1.5

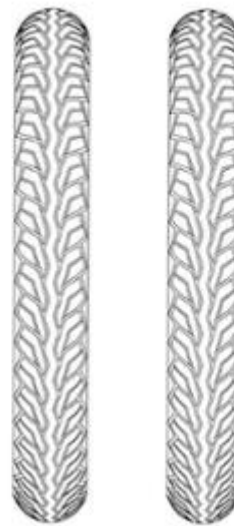

1.6

1.7

- (11) **36728**  
(21) 3-2019-01715 (28) 1  
(54) **CHAI** (51) **09-01**  
(22) 05/07/2019 (43) 25/10/2019  
(73) CÔNG TY CỔ PHẦN SỮA VIỆT NAM (VINAMILK) (VN)  
Số 10, đường Tân Trào, phường Tân Phú, Quận 7 Thành phố Hồ Chí Minh  
(72) BÙI HỢP LIÊN CHÂU (VN)  
(74) Công ty Cổ phần Sở hữu công nghiệp INVESTIP (INVESTIP)  
(55)



1.1



1.2



1.3



1.4

- (11) **36729**  
(21) 3-2019-01443 (28) 1  
(54) **THANH KIM LOẠI ĐỊNH HÌNH** (51) **25-01**  
(22) 05/06/2019 (43) 25/10/2019  
(73) CÔNG TY CỔ PHẦN CÔNG NGHIỆP G9 (VN)  
Thị tứ Quang Phục, xã Quang Phục, huyện Tứ Kỳ, tỉnh Hải Dương  
(72) Nguyễn Văn Điệp (VN)  
(74) Công ty TNHH Sở hữu trí tuệ PADEMARK (PADEMARK CO.,LTD.)  
(55)



1.1



1.2



1.3

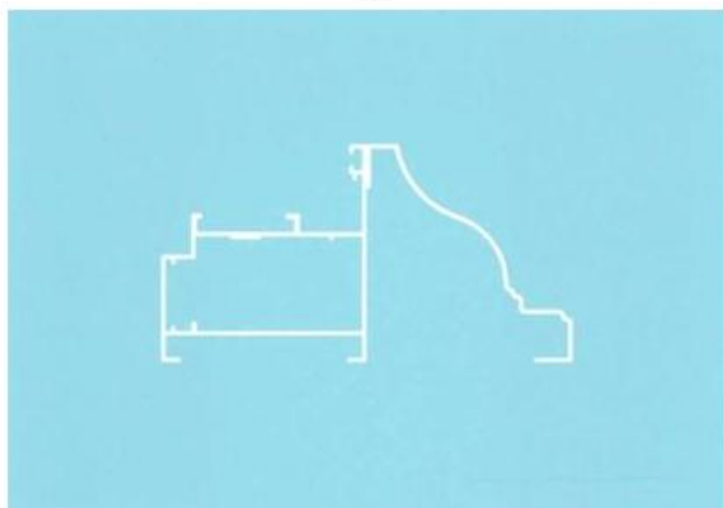

1.4

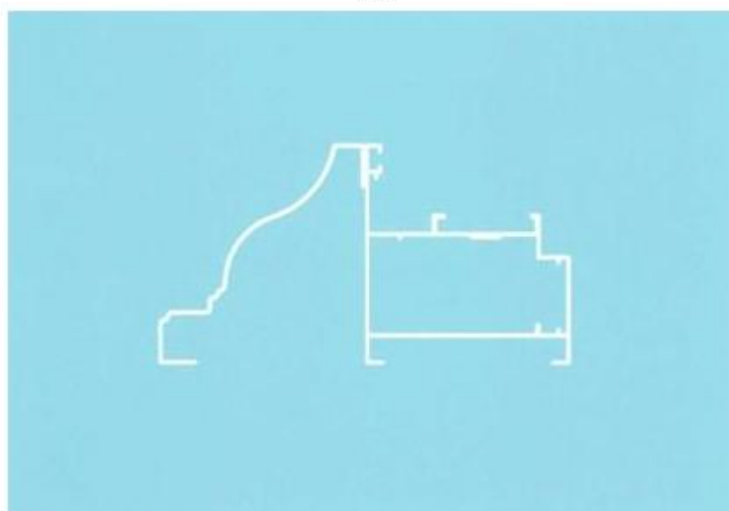

1.5



1.6



1.7

- (11) **36730**  
(21) 3-2019-01494 (28) 1  
(54) **QUẠT HƠI NƯỚC** (51) **23-04**  
(22) 11/06/2019 (43) 25/10/2019  
LEADER BRIGHT INDUSTRIES LIMITED (HK)  
(73) E2, 1/F., Tuen Mun Industrial Centre, Pui To Road, TMTL 76, Tuen Mun, New Territories, Hong Kong  
(72) 1. WON KWONG MING, ARTHUR (CN)  
2. LEUNG WING HONG (CN)  
(74) Công ty Cổ phần Sở hữu công nghiệp INVESTIP (INVESTIP)  
(55)

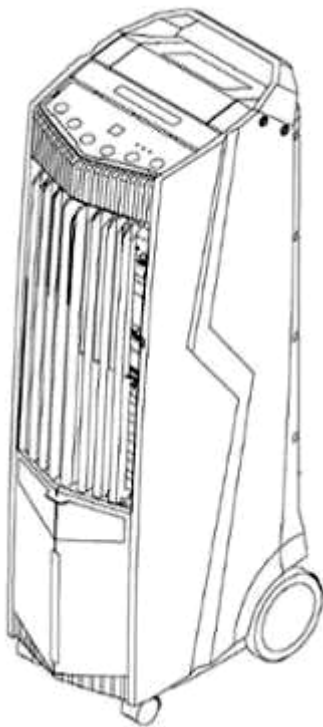

1.1

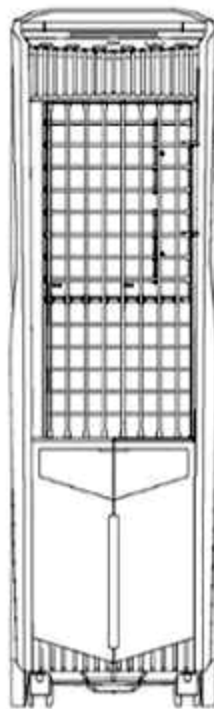

1.2



1.3

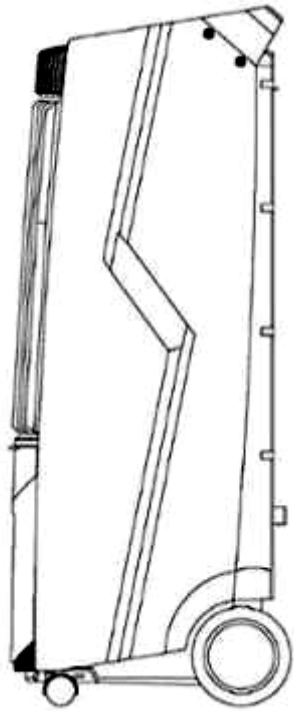

1.4

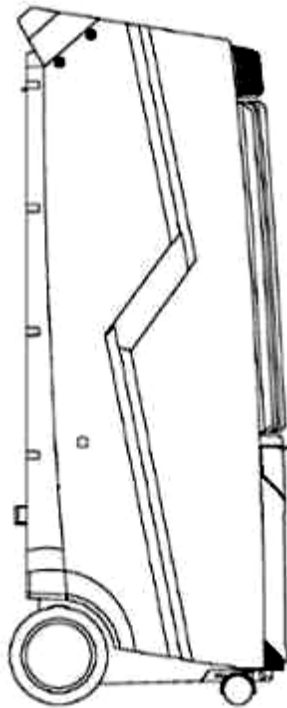

1.5

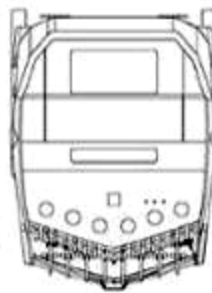

1.6

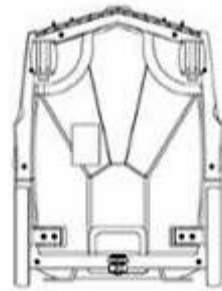

1.7



- (11) **36731**  
(21) 3-2019-01727 (28) 1  
(54) **NHÃN SẢN PHẨM** (51) **19-08**  
(22) 08/07/2019 (43) 25/10/2019  
(73) CÔNG TY TNHH MỘT THÀNH VIÊN THUỐC LÁ THANH HÓA (VN)  
(72) Thị Trần Hà Trung, huyện Hà Trung, tỉnh Thanh Hóa  
(72) Nguyễn Thanh Tâm (VN)  
(55)



1.1

- (11) **36732**  
(21) 3-2019-01728 (28) 1  
(54) **NHÃN SẢN PHẨM** (51) **19-08**  
(22) 08/07/2019 (43) 25/10/2019  
(73) CÔNG TY TNHH MỘT THÀNH VIÊN THUỐC LÁ THANH HÓA (VN)  
Thị Trấn Hà Trung, huyện Hà Trung, tỉnh Thanh Hóa  
(72) Nguyễn Thanh Tâm (VN)  
(55)

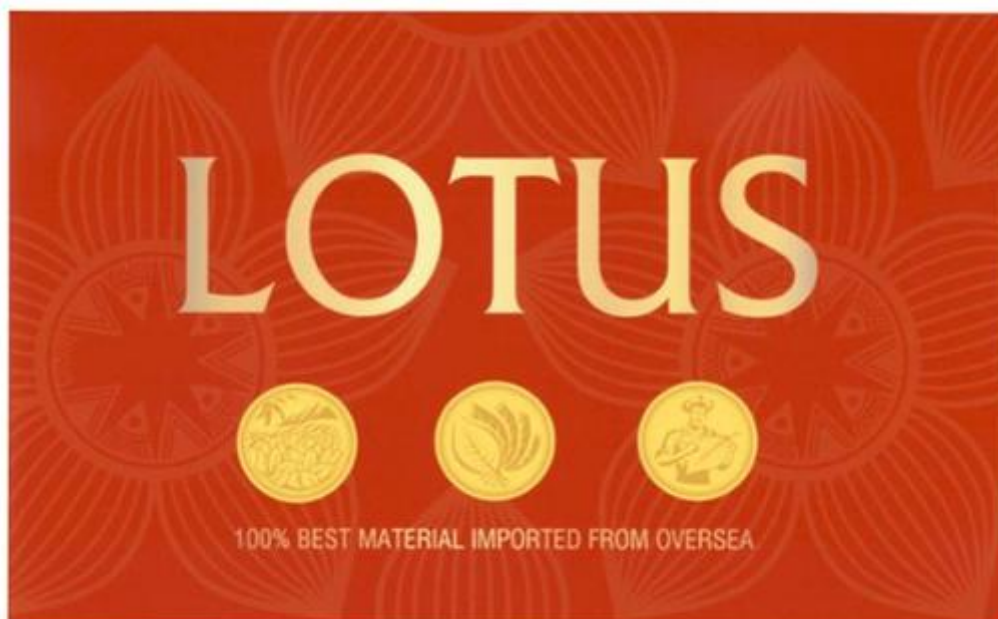

1.1

- (11) **36733**  
(21) 3-2019-01729 (28) 1  
(54) **NHÃN SẢN PHẨM** (51) **19-08**  
(22) 08/07/2019 (43) 25/10/2019  
(73) CÔNG TY TNHH MỘT THÀNH VIÊN THUỐC LÁ THANH HÓA (VN)  
(73) Thị Trấn Hà Trung, huyện Hà Trung, tỉnh Thanh Hóa  
(72) Nguyễn Thanh Tâm (VN)  
(55)

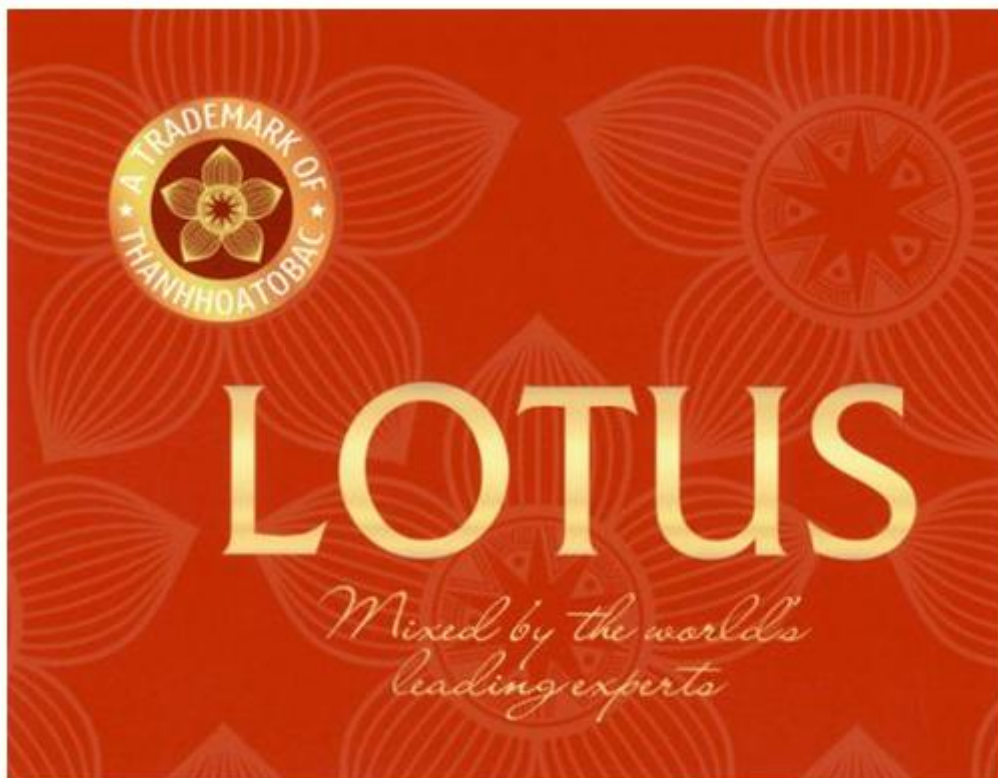

1.1

- (11) **36734**  
(21) 3-2019-01736 (28) 1  
(54) **BÌNH XỊT CÓ NẮP** (51) **22-06**  
(22) 08/07/2019 (43) 25/10/2019  
(30) 2019-000479 11/01/2019 JP;  
FUMAKILLA LIMITED (JP)  
(73) 11, Kandamikura-cho, Chiyoda-ku, Tokyo 101-8606, Japan  
1. KEN WAKATSUKI (JP)  
(72) 2. MAKOTO AMAGAI (JP)  
3. KEI YAMAZATO (JP)  
(74) Công ty TNHH Tầm nhìn và Liên danh (VISION & ASSOCIATES CO.LTD.)  
(55)



1.1



1.2



1.3



1.4



1.5

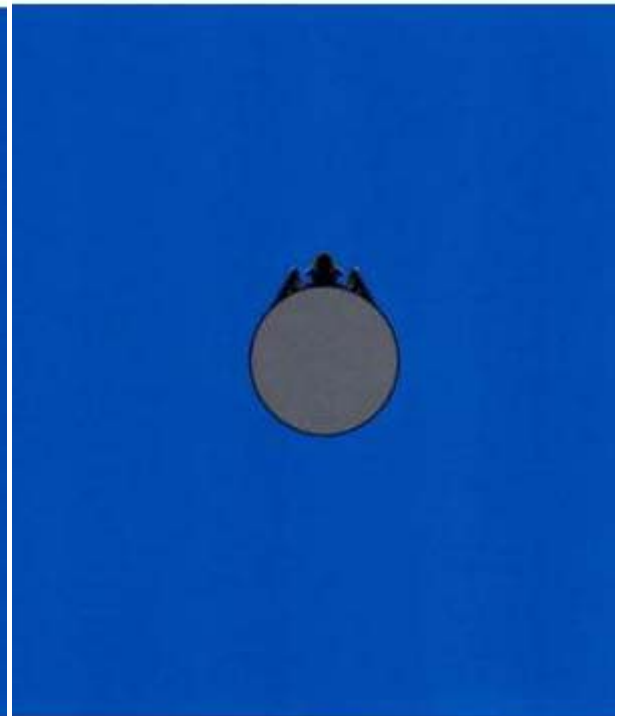

1.6



1.7



1.8



1.9



1.10



1.11

- (11) **36735**  
(21) 3-2019-01735 (28) 1  
(54) **ĐIỆN THOẠI DI ĐỘNG** (51) **14-03**  
(22) 08/07/2019 (43) 25/10/2019  
(30) 201930011365.8 09/01/2019 CN;  
HUAWEI TECHNOLOGIES CO., LTD. (CN)  
(73) Huawei Administration Building, Bantian, Longgang District, Shenzhen,  
Guangdong 518129, China  
1. GUANG CAO (CN)  
(72) 2. TING XU (CN)  
3. JIE HUANG (CN)  
(74) Công ty TNHH một thành viên Sở hữu trí tuệ VCCI (VCCI-IP CO.,LTD.)  
(55)



1.1



1.2



1.3





1.4



1.5



1.6



1.7



1.8



1.9



1.10



1.11



1.12

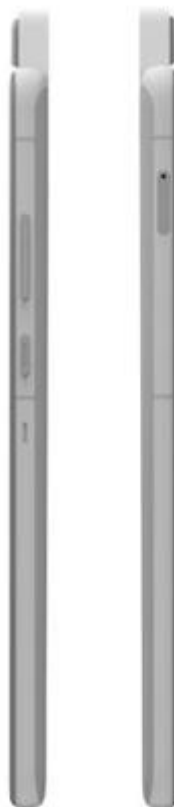

1.13

1.14



1.15



1.16

- (11) **36736**  
(21) 3-2019-00029 (28) 1  
(54) **XE MÔ TÔ ĐIỆN** (51) **12-11**  
(22) 03/01/2019 (43) 25/10/2019  
CÔNG TY CỔ PHẦN XE ĐIỆN TOÀN CẦU PEGA LTT (VN)  
(73) Lô 15-17 cụm công nghiệp Nội Hoàng, xã Nội Hoàng, huyện Yên Dũng, tỉnh Bắc  
Giang  
(72) Trương Mạnh Hà (VN)  
(55)



1.1



1.2



1.3



1.4

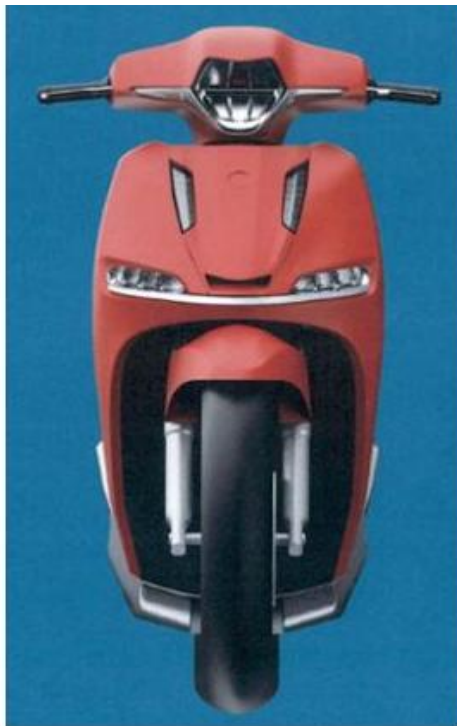

1.5

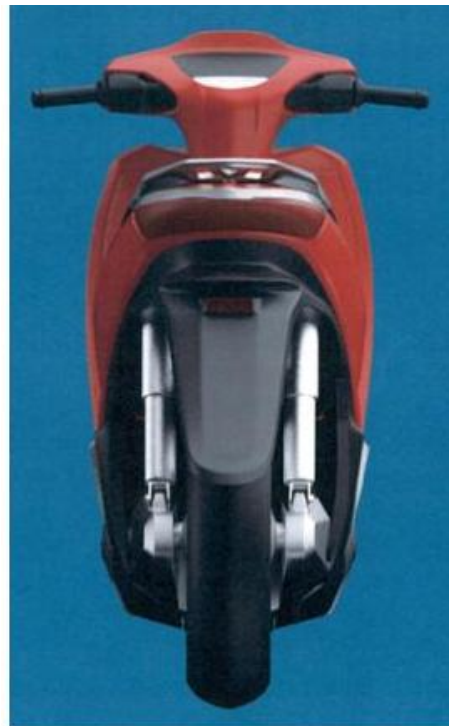

1.6



1.7



1.8



1.9



1.10

- (11) **36737**  
(21) 3-2019-01191 (28) 1  
(54) **THIẾT BỊ CHỐNG SÉT** (51) **13-03**  
(22) 29/01/2018 (43) 25/10/2019  
(30) A2017/01226 01/08/2017 ZA;  
THE TRUSTEES FOR THE TIME BEING OF THE LIVE LINE  
(73) INTERNATIONAL TRUST (GB)  
Acclaim House, 12 Mount Havelock, DOUGLAS IMI 2QG, ISLE OF MAN  
(72) Kevin Philip RISI (ZA)  
(74) Công ty Luật TNHH Phạm và Liên danh (PHAM & ASSOCIATES)  
(55)

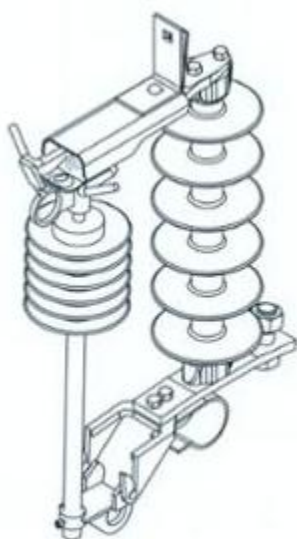

1.1

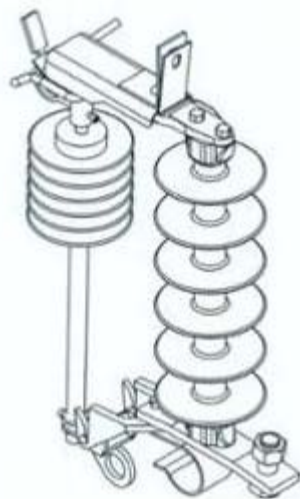

1.2

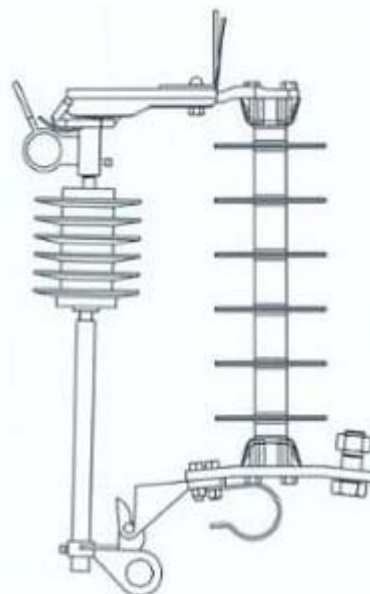

1.3





1.4



1.5

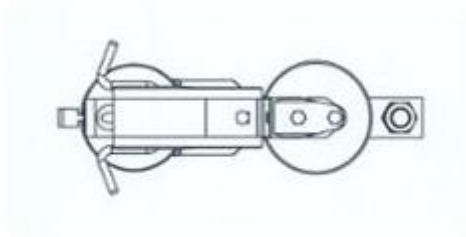

1.6

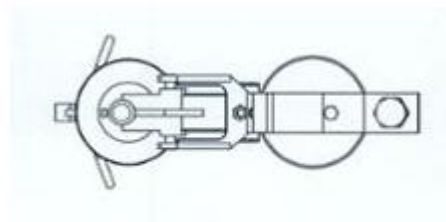

1.7

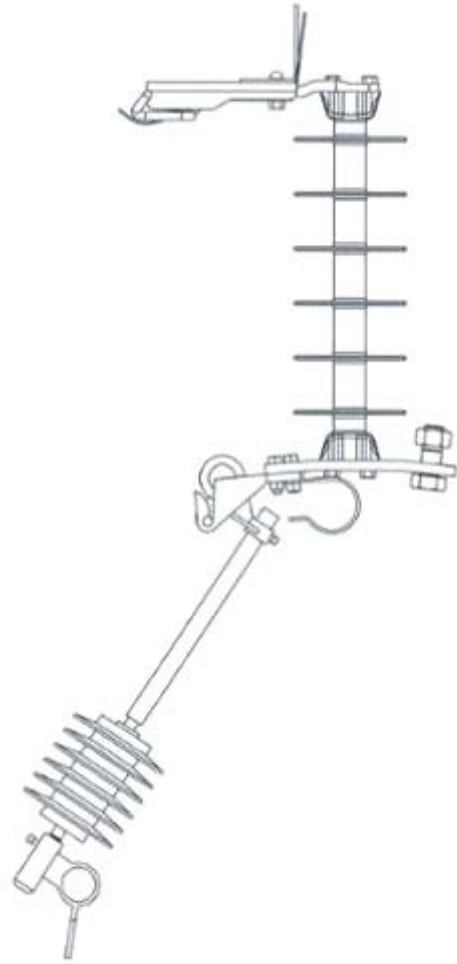

1.8

- (11) **36738**  
(21) 3-2018-01849 (28) 1  
(54) **NẮP CHỤP ỐNG XẢ** (51) **12-16**  
(22) 29/08/2018 (43) 25/10/2019  
(30) 004950509-0001 22/03/2018 EM;  
IGOR AKRAPOVIC (SI)  
(73) Rozna Dolina C.VIII/10A, SI-1000 LJUBLJANA, Slovenia  
1. IGOR AKRAPOVIC (SI)  
2. ERMIN KOSOVEL (SI)  
(72) 3. JOZE RAJNAR (SI)  
4. MARKO IVANUSIC (SI)  
5. MATEJ BULC (SI)  
(74) Công ty TNHH Đại Tín và Liên Danh (DAITIN AND ASSOCIATES CO.,LTD)  
(55)



1.1



1.2



1.3



1.4



1.5



1.6



1.7

- (11) **36739**  
(21) 3-2018-01156 (28) 1  
(54) **MÁY CỬA VÒNG** (51) **15-09**  
(22) 04/06/2018 (43) 25/10/2019  
CÔNG TY TNHH MỘT THÀNH VIÊN CƠ KHÍ HÀ NỘI (VN)  
(73) Số 76, đường Nguyễn Trãi, phường Thượng Đình, quận Thanh Xuân, thành phố Hà Nội  
(72) Đỗ Hoài Nam (VN)  
(55)

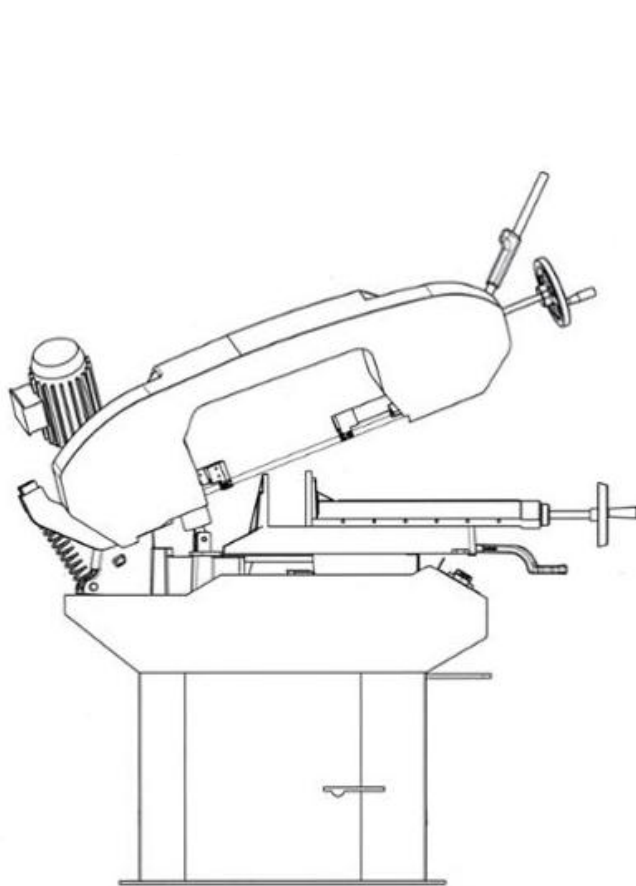

1.1

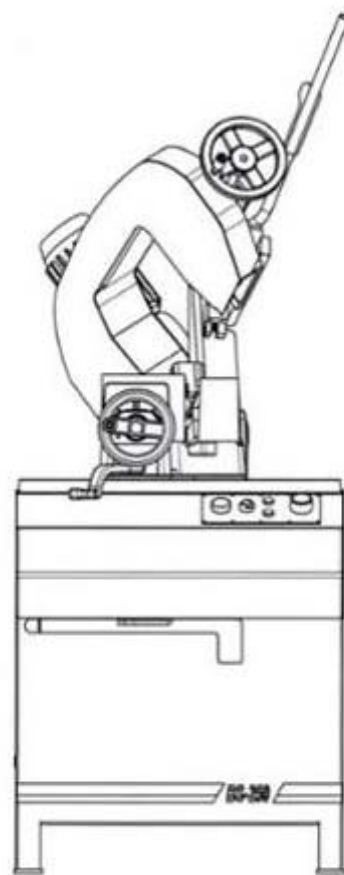

1.2

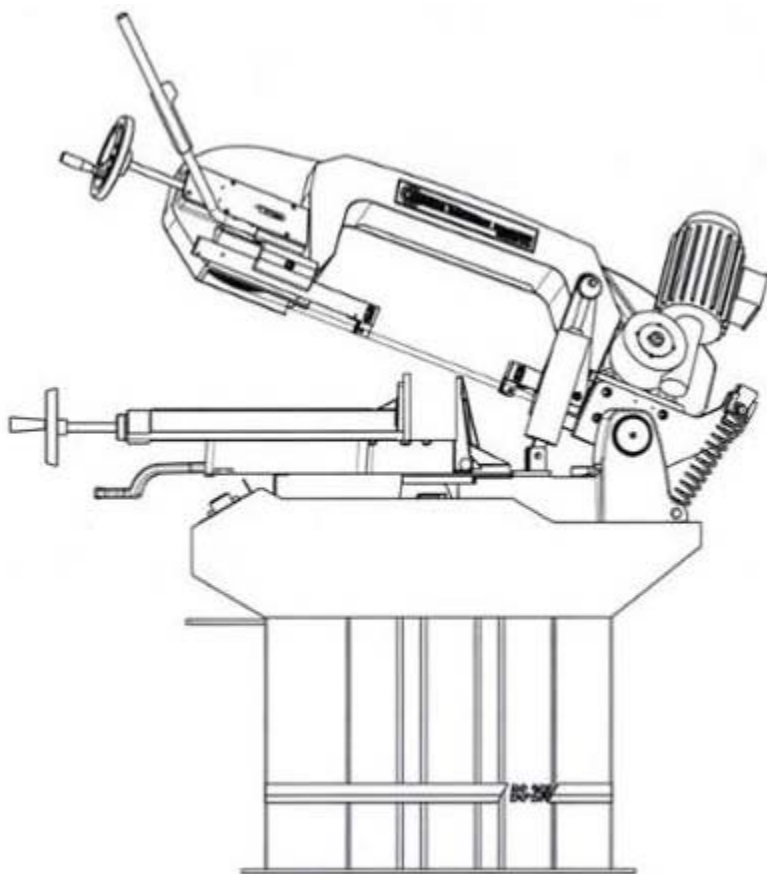

1.3

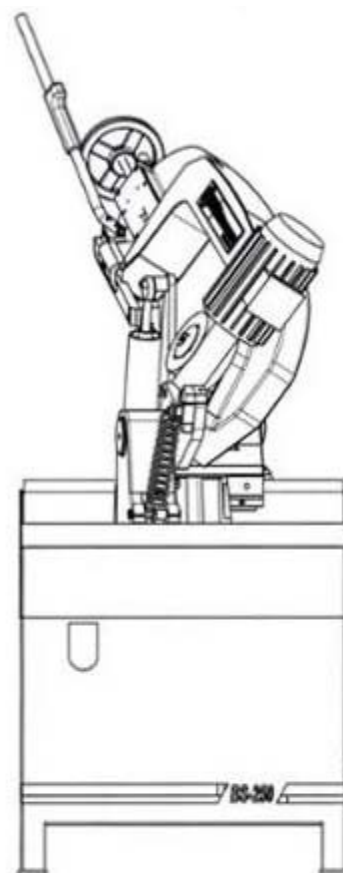

1.4

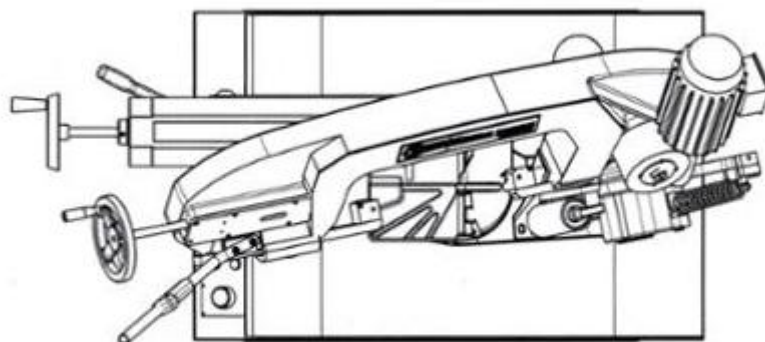

1.5

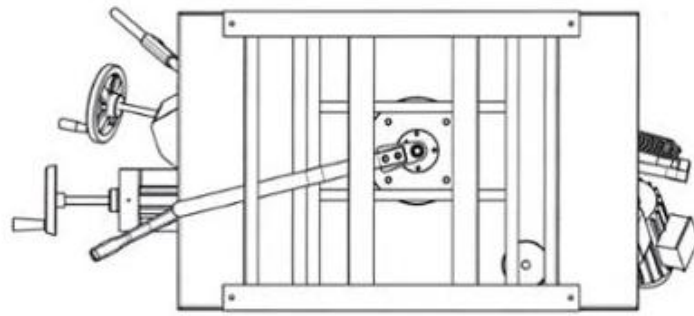

1.6

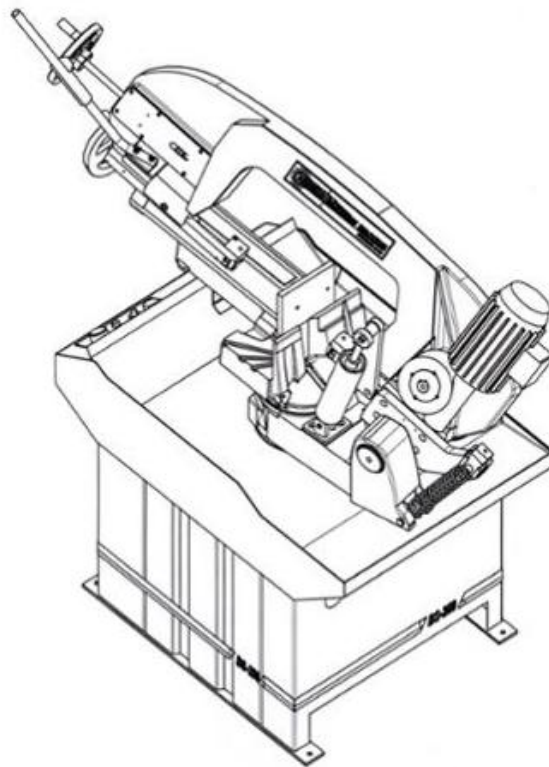

1.7

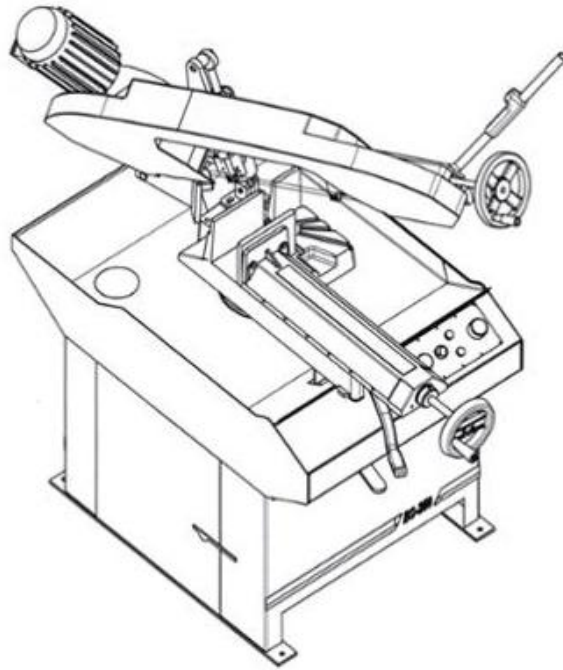

1.8

- (11) **36740**  
(21) 3-2019-01194 (28) 1  
(54) **MÁY HÚT ẨM VÀ TẠO ION** (51) **23-04**  
(22) 16/05/2019 (43) 25/10/2019  
(30) 2018-025931 29/11/2018 JP;  
SHARP KABUSHIKI KAISHA (JP)  
(73) 1 Takumi-cho, Sakai-ku, Sakai City, Osaka 590-8522, Japan  
1. NORIYUKI TAKAHASHI (JP)  
(72) 2. NOBUHIRO FUJII (JP)  
3. JINNI ZHANG (CN)  
(74) Công ty TNHH một thành viên Sở hữu trí tuệ VCCI (VCCI-IP CO.,LTD)  
(55)



1.1

1.2

1.3

1.4



1.5

1.6

1.7

1.8





1.9



1.10



1.11

- (11) **36741**  
(21) 3-2019-01243 (28) 1  
(54) **LOA** (51) **14-01**  
(22) 21/05/2019 (43) 25/10/2019  
(30) 2018-028584 27/12/2018 JP;  
PIONEER CORPORATION (JP)  
(73) 28-8, Honkomagome 2-chome, Bunkyo-ku, Tokyo, JAPAN  
(72) 1. YUTO HORIUCHI (JP)  
2. MAHO MIYAMOTO (JP)  
(74) Công ty Luật TNHH AMBYS Hà Nội (AMBYS HANOI)  
(55)



1.1



1.2



1.3



1.4



1.5



1.6



1.7

- (11) **36742**  
(21) 3-2019-01056 (28) 1  
(54) **NHÃN SẢN PHẨM** (51) **19-08**  
(22) 26/04/2019 (43) 25/10/2019  
(73) **CÔNG TY CỔ PHẦN THỰC PHẨM THƠM THỰC (VN)**  
Thôn Lũng Khê, xã Thanh Khương, huyện Thuận Thành, tỉnh Bắc Ninh  
(72) Nguyễn Văn Thực (VN)  
(55)



- (11) **36743**  
(21) 3-2019-01333 (28) 1  
(54) **TẮM CẢN VÀ PHÍA TRƯỚC XE Ô TÔ** (51) **12-16**  
(22) 22/05/2019 (43) 25/10/2019  
(30) 2018-026055 30/11/2018 JP;  
HONDA MOTOR CO., LTD. (JP)  
(73) 1-1, Minami-Aoyama 2-chome, Minato-ku, Tokyo, 107-8556 Japan  
(72) Sungjun BAE (KR)  
(74) Công ty Luật TNHH Phạm và Liên danh (PHAM & ASSOCIATES)  
(55)



1.1



1.2



1.3



1.4



1.5



1.6



1.7



1.8

- (11) **36744**  
(21) 3-2019-00672 (28) 1  
(54) **TẤM ÓP TRẦN** (51) **25-01**  
(22) 19/03/2019 (43) 25/10/2019  
(73) **VŨ VĂN TRỌNG (VN)**  
Số 146, phố Bà Triệu, phường Cẩm Đông, thành phố Cẩm Phả, tỉnh Quảng Ninh  
(72) Vũ Văn Trọng (VN)  
(74) Công ty TNHH Tư vấn đầu tư và Sở hữu trí tuệ Hoàng Phi (HOANG PHI INVEST & I.P CO., LTD)  
(55)



1.1



1.2



1.3



1.4



1.5





1.6

- (11) **36745**  
(21) 3-2019-01235 (28) 1  
(54) **HỘP ĐỰNG SẢN PHẨM** (51) **09-03**  
(22) 05/04/2018 (43) 25/10/2019  
(73) CÔNG TY TNHH VIỆT LAI HƯƠNG (VN)  
203A Võ Thị Sáu, phường 7, quận 3, thành phố Hồ Chí Minh  
(72) Lê Thị Lan (VN)  
(74) Công ty TNHH Sở hữu trí tuệ ALNGUYEN (ALNGUYEN IP CO.,LTD.)  
(55)

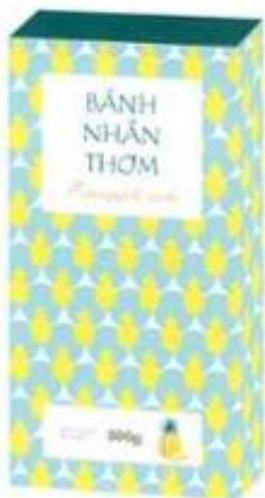

1.1



1.2

- (11) **36746**  
(21) 3-2019-00854 (28) 1  
(54) **BÀN CHẢI ĐÁNH RĂNG** (51) **04-02**  
(22) 03/04/2019 (43) 25/10/2019  
(30) 005777513-0001 09/10/2018 EM;  
(73) UNILEVER N.V. (NL)  
Weena 455, 3013 AL Rotterdam, The Netherlands  
(72) 1. THAKKAR NISHIT MUKESH (IN)  
2. YU CHUNBAO (CN)  
(74) Công ty TNHH Trần Hữu Nam và Đồng sự (TRAN H.N & ASS.)  
(55)



- (11) **36747**  
(21) 3-2019-00981 (28) 1  
(54) **ĐỒ CHỨA THỰC PHẨM** (51) **07-99; 09-03**  
(22) 18/04/2019 (43) 25/10/2019  
(30) 30-2018-0054195 21/11/2018 KR;  
(73) CJ CHEILJEDANG CORPORATION (KR)  
(Ssangnim-dong) 330, Dongho-ro, Jung-gu, Seoul 04560 Republic of Korea  
1. AN, YEON MI (KR)  
(72) 2. BAEK, YUN JUNG (KR)  
3. LEE, SEUNG PYO (KR)  
(74) Công ty TNHH Sở hữu công nghiệp Sao Bắc Đẩu (SAO BAC DAU IP CO.,LTD)  
(55)



- (11) **36748**  
(21) 3-2019-01051 (28) 1  
(54) **DỤNG CỤ ĐỂ RỬA RAU QUẢ** (51) **07-04**  
(22) 26/04/2019 (43) 25/10/2019  
(30) 30-2018-0055369 27/11/2018 KR;  
JISUNG INDUSTRY INC. (KR)  
(73) #602 Chum-Dan Knowledge Indusrty Center, 17-17, 208 High-Tech Kwaki-ro,  
Buk-gu, Gwangju city, Korea  
(72) KIM, Min-Joon (KR)  
(74) Công ty TNHH Sở hữu trí tuệ Việt á (VIET A IP CO.,LTD)  
(55)

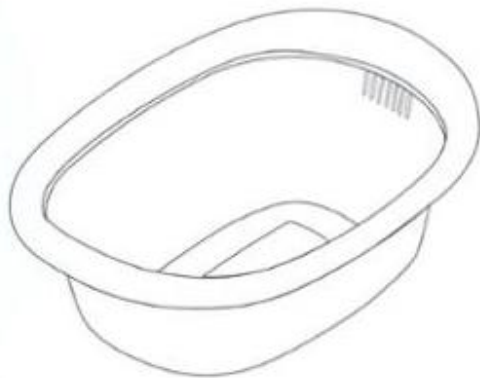

1.1

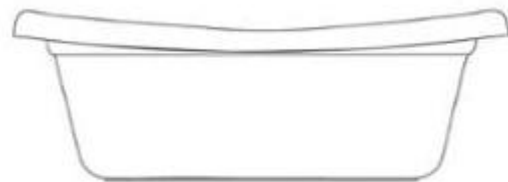

1.2



1.3



1.4

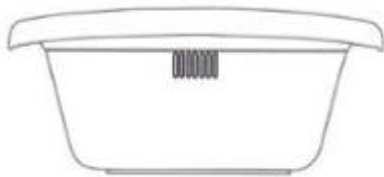

1.5

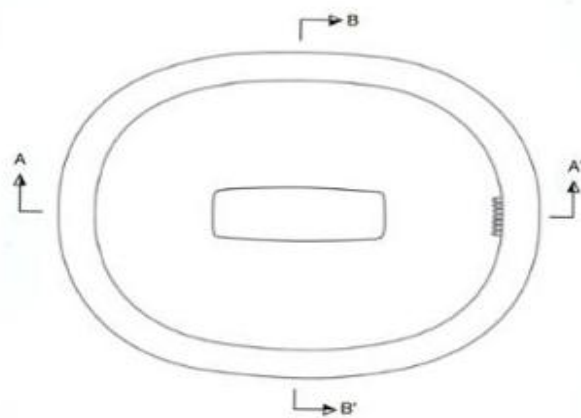

1.6

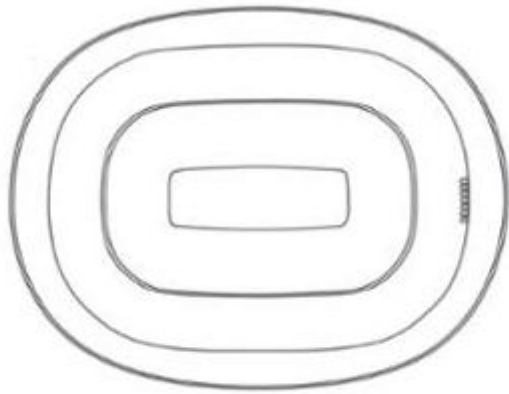

1.7

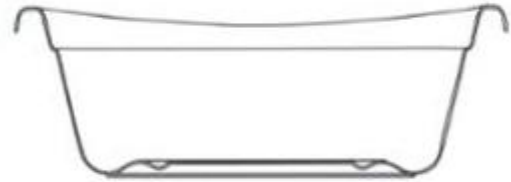

1.8

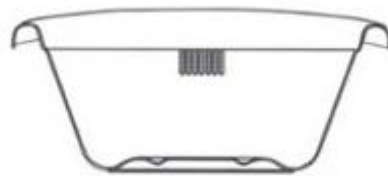

1.9

- (11) **36749**  
(21) 3-2018-02435 (28) 1  
(54) **THIẾT BỊ ĐA NĂNG** (51) **15-04; 15-99**  
(22) 16/11/2018 (43) 25/10/2019  
(30) 307226 29/06/2018 IN;  
CDE ASIA LIMITED (IN)  
(73) Ecospace Business Park, Block 4A, 6th Floor, Action Area II, New Town,  
Kolkata-700156, State of West Bengal, India  
(72) Manish Bhartia (IN)  
(74) Công ty TNHH Tầm nhìn và Liên danh (VISION & ASSOCIATES CO.LTD.)  
(55)



1.1

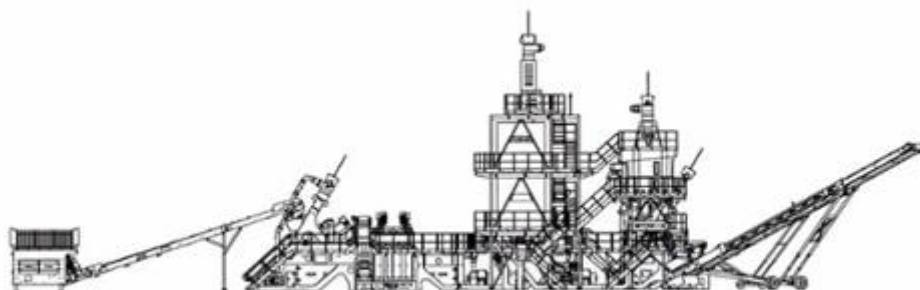

1.2

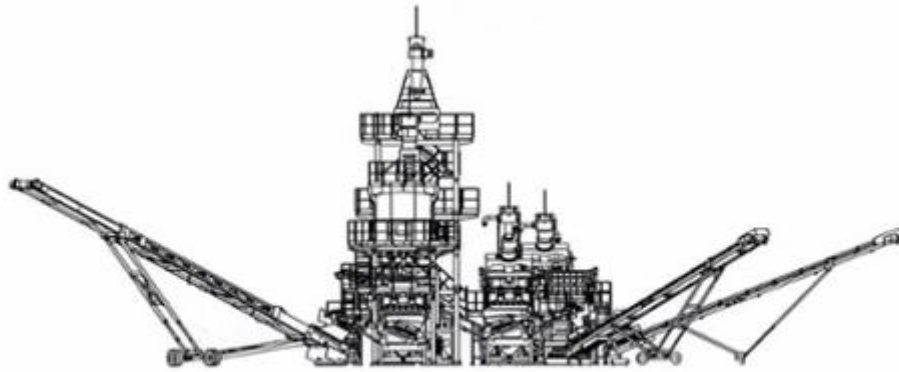

1.3



1.4



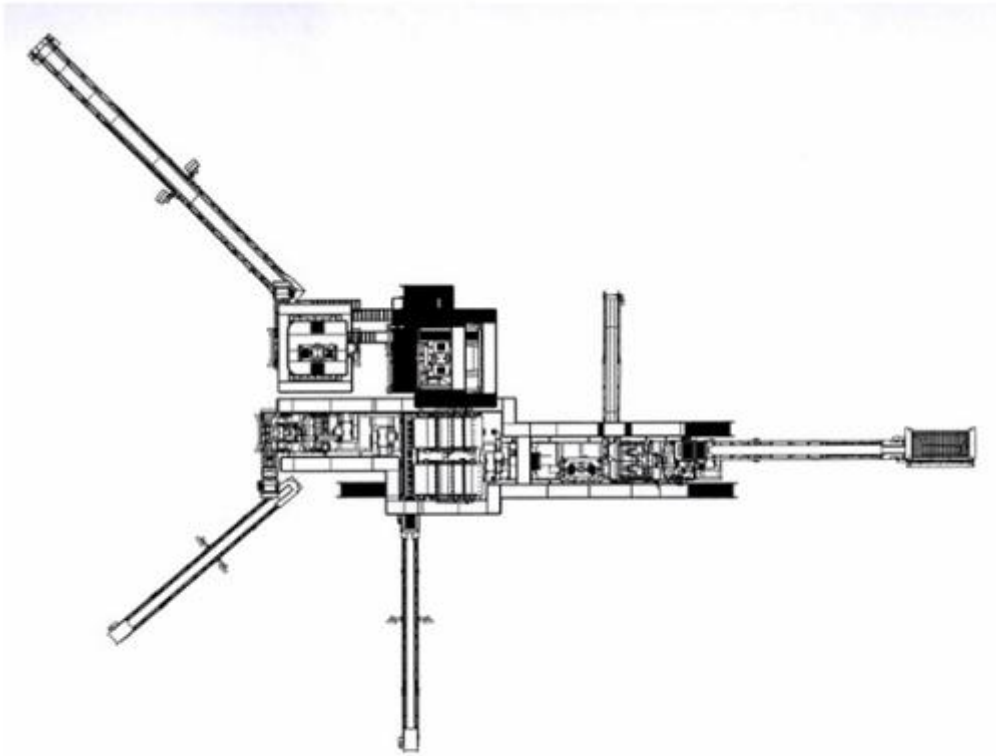

1.5

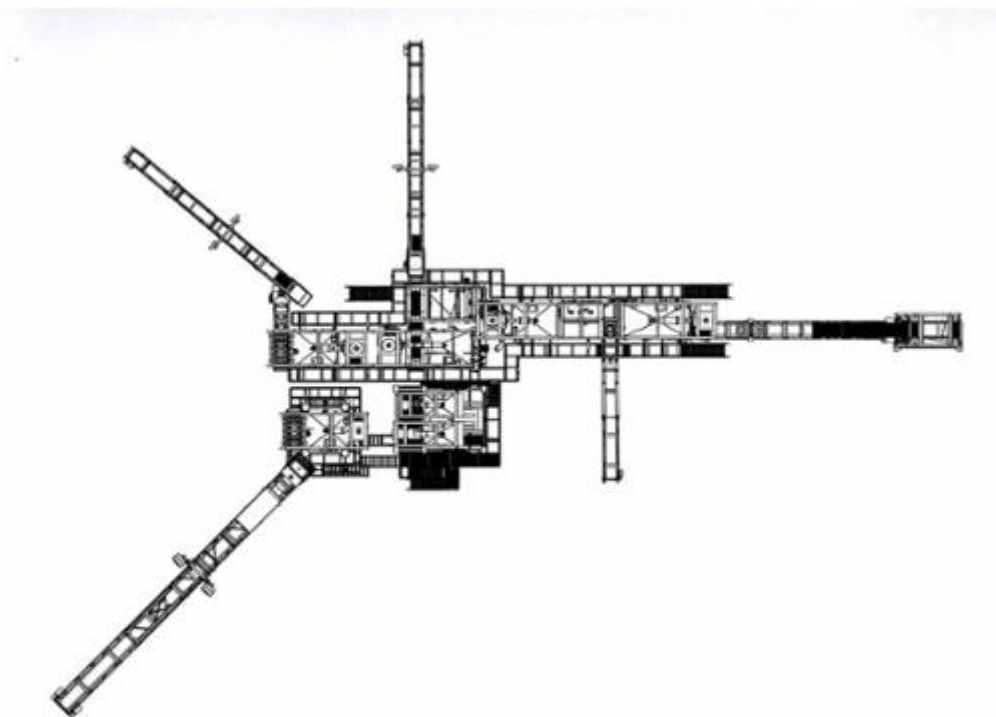

1.6

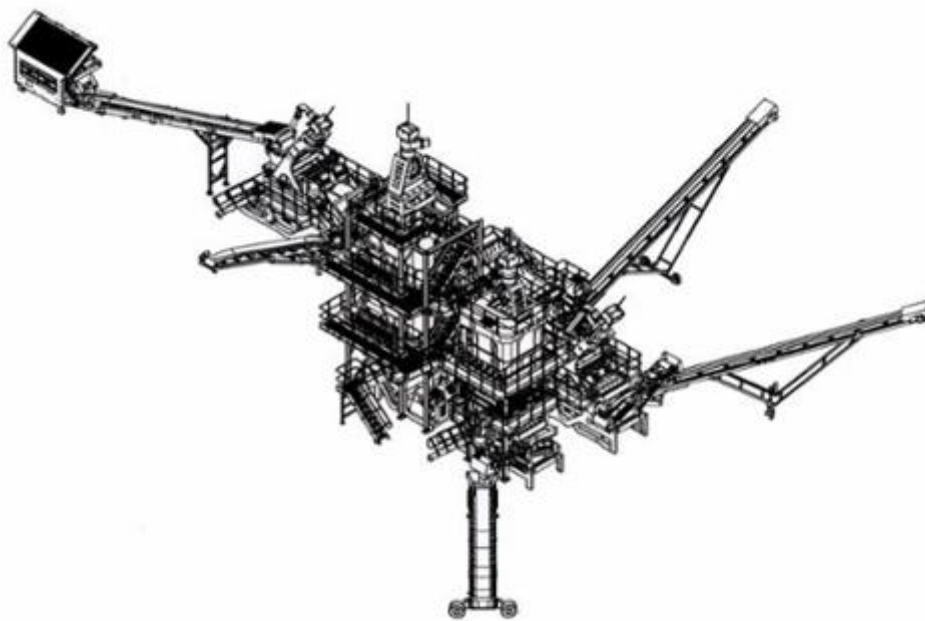

1.7

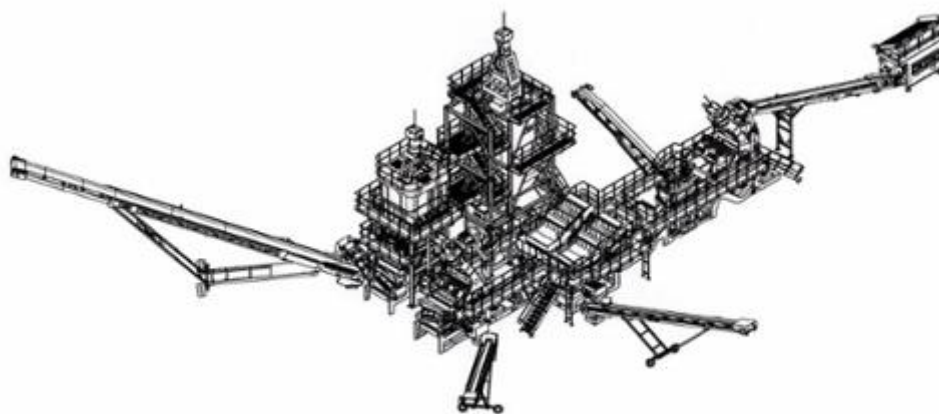

1.8

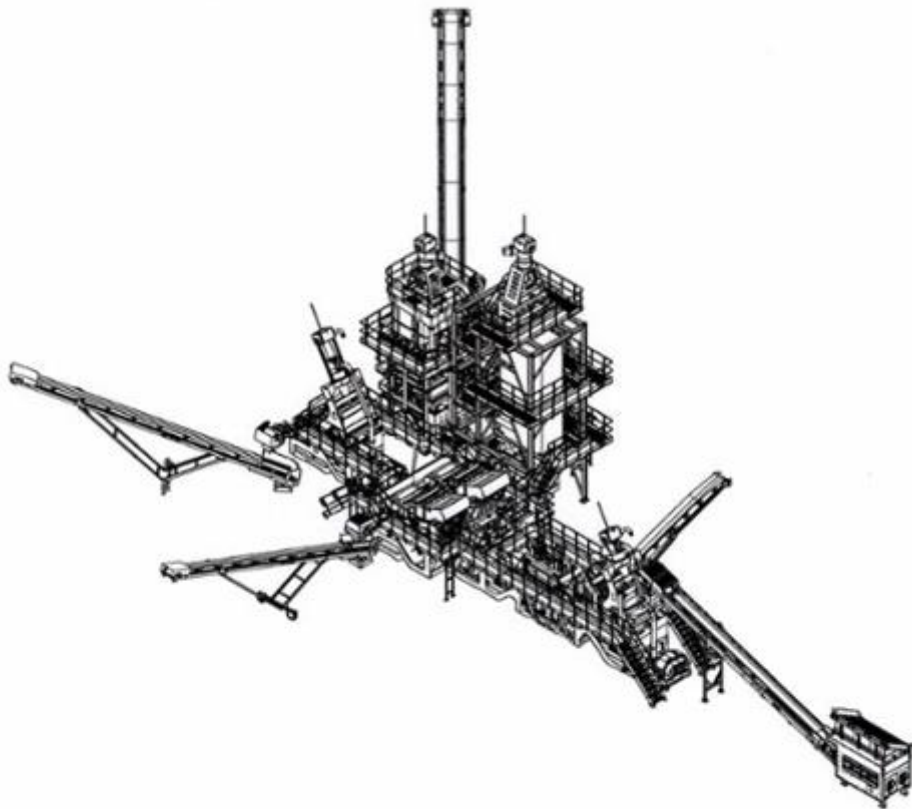

1.9

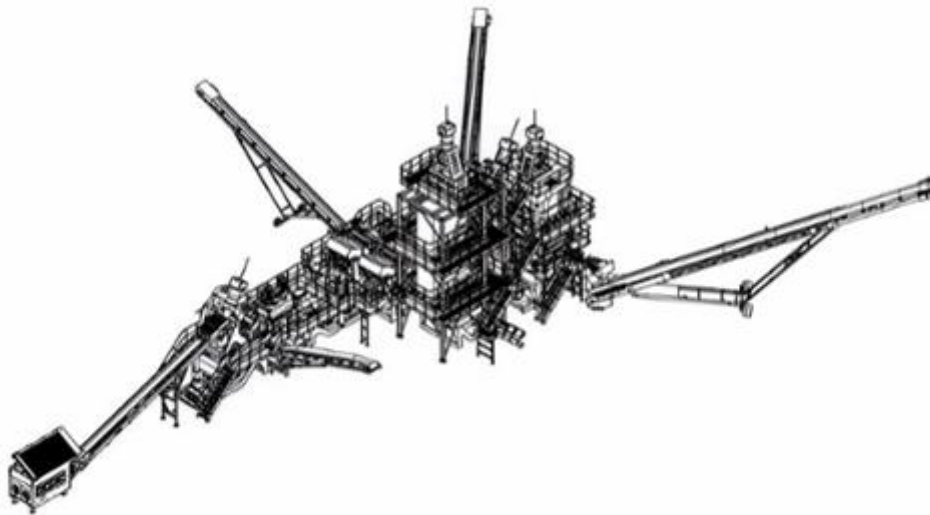

1.10

- (11) **36750**  
(21) 3-2018-02783 (28) 1  
(54) **XE SCUTO** (51) **12-11**  
(22) 20/12/2018 (43) 25/10/2019  
(73) KWANG YANG MOTOR CO., LTD. (TW)  
No. 35, Wan Hsing Street, Sanmin District, Kaohsiung City, Taiwan  
(72) HUANG, Kuo-Feng (TW)  
(74) Công ty TNHH Nghiên cứu và Tư vấn chuyên giao công nghệ và đầu tư  
(CONCETTI)  
(55)



1.1



1.2

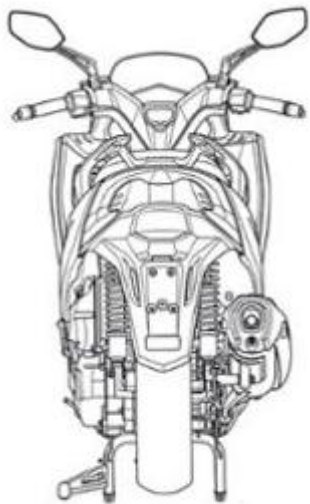

1.3

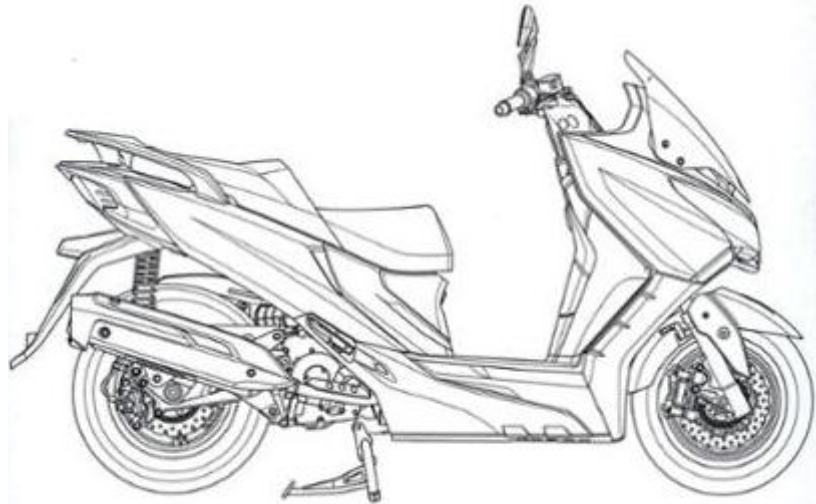

1.4

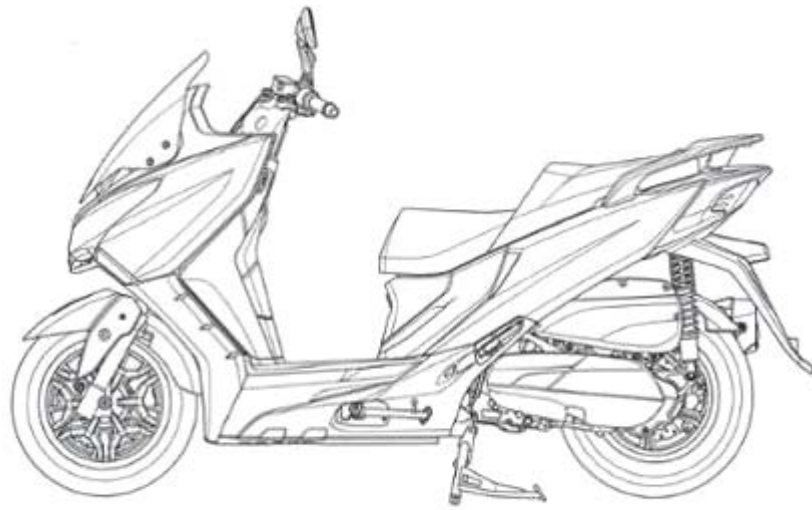

1.5

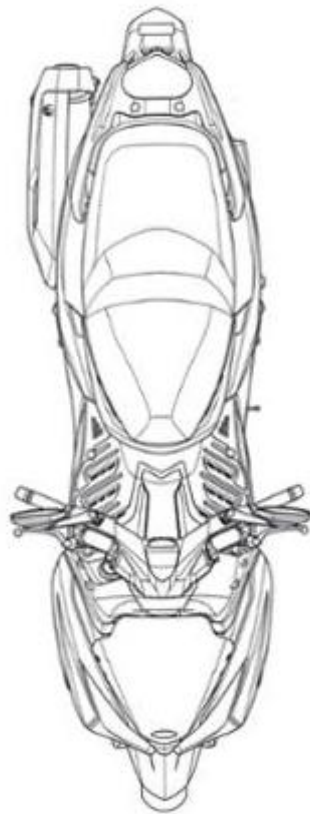

1.6

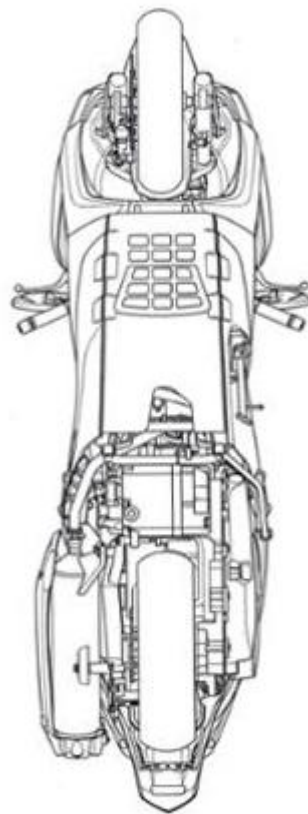

1.7

- (11) **36751**  
(21) 3-2019-01145 (28) 1  
(54) **TẮM TRANG TRÍ PHÍA DƯỚI TRƯỚC XE Ô TÔ** (51) **12-16**  
(22) 08/05/2019 (43) 25/10/2019  
(30) 2018-024598 09/11/2018 JP;  
(73) HONDA MOTOR CO., LTD. (JP)  
(73) 1-1, Minami-Aoyama 2-chome, Minato-ku, Tokyo, 107-8556 Japan  
(72) Chavakorn JIRAPIRIYALERT (TH)  
(74) Công ty Luật TNHH Phạm và Liên danh (PHAM & ASSOCIATES)  
(55)



1.1

1.2



1.3



1.4



1.5



1.6



1.7



1.8

- (11) **36752**  
(21) 3-2019-01147 (28) 1  
(54) **TẮM CẢN VA PHÍA DƯỚI SAU XE Ô TÔ** (51) **12-16**  
(22) 08/05/2019 (43) 25/10/2019  
(30) 2018-024600 09/11/2018 JP;  
HONDA MOTOR CO., LTD. (JP)  
(73) 1-1, Minami-Aoyama 2-chome, Minato-ku, Tokyo, 107-8556 Japan  
(72) Chavakorn JIRAPIRIYALERT (TH)  
(74) Công ty Luật TNHH Phạm và Liên danh (PHAM & ASSOCIATES)  
(55)



1.1



1.2



1.3



1.4



1.5



1.6

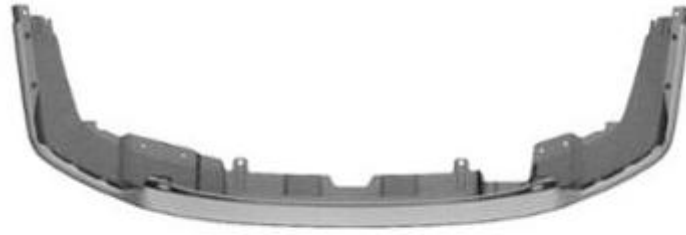

1.7



1.8



- (11) **36753**  
(21) 3-2018-01446 (28) 1  
(54) **BÀN TRANG ĐIỂM** (51) **06-03**  
(22) 12/07/2018 (43) 25/10/2019  
(73) PARK, YOUNG MAN (KR)  
9, Hangeo 1-gil, Gyeonam-myeon, Jangsu-gun, Jeollabuk-do, Republic of Korea  
(72) Kang, Rae Seung (KR)  
(74) Công ty cổ phần Tư vấn S&B (S&B CONSULTANT., CORP.)  
(55)

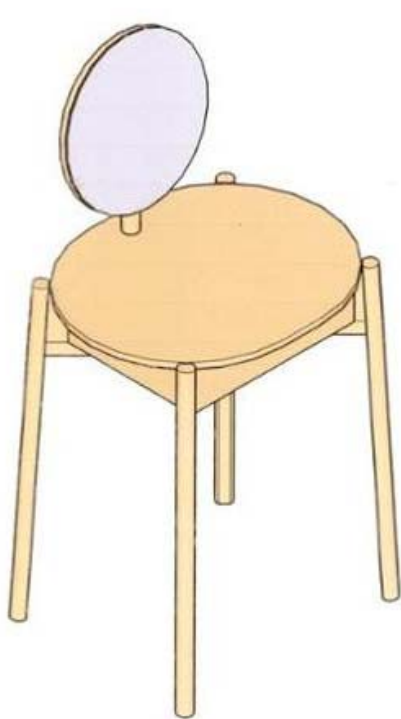

1.1

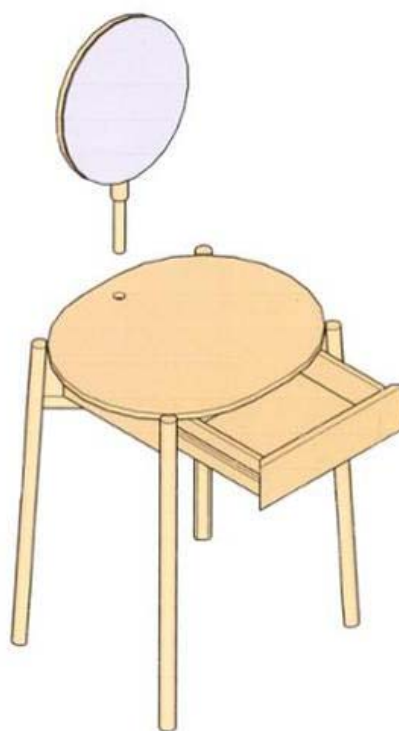

1.2

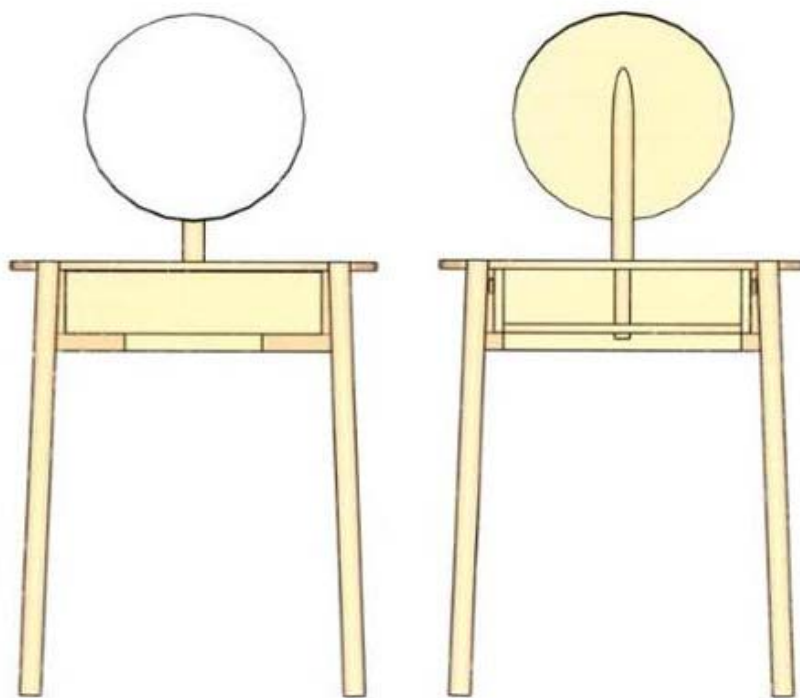

1.3

1.4

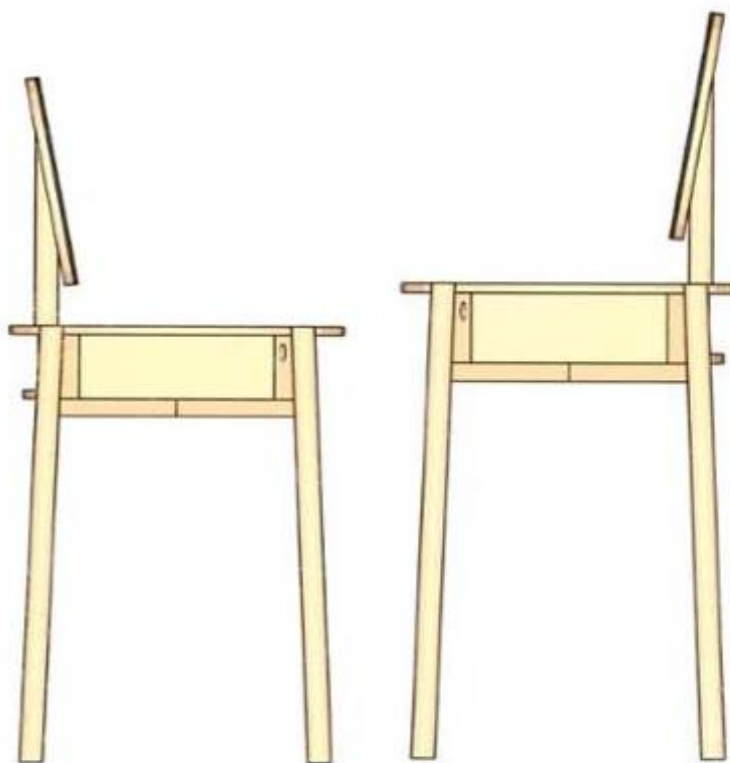

1.5

1.6



1.7

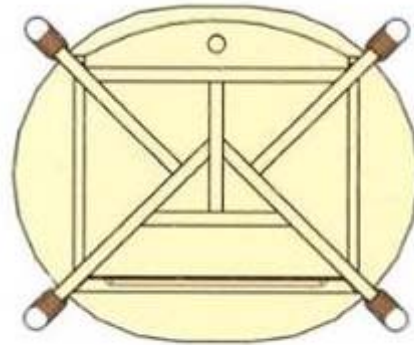

1.8

- (11) **36754**  
(21) 3-2019-00758 (28) 1  
(54) **BAO GỐI SẢN PHẨM** (51) **09-05**  
(22) 26/03/2019 (43) 25/10/2019  
(73) **CÔNG TY CỔ PHẦN SẢN XUẤT & THƯƠNG MẠI TÂN NÔNG (VN)**  
Số 38, đường Tân Ninh, phường Trần Phú, thành phố Bắc Giang, tỉnh Bắc Giang  
(72) **Đặng Huy Khiêm (VN)**  
(74) Công ty TNHH Sở hữu trí tuệ PADEMARK (PADEMARK CO.,LTD.)  
(55)

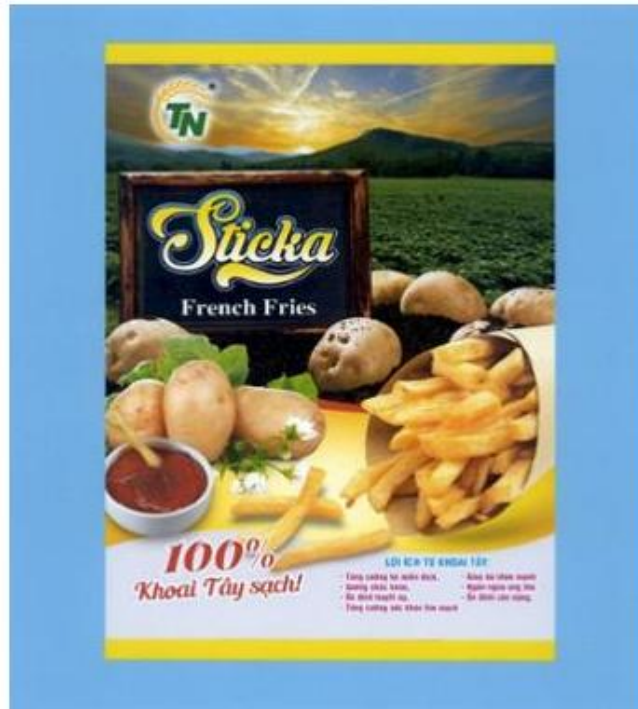

1.1



1.2

- (11) **36755**  
(21) 3-2019-01005 (28) 1  
(54) **NHÃN DÁN SẢN PHẨM** (51) **19-08**  
(22) 23/04/2019 (43) 25/10/2019  
CÔNG TY TNHH THỰC PHẨM THIÊN NHIÊN (NAFOOCO) (VN)  
(73) 100/17 Trung Mỹ, ấp Chánh 1, xã Tân Xuân, huyện Hóc Môn, thành phố Hồ Chí Minh  
(72) Võ Thị Ngọc (VN)  
(55)



1.1



1.2

- (11) **36756**  
(21) 3-2019-01126 (28) 1  
(54) **ĐẦU ĐỌC CHO THIẾT BỊ THANH TOÁN** (51) **14-02**  
(22) 07/05/2019 (43) 25/10/2019  
SOFT SPACE SDN BHD (MY)  
(73) Q Sentral, Level 15, Unit 15-15, 2A, Jalan Stesen Sentral 2, Kuala Lumpur  
Sentral, 50470 Kuala Lumpur, Malaysia  
(72) JOEL TAY JIN GHEE (MY)  
(74) Công ty TNHH Sở hữu trí tuệ NTT (NTT IP CO.,LTD)  
(55)

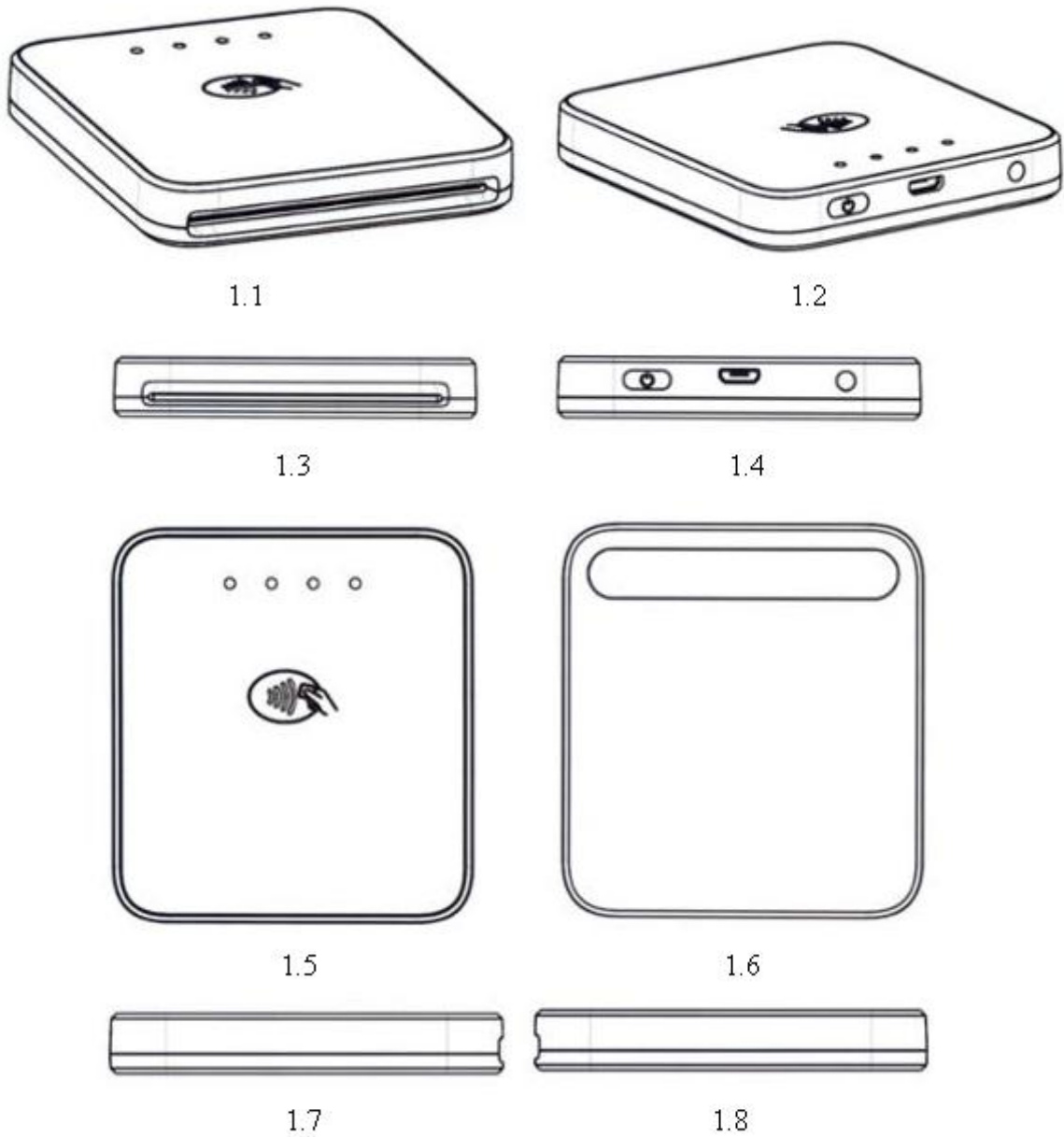

- (11) **36757**  
(21) 3-2019-01158 (28) 1  
(54) **DỤNG CỤ KẸP** (51) **08-08**  
(22) 10/05/2019 (43) 25/10/2019  
(30) 2018-024795 13/11/2018 JP;  
NAGAKI SEIKI CO., LTD. (JP)  
(73) 4-31, Tashiden 3-chome, Daito-shi, Osaka, 574-0045, JAPAN  
(72) 1. TAKAYUKI NAGAKI (JP)  
2. TAMOTSU IWAMA (JP)  
(74) Công ty Luật TNHH Phạm và Liên danh (PHAM & ASSOCIATES)  
(55)

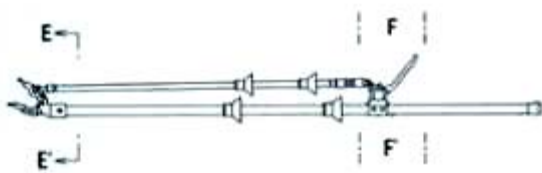

1.1

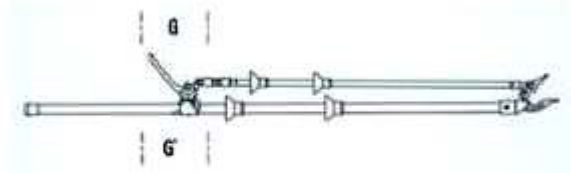

1.2



1.3

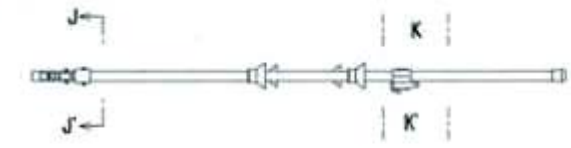

1.4



1.5



1.6

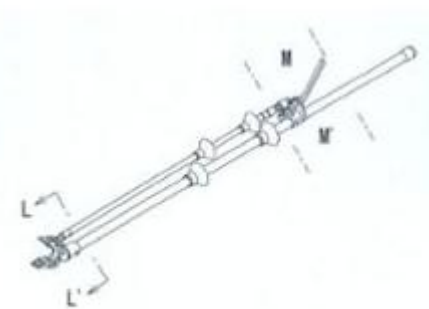

1.7

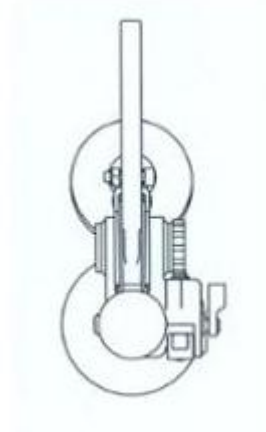

1.8

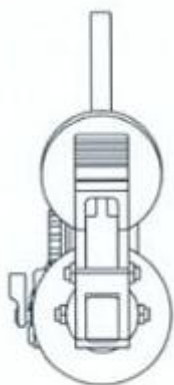

1.9

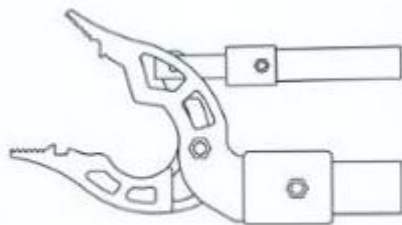

1.10

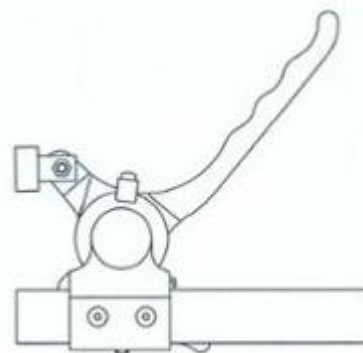

1.11

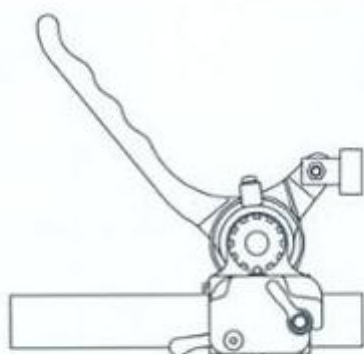

1.12

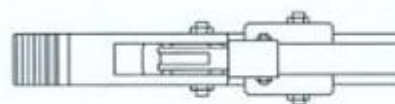

1.13

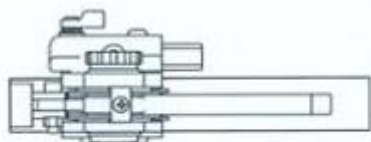

1.14

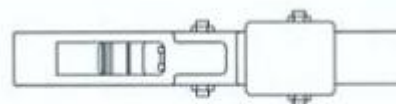

1.15

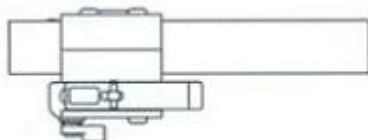

1.16



1.17



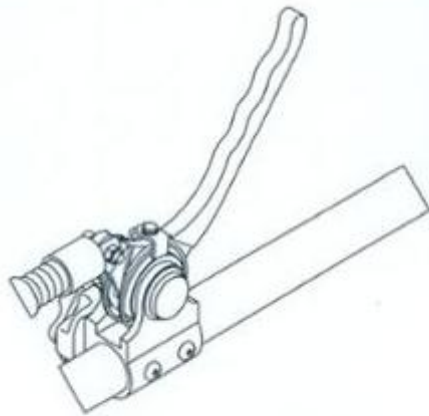

1.18

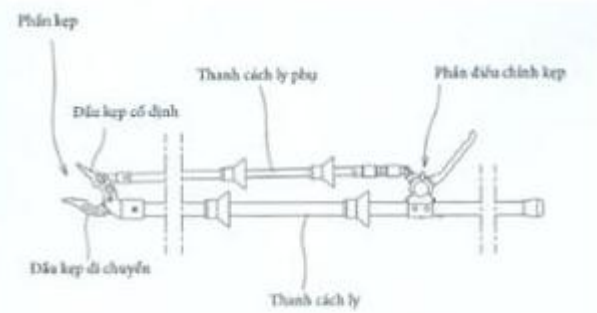

1.19

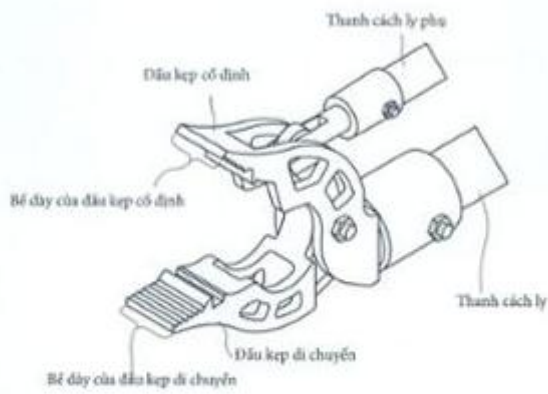

1.20

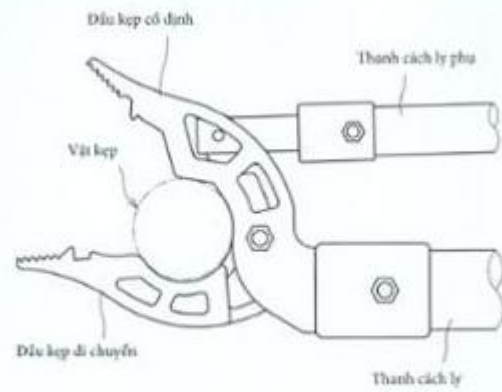

1.21

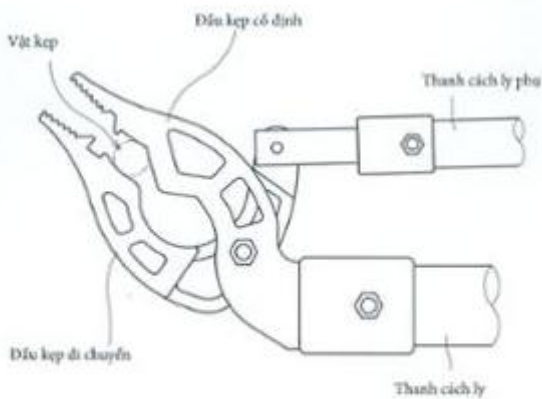

1.22

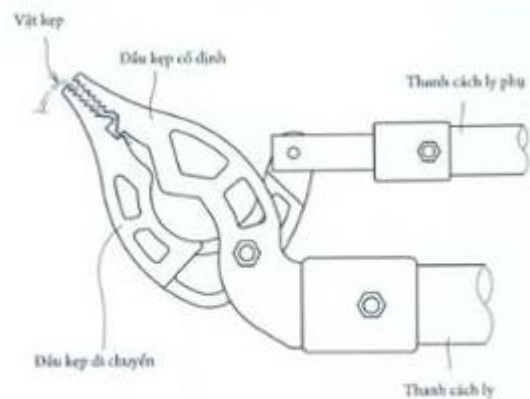

1.23

- (11) **36758**  
(21) 3-2018-02846 (28) 1  
(54) **NẤP CỬA THIẾT BỊ SẠC ĐIỆN** (51) **13-02; 27-99**  
(22) 26/12/2018 (43) 25/10/2019  
(30) 29/654,823 27/06/2018 US;  
JUUL LABS, INC. (US)  
(73) 560 20th Street, Building 104, San Francisco, CA 94107, United States of  
America  
(72) 1. CLAIRE O'MALLEY (US)  
2. BRANDON CHEUNG (US)  
(74) Công ty TNHH Tầm nhìn và Liên danh (VISION & ASSOCIATES CO.LTD.)  
(55)

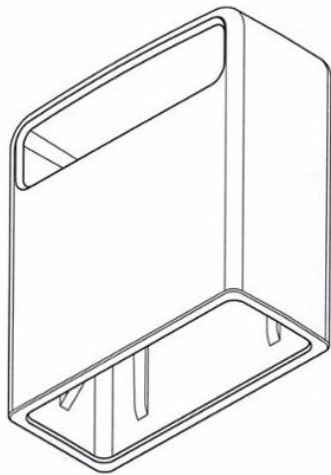

1.1

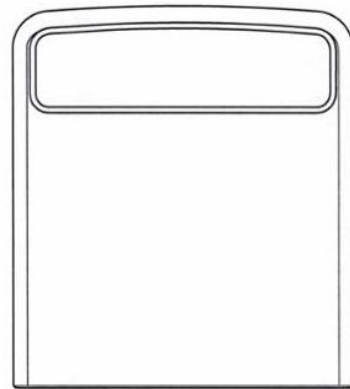

1.2

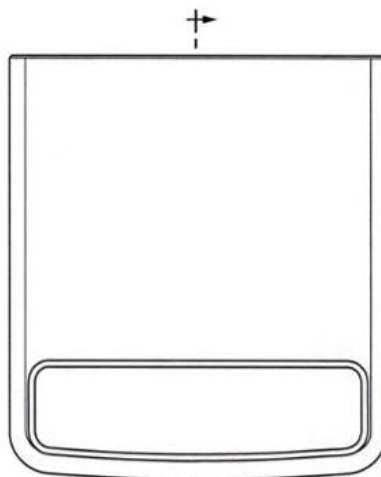

1.3

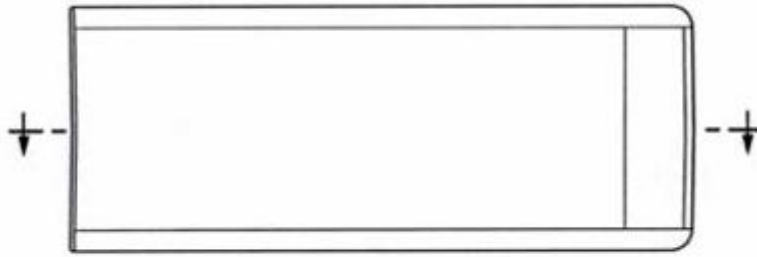

1.4

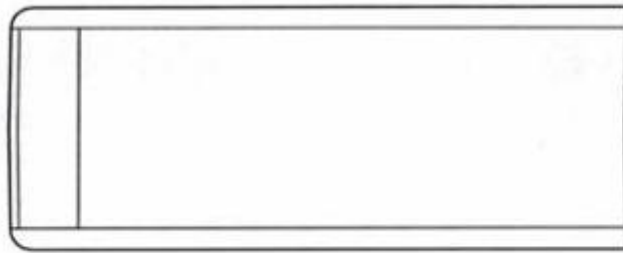

1.5

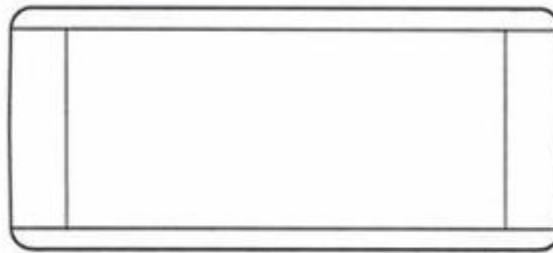

1.6

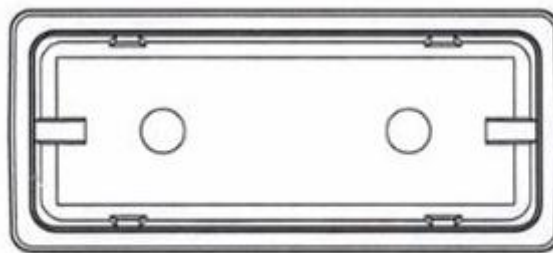

1.7

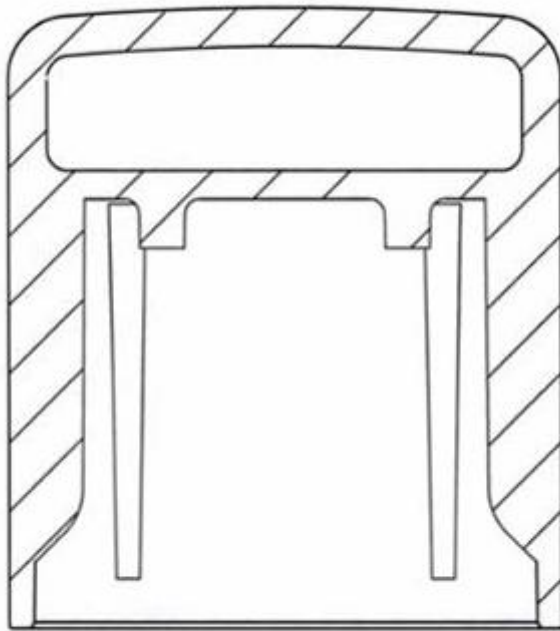

1.8

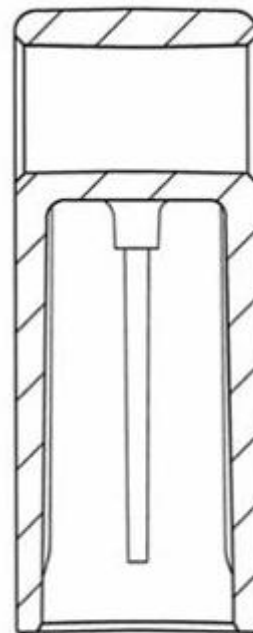

1.9

- (11) **36759**  
(21) 3-2019-00074 (28) 1  
(54) **XẼNG** (51) **07-02**  
(22) 09/01/2019 (43) 25/10/2019  
CÔNG TY CỔ PHẦN CAO SU THÁI DƯƠNG (VN)  
(73) Lô số 4, đường số 7, khu công nghiệp Tân Tạo, phường Tân Tạo, quận Bình Tân, thành phố Hồ Chí Minh  
(72) Giang Ngọc Tuấn (VN)  
(55)



1.1



1.2



1.3



1.4



1.5



1.6

1.7

- (11) **36760**  
(21) 3-2019-01233 (28) 1  
(54) **HỘP ĐỰNG SẢN PHẨM** (51) **09-03**  
(22) 05/04/2018 (43) 25/10/2019  
(73) CÔNG TY TNHH VIỆT LAI HƯƠNG (VN)  
203A Võ Thị Sáu, phường 7, quận 3, thành phố Hồ Chí Minh  
(72) Lê Thị Lan (VN)  
(74) Công ty TNHH Sở hữu trí tuệ ALNGUYEN (ALNGUYEN IP CO.,LTD.)  
(55)



1.1

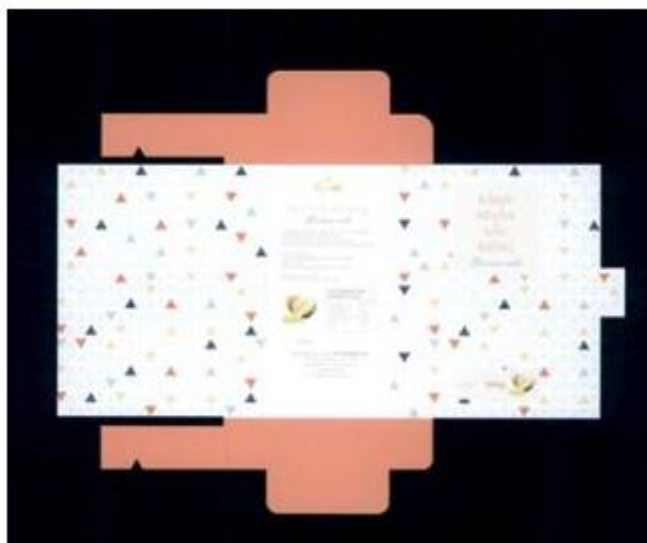

1.2

- (11) **36761**  
(21) 3-2019-01359 (28) 1  
(54) **MÁY LỌC NƯỚC** (51) **23-01**  
(22) 23/05/2019 (43) 25/10/2019  
(30) 30-2019-0001369 10/01/2019 KR;  
(73) CUCKOO HOMESYS CO., LTD. (KR)  
(73) 349, Emtibeuibuk-ro, Siheung-si, Gyeonggi-do, 15117, Republic of Korea  
(72) PARK, SEO JUN (KR)  
(74) Công ty TNHH Sáng chế ACTIP (ACTIP PATENT LIMITED)  
(55)

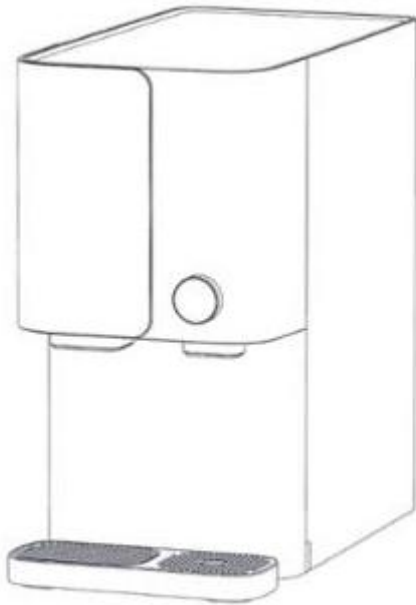

1.1

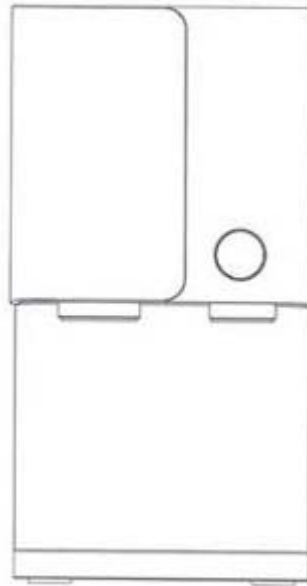

1.2



1.3

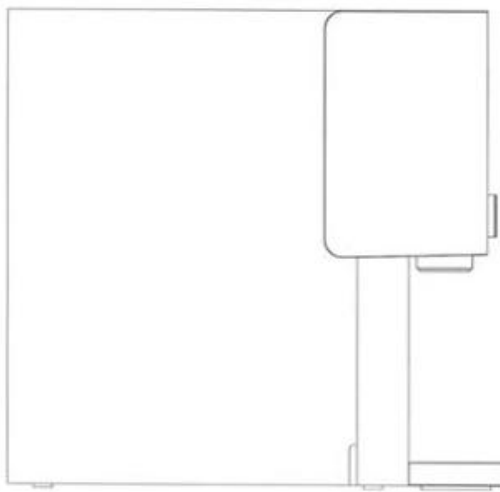

1.4

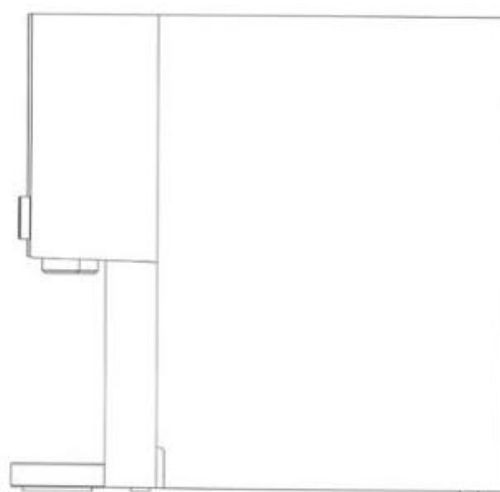

1.5





1.6

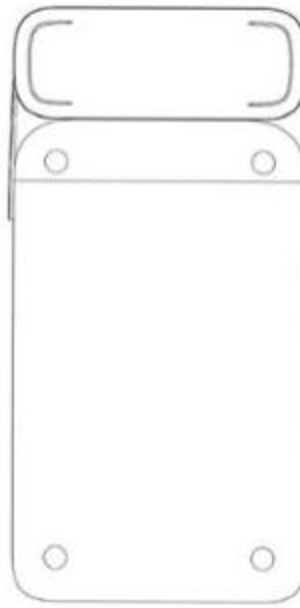

1.7

- (11) **36762**  
(21) 3-2019-00873 (28) 1  
(54) **CHAI** (51) **09-01**  
(22) 05/04/2019 (43) 25/10/2019  
(73) CÔNG TY CỔ PHẦN GREEN MODE (VN)  
C3/F30 Chánh Hưng, xã Bình Hưng, huyện Bình Chánh, thành phố Hồ Chí Minh  
(72) Võ Chí Công (VN)  
(74) Công ty TNHH một thành viên Trường Luật (Trường Luật)  
(55)



1.1

1.2

1.3

1.4

1.5



1.6

1.7

- (11) **36763**  
(21) 3-2019-01176 (28) 1  
(54) **MÁY LỌC KHÔNG KHÍ** (51) **23-04**  
(22) 14/05/2019 (43) 25/10/2019  
(30) 2018-028015 21/12/2018 JP;  
DAIKIN INDUSTRIES LTD. (JP)  
(73) UMEDA CENTER BUILDING, 4-12, Nakazaki-Nishi 2-chome, Kita-ku, Osaka-shi, Osaka-fu, Japan  
(72) Junji NAKAMURA (JP)  
(74) Công ty TNHH một thành viên Sở hữu trí tuệ VCCI (VCCI-IP CO.,LTD)  
(55)

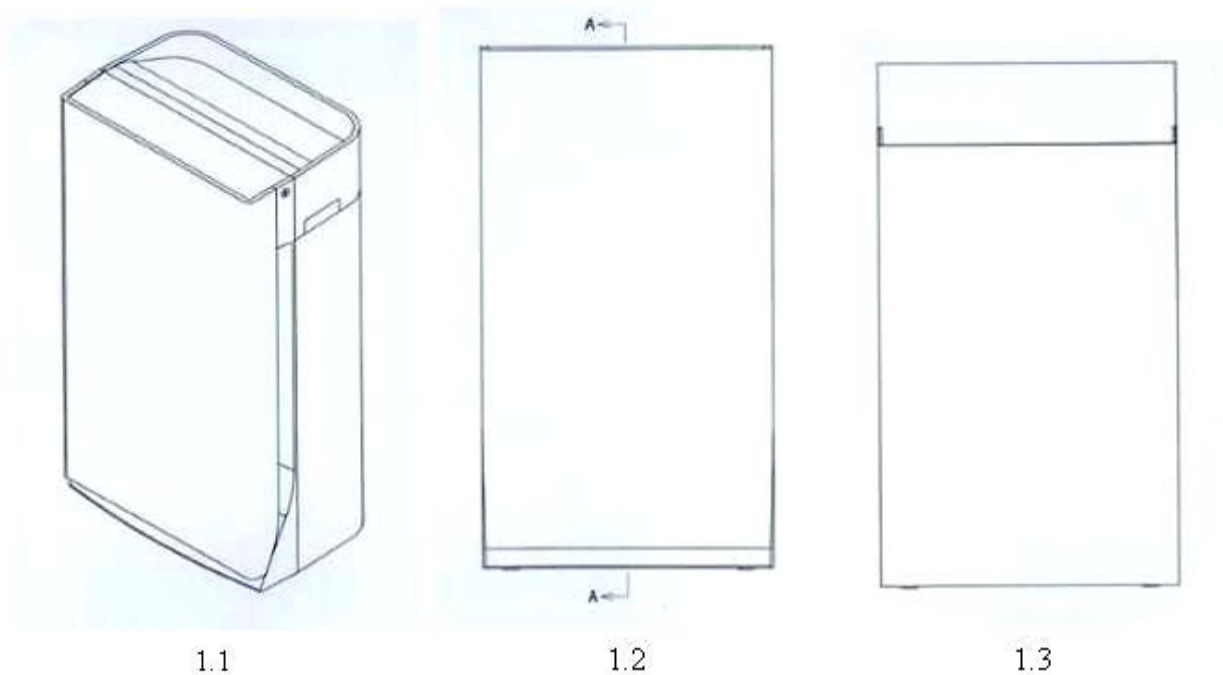

1.1

1.2

1.3

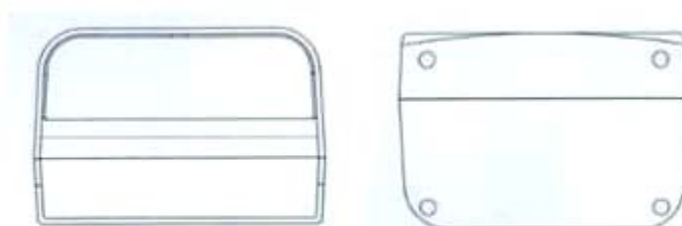

1.4

1.5

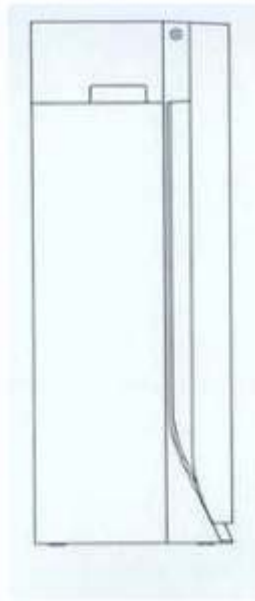

1.6

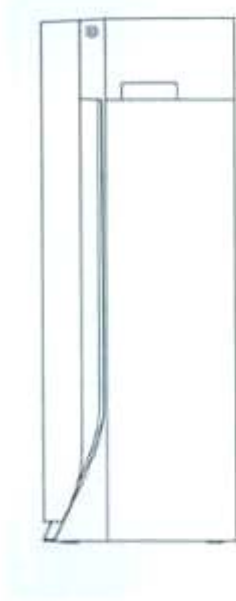

1.7

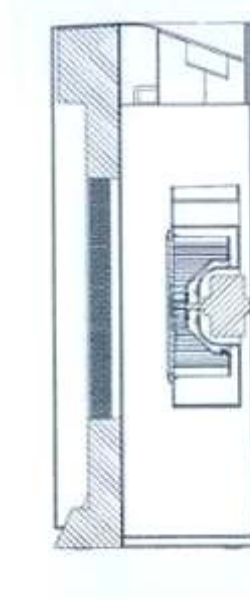

1.8

- (11) **36764**  
(21) 3-2019-00983 (28) 1  
(54) **ĐỒ CHỨA THỰC PHẨM** (51) **07-99; 09-03**  
(22) 18/04/2019 (43) 25/10/2019  
(30) 30-2018-0054197 21/11/2018 KR;  
(73) CJ CHEILJEDANG CORPORATION (KR)  
(Ssangnim-dong) 330, Dongho-ro, Jung-gu, Seoul 04560 Republic of Korea  
1. AN, YEON MI (KR)  
(72) 2. BAEK, YUN JUNG (KR)  
3. LEE, SEUNG PYO (KR)  
(74) Công ty TNHH Sở hữu công nghiệp Sao Bắc Đẩu (SAO BAC DAU IP CO.,LTD)  
(55)



- (11) **36765**  
(21) 3-2019-00976 (28) 1  
(54) **BẢN DƯỚI CỦA NÚT BẮM** (51) **02-07**  
(22) 12/07/2018 (43) 25/10/2019  
(30) 201830015063.3 12/01/2018 CN;  
DURAFLEX HONG KONG LIMITED (HK)  
(73) 15/F., Tern Centre, Tower 1, 237 Queen's Road Central, Sheung Wan, HONG KONG  
(72) CHAN Man Chak (CN)  
(74) Công ty TNHH Trà và cộng sự (TRA & ASSOCIATES CO.,LTD)  
(55)

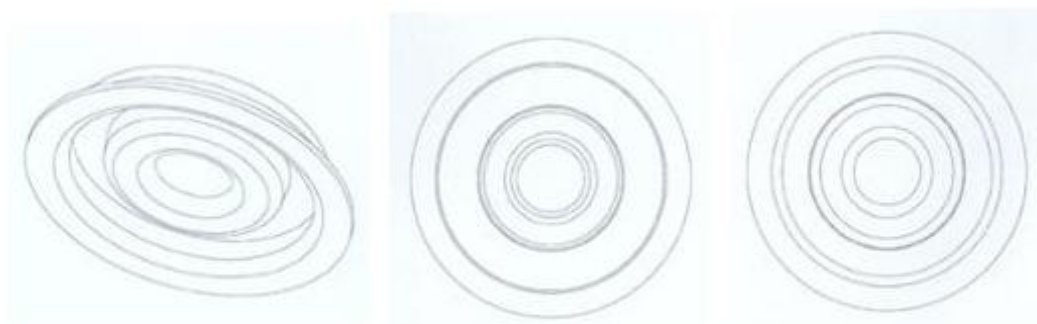

1.1

1.2

1.3



1.4

1.5

1.6

1.7

- (11) **36766**  
(21) 3-2019-01229 (28) 1  
(54) **LỚP XE** (51) **12-15**  
(22) 20/05/2019 (43) 25/10/2019  
(30) 201830681021.3 28/11/2018 CN;  
COOPER TIRE & RUBBER COMPANY (US)  
(73) 701 Lima Avenue, Findlay, Ohio, 45840, United States of America  
(72) Hui DING (CN)  
(74) Công ty Luật TNHH AMBYS Hà Nội (AMBYS HANOI)  
(55)

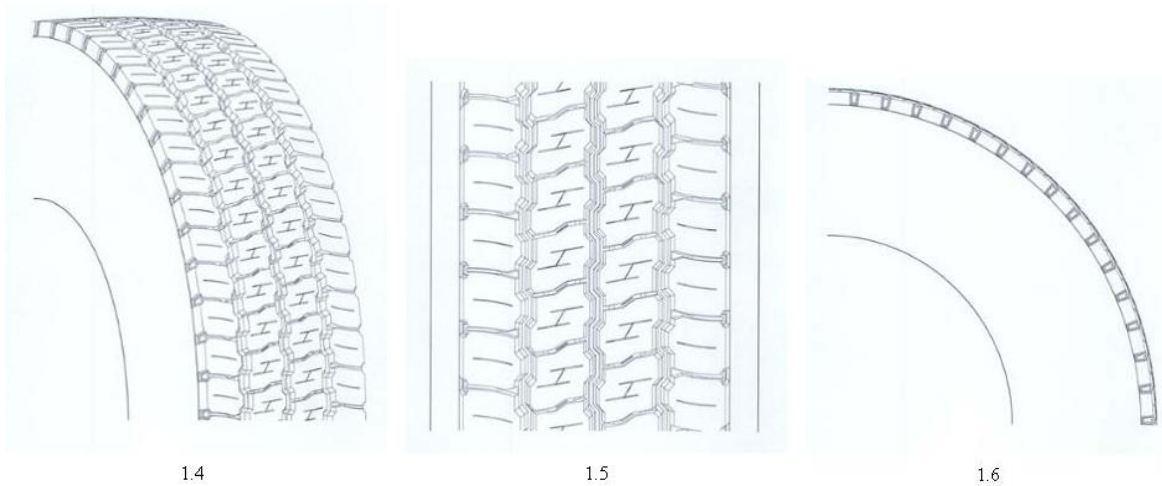
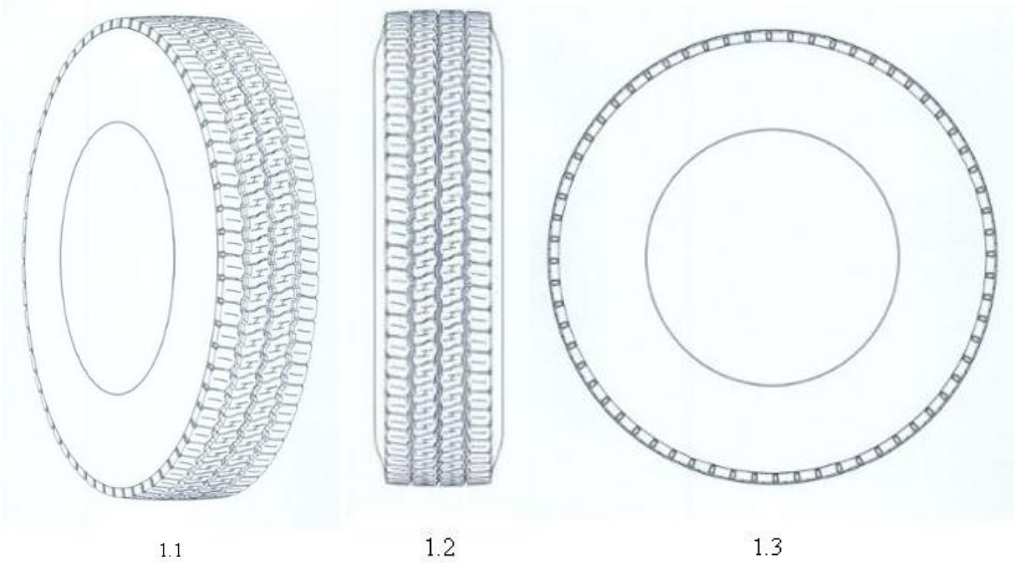

- (11) **36767**  
(21) 3-2019-00578 (28) 1  
(54) **TAY CẦM DỪNG CHO VÒI NƯỚC** (51) **23-01**  
(22) 08/03/2019 (43) 25/10/2019  
(30) 2018-028777 27/12/2018 JP;  
TOTO LTD. (JP)  
(73) 1-1, Nakashima 2-chome, Kokurakita-ku, Kitakyushu-shi, Fukuoka 802-8601  
Japan  
1. YASUSHI TAKAHASHI (JP)  
2. SHOGO TAKAYAMA (JP)  
3. TAKANORI SHIMAZOE (JP)  
(72) 4. KANAKO FUKUOKA (JP)  
5. TOMOHIRO MIYAZAKI (JP)  
6. MARK SYDAVONG (US)  
(74) Công ty Cổ phần Sở hữu công nghiệp INVESTIP (INVESTIP)  
(55)



1.1



1.2



1.3



1.4



1.5



1.6



1.7



- (11) **36768**  
(21) 3-2019-01218 (28) 1  
(54) **QUẠT LÀM MÁT KHÔNG KHÍ** (51) **23-04**  
(22) 17/05/2019 (43) 25/10/2019  
(30) 201830694084.2 03/12/2018 CN;  
GREE ELECTRIC APPLIANCES, INC. OF ZHUHAI (CN)  
(73) No.789, West Jinji Road, Qianshan Zhuhai, Guangdong 519070, China  
1. KANG, WANG (CN)  
2. SHA, LI (CN)  
3. NANFEI, CHEN (CN)  
(72) 4. YANG, ZHAO (CN)  
5. SHUAIWEN, ZHOU (CN)  
6. YUNJIE, DU (CN)  
(74) Công ty TNHH Tầm nhìn và Liên danh (VISION & ASSOCIATES CO.LTD.)  
(55)



1.1

1.2

1.3

1.4

1.5



1.6

1.7

- (11) **36769**
- (21) 3-2019-01073
- (54) **THIẾT BỊ PHÁT HIỆN SỰ ẪN MÒN CHI TIẾT KIM**
- (22) 26/04/2019
- (30) 30201805823Q 01/11/2018 SG;
- (73) RAYONG ENGINEERING AND PLANT SERVICE CO., LTD. (TH)  
1 Siam Cement Road, Bangsue, Bangkok Thailand 10800
- (72) 1. HEH KOK BOON (SG)  
2. PONGPAT LORTRAKUL (TH)  
3. CHAYATHORN CHUENMUNEEWONG (TH)  
4. WEE KENG LAY (SG)  
5. LIM ENG SENG (SG)  
6. CHEONG SIAH CHONG (SG)
- (74) Công ty TNHH Sở hữu công nghiệp Sao Bắc Đẩu (SAO BAC DAU IP CO.,LTD)
- (55)

(28) 1

(51) **10-05**

(43) 25/10/2019

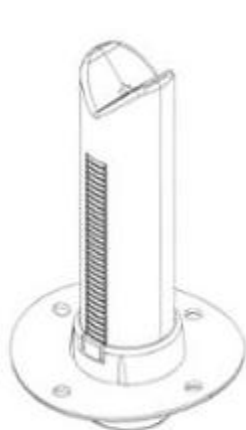

1.1



1.2



1.3



1.4



1.5

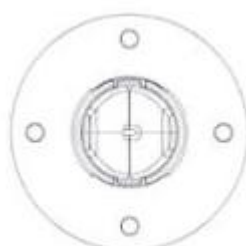

1.6

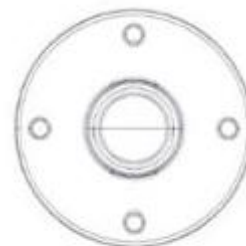

1.7

- (11) **36770**  
(21) 3-2019-01055 (28) 1  
(54) **NHÃN SẢN PHẨM** (51) **19-08**  
(22) 26/04/2019 (43) 25/10/2019  
(73) **CÔNG TY CỔ PHẦN THỰC PHẨM THƠM THỰC (VN)**  
Thôn Lũng Khê, xã Thanh Khương, huyện Thuận Thành, tỉnh Bắc Ninh  
(72) Nguyễn Văn Thực (VN)  
(55)



- (11) **36771**  
(21) 3-2018-01621 (28) 1  
(54) **MÔ HÌNH SÂN CHƠI GÔN** (51) **21-01**  
(22) 06/08/2018 (43) 25/10/2019  
(73) TẠ VĂN HIẾN (VN)  
(73) 09 Nguyễn Huệ, phường 1, thị xã Vĩnh Châu, tỉnh Sóc Trăng  
(72) Tạ Văn Hiến (VN)  
(74) Công ty TNHH Sở hữu trí tuệ Đông Dương (DONG DUONG IP CO.,LTD)  
(55)



1.1



1.2



1.3



1.4



1.5

- (11) **36772**  
(21) 3-2019-01738 (28) 1  
(54) **CHẬU RỬA** (51) **23-02**  
(22) 09/07/2019 (43) 25/10/2019  
(73) PI TSUNG, LIU (TW)  
5F-5, No. 10, Jinshan Rd., West District, Taichung City 403, Taiwan  
(72) Pi Tsung, Liu (TW)  
(74) Công ty TNHH Tư vấn Phạm Anh Nguyên (ANPHAMCO CO.,LTD.)  
(55)



1.1

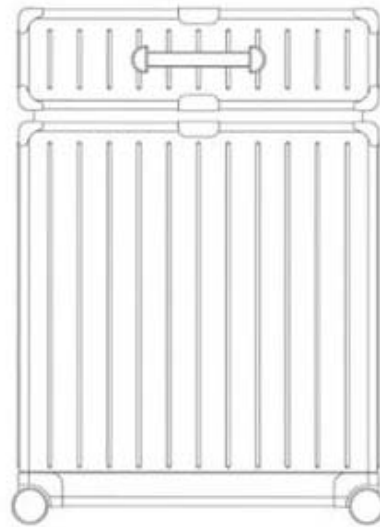

1.2

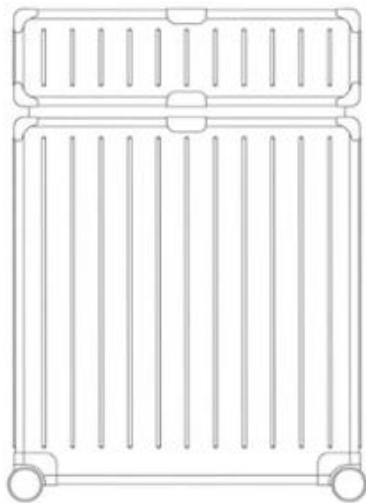

1.3

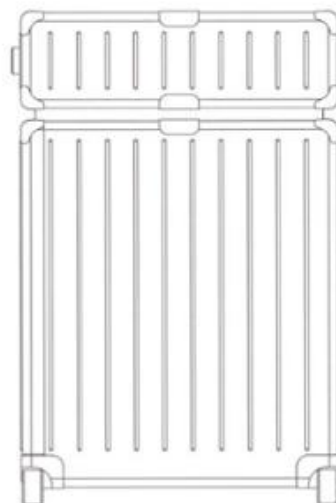

1.4

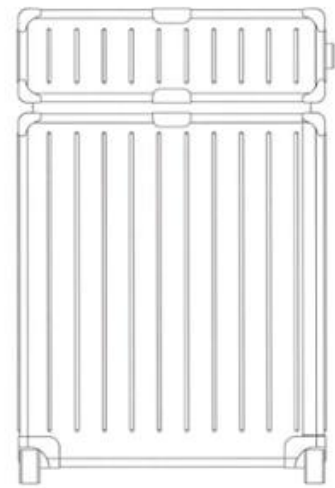

1.5

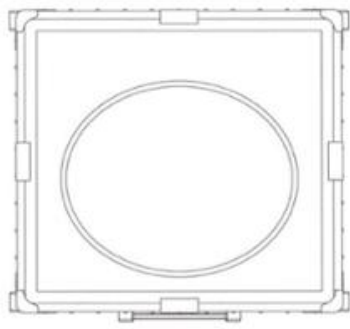

1.6

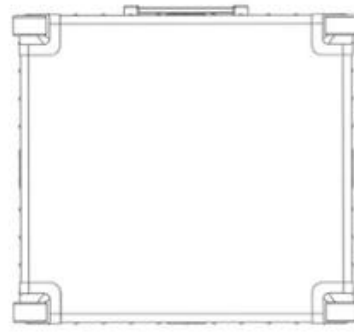

1.7

- (11) **36773**  
(21) 3-2018-01836 (28) 1  
(54) **CẤU KIỆN TẠO RỔNG CHO SÀN BÊ TÔNG CỐT THÉP** (51) **25-01; 25-02**  
(22) 29/08/2018 (43) 25/10/2019  
CÔNG TY CỔ PHẦN THIẾT KẾ XÂY DỰNG LASTING (VN)  
(73) Ô số 01, lô B8 KĐT mới Cao Xanh, Hà Khánh A, phường Cao Xanh, thành phố Hạ Long, tỉnh Quảng Ninh  
(72) Nguyễn Tiến Hiệp (VN)  
(55)

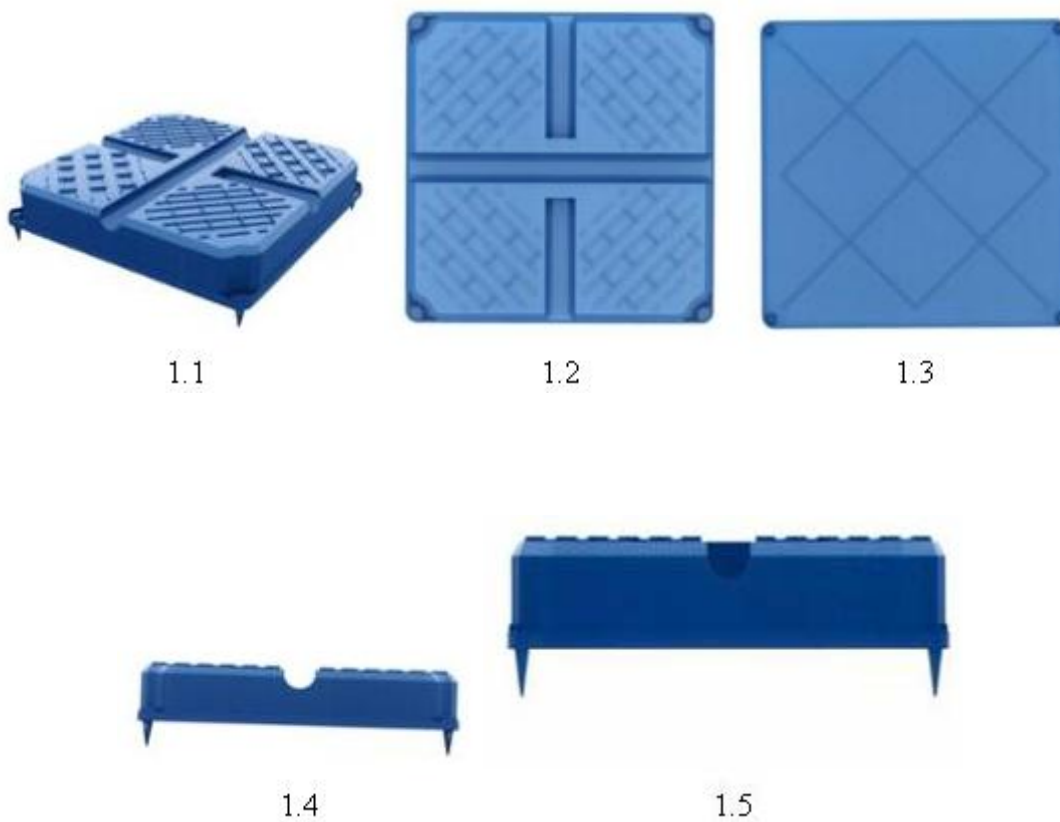



- (11) **36774**  
(21) 3-2018-01523 (28) 1  
(54) **MÁY ĐO ĐỘ ẨM HẠT ĐIỀU** (51) **10-04**  
(22) 23/07/2018 (43) 25/10/2019  
(73) CÔNG TY TNHH CÂN ĐIỆN TỬ THÀNH ĐƯỢC (VN)  
100 đường Liên Tỉnh 5, phường 6, quận 8, thành phố Hồ Chí Minh  
1. **VÕ QUANG SANG (VN)**  
2. **NGÔ MINH TIẾN (VN)**  
(72) 3. **TRẦN MINH HOÀNG (VN)**  
4. **TRƯƠNG CÔNG LỢI (VN)**  
(74) Công ty Luật TNHH ANT (ANT LAWYERS COMPANY LIMITED)  
(55)



1.1



1.2



1.3



1.4



1.5



1.6



1.7

- (11) **36775**  
(21) 3-2018-00351 (28) 1  
(54) **GIÁ ĐỠ KÍNH LỘC CHO MÁY ẢNH** (51) **16-05; 16-99**  
(22) 13/02/2018 (43) 25/10/2019  
(73) DOANH NGHIỆP TƯ NHÂN SẢN XUẤT BOMBO (VN)  
(73) 22/2 Lữ Gia, phường 15, quận 11, thành phố Hồ Chí Minh  
(72) Phạm Trung Kiên (VN)  
(55)



1.1



1.2



1.3



1.4



1.5



1.6



1.7

**CÔNG BÁO SỞ HỮU CÔNG NGHIỆP SỐ 379 TẬP A – QUYỀN 2 (10.2019)**

- (11) **36776**  
(21) 3-2019-01050 (28) 1  
(54) **XE HAI BÁNH** (51) **12-11**  
(22) 26/04/2019 (43) 25/10/2019  
(73) GOGORO INC. (HK)  
3806 CENTRAL PLAZA, 18 HARBOUR ROAD, WANCHAI, HONG KONG  
1. WANG, SUNG-FU (TW)  
(72) 2. SU, HSIN-WEN (TW)  
3. WENG, CHIEN-CHIH (TW)  
4. CHEN, HSI-WEN (TW)  
(74) Công ty TNHH Trà và cộng sự (TRA & ASSOCIATES CO.,LTD)  
(55)



1.1



1.2



1.3



1.4



1.5

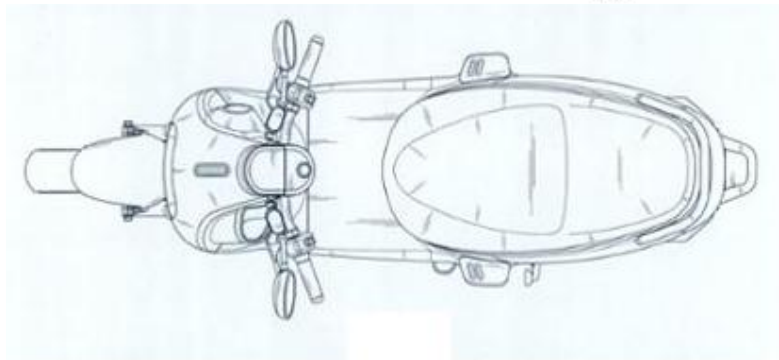

1.6

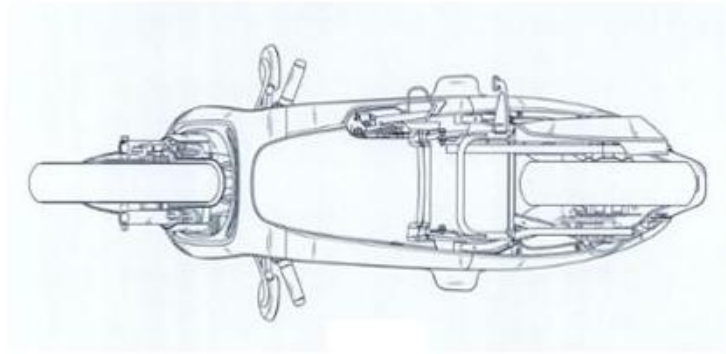

1.7



1.8

- (11) **36777**
- (21) 3-2019-00729 (28) 1
- (54) **BƠM DÙNG ĐỂ BƠM CHẤT LÀM LẠNH DẠNG  
LỎNG TRONG HỆ THỐNG LÀM LẠNH** (51) **15-07**
- (22) 22/03/2019 (43) 25/10/2019
- (30) 30-2019-0011044 12/03/2019 KR;
1. SU-MIN KIM (KR)  
A-102, 29-12, Sinsu-ro, Mapo-gu, Seoul 04092, Republic of Korea
2. BONG-SUCK KIM (KR)
- (73) 3-8, Sinjang-gil 3-gil, Beopseong-myeon, Yeonggwang-gun, Jeollanam-do 57021,  
Republic of Korea
3. MYUNG-SUNG KIM (KR)  
A-102, 29-12, Sinsu-ro, Mapo-gu, Seoul 04092, Republic of Korea
1. BONG-SUCK KIM (KR)
- (72) 2. SU-MIN KIM (KR)
3. MYUNG-SUNG KIM (KR)
- (74) Công ty Cổ phần Sở hữu công nghiệp INVESTIP (INVESTIP)
- (55)

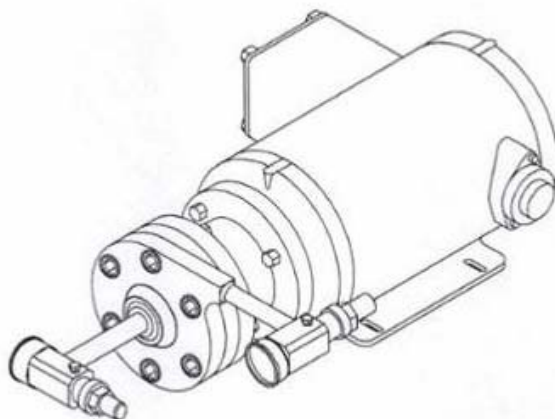

1.1

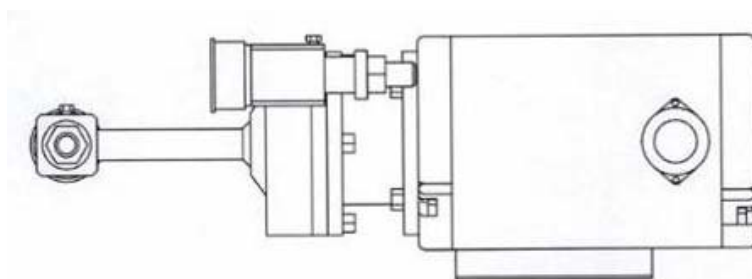

1.2



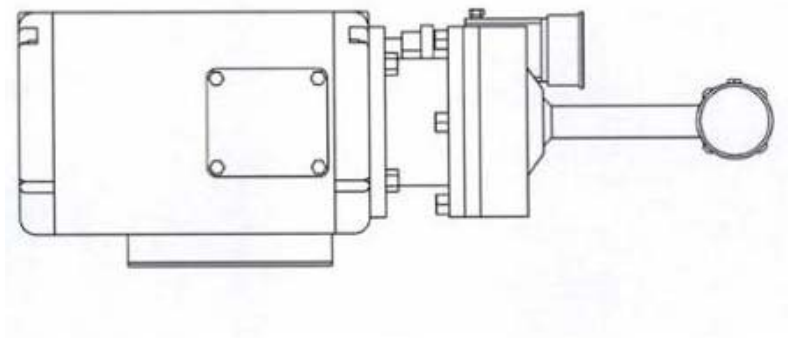

1.3

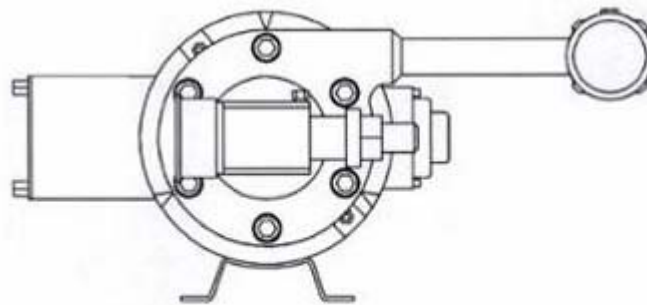

1.4

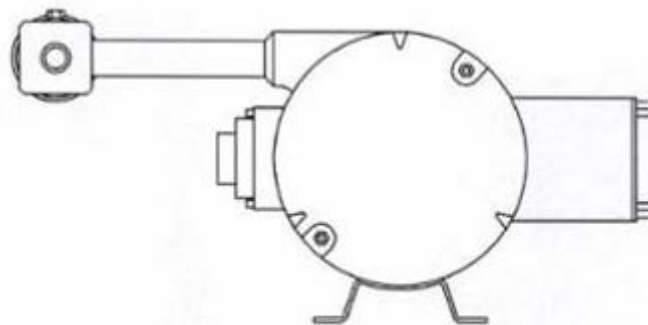

1.5

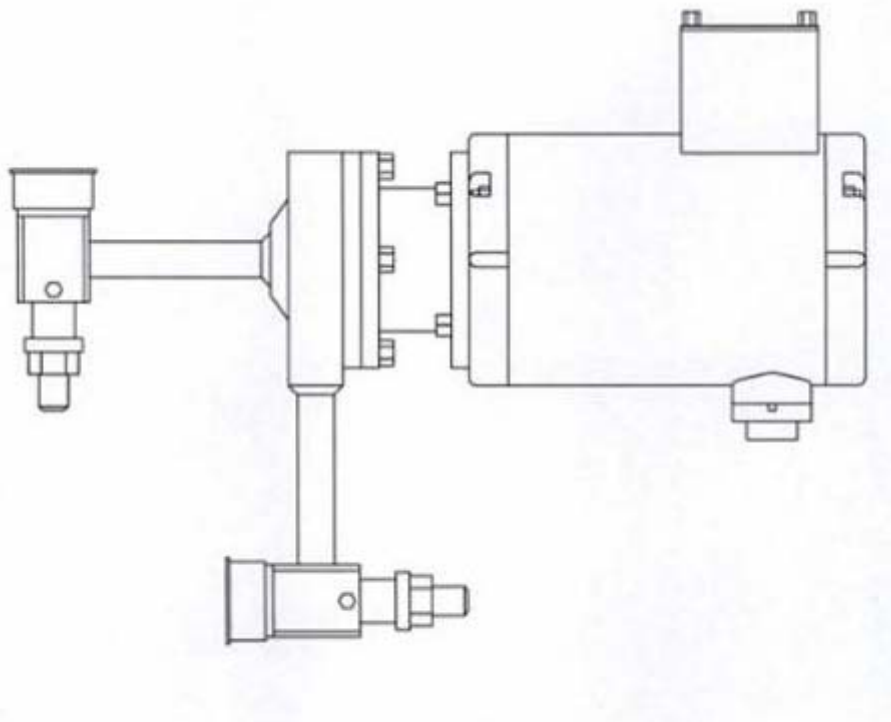

1.6

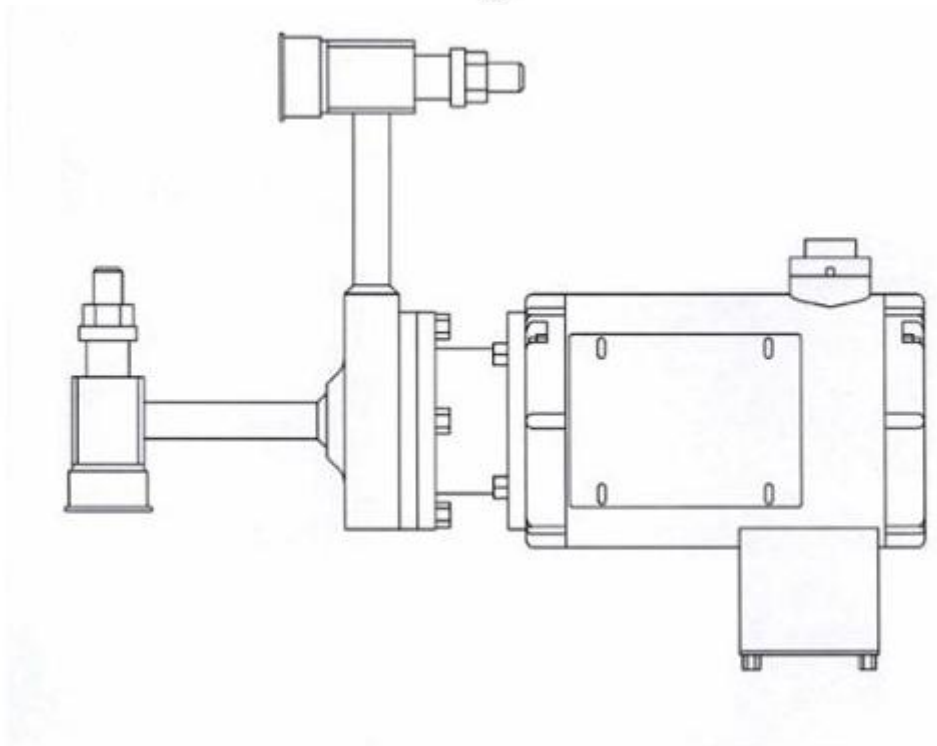

1.7

- (11) **36778**  
(21) 3-2018-02650 (28) 1  
(54) **GHẾ CAO CHO TRẺ CON NGỒI ĂN** (51) **06-01**  
(22) 10/12/2018 (43) 25/10/2019  
APIDAE BABY GROUP LIMITED (HK)  
(73) Room 826-828 One Island South, 2 Heung Yip Road, Wong Chuk Hang, Hong Kong  
(72) TSANG, Waveman (CN)  
(74) Công ty TNHH Trà và cộng sự (TRA & ASSOCIATES CO.,LTD)  
(55)



1.1



1.2



1.3



1.4

1.5



1.6



1.7



1.8

- (11) **36779**  
(21) 3-2018-02845 (28) 1  
(54) **THIẾT BỊ SẠC ĐIỆN** (51) **13-02**  
(22) 26/12/2018 (43) 25/10/2019  
(30) 29/654,823 27/06/2018 US;  
JUUL LABS, INC. (US)  
(73) 560 20th Street, Building 104, San Francisco, CA 94107, United States of  
America  
(72) 1. BRANDON CHEUNG (US)  
2. CLAIRE O'MALLEY (US)  
(74) Công ty TNHH Tầm nhìn và Liên danh (VISION & ASSOCIATES CO.LTD.)  
(55)

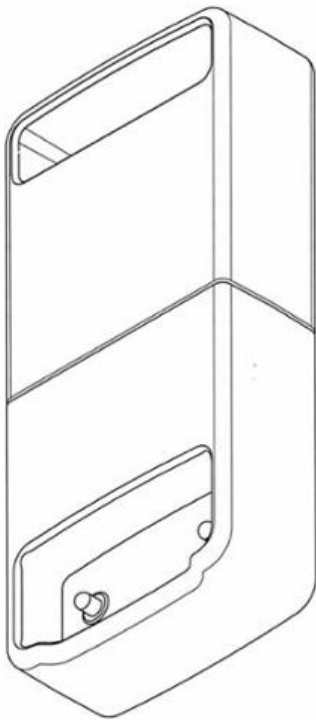

1.1

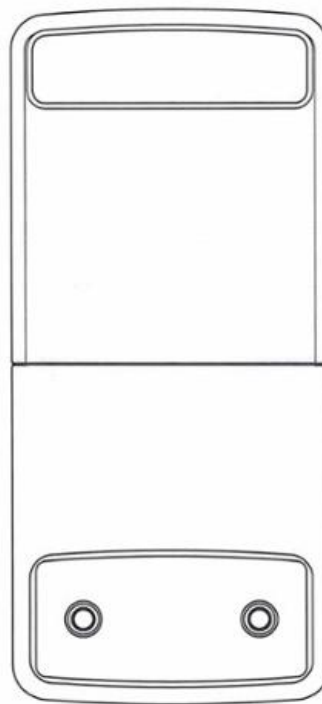

1.2

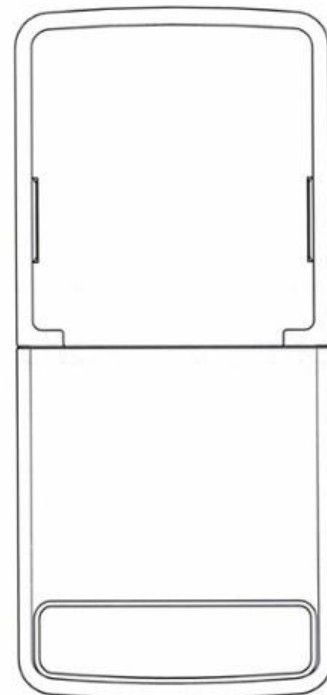

1.3

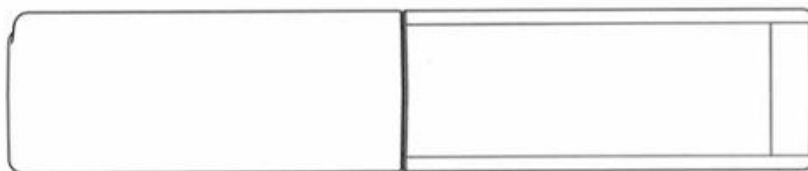

1.4

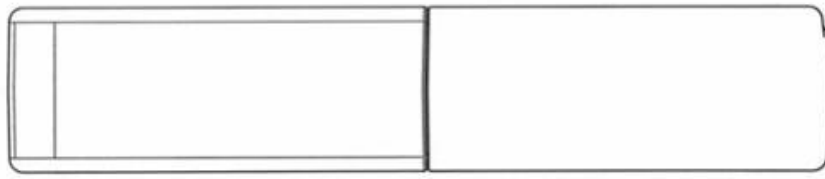

1.5

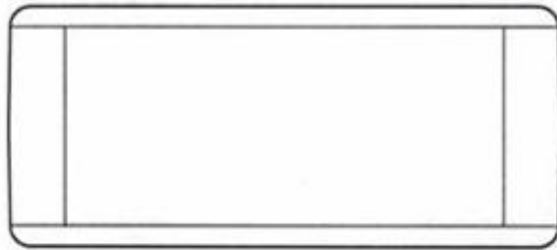

1.6

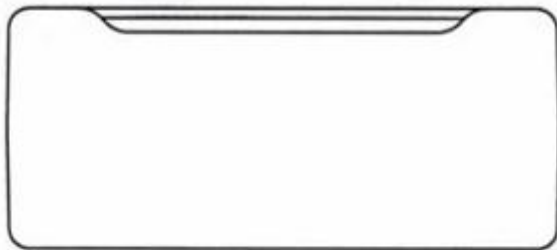

1.7

- (11) **36780**  
(21) 3-2018-02847 (28) 1  
(54) **NẮP CỬA THIẾT BỊ SẠC ĐIỆN** (51) **13-02**  
(22) 26/12/2018 (43) 25/10/2019  
(30) 29/667,663 23/10/2018 US;  
JUUL LABS, INC. (US)  
(73) 560 20th Street, Building 104, San Francisco, CA 94107, United States of  
America  
(72) 1. BRANDON CHEUNG (US)  
2. CLAIRE O'MALLEY (US)  
(74) Công ty TNHH Tầm nhìn và Liên danh (VISION & ASSOCIATES CO.LTD.)  
(55)

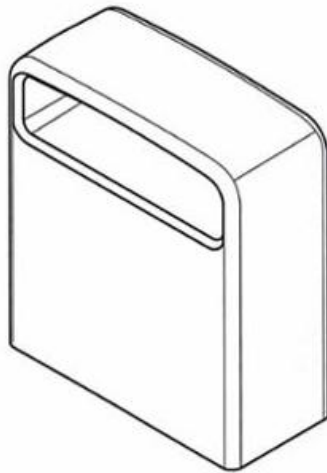

1.1

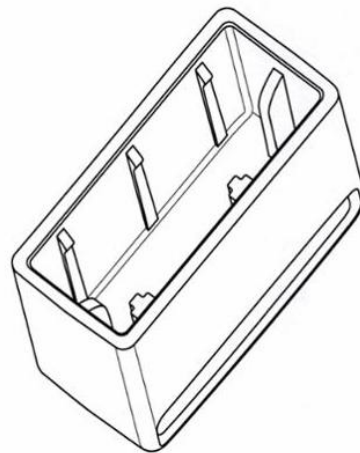

1.2

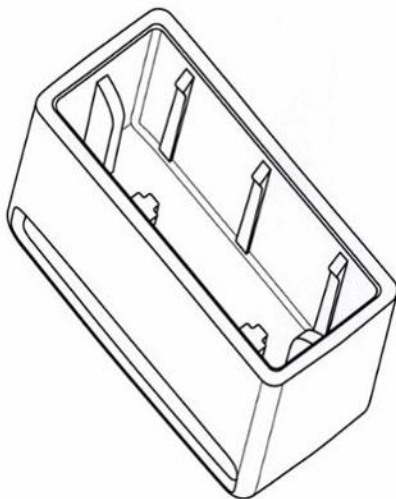

1.3

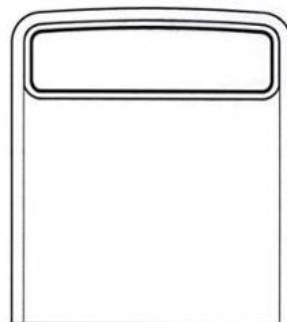

1.4

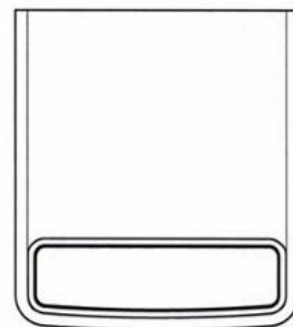

1.5

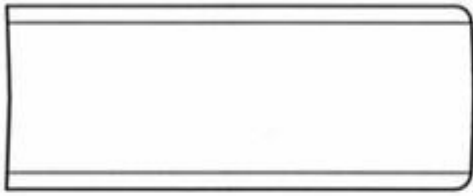

1.6

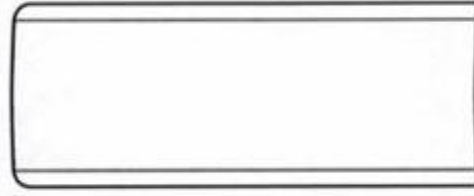

1.7

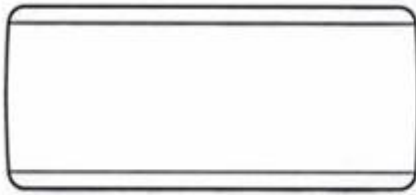

1.8

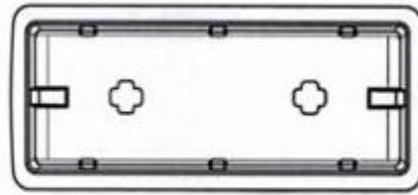

1.9



- (11) **36781**  
(21) 3-2019-00875 (28) 1  
(54) **NỒI** (51) **07-02**  
(22) 05/04/2019 (43) 25/10/2019  
CÔNG TY TNHH MỘT THÀNH VIÊN GỐM SỨ PHƯƠNG ĐÔNG (VN)  
(73) Lô B12A-B13, đường số 10, KCN Hải Sơn, ấp Bình Tiên 2, xã Đức Hòa Hạ,  
huyện Đức Hòa, tỉnh Long An  
(72) Dương Quốc Cường (VN)  
(74) Công ty TNHH Trường Xuân (AGELESS CO.,LTD.)  
(55)



1.1



1.2



1.3

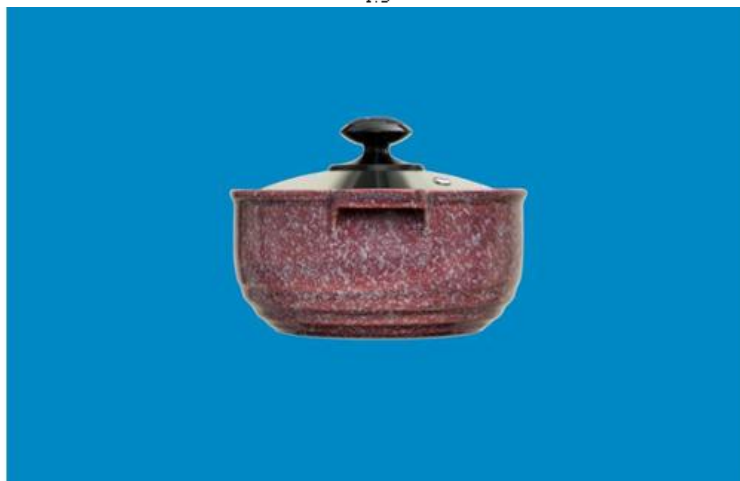

1.4



1.5



1.6



1.7

- (11) **36782**  
(21) 3-2019-00877 (28) 1  
(54) **CHẢO** (51) **07-02**  
(22) 05/04/2019 (43) 25/10/2019  
CÔNG TY TNHH MỘT THÀNH VIÊN GỐM SỨ PHƯƠNG ĐÔNG (VN)  
(73) Lô B12A-B13, đường số 10, KCN Hải Sơn, ấp Bình Tiên 2, xã Đức Hòa Hạ,  
huyện Đức Hòa, tỉnh Long An  
(72) Dương Quốc Cường (VN)  
(74) Công ty TNHH Trường Xuân (AGELESS CO.,LTD.)  
(55)



1.1



1.2

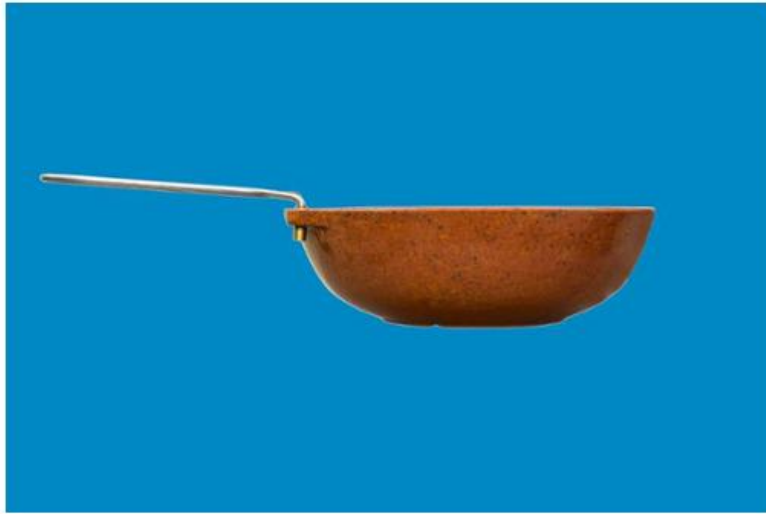

1.3



1.4



1.5



1.6

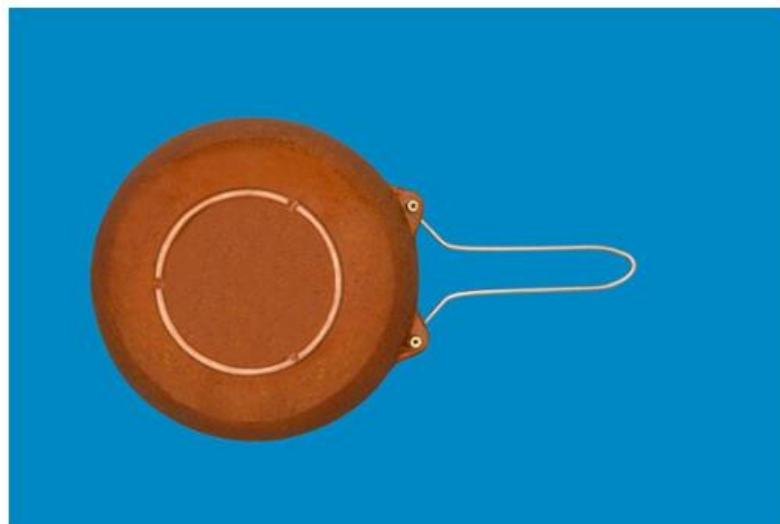

1.7

- (11) **36783**  
(21) 3-2019-00989 (28) 1  
(54) **MÁNG CÁP DẠNG LƯỚI** (51) **13-03**  
(22) 19/04/2019 (43) 25/10/2019  
(73) CÔNG TY CỔ PHẦN BESTRAY (VN)  
180/7B, ấp Tân Thới 3, xã Tân Hiệp, huyện Hóc Môn, thành phố Hồ Chí Minh  
(72) Đồng Công Quốc (VN)  
(55)

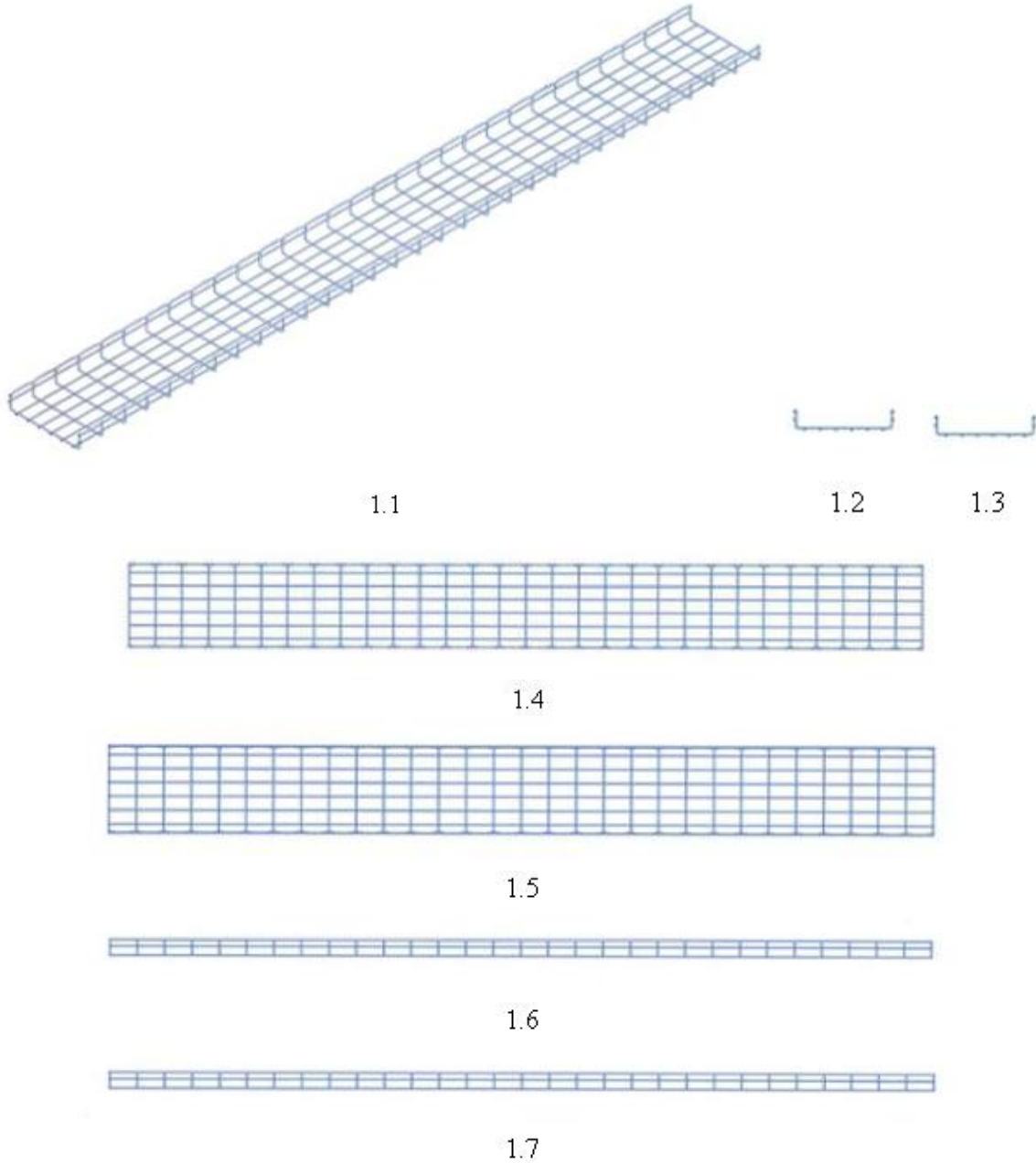

- (11) **36784**  
(21) 3-2019-01114 (28) 1  
(54) **QUẢ BÓNG** (51) **21-02**  
(22) 06/05/2019 (43) 25/10/2019  
(73) CÔNG TY CỔ PHẦN ĐỘNG LỰC (VN)  
Số 130 phố Hạ Đình, phường Hạ Đình, quận Thanh Xuân, thành phố Hà Nội  
(72) Ngô Phú Sơn (VN)  
(55)



1.1



1.2



1.3



1.4





1.5



1.6



1.7

- (11) **36785**  
(21) 3-2019-01008 (28) 1  
(54) **NHÃN DÁN SẢN PHẨM** (51) **19-08**  
(22) 23/04/2019 (43) 25/10/2019  
CÔNG TY TNHH THỰC PHẨM THIÊN NHIÊN (NAFOOCO) (VN)  
(73) 100/17 Trung Mỹ, ấp Chánh 1, xã Tân Xuân, huyện Hóc Môn, thành phố Hồ Chí Minh  
(72) Võ Thị Ngọc (VN)  
(55)



1.1



1.2

- (11) **36786**  
(21) 3-2019-01192 (28) 1  
(54) **DỤNG CỤ DẪN THUỐC TRONG CƠ THỂ SỐNG** (51) **24-02**  
(22) 16/05/2019 (43) 25/10/2019  
(30) 30-2018-0053247 16/11/2018 KR;  
NICEDAY365 CO.,LTD. (KR)  
(73) #804, 242 Digital-ro, Guro-gu, Seoul, Republic of Korea  
(72) Doo Eun Lee (KR)  
(74) Công ty TNHH Trà và cộng sự (TRA & ASSOCIATES CO.,LTD)  
(55)



- (11) **36787**  
(21) 3-2019-01234 (28) 1  
(54) **HỘP ĐỰNG SẢN PHẨM** (51) **09-03**  
(22) 05/04/2018 (43) 25/10/2019  
(73) CÔNG TY TNHH VIỆT LAI HƯƠNG (VN)  
203A Võ Thị Sáu, phường 7, quận 3, thành phố Hồ Chí Minh  
(72) Lê Thị Lan (VN)  
(74) Công ty TNHH Sở hữu trí tuệ ALNGUYEN (ALNGUYEN IP CO.,LTD.)  
(55)



1.1



1.2

- (11) **36788**  
(21) 3-2019-00673 (28) 2  
(54) **BAO GÓI** (51) **09-05**  
(22) 19/03/2019 (43) 25/10/2019  
CÔNG TY CỔ PHẦN ACECOOK VIỆT NAM (VN)  
(73) Lô số II-3, đường số 11, nhóm CN II, khu công nghiệp Tân Bình, phường Tây Thạnh, quận Tân Phú, thành phố Hồ Chí Minh  
(72) Kajiwara Junichi (JP)  
(74) Công ty Luật TNHH Phạm và Liên danh (PHAM & ASSOCIATES)  
(55)



1.1



1.2



2.1



2.2

- (11) **36789**  
(21) 3-2019-01134 (28) 1  
(54) **NHÀ GIẤY ĐỒ CHƠI CHO TRẺ EM** (51) **21-01**  
(22) 07/05/2019 (43) 25/10/2019  
CÔNG TY TNHH THƯƠNG MẠI SẢN XUẤT BAO BÌ MAI THƯ (VN)  
(73) Số 20, VSIP II-A, đường số 12, KCN Việt Nam - Singapore II-A, xã Vĩnh Tân, thị xã Tân Uyên, tỉnh Bình Dương  
(72) Nguyễn Mai Minh Thư (VN)  
(74) Công ty TNHH Tư vấn Sở hữu trí tuệ Á Đông (Á Đông IP CONSULTANCY CO.,LTD.)  
(55)



1.1



1.2

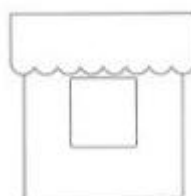

1.3

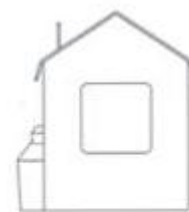

1.4



1.5



1.6



1.7

- (11) **36790**  
(21) 3-2019-00982 (28) 1  
(54) **ĐỒ CHỨA THỰC PHẨM** (51) **07-99; 09-03**  
(22) 18/04/2019 (43) 25/10/2019  
(30) 30-2018-0054196 21/11/2018 KR;  
CJ CHEILJEDANG CORPORATION (KR)  
(73) (Ssangnim-dong) 330, Dongho-ro, Jung-gu, Seoul 04560 Republic of Korea  
1. AN, YEON MI (KR)  
(72) 2. BAEK, YUN JUNG (KR)  
3. LEE, SEUNG PYO (KR)  
(74) Công ty TNHH Sở hữu công nghiệp Sao Bắc Đẩu (SAO BAC DAU IP CO.,LTD)  
(55)





- (11) **36791**  
(21) 3-2019-00980 (28) 1  
(54) **ĐỒ CHỨA THỰC PHẨM** (51) **07-99; 09-03**  
(22) 18/04/2019 (43) 25/10/2019  
(30) 30-2018-0054194 21/11/2018 KR;  
(73) CJ CHEILJEDANG CORPORATION (KR)  
(Ssangnim-dong) 330, Dongho-ro, Jung-gu, Seoul 04560 Republic of Korea  
1. BAEK, YUN JUNG (KR)  
(72) 2. AN, YEON MI (KR)  
3. LEE, SEUNG PYO (KR)  
(74) Công ty TNHH Sở hữu công nghiệp Sao Bắc Đẩu (SAO BAC DAU IP CO.,LTD)  
(55)



- (11) **36792**  
(21) 3-2019-01175 (28) 1  
(54) **MÁY LỌC KHÔNG KHÍ** (51) **23-04**  
(22) 14/05/2019 (43) 25/10/2019  
(30) 2018-028009 21/12/2018 JP;  
DAIKIN INDUSTRIES LTD. (JP)  
(73) UMEDA CENTER BUILDING, 4-12, Nakazaki-Nishi 2-chome, Kita-ku, Osaka-shi, Osaka-fu, Japan  
(72) Junji NAKAMURA (JP)  
(74) Công ty TNHH một thành viên Sở hữu trí tuệ VCCI (VCCI-IP CO.,LTD)  
(55)



1.1



1.2

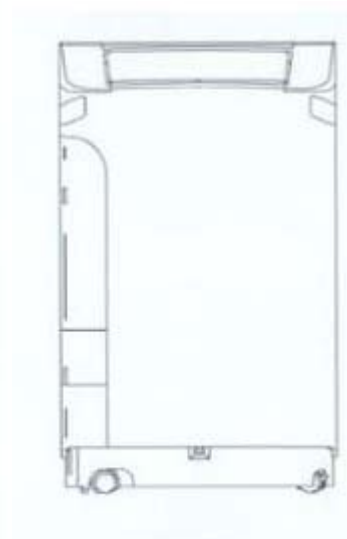

1.3



1.4



1.5

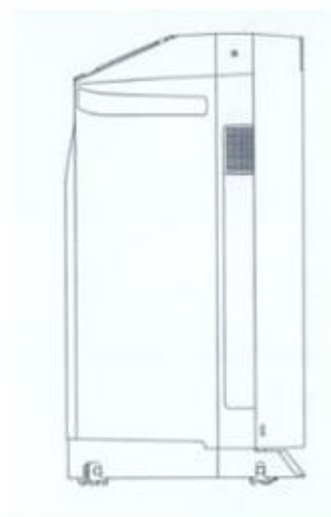

1.6



1.7

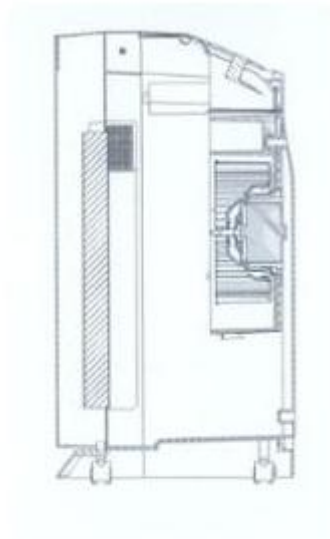

1.8

- (11) **36793**  
(21) 3-2019-01174  
(54) **MÁY ĐIỀU HÒA NHIỆT ĐỘ**  
(22) 14/05/2019  
(30) 2018-028001 21/12/2018 JP;  
DAIKIN INDUSTRIES LTD. (JP)  
(73) UMEDA CENTER BUILDING, 4-12, Nakazaki-Nishi 2-chome, Kita-ku, Osaka-shi, Osaka-fu, Japan  
(72) Kentarou NIKI (JP)  
(74) Công ty TNHH một thành viên Sở hữu trí tuệ VCCI (VCCI-IP CO.,LTD)  
(55)
- (28) 1  
(51) **23-04**  
(43) 25/10/2019



1.1

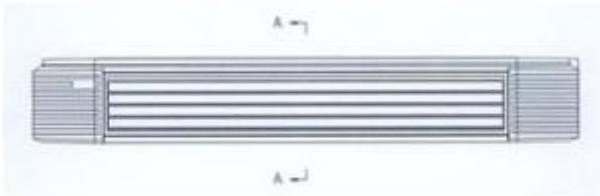

1.2



1.3

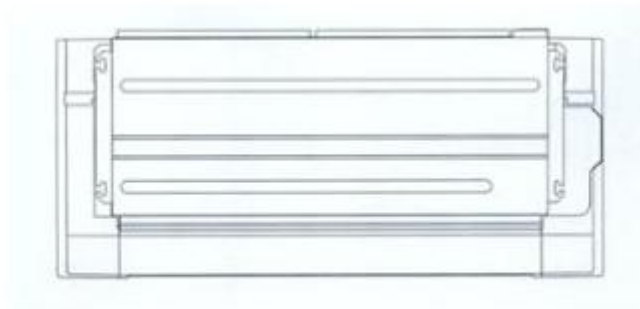

1.4

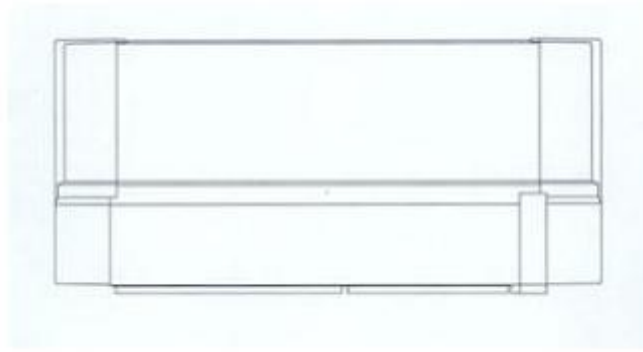

1.5



1.6



1.7



1.8

(11) **36794**

(21) 3-2018-02744

(28) 3

(54) **TÚI GIẤY ĐỰNG KIM**

(51) **09-05**

(22) 17/12/2018

(43) 25/10/2019

(73) ORGAN NEEDLE CO., LTD. (JP)

1 Maeyama, Ueda-shi, Nagano-ken 386-1436, Japan

(72) 1. TERUAKI SUZUKI (JP)

2. KAZUMASA OHMIYA (JP)

3. TOMOKI OKUGUCHI (JP)

(74) Công ty Cổ phần Hỗ trợ phát triển công nghệ Detech (DETECH)

(55)

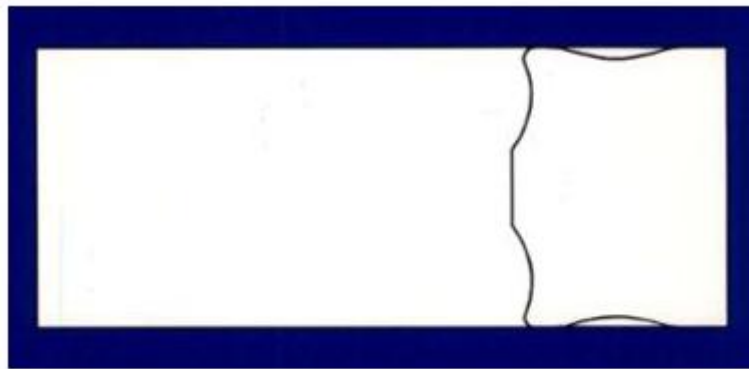

1.1



1.2

1.3

1.4



1.5



1.6

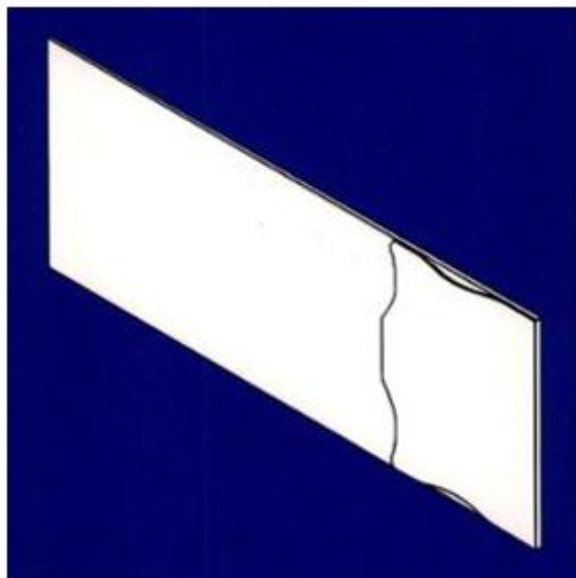

1.7

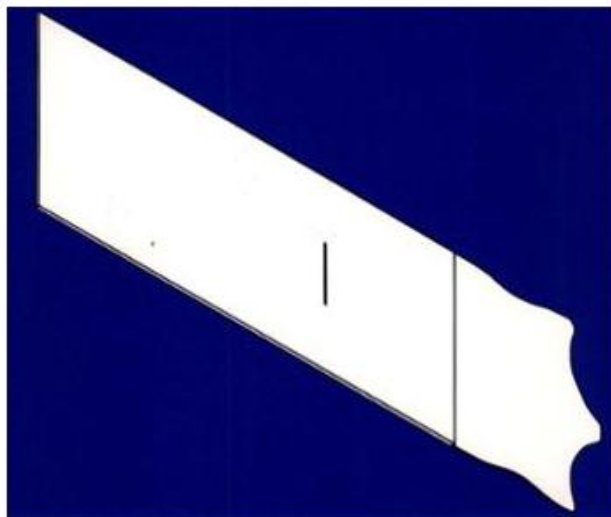

1.8

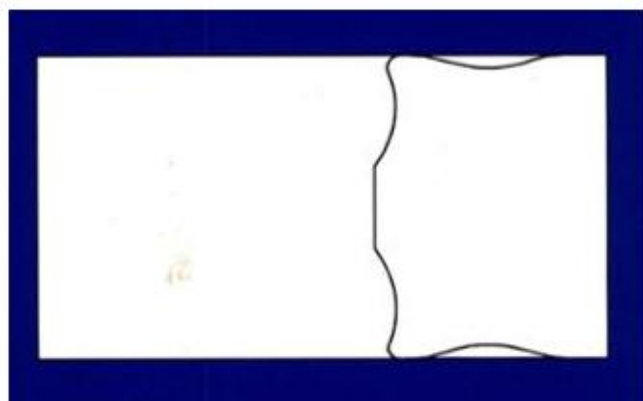

2.1



2.2

2.3

2.4



2.5



2.6

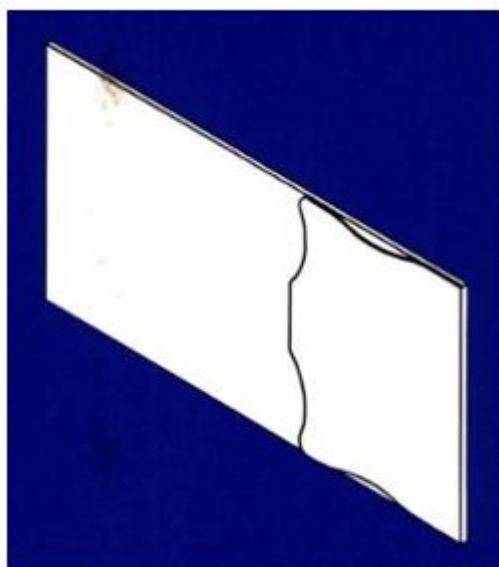

2.7



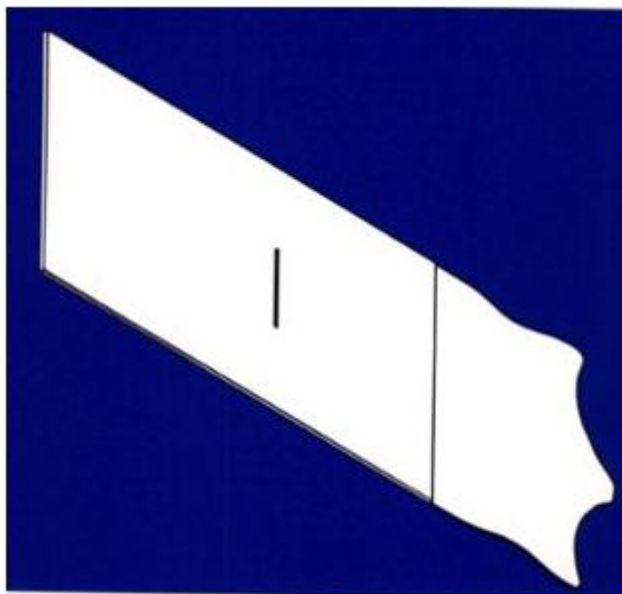

2.8

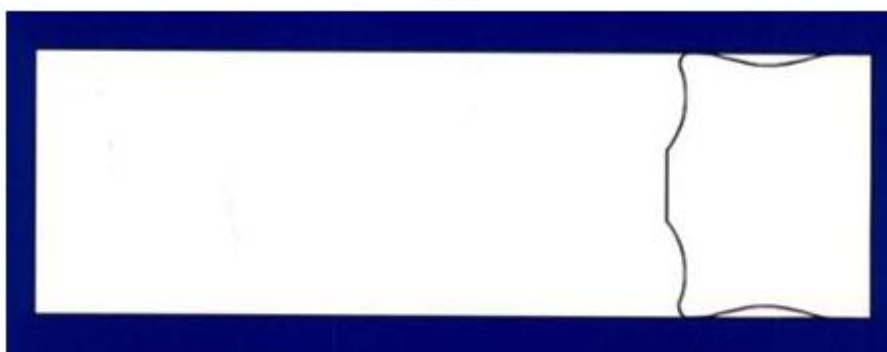

3.1



3.2



3.3



3.4



3.5



3.6

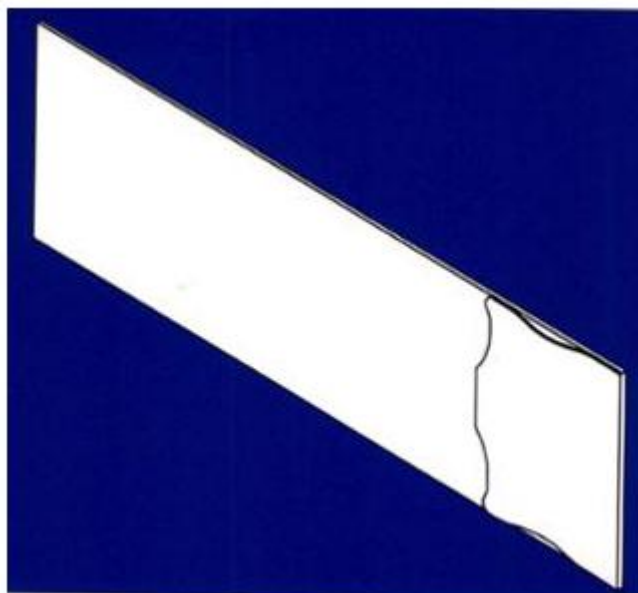

3.7

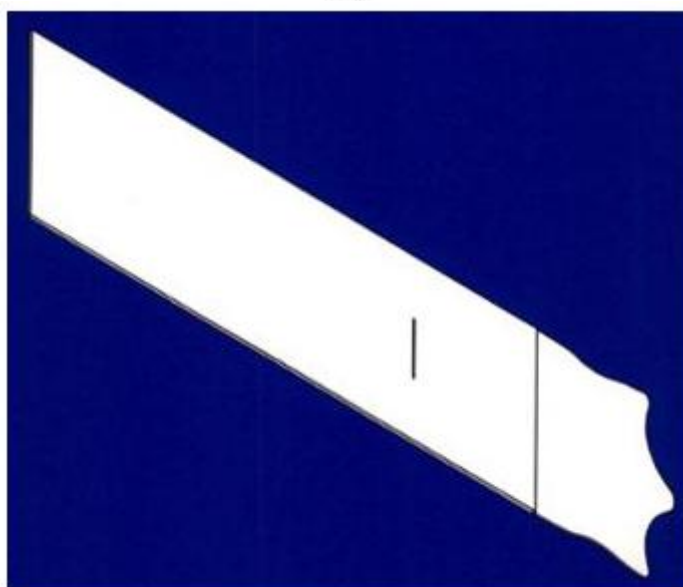

3.8

- (11) **36795**  
(21) 3-2019-00393 (28) 2  
(54) **BỘ BAO GÓI ĐỰNG DỤNG CỤ CHĂM SÓC RĂNG** (51) **09-05**  
**MIỆNG**  
(22) 11/02/2019 (43) 25/10/2019  
(30) 29/659616 10/08/2018 US;  
(73) COLGATE-PALMOLIVE COMPANY (US)  
300 Park Avenue, New York, New York 10022, United States of America  
1. MANEESH KUMAR (IN)  
(72) 2. DEVESH BADOLA (IN)  
3. SWAPNIL RAUT (IN)  
(74) Văn phòng Luật sư Ân Nam (ANNAM IP & LAW)  
(55)

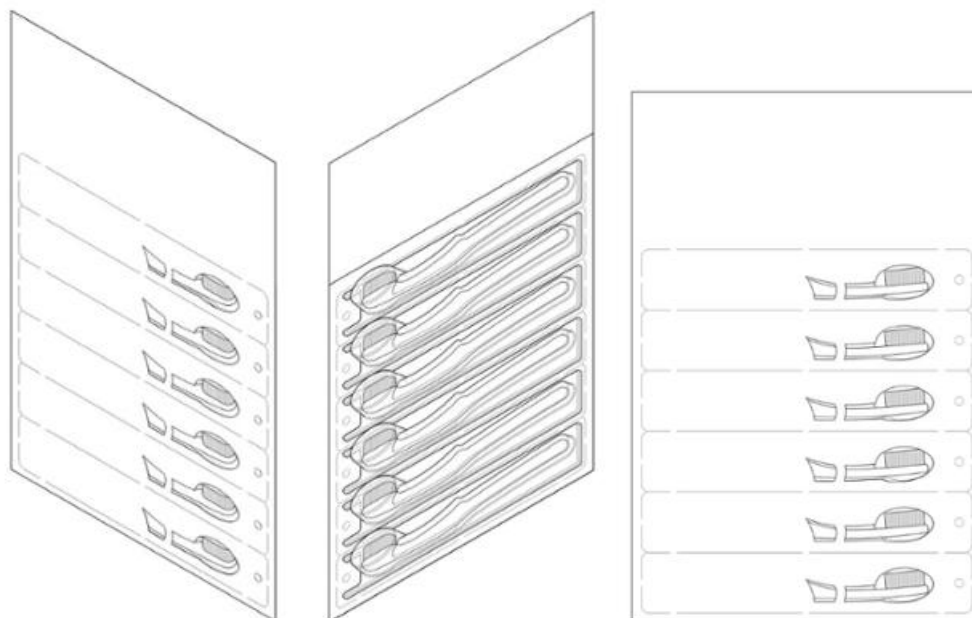

1.1

1.2

1.3

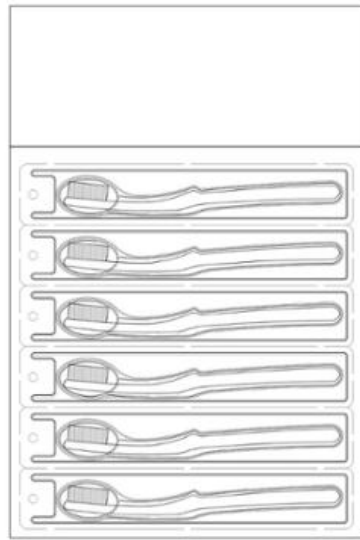

1.4



1.5

1.6



1.7



1.8

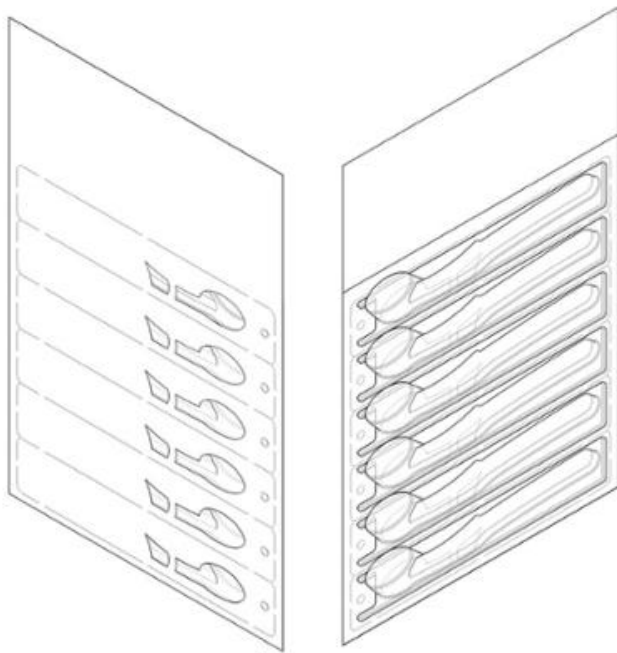

2.1

2.2

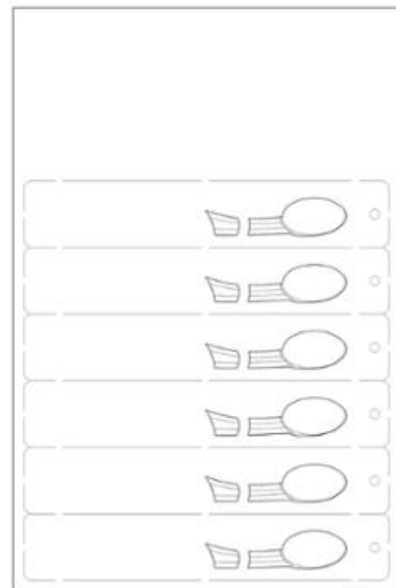

2.3

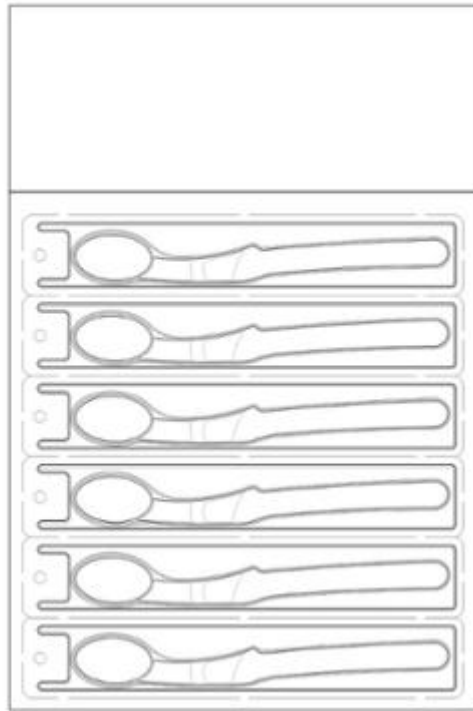

2.4



2.5

2.6



2.7



2.8

- (11) **36796**  
(21) 3-2019-01148 (28) 1  
(54) **TẮM TRANG TRÍ PHÍA DƯỚI SAU XE Ô TÔ** (51) **12-16**  
(22) 08/05/2019 (43) 25/10/2019  
(30) 2018-024601 09/11/2018 JP;  
HONDA MOTOR CO., LTD. (JP)  
(73) 1-1, Minami-Aoyama 2-chome, Minato-ku, Tokyo, 107-8556 Japan  
(72) Chavakorn JIRAPIRIYALERT (TH)  
(74) Công ty Luật TNHH Phạm và Liên danh (PHAM & ASSOCIATES)  
(55)



1.1



1.2



1.3



1.4



1.5



1.6



1.7



1.8

- (11) **36797**  
(21) 3-2019-00975 (28) 1  
(54) **BẢN TRÊN CỦA NÚT BẮM** (51) **02-07**  
(22) 12/07/2018 (43) 25/10/2019  
(30) 201830015063.3 12/01/2018 CN;  
DURAFLEX HONG KONG LIMITED (HK)  
(73) 15/F., Tern Centre, Tower 1, 237 Queen's Road Central, Sheung Wan, HONG KONG  
(72) CHAN Man Chak (CN)  
(74) Công ty TNHH Trà và cộng sự (TRA & ASSOCIATES CO.,LTD)  
(55)



1.1



1.2



1.3

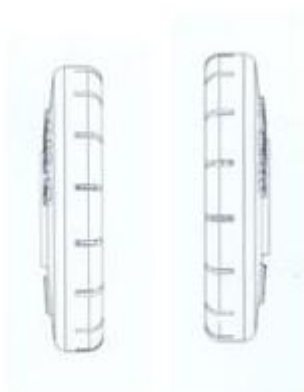

1.4



1.5



1.6



1.7



- (11) **36798**  
(21) 3-2019-00984 (28) 4  
(54) **ĐỒ CHỨA THỰC PHẨM** (51) **09-03**  
(22) 18/04/2019 (43) 25/10/2019  
(30) 30-2018-0054447 22/11/2018 KR; 30-2018-0054450 22/11/2018 KR; 30-2018-0054449 22/11/2018 KR; 30-2018-0054448 22/11/2018 KR;  
(73) CJ CHEILJEDANG CORPORATION (KR)  
(73) (Ssangnim-dong) 330, Dongho-ro, Jung-gu, Seoul 04560 Republic of Korea  
(72) 1. AN, YEON MI (KR)  
(72) 2. BAEK, YUN JUNG (KR)  
(72) 3. LEE, SEUNG PYO (KR)  
(74) Công ty TNHH Sở hữu công nghiệp Sao Bắc Đẩu (SAO BAC DAU IP CO.,LTD)  
(55)



1.1



1.2



1.3



1.4



1.5



1.6



1.7



2.1



2.2



2.3



2.4



2.5



2.6



2.7



3.1



3.2



3.3



3.4



3.5

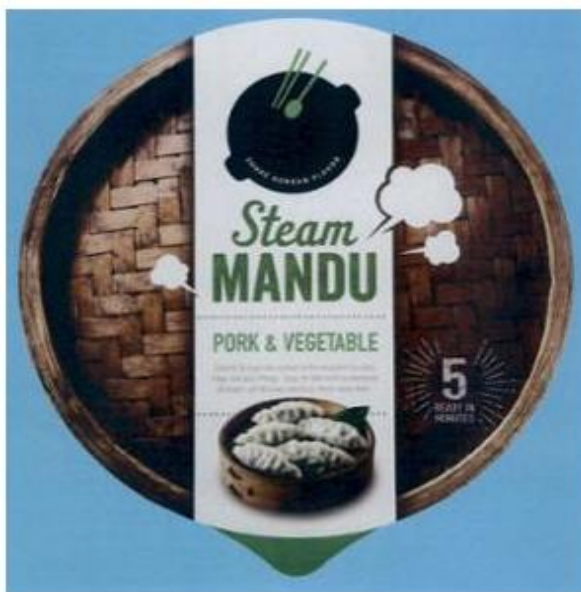

3.6



3.7

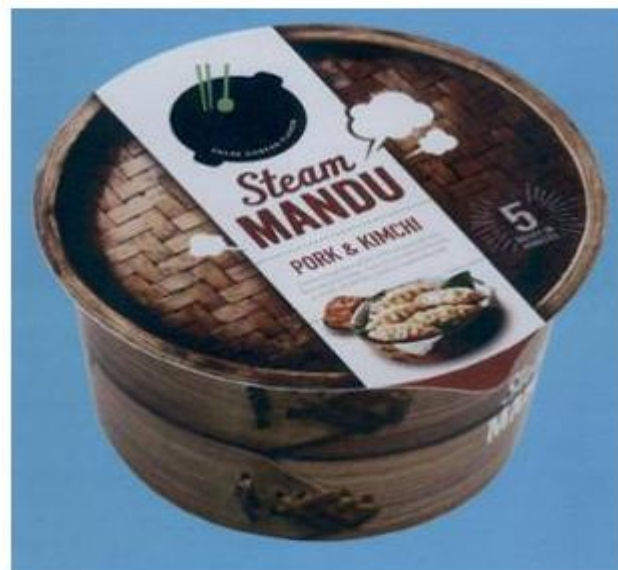

4.1



4.2



4.3



4.4



4.5



4.6



4.7



- (11) **36799**  
(21) 3-2019-00308 (28) 1  
(54) **DÂY ĐAI KIỆN HÀNG** (51) **08-08; 09-06**  
(22) 28/01/2019 (43) 25/10/2019
1. Nguyễn Trung Hiếu (VN)  
214/B1 Bis Nguyễn Trãi, phường Nguyễn Cư Trinh, quận 1, thành phố Hồ Chí Minh
- (73) 2. Lê Hoàng Quốc Việt (VN)  
40 khu phố 5, phường An Lạc, quận Bình Tân, thành phố Hồ Chí Minh  
3. Phạm Thị Quỳnh Giao (VN)  
985 Lạc Long Quân, phường 11, quận Tân Bình, thành phố Hồ Chí Minh
1. LÊ HOÀNG QUỐC VIỆT (VN)  
(72) 2. NGUYỄN TRUNG HIẾU (VN)  
3. PHẠM THỊ QUỲNH GIAO (VN)
- (55)



- (11) **36800**  
(21) 3-2019-01187 (28) 1  
(54) **TỦ LẠNH** (51) **15-07**  
(22) 15/05/2019 (43) 25/10/2019  
(30) 2018-025176 19/11/2018 JP;  
(73) PANASONIC INTELLECTUAL PROPERTY MANAGEMENT CO., LTD. (JP)  
1-61, Shiromi 2-chome, Chuo-ku, Osaka-shi, Osaka 540-6207 Japan  
(72) 1. KEN OHMAE (JP)  
2. KHAIRUL ANUAR KHAIRUDIN (MY)  
(74) Công ty TNHH một thành viên Sở hữu trí tuệ VCCI (VCCI-IP CO.,LTD)  
(55)



1.1



1.2

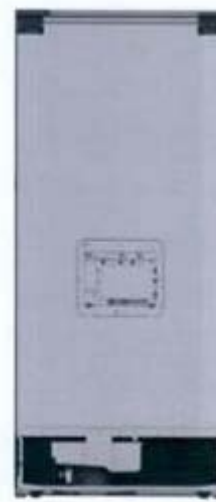

1.3



1.4

1.5

1.6

1.7

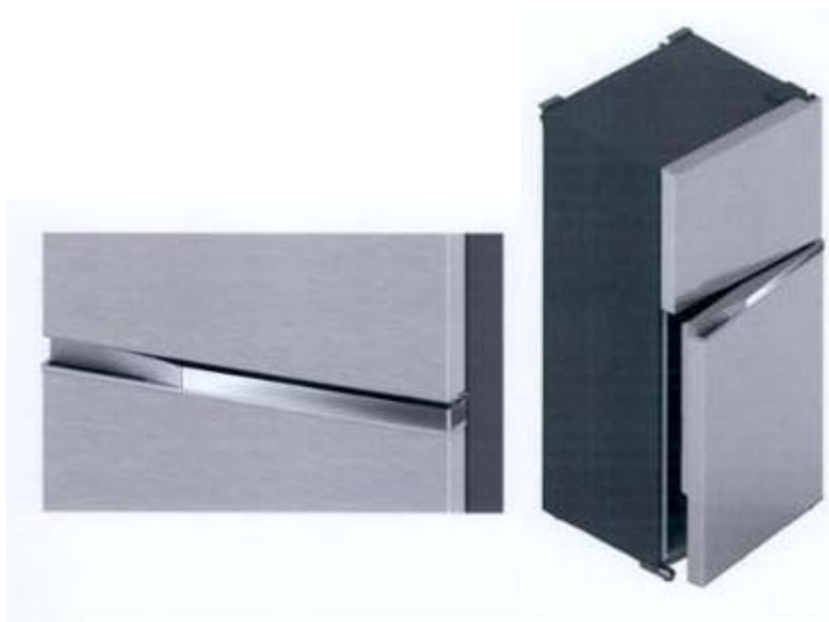

1.8

1.9

- (11) **36801**  
(21) 3-2019-01047 (28) 1  
(54) **HỌNG NẤU CỦA BẾP GA CÔNG NGHIỆP** (51) **07-02**  
(22) 25/04/2019 (43) 25/10/2019  
LÊ TIẾN THẮNG (VN)  
(73) 6/2 đường số 15, phường Hiệp Bình Phước, quận Thủ Đức, thành phố Hồ Chí Minh  
(72) Lê Tiến Thắng (VN)  
(74) Công ty TNHH Tư vấn Sở hữu trí tuệ Á Đông (Á Đông IP CONSULTANCY CO.,LTD.)  
(55)



1.1



1.2



1.3



1.4



1.5



1.6

- (11) **36802**  
(21) 3-2019-01334 (28) 1  
(54) **TẮM TẢN NHIỆT PHÍA TRƯỚC XE Ô TÔ** (51) **12-16**  
(22) 22/05/2019 (43) 25/10/2019  
(30) 2018-026056 30/11/2018 JP;  
HONDA MOTOR CO., LTD. (JP)  
(73) 1-1, Minami-Aoyama 2-chome, Minato-ku, Tokyo, 107-8556 Japan  
(72) Sungjun BAE (KR)  
(74) Công ty Luật TNHH Phạm và Liên danh (PHAM & ASSOCIATES)  
(55)



1.1



1.2



1.3

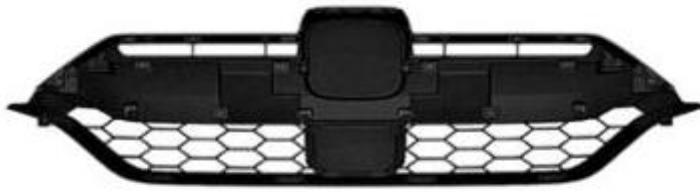

1.4



1.5



1.6



1.7



1.8

- (11) **36803**  
(21) 3-2019-01230 (28) 1  
(54) **ỐNG HÚT** (51) **07-06**  
(22) 20/05/2019 (43) 25/10/2019  
(30) 2018-025507 22/11/2018 JP;  
AQURAHOME CO., LTD. (JP)  
(73) Shinjuku Sumitomo Building, 34th Floor, 2-6-1, Nishishinjuku, Shinjuku-ku,  
Tokyo 163-0234, JAPAN  
(72) Daisuke TAKAHASHI (JP)  
(74) Công ty Luật TNHH AMBYS Hà Nội (AMBYS HANOI)  
(55)



1.1

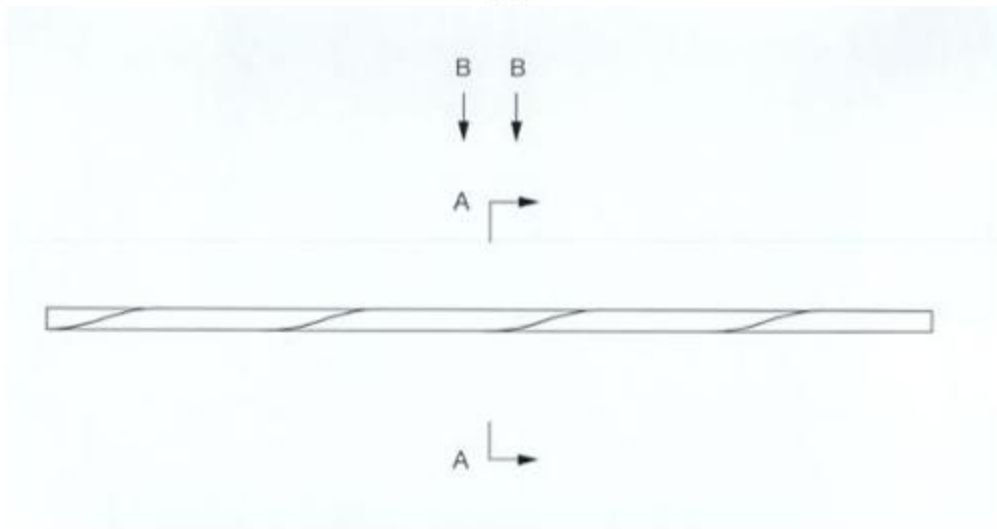

1.2



1.3

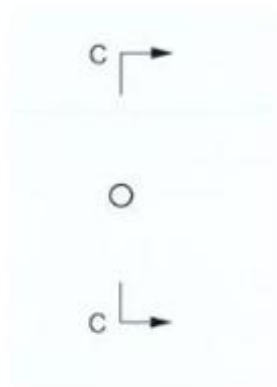

1.6



1.7



1.8



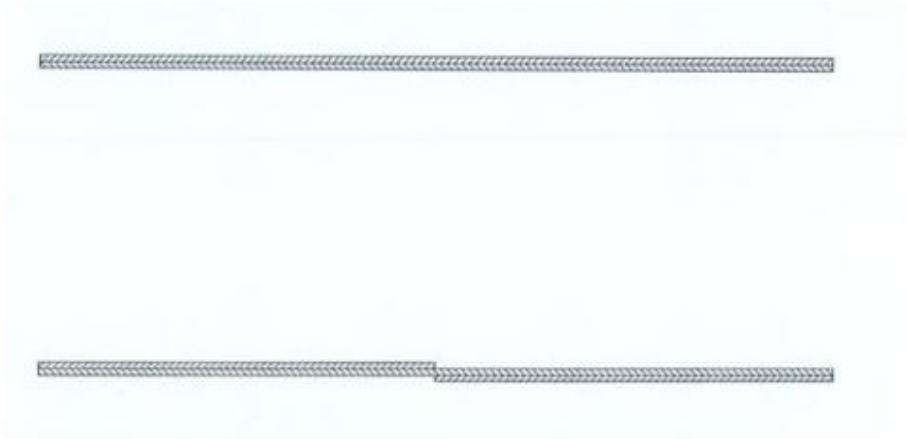

1.9

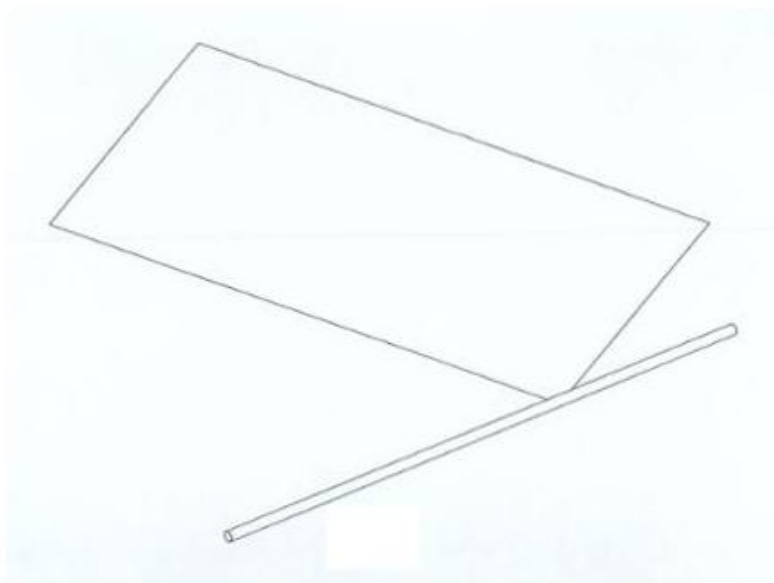

1.10

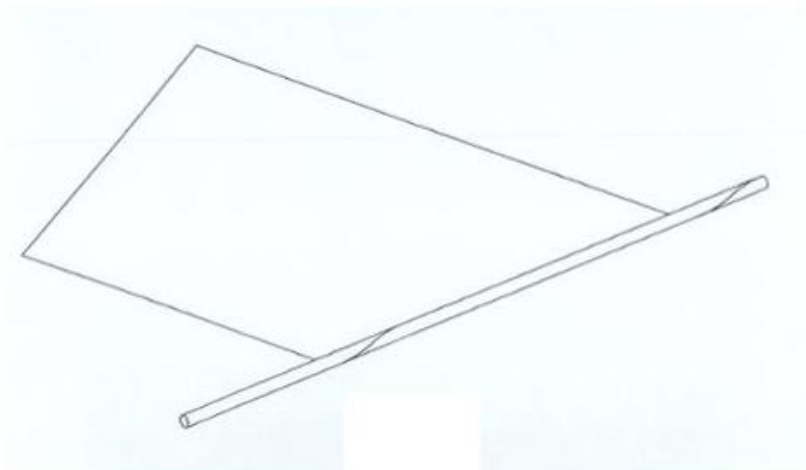

1.11



1.12

- (11) **36804**  
(21) 3-2019-00671 (28) 1  
(54) **TẤM ỐP TRẦN** (51) **25-01**  
(22) 19/03/2019 (43) 25/10/2019  
(73) **VŨ VĂN TRỌNG (VN)**  
Số 146, phố Bà Triệu, phường Cẩm Đông, thành phố Cẩm Phả, tỉnh Quảng Ninh  
(72) Vũ Văn Trọng (VN)  
(74) Công ty TNHH Tư vấn đầu tư và Sở hữu trí tuệ Hoàng Phi (HOANG PHI INVEST & I.P CO., LTD)  
(55)

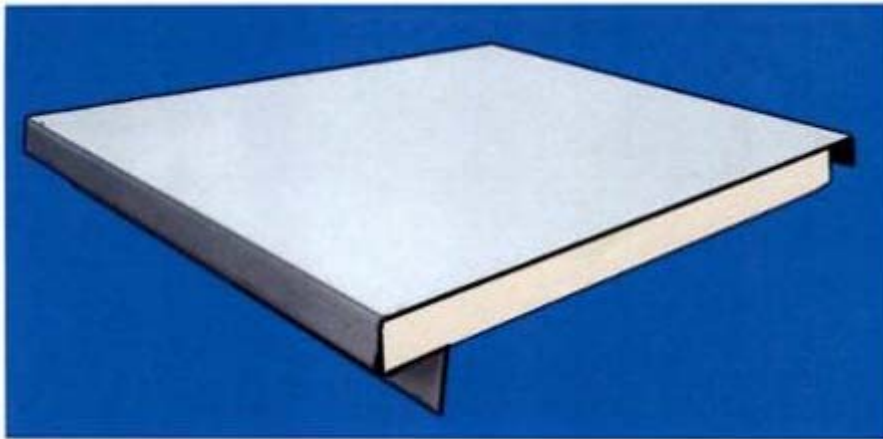

1.1



1.2



1.3



1.4

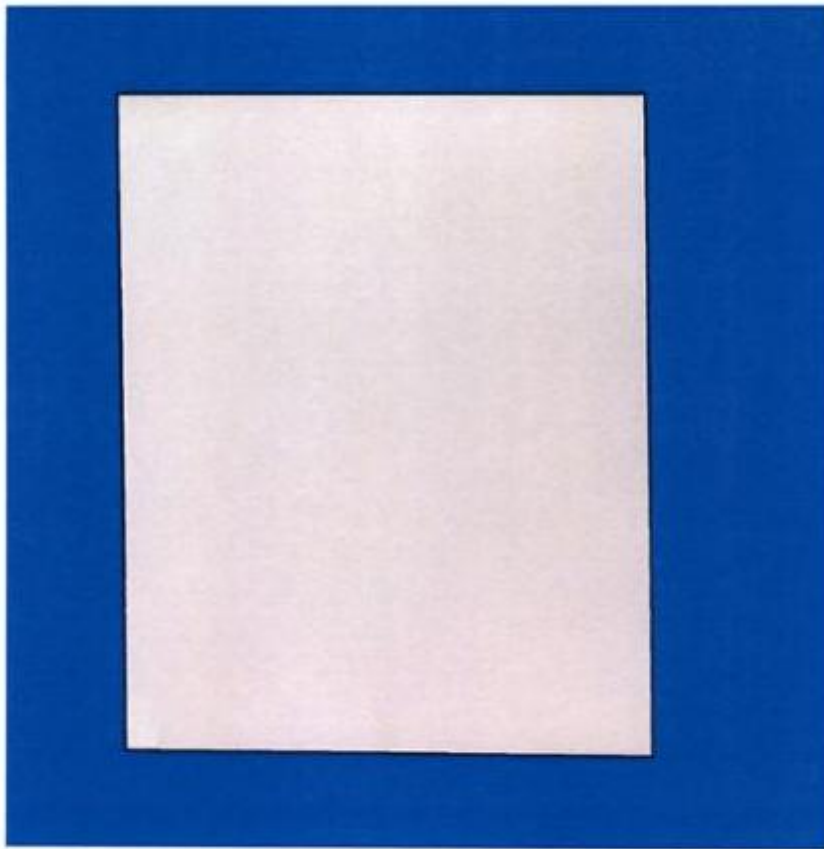

1.5



1.6

- (11) **36805**  
(21) 3-2019-01231 (28) 1  
(54) **LÒ SỬỞI ĐIỆN TỬ** (51) **23-03**  
(22) 20/05/2019 (43) 25/10/2019  
DONG GUAN SONG WEI ELECTRIC TECHNOLOGY CO., LTD. (CN)  
(73) Dapian Mei Village, Daling Shan Town, Dongguan City, Guangdong 523000, China  
(72) Weilin Lu (CN)  
(74) Công ty TNHH Trường Xuân (AGELESS CO.,LTD.)  
(55)

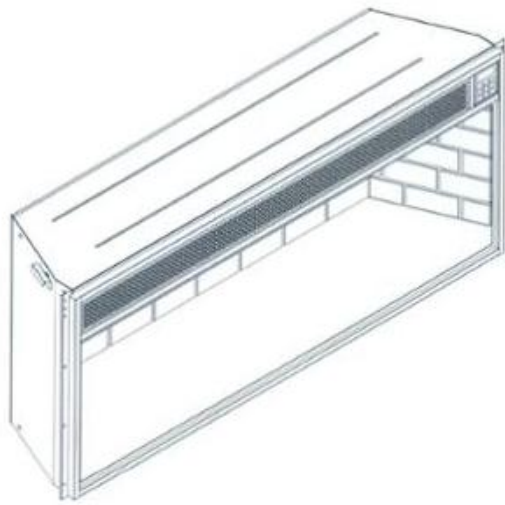

1.1



1.2



1.3



1.4



1.5

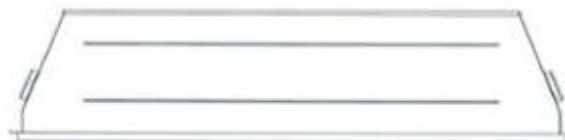

1.6

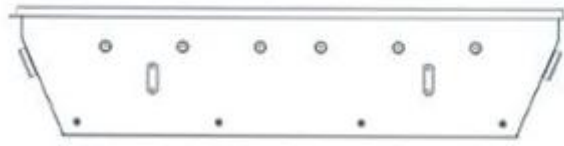

1.7

- (11) **36806**  
(21) 3-2019-01236 (28) 1  
(54) **HỘP ĐỰNG SẢN PHẨM** (51) **09-03**  
(22) 05/04/2018 (43) 25/10/2019  
(73) CÔNG TY TNHH VIỆT LAI HƯƠNG (VN)  
203A Võ Thị Sáu, phường 7, quận 3, thành phố Hồ Chí Minh  
(72) Lê Thị Lan (VN)  
(74) Công ty TNHH Sở hữu trí tuệ ALNGUYEN (ALNGUYEN IP CO.,LTD.)  
(55)



1.1



1.2



- (11) **36807**  
(21) 3-2019-01742 (28) 1  
(54) **THANH KIM LOẠI ĐỊNH HÌNH** (51) **25-01**  
(22) 09/07/2019 (43) 25/10/2019  
BÙI MINH TUẤN (VN)  
(73) P.706 NƠ 5, KĐT Pháp Vân - Tứ Hiệp, phường Hoàng Liệt, quận Hoàng Mai, thành phố Hà Nội  
(72) Bùi Minh Tuấn (VN)  
(74) Công ty TNHH Sở hữu trí tuệ PADEMARK (PADEMARK CO.,LTD.)  
(55)

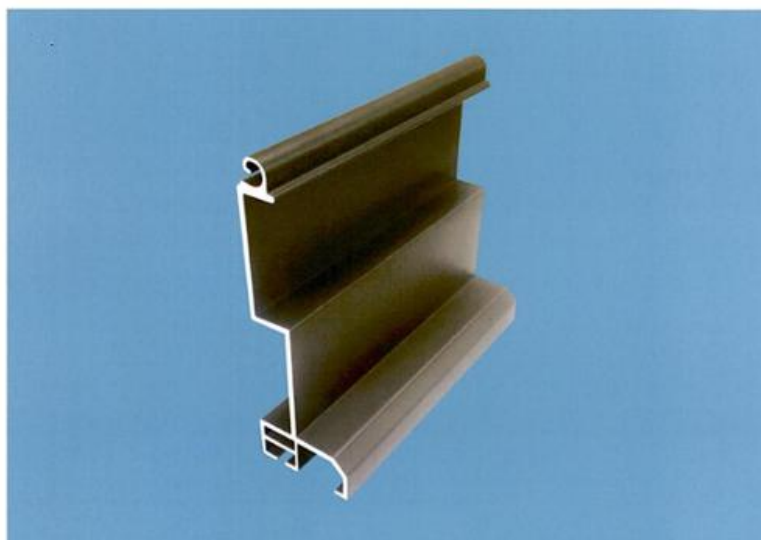

1.1

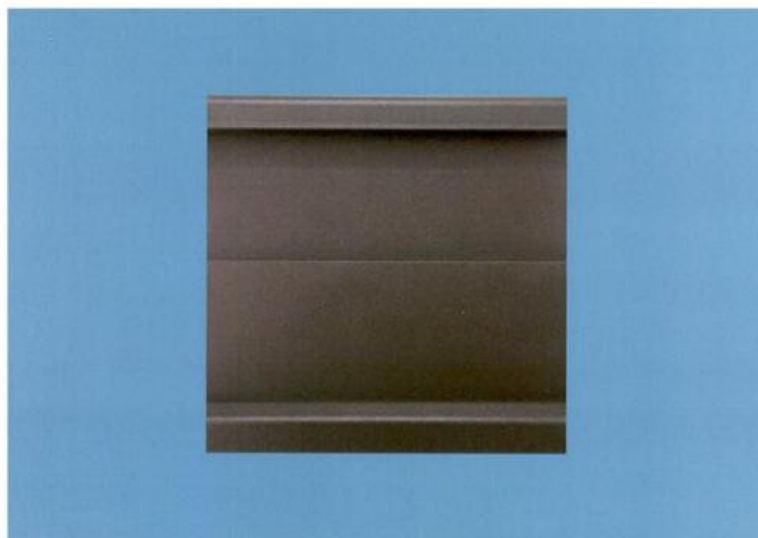

1.2

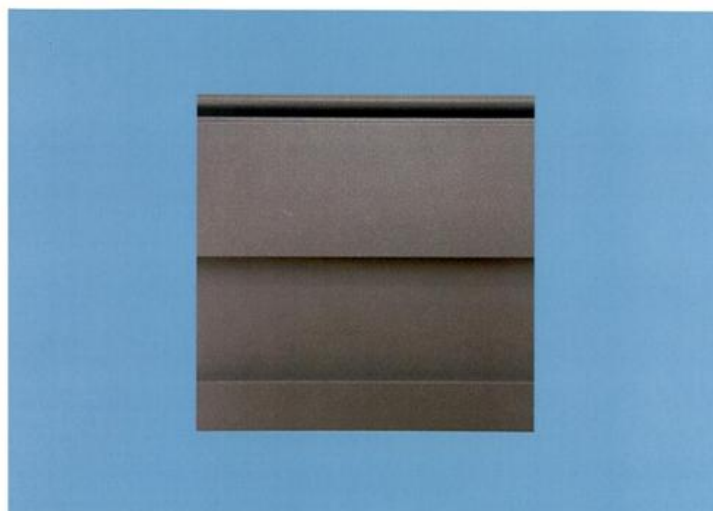

1.3

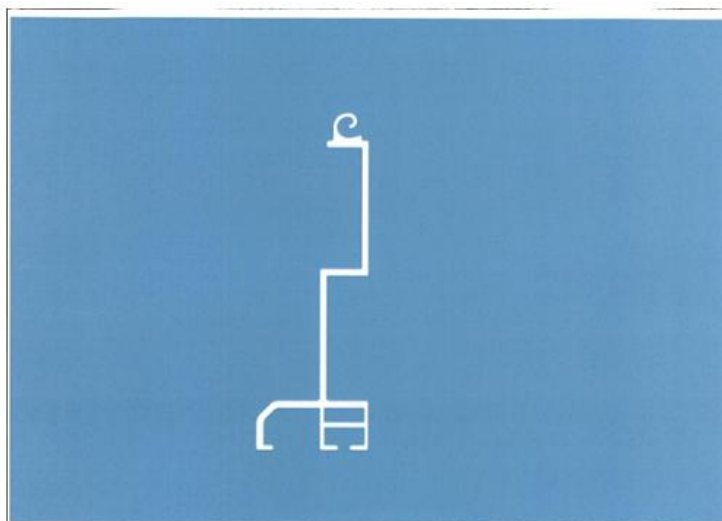

1.4

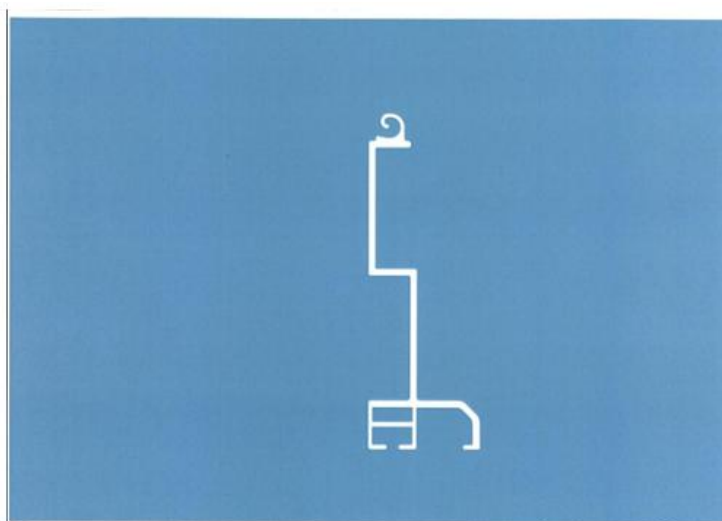

1.5

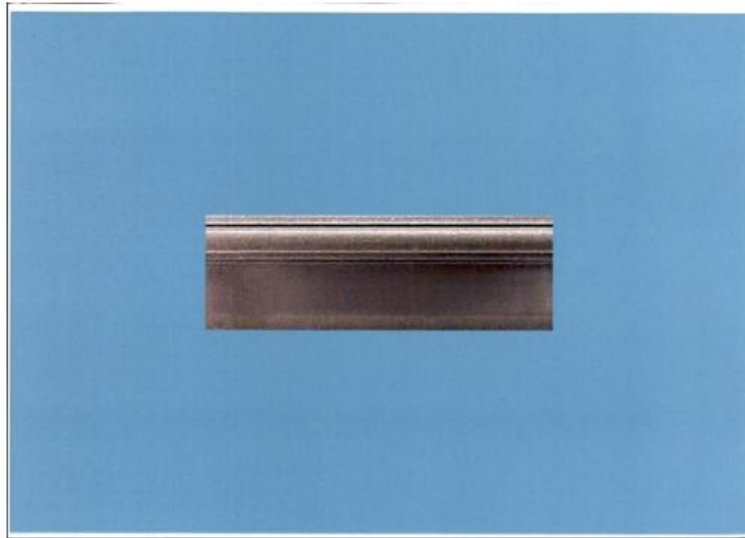

1.6

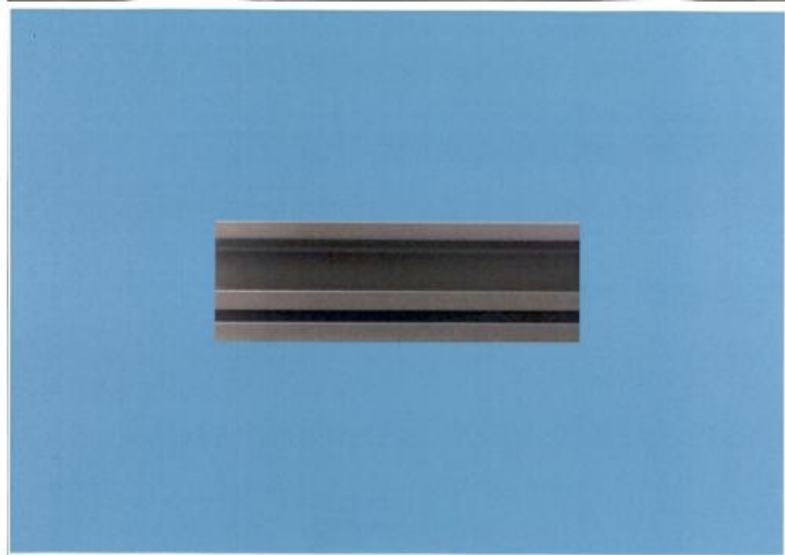

1.7

**CÔNG BÁO SỞ HỮU CÔNG NGHIỆP SỐ 379 TẬP A – QUYỀN 2 (10.2019)**

- (11) **36808**  
(21) 3-2019-01752 (28) 1  
(54) **NHÃN SẢN PHẨM** (51) **19-08**  
(22) 10/07/2019 (43) 25/10/2019  
(73) CÔNG TY TNHH ĐẦU TƯ THƯƠNG MẠI VÀ XUẤT NHẬP KHẨU HC (VN)  
Số 522 Minh Khai, phường Vĩnh Tuy, quận Hai Bà Trưng, thành phố Hà Nội  
(72) Nguyễn Thị Huyền Châu (VN)  
(55)



- (11) **36809**  
(21) 3-2019-01753 (28) 1  
(54) **NHÃN SẢN PHẨM** (51) **19-08**  
(22) 10/07/2019 (43) 25/10/2019  
(73) CÔNG TY TNHH NEW TULIP (VN)  
Khu Dương Ổ, phường Phong Khê, thành phố Bắc Ninh, tỉnh Bắc Ninh  
(72) Nguyễn Văn Long (VN)  
(55)



- (11) **36810**  
(21) 3-2019-01754 (28) 1  
(54) **LỘ ĐỪNG** (51) **09-01**  
(22) 10/07/2019 (43) 25/10/2019  
(73) LG HOUSEHOLD & HEALTH CARE LTD. (KR)  
58, Saemunan-ro, Jongno-gu, Seoul, Republic of Korea  
(72) 1. LEE, HYUN SEUNG (KR)  
2. JEONG, SONG EUN (KR)  
(74) Công ty TNHH Sở hữu trí tuệ Việt Á (VIET A IP CO.,LTD)  
(55)



1.1



1.2



1.3



1.4



1.5



1.6



1.7

- (11) **36811**  
(21) 3-2019-01755 (28) 1  
(54) **LỘ ĐỪNG** (51) **09-01**  
(22) 10/07/2019 (43) 25/10/2019  
(73) LG HOUSEHOLD & HEALTH CARE LTD. (KR)  
58, Saemunan-ro, Jongno-gu, Seoul, Republic of Korea  
(72) 1. LEE, HYUN SEUNG (KR)  
2. JEONG, SONG EUN (KR)  
(74) Công ty TNHH Sở hữu trí tuệ Việt Á (VIET A IP CO.,LTD)  
(55)



1.1



1.2



1.3



1.4





1.5



1.6



1.7

- (11) **36812**  
(21) 3-2019-01757 (28) 1  
(54) **NHÃN SẢN PHẨM** (51) **19-08**  
(22) 10/07/2019 (43) 25/10/2019  
(73) CÔNG TY TNHH MTV THUỐC LÁ THANH HÓA (VN)  
Thị trấn Hà Trung - huyện Hà Trung, tỉnh Thanh Hoá  
(72) Nguyễn Thanh Tâm (VN)  
(74) Công ty TNHH T&T INVENMARK Sở hữu trí tuệ Quốc tế (T&T INVENMARK  
CO., LTD.)  
(55)



1.1

- (11) **36813**  
(21) 3-2019-01758 (28) 1  
(54) **NHÃN SẢN PHẨM** (51) **19-08**  
(22) 10/07/2019 (43) 25/10/2019  
(73) CÔNG TY TNHH MTV THUỐC LÁ THANH HOÁ (VN)  
Thị trấn Hà Trung - huyện Hà Trung, tỉnh Thanh Hoá  
(72) Nguyễn Thanh Tâm (VN)  
(74) Công ty TNHH T&T INVENMARK Sở hữu trí tuệ Quốc tế (T&T INVENMARK  
CO., LTD.)  
(55)



1.1

- (11) **36814**  
(21) 3-2019-01759 (28) 1  
(54) **NHÃN SẢN PHẨM** (51) **19-08**  
(22) 10/07/2019 (43) 25/10/2019  
(73) CÔNG TY TNHH MTV THUỐC LÁ THANH HOÁ (VN)  
Thị trấn Hà Trung - huyện Hà Trung, tỉnh Thanh Hoá  
(72) Nguyễn Thanh Tâm (VN)  
(74) Công ty TNHH T&T INVENMARK Sở hữu trí tuệ Quốc tế (T&T INVENMARK  
CO., LTD.)  
(55)



1.1

- (11) **36815**  
(21) 3-2019-01747 (28) 1  
(54) **BỆ VỆ SINH** (51) **23-02**  
(22) 10/07/2019 (43) 25/10/2019  
(30) 201930027878.8 18/01/2019 CN;  
LIXIL INTERNATIONAL PTE. LTD. (SG)  
(73) 8 Temasek Boulevard #18-01/02 Suntec Tower 3 Singapore 038988  
1. ANTOINE BESSEYRE DES HORTS (FR)  
(72) 2. SUNGHYUN HWANG (KR)  
3. KANKAMON MAMEEWATTANA (TH)  
(74) Công ty Luật TNHH Phạm và Liên danh (PHAM & ASSOCIATES)  
(55)



1.1



1.2



1.3



1.4



1.5



1.6



1.7



1.8

- (11) **36816**  
(21) 3-2019-01748 (28) 1  
(54) **BỆ VỆ SINH** (51) **23-02**  
(22) 10/07/2019 (43) 25/10/2019  
(30) 201930027886.2 18/01/2019 CN;  
LIXIL INTERNATIONAL PTE. LTD. (SG)  
(73) 8 Temasek Boulevard #18-01/02 Suntec Tower 3 Singapore 038988  
1. ANTOINE BESSEYRE DES HORTS (FR)  
(72) 2. SUNGHYUN HWANG (KR)  
3. SINLAPACHAI PUTPAN (TH)  
(74) Công ty Luật TNHH Phạm và Liên danh (PHAM & ASSOCIATES)  
(55)



1.1

1.2



1.3

1.4



1.5



1.6



1.7



1.8



- (11) **36817**  
(21) 3-2019-01749 (28) 1  
(54) **CỤM VÒI SEN** (51) **23-01**  
(22) 10/07/2019 (43) 25/10/2019  
(30) 201930058834.1 01/02/2019 CN;  
(73) LIXIL INTERNATIONAL PTE. LTD. (SG)  
8 Temasek Boulevard #18-01/02 Suntec Tower 3 Singapore 038988  
(72) 1. ANTOINE BESSEYRE DES HORTS (FR)  
2. SUNGHYUN HWANG (KR)  
(74) Công ty Luật TNHH Phạm và Liên danh (PHAM & ASSOCIATES)  
(55)



1.1



1.2



1.3



1.4

1.5



1.6



1.7

- (11) **36818**  
(21) 3-2019-01751 (28) 1  
(54) **CHẬU RỬA** (51) **23-02**  
(22) 10/07/2019 (43) 25/10/2019  
(30) 201930057017.4 31/01/2019 CN;  
(73) LIXIL INTERNATIONAL PTE. LTD. (SG)  
8 Temasek Boulevard #18-01/02 Suntec Tower 3 Singapore 038988  
(72) 1. ANTOINE BESSEYRE DES HORTS (FR)  
2. SUNGHYUN HWANG (KR)  
(74) Công ty Luật TNHH Phạm và Liên danh (PHAM & ASSOCIATES)  
(55)



1.1



1.2

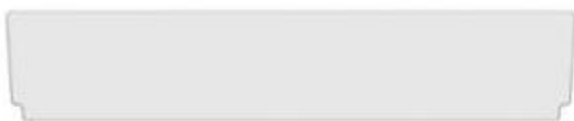

1.3



1.4



1.5



1.6



1.7

- (11) **36819**  
(21) 3-2019-01763 (28) 1  
(54) **BÚT BI** (51) **19-06**  
(22) 11/07/2019 (43) 25/10/2019  
CÔNG TY TNHH THANH CHƯỜNG (VN)  
(73) Số 22 Khu tập thể giám định máy nông nghiệp, thị trấn Trâu Quỳ, huyện Gia  
Lâm, thành phố Hà Nội  
(72) Phan Văn Cường (VN)  
(74) Công ty TNHH Sở hữu trí tuệ Bình Minh (SUNRISE IP CO.,LTD.)  
(55)



- (11) **36820**  
(21) 3-2019-01772 (28) 1  
(54) **THUYỀN** (51) **12-06**  
(22) 11/07/2019 (43) 25/10/2019  
(30) 30-2019-0005050 31/01/2019 KR;  
1. PARK, Sung A (KR)  
No. 101, Saman Villa, 199, Danwon-ro, Andong-si, Gyeongsangbuk-do 36689,  
Republic of Korea  
(73) 2. SONG, Jin Ho (KR)  
No. 101, Saman Villa, 199, Danwon-ro, Andong-si, Gyeongsangbuk-do 36689,  
Republic of Korea  
(72) 1. PARK, SUNG A (KR)  
2. SONG, JIN HO (KR)  
(74) Công ty TNHH Tầm nhìn và Liên danh (VISION & ASSOCIATES CO.LTD.)  
(55)

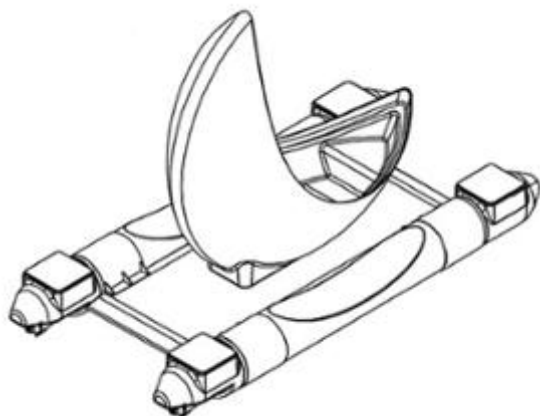

1.1

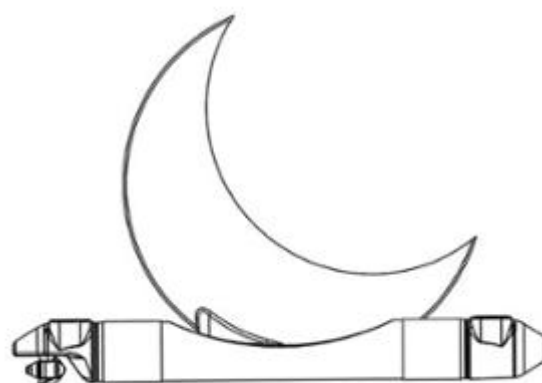

1.2

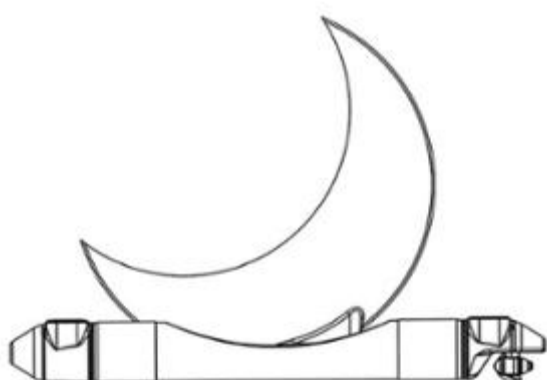

1.3

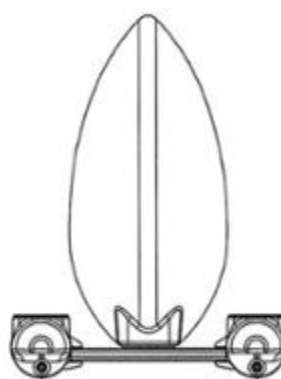

1.4

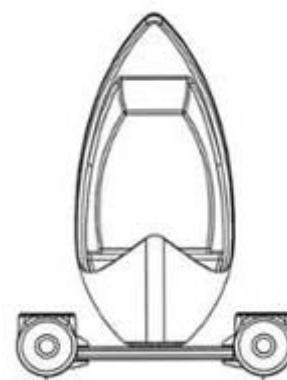

1.5

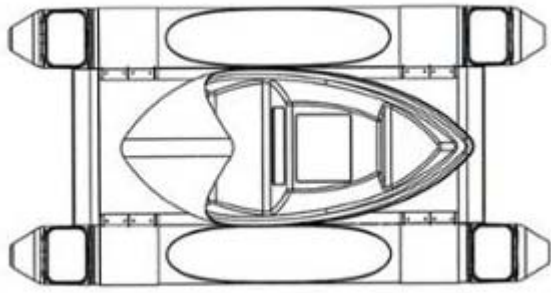

1.6

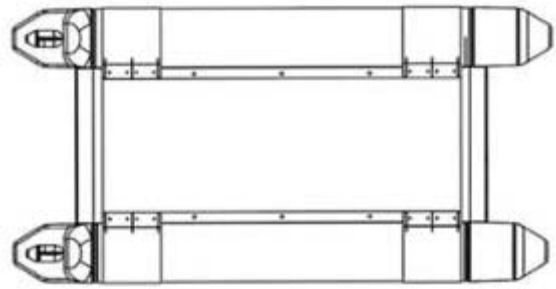

1.7

- (11) **36821**  
(21) 3-2019-01771 (28) 4  
(54) **HỘP ĐỰNG** (51) **09-03**  
(22) 11/07/2019 (43) 25/10/2019  
(73) BINGGRAE CO., LTD. (KR)  
45, Dasansunhwan-ro, Namyangju-si, Gyeonggi-do, Republic of Korea  
(72) Kwon Eunji (KR)  
(74) Công ty TNHH Trường Xuân (AGELESS CO.,LTD.)  
(55)



1.1



1.2



1.3



1.4



1.5

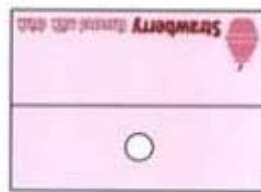

1.6

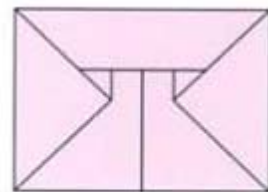

1.7



18





2.1



2.2



2.3



2.4



2.5



2.6

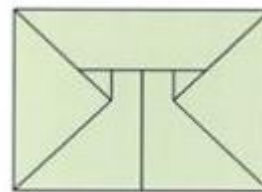

2.7



2.8



3.1



3.2



3.3



3.4



3.5



3.6

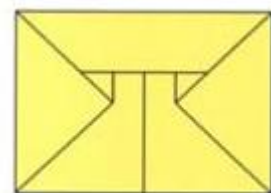

3.7



3.8



4.1



4.2



4.3



4.4



4.5

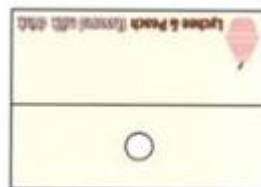

4.6

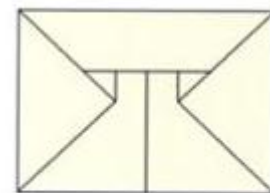

4.7

**Lychee & Peach Flavored milk drink**

**Ginggrae**

**Lychee & Peach**

Flavored milk drink

Bonjour au Lait. Amable au Lait et à la Pêche

**Korea's Favorite**

**ORIGINAL**

MILK DRINK



**빙그레**

**리치피치맛**

**우유**

**LYCHEE & PEACH**

**ORIGINAL**



**빙그레**

**리치피치맛**

**우유**

**LYCHEE & PEACH**

**ORIGINAL**

**Nutrition Facts / Valeur nutritive**

Serving size 200 mL (8 fl. oz.)

Calories / Calories 160

Total Fat / Lipides	0g	0%
Saturated Fat / Acides gras	0g	0%
Trans Fat / Trans	0g	0%
Cholesterol / Cholestérol	0mg	0%
Sodium / Sodium	0mg	0%
Total Carbohydrate / Glucides	20g	4%
Sugar / Sucre	0g	0%
Total Sugar / Sucre	20g	40%
Protein / Protéines	10g	20%

**빙그레 리치피치맛 우유**

**리치피치맛 우유**

4.8

- (11) **36822**  
(21) 3-2019-01773 (28) 1  
(54) **CHAI ĐỰNG** (51) **09-01**  
(22) 12/07/2019 (43) 25/10/2019  
(73) CÔNG TY TNHH DẦU THỰC VẬT DABACO (VN)  
(72) Cụm công nghiệp Tân Chi, xã Tân Chi, huyện Tiên Du, tỉnh Bắc Ninh  
(72) Nguyễn Như So (VN)  
(55)



1.1

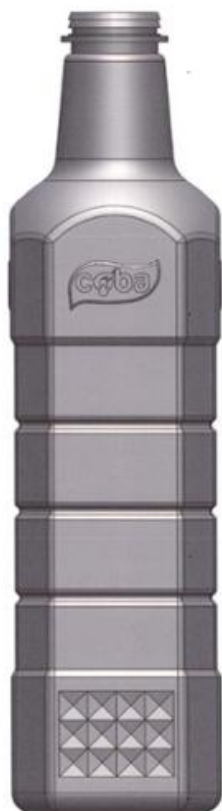

1.2



1.3



1.4

- (11) **36823**  
(21) 3-2018-02719 (28) 1  
(54) **CHAI** (51) **09-01**  
(22) 14/12/2018 (43) 25/10/2019  
(73) **CÔNG TY CỔ PHẦN THỰC PHẨM SỮA TH (VN)**  
Xã Nghĩa Sơn, huyện Nghĩa Đàn, tỉnh Nghệ An  
(72) Vũ Phạm Duy (VN)  
(74) Công ty Luật TNHH IP MAX (IPMAX LAW FIRM)  
(55)



1.1



1.2



1.3



1.4

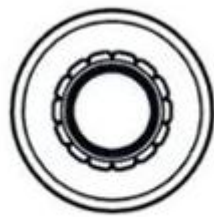

1.5



1.6



1.7



- (11) **36824**  
(21) 3-2019-00373 (28) 1  
(54) **VA-LI** (51) **03-01**  
(22) 01/02/2019 (43) 25/10/2019  
(30) 2018-3647 03/08/2018 FR;  
(73) LOUIS VUITTON MALLETIER (FR)  
2 rue du Pont-Neuf, 75001 Paris, France  
(72) Marc NEWSON (AU)  
(74) Công ty Luật TNHH quốc tế BMVN (BMVN INTERNATIONAL LLC)  
(55)

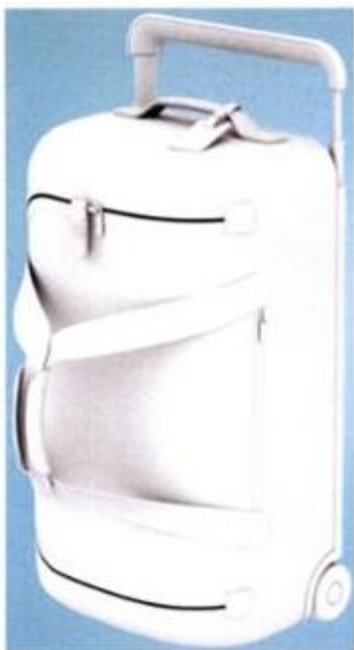

1.1



1.2

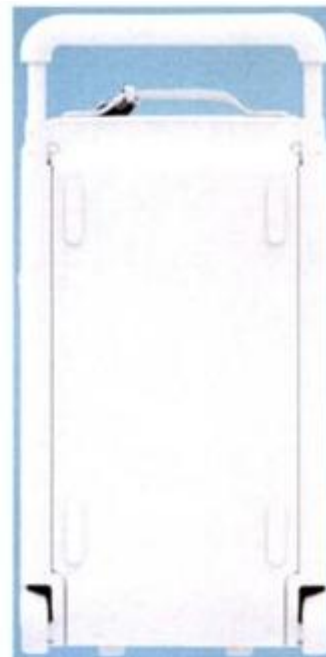

1.3



1.4



1.5



1.6



1.7

- (11) **36825**  
(21) 3-2019-01335 (28) 1  
(54) **TẮM CẢN VA PHÍA TRƯỚC XE Ô TÔ** (51) **12-16**  
(22) 22/05/2019 (43) 25/10/2019  
(30) 2018-026059 30/11/2018 JP;  
HONDA MOTOR CO., LTD. (JP)  
(73) 1-1, Minami-Aoyama 2-chome, Minato-ku, Tokyo, 107-8556 Japan  
(72) Wataru MURAKAMI (JP)  
(74) Công ty Luật TNHH Phạm và Liên danh (PHAM & ASSOCIATES)  
(55)



1.1



1.2



1.3



1.4



1.5



1.6



1.7



1.8

- (11) **36826**  
(21) 3-2019-01987 (28) 1  
(54) **BẾP** (51) **07-02**  
(22) 07/08/2019 (43) 25/10/2019  
(73) CÔNG TY TNHH SẢN XUẤT THAN VIỆT (VN)  
Nhà A1B số 25 Láng Hạ, phường Thành Công, quận Ba Đình, thành phố Hà Nội  
(72) Nguyễn Thị Hồng Hạnh (VN)  
(55)



1.1

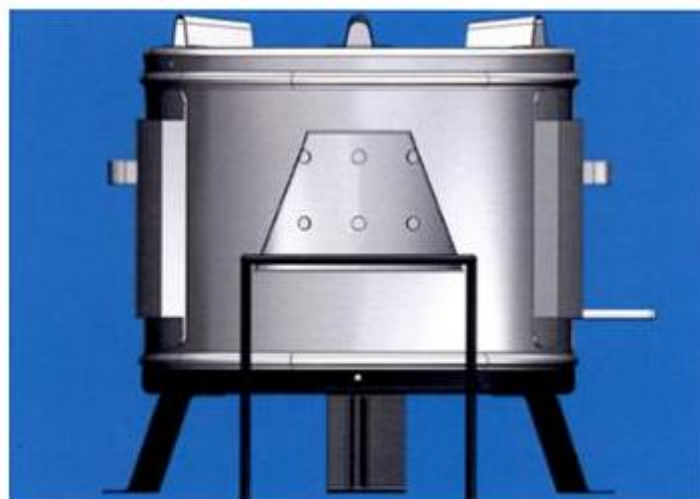

1.2



1.3

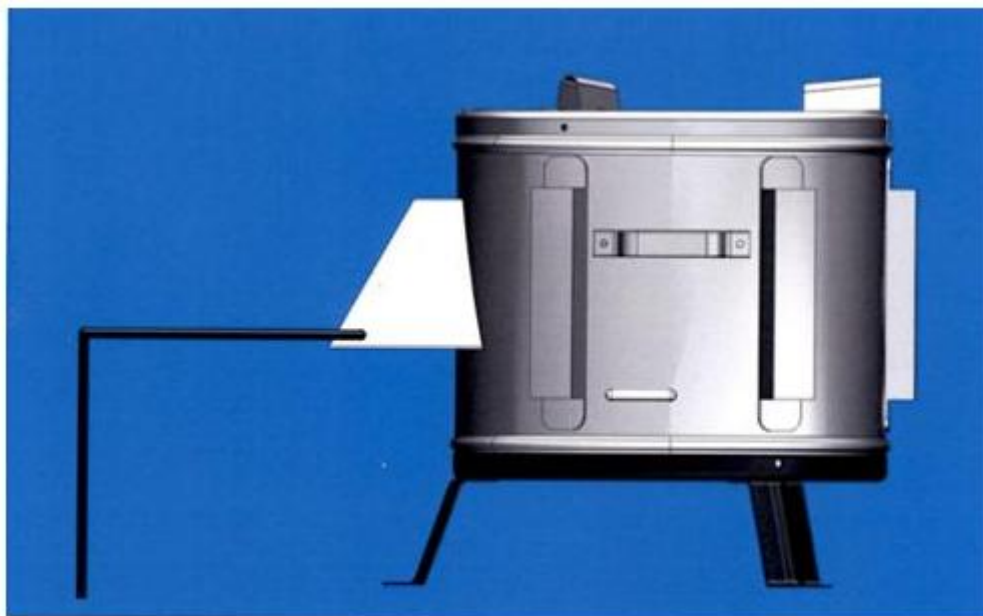

1.4

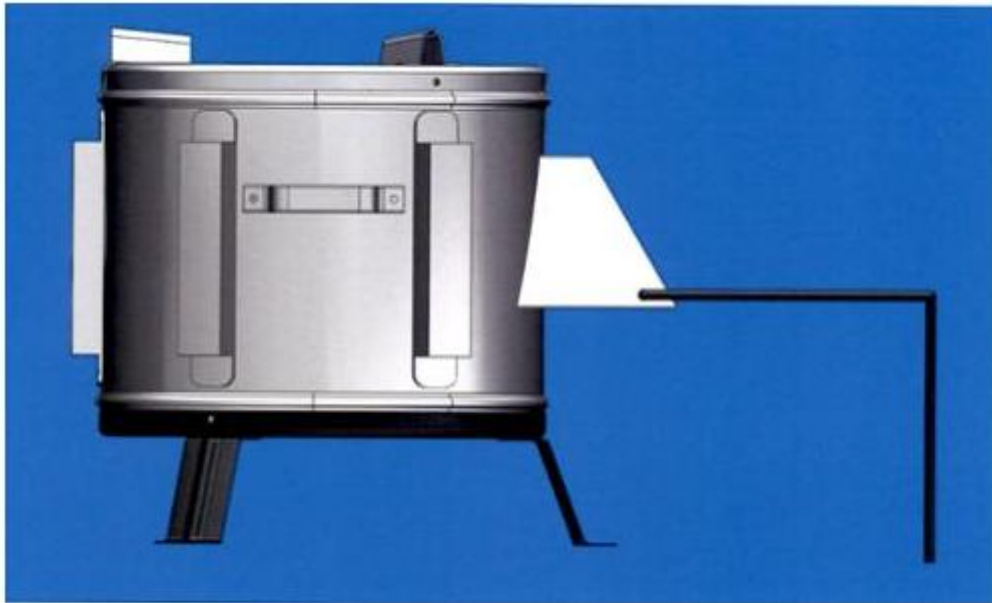

1.5

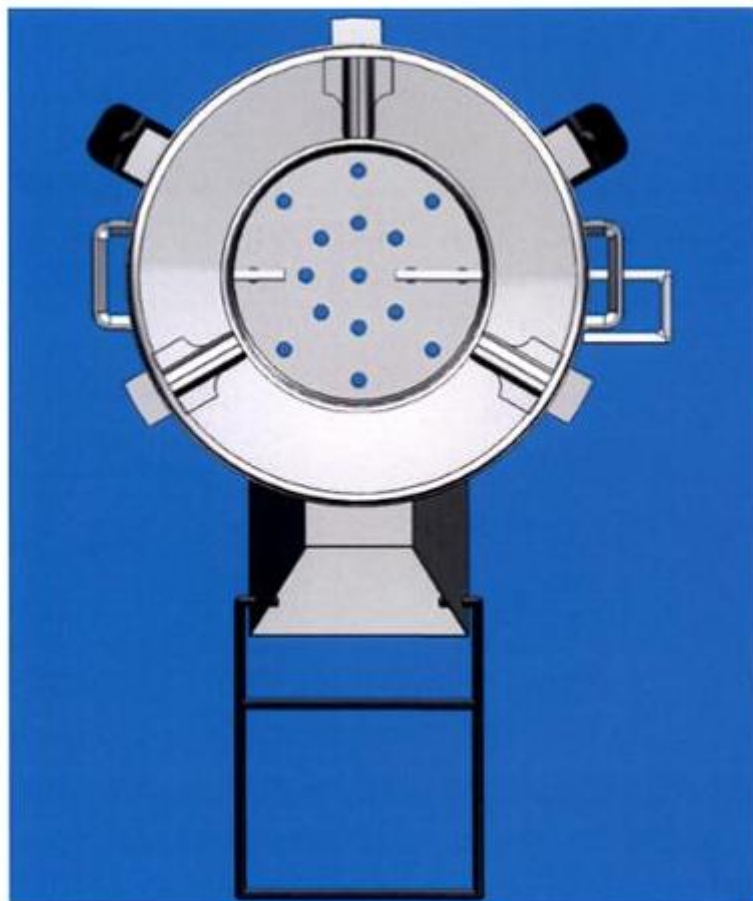

1.6

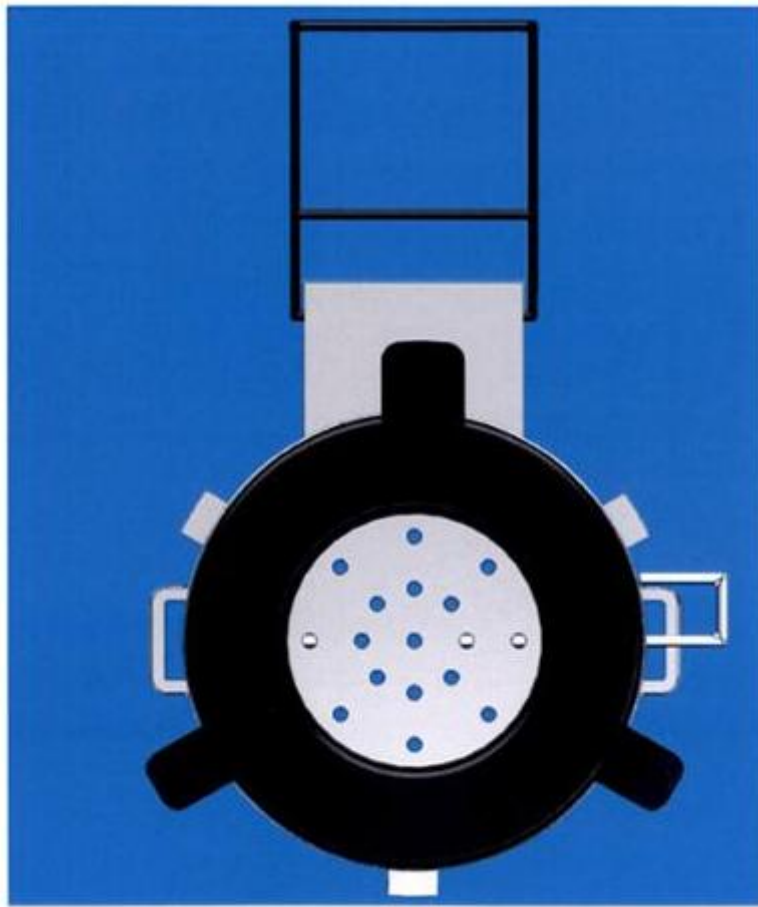

1.7



- (11) **36827**  
(21) 3-2019-01725 (28) 1  
(54) **HỘP ĐỰNG TRÀ** (51) **09-03**  
(22) 08/07/2019 (43) 25/10/2019  
CÔNG TY TNHH SẢN XUẤT Y HỌC CỔ TRUYỀN VÀ ĐÔNG DƯỢC THỂ  
(73) GIA (VN)  
Thôn Thác Hoa 3, xã Sơn Thịnh, huyện Văn Chấn, tỉnh Yên Bái  
(72) Hà Thị Hằng (VN)  
(74) Công ty TNHH SHARETOLINK Việt Nam (VN SHARETOLINK COMPANY LIMITED)  
(55)



1.1



1.2

- (11) **36828**  
(21) 3-2019-00900 (28) 1  
(54) **DÉP** (51) **02-04**  
(22) 09/04/2019 (43) 25/10/2019  
(73) CÔNG TY TNHH GIÀY Á CHÂU (VN)  
451/29/8 Tô Hiến Thành, phường 14, quận 10, thành phố Hồ Chí Minh  
(72) Nguyễn Đình Kim (VN)  
(74) Văn phòng Luật sư A Hoà (AHOA LAW OFFICE)  
(55)



1.1



1.2



1.3



1.4



1.5



1.6



1.7



1.8

**CÔNG BÁO SỞ HỮU CÔNG NGHIỆP SỐ 379 TẬP A – QUYỀN 2 (10.2019)**

- (11) **36829**  
(21) 3-2019-01108 (28) 1  
(54) **HỘP ĐỰNG SẢN PHẨM** (51) **09-03**  
(22) 06/05/2019 (43) 25/10/2019  
CÔNG TY CỔ PHẦN NHÀ MÁY TRANG THIẾT BỊ Y TẾ USM  
HEALTHCARE (VN)  
(73) Lô I-4b-1.3, đường N3, khu Công Nghệ Cao, phường Long Thạnh Mỹ, quận 9,  
thành phố Hồ Chí Minh  
(72) Võ Xuân Bội Lâm (VN)  
(55)



1.1

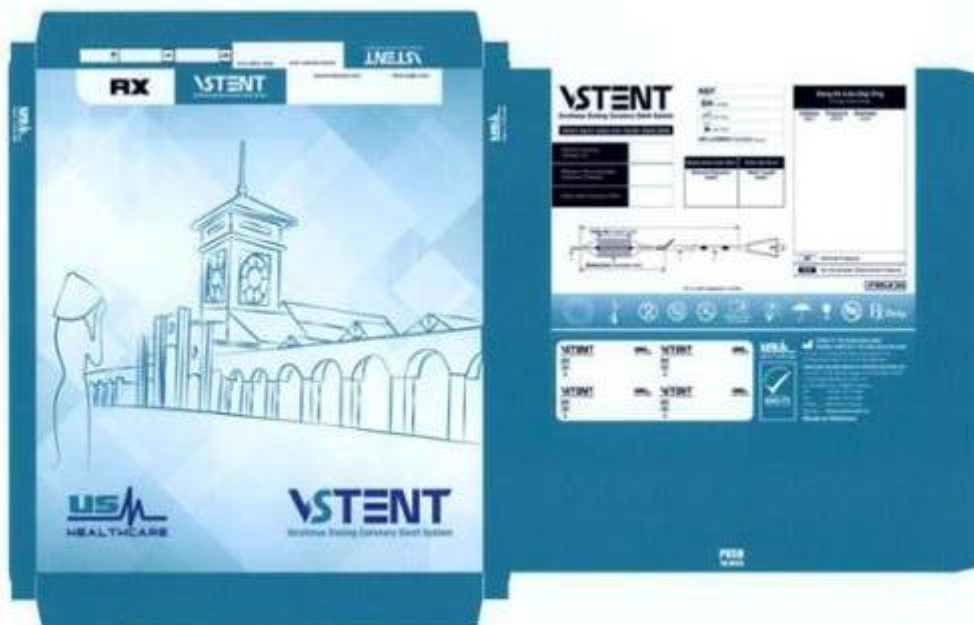

1.2

(11) **36830**

(21) 3-2018-02155

(54) **NẠNG**

(22) 11/10/2018

CÔNG TY TNHH SẢN XUẤT THƯƠNG MẠI DỊCH VỤ TÂN THÁI BÌNH

(73) DƯƠNG (VN)

Số 146 Lò Siêu, phường 12, quận 11, thành phố Hồ Chí Minh

(72) Liêu Chí Siêu (VN)

(55)

(28) 1

(51) **03-03**

(43) 25/10/2019



- (11) **36831**  
(21) 3-2019-00420 (28) 1  
(54) **BỘ LÀM NÓNG** (51) **15-99**  
(22) 14/02/2019 (43) 25/10/2019  
(73) WANG FENG LING (CN)  
NO. 22 JIAN GUO MEN WAI AVE. BEIJING, 100004 P. R. CHINA  
(72) WANG FENG LING (CN)  
(74) Công ty cổ phần Tư vấn S&B (S&B CONSULTANT., CORP.)  
(55)

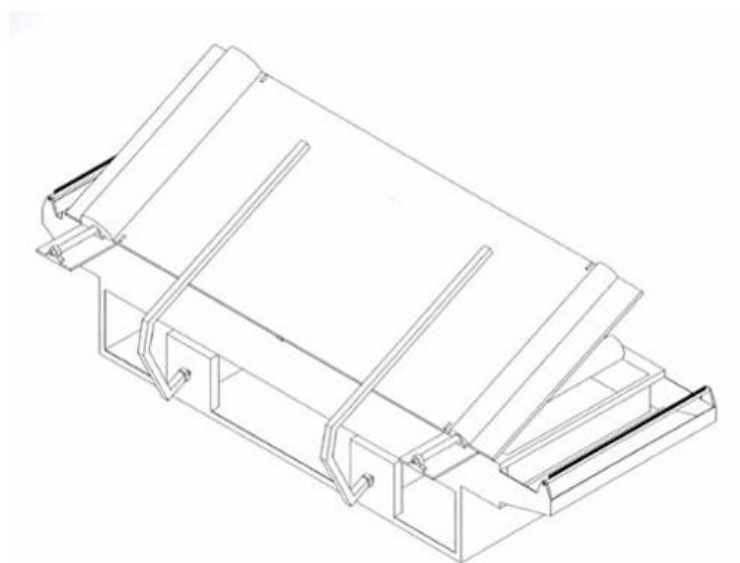

1.1

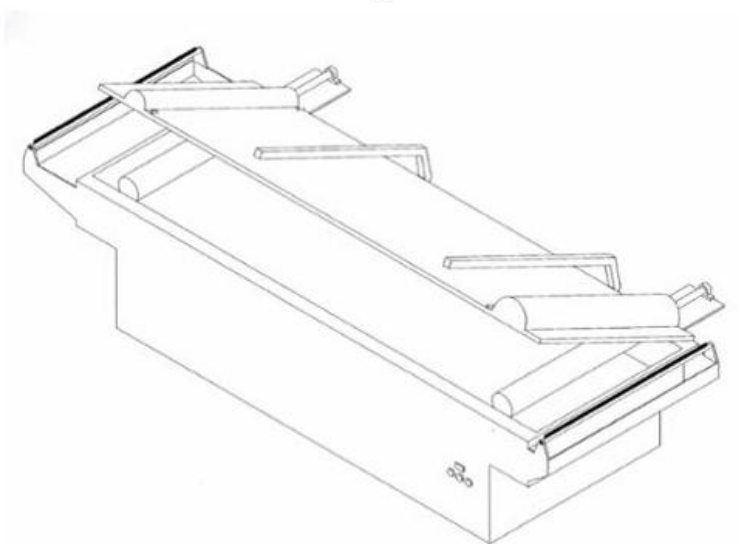

1.2



1.3

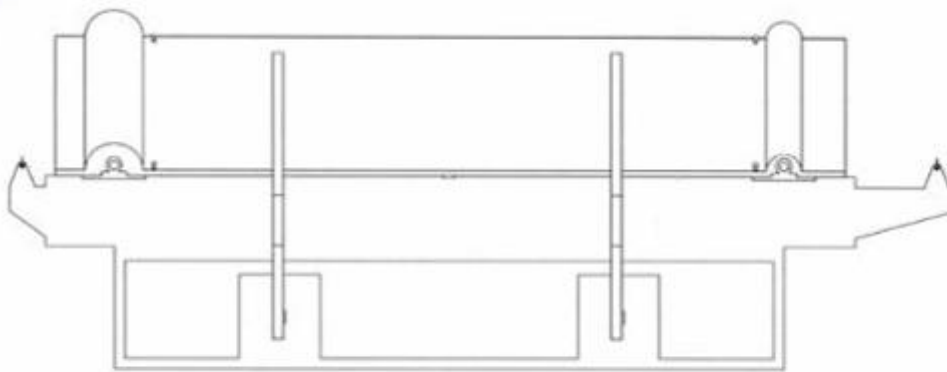

1.4

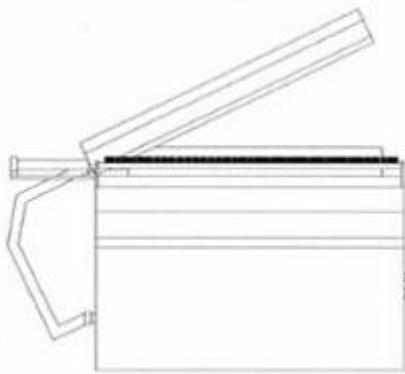

1.5

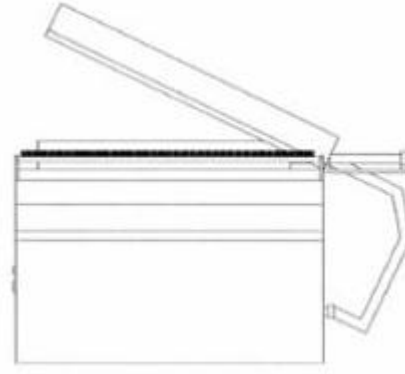

1.6

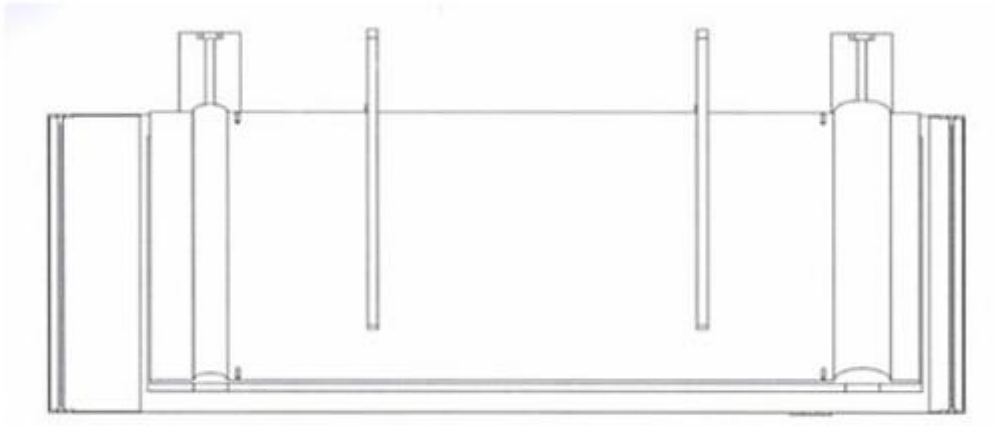

1.7

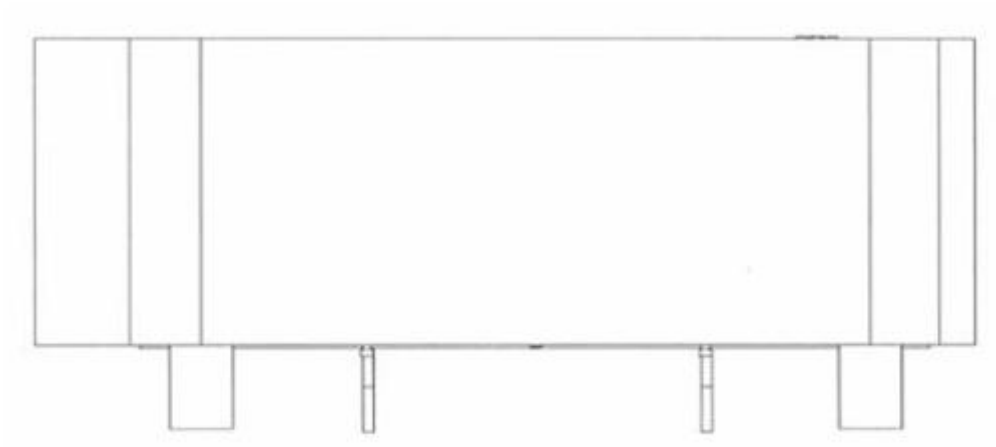

1.8



- (11) **36832**  
(21) 3-2019-01384 (28) 1  
(54) **ĐIỆN THOẠI DI ĐỘNG** (51) **14-03**  
(22) 28/05/2019 (43) 25/10/2019  
(30) 201830685271.4 29/11/2018 CN;  
HUAWEI TECHNOLOGIES CO., LTD. (CN)  
(73) Huawei Administration Building, Bantian, Longgang, Shenzhen, Guangdong  
518129, China  
(72) 1. YANG ZHANG (CN)  
2. ZE YUAN (CN)  
(74) Công ty Luật TNHH Phạm và Liên danh (PHAM & ASSOCIATES)  
(55)

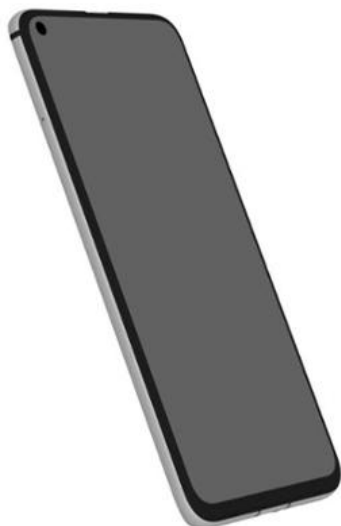

1.1



1.2



1.3



1.4



1.5



1.6



1.7



1.8

- (11) **36833**  
(21) 3-2019-01361 (28) 1  
(54) **TẤM TẢN NHIỆT DÙNG CHO QUẠT THÔNG GIÓ** (51) **23-04**  
(22) 24/05/2019 (43) 25/10/2019  
(73) PANASONIC INTELLECTUAL PROPERTY MANAGEMENT CO., LTD. (JP)  
1-61, Shiromi 2-chome, Chuo-ku, Osaka-shi, Osaka 540-6207 Japan  
(72) 1. NOBUYUKI MASE (JP)  
2. YASHIO SHIMADA (JP)  
(74) Công ty Luật TNHH Phạm và Liên danh (PHAM & ASSOCIATES)  
(55)

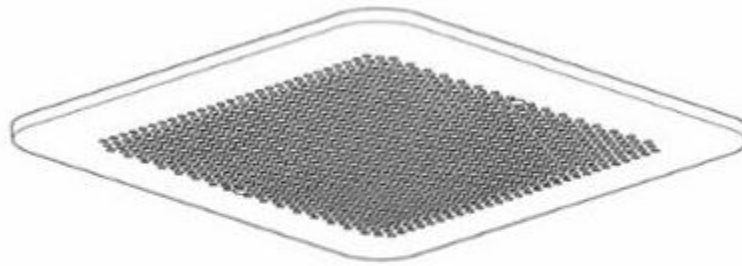

1.1

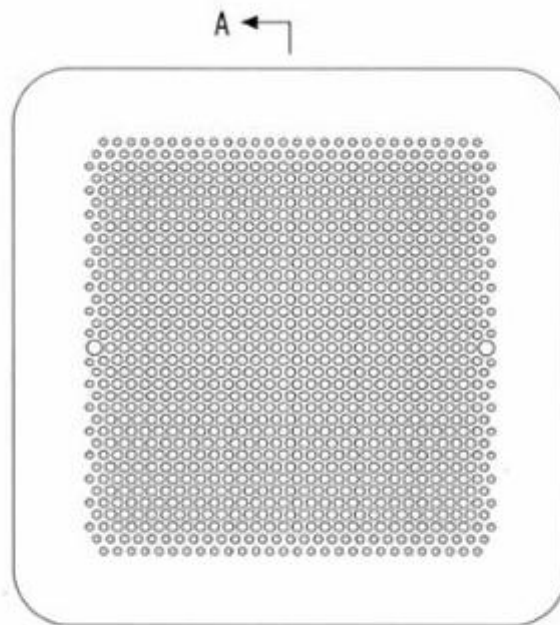

1.2

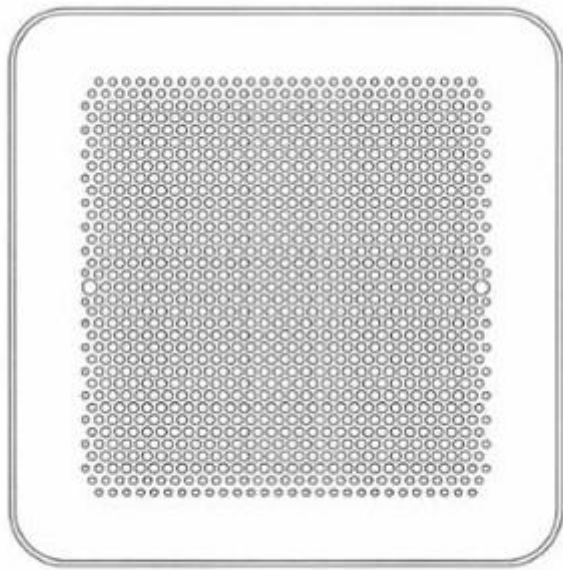

1.3



1.4



1.5



1.6

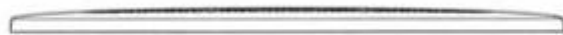

1.7



1.8

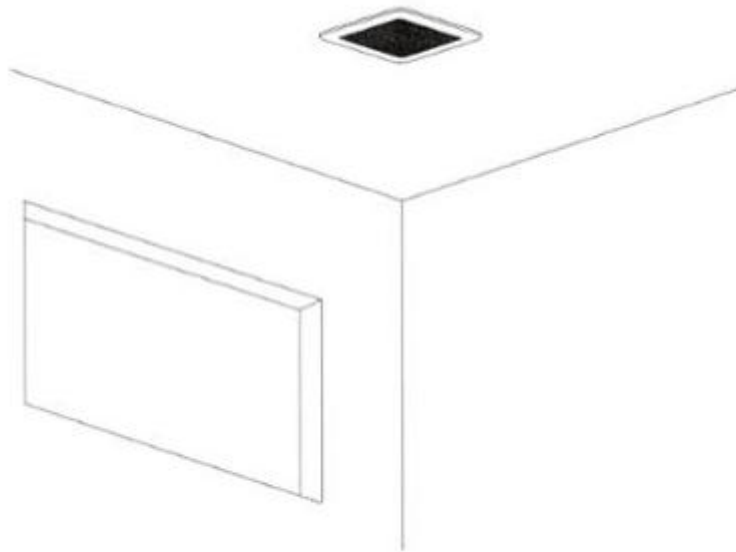

1.9

- (11) **36834**  
(21) 3-2019-01372 (28) 1  
(54) **MÓC TREO GIÀY** (51) **08-08**  
(22) 24/05/2019 (43) 25/10/2019  
GAO HUAWEN (CN)  
(73) Xiaoyanwan Group, Tudipo Village, Zoushi Town, Taoyuan County, Changde, Hunan Province, China  
(72) Gao Huawen (CN)  
(74) Công ty TNHH Trường Xuân (AGELESS CO.,LTD.)  
(55)



1.1



1.2



1.3



1.4

1.5



1.6

1.7

- (11) **36835**  
(21) 3-2019-01374 (28) 1  
(54) **LỌ ĐỰNG** (51) **09-01**  
(22) 27/05/2019 (43) 25/10/2019  
(30) 30-2019-0024056 22/05/2019 KR;  
(73) LG HOUSEHOLD & HEALTH CARE LTD. (KR)  
58, Saemunan-ro, Jongno-gu, Seoul, Republic of Korea  
(72) CHOI, Jae Eun (KR)  
(74) Công ty TNHH Sở hữu trí tuệ Việt Á (VIET A IP CO.,LTD)  
(55)

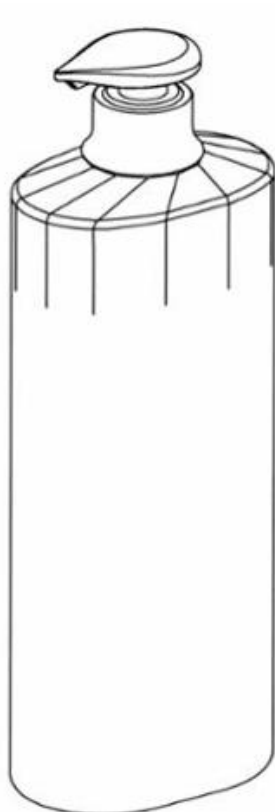

1.1



1.2



1.3



1.4





1.5

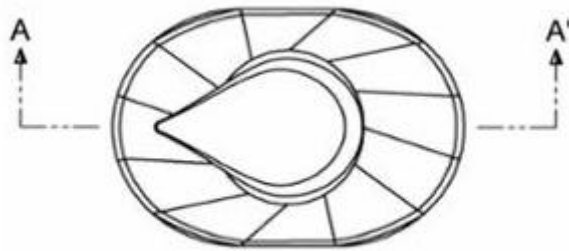

1.6

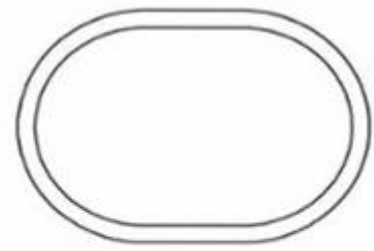

1.7

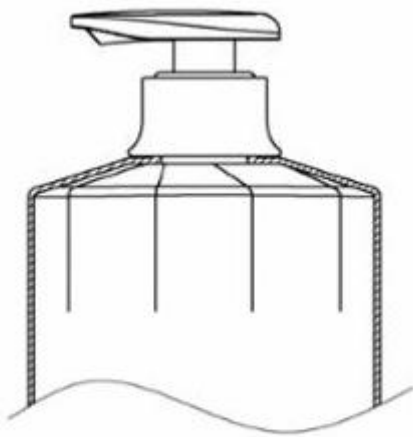

1.8

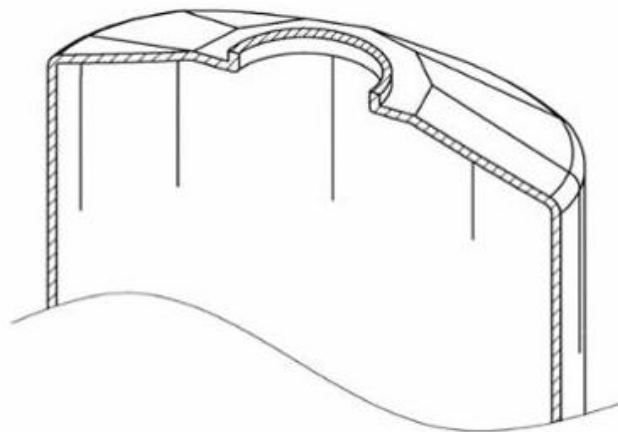

1.9

- (11) **36836**  
(21) 3-2019-01375 (28) 1  
(54) **DỤNG CỤ VI KIM DÙNG ĐỂ CHĂM SÓC DA** (51) **28-03**  
(22) 27/05/2019 (43) 25/10/2019  
(30) 30-2019-0024057 22/05/2019 KR;  
(73) LG HOUSEHOLD & HEALTH CARE LTD. (KR)  
58, Saemunan-ro, Jongno-gu, Seoul, Republic of Korea  
(72) LEE, Hye Jin (KR)  
(74) Công ty TNHH Sở hữu trí tuệ Việt Á (VIET A IP CO.,LTD)  
(55)

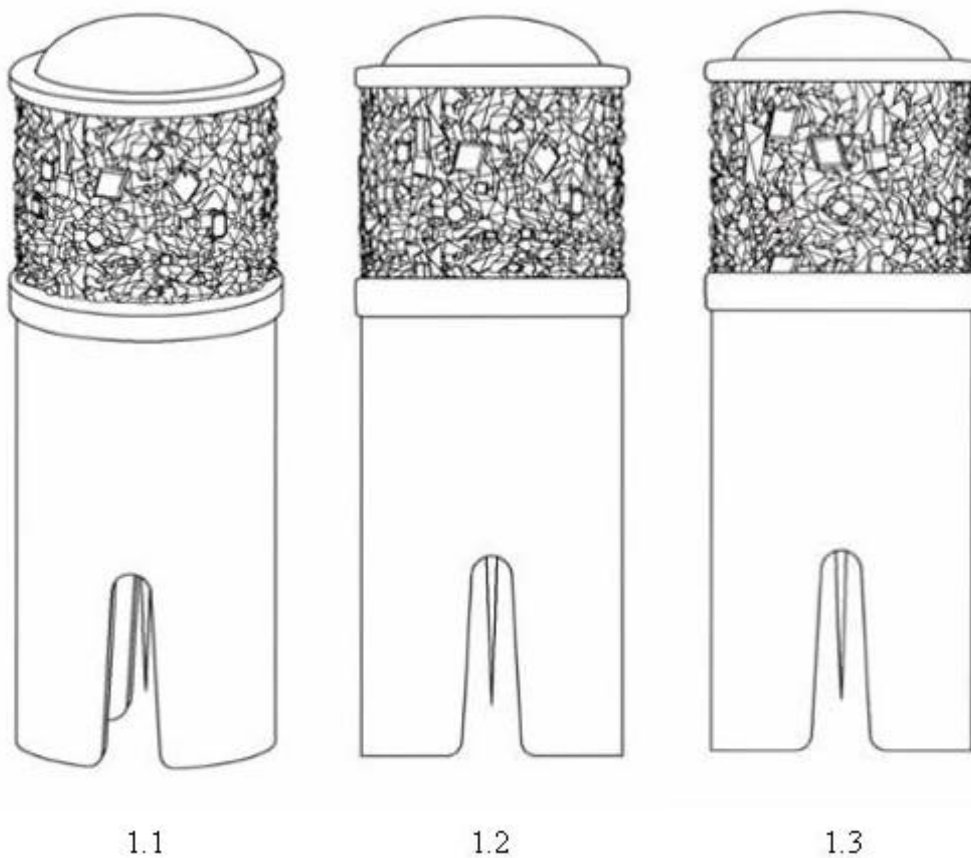

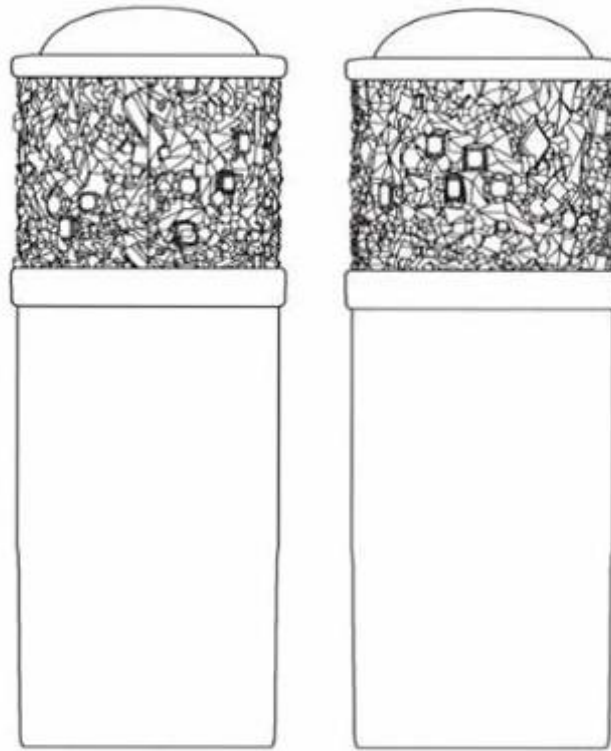

1.4

1.5

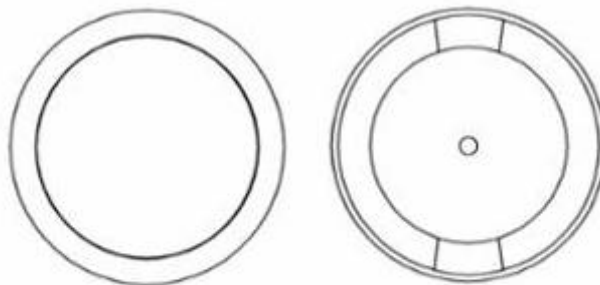

1.6

1.7

- (11) **36837**  
(21) 3-2019-01376 (28) 1  
(54) **HỘP Đựng ĐỒ LÀM ĐẸP** (51) **28-02**  
(22) 27/05/2019 (43) 25/10/2019  
(30) 30-2019-0024058 22/05/2019 KR;  
(73) LG HOUSEHOLD & HEALTH CARE LTD. (KR)  
58, Saemunan-ro, Jongno-gu, Seoul, Republic of Korea  
(72) LEE, Hye Jin (KR)  
(74) Công ty TNHH Sở hữu trí tuệ Việt Á (VIET A IP CO.,LTD)  
(55)



1.1

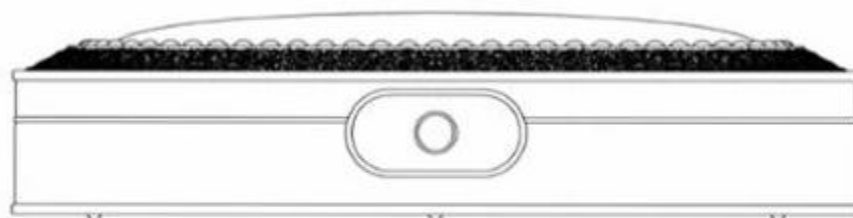

1.2

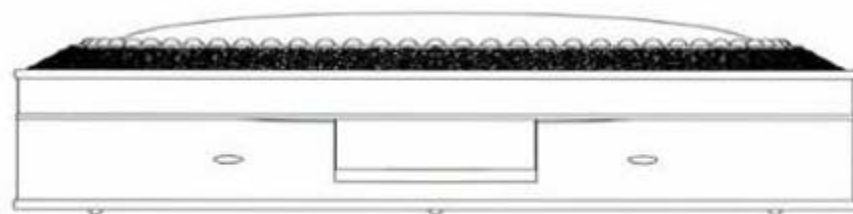

1.3

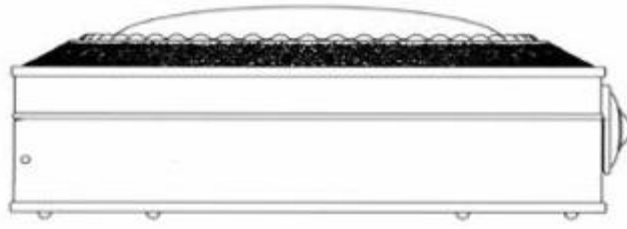

1.4

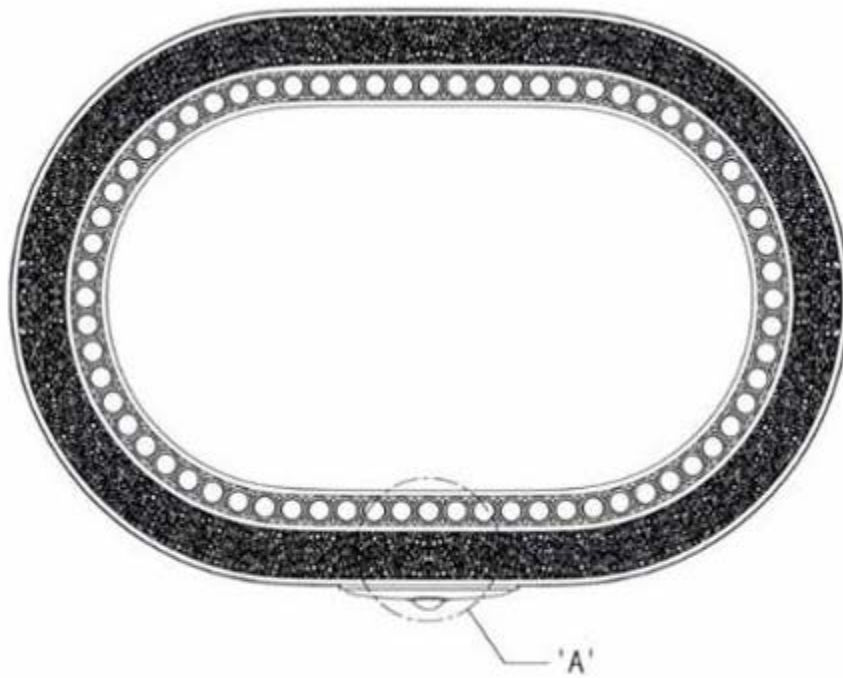

1.5

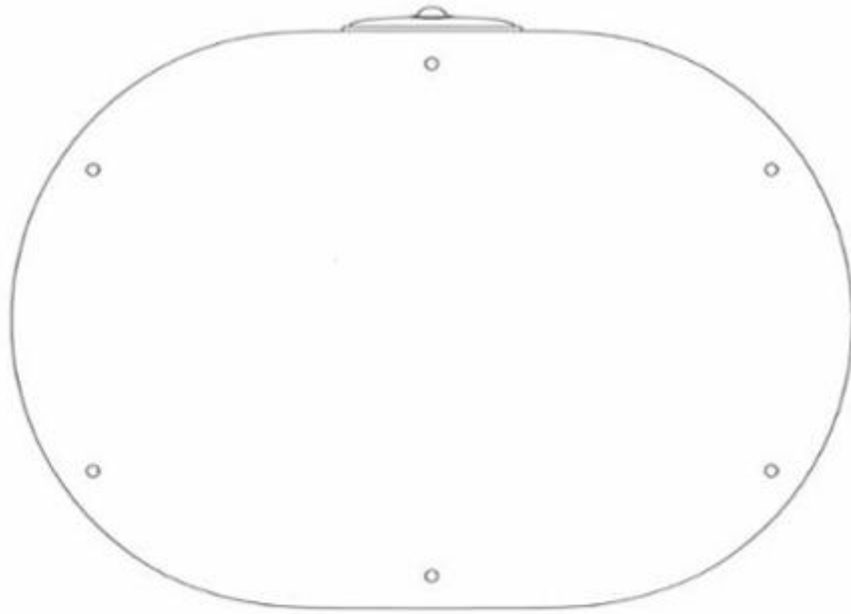

1.6

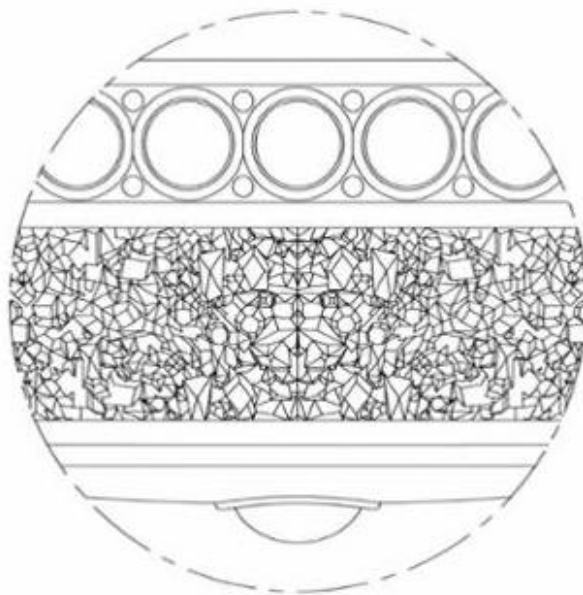

1.7

- (11) **36838**  
(21) 3-2019-01380 (28) 1  
(54) **MŨ BẢO HIỂM** (51) **02-03**  
(22) 27/05/2019 (43) 25/10/2019  
(30) 19-E0028-0101 03/05/2019 MY;  
HENRY TEDJAKUSUMA (ID)  
(73) Jalan Wuluh Blok II/3, RT/RW 009/006, Kota Bambu Utara, Palmerah, Jakarta  
Barat Indonesia  
(72) Henry Tedjakusuma (ID)  
(74) Công ty TNHH Sở hữu trí tuệ HA VIP (HAVIP CO., LTD.)  
(55)

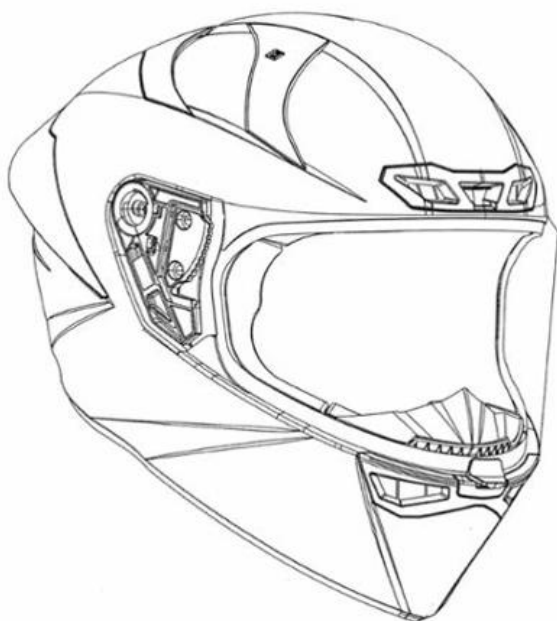

1.1

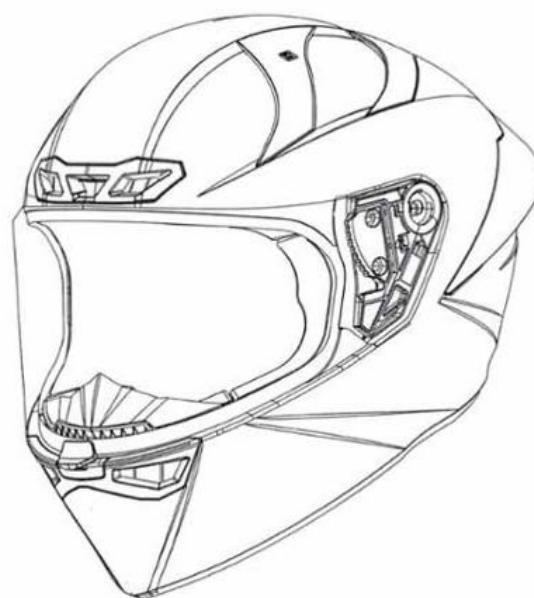

1.2



1.3



1.4

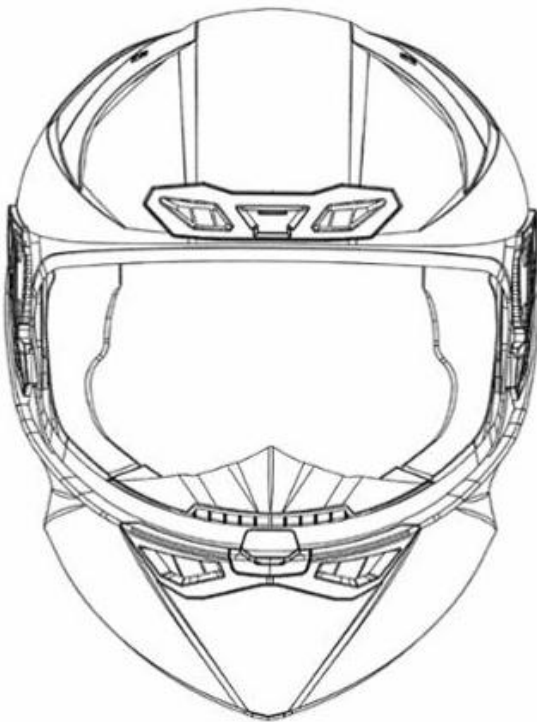

1.5

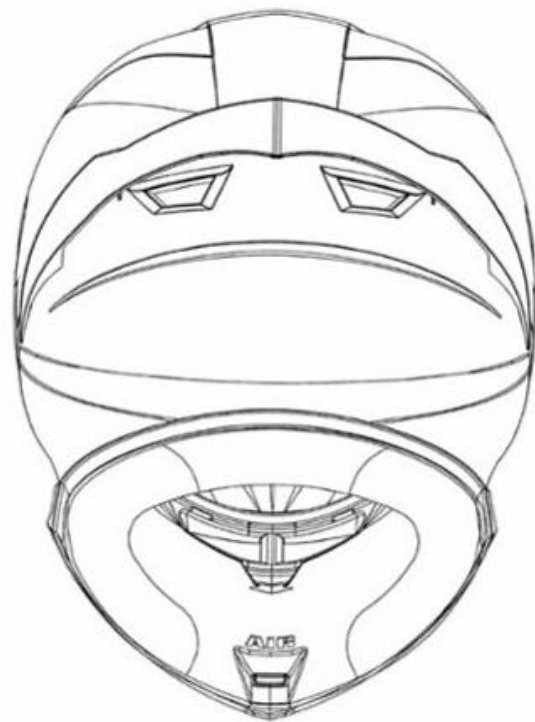

1.6



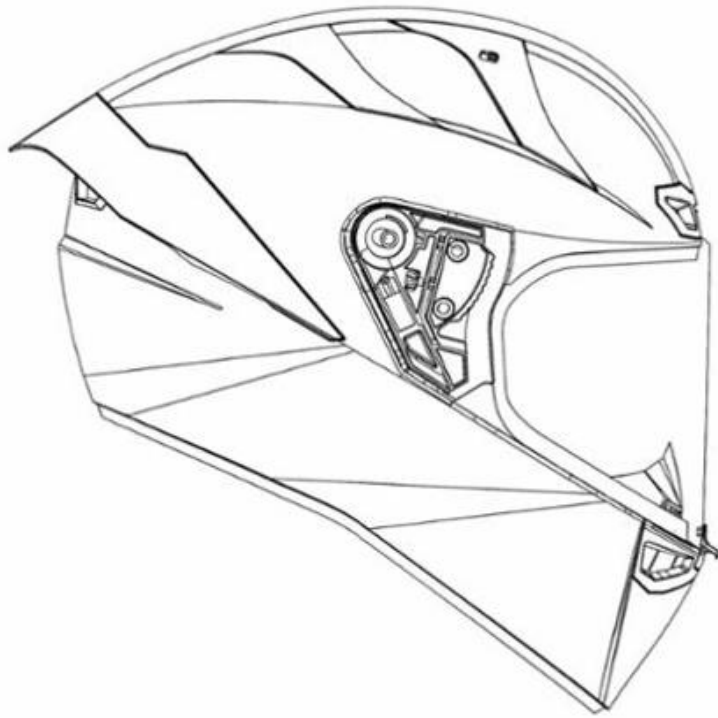

1.7

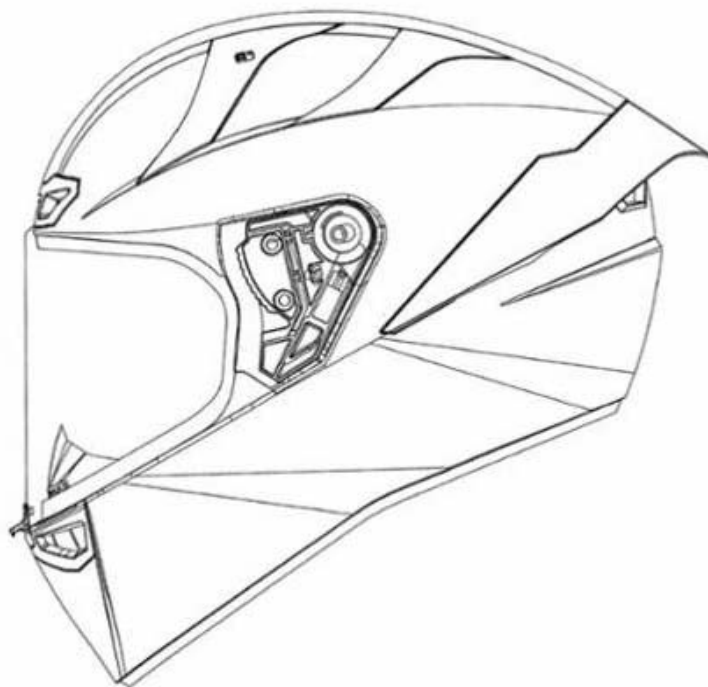

1.8

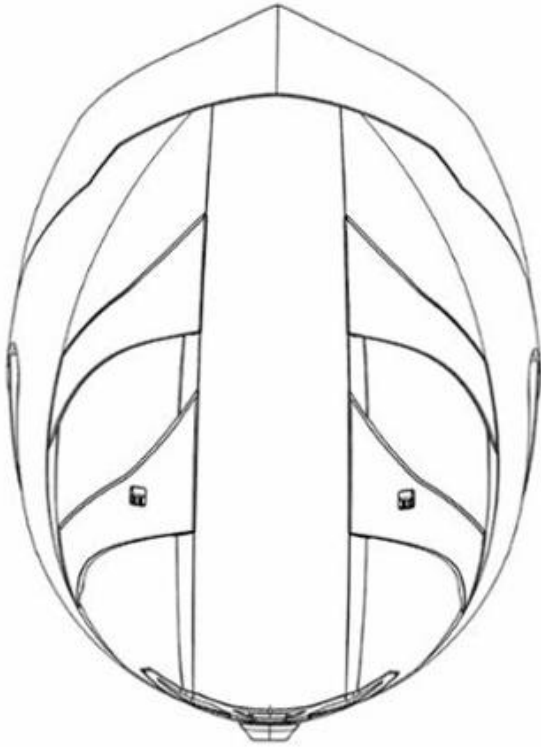

1.9

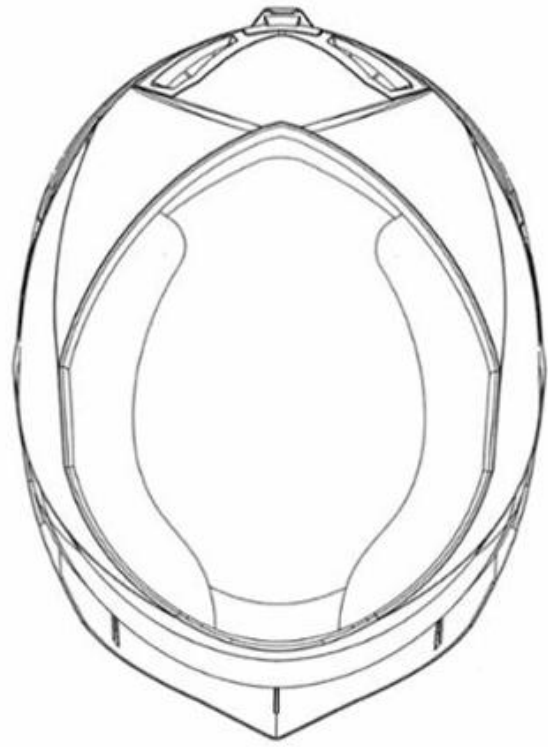

1.10

- (11) **36839**  
(21) 3-2019-01377 (28) 1  
(54) **ĐIỆN THOẠI DI ĐỘNG** (51) **14-03**  
(22) 27/05/2019 (43) 25/10/2019  
(30) 201830681248.8 28/11/2018 CN;  
HUAWEI TECHNOLOGIES CO., LTD. (CN)  
(73) Huawei Administration Building, Bantian, Longgang, Shenzhen, Guangdong  
518129, China  
1. GUOPING WU (CN)  
(72) 2. HAIQI ZHANG (CN)  
3. WEISI LI (CN)  
(74) Công ty Luật TNHH Phạm và Liên danh (PHAM & ASSOCIATES)  
(55)



1.1



1.2



1.3



1.4



1.5



1.6



1.7

- (11) **36840**  
(21) 3-2019-01378 (28) 1  
(54) **ĐIỆN THOẠI DI ĐỘNG** (51) **14-03**  
(22) 27/05/2019 (43) 25/10/2019  
(30) 201830680826.6 28/11/2018 CN;  
HUAWEI TECHNOLOGIES CO., LTD. (CN)  
(73) Huawei Administration Building, Bantian, Longgang District, Shenzhen,  
Guangdong 518129, China  
1. WU, GUOPING (CN)  
(72) 2. ZHANG, HAIQI (CN)  
3. LI, WEISI (CN)  
(74) [Công ty TNHH một thành viên Sở hữu trí tuệ VCCI] ()  
(55)



1.1



1.2



1.3



1.4



1.5



1.6



1.7

- (11) **36841**  
(21) 3-2019-01389 (28) 1  
(54) **ĐÈN BÀN** (51) **26-05**  
(22) 29/05/2019 (43) 25/10/2019  
BEIJING XIAOMI MOBILE SOFTWARE CO., LTD. (CN)  
(73) Room 01, Floor 9, Rainbow City Shopping Mall II of China Resources, NO. 68,  
Qinghe Middle Street, Haidian District, Beijing, 100085 China  
1. PANPAN YANG (CN)  
(72) 2. YUANYUAN REN (CN)  
3. NINGNING LI (CN)  
(74) Công ty TNHH Sở hữu trí tuệ Vàng (GINTASSET CO., LTD.)  
(55)



1.1

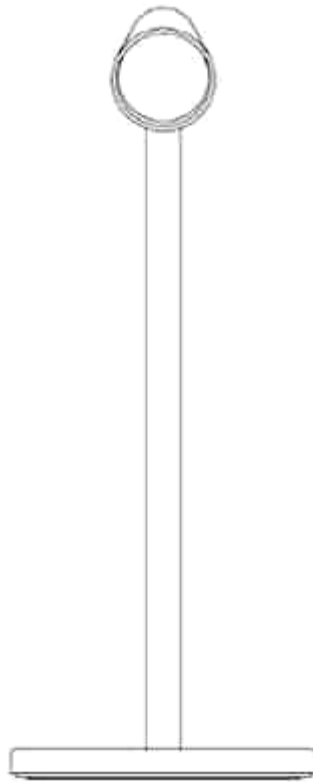

1.2

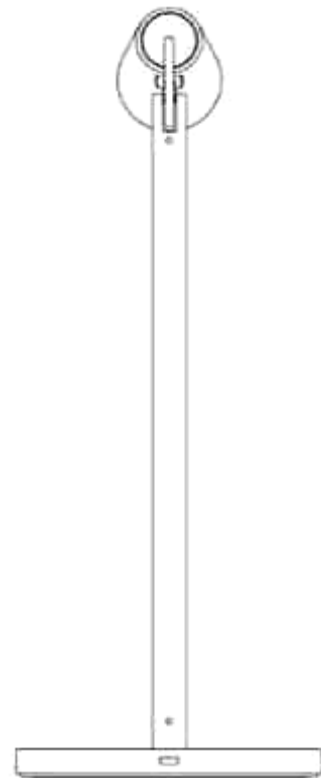

1.3

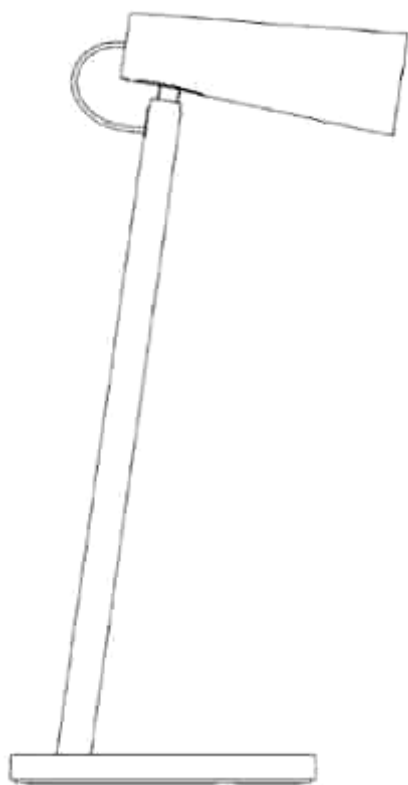

1.4

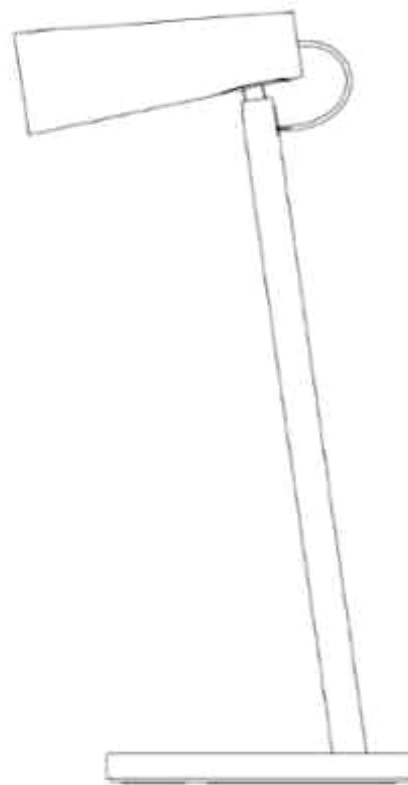

1.5



1.6



1.7





1.8

**CÔNG BÁO SỞ HỮU CÔNG NGHIỆP SỐ 379 TẬP A – QUYỀN 2 (10.2019)**

- (11) **36842**  
(21) 3-2019-01394 (28) 1  
(54) **XE MÁY** (51) **12-11**  
(22) 30/05/2019 (43) 25/10/2019  
(30) 2018-026009 30/11/2018 JP;  
YAMAHA HATSUDOKI KABUSHIKI KAISHA (JP)  
(73) 2500 Shingai, Iwata-shi, Shizuoka-ken 438-8501, Japan  
1. YAO-TE WANG (TW)  
(72) 2. HUNG-MING LIU (TW)  
(74) Công ty TNHH Tư vấn - Đầu tư N.T.K. (N.T.K. CO., LTD.)  
(55)



1.1



1.2



1.3



1.4



1.5



1.6



1.7



1.8



1.9

**PHẦN II**

**SỬA ĐỔI ĐƠN**

*Ghi nhận sửa đổi đơn yêu cầu cấp Bằng độc quyền kiểu dáng công nghiệp*

<b>STT</b>	<b>SỐ KÝ HIỆU VĂN BẢN</b>		<b>NGÀY BAN HÀNH</b>	<b>SỐ YÊU CẦU</b>	<b>SỐ ĐƠN/BẰNG LIÊN QUAN</b>
1	30754w	/TB-SHTT	24/09/2019	SĐ3-2019-00732	3-2018-00768

**BỘ KHOA HỌC VÀ CÔNG NGHỆ  
CỤC SỞ HỮU TRÍ TUỆ**

**CỘNG HOÀ XÃ HỘI CHỦ NGHĨA VIỆT NAM  
Độc lập - Tự do - Hạnh phúc**

Số: 30754w/SHTT-KDCN

*Hà Nội, ngày 24 tháng 09 năm 2019*

**THÔNG BÁO**  
**Ghi nhận sửa đổi đơn**

Kính gửi:

**Căn cứ kết quả thẩm định yêu cầu sửa đổi, bổ sung đơn:**

Số đơn: SĐ3-2019-00732

Ngày nộp đơn: 03/06/2019

**Liên quan đến Đơn yêu cầu cấp Bằng độc quyền kiểu dáng công nghiệp:**

Số đơn: 3-2018-00768

Ngày nộp đơn: 16/04/2018

Chủ đơn(\*): Columbia Sportswear North America, Inc. (US) (US)

Địa chỉ: 14375 NW Science Park Drive, Portland, OR 97229, United States of America

Đại diện của chủ đơn: Công ty TNHH Ban Ca

Tên kiểu dáng công nghiệp: VÁI

Ngày ưu tiên(\*\*): 16/10/2017 Số đơn ưu tiên: 29/622,247 Nước ưu tiên: US

**CỤC SỞ HỮU TRÍ TUỆ CÓ Ý KIẾN NHƯ SAU:**

Yêu cầu sửa đổi, bổ sung đơn nêu trên được chấp nhận.

Đơn yêu cầu cấp Bằng độc quyền kiểu dáng công nghiệp số **3-2018-00768** đã được ghi nhận sửa đổi với nội dung là :

Bổ sung 01 tác giả

Mark Gingo

835 sw 166th Ave, Beaverton, OR. 97006, United States of America

**Nơi nhận:**

- Như trên;
- TT (để công bố)
- Lưu: VT, HT.

**KT. CỤC TRƯỞNG  
PHÓ CỤC TRƯỞNG**

*(Đã ký)*

Lê Ngọc Lâm

PHẦN III

**THAY ĐỔI CHỦ ĐƠN**

*Ghi nhận thay đổi chủ đơn sáng chế kiểu dáng công nghiệp*

STT	SỐ KÝ HIỆU VĂN BẢN	NGÀY BAN HÀNH	SỐ YÊU CẦU	SỐ ĐƠN/BẰNG LIÊN QUAN
1	30396w/TB-SHTT	30/08/2019	CĐ3-2019-00439	3-2018-01815
2	30755w/TB-SHTT	25/09/2019	CĐ3-2019-00200	3-2017-01498



BỘ KHOA HỌC VÀ CÔNG NGHỆ

CỘNG HOÀ XÃ HỘI CHỦ NGHĨA VIỆT NAM

CỤC SỞ HỮU TRÍ TUỆ

Độc lập - Tự do - Hạnh phúc

Số: 30396w/SHTT-KDCN

Hà Nội, ngày 30 tháng 08 năm 2019

**THÔNG BÁO**  
**Ghi nhận thay đổi chủ đơn**

Kính gửi: Công ty TNHH Sở hữu trí tuệ M.I.T  
Nhà số 8, ngõ 1060, tổ 4, phường Yên Nghĩa, quận Hà  
Đông, TP. Hà Nội

**Căn cứ kết quả thẩm định yêu cầu ghi nhận thay đổi chủ đơn:**

Số Yêu cầu: CD3-2019-00439 Ngày nộp: 01/08/2019

**Liên quan đến Đơn yêu cầu cấp Bằng độc quyền kiểu dáng công nghiệp:**

Số đơn: 3-2018-01815 Ngày nộp đơn: 24/08/2018

Chủ đơn(\*): Cục Quân nhu - Tổng cục Hậu cần (VN)

Địa chỉ: Số 5 Nguyễn Tri Phương, phường Quán Thánh, quận Ba Đình, thành phố Hà Nội

Đại diện của chủ đơn: Công ty TNHH Sở hữu trí tuệ M.I.T

Tên kiểu dáng công nghiệp: HỆ THỐNG BÉP

**CỤC SỞ HỮU TRÍ TUỆ CÓ Ý KIẾN NHƯ SAU**

Yêu cầu ghi nhận thay đổi chủ đơn nêu trên được chấp nhận.

Đơn yêu cầu cấp Bằng độc quyền kiểu dáng công nghiệp số 3-2018-01815 đã được ghi nhận chuyển nhượng từ:

Bên chuyển nhượng: CỤC QUÂN NHU - TỔNG CỤC HẬU CẦN (VN)

Địa chỉ: Số 5 Nguyễn Tri Phương, phường Quán Thánh, quận Ba Đình, thành phố Hà Nội

Bên được chuyển nhượng: CÔNG TY CỔ PHẦN 22 (VN)

Địa chỉ: Số 763 đường Nguyễn Văn Linh, phường Sài Đồng, quận Long Biên, thành phố Hà Nội

**Nơi nhận:**

- Như trên;
- CÔNG TY CỔ PHẦN 22 (VN);
- TT (để công bố);
- Lưu: VT, HT.

KT. CỤC TRƯỞNG  
PHÓ CỤC TRƯỞNG

(Đã ký)

Lê Ngọc Lâm

BỘ KHOA HỌC VÀ CÔNG NGHỆ  
**CỤC SỞ HỮU TRÍ TUỆ**

CỘNG HOÀ XÃ HỘI CHỦ NGHĨA VIỆT NAM  
**Độc lập - Tự do - Hạnh phúc**

Số: 30755w/SHTT-KDCN

Hà Nội, ngày 25 tháng 09 năm 2019

**THÔNG BÁO**  
**Ghi nhận thay đổi chủ đơn**

Kính gửi: Công ty TNHH Tâm nhìn và Liên danh  
Phòng 308-310, tầng 3, Tháp Hà Nội, số 49 Hai Bà  
Trung, phường Trần Hưng Đạo, quận Hoàn Kiếm, thành  
phố Hà Nội

**Căn cứ kết quả thẩm định yêu cầu ghi nhận thay đổi chủ đơn:**

Số Yêu cầu: CĐ3-2019-00200 Ngày nộp: 17/04/2019

**Liên quan đến Đơn yêu cầu cấp Bằng độc quyền kiểu dáng công nghiệp:**

Số đơn: 3-2017-01498 Ngày nộp đơn: 07/08/2017

Chủ đơn(\*): Suntory Beverage & Food Limited (JP)

Địa chỉ: 3-1-1 Kyobashi, Chuo-ku, Tokyo 104-0031, Japan

Đại diện của chủ đơn: Công ty TNHH Tâm nhìn và Liên danh

Tên kiểu dáng công nghiệp:

Ngày ưu tiên(\*\*): 10/02/2017 Số đơn ưu tiên: 2017-002543 Nước ưu tiên: JP

**CỤC SỞ HỮU TRÍ TUỆ CÓ Ý KIẾN NHƯ SAU**

Yêu cầu ghi nhận thay đổi chủ đơn nêu trên được chấp nhận.

Đơn yêu cầu cấp Bằng độc quyền kiểu dáng công nghiệp số 3-2017-01498 đã được ghi nhận chuyển nhượng từ:

Bên chuyển nhượng: SUNTORY BEVERAGE & FOOD LIMITED (JP)

Địa chỉ: 3-1-1 Kyobashi, Chuo-ku, Tokyo 104-0031, Japan

Bên được chuyển nhượng: SUNTORY HOLDINGS LIMITED (JP)

Địa chỉ: 1-40, Dojimahama 2-chome, Kita-ku, Osaka-shi, Osaka 530-8203, Japan

**Nơi nhận:**

- Như trên;
- SUNTORY HOLDINGS LIMITED (JP);
- TT (để công bố);
- Lưu: VT, HT.

KT. CỤC TRƯỞNG  
PHÓ CỤC TRƯỞNG

(Đã ký)

Lê Ngọc Lâm

## **CÔNG BÁO SỞ HỮU CÔNG NGHIỆP**

*Do Cục Sở hữu trí tuệ thuộc Bộ Khoa học và Công nghệ ấn hành theo Luật Sở hữu trí tuệ số 50/2005/QH11 được Quốc hội thông qua ngày 29 tháng 11 năm 2005 và được sửa đổi bằng Luật sửa đổi, bổ sung một số điều của Luật sở hữu trí tuệ số 50/2005/QH11 được Quốc hội thông qua ngày 19 tháng 6 năm 2009.*

### ***Địa chỉ liên hệ:***

384-386 đường Nguyễn Trãi, quận Thanh Xuân,  
thành phố Hà Nội, Việt Nam  
ĐT: 024. 38583069  
Fax: 024. 38588449