

CỘNG HÒA XÃ HỘI CHỦ NGHĨA VIỆT NAM  
BỘ KHOA HỌC VÀ CÔNG NGHỆ

CỤC SỞ HỮU TRÍ TUỆ

CÔNG BÁO  
SỞ HỮU CÔNG NGHIỆP

TẬP A

QUYỂN 2: KIỂU DÁNG CÔNG NGHIỆP

10 - 2024

439

CỘNG HOÀ XÃ HỘI CHỦ NGHĨA VIỆT NAM  
BỘ KHOA HỌC VÀ CÔNG NGHỆ  
CỤC SỞ HỮU TRÍ TUỆ

---

CÔNG BÁO  
SỞ HỮU CÔNG NGHIỆP  
TẬP A

QUYỀN 2: KIỂU DÁNG CÔNG NGHIỆP

10 - 2024

439

---

HÀ NỘI

## MỤC LỤC

	Trang
<u>PHẦN I:</u> Đơn yêu cầu cấp Bằng độc quyền kiểu dáng công nghiệp	7
<u>PHẦN II:</u> Sửa đổi đơn	129

## CONTENTS

<u>PART I:</u> Applications for Industrial Design Patents	7
<u>PART II:</u> Amendment of Applications	129

---

MÃ SỐ HAI CHỮ CÁI THỂ HIỆN TÊN NƯỚC VÀ CÁC THỰC THỂ KHÁC TRONG CÁC TƯ LIỆU SỞ HỮU CÔNG NGHIỆP THEO TIÊU CHUẨN ST3 CỦA WIPO

AE	United Arab Emirates	CN	China	HK	Hong Kong
AF	Afganistan	CO	Colombia	HN	Honduras
AG	Antihua and Barbuda	CR	Costa Rica	HR	Croatia
AI	Anguilla	CU	Cuba	HT	Haiti
AL	Albania	CV	Cape Verde	HU	Hungary
AN	Netherlands Antilles	CY	Cyprus	ID	Indonesia
AO	Angola	CZ	Czech Republic	IE	Ireland
AR	Argentina	DE	Germany	IL	Israel
AT	Austria	DJ	Djibouti	IN	India
AU	Australia	DK	Denmark	IQ	Iraq
AW	Aruba	DM	Dominica	IR	Iran (Islamic Republic of)
BB	Barbados	DO	Dominican Republic	IS	Iceland
BD	Bangladesh	DZ	Algeria	IT	Italy
BE	Belgium	EC	Ecuador	JM	Jamaica
BF	Burkina Faso	EE	Estonia	JO	Jordan
BG	Bulgaria	EG	Egypt	JP	Japan
BH	Bahrain	ES	Spain	KE	Kenya
BI	Burundi	ET	Ethiopia	KH	Cambodia
BJ	Benin	FI	Finland	KI	Kiribati
BM	Bermuda	FJ	Fiji	KM	Comoros
BN	Brunei Darussalam	FK	Falkand Islands (Malvinas)	KN	Saint Kitts and Nevis
BO	Bolivia	FR	France	KP	Democratic People's Republic of Korea
BR	Brazil	GA	Gabon	KR	Republic of Korea
BS	Bahamas	GB	United Kingdom	KW	Kuwait
BT	Bhutan	GD	Grenada	KY	Cayman Islands
BW	Botswana	GE	Georgia	KZ	Kazakhstan
BY	Belarus	GH	Ghana	LA	Laos
BZ	Belize	GI	Gibraltar	LB	Lebanon
CA	Canada	GM	Gambia	LC	Saint Lucia
CF	Central African Republic	GN	Guinea	LI	Liechtenstein
CG	Congo	GQ	Equatorial Guinea	LK	SriLanka
CH	Switzerland	GR	Greece	LR	Liberia
CI	Côte d'Ivoire	GT	Guatemala	LS	Lesotho
CL	Chile	GW	Guinea-Bissau	LT	Lithuania
CM	Cameroon	GY	Guyana	TC	Turk and Caicos Islands
LU	Luxembourg	PA	Panama	TD	Chad
LV	Latvia	PE	Peru	TG	Togo
LY	Lybya	PG	Papua New Guinea	TH	Thailand
MA	Morocco	PH	Philippines	TN	Tunisia
MC	Monaco	PK	Pakistan	TO	Tonga
MD	Republic of Moldova	PL	Poland	TR	Turkey

**CÔNG BÁO SỞ HỮU CÔNG NGHIỆP SỐ 439 TẬP A - QUYỂN 2 (10.2024)**

MG	Madagascar	PT	Portugal	TT	Trinidad and Tobago
ML	Mali	PY	Paraguay	TV	Tuvalu
MM	Myanmar	QA	Qatar	TW	Taiwan, Province of China
MN	Mongolia	RO	Rumania	TZ	United Republic of Tanzania
MO	Macau	RU	Russian Federation	UA	Ukraine
MR	Mauritania	RW	Rwanda	UG	Uganda
MS	Montserrat	SA	Saudi Arabia	US	United States of America
MT	Malta	SB	Solomon Islands	UY	Uruguay
MU	Mauritius	SC	Seychelles	UZ	Uzbekistan
MV	Maldives	SD	Sudan	VA	Holy see
MW	Malawi	SE	Sweden	VC	Saint Vincent and the Grenadines
MX	Mexico	SG	Singapore	VE	Venezuela
MY	Malaysia	SH	Saint Helena	VG	Virgin Islands (British)
MZ	Mozambique	SL	Slovenia	VN	Vietnam
NA	Namibia	SK	Slovakia	VU	Vanuatu
NE	Niger	SL	Sierra Leone	WS	Samoa
NG	Nigeria	SM	San Marino	YE	Yemen
NJ	Nicaragua	SN	Senegal	YU	Yugoslavia
NL	Netherlands	SO	Somalia	ZA	South Africa
NO	Norway	SR	Suriname	ZM	Zambia
NP	Nepal	ST	Sao Tome and Principe	ZR	Zaire
NR	Nauru	SV	El Sanvador	ZW	Zimbabwe
NZ	New Zealand	SY	Syria		
OM	Oman	SZ	Swaziland		

**CÁC TỔ CHỨC QUỐC TẾ**

AO	African Intellectual Property Organization (OAPI)
AP	African Regional Industrial Property Organization (ARIPO)
BX	Benelux Trademark Office and Benelux Designs Office
EP	European Patent Office (EPO)
IB, WO	International Bureau of the World Intellectual Property Organization (WIPO)

**NHỮNG MÃ SỐ INID TRÍCH TỪ TIÊU CHUẨN ST80 CỦA TỔ CHỨC SỞ HỮU TRÍ TUỆ THẾ GIỚI (WIPO) ĐỂ NHẬN BIẾT CÁC DỮ LIỆU THƯ MỤC DÙNG CÔNG BỐ ĐƠN VÀ BẰNG ĐỘC QUYỀN KIỂU DÁNG CÔNG NGHIỆP**

- (11) Số bằng độc quyền kiểu dáng công nghiệp / Số công bố đơn
- (15) Ngày cấp
- (18) Ngày hết hạn hiệu lực của bằng độc quyền kiểu dáng công nghiệp
- (21) Số đơn
- (22) Ngày nộp đơn
- (23) Tên triển lãm, ngày và nơi triển lãm
- (28) Số phương án yêu cầu bảo hộ
- (30) Số đơn ưu tiên, ngày nộp đơn ưu tiên
- (43) Ngày công bố đơn
- (45) Ngày công bố bằng độc quyền kiểu dáng công nghiệp
- (51) Phân loại quốc tế kiểu dáng công nghiệp
- (54) Tên sản phẩm mang kiểu dáng công nghiệp
- (55) Ảnh chụp / hình vẽ kiểu dáng công nghiệp
- (57) Đặc điểm khác biệt yêu cầu bảo hộ của kiểu dáng công nghiệp
- (62) Số và ngày nộp đơn, số bằng độc quyền KDCN hoặc số công bố đơn liên quan đến tách đơn
- (71) Tên và địa chỉ của người nộp đơn
- (72) Tên của tác giả KDCN
- (73) Tên, địa chỉ của chủ bằng độc quyền KDCN
- (74) Tên của người đại diện SHCN

PHẦN I

**ĐƠN YÊU CẦU CẤP BẰNG ĐỘC QUYỀN KIỂU DÁNG CÔNG NGHIỆP**

- (11) **51494**  
(21) 3-2020-01083 (28) 1  
(54) **BAO GÓI** (51) **09-05**  
(22) 12/05/2020 (43) 25/10/2024  
(73) **HK INNO.N CORP. (KR)**  
6F, 7F, 8F, 100, Eulji-ro, Jung-gu, Seoul, Republic of Korea  
(72) 1. KIM, HYUNG SANG (KR)  
2. LEE, JE MIN (KR)  
3. AN, JI YEON (KR)  
4. CHOI, IM SIK (KR)  
(74) Công ty TNHH Trường Xuân (AGELESS CO.,LTD.)  
(55)



1.1



1.2

**CÔNG BÁO SỞ HỮU CÔNG NGHIỆP SỐ 439 TẬP A – QUYỀN 2 (10.2024)**

- (11) **51495**
- (21) 3-2020-01085 (28) 1
- (54) **BAO GÓI** (51) **09-05**
- (22) 12/05/2020 (43) 25/10/2024
- (73) **HK INNO.N CORP. (KR)**  
6F, 7F, 8F, 100, Eulji-ro, Jung-gu, Seoul, Republic of Korea
- (72) 1. KIM, HYUNG SANG (KR)  
2. LEE, JE MIN (KR)  
3. AN, JI YEON (KR)  
4. CHOI, IM SIK (KR)
- (74) Công ty TNHH Trường Xuân (AGELESS CO.,LTD.)
- (55)



1.1



1.2



**CÔNG BÁO SỞ HỮU CÔNG NGHIỆP SỐ 439 TẬP A – QUYỀN 2 (10.2024)**

- (11) **51496**  
(21) 3-2022-01321 (28) 1  
(54) **THÙNG ĐỰNG DƯA LƯỚI** (51) **09-03**  
(22) 30/06/2022 (43) 25/10/2024  
(73) **CÔNG TY CỔ PHẦN HOA QUẢ SẠCH TRUNG ƯƠNG (VN)**  
Số 7, tổ 5, đường Văn Nội, phường Phú Lương, quận Hà Đông, thành phố Hà Nội  
(72) Đào Văn Sinh (VN)  
(74) Công ty TNHH Tư vấn IPNG (IPNG CO.,LTD)  
(55)

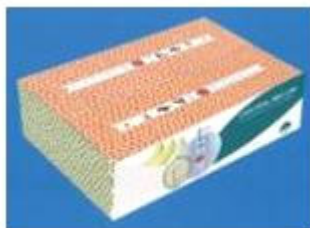

1.1



1.2

**CÔNG BÁO SỞ HỮU CÔNG NGHIỆP SỐ 439 TẬP A – QUYỀN 2 (10.2024)**

- (11) **51497**  
(21) 3-2023-00099 (28) 2  
(54) **HỘP GIẤY ĐỰNG CHÉN CHÈ YẾN** (51) **09-03**  
(22) 11/01/2023 (43) 25/10/2024  
(73) **CÔNG TY TNHH THƯƠNG MẠI SẢN XUẤT HẢI NAM (VN)**  
55 Phạm Ngọc Thạch, phường Võ Thị Sáu, quận 3, thành phố Hồ Chí Minh  
(72) Nguyễn Tất Cường (VN)  
(55)



1.1

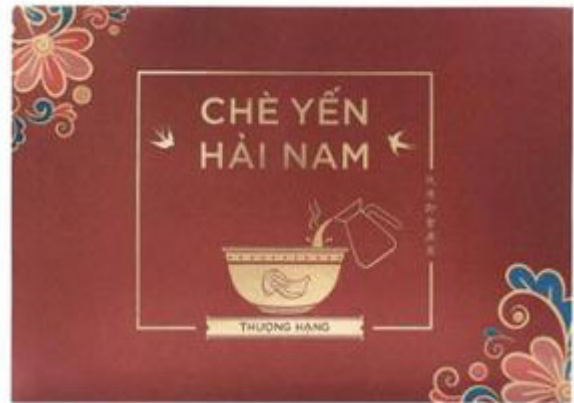

1.2



1.3



1.4



1.5



1.6



1.7



2.1



2.2



2.3



2.4



2.5



2.6



2.7

**CÔNG BÁO SỞ HỮU CÔNG NGHIỆP SỐ 439 TẬP A – QUYỀN 2 (10.2024)**

- (11) **51498**
- (21) 3-2023-00412 (28) 1
- (54) **DÂY** (51) **10-07; 11-01; 14-99; 24-99**
- (22) 01/03/2023 (43) 25/10/2024
- (30) 29/852,152 02/09/2022 US; 29/852,193 04/09/2022 US;
- (73) **APPLE INC. (US)**  
One Apple Park Way, Cupertino, California 95014, United States of America
- (72) 1. MOLLY ANDERSON (GB)  
2. BARTLEY K. ANDRE (US)  
3. SHOTA AOYAGI (JP)  
4. MARINE C. BATAILLE (FR)  
5. ABIDUR RAHMAN CHOWDHURY (GB)  
6. CLARA GENEVIÈVE MARINE COURTAIGNE (FR)  
7. MARKUS DIEBEL (DE)  
8. JONATHAN GOMEZ GARCIA (GB)  
9. M. EVANS HANKEY (US)  
10. ANNE-MARIE HECK (CH)  
11. MOISES HERNANDEZ HERNANDEZ (MX)  
12. RICHARD P. HOWARTH (GB)  
13. JULIAN JAEDE (DE)  
14. DUNCAN ROBERT KERR (GB)  
15. KAINOA KWON-PEREZ (US)  
16. NICOLAS PEDRO LYLYK (AR)  
17. PETER RUSSELL-CLARKE (AU)  
18. BENJAMIN ANDREW SHAFFER (US)  
19. CLEMENT TISSANDIER (FR)
- (74) Công ty TNHH Lê & Lê (LE & LE)
- (55)



1.1

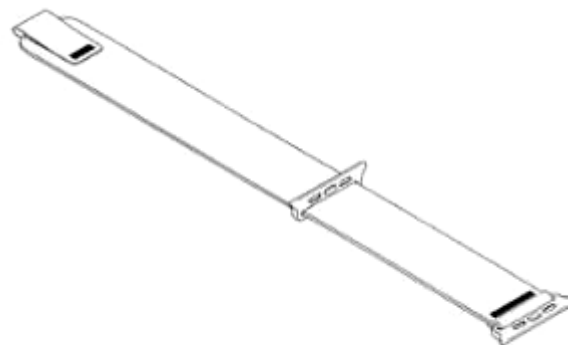

1.2

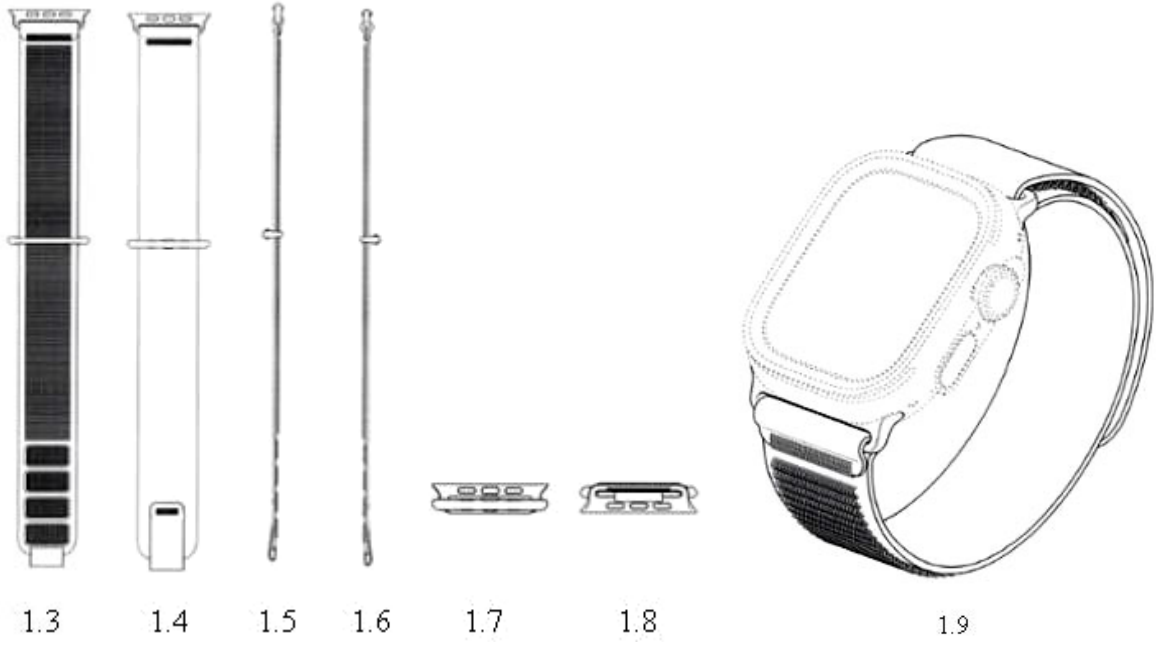

**CÔNG BÁO SỞ HỮU CÔNG NGHIỆP SỐ 439 TẬP A – QUYỀN 2 (10.2024)**

- (11) **51499**
- (21) 3-2023-01477 (28) 2
- (54) **THÙNG PHỞ** (51) **09-03**
- (22) 03/07/2023 (43) 25/10/2024
- (73) **CÔNG TY CỔ PHẦN ACECOOK VIỆT NAM (VN)**  
Lô số II-3, đường số 11, nhóm CN II, khu công nghiệp Tân Bình, phường Tây Thạnh, quận Tân Phú, thành phố Hồ Chí Minh
- (72) Kajiwara Junichi (JP)
- (74) Công ty Luật TNHH Phạm và Liên danh (PHAM & ASSOCIATES)
- (55)

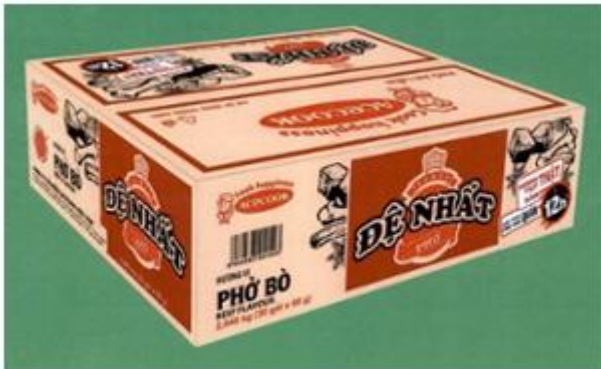

1.1



1.2



2.1



2.2

**CÔNG BÁO SỞ HỮU CÔNG NGHIỆP SỐ 439 TẬP A – QUYỀN 2 (10.2024)**

- (11) **51500**  
(21) 3-2023-01554 (28) 1  
(54) **GIỎ** (51) **09-04**  
(22) 10/07/2023 (43) 25/10/2024  
(73) **CÔNG TY TNHH MỘT THÀNH VIÊN DỊCH VỤ THƯƠNG MẠI KIỆT ANH PHONG (VN)**  
138 Thái Phiên, phường 8, quận 11, thành phố Hồ Chí Minh  
(72) Giang Ngọc Đức (VN)  
(74) Công ty TNHH Tư vấn sở hữu trí tuệ Việt (VIET IP CO.,LTD.)  
(55)



1.1

1.2

1.3



1.4

1.5

1.6



1.7

1.8

**CÔNG BÁO SỞ HỮU CÔNG NGHIỆP SỐ 439 TẬP A – QUYỀN 2 (10.2024)**

- (11) **51501**  
(21) 3-2023-01621 (28) 1  
(54) **BAO GÓI** (51) **09-05**  
(22) 14/07/2023 (43) 25/10/2024  
(73) **ORION CORPORATION (KR)**  
13, Baekbeom-ro 90da-gil, Yongsan-gu, Seoul 04369, Republic of Korea  
(72) 1. LEE, HYUN A (KR)  
2. LEE, A REUM (KR)  
(74) Công ty Luật TNHH quốc tế BMVN (BMVN INTERNATIONAL LLC)  
(55)



1.1



1.2



**CÔNG BÁO SỞ HỮU CÔNG NGHIỆP SỐ 439 TẬP A – QUYỀN 2 (10.2024)**

- (11) **51502**  
(21) 3-2023-01632 (28) 1  
(54) **BAO GÓI** (51) **09-05**  
(22) 17/07/2023 (43) 25/10/2024  
(73) **ORION CORPORATION (KR)**  
13, Baekbeom-ro 90da-gil, Yongsan-gu, Seoul 04369, Republic of Korea  
(72) 1. LEE, HYUN A (KR)  
2. LEE, A REUM (KR)  
(74) Công ty Luật TNHH quốc tế BMVN (BMVN INTERNATIONAL LLC)  
(55)



1.1



1.2

**CÔNG BÁO SỞ HỮU CÔNG NGHIỆP SỐ 439 TẬP A – QUYỀN 2 (10.2024)**

- (11) **51503**  
(21) 3-2023-02778 (28) 4  
(54) **THIẾT BỊ ĐO DÙNG CHO NGẮT MẠCH** (51) **10-04**  
(22) 17/11/2023 (43) 25/10/2024  
(30) 2023-010650 26/05/2023 JP; 2023-010653 26/05/2023 JP; 2023-010652 26/05/2023 JP; 2023-010651 26/05/2023 JP;  
(73) **MITSUBISHI ELECTRIC CORPORATION (JP)**  
7-3, Marunouchi 2-chome, Chiyoda-ku, Tokyo, 100-8310 Japan  
(72) 1. ASAKO AKIYAMA (JP)  
2. YUYA IMADA (JP)  
3. YUSUKE TAKIGAWA (JP)  
4. ATSUSHI KONDO (JP)  
(74) Công ty TNHH Tầm nhìn và Liên danh (VISION & ASSOCIATES CO.LTD.)  
(55)

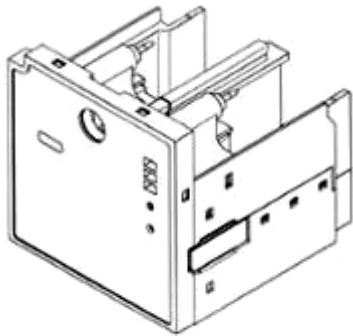

1.1

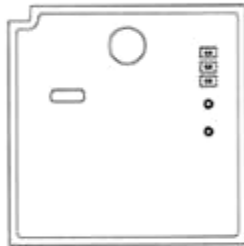

1.2

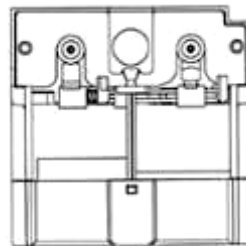

1.3

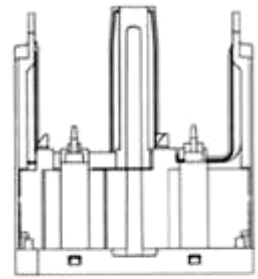

1.4

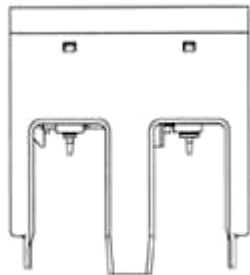

1.5

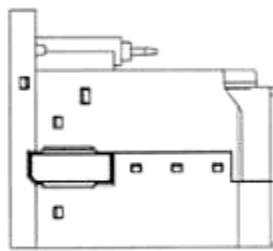

1.6

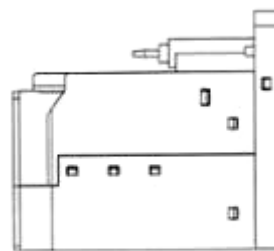

1.7

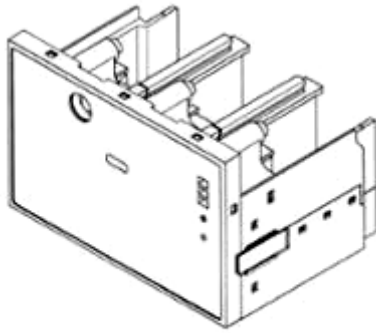

2.1

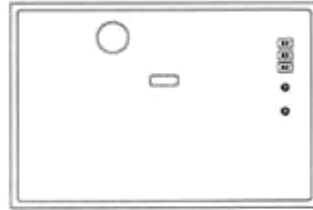

2.2

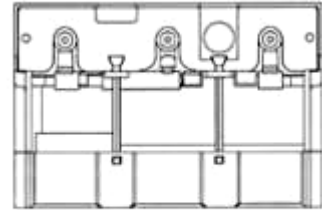

2.3

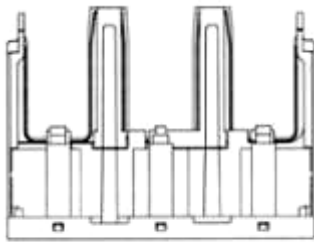

2.4

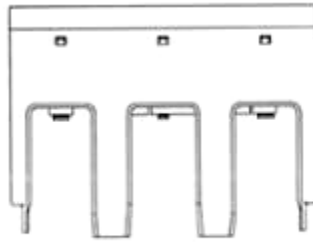

2.5

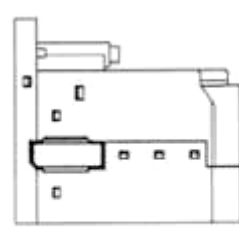

2.6

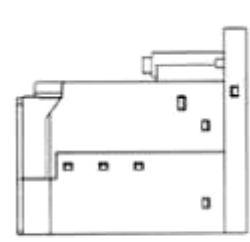

2.7

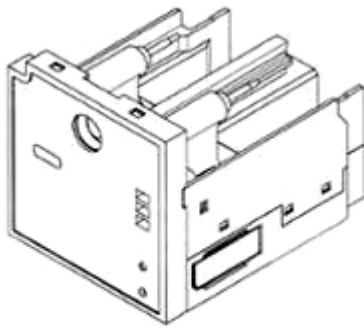

3.1

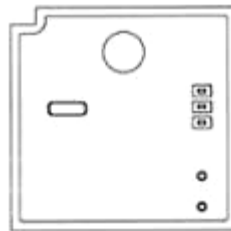

3.2

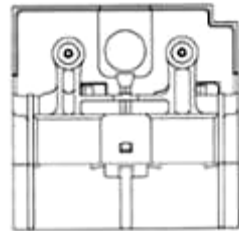

3.3

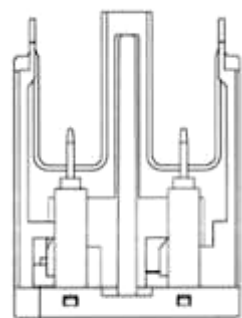

3.4

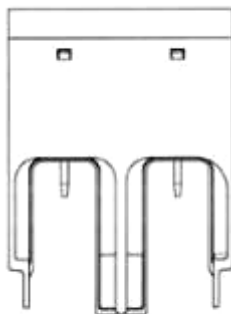

3.5

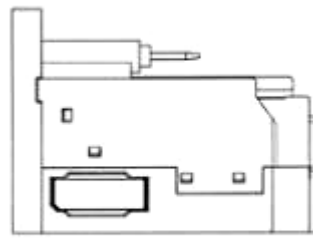

3.6

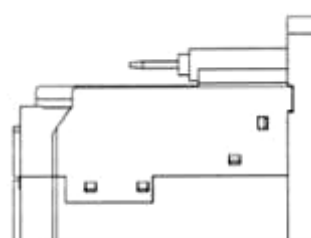

3.7

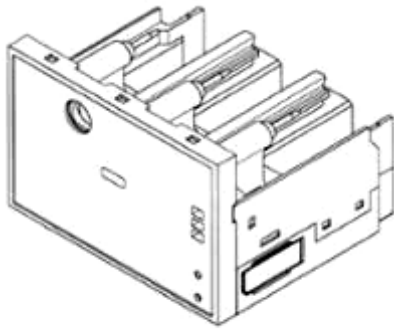

4.1

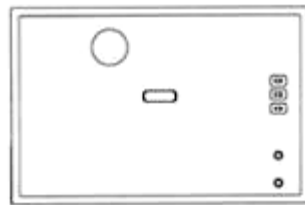

4.2

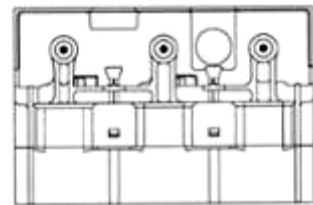

4.3

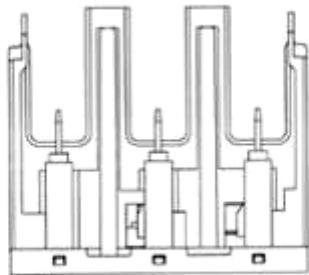

4.4

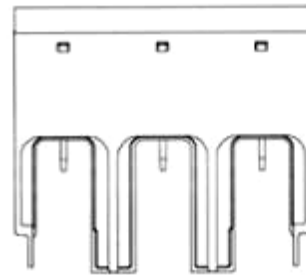

4.5

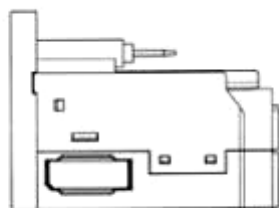

4.6

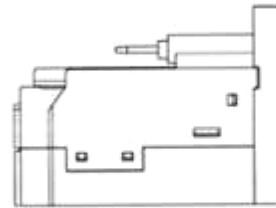

4.7

**CÔNG BÁO SỞ HỮU CÔNG NGHIỆP SỐ 439 TẬP A – QUYỀN 2 (10.2024)**

- (11) **51504**  
(21) 3-2023-02889 (28) 1  
(54) **BAO GÓI** (51) **09-05**  
(22) 01/12/2023 (43) 25/10/2024  
(73) **CÔNG TY CỔ PHẦN VITHAICO (VN)**  
Số 6, cụm công nghiệp Trường An, xã An Khánh, huyện Hoài Đức, thành phố Hà Nội  
(72) Nguyễn Hữu Thi (VN)  
(55)



1.1



1.2

**CÔNG BÁO SỞ HỮU CÔNG NGHIỆP SỐ 439 TẬP A – QUYỀN 2 (10.2024)**

(11) **51505**

(21) 3-2023-03149

(28) 1

(54) **NẮP CHAI**

(51) **09-07**

(22) 26/12/2023

(43) 25/10/2024

(73) **CÔNG TY TNHH LIÊN DOANH OCANY VIỆT NAM (VN)**

Số 78/2A, khu phố Bình Đáng, phường Bình Hòa, thành phố Thuận An, tỉnh Bình Dương

(72) Đặng Trần Thi (VN)

(74) Công ty TNHH Sở hữu trí tuệ ALNGUYEN (ALNGUYEN IP CO.,LTD.)

(55)



1.1



1.2



1.3

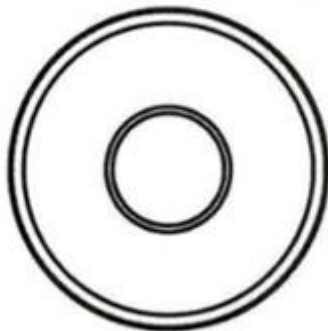

1.4



1.5

**CÔNG BÁO SỞ HỮU CÔNG NGHIỆP SỐ 439 TẬP A – QUYỀN 2 (10.2024)**

(11) **51506**

(21) 3-2023-03182

(28) 1

(54) **HỆ THỐNG SÀNG HẠT ĐIỀU**

(51) **15-03**

(22) 28/12/2023

(43) 25/10/2024

(73) **NGUYỄN VĂN LIÊN (VN)**

Khu phố Phước Trung, xã Phước Bình, thị xã Phước Long, tỉnh Bình Phước

(72) Nguyễn Văn Liên (VN)

(55)

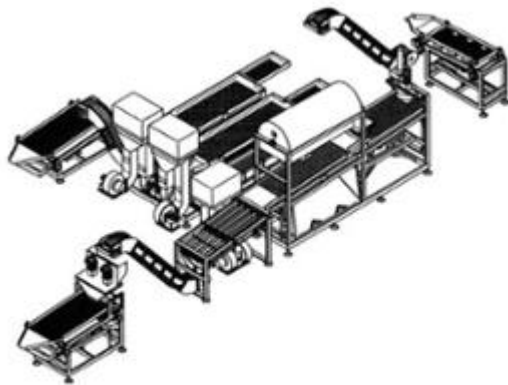

1.1

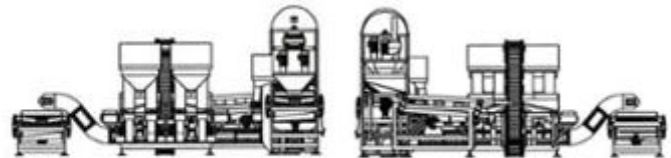

1.2

1.3

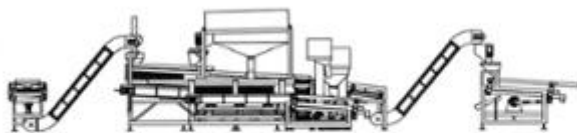

1.4

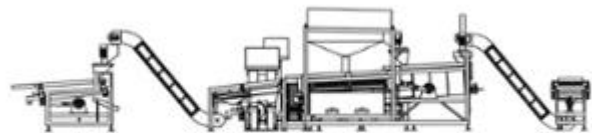

1.5

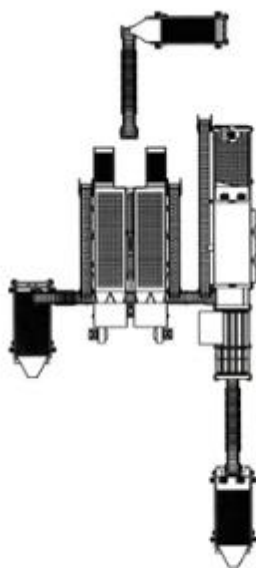

1.6

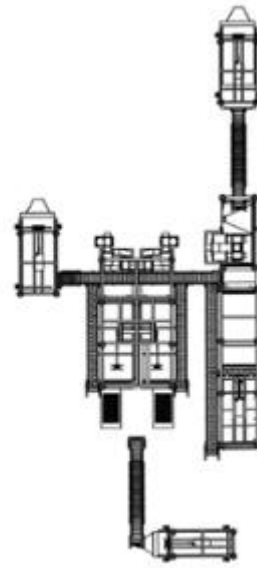

1.7

**CÔNG BÁO SỞ HỮU CÔNG NGHIỆP SỐ 439 TẬP A – QUYỀN 2 (10.2024)**

(11) **51507**

(21) 3-2023-03186

(54) **ĐẦU MÁY CHÈ HẠT ĐIỀU**

(22) 28/12/2023

(73) **NGUYỄN VĂN LIÊN (VN)**

Khu phố Phước Trung, xã Phước Bình, thị xã Phước Long, tỉnh Bình Phước

(72) Nguyễn Văn Liên (VN)

(55)

(28) 1

(51) **15-03**

(43) 25/10/2024



1.1



1.2



1.3



1.4



1.5



1.6



1.7



**CÔNG BÁO SỞ HỮU CÔNG NGHIỆP SỐ 439 TẬP A – QUYỀN 2 (10.2024)**

(11) **51508**

(21) 3-2023-03209

(28) 1

(54) **CHÂN GHẾ**

(51) **06-01**

(22) 29/12/2023

(43) 25/10/2024

(73) **CÔNG TY TNHH SẢN XUẤT THƯƠNG MẠI ĐẦU TƯ VÀ NỘI THẤT ZHI SHANG (VIỆT NAM) (VN)**

Một phần lô B19, đường N1, KCN KSB - khu A, xã Đất Cuốc, huyện Bắc Tân Uyên, tỉnh Bình Dương

(72) YU, YOUFANG (CN)

(74) Công ty TNHH Quản trị tài sản trí tuệ VIHABRAND (VIHABRAND CO.,LTD.)

(55)

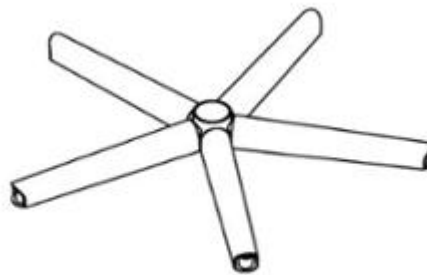

1.1



1.2



1.3



1.4



1.5

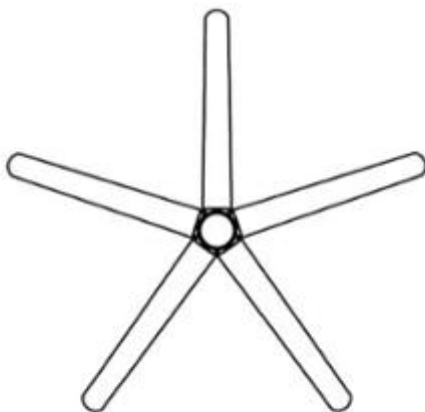

1.6

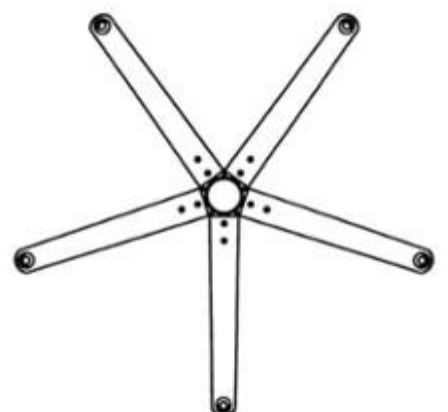

1.7

**CÔNG BÁO SỞ HỮU CÔNG NGHIỆP SỐ 439 TẬP A – QUYỀN 2 (10.2024)**

(11) **51509**

(21) 3-2023-03210

(28) 1

(54) **CHÂN GHẾ**

(51) **06-01**

(22) 29/12/2023

(43) 25/10/2024

(73) **CÔNG TY TNHH SẢN XUẤT THƯƠNG MẠI ĐẦU TƯ VÀ NỘI THẤT ZHI SHANG (VIỆT NAM) (VN)**

Một phần lô B19, đường N1, KCN KSB - khu A, xã Đất Cuốc, huyện Bắc Tân Uyên, tỉnh Bình Dương

(72) YU, YOUFANG (CN)

(74) Công ty TNHH Quản trị tài sản trí tuệ VIHABRAND (VIHABRAND CO.,LTD.)

(55)

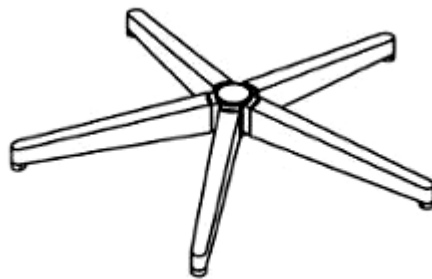

1.1



1.2



1.3



1.4



1.5

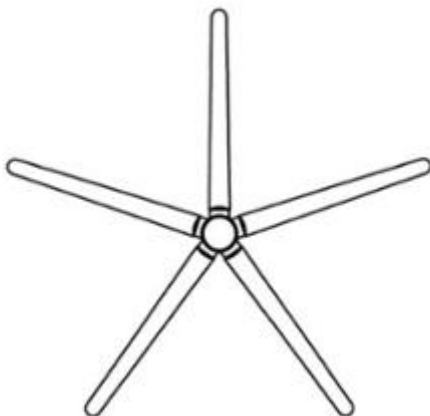

1.6

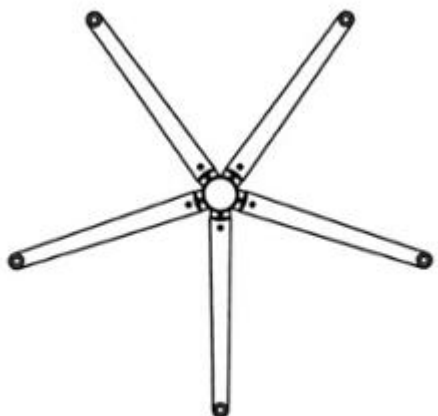

1.7

**CÔNG BÁO SỞ HỮU CÔNG NGHIỆP SỐ 439 TẬP A – QUYỀN 2 (10.2024)**

(11) **51510**

(21) 3-2024-00126

(28) 1

(54) **MÓC NHỰA**

(51) **08-07**

(22) 12/01/2024

(43) 25/10/2024

(73) **CÔNG TY TNHH VIỆT PHÁP (VN)**

Lô A 44, cụm công nghiệp Diên Phú, xã Diên Phú, huyện Diên Khánh, tỉnh Khánh Hòa

(72) Nguyễn Ngọc Tiên (VN)

(74) Văn phòng Luật sư A Hoà (AHOA LAW OFFICE)

(55)



1.1



1.2



1.3



1.4



1.5

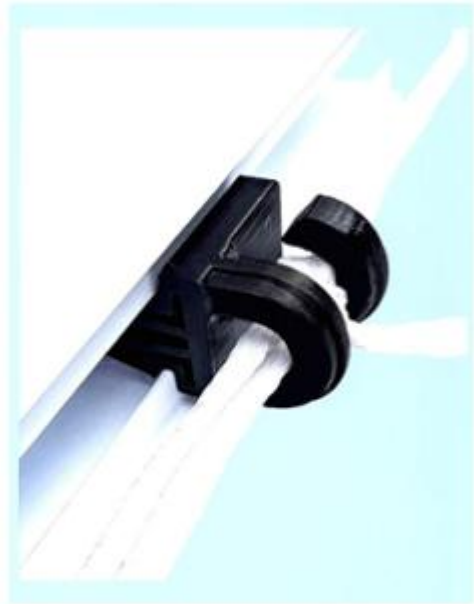

1.6

**CÔNG BÁO SỞ HỮU CÔNG NGHIỆP SỐ 439 TẬP A – QUYỀN 2 (10.2024)**

(11) **51511**

(21) 3-2024-00197

(28) 1

(54) **CAN**

(51) **09-02**

(22) 23/01/2024

(43) 25/10/2024

(73) **CÔNG TY TNHH THƯƠNG MẠI VÀ DỊCH VỤ HELISA (VN)**

Số 53 ngõ 151 B Thái Hà, phường Láng Hạ, quận Đống Đa, thành phố Hà Nội

(72) Vũ Trọng Hiếu (VN)

(74) Công ty Cổ phần ICHECK (ICHECK.,JSC)

(55)



1.1



1.2



1.3



1.4



1.5



1.6



1.7

**CÔNG BÁO SỞ HỮU CÔNG NGHIỆP SỐ 439 TẬP A – QUYỀN 2 (10.2024)**

(11) **51512**

(21) 3-2024-00266

(28) 1

(54) **BỀ CÁ CẢNH**

(51) **30-02**

(22) 30/01/2024

(43) 25/10/2024

(73) **VŨ TRUNG KIÊN (VN)**

Số 307 đường Trần Hưng Đạo, phường Nhị Châu, thành phố Hải Dương, tỉnh Hải Dương

(72) Vũ Trung Kiên (VN)

(55)



1.1



1.2



1.3

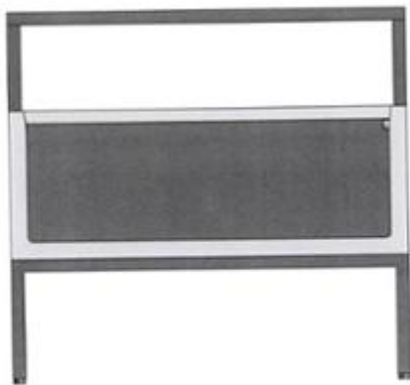

1.4



1.5



1.6

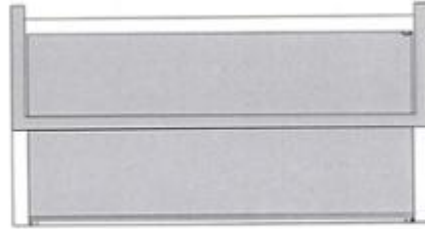

1.7

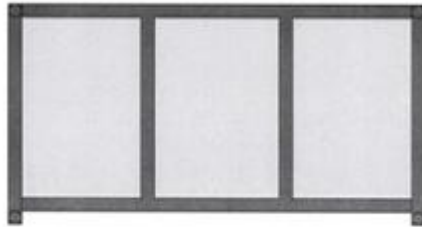

1.8

**CÔNG BÁO SỞ HỮU CÔNG NGHIỆP SỐ 439 TẬP A – QUYỀN 2 (10.2024)**

- (11) **51513**
- (21) 3-2024-00356
- (54) **TỦ LẠNH**
- (22) 07/02/2024
- (30) 2023-019436 22/09/2023 JP;
- (73) **PANASONIC INTELLECTUAL PROPERTY MANAGEMENT CO., LTD.**  
(JP)  
22-6, Moto-machi, Kadoma-shi, Osaka 571-0057 Japan
- (72) Kensaku OKABE (JP)
- (74) Công ty TNHH một thành viên Sở hữu trí tuệ VCCI (VCCI-IP CO.,LTD)
- (55)

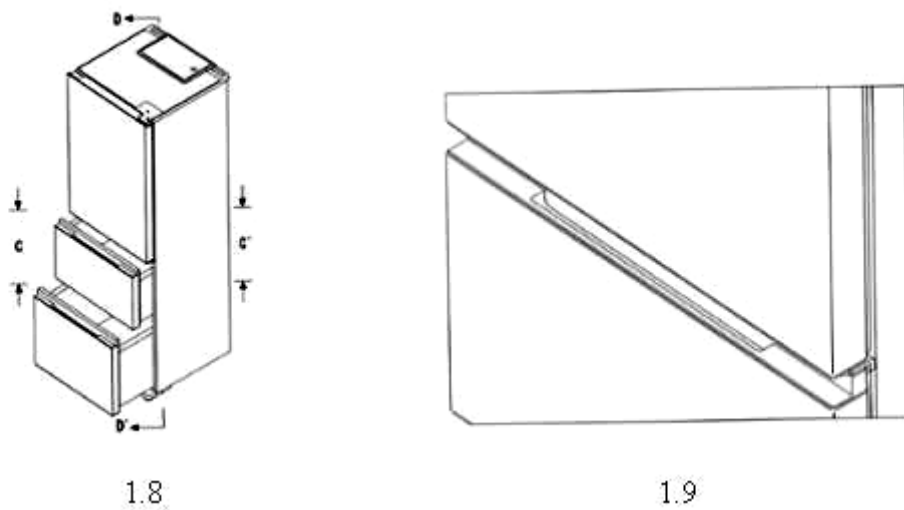
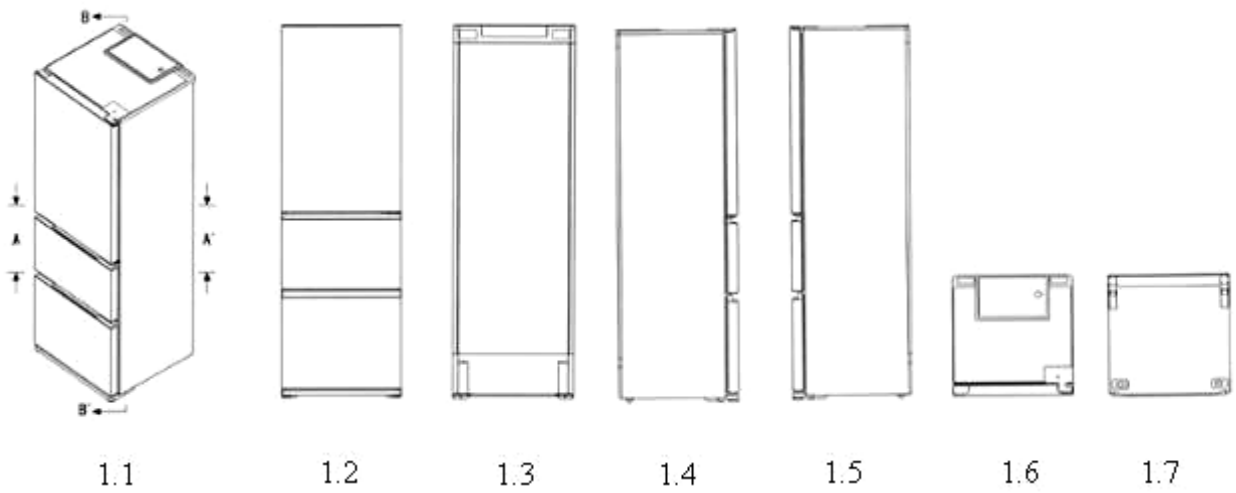



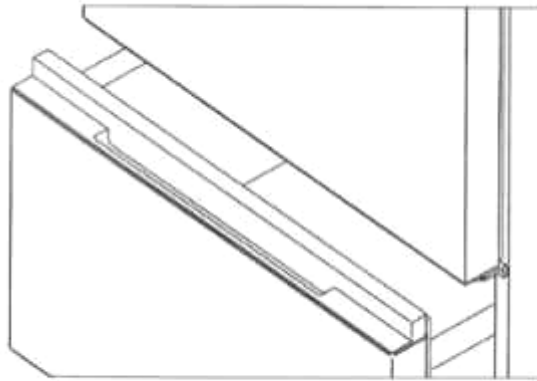

1.10

**CÔNG BÁO SỞ HỮU CÔNG NGHIỆP SỐ 439 TẬP A – QUYỀN 2 (10.2024)**

- (11) **51514**  
(21) 3-2024-00428 (28) 1  
(54) **MÁY ĐIỀU HÒA NHIỆT ĐỘ** (51) **23-04**  
(22) 23/02/2024 (43) 25/10/2024  
(30) 30-2023-0033277 25/08/2023 KR;  
(73) **LG ELECTRONICS INC. (KR)**  
128, Yeoui-daero, Yeongdeungpo-gu, Seoul, 07336, Republic of Korea  
(72) 1. INHYEUK CHOI (KR)  
2. SEUNGHO BAEK (KR)  
3. JOOGYEOM KIM (KR)  
4. JIUG HA (KR)  
5. JEONGHWAN SOHN (KR)  
(74) Công ty TNHH một thành viên Sở hữu trí tuệ VCCI (VCCI-IP CO.,LTD)  
(55)

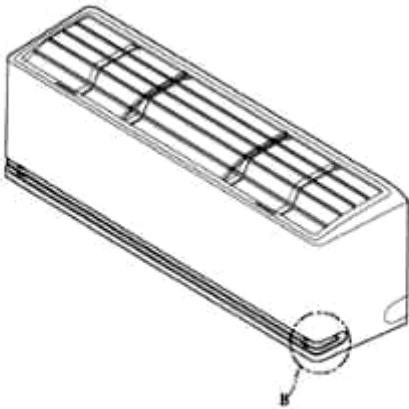

1.1

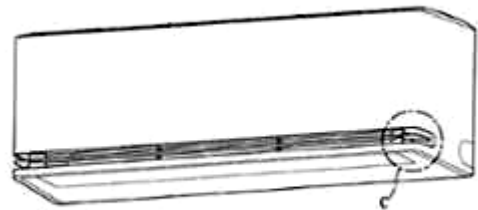

1.2



1.3



1.4



1.5



1.6



1.7



1.8



1.9

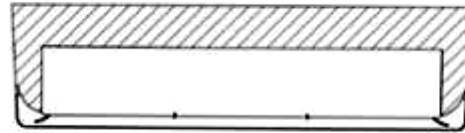

1.10

**CÔNG BÁO SỞ HỮU CÔNG NGHIỆP SỐ 439 TẬP A – QUYỀN 2 (10.2024)**

- (11) **51515**  
(21) 3-2024-00435 (28) 1  
(54) **TẮM TẢN NHIỆT CHO XE Ô TÔ** (51) **12-16**  
(22) 26/02/2024 (43) 25/10/2024  
(30) 2023-017747 31/08/2023 JP;  
(73) **HONDA MOTOR CO., LTD. (JP)**  
1-1, Minami-Aoyama 2-Chome, Minato-ku, Tokyo, 107-8556 Japan  
(72) Keisuke MORIOKA (JP)  
(74) Công ty Luật TNHH Phạm và Liên danh (PHAM & ASSOCIATES)  
(55)



1.1



1.2



1.3



1.4



1.5



1.6



1.7



1.8

**CÔNG BÁO SỞ HỮU CÔNG NGHIỆP SỐ 439 TẬP A – QUYỀN 2 (10.2024)**

- (11) **51516**  
(21) 3-2024-00443 (28) 1  
(54) **THIẾT BỊ MỞ RỘNG VÙNG PHỦ SÓNG WIFI** (51) **14-03**  
(22) 27/02/2024 (43) 25/10/2024  
(30) 30-2023-0036576 15/09/2023 KR;  
(73) **SAMSUNG ELECTRONICS CO., LTD. (KR)**  
129, Samsung-ro, Yeongtong-gu, Suwon-si, Gyeonggi-do 16677, Republic of Korea  
(72) 1. KOO, HYUNGJUN (KR)  
2. KWAK, JIHEE (KR)  
(74) Công ty Luật TNHH WINCO (WINCO LAW FIRM)  
(55)

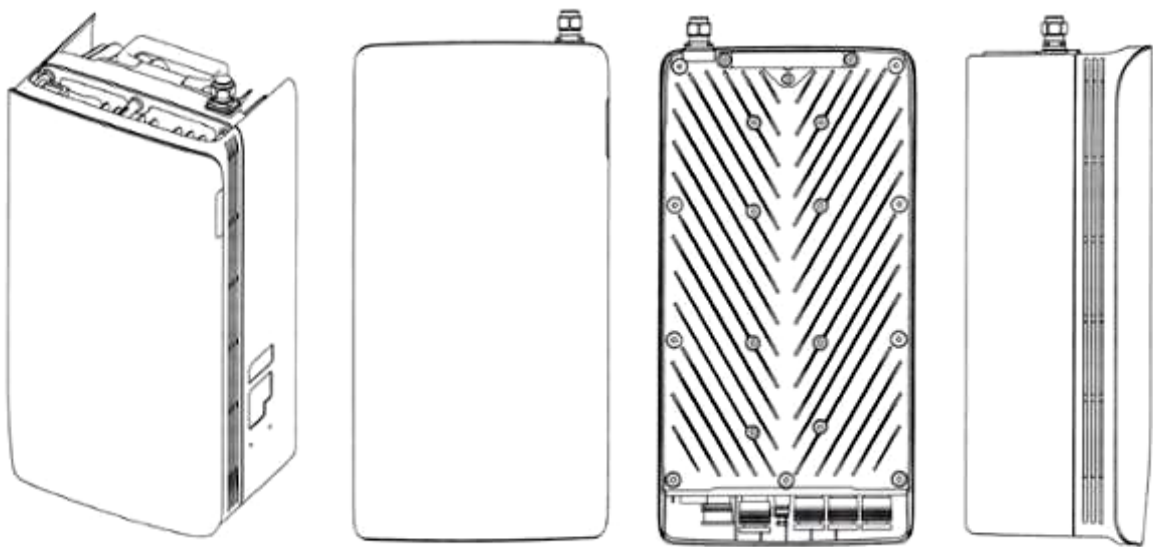

1.1

1.2

1.3

1.4

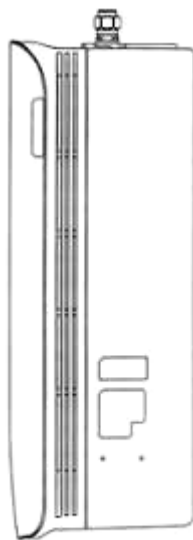

1.5

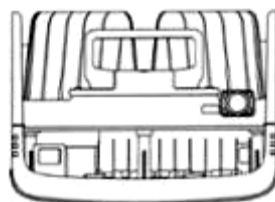

1.6

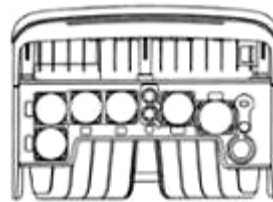

1.7

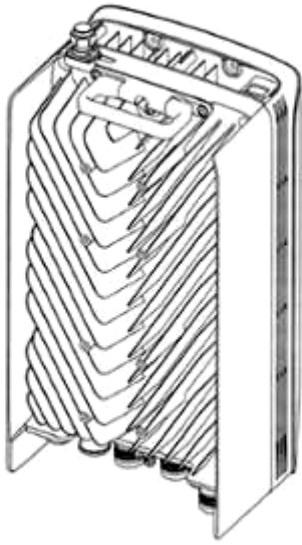

1.8

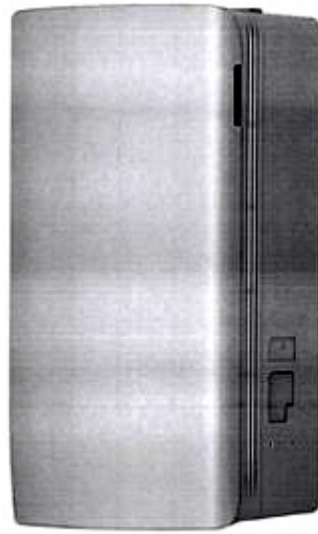

1.9

**CÔNG BÁO SỞ HỮU CÔNG NGHIỆP SỐ 439 TẬP A – QUYỀN 2 (10.2024)**

- (11) **51517**  
(21) 3-2024-00483 (28) 1  
(54) **HỘP MỰC** (51) **18-02**  
(22) 29/02/2024 (43) 25/10/2024  
(30) 2023-018040 05/09/2023 JP;  
(73) **BROTHER INDUSTRIES, LTD. (JP)**  
15-1 Naeshiro-cho, Mizuho-ku, Nagoya-shi, Aichi-ken, Japan  
(72) 1. TAKUYA AMAIKE (JP)  
2. KOJI ABE (JP)  
3. MICHIO FUJIOKA (JP)  
4. GO IWASA (JP)  
5. TSUBASA KIRIYAMA (JP)  
6. KAZUKI NAKANO (JP)  
7. HIROMITSU TANAKA (JP)  
(74) Công ty TNHH Ban Ca (BANCA)  
(55)

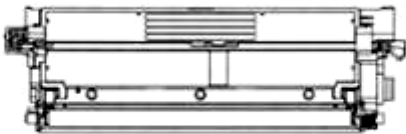

1.1

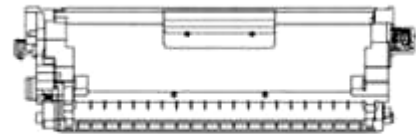

1.2



1.3



1.4



1.5



1.6

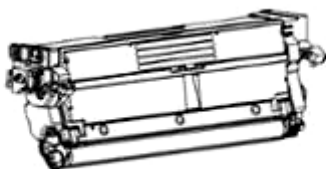

1.7

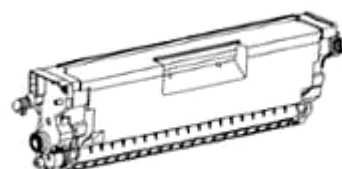

1.8

**CÔNG BÁO SỞ HỮU CÔNG NGHIỆP SỐ 439 TẬP A – QUYỀN 2 (10.2024)**

- (11) **51518**  
(21) 3-2024-00602 (28) 1  
(54) **HỘP KEO DÁN GẠCH** (51) **09-03**  
(22) 13/03/2024 (43) 25/10/2024  
(73) **CÔNG TY TNHH THƯƠNG MẠI DỊCH VỤ & SẢN XUẤT HNT  
NEWVISION (VN)**  
92 đường số 6, KP2, phường Bình Chiểu, thành phố Thủ Đức, thành phố Hồ Chí Minh  
(72) Dương Minh Hùng (VN)  
(74) Công ty Luật TNHH T2H (T2H LIMITED LIABILITY LAW COMPANY)  
(55)



1.1



1.2



**CÔNG BÁO SỞ HỮU CÔNG NGHIỆP SỐ 439 TẬP A – QUYỀN 2 (10.2024)**

- (11) **51519**  
(21) 3-2024-00603 (28) 1  
(54) **BAO GÓI KEO DÁN GẠCH** (51) **09-05**  
(22) 13/03/2024 (43) 25/10/2024  
(73) **CÔNG TY TNHH THƯƠNG MẠI DỊCH VỤ & SẢN XUẤT HNT  
NEWVISION (VN)**  
92 đường số 6, KP2, phường Bình Chiểu, thành phố Thủ Đức, thành phố Hồ Chí Minh  
(72) Dương Minh Hùng (VN)  
(74) Công ty Luật TNHH T2H (T2H LIMITED LIABILITY LAW COMPANY)  
(55)



1.1



1.2

**CÔNG BÁO SỞ HỮU CÔNG NGHIỆP SỐ 439 TẬP A – QUYỀN 2 (10.2024)**

- (11) **51520**  
(21) 3-2024-00639 (28) 1  
(54) **CHAI** (51) **09-01**  
(22) 18/03/2024 (43) 25/10/2024  
(73) **CÔNG TY CỔ PHẦN VIỆT THẮNG GROUP (VN)**  
Lô MM5, đường số 5, khu công nghiệp Đức Hòa 1, ấp 5, xã Đức Hòa Đông, huyện Đức Hoà, tỉnh Long An  
(72) Lê Văn Thế (VN)  
(74) Công ty cổ phần Tư vấn và đầu tư công nghệ IPS (Công ty CPTV&ĐT công nghệ IPS)  
(55)



1.1



1.2



1.3



1.4



1.5

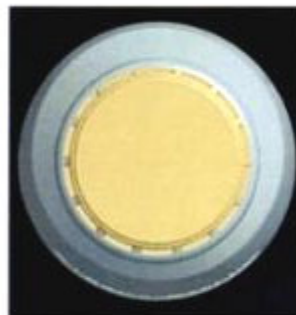

1.6

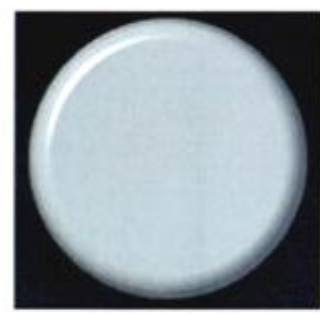

1.7

**CÔNG BÁO SỞ HỮU CÔNG NGHIỆP SỐ 439 TẬP A – QUYỀN 2 (10.2024)**

(11) **51521**

(21) 3-2024-00696

(28) 1

(54) **ĐẦU MÁY CẮT TÁCH VỎ CỨNG HẠT ĐIỀU**

(51) **15-03**

(22) 21/03/2024

(43) 25/10/2024

(73) **NGUYỄN VĂN LIÊN (VN)**

Khu phố Phước Trung, xã Phước Bình, thị xã Phước Long, tỉnh Bình Phước

(72) Nguyễn Văn Liên (VN)

(55)

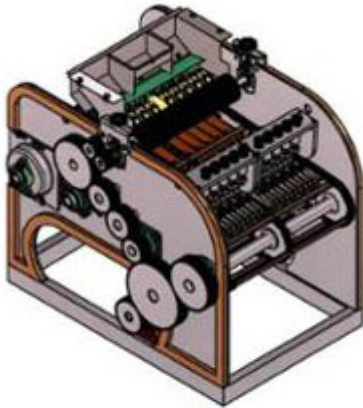

1.1

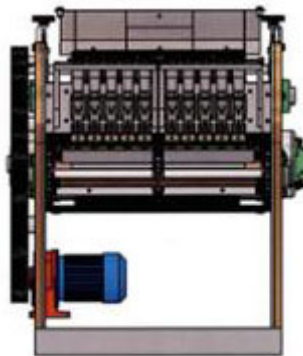

1.2

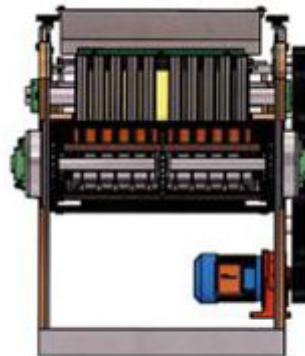

1.3

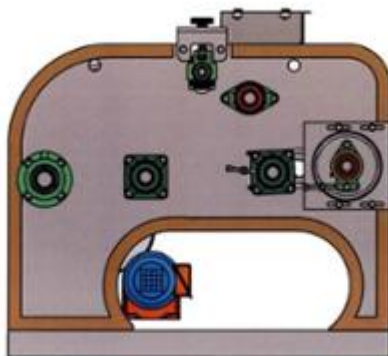

1.4

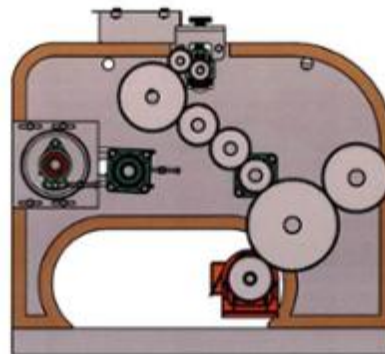

1.5

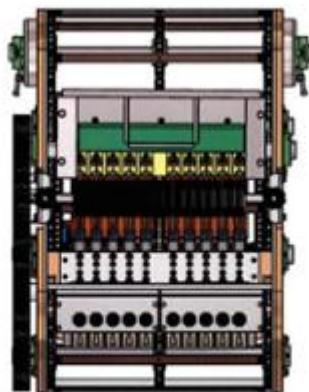

1.6

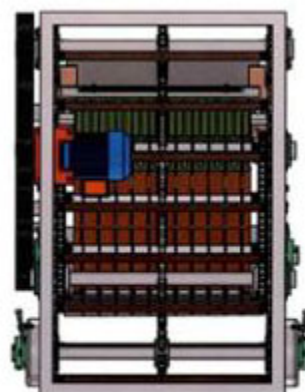

1.7

**CÔNG BÁO SỞ HỮU CÔNG NGHIỆP SỐ 439 TẬP A – QUYỀN 2 (10.2024)**

- (11) **51522**
- (21) 3-2024-00748 (28) 1
- (54) **NHÃN SẢN PHẨM** (51) **19-08**
- (22) 28/03/2024 (43) 25/10/2024
- (73) **CÔNG TY TNHH MTV THUỐC THÚ Y & CHẾ PHẨM SINH HỌC  
VEMEDIM (VN)**  
Khu công nghiệp Sông Hậu, giai đoạn 1, xã Đông Phú, huyện Châu Thành, tỉnh Hậu  
Giang
- (72) Lưu Phước Hậu (VN)
- (55)

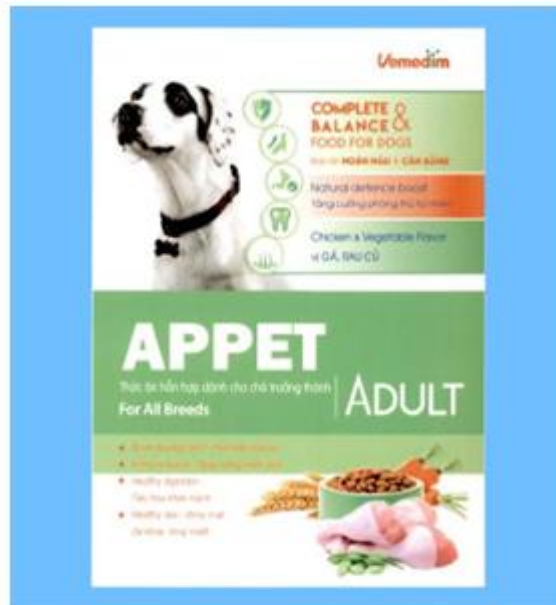

**CÔNG BÁO SỞ HỮU CÔNG NGHIỆP SỐ 439 TẬP A – QUYỀN 2 (10.2024)**

- (11) **51523**  
(21) 3-2024-00767 (28) 1  
(54) **TẮM ỐP BÊN ĐẦU XE SCUTO** (51) **12-16**  
(22) 29/03/2024 (43) 25/10/2024  
(30) 2023-020385 03/10/2023 JP;  
(73) **HONDA MOTOR CO., LTD. (JP)**  
1-1, Minami-Aoyama 2-chome, Minato-ku, Tokyo, 107-8556 Japan  
(72) 1. SORAWIT MALIPHAN (TH)  
2. TAKASHI WATANABE (JP)  
(74) Công ty Luật TNHH Phạm và Liên danh (PHAM & ASSOCIATES)  
(55)



- (11) **51524**  
(21) 3-2024-00768 (28) 1  
(54) **TẮM ỐP SƯỜN XE SCUTO** (51) **12-16**  
(22) 29/03/2024 (43) 25/10/2024  
(30) 2023-020389 03/10/2023 JP;  
(73) **HONDA MOTOR CO., LTD. (JP)**  
1-1, Minami-Aoyama 2-chome, Minato-ku, Tokyo, 107-8556 Japan  
(72) 1. SORAWIT MALIPHAN (TH)  
2. TAKASHI WATANABE (JP)  
(74) Công ty Luật TNHH Phạm và Liên danh (PHAM & ASSOCIATES)  
(55)



1.1



1.2



1.3



1.4



1.5



1.6



1.7



1.8



1.9



1.10



1.11

**CÔNG BÁO SỞ HỮU CÔNG NGHIỆP SỐ 439 TẬP A – QUYỀN 2 (10.2024)**

- (11) **51525**  
(21) 3-2024-01312 (28) 1  
(54) **LON BIA** (51) **09-03**  
(22) 07/06/2024 (43) 25/10/2024  
(73) **TỔNG CÔNG TY CỔ PHẦN BIA - RƯỢU - NƯỚC GIẢI KHÁT SÀI GÒN (VN)**  
187 Nguyễn Chí Thanh, Phường 12, Quận 5, Thành phố Hồ Chí Minh  
(72) Tan Teck Chuan Lester (SG)  
(74) Công ty TNHH Luật ALIAT (ALIAT LEGAL)  
(55)



1.1



1.2



1.3



1.4





1.5



1.6



1.7

- (11) **51526**  
(21) 3-2024-01408 (28) 1  
(54) **HỘP ĐỰNG THỨC ĂN CHO THÚ CỪNG** (51) **09-03**  
(22) 19/11/2021 (43) 25/10/2024  
(30) 2021-010750 21/05/2021 JP;  
(73) **UNICHARM CORPORATION (JP)**  
182, Shimobun, Kinsei-cho, Shikokuchuo-shi, Ehime-ken, 799-0111 Japan  
(72) 1. TADATOSHI NOBATA (JP)  
2. SAYAKA YAMAMOTO (JP)  
3. YUNYI WONG (JP)  
4. YUMA IKEZAKI (JP)  
(74) Công ty Cổ phần Sở hữu công nghiệp INVESTIP (INVESTIP)  
(55)



1.1



1.2



1.3



1.4

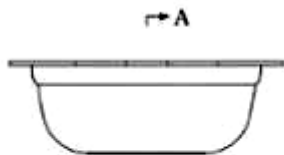

A

1.5



1.6

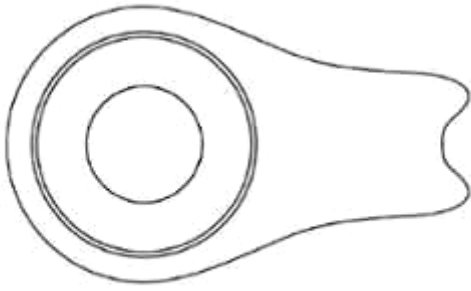

1.7

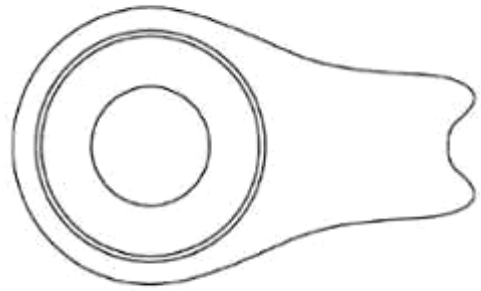

1.8

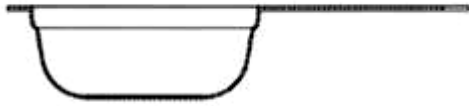

1.9



1.10

**CÔNG BÁO SỞ HỮU CÔNG NGHIỆP SỐ 439 TẬP A – QUYỀN 2 (10.2024)**

- (11) **51527**  
(21) 3-2024-01415 (28) 2  
(54) **MÁY TẮY BÃ NHÒN** (51) **28-03**  
(22) 19/06/2024 (43) 25/10/2024  
(73) **LG H&H CO., LTD. (KR)**  
58, Saemunan-ro, Jongno-gu, Seoul, Republic of Korea  
(72) KIM, Joung Eun (KR)  
(74) Công ty TNHH Tầm nhìn và Liên danh (VISION & ASSOCIATES CO.LTD.)  
(55)

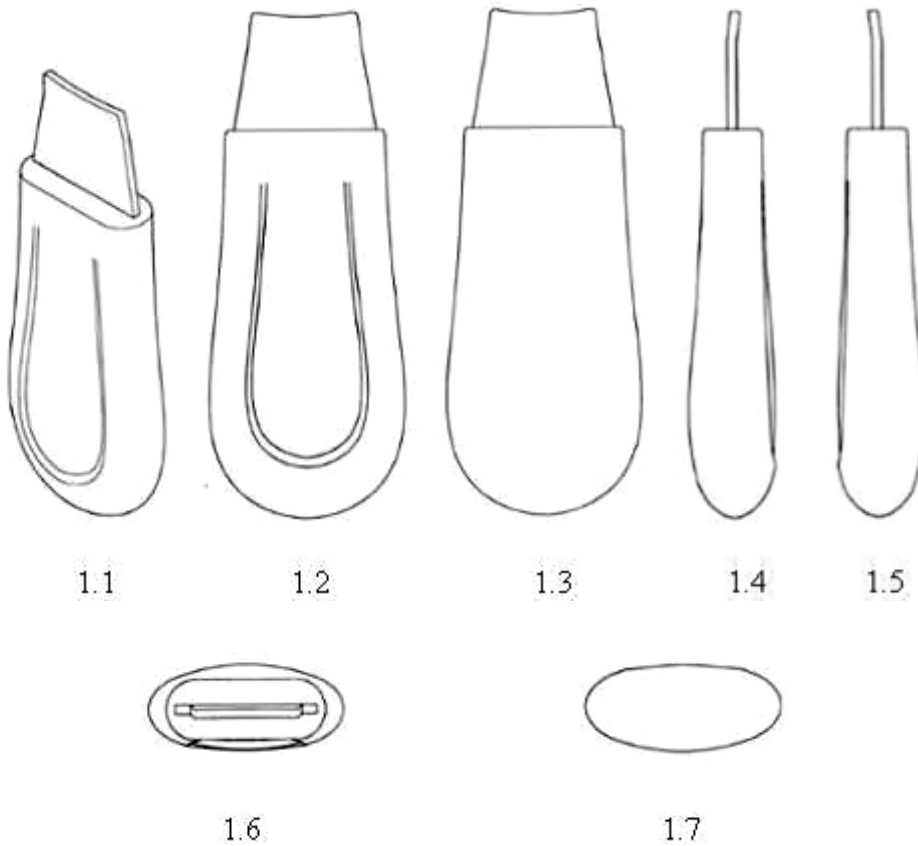

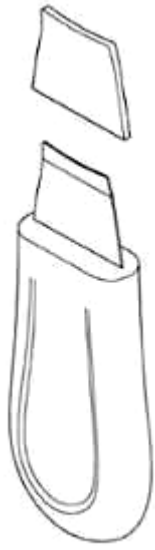

1.8



2.1



2.2



2.3



2.4



2.5



2.6



2.7

**CÔNG BÁO SỞ HỮU CÔNG NGHIỆP SỐ 439 TẬP A – QUYỀN 2 (10.2024)**

- (11) **51528**  
(21) 3-2024-01416 (28) 1  
(54) **ẤM ĐUN NƯỚC** (51) **07-02**  
(22) 19/06/2024 (43) 25/10/2024  
(30) 202330836164.8 19/12/2023 CN;  
(73) **GUANGDONG MIDEA CONSUMER ELECTRIC MANUFACTURING CO., LTD. (CN)**  
San Le Road #19, Beijiao, Shunde, Foshan, Guangdong Province 528311, China  
(72) 1. ZHENG, XIAOCHENG (CN)  
2. GUO, YUQIANG (CN)  
3. CHEN, SHISHI (CN)  
(74) Công ty TNHH Tâm nhìn và Liên danh (VISION & ASSOCIATES CO.LTD.)  
(55)



1.1



1.2



1.3



1.4



1.5



1.6



1.7

**CÔNG BÁO SỞ HỮU CÔNG NGHIỆP SỐ 439 TẬP A – QUYỀN 2 (10.2024)**

- (11) **51529**  
(21) 3-2024-01434 (28) 1  
(54) **BÚT** (51) **19-06**  
(22) 21/06/2024 (43) 25/10/2024  
(30) 2024300041542 04/01/2024 CN;  
(73) **BEIFA GROUP CO., LTD.** (CN)  
Bldg.4-1, Bldg.1-1, No.68 Weiliu Rd., Xiaogang, Beilun Dist, Ningbo, Zhejiang,  
315821, China  
(72) LIN Yuke (CN)  
(74) Công ty TNHH Dịch vụ Sở hữu trí tuệ BIG5 (BIG5 IP CO.,LTD)  
(55)



1.1

1.2

1.3

1.4

1.5



1.6



1.7



**CÔNG BÁO SỞ HỮU CÔNG NGHIỆP SỐ 439 TẬP A – QUYỀN 2 (10.2024)**

- (11) **51530**  
(21) 3-2024-01435 (28) 1  
(54) **BÚT** (51) **19-06**  
(22) 21/06/2024 (43) 25/10/2024  
(30) 2024300041186 04/01/2024 CN;  
(73) **BEIFA GROUP CO., LTD.** (CN)  
Bldg.4-1, Bldg.1-1, No.68 Weiliu Rd., Xiaogang, Beilun Dist, Ningbo, Zhejiang,  
315821, China  
(72) LIN Yuke (CN)  
(74) Công ty TNHH Dịch vụ Sở hữu trí tuệ BIG5 (BIG5 IP CO.,LTD)  
(55)

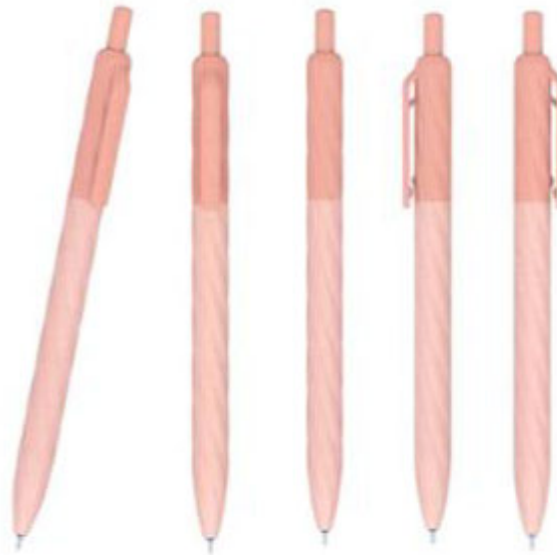

1.1 1.2 1.3 1.4 1.5



1.6 1.7

**CÔNG BÁO SỞ HỮU CÔNG NGHIỆP SỐ 439 TẬP A – QUYỀN 2 (10.2024)**

- (11) **51531**  
(21) 3-2024-01438 (28) 1  
(54) **MÁY TÍNH ĐIỆN TỬ** (51) **18-01**  
(22) 21/06/2024 (43) 25/10/2024  
(73) **WANJUN LIAN (CN)**  
3rd Floor, No. 69 Tianhezhi Street, Tianhe District, Guangzhou City, Guangdong  
Province, China  
(72) Wanjun Lian (CN)  
(74) Công ty TNHH Trà và cộng sự (TRA & ASSOCIATES CO.,LTD)  
(55)



1.1



1.2



1.3



1.4



1.5



1.6



1.7

**CÔNG BÁO SỞ HỮU CÔNG NGHIỆP SỐ 439 TẬP A – QUYỀN 2 (10.2024)**

- (11) **51532**  
(21) 3-2024-01472 (28) 1  
(54) **DÀN NÓNG CỦA MÁY ĐIỀU HÒA KHÔNG KHÍ** (51) **23-04**  
(22) 25/06/2024 (43) 25/10/2024  
(30) 2024-000540 15/01/2024 JP;  
(73) **DAIKIN INDUSTRIES, LTD.** (JP)  
Osaka Umeda Twin Towers South, 1-13-1, Umeda, Kita-ku, Osaka-shi, Osaka,  
Japan  
(72) Kentaro NIKI (JP)  
(74) Công ty TNHH một thành viên Sở hữu trí tuệ VCCI (VCCI-IP CO.,LTD)  
(55)

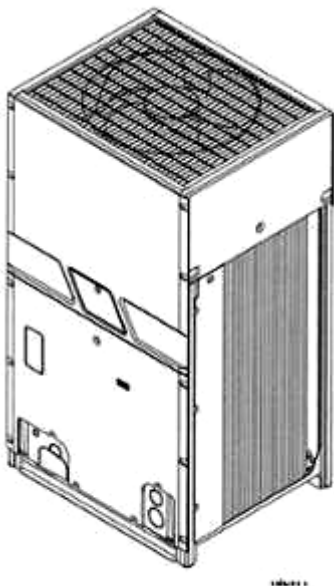

1.1

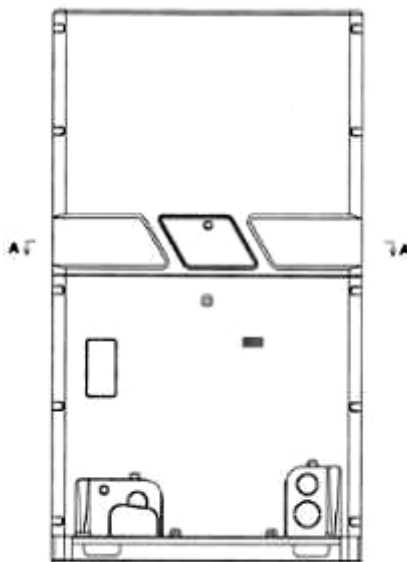

1.2

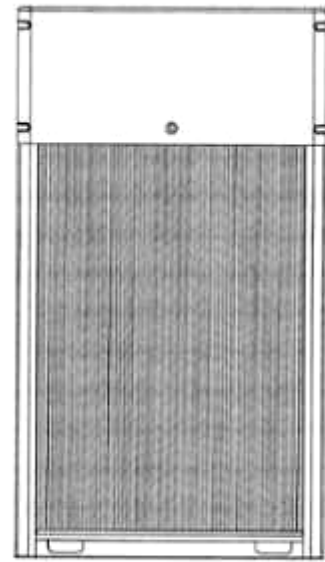

1.3

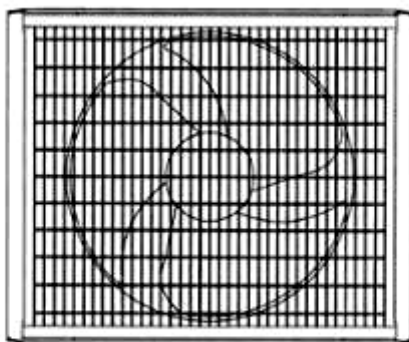

1.4

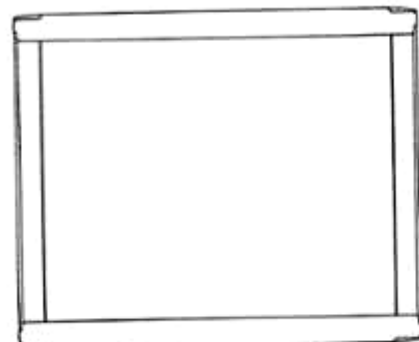

1.5

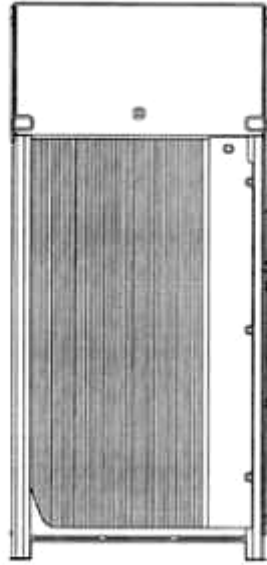

1.6

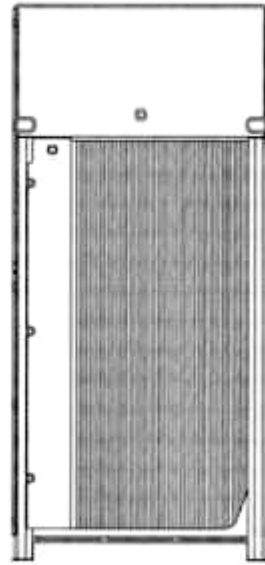

1.7

- (11) **51533**  
(21) 3-2024-01473 (28) 1  
(54) **MÁY ĐIỀU HÒA KHÔNG KHÍ** (51) **23-04**  
(22) 25/06/2024 (43) 25/10/2024  
(30) 2024-000597 15/01/2024 JP;  
(73) **DAIKIN INDUSTRIES, LTD. (JP)**  
Osaka Umeda Twin Towers South, 1-13-1, Umeda, Kita-ku, Osaka-shi, Osaka,  
Japan  
(72) Kentaro NIKI (JP)  
(74) Công ty TNHH một thành viên Sở hữu trí tuệ VCCI (VCCI-IP CO.,LTD)  
(55)

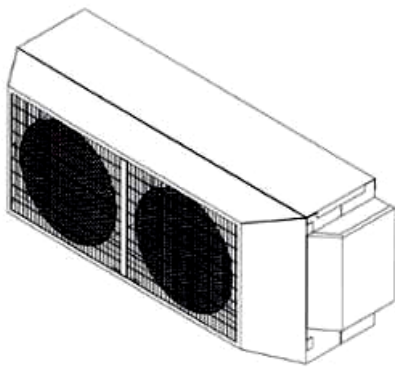

1.1

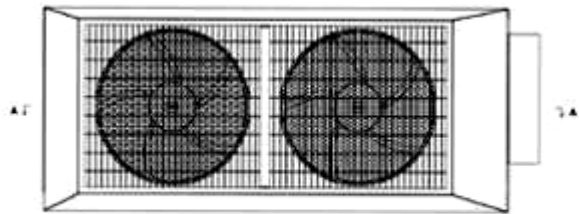

1.2



1.3

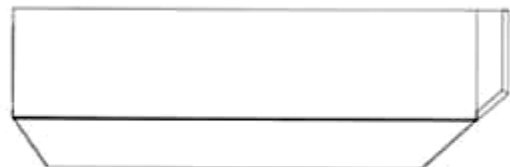

1.4

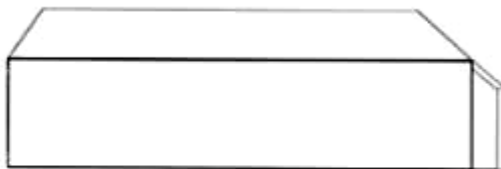

1.5



1.6



1.7

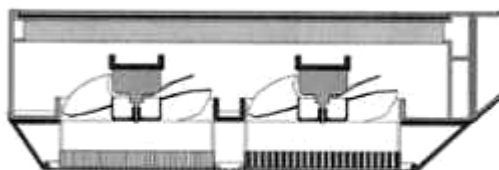

1.8

**CÔNG BÁO SỞ HỮU CÔNG NGHIỆP SỐ 439 TẬP A – QUYỀN 2 (10.2024)**

- (11) **51534**  
(21) 3-2024-01474 (28) 2  
(54) **DÀN NÓNG CỦA MÁY ĐIỀU HÒA KHÔNG KHÍ** (51) **23-04**  
(22) 25/06/2024 (43) 25/10/2024  
(30) 2024-000596 15/01/2024 JP; 2024-000595 15/01/2024 JP;  
(73) **DAIKIN INDUSTRIES, LTD.** (JP)  
Osaka Umeda Twin Towers South, 1-13-1, Umeda, Kita-ku, Osaka-shi, Osaka,  
Japan  
(72) 1. TERUHIKO SUGITO (JP)  
2. KENICHIRO INOUE (JP)  
(74) Công ty TNHH một thành viên Sở hữu trí tuệ VCCI (VCCI-IP CO.,LTD)  
(55)

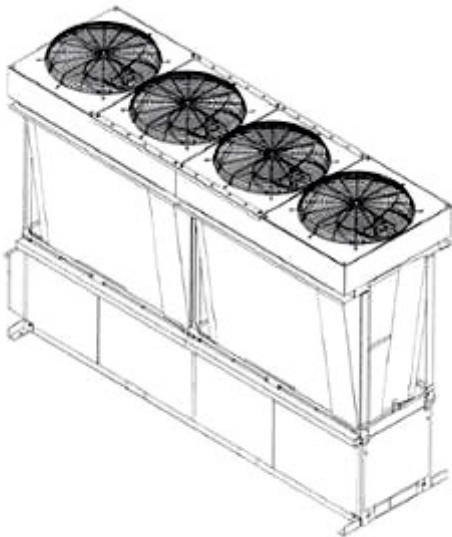

1.1

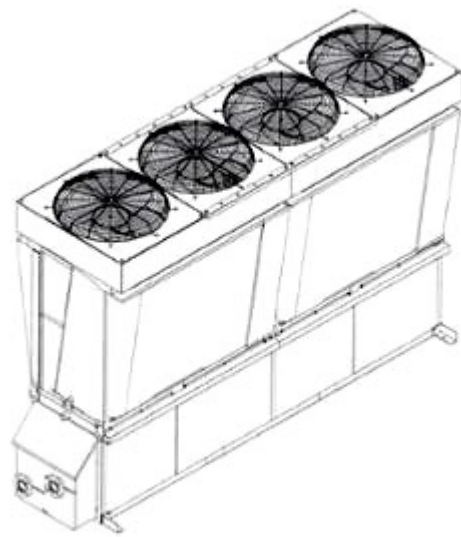

1.2

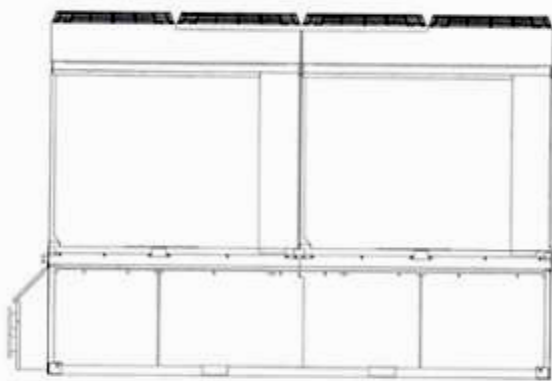

1.3

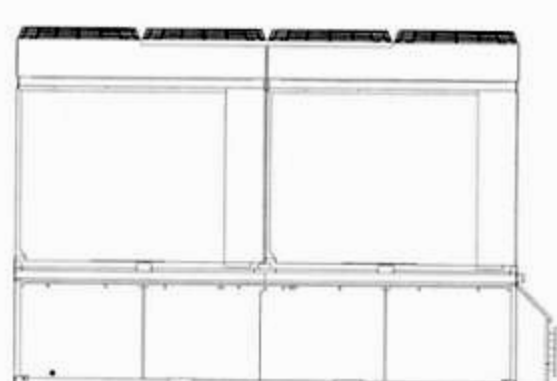

1.4

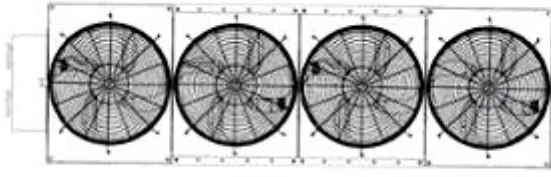

1.5

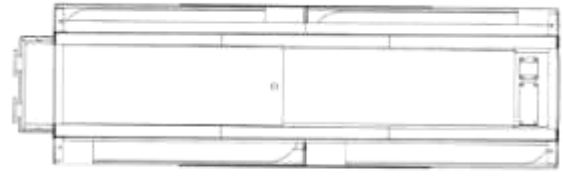

1.6



1.7



1.8

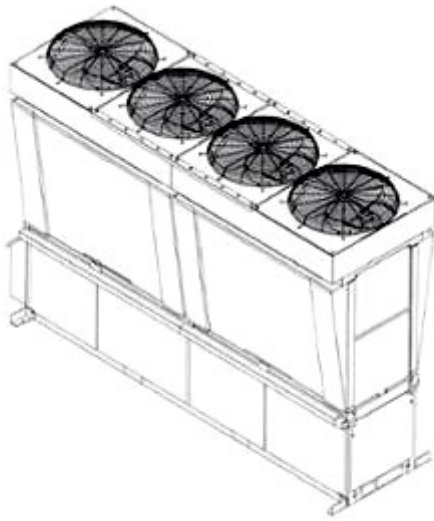

2.1

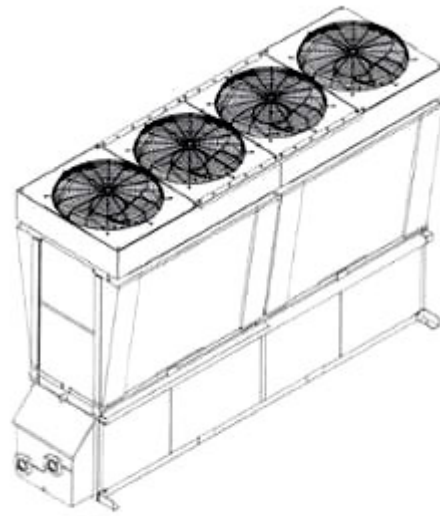

2.2

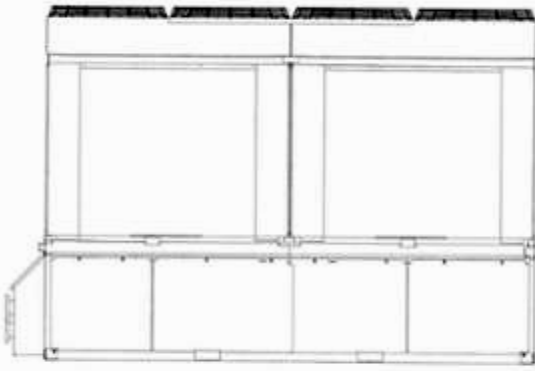

2.3

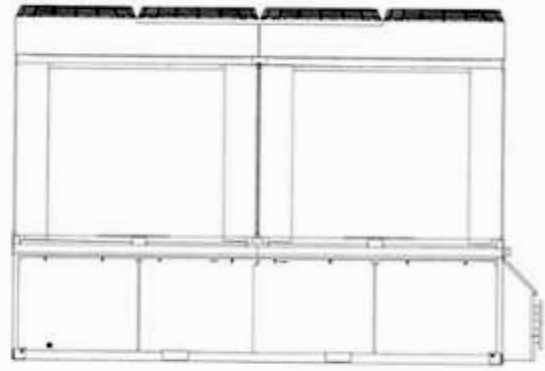

2.4

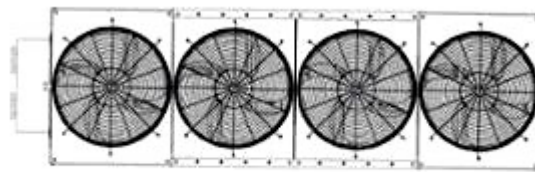

2.5

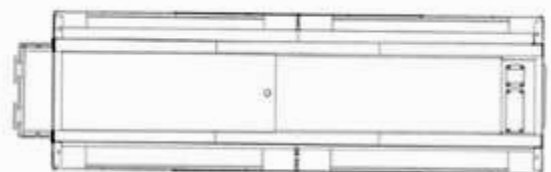

2.6



2.7



2.8



**CÔNG BÁO SỞ HỮU CÔNG NGHIỆP SỐ 439 TẬP A – QUYỀN 2 (10.2024)**

- (11) **51535**  
(21) 3-2024-01551 (28) 2  
(54) **NHÃN SẢN PHẨM** (51) **19-08**  
(22) 04/07/2024 (43) 25/10/2024  
(73) **CÔNG TY CỔ PHẦN THỰC PHẨM VÀ NƯỚC GIẢI KHÁT PTT (VN)**  
76 đường số 25, phường Tân Phong, quận 7, thành phố Hồ Chí Minh  
(72) Lê Trung Thành (VN)  
(74) Công ty Luật TNHH Phạm và Liên danh (PHAM & ASSOCIATES)  
(55)



1



2

**CÔNG BÁO SỞ HỮU CÔNG NGHIỆP SỐ 439 TẬP A – QUYỀN 2 (10.2024)**

- (11) **51536**  
(21) 3-2024-01581 (28) 1  
(54) **MÁY MÁT XA** (51) **28-03**  
(22) 10/07/2024 (43) 25/10/2024  
(73) **AN, YOUNGKWON (CN)**  
Flat F, 27/F, Kimberley 26, 26 Kimberley Road, Tsim Sha Tsui, Kowloon, Hong Kong  
(72) AN, Youngkwon (CN)  
(74) Công ty TNHH Sở hữu trí tuệ NTT (NTT IP CO.,LTD)  
(55)

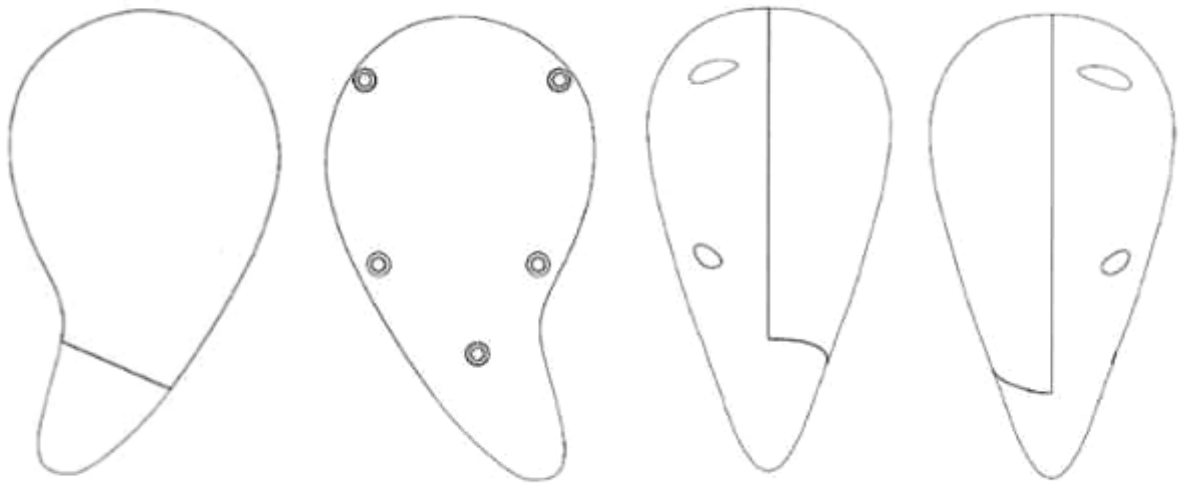

1.1

1.2

1.3

1.4

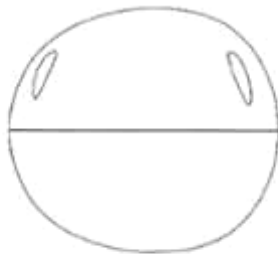

1.5

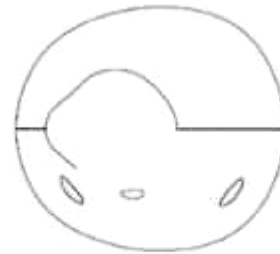

1.6



1.7



1.8

**CÔNG BÁO SỞ HỮU CÔNG NGHIỆP SỐ 439 TẬP A – QUYỀN 2 (10.2024)**

- (11) **51537**  
(21) 3-2024-01582 (28) 4  
(54) **ĐẦU NỐI CÁP DẸT** (51) **13-03**  
(22) 10/07/2024 (43) 25/10/2024  
(30) 2024301369817 18/03/2024 CN;  
(73) **HIROSE ELECTRIC CO., LTD., (JP)**  
2-6-3, NAKAGAWACHUO, TSUZUKI-KU, YOKOHAMA, KANAGAWA 224-8540 JAPAN  
(72) Sae YOKOYAMA (JP)  
(74) Công ty TNHH một thành viên Sở hữu trí tuệ VCCI (VCCI-IP CO.,LTD)  
(55)

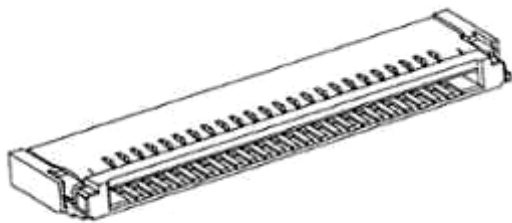

1.1

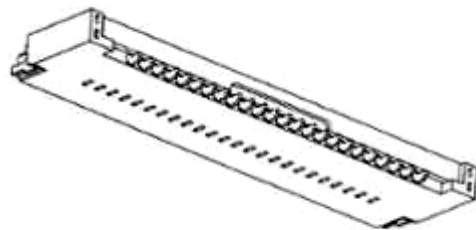

1.2

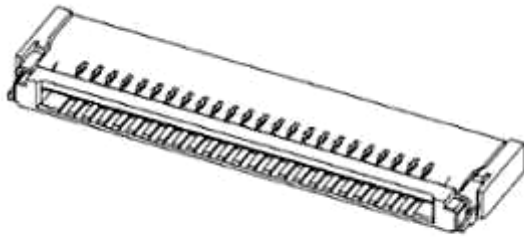

1.3

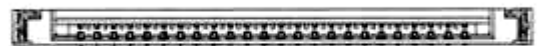

1.4



1.5



1.6



1.7

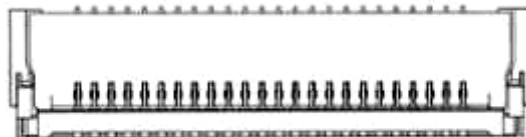

1.8

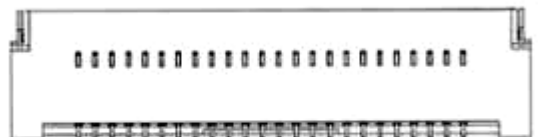

1.9



2.1

2.2

2.3

2.4

2.5

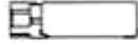

2.6

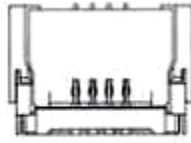

2.7

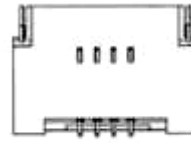

2.8



2.9

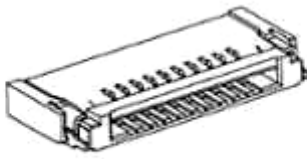

3.1

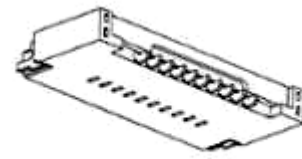

3.2



3.3

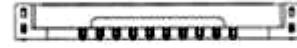

3.4



3.5



3.6

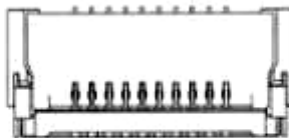

3.7



3.8

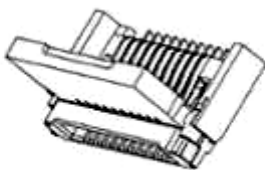

3.9

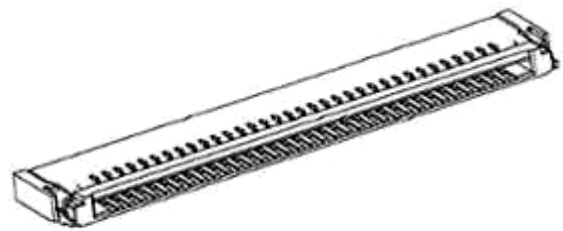

4.1

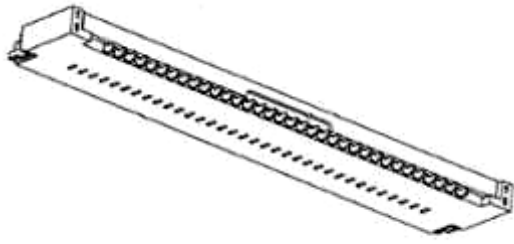

4.2



4.3



4.4



4.5

4.6



4.7



4.8



4.9

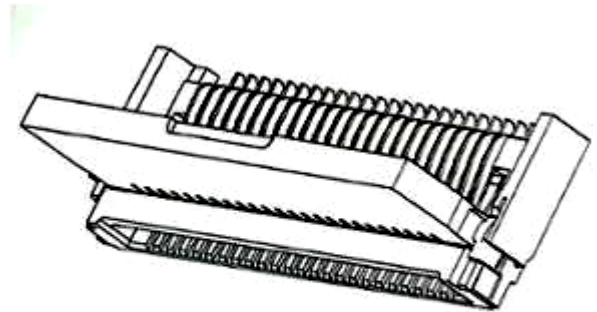

1.10

**CÔNG BÁO SỞ HỮU CÔNG NGHIỆP SỐ 439 TẬP A – QUYỀN 2 (10.2024)**

(11) **51538**

(21) 3-2024-01605

(28) 1

(54) **MÁY MÁT XA DA ĐẦU**

(51) **28-03**

(22) 11/07/2024

(43) 25/10/2024

(73) **GOPANG CO., LTD. (KR)**

405-ho, 213-65 Cheomdan-ro, Jeju-si, Jeju-do 63309, Republic of Korea

(72) Hyun Hong Jun (KR)

(74) Công ty TNHH Sáng chế ACTIP (ACTIP PATENT LIMITED)

(55)

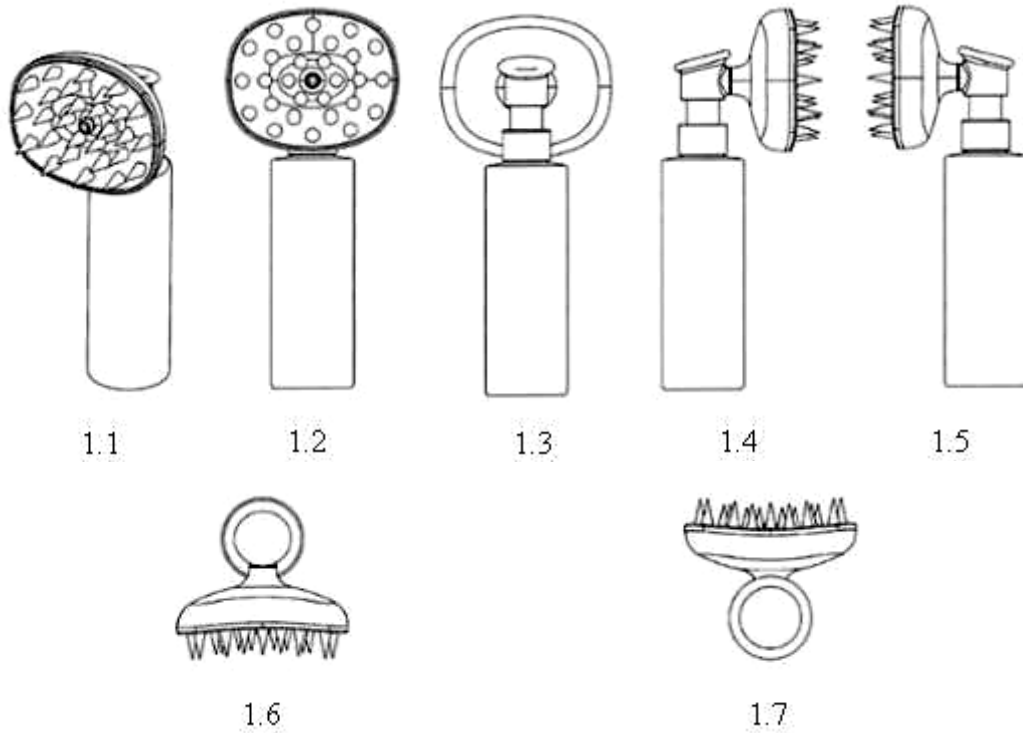

**CÔNG BÁO SỞ HỮU CÔNG NGHIỆP SỐ 439 TẬP A – QUYỀN 2 (10.2024)**

- (11) **51539**  
(21) 3-2024-01633 (28) 1  
(54) **THÂN THIẾT BỊ NẤU** (51) **31-00**  
(22) 16/07/2024 (43) 25/10/2024  
(30) 2024300381332 19/01/2024 CN;  
(73) **GUANGDONG MIDEA CONSUMER ELECTRIC MANUFACTURING CO., LTD. (CN)**  
San Le Road #19, Beijiao, Shunde, Foshan, Guangdong 528311 China  
(72) 1. CAO, YUXIN (CN)  
2. DENG, ZHIPENG (CN)  
3. HUANG, YINGWEN (CN)  
(74) Công ty Cổ phần Sở hữu công nghiệp INVESTIP (INVESTIP)  
(55)



1.1



1.2



1.3



1.4



1.5



1.6



1.7



1.8



**CÔNG BÁO SỞ HỮU CÔNG NGHIỆP SỐ 439 TẬP A – QUYỀN 2 (10.2024)**

- (11) **51540**  
(21) 3-2024-01634 (28) 1  
(54) **THÂN THIẾT BỊ NẤU** (51) **31-00**  
(22) 16/07/2024 (43) 25/10/2024  
(30) 2024300386177 19/01/2024 CN;  
(73) **GUANGDONG MIDEA CONSUMER ELECTRIC MANUFACTURING CO., LTD. (CN)**  
San Le Road #19, Beijiao, Shunde, Foshan, Guangdong 528311 China  
(72) 1. DENG, ZHIPENG (CN)  
2. HUANG, YINGWEN (CN)  
3. CAO, YUXIN (CN)  
(74) Công ty Cổ phần Sở hữu công nghiệp INVESTIP (INVESTIP)  
(55)



1.1



1.2



1.3



1.4



1.5



1.6



1.7



1.8

**CÔNG BÁO SỞ HỮU CÔNG NGHIỆP SỐ 439 TẬP A – QUYỀN 2 (10.2024)**

- (11) **51541**  
(21) 3-2024-01718 (28) 1  
(54) **XE SCUTO** (51) **12-11**  
(22) 23/07/2024 (43) 25/10/2024  
(30) 2024-001961 31/01/2024 JP;  
(73) **HONDA MOTOR CO., LTD. (JP)**  
1-1, Minami-Aoyama 2-chome, Minato-ku, Tokyo, 107-8556 Japan  
(72) 1. AYUMU TSUJI (JP)  
2. RINA ITO (JP)  
(74) Công ty Luật TNHH Phạm và Liên danh (PHAM & ASSOCIATES)  
(55)



1.1



1.2



1.3



1.4



1.5



1.6



1.7



1.8



1.9



1.10

**CÔNG BÁO SỞ HỮU CÔNG NGHIỆP SỐ 439 TẬP A – QUYỀN 2 (10.2024)**

- (11) **51542**  
(21) 3-2024-01719 (28) 1  
(54) **TẮM ỐP BÊN ĐẦU XE SCUTO** (51) **12-16**  
(22) 23/07/2024 (43) 25/10/2024  
(30) 2024-001962 31/01/2024 JP;  
(73) **HONDA MOTOR CO., LTD. (JP)**  
1-1, Minami-Aoyama 2-chome, Minato-ku, Tokyo, 107-8556 Japan  
(72) 1. AYUMU TSUJI (JP)  
2. RINA ITO (JP)  
(74) Công ty Luật TNHH Phạm và Liên danh (PHAM & ASSOCIATES)  
(55)

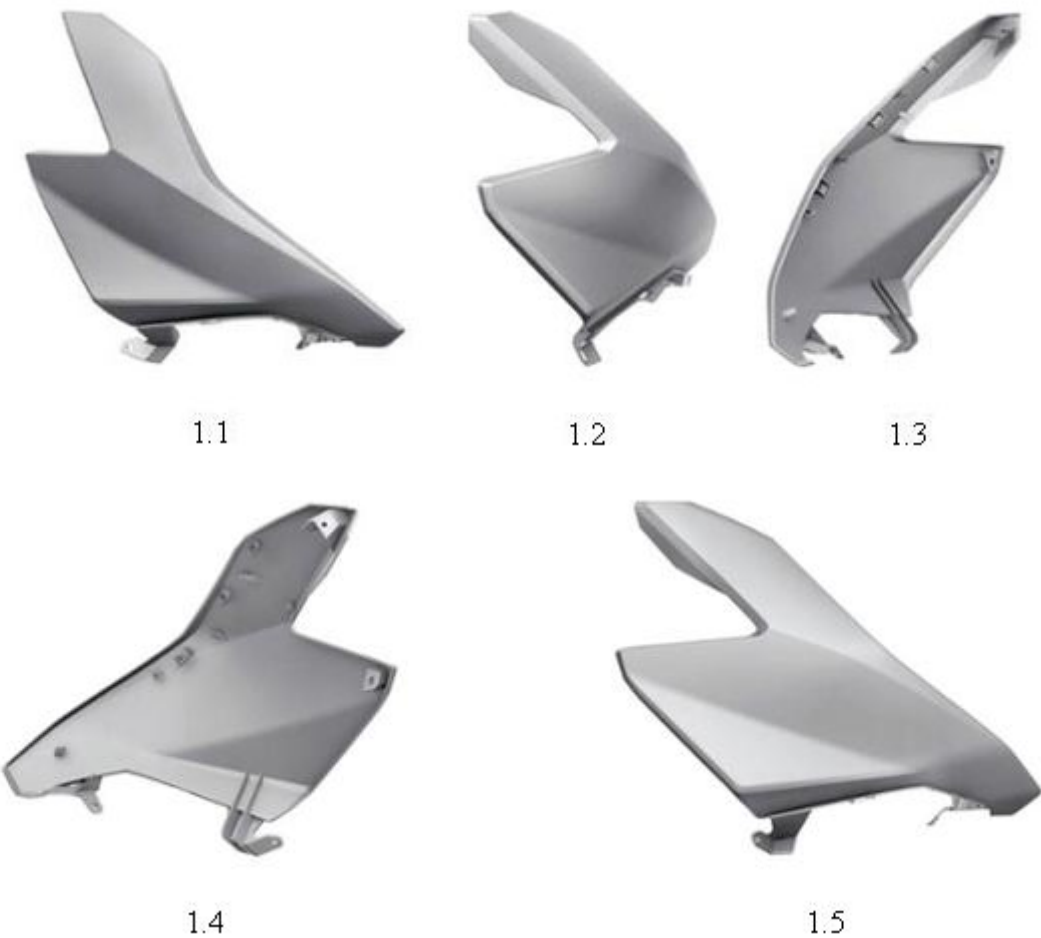



1.6



1.7



1.8



1.9



1.10



1.11

**CÔNG BÁO SỞ HỮU CÔNG NGHIỆP SỐ 439 TẬP A – QUYỀN 2 (10.2024)**

- (11) **51543**  
(21) 3-2024-01720 (28) 1  
(54) **TẮM ỐP SƯỜN XE SCUTO** (51) **12-16**  
(22) 23/07/2024 (43) 25/10/2024  
(30) 2024-001963 31/01/2024 JP;  
(73) **HONDA MOTOR CO., LTD. (JP)**  
1-1, Minami-Aoyama 2-chome, Minato-ku, Tokyo, 107-8556 Japan  
(72) 1. AYUMU TSUJI (JP)  
2. RINA ITO (JP)  
(74) Công ty Luật TNHH Phạm và Liên danh (PHAM & ASSOCIATES)  
(55)



1.1



1.2



1.3



1.4



1.5



1.6



1.7



1.8



1.9



1.10



1.11



**CÔNG BÁO SỞ HỮU CÔNG NGHIỆP SỐ 439 TẬP A – QUYỀN 2 (10.2024)**

- (11) **51544**  
(21) 3-2024-01727 (28) 1  
(54) **CHỖI** (51) **04-01**  
(22) 23/07/2024 (43) 25/10/2024  
(73) **ZHEJIANG CHEROMAY HOUSEWARE CO., LTD. (CN)**  
Shi Yuan Xian Industrial Zone, Nancheng Street, Huangyan, Taizhou, Zhejiang,  
China  
(72) Jianxin WANG (CN)  
(74) Công ty TNHH Trường Xuân (AGELESS CO.,LTD.)  
(55)



1.1



1.2



1.3



1.4



1.5



1.6

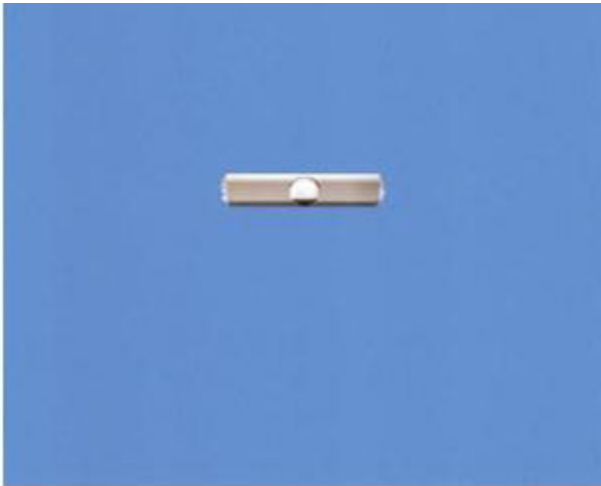

1.7



1.8



1.9



1.10

**CÔNG BÁO SỞ HỮU CÔNG NGHIỆP SỐ 439 TẬP A – QUYỀN 2 (10.2024)**

(11) **51545**

(21) 3-2024-01730

(28) 1

(54) **ĐÈN ĐIỀU HÒA DÙNG CHO PHÒNG TẮM**

(51) **26-05**

(22) 23/07/2024

(43) 25/10/2024

(73) **CÔNG TY CỔ PHẦN BÓNG ĐÈN PHÍCH NƯỚC RẠNG ĐÔNG (VN)**

87-89 phố Hạ Đình, phường Thanh Xuân Trung, quận Thanh Xuân, thành phố Hà Nội

(72) Trần Trung Tường (VN)

(55)



1.1



1.2

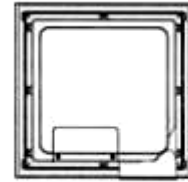

1.3



1.4



1.5



1.6

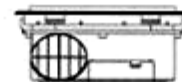

1.7

**CÔNG BÁO SỞ HỮU CÔNG NGHIỆP SỐ 439 TẬP A – QUYỀN 2 (10.2024)**

- (11) **51546**  
(21) 3-2024-01731 (28) 1  
(54) **ĐÈN ĐIỀU HÒA DÙNG CHO PHÒNG TẮM** (51) **26-05**  
(22) 23/07/2024 (43) 25/10/2024  
(73) **CÔNG TY CỔ PHẦN BÓNG ĐÈN PHÍCH NƯỚC RẠNG ĐÔNG (VN)**  
87-89 phố Hạ Đình, phường Thanh Xuân Trung, quận Thanh Xuân, thành phố Hà Nội  
(72) Trần Trung Tường (VN)  
(55)

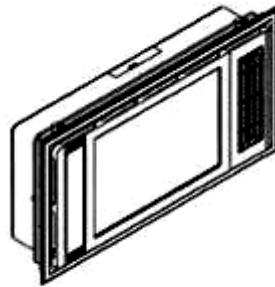

1.1

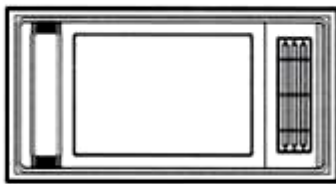

1.2

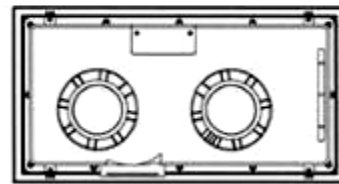

1.3



1.4



1.5



1.6



1.7

**CÔNG BÁO SỞ HỮU CÔNG NGHIỆP SỐ 439 TẬP A – QUYỀN 2 (10.2024)**

- (11) **51547**  
(21) 3-2024-01749 (28) 1  
(54) **XE ĐẨY TAY** (51) **12-02**  
(22) 24/07/2024 (43) 25/10/2024  
(73) **CÔNG TY CỔ PHẦN MỸ PHẨM BAK (VN)**  
68/4 Nguyễn Bá Tông, phường 11, quận Tân Bình, thành phố Hồ Chí Minh  
(72) Thái Quang Vinh (VN)  
(74) Công ty TNHH Dịch vụ thương mại và sở hữu công nghiệp Song Ngọc (I.P.T.S.)  
(55)



1.1



1.2



1.3



1.4



1.5



1.6



1.7

**CÔNG BÁO SỞ HỮU CÔNG NGHIỆP SỐ 439 TẬP A – QUYỀN 2 (10.2024)**

(11) **51548**

(21) 3-2024-01754

(28) 2

(54) **Ổ KHÓA**

(51) **08-07**

(22) 25/07/2024

(43) 25/10/2024

(30) 2402001337 21/03/2024 TH;

(73) **1. SIAM INTER LOCK TEK CO., LTD. (TH)**

Samut Sakhon Industrial Zone 1/8, 1/10, 1/138, Moo 2, Rama 2 road, Tha Sai subdistrict, Mueang Samut Sakhon district, Samut Sakhon 74000, Thailand

**2. SUVICHAI JANETHANA-ARTHAKIJ (TH)**

10, Soi Suksawat 30 Allay, 4 Junction, Bang Pakok sub-district, Ratchaburana district, Bangkok 10140, Thailand

(72) Suvichai Janethana-arthakij (TH)

(74) Công ty TNHH Dịch vụ Sở hữu trí tuệ KENFOX (KENFOX IP SERVICE CO.,LTD.)

(55)

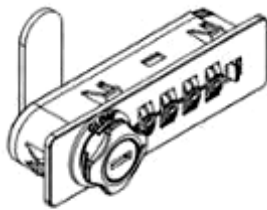

1.1

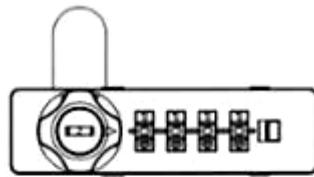

1.2

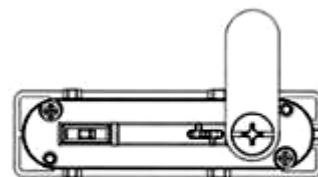

1.3

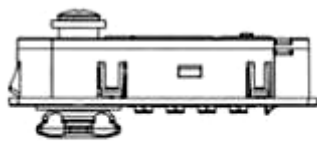

1.4

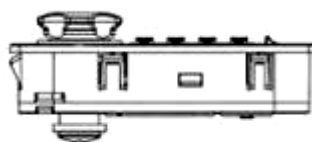

1.5

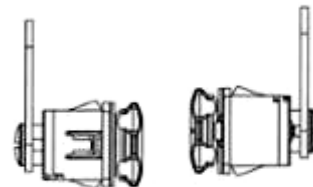

1.6

1.7

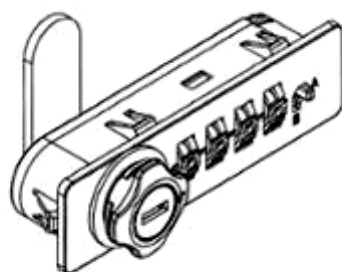

2.1

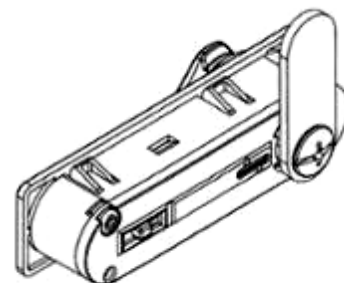

2.2

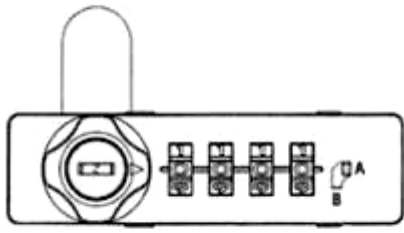

2.3

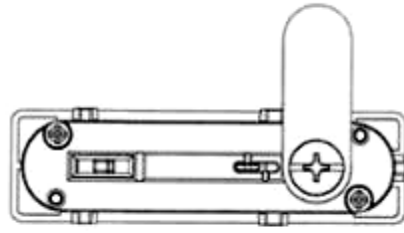

2.4

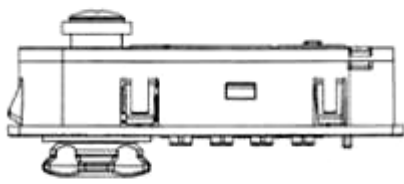

2.5

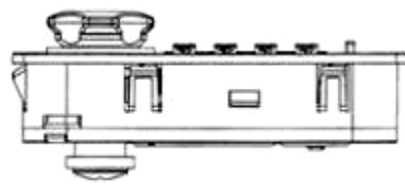

2.6

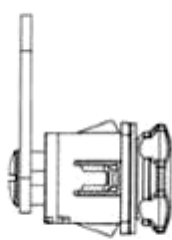

2.7

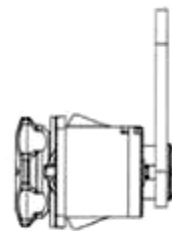

2.8

**CÔNG BÁO SỞ HỮU CÔNG NGHIỆP SỐ 439 TẬP A – QUYỀN 2 (10.2024)**

- (11) **51549**  
(21) 3-2024-01755 (28) 1  
(54) **KHÓA CỬA KỸ THUẬT SỐ** (51) **08-06; 08-07**  
(22) 25/07/2024 (43) 25/10/2024  
(30) 2402001954 29/04/2024 TH;  
(73) 1. **SIAM INTER LOCK TEK CO., LTD.** (TH)  
Samut Sakhon Industrial Zone 1/8, 1/10, 1/138, Moo 2, Rama 2 road, Tha Sai subdistrict, Mueang Samut Sakhon district, Samut Sakhon 74000, Thailand  
2. **SUVICHAI JANETHANA-ARTHAKIJ** (TH)  
10, Soi Suksawat 30 Allay, 4 Junction, Bang Pakok sub-district, Ratchaburana district, Bangkok 10140, Thailand  
(72) Suvichai Janethana-arthakij (TH)  
(74) Công ty TNHH Dịch vụ Sở hữu trí tuệ KENFOX (KENFOX IP SERVICE CO.,LTD.)  
(55)

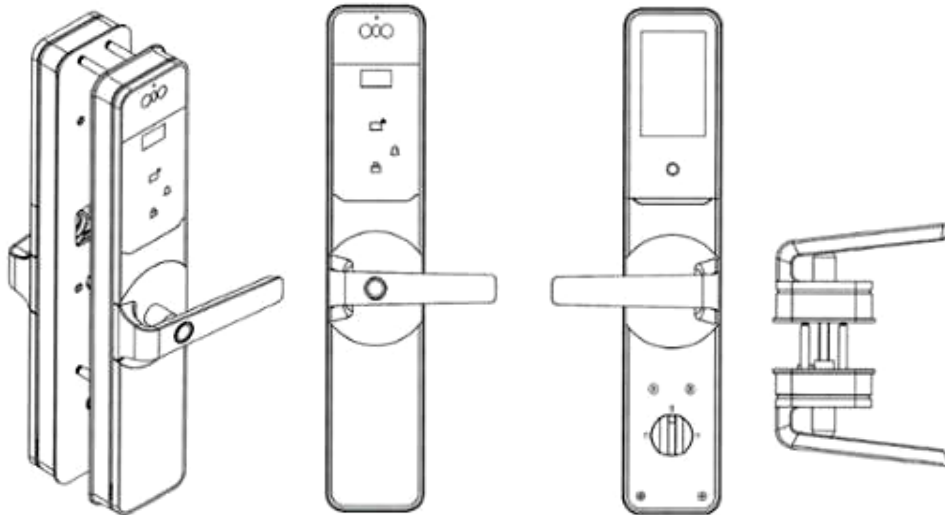

1.1

1.2

1.3

1.4

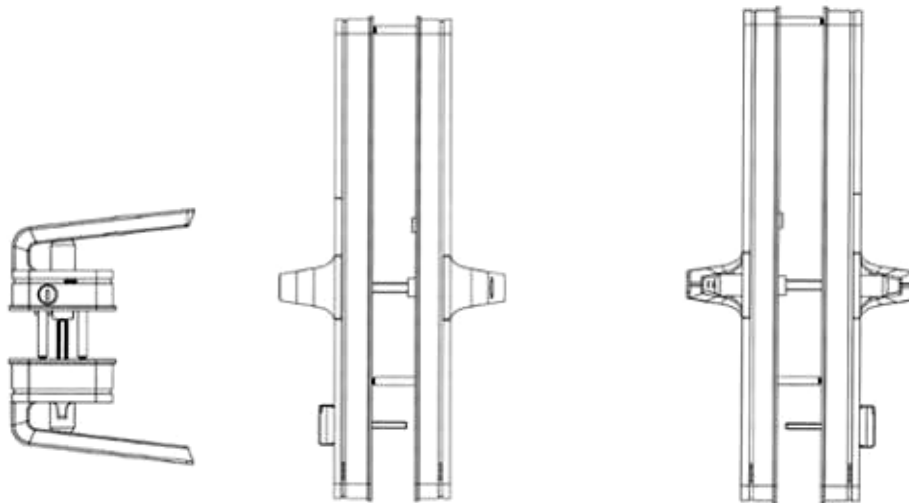

1.5

1.6

1.7



**CÔNG BÁO SỞ HỮU CÔNG NGHIỆP SỐ 439 TẬP A – QUYỀN 2 (10.2024)**

- (11) **51550**  
(21) 3-2024-01756 (28) 1  
(54) **KHÓA CỬA KỸ THUẬT SỐ** (51) **08-06; 08-07**  
(22) 25/07/2024 (43) 25/10/2024  
(30) 2402001953 29/04/2024 TH;  
(73) 1. **SIAM INTER LOCK TEK CO., LTD.** (TH)  
Samut Sakhon Industrial Zone 1/8, 1/10, 1/138, Moo 2, Rama 2 road, Tha Sai subdistrict, Mueang Samut Sakhon district, Samut Sakhon 74000, Thailand  
2. **SUVICHAI JANETHANA-ARTHAKIJ** (TH)  
10, Soi Suksawat 30 Allay, 4 Junction, Bang Pakok sub-district, Ratchaburana district, Bangkok 10140, Thailand  
(72) Suvichai Janethana-arthakij (TH)  
(74) Công ty TNHH Dịch vụ Sở hữu trí tuệ KENFOX (KENFOX IP SERVICE CO.,LTD.)  
(55)

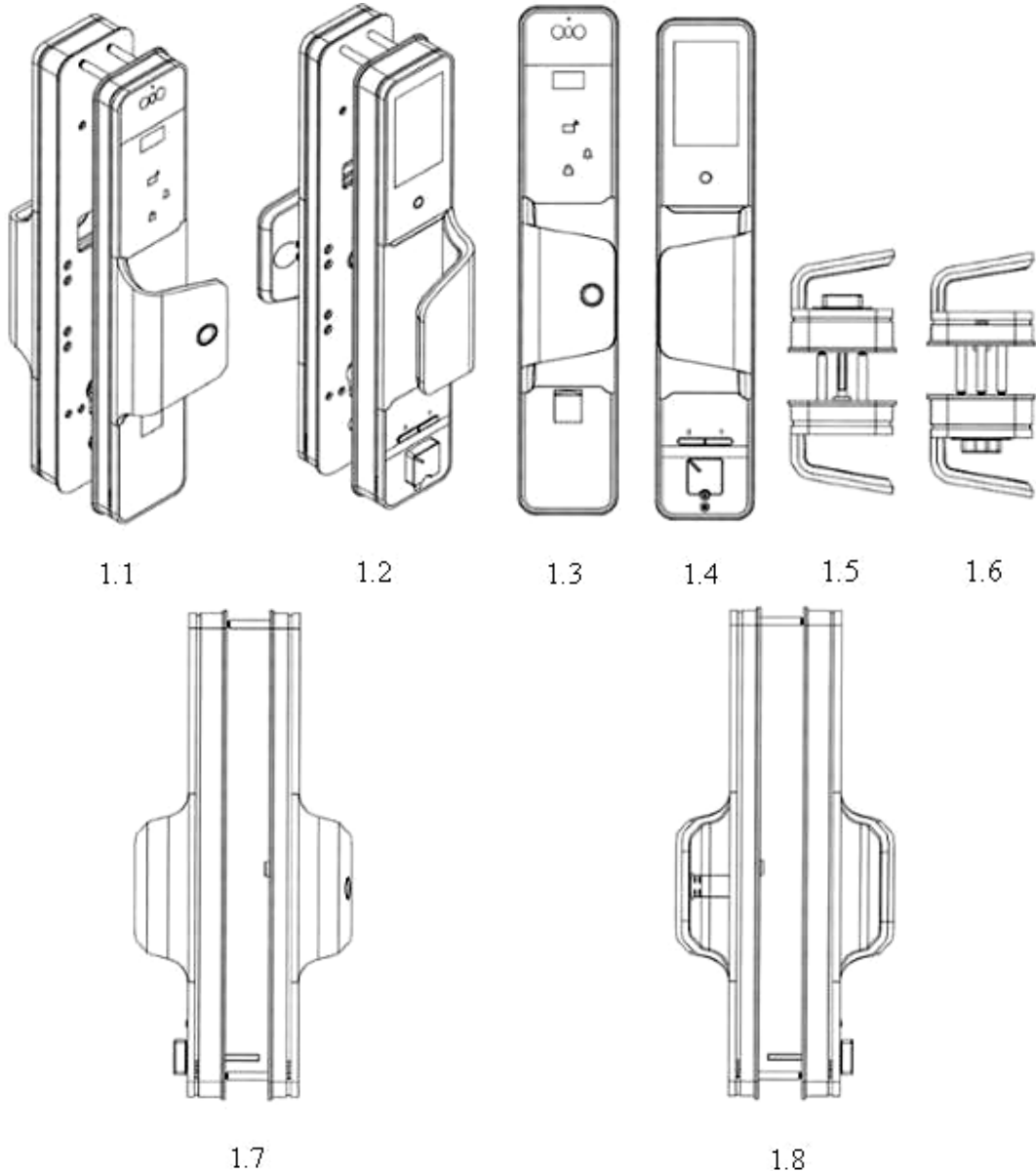

**CÔNG BÁO SỞ HỮU CÔNG NGHIỆP SỐ 439 TẬP A – QUYỀN 2 (10.2024)**

- (11) **51551**  
(21) 3-2024-01759 (28) 1  
(54) **HỆ THỐNG GIÁM SÁT PHÁT THẢI KHÍ METHANE** (51) **10-04; 10-05**  
(22) 25/07/2024 (43) 25/10/2024  
(73) **CÔNG TY CỔ PHẦN RYNAN TECHNOLOGIES VIETNAM (VN)**  
Ấp Long Trị, xã Long Đức, thành phố Trà Vinh, tỉnh Trà Vinh  
(72) 1. NGUYỄN THANH MỸ (VN)  
2. HỒNG QUỐC CƯỜNG (VN)  
3. LÊ THANH TRIỀU (VN)  
4. TRẦN QUỐC TOẢN (VN)  
5. VÕ VŨ KHANH (VN)  
6. NGUYỄN HỮU ĐỨC (VN)  
(74) Công ty TNHH Đại Tín và Liên Danh (DAITIN AND ASSOCIATES CO.,LTD)  
(55)

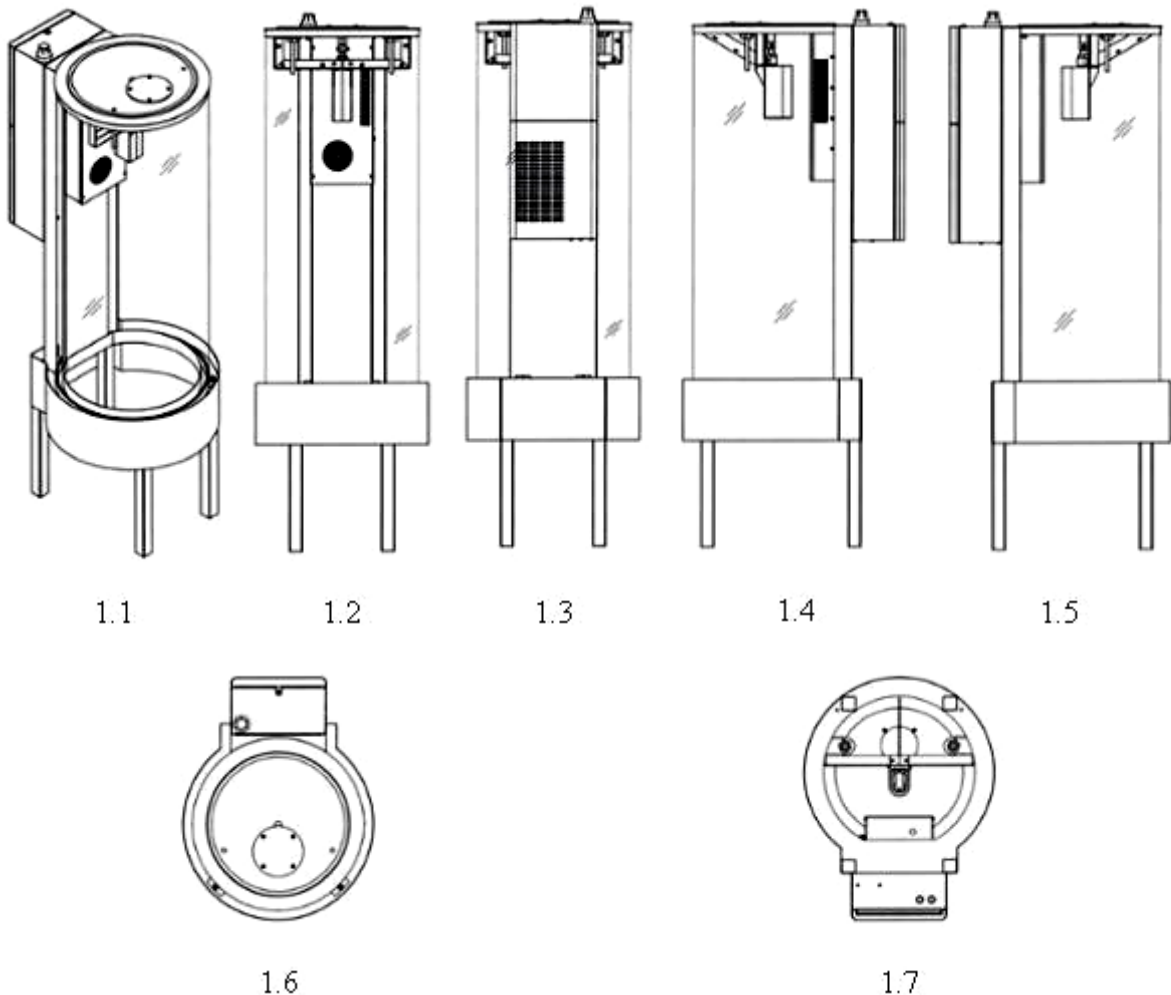

**CÔNG BÁO SỞ HỮU CÔNG NGHIỆP SỐ 439 TẬP A – QUYỀN 2 (10.2024)**

- (11) **51552**  
(21) 3-2024-01764 (28) 1  
(54) **XE SCUTO** (51) **12-11**  
(22) 26/07/2024 (43) 25/10/2024  
(30) 2024-001841 30/01/2024 JP;  
(73) **HONDA MOTOR CO., LTD. (JP)**  
1-1, Minami-Aoyama 2-Chome, Minato-ku, Tokyo, 107-8556 Japan  
(72) 1. TAKESHI FUTAMATA (JP)  
2. MASAYA KIKUCHI (JP)  
(74) Công ty Luật TNHH Phạm và Liên danh (PHAM & ASSOCIATES)  
(55)



1.1



1.2



1.3



1.4



1.5



1.6



1.7



1.8



1.9

- (11) **51553**  
(21) 3-2024-01765 (28) 1  
(54) **YẾM XE SCUTO** (51) **12-16**  
(22) 26/07/2024 (43) 25/10/2024  
(30) 2024-001842 30/01/2024 JP;  
(73) **HONDA MOTOR CO., LTD. (JP)**  
1-1, Minami-Aoyama 2-Chome, Minato-ku, Tokyo, 107-8556 Japan  
(72) 1. TAKESHI FUTAMATA (JP)  
2. MASAYA KIKUCHI (JP)  
(74) Công ty Luật TNHH Phạm và Liên danh (PHAM & ASSOCIATES)  
(55)

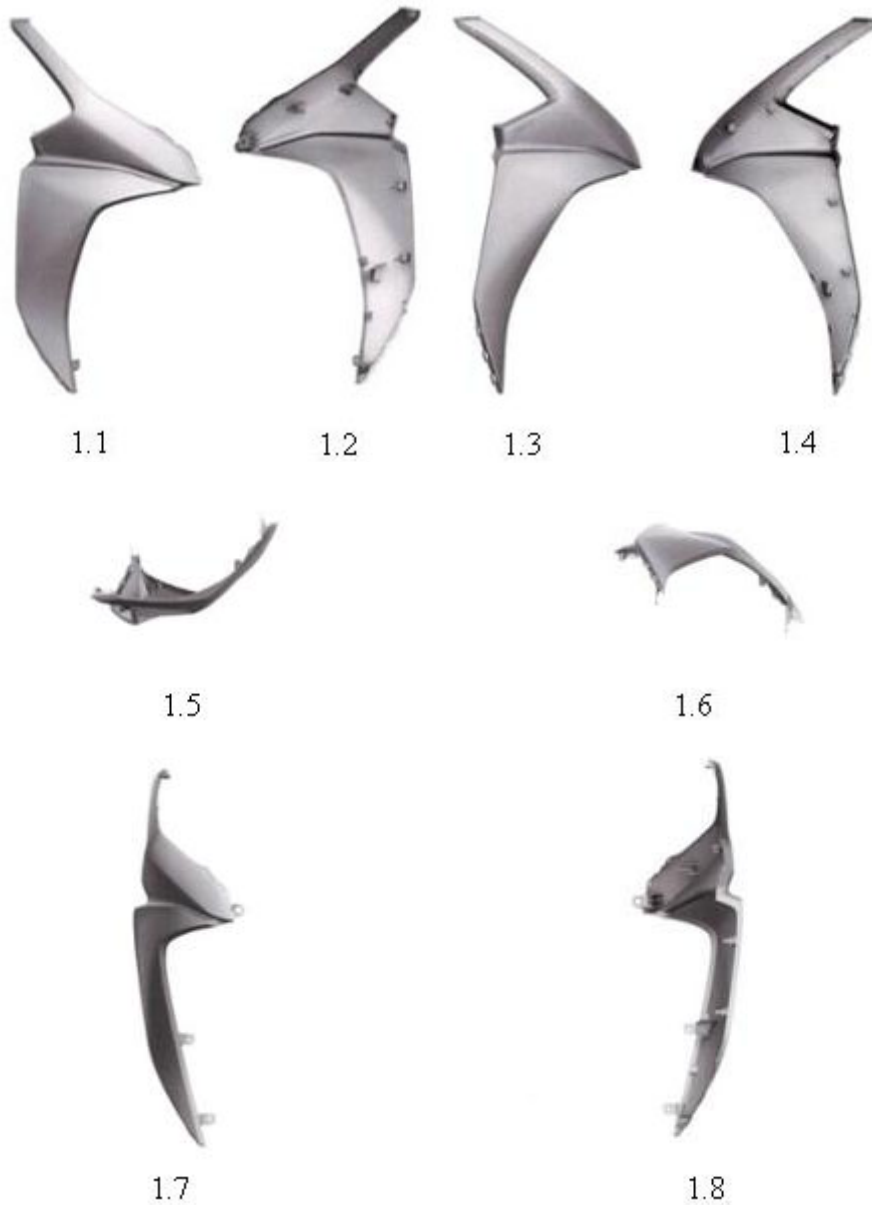

**CÔNG BÁO SỞ HỮU CÔNG NGHIỆP SỐ 439 TẬP A – QUYỀN 2 (10.2024)**

- (11) **51554**  
(21) 3-2024-01766 (28) 1  
(54) **CỤM ĐÈN SAU XE SCUTO** (51) **26-06**  
(22) 26/07/2024 (43) 25/10/2024  
(30) 2024-001843 30/01/2024 JP;  
(73) **HONDA MOTOR CO., LTD. (JP)**  
1-1, Minami-Aoyama 2-Chome, Minato-ku, Tokyo, 107-8556 Japan  
(72) 1. HIROAKI TSUKUI (JP)  
2. MASAYA KIKUCHI (JP)  
(74) Công ty Luật TNHH Phạm và Liên danh (PHAM & ASSOCIATES)  
(55)



1.1



1.2



1.3



1.4



1.5



1.6



1.7



1.8

**CÔNG BÁO SỞ HỮU CÔNG NGHIỆP SỐ 439 TẬP A – QUYỀN 2 (10.2024)**

- (11) **51555**
- (21) 3-2024-01767 (28) 1
- (54) **ĐỒ CHỨA THỰC PHẨM** (51) **09-03**
- (22) 26/07/2024 (43) 25/10/2024
- (73) **CJ CHEILJEDANG CORPORATION (KR)**  
(Ssangnim-dong) 330, Dongho-ro, Jung-gu, Seoul 04560 Republic of Korea
- (72) 1. LEE, JI YEONG (KR)  
2. LEE, MAG (KR)  
3. KIM, YUL JOONG (KR)
- (74) Công ty Luật TNHH ROUSE Việt Nam (ROUSE LEGAL VIETNAM LTD.)
- (55)



1.1



1.2



1.3



1.4



1.5



1.6



1.7



**CÔNG BÁO SỞ HỮU CÔNG NGHIỆP SỐ 439 TẬP A – QUYỀN 2 (10.2024)**

- (11) **51556**  
(21) 3-2024-01768 (28) 1  
(54) **GIÀY** (51) **02-04**  
(22) 26/07/2024 (43) 25/10/2024  
(30) DM/236435 08/03/2024 WO;  
(73) **CHRISTIAN DIOR COUTURE (FR)**  
30 Avenue Montaigne, 75008 Paris, France  
(72) Kim JONES (GB)  
(74) Công ty TNHH một thành viên Sở hữu trí tuệ VCCI (VCCI-IP CO.,LTD)  
(55)



1.1

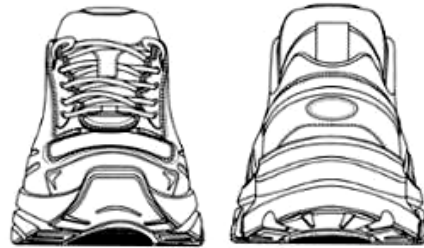

1.2

1.3



1.4



1.5

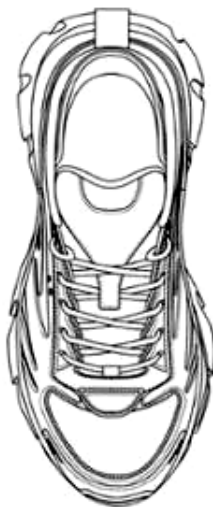

1.6



1.7

**CÔNG BÁO SỞ HỮU CÔNG NGHIỆP SỐ 439 TẬP A – QUYỀN 2 (10.2024)**

- (11) **51557**  
(21) 3-2024-01772 (28) 1  
(54) **THANH KIM LOẠI ĐỊNH HÌNH** (51) **25-01**  
(22) 26/07/2024 (43) 25/10/2024  
(73) **CÔNG TY CỔ PHẦN TẬP ĐOÀN KENWIN (VN)**  
Tầng 4 tòa nhà VG Building, số 235 đường Nguyễn Trãi, phường Thanh Xuân  
Trung, quận Thanh Xuân, thành phố Hà Nội  
(72) Ngô Thọ Long (VN)  
(74) Công ty TNHH Sở hữu trí tuệ PADEMARK (PADEMARK CO.,LTD.)  
(55)

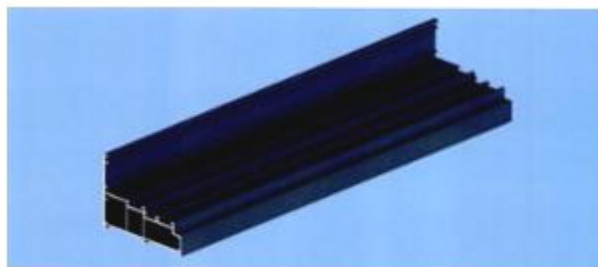

1.1

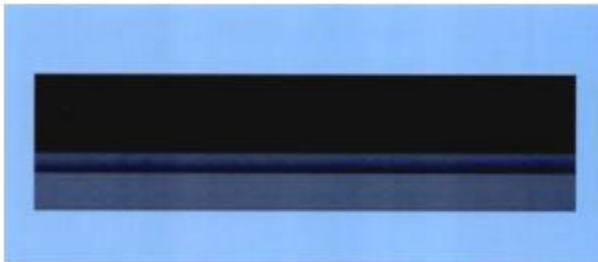

1.2



1.3

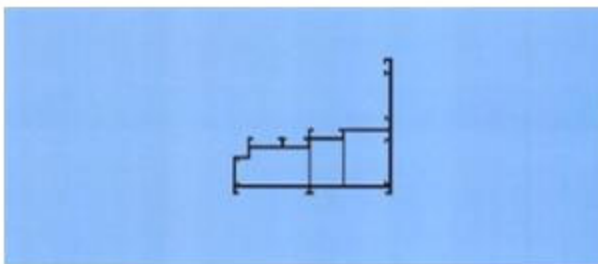

1.4

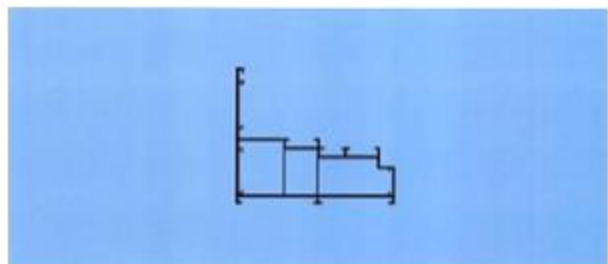

1.5



1.6



1.7

**CÔNG BÁO SỞ HỮU CÔNG NGHIỆP SỐ 439 TẬP A – QUYỀN 2 (10.2024)**

- (11) **51558**  
(21) 3-2024-01773 (28) 1  
(54) **THANH KIM LOẠI ĐỊNH HÌNH** (51) **25-01**  
(22) 26/07/2024 (43) 25/10/2024  
(73) **CÔNG TY CỔ PHẦN TẬP ĐOÀN KENWIN (VN)**  
Tầng 4 tòa nhà VG Building, số 235 đường Nguyễn Trãi, phường Thanh Xuân  
Trung, quận Thanh Xuân, thành phố Hà Nội  
(72) Ngô Thọ Long (VN)  
(74) Công ty TNHH Sở hữu trí tuệ PADEMARK (PADEMARK CO.,LTD.)  
(55)



1.1



1.2



1.3

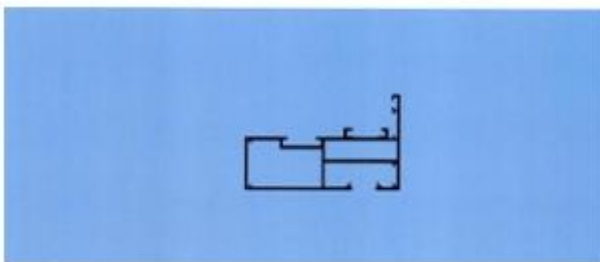

1.4

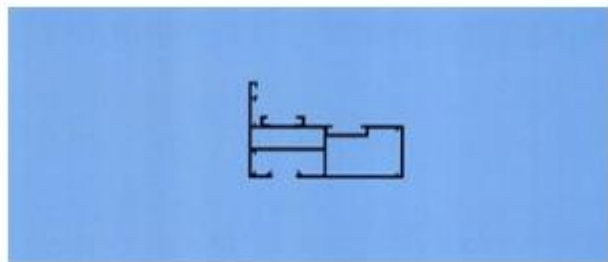

1.5



1.6



1.7

**CÔNG BÁO SỞ HỮU CÔNG NGHIỆP SỐ 439 TẬP A – QUYỀN 2 (10.2024)**

(11) **51559**

(21) 3-2024-01783

(28) 1

(54) **QUẠT CÂY**

(51) **23-04**

(22) 29/07/2024

(43) 25/10/2024

(73) **CÔNG TY CỔ PHẦN GCOOL (VN)**

Số 158/2 phố Hồng Mai, phường Quỳnh Lôi, quận Hai Bà Trưng, thành phố Hà Nội

(72) 1. TRẦN BÌNH MINH (VN)

2. HOÀNG ANH LỘC (VN)

3. TRẦN ANH (VN)

4. NGUYỄN ĐỨC BẰNG (VN)

5. ĐẶNG ĐỨC TRUNG (VN)

6. NGUYỄN THỊ HẢI YẾN (VN)

7. TRẦN HỒNG HẢI (VN)

8. NGUYỄN ĐỨC HÒA (VN)

9. TRẦN ĐÌNH QUÂN (VN)

10. NGUYỄN TUẤN PHONG (VN)

11. PHẠM ĐỨC HIỆP (VN)

12. LÊ TUẤN SƠN (VN)

13. NGUYỄN VĂN TRỌNG (VN)

14. PHẠM VĂN NHUNG (VN)

15. PHẠM THỊ ANH (VN)

16. LÊ ĐỨC ÂN (VN)

(55)



1.1



1.2



1.3



1.4



1.5



1.6



1.7

(11) **51560**

(21) 3-2024-01784

(28) 1

(54) **QUẠT TRẦN**

(51) **23-04**

(22) 29/07/2024

(43) 25/10/2024

(73) **CÔNG TY CỔ PHẦN GCOOL (VN)**

Số 158/2 phố Hồng Mai, phường Quỳnh Lôi, quận Hai Bà Trưng, thành phố Hà Nội

(72) 1. TRẦN BÌNH MINH (VN)

2. HOÀNG ANH LỘC (VN)

3. TRẦN ANH (VN)

4. NGUYỄN ĐỨC BẰNG (VN)

5. ĐẶNG ĐỨC TRUNG (VN)

6. NGUYỄN THỊ HẢI YÊN (VN)

7. TRẦN HỒNG HẢI (VN)

8. TRẦN ĐÌNH QUÂN (VN)

9. NGUYỄN TUẤN PHONG (VN)

10. PHẠM ĐỨC HIỆP (VN)

11. LÊ TUẤN SƠN (VN)

12. NGUYỄN VĂN TRỌNG (VN)

13. PHẠM VĂN NHUNG (VN)

14. PHẠM THỊ ANH (VN)

15. LÊ ĐỨC ÂN (VN)

(55)

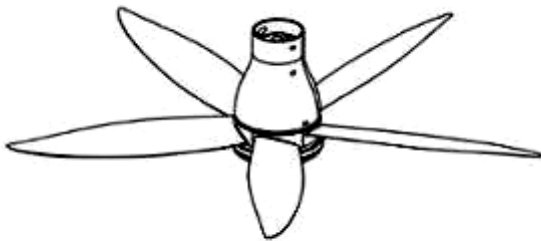

1.1



1.2



1.3



1.4



1.5

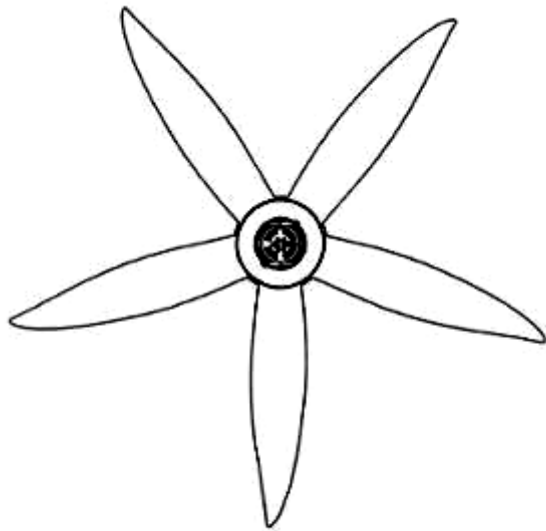

1.6

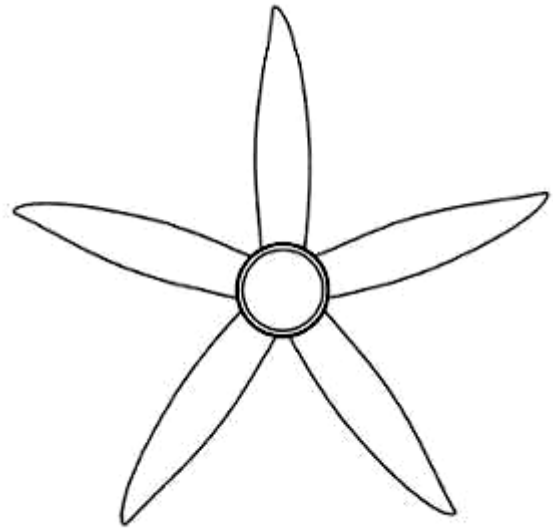

1.7

**CÔNG BÁO SỞ HỮU CÔNG NGHIỆP SỐ 439 TẬP A – QUYỀN 2 (10.2024)**

- (11) **51561**  
(21) 3-2024-01787 (28) 1  
(54) **XE SCUTO** (51) **12-11**  
(22) 30/07/2024 (43) 25/10/2024  
(30) 2024-002583 07/02/2024 JP;  
(73) **HONDA MOTOR CO., LTD. (JP)**  
1-1, Minami-Aoyama 2-chome, Minato-ku, Tokyo, 107-8556 Japan  
(72) 1. ABDUR ROSYID PRATAMA (ID)  
2. KEN SAKAMOTO (JP)  
(74) Công ty Luật TNHH Phạm và Liên danh (PHAM & ASSOCIATES)  
(55)



1.1



1.2



1.3



1.4





1.5



1.6



1.7



1.8



1.9



1.10

**CÔNG BÁO SỞ HỮU CÔNG NGHIỆP SỐ 439 TẬP A – QUYỀN 2 (10.2024)**

- (11) **51562**  
(21) 3-2024-01792 (28) 1  
(54) **ẤM ĐUN NƯỚC ĐIỆN** (51) **07-02**  
(22) 30/07/2024 (43) 25/10/2024  
(30) 2024300820518 06/02/2024 CN;  
(73) **GUANGDONG MIDEA CONSUMER ELECTRIC MANUFACTURING CO., LTD. (CN)**  
San Le Road #19, Beijiao, Shunde, Foshan, Guangdong 528311, China  
(72) 1. WU, DI (CN)  
2. CHEN, SHISHI (CN)  
3. MA, XIAOXUE (CN)  
(74) Công ty Cổ phần Sở hữu công nghiệp INVESTIP (INVESTIP)  
(55)



1.1



1.2



1.3



1.4



1.5



1.6



1.7

**CÔNG BÁO SỞ HỮU CÔNG NGHIỆP SỐ 439 TẬP A – QUYỀN 2 (10.2024)**

(11) **51563**

(21) 3-2024-01793

(28) 2

(54) **MÁY UỐN TÓC**

(51) **28-03**

(22) 30/07/2024

(43) 25/10/2024

(30) 202430153843.X 25/03/2024 CN;

(73) **CHEN JIALI (CN)**

57 Hujing Village, Baihualang Village Committee, Jintan Town, Qingxin County, Qingyuan, Guangdong 511885, China

(72) CHEN Jiali (CN)

(74) Công ty TNHH Tầm nhìn và Liên danh (VISION & ASSOCIATES CO.LTD.)

(55)



1.1

1.2

1.3

1.4

1.5

1.6

1.7



1.8

2.1

2.2

2.3

2.4

2.5



2.6

2.7

2.8

**CÔNG BÁO SỞ HỮU CÔNG NGHIỆP SỐ 439 TẬP A – QUYỀN 2 (10.2024)**

- (11) **51564**  
(21) 3-2024-01801 (28) 2  
(54) **LỖ NAM CHÂM CỦA PHẦN CẢM** (51) **13-02**  
(22) 31/07/2024 (43) 25/10/2024  
(30) 113303169D01 21/06/2024 TW; 113303169 21/06/2024 TW;  
(73) **HONG DANG TECHNOLOGY CO., LTD. (TW)**  
5F., No. 88, Baozhong Rd., Xindian Dist., New Taipei City 231, Taiwan  
(72) Shun-Fa CHUANG (TW)  
(74) Công ty Luật TNHH T&G (TGVN)  
(55)

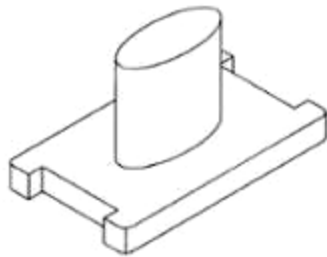

1.1

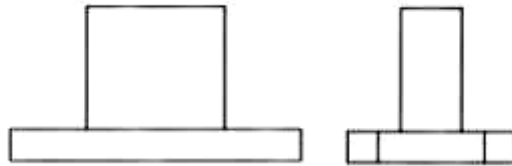

1.2

1.3



1.4



1.5

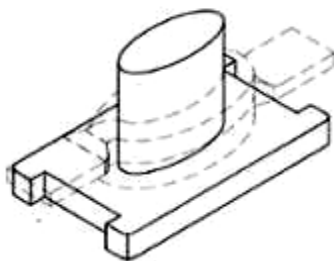

1.6

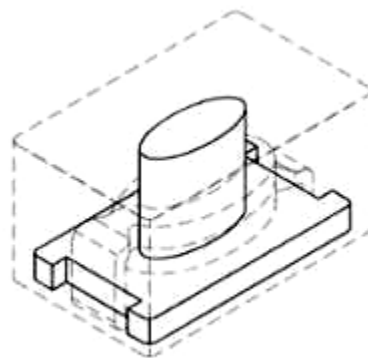

1.7

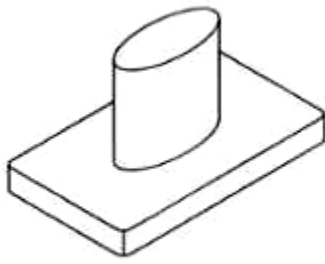

2.1

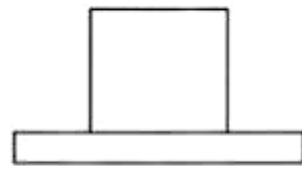

2.2

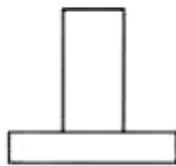

2.3



2.4



2.5

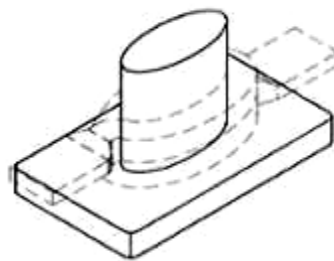

2.6

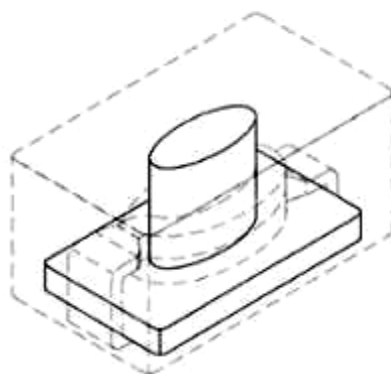

2.7

**CÔNG BÁO SỞ HỮU CÔNG NGHIỆP SỐ 439 TẬP A – QUYỀN 2 (10.2024)**

- (11) **51565**
- (21) 3-2024-01812 (28) 1
- (54) **TẮM PHỦ NGUYỄN TRANG XE Ô TÔ** (51) **12-99**
- (22) 31/07/2024 (43) 25/10/2024
- (73) 1. **VŨ HỮU KHÁNH (VN)**  
Viện Vật lý Kỹ thuật, số 17 phố Hoàng Sâm, phường Nghĩa Đô, quận Cầu Giấy, thành phố Hà Nội
2. **NGUYỄN ANH TUẤN (VN)**  
Viện Vật lý Kỹ thuật, số 17 phố Hoàng Sâm, phường Nghĩa Đô, quận Cầu Giấy, thành phố Hà Nội
- (72) 1. **VŨ HỮU KHÁNH (VN)**  
2. **NGUYỄN ANH TUẤN (VN)**  
3. **NGUYỄN ĐÌNH PHƯƠNG (VN)**  
4. **TRẦN TIẾN BẢO (VN)**  
5. **NGUYỄN THÀNH LÂM (VN)**  
6. **TÔNG MINH HÒA (VN)**
- (74) Công ty TNHH Sở hữu trí tuệ HA VIP (HAVIP CO., LTD.)
- (55)



1.1



1.2



1.3



1.4





1.5



1.6



1.7

**CÔNG BÁO SỞ HỮU CÔNG NGHIỆP SỐ 439 TẬP A – QUYỀN 2 (10.2024)**

- (11) **51566**  
(21) 3-2024-01814 (28) 1  
(54) **LỖI LỌC NƯỚC** (51) **23-01**  
(22) 31/07/2024 (43) 25/10/2024  
(73) **CÔNG TY CỔ PHẦN LIÊN DOANH KANGAROO QUỐC TẾ (VN)**  
Thôn Vĩnh Lộc, xã Tân Tiến, huyện Văn Giang, tỉnh Hưng Yên  
(72) 1. NGUYỄN THÀNH PHƯƠNG (VN)  
2. NGUYỄN VĂN CHUNG (VN)  
(74) Công ty TNHH Sở hữu trí tuệ HA VIP (HAVIP CO., LTD.)  
(55)



1.1



1.2



1.3



1.4



1.5

- (11) **51567**  
(21) 3-2024-01816 (28) 1  
(54) **THIẾT BỊ CHIẾU SÁNG ĐỂ LÀM ĐẸP** (51) **28-03**  
(22) 01/08/2024 (43) 25/10/2024  
(30) 2024301280254 13/03/2024 CN;  
(73) **SHENZHEN ULIKE SMART ELECTRONICS CO., LTD. (CN)**  
Room 810, Building 1, Xunmei Technology Plaza, No. 8 Keyuan Road, Science and  
Technology Park Community, Yuehai Street, Nanshan District, Shenzhen,  
Guangdong 518000, China  
(72) Yuan YANG (CN)  
(74) Công ty Luật TNHH Phạm và Liên danh (PHAM & ASSOCIATES)  
(55)

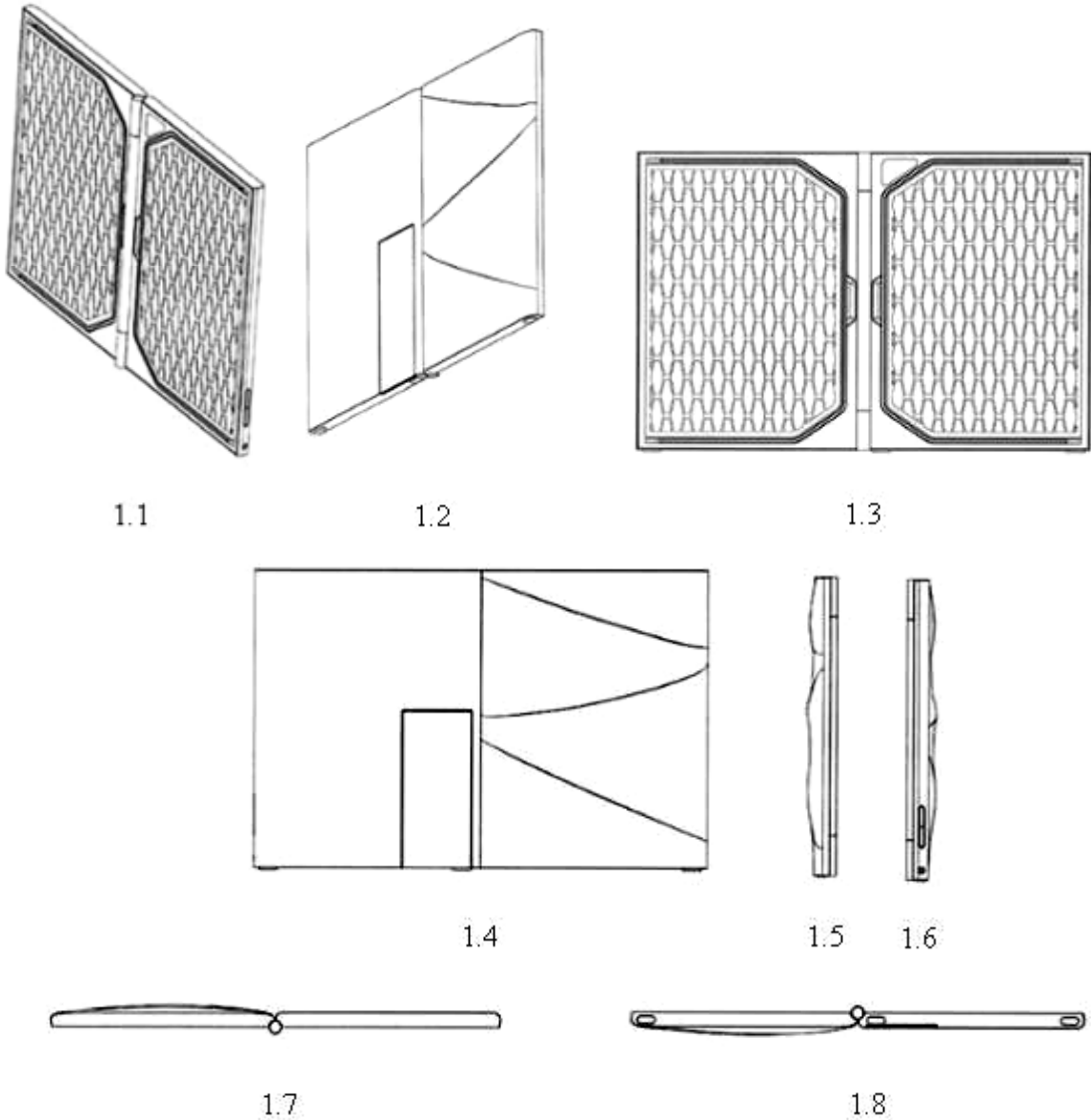



1.9

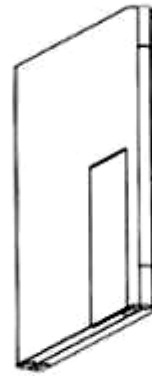

1.10

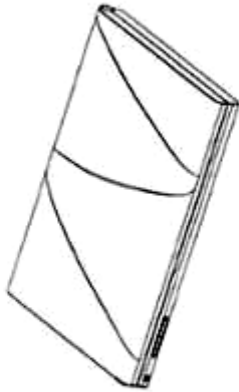

1.11



1.12

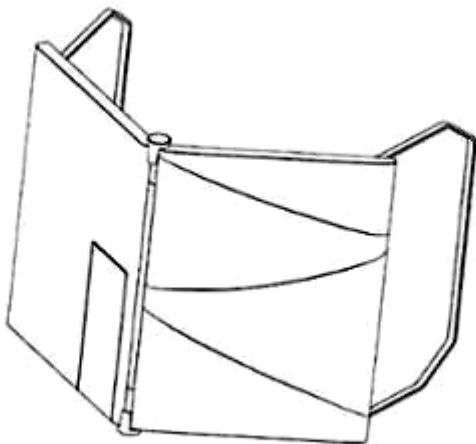

1.13

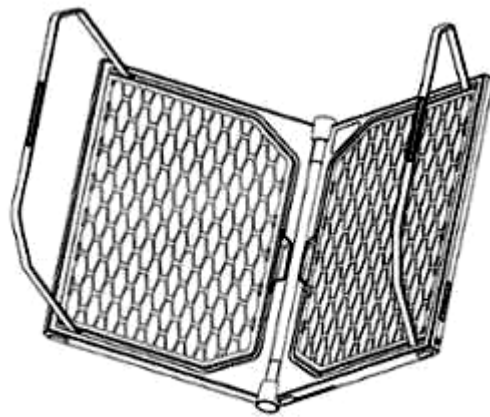

1.14

**CÔNG BÁO SỞ HỮU CÔNG NGHIỆP SỐ 439 TẬP A – QUYỀN 2 (10.2024)**

- (11) **51568**  
(21) 3-2024-01831 (28) 1  
(54) **NẮP CHE THIẾT BỊ TRUYỀN VÀ PHÁT DỮ LIỆU** (51) **02-03**  
(22) 02/08/2024 (43) 25/10/2024  
(73) **HENRY TEDJAKUSUMA (ID)**  
Jalan Wuluh Blok II/3, RT/RW 009/006, Kota Bambu Utara, Palmerah Jakarta Barat 11420, Indonesia  
(72) Henry Tedjakusuma (ID)  
(74) Công ty TNHH Sở hữu trí tuệ HA VIP (HAVIP CO., LTD.)  
(55)

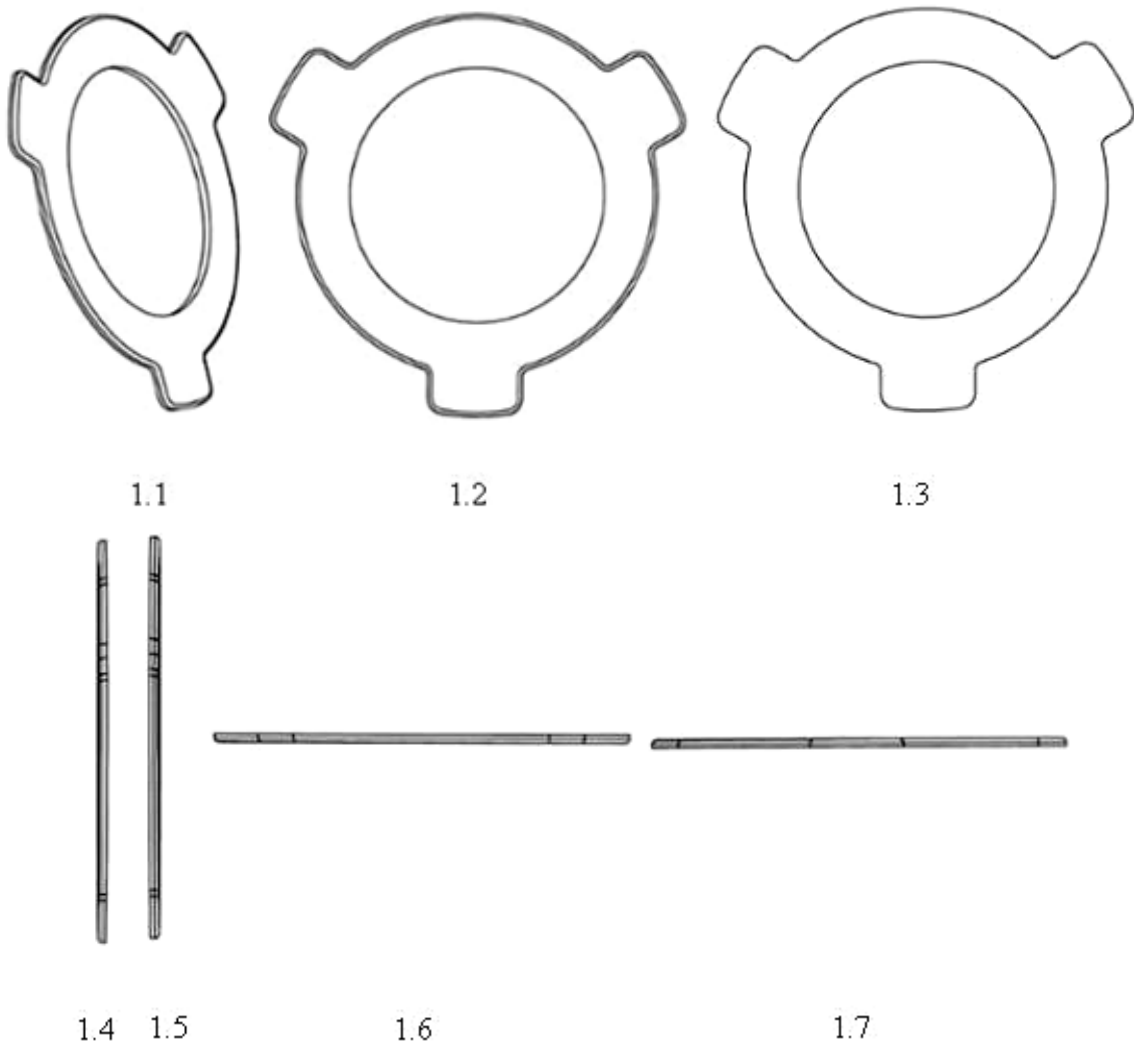

**CÔNG BÁO SỞ HỮU CÔNG NGHIỆP SỐ 439 TẬP A – QUYỀN 2 (10.2024)**

- (11) **51569**  
(21) 3-2024-01832 (28) 1  
(54) **CHẢO NƯỚNG** (51) **07-02**  
(22) 02/08/2024 (43) 25/10/2024  
(73) **JIANGMEN YISHAN METAL PRODUCTS CO., LTD. (CN)**  
Jiaobeishan, Niushan, Dalingtou, Qikan, etc, Shiming village, Siqian, Xinhui,  
Jiangmen City, Guangdong Province 529100, China  
(72) 1. LEE CHANGHO (KR)  
2. LEE WON YOUNG (KR)  
3. GUAN JINLIAN (CN)  
4. LI YAOJIN (CN)  
(74) Công ty TNHH ASL LAW (ASL LAW CO.,LTD)  
(55)



**CÔNG BÁO SỞ HỮU CÔNG NGHIỆP SỐ 439 TẬP A – QUYỀN 2 (10.2024)**

(11) **51570**

(21) 3-2024-01833

(28) 1

(54) **CHAI**

(51) **09-01**

(22) 02/08/2024

(43) 25/10/2024

(73) **CÔNG TY TNHH NOBLE STARS (VN)**

Số 14 đường Kênh Nước Đen, phường Bình Hưng Hoà A, quận Bình Tân, thành phố Hồ Chí Minh

(72) Nguyễn Thị Thanh Thủy (VN)

(55)



1.1



1.2



1.3



1.4

**CÔNG BÁO SỞ HỮU CÔNG NGHIỆP SỐ 439 TẬP A – QUYỀN 2 (10.2024)**

- (11) **51571**  
(21) 3-2024-01857 (28) 1  
(54) **THANH KIM LOẠI ĐỊNH HÌNH** (51) **25-01**  
(22) 05/08/2024 (43) 25/10/2024  
(73) **CÔNG TY TNHH CÔNG NGHỆ AKCOME VIỆT NAM (VN)**  
12.09 tòa nhà Golden King, số 15 Nguyễn Lương Bằng, phường Tân Phú, quận 7,  
thành phố Hồ Chí Minh  
(72) ZHOU YU FENG (CN)  
(74) Công ty TNHH Sở hữu trí tuệ Gia Việt (GIAVIET CO., LTD.)  
(55)



1.1



1.2



1.3



1.4



1.5



1.6



**CÔNG BÁO SỞ HỮU CÔNG NGHIỆP SỐ 439 TẬP A – QUYỀN 2 (10.2024)**

- (11) **51572**  
(21) 3-2024-01858 (28) 1  
(54) **THANH KIM LOẠI ĐỊNH HÌNH** (51) **25-01**  
(22) 05/08/2024 (43) 25/10/2024  
(73) **CÔNG TY TNHH CÔNG NGHỆ AKCOME VIỆT NAM (VN)**  
12.09 tòa nhà Golden King, số 15 Nguyễn Lương Bằng, phường Tân Phú, quận 7,  
thành phố Hồ Chí Minh  
(72) ZHOU YU FENG (CN)  
(74) Công ty TNHH Sở hữu trí tuệ Gia Việt (GIAVIET CO., LTD.)  
(55)



1.1



1.2



1.3



1.4



1.5



1.6

**CÔNG BÁO SỞ HỮU CÔNG NGHIỆP SỐ 439 TẬP A – QUYỀN 2 (10.2024)**

- (11) **51573**  
(21) 3-2024-01860 (28) 1  
(54) **THANH KIM LOẠI ĐỊNH HÌNH** (51) **25-01**  
(22) 05/08/2024 (43) 25/10/2024  
(73) **CÔNG TY TNHH CÔNG NGHỆ AKCOME VIỆT NAM (VN)**  
12.09 tòa nhà Golden King, số 15 Nguyễn Lương Bằng, phường Tân Phú, quận 7,  
thành phố Hồ Chí Minh  
(72) ZHOU YU FENG (CN)  
(74) Công ty TNHH Sở hữu trí tuệ Gia Việt (GIAVIET CO., LTD.)  
(55)



1.1



1.2



1.3

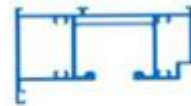

1.4



1.5



1.6

**CÔNG BÁO SỞ HỮU CÔNG NGHIỆP SỐ 439 TẬP A – QUYỀN 2 (10.2024)**

- (11) **51574**  
(21) 3-2024-01861 (28) 1  
(54) **THANH KIM LOẠI ĐỊNH HÌNH** (51) **25-01**  
(22) 05/08/2024 (43) 25/10/2024  
(73) **CÔNG TY TNHH CÔNG NGHỆ AKCOME VIỆT NAM (VN)**  
12.09 tòa nhà Golden King, số 15 Nguyễn Lương Bằng, phường Tân Phú, quận 7,  
thành phố Hồ Chí Minh  
(72) ZHOU YU FENG (CN)  
(74) Công ty TNHH Sở hữu trí tuệ Gia Việt (GIAVIET CO., LTD.)  
(55)



1.1



1.2



1.3



1.4



1.5



1.6

**CÔNG BÁO SỞ HỮU CÔNG NGHIỆP SỐ 439 TẬP A – QUYỀN 2 (10.2024)**

- (11) **51575**  
(21) 3-2024-01862 (28) 1  
(54) **THANH KIM LOẠI ĐỊNH HÌNH** (51) **25-01**  
(22) 05/08/2024 (43) 25/10/2024  
(73) **CÔNG TY TNHH CÔNG NGHỆ AKCOME VIỆT NAM (VN)**  
12.09 tòa nhà Golden King, số 15 Nguyễn Lương Bằng, phường Tân Phú, quận 7,  
thành phố Hồ Chí Minh  
(72) ZHOU YU FENG (CN)  
(74) Công ty TNHH Sở hữu trí tuệ Gia Việt (GIAVIET CO., LTD.)  
(55)



1.1



1.2



1.3



1.4



1.5



1.6

**CÔNG BÁO SỞ HỮU CÔNG NGHIỆP SỐ 439 TẬP A – QUYỀN 2 (10.2024)**

- (11) **51576**  
(21) 3-2024-01879 (28) 1  
(54) **CHAI** (51) **09-01**  
(22) 06/08/2024 (43) 25/10/2024  
(73) **CÔNG TY TNHH CÁNH ĐỒNG VÀNG (VN)**  
7 đường số 5, khu phố 4, phường An Phú, thành phố Thủ Đức, thành phố Hồ Chí Minh  
(72) Lê Khanh Kim (US)  
(74) Công ty TNHH Sở hữu trí tuệ INVENTIO (INVENTIO CO.,LTD)  
(55)



1.1

1.2

1.3

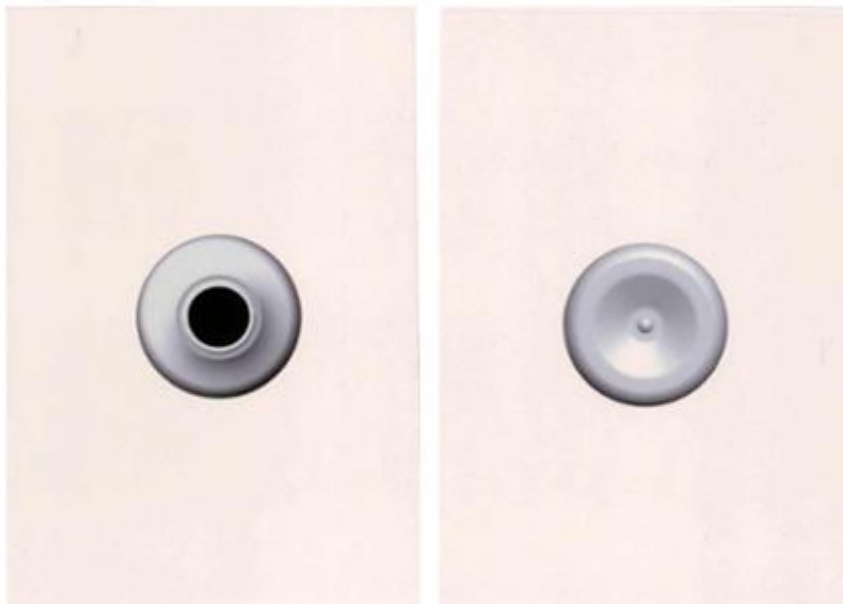

1.4

1.5

**CÔNG BÁO SỞ HỮU CÔNG NGHIỆP SỐ 439 TẬP A – QUYỀN 2 (10.2024)**

- (11) **51577**  
(21) 3-2024-01914 (28) 3  
(54) **MÁY LỌC NƯỚC** (51) **23-01**  
(22) 09/08/2024 (43) 25/10/2024  
(73) **GUANGDONG AQUASHIELD HEALTH TECHNOLOGY CO., LTD. (CN)**  
No. 4-5 Longhui Road, Malong Village, Beijiao Town, Shunde District, Foshan  
City, Guangdong 528000, China  
(72) 1. DECHANG CHEN (CN)  
2. JINXING LIN (CN)  
3. XINGLIN HUANG (CN)  
4. FENG YU (CN)  
(74) **CÔNG TY TRÁCH NHIỆM HỮU HẠN TƯ VẤN ĐẦU TƯ VÀ SỞ HỮU TRÍ  
TUỆ INTERFIVE (INTERFIVE CO., LTD)**  
(55)

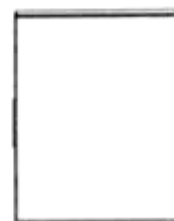
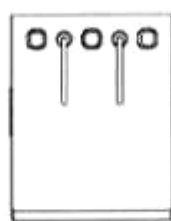
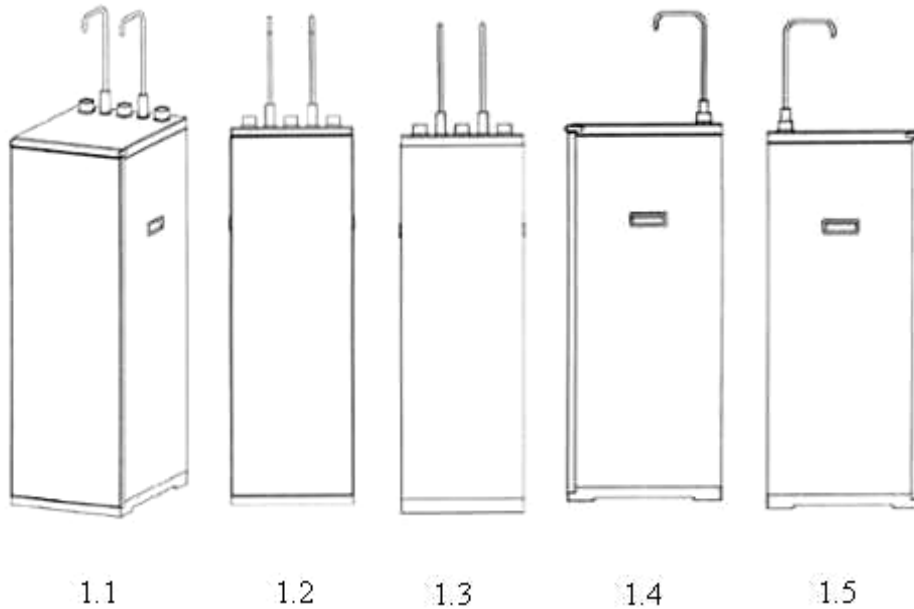

1.6

1.7

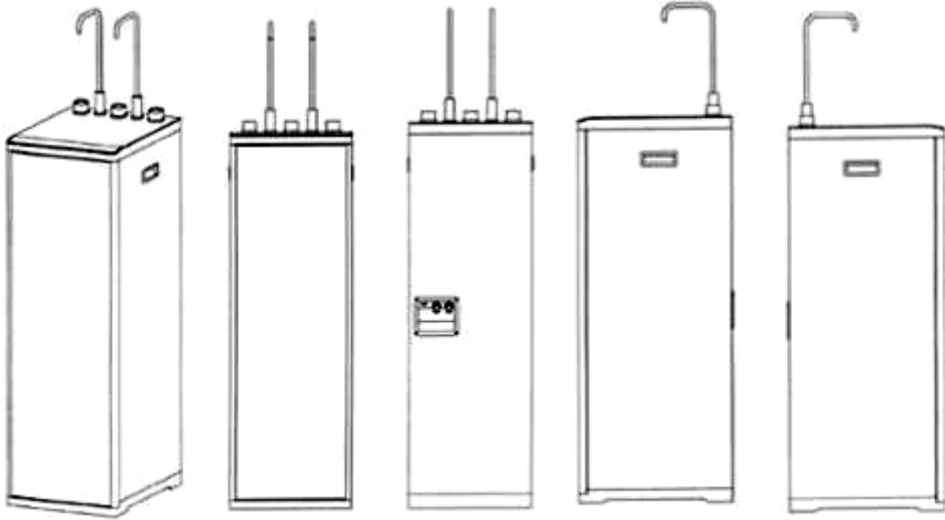

2.1

2.2

2.3

2.4

2.5

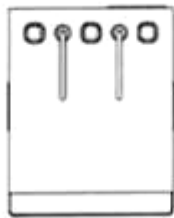

2.6



2.7

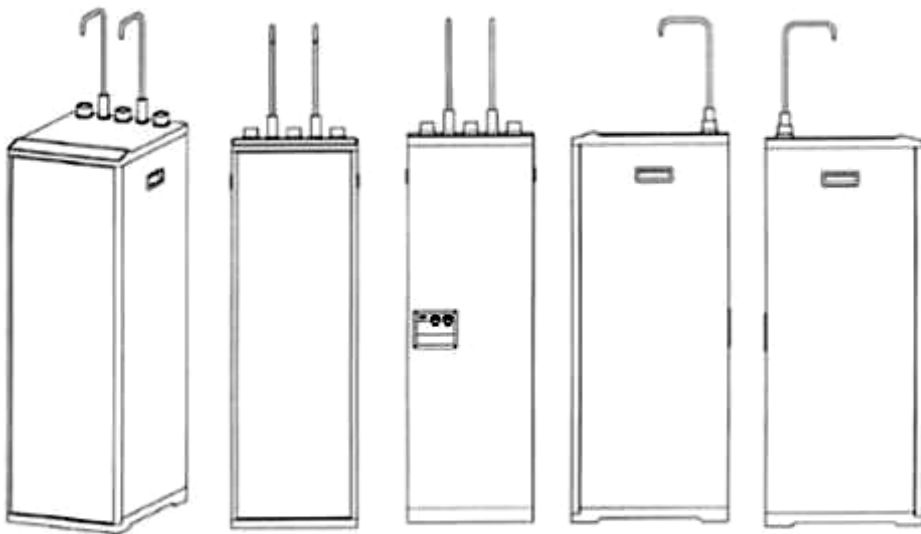

3.1

3.2

3.3

3.4

3.5

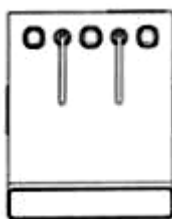

3.6



3.7

(11) **51578**

(21) 3-2024-01938

(28) 1

(54) **MÁY PHÂN LOẠI HẠT ĐIỀU THÔ**

(51) **15-03**

(22) 14/08/2024

(43) 25/10/2024

(73) **NGUYỄN VĂN LIÊN (VN)**

Khu phố Phước Trung, xã Phước Bình, thị xã Phước Long, tỉnh Bình Phước

(72) Nguyễn Văn Liên (VN)

(55)

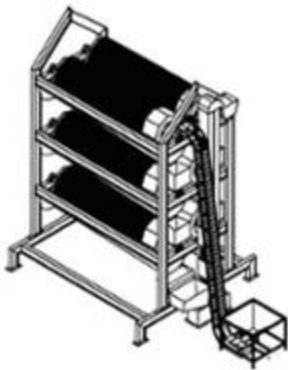

1.1

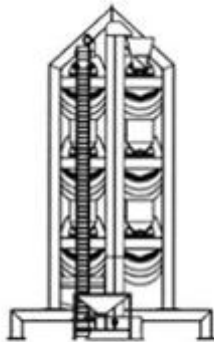

1.2

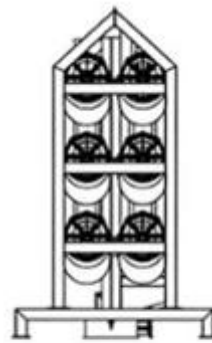

1.3

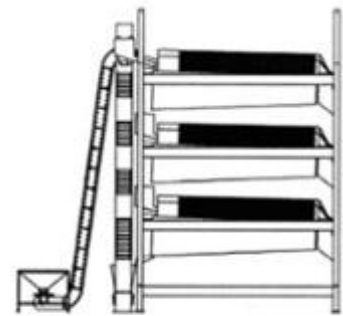

1.4

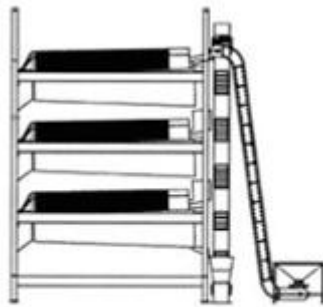

1.5

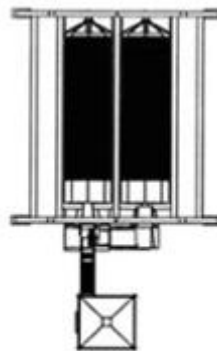

1.6

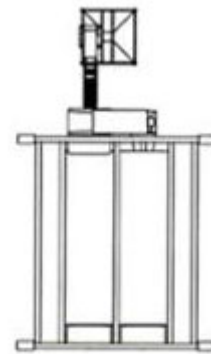

1.7



**PHẦN II**

**SỬA ĐỔI ĐƠN**

Thông báo số: 92935/TB-SHTT.IP, ngày 26/09/2024 về việc ghi nhận sửa đổi đơn

Số Yêu cầu: SĐ3-2023-01868 Ngày nộp: 09/10/2023

Liên quan đến đơn yêu cầu cấp Bằng độc quyền kiểu dáng công nghiệp:

(21) Số đơn	(22) Ngày nộp đơn
3-2019-00471	21/02/2019

Mục sửa đổi: Bổ sung phương án

Nội dung mới: Bổ sung phương án 3 của kiểu dáng công nghiệp.

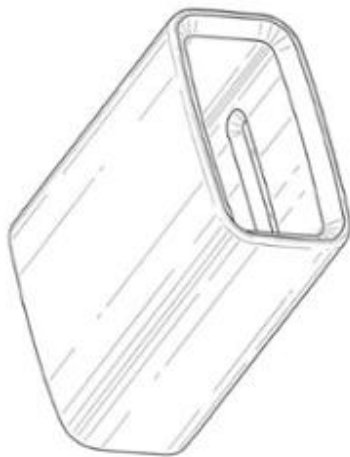

3.1



3.2

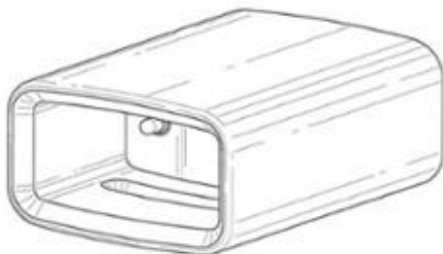

3.3

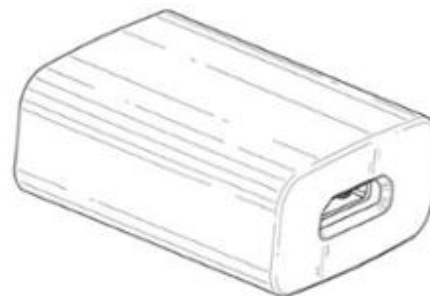

3.4



3.5

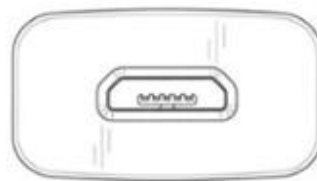

3.6



3.7

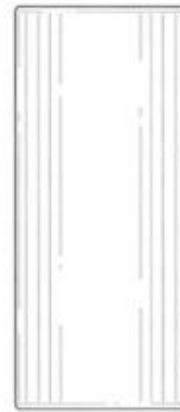

3.8

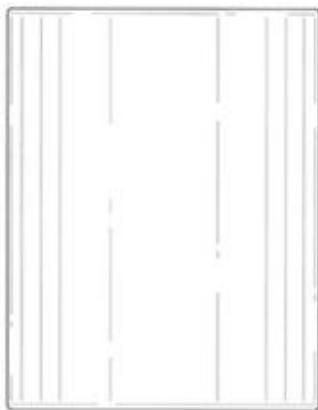

3.9

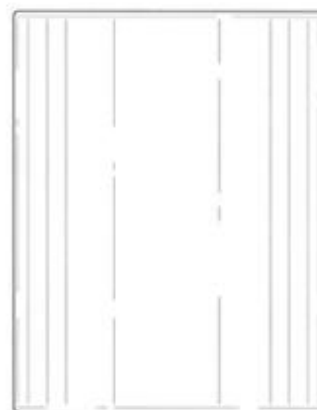

3.10

## **CÔNG BÁO SỞ HỮU CÔNG NGHIỆP**

*Do Cục Sở hữu trí tuệ thuộc Bộ Khoa học và Công nghệ ấn hành theo Luật Sở hữu trí tuệ số 50/2005/QH11 được Quốc hội thông qua ngày 29 tháng 11 năm 2005 và được sửa đổi bằng Luật sửa đổi, bổ sung một số điều của Luật sở hữu trí tuệ số 50/2005/QH11 được Quốc hội thông qua ngày 19 tháng 6 năm 2009.*

### ***Địa chỉ liên hệ:***

384-386 đường Nguyễn Trãi, quận Thanh Xuân,  
thành phố Hà Nội, Việt Nam  
ĐT: 024. 38583069  
Fax: 024. 38588449