

CỘNG HÒA XÃ HỘI CHỦ NGHĨA VIỆT NAM
BỘ KHOA HỌC VÀ CÔNG NGHỆ

CỤC SỞ HỮU TRÍ TUỆ

CÔNG BÁO
SỞ HỮU CÔNG NGHIỆP

TẬP A

QUYỂN 2: KIỂU DÁNG CÔNG NGHIỆP

09 - 2024

438

CỘNG HOÀ XÃ HỘI CHỦ NGHĨA VIỆT NAM
BỘ KHOA HỌC VÀ CÔNG NGHỆ
CỤC SỞ HỮU TRÍ TUỆ

CÔNG BÁO
SỞ HỮU CÔNG NGHIỆP
TẬP A

QUYỀN 2: KIỂU DÁNG CÔNG NGHIỆP

09 - 2024

438

HÀ NỘI

MỤC LỤC

	Trang
<u>PHẦN I:</u> Đơn yêu cầu cấp Bằng độc quyền kiểu dáng công nghiệp	7
<u>PHẦN II:</u> Sửa đổi đơn	333

CONTENTS

<u>PART I:</u> Applications for Industrial Design Patents	7
<u>PART II:</u> Amendment of Applications	333

MÃ SỐ HAI CHỮ CÁI THỂ HIỆN TÊN NƯỚC VÀ CÁC THỰC THỂ KHÁC TRONG CÁC TƯ LIỆU SỞ HỮU CÔNG NGHIỆP THEO TIÊU CHUẨN ST3 CỦA WIPO

AE	United Arab Emirates	CN	China	HK	Hong Kong
AF	Afganistan	CO	Colombia	HN	Honduras
AG	Antihua and Barbuda	CR	Costa Rica	HR	Croatia
AI	Anguilla	CU	Cuba	HT	Haiti
AL	Albania	CV	Cape Verde	HU	Hungary
AN	Netherlands Antilles	CY	Cyprus	ID	Indonesia
AO	Angola	CZ	Czech Republic	IE	Ireland
AR	Argentina	DE	Germany	IL	Israel
AT	Austria	DJ	Djibouti	IN	India
AU	Australia	DK	Denmark	IQ	Iraq
AW	Aruba	DM	Dominica	IR	Iran (Islamic Republic of)
BB	Barbados	DO	Dominican Republic	IS	Iceland
BD	Bangladesh	DZ	Algeria	IT	Italy
BE	Belgium	EC	Ecuador	JM	Jamaica
BF	Burkina Faso	EE	Estonia	JO	Jordan
BG	Bulgaria	EG	Egypt	JP	Japan
BH	Bahrain	ES	Spain	KE	Kenya
BI	Burundi	ET	Ethiopia	KH	Cambodia
BJ	Benin	FI	Finland	KI	Kiribati
BM	Bermuda	FJ	Fiji	KM	Comoros
BN	Brunei Darussalam	FK	Falkand Islands (Malvinas)	KN	Saint Kitts and Nevis
BO	Bolivia	FR	France	KP	Democratic People's Republic of Korea
BR	Brazil	GA	Gabon	KR	Republic of Korea
BS	Bahamas	GB	United Kingdom	KW	Kuwait
BT	Bhutan	GD	Grenada	KY	Cayman Islands
BW	Botswana	GE	Georgia	KZ	Kazakhstan
BY	Belarus	GH	Ghana	LA	Laos
BZ	Belize	GI	Gibraltar	LB	Lebanon
CA	Canada	GM	Gambia	LC	Saint Lucia
CF	Central African Republic	GN	Guinea	LI	Liechtenstein
CG	Congo	GQ	Equatorial Guinea	LK	SriLanka
CH	Switzerland	GR	Greece	LR	Liberia
CI	Côte d'Ivoire	GT	Guatemala	LS	Lesotho
CL	Chile	GW	Guinea-Bissau	LT	Lithuania
CM	Cameroon	GY	Guyana	TC	Turk and Caicos Islands
LU	Luxembourg	PA	Panama	TD	Chad
LV	Latvia	PE	Peru	TG	Togo
LY	Lybya	PG	Papua New Guinea	TH	Thailand
MA	Morocco	PH	Philippines	TN	Tunisia
MC	Monaco	PK	Pakistan	TO	Tonga
MD	Republic of Moldova	PL	Poland	TR	Turkey

CÔNG BÁO SỞ HỮU CÔNG NGHIỆP SỐ 438 TẬP A - QUYỂN 2 (09.2024)

MG	Madagascar	PT	Portugal	TT	Trinidad and Tobago
ML	Mali	PY	Paraguay	TV	Tuvalu
MM	Myanmar	QA	Qatar	TW	Taiwan, Province of China
MN	Mongolia	RO	Rumania	TZ	United Republic of Tanzania
MO	Macau	RU	Russian Federation	UA	Ukraine
MR	Mauritania	RW	Rwanda	UG	Uganda
MS	Montserrat	SA	Saudi Arabia	US	United States of America
MT	Malta	SB	Solomon Islands	UY	Uruguay
MU	Mauritius	SC	Seychelles	UZ	Uzbekistan
MV	Maldives	SD	Sudan	VA	Holy see
MW	Malawi	SE	Sweden	VC	Saint Vincent and the Grenadines
MX	Mexico	SG	Singapore	VE	Venezuela
MY	Malaysia	SH	Saint Helena	VG	Virgin Islands (British)
MZ	Mozambique	SL	Slovenia	VN	Vietnam
NA	Namibia	SK	Slovakia	VU	Vanuatu
NE	Niger	SL	Sierra Leone	WS	Samoa
NG	Nigeria	SM	San Marino	YE	Yemen
NJ	Nicaragua	SN	Senegal	YU	Yugoslavia
NL	Netherlands	SO	Somalia	ZA	South Africa
NO	Norway	SR	Suriname	ZM	Zambia
NP	Nepal	ST	Sao Tome and Principe	ZR	Zaire
NR	Nauru	SV	El Sanvador	ZW	Zimbabwe
NZ	New Zealand	SY	Syria		
OM	Oman	SZ	Swaziland		

CÁC TỔ CHỨC QUỐC TẾ

AO	African Intellectual Property Organization (OAPI)
AP	African Regional Industrial Property Organization (ARIPO)
BX	Benelux Trademark Office and Benelux Designs Office
EP	European Patent Office (EPO)
IB, WO	International Bureau of the World Intellectual Property Organization (WIPO)

NHỮNG MÃ SỐ INID TRÍCH TỪ TIÊU CHUẨN ST80 CỦA TỔ CHỨC SỞ HỮU TRÍ TUỆ THẾ GIỚI (WIPO) ĐỂ NHẬN BIẾT CÁC DỮ LIỆU THƯ MỤC DÙNG CÔNG BỐ ĐƠN VÀ BẰNG ĐỘC QUYỀN KIỂU DÁNG CÔNG NGHIỆP

- (11) Số bằng độc quyền kiểu dáng công nghiệp / Số công bố đơn
- (15) Ngày cấp
- (18) Ngày hết hạn hiệu lực của bằng độc quyền kiểu dáng công nghiệp
- (21) Số đơn
- (22) Ngày nộp đơn
- (23) Tên triển lãm, ngày và nơi triển lãm
- (28) Số phương án yêu cầu bảo hộ
- (30) Số đơn ưu tiên, ngày nộp đơn ưu tiên
- (43) Ngày công bố đơn
- (45) Ngày công bố bằng độc quyền kiểu dáng công nghiệp
- (51) Phân loại quốc tế kiểu dáng công nghiệp
- (54) Tên sản phẩm mang kiểu dáng công nghiệp
- (55) Ảnh chụp / hình vẽ kiểu dáng công nghiệp
- (57) Đặc điểm khác biệt yêu cầu bảo hộ của kiểu dáng công nghiệp
- (62) Số và ngày nộp đơn, số bằng độc quyền KDCN hoặc số công bố đơn liên quan đến tách đơn
- (71) Tên và địa chỉ của người nộp đơn
- (72) Tên của tác giả KDCN
- (73) Tên, địa chỉ của chủ bằng độc quyền KDCN
- (74) Tên của người đại diện SHCN

PHẦN I

ĐƠN YÊU CẦU CẤP BẰNG ĐỘC QUYỀN KIỂU DÁNG CÔNG NGHIỆP

- (11) **51265**
(21) 3-2022-00470 (28) 11
(54) **CUỘN CẢM CÔNG SUẤT** (51) **13-03**
(22) 17/03/2022 (43) 25/09/2024
(30) 29/808,325 17/09/2021 US;
(73) **COILCRAFT, INCORPORATED (US)**
1102 Silver Lake Road, Cary, Illinois 60013, United States of America
(72) 1. ANDREW KLESYK (US)
2. LAWRENCE B. LESTARGE (US)
3. SCOTT HESS (US)
4. MATT GOEDKEN (US)
(74) Công ty TNHH Tâm nhìn và Liên danh (VISION & ASSOCIATES CO.LTD.)
(55)

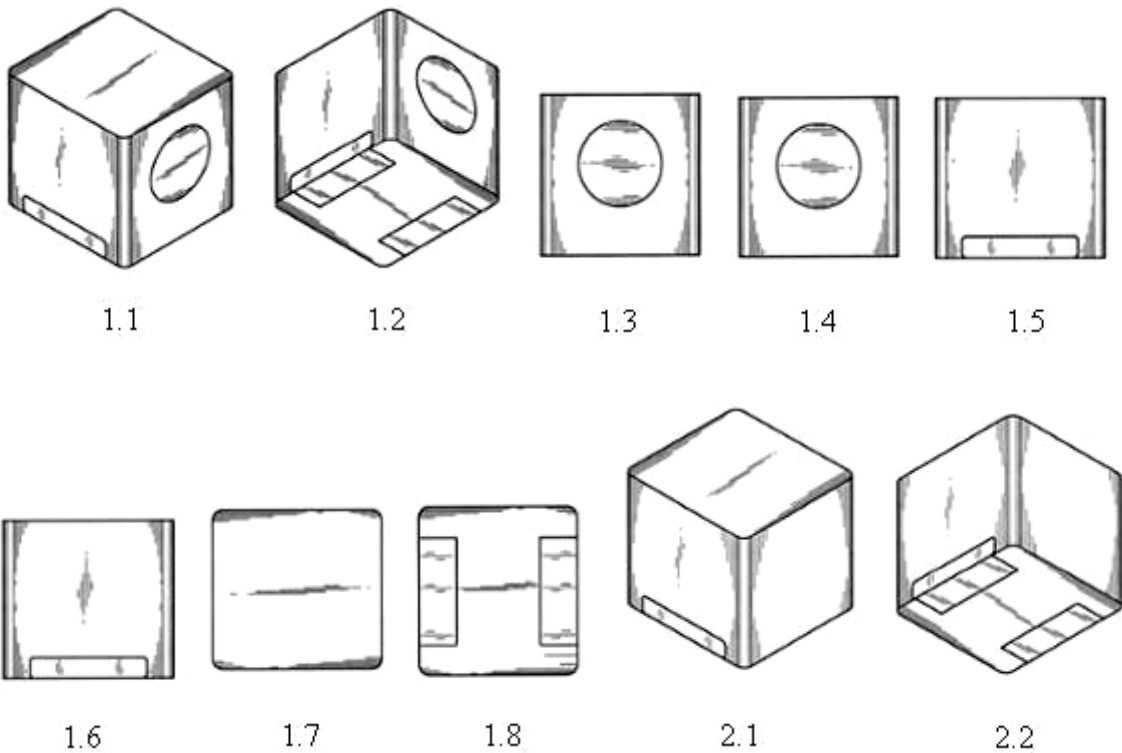

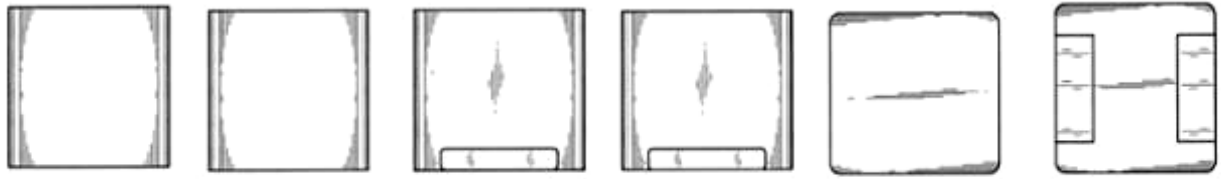

2.3

2.4

2.5

2.6

2.7

2.8

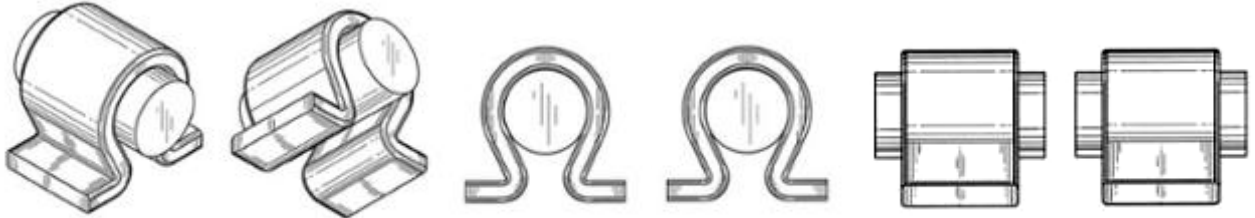

3.1

3.2

3.3

3.4

3.5

3.6

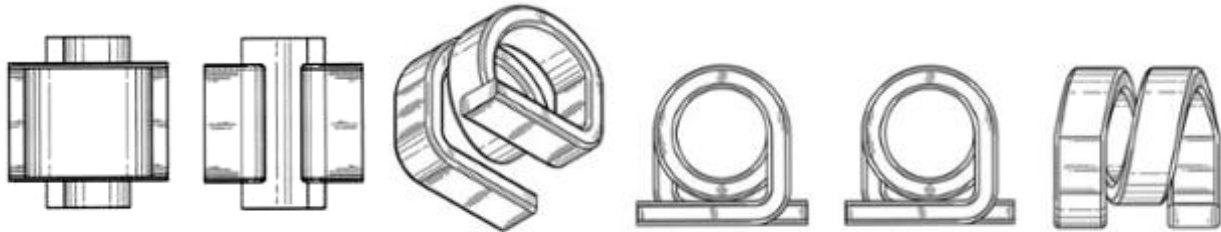

3.7

3.8

4.1

4.2

4.3

4.4

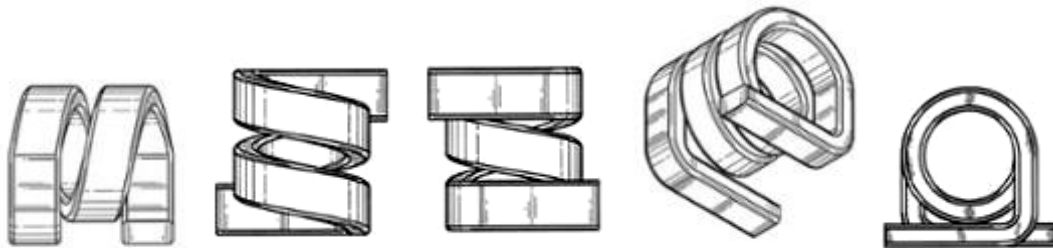

4.5

4.6

4.7

5.1

5.2



5.3

5.4

5.5

5.6

5.7

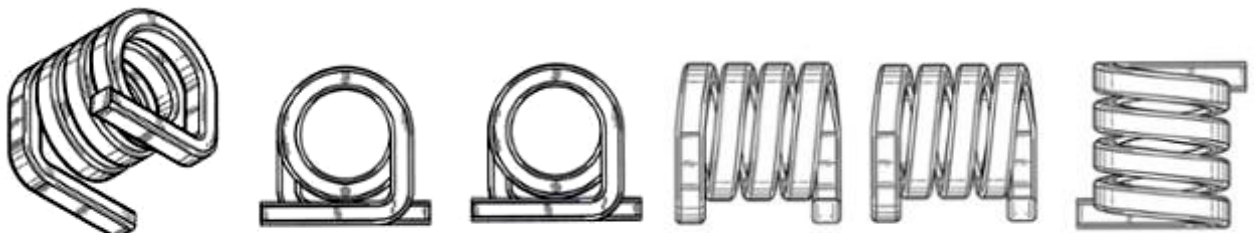

6.1

6.2

6.3

6.4

6.5

6.6

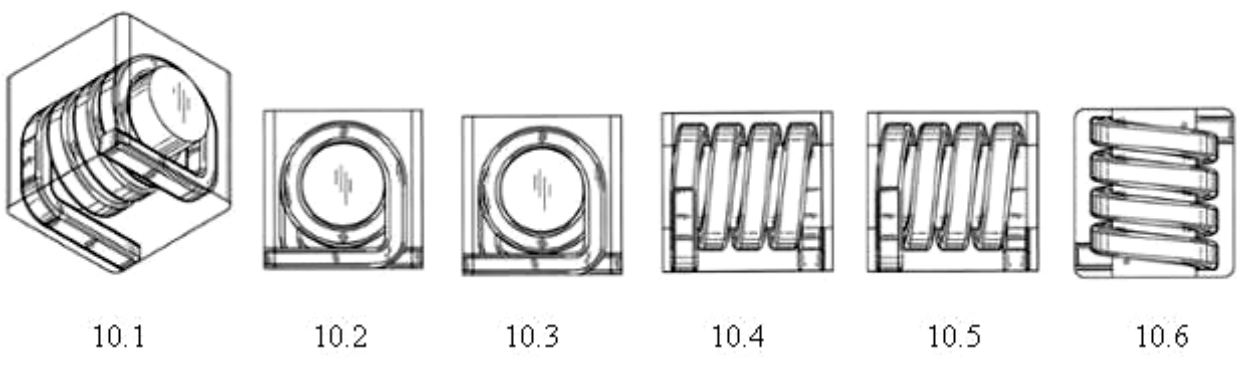
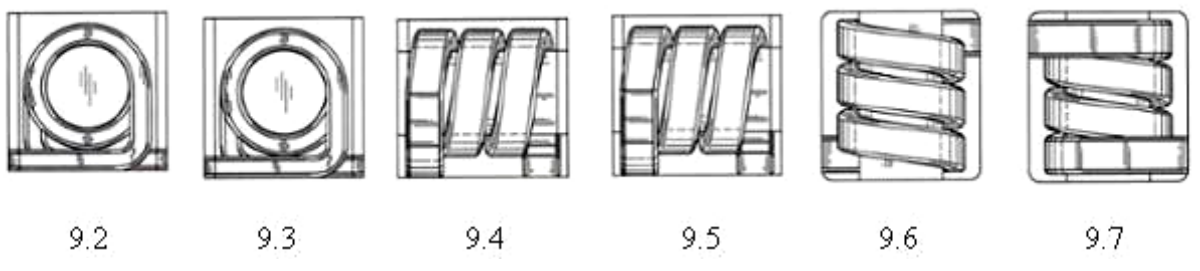
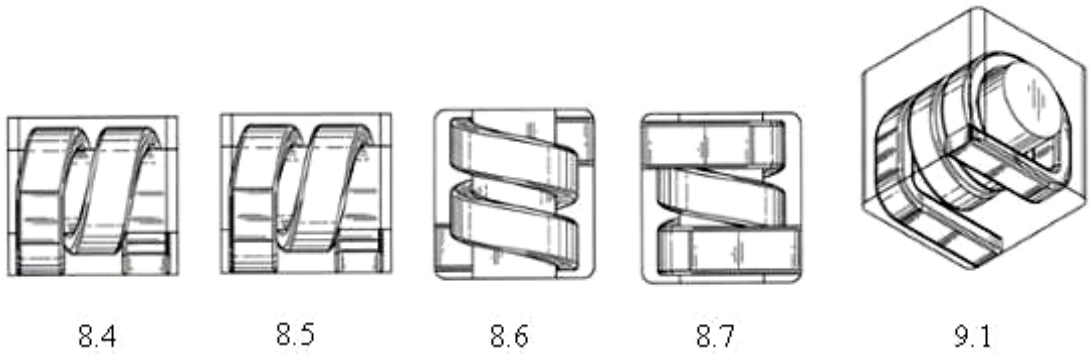
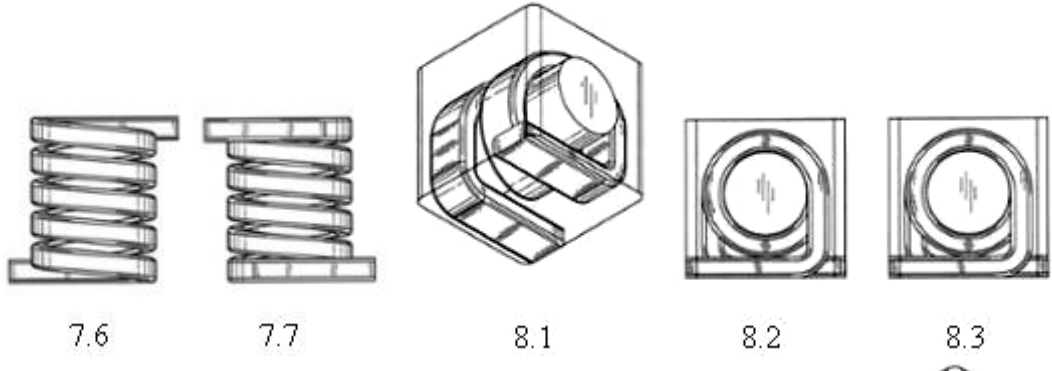
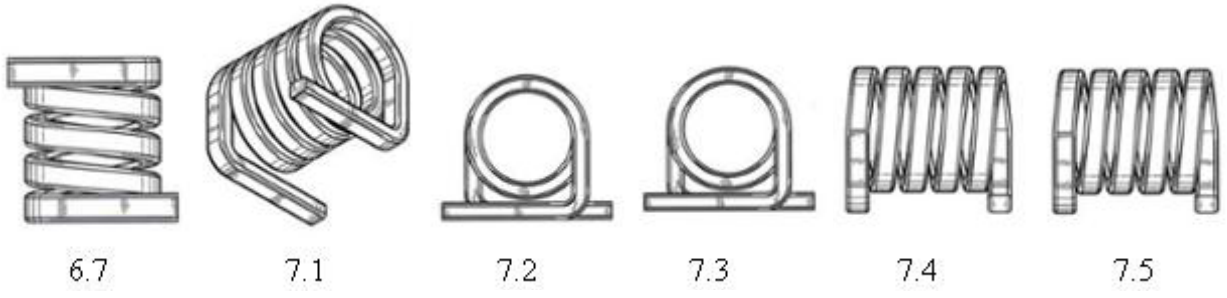



10.7

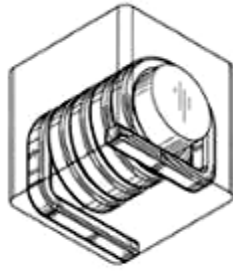

11.1

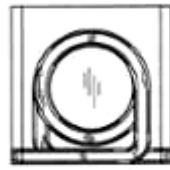

11.2

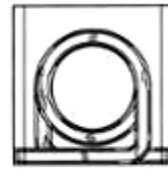

11.3

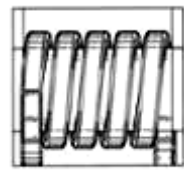

11.4

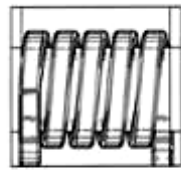

11.5

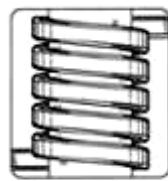

11.6

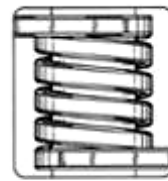

11.7

CÔNG BÁO SỞ HỮU CÔNG NGHIỆP SỐ 438 TẬP A – QUYỀN 2 (09.2024)

- (11) **51266**
(21) 3-2022-00472 (28) 1
(54) **BỘ BIẾN THỂ NGUỒN** (51) **13-02**
(22) 17/03/2022 (43) 25/09/2024
(30) 29/808,307 17/09/2021 US;
(73) **COILCRAFT, INCORPORATED (US)**
1102 Silver Lake Road, Cary, Illinois 60013, United States of America
(72) 1. ANDREW KLESYK (US)
2. LAWRENCE B. LESTARGE (US)
3. SCOTT HESS (US)
4. HYEONCHUL PARK (US)
(74) Công ty TNHH Tâm nhìn và Liên danh (VISION & ASSOCIATES CO.LTD.)
(55)

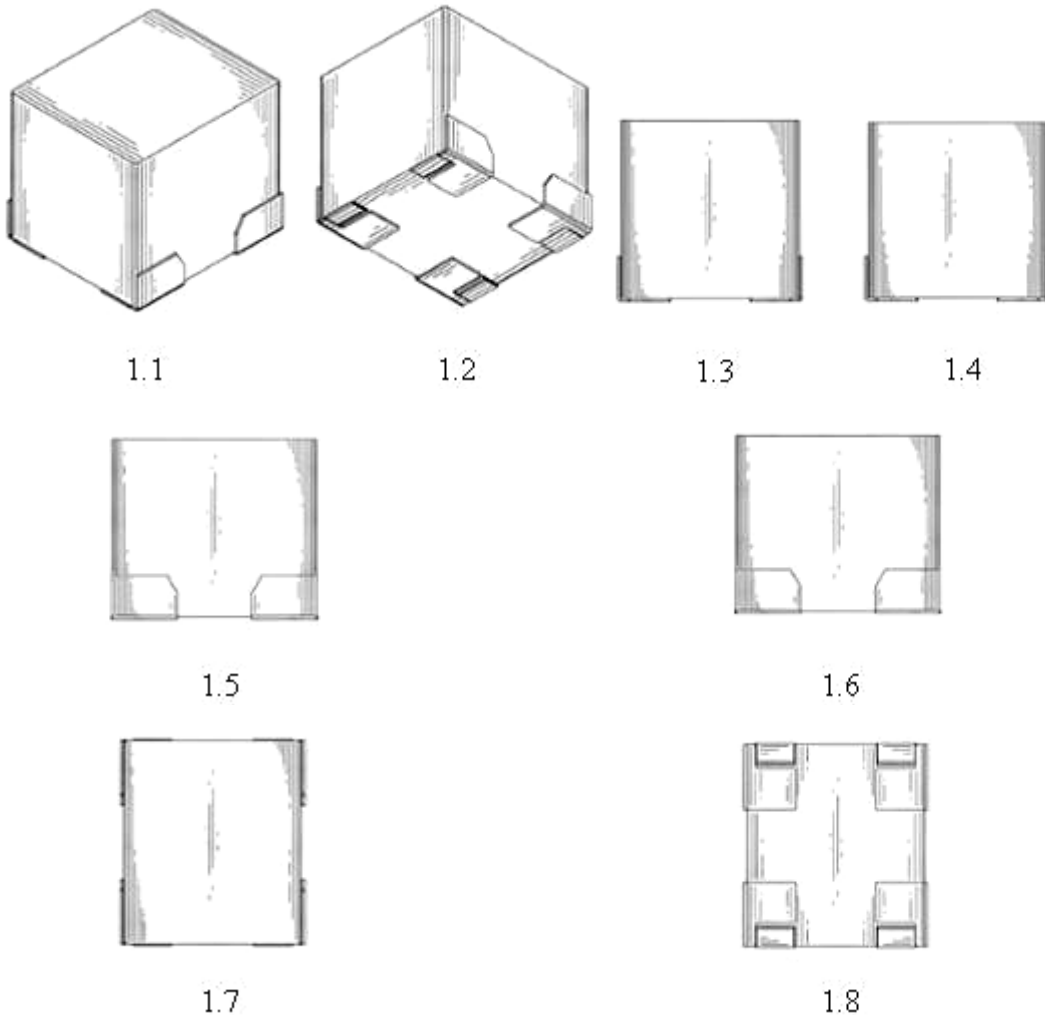

CÔNG BÁO SỞ HỮU CÔNG NGHIỆP SỐ 438 TẬP A – QUYỀN 2 (09.2024)

- (11) **51267**
(21) 3-2023-00703 (28) 1
(54) **THANH NHÔM ĐỊNH HÌNH** (51) **25-01**
(22) 30/03/2023 (43) 25/09/2024
(73) **CÔNG TY TNHH THANH PHÚC WINDOW (VN)**
478 Nguyễn Thị Thập, phường Tân Quy, quận 7, thành phố Hồ Chí Minh
(72) Nguyễn Thị Kim Hoàn (VN)
(55)



1.1



1.2



1.3



1.4

1.5



1.6



1.7

CÔNG BÁO SỞ HỮU CÔNG NGHIỆP SỐ 438 TẬP A – QUYỀN 2 (09.2024)

- (11) **51268**
(21) 3-2023-00930 (28) 1
(54) **BẢNG CHỈ DẪN ĐƯỜNG** (51) **10-06**
(22) 27/04/2023 (43) 25/09/2024
(73) **CÔNG TY TNHH THƯƠNG MẠI DỊCH VỤ TỔNG HỢP HIQ THIÊN AN (VN)**
Số 33 đường 31 tháng 03, phường Lê Lợi, thành phố Quy Nhơn, tỉnh Bình Định
(72) Nguyễn Ngọc Minh (VN)
(55)



1.1



1.2

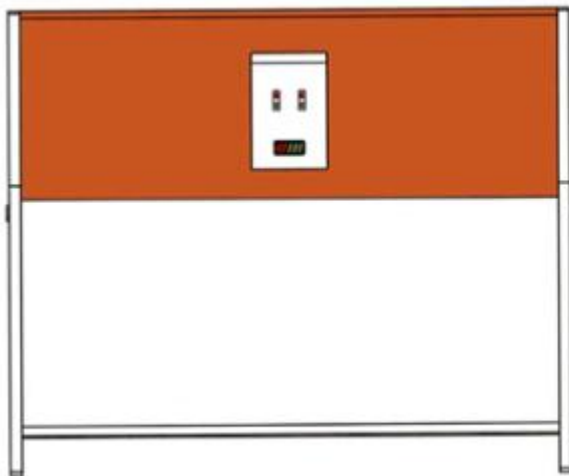

1.3

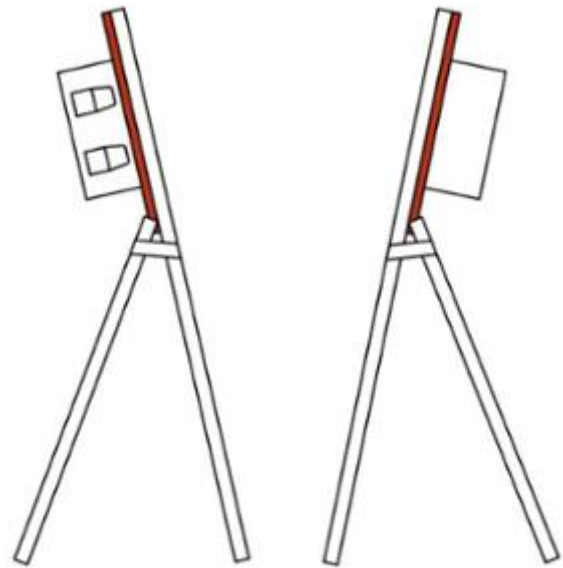

1.4

1.5

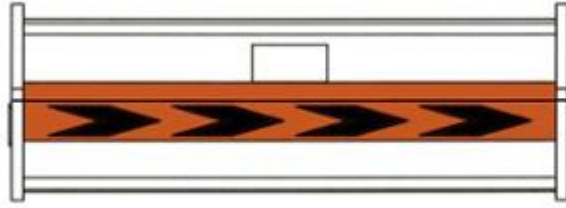

1.6

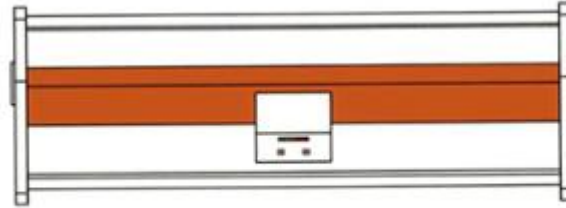

1.7

CÔNG BÁO SỞ HỮU CÔNG NGHIỆP SỐ 438 TẬP A – QUYỀN 2 (09.2024)

- (11) **51269**
(21) 3-2023-01502 (28) 1
(54) **NHÀ LẮP GHÉP** (51) **25-03**
(22) 04/07/2023 (43) 25/09/2024
(73) **CÔNG TY TNHH THIẾT KẾ KIẾN TRÚC NỘI THẤT ÔNG KIẾN (VN)**
Tầng 12B, tòa nhà Cienco4, 180 Nguyễn Thị Minh Khai, phường Võ Thị Sáu, quận
3, thành phố Hồ Chí Minh
(72) Nguyễn Văn Tịnh (VN)
(74) Công ty TNHH thương mại dịch vụ tổng hợp Nguyễn và Cộng sự (NVCS
GENERAL TRADING SERVICES CO.,LTD)
(55)



1.1



1.2



1.3

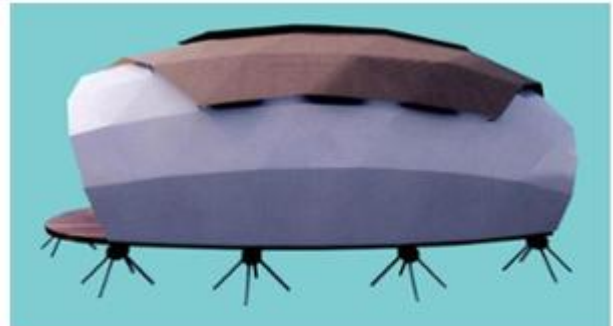

1.4

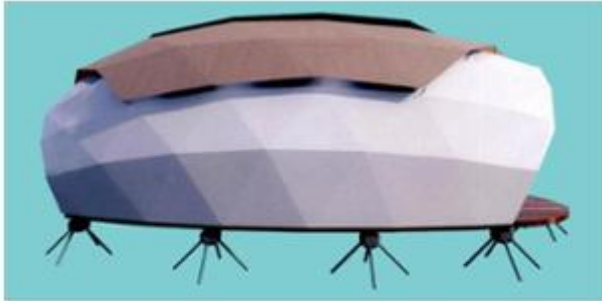

1.5

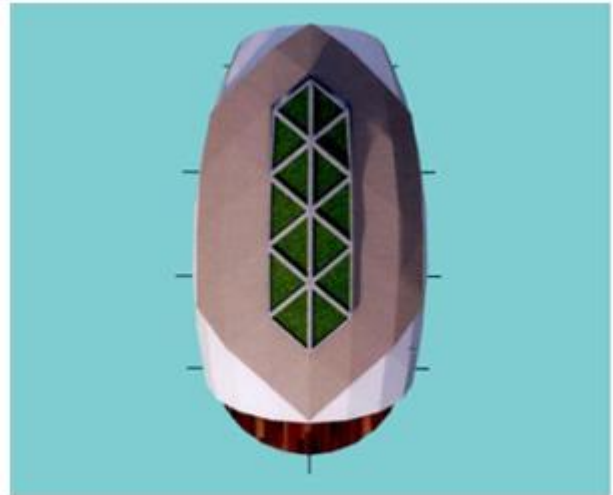

1.6



1.7

CÔNG BÁO SỞ HỮU CÔNG NGHIỆP SỐ 438 TẬP A – QUYỀN 2 (09.2024)

(11) **51270**

(21) 3-2023-01772

(28) 1

(54) **DỤNG CỤ CỨU HỘ LỚP XE ÔTÔ**

(51) **12-05**

(22) 03/08/2023

(43) 25/09/2024

(73) **CÔNG TY CỔ PHẦN CAO SU KỸ THUẬT TDR (VN)**

Xóm 2, thôn Trình Nhi, xã An Ninh, huyện Tiên Hải, tỉnh Thái Bình

(72) Nguyễn Quang Duy (VN)

(55)



1.1



1.2



1.3



1.4



1.5



1.6



1.7



1.8



1.9

CÔNG BÁO SỞ HỮU CÔNG NGHIỆP SỐ 438 TẬP A – QUYỀN 2 (09.2024)

(11) **51271**

(21) 3-2023-01970

(28) 1

(54) **KÉO**

(51) **08-03**

(22) 23/08/2023

(43) 25/09/2024

(73) **CÔNG TY TNHH THÉP BẢO TÍN (VN)**

551/156 Lê Văn Khương, phường Hiệp Thành, quận 12, thành phố Hồ Chí Minh

(72) Giáp Văn Trường (VN)

(55)



1.1



1.2



1.3



1.4



1.5



1.6



1.7

CÔNG BÁO SỞ HỮU CÔNG NGHIỆP SỐ 438 TẬP A – QUYỀN 2 (09.2024)

- (11) **51272**
(21) 3-2023-02196 (28) 1
(54) **MÁY CẠO RÂU** (51) **28-03**
(22) 19/09/2023 (43) 25/09/2024
(30) 29/874,355 18/04/2023 US;
(73) **MANSCAPED, LLC (US)**
3753 Howard Hughes Parkway, Suite 200, Las Vegas, NV 89169, United States of America
(72) 1. ANH HAO TRAN (US)
2. DANIEL MOTA VEIGA (PT)
3. EDILBERT NERI ABILLAR (US)
4. HUGO ARANHA (BR)
5. JOSHUA GIBERSON (US)
6. CHEE HONG (US)
7. BRIAN DUNFEE (US)
(74) Công ty cổ phần tư vấn Trung Thực (TRUNG THUC.,JSC)
(55)

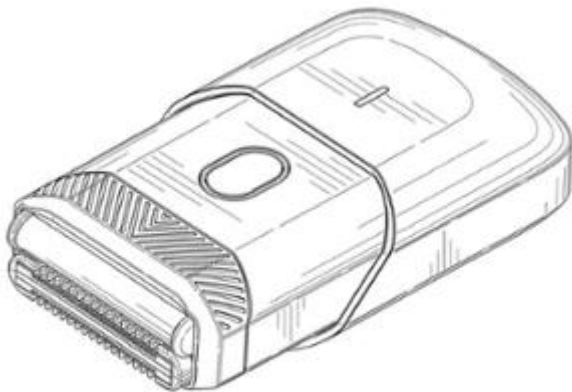

1.1

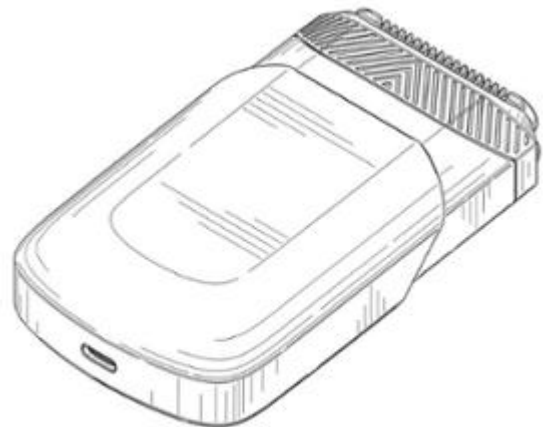

1.2

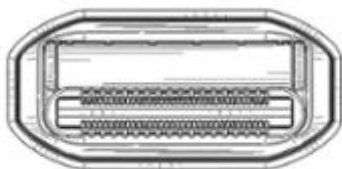

1.3



1.4

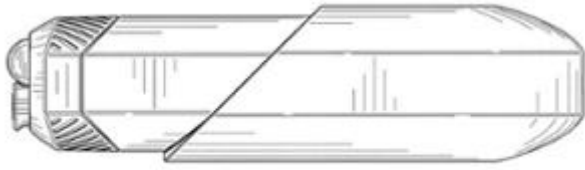

1.5

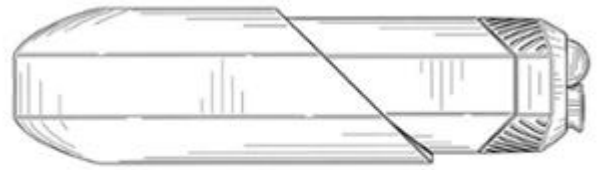

1.6



1.7



1.8

- (11) **51273**
- (21) 3-2023-02201
- (54) **HỘP LƯU TRỮ**
- (22) 20/09/2023
- (30) 2023-005856 24/03/2023 JP;
- (73) **TENMA CORPORATION (JP)**
1-63-6, Akabane, Kita-ku, Tokyo, Japan
- (72) 1. WATARU ISHIZUKA (JP)
2. SHUHEI TOYODA (JP)
- (74) Công ty Luật TNHH Phạm và Liên danh (PHAM & ASSOCIATES)
- (55)

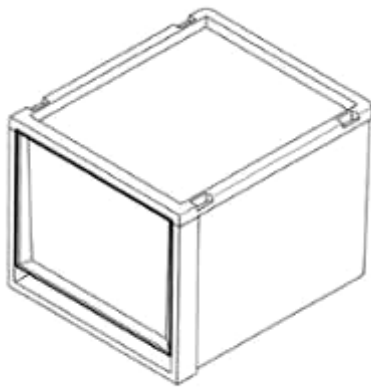

1.1

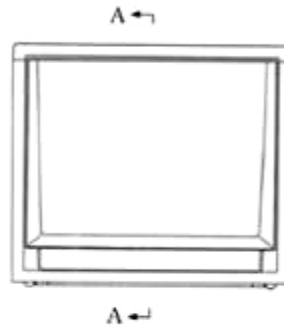

1.2



1.3



1.4

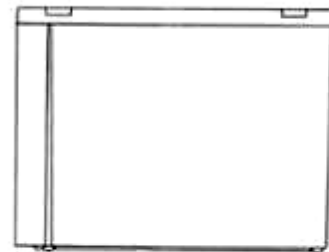

1.5

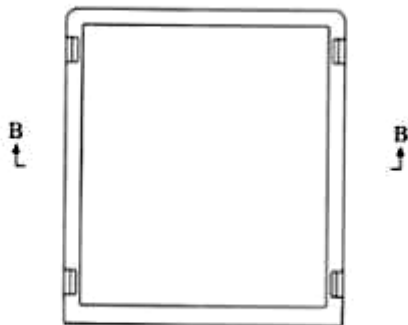

1.6

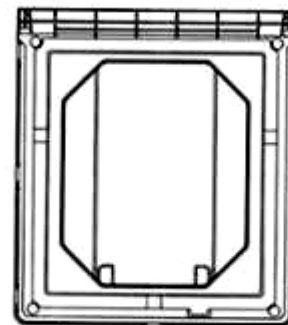

1.7

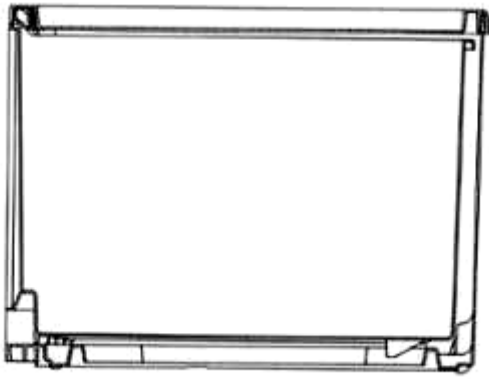

1.8

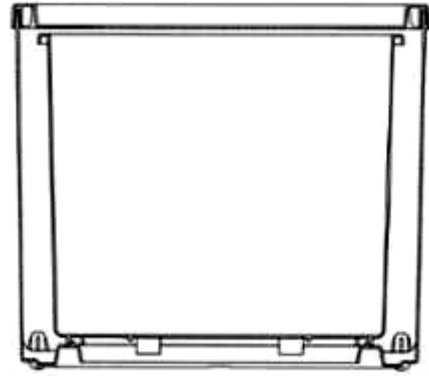

1.9

CÔNG BÁO SỞ HỮU CÔNG NGHIỆP SỐ 438 TẬP A – QUYỀN 2 (09.2024)

- (11) **51274**
(21) 3-2023-02357 (28) 1
(54) **PHAO** (51) **10-04; 10-05**
(22) 05/10/2023 (43) 25/09/2024
(30) 30-2023-0025969 06/07/2023 KR;
(73) **ODN CO.,LTD. (KR)**
218, 13 Yulchonsandan 4-ro, Haeryong-myeon, Suncheon-si, Jeollanam-do, 58034,
Republic of Korea
(72) HWANG, Yong Hee (KR)
(74) Công ty TNHH Tầm nhìn và Liên danh (VISION & ASSOCIATES CO.LTD.)
(55)

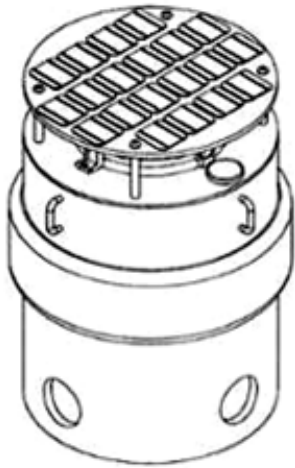

1.1

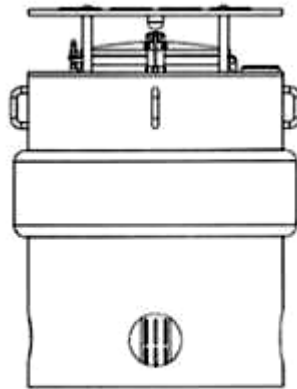

1.2

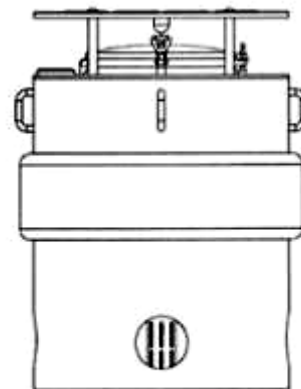

1.3

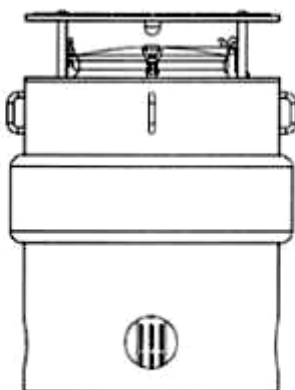

1.4

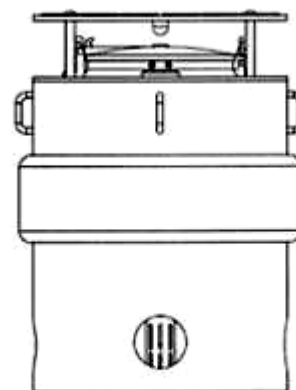

1.5

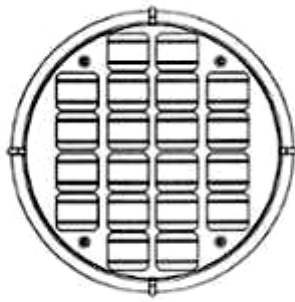

1.6

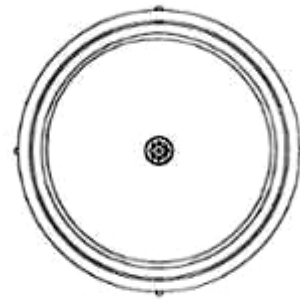

1.7

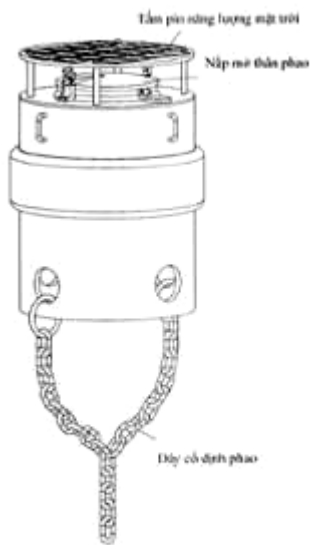

1.8

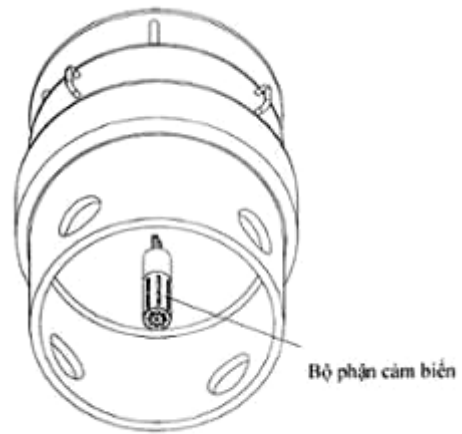

1.9

CÔNG BÁO SỞ HỮU CÔNG NGHIỆP SỐ 438 TẬP A – QUYỀN 2 (09.2024)

- (11) **51275**
(21) 3-2023-02683 (28) 1
(54) **SÁP MÀU** (51) **19-06**
(22) 09/11/2023 (43) 25/09/2024
(73) **CÔNG TY CỔ PHẦN TẬP ĐOÀN THIÊN LONG (VN)**
Tầng 10, Sofic Tower, số 10 đường Mai Chí Thọ, phường Thủ Thiêm, thành phố Thủ Đức, thành phố Hồ Chí Minh
(72) Cô Gia Thọ (VN)
(74) Công ty TNHH Tư vấn sở hữu trí tuệ Việt (VIET IP CO.,LTD.)
(55)



1.1



1.2



1.3



1.4



1.5



1.6



1.7

CÔNG BÁO SỞ HỮU CÔNG NGHIỆP SỐ 438 TẬP A – QUYỀN 2 (09.2024)

- (11) **51276**
(21) 3-2023-02737 (28) 1
(54) **THANH NHÔM ĐỊNH HÌNH** (51) **25-01**
(22) 14/11/2023 (43) 25/09/2024
(73) **TRẦN ĐÌNH THI (VN)**
3X8-03 Sky Garden 3, phường Tân Phong, quận 7, thành phố Hồ Chí Minh
(72) Trần Đình Thi (VN)
(74) Công ty Luật TNHH MINH KHUÊ (MK LAW FIRM)
(55)

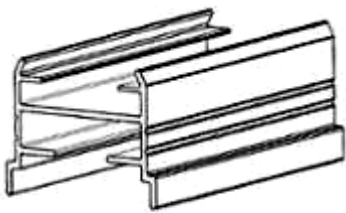

1.1

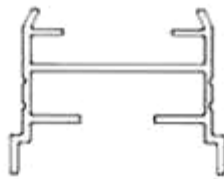

1.2

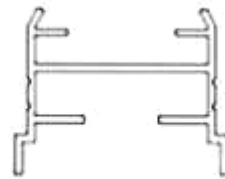

1.3

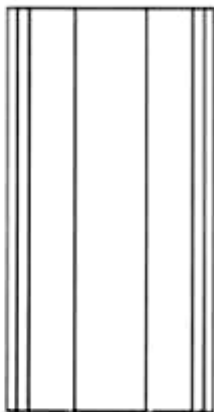

1.4

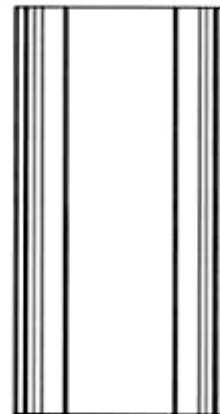

1.5



1.6



1.7

CÔNG BÁO SỞ HỮU CÔNG NGHIỆP SỐ 438 TẬP A – QUYỀN 2 (09.2024)

- (11) **51277**
(21) 3-2023-02797 (28) 2
(54) **BÚT** (51) **19-06**
(22) 20/11/2023 (43) 25/09/2024
(73) **CÔNG TY CỔ PHẦN TẬP ĐOÀN THIÊN LONG (VN)**
Tầng 10, Sofic Tower, số 10 đường Mai Chí Thọ, phường Thủ Thiêm, thành phố Thủ Đức, thành phố Hồ Chí Minh
(72) Cô Gia Thọ (VN)
(74) Công ty TNHH Tư vấn sở hữu trí tuệ Việt (VIET IP CO.,LTD.)
(55)

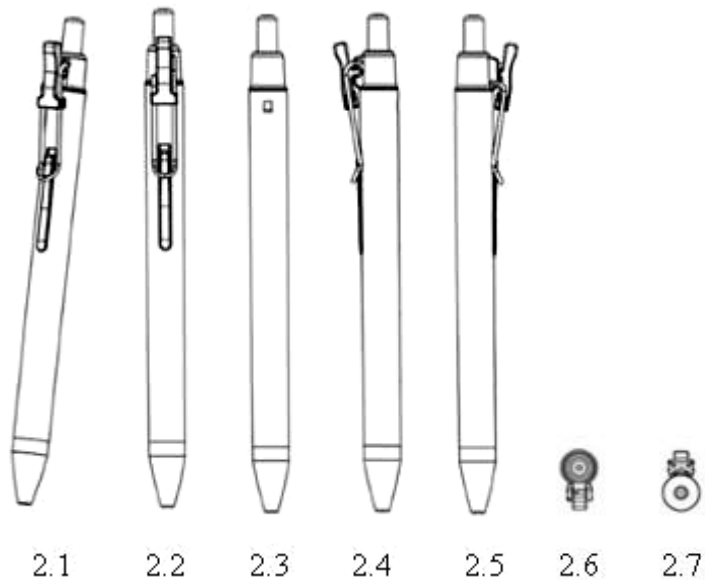
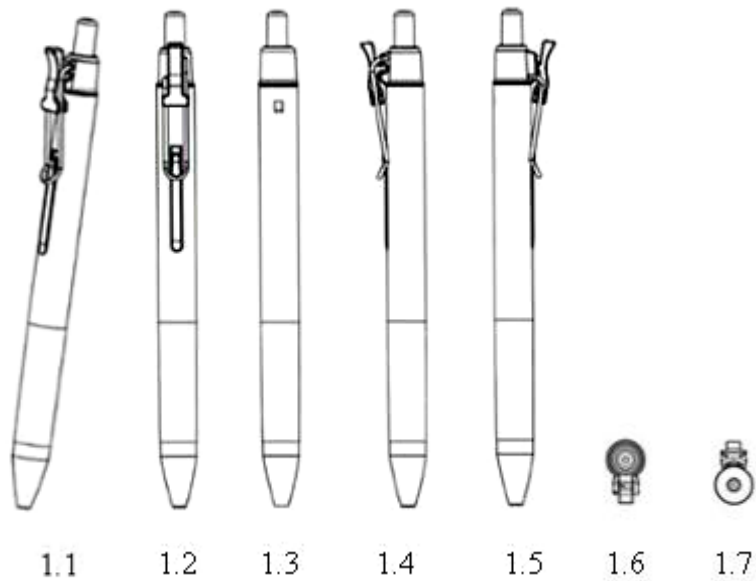

CÔNG BÁO SỞ HỮU CÔNG NGHIỆP SỐ 438 TẬP A – QUYỀN 2 (09.2024)

- (11) **51278**
(21) 3-2023-02824 (28) 1
(54) **THANH NHÔM ĐỊNH HÌNH** (51) **25-01**
(22) 23/11/2023 (43) 25/09/2024
(73) **CÔNG TY TNHH THANH PHÚC WINDOW (VN)**
478 Nguyễn Thị Thập, phường Tân Quy, quận 7, thành phố Hồ Chí Minh
(72) Nguyễn Thị Kim Hoàn (VN)
(55)



1.1



1.2



1.3



1.4

CÔNG BÁO SỞ HỮU CÔNG NGHIỆP SỐ 438 TẬP A – QUYỀN 2 (09.2024)

- (11) **51279**
(21) 3-2023-03008 (28) 1
(54) **BAO BÌ NƯỚC HOA** (51) **09-03**
(22) 08/12/2023 (43) 25/09/2024
(30) 015027140-0001 06/07/2023 EM;
(73) **FENDI S.R.L. (IT)**
Palazzo della Civiltà Italiana, Quadrato della Concordia, 3, I-00144 ROMA, ITALY
(72) François GAUTIER (FR)
(74) Công ty Luật TNHH ROUSE Việt Nam (ROUSE LEGAL VIETNAM LTD.)
(55)

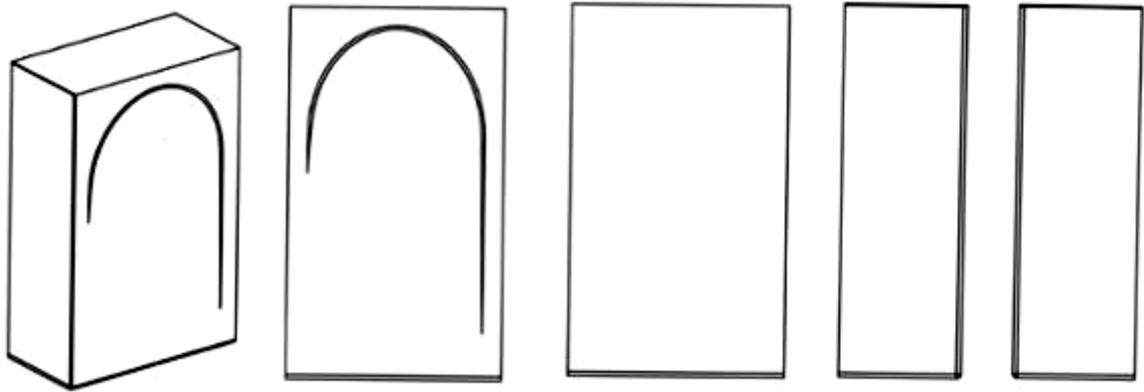

1.1

1.2

1.3

1.4

1.5



1.6



1.7

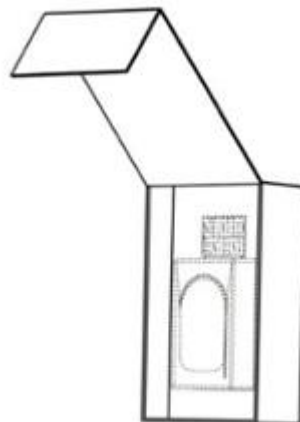

1.8

CÔNG BÁO SỞ HỮU CÔNG NGHIỆP SỐ 438 TẬP A – QUYỀN 2 (09.2024)

- (11) **51280**
(21) 3-2023-03143 (28) 1
(54) **HỘP** (51) **09-03**
(22) 26/12/2023 (43) 25/09/2024
(73) **HỘ KINH DOANH NGỌC THẠCH (VN)**
Thôn Huy Hoàng, xã Ia Rsuom, huyện Krông Pa, tỉnh Gia Lai
(72) Võ Thị Thạch (VN)
(55)



1.1



1.2

CÔNG BÁO SỞ HỮU CÔNG NGHIỆP SỐ 438 TẬP A – QUYỀN 2 (09.2024)

- (11) **51281**
(21) 3-2023-03202 (28) 2
(54) **NẮP CHE QUẠT SƯỜI VÀ THÔNG GIÓ** (51) **23-04**
(22) 29/12/2023 (43) 25/09/2024
(30) 202330406086.8 30/06/2023 CN; 202330406085.3 30/06/2023 CN;
(73) **PANASONIC ECOLOGY SYSTEMS GUANGDONG CO., LTD.** (CN)
2 South Chaogui Road, Shunde High-Tech Industrial Zone (Ronggui), Foshan,
Guangdong 528306, China
(72) Quanyu GUAN (CN)
(74) Công ty TNHH Tầm nhìn và Liên danh (VISION & ASSOCIATES CO.LTD.)
(55)



1.1

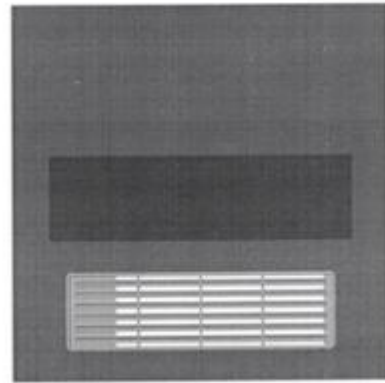

1.2

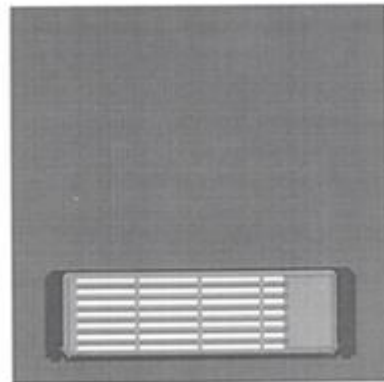

1.3



1.4

1.5



1.6



1.7



2.1

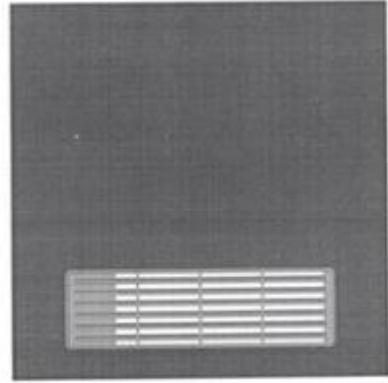

2.2

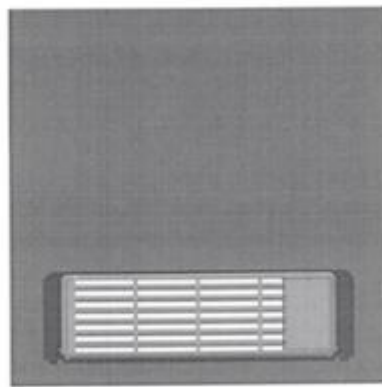

2.3

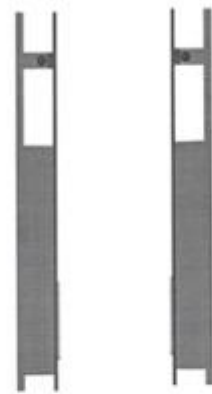

2.4

2.5



2.6



2.7

- (11) **51282**
(21) 3-2024-00085 (28) 1
(54) **THÂN CHÍNH CỦA MÁY LỌC KHÔNG KHÍ** (51) **23-04**
(22) 09/01/2024 (43) 25/09/2024
(30) 30-2023-0026379 10/07/2023 KR;
(73) **COWAY CO., LTD. (KR)**
136-23, Yugumagoksa-ro, Yugu-eup, Gongju-si, Choongcheongnam-do, Korea
(72) 1. SHIN, SU MIN (KR)
2. JUNG, JUN YOUNG (KR)
3. CHOI, JONG HO (KR)
4. NA, SO YEON (KR)
5. NOH, SEUNG YOON (KR)
6. PARK, EUNG KYU (KR)
(74) Công ty TNHH Luật ALIAT (ALIAT LEGAL)
(55)



1.1



1.2



1.3



1.4



1.5



1.6



1.7

CÔNG BÁO SỞ HỮU CÔNG NGHIỆP SỐ 438 TẬP A – QUYỀN 2 (09.2024)

- (11) **51283**
(21) 3-2024-00154 (28) 1
(54) **NẮP CHE BỤI CỦA MÁY GẶT ĐẬP LIÊN HỢP** (51) **15-03**
(22) 19/01/2024 (43) 25/09/2024
(30) 2023-015351 26/07/2023 JP;
(73) **ISEKI & CO., LTD. (JP)**
700 Umaki-cho, Matsuyama-shi, Ehime-ken, Japan
(72) 1. TAKASHI KAWAHARADA (JP)
2. NORIYUKI SAKAMOTO (JP)
3. KATSUTOMO FUJII (JP)
4. RYOTA HIRAGA (JP)
(74) **CÔNG TY LUẬT TRÁCH NHIỆM HỮU HẠN AMBYS HÀ NỘI (AMBYS HANOI)**
(55)



1.1



1.2



1.3



1.4



1.5



1.6



1.7



1.8

- (11) **51284**
- (21) 3-2024-00159 (28) 1
- (54) **CABIN CỦA MÁY GẶT ĐẬP LIÊN HỢP** (51) **15-03**
- (22) 19/01/2024 (43) 25/09/2024
- (30) 2023-015341 26/07/2023 JP;
- (73) **ISEKI & CO., LTD. (JP)**
700 Umaki-cho, Matsuyama-shi, Ehime-ken, Japan
- (72) 1. MAKOTO TAKAGI (JP)
2. TAKASHI KAWAHARADA (JP)
3. SEIJI TANAKA (JP)
4. TAKATOSHI INOUE (JP)
5. TATSUYA MIYAKE (JP)
6. HIROSHI NISHIZAKI (JP)
7. NORIYUKI SAKAMOTO (JP)
8. KAZUMI GOTO (JP)
9. HIDENORI OKAZAKI (JP)
10. KATSUTOMO FUJII (JP)
11. KAZUYA OKUMURA (JP)
12. MAKOTO ITAYAMA (JP)
13. HIROMASA OOTAKA (JP)
14. RYOTA HIRAGA (JP)
15. KOJI KUSUME (JP)
16. HIROYUKI MORIMOTO (JP)
17. HIROKI KURIHARA (JP)
18. JIRO YAMAMOTO (JP)
19. ATSUSHI SENBA (JP)
20. HIROKI WATANABE (JP)
21. EITA KAWANO (JP)
- (74) **CÔNG TY LUẬT TRÁCH NHIỆM HỮU HẠN AMBYS HÀ NỘI (AMBYS HANOI)**
- (55)



1.1



1.2



1.3



1.4



1.5



1.6

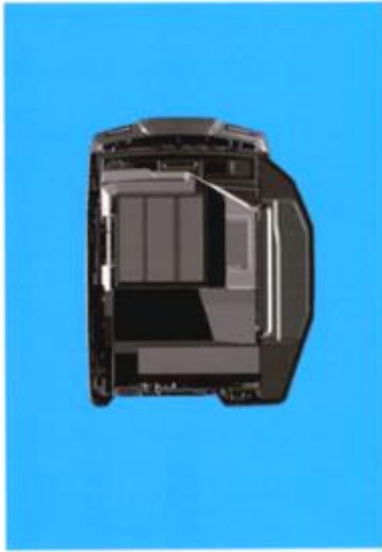

1.7



1.8

- (11) **51285**
- (21) 3-2024-00160 (28) 1
- (54) **MÁY GẶT ĐẬP LIÊN HỢP** (51) **15-03**
- (22) 19/01/2024 (43) 25/09/2024
- (30) 2023-015340 26/07/2023 JP;
- (73) **ISEKI & CO., LTD. (JP)**
700 Umaki-cho, Matsuyama-shi, Ehime-ken, Japan
- (72) 1. MAKOTO TAKAGI (JP)
2. TAKASHI KAWAHARADA (JP)
3. SEIJI TANAKA (JP)
4. TAKATOSHI INOUE (JP)
5. TATSUYA MIYAKE (JP)
6. HIROSHI NISHIZAKI (JP)
7. NORIYUKI SAKAMOTO (JP)
8. KAZUMI GOTO (JP)
9. HIDENORI OKAZAKI (JP)
10. KATSUTOMO FUJII (JP)
11. KAZUYA OKUMURA (JP)
12. MAKOTO ITAYAMA (JP)
13. HIROMASA OOTAKA (JP)
14. RYOTA HIRAGA (JP)
15. KOJI KUSUME (JP)
16. HIROYUKI MORIMOTO (JP)
17. HIROKI KURIHARA (JP)
18. JIRO YAMAMOTO (JP)
19. ATSUSHI SENBA (JP)
20. HIROKI WATANABE (JP)
21. EITA KAWANO (JP)
- (74) **CÔNG TY LUẬT TRÁCH NHIỆM HỮU HẠN AMBYS HÀ NỘI (AMBYS HANOI)**
- (55)



1.1



1.2

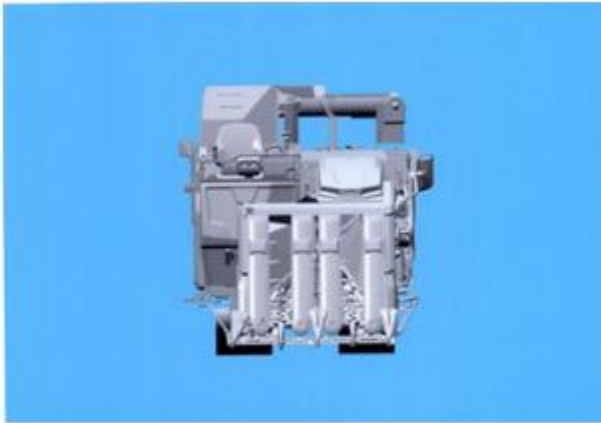

1.3



1.4



1.5

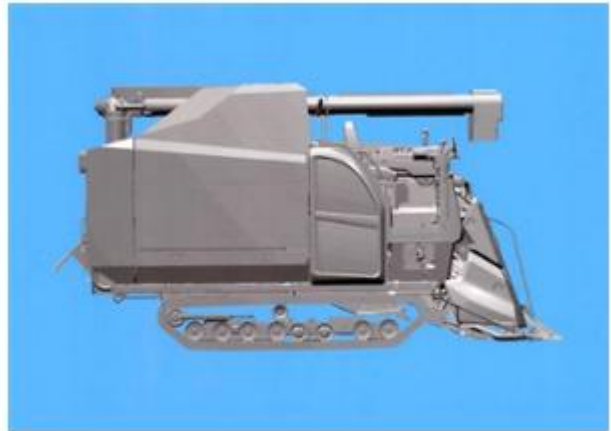

1.6



1.7

CÔNG BÁO SỞ HỮU CÔNG NGHIỆP SỐ 438 TẬP A – QUYỀN 2 (09.2024)

- (11) **51286**
(21) 3-2024-00185 (28) 1
(54) **CỬ CHẠM KHE CỦA BĂNG TẢI** (51) **12-05**
(22) 22/01/2024 (43) 25/09/2024
(73) **FLEXIBLE STEEL LACING COMPANY (US)**
2525 Wisconsin Avenue, Downers Grove, Illinois, 60515, United States of America
(72) Mark Steven Pettinga (US)
(74) Công ty TNHH Sở hữu trí tuệ Thảo Thọ Quyên (INVENCO.,LTD)
(55)

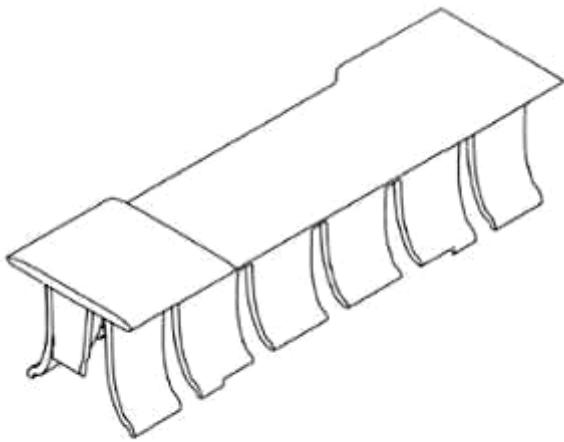

1.1

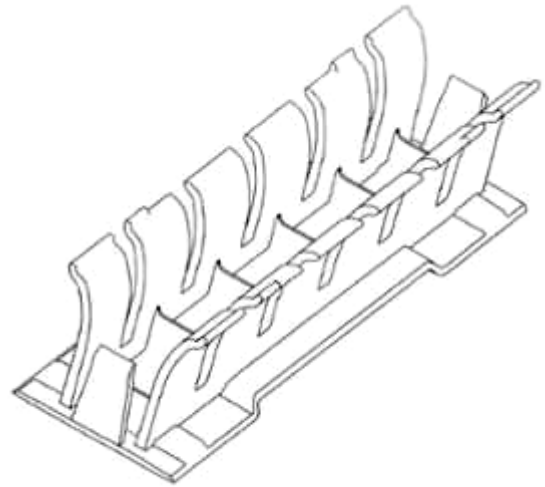

1.2

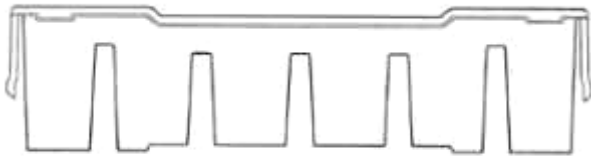

1.3



1.4



1.5

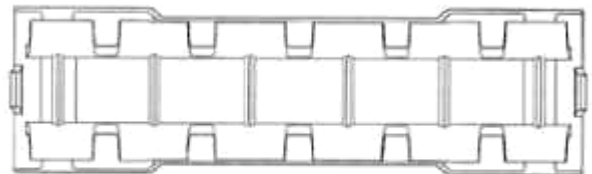

1.6

CÔNG BÁO SỞ HỮU CÔNG NGHIỆP SỐ 438 TẬP A – QUYỀN 2 (09.2024)

- (11) **51287**
(21) 3-2024-00214 (28) 1
(54) **XE Ô TÔ** (51) **12-08**
(22) 24/01/2024 (43) 25/09/2024
(73) **CÔNG TY CỔ PHẦN SẢN XUẤT VÀ KINH DOANH VINFAST (VN)**
Khu Kinh tế Đình Vũ-Cát Hải, đảo Cát Hải, thị trấn Cát Hải, huyện Cát Hải, thành phố Hải Phòng
(72) 1. JOAO MARCOS DE OLIVEIRA RAMOS (BR)
2. JAE HOON LEE (NZ)
(74) **CÔNG TY LUẬT TRÁCH NHIỆM HỮU HẠN AMBYS HÀ NỘI (AMBYS HANOI)**
(55)



1.1



1.2



1.3

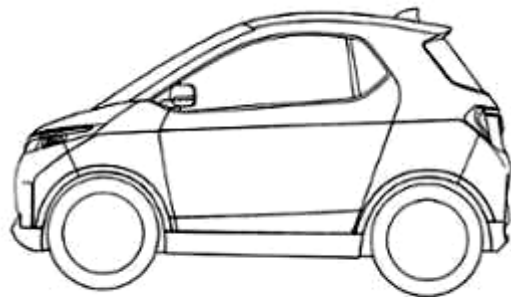

1.4

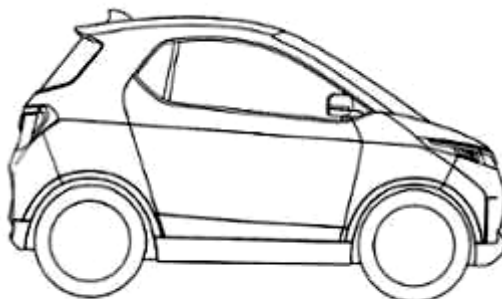

1.5

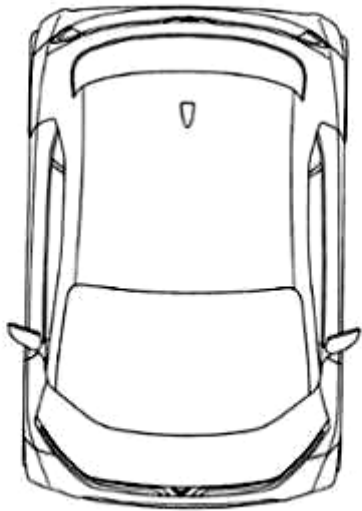

1.6

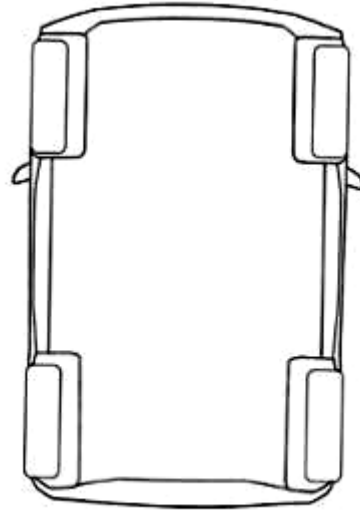

1.7

- (11) **51288**
- (21) 3-2024-00333
- (54) **DÂY ĐAI ĐÓNG GÓI**
- (22) 05/02/2024
- (30) 202330567694.7 01/09/2023 CN;
- (73) **ZHEJIANG YOUNGSUN MACHINERY CO., LTD.** (CN)
No.488, Xingyuan Road, Economic Development Zone, Linping, Hangzhou,
Zhejiang, 311122, China
- (72) LUO Bangyi (CN)
- (74) Công ty TNHH Sở hữu trí tuệ Thảo Thọ Quyển (INVENCO.,LTD)
- (55)

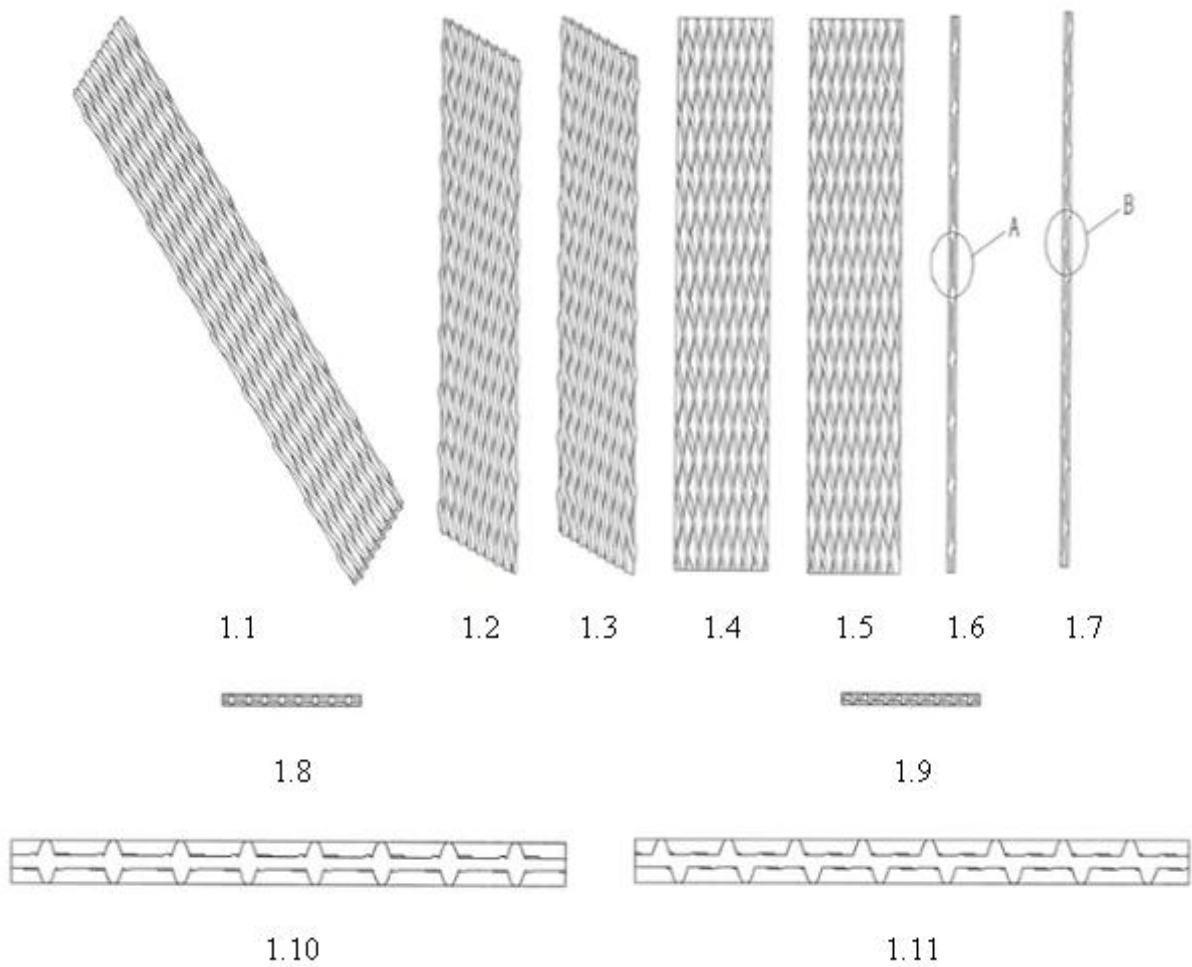

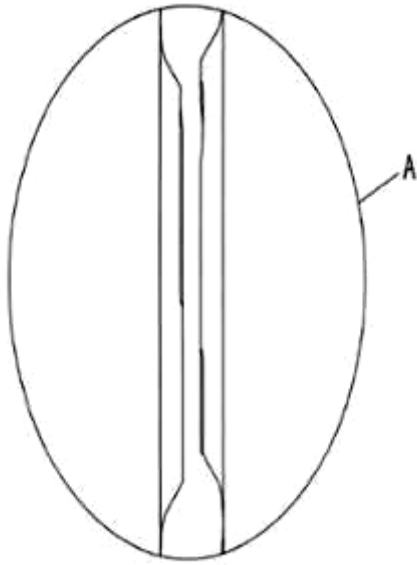

1.12

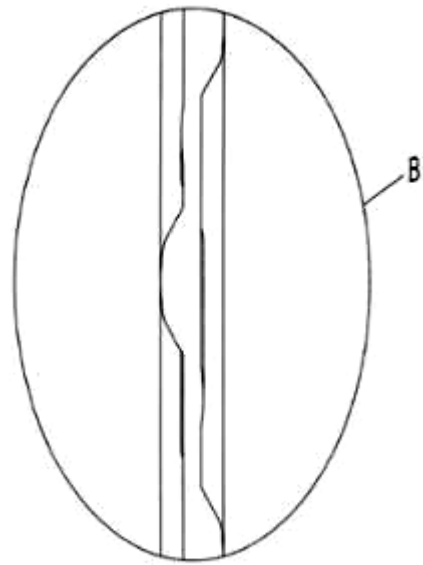

1.13

- (11) **51289**
- (21) 3-2024-00334
- (54) **DÂY ĐAI ĐÓNG GÓI**
- (22) 05/02/2024
- (30) 202330567681.X 01/09/2023 CN;
- (73) **ZHEJIANG YOUNGSUN MACHINERY CO., LTD. (CN)**
No.488, Xingyuan Road, Economic Development Zone, Linping, Hangzhou,
Zhejiang, 311122, China
- (72) LUO Bangyi (CN)
- (74) Công ty TNHH Sở hữu trí tuệ Thảo Thọ Quyên (INVENCO.,LTD)
- (55)

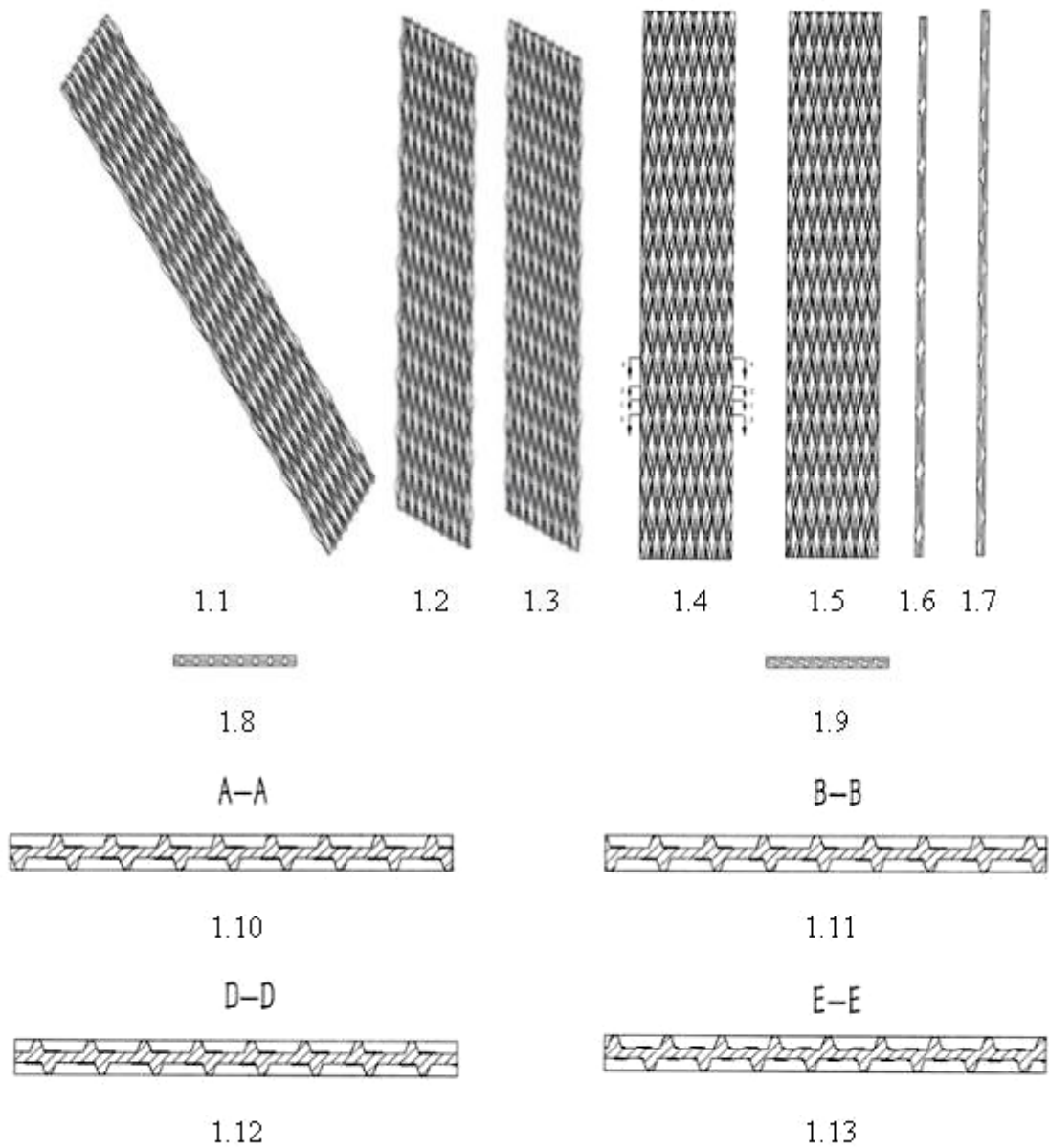



1.14



1.15



1.16

- (11) **51290**
(21) 3-2024-00376 (28) 1
(54) **ĐÈN CHIẾU SÁNG ĐƯỜNG PHỐ** (51) **26-03**
(22) 19/02/2024 (43) 25/09/2024
(73) **CÔNG TY TNHH SẢN XUẤT THƯƠNG MẠI DỊCH VỤ BELED VIỆT NAM**
(VN)
231/25, Nguyễn Duy Dương, phường 4, quận 10, thành phố Hồ Chí Minh
(72) Trần Đại Dương (VN)
(55)



1.1

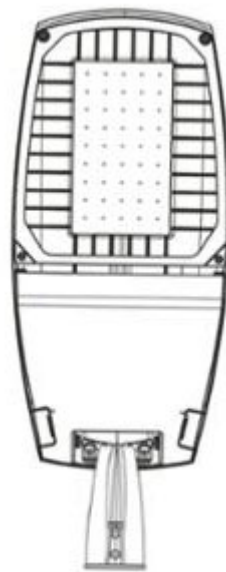

1.2



1.3



1.4



1.5

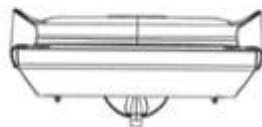

1.6

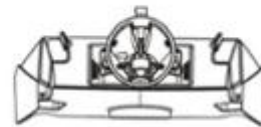

1.7

CÔNG BÁO SỞ HỮU CÔNG NGHIỆP SỐ 438 TẬP A – QUYỀN 2 (09.2024)

- (11) **51291**
- (21) 3-2024-00387 (28) 5
- (54) **ĐỒNG HỒ** (51) **10-02**
- (22) 20/02/2024 (43) 25/09/2024
- (30) DM/232697 21/08/2023 WO; DM/232646 23/08/2023 WO;
- (73) **BLANCPAIN SA (CH)**
Le Rocher 12, 1348 Le Brassus, Switzerland
- (72) Gregory Kissling (CH)
- (74) Công ty Luật TNHH T&G (TGVN)
- (55)



1.1



1.2



1.3



1.4



1.5

1.6



1.7



2.1



2.2



2.3



2.4



2.5



2.6



2.7



3.1



3.2



3.3



3.4



3.5



3.6



3.7



4.1



4.2



4.3



4.4



4.5



4.6



4.7



5.1



5.2



5.3



5.4



5.5



5.6



5.7

CÔNG BÁO SỞ HỮU CÔNG NGHIỆP SỐ 438 TẬP A – QUYỀN 2 (09.2024)

- (11) **51292**
(21) 3-2024-00399 (28) 1
(54) **GHẾ** (51) **06-01**
(22) 21/02/2024 (43) 25/09/2024
(30) 2023305389779 22/08/2023 CN;
(73) **SHENZHEN QIANHAI YAHEE E-COMMERCE CO., LTD (CN)**
Room 4301, Block C, Minzhi Stock Business Center, North Station Community,
Minzhi Street, Longhua District, Shenzhen, 518110, China
(72) 1. YINGJIE WANG (CN)
2. JIANXIN MA (CN)
(74) Công ty TNHH ADAstra IP (VIỆT NAM) (ADASTRA IP (VIETNAM) CO.,
LTD.)
(55)



1.1



1.2



1.3



1.4



1.5



1.6

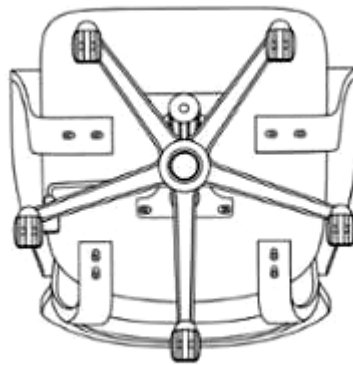

1.7

CÔNG BÁO SỞ HỮU CÔNG NGHIỆP SỐ 438 TẬP A – QUYỀN 2 (09.2024)

- (11) **51293**
(21) 3-2024-00484 (28) 1
(54) **MÁY CẮT ĐỀ CAN** (51) **18-02; 18-04**
(22) 29/02/2024 (43) 25/09/2024
(30) 2023-017970 04/09/2023 JP;
(73) **SILHOUETTE JAPAN CORPORATION (JP)**
503-10 Shinano-cho, Totsuka-ku, Yokohama, Kanagawa 244-0801 Japan
(72) 1. MAYUMI SATO (JP)
2. YOSHITAKA TSUNOI (JP)
(74) **CÔNG TY LUẬT TRÁCH NHIỆM HỮU HẠN AMBYS HÀ NỘI (AMBYS HANOI)**
(55)



1.1

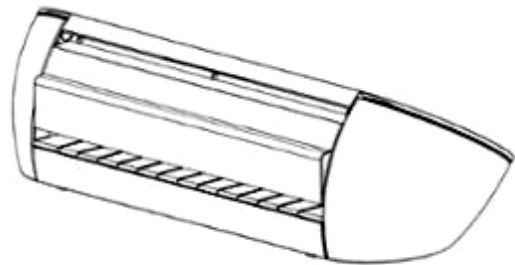

1.2

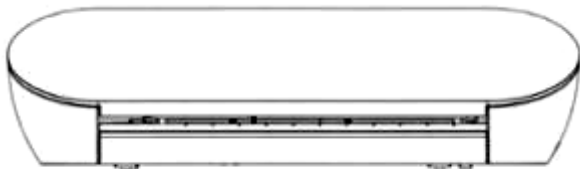

1.3

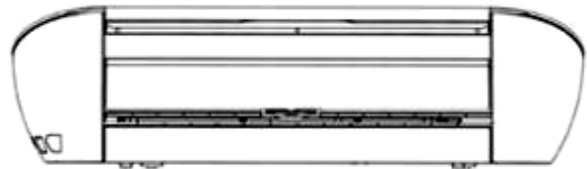

1.4

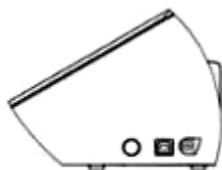

1.5



1.6



1.7

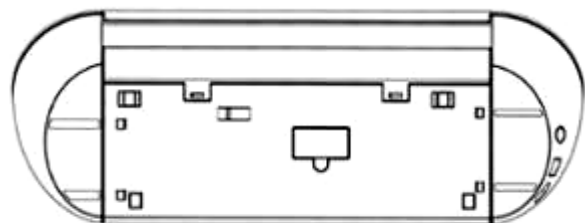

1.8

CÔNG BÁO SỞ HỮU CÔNG NGHIỆP SỐ 438 TẬP A – QUYỀN 2 (09.2024)

- (11) **51294**
(21) 3-2024-00485 (28) 1
(54) **DỤNG CỤ HẤP PHỤ TÍNH ĐIỆN CHO MÁY CẮT ĐỀ CAN** (51) **18-02; 18-04**
(22) 29/02/2024 (43) 25/09/2024
(30) 2023-017971 04/09/2023 JP;
(73) **SILHOUETTE JAPAN CORPORATION (JP)**
503-10 Shinano-cho, Totsuka-ku, Yokohama, Kanagawa 244-0801 Japan
(72) Mayumi SATO (JP)
(74) **CÔNG TY LUẬT TRÁCH NHIỆM HỮU HẠN AMBYS HÀ NỘI (AMBYS HANOI)**
(55)



1.1



1.2

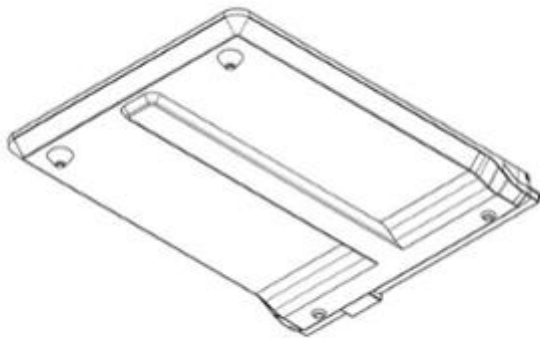

1.3



1.4



1.5



1.6



1.7

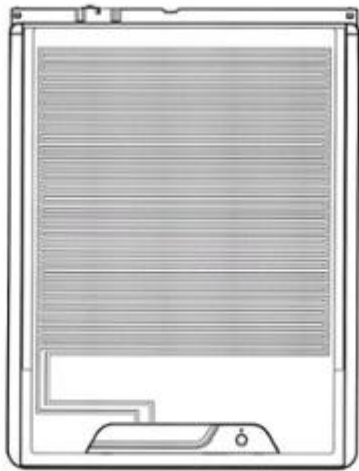

1.8

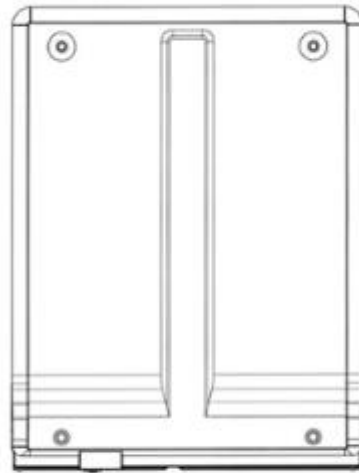

1.9

CÔNG BÁO SỞ HỮU CÔNG NGHIỆP SỐ 438 TẬP A – QUYỀN 2 (09.2024)

- (11) **51295**
(21) 3-2024-00486 (28) 1
(54) **BỘ PHẬN GIỮ VẬT LIỆU DẠNG CUỘN CHO MÁY CẮT ĐỀ CAN** (51) **18-02; 18-04**
(22) 29/02/2024 (43) 25/09/2024
(30) 2023-017972 04/09/2023 JP;
(73) **SILHOUETTE JAPAN CORPORATION (JP)**
503-10 Shinano-cho, Totsuka-ku, Yokohama, Kanagawa 244-0801 Japan
(72) 1. MAYUMI SATO (JP)
2. HIRONARI SOMEYA (JP)
(74) **CÔNG TY LUẬT TRÁCH NHIỆM HỮU HẠN AMBYS HÀ NỘI (AMBYS HANOI)**
(55)



1.1



1.2



1.3



1.4



1.5



1.6

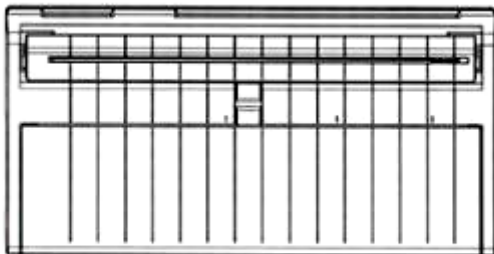

1.7



1.8



1.9



1.10

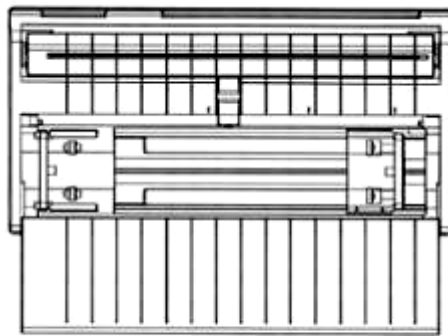

1.11

CÔNG BÁO SỞ HỮU CÔNG NGHIỆP SỐ 438 TẬP A – QUYỀN 2 (09.2024)

- (11) **51296**
(21) 3-2024-00487 (28) 1
(54) **MÁY CẮT ĐỀ CAN** (51) **18-02; 18-04**
(22) 29/02/2024 (43) 25/09/2024
(30) 2023-017969 04/09/2023 JP;
(73) **SILHOUETTE JAPAN CORPORATION (JP)**
503-10 Shinano-cho, Totsuka-ku, Yokohama, Kanagawa 244-0801 Japan
(72) 1. MAYUMI SATO (JP)
2. HIRONARI SOMEYA (JP)
(74) **CÔNG TY LUẬT TRÁCH NHIỆM HỮU HẠN AMBYS HÀ NỘI (AMBYS HANOI)**
(55)

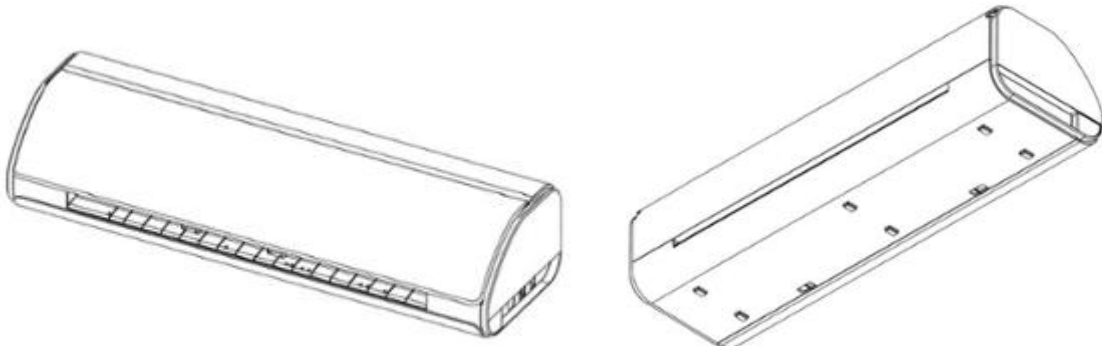

1.1

1.2

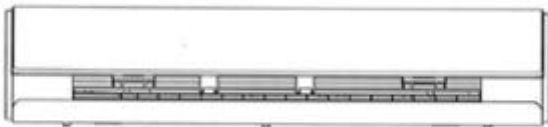

1.3

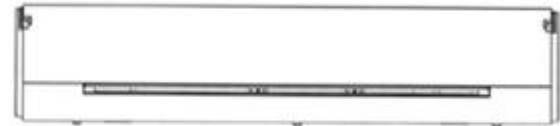

1.4



1.5



1.6



1.7

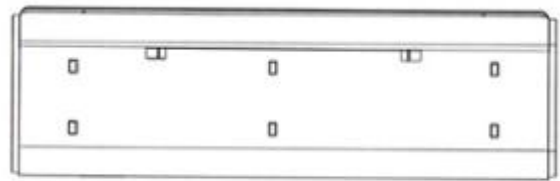

1.8

CÔNG BÁO SỞ HỮU CÔNG NGHIỆP SỐ 438 TẬP A – QUYỀN 2 (09.2024)

- (11) **51297**
(21) 3-2024-00559 (28) 1
(54) **CHAI** (51) **09-01**
(22) 07/03/2024 (43) 25/09/2024
(73) **CÔNG TY CỔ PHẦN HÀNG TIÊU DÙNG BIÊN HÒA (VN)**
Khu công nghiệp Biên Hòa 1, phường An Bình, thành phố Biên Hòa, tỉnh Đồng Nai
(72) Quang Nhật Trung (VN)
(74) Công ty TNHH Tư vấn sở hữu trí tuệ Việt (VIET IP CO.,LTD.)
(55)



1.1

1.2

1.3

1.4

1.5



1.6



1.7

CÔNG BÁO SỞ HỮU CÔNG NGHIỆP SỐ 438 TẬP A – QUYỀN 2 (09.2024)

- (11) **51298**
(21) 3-2024-00721 (28) 1
(54) **MÁY XAY ĐUN ĐA NĂNG** (51) **31-00**
(22) 22/03/2024 (43) 25/09/2024
(73) **CÔNG TY CỔ PHẦN ĐẦU TƯ THƯƠNG MẠI BÁCH TƯỜNG PHÁT (VN)**
Tầng 5, N01-T4 Tower, Chung cư Phú Mỹ Complex, khu Ngoại Giao Đoàn,
phường Xuân Tảo, quận Bắc Từ Liêm, thành phố Hà Nội
(72) Hoàng Minh Tuấn (VN)
(55)



1.1



1.2



1.3



1.4



1.5



1.6



1.7

CÔNG BÁO SỞ HỮU CÔNG NGHIỆP SỐ 438 TẬP A – QUYỀN 2 (09.2024)

(11) **51299**

(21) 3-2024-00732

(28) 1

(54) **KÌM**

(51) **08-05**

(22) 27/03/2024

(43) 25/09/2024

(73) **CHAO-CHIH LIU (TW)**

6F., No.324, Sec. 1, Wenxin Rd., Nantun Dist., Taichung City 40866, Taiwan

(72) Chao-Chih Liu (TW)

(74) Công ty TNHH Sở hữu trí tuệ NTT (NTT IP CO.,LTD)

(55)

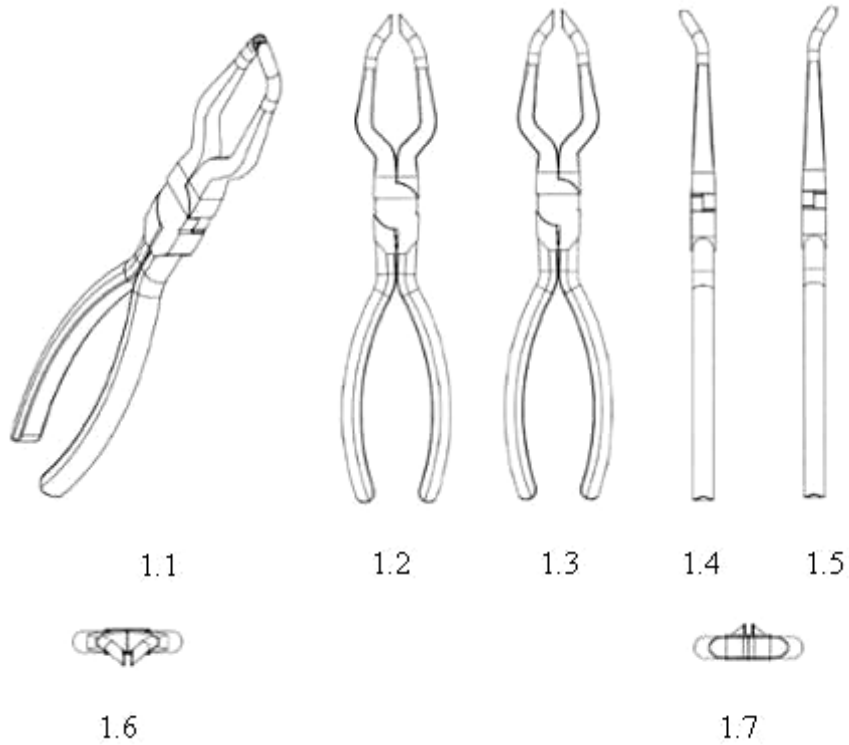

CÔNG BÁO SỞ HỮU CÔNG NGHIỆP SỐ 438 TẬP A – QUYỀN 2 (09.2024)

(11) **51300**

(21) 3-2024-00750

(28) 1

(54) **CÂY LAU NHÀ**

(51) **04-01**

(22) 28/03/2024

(43) 25/09/2024

(73) **CÔNG TY CỔ PHẦN SẢN XUẤT NHỰA DUY TÂN (VN)**

298 Hồ Học Lãm, phường An Lạc, quận Bình Tân, thành phố Hồ Chí Minh

(72) Trần Đức Xuyên (VN)

(74) Công ty TNHH Sở hữu trí tuệ INVENTIO (INVENTIO CO.,LTD)

(55)



1.1



1.2

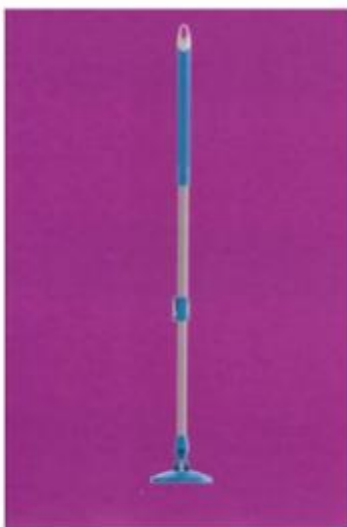

1.3

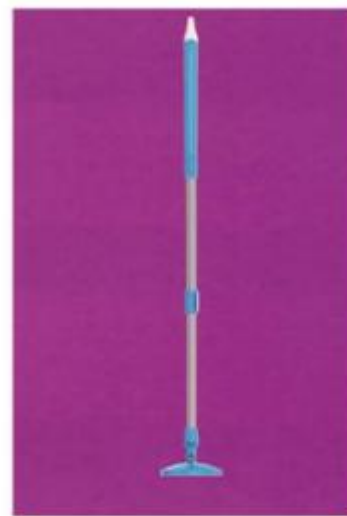

1.4



1.5



1.6



1.7

CÔNG BÁO SỞ HỮU CÔNG NGHIỆP SỐ 438 TẬP A – QUYỀN 2 (09.2024)

(11) **51301**

(21) 3-2024-00751

(28) 1

(54) **CHẬU TẮM**

(51) **07-07**

(22) 28/03/2024

(43) 25/09/2024

(73) **CÔNG TY CỔ PHẦN SẢN XUẤT NHỰA DUY TÂN (VN)**

298 Hồ Học Lãm, phường An Lạc, quận Bình Tân, thành phố Hồ Chí Minh

(72) Trần Đức Xuyên (VN)

(74) Công ty TNHH Sở hữu trí tuệ INVENTIO (INVENTIO CO.,LTD)

(55)



1.1



1.2



1.3



1.4



1.5



1.6



1.7



1.8

(11) **51302**

(21) 3-2024-00756

(28) 2

(54) **GHẾ**

(51) **06-01**

(22) 28/03/2024

(43) 25/09/2024

(73) **TRƯỜNG ĐẠI HỌC VĂN LANG (VN)**

45 Nguyễn Khắc Nhu, phường Cô Giang, quận 1, thành phố Hồ Chí Minh

(72) Dương Toàn Thịnh (VN)

(55)



1.1



1.2

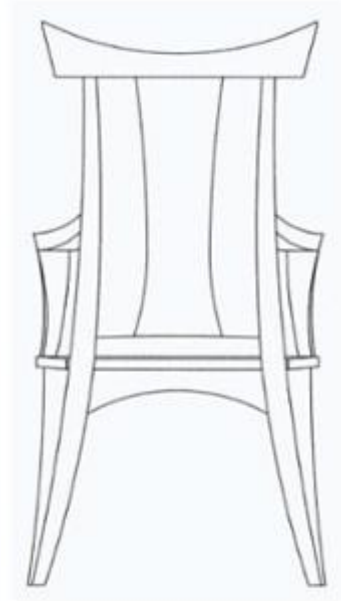

1.3

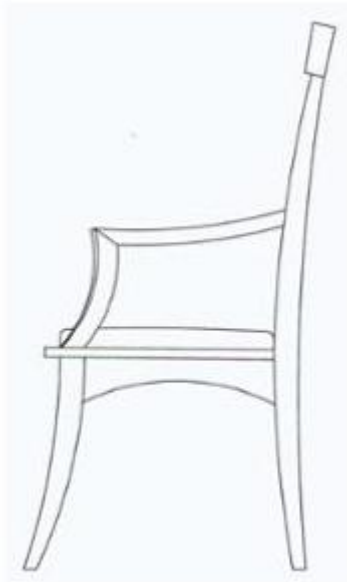

1.4



1.5



1.6



2.1



2.2



2.3



2.4



2.5



2.6

CÔNG BÁO SỞ HỮU CÔNG NGHIỆP SỐ 438 TẬP A – QUYỀN 2 (09.2024)

- (11) **51303**
(21) 3-2024-00775 (28) 1
(54) **HỘP** (51) **09-03**
(22) 29/03/2024 (43) 25/09/2024
(73) **CÔNG TY TNHH PDA HEALTHCARE & BEAUTY (VN)**
221E/5 Trần Huy Liệu, phường 8, quận Phú Nhuận, thành phố Hồ Chí Minh
(72) Trần Thị Thảo Nguyên (VN)
(55)



1.1



1.2

CÔNG BÁO SỞ HỮU CÔNG NGHIỆP SỐ 438 TẬP A – QUYỀN 2 (09.2024)

- (11) **51304**
(21) 3-2024-00799 (28) 1
(54) **GIÁ ĐÈ ĐIỆN THOẠI DI ĐỘNG** (51) **14-99**
(22) 03/04/2024 (43) 25/09/2024
(73) **DONGGUANSHI ZHUOSHI INTELLIGENT TECH CO., LTD (CN)**
No.7 Lianxin Road, Chang'an Town, Dongguan City, Guangdong Province, China
(72) Hui Zeng (CN)
(74) Công ty TNHH Dịch vụ Sở hữu trí tuệ BIG5 (BIG5 IP CO.,LTD)
(55)

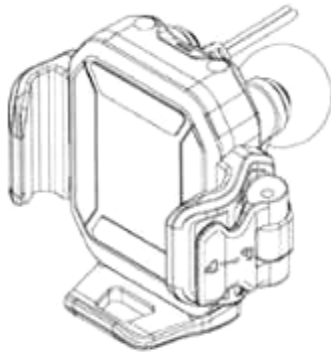

1.1

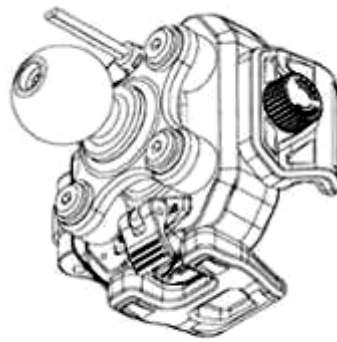

1.2



1.3

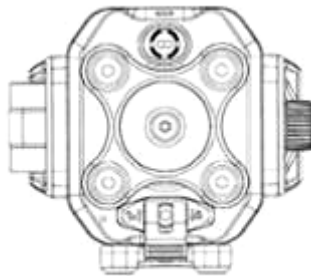

1.4

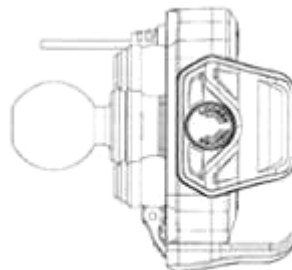

1.5

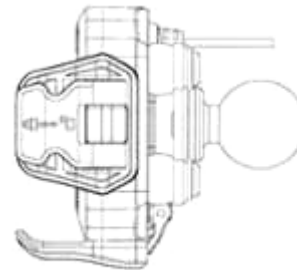

1.6

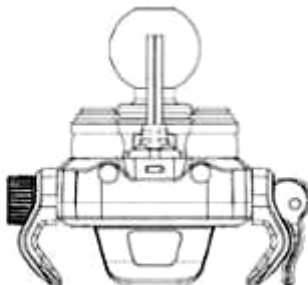

1.7

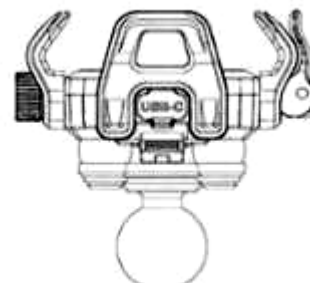

1.8

CÔNG BÁO SỞ HỮU CÔNG NGHIỆP SỐ 438 TẬP A – QUYỀN 2 (09.2024)

- (11) **51305**
- (21) 3-2024-00810
- (54) **CỐC**
- (22) 04/04/2024
- (30) DM/232439 09/10/2023 WO; DM/232619 17/10/2023 WO;
- (73) **Pi-Design AG (CH)**
Altgasse 82, CH-6340 Baar, Switzerland
- (72) Jorgen BODUM (CH)
- (74) Công ty Luật TNHH T&G (TGVN)
- (55)



1.1

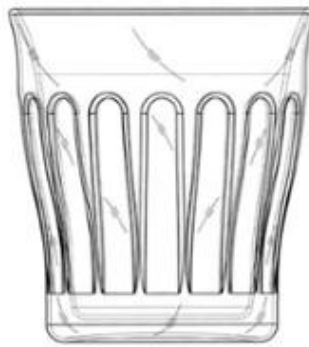

1.2



1.3

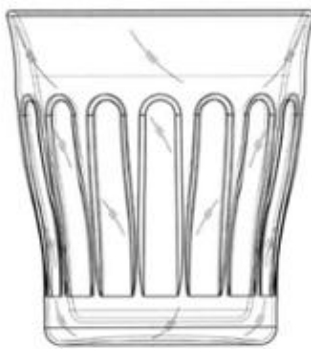

1.4



1.5

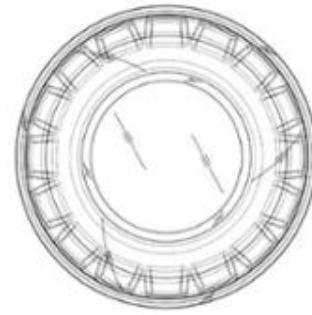

1.6



1.7



2.1



2.2



2.3



2.4



2.5



2.6



2.7



3.1

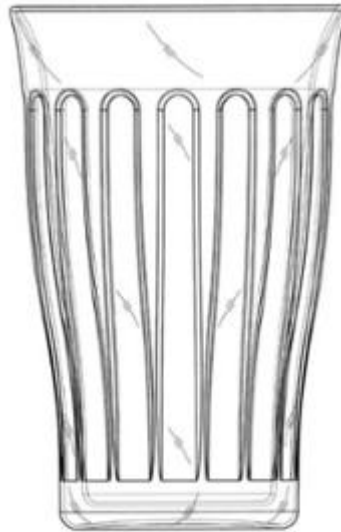

3.2

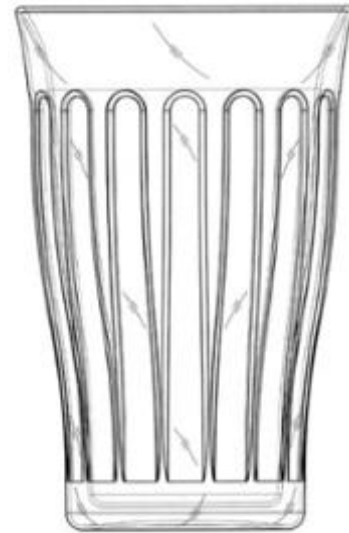

3.3

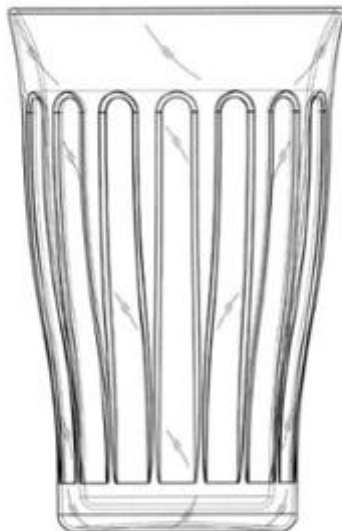

3.4

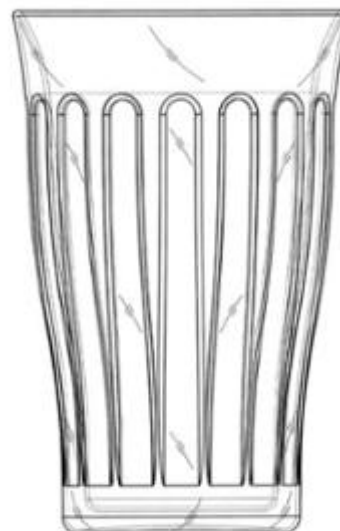

3.5

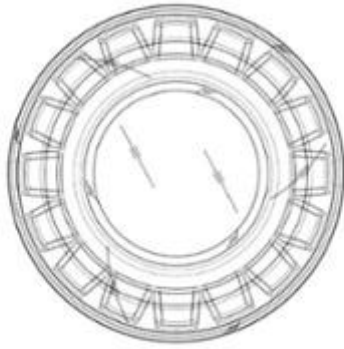

3.6



3.7



4.1



4.2



4.3



4.4



4.5

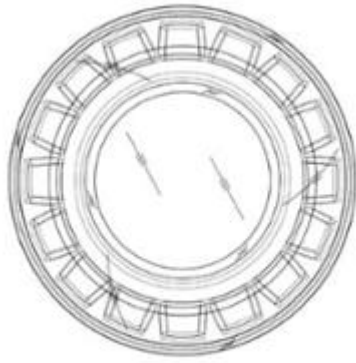

4.6



4.7

- (11) **51306**
(21) 3-2024-00821 (28) 1
(54) **NẮP HỘP** (51) **09-07**
(22) 30/12/2022 (43) 25/09/2024
(30) 29/847,026 21/07/2022 US;
(73) **DART INDUSTRIES INC. (US)**
14901 S. Orange Blossom Trail, Orlando, Florida, 32837, United States of America
(72) 1. DONGJIN BYEON (KR)
2. ALEC VERCRUYSSSEN (BE)
3. ARTHUR LORRÉ (BE)
4. DIMITRI M.C.J. BACKAERT (BE)
(74) **CÔNG TY LUẬT TRÁCH NHIỆM HỮU HẠN AMBYS HÀ NỘI (AMBYS HANOI)**
(55)



1.1



1.2



1.3



1.4



1.5



1.6

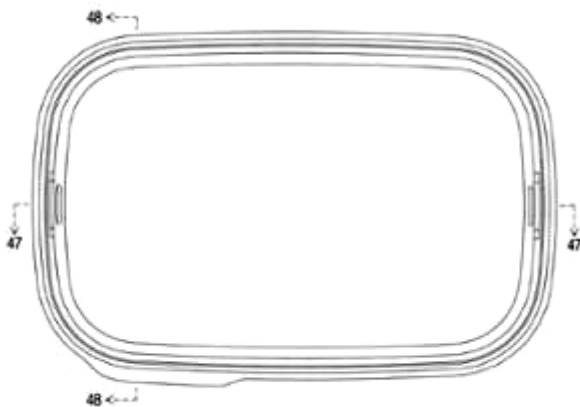

1.7

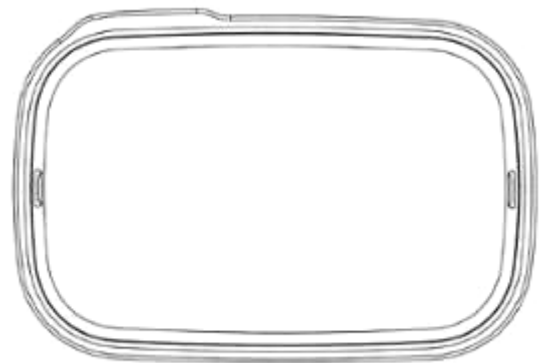

1.8



1.9



1.10



2.1



2.2



2.3



2.4



2.5



2.6

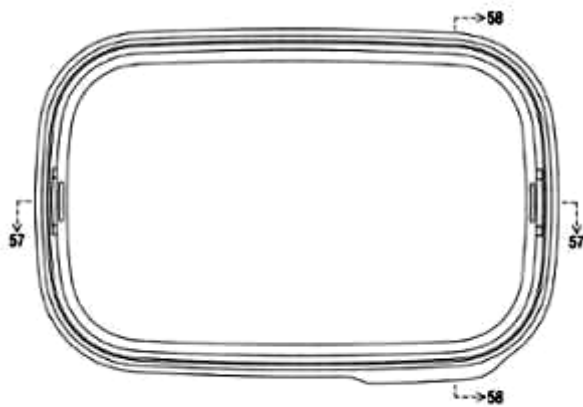

2.7



2.8



2.9



2.10

- (11) **51307**
(21) 3-2024-00822 (28) 2
(54) **NẮP HỘP** (51) **09-07**
(22) 30/12/2022 (43) 25/09/2024
(30) 29/847,026 21/07/2022 US;
(73) **DART INDUSTRIES INC. (US)**
14901 S. Orange Blossom Trail, Orlando, Florida, 32837, United States of America
(72) 1. DONGJIN BYEON (KR)
2. ALEC VERCRUYSSSEN (BE)
3. ARTHUR LORRÉ (BE)
4. DIMITRI M.C.J. BACKAERT (BE)
(74) **CÔNG TY LUẬT TRÁCH NHIỆM HỮU HẠN AMBYS HÀ NỘI (AMBYS HANOI)**
(55)

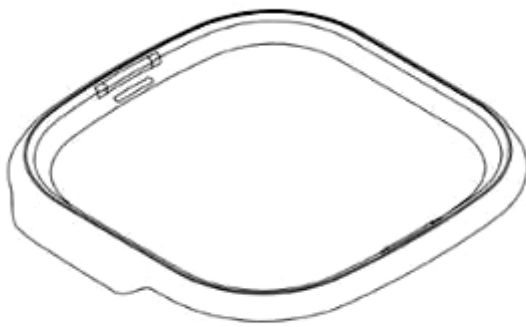

1.1



1.2



1.3



1.4



1.6



1.5

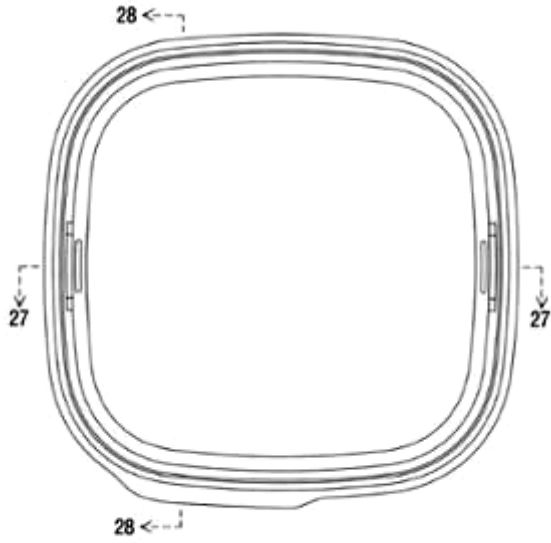

1.7



1.8



1.9

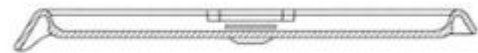

1.10



2.1



2.2



2.3



2.4



2.5



2.6

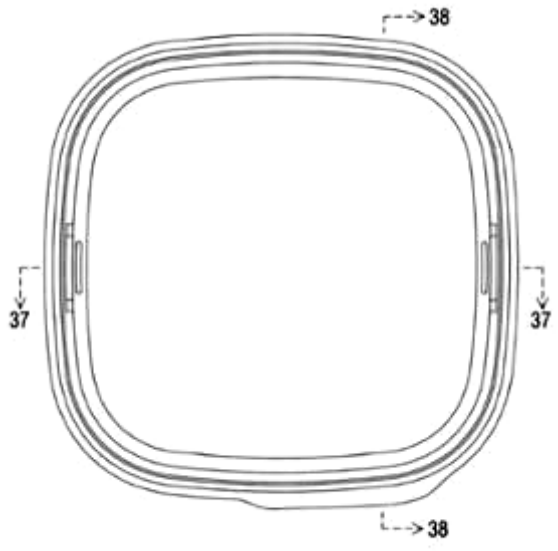

2.7



2.8

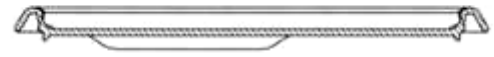

2.9



2.10

- (11) **51308**
(21) 3-2024-00823 (28) 1
(54) **NẮP HỘP** (51) **09-07**
(22) 30/12/2022 (43) 25/09/2024
(30) 29/847,026 21/07/2022 US;
(73) **DART INDUSTRIES INC. (US)**
14901 S. Orange Blossom Trail, Orlando, Florida, 32837, United States of America
(72) 1. DONGJIN BYEON (KR)
2. ALEC VERCRUYSSSEN (BE)
3. ARTHUR LORRÉ (BE)
4. DIMITRI M.C.J. BACKAERT (BE)
(74) **CÔNG TY LUẬT TRÁCH NHIỆM HỮU HẠN AMBYS HÀ NỘI (AMBYS HANOI)**
(55)

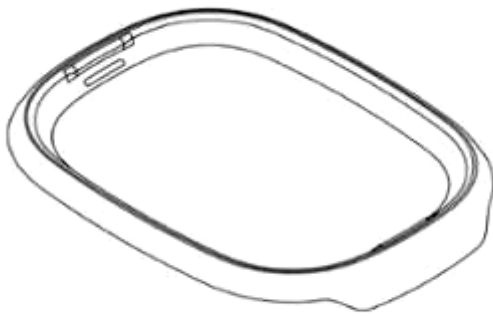

1.1



1.2



1.3



1.4



1.5

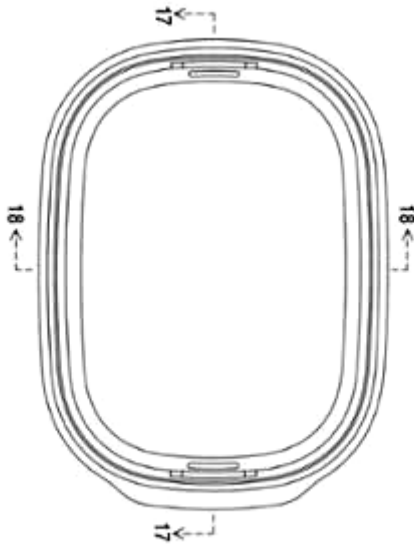

1.6

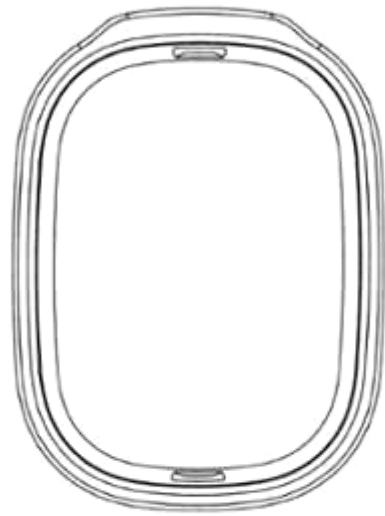

1.7



1.8



1.9

CÔNG BÁO SỞ HỮU CÔNG NGHIỆP SỐ 438 TẬP A – QUYỀN 2 (09.2024)

- (11) **51309**
(21) 3-2024-00834 (28) 1
(54) **HỘP ĐỰNG** (51) **09-03**
(22) 05/04/2024 (43) 25/09/2024
(30) 30-2023-0040872 19/10/2023 KR;
(73) **AEKYUNG INDUSTRIAL CO., LTD.** (KR)
188, Yanghwa-ro, Mapo-gu, Seoul, Republic of Korea
(72) **PARK NURI** (KR)
(74) Công ty Luật TNHH WINCO (WINCO LAW FIRM)
(55)



- (11) **51310**
(21) 3-2024-00847 (28) 2
(54) **TẤ LÓT DÙNG MỘT LẦN** (51) **02-01**
(22) 08/04/2024 (43) 25/09/2024
(30) 2023306580706 11/10/2023 CN;
(73) **UNICHARM CORPORATION (JP)**
182, Shimobun, Kinsei-cho, Shikokuchuo-City, Ehime 799-0111, Japan
(72) 1. TOSHIFUMI OHTSUBO (JP)
2. **ĐẶNG THỊ QUYÊN (VN)**
(74) Công ty Cổ phần Sở hữu công nghiệp INVESTIP (INVESTIP)
(55)

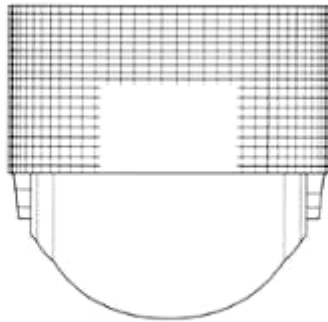

1.1

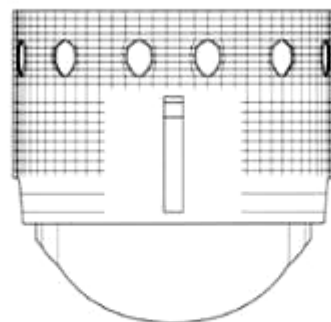

1.2

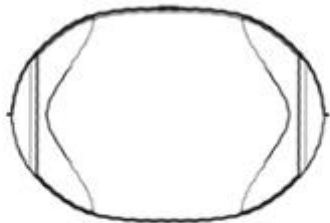

1.3

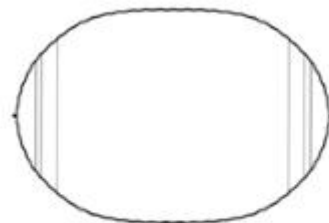

1.4

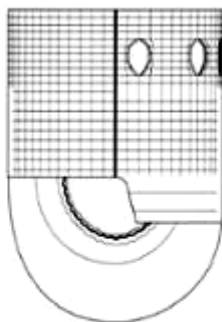

1.5

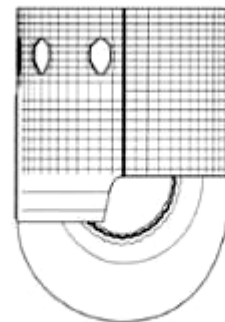

1.6

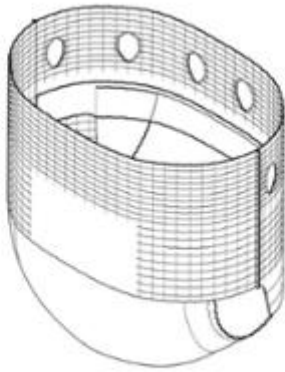

1.7

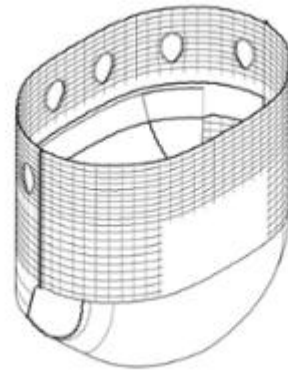

1.8

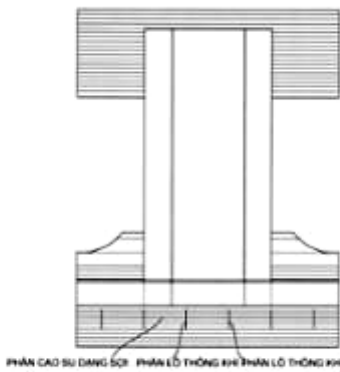

1.9

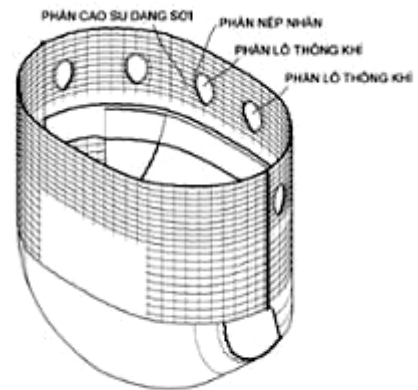

1.10

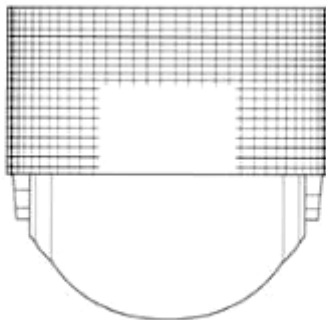

2.1

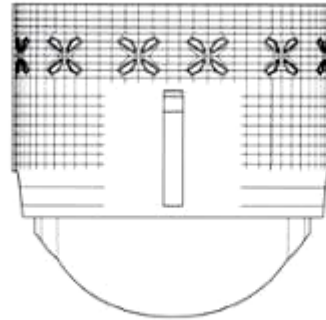

2.2

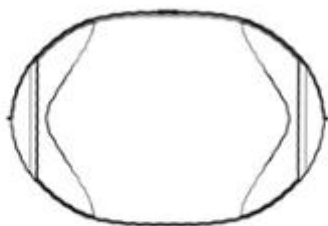

2.3

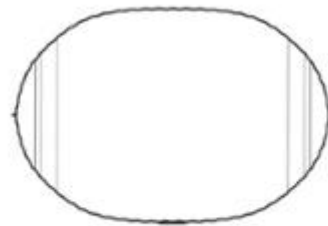

2.4

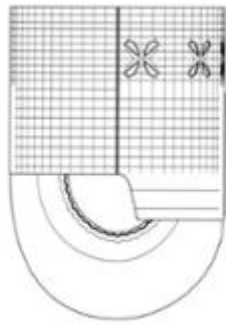

2.5

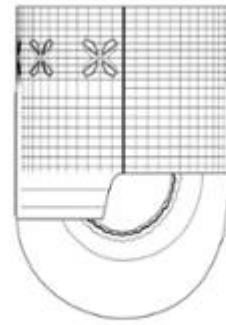

2.6

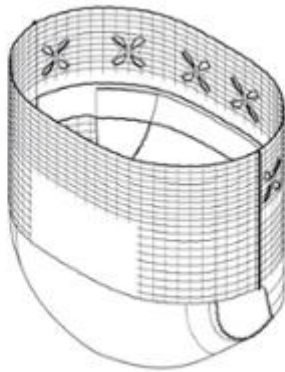

2.7

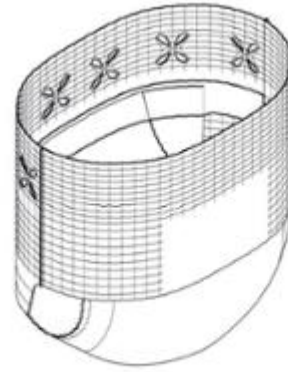

2.8

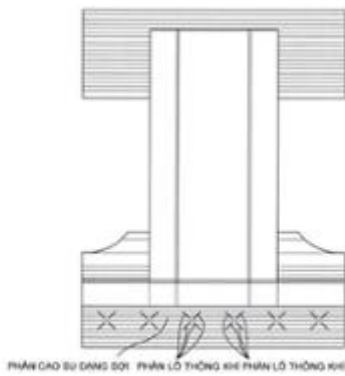

2.9

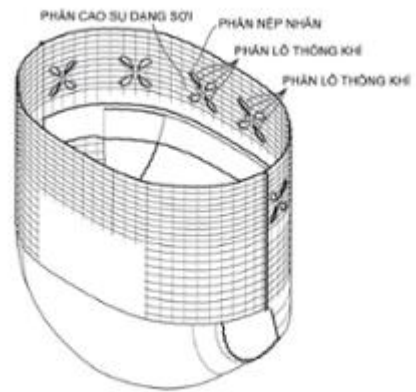

2.10

- (11) **51311**
(21) 3-2024-00848 (28) 4
(54) **TẤ LÓT DÙNG MỘT LẦN** (51) **02-01**
(22) 08/04/2024 (43) 25/09/2024
(30) 2023306580706 11/10/2023 CN;
(73) **UNICHARM CORPORATION (JP)**
182, Shimobun, Kinsei-cho, Shikokuchuo-City, Ehime 799-0111, Japan
(72) 1. TOSHIFUMI OHTSUBO (JP)
2. **ĐẶNG THỊ QUYÊN (VN)**
(74) Công ty Cổ phần Sở hữu công nghiệp INVESTIP (INVESTIP)
(55)

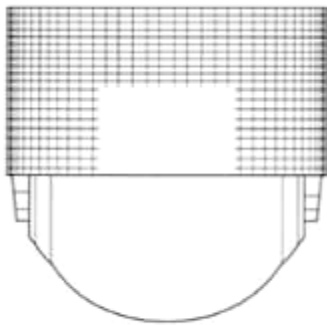

1.1

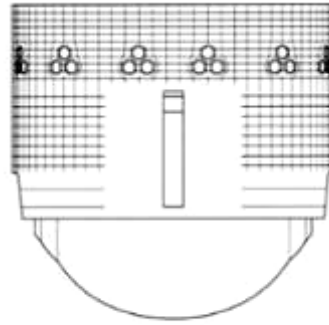

1.2

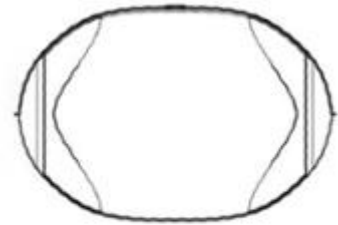

1.3

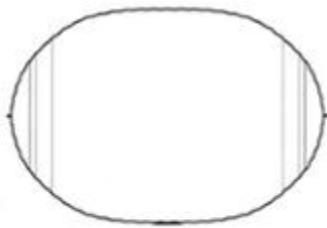

1.4

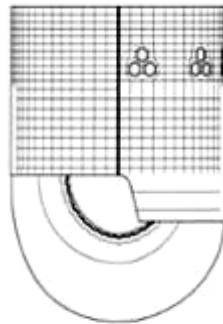

1.5

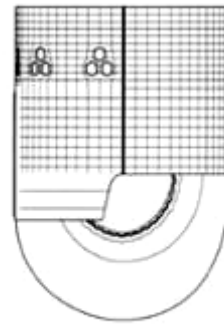

1.6

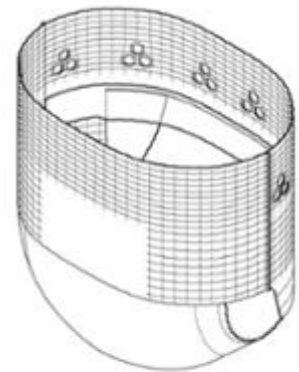

1.7

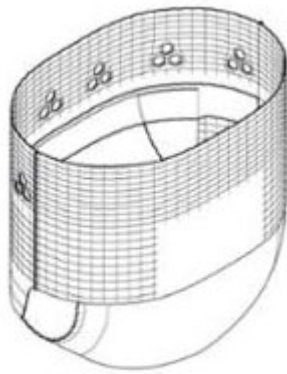

1.8

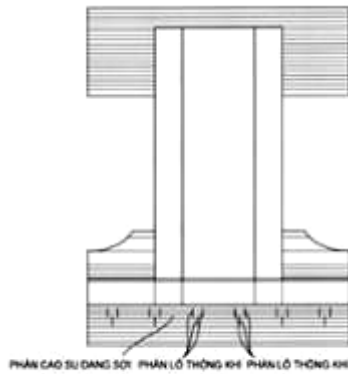

1.9

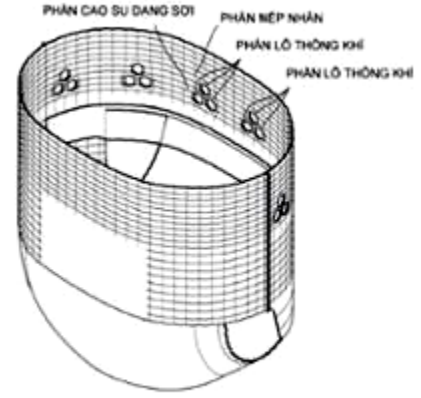

1.10

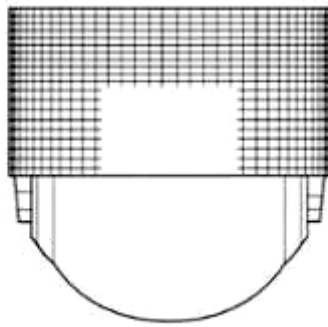

2.1

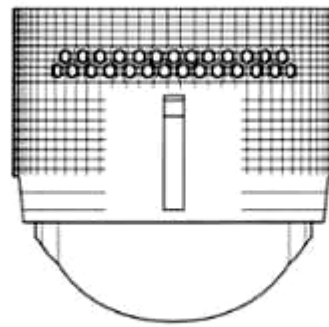

2.2

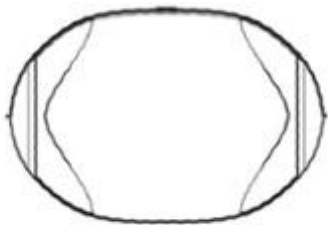

2.3

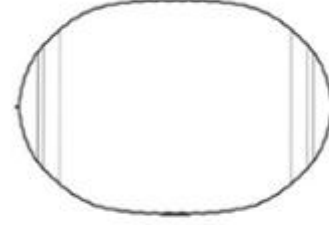

2.4

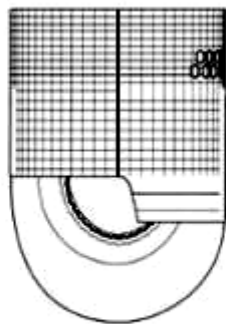

2.5

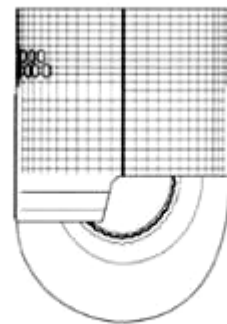

2.6

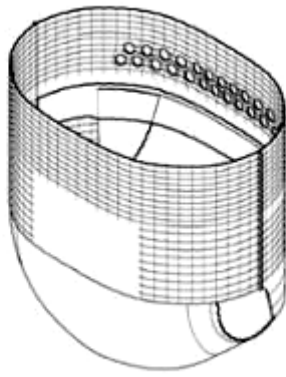

2.7

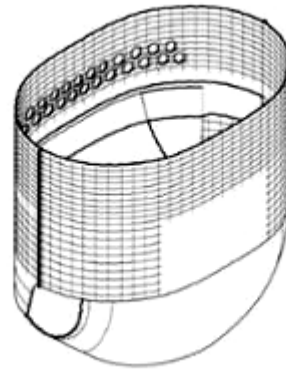

2.8

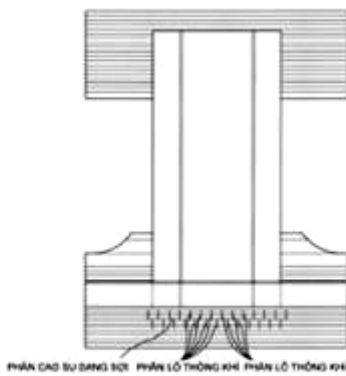

2.9

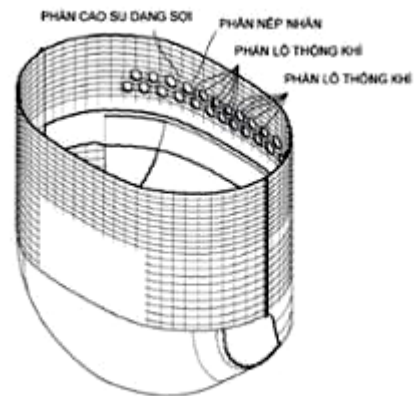

2.10

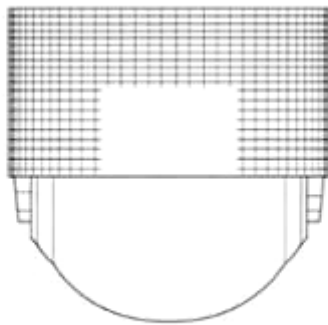

3.1

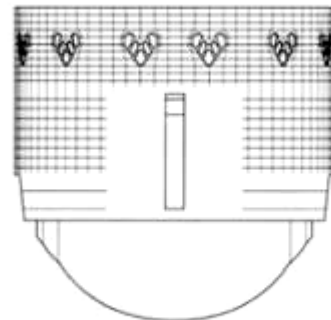

3.2

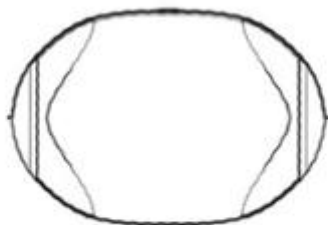

3.3

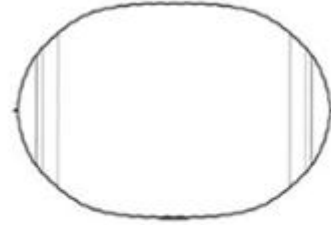

3.4

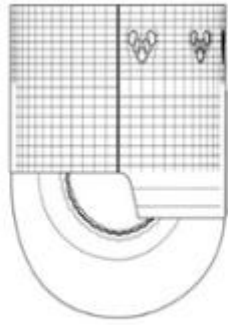

3.5

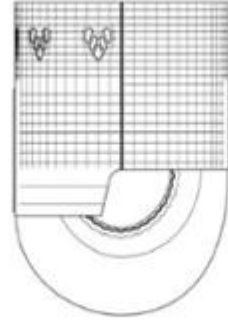

3.6

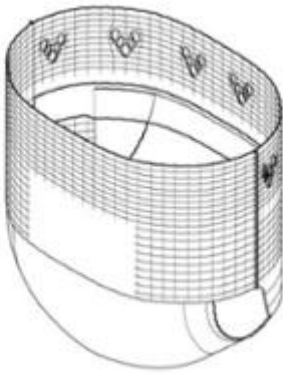

3.7

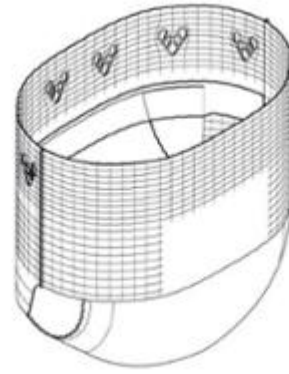

3.8

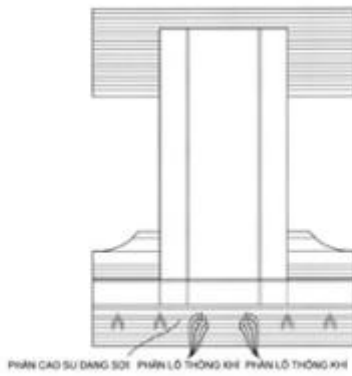

3.9

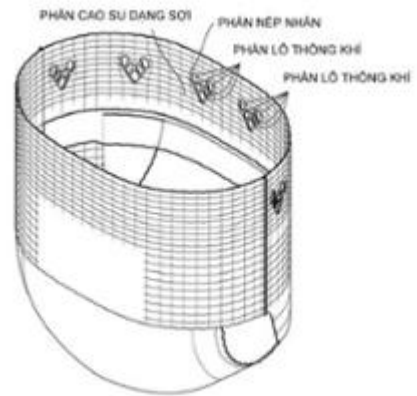

3.10

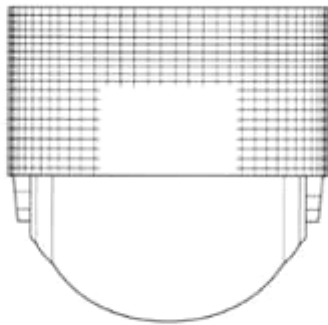

4.1

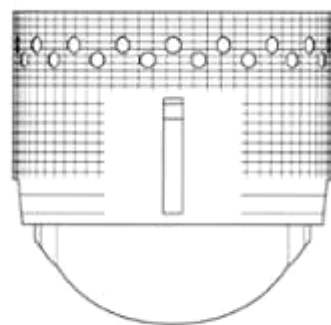

4.2

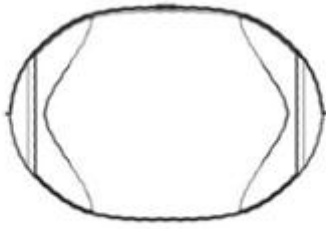

4.3

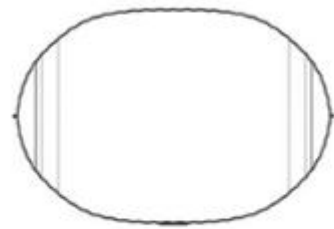

4.4

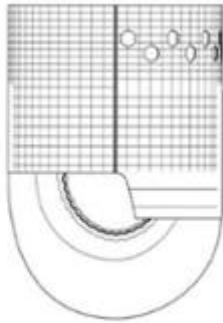

4.5

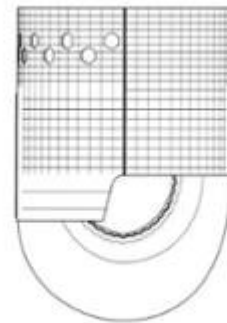

4.6

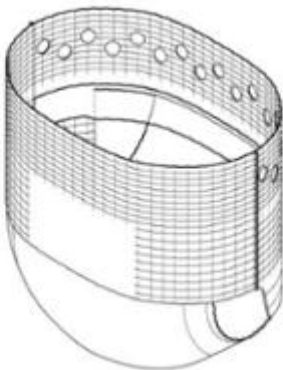

4.7

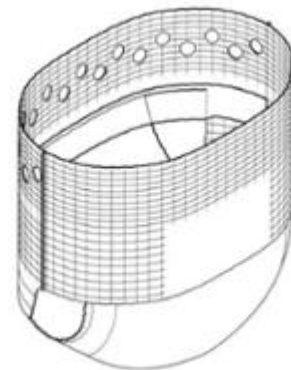

4.8

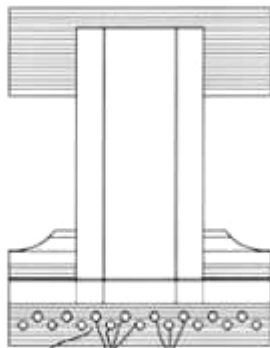

PHẦN CAO SU DANG SỢI PHẦN LỖ THÔNG KHÍ PHẦN LỖ THÔNG KHÍ

4.9

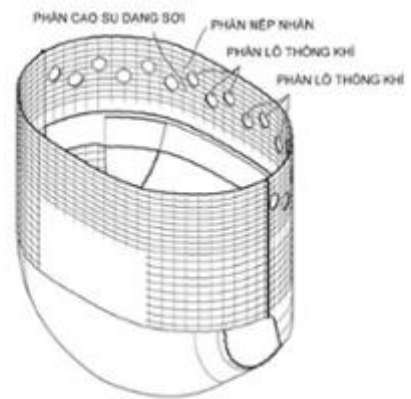

4.10

CÔNG BÁO SỞ HỮU CÔNG NGHIỆP SỐ 438 TẬP A – QUYỀN 2 (09.2024)

(11) **51312**

(21) 3-2024-00884

(28) 1

(54) **LY**

(51) **07-01**

(22) 10/04/2024

(43) 25/09/2024

(73) **CÔNG TY CỔ PHẦN SẢN XUẤT NHỰA DUY TÂN (VN)**

298 Hồ Học Lãm, phường An Lạc, quận Bình Tân, thành phố Hồ Chí Minh

(72) Trần Đức Xuyên (VN)

(74) Công ty TNHH Sở hữu trí tuệ INVENTIO (INVENTIO CO.,LTD)

(55)



1.1



1.2



1.3



1.4



1.5



1.6



1.7

- (11) **51313**
(21) 3-2024-00885 (28) 1
(54) **BAO GÓI** (51) **09-05**
(22) 28/10/2022 (43) 25/09/2024
(30) 202230246575.7 28/04/2022 CN;
(73) **UNICHARM CORPORATION (JP)**
182, Shimobun, Kinsei-cho, Shikokuchuo-City, Ehime 799-0111, Japan
(72) 1. AYA YOKOICHI (JP)
2. TAKAHIRO UEDA (JP)
3. TOSHIYUKI TANIO (JP)
(74) Công ty Cổ phần Sở hữu công nghiệp INVESTIP (INVESTIP)
(55)

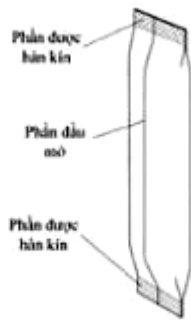
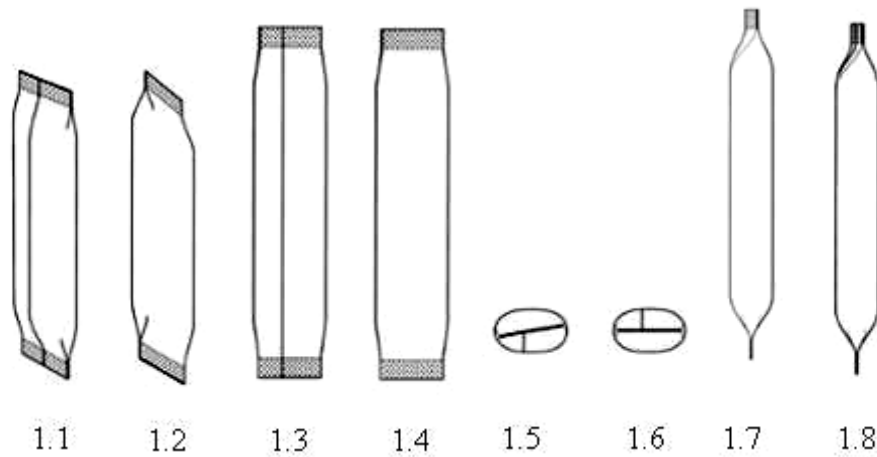

1.9

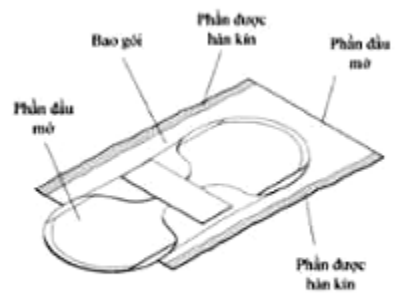

1.10

CÔNG BÁO SỞ HỮU CÔNG NGHIỆP SỐ 438 TẬP A – QUYỀN 2 (09.2024)

- (11) **51314**
(21) 3-2024-00886 (28) 1
(54) **CỤM ỐNG THỎ** (51) **24-02**
(22) 10/04/2024 (43) 25/09/2024
(30) 29/914,025 11/10/2023 US;
(73) **FISHER & PAYKEL HEALTHCARE LIMITED (NZ)**
15 Maurice Paykel Place, East Tamaki, Auckland 2013, New Zealand
(72) 1. KIERAN JAMES HATCHER (NZ)
2. ANTHONY JAMES NEWLAND (NZ)
3. BHUVAN GARG (NZ)
(74) Công ty TNHH Tầm nhìn và Liên danh (VISION & ASSOCIATES CO.LTD.)
(55)



1.1

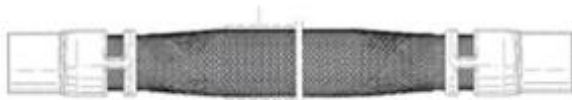

1.2



1.3



1.4



1.5



1.6

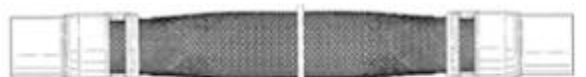

1.7



1.8

CÔNG BÁO SỞ HỮU CÔNG NGHIỆP SỐ 438 TẬP A – QUYỀN 2 (09.2024)

- (11) **51315**
(21) 3-2024-00910 (28) 1
(54) **TÚI ĐỰNG ĐỒ CHỨA** (51) **03-01**
(22) 15/04/2024 (43) 25/09/2024
(30) 29/917,793 22/11/2023 US;
(73) **PACIFIC MARKET INTERNATIONAL, LLC (US)**
2401 Elliott Avenue, Suite 4 Seattle, Washington 98121, United States of America
(72) 1. MUNIE, JEFFREY CHARLES (US)
2. CHARI, VIGNESH (US)
3. WAGONER, GRAEME (US)
4. METROLIS-POOLE, MELISSA (US)
(74) Công ty TNHH Sở hữu trí tuệ Thảo Thọ Quyên (INVENCO.,LTD)
(55)

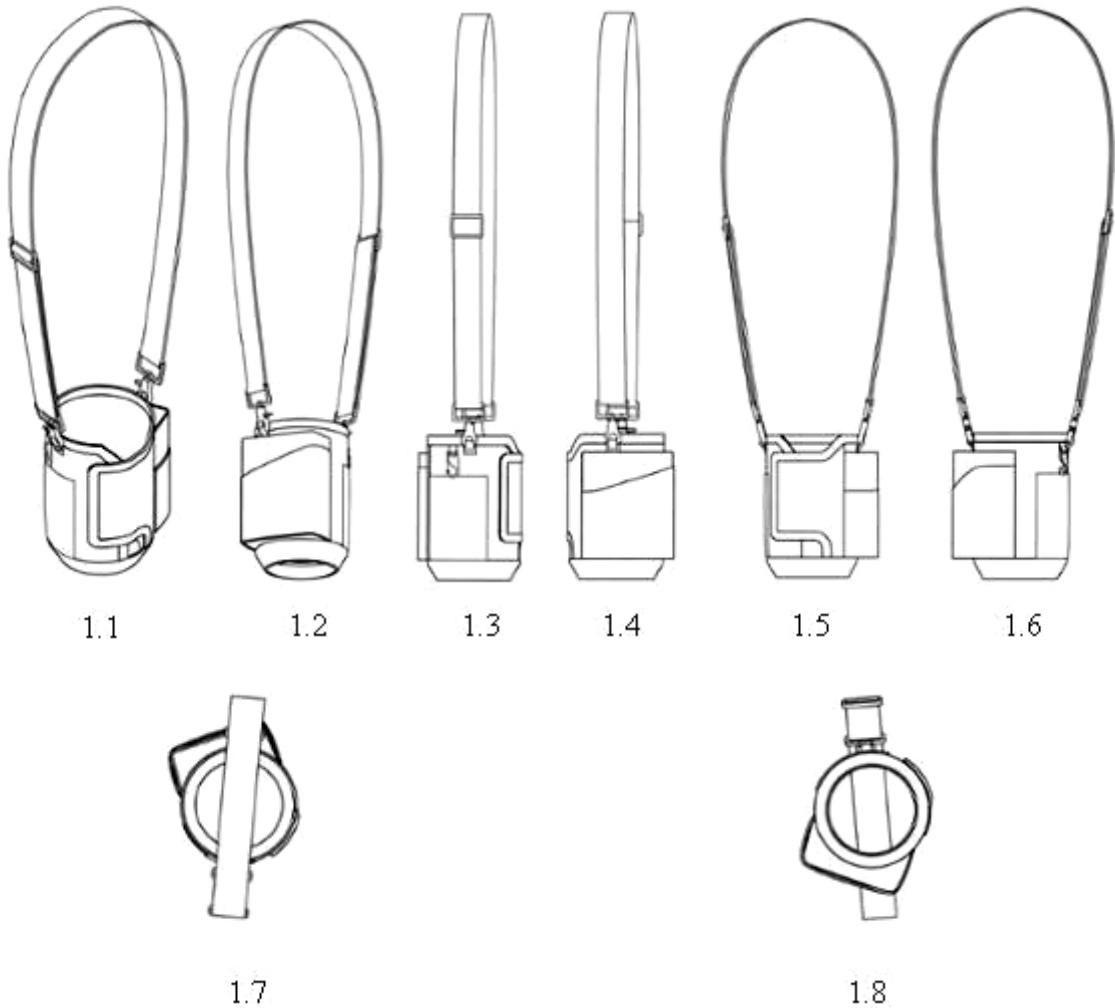

CÔNG BÁO SỞ HỮU CÔNG NGHIỆP SỐ 438 TẬP A – QUYỀN 2 (09.2024)

- (11) **51316**
(21) 3-2024-00941 (28) 1
(54) **BỘ CẤP ĐIỆN CHO THIẾT BỊ PHUN ĐIỆN TỬ** (51) **13-02**
(22) 17/04/2024 (43) 25/09/2024
(30) 202330693896.6 25/10/2023 CN;
(73) **IMIRACLE (SHENZHEN) TECHNOLOGY CO., LTD.** (CN)
Room 1606, Office building T5, Qianhai China Resources Financial Center,
No.5035, Menghai Avenue, Nanshan Street, Qianhai HongKong-Shenzhen
Cooperation Zone Shenzhen, China
(72) DONG Duwei (CN)
(74) Công ty TNHH Trà và cộng sự (TRA & ASSOCIATES CO.,LTD)
(55)

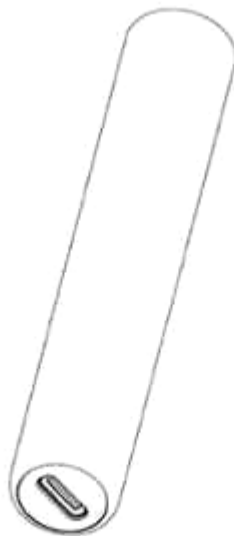
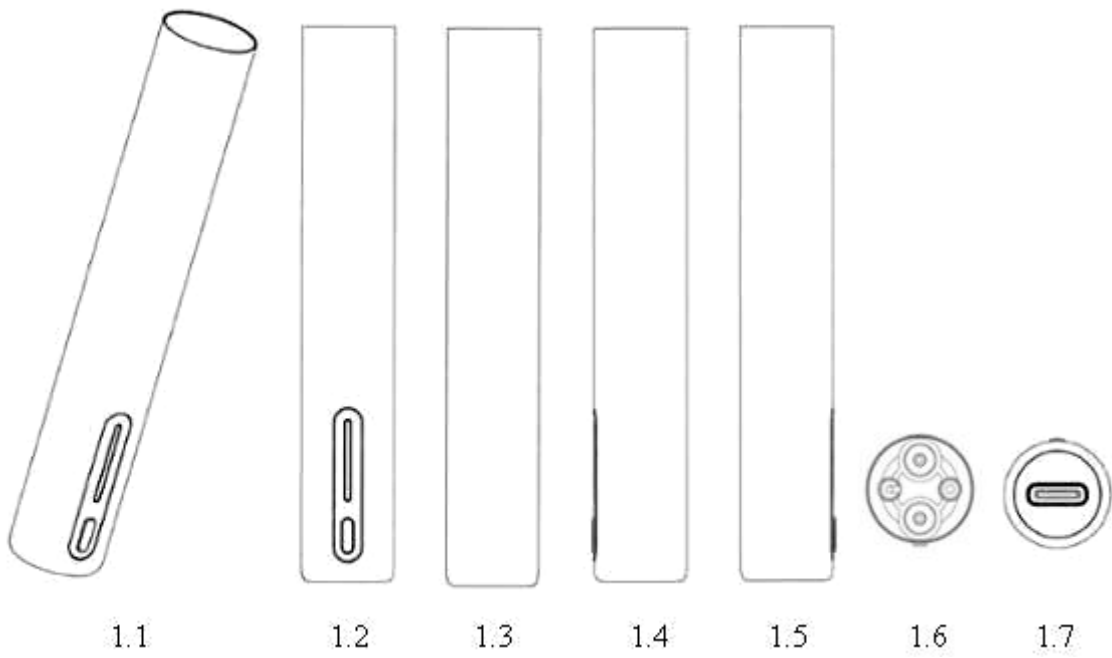

1.8

CÔNG BÁO SỞ HỮU CÔNG NGHIỆP SỐ 438 TẬP A – QUYỀN 2 (09.2024)

- (11) **51317**
(21) 3-2024-00944 (28) 1
(54) **THANH NHÔM ĐỊNH HÌNH** (51) **25-01**
(22) 17/04/2024 (43) 25/09/2024
(73) **CÔNG TY CỔ PHẦN XÂY DỰNG VÀ THƯƠNG MẠI GLASSHOUSE (VN)**
Tầng 9, tòa nhà Gelex Tower, số 52 phố Lê Đại Hành, phường Lê Đại Hành, quận Hai Bà Trưng, thành phố Hà Nội
(72) Nguyễn Đức Hiếu (VN)
(74) **CÔNG TY TNHH SỞ HỮU TRÍ TUỆ ANLIS VIỆT NAM (ANLIS IP CO.,LTD)**
(55)

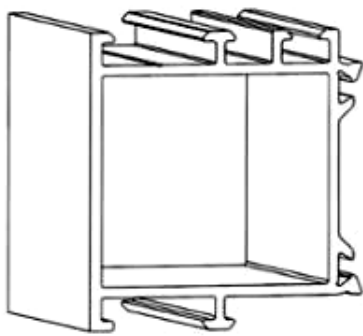

1.1

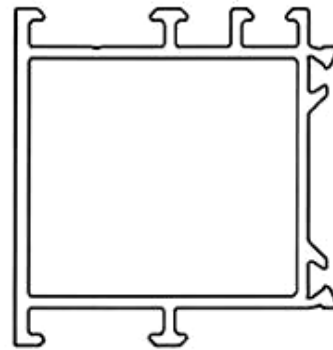

1.2



1.3

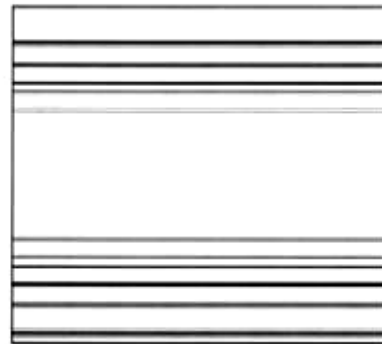

1.4

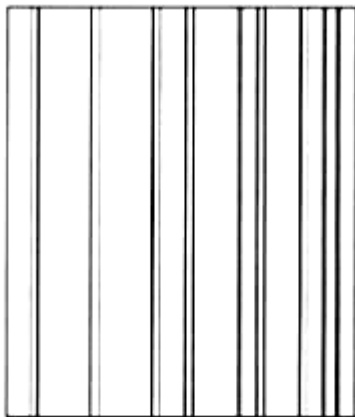

1.5

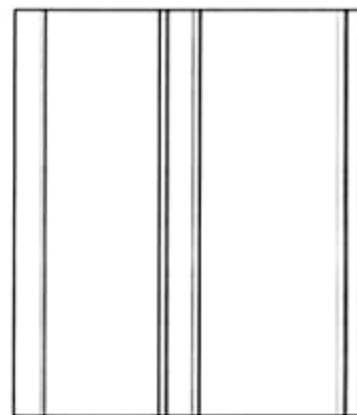

1.6

CÔNG BÁO SỞ HỮU CÔNG NGHIỆP SỐ 438 TẬP A – QUYỀN 2 (09.2024)

- (11) **51318**
(21) 3-2024-00945 (28) 1
(54) **THANH NHÔM ĐỊNH HÌNH** (51) **25-01**
(22) 17/04/2024 (43) 25/09/2024
(73) **CÔNG TY CỔ PHẦN XÂY DỰNG VÀ THƯƠNG MẠI GLASSHOUSE (VN)**
Tầng 9, tòa nhà Gelex Tower, số 52 phố Lê Đại Hành, phường Lê Đại Hành, quận
Hai Bà Trưng, thành phố Hà Nội
(72) Nguyễn Đức Hiếu (VN)
(74) **CÔNG TY TNHH SỞ HỮU TRÍ TUỆ ANLIS VIỆT NAM (ANLIS IP CO.,LTD)**
(55)

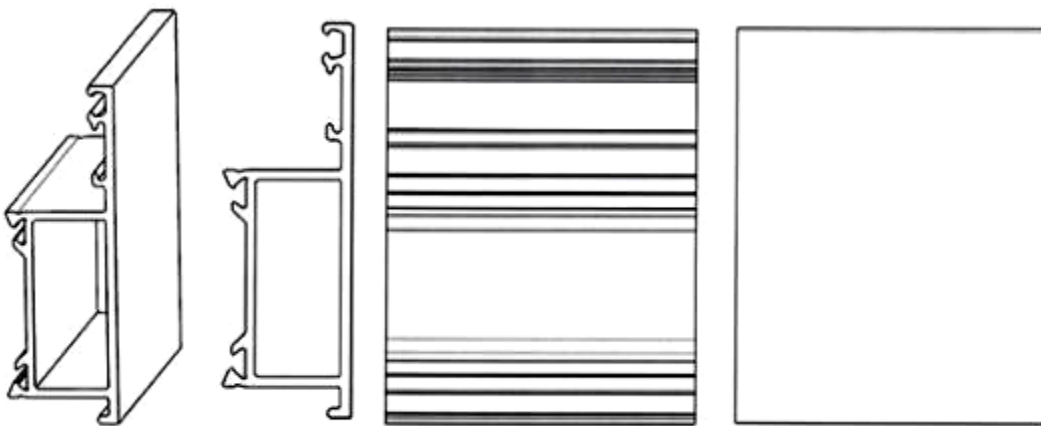

1.1

1.2

1.3

1.4



1.5

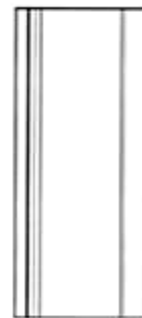

1.6

CÔNG BÁO SỞ HỮU CÔNG NGHIỆP SỐ 438 TẬP A – QUYỀN 2 (09.2024)

(11) **51319**

(21) 3-2024-00951

(28) 1

(54) **CHAI**

(51) **09-01**

(22) 19/04/2024

(43) 25/09/2024

(73) **LÊ ĐÌNH HÙNG (VN)**

Số 14 phố Trần Văn Chuông, phường Yết Kiêu, quận Hà Đông, thành phố Hà Nội

(72) Lê Đình Hùng (VN)

(55)

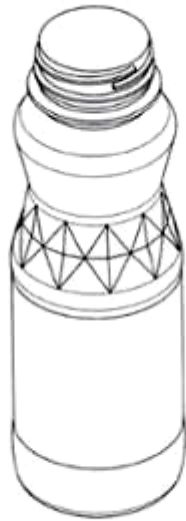

1.1

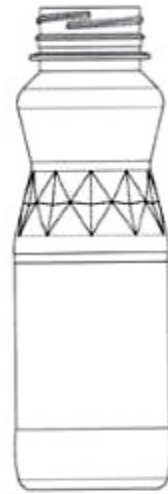

1.2



1.3



1.4

CÔNG BÁO SỞ HỮU CÔNG NGHIỆP SỐ 438 TẬP A – QUYỀN 2 (09.2024)

- (11) **51320**
(21) 3-2024-00957 (28) 1
(54) **CHAI** (51) **09-01**
(22) 22/04/2024 (43) 25/09/2024
(73) **CÔNG TY TNHH THỰC PHẨM NGUỒN XANH (VN)**
28/57 đường số 18, phường Bình Hưng Hòa, quận Bình Tân, thành phố Hồ Chí Minh
(72) Đặng Thị Yên (VN)
(55)



1.1



1.2



1.3



1.4



1.5



1.6



1.7

CÔNG BÁO SỞ HỮU CÔNG NGHIỆP SỐ 438 TẬP A – QUYỀN 2 (09.2024)

- (11) **51321**
(21) 3-2024-00962 (28) 1
(54) **MÁY ĐIỀU HÒA KHÔNG KHÍ** (51) **23-04**
(22) 22/04/2024 (43) 25/09/2024
(30) 202330709487.0 31/10/2023 CN;
(73) **GD MIDEA AIR-CONDITIONING EQUIPMENT CO., LTD.** (CN)
No. 22, Lingang Road, Beijiao, Shunde, Foshan, Guangdong 528311, China
(72) 1. YANG, YONGYI (CN)
2. HAH, SANG SOO (KR)
(74) Công ty TNHH Dịch vụ Sở hữu trí tuệ KENFOX (KENFOX IP SERVICE
CO.,LTD.)
(55)



1.1



1.2



1.3



1.4



1.5



1.6



1.7

CÔNG BÁO SỞ HỮU CÔNG NGHIỆP SỐ 438 TẬP A – QUYỀN 2 (09.2024)

(11) **51322**

(21) 3-2024-00966

(28) 1

(54) **CHỐT CỬA**

(51) **08-07**

(22) 23/04/2024

(43) 25/09/2024

(73) **Công ty TNHH FUCASI JAPAN (VN)**

(NR Nguyễn Văn Tiến) thôn Văn Phong, xã Châu Phong, huyện Quế Võ, tỉnh Bắc Ninh

(72) Nguyễn Văn Tiến (VN)

(74) Công ty TNHH Tư vấn đầu tư và Sở hữu trí tuệ Hoàng Phi (HOANG PHI INVEST & I.P CO., LTD)

(55)

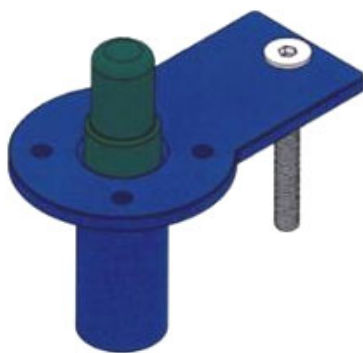

1.1



1.2

1.3

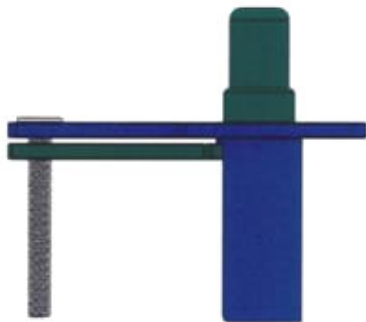

1.4



1.5

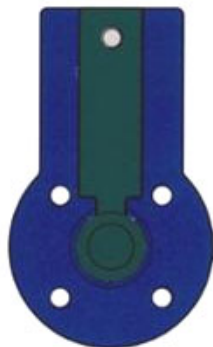

1.6

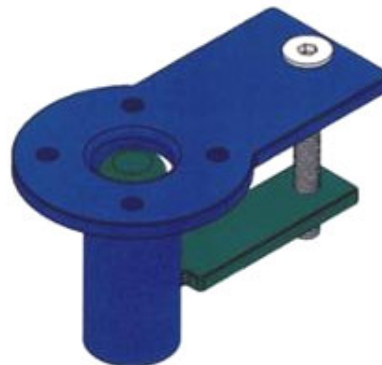

1.7

(11) **51323**

(21) 3-2024-00987

(28) 1

(54) **THIẾT BỊ GẠT PHẪNG RUỘNG**

(51) **15-03**

(22) 26/04/2024

(43) 25/09/2024

(73) **CÔNG TY TNHH KỸ THUẬT MÁY KTM (VN)**

Khu phố Thiết Định, thị trấn Quán Lào, huyện Yên Định, tỉnh Thanh Hoá

(72) Lê Đình Mạnh (VN)

(55)



1.1



1.2



1.3



1.4



1.5



1.6



1.7

- (11) **51324**
(21) 3-2024-01003 (28) 1
(54) **LON CHỨA THỰC PHẨM HOẶC ĐỒ UỐNG** (51) **09-03**
(22) 26/04/2024 (43) 25/09/2024
(30) 015038873-0001 30/10/2023 EM;
(73) **CROWN PACKAGING TECHNOLOGY, INC. (US)**
18410 Crossing Drive, Suite A, Tinley Park, IL 60487 - 9286, U.S.A.
(72) Luke Steven Moreland (GB)
(74) **CÔNG TY LUẬT TNHH IP MAX (IPMAX LAW FIRM)**
(55)



1.1

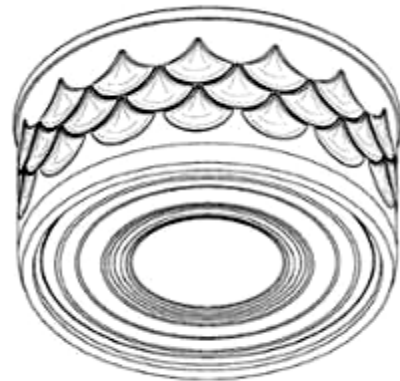

1.2

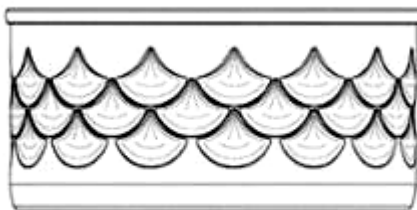

1.3

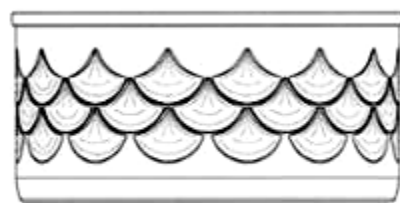

1.4

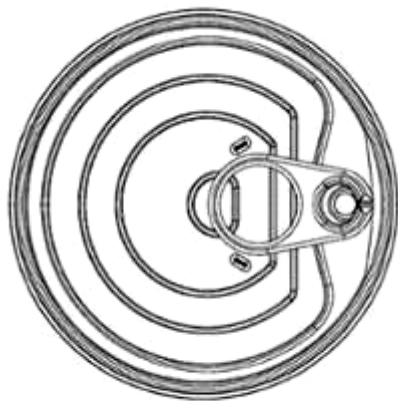

1.5

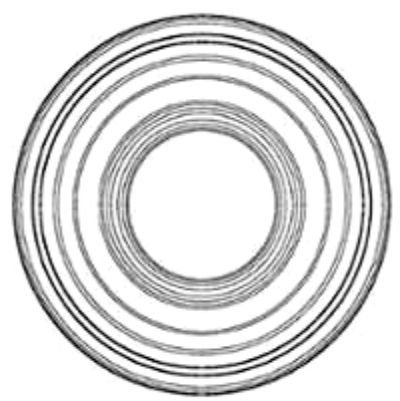

1.6

- (11) **51325**
(21) 3-2024-01004 (28) 1
(54) **LON CHỨA THỰC PHẨM HOẶC ĐỒ UỐNG** (51) **09-03**
(22) 26/04/2024 (43) 25/09/2024
(30) 015038873-0002 30/10/2023 EM;
(73) **CROWN PACKAGING TECHNOLOGY, INC. (US)**
18410 Crossing Drive, Suite A, Tinley Park, IL 60487 - 9286, U.S.A.
(72) Luke Steven Moreland (GB)
(74) **CÔNG TY LUẬT TNHH IP MAX (IPMAX LAW FIRM)**
(55)



1.1

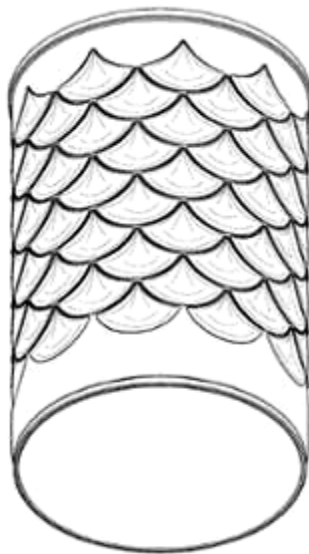

1.2

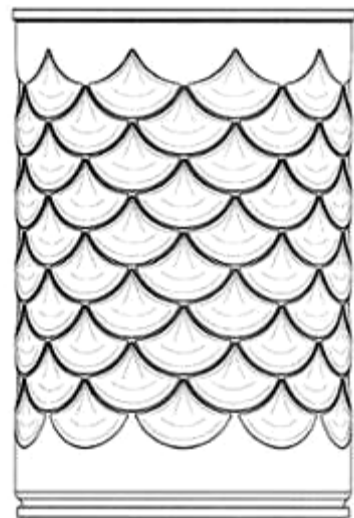

1.3

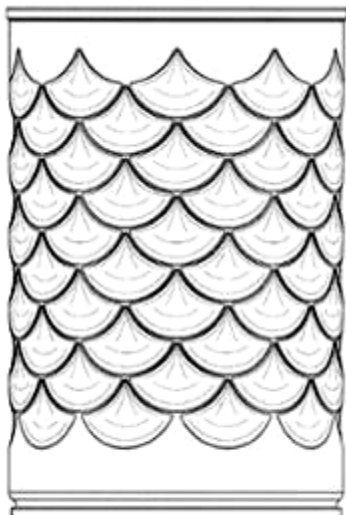

1.4

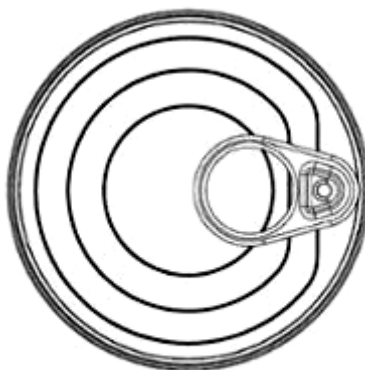

1.5



1.6

- (11) **51326**
(21) 3-2024-01005 (28) 1
(54) **LON CHỨA THỰC PHẨM HOẶC ĐỒ UỐNG** (51) **09-03**
(22) 26/04/2024 (43) 25/09/2024
(30) 015038873-0003 30/10/2023 EM;
(73) **CROWN PACKAGING TECHNOLOGY, INC. (US)**
18410 Crossing Drive, Suite A, Tinley Park, IL 60487 - 9286, U.S.A.
(72) Luke Steven Moreland (GB)
(74) **CÔNG TY LUẬT TNHH IP MAX (IPMAX LAW FIRM)**
(55)



1.1

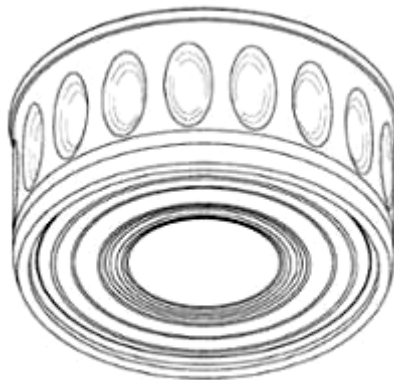

1.2

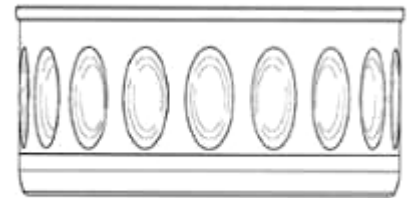

1.3



1.4

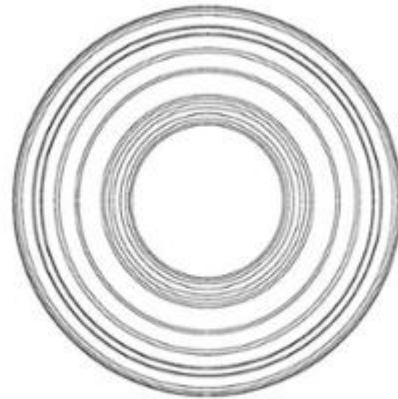

1.5

- (11) **51327**
(21) 3-2024-01006 (28) 1
(54) **LON CHỨA THỰC PHẨM HOẶC ĐỒ UỐNG** (51) **09-03**
(22) 26/04/2024 (43) 25/09/2024
(30) 015038873-0004 30/10/2023 EM;
(73) **CROWN PACKAGING TECHNOLOGY, INC. (US)**
18410 Crossing Drive, Suite A, Tinley Park, IL 60487 - 9286, U.S.A.
(72) Luke Steven Moreland (GB)
(74) **CÔNG TY LUẬT TNHH IP MAX (IPMAX LAW FIRM)**
(55)



1.1

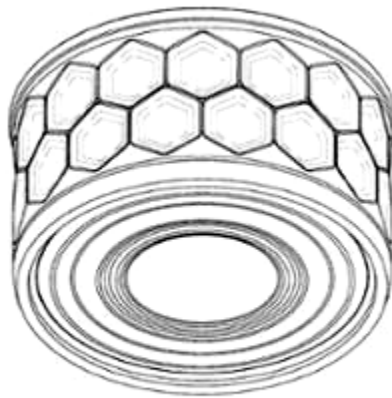

1.2

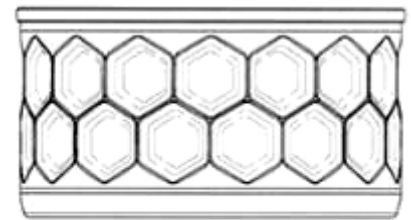

1.3

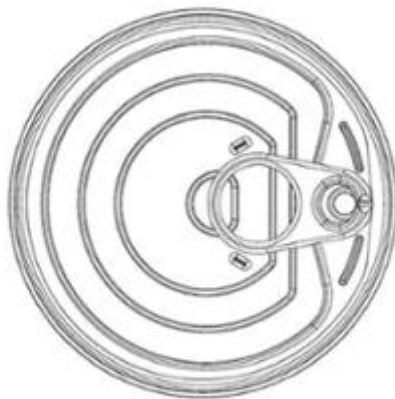

1.4

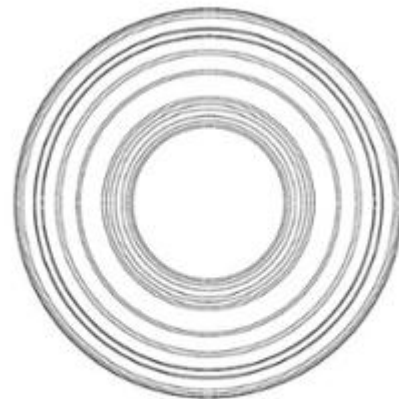

1.5

CÔNG BÁO SỞ HỮU CÔNG NGHIỆP SỐ 438 TẬP A – QUYỀN 2 (09.2024)

- (11) **51328**
(21) 3-2024-01010 (28) 1
(54) **THANH ĐỊNH HÌNH** (51) **25-01**
(22) 26/04/2024 (43) 25/09/2024
(73) **CÔNG TY TNHH NHÔM VĨNH HƯNG VIỆT NAM (VN)**
Lô 129, 130, 131A khu công nghiệp Long Giang, xã Tân Lập 1, huyện Tân Phước,
tỉnh Tiền Giang
(72) Zhang Xing Gao (CN)
(74) **CÔNG TY LUẬT TRÁCH NHIỆM HỮU HẠN AMBYS HÀ NỘI (AMBYS
HANOI)**
(55)



1.1



1.2



1.3



1.4



1.5



1.6



1.7

- (11) **51329**
 (21) 3-2024-01012 (28) 12
 (54) **BỘ TRUYỀN ĐỘNG QUAY** (51) **15-99**
 (22) 26/04/2024 (43) 25/09/2024
 (73) **KOKUSAI KEISOKUKI KABUSHIKI KAISHA (JP)**
 21-1, Nagayama 6-chome, Tama-shi, Tokyo 206-0025, Japan
 (72) 1. SIGERU MATSUMOTO (JP)
 2. SHINICHI MATSUMOTO (JP)
 3. KAZUHIRO MURAUCHI (JP)
 4. HIROSHI MIYASHITA (JP)
 5. MASAMI SUZUKI (JP)
 (74) Công ty TNHH Tư vấn đầu tư và chuyển giao công nghệ (INVESTCONSULT)
 (55)

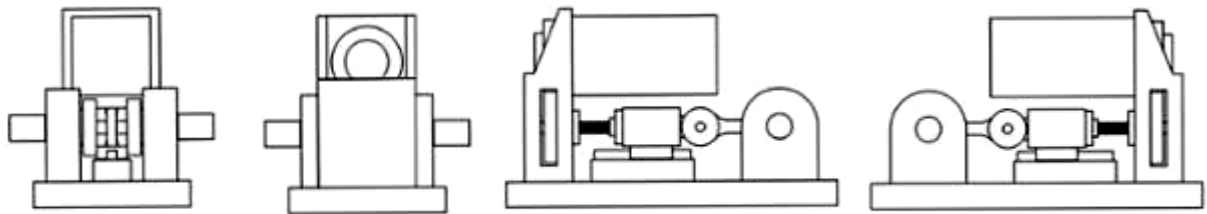

1.1

1.2

1.3

1.4

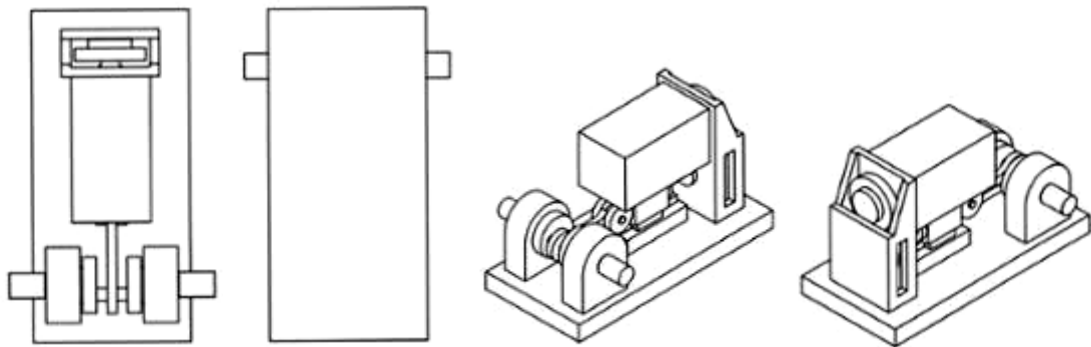

1.5

1.6

1.7

1.8

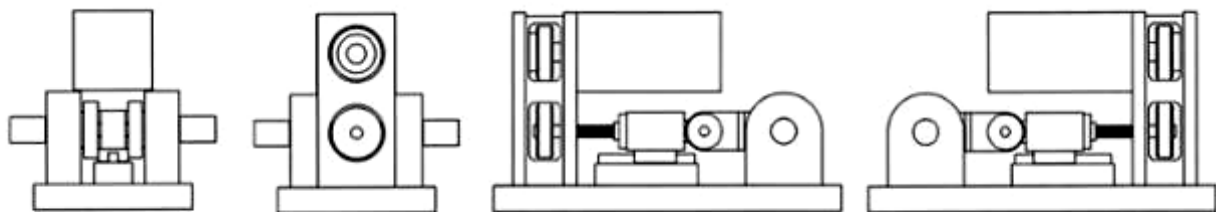

2.1

2.2

2.3

2.4

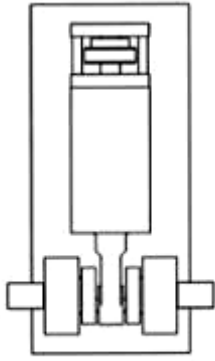

2.5

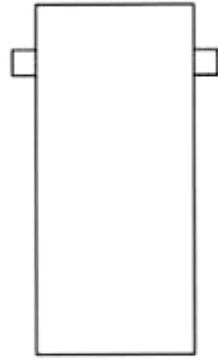

2.6

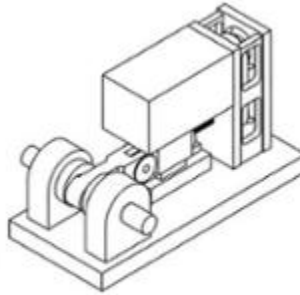

2.7

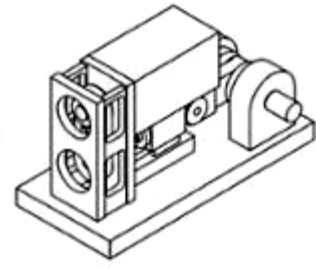

2.8

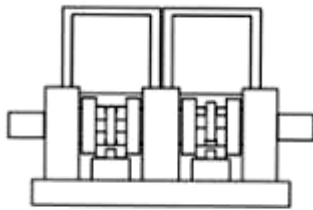

3.1

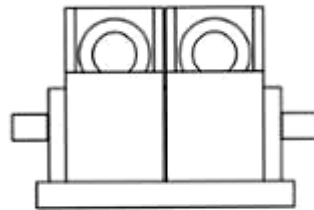

3.2

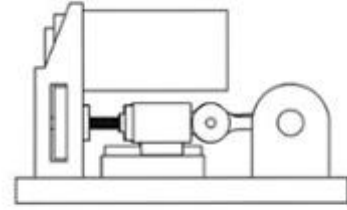

3.3

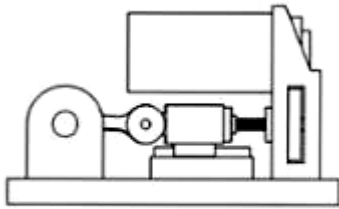

3.4

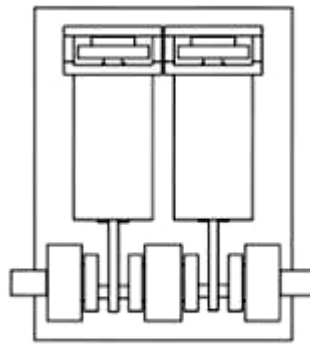

3.5

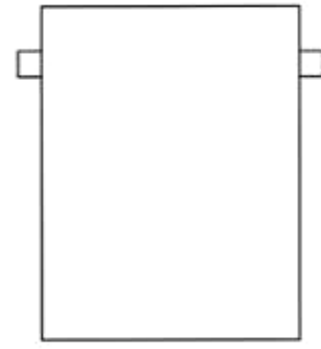

3.6

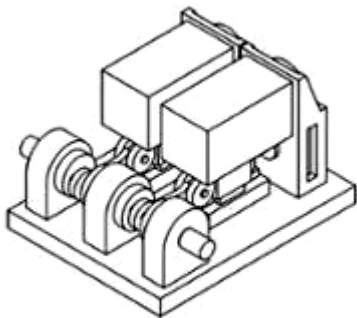

3.7

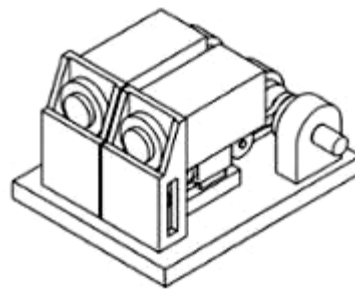

3.8

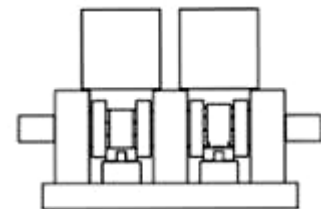

4.1

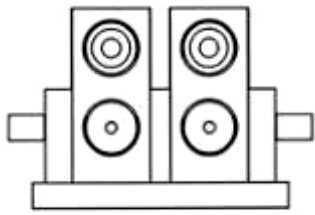

4.2

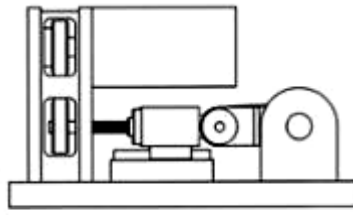

4.3

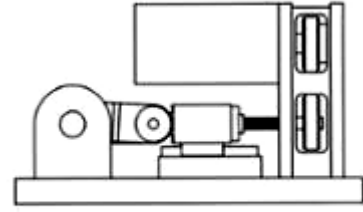

4.4

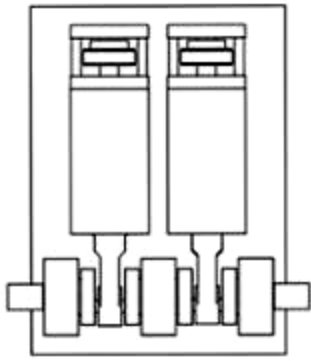

4.5

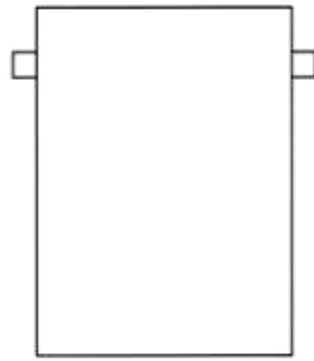

4.6

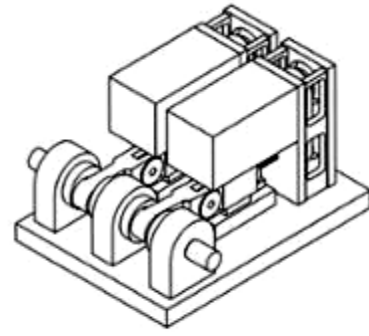

4.7

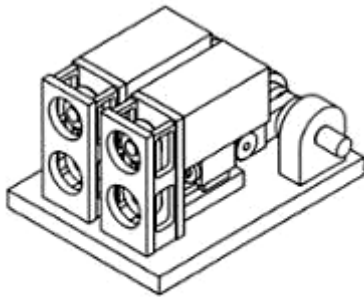

4.8

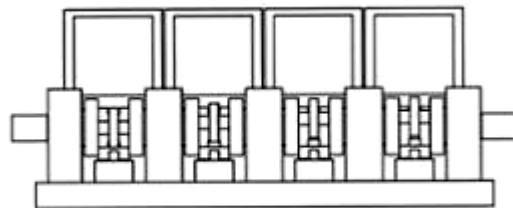

5.1

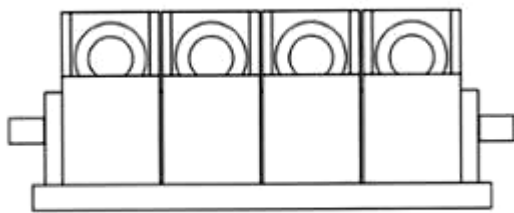

5.2

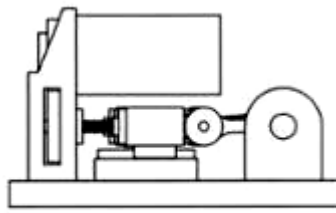

5.3

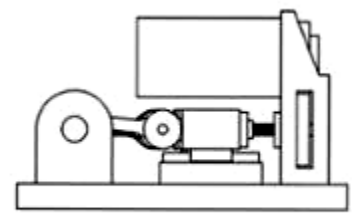

5.4

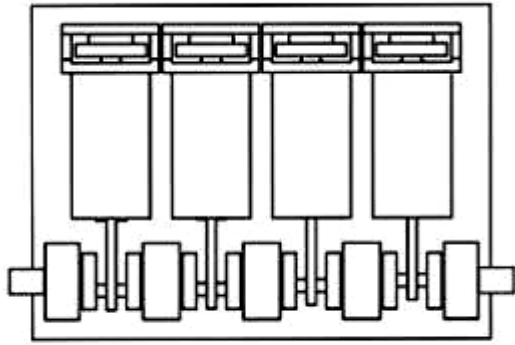

5.5



5.6

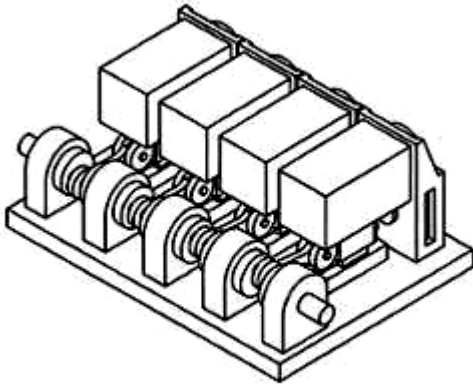

5.7

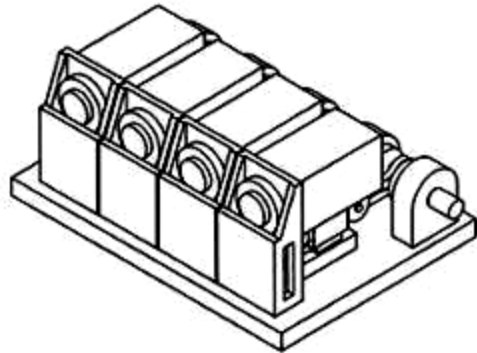

5.8

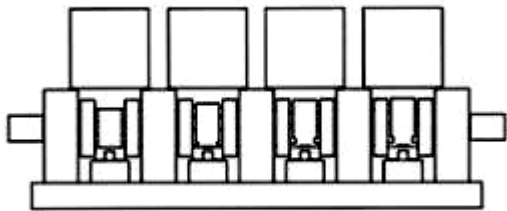

6.1

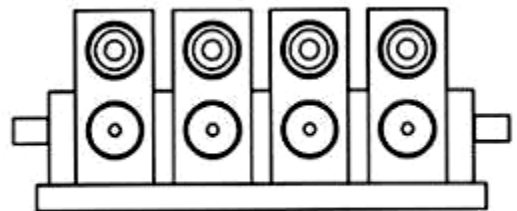

6.2

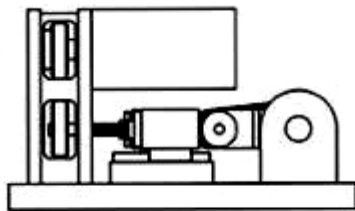

6.3

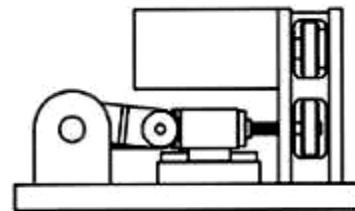

6.4

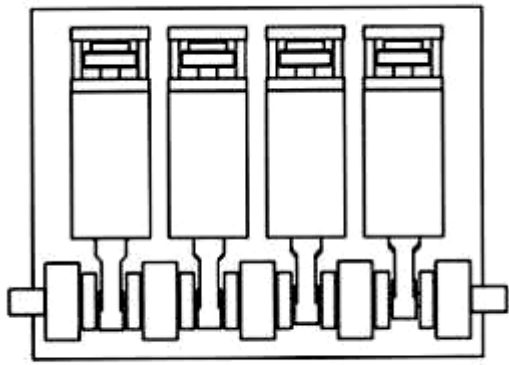

6.5

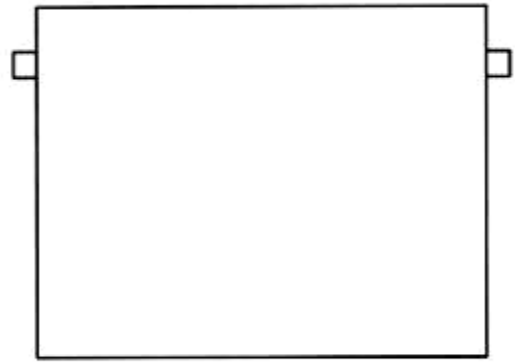

6.6

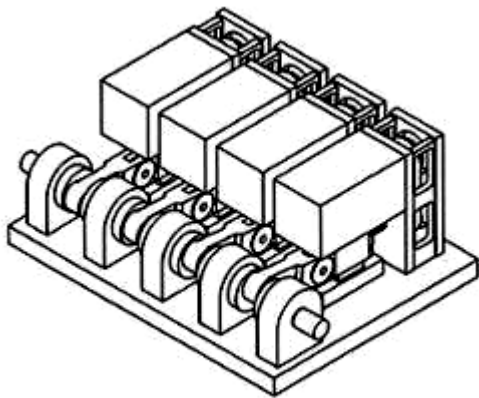

6.7

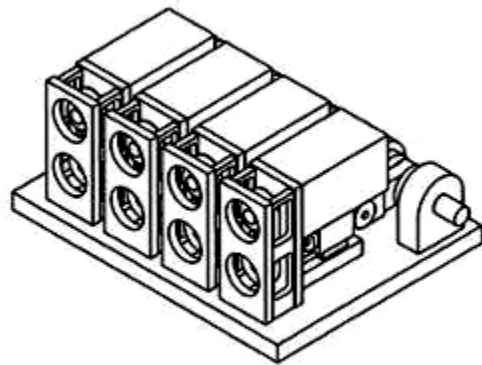

6.8

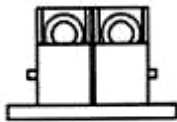

7.1

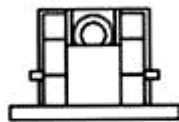

7.2



7.3



7.4

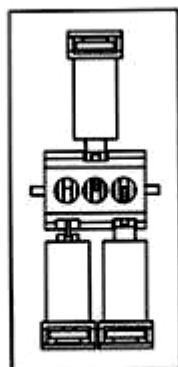

7.5



7.6

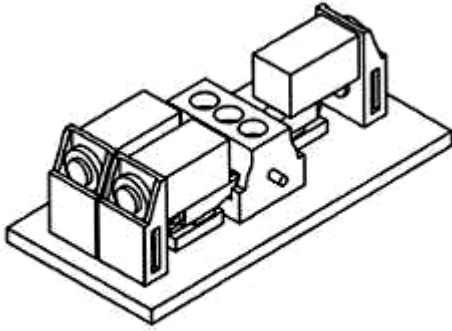

7.7

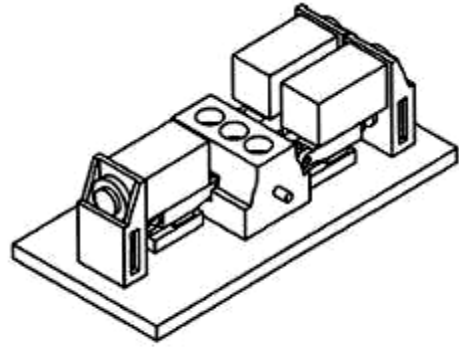

7.8

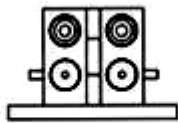

8.1

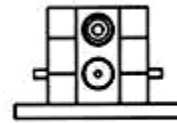

8.2

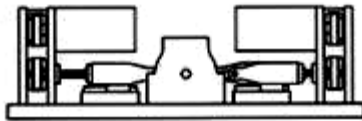

8.3

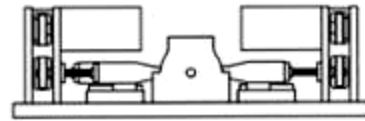

8.4

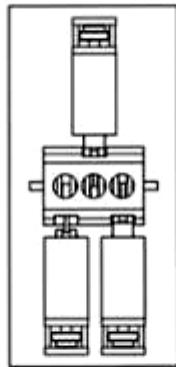

8.5



8.6

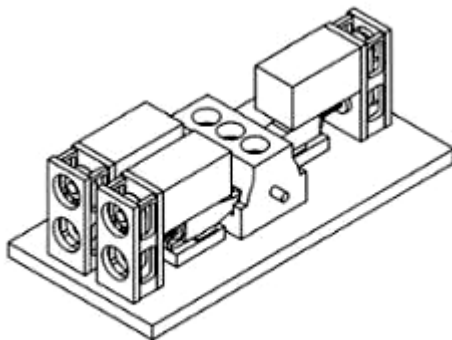

8.7

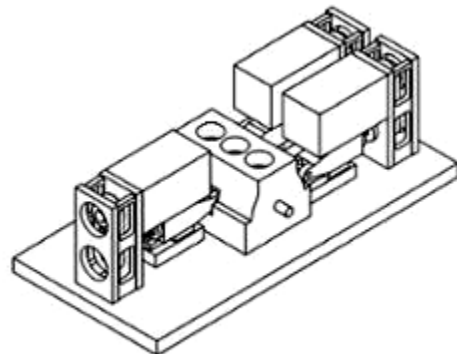

8.8

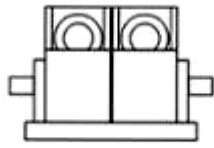

9.1

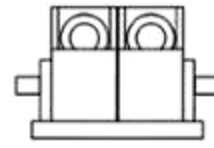

9.2

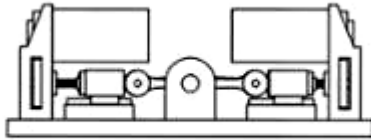

9.3

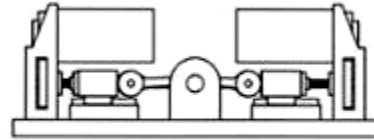

9.4

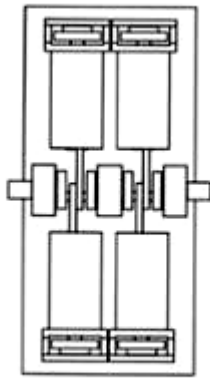

9.5

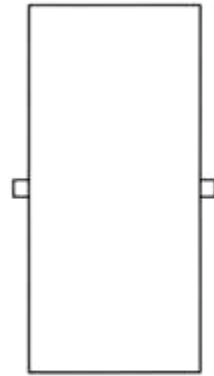

9.6

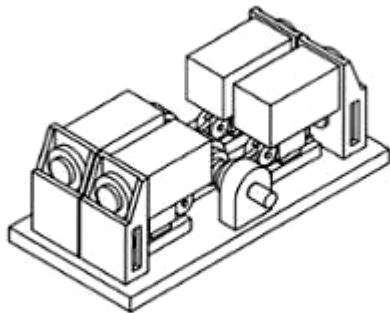

9.7

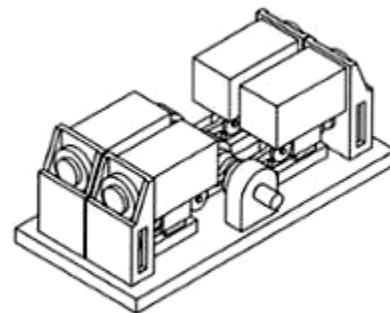

9.8

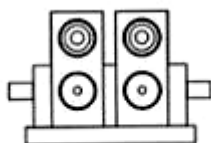

10.1

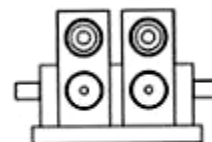

10.2

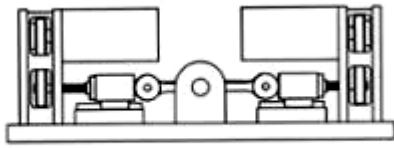

10.3

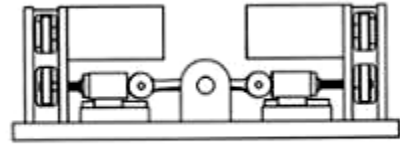

10.4

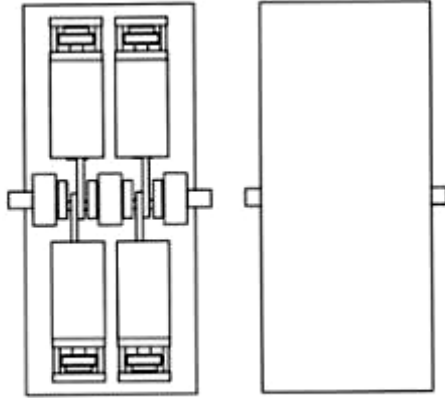

10.5

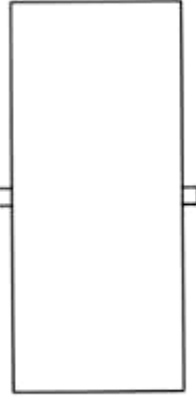

10.6

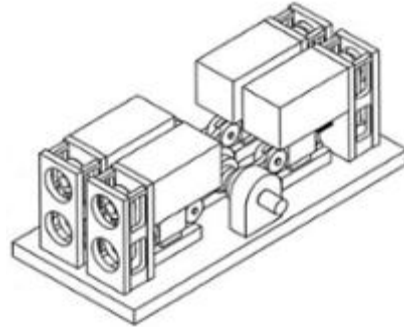

10.7

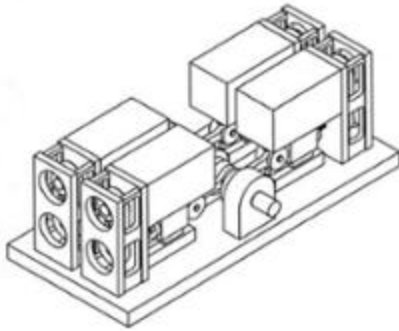

10.8

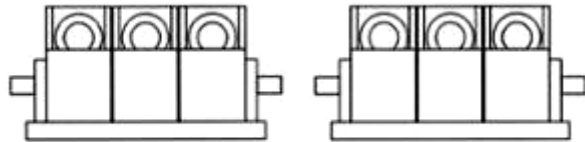

11.1



11.2

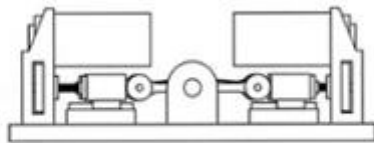

11.3

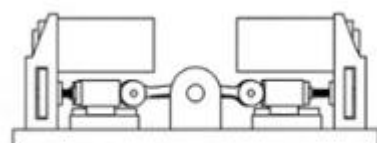

11.4

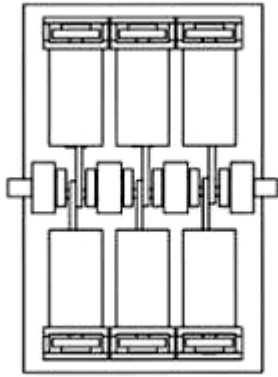

11.5

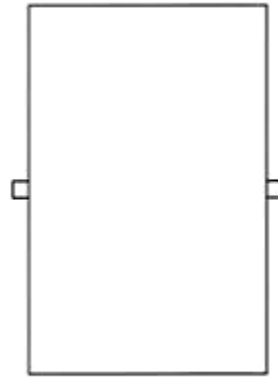

11.6

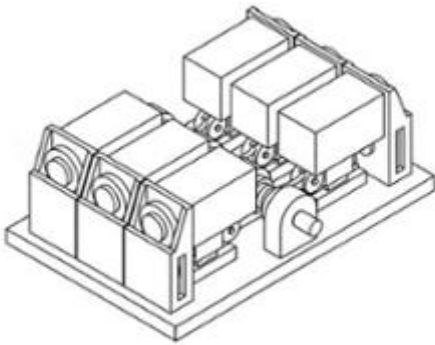

11.7

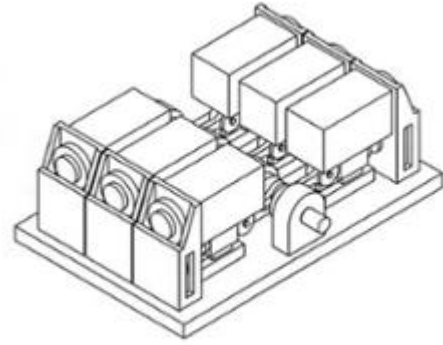

11.8

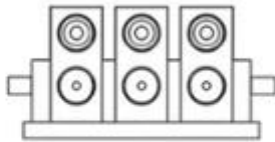

12.1

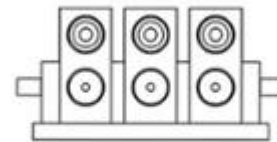

12.2

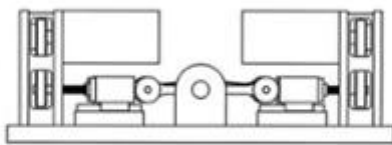

12.3

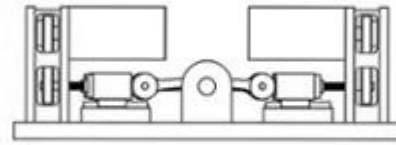

12.4

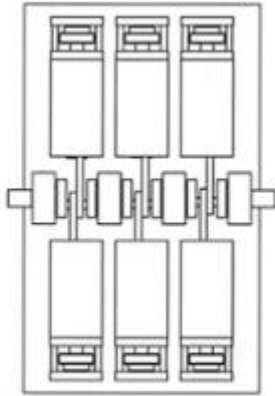

12.5

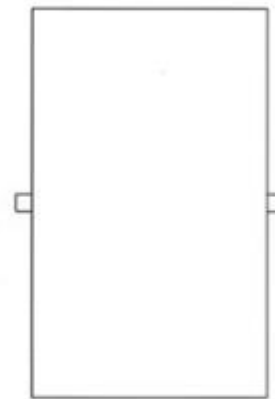

12.6

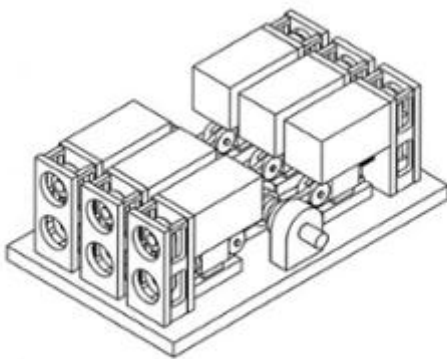

12.7

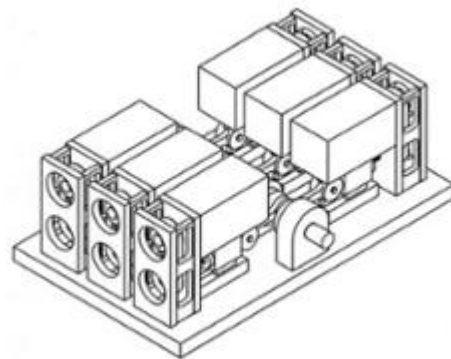

12.8

CÔNG BÁO SỞ HỮU CÔNG NGHIỆP SỐ 438 TẬP A – QUYỀN 2 (09.2024)

- (11) **51330**
(21) 3-2024-01018 (28) 1
(54) **HỘP ĐỰNG MỸ PHẨM** (51) **09-03**
(22) 02/05/2024 (43) 25/09/2024
(73) **LG H&H CO., LTD. (KR)**
58, Saemunan-ro, Jongno-gu, Seoul, Republic of Korea
(72) Kim, Joung eun (KR)
(74) Công ty TNHH Tầm nhìn và Liên danh (VISION & ASSOCIATES CO.LTD.)
(55)



1.1



1.2



1.3

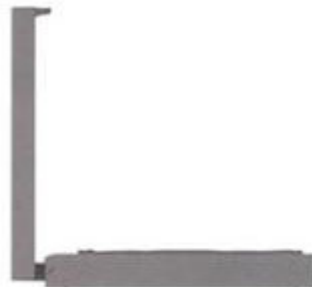

1.4



1.5



1.6



1.7

CÔNG BÁO SỞ HỮU CÔNG NGHIỆP SỐ 438 TẬP A – QUYỀN 2 (09.2024)

- (11) **51331**
(21) 3-2024-01059 (28) 2
(54) **NHÃN SẢN PHẨM** (51) **19-08**
(22) 08/05/2024 (43) 25/09/2024
(73) **CÔNG TY TNHH TOÀN CẦU BEVERAGE (VN)**
Số 8B đường Ngô Quyền, khu 4, phường Cẩm Thượng, thành phố Hải Dương, tỉnh Hải Dương
(72) Nguyễn Thế Phương (VN)
(74) Công ty TNHH Sở hữu trí tuệ M.I.T (M.I.T IP CO., LTD)
(55)



1.1



2.1

CÔNG BÁO SỞ HỮU CÔNG NGHIỆP SỐ 438 TẬP A – QUYỀN 2 (09.2024)

- (11) **51332**
(21) 3-2024-01060 (28) 2
(54) **NHÃN SẢN PHẨM** (51) **19-08**
(22) 08/05/2024 (43) 25/09/2024
(73) **CÔNG TY TNHH TOÀN CẦU BEVERAGE (VN)**
Số 8B đường Ngô Quyền, khu 4, phường Cẩm Thượng, thành phố Hải Dương, tỉnh Hải Dương
(72) Nguyễn Thế Phương (VN)
(74) Công ty TNHH Sở hữu trí tuệ M.I.T (M.I.T IP CO., LTD)
(55)



1.1



2.1

CÔNG BÁO SỞ HỮU CÔNG NGHIỆP SỐ 438 TẬP A – QUYỀN 2 (09.2024)

- (11) **51333**
(21) 3-2024-01061 (28) 2
(54) **NHÃN SẢN PHẨM** (51) **19-08**
(22) 08/05/2024 (43) 25/09/2024
(73) **CÔNG TY TNHH TOÀN CẦU BEVERAGE (VN)**
Số 8B đường Ngô Quyền, khu 4, phường Cẩm Thượng, thành phố Hải Dương, tỉnh Hải Dương
(72) Nguyễn Thế Phương (VN)
(74) Công ty TNHH Sở hữu trí tuệ M.I.T (M.I.T IP CO., LTD)
(55)



1.1



2.1

CÔNG BÁO SỞ HỮU CÔNG NGHIỆP SỐ 438 TẬP A – QUYỀN 2 (09.2024)

- (11) **51334**
- (21) 3-2024-01064 (28) 2
- (54) **NHÃN SẢN PHẨM** (51) **19-08**
- (22) 08/05/2024 (43) 25/09/2024
- (73) **CÔNG TY TNHH TOÀN CẦU BEVERAGE (VN)**
Số 8B đường Ngô Quyền, khu 4, phường Cẩm Thượng, thành phố Hải Dương, tỉnh Hải Dương
- (72) Nguyễn Thế Phương (VN)
- (74) Công ty TNHH Sở hữu trí tuệ M.I.T (M.I.T IP CO., LTD)
- (55)



1.1



2.1

CÔNG BÁO SỞ HỮU CÔNG NGHIỆP SỐ 438 TẬP A – QUYỀN 2 (09.2024)

- (11) **51335**
(21) 3-2024-01065 (28) 2
(54) **NHÃN SẢN PHẨM** (51) **19-08**
(22) 08/05/2024 (43) 25/09/2024
(73) **CÔNG TY TNHH TOÀN CẦU BEVERAGE (VN)**
Số 8B đường Ngô Quyền, khu 4, phường Cẩm Thượng, thành phố Hải Dương, tỉnh Hải Dương
(72) Nguyễn Thế Phương (VN)
(74) Công ty TNHH Sở hữu trí tuệ M.I.T (M.I.T IP CO., LTD)
(55)



1.1



2.1

CÔNG BÁO SỞ HỮU CÔNG NGHIỆP SỐ 438 TẬP A – QUYỀN 2 (09.2024)

- (11) **51336**
(21) 3-2024-01093 (28) 1
(54) **BAO GÓI** (51) **09-05**
(22) 10/05/2024 (43) 25/09/2024
(73) **CÔNG TY CỔ PHẦN NGỌC TRAI HOÀNG GIA (VN)**
1158 Huỳnh Tấn Phát, KP5, phường Tân Phú, quận 7, thành phố Hồ Chí Minh
(72) Hồ Thanh Tuấn (VN)
(74) Công ty Cổ phần Sở hữu công nghiệp INVESTIP (INVESTIP)
(55)



1.1

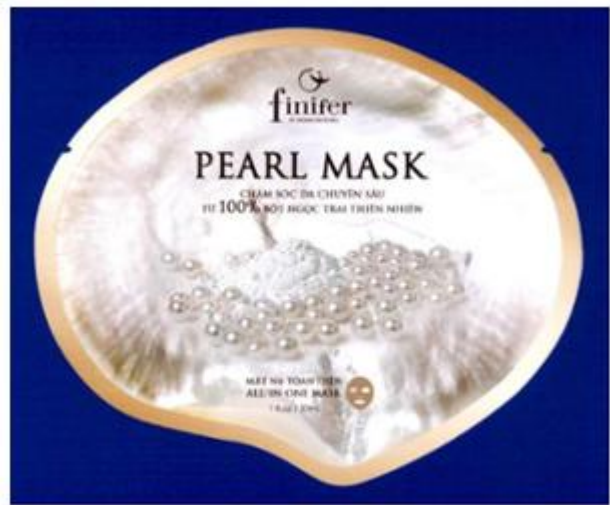

1.2



1.3

(11) **51337**

(21) 3-2024-01094

(28) 1

(54) **TẤM CHẮN BÌNH PHONG**

(51) **06-05; 06-99**

(22) 10/05/2024

(43) 25/09/2024

(73) **TRƯỜNG ĐẠI HỌC VĂN LANG (VN)**

45 Nguyễn Khắc Nhu, phường Cô Giang, quận 1, thành phố Hồ Chí Minh

(72) 1. **TRẦN PHƯƠNG LAM (VN)**

2. **NGÔ THỊ THÚY ANH (VN)**

(55)

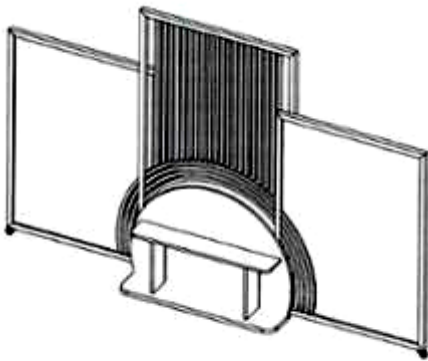

1.1

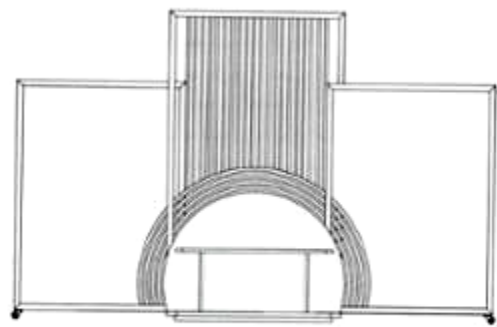

1.2

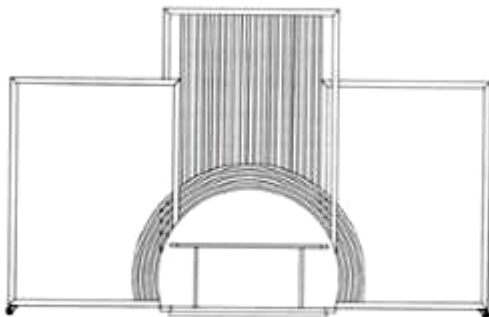

1.3



1.4



1.5



1.6



1.7



1.8

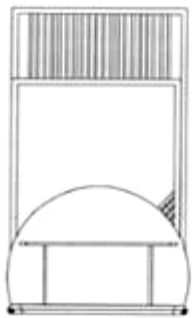

1.9



1.10



1.11



1.12

CÔNG BÁO SỞ HỮU CÔNG NGHIỆP SỐ 438 TẬP A – QUYỀN 2 (09.2024)

- (11) **51338**
(21) 3-2024-01096 (28) 1
(54) **GIÀN NHÚN** (51) **21-02**
(22) 13/05/2024 (43) 25/09/2024
(30) 015041037-0001 14/11/2023 EM;
(73) **DECATHLON (FR)**
4, Boulevard de Mons, F-59650 Villeneuve d'Ascq, France
(72) Edouard SION (FR)
(74) Công ty Luật TNHH T&G (TGVN)
(55)



1.1

1.2

1.3



1.4



1.5



1.6



1.7

- (11) **51339**
- (21) 3-2024-01113
- (54) **HỘP ĐỰNG**
- (22) 15/05/2024
- (30) DM/233268 17/11/2023 WO;
- (73) **PI-DESIGN AG (CH)**
Altgasse 82, CH-6340 Baar, Switzerland
- (72) Jorgen BODUM (CH)
- (74) Công ty Luật TNHH T&G (TGVN)
- (55)
- (28) 1
- (51) **07-07**
- (43) 25/09/2024



1.1

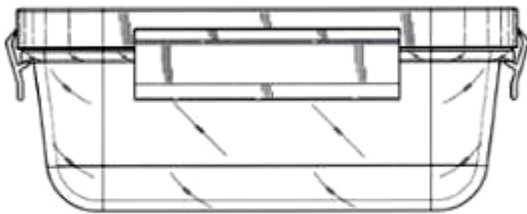

1.2

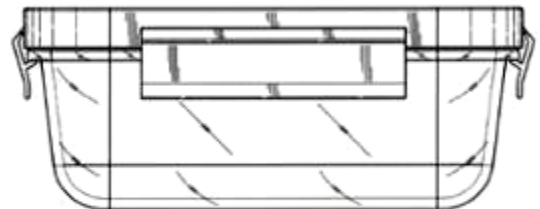

1.3

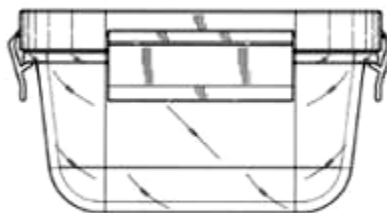

1.4

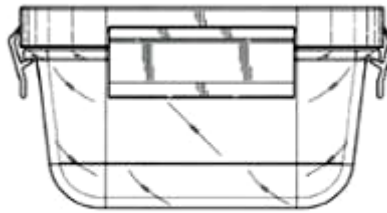

1.5



1.6

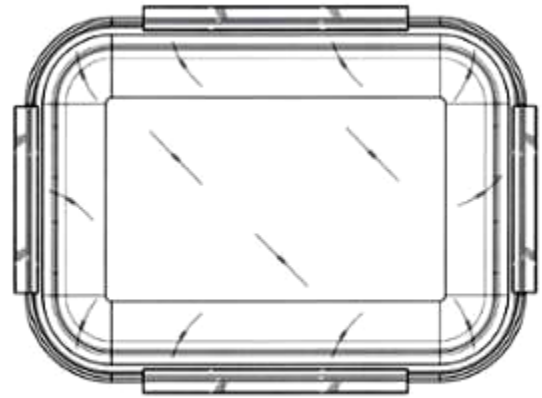

1.7

CÔNG BÁO SỞ HỮU CÔNG NGHIỆP SỐ 438 TẬP A – QUYỀN 2 (09.2024)

- (11) **51340**
(21) 3-2024-01139 (28) 2
(54) **CHÂN TIẾP XÚC** (51) **10-05**
(22) 17/05/2024 (43) 25/09/2024
(30) 29/917,131 17/11/2023 US; 29/941,010 07/05/2024 US;
(73) **JOHNSTECH INTERNATIONAL CORPORATION (US)**
1210 New Brighton Boulevard, Minneapolis, Minnesota 55413, United States of America
(72) Melissa Hasskamp (US)
(74) Công ty TNHH Lê & Lê (LE & LE)
(55)

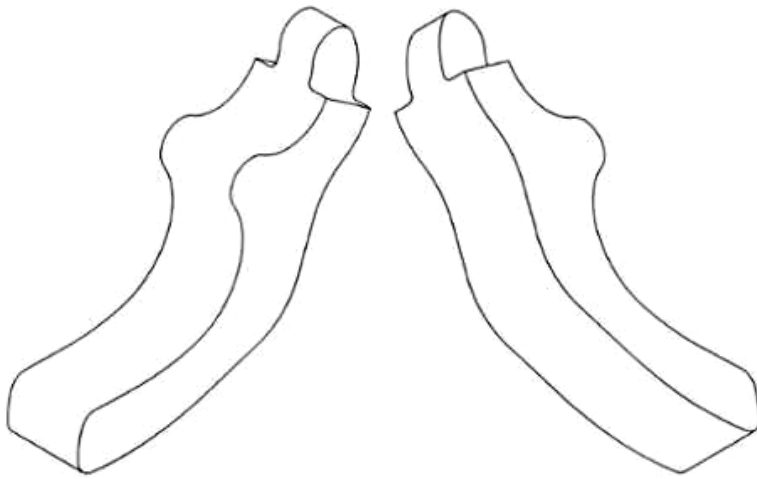

1.1

1.2

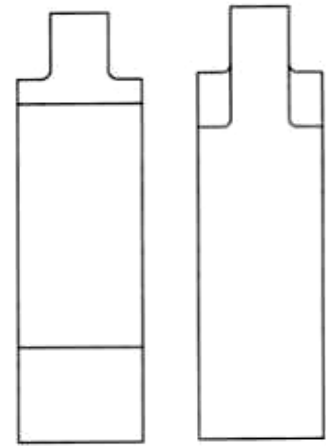

1.3

1.4

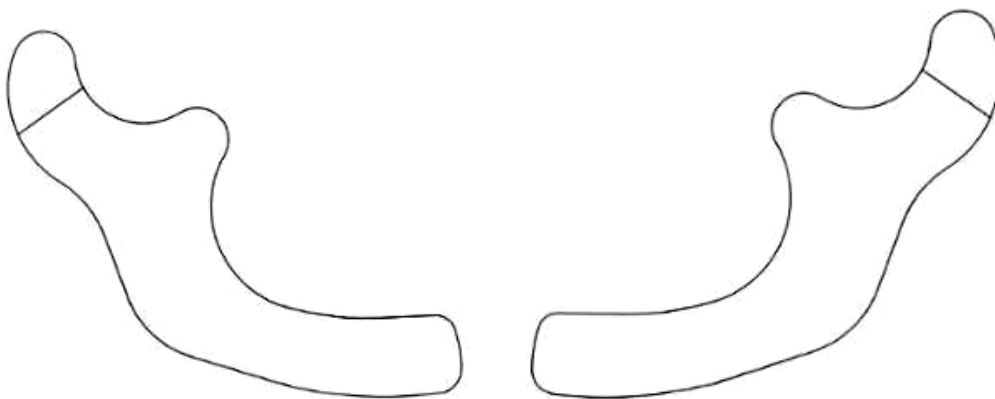

1.5

1.6

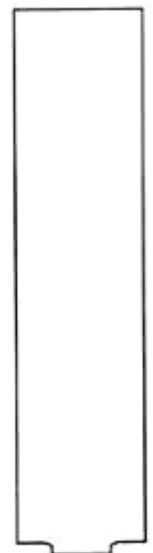

1.7

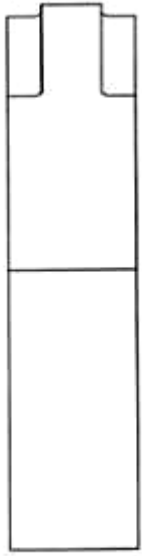

1.8

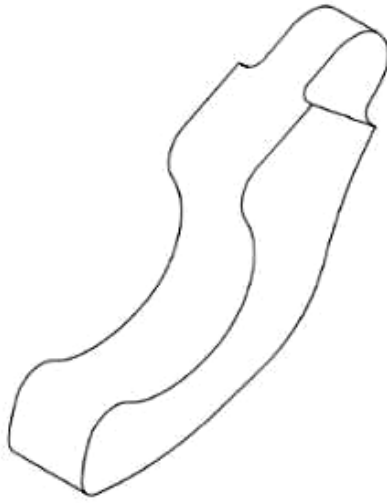

2.1

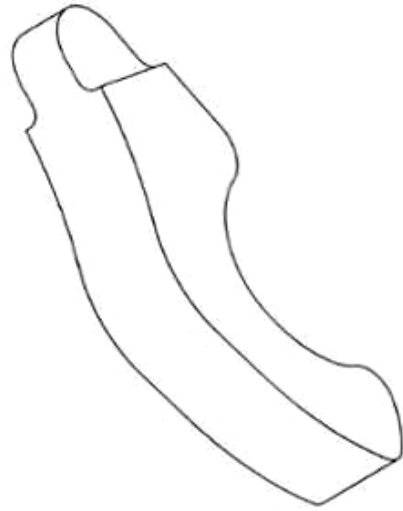

2.2



2.3



2.4

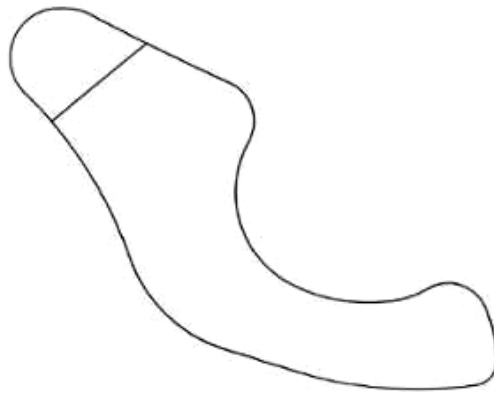

2.5

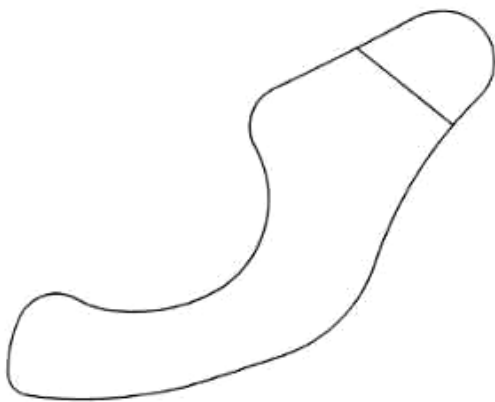

2.6



2.7



2.8

- (11) **51341**
- (21) 3-2024-01183
- (54) **THUỐC LÁ ĐIỆN TỬ**
- (22) 23/05/2024
- (30) 2024302097881 15/04/2024 CN;
- (73) **HG INNOVATION LIMITED (CN)**
Flat/Rm 06, 23/F, The Metropolis Tower, 10 Metropolis Drive, Hung Hom,
Kowloon, Hong Kong, China
- (72) LI Caihao (CN)
- (74) Công ty TNHH Trà và cộng sự (TRA & ASSOCIATES CO.,LTD)
- (55)



1.1

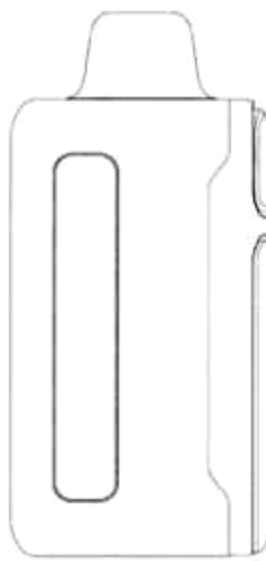

1.2



1.3



1.4



1.5



1.6

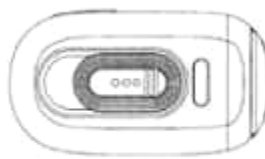

1.7

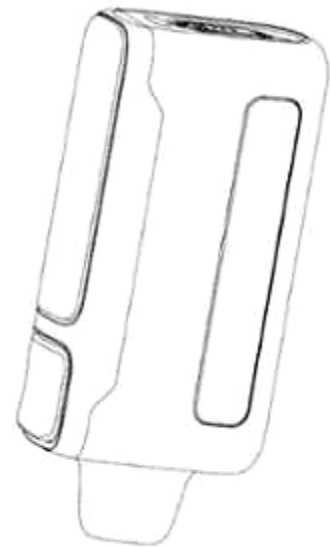

1.8

CÔNG BÁO SỞ HỮU CÔNG NGHIỆP SỐ 438 TẬP A – QUYỀN 2 (09.2024)

- (11) **51342**
- (21) 3-2024-01190 (28) 2
- (54) **NHÃN SẢN PHẨM** (51) **19-08**
- (22) 24/05/2024 (43) 25/09/2024
- (73) **CÔNG TY CỔ PHẦN ĐẦU TƯ THƯƠNG MẠI VÀ PHÁT TRIỂN NÔNG NGHIỆP ADI (VN)**
Số 2, ngõ 192, phố Đại Từ, phường Đại Kim, quận Hoàng Mai, thành phố Hà Nội
- (72) Lê Thanh Hải (VN)
- (74) Công ty TNHH Sở hữu trí tuệ M.I.T (M.I.T IP CO., LTD)
- (55)



1.1



2.1

CÔNG BÁO SỞ HỮU CÔNG NGHIỆP SỐ 438 TẬP A – QUYỀN 2 (09.2024)

- (11) **51343**
(21) 3-2024-01202 (28) 1
(54) **ĐỒ LƯU NIỆM** (51) **11-02**
(22) 28/05/2024 (43) 25/09/2024
(73) **NGUYỄN THANH TÂN (VN)**
K185/8 Hoàng Diệu, phường Nam Dương, quận Hải Châu, thành phố Đà Nẵng
(72) Nguyễn Thanh Tân (VN)
(55)



1.1



1.2



1.3



1.4



1.5

CÔNG BÁO SỞ HỮU CÔNG NGHIỆP SỐ 438 TẬP A – QUYỀN 2 (09.2024)

- (11) **51344**
(21) 3-2024-01203 (28) 1
(54) **ĐỒ LƯU NIỆM** (51) **11-02**
(22) 28/05/2024 (43) 25/09/2024
(73) **NGUYỄN THANH TÂN (VN)**
K185/8 Hoàng Diệu, phường Nam Dương, quận Hải Châu, thành phố Đà Nẵng
(72) Nguyễn Thanh Tân (VN)
(55)



1.1



1.2



1.3



1.4



1.5

- (11) **51345**
(21) 3-2024-01204 (28) 1
(54) **ĐỒ LƯU NIỆM** (51) **11-02**
(22) 28/05/2024 (43) 25/09/2024
(73) **NGUYỄN THANH TÂN (VN)**
K185/8 Hoàng Diệu, phường Nam Dương, quận Hải Châu, thành phố Đà Nẵng
(72) Nguyễn Thanh Tân (VN)
(55)



1.1



1.2



1.3



1.4



1.5



1.6

CÔNG BÁO SỞ HỮU CÔNG NGHIỆP SỐ 438 TẬP A – QUYỀN 2 (09.2024)

- (11) **51346**
(21) 3-2024-01205 (28) 1
(54) **ĐỒ LƯU NIỆM** (51) **11-02**
(22) 28/05/2024 (43) 25/09/2024
(73) **NGUYỄN THANH TÂN (VN)**
K185/8 Hoàng Diệu, phường Nam Dương, quận Hải Châu, thành phố Đà Nẵng
(72) Nguyễn Thanh Tân (VN)
(55)



1.1



1.2



1.3



1.4



1.5

- (11) **51347**
(21) 3-2024-01206 (28) 1
(54) **HỘP** (51) **09-03**
(22) 28/05/2024 (43) 25/09/2024
(30) 2023-024653 29/11/2023 JP;
(73) **S.T. CORPORATION (JP)**
1-4-10, Shimo-ochiai, Shinjuku-ku, Tokyo 161-8540 Japan
(72) 1. YUTA ONO (JP)
2. REIKA MORIYAMA (JP)
3. SHOKO KATAGI (JP)
4. KOICHI HARADA (JP)
5. TATSUYA ICHII (JP)
(74) Công ty TNHH Một thành viên Sở hữu trí tuệ VCCI (VCCI-IP CO.,LTD)
(55)



1.1



1.2



1.3



1.4



1.5

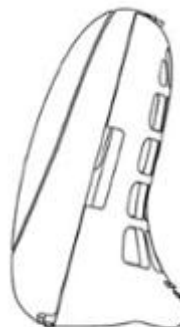

1.6



1.7



1.8



1.9

- (11) **51348**
(21) 3-2024-01207 (28) 1
(54) **HỘP** (51) **09-03**
(22) 28/05/2024 (43) 25/09/2024
(30) 2023-024654 29/11/2023 JP;
(73) **S.T. CORPORATION (JP)**
1-4-10, Shimo-ochiai, Shinjuku-ku, Tokyo 161-8540 Japan
(72) 1. YUTA ONO (JP)
2. HUANG CHI-CHUAN (TW)
(74) Công ty TNHH Một thành viên Sở hữu trí tuệ VCCI (VCCI-IP CO.,LTD)
(55)



1.1



1.2

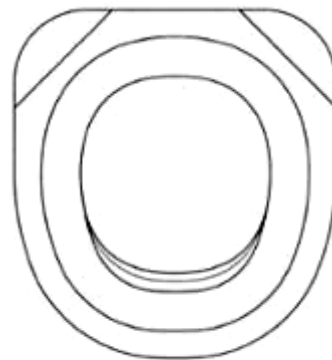

1.3

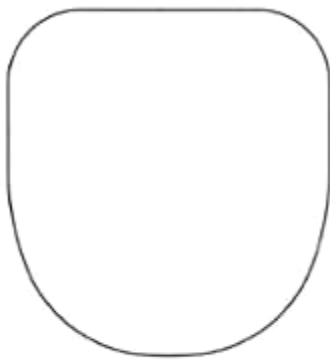

1.4

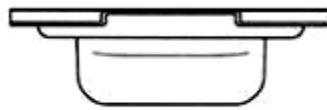

1.5

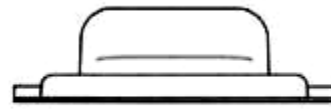

1.6



1.7



1.8



1.9



1.10

- (11) **51349**
(21) 3-2024-01218 (28) 1
(54) **BỘ PHẬN LÀM LẠNH** (51) **23-04**
(22) 29/05/2024 (43) 25/09/2024
(30) 2024-001473 26/01/2024 JP;
(73) **TOSHIBA CARRIER CORPORATION (JP)**
72-34, Horikawa-cho, Saiwai-ku, Kawasaki-shi, Kanagawa 212-8585, Japan
(72) 1. KENJIRO MATSUMOTO (JP)
2. KAORU MATSUSHITA (JP)
3. SHINGO TOOYAMA (JP)
(74) Công ty Luật TNHH WINCO (WINCO LAW FIRM)
(55)

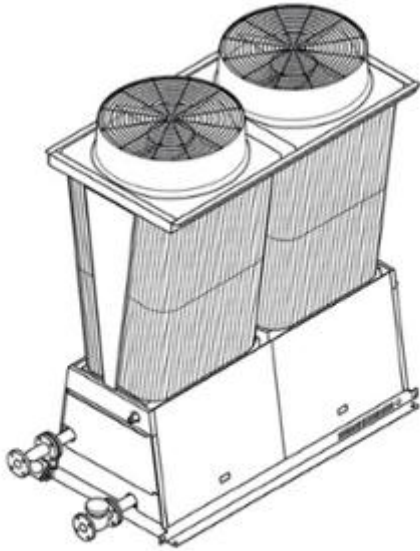

1.1

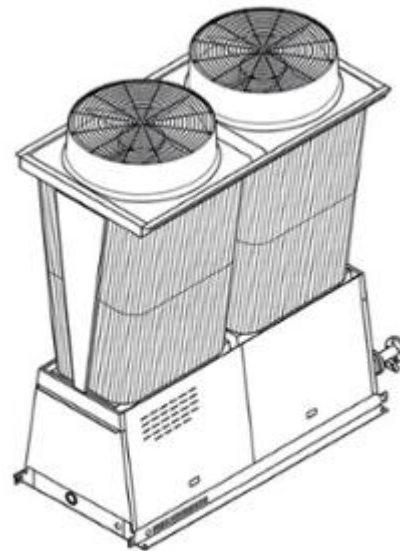

1.2

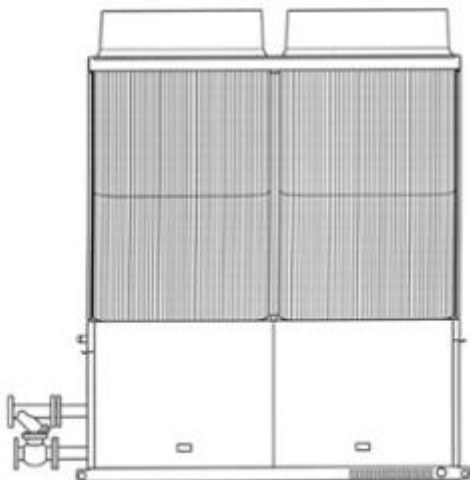

1.3

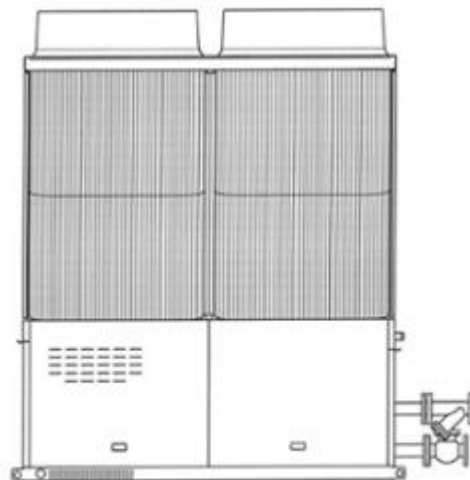

1.4

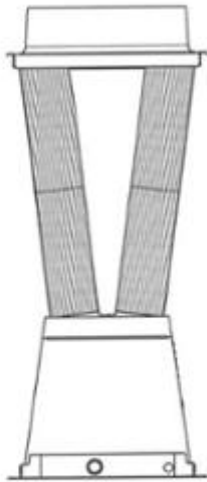

1.5



1.6

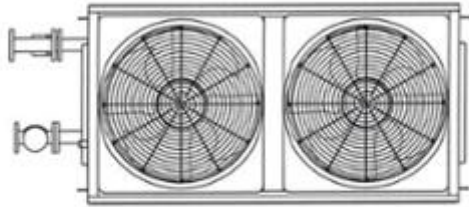

1.7



1.8

CÔNG BÁO SỞ HỮU CÔNG NGHIỆP SỐ 438 TẬP A – QUYỀN 2 (09.2024)

- (11) **51350**
(21) 3-2024-01219 (28) 1
(54) **BỘ PHẬN LÀM LẠNH** (51) **23-04**
(22) 29/05/2024 (43) 25/09/2024
(30) 2024-001483 26/01/2024 JP;
(73) **TOSHIBA CARRIER CORPORATION (JP)**
72-34, Horikawa-cho, Saiwai-ku, Kawasaki-shi, Kanagawa 212-8585, Japan
(72) 1. KENJIRO MATSUMOTO (JP)
2. KAORU MATSUSHITA (JP)
3. SHINGO TOOYAMA (JP)
(74) Công ty Luật TNHH WINCO (WINCO LAW FIRM)
(55)

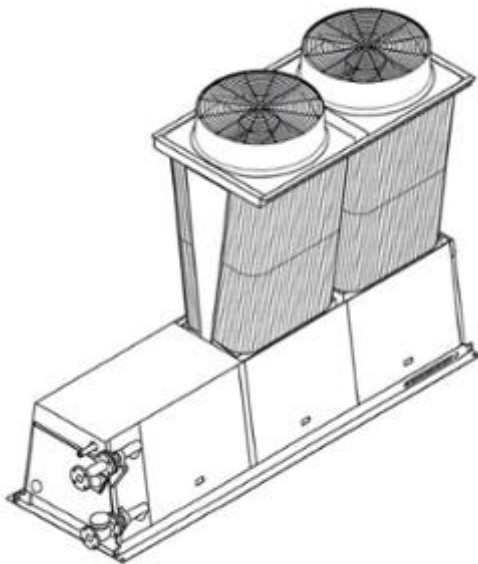

1.1

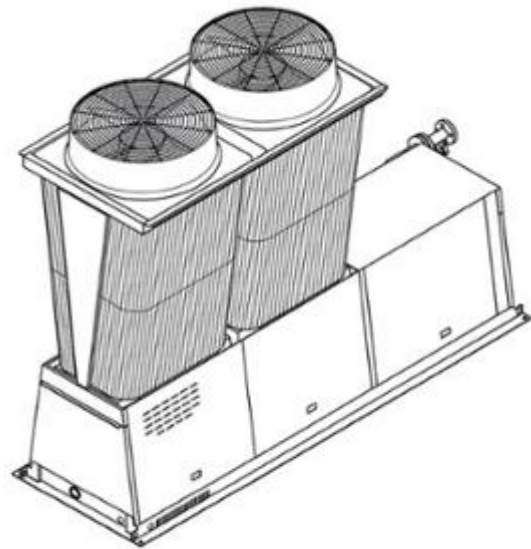

1.2

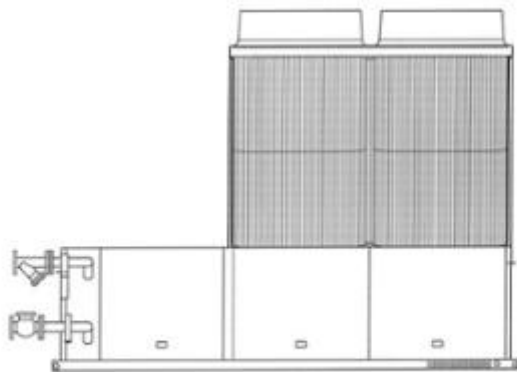

1.3

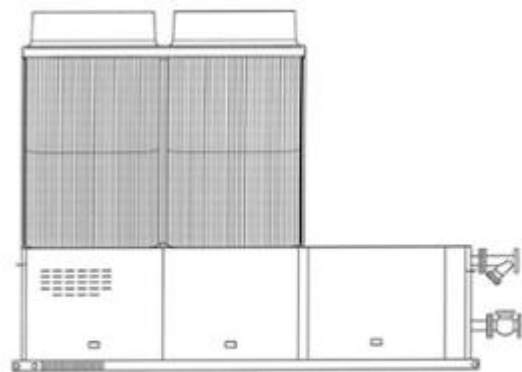

1.4

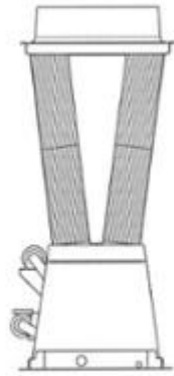

1.5

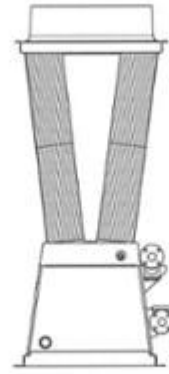

1.6

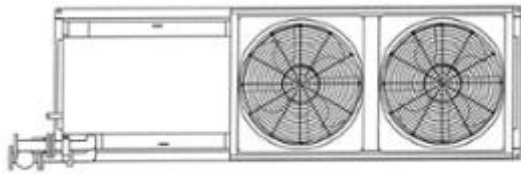

1.7



1.8

CÔNG BÁO SỞ HỮU CÔNG NGHIỆP SỐ 438 TẬP A – QUYỀN 2 (09.2024)

- (11) **51351**
(21) 3-2024-01231 (28) 1
(54) **THUỐC LÁ ĐIỆN TỬ** (51) **27-02**
(22) 30/05/2024 (43) 25/09/2024
(30) 2024302042179 12/04/2024 CN;
(73) **HG INNOVATION LIMITED (CN)**
Flat/Rm 06, 23/F, The Metropolis Tower, 10 Metropolis Drive, Hung Hom,
Kowloon, Hong Kong, China
(72) Caihao LI (CN)
(74) Công ty TNHH ADASTRA IP (VIỆT NAM) (ADASTRA IP (VIETNAM) CO.,
LTD.)
(55)



1.1

1.2

1.3



1.4

1.5

1.6



1.7



1.8

CÔNG BÁO SỞ HỮU CÔNG NGHIỆP SỐ 438 TẬP A – QUYỀN 2 (09.2024)

- (11) **51352**
(21) 3-2024-01232 (28) 1
(54) **NGUỒN CẤP ĐIỆN THUỐC LÁ ĐIỆN TỬ** (51) **13-02**
(22) 30/05/2024 (43) 25/09/2024
(30) 2024302042179 12/04/2024 CN;
(73) **HG INNOVATION LIMITED (CN)**
Flat/Rm 06, 23/F, The Metropolis Tower, 10 Metropolis Drive, Hung Hom,
Kowloon, Hong Kong, China
(72) Caihao LI (CN)
(74) Công ty TNHH ADASTRA IP (VIỆT NAM) (ADASTRA IP (VIETNAM) CO.,
LTD.)
(55)



CÔNG BÁO SỞ HỮU CÔNG NGHIỆP SỐ 438 TẬP A – QUYỀN 2 (09.2024)

- (11) **51353**
(21) 3-2024-01251 (28) 1
(54) **BAO GÓI** (51) **09-05**
(22) 31/05/2024 (43) 25/09/2024
(73) **NGÔ THỊ HỒNG THẨM (VN)**
Khu Dương Ổ, phường Phong Khê, thành phố Bắc Ninh, tỉnh Bắc Ninh
(72) Ngô Thị Hồng Thẩm (VN)
(74) Công ty Cổ phần ICHECK (ICHECK.,JSC)
(55)



1.1



1.2

CÔNG BÁO SỞ HỮU CÔNG NGHIỆP SỐ 438 TẬP A – QUYỀN 2 (09.2024)

- (11) **51354**
- (21) 3-2024-01253
- (54) **GIOĂNG CỬA**
- (22) 31/05/2024
- (73) **CÔNG TY TNHH CÔNG NGHỆ EURO (VN)**
Số 167, đường Vũ Quang, phường Thạch Linh, thành phố Hà Tĩnh, tỉnh Hà Tĩnh
- (72) Nguyễn Mạnh Cường (VN)
- (74) Công ty TNHH Luật ALIAT (ALIAT LEGAL)
- (55)
- (28) 1
- (51) **25-01**
- (43) 25/09/2024

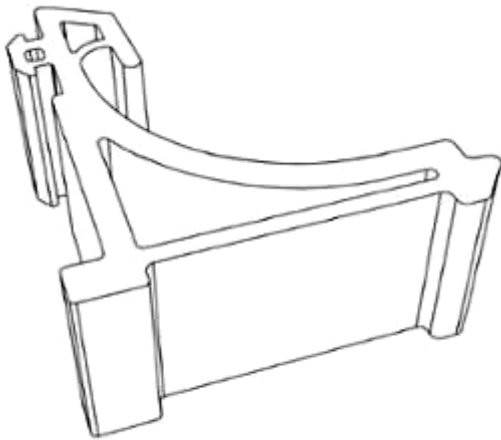

1.1



1.2



1.3



1.4

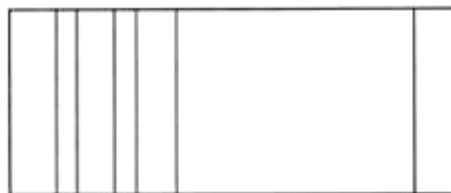

1.5

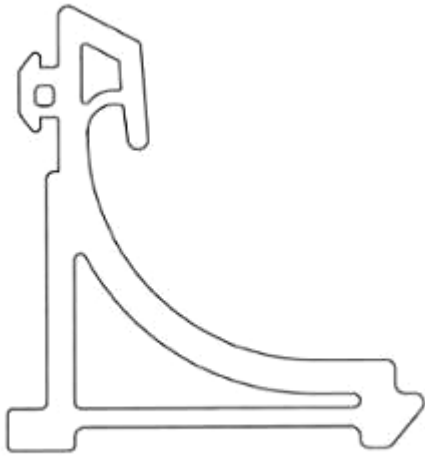

1.6

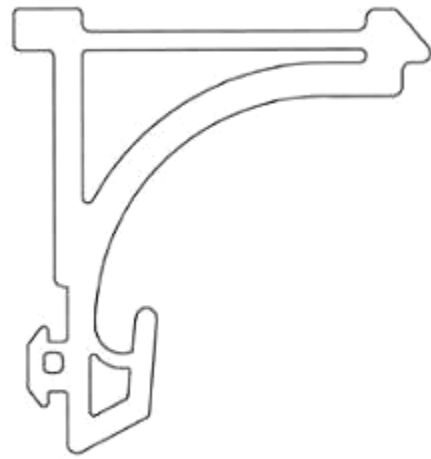

1.7

CÔNG BÁO SỞ HỮU CÔNG NGHIỆP SỐ 438 TẬP A – QUYỀN 2 (09.2024)

- (11) **51355**
(21) 3-2024-01268 (28) 1
(54) **THANH KIM LOẠI ĐỊNH HÌNH** (51) **25-01**
(22) 03/06/2024 (43) 25/09/2024
(73) **CÔNG TY CỔ PHẦN TẬP ĐOÀN KENWIN (VN)**
Tầng 4 tòa nhà VG Building, số 235 đường Nguyễn Trãi, phường Thanh Xuân
Trung, quận Thanh Xuân, thành phố Hà Nội
(72) Ngô Thọ Long (VN)
(74) Công ty TNHH Sở hữu trí tuệ PADEMARK (PADEMARK CO.,LTD.)
(55)



1.1



1.2



1.3

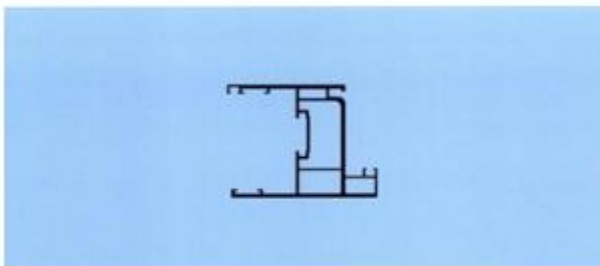

1.4

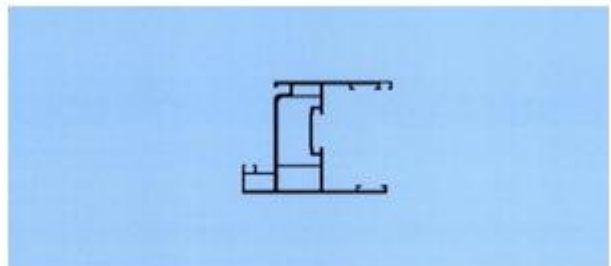

1.5



1.6



1.7

CÔNG BÁO SỞ HỮU CÔNG NGHIỆP SỐ 438 TẬP A – QUYỀN 2 (09.2024)

- (11) **51356**
(21) 3-2024-01286 (28) 1
(54) **NHÃN SẢN PHẨM** (51) **19-08**
(22) 04/06/2024 (43) 25/09/2024
(73) **TRẦN THỊ HIỀN (VN)**
Phòng 409, Chung cư An Lạc, đường Lưu Hữu Phước, phường Cầu Diễn, quận
Nam Từ Liêm, thành phố Hà Nội
(72) Trần Thị Hiền (VN)
(55)



CÔNG BÁO SỞ HỮU CÔNG NGHIỆP SỐ 438 TẬP A – QUYỀN 2 (09.2024)

- (11) **51357**
- (21) 3-2024-01290 (28) 4
- (54) **THANH ĐỊNH HÌNH** (51) **25-01**
- (22) 05/06/2024 (43) 25/09/2024
- (30) A00202305705 06/12/2023 ID; A00202305708 06/12/2023 ID; A00202305707 06/12/2023 ID; A00202305706 06/12/2023 ID;
- (73) **YKK AP INC. (JP)**
1, Kandaizumi-Cho, Chiyoda-Ku, Tokyo 101-0024 Japan
- (72) 1. SARI SASAKI (JP)
2. SEIYA SAKURAI (JP)
- (74) Công ty TNHH một thành viên Sở hữu trí tuệ VCCI (VCCI-IP CO.,LTD)
- (55)

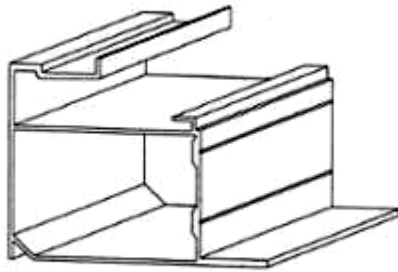

1.1

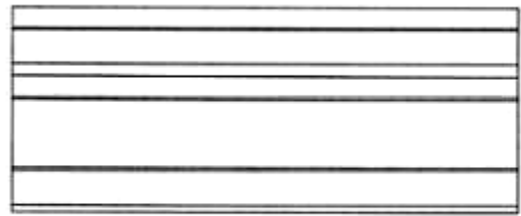

1.2

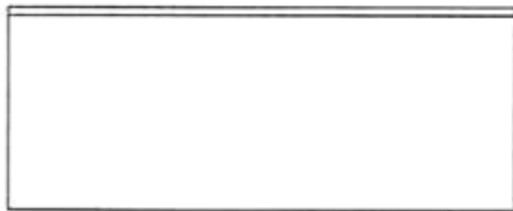

1.3

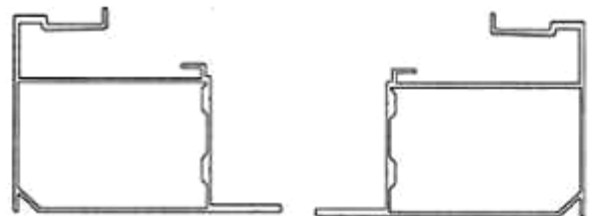

1.4

1.5

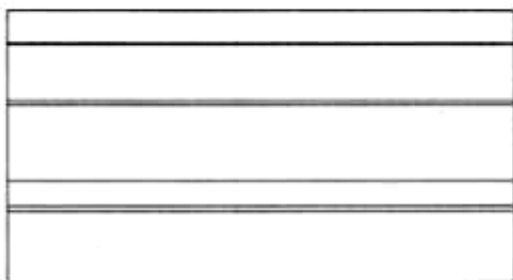

1.6

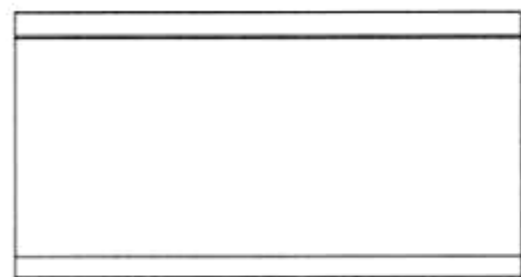

1.7



2.1



2.2



2.3

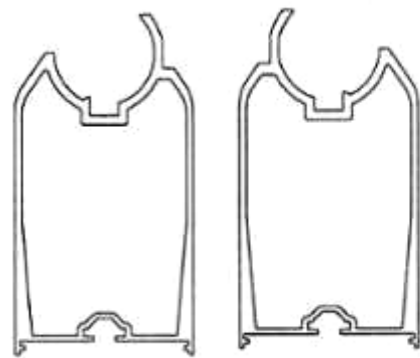

2.4

2.5

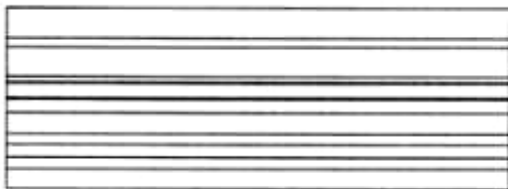

2.6



2.7

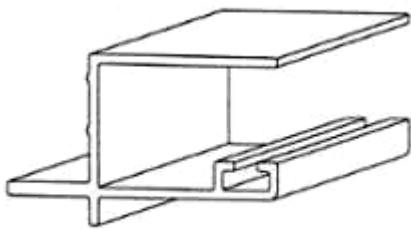

3.1

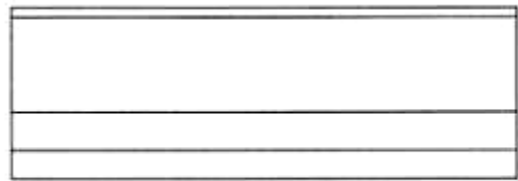

3.2

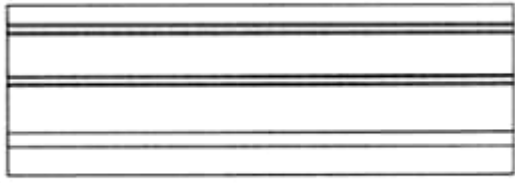

3.3

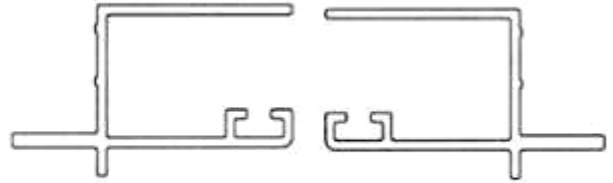

3.4

3.5

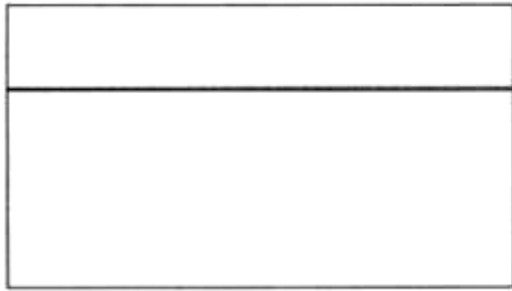

3.6

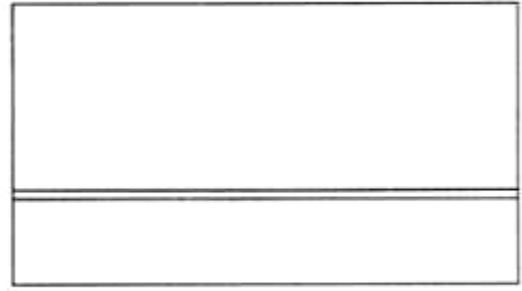

3.7

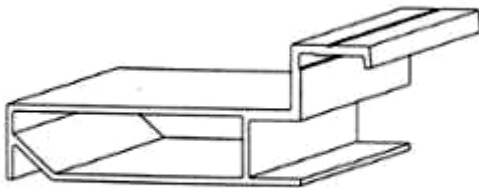

4.1

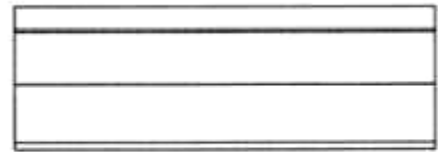

4.2

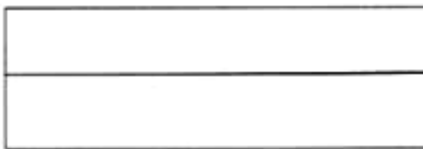

4.3



4.4



4.5

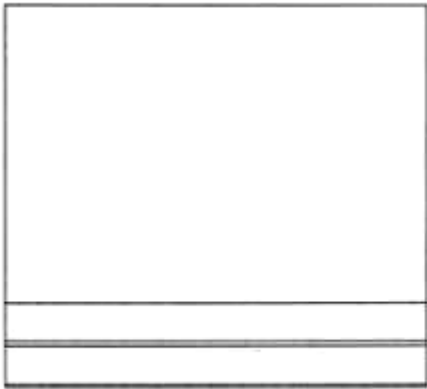

4.6

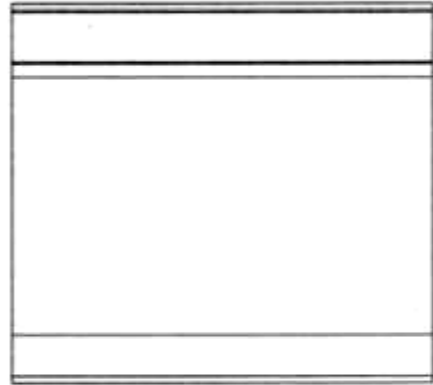

4.7

CÔNG BÁO SỞ HỮU CÔNG NGHIỆP SỐ 438 TẬP A – QUYỀN 2 (09.2024)

- (11) **51358**
- (21) 3-2024-01300 (28) 1
- (54) **NHÃN SẢN PHẨM** (51) **19-08**
- (22) 06/06/2024 (43) 25/09/2024
- (73) **CÔNG TY CỔ PHẦN SẢN XUẤT & THƯƠNG MẠI CÁT TƯỜNG GROUP (VN)**
Thôn An Lộc, xã Đồng Sơn, huyện Nam Trực, tỉnh Nam Định
- (72) Nguyễn Văn Chính (VN)
- (74) **CÔNG TY TNHH SỞ HỮU TRÍ TUỆ SETHACO (SETHACO IP CO.,LTD)**
- (55)



CÔNG BÁO SỞ HỮU CÔNG NGHIỆP SỐ 438 TẬP A – QUYỀN 2 (09.2024)

- (11) **51359**
(21) 3-2024-01316 (28) 1
(54) **KẾT ĐỰNG CHAI** (51) **09-04**
(22) 07/06/2024 (43) 25/09/2024
(73) **TỔNG CÔNG TY CỔ PHẦN BIA - RƯỢU - NƯỚC GIẢI KHÁT SÀI GÒN (VN)**
187 Nguyễn Chí Thanh, phường 12, quận 5, thành phố Hồ Chí Minh
(72) Tan Teck Chuan Lester (SG)
(74) Công ty TNHH Luật ALIAT (ALIAT LEGAL)
(55)



1.1



1.2



1.3

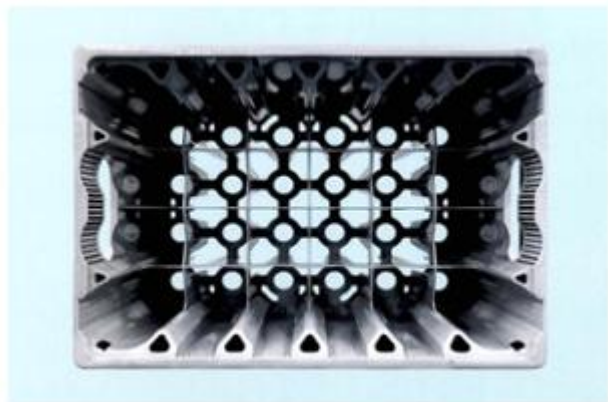

1.4

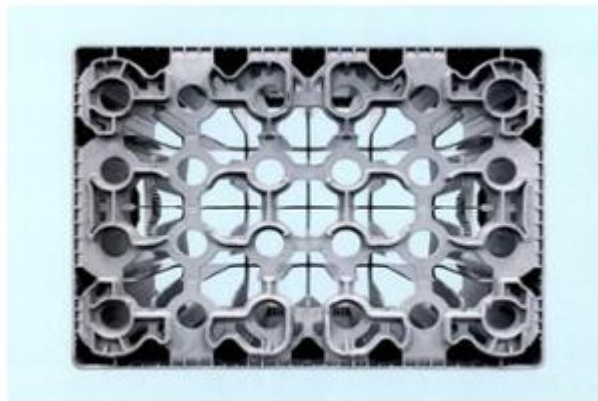

1.5

CÔNG BÁO SỞ HỮU CÔNG NGHIỆP SỐ 438 TẬP A – QUYỀN 2 (09.2024)

- (11) **51360**
(21) 3-2024-01346 (28) 1
(54) **NỒI CƠM ĐIỆN** (51) **07-02**
(22) 11/06/2024 (43) 25/09/2024
(73) **CÔNG TY TNHH SẢN XUẤT ĐỒ GIA DỤNG SUNHOUSE (VN)**
Ngọc Liệp, xã Ngọc Liệp, huyện Quốc Oai, thành phố Hà Nội
(72) Lại Văn Kiên (VN)
(74) Công ty TNHH Sở hữu Trí tuệ Bình Minh (SUNRISE IP CO.,LTD.)
(55)



1.1



1.2



1.3



1.4



1.5



1.6



1.7

CÔNG BÁO SỞ HỮU CÔNG NGHIỆP SỐ 438 TẬP A – QUYỀN 2 (09.2024)

- (11) **51361**
(21) 3-2024-01348 (28) 1
(54) **CHẢO** (51) **07-02**
(22) 11/06/2024 (43) 25/09/2024
(73) **CÔNG TY TNHH SẢN XUẤT ĐỒ GIA DỤNG SUNHOUSE (VN)**
Ngọc Liệp, xã Ngọc Liệp, huyện Quốc Oai, thành phố Hà Nội
(72) Lại Văn Kiên (VN)
(74) Công ty TNHH Sở hữu Trí tuệ Bình Minh (SUNRISE IP CO.,LTD.)
(55)



1.1



1.2



1.3



1.4



1.5



1.6



1.7

CÔNG BÁO SỞ HỮU CÔNG NGHIỆP SỐ 438 TẬP A – QUYỀN 2 (09.2024)

- (11) **51362**
(21) 3-2024-01350 (28) 1
(54) **NỒI NẤU** (51) **07-02**
(22) 11/06/2024 (43) 25/09/2024
(73) **CÔNG TY TNHH SẢN XUẤT ĐỒ GIA DỤNG SUNHOUSE (VN)**
Ngọc Liệp, xã Ngọc Liệp, huyện Quốc Oai, thành phố Hà Nội
(72) Lại Văn Kiên (VN)
(74) Công ty TNHH Sở hữu Trí tuệ Bình Minh (SUNRISE IP CO.,LTD.)
(55)



1.1



1.2



1.3



1.4



1.5

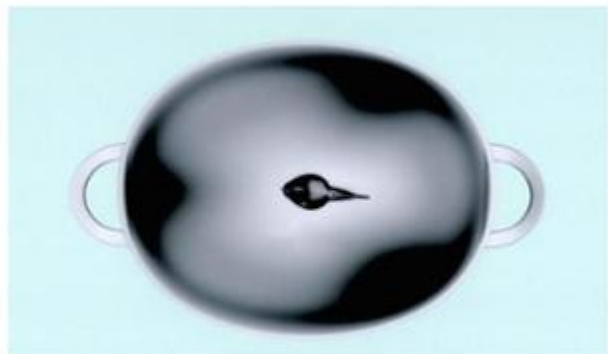

1.6



1.7

CÔNG BÁO SỞ HỮU CÔNG NGHIỆP SỐ 438 TẬP A – QUYỀN 2 (09.2024)

(11) **51363**

(21) 3-2024-01351

(28) 1

(54) **NỒI CƠM ĐIỆN**

(51) **07-02**

(22) 11/06/2024

(43) 25/09/2024

(73) **CÔNG TY TNHH SẢN XUẤT ĐỒ GIA DỤNG SUNHOUSE (VN)**

Ngọc Liệp, xã Ngọc Liệp, huyện Quốc Oai, thành phố Hà Nội

(72) Lại Văn Kiên (VN)

(74) Công ty TNHH Sở hữu Trí tuệ Bình Minh (SUNRISE IP CO.,LTD.)

(55)



1.1



1.2



1.3

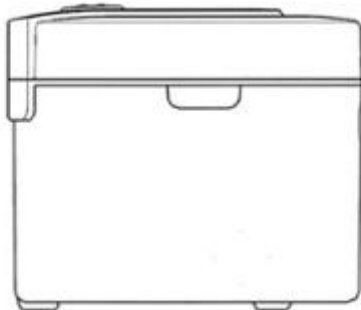

1.4

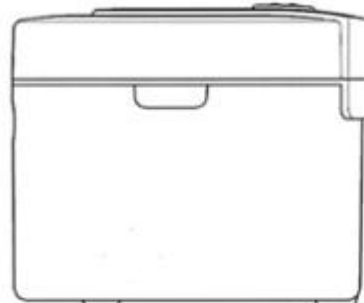

1.5



1.6

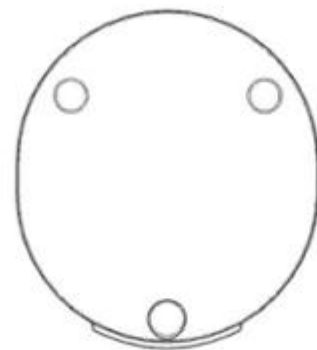

1.7

CÔNG BÁO SỞ HỮU CÔNG NGHIỆP SỐ 438 TẬP A – QUYỀN 2 (09.2024)

- (11) **51364**
(21) 3-2024-01367 (28) 1
(54) **MŨ BẢO HIỂM** (51) **02-03**
(22) 13/06/2024 (43) 25/09/2024
(73) **CÔNG TY TNHH TẬP ĐOÀN QUỐC TẾ Á CHÂU (VN)**
Lô F19, đường Kênh Tây, cụm KCN Đức Hòa Đông, xã Đức Hòa Hạ, huyện Đức
Hoà, tỉnh Long An
(72) Mai Văn Thuận (VN)
(74) Công ty TNHH Sở hữu trí tuệ Việt Á (VIET A IP CO.,LTD)
(55)



1.1



1.2



1.3



1.4



1.5



1.6



1.7

(11) **51365**

(21) 3-2024-01369

(28) 1

(54) **THANH NHÔM ĐỊNH HÌNH**

(51) **25-01**

(22) 13/06/2024

(43) 25/09/2024

(73) **CÔNG TY CỔ PHẦN EUROHOUSE VIỆT NAM (VN)**

374 đường Nguyễn Thiện Thuật, phường Nhân Hòa, thị xã Mỹ Hào, tỉnh Hưng Yên

(72) Phạm Trường Giang (VN)

(55)

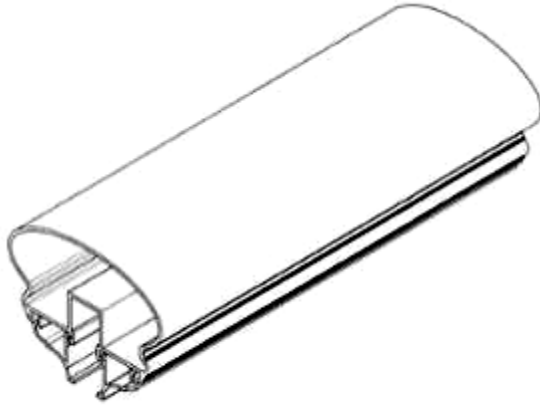

1.1



1.2



1.3



1.4

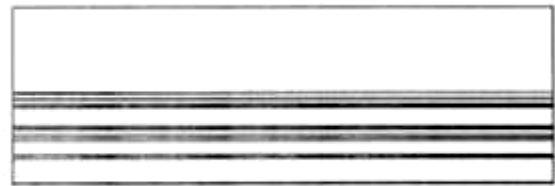

1.5



1.6

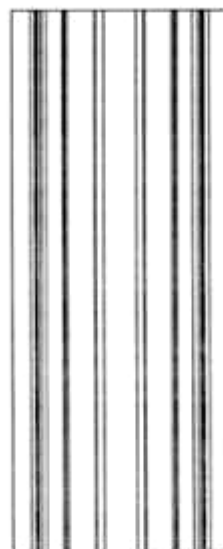

1.7

CÔNG BÁO SỞ HỮU CÔNG NGHIỆP SỐ 438 TẬP A – QUYỀN 2 (09.2024)

- (11) **51366**
(21) 3-2024-01396 (28) 1
(54) **CHÂN BÁNH XE NÂNG** (51) **12-05**
(22) 17/06/2024 (43) 25/09/2024
(30) 113200553 16/01/2024 TW;
(73) **LI FUNG DA INDUSTRY CO., LTD. (TW)**
No. 48, Nanhua Rd., Tongxiao Township, Miaoli County 357004, Taiwan
(72) LIN, CHUNG-YOU (TW)
(74) Công ty TNHH Sở hữu trí tuệ Hải Hân (HAI HAN IP CO., LTD.)
(55)

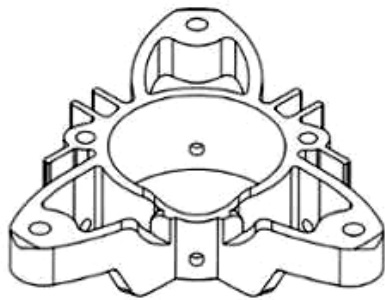

1.1

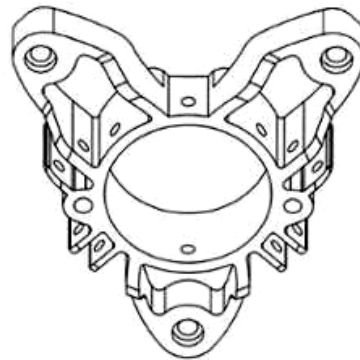

1.2



1.5



1.6

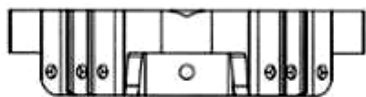

1.4

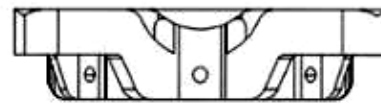

1.3

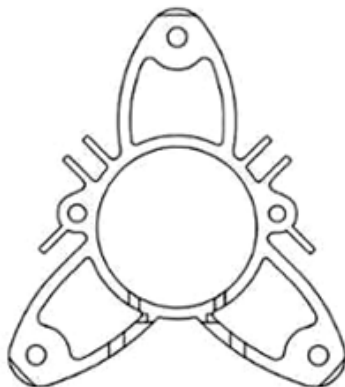

1.7

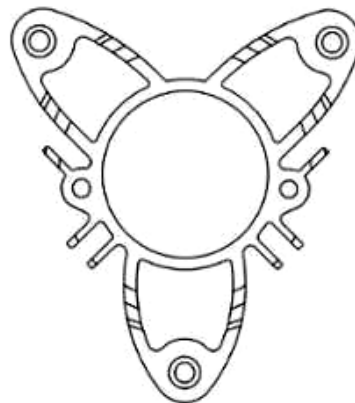

1.8

CÔNG BÁO SỞ HỮU CÔNG NGHIỆP SỐ 438 TẬP A – QUYỀN 2 (09.2024)

- (11) **51367**
(21) 3-2024-01411 (28) 1
(54) **THANH KIM LOẠI ĐỊNH HÌNH** (51) **25-01**
(22) 19/06/2024 (43) 25/09/2024
(73) **TRẦN QUANG ÁNH (VN)**
1/1 Sơn Kỳ, phường Sơn Kỳ, quận Tân Phú, thành phố Hồ Chí Minh
(72) Trần Quang Ánh (VN)
(74) Công ty TNHH Sở hữu trí tuệ PADEMARK (PADEMARK CO.,LTD.)
(55)

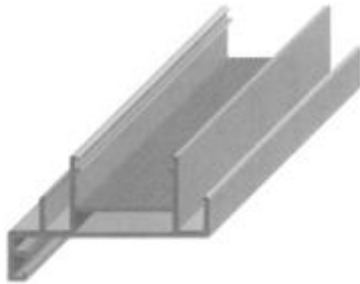

1.1

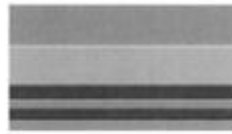

1.2



1.3



1.4

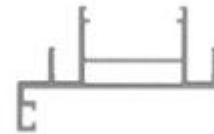

1.5

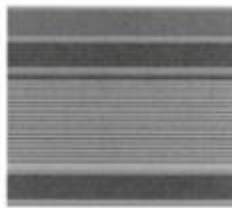

1.6



1.7

CÔNG BÁO SỞ HỮU CÔNG NGHIỆP SỐ 438 TẬP A – QUYỀN 2 (09.2024)

- (11) **51368**
(21) 3-2024-01419 (28) 3
(54) **CÔNG TẮC ĐIỆN** (51) **13-03**
(22) 20/06/2024 (43) 25/09/2024
(30) 2302005561 22/12/2023 TH; 2302005563 22/12/2023 TH; 2302005562 22/12/2023 TH;
(73) **PANASONIC HOLDINGS CORPORATION (JP)**
1006, Oaza Kadoma, Kadoma-shi, Osaka 571-8501 Japan
(72) Kazuaki OHARA (JP)
(74) Công ty Luật TNHH Phạm và Liên danh (PHAM & ASSOCIATES)
(55)

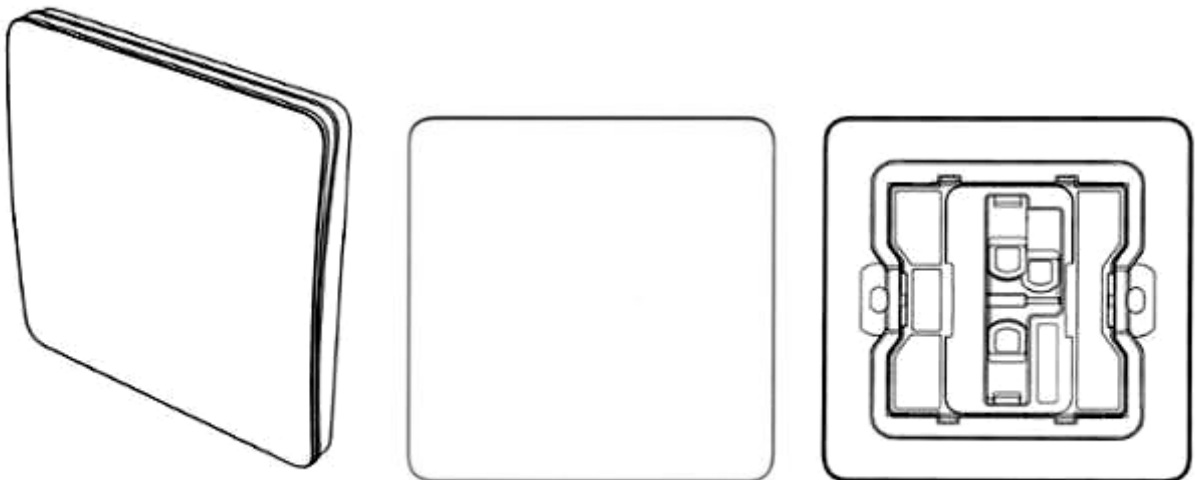

1.1

1.2

1.3

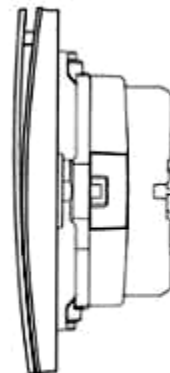
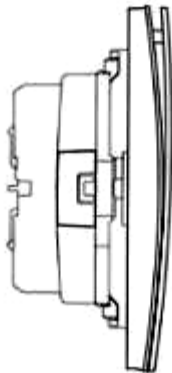

1.4

1.5

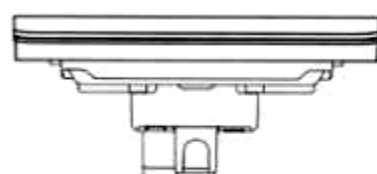
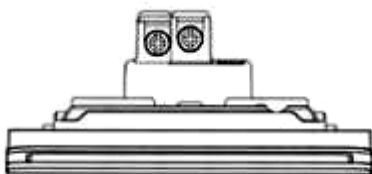

1.6

1.7

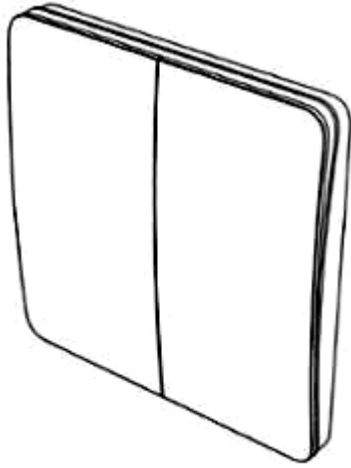

2.1

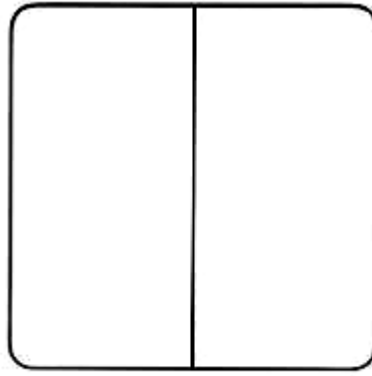

2.2

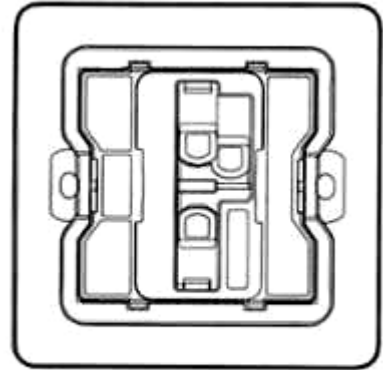

2.3

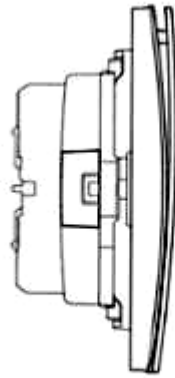

2.4

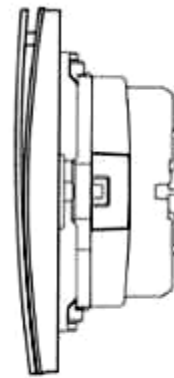

2.5

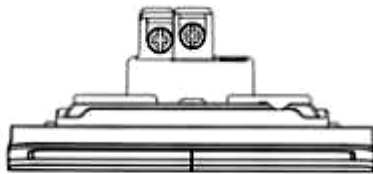

2.6

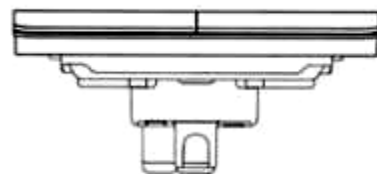

2.7

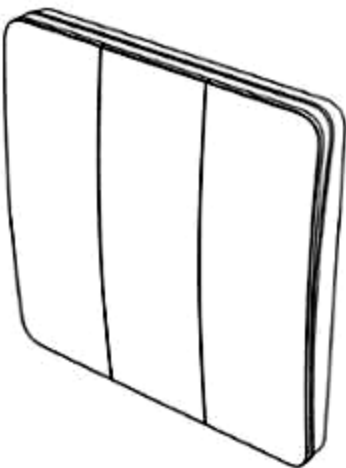

3.1

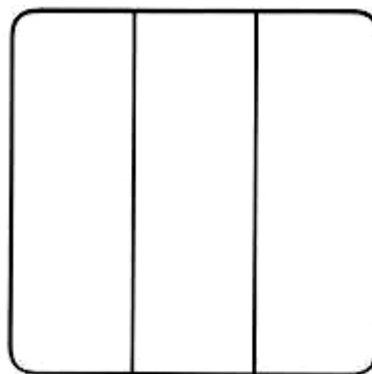

3.2

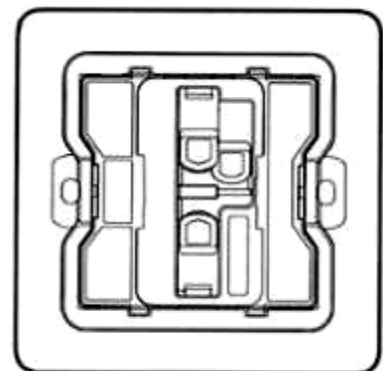

3.3

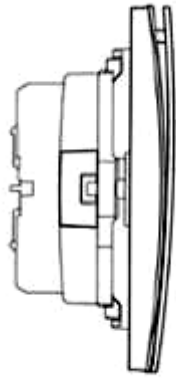

3.4

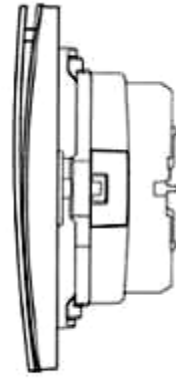

3.5

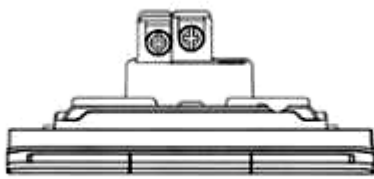

3.6

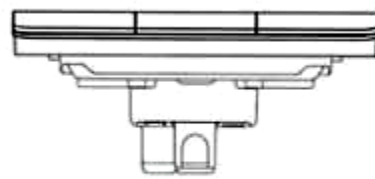

3.7

(11) **51369**

(21) 3-2024-01439

(54) **BỘ SẢN PHẨM NỘI THẤT**

(22) 24/06/2024

(73) **TRƯỜNG ĐẠI HỌC VĂN LANG (VN)**

45 Nguyễn Khắc Nhu, phường Cô Giang, quận 1, thành phố Hồ Chí Minh

(72) 1. **TRẦN HƯƠNG GIANG (VN)**

2. **NGUYỄN THỊ UYÊN UYÊN (VN)**

(55)

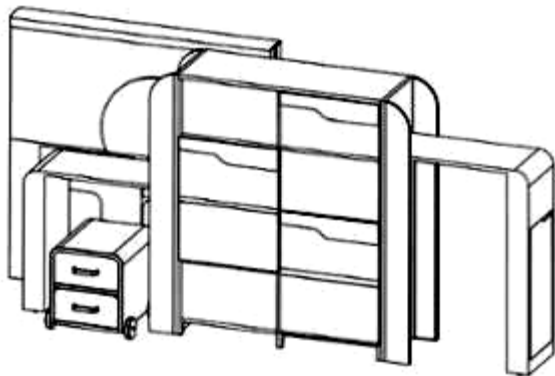

1.1

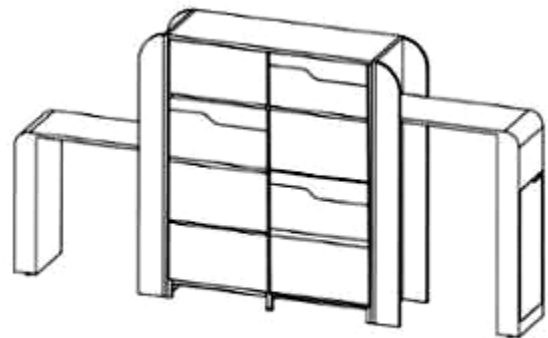

1.2

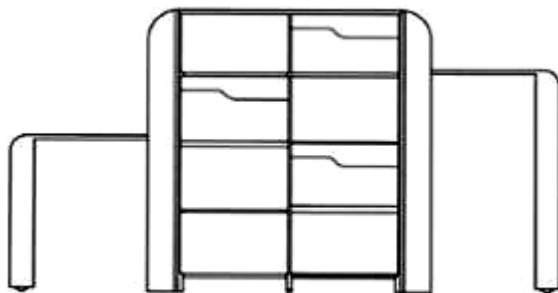

1.3

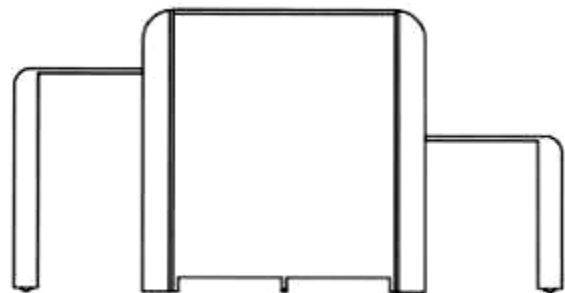

1.4

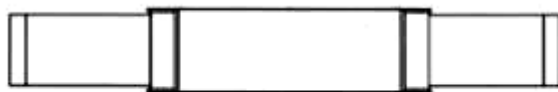

1.5



1.6



1.7



1.8



1.9



1.10



1.11



1.12

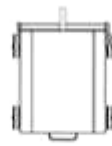

1.13



1.14



1.15

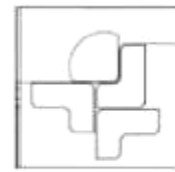

1.16



1.17



1.18

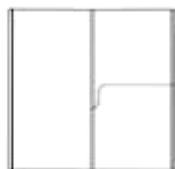

1.19



1.20



1.21

(11) **51370**

(21) 3-2024-01440

(28) 2

(54) **GHẾ**

(51) **06-01**

(22) 24/06/2024

(43) 25/09/2024

(73) **TRƯỜNG ĐẠI HỌC VĂN LANG (VN)**

45 Nguyễn Khắc Nhu, phường Cô Giang, quận 1, thành phố Hồ Chí Minh

(72) 1. **PHẠM KHÁNH NGHI (VN)**

2. **THÁI LONG QUÂN (VN)**

(55)



1.1

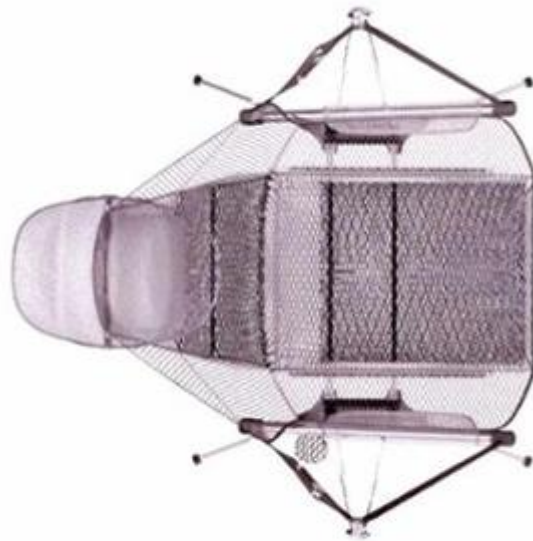

1.2

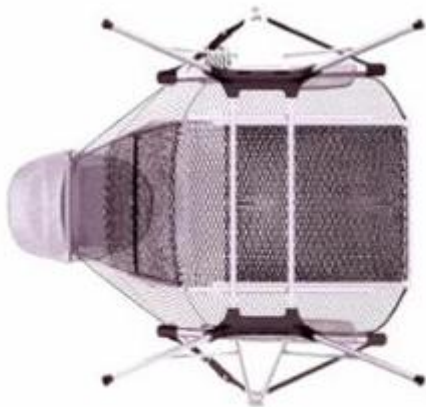

1.3



1.4



1.5



1.6



2.1



2.2

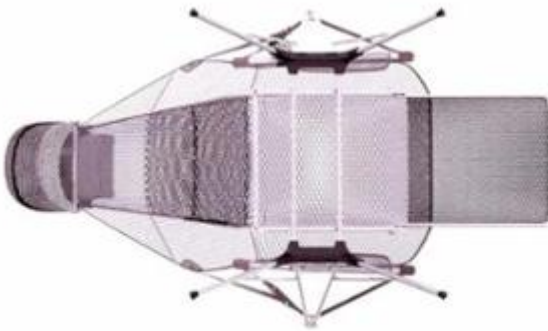

2.3



2.4



2.5



2.6

(11) **51371**

(21) 3-2024-01441

(28) 1

(54) **GIƯỜNG TẦNG**

(51) **06-02**

(22) 24/06/2024

(43) 25/09/2024

(73) **TRƯỜNG ĐẠI HỌC VĂN LANG (VN)**

45 Nguyễn Khắc Nhu, phường Cô Giang, quận 1, thành phố Hồ Chí Minh

(72) 1. NGUYỄN NGỌC MINH TÂM (VN)

2. NGUYỄN THỊ UYÊN UYÊN (VN)

(55)



1.1



1.2

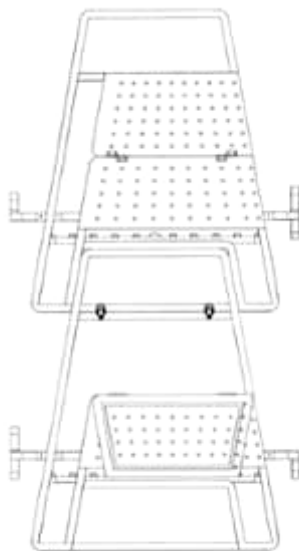

1.3

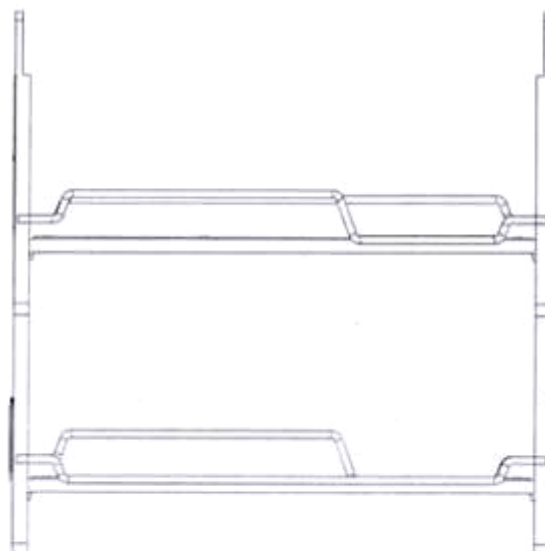

1.4



1.5



1.6



1.7

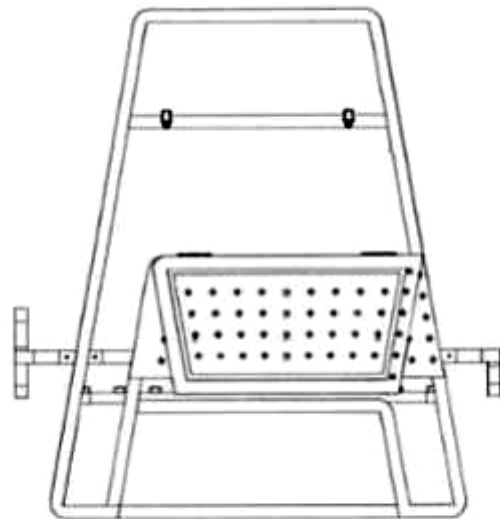

1.8

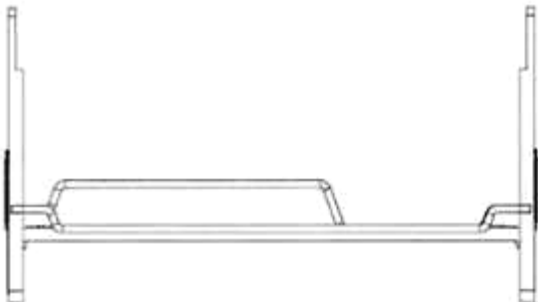

1.9

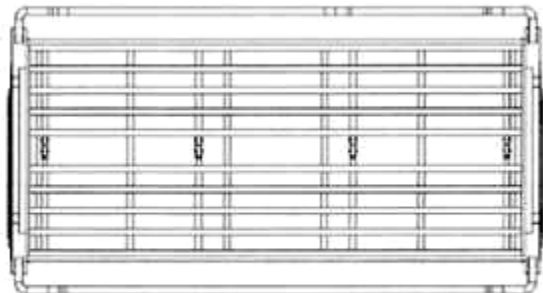

1.10

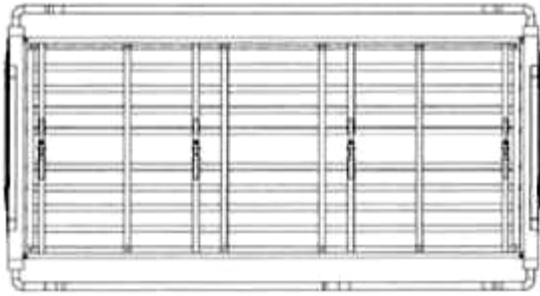

1.11

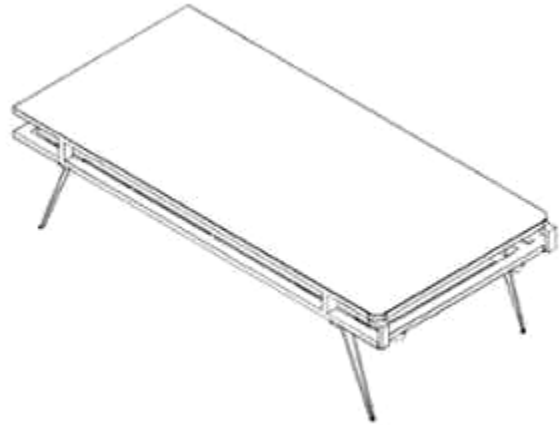

1.12



1.13



1.14

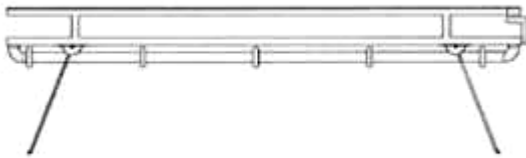

1.15



1.16

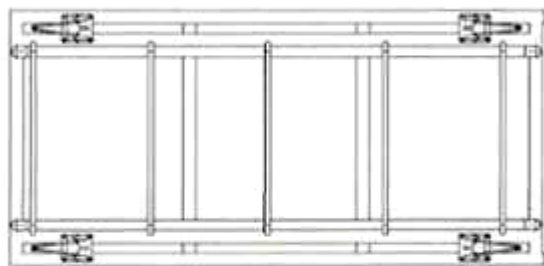

1.17

CÔNG BÁO SỞ HỮU CÔNG NGHIỆP SỐ 438 TẬP A – QUYỀN 2 (09.2024)

- (11) **51372**
(21) 3-2024-01456 (28) 2
(54) **CHI TIẾT ĐẦU VÒI SEN** (51) **23-02**
(22) 24/06/2024 (43) 25/09/2024
(30) 29/927,115 02/02/2024 US;
(73) **DELTA FAUCET COMPANY (US)**
55 E. 111th Street, Indianapolis, Indiana 46280, USA
(72) Susana Peredo-Muniz (US)
(74) Công ty TNHH Trường Xuân (AGELESS CO.,LTD.)
(55)

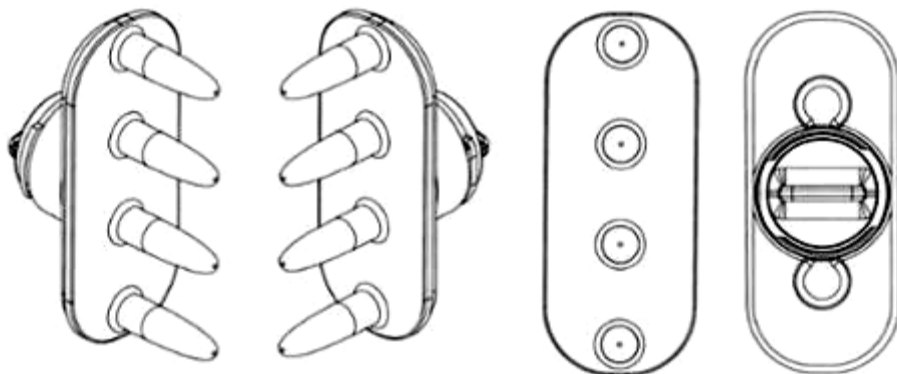

1.1

1.2

1.3

1.4

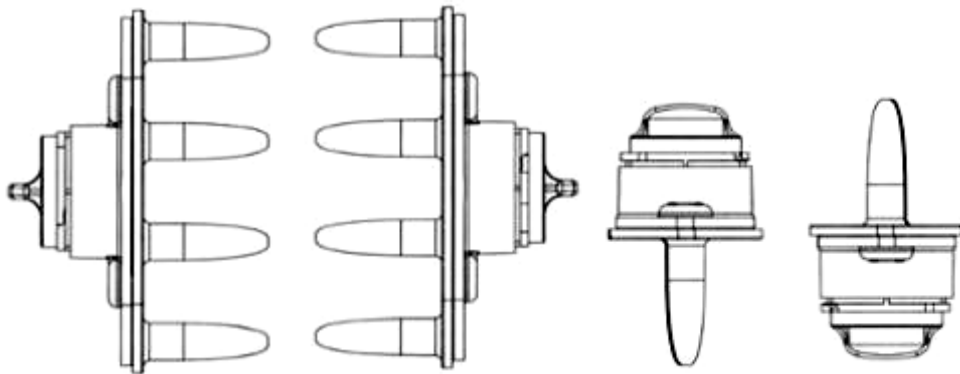

1.5

1.6

1.7

1.8

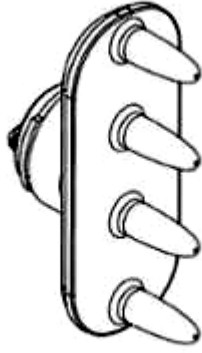

2.1

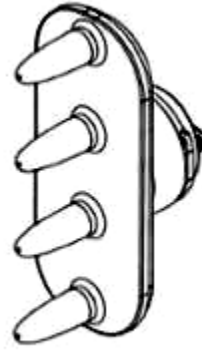

2.2

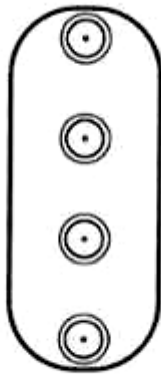

2.3

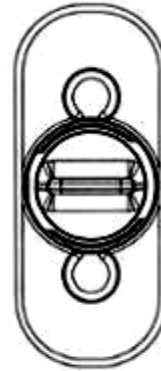

2.4

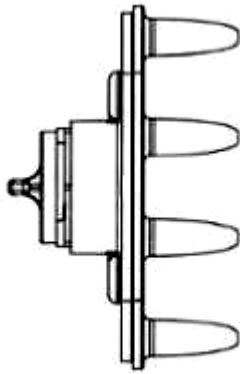

2.5

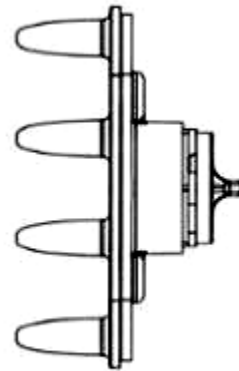

2.6

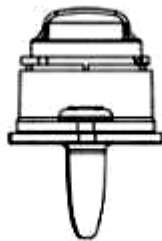

2.7

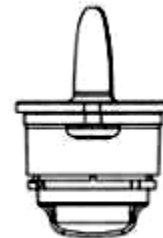

2.8

- (11) **51373**
- (21) 3-2024-01457 (28) 2
- (54) **CHI TIẾT ĐẦU VÒI SEN** (51) **23-02**
- (22) 24/06/2024 (43) 25/09/2024
- (30) 29/927,144 02/02/2024 US;
- (73) **DELTA FAUCET COMPANY (US)**
55 E. 111th Street, Indianapolis, Indiana 46280, USA
- (72) Susana Peredo-Muniz (US)
- (74) Công ty TNHH Trường Xuân (AGELESS CO.,LTD.)
- (55)

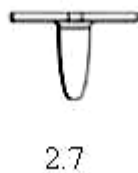
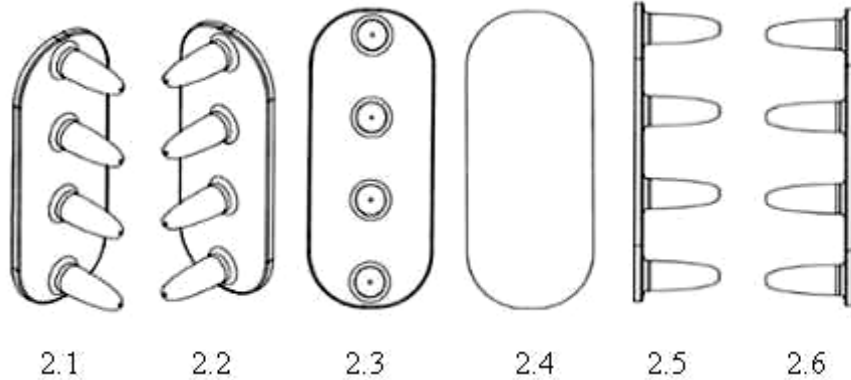
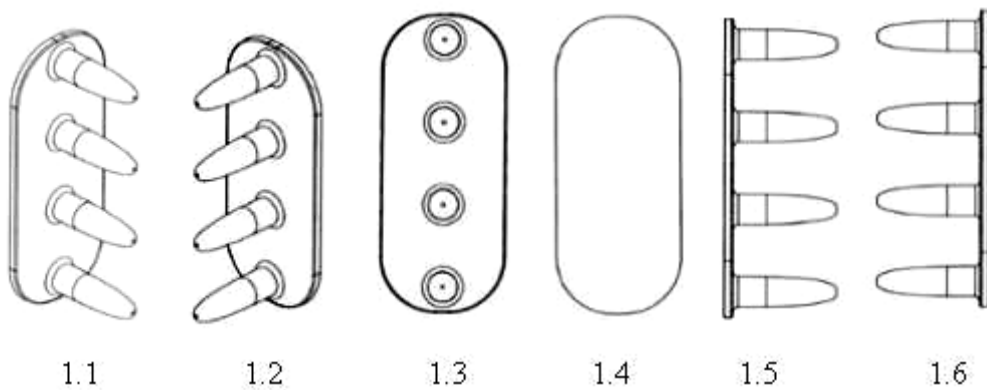

CÔNG BÁO SỞ HỮU CÔNG NGHIỆP SỐ 438 TẬP A – QUYỀN 2 (09.2024)

- (11) **51374**
(21) 3-2024-01458 (28) 1
(54) **CHI TIẾT ĐẦU VÒI SEN** (51) **23-02**
(22) 24/06/2024 (43) 25/09/2024
(30) 29/927,156 02/02/2024 US;
(73) **DELTA FAUCET COMPANY (US)**
55 E. 111th Street, Indianapolis, Indiana 46280, USA
(72) Susana Peredo-Muniz (US)
(74) Công ty TNHH Trường Xuân (AGELESS CO.,LTD.)
(55)

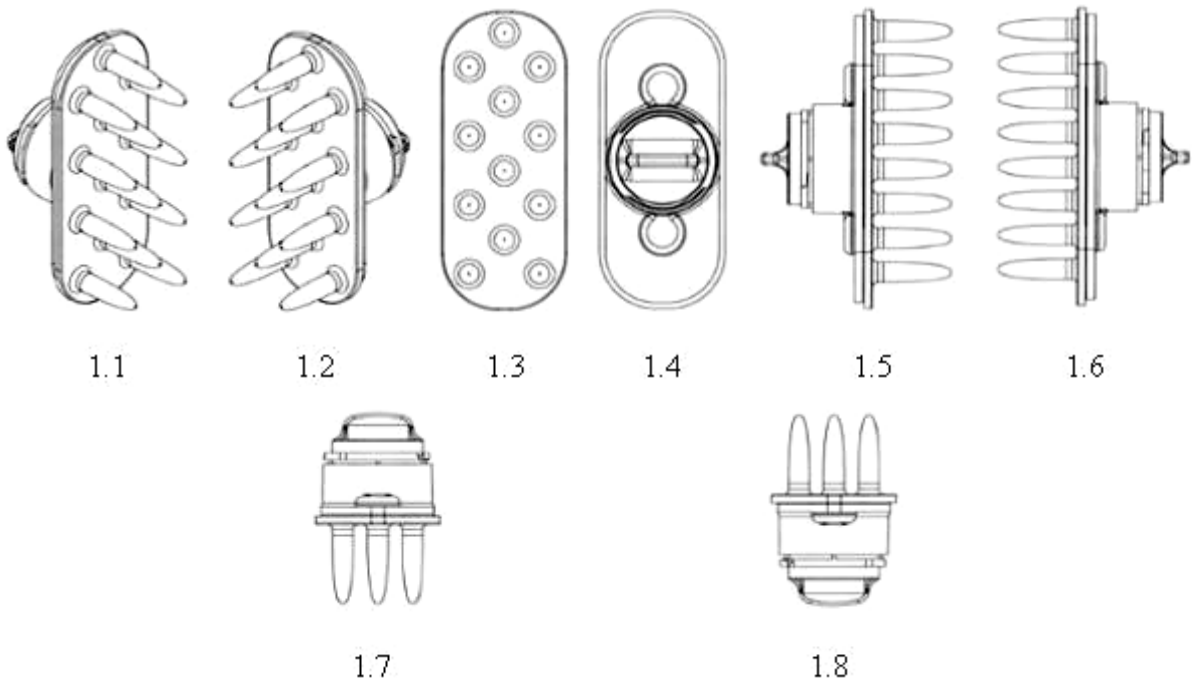

CÔNG BÁO SỞ HỮU CÔNG NGHIỆP SỐ 438 TẬP A – QUYỀN 2 (09.2024)

- (11) **51375**
(21) 3-2024-01459 (28) 1
(54) **CHI TIẾT ĐẦU VÒI SEN** (51) **23-02**
(22) 24/06/2024 (43) 25/09/2024
(30) 29/927,168 02/02/2024 US;
(73) **DELTA FAUCET COMPANY (US)**
55 E. 111th Street, Indianapolis, Indiana 46280, USA
(72) Susana Peredo-Muniz (US)
(74) Công ty TNHH Trường Xuân (AGELESS CO.,LTD.)
(55)

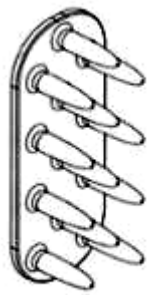

1.1



1.2

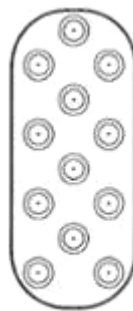

1.3



1.4

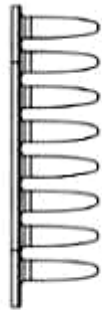

1.5

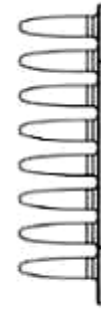

1.6

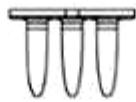

1.7

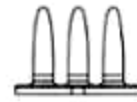

1.8

CÔNG BÁO SỞ HỮU CÔNG NGHIỆP SỐ 438 TẬP A – QUYỀN 2 (09.2024)

- (11) **51376**
(21) 3-2024-01460 (28) 1
(54) **CHI TIẾT ĐẦU VÒI SEN** (51) **23-02**
(22) 24/06/2024 (43) 25/09/2024
(30) 29/927,180 02/02/2024 US;
(73) **DELTA FAUCET COMPANY (US)**
55 E. 111th Street, Indianapolis, Indiana 46280, USA
(72) Susana Peredo-Muniz (US)
(74) Công ty TNHH Trường Xuân (AGELESS CO.,LTD.)
(55)



1.1

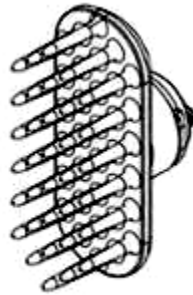

1.2



1.3



1.4

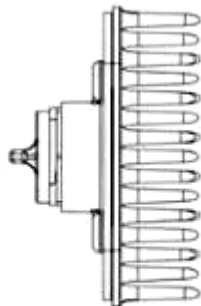

1.5

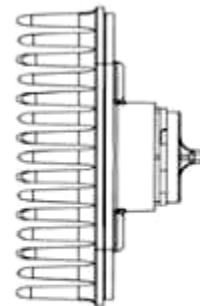

1.6

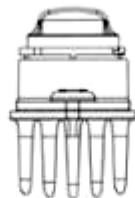

1.7

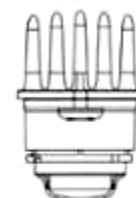

1.8

CÔNG BÁO SỞ HỮU CÔNG NGHIỆP SỐ 438 TẬP A – QUYỀN 2 (09.2024)

- (11) **51377**
(21) 3-2024-01461 (28) 1
(54) **CHI TIẾT ĐẦU VÒI SEN** (51) **23-02**
(22) 24/06/2024 (43) 25/09/2024
(30) 29/927,191 02/02/2024 US;
(73) **DELTA FAUCET COMPANY (US)**
55 E. 111th Street, Indianapolis, Indiana 46280, USA
(72) Susana Peredo-Muniz (US)
(74) Công ty TNHH Trường Xuân (AGELESS CO.,LTD.)
(55)

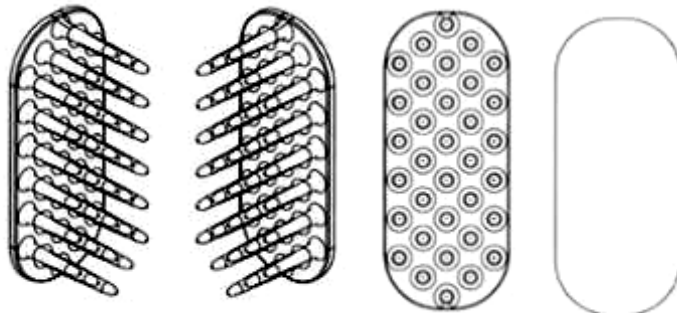

1.1

1.2

1.3

1.4

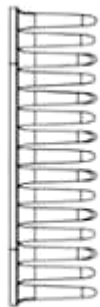

1.5



1.6

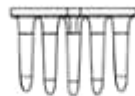

1.7

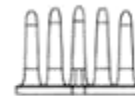

1.8

CÔNG BÁO SỞ HỮU CÔNG NGHIỆP SỐ 438 TẬP A – QUYỀN 2 (09.2024)

- (11) **51378**
(21) 3-2024-01462 (28) 1
(54) **CHI TIẾT ĐẦU VÒI SEN** (51) **23-02**
(22) 24/06/2024 (43) 25/09/2024
(30) 29/927,202 02/02/2024 US;
(73) **DELTA FAUCET COMPANY (US)**
55 E. 111th Street, Indianapolis, Indiana 46280, USA
(72) Susana Peredo-Muniz (US)
(74) Công ty TNHH Trường Xuân (AGELESS CO.,LTD.)
(55)



1.1

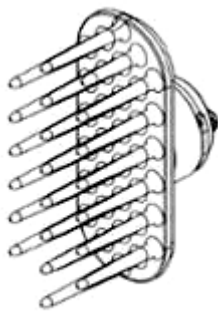

1.2



1.3

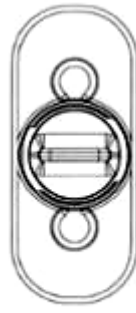

1.4

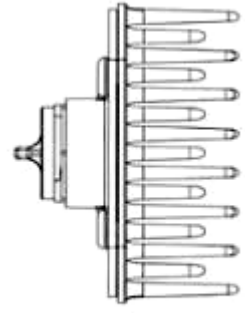

1.5

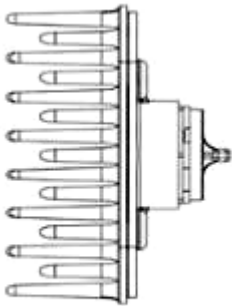

1.6

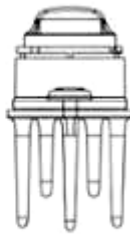

1.7

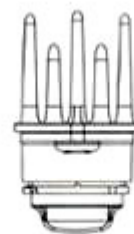

1.8

CÔNG BÁO SỞ HỮU CÔNG NGHIỆP SỐ 438 TẬP A – QUYỀN 2 (09.2024)

- (11) **51379**
(21) 3-2024-01463 (28) 1
(54) **CHI TIẾT ĐẦU VÒI SEN** (51) **23-02**
(22) 24/06/2024 (43) 25/09/2024
(30) 29/927,217 02/02/2024 US;
(73) **DELTA FAUCET COMPANY (US)**
55 E. 111th Street, Indianapolis, Indiana 46280, USA
(72) Susana Peredo-Muniz (US)
(74) Công ty TNHH Trường Xuân (AGELESS CO.,LTD.)
(55)

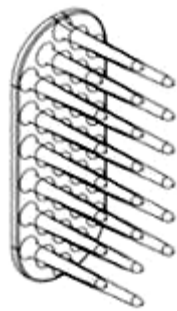

1.1

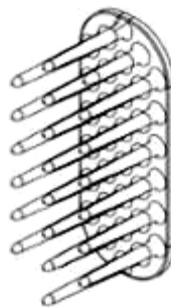

1.2



1.3



1.4

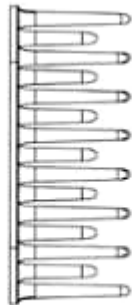

1.5



1.6



1.7

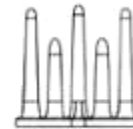

1.8

CÔNG BÁO SỞ HỮU CÔNG NGHIỆP SỐ 438 TẬP A – QUYỀN 2 (09.2024)

- (11) **51380**
(21) 3-2024-01464 (28) 1
(54) **CHI TIẾT ĐẦU VÒI SEN** (51) **23-02**
(22) 24/06/2024 (43) 25/09/2024
(30) 29/927,239 02/02/2024 US;
(73) **DELTA FAUCET COMPANY (US)**
55 E. 111th Street, Indianapolis, Indiana 46280, USA
(72) Susana Peredo-Muniz (US)
(74) Công ty TNHH Trường Xuân (AGELESS CO.,LTD.)
(55)

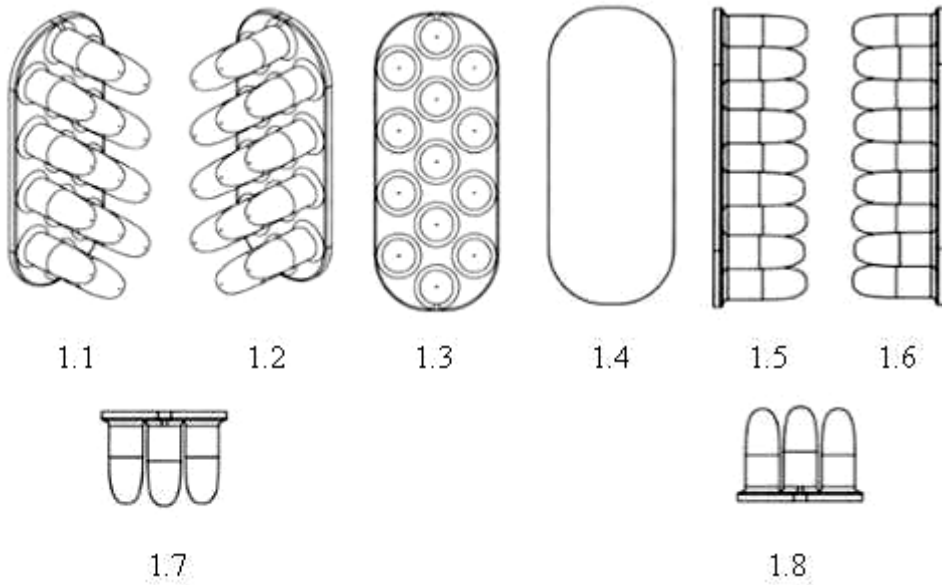

CÔNG BÁO SỞ HỮU CÔNG NGHIỆP SỐ 438 TẬP A – QUYỀN 2 (09.2024)

(11) **51381**

(21) 3-2024-01465

(28) 1

(54) **CHI TIẾT ĐẦU VÒI SEN**

(51) **23-02**

(22) 24/06/2024

(43) 25/09/2024

(30) 29/927,257 02/02/2024 US;

(73) **DELTA FAUCET COMPANY (US)**

55 E. 111th Street, Indianapolis, Indiana 46280, USA

(72) Susana Peredo-Muniz (US)

(74) Công ty TNHH Trường Xuân (AGELESS CO.,LTD.)

(55)

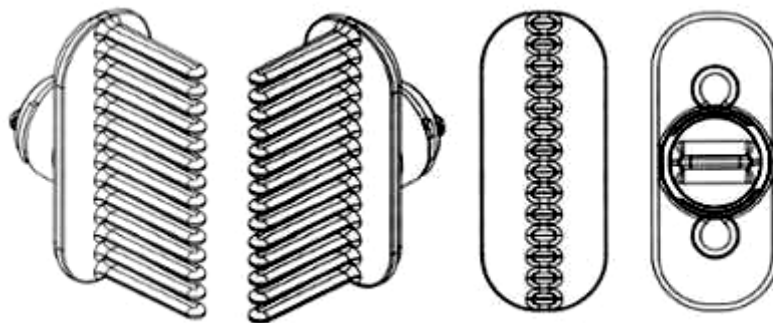

1.1

1.2

1.3

1.4

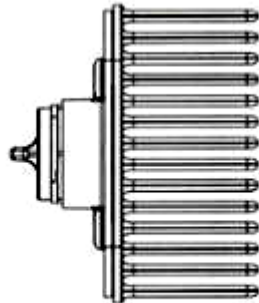

1.5

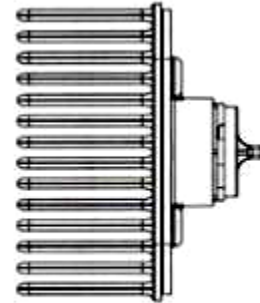

1.6

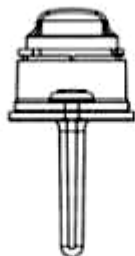

1.7

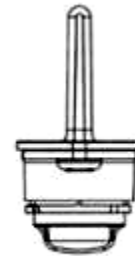

1.8

CÔNG BÁO SỞ HỮU CÔNG NGHIỆP SỐ 438 TẬP A – QUYỀN 2 (09.2024)

- (11) **51382**
(21) 3-2024-01466 (28) 1
(54) **CHI TIẾT ĐẦU VÒI SEN** (51) **23-02**
(22) 24/06/2024 (43) 25/09/2024
(30) 29/927,267 02/02/2024 US;
(73) **DELTA FAUCET COMPANY (US)**
55 E. 111th Street, Indianapolis, Indiana 46280, USA
(72) Susana Peredo-Muniz (US)
(74) Công ty TNHH Trường Xuân (AGELESS CO.,LTD.)
(55)

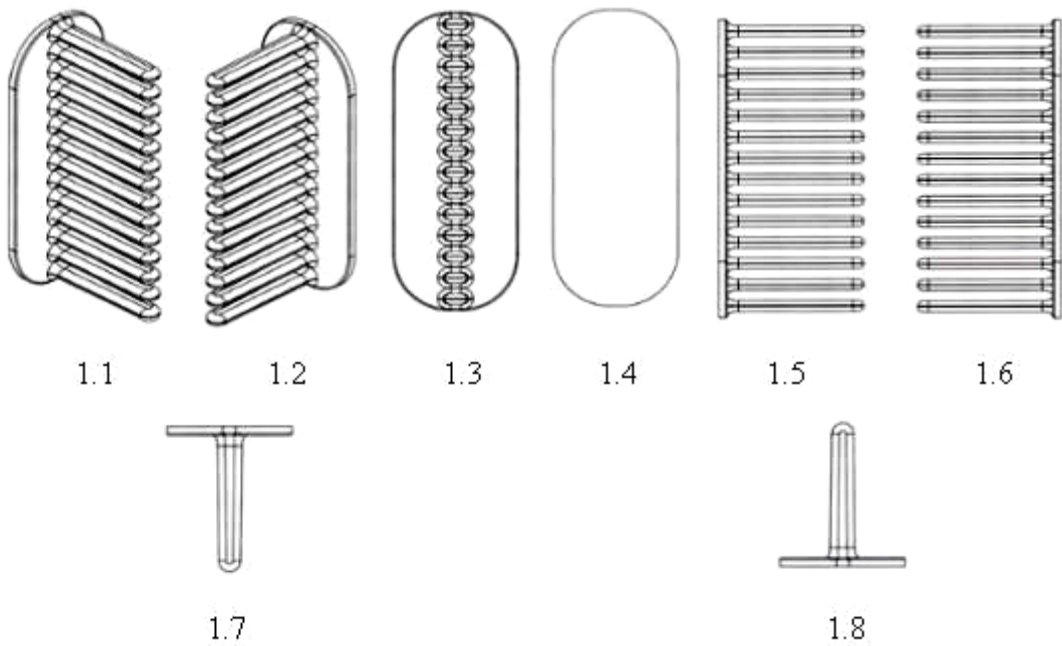

CÔNG BÁO SỞ HỮU CÔNG NGHIỆP SỐ 438 TẬP A – QUYỀN 2 (09.2024)

- (11) **51383**
(21) 3-2024-01467 (28) 1
(54) **BAO GÓI** (51) **09-05**
(22) 24/06/2024 (43) 25/09/2024
(73) **CÔNG TY CỔ PHẦN LIWAYWAY VIỆT NAM (VN)**
Số 14, đường số 05, khu công nghiệp Việt Nam - Singapore, phường Bình Hòa,
thành phố Thuận An, tỉnh Bình Dương
(72) Robert Tan Li (PH)
(74) Văn phòng Luật sư Tân Hà (VPLS TAN HA)
(55)



1.1



1.2

CÔNG BÁO SỞ HỮU CÔNG NGHIỆP SỐ 438 TẬP A – QUYỀN 2 (09.2024)

- (11) **51384**
(21) 3-2024-01470 (28) 1
(54) **CHI TIẾT ĐẦU VÒI SEN** (51) **23-02**
(22) 24/06/2024 (43) 25/09/2024
(30) 29/927,231 02/02/2024 US;
(73) **DELTA FAUCET COMPANY (US)**
55 E. 111th Street, Indianapolis, Indiana 46280, USA
(72) Susana Peredo-Muniz (US)
(74) Công ty TNHH Trường Xuân (AGELESS CO.,LTD.)
(55)

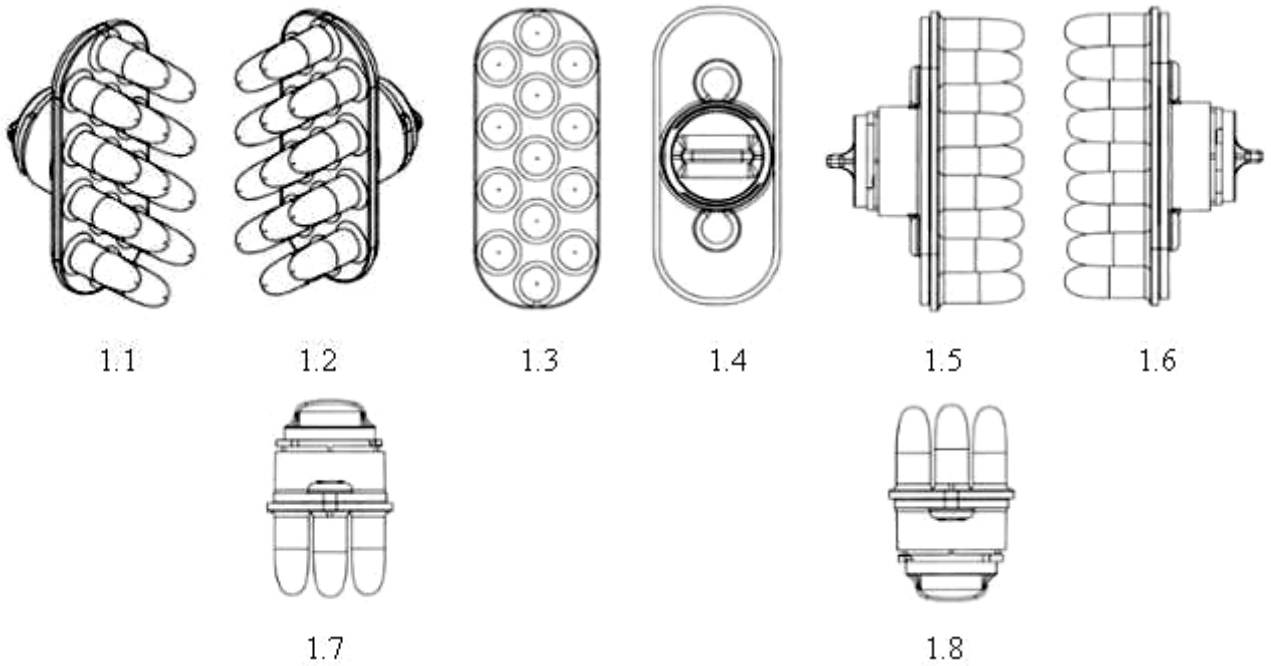

- (11) **51385**
(21) 3-2024-01478 (28) 1
(54) **CHAI** (51) **09-01**
(22) 25/06/2024 (43) 25/09/2024
(30) 2023-027151 27/12/2023 JP;
(73) **SUNTORY HOLDINGS LIMITED (JP)**
2-1-40 Dojimahama, Kita-ku, Osaka City, Osaka, Japan
(72) 1. MOTO MURAI (JP)
2. SEIYA IWAGUMA (JP)
(74) Công ty Luật TNHH Ambys Hà Nội (AMBYSS HANOI)
(55)



1.1



1.2



1.3

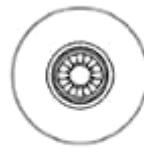

1.4



1.5



1.6



1.7

CÔNG BÁO SỞ HỮU CÔNG NGHIỆP SỐ 438 TẬP A – QUYỀN 2 (09.2024)

- (11) **51386**
- (21) 3-2024-01484 (28) 1
- (54) **QUE VỆ SINH** (51) **24-02**
- (22) 25/06/2024 (43) 25/09/2024
- (30) 2024303032070 22/05/2024 CN;
- (73) **JIALUN WANG (CN)**
Building 3, No. 189, Jinglian Road, Minhang District, Shanghai, China
- (72) Jialun Wang (CN)
- (74) Công ty TNHH Sở hữu trí tuệ Trần & Trần (TRAN & TRAN CO., LTD.)
- (55)

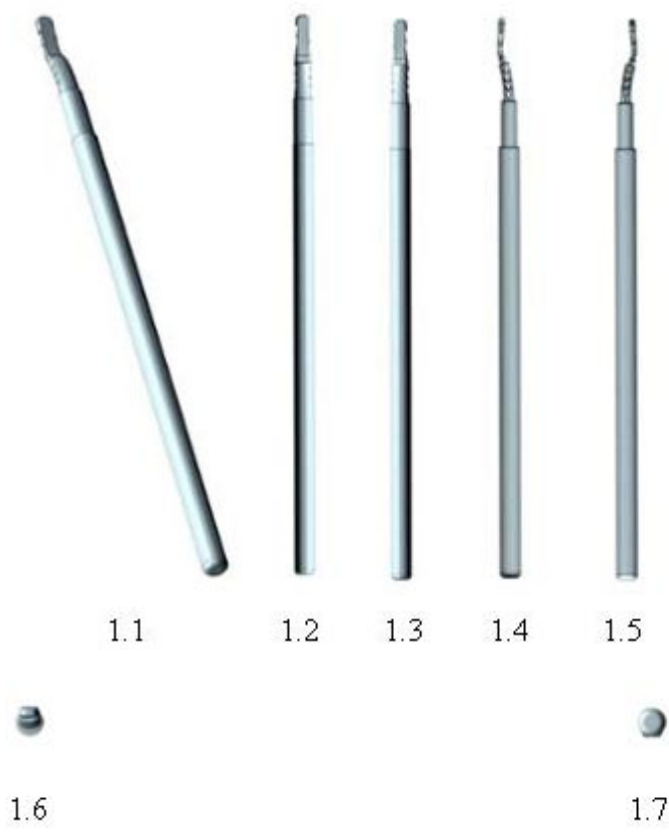

CÔNG BÁO SỞ HỮU CÔNG NGHIỆP SỐ 438 TẬP A – QUYỀN 2 (09.2024)

- (11) **51387**
(21) 3-2024-01485 (28) 1
(54) **QUE VỆ SINH** (51) **24-02**
(22) 25/06/2024 (43) 25/09/2024
(30) 2024303032028 22/05/2024 CN;
(73) **TINGWEI CUI (CN)**
Building 3, No. 189, Jinglian Road, Minhang District, Shanghai, China
(72) Tingwei Cui (CN)
(74) Công ty TNHH Sở hữu trí tuệ Trần & Trần (TRAN & TRAN CO., LTD.)
(55)



1.1 1.2 1.3 1.4 1.5



1.6



1.7

CÔNG BÁO SỞ HỮU CÔNG NGHIỆP SỐ 438 TẬP A – QUYỀN 2 (09.2024)

- (11) **51388**
(21) 3-2024-01501 (28) 1
(54) **BAO GÓI BÁNH** (51) **09-05**
(22) 27/06/2024 (43) 25/09/2024
(73) **CÔNG TY TNHH FFC GROUP VIỆT NAM (VN)**
SB01.SP01 31 Khu đô thị Vinhomes Ocean Park 1, xã Đa Tốn, huyện Gia Lâm,
thành phố Hà Nội
(72) Lê Mạnh Tường (VN)
(55)



1.3



1.1



1.2

CÔNG BÁO SỞ HỮU CÔNG NGHIỆP SỐ 438 TẬP A – QUYỀN 2 (09.2024)

- (11) **51389**
(21) 3-2024-01502 (28) 1
(54) **HỘP** (51) **09-03**
(22) 27/06/2024 (43) 25/09/2024
(73) **NGUYỄN HOÀNG THANH (VN)**
Số 11 đường D2, KDC Vườn Lài, KP2, phường An Phú Đông, quận 12, thành phố Hồ Chí Minh
(72) Nguyễn Hoàng Thanh (VN)
(74) Công ty TNHH Sở hữu trí tuệ INVENTIO (INVENTIO CO.,LTD)
(55)



1.1



1.2

CÔNG BÁO SỞ HỮU CÔNG NGHIỆP SỐ 438 TẬP A – QUYỀN 2 (09.2024)

- (11) **51390**
(21) 3-2024-01519 (28) 1
(54) **BÀN ĂN** (51) **06-03**
(22) 01/07/2024 (43) 25/09/2024
(30) 29/934,579 26/03/2024 US;
(73) **SUNCAST TECHNOLOGIES, LLC (US)**
2855 PGA Boulevard, Palm Beach Gardens, FL 33410, United States of America
(72) 1. STEPHEN WHITEHEAD (US)
2. TORRENCE ANDERSON (US)
3. ROBERT KOPP (US)
(74) Công ty TNHH Tầm nhìn và Liên danh (VISION & ASSOCIATES CO.LTD.)
(55)

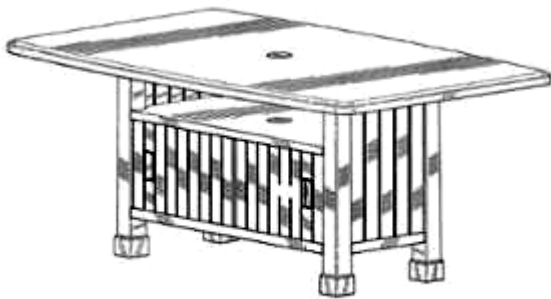

1.1



1.2

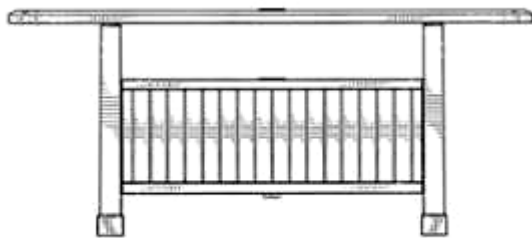

1.3

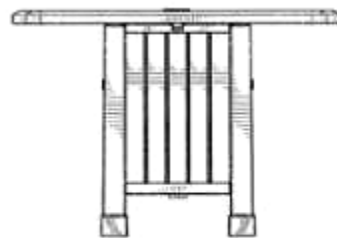

1.4

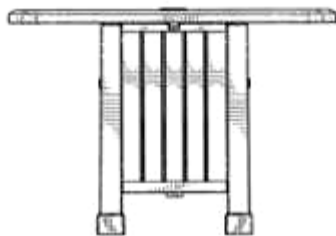

1.5

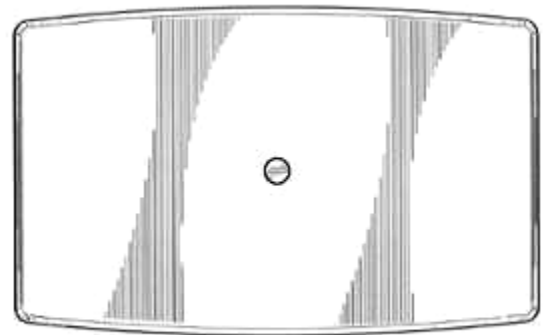

1.6

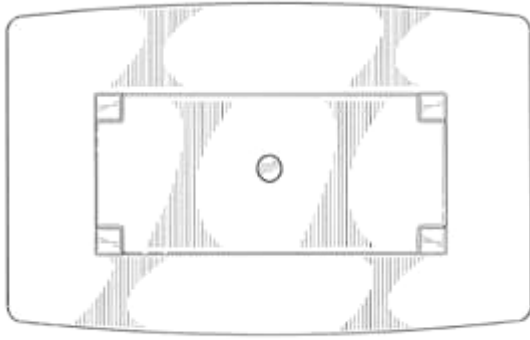

1.7

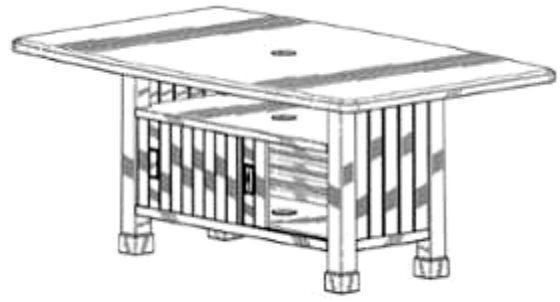

1.8

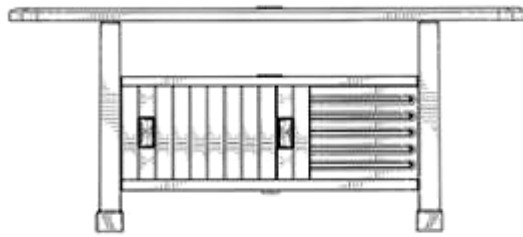

1.9

- (11) **51391**
(21) 3-2024-01520 (28) 1
(54) **THÙNG** (51) **09-02**
(22) 01/07/2024 (43) 25/09/2024
(30) 29/937,727 16/04/2024 US;
(73) **SUNCAST TECHNOLOGIES, LLC (US)**
2855 PGA Boulevard, Palm Beach Gardens, FL 33410, United States of America
(72) 1. STEPHEN WHITEHEAD (US)
2. TORRENCE ANDERSON (US)
3. ROBERT KOPP (US)
(74) Công ty TNHH Tầm nhìn và Liên danh (VISION & ASSOCIATES CO.LTD.)
(55)

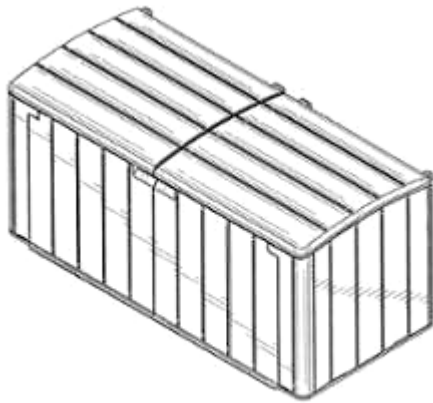

1.1



1.2

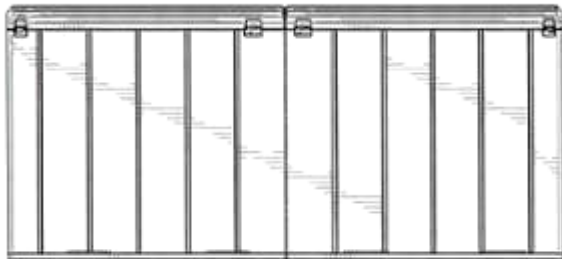

1.3



1.4



1.5



1.6

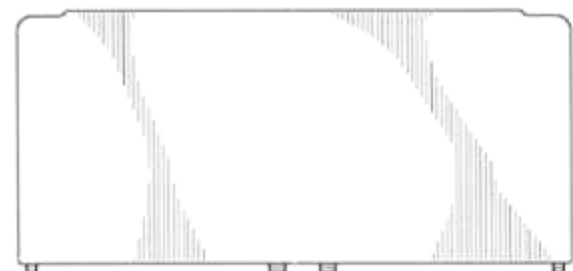

1.7

(11) **51392**

(21) 3-2024-01524

(54) **MÁY MÀI ĐAO**

(22) 01/07/2024

(73) **ĐỖ CAO THẮNG (VN)**

428/10/5 Hoàng Ngân, phường 16, quận 8, thành phố Hồ Chí Minh

(72) 1. ĐỖ CAO THẮNG (VN)

2. PHẠM THỊ BẮC (VN)

(55)

(28) 1

(51) **15-09**

(43) 25/09/2024

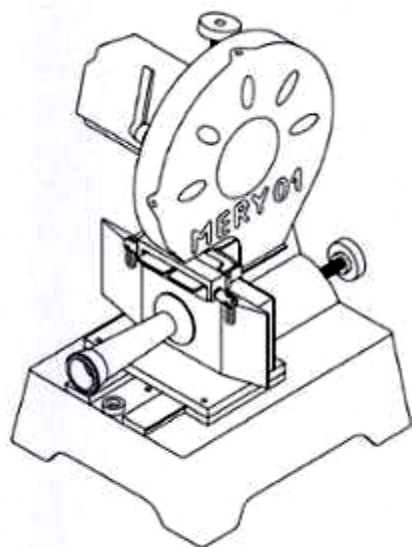

1.1

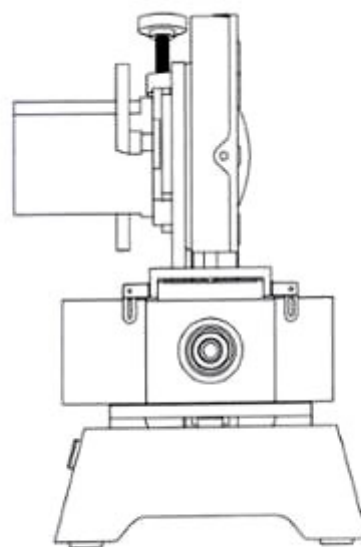

1.2

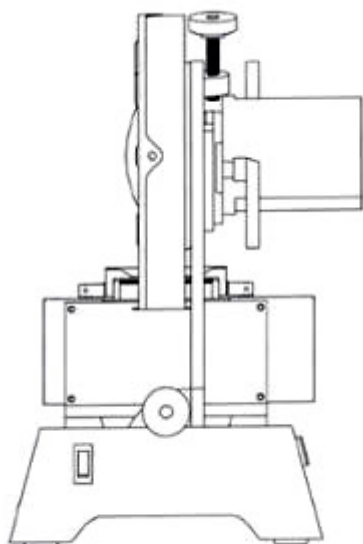

1.3

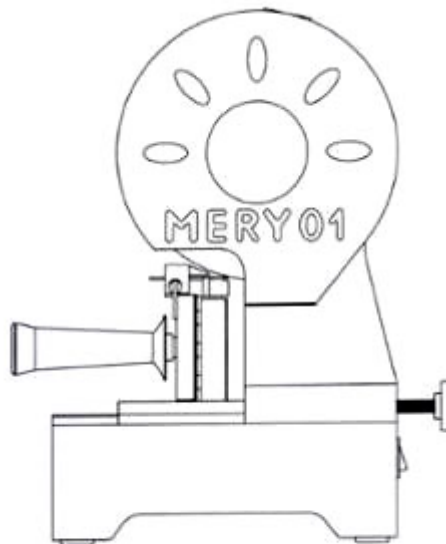

1.4

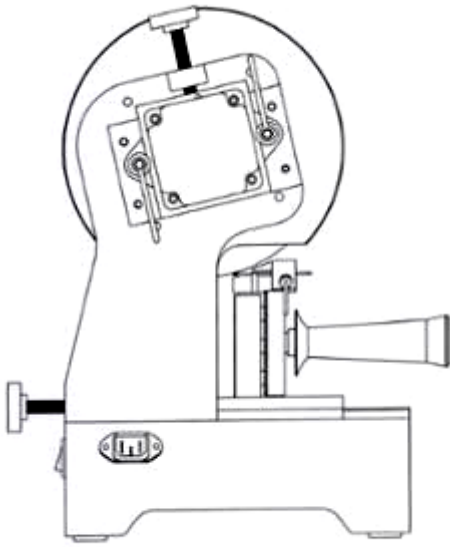

1.5

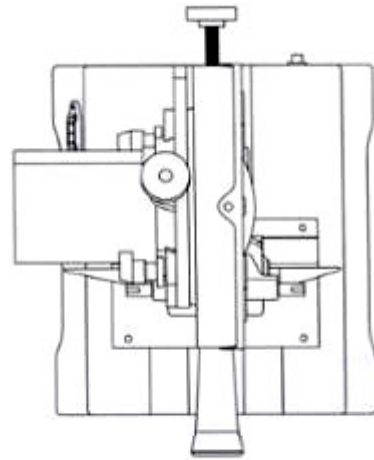

1.6

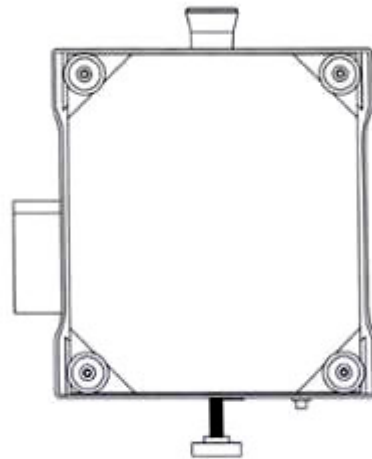

1.7

- (11) **51393**
(21) 3-2024-01528 (28) 1
(54) **THIẾT BỊ CHĂM SÓC DA** (51) **28-03**
(22) 02/07/2024 (43) 25/09/2024
(30) 2024300013400 02/01/2024 CN;
(73) **SHENZHEN JINMO TECHNOLOGY CO., LTD. (CN)**
Room 808, Building 1, Xunmei Technology Plaza, No. 8 Keyuan Road, Science and
Technology Park Community, Yuehai Street, Nanshan District, Shenzhen,
Guangdong 518000, China
(72) Jin LIU (CN)
(74) Công ty Luật TNHH Phạm và Liên danh (PHAM & ASSOCIATES)
(55)



1.1



1.2



1.3

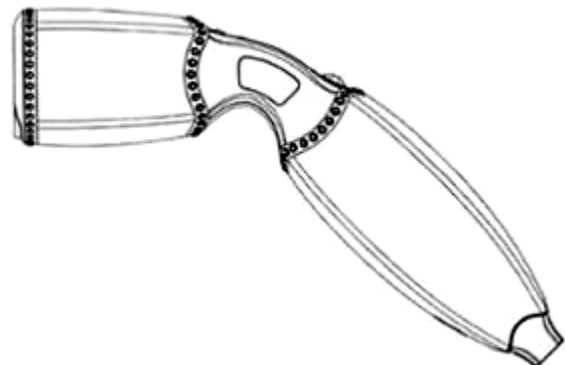

1.4



1.5



1.6



1.7

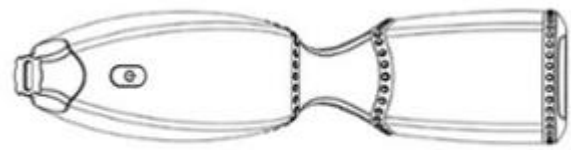

1.8

CÔNG BÁO SỞ HỮU CÔNG NGHIỆP SỐ 438 TẬP A – QUYỀN 2 (09.2024)

- (11) **51394**
(21) 3-2024-01529 (28) 1
(54) **LẤY DÙNG CHO NẮP BÌNH NƯỚC** (51) **09-07**
(22) 02/07/2024 (43) 25/09/2024
(73) **WUYI TACHISO DRINKWARE CORPORATION (CN)**
No. 20, Mudan South Road, Shenzhai Village, Baiyang Industrial Functional Zone,
Baiyang Street, Wuyi County, Jinhua City, Zhejiang Province, 321200, China
(72) Xingyu CHEN (CN)
(74) Công ty TNHH ADAstra IP (VIỆT NAM) (ADAstra IP (VIETNAM) CO.,
LTD.)
(55)



1.1



1.2



1.3



1.4



1.5



1.6



1.7

CÔNG BÁO SỞ HỮU CÔNG NGHIỆP SỐ 438 TẬP A – QUYỀN 2 (09.2024)

(11) **51395**

(21) 3-2024-01534

(28) 1

(54) **HỘP ĐỰNG**

(51) **03-01**

(22) 02/07/2024

(43) 25/09/2024

(73) **ALLSTAR HOUSEWARE LTD (CN)**

No. 29 Jiatai Road, China (Shanghai) Pilot Free Trade Zone 200131, China

(72) SONG, Xiaowei (CN)

(74) Công ty TNHH Trường Xuân (AGELESS CO.,LTD.)

(55)

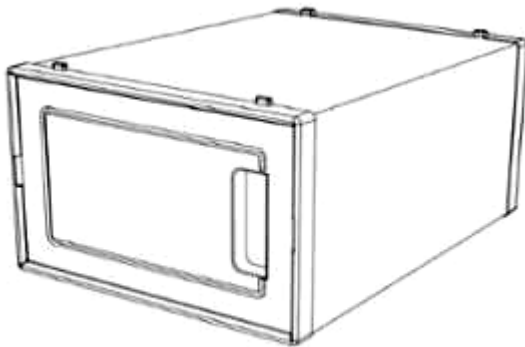

1.1

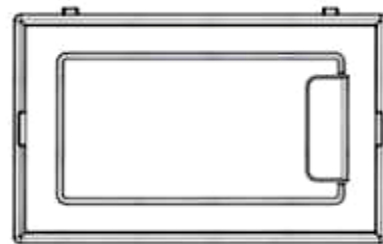

1.2

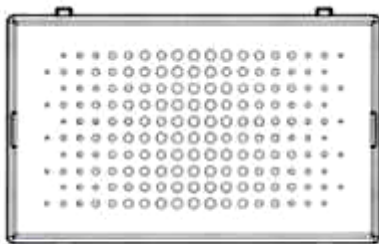

1.3



1.4



1.5

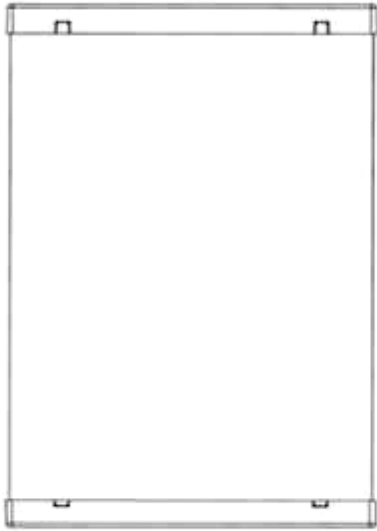

1.6

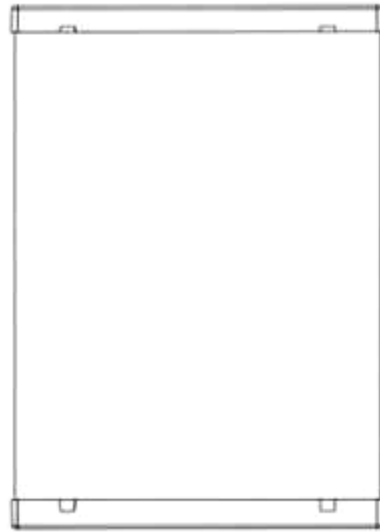

1.7

CÔNG BÁO SỞ HỮU CÔNG NGHIỆP SỐ 438 TẬP A – QUYỀN 2 (09.2024)

- (11) **51396**
(21) 3-2024-01547 (28) 1
(54) **THANH NHÔM ĐỊNH HÌNH** (51) **25-01**
(22) 03/07/2024 (43) 25/09/2024
(73) **CÔNG TY TNHH XÂY DỰNG THƯƠNG MẠI TỔNG HỢP TRUNG THÀNH (VN)**
Tiểu khu 4, thị trấn Hoàn Lão, huyện Bố Trạch, tỉnh Quảng Bình
(72) Nguyễn Trung Thành (VN)
(74) **CÔNG TY TNHH SỞ HỮU TRÍ TUỆ ANLIS VIỆT NAM (ANLIS IP CO.,LTD)**
(55)

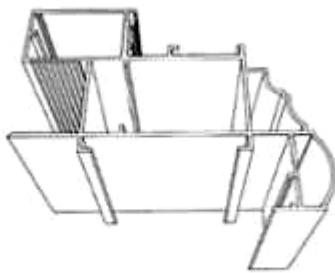

1.1

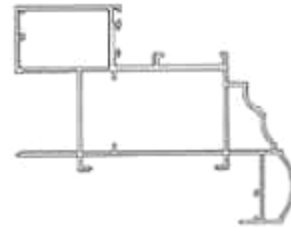

1.2



1.3



1.4



1.5



1.6

CÔNG BÁO SỞ HỮU CÔNG NGHIỆP SỐ 438 TẬP A – QUYỀN 2 (09.2024)

- (11) **51397**
(21) 3-2024-01550 (28) 1
(54) **ĐỒNG HỒ** (51) **10-02**
(22) 04/07/2024 (43) 25/09/2024
(30) DM/235303 08/01/2024 WO;
(73) **BLANCPAIN SA (CH)**
Le Rocher 12, 1348 Le Brassus, Switzerland
(72) Gregory Kissling (CH)
(74) Công ty Luật TNHH T&G (TGVN)
(55)



1.1



1.2



1.3



1.4



1.5



1.6



1.7



1.8

CÔNG BÁO SỞ HỮU CÔNG NGHIỆP SỐ 438 TẬP A – QUYỀN 2 (09.2024)

(11) **51398**

(21) 3-2024-01559

(28) 1

(54) **MÁY HÀN CHẬP**

(51) **15-09**

(22) 04/07/2024

(43) 25/09/2024

(73) **CÔNG TY TNHH MERKEL VIỆT NAM (VN)**

Lô M17, khu đô thị mới phường Đình Bảng, thành phố Từ Sơn, tỉnh Bắc Ninh

(72) Trần Văn An (VN)

(55)

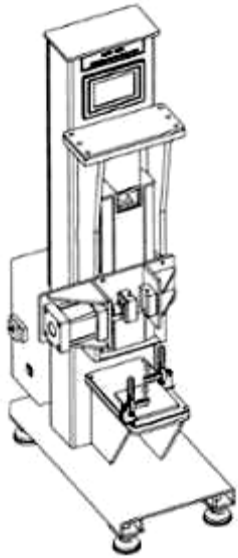

1.1

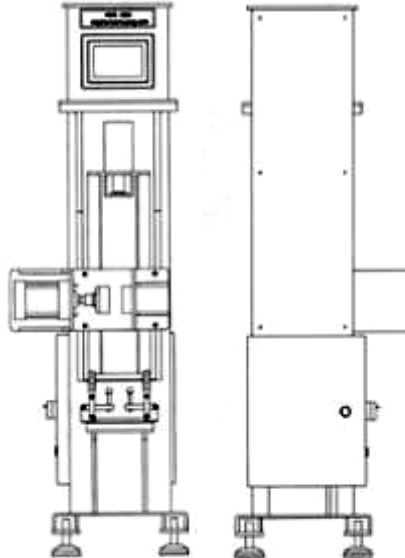

1.2

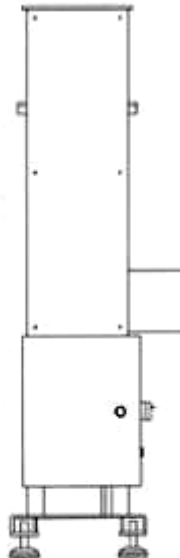

1.3

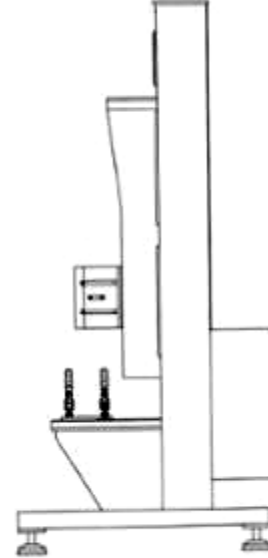

1.4

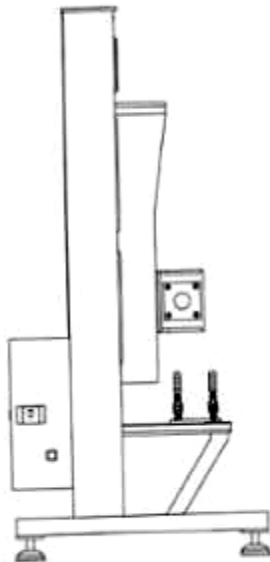

1.5

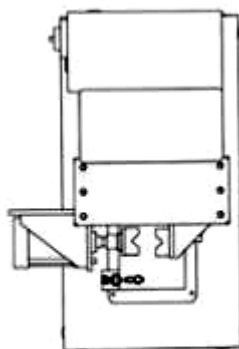

1.6

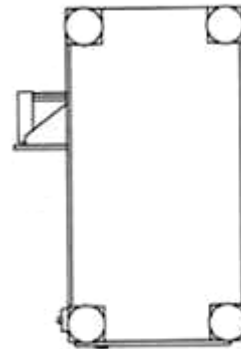

1.7

CÔNG BÁO SỞ HỮU CÔNG NGHIỆP SỐ 438 TẬP A – QUYỀN 2 (09.2024)

(11) **51399**

(21) 3-2024-01560

(28) 1

(54) **Ồ CẮM ĐIỆN**

(51) **13-03**

(22) 04/07/2024

(43) 25/09/2024

(73) **CÔNG TY TNHH THƯƠNG MẠI VÀ XUẤT NHẬP KHẨU MẠNH DŨNG (VN)**

Số 10, ngõ 202, đường Cổ Linh, phường Long Biên, quận Long Biên, thành phố Hà Nội

(72) Dương Mạnh Dũng (VN)

(55)

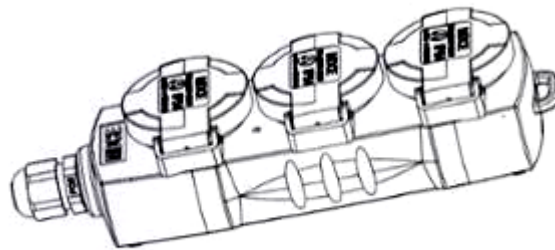

1.1

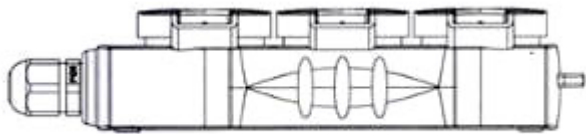

1.2

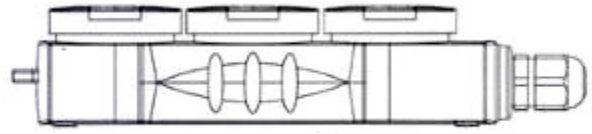

1.3

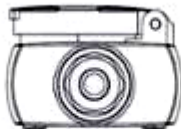

1.4

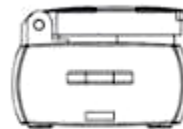

1.5

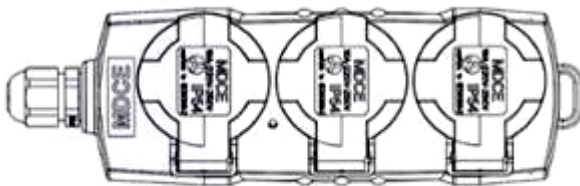

1.6

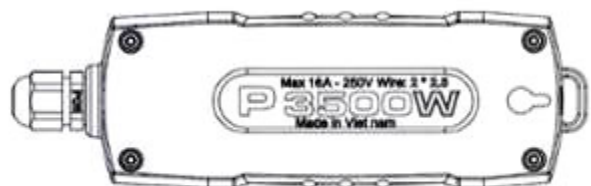

1.7

CÔNG BÁO SỞ HỮU CÔNG NGHIỆP SỐ 438 TẬP A – QUYỀN 2 (09.2024)

- (11) **51400**
(21) 3-2024-01565 (28) 1
(54) **THANH KIM LOẠI ĐỊNH HÌNH** (51) **25-01**
(22) 05/07/2024 (43) 25/09/2024
(73) **CÔNG TY CỔ PHẦN TẬP ĐOÀN KENWIN (VN)**
Tầng 4 tòa nhà VG Building, số 235 đường Nguyễn Trãi, phường Thanh Xuân
Trung, quận Thanh Xuân, thành phố Hà Nội
(72) Ngô Thọ Long (VN)
(74) Công ty TNHH Sở hữu trí tuệ PADEMARK (PADEMARK CO.,LTD.)
(55)



1.1



1.2



1.3

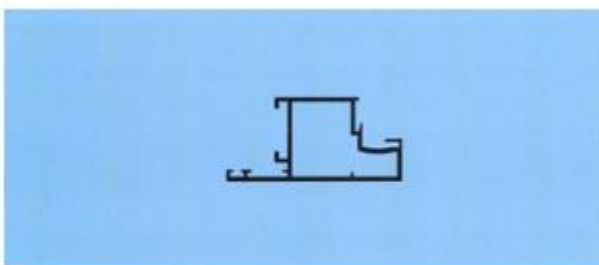

1.4

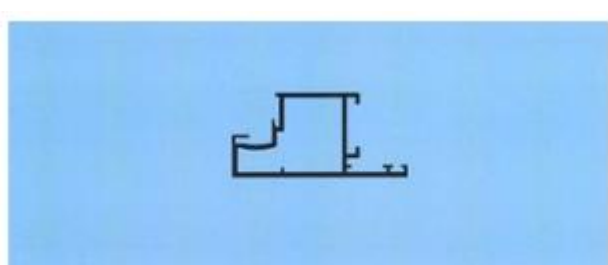

1.5



1.6



1.7

CÔNG BÁO SỞ HỮU CÔNG NGHIỆP SỐ 438 TẬP A – QUYỀN 2 (09.2024)

- (11) **51401**
(21) 3-2024-01566 (28) 1
(54) **THANH KIM LOẠI ĐỊNH HÌNH** (51) **25-01**
(22) 05/07/2024 (43) 25/09/2024
(73) **CÔNG TY CỔ PHẦN TẬP ĐOÀN KENWIN (VN)**
Tầng 4 tòa nhà VG Building, số 235 đường Nguyễn Trãi, phường Thanh Xuân
Trung, quận Thanh Xuân, thành phố Hà Nội
(72) Ngô Thọ Long (VN)
(74) Công ty TNHH Sở hữu trí tuệ PADEMARK (PADEMARK CO.,LTD.)
(55)



1.1



1.2



1.3

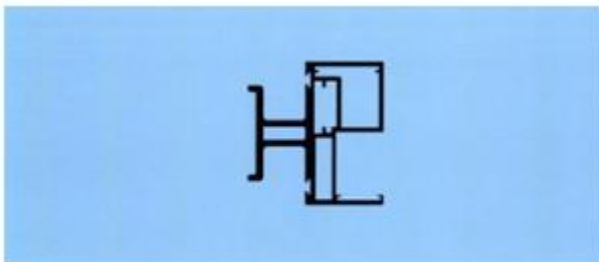

1.4

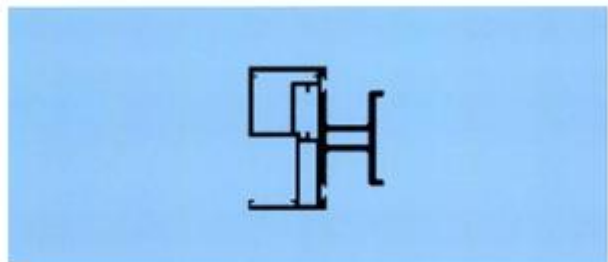

1.5

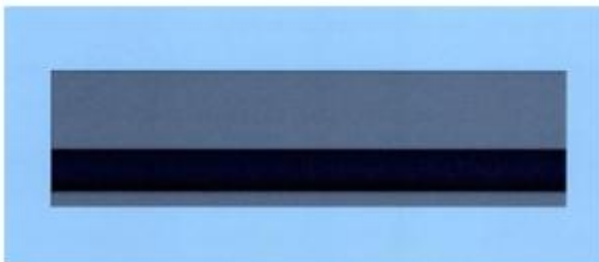

1.6



1.7

CÔNG BÁO SỞ HỮU CÔNG NGHIỆP SỐ 438 TẬP A – QUYỀN 2 (09.2024)

(11) **51402**

(21) 3-2024-01567

(54) **THÂN BỘ TIẾT LƯU**

(22) 05/07/2024

(73) **HITACHI ASTEMO, LTD. (JP)**

2520 Takaba, Hitachinaka-shi, Ibaraki, Japan

(72) 1. KOHEI NAGASHIMA (JP)

2. AKIHIRO TANNO (JP)

(74) Công ty Luật TNHH T&G (TGVN)

(55)

(28) 1

(51) **15-01**

(43) 25/09/2024

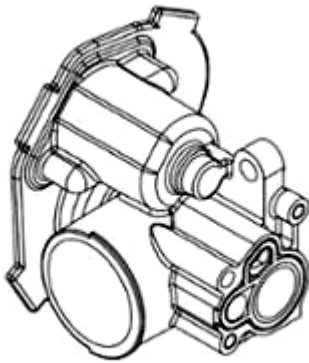

1.1

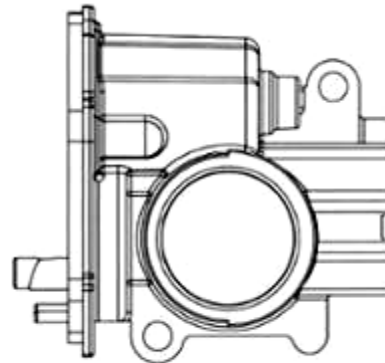

1.2

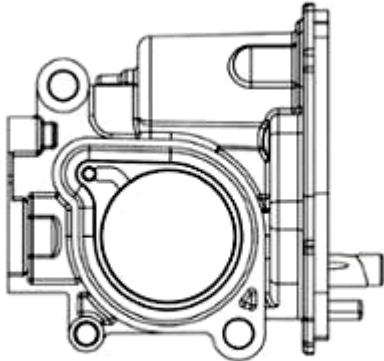

1.3

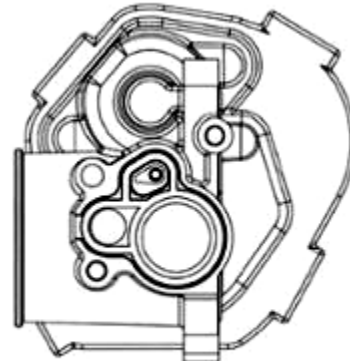

1.4

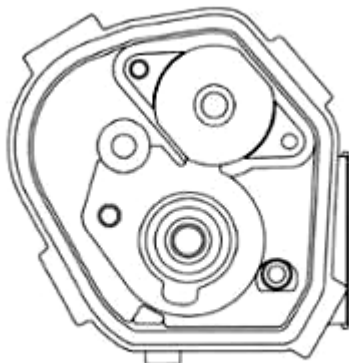

1.5

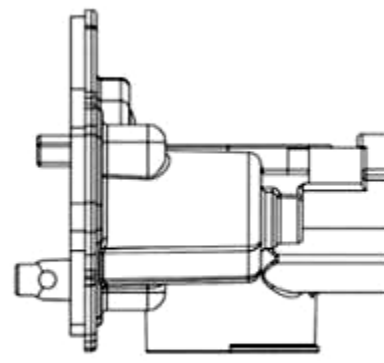

1.6

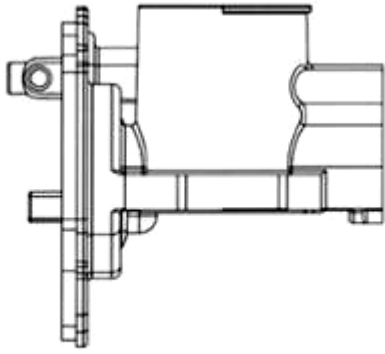

1.7

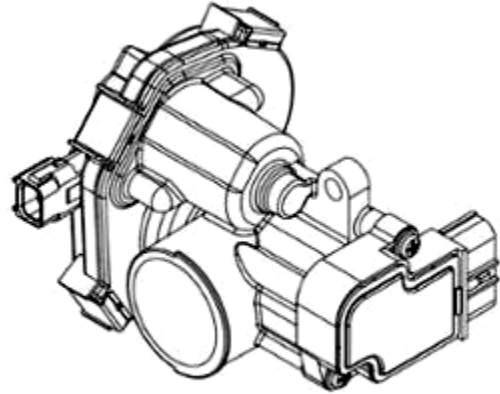

1.8

CÔNG BÁO SỞ HỮU CÔNG NGHIỆP SỐ 438 TẬP A – QUYỀN 2 (09.2024)

(11) **51403**

(21) 3-2024-01569

(28) 1

(54) **BỘ GIÁ TREO THIẾT BỊ THU PHÁT SÓNG**

(51) **14-99**

(22) 05/07/2024

(43) 25/09/2024

(73) **TẬP ĐOÀN CÔNG NGHIỆP - VIỆN THÔNG QUÂN ĐỘI (VN)**

Lô D26 Khu đô thị mới Cầu Giấy, phường Yên Hoà, quận Cầu Giấy, thành phố Hà Nội

(72) 1. NGUYỄN ĐỨC THỊNH (VN)

2. VŨ TUẤN ĐỨC (VN)

3. KHÔNG VĂN MẠNH (VN)

4. NGUYỄN ĐÌNH DƯƠNG (VN)

5. ĐÌNH VĂN HẢI (VN)

(74) Công ty TNHH NACILAW (NACILAW)

(55)



1.1

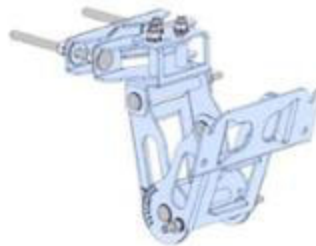

1.2



1.3

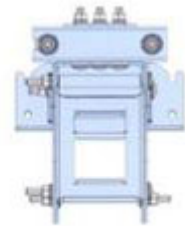

1.4

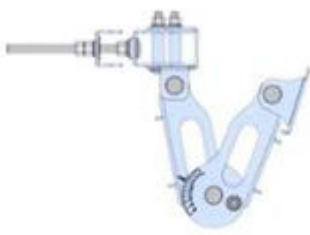

1.5

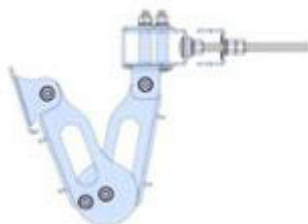

1.6

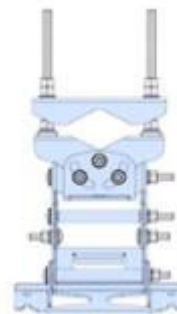

1.7



1.8



1.9

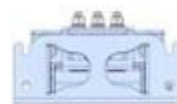

1.10



1.11

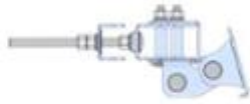

1.12

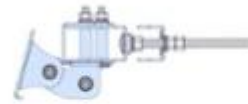

1.13



1.14



1.15

CÔNG BÁO SỞ HỮU CÔNG NGHIỆP SỐ 438 TẬP A – QUYỀN 2 (09.2024)

- (11) **51404**
(21) 3-2024-01572 (28) 1
(54) **THIẾT BỊ THU PHÁT VÔ TUYẾN** (51) **14-03**
(22) 05/07/2024 (43) 25/09/2024
(73) **TẬP ĐOÀN CÔNG NGHIỆP - VIỆN THÔNG QUÂN ĐỘI (VN)**
Lô D26 khu đô thị mới Cầu Giấy, phường Yên Hoà, quận Cầu Giấy, thành phố Hà Nội
(72) 1. NGUYỄN VĂN HƯỚNG (VN)
2. NGUYỄN CHÍ LINH (VN)
3. KHÔNG VĂN MẠNH (VN)
4. ĐÌNH VĂN HẢI (VN)
5. NGUYỄN QUỐC HÙNG (VN)
6. NGUYỄN ĐÌNH DƯƠNG (VN)
(74) Công ty TNHH NACILAW (NACILAW)
(55)



1.1

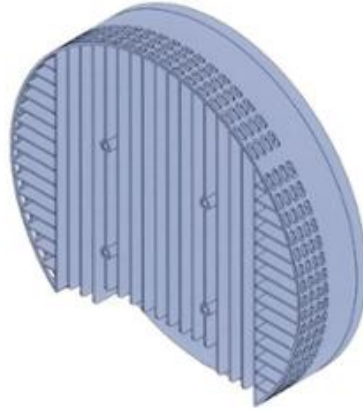

1.2

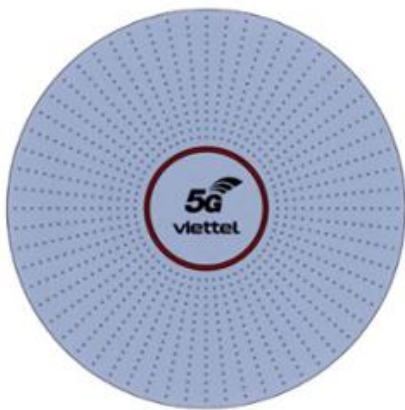

1.3

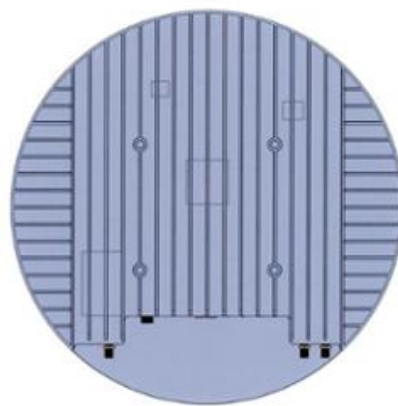

1.4

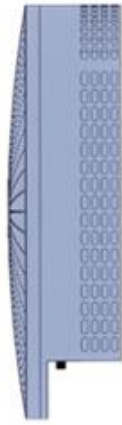

1.5



1.6

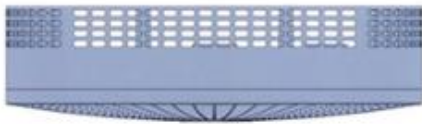

1.7



1.8

CÔNG BÁO SỞ HỮU CÔNG NGHIỆP SỐ 438 TẬP A – QUYỀN 2 (09.2024)

- (11) **51405**
(21) 3-2024-01574 (28) 1
(54) **CHAI** (51) **09-01**
(22) 05/07/2024 (43) 25/09/2024
(73) **CÔNG TY TNHH NOBLE STARS (VN)**
Số 14 đường Kênh Nước Đen, phường Bình Hưng Hòa A, quận Bình Tân, thành phố Hồ Chí Minh
(72) Nguyễn Thị Thanh Thủy (VN)
(55)



1.1



1.2



1.3



1.4



1.5

CÔNG BÁO SỞ HỮU CÔNG NGHIỆP SỐ 438 TẬP A – QUYỀN 2 (09.2024)

- (11) **51406**
- (21) 3-2024-01575 (28) 1
- (54) **THUỐC LÁ ĐIỆN TỬ** (51) **27-02**
- (22) 08/07/2024 (43) 25/09/2024
- (30) 202430069972.0 01/02/2024 CN;
- (73) **HG INNOVATION LIMITED (CN)**
Flat/Rm 06, 23/F, The Metropolis Tower, 10 Metropolis Drive, Hung Hom,
Kowloon, Hong Kong, China
- (72) LEI KING HO (CN)
- (74) Công ty TNHH Trà và cộng sự (TRA & ASSOCIATES CO.,LTD)
- (55)

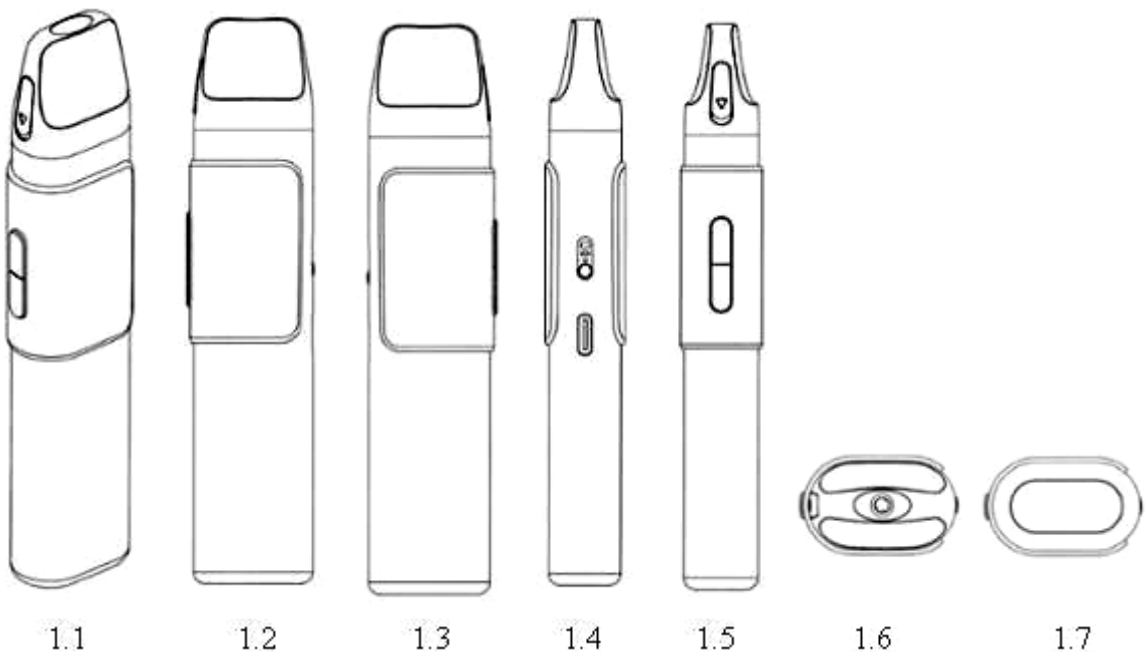

1.8

CÔNG BÁO SỞ HỮU CÔNG NGHIỆP SỐ 438 TẬP A – QUYỀN 2 (09.2024)

- (11) **51407**
(21) 3-2024-01576 (28) 1
(54) **CẤU KIỆN VÒNG BÍT KÍN DÙNG CHO GHẾ VỆ SINH** (51) **23-02**
(22) 09/07/2024 (43) 25/09/2024
(73) **YONGYUAN HONG (CN)**
Hongshanbing Community, Hongwen Village, Siming District, Xiamen, Fujian, China
(72) Yongyuan Hong (CN)
(74) **CÔNG TY TRÁCH NHIỆM HỮU HẠN TƯ VẤN ĐẦU TƯ VÀ SỞ HỮU TRÍ TUỆ INTERFIVE (INTERFIVE CO., LTD)**
(55)



1.1

1.2

1.3



1.4

1.5

1.6



1.7

1.8

CÔNG BÁO SỞ HỮU CÔNG NGHIỆP SỐ 438 TẬP A – QUYỀN 2 (09.2024)

- (11) **51408**
(21) 3-2024-01583 (28) 1
(54) **TÂY** (51) **19-06**
(22) 10/07/2024 (43) 25/09/2024
(73) **CÔNG TY CỔ PHẦN TẬP ĐOÀN THIÊN LONG (VN)**
Tầng 10, Sofic Tower, số 10 đường Mai Chí Thọ, phường Thủ Thiêm, thành phố Thủ Đức, thành phố Hồ Chí Minh
(72) Cô Gia Thọ (VN)
(74) Công ty TNHH Tư vấn sở hữu trí tuệ Việt (VIET IP CO.,LTD.)
(55)



1.1



1.2



1.3



1.4



1.5



1.6

CÔNG BÁO SỞ HỮU CÔNG NGHIỆP SỐ 438 TẬP A – QUYỀN 2 (09.2024)

- (11) **51409**
(21) 3-2024-01585 (28) 1
(54) **TẤY** (51) **19-06**
(22) 10/07/2024 (43) 25/09/2024
(73) **CÔNG TY CỔ PHẦN TẬP ĐOÀN THIÊN LONG (VN)**
Tầng 10, Sofic Tower, số 10 đường Mai Chí Thọ, phường Thủ Thiêm, thành phố
Thủ Đức, thành phố Hồ Chí Minh
(72) Cô Gia Thọ (VN)
(74) Công ty TNHH Tư vấn sở hữu trí tuệ Việt (VIET IP CO.,LTD.)
(55)



1.1

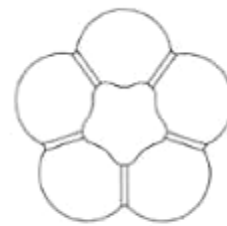

1.2



1.3



1.4

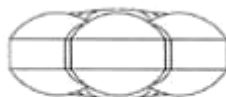

1.5



1.6

CÔNG BÁO SỞ HỮU CÔNG NGHIỆP SỐ 438 TẬP A – QUYỀN 2 (09.2024)

(11) **51410**

(21) 3-2024-01586

(28) 1

(54) **CHAI**

(51) **09-01**

(22) 10/07/2024

(43) 25/09/2024

(73) **CÔNG TY TNHH KIM LÂM (VN)**

Lô A2.CN7 - Cụm công nghiệp tập trung vừa và nhỏ Từ Liêm, phường Phương Canh, quận Nam Từ Liêm, thành phố Hà Nội

(72) **Võ Thị Liễu Trâm (VN)**

(55)

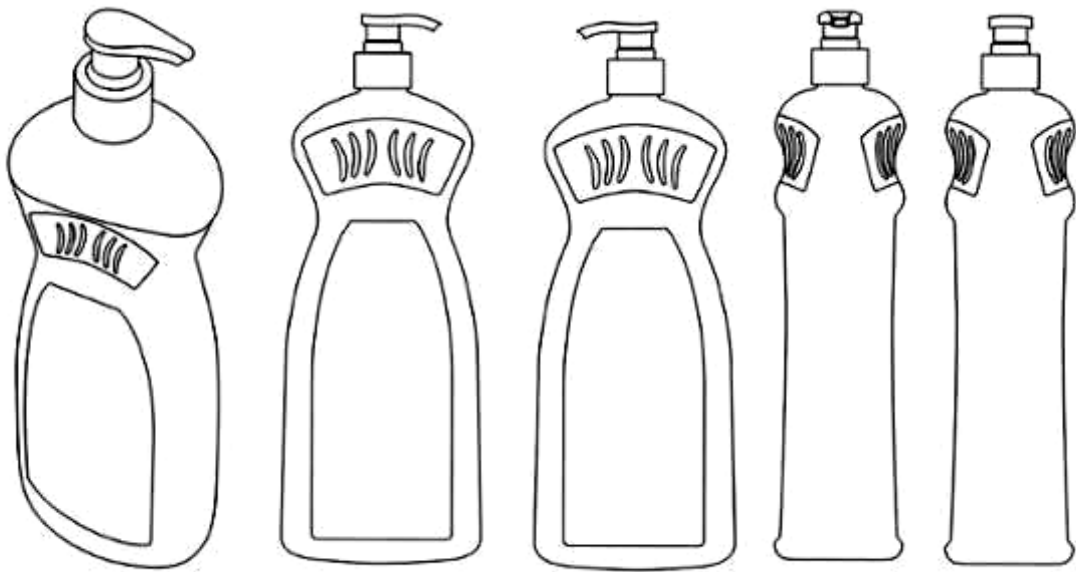

1.1

1.2

1.3

1.4

1.5

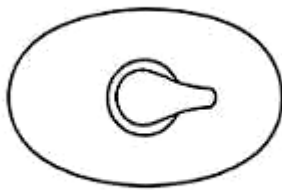

1.6



1.7

CÔNG BÁO SỞ HỮU CÔNG NGHIỆP SỐ 438 TẬP A – QUYỀN 2 (09.2024)

(11) **51411**

(21) 3-2024-01587

(28) 1

(54) **CHAI**

(51) **09-01**

(22) 10/07/2024

(43) 25/09/2024

(73) **CÔNG TY TNHH KIM LÂM (VN)**

Lô A2.CN7 - Cụm công nghiệp tập trung vừa và nhỏ Từ Liêm, phường Phương Canh, quận Nam Từ Liêm, thành phố Hà Nội

(72) Võ Thị Liễu Trâm (VN)

(55)



1.1

1.2

1.3

1.4

1.5

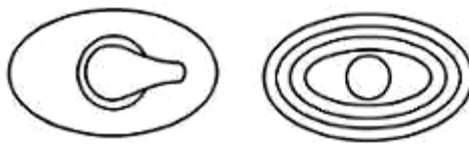

1.6

1.7

CÔNG BÁO SỞ HỮU CÔNG NGHIỆP SỐ 438 TẬP A – QUYỀN 2 (09.2024)

(11) **51412**

(21) 3-2024-01588

(28) 1

(54) **CHAI**

(51) **09-01**

(22) 10/07/2024

(43) 25/09/2024

(73) **CÔNG TY TNHH KIM LÂM (VN)**

Lô A2.CN7 - Cụm công nghiệp tập trung vừa và nhỏ Từ Liêm, phường Phương Canh, quận Nam Từ Liêm, thành phố Hà Nội

(72) **Võ Thị Liễu Trâm (VN)**

(55)

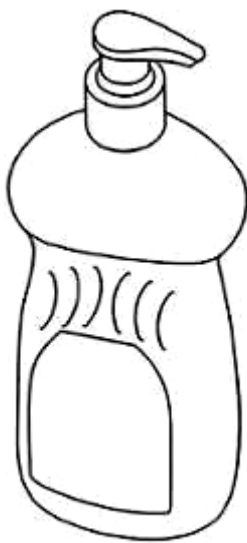

1.1

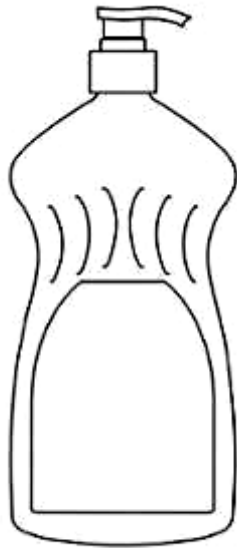

1.2

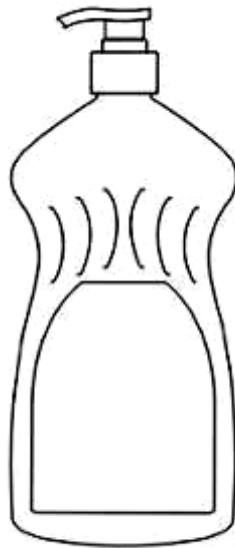

1.3



1.4



1.5

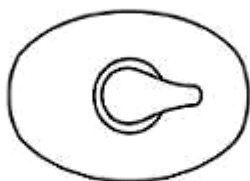

1.6



1.7

CÔNG BÁO SỞ HỮU CÔNG NGHIỆP SỐ 438 TẬP A – QUYỀN 2 (09.2024)

(11) **51413**

(21) 3-2024-01589

(28) 1

(54) **CAN**

(51) **09-02**

(22) 10/07/2024

(43) 25/09/2024

(73) **CÔNG TY TNHH KIM LÂM (VN)**

Lô A2.CN7 - Cụm công nghiệp tập trung vừa và nhỏ Từ Liêm, phường Phương Canh, quận Nam Từ Liêm, thành phố Hà Nội

(72) **Võ Thị Liễu Trâm (VN)**

(55)



1.1

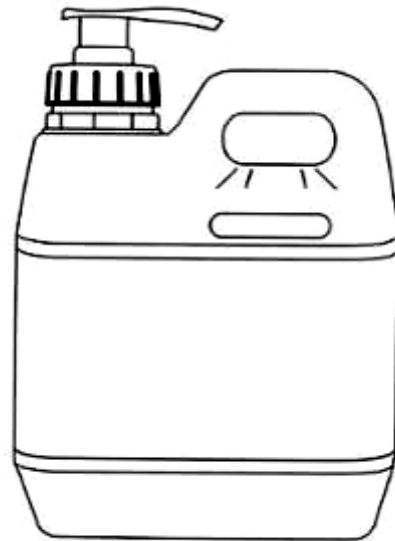

1.2



1.3



1.4



1.5

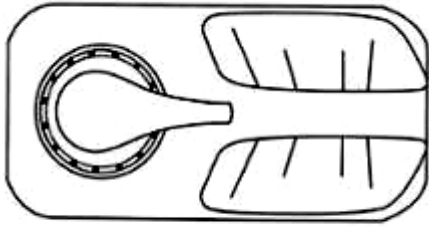

1.6

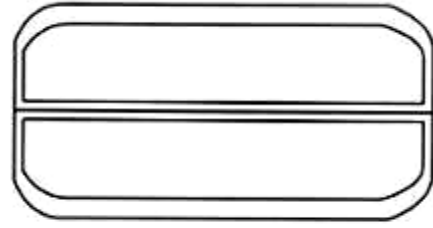

1.7

CÔNG BÁO SỞ HỮU CÔNG NGHIỆP SỐ 438 TẬP A – QUYỀN 2 (09.2024)

(11) **51414**

(21) 3-2024-01596

(28) 1

(54) **KỆP TREO LÒA CỬA KÍNH**

(51) **08-08**

(22) 11/07/2024

(43) 25/09/2024

(73) **CÔNG TY TNHH SGD VIỆT NAM (VN)**

Số 1 ngõ 32, phố Lệ Mật, phường Việt Hưng, quận Long Biên, thành phố Hà Nội

(72) Bùi Hạnh Kiểm (VN)

(55)



1.1



1.2



1.3



1.4



1.5



1.6



1.7

- (11) **51415**
- (21) 3-2024-01601
- (54) **PIN LẠNH**
- (22) 11/07/2024
- (73) **CÔNG TY TNHH VOX COOL (VN)**
103 Trần Quý Khoách, tổ 78, phường Hòa Minh, quận Liên Chiểu, thành phố Đà Nẵng
- (72) 1. LÊ XUÂN KHOA (VN)
2. NGUYỄN PHÚ SINH (VN)
- (74) Công ty Luật TNHH quốc tế BMVN (BMVN INTERNATIONAL LLC)
- (55)

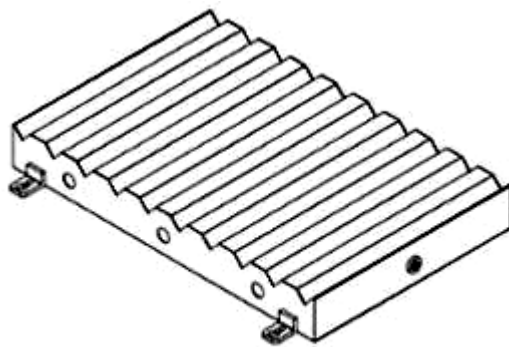

1.1

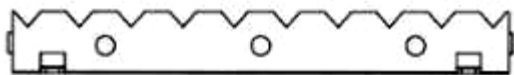

1.2

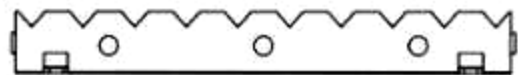

1.3

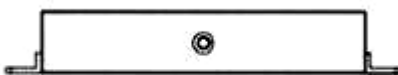

1.4

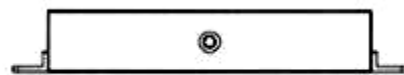

1.5

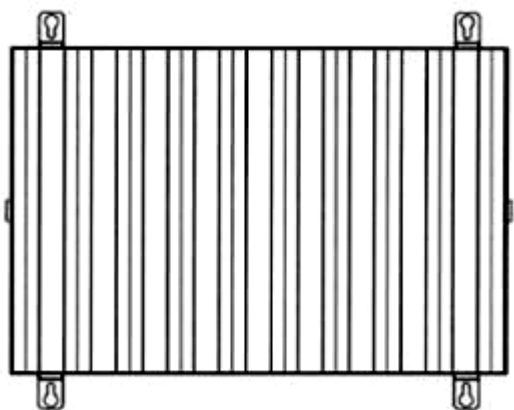

1.6

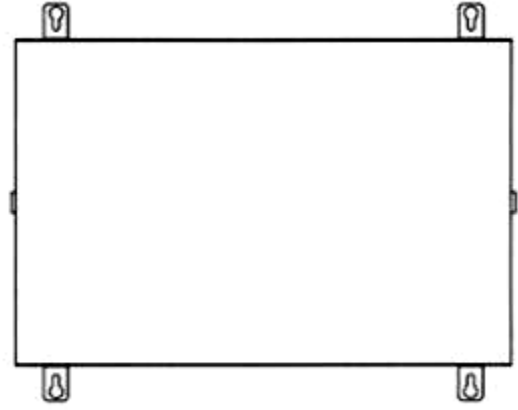

1.7

CÔNG BÁO SỞ HỮU CÔNG NGHIỆP SỐ 438 TẬP A – QUYỀN 2 (09.2024)

- (11) **51416**
(21) 3-2024-01613 (28) 1
(54) **TẤM ỐP GÓC DÙNG CHO CỬA NHÔM KÍNH** (51) **25-01**
(22) 12/07/2024 (43) 25/09/2024
(73) **CÔNG TY CỔ PHẦN ĐẦU TƯ VÀ THƯƠNG MẠI QUEENVIET (VN)**
Tầng 1, số 530 đường Trường Chinh, phường Ngã Tư Sở, quận Đống Đa, thành phố Hà Nội
(72) Nguyễn Mạnh Cường (VN)
(74) Công ty Luật TNHH SMARTLAW (SMARTLAW LEGAL SERVICE CO.,LTD.)
(55)

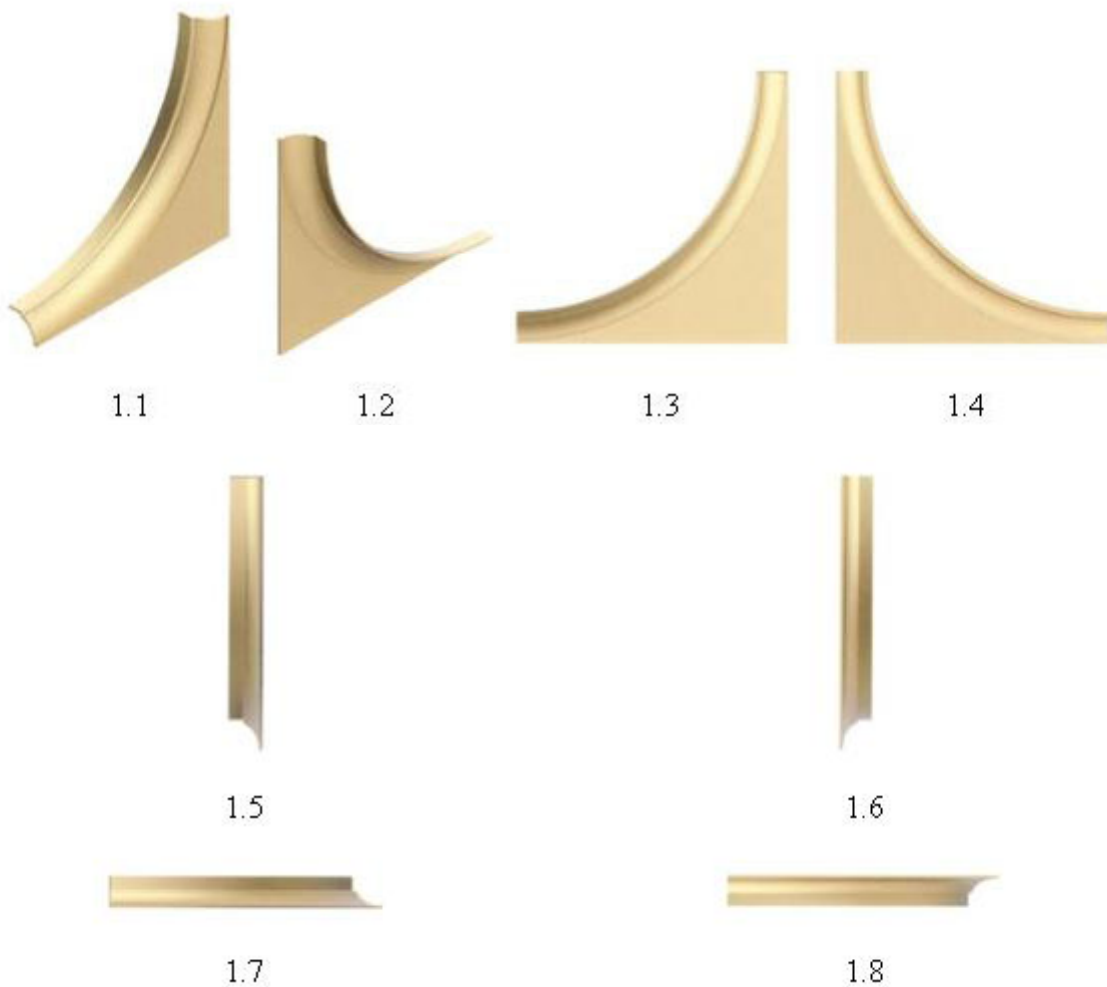

CÔNG BÁO SỞ HỮU CÔNG NGHIỆP SỐ 438 TẬP A – QUYỀN 2 (09.2024)

- (11) **51417**
- (21) 3-2024-01617 (28) 1
- (54) **HỘP ĐỰNG THUỐC** (51) **09-03**
- (22) 15/07/2024 (43) 25/09/2024
- (73) **CÔNG TY CỔ PHẦN ASTA HEALTHCARE USA (VN)**
Lô D1, D2, D6, D7 và D8 tại KCN Hòa Hiệp 1, phường Hòa Hiệp Bắc, thị xã Đông
Hoà, tỉnh Phú Yên
- (72) Huỳnh Tấn Nam (VN)
- (74) Công ty TNHH Nam Việt và Liên danh (VIPCO)
- (55)



1.1



1.2

CÔNG BÁO SỞ HỮU CÔNG NGHIỆP SỐ 438 TẬP A – QUYỀN 2 (09.2024)

- (11) **51418**
- (21) 3-2024-01618
- (54) **HỘP ĐỰNG THUỐC**
- (22) 15/07/2024
- (73) **CÔNG TY CỔ PHẦN ASTA HEALTHCARE USA (VN)**
Lô D1, D2, D6, D7 và D8 tại KCN Hòa Hiệp 1, phường Hòa Hiệp Bắc, thị xã Đông Hoà, tỉnh Phú Yên
- (72) Huỳnh Tấn Nam (VN)
- (74) Công ty TNHH Nam Việt và Liên danh (VIPCO)
- (55)
- (28) 1
- (51) **09-03**
- (43) 25/09/2024



1.1



1.2

CÔNG BÁO SỞ HỮU CÔNG NGHIỆP SỐ 438 TẬP A – QUYỀN 2 (09.2024)

(11) **51419**

(21) 3-2024-01622

(28) 1

(54) **MŨ BẢO HIỂM**

(51) **02-03**

(22) 15/07/2024

(43) 25/09/2024

(73) **HENRY TEDJAKUSUMA (ID)**

Jalan Wuluh Blok II/3, RT/RW 009/006, Kota Bambu Utara, Palmerah Jakarta Barat 11420, Indonesia

(72) Henry Tedjakusuma (ID)

(74) Công ty TNHH Sở hữu trí tuệ HA VIP (HAVIP CO., LTD.)

(55)



1.1



1.2



1.3



1.4



1.5

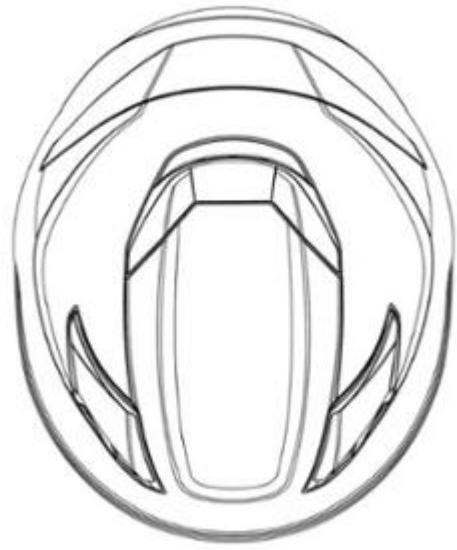

1.6



1.7

CÔNG BÁO SỞ HỮU CÔNG NGHIỆP SỐ 438 TẬP A – QUYỀN 2 (09.2024)

(11) **51420**

(21) 3-2024-01623

(28) 1

(54) **ĐUÔI GIÓ MŨ BẢO HIỂM**

(51) **02-03**

(22) 15/07/2024

(43) 25/09/2024

(73) **HENRY TEDJAKUSUMA (ID)**

Jalan Wuluh Blok II/3, RT/RW 009/006, Kota Bambu Utara, Palmerah Jakarta Barat 11420, Indonesia

(72) Henry Tedjakusuma (ID)

(74) Công ty TNHH Sở hữu trí tuệ HA VIP (HAVIP CO., LTD.)

(55)



1.1



1.2



1.3



1.4



1.5



1.6



1.7

CÔNG BÁO SỞ HỮU CÔNG NGHIỆP SỐ 438 TẬP A – QUYỀN 2 (09.2024)

- (11) **51421**
(21) 3-2024-01624 (28) 1
(54) **KÍNH MŨ BẢO HIỂM** (51) **02-03**
(22) 15/07/2024 (43) 25/09/2024
(73) **HENRY TEDJAKUSUMA (ID)**
Jalan Wuluh Blok II/3, RT/RW 009/006, Kota Bambu Utara, Palmerah Jakarta Barat 11420, Indonesia
(72) Henry Tedjakusuma (ID)
(74) Công ty TNHH Sở hữu trí tuệ HA VIP (HAVIP CO., LTD.)
(55)



1.1

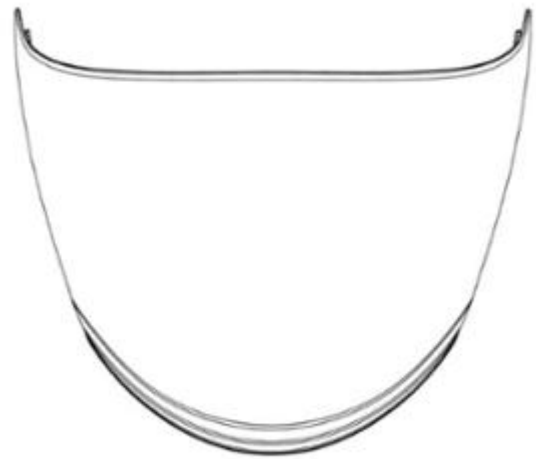

1.2

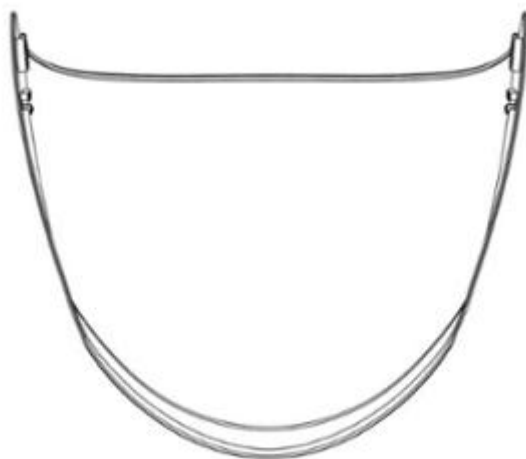

1.3



1.4

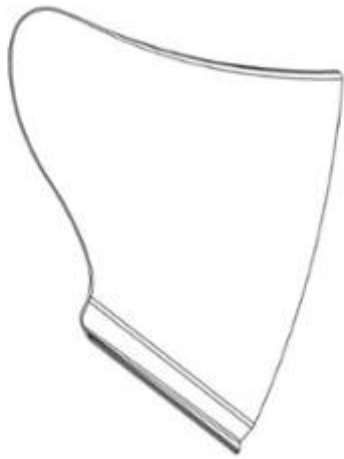

1.5



1.6



1.7

CÔNG BÁO SỞ HỮU CÔNG NGHIỆP SỐ 438 TẬP A – QUYỀN 2 (09.2024)

- (11) **51422**
- (21) 3-2024-01625 (28) 1
- (54) **MÁY BÁN THỰC PHẨM CHIÊN** (51) **20-01**
- (22) 15/07/2024 (43) 25/09/2024
- (73) **CÔNG TY CỔ PHẦN RYNAN TECHNOLOGIES VIETNAM (VN)**
Ấp Long Trị, xã Long Đức, thành phố Trà Vinh, tỉnh Trà Vinh
- (72) 1. NGUYỄN THANH MỸ (VN)
2. PHẠM THÁI BÌNH (VN)
3. ĐÀO THANH TUẤN (VN)
4. NGUYỄN HỮU CHÍ (VN)
5. NGUYỄN TRUNG HIẾU (VN)
6. THÁI THẨM (VN)
7. TÔ HUỖNH NGỌC DUY (VN)
8. TRẦN QUANG HẬU (VN)
9. TRẦN MINH TUẤN (VN)
10. ĐẶNG MINH THÀNH (VN)
11. HUỖNH HOÀNG DUY (VN)
12. LÂM QUAN THẠNH (VN)
- (74) Công ty TNHH Đại Tín và Liên Danh (DAITIN AND ASSOCIATES CO.,LTD)
- (55)

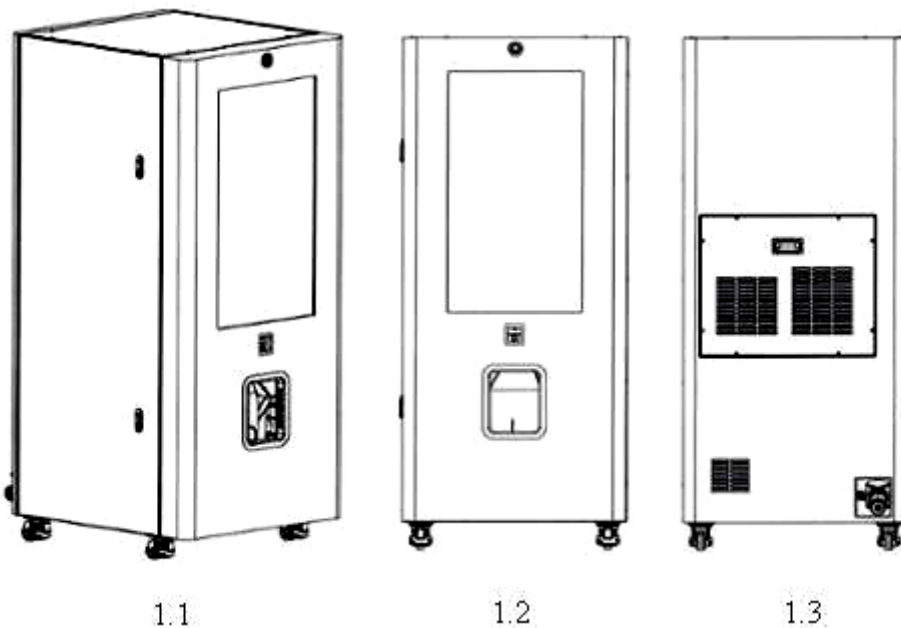

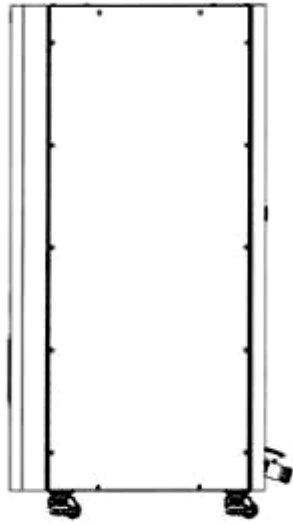

1.4

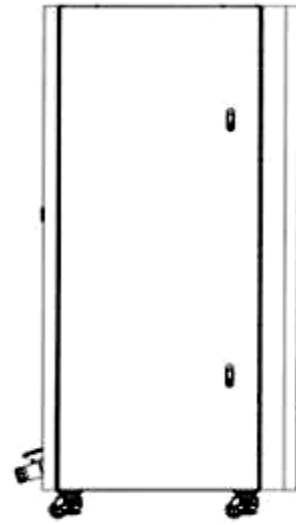

1.5

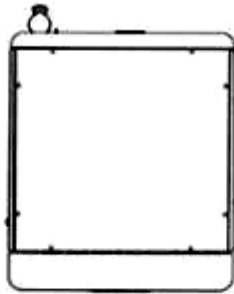

1.6

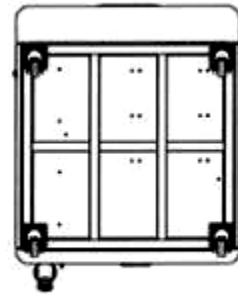

1.7

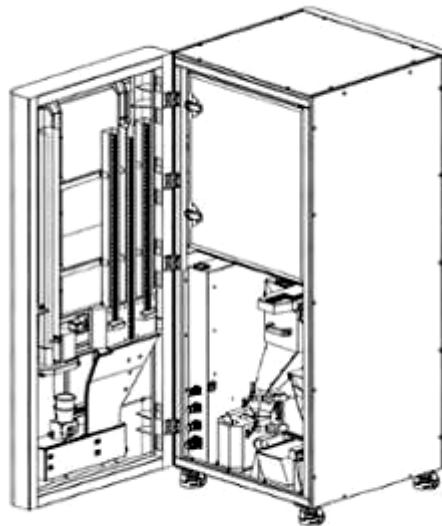

1.8

CÔNG BÁO SỞ HỮU CÔNG NGHIỆP SỐ 438 TẬP A – QUYỀN 2 (09.2024)

- (11) **51423**
(21) 3-2024-01626 (28) 1
(54) **BAO BÌ** (51) **09-05**
(22) 15/07/2024 (43) 25/09/2024
(73) **CÔNG TY TNHH VẬN TẢI PHÂN BÓN TUẤN VŨ (VN)**
134 khu 1, ấp Bảo Định, xã Xuân Định, huyện Xuân Lộc, tỉnh Đồng Nai
(72) Vũ Quốc Tuấn (VN)
(74) Công ty TNHH ASL LAW (ASL LAW CO.,LTD)
(55)

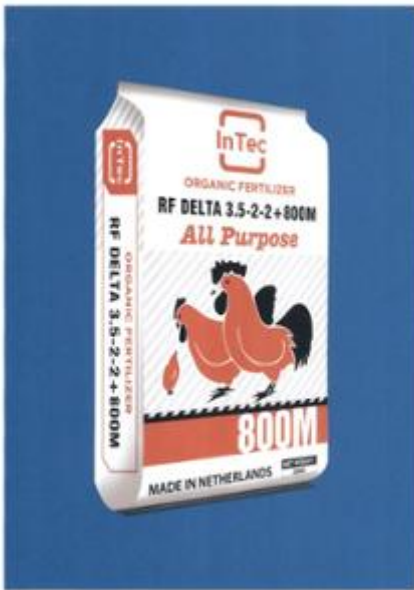

1.1



1.2

CÔNG BÁO SỞ HỮU CÔNG NGHIỆP SỐ 438 TẬP A – QUYỀN 2 (09.2024)

- (11) **51424**
(21) 3-2024-01628 (28) 1
(54) **GIOĂNG CAO SU NỆP KÍNH** (51) **25-01**
(22) 16/07/2024 (43) 25/09/2024
(73) **CÔNG TY TNHH HỆ THỐNG XÂY DỰNG CHÂU ÂU (VN)**
P1201-2, tầng 12 Keangnam Hanoi Landmark 72, khu E6, phường Mỹ Trì, quận
Nam Từ Liêm, thành phố Hà Nội
(72) **KALKAVAN SIBEL ÜLKÜ (TR)**
(74) Công ty Cổ phần Tư vấn ENCO (ENCO CONSULTANCY CORP.)
(55)



1.1



1.2



1.3



1.4



1.5

CÔNG BÁO SỞ HỮU CÔNG NGHIỆP SỐ 438 TẬP A – QUYỀN 2 (09.2024)

- (11) **51425**
(21) 3-2024-01629 (28) 1
(54) **THUỐC LÁ ĐIỆN TỬ** (51) **27-02**
(22) 16/07/2024 (43) 25/09/2024
(30) 30-2024-0002390 18/01/2024 KR;
(73) **KT & G CORPORATION (KR)**
71, Beotkkot-gil, Daedeok-gu, Daejeon 34337, Republic of Korea
(72) LEE, Han Na (KR)
(74) Công ty Luật TNHH WINCO (WINCO LAW FIRM)
(55)

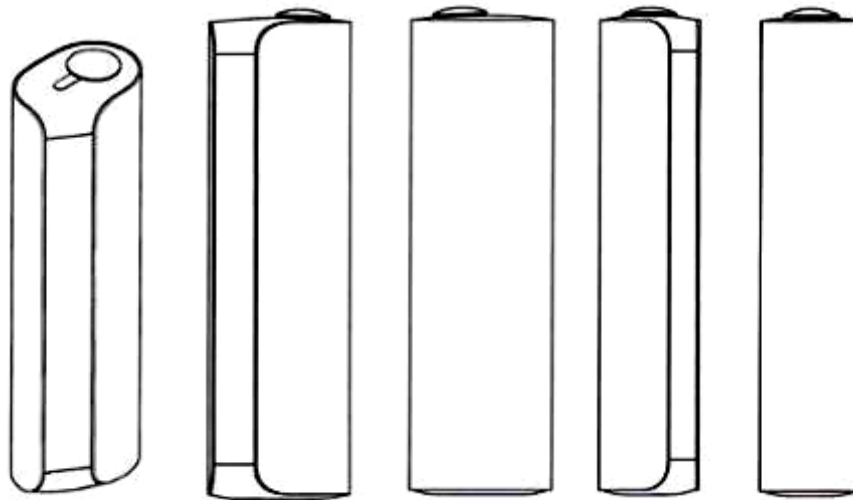

1.1

1.2

1.3

1.4

1.5

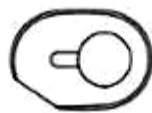

1.6



1.7

CÔNG BÁO SỞ HỮU CÔNG NGHIỆP SỐ 438 TẬP A – QUYỀN 2 (09.2024)

- (11) **51426**
- (21) 3-2024-01630 (28) 1
- (54) **THUỐC LÁ ĐIỆN TỬ** (51) **27-02**
- (22) 16/07/2024 (43) 25/09/2024
- (30) 30-2024-0002391 18/01/2024 KR;
- (73) **KT & G CORPORATION (KR)**
71, Beotkkot-gil, Daedeok-gu, Daejeon 34337, Republic of Korea
- (72) SONG, Ho Jin (KR)
- (74) Công ty Luật TNHH WINCO (WINCO LAW FIRM)
- (55)

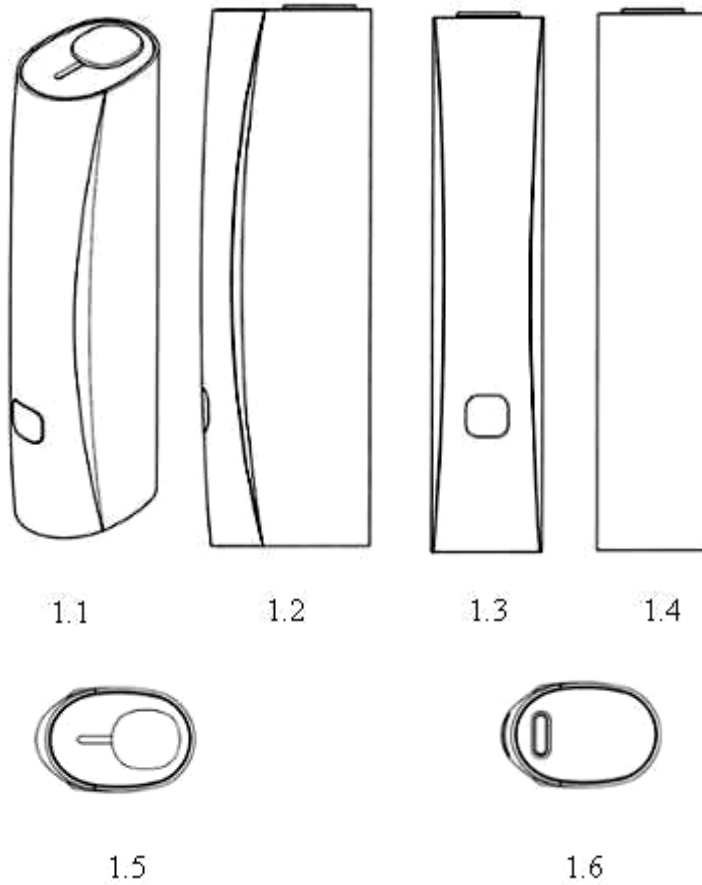

CÔNG BÁO SỞ HỮU CÔNG NGHIỆP SỐ 438 TẬP A – QUYỀN 2 (09.2024)

- (11) **51427**
(21) 3-2024-01631 (28) 1
(54) **BAO GÓI** (51) **09-05**
(22) 16/07/2024 (43) 25/09/2024
(73) **CÔNG TY TNHH SẢN XUẤT - THƯƠNG MẠI HUCAFOD (VN)**
Tổ 9, Hòa Bắc, phường Vĩnh Hòa, thành phố Nha Trang, tỉnh Khánh Hòa
(72) Nguyễn Thị Kim Dung (VN)
(55)



1.1



1.2

CÔNG BÁO SỞ HỮU CÔNG NGHIỆP SỐ 438 TẬP A – QUYỀN 2 (09.2024)

- (11) **51428**
(21) 3-2024-01632 (28) 1
(54) **BAO GÓI** (51) **09-05**
(22) 16/07/2024 (43) 25/09/2024
(73) **CÔNG TY TNHH SẢN XUẤT - THƯƠNG MẠI HUCAFOD (VN)**
Tổ 9, Hòa Bắc, phường Vĩnh Hòa, thành phố Nha Trang, tỉnh Khánh Hòa
(72) Nguyễn Thị Kim Dung (VN)
(55)



1.1



1.2

CÔNG BÁO SỞ HỮU CÔNG NGHIỆP SỐ 438 TẬP A – QUYỀN 2 (09.2024)

- (11) **51429**
(21) 3-2024-01642 (28) 1
(54) **BAO GÓI** (51) **09-05**
(22) 16/07/2024 (43) 25/09/2024
(73) **THẠCH KHÔI NGUYỄN (VN)**
2.11 Chung cư Ngô Thời Nhiệm, 78/30A Hồ Bá Phấn, phường Phước Long A,
thành phố Thủ Đức, thành phố Hồ Chí Minh
(72) Thạch Khôi Nguyễn (VN)
(74) Công ty Cổ phần Sở hữu công nghiệp INVESTIP (INVESTIP)
(55)



1.1



1.2

CÔNG BÁO SỞ HỮU CÔNG NGHIỆP SỐ 438 TẬP A – QUYỀN 2 (09.2024)

- (11) **51430**
(21) 3-2024-01646 (28) 1
(54) **GIÁ CỬA MÁY LỌC NƯỚC** (51) **23-01**
(22) 17/07/2024 (43) 25/09/2024
(73) **CÔNG TY TNHH KAROFI R&D (VN)**
Thôn Từ Hồ, xã Yên Phú, huyện Yên Mỹ, tỉnh Hưng Yên
(72) Ngô Thị Thanh Hải (VN)
(55)



1.1



1.2



1.3



1.4



1.5

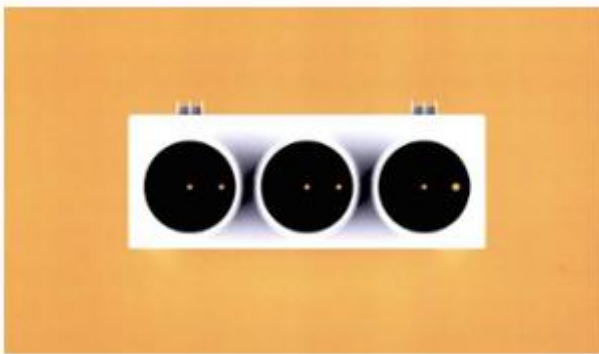

1.6

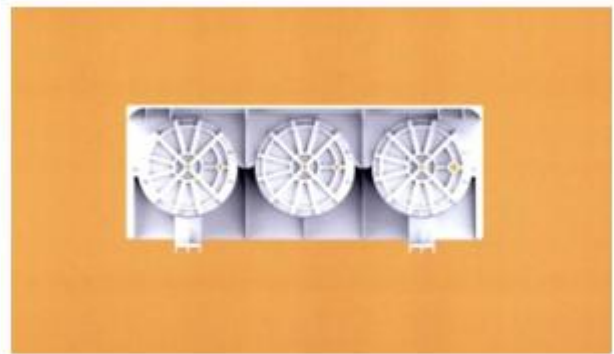

1.7

CÔNG BÁO SỞ HỮU CÔNG NGHIỆP SỐ 438 TẬP A – QUYỀN 2 (09.2024)

- (11) **51431**
(21) 3-2024-01648 (28) 1
(54) **GIÁ CỬA MÁY LỌC NƯỚC** (51) **23-01**
(22) 17/07/2024 (43) 25/09/2024
(73) **CÔNG TY TNHH KAROFI R&D (VN)**
Thôn Từ Hồ, xã Yên Phú, huyện Yên Mỹ, tỉnh Hưng Yên
(72) Ngô Thị Thanh Hải (VN)
(55)



1.1

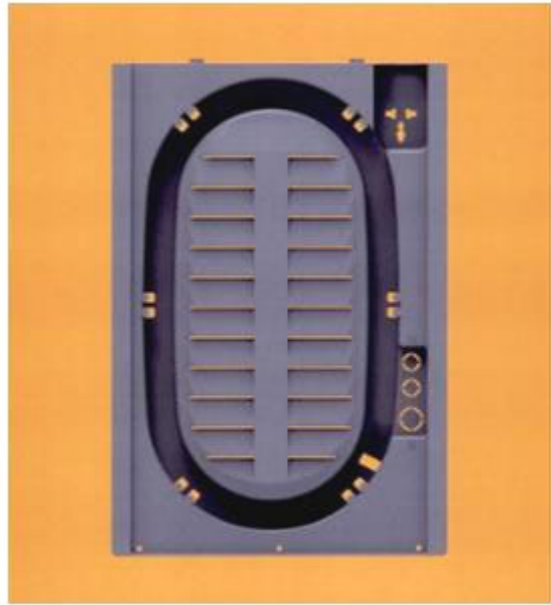

1.2



1.3



1.4



1.5

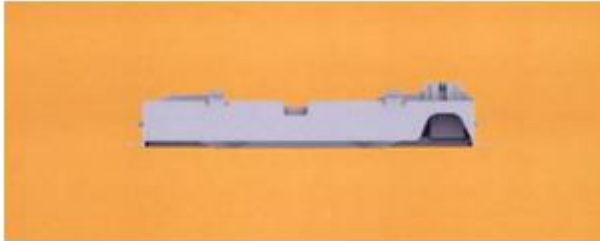

1.6



1.7

(11) **51432**

(21) 3-2024-01649

(54) **KHAY THU NƯỚC CỦA MÁY LỌC NƯỚC**

(22) 17/07/2024

(73) **CÔNG TY TNHH KAROFI R&D (VN)**

Thôn Từ Hồ, xã Yên Phú, huyện Yên Mỹ, tỉnh Hưng Yên

(72) Ngô Thị Thanh Hải (VN)

(55)

(28) 1

(51) **23-01**

(43) 25/09/2024



1.1



1.2



1.3



1.4



1.5

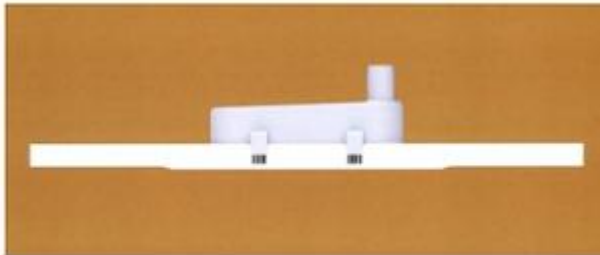

1.6



1.7

CÔNG BÁO SỞ HỮU CÔNG NGHIỆP SỐ 438 TẬP A – QUYỀN 2 (09.2024)

- (11) **51433**
(21) 3-2024-01650 (28) 1
(54) **NẮP CỦA LỖ LỌC NƯỚC** (51) **23-01**
(22) 17/07/2024 (43) 25/09/2024
(73) **CÔNG TY TNHH KAROFI R&D (VN)**
Thôn Từ Hồ, xã Yên Phú, huyện Yên Mỹ, tỉnh Hưng Yên
(72) Ngô Thị Thanh Hải (VN)
(55)



1.1

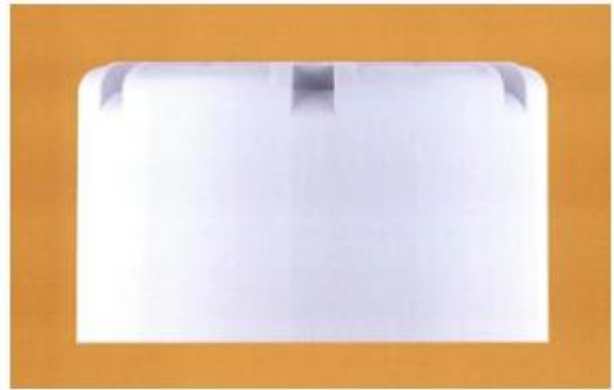

1.2



1.3



1.4



1.5



1.6



1.7

CÔNG BÁO SỞ HỮU CÔNG NGHIỆP SỐ 438 TẬP A – QUYỀN 2 (09.2024)

- (11) **51434**
- (21) 3-2024-01665 (28) 3
- (54) **HỘP ĐÓNG GÓI** (51) **09-03**
- (22) 17/07/2024 (43) 25/09/2024
- (73) **ANHUI MUENTE MEDICAL INSTRUMENT CO., LTD (CN)**
7th floor, Villa 1, BaiHui Mall, HuXin South Road, YingJiang District, AnQing,
AnHui Province, China 246000
- (72) Anlin Wang (CN)
- (74) Công ty TNHH Dịch vụ Sở hữu trí tuệ BIG5 (BIG5 IP CO.,LTD)
- (55)

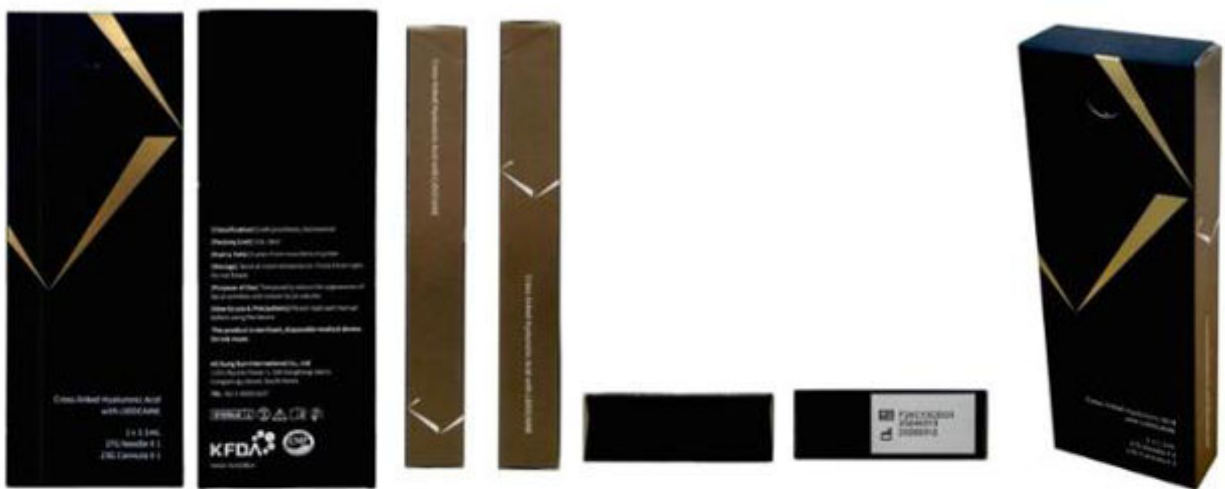

1.1 1.2 1.3 1.4 1.5 1.6 1.7

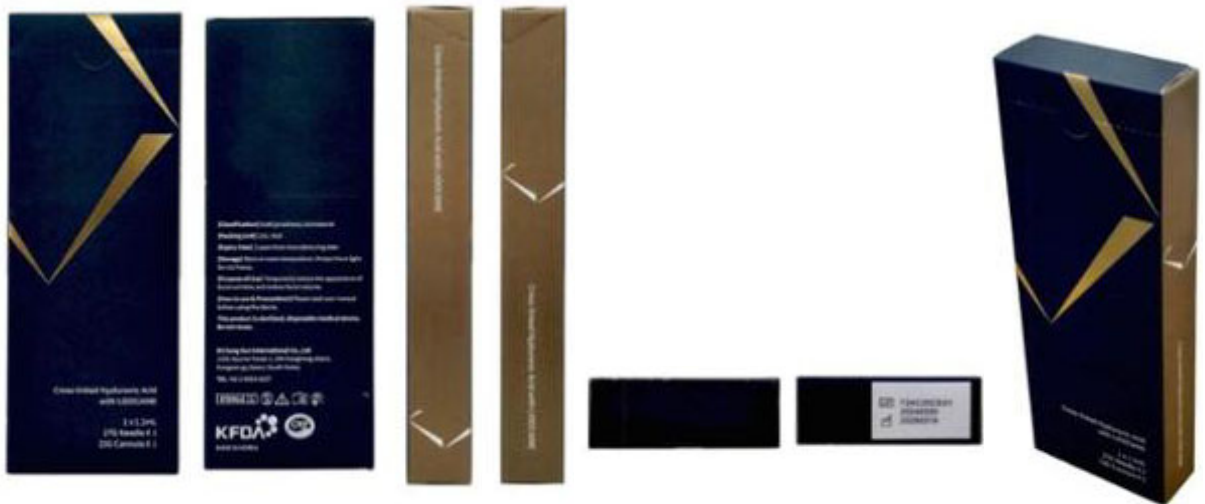

2.1 2.2 2.3 2.4 2.5 2.6 2.7



3.1

3.2

3.3

3.4

3.5

3.6

3.7

CÔNG BÁO SỞ HỮU CÔNG NGHIỆP SỐ 438 TẬP A – QUYỀN 2 (09.2024)

- (11) **51435**
- (21) 3-2024-01666
- (54) **HỘP ĐÓNG GÓI**
- (22) 17/07/2024
- (73) **ANHUI MUENTE MEDICAL INSTRUMENT CO., LTD (CN)**
7th floor, Villa 1, BaiHui Mall, HuXin South Road, YingJiang District, AnQing,
AnHui Province, China 246000
- (72) Anlin Wang (CN)
- (74) Công ty TNHH Dịch vụ Sở hữu trí tuệ BIG5 (BIG5 IP CO.,LTD)
- (55)



1.1



1.2



1.3



1.4



1.5



1.6

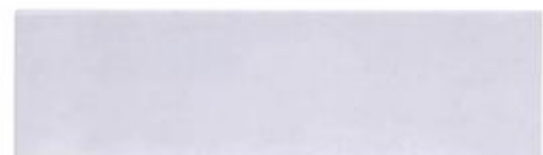

1.7

CÔNG BÁO SỞ HỮU CÔNG NGHIỆP SỐ 438 TẬP A – QUYỀN 2 (09.2024)

- (11) **51436**
(21) 3-2024-01667 (28) 1
(54) **LỚP XE** (51) **12-15**
(22) 17/07/2024 (43) 25/09/2024
(30) 407083-001 09/02/2024 IN;
(73) **CEAT LIMITED (IN)**
RPG House, 463, Dr. Annie Besant Road, Worli, Mumbai, 400030, India
(72) Ajaykumar Parmar (IN)
(74) Công ty TNHH Dịch vụ Sở hữu trí tuệ KASS Việt Nam (KASS VIETNAM CO.,LTD.)
(55)



1.1



1.2



1.3

CÔNG BÁO SỞ HỮU CÔNG NGHIỆP SỐ 438 TẬP A – QUYỀN 2 (09.2024)

- (11) **51437**
(21) 3-2024-01668 (28) 3
(54) **ĐỒ CHỨA MỸ PHẨM** (51) **09-01**
(22) 17/07/2024 (43) 25/09/2024
(73) **ZERO TO SEVEN INC. (KR)**
(Sangam-Dong, YTN-Newsquare), 17F/18F, 76 Sangamsan-Ro, Mapo-Gu, Seoul
03926, Republic of Korea
(72) Lee HyunJoo (KR)
(74) Công ty Luật TNHH ROUSE Việt Nam (ROUSE LEGAL VIETNAM LTD.)
(55)



1.1



1.2



1.3



1.4



1.5

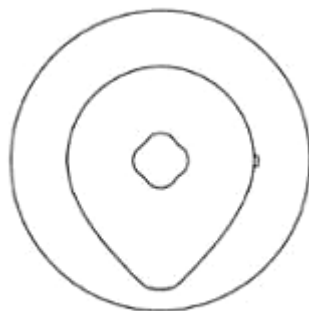

1.6

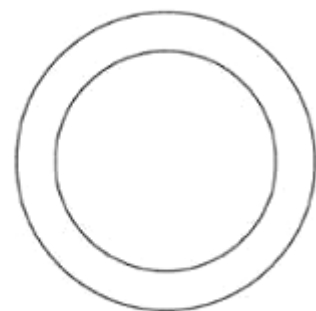

1.7



2.1



2.2

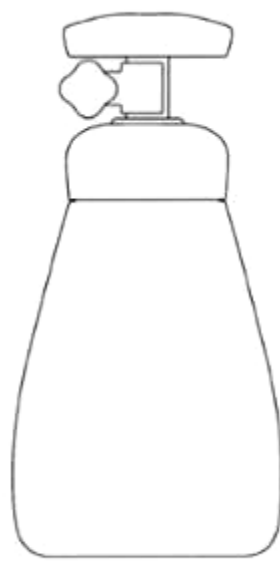

2.3



2.4



2.5

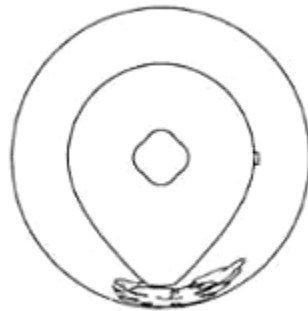

2.6

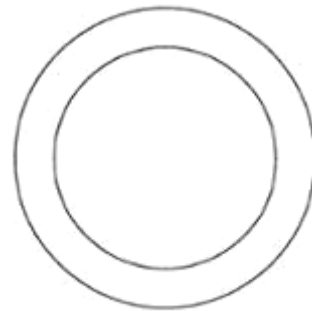

2.7



3.1



3.2



3.3

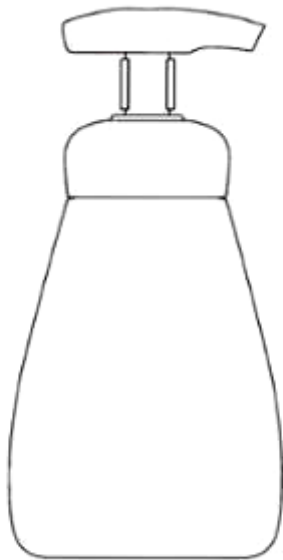

3.4



3.5

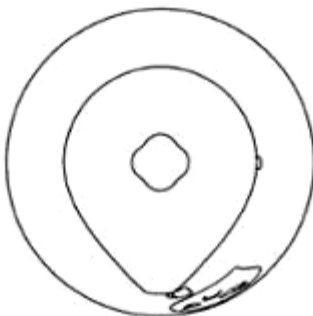

3.6

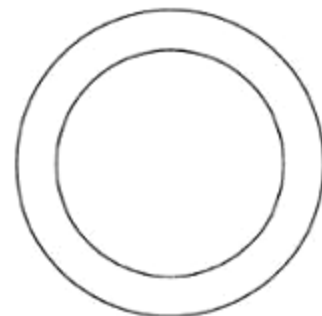

3.7

(11) **51438**

(21) 3-2024-01671

(28) 1

(54) **VÒNG BAY**

(51) **21-01; 21-02**

(22) 18/07/2024

(43) 25/09/2024

(73) **1. CÔNG TY TNHH SẢN XUẤT ROBOT TOSY (VN)**

Tầng 2, 3, 4 tòa nhà Starcity, số 23 Lê Văn Lương, phường Nhân Chính, quận Thanh Xuân, thành phố Hà Nội

2. HỒ VĨNH HOÀNG (VN)

Số 38 Trần Phú, tổ dân phố 3, phường Mộ Lao, quận Hà Đông, thành phố Hà Nội

(72) Hồ Vĩnh Hoàng (VN)

(55)



1.1

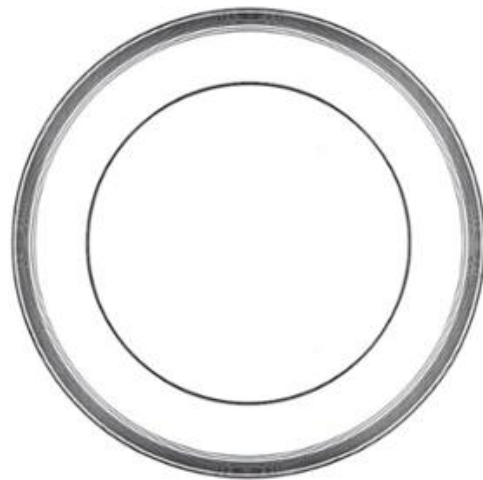

1.2

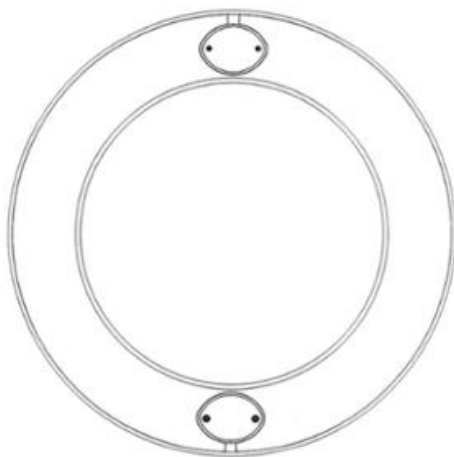

1.3



1.4

1.5



1.6



1.7

CÔNG BÁO SỞ HỮU CÔNG NGHIỆP SỐ 438 TẬP A – QUYỀN 2 (09.2024)

- (11) **51439**
(21) 3-2024-01672 (28) 1
(54) **BAO GÓI** (51) **09-05**
(22) 18/07/2024 (43) 25/09/2024
(73) **CÔNG TY TNHH SẢN XUẤT - THƯƠNG MẠI HUCAFOD (VN)**
Tổ 9, Hòa Bắc, phường Vĩnh Hòa, thành phố Nha Trang, tỉnh Khánh Hòa
(72) Nguyễn Thị Kim Dung (VN)
(55)



1.1



1.2

CÔNG BÁO SỞ HỮU CÔNG NGHIỆP SỐ 438 TẬP A – QUYỀN 2 (09.2024)

- (11) **51440**
(21) 3-2024-01673 (28) 1
(54) **HỘP** (51) **09-03**
(22) 18/07/2024 (43) 25/09/2024
(73) **CÔNG TY TNHH SẢN XUẤT - THƯƠNG MẠI HUCAFOD (VN)**
Tổ 9, Hòa Bắc, phường Vĩnh Hòa, thành phố Nha Trang, tỉnh Khánh Hòa
(72) Nguyễn Thị Kim Dung (VN)
(55)



1.1



1.2

CÔNG BÁO SỞ HỮU CÔNG NGHIỆP SỐ 438 TẬP A – QUYỀN 2 (09.2024)

- (11) **51441**
(21) 3-2024-01674 (28) 1
(54) **HỘP** (51) **09-03**
(22) 18/07/2024 (43) 25/09/2024
(73) **CÔNG TY TNHH SẢN XUẤT - THƯƠNG MẠI HUCAFOD (VN)**
Tổ 9, Hòa Bắc, phường Vĩnh Hòa, thành phố Nha Trang, tỉnh Khánh Hòa
(72) Nguyễn Thị Kim Dung (VN)
(55)



1.1



1.2

CÔNG BÁO SỞ HỮU CÔNG NGHIỆP SỐ 438 TẬP A – QUYỀN 2 (09.2024)

- (11) 51442
- (21) 3-2024-01677
- (54) **HỘP**
- (22) 18/07/2024
- (73) **CÔNG TY TNHH SẢN XUẤT - THƯƠNG MẠI HUCAFOD (VN)**
Tổ 9, Hòa Bắc, phường Vĩnh Hòa, thành phố Nha Trang, tỉnh Khánh Hòa
- (72) Nguyễn Thị Kim Dung (VN)
- (55)

- (28) 3
- (51) **09-03**
- (43) 25/09/2024



1.1



1.2



2.1



2.2



3.1



3.2

CÔNG BÁO SỞ HỮU CÔNG NGHIỆP SỐ 438 TẬP A – QUYỀN 2 (09.2024)

- (11) **51443**
- (21) 3-2024-01687
- (54) **HỘP**
- (22) 19/07/2024
- (73) **CÔNG TY TNHH SẢN XUẤT - THƯƠNG MẠI HUCAFOD (VN)**
Tổ 9, Hòa Bắc, phường Vĩnh Hòa, thành Phố Nha Trang, tỉnh Khánh Hòa
- (72) Nguyễn Thị Kim Dung (VN)
- (55)



1.1

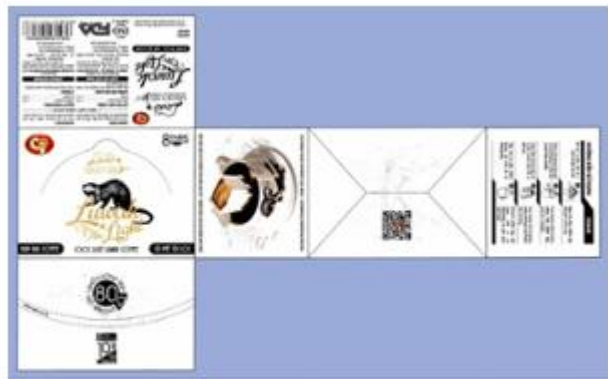

1.2



2.1

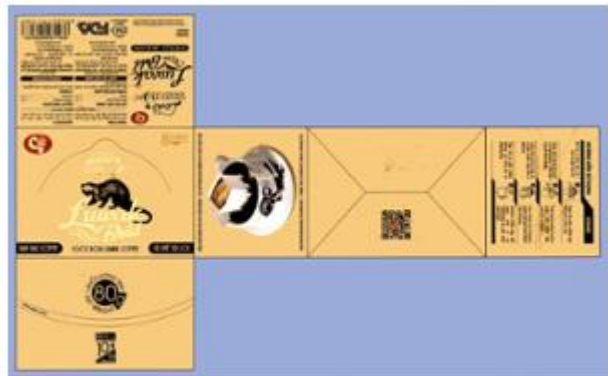

2.2

CÔNG BÁO SỞ HỮU CÔNG NGHIỆP SỐ 438 TẬP A – QUYỀN 2 (09.2024)

- (11) **51444**
(21) 3-2024-01690 (28) 1
(54) **THIẾT BỊ CHỐNG ĐÓNG BẨM CẦU CẶN** (51) **23-99**
(22) 19/07/2024 (43) 25/09/2024
(73) **CÔNG TY CP THIẾT BỊ NĂM SAO VIỆT (VN)**
Số 123, ngõ 85, đường Tân Xuân, phường Xuân Đình, quận Bắc Từ Liêm, thành phố Hà Nội
(72) Nguyễn Đình Uyên (VN)
(74) Công ty TNHH Sở hữu trí tuệ M.I.T (M.I.T IP CO., LTD)
(55)

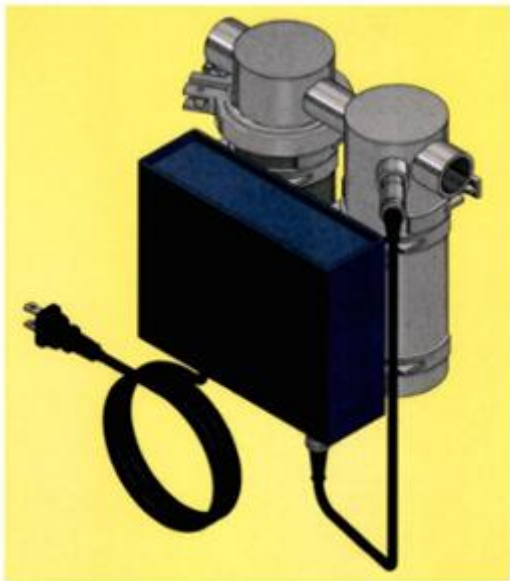

1.1



1.2

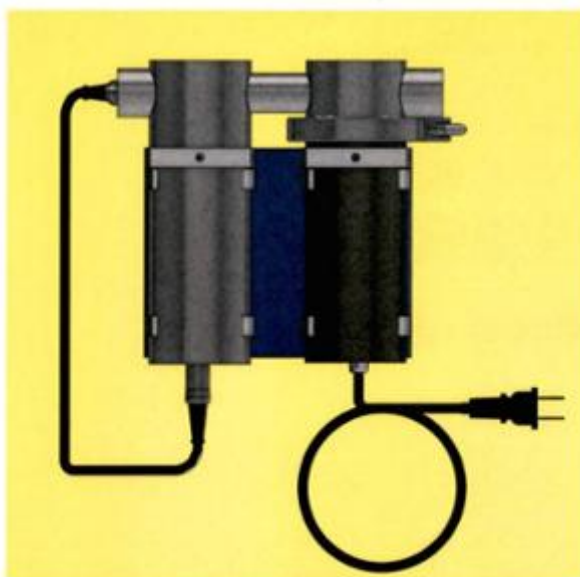

1.3

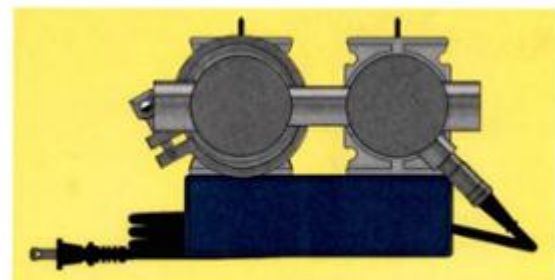

1.4

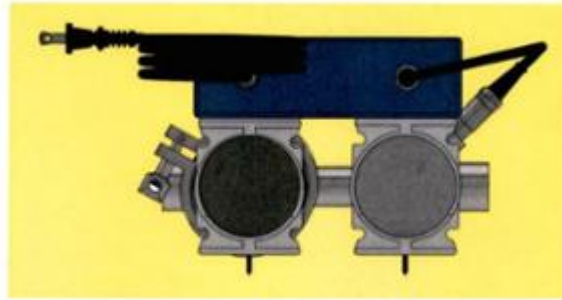

1.5



1.6

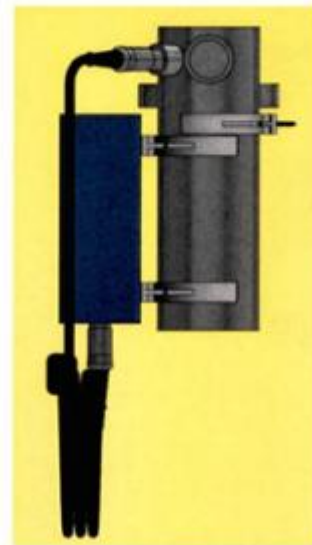

1.7

CÔNG BÁO SỞ HỮU CÔNG NGHIỆP SỐ 438 TẬP A – QUYỀN 2 (09.2024)

- (11) **51445**
- (21) 3-2024-01691
- (54) **MÁY RỬA BÁT**
- (22) 19/07/2024
- (73) **CÔNG TY CP THIẾT BỊ NĂM SAO VIỆT (VN)**
Số 123, ngõ 85, đường Tân Xuân, phường Xuân Đình, quận Bắc Từ Liêm, thành phố Hà Nội
- (72) Nguyễn Đình Uyên (VN)
- (74) Công ty TNHH Sở hữu trí tuệ M.I.T (M.I.T IP CO., LTD)
- (55)

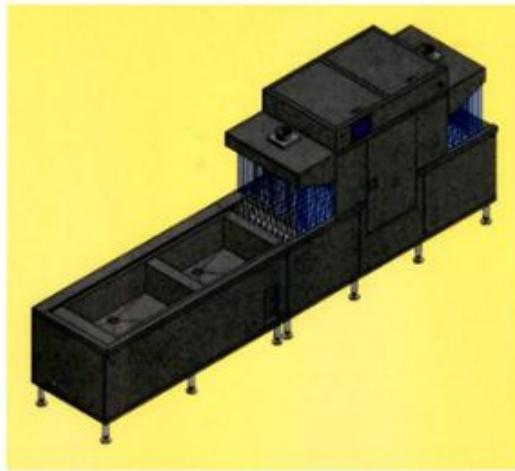

1.1



1.2



1.3



1.4



1.5



1.6



1.7

CÔNG BÁO SỞ HỮU CÔNG NGHIỆP SỐ 438 TẬP A – QUYỀN 2 (09.2024)

- (11) **51446**
(21) 3-2024-01697 (28) 1
(54) **HỘP** (51) **09-03**
(22) 19/07/2024 (43) 25/09/2024
(73) **CÔNG TY CỔ PHẦN MASAN JINJU (VN)**
Nhà xưởng F5, lô 6, khu công nghiệp Tân Đông Hiệp A, phường Tân Đông Hiệp,
thành phố Dĩ An, tỉnh Bình Dương
(72) 1. TRỊNH VĨ TÙNG (VN)
2. BÙI HOÀNG THANH NHÃ (VN)
(74) Công ty cổ phần Sở hữu trí tuệ BROSS và Cộng sự (BROSS & PARTNERS., JSC)
(55)



1.1



1.2

CÔNG BÁO SỞ HỮU CÔNG NGHIỆP SỐ 438 TẬP A – QUYỀN 2 (09.2024)

- (11) **51447**
(21) 3-2024-01702 (28) 1
(54) **HỘP ĐỰNG RƯỢU** (51) **09-03**
(22) 19/07/2024 (43) 25/09/2024
(73) **CÔNG TY TNHH THƯƠNG MẠI DỊCH VỤ NHUNG HƯƠNG HIỀN NGỌC (VN)**
Thôn 7, xã Sơn Giang, huyện Hương Sơn, tỉnh Hà Tĩnh
(72) Nguyễn Thu Hiền (VN)
(74) Công ty TNHH Luật ALIAT (ALIAT LEGAL)
(55)



1.1



1.2

CÔNG BÁO SỞ HỮU CÔNG NGHIỆP SỐ 438 TẬP A – QUYỀN 2 (09.2024)

- (11) **51448**
(21) 3-2024-01703 (28) 1
(54) **HỘP ĐỰNG MẬT ONG** (51) **09-03**
(22) 19/07/2024 (43) 25/09/2024
(73) **HỢP TÁC XÃ MẬT ONG CƯỜNG NGA HƯƠNG SƠN (VN)**
Thôn 5, xã Quang Diệm, huyện Hương Sơn, tỉnh Hà Tĩnh
(72) Nguyễn Văn Đào (VN)
(74) Công ty TNHH Luật ALIAT (ALIAT LEGAL)
(55)



1.1



1.2

CÔNG BÁO SỞ HỮU CÔNG NGHIỆP SỐ 438 TẬP A – QUYỀN 2 (09.2024)

- (11) **51449**
(21) 3-2024-01704 (28) 1
(54) **BAO GÓI** (51) **09-05**
(22) 22/07/2024 (43) 25/09/2024
(73) **CÔNG TY TNHH SẢN XUẤT - THƯƠNG MẠI HUCAFOD (VN)**
Tổ 9, Hòa Bắc, phường Vĩnh Hòa, thành phố Nha Trang, tỉnh Khánh Hòa
(72) Nguyễn Thị Kim Dung (VN)
(55)



1.1



1.2

CÔNG BÁO SỞ HỮU CÔNG NGHIỆP SỐ 438 TẬP A – QUYỀN 2 (09.2024)

(11) **51450**

(21) 3-2024-01728

(28) 1

(54) **ĐÈN**

(51) **26-03**

(22) 23/07/2024

(43) 25/09/2024

(73) **CÔNG TY CỔ PHẦN BÓNG ĐÈN PHÍCH NƯỚC RẠNG ĐÔNG (VN)**

87-89 phố Hạ Đình, phường Thanh Xuân Trung, quận Thanh Xuân, thành phố Hà Nội

(72) Trần Trung Tường (VN)

(55)

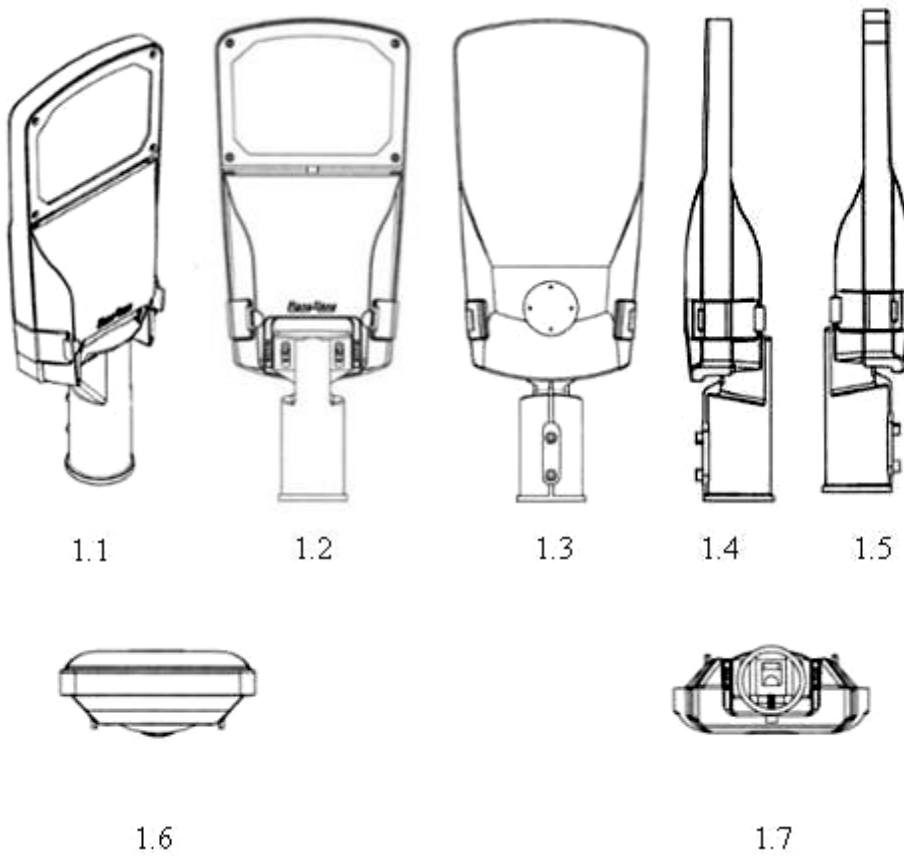

CÔNG BÁO SỞ HỮU CÔNG NGHIỆP SỐ 438 TẬP A – QUYỀN 2 (09.2024)

(11) **51451**

(21) 3-2024-01729

(28) 1

(54) **ĐÈN**

(51) **26-05**

(22) 23/07/2024

(43) 25/09/2024

(73) **CÔNG TY CỔ PHẦN BÓNG ĐÈN PHÍCH NƯỚC RẠNG ĐÔNG (VN)**

87-89 phố Hạ Đình, phường Thanh Xuân Trung, quận Thanh Xuân, thành phố Hà Nội

(72) Trần Trung Tường (VN)

(55)

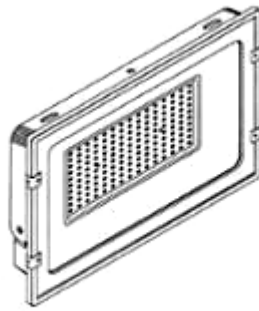

1.1

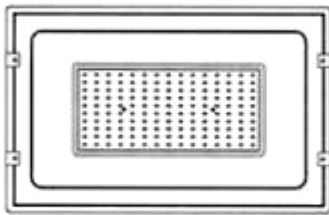

1.2

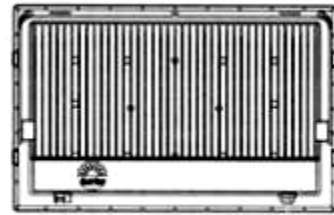

1.3



1.4



1.5

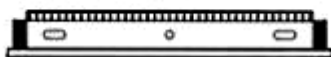

1.6



1.7

CÔNG BÁO SỞ HỮU CÔNG NGHIỆP SỐ 438 TẬP A – QUYỀN 2 (09.2024)

- (11) **51452**
(21) 3-2024-01735 (28) 1
(54) **HỘP SỮA** (51) **09-03**
(22) 24/07/2024 (43) 25/09/2024
(73) **CÔNG TY TNHH YẾN SÀO FLY (VN)**
Thôn Tân Phú, xã Vạn Phú, huyện Vạn Ninh, tỉnh Khánh Hòa
(72) Trịnh Chí Huy (VN)
(55)



1.1



1.2

CÔNG BÁO SỞ HỮU CÔNG NGHIỆP SỐ 438 TẬP A – QUYỀN 2 (09.2024)

- (11) **51453**
(21) 3-2024-01736 (28) 1
(54) **HỘP SỮA** (51) **09-03**
(22) 24/07/2024 (43) 25/09/2024
(73) **CÔNG TY TNHH YẾN SÀO FLY (VN)**
Thôn Tân Phú, xã Vạn Phú, huyện Vạn Ninh, tỉnh Khánh Hòa
(72) Trịnh Chí Huy (VN)
(55)



1.1



1.2

CÔNG BÁO SỞ HỮU CÔNG NGHIỆP SỐ 438 TẬP A – QUYỀN 2 (09.2024)

- (11) **51454**
(21) 3-2024-01752 (28) 1
(54) **BAO GÓI SẢN PHẨM** (51) **09-05**
(22) 25/07/2024 (43) 25/09/2024
(73) **CÔNG TY TNHH THƯƠNG MẠI VÀ DỊCH VỤ HƯƠNG HƯƠNG PHÚ**
(VN)
Thôn Liên Trì 1, xã Bình Kiến, thành phố Tuy Hòa, tỉnh Phú Yên
(72) Nguyễn Thị Thu Hương (VN)
(74) Công ty Luật TNHH WINCO (WINCO LAW FIRM)
(55)



1.1



1.2

CÔNG BÁO SỞ HỮU CÔNG NGHIỆP SỐ 438 TẬP A – QUYỀN 2 (09.2024)

- (11) **51455**
(21) 3-2024-01769 (28) 1
(54) **NHÃN SẢN PHẨM** (51) **19-08**
(22) 26/07/2024 (43) 25/09/2024
(73) **CÔNG TY TNHH MỘT THÀNH VIÊN HÓA CHẤT 21 (VN)**
Xã Phú Hộ, thị xã Phú Thọ, tỉnh Phú Thọ
(72) Lê Quang Hoà (VN)
(74) **CÔNG TY LUẬT TNHH LEGOS (CÔNG TY LUẬT TNHH LEGOS)**
(55)



CÔNG BÁO SỞ HỮU CÔNG NGHIỆP SỐ 438 TẬP A – QUYỀN 2 (09.2024)

- (11) **51456**
- (21) 3-2024-01770 (28) 1
- (54) **NHÃN SẢN PHẨM** (51) **19-08**
- (22) 26/07/2024 (43) 25/09/2024
- (73) **CÔNG TY TNHH MỘT THÀNH VIÊN HÓA CHẤT 21 (VN)**
Xã Phú Hộ, thị xã Phú Thọ, tỉnh Phú Thọ
- (72) Lê Quang Hoà (VN)
- (74) **CÔNG TY LUẬT TNHH LEGOS (CÔNG TY LUẬT TNHH LEGOS)**
- (55)



CÔNG BÁO SỞ HỮU CÔNG NGHIỆP SỐ 438 TẬP A – QUYỀN 2 (09.2024)

- (11) **51457**
- (21) 3-2024-01771 (28) 1
- (54) **NHÃN SẢN PHẨM** (51) **19-08**
- (22) 26/07/2024 (43) 25/09/2024
- (73) **CÔNG TY TNHH MỘT THÀNH VIÊN HÓA CHẤT 21 (VN)**
Xã Phú Hộ, thị xã Phú Thọ, tỉnh Phú Thọ
- (72) Lê Quang Hoà (VN)
- (74) **CÔNG TY LUẬT TNHH LEGOS (CÔNG TY LUẬT TNHH LEGOS)**
- (55)

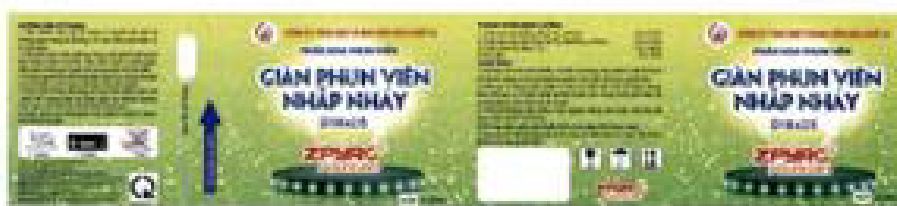

CÔNG BÁO SỞ HỮU CÔNG NGHIỆP SỐ 438 TẬP A – QUYỀN 2 (09.2024)

- (11) **51458**
(21) 3-2024-01785 (28) 1
(54) **TRẠM SẠC XE MÁY, XE ĐẠP ĐIỆN** (51) **13-02**
(22) 29/07/2024 (43) 25/09/2024
(73) **CÔNG TY CỔ PHẦN ĐẦU TƯ KỸ THUẬT VÀ THƯƠNG MẠI THÀNH LONG (VN)**
Số nhà 243, tổ 23, thị trấn Đông Anh, huyện Đông Anh, thành phố Hà Nội
(72) Nguyễn Thị Kim Oanh (VN)
(74) Công ty TNHH Sở hữu trí tuệ Trần & Trần (TRAN & TRAN CO., LTD.)
(55)

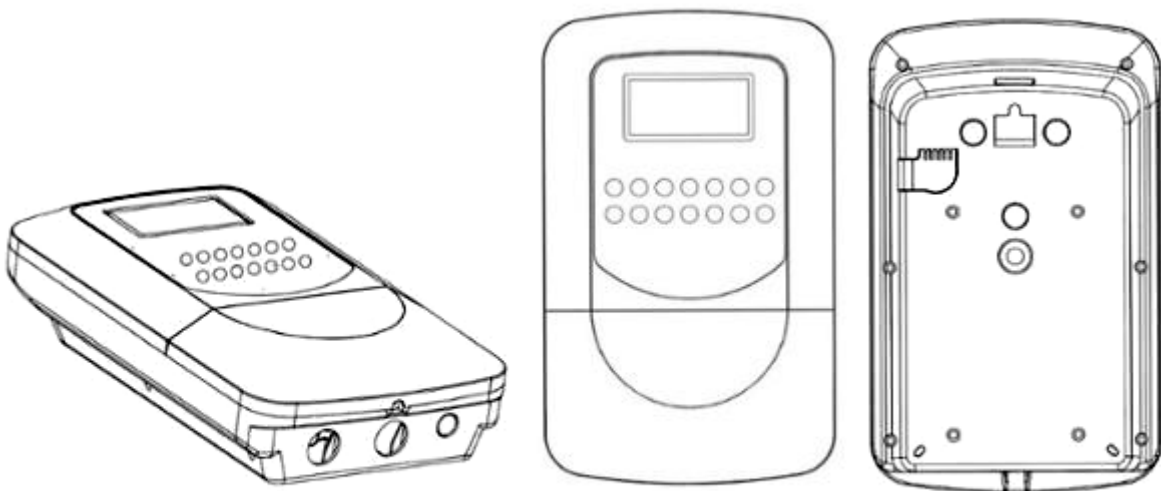

1.1

1.2

1.3

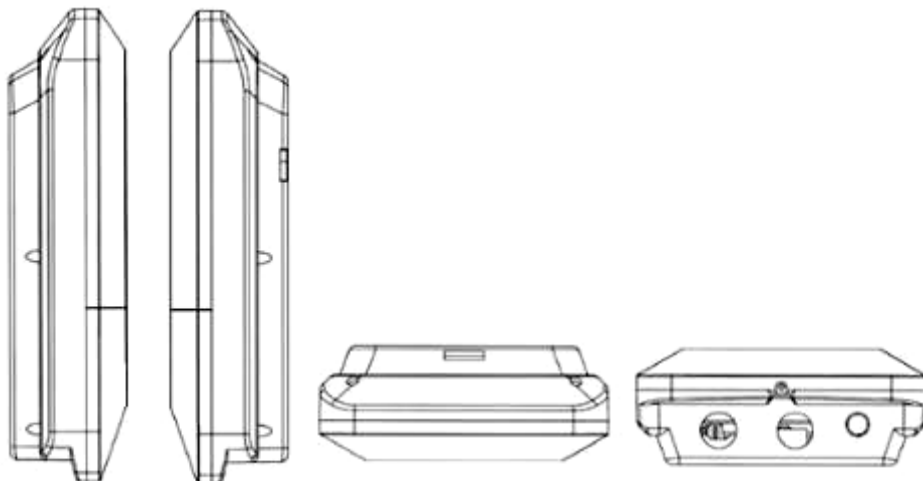

1.4

1.5

1.6

1.7

CÔNG BÁO SỞ HỮU CÔNG NGHIỆP SỐ 438 TẬP A – QUYỀN 2 (09.2024)

- (11) **51459**
(21) 3-2024-01791 (28) 1
(54) **BAO GÓI** (51) **09-05**
(22) 30/07/2024 (43) 25/09/2024
(73) **ORION CORPORATION (KR)**
13, Baekbeom-ro 90da-gil, Yongsan-gu, Seoul 04369 Republic of Korea
(72) 1. CHOE, EUNJE (KR)
2. OH, HYUN SUN (KR)
(74) Công ty Luật TNHH quốc tế BMVN (BMVN INTERNATIONAL LLC)
(55)



1.1



1.2

CÔNG BÁO SỞ HỮU CÔNG NGHIỆP SỐ 438 TẬP A – QUYỀN 2 (09.2024)

- (11) **51460**
(21) 3-2024-01797 (28) 1
(54) **HỘP** (51) **09-03**
(22) 31/07/2024 (43) 25/09/2024
(73) **NGUYỄN DUYÊN TOÀN (VN)**
Phòng 2203 tòa CT1B chung cư Nam Đô, 609 Trương Định, phường Thịnh Liệt,
quận Hoàng Mai, thành phố Hà Nội
(72) Nguyễn Duyên Toàn (VN)
(74) **CÔNG TY LUẬT TNHH QUỐC TẾ ICT (ICT LAW INTERNATIONAL CO.,
LTD)**
(55)



1.1



1.2

CÔNG BÁO SỞ HỮU CÔNG NGHIỆP SỐ 438 TẬP A – QUYỀN 2 (09.2024)

- (11) **51461**
(21) 3-2024-01835 (28) 1
(54) **Ô TÔ** (51) **12-08**
(22) 05/08/2024 (43) 25/09/2024
(30) DM/235325 06/02/2024 WO;
(73) **FERRARI S.P.A. (IT)**
Via Emilia Est 1163, MODENA, ITALY
(72) Enrico CARDILE (IT)
(74) Công ty TNHH một thành viên Sở hữu trí tuệ VCCI (VCCI-IP CO.,LTD)
(55)

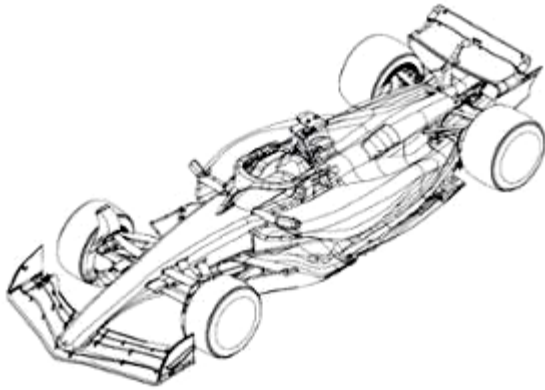

1.1

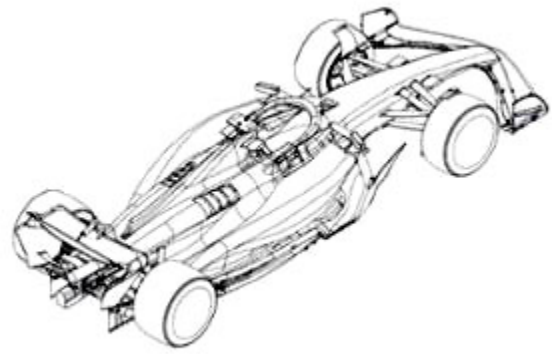

1.2



1.3

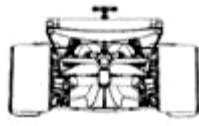

1.4



1.5

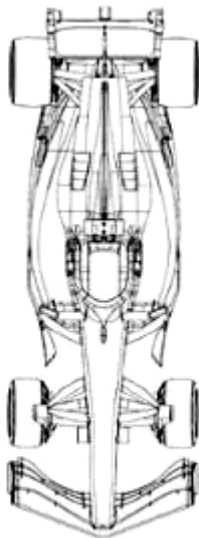

1.6

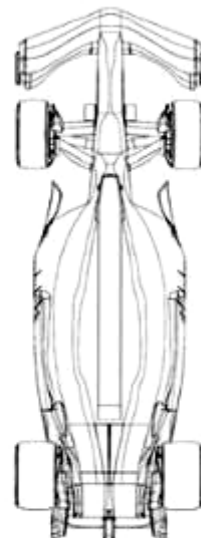

1.7

- (11) **51462**
- (21) 3-2024-01836
- (54) **Ô TÔ ĐỒ CHƠI**
- (22) 05/08/2024
- (30) DM/235113 06/02/2024 WO;
- (73) **FERRARI S.P.A. (IT)**
Via Emilia Est 1163, MODENA, ITALY
- (72) Enrico CARDILE (IT)
- (74) Công ty TNHH một thành viên Sở hữu trí tuệ VCCI (VCCI-IP CO.,LTD)
- (55)

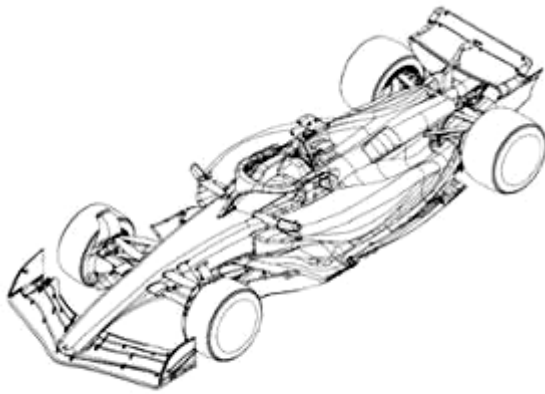

1.1

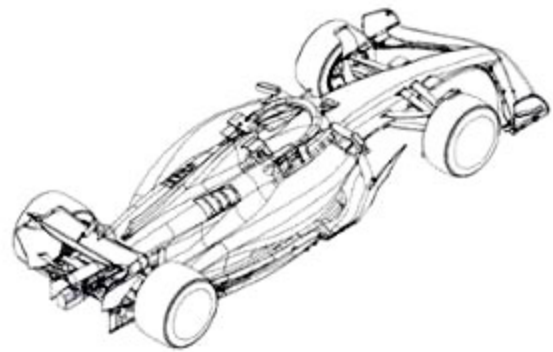

1.2



1.3



1.4



1.5

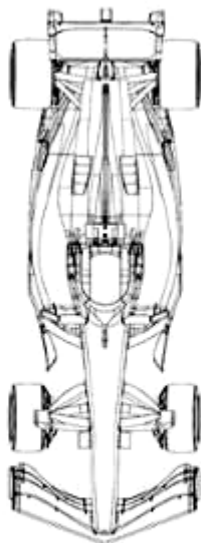

1.6

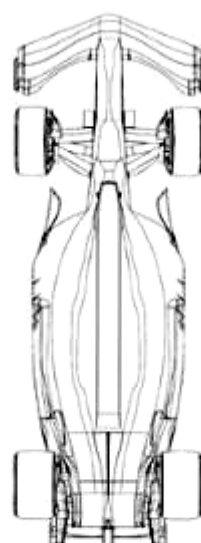

1.7

CÔNG BÁO SỞ HỮU CÔNG NGHIỆP SỐ 438 TẬP A – QUYỀN 2 (09.2024)

- (11) **51463**
(21) 3-2024-01839 (28) 1
(54) **THANH KIM LOẠI ĐỊNH HÌNH** (51) **25-01**
(22) 05/08/2024 (43) 25/09/2024
(73) **CÔNG TY TNHH CÔNG NGHỆ AKCOME VIỆT NAM (VN)**
12.09 tòa nhà Golden King, số 15 Nguyễn Lương Bằng, phường Tân Phú, quận 7,
thành phố Hồ Chí Minh
(72) ZHOU YU FENG (CN)
(74) Công ty TNHH Sở hữu trí tuệ Gia Việt (GIAVIET CO., LTD.)
(55)



1.1



1.2



1.3



1.4



1.5

CÔNG BÁO SỞ HỮU CÔNG NGHIỆP SỐ 438 TẬP A – QUYỀN 2 (09.2024)

- (11) **51464**
(21) 3-2024-01840 (28) 1
(54) **THANH KIM LOẠI ĐỊNH HÌNH** (51) **25-01**
(22) 05/08/2024 (43) 25/09/2024
(73) **CÔNG TY TNHH CÔNG NGHỆ AKCOME VIỆT NAM (VN)**
12.09 tòa nhà Golden King, số 15 Nguyễn Lương Bằng, phường Tân Phú, quận 7,
thành phố Hồ Chí Minh
(72) ZHOU YU FENG (CN)
(74) Công ty TNHH Sở hữu trí tuệ Gia Việt (GIAVIET CO., LTD.)
(55)



1.1



1.2



1.3



1.4

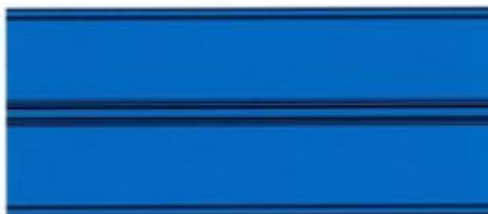

1.5

CÔNG BÁO SỞ HỮU CÔNG NGHIỆP SỐ 438 TẬP A – QUYỀN 2 (09.2024)

- (11) **51465**
(21) 3-2024-01841 (28) 1
(54) **THANH KIM LOẠI ĐỊNH HÌNH** (51) **25-01**
(22) 05/08/2024 (43) 25/09/2024
(73) **CÔNG TY TNHH CÔNG NGHỆ AKCOME VIỆT NAM (VN)**
12.09 tòa nhà Golden King, số 15 Nguyễn Lương Bằng, phường Tân Phú, quận 7,
thành phố Hồ Chí Minh
(72) ZHOU YU FENG (CN)
(74) Công ty TNHH Sở hữu trí tuệ Gia Việt (GIAVIET CO., LTD.)
(55)



1.1



1.2

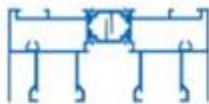

1.3



1.4



1.5

CÔNG BÁO SỞ HỮU CÔNG NGHIỆP SỐ 438 TẬP A – QUYỀN 2 (09.2024)

- (11) **51466**
(21) 3-2024-01842 (28) 1
(54) **THANH KIM LOẠI ĐỊNH HÌNH** (51) **25-01**
(22) 05/08/2024 (43) 25/09/2024
(73) **CÔNG TY TNHH CÔNG NGHỆ AKCOME VIỆT NAM (VN)**
12.09 tòa nhà Golden King, số 15 Nguyễn Lương Bằng, phường Tân Phú, quận 7,
thành phố Hồ Chí Minh
(72) ZHOU YU FENG (CN)
(74) Công ty TNHH Sở hữu trí tuệ Gia Việt (GIAVIET CO., LTD.)
(55)



1.1



1.2



1.3



1.4



1.5

CÔNG BÁO SỞ HỮU CÔNG NGHIỆP SỐ 438 TẬP A – QUYỀN 2 (09.2024)

- (11) **51467**
- (21) 3-2024-01843 (28) 1
- (54) **THANH KIM LOẠI ĐỊNH HÌNH** (51) **25-01**
- (22) 05/08/2024 (43) 25/09/2024
- (73) **CÔNG TY TNHH CÔNG NGHỆ AKCOME VIỆT NAM (VN)**
12.09 tòa nhà Golden King, số 15 Nguyễn Lương Bằng, phường Tân Phú, quận 7,
thành phố Hồ Chí Minh
- (72) ZHOU YU FENG (CN)
- (74) Công ty TNHH Sở hữu trí tuệ Gia Việt (GIAVIET CO., LTD.)
- (55)



1.1



1.2



1.3

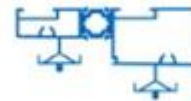

1.4



1.5



1.6

CÔNG BÁO SỞ HỮU CÔNG NGHIỆP SỐ 438 TẬP A – QUYỀN 2 (09.2024)

- (11) **51468**
(21) 3-2024-01844 (28) 1
(54) **THANH KIM LOẠI ĐỊNH HÌNH** (51) **25-01**
(22) 05/08/2024 (43) 25/09/2024
(73) **CÔNG TY TNHH CÔNG NGHỆ AKCOME VIỆT NAM (VN)**
12.09 tòa nhà Golden King, số 15 Nguyễn Lương Bằng, phường Tân Phú, quận 7,
thành phố Hồ Chí Minh
(72) ZHOU YU FENG (CN)
(74) Công ty TNHH Sở hữu trí tuệ Gia Việt (GIAVIET CO., LTD.)
(55)



1.1



1.2



1.3

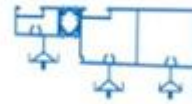

1.4



1.5



1.6

CÔNG BÁO SỞ HỮU CÔNG NGHIỆP SỐ 438 TẬP A – QUYỀN 2 (09.2024)

- (11) **51469**
(21) 3-2024-01845 (28) 1
(54) **THANH KIM LOẠI ĐỊNH HÌNH** (51) **25-01**
(22) 05/08/2024 (43) 25/09/2024
(73) **CÔNG TY TNHH CÔNG NGHỆ AKCOME VIỆT NAM (VN)**
12.09 tòa nhà Golden King, số 15 Nguyễn Lương Bằng, phường Tân Phú, quận 7,
thành phố Hồ Chí Minh
(72) ZHOU YU FENG (CN)
(74) Công ty TNHH Sở hữu trí tuệ Gia Việt (GIAVIET CO., LTD.)
(55)



1.1



1.2



1.3

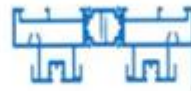

1.4



1.5



1.6

CÔNG BÁO SỞ HỮU CÔNG NGHIỆP SỐ 438 TẬP A – QUYỀN 2 (09.2024)

- (11) **51470**
(21) 3-2024-01846 (28) 1
(54) **THANH KIM LOẠI ĐỊNH HÌNH** (51) **25-01**
(22) 05/08/2024 (43) 25/09/2024
(73) **CÔNG TY TNHH CÔNG NGHỆ AKCOME VIỆT NAM (VN)**
12.09 tòa nhà Golden King, số 15 Nguyễn Lương Bằng, phường Tân Phú, quận 7,
thành phố Hồ Chí Minh
(72) ZHOU YU FENG (CN)
(74) Công ty TNHH Sở hữu trí tuệ Gia Việt (GIAVIET CO., LTD.)
(55)



1.1



1.2



1.3



1.4



1.5



1.6

CÔNG BÁO SỞ HỮU CÔNG NGHIỆP SỐ 438 TẬP A – QUYỀN 2 (09.2024)

- (11) **51471**
(21) 3-2024-01847 (28) 1
(54) **THANH KIM LOẠI ĐỊNH HÌNH** (51) **25-01**
(22) 05/08/2024 (43) 25/09/2024
(73) **CÔNG TY TNHH CÔNG NGHỆ AKCOME VIỆT NAM (VN)**
12.09 tòa nhà Golden King, số 15 Nguyễn Lương Bằng, phường Tân Phú, quận 7,
thành phố Hồ Chí Minh
(72) ZHOU YU FENG (CN)
(74) Công ty TNHH Sở hữu trí tuệ Gia Việt (GIAVIET CO., LTD.)
(55)



1.1



1.2



1.3



1.4



1.5



1.6

CÔNG BÁO SỞ HỮU CÔNG NGHIỆP SỐ 438 TẬP A – QUYỀN 2 (09.2024)

- (11) **51472**
(21) 3-2024-01848 (28) 1
(54) **THANH KIM LOẠI ĐỊNH HÌNH** (51) **25-01**
(22) 05/08/2024 (43) 25/09/2024
(73) **CÔNG TY TNHH CÔNG NGHỆ AKCOME VIỆT NAM (VN)**
12.09 tòa nhà Golden King, số 15 Nguyễn Lương Bằng, phường Tân Phú, quận 7,
thành phố Hồ Chí Minh
(72) ZHOU YU FENG (CN)
(74) Công ty TNHH Sở hữu trí tuệ Gia Việt (GIAVIET CO., LTD.)
(55)



1.1



1.2



1.3



1.4



1.5



1.6

CÔNG BÁO SỞ HỮU CÔNG NGHIỆP SỐ 438 TẬP A – QUYỀN 2 (09.2024)

- (11) **51473**
(21) 3-2024-01849 (28) 1
(54) **THANH KIM LOẠI ĐỊNH HÌNH** (51) **25-01**
(22) 05/08/2024 (43) 25/09/2024
(73) **CÔNG TY TNHH CÔNG NGHỆ AKCOME VIỆT NAM (VN)**
12.09 tòa nhà Golden King, số 15 Nguyễn Lương Bằng, phường Tân Phú, quận 7,
thành phố Hồ Chí Minh
(72) ZHOU YU FENG (CN)
(74) Công ty TNHH Sở hữu trí tuệ Gia Việt (GIAVIET CO., LTD.)
(55)



1.1



1.2



1.3



1.4



1.5



1.6

CÔNG BÁO SỞ HỮU CÔNG NGHIỆP SỐ 438 TẬP A – QUYỀN 2 (09.2024)

- (11) **51474**
(21) 3-2024-01850 (28) 1
(54) **THANH KIM LOẠI ĐỊNH HÌNH** (51) **25-01**
(22) 05/08/2024 (43) 25/09/2024
(73) **CÔNG TY TNHH CÔNG NGHỆ AKCOME VIỆT NAM (VN)**
12.09 tòa nhà Golden King, số 15 Nguyễn Lương Bằng, phường Tân Phú, quận 7,
thành phố Hồ Chí Minh
(72) ZHOU YU FENG (CN)
(74) Công ty TNHH Sở hữu trí tuệ Gia Việt (GIAVIET CO., LTD.)
(55)



1.1



1.2



1.3

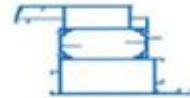

1.4



1.5



1.6

CÔNG BÁO SỞ HỮU CÔNG NGHIỆP SỐ 438 TẬP A – QUYỀN 2 (09.2024)

- (11) **51475**
(21) 3-2024-01851 (28) 1
(54) **THANH KIM LOẠI ĐỊNH HÌNH** (51) **25-01**
(22) 05/08/2024 (43) 25/09/2024
(73) **CÔNG TY TNHH CÔNG NGHỆ AKCOME VIỆT NAM (VN)**
12.09 tòa nhà Golden King, số 15 Nguyễn Lương Bằng, phường Tân Phú, quận 7,
thành phố Hồ Chí Minh
(72) ZHOU YU FENG (CN)
(74) Công ty TNHH Sở hữu trí tuệ Gia Việt (GIAVIET CO., LTD.)
(55)



1.1



1.2



1.3



1.4



1.5



1.6

CÔNG BÁO SỞ HỮU CÔNG NGHIỆP SỐ 438 TẬP A – QUYỀN 2 (09.2024)

- (11) **51476**
(21) 3-2024-01852 (28) 1
(54) **THANH KIM LOẠI ĐỊNH HÌNH** (51) **25-01**
(22) 05/08/2024 (43) 25/09/2024
(73) **CÔNG TY TNHH CÔNG NGHỆ AKCOME VIỆT NAM (VN)**
12.09 tòa nhà Golden King, số 15 Nguyễn Lương Bằng, phường Tân Phú, quận 7,
thành phố Hồ Chí Minh
(72) ZHOU YU FENG (CN)
(74) Công ty TNHH Sở hữu trí tuệ Gia Việt (GIAVIET CO., LTD.)
(55)



1.1



1.2



1.3



1.4



1.5



1.6

CÔNG BÁO SỞ HỮU CÔNG NGHIỆP SỐ 438 TẬP A – QUYỀN 2 (09.2024)

- (11) **51477**
(21) 3-2024-01853 (28) 1
(54) **THANH KIM LOẠI ĐỊNH HÌNH** (51) **25-01**
(22) 05/08/2024 (43) 25/09/2024
(73) **CÔNG TY TNHH CÔNG NGHỆ AKCOME VIỆT NAM (VN)**
12.09 tòa nhà Golden King, số 15 Nguyễn Lương Bằng, phường Tân Phú, quận 7,
thành phố Hồ Chí Minh
(72) ZHOU YU FENG (CN)
(74) Công ty TNHH Sở hữu trí tuệ Gia Việt (GIAVIET CO., LTD.)
(55)



1.1



1.2



1.3



1.4



1.5



1.6

CÔNG BÁO SỞ HỮU CÔNG NGHIỆP SỐ 438 TẬP A – QUYỀN 2 (09.2024)

- (11) **51478**
(21) 3-2024-01854 (28) 1
(54) **THANH KIM LOẠI ĐỊNH HÌNH** (51) **25-01**
(22) 05/08/2024 (43) 25/09/2024
(73) **CÔNG TY TNHH CÔNG NGHỆ AKCOME VIỆT NAM (VN)**
12.09 tòa nhà Golden King, số 15 Nguyễn Lương Bằng, phường Tân Phú, quận 7,
thành phố Hồ Chí Minh
(72) ZHOU YU FENG (CN)
(74) Công ty TNHH Sở hữu trí tuệ Gia Việt (GIAVIET CO., LTD.)
(55)



1.1



1.2



1.3



1.4



1.5



1.6

CÔNG BÁO SỞ HỮU CÔNG NGHIỆP SỐ 438 TẬP A – QUYỀN 2 (09.2024)

- (11) **51479**
(21) 3-2024-01855 (28) 1
(54) **THANH KIM LOẠI ĐỊNH HÌNH** (51) **25-01**
(22) 05/08/2024 (43) 25/09/2024
(73) **CÔNG TY TNHH CÔNG NGHỆ AKCOME VIỆT NAM (VN)**
12.09 tòa nhà Golden King, số 15 Nguyễn Lương Bằng, phường Tân Phú, quận 7,
thành phố Hồ Chí Minh
(72) ZHOU YU FENG (CN)
(74) Công ty TNHH Sở hữu trí tuệ Gia Việt (GIAVIET CO., LTD.)
(55)



1.1



1.2



1.3



1.4



1.5



1.6

CÔNG BÁO SỞ HỮU CÔNG NGHIỆP SỐ 438 TẬP A – QUYỀN 2 (09.2024)

- (11) **51480**
(21) 3-2024-01856 (28) 1
(54) **THANH KIM LOẠI ĐỊNH HÌNH** (51) **25-01**
(22) 05/08/2024 (43) 25/09/2024
(73) **CÔNG TY TNHH CÔNG NGHỆ AKCOME VIỆT NAM (VN)**
12.09 tòa nhà Golden King, số 15 Nguyễn Lương Bằng, phường Tân Phú, quận 7,
thành phố Hồ Chí Minh
(72) ZHOU YU FENG (CN)
(74) Công ty TNHH Sở hữu trí tuệ Gia Việt (GIAVIET CO., LTD.)
(55)



1.1



1.2



1.3



1.4



1.5



1.6

- (11) **51481**
(21) 3-2024-01872 (28) 1
(54) **THÂN NGÀM PHANH CỦA PHANH ĐĨA** (51) **12-16**
(22) 06/08/2024 (43) 25/09/2024
(30) 2024-006513 29/03/2024 JP;
(73) **HITACHI ASTEMO, LTD.** (JP)
2520 Takaba, Hitachinaka-shi, Ibaraki 3128503, Japan
(72) 1. KAZUMASA UEHARA (JP)
2. GENICHI HATAKOSHI (JP)
(74) Công ty TNHH Sở hữu trí tuệ Vàng (GINTASSET CO., LTD.)
(55)

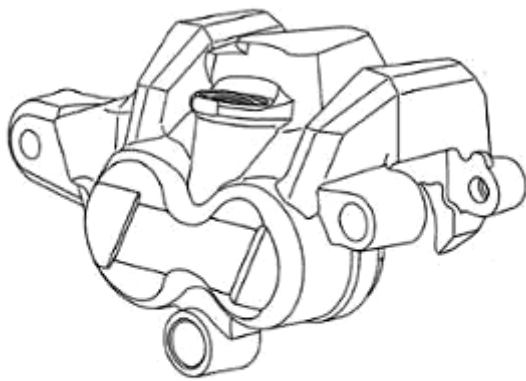

1.1

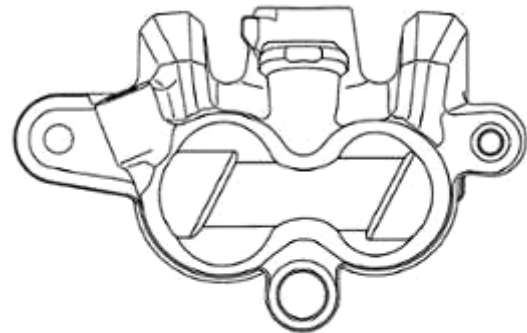

1.2

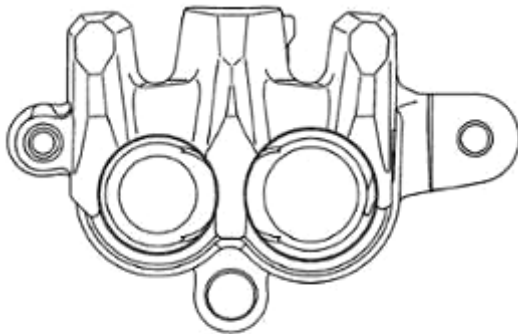

1.3

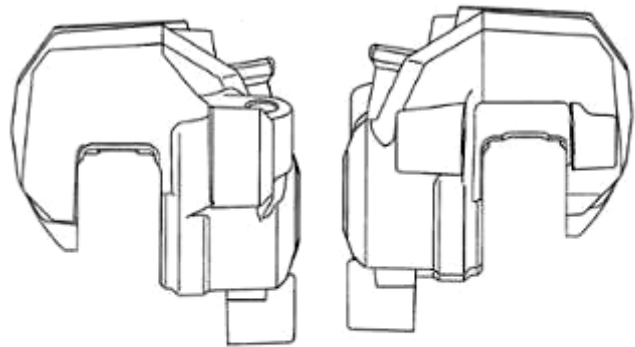

1.4

1.5

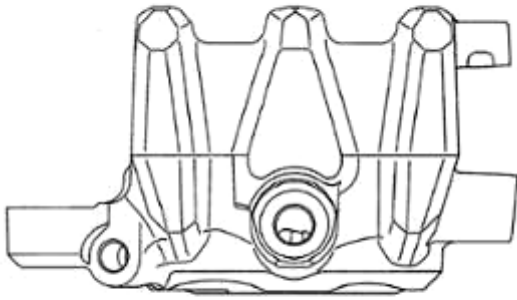

1.6

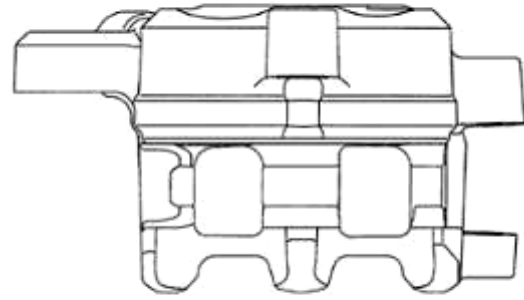

1.7

CÔNG BÁO SỞ HỮU CÔNG NGHIỆP SỐ 438 TẬP A – QUYỀN 2 (09.2024)

- (11) **51482**
(21) 3-2024-01877 (28) 1
(54) **CHẢO** (51) **07-02**
(22) 06/08/2024 (43) 25/09/2024
(73) **CÔNG TY TNHH SẢN XUẤT ĐỒ GIA DỤNG SUNHOUSE (VN)**
Ngọc Liệp, xã Ngọc Liệp, huyện Quốc Oai, thành phố Hà Nội
(72) Lại Văn Kiên (VN)
(74) Công ty TNHH Sở hữu trí tuệ Bình Minh (SUNRISE IP CO.,LTD.)
(55)



1.1

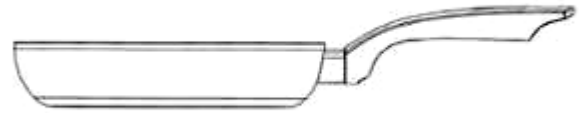

1.2



1.3

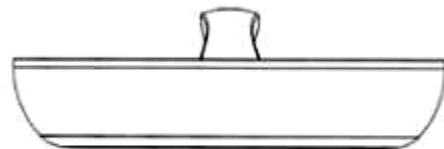

1.4



1.5

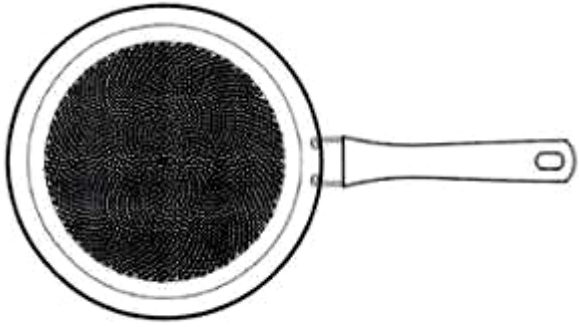

1.6

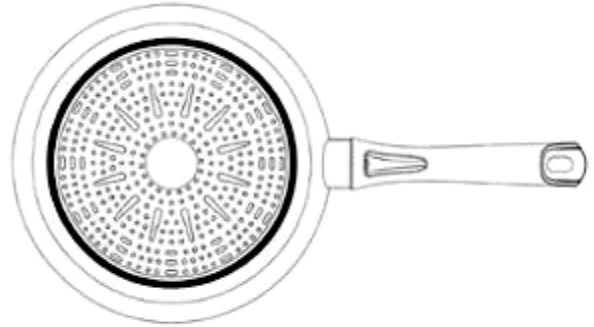

1.7

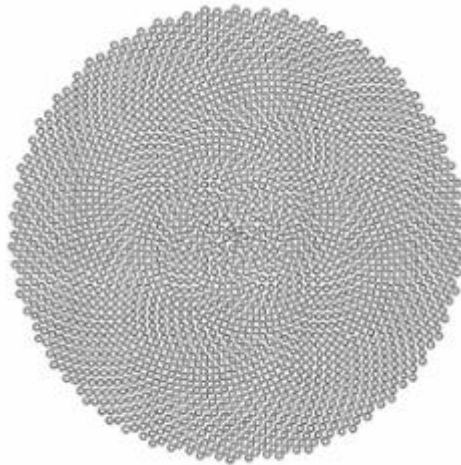

1.8

CÔNG BÁO SỞ HỮU CÔNG NGHIỆP SỐ 438 TẬP A – QUYỀN 2 (09.2024)

(11) **51483**

(21) 3-2024-01878

(28) 1

(54) **BÀN THỜ**

(51) **99-00**

(22) 06/08/2024

(43) 25/09/2024

(73) **CÔNG TY CỔ PHẦN NỘI THẤT MANT (VN)**

Số 04, ngõ 186 Ngọc Hà, phường Ngọc Hà, quận Ba Đình, thành phố Hà Nội

(72) Nguyễn Mạnh Hùng (VN)

(74) **CÔNG TY TNHH SỞ HỮU TRÍ TUỆ ANLIS VIỆT NAM (ANLIS IP CO.,LTD)**

(55)



1.1



1.2



1.3



1.4

1.5



1.6



1.7

CÔNG BÁO SỞ HỮU CÔNG NGHIỆP SỐ 438 TẬP A – QUYỀN 2 (09.2024)

- (11) **51484**
(21) 3-2024-01882 (28) 1
(54) **CHAI** (51) **09-01**
(22) 06/08/2024 (43) 25/09/2024
(73) **CÔNG TY CỔ PHẦN HÀNG TIÊU DÙNG MASAN (VN)**
Số 23 Lê Duẩn, phường Bến Nghé, quận 1, thành phố Hồ Chí Minh
(72) Nguyễn Hoàng Yên (VN)
(74) Công ty cổ phần Sở hữu trí tuệ BROSS và Cộng sự (BROSS & PARTNERS., JSC)
(55)



1.1

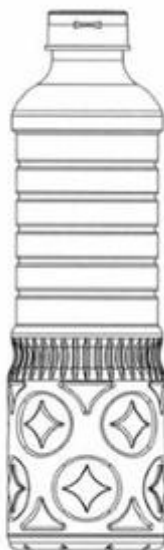

1.2

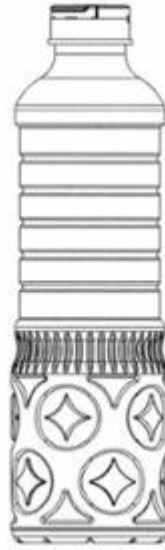

1.3

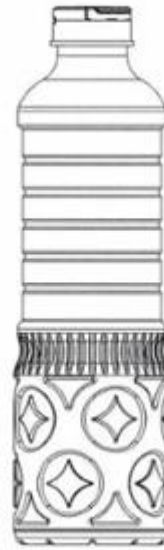

1.4



1.5



1.6



1.7

CÔNG BÁO SỞ HỮU CÔNG NGHIỆP SỐ 438 TẬP A – QUYỀN 2 (09.2024)

- (11) **51485**
(21) 3-2024-01888 (28) 1
(54) **THANH KIM LOẠI ĐỊNH HÌNH** (51) **25-01**
(22) 07/08/2024 (43) 25/09/2024
(73) **CÔNG TY TNHH CÔNG NGHỆ AKCOME VIỆT NAM (VN)**
12.09 tòa nhà Golden King, số 15 Nguyễn Lương Bằng, phường Tân Phú, quận 7,
thành phố Hồ Chí Minh
(72) ZHOU YU FENG (CN)
(74) Công ty TNHH Sở hữu trí tuệ Gia Việt (GIAVIET CO., LTD.)
(55)

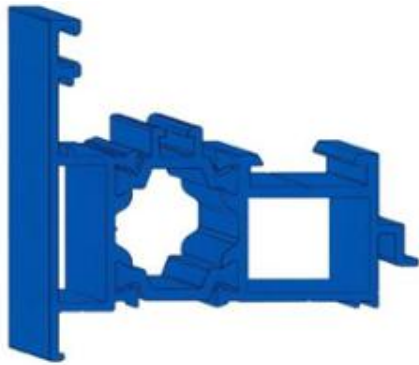

1.1



1.2



1.3

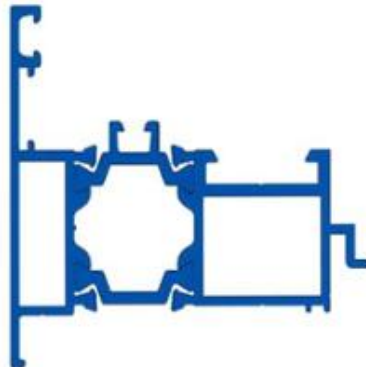

1.4



1.5

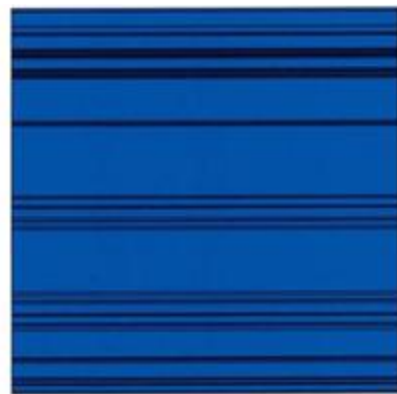

1.6

- (11) **51486**
(21) 3-2024-01899 (28) 1
(54) **QUE LẤY MẪU** (51) **24-02**
(22) 07/08/2024 (43) 25/09/2024
(73) **HYGEIA TOUCH INC. (TW)**
11F.-2, No. 50, Linsen N. Rd., Zhongshan Dist., Taipei City 104, Taiwan
(72) 1. CHANG, TING-CHANG (TW)
2. YANG, CHUNG-YAO (TW)
3. ZHOU, ZONGJIONG (TW)
(74) Công ty TNHH Dịch vụ Sở hữu trí tuệ KASS Việt Nam (KASS VIETNAM CO.,LTD.)
(55)

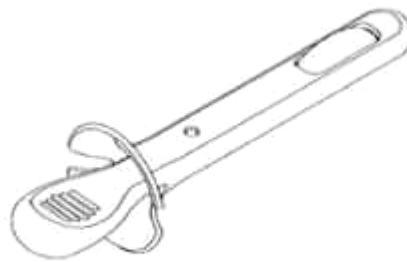

1.1



1.2



1.3



1.4



1.5

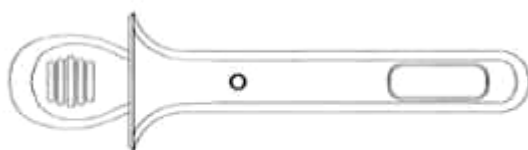

1.6

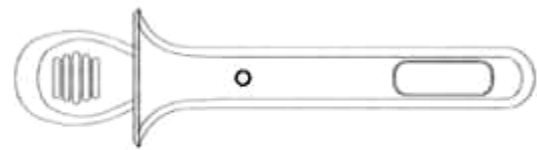

1.7

CÔNG BÁO SỞ HỮU CÔNG NGHIỆP SỐ 438 TẬP A – QUYỀN 2 (09.2024)

- (11) **51487**
(21) 3-2024-01903 (28) 1
(54) **XE MÁY ĐIỆN** (51) **12-11**
(22) 08/08/2024 (43) 25/09/2024
(73) **CÔNG TY CỔ PHẦN SẢN XUẤT VÀ KINH DOANH VINFAST (VN)**
Khu Kinh tế Đình Vũ-Cát Hải, đảo Cát Hải, thị trấn Cát Hải, huyện Cát Hải, thành phố Hải Phòng
(72) Languo Zuo (CN)
(74) **CÔNG TY LUẬT TRÁCH NHIỆM HỮU HẠN AMBYS HÀ NỘI (AMBYS HANOI)**
(55)



1.1



1.2



1.3



1.4



1.5



1.6



1.7

CÔNG BÁO SỞ HỮU CÔNG NGHIỆP SỐ 438 TẬP A – QUYỀN 2 (09.2024)

- (11) **51488**
(21) 3-2024-01904 (28) 1
(54) **XE MÁY ĐIỆN** (51) **12-11**
(22) 08/08/2024 (43) 25/09/2024
(73) **CÔNG TY CỔ PHẦN SẢN XUẤT VÀ KINH DOANH VINFAST (VN)**
Khu Kinh tế Đình Vũ-Cát Hải, đảo Cát Hải, thị trấn Cát Hải, huyện Cát Hải, thành phố Hải Phòng
(72) Languo Zuo (CN)
(74) **CÔNG TY LUẬT TRÁCH NHIỆM HỮU HẠN AMBYS HÀ NỘI (AMBYS HANOI)**
(55)



1.1



1.2



1.3



1.4



1.5



1.6



1.7

CÔNG BÁO SỞ HỮU CÔNG NGHIỆP SỐ 438 TẬP A – QUYỀN 2 (09.2024)

- (11) **51489**
(21) 3-2024-01905 (28) 1
(54) **MÓC** (51) **02-07**
(22) 08/08/2024 (43) 25/09/2024
(30) 2024-004162 29/02/2024 JP;
(73) **GLOBERIDE, INC. (JP)**
3-14-16, Maesawa, Higashi Kurume, Tokyo 203-8511, Japan
(72) Haruna TAKAHASHI (JP)
(74) CÔNG TY LUẬT TRÁCH NHIỆM HỮU HẠN AMBYS HÀ NỘI (AMBYS HANOI)
(55)



1.1

1.2

1.3



1.4



1.5



1.6



1.7

CÔNG BÁO SỞ HỮU CÔNG NGHIỆP SỐ 438 TẬP A – QUYỀN 2 (09.2024)

- (11) **51490**
(21) 3-2024-01906 (28) 1
(54) **KẸP** (51) **02-07**
(22) 08/08/2024 (43) 25/09/2024
(30) 2024-004163 29/02/2024 JP;
(73) **GLOBERIDE, INC. (JP)**
3-14-16, Maesawa, Higashi Kurume, Tokyo 203-8511, Japan
(72) Haruna TAKAHASHI (JP)
(74) CÔNG TY LUẬT TRÁCH NHIỆM HỮU HẠN AMBYS HÀ NỘI (AMBYS HANOI)
(55)



1.1



1.2



1.3



1.4



1.5



1.6



1.7

- (11) **51491**
(21) 3-2024-01907 (28) 1
(54) **GIÁ TREO** (51) **08-08**
(22) 18/05/2022 (43) 25/09/2024
(30) 29/825,924 07/02/2022 US; 29/833,725 06/04/2022 US;
(73) **TECHTRONIC CORDLESS GP (US)**
100 Innovation Way, Anderson, SC 29621, United States of America
(72) 1. JEFFREY GROVES (US)
2. STEPHEN A. HUGHETT (US)
3. TYLER H. KNIGHT (US)
(74) Công ty TNHH Tầm nhìn và Liên danh (VISION & ASSOCIATES CO.LTD.)
(55)

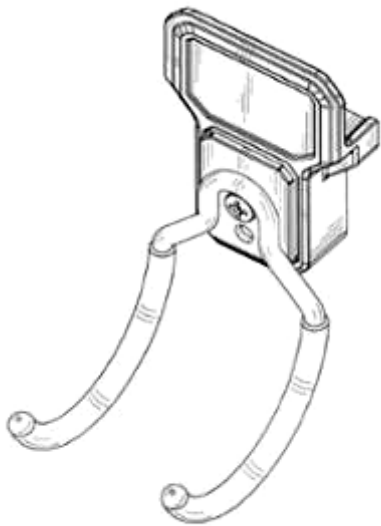

1.1



1.2

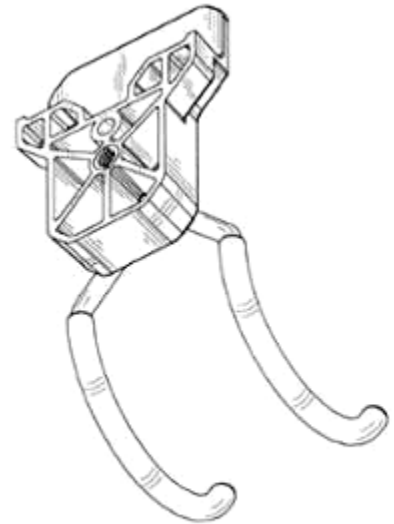

1.3

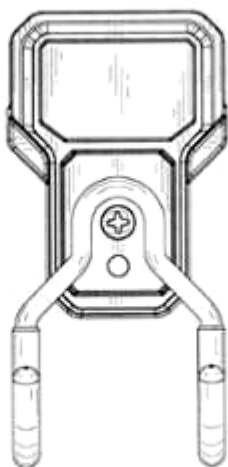

1.4

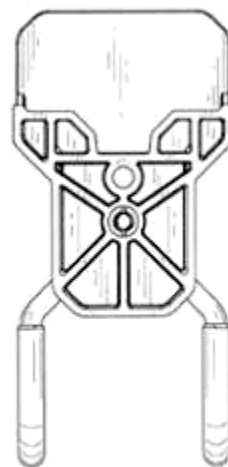

1.5

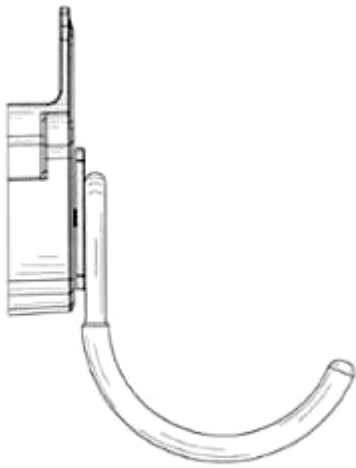

1.6

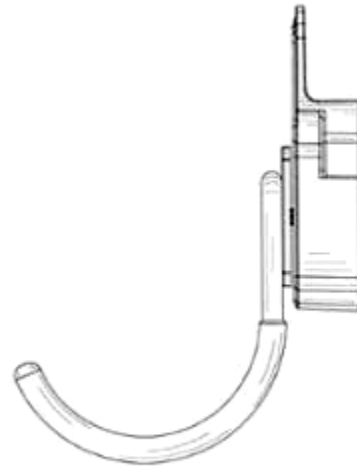

1.7



1.8



1.9

CÔNG BÁO SỞ HỮU CÔNG NGHIỆP SỐ 438 TẬP A – QUYỀN 2 (09.2024)

- (11) **51492**
(21) 3-2024-01916 (28) 1
(54) **THIẾT BỊ XỬ LÝ CÁU CẶN CANXI** (51) **23-01; 23-99**
(22) 09/08/2024 (43) 25/09/2024
(73) **CÔNG TY CP THIẾT BỊ NĂM SAO VIỆT (VN)**
Số 123, ngõ 85, đường Tân Xuân, phường Xuân Đình, quận Bắc Từ Liêm, thành phố Hà Nội
(72) Nguyễn Đình Uyên (VN)
(74) Công ty TNHH Sở hữu trí tuệ M.I.T (M.I.T IP CO., LTD)
(55)

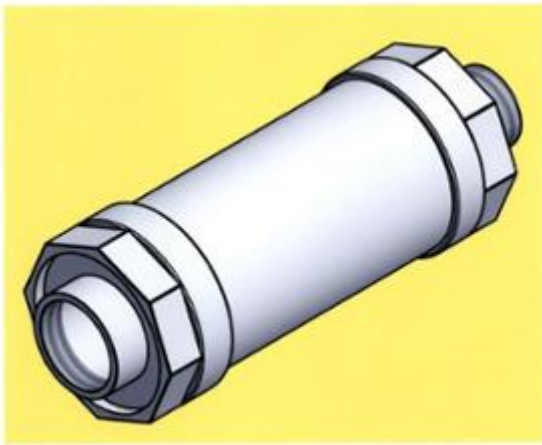

1.1



1.2



1.3

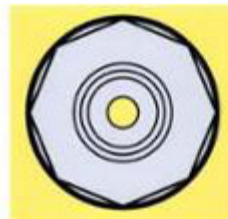

1.4

CÔNG BÁO SỞ HỮU CÔNG NGHIỆP SỐ 438 TẬP A – QUYỀN 2 (09.2024)

- (11) **51493**
(21) 3-2024-01917 (28) 1
(54) **NHÃN SẢN PHẨM** (51) **19-08**
(22) 12/08/2024 (43) 25/09/2024
(73) **HỘ KINH DOANH HÍ SHOP (VN)**
54 Bàu Cát 6, phường 14, quận Tân Bình, thành phố Hồ Chí Minh
(72) Lê Duy Sành (VN)
(55)



PHẦN II

SỬA ĐỔI ĐƠN

Thông báo số: 83577/TB-SHTT._{IP}, ngày 26/08/2024 về việc ghi nhận sửa đổi đơn

Số Yêu cầu: SĐ3-2023-01820 Ngày nộp: 29/09/2023

Liên quan đến đơn yêu cầu cấp Bằng độc quyền kiểu dáng công nghiệp:

(21) Số đơn	(22) Ngày nộp đơn
3-2020-00811	13/04/2020

Mục sửa đổi: Tên, địa chỉ chủ đơn

Nội dung mới: Công ty TNHH FUJI Việt Nam (VN)
Thôn Bình Dy, xã Đại Sơn, huyện Tứ Kỳ, tỉnh Hải Dương

CÔNG BÁO SỞ HỮU CÔNG NGHIỆP

Do Cục Sở hữu trí tuệ thuộc Bộ Khoa học và Công nghệ ấn hành theo Luật Sở hữu trí tuệ số 50/2005/QH11 được Quốc hội thông qua ngày 29 tháng 11 năm 2005 và được sửa đổi bằng Luật sửa đổi, bổ sung một số điều của Luật sở hữu trí tuệ số 50/2005/QH11 được Quốc hội thông qua ngày 19 tháng 6 năm 2009.

Địa chỉ liên hệ:

384-386 đường Nguyễn Trãi, quận Thanh Xuân,
thành phố Hà Nội, Việt Nam
ĐT: 024. 38583069
Fax: 024. 38588449