

CỘNG HÒA XÃ HỘI CHỦ NGHĨA VIỆT NAM
BỘ KHOA HỌC VÀ CÔNG NGHỆ

CỤC SỞ HỮU TRÍ TUỆ

CÔNG BÁO
SỞ HỮU CÔNG NGHIỆP

TẬP A

QUYỂN 2: KIỂU DÁNG CÔNG NGHIỆP

08 - 2024

437

CỘNG HOÀ XÃ HỘI CHỦ NGHĨA VIỆT NAM
BỘ KHOA HỌC VÀ CÔNG NGHỆ
CỤC SỞ HỮU TRÍ TUỆ

CÔNG BÁO
SỞ HỮU CÔNG NGHIỆP
TẬP A

QUYỀN 2: KIỂU DÁNG CÔNG NGHIỆP

08 - 2024

437

HÀ NỘI

MÃ SỐ HAI CHỮ CÁI THỂ HIỆN TÊN NƯỚC VÀ CÁC THỰC THỂ KHÁC TRONG CÁC TƯ LIỆU SỞ HỮU CÔNG NGHIỆP THEO TIÊU CHUẨN ST3 CỦA WIPO

AE	United Arab Emirates	CN	China	HK	Hong Kong
AF	Afganistan	CO	Colombia	HN	Honduras
AG	Antihua and Barbuda	CR	Costa Rica	HR	Croatia
AI	Anguilla	CU	Cuba	HT	Haiti
AL	Albania	CV	Cape Verde	HU	Hungary
AN	Netherlands Antilles	CY	Cyprus	ID	Indonesia
AO	Angola	CZ	Czech Republic	IE	Ireland
AR	Argentina	DE	Germany	IL	Israel
AT	Austria	DJ	Djibouti	IN	India
AU	Australia	DK	Denmark	IQ	Iraq
AW	Aruba	DM	Dominica	IR	Iran (Islamic Republic of)
BB	Barbados	DO	Dominican Republic	IS	Iceland
BD	Bangladesh	DZ	Algeria	IT	Italy
BE	Belgium	EC	Ecuador	JM	Jamaica
BF	Burkina Faso	EE	Estonia	JO	Jordan
BG	Bulgaria	EG	Egypt	JP	Japan
BH	Bahrain	ES	Spain	KE	Kenya
BI	Burundi	ET	Ethiopia	KH	Cambodia
BJ	Benin	FI	Finland	KI	Kiribati
BM	Bermuda	FJ	Fiji	KM	Comoros
BN	Brunei Darussalam	FK	Falkand Islands (Malvinas)	KN	Saint Kitts and Nevis
BO	Bolivia	FR	France	KP	Democratic People's Republic of Korea
BR	Brazil	GA	Gabon	KR	Republic of Korea
BS	Bahamas	GB	United Kingdom	KW	Kuwait
BT	Bhutan	GD	Grenada	KY	Cayman Islands
BW	Botswana	GE	Georgia	KZ	Kazakhstan
BY	Belarus	GH	Ghana	LA	Laos
BZ	Belize	GI	Gibraltar	LB	Lebanon
CA	Canada	GM	Gambia	LC	Saint Lucia
CF	Central African Republic	GN	Guinea	LI	Liechtenstein
CG	Congo	GQ	Equatorial Guinea	LK	SriLanka
CH	Switzerland	GR	Greece	LR	Liberia
CI	Côte d'Ivoire	GT	Guatemala	LS	Lesotho
CL	Chile	GW	Guinea-Bissau	LT	Lithuania
CM	Cameroon	GY	Guyana	TC	Turk and Caicos Islands
LU	Luxembourg	PA	Panama	TD	Chad
LV	Latvia	PE	Peru	TG	Togo
LY	Lybya	PG	Papua New Guinea	TH	Thailand
MA	Morocco	PH	Philippines	TN	Tunisia
MC	Monaco	PK	Pakistan	TO	Tonga
MD	Republic of Moldova	PL	Poland	TR	Turkey

CÔNG BÁO SỞ HỮU CÔNG NGHIỆP SỐ 437 TẬP A - QUYỂN 2 (08.2024)

MG	Madagascar	PT	Portugal	TT	Trinidad and Tobago
ML	Mali	PY	Paraguay	TV	Tuvalu
MM	Myanmar	QA	Qatar	TW	Taiwan, Province of China
MN	Mongolia	RO	Rumania	TZ	United Republic of Tanzania
MO	Macau	RU	Russian Federation	UA	Ukraine
MR	Mauritania	RW	Rwanda	UG	Uganda
MS	Montserrat	SA	Saudi Arabia	US	United States of America
MT	Malta	SB	Solomon Islands	UY	Uruguay
MU	Mauritius	SC	Seychelles	UZ	Uzbekistan
MV	Maldives	SD	Sudan	VA	Holy see
MW	Malawi	SE	Sweden	VC	Saint Vincent and the Grenadines
MX	Mexico	SG	Singapore	VE	Venezuela
MY	Malaysia	SH	Saint Helena	VG	Virgin Islands (British)
MZ	Mozambique	SL	Slovenia	VN	Vietnam
NA	Namibia	SK	Slovakia	VU	Vanuatu
NE	Niger	SL	Sierra Leone	WS	Samoa
NG	Nigeria	SM	San Marino	YE	Yemen
NJ	Nicaragua	SN	Senegal	YU	Yugoslavia
NL	Netherlands	SO	Somalia	ZA	South Africa
NO	Norway	SR	Suriname	ZM	Zambia
NP	Nepal	ST	Sao Tome and Principe	ZR	Zaire
NR	Nauru	SV	El Sanvador	ZW	Zimbabwe
NZ	New Zealand	SY	Syria		
OM	Oman	SZ	Swaziland		

CÁC TỔ CHỨC QUỐC TẾ

AO	African Intellectual Property Organization (OAPI)
AP	African Regional Industrial Property Organization (ARIPO)
BX	Benelux Trademark Office and Benelux Designs Office
EP	European Patent Office (EPO)
IB, WO	International Bureau of the World Intellectual Property Organization (WIPO)

NHỮNG MÃ SỐ INID TRÍCH TỪ TIÊU CHUẨN ST80 CỦA TỔ CHỨC SỞ HỮU TRÍ TUỆ THẾ GIỚI (WIPO) ĐỂ NHẬN BIẾT CÁC DỮ LIỆU THƯ MỤC DÙNG CÔNG BỐ ĐƠN VÀ BẰNG ĐỘC QUYỀN KIỂU DÁNG CÔNG NGHIỆP

- (11) Số bằng độc quyền kiểu dáng công nghiệp / Số công bố đơn
- (15) Ngày cấp
- (18) Ngày hết hạn hiệu lực của bằng độc quyền kiểu dáng công nghiệp
- (21) Số đơn
- (22) Ngày nộp đơn
- (23) Tên triển lãm, ngày và nơi triển lãm
- (28) Số phương án yêu cầu bảo hộ
- (30) Số đơn ưu tiên, ngày nộp đơn ưu tiên
- (43) Ngày công bố đơn
- (45) Ngày công bố bằng độc quyền kiểu dáng công nghiệp
- (51) Phân loại quốc tế kiểu dáng công nghiệp
- (54) Tên sản phẩm mang kiểu dáng công nghiệp
- (55) Ảnh chụp / hình vẽ kiểu dáng công nghiệp
- (57) Đặc điểm khác biệt yêu cầu bảo hộ của kiểu dáng công nghiệp
- (62) Số và ngày nộp đơn, số bằng độc quyền KDCN hoặc số công bố đơn liên quan đến tách đơn
- (71) Tên và địa chỉ của người nộp đơn
- (72) Tên của tác giả KDCN
- (73) Tên, địa chỉ của chủ bằng độc quyền KDCN
- (74) Tên của người đại diện SHCN

MỤC LỤC

	Trang
<u>PHẦN I:</u> Đơn yêu cầu cấp Bằng độc quyền kiểu dáng công nghiệp	7-351

CONTENTS

<u>PART I:</u> Applications for Industrial Design Patents	7-351
---	-------

PHẦN I

ĐƠN YÊU CẦU CẤP BẰNG ĐỘC QUYỀN KIỂU DÁNG CÔNG NGHIỆP

- (11) **51029**
(21) 3-2024-01270 (28) 1
(54) **THANH KIM LOẠI ĐỊNH HÌNH** (51) **25-01**
(22) 03/06/2024 (43) 26/08/2024
(73) **CÔNG TY CỔ PHẦN TẬP ĐOÀN KENWIN (VN)**
Tầng 4 tòa nhà VG Building, số 235 đường Nguyễn Trãi, phường Thanh Xuân
Trung, quận Thanh Xuân, thành phố Hà Nội
(72) Ngô Thọ Long (VN)
(74) Công ty TNHH Sở hữu trí tuệ PADEMARK (PADEMARK CO.,LTD.)
(55)



1.1



1.2



1.3

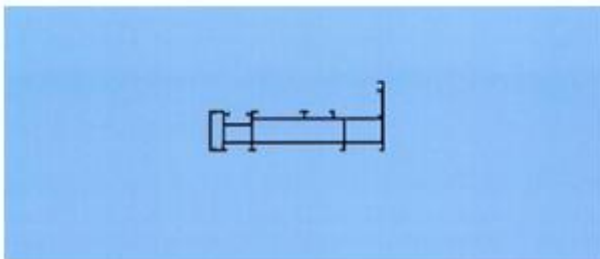

1.4

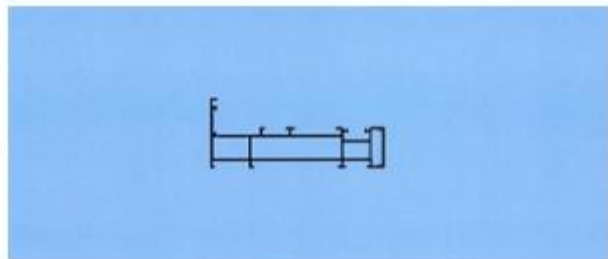

1.5



1.6



1.7

CÔNG BÁO SỞ HỮU CÔNG NGHIỆP SỐ 437 TẬP A – QUYỀN 2 (08.2024)

- (11) **51030**
(21) 3-2024-01274 (28) 1
(54) **QUẠT CÓ CHÂN KẸP** (51) **23-04**
(22) 03/06/2024 (43) 26/08/2024
(30) 202330813495X 11/12/2023 CN;
(73) **DONGGUAN JIANHUA PLASTIC MOULD CO., LTD. (CN)**
Room 601, Building 2, No. 63, Xiangfeng Street, Dalingshan Town, Dongguan
City, Guangdong Province, China
(72) Fanchuan Zhang (CN)
(74) Công ty TNHH Dịch vụ Sở hữu trí tuệ GREENIP (GREENIP CO., LTD)
(55)



1.1



1.2



1.3



1.4



1.5



1.6



1.7



1.8

CÔNG BÁO SỞ HỮU CÔNG NGHIỆP SỐ 437 TẬP A – QUYỀN 2 (08.2024)

- (11) **51031**
(21) 3-2024-01417 (28) 6
(54) **HỘP** (51) **09-03**
(22) 19/06/2024 (43) 26/08/2024
(73) **CÔNG TY CỔ PHẦN MASAN JINJU (VN)**
Nhà xưởng F5, lô 6, khu công nghiệp Tân Đông Hiệp A, phường Tân Đông Hiệp,
thành phố Dĩ An, tỉnh Bình Dương
(72) 1. TRỊNH VĨ TÙNG (VN)
2. BÙI HOÀNG THANH NHÃ (VN)
(74) Công ty cổ phần Sở hữu trí tuệ BROSS và Cộng sự (BROSS & PARTNERS., JSC)
(55)



1.1



1.2



2.1



2.2



3.1



3.2



4.1



4.2



5.1



5.2



6.1



6.2

CÔNG BÁO SỞ HỮU CÔNG NGHIỆP SỐ 437 TẬP A – QUYỀN 2 (08.2024)

- (11) **51032**
(21) 3-2024-01106 (28) 1
(54) **NẮP BÌNH** (51) **07-07**
(22) 14/05/2024 (43) 26/08/2024
(30) 30-2024-0002597 19/01/2024 KR;
(73) **LOCK & LOCK CO., LTD.** (KR)
1260, Manse-ro, Wongok-myeon, Anseong-si, Gyeonggi-do, Republic of Korea
(72) LEE, Hye Ri (KR)
(74) Công ty TNHH Tầm nhìn và Liên danh (VISION & ASSOCIATES CO.LTD.)
(55)



1.1



1.2



1.3



1.4



1.5



1.6



1.7



1.8

CÔNG BÁO SỞ HỮU CÔNG NGHIỆP SỐ 437 TẬP A – QUYỀN 2 (08.2024)

(11) **51033**

(21) 3-2024-01114

(54) **THIẾT BỊ TẠO KHÍ HYDRO**

(22) 15/05/2024

(73) **PHẠM VĂN THỨ** (VN)

4F Bùi Thị Xuân, phường 2, thành phố Đà Lạt, tỉnh Lâm Đồng

(72) Phạm Văn Thứ (VN)

(55)

(28) 1

(51) **23-04**

(43) 26/08/2024



1.1

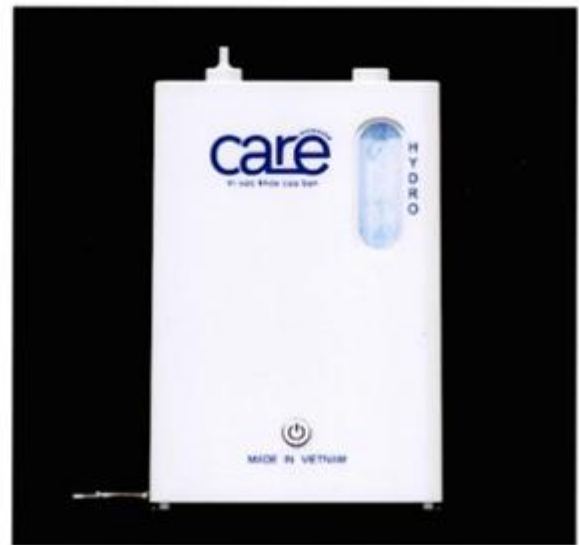

1.2



1.3



1.4



1.5



1.6

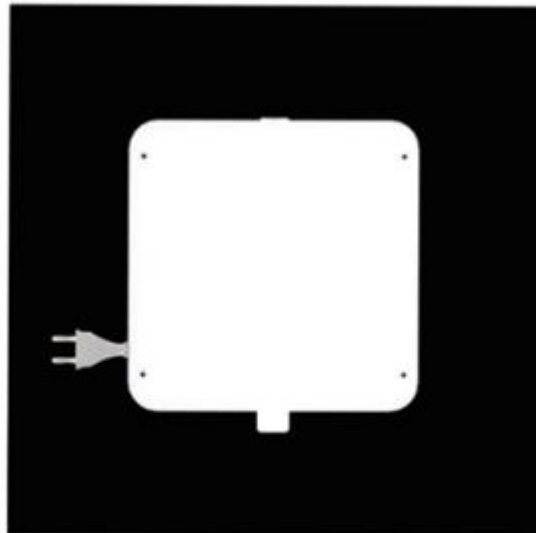

1.7

CÔNG BÁO SỞ HỮU CÔNG NGHIỆP SỐ 437 TẬP A – QUYỀN 2 (08.2024)

- (11) **51034**
(21) 3-2024-01119 (28) 1
(54) **MŨ BẢO HIỂM** (51) **02-03**
(22) 15/05/2024 (43) 26/08/2024
(30) 29/917,900 22/11/2023 US;
(73) **BELL SPORTS, INC. (US)**
5550 Scotts Valley Drive, Scotts Valley, California 95066, USA
(72) 1. DAVID M. THOMPSON (US)
2. MARK A. BUSSE (US)
3. GARRETT J. TOLLETTE (US)
(74) Công ty TNHH Sở hữu trí tuệ Thảo Thọ Quyển (INVENCO.,LTD)
(55)



1.1



1.2



1.3



1.4

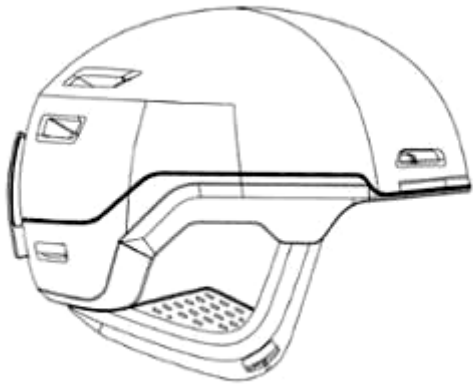

1.5

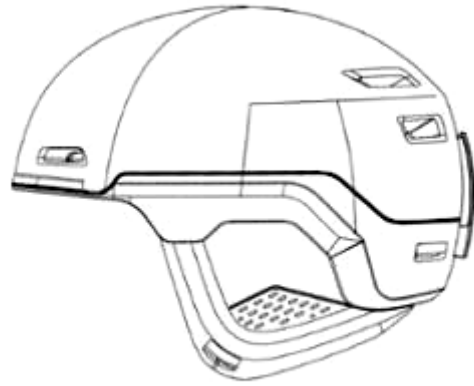

1.6



1.7



1.8

CÔNG BÁO SỞ HỮU CÔNG NGHIỆP SỐ 437 TẬP A – QUYỀN 2 (08.2024)

- (11) **51035**
(21) 3-2024-01129 (28) 1
(54) **XE BÁN TẢI** (51) **12-08**
(22) 16/05/2024 (43) 26/08/2024
(30) 2023307493300 16/11/2023 CN;
(73) **ZHEJIANG YUNLAI IMPORT AND EXPORT CO.,LTD (CN)**
NO.G1-105,HUZHOU INTERNATIONAL COMMODITY CITY, NO.1881,
ERHUAN WEST ROAD, KANGSHAN STREET, SOUTH THE TAIHU LAKE
NEW DISTRICT, HUZHOU CITY, ZHEJIANG PROVINCE, CHINA
(72) Chen Xinmin (CN)
(74) Công ty TNHH ADASTRA IP (VIỆT NAM) (ADASTRA IP (VIETNAM) CO.,
LTD.)
(55)



1.1



1.2



1.3



1.4



1.5



1.6



1.7



1.8

- (11) **51036**
(21) 3-2024-01147 (28) 1
(54) **ĐUÔI GIÓ MŨ BẢO HIỂM** (51) **02-03**
(22) 17/05/2024 (43) 26/08/2024
(30) 112306620 15/12/2023 TW;
(73) **HENRY TEDJAKUSUMA (ID)**
Jalan Wuluh Blok II/3, RT/RW 009/006, Kota Bambu Utara, Palmerah Jakarta Barat 11420, Indonesia
(72) Henry Tedjakusuma (ID)
(74) Công ty TNHH Sở hữu trí tuệ HA VIP (HAVIP CO., LTD.)
(55)

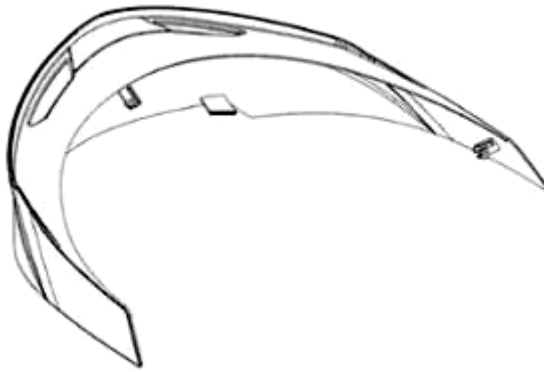

1.1

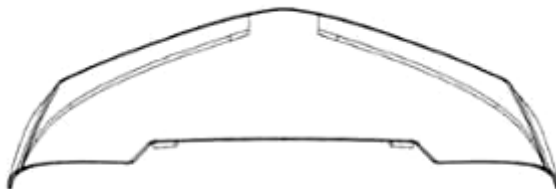

1.2

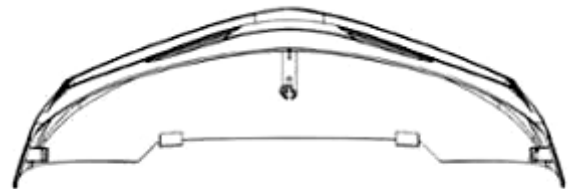

1.3



1.4



1.5



1.6



1.7

CÔNG BÁO SỞ HỮU CÔNG NGHIỆP SỐ 437 TẬP A – QUYỀN 2 (08.2024)

- (11) **51037**
(21) 3-2024-01171 (28) 1
(54) **LỚP XE** (51) **12-15**
(22) 22/05/2024 (43) 26/08/2024
(73) **CHENG SHIN RUBBER IND. CO., LTD. (TW)**
No. 215, Meigang Rd., Dacun Township, Changhua County 515, Taiwan
(72) 1. MIN-CHI LIN (TW)
2. QI-WEN HUANG (TW)
3. JYUN-YI KE (TW)
4. CHEN-YANG YU (TW)
5. CHENG-YU LI (TW)
(74) Công ty Cổ phần Sở hữu công nghiệp INVESTIP (INVESTIP)
(55)

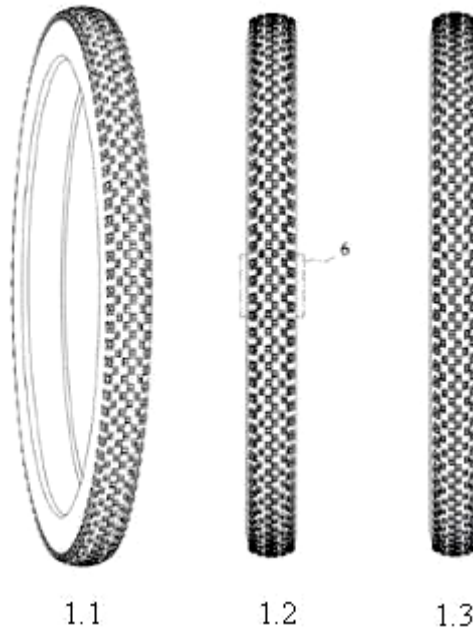



1.4



1.5

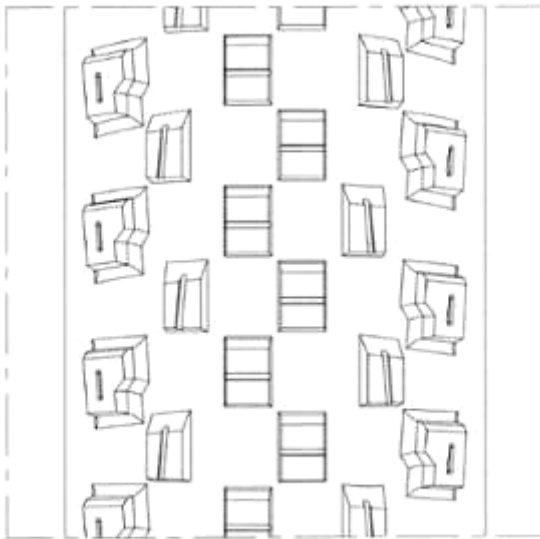

1.6

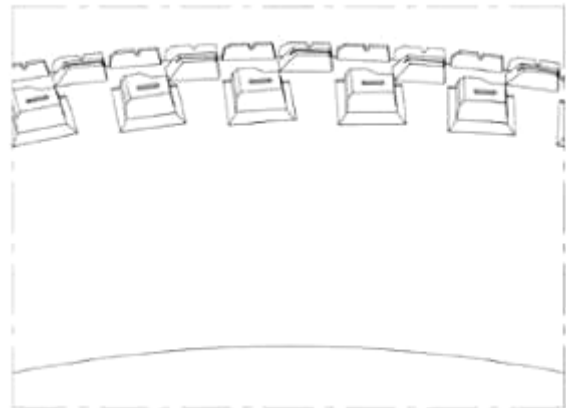

1.7

CÔNG BÁO SỞ HỮU CÔNG NGHIỆP SỐ 437 TẬP A – QUYỀN 2 (08.2024)

- (11) **51038**
(21) 3-2024-01173 (28) 1
(54) **MÁY KHUẾCH TÁN HƯƠNG THƠM** (51) **23-04**
(22) 22/05/2024 (43) 26/08/2024
(73) **CÔNG TY CỔ PHẦN TMDV XNK DŨNG VINH (VN)**
Số 19 ngõ 10 đường Nguyễn Thị Định, phường Trung Hoà, quận Cầu Giấy, thành phố Hà Nội
(72) Nguyễn Thị Hồng Đăng (VN)
(74) Công ty TNHH Sở hữu trí tuệ VNNA & Associates (IP NGOC ANH TRADE AND SERVICE COMPANY LIMITED)
(55)



1.1

1.2

1.3

1.4



1.5



1.6



1.7

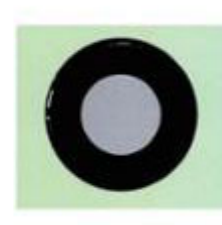

1.8

CÔNG BÁO SỞ HỮU CÔNG NGHIỆP SỐ 437 TẬP A – QUYỀN 2 (08.2024)

- (11) **51039**
(21) 3-2024-01175 (28) 1
(54) **THÙNG ĐÁ** (51) **07-07**
(22) 23/05/2024 (43) 26/08/2024
(73) **CÔNG TY CỔ PHẦN SẢN XUẤT - THƯƠNG MẠI - NHỰA HIỆP THÀNH (VN)**
34-36 Cao Văn Lầu, phường 1, quận 6, thành phố Hồ Chí Minh
(72) Trương Văn Ngọc (VN)
(55)



1.1



1.2

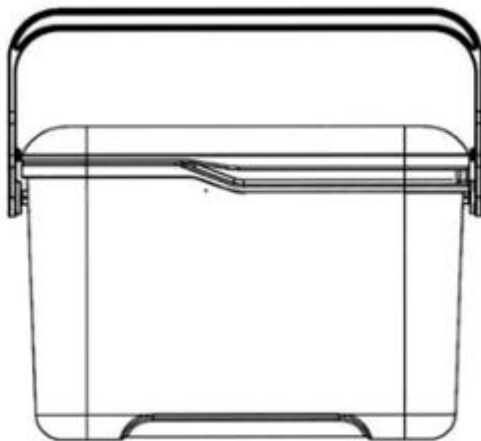

1.3



1.4

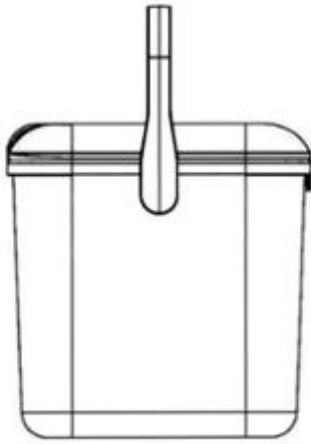

1.5

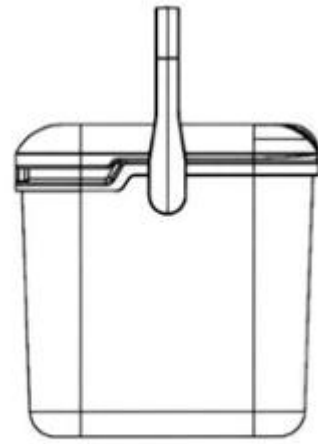

1.6

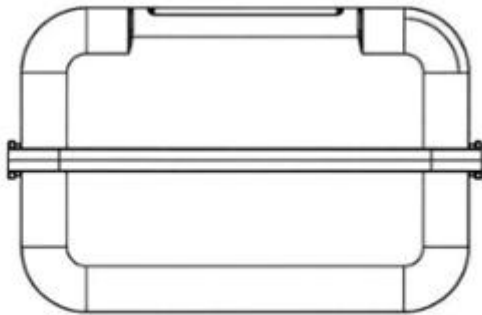

1.7

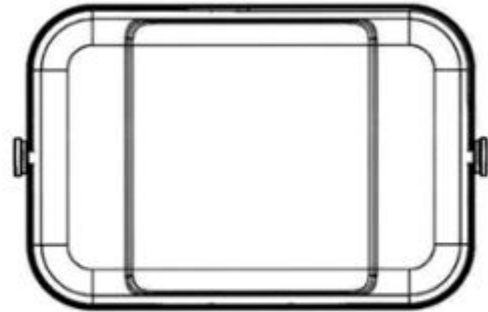

1.8

- (11) **51040**
(21) 3-2024-01177 (28) 17
(54) **CHUỖI RĂNG CỦA KHÓA KÉO** (51) **02-07**
(22) 23/05/2024 (43) 26/08/2024
(30) 202330770310.1 24/11/2023 CN; 202430117386.9 08/03/2024 CN;
202430117385.4 08/03/2024 CN;
(73) **YKK CORPORATION (JP)**
1, Kanda Izumi-cho, Chiyoda-ku, Tokyo 101-8642 Japan
(72) Takahiro YAMAMOTO (JP)
(74) Công ty Luật TNHH Phạm và Liên danh (PHAM & ASSOCIATES)
(55)



1.1



1.2



1.3



1.4



1.5



1.6



1.7



1.8



1.9



2.1



2.2



2.3



2.4



2.5



2.6



2.7



2.8



2.9



3.1



3.2



3.3



3.4



3.5



3.6



3.7



3.8

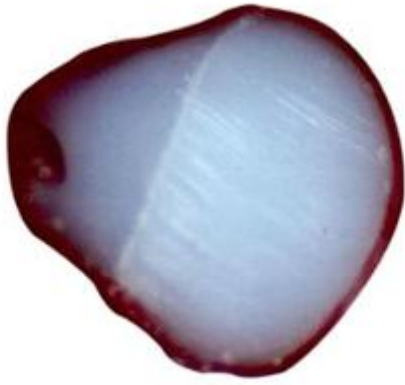

3.9



4.1



4.2



4.3



4.4



4.5

4.6



4.7



4.8

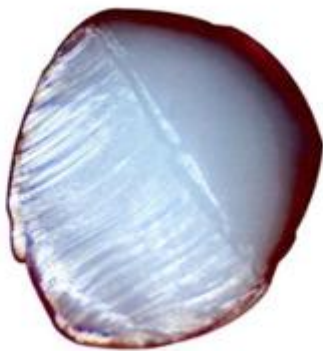

4.9



5.1



5.2



5.3



5.4



5.5

5.6



5.7



5.8



5.9



6.1



6.2



6.3



6.4



6.5

6.6



6.7



6.8



6.9



7.1



7.2



7.3



7.4



7.5

7.6



7.7



7.8

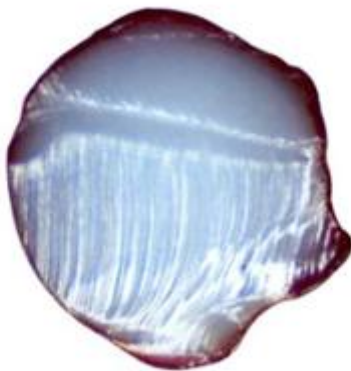

7.9



8.1



8.2



8.3



8.4



8.5



8.6



8.7



8.8



8.9



9.1



9.2



9.3

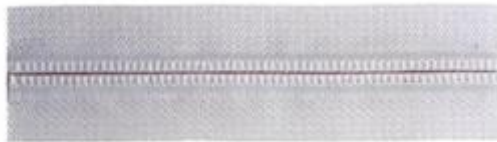

9.4



9.5



9.6



9.7



9.8



9.9



10.1



10.2



10.3



10.4



10.5



10.6



10.7



10.8

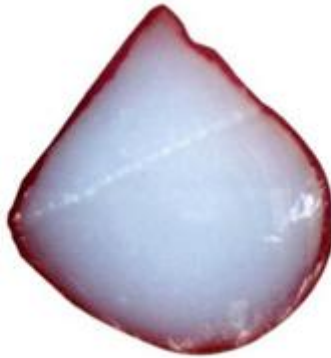

10.9



11.1



11.2



11.3



11.4



11.5



11.6



11.7



11.8



11.9



12.1



12.2



12.3



12.4



12.5



12.6



12.7



12.8



12.9



13.1



13.2



13.3



13.4



13.5



13.6



13.7



13.8



13.9



14.1



14.2



14.3



14.4



14.5



14.6



14.7



14.8



14.9



15.1



15.2



15.3



15.4



15.5



15.6



15.7



15.8



15.9



16.1



16.2



16.3



16.4



16.5



16.6



16.7



16.8

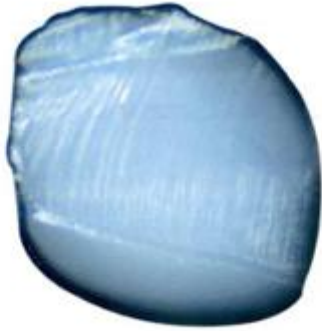

16.9



17.1



17.2



17.3



17.4



17.5



17.6



17.7



17.8

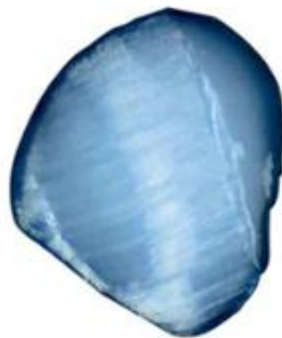

17.9

CÔNG BÁO SỞ HỮU CÔNG NGHIỆP SỐ 437 TẬP A – QUYỀN 2 (08.2024)

- (11) **51041**
(21) 3-2024-01180 (28) 1
(54) **ẮC QUY** (51) **13-02**
(22) 23/05/2024 (43) 26/08/2024
(30) 2023-026902 26/12/2023 JP;
(73) 1. **THE FURUKAWA BATTERY CO., LTD.** (JP)
2-4-1, Hoshikawa, Hodogaya-ku, Yokohama-shi, Kanagawa 240-0006 Japan
2. **FURUKAWA ELECTRIC CO., LTD.** (JP)
6-4, Otemachi 2-chome, Chiyoda-ku, Tokyo 100-8322, Japan
(72) Nozomi TOMINAGA (JP)
(74) Công ty TNHH một thành viên Sở hữu trí tuệ VCCI (VCCI-IP CO.,LTD)
(55)

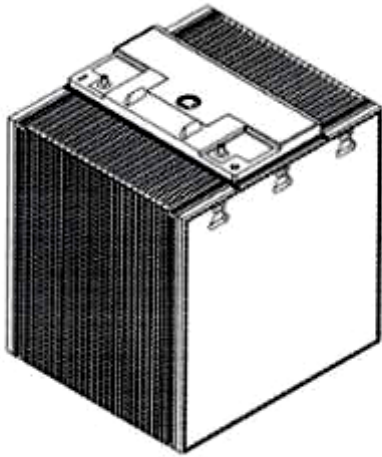

1.1

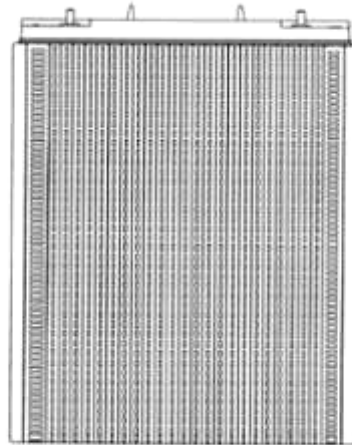

1.2

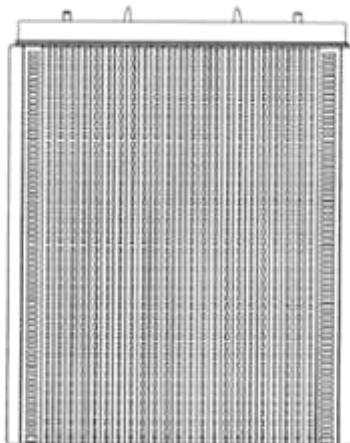

1.3

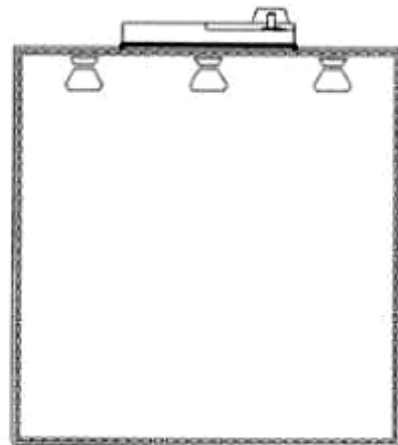

1.4

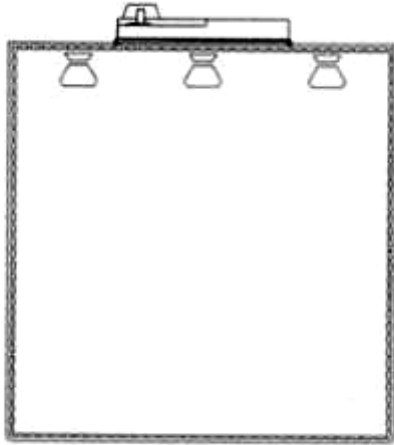

1.5

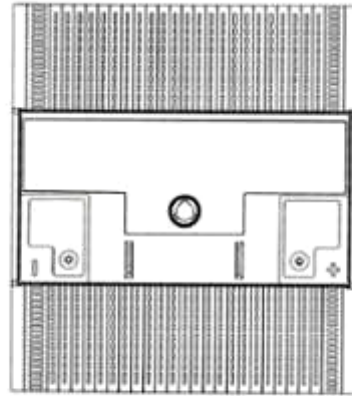

1.6

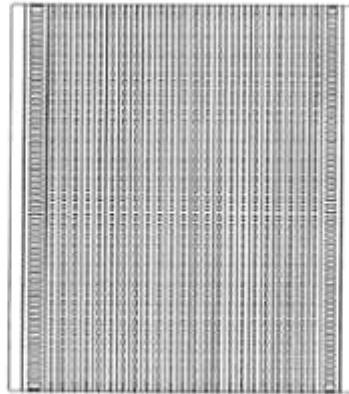

1.7

CÔNG BÁO SỞ HỮU CÔNG NGHIỆP SỐ 437 TẬP A – QUYỀN 2 (08.2024)

- (11) **51042**
(21) 3-2024-01181 (28) 1
(54) **ẮC QUY** (51) **13-02**
(22) 23/05/2024 (43) 26/08/2024
(30) 2024-003833 26/02/2024 JP;
(73) 1. **THE FURUKAWA BATTERY CO., LTD.** (JP)
2-4-1, Hoshikawa, Hodogaya-ku, Yokohama-shi, Kanagawa 240-0006 Japan
2. **FURUKAWA ELECTRIC CO., LTD.** (JP)
6-4, Otemachi 2-chome, Chiyoda-ku, Tokyo 100-8322, Japan
(72) Nozomi TOMINAGA (JP)
(74) Công ty TNHH một thành viên Sở hữu trí tuệ VCCI (VCCI-IP CO.,LTD)
(55)

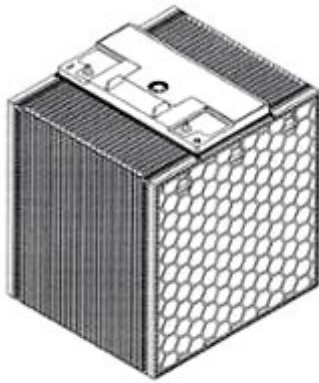

1.1

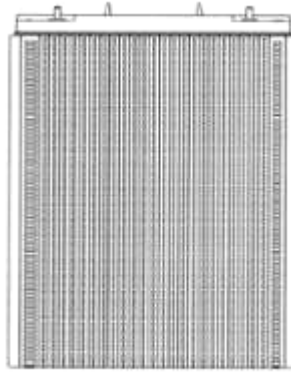

1.2

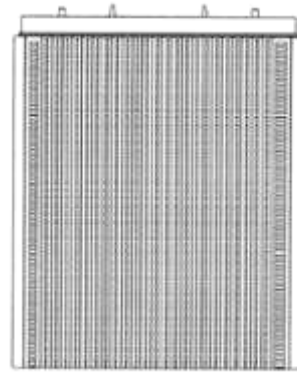

1.3

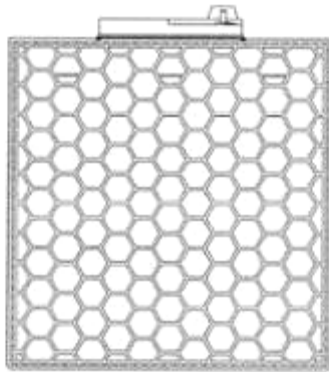

1.4

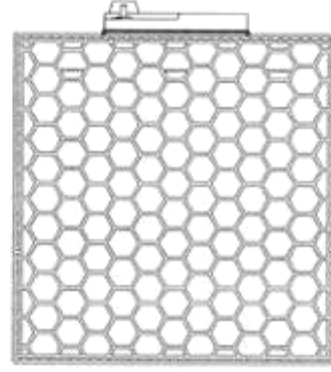

1.5

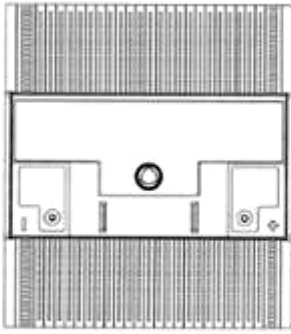

1.6

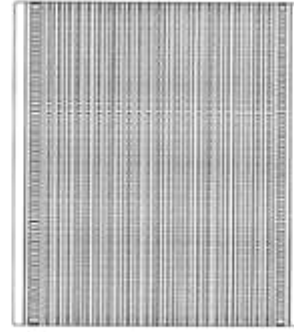

1.7

CÔNG BÁO SỞ HỮU CÔNG NGHIỆP SỐ 437 TẬP A – QUYỀN 2 (08.2024)

- (11) **51043**
(21) 3-2024-01186 (28) 1
(54) **Ô TÔ** (51) **12-08**
(22) 26/04/2022 (43) 26/08/2024
(30) 2021-023420 27/10/2021 JP;
(73) **DAIHATSU MOTOR CO., LTD. (JP)**
1-1, DAIHATSU-CHO, IKEDA-SHI, OSAKA 563-8651 JAPAN
(72) 1. HIDEYU HONDA (JP)
2. KOICHI MIZUTA (JP)
3. JIRO MATSUEDA (JP)
4. KATSUTARO KIMURA (JP)
(74) Công ty TNHH một thành viên Sở hữu trí tuệ VCCI (VCCI-IP CO.,LTD)
(55)



1.1



1.2



1.3



1.4



1.5



1.6



1.7

CÔNG BÁO SỞ HỮU CÔNG NGHIỆP SỐ 437 TẬP A – QUYỀN 2 (08.2024)

- (11) **51044**
(21) 3-2024-01188 (28) 1
(54) **THANH KIM LOẠI ĐỊNH HÌNH** (51) **25-01**
(22) 24/05/2024 (43) 26/08/2024
(73) **CÔNG TY CỔ PHẦN OCIMI VIỆT NAM (VN)**
Số nhà 19D, ngõ 180 Nam Dư, tổ 19, phường Lĩnh Nam, quận Hoàng Mai, thành phố Hà Nội
(72) Ngô Thọ Thịnh (VN)
(74) Công ty TNHH Sở hữu trí tuệ PADEMARK (PADEMARK CO.,LTD.)
(55)



1.1



1.2



1.3

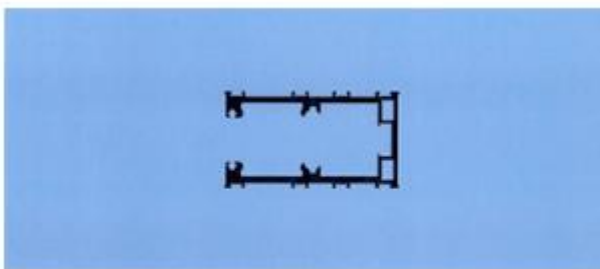

1.4



1.5



1.6



1.7

CÔNG BÁO SỞ HỮU CÔNG NGHIỆP SỐ 437 TẬP A – QUYỀN 2 (08.2024)

- (11) **51045**
(21) 3-2024-01199 (28) 1
(54) **NHÃN SẢN PHẨM** (51) **19-08**
(22) 27/05/2024 (43) 26/08/2024
(73) **CÔNG TY CỔ PHẦN D-SHINING (VN)**
7C Nguyễn Ngọc Phương, phường 19, quận Bình Thạnh, thành phố Hồ Chí Minh
(72) Ngô Văn Phước (VN)
(74) Văn phòng Luật sư D và T (D & T LAW OFFICE)
(55)



1.1



1.2

CÔNG BÁO SỞ HỮU CÔNG NGHIỆP SỐ 437 TẬP A – QUYỀN 2 (08.2024)

- (11) **51046**
(21) 3-2024-01200 (28) 1
(54) **THANH NHÔM ĐỊNH HÌNH** (51) **25-01**
(22) 27/05/2024 (43) 26/08/2024
(73) **CÔNG TY TNHH XÂY DỰNG THƯƠNG MẠI TỔNG HỢP TRUNG THÀNH (VN)**
Tiểu khu 4, thị trấn Hoàn Lão, huyện Bố Trạch, tỉnh Quảng Bình
(72) Nguyễn Trung Thành (VN)
(74) **CÔNG TY TNHH SỞ HỮU TRÍ TUỆ ANLIS VIỆT NAM (ANLIS IP CO.,LTD)**
(55)



1.1

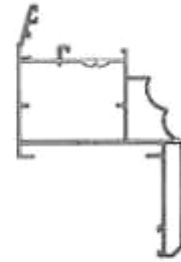

1.2



1.3



1.4

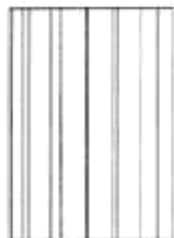

1.5

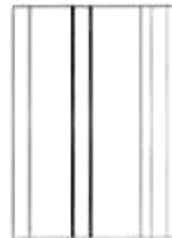

1.6

CÔNG BÁO SỞ HỮU CÔNG NGHIỆP SỐ 437 TẬP A – QUYỀN 2 (08.2024)

- (11) **51047**
(21) 3-2024-01201 (28) 1
(54) **THANH NHÔM ĐỊNH HÌNH** (51) **25-01**
(22) 27/05/2024 (43) 26/08/2024
(73) **CÔNG TY TNHH XÂY DỰNG THƯƠNG MẠI TỔNG HỢP TRUNG THÀNH (VN)**
Tiểu khu 4, thị trấn Hoàn Lão, huyện Bố Trạch, tỉnh Quảng Bình
(72) Nguyễn Trung Thành (VN)
(74) **CÔNG TY TNHH SỞ HỮU TRÍ TUỆ ANLIS VIỆT NAM (ANLIS IP CO.,LTD)**
(55)

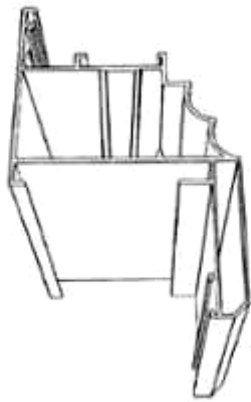

1.1

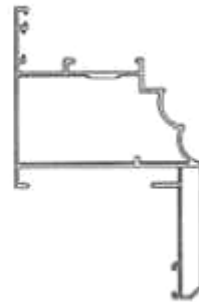

1.2



1.3



1.4

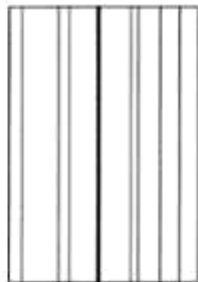

1.5



1.6

CÔNG BÁO SỞ HỮU CÔNG NGHIỆP SỐ 437 TẬP A – QUYỀN 2 (08.2024)

- (11) **51048**
(21) 3-2024-01209 (28) 1
(54) **THANH KIM LOẠI ĐỊNH HÌNH** (51) **25-01**
(22) 28/05/2024 (43) 26/08/2024
(73) **CÔNG TY CỔ PHẦN SẢN XUẤT VÀ ĐẦU TƯ HƯNG PHÁT (VN)**
Tổ dân phố Thịnh Vạn, phường Minh Đức, thị xã Mỹ Hào, tỉnh Hưng Yên
(72) Nguyễn Văn Tâm (VN)
(74) Công ty TNHH Sở hữu trí tuệ Gia Việt (GIAVIET CO., LTD.)
(55)

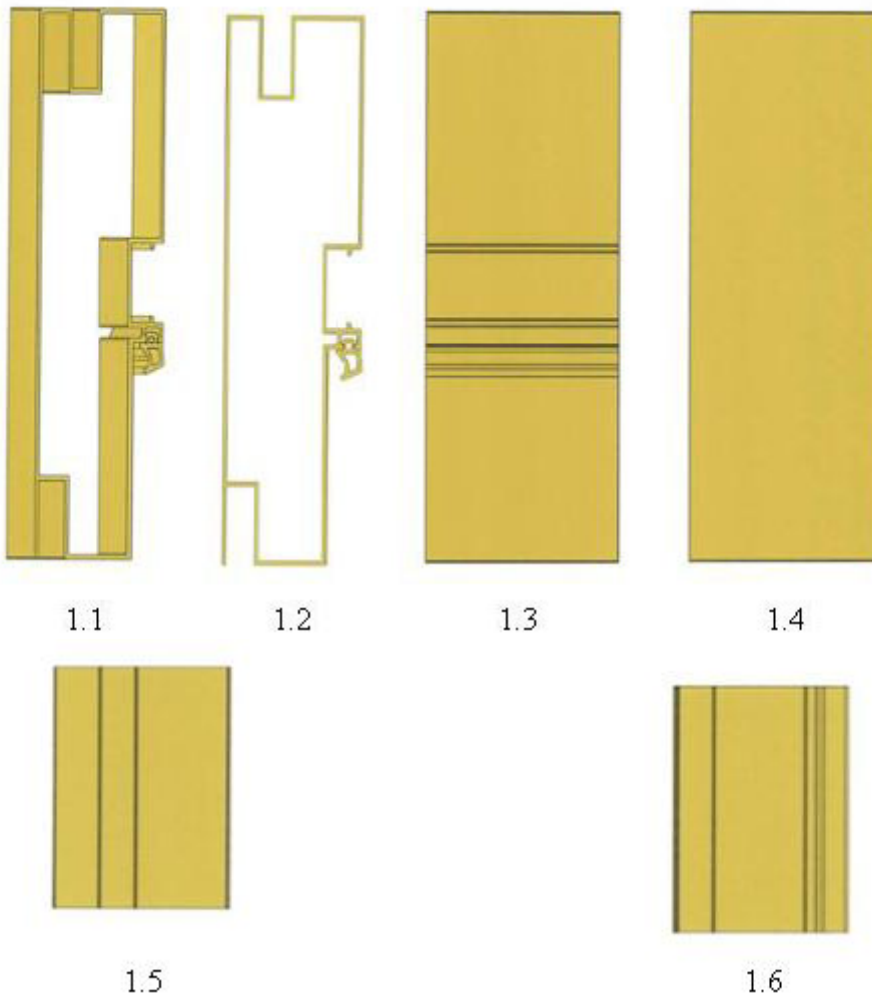

CÔNG BÁO SỞ HỮU CÔNG NGHIỆP SỐ 437 TẬP A – QUYỀN 2 (08.2024)

- (11) **51049**
(21) 3-2024-01210 (28) 1
(54) **THANH KIM LOẠI ĐỊNH HÌNH** (51) **25-01**
(22) 28/05/2024 (43) 26/08/2024
(73) **CÔNG TY CỔ PHẦN SẢN XUẤT VÀ ĐẦU TƯ HƯNG PHÁT (VN)**
Tổ dân phố Thịnh Vạn, phường Minh Đức, thị xã Mỹ Hào, tỉnh Hưng Yên
(72) Nguyễn Văn Tâm (VN)
(74) Công ty TNHH Sở hữu trí tuệ Gia Việt (GIAVIET CO., LTD.)
(55)

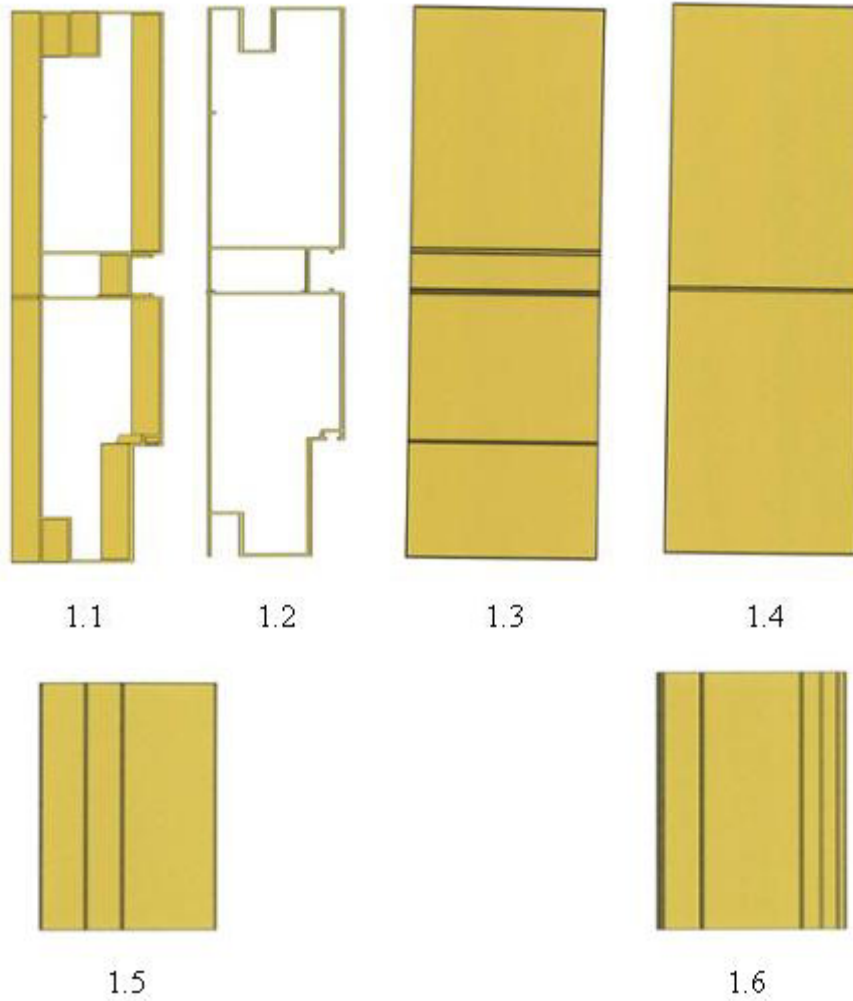

CÔNG BÁO SỞ HỮU CÔNG NGHIỆP SỐ 437 TẬP A – QUYỀN 2 (08.2024)

- (11) **51050**
(21) 3-2024-01212 (28) 1
(54) **NHÃN SẢN PHẨM** (51) **19-08**
(22) 28/05/2024 (43) 26/08/2024
(73) **PHẠM THỊ HẰNG (VN)**
Số 14/855 Tôn Đức Thắng, phường Sở Dầu, quận Hồng Bàng, thành phố Hải Phòng
(72) Phạm Thị Hằng (VN)
(74) Công ty TNHH NACILAW (NACILAW)
(55)



1.1

CÔNG BÁO SỞ HỮU CÔNG NGHIỆP SỐ 437 TẬP A – QUYỀN 2 (08.2024)

(11) **51051**

(21) 3-2024-01221

(28) 1

(54) **MŨ**

(51) **02-03**

(22) 29/05/2024

(43) 26/08/2024

(73) **CHEVEUX CORPORATION (US)**

463 BARELL AVENUE, CARLSTADT, NEW JERSEY, UNITED STATES 07072

(72) HYO J. YIM (US)

(74) Công ty Luật TNHH Phạm và Liên danh (PHAM & ASSOCIATES)

(55)



1.1

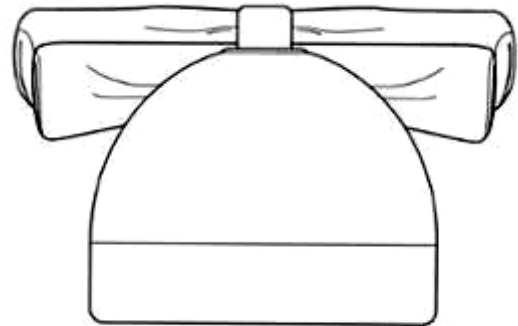

1.2

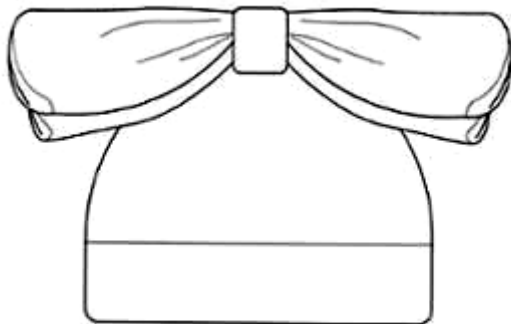

1.3

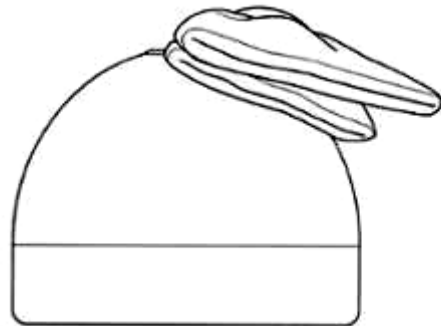

1.4

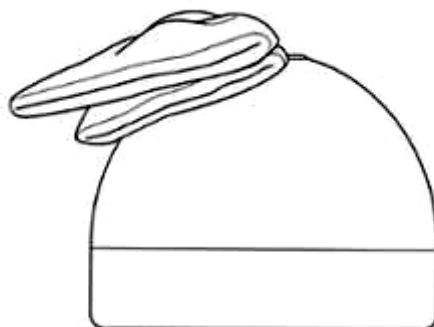

1.5

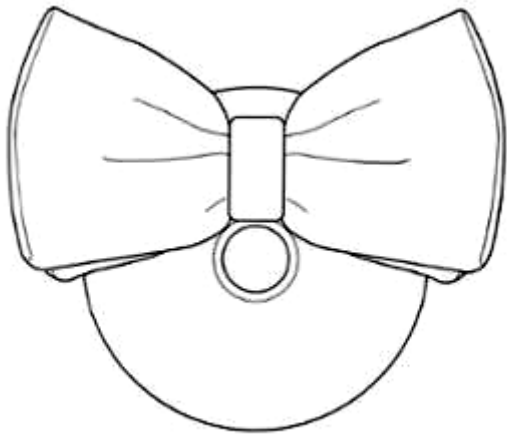

1.6

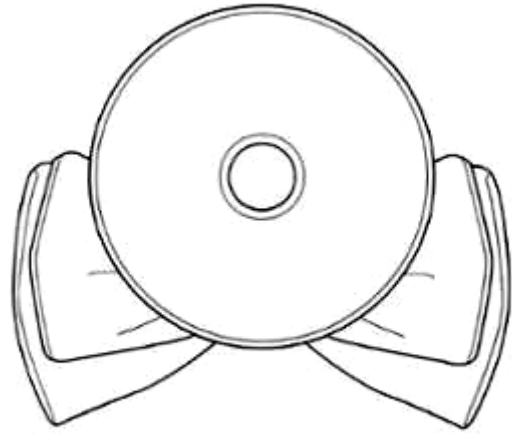

1.7

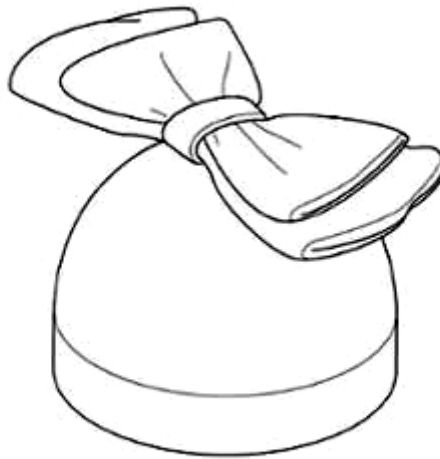

1.8

CÔNG BÁO SỞ HỮU CÔNG NGHIỆP SỐ 437 TẬP A – QUYỀN 2 (08.2024)

- (11) **51052**
- (21) 3-2024-01222
- (54) **HỘP ĐỰNG**
- (22) 29/05/2024
- (73) **CÔNG TY TNHH HIỆP PHONG (VN)**
Tầng 1,2 tòa nhà CT2,3 khu đô thị Dream Town, đường 70, phường Tây Mỗ, quận Nam Từ Liêm, thành phố Hà Nội
- (72) Trần Minh Trung (VN)
- (74) Công ty TNHH Trường Xuân (AGELESS CO.,LTD.)
- (55)



1.1



1.2



1.3



1.4



1.5



1.6



1.7

CÔNG BÁO SỞ HỮU CÔNG NGHIỆP SỐ 437 TẬP A – QUYỀN 2 (08.2024)

(11) **51053**

(21) 3-2024-01225

(28) 1

(54) **CỐC NỀN**

(51) **26-01**

(22) 29/05/2024

(43) 26/08/2024

(73) **CÔNG TY TNHH MINH LONG I (VN)**

Số 333 đường Hưng Định 24, khu phố Hưng Lộc, phường Hưng Định, thành phố Thuận An, tỉnh Bình Dương

(72) Lý Huy Sáng (VN)

(55)



1.1

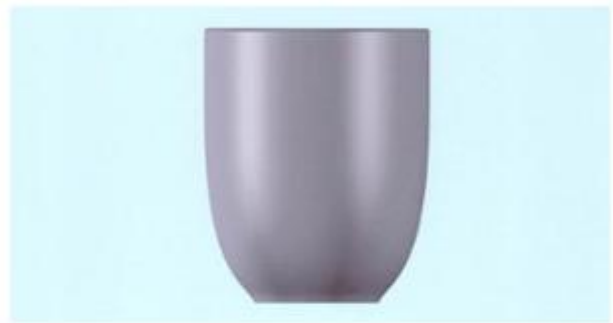

1.2



1.3



1.4

CÔNG BÁO SỞ HỮU CÔNG NGHIỆP SỐ 437 TẬP A – QUYỀN 2 (08.2024)

- (11) **51054**
(21) 3-2024-01229 (28) 4
(54) **NHÃN SẢN PHẨM** (51) **19-08**
(22) 30/05/2024 (43) 26/08/2024
(73) **CÔNG TY CỔ PHẦN ACECOOK VIỆT NAM (VN)**
Lô số II-3, đường số 11, nhóm CN II, khu công nghiệp Tân Bình, phường Tây
Thạnh, quận Tân Phú, thành phố Hồ Chí Minh
(72) KANEDA HIROKI (JP)
(74) Công ty Luật TNHH Phạm và Liên danh (PHAM & ASSOCIATES)
(55)



1.1

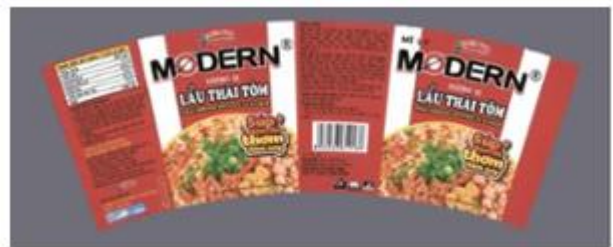

2.1

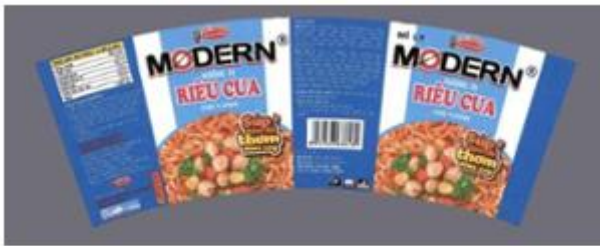

3.1



4.1

CÔNG BÁO SỞ HỮU CÔNG NGHIỆP SỐ 437 TẬP A – QUYỀN 2 (08.2024)

- (11) **51055**
(21) 3-2024-01233 (28) 1
(54) **XE ĐẠP ĐIỆN** (51) **12-11**
(22) 30/05/2024 (43) 26/08/2024
(30) 2024302430795 26/04/2024 CN;
(73) **TIANJIN YADEA INDUSTRIAL CO., LTD. (CN)**
Tianjin Medical Devices Industry Park, Beichen District, Tianjin, China
(72) 1. CUI JIAXIN (CN)
2. ZANG XIAOMENG (CN)
3. MA YUEFENG (CN)
4. ZHENG ZIMING (CN)
(74) Công ty TNHH ADASTRA IP (VIỆT NAM) (ADASTRA IP (VIETNAM) CO., LTD.)
(55)



1.1



1.2



1.3



1.4



1.5



1.6



1.7

CÔNG BÁO SỞ HỮU CÔNG NGHIỆP SỐ 437 TẬP A – QUYỀN 2 (08.2024)

- (11) **51056**
- (21) 3-2024-01235 (28) 1
- (54) **NHÃN SẢN PHẨM** (51) **19-08**
- (22) 30/05/2024 (43) 26/08/2024
- (73) **CÔNG TY CỔ PHẦN SẢN XUẤT & THƯƠNG MẠI CÁT TƯỜNG GROUP (VN)**
Thôn An Lộc, xã Đồng Sơn, huyện Nam Trực, tỉnh Nam Định
- (72) Nguyễn Văn Chính (VN)
- (74) **CÔNG TY TNHH SỞ HỮU TRÍ TUỆ SETHACO (SETHACO IP CO.,LTD)**
- (55)



CÔNG BÁO SỞ HỮU CÔNG NGHIỆP SỐ 437 TẬP A – QUYỀN 2 (08.2024)

- (11) **51057**
(21) 3-2024-01244 (28) 1
(54) **ỐNG HÚT** (51) **07-06**
(22) 30/05/2024 (43) 26/08/2024
(73) **CÔNG TY CỔ PHẦN MASAN JINJU (VN)**
Nhà xưởng F5, lô 6, khu công nghiệp Tân Đông Hiệp A, phường Tân Đông Hiệp,
thành phố Dĩ An, tỉnh Bình Dương
(72) 1. HÀ HUY KHÁNH (VN)
2. VƯƠNG TRUNG HIẾU (VN)
(74) Công ty cổ phần Sở hữu trí tuệ BROSS và Cộng sự (BROSS & PARTNERS., JSC)
(55)

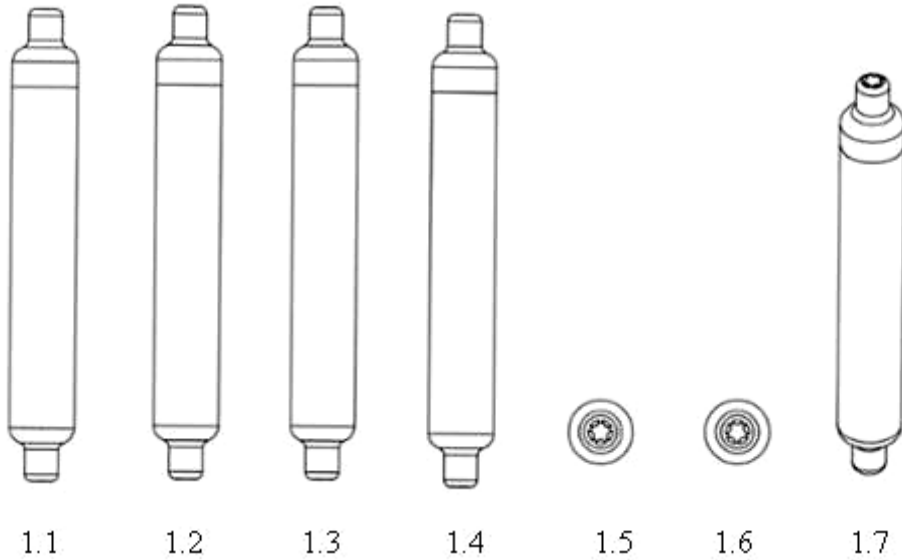

CÔNG BÁO SỞ HỮU CÔNG NGHIỆP SỐ 437 TẬP A – QUYỀN 2 (08.2024)

- (11) **51058**
(21) 3-2024-01245 (28) 1
(54) **NẮP ỐNG HÚT** (51) **07-06**
(22) 30/05/2024 (43) 26/08/2024
(73) **CÔNG TY CỔ PHẦN MASAN JINJU (VN)**
Nhà xưởng F5, lô 6, khu công nghiệp Tân Đông Hiệp A, phường Tân Đông Hiệp,
thành phố Dĩ An, tỉnh Bình Dương
(72) 1. HÀ HUY KHÁNH (VN)
2. VƯƠNG TRUNG HIẾU (VN)
(74) Công ty cổ phần Sở hữu trí tuệ BROSS và Cộng sự (BROSS & PARTNERS., JSC)
(55)



1.1



1.2



1.3



1.4



1.5



1.6



1.7

CÔNG BÁO SỞ HỮU CÔNG NGHIỆP SỐ 437 TẬP A – QUYỀN 2 (08.2024)

- (11) **51059**
(21) 3-2024-01246 (28) 1
(54) **THÂN ỐNG HÚT** (51) **07-06**
(22) 30/05/2024 (43) 26/08/2024
(73) **CÔNG TY CỔ PHẦN MASAN JINJU (VN)**
Nhà xưởng F5, lô 6, khu công nghiệp Tân Đông Hiệp A, phường Tân Đông Hiệp,
thành phố Dĩ An, tỉnh Bình Dương
(72) 1. HÀ HUY KHÁNH (VN)
2. VƯƠNG TRUNG HIẾU (VN)
(74) Công ty cổ phần Sở hữu trí tuệ BROSS và Cộng sự (BROSS & PARTNERS., JSC)
(55)

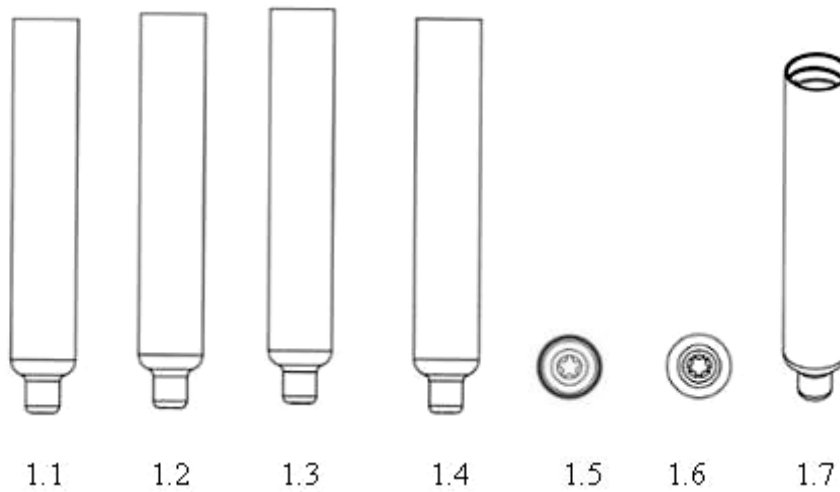

- (11) **51060**
(21) 3-2024-01254 (28) 1
(54) **CHI TIẾT ĐIỀU CHỈNH DÂY** (51) **08-05**
(22) 31/05/2024 (43) 26/08/2024
(30) 30-2023-0049764 07/12/2023 KR;
(73) **WOOJIN PLASTIC CO.,LTD. (KR)**
45, Paryasandan-ro, Jinjeop-eup, Namyangju-si, Gyeonggi-do 12017 Republic of Korea.
(72) 1. JISOOK PAIK (KR)
2. NAN HEE PAIK (KR)
3. JI HYE PAIK (KR)
4. JI WON SON (US)
(74) Công ty TNHH Trường Xuân (AGELESS CO.,LTD.)
(55)

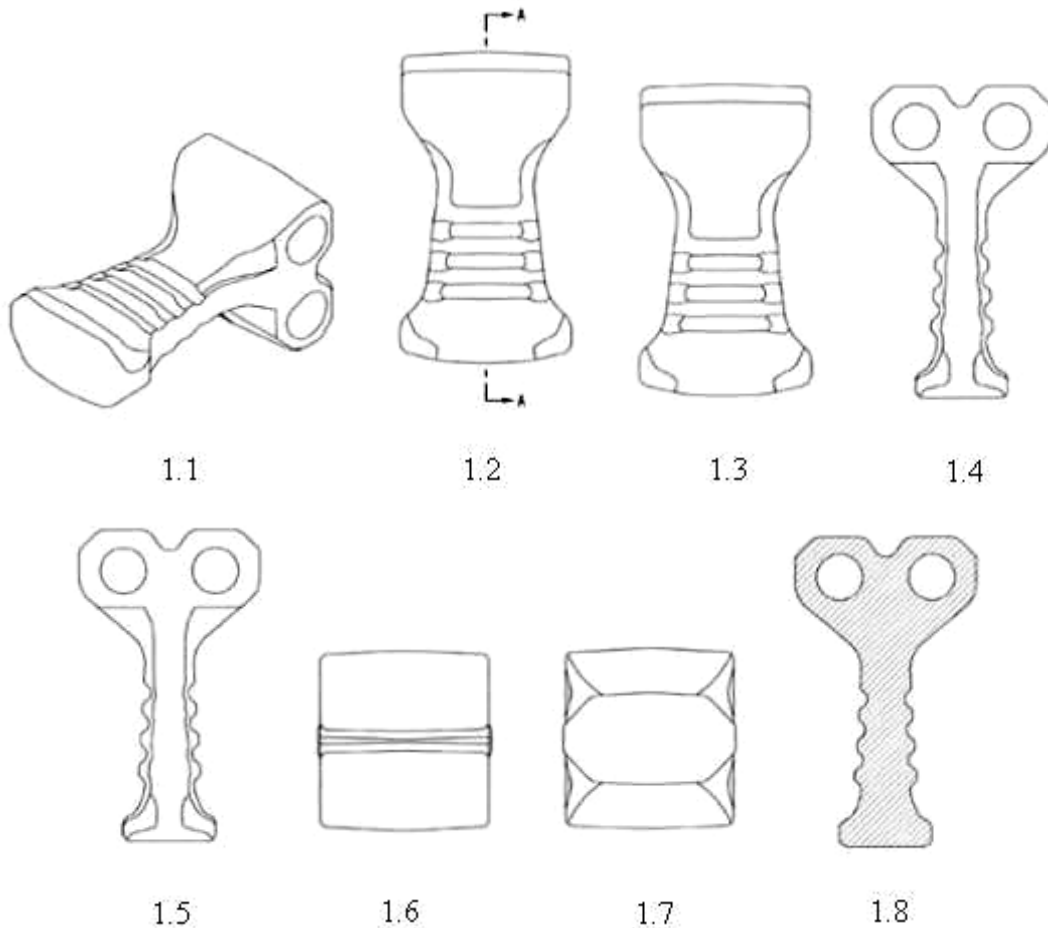

CÔNG BÁO SỞ HỮU CÔNG NGHIỆP SỐ 437 TẬP A – QUYỀN 2 (08.2024)

- (11) **51061**
(21) 3-2024-01267 (28) 1
(54) **BAO GÓI SẢN PHẨM** (51) **09-05**
(22) 03/06/2024 (43) 26/08/2024
(73) **HỢP TÁC XÃ NÔNG NGHIỆP HẢO ANH (VN)**
Thôn Cánh Chín, xã Vạn Hoà, thành phố Lào Cai, tỉnh Lào Cai
(72) Phạm Thị Hảo (VN)
(74) Công ty TNHH MASTERBRAND (MASTERBRAND)
(55)



1.1



1.2

CÔNG BÁO SỞ HỮU CÔNG NGHIỆP SỐ 437 TẬP A – QUYỀN 2 (08.2024)

- (11) **51062**
(21) 3-2024-01269 (28) 1
(54) **THANH KIM LOẠI ĐỊNH HÌNH** (51) **25-01**
(22) 03/06/2024 (43) 26/08/2024
(73) **CÔNG TY CỔ PHẦN TẬP ĐOÀN KENWIN (VN)**
Tầng 4 tòa nhà VG Building, số 235 đường Nguyễn Trãi, phường Thanh Xuân
Trung, quận Thanh Xuân, thành phố Hà Nội
(72) Ngô Thọ Long (VN)
(74) Công ty TNHH Sở hữu trí tuệ PADEMARK (PADEMARK CO.,LTD.)
(55)



1.1



1.2

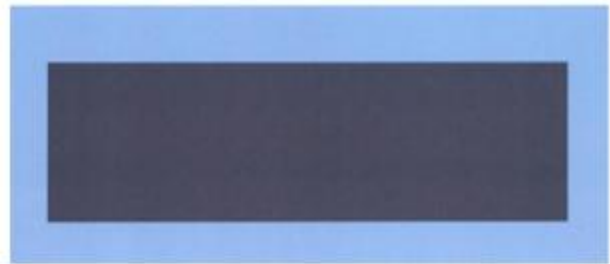

1.3

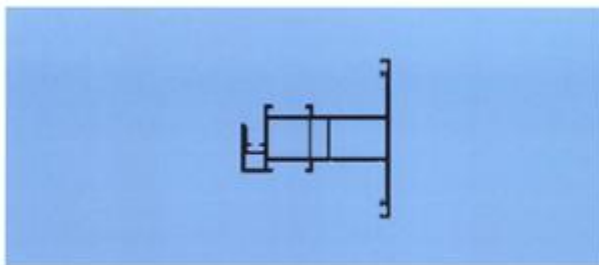

1.4

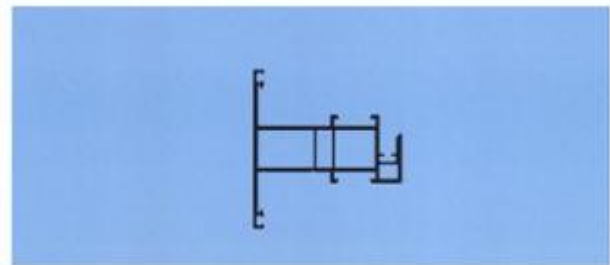

1.5



1.6



1.7

- (11) **51063**
- (21) 3-2024-01298 (28) 2
- (54) **CHUỖI RĂNG CỦA KHÓA KÉO** (51) **02-07**
- (22) 06/06/2024 (43) 26/08/2024
- (30) 2024300116356 09/01/2024 CN;
- (73) **YKK CORPORATION (JP)**
1, Kanda Izumi-cho, Chiyoda-ku, Tokyo 101-8642 Japan
- (72) 1. KOHEI KAWARADA (JP)
2. TIAN TIAN FENG (CN)
- (74) Công ty Luật TNHH Phạm và Liên danh (PHAM & ASSOCIATES)
- (55)

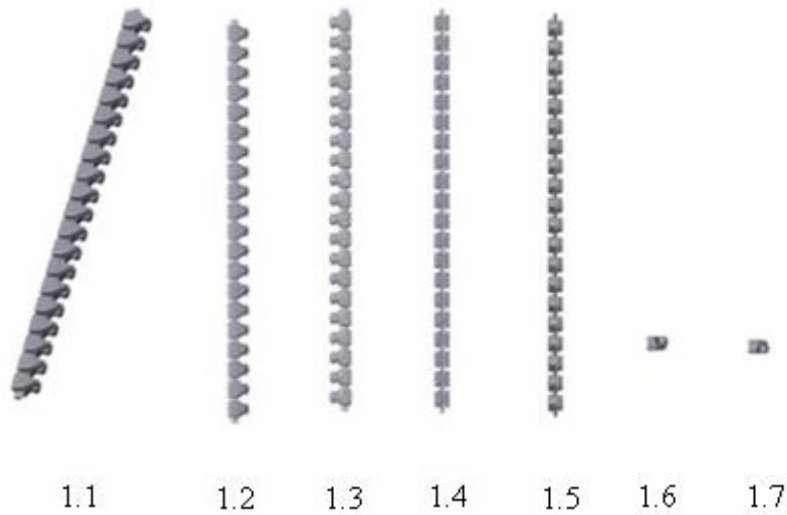

- (11) **51064**
(21) 3-2024-01299 (28) 2
(54) **CHUỖI RĂNG CỦA KHÓA KÉO** (51) **02-07**
(22) 06/06/2024 (43) 26/08/2024
(30) 202430011635.6 09/01/2024 CN;
(73) **YKK CORPORATION (JP)**
1, Kanda Izumi-cho, Chiyoda-ku, Tokyo 101-8642 Japan
(72) 1. KOHEI KAWARADA (JP)
2. TIAN TIAN FENG (CN)
(74) Công ty Luật TNHH Phạm và Liên danh (PHAM & ASSOCIATES)
(55)

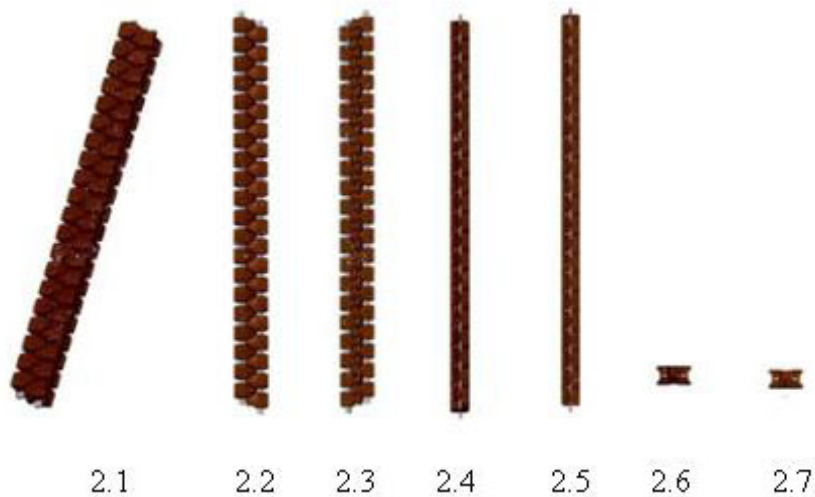
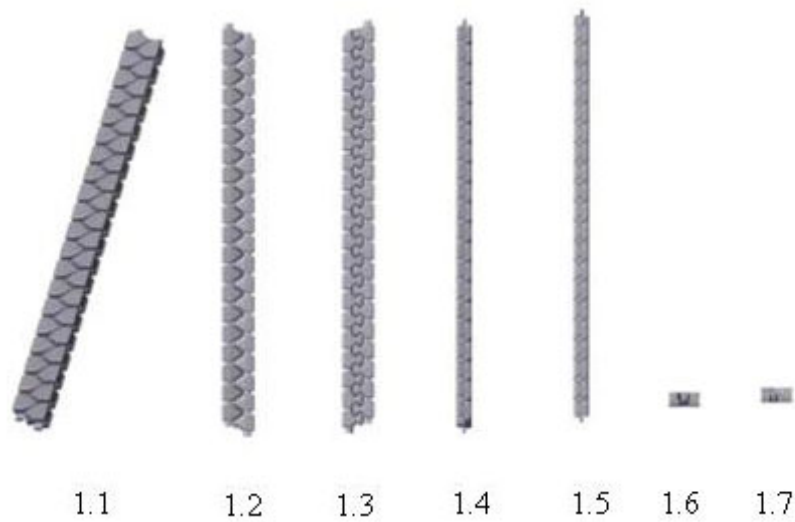

CÔNG BÁO SỞ HỮU CÔNG NGHIỆP SỐ 437 TẬP A – QUYỀN 2 (08.2024)

- (11) **51065**
(21) 3-2024-01313 (28) 1
(54) **THÙNG BIA** (51) **09-03**
(22) 07/06/2024 (43) 26/08/2024
(73) **TỔNG CÔNG TY CỔ PHẦN BIA - RƯỢU - NƯỚC GIẢI KHÁT SÀI GÒN (VN)**
187 Nguyễn Chí Thanh, phường 12, quận 5, thành phố Hồ Chí Minh
(72) Tan Teck Chuan Lester (SG)
(74) Công ty TNHH Luật ALIAT (ALIAT LEGAL)
(55)



1.1

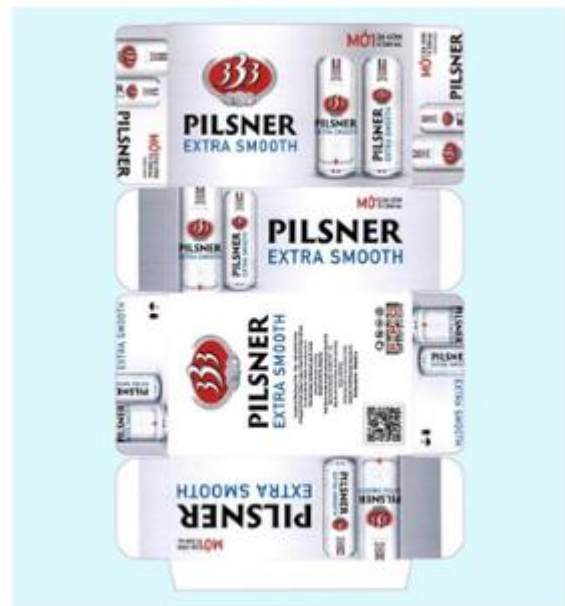

1.2

CÔNG BÁO SỞ HỮU CÔNG NGHIỆP SỐ 437 TẬP A – QUYỀN 2 (08.2024)

- (11) **51066**
(21) 3-2024-01314 (28) 2
(54) **BỘ NHÃN SẢN PHẨM** (51) **19-08**
(22) 07/06/2024 (43) 26/08/2024
(73) **TỔNG CÔNG TY CỔ PHẦN BIA - RƯỢU - NƯỚC GIẢI KHÁT SÀI GÒN (VN)**
187 Nguyễn Chí Thanh, phường 12, quận 5, thành phố Hồ Chí Minh
(72) Tan Teck Chuan Lester (SG)
(74) Công ty TNHH Luật ALIAT (ALIAT LEGAL)
(55)



1.1



1.2



1.3



1.4

CÔNG BÁO SỞ HỮU CÔNG NGHIỆP SỐ 437 TẬP A – QUYỀN 2 (08.2024)

- (11) **51067**
(21) 3-2024-01315 (28) 1
(54) **NHÃN SẢN PHẨM** (51) **19-08**
(22) 07/06/2024 (43) 26/08/2024
(73) **TỔNG CÔNG TY CỔ PHẦN BIA - RƯỢU - NƯỚC GIẢI KHÁT SÀI GÒN (VN)**
187 Nguyễn Chí Thanh, phường 12, quận 5, thành phố Hồ Chí Minh
(72) Tan Teck Chuan Lester (SG)
(74) Công ty TNHH Luật ALIAT (ALIAT LEGAL)
(55)



1.1



1.2

CÔNG BÁO SỞ HỮU CÔNG NGHIỆP SỐ 437 TẬP A – QUYỀN 2 (08.2024)

- (11) **51068**
(21) 3-2024-01319 (28) 1
(54) **BÚT** (51) **19-06**
(22) 07/06/2024 (43) 26/08/2024
(73) **CÔNG TY CỔ PHẦN TẬP ĐOÀN THIÊN LONG (VN)**
Tầng 10, Sofic Tower, số 10 đường Mai Chí Thọ, phường Thủ Thiêm, thành phố Thủ Đức, thành phố Hồ Chí Minh
(72) Cô Gia Thọ (VN)
(74) Công ty TNHH Tư vấn sở hữu trí tuệ Việt (VIET IP CO.,LTD.)
(55)

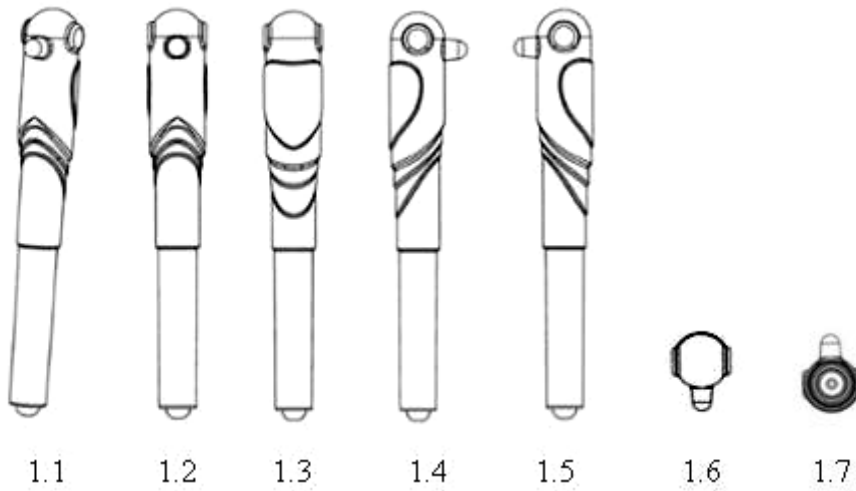

CÔNG BÁO SỞ HỮU CÔNG NGHIỆP SỐ 437 TẬP A – QUYỀN 2 (08.2024)

- (11) **51069**
(21) 3-2024-01320 (28) 1
(54) **NẮP BÚT** (51) **19-06**
(22) 07/06/2024 (43) 26/08/2024
(73) **CÔNG TY CỔ PHẦN TẬP ĐOÀN THIÊN LONG (VN)**
Tầng 10, Sofic Tower, số 10 đường Mai Chí Thọ, phường Thủ Thiêm, thành phố
Thủ Đức, thành phố Hồ Chí Minh
(72) Cô Gia Thọ (VN)
(74) Công ty TNHH Tư vấn sở hữu trí tuệ Việt (VIET IP CO.,LTD.)
(55)

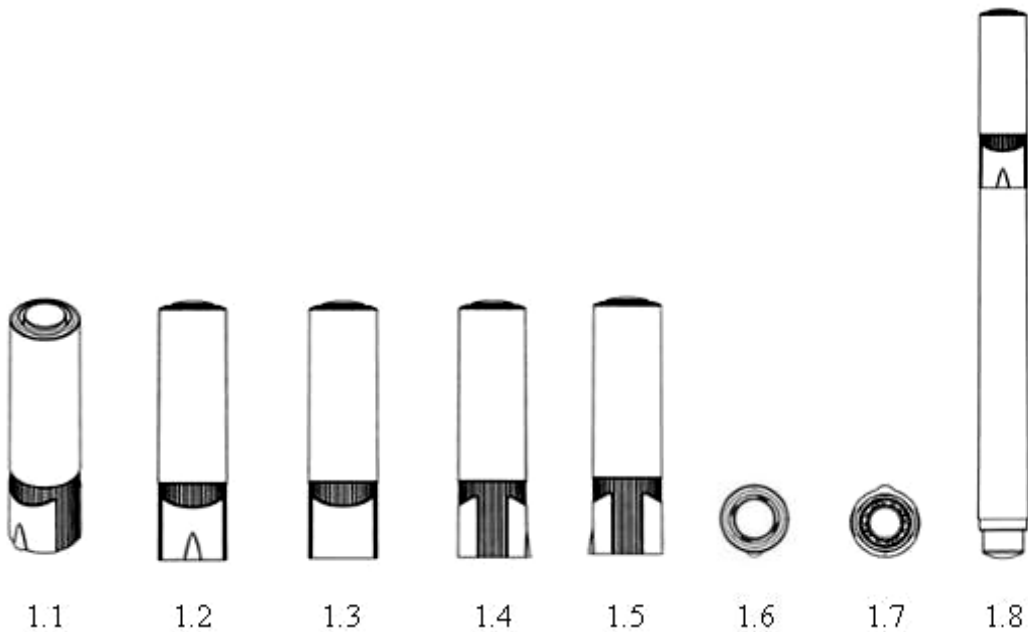

CÔNG BÁO SỞ HỮU CÔNG NGHIỆP SỐ 437 TẬP A – QUYỀN 2 (08.2024)

- (11) **51070**
(21) 3-2024-01321 (28) 1
(54) **HỘP ĐỰNG MÌ** (51) **09-03**
(22) 10/06/2024 (43) 26/08/2024
(73) **CÔNG TY CỔ PHẦN THỰC PHẨM QUỐC TẾ TORKI (VN)**
120/5 Lê Văn Quới, phường Bình Hưng Hòa A, quận Bình Tân, thành phố Hồ Chí Minh
(72) Lê Quốc Thạch (VN)
(74) Công ty Luật TNHH Phạm và Liên danh (PHAM & ASSOCIATES)
(55)



1.1



1.2

CÔNG BÁO SỞ HỮU CÔNG NGHIỆP SỐ 437 TẬP A – QUYỀN 2 (08.2024)

- (11) **51071**
(21) 3-2024-01322 (28) 1
(54) **HỘP BÁNH** (51) **09-03**
(22) 10/06/2024 (43) 26/08/2024
(73) **CÔNG TY CỔ PHẦN THỰC PHẨM QUỐC TẾ TORKI (VN)**
120/5 Lê Văn Quới, phường Bình Hưng Hòa A, quận Bình Tân, thành phố Hồ Chí Minh
(72) Lê Quốc Thạch (VN)
(74) Công ty Luật TNHH Phạm và Liên danh (PHAM & ASSOCIATES)
(55)



1.1



1.2

CÔNG BÁO SỞ HỮU CÔNG NGHIỆP SỐ 437 TẬP A – QUYỀN 2 (08.2024)

- (11) **51072**
- (21) 3-2024-01329 (28) 1
- (54) **NHÃN SẢN PHẨM** (51) **19-08**
- (22) 10/06/2024 (43) 26/08/2024
- (73) **CÔNG TY CỔ PHẦN TẬP ĐOÀN APOLLO SILICONE (VN)**
18-20 Lê Quý Đôn, phường Võ Thị Sáu, quận 3, thành phố Hồ Chí Minh
- (72) Ngô Quốc Cường (VN)
- (74) Công ty TNHH Tâm nhìn và Liên danh (VISION & ASSOCIATES CO.LTD.)
- (55)



CÔNG BÁO SỞ HỮU CÔNG NGHIỆP SỐ 437 TẬP A – QUYỀN 2 (08.2024)

- (11) **51073**
- (21) 3-2024-01330 (28) 1
- (54) **NHÃN SẢN PHẨM** (51) **19-08**
- (22) 10/06/2024 (43) 26/08/2024
- (73) **CÔNG TY CỔ PHẦN TẬP ĐOÀN APOLLO SILICONE (VN)**
18-20 Lê Quý Đôn, phường Võ Thị Sáu, quận 3, thành phố Hồ Chí Minh
- (72) Ngô Quốc Cường (VN)
- (74) Công ty TNHH Tâm nhìn và Liên danh (VISION & ASSOCIATES CO.LTD.)
- (55)



CÔNG BÁO SỞ HỮU CÔNG NGHIỆP SỐ 437 TẬP A – QUYỀN 2 (08.2024)

- (11) **51074**
(21) 3-2024-01331 (28) 1
(54) **NHÃN SẢN PHẨM** (51) **19-08**
(22) 10/06/2024 (43) 26/08/2024
(73) **CÔNG TY CỔ PHẦN TẬP ĐOÀN APOLLO SILICONE (VN)**
18-20 Lê Quý Đôn, phường Võ Thị Sáu, quận 3, thành phố Hồ Chí Minh
(72) Ngô Quốc Cường (VN)
(74) Công ty TNHH Tầm nhìn và Liên danh (VISION & ASSOCIATES CO.LTD.)
(55)



CÔNG BÁO SỞ HỮU CÔNG NGHIỆP SỐ 437 TẬP A – QUYỀN 2 (08.2024)

- (11) **51075**
(21) 3-2024-01332 (28) 1
(54) **NHÃN SẢN PHẨM** (51) **19-08**
(22) 10/06/2024 (43) 26/08/2024
(73) **CÔNG TY CỔ PHẦN TẬP ĐOÀN APOLLO SILICONE (VN)**
18-20 Lê Quý Đôn, phường Võ Thị Sáu, quận 3, thành phố Hồ Chí Minh
(72) Ngô Quốc Cường (VN)
(74) Công ty TNHH Tâm nhìn và Liên danh (VISION & ASSOCIATES CO.LTD.)
(55)



CÔNG BÁO SỞ HỮU CÔNG NGHIỆP SỐ 437 TẬP A – QUYỀN 2 (08.2024)

- (11) **51076**
(21) 3-2024-01341 (28) 1
(54) **VÀNH BÁNH XE** (51) **12-16**
(22) 10/06/2024 (43) 26/08/2024
(30) 24-E0494-0101 26/03/2024 MY;
(73) **MENG KAH AUTO PARTS TRADING SDN. BHD. (MY)**
No. 40, Jalan TPP 5, Taman Perindustrian Putra, 47130 Puchong, Selangor,
Malaysia
(72) LEE CONG QUAN (MY)
(74) Công ty TNHH Trường Xuân (AGELESS CO.,LTD.)
(55)



1.1



1.2



1.3



1.4

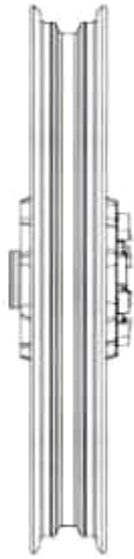

1.5

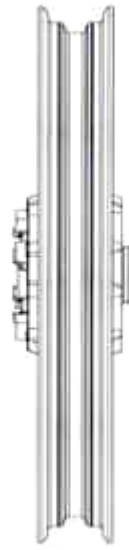

1.6

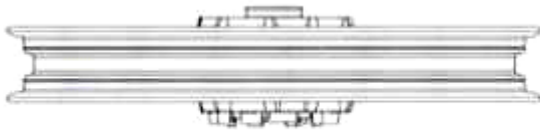

1.7

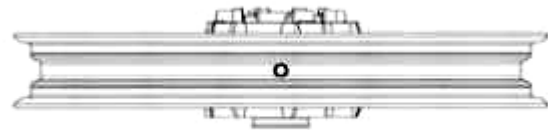

1.8

CÔNG BÁO SỞ HỮU CÔNG NGHIỆP SỐ 437 TẬP A – QUYỀN 2 (08.2024)

- (11) **51077**
- (21) 3-2024-01342 (28) 1
- (54) **BAO GÓI** (51) **09-05**
- (22) 10/06/2024 (43) 26/08/2024
- (73) **ĐẶNG THỊ KIM MẠNH (VN)**
Tổ 3, phường Nghĩa Lộ, thành phố Quảng Ngãi, tỉnh Quảng Ngãi
- (72) Đặng Thị Kim Mạnh (VN)
- (74) Văn phòng Luật sư D và T (D & T LAW OFFICE)
- (55)



1.1



1.2

CÔNG BÁO SỞ HỮU CÔNG NGHIỆP SỐ 437 TẬP A – QUYỀN 2 (08.2024)

(11) **51078**

(21) 3-2024-01354

(28) 1

(54) **TẤM PANEL**

(51) **25-01**

(22) 11/06/2024

(43) 26/08/2024

(73) **CÔNG TY CỔ PHẦN GREENPAN (VN)**

Lô 25-27, đường Trung Tâm, khu công nghiệp Tân Tạo, phường Tân Tạo A, quận Bình Tân, thành phố Hồ Chí Minh

(72) Đào Ngọc Long (VN)

(74) Công ty TNHH Sở hữu trí tuệ Đông Dương (DONG DUONG IP CO.,LTD)

(55)

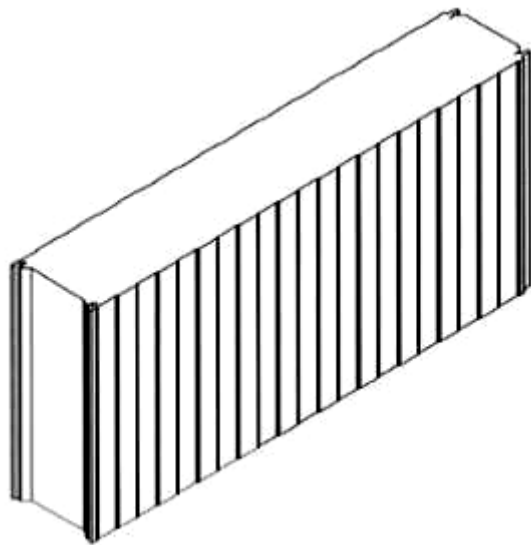

1.1

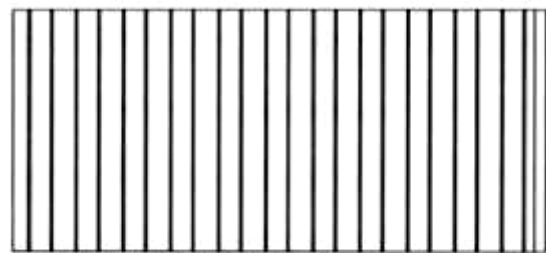

1.2

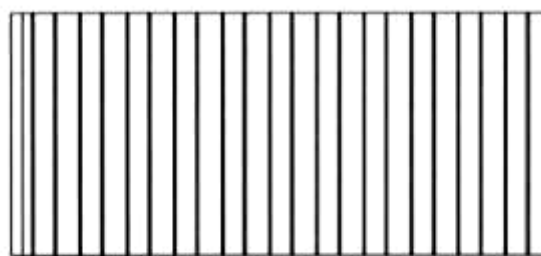

1.3



1.4



1.5

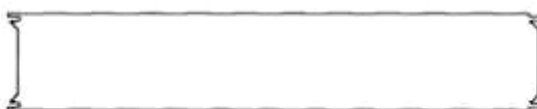

1.6



1.7

- (11) **51079**
(21) 3-2024-01355 (28) 1
(54) **ĐÉ GIÀY** (51) **02-04**
(22) 11/06/2024 (43) 26/08/2024
(30) 29/920,666 12/12/2023 US;
(73) **CROCS, INC. (US)**
500 Eldorado Boulevard, Building 5, Broomfield, Colorado 80021, United States of America
(72) 1. BRIAN DOUGLAS ROTTMAN (US)
2. JIE LIU (US)
3. MICHAEL SARANTAKOS (US)
(74) Công ty Luật TNHH quốc tế BMVN (BMVN INTERNATIONAL LLC)
(55)

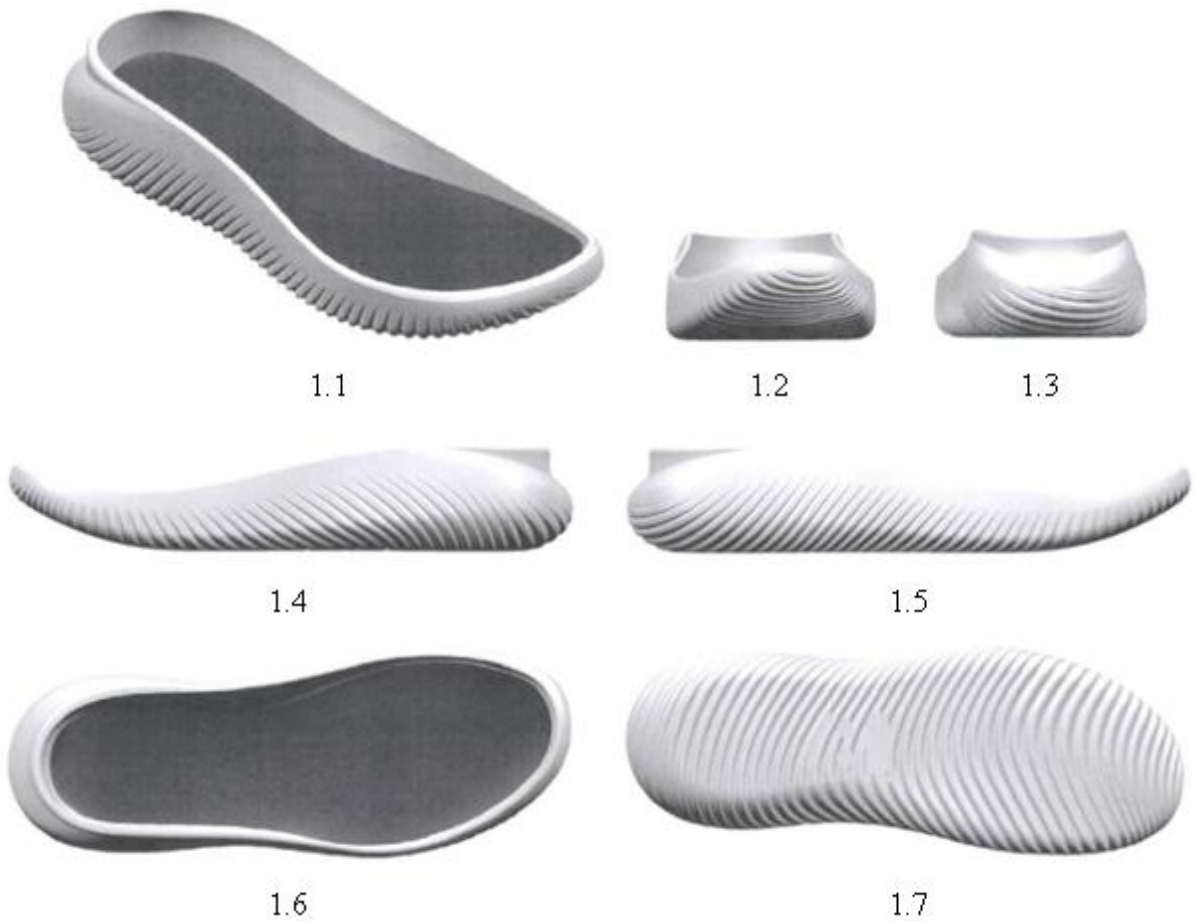

CÔNG BÁO SỞ HỮU CÔNG NGHIỆP SỐ 437 TẬP A – QUYỀN 2 (08.2024)

- (11) **51080**
(21) 3-2024-01358 (28) 1
(54) **ĐÈN PHA CÓ TẢN NHIỆT** (51) **26-03**
(22) 12/06/2024 (43) 26/08/2024
(73) **RRR OPTOELECTRONIC CO., LTD (CN)**
No. 822 Lingzhan Road, Lingkun Street, Oujiangkou Industrial Cluster Zone,
Wenzhou City, Zhejiang Province, China
(72) 1. YUJIA ZHENG (CN)
2. LIANMENG ZHENG (CN)
3. HAICHUAN WANG (CN)
4. JU LU (CN)
(74) Công ty TNHH IPCELLS & Cộng Sự (IPCELLS & ASSOCIATED CO.,LTD)
(55)

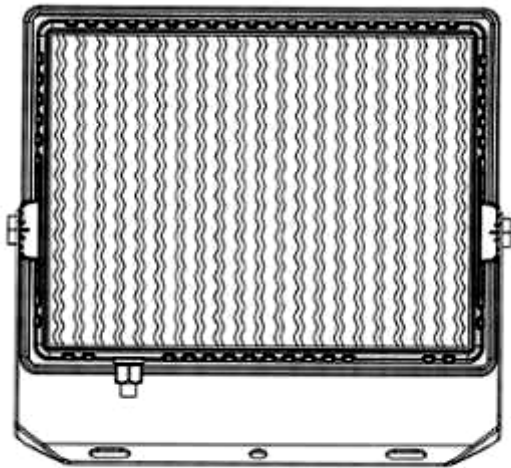

1.1

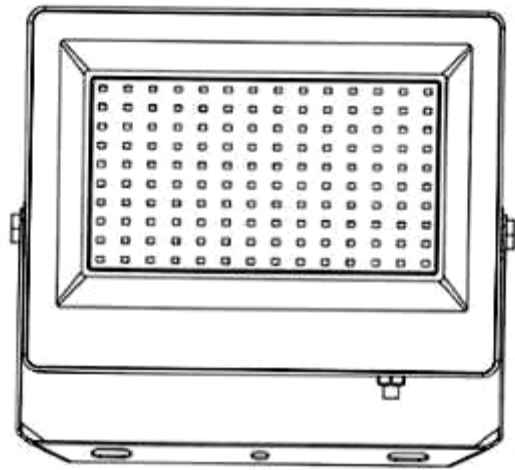

1.2



1.3

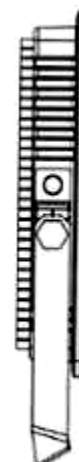

1.4



1.5

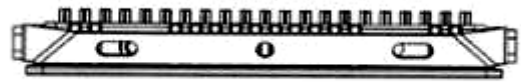

1.6

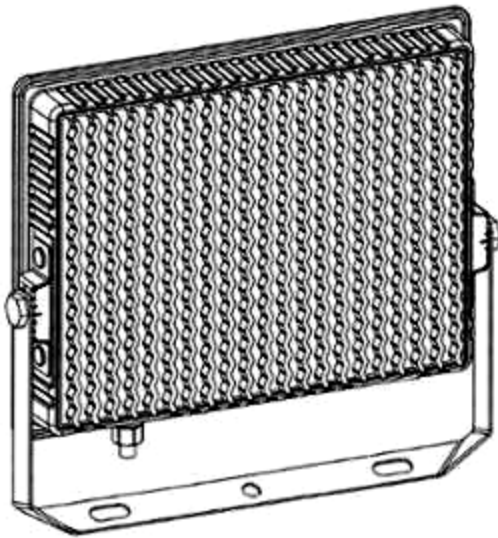

1.7

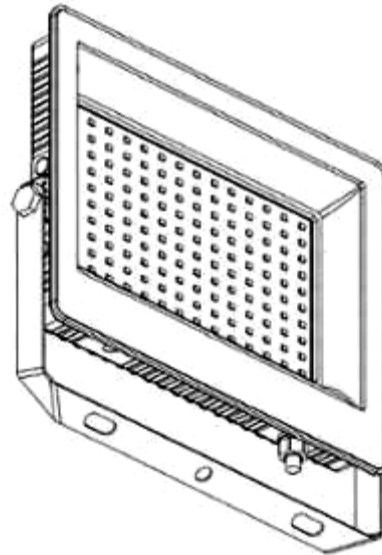

1.8

(11) **51081**

(21) 3-2024-01362

(28) 1

(54) **GẠCH LÁT NỀN**

(51) **25-01**

(22) 13/06/2024

(43) 26/08/2024

(73) **VŨ KIM DIỄN (VN)**

Trường Cao đẳng Công nghiệp và Xây dựng, số 54, khu Liên Phương, phường Phương Đông, thành phố Uông Bí, tỉnh Quảng Ninh

(72) 1. **VŨ KIM DIỄN (VN)**

2. **NGUYỄN CÔNG LÝ (VN)**

3. **ĐỖ MINH CHIẾN (VN)**

4. **LÊ VĂN LỢI (VN)**

5. **HOÀNG MINH THUẬN (VN)**

6. **NGUYỄN VĂN DƯƠNG (VN)**

7. **THÁI THANH PHÚ (VN)**

8. **TRẦN VĂN BIÊN (VN)**

(55)



1.1



1.2



1.3



1.4



1.5

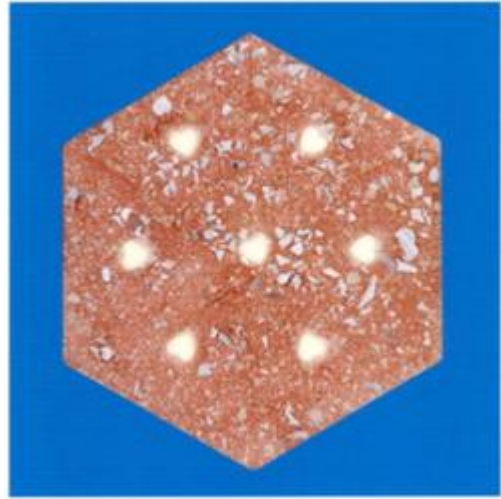

1.6

(11) **51082**

(21) 3-2024-01363

(28) 1

(54) **GẠCH LÁT NỀN**

(51) **25-01**

(22) 13/06/2024

(43) 26/08/2024

(73) **VŨ KIM DIỄN (VN)**

Trường Cao đẳng Công nghiệp và Xây dựng, số 54, khu Liên Phương, phường Phương Đông, thành phố Uông Bí, tỉnh Quảng Ninh

(72) 1. **VŨ KIM DIỄN (VN)**

2. **NGUYỄN CÔNG LÝ (VN)**

3. **ĐỖ MINH CHIẾN (VN)**

4. **LÊ VĂN LỢI (VN)**

5. **KHÔNG VĂN QUỲNH (VN)**

6. **HOÀNG VĂN ĐIỀN (VN)**

7. **THÁI THANH PHÚ (VN)**

8. **TRẦN VĂN BIÊN (VN)**

(55)



1.1



1.2



1.3



1.4



1.5



1.6



1.7

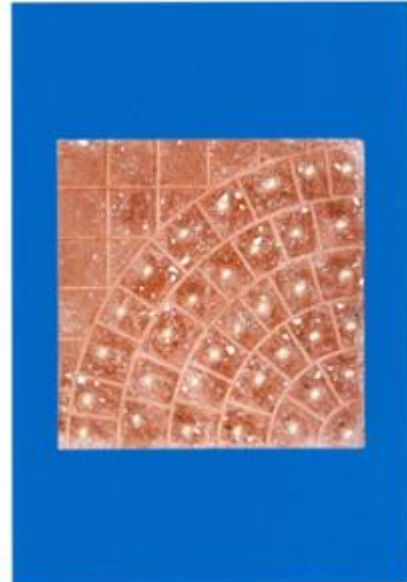

1.8

CÔNG BÁO SỞ HỮU CÔNG NGHIỆP SỐ 437 TẬP A – QUYỀN 2 (08.2024)

- (11) **51083**
(21) 3-2024-01370 (28) 1
(54) **ĐÈN CHIẾU SÁNG ĐƯỜNG PHỐ** (51) **26-03**
(22) 13/06/2024 (43) 26/08/2024
(73) **NGUYỄN THÁI NHẬT (VN)**
Tổ 8, phường Vĩnh Hưng, quận Hoàng Mai, thành phố Hà Nội
(72) Nguyễn Thái Nhật (VN)
(74) Công ty TNHH Sở hữu trí tuệ VIPATCO (VIPATCO CO., LTD.)
(55)



1.1



1.2



1.3



1.4



1.5



1.6

1.7

CÔNG BÁO SỞ HỮU CÔNG NGHIỆP SỐ 437 TẬP A – QUYỀN 2 (08.2024)

- (11) **51084**
(21) 3-2024-00538 (28) 1
(54) **CHAI** (51) **09-01**
(22) 05/03/2024 (43) 26/08/2024
(73) **CÔNG TY CỔ PHẦN HÀNG TIÊU DÙNG MASAN (VN)**
Số 23 Lê Duẩn, phường Bến Nghé, quận 1, thành phố Hồ Chí Minh
(72) Nguyễn Hoàng Yên (VN)
(74) Công ty cổ phần Sở hữu trí tuệ BROSS và Cộng sự (BROSS & PARTNERS., JSC)
(55)

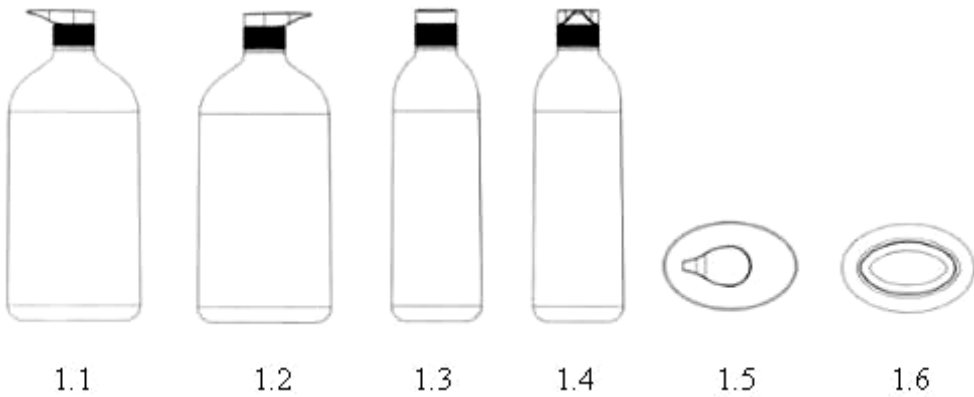

1.7

CÔNG BÁO SỞ HỮU CÔNG NGHIỆP SỐ 437 TẬP A – QUYỀN 2 (08.2024)

- (11) **51085**
(21) 3-2024-00667 (28) 1
(54) **BỘ ĐIỀU KHIỂN** (51) **13-03**
(22) 19/03/2024 (43) 26/08/2024
(30) 202430089793.3 21/02/2024 CN;
(73) **EMOMO TECH (ZHEJIANG) CO.,LTD (CN)**
7# Workshop, Kangshan Industrial Park, West Road of Jier Road, Dipu Sub-district,
Anji County, Huzhou City, Zhejiang Province, China
(72) 1. YUSHU ZHAO (CN)
2. WENJI TANG (CN)
3. JING SONG (CN)
4. WEI ZHOU (CN)
5. ZHIGANG WANG (CN)
6. JUN GUO (CN)
(74) Công ty TNHH Đại Tín và Liên Danh (DAITIN AND ASSOCIATES CO.,LTD)
(55)

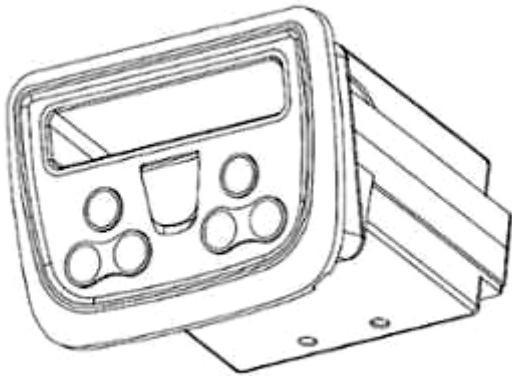

1.1

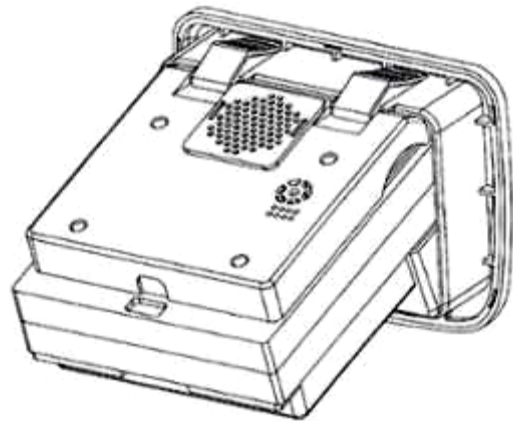

1.2

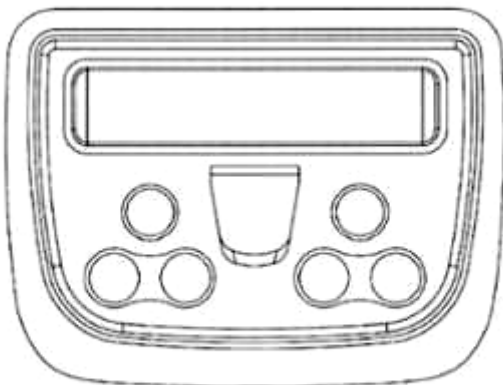

1.3

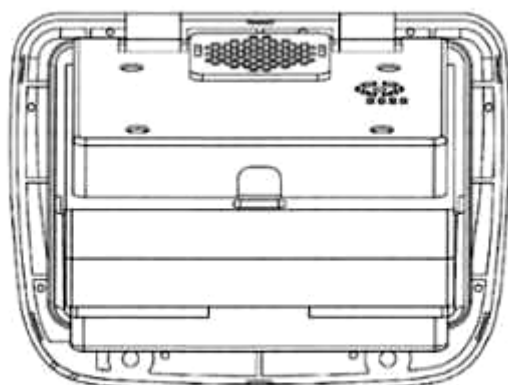

1.4

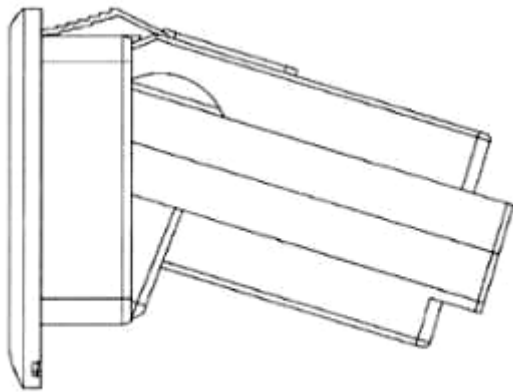

1.5

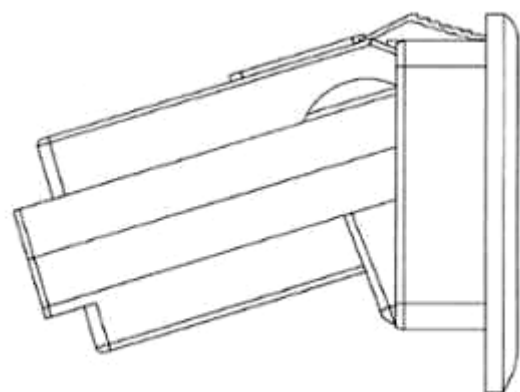

1.6

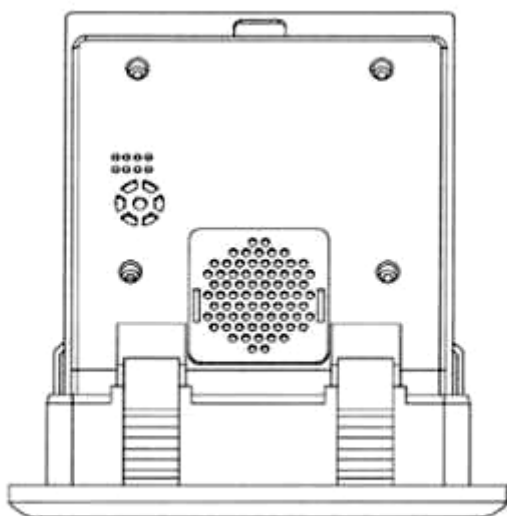

1.7

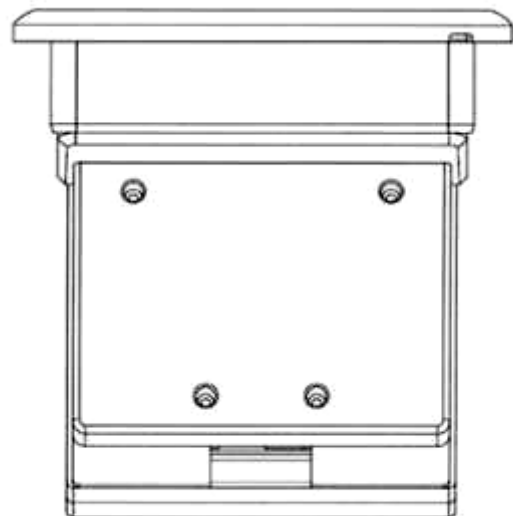

1.8

CÔNG BÁO SỞ HỮU CÔNG NGHIỆP SỐ 437 TẬP A – QUYỀN 2 (08.2024)

- (11) **51086**
(21) 3-2024-00685 (28) 1
(54) **THANH KIM LOẠI ĐỊNH HÌNH** (51) **25-01**
(22) 20/03/2024 (43) 26/08/2024
(73) **CÔNG TY TNHH SGD VIỆT NAM (VN)**
Số 1 ngõ 32, phố Lệ Mật, phường Việt Hưng, quận Long Biên, thành phố Hà Nội
(72) Bùi Hạnh Kiểm (VN)
(55)



1.1

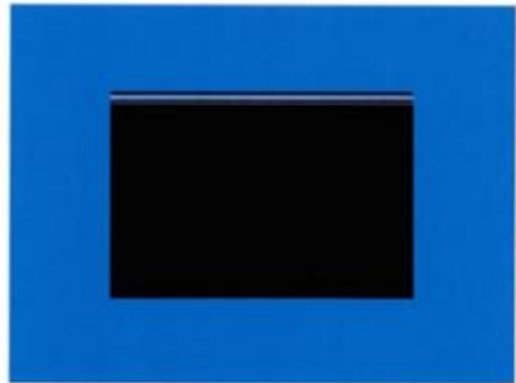

1.2



1.3

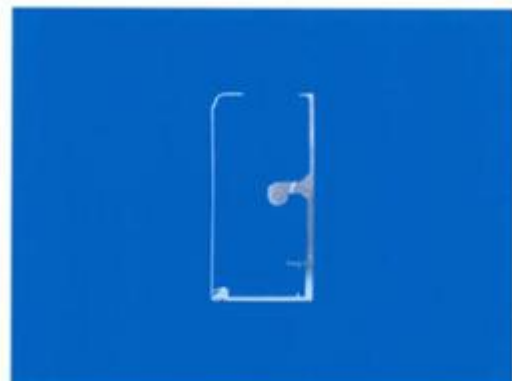

1.4



1.5



1.6



1.7

CÔNG BÁO SỞ HỮU CÔNG NGHIỆP SỐ 437 TẬP A – QUYỀN 2 (08.2024)

- (11) **51087**
(21) 3-2024-00690 (28) 1
(54) **THANH NHÔM ĐỊNH HÌNH** (51) **25-01**
(22) 20/03/2024 (43) 26/08/2024
(73) **CÔNG TY CP TẬP ĐOÀN SINGHAL (VN)**
Cụm CN Hà Mãn - Trí Quả, phường Trí Quả, thị xã Thuận Thành, tỉnh Bắc Ninh
(72) Tô Văn Mạnh (VN)
(74) **CÔNG TY TNHH SỞ HỮU TRÍ TUỆ ANLIS VIỆT NAM (ANLIS IP CO.,LTD)**
(55)

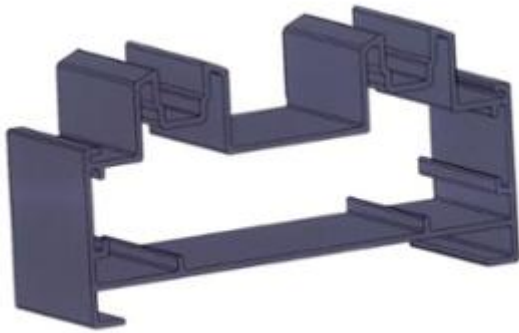

1.1

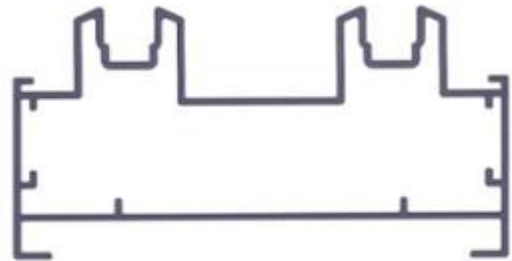

1.2



1.3



1.4



1.5

CÔNG BÁO SỞ HỮU CÔNG NGHIỆP SỐ 437 TẬP A – QUYỀN 2 (08.2024)

- (11) **51088**
(21) 3-2024-00700 (28) 1
(54) **ỐNG CỔ GẬY GÔN** (51) **21-02**
(22) 21/03/2024 (43) 26/08/2024
(30) 2023306169441 21/09/2023 CN;
(73) **DONGGUAN YICHENG PRECISION MOLD CO.,LTD (CN)**
No.1548 Meijingzhong Rd., Dalang Town, Dongguan City, Guangdong Province,
523000, China
(72) CHU, Ming-Chou (TW)
(74) Công ty TNHH Sáng chế ACTIP (ACTIP PATENT LIMITED)
(55)

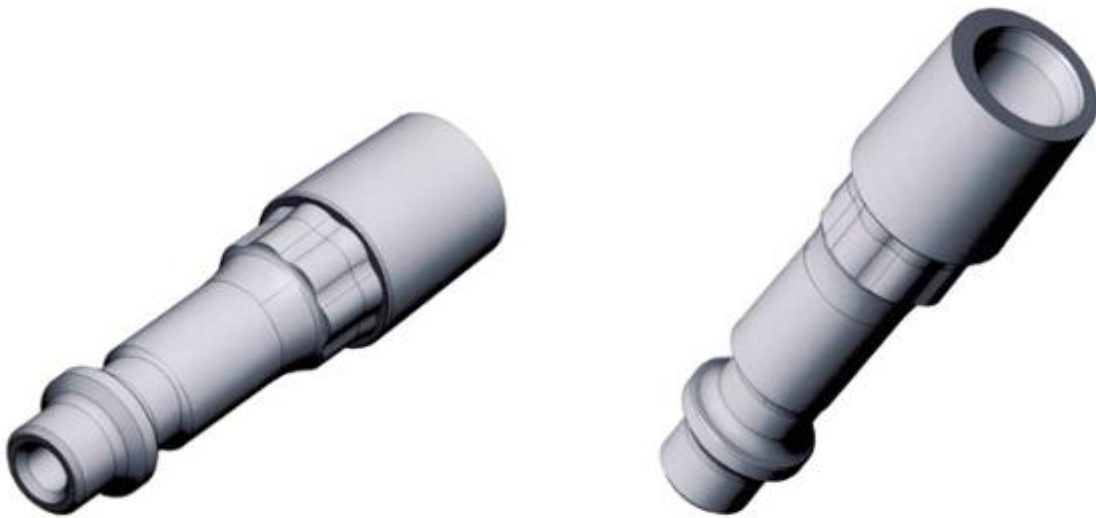

1.1

1.2

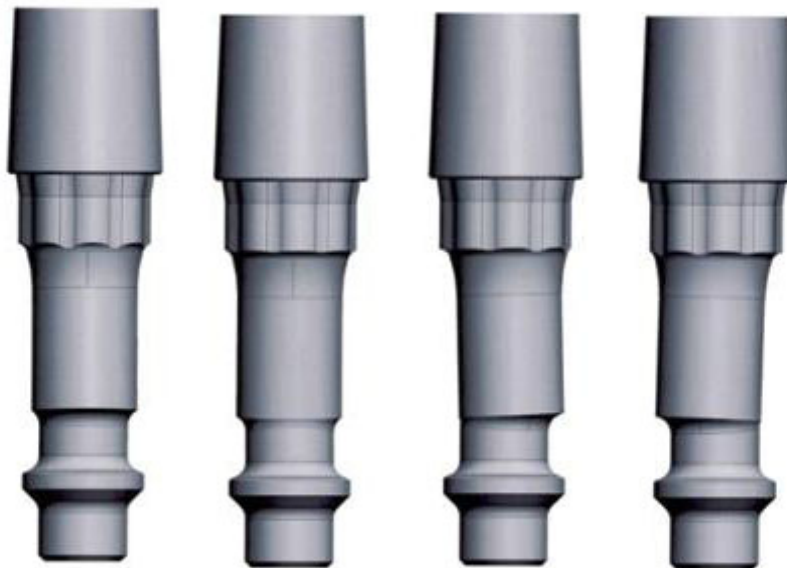

1.3

1.4

1.5

1.6



1.7



1.8

CÔNG BÁO SỞ HỮU CÔNG NGHIỆP SỐ 437 TẬP A – QUYỀN 2 (08.2024)

- (11) **51089**
(21) 3-2024-00702 (28) 1
(54) **HẠT CHẾ PHẨM XỬ LÝ MÔI TRƯỜNG** (51) **28-01**
(22) 21/03/2024 (43) 26/08/2024
(73) **CÔNG TY TNHH HẠNH NGUYỄN VINA (VN)**
Khu phố Phú Hiệp 2, phường Hiệp Hòa Trung, thị xã Đông Hòa, tỉnh Phú Yên
(72) Nguyễn Hồng Thái (VN)
(55)



1.1



1.2



1.3

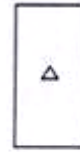

1.4



1.5



1.6



1.7

CÔNG BÁO SỞ HỮU CÔNG NGHIỆP SỐ 437 TẬP A – QUYỀN 2 (08.2024)

- (11) **51090**
(21) 3-2024-00717 (28) 1
(54) **HỘP** (51) **09-03**
(22) 22/03/2024 (43) 26/08/2024
(73) **CÔNG TY CỔ PHẦN NƯỚC GIẢI KHÁT YẾN SÀO KHÁNH HÒA (VN)**
Quốc lộ 1A, xã Suối Hiệp, huyện Diên Khánh, tỉnh Khánh Hòa
(72) Trịnh Thị Hồng Vân (VN)
(74) Công ty TNHH Tư Vấn Sở Hữu Trí Tuệ Việt (VIET IP CO.,LTD.)
(55)



1.1



1.2



1.3



1.4



1.5



1.6



1.7

CÔNG BÁO SỞ HỮU CÔNG NGHIỆP SỐ 437 TẬP A – QUYỀN 2 (08.2024)

- (11) **51091**
(21) 3-2024-00718 (28) 1
(54) **HỘP** (51) **09-03**
(22) 22/03/2024 (43) 26/08/2024
(73) **CÔNG TY CỔ PHẦN NƯỚC GIẢI KHÁT YẾN SÀO KHÁNH HÒA (VN)**
Quốc lộ 1A, xã Suối Hiệp, huyện Diên Khánh, tỉnh Khánh Hòa
(72) Trịnh Thị Hồng Vân (VN)
(74) Công ty TNHH Tư Vấn Sở Hữu Trí Tuệ Việt (VIET IP CO.,LTD.)
(55)



1.1



1.2



1.3



1.4



1.5



1.6



1.7

CÔNG BÁO SỞ HỮU CÔNG NGHIỆP SỐ 437 TẬP A – QUYỀN 2 (08.2024)

- (11) **51092**
(21) 3-2024-00719 (28) 1
(54) **HỘP** (51) **09-03**
(22) 22/03/2024 (43) 26/08/2024
(73) **CÔNG TY CỔ PHẦN NƯỚC GIẢI KHÁT YẾN SÀO KHÁNH HÒA (VN)**
Quốc lộ 1A, xã Suối Hiệp, huyện Diên Khánh, tỉnh Khánh Hòa
(72) Trịnh Thị Hồng Vân (VN)
(74) Công ty TNHH Tư Vấn Sở Hữu Trí Tuệ Việt (VIET IP CO.,LTD.)
(55)



1.1



1.2



1.3



1.4



1.5



1.6



1.7

CÔNG BÁO SỞ HỮU CÔNG NGHIỆP SỐ 437 TẬP A – QUYỀN 2 (08.2024)

- (11) **51093**
(21) 3-2024-00783 (28) 1
(54) **HỘP** (51) **09-03**
(22) 01/04/2024 (43) 26/08/2024
(73) **CÔNG TY TNHH THƯƠNG MẠI SẢN XUẤT TÂN PHÚ NHUẬN (VN)**
133 Nguyễn Hồng Đào, phường 14, quận Tân Bình, thành phố Hồ Chí Minh
(72) Huỳnh Hữu Vương (VN)
(55)



1.1



1.2



1.3



1.4



1.5



1.6



1.7



1.8

CÔNG BÁO SỞ HỮU CÔNG NGHIỆP SỐ 437 TẬP A – QUYỀN 2 (08.2024)

- (11) **51094**
(21) 3-2024-00833 (28) 1
(54) **BAO GÓI** (51) **09-05**
(22) 05/04/2024 (43) 26/08/2024
(73) **CÔNG TY TNHH MTK (VN)**
L5-05.OT05 Tòa nhà Landmark 5, Vinhomes Central Park, 720A Điện Biên Phủ,
phường 22, quận Bình Thạnh, thành phố Hồ Chí Minh
(72) Trương Thành Trung (VN)
(74) Công ty Luật TNHH Phạm và Liên danh (PHAM & ASSOCIATES)
(55)



1.1



1.2

CÔNG BÁO SỞ HỮU CÔNG NGHIỆP SỐ 437 TẬP A – QUYỀN 2 (08.2024)

- (11) **51095**
(21) 3-2024-00840 (28) 1
(54) **BAO GÓI** (51) **09-05**
(22) 05/04/2024 (43) 26/08/2024
(73) **CÔNG TY CỔ PHẦN LIWAYWAY VIỆT NAM (VN)**
Số 14, đường số 05, khu công nghiệp Việt Nam - Singapore, phường Bình Hòa,
thành phố Thuận An, tỉnh Bình Dương
(72) Robert Tan Li (PH)
(74) Văn phòng Luật sư Tân Hà (VPLS TAN HA)
(55)



1.1



1.2

CÔNG BÁO SỞ HỮU CÔNG NGHIỆP SỐ 437 TẬP A – QUYỀN 2 (08.2024)

- (11) **51096**
(21) 3-2024-00863 (28) 1
(54) **BAO GÓI** (51) **09-05**
(22) 09/04/2024 (43) 26/08/2024
(73) **NGUYỄN HOÀNG THANH (VN)**
Số 11 đường D2, KDC Vườn Lài, KP2, phường An Phú Đông, quận 12, thành phố Hồ Chí Minh
(72) Nguyễn Hoàng Thanh (VN)
(74) Công ty TNHH Sở hữu trí tuệ INVENTIO (INVENTIO CO.,LTD)
(55)



1.1



1.2

CÔNG BÁO SỞ HỮU CÔNG NGHIỆP SỐ 437 TẬP A – QUYỀN 2 (08.2024)

- (11) **51097**
(21) 3-2024-00870 (28) 1
(54) **THANH NHÔM ĐỊNH HÌNH** (51) **25-01**
(22) 10/04/2024 (43) 26/08/2024
(73) **CÔNG TY TNHH NHÔM NAM SUNG (VN)**
Lô N1-3, đường số 2, KCN Hải Sơn (GD 3+4), ấp Bình Tiên 2, xã Đức Hòa Hạ,
huyện Đức Hoà, tỉnh Long An
(72) Đoàn Tiến Đạt (VN)
(74) Công ty Cổ phần Sở hữu trí tuệ Việt Mỹ (VIET MY IPC)
(55)

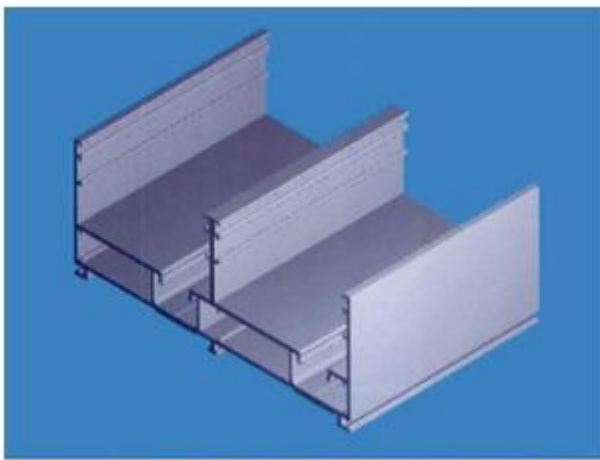

1.1



1.2

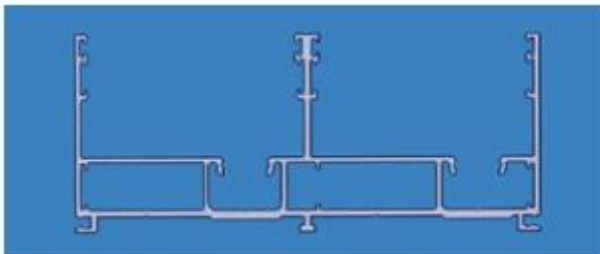

1.3

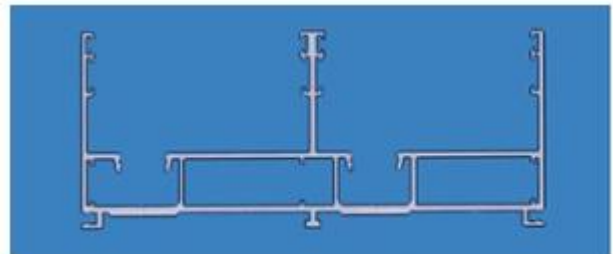

1.4



1.5



1.6

CÔNG BÁO SỞ HỮU CÔNG NGHIỆP SỐ 437 TẬP A – QUYỀN 2 (08.2024)

- (11) **51098**
(21) 3-2024-00871 (28) 1
(54) **THANH NHÔM ĐỊNH HÌNH** (51) **25-01**
(22) 10/04/2024 (43) 26/08/2024
(73) **CÔNG TY TNHH NHÔM NAM SUNG (VN)**
Lô N1-3, đường số 2, KCN Hải Sơn (GD 3+4), ấp Bình Tiên 2, xã Đức Hòa Hạ,
huyện Đức Hoà, tỉnh Long An
(72) Đoàn Tiên Đạt (VN)
(74) Công ty Cổ phần Sở hữu trí tuệ Việt Mỹ (VIET MY IPC)
(55)



1.1

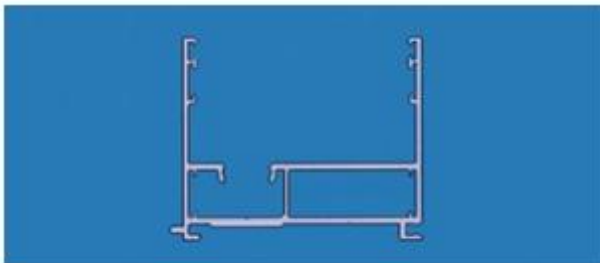

1.2

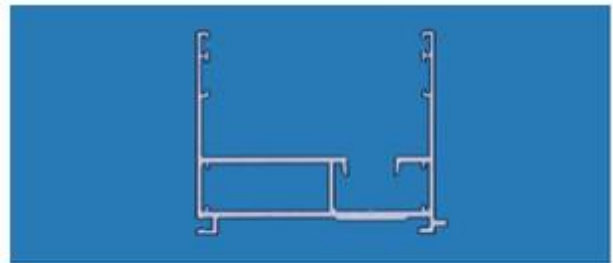

1.3



1.4



1.5

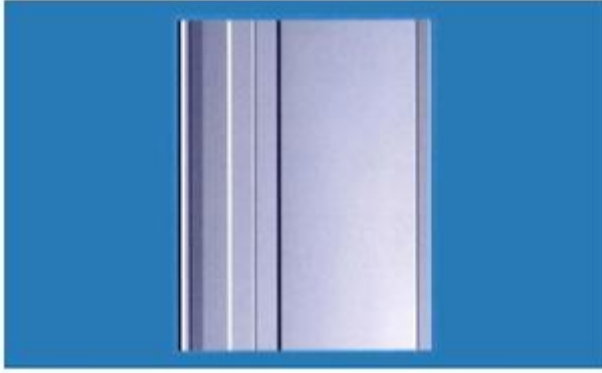

1.6

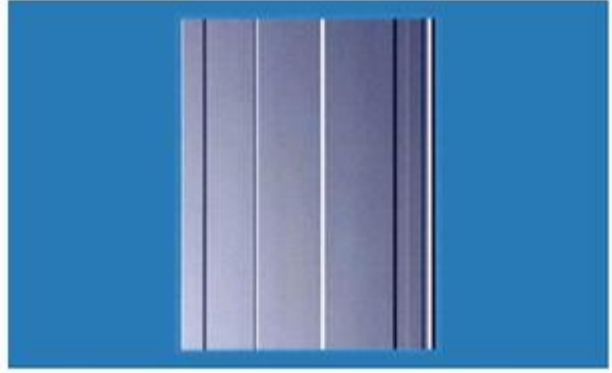

1.7

CÔNG BÁO SỞ HỮU CÔNG NGHIỆP SỐ 437 TẬP A – QUYỀN 2 (08.2024)

- (11) **51099**
(21) 3-2024-00872 (28) 1
(54) **THANH NHÔM ĐỊNH HÌNH** (51) **25-01**
(22) 10/04/2024 (43) 26/08/2024
(73) **CÔNG TY TNHH NHÔM NAM SUNG (VN)**
Lô N1-3, đường số 2, KCN Hải Sơn (GD 3+4), ấp Bình Tiên 2, xã Đức Hòa Hạ,
huyện Đức Hoà, tỉnh Long An
(72) Đoàn Tiên Đạt (VN)
(74) Công ty Cổ phần Sở hữu trí tuệ Việt Mỹ (VIET MY IPC)
(55)

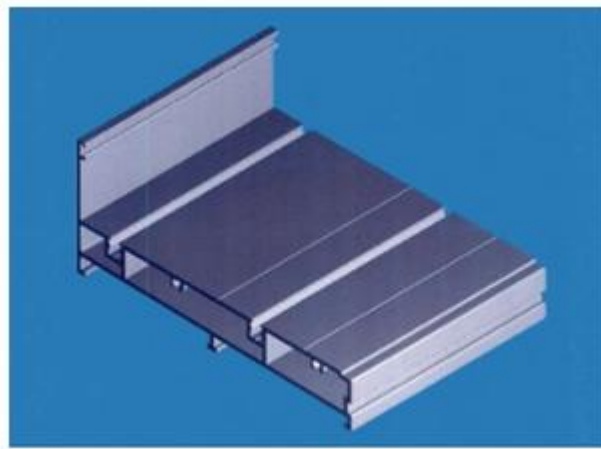

1.1

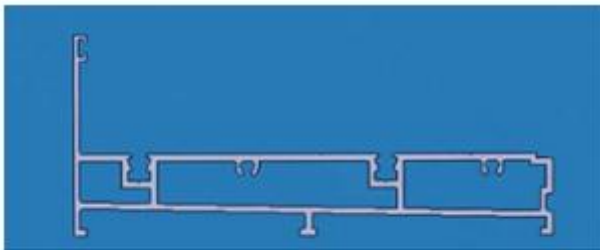

1.2

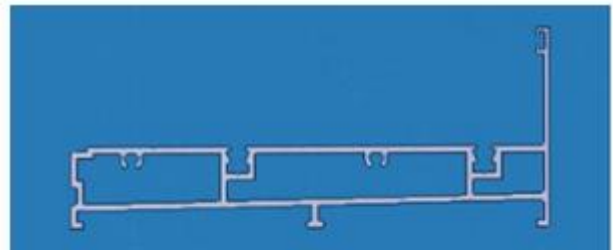

1.3



1.4



1.5



1.6



1.7

CÔNG BÁO SỞ HỮU CÔNG NGHIỆP SỐ 437 TẬP A – QUYỀN 2 (08.2024)

- (11) **51100**
(21) 3-2024-00873 (28) 1
(54) **THANH NHÔM ĐỊNH HÌNH** (51) **25-01**
(22) 10/04/2024 (43) 26/08/2024
(73) **CÔNG TY TNHH NHÔM NAM SUNG (VN)**
Lô N1-3, đường số 2, KCN Hải Sơn (GD 3+4), ấp Bình Tiên 2, xã Đức Hòa Hạ,
huyện Đức Hoà, tỉnh Long An
(72) Đoàn Tiến Đạt (VN)
(74) Công ty Cổ phần Sở hữu trí tuệ Việt Mỹ (VIET MY IPC)
(55)

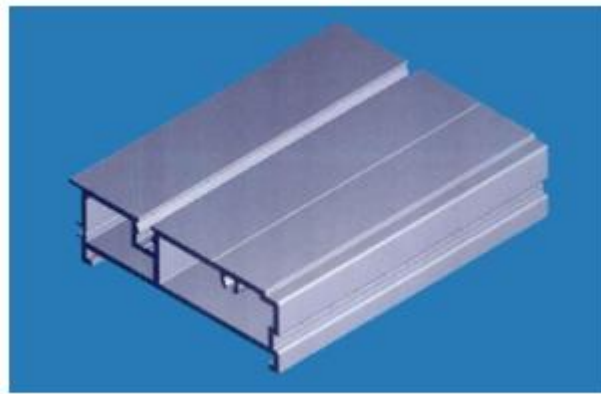

1.1

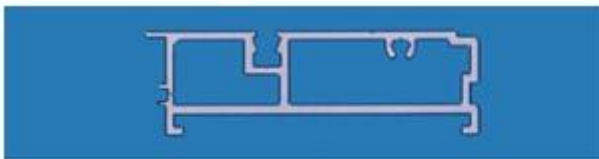

1.2

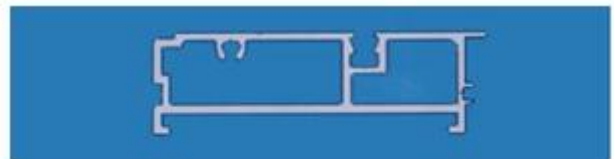

1.3



1.4



1.5



1.6



1.7

CÔNG BÁO SỞ HỮU CÔNG NGHIỆP SỐ 437 TẬP A – QUYỀN 2 (08.2024)

- (11) **51101**
(21) 3-2024-00874 (28) 1
(54) **THANH NHÔM ĐỊNH HÌNH** (51) **25-01**
(22) 10/04/2024 (43) 26/08/2024
(73) **CÔNG TY TNHH NHÔM NAM SUNG (VN)**
Lô N1-3, đường số 2, KCN Hải Sơn (GD 3+4), ấp Bình Tiên 2, xã Đức Hòa Hạ,
huyện Đức Hoà, tỉnh Long An
(72) Đoàn Tiến Đạt (VN)
(74) Công ty Cổ phần Sở hữu trí tuệ Việt Mỹ (VIET MY IPC)
(55)

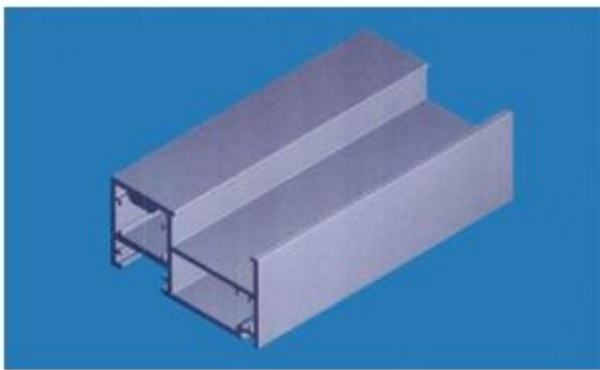

1.1



1.2

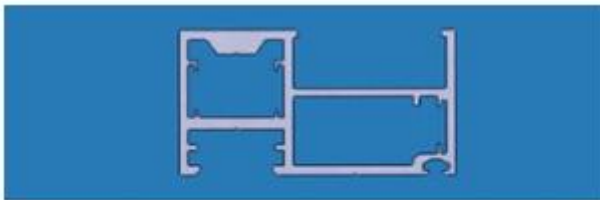

1.3

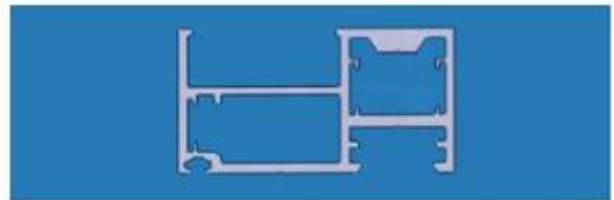

1.4



1.5

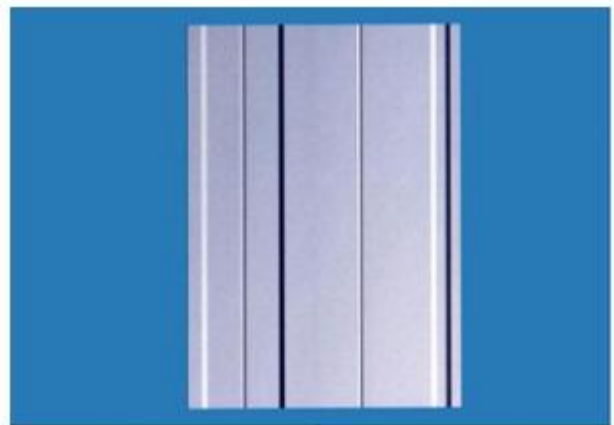

1.6

CÔNG BÁO SỞ HỮU CÔNG NGHIỆP SỐ 437 TẬP A – QUYỀN 2 (08.2024)

- (11) **51102**
(21) 3-2024-00875 (28) 1
(54) **THANH NHÔM ĐỊNH HÌNH** (51) **25-01**
(22) 10/04/2024 (43) 26/08/2024
(73) **CÔNG TY TNHH NHÔM NAM SUNG (VN)**
Lô N1-3, đường số 2, KCN Hải Sơn (GD 3+4), ấp Bình Tiên 2, xã Đức Hòa Hạ,
huyện Đức Hoà, tỉnh Long An
(72) Đoàn Tiến Đạt (VN)
(74) Công ty Cổ phần Sở hữu trí tuệ Việt Mỹ (VIET MY IPC)
(55)

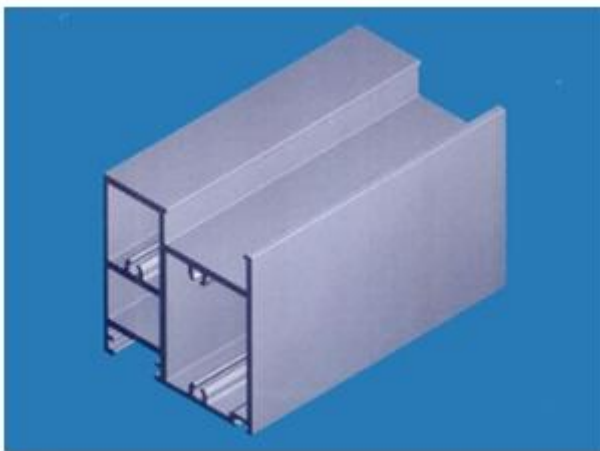

1.1



1.2

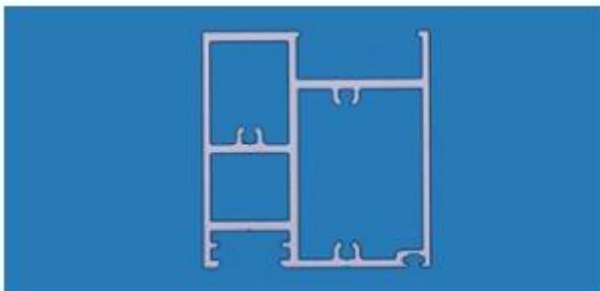

1.3



1.4

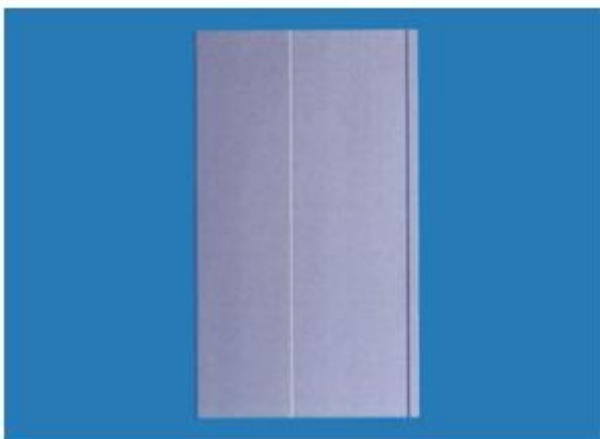

1.5

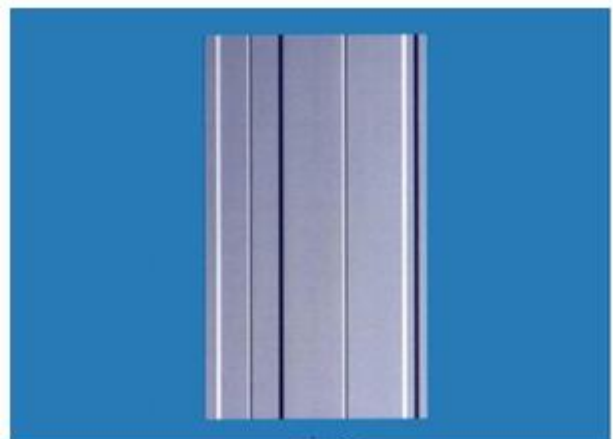

1.6

CÔNG BÁO SỞ HỮU CÔNG NGHIỆP SỐ 437 TẬP A – QUYỀN 2 (08.2024)

(11) **51103**

(21) 3-2024-00876

(28) 1

(54) **THANH NHÔM ĐỊNH HÌNH**

(51) **25-01**

(22) 10/04/2024

(43) 26/08/2024

(73) **CÔNG TY TNHH NHÔM NAM SUNG (VN)**

Lô N1-3, đường số 2, KCN Hải Sơn (GD 3+4), ấp Bình Tiên 2, xã Đức Hòa Hạ, huyện Đức Hoà, tỉnh Long An

(72) Đoàn Tiến Đạt (VN)

(74) Công ty Cổ phần Sở hữu trí tuệ Việt Mỹ (VIET MY IPC)

(55)

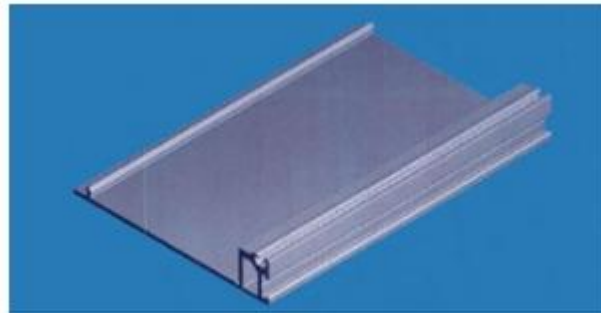

1.1



1.2



1.3



1.4

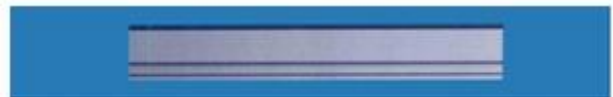

1.5



1.6

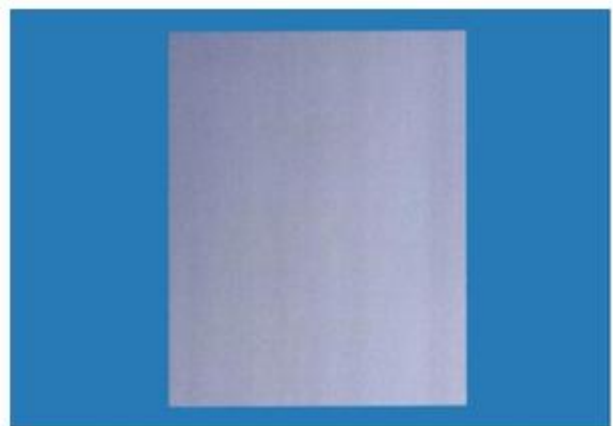

1.7

CÔNG BÁO SỞ HỮU CÔNG NGHIỆP SỐ 437 TẬP A – QUYỀN 2 (08.2024)

- (11) **51104**
(21) 3-2024-00877 (28) 1
(54) **THANH NHÔM ĐỊNH HÌNH** (51) **25-01**
(22) 10/04/2024 (43) 26/08/2024
(73) **CÔNG TY TNHH NHÔM NAM SUNG (VN)**
Lô N1-3, đường số 2, KCN Hải Sơn (GD 3+4), ấp Bình Tiên 2, xã Đức Hòa Hạ,
huyện Đức Hoà, tỉnh Long An
(72) Đoàn Tiến Đạt (VN)
(74) Công ty Cổ phần Sở hữu trí tuệ Việt Mỹ (VIET MY IPC)
(55)

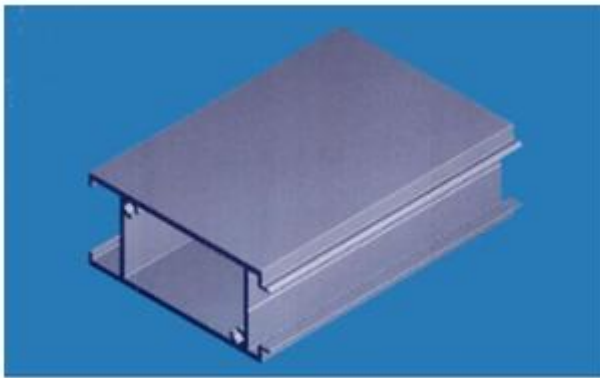

1.1



1.2

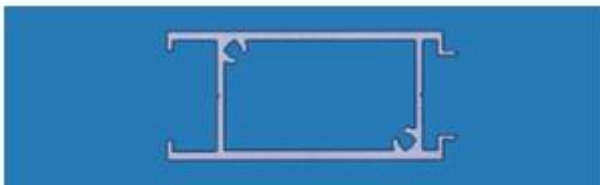

1.3

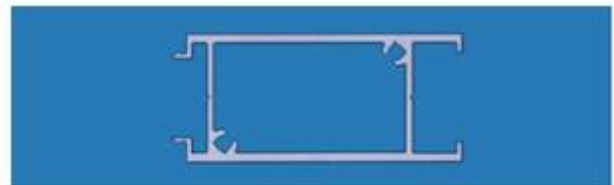

1.4



1.5



1.6

- (11) **51105**
- (21) 3-2024-00887
- (54) **MÓC TRỪNG BÀY**
- (22) 10/04/2024
- (30) 29/915,890 06/11/2023 US;
- (73) **ALLEN FIELD COMPANY, INC. (US)**
1450 Bridgewater Road, Bensalem, PA 19020, United States of America
- (72) 1. ANDREW FRANZONE JR (US)
2. ROBERT AHEARN (US)
- (74) Công ty TNHH Trà và cộng sự (TRA & ASSOCIATES CO.,LTD)
- (55)

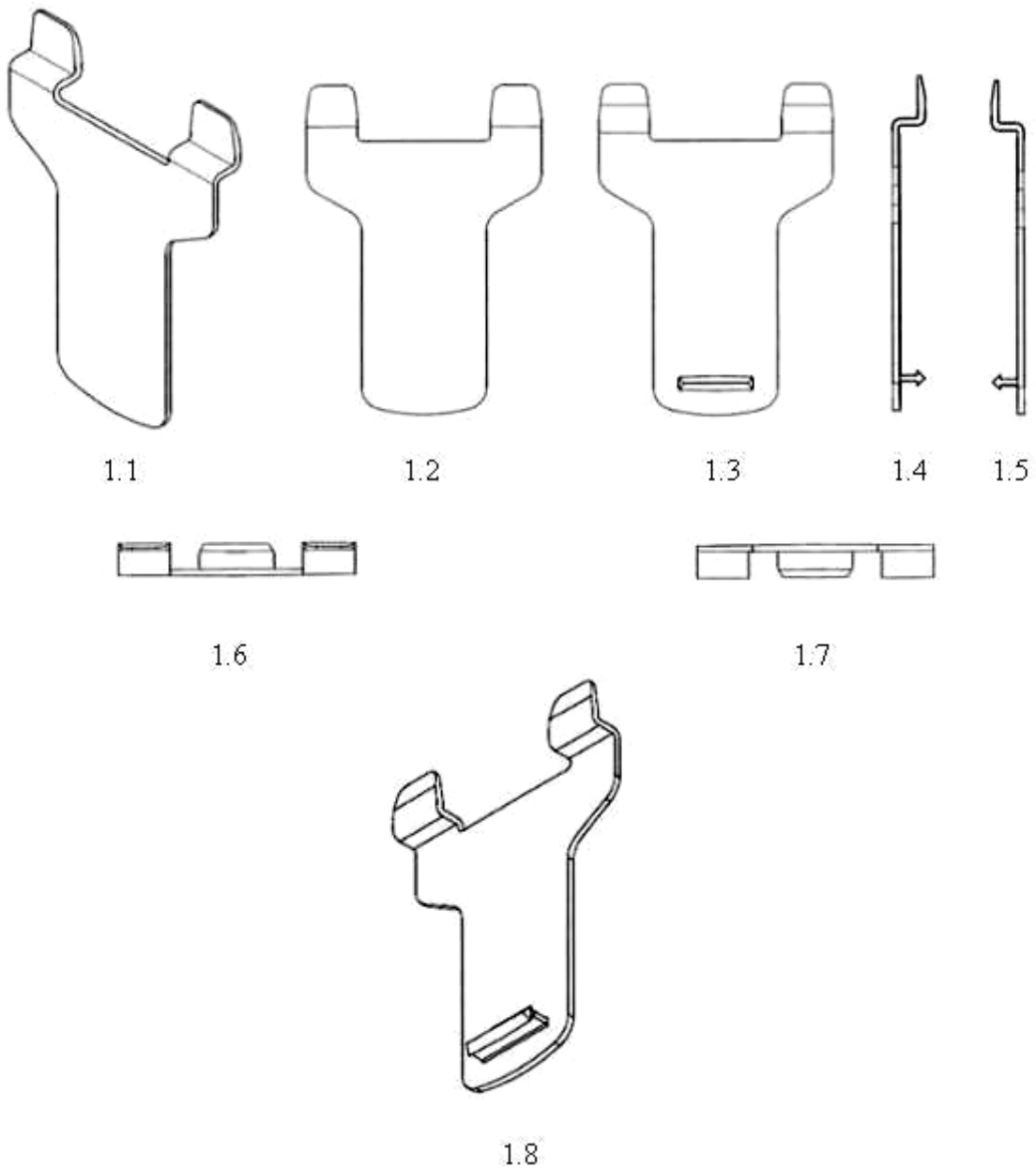

CÔNG BÁO SỞ HỮU CÔNG NGHIỆP SỐ 437 TẬP A – QUYỀN 2 (08.2024)

(11) **51106**

(21) 3-2024-00889

(28) 1

(54) **KHÓA KỸ THUẬT SỐ**

(51) **08-07**

(22) 10/04/2024

(43) 26/08/2024

(30) 2402000928 28/02/2024 TH;

(73) 1. **SIAM INTER LOCK TEK CO., LTD.** (TH)

Samut Sakhon Industrial Zone 1/8, 1/10, 1/138, Moo 2, Rama 2 road, Tha Sai subdistrict, Mueang Samut Sakhon district, Samut Sakhon 74000, Thailand

2. **SUVICHAI JANETHANA-ARTHAKIJ** (TH)

10, Soi Suksawat 30 Allay, 4 Junction, Bang Pakok sub-district, Ratchaburana district, Bangkok 10140, Thailand

(72) SUVICHAI JANETHANA-ARTHAKIJ (TH)

(74) Công ty TNHH Dịch vụ Sở hữu trí tuệ KENFOX (KENFOX IP SERVICE CO.,LTD.)

(55)

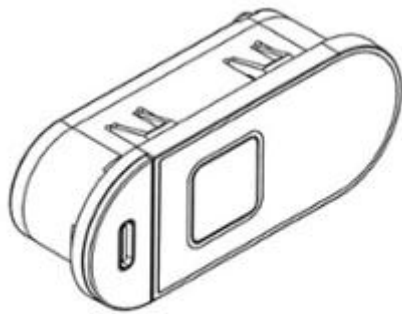

1.1



1.2

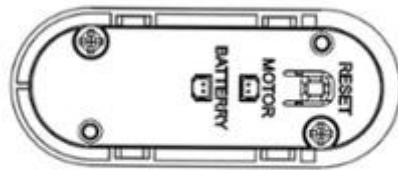

1.3

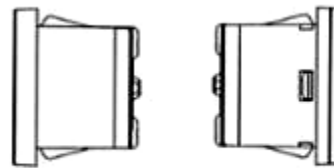

1.4

1.5

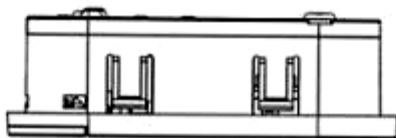

1.6

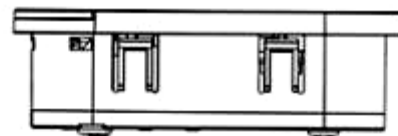

1.7

- (11) **51107**
(21) 3-2024-00890 (28) 1
(54) **KHÓA KỸ THUẬT SỐ** (51) **08-07**
(22) 10/04/2024 (43) 26/08/2024
(30) 2402000927 28/02/2024 TH;
(73) 1. **SIAM INTER LOCK TEK CO., LTD.** (TH)
Samut Sakhon Industrial Zone 1/8, 1/10, 1/138, Moo 2, Rama 2 road, Tha Sai subdistrict, Mueang Samut Sakhon district, Samut Sakhon 74000, Thailand
2. **SUVICHAI JANETHANA-ARTHAKIJ** (TH)
10, Soi Suksawat 30 Allay, 4 Junction, Bang Pakok sub-district, Ratchaburana district, Bangkok 10140, Thailand
(72) SUVICHAI JANETHANA-ARTHAKIJ (TH)
(74) Công ty TNHH Dịch vụ Sở hữu trí tuệ KENFOX (KENFOX IP SERVICE CO.,LTD.)
(55)



1.1

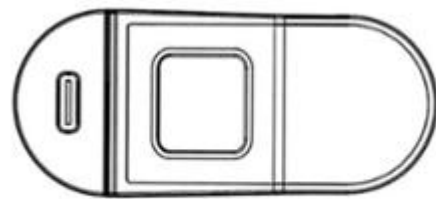

1.2

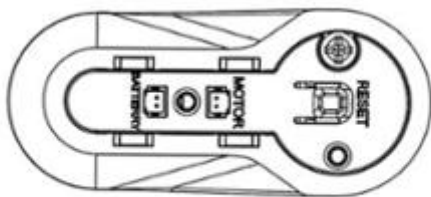

1.3

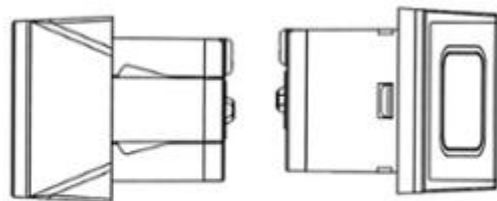

1.4

1.5

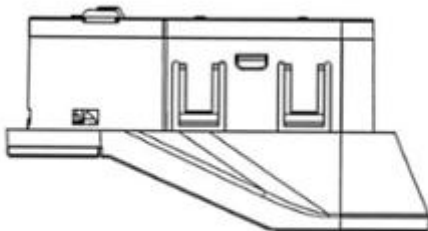

1.6

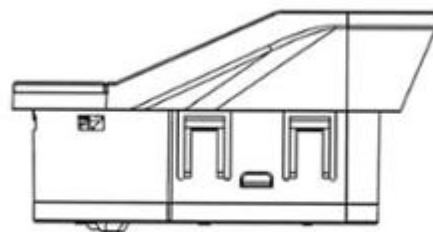

1.7

CÔNG BÁO SỞ HỮU CÔNG NGHIỆP SỐ 437 TẬP A – QUYỀN 2 (08.2024)

(11) **51108**

(21) 3-2024-00891

(28) 1

(54) **KHÓA KỸ THUẬT SỐ**

(51) **08-07**

(22) 10/04/2024

(43) 26/08/2024

(30) 2402000930 28/02/2024 TH;

(73) 1. **SIAM INTER LOCK TEK CO., LTD.** (TH)

Samut Sakhon Industrial Zone 1/8, 1/10, 1/138, Moo 2, Rama 2 road, Tha Sai subdistrict, Mueang Samut Sakhon district, Samut Sakhon 74000, Thailand

2. **SUVICHAI JANETHANA-ARTHAKIJ** (TH)

10, Soi Suksawat 30 Allay, 4 Junction, Bang Pakok sub-district, Ratchaburana district, Bangkok 10140, Thailand

(72) SUVICHAI JANETHANA-ARTHAKIJ (TH)

(74) Công ty TNHH Dịch vụ Sở hữu trí tuệ KENFOX (KENFOX IP SERVICE CO.,LTD.)

(55)

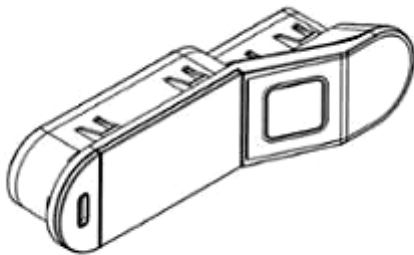

1.1

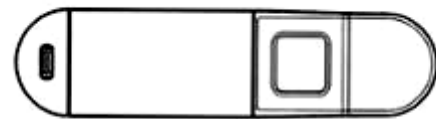

1.2

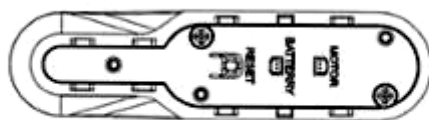

1.3



1.4



1.5

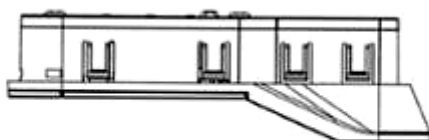

1.6

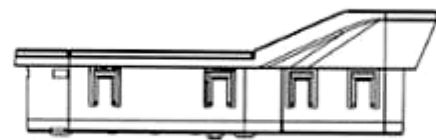

1.7

CÔNG BÁO SỞ HỮU CÔNG NGHIỆP SỐ 437 TẬP A – QUYỀN 2 (08.2024)

- (11) **51109**
(21) 3-2024-00892 (28) 1
(54) **KHÓA KỸ THUẬT SỐ** (51) **08-07**
(22) 10/04/2024 (43) 26/08/2024
(30) 2402000929 28/02/2024 TH;
(73) 1. **SIAM INTER LOCK TEK CO., LTD.** (TH)
Samut Sakhon Industrial Zone 1/8, 1/10, 1/138, Moo 2, Rama 2 road, Tha Sai subdistrict, Mueang Samut Sakhon district, Samut Sakhon 74000, Thailand
2. **SUVICHAI JANETHANA-ARTHAKIJ** (TH)
10, Soi Suksawat 30 Allay, 4 Junction, Bang Pakok sub-district, Ratchaburana district, Bangkok 10140, Thailand
(72) SUVICHAI JANETHANA-ARTHAKIJ (TH)
(74) Công ty TNHH Dịch vụ Sở hữu trí tuệ KENFOX (KENFOX IP SERVICE CO.,LTD.)
(55)

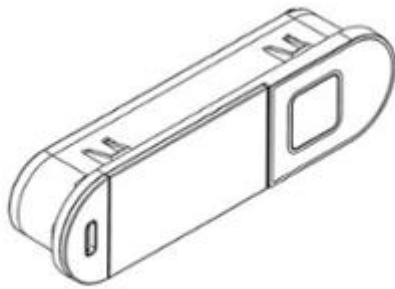

1.1



1.2



1.3

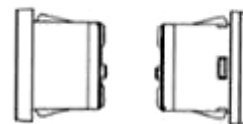

1.4

1.5



1.6

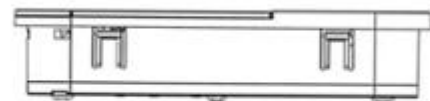

1.7

CÔNG BÁO SỞ HỮU CÔNG NGHIỆP SỐ 437 TẬP A – QUYỀN 2 (08.2024)

(11) **51110**

(21) 3-2024-00893

(28) 1

(54) **Ổ KHOÁ**

(51) **08-07**

(22) 10/04/2024

(43) 26/08/2024

(30) 2402000474 01/02/2024 TH;

(73) 1. **SIAM INTER LOCK TEK CO., LTD.** (TH)

Samut Sakhon Industrial Zone 1/8, 1/10, 1/138, Moo 2, Rama 2 road, Tha Sai subdistrict, Mueang Samut Sakhon district, Samut Sakhon 74000, Thailand

2. **SUVICHAI JANETHANA-ARTHAKIJ** (TH)

10, Soi Suksawat 30 Allay, 4 Junction, Bang Pakok sub-district, Ratchaburana district, Bangkok 10140, Thailand

(72) SUVICHAI JANETHANA-ARTHAKIJ (TH)

(74) Công ty TNHH Dịch vụ Sở hữu trí tuệ KENFOX (KENFOX IP SERVICE CO.,LTD.)

(55)

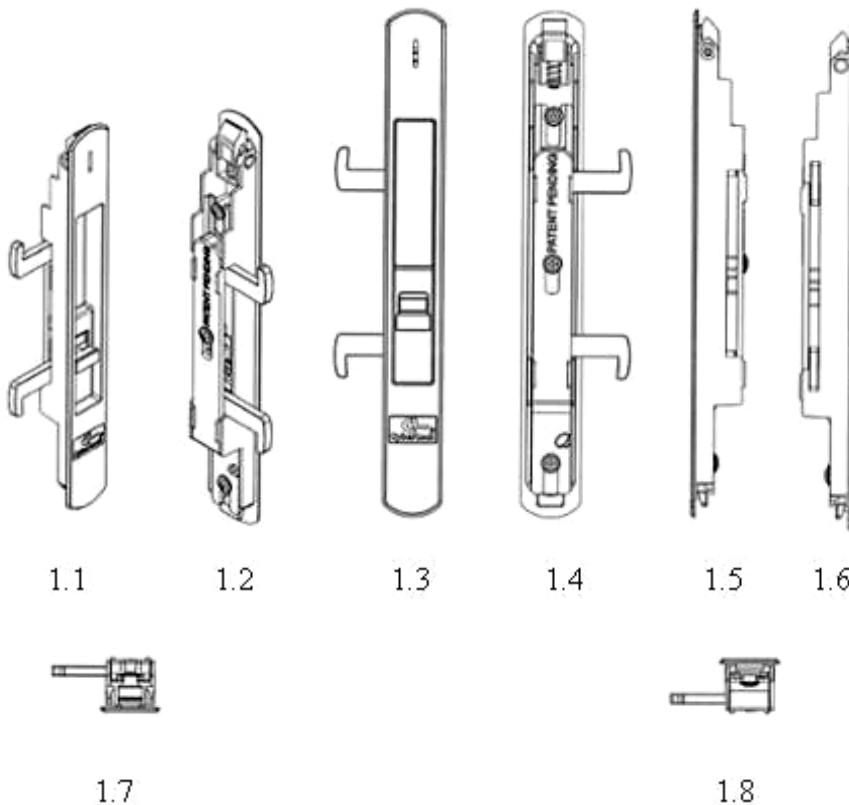

CÔNG BÁO SỞ HỮU CÔNG NGHIỆP SỐ 437 TẬP A – QUYỀN 2 (08.2024)

- (11) **5111**
(21) 3-2024-00894 (28) 1
(54) **Ổ KHOÁ** (51) **08-07**
(22) 10/04/2024 (43) 26/08/2024
(30) 2402000473 01/02/2024 TH;
(73) 1. **SIAM INTER LOCK TEK CO., LTD.** (TH)
Samut Sakhon Industrial Zone 1/8, 1/10, 1/138, Moo 2, Rama 2 road, Tha Sai subdistrict, Mueang Samut Sakhon district, Samut Sakhon 74000, Thailand
2. **SUVICHAI JANETHANA-ARTHAKIJ** (TH)
10, Soi Suksawat 30 Allay, 4 Junction, Bang Pakok sub-district, Ratchaburana district, Bangkok 10140, Thailand
(72) SUVICHAI JANETHANA-ARTHAKIJ (TH)
(74) Công ty TNHH Dịch vụ Sở hữu trí tuệ KENFOX (KENFOX IP SERVICE CO.,LTD.)
(55)

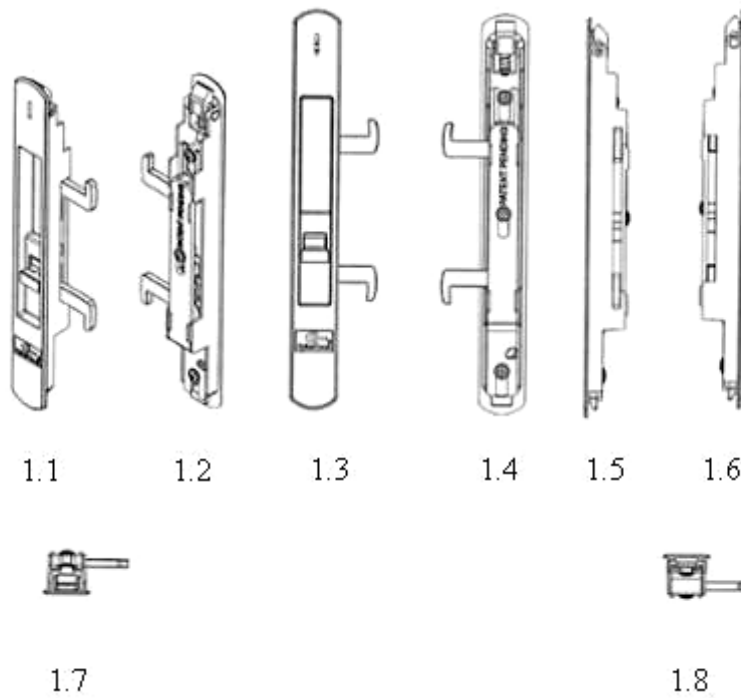

CÔNG BÁO SỞ HỮU CÔNG NGHIỆP SỐ 437 TẬP A – QUYỀN 2 (08.2024)

- (11) **51112**
(21) 3-2024-00895 (28) 1
(54) **HỘP** (51) **09-03**
(22) 10/04/2024 (43) 26/08/2024
(73) **CÔNG TY TNHH TM VÀ SX CƠ KHÍ PHƯƠNG LÂM (VN)**
Số 26, thôn Từ Am, xã Thanh Thùy, huyện Thanh Oai, thành phố Hà Nội
(72) Cao Văn Hữu (VN)
(74) Công ty TNHH ASL LAW (ASL LAW CO.,LTD)
(55)



1.1



1.2

CÔNG BÁO SỞ HỮU CÔNG NGHIỆP SỐ 437 TẬP A – QUYỀN 2 (08.2024)

- (11) **51113**
- (21) 3-2024-00897
- (54) **BAO GÓI KHĂN ƯỚT**
- (22) 11/04/2024
- (73) **CÔNG TY TNHH SẢN XUẤT THƯƠNG MẠI XUẤT NHẬP KHẨU DR MAN (VN)**
131/17 Kinh Dương Vương, phường 12, quận 6, thành phố Hồ Chí Minh
- (72) Nguyễn Thị Mai Dung (VN)
- (55)



1.1



1.2



1.3



1.4



1.5



1.6

CÔNG BÁO SỞ HỮU CÔNG NGHIỆP SỐ 437 TẬP A – QUYỀN 2 (08.2024)

(11) **51114**

(21) 3-2024-00901

(28) 1

(54) **CHAI**

(51) **09-01**

(22) 12/04/2024

(43) 26/08/2024

(73) **UPL LIMITED (IN)**

UPL House, CTS No 610 B/2, Off Western Express Highway, Teacher's Colony,
Bandra East, Mumbai, Maharashtra - 400051, India

(72) Pushpaksen P Asher (IN)

(74) Công ty cổ phần tư vấn Trung Thực (TRUNG THUC.,JSC)

(55)

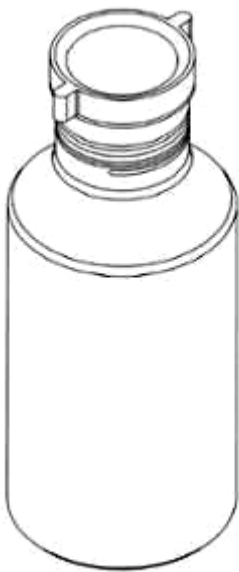

1.1



1.2



1.3

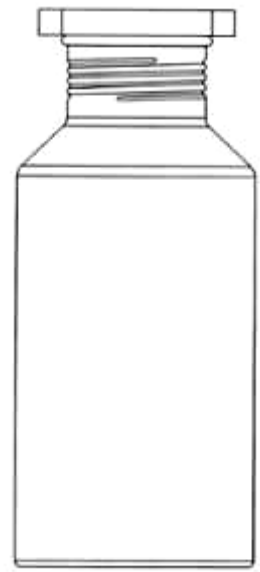

1.4

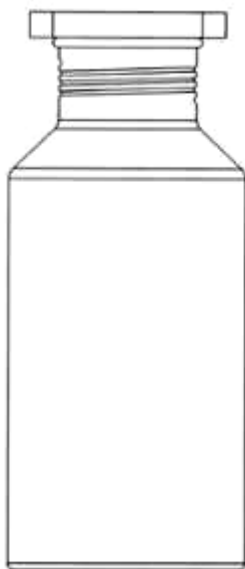

1.5

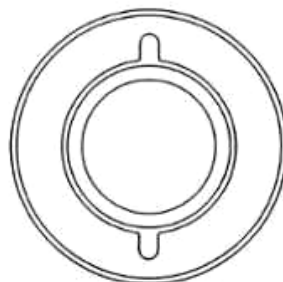

1.6

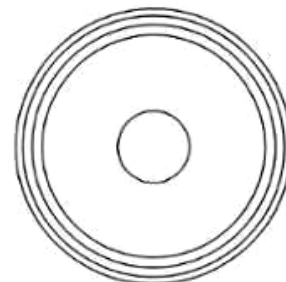

1.7

CÔNG BÁO SỞ HỮU CÔNG NGHIỆP SỐ 437 TẬP A – QUYỀN 2 (08.2024)

- (11) **51115**
(21) 3-2024-00906 (28) 1
(54) **HỘP** (51) **09-03**
(22) 15/04/2024 (43) 26/08/2024
(73) **CÔNG TY CỔ PHẦN DỊCH VỤ THƯƠNG MẠI TỔNG HỢP TRĂNG TIỀN (VN)**
Thôn Đại Lan, xã Duyên Hà, huyện Thanh Trì, thành phố Hà Nội
(72) Phạm Hoàng Phương (VN)
(74) **CÔNG TY TNHH SỞ HỮU TRÍ TUỆ SETHACO (SETHACO IP CO.,LTD)**
(55)



1.1



1.2

CÔNG BÁO SỞ HỮU CÔNG NGHIỆP SỐ 437 TẬP A – QUYỀN 2 (08.2024)

- (11) **51116**
(21) 3-2024-00930 (28) 2
(54) **ĐỘNG CƠ ĐIỆN** (51) **13-01**
(22) 24/02/2021 (43) 26/08/2024
(73) **PANASONIC INTELLECTUAL PROPERTY MANAGEMENT CO., LTD.**
(JP)
1-61, Shiromi 2-chome, Chuo-ku, Osaka-shi, Osaka 540-6207 Japan
(72) Masatomo KUMASHIRO (JP)
(74) Công ty TNHH một thành viên Sở hữu trí tuệ VCCI (VCCI-IP CO.,LTD)
(55)

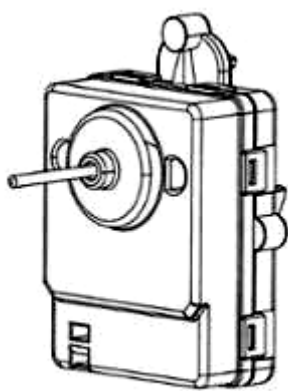

1.1

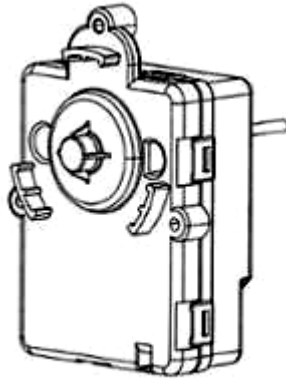

1.2

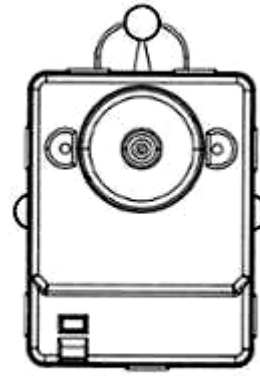

1.3

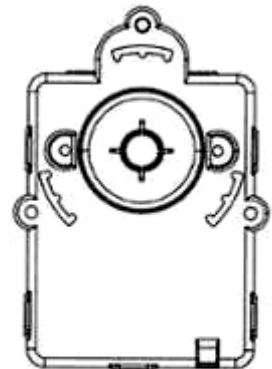

1.4

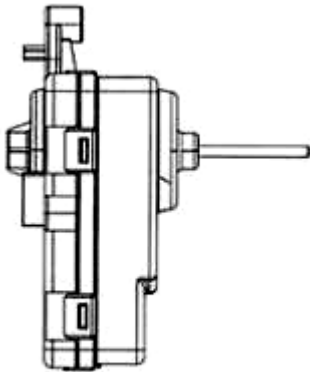

1.5

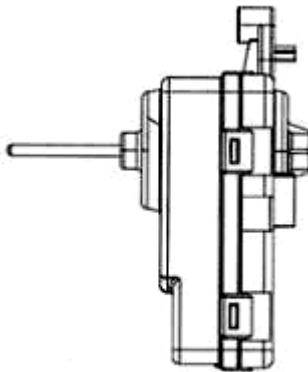

1.6

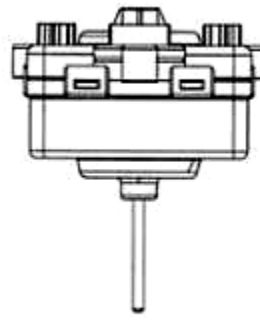

1.7

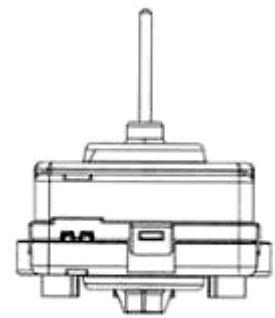

1.8

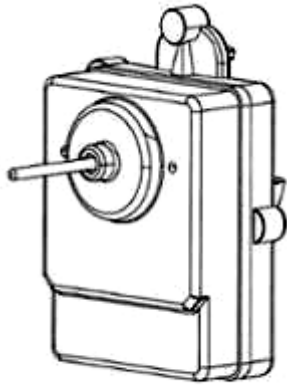

2.1

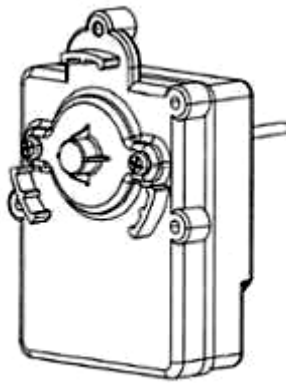

2.2

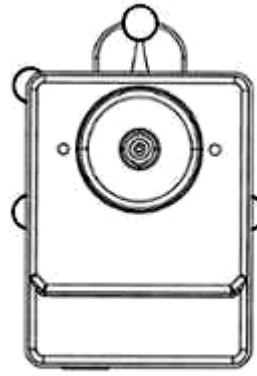

2.3

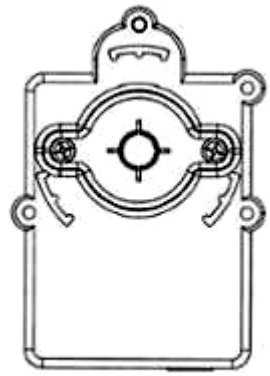

2.4

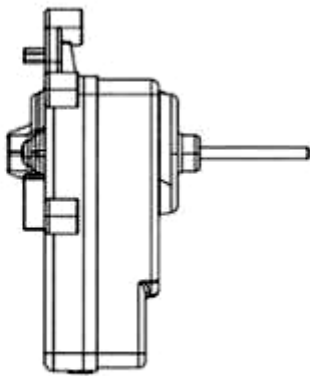

2.5

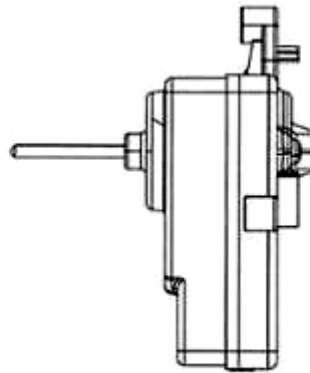

2.6

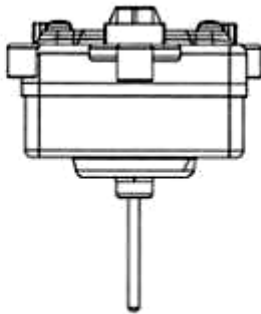

2.7

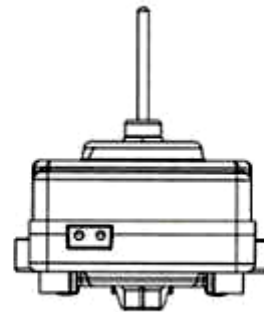

2.8

CÔNG BÁO SỞ HỮU CÔNG NGHIỆP SỐ 437 TẬP A – QUYỀN 2 (08.2024)

- (11) **51117**
(21) 3-2024-00931 (28) 1
(54) **ĐỘNG CƠ ĐIỆN** (51) **13-01**
(22) 24/02/2021 (43) 26/08/2024
(73) **PANASONIC INTELLECTUAL PROPERTY MANAGEMENT CO., LTD.**
(JP)
1-61, Shiromi 2-chome, Chuo-ku, Osaka-shi, Osaka 540-6207 Japan
(72) Masatomo KUMASHIRO (JP)
(74) Công ty TNHH một thành viên Sở hữu trí tuệ VCCI (VCCI-IP CO.,LTD)
(55)

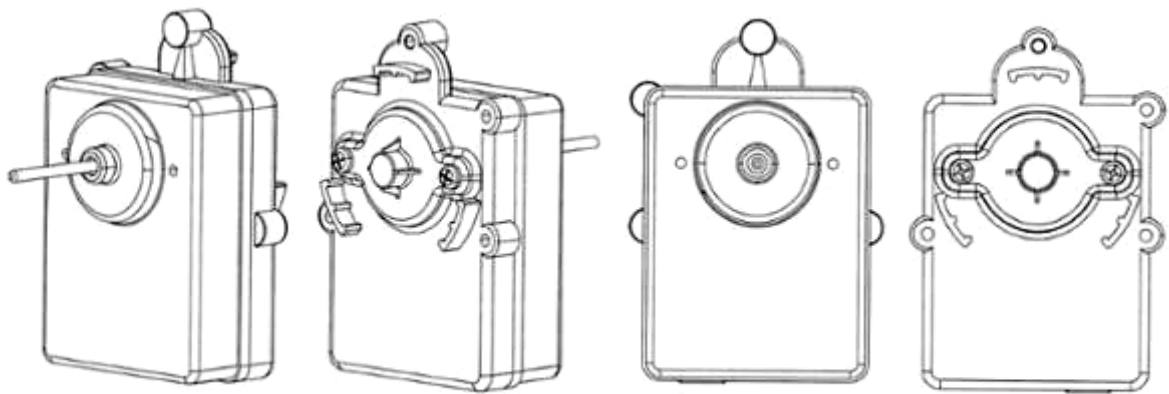

1.1

1.2

1.3

1.4

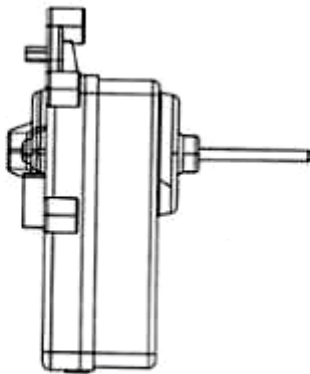

1.5

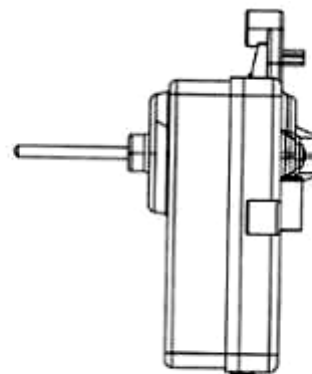

1.6

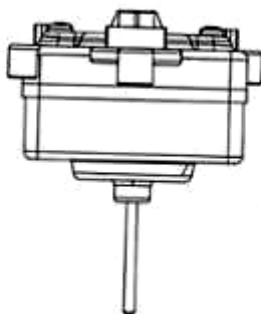

1.7

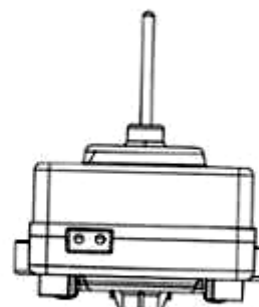

1.8

- (11) **51118**
(21) 3-2024-00932 (28) 1
(54) **ĐỘNG CƠ ĐIỆN** (51) **13-01**
(22) 24/02/2021 (43) 26/08/2024
(73) **PANASONIC INTELLECTUAL PROPERTY MANAGEMENT CO., LTD.**
(JP)
1-61, Shiromi 2-chome, Chuo-ku, Osaka-shi, Osaka 540-6207 Japan
(72) Masatomo KUMASHIRO (JP)
(74) Công ty TNHH một thành viên Sở hữu trí tuệ VCCI (VCCI-IP CO.,LTD)
(55)

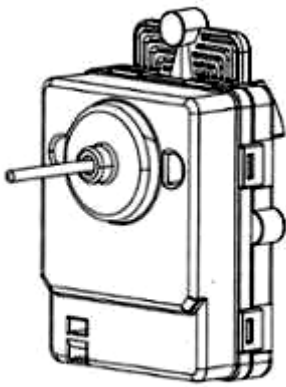

1.1

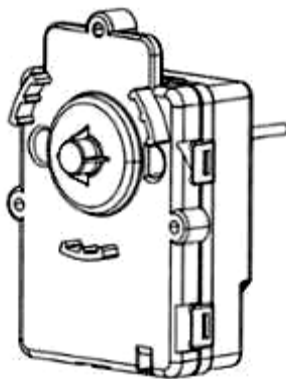

1.2

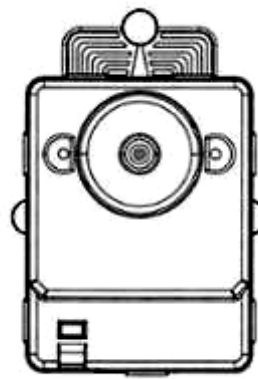

1.3

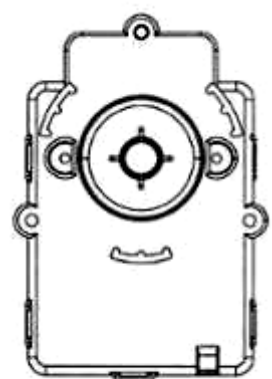

1.4

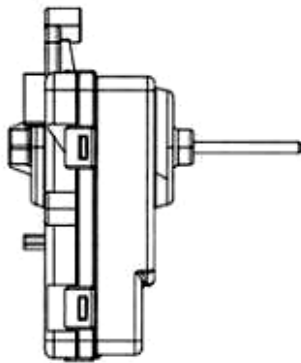

1.5

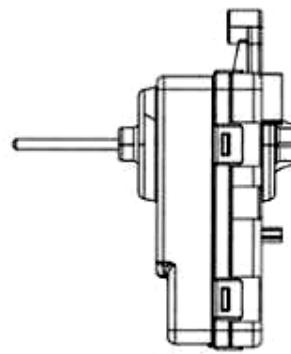

1.6

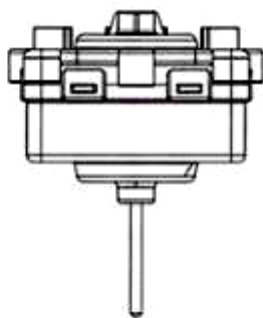

1.7

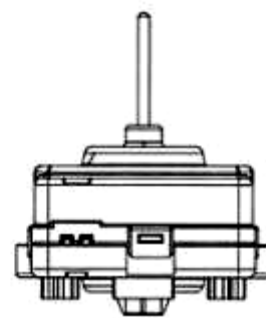

1.8

CÔNG BÁO SỞ HỮU CÔNG NGHIỆP SỐ 437 TẬP A – QUYỀN 2 (08.2024)

- (11) **51119**
(21) 3-2024-00950 (28) 1
(54) **BAO GÓI KHĂN ƯỚT** (51) **09-05**
(22) 19/04/2024 (43) 26/08/2024
(73) **CÔNG TY TNHH SẢN XUẤT THƯƠNG MẠI XUẤT NHẬP KHẨU DR MAN (VN)**
131/17 Kinh Dương Vương, phường 12, quận 6, thành phố Hồ Chí Minh
(72) Nguyễn Thị Mai Dung (VN)
(55)



1.1



1.2



1.3



1.4



1.5



1.6

CÔNG BÁO SỞ HỮU CÔNG NGHIỆP SỐ 437 TẬP A – QUYỀN 2 (08.2024)

- (11) **51120**
(21) 3-2024-00953 (28) 1
(54) **HỘP** (51) **09-03**
(22) 19/04/2024 (43) 26/08/2024
(73) **CÔNG TY TNHH MTV XUẤT NHẬP KHẨU DƯỢC LIỆU KIM SƠN (VN)**
Thôn Mỏ Nhài, xã Hưng Vũ, huyện Bắc Sơn, tỉnh Lạng Sơn
(72) Phạm Trung Kiên (VN)
(74) Công ty Cổ phần ICHECK (ICHECK.,JSC)
(55)



1.1



1.2

CÔNG BÁO SỞ HỮU CÔNG NGHIỆP SỐ 437 TẬP A – QUYỀN 2 (08.2024)

- (11) **51121**
(21) 3-2024-00958 (28) 1
(54) **THANH NHÔM ĐỊNH HÌNH** (51) **25-01**
(22) 22/04/2024 (43) 26/08/2024
(73) **CÔNG TY CỔ PHẦN NHÔM BLK VIỆT NAM (VN)**
Km 9 đường 35, thôn Thanh Hà, xã Nam Sơn, huyện Sóc Sơn, thành phố Hà Nội
(72) Vũ Bá Trường (VN)
(74) **CÔNG TY TNHH SỞ HỮU TRÍ TUỆ ANLIS VIỆT NAM (ANLIS IP CO.,LTD)**
(55)

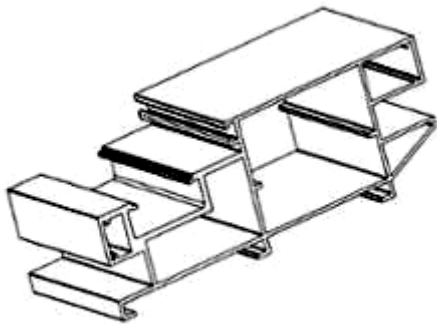

1.1

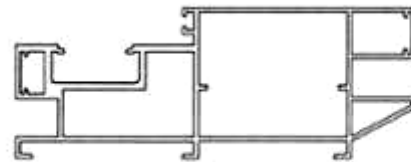

1.2



1.3

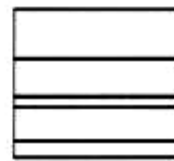

1.4



1.5



1.6

CÔNG BÁO SỞ HỮU CÔNG NGHIỆP SỐ 437 TẬP A – QUYỀN 2 (08.2024)

(11) **51122**

(21) 3-2024-00959

(28) 1

(54) **THANH NHÔM ĐỊNH HÌNH**

(51) **25-01**

(22) 22/04/2024

(43) 26/08/2024

(73) **CÔNG TY CỔ PHẦN NHÔM BLK VIỆT NAM (VN)**

Km 9 đường 35, thôn Thanh Hà, xã Nam Sơn, huyện Sóc Sơn, thành phố Hà Nội

(72) Vũ Bá Trường (VN)

(74) **CÔNG TY TNHH SỞ HỮU TRÍ TUỆ ANLIS VIỆT NAM (ANLIS IP CO.,LTD)**

(55)

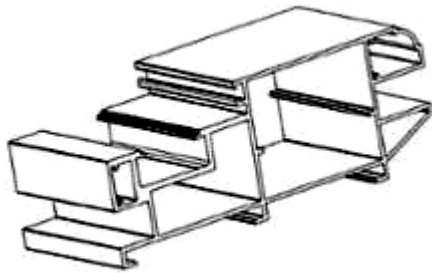

1.1

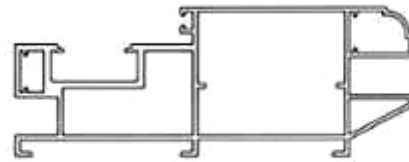

1.2

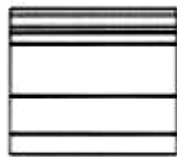

1.3

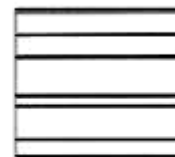

1.4



1.5

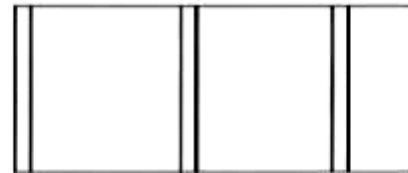

1.6

CÔNG BÁO SỞ HỮU CÔNG NGHIỆP SỐ 437 TẬP A – QUYỀN 2 (08.2024)

- (11) **51123**
(21) 3-2024-00960 (28) 1
(54) **BỒN CHỨA** (51) **23-01; 23-99**
(22) 22/04/2024 (43) 26/08/2024
(73) **CÔNG TY CỔ PHẦN QUỐC TẾ SATA (VN)**
Số 9, ngách 43/98, TDP Đống 6, đường Cổ Nhuế, phường Cổ Nhuế 2, quận Bắc Từ Liêm, thành phố Hà Nội
(72) 1. VŨ NGỌC ĐIỆP (VN)
2. TRỊNH DUY DŨNG (VN)
3. NGUYỄN VĂN THANH (VN)
(74) Công ty TNHH Nghiên cứu và Tư vấn chuyên giao công nghệ và đầu tư (CONCETTI)
(55)



1.1



1.2



1.3



1.4



1.5



1.6



1.7

CÔNG BÁO SỞ HỮU CÔNG NGHIỆP SỐ 437 TẬP A – QUYỀN 2 (08.2024)

- (11) **51124**
- (21) 3-2024-00972 (28) 1
- (54) **BAO GÓI** (51) **09-05**
- (22) 24/04/2024 (43) 26/08/2024
- (73) **CÔNG TY TNHH NTPM (VIỆT NAM) (VN)**
Số 22 VSIP II-A, đường số 23, khu công nghiệp Việt Nam - Singapore II-A,
phường Vĩnh Tân, thành phố Tân Uyên, tỉnh Bình Dương
- (72) LEE KUAN PHENG (MY)
- (74) Công ty TNHH Sở hữu trí tuệ HA VIP (HAVIP CO., LTD.)
- (55)



1.1



1.2

CÔNG BÁO SỞ HỮU CÔNG NGHIỆP SỐ 437 TẬP A – QUYỀN 2 (08.2024)

- (11) **51125**
(21) 3-2024-00975 (28) 1
(54) **THIẾT BỊ GIẢM XÓC** (51) **12-16**
(22) 24/04/2024 (43) 26/08/2024
(30) A00202304747 24/10/2023 ID;
(73) **MENG KAH AUTO PARTS TRADING SDN. BHD. (MY)**
No. 40, Jalan TPP 5, Taman Perindustrian Putra, 47130 Puchong, Selangor Darul
Ehsan, Malaysia
(72) LEE CONG QUAN (MY)
(74) Công ty TNHH ASL LAW (ASL LAW CO.,LTD)
(55)

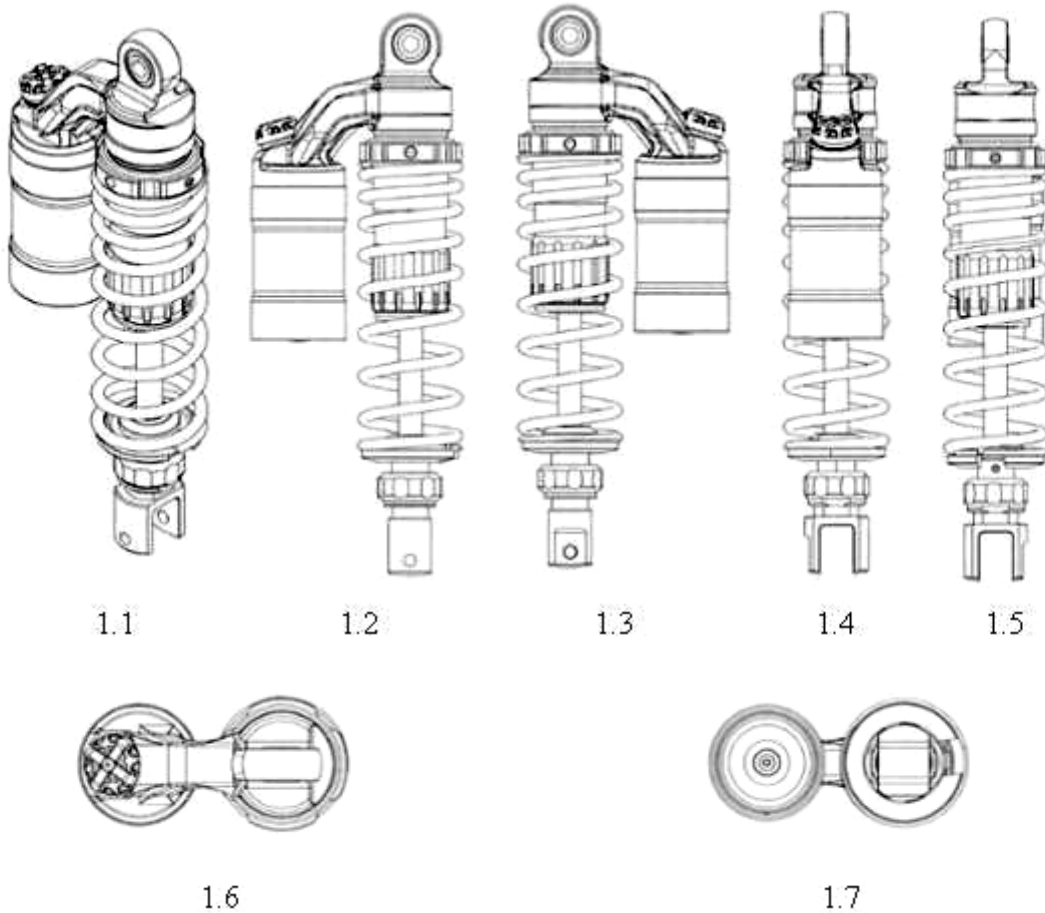

CÔNG BÁO SỞ HỮU CÔNG NGHIỆP SỐ 437 TẬP A – QUYỀN 2 (08.2024)

- (11) **51126**
(21) 3-2024-00976 (28) 1
(54) **THIẾT BỊ GIẢM XÓC** (51) **12-16**
(22) 24/04/2024 (43) 26/08/2024
(30) A00202304746 24/10/2023 ID;
(73) **MENG KAH AUTO PARTS TRADING SDN. BHD. (MY)**
No. 40, Jalan TPP 5, Taman Perindustrian Putra, 47130 Puchong, Selangor Darul
Ehsan, Malaysia
(72) LEE CONG QUAN (MY)
(74) Công ty TNHH ASL LAW (ASL LAW CO.,LTD)
(55)

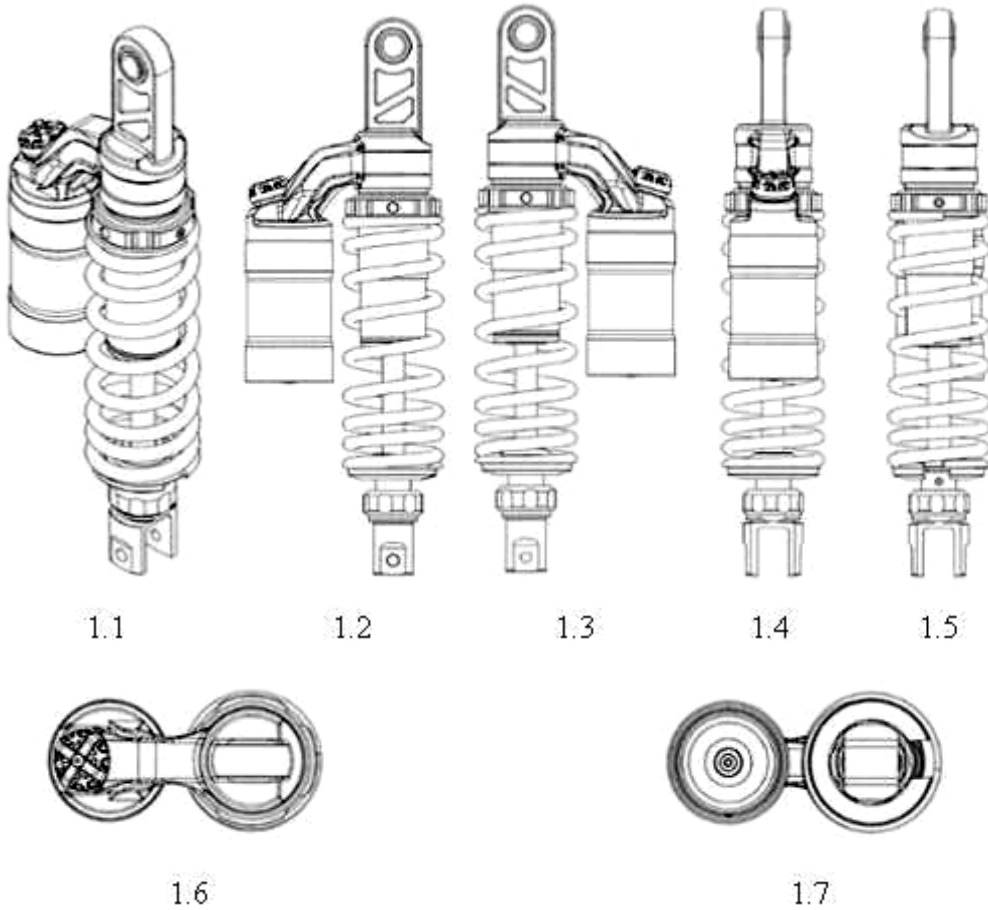

CÔNG BÁO SỞ HỮU CÔNG NGHIỆP SỐ 437 TẬP A – QUYỀN 2 (08.2024)

- (11) **511127**
 - (21) 3-2024-00986
 - (54) **BAO GÓI**
 - (22) 25/04/2024
 - (73) **CÔNG TY TNHH SẢN XUẤT THƯƠNG MẠI THÀNH DANH (VN)**
Số 67 Lương Văn Chánh, phường 5, thành phố Tuy Hòa, tỉnh Phú Yên
 - (72) Nguyễn Thị Tình (VN)
 - (74) Công ty Luật TNHH ELITE (ELITE LAW FIRM)
 - (55)
- (28) 1
 - (51) **09-05**
 - (43) 26/08/2024



1.1



1.2



1.3

CÔNG BÁO SỞ HỮU CÔNG NGHIỆP SỐ 437 TẬP A – QUYỀN 2 (08.2024)

- (11) **51128**
(21) 3-2024-00990 (28) 1
(54) **HỘP ĐỰNG** (51) **09-03**
(22) 26/04/2024 (43) 26/08/2024
(73) **TRẦN XUÂN DŨNG (VN)**
Tổ 5, khu 1, phường Bạch Đằng, thành phố Hạ Long, tỉnh Quảng Ninh
(72) Trần Xuân Dũng (VN)
(74) Công ty TNHH Nghiên cứu và Đầu tư S&D (S&D INVEST CO., LTD)
(55)



1.1



1.2

- (11) **51129**
 - (21) 3-2024-00991
 - (54) **NHÃN**
 - (22) 26/04/2024
 - (30) WIPO145177 28/02/2024 WO;
 - (73) **CHRISTIAN DIOR COUTURE (FR)**
30 Avenue Montaigne, 75008 Paris, France
 - (72) Victoire de Castellane (FR)
 - (74) Công ty TNHH một thành viên Sở hữu trí tuệ VCCI (VCCI-IP CO.,LTD)
 - (55)
- (28) 1
 - (51) **11-01**
 - (43) 26/08/2024



1.1

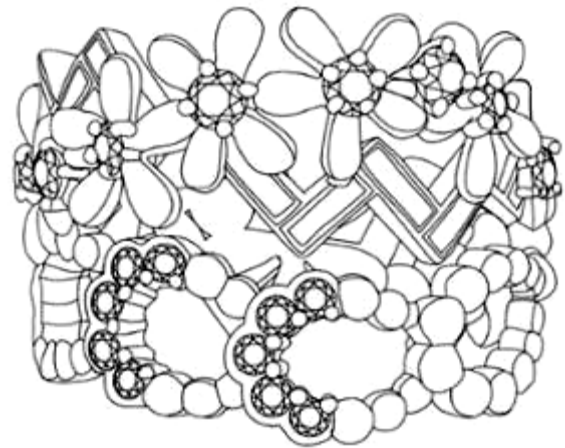

1.2



1.3



1.4

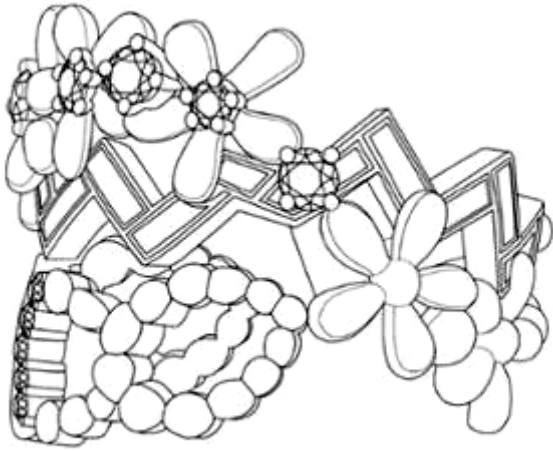

1.5

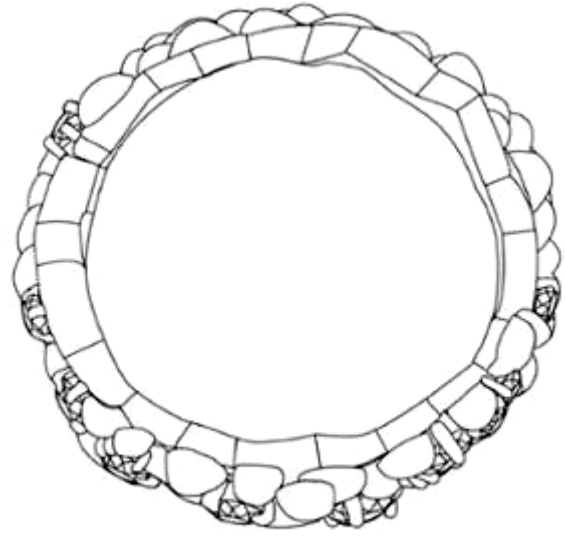

1.6

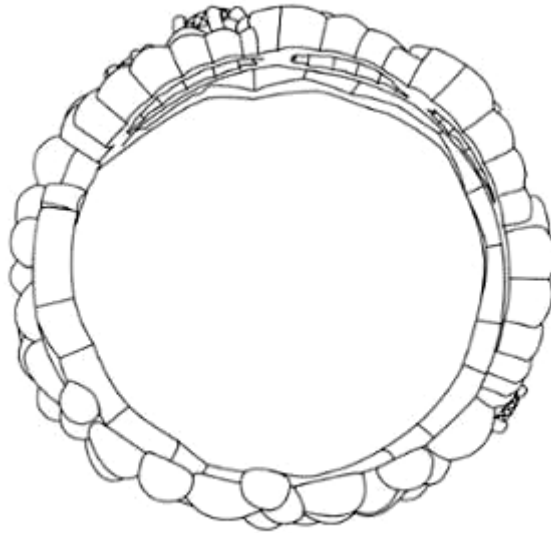

1.7

- (11) **51130**
(21) 3-2024-00992 (28) 1
(54) **KHUYÊN TAI** (51) **11-01**
(22) 26/04/2024 (43) 26/08/2024
(30) WIPO145177 28/02/2024 WO;
(73) **CHRISTIAN DIOR COUTURE (FR)**
30 Avenue Montaigne, 75008 Paris, FranceFR
(72) Victoire de Castellane (FR)
(74) Công ty TNHH một thành viên Sở hữu trí tuệ VCCI (VCCI-IP CO.,LTD)
(55)

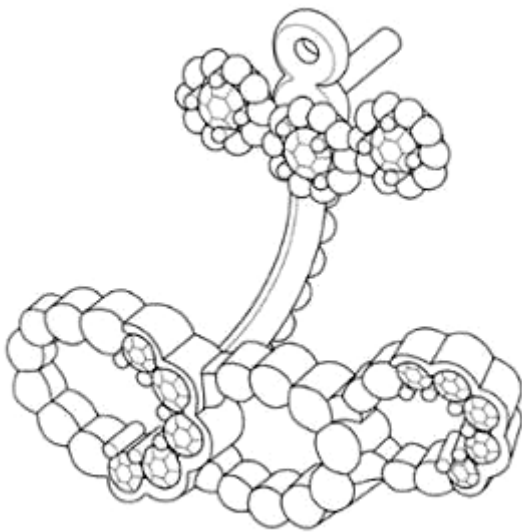

1.1

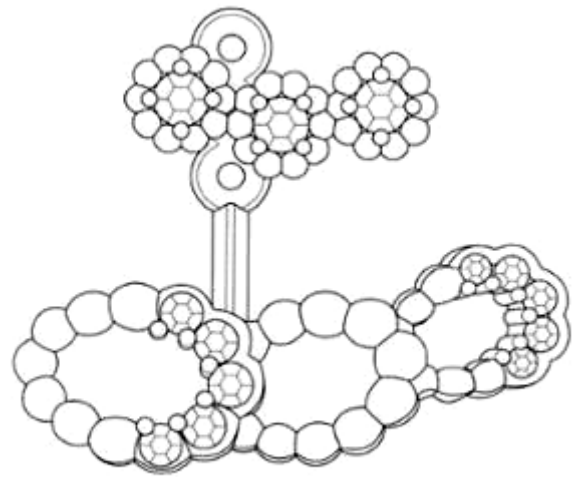

1.2

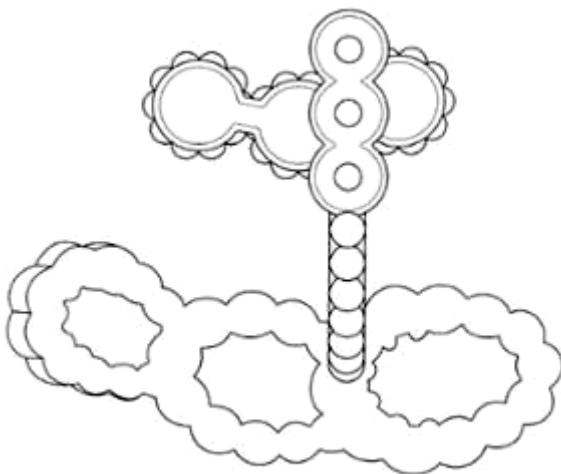

1.3

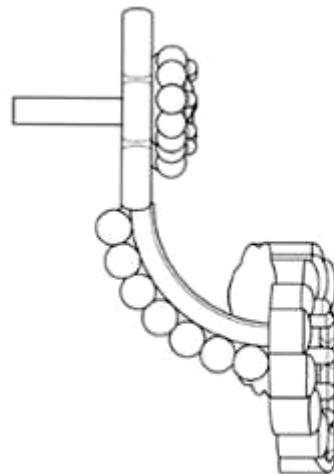

1.4

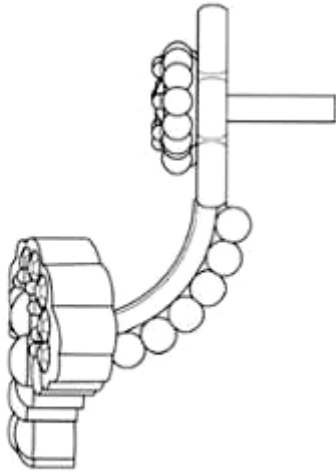

1.5

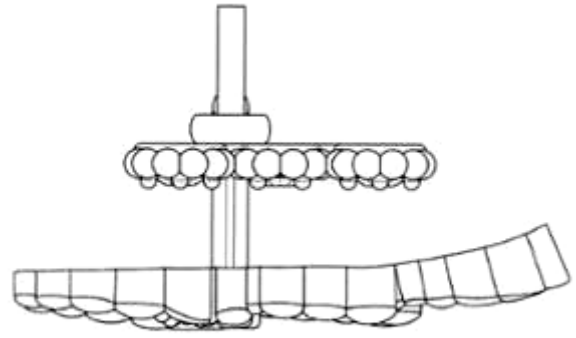

1.6

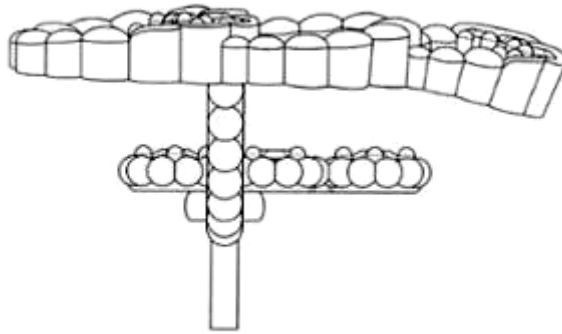

1.7

- (11) **51131**
(21) 3-2024-00993 (28) 1
(54) **KHUYÊN TAI** (51) **11-01**
(22) 26/04/2024 (43) 26/08/2024
(30) WIPO145177 28/02/2024 WO;
(73) **CHRISTIAN DIOR COUTURE (FR)**
30 Avenue Montaigne, 75008 Paris, France
(72) Victoire de Castellane (FR)
(74) Công ty TNHH một thành viên Sở hữu trí tuệ VCCI (VCCI-IP CO.,LTD)
(55)

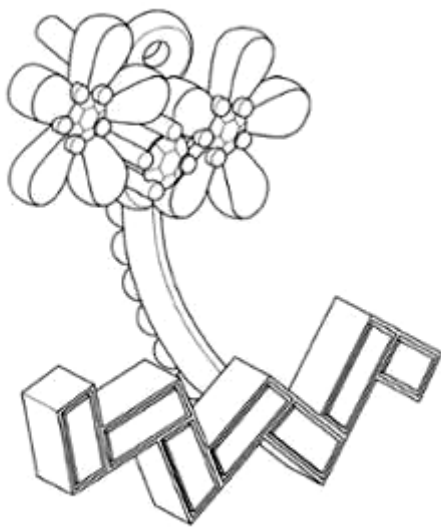

1.1

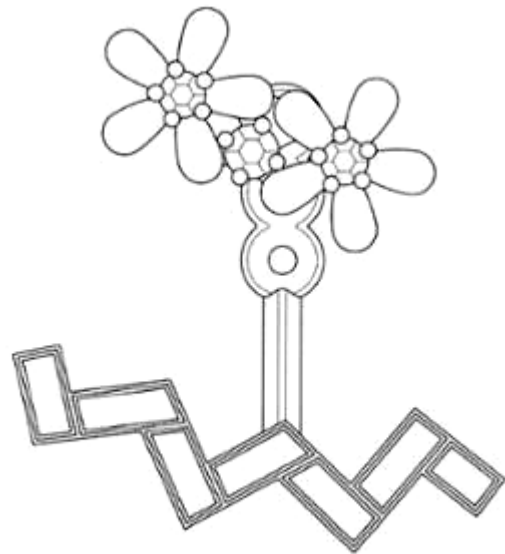

1.2

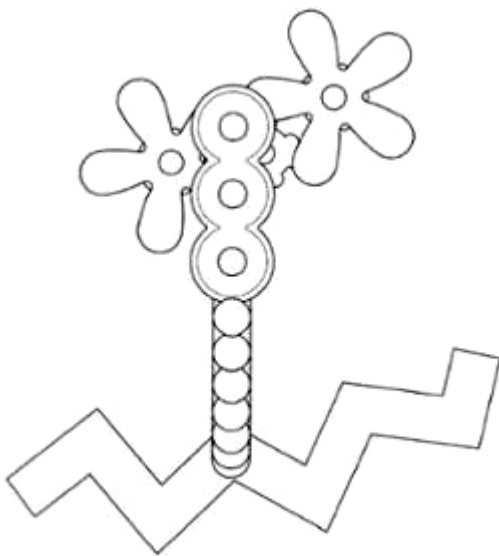

1.3

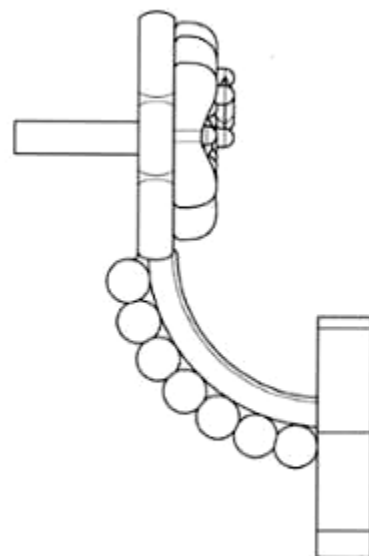

1.4

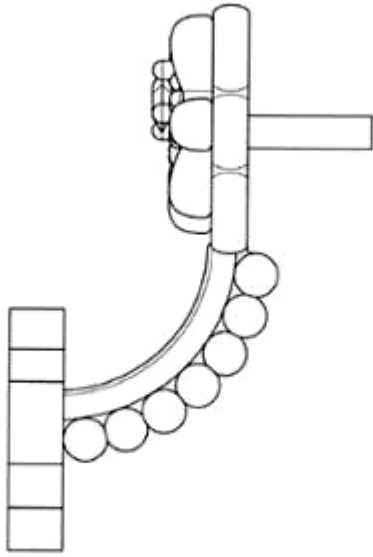

1.5

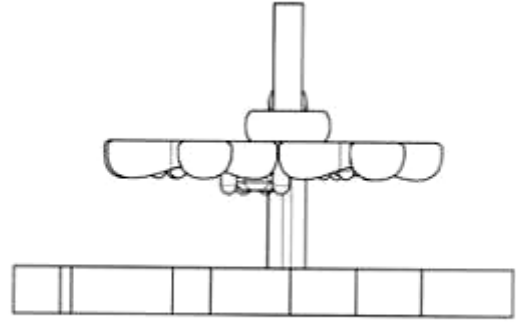

1.6

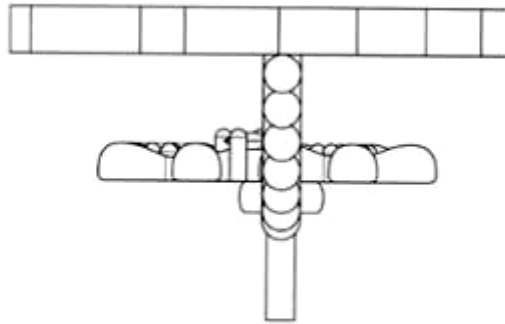

1.7

- (11) **51132**
- (21) 3-2024-00994
- (54) **VÒNG TAY**
- (22) 26/04/2024
- (30) WIPO145177 28/02/2024 WO;
- (73) **CHRISTIAN DIOR COUTURE (FR)**
30 Avenue Montaigne, 75008 Paris, France
- (72) Victoire de Castellane (FR)
- (74) Công ty TNHH một thành viên Sở hữu trí tuệ VCCI (VCCI-IP CO.,LTD)
- (55)

- (28) 1
- (51) **11-01**
- (43) 26/08/2024



1.1

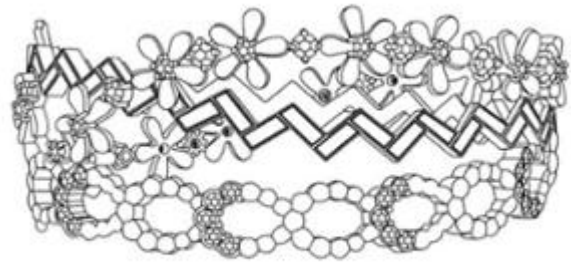

1.2

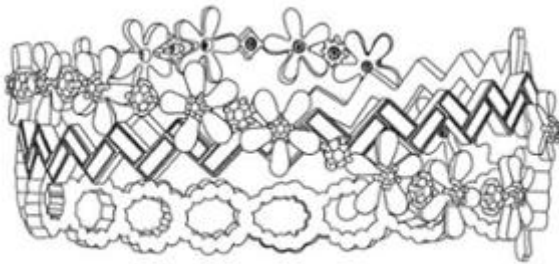

1.3

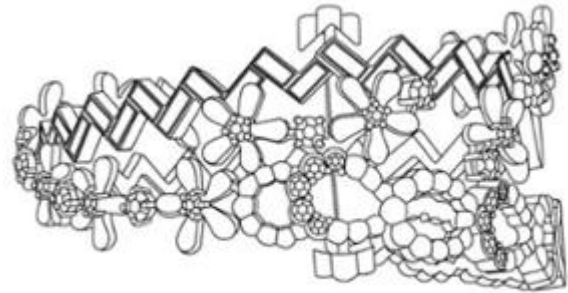

1.4

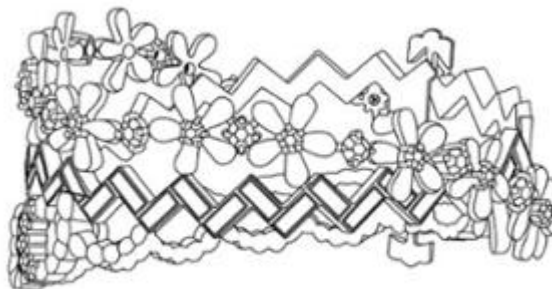

1.5



1.6



1.7

CÔNG BÁO SỞ HỮU CÔNG NGHIỆP SỐ 437 TẬP A – QUYỀN 2 (08.2024)

- (11) **51133**
(21) 3-2024-01041 (28) 1
(54) **BAO GÓI** (51) **09-05**
(22) 06/05/2024 (43) 26/08/2024
(73) **CÔNG TY TNHH SẢN XUẤT VÀ THƯƠNG MẠI DUY QUÂN BN (VN)**
Thôn Xuân Lai, xã Xuân Lai, huyện Gia Bình, tỉnh Bắc Ninh
(72) Lê Đình Dục (VN)
(74) Công ty Cổ phần ICHECK (ICHECK.,JSC)
(55)



1.1



1.2

CÔNG BÁO SỞ HỮU CÔNG NGHIỆP SỐ 437 TẬP A – QUYỀN 2 (08.2024)

- (11) **51134**
(21) 3-2024-01045 (28) 1
(54) **CHAI** (51) **09-02**
(22) 06/05/2024 (43) 26/08/2024
(73) **CÔNG TY CỔ PHẦN THƯƠNG MẠI DẦU KHÍ ĐỒNG THÁP (VN)**
Số 472, đường Nguyễn Huệ, phường Mỹ Phú, thành phố Cao Lãnh, tỉnh Đồng Tháp
(72) Lê Thanh Mân (VN)
(74) Công ty Luật TNHH AGL (AGL LAW)
(55)



1.1



1.2



1.3



1.5



1.4



1.6



1.7

CÔNG BÁO SỞ HỮU CÔNG NGHIỆP SỐ 437 TẬP A – QUYỀN 2 (08.2024)

- (11) **51135**
(21) 3-2024-01046 (28) 1
(54) **CHAI** (51) **09-02**
(22) 06/05/2024 (43) 26/08/2024
(73) **CÔNG TY CỔ PHẦN THƯƠNG MẠI DẦU KHÍ ĐỒNG THÁP (VN)**
Số 472, đường Nguyễn Huệ, phường Mỹ Phú, thành phố Cao Lãnh, tỉnh Đồng Tháp
(72) Lê Thanh Mân (VN)
(74) Công ty Luật TNHH AGL (AGL LAW)
(55)



1.1

1.2

1.3

1.4



1.5



1.6



1.7

CÔNG BÁO SỞ HỮU CÔNG NGHIỆP SỐ 437 TẬP A – QUYỀN 2 (08.2024)

- (11) **51136**
(21) 3-2024-01047 (28) 1
(54) **CHAI** (51) **09-02**
(22) 06/05/2024 (43) 26/08/2024
(73) **CÔNG TY CỔ PHẦN THƯƠNG MẠI DẦU KHÍ ĐỒNG THÁP (VN)**
Số 472, đường Nguyễn Huệ, phường Mỹ Phú, thành phố Cao Lãnh, tỉnh Đồng Tháp
(72) Lê Thanh Mân (VN)
(74) Công ty Luật TNHH AGL (AGL LAW)
(55)



1.1



1.2



1.3



1.4



1.5



1.6



1.7

- (11) **51137**
(21) 3-2024-01050 (28) 1
(54) **BỆ SẢN XUẤT LINH HOẠT** (51) **15-09; 15-99**
(22) 07/05/2024 (43) 26/08/2024
(30) 202330725663X 07/11/2023 CN;
(73) **JABIL CIRCUIT (SINGAPORE) PTE. LTD. (SG)**
16 Tampines Industrial Crescent, Singapore, 528604, Singapore
(72) 1. HARPUNEET SINGH (US)
2. CHIEN CHENG CHU (TW)
3. WEI-HSIU HSIEH (TW)
4. LEI HU (SG)
5. TIKE HOONG PHUA (SG)
6. LI YUN CHEE (MY)
7. XIAOTING ZHENG (CN)
(74) Văn phòng Luật sư Ân Nam (ANNAM IP & LAW)
(55)

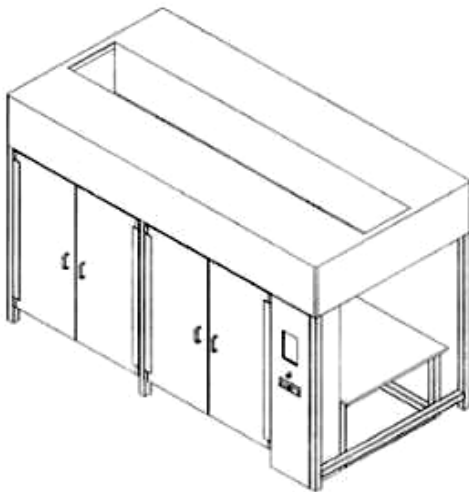

1.1

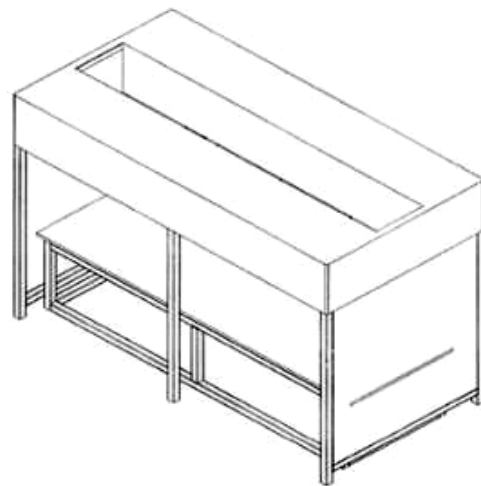

1.2

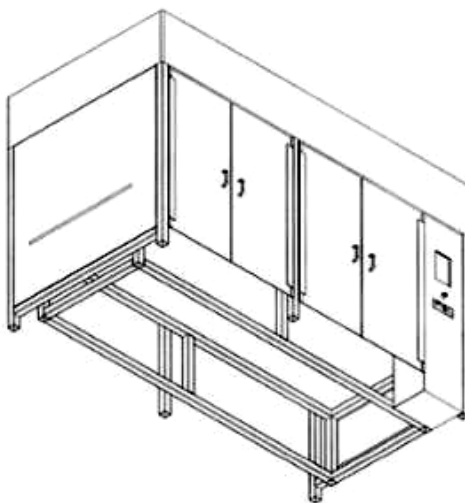

1.3

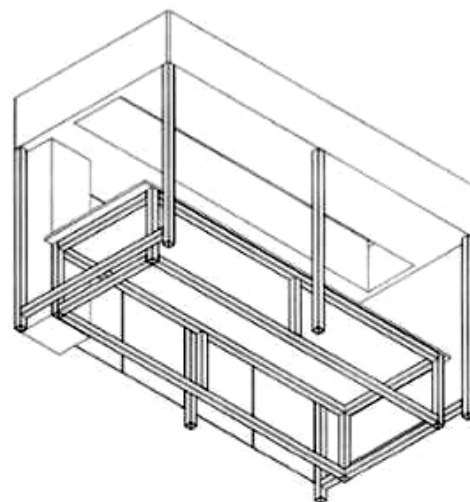

1.4

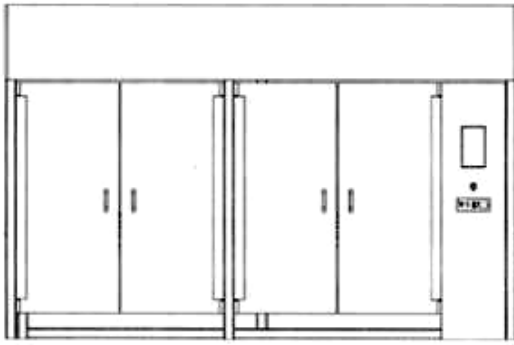

1.5

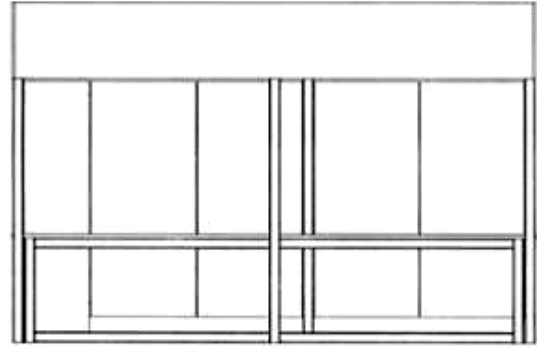

1.6

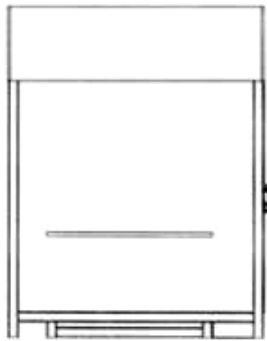

1.7

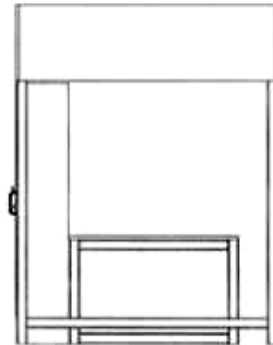

1.8

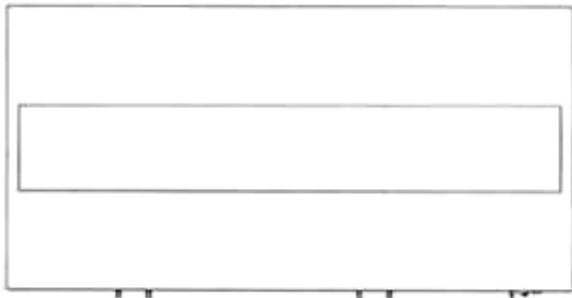

1.9

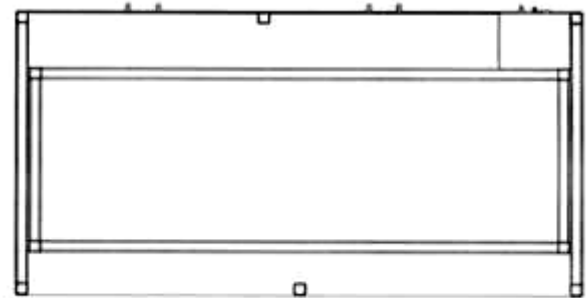

1.10



1.11



1.12



1.13

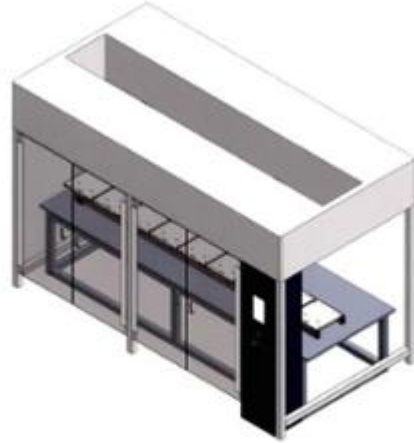

1.14



1.15



1.16

CÔNG BÁO SỞ HỮU CÔNG NGHIỆP SỐ 437 TẬP A – QUYỀN 2 (08.2024)

- (11) **51138**
- (21) 3-2024-01066 (28) 1
- (54) **HỘP ĐỰNG BÁNH** (51) **09-03**
- (22) 08/05/2024 (43) 26/08/2024
- (73) **CÔNG TY CỔ PHẦN THƯƠNG MẠI XÂY DỰNG RỒNG VÀNG MINH NGỌC (VN)**
 Khu 6 phường Cẩm Thượng, thành phố Hải Dương, tỉnh Hải Dương
- (72) Thái Thị Vân Anh (VN)
- (74) Công ty TNHH Sở hữu trí tuệ M.I.T (M.I.T IP CO., LTD)
- (55)



1.1



1.2



1.3



1.4

- (11) **51139**
(21) 3-2024-01075 (28) 1
(54) **BỘ LỌC CHO VÒI HOA SEN** (51) **23-01**
(22) 09/05/2024 (43) 26/08/2024
(30) 30-2024-0010971 21/03/2024 KR;
(73) 1. **KEVIN YOUNG KIM (US)**
1128 Ala Napunani St. #708, Honolulu, Hawaii 96818, USA
2. **JONATHAN SANO SON (US)**
1128 Ala Napunani St. #708, Honolulu, Hawaii 96818, USA
(72) 1. KEVIN YOUNG KIM (US)
2. JONATHAN SANO SON (US)
(74) **CÔNG TY LUẬT TRÁCH NHIỆM HỮU HẠN AMBYS HÀ NỘI (AMBYS HANOI)**
(55)



1.1

1.2

1.3

1.4

1.5

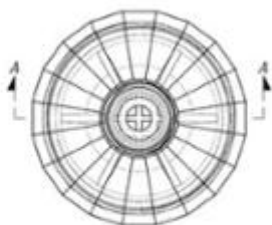

1.6

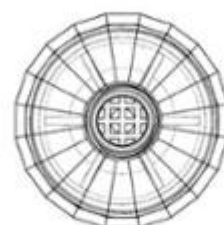

1.7

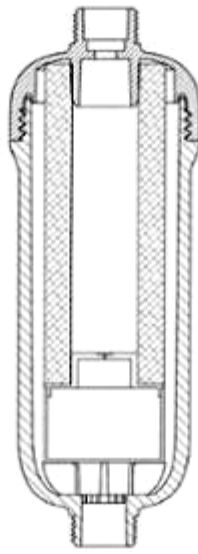

1.8



1.9

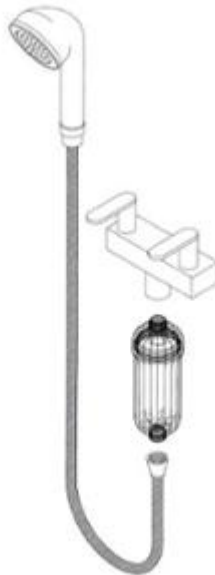

1.10

CÔNG BÁO SỞ HỮU CÔNG NGHIỆP SỐ 437 TẬP A – QUYỀN 2 (08.2024)

- (11) **51140**
- (21) 3-2024-01077
- (54) **BAO GÓI**
- (22) 09/05/2024
- (73) **CÔNG TY TNHH MỘT THÀNH VIÊN SAO PHƯƠNG NAM AG (VN)**
Ấp Hòa Phú 1, thị trấn An Châu, huyện Châu Thành, tỉnh An Giang
- (72) Hồ Lê Anh Khoa (VN)
- (74) Công ty TNHH Sở hữu trí tuệ HA VIP (HAVIP CO., LTD.)
- (55)



1.1



1.2



2.1



2.2

- (11) **51141**
(21) 3-2024-01082 (28) 1
(54) **CỤM THÂN VỎ PHÍA TRƯỚC XE MÁY** (51) **12-16**
(22) 09/05/2024 (43) 26/08/2024
(30) 2024301961710 10/04/2024 CN;
(73) **TAIZHOU HUANGYAN JUFENG MOTORCYCLES CO., LTD. (CN)**
No. 38 Minghui Road, Xinqian Sub-district, Huangyan District, Taizhou City,
Zhejiang Province, China
(72) Hui CHEN (CN)
(74) Công ty TNHH Sáng chế ACTIP (ACTIP PATENT LIMITED)
(55)

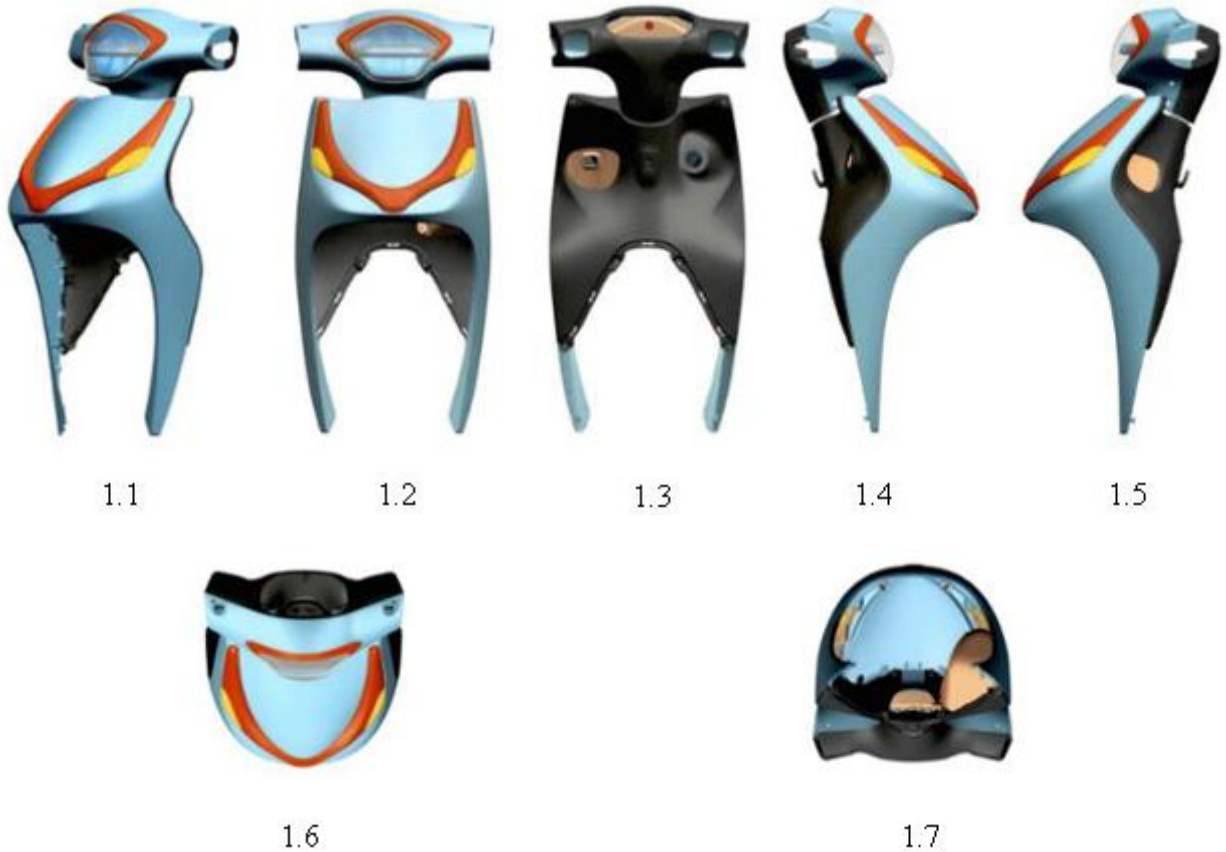

CÔNG BÁO SỞ HỮU CÔNG NGHIỆP SỐ 437 TẬP A – QUYỀN 2 (08.2024)

- (11) **51142**
(21) 3-2024-01086 (28) 1
(54) **KHAY HỘP ĐỰNG THỰC PHẨM** (51) **07-07**
(22) 10/05/2024 (43) 26/08/2024
(30) 30-2023-0044944 13/11/2023 KR;
(73) **LOCK & LOCK CO., LTD.** (KR)
1260, Manse-ro, Wongok-myeon, Anseong-si, Gyeonggi-do, Republic of Korea
(72) SHIM, Dong Seop (KR)
(74) Công ty TNHH Tầm nhìn và Liên danh (VISION & ASSOCIATES CO.LTD.)
(55)



1.1



1.2



1.3



1.4



1.5



1.6

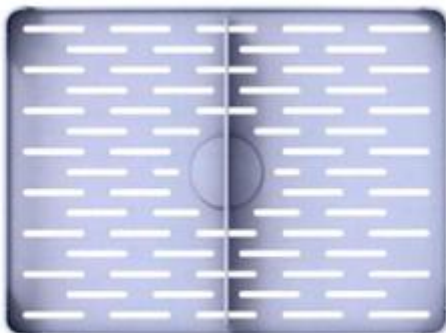

1.7



1.8



1.9



1.10

CÔNG BÁO SỞ HỮU CÔNG NGHIỆP SỐ 437 TẬP A – QUYỀN 2 (08.2024)

- (11) **51143**
(21) 3-2024-01087 (28) 1
(54) **KHAY HỘP ĐỰNG THỰC PHẨM** (51) **07-07**
(22) 10/05/2024 (43) 26/08/2024
(30) 30-2023-0044945 13/11/2023 KR;
(73) **LOCK & LOCK CO., LTD.** (KR)
1260, Manse-ro, Wongok-myeon, Anseong-si, Gyeonggi-do, Republic of Korea
(72) SHIM, Dong Seop (KR)
(74) Công ty TNHH Tâm nhìn và Liên danh (VISION & ASSOCIATES CO.LTD.)
(55)



1.1



1.2



1.3



1.4



1.5



1.6



1.7



1.8



1.9



1.10

CÔNG BÁO SỞ HỮU CÔNG NGHIỆP SỐ 437 TẬP A – QUYỀN 2 (08.2024)

- (11) **51144**
(21) 3-2024-01088 (28) 1
(54) **CAN** (51) **09-02**
(22) 10/05/2024 (43) 26/08/2024
(73) **CÔNG TY TNHH QUICK ONE (VN)**
46E đường Cây Keo, khu phố 1, phường Tam Phú, thành phố Thủ Đức, thành phố Hồ Chí Minh
(72) Bùi Văn Trung (VN)
(74) Công ty TNHH Tâm nhìn và Liên danh (VISION & ASSOCIATES CO.LTD.)
(55)



1.1



1.2



1.3



1.4



1.5



1.6



1.7

CÔNG BÁO SỞ HỮU CÔNG NGHIỆP SỐ 437 TẬP A – QUYỀN 2 (08.2024)

- (11) **51145**
(21) 3-2024-01089 (28) 1
(54) **NẤP HỘP ĐỰNG THỰC PHẨM** (51) **07-07**
(22) 10/05/2024 (43) 26/08/2024
(30) 30-2023-0044942 13/11/2023 KR;
(73) **LOCK & LOCK CO., LTD.** (KR)
1260, Manse-ro, Wongok-myeon, Anseong-si, Gyeonggi-do, Republic of Korea
(72) SHIM, Dong Seop (KR)
(74) Công ty TNHH Tầm nhìn và Liên danh (VISION & ASSOCIATES CO.LTD.)
(55)



1.1



1.2



1.3



1.4



1.5



1.6



1.7



1.8

CÔNG BÁO SỞ HỮU CÔNG NGHIỆP SỐ 437 TẬP A – QUYỀN 2 (08.2024)

- (11) **51146**
(21) 3-2024-01090 (28) 1
(54) **NẮP HỘP ĐỰNG THỰC PHẨM** (51) **07-07**
(22) 10/05/2024 (43) 26/08/2024
(30) 30-2023-0044941 13/11/2023 KR;
(73) **LOCK & LOCK CO., LTD.** (KR)
1260, Manse-ro, Wongok-myeon, Anseong-si, Gyeonggi-do, Republic of Korea
(72) SHIM, Dong Seop (KR)
(74) Công ty TNHH Tầm nhìn và Liên danh (VISION & ASSOCIATES CO.LTD.)
(55)



1.1



1.2



1.3



1.4



1.5



1.6



1.7



1.8

CÔNG BÁO SỞ HỮU CÔNG NGHIỆP SỐ 437 TẬP A – QUYỀN 2 (08.2024)

- (11) **51147**
(21) 3-2024-01091 (28) 1
(54) **HỘP ĐỰNG THỰC PHẨM** (51) **07-07**
(22) 10/05/2024 (43) 26/08/2024
(30) 30-2023-0044943 13/11/2023 KR;
(73) **LOCK & LOCK CO., LTD.** (KR)
1260, Manse-ro, Wongok-myeon, Anseong-si, Gyeonggi-do, Republic of Korea
(72) SHIM, Dong Seop (KR)
(74) Công ty TNHH Tầm nhìn và Liên danh (VISION & ASSOCIATES CO.LTD.)
(55)



1.1



1.2



1.3



1.4



1.5



1.6



1.7

CÔNG BÁO SỞ HỮU CÔNG NGHIỆP SỐ 437 TẬP A – QUYỀN 2 (08.2024)

- (11) **51148**
(21) 3-2024-01099 (28) 1
(54) **THANH NHÔM ĐỊNH HÌNH** (51) **25-01**
(22) 13/05/2024 (43) 26/08/2024
(73) **CÔNG TY CỔ PHẦN ĐẦU TƯ VÀ THƯƠNG MẠI QUEENVIET (VN)**
Tầng 1, số 530 đường Trường Chinh, phường Ngã Tư Sở, quận Đống Đa, thành phố Hà Nội
(72) Nguyễn Mạnh Cường (VN)
(74) Công ty Luật TNHH SMARTLAW (SMARTLAW LEGAL SERVICE CO.,LTD.)
(55)



1.1



1.2



1.3



1.4



1.5



1.6



1.7

CÔNG BÁO SỞ HỮU CÔNG NGHIỆP SỐ 437 TẬP A – QUYỀN 2 (08.2024)

(11) **51149**

(21) 3-2022-00884

(28) 1

(54) **MÁY PHA CÀ PHÊ**

(51) **07-02**

(22) 06/05/2022

(43) 26/08/2024

(73) **ĐOÀN SƠN TÙNG (VN)**

Tổ dân phố 8, thị trấn Di Linh, huyện Di Linh, tỉnh Lâm Đồng

(72) Đoàn Sơn Tùng (VN)

(74) Công ty Cổ phần Sở hữu trí tuệ Việt Mỹ (VIET MY IPC)

(55)

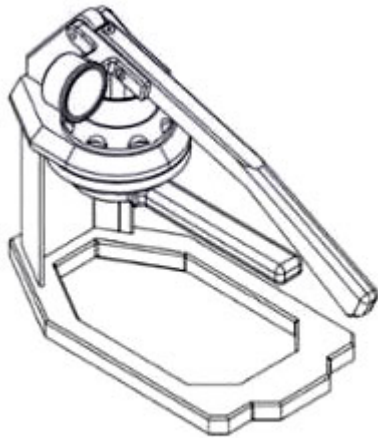

1.1

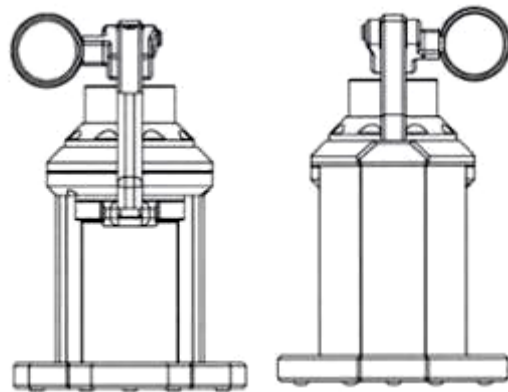

1.2

1.3

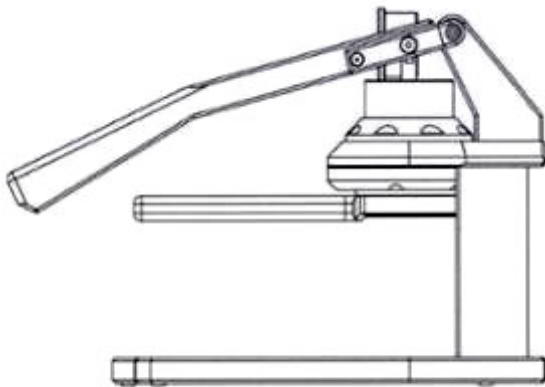

1.4

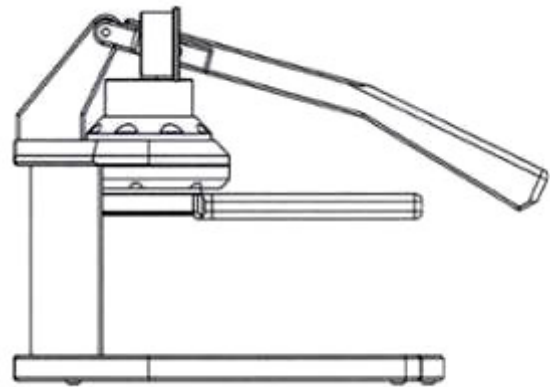

1.5

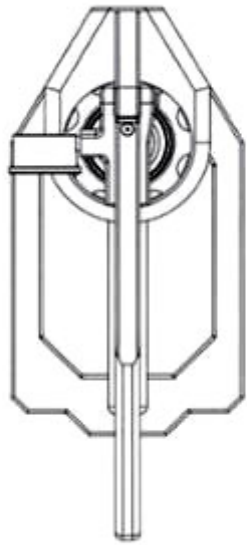

1.6

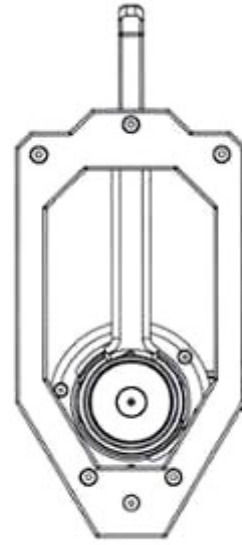

1.7

CÔNG BÁO SỞ HỮU CÔNG NGHIỆP SỐ 437 TẬP A – QUYỀN 2 (08.2024)

(11) **51150**

(21) 3-2023-01113

(28) 1

(54) **BAO BÌ**

(51) **09-05**

(22) 23/05/2023

(43) 26/08/2024

(73) **CÔNG TY TNHH FPS FLEXIBLES VIỆT NAM (VN)**

Nhà xưởng số 2, đường số 7, KCN Giang Điền, xã Giang Điền, huyện Trảng Bom, tỉnh Đồng Nai

(72) Nguyễn Thị Vinh (VN)

(74) Công ty TNHH ASL LAW (ASL LAW CO.,LTD)

(55)

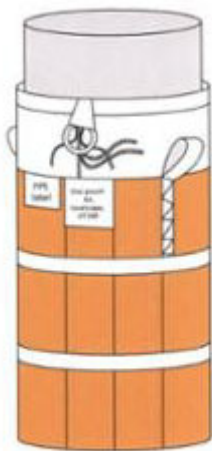

1.1

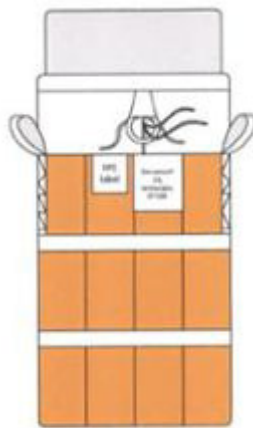

1.2

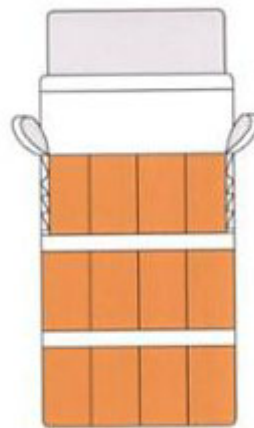

1.3

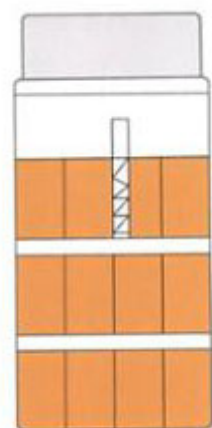

1.4



1.5



1.6



1.7

(11) **51151**

(21) 3-2023-01400

(28) 1

(54) **MÒI CÂU CÁ**

(51) **22-05**

(22) 23/06/2023

(43) 26/08/2024

(73) **NGUYỄN MẠNH TOÁN (VN)**

21 Bùi Bằng Đoàn, phường Nguyễn Trãi, quận Hà Đông, thành phố Hà Nội

(72) Nguyễn Mạnh Toán (VN)

(55)



1.1



1.2



1.3



1.4



1.5



1.6



1.7

(11) **51152**

(21) 3-2023-01401

(28) 1

(54) **MÒI CÂU CÁ**

(51) **22-05**

(22) 23/06/2023

(43) 26/08/2024

(73) **NGUYỄN MẠNH TOÁN (VN)**

21 Bùi Bằng Đoàn, phường Nguyễn Trãi, quận Hà Đông, thành phố Hà Nội

(72) Nguyễn Mạnh Toán (VN)

(55)



1.1



1.2



1.3

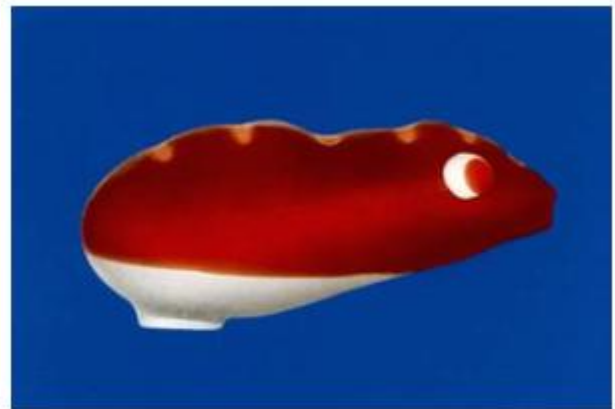

1.4

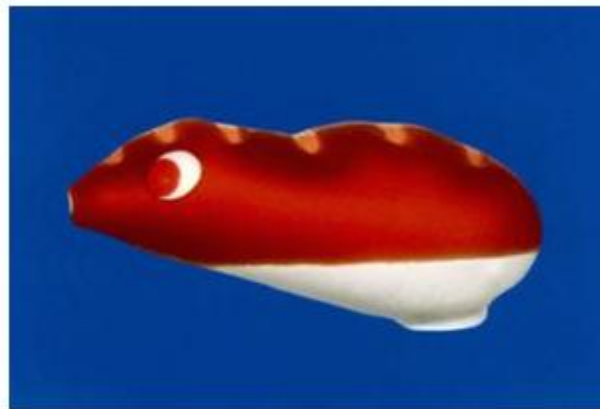

1.5



1.6



1.7

CÔNG BÁO SỞ HỮU CÔNG NGHIỆP SỐ 437 TẬP A – QUYỀN 2 (08.2024)

- (11) **51153**
- (21) 3-2023-01733 (28) 1
- (54) **BỘ PIN SẠC** (51) **13-02**
- (22) 28/07/2023 (43) 26/08/2024
- (30) 30-2023-0003554 31/01/2023 KR;
- (73) **HANWHA SOLUTIONS CORPORATION (KR)**
(Janggyo-dong) 86, Cheonggyecheon-ro, Jung-gu, Seoul, 04541 Republic of Korea
- (72) JEON DONGJUN (KR)
- (74) Văn phòng Luật sư Ân Nam (ANNAM IP & LAW)
- (55)

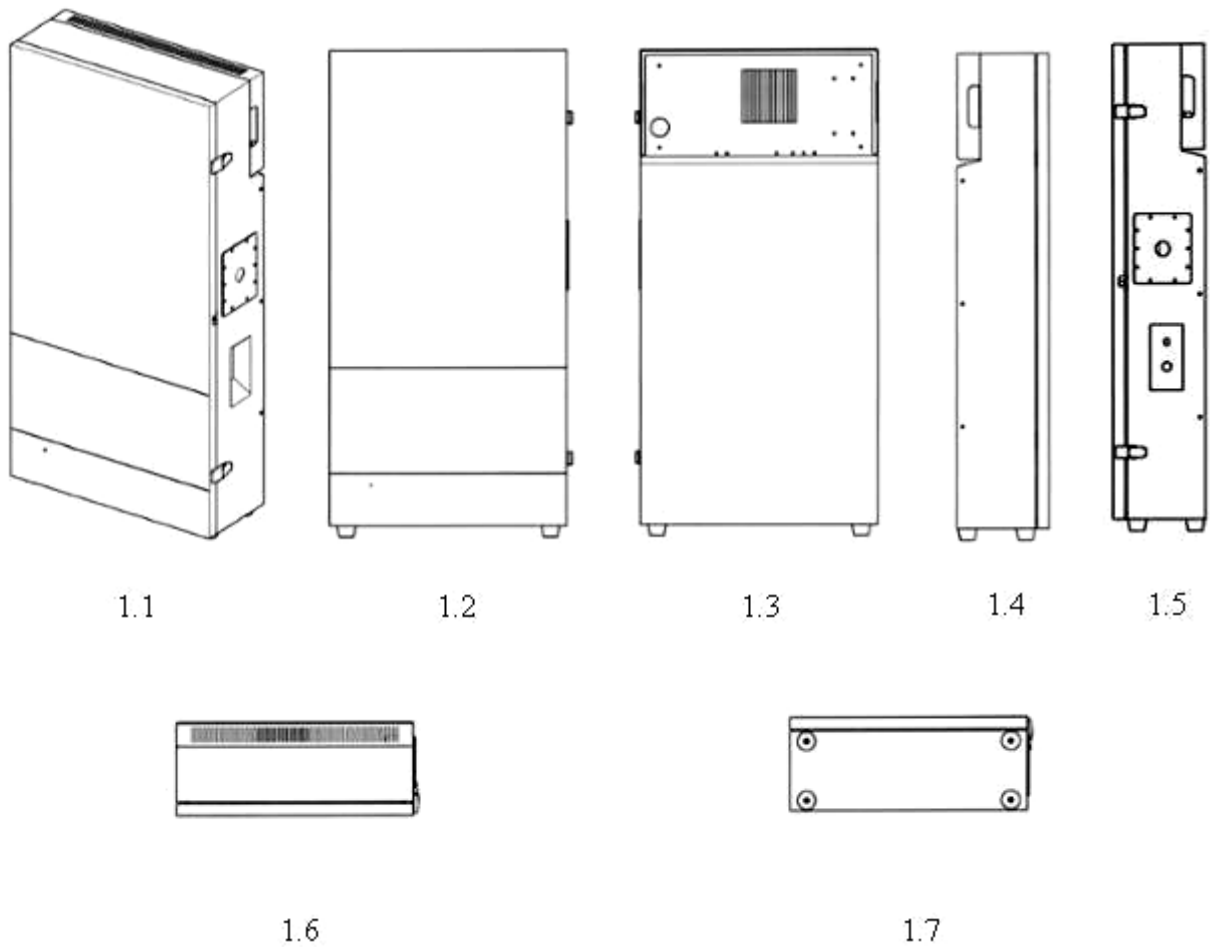

CÔNG BÁO SỞ HỮU CÔNG NGHIỆP SỐ 437 TẬP A – QUYỀN 2 (08.2024)

- (11) **51154**
(21) 3-2023-01734 (28) 1
(54) **THIẾT BỊ LƯU TRỮ NĂNG LƯỢNG** (51) **13-02**
(22) 28/07/2023 (43) 26/08/2024
(30) 30-2023-0003555 31/01/2023 KR;
(73) **HANWHA SOLUTIONS CORPORATION (KR)**
(Janggyo-dong) 86, Cheonggyecheon-ro, Jung-gu, Seoul, 04541 Republic of Korea
(72) JEON DONGJUN (KR)
(74) Văn phòng Luật sư Ân Nam (ANNAM IP & LAW)
(55)

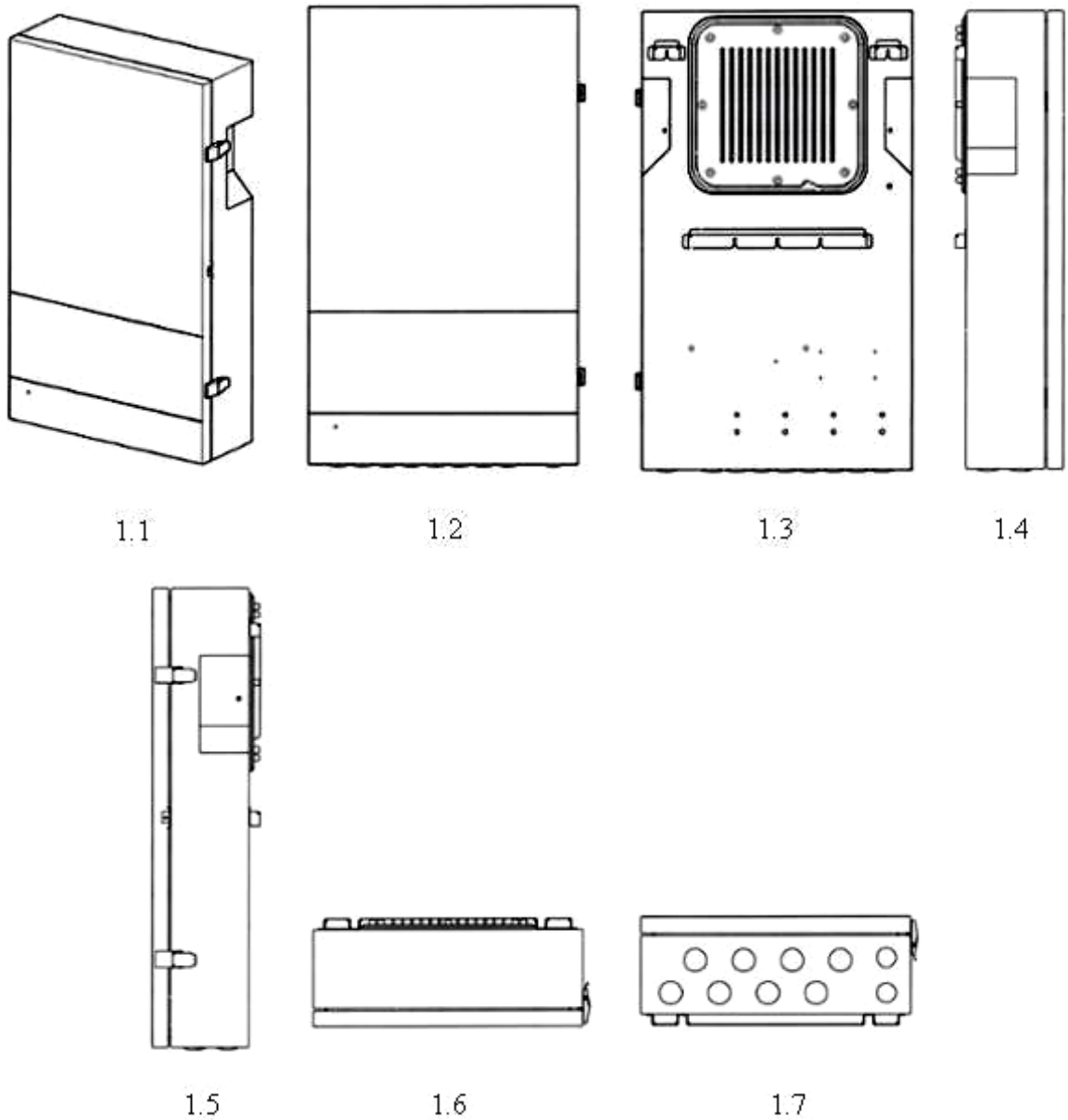

CÔNG BÁO SỞ HỮU CÔNG NGHIỆP SỐ 437 TẬP A – QUYỀN 2 (08.2024)

- (11) **51155**
(21) 3-2023-01956 (28) 1
(54) **ĐÈN CHIẾU SÁNG PHÍA TRƯỚC XE GẮN MÁY** (51) **26-06**
(22) 22/08/2023 (43) 26/08/2024
(73) **CÔNG TY CỔ PHẦN SẢN XUẤT VÀ THƯƠNG MẠI ĐỨC MINH (VN)**
Thôn Nhuận Tháp, xã Phụng Công, huyện Văn Giang, tỉnh Hưng Yên
(72) Nghiêm Xuân Minh (VN)
(55)



1.1

1.2

1.3



1.4

1.5



1.6



1.7

CÔNG BÁO SỞ HỮU CÔNG NGHIỆP SỐ 437 TẬP A – QUYỀN 2 (08.2024)

- (11) **51156**
(21) 3-2023-02140 (28) 1
(54) **BÚT BI** (51) **19-06**
(22) 08/09/2023 (43) 26/08/2024
(73) **LI, JUNHUA (CN)**
Room 601, Wan'an Building, No. 115, Wujiang North Road, Wujiang District,
Shaoguan City, Guangdong Province, China
(72) **LI, JUNHUA (CN)**
(74) Công ty TNHH một thành viên Trường Luật (Trường Luật)
(55)



1.1

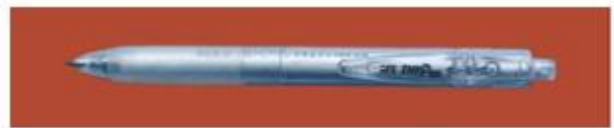

1.2



1.3



1.4



1.5



1.6

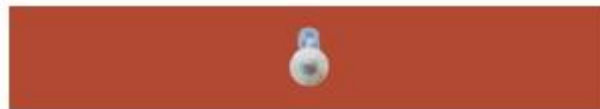

1.7

CÔNG BÁO SỞ HỮU CÔNG NGHIỆP SỐ 437 TẬP A – QUYỀN 2 (08.2024)

- (11) **51157**
(21) 3-2023-02141 (28) 1
(54) **BÚT BI** (51) **19-06**
(22) 08/09/2023 (43) 26/08/2024
(73) **LI, JUNHUA (CN)**
Room 601, Wan'an Building, No. 115, Wujiang North Road, Wujiang District,
Shaoguan City, Guangdong Province, China
(72) LI, JUNHUA (CN)
(74) Công ty TNHH một thành viên Trường Luật (Trường Luật)
(55)



1.1



1.2



1.3



1.4



1.5



1.6



1.7

CÔNG BÁO SỞ HỮU CÔNG NGHIỆP SỐ 437 TẬP A – QUYỀN 2 (08.2024)

- (11) **51158**
(21) 3-2023-02248 (28) 1
(54) **THIẾT BỊ GIÁM SÁT TẬP TRUNG** (51) **14-02**
(22) 25/09/2023 (43) 26/08/2024
(73) **CÔNG TY CỔ PHẦN SMATEC (VN)**
TT17 - B24, khu đô thị Văn Quán - Yên Phúc, phường Phúc La, quận Hà Đông,
thành phố Hà Nội
(72) 1. NGUYỄN HỒNG SƠN (VN)
2. LÊ BÌNH DẦN (VN)
(55)

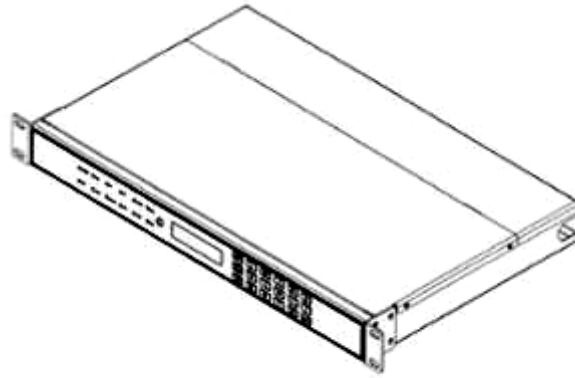

1.1



1.2



1.3



1.5



1.4

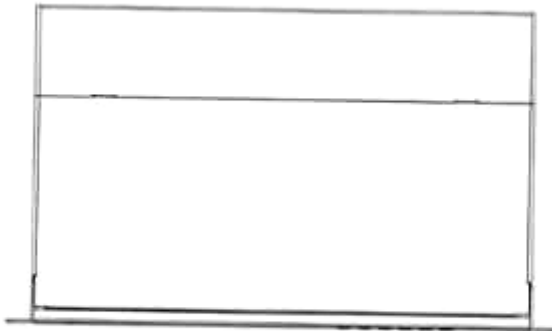

1.6

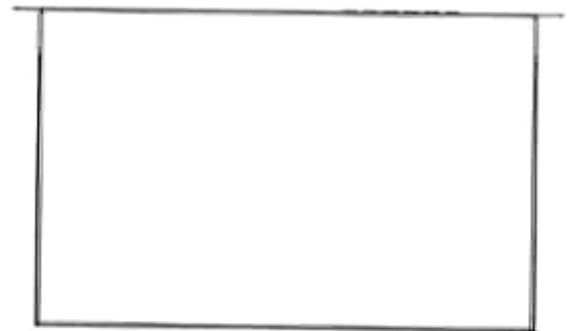

1.7

- (11) **51159**
(21) 3-2023-02332 (28) 2
(54) **CHAI** (51) **09-01**
(22) 03/10/2023 (43) 26/08/2024
(30) DM/228325 03/04/2023 WO;
(73) **ISLE OF HARRIS DISTILLERS LIMITED (GB)**
Isle of Harris Distillery, HS3 3DJ Tarbert, Isle of Harris, United Kingdom
(72) Ivan Bell (GB)
(74) **CÔNG TY LUẬT TNHH IP MAX (IPMAX LAW FIRM)**
(55)



1.1



1.2



1.3



1.4



1.5



1.6



1.7



2.1



2.2



2.3



2.4



2.5



2.6



2.7

(11) **51160**

(21) 3-2023-02502

(28) 1

(54) **MÁY RỬA XE**

(51) **15-05**

(22) 23/10/2023

(43) 26/08/2024

(73) **CÔNG TY TNHH THƯƠNG MẠI KỸ THUẬT TÂM KẾT (VN)**

Khu tập thể may 2, đường Hoàng Hoa Thám, phường An Tảo, thành phố Hưng Yên, tỉnh Hưng Yên

(72) Dương Ngọc Tùng (VN)

(74) Công ty TNHH Trường Xuân (AGELESS CO.,LTD.)

(55)

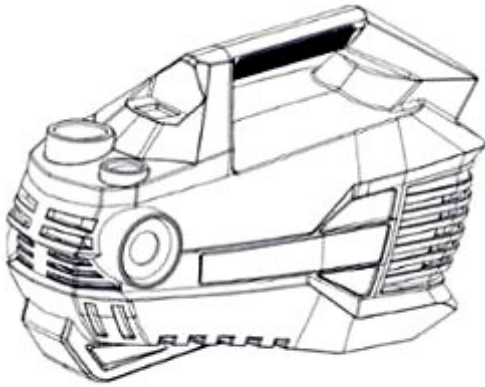

1.1

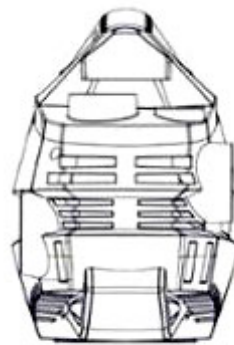

1.2

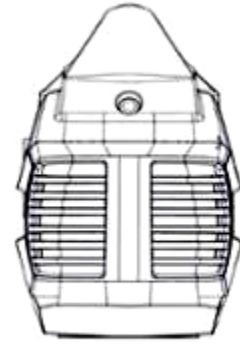

1.3

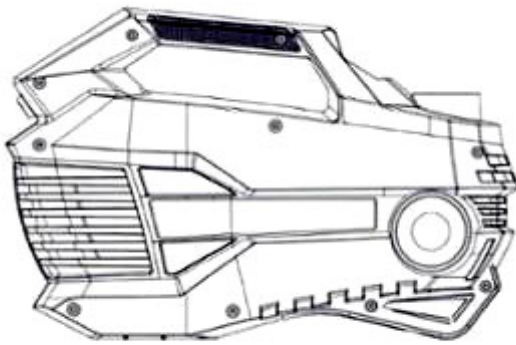

1.4

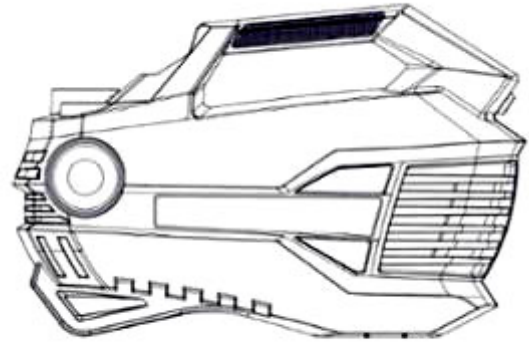

1.5

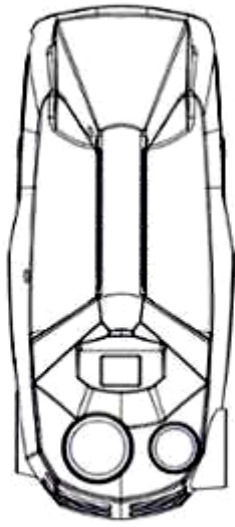

1.6

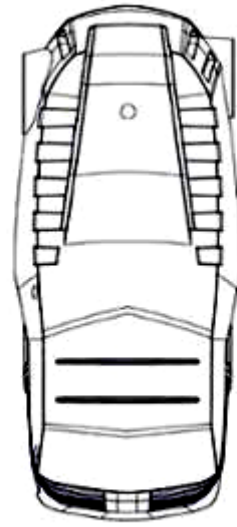

1.7

- (11) **51161**
(21) 3-2023-02628 (28) 1
(54) **NHÃN** (51) **11-01**
(22) 07/11/2023 (43) 26/08/2024
(30) WIPO140093 26/10/2023 WO;
(73) **CHRISTIAN DIOR COUTURE (FR)**
30 Avenue Montaigne, 75008 Paris, France
(72) Victoire de Castellane (FR)
(74) Công ty TNHH một thành viên Sở hữu trí tuệ VCCI (VCCI-IP CO.,LTD)
(55)

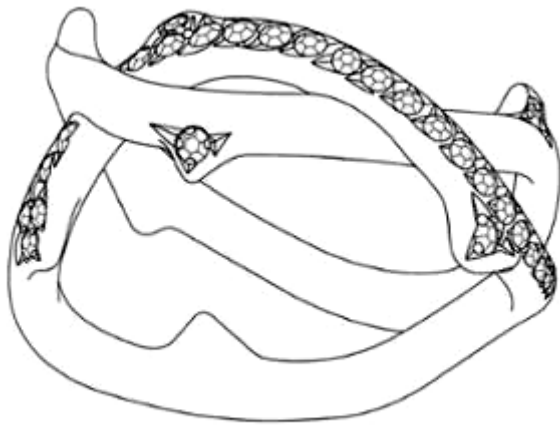

1.1

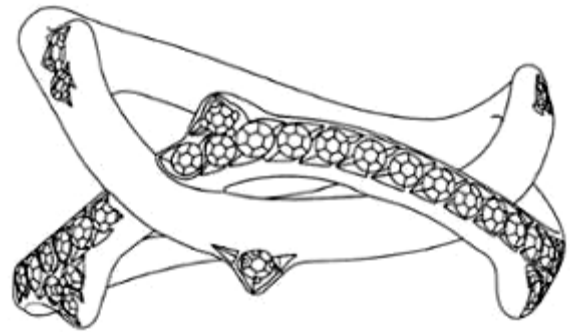

1.2

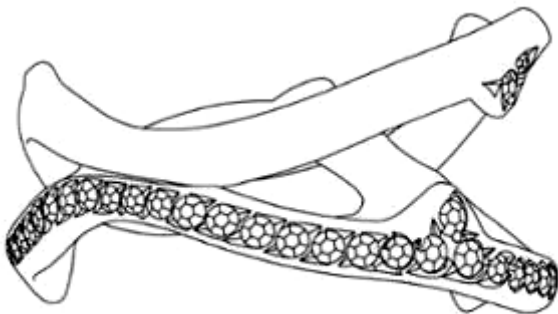

1.3



1.4

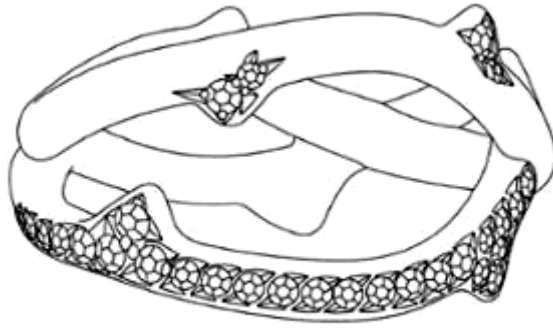

1.5

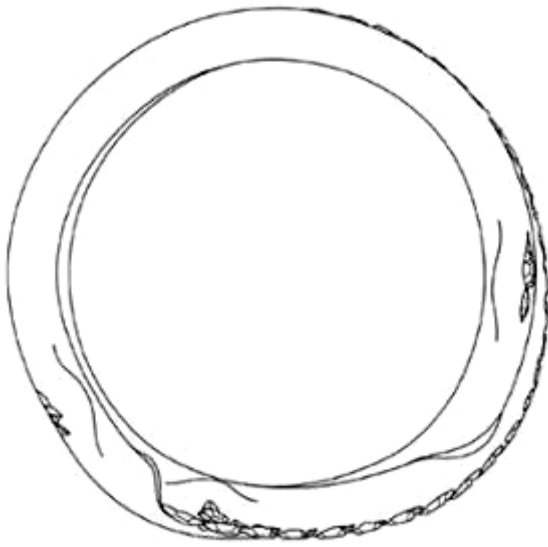

1.6

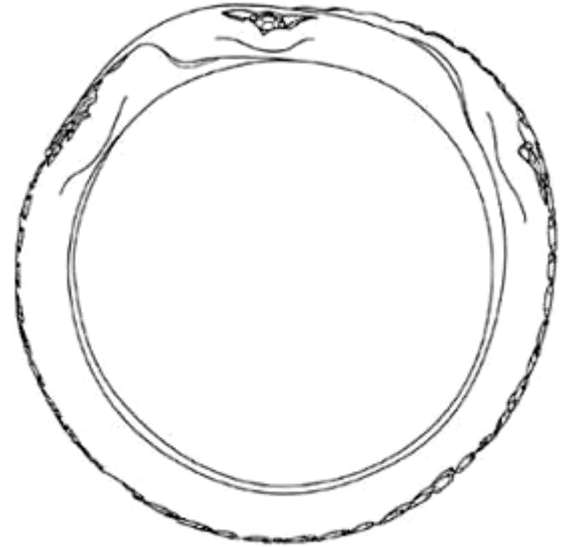

1.7

- (11) **51162**
- (21) 3-2023-02630
- (54) **KHUYÊN TAI**
- (22) 07/11/2023
- (30) WIPO140093 26/10/2023 WO;
- (73) **CHRISTIAN DIOR COUTURE (FR)**
30 Avenue Montaigne, 75008 Paris, France
- (72) Victoire de Castellane (FR)
- (74) Công ty TNHH một thành viên Sở hữu trí tuệ VCCI (VCCI-IP CO.,LTD)
- (55)



1.1



1.2

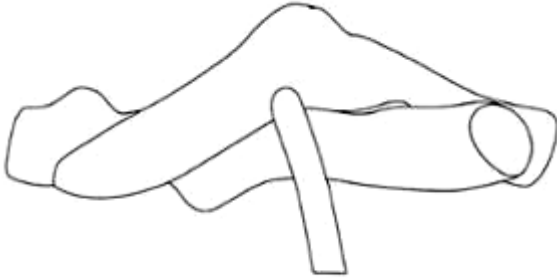

1.3



1.4

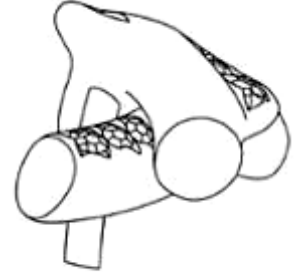

1.5

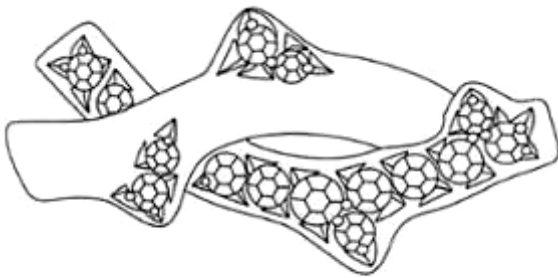

1.6



1.7

- (11) **51163**
(21) 3-2023-02631 (28) 1
(54) **KHUYÊN VÀNH TAI** (51) **11-01**
(22) 07/11/2023 (43) 26/08/2024
(30) WIPO140093 26/10/2023 WO;
(73) **CHRISTIAN DIOR COUTURE (FR)**
30 Avenue Montaigne, 75008 Paris, France
(72) Victoire de Castellane (FR)
(74) Công ty TNHH một thành viên Sở hữu trí tuệ VCCI (VCCI-IP CO.,LTD)
(55)

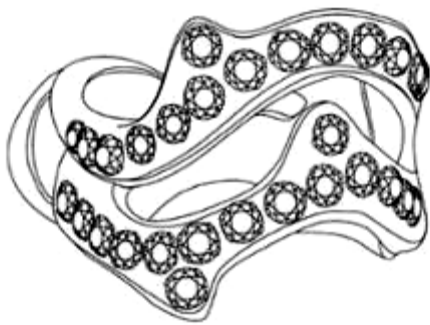

1.1

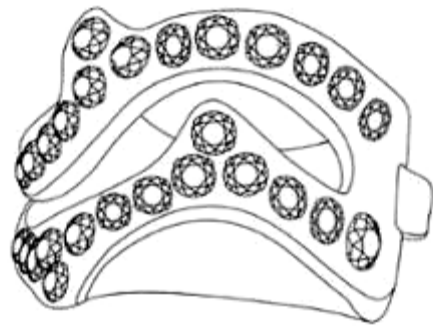

1.2

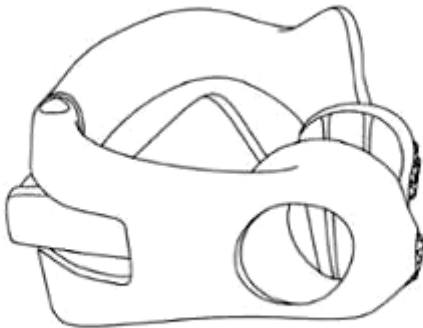

1.3

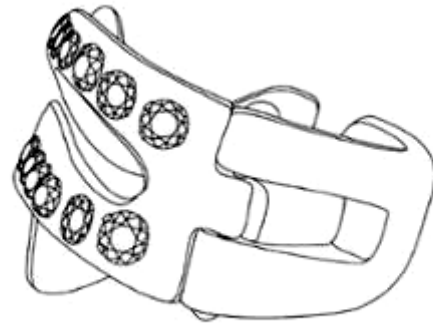

1.4

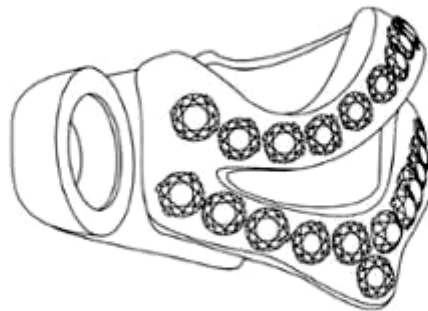

1.5



1.6



1.7

CÔNG BÁO SỞ HỮU CÔNG NGHIỆP SỐ 437 TẬP A – QUYỀN 2 (08.2024)

- (11) **51164**
(21) 3-2023-02804 (28) 1
(54) **XE MÔ TÔ** (51) **12-11**
(22) 21/11/2023 (43) 26/08/2024
(73) **SANYANG MOTOR CO., LTD. (TW)**
No. 184, Keng Tzu Kou, Shang Keng Village, Hsin Fong Shiang, Hsinchu County
304, Taiwan
(72) Chia I HSIEH (TW)
(74) Công ty TNHH Trường Xuân (AGELESS CO.,LTD.)
(55)



1.1



1.2

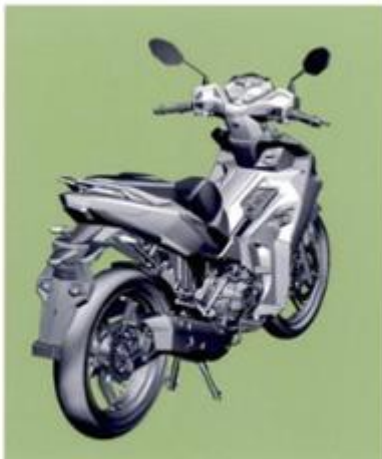

1.3



1.4



1.5



1.6



1.7



1.8



1.9



1.10

- (11) **51165**
(21) 3-2023-02806 (28) 1
(54) **CHAI** (51) **09-01**
(22) 21/11/2023 (43) 26/08/2024
(73) **CÔNG TY TNHH ĐẦU TƯ SẢN XUẤT NAM PHÁT (VN)**
Thôn 3, xã Vạn Phúc, huyện Thanh Trì, thành phố Hà Nội
(72) Nguyễn Mạnh Diện (VN)
(55)



1.1



1.2



1.3



1.4



1.5



1.6

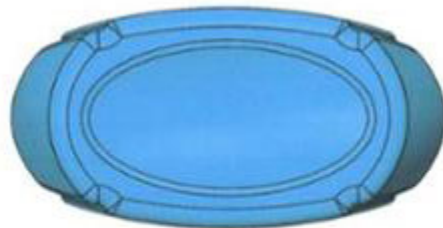

1.7

CÔNG BÁO SỞ HỮU CÔNG NGHIỆP SỐ 437 TẬP A – QUYỀN 2 (08.2024)

- (11) **51166**
(21) 3-2023-03006 (28) 1
(54) **CHAI** (51) **09-02**
(22) 08/12/2023 (43) 26/08/2024
(73) **CÔNG TY CỔ PHẦN HÀNG TIÊU DÙNG MASAN (VN)**
Số 23 Lê Duẩn, phường Bến Nghé, Quận 1, thành phố Hồ Chí Minh
(72) Nguyễn Hoàng Yên (VN)
(74) Công ty cổ phần Sở hữu trí tuệ BROSS và Cộng sự (BROSS & PARTNERS., JSC)
(55)



1.1



1.2



1.3



1.4



1.5



1.6



1.7

CÔNG BÁO SỞ HỮU CÔNG NGHIỆP SỐ 437 TẬP A – QUYỀN 2 (08.2024)

- (11) **51167**
(21) 3-2023-03120 (28) 1
(54) **THIẾT BỊ CHỐNG SỐC ĐIỆN CÁCH LY** (51) **13-03**
(22) 22/12/2023 (43) 26/08/2024
(73) **CÔNG TY CỔ PHẦN TẬP ĐOÀN CÔNG NGHỆ T-TECH VIỆT NAM (VN)**
Tầng 24, tòa nhà TASCOS, đường Phạm Hùng, phường Mỹ Trì, quận Nam Từ Liêm,
thành phố Hà Nội
(72) Nguyễn Đình Trọng (VN)
(55)



1.1



1.2

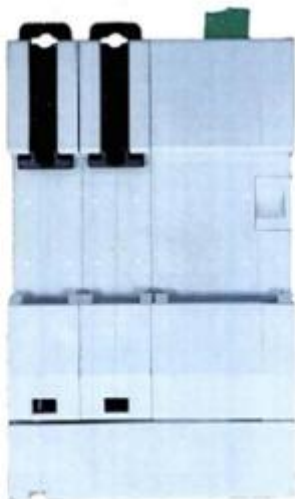

1.3

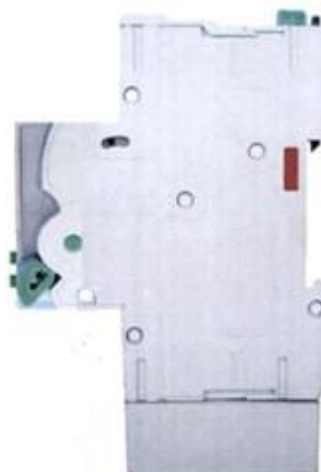

1.4



1.5



1.6

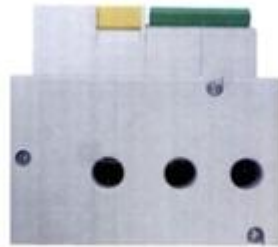

1.7

CÔNG BÁO SỞ HỮU CÔNG NGHIỆP SỐ 437 TẬP A – QUYỀN 2 (08.2024)

- (11) **51168**
(21) 3-2023-03121 (28) 1
(54) **THIẾT BỊ CHỐNG SỐC ĐIỆN CÁCH LY** (51) **13-03**
(22) 22/12/2023 (43) 26/08/2024
(73) **CÔNG TY CỔ PHẦN TẬP ĐOÀN CÔNG NGHỆ T-TECH VIỆT NAM (VN)**
Tầng 24, tòa nhà TASCOS, đường Phạm Hùng, phường Mỹ Trì, quận Nam Từ Liêm,
thành phố Hà Nội
(72) Nguyễn Đình Trọng (VN)
(55)



1.1



1.2

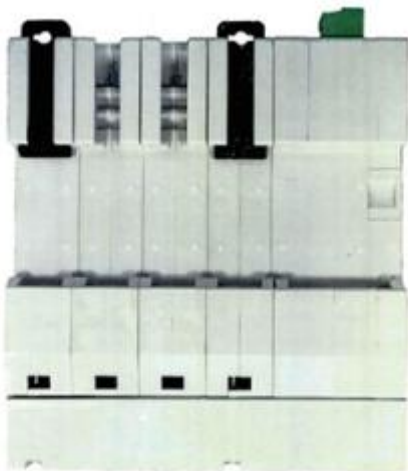

1.3

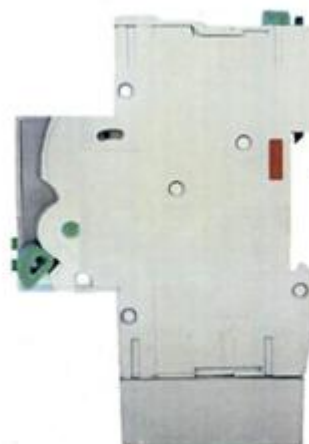

1.4



1.5



1.6

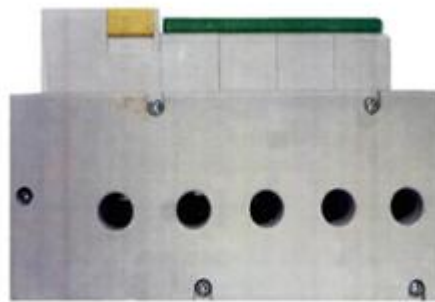

1.7

CÔNG BÁO SỞ HỮU CÔNG NGHIỆP SỐ 437 TẬP A – QUYỀN 2 (08.2024)

- (11) **51169**
(21) 3-2023-03131 (28) 1
(54) **THANH KIM LOẠI ĐỊNH HÌNH** (51) **25-01**
(22) 21/10/2022 (43) 26/08/2024
(73) **CÔNG TY TNHH SẢN XUẤT VÀ THƯƠNG MẠI BÁCH VIỆT (VN)**
Số 101, đường Đại Cồ Việt, phường Lê Đại Hành, quận Hai Bà Trưng, thành phố Hà Nội
(72) Vũ Xuân Hòa (VN)
(74) Công ty TNHH Sở hữu trí tuệ Bình Minh (SUNRISE IP CO.,LTD.)
(55)



1.1

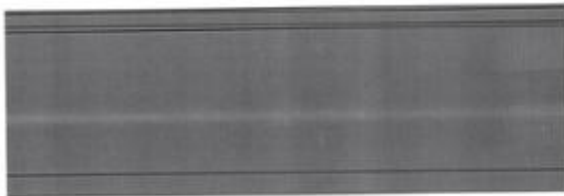

1.2



1.3



1.4



1.5



1.6



1.7

CÔNG BÁO SỞ HỮU CÔNG NGHIỆP SỐ 437 TẬP A – QUYỀN 2 (08.2024)

- (11) **51170**
- (21) 3-2024-00062 (28) 1
- (54) **HỆ THỐNG LỌC NƯỚC SẠCH DÙNG CHO XE BẾP TỰ HÀNH** (51) **23-01**
- (22) 05/01/2024 (43) 26/08/2024
- (73) **CÔNG TY CP THIẾT BỊ NĂM SAO VIỆT (VN)**
Số 123, ngõ 85, đường Tân Xuân, phường Xuân Đình, quận Bắc Từ Liêm, thành phố Hà Nội
- (72) Nguyễn Đình Uyên (VN)
- (74) Công ty TNHH Sở hữu trí tuệ M.I.T (M.I.T IP CO., LTD)
- (55)

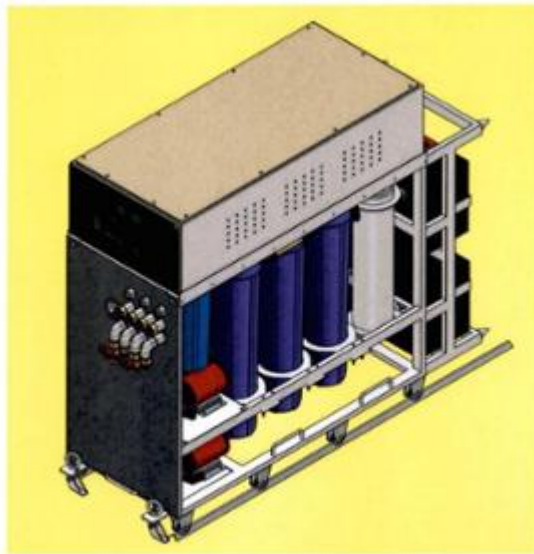

1.1

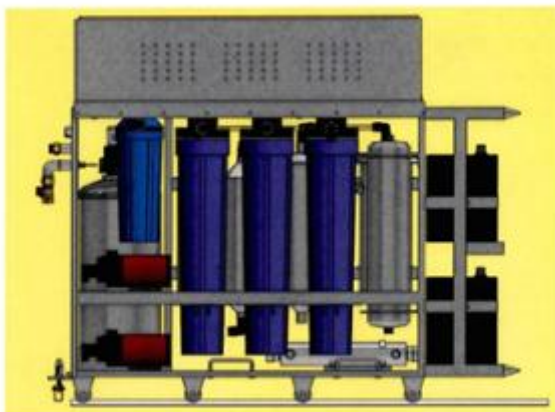

1.2

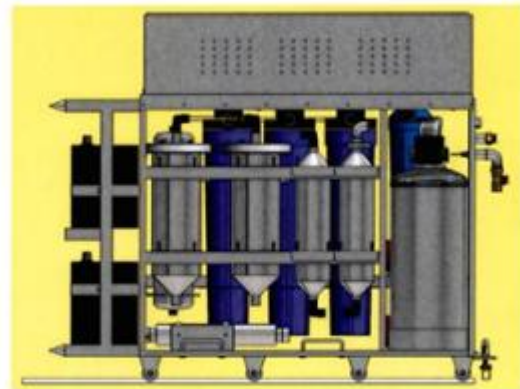

1.3



1.4

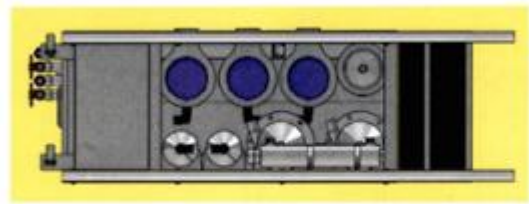

1.5



1.6



1.7

CÔNG BÁO SỞ HỮU CÔNG NGHIỆP SỐ 437 TẬP A – QUYỀN 2 (08.2024)

(11) **51171**

(21) 3-2024-00345

(28) 1

(54) **REN**

(51) **08-08**

(22) 06/02/2024

(43) 26/08/2024

(73) **CÔNG TY TNHH MINH LONG I (VN)**

Số 333 đường Hưng Định 24, khu phố Hưng Lộc, phường Hưng Định, thành phố Thuận An, tỉnh Bình Dương

(72) Lý Huy Sáng (VN)

(55)

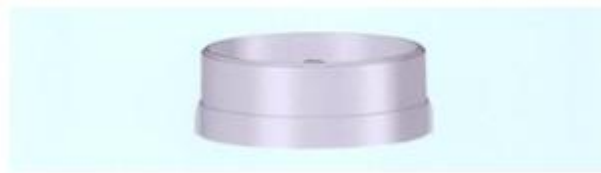

1.1



1.2



1.3



1.4



1.5

CÔNG BÁO SỞ HỮU CÔNG NGHIỆP SỐ 437 TẬP A – QUYỀN 2 (08.2024)

- (11) **51172**
(21) 3-2024-00361 (28) 1
(54) **DỤNG CỤ ĐÁNH DẤU MẶT ĐƯỜNG** (51) **10-06**
(22) 15/02/2024 (43) 26/08/2024
(30) 392321-001 09/08/2023 IN;
(73) **3M INNOVATIVE PROPERTIES COMPANY (US)**
3M Center, P.O. Box 33427, St. Paul, Minnesota 55133-3427, United States of America
(72) 1. SANTHOSH KUMAR RAJENDRAN (IN)
2. AMBUJ SHARMA (IN)
(74) Công ty TNHH Tầm nhìn và Liên danh (VISION & ASSOCIATES CO.LTD.)
(55)

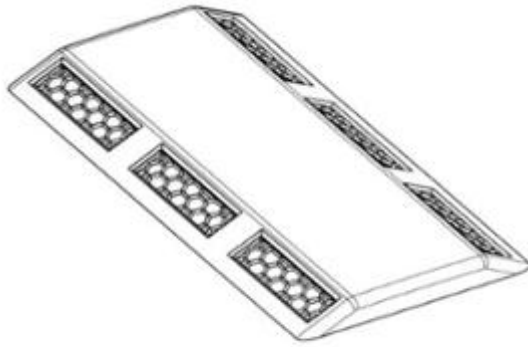

1.1



1.2

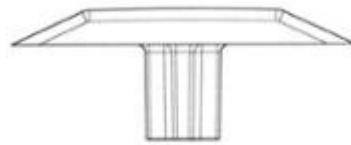

1.3



1.4



1.5

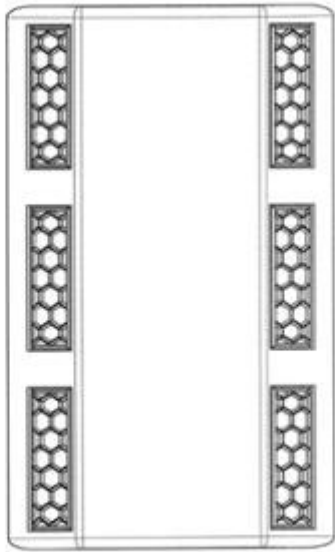

1.6



1.7

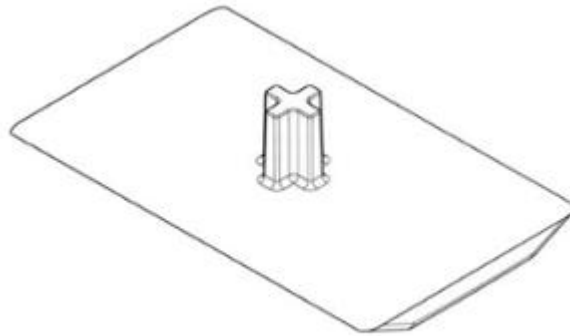

1.8

(11) **51173**

(21) 3-2024-00445

(28) 1

(54) **QUẠT TRẦN**

(51) **23-04**

(22) 27/02/2024

(43) 26/08/2024

(73) **CÔNG TY CỔ PHẦN GCOOL (VN)**

Số 158/2 phố Hồng Mai, phường Quỳnh Lôi, quận Hai Bà Trưng, thành phố Hà Nội

1. TRẦN BÌNH MINH (VN)

2. HOÀNG ANH LỘC (VN)

3. TRẦN ANH (VN)

4. NGUYỄN ĐỨC BẰNG (VN)

5. ĐẶNG ĐỨC TRUNG (VN)

6. NGUYỄN THỊ HẢI YẾN (VN)

7. TRẦN HỒNG HẢI (VN)

(72) 8. NGUYỄN ĐỨC HÒA (VN)

9. TRẦN ĐÌNH QUÂN (VN)

10. NGUYỄN TUẤN PHONG (VN)

11. PHẠM ĐỨC HIỆP (VN)

12. LÊ TUẤN SƠN (VN)

13. NGUYỄN VĂN TRỌNG (VN)

14. PHẠM VĂN NHUNG (VN)

15. PHẠM THỊ ANH (VN)

16. LÊ ĐỨC ÂN (VN)

(55)

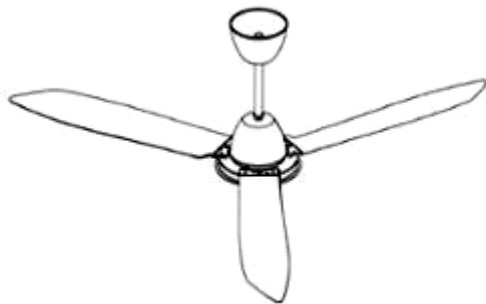

1.1



1.2



1.3



1.4



1.5



1.6

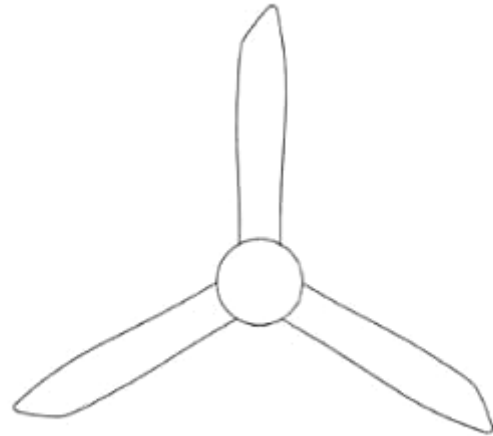

1.7

CÔNG BÁO SỞ HỮU CÔNG NGHIỆP SỐ 437 TẬP A – QUYỀN 2 (08.2024)

- (11) **51174**
(21) 3-2024-00461 (28) 1
(54) **BÀN CHẢI ĐÁNH RĂNG ĐIỆN** (51) **04-02**
(22) 28/02/2024 (43) 26/08/2024
(30) 29/901,136 29/08/2023 US;
(73) **QUIP NYC INC. (US)**
45 Main Street, Brooklyn Heights, New York 11201, United States of America
(72) 1. JONATHAN HENRY FRATTI (US)
2. LOUIS ANTHONY FILOSA (US)
3. SIMON J.M. ENEVER (US)
4. MICHAEL J. LAWLOR (US)
(74) Công ty Luật TNHH Phạm và Liên danh (PHAM & ASSOCIATES)
(55)

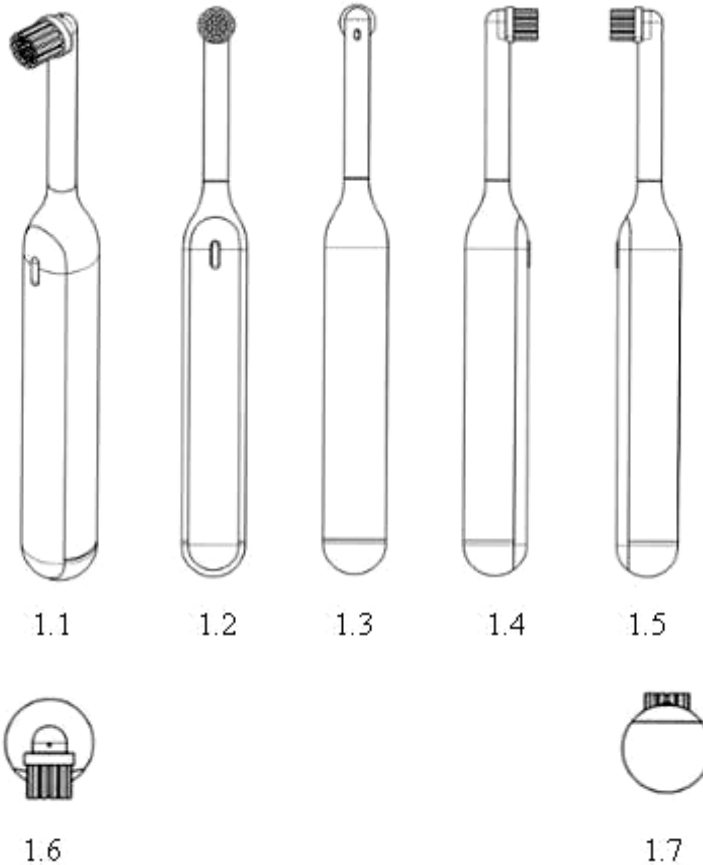

CÔNG BÁO SỞ HỮU CÔNG NGHIỆP SỐ 437 TẬP A – QUYỀN 2 (08.2024)

- (11) **51175**
(21) 3-2024-00462 (28) 1
(54) **ĐẦU THAY THỂ CHO BÀN CHẢI ĐÁNH RĂNG ĐIỆN** (51) **04-02**
(22) 28/02/2024 (43) 26/08/2024
(30) 29/901,138 29/08/2023 US;
(73) **QUIP NYC INC. (US)**
45 Main Street, Brooklyn Heights, New York 11201, United States of America
(72) 1. JONATHAN HENRY FRATTI (US)
2. LOUIS ANTHONY FILOSA (US)
3. SIMON J.M. ENEVER (US)
4. MICHAEL J. LAWLOR (US)
(74) Công ty Luật TNHH Phạm và Liên danh (PHAM & ASSOCIATES)
(55)

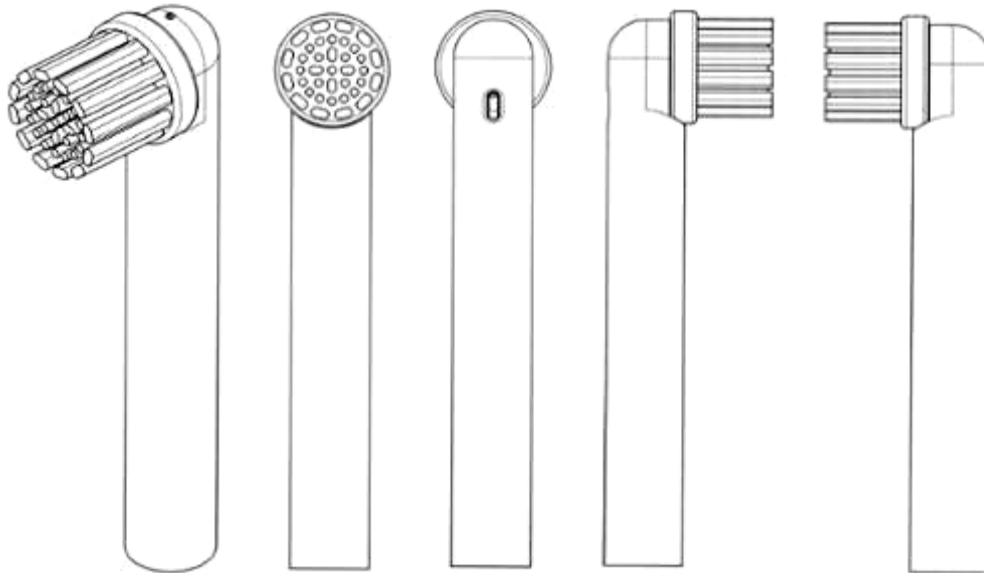

1.1

1.2

1.3

1.4

1.5



1.6

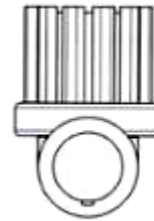

1.7

CÔNG BÁO SỞ HỮU CÔNG NGHIỆP SỐ 437 TẬP A – QUYỀN 2 (08.2024)

(11) **51176**

(21) 3-2024-00502

(28) 1

(54) **CHAI**

(51) **09-01**

(22) 04/03/2024

(43) 26/08/2024

(73) **CÔNG TY TNHH KIM LÂM (VN)**

Lô A2.CN7 - Cụm công nghiệp tập trung vừa và nhỏ Từ Liêm, phường Phương Canh, quận Nam Từ Liêm, thành phố Hà Nội

(72) **Võ Thị Liễu Trâm (VN)**

(55)



1.1

1.2

1.3

1.4

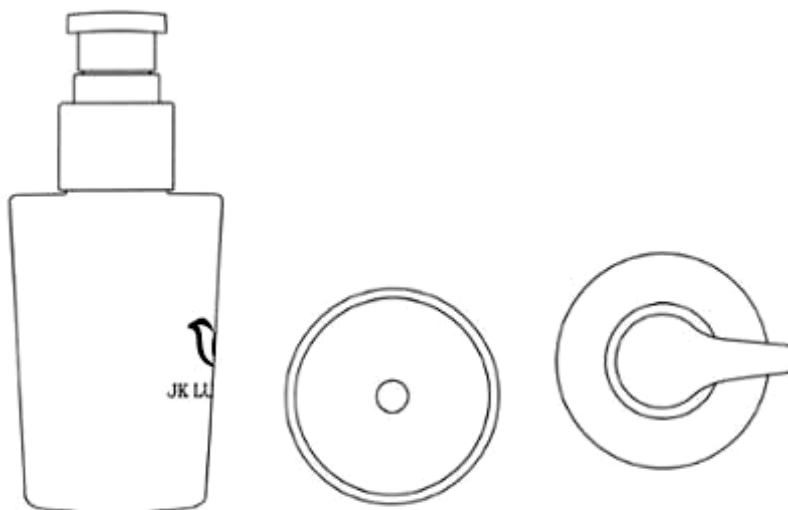

1.5

1.7

1.6

CÔNG BÁO SỞ HỮU CÔNG NGHIỆP SỐ 437 TẬP A – QUYỀN 2 (08.2024)

- (11) **51177**
(21) 3-2024-01424 (28) 1
(54) **BAO GÓI** (51) **09-05**
(22) 20/06/2024 (43) 26/08/2024
(73) **CÔNG TY TNHH HUDOCO VIỆT NAM (VN)**
Thôn Minh Hoà 4, xã Minh Khai, huyện Hoài Đức, thành phố Hà Nội
(72) Đỗ Thị Thắng (VN)
(74) Công ty TNHH Sở hữu trí tuệ HA VIP (HAVIP CO., LTD.)
(55)



1.1



1.2

CÔNG BÁO SỞ HỮU CÔNG NGHIỆP SỐ 437 TẬP A – QUYỀN 2 (08.2024)

- (11) **51178**
(21) 3-2024-01425 (28) 1
(54) **LỚP XE** (51) **12-15**
(22) 20/06/2024 (43) 26/08/2024
(30) 2024302202411 18/04/2024 CN;
(73) **SHANDONG HAOHUA TIRE CO., LTD. (CN)**
West of Dadi Road, North of Xinhai Road, Houzhen Industry Zone, Shouguang,
Weifang, Shandong 262700, China
(72) 1. WANG, KEQIANG (CN)
2. SUI, FEIFEI (CN)
3. SUI, LUCHAO (CN)
(74) Công ty TNHH Đại Tín và Liên Danh (DAITIN AND ASSOCIATES CO.,LTD)
(55)



1.1

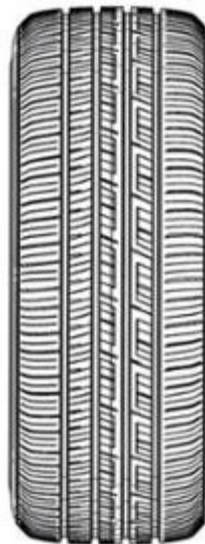

1.2

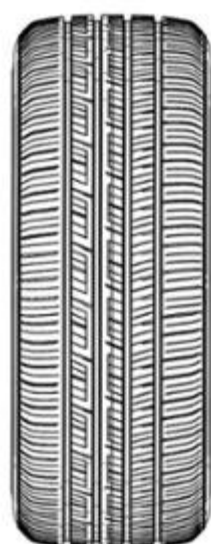

1.3



1.4



1.5

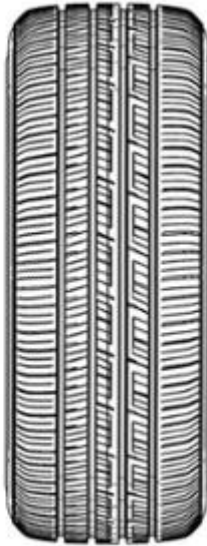

1.6

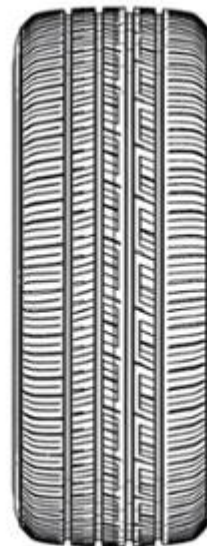

1.7

CÔNG BÁO SỞ HỮU CÔNG NGHIỆP SỐ 437 TẬP A – QUYỀN 2 (08.2024)

- (11) **51179**
(21) 3-2024-01426 (28) 1
(54) **BÉC TƯỚI** (51) **23-01**
(22) 20/06/2024 (43) 26/08/2024
(73) **DƯƠNG DUYÊN NGHỆ (VN)**
Áp 5, xã An Thạnh, huyện Bến Lức, tỉnh Long An
(72) Dương Duyên Nghệ (VN)
(74) Công ty cổ phần FAS INVEST (FAS INVEST JSC)
(55)

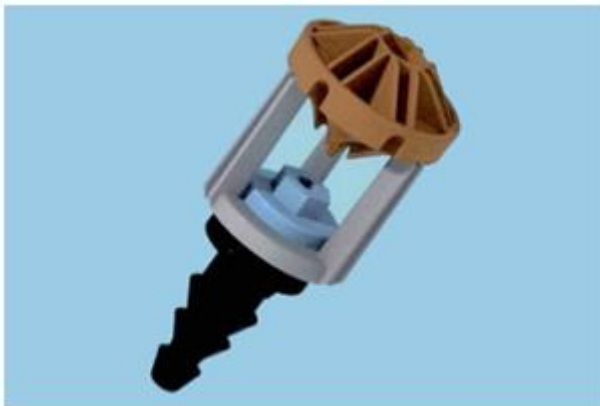

1.1

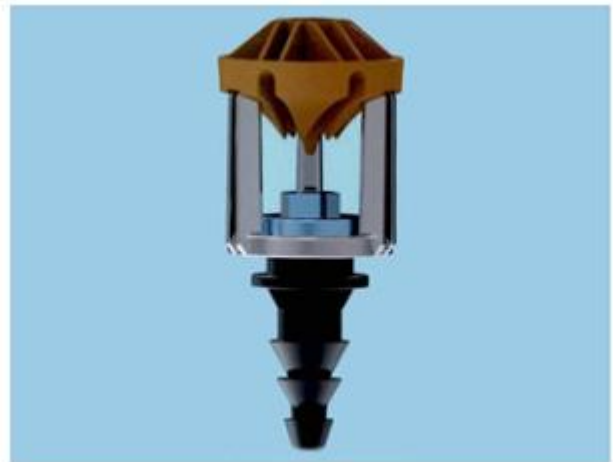

1.2

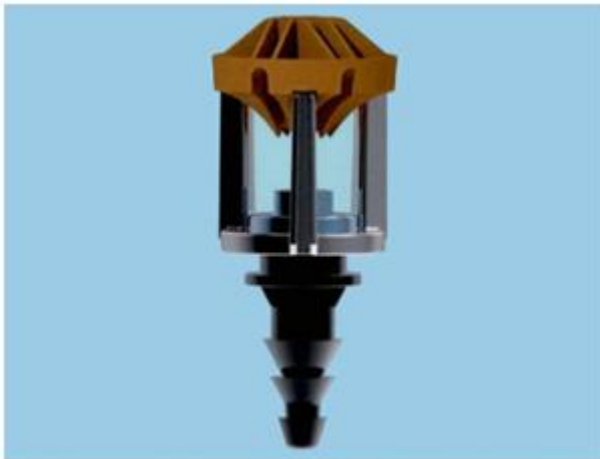

1.3

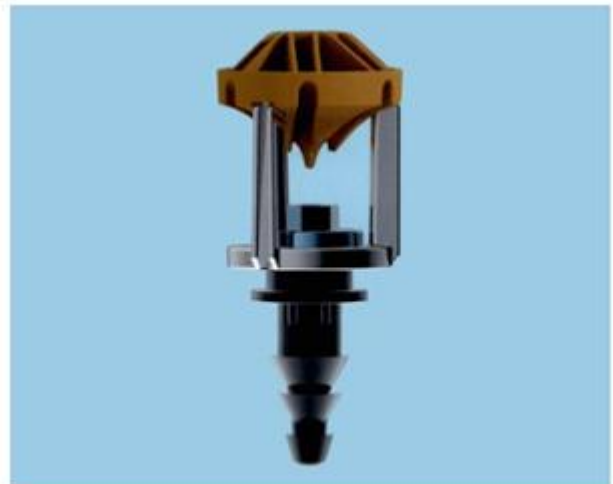

1.4

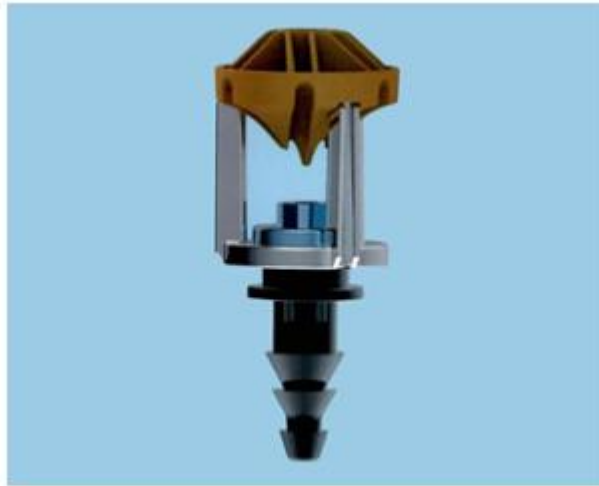

1.5

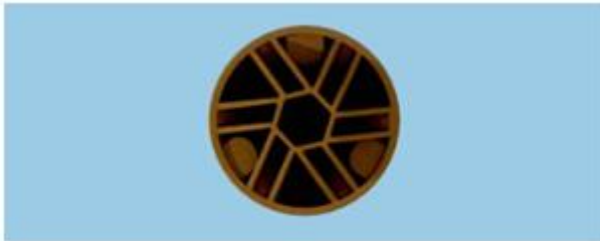

1.6

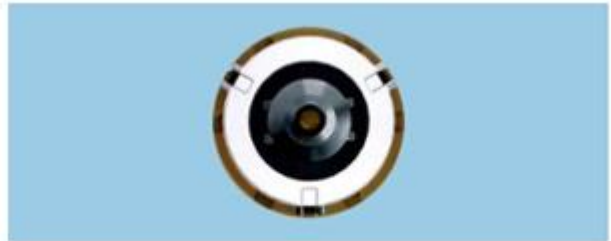

1.7

CÔNG BÁO SỞ HỮU CÔNG NGHIỆP SỐ 437 TẬP A – QUYỀN 2 (08.2024)

- (11) **51180**
(21) 3-2024-01427 (28) 1
(54) **BÉC TƯỚI** (51) **23-01**
(22) 20/06/2024 (43) 26/08/2024
(73) **DƯƠNG DUYÊN NGHỆ (VN)**
Áp 5, xã An Thạnh, huyện Bến Lức, tỉnh Long An
(72) Dương Duyên Nghệ (VN)
(74) Công ty cổ phần FAS INVEST (FAS INVEST JSC)
(55)



1.1

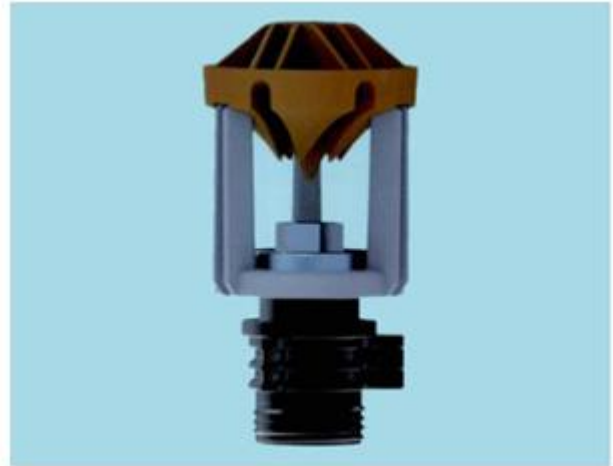

1.2

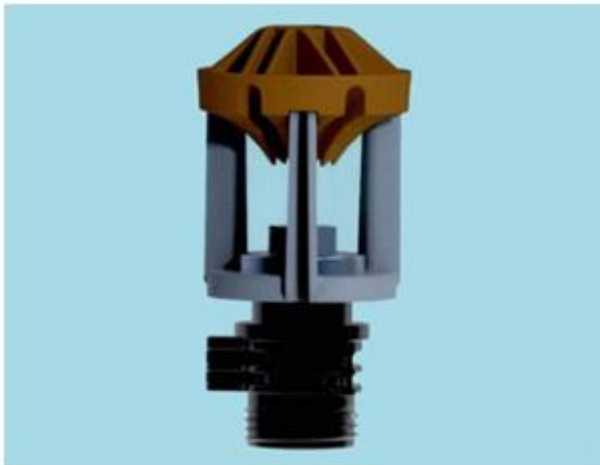

1.3

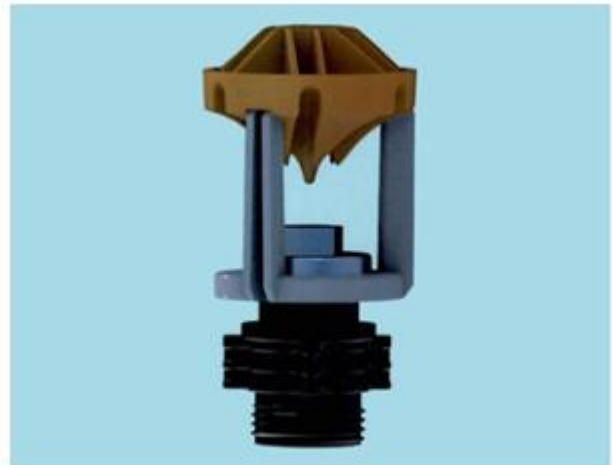

1.4

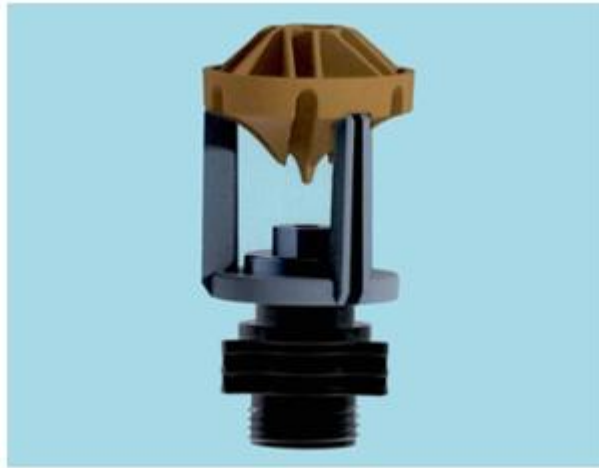

1.5



1.6

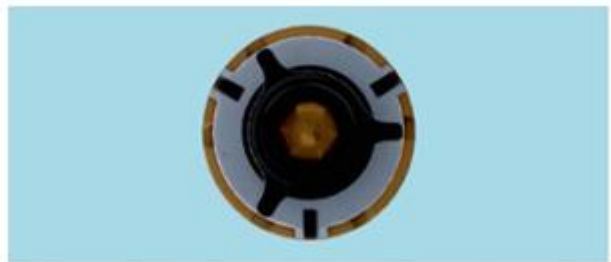

1.7

CÔNG BÁO SỞ HỮU CÔNG NGHIỆP SỐ 437 TẬP A – QUYỀN 2 (08.2024)

- (11) **51181**
(21) 3-2024-01428 (28) 3
(54) **Ô TÔ** (51) **12-08**
(22) 21/06/2024 (43) 26/08/2024
(30) DM/234191 22/12/2023 WO;
(73) **FERRARI S.P.A. (IT)**
Via Emilia Est 1163, Modena, Italy
(72) Flavio MANZONI (IT)
(74) Công ty TNHH một thành viên Sở hữu trí tuệ VCCI (VCCI-IP CO.,LTD)
(55)



1.1

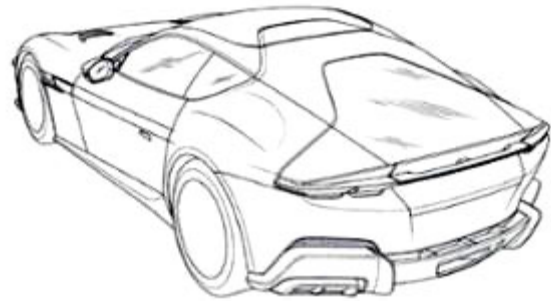

1.2



1.3

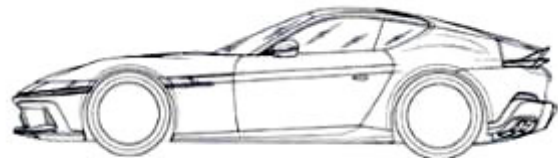

1.4



1.5



1.6

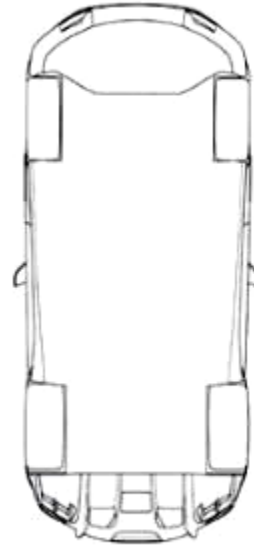

1.7



2.1

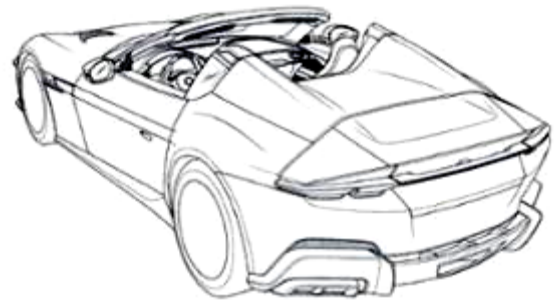

2.2



2.3

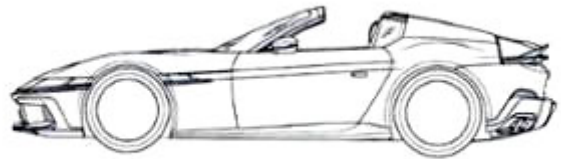

2.4



2.5

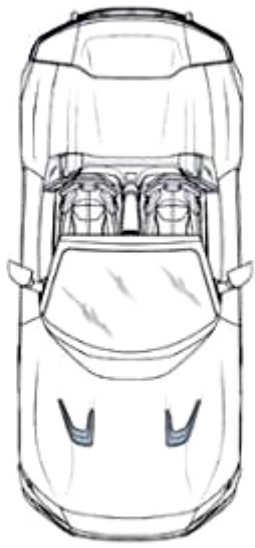

2.6

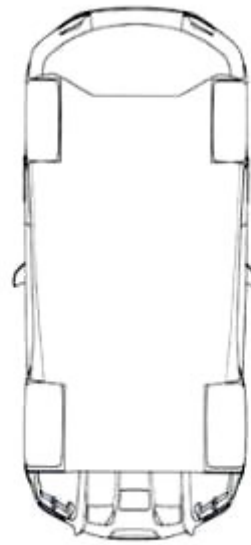

2.7



3.1

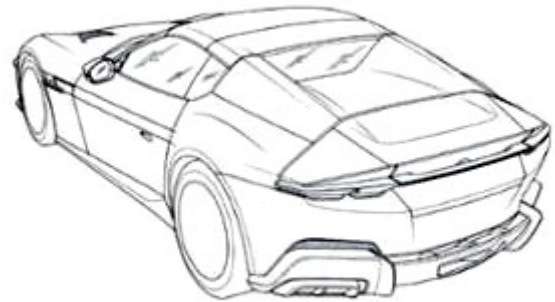

3.2



3.3

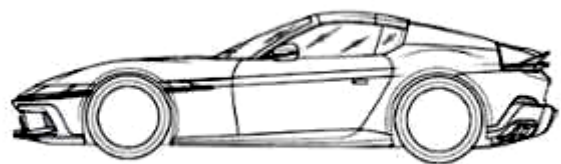

3.4



3.5



3.6

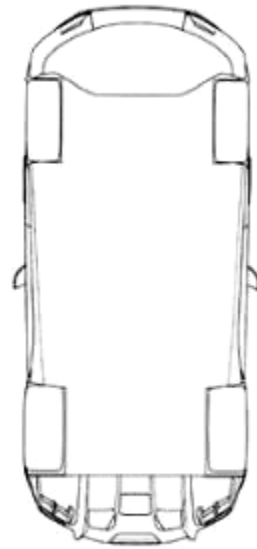

3.7

CÔNG BÁO SỞ HỮU CÔNG NGHIỆP SỐ 437 TẬP A – QUYỀN 2 (08.2024)

- (11) **51182**
- (21) 3-2024-01430 (28) 1
- (54) **NHÃN SẢN PHẨM** (51) **19-08**
- (22) 21/06/2024 (43) 26/08/2024
- (73) **CÔNG TY CỔ PHẦN SẢN XUẤT & THƯƠNG MẠI CÁT TƯỜNG GROUP (VN)**
Thôn An Lộc, xã Đồng Sơn, huyện Nam Trực, tỉnh Nam Định
- (72) Nguyễn Văn Chính (VN)
- (74) **CÔNG TY TNHH SỞ HỮU TRÍ TUỆ SETHACO (SETHACO IP CO.,LTD)**
- (55)



CÔNG BÁO SỞ HỮU CÔNG NGHIỆP SỐ 437 TẬP A – QUYỀN 2 (08.2024)

- (11) **51183**
- (21) 3-2024-01431 (28) 1
- (54) **NHÃN SẢN PHẨM** (51) **19-08**
- (22) 21/06/2024 (43) 26/08/2024
- (73) **CÔNG TY CỔ PHẦN SẢN XUẤT & THƯƠNG MẠI CÁT TƯỜNG GROUP (VN)**
Thôn An Lộc, xã Đồng Sơn, huyện Nam Trực, tỉnh Nam Định
- (72) Nguyễn Văn Chính (VN)
- (74) **CÔNG TY TNHH SỞ HỮU TRÍ TUỆ SETHACO (SETHACO IP CO.,LTD)**
- (55)



- (11) **51184**
(21) 3-2024-01442 (28) 1
(54) **CƠ CẤU CHỐNG CÔN TRÙNG** (51) **22-06**
(22) 24/06/2024 (43) 26/08/2024
(30) 2023-026785 25/12/2023 JP;
(73) 1. **DAINIHON JOCHUGIKU CO., LTD.** (JP)
4-11, Tosabori 1-chome, Nishi-ku, Osaka-shi, Osaka 550-0001, Japan
2. **KYOEI SANGYO CO, LTD.** (JP)
45-1, Ikuno 6-chome, Katano-shi, Osaka 5760054, Japan
(72) 1. NAOTO IMUTA (JP)
2. TAIJI ONO (JP)
3. RYOKO UKITA (JP)
4. SHOUTA FUNAYAMA (JP)
(74) Công ty Luật TNHH T&G (TGVN)
(55)

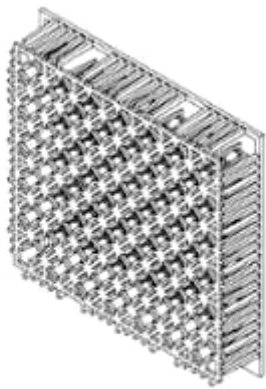

1.1

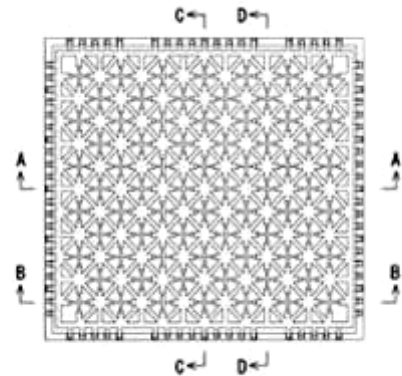

1.2

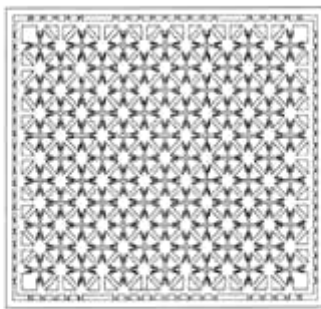

1.3



1.4



1.5



1.6



1.7



1.8



1.9



1.10



1.11

(a) bề mặt lắp đặt là bề mặt dưới (b) bề mặt lắp đặt là bề mặt trên



1.12

- (11) **51185**
- (21) 3-2024-01443 (28) 1
- (54) **CƠ CẤU CHỐNG CÔN TRÙNG** (51) **22-06**
- (22) 24/06/2024 (43) 26/08/2024
- (30) 2023-026786 25/12/2023 JP;
- (73) **DAIINHON JOCHUGIKU CO., LTD. (JP)**
4-11, Tosabori 1-chome, Nishi-ku, Osaka-shi, Osaka 550-0001, Japan
- (72) 1. SHIGEYUKI TAKAO (JP)
2. YUKI INOUE (JP)
3. KIYOSHI YOSHIOKA (JP)
4. CHIE NAKANO (JP)
- (74) Công ty Luật TNHH T&G (TGVN)
- (55)

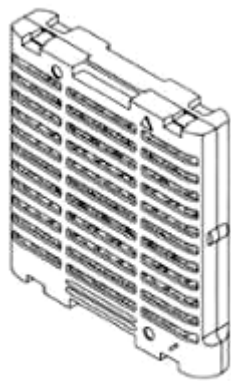

1.1

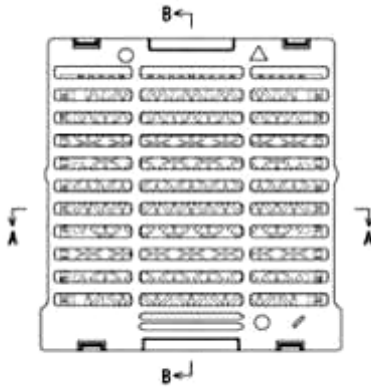

1.2

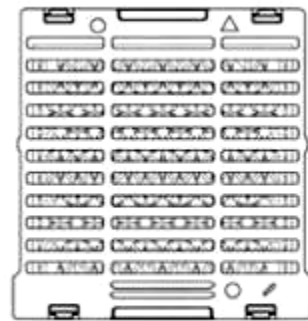

1.3



1.4

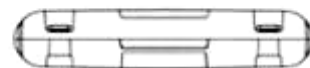

1.5



1.6



1.7



1.8



1.9



1.10

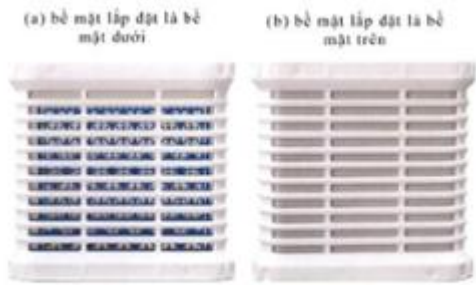

1.11

- (11) **51186**
(21) 3-2024-01444 (28) 1
(54) **CƠ CẤU CHỐNG CÔN TRÙNG** (51) **22-06**
(22) 24/06/2024 (43) 26/08/2024
(30) 2023-026787 25/12/2023 JP;
(73) **DAIINHON JOCHUGIKU CO., LTD.** (JP)
4-11, Tosabori 1-chome, Nishi-ku, Osaka-shi, Osaka 550-0001, Japan
(72) 1. SHIGEYUKI TAKAO (JP)
2. YUKI INOUE (JP)
3. KIYOSHI YOSHIOKA (JP)
4. CHIE NAKANO (JP)
(74) Công ty Luật TNHH T&G (TGVN)
(55)

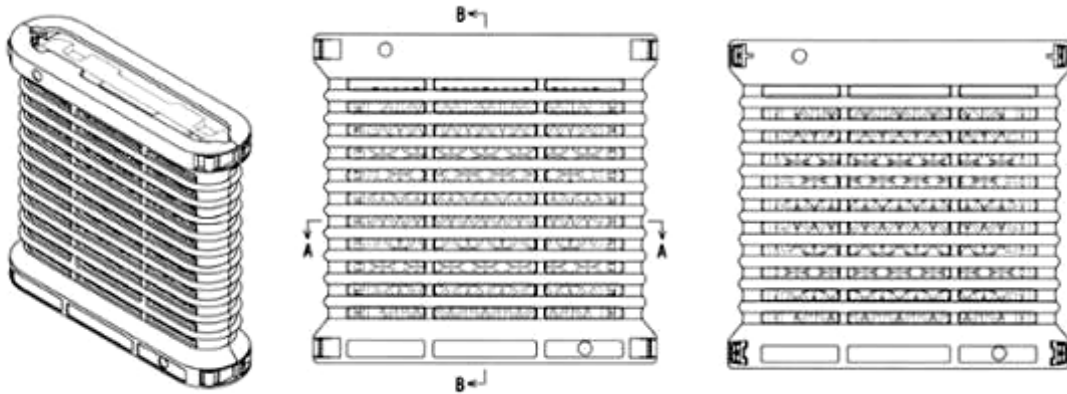

1.1

1.2

1.3

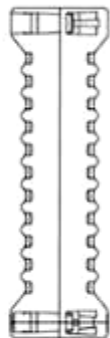

1.4



1.5

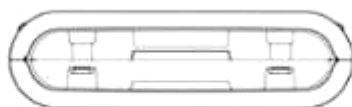

1.6

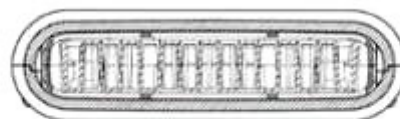

1.7

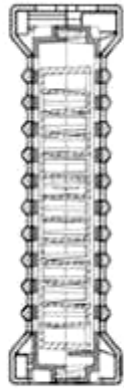

1.8



1.9



1.10



1.11

- (11) **51187**
(21) 3-2024-00995 (28) 1
(54) **VÒNG CỔ** (51) **11-01**
(22) 26/04/2024 (43) 26/08/2024
(30) WIPO145177 28/02/2024 WO;
(73) **CHRISTIAN DIOR COUTURE (FR)**
30 Avenue Montaigne, 75008 Paris, France
(72) Victoire de Castellane (FR)
(74) Công ty TNHH một thành viên Sở hữu trí tuệ VCCI (VCCI-IP CO.,LTD)
(55)



1.1



1.2



1.3



1.4

1.5



1.6

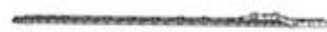

1.7

CÔNG BÁO SỞ HỮU CÔNG NGHIỆP SỐ 437 TẬP A – QUYỀN 2 (08.2024)

- (11) **51188**
(21) 3-2024-01021 (28) 1
(54) **HỘP** (51) **09-03**
(22) 02/05/2024 (43) 26/08/2024
(73) **CÔNG TY CỔ PHẦN SỮA VIỆT NAM (VN)**
10 Tân Trào, phường Tân Phú, quận 7, thành phố Hồ Chí Minh
(72) Nguyễn Thanh Mai (VN)
(74) Công ty cổ phần Sở hữu trí tuệ BROSS và Cộng sự (BROSS & PARTNERS., JSC)
(55)



1.1



1.2

CÔNG BÁO SỞ HỮU CÔNG NGHIỆP SỐ 437 TẬP A – QUYỀN 2 (08.2024)

- (11) **51189**
- (21) 3-2024-01429
- (54) **Ô TÔ ĐỒ CHƠI**
- (22) 21/06/2024
- (30) DM/234192 22/12/2023 WO;
- (73) **FERRARI S.P.A. (IT)**
Via Emilia Est 1163, Modena, Italy
- (72) Flavio MANZONI (IT)
- (74) Công ty TNHH một thành viên Sở hữu trí tuệ VCCI (VCCI-IP CO.,LTD)
- (55)

- (28) 3
- (51) **21-01**
- (43) 26/08/2024



1.1

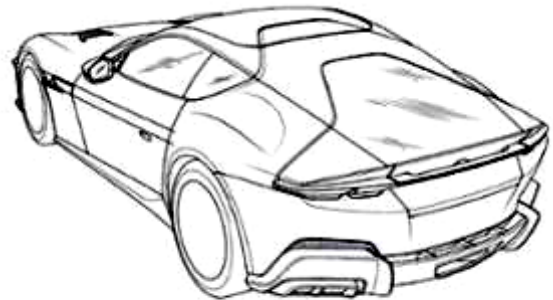

1.2



1.3

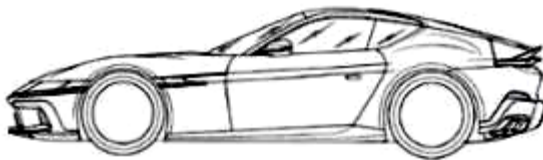

1.4



1.5



1.6

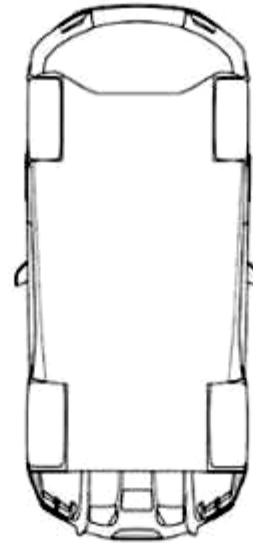

1.7



2.1

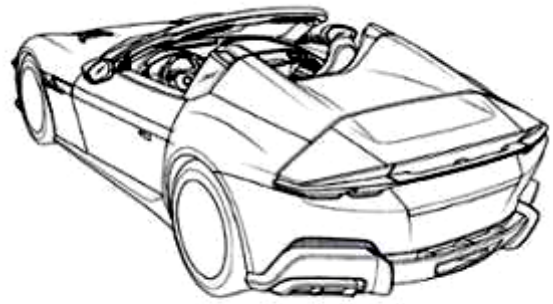

2.2

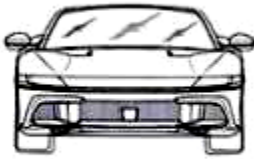

2.3

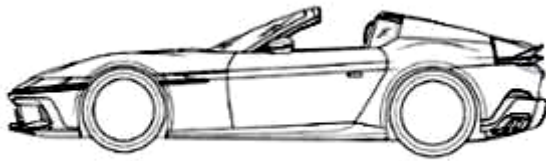

2.4



2.5

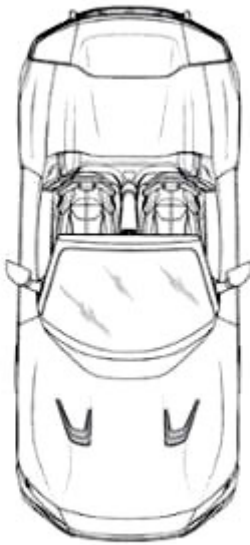

2.6

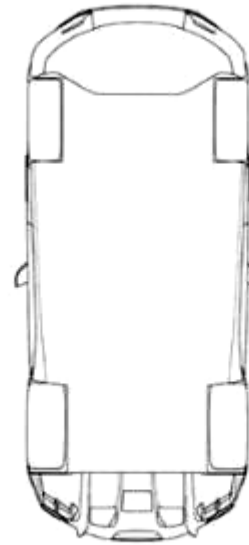

2.7



3.1

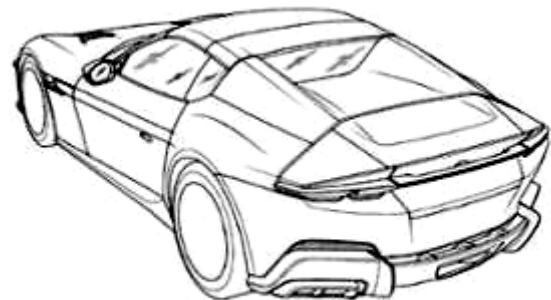

3.2



3.3

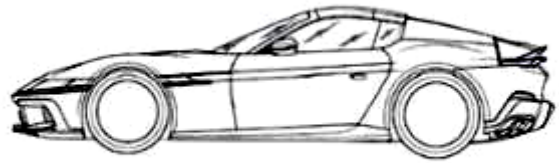

3.4



3.5



3.6

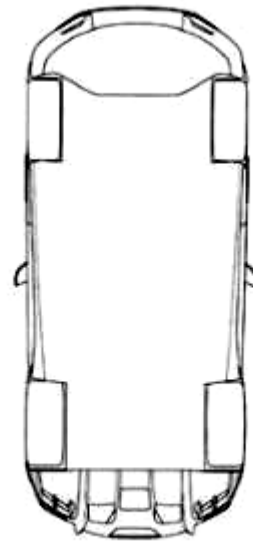

3.7

CÔNG BÁO SỞ HỮU CÔNG NGHIỆP SỐ 437 TẬP A – QUYỀN 2 (08.2024)

(11) **51190**

(21) 3-2024-01450

(28) 1

(54) **ĐÈN**

(51) **26-05**

(22) 24/06/2024

(43) 26/08/2024

(73) **CÔNG TY CỔ PHẦN BÓNG ĐÈN PHÍCH NƯỚC RẠNG ĐÔNG (VN)**

87-89 phố Hạ Đình, phường Thanh Xuân Trung, quận Thanh Xuân, thành phố Hà Nội

(72) Trần Trung Tường (VN)

(55)

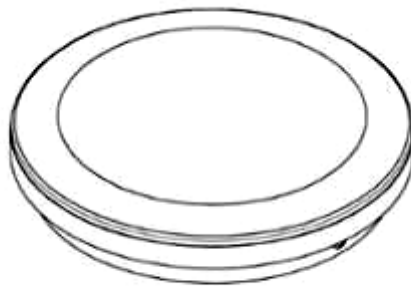

1.1

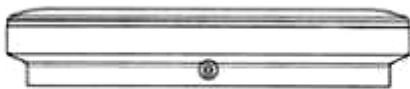

1.2



1.3



1.4



1.5

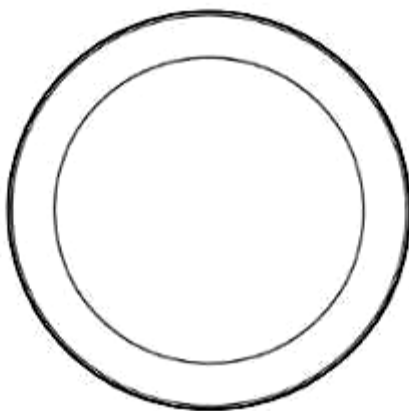

1.6

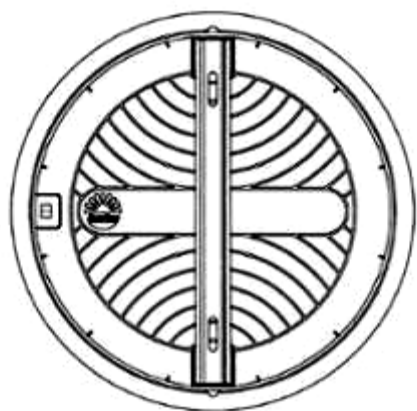

1.7

CÔNG BÁO SỞ HỮU CÔNG NGHIỆP SỐ 437 TẬP A – QUYỀN 2 (08.2024)

(11) **51191**

(21) 3-2024-01451

(28) 1

(54) **ĐÈN**

(51) **26-05**

(22) 24/06/2024

(43) 26/08/2024

(73) **CÔNG TY CỔ PHẦN BÓNG ĐÈN PHÍCH NƯỚC RẠNG ĐÔNG (VN)**

87-89 phố Hạ Đình, phường Thanh Xuân Trung, quận Thanh Xuân, thành phố Hà Nội

(72) Trần Trung Tường (VN)

(55)

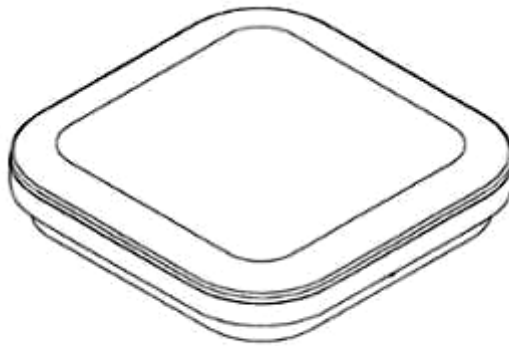

1.1

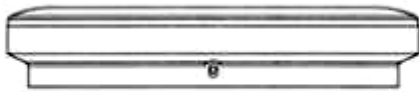

1.2



1.3



1.4



1.5

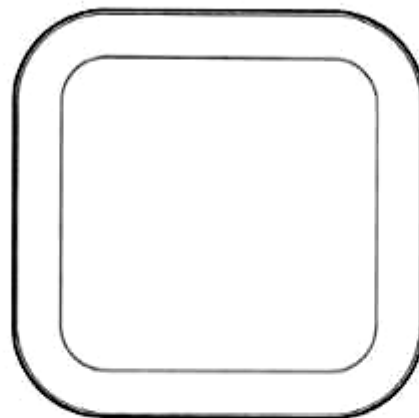

1.6



1.7

CÔNG BÁO SỞ HỮU CÔNG NGHIỆP SỐ 437 TẬP A – QUYỀN 2 (08.2024)

- (11) **51192**
(21) 3-2024-01453 (28) 1
(54) **BÌNH GIỮ NHIỆT** (51) **07-07**
(22) 24/06/2024 (43) 26/08/2024
(73) **CÔNG TY CỔ PHẦN BÓNG ĐÈN PHÍCH NƯỚC RẠNG ĐÔNG (VN)**
87-89 phố Hạ Đình, phường Thanh Xuân Trung, quận Thanh Xuân, thành phố Hà Nội
(72) Trần Trung Tường (VN)
(55)



1.1



1.2



1.3

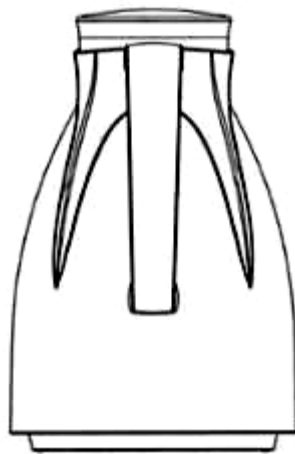

1.4



1.5

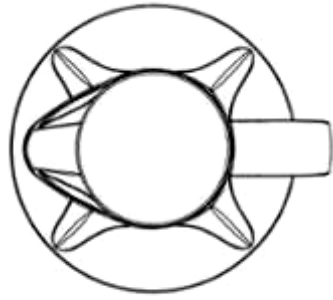

1.6

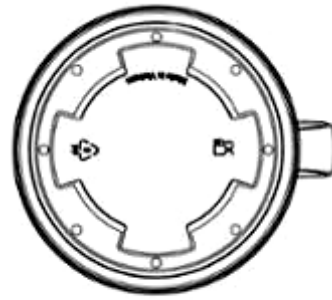

1.7

CÔNG BÁO SỞ HỮU CÔNG NGHIỆP SỐ 437 TẬP A – QUYỀN 2 (08.2024)

- (11) **51193**
(21) 3-2024-01454 (28) 1
(54) **BÌNH ĐỰNG NƯỚC** (51) **07-07**
(22) 24/06/2024 (43) 26/08/2024
(73) **CÔNG TY CỔ PHẦN BÓNG ĐÈN PHÍCH NƯỚC RẠNG ĐÔNG (VN)**
87-89 phố Hạ Đình, phường Thanh Xuân Trung, quận Thanh Xuân, thành phố Hà Nội
(72) Trần Trung Tường (VN)
(55)

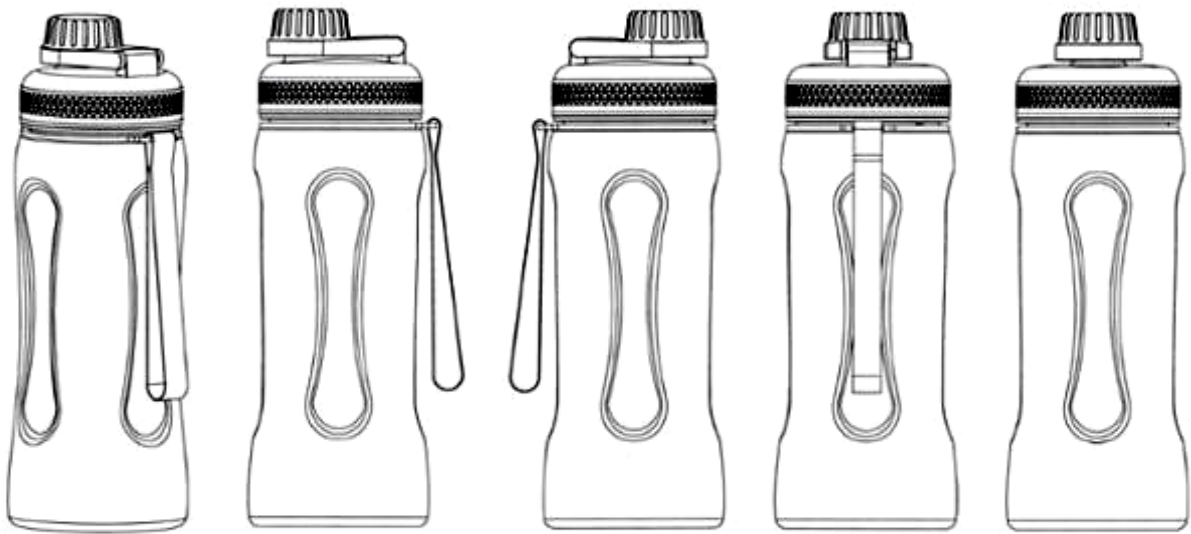

1.1

1.2

1.3

1.4

1.5



1.6



1.7

CÔNG BÁO SỞ HỮU CÔNG NGHIỆP SỐ 437 TẬP A – QUYỀN 2 (08.2024)

- (11) **51194**
(21) 3-2024-01480 (28) 1
(54) **PHẦN THÔNG GIÓ PHÍA TRÊN CỦA MŨ BẢO HIỂM** (51) **02-03**
(22) 25/06/2024 (43) 26/08/2024
(73) **HENRY TEDJAKUSUMA (ID)**
Jalan Wuluh Blok II/3, RT/RW 009/006, Kota Bambu Utara, Palmerah Jakarta Barat 11420, Indonesia
(72) Henry Tedjakusuma (ID)
(74) Công ty TNHH Sở hữu trí tuệ HA VIP (HAVIP CO., LTD.)
(55)

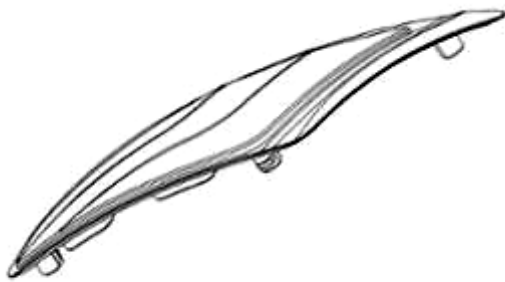

1.1



1.2



1.3



1.4

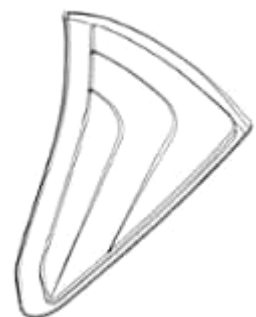

1.5



1.6

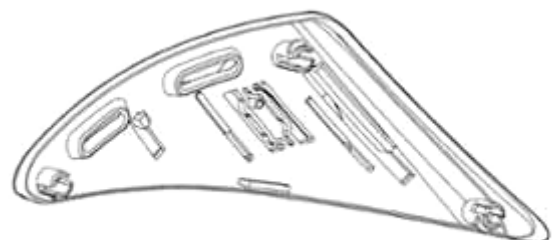

1.7

CÔNG BÁO SỞ HỮU CÔNG NGHIỆP SỐ 437 TẬP A – QUYỀN 2 (08.2024)

- (11) **51195**
(21) 3-2024-01482 (28) 1
(54) **PHẦN THÔNG GIÓ PHÍA TRÊN CỦA MŨ BẢO HIỂM** (51) **02-03**
(22) 25/06/2024 (43) 26/08/2024
(73) **HENRY TEDJAKUSUMA (ID)**
Jalan Wuluh Blok II/3, RT/RW 009/006, Kota Bambu Utara, Palmerah Jakarta Barat 11420, Indonesia
(72) Henry Tedjakusuma (ID)
(74) Công ty TNHH Sở hữu trí tuệ HA VIP (HAVIP CO., LTD.)
(55)



1.1



1.2



1.3

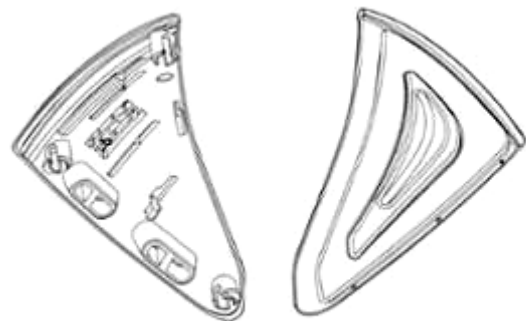

1.4

1.5



1.6

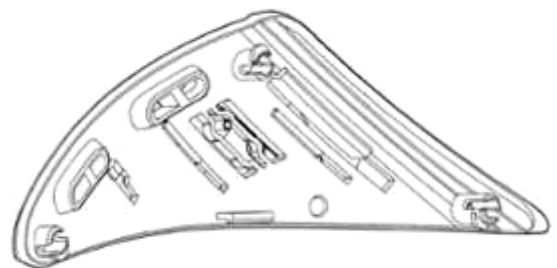

1.7

CÔNG BÁO SỞ HỮU CÔNG NGHIỆP SỐ 437 TẬP A – QUYỀN 2 (08.2024)

- (11) **51196**
- (21) 3-2024-01483 (28) 1
- (54) **MÁY ĐA NĂNG DÙNG TRONG NUÔI TRỒNG THỦY SẢN** (51) **15-03**
- (22) 25/06/2024 (43) 26/08/2024
- (73) **CÔNG TY CỔ PHẦN RYNAN TECHNOLOGIES VIETNAM (VN)**
Ấp Long Trì, xã Long Đức, thành phố Trà Vinh, tỉnh Trà Vinh
- (72) 1. NGUYỄN THANH MỸ (VN)
2. HỒNG QUỐC CƯỜNG (VN)
3. TRẦN QUỐC TOÀN (VN)
4. HUỖNH TRUNG HẬU (VN)
5. NGUYỄN PHÚC BẢO ANH (VN)
6. VÕ VŨ KHANH (VN)
7. TRẦN QUỐC TOÀN (VN)
8. VÕ QUỐC VIỆT (VN)
- (74) Công ty TNHH Đại Tín và Liên Danh (DAITIN AND ASSOCIATES CO.,LTD)
- (55)

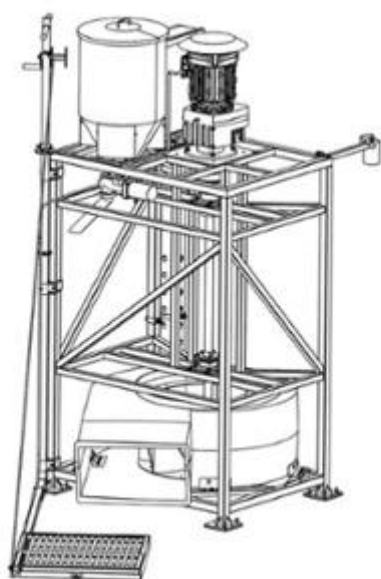

1.1

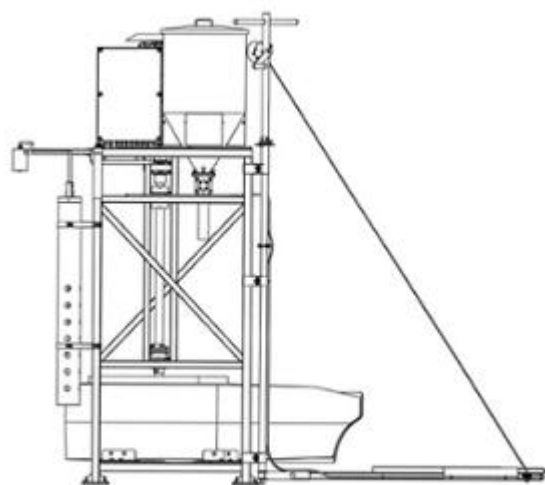

1.2

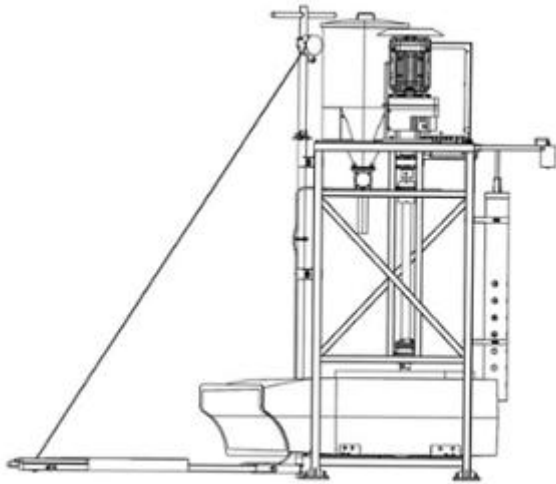

1.3

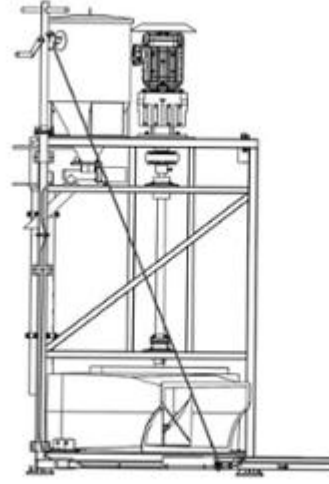

1.4

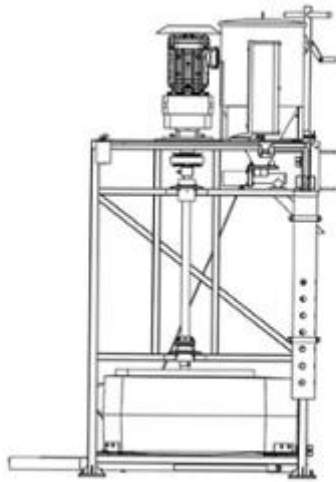

1.5

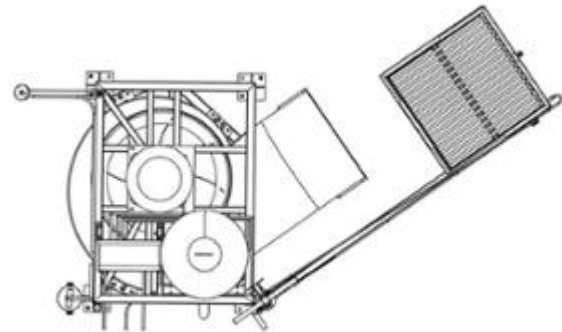

1.6

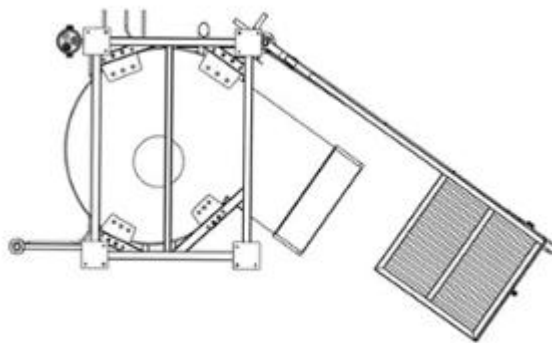

1.7

CÔNG BÁO SỞ HỮU CÔNG NGHIỆP SỐ 437 TẬP A – QUYỀN 2 (08.2024)

- (11) **51197**
(21) 3-2024-01486 (28) 1
(54) **QUẠT ĐỂ BÀN** (51) **23-04**
(22) 26/06/2024 (43) 26/08/2024
(30) 2024300634815 30/01/2024 CN;
(73) **GUANGZHOU LINJIE ELECTRONIC MANUFACTURING CO., LTD. (CN)**
No.12, Da Kengkou 3rd Street, Guang Tang Village, Xin Ya Street Huadu District,
Guangzhou, China.
(72) 1. JIALIN PENG (CN)
2. MENG YUAN (CN)
(74) Công ty TNHH ADAstra IP (VIỆT NAM) (ADASTRA IP (VIETNAM) CO.,
LTD.)
(55)



1.1



1.2

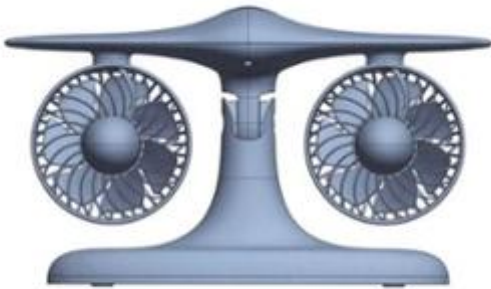

1.3



1.4



1.5



1.6



1.7



1.8

CÔNG BÁO SỞ HỮU CÔNG NGHIỆP SỐ 437 TẬP A – QUYỀN 2 (08.2024)

- (11) **51198**
(21) 3-2024-01492 (28) 1
(54) **LOA** (51) **14-01; 26-04**
(22) 26/06/2024 (43) 26/08/2024
(73) **EMOMO TECH (ZHEJIANG) CO.,LTD (CN)**
7# Workshop, Kangshan Industrial Park, West Road of Jier Road, Dipu Sub-district,
Anji County, Huzhou City, Zhejiang Province, China
(72) 1. YUSHU ZHAO (CN)
2. WENJI TANG (CN)
3. JING SONG (CN)
4. JUN YANG (CN)
5. WEI ZHOU (CN)
6. XUEYAN ZHANG (CN)
(74) Công ty TNHH Đại Tín và Liên Danh (DAITIN AND ASSOCIATES CO.,LTD)
(55)

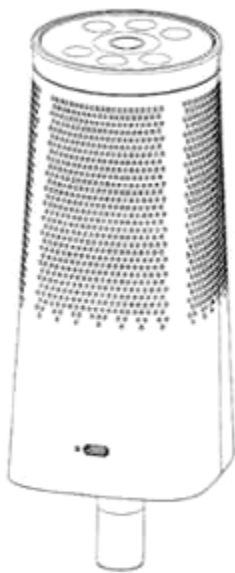

1.1

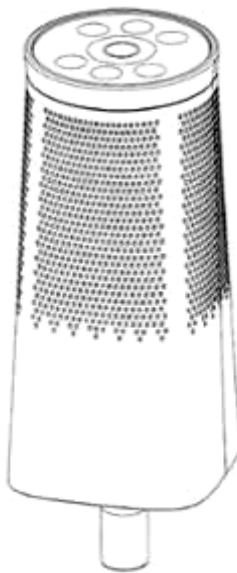

1.2

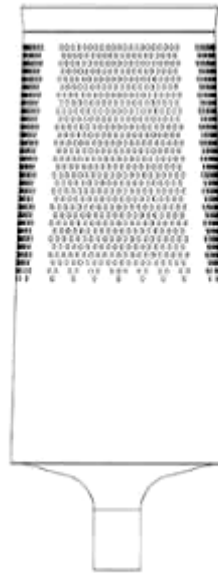

1.3

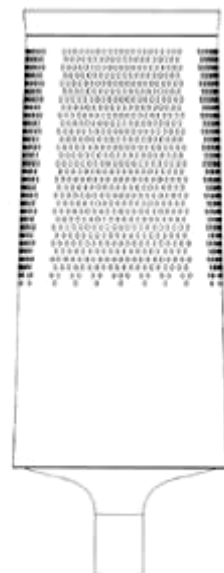

1.4

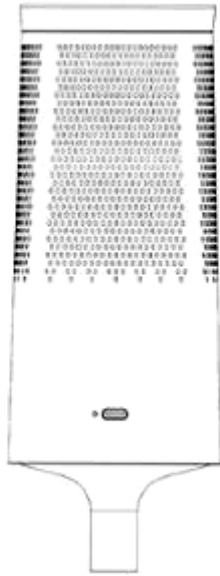

1.5



1.6



1.7



1.8

CÔNG BÁO SỞ HỮU CÔNG NGHIỆP SỐ 437 TẬP A – QUYỀN 2 (08.2024)

- (11) **51199**
(21) 3-2024-01493 (28) 1
(54) **THIẾT BỊ TẠO KHÓI ĐIỆN TỬ** (51) **27-99**
(22) 26/06/2024 (43) 26/08/2024
(30) 2023308700064 29/12/2023 CN;
(73) **HUMBLE GRACE LIMITED (CN)**
19H Maxgrand Plaza, No.3 Tai Yau Street, San Po Kong, Kowloon, Hong Kong,
China
(72) Zezheng ZHU (CN)
(74) Công ty TNHH Sáng chế ACTIP (ACTIP PATENT LIMITED)
(55)



1.1



1.2



1.3



1.4



1.5



1.6



1.7



1.8

- (11) **51200**
(21) 3-2024-01503 (28) 1
(54) **LỚP XE** (51) **12-15**
(22) 27/06/2024 (43) 26/08/2024
(73) **CHENG SHIN RUBBER IND. CO., LTD. (TW)**
No. 215, Meigang Rd., Dacun Township, Changhua County 515, Taiwan
(72) 1. MIN-CHI LIN (TW)
2. JYUN-YI KE (TW)
3. QI-WEN HUANG (TW)
4. CHEN-YANG YU (TW)
5. JIAN-RONG CHENG (TW)
(74) Công ty Cổ phần Sở hữu công nghiệp INVESTIP (INVESTIP)
(55)

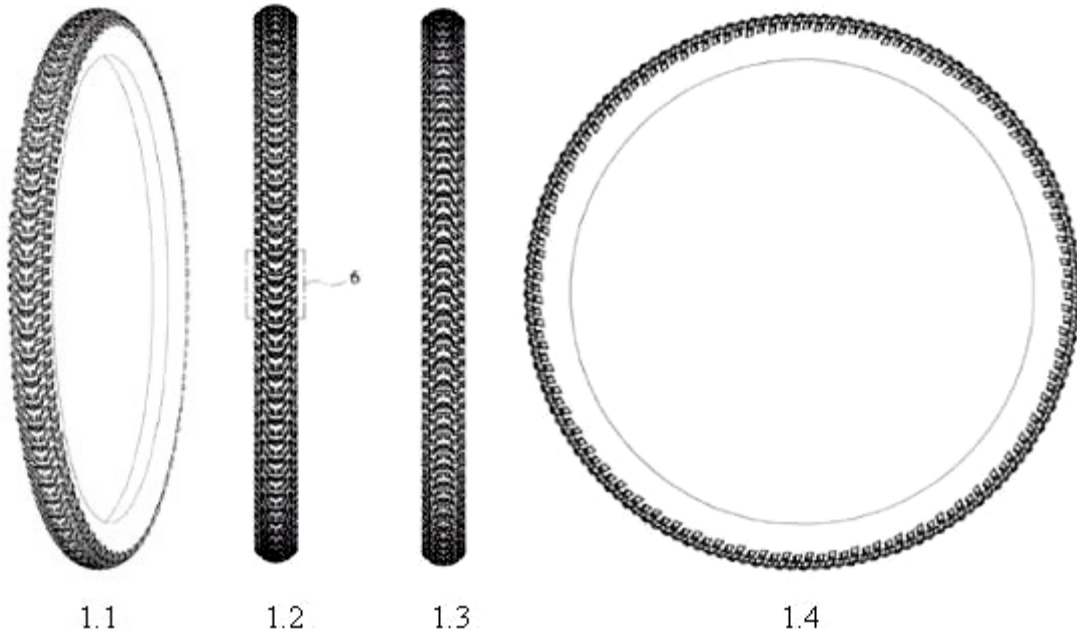



1.5

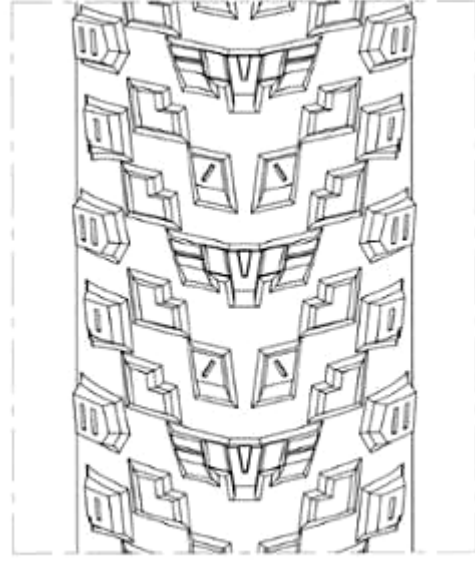

1.6

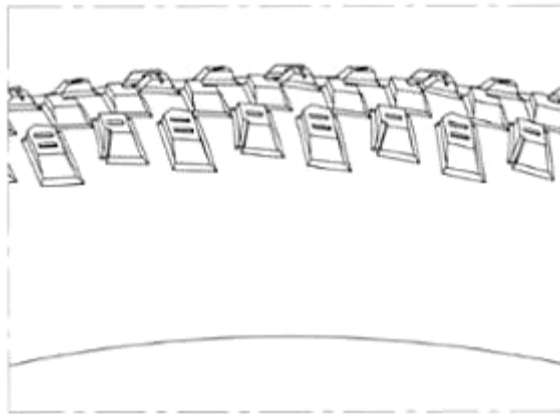

1.7

(11) **51201**

(21) 3-2024-01504

(28) 1

(54) **BÀN**

(51) **06-03**

(22) 27/06/2024

(43) 26/08/2024

(73) **CÔNG TY TNHH ATRIUM DESIGN AND BUILD (VN)**

L3-19, tầng 3, Khu Cao Ốc Văn Phòng - Thương mại - Dịch vụ Tổng hợp Lô 5.5, số 8-10, đường Mai Chí Thọ, phường Thủ Thiêm, thành phố Thủ Đức, thành phố Hồ Chí Minh

(72) Trần Viên Ngọc Trân (VN)

(74) Công ty TNHH T&T INVENMARK Sở hữu trí tuệ Quốc tế (T&T INVENMARK CO., LTD.)

(55)



1.1



1.2



1.3



1.4

1.5



1.6



1.7

CÔNG BÁO SỞ HỮU CÔNG NGHIỆP SỐ 437 TẬP A – QUYỀN 2 (08.2024)

(11) **51202**

(21) 3-2024-01513

(28) 2

(54) **XE Ô TÔ**

(51) **12-08**

(22) 28/06/2024

(43) 26/08/2024

(30) 202430016699.5 10/01/2024 CN;

(73) **BYD COMPANY LIMITED (CN)**

No. 3009, BYD Road, Pingshan, Shenzhen, Guangdong 518118, China

(72) 1. LIAN, YUBO (CN)

2. EGGER, WOLFGANG JOSEF (DE)

3. FAN, JIHAN (CN)

4. YIN, YADONG (CN)

5. CHEN, SHUAIZHI (CN)

(74) Công ty TNHH Sở hữu trí tuệ Thảo Thọ Quyển (INVENCO.,LTD)

(55)



1.1



1.2



1.3



1.4



1.5



1.6



1.7



2.1



2.2



2.3



2.4



2.5



2.6

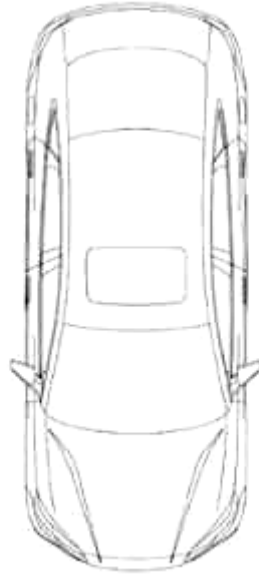

2.7

CÔNG BÁO SỞ HỮU CÔNG NGHIỆP SỐ 437 TẬP A – QUYỀN 2 (08.2024)

(11) **51203**

(21) 3-2024-01514

(28) 2

(54) **XE Ô TÔ**

(51) **12-08**

(22) 28/06/2024

(43) 26/08/2024

(30) 202430016715.0 10/01/2024 CN;

(73) **BYD COMPANY LIMITED (CN)**

No. 3009, BYD Road, Pingshan, Shenzhen, Guangdong 518118, China

(72) 1. LIAN, YUBO (CN)

2. EGGER, WOLFGANG JOSEF (DE)

3. LI, QIUHONG (CN)

4. PAN, ZILIN (CN)

5. ZHU, DONGER (CN)

(74) Công ty TNHH Sở hữu trí tuệ Thảo Thọ Quyển (INVENCO.,LTD)

(55)



1.1



1.2



1.3



1.4



1.5



1.6



1.7



2.1



2.2



2.3



2.4

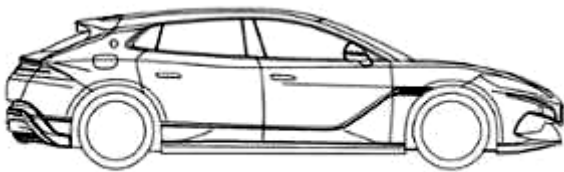

2.5



2.6

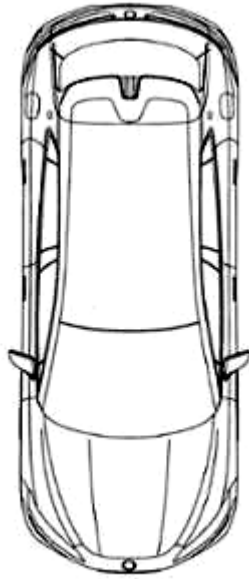

2.7

CÔNG BÁO SỞ HỮU CÔNG NGHIỆP SỐ 437 TẬP A – QUYỀN 2 (08.2024)

- (11) **51204**
- (21) 3-2024-01523
- (54) **CHẢO NƯỚNG**
- (22) 01/07/2024
- (73) **JIANGMEN YISHAN METAL PRODUCTS CO., LTD. (CN)**
Jiaobeishan, Niushan, Dalingtou, Qikan, etc, Shiming village, Siqian, Xinhui,
Jiangmen City, Guangdong Province 529100, China
- (72) 1. LEE CHANGHO (KR)
2. LEE WONYOUNG (KR)
- (74) Công ty TNHH ASL LAW (ASL LAW CO.,LTD)
- (55)
- (28) 1
- (51) **07-02**
- (43) 26/08/2024



1.1



1.2

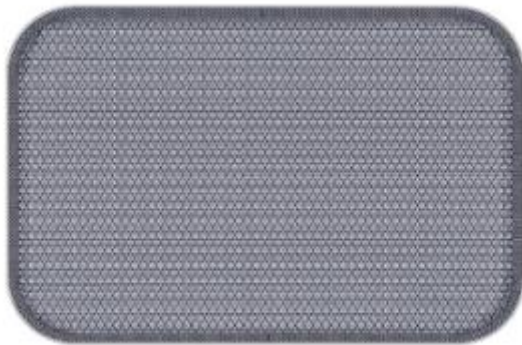

1.3

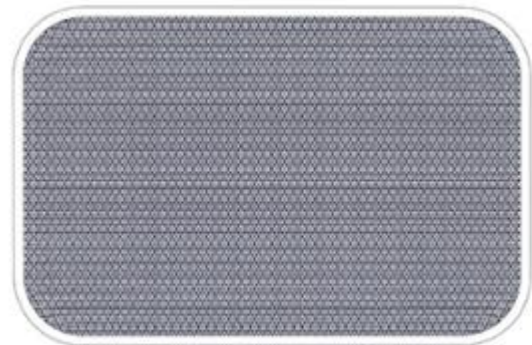

1.4



1.5



1.6



1.7

1.8

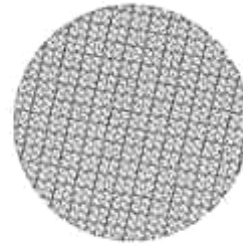

1.9

1.10

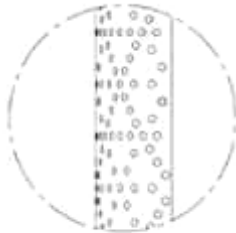

1.11

1.12

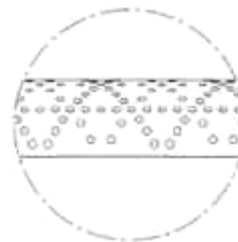
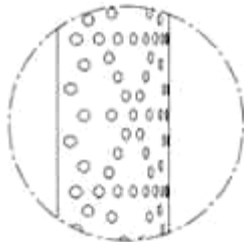

1.13

1.14

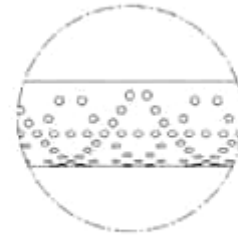

1.15

1.16

CÔNG BÁO SỞ HỮU CÔNG NGHIỆP SỐ 437 TẬP A – QUYỀN 2 (08.2024)

- (11) **51205**
- (21) 3-2024-01525 (28) 1
- (54) **NHÃN SẢN PHẨM** (51) **19-08**
- (22) 02/07/2024 (43) 26/08/2024
- (30) 30-2024-0001268 10/01/2024 KR;
- (73) **OSSTEM IMPLANT CO., LTD.** (KR)
3, Magokjungang 12-ro, Gangseo-gu, Seoul 07787, Republic of Korea
- (72) 1. JANG, HA EUN (KR)
2. KIM, JAE KYEOM (KR)
3. SHIM, SOO YEON (KR)
4. KIM, YONG JIN (KR)
- (74) Công ty Luật TNHH WINCO (WINCO LAW FIRM)
- (55)



CÔNG BÁO SỞ HỮU CÔNG NGHIỆP SỐ 437 TẬP A – QUYỀN 2 (08.2024)

- (11) **51206**
(21) 3-2024-01530 (28) 1
(54) **KHUYÊN TAI** (51) **11-01**
(22) 02/07/2024 (43) 26/08/2024
(30) 015046432 03/01/2024 EM;
(73) **FRED PARIS (FR)**
29 rue des Pyramides, 75001 PARIS, FRANCE
(72) OBADIA Quentin (FR)
(74) Công ty Cổ phần Sở hữu công nghiệp INVESTIP (INVESTIP)
(55)

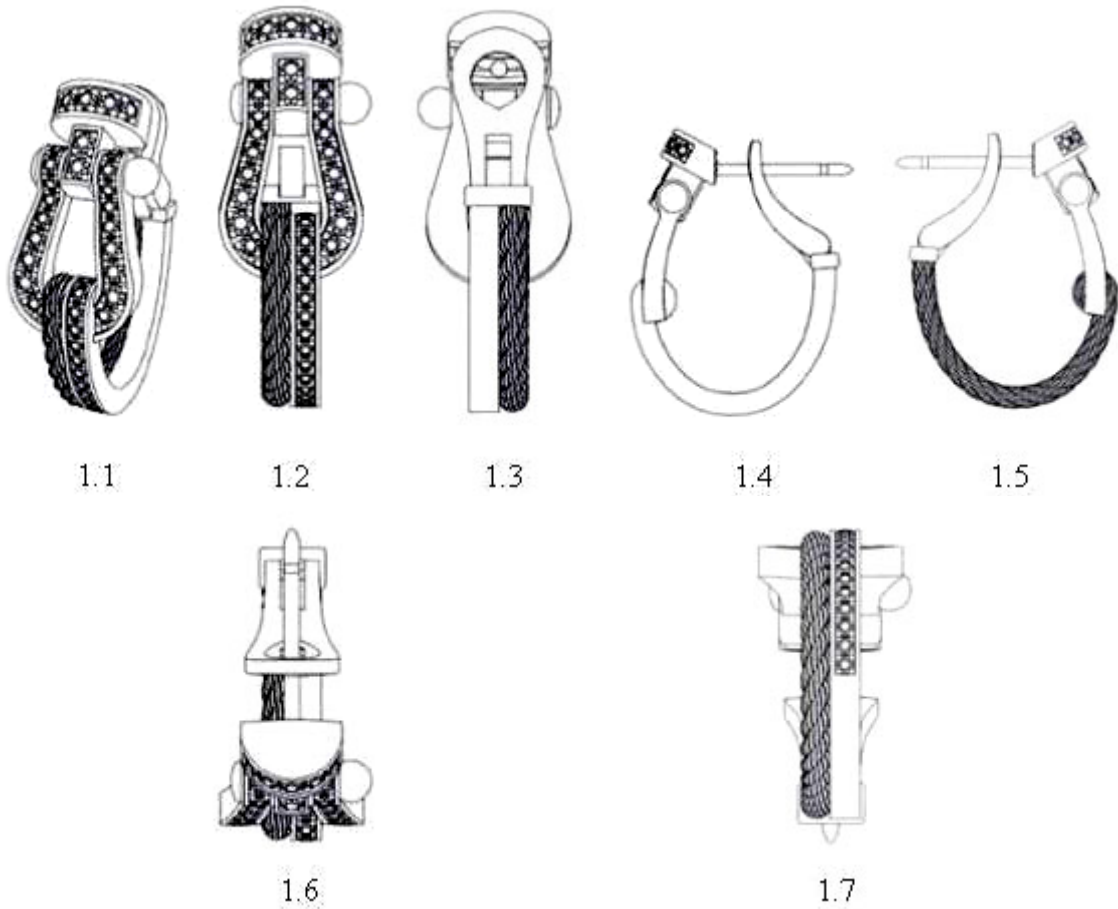

CÔNG BÁO SỞ HỮU CÔNG NGHIỆP SỐ 437 TẬP A – QUYỀN 2 (08.2024)

- (11) **51207**
(21) 3-2024-01531 (28) 1
(54) **KHUYÊN TAI** (51) **11-01**
(22) 02/07/2024 (43) 26/08/2024
(30) 015046432 03/01/2024 EM;
(73) **FRED PARIS (FR)**
29 rue des Pyramides, 75001 PARIS, FRANCE
(72) OBADIA Quentin (FR)
(74) Công ty Cổ phần Sở hữu công nghiệp INVESTIP (INVESTIP)
(55)



1.1



1.2

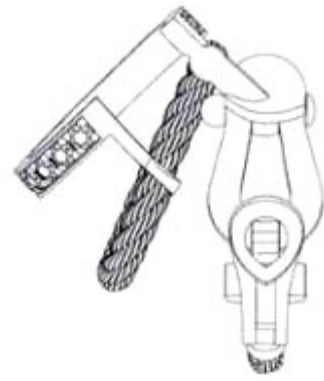

1.3



1.4



1.5



1.6

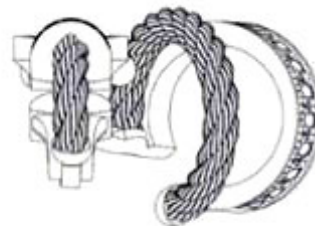

1.7

CÔNG BÁO SỞ HỮU CÔNG NGHIỆP SỐ 437 TẬP A – QUYỀN 2 (08.2024)

(11) **51208**

(21) 3-2024-01532

(54) **MẶT DÂY CHUYỀN**

(22) 02/07/2024

(30) 015046432 03/01/2024 EM;

(73) **FRED PARIS (FR)**

29 rue des Pyramides, 75001 PARIS, FRANCE

(72) OBADIA Quentin (FR)

(74) Công ty Cổ phần Sở hữu công nghiệp INVESTIP (INVESTIP)

(55)

(28) 1

(51) **11-01**

(43) 26/08/2024



1.1

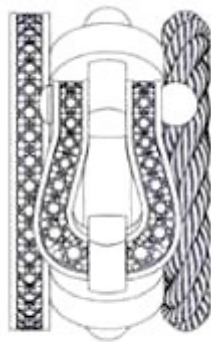

1.2

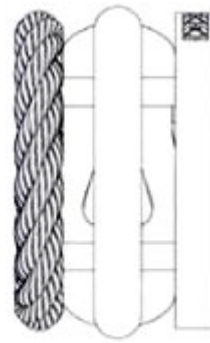

1.3



1.4



1.5

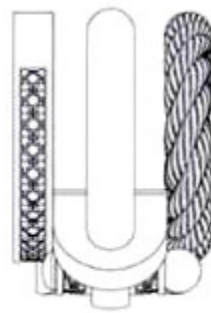

1.6



1.7

- (11) **51209**
(21) 3-2024-01535 (28) 1
(54) **CAN** (51) **09-02**
(22) 03/07/2024 (43) 26/08/2024
(30) 30-2024-0001302 10/01/2024 KR;
(73) **HD HYUNDAI OILBANK CO., LTD.** (KR)
182, Pyeongsin 2-ro, Daesan-eup, Seosan-si, Chungcheongnam-do, Republic of Korea
(72) CHU, Young-min (KR)
(74) Công ty TNHH một thành viên Sở hữu trí tuệ VCCI (VCCI-IP CO.,LTD)
(55)

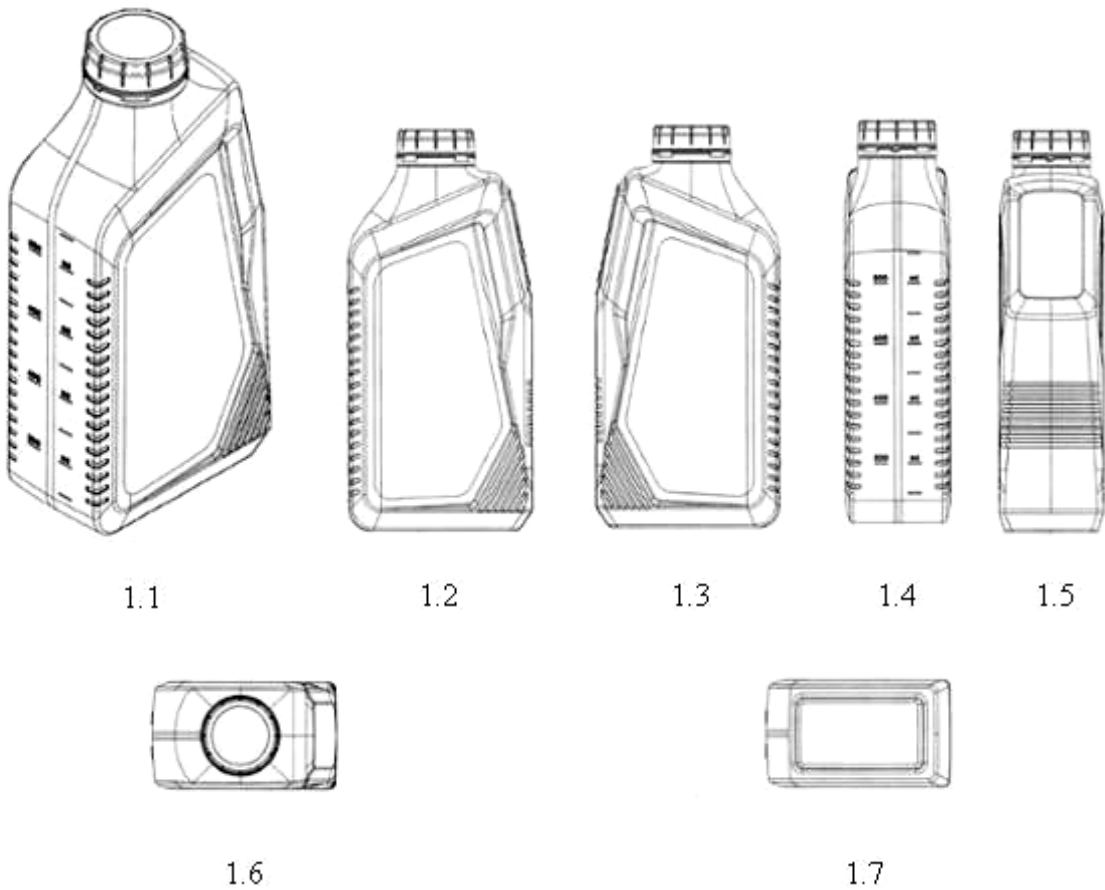

CÔNG BÁO SỞ HỮU CÔNG NGHIỆP SỐ 437 TẬP A – QUYỀN 2 (08.2024)

- (11) **51210**
(21) 3-2024-01536 (28) 1
(54) **CAN** (51) **09-02**
(22) 03/07/2024 (43) 26/08/2024
(30) 30-2024-0001303 10/01/2024 KR;
(73) **HD HYUNDAI OILBANK CO., LTD.** (KR)
182, Pyeongsin 2-ro, Daesan-eup, Seosan-si, Chungcheongnam-do, Republic of Korea
(72) CHU, Young-min (KR)
(74) Công ty TNHH một thành viên Sở hữu trí tuệ VCCI (VCCI-IP CO.,LTD)
(55)

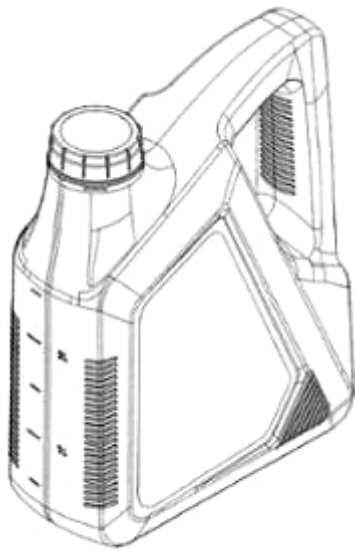

1.1

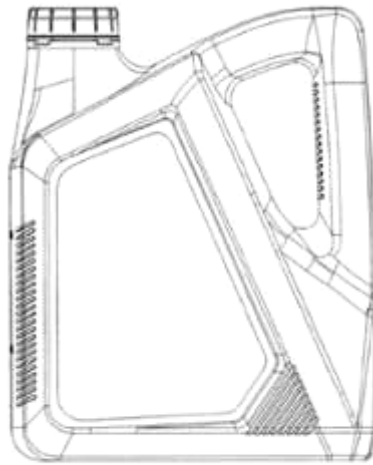

1.2

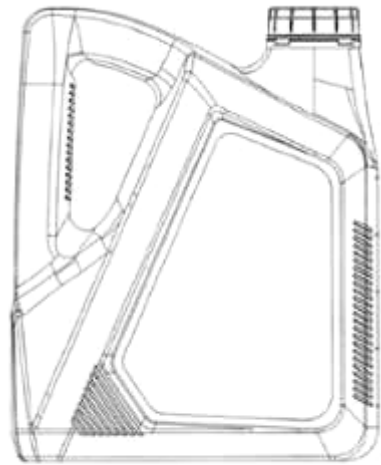

1.3

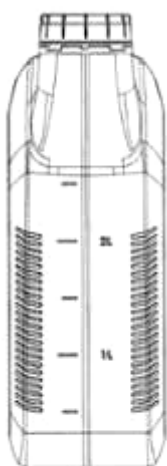

1.4

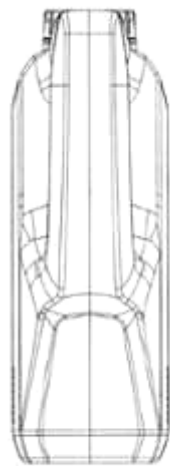

1.5

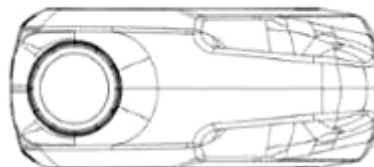

1.6



1.7

CÔNG BÁO SỞ HỮU CÔNG NGHIỆP SỐ 437 TẬP A – QUYỀN 2 (08.2024)

- (11) **51211**
- (21) 3-2024-01537 (28) 1
- (54) **CAN** (51) **09-02**
- (22) 03/07/2024 (43) 26/08/2024
- (30) 30-2024-0001329 10/01/2024 KR;
- (73) **HD HYUNDAI OILBANK CO., LTD. (KR)**
182, Pyeongsin 2-ro, Daesan-eup, Seosan-si, Chungcheongnam-do, Republic of Korea
- (72) CHU, Young-min (KR)
- (74) Công ty TNHH một thành viên Sở hữu trí tuệ VCCI (VCCI-IP CO.,LTD)
- (55)

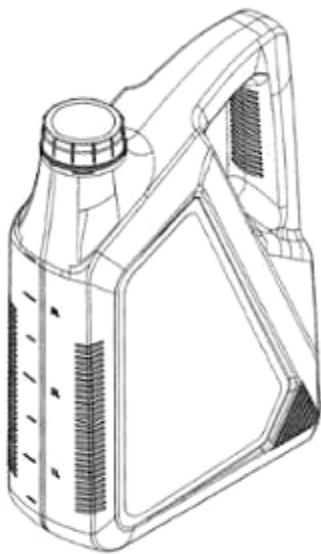

1.1

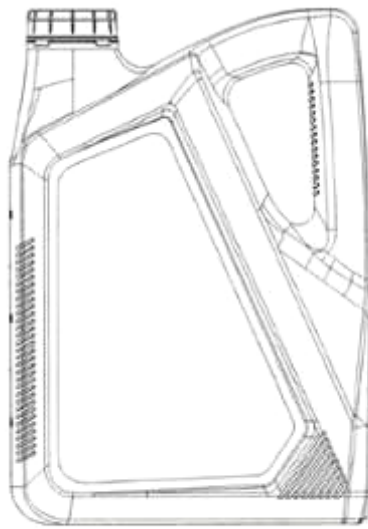

1.2

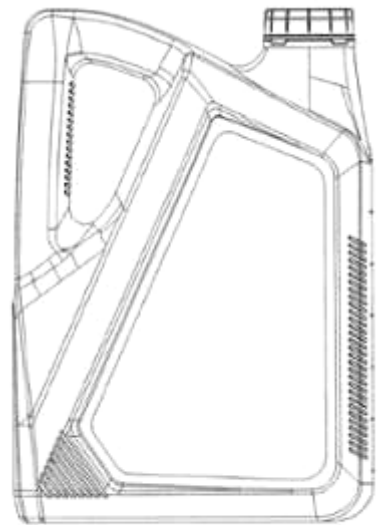

1.3



1.4

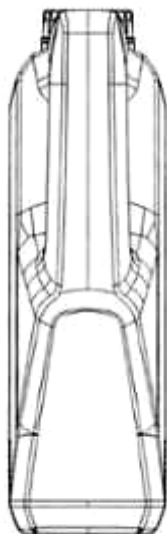

1.5

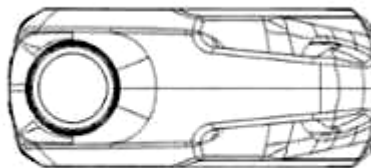

1.6



1.7

CÔNG BÁO SỞ HỮU CÔNG NGHIỆP SỐ 437 TẬP A – QUYỀN 2 (08.2024)

- (11) **51212**
(21) 3-2024-01538 (28) 1
(54) **CAN** (51) **09-02**
(22) 03/07/2024 (43) 26/08/2024
(30) 30-2024-0001330 10/01/2024 KR;
(73) **HD HYUNDAI OILBANK CO., LTD. (KR)**
182, Pyeongsin 2-ro, Daesan-eup, Seosan-si, Chungcheongnam-do, Republic of Korea
(72) CHU, Young-min (KR)
(74) Công ty TNHH một thành viên Sở hữu trí tuệ VCCI (VCCI-IP CO.,LTD)
(55)

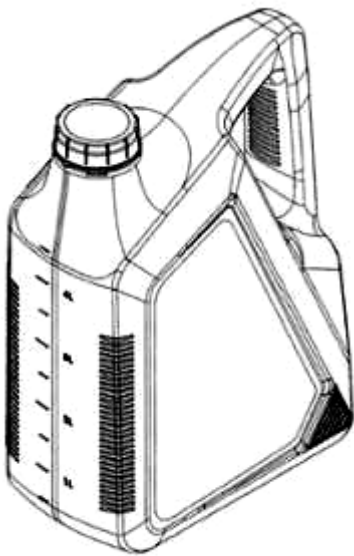

1.1

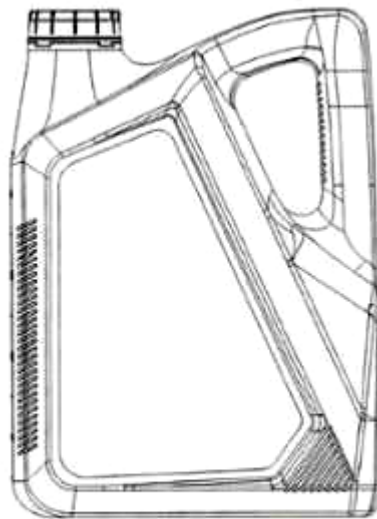

1.2

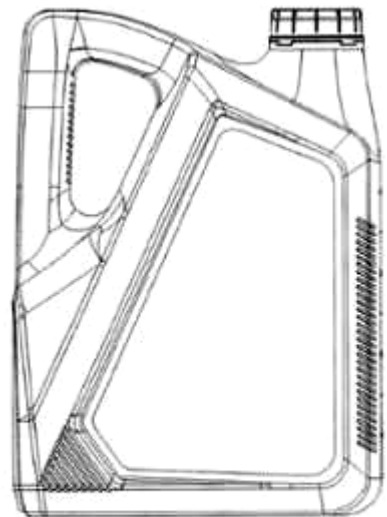

1.3

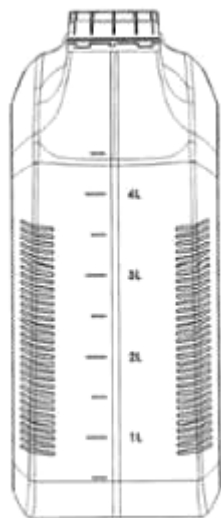

1.4

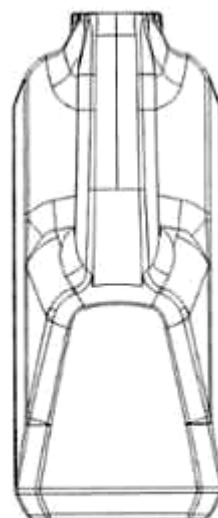

1.5

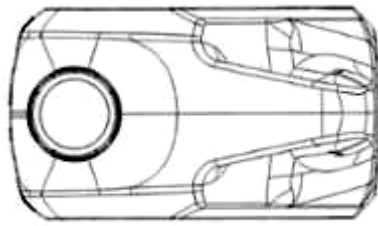

1.6

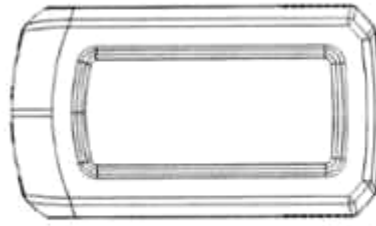

1.7

CÔNG BÁO SỞ HỮU CÔNG NGHIỆP SỐ 437 TẬP A – QUYỀN 2 (08.2024)

- (11) **51213**
(21) 3-2024-01539 (28) 1
(54) **CAN** (51) **09-02**
(22) 03/07/2024 (43) 26/08/2024
(30) 30-2024-0001331 10/01/2024 KR;
(73) **HD HYUNDAI OILBANK CO., LTD. (KR)**
182, Pyeongsin 2-ro, Daesan-eup, Seosan-si, Chungcheongnam-do, Republic of Korea
(72) CHU, Young-min (KR)
(74) Công ty TNHH một thành viên Sở hữu trí tuệ VCCI (VCCI-IP CO.,LTD)
(55)

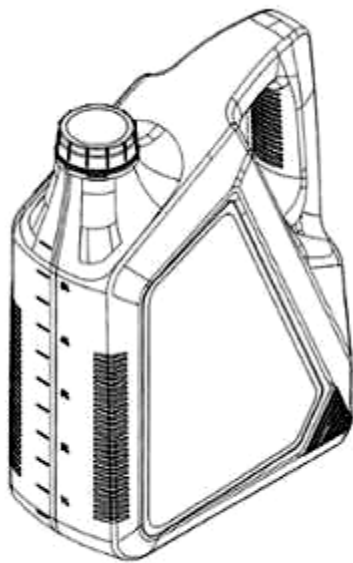

1.1

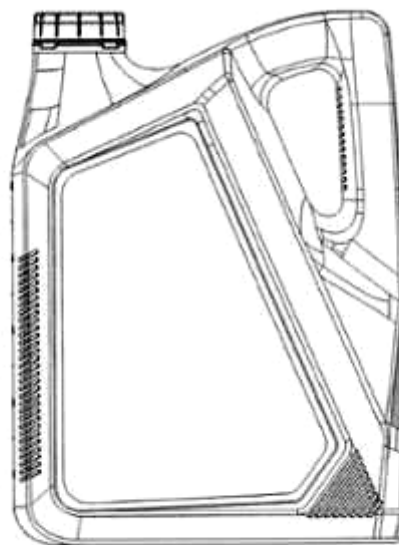

1.2

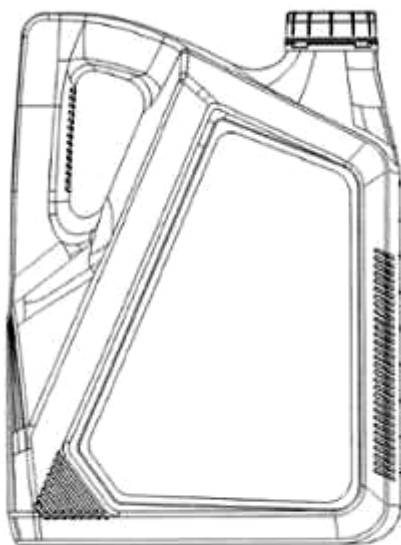

1.3

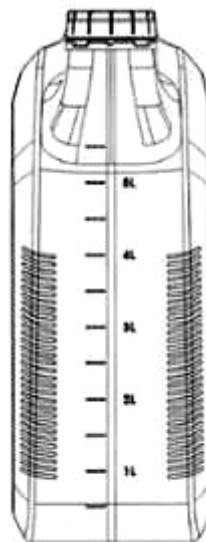

1.4

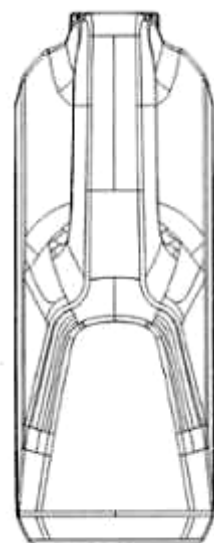

1.5

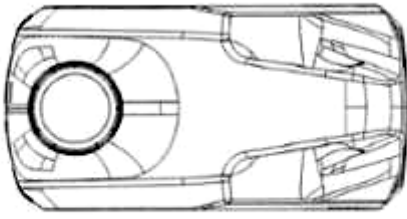

1.6

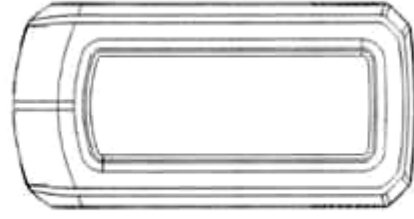

1.7

CÔNG BÁO SỞ HỮU CÔNG NGHIỆP SỐ 437 TẬP A – QUYỀN 2 (08.2024)

(11) **51214**

(21) 3-2024-01568

(28) 1

(54) **GHẾ**

(51) **06-01**

(22) 05/07/2024

(43) 26/08/2024

(73) **CÔNG TY TNHH ATRIUM DESIGN AND BUILD (VN)**

L3-19, tầng 3, khu Cao Ốc Văn Phòng - Thương mại - Dịch vụ Tổng hợp lô 5.5, số 8-10, đường Mai Chí Thọ, phường Thủ Thiêm, thành phố Thủ Đức, thành phố Hồ Chí Minh

(72) Trần Viên Ngọc Trân (VN)

(74) Công ty TNHH T&T INVENMARK Sở hữu trí tuệ Quốc tế (T&T INVENMARK CO., LTD.)

(55)



1.1



1.2



1.3



1.4



1.5



1.6



1.7

CÔNG BÁO SỞ HỮU CÔNG NGHIỆP SỐ 437 TẬP A – QUYỀN 2 (08.2024)

- (11) **51215**
- (21) 3-2024-01570 (28) 1
- (54) **NẮP CHE MẠCH NGUỒN TRONG THIẾT BỊ THU PHÁT SÓNG** (51) **14-03**
- (22) 05/07/2024 (43) 26/08/2024
- (73) **TẬP ĐOÀN CÔNG NGHIỆP - VIỆN THÔNG QUÂN ĐỘI (VN)**
Lô D26 khu đô thị mới Cầu Giấy, phường Yên Hoà, quận Cầu Giấy, thành phố Hà Nội
- (72) 1. ĐINH VĂN HẢI (VN)
2. KHÔNG VĂN MẠNH (VN)
3. NGUYỄN ĐỨC THỊNH (VN)
4. NGUYỄN ĐÌNH DƯƠNG (VN)
5. NGUYỄN VĂN HƯỚNG (VN)
6. NGUYỄN QUỐC HÙNG (VN)
- (74) Công ty TNHH NACILAW (NACILAW)
- (55)

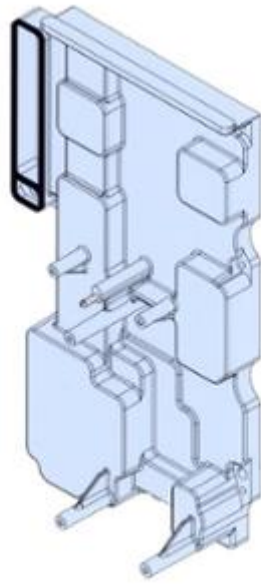

1.1

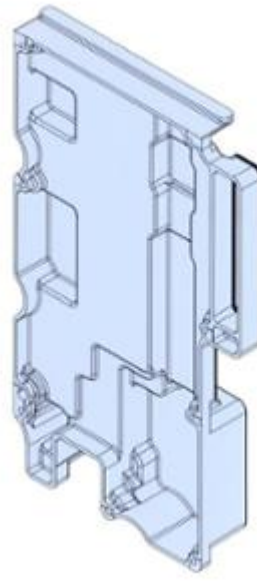

1.2

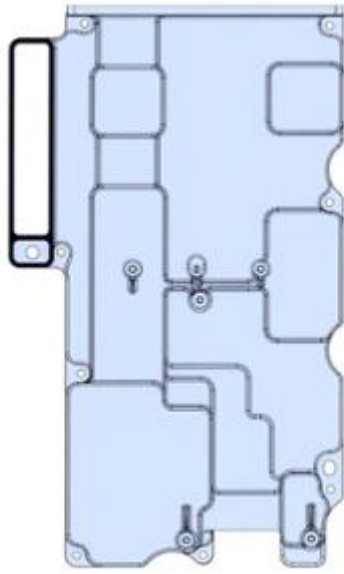

1.3

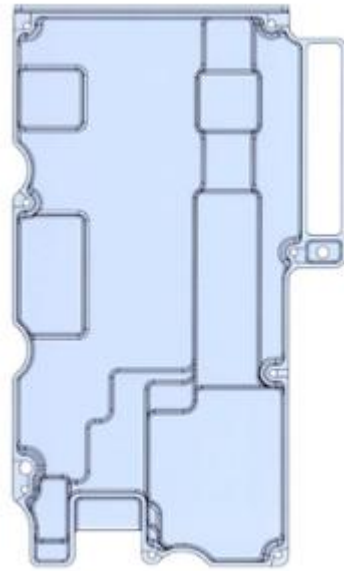

1.4

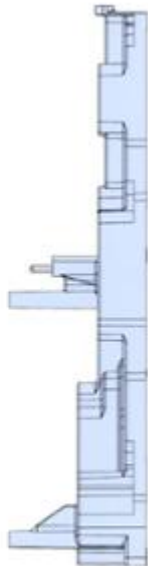

1.5

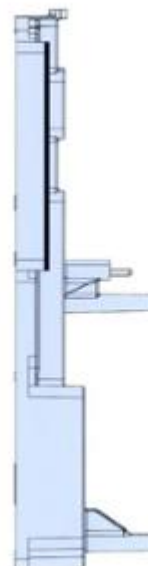

1.6

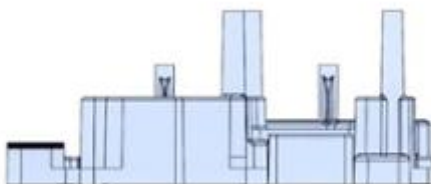

1.8

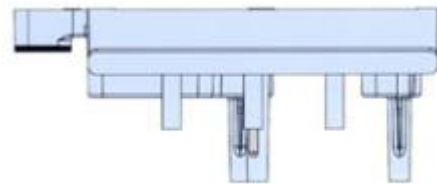

1.7

CÔNG BÁO SỞ HỮU CÔNG NGHIỆP SỐ 437 TẬP A – QUYỀN 2 (08.2024)

- (11) **51216**
(21) 3-2024-01571 (28) 1
(54) **THIẾT BỊ THU PHÁT VÔ TUYẾN** (51) **14-03**
(22) 05/07/2024 (43) 26/08/2024
(73) **TẬP ĐOÀN CÔNG NGHIỆP - VIỄN THÔNG QUÂN ĐỘI (VN)**
Lô D26 khu đô thị mới Cầu Giấy, phường Yên Hoà, quận Cầu Giấy, thành phố Hà Nội
(72) 1. NGUYỄN ĐỨC THỊNH (VN)
2. HOÀNG ĐÌNH HẢI TRUYỀN (VN)
3. KHÔNG VĂN MẠNH (VN)
4. NGUYỄN QUỐC HÙNG (VN)
(74) Công ty TNHH NACILAW (NACILAW)
(55)



1.1

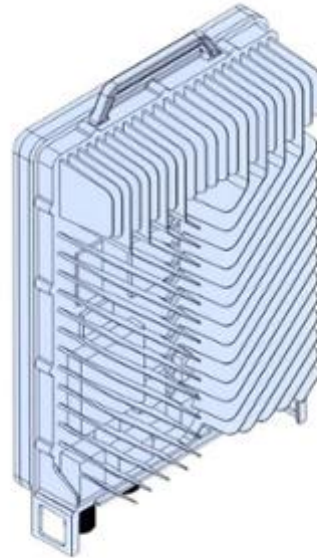

1.2



1.3



1.4

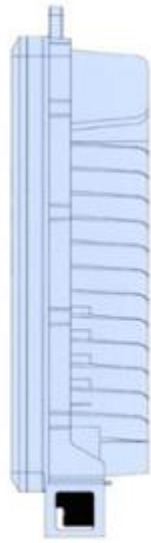

1.5



1.6

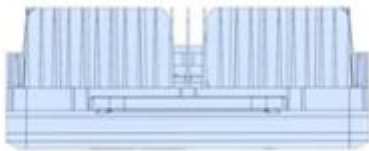

1.7



1.8

CÔNG BÁO SỞ HỮU CÔNG NGHIỆP SỐ 437 TẬP A – QUYỀN 2 (08.2024)

- (11) **51217**
(21) 3-2024-01635 (28) 1
(54) **GHẾ** (51) **06-01**
(22) 16/07/2024 (43) 26/08/2024
(73) **CÔNG TY TNHH ATRIUM DESIGN AND BUILD (VN)**
L3-19, tầng 3, khu Cao Ốc Văn Phòng - Thương mại - Dịch vụ Tổng hợp Lô 5.5, số
8-10, đường Mai Chí Thọ, phường Thủ Thiêm, thành phố Thủ Đức, thành phố Hồ
Chí Minh
(72) Trần Viên Ngọc Trân (VN)
(74) Công ty TNHH T&T INVENMARK Sở hữu trí tuệ Quốc tế (T&T INVENMARK
CO., LTD.)
(55)



1.1



1.2



1.3



1.4



1.5



1.6



1.7

CÔNG BÁO SỞ HỮU CÔNG NGHIỆP SỐ 437 TẬP A – QUYỀN 2 (08.2024)

- (11) **51218**
(21) 3-2024-01651 (28) 1
(54) **NHÃN SẢN PHẨM** (51) **19-08**
(22) 17/07/2024 (43) 26/08/2024
(73) **CÔNG TY CỔ PHẦN THỰC PHẨM SỮA TH (VN)**
Xã Nghĩa Sơn, huyện Nghĩa Đàn, tỉnh Nghệ An
(72) Nguyễn Huy Trọng (VN)
(74) **CÔNG TY LUẬT TNHH IP MAX (IPMAX LAW FIRM)**
(55)



CÔNG BÁO SỞ HỮU CÔNG NGHIỆP SỐ 437 TẬP A – QUYỀN 2 (08.2024)

- (11) **51219**
(21) 3-2024-01653 (28) 1
(54) **NHÃN SẢN PHẨM** (51) **19-08**
(22) 17/07/2024 (43) 26/08/2024
(73) **CÔNG TY CỔ PHẦN THỰC PHẨM SỮA TH (VN)**
Xã Nghĩa Sơn, huyện Nghĩa Đàn, tỉnh Nghệ An
(72) Nguyễn Huy Trọng (VN)
(74) **CÔNG TY LUẬT TNHH IP MAX (IPMAX LAW FIRM)**
(55)



CÔNG BÁO SỞ HỮU CÔNG NGHIỆP SỐ 437 TẬP A – QUYỀN 2 (08.2024)

- (11) **51220**
(21) 3-2024-01669 (28) 2
(54) **ĐỒ CHỨA MỸ PHẨM** (51) **09-03**
(22) 17/07/2024 (43) 26/08/2024
(73) **ZERO TO SEVEN INC. (KR)**
(Sangam-Dong, YTN-Newsquare), 17F/18F, 76 Sangamsan-Ro, Mapo-Gu, Seoul
03926, Republic of Korea
(72) Lee HyunJoo (KR)
(74) Công ty Luật TNHH ROUSE Việt Nam (ROUSE LEGAL VIETNAM LTD.)
(55)



1.1

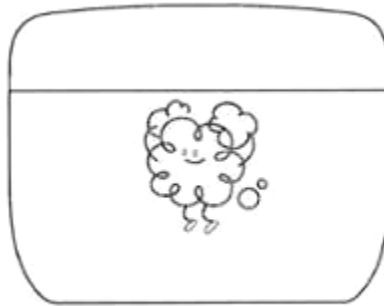

1.2

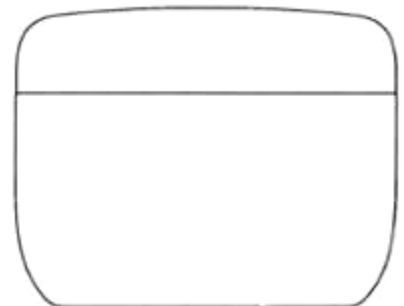

1.3

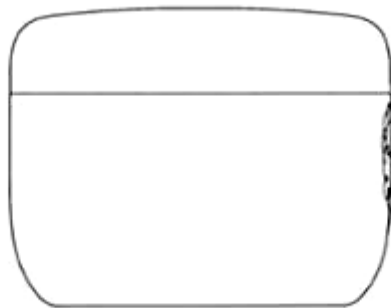

1.4

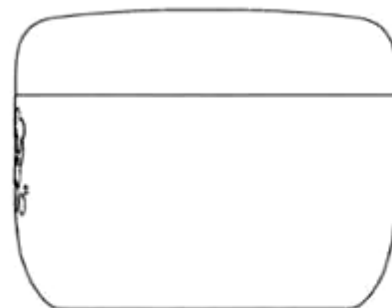

1.5

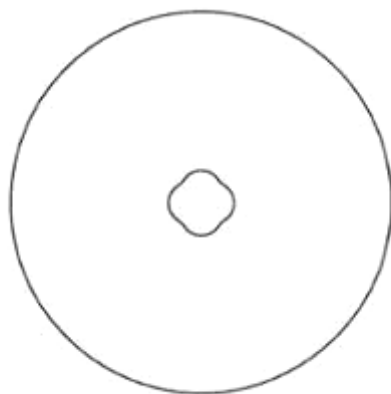

1.6

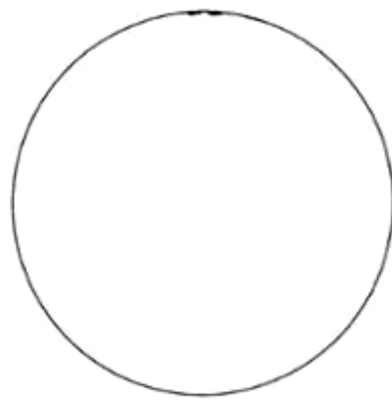

1.7

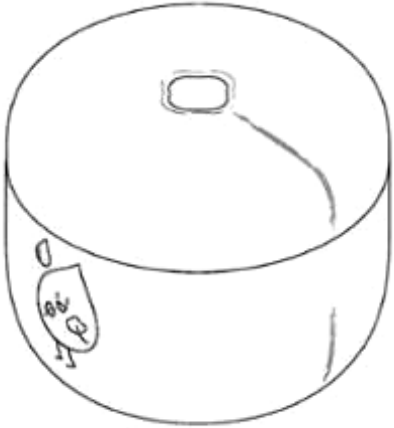

2.1

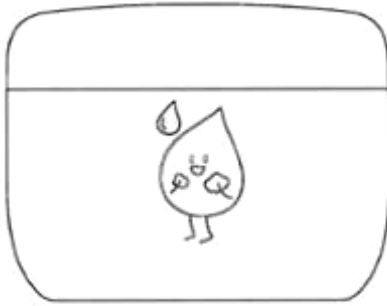

2.2

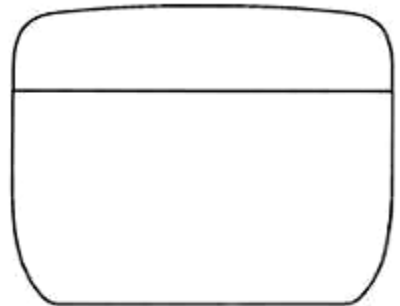

2.3

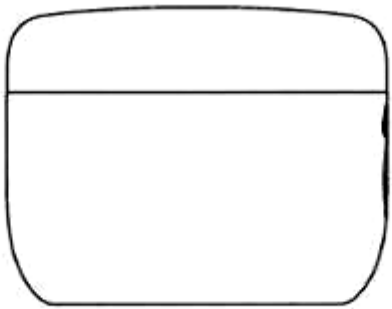

2.4

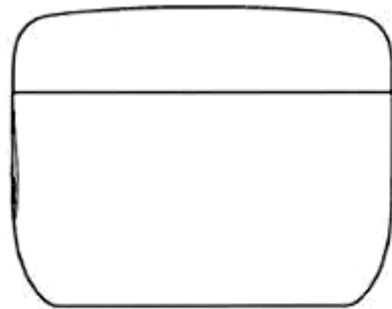

2.5

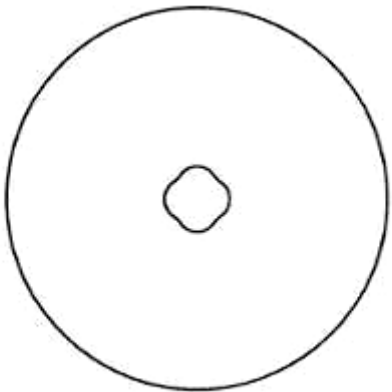

2.6

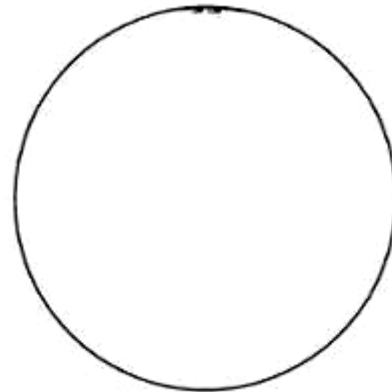

2.7

CÔNG BÁO SỞ HỮU CÔNG NGHIỆP SỐ 437 TẬP A – QUYỀN 2 (08.2024)

- (11) **51221**
(21) 3-2024-01670 (28) 2
(54) **ĐỒ CHỨA MỸ PHẨM** (51) **09-03**
(22) 17/07/2024 (43) 26/08/2024
(73) **ZERO TO SEVEN INC. (KR)**
(Sangam-Dong, YTN-Newsquare), 17F/18F, 76 Sangamsan-Ro, Mapo-Gu, Seoul
03926, Republic of Korea
(72) Lee HyunJoo (KR)
(74) Công ty Luật TNHH ROUSE Việt Nam (ROUSE LEGAL VIETNAM LTD.)
(55)

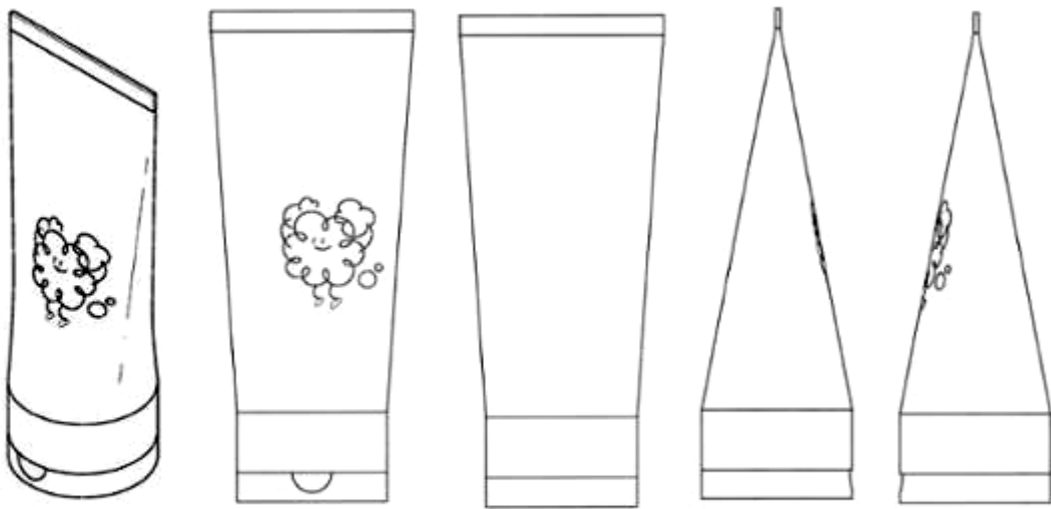

1.1

1.2

1.3

1.4

1.5



1.6

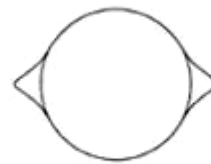

1.7



2.1



2.2

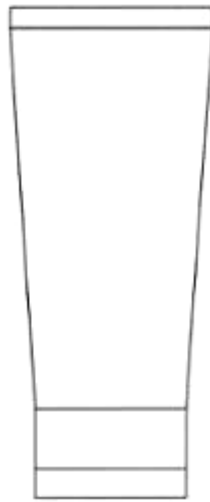

2.3



2.4



2.5



2.6

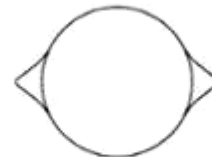

2.7

CÔNG BÁO SỞ HỮU CÔNG NGHIỆP SỐ 437 TẬP A – QUYỀN 2 (08.2024)

- (11) **51222**
(21) 3-2024-01678 (28) 1
(54) **MIẾNG ĐỘN GÓT GIÀY** (51) **02-04**
(22) 18/07/2024 (43) 26/08/2024
(73) **SHINYOH CO., LTD. (JP)**
3 CHO 22 BANCHI, EBISUJIMA-CHO, SAKAI-KU, SAKAI-SHI, OSAKA-FU,
JAPAN 590-0985
(72) WATANABE, Wataru (JP)
(74) Công ty Luật TNHH WINCO (WINCO LAW FIRM)
(55)



1.1

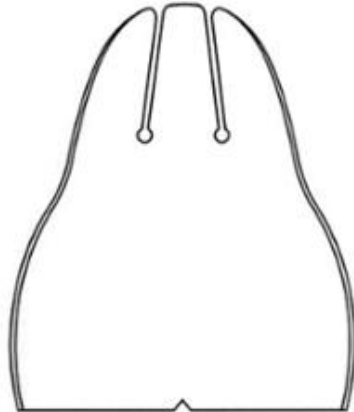

1.2

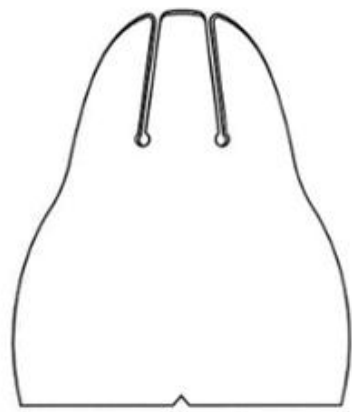

1.3



1.4



1.5

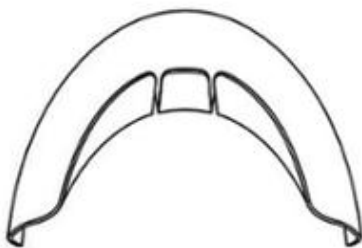

1.6



1.7

CÔNG BÁO SỞ HỮU CÔNG NGHIỆP SỐ 437 TẬP A – QUYỀN 2 (08.2024)

- (11) **51223**
(21) 3-2024-01681 (28) 1
(54) **NHÃN SẢN PHẨM** (51) **19-08**
(22) 18/07/2024 (43) 26/08/2024
(73) **CÔNG TY TNHH HÀ ĐẠI PHÁT (VN)**
Thôn Cầu Trong, xã Mỹ Thái, huyện Lạng Giang, tỉnh Bắc Giang
(72) Hà Văn Học (VN)
(74) Công ty TNHH Sở hữu trí tuệ Bình Minh (SUNRISE IP CO.,LTD.)
(55)



CÔNG BÁO SỞ HỮU CÔNG NGHIỆP SỐ 437 TẬP A – QUYỀN 2 (08.2024)

- (11) **51224**
(21) 3-2024-01371 (28) 1
(54) **CHAI** (51) **09-01**
(22) 13/06/2024 (43) 26/08/2024
(73) **CÔNG TY TNHH MTV TẬP ĐOÀN PHARMA THÀNH PHONG (VN)**
Số 31B đường số 23, khu phố 5, phường Hiệp Bình Chánh, thành phố Thủ Đức,
thành phố Hồ Chí Minh
(72) Nguyễn Thanh Tùng (VN)
(74) Công ty TNHH Sở hữu trí tuệ Bình Minh (SUNRISE IP CO.,LTD.)
(55)



1.1



1.2



1.3



1.4



1.5

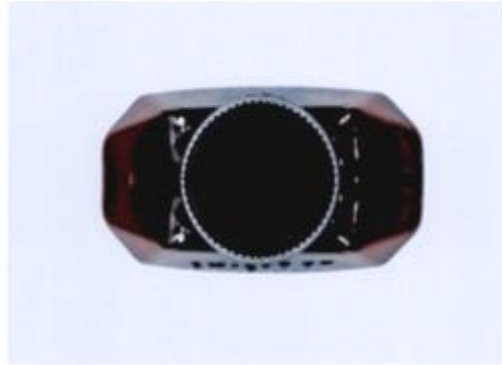

1.6



1.7

CÔNG BÁO SỞ HỮU CÔNG NGHIỆP SỐ 437 TẬP A – QUYỀN 2 (08.2024)

- (11) **51225**
(21) 3-2024-01373 (28) 1
(54) **ĐẦU GIẺNG DỪNG CHO HỆ GIÀN GIÁO** (51) **25-04**
(22) 13/06/2024 (43) 26/08/2024
(73) **CÔNG TY TNHH CƠ KHÍ NAM LONG (VN)**
61/4/2 quốc lộ 1A, khu phố 5, phường Bình Hưng Hòa B, quận Bình Tân, thành phố Hồ Chí Minh
(72) Trần Cảnh Nam (VN)
(74) Văn phòng Luật sư D và T (D & T LAW OFFICE)
(55)

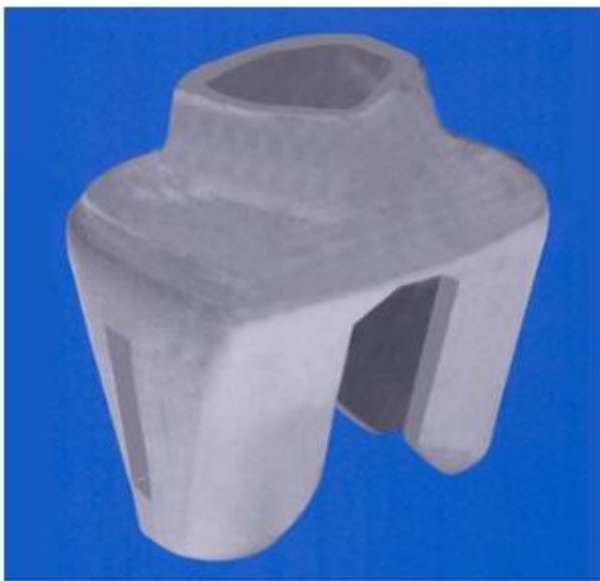

1.1

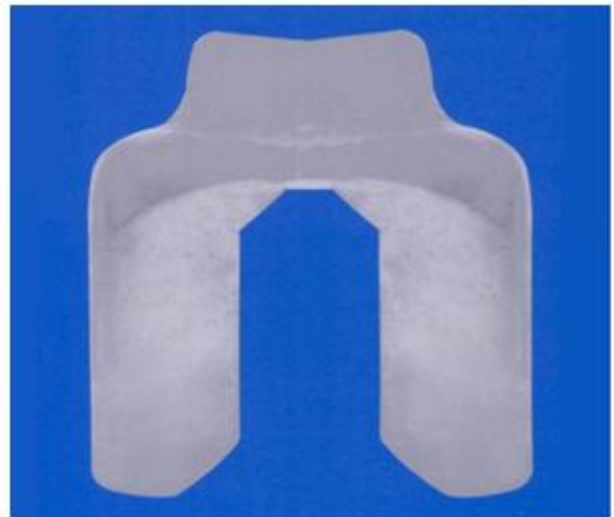

1.2



1.3

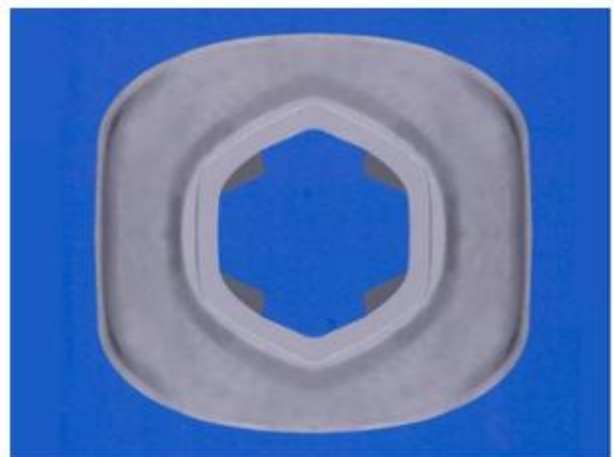

1.4

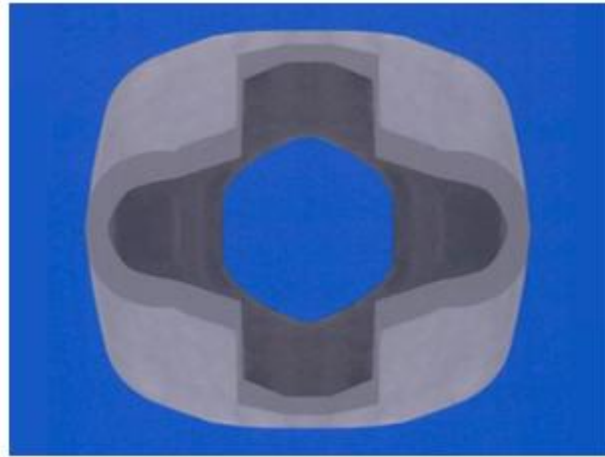

1.5

CÔNG BÁO SỞ HỮU CÔNG NGHIỆP SỐ 437 TẬP A – QUYỀN 2 (08.2024)

- (11) **51226**
(21) 3-2024-01375 (28) 1
(54) **QUẠT GẮN THẮT LƯNG** (51) **23-04**
(22) 13/06/2024 (43) 26/08/2024
(30) 2024300126396 09/01/2024 CN;
(73) 1. **GUANGXI HUOFU TRADING CO., LTD.** (CN)
Room 1703, Floor 17, Building C16, Nanning Jiangnan Wanda Plaza, No. 48-1,
Tinghong Road, Jiangnan District, Nanning City, Guangxi Province, China
2. **DONGGUAN BRIGHT ELECTRONIC TECHNOLOGY CO., LTD.** (CN)
Room 201, Building 3, No. 1, Nanba Street, Heshi Road, Qiaotou Town, Dongguan
City, Guangdong Province, China
(72) Pan Mingliang (CN)
(74) Công ty cổ phần Sở hữu trí tuệ BROSS và Cộng sự (BROSS & PARTNERS., JSC)
(55)



1.1



1.2



1.3



1.4



1.5



1.6



1.7



1.8

CÔNG BÁO SỞ HỮU CÔNG NGHIỆP SỐ 437 TẬP A – QUYỀN 2 (08.2024)

(11) **51227**

(21) 3-2024-01376

(28) 1

(54) **NẮP BÚT**

(51) **19-06**

(22) 13/06/2024

(43) 26/08/2024

(73) **CÔNG TY CỔ PHẦN TẬP ĐOÀN THIÊN LONG (VN)**

Tầng 10, Sofic Tower, số 10 đường Mai Chí Thọ, phường Thủ Thiêm, thành phố Thủ Đức, thành phố Hồ Chí Minh

(72) Cô Gia Thọ (VN)

(74) Công ty TNHH Tư vấn sở hữu trí tuệ Việt (VIET IP CO.,LTD.)

(55)



1.1



1.2



1.3



1.4



1.5



1.6



1.7

CÔNG BÁO SỞ HỮU CÔNG NGHIỆP SỐ 437 TẬP A – QUYỀN 2 (08.2024)

- (11) **51228**
(21) 3-2024-01377 (28) 2
(54) **MÁY SẤY TÓC** (51) **28-03**
(22) 14/06/2024 (43) 26/08/2024
(30) 2023-026124 15/12/2023 JP; 2023-026123 15/12/2023 JP;
(73) **PANASONIC INTELLECTUAL PROPERTY MANAGEMENT CO., LTD.**
(JP)
22-6, Moto-machi, Kadoma-shi, Osaka 571-0057 Japan
(72) 1. MASASHI KIDO (JP)
2. HIROTOSHI HADA (JP)
(74) Công ty TNHH một thành viên Sở hữu trí tuệ VCCI (VCCI-IP CO.,LTD)
(55)



1.1



1.2



1.3



1.4



1.5



1.6



1.7



1.8



2.1



2.2



2.3



2.4



2.5



2.6



2.7



2.8

CÔNG BÁO SỞ HỮU CÔNG NGHIỆP SỐ 437 TẬP A – QUYỀN 2 (08.2024)

- (11) **51229**
(21) 3-2024-01379 (28) 1
(54) **PHỔ KẾ HUỲNH QUANG TIA X** (51) **10-04**
(22) 14/06/2024 (43) 26/08/2024
(73) **PURERAY INSTRUMENT CO., LTD. (CN)**
10th floor, No.2 Building, No.128 Shangnan East Road, Huangpu Community,
Xinqiao Street, Baoan District, Shenzhen City, China
(72) Bo Shao (CN)
(74) Công ty TNHH Dịch vụ Sở hữu trí tuệ GREENIP (GREENIP CO., LTD)
(55)



1.1



1.2



1.3



1.4

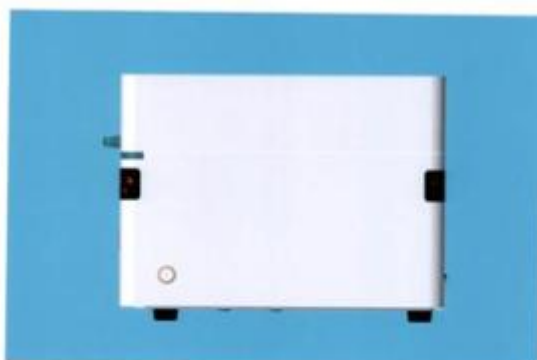

1.5



1.6



1.7



1.8

CÔNG BÁO SỞ HỮU CÔNG NGHIỆP SỐ 437 TẬP A – QUYỀN 2 (08.2024)

- (11) **51230**
(21) 3-2024-01380 (28) 1
(54) **GIÁ CHỨA ĐỒ** (51) **06-04**
(22) 14/06/2024 (43) 26/08/2024
(73) **BOLUO COUNTY FUKAI HARDWARE PRODUCTS CO., LTD. (CN)**
Nanya, Shenli Village, Yuanzhou Town, Boluo County, Huizhou City, Guangdong
Province, China
(72) KUAN-KAI FU (CN)
(74) Công ty TNHH Dịch vụ Sở hữu trí tuệ GREENIP (GREENIP CO., LTD)
(55)



1.1



1.2



1.3



1.4



1.5



1.6



1.7



1.8

CÔNG BÁO SỞ HỮU CÔNG NGHIỆP SỐ 437 TẬP A – QUYỀN 2 (08.2024)

- (11) **51231**
(21) 3-2024-01381 (28) 1
(54) **BÌNH PHUN NÔNG NGHIỆP** (51) **22-06**
(22) 14/06/2024 (43) 26/08/2024
(73) **TAIZHOU CITY CHUNFENG MACHINERY CO., LTD. (CN)**
NO.88, BINFENG ROAD, SANJIA STREET, TAIZHOU BAY NEW AREA,
TAIZHOU, ZHEJIANG, CHINA 318014
(72) 1. ANPING CAI (CN)
2. ENFU CHEN (CN)
(74) Công ty TNHH Dịch vụ Sở hữu trí tuệ BIG5 (BIG5 IP CO.,LTD)
(55)

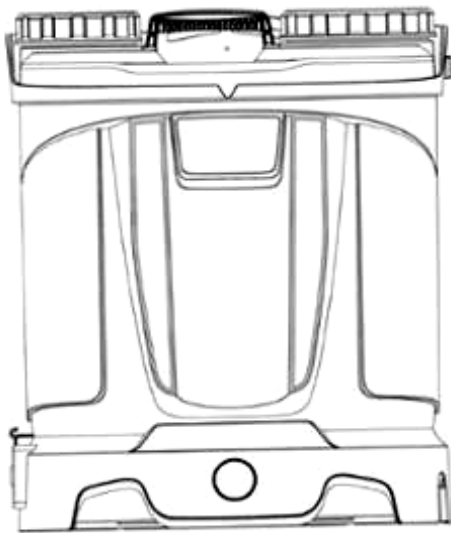

1.1

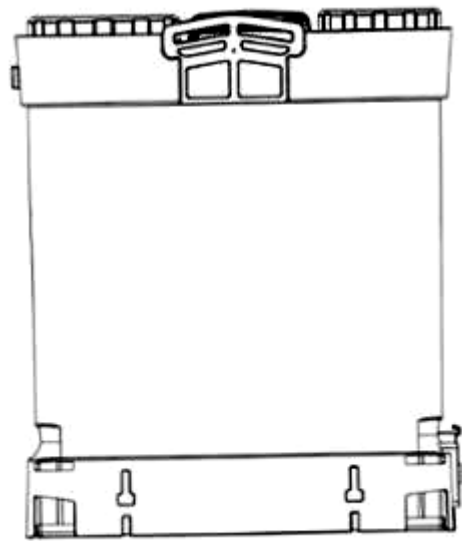

1.2



1.3

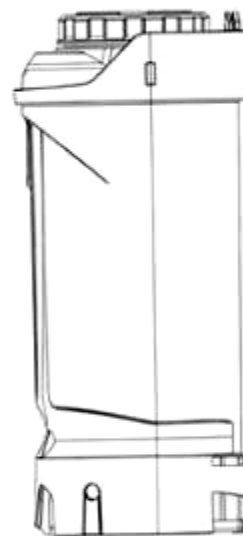

1.4

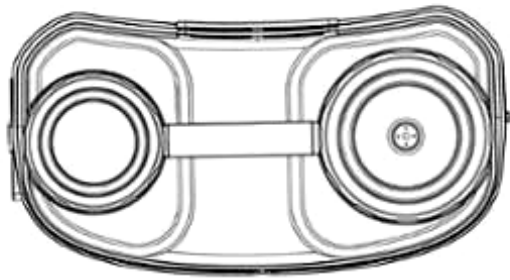

1.5

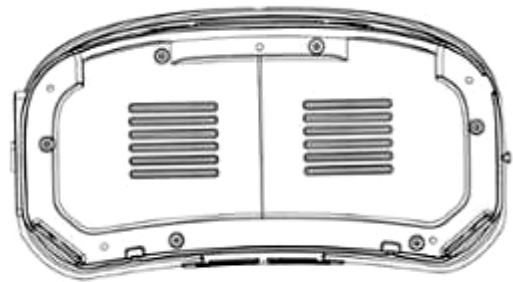

1.6

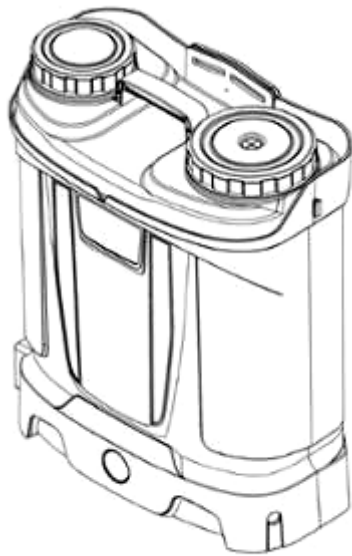

1.7

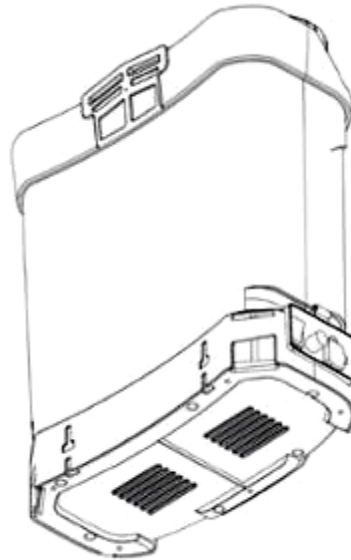

1.8

- (11) **51232**
(21) 3-2024-01388 (28) 2
(54) **ĐÈN XE MÁY** (51) **26-06**
(22) 17/06/2024 (43) 26/08/2024
(73) **CÔNG TY TNHH SẢN XUẤT - THƯƠNG MẠI - DỊCH VỤ ĐÀI PHONG (VN)**
Số 382 đường số 1, phường Bình Trị Đông B, quận Bình Tân, thành phố Hồ Chí Minh
(72) Hà Quảng Chánh (VN)
(74) Công ty TNHH Tư vấn sở hữu trí tuệ Việt (VIET IP CO.,LTD.)
(55)

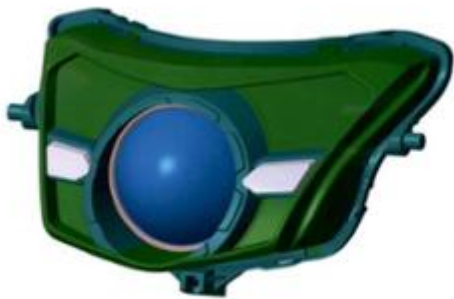

1.1

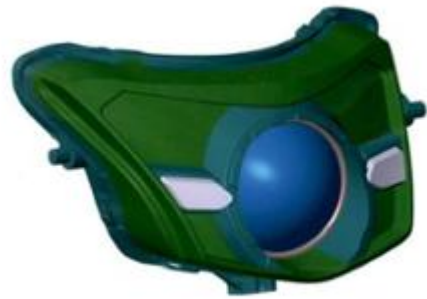

1.2

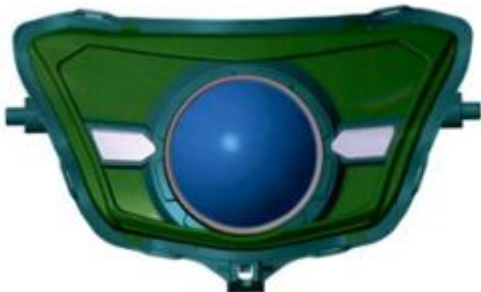

1.3



1.4



1.5



1.6



1.7



1.8



2.1



2.2



2.3



2.4



2.5



2.6



2.7



2.8

CÔNG BÁO SỞ HỮU CÔNG NGHIỆP SỐ 437 TẬP A – QUYỀN 2 (08.2024)

(11) **51233**

(21) 3-2024-01389

(28) 1

(54) **CỤM ĐÈN TRƯỚC XE MÁY**

(51) **26-06**

(22) 17/06/2024

(43) 26/08/2024

(73) **CÔNG TY TNHH SẢN XUẤT - THƯƠNG MẠI - DỊCH VỤ ĐÀI PHONG (VN)**
Số 382 đường số 1, phường Bình Trị Đông B, quận Bình Tân, thành phố Hồ Chí Minh

(72) Hà Quảng Chánh (VN)

(74) Công ty TNHH Tư vấn sở hữu trí tuệ Việt (VIET IP CO.,LTD.)

(55)



1.1



1.2

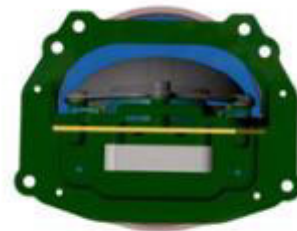

1.3

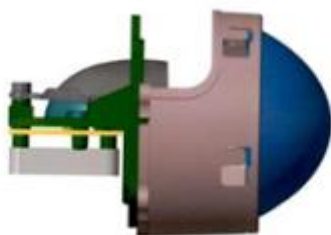

1.4

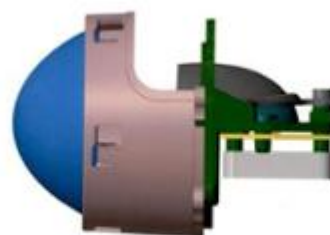

1.5



1.6

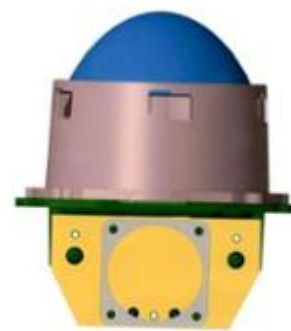

1.7

CÔNG BÁO SỞ HỮU CÔNG NGHIỆP SỐ 437 TẬP A – QUYỀN 2 (08.2024)

- (11) **51234**
(21) 3-2024-01393 (28) 1
(54) **NHÃN SẢN PHẨM** (51) **19-08**
(22) 17/06/2024 (43) 26/08/2024
(73) **CÔNG TY CỔ PHẦN NƯỚC GIẢI KHÁT SANEST KHÁNH HÒA (VN)**
Quốc lộ 1A, thôn Mỹ Thanh, xã Cam Thịnh Đông, thành phố Cam Ranh, tỉnh
Khánh Hòa
(72) Lê Đức Tiến (VN)
(74) Công ty TNHH Tư vấn sở hữu trí tuệ Việt (VIET IP CO.,LTD.)
(55)



1.1



1.2

CÔNG BÁO SỞ HỮU CÔNG NGHIỆP SỐ 437 TẬP A – QUYỀN 2 (08.2024)

- (11) **51235**
(21) 3-2024-01395 (28) 1
(54) **BAO GÓI** (51) **09-05**
(22) 17/06/2024 (43) 26/08/2024
(73) **CÔNG TY CỔ PHẦN KEM 35 (VN)**
Thôn 5, xã Yên Bình, huyện Thạch Thất, thành phố Hà Nội
(72) Hoàng Văn Nhật (VN)
(74) Công ty TNHH Sở hữu trí tuệ HA VIP (HAVIP CO., LTD.)
(55)



1.1



1.2

CÔNG BÁO SỞ HỮU CÔNG NGHIỆP SỐ 437 TẬP A – QUYỀN 2 (08.2024)

- (11) **51236**
- (21) 3-2024-01397 (28) 1
- (54) **NHÃN SẢN PHẨM** (51) **19-08**
- (22) 18/06/2024 (43) 26/08/2024
- (73) **CÔNG TY CỔ PHẦN TẬP ĐOÀN THAICOM (VN)**
Thôn Ngọc Lịch, xã Trung Trắc, huyện Văn Lâm, tỉnh Hưng Yên
- (72) Trần Văn Khanh (VN)
- (55)



CÔNG BÁO SỞ HỮU CÔNG NGHIỆP SỐ 437 TẬP A – QUYỀN 2 (08.2024)

- (11) **51237**
(21) 3-2024-01398 (28) 1
(54) **BÌNH CHỨA** (51) **09-01**
(22) 18/06/2024 (43) 26/08/2024
(30) 2024-000538 15/01/2024 JP;
(73) **EARTH CORPORATION (JP)**
12-1, Kanda-Tsukasamachi 2-chome, Chiyoda-ku, Tokyo, Japan
(72) 1. KENGO TAKAHATA (JP)
2. YUYA SUZUKI (JP)
3. KYOICHI YAHAGI (JP)
(74) Công ty Luật TNHH Phạm và Liên danh (PHAM & ASSOCIATES)
(55)



1.1



1.2



1.3



1.4

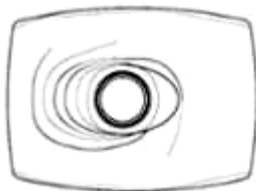

1.5



1.6



1.7



1.8



1.9



1.10



1.11

CÔNG BÁO SỞ HỮU CÔNG NGHIỆP SỐ 437 TẬP A – QUYỀN 2 (08.2024)

- (11) **51238**
(21) 3-2024-01407 (28) 1
(54) **THIẾT BỊ CẢM ỨNG** (51) **23-04**
(22) 18/06/2024 (43) 26/08/2024
(30) 2023-026674 22/12/2023 JP;
(73) 1. **OBAYASHI CORPORATION** (JP)
2-15-2, Konan, Minato-ku, Tokyo 1088502, Japan
2. **KYORITSU AIR TECH INC.** (JP)
7-1, Wada 5-chome, Sasaguri-machi, Kasuya-gun, Fukuoka 8112414 Japan
(72) 1. WADA, HAJIME (JP)
2. NAKAYAMA, KAZUKI (JP)
3. KATO, HIROKI (JP)
4. KATO, TAKAYA (JP)
5. SHIGEMATSU, TAKUYA (JP)
6. KOBAYASHI, TAKAYUKI (JP)
7. NAMBU, KENTA (JP)
(74) Công ty TNHH Tầm nhìn và Liên danh (VISION & ASSOCIATES CO.LTD.)
(55)

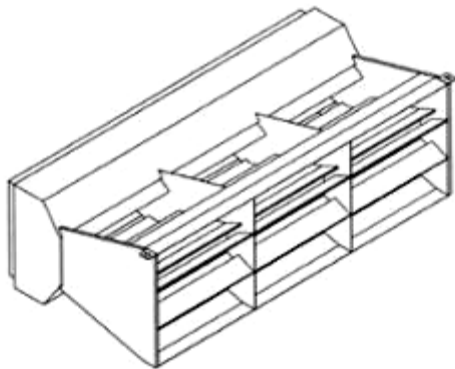

1.1

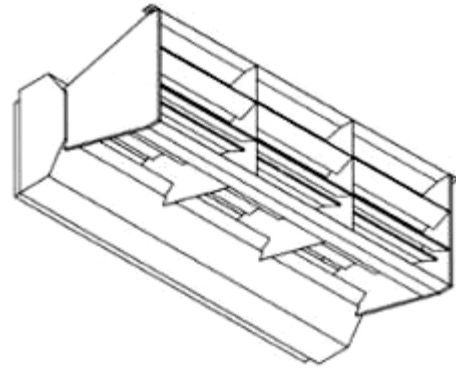

1.2

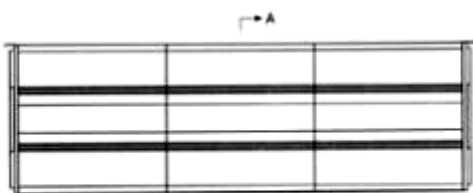

1.3



1.4

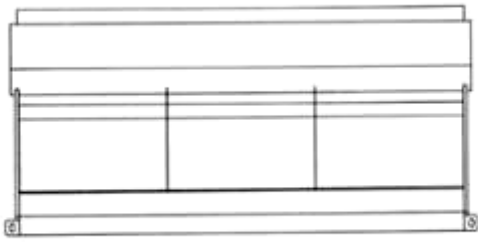

1.5

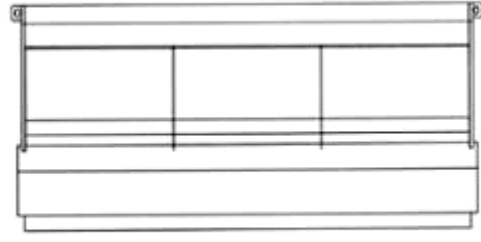

1.6

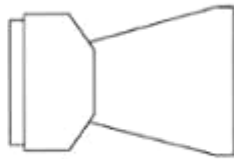

1.7

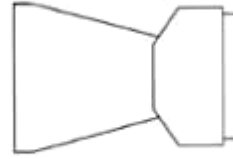

1.8

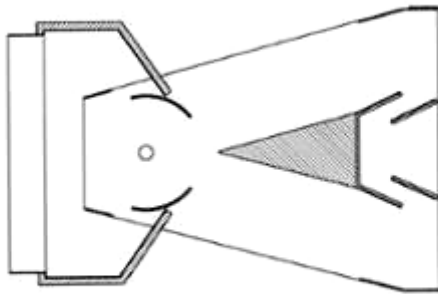

1.9

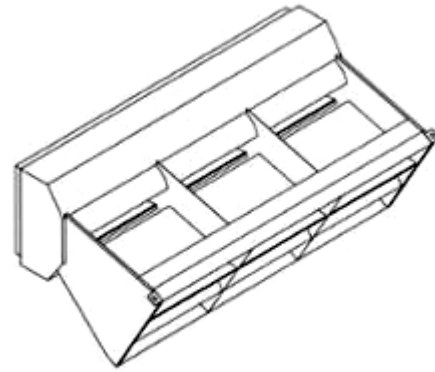

1.10

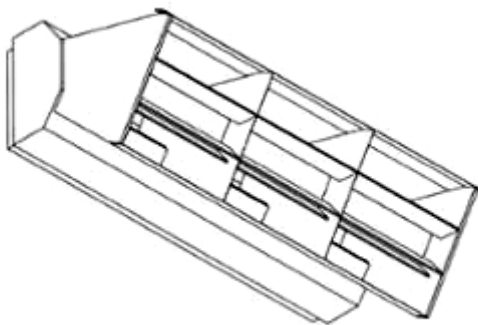

1.11

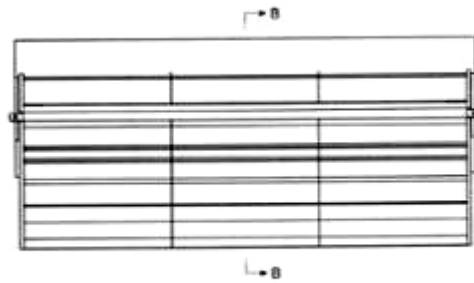

1.12



1.13

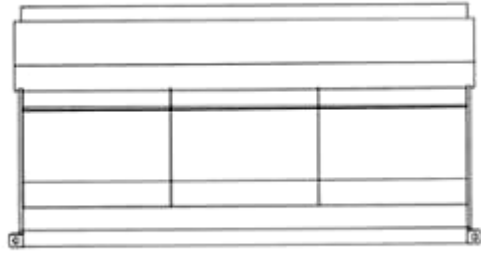

1.14



1.15

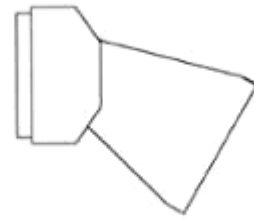

1.16

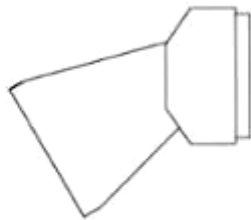

1.17

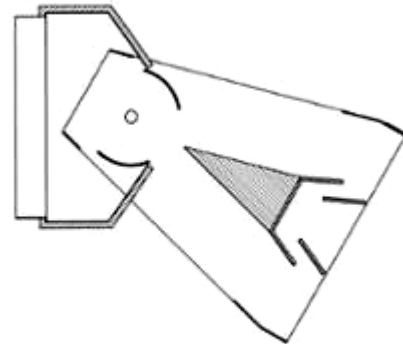

1.18

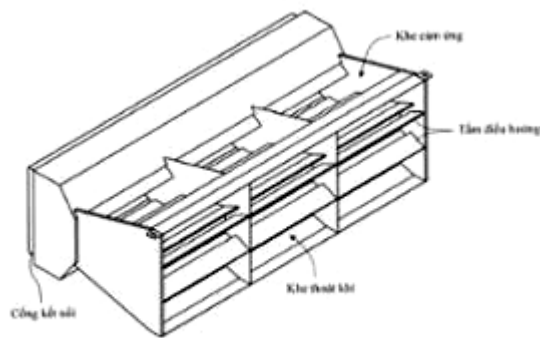

1.19

- (11) **51239**
(21) 3-2024-01414 (28) 1
(54) **LỚP XE** (51) **12-15**
(22) 19/06/2024 (43) 26/08/2024
(73) **CHENG SHIN RUBBER IND. CO., LTD. (TW)**
No. 215, Meigang Rd., Dacun Township, Changhua County 515, Taiwan
(72) 1. CHIA-FONG CHANG (TW)
2. YI-HSIN CHEN (TW)
(74) Công ty Cổ phần Sở hữu công nghiệp INVESTIP (INVESTIP)
(55)



1.1

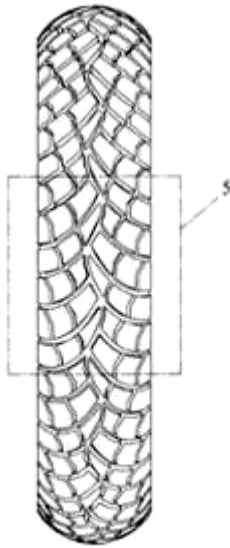

1.2

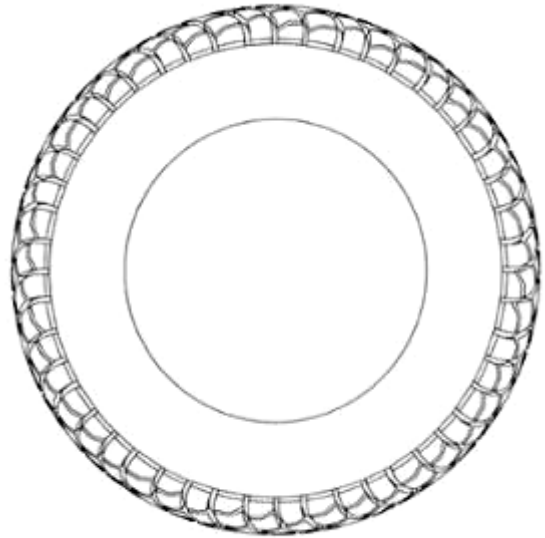

1.3

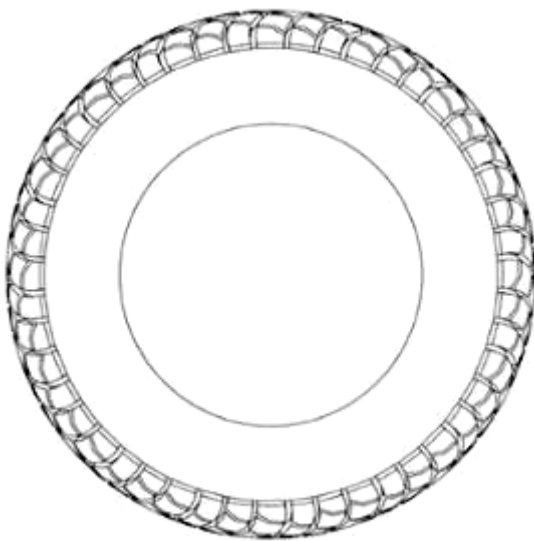

1.4

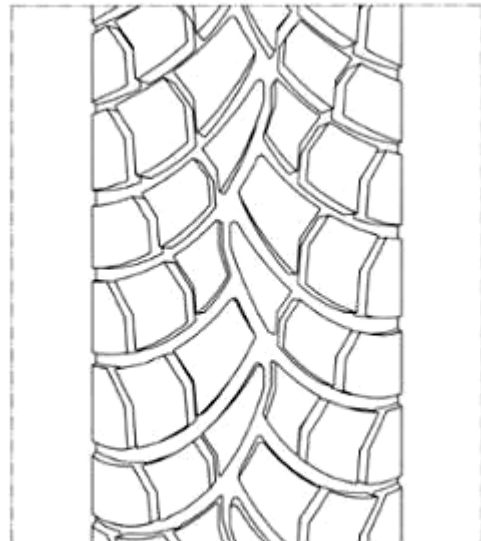

1.5

- (11) **51240**
(21) 3-2023-03122 (28) 1
(54) **DỤNG CỤ CHĂM SÓC DA** (51) **28-03**
(22) 22/12/2023 (43) 26/08/2024
(30) 2023-013253 28/06/2023 JP;
(73) **MTG CO., LTD. (JP)**
2-32 Honjin-tori, Nakamura-ku, Nagoya-shi, Aichi 4530041, Japan
(72) 1. KEI ITO (JP)
2. TAKAYUKI NAKAGAWA (JP)
(74) CÔNG TY LUẬT TRÁCH NHIỆM HỮU HẠN AMBYS HÀ NỘI (AMBYS HANOI)
(55)

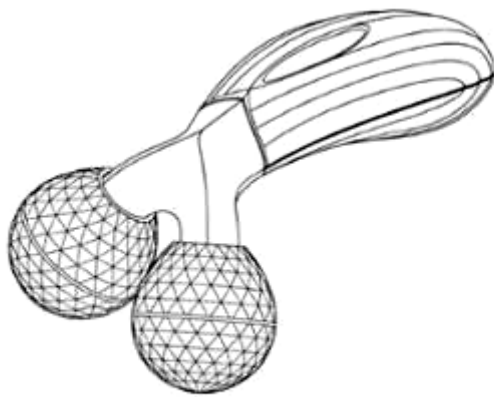

1.1

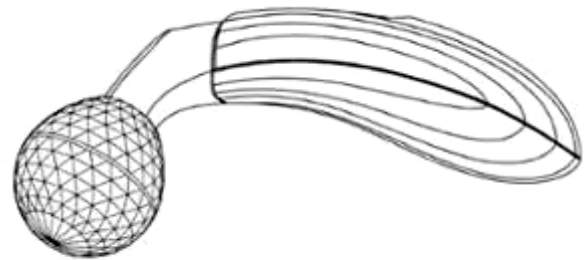

1.2

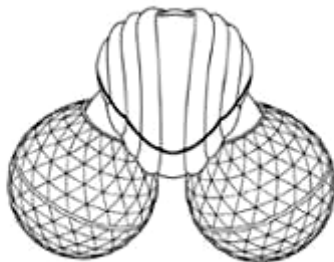

1.3



1.4

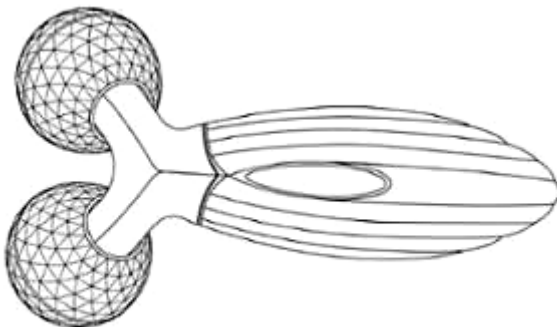

1.5

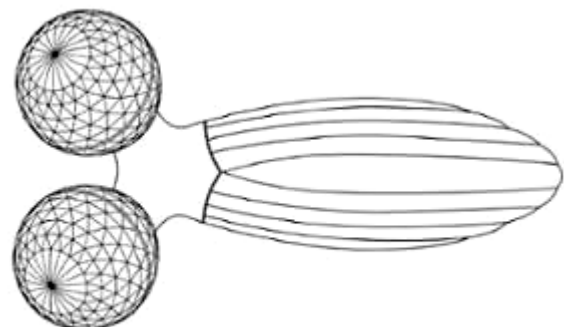

1.6

CÔNG BÁO SỞ HỮU CÔNG NGHIỆP SỐ 437 TẬP A – QUYỀN 2 (08.2024)

- (11) **51241**
(21) 3-2024-01277 (28) 1
(54) **NHÃN SẢN PHẨM** (51) **19-08**
(22) 03/06/2024 (43) 26/08/2024
(73) **CÔNG TY TNHH SẢN XUẤT VÀ THƯƠNG MẠI NÔNG SẢN THÁI THUẬN - NINH THUẬN (VN)**
Thôn Lương Cang 2, xã Nhơn Sơn, huyện Ninh Sơn, tỉnh Ninh Thuận
(72) Nguyễn Đình Quang (VN)
(55)



CÔNG BÁO SỞ HỮU CÔNG NGHIỆP SỐ 437 TẬP A – QUYỀN 2 (08.2024)

- (11) **51242**
(21) 3-2024-01285 (28) 1
(54) **CHAI** (51) **09-01**
(22) 04/06/2024 (43) 26/08/2024
(73) **CÔNG TY TNHH THỰC PHẨM NGUỒN XANH (VN)**
28/57 đường số 18, phường Bình Hưng Hòa, quận Bình Tân, thành phố Hồ Chí Minh
(72) Đặng Thị Yên (VN)
(55)



1.1



1.2



1.3



1.4



1.5



1.6



1.7

CÔNG BÁO SỞ HỮU CÔNG NGHIỆP SỐ 437 TẬP A – QUYỀN 2 (08.2024)

- (11) **51243**
(21) 3-2024-01287 (28) 1
(54) **HỘP THUỐC** (51) **09-03**
(22) 04/06/2024 (43) 26/08/2024
(73) **TRẦN THỊ HIỀN (VN)**
Phòng 409, Chung cư An Lạc, đường Lưu Hữu Phước, phường Cầu Diễn, quận
Nam Từ Liêm, thành phố Hà Nội
(72) Trần Thị Hiền (VN)
(55)



1.1



1.2

CÔNG BÁO SỞ HỮU CÔNG NGHIỆP SỐ 437 TẬP A – QUYỀN 2 (08.2024)

- (11) **51244**
- (21) 3-2024-01289 (28) 1
- (54) **NHÃN SẢN PHẨM** (51) **19-08**
- (22) 04/06/2024 (43) 26/08/2024
- (73) **CÔNG TY TNHH SẢN XUẤT PHÂN BÓN HỮU CƠ SINH HỌC NÔNG THỊNH PHÁT (VN)**
Tổ 16, ấp 2, xã Mỹ Hiệp, huyện Cao Lãnh, tỉnh Đồng Tháp
- (72) Nguyễn Thành Trung (VN)
- (74) Công ty Luật TNHH AGL (AGL LAW)
- (55)



CÔNG BÁO SỞ HỮU CÔNG NGHIỆP SỐ 437 TẬP A – QUYỀN 2 (08.2024)

- (11) **51245**
(21) 3-2023-01957 (28) 1
(54) **CỤM YÊN NGỒI PHÍA SAU XE GẮN MÁY** (51) **12-16**
(22) 22/08/2023 (43) 26/08/2024
(73) **CÔNG TY CỔ PHẦN SẢN XUẤT VÀ THƯƠNG MẠI ĐỨC MINH (VN)**
Thôn Nhuận Tháp, xã Phụng Công, huyện Văn Giang, tỉnh Hưng Yên
(72) Nghiêm Xuân Minh (VN)
(55)



1.1



1.2



1.3



1.4



1.5



1.6



1.7

CÔNG BÁO SỞ HỮU CÔNG NGHIỆP SỐ 437 TẬP A – QUYỀN 2 (08.2024)

- (11) **51246**
(21) 3-2023-01958 (28) 1
(54) **CỤM ỐP BẢO VỆ PHÍA TRƯỚC XE GẮN MÁY** (51) **12-16**
(22) 22/08/2023 (43) 26/08/2024
(73) **CÔNG TY CỔ PHẦN SẢN XUẤT VÀ THƯƠNG MẠI ĐỨC MINH (VN)**
Thôn Nhuận Tháp, xã Phụng Công, huyện Văn Giang, tỉnh Hưng Yên
(72) Nghiêm Xuân Minh (VN)
(55)



1.1



1.2



1.3



1.4



1.5



1.6



1.7

CÔNG BÁO SỞ HỮU CÔNG NGHIỆP SỐ 437 TẬP A – QUYỀN 2 (08.2024)

- (11) **51247**
(21) 3-2023-02085 (28) 1
(54) **THIẾT BỊ HÀN KHÒ GIA NHIỆT** (51) **15-09**
(22) 31/08/2023 (43) 26/08/2024
(73) **CÔNG TY CỔ PHẦN CÔNG NGHỆ WELGUN (VN)**
Tầng 01, số 04 đường Nguyễn Thị Minh Khai, phường Đa Kao, quận 1, thành phố Hồ Chí Minh
(72) Lê Bảo Quốc (VN)
(74) Công ty TNHH Dịch vụ thương mại và sở hữu công nghiệp Song Ngọc (I.P.T.S.)
(55)



1.1



1.2



1.3



1.4



1.5



1.6



1.7

CÔNG BÁO SỞ HỮU CÔNG NGHIỆP SỐ 437 TẬP A – QUYỀN 2 (08.2024)

- (11) **51248**
(21) 3-2024-00506 (28) 1
(54) **CHAI** (51) **09-01**
(22) 04/03/2024 (43) 26/08/2024
(73) **CÔNG TY TNHH KIM LÂM (VN)**
Lô A2.CN7 - Cụm công nghiệp tập trung vừa và nhỏ Từ Liêm, phường Phương Canh, quận Nam Từ Liêm, thành phố Hà Nội
(72) Võ Thị Liễu Trâm (VN)
(55)



1.1



1.2



1.3



1.4



1.5

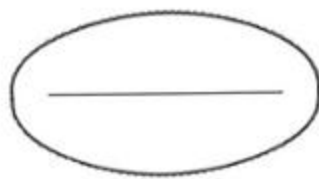

1.7

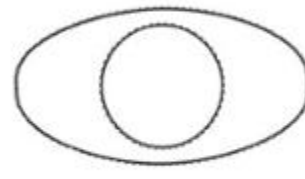

1.6

CÔNG BÁO SỞ HỮU CÔNG NGHIỆP SỐ 437 TẬP A – QUYỀN 2 (08.2024)

- (11) **51249**
(21) 3-2024-00537 (28) 1
(54) **CHAI** (51) **09-01**
(22) 05/03/2024 (43) 26/08/2024
(73) **CÔNG TY CỔ PHẦN HÀNG TIÊU DÙNG MASAN (VN)**
Số 23 Lê Duẩn, phường Bến Nghé, quận 1, thành phố Hồ Chí Minh
(72) Nguyễn Hoàng Yên (VN)
(74) Công ty cổ phần Sở hữu trí tuệ BROSS và Cộng sự (BROSS & PARTNERS., JSC)
(55)



1.1



1.2



1.3



1.4



1.5



1.6



1.7

CÔNG BÁO SỞ HỮU CÔNG NGHIỆP SỐ 437 TẬP A – QUYỀN 2 (08.2024)

(11) **51250**

(21) 3-2024-01452

(28) 1

(54) **BÌNH GIỮ NHIỆT**

(51) **07-07**

(22) 24/06/2024

(43) 26/08/2024

(73) **CÔNG TY CỔ PHẦN BÓNG ĐÈN PHÍCH NƯỚC RẠNG ĐÔNG (VN)**

87-89 phố Hạ Đình, phường Thanh Xuân Trung, quận Thanh Xuân, thành phố Hà Nội

(72) Trần Trung Tường (VN)

(55)

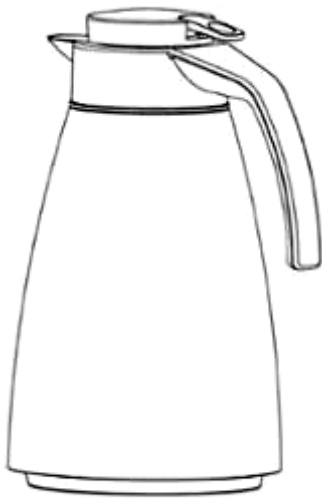

1.1

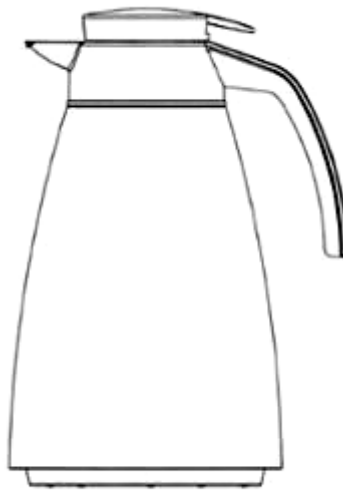

1.2

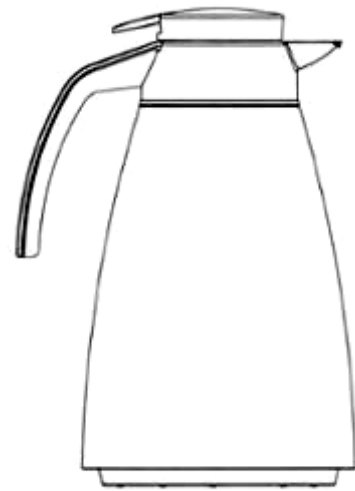

1.3

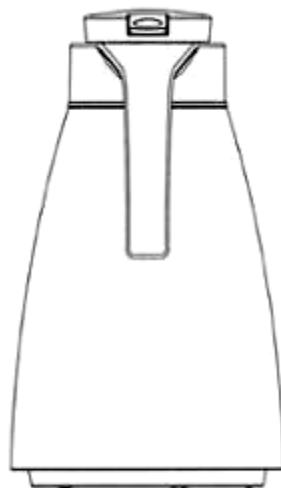

1.4



1.5

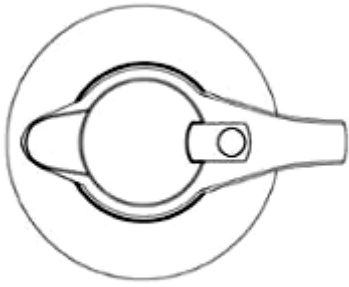

1.6

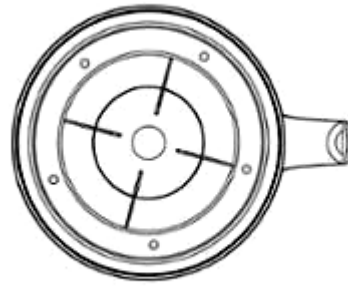

1.7

CÔNG BÁO SỞ HỮU CÔNG NGHIỆP SỐ 437 TẬP A – QUYỀN 2 (08.2024)

- (11) **51251**
(21) 3-2024-01516 (28) 1
(54) **PHỔ KẾ HUỖNH QUANG TIA X** (51) **10-04**
(22) 28/06/2024 (43) 26/08/2024
(73) **PURERAY INSTRUMENT CO., LTD. (CN)**
10th floor, No.2 Building, No.128 Shangnan East Road, Huangpu Community,
Xinqiao Street, Baoan District, Shenzhen City, China
(72) Bo Shao (CN)
(74) Công ty TNHH Dịch vụ Sở hữu trí tuệ GREENIP (GREENIP CO., LTD)
(55)



1.1



1.2



1.3



1.4



1.5



1.6



1.7



1.8

CÔNG BÁO SỞ HỮU CÔNG NGHIỆP SỐ 437 TẬP A – QUYỀN 2 (08.2024)

(11) **51252**

(21) 3-2024-01548

(28) 1

(54) **TỦ**

(51) **06-04**

(22) 03/07/2024

(43) 26/08/2024

(73) **CÔNG TY CỔ PHẦN SEMA GROUP (VN)**

Số 69, đường 23, khu đô thị thành phố Giao lưu, phường Cổ Nhuế 1, quận Bắc Từ Liêm, thành phố Hà Nội

(72) 1. NGUYỄN PHƯƠNG CHI (VN)

2. NGUYỄN ĐÌNH PHÚC (VN)

3. TRẦN VĂN LINH (VN)

(74) Công ty TNHH NACILAW (NACILAW)

(55)



1.1



1.2



1.3



1.4



1.5



1.6

CÔNG BÁO SỞ HỮU CÔNG NGHIỆP SỐ 437 TẬP A – QUYỀN 2 (08.2024)

- (11) **51253**
- (21) 3-2024-01420 (28) 1
- (54) **NHÃN SẢN PHẨM** (51) **19-08**
- (22) 20/06/2024 (43) 26/08/2024
- (73) **CÔNG TY CỔ PHẦN SẢN XUẤT & THƯƠNG MẠI CÁT TƯỜNG GROUP (VN)**
Thôn An Lộc, xã Đồng Sơn, huyện Nam Trực, tỉnh Nam Định
- (72) Nguyễn Văn Chính (VN)
- (74) **CÔNG TY TNHH SỞ HỮU TRÍ TUỆ SETHACO (SETHACO IP CO.,LTD)**
- (55)



CÔNG BÁO SỞ HỮU CÔNG NGHIỆP SỐ 437 TẬP A – QUYỀN 2 (08.2024)

- (11) **51254**
(21) 3-2024-01423 (28) 1
(54) **HỮ** (51) **09-01**
(22) 20/06/2024 (43) 26/08/2024
(73) **CÔNG TY CỔ PHẦN HÀNG TIÊU DÙNG MASAN (VN)**
Số 23 Lê Duẩn, phường Bến Nghé, quận 1, thành phố Hồ Chí Minh
(72) Nguyễn Hoàng Yên (VN)
(74) Công ty cổ phần Sở hữu trí tuệ BROSS và Cộng sự (BROSS & PARTNERS., JSC)
(55)

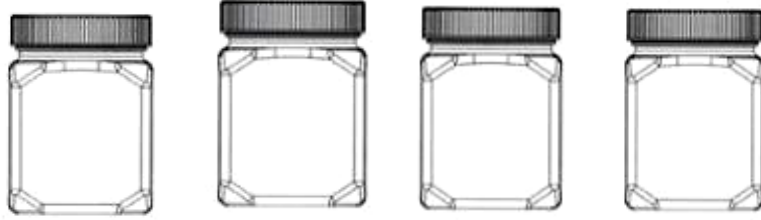

1.1

1.2

1.3

1.4

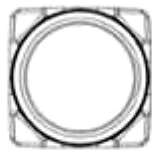

1.5

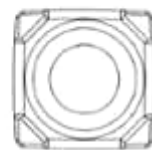

1.6

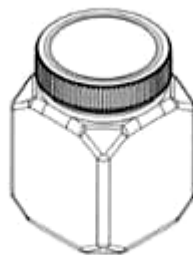

1.7

CÔNG BÁO SỞ HỮU CÔNG NGHIỆP SỐ 437 TẬP A – QUYỀN 2 (08.2024)

- (11) **51255**
(21) 3-2024-01067 (28) 1
(54) **HỘP ĐỰNG BÁNH** (51) **09-03**
(22) 08/05/2024 (43) 26/08/2024
(73) **CÔNG TY CỔ PHẦN THƯƠNG MẠI XÂY DỰNG RỒNG VÀNG MINH NGỌC (VN)**
Khu 6 phường Cẩm Thượng, thành phố Hải Dương, tỉnh Hải Dương
(72) Thái Thị Vân Anh (VN)
(74) Công ty TNHH Sở hữu trí tuệ M.I.T (M.I.T IP CO., LTD)
(55)



1.1

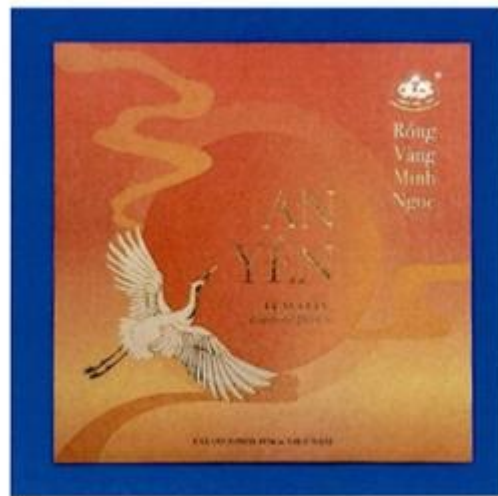

1.2



1.3



1.4



1.5



1.6



1.7

CÔNG BÁO SỞ HỮU CÔNG NGHIỆP SỐ 437 TẬP A – QUYỀN 2 (08.2024)

- (11) **51256**
(21) 3-2024-01101 (28) 1
(54) **THANH NHÔM ĐỊNH HÌNH** (51) **25-01**
(22) 13/05/2024 (43) 26/08/2024
(73) **CÔNG TY CỔ PHẦN ĐẦU TƯ VÀ THƯƠNG MẠI QUEENViet (VN)**
Tầng 1, số 530 đường Trường Chinh, phường Ngã Tư Sở, quận Đống Đa, thành phố Hà Nội
(72) Nguyễn Mạnh Cường (VN)
(74) Công ty Luật TNHH SMARTLAW (SMARTLAW LEGAL SERVICE CO.,LTD.)
(55)



1.1



1.2



1.3



1.4



1.5



1.6



1.7

CÔNG BÁO SỞ HỮU CÔNG NGHIỆP SỐ 437 TẬP A – QUYỀN 2 (08.2024)

- (11) **51257**
(21) 3-2024-01105 (28) 1
(54) **HỘP ĐỰNG** (51) **09-03**
(22) 14/05/2024 (43) 26/08/2024
(30) 30-2023-0050677 12/12/2023 KR;
(73) 1. **HAOREN TECH CO.,LTD.** (KR)
(Dohwa-dong, teuin techno 6) # 103 B dong, 103, Yeomjeon-ro, Michuhol-gu,
Incheon, Republic of Korea (Postal code : 22107)
2. **KIM, JONG BAE** (KR)
302ho 105 dong Daerim Apt, Yeonsu-3dong, Yeonsu-gu, Incheon, Republic of
Korea
(72) KIM, Jong Bae (KR)
(74) Công ty TNHH Đại Tín và Liên Danh (DAITIN AND ASSOCIATES CO.,LTD)
(55)



1.1



1.2

CÔNG BÁO SỞ HỮU CÔNG NGHIỆP SỐ 437 TẬP A – QUYỀN 2 (08.2024)

- (11) **51258**
(21) 3-2024-01522 (28) 1
(54) **HỆ THỐNG ĐO KHÍ NHÀ KÍNH** (51) **10-04**
(22) 01/07/2024 (43) 26/08/2024
(73) **CÔNG TY CỔ PHẦN RYNAN TECHNOLOGIES VIETNAM (VN)**
Áp Long Trị, xã Long Đức, thành phố Trà Vinh, tỉnh Trà Vinh
(72) 1. NGUYỄN THANH MỸ (VN)
2. HỒNG QUỐC CƯỜNG (VN)
3. LÊ THANH TRIỀU (VN)
4. TRẦN QUỐC TOẢN (VN)
5. VÕ VŨ KHANH (VN)
6. NGUYỄN HỮU ĐỨC (VN)
(74) Công ty TNHH Đại Tín và Liên Danh (DAITIN AND ASSOCIATES CO.,LTD)
(55)

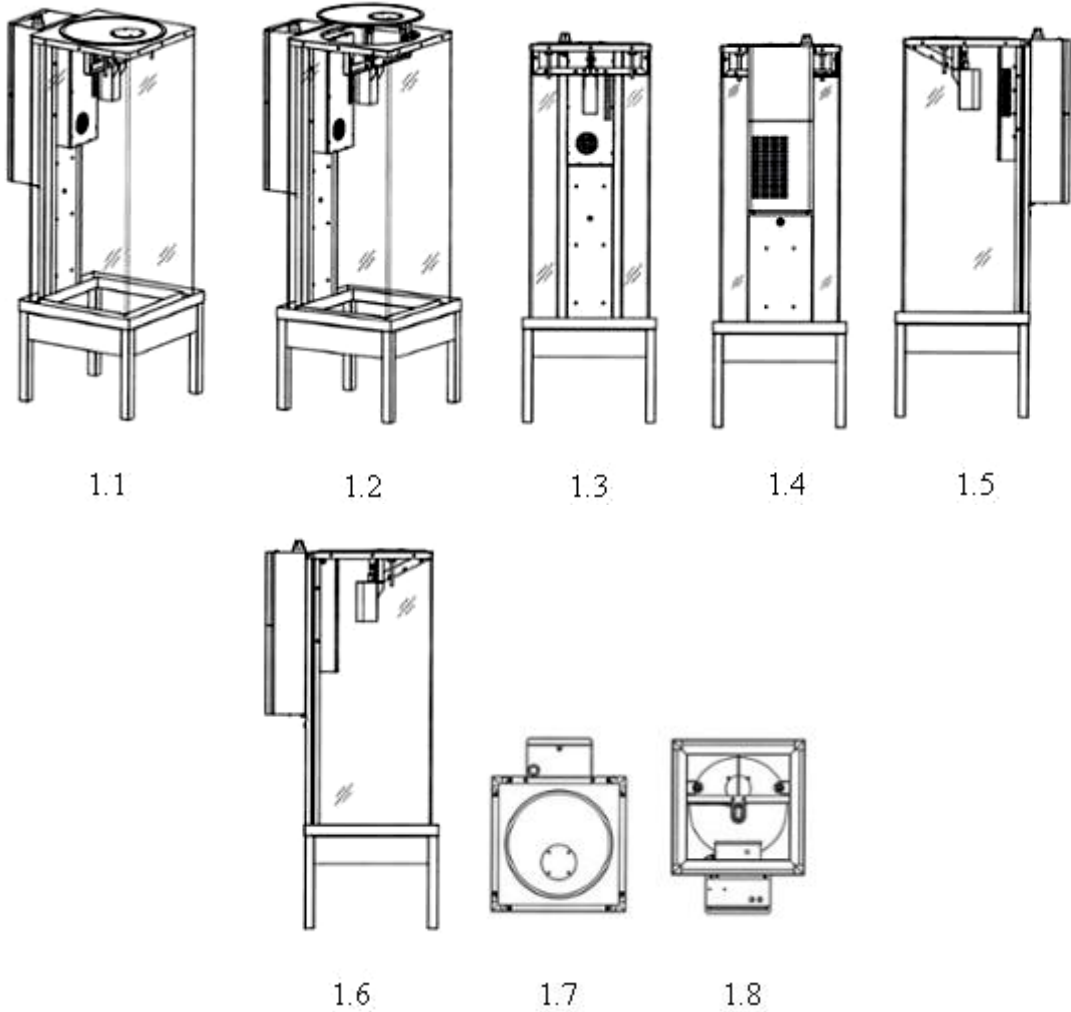

CÔNG BÁO SỞ HỮU CÔNG NGHIỆP SỐ 437 TẬP A – QUYỀN 2 (08.2024)

- (11) **51259**
(21) 3-2024-01555 (28) 1
(54) **NHÃN SẢN PHẨM** (51) **19-08**
(22) 04/07/2024 (43) 26/08/2024
(73) **CÔNG TY TNHH SƠN KOVA (VN)**
Đường CN6, cụm công nghiệp Từ Liêm, phường Minh Khai, quận Bắc Từ Liêm,
thành phố Hà Nội
(72) Ngô Sỹ Quang (VN)
(74) Công ty Luật TNHH VIETTHINK (VIETTHINK LAW FIRM)
(55)



1.1



1.2

CÔNG BÁO SỞ HỮU CÔNG NGHIỆP SỐ 437 TẬP A – QUYỀN 2 (08.2024)

- (11) **51260**
(21) 3-2024-01556 (28) 1
(54) **NHÃN SẢN PHẨM** (51) **19-08**
(22) 04/07/2024 (43) 26/08/2024
(73) **CÔNG TY TNHH SƠN KOVA (VN)**
Đường CN6, cụm công nghiệp Từ Liêm, phường Minh Khai, quận Bắc Từ Liêm,
thành phố Hà Nội
(72) Ngô Sỹ Quang (VN)
(74) Công ty Luật TNHH VIETTHINK (VIETTHINK LAW FIRM)
(55)



1.1



1.2

CÔNG BÁO SỞ HỮU CÔNG NGHIỆP SỐ 437 TẬP A – QUYỀN 2 (08.2024)

- (11) **51261**
(21) 3-2024-01557 (28) 2
(54) **NHÃN SẢN PHẨM** (51) **19-08**
(22) 04/07/2024 (43) 26/08/2024
(73) **CÔNG TY TNHH SƠN KOVA (VN)**
Đường CN6, cụm công nghiệp Từ Liêm, phường Minh Khai, quận Bắc Từ Liêm,
thành phố Hà Nội
(72) Ngô Sỹ Quang (VN)
(74) Công ty Luật TNHH VIETTHINK (VIETTHINK LAW FIRM)
(55)



1.1

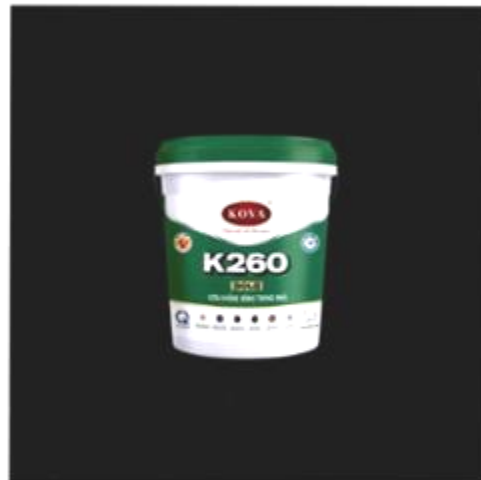

1.2



2.1

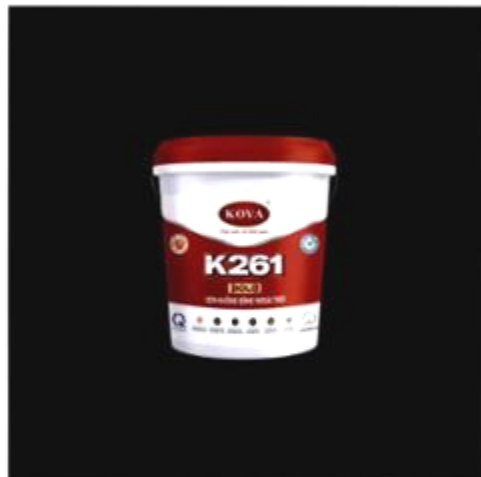

2.2

CÔNG BÁO SỞ HỮU CÔNG NGHIỆP SỐ 437 TẬP A – QUYỀN 2 (08.2024)

- (11) **51262**
(21) 3-2024-01558 (28) 1
(54) **NHÃN SẢN PHẨM** (51) **19-08**
(22) 04/07/2024 (43) 26/08/2024
(73) **CÔNG TY TNHH SƠN KOVA (VN)**
Đường CN6, cụm công nghiệp Từ Liêm, phường Minh Khai, quận Bắc Từ Liêm,
thành phố Hà Nội
(72) Ngô Sỹ Quang (VN)
(74) Công ty Luật TNHH VIETTHINK (VIETTHINK LAW FIRM)
(55)



1.1



1.2

CÔNG BÁO SỞ HỮU CÔNG NGHIỆP SỐ 437 TẬP A – QUYỀN 2 (08.2024)

- (11) **51263**
(21) 3-2024-01288 (28) 2
(54) **GHẾ** (51) **06-01**
(22) 04/06/2024 (43) 26/08/2024
(73) **CÔNG TY TNHH SẢN XUẤT THƯƠNG MẠI DỊCH VỤ QUI PHÚC (VN)**
217 Bình Long, phường Bình Hưng Hòa A, quận Bình Tân, thành phố Hồ Chí Minh
(72) Nguyễn Thanh Hải (VN)
(74) Công ty TNHH Sở hữu trí tuệ Thảo Thọ Quyển (INVENCO.,LTD)
(55)



1.1



1.2



1.3



1.4



1.5



1.6



1.7



2.1



2.2



2.3



2.4



2.5



2.6



2.7

CÔNG BÁO SỞ HỮU CÔNG NGHIỆP SỐ 437 TẬP A – QUYỀN 2 (08.2024)

- (11) **51264**
(21) 3-2024-01515 (28) 2
(54) **XE Ô TÔ** (51) **12-08**
(22) 28/06/2024 (43) 26/08/2024
(30) 202430016679.8 10/01/2024 CN;
(73) **BYD COMPANY LIMITED (CN)**
No. 3009, BYD Road, Pingshan, Shenzhen, Guangdong 518118, China
(72) 1. LIAN, YUBO (CN)
2. EGGER, WOLFGANG JOSEF (DE)
3. PAN, ZILIN (CN)
4. LI, QIUHONG (CN)
5. ZHU, DONGER (CN)
(74) Công ty TNHH Sở hữu trí tuệ Thảo Thọ Quyển (INVENCO.,LTD)
(55)



1.1



1.2



1.3



1.4



1.5



1.6



1.7



2.1



2.2



2.3



2.4



2.5

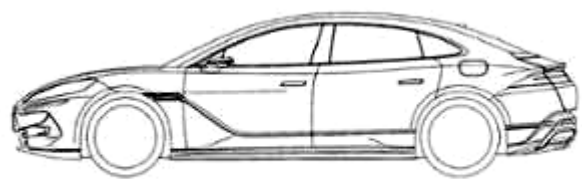

2.6

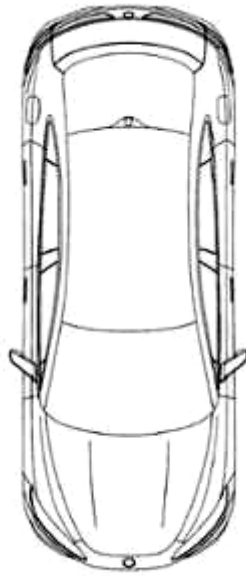

2.7

CÔNG BÁO SỞ HỮU CÔNG NGHIỆP

Do Cục Sở hữu trí tuệ thuộc Bộ Khoa học và Công nghệ ấn hành theo Luật Sở hữu trí tuệ số 50/2005/QH11 được Quốc hội thông qua ngày 29 tháng 11 năm 2005 và được sửa đổi bằng Luật sửa đổi, bổ sung một số điều của Luật sở hữu trí tuệ số 50/2005/QH11 được Quốc hội thông qua ngày 19 tháng 6 năm 2009.

Địa chỉ liên hệ:

384-386 đường Nguyễn Trãi, quận Thanh Xuân,
thành phố Hà Nội, Việt Nam
ĐT: 024. 38583069
Fax: 024. 38588449