

ISSN 0868 - 2534

CỘNG HÒA XÃ HỘI CHỦ NGHĨA VIỆT NAM
BỘ KHOA HỌC VÀ CÔNG NGHỆ

CỤC SỞ HỮU TRÍ TUỆ

CÔNG BÁO
SỞ HỮU CÔNG NGHIỆP

TẬP A

QUYỂN 2: KIỂU DÁNG CÔNG NGHIỆP

07 - 2024

436

HÀ NỘI

CỘNG HOÀ XÃ HỘI CHỦ NGHĨA VIỆT NAM
BỘ KHOA HỌC VÀ CÔNG NGHỆ
CỤC SỞ HỮU TRÍ TUỆ

CÔNG BÁO
SỞ HỮU CÔNG NGHIỆP
TẬP A

QUYỀN 2: KIỂU DÁNG CÔNG NGHIỆP

07 - 2024

436

HÀ NỘI

MỤC LỤC

	Trang
<u>PHẦN I:</u> Đơn yêu cầu cấp Bằng độc quyền kiểu dáng công nghiệp	7
<u>PHẦN II:</u> Sửa đổi đơn	674

CONTENTS

<u>PART I:</u> Applications for Industrial Design Patents	7
<u>PART II:</u> Amendment of Applications	674

MÃ SỐ HAI CHỮ CÁI THỂ HIỆN TÊN NƯỚC VÀ CÁC THỰC THỂ KHÁC TRONG CÁC TƯ LIỆU SỞ HỮU CÔNG NGHIỆP THEO TIÊU CHUẨN ST3 CỦA WIPO

AE	United Arab Emirates	CN	China	HK	Hong Kong
AF	Afganistan	CO	Colombia	HN	Honduras
AG	Antihua and Barbuda	CR	Costa Rica	HR	Croatia
AI	Anguilla	CU	Cuba	HT	Haiti
AL	Albania	CV	Cape Verde	HU	Hungary
AN	Netherlands Antilles	CY	Cyprus	ID	Indonesia
AO	Angola	CZ	Czech Republic	IE	Ireland
AR	Argentina	DE	Germany	IL	Israel
AT	Austria	DJ	Djibouti	IN	India
AU	Australia	DK	Denmark	IQ	Iraq
AW	Aruba	DM	Dominica	IR	Iran (Islamic Republic of)
BB	Barbados	DO	Dominican Republic	IS	Iceland
BD	Bangladesh	DZ	Algeria	IT	Italy
BE	Belgium	EC	Ecuador	JM	Jamaica
BF	Burkina Faso	EE	Estonia	JO	Jordan
BG	Bulgaria	EG	Egypt	JP	Japan
BH	Bahrain	ES	Spain	KE	Kenya
BI	Burundi	ET	Ethiopia	KH	Cambodia
BJ	Benin	FI	Finland	KI	Kiribati
BM	Bermuda	FJ	Fiji	KM	Comoros
BN	Brunei Darussalam	FK	Falkand Islands (Malvinas)	KN	Saint Kitts and Nevis
BO	Bolivia	FR	France	KP	Democratic People's Republic of Korea
BR	Brazil	GA	Gabon	KR	Republic of Korea
BS	Bahamas	GB	United Kingdom	KW	Kuwait
BT	Bhutan	GD	Grenada	KY	Cayman Islands
BW	Botswana	GE	Georgia	KZ	Kazakhstan
BY	Belarus	GH	Ghana	LA	Laos
BZ	Belize	GI	Gibraltar	LB	Lebanon
CA	Canada	GM	Gambia	LC	Saint Lucia
CF	Central African Republic	GN	Guinea	LI	Liechtenstein
CG	Congo	GQ	Equatorial Guinea	LK	SriLanka
CH	Switzerland	GR	Greece	LR	Liberia
CI	Côte d'Ivoire	GT	Guatemala	LS	Lesotho
CL	Chile	GW	Guinea-Bissau	LT	Lithuania
CM	Cameroon	GY	Guyana	TC	Turk and Caicos Islands
LU	Luxembourg	PA	Panama	TD	Chad
LV	Latvia	PE	Peru	TG	Togo
LY	Lybya	PG	Papua New Guinea	TH	Thailand
MA	Morocco	PH	Philippines	TN	Tunisia
MC	Monaco	PK	Pakistan	TO	Tonga
MD	Republic of Moldova	PL	Poland	TR	Turkey

CÔNG BÁO SỞ HỮU CÔNG NGHIỆP SỐ 436 TẬP A - QUYỂN 2 (07.2024)

MG	Madagascar	PT	Portugal	TT	Trinidad and Tobago
ML	Mali	PY	Paraguay	TV	Tuvalu
MM	Myanmar	QA	Qatar	TW	Taiwan, Province of China
MN	Mongolia	RO	Rumania	TZ	United Republic of Tanzania
MO	Macau	RU	Russian Federation	UA	Ukraine
MR	Mauritania	RW	Rwanda	UG	Uganda
MS	Montserrat	SA	Saudi Arabia	US	United States of America
MT	Malta	SB	Solomon Islands	UY	Uruguay
MU	Mauritius	SC	Seychelles	UZ	Uzbekistan
MV	Maldives	SD	Sudan	VA	Holy see
MW	Malawi	SE	Sweden	VC	Saint Vincent and the Grenadines
MX	Mexico	SG	Singapore	VE	Venezuela
MY	Malaysia	SH	Saint Helena	VG	Virgin Islands (British)
MZ	Mozambique	SL	Slovenia	VN	Vietnam
NA	Namibia	SK	Slovakia	VU	Vanuatu
NE	Niger	SL	Sierra Leone	WS	Samoa
NG	Nigeria	SM	San Marino	YE	Yemen
NJ	Nicaragua	SN	Senegal	YU	Yugoslavia
NL	Netherlands	SO	Somalia	ZA	South Africa
NO	Norway	SR	Suriname	ZM	Zambia
NP	Nepal	ST	Sao Tome and Principe	ZR	Zaire
NR	Nauru	SV	El Sanvador	ZW	Zimbabwe
NZ	New Zealand	SY	Syria		
OM	Oman	SZ	Swaziland		

CÁC TỔ CHỨC QUỐC TẾ

AO	African Intellectual Property Organization (OAPI)
AP	African Regional Industrial Property Organization (ARIPO)
BX	Benelux Trademark Office and Benelux Designs Office
EP	European Patent Office (EPO)
IB, WO	International Bureau of the World Intellectual Property Organization (WIPO)

NHỮNG MÃ SỐ INID TRÍCH TỪ TIÊU CHUẨN ST80 CỦA TỔ CHỨC SỞ HỮU TRÍ TUỆ THẾ GIỚI (WIPO) ĐỂ NHẬN BIẾT CÁC DỮ LIỆU THƯ MỤC DÙNG CÔNG BỐ ĐƠN VÀ BẰNG ĐỘC QUYỀN KIỂU DÁNG CÔNG NGHIỆP

- (11) Số bằng độc quyền kiểu dáng công nghiệp / Số công bố đơn
- (15) Ngày cấp
- (18) Ngày hết hạn hiệu lực của bằng độc quyền kiểu dáng công nghiệp
- (21) Số đơn
- (22) Ngày nộp đơn
- (23) Tên triển lãm, ngày và nơi triển lãm
- (28) Số phương án yêu cầu bảo hộ
- (30) Số đơn ưu tiên, ngày nộp đơn ưu tiên
- (43) Ngày công bố đơn
- (45) Ngày công bố bằng độc quyền kiểu dáng công nghiệp
- (51) Phân loại quốc tế kiểu dáng công nghiệp
- (54) Tên sản phẩm mang kiểu dáng công nghiệp
- (55) Ảnh chụp / hình vẽ kiểu dáng công nghiệp
- (57) Đặc điểm khác biệt yêu cầu bảo hộ của kiểu dáng công nghiệp
- (62) Số và ngày nộp đơn, số bằng độc quyền KDCN hoặc số công bố đơn liên quan đến tách đơn
- (71) Tên và địa chỉ của người nộp đơn
- (72) Tên của tác giả KDCN
- (73) Tên, địa chỉ của chủ bằng độc quyền KDCN
- (74) Tên của người đại diện SHCN

PHẦN I

ĐƠN YÊU CẦU CẤP BẰNG ĐỘC QUYỀN KIỂU DÁNG CÔNG NGHIỆP

- (11) **50567**
(21) 3-2019-02886 (28) 3
(54) **KÍNH AN TOÀN** (51) **16-06**
(22) 13/11/2019 (43) 25/07/2024
(30) 29/692,250 23/05/2019 US;
(73) **MILWAUKEE ELECTRIC TOOL CORPORATION (US)**
13135 West Lisbon Road Brookfield, Wisconsin 53005, United States of America
(72) Casey Bonath (US)
(74) Công ty TNHH T&T INVENMARK Sở hữu trí tuệ Quốc tế (T&T INVENMARK CO., LTD.)
(55)

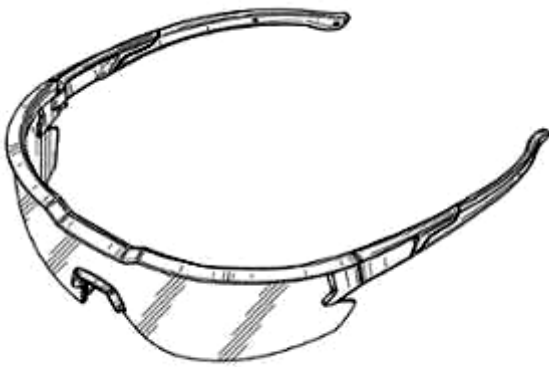

1.1

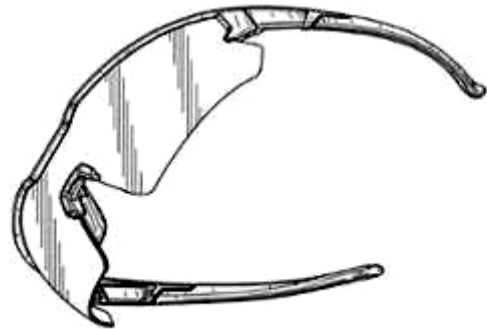

1.2

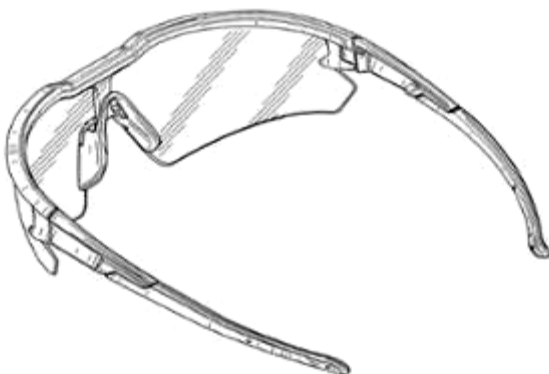

1.3



1.4



1.5



1.6



1.7



1.8



1.9



1.10



2.1



2.2



2.3



2.4



2.5



2.6

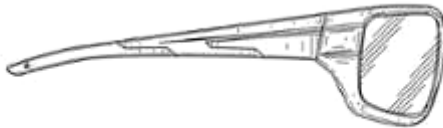

2.7

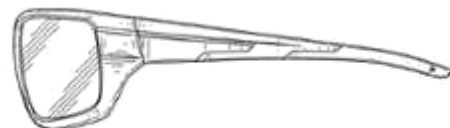

2.8



2.9



2.10



3.1

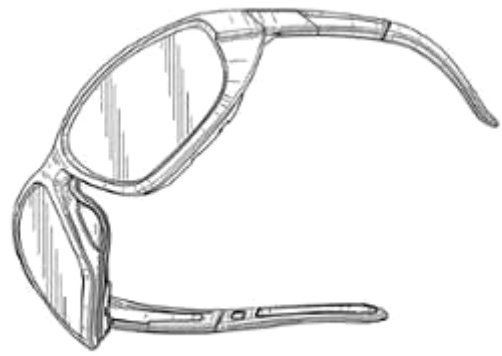

3.2

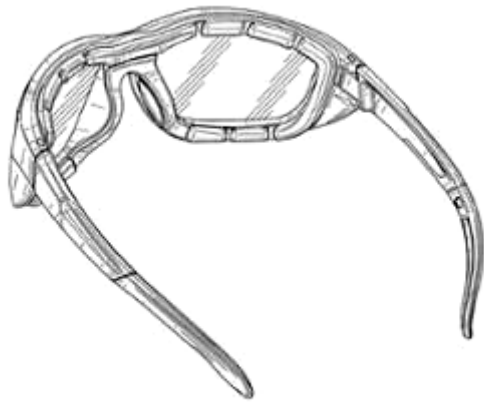

3.3



3.4



3.5



3.6

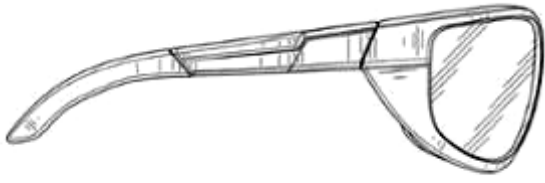

3.7



3.8



3.9



3.10

CÔNG BÁO SỞ HỮU CÔNG NGHIỆP SỐ 436 TẬP A – QUYỀN 2 (07.2024)

- (11) **50568**
(21) 3-2022-02324 (28) 1
(54) **CHAI** (51) **09-01**
(22) 26/10/2022 (43) 25/07/2024
(73) **CÔNG TY CỔ PHẦN DẦU THỰC VẬT TÂN BÌNH (VN)**
889 Trường Chinh, phường Tây Thạnh, quận Tân Phú, thành phố Hồ Chí Minh
(72) Huỳnh Trung Lập (VN)
(74) **CÔNG TY TNHH SỞ HỮU TRÍ TUỆ SETHACO (SETHACO IP CO.,LTD)**
(55)

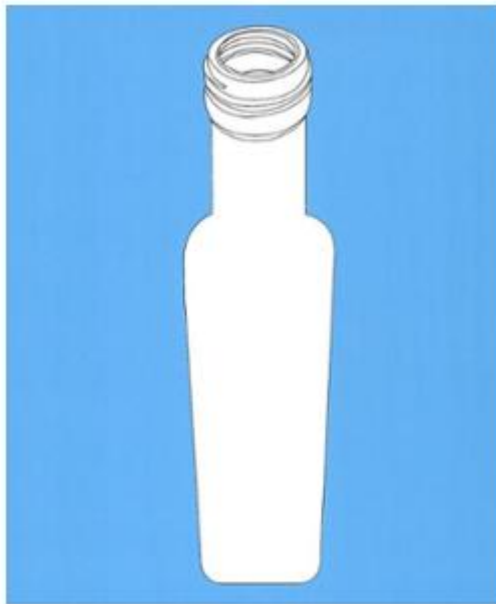

1.1



1.2



1.3



1.4



1.5



1.6



1.7

CÔNG BÁO SỞ HỮU CÔNG NGHIỆP SỐ 436 TẬP A – QUYỀN 2 (07.2024)

- (11) **50569**
(21) 3-2023-00125 (28) 1
(54) **HỆ THỐNG SẢN XUẤT VẢI KHÔNG DỆT** (51) **15-06**
(22) 12/01/2023 (43) 25/07/2024
(73) **CÔNG TY TNHH HỒ HOÀN CẦU (VN)**
Xóm 6, xã Quỳnh Văn, huyện Quỳnh Lưu, tỉnh Nghệ An
(72) Hồ Xuân Vinh (VN)
(55)



1.1



1.2

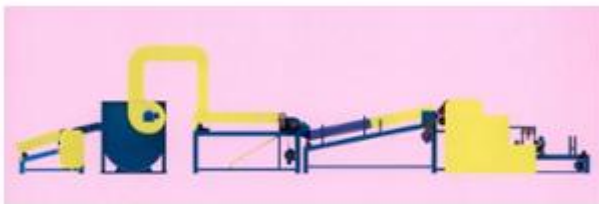

1.3

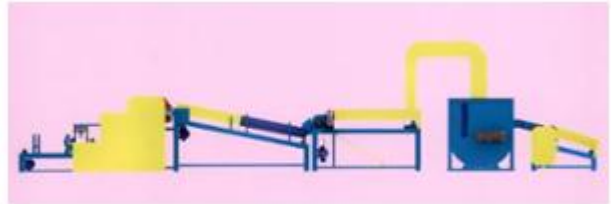

1.4

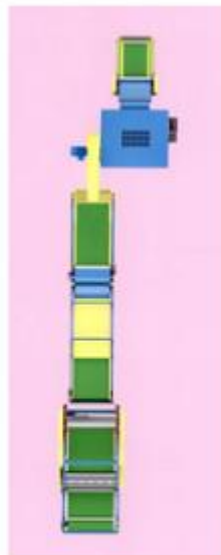

1.5



1.6



1.7



1.8

(11) **50570**

(21) 3-2023-00121

(54) **LÔNG QUẠT**

(22) 12/01/2023

(73) **CÔNG TY CỔ PHẦN GROUPE SEB VIỆT NAM (VN)**

Tầng 15, tháp B, tòa nhà Viettel, 285 Cách Mạng Tháng Tám, phường 12, quận 10, thành phố Hồ Chí Minh

(72) Phan Lê Hoàng Nam (VN)

(55)

(28) 1

(51) **23-04**

(43) 25/07/2024



1.1



1.2

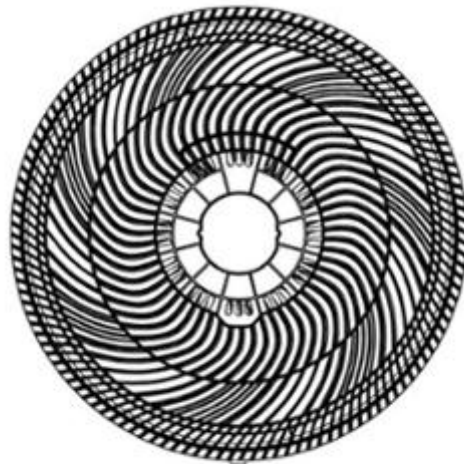

1.3



1.4

1.5

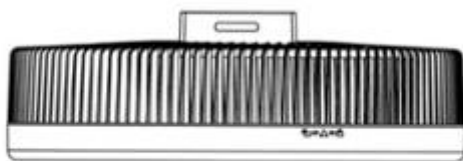

1.6

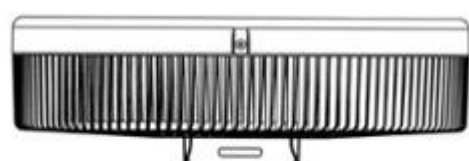

1.7

CÔNG BÁO SỞ HỮU CÔNG NGHIỆP SỐ 436 TẬP A – QUYỀN 2 (07.2024)

(11) **50571**

(21) 3-2023-02041

(28) 3

(54) **BỘ BÀN GHẾ**

(51) **06-01; 06-03**

(22) 29/08/2023

(43) 25/07/2024

(73) **CÔNG TY CỔ PHẦN LANDCO (VN)**

CH-02-19 số 2 đường 2.5 khu đô thị Gamuda Gardens, phường Trần Phú, quận Hoàng Mai, thành phố Hà Nội

(72) Phạm Xuân Thiết (VN)

(55)



1.1



1.2



1.3



1.4



1.5



1.6



1.7

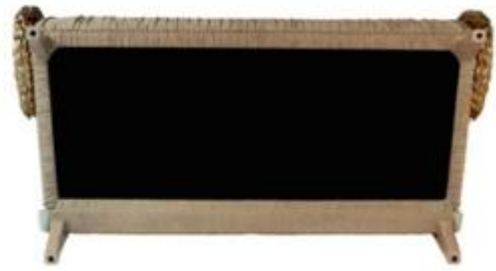

1.8



1.9



1.10



1.11



1.12



1.13



1.14



1.15



1.16



1.17



1.18



1.19



1.20



1.21



1.22

CÔNG BÁO SỞ HỮU CÔNG NGHIỆP SỐ 436 TẬP A – QUYỀN 2 (07.2024)

- (11) **50572**
(21) 3-2023-02718 (28) 1
(54) **THIẾT BỊ LIÊN LẠC NỘI BỘ** (51) **14-03**
(22) 13/11/2023 (43) 25/07/2024
(30) 2023-013693 03/07/2023 JP;
(73) **PANASONIC INTELLECTUAL PROPERTY MANAGEMENT CO., LTD.**
(JP)
22-6, Moto-machi, Kadoma-shi, Osaka 571-0057 Japan
(72) Miki KOBAYASHI (JP)
(74) Công ty TNHH một thành viên Sở hữu trí tuệ VCCI (VCCI-IP CO.,LTD)
(55)

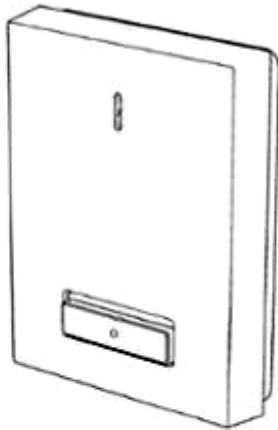

1.1

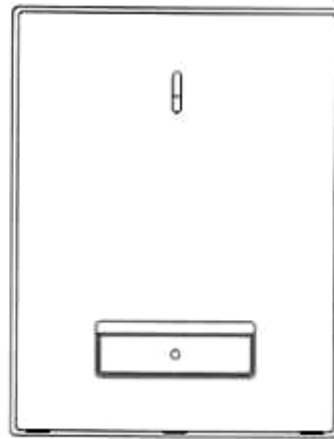

1.2

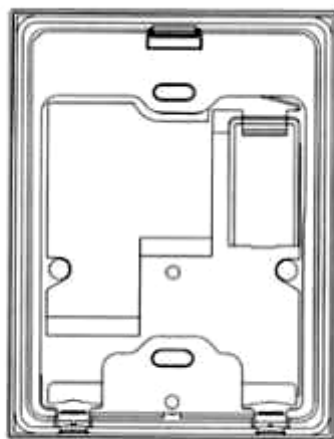

1.3

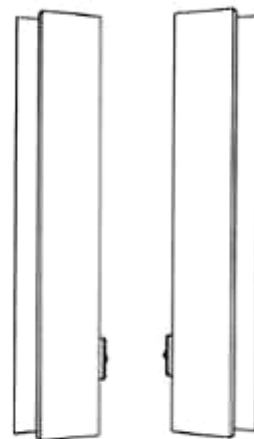

1.4

1.5

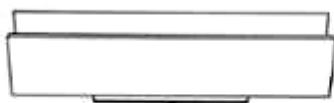

1.6

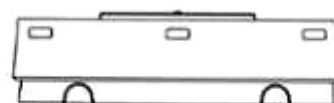

1.7

- (11) **50573**
(21) 3-2023-02851 (28) 1
(54) **LƯỢC CHẢI TÓC** (51) **28-03**
(22) 28/11/2023 (43) 25/07/2024
(30) 2023-010879 30/05/2023 JP;
(73) **MTG CO., LTD.** (JP)
2-32 Honjin-tori, Nakamura-ku, Nagoya-shi, Aichi 4530041, Japan
(72) Kei ITO (JP)
(74) **CÔNG TY LUẬT TRÁCH NHIỆM HỮU HẠN AMBYS HÀ NỘI (AMBYS HANOI)**
(55)

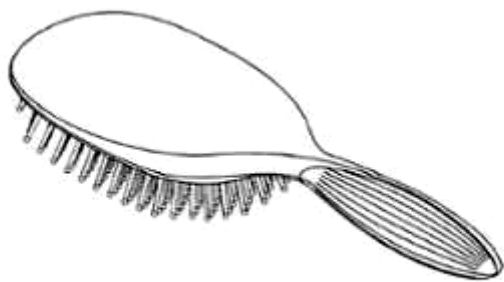

1.1

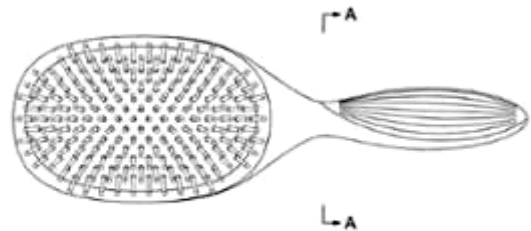

1.2



1.3

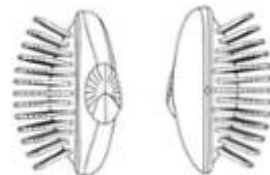

1.4

1.5



1.6



1.7



1.8

CÔNG BÁO SỞ HỮU CÔNG NGHIỆP SỐ 436 TẬP A – QUYỀN 2 (07.2024)

- (11) **50574**
(21) 3-2023-02852 (28) 1
(54) **MÁY IN** (51) **18-02**
(22) 28/11/2023 (43) 25/07/2024
(30) 2023-010896 30/05/2023 JP;
(73) **BROTHER INDUSTRIES, LTD. (JP)**
15-1 Naeshiro-cho, Mizuho-ku, Nagoya-shi, Aichi-ken, Japan
(72) 1. HIROMITSU TANAKA (JP)
2. KAZUKI NAKANO (JP)
3. YUKIHIKO SATO (JP)
(74) Công ty TNHH Ban Ca (BANCA)
(55)

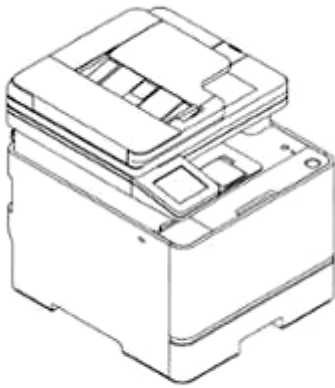

1.1

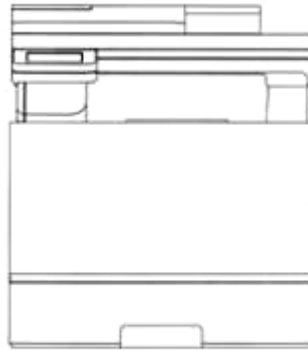

1.2

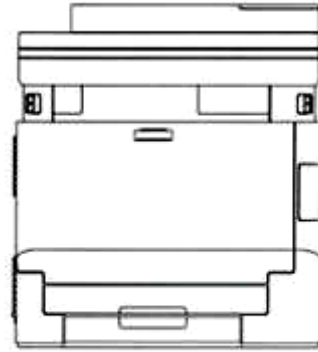

1.3

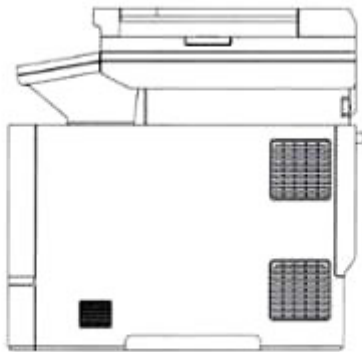

1.4

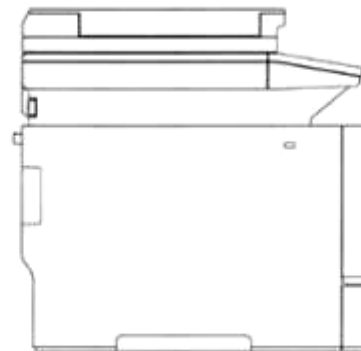

1.5



1.6

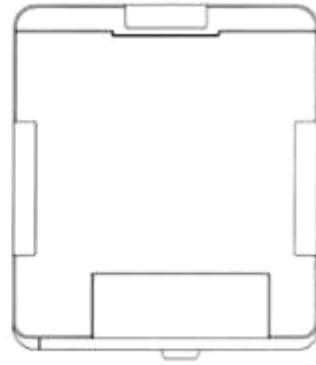

1.7

(11) **50575**

(21) 3-2023-02623

(28) 1

(54) **ỐNG THÉP**

(51) **23-01**

(22) 07/11/2023

(43) 25/07/2024

(73) **CÔNG TY CỔ PHẦN CÔNG NGHIỆP E.NHẤT (VN)**

Số 11/42 phố Lạc Trung, phường Thanh Lương, quận Hai Bà Trưng, thành phố Hà Nội

(72) Lê Hoàng Anh (VN)

(55)

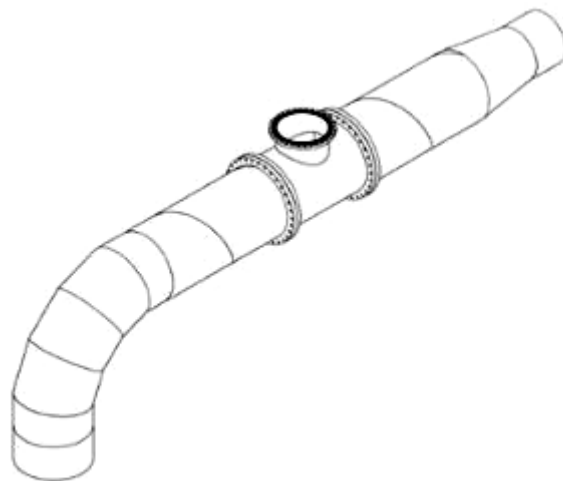

1.1

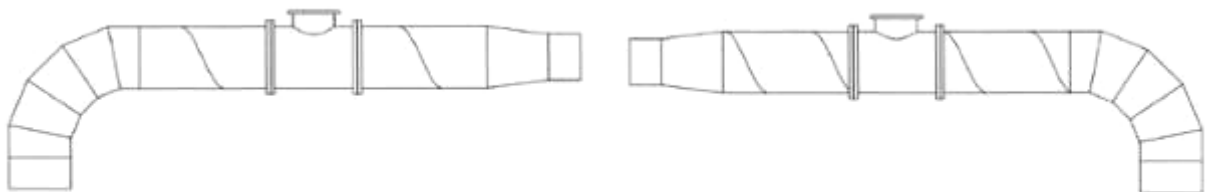

1.2

1.3

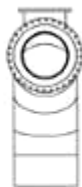

1.4

1.5



1.6

1.7

CÔNG BÁO SỞ HỮU CÔNG NGHIỆP SỐ 436 TẬP A – QUYỀN 2 (07.2024)

- (11) **50576**
(21) 3-2023-00331 (28) 1
(54) **HỆ THỐNG SẢN XUẤT NƯỚC MẮM** (51) **15-99**
(22) 21/02/2023 (43) 25/07/2024
(73) **CÔNG TY TNHH HỒ HOÀN CẦU (VN)**
Xóm 6, xã Quỳnh Văn, huyện Quỳnh Lưu, tỉnh Nghệ An
(72) 1. HỒ XUÂN VINH (VN)
2. TRẦN THỊ HỒNG THẨM (VN)
3. HỒ SỸ CẦU (VN)
(55)



1.1



1.2



1.3



1.4

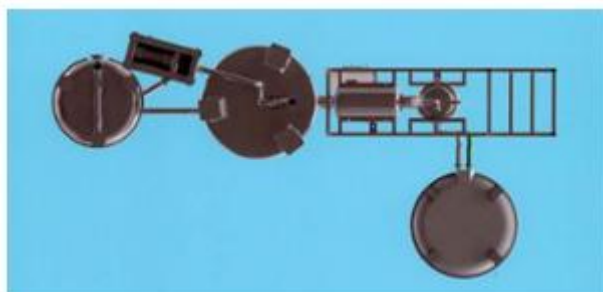

1.5



1.6



1.7



1.8

CÔNG BÁO SỞ HỮU CÔNG NGHIỆP SỐ 436 TẬP A – QUYỀN 2 (07.2024)

- (11) **50577**
(21) 3-2023-01721 (28) 1
(54) **ÁO NAM** (51) **02-02**
(22) 27/07/2023 (43) 25/07/2024
(30) 202310639 03/02/2023 AU;
(73) **CATAPULT GROUP INTERNATIONAL LTD (AU)**
75 High Street, Prahran VIC 3181, Australia
(72) 1. ARDALAN KATEBI (IR)
2. JAMES MOHAN (US)
3. ANNA ASNIS (US)
(74) Công ty TNHH Đại Tín và Liên Danh (DAITIN AND ASSOCIATES CO.,LTD)
(55)

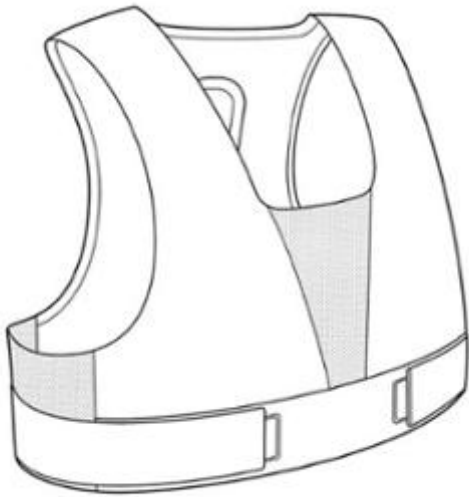

1.1

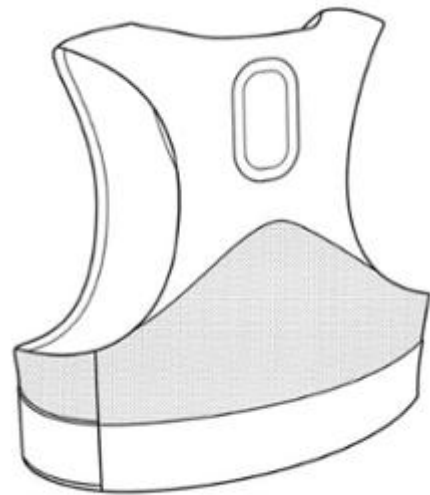

1.2

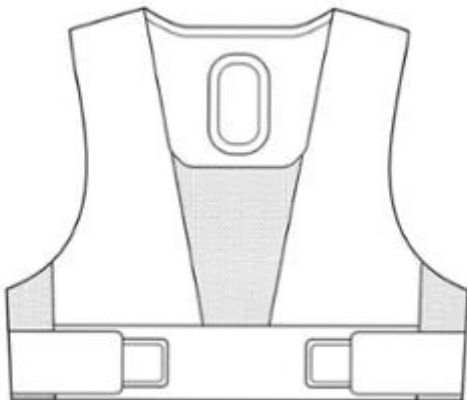

1.3

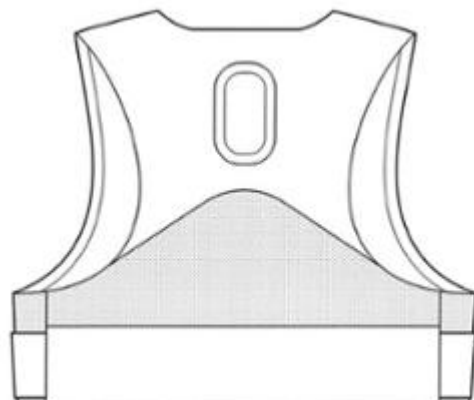

1.4

CÔNG BÁO SỞ HỮU CÔNG NGHIỆP SỐ 436 TẬP A – QUYỀN 2 (07.2024)

- (11) **50578**
(21) 3-2024-01349 (28) 1
(54) **MÁY LỌC NƯỚC** (51) **23-01**
(22) 11/06/2024 (43) 25/07/2024
(73) **CÔNG TY TNHH SẢN XUẤT ĐỒ GIA DỤNG SUNHOUSE (VN)**
Ngọc Liệp, xã Ngọc Liệp, huyện Quốc Oai, thành phố Hà Nội
(72) Lại Văn Kiên (VN)
(74) Công ty TNHH Sở hữu trí tuệ Bình Minh (SUNRISE IP CO.,LTD.)
(55)

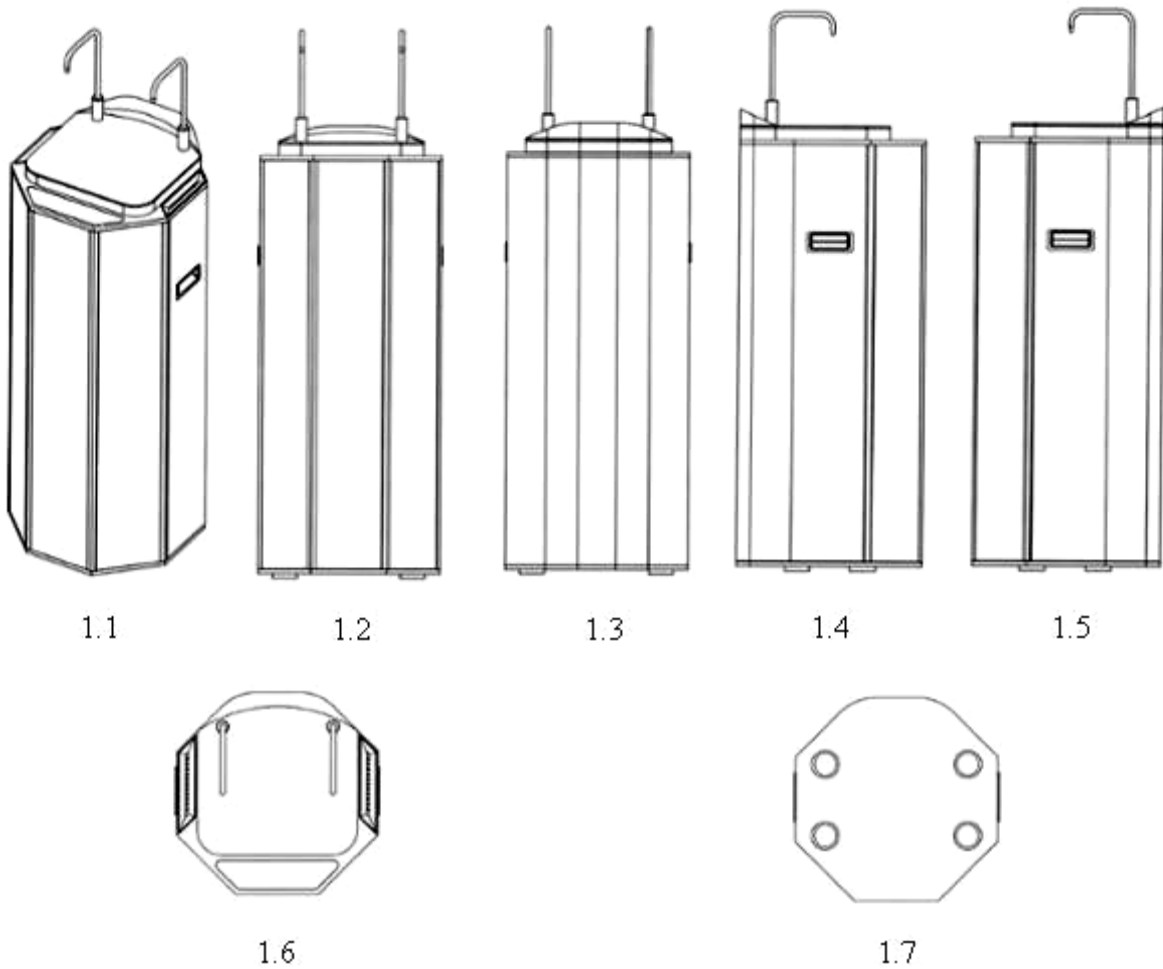

CÔNG BÁO SỞ HỮU CÔNG NGHIỆP SỐ 436 TẬP A – QUYỀN 2 (07.2024)

- (11) **50579**
(21) 3-2024-00422 (28) 1
(54) **XE HAI BÁNH** (51) **12-11**
(22) 23/02/2024 (43) 25/07/2024
(30) 393439-001 23/08/2023 IN;
(73) **TVS MOTOR COMPANY LIMITED (IN)**
Chaitanya, No. 12, Khader Nawaz Khan Road, Nungambakkam, Chennai 600 006,
INDIA
(72) HARNE VINAY CHANDRAKANT (IN)
(74) Công ty Luật TNHH T&G (TGVN)
(55)



1.1



1.2



1.3



1.4



1.5



1.6



1.7



1.8



1.9

CÔNG BÁO SỞ HỮU CÔNG NGHIỆP SỐ 436 TẬP A – QUYỀN 2 (07.2024)

(11) **50580**

(21) 3-2024-00429

(28) 1

(54) **DÉP**

(51) **02-04**

(22) 23/02/2024

(43) 25/07/2024

(73) **CÔNG TY TNHH GIÀY Á CHÂU (VN)**

451/29/8 Tô Hiến Thành, phường 14, quận 10, thành phố Hồ Chí Minh

(72) Nguyễn Đình Kim (VN)

(74) Văn phòng Luật sư A Hoà (AHOA LAW OFFICE)

(55)



1.1



1.2



1.3



1.4



1.5



1.6



1.7



1.8

CÔNG BÁO SỞ HỮU CÔNG NGHIỆP SỐ 436 TẬP A – QUYỀN 2 (07.2024)

- (11) **50581**
(21) 3-2024-00614 (28) 4
(54) **NỒI CHIÊN KHÔNG KHÍ** (51) **07-02**
(22) 14/03/2024 (43) 25/07/2024
(30) 2023306086491 18/09/2023 CN;
(73) **FOSHAN SHUNDE MIDEA ELECTRICAL HEATING APPLIANCES
MANUFACTURING CO., LTD. (CN)**
San Le Road #19, Beijiao, Shunde, Foshan, Guangdong Province 528311, China
(72) 1. LIANG, BINGCAN (CN)
2. HUANG, YINGWEN (CN)
(74) Công ty Cổ phần Sở hữu công nghiệp INVESTIP (INVESTIP)
(55)



1.1



1.2



1.3



1.4



1.5



1.6



1.7



2.1



2.2



2.3



2.4



2.5



2.6



2.7



3.1



3.2



3.3



3.4



3.5



3.6



3.7



4.1



4.2



4.3



4.4



4.5



4.6



4.7

CÔNG BÁO SỞ HỮU CÔNG NGHIỆP SỐ 436 TẬP A – QUYỀN 2 (07.2024)

- (11) **50582**
(21) 3-2024-00615 (28) 3
(54) **LÒNG NỒI CƠM ĐIỆN** (51) **07-02**
(22) 14/03/2024 (43) 25/07/2024
(30) 2023306650732 13/10/2023 CN;
(73) **FOSHAN SHUNDE MIDEA ELECTRICAL HEATING APPLIANCES
MANUFACTURING CO., LTD. (CN)**
San Le Road #19, Beijiao, Shunde, Foshan, Guangdong Province 528311, China
(72) MA, Yufeng (CN)
(74) Công ty Cổ phần Sở hữu công nghiệp INVESTIP (INVESTIP)
(55)



1.1



1.2



1.3



1.4



1.5



1.6



1.7



2.1



2.2



2.3



2.4



2.5



2.6



2.7



3.1



3.2



3.3



3.4



3.5



3.6



3.7

CÔNG BÁO SỞ HỮU CÔNG NGHIỆP SỐ 436 TẬP A – QUYỀN 2 (07.2024)

- (11) **50583**
(21) 3-2024-00618 (28) 10
(54) **THIẾT BỊ CHUYỂN MẠCH** (51) **13-03**
(22) 14/03/2024 (43) 25/07/2024
(30) 202330604630X 15/09/2023 CN;
(73) **SCHNEIDER ELECTRIC INDUSTRIES SAS (FR)**
35 Rue Joseph Monier, Rueil Malmaison, 92500 France
(72) 1. YUN LI (CN)
2. HUANBIN MENG (CN)
3. QINGHUI MENG (CN)
4. TO CHI WONG (CN)
(74) Công ty TNHH Sở hữu trí tuệ Thảo Thọ Quyên (INVENCO.,LTD)
(55)

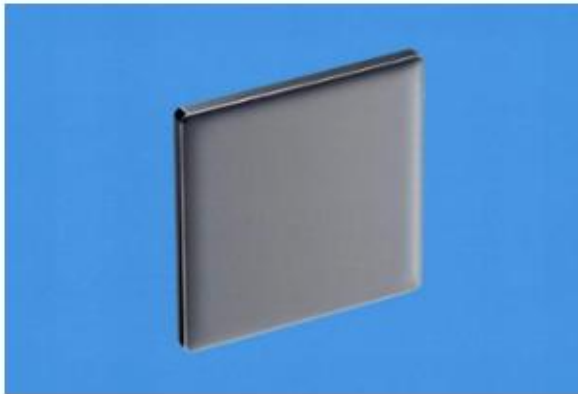

1.1

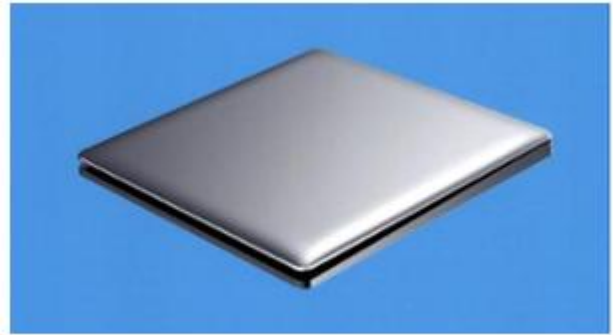

1.2

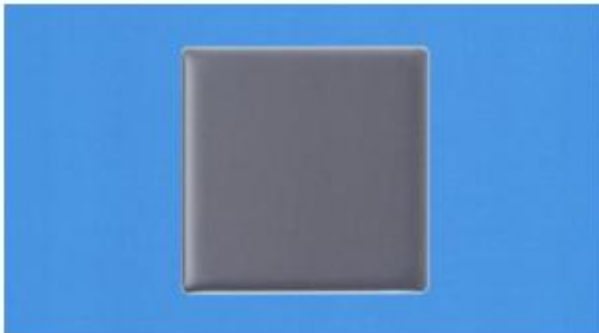

1.3



1.4



1.5



1.6



1.7



1.8



2.1

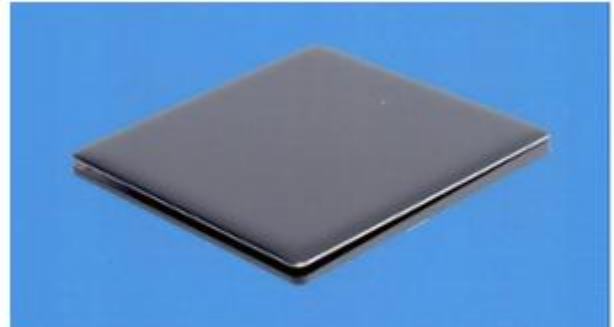

2.2

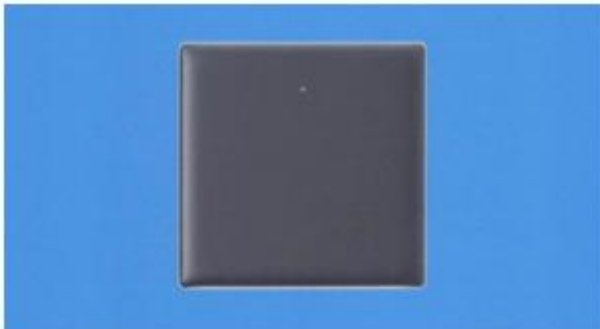

2.3



2.4



2.5



2.6



2.7



2.8

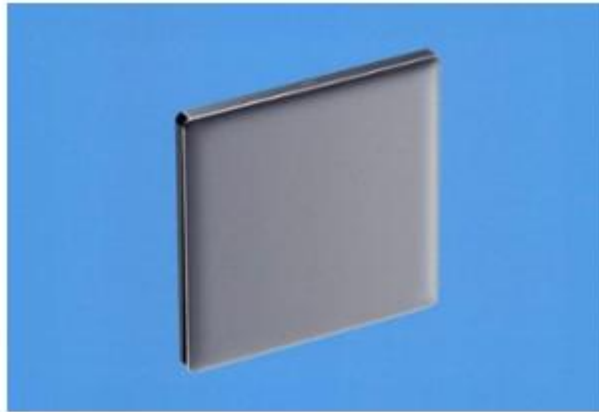

3.1

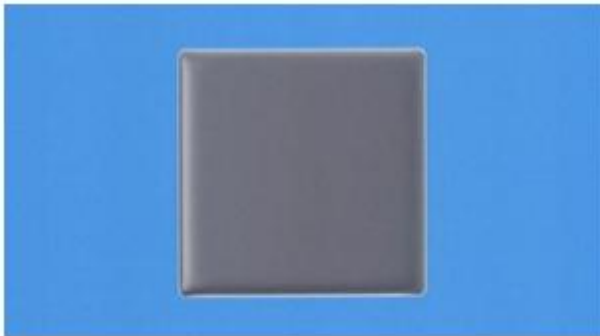

3.2



3.3



3.4



3.5



3.6



3.7

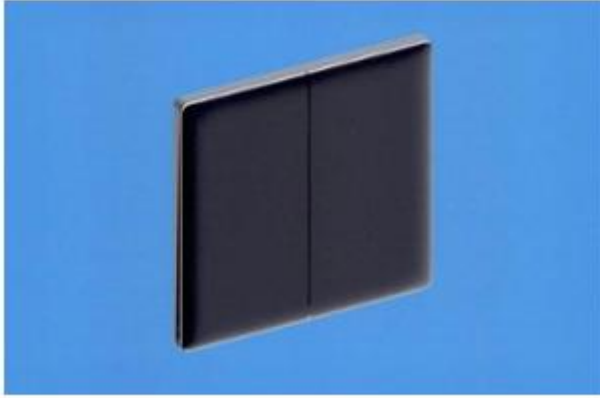

4.1

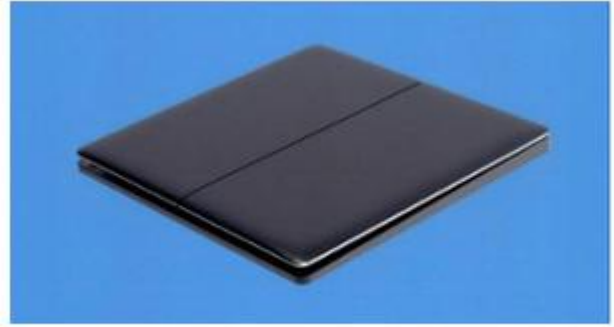

4.2



4.3

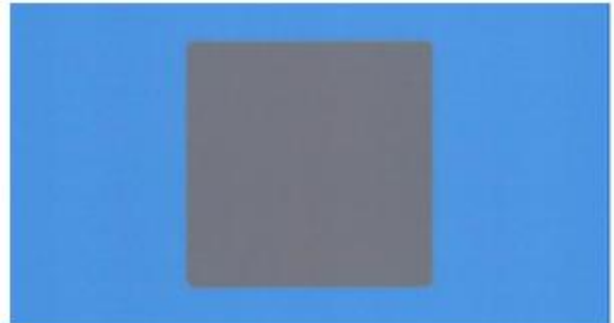

4.4



4.5



4.6



4.7



4.8

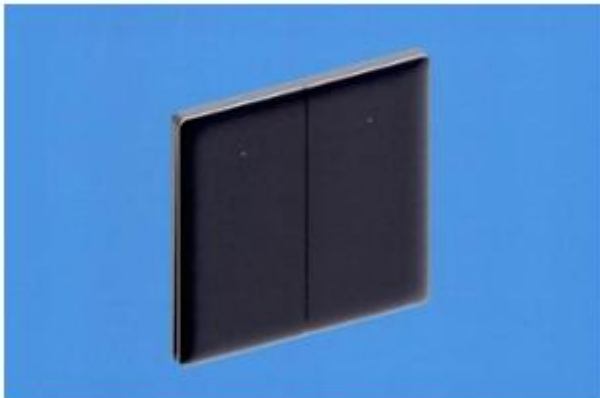

5.1



5.2



5.3

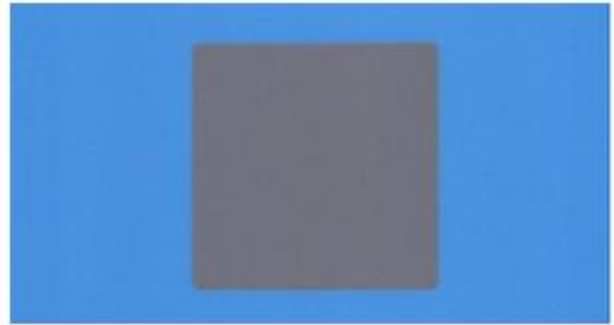

5.4

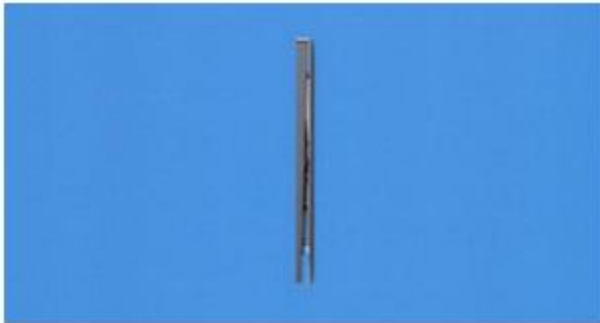

5.5



5.6



5.7



5.8

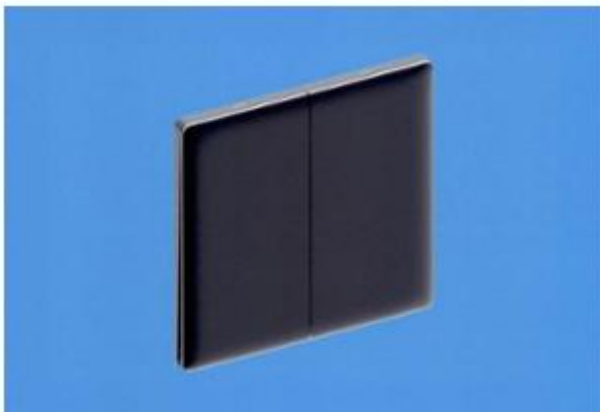

6.1



6.2

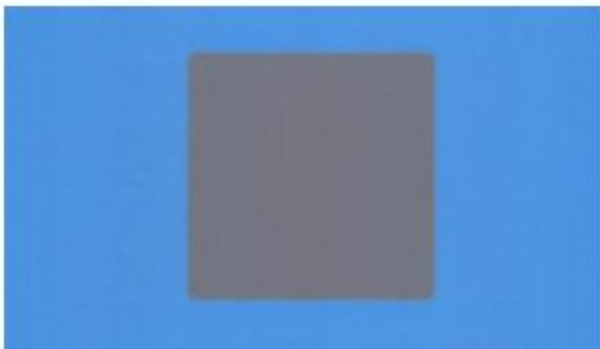

6.3



6.4



6.5



6.6



6.7

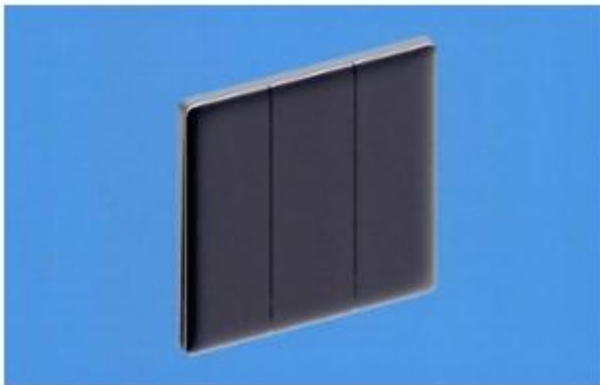

7.1

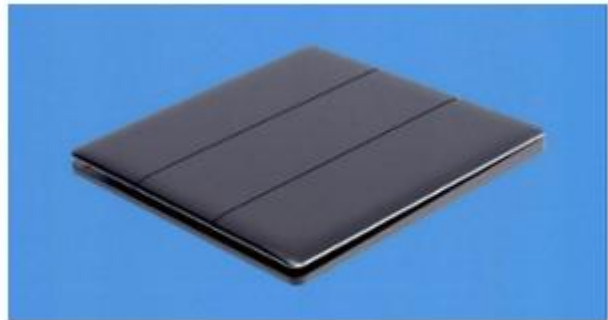

7.2



7.3



7.4



7.5



7.6



7.7



7.8

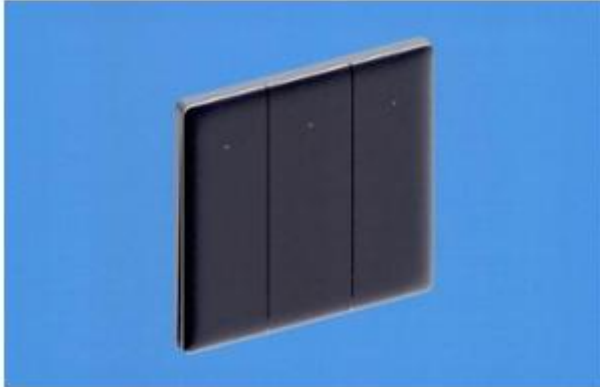

8.1

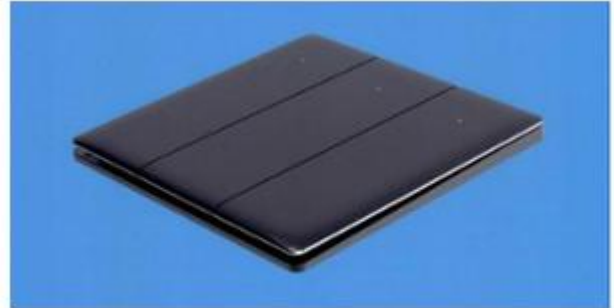

8.2



8.3

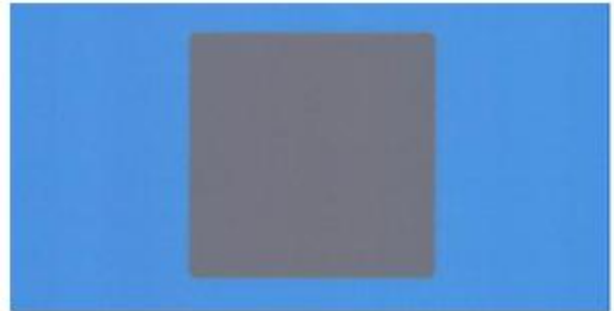

8.4



8.5



8.6



8.7



8.8

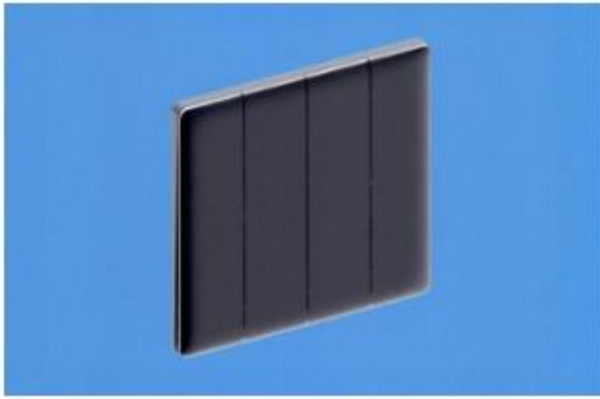

9.1

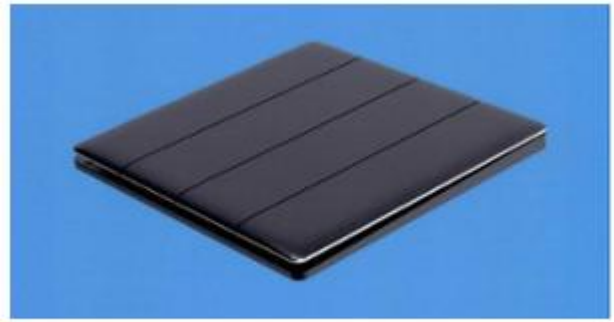

9.2



9.3



9.4



9.5



9.6



9.7



9.8



10.1

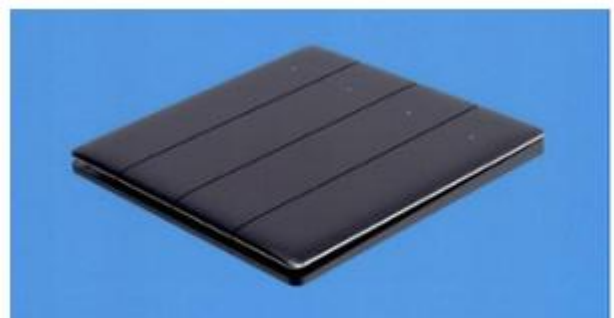

10.2



10.3

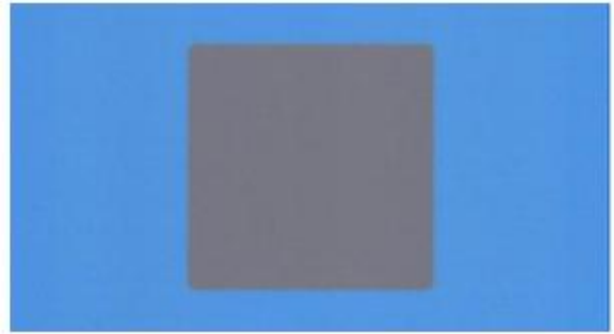

10.4



10.5

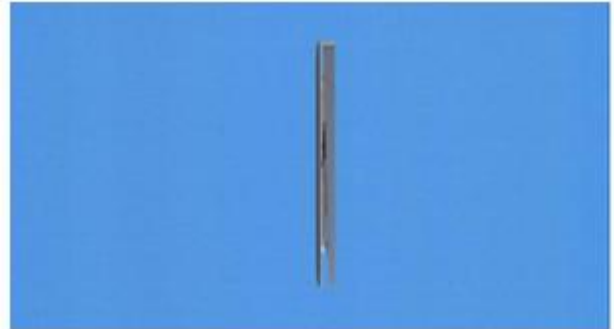

10.6



10.7



10.8

CÔNG BÁO SỞ HỮU CÔNG NGHIỆP SỐ 436 TẬP A – QUYỀN 2 (07.2024)

- (11) **50584**
(21) 3-2024-00622 (28) 1
(54) **ĐUÔI ỐNG XẢ** (51) **12-16**
(22) 14/03/2024 (43) 25/07/2024
(30) 015036250-0001 05/10/2023 EM;
(73) **IGOR AKRAPOVIČ (SI)**
Rožna Dolina C.VIII/10A, SI-1000 Ljubljana, Slovenia
(72) 1. IGOR AKRAPOVIČ (SI)
2. DENIS PUGELJ (SI)
3. ŽIGA DOSTAL (SI)
(74) Công ty TNHH Đại Tín và Liên Danh (DAITIN AND ASSOCIATES CO.,LTD)
(55)



1.1



1.2



1.3



1.4



1.5



1.6

1.7

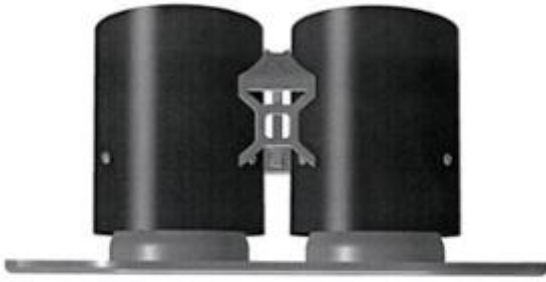

1.8



1.9

CÔNG BÁO SỞ HỮU CÔNG NGHIỆP SỐ 436 TẬP A – QUYỀN 2 (07.2024)

- (11) **50585**
(21) 3-2024-00623 (28) 1
(54) **ỐNG XẢ** (51) **12-16**
(22) 14/03/2024 (43) 25/07/2024
(30) 015036049-0001 05/10/2023 EM;
(73) **IGOR AKRAPOVIČ (SI)**
Rožna Dolina C.VIII/10A, SI-1000 Ljubljana, Slovenia
(72) 1. IGOR AKRAPOVIČ (SI)
2. ERMIN KOSOVEL (SI)
3. DORIAN TOMAŽIN (SI)
(74) Công ty TNHH Đại Tín và Liên Danh (DAITIN AND ASSOCIATES CO.,LTD)
(55)



1.1



1.2



1.3



1.4

1.5



1.6



1.7



1.8



1.9

CÔNG BÁO SỞ HỮU CÔNG NGHIỆP SỐ 436 TẬP A – QUYỀN 2 (07.2024)

- (11) **50586**
(21) 3-2024-00846 (28) 1
(54) **ĐỒNG HỒ ĐEO TAY** (51) **10-02**
(22) 08/04/2024 (43) 25/07/2024
(30) WIPO145013 26/02/2024 WO;
(73) **CARTIER INTERNATIONAL AG (CH)**
Hinterbergstrasse 22, 6312 Steinhausen, Switzerland
(72) Nicole Gimenez (CH)
(74) Công ty TNHH tư vấn Sở hữu trí tuệ IPFLAME (IPFLAME CO.,LTD)
(55)

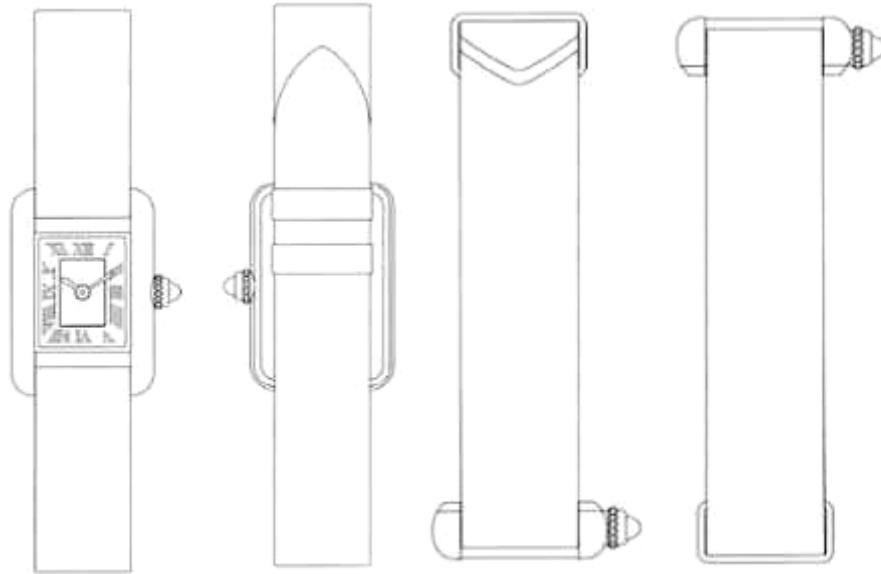

1.1

1.2

1.3

1.4

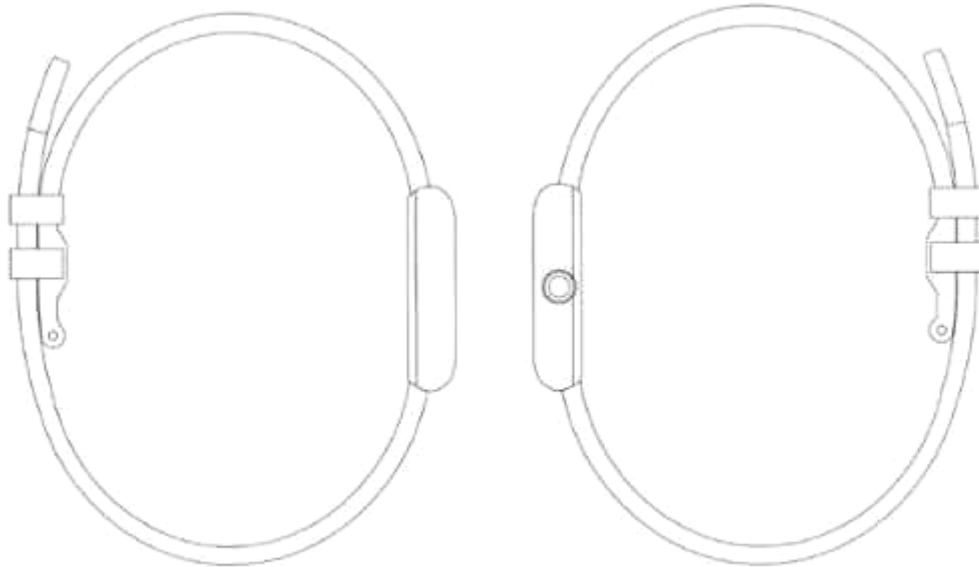

1.5

1.6

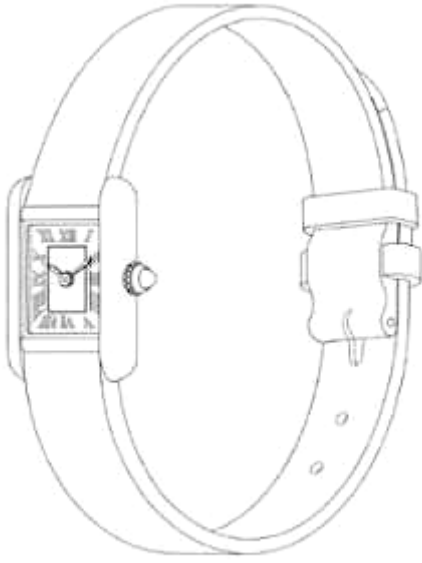

1.7

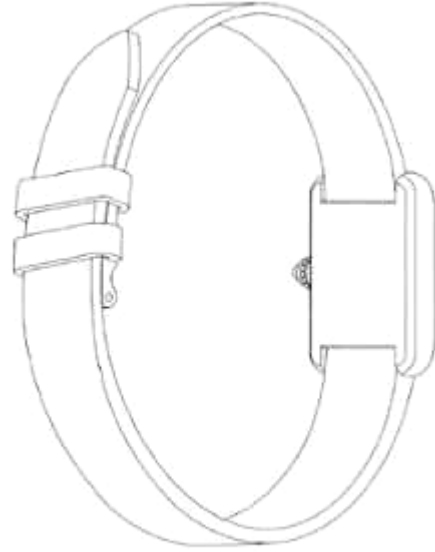

1.8

- (11) **50587**
(21) 3-2024-00851 (28) 1
(54) **VIÊN GIẶT** (51) **28-99**
(22) 08/04/2024 (43) 25/07/2024
(30) 23-01482-0101 13/10/2023 MY;
(73) **NEUTROVIS SDN. BHD.** (MY)
Block C, PJ City Development, 15A, Jalan 51a/219, Seksyen 51a, 46100 Petaling
Jaya, Selangor, Malaysia
(72) William Lee (MY)
(74) Công ty TNHH Dịch vụ Sở hữu trí tuệ KASS Việt Nam (KASS VIETNAM
CO.,LTD.)
(55)



1.1

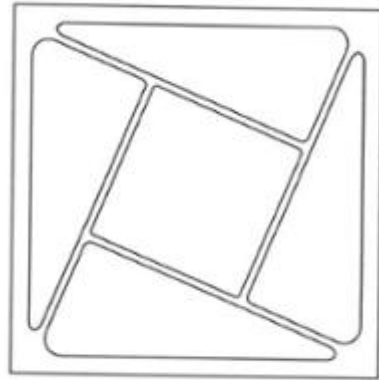

1.2

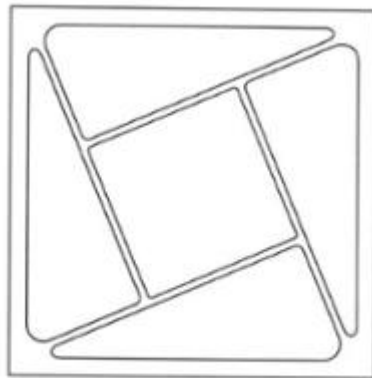

1.3



1.4



1.5

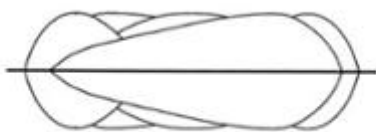

1.6

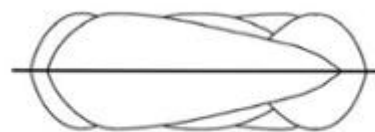

1.7

CÔNG BÁO SỞ HỮU CÔNG NGHIỆP SỐ 436 TẬP A – QUYỀN 2 (07.2024)

- (11) **50588**
(21) 3-2024-01071 (28) 1
(54) **NHÃN SẢN PHẨM** (51) **19-08**
(22) 09/05/2024 (43) 25/07/2024
(73) **CÔNG TY TNHH MỘT THÀNH VIÊN HÓA CHẤT 21 (VN)**
Xã Phú Hộ, thị xã Phú Thọ, tỉnh Phú Thọ
(72) Lê Quang Hoà (VN)
(74) **CÔNG TY LUẬT TNHH LEGOS (CÔNG TY LUẬT TNHH LEGOS)**
(55)



CÔNG BÁO SỞ HỮU CÔNG NGHIỆP SỐ 436 TẬP A – QUYỀN 2 (07.2024)

- (11) **50589**
(21) 3-2024-01072 (28) 1
(54) **NHÃN SẢN PHẨM** (51) **19-08**
(22) 09/05/2024 (43) 25/07/2024
(73) **CÔNG TY TNHH MỘT THÀNH VIÊN HÓA CHẤT 21 (VN)**
Xã Phú Hộ, thị xã Phú Thọ, tỉnh Phú Thọ
(72) Nguyễn Văn Hà (VN)
(74) **CÔNG TY LUẬT TNHH LEGOS (CÔNG TY LUẬT TNHH LEGOS)**
(55)



CÔNG BÁO SỞ HỮU CÔNG NGHIỆP SỐ 436 TẬP A – QUYỀN 2 (07.2024)

- (11) **50590**
(21) 3-2024-01074 (28) 1
(54) **NHÃN SẢN PHẨM** (51) **19-08**
(22) 09/05/2024 (43) 25/07/2024
(73) **CÔNG TY TNHH MỘT THÀNH VIÊN HÓA CHẤT 21 (VN)**
Xã Phú Hộ, thị xã Phú Thọ, tỉnh Phú Thọ
(72) Nguyễn Văn Hà (VN)
(74) **CÔNG TY LUẬT TNHH LEGOS (CÔNG TY LUẬT TNHH LEGOS)**
(55)



- (11) **50591**
(21) 3-2024-00955 (28) 1
(54) **TƯỢNG TRANG TRÍ** (51) **11-02**
(22) 19/04/2024 (43) 25/07/2024
(73) **VŨ QUỐC BẢO (VN)**
686/72/82 Cách Mạng Tháng Tám, phường 11, quận 3, thành phố Hồ Chí Minh
(72) Vũ Quốc Bảo (VN)
(55)



1.1



1.2



1.3



1.4



1.5



1.6



1.7

CÔNG BÁO SỞ HỮU CÔNG NGHIỆP SỐ 436 TẬP A – QUYỀN 2 (07.2024)

- (11) **50592**
(21) 3-2024-00956 (28) 1
(54) **GHẾ** (51) **06-01**
(22) 19/04/2024 (43) 25/07/2024
(30) 2023306857530 23/10/2023 CN;
(73) **ANJI HENGLIN TECHNOLOGY DEVELOPMENT CO., LTD. (CN)**
No.378-380 Jiaxi Road, Dipu Subdistrict, Anji County, 313300 Huzhou Zhejiang,
China
(72) Jianglin, Wang (CN)
(74) Công ty TNHH Sáng chế ACTIP (ACTIP PATENT LIMITED)
(55)



1.1



1.2



1.3



1.4



1.5



1.6



1.7



1.8

CÔNG BÁO SỞ HỮU CÔNG NGHIỆP SỐ 436 TẬP A – QUYỀN 2 (07.2024)

- (11) **50593**
(21) 3-2024-00952 (28) 1
(54) **NHÃN SẢN PHẨM** (51) **19-08**
(22) 19/04/2024 (43) 25/07/2024
(73) **LÝ QUỐC DÂN (VN)**
Khu phố Lâm Trúc 1, phường Hoài Thanh, thị xã Hoài Nhơn, tỉnh Bình Định
(72) Lý Quốc Dân (VN)
(74) **CÔNG TY TNHH SỞ HỮU TRÍ TUỆ SETHACO (SETHACO IP CO.,LTD)**
(55)



CÔNG BÁO SỞ HỮU CÔNG NGHIỆP SỐ 436 TẬP A – QUYỀN 2 (07.2024)

- (11) **50594**
(21) 3-2024-00758 (28) 1
(54) **LỌ** (51) **09-01**
(22) 28/03/2024 (43) 25/07/2024
(73) **LG H&H CO., LTD. (KR)**
58, Saemunan-ro, Jongno-gu, Seoul, Republic of Korea
(72) Yun, Taeung (KR)
(74) Công ty TNHH Tâm nhìn và Liên danh (VISION & ASSOCIATES CO.LTD.)
(55)



1.1

1.2

1.3

1.4

1.5



1.6

CÔNG BÁO SỞ HỮU CÔNG NGHIỆP SỐ 436 TẬP A – QUYỀN 2 (07.2024)

- (11) **50595**
(21) 3-2024-00759 (28) 1
(54) **TAY VẶN CỐC LỘC NƯỚC** (51) **08-05**
(22) 28/03/2024 (43) 25/07/2024
(73) **CÔNG TY TNHH CƠ KHÍ VÀ THƯƠNG MẠI LONG THÀNH (VN)**
Số 15 ngõ 218/45, đường Lĩnh Nam, phường Lĩnh Nam, quận Hoàng Mai, thành phố Hà Nội
(72) Lê Xuân Long (VN)
(74) Công ty Luật TNHH MINH KHUÊ (MK LAW FIRM)
(55)

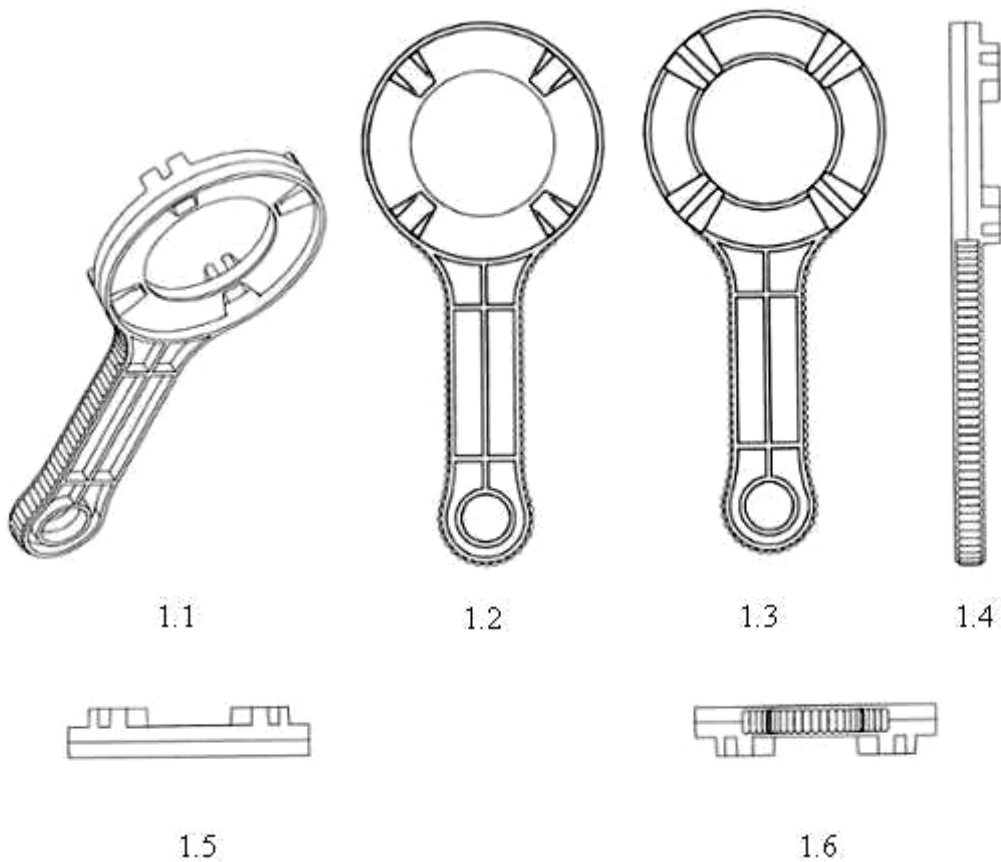

CÔNG BÁO SỞ HỮU CÔNG NGHIỆP SỐ 436 TẬP A – QUYỀN 2 (07.2024)

- (11) **50596**
- (21) 3-2024-01062 (28) 1
- (54) **NHÃN SẢN PHẨM** (51) **19-08**
- (22) 08/05/2024 (43) 25/07/2024
- (73) **CÔNG TY TNHH TOÀN CẦU BEVERAGE (VN)**
Số 8B đường Ngô Quyền, khu 4, phường Cẩm Thượng, thành phố Hải Dương, tỉnh Hải Dương
- (72) Nguyễn Thế Phương (VN)
- (74) Công ty TNHH Sở hữu trí tuệ M.I.T (M.I.T IP CO., LTD)
- (55)



CÔNG BÁO SỞ HỮU CÔNG NGHIỆP SỐ 436 TẬP A – QUYỀN 2 (07.2024)

- (11) **50597**
(21) 3-2024-01083 (28) 1
(54) **QUẠT TRẦN** (51) **23-04**
(22) 10/05/2024 (43) 25/07/2024
(73) **PANASONIC INTELLECTUAL PROPERTY MANAGEMENT CO., LTD.**
(JP)
22-6, Moto-machi, Kadoma-shi, Osaka 571-0057 Japan
(72) Kai Wen YAP (MY)
(74) Công ty Luật TNHH Phạm và Liên danh (PHAM & ASSOCIATES)
(55)

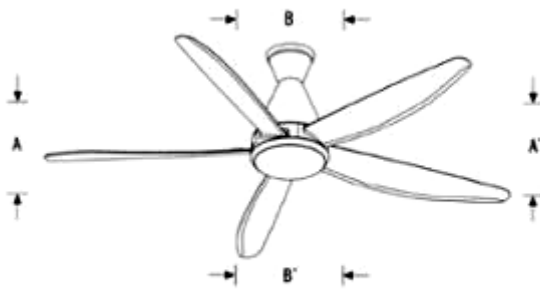

1.1



1.2



1.3



1.4



1.5

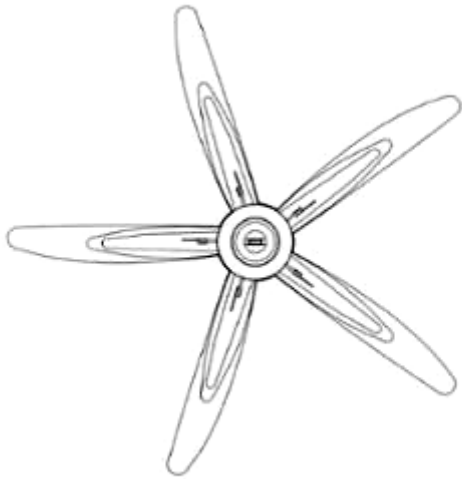

1.6

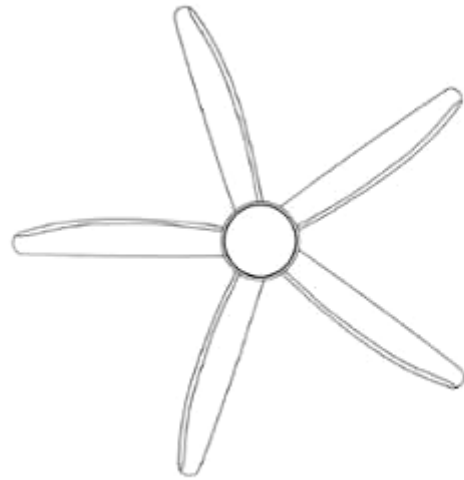

1.7

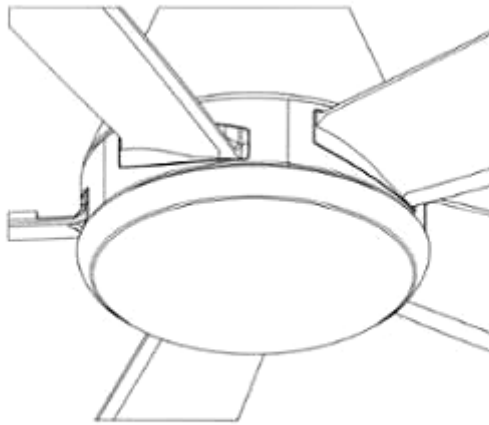

1.8

CÔNG BÁO SỞ HỮU CÔNG NGHIỆP SỐ 436 TẬP A – QUYỀN 2 (07.2024)

- (11) **50598**
(21) 3-2024-01084 (28) 1
(54) **QUẠT TRẦN** (51) **23-04**
(22) 10/05/2024 (43) 25/07/2024
(73) **PANASONIC INTELLECTUAL PROPERTY MANAGEMENT CO., LTD.**
(JP)
22-6, Moto-machi, Kadoma-shi, Osaka 571-0057 Japan
(72) Kai Wen YAP (MY)
(74) Công ty Luật TNHH Phạm và Liên danh (PHAM & ASSOCIATES)
(55)

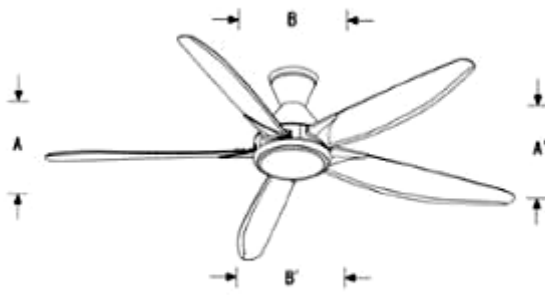

1.1



1.2



1.3



1.4



1.5

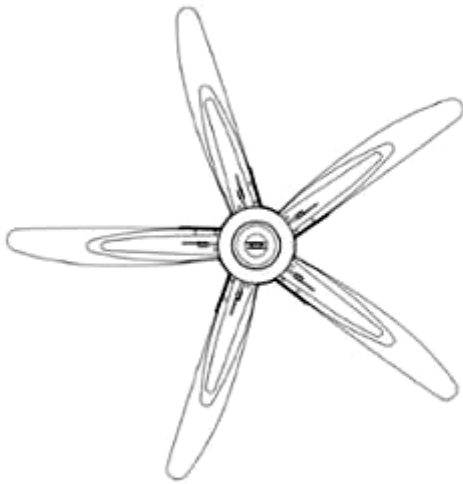

1.6

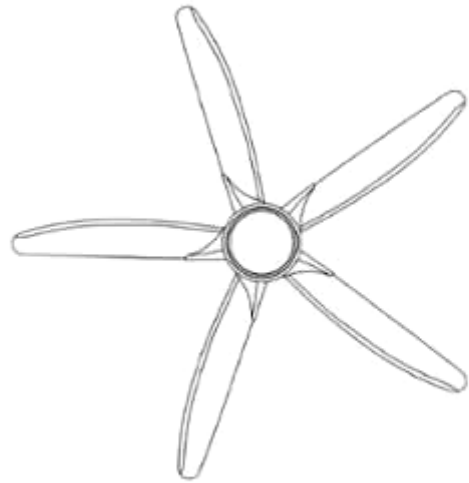

1.7

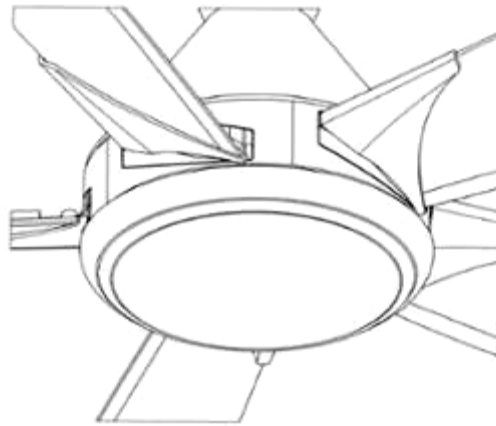

1.8

CÔNG BÁO SỞ HỮU CÔNG NGHIỆP SỐ 436 TẬP A – QUYỀN 2 (07.2024)

- (11) **50599**
(21) 3-2024-01085 (28) 1
(54) **GIƯỜNG KHÁM NHA KHOA HAI MẶT** (51) **24-02**
(22) 10/05/2024 (43) 25/07/2024
(73) **NGUYỄN BÁ HIỀN (VN)**
Số 24, đường 232 Cao Lỗ, phường 4, quận 8, thành phố Hồ Chí Minh
(72) Nguyễn Bá Hiền (VN)
(55)

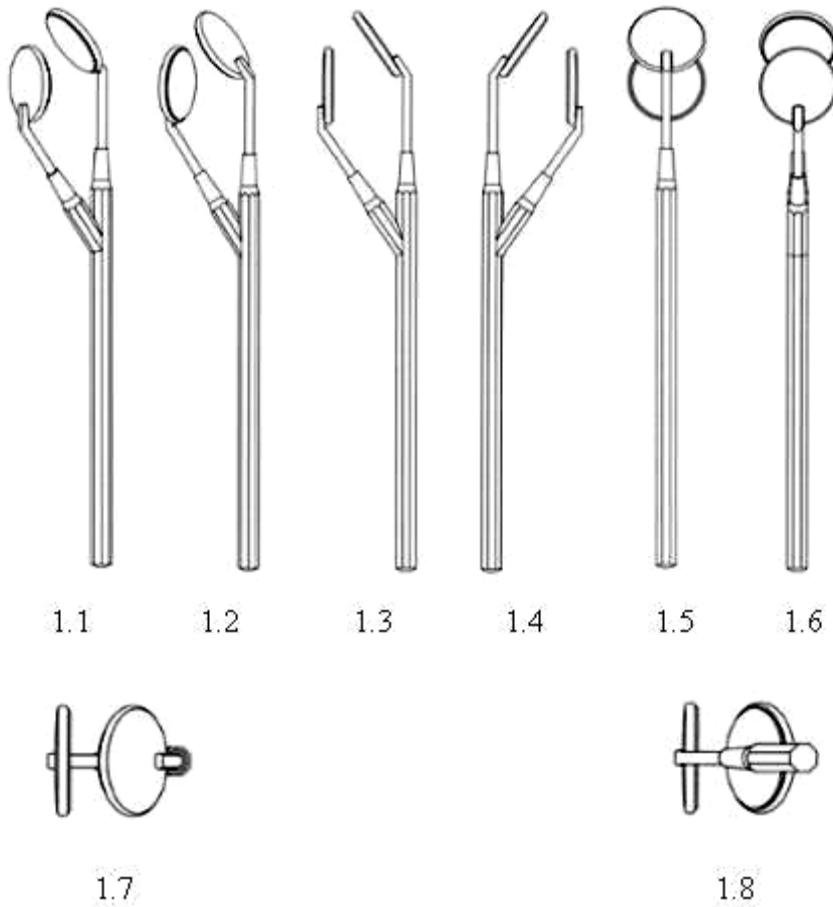

CÔNG BÁO SỞ HỮU CÔNG NGHIỆP SỐ 436 TẬP A – QUYỀN 2 (07.2024)

- (11) **50600**
- (21) 3-2024-01249 (28) 1
- (54) **HỘP ĐIỀU KHIỂN DỪNG CHO QUẠT** (51) **13-03**
- (22) 31/05/2024 (43) 25/07/2024
- (73) **CÔNG TY CỔ PHẦN GCOOL (VN)**
Số 158/2 phố Hồng Mai, phường Quỳnh Lôi, quận Hai Bà Trưng, thành phố Hà Nội
- (72) 1. TRẦN BÌNH MINH (VN)
2. HOÀNG ANH LỘC (VN)
3. TRẦN ANH (VN)
4. NGUYỄN ĐỨC BẰNG (VN)
5. ĐẶNG ĐỨC TRUNG (VN)
6. NGUYỄN THỊ HẢI YẾN (VN)
7. TRẦN HỒNG HẢI (VN)
8. NGUYỄN ĐỨC TOÀN (VN)
9. NGUYỄN TUẤN PHONG (VN)
10. PHẠM ĐỨC HIỆP (VN)
11. LÊ TUẤN SƠN (VN)
12. NGUYỄN VĂN TRỌNG (VN)
13. BÙI VĂN QUỲNH (VN)
14. PHẠM THỊ ANH (VN)
15. LÊ ĐỨC ÂN (VN)
16. NGUYỄN ĐÌNH THẮNG (VN)
- (55)



1.1



1.2

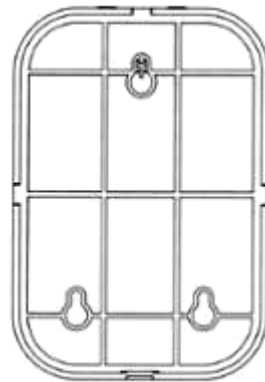

1.3

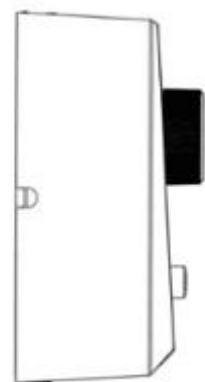

1.4

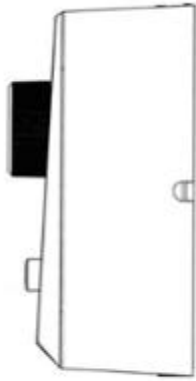

1.5

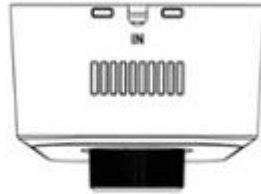

1.6

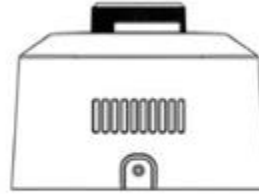

1.7

CÔNG BÁO SỞ HỮU CÔNG NGHIỆP SỐ 436 TẬP A – QUYỀN 2 (07.2024)

- (11) **50601**
(21) 3-2024-01250 (28) 1
(54) **THIẾT BỊ ĐIỀU KHIỂN TỪ XA DÙNG CHO QUẠT** (51) **14-03**
(22) 31/05/2024 (43) 25/07/2024
(73) **CÔNG TY CỔ PHẦN GCOOL (VN)**
Số 158/2 phố Hồng Mai, phường Quỳnh Lôi, quận Hai Bà Trưng, thành phố Hà Nội
(72) 1. TRẦN BÌNH MINH (VN)
2. HOÀNG ANH LỘC (VN)
3. TRẦN ANH (VN)
4. NGUYỄN ĐỨC BẰNG (VN)
5. ĐẶNG ĐỨC TRUNG (VN)
6. NGUYỄN THỊ HẢI YẾN (VN)
7. TRẦN HỒNG HẢI (VN)
8. NGUYỄN TUẤN PHONG (VN)
9. PHẠM ĐỨC HIỆP (VN)
10. LÊ TUẤN SƠN (VN)
11. NGUYỄN VĂN TRỌNG (VN)
12. PHẠM THỊ ANH (VN)
13. LÊ ĐỨC ÂN (VN)
14. BUI VĂN QUỲNH (VN)
15. NGUYỄN ĐÌNH THẮNG (VN)
16. NGUYỄN ĐỨC TOÀN (VN)
17. ĐOÀN KHÁNH THƯ (VN)

(55)

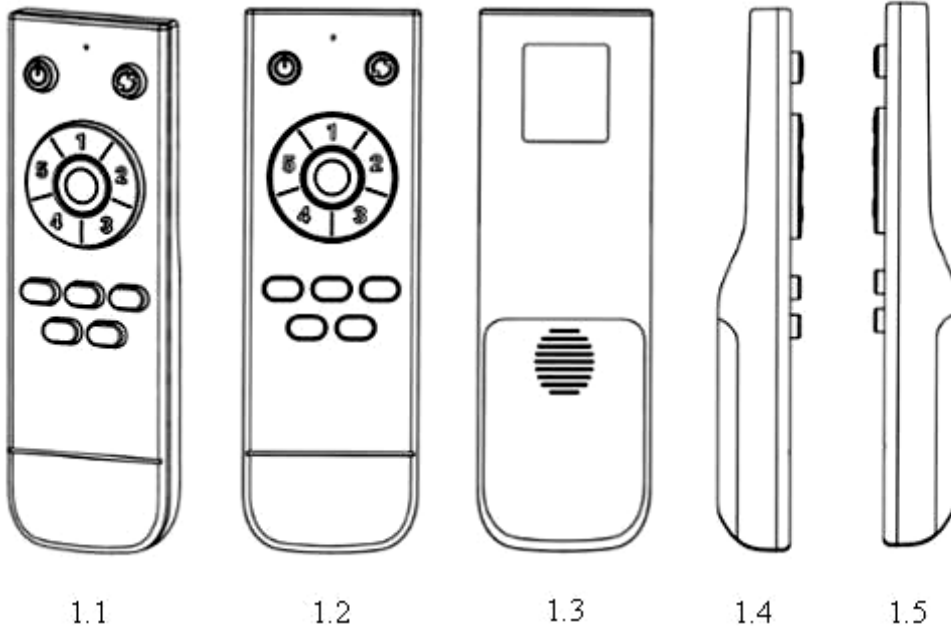



1.6

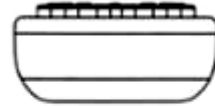

1.7

CÔNG BÁO SỞ HỮU CÔNG NGHIỆP SỐ 436 TẬP A – QUYỀN 2 (07.2024)

- (11) **50602**
(21) 3-2024-01248 (28) 1
(54) **CHAI** (51) **09-01**
(22) 31/05/2024 (43) 25/07/2024
(73) **CÔNG TY TNHH SẢN XUẤT TỔNG HỢP HÙNG THỊNH PHÁT (VN)**
Đường 26 Trần Huy Liệu, phường Hoài Hương, thị xã Hoài Nhơn, tỉnh Bình Định
(72) Trần Trí Thức (VN)
(55)

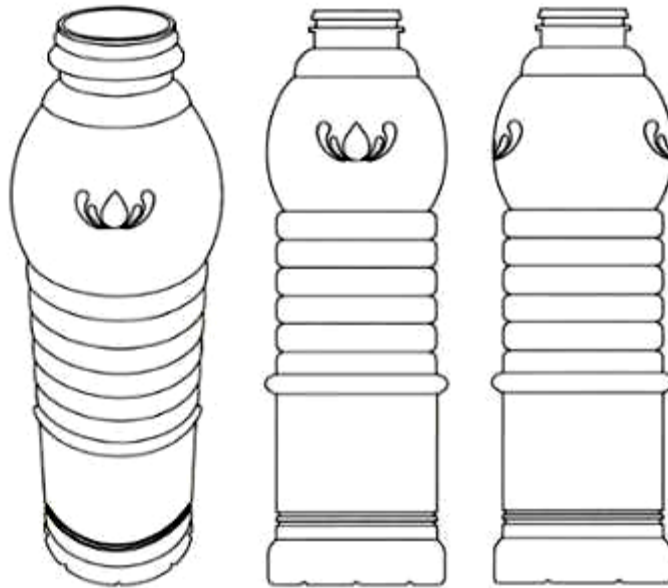

1.1

1.2

1.3



1.4

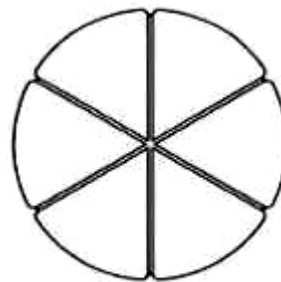

1.5

CÔNG BÁO SỞ HỮU CÔNG NGHIỆP SỐ 436 TẬP A – QUYỀN 2 (07.2024)

- (11) **50603**
(21) 3-2024-01324 (28) 1
(54) **DỤNG CỤ CHƠI BÓNG TENNIS CHO THÚ CỨNG** (51) **30-99**
(22) 10/06/2024 (43) 25/07/2024
(73) **CÔNG TY TNHH MỘT THÀNH VIÊN ANKH (VN)**
Số 03, hẻm 109, quốc lộ 22B, khu phố Hiệp Hòa, phường Hiệp Tân, thị xã Hoà
Thành, tỉnh Tây Ninh
(72) Nguyễn Quyết Tiên (VN)
(74) **CÔNG TY TNHH SỞ HỮU TRÍ TUỆ SETHACO (SETHACO IP CO.,LTD)**
(55)



1.1



1.2



1.3



1.4



1.5



1.6



1.7

CÔNG BÁO SỞ HỮU CÔNG NGHIỆP SỐ 436 TẬP A – QUYỀN 2 (07.2024)

- (11) **50604**
(21) 3-2024-00073 (28) 1
(54) **ỐNG XẢ** (51) **12-16**
(22) 08/01/2024 (43) 25/07/2024
(30) 015028401-0001 18/07/2023 EM;
(73) **IGOR AKRAPOVIČ (SI)**
Rožna Dolina C.VIII/10A, SI-1000 Ljubljana, Slovenia
(72) 1. IGOR AKRAPOVIČ (SI)
2. JURE BAMBIČ (SI)
(74) Công ty TNHH Đại Tín và Liên Danh (DAITIN AND ASSOCIATES CO.,LTD)
(55)



1.1



1.2



1.3



1.4



1.5



1.6



1.7

CÔNG BÁO SỞ HỮU CÔNG NGHIỆP SỐ 436 TẬP A – QUYỀN 2 (07.2024)

- (11) **50605**
(21) 3-2024-00074 (28) 1
(54) **ỐNG XẢ** (51) **12-16**
(22) 08/01/2024 (43) 25/07/2024
(30) 015028200-0001 17/07/2023 EM;
(73) **IGOR AKRAPOVIČ (SI)**
Rožna Dolina C.VIII/10A, SI-1000 Ljubljana, Slovenia
(72) 1. IGOR AKRAPOVIČ (SI)
2. JURE BAMBIČ (SI)
(74) Công ty TNHH Đại Tín và Liên Danh (DAITIN AND ASSOCIATES CO.,LTD)
(55)



1.1



1.2

1.3



1.4



1.5



1.6



1.7

CÔNG BÁO SỞ HỮU CÔNG NGHIỆP SỐ 436 TẬP A – QUYỀN 2 (07.2024)

- (11) **50606**
(21) 3-2024-00730 (28) 1
(54) **NHÃN SẢN PHẨM** (51) **19-08**
(22) 26/03/2024 (43) 25/07/2024
(73) **CÔNG TY CỔ PHẦN TINGCO BÌNH ĐỊNH (VN)**
Lô A3.12+A3.13, khu công nghiệp Nhơn Hội (Khu A), khu kinh tế Nhơn Hội, xã
Nhơn Hội, thành phố Quy Nhơn, tỉnh Bình Định
(72) Võ Thị Nguyệt Nga (VN)
(74) Công ty Cổ phần Sở hữu công nghiệp INVESTIP (INVESTIP)
(55)



1.1



1.2

CÔNG BÁO SỞ HỮU CÔNG NGHIỆP SỐ 436 TẬP A – QUYỀN 2 (07.2024)

- (11) **50607**
(21) 3-2023-03117 (28) 1
(54) **ROBOT DẠY HỌC** (51) **19-07**
(22) 22/12/2023 (43) 25/07/2024
(73) **CÔNG TY TNHH STEMSMARTSCHOOL (VN)**
Số 6 Đường 817A Tạ Quang Bửu, Phường 5, Quận 8, Thành phố Hồ Chí Minh
(72) Nguyễn Ngọc Phương (VN)
(74) Công ty luật TNHH Apolat Legal (APOLAT LEGAL)
(55)



1.1

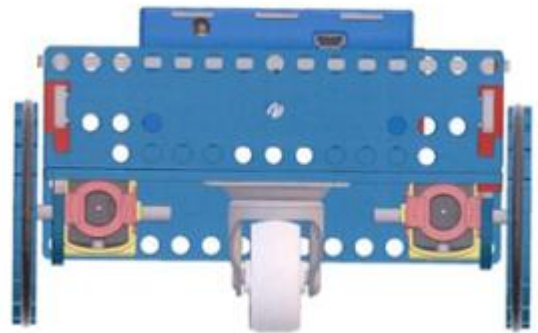

1.2



1.3

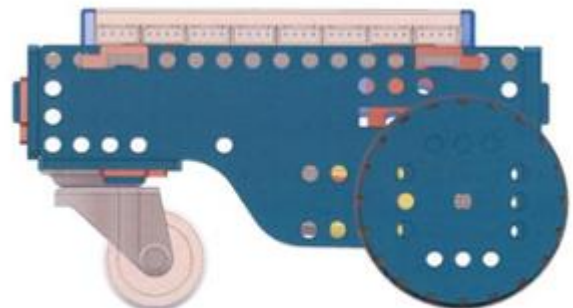

1.4

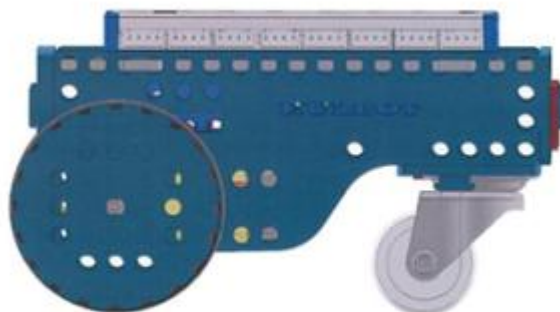

1.5



1.6

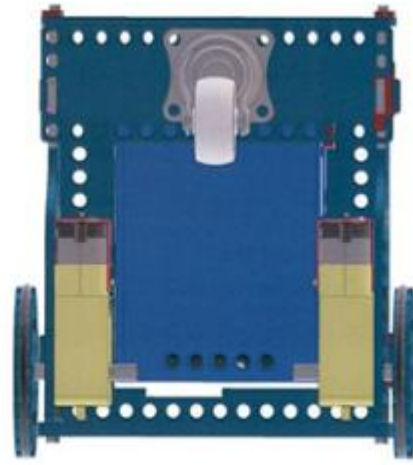

1.7

(11) **50608**

(21) 3-2024-01013

(28) 1

(54) **NHÃN**

(51) **11-01**

(22) 02/05/2024

(43) 25/07/2024

(30) WIPO145236 29/02/2024 WO;

(73) **VAN CLEEF & ARPELS SA (CH)**

Route des Biches 8, 1752 Villars-sur-Glâne, Switzerland

(72) Marie Laure Giroux (FR)

(74) Công ty TNHH tư vấn Sở hữu trí tuệ IPFLAME (IPFLAME CO.,LTD)

(55)



1.1



1.2

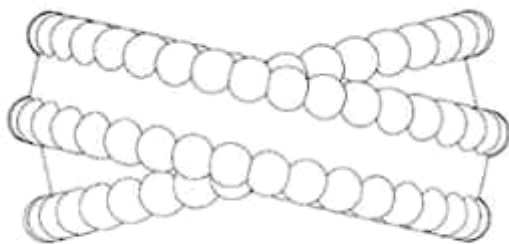

1.3

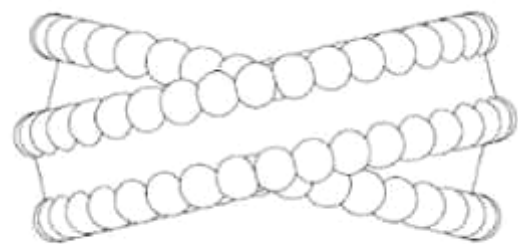

1.4

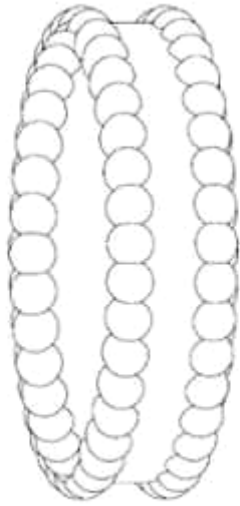

1.5



1.6

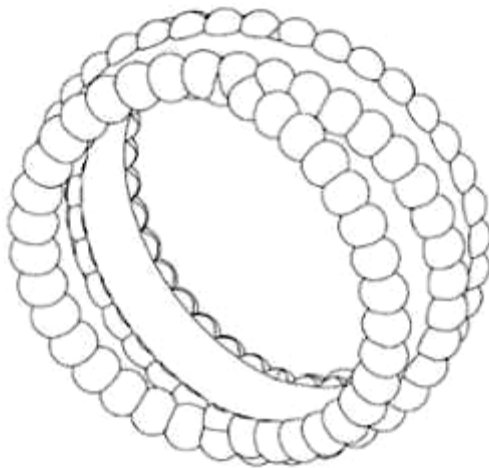

1.7

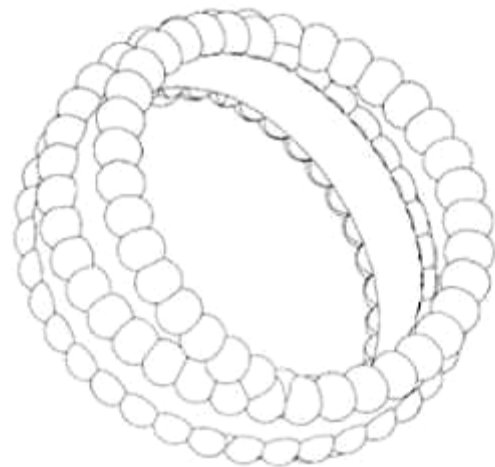

1.8

(11) **50609**

(21) 3-2024-01014

(28) 1

(54) **NHÃN**

(51) **11-01**

(22) 02/05/2024

(43) 25/07/2024

(30) WIPO145238 29/02/2024 WO;

(73) **VAN CLEEF & ARPELS SA (CH)**

Route des Biches 8, 1752 Villars-sur-Glâne, Switzerland

(72) Marie Laure Giroux (FR)

(74) Công ty TNHH tư vấn Sở hữu trí tuệ IPFLAME (IPFLAME CO.,LTD)

(55)



1.1



1.2

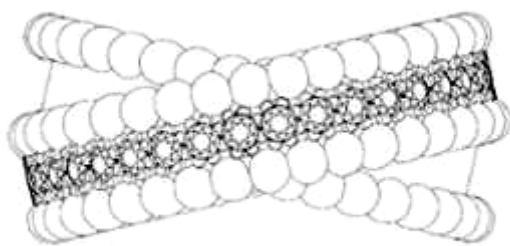

1.3

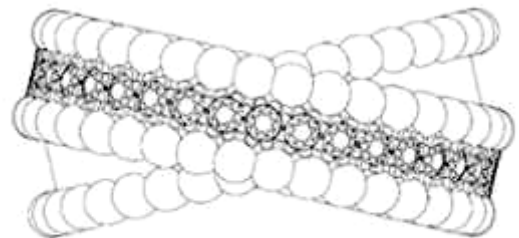

1.4

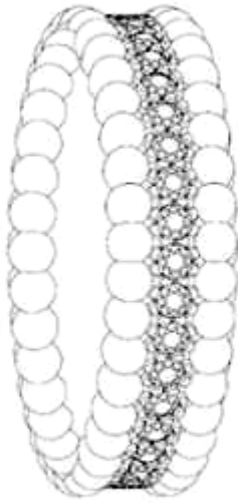

1.5

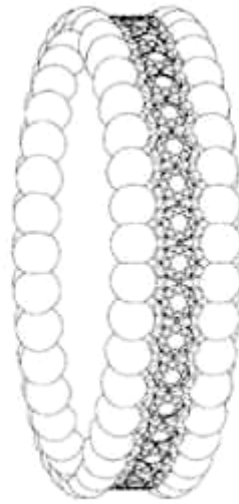

1.6



1.7



1.8

CÔNG BÁO SỞ HỮU CÔNG NGHIỆP SỐ 436 TẬP A – QUYỀN 2 (07.2024)

(11) **50610**

(21) 3-2024-01015

(28) 1

(54) **KHUYÊN TAI**

(51) **11-01**

(22) 02/05/2024

(43) 25/07/2024

(30) WIPO145234 29/02/2024 WO;

(73) **VAN CLEEF & ARPELS SA (CH)**

Route des Biches 8, 1752 Villars-sur-Glâne, Switzerland

(72) Marie Laure Giroux (FR)

(74) Công ty TNHH tư vấn Sở hữu trí tuệ IPFLAME (IPFLAME CO.,LTD)

(55)



1.1

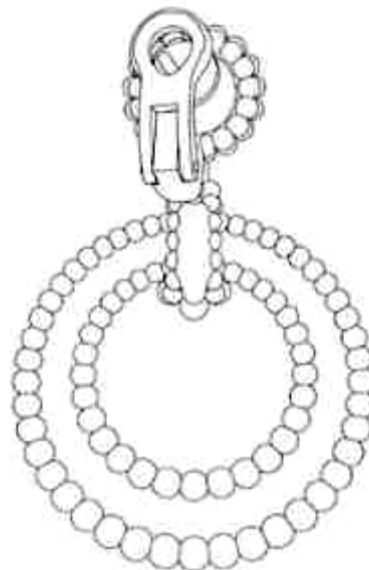

1.2

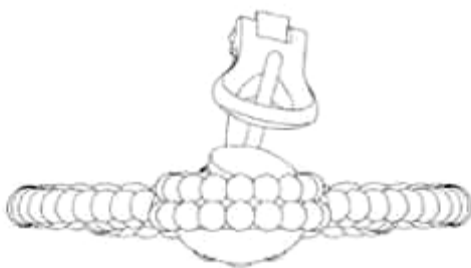

1.3

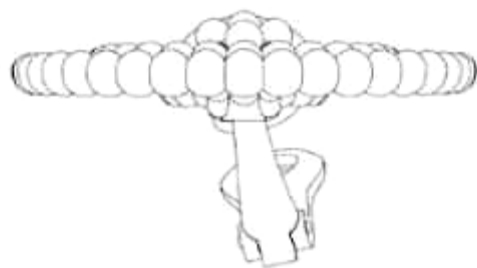

1.4

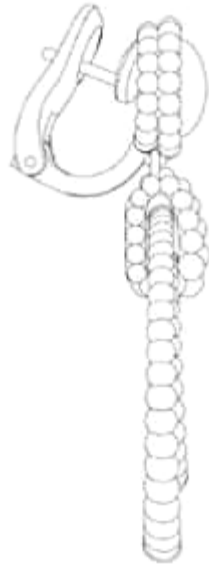

1.5

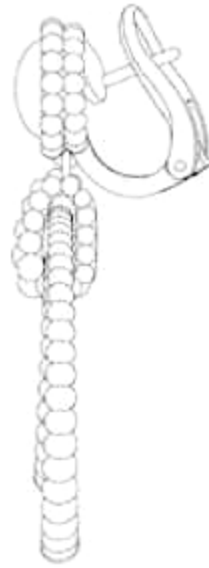

1.6



1.7

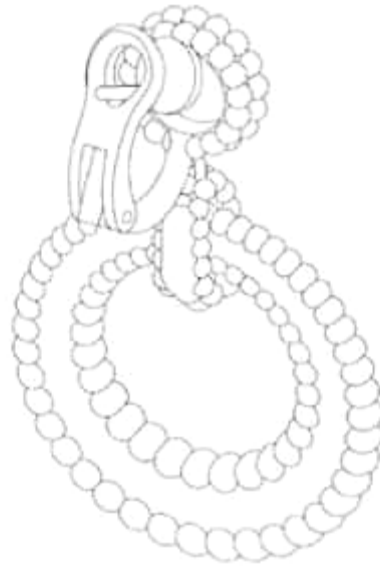

1.8

(11) **50611**

(21) 3-2024-01016

(28) 1

(54) **KHUYÊN TAI**

(51) **11-01**

(22) 02/05/2024

(43) 25/07/2024

(30) WIPO145235 29/02/2024 WO;

(73) **VAN CLEEF & ARPELS SA (CH)**

Route des Biches 8, 1752 Villars-sur-Glâne, Switzerland

(72) Marie Laure Giroux (FR)

(74) Công ty TNHH tư vấn Sở hữu trí tuệ IPFLAME (IPFLAME CO.,LTD)

(55)



1.1



1.2

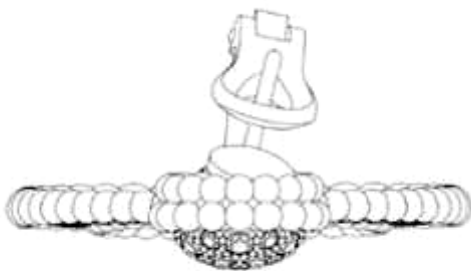

1.3

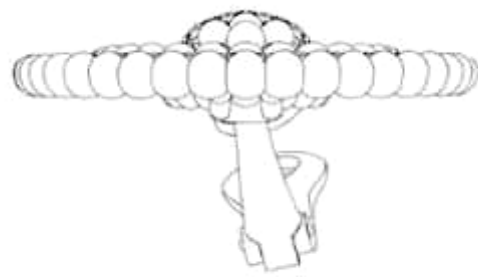

1.4

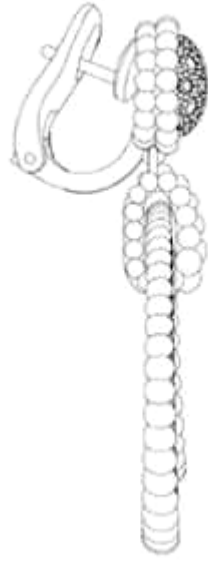

1.5

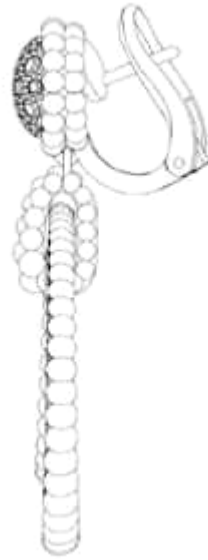

1.6



1.7



1.8

CÔNG BÁO SỞ HỮU CÔNG NGHIỆP SỐ 436 TẬP A – QUYỀN 2 (07.2024)

- (11) **50612**
- (21) 3-2024-01017 (28) 1
- (54) **NHÃN SẢN PHẨM** (51) **19-08**
- (22) 02/05/2024 (43) 25/07/2024
- (73) **CÔNG TY CỔ PHẦN GIẤY VIỆT PHÁP (VN)**
Khu Dương Ô, phường Phong Khê, thành phố Bắc Ninh, tỉnh Bắc Ninh
- (72) Nguyễn Thị Thanh Ngọc (VN)
- (55)



- (11) **50613**
- (21) 3-2024-01019
- (54) **CHAI**
- (22) 02/05/2024
- (30) 30202400297P 22/03/2024 SG;
- (73) **LAM SOON SINGAPORE PTE LTD. (SG)**
15 SCOTTS ROAD, #05-01/03 15 SCOTTS SINGAPORE 228218
- (72) Whang Shang Ying (SG)
- (74) Công ty TNHH Tầm nhìn và Liên danh (VISION & ASSOCIATES CO.LTD.)
- (55)

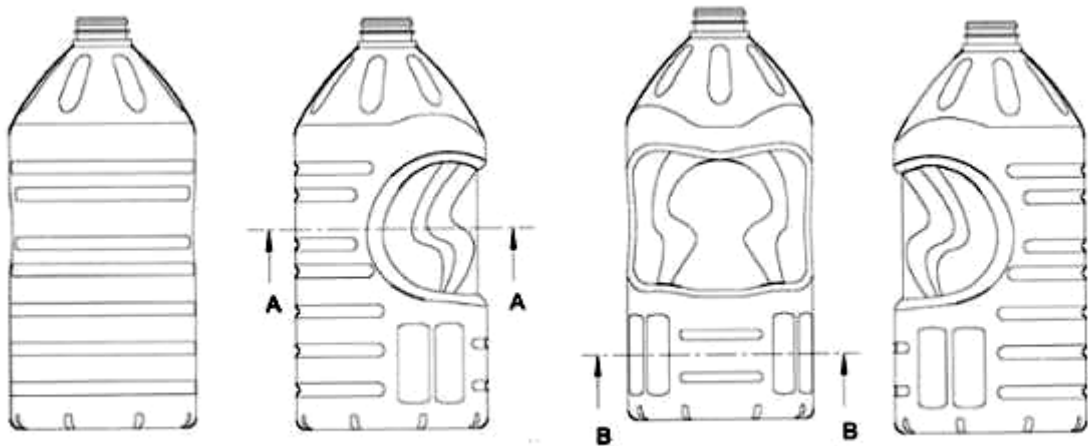

1.1

1.2

1.3

1.4

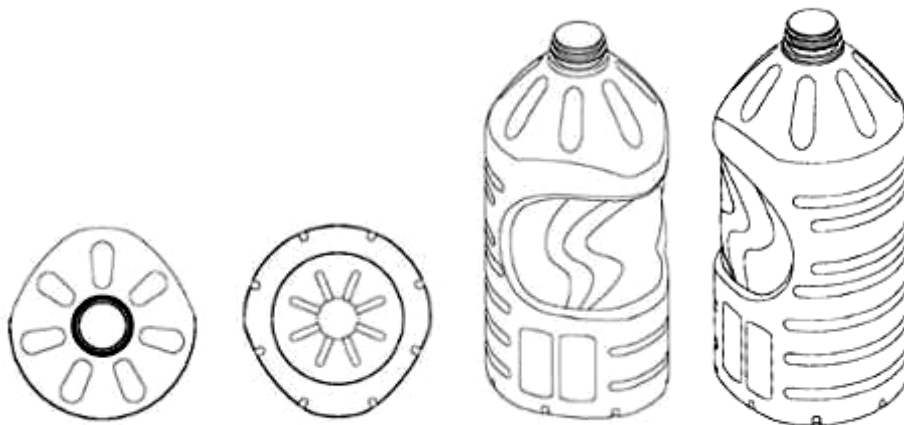

1.5

1.6

1.7

1.8



1.9



1.10



1.11



1.12



1.13

CÔNG BÁO SỞ HỮU CÔNG NGHIỆP SỐ 436 TẬP A – QUYỀN 2 (07.2024)

- (11) **50614**
(21) 3-2024-01020 (28) 1
(54) **THÙNG RÁC** (51) **09-09**
(22) 02/05/2024 (43) 25/07/2024
(73) **TRUNG TÂM NGHIÊN CỨU ỨNG DỤNG VÀ DỊCH VỤ KHOA HỌC CÔNG NGHỆ (VN)**
Ấp Hội Gia, xã Mỹ Phong, thành phố Mỹ Tho, tỉnh Tiền Giang
(72) Đặng Thị Hồng Yến (VN)
(74) Công ty TNHH Luật ALIAT (ALIAT LEGAL)
(55)

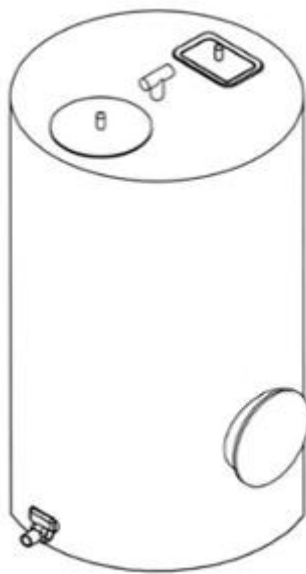

1.1



1.2

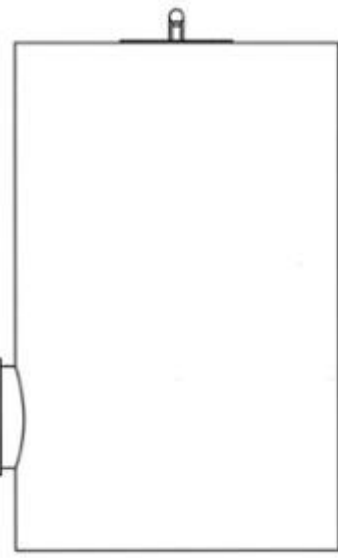

1.3

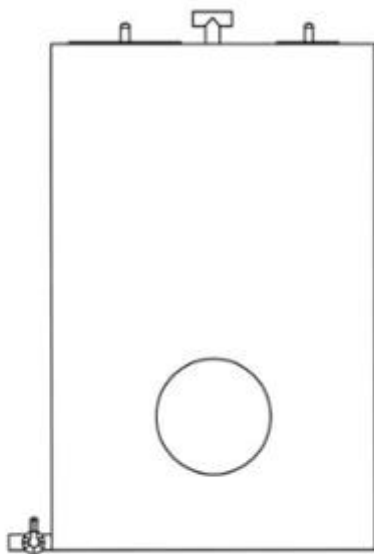

1.4

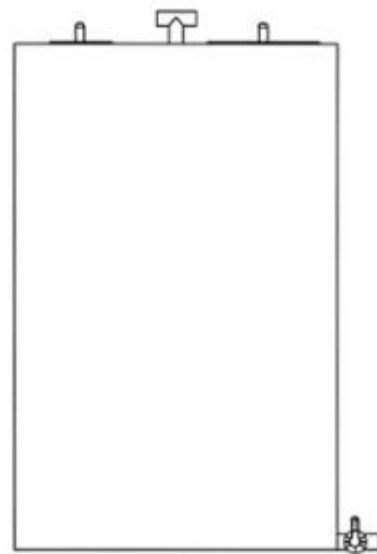

1.5

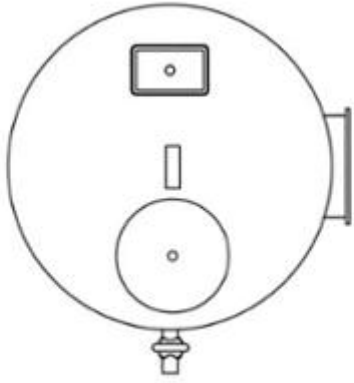

1.6

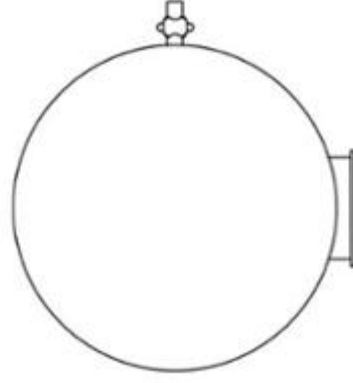

1.7

CÔNG BÁO SỞ HỮU CÔNG NGHIỆP SỐ 436 TẬP A – QUYỀN 2 (07.2024)

- (11) **50615**
- (21) 3-2023-02374 (28) 1
- (54) **NHÃN SẢN PHẨM** (51) **19-08**
- (22) 09/10/2023 (43) 25/07/2024
- (73) **CÔNG TY CỔ PHẦN BÁNH KẸO TRÀNG AN 2 - VIỆT NAM (VN)**
Số 233, đường Sào Nam, phường Nghi Thu, thị xã Cửa Lò, tỉnh Nghệ An
- (72) Trịnh Sỹ (VN)
- (74) Công ty TNHH T&T INVENMARK Sở hữu trí tuệ Quốc tế (T&T INVENMARK CO., LTD.)
- (55)



CÔNG BÁO SỞ HỮU CÔNG NGHIỆP SỐ 436 TẬP A – QUYỀN 2 (07.2024)

- (11) **50616**
(21) 3-2024-00579 (28) 1
(54) **ẤM ĐUN NƯỚC** (51) **07-02**
(22) 11/03/2024 (43) 25/07/2024
(73) **CÔNG TY CỔ PHẦN BÓNG ĐÈN PHÍCH NƯỚC RẠNG ĐÔNG (VN)**
87-89 phố Hạ Đình, phường Thanh Xuân Trung, quận Thanh Xuân, thành phố Hà Nội
(72) Trần Trung Tường (VN)
(55)



1.1

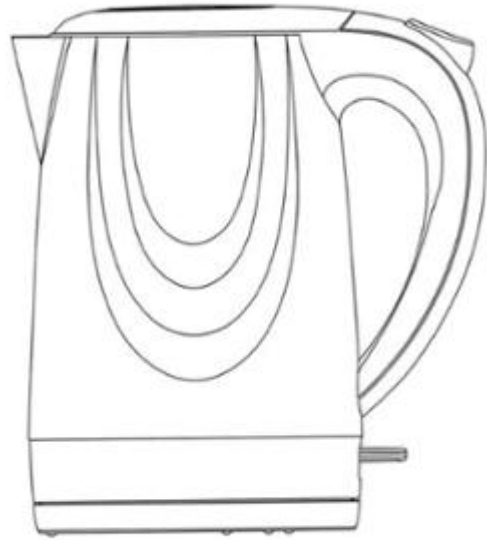

1.2

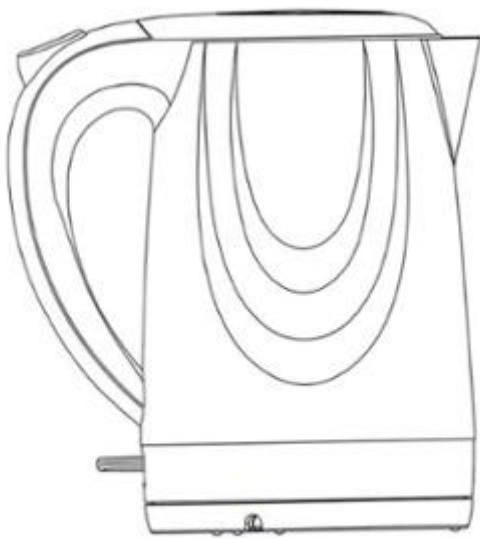

1.3

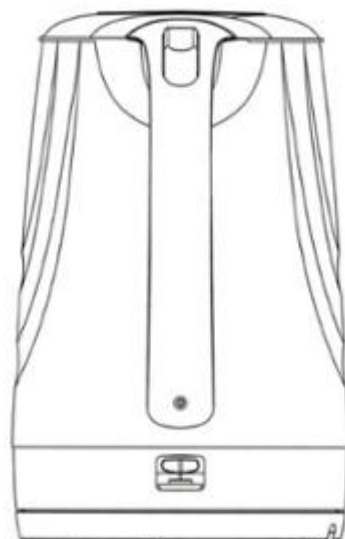

1.4



1.5

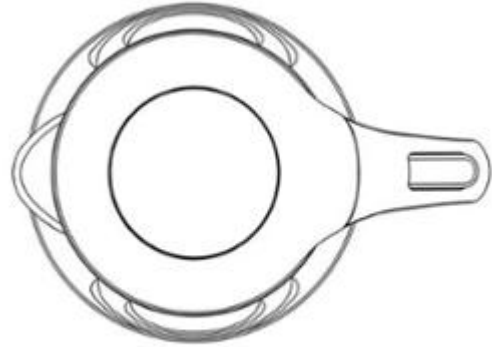

1.6

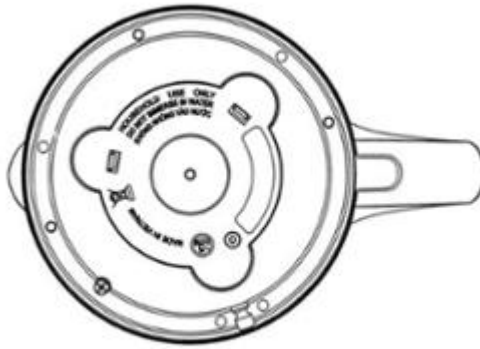

1.7

CÔNG BÁO SỞ HỮU CÔNG NGHIỆP SỐ 436 TẬP A – QUYỀN 2 (07.2024)

- (11) **50617**
(21) 3-2024-00591 (28) 1
(54) **BÚT BI** (51) **19-06**
(22) 11/03/2024 (43) 25/07/2024
(73) **Công ty TNHH LEADERART INDUSTRIES (VIETNAM) (VN)**
Số 22 VSIP II-A, đường số 30, khu công nghiệp Việt Nam - Singapore II-A,
phường Vĩnh Tân, thành phố Tân Uyên, tỉnh Bình Dương
(72) Peter Liu (TW)
(74) Công ty TNHH NACILAW (NACILAW)
(55)

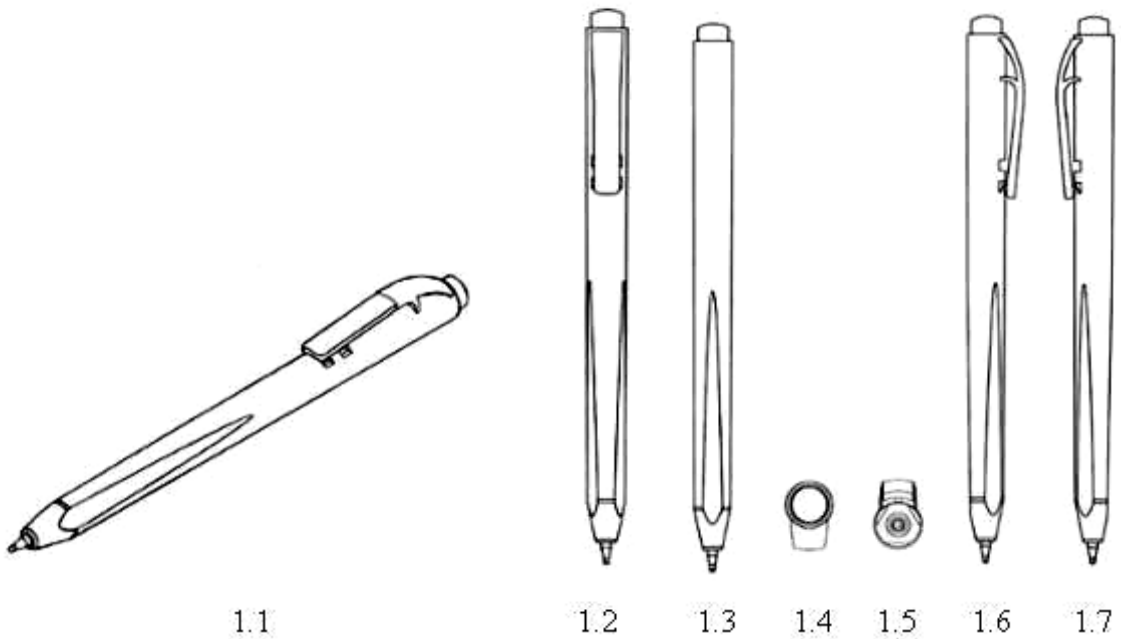

CÔNG BÁO SỞ HỮU CÔNG NGHIỆP SỐ 436 TẬP A – QUYỀN 2 (07.2024)

- (11) **50618**
(21) 3-2024-00583 (28) 2
(54) **HỘP** (51) **09-03**
(22) 11/03/2024 (43) 25/07/2024
(73) **CÔNG TY CỔ PHẦN BỘT GIẶT LIX (VN)**
Số 3, đường số 2, khu phố 4, phường Linh Trung, thành phố Thủ Đức, thành phố Hồ Chí Minh
(72) Cao Thành Tín (VN)
(74) Văn phòng Luật sư A Hoà (AHOA LAW OFFICE)
(55)



1.1



1.2



2.1



2.2

CÔNG BÁO SỞ HỮU CÔNG NGHIỆP SỐ 436 TẬP A – QUYỀN 2 (07.2024)

- (11) **50619**
(21) 3-2024-00584 (28) 2
(54) **BỘ NHÃN SẢN PHẨM** (51) **19-08**
(22) 11/03/2024 (43) 25/07/2024
(73) **CÔNG TY CỔ PHẦN BỘT GIẶT LIX (VN)**
Số 3, đường số 2, khu phố 4, phường Linh Trung, thành phố Thủ Đức, thành phố Hồ Chí Minh
(72) Cao Thành Tín (VN)
(74) Văn phòng Luật sư A Hoà (AHOA LAW OFFICE)
(55)



1.1



1.2

CÔNG BÁO SỞ HỮU CÔNG NGHIỆP SỐ 436 TẬP A – QUYỀN 2 (07.2024)

- (11) **50620**
(21) 3-2024-00585 (28) 2
(54) **BỘ NHÃN SẢN PHẨM** (51) **19-08**
(22) 11/03/2024 (43) 25/07/2024
(73) **CÔNG TY CỔ PHẦN BỘT GIẶT LIX (VN)**
Số 3, đường số 2, khu phố 4, phường Linh Trung, thành phố Thủ Đức, thành phố Hồ Chí Minh
(72) Cao Thành Tín (VN)
(74) Văn phòng Luật sư A Hoà (AHOA LAW OFFICE)
(55)



1.1



1.2

- (11) **50621**
- (21) 3-2023-00411 (28) 1
- (54) **THIẾT BỊ ĐEO ĐƯỢC** (51) **10-02; 10-03; 10-04; 14-01; 14-02; 14-03; 24-02**
- (22) 01/03/2023 (43) 25/07/2024
- (30) 29/852,191 04/09/2022 US;
- (73) **APPLE INC. (US)**
One Apple Park Way, Cupertino, California 95014, United States of America
- (72) 1. JODY AKANA (US)
2. MOLLY ANDERSON (GB)
3. BARTLEY K. ANDRE (US)
4. SHOTA AOYAGI (JP)
5. ANTHONY MICHAEL ASHCROFT (FR)
6. MARINE C. BATAILLE (FR)
7. JEREMY BATAILLOU (FR)
8. ABIDUR RAHMAN CHOWDHURY (GB)
9. CLARA GENEVIÈVE MARINE COURTAIGNE (FR)
10. MARKUS DIEBEL (DE)
11. JONATHAN GOMEZ GARCIA (GB)
12. M. EVANS HANKEY (US)
13. ANNE-MARIE HECK (CH)
14. MOISES HERNANDEZ HERNANDEZ (MX)
15. RICHARD P. HOWARTH (GB)
16. JONATHAN P. IVE (GB)
17. JULIAN JAEDE (DE)
18. DUNCAN ROBERT KERR (GB)
19. KAINOA KWON-PEREZ (US)
20. NICOLAS PEDRO LYLYK (AR)
21. MARC A. NEWSON (AU)
22. PETER RUSSELL-CLARKE (AU)
23. BENJAMIN ANDREW SHAFFER (US)
24. CLEMENT TISSANDIER (FR)
25. EUGENE ANTONY WHANG (CA)
- (74) Công ty TNHH Lê & Lê (LE & LE)
- (55)



1.1



1.2



1.3



1.4



1.5



1.6



1.7



1.8



1.9



1.10

CÔNG BÁO SỞ HỮU CÔNG NGHIỆP SỐ 436 TẬP A – QUYỀN 2 (07.2024)

- (11) **50622**
(21) 3-2024-00879 (28) 1
(54) **ĐẦU CẮT CỦA TÔNG ĐƠ** (51) **28-03**
(22) 10/04/2024 (43) 25/07/2024
(30) 29/913,990 11/10/2023 US;
(73) **MANSCAPED, LLC (US)**
3753 Howard Hughes Parkway, Suite 200, Las Vegas, NV 89169, United States of America
(72) 1. ANH HAO TRAN (US)
2. DANIEL VEIGA (PT)
3. EDILBERT NERI ABILLAR (US)
4. MARCELO KERTESZ (US)
5. CHEE HONG (US)
6. BRIAN DUNFEE (US)
7. JASON PAULK (US)
(74) Công ty cổ phần tư vấn Trung Thực (TRUNG THUC.,JSC)
(55)

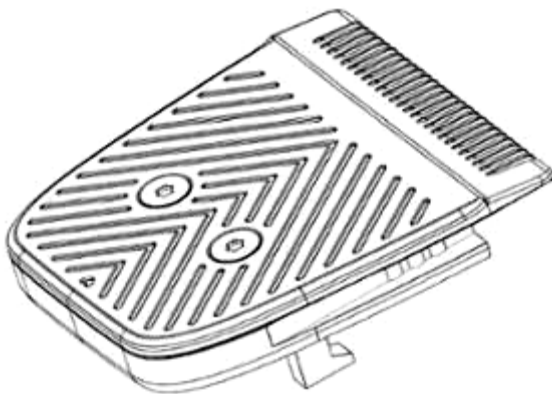

1.1

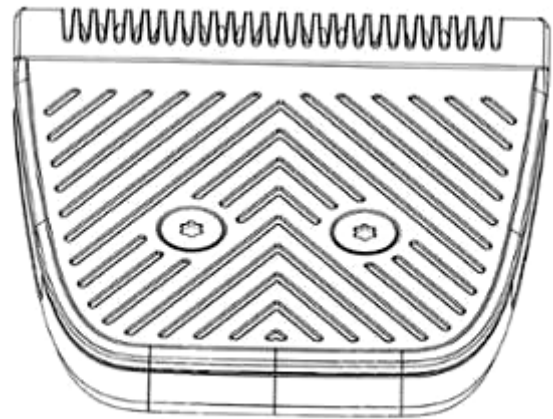

1.2

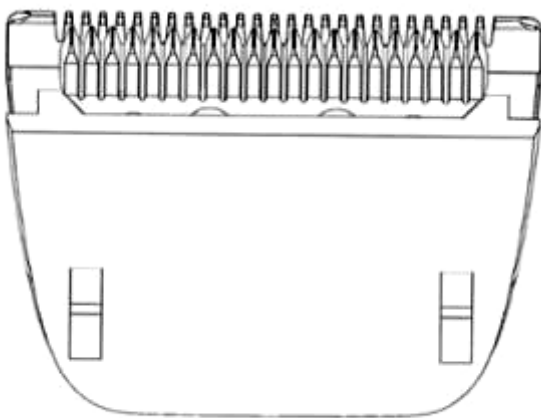

1.3

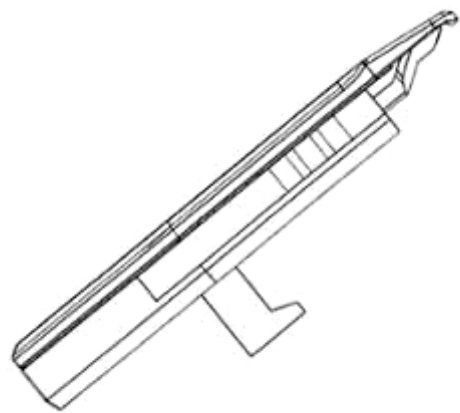

1.4

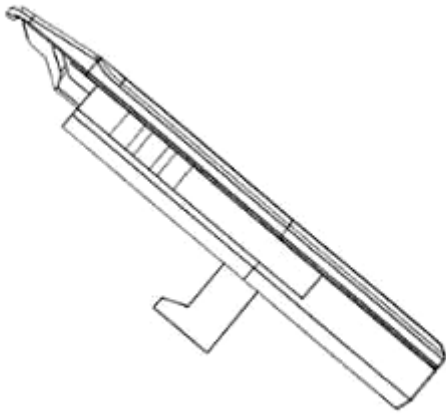

1.5

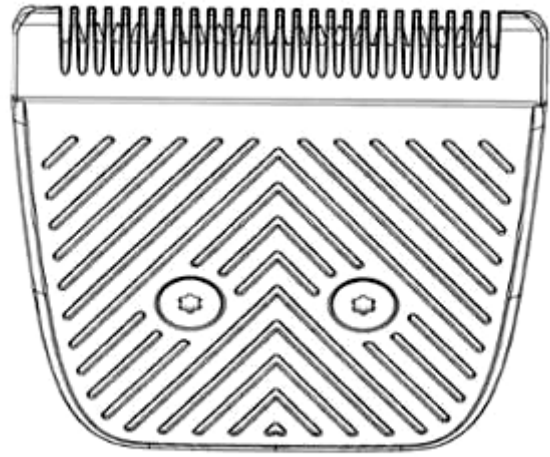

1.6

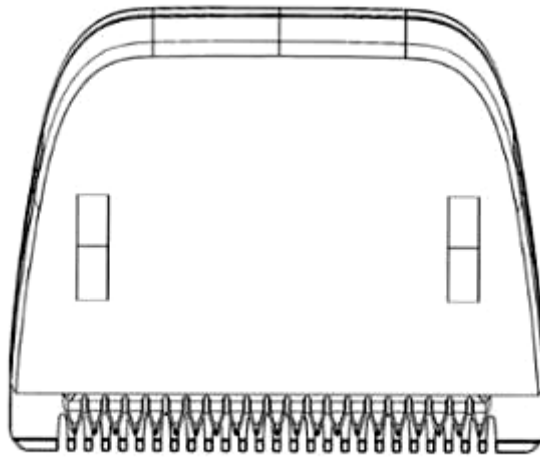

1.7

CÔNG BÁO SỞ HỮU CÔNG NGHIỆP SỐ 436 TẬP A – QUYỀN 2 (07.2024)

- (11) **50623**
(21) 3-2024-00880 (28) 1
(54) **ĐẦU CẠO CỦA TÔNG ĐƠ** (51) **28-03**
(22) 10/04/2024 (43) 25/07/2024
(30) 29/913,990 11/10/2023 US;
(73) **MANSCAPED, LLC (US)**
3753 Howard Hughes Parkway, Suite 200, Las Vegas, NV 89169, United States of America
(72) 1. ANH HAO TRAN (US)
2. DANIEL VEIGA (PT)
3. EDILBERT NERI ABILLAR (US)
4. MARCELO KERTESZ (US)
5. CHEE HONG (US)
6. BRIAN DUNFEE (US)
7. JASON PAULK (US)
(74) Công ty cổ phần tư vấn Trung Thực (TRUNG THUC.,JSC)
(55)

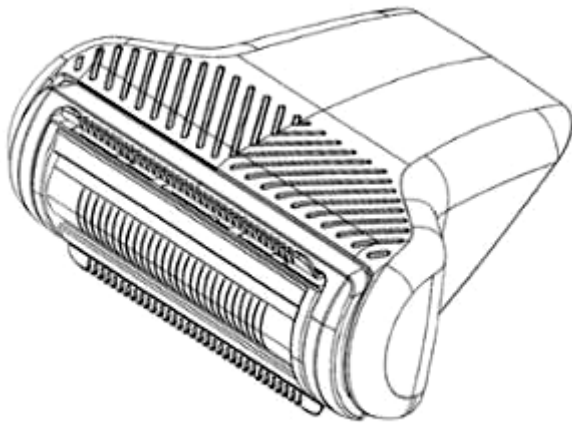

1.1

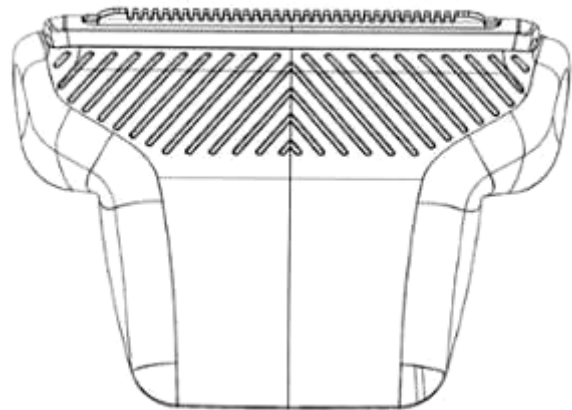

1.2

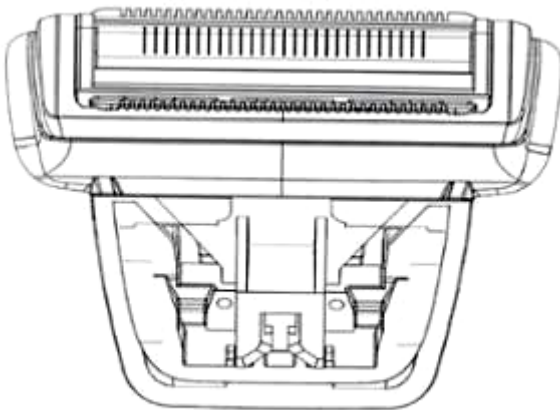

1.3

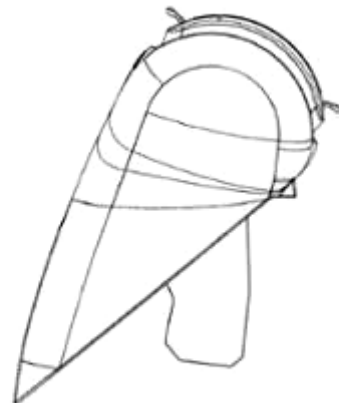

1.4

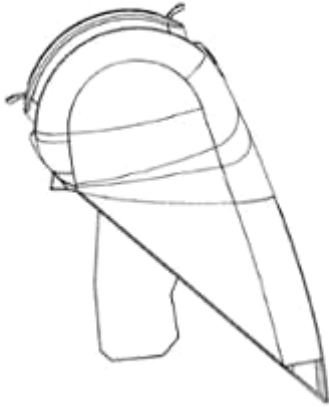

1.5

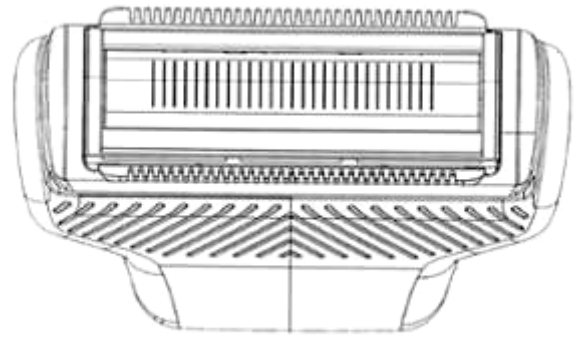

1.6

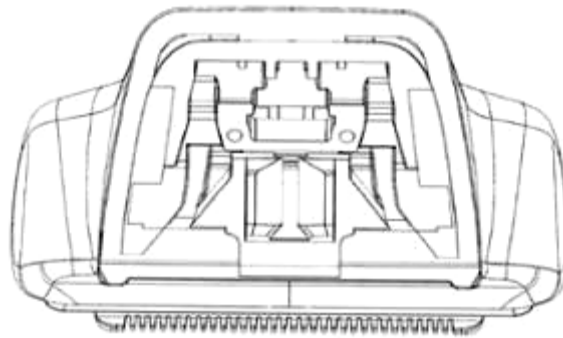

1.7

- (11) **50624**
- (21) 3-2023-02892 (28) 1
- (54) **BỘ PHẬN CHẴN SÁNG** (51) **14-02**
- (22) 01/12/2023 (43) 25/07/2024
- (30) 29/893,887 03/06/2023 US;
- (73) **APPLE INC. (US)**
One Apple Park Way, Cupertino, California 95014, United States of America
- (72) 1. MOLLY ANDERSON (GB)
2. BARTLEY K. ANDRE (US)
3. SHOTA AOYAGI (JP)
4. MARINE C. BATAILLE (FR)
5. ABIBUR RAHMAN CHOWDHURY (GB)
6. CLARA GENEVIÈVE MARINE COURTAIGNE (FR)
7. MARKUS DIEBEL (DE)
8. ALEXANDRE B. GIRARD (US)
9. JONATHAN GOMEZ GARCIA (GB)
10. M. EVANS HANKEY (US)
11. ANNE-MARIE HECK (CH)
12. MOISES HERNANDEZ HERNANDEZ (MX)
13. RICHARD P. HOWARTH (GB)
14. JULIAN JAEDE (DE)
15. DUNCAN ROBERT KERR (GB)
16. KAINOA KWON-PEREZ (US)
17. NICOLAS PEDRO LYLYK (AR)
18. PETER RUSSELL-CLARKE (AU)
19. BENJAMIN ANDREW SHAFFER (US)
20. ROBERT V. TANG (CA)
21. CLEMENT TISSANDIER (FR)
- (74) Công ty TNHH Lê & Lê (LE & LE)
- (55)



1.1



1.2



1.3



1.4



1.5



1.6



1.7



1.8



1.9



1.10



1.11



1.12

- (11) **50625**
- (21) 3-2023-02893 (28) 1
- (54) **MÀN HÌNH ĐEO ĐẦU** (51) **14-02**
- (22) 01/12/2023 (43) 25/07/2024
- (30) 29/877,254 04/06/2023 US;
- (73) **APPLE INC. (US)**
One Apple Park Way, Cupertino, California 95014, United States of America
- (72) 1. JODY AKANA (US)
2. MOLLY ANDERSON (GB)
3. BARTLEY K. ANDRE (US)
4. SHOTA AOYAGI (JP)
5. ANTHONY MICHAEL ASHCROFT (FR)
6. MARINE C. BATAILLE (FR)
7. JEREMY BATAILLOU (FR)
8. ABIBUR RAHMAN CHOWDHURY (GB)
9. CLARA GENEVIÈVE MARINE COURTAIGNE (FR)
10. MARKUS DIEBEL (DE)
11. ALEXANDRE B. GIRARD (US)
12. JONATHAN GOMEZ GARCIA (GB)
13. M. EVANS HANKEY (US)
14. ANNE-MARIE HECK (CH)
15. MOISES HERNANDEZ HERNANDEZ (MX)
16. JULIAN HOENIG (AT)
17. RICHARD P. HOWARTH (GB)
18. JONATHAN P. IVE (GB)
19. JULIAN JAEDE (DE)
20. DUNCAN ROBERT KERR (GB)
21. KAINOA KWON-PEREZ (US)
22. NICOLAS PEDRO LYLYK (AR)
23. MARC A. NEWSON (AU)
24. PETER RUSSELL-CLARKE (AU)
25. BENJAMIN ANDREW SHAFFER (US)
26. JOE SUNG-HO TAN (US)
27. ROBERT V. TANG (CA)
28. CLEMENT TISSANDIER (FR)
29. EUGENE ANTONY WHANG (CA)
- (74) Công ty TNHH Lê & Lê (LE & LE)
- (55)

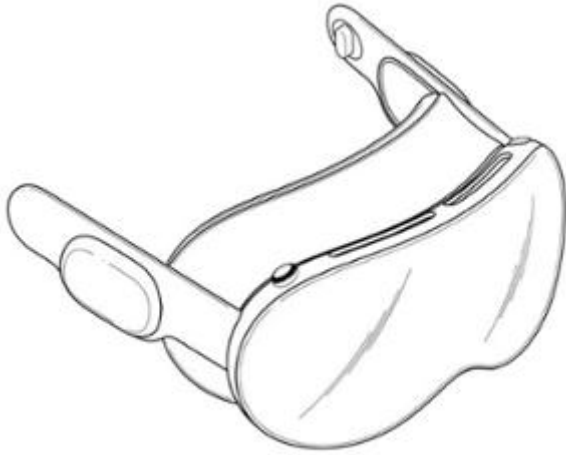

1.1

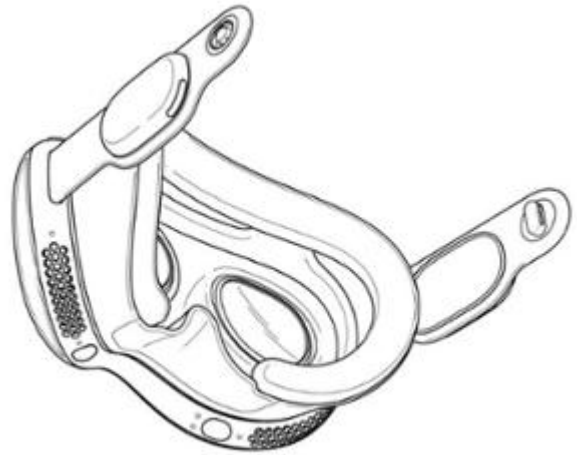

1.2



1.3

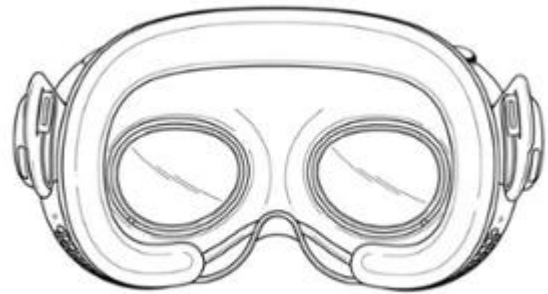

1.4



1.5

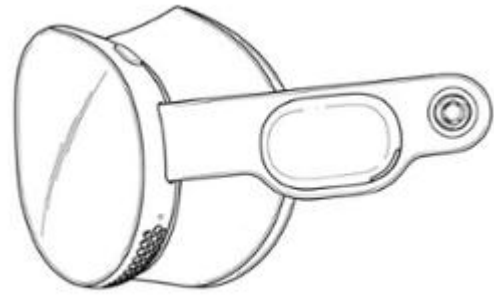

1.6

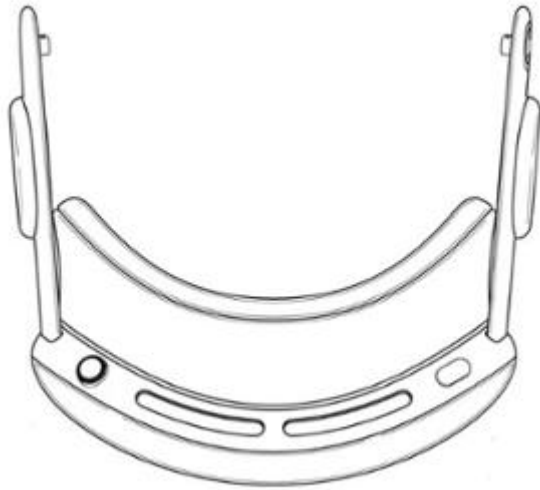

1.7



1.8

- (11) **50626**
- (21) 3-2023-02894 (28) 1
- (54) **MÀN HÌNH ĐEO ĐẦU** (51) **14-02**
- (22) 01/12/2023 (43) 25/07/2024
- (30) 29/877,254 04/06/2023 US;
- (73) **APPLE INC. (US)**
One Apple Park Way, Cupertino, California 95014, United States of America
- (72) 1. JODY AKANA (US)
2. MOLLY ANDERSON (GB)
3. BARTLEY K. ANDRE (US)
4. SHOTA AOYAGI (JP)
5. ANTHONY MICHAEL ASHCROFT (FR)
6. MARINE C. BATAILLE (FR)
7. JEREMY BATAILLOU (FR)
8. ABIBUR RAHMAN CHOWDHURY (GB)
9. CLARA GENEVIÈVE MARINE COURTAIGNE (FR)
10. MARKUS DIEBEL (DE)
11. ALEXANDRE B. GIRARD (US)
12. JONATHAN GOMEZ GARCIA (GB)
13. M. EVANS HANKEY (US)
14. ANNE-MARIE HECK (CH)
15. MOISES HERNANDEZ HERNANDEZ (MX)
16. JULIAN HOENIG (AT)
17. RICHARD P. HOWARTH (GB)
18. JONATHAN P. IVE (GB)
19. JULIAN JAEDE (DE)
20. DUNCAN ROBERT KERR (GB)
21. KAINOA KWON-PEREZ (US)
22. NICOLAS PEDRO LYLYK (AR)
23. MARC A. NEWSON (AU)
24. PETER RUSSELL-CLARKE (AU)
25. BENJAMIN ANDREW SHAFFER (US)
26. JOE SUNG-HO TAN (US)
27. ROBERT V. TANG (CA)
28. CLEMENT TISSANDIER (FR)
29. EUGENE ANTONY WHANG (CA)
- (74) Công ty TNHH Lê & Lê (LE & LE)
- (55)

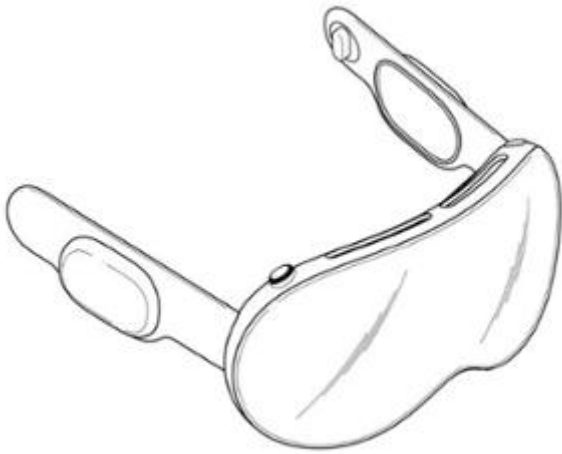

1.1



1.2



1.3



1.4

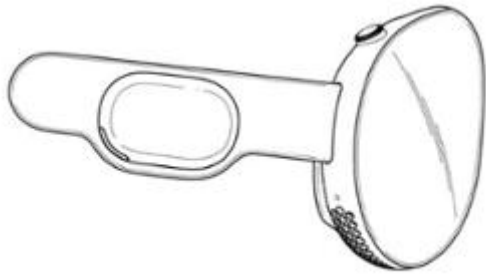

1.5

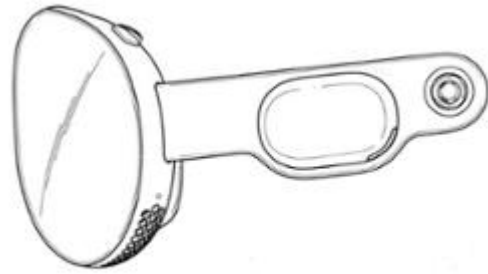

1.6

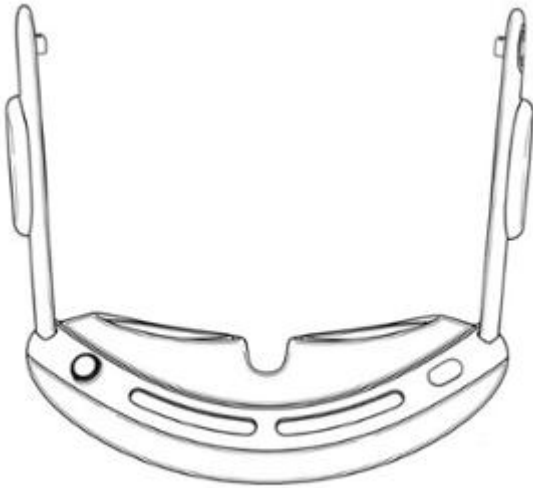

1.7

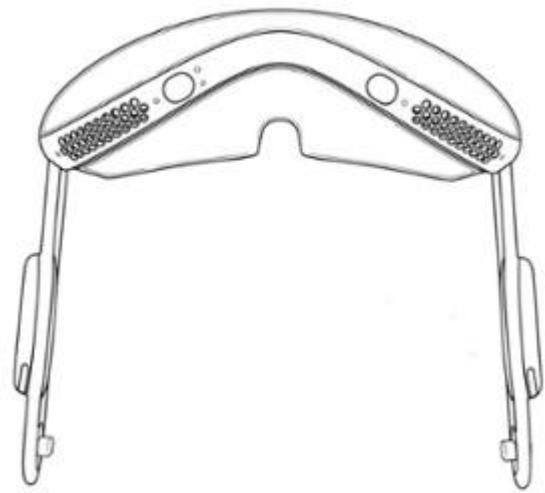

1.8

- (11) **50627**
- (21) 3-2023-02897 (28) 1
- (54) **DÂY ĐAI** (51) **14-02**
- (22) 01/12/2023 (43) 25/07/2024
- (30) 29/877,258 05/06/2023 US;
- (73) **APPLE INC. (US)**
One Apple Park Way, Cupertino, California 95014, United States of America
- (72) 1. MOLLY ANDERSON (GB)
2. BARTLEY K. ANDRE (US)
3. SHOTA AOYAGI (JP)
4. MARINE C. BATAILLE (FR)
5. ABIBUR RAHMAN CHOWDHURY (GB)
6. CLARA GENEVIÈVE MARINE COURTAIGNE (FR)
7. MARKUS DIEBEL (DE)
8. ALEXANDRE B. GIRARD (US)
9. JONATHAN GOMEZ GARCIA (GB)
10. M. EVANS HANKEY (US)
11. ANNE-MARIE HECK (CH)
12. MOISES HERNANDEZ HERNANDEZ (MX)
13. RICHARD P. HOWARTH (GB)
14. JULIAN JAEDE (DE)
15. DUNCAN ROBERT KERR (GB)
16. KAINOA KWON-PEREZ (US)
17. NICOLAS PEDRO LYLYK (AR)
18. PETER RUSSELL-CLARKE (AU)
19. BENJAMIN ANDREW SHAFFER (US)
20. ROBERT V. TANG (CA)
21. CLEMENT TISSANDIER (FR)
- (74) Công ty TNHH Lê & Lê (LE & LE)
- (55)

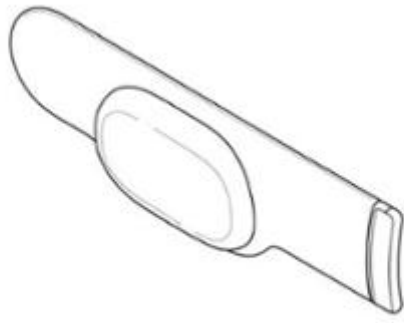

1.1

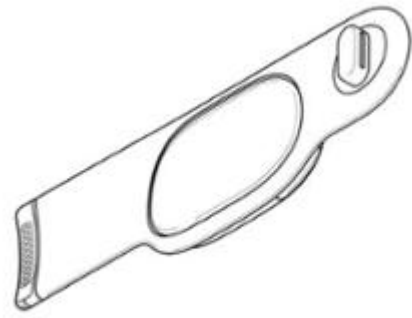

1.2



1.3



1.4



1.5

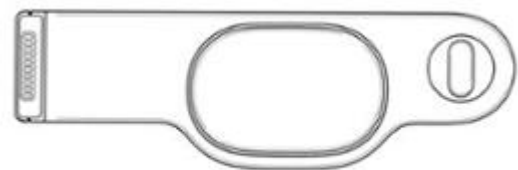

1.6



1.7



1.8

CÔNG BÁO SỞ HỮU CÔNG NGHIỆP SỐ 436 TẬP A – QUYỀN 2 (07.2024)

- (11) **50628**
- (21) 3-2024-00896 (28) 3
- (54) **DỤNG CỤ CHĂM SÓC CÁ NHÂN** (51) **04-02**
- (22) 10/04/2024 (43) 25/07/2024
- (30) 29/915,003 24/10/2023 US;
- (73) **COLGATE-PALMOLIVE COMPANY (US)**
300 Park Avenue, New York, New York 10022, United States of America
- (72) Jennifer Erin DOX (US)
- (74) Văn phòng Luật sư Ân Nam (ANNAM IP & LAW)
- (55)

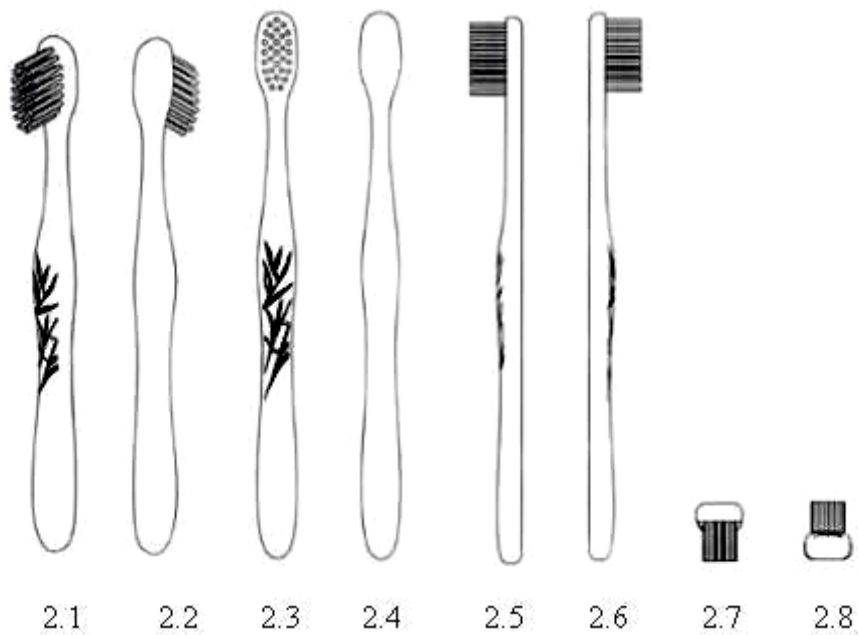
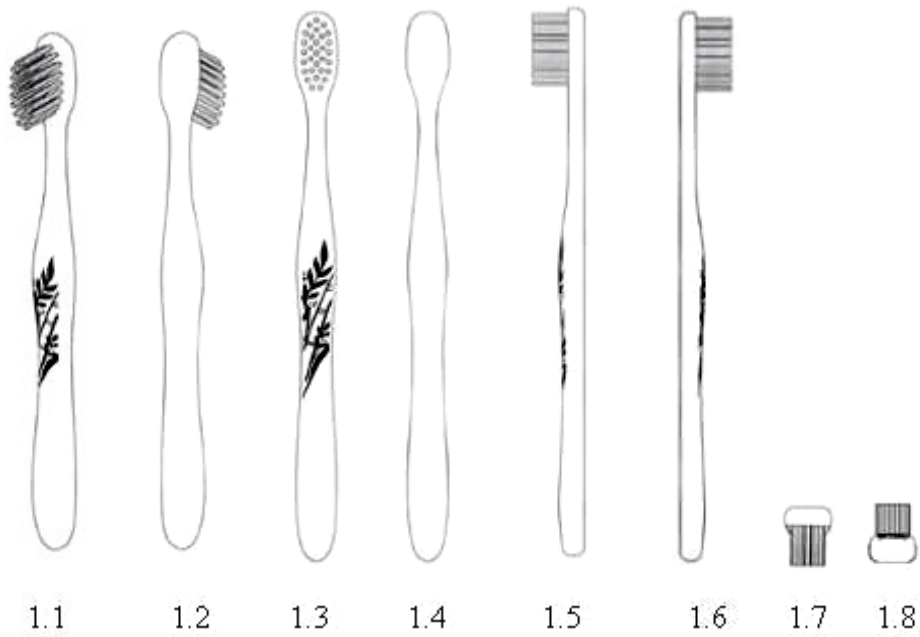

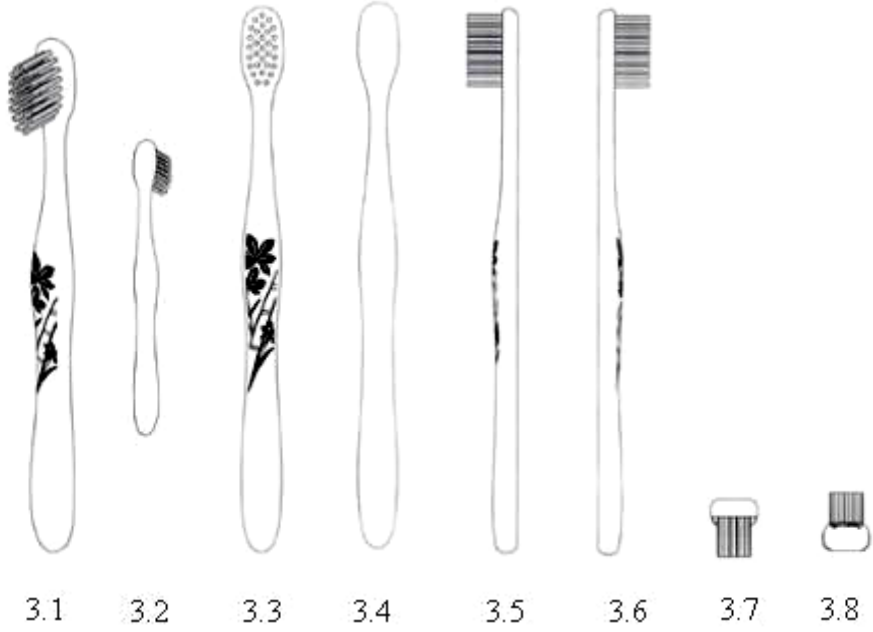

CÔNG BÁO SỞ HỮU CÔNG NGHIỆP SỐ 436 TẬP A – QUYỀN 2 (07.2024)

- (11) **50629**
(21) 3-2024-00881 (28) 1
(54) **NHÃN SẢN PHẨM** (51) **19-08**
(22) 10/04/2024 (43) 25/07/2024
(73) **LÝ QUỐC DÂN (VN)**
Khu phố Lâm Trúc 1, phường Hoài Thanh, thị xã Hoài Nhơn, tỉnh Bình Định
(72) Lý Quốc Dân (VN)
(74) **CÔNG TY TNHH SỞ HỮU TRÍ TUỆ SETHACO (SETHACO IP CO.,LTD)**
(55)



CÔNG BÁO SỞ HỮU CÔNG NGHIỆP SỐ 436 TẬP A – QUYỀN 2 (07.2024)

- (11) **50630**
- (21) 3-2024-00882 (28) 1
- (54) **NHÃN SẢN PHẨM** (51) **19-08**
- (22) 10/04/2024 (43) 25/07/2024
- (73) **LÝ QUỐC DÂN (VN)**
Khu phố Lâm Trúc 1, phường Hoài Thanh, thị xã Hoài Nhơn, tỉnh Bình Định
- (72) Lý Quốc Dân (VN)
- (74) CÔNG TY TNHH SỞ HỮU TRÍ TUỆ SETHACO (SETHACO IP CO.,LTD)
- (55)



CÔNG BÁO SỞ HỮU CÔNG NGHIỆP SỐ 436 TẬP A – QUYỀN 2 (07.2024)

- (11) **50631**
- (21) 3-2024-00586 (28) 2
- (54) **BỘ NHÃN SẢN PHẨM** (51) **19-08**
- (22) 11/03/2024 (43) 25/07/2024
- (73) **CÔNG TY CỔ PHẦN BỘT GIẶT LIX (VN)**
Số 3, đường số 2, khu phố 4, phường Linh Trung, thành phố Thủ Đức, thành phố Hồ Chí Minh
- (72) Cao Thành Tín (VN)
- (74) Văn phòng Luật sư A Hoà (AHOA LAW OFFICE)
- (55)



1.1



1.2

CÔNG BÁO SỞ HỮU CÔNG NGHIỆP SỐ 436 TẬP A – QUYỀN 2 (07.2024)

- (11) **50632**
(21) 3-2024-00587 (28) 2
(54) **BỘ NHÃN SẢN PHẨM** (51) **19-08**
(22) 11/03/2024 (43) 25/07/2024
(73) **CÔNG TY CỔ PHẦN BỘT GIẶT LIX (VN)**
Số 3, đường số 2, khu phố 4, phường Linh Trung, thành phố Thủ Đức, thành phố Hồ Chí Minh
(72) Cao Thành Tín (VN)
(74) Văn phòng Luật sư A Hoà (AHOA LAW OFFICE)
(55)



1.1



1.2

CÔNG BÁO SỞ HỮU CÔNG NGHIỆP SỐ 436 TẬP A – QUYỀN 2 (07.2024)

- (11) **50633**
(21) 3-2024-00784 (28) 1
(54) **THANH KIM LOẠI ĐỊNH HÌNH** (51) **25-01**
(22) 01/04/2024 (43) 25/07/2024
(73) **CÔNG TY CỔ PHẦN SẢN XUẤT VÀ THƯƠNG MẠI XUẤT NHẬP KHẨU GOONSAN (VN)**
Lô CN7, cụm công nghiệp Hoàng Xá, xã Hoàng Xá, huyện Thanh Thủy, tỉnh Phú Thọ
(72) Nguyễn Văn Sơn (VN)
(55)



1.1



1.2



1.3



1.4



1.5



1.6



1.7

CÔNG BÁO SỞ HỮU CÔNG NGHIỆP SỐ 436 TẬP A – QUYỀN 2 (07.2024)

- (11) **50634**
(21) 3-2024-00785 (28) 1
(54) **THANH KIM LOẠI ĐỊNH HÌNH** (51) **25-01**
(22) 01/04/2024 (43) 25/07/2024
(73) **CÔNG TY CỔ PHẦN SẢN XUẤT VÀ THƯƠNG MẠI XUẤT NHẬP KHẨU GOONSAN (VN)**
Lô CN7, cụm công nghiệp Hoàng Xá, xã Hoàng Xá, huyện Thanh Thủy, tỉnh Phú Thọ
(72) Nguyễn Văn Sơn (VN)
(55)

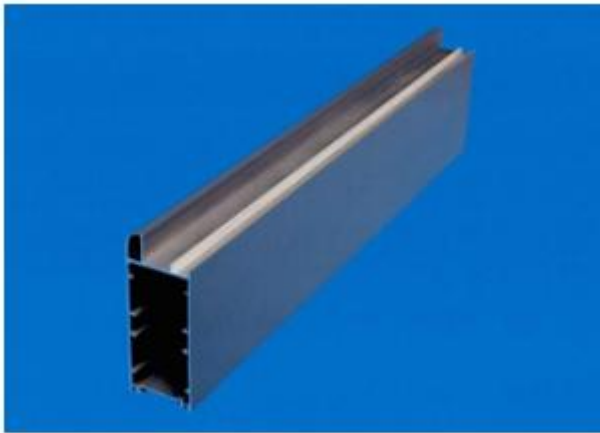

1.1



1.2



1.3



1.4



1.5



1.6



1.7

CÔNG BÁO SỞ HỮU CÔNG NGHIỆP SỐ 436 TẬP A – QUYỀN 2 (07.2024)

- (11) **50635**
(21) 3-2024-00786 (28) 1
(54) **THANH KIM LOẠI ĐỊNH HÌNH** (51) **25-01**
(22) 01/04/2024 (43) 25/07/2024
(73) **CÔNG TY CỔ PHẦN SẢN XUẤT VÀ THƯƠNG MẠI XUẤT NHẬP KHẨU GOONSAN (VN)**
Lô CN7, cụm công nghiệp Hoàng Xá, xã Hoàng Xá, huyện Thanh Thủy, tỉnh Phú Thọ
(72) Nguyễn Văn Sơn (VN)
(55)



1.1



1.2



1.3



1.4



1.5



1.6



1.7

CÔNG BÁO SỞ HỮU CÔNG NGHIỆP SỐ 436 TẬP A – QUYỀN 2 (07.2024)

- (11) **50636**
(21) 3-2024-00787 (28) 1
(54) **LỌ ĐỰNG SON MÔI** (51) **28-02**
(22) 01/04/2024 (43) 25/07/2024
(73) **LG H&H Co., LTD. (KR)**
58, Saemunan-ro, Jongno-gu, Seoul, Republic of Korea
(72) 1. LEE, DA LIN (KR)
2. KIM, EUL RAN (KR)
3. KIM, JOUNG EUN (KR)
4. KANG, KEUN AH (KR)
(74) Công ty TNHH Tầm nhìn và Liên danh (VISION & ASSOCIATES CO.LTD.)
(55)



1.1

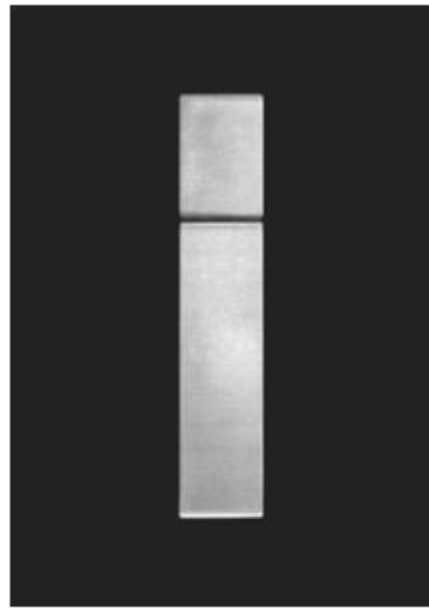

1.2

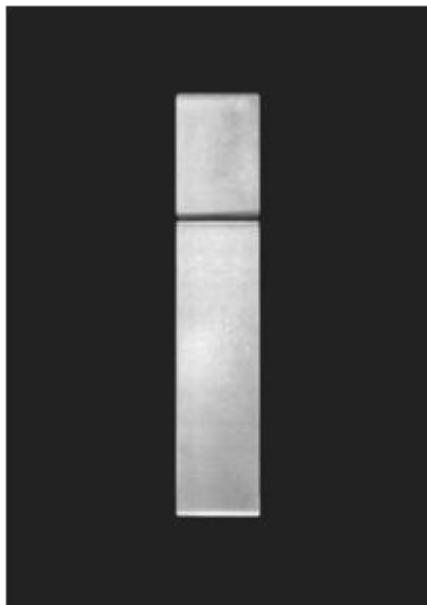

1.3



1.4



1.5

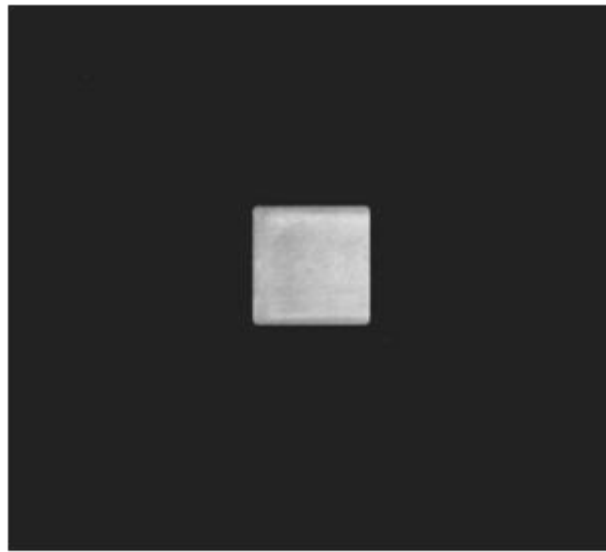

1.6

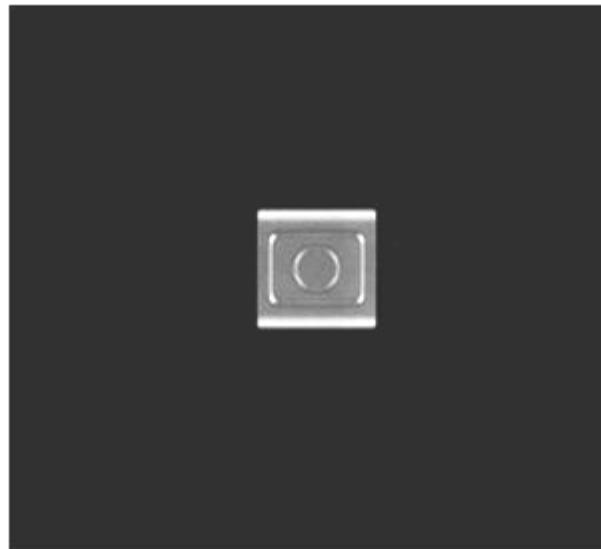

1.7

CÔNG BÁO SỞ HỮU CÔNG NGHIỆP SỐ 436 TẬP A – QUYỀN 2 (07.2024)

- (11) **50637**
(21) 3-2024-00788 (28) 1
(54) **THANH NHÔM ĐỊNH HÌNH** (51) **25-01**
(22) 01/04/2024 (43) 25/07/2024
(73) **CÔNG TY CỔ PHẦN NHÔM BLK VIỆT NAM (VN)**
Km 9 đường 35, thôn Thanh Hà, xã Nam Sơn, huyện Sóc Sơn, thành phố Hà Nội
(72) Vũ Bá Trường (VN)
(74) **CÔNG TY TNHH SỞ HỮU TRÍ TUỆ ANLIS VIỆT NAM (ANLIS IP CO.,LTD)**
(55)

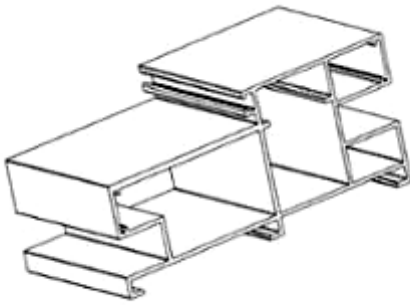

1.1

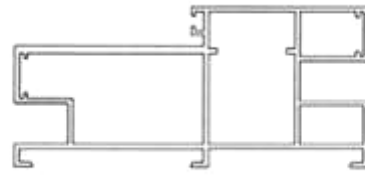

1.2

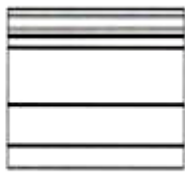

1.3

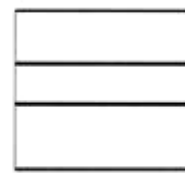

1.4



1.5



1.6

- (11) **50638**
(21) 3-2024-00909 (28) 1
(54) **MÁY THU HOẠCH CÀ PHÊ** (51) **15-03**
(22) 15/04/2024 (43) 25/07/2024
(73) **TRUNG TÂM GIÁM ĐỊNH MÁY VÀ THIẾT BỊ (VN)**
Ngõ 64, phố Ngô Xuân Quảng, thị trấn Trâu Quỳ, huyện Gia Lâm, thành phố Hà Nội
(72) Nguyễn Tuấn Anh (VN)
(55)

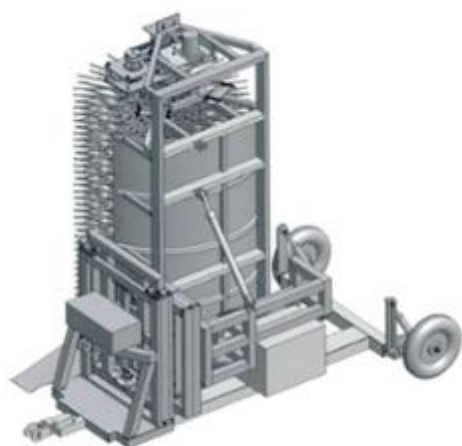

1.1

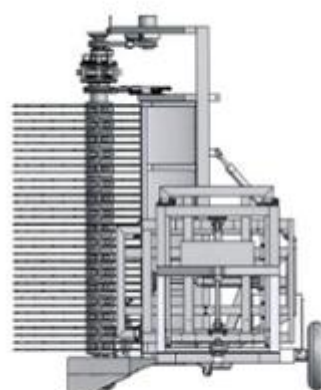

1.2

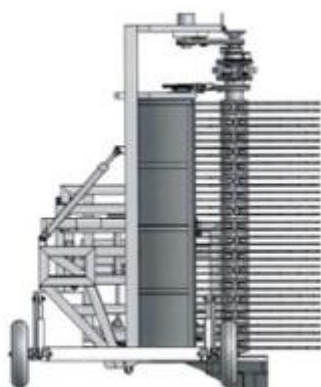

1.3



1.4

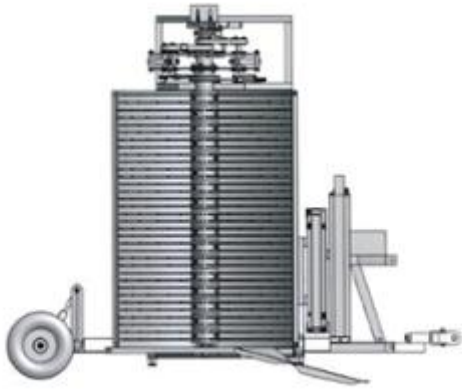

1.5

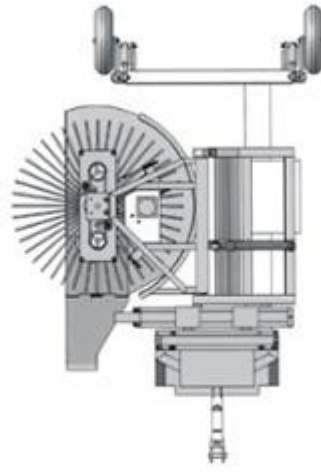

1.6

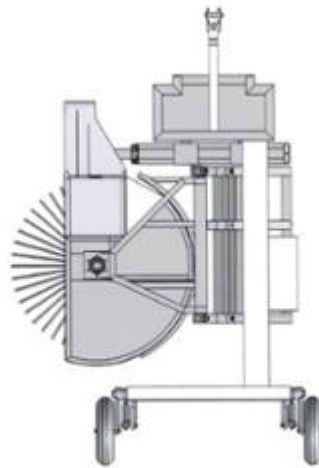

1.7

CÔNG BÁO SỞ HỮU CÔNG NGHIỆP SỐ 436 TẬP A – QUYỀN 2 (07.2024)

- (11) **50639**
(21) 3-2024-00911 (28) 1
(54) **TÚI LÀM LẠNH XÁCH TAY** (51) **07-07**
(22) 15/04/2024 (43) 25/07/2024
(30) 29/917,801 22/11/2023 US;
(73) **PACIFIC MARKET INTERNATIONAL, LLC (US)**
2401 Elliott Avenue, Suite 4 Seattle, Washington 98121, United States of America
(72) 1. MUNIE, JEFFREY CHARLES (US)
2. CHARI, VIGNESH (US)
3. WAGONER, GRAEME (US)
4. METROLIS-POOLE, MELISSA (US)
(74) Công ty TNHH Sở hữu trí tuệ Thảo Thọ Quyên (INVENCO.,LTD)
(55)



1.1

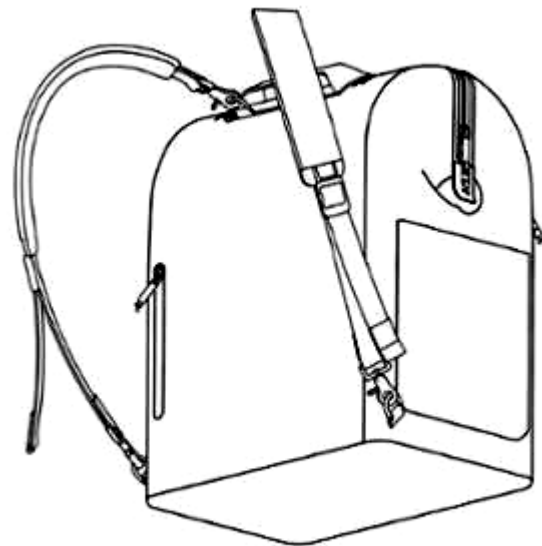

1.2

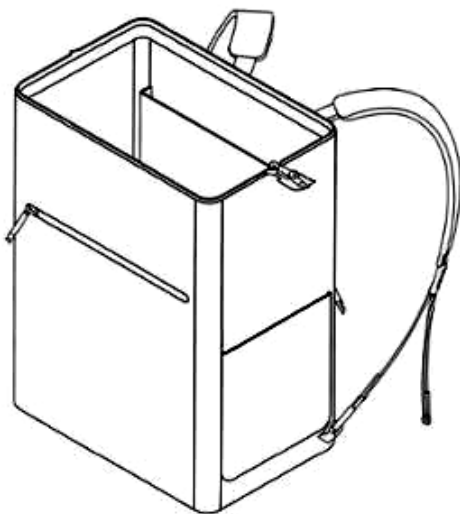

1.3



1.4



1.5



1.6

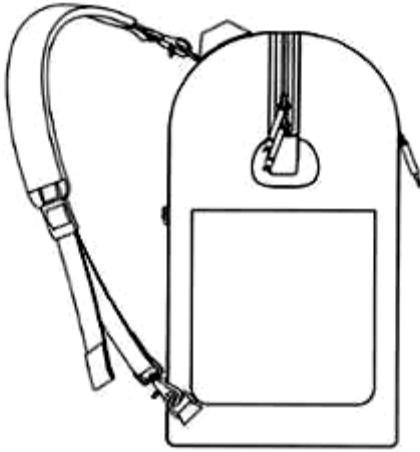

1.7

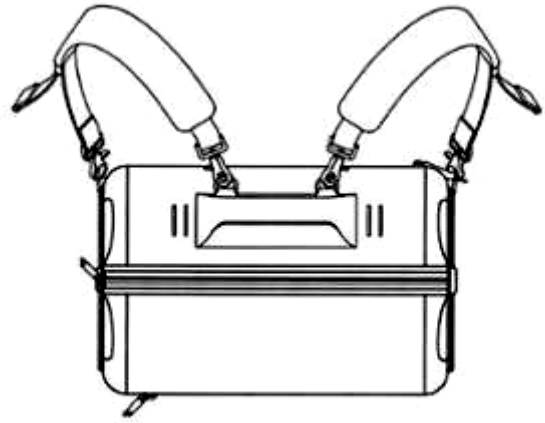

1.8



1.9

CÔNG BÁO SỞ HỮU CÔNG NGHIỆP SỐ 436 TẬP A – QUYỀN 2 (07.2024)

- (11) **50640**
(21) 3-2024-00912 (28) 1
(54) **TÚI LÀM LẠNH XÁCH TAY** (51) **07-07**
(22) 15/04/2024 (43) 25/07/2024
(30) 29/917,811 22/11/2023 US;
(73) **PACIFIC MARKET INTERNATIONAL, LLC (US)**
2401 Elliott Avenue, Suite 4 Seattle, Washington 98121, United States of America
(72) 1. MUNIE, JEFFREY CHARLES (US)
2. CHARI, VIGNESH (US)
3. WAGONER, GRAEME (US)
4. METROLIS-POOLE, MELISSA (US)
(74) Công ty TNHH Sở hữu trí tuệ Thảo Thọ Quyên (INVENCO.,LTD)
(55)



1.1



1.2

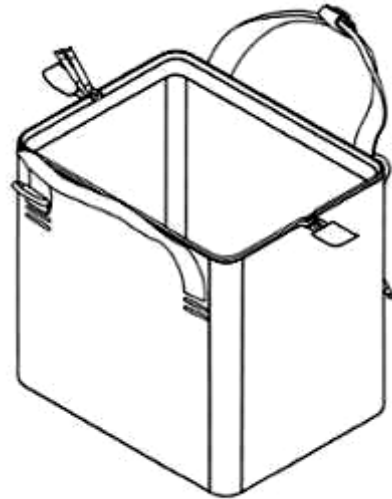

1.3

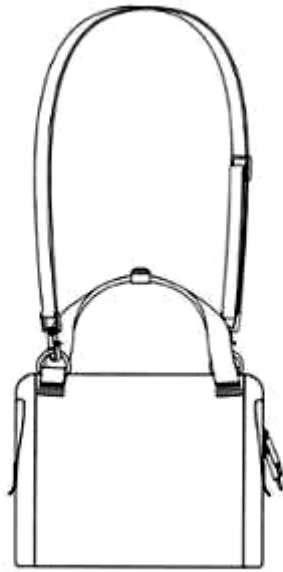

1.4



1.5

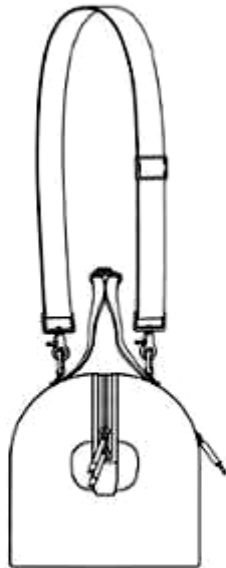

1.6

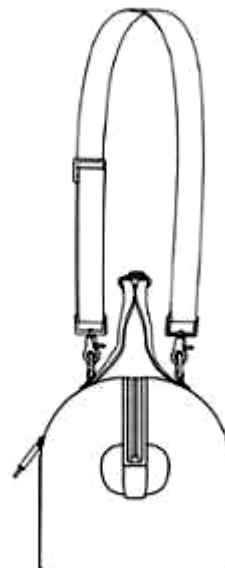

1.7

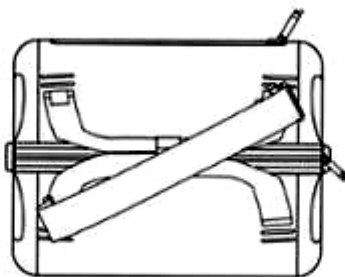

1.8

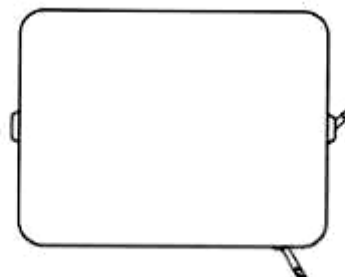

1.9

CÔNG BÁO SỞ HỮU CÔNG NGHIỆP SỐ 436 TẬP A – QUYỀN 2 (07.2024)

- (11) **50641**
- (21) 3-2024-00913 (28) 1
- (54) **PIN MẶT TRỜI** (51) **13-99**
- (22) 08/06/2022 (43) 25/07/2024
- (30) 008790414 08/12/2021 EM;
- (73) **REC SOLAR PTE. LTD. (US)**
20 Tuas South Avenue 14, Singapore 637312, Singapore
- (72) Kenta Nakayashiki (JP)
- (74) Công ty TNHH Tầm nhìn và Liên danh (VISION & ASSOCIATES CO.LTD.)
- (55)

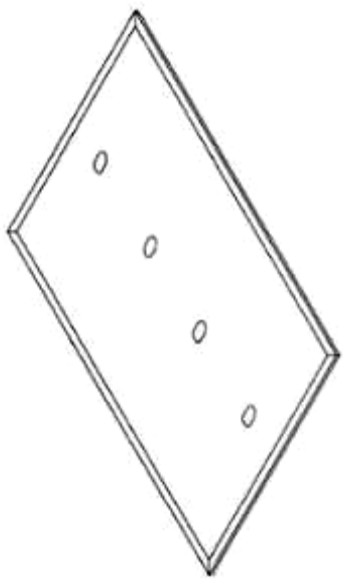

1.1

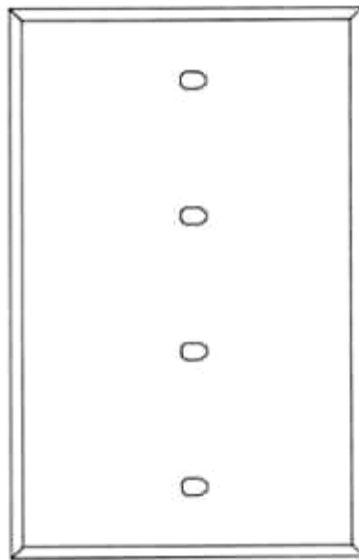

1.2

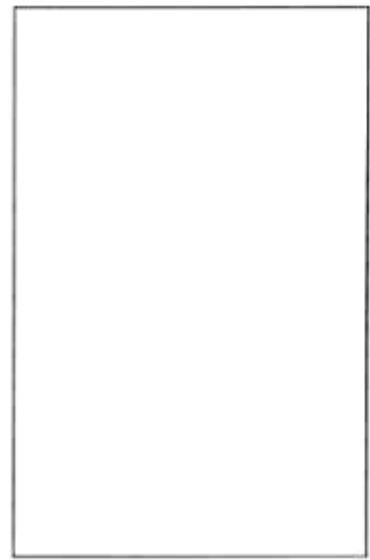

1.3



1.4



1.5



1.6



1.7

CÔNG BÁO SỞ HỮU CÔNG NGHIỆP SỐ 436 TẬP A – QUYỀN 2 (07.2024)

- (11) **50642**
- (21) 3-2024-00914 (28) 1
- (54) **PIN MẶT TRỜI** (51) **13-99**
- (22) 08/06/2022 (43) 25/07/2024
- (30) 008790414 08/12/2021 EM;
- (73) **REC SOLAR PTE. LTD. (SG)**
20 Tuas South Avenue 14, Singapore 637312, Singapore
- (72) Kenta Nakayashiki (JP)
- (74) Công ty TNHH Tầm nhìn và Liên danh (VISION & ASSOCIATES CO.LTD.)
- (55)



1.1

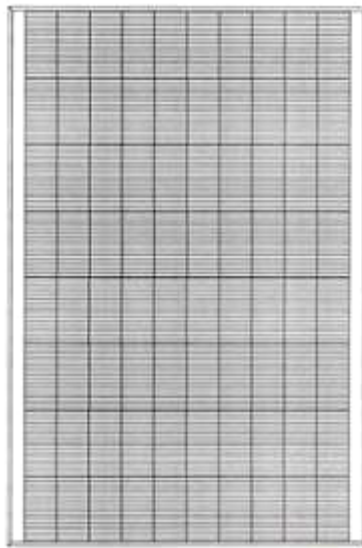

1.2

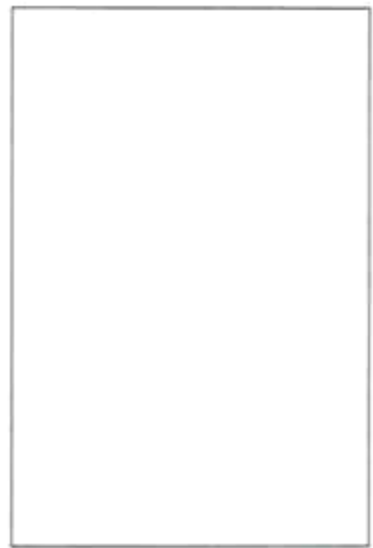

1.3



1.4



1.5



1.6



1.7

CÔNG BÁO SỞ HỮU CÔNG NGHIỆP SỐ 436 TẬP A – QUYỀN 2 (07.2024)

- (11) **50643**
- (21) 3-2024-00915 (28) 1
- (54) **PIN MẶT TRỜI** (51) **13-99**
- (22) 08/06/2022 (43) 25/07/2024
- (30) 008790414 08/12/2021 EM;
- (73) **REC SOLAR PTE. LTD. (SG)**
20 Tuas South Avenue 14, Singapore 637312, Singapore
- (72) Kenta Nakayashiki (JP)
- (74) Công ty TNHH Tầm nhìn và Liên danh (VISION & ASSOCIATES CO.LTD.)
- (55)



1.1

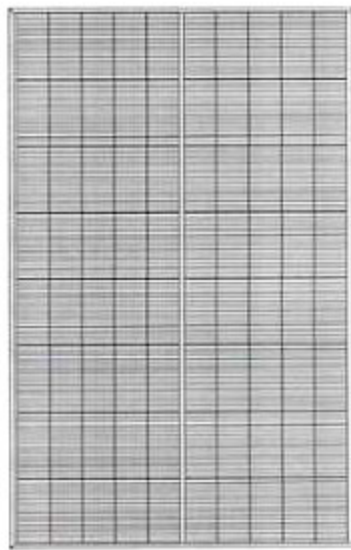

1.2

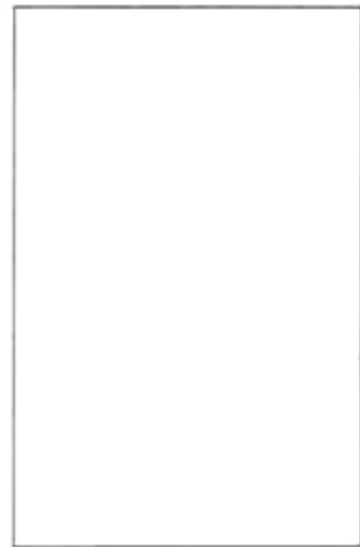

1.3



1.4



1.5



1.6



1.7

CÔNG BÁO SỞ HỮU CÔNG NGHIỆP SỐ 436 TẬP A – QUYỀN 2 (07.2024)

- (11) **50644**
- (21) 3-2024-00916
- (54) **PIN MẶT TRỜI**
- (22) 08/06/2022
- (30) 008790414 08/12/2021 EM;
- (73) **REC SOLAR PTE. LTD.** (SG)
20 Tuas South Avenue 14, Singapore 637312, Singapore
- (72) Kenta Nakayashiki (JP)
- (74) Công ty TNHH Tầm nhìn và Liên danh (VISION & ASSOCIATES CO.LTD.)
- (55)



1.1

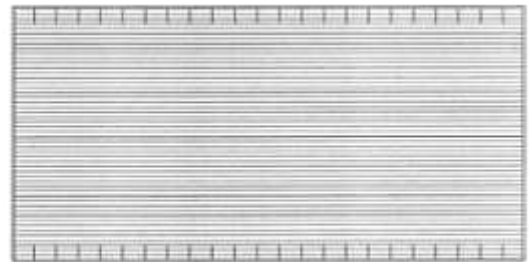

1.2



1.3



1.4



1.5



1.6



1.7



2.1

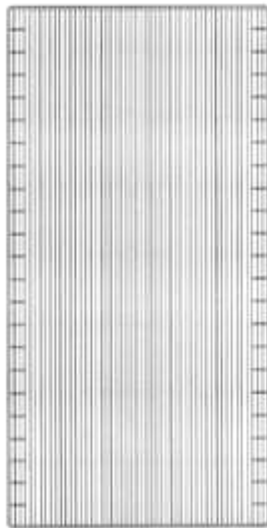

2.2



2.3



2.4



2.5



2.6



2.7

CÔNG BÁO SỞ HỮU CÔNG NGHIỆP SỐ 436 TẬP A – QUYỀN 2 (07.2024)

- (11) **50645**
- (21) 3-2024-00917
- (54) **PIN MẶT TRỜI**
- (22) 08/06/2022
- (30) 008790414 08/12/2021 EM;
- (73) **REC SOLAR PTE. LTD. (SG)**
20 Tuas South Avenue 14, Singapore 637312, Singapore
- (72) Kenta Nakayashiki (JP)
- (74) Công ty TNHH Tầm nhìn và Liên danh (VISION & ASSOCIATES CO.LTD.)
- (55)



1.1

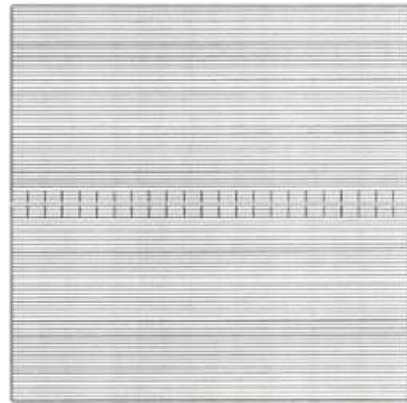

1.2

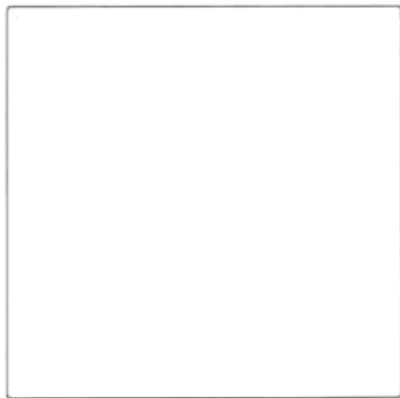

1.3



1.4



1.5



1.6



1.7

CÔNG BÁO SỞ HỮU CÔNG NGHIỆP SỐ 436 TẬP A – QUYỀN 2 (07.2024)

- (11) **50646**
(21) 3-2024-00918 (28) 1
(54) **PIN MẶT TRỜI** (51) **13-99**
(22) 08/06/2022 (43) 25/07/2024
(30) 008790414 08/12/2021 EM;
(73) **REC SOLAR PTE. LTD.** (SG)
20 Tuas South Avenue 14, Singapore 637312, Singapore
(72) Kenta Nakayashiki (JP)
(74) Công ty TNHH Tầm nhìn và Liên danh (VISION & ASSOCIATES CO.LTD.)
(55)

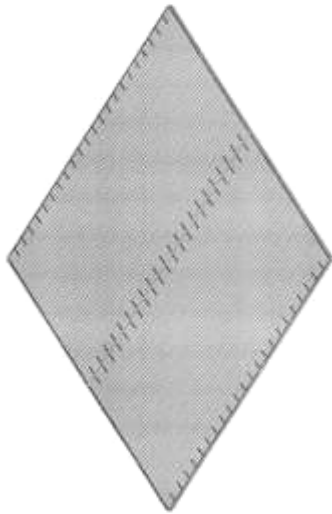

1.1

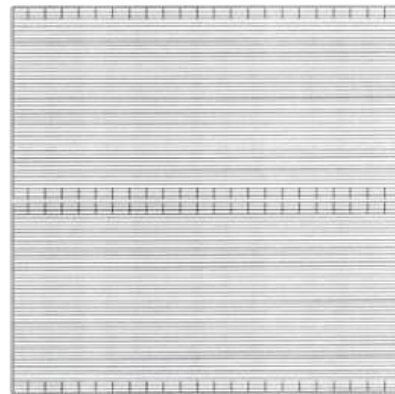

1.2

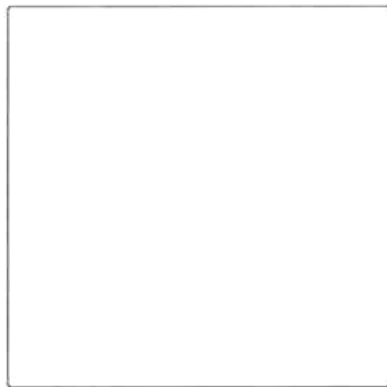

1.3



1.4



1.5



1.6



1.7

CÔNG BÁO SỞ HỮU CÔNG NGHIỆP SỐ 436 TẬP A – QUYỀN 2 (07.2024)

- (11) **50647**
- (21) 3-2024-00919 (28) 1
- (54) **PIN MẶT TRỜI** (51) **13-99**
- (22) 08/06/2022 (43) 25/07/2024
- (30) 008790414 08/12/2021 EM;
- (73) **REC SOLAR PTE. LTD.** (SG)
20 Tuas South Avenue 14, Singapore 637312, Singapore
- (72) Kenta Nakayashiki (JP)
- (74) Công ty TNHH Tầm nhìn và Liên danh (VISION & ASSOCIATES CO.LTD.)
- (55)

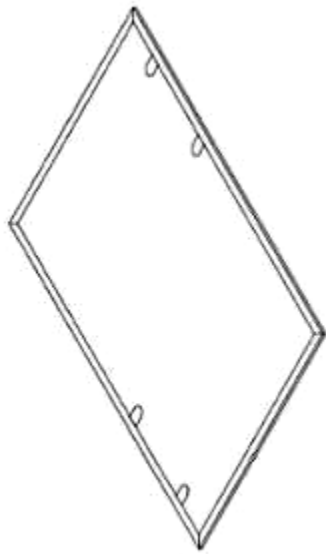

1.1

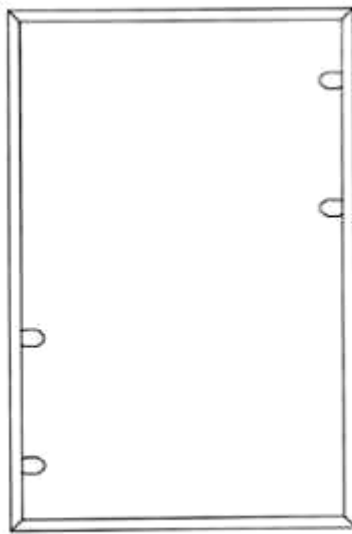

1.2



1.3



1.4



1.5



1.6



1.7

CÔNG BÁO SỞ HỮU CÔNG NGHIỆP SỐ 436 TẬP A – QUYỀN 2 (07.2024)

- (11) **50648**
- (21) 3-2024-00922 (28) 1
- (54) **NHÃN SẢN PHẨM** (51) **19-08**
- (22) 15/04/2024 (43) 25/07/2024
- (73) **TRẦN THỊ ÁI THU (VN)**
17 Phan Bội Châu, khu phố 2, phường 1, thành phố Đông Hà, tỉnh Quảng Trị
- (72) Trần Thị Ái Thu (VN)
- (74) Công ty TNHH Sở hữu trí tuệ VIPATCO (VIPATCO CO., LTD.)
- (55)



CÔNG BÁO SỞ HỮU CÔNG NGHIỆP SỐ 436 TẬP A – QUYỀN 2 (07.2024)

- (11) **50649**
(21) 3-2024-00789 (28) 1
(54) **THANH NHÔM ĐỊNH HÌNH** (51) **25-01**
(22) 01/04/2024 (43) 25/07/2024
(73) **CÔNG TY CỔ PHẦN NHÔM BLK VIỆT NAM (VN)**
Km 9 đường 35, thôn Thanh Hà, xã Nam Sơn, huyện Sóc Sơn, thành phố Hà Nội
(72) Vũ Bá Trường (VN)
(74) **CÔNG TY TNHH SỞ HỮU TRÍ TUỆ ANLIS VIỆT NAM (ANLIS IP CO.,LTD)**
(55)

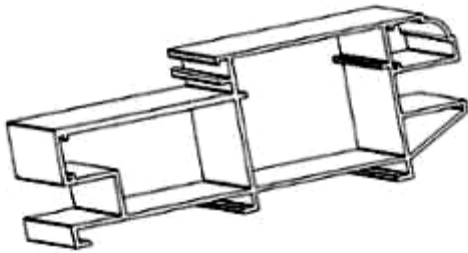

1.1

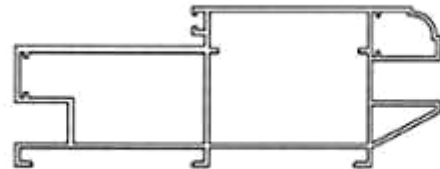

1.2

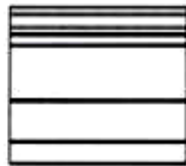

1.3

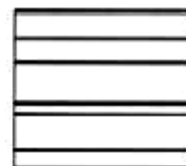

1.4



1.5

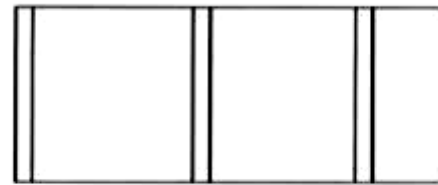

1.6

CÔNG BÁO SỞ HỮU CÔNG NGHIỆP SỐ 436 TẬP A – QUYỀN 2 (07.2024)

(11) **50650**

(21) 3-2024-00790

(28) 1

(54) **THANH NHÔM ĐỊNH HÌNH**

(51) **25-01**

(22) 01/04/2024

(43) 25/07/2024

(73) **CÔNG TY CỔ PHẦN NHÔM BLK VIỆT NAM (VN)**

Km 9 đường 35, thôn Thanh Hà, xã Nam Sơn, huyện Sóc Sơn, thành phố Hà Nội

(72) Vũ Bá Trường (VN)

(74) **CÔNG TY TNHH SỞ HỮU TRÍ TUỆ ANLIS VIỆT NAM (ANLIS IP CO.,LTD)**

(55)

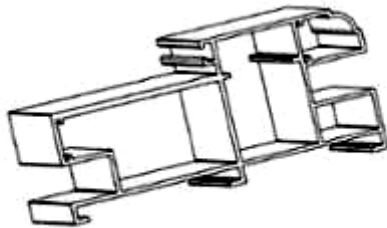

1.1

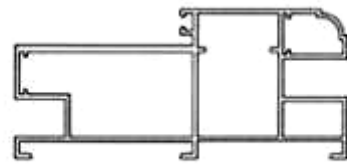

1.2



1.3



1.4

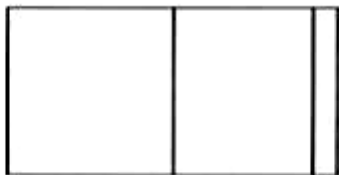

1.5



1.6

CÔNG BÁO SỞ HỮU CÔNG NGHIỆP SỐ 436 TẬP A – QUYỀN 2 (07.2024)

- (11) **50651**
(21) 3-2024-01029 (28) 1
(54) **NỒI CÓ TAY CẦM** (51) **07-02**
(22) 05/07/2023 (43) 25/07/2024
(30) 29/881,779 06/01/2023 US;
(73) **DART INDUSTRIES INC. (US)**
14901 S. Orange Blossom Trail, Orlando, Florida, 32837, United States of America
(72) Andrea Boscic (BE)
(74) **CÔNG TY LUẬT TRÁCH NHIỆM HỮU HẠN AMBYS HÀ NỘI (AMBYS HANOI)**
(55)



1.1



1.2



1.3

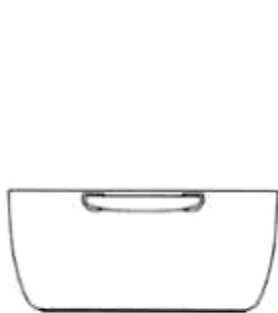

1.4

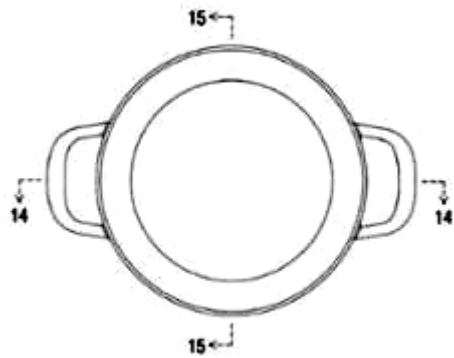

1.5

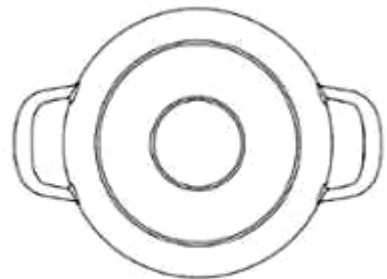

1.6



1.7



1.8

CÔNG BÁO SỞ HỮU CÔNG NGHIỆP SỐ 436 TẬP A – QUYỀN 2 (07.2024)

- (11) **50652**
(21) 3-2024-01030 (28) 1
(54) **NỒI CÓ TAY CẦM** (51) **07-02**
(22) 05/07/2023 (43) 25/07/2024
(30) 29/881,779 06/01/2023 US;
(73) **DART INDUSTRIES INC. (US)**
14901 S. Orange Blossom Trail, Orlando, Florida, 32837, United States of America
(72) Andrea Boscic (BE)
(74) **CÔNG TY LUẬT TRÁCH NHIỆM HỮU HẠN AMBYS HÀ NỘI (AMBYS HANOI)**
(55)



1.1



1.2



1.3



1.4

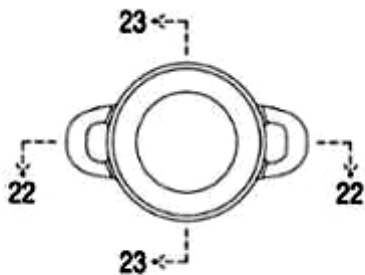

1.5



1.6



1.7



1.8

CÔNG BÁO SỞ HỮU CÔNG NGHIỆP SỐ 436 TẬP A – QUYỀN 2 (07.2024)

- (11) **50653**
(21) 3-2024-01031 (28) 1
(54) **NỒI CÓ TAY CẦM** (51) **07-02**
(22) 05/07/2023 (43) 25/07/2024
(30) 29/881,779 06/01/2023 US;
(73) **DART INDUSTRIES INC. (US)**
14901 S. Orange Blossom Trail, Orlando, Florida, 32837, United States of America
(72) Andrea Boscic (BE)
(74) CÔNG TY LUẬT TRÁCH NHIỆM HỮU HẠN AMBYS HÀ NỘI (AMBYS HANOI)
(55)

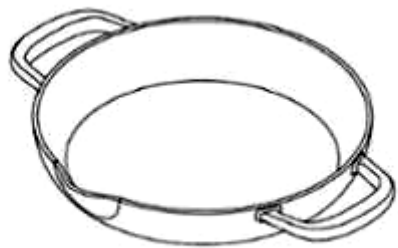

1.1

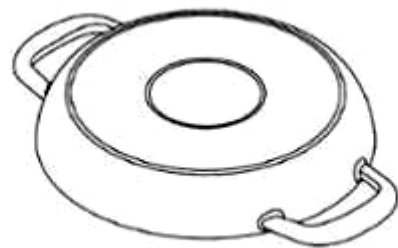

1.2



1.3



1.4



1.5

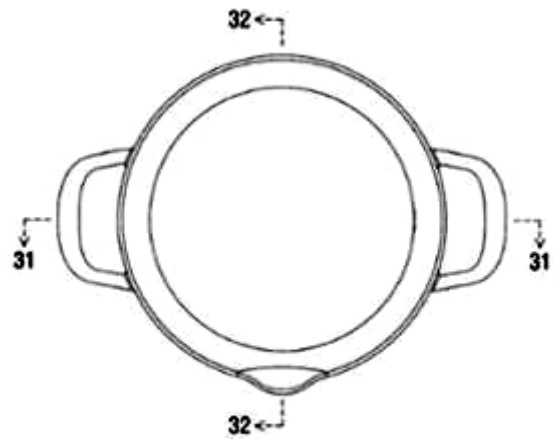

1.6

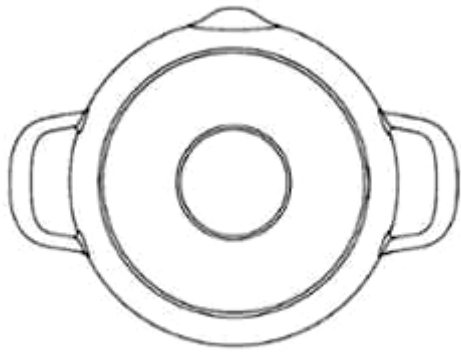

1.7



1.8



1.9

CÔNG BÁO SỞ HỮU CÔNG NGHIỆP SỐ 436 TẬP A – QUYỀN 2 (07.2024)

- (11) **50654**
(21) 3-2024-01035 (28) 1
(54) **ĐẦU NỐI PIN** (51) **13-02**
(22) 12/08/2022 (43) 25/07/2024
(30) 29/826,650 14/02/2022 US;
(73) **TECHTRONIC CORDLESS GP (US)**
100 Innovation Way, Anderson, SC 29621, United States of America
(72) 1. CLINT CAGLE (US)
2. JONATHAN R. FELDKAMP (US)
3. RAONY BARRIOS (US)
(74) Công ty TNHH Tầm nhìn và Liên danh (VISION & ASSOCIATES CO.LTD.)
(55)

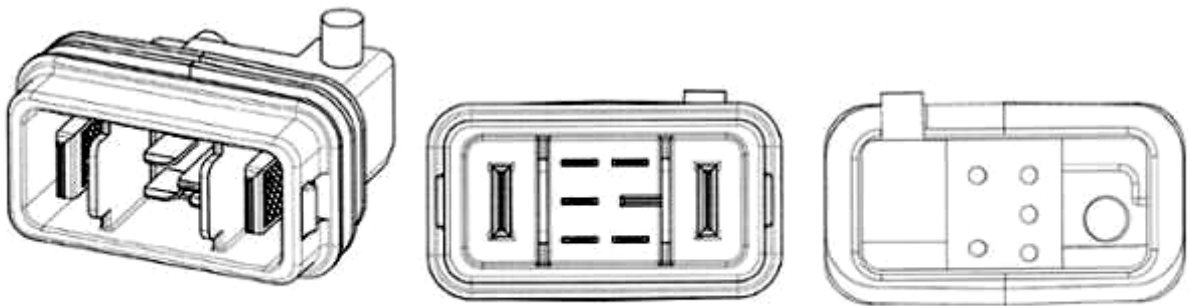

1.1

1.2

1.3

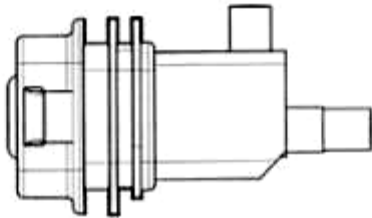

1.4

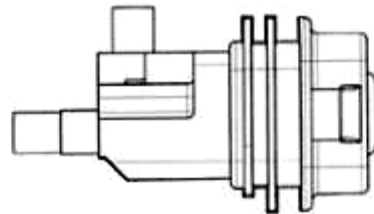

1.5

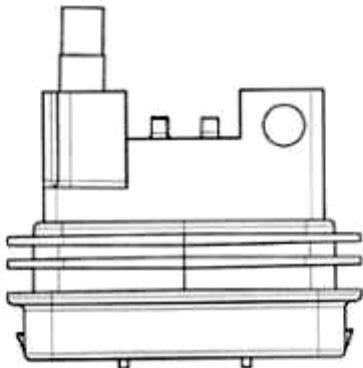

1.6

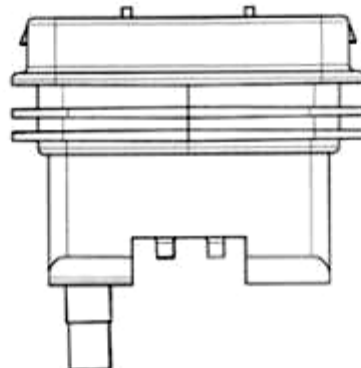

1.7

CÔNG BÁO SỞ HỮU CÔNG NGHIỆP SỐ 436 TẬP A – QUYỀN 2 (07.2024)

- (11) **50655**
(21) 3-2024-01036 (28) 1
(54) **CỤM SẠC ĐIỆN** (51) **13-02**
(22) 12/08/2022 (43) 25/07/2024
(30) 29/826,653 14/02/2022 US;
(73) **TECHTRONIC CORDLESS GP (US)**
100 Innovation Way, Anderson, SC 29621, United States of America
(72) 1. CLINT CAGLE (US)
2. JONATHAN R. FELDKAMP (US)
3. RAONY BARRIOS (US)
(74) Công ty TNHH Tầm nhìn và Liên danh (VISION & ASSOCIATES CO.LTD.)
(55)

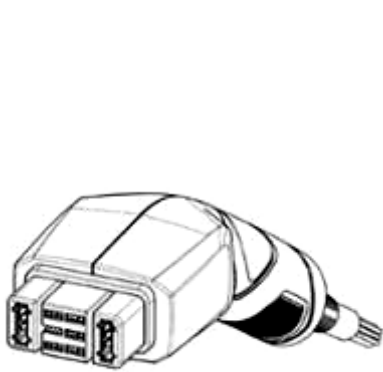

1.1



1.2



1.3



1.4



1.5



1.6



1.7

CÔNG BÁO SỞ HỮU CÔNG NGHIỆP SỐ 436 TẬP A – QUYỀN 2 (07.2024)

- (11) **50656**
(21) 3-2024-01037 (28) 1
(54) **ĐẦU NỐI PIN** (51) **13-02**
(22) 12/08/2022 (43) 25/07/2024
(30) 29/826,647 14/02/2022 US;
(73) **TECHTRONIC CORDLESS GP (US)**
100 Innovation Way, Anderson, SC 29621, United States of America
(72) 1. CLINT CAGLE (US)
2. JONATHAN R. FELDKAMP (US)
3. RAONY BARRIOS (US)
(74) Công ty TNHH Tầm nhìn và Liên danh (VISION & ASSOCIATES CO.LTD.)
(55)

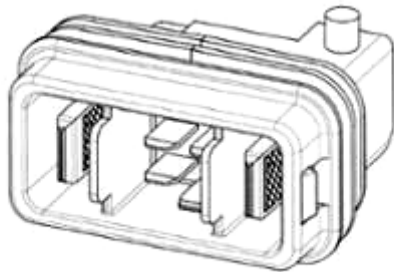

1.1

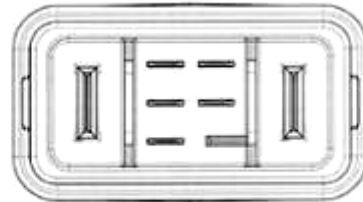

1.2

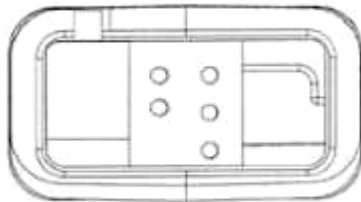

1.3

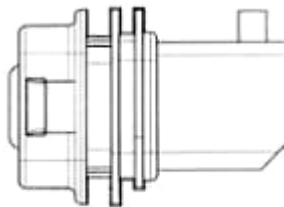

1.4

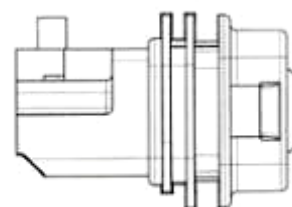

1.5

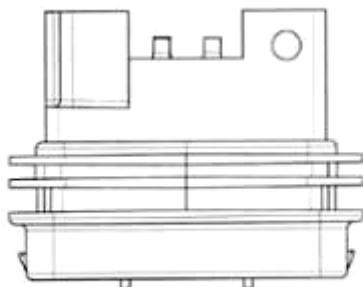

1.6

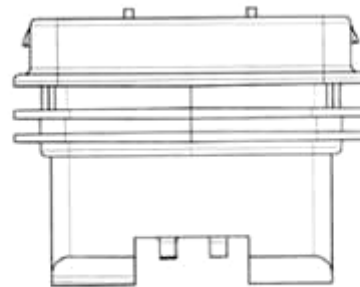

1.7

CÔNG BÁO SỞ HỮU CÔNG NGHIỆP SỐ 436 TẬP A – QUYỀN 2 (07.2024)

- (11) **50657**
(21) 3-2024-01038 (28) 2
(54) **NHÃN SẢN PHẨM** (51) **19-08**
(22) 04/05/2024 (43) 25/07/2024
(73) **CÔNG TY CỔ PHẦN SỮA VIỆT NAM (VN)**
10 Tân Trào, phường Tân Phú, quận 7, thành phố Hồ Chí Minh
(72) Megan Nicole Bowker (US)
(74) Công ty cổ phần Sở hữu trí tuệ BROSS và Cộng sự (BROSS & PARTNERS., JSC)
(55)



1.1



2.1

CÔNG BÁO SỞ HỮU CÔNG NGHIỆP SỐ 436 TẬP A – QUYỀN 2 (07.2024)

- (11) **50658**
(21) 3-2024-01039 (28) 3
(54) **NHÃN SẢN PHẨM** (51) **19-08**
(22) 04/05/2024 (43) 25/07/2024
(73) **CÔNG TY CỔ PHẦN SỮA VIỆT NAM (VN)**
10 Tân Trào, phường Tân Phú, quận 7, thành phố Hồ Chí Minh
(72) Megan Nicole Bowker (US)
(74) Công ty cổ phần Sở hữu trí tuệ BROSS và Cộng sự (BROSS & PARTNERS., JSC)
(55)

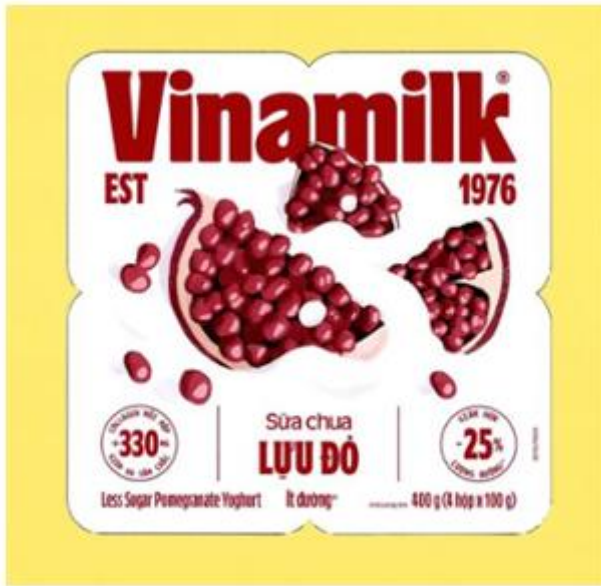

1.1



2.1

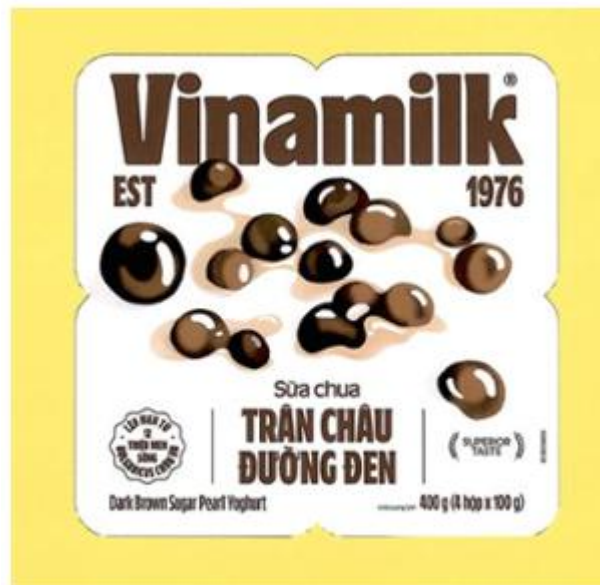

3.1

CÔNG BÁO SỞ HỮU CÔNG NGHIỆP SỐ 436 TẬP A – QUYỀN 2 (07.2024)

- (11) **50659**
- (21) 3-2024-01028 (28) 1
- (54) **NHÃN SẢN PHẨM** (51) **19-08**
- (22) 03/05/2024 (43) 25/07/2024
- (73) **CÔNG TY TNHH NAK VIỆT NAM (VN)**
45 đường D4A, khu dân cư Hưng Phú, phường Phước Long B, thành phố Thủ Đức,
thành phố Hồ Chí Minh
- (72) Đàm Việt Trung (VN)
- (74) Công ty Luật TNHH AGL (AGL LAW)
- (55)



- (11) **50660**
(21) 3-2024-00592 (28) 1
(54) **DÂY** (51) **10-07; 11-01; 14-99; 24-99**
(22) 12/03/2024 (43) 25/07/2024
(30) 29/912,032 12/09/2023 US;
(73) **APPLE INC. (US)**
One Apple Park Way, Cupertino, California 95014, United States of America
(72) 1. MOLLY ANDERSON (GB)
2. BARTLEY K.ANDRE (US)
3. SHOTA AOYAGI (JP)
4. MARINE C.BATAILLE (FR)
5. ABIDUR RAHMAN CHOWDHURY (GB)
6. CLARA GENEVIÈVE MARINE COURTAIGNE (FR)
7. MARKUS DIEBEL (DE)
8. ALEXANDRE B. GIRARD (US)
9. M. EVANS HANKEY (US)
10. ANNE-MARIE HECK (CH)
11. MOISE HERNANDEZ HERNANDEZ (MX)
12. RICHARD P. HOWARTH (GB)
13. JULIAN JAEDE (DE)
14. DUNCAN ROBERT KERR (GB)
15. KAINOA KWON-PEREZ (US)
16. NICOLAS PEDRO LYLYK (AR)
17. PETER RIERING-CZEKALLA (DE)
18. PETER RUSSELL-CLARKE (AU)
19. BENJAMIN ANDREW SHAFFER (US)
20. CLEMENT TISSANDIER (FR)
(74) Công ty TNHH Lê & Lê (LE & LE)
(55)

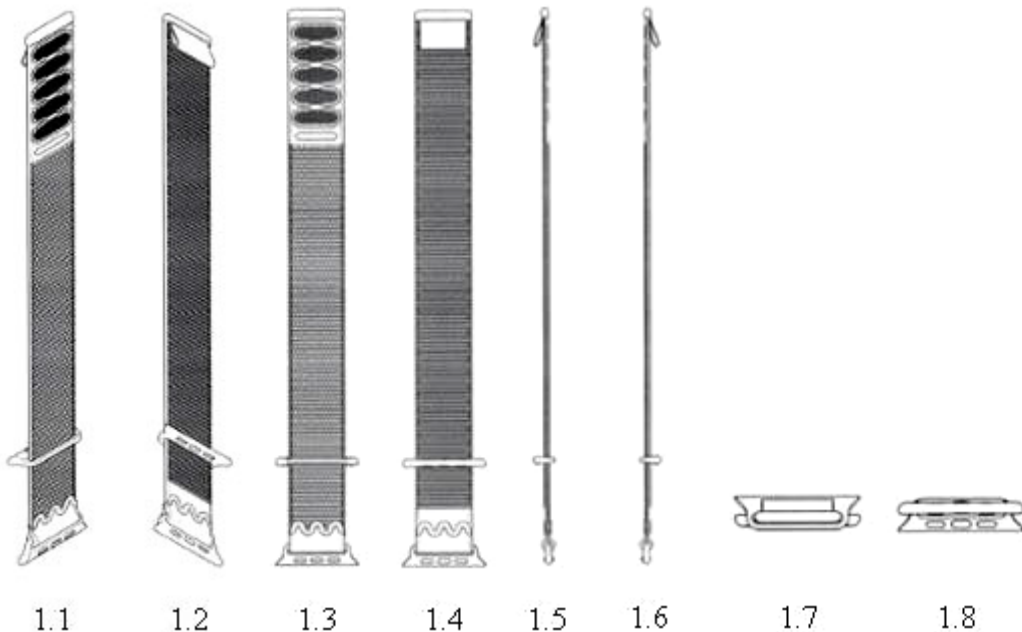

CÔNG BÁO SỞ HỮU CÔNG NGHIỆP SỐ 436 TẬP A – QUYỀN 2 (07.2024)

- (11) **50661**
(21) 3-2024-00593 (28) 1
(54) **KHOÁ ĐIỀU CHỈNH DÂY** (51) **02-07**
(22) 12/03/2024 (43) 25/07/2024
(73) **DURAFLEX HONG KONG LIMITED (CN)**
Block 1, 15/F, Tern Centre, 237 Queen's Road Central, Sheung Wan, Hong Kong
(72) Yick Fai CHAN (CN)
(74) Công ty Luật TNHH Phạm và Liên danh (PHAM & ASSOCIATES)
(55)

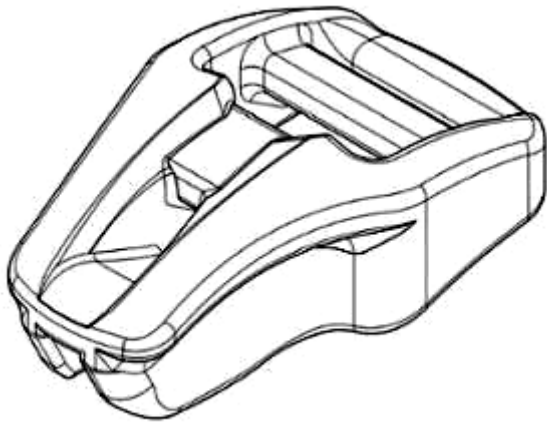

1.1

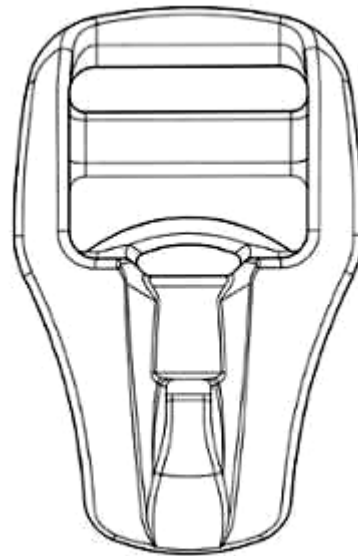

1.2

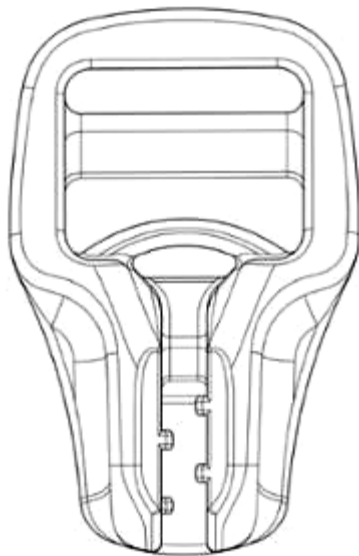

1.3



1.4



1.5

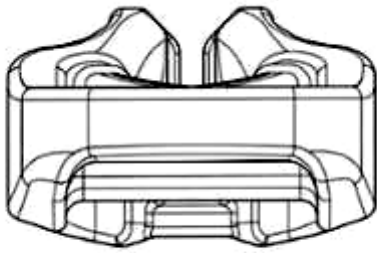

1.6

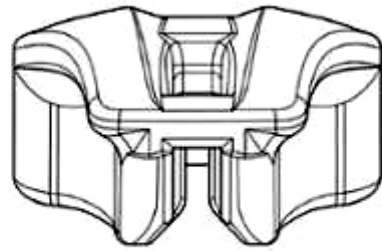

1.7

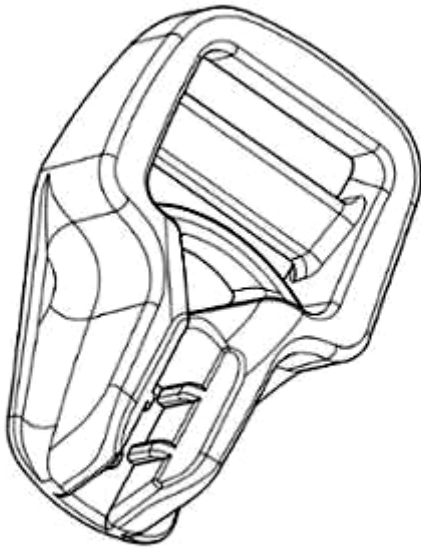

1.8

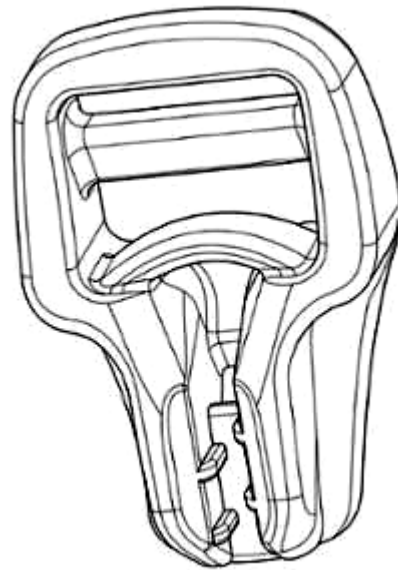

1.9

CÔNG BÁO SỞ HỮU CÔNG NGHIỆP SỐ 436 TẬP A – QUYỀN 2 (07.2024)

- (11) **50662**
(21) 3-2023-03084 (28) 1
(54) **NHÃN SẢN PHẨM** (51) **19-08**
(22) 07/10/2020 (43) 25/07/2024
(73) **CÔNG TY TNHH MỘT THÀNH VIÊN SẢN XUẤT THƯƠNG MẠI VÀ DỊCH VỤ THIÊN NGÀ (VN)**
Số 139 Nguyễn Tất Thành, khu 10, thị trấn Tân Phú, huyện Tân Phú, tỉnh Đồng Nai
(72) Lê Thị Tố Nga (VN)
(74) Công ty TNHH Tư vấn sở hữu trí tuệ Việt (VIET IP CO.,LTD.)
(55)



1.1



1.2

CÔNG BÁO SỞ HỮU CÔNG NGHIỆP SỐ 436 TẬP A – QUYỀN 2 (07.2024)

- (11) **50663**
(21) 3-2023-03085 (28) 1
(54) **NHÃN SẢN PHẨM** (51) **19-08**
(22) 07/10/2020 (43) 25/07/2024
(73) **CÔNG TY TNHH MỘT THÀNH VIÊN SẢN XUẤT THƯƠNG MẠI VÀ DỊCH VỤ THIÊN NGÀ (VN)**
Số 139 Nguyễn Tất Thành, khu 10, thị trấn Tân Phú, huyện Tân Phú, tỉnh Đồng Nai
(72) Lê Thị Tố Nga (VN)
(74) Công ty TNHH Tư vấn sở hữu trí tuệ Việt (VIET IP CO.,LTD.)
(55)



1.1



1.2

- (11) **50664**
- (21) 3-2024-01116 (28) 1
- (54) **QUẠT TUẦN HOÀN KHÔNG KHÍ** (51) **23-04**
- (22) 15/05/2024 (43) 25/07/2024
- (30) 2023-023899 20/11/2023 JP;
- (73) **SHARP KABUSHIKI KAISHA (JP)**
1, Takumi-cho, Sakai-ku, Sakai City, Osaka 590-8522, Japan
- (72) 1. EIICHI SHIMIZU (JP)
2. YUKI OKA (JP)
3. TADAHIKO SAIMEN (JP)
- (74) Công ty TNHH một thành viên Sở hữu trí tuệ VCCI (VCCI-IP CO.,LTD)
- (55)

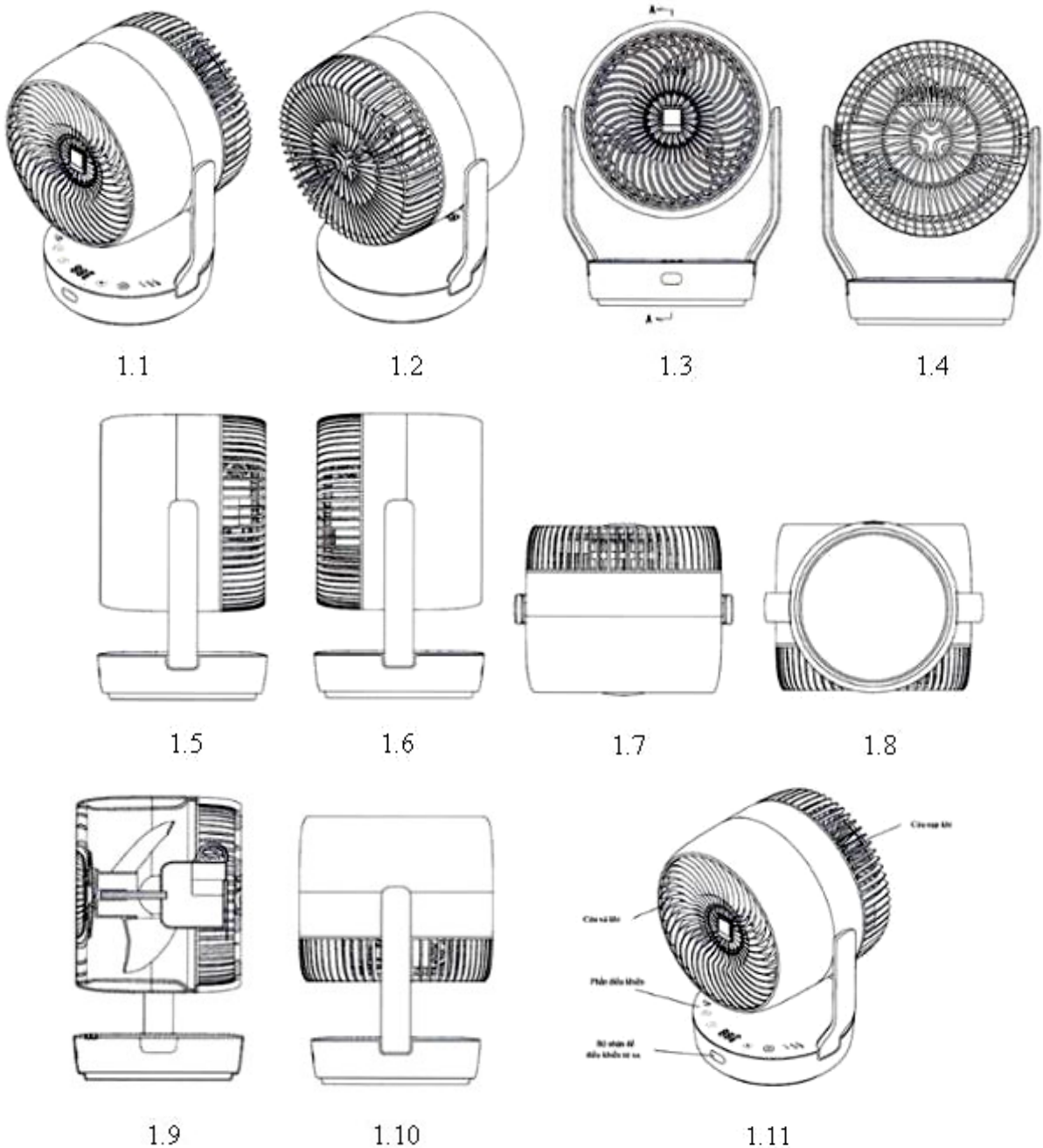

CÔNG BÁO SỞ HỮU CÔNG NGHIỆP SỐ 436 TẬP A – QUYỀN 2 (07.2024)

- (11) **50665**
(21) 3-2024-01120 (28) 1
(54) **MÁY SẤY TÓC** (51) **28-03**
(22) 15/05/2024 (43) 25/07/2024
(73) **GUANGDONG CONFU ELECTRICAL APPLIANCES CO., LTD. (CN)**
North of Yu 13th Road, Tianfu Road East, Airport and Economic District, Jieyang
City, China
(72) Mincong Huang (CN)
(74) **CÔNG TY TNHH SỞ HỮU TRÍ TUỆ ANLIS VIỆT NAM (ANLIS IP CO.,LTD)**
(55)



CÔNG BÁO SỞ HỮU CÔNG NGHIỆP SỐ 436 TẬP A – QUYỀN 2 (07.2024)

- (11) **50666**
(21) 3-2024-00442 (28) 1
(54) **THIẾT BỊ MỞ RỘNG VÙNG PHỦ SÓNG WIFI** (51) **14-03**
(22) 27/02/2024 (43) 25/07/2024
(30) 30-2023-0036575 15/09/2023 KR;
(73) **SAMSUNG ELECTRONICS CO., LTD. (KR)**
129, Samsung-ro, Yeongtong-gu, Suwon-si, Gyeonggi-do 16677, Republic of Korea
(72) 1. KOO, HYUNGJUN (KR)
2. KWAK, JIHEE (KR)
(74) Công ty Luật TNHH WINCO (WINCO LAW FIRM)
(55)

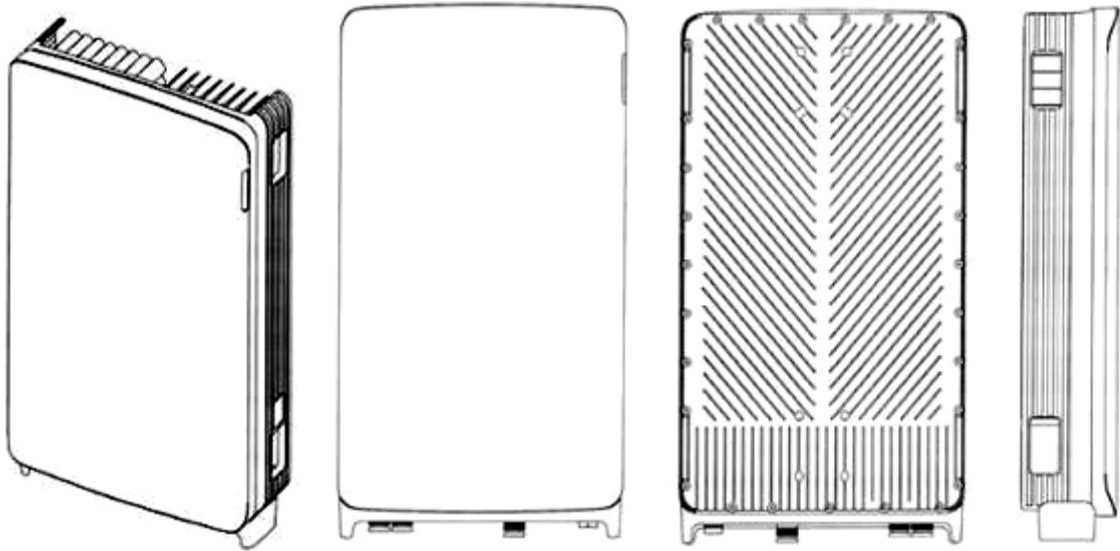

1.1

1.2

1.3

1.4

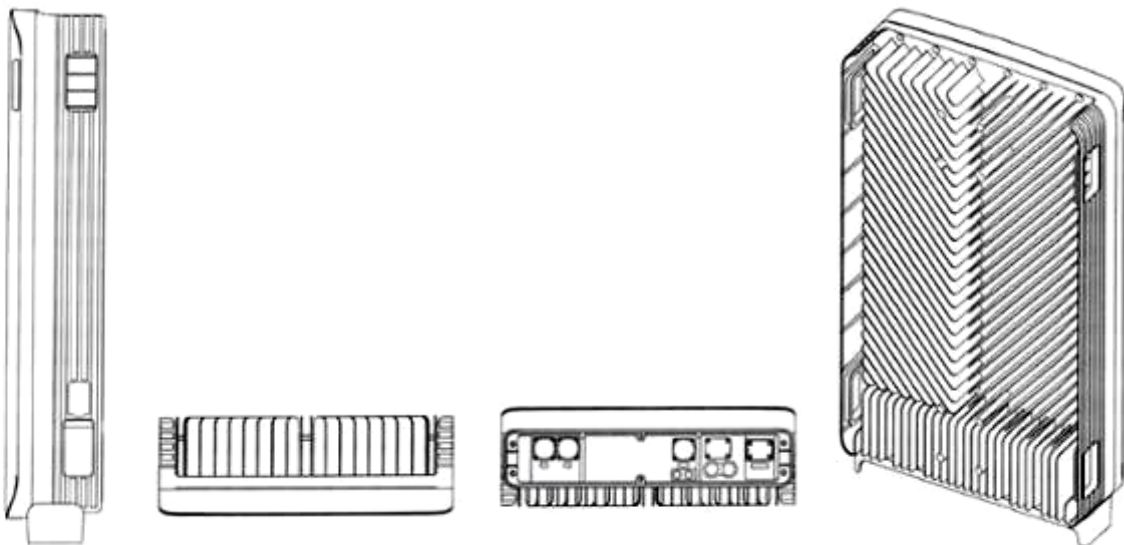

1.5

1.6

1.7

1.8



1.9

CÔNG BÁO SỞ HỮU CÔNG NGHIỆP SỐ 436 TẬP A – QUYỀN 2 (07.2024)

- (11) **50667**
(21) 3-2024-00447 (28) 1
(54) **BỒN CẦU** (51) **23-02**
(22) 27/02/2024 (43) 25/07/2024
(30) 29/901,021 28/08/2023 US;
(73) **AS AMERICA, INC. (US)**
865 Centennial Avenue, Piscataway NJ 08854, United States of America
(72) 1. CHRISTOPHE BUCHER (US)
2. JEAN-JACQUES L'HENAFF (FR)
(74) Công ty Luật TNHH T&G (TGVN)
(55)



1.1



1.2



1.3

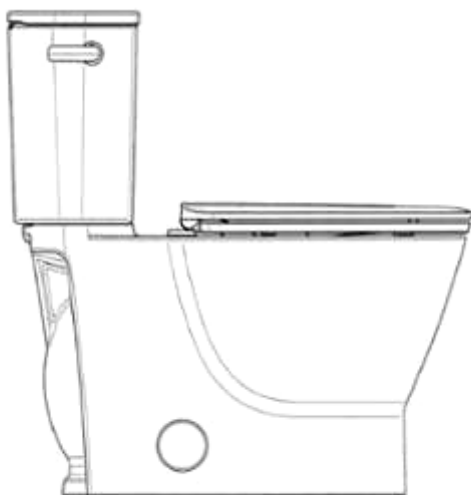

1.4



1.5



1.6

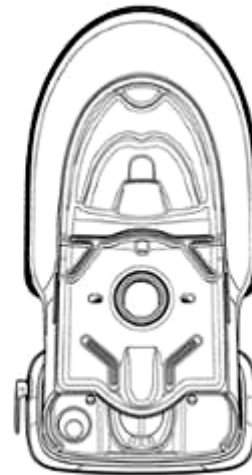

1.7

CÔNG BÁO SỞ HỮU CÔNG NGHIỆP SỐ 436 TẬP A – QUYỀN 2 (07.2024)

- (11) **50668**
- (21) 3-2024-00453 (28) 1
- (54) **NHÃN SẢN PHẨM** (51) **19-08**
- (22) 27/02/2024 (43) 25/07/2024
- (73) **CÔNG TY TNHH THƯỜNG MẠI DỊCH VỤ BIHACO (VN)**
Đường Nguyễn Hữu Tiến, tổ 6, phường Lê Hồng Phong, thành phố Phủ Lý, tỉnh Hà Nam
- (72) Nguyễn Văn Bình (VN)
- (74) Công ty TNHH một thành viên Trường Luật (Trường Luật)
- (55)



CÔNG BÁO SỞ HỮU CÔNG NGHIỆP SỐ 436 TẬP A – QUYỀN 2 (07.2024)

- (11) **50669**
- (21) 3-2024-00454 (28) 3
- (54) **NHÃN SẢN PHẨM** (51) **19-08**
- (22) 27/02/2024 (43) 25/07/2024
- (73) **CÔNG TY TNHH THƯƠNG MẠI DỊCH VỤ BIHACO (VN)**
Đường Nguyễn Hữu Tiên, tổ 6, phường Lê Hồng Phong, thành phố Phủ Lý, tỉnh Hà Nam
- (72) Nguyễn Văn Bình (VN)
- (74) Công ty TNHH một thành viên Trường Luật (Trường Luật)
- (55)



1.1



2.1



3.1

- (11) **50670**
- (21) 3-2024-00491
- (54) **BÁT**
- (22) 01/03/2024
- (30) DM/231458 04/09/2023 WO;
- (73) **PI-DESIGN AG (CH)**
Altgasse 82, CH-6340 Baar, Switzerland
- (72) Jorgen BODUM (CH)
- (74) Công ty Luật TNHH T&G (TGVN)
- (55)
- (28) 3
- (51) **07-01**
- (43) 25/07/2024

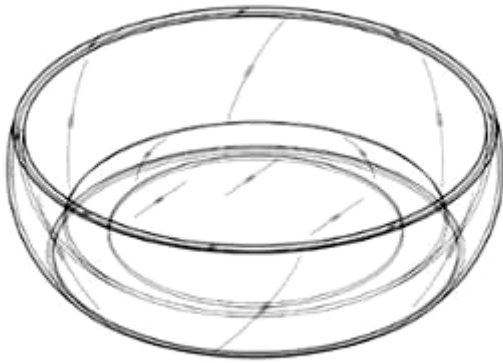

1.1



1.2



1.3



1.4



1.5

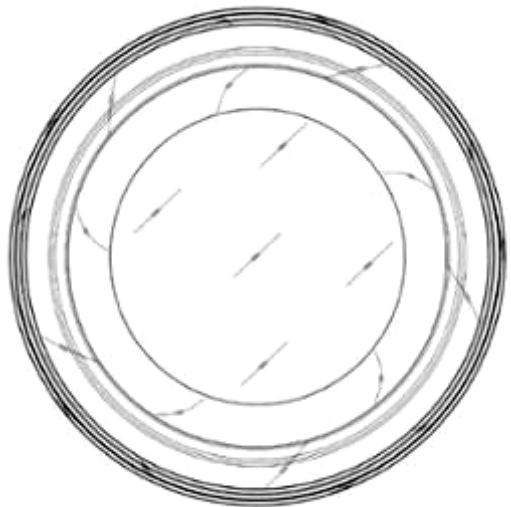

1.6

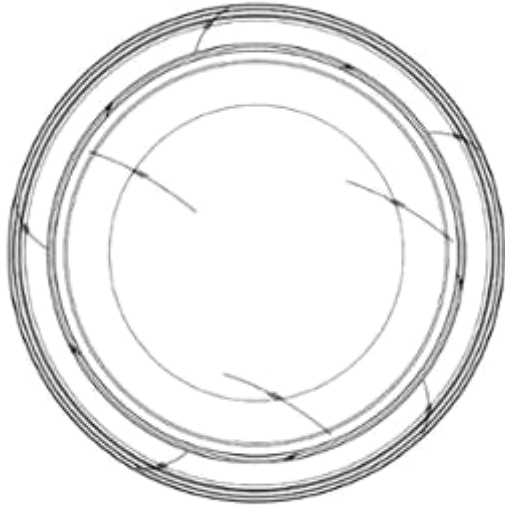

1.7

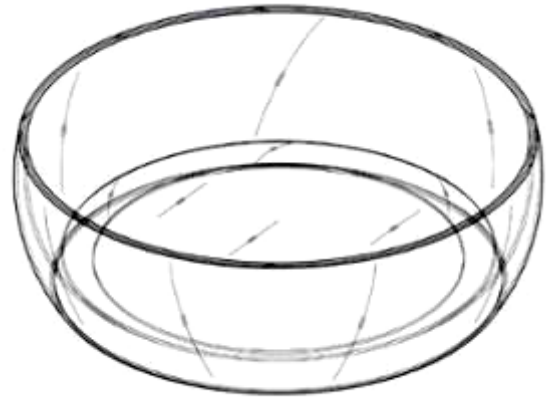

2.1



2.2



2.3

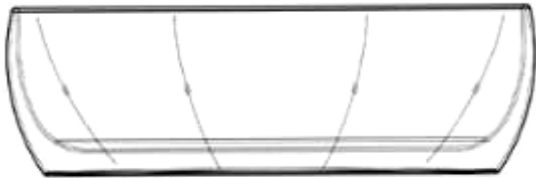

2.4



2.5

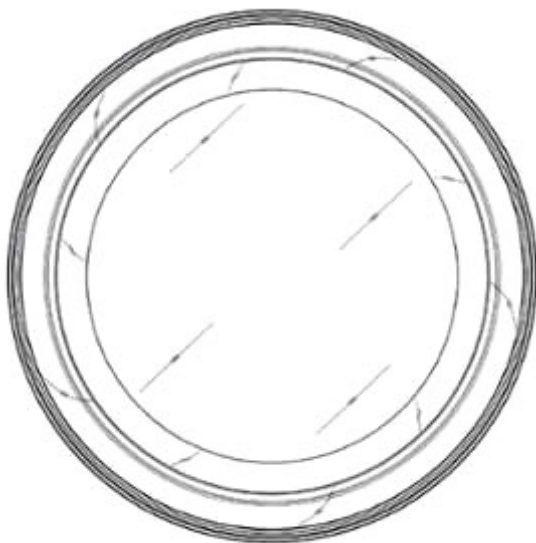

2.6

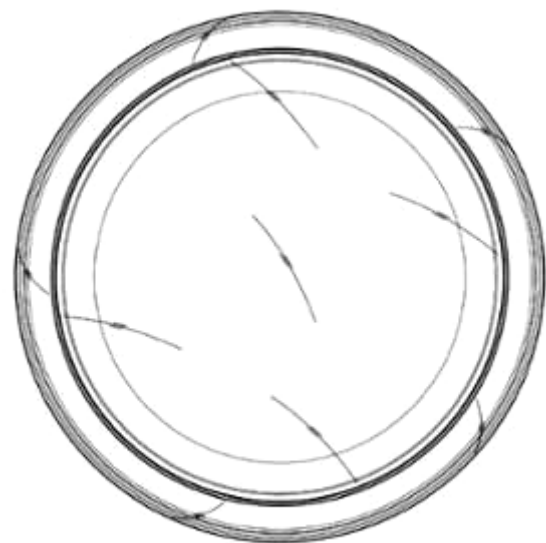

2.7



3.1



3.2



3.3



3.4



3.5

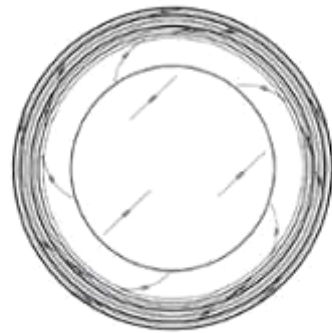

3.6

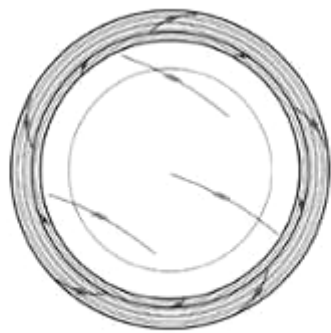

3.7

CÔNG BÁO SỞ HỮU CÔNG NGHIỆP SỐ 436 TẬP A – QUYỀN 2 (07.2024)

- (11) **50671**
(21) 3-2024-00497 (28) 1
(54) **BÚT XÓA BĂNG** (51) **19-02**
(22) 01/03/2024 (43) 25/07/2024
(73) **MCAIDE ENTERPRISE CO., LTD. (TW)**
12F., No. 2, Sec. 4, Zhongyang Rd., Tucheng Dist., New Taipei City 236, Taiwan
(72) Ming-Hua YEN (TW)
(74) Công ty TNHH Sáng chế ACTIP (ACTIP PATENT LIMITED)
(55)



CÔNG BÁO SỞ HỮU CÔNG NGHIỆP SỐ 436 TẬP A – QUYỀN 2 (07.2024)

(11) **50672**

(21) 3-2024-00498

(28) 1

(54) **BÚT XÓA BĂNG**

(51) **19-02**

(22) 01/03/2024

(43) 25/07/2024

(73) **MCAIDE ENTERPRISE CO., LTD. (TW)**

12F., No. 2, Sec. 4, Zhongyang Rd., Tucheng Dist., New Taipei City 236, Taiwan

(72) Ming-Hua YEN (TW)

(74) Công ty TNHH Sáng chế ACTIP (ACTIP PATENT LIMITED)

(55)



1.1

1.2

1.3

1.4

1.5

1.6

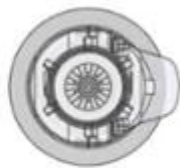

1.7

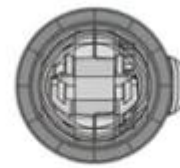

1.8

CÔNG BÁO SỞ HỮU CÔNG NGHIỆP SỐ 436 TẬP A – QUYỀN 2 (07.2024)

- (11) **50673**
(21) 3-2024-00495 (28) 1
(54) **NẤP BÚT** (51) **19-06**
(22) 01/03/2024 (43) 25/07/2024
(73) **CÔNG TY CỔ PHẦN TẬP ĐOÀN THIÊN LONG (VN)**
Tầng 10, Sofic Tower, số 10 đường Mai Chí Thọ, phường Thủ Thiêm, thành phố Thủ Đức, thành phố Hồ Chí Minh
(72) Cô Gia Thọ (VN)
(74) Công ty TNHH Tư vấn sở hữu trí tuệ Việt (VIET IP CO.,LTD.)
(55)

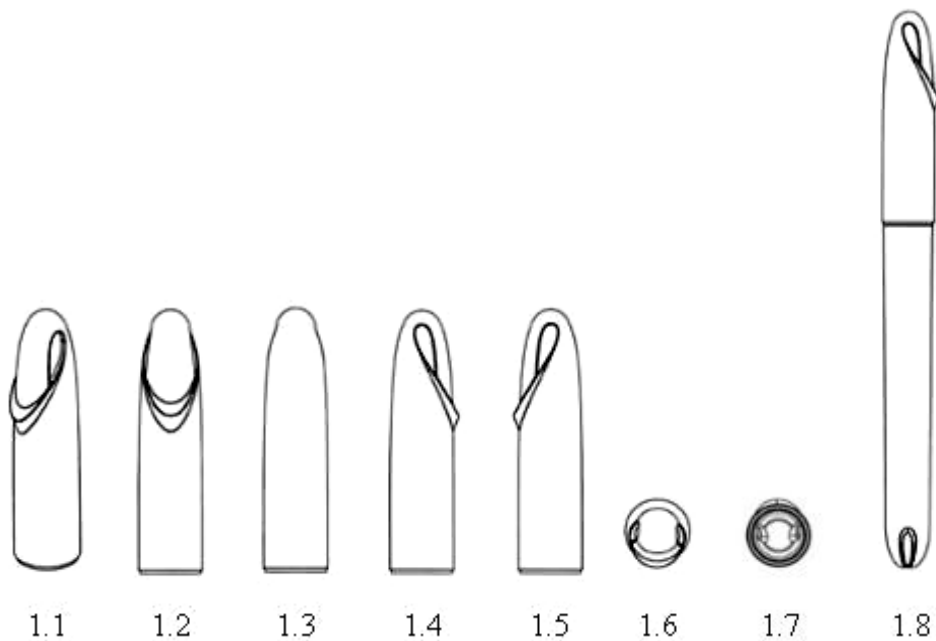

(11) **50674**

(21) 3-2023-02569

(28) 1

(54) **PHỄU HÚT SỮA**

(51) **24-02**

(22) 31/10/2023

(43) 25/07/2024

(73) **CÔNG TY TNHH JSJB VIỆT NAM (VN)**

Tầng 11, tòa nhà Zen Tower, số 12 đường Khuất Duy Tiến, phường Thanh Xuân Trung, thành phố Hà Nội

(72) Hoàng Quốc Khánh (VN)

(55)

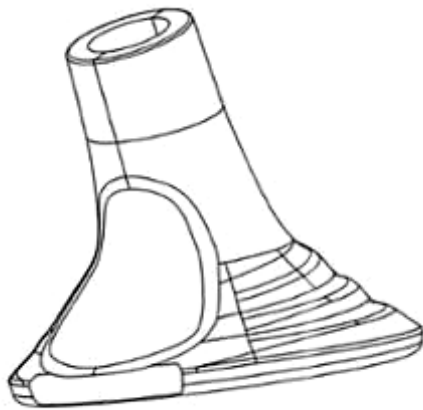

1.1

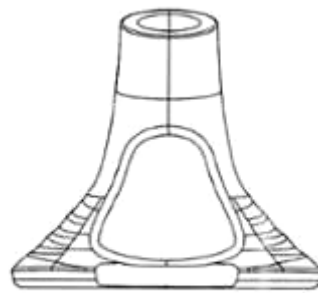

1.2

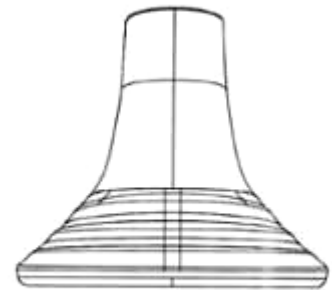

1.3

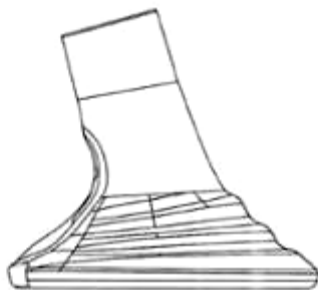

1.4

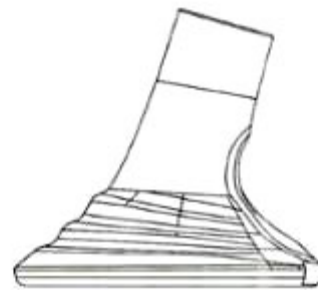

1.5

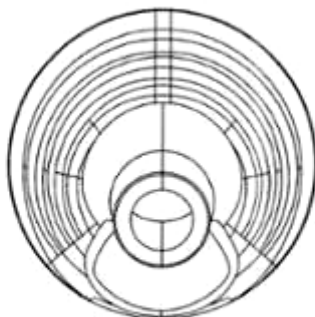

1.6

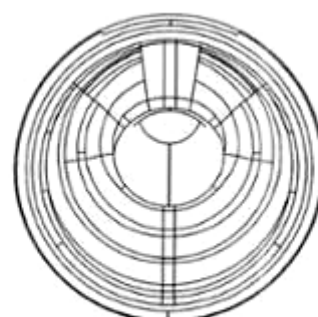

1.7

CÔNG BÁO SỞ HỮU CÔNG NGHIỆP SỐ 436 TẬP A – QUYỀN 2 (07.2024)

- (11) **50675**
(21) 3-2024-00778 (28) 4
(54) **NHÃN SẢN PHẨM** (51) **19-08**
(22) 29/03/2024 (43) 25/07/2024
(73) **CÔNG TY CỔ PHẦN THỰC PHẨM VÀ NƯỚC GIẢI KHÁT NAM VIỆT (VN)**
Số 994/1C, đường Nguyễn Thị Minh Khai, khu phố Tân Thắng, phường Tân Bình, thành phố Dĩ An, tỉnh Bình Dương
(72) Bùi Thị Thu Hương (VN)
(74) **CÔNG TY TNHH SỞ HỮU TRÍ TUỆ ANLIS VIỆT NAM (ANLIS IP CO.,LTD)**
(55)



1.1



1.2



2.1



2.2



3.1



3.2



4.1



4.2

CÔNG BÁO SỞ HỮU CÔNG NGHIỆP SỐ 436 TẬP A – QUYỀN 2 (07.2024)

- | | | | |
|------|--|------|--------------|
| (11) | 50676 | | |
| (21) | 3-2024-01076 | (28) | 2 |
| (54) | BỘ NHÃN SẢN PHẨM | (51) | 19-08 |
| (22) | 09/05/2024 | (43) | 25/07/2024 |
| (73) | CÔNG TY TNHH NAK VIỆT NAM (VN)
45 đường D4A, khu dân cư Hưng Phú, phường Phước Long B, thành phố Thủ Đức,
thành phố Hồ Chí Minh | | |
| (72) | Nguyễn Thị Bích Ly (VN) | | |
| (74) | Công ty Luật TNHH AGL (AGL LAW) | | |
| (55) | | | |



1.1



1.2

CÔNG BÁO SỞ HỮU CÔNG NGHIỆP SỐ 436 TẬP A – QUYỀN 2 (07.2024)

- (11) **50677**
(21) 3-2024-01121 (28) 1
(54) **HỘP ĐỰNG YẾN** (51) **09-03**
(22) 15/05/2024 (43) 25/07/2024
(73) **LÊ PHẠM LAN ANH (VN)**
V3.28.02 C/Cư Sunrise City, phường Tân Hưng, quận 7, thành phố Hồ Chí Minh
(72) Lê Phạm Lan Anh (VN)
(74) Văn phòng Luật sư D và T (D & T LAW OFFICE)
(55)



1.1



1.2

CÔNG BÁO SỞ HỮU CÔNG NGHIỆP SỐ 436 TẬP A – QUYỀN 2 (07.2024)

- (11) **50678**
(21) 3-2024-01122 (28) 2
(54) **BAO GÓI** (51) **09-05**
(22) 15/05/2024 (43) 25/07/2024
(73) **LÊ PHẠM LAN ANH (VN)**
V3.28.02 C/Cư Sunrise City, phường Tân Hưng, quận 7, thành phố Hồ Chí Minh
(72) Lê Phạm Lan Anh (VN)
(74) Văn phòng Luật sư D và T (D & T LAW OFFICE)
(55)



1.1



1.2



2.1



2.2

CÔNG BÁO SỞ HỮU CÔNG NGHIỆP SỐ 436 TẬP A – QUYỀN 2 (07.2024)

- (11) **50679**
(21) 3-2024-01123 (28) 1
(54) **BAO GÓI** (51) **09-05**
(22) 15/05/2024 (43) 25/07/2024
(73) **LÊ PHẠM LAN ANH (VN)**
V3.28.02 C/Cư Sunrise City, phường Tân Hưng, quận 7, thành phố Hồ Chí Minh
(72) Lê Phạm Lan Anh (VN)
(74) Văn phòng Luật sư D và T (D & T LAW OFFICE)
(55)



1.1



1.2

CÔNG BÁO SỞ HỮU CÔNG NGHIỆP SỐ 436 TẬP A – QUYỀN 2 (07.2024)

- (11) **50680**
(21) 3-2024-01124 (28) 2
(54) **BAO GÓI** (51) **09-05**
(22) 15/05/2024 (43) 25/07/2024
(73) **LÊ PHẠM LAN ANH (VN)**
V3.28.02 C/Cư Sunrise City, phường Tân Hưng, quận 7, thành phố Hồ Chí Minh
(72) Lê Phạm Lan Anh (VN)
(74) Văn phòng Luật sư D và T (D & T LAW OFFICE)
(55)



1.1



1.2



2.1



2.2

CÔNG BÁO SỞ HỮU CÔNG NGHIỆP SỐ 436 TẬP A – QUYỀN 2 (07.2024)

- (11) **50681**
(21) 3-2024-01125 (28) 1
(54) **BAO GÓI** (51) **09-05**
(22) 15/05/2024 (43) 25/07/2024
(73) **LÊ PHẠM LAN ANH (VN)**
V3.28.02 C/Cư Sunrise City, phường Tân Hưng, quận 7, thành phố Hồ Chí Minh
(72) Lê Phạm Lan Anh (VN)
(74) Văn phòng Luật sư D và T (D & T LAW OFFICE)
(55)



1.1



1.2

CÔNG BÁO SỞ HỮU CÔNG NGHIỆP SỐ 436 TẬP A – QUYỀN 2 (07.2024)

- (11) **50682**
(21) 3-2024-01126 (28) 1
(54) **BAO GÓI** (51) **09-05**
(22) 15/05/2024 (43) 25/07/2024
(73) **LÊ PHẠM LAN ANH (VN)**
V3.28.02 C/Cư Sunrise City, phường Tân Hưng, quận 7, thành phố Hồ Chí Minh
(72) Lê Phạm Lan Anh (VN)
(74) Văn phòng Luật sư D và T (D & T LAW OFFICE)
(55)



1.1



1.2

CÔNG BÁO SỞ HỮU CÔNG NGHIỆP SỐ 436 TẬP A – QUYỀN 2 (07.2024)

- (11) **50683**
(21) 3-2024-01359 (28) 1
(54) **TÚI** (51) **03-01**
(22) 12/06/2024 (43) 25/07/2024
(30) 2024-001529 26/01/2024 JP;
(73) **KOKUYO CO., LTD. (JP)**
1-1, Oimazato-minami 6-chome, Higashinari-ku, Osaka-shi, Osaka, Japan
(72) 1. KAZUNORI BAN (JP)
2. YOICHI HANAKAWA (JP)
(74) Công ty TNHH Sở hữu trí tuệ HA VIP (HAVIP CO., LTD.)
(55)



1.1



1.2



1.3



1.4



1.5



1.6



1.7



1.8



1.9

- (11) **50684**
(21) 3-2024-00049 (28) 1
(54) **LY ĐỰNG NÉN** (51) **26-01**
(22) 05/01/2024 (43) 25/07/2024
(73) **CÔNG TY TNHH SẢN XUẤT THƯƠNG MẠI QUANG NGHỆ (VN)**
205B/28 Âu Cơ, phường 5, quận 11, thành phố Hồ Chí Minh
(72) Thi Lương (VN)
(55)

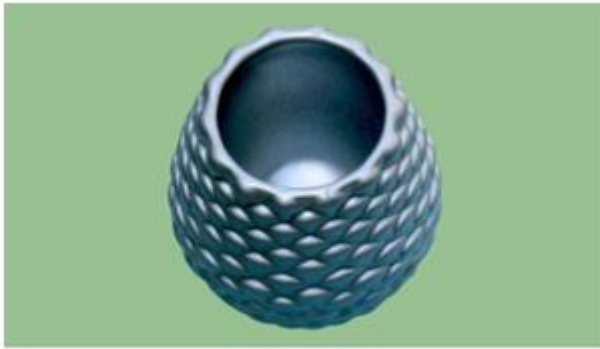

1.1

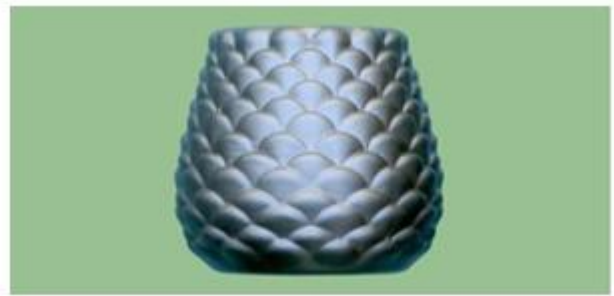

1.2

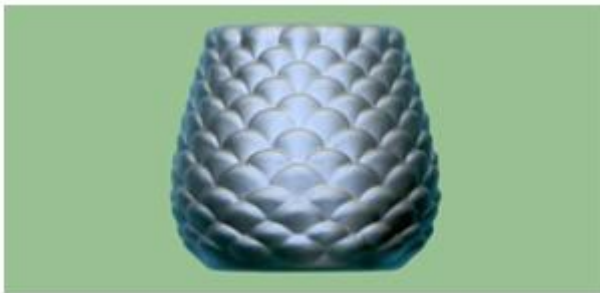

1.3

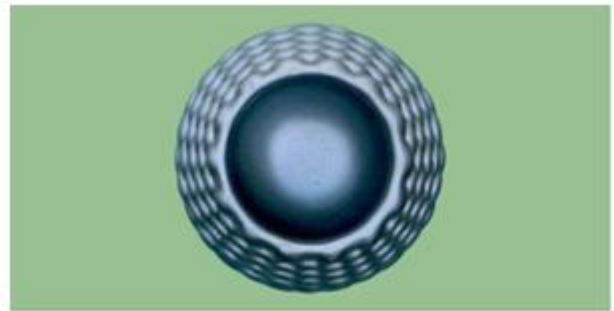

1.4



1.5

CÔNG BÁO SỞ HỮU CÔNG NGHIỆP SỐ 436 TẬP A – QUYỀN 2 (07.2024)

- (11) **50685**
(21) 3-2024-00985 (28) 1
(54) **TỰA LƯNG GHẾ** (51) **06-01**
(22) 25/04/2024 (43) 25/07/2024
(30) 202430123609.2 12/03/2024 CN;
(73) **ANJI HENGYOU TECHNOLOGY CO., LTD. (CN)**
No.268#, Tiaoxiu east road, Block 3#, Sunshine Industrial Park, Anji County,
Huzhou City, Zhejiang Province, 313300, China
(72) Jianglin Wang (CN)
(74) Công ty TNHH ADAstra IP (VIỆT NAM) (ADAstra IP (VIETNAM) CO.,
LTD.)
(55)



1.1



1.2



1.3



1.4

1.5



1.6



1.7

CÔNG BÁO SỞ HỮU CÔNG NGHIỆP SỐ 436 TẬP A – QUYỀN 2 (07.2024)

- (11) **50686**
(21) 3-2024-00984 (28) 1
(54) **MÁY VÒM NHIỆT** (51) **23-03**
(22) 25/04/2024 (43) 25/07/2024
(73) **NGUYỄN VĂN NAM (VN)**
77 đường số 7A, phường Bình Trị Đông B, quận Bình Tân, thành phố Hồ Chí Minh
(72) Nguyễn Văn Nam (VN)
(74) Công ty TNHH Nam Việt và Liên danh (VIPCO)
(55)



1.1



1.2



1.3



1.4



1.5



1.6



1.7

CÔNG BÁO SỞ HỮU CÔNG NGHIỆP SỐ 436 TẬP A – QUYỀN 2 (07.2024)

- (11) **50687**
(21) 3-2023-02118 (28) 1
(54) **LỌ** (51) **09-01**
(22) 07/09/2023 (43) 25/07/2024
(73) **CÔNG TY CỔ PHẦN TẬP ĐOÀN MERAP (VN)**
Thôn Bá Khê, xã Tân Tiến, huyện Văn Giang, tỉnh Hưng Yên
(72) Nguyễn Hoàng Nam (VN)
(74) Công ty TNHH Tâm nhìn và Liên danh (VISION & ASSOCIATES CO.LTD.)
(55)

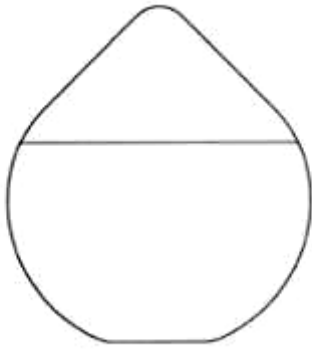

1.1



1.2



1.3

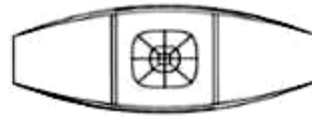

1.4



1.5

CÔNG BÁO SỞ HỮU CÔNG NGHIỆP SỐ 436 TẬP A – QUYỀN 2 (07.2024)

- (11) **50688**
(21) 3-2023-02497 (28) 1
(54) **CHAI** (51) **09-01**
(22) 23/10/2023 (43) 25/07/2024
(73) **CÔNG TY TNHH CÁNH ĐỒNG VÀNG (VN)**
7 đường số 5, khu phố 4, phường An Phú, thành phố Thủ Đức, thành phố Hồ Chí Minh
(72) Lê Kim Khánh (VN)
(74) Công ty TNHH Sở hữu trí tuệ INVENTIO (INVENTIO CO.,LTD)
(55)

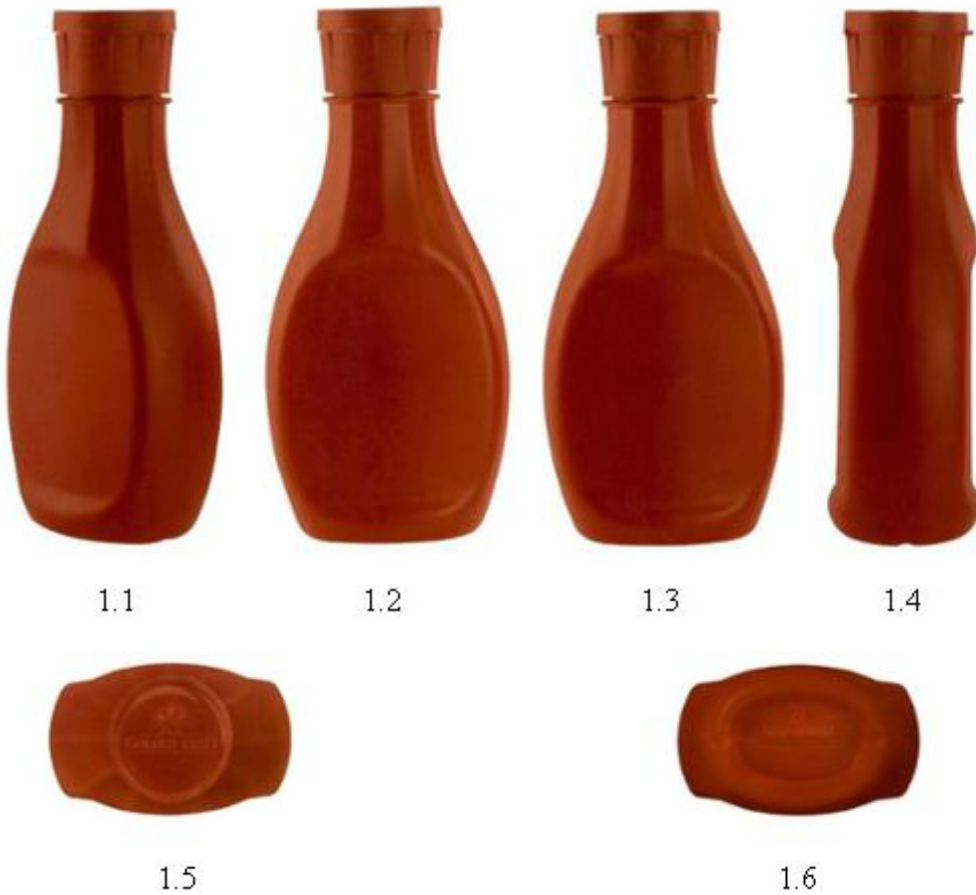

- (11) **50689**
(21) 3-2023-02664 (28) 1
(54) **KHUYÊN TAI** (51) **11-01**
(22) 09/11/2023 (43) 25/07/2024
(30) WIPO140090 26/10/2023 WO;
(73) **CHRISTIAN DIOR COUTURE (FR)**
30 Avenue Montaigne, 75008 Paris, France
(72) Victoire de Castellane (FR)
(74) Công ty TNHH một thành viên Sở hữu trí tuệ VCCI (VCCI-IP CO.,LTD)
(55)



1.1

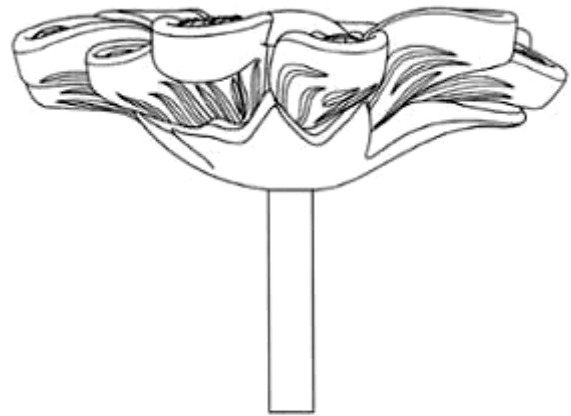

1.2

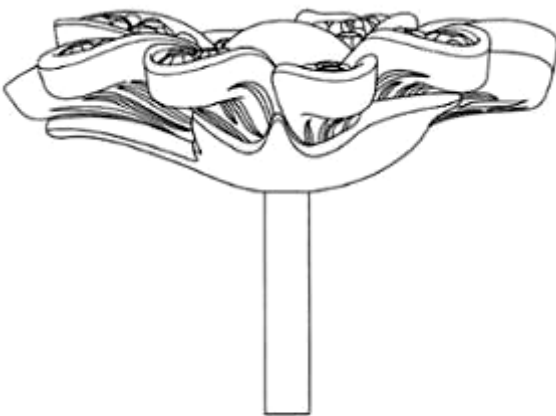

1.3

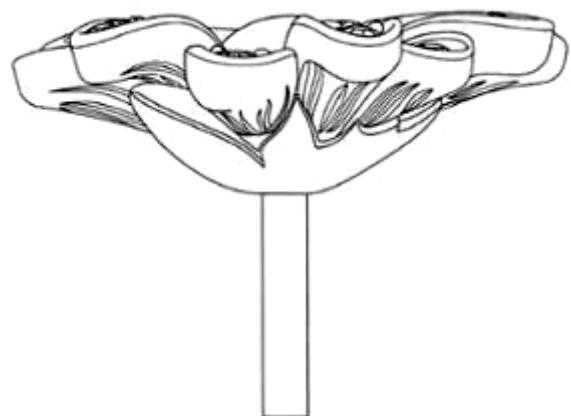

1.4

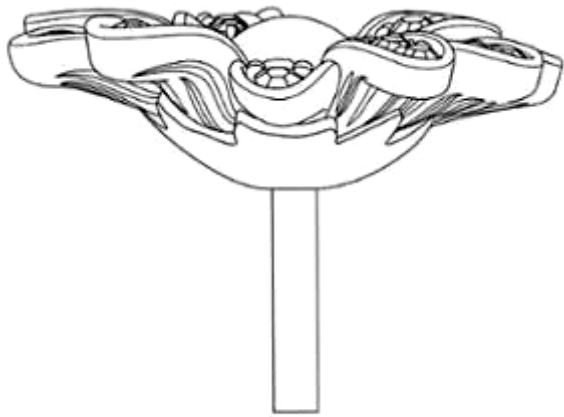

1.5

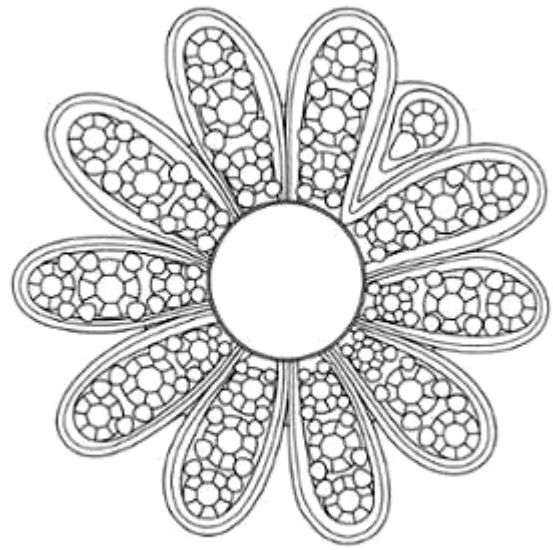

1.6

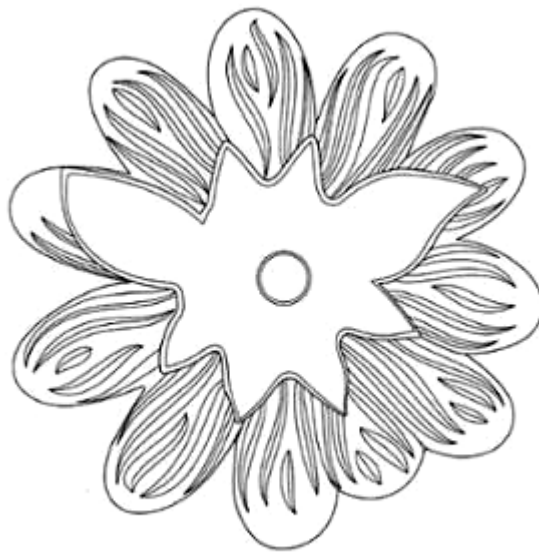

1.7

- (11) **50690**
(21) 3-2023-02665 (28) 1
(54) **KHUYÊN TAI** (51) **11-01**
(22) 09/11/2023 (43) 25/07/2024
(30) WIPO140090 26/10/2023 WO;
(73) **CHRISTIAN DIOR COUTURE (FR)**
30 Avenue Montaigne, 75008 Paris, France
(72) Victoire de Castellane (FR)
(74) Công ty TNHH một thành viên Sở hữu trí tuệ VCCI (VCCI-IP CO.,LTD)
(55)



1.1



1.2



1.3

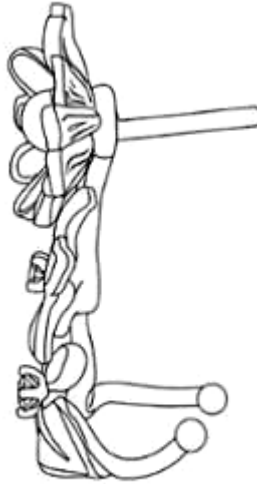

1.4

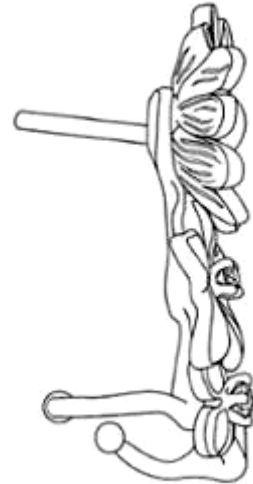

1.5



1.6



1.7

- (11) **50691**
(21) 3-2023-02666 (28) 1
(54) **KHUYÊN TAI** (51) **11-01**
(22) 09/11/2023 (43) 25/07/2024
(30) WIPO140090 26/10/2023 WO;
(73) **CHRISTIAN DIOR COUTURE (FR)**
30 Avenue Montaigne, 75008 Paris, France
(72) Victoire de Castellane (FR)
(74) Công ty TNHH một thành viên Sở hữu trí tuệ VCCI (VCCI-IP CO.,LTD)
(55)



1.1

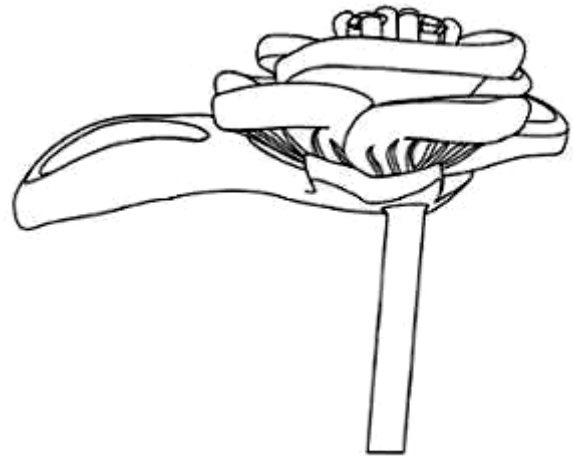

1.2

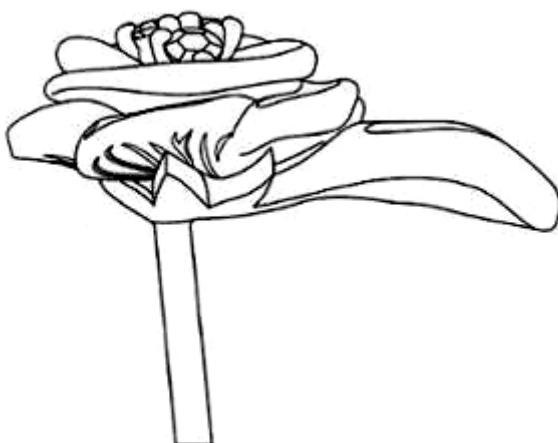

1.3

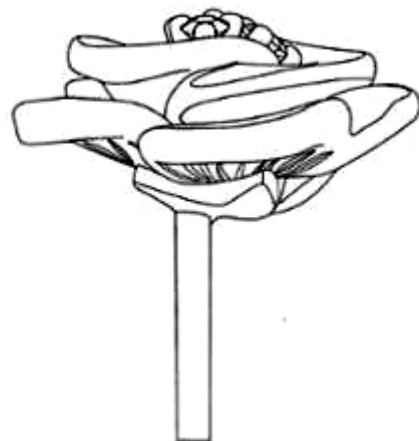

1.4

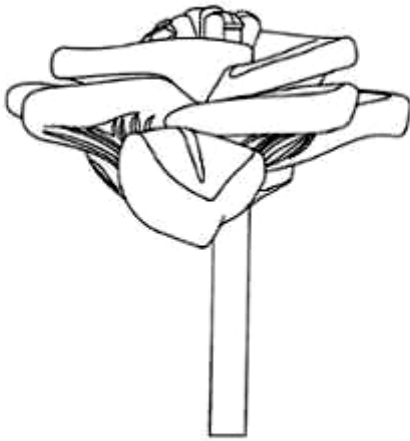

1.5

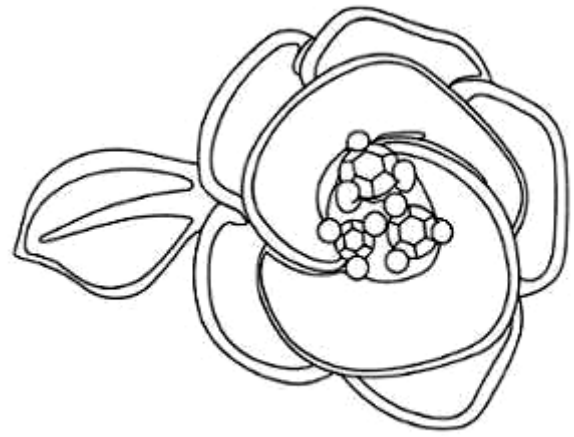

1.6

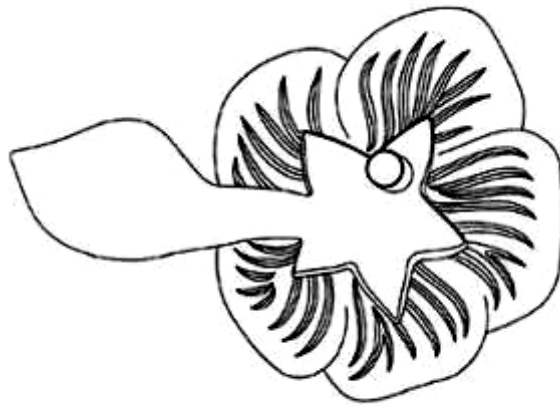

1.7

CÔNG BÁO SỞ HỮU CÔNG NGHIỆP SỐ 436 TẬP A – QUYỀN 2 (07.2024)

(11) **50692**

(21) 3-2024-00749

(28) 1

(54) **TRỤ SẠC ĐIỆN**

(51) **13-02**

(22) 28/03/2024

(43) 25/07/2024

(73) **NGUYỄN DUY THỊNH (VN)**

177/15 Bùi Minh Trực, phường 5, quận 8, thành phố Hồ Chí Minh

(72) Nguyễn Duy Thịnh (VN)

(55)

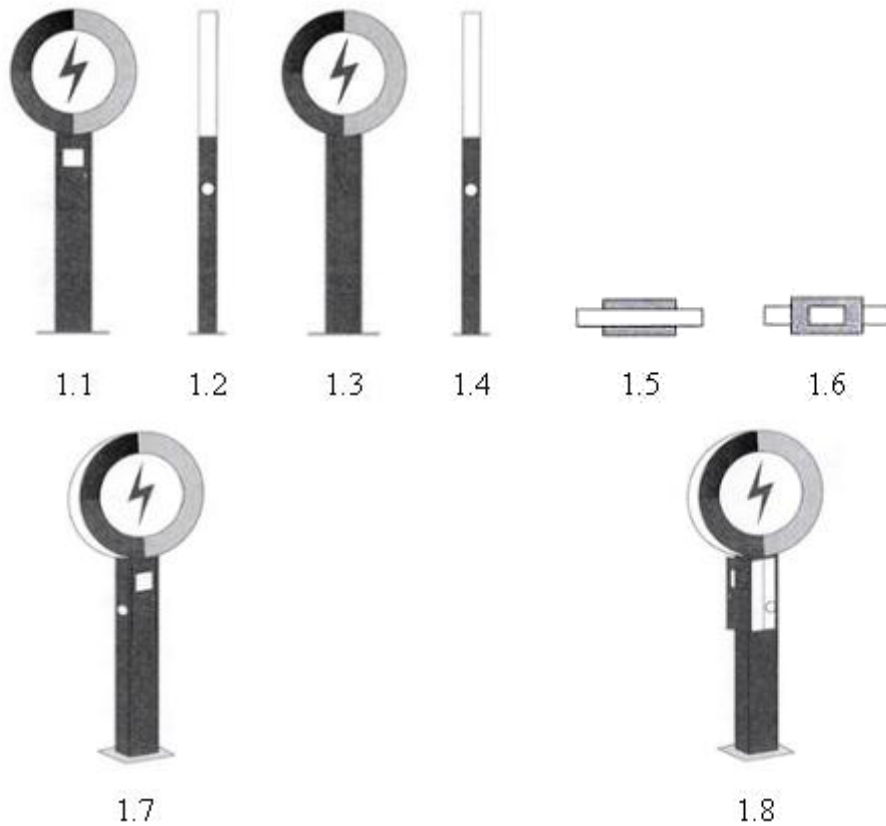

(11) **50693**

(21) 3-2024-00755

(28) 2

(54) **GHẾ**

(51) **06-01**

(22) 28/03/2024

(43) 25/07/2024

(73) **TRƯỜNG ĐẠI HỌC VĂN LANG (VN)**

45 Nguyễn Khắc Nhu, phường Cô Giang, quận 1, thành phố Hồ Chí Minh

(72) Nguyễn Trần Vân Anh (VN)

(55)

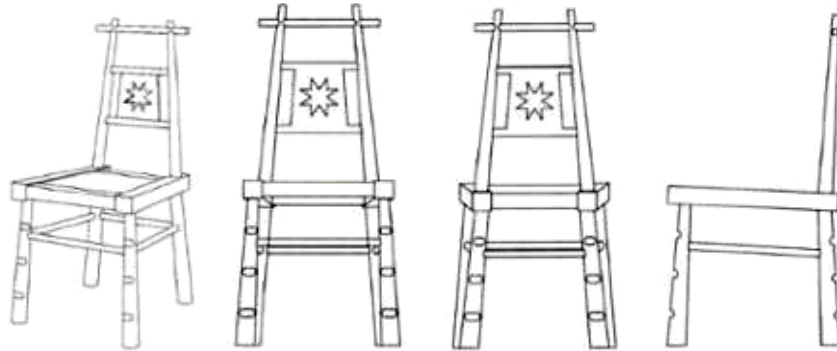

1.1

1.2

1.3

1.4

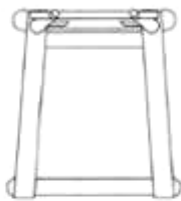

1.5



1.6



2.1

2.2

2.3

2.4



2.5



2.6

(11) **50694**

(21) 3-2024-00757

(28) 2

(54) **GHẾ**

(51) **06-01**

(22) 28/03/2024

(43) 25/07/2024

(73) **TRƯỜNG ĐẠI HỌC VĂN LANG (VN)**

45 Nguyễn Khắc Nhu, phường Cô Giang, quận 1, thành phố Hồ Chí Minh

(72) Nguyễn Vũ Thiên Ái (VN)

(55)

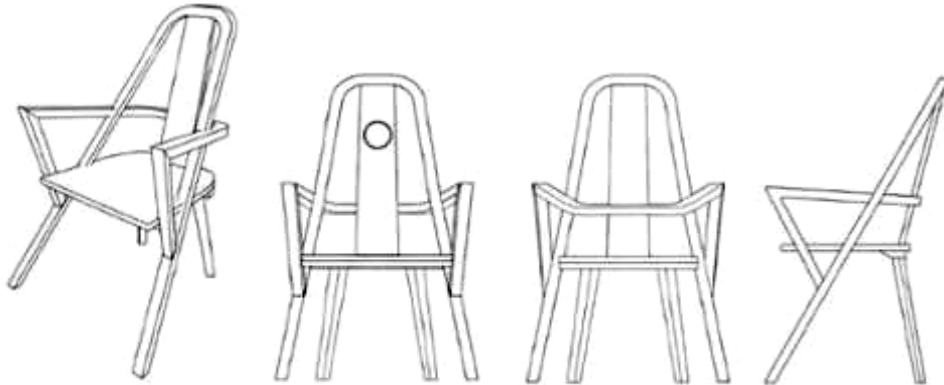

1.1

1.2

1.3

1.4



1.5



1.6



2.1

2.2

2.3

2.4



2.5



2.6

CÔNG BÁO SỞ HỮU CÔNG NGHIỆP SỐ 436 TẬP A – QUYỀN 2 (07.2024)

(11) **50695**

(21) 3-2024-01187

(28) 1

(54) **THIẾT BỊ ỔN ĐỊNH ĐIỆN ÁP**

(51) **13-02**

(22) 24/05/2024

(43) 25/07/2024

(73) **TRƯỜNG ĐẠI HỌC ĐIỆN LỰC (VN)**

235 Hoàng Quốc Việt, phường Cổ Nhuế, quận Bắc Từ Liêm, thành phố Hà Nội

(72) Nguyễn Thị Điệp (VN)

(55)



1.1

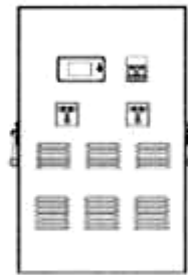

1.2



1.3

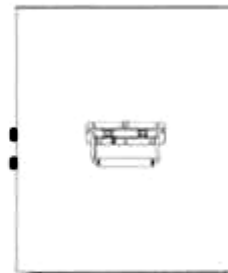

1.4



1.5



1.6

CÔNG BÁO SỞ HỮU CÔNG NGHIỆP SỐ 436 TẬP A – QUYỀN 2 (07.2024)

- (11) **50696**
(21) 3-2024-01107 (28) 1
(54) **NỒI ĐIỆN** (51) **07-02**
(22) 14/05/2024 (43) 25/07/2024
(30) 30-2024-0002550 19/01/2024 KR;
(73) **LOCK & LOCK CO., LTD.** (KR)
1260, Manse-ro, Wongok-myeon, Anseong-si, Gyeonggi-do, Republic of Korea
(72) YOU, Sung Ik (KR)
(74) Công ty TNHH Tầm nhìn và Liên danh (VISION & ASSOCIATES CO.LTD.)
(55)



1.1



1.2



1.3



1.4



1.5



1.6



1.7



1.8

CÔNG BÁO SỞ HỮU CÔNG NGHIỆP SỐ 436 TẬP A – QUYỀN 2 (07.2024)

- (11) **50697**
(21) 3-2024-01109 (28) 1
(54) **CHAI** (51) **09-01**
(22) 14/05/2024 (43) 25/07/2024
(30) 30-2024-0005677 08/02/2024 KR;
(73) **LOCK & LOCK CO., LTD.** (KR)
1260, Manse-ro, Wongok-myeon, Anseong-si, Gyeonggi-do, Republic of Korea
(72) KIM, Kwang Ik (KR)
(74) Công ty TNHH Tầm nhìn và Liên danh (VISION & ASSOCIATES CO.LTD.)
(55)



1.1



1.2



1.3



1.4



1.5



1.6



1.7



1.8

CÔNG BÁO SỞ HỮU CÔNG NGHIỆP SỐ 436 TẬP A – QUYỀN 2 (07.2024)

- (11) **50698**
(21) 3-2024-01110 (28) 1
(54) **BAO GÓI** (51) **09-05**
(22) 14/05/2024 (43) 25/07/2024
(73) **CÔNG TY TNHH THƯƠNG MẠI XUẤT NHẬP KHẨU NGUYỄN HỮU THẮNG (VN)**
Số 36B/14 đường 762 Hồng Bàng, phường 1, quận 11, thành phố Hồ Chí Minh
(72) Nguyễn Đình Thái (VN)
(74) Công ty TNHH một thành viên Trường Luật (Trường Luật)
(55)



1.1



1.2

CÔNG BÁO SỞ HỮU CÔNG NGHIỆP SỐ 436 TẬP A – QUYỀN 2 (07.2024)

- (11) **50699**
(21) 3-2024-01111 (28) 1
(54) **BAO GÓI** (51) **09-05**
(22) 14/05/2024 (43) 25/07/2024
(73) **CÔNG TY TNHH THƯƠNG MẠI XUẤT NHẬP KHẨU NGUYỄN HỮU THẮNG (VN)**
Số 36B/14 đường 762 Hồng Bàng, phường 1, quận 11, thành phố Hồ Chí Minh
(72) Nguyễn Đình Thái (VN)
(74) Công ty TNHH một thành viên Trường Luật (Trường Luật)
(55)



1.1



1.2

- (11) **50700**
(21) 3-2024-01167 (28) 1
(54) **MÁY MÀI** (51) **08-05**
(22) 22/05/2024 (43) 25/07/2024
(30) 29/919,979 07/12/2023 US;
(73) **DAREX, LLC (US)**
210 East Hersey Street, Ashland, Oregon 97520 U.S.A.
(72) 1. CONNER S. MACFARLANE (US)
2. JOEY T. ZACHARISSSEN (US)
3. DANIEL RIEGELS (US)
4. TRAVIS CAMPBELL (US)
(74) Công ty TNHH Quốc tế D &N (D&N INTERNATIONAL CO.,LTD.)
(55)

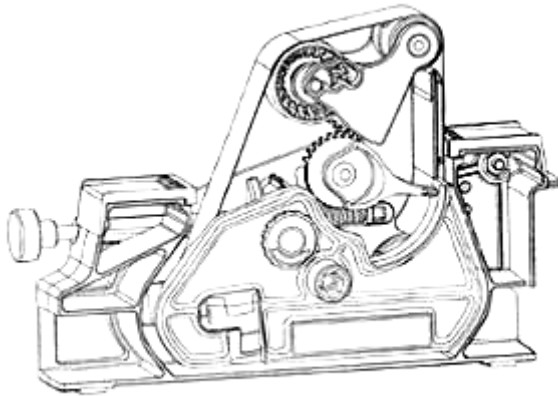

1.1

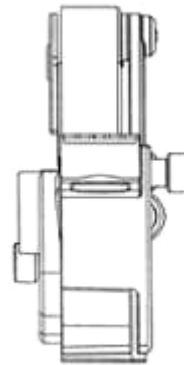

1.2

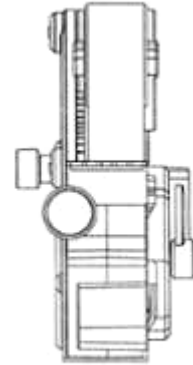

1.3

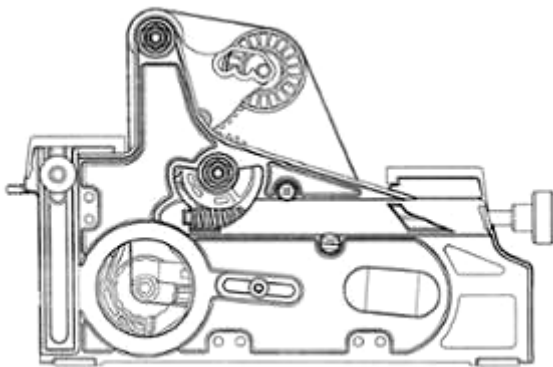

1.4

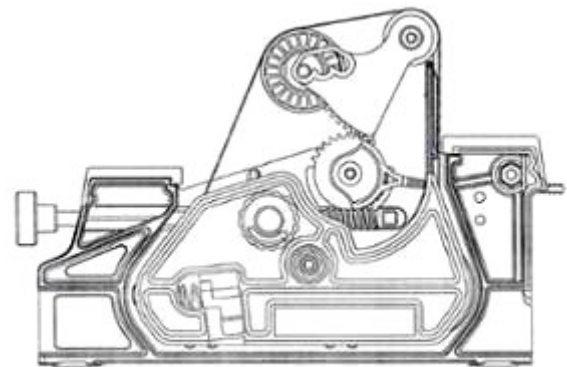

1.5

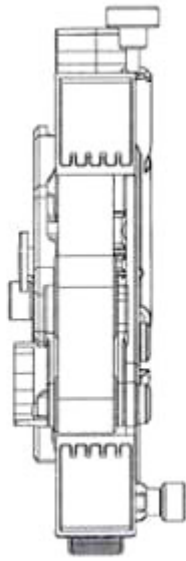

1.6

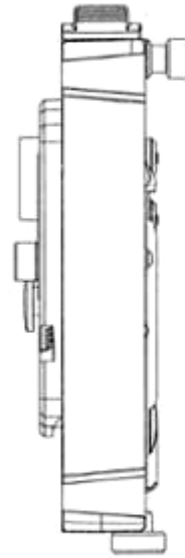

1.7

CÔNG BÁO SỞ HỮU CÔNG NGHIỆP SỐ 436 TẬP A – QUYỀN 2 (07.2024)

- (11) **50701**
(21) 3-2024-01172 (28) 1
(54) **HỘP ĐỰNG CHỈ NHA KHOA** (51) **09-03**
(22) 22/05/2024 (43) 25/07/2024
(73) **LG H&H CO., LTD. (KR)**
58, Saemunan-ro, Jongno-gu, Seoul, Republic of Korea
(72) Jang, Wan Sik (KR)
(74) Công ty TNHH Tầm nhìn và Liên danh (VISION & ASSOCIATES CO.LTD.)
(55)



1.1



1.2



1.3



1.4



1.5



1.6



1.7

CÔNG BÁO SỞ HỮU CÔNG NGHIỆP SỐ 436 TẬP A – QUYỀN 2 (07.2024)

- (11) **50702**
(21) 3-2024-01174 (28) 1
(54) **CHAI** (51) **09-01**
(22) 22/05/2024 (43) 25/07/2024
(73) **CÔNG TY CỔ PHẦN HÀNG TIÊU DÙNG MASAN (VN)**
Số 23 Lê Duẩn, phường Bến Nghé, quận 1, thành phố Hồ Chí Minh
(72) Nguyễn Hoàng Yên (VN)
(74) Công ty cổ phần Sở hữu trí tuệ BROSS và Cộng sự (BROSS & PARTNERS., JSC)
(55)

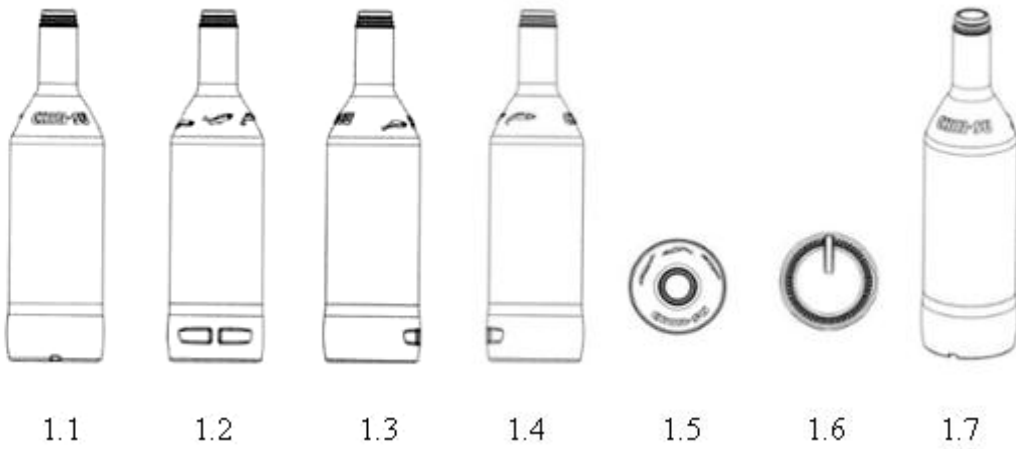

- (11) **50703**
(21) 3-2024-01275 (28) 1
(54) **KẸP SẮP XẾP DÂY CÁP** (51) **13-03**
(22) 03/06/2024 (43) 25/07/2024
(30) 113301778 18/04/2024 TW;
(73) **CHANNEL WELL TECHNOLOGY CO., LTD. (TW)**
13F., No. 208, Xingfu Rd., Taoyuan Dist., Taoyuan City 330063, Taiwan
(72) 1. PAN, YEN-CHENG (TW)
2. HSU, YI-LUN (TW)
3. CHIU, TZU-YING (TW)
(74) **CÔNG TY LUẬT TNHH IP MAX (IPMAX LAW FIRM)**
(55)

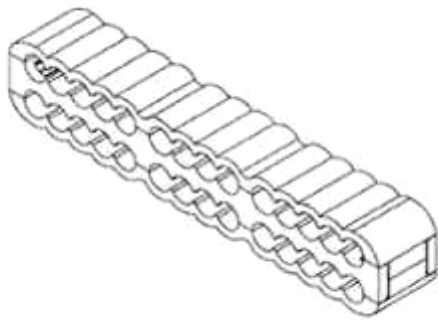

1.1

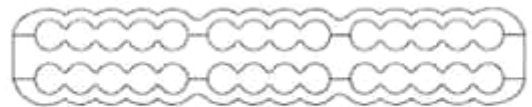

1.2

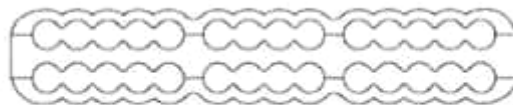

1.3

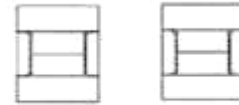

1.4

1.5

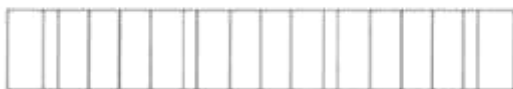

1.6



1.7

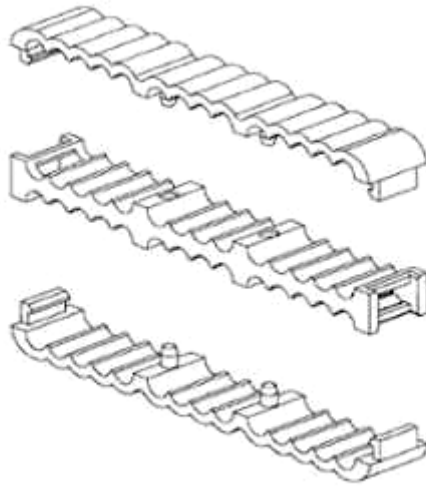

1.8

CÔNG BÁO SỞ HỮU CÔNG NGHIỆP SỐ 436 TẬP A – QUYỀN 2 (07.2024)

- (11) **50704**
(21) 3-2024-00687 (28) 1
(54) **NỒI CƠM ĐIỆN** (51) **07-02**
(22) 20/03/2024 (43) 25/07/2024
(30) 2023307098354 31/10/2023 CN;
(73) **FOSHAN SHUNDE MIDEA ELECTRICAL HEATING APPLIANCES
MANUFACTURING CO., LTD. (CN)**
San Le Road #19, Beijiao, Shunde, Foshan, Guangdong Province 528311, China
(72) 1. LIANG, ZHIFENG (CN)
2. LI, ZHI (CN)
3. ZHANG, CHUNYU (CN)
(74) Công ty Cổ phần Sở hữu công nghiệp INVESTIP (INVESTIP)
(55)



1.1



1.2



1.3



1.4



1.5



1.6



1.7

CÔNG BÁO SỞ HỮU CÔNG NGHIỆP SỐ 436 TẬP A – QUYỀN 2 (07.2024)

- (11) **50705**
(21) 3-2024-00688 (28) 1
(54) **NẮP HỘ ĐỪNG THỰC PHẨM** (51) **07-07**
(22) 20/03/2024 (43) 25/07/2024
(73) **LOCK & LOCK CO., LTD. (KR)**
1260, Manse-ro, Wongok-myeon, Anseong-si, Gyeonggi-do, Republic of Korea
(72) YOU, Sung Ik (KR)
(74) Công ty TNHH Tầm nhìn và Liên danh (VISION & ASSOCIATES CO.LTD.)
(55)



1.1



1.2



1.3



1.4



1.5



1.6



1.7



1.8

- (11) **50706**
(21) 3-2024-00689 (28) 1
(54) **CHAI** (51) **09-01**
(22) 20/03/2024 (43) 25/07/2024
(30) 2023-020011 28/09/2023 JP;
(73) **SUNTORY HOLDINGS LIMITED (JP)**
1-40, Dojimahama 2-chome, Kita-ku, Osaka-shi, Osaka 5308203, Japan
(72) 1. TAKAFUMI YAMASHITA (JP)
2. YOSHIKO KOSHIKAWA (JP)
(74) Công ty TNHH Tầm nhìn và Liên danh (VISION & ASSOCIATES CO.LTD.)
(55)

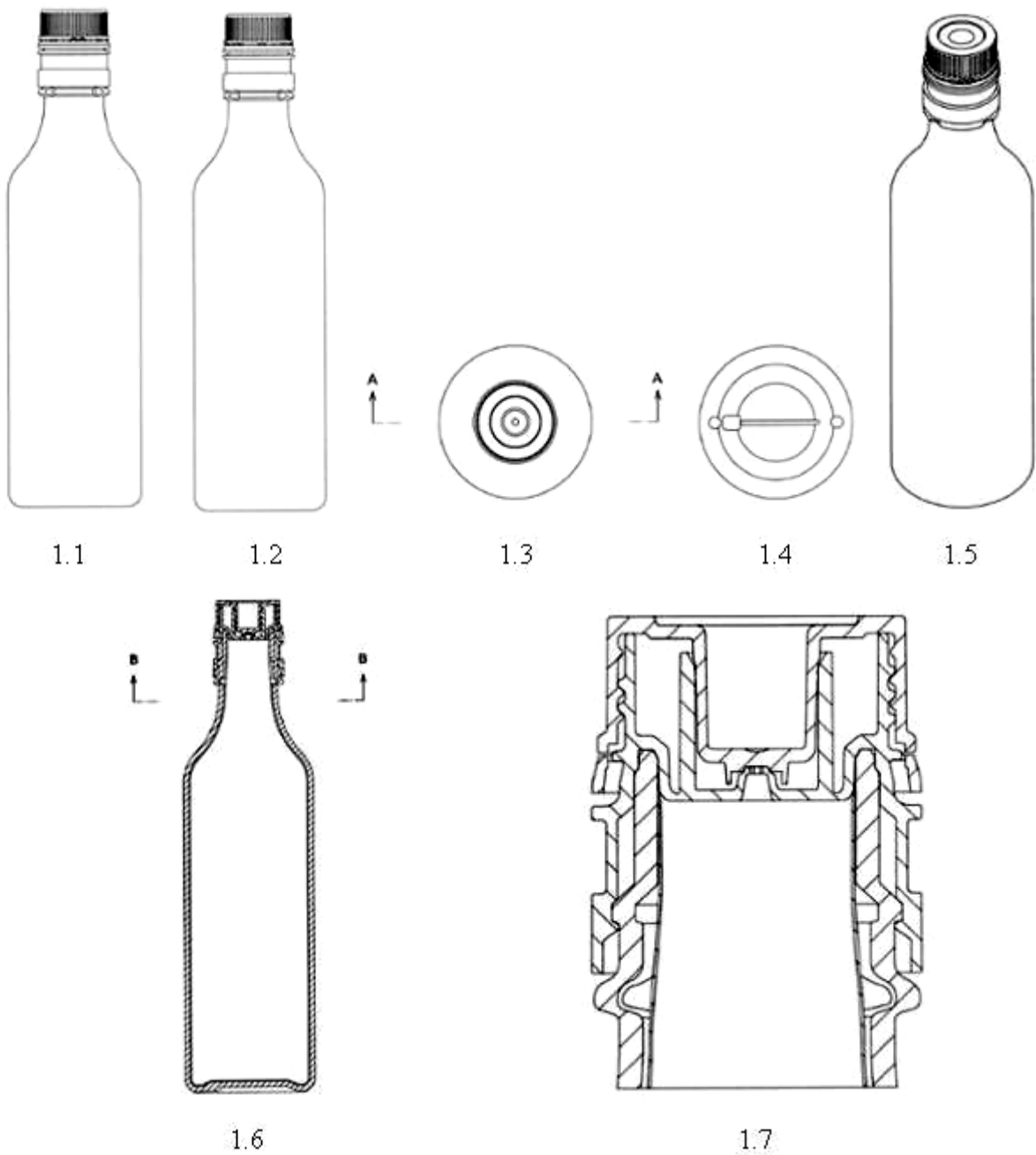

CÔNG BÁO SỞ HỮU CÔNG NGHIỆP SỐ 436 TẬP A – QUYỀN 2 (07.2024)

- (11) **50707**
(21) 3-2024-00864 (28) 1
(54) **THANH KIM LOẠI ĐỊNH HÌNH** (51) **25-01**
(22) 09/04/2024 (43) 25/07/2024
(73) **CÔNG TY TNHH SẢN XUẤT VÀ THƯƠNG MẠI HÙNG LONG (VN)**
Thôn Tráng Vũ, xã Đồng Than, huyện Yên Mỹ, tỉnh Hưng Yên
(72) Vũ Xuân Quân (VN)
(74) Công ty TNHH Sở hữu trí tuệ Gia Việt (GIAVIET CO., LTD.)
(55)



1.1



1.2



1.3



1.4

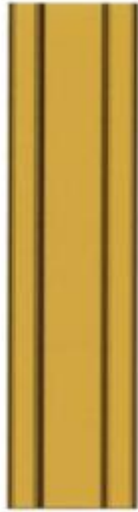

1.5



1.6

CÔNG BÁO SỞ HỮU CÔNG NGHIỆP SỐ 436 TẬP A – QUYỀN 2 (07.2024)

- (11) **50708**
(21) 3-2024-00865 (28) 1
(54) **THANH KIM LOẠI ĐỊNH HÌNH** (51) **25-01**
(22) 09/04/2024 (43) 25/07/2024
(73) **CÔNG TY CỔ PHẦN TẬP ĐOÀN KENWIN (VN)**
Tầng 4 tòa nhà VG Building, số 235 đường Nguyễn Trãi, phường Thanh Xuân
Trung, quận Thanh Xuân, thành phố Hà Nội
(72) Ngô Thọ Long (VN)
(74) Công ty TNHH Sở hữu trí tuệ PADEMARK (PADEMARK CO.,LTD.)
(55)



1.1



1.2



1.3



1.4



1.5



1.6



1.7

CÔNG BÁO SỞ HỮU CÔNG NGHIỆP SỐ 436 TẬP A – QUYỀN 2 (07.2024)

- (11) **50709**
(21) 3-2024-00866 (28) 1
(54) **THANH KIM LOẠI ĐỊNH HÌNH** (51) **25-01**
(22) 09/04/2024 (43) 25/07/2024
(73) **CÔNG TY CỔ PHẦN TẬP ĐOÀN KENWIN (VN)**
Tầng 4 tòa nhà VG Building, số 235 đường Nguyễn Trãi, phường Thanh Xuân
Trung, quận Thanh Xuân, thành phố Hà Nội
(72) Ngô Thọ Long (VN)
(74) Công ty TNHH Sở hữu trí tuệ PADEMARK (PADEMARK CO.,LTD.)
(55)



1.1



1.2



1.3

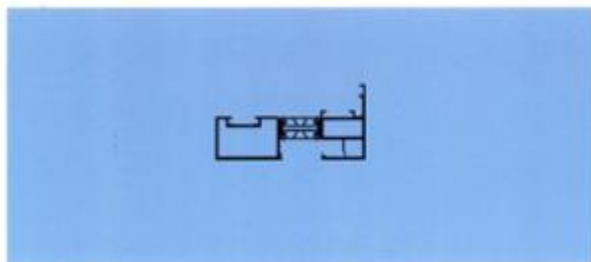

1.4

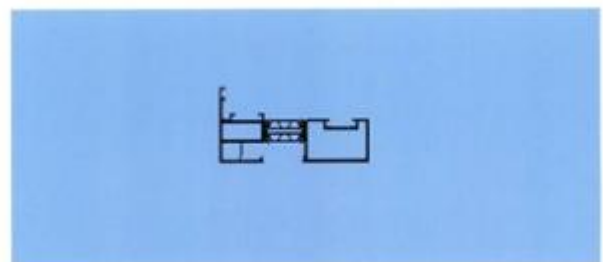

1.5



1.6



1.7

CÔNG BÁO SỞ HỮU CÔNG NGHIỆP SỐ 436 TẬP A – QUYỀN 2 (07.2024)

(11) **50710**

(21) 3-2024-00854

(28) 1

(54) **KỆ GIẤY**

(51) **06-04**

(22) 09/04/2024

(43) 25/07/2024

(73) **CÔNG TY CỔ PHẦN GIẢI PHÁP ĐÓNG GÓI MAGIX (VN)**

Số 02-04 Alexandre de Rhodes, phường Bến Nghé, quận 1, thành phố Hồ Chí Minh

(72) Đỗ Hữu Tân (VN)

(74) Công ty TNHH MASTERBRAND (MASTERBRAND)

(55)



1.1



1.2



1.3



1.4



1.5



1.6



1.7

(11) **50711**

(21) 3-2024-00691

(28) 1

(54) **BÀN**

(51) **06-03**

(22) 20/03/2024

(43) 25/07/2024

(73) **CÔNG TY CỔ PHẦN TƯ VẤN NHÀ ĐẸP CHÂU ÂU (VN)**

Số 36 đường Phạm Văn Đồng, phường Anh Dũng, quận Dương Kinh, thành phố Hải Phòng

(72) Nguyễn Việt Tùng (VN)

(55)



1.1



1.2



1.3



1.4



1.5



1.6



1.7

CÔNG BÁO SỞ HỮU CÔNG NGHIỆP SỐ 436 TẬP A – QUYỀN 2 (07.2024)

- (11) **50712**
(21) 3-2024-00692 (28) 1
(54) **VẢI** (51) **05-06**
(22) 20/03/2024 (43) 25/07/2024
(30) 30-2023-0039450 10/10/2023 KR;
(73) **JEON, YANG ZIN (KR)**
(Ilsan-dong, Hugok Maeul) 504-dong 601-ho, 35 Hugok-ro, Ilsanseo-gu, Goyang-si,
Gyeonggido, Republic of Korea
(72) JEON, Yang Zin (KR)
(74) Công ty TNHH Trường Xuân (AGELESS CO.,LTD.)
(55)



1.1



1.2

CÔNG BÁO SỞ HỮU CÔNG NGHIỆP SỐ 436 TẬP A – QUYỀN 2 (07.2024)

- (11) **50713**
(21) 3-2024-00094 (28) 1
(54) **BAO GÓI KHĂN GIẤY ƯỚT** (51) **09-05**
(22) 10/01/2024 (43) 25/07/2024
(73) **CÔNG TY TNHH SẢN XUẤT THƯƠNG MẠI GIẤY GIA NGUYỄN (VN)**
16/1 ấp 7, xã Xuân Thới Thượng, huyện Hóc Môn, thành phố Hồ Chí Minh
(72) Nguyễn Thanh Phong (VN)
(74) **CÔNG TY TNHH KHANG LUẬT (KHANGLAW)**
(55)



1.1



1.2



1.3



1.4



1.5



1.6



1.7

CÔNG BÁO SỞ HỮU CÔNG NGHIỆP SỐ 436 TẬP A – QUYỀN 2 (07.2024)

- (11) **50714**
- (21) 3-2024-00638
- (54) **HỘP**
- (22) 15/03/2024
- (73) **CÔNG TY CỔ PHẦN SỮA VIỆT NAM (VN)**
10 Tân Trào, phường Tân Phú, quận 7, thành phố Hồ Chí Minh
- (72) Richardson Patrick Christopher (US)
- (74) Công ty cổ phần Sở hữu trí tuệ BROSS và Cộng sự (BROSS & PARTNERS., JSC)
- (55)



1.1



1.2



2.1



2.2



3.1



3.2

CÔNG BÁO SỞ HỮU CÔNG NGHIỆP SỐ 436 TẬP A – QUYỀN 2 (07.2024)

- (11) **50715**
(21) 3-2024-00626 (28) 1
(54) **NHÃN SẢN PHẨM** (51) **19-08**
(22) 15/03/2024 (43) 25/07/2024
(73) **CÔNG TY CỔ PHẦN IPP SACHI (VN)**
Khu phố 8, phường Tam Quan, thị xã Hoài Nhơn, tỉnh Bình Định
(72) Nguyễn Hữu Vinh (VN)
(74) **CÔNG TY TNHH SỞ HỮU TRÍ TUỆ SETHACO (SETHACO IP CO.,LTD)**
(55)



CÔNG BÁO SỞ HỮU CÔNG NGHIỆP SỐ 436 TẬP A – QUYỀN 2 (07.2024)

- (11) **50716**
(21) 3-2024-00627 (28) 1
(54) **NHÃN SẢN PHẨM** (51) **19-08**
(22) 15/03/2024 (43) 25/07/2024
(73) **CÔNG TY CỔ PHẦN IPP SACHI (VN)**
Khu phố 8, phường Tam Quan, thị xã Hoài Nhơn, tỉnh Bình Định
(72) Nguyễn Hữu Vinh (VN)
(74) **CÔNG TY TNHH SỞ HỮU TRÍ TUỆ SETHACO (SETHACO IP CO.,LTD)**
(55)



CÔNG BÁO SỞ HỮU CÔNG NGHIỆP SỐ 436 TẬP A – QUYỀN 2 (07.2024)

- (11) **50717**
(21) 3-2024-00628 (28) 1
(54) **NHÃN SẢN PHẨM** (51) **19-08**
(22) 15/03/2024 (43) 25/07/2024
(73) **CÔNG TY CỔ PHẦN IPP SACHI (VN)**
Khu phố 8, phường Tam Quan, thị xã Hoài Nhơn, tỉnh Bình Định
(72) Nguyễn Hữu Vinh (VN)
(74) **CÔNG TY TNHH SỞ HỮU TRÍ TUỆ SETHACO (SETHACO IP CO.,LTD)**
(55)



CÔNG BÁO SỞ HỮU CÔNG NGHIỆP SỐ 436 TẬP A – QUYỀN 2 (07.2024)

- (11) **50718**
(21) 3-2024-00629 (28) 1
(54) **NHÃN SẢN PHẨM** (51) **19-08**
(22) 15/03/2024 (43) 25/07/2024
(73) **CÔNG TY CỔ PHẦN IPP SACHI (VN)**
Khu phố 8, phường Tam Quan, thị xã Hoài Nhơn, tỉnh Bình Định
(72) Nguyễn Hữu Vinh (VN)
(74) **CÔNG TY TNHH SỞ HỮU TRÍ TUỆ SETHACO (SETHACO IP CO.,LTD)**
(55)



CÔNG BÁO SỞ HỮU CÔNG NGHIỆP SỐ 436 TẬP A – QUYỀN 2 (07.2024)

- (11) **50719**
(21) 3-2024-00632 (28) 1
(54) **VAN AN TOÀN** (51) **23-01**
(22) 15/03/2024 (43) 25/07/2024
(73) **CÔNG TY TNHH MỘT THÀNH VIÊN MAI FA (VN)**
Thửa đất số 26, 313, tờ bản đồ số 8, khu phố Phước Hải, phường Thái Hòa, thành phố Tân Uyên, tỉnh Bình Dương
(72) Mai Quang Nhật (VN)
(74) Công ty TNHH Sở hữu trí tuệ Đông Dương (DONG DUONG IP CO.,LTD)
(55)



1.1



1.2



1.3



1.4



1.5



1.6



1.7

CÔNG BÁO SỞ HỮU CÔNG NGHIỆP SỐ 436 TẬP A – QUYỀN 2 (07.2024)

- (11) **50720**
(21) 3-2024-00082 (28) 1
(54) **THÂN MÁY LỌC KHÔNG KHÍ MANG ĐI ĐƯỢC** (51) **23-04**
(22) 09/01/2024 (43) 25/07/2024
(30) 202330813959.7 11/12/2023 CN;
(73) **LASKO OPERATION HOLDINGS, LLC (US)**
820 Lincoln Avenue, West Chester, PA. 19380, USA
(72) 1. HANEY, SEAN (US)
2. NORLAND, LEIF (US)
(74) Công ty TNHH Trà và cộng sự (TRA & ASSOCIATES CO.,LTD)
(55)

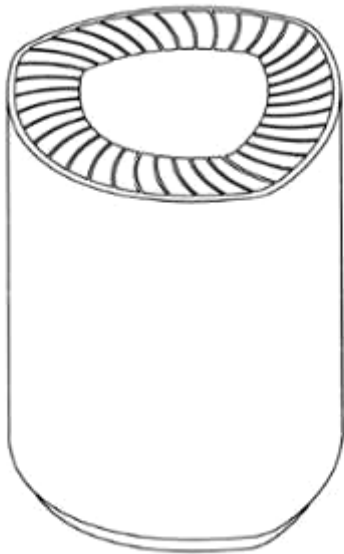

1.1



1.2



1.3



1.4

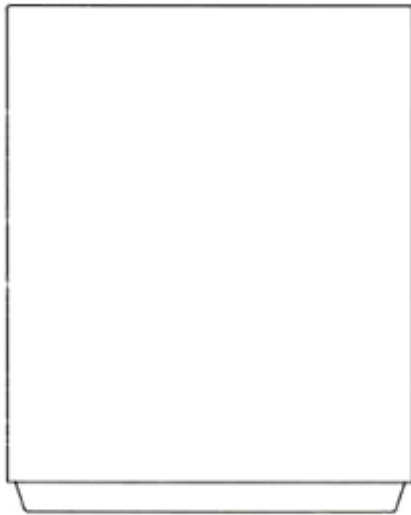

1.5

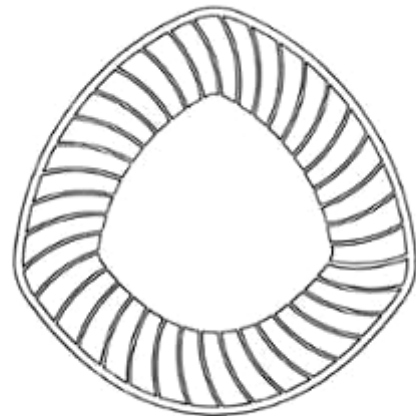

1.6

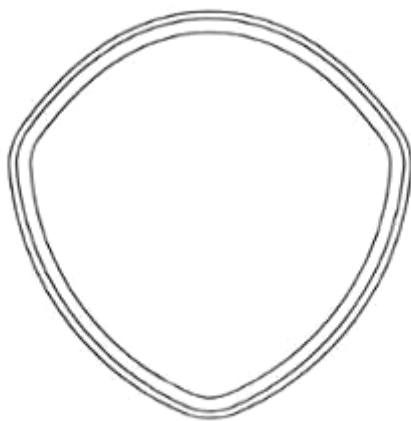

1.7

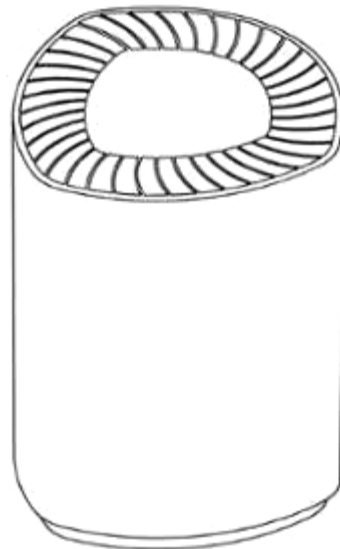

1.8

CÔNG BÁO SỞ HỮU CÔNG NGHIỆP SỐ 436 TẬP A – QUYỀN 2 (07.2024)

- (11) **50721**
(21) 3-2024-00083 (28) 1
(54) **THÂN MÁY LỌC KHÔNG KHÍ MANG ĐI ĐƯỢC** (51) **23-04**
(22) 09/01/2024 (43) 25/07/2024
(30) 202330813961.4 11/12/2023 CN;
(73) **LASKO OPERATION HOLDINGS, LLC (US)**
820 Lincoln Avenue, West Chester, PA. 19380, USA
(72) 1. HANEY, SEAN (US)
2. NORLAND, LEIF (US)
(74) Công ty TNHH Trà và cộng sự (TRA & ASSOCIATES CO.,LTD)
(55)

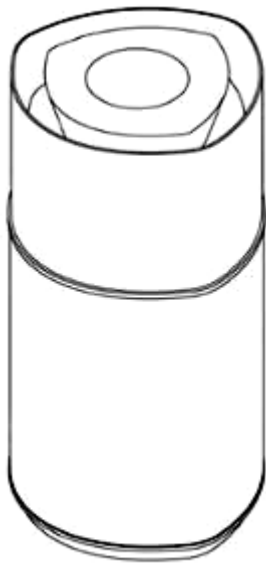

1.1



1.2



1.3



1.4



1.5



1.6



1.7



1.8

CÔNG BÁO SỞ HỮU CÔNG NGHIỆP SỐ 436 TẬP A – QUYỀN 2 (07.2024)

- (11) **50722**
(21) 3-2024-00084 (28) 1
(54) **THÂN MÁY LỌC KHÔNG KHÍ MANG ĐI ĐƯỢC** (51) **23-04**
(22) 09/01/2024 (43) 25/07/2024
(30) 202330813960.X 11/12/2023 CN;
(73) **LASKO OPERATION HOLDINGS, LLC (US)**
820 Lincoln Avenue, West Chester, PA. 19380, USA
(72) Haney, Sean (US)
(74) Công ty TNHH Trà và cộng sự (TRA & ASSOCIATES CO.,LTD)
(55)

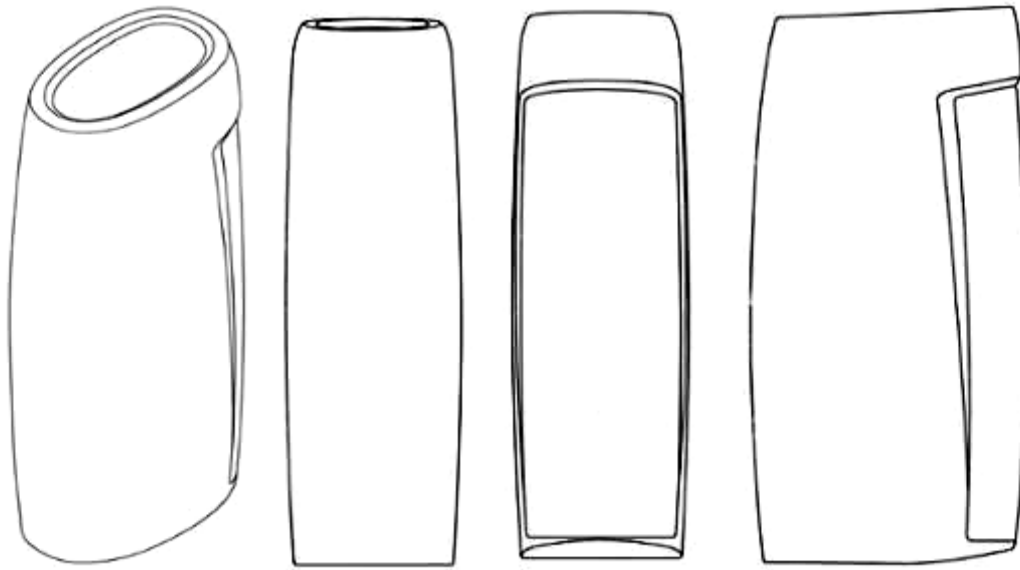

1.1

1.2

1.3

1.4



1.5



1.6



1.7

CÔNG BÁO SỞ HỮU CÔNG NGHIỆP SỐ 436 TẬP A – QUYỀN 2 (07.2024)

- (11) **50723**
(21) 3-2024-00473 (28) 1
(54) **GHẾ** (51) **06-01**
(22) 29/02/2024 (43) 25/07/2024
(30) 2023-020080 28/09/2023 JP;
(73) **OKAMURA CORPORATION (JP)**
7-18, Kitasaiwai 2-chome, Nishi-ku, Yokohama-shi, Kanagawa 220-0004 Japan
(72) 1. CHRISTOPHER SCHMIDT (DE)
2. HIROYUKI MORITA (JP)
3. KOSUKE TOKUI (JP)
(74) Công ty Luật TNHH T&G (TGVN)
(55)



1.1



1.2



1.3



1.4



1.5



1.6



1.7



1.8

CÔNG BÁO SỞ HỮU CÔNG NGHIỆP SỐ 436 TẬP A – QUYỀN 2 (07.2024)

(11) **50724**

(21) 3-2024-00474

(28) 1

(54) **BÀN**

(51) **06-03**

(22) 29/02/2024

(43) 25/07/2024

(30) 2023-022878 02/11/2023 JP;

(73) **OKAMURA CORPORATION (JP)**

7-18, Kitasaiwai 2-chome, Nishi-ku, Yokohama-shi, Kanagawa 220-0004 Japan

(72) Noboru NAGAISHI (JP)

(74) Công ty Luật TNHH T&G (TGVN)

(55)

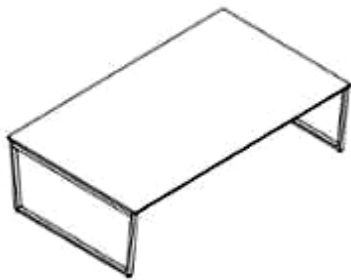

1.1



1.2



1.3



1.4



1.5

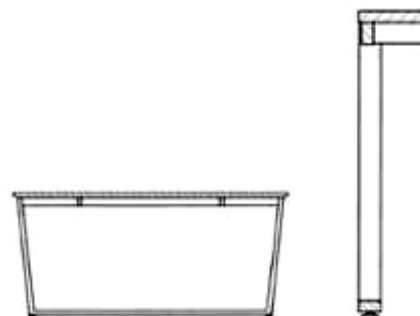

1.6



1.7

CÔNG BÁO SỞ HỮU CÔNG NGHIỆP SỐ 436 TẬP A – QUYỀN 2 (07.2024)

- (11) **50725**
(21) 3-2024-00479 (28) 1
(54) **XE MÁY ĐIỆN** (51) **12-11**
(22) 29/02/2024 (43) 25/07/2024
(30) 202430057441X 29/01/2024 CN;
(73) **JIANGSU ZHONGXING MOTORCYCLE CO., LTD. (CN)**
XIHU ROAD, ZHAQIAO, ANZHEN TOWN, XISHAN DISTRICT, WUXI CITY,
JIANGSU PROVINCE, CHINA
(72) 1. YANG, JIANG (CN)
2. GUO, YIMIN (CN)
3. SHENG, HUA (CN)
4. WU, RENQIANG (CN)
(74) Công ty TNHH Dịch vụ Sở hữu trí tuệ BIG5 (BIG5 IP CO.,LTD)
(55)



1.1



1.2



1.3



1.4



1.5



1.6



1.7



1.8

CÔNG BÁO SỞ HỮU CÔNG NGHIỆP SỐ 436 TẬP A – QUYỀN 2 (07.2024)

- (11) **50726**
(21) 3-2024-00480 (28) 1
(54) **BÚT** (51) **19-06**
(22) 29/02/2024 (43) 25/07/2024
(30) 2023306595025 12/10/2023 CN;
(73) **BEIFA GROUP CO., LTD.** (CN)
Bldg.4-1, Bldg.1-1, No.68 Weiliu Rd., Xiaogang, Beilun Dist., Ningbo, Zhejiang,
315821, China
(72) LIN Yuke (CN)
(74) Công ty TNHH Dịch vụ Sở hữu trí tuệ BIG5 (BIG5 IP CO.,LTD)
(55)

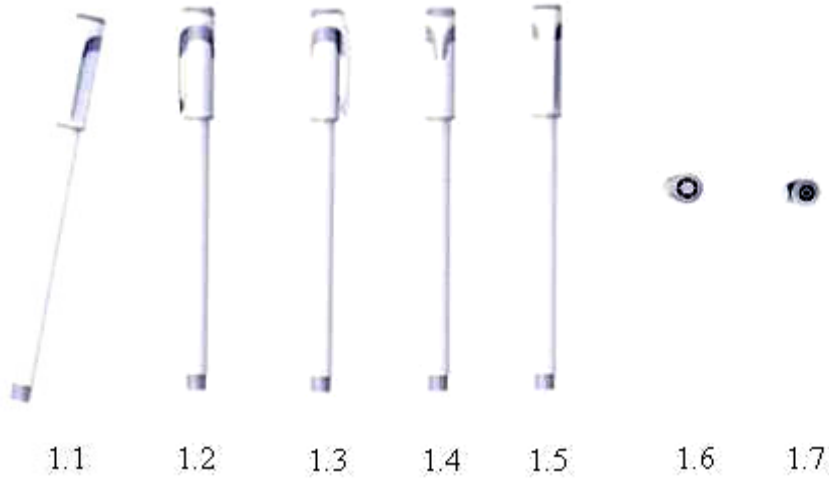

CÔNG BÁO SỞ HỮU CÔNG NGHIỆP SỐ 436 TẬP A – QUYỀN 2 (07.2024)

- (11) **50727**
(21) 3-2024-00481 (28) 1
(54) **BÚT** (51) **19-06**
(22) 29/02/2024 (43) 25/07/2024
(30) 202330659503X 12/10/2023 CN;
(73) **BEIFA GROUP CO., LTD.** (CN)
Bldg.4-1, Bldg.1-1, No.68 Weiliu Rd., Xiaogang, Beilun Dist., Ningbo, Zhejiang,
315821, China
(72) LIN Yuke (CN)
(74) Công ty TNHH Dịch vụ Sở hữu trí tuệ BIG5 (BIG5 IP CO.,LTD)
(55)

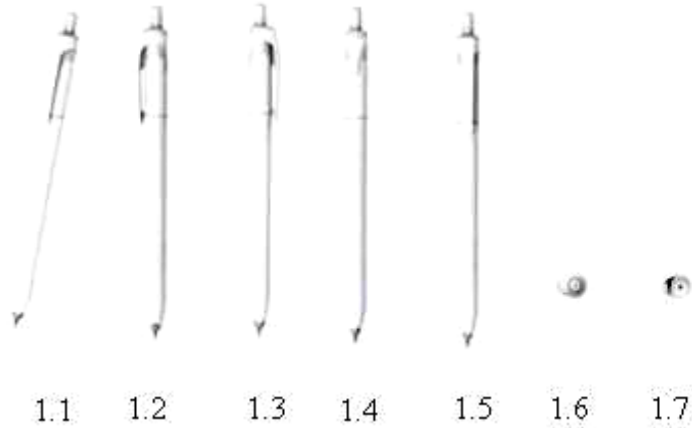

- (11) **50728**
- (21) 3-2024-00488 (28) 1
- (54) **ĐUÔI GIÓ MŨ BẢO HIỂM** (51) **02-03**
- (22) 29/02/2024 (43) 25/07/2024
- (73) **HENRY TEDJAKUSUMA (ID)**
Jalan Wuluh Blok II/3, RT/RW 009/006, Kota Bambu Utara, Palmerah Jakarta Barat 11420, Indonesia
- (72) Henry Tedjakusuma (ID)
- (74) Công ty TNHH Sở hữu trí tuệ HA VIP (HAVIP CO., LTD.)
- (55)

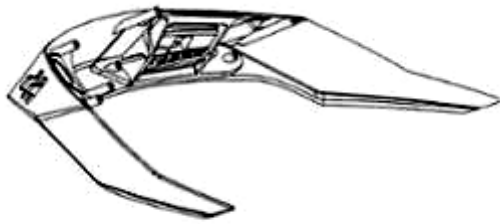

1.1

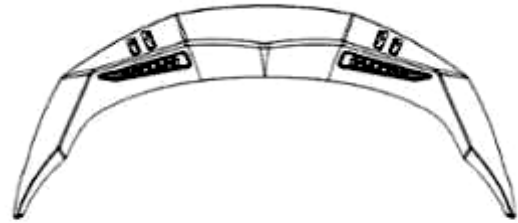

1.2



1.3



1.4

1.5

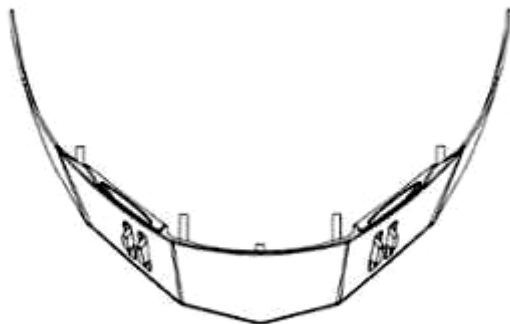

1.6



1.7

CÔNG BÁO SỞ HỮU CÔNG NGHIỆP SỐ 436 TẬP A – QUYỀN 2 (07.2024)

- (11) **50729**
(21) 3-2024-00489 (28) 1
(54) **LỌ** (51) **09-01**
(22) 29/02/2024 (43) 25/07/2024
(73) **LG H&H CO., LTD. (KR)**
58, Saemunan-ro, Jongno-gu, Seoul, Republic of Korea
(72) Park, Jin Won (KR)
(74) Công ty TNHH Tầm nhìn và Liên danh (VISION & ASSOCIATES CO.LTD.)
(55)



1.1



1.2



1.3



1.4



1.5



1.6



1.7



1.8

CÔNG BÁO SỞ HỮU CÔNG NGHIỆP SỐ 436 TẬP A – QUYỀN 2 (07.2024)

- (11) **50730**
(21) 3-2024-00640 (28) 1
(54) **HỘP** (51) **09-03**
(22) 18/03/2024 (43) 25/07/2024
(73) **CÔNG TY CỔ PHẦN THỰC PHẨM VÀ ĐỒ UỐNG QUỐC TẾ (INTERBOS)**
(VN)
Cụm công nghiệp sạch, xã Tân Tiến, huyện Văn Giang, tỉnh Hưng Yên
(72) Tạ Duy Dũng (VN)
(74) Công ty TNHH Tâm nhìn và Liên danh (VISION & ASSOCIATES CO.LTD.)
(55)



1.1



1.2



1.3



1.4



1.5



1.6



1.7

CÔNG BÁO SỞ HỮU CÔNG NGHIỆP SỐ 436 TẬP A – QUYỀN 2 (07.2024)

- (11) **50731**
(21) 3-2024-00641 (28) 1
(54) **CHAI NHỰA** (51) **09-01**
(22) 18/03/2024 (43) 25/07/2024
(73) **CÔNG TY CỔ PHẦN TẬP ĐOÀN THẮT SƠN (VN)**
201 Ung Văn Khiêm, phường Mỹ Phước, thành phố Long Xuyên, tỉnh An Giang
(72) Nguyễn Trường Trí (VN)
(74) Công ty TNHH Sở hữu trí tuệ INNETCO-Hoàng Phúc (INNETCO CO., LTD)
(55)



1.1



1.2



1.3



1.4



1.5



1.6



1.7

CÔNG BÁO SỞ HỮU CÔNG NGHIỆP SỐ 436 TẬP A – QUYỀN 2 (07.2024)

- (11) **50732**
(21) 3-2024-00648 (28) 1
(54) **HỘP ĐỰNG** (51) **09-03**
(22) 18/03/2024 (43) 25/07/2024
(73) **CÔNG TY TNHH TẬP ĐOÀN DƯỢC PHẨM VÀ THIẾT BỊ Y TẾ HÙNG THỊNH (VN)**
Thôn Yên Ngu, xã Tam Hiệp, huyện Thanh Trì, thành phố Hà Nội
(72) Trần Văn Quân (VN)
(74) Công ty TNHH Đại Tín và Liên Danh (DAITIN AND ASSOCIATES CO.,LTD)
(55)



1.1



1.2

CÔNG BÁO SỞ HỮU CÔNG NGHIỆP SỐ 436 TẬP A – QUYỀN 2 (07.2024)

- (11) **50733**
(21) 3-2024-00744 (28) 1
(54) **CỐC LỌC NƯỚC** (51) **23-01**
(22) 27/03/2024 (43) 25/07/2024
(73) **CÔNG TY TNHH CƠ KHÍ VÀ THƯƠNG MẠI LONG THÀNH (VN)**
Số 15 ngõ 218/45, đường Lĩnh Nam, phường Lĩnh Nam, quận Hoàng Mai, thành phố Hà Nội
(72) Lê Xuân Long (VN)
(74) Công ty Luật TNHH MINH KHUÊ (MK LAW FIRM)
(55)

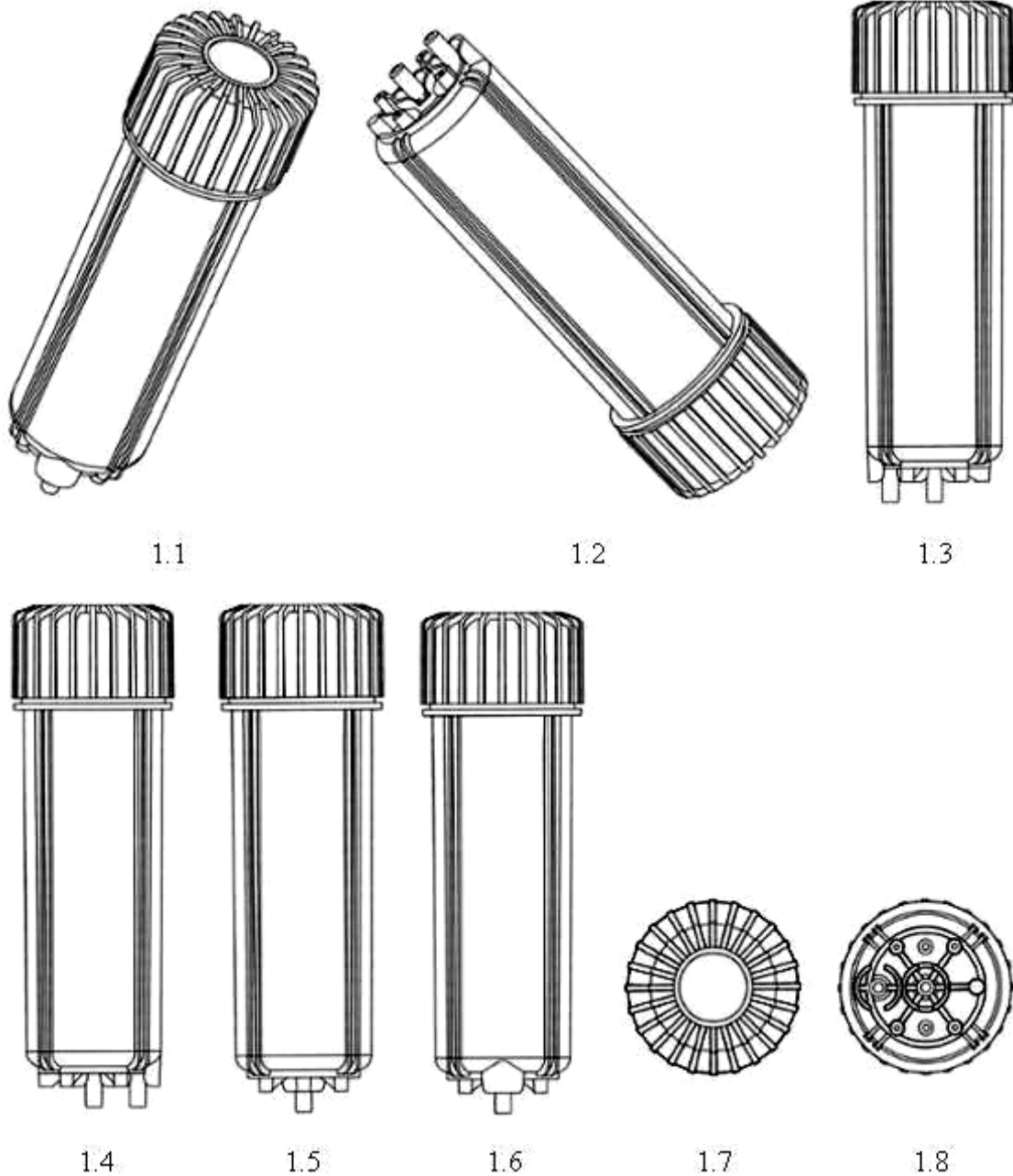

CÔNG BÁO SỞ HỮU CÔNG NGHIỆP SỐ 436 TẬP A – QUYỀN 2 (07.2024)

- (11) **50734**
- (21) 3-2024-00747 (28) 1
- (54) **NHÃN SẢN PHẨM** (51) **19-08**
- (22) 27/03/2024 (43) 25/07/2024
- (73) **NGUYỄN DUYÊN TOÀN (VN)**
Phòng 2203 tòa CT1B chung cư Nam Đô, 609 Trương Định, quận Hoàng Mai,
thành phố Hà Nội
- (72) Nguyễn Duyên Toàn (VN)
- (55)



- (11) **50735**
(21) 3-2024-00307 (28) 1
(54) **ĐỀ** (51) **99-00**
(22) 01/02/2024 (43) 25/07/2024
(73) **HỘ KINH DOANH AN VĨNH PHÁT (VN)**
R23/38/36 cư xá Phú Lâm A, phường 12, quận 06, thành phố Hồ Chí Minh
(72) Khuu Sở Dinh (VN)
(55)



1.1



1.2



1.3



1.4

(11) **50736**

(21) 3-2024-00308

(54) **HỘP**

(22) 01/02/2024

(73) **HỘ KINH DOANH AN VĨNH PHÁT (VN)**

R23/39/36 cư xá Phú Lâm A, phường 12, quận 06, thành phố Hồ Chí Minh

(72) Khuu Sở Dinh (VN)

(55)

(28) 1

(51) **09-03**

(43) 25/07/2024



1.1



1.2



1.3



1.4



1.5



1.6



1.7

CÔNG BÁO SỞ HỮU CÔNG NGHIỆP SỐ 436 TẬP A – QUYỀN 2 (07.2024)

- (11) **50737**
(21) 3-2024-00315 (28) 1
(54) **THIẾT BỊ VỆ SINH KIM PHUN XĂNG ĐIỆN TỬ** (51) **08-05**
(22) 01/02/2024 (43) 25/07/2024
(73) **QUÁCH MẠNH CƯỜNG (VN)**
Đường Từ Dũ, ấp Hưng Hòa, xã Long Hưng, thị xã Gò Công, Tiền Giang
(72) Quách Mạnh Cường (VN)
(74) Công ty TNHH Luật ALIAT (ALIAT LEGAL)
(55)



1.1



1.2

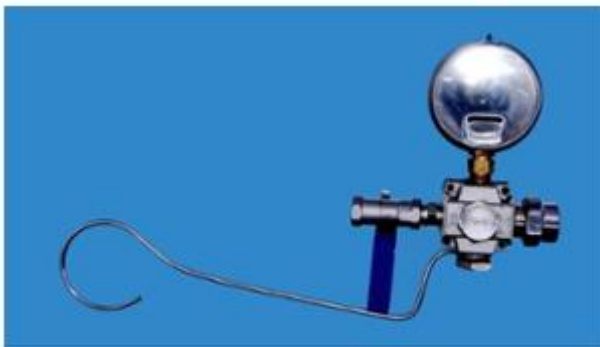

1.3



1.4

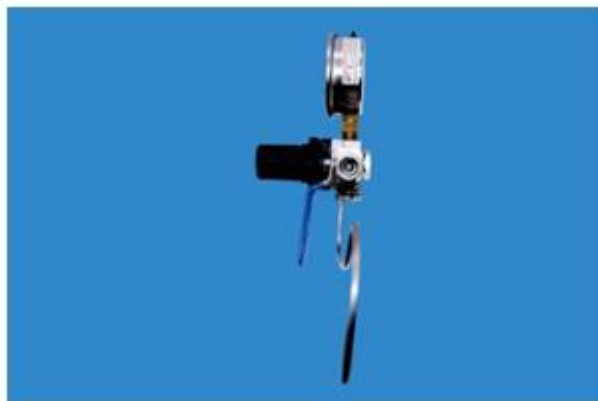

1.5



1.6



1.7

CÔNG BÁO SỞ HỮU CÔNG NGHIỆP SỐ 436 TẬP A – QUYỀN 2 (07.2024)

- (11) **50738**
(21) 3-2024-00923 (28) 1
(54) **NHÃN SẢN PHẨM** (51) **19-08**
(22) 16/04/2024 (43) 25/07/2024
(73) **TRẦN THỊ ÁI THU (VN)**
17 Phan Bội Châu, khu phố 2, phường 1, thành phố Đông Hà, tỉnh Quảng Trị
(72) Trần Thị Ái Thu (VN)
(74) Công ty TNHH Sở hữu trí tuệ VIPATCO (VIPATCO CO., LTD.)
(55)



CÔNG BÁO SỞ HỮU CÔNG NGHIỆP SỐ 436 TẬP A – QUYỀN 2 (07.2024)

(11) **50739**

(21) 3-2024-00924

(28) 1

(54) **MŨ BẢO HIỂM**

(51) **02-03**

(22) 16/04/2024

(43) 25/07/2024

(73) **CÔNG TY TNHH QUỐC TẾ GRAND WINNER VN (VN)**

Lô L15 đường số 7, khu công nghiệp Hải Sơn (GD 3+4), xã Đức Hòa Hạ, huyện Đức Hòa, tỉnh Long An

(72) LIN, HU CHING (CN)

(74) Công ty Luật TNHH WINCO (WINCO LAW FIRM)

(55)



1.1



1.2



1.3



1.4



1.5



1.6



1.7



1.8

CÔNG BÁO SỞ HỮU CÔNG NGHIỆP SỐ 436 TẬP A – QUYỀN 2 (07.2024)

- (11) **50740**
(21) 3-2024-00633 (28) 1
(54) **BẾP GAS MINI** (51) **07-02**
(22) 15/03/2024 (43) 25/07/2024
(73) **CÔNG TY TNHH MỘT THÀNH VIÊN MAI FA (VN)**
Thửa đất số 26, 313, tờ bản đồ số 8, khu phố Phước Hải, phường Thái Hòa, thành phố Tân Uyên, tỉnh Bình Dương
(72) Mai Quang Nhật (VN)
(74) Công ty TNHH Sở hữu trí tuệ Đông Dương (DONG DUONG IP CO.,LTD)
(55)



1.1



1.2



1.3



1.4



1.5



1.6



1.7

CÔNG BÁO SỞ HỮU CÔNG NGHIỆP SỐ 436 TẬP A – QUYỀN 2 (07.2024)

- (11) **50741**
(21) 3-2024-00925 (28) 1
(54) **NHÃN SẢN PHẨM** (51) **19-08**
(22) 16/04/2024 (43) 25/07/2024
(73) **NGÔ QUỐC MINH KỶ (VN)**
Thôn Lương Cang 1, xã Nhơn Sơn, huyện Ninh Sơn, tỉnh Ninh Thuận
(72) Ngô Quốc Minh Kỳ (VN)
(55)



CÔNG BÁO SỞ HỮU CÔNG NGHIỆP SỐ 436 TẬP A – QUYỀN 2 (07.2024)

- (11) **50742**
(21) 3-2024-00926 (28) 1
(54) **NHÃN SẢN PHẨM** (51) **19-08**
(22) 16/04/2024 (43) 25/07/2024
(73) **NGÔ QUỐC MINH KỶ (VN)**
Thôn Lương Cang 1, xã Nhơn Sơn, huyện Ninh Sơn, tỉnh Ninh Thuận
(72) Ngô Quốc Minh Kỳ (VN)
(55)



CÔNG BÁO SỞ HỮU CÔNG NGHIỆP SỐ 436 TẬP A – QUYỀN 2 (07.2024)

(11) **50743**

(21) 3-2024-01158

(28) 1

(54) **GIÁ ĐỖ**

(51) **13-99**

(22) 21/05/2024

(43) 25/07/2024

(73) **CÔNG TY CỔ PHẦN BÓNG ĐÈN PHÍCH NƯỚC RẠNG ĐÔNG (VN)**

87-89 phố Hạ Đình, phường Thanh Xuân Trung, quận Thanh Xuân, thành phố Hà Nội

(72) Trần Trung Tường (VN)

(55)

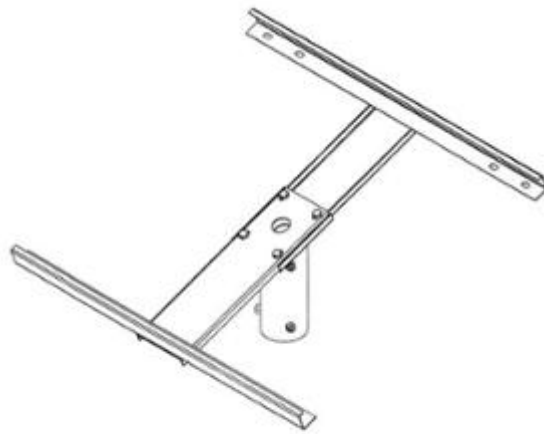

1.1

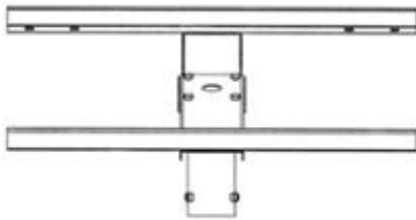

1.2

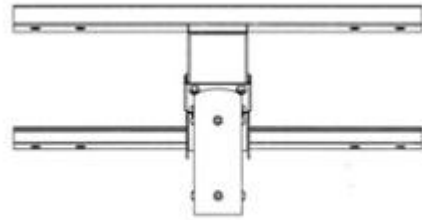

1.3



1.4



1.5

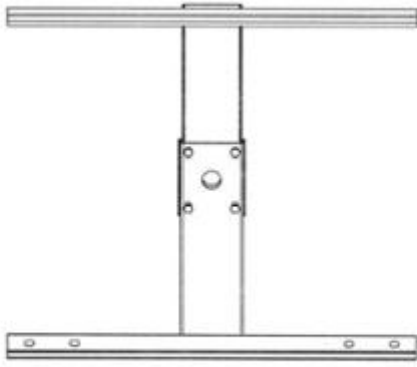

1.6

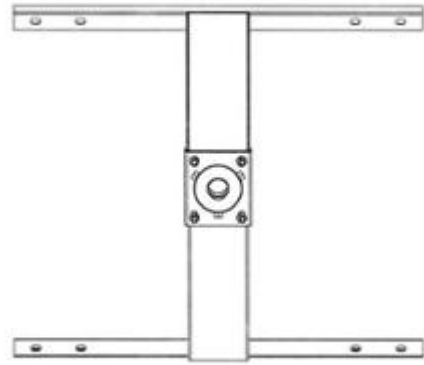

1.7

CÔNG BÁO SỞ HỮU CÔNG NGHIỆP SỐ 436 TẬP A – QUYỀN 2 (07.2024)

(11) **50744**

(21) 3-2024-01159

(28) 1

(54) **ĐÈN**

(51) **26-05**

(22) 21/05/2024

(43) 25/07/2024

(73) **CÔNG TY CỔ PHẦN BÓNG ĐÈN PHÍCH NƯỚC RẠNG ĐÔNG (VN)**

87-89 phố Hạ Đình, phường Thanh Xuân Trung, quận Thanh Xuân, thành phố Hà Nội

(72) Trần Trung Tường (VN)

(55)

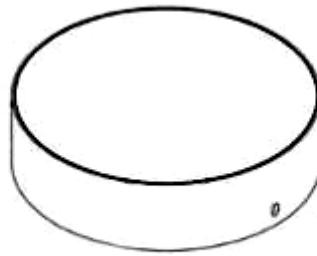

1.1

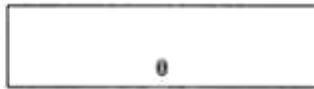

1.2

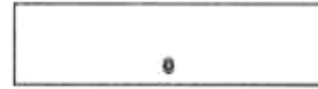

1.3



1.4



1.5

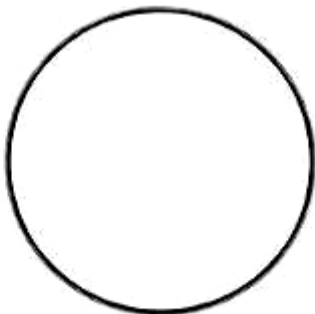

1.6

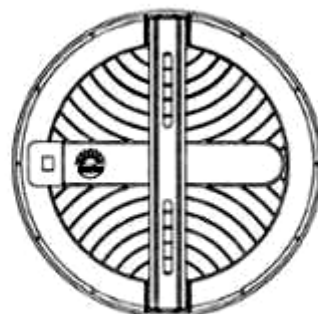

1.7

(11) **50745**

(21) 3-2024-01160

(28) 1

(54) **ĐÈN**

(51) **26-05**

(22) 21/05/2024

(43) 25/07/2024

(73) **CÔNG TY CỔ PHẦN BÓNG ĐÈN PHÍCH NƯỚC RẠNG ĐÔNG (VN)**

87-89 phố Hạ Đình, phường Thanh Xuân Trung, quận Thanh Xuân, thành phố Hà Nội

(72) Trần Trung Tường (VN)

(55)

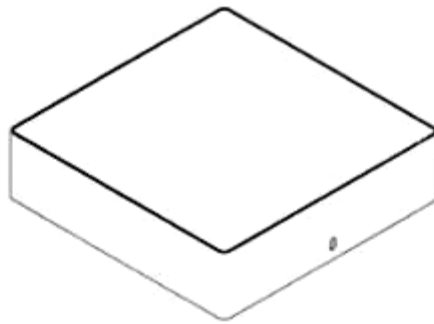

1.1

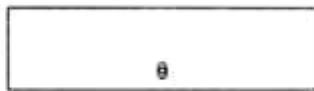

1.2

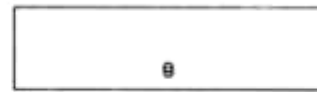

1.3



1.4



1.5



1.6

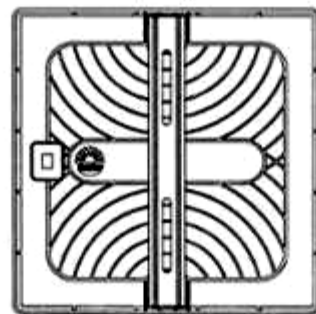

1.7

CÔNG BÁO SỞ HỮU CÔNG NGHIỆP SỐ 436 TẬP A – QUYỀN 2 (07.2024)

- (11) **50746**
(21) 3-2024-01164 (28) 1
(54) **LỚP XE** (51) **12-15**
(22) 21/05/2024 (43) 25/07/2024
(30) 2024302202360 18/04/2024 CN;
(73) **SHANDONG HAOHUA TIRE CO., LTD.** (CN)
West of Dadi Road, North of Xinhai Road, Houzhen Industry Zone, Shouguang,
Weifang, Shandong 262700, China
(72) 1. WANG, KEQIANG (CN)
2. SUI, FEIFEI (CN)
3. SUI, LUCHAO (CN)
(74) Công ty TNHH Đại Tín và Liên Danh (DAITIN AND ASSOCIATES CO.,LTD)
(55)



1.1



1.2



1.3



1.4



1.5



1.6



1.7

- (11) **50747**
(21) 3-2024-01165 (28) 1
(54) **LỚP XE** (51) **12-15**
(22) 21/05/2024 (43) 25/07/2024
(30) 2024302202375 18/04/2024 CN;
(73) **SHANDONG HAOHUA TIRE CO., LTD.** (CN)
West of Dadi Road, North of Xinhai Road, Houzhen Industry Zone, Shouguang,
Weifang, Shandong 262700, China
(72) 1. SUI, FEIFEI (CN)
2. WANG, KEQIANG (CN)
3. SUI, LUCHAO (CN)
(74) Công ty TNHH Đại Tín và Liên Danh (DAITIN AND ASSOCIATES CO.,LTD)
(55)



1.1



1.2

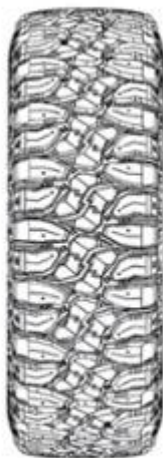

1.3

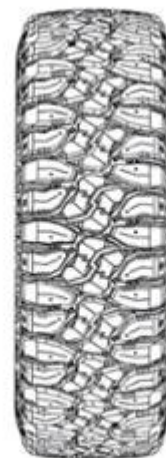

1.4

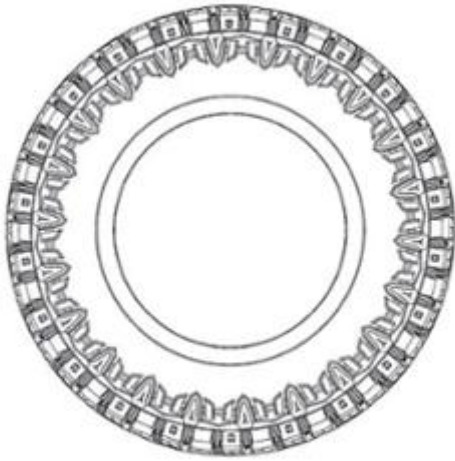

1.5

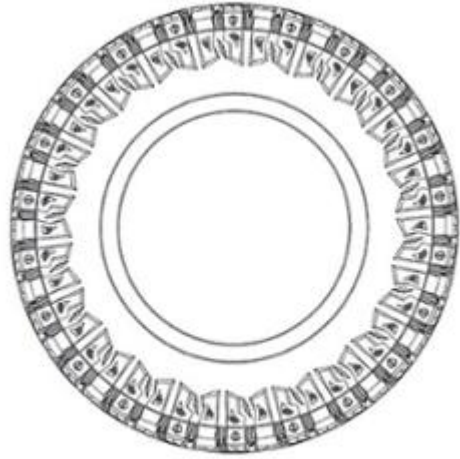

1.6

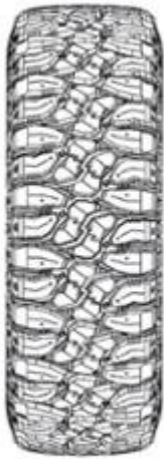

1.7

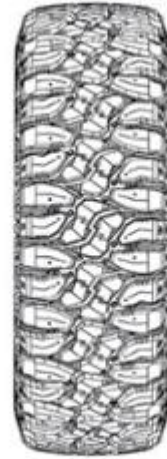

1.8

CÔNG BÁO SỞ HỮU CÔNG NGHIỆP SỐ 436 TẬP A – QUYỀN 2 (07.2024)

- (11) **50748**
(21) 3-2024-01166 (28) 1
(54) **HỘP** (51) **09-03**
(22) 21/05/2024 (43) 25/07/2024
(73) **CÔNG TY CỔ PHẦN MASAN JINJU (VN)**
Nhà xưởng F5, lô 6, khu công nghiệp Tân Đông Hiệp A, phường Tân Đông Hiệp,
thành phố Dĩ An, tỉnh Bình Dương
(72) Huỳnh Nam Quốc (VN)
(74) Công ty cổ phần Sở hữu trí tuệ BROSS và Cộng sự (BROSS & PARTNERS., JSC)
(55)



1.1

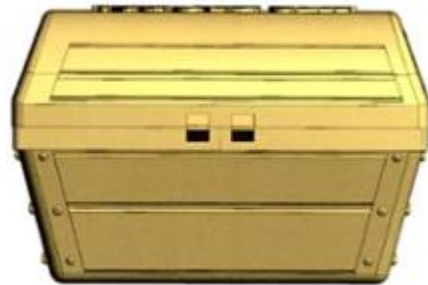

1.2



1.3



1.4



1.5



1.6



1.7

CÔNG BÁO SỞ HỮU CÔNG NGHIỆP SỐ 436 TẬP A – QUYỀN 2 (07.2024)

(11) **50749**

(21) 3-2024-01161

(28) 1

(54) **MÁY ÉP TRÁI CÂY**

(51) **31-00**

(22) 21/05/2024

(43) 25/07/2024

(73) **HỘ KINH DOANH KHANG MINH (VN)**

Số 42 Nguyễn Trãi, tổ 9, xóm Mỹ Thuận, thị trấn Mỹ Thọ, huyện Cao Lãnh, tỉnh Đồng Tháp

(72) Võ Văn Nhu (VN)

(74) Công ty Luật TNHH AGL (AGL LAW)

(55)

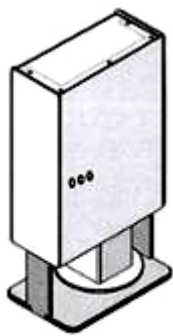

1.1

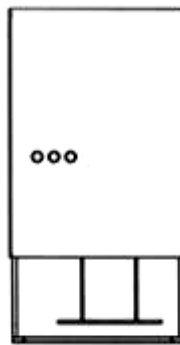

1.2

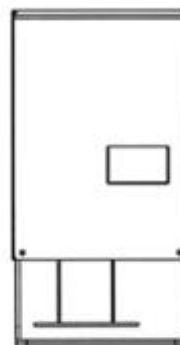

1.3

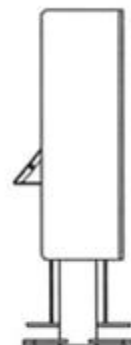

1.4

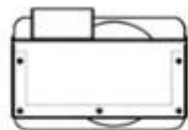

1.5

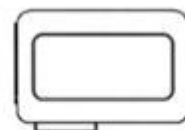

1.6

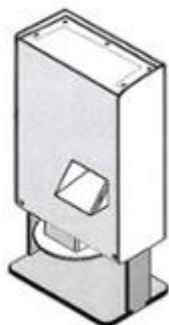

1.7

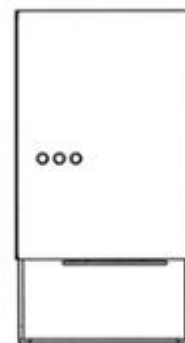

1.8

(11) **50750**

(21) 3-2024-01384

(28) 1

(54) **ĐUÔI GIÓ MŨ BẢO HIỂM**

(51) **02-03**

(22) 14/06/2024

(43) 25/07/2024

(73) **HENRY TEDJAKUSUMA (ID)**

Jalan Wuluh Blok II/3, RT/RW 009/006, Kota Bambu Utara, Palmerah Jakarta Barat 11420, Indonesia

(72) Henry Tedjakusuma (ID)

(74) Công ty TNHH Sở hữu trí tuệ HA VIP (HAVIP CO., LTD.)

(55)

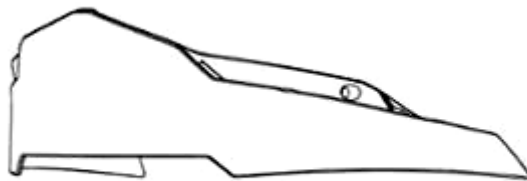

1.1

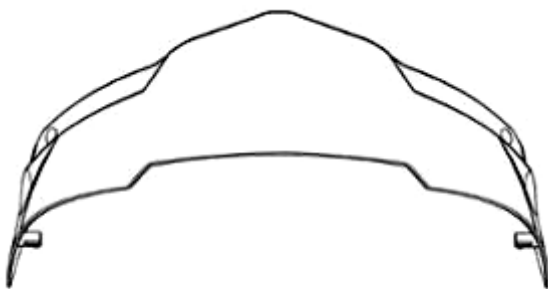

1.2

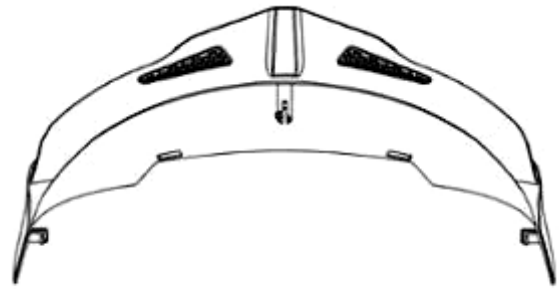

1.3

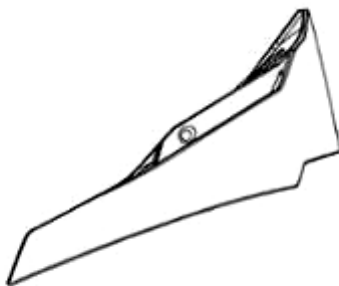

1.4

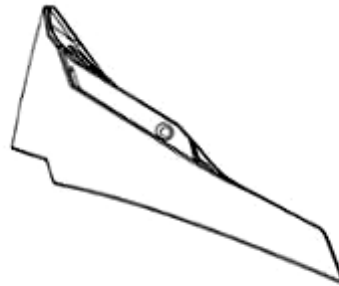

1.5

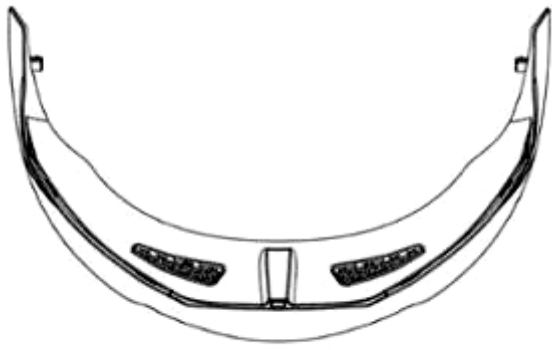

1.6

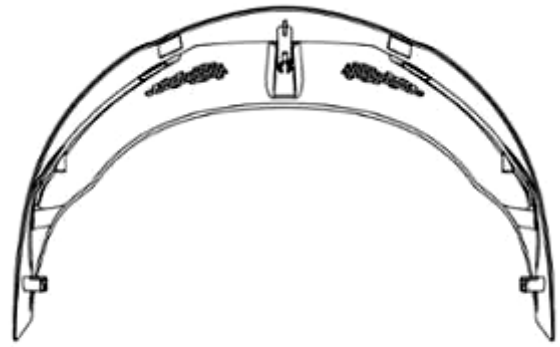

1.7



1.8

CÔNG BÁO SỞ HỮU CÔNG NGHIỆP SỐ 436 TẬP A – QUYỀN 2 (07.2024)

- (11) **50751**
(21) 3-2024-01032 (28) 1
(54) **NỒI CÓ TAY CẦM** (51) **07-02**
(22) 05/07/2023 (43) 25/07/2024
(30) 29/881,779 06/01/2023 US;
(73) **DART INDUSTRIES INC. (US)**
14901 S. Orange Blossom Trail, Orlando, Florida, 32837, United States of America
(72) Andrea Boscic (BE)
(74) **CÔNG TY LUẬT TRÁCH NHIỆM HỮU HẠN AMBYS HÀ NỘI (AMBYS HANOI)**
(55)



1.1

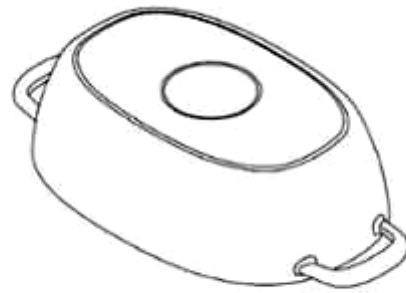

1.2



1.3

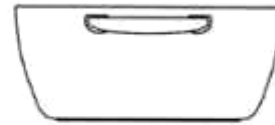

1.4

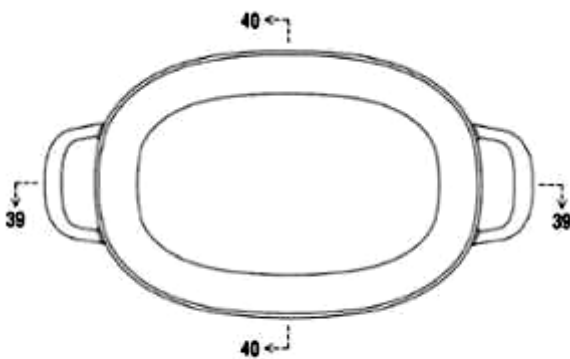

1.5

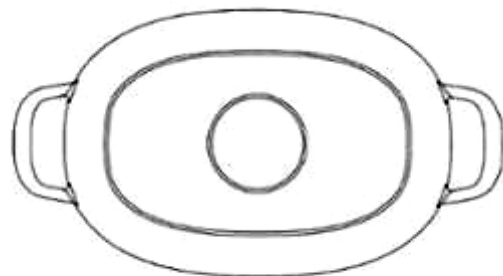

1.6



1.7

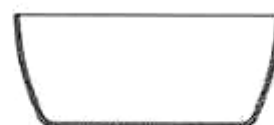

1.8

- (11) **50752**
(21) 3-2024-01033 (28) 1
(54) **NỒI CÓ TAY CẦM** (51) **07-02**
(22) 05/07/2023 (43) 25/07/2024
(30) 29/881,779 06/01/2023 US;
(73) **DART INDUSTRIES INC. (US)**
14901 S. Orange Blossom Trail, Orlando, Florida 32837, United States of America
(72) Andrea Boscic (BE)
(74) **CÔNG TY LUẬT TRÁCH NHIỆM HỮU HẠN AMBYS HÀ NỘI (AMBYS HANOI)**
(55)



1.1

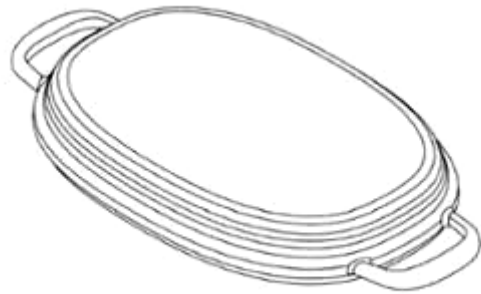

1.2



1.3



1.4

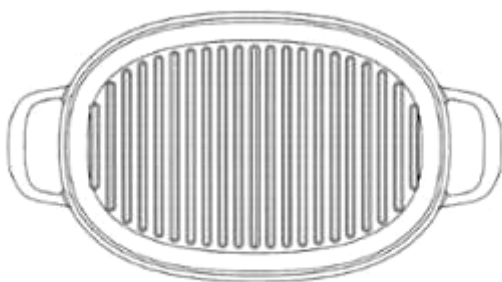

1.5

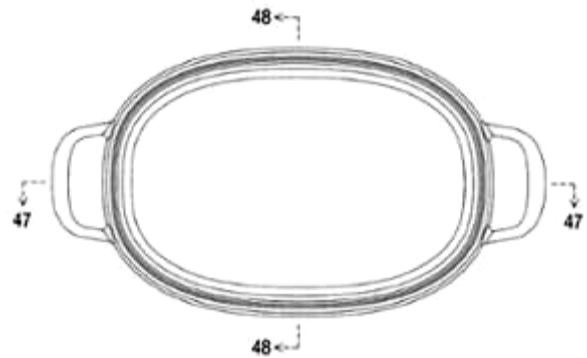

1.6



1.7



1.8

- (11) **50753**
- (21) 3-2023-02771
- (54) **TẤ DÙNG MỘT LẦN**
- (22) 16/11/2023
- (30) 2023-010587 25/05/2023 JP;
- (73) **DAIO PAPER CORPORATION (JP)**
2-60, Mishimakamiya-cho, Shikokuchuo-shi, Ehime 799-0492 Japan
- (72) Yuto FUJIWARA (JP)
- (74) Công ty TNHH Đại Tín và Liên Danh (DAITIN AND ASSOCIATES CO.,LTD)
- (55)

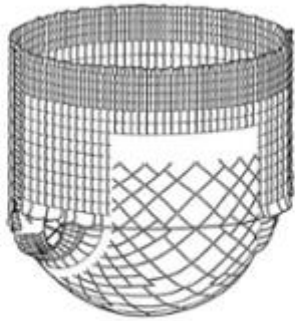

1.1

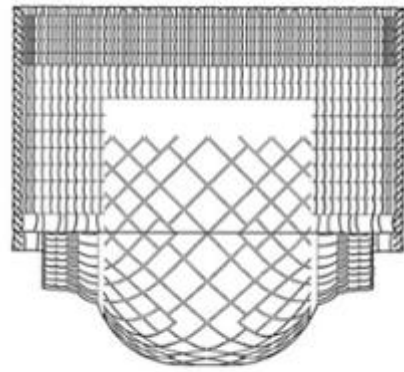

1.2

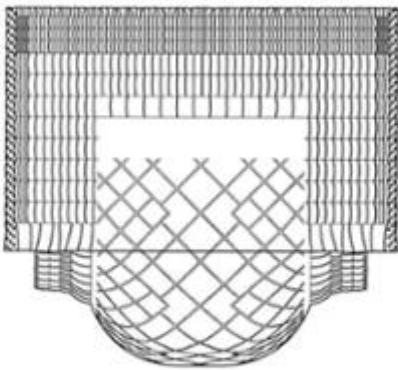

1.3

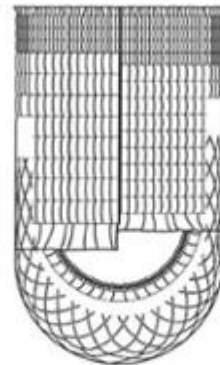

1.4

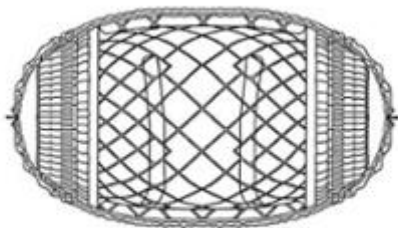

1.5

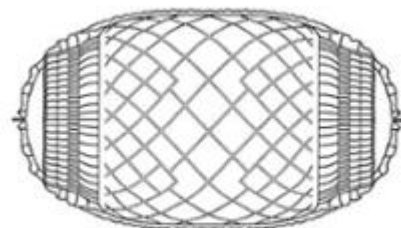

1.6

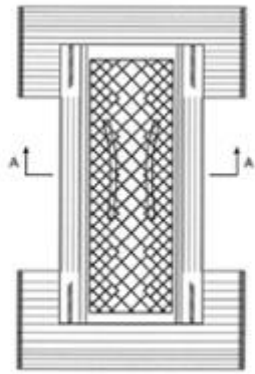

1.7



1.8



1.9

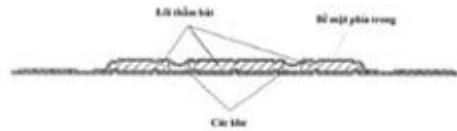

1.10

CÔNG BÁO SỞ HỮU CÔNG NGHIỆP SỐ 436 TẬP A – QUYỀN 2 (07.2024)

- (11) **50754**
(21) 3-2024-01217 (28) 1
(54) **BỘ NHÃN SẢN PHẨM** (51) **19-08**
(22) 29/05/2024 (43) 25/07/2024
(73) **CÔNG TY TNHH SẢN XUẤT - XUẤT NHẬP KHẨU HÓA MỸ PHẨM
THIÊN PHÚC (VN)**
227/21A Dương Thị Mười, phường Tân Chánh Hiệp, quận 12, thành phố Hồ Chí
Minh
(72) Huỳnh Thị Đức Như (VN)
(55)



1.1



1.2

CÔNG BÁO SỞ HỮU CÔNG NGHIỆP SỐ 436 TẬP A – QUYỀN 2 (07.2024)

- (11) **50755**
(21) 3-2024-00601 (28) 2
(54) **BỘ NHÃN SẢN PHẨM** (51) **19-08**
(22) 13/03/2024 (43) 25/07/2024
(73) **CÔNG TY CỔ PHẦN ACECOOK VIỆT NAM (VN)**
Lô số II-3, đường số 11, nhóm CN II, khu công nghiệp Tân Bình, phường Tây
Thạnh, quận Tân Phú, thành phố Hồ Chí Minh
(72) KANEDA HIROKI (JP)
(74) Công ty Luật TNHH Phạm và Liên danh (PHAM & ASSOCIATES)
(55)



1.1



1.2



1.3

CÔNG BÁO SỞ HỮU CÔNG NGHIỆP SỐ 436 TẬP A – QUYỀN 2 (07.2024)

- (11) **50756**
(21) 3-2023-03161 (28) 1
(54) **THÙNG ĐỰNG SƠN** (51) **09-02**
(22) 27/12/2023 (43) 25/07/2024
(73) **CÔNG TY TNHH JIA BAO VIỆT NAM (VN)**
Lô A1-3 (khu A4), đường D9, khu công nghiệp Rạch Bắp, xã An Tây, thị xã Bến Cát, tỉnh Bình Dương
(72) Yuan Anfu (CN)
(74) Công ty luật TNHH APOLAT LEGAL (APOLAT LEGAL)
(55)



1.1



1.2



1.3



1.4



1.5



1.6



1.7

(11) **50757**

(21) 3-2024-00003

(28) 2

(54) **KÈ CHẮN CÓ BUỒNG TIÊU SÓNG**

(51) **25-02**

(22) 02/01/2024

(43) 25/07/2024

(73) **CÔNG TY CỔ PHẦN KHOA HỌC CÔNG NGHỆ VIỆT NAM (VN)**

Số 6 đường 3 tháng 2, phường 8, thành phố Vũng Tàu, tỉnh Bà Rịa - Vũng Tàu

(72) Hoàng Đức Thảo (VN)

(55)

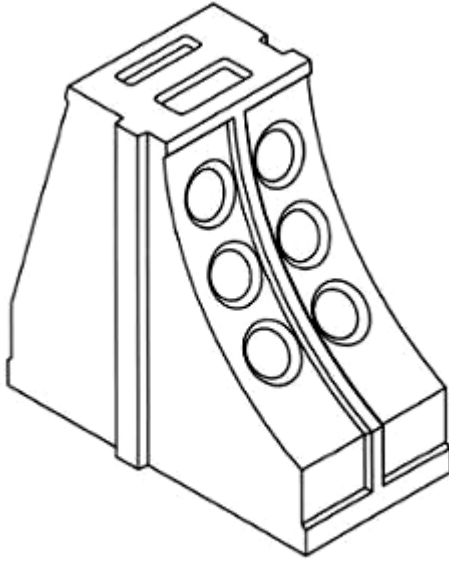

1.1

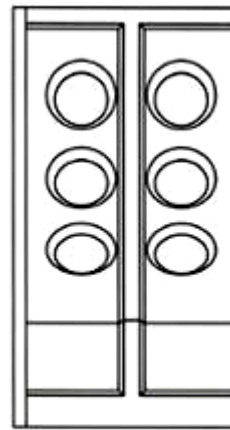

1.2

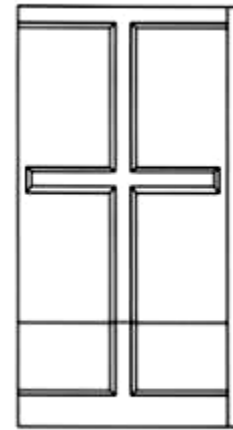

1.3

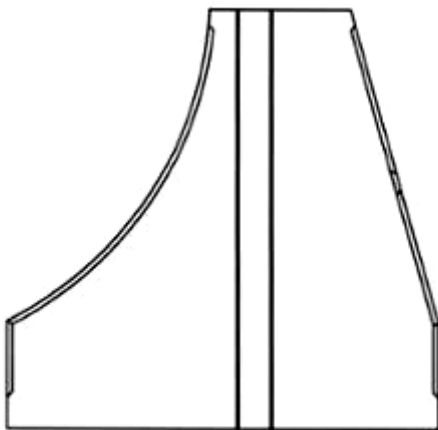

1.4

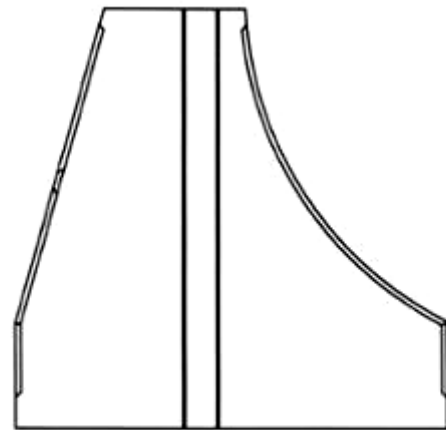

1.5

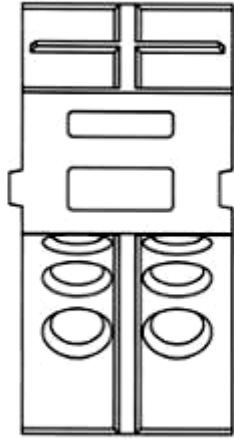

1.6

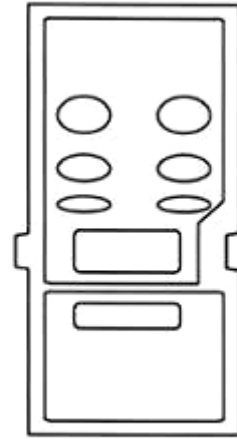

1.7

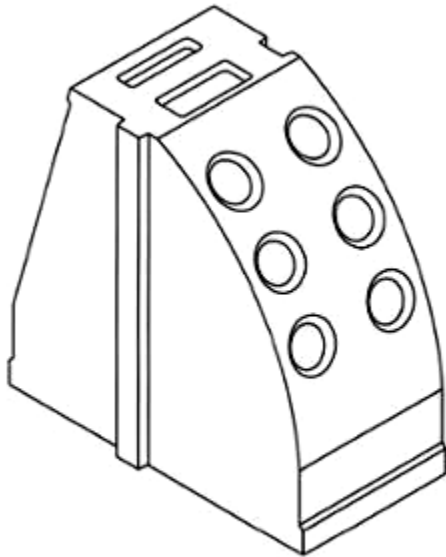

2.1

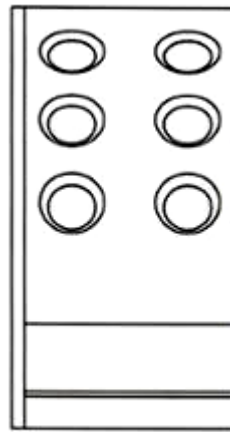

2.2

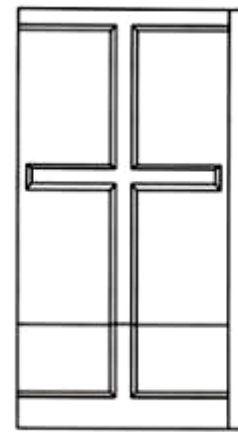

2.3

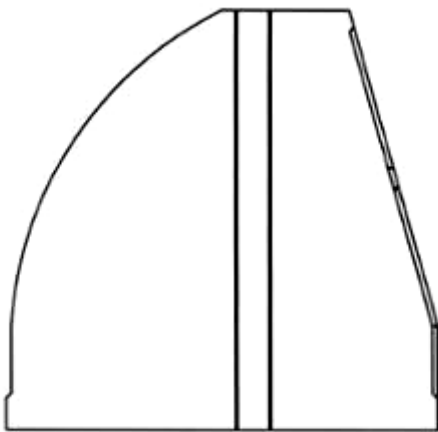

2.4

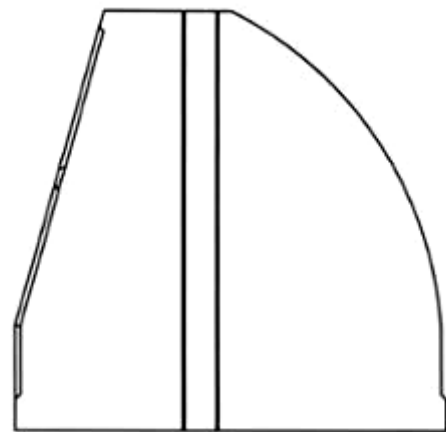

2.5

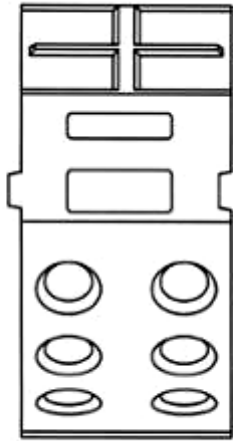

2.6

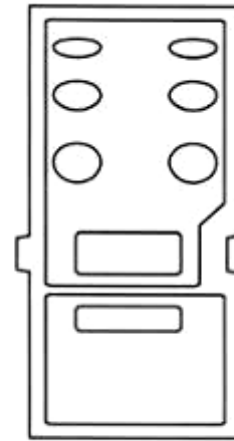

2.7

(11) **50758**

(21) 3-2024-00004

(28) 2

(54) **KÈ CHẨN CỐ BUỒNG TIÊU SÓNG**

(51) **25-02**

(22) 02/01/2024

(43) 25/07/2024

(73) **CÔNG TY CỔ PHẦN KHOA HỌC CÔNG NGHỆ VIỆT NAM (VN)**

Số 6 đường 3 tháng 2, phường 8, thành phố Vũng Tàu, tỉnh Bà Rịa - Vũng Tàu

(72) Hoàng Đức Thảo (VN)

(55)

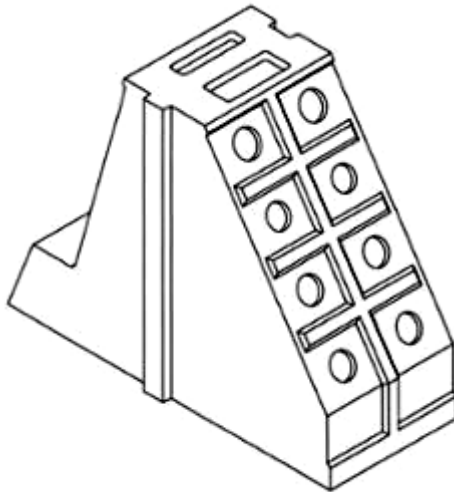

1.1

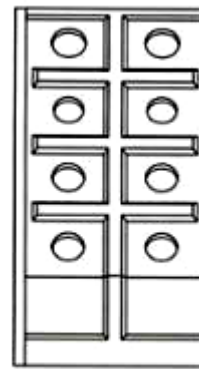

1.2

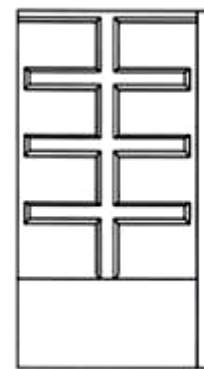

1.3

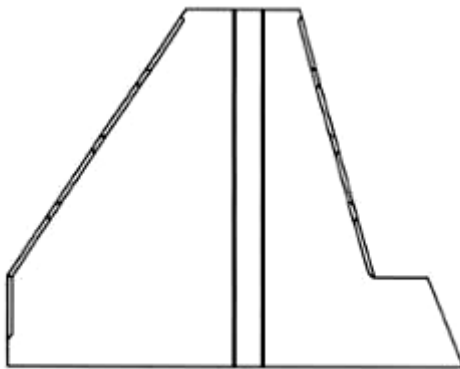

1.4

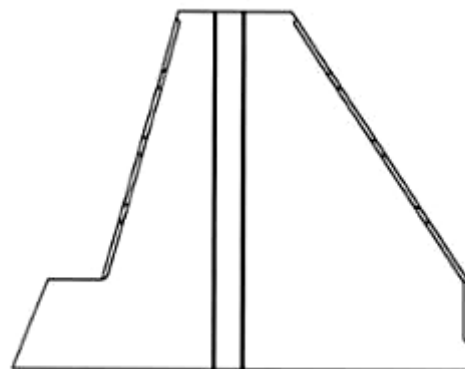

1.5

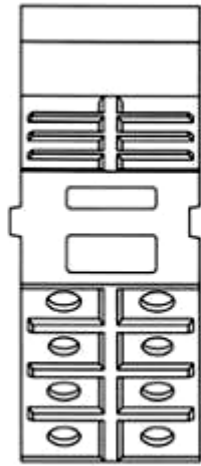

1.6

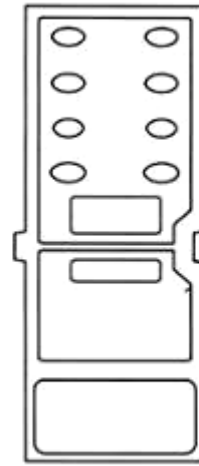

1.7

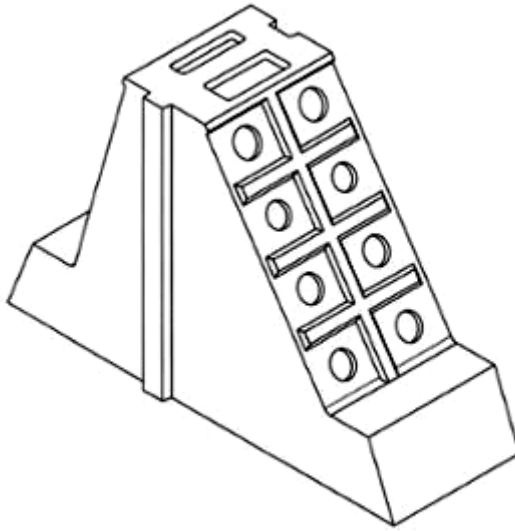

2.1

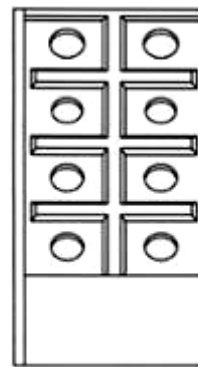

2.2

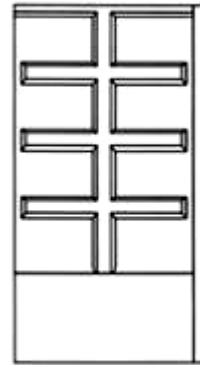

2.3

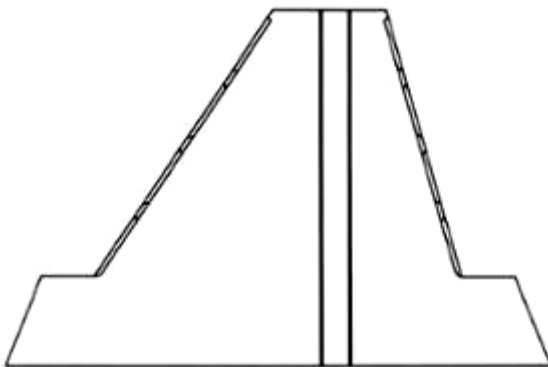

2.4

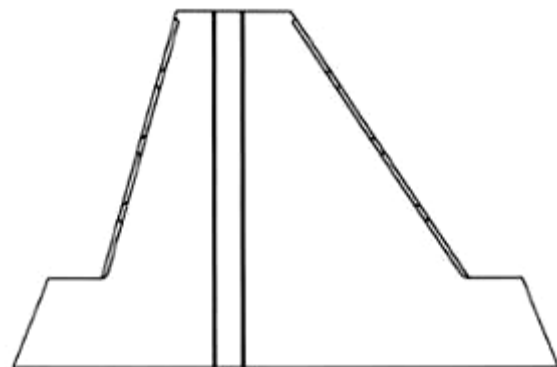

2.5

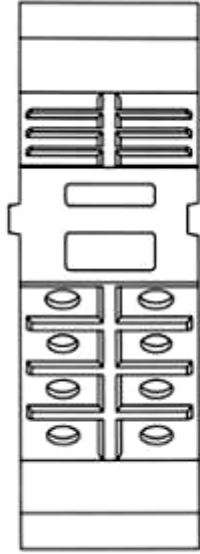

2.6

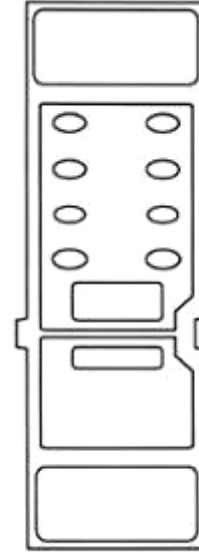

2.7

CÔNG BÁO SỞ HỮU CÔNG NGHIỆP SỐ 436 TẬP A – QUYỀN 2 (07.2024)

- (11) **50759**
(21) 3-2024-00008 (28) 1
(54) **BAO BÌ SẢN PHẨM** (51) **09-05**
(22) 02/01/2024 (43) 25/07/2024
(73) **CÔNG TY CỔ PHẦN PHÂN BÓN NA UY (VN)**
Lô A2, KCN Tân Kim Mở Rộng, thị trấn Cần Giuộc, huyện Cần Giuộc, tỉnh Long An
(72) Nguyễn Chí Cao (VN)
(55)



1.1



1.2

CÔNG BÁO SỞ HỮU CÔNG NGHIỆP SỐ 436 TẬP A – QUYỀN 2 (07.2024)

- (11) **50760**
(21) 3-2024-00009 (28) 1
(54) **BAO BÌ SẢN PHẨM** (51) **09-05**
(22) 02/01/2024 (43) 25/07/2024
(73) **CÔNG TY CỔ PHẦN PHÂN BÓN NA UY (VN)**
Lô A2, KCN Tân Kim Mở Rộng, thị trấn Cần Giuộc, huyện Cần Giuộc, tỉnh Long An
(72) Nguyễn Chí Cao (VN)
(55)



1.1



1.2

CÔNG BÁO SỞ HỮU CÔNG NGHIỆP SỐ 436 TẬP A – QUYỀN 2 (07.2024)

- (11) **50761**
(21) 3-2024-00701 (28) 1
(54) **THIẾT BỊ HIỂN THỊ KHUẾCH ĐẠI MÀN HÌNH** (51) **14-02**
(22) 21/03/2024 (43) 25/07/2024
(73) **FAR VISION TECHNOLOGY CO., LTD. (TW)**
4F-9, No. 186, Shishi Beiqi Rd., Xitun District, Taichung City, Taiwan
(72) **STEPHEN, CHEN (TW)**
(74) Công ty TNHH Trường Xuân (AGELESS CO.,LTD.)
(55)



1.1



1.2

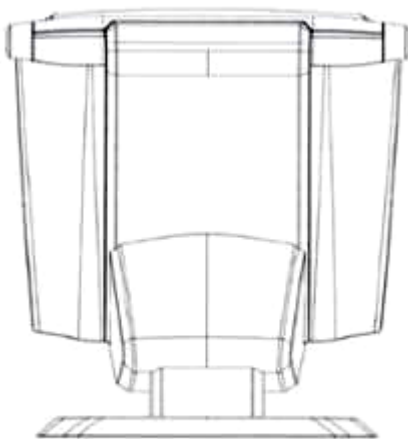

1.3



1.4



1.5



1.6



1.7

CÔNG BÁO SỞ HỮU CÔNG NGHIỆP SỐ 436 TẬP A – QUYỀN 2 (07.2024)

- (11) **50762**
(21) 3-2024-00703 (28) 1
(54) **NHÃN SẢN PHẨM** (51) **19-08**
(22) 22/03/2024 (43) 25/07/2024
(73) **CÔNG TY TNHH MỘT THÀNH VIÊN THỰC PHẨM HUẾ (VN)**
Số 4 Hoài Thanh, phường Thủy Xuân, thành phố Huế, tỉnh Thừa Thiên Huế
(72) SHIMMURA ATSUNORI (JP)
(74) Văn phòng Luật sư Bạch Minh (VPLS BACH MINH)
(55)



1.1



1.2

CÔNG BÁO SỞ HỮU CÔNG NGHIỆP SỐ 436 TẬP A – QUYỀN 2 (07.2024)

- (11) **50763**
(21) 3-2024-00704 (28) 2
(54) **NHÃN SẢN PHẨM** (51) **19-08**
(22) 22/03/2024 (43) 25/07/2024
(73) **CÔNG TY TNHH MỘT THÀNH VIÊN THỰC PHẨM HUẾ (VN)**
Số 4 Hoài Thanh, phường Thủy Xuân, thành phố Huế, tỉnh Thừa Thiên Huế
(72) SHIMMURA ATSUNORI (JP)
(74) Văn phòng Luật sư Bạch Minh (VPLS BACH MINH)
(55)



1.1



1.2

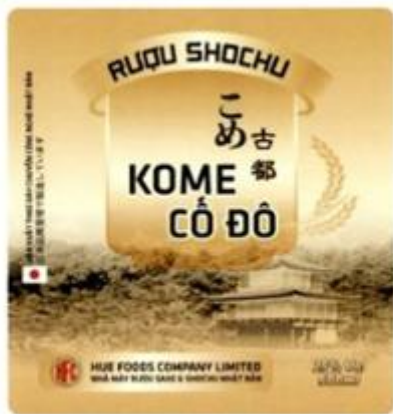

2.1



2.2

- (11) **50764**
(21) 3-2024-00711 (28) 1
(54) **CHAI** (51) **09-01**
(22) 22/03/2024 (43) 25/07/2024
(30) 2023-019460 22/09/2023 JP;
(73) **OTSUKA PHARMACEUTICAL FACTORY, INC. (JP)**
115 Aza Kuguhara, Tateiwa, Muya-cho, Naruto-shi, Tokushima 772-8601 Japan
(72) 1. KUNIHICO KOMATSU (JP)
2. HIROYUKI YOSHIKAWA (JP)
(74) Công ty TNHH một thành viên Sở hữu trí tuệ VCCI (VCCI-IP CO.,LTD)
(55)

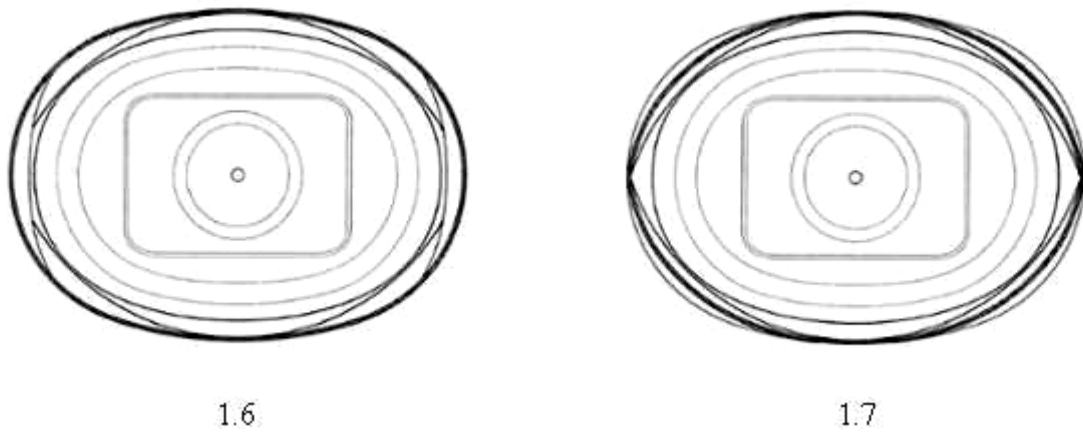
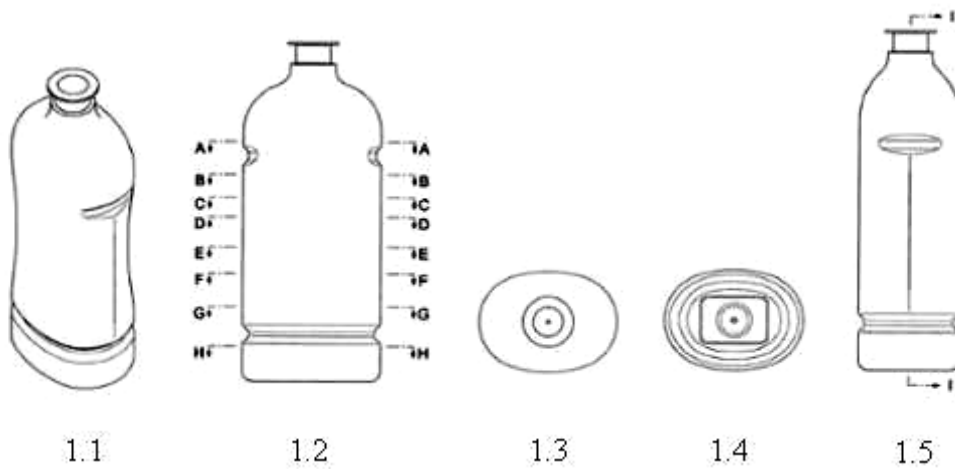

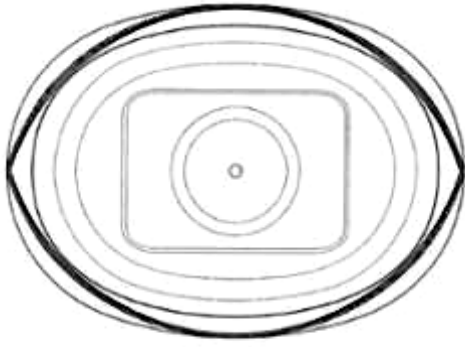

1.8

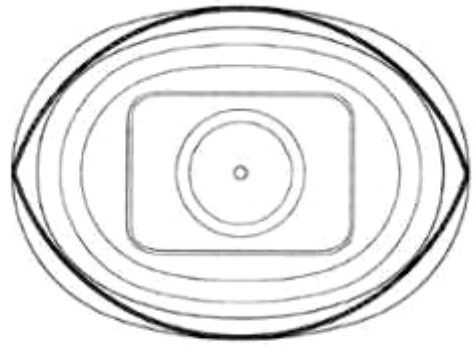

1.9

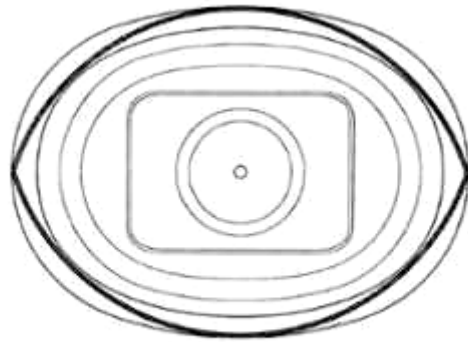

1.10

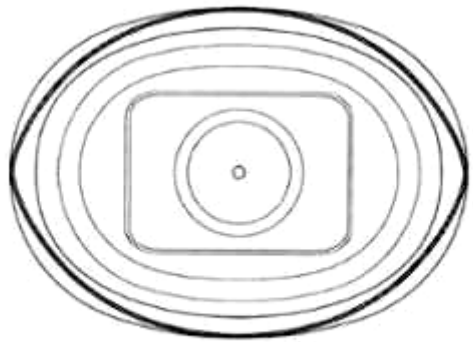

1.11

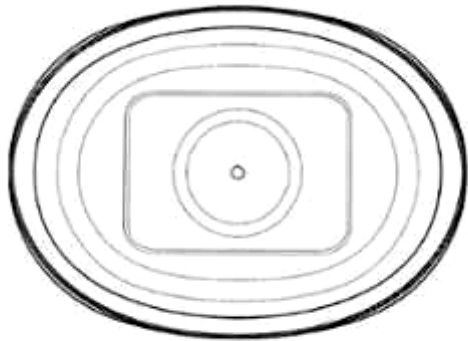

1.12

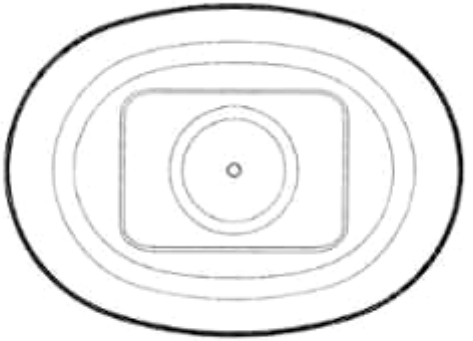

1.13



1.14



1.15

CÔNG BÁO SỞ HỮU CÔNG NGHIỆP SỐ 436 TẬP A – QUYỀN 2 (07.2024)

- (11) **50765**
- (21) 3-2024-00713 (28) 1
- (54) **NHÃN SẢN PHẨM** (51) **19-08**
- (22) 22/03/2024 (43) 25/07/2024
- (73) **CÔNG TY TNHH ĐẠI DƯƠNG Ý TƯỞNG (VN)**
Y10 Hồng Lĩnh, phường 15, quận 10, thành phố Hồ Chí Minh
- (72) Lâm Quang Thành Chung (VN)
- (74) **CÔNG TY LUẬT TNHH KHÔI NGỌC (KHOI NGOC LAW COMPANY LTD)**
- (55)



CÔNG BÁO SỞ HỮU CÔNG NGHIỆP SỐ 436 TẬP A – QUYỀN 2 (07.2024)

- (11) **50766**
(21) 3-2024-00714 (28) 1
(54) **TẤ LÓT DÙNG MỘT LẦN CHO VẬT NUÔI** (51) **30-01**
(22) 22/03/2024 (43) 25/07/2024
(30) 2023-019653 26/09/2023 JP;
(73) **UNICHARM CORPORATION (JP)**
182, Shimobun, Kinsei-cho, Shikokuchuo-City, Ehime 799-0111 Japan
(72) Daisuke KOMATSUBARA (JP)
(74) Công ty Cổ phần Sở hữu công nghiệp INVESTIP (INVESTIP)
(55)

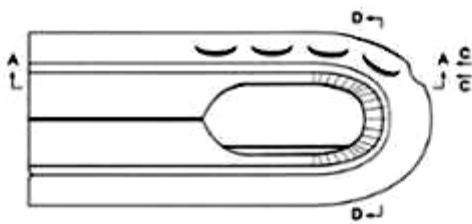

1.1

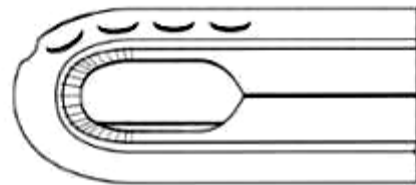

1.2

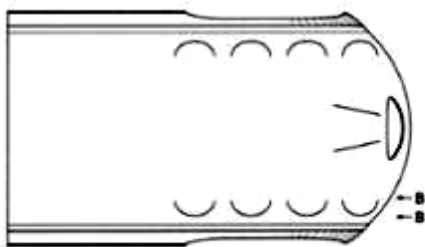

1.3



1.4

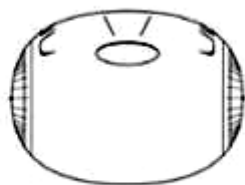

1.5



1.6



1.7

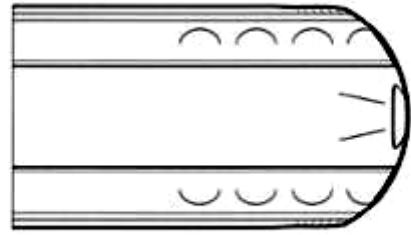

1.8



1.9

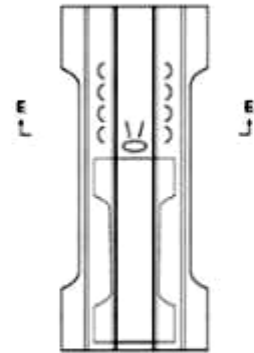

1.10



1.11

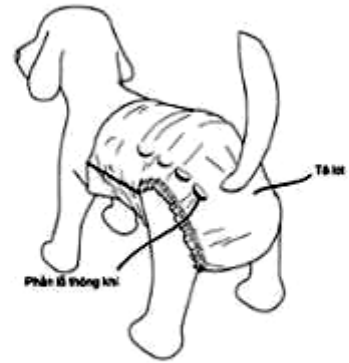

1.12

CÔNG BÁO SỞ HỮU CÔNG NGHIỆP SỐ 436 TẬP A – QUYỀN 2 (07.2024)

- (11) **50767**
(21) 3-2024-00715 (28) 1
(54) **TẤ LÓT DÙNG MỘT LẦN CHO VẬT NUÔI** (51) **30-01**
(22) 22/03/2024 (43) 25/07/2024
(30) 2023-019658 26/09/2023 JP;
(73) **UNICHARM CORPORATION (JP)**
182, Shimobun, Kinsei-cho, Shikokuchuo-City, Ehime 799-0111 Japan
(72) Daisuke KOMATSUBARA (JP)
(74) Công ty Cổ phần Sở hữu công nghiệp INVESTIP (INVESTIP)
(55)

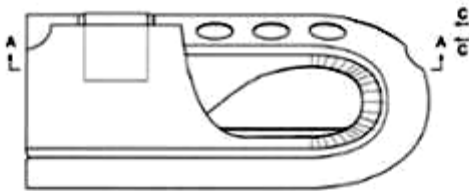

1.1

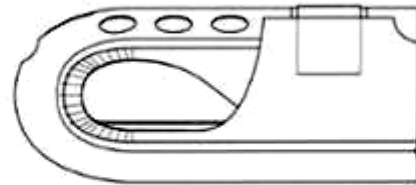

1.2

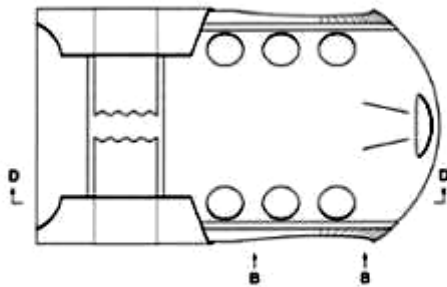

1.3



1.4

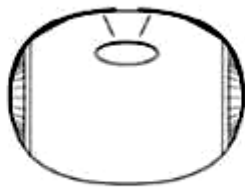

1.5



1.6

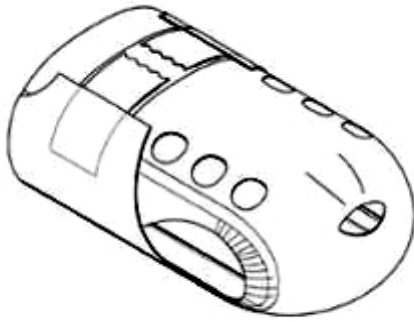

1.7

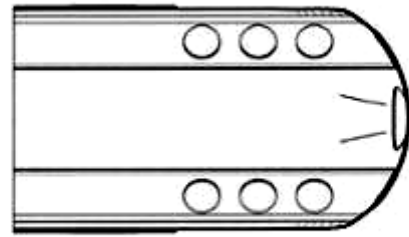

1.8



1.9

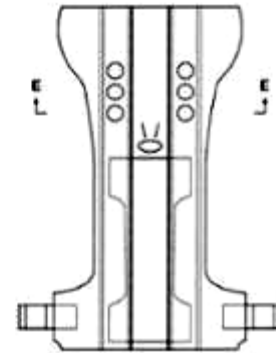

1.10



1.11

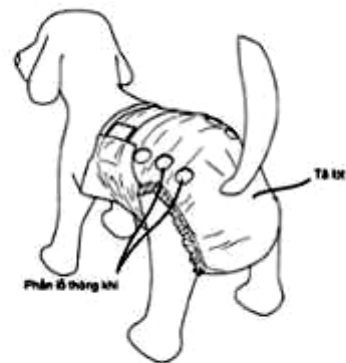

1.12

CÔNG BÁO SỞ HỮU CÔNG NGHIỆP SỐ 436 TẬP A – QUYỀN 2 (07.2024)

- (11) **50768**
(21) 3-2024-00716 (28) 1
(54) **TẤ LÓT DÙNG MỘT LẦN CHO VẬT NUÔI** (51) **30-01**
(22) 22/03/2024 (43) 25/07/2024
(30) 2023-019652 26/09/2023 JP;
(73) **UNICHARM CORPORATION (JP)**
182, Shimobun, Kinsei-cho, Shikokuchuo-City, Ehime 799-0111 Japan
(72) Daisuke KOMATSUBARA (JP)
(74) Công ty Cổ phần Sở hữu công nghiệp INVESTIP (INVESTIP)
(55)

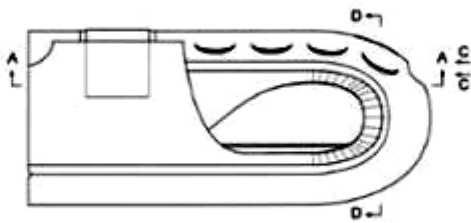

1.1

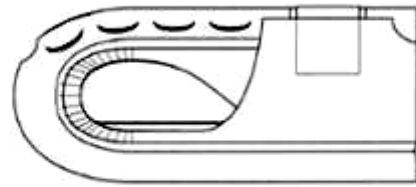

1.2

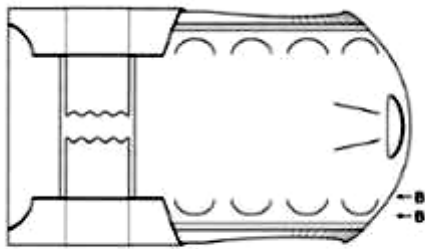

1.3



1.4



1.5



1.6



1.7

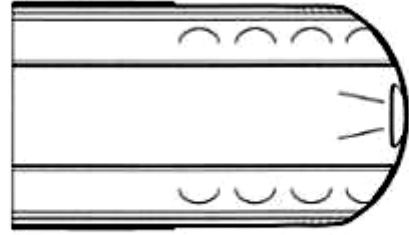

1.8



1.9

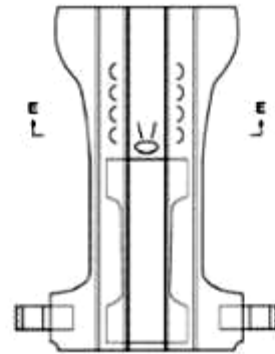

1.10



1.11

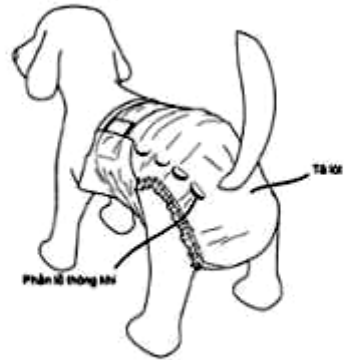

1.12

CÔNG BÁO SỞ HỮU CÔNG NGHIỆP SỐ 436 TẬP A – QUYỀN 2 (07.2024)

- (11) **50769**
(21) 3-2024-00139 (28) 1
(54) **CHAI** (51) **09-01**
(22) 16/01/2024 (43) 25/07/2024
(73) **CÔNG TY CỔ PHẦN LƯƠNG THỰC THỰC PHẨM COLUSA-MILIKET (VN)**
1230 Kha Vạn Cân, phường Linh Trung, thành phố Thủ Đức, thành phố Hồ Chí Minh
(72) Trần Hoàng Ngân (VN)
(74) Công ty Cổ phần Sở hữu công nghiệp INVESTIP (INVESTIP)
(55)

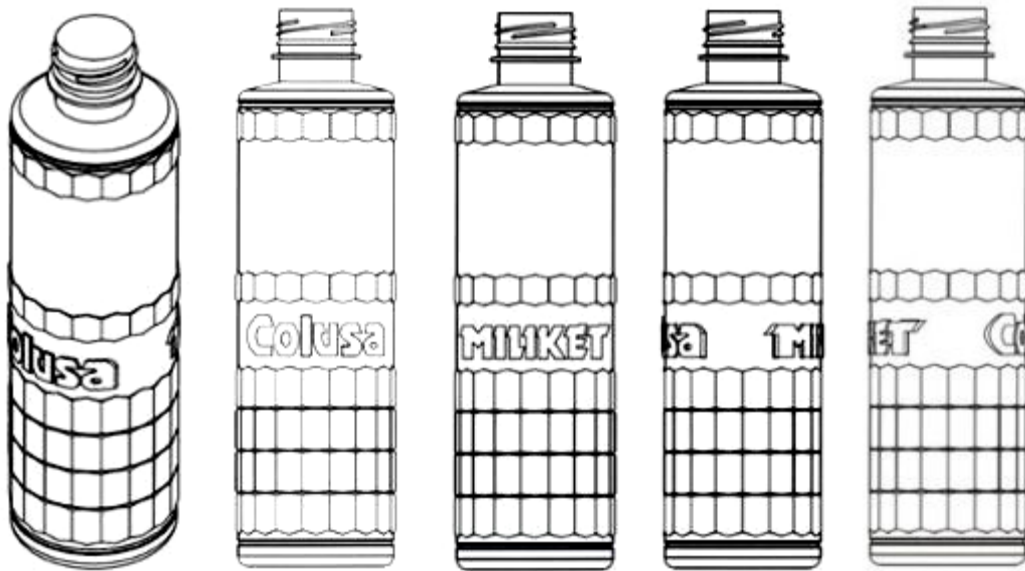

1.1

1.2

1.3

1.4

1.5



1.6

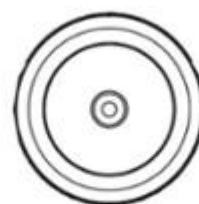

1.7

CÔNG BÁO SỞ HỮU CÔNG NGHIỆP SỐ 436 TẬP A – QUYỀN 2 (07.2024)

- (11) **50770**
(21) 3-2024-00722 (28) 1
(54) **ĐÈN NĂNG LƯỢNG MẶT TRỜI** (51) **26-03**
(22) 22/03/2024 (43) 25/07/2024
(73) **TIANHE RUNDA (XIAMEN) SUPPLY CHAIN MANAGEMENT CO., LTD**
(CN)
Room 406, No. 762 Lianqian East Road, Siming District, Xiamen 361000, China
(72) Fengxia Wei (CN)
(74) Công ty TNHH Sáng chế ACTIP (ACTIP PATENT LIMITED)
(55)



1.1



1.2



1.3



1.4



1.5



1.6

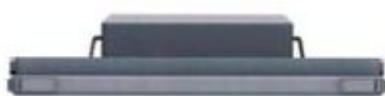

1.7



1.8

CÔNG BÁO SỞ HỮU CÔNG NGHIỆP SỐ 436 TẬP A – QUYỀN 2 (07.2024)

- (11) **50771**
(21) 3-2024-00723 (28) 1
(54) **ĐÈN NĂNG LƯỢNG MẶT TRỜI** (51) **26-03**
(22) 22/03/2024 (43) 25/07/2024
(73) **TIANHE RUNDA (XIAMEN) SUPPLY CHAIN MANAGEMENT CO., LTD**
(CN)
Room 406, No. 762 Lianqian East Road, Siming District, Xiamen 361000, China
(72) Fengxia Wei (CN)
(74) Công ty TNHH Sáng chế ACTIP (ACTIP PATENT LIMITED)
(55)



1.1



1.2



1.3



1.4



1.5



1.6



1.7



1.8

CÔNG BÁO SỞ HỮU CÔNG NGHIỆP SỐ 436 TẬP A – QUYỀN 2 (07.2024)

- (11) **50772**
(21) 3-2024-00724 (28) 1
(54) **MÁY XAY THỰC PHẨM** (51) **31-00**
(22) 22/03/2024 (43) 25/07/2024
(73) **CÔNG TY CỔ PHẦN ĐẦU TƯ THƯƠNG MẠI BÁCH TƯỜNG PHÁT (VN)**
Tầng 5, N01-T4 Tower, Chung cư Phú Mỹ Complex, khu Ngoại Giao Đoàn,
phường Xuân Tảo, quận Bắc Từ Liêm, thành phố Hà Nội
(72) Hoàng Minh Tuấn (VN)
(55)



1.1



1.2



1.3



1.4



1.5



1.6

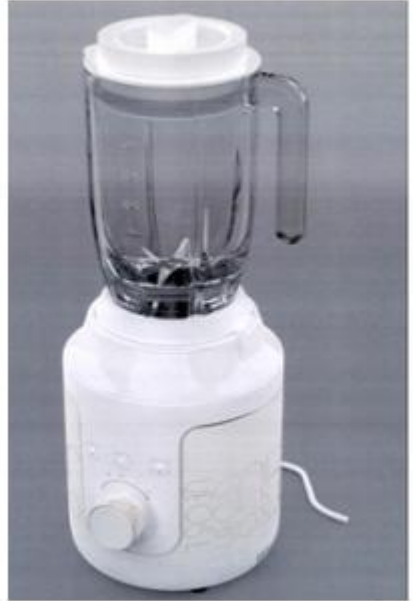

1.7

CÔNG BÁO SỞ HỮU CÔNG NGHIỆP SỐ 436 TẬP A – QUYỀN 2 (07.2024)

- (11) **50773**
(21) 3-2024-00720 (28) 3
(54) **CHÂN ĐỂ CỐ ĐỊNH DÂY CỨU SINH** (51) **08-08**
(22) 22/03/2024 (43) 25/07/2024
(73) **CÔNG TY CỔ PHẦN AN TOÀN SSTC (VN)**
372/6 Dương Thị Mười, khu phố 3, phường Tân Thới Hiệp, quận 12, thành phố Hồ Chí Minh
(72) Dương Đình Luân (VN)
(74) Công ty Cổ phần Sở hữu công nghiệp INVESTIP (INVESTIP)
(55)

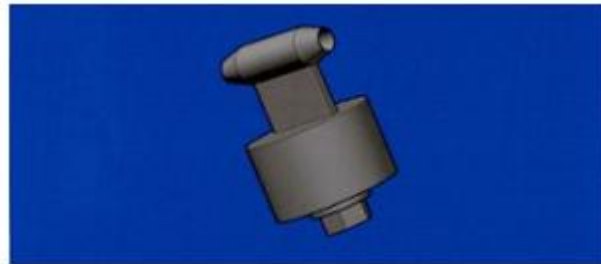

1.1

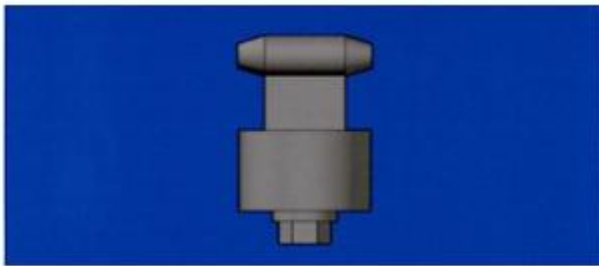

1.2

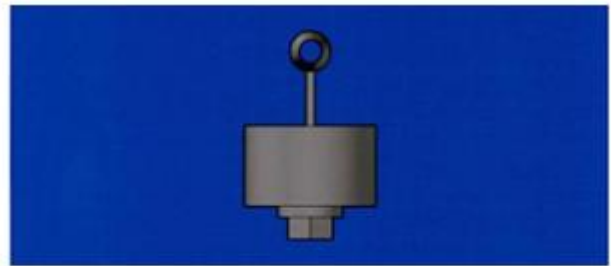

1.3



1.4



1.5



2.1



2.2



2.3

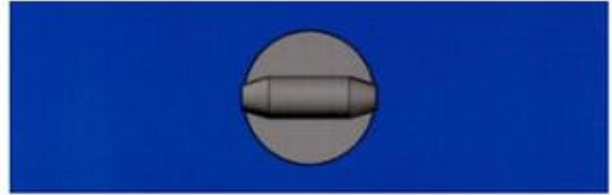

2.4



2.5



3.1



3.2



3.3

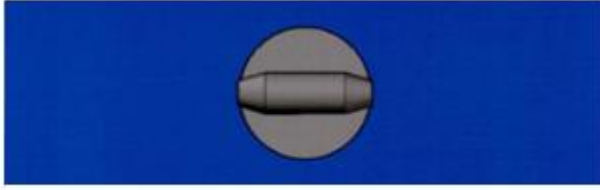

3.4



3.5

CÔNG BÁO SỞ HỮU CÔNG NGHIỆP SỐ 436 TẬP A – QUYỀN 2 (07.2024)

- (11) **50774**
- (21) 3-2024-00161 (28) 1
- (54) **NHÃN SẢN PHẨM** (51) **19-08**
- (22) 19/01/2024 (43) 25/07/2024
- (73) **CÔNG TY TNHH GẠO NGON NHẤT (VN)**
11/22 đường 10, khu phố 3, phường Bình Thuận, quận 7, thành phố Hồ Chí Minh
- (72) Nguyễn Lưu Tường (VN)
- (55)



CÔNG BÁO SỞ HỮU CÔNG NGHIỆP SỐ 436 TẬP A – QUYỀN 2 (07.2024)

- (11) **50775**
(21) 3-2024-00168 (28) 1
(54) **NHÃN SẢN PHẨM** (51) **19-08**
(22) 19/01/2024 (43) 25/07/2024
(73) **CÔNG TY TNHH HOÀNG HÙNG LONG FOODS & DRINKS (VN)**
255A đường Quốc lộ 13 cũ, khu phố 1, phường Hiệp Bình Phước, thành phố Thủ Đức, thành phố Hồ Chí Minh
(72) Trần Hữu Phương (VN)
(55)



CÔNG BÁO SỞ HỮU CÔNG NGHIỆP SỐ 436 TẬP A – QUYỀN 2 (07.2024)

- (11) **50776**
(21) 3-2024-00171 (28) 1
(54) **BÌNH** (51) **11-02**
(22) 19/01/2024 (43) 25/07/2024
(73) **CÔNG TY CỔ PHẦN VIỆN PHONG THỦY KHOA HỌC TOÀN CẦU (VN)**
Số 73No5 Khu đô thị mới Sở Dầu, phường Sở Dầu, quận Hồng Bàng, thành phố Hải Phòng
(72) Nguyễn Trọng Mạnh (VN)
(74) Công ty TNHH Tư vấn sở hữu trí tuệ Việt (VIET IP CO.,LTD.)
(55)



1.1



1.2



1.3



1.4



1.5



1.6



1.7

CÔNG BÁO SỞ HỮU CÔNG NGHIỆP SỐ 436 TẬP A – QUYỀN 2 (07.2024)

- (11) **50777**
(21) 3-2024-00172 (28) 1
(54) **BÌNH** (51) **11-02**
(22) 19/01/2024 (43) 25/07/2024
(73) **CÔNG TY CỔ PHẦN VIỆN PHONG THỦY KHOA HỌC TOÀN CẦU (VN)**
Số 73No5 Khu đô thị mới Sở Dầu, phường Sở Dầu, quận Hồng Bàng, thành phố Hải Phòng
(72) Nguyễn Trọng Mạnh (VN)
(74) Công ty TNHH Tư vấn sở hữu trí tuệ Việt (VIET IP CO.,LTD.)
(55)



1.1



1.2



1.3



1.4



1.5



1.6

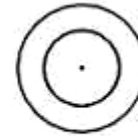

1.7

CÔNG BÁO SỞ HỮU CÔNG NGHIỆP SỐ 436 TẬP A – QUYỀN 2 (07.2024)

- (11) **50778**
(21) 3-2024-00173 (28) 1
(54) **BÚT** (51) **19-06**
(22) 19/01/2024 (43) 25/07/2024
(73) **CÔNG TY CỔ PHẦN TẬP ĐOÀN THIÊN LONG (VN)**
Tầng 10, Sofic Tower, số 10 đường Mai Chí Thọ, phường Thủ Thiêm, thành phố
Thủ Đức, thành phố Hồ Chí Minh
(72) Cô Gia Thọ (VN)
(74) Công ty TNHH Tư vấn sở hữu trí tuệ Việt (VIET IP CO.,LTD.)
(55)

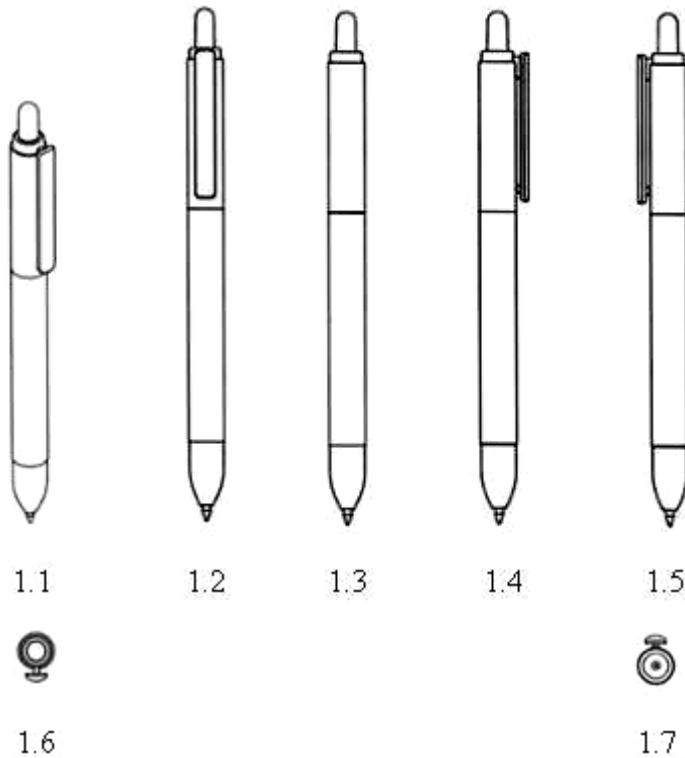

CÔNG BÁO SỞ HỮU CÔNG NGHIỆP SỐ 436 TẬP A – QUYỀN 2 (07.2024)

- (11) **50779**
(21) 3-2024-00174 (28) 1
(54) **BÚT** (51) **19-06**
(22) 19/01/2024 (43) 25/07/2024
(73) **CÔNG TY CỔ PHẦN TẬP ĐOÀN THIÊN LONG (VN)**
Tầng 10, Sofic Tower, số 10 đường Mai Chí Thọ, phường Thủ Thiêm, thành phố
Thủ Đức, thành phố Hồ Chí Minh
(72) Cô Gia Thọ (VN)
(74) Công ty TNHH Tư vấn sở hữu trí tuệ Việt (VIET IP CO.,LTD.)
(55)

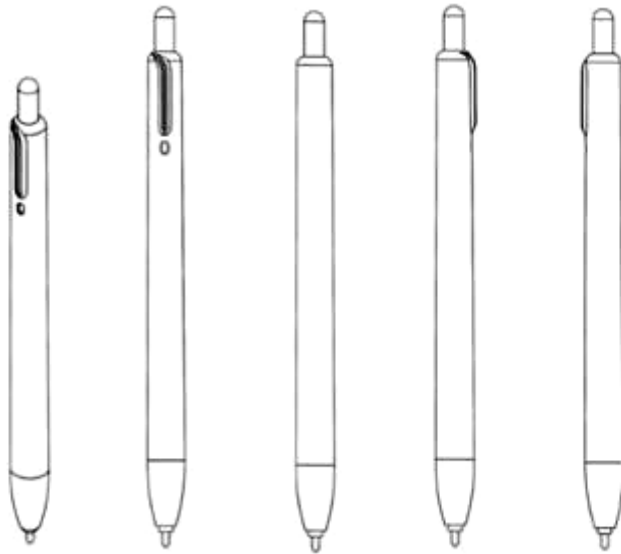

1.1

1.2

1.3

1.4

1.5



1.6



1.7

CÔNG BÁO SỞ HỮU CÔNG NGHIỆP SỐ 436 TẬP A – QUYỀN 2 (07.2024)

- (11) **50780**
(21) 3-2024-00175 (28) 1
(54) **BÚT** (51) **19-06**
(22) 19/01/2024 (43) 25/07/2024
(73) **CÔNG TY CỔ PHẦN TẬP ĐOÀN THIÊN LONG (VN)**
Tầng 10, Sofic Tower, số 10 đường Mai Chí Thọ, phường Thủ Thiêm, thành phố
Thủ Đức, thành phố Hồ Chí Minh
(72) Cô Gia Thọ (VN)
(74) Công ty TNHH Tư vấn sở hữu trí tuệ Việt (VIET IP CO.,LTD.)
(55)

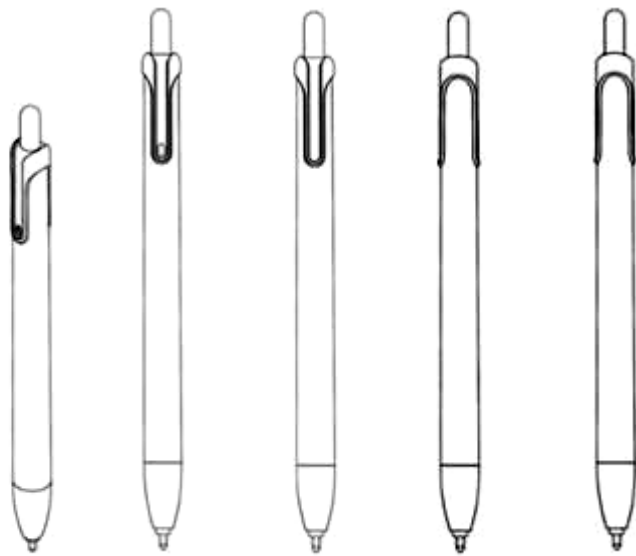

1.1

1.2

1.3

1.4

1.5



1.6



1.7

CÔNG BÁO SỞ HỮU CÔNG NGHIỆP SỐ 436 TẬP A – QUYỀN 2 (07.2024)

- (11) **50781**
(21) 3-2024-00176 (28) 1
(54) **BÚT** (51) **19-06**
(22) 19/01/2024 (43) 25/07/2024
(73) **CÔNG TY CỔ PHẦN TẬP ĐOÀN THIÊN LONG (VN)**
Tầng 10, Sofic Tower, số 10 đường Mai Chí Thọ, phường Thủ Thiêm, thành phố Thủ Đức, thành phố Hồ Chí Minh
(72) Cô Gia Thọ (VN)
(74) Công ty TNHH Tư vấn sở hữu trí tuệ Việt (VIET IP CO.,LTD.)
(55)

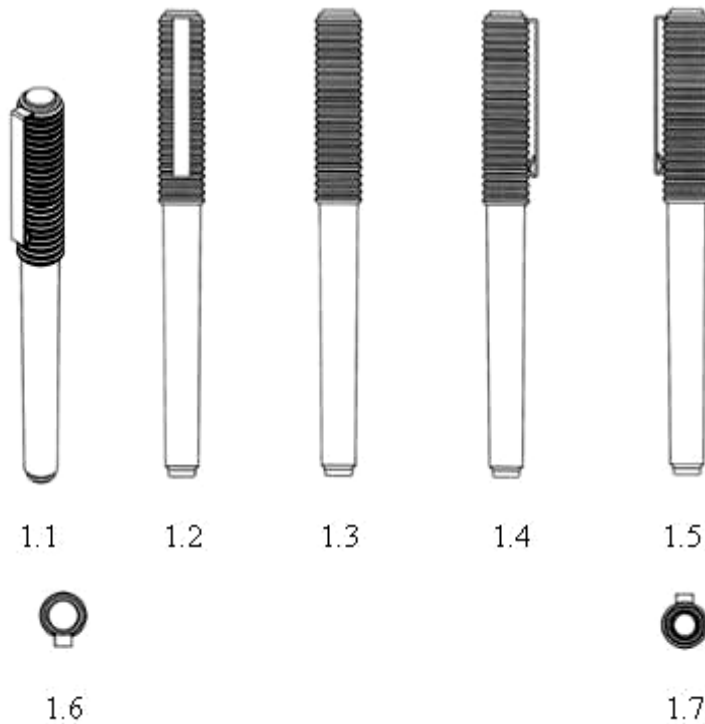

CÔNG BÁO SỞ HỮU CÔNG NGHIỆP SỐ 436 TẬP A – QUYỀN 2 (07.2024)

- (11) **50782**
(21) 3-2024-00177 (28) 1
(54) **BAO GÓI** (51) **09-05**
(22) 19/01/2024 (43) 25/07/2024
(73) **CÔNG TY TNHH THƯƠNG MẠI XUẤT NHẬP KHẨU NGUYỄN HỮU THẮNG (VN)**
Số 36B/14 đường 762 Hồng Bàng, phường 1, quận 11, thành phố Hồ Chí Minh
(72) Nguyễn Đình Thái (VN)
(74) Công ty TNHH một thành viên Trường Luật (Trường Luật)
(55)



1.1

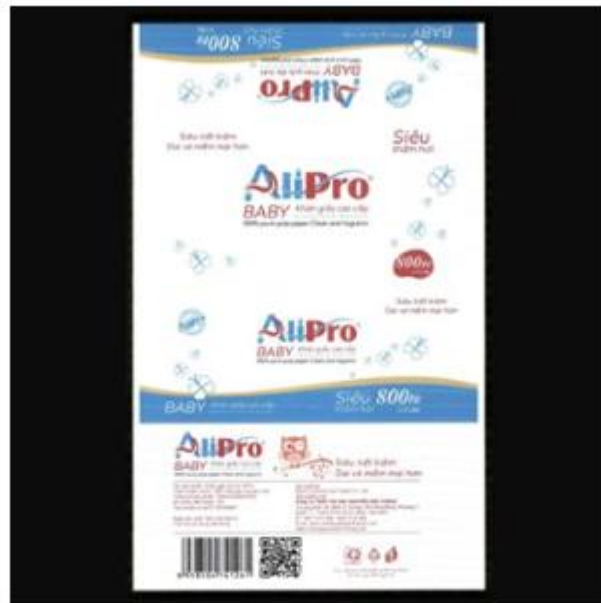

1.2

CÔNG BÁO SỞ HỮU CÔNG NGHIỆP SỐ 436 TẬP A – QUYỀN 2 (07.2024)

- (11) **50783**
(21) 3-2024-00178 (28) 1
(54) **BAO GÓI** (51) **09-05**
(22) 19/01/2024 (43) 25/07/2024
(73) **CÔNG TY TNHH THƯƠNG MẠI XUẤT NHẬP KHẨU NGUYỄN HỮU THẮNG (VN)**
Số 36B/14 đường 762 Hồng Bàng, phường 1, quận 11, thành phố Hồ Chí Minh
(72) Nguyễn Đình Thái (VN)
(74) Công ty TNHH một thành viên Trường Luật (Trường Luật)
(55)



1.1



1.2

CÔNG BÁO SỞ HỮU CÔNG NGHIỆP SỐ 436 TẬP A – QUYỀN 2 (07.2024)

- (11) **50784**
(21) 3-2024-00179 (28) 1
(54) **BAO GÓI** (51) **09-05**
(22) 19/01/2024 (43) 25/07/2024
(73) **CÔNG TY TNHH THƯƠNG MẠI XUẤT NHẬP KHẨU NGUYỄN HỮU THẮNG (VN)**
Số 36B/14 đường 762 Hồng Bàng, phường 1, quận 11, thành phố Hồ Chí Minh
(72) Nguyễn Đình Thái (VN)
(74) Công ty TNHH một thành viên Trường Luật (Trường Luật)
(55)

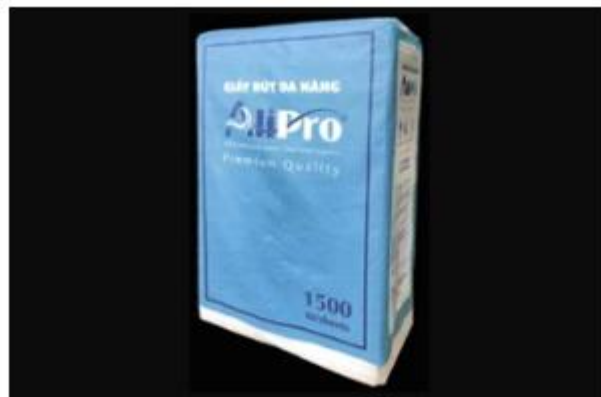

1.1



1.2

CÔNG BÁO SỞ HỮU CÔNG NGHIỆP SỐ 436 TẬP A – QUYỀN 2 (07.2024)

- (11) **50785**
(21) 3-2024-00180 (28) 1
(54) **BAO GÓI** (51) **09-05**
(22) 19/01/2024 (43) 25/07/2024
(73) **CÔNG TY TNHH THƯƠNG MẠI XUẤT NHẬP KHẨU NGUYỄN HỮU THẮNG (VN)**
Số 36B/14 đường 762 Hồng Bàng, phường 1, quận 11, thành phố Hồ Chí Minh
(72) Nguyễn Đình Thái (VN)
(74) Công ty TNHH một thành viên Trường Luật (Trường Luật)
(55)



1.1



1.2

CÔNG BÁO SỞ HỮU CÔNG NGHIỆP SỐ 436 TẬP A – QUYỀN 2 (07.2024)

- (11) **50786**
(21) 3-2023-01902 (28) 1
(54) **DÂY CHUYỀN ĐEO CỔ** (51) **11-01**
(22) 14/08/2023 (43) 25/07/2024
(73) **CÔNG TY CỔ PHẦN VÀNG BẠC ĐÁ QUÝ PHÚ NHUẬN (VN)**
170E Phan Đăng Lưu, phường 3, quận Phú Nhuận, thành phố Hồ Chí Minh
(72) Nguyễn Khoa Hồng Thành (VN)
(74) Công ty TNHH Sở hữu trí tuệ Việt Á (VIET A IP CO.,LTD)
(55)



1.1



1.2



1.3



1.4



1.5



1.6



1.7

CÔNG BÁO SỞ HỮU CÔNG NGHIỆP SỐ 436 TẬP A – QUYỀN 2 (07.2024)

- (11) **50787**
(21) 3-2024-00127 (28) 1
(54) **NHÃN SẢN PHẨM** (51) **19-08**
(22) 12/01/2024 (43) 25/07/2024
(73) **CÔNG TY TRÁCH NHIỆM HỮU HẠN CON CÒ VÀNG (VN)**
23 lô B, đường số 1, phường Phú Thuận, quận 7, thành phố Hồ Chí Minh
(72) Hoàng Mai Dẫn (VN)
(74) Công ty TNHH một thành viên Trường Luật (Trường Luật)
(55)



CÔNG BÁO SỞ HỮU CÔNG NGHIỆP SỐ 436 TẬP A – QUYỀN 2 (07.2024)

- (11) **50788**
(21) 3-2024-00535 (28) 1
(54) **BÚT** (51) **19-06**
(22) 05/03/2024 (43) 25/07/2024
(30) 30-2023-0035789 11/09/2023 KR;
(73) **MORRIS CORPORATION (KR)**
114, Yeomjeon-ro, Michuol-Gu, Incheon, Republic of Korea
(72) MOON, YOON HO (KR)
(74) Công ty TNHH Trường Xuân (AGELESS CO.,LTD.)
(55)

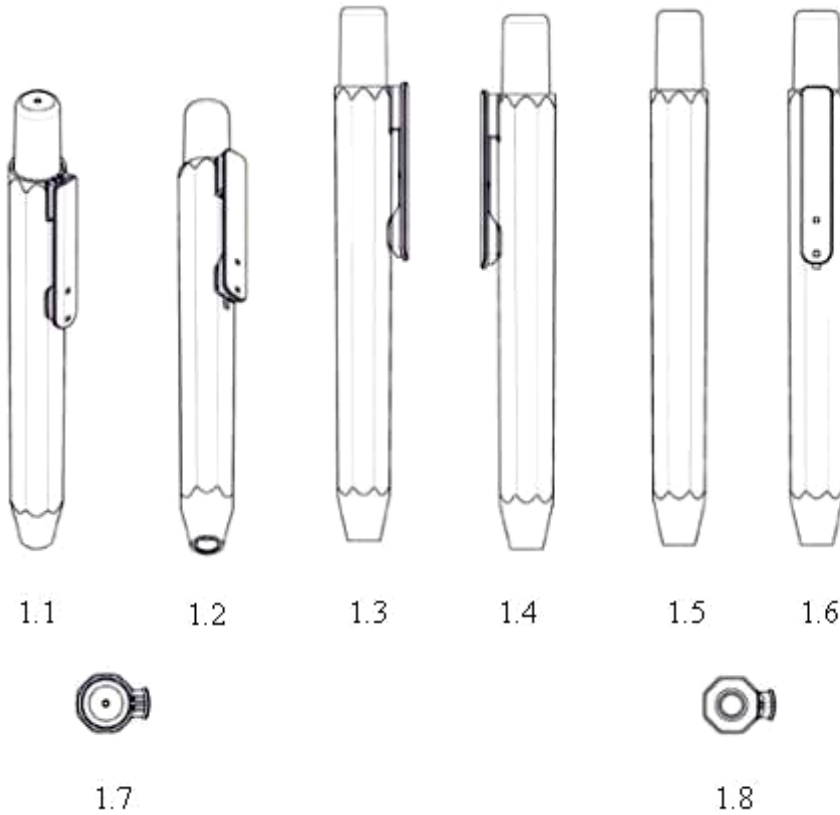

CÔNG BÁO SỞ HỮU CÔNG NGHIỆP SỐ 436 TẬP A – QUYỀN 2 (07.2024)

- (11) **50789**
(21) 3-2024-00536 (28) 1
(54) **CHÂN BÒN NGANG** (51) **12-16**
(22) 05/03/2024 (43) 25/07/2024
(73) **CÔNG TY CỔ PHẦN MÁY VÀ THIẾT BỊ CÔNG NGHIỆP QUỐC TẾ (VN)**
156 Nam Kỳ Khởi Nghĩa, phường Bến Nghé, quận 1, thành phố Hồ Chí Minh
(72) Đào Quốc Hưng (VN)
(74) Công ty TNHH Tư vấn đầu tư và Sở hữu trí tuệ Hoàng Phi (HOANG PHI INVEST & I.P CO., LTD)
(55)

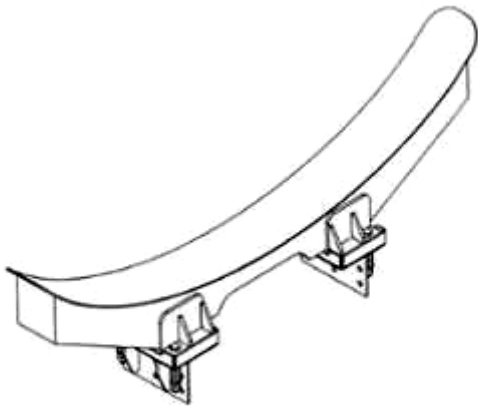

1.1

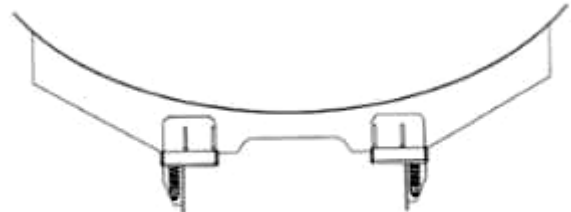

1.2

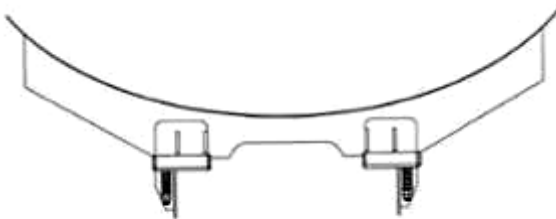

1.3



1.4



1.5



1.6

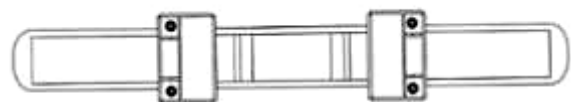

1.7

(11) **50790**

(21) 3-2024-00530

(28) 1

(54) **ĐÉ GIÀY**

(51) **02-04**

(22) 05/03/2024

(43) 25/07/2024

(73) **CÔNG TY TNHH BÌNH TIÊN BIÊN HÒA (VN)**

Lô 101/2 khu công nghiệp Amata, phường Long Bình, thành phố Biên Hòa, tỉnh Đồng Nai

(72) Lai Khiêm (VN)

(74) Công ty TNHH Tư vấn sở hữu trí tuệ Việt (VIET IP CO.,LTD.)

(55)



1.1



1.2



1.3



1.4



1.5



1.6



1.7

CÔNG BÁO SỞ HỮU CÔNG NGHIỆP SỐ 436 TẬP A – QUYỀN 2 (07.2024)

(11) **50791**

(21) 3-2024-00531

(28) 1

(54) **ĐÉ GIẦY**

(51) **02-04**

(22) 05/03/2024

(43) 25/07/2024

(73) **CÔNG TY TNHH BÌNH TIÊN BIÊN HÒA (VN)**

Lô 101/2 khu công nghiệp Amata, phường Long Bình, thành phố Biên Hòa, tỉnh Đồng Nai

(72) Lai Khiêm (VN)

(74) Công ty TNHH Tư vấn sở hữu trí tuệ Việt (VIET IP CO.,LTD.)

(55)



1.1



1.2



1.3



1.4



1.5



1.6



1.7

CÔNG BÁO SỞ HỮU CÔNG NGHIỆP SỐ 436 TẬP A – QUYỀN 2 (07.2024)

(11) **50792**

(21) 3-2024-00532

(28) 1

(54) **ĐỀ GIÀY**

(51) **02-04**

(22) 05/03/2024

(43) 25/07/2024

(73) **CÔNG TY TNHH BÌNH TIÊN BIÊN HÒA (VN)**

Lô 101/2 khu công nghiệp Amata, phường Long Bình, thành phố Biên Hòa, tỉnh Đồng Nai

(72) Lai Khiêm (VN)

(74) Công ty TNHH Tư vấn sở hữu trí tuệ Việt (VIET IP CO.,LTD.)

(55)



1.1



1.2



1.3



1.4



1.5



1.6



1.7

CÔNG BÁO SỞ HỮU CÔNG NGHIỆP SỐ 436 TẬP A – QUYỀN 2 (07.2024)

(11) **50793**

(21) 3-2024-00533

(28) 1

(54) **DÉP**

(51) **02-04**

(22) 05/03/2024

(43) 25/07/2024

(73) **CÔNG TY TNHH BÌNH TIÊN BIÊN HÒA (VN)**

Lô 101/2 khu công nghiệp Amata, phường Long Bình, thành phố Biên Hòa, tỉnh Đồng Nai

(72) Lai Khiêm (VN)

(74) Công ty TNHH Tư vấn sở hữu trí tuệ Việt (VIET IP CO.,LTD.)

(55)



1.1



1.2



1.3



1.4



1.5

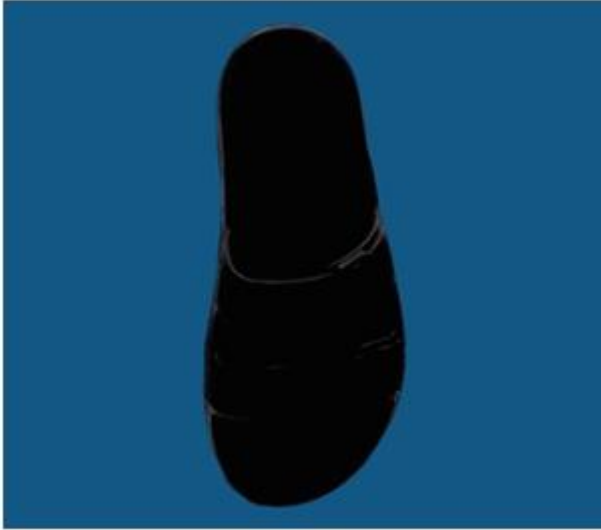

1.6



1.7

CÔNG BÁO SỞ HỮU CÔNG NGHIỆP SỐ 436 TẬP A – QUYỀN 2 (07.2024)

(11) **50794**

(21) 3-2024-00534

(28) 1

(54) **ĐÉ DÉP**

(51) **02-04**

(22) 05/03/2024

(43) 25/07/2024

(73) **CÔNG TY TNHH BÌNH TIÊN BIÊN HÒA (VN)**

Lô 101/2 khu công nghiệp Amata, phường Long Bình, thành phố Biên Hòa, tỉnh Đồng Nai

(72) Lai Khiêm (VN)

(74) Công ty TNHH Tư vấn sở hữu trí tuệ Việt (VIET IP CO.,LTD.)

(55)



1.1



1.2



1.3



1.4



1.5



1.6



1.7

CÔNG BÁO SỞ HỮU CÔNG NGHIỆP SỐ 436 TẬP A – QUYỀN 2 (07.2024)

- (11) **50795**
(21) 3-2024-00553 (28) 1
(54) **MÁY SẤY TÓC** (51) **28-03**
(22) 07/03/2024 (43) 25/07/2024
(73) **GUANGDONG CONFU ELECTRICAL APPLIANCES CO., LTD. (CN)**
North of Yu 13th Road, Tianfu Road East, Airport and Economic District, Jieyang
City, China
(72) Mincong Huang (CN)
(74) **CÔNG TY TNHH SỞ HỮU TRÍ TUỆ ANLIS VIỆT NAM (ANLIS IP CO.,LTD)**
(55)



1.1



1.2



1.3



1.4



1.5



1.6



1.7



1.8

CÔNG BÁO SỞ HỮU CÔNG NGHIỆP SỐ 436 TẬP A – QUYỀN 2 (07.2024)

- (11) **50796**
(21) 3-2024-00554 (28) 1
(54) **MÁY SẤY TÓC** (51) **28-03**
(22) 07/03/2024 (43) 25/07/2024
(73) **GUANGDONG CONFU ELECTRICAL APPLIANCES CO., LTD. (CN)**
North of Yu 13th Road, Tianfu Road East, Airport and Economic District, Jieyang
City, China
(72) Mincong Huang (CN)
(74) **CÔNG TY TNHH SỞ HỮU TRÍ TUỆ ANLIS VIỆT NAM (ANLIS IP CO.,LTD)**
(55)



CÔNG BÁO SỞ HỮU CÔNG NGHIỆP SỐ 436 TẬP A – QUYỀN 2 (07.2024)

(11) **50797**

(21) 3-2024-00385

(28) 1

(54) **MÁY ÉP NÓN**

(51) **15-99**

(22) 20/02/2024

(43) 25/07/2024

(73) **CÔNG TY TNHH DAESUNG TS (VN)**

Lô 1-2, đường D4, khu F1, KCN Tân Thới Hiệp, phường Hiệp Thành, quận 12, thành phố Hồ Chí Minh

(72) Kim Ji Young (KR)

(74) Công ty TNHH MASTERBRAND (MASTERBRAND)

(55)

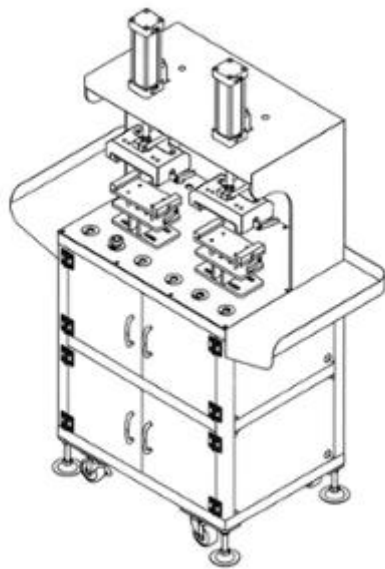

1.1

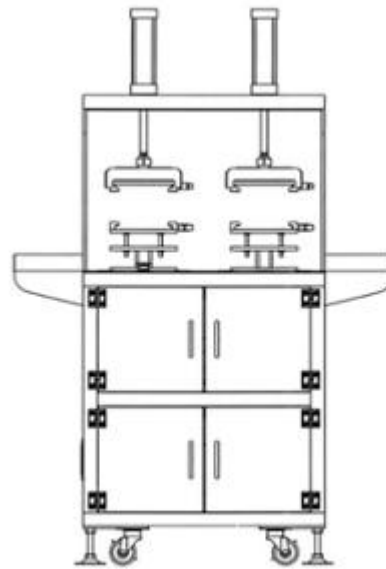

1.2

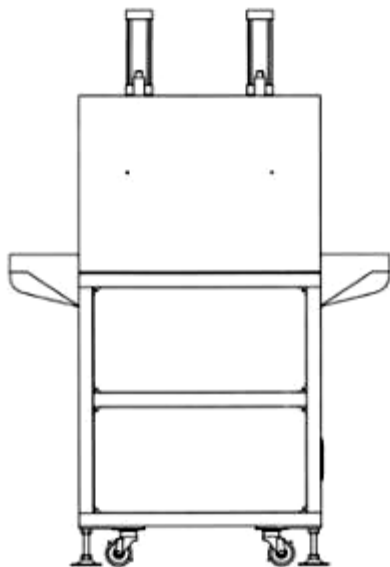

1.3

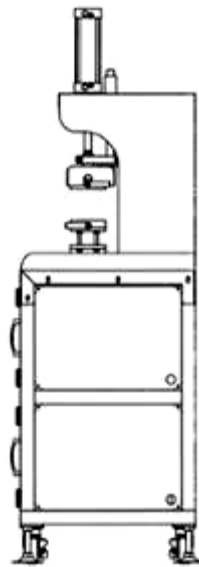

1.4

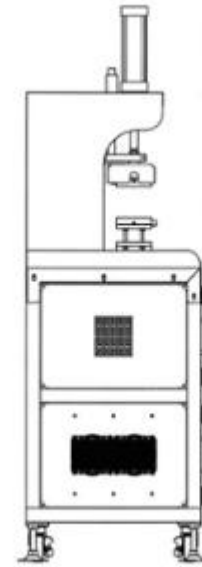

1.5

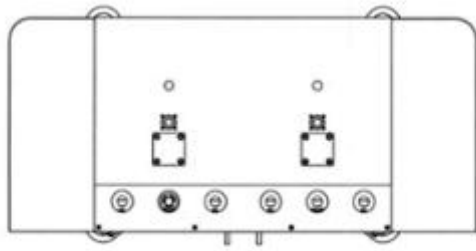

1.6

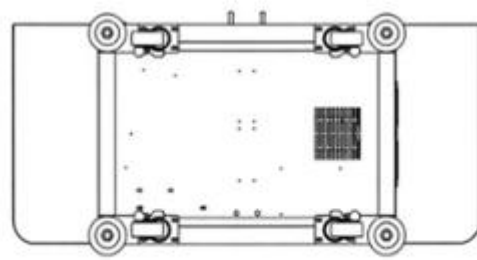

1.7

CÔNG BÁO SỞ HỮU CÔNG NGHIỆP SỐ 436 TẬP A – QUYỀN 2 (07.2024)

(11) **50798**

(21) 3-2024-00386

(28) 1

(54) **MÁY ÉP NHẪN**

(51) **15-99**

(22) 20/02/2024

(43) 25/07/2024

(73) **CÔNG TY TNHH DAESUNG TS (VN)**

Lô 1-2, đường D4, khu F1, KCN Tân Thới Hiệp, phường Hiệp Thành, quận 12, thành phố Hồ Chí Minh

(72) Kim Ji Young (KR)

(74) **CÔNG TY TNHH MASTERBRAND (MASTERBRAND)**

(55)

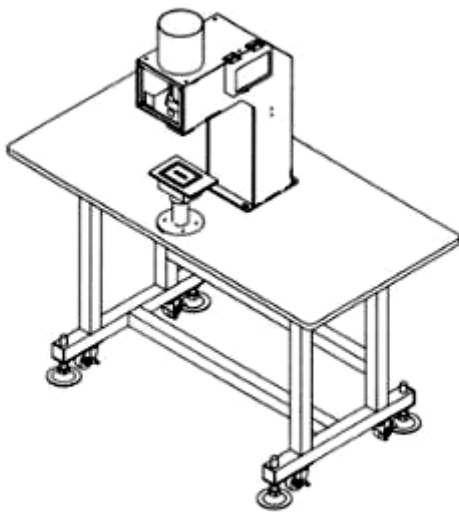

1.1

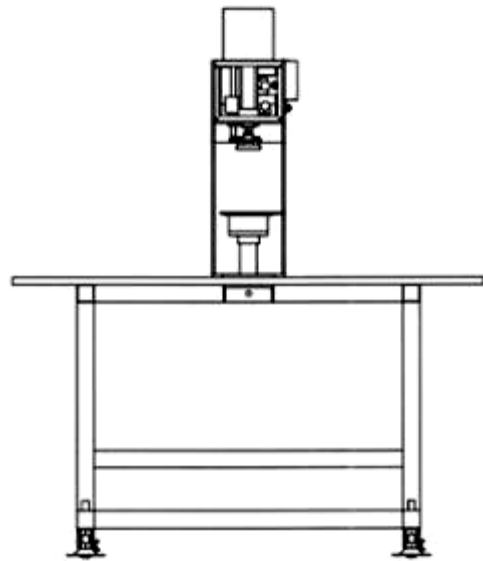

1.2

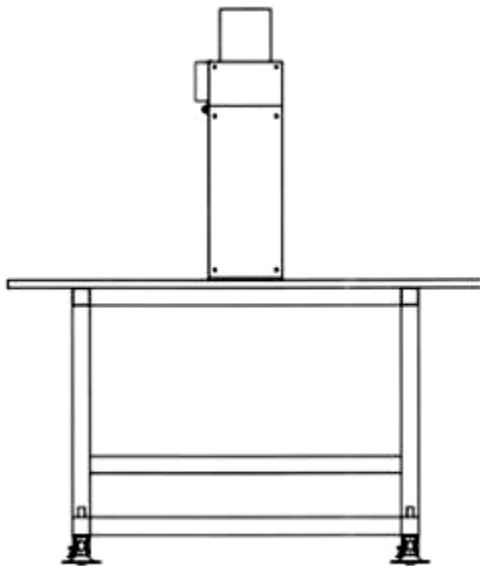

1.3

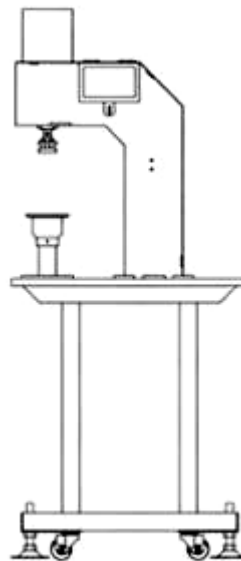

1.4

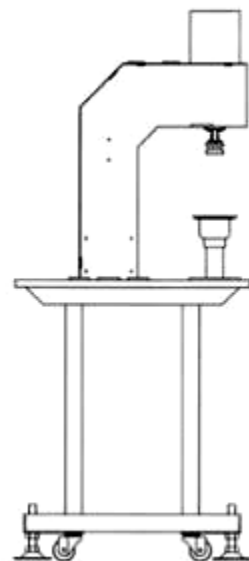

1.5

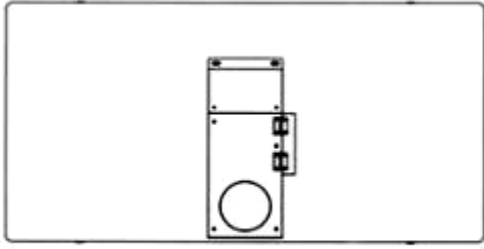

1.6

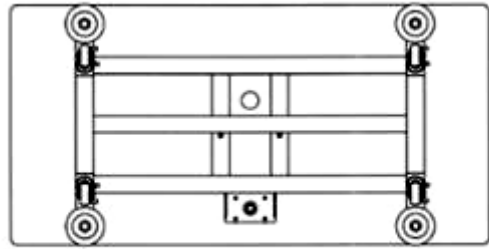

1.7

CÔNG BÁO SỞ HỮU CÔNG NGHIỆP SỐ 436 TẬP A – QUYỀN 2 (07.2024)

- (11) **50799**
(21) 3-2024-00392 (28) 1
(54) **BAO GÓI** (51) **09-05**
(22) 20/02/2024 (43) 25/07/2024
(73) **CÔNG TY TRÁCH NHIỆM HỮU HẠN CON CÒ VÀNG (VN)**
23 Lô B đường số 1, phường Phú Thuận, quận 7, thành phố Hồ Chí Minh
(72) Hoàng Mai Dẫn (VN)
(74) Công ty TNHH một thành viên Trường Luật (Trường Luật)
(55)



1.1



1.2

CÔNG BÁO SỞ HỮU CÔNG NGHIỆP SỐ 436 TẬP A – QUYỀN 2 (07.2024)

- (11) **50800**
(21) 3-2024-00393 (28) 1
(54) **BAO GÓI** (51) **09-05**
(22) 20/02/2024 (43) 25/07/2024
(73) **CÔNG TY TRÁCH NHIỆM HỮU HẠN CON CÒ VÀNG (VN)**
23 Lô B đường số 1, phường Phú Thuận, quận 7, thành phố Hồ Chí Minh
(72) Hoàng Mai Dẫn (VN)
(74) Công ty TNHH một thành viên Trường Luật (Trường Luật)
(55)



1.1



1.2

CÔNG BÁO SỞ HỮU CÔNG NGHIỆP SỐ 436 TẬP A – QUYỀN 2 (07.2024)

- (11) **50801**
(21) 3-2024-00394 (28) 1
(54) **BAO GÓI** (51) **09-05**
(22) 20/02/2024 (43) 25/07/2024
(73) **CÔNG TY TRÁCH NHIỆM HỮU HẠN CON CÒ VÀNG (VN)**
23 Lô B đường số 1, phường Phú Thuận, quận 7, thành phố Hồ Chí Minh
(72) Hoàng Mai Dẫn (VN)
(74) Công ty TNHH một thành viên Trường Luật (Trường Luật)
(55)



1.1



1.2

CÔNG BÁO SỞ HỮU CÔNG NGHIỆP SỐ 436 TẬP A – QUYỀN 2 (07.2024)

- (11) **50802**
(21) 3-2024-00395 (28) 1
(54) **BAO GÓI** (51) **09-05**
(22) 20/02/2024 (43) 25/07/2024
(73) **CÔNG TY TRÁCH NHIỆM HỮU HẠN CON CÒ VÀNG (VN)**
23 Lô B đường số 1, phường Phú Thuận, quận 7, thành phố Hồ Chí Minh
(72) Hoàng Mai Dẫn (VN)
(74) Công ty TNHH một thành viên Trường Luật (Trường Luật)
(55)



1.1



1.2

- (11) **50803**
(21) 3-2023-01650 (28) 1
(54) **BAO BÌ VẬN CHUYỂN** (51) **09-05**
(22) 19/07/2023 (43) 25/07/2024
(30) 29/883143 24/01/2023 US; 218771 24/01/2023 CA;
(73) **RAPID AID CORP. (CA)**
4120A Sladeview Crescent, Mississauga, Ontario L5L 5Z3, Canada
(72) 1. ALLEVA, ANTHONY SCOTT (US)
2. SANDERS, RYAN LAWRENCE MCKENZIE (CA)
3. SCOTT, CURTIS BRIAN (CA)
4. WHITELY, JEFFREY THOMAS (CA)
5. WALKER, CHANTAL ANN (CA)
(74) Công ty TNHH Trà và cộng sự (TRA & ASSOCIATES CO.,LTD)
(55)

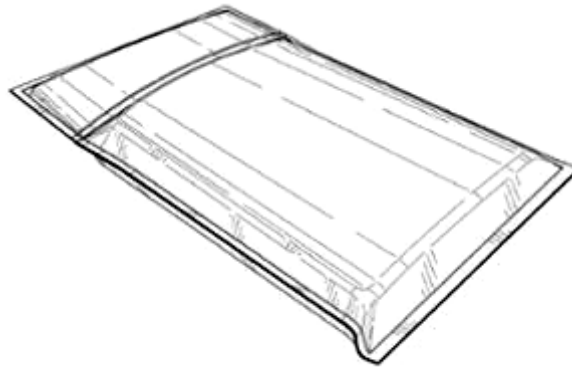

1.1



1.2



1.3



1.4



1.5

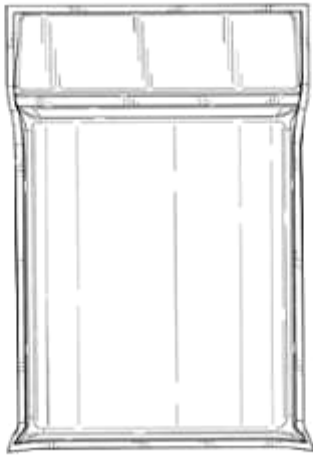

1.6

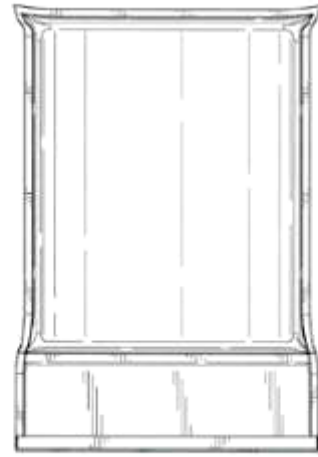

1.7

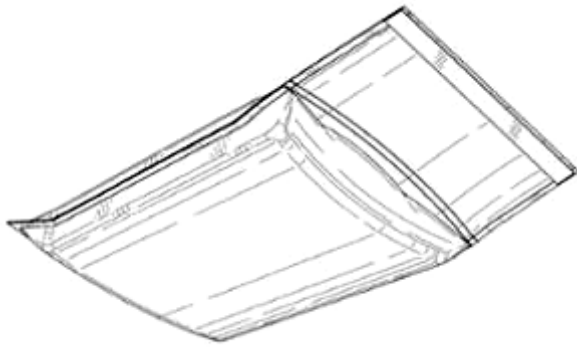

1.8

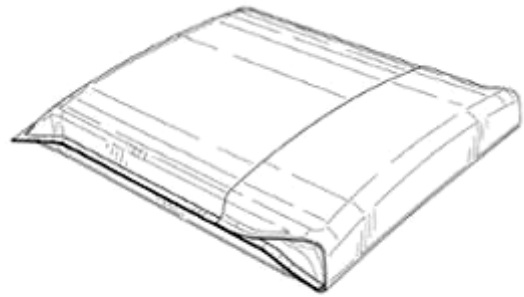

1.9

CÔNG BÁO SỞ HỮU CÔNG NGHIỆP SỐ 436 TẬP A – QUYỀN 2 (07.2024)

- (11) **50804**
(21) 3-2024-00357 (28) 1
(54) **TẮM HƯỚNG GIÓ CHO XE CỘ** (51) **12-16**
(22) 07/02/2024 (43) 25/07/2024
(30) 015032032-0001 23/08/2023 EM;
(73) **IGOR AKRAPOVIČ (SI)**
Rožna Dolina C.VIII/10A, SI-1000 Ljubljana, Slovenia
(72) 1. IGOR AKRAPOVIČ (SI)
2. ERMIN KOSOVEL (SI)
3. PRIMOŽ TOPLIKAR (SI)
(74) Công ty TNHH Đại Tín và Liên Danh (DAITIN AND ASSOCIATES CO.,LTD)
(55)



1.1



1.2



1.3



1.4



1.5



1.6



1.7

CÔNG BÁO SỞ HỮU CÔNG NGHIỆP SỐ 436 TẬP A – QUYỀN 2 (07.2024)

- (11) **50805**
(21) 3-2023-03160 (28) 1
(54) **HỘP** (51) **09-03**
(22) 26/12/2023 (43) 25/07/2024
(73) **HỘ KINH DOANH CƠ SỞ SẢN XUẤT BÁNH KHÔ MÈ BÀ LIÊU MẸ (VN)**
Số 200/01 Ông Ích Đường, phường Hòa Thọ Đông, quận Cẩm Lệ, thành phố Đà Nẵng
(72) Huỳnh Đức Khiển (VN)
(55)



1.1



1.2

CÔNG BÁO SỞ HỮU CÔNG NGHIỆP SỐ 436 TẬP A – QUYỀN 2 (07.2024)

- (11) **50806**
(21) 3-2024-00044 (28) 1
(54) **NHÃN SẢN PHẨM** (51) **19-08**
(22) 05/01/2024 (43) 25/07/2024
(73) **CÔNG TY CỔ PHẦN SONG LONG KHÁNH HÒA (VN)**
Số 23 đường 53B, phường Tân Tạo, quận Bình Tân, thành phố Hồ Chí Minh
(72) Võ Thị Tuyết Hà (VN)
(74) Công ty TNHH MASTERBRAND (MASTERBRAND)
(55)



CÔNG BÁO SỞ HỮU CÔNG NGHIỆP SỐ 436 TẬP A – QUYỀN 2 (07.2024)

- (11) **50807**
(21) 3-2024-00046 (28) 1
(54) **LY ĐỰNG NÉN** (51) **26-01**
(22) 05/01/2024 (43) 25/07/2024
(73) **CÔNG TY TNHH SẢN XUẤT THƯƠNG MẠI QUANG NGHỆ (VN)**
205B/28 Âu Cơ, phường 5, quận 11, thành phố Hồ Chí Minh
(72) Thi Lương (VN)
(55)



1.1



1.2



1.3



1.4



1.5



1.6

CÔNG BÁO SỞ HỮU CÔNG NGHIỆP SỐ 436 TẬP A – QUYỀN 2 (07.2024)

- (11) **50808**
(21) 3-2024-00047 (28) 1
(54) **LY ĐỰNG NÉN** (51) **26-01**
(22) 05/01/2024 (43) 25/07/2024
(73) **CÔNG TY TNHH SẢN XUẤT THƯƠNG MẠI QUANG NGHỆ (VN)**
205B/28 Âu Cơ, phường 5, quận 11, thành phố Hồ Chí Minh
(72) Thi Lương (VN)
(55)

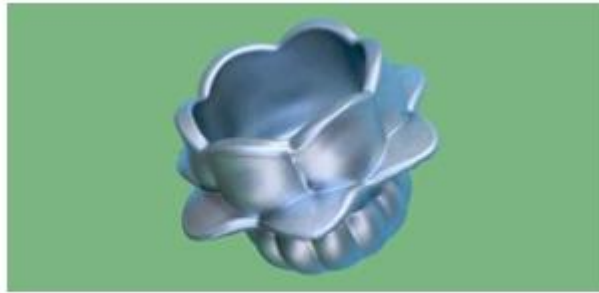

1.1

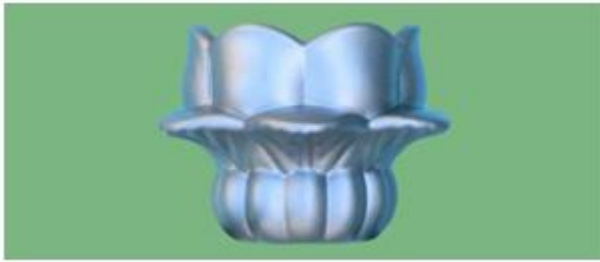

1.2

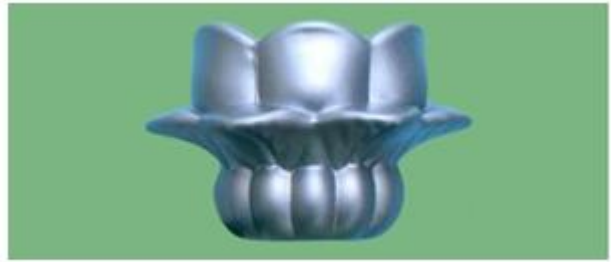

1.3



1.4



1.5

CÔNG BÁO SỞ HỮU CÔNG NGHIỆP SỐ 436 TẬP A – QUYỀN 2 (07.2024)

- (11) **50809**
(21) 3-2024-00048 (28) 1
(54) **LY ĐỰNG NÉN** (51) **26-01**
(22) 05/01/2024 (43) 25/07/2024
(73) **CÔNG TY TNHH SẢN XUẤT THƯƠNG MẠI QUANG NGHỆ (VN)**
205B/28 Âu Cơ, phường 5, quận 11, thành phố Hồ Chí Minh
(72) Thi Lương (VN)
(55)

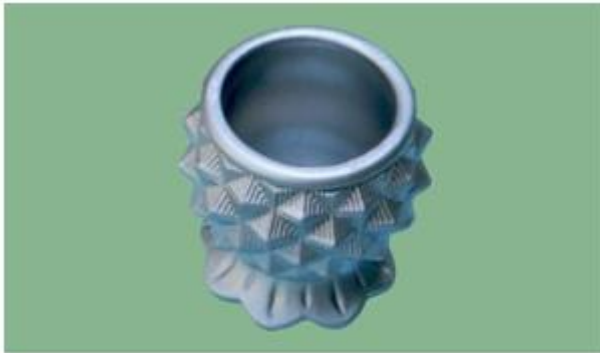

1.1

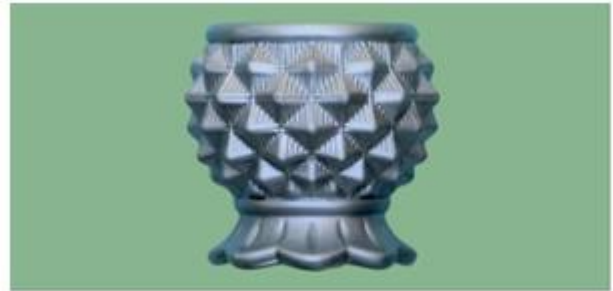

1.2



1.3



1.4

- (11) **50810**
(21) 3-2024-00050 (28) 1
(54) **LY ĐỰNG NÉN** (51) **26-01**
(22) 05/01/2024 (43) 25/07/2024
(73) **CÔNG TY TNHH SẢN XUẤT THƯƠNG MẠI QUANG NGHỆ (VN)**
205B/28 Âu Cơ, phường 5, quận 11, thành phố Hồ Chí Minh
(72) Thi Lương (VN)
(55)

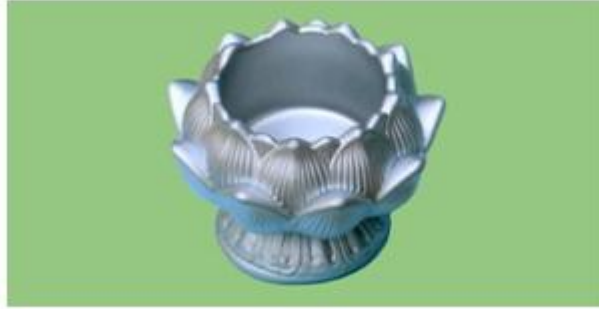

1.1



1.2



1.3



1.4



1.5



1.6



1.7

CÔNG BÁO SỞ HỮU CÔNG NGHIỆP SỐ 436 TẬP A – QUYỀN 2 (07.2024)

(11) **50811**

(21) 3-2024-00058

(28) 1

(54) **NỒI**

(51) **07-02**

(22) 05/01/2024

(43) 25/07/2024

(73) **CÔNG TY TNHH MINH LONG I (VN)**

Số 333 đường Hưng Định 24, khu phố Hưng Lộc, phường Hưng Định, thành phố Thuận An, tỉnh Bình Dương

(72) Lý Ngọc Minh (VN)

(55)



1.1



1.2



1.3



1.4



1.5

CÔNG BÁO SỞ HỮU CÔNG NGHIỆP SỐ 436 TẬP A – QUYỀN 2 (07.2024)

- (11) **50812**
(21) 3-2024-00059 (28) 1
(54) **KHAY NHỰA ĐA NĂNG** (51) **07-06**
(22) 05/01/2024 (43) 25/07/2024
(73) **CÔNG TY TNHH MỘT THÀNH VIÊN SẢN XUẤT THƯƠNG MẠI XUẤT NHẬP KHẨU THẮNG LỢI (VN)**
Số 334D đường Mã Lò, khu phố 6, phường Bình Trị Đông A, quận Bình Tân, thành phố Hồ Chí Minh
(72) Tô Lợi Thành (VN)
(74) Công ty Cổ phần PHANLAW VIETNAM (PHANLAW VIETNAM JSC)
(55)

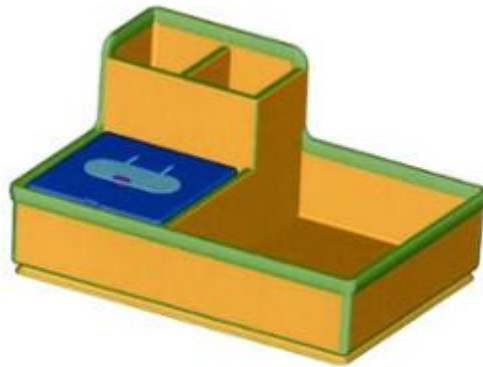

1.1

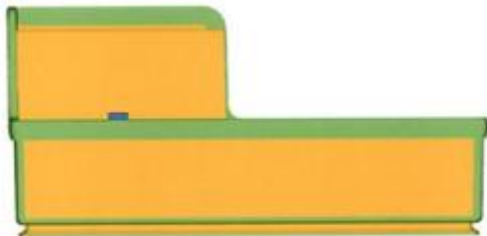

1.2



1.3

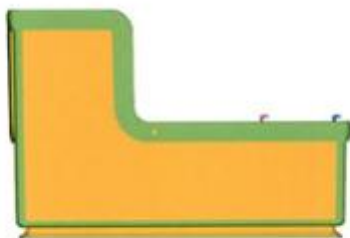

1.4

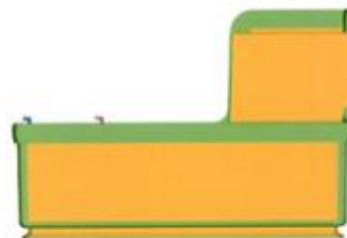

1.5

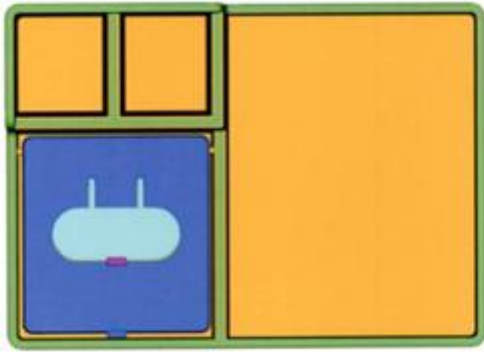

1.6

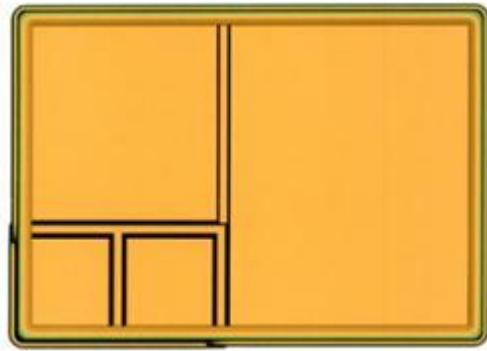

1.7

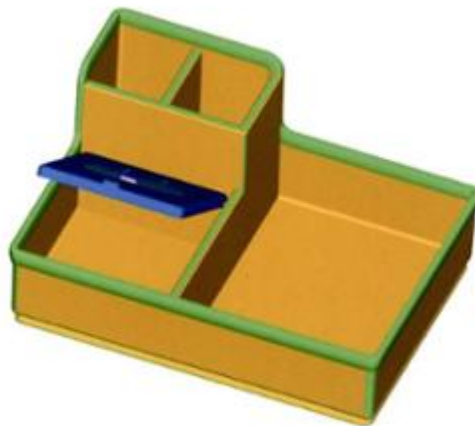

1.8

CÔNG BÁO SỞ HỮU CÔNG NGHIỆP SỐ 436 TẬP A – QUYỀN 2 (07.2024)

(11) **50813**

(21) 3-2024-00060

(28) 1

(54) **KHAY NHỰA ĐA NĂNG**

(51) **07-06**

(22) 05/01/2024

(43) 25/07/2024

(73) **CÔNG TY TNHH MỘT THÀNH VIÊN SẢN XUẤT THƯƠNG MẠI XUẤT NHẬP KHẨU THẮNG LỢI (VN)**

Số 334D đường Mã Lò, khu phố 6, phường Bình Trị Đông A, quận Bình Tân, thành phố Hồ Chí Minh

(72) Tô Lợi Thành (VN)

(74) **CÔNG TY CỔ PHẦN PHANLAW VIETNAM (PHANLAW VIETNAM JSC)**

(55)

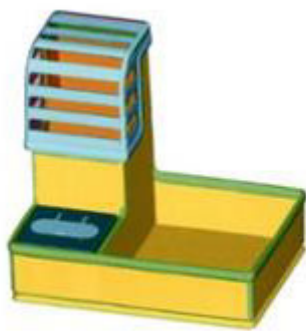

1.1

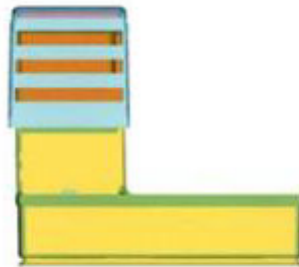

1.2

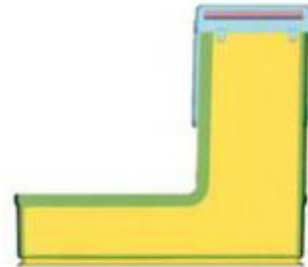

1.3

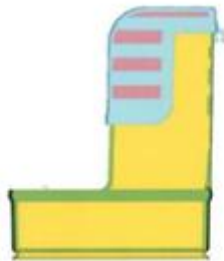

1.4

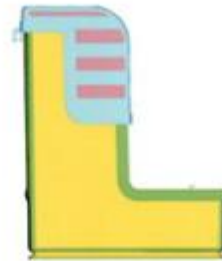

1.5

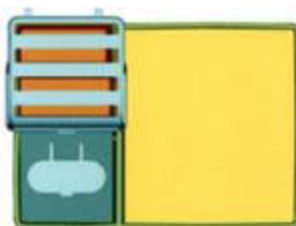

1.6

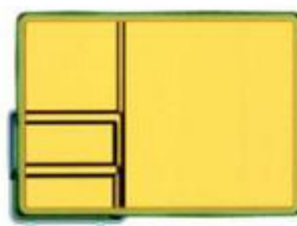

1.7



1.8

CÔNG BÁO SỞ HỮU CÔNG NGHIỆP SỐ 436 TẬP A – QUYỀN 2 (07.2024)

- (11) **50814**
(21) 3-2024-01000 (28) 1
(54) **BAO GÓI KHĂN XUA MUỐI** (51) **09-05**
(22) 26/04/2024 (43) 25/07/2024
(73) **CÔNG TY CỔ PHẦN DIANA UNICHARM (VN)**
Khu công nghiệp Vĩnh Tuy, đường Lĩnh Nam, phường Vĩnh Hưng, quận Hoàng
Mai, thành phố Hà Nội
(72) Đỗ Anh Tú (VN)
(74) Công ty TNHH Sở hữu trí tuệ và Công nghệ Thủ đô (CAPITAL IP&T CO.LTD.)
(55)



1.1



1.2

CÔNG BÁO SỞ HỮU CÔNG NGHIỆP SỐ 436 TẬP A – QUYỀN 2 (07.2024)

- (11) **50815**
(21) 3-2024-01007 (28) 1
(54) **NHÃN SẢN PHẨM** (51) **19-08**
(22) 26/04/2024 (43) 25/07/2024
(73) **CÔNG TY TNHH ĐẠI DƯƠNG Ý TƯỞNG (VN)**
Y10 Hồng Lĩnh, phường 15, quận 10, thành phố Hồ Chí Minh
(72) Lâm Quang Thành Chung (VN)
(74) **CÔNG TY LUẬT TNHH KHÔI NGỌC (KHOI NGOC LAW COMPANY LTD)**
(55)



CÔNG BÁO SỞ HỮU CÔNG NGHIỆP SỐ 436 TẬP A – QUYỀN 2 (07.2024)

- (11) **50816**
(21) 3-2024-01008 (28) 1
(54) **NHÃN SẢN PHẨM** (51) **19-08**
(22) 26/04/2024 (43) 25/07/2024
(73) **CÔNG TY TNHH ĐẠI DƯƠNG Ý TƯỞNG (VN)**
Y10 Hồng Lĩnh, phường 15, quận 10, thành phố Hồ Chí Minh
(72) Lâm Quang Thành Chung (VN)
(74) **CÔNG TY LUẬT TNHH KHÔI NGỌC (KHOI NGOC LAW COMPANY LTD)**
(55)



CÔNG BÁO SỞ HỮU CÔNG NGHIỆP SỐ 436 TẬP A – QUYỀN 2 (07.2024)

(11) **50817**

(21) 3-2024-01011

(28) 1

(54) **MÁY BƠM**

(51) **15-02**

(22) 26/04/2024

(43) 25/07/2024

(73) **CÔNG TY TNHH THƯƠNG MẠI KỸ THUẬT TÂM KẾT (VN)**

Khu tập thể may 2, đường Hoàng Hoa Thám, phường An Tảo, thành phố Hưng Yên, tỉnh Hưng Yên

(72) Dương Ngọc Tùng (VN)

(74) Công ty TNHH Trường Xuân (AGELESS CO.,LTD.)

(55)



1.1

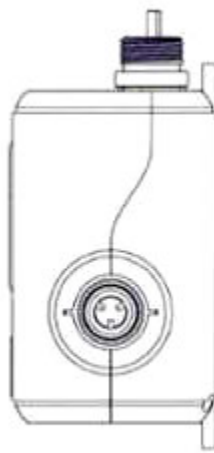

1.2

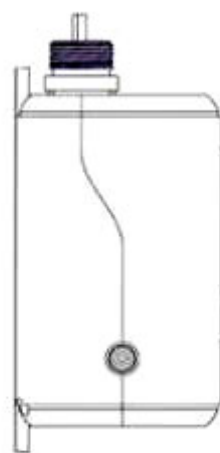

1.3

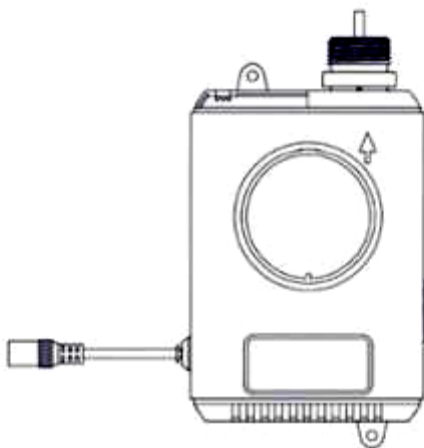

1.4

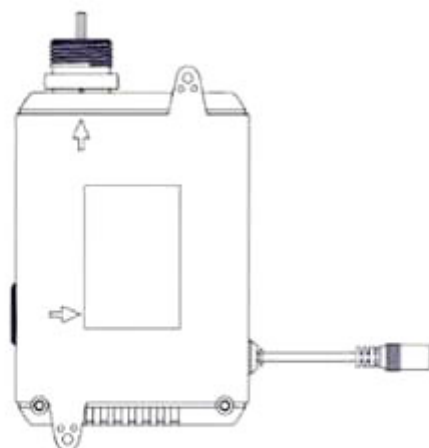

1.5



1.6



1.7

CÔNG BÁO SỞ HỮU CÔNG NGHIỆP SỐ 436 TẬP A – QUYỀN 2 (07.2024)

(11) **50818**

(21) 3-2024-01103

(28) 1

(54) **VA LI ĐIỆN**

(51) **03-01**

(22) 13/05/2024

(43) 25/07/2024

(30) 2024301471406 21/03/2024 CN;

(73) **EAST SUN (SHANGHAI) GROUP CO., LTD.** (CN)

Room B128, Building 2, No. 139, Fanghua Road, Pudong New District, Shanghai 201204, China

(72) Yen-I Chen (CN)

(74) Công ty TNHH ADASTRA IP (VIỆT NAM) (ADASTRA IP (VIETNAM) CO., LTD.)

(55)



1.1



1.2

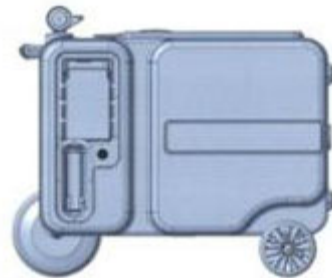

1.3

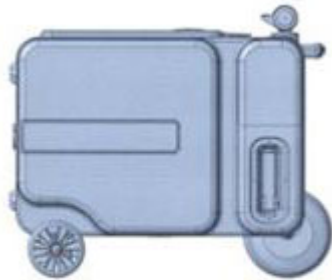

1.4



1.5

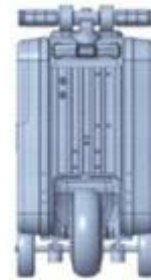

1.6



1.7



1.8

CÔNG BÁO SỞ HỮU CÔNG NGHIỆP SỐ 436 TẬP A – QUYỀN 2 (07.2024)

- (11) **50819**
(21) 3-2023-00401 (28) 1
(54) **THIẾT BỊ TRAO ĐỔI NHIỆT** (51) **15-01**
(22) 28/02/2023 (43) 25/07/2024
(73) **TẬP ĐOÀN CÔNG NGHIỆP - VIỆN THÔNG QUÂN ĐỘI (VN)**
Lô D26 khu đô thị mới Cầu Giấy, phường Yên Hoà, quận Cầu Giấy, thành phố Hà Nội
(72) 1. PHẠM NGỌC DŨNG (VN)
2. NGUYỄN TUẤN ANH (VN)
3. HOÀNG NHƯ VŨ (VN)
4. TRẦN DUY HẢI (VN)
5. NGUYỄN VĂN NAM (VN)
(74) Công ty TNHH NACILAW (NACILAW)
(55)

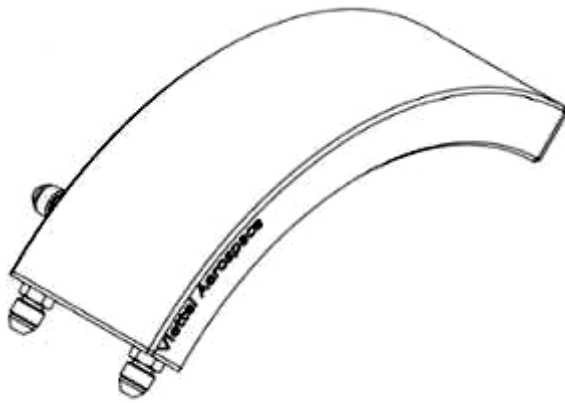

1.1

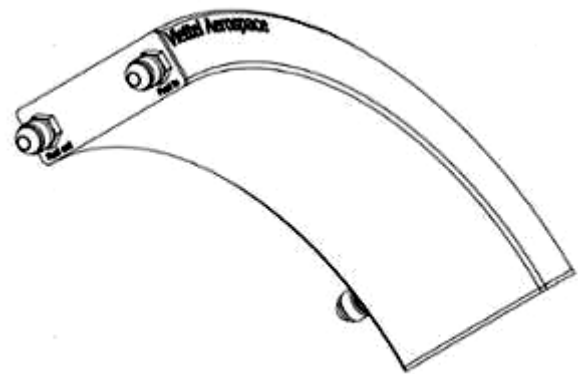

1.2



1.3



1.4

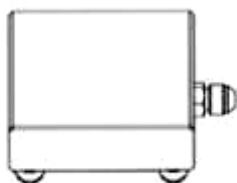

1.5

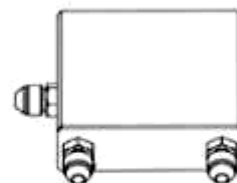

1.6



1.7



1.8

- (11) **50820**
(21) 3-2023-02719 (28) 1
(54) **THIẾT BỊ LIÊN LẠC NỘI BỘ** (51) **14-03**
(22) 13/11/2023 (43) 25/07/2024
(30) 2023-013694 03/07/2023 JP;
(73) **PANASONIC INTELLECTUAL PROPERTY MANAGEMENT CO., LTD.**
(JP)
22-6, Moto-machi, Kadoma-shi, Osaka 571-0057 Japan
(72) Miki KOBAYASHI (JP)
(74) Công ty TNHH một thành viên Sở hữu trí tuệ VCCI (VCCI-IP CO.,LTD)
(55)

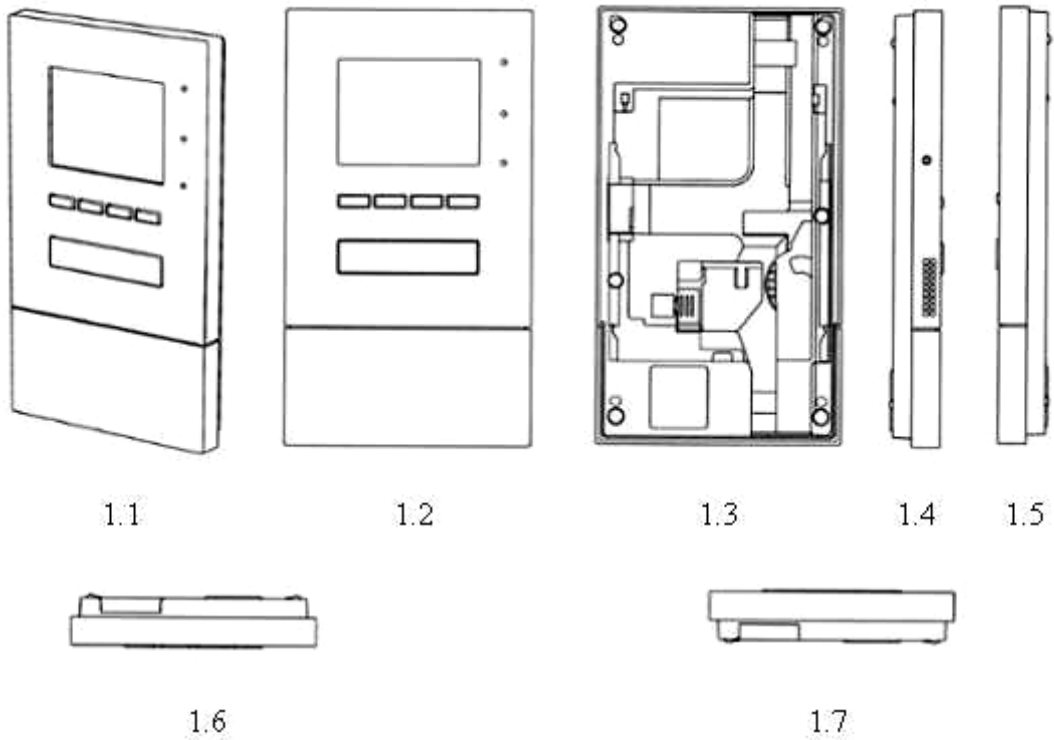

CÔNG BÁO SỞ HỮU CÔNG NGHIỆP SỐ 436 TẬP A – QUYỀN 2 (07.2024)

- (11) **50821**
- (21) 3-2024-01063 (28) 1
- (54) **NHÃN SẢN PHẨM** (51) **19-08**
- (22) 08/05/2024 (43) 25/07/2024
- (73) **CÔNG TY TNHH TOÀN CẦU BEVERAGE (VN)**
Số 8B đường Ngô Quyền, khu 4, phường Cẩm Thượng, thành phố Hải Dương, tỉnh Hải Dương
- (72) Nguyễn Thế Phương (VN)
- (74) Công ty TNHH Sở hữu trí tuệ M.I.T (M.I.T IP CO., LTD)
- (55)



CÔNG BÁO SỞ HỮU CÔNG NGHIỆP SỐ 436 TẬP A – QUYỀN 2 (07.2024)

- (11) **50822**
(21) 3-2024-01068 (28) 1
(54) **TÚI ĐỰNG THUỐC TRỪ CỎ** (51) **09-05**
(22) 08/05/2024 (43) 25/07/2024
(73) **CÔNG TY CỔ PHẦN ĐẦU TƯ THƯƠNG MẠI VÀ PHÁT TRIỂN NÔNG NGHIỆP ADI (VN)**
Số 2, ngõ 192, phố Đại Từ, phường Đại Kim, quận Hoàng Mai, thành phố Hà Nội
(72) Lê Thanh Hải (VN)
(74) Công ty TNHH Sở hữu trí tuệ M.I.T (M.I.T IP CO., LTD)
(55)



1.1



1.2

CÔNG BÁO SỞ HỮU CÔNG NGHIỆP SỐ 436 TẬP A – QUYỀN 2 (07.2024)

- (11) **50823**
(21) 3-2024-00347 (28) 1
(54) **TAY NẮM CỬA** (51) **08-06**
(22) 06/02/2024 (43) 25/07/2024
(73) **TRẦN ĐÌNH THI (VN)**
3X8-03 Sky Garden 3, phường Tân Phong, quận 7, thành phố Hồ Chí Minh
(72) Trần Đình Thi (VN)
(74) Công ty Luật TNHH MINH KHUÊ (MK LAW FIRM)
(55)

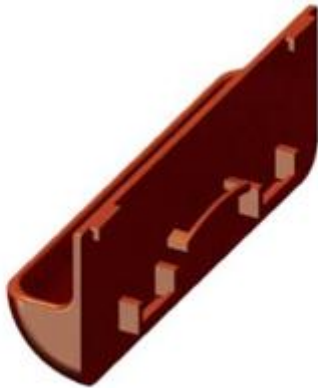

1.1



1.2

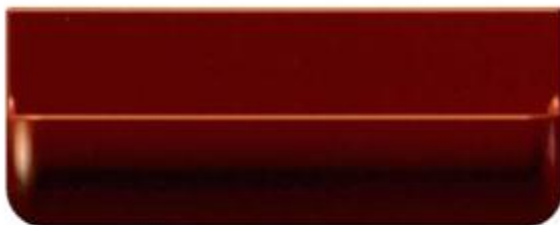

1.3

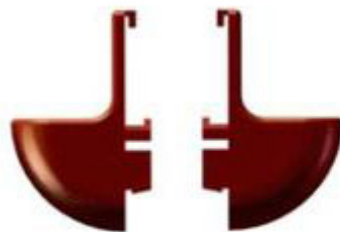

1.4

1.5



1.6



1.7

CÔNG BÁO SỞ HỮU CÔNG NGHIỆP SỐ 436 TẬP A – QUYỀN 2 (07.2024)

- (11) **50824**
(21) 3-2024-00338 (28) 1
(54) **BAO GÓI** (51) **09-05**
(22) 06/02/2024 (43) 25/07/2024
(73) **CÔNG TY TNHH THƯƠNG MẠI SẢN XUẤT VẠN THỊNH (VN)**
Số 5-7-9-11 đường Huỳnh Lan Khanh, phường 2, quận Tân Bình, thành phố Hồ Chí Minh
(72) Phan Thiện Ân (VN)
(74) **CÔNG TY TNHH SỞ HỮU TRÍ TUỆ SETHACO (SETHACO IP CO.,LTD)**
(55)



1.1



1.2

CÔNG BÁO SỞ HỮU CÔNG NGHIỆP SỐ 436 TẬP A – QUYỀN 2 (07.2024)

- (11) **50825**
(21) 3-2024-01234 (28) 1
(54) **QUẠT** (51) **23-04**
(22) 30/05/2024 (43) 25/07/2024
(30) 2024300549899 26/01/2024 CN;
(73) **WANG, CHENGUANG (CN)**
Room 2B, Block B, Building 3, Phase I, Deyi Mingju, No. 4221 Xilihu Road,
Nanshan District, Shenzhen, Guangdong, China
(72) WANG, Chenguang (CN)
(74) Công ty TNHH Sở hữu trí tuệ VIPATCO (VIPATCO CO., LTD.)
(55)



1.1



1.2



1.3



1.4



1.5



1.6



1.7



1.8

CÔNG BÁO SỞ HỮU CÔNG NGHIỆP SỐ 436 TẬP A – QUYỀN 2 (07.2024)

- (11) **50826**
(21) 3-2023-03191 (28) 1
(54) **BÚT** (51) **19-06**
(22) 31/08/2022 (43) 25/07/2024
(73) **CÔNG TY CỔ PHẦN TẬP ĐOÀN THIÊN LONG (VN)**
Tầng 10, Sofic Tower, số 10 đường Mai Chí Thọ, phường Thủ Thiêm, thành phố
Thủ Đức, thành phố Hồ Chí Minh
(72) Cô Gia Thọ (VN)
(74) Công ty TNHH Tư vấn sở hữu trí tuệ Việt (VIET IP CO.,LTD.)
(55)

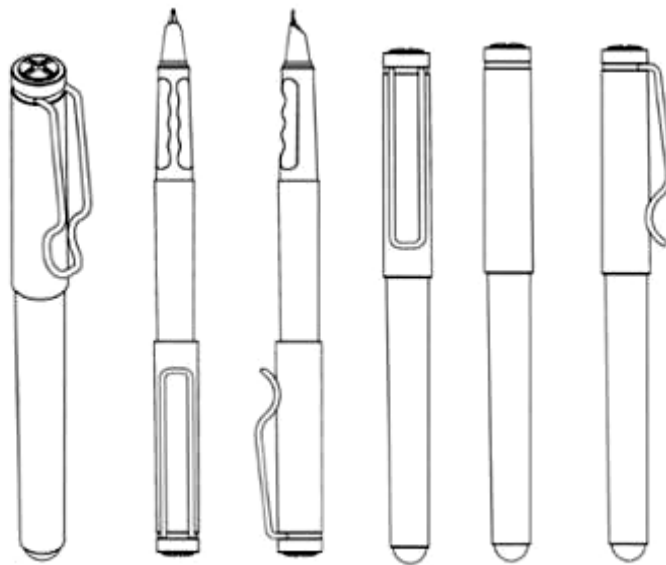

1.1

1.2

1.3

1.4

1.5

1.6



1.7



1.8

CÔNG BÁO SỞ HỮU CÔNG NGHIỆP SỐ 436 TẬP A – QUYỀN 2 (07.2024)

- (11) **50827**
(21) 3-2023-03192 (28) 1
(54) **BÚT** (51) **19-06**
(22) 31/08/2022 (43) 25/07/2024
(73) **CÔNG TY CỔ PHẦN TẬP ĐOÀN THIÊN LONG (VN)**
Tầng 10, Sofic Tower, số 10 đường Mai Chí Thọ, phường Thủ Thiêm, thành phố
Thủ Đức, thành phố Hồ Chí Minh
(72) Cô Gia Thọ (VN)
(74) Công ty TNHH Tư vấn sở hữu trí tuệ Việt (VIET IP CO.,LTD.)
(55)

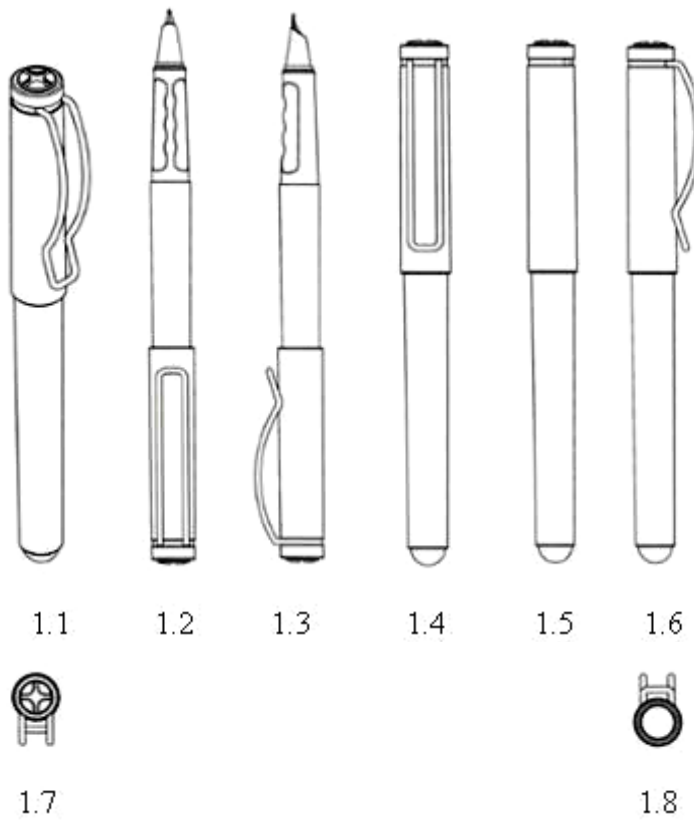

CÔNG BÁO SỞ HỮU CÔNG NGHIỆP SỐ 436 TẬP A – QUYỀN 2 (07.2024)

- (11) **50828**
(21) 3-2024-00232 (28) 1
(54) **THANH KIM LOẠI ĐỊNH HÌNH** (51) **25-01**
(22) 26/01/2024 (43) 25/07/2024
(73) **CÔNG TY CỔ PHẦN TẬP ĐOÀN EUROTECH (VN)**
Km số 3+500, đường Nguyễn Văn Linh, tổ 1, phường Thạch Bàn, quận Long Biên,
thành phố Hà Nội
(72) Nguyễn Văn Hoan (VN)
(55)

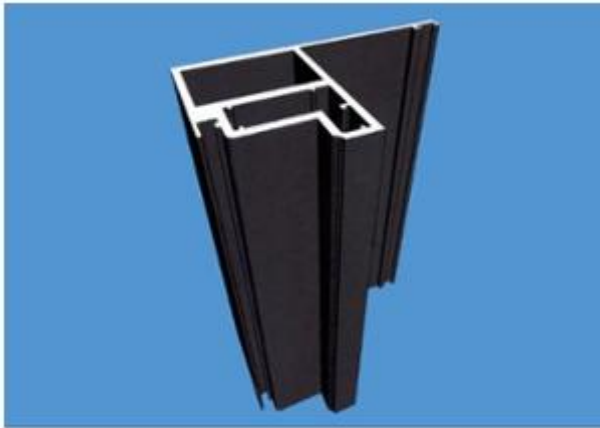

1.1

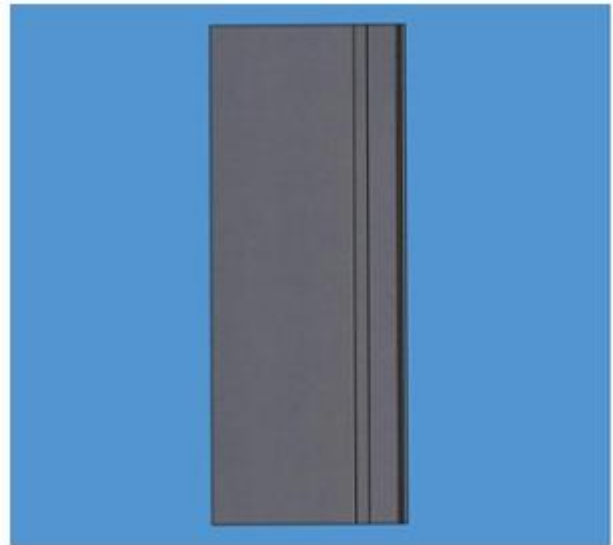

1.2

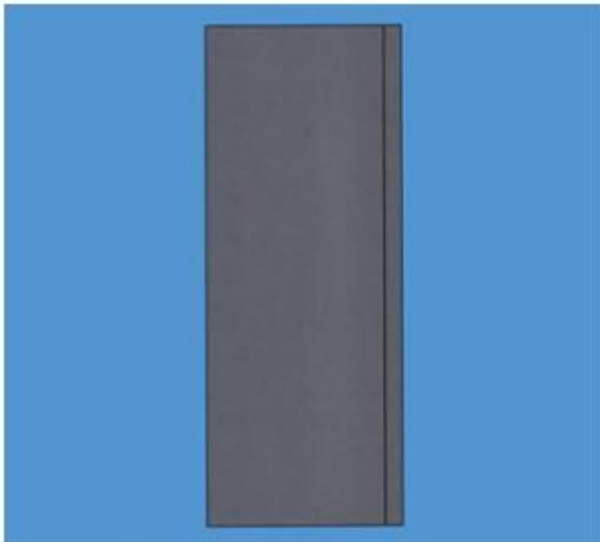

1.3

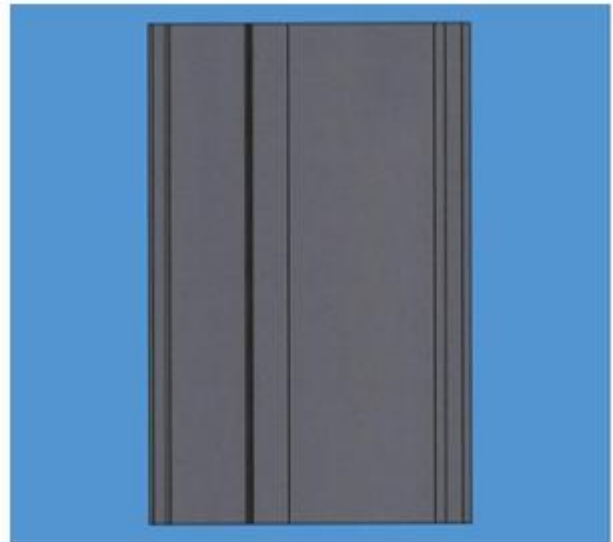

1.4

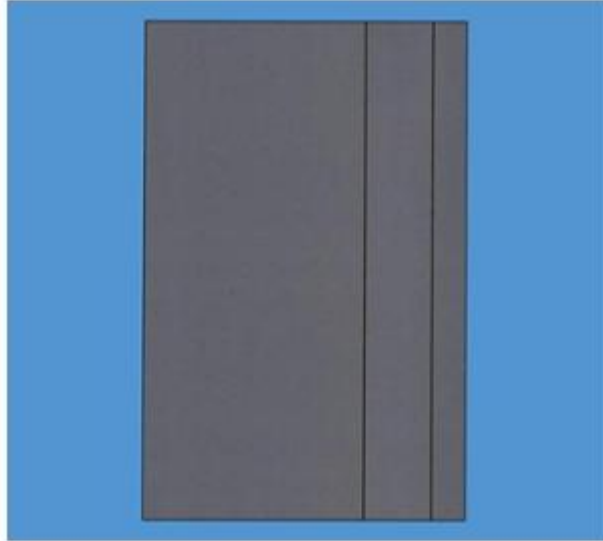

1.5

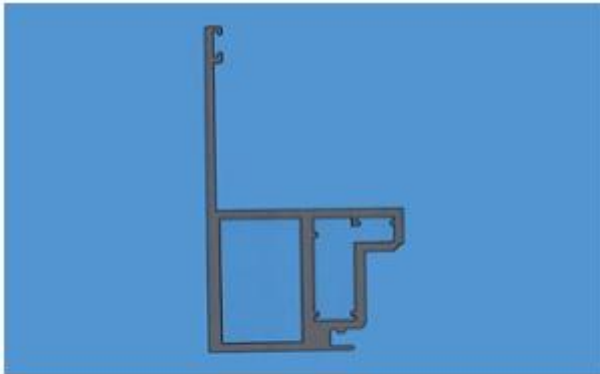

1.6

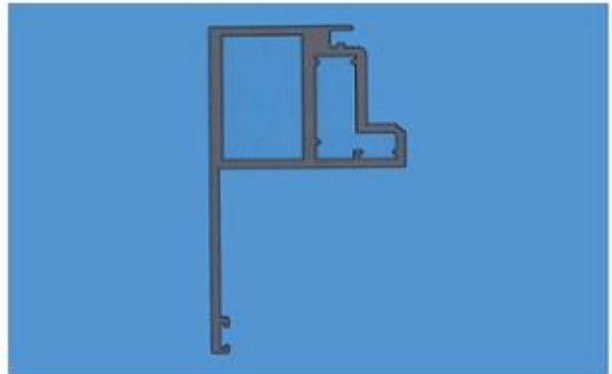

1.7

CÔNG BÁO SỞ HỮU CÔNG NGHIỆP SỐ 436 TẬP A – QUYỀN 2 (07.2024)

- (11) **50829**
(21) 3-2024-00233 (28) 1
(54) **THANH KIM LOẠI ĐỊNH HÌNH** (51) **25-01**
(22) 26/01/2024 (43) 25/07/2024
(73) **CÔNG TY CỔ PHẦN TẬP ĐOÀN EUROTECH (VN)**
Km số 3+500, đường Nguyễn Văn Linh, tổ 1, phường Thạch Bàn, quận Long Biên,
thành phố Hà Nội
(72) Nguyễn Văn Hoan (VN)
(55)

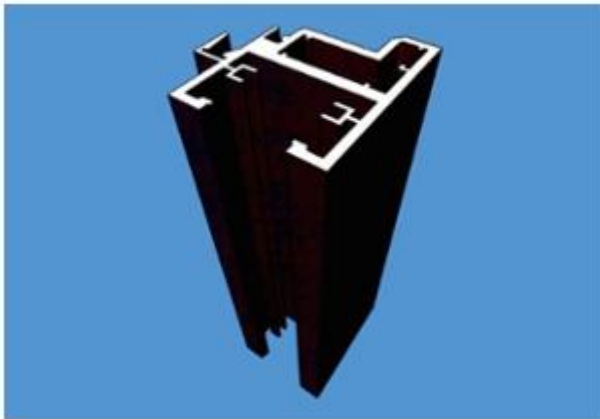

1.1

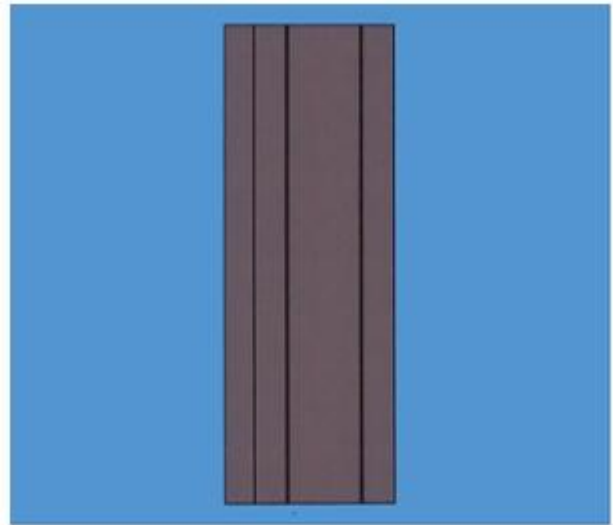

1.2

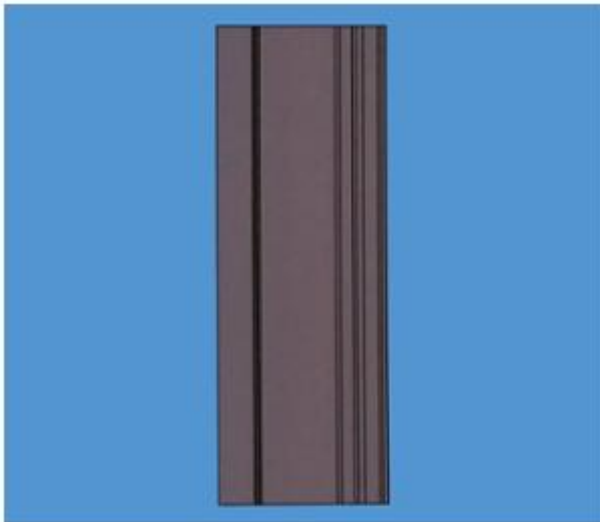

1.3

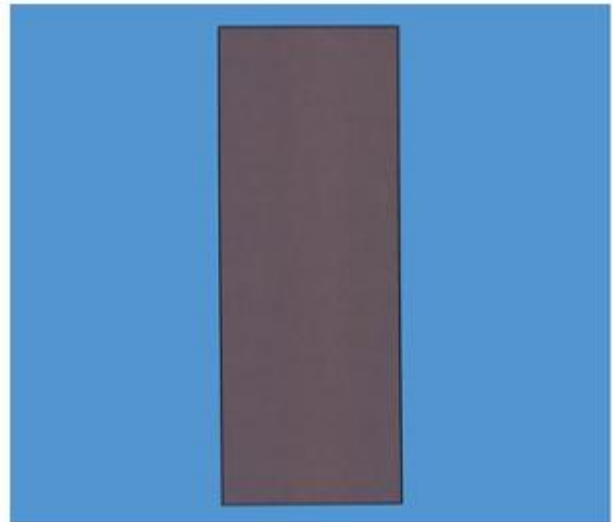

1.4

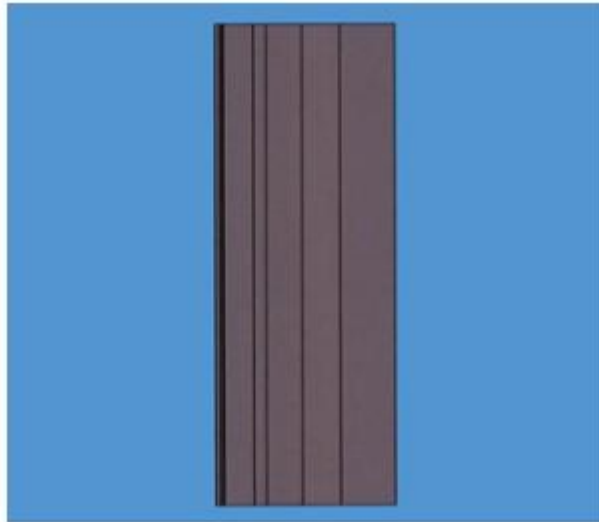

1.5

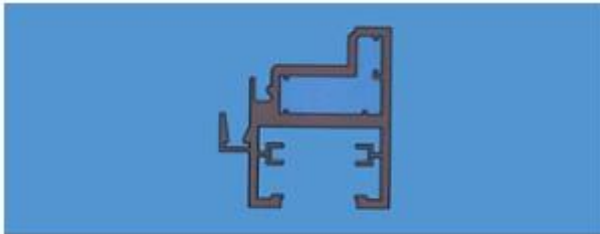

1.6

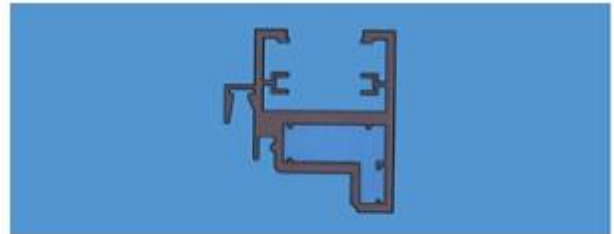

1.7

CÔNG BÁO SỞ HỮU CÔNG NGHIỆP SỐ 436 TẬP A – QUYỀN 2 (07.2024)

- (11) **50830**
(21) 3-2024-00234 (28) 1
(54) **THANH KIM LOẠI ĐỊNH HÌNH** (51) **25-01**
(22) 26/01/2024 (43) 25/07/2024
(73) **CÔNG TY CỔ PHẦN TẬP ĐOÀN EUROTECH (VN)**
Km số 3+500, đường Nguyễn Văn Linh, tổ 1, phường Thạch Bàn, quận Long Biên,
thành phố Hà Nội
(72) Nguyễn Văn Hoan (VN)
(55)

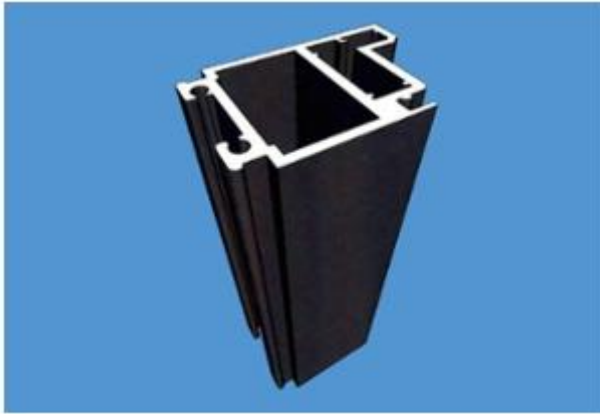

1.1

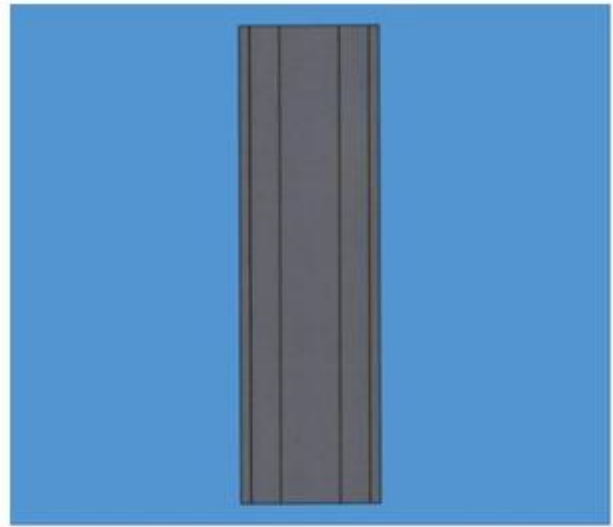

1.2

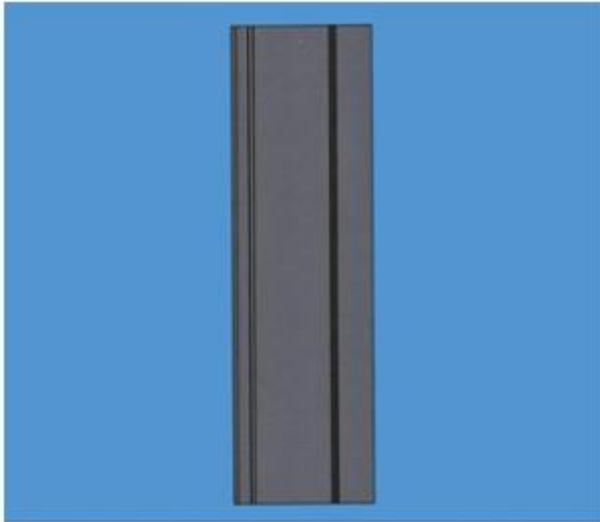

1.3

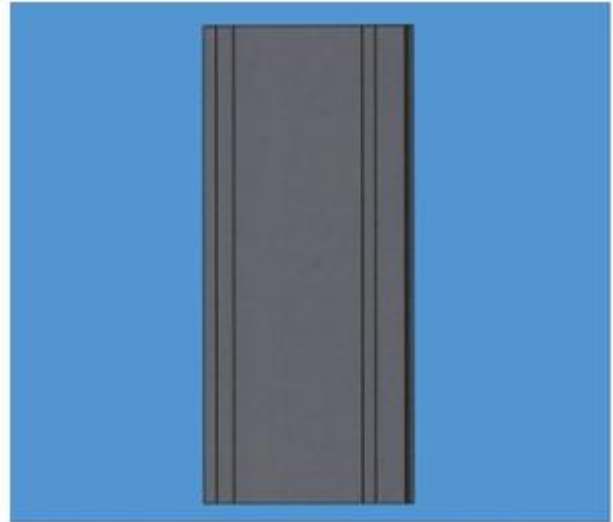

1.4

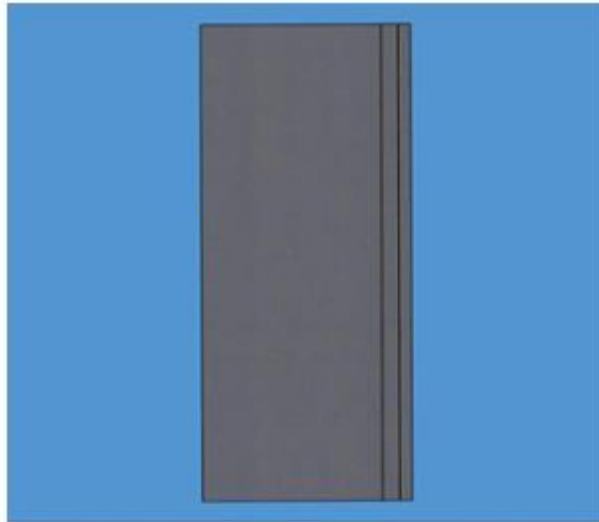

1.5

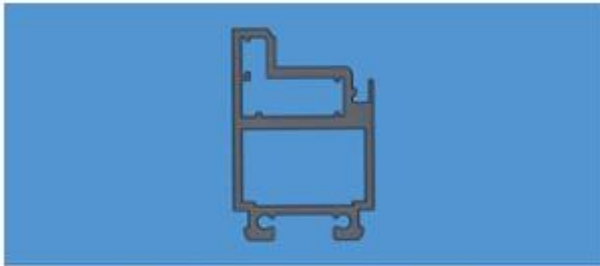

1.6

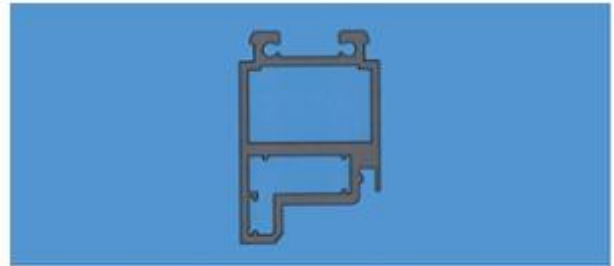

1.7

CÔNG BÁO SỞ HỮU CÔNG NGHIỆP SỐ 436 TẬP A – QUYỀN 2 (07.2024)

- (11) **50831**
(21) 3-2024-00237 (28) 1
(54) **BÚT** (51) **19-06**
(22) 26/01/2024 (43) 25/07/2024
(73) **CÔNG TY CỔ PHẦN TẬP ĐOÀN THIÊN LONG (VN)**
Tầng 10, Sofic Tower, số 10 đường Mai Chí Thọ, phường Thủ Thiêm, thành phố
Thủ Đức, thành phố Hồ Chí Minh
(72) Cô Gia Thọ (VN)
(74) Công ty TNHH Tư vấn sở hữu trí tuệ Việt (VIET IP CO.,LTD.)
(55)

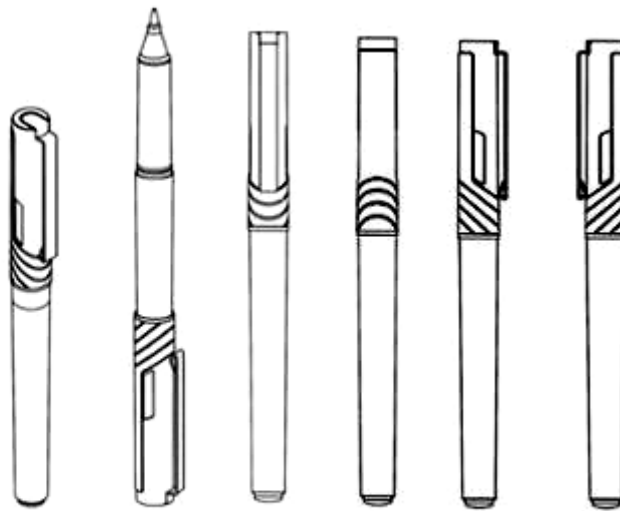

1.1

1.2

1.3

1.4

1.5

1.6



1.7



1.8

CÔNG BÁO SỞ HỮU CÔNG NGHIỆP SỐ 436 TẬP A – QUYỀN 2 (07.2024)

- (11) **50832**
(21) 3-2024-00265 (28) 1
(54) **DỤNG CỤ MÀI ĐAO** (51) **08-05**
(22) 30/01/2024 (43) 25/07/2024
(30) 29/910,106 15/08/2023 US;
(73) **DAREX, LLC (US)**
210 East Hersey Street, Ashland, Oregon 97520, United States of America
(72) 1. JOSEPH T. ZACHARIASEN (US)
2. CONNER S. MACFARLANE (US)
(74) Công ty TNHH Quốc tế D&N (D&N INTERNATIONAL CO.,LTD.)
(55)

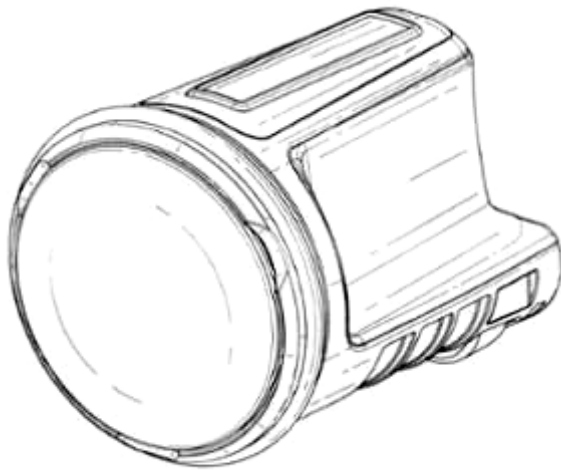

1.1



1.2

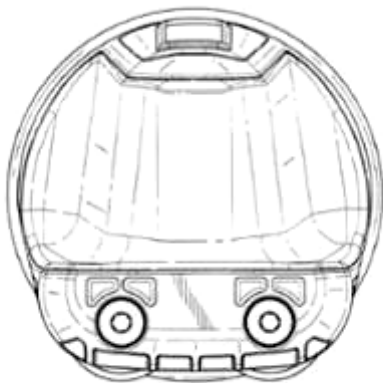

1.3

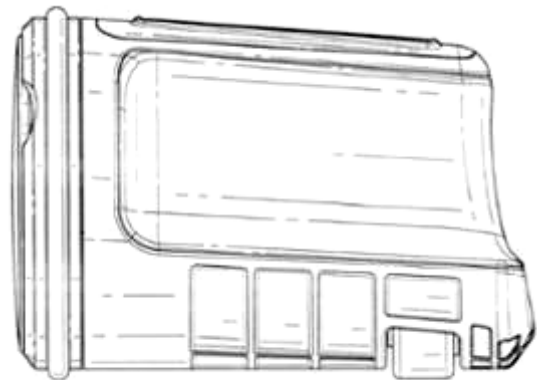

1.4

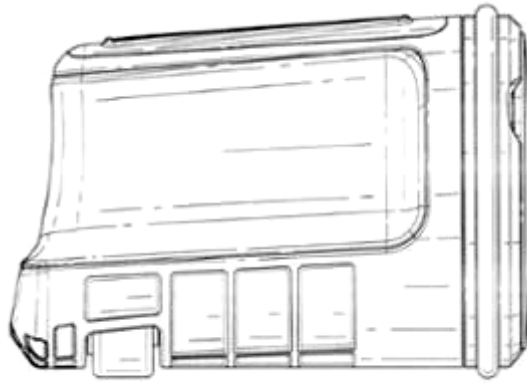

1.5

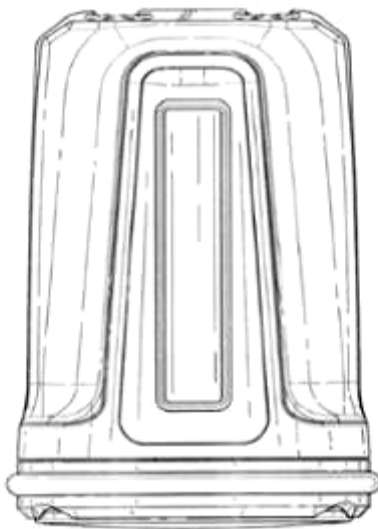

1.6

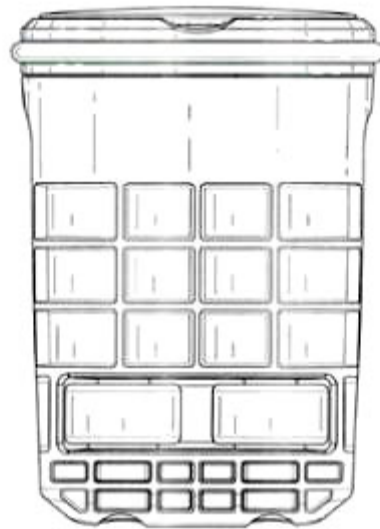

1.7

CÔNG BÁO SỞ HỮU CÔNG NGHIỆP SỐ 436 TẬP A – QUYỀN 2 (07.2024)

- (11) **50833**
(21) 3-2024-00264 (28) 1
(54) **LY ĐỤNG NÉN** (51) **26-01**
(22) 30/01/2024 (43) 25/07/2024
(73) **CÔNG TY TNHH SẢN XUẤT THƯƠNG MẠI QUANG NGHỆ (VN)**
205B/28 Âu Cơ, phường 5, quận 11, thành phố Hồ Chí Minh
(72) Thi Lương (VN)
(55)



1.1



1.2



1.3



1.4



1.5

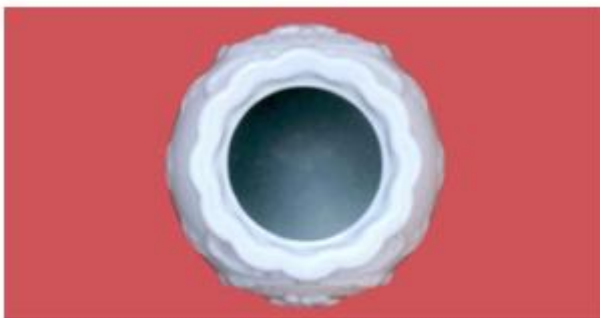

1.6



1.7

CÔNG BÁO SỞ HỮU CÔNG NGHIỆP SỐ 436 TẬP A – QUYỀN 2 (07.2024)

- (11) **50834**
(21) 3-2024-00267 (28) 1
(54) **THANH KIM LOẠI ĐỊNH HÌNH** (51) **25-01**
(22) 30/01/2024 (43) 25/07/2024
(73) **CÔNG TY CỔ PHẦN TẬP ĐOÀN EUROTECH (VN)**
Km số 3+500, đường Nguyễn Văn Linh, tổ 1, phường Thạch Bàn, quận Long Biên,
thành phố Hà Nội
(72) Nguyễn Văn Hoan (VN)
(55)



1.1

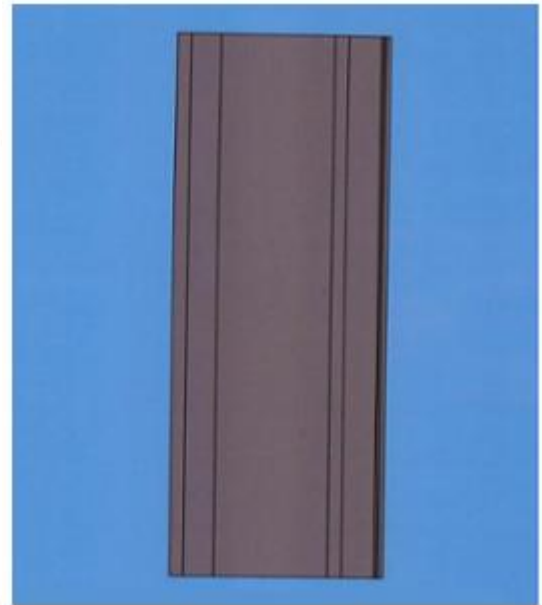

1.2

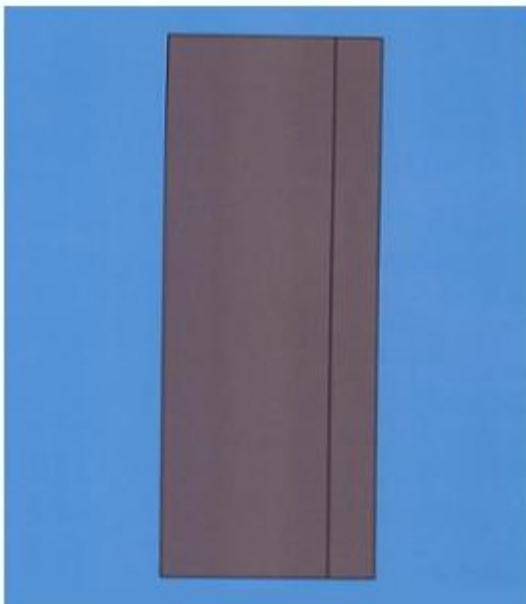

1.3

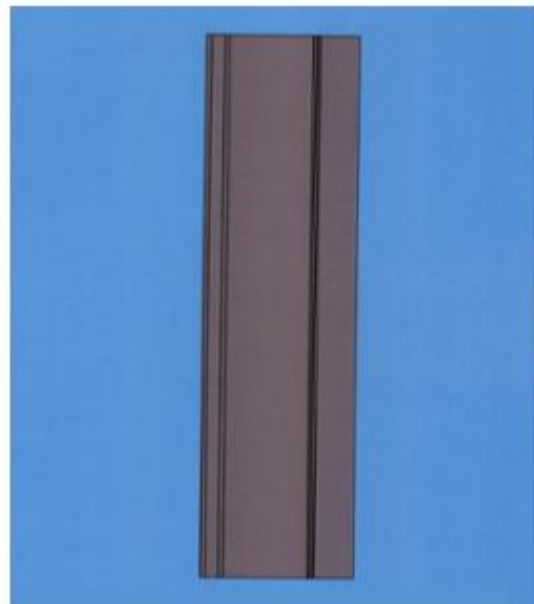

1.4

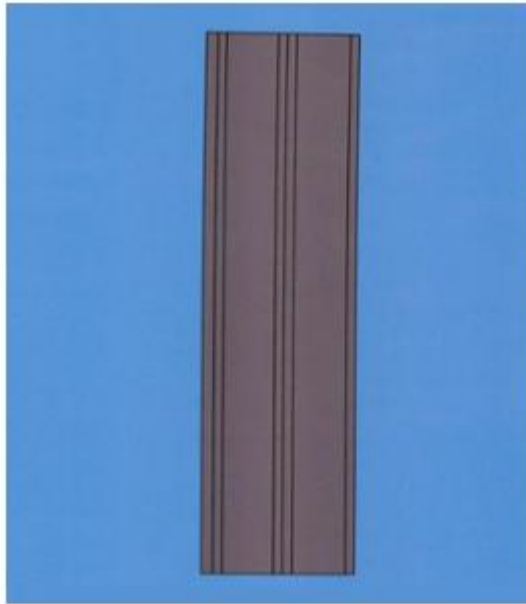

1.5

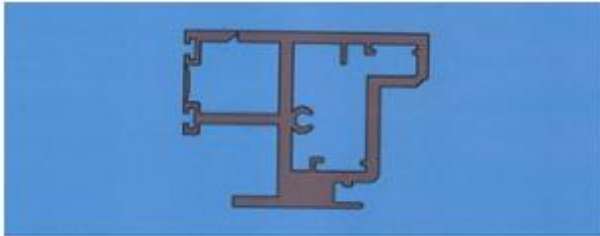

1.6

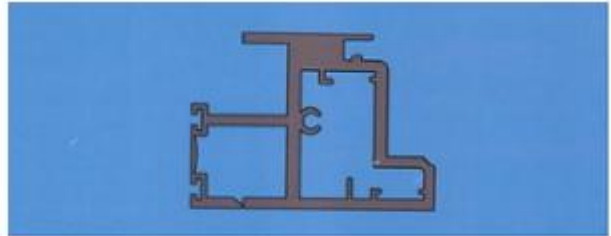

1.7

CÔNG BÁO SỞ HỮU CÔNG NGHIỆP SỐ 436 TẬP A – QUYỀN 2 (07.2024)

- (11) **50835**
(21) 3-2024-00268 (28) 1
(54) **THANH KIM LOẠI ĐỊNH HÌNH** (51) **25-01**
(22) 30/01/2024 (43) 25/07/2024
(73) **CÔNG TY CỔ PHẦN TẬP ĐOÀN EUROTECH (VN)**
Km số 3+500, đường Nguyễn Văn Linh, tổ 1, phường Thạch Bàn, quận Long Biên,
thành phố Hà Nội
(72) Nguyễn Văn Hoan (VN)
(55)

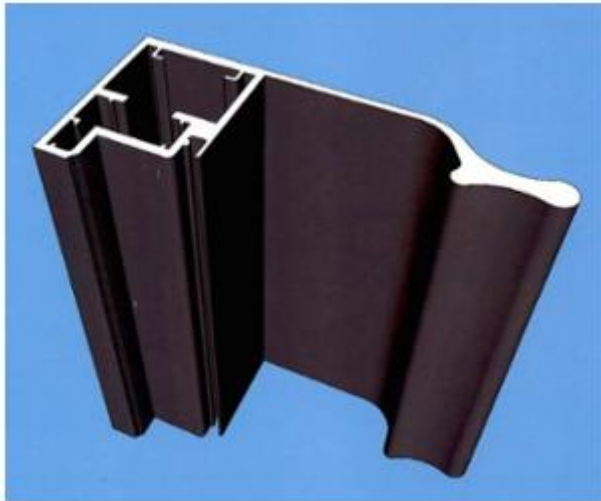

1.1

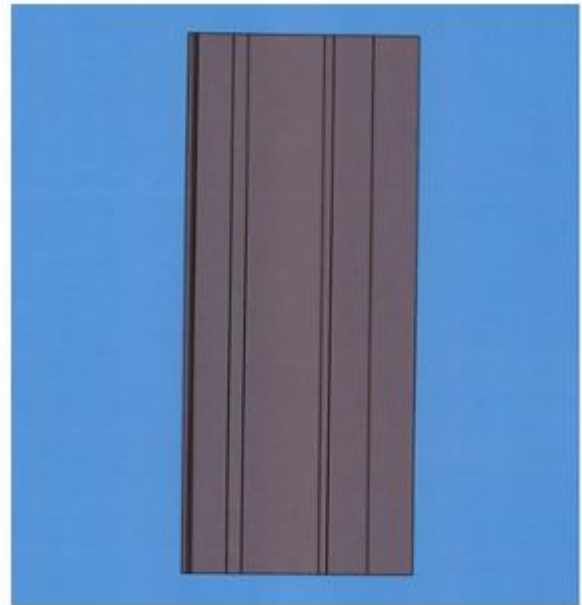

1.2

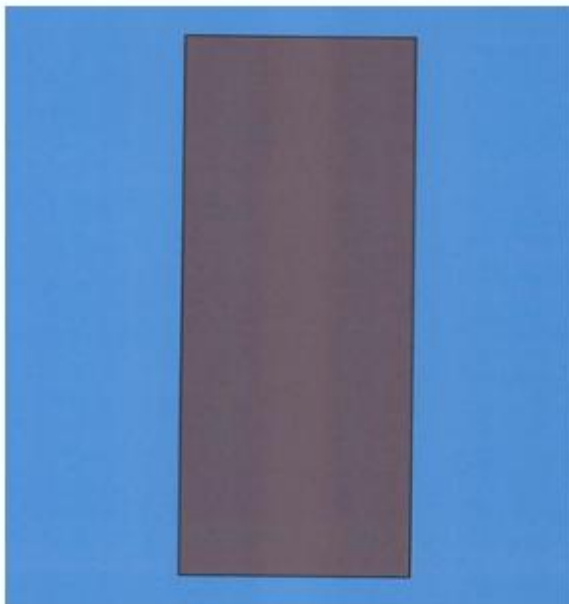

1.3



1.4

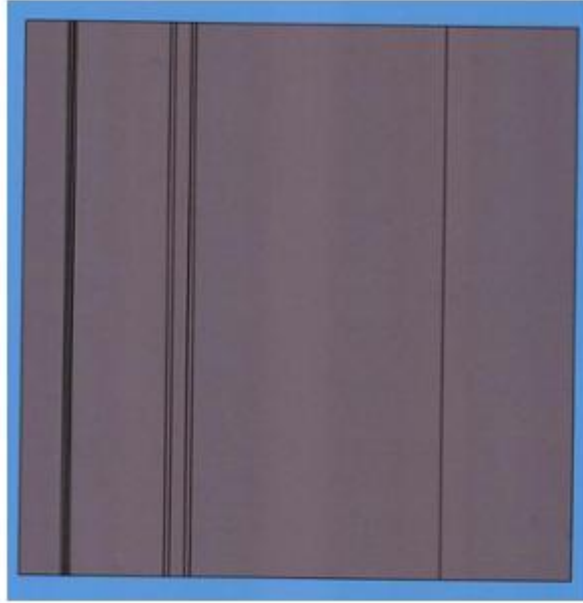

1.5

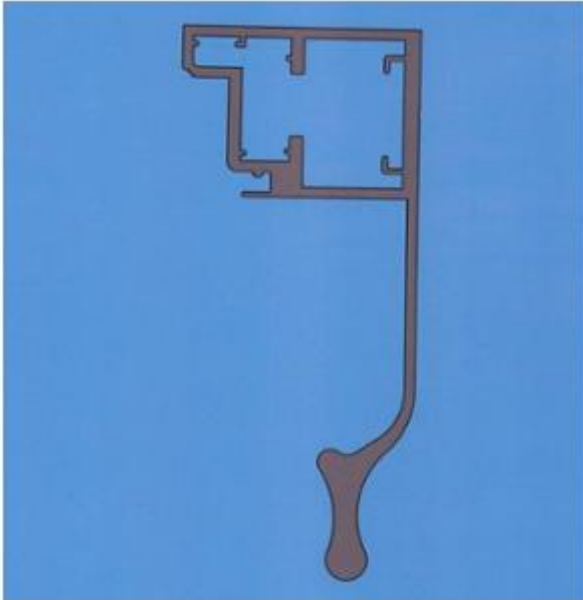

1.6

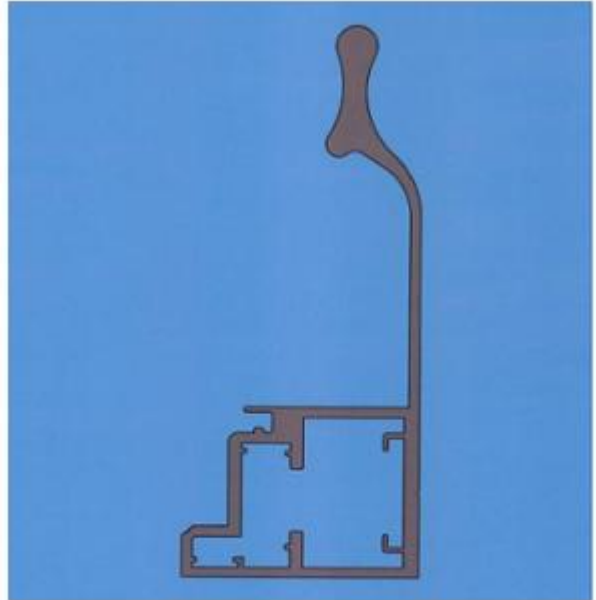

1.7

CÔNG BÁO SỞ HỮU CÔNG NGHIỆP SỐ 436 TẬP A – QUYỀN 2 (07.2024)

(11) **50836**

(21) 3-2024-01347

(28) 1

(54) **MÁY LỌC NƯỚC**

(51) **23-01**

(22) 11/06/2024

(43) 25/07/2024

(73) **CÔNG TY TNHH SẢN XUẤT ĐỒ GIA DỤNG SUNHOUSE (VN)**

Ngọc Liệp, xã Ngọc Liệp, huyện Quốc Oai, thành phố Hà Nội

(72) Lại Văn Kiên (VN)

(74) Công ty TNHH Sở hữu trí tuệ Bình Minh (SUNRISE IP CO.,LTD.)

(55)

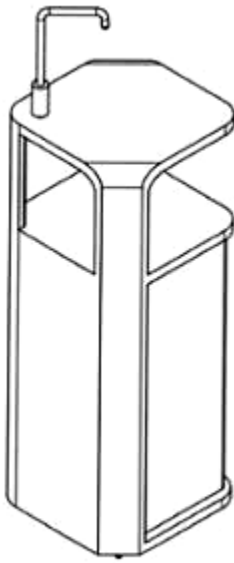

1.1

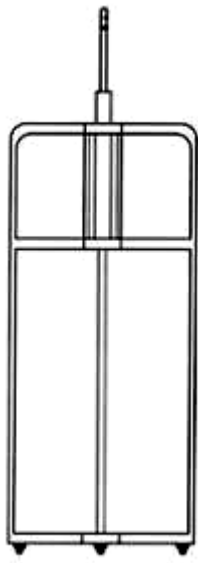

1.2

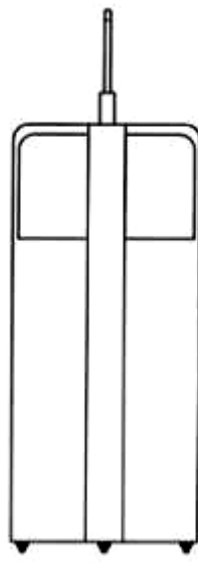

1.3



1.4

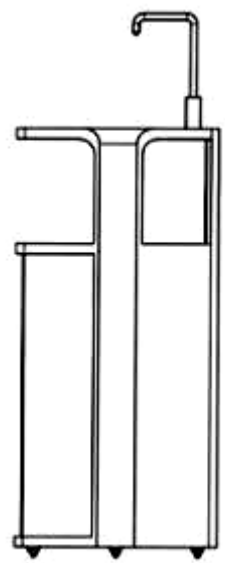

1.5

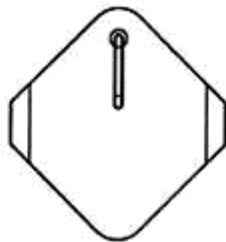

1.6

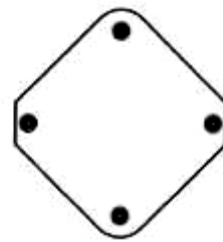

1.7

CÔNG BÁO SỞ HỮU CÔNG NGHIỆP SỐ 436 TẬP A – QUYỀN 2 (07.2024)

- (11) **50837**
(21) 3-2024-01357 (28) 1
(54) **THIẾT BỊ PHÁT HƯƠNG THƠM CHO XE HƠI** (51) **23-04**
(22) 11/06/2024 (43) 25/07/2024
(73) **CÔNG TY CỔ PHẦN TMDV XNK DŨNG VINH (VN)**
Số 19 ngõ 10 đường Nguyễn Thị Định, phường Trung Hoà, quận Cầu Giấy, thành phố Hà Nội
(72) Nguyễn Thị Hồng Đăng (VN)
(74) Công ty TNHH Sở hữu trí tuệ VNNA & Associates (IP NGOC ANH TRADE AND SERVICE COMPANY LIMITED)
(55)



1.1



1.2



1.3



1.4



1.5



1.6

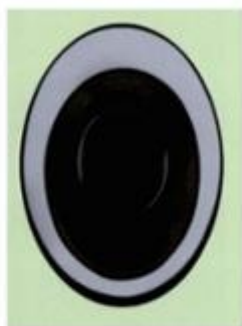

1.7



1.8

CÔNG BÁO SỞ HỮU CÔNG NGHIỆP SỐ 436 TẬP A – QUYỀN 2 (07.2024)

- (11) **50838**
(21) 3-2023-01508 (28) 2
(54) **NẮP NỒI** (51) **07-02**
(22) 05/07/2023 (43) 25/07/2024
(30) 29/881,781 06/01/2023 US;
(73) **DART INDUSTRIES INC. (US)**
14901 S. Orange Blossom Trail, Orlando, Florida, 32837, United States of America
(72) Andrea Boscic (BE)
(74) **CÔNG TY LUẬT TRÁCH NHIỆM HỮU HẠN AMBYS HÀ NỘI (AMBYS HANOI)**
(55)



1.1

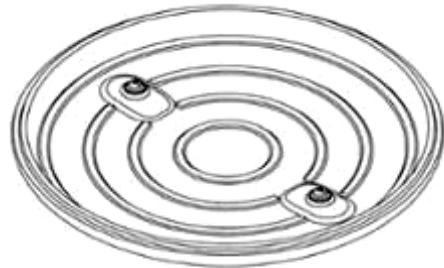

1.2



1.3

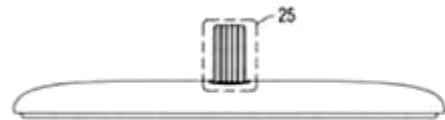

1.4

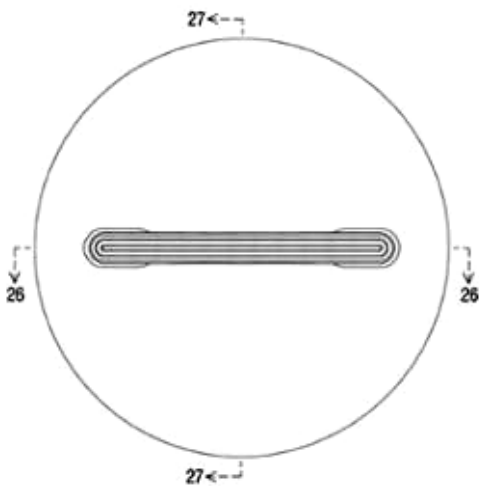

1.5

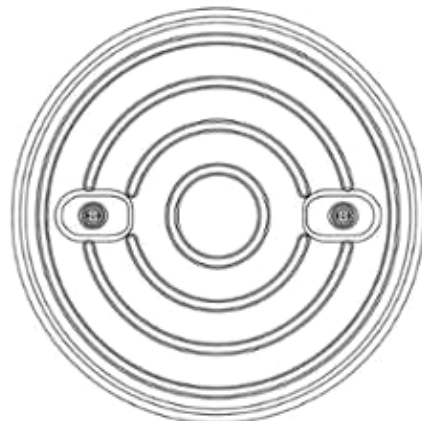

1.6

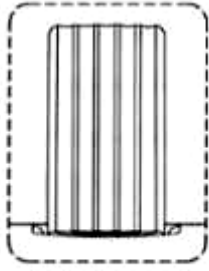

1.7

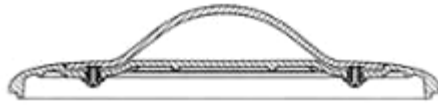

1.8

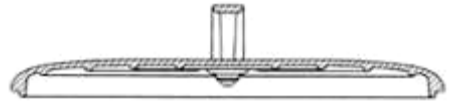

1.9



2.1



2.2



2.3

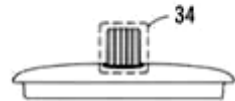

2.4

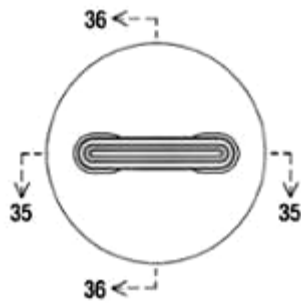

2.5

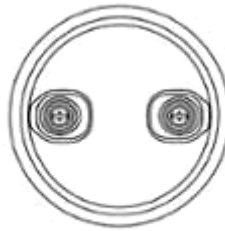

2.6

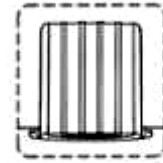

2.7



2.8



2.9

CÔNG BÁO SỞ HỮU CÔNG NGHIỆP SỐ 436 TẬP A – QUYỀN 2 (07.2024)

- (11) **50839**
(21) 3-2024-00269 (28) 1
(54) **THANH KIM LOẠI ĐỊNH HÌNH** (51) **25-01**
(22) 30/01/2024 (43) 25/07/2024
(73) **CÔNG TY CỔ PHẦN TẬP ĐOÀN EUROTECH (VN)**
Km số 3+500, đường Nguyễn Văn Linh, tổ 1, phường Thạch Bàn, quận Long Biên,
thành phố Hà Nội
(72) Nguyễn Văn Hoan (VN)
(55)

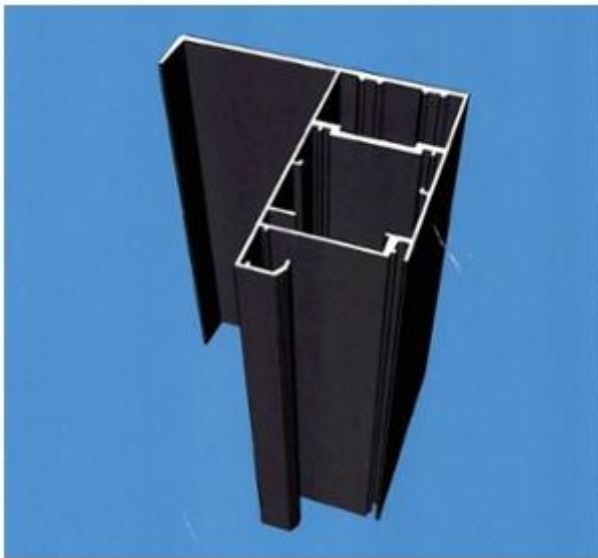

1.1



1.2

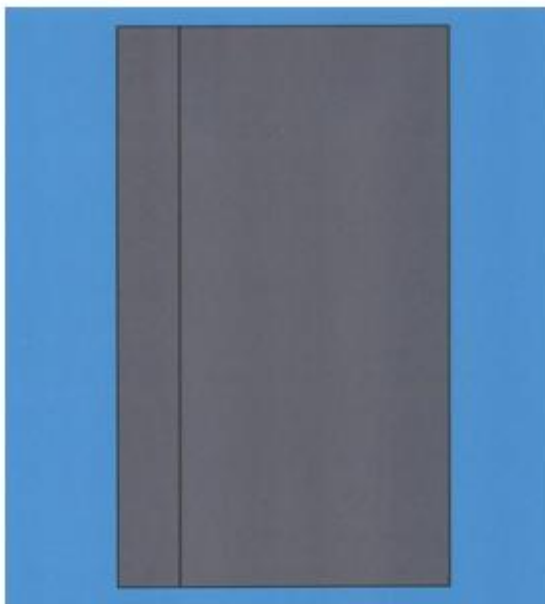

1.3

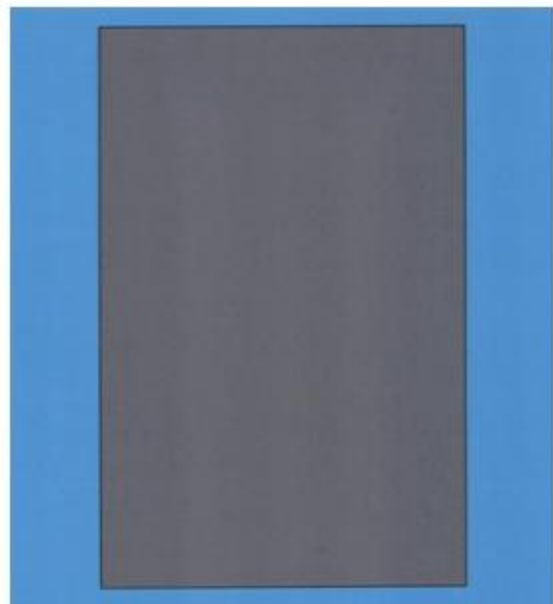

1.4

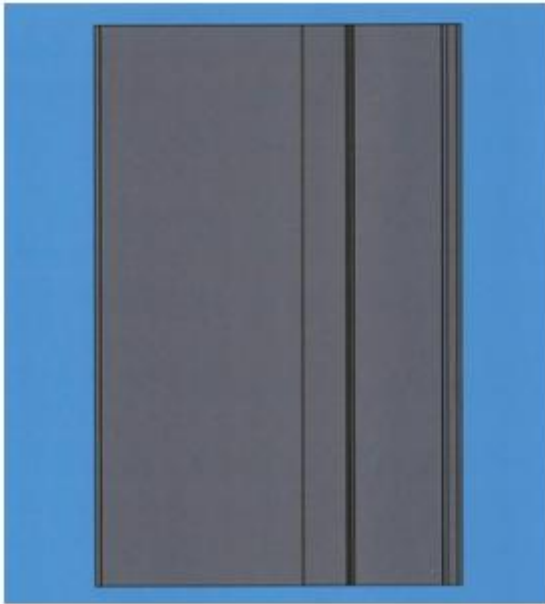

1.5

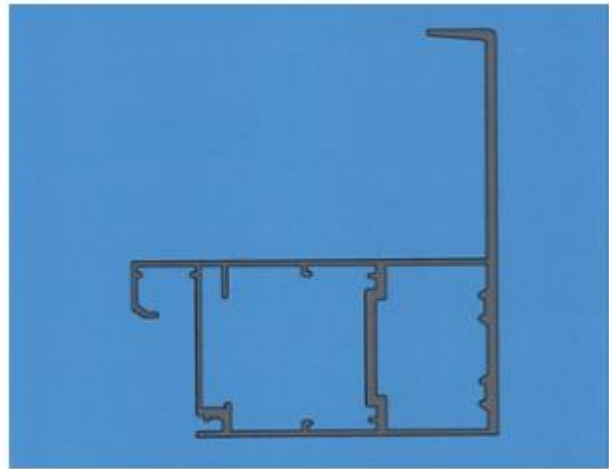

1.6

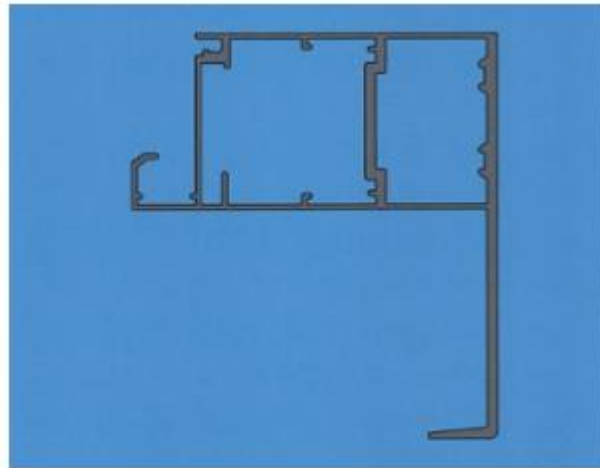

1.7

CÔNG BÁO SỞ HỮU CÔNG NGHIỆP SỐ 436 TẬP A – QUYỀN 2 (07.2024)

- (11) **50840**
(21) 3-2024-00270 (28) 1
(54) **THANH KIM LOẠI ĐỊNH HÌNH** (51) **25-01**
(22) 30/01/2024 (43) 25/07/2024
(73) **CÔNG TY CỔ PHẦN TẬP ĐOÀN EUROTECH (VN)**
Km số 3+500, đường Nguyễn Văn Linh, tổ 1, phường Thạch Bàn, quận Long Biên,
thành phố Hà Nội
(72) Nguyễn Văn Hoan (VN)
(55)

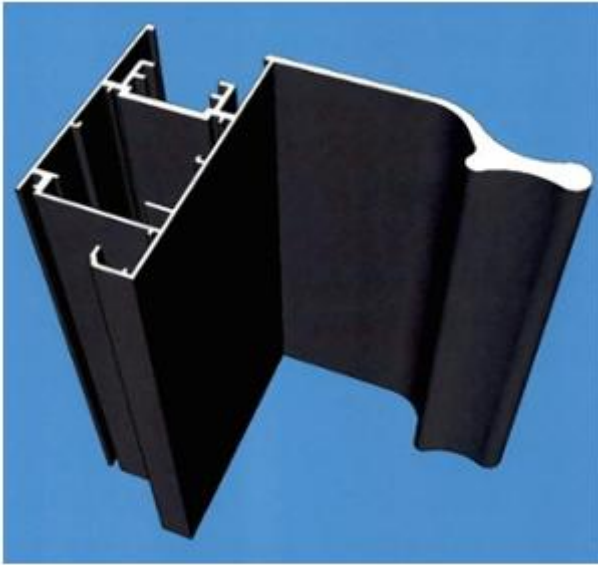

1.1

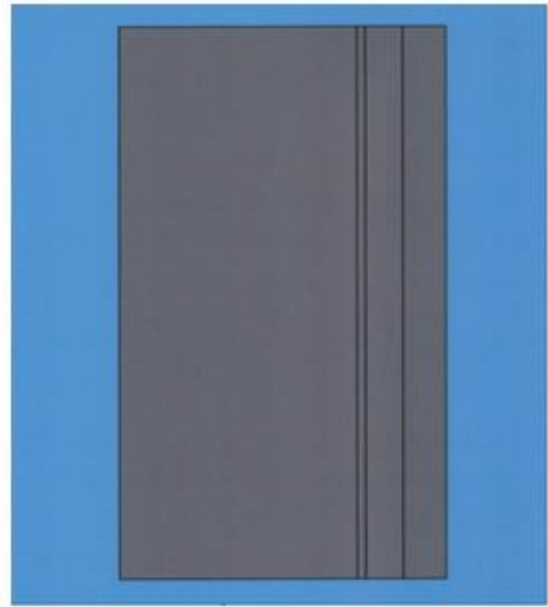

1.2

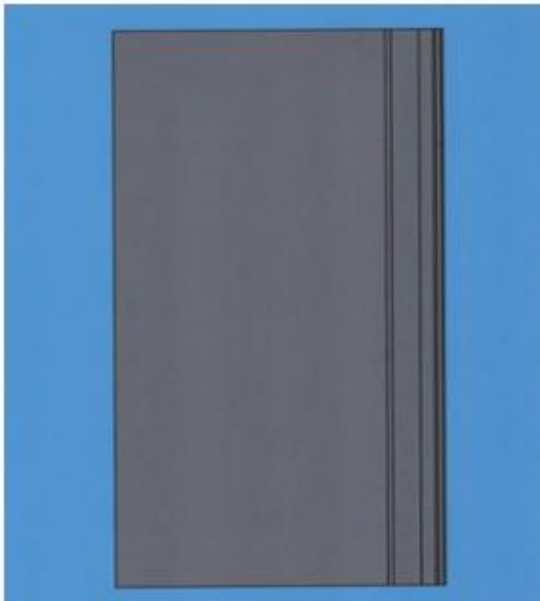

1.3



1.4



1.5

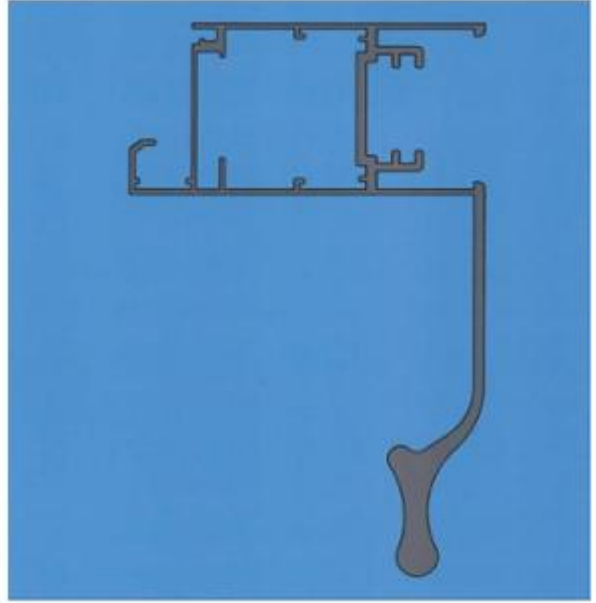

1.6

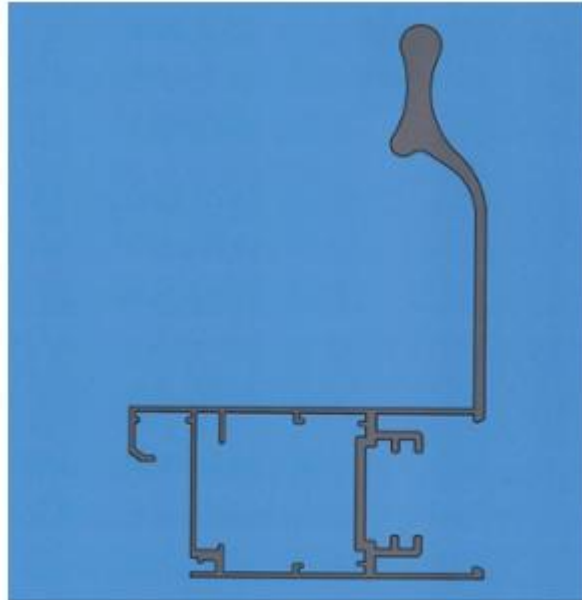

1.7

CÔNG BÁO SỞ HỮU CÔNG NGHIỆP SỐ 436 TẬP A – QUYỀN 2 (07.2024)

- (11) **50841**
(21) 3-2024-00275 (28) 1
(54) **CHAI** (51) **09-01**
(22) 30/01/2024 (43) 25/07/2024
(73) **CÔNG TY TNHH SẢN XUẤT MỸ PHẨM ANH ĐÀO (VN)**
Số 1/18D, đường Chi Lăng, phường Vĩnh Bảo, thành phố Rạch Giá, tỉnh Kiên Giang
(72) Phạm Thị Đào (VN)
(74) Công ty TNHH Tư vấn - Dịch thuật - Sở hữu trí tuệ Á Đông (Á Đông IP CONSULTANCY CO.,LTD.)
(55)



1.1



1.2



1.3



1.4



1.5

CÔNG BÁO SỞ HỮU CÔNG NGHIỆP SỐ 436 TẬP A – QUYỀN 2 (07.2024)

- (11) **50842**
(21) 3-2024-00564 (28) 1
(54) **TẤM TƯỜNG BÊ TÔNG RỖNG ĐÚC SẴN LẮP GHÉP** (51) **25-02**
(22) 08/03/2024 (43) 25/07/2024
(73) **NGUYỄN XUÂN THỦY (VN)**
Tổ 3, khu 10, phường Bãi Cháy, thành phố Hạ Long, tỉnh Quảng Ninh
(72) Nguyễn Xuân Thủy (VN)
(55)

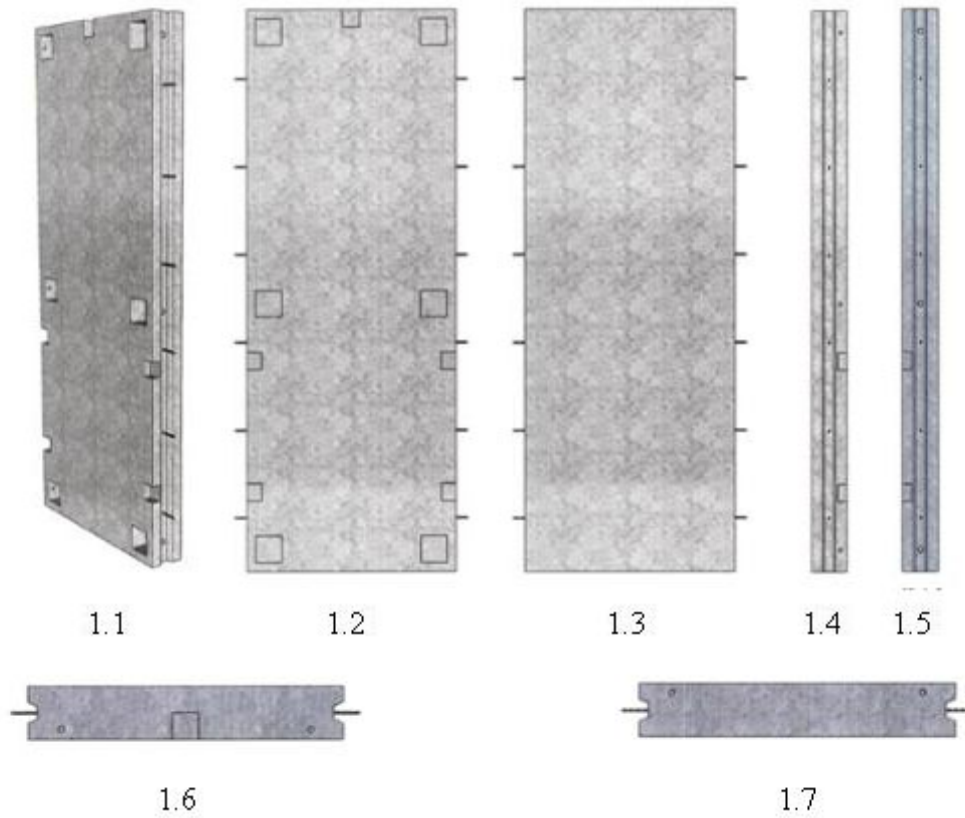

CÔNG BÁO SỞ HỮU CÔNG NGHIỆP SỐ 436 TẬP A – QUYỀN 2 (07.2024)

- (11) **50843**
(21) 3-2024-00569 (28) 1
(54) **NHÃN SẢN PHẨM** (51) **19-08**
(22) 08/03/2024 (43) 25/07/2024
(73) **CÔNG TY TNHH NAM PHƯƠNG V.N (VN)**
124 Lê Lai, phường 03, quận Gò Vấp, thành phố Hồ Chí Minh
(72) Hoàng Thị Minh Hiếu (VN)
(74) Công ty Luật TNHH Phạm và Liên danh (PHAM & ASSOCIATES)
(55)



CÔNG BÁO SỞ HỮU CÔNG NGHIỆP SỐ 436 TẬP A – QUYỀN 2 (07.2024)

- (11) **50844**
(21) 3-2024-00501 (28) 1
(54) **MÓC ĐIỀU CHỈNH DÂY** (51) **02-07**
(22) 04/03/2024 (43) 25/07/2024
(30) 202330603099.4 15/09/2023 CN;
(73) **DURAFLEX HONG KONG LIMITED (CN)**
Block 1, 15/F, Tern Centre, 237 Queen's Road Central, Sheung Wan, Hong Kong
(72) Yick Fai CHAN (CN)
(74) Công ty Luật TNHH Phạm và Liên danh (PHAM & ASSOCIATES)
(55)

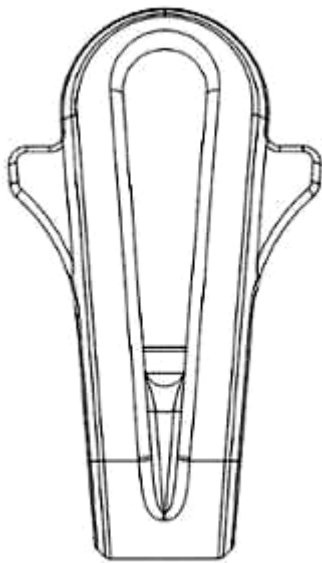

1.1

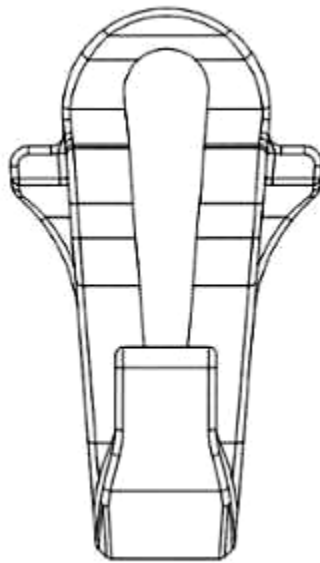

1.2

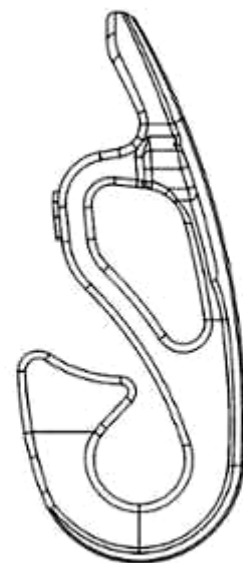

1.3

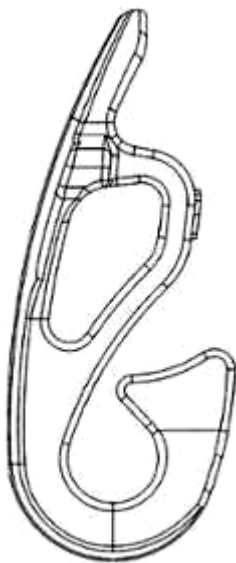

1.4

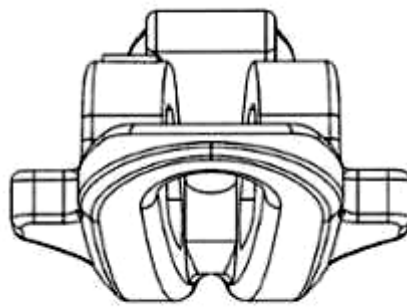

1.5

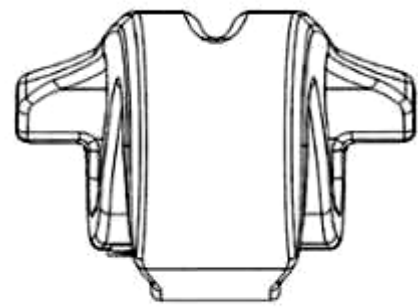

1.6

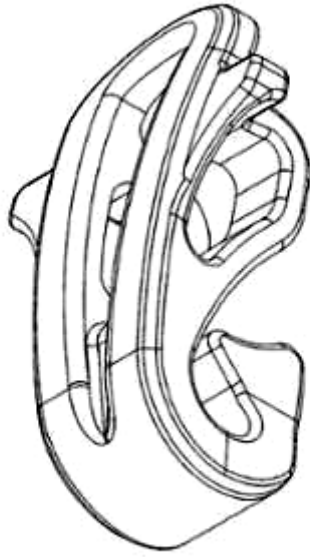

1.7

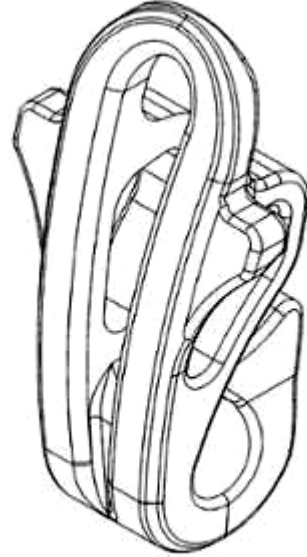

1.8

CÔNG BÁO SỞ HỮU CÔNG NGHIỆP SỐ 436 TẬP A – QUYỀN 2 (07.2024)

(11) **50845**

(21) 3-2024-00503

(28) 1

(54) **CHAI**

(51) **09-01**

(22) 04/03/2024

(43) 25/07/2024

(73) **CÔNG TY TNHH KIM LÂM (VN)**

Lô A2.CN7 - Cụm công nghiệp tập trung vừa và nhỏ Từ Liêm, phường Phương Canh, quận Nam Từ Liêm, thành phố Hà Nội

(72) **Võ Thị Liễu Trâm (VN)**

(55)



1.1



1.2

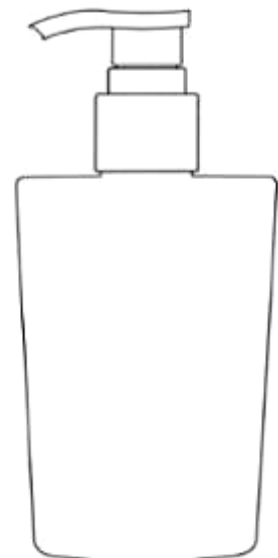

1.3



1.4



1.5

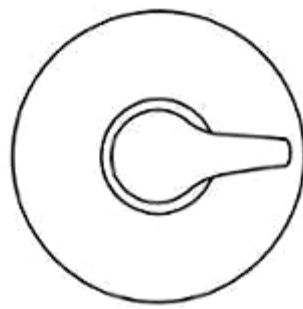

1.6

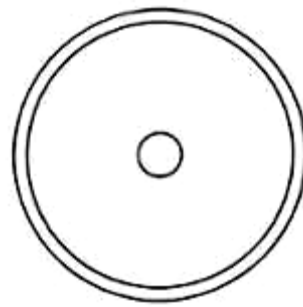

1.7

CÔNG BÁO SỞ HỮU CÔNG NGHIỆP SỐ 436 TẬP A – QUYỀN 2 (07.2024)

(11) **50846**

(21) 3-2024-00504

(28) 1

(54) **CHAI**

(51) **09-01**

(22) 04/03/2024

(43) 25/07/2024

(73) **CÔNG TY TNHH KIM LÂM (VN)**

Lô A2.CN7 - Cụm công nghiệp tập trung vừa và nhỏ Từ Liêm, phường Phương Canh, quận Nam Từ Liêm, thành phố Hà Nội

(72) **Võ Thị Liễu Trâm (VN)**

(55)



1.1



1.2

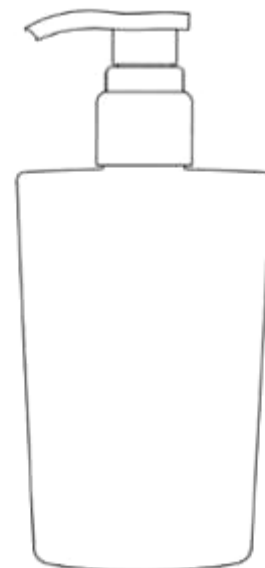

1.3



1.4



1.5

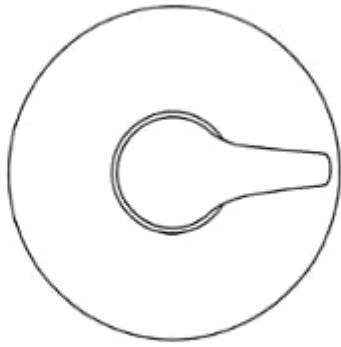

1.6

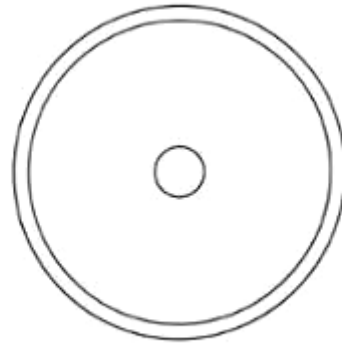

1.7

CÔNG BÁO SỞ HỮU CÔNG NGHIỆP SỐ 436 TẬP A – QUYỀN 2 (07.2024)

(11) **50847**

(21) 3-2024-00505

(28) 1

(54) **CHAI**

(51) **09-01**

(22) 04/03/2024

(43) 25/07/2024

(73) **CÔNG TY TNHH KIM LÂM (VN)**

Lô A2.CN7 - Cụm công nghiệp tập trung vừa và nhỏ Từ Liêm, phường Phương Canh, quận Nam Từ Liêm, thành phố Hà Nội

(72) **Võ Thị Liễu Trâm (VN)**

(55)

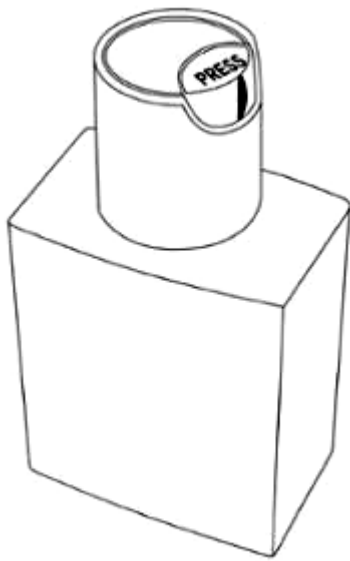

1.1

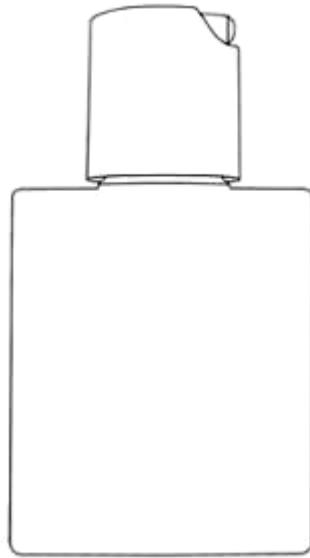

1.2

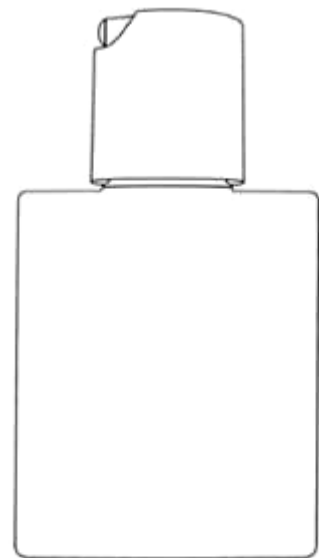

1.3



1.4

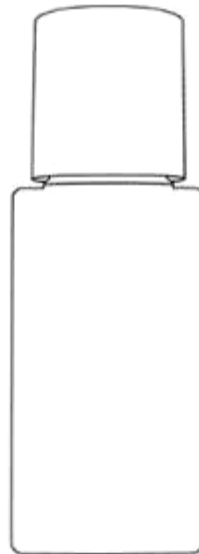

1.5

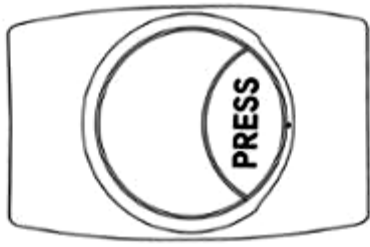

1.6

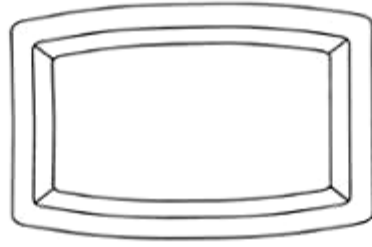

1.7

CÔNG BÁO SỞ HỮU CÔNG NGHIỆP SỐ 436 TẬP A – QUYỀN 2 (07.2024)

- (11) **50848**
(21) 3-2024-00509 (28) 1
(54) **VÒI NƯỚC** (51) **23-01**
(22) 04/03/2024 (43) 25/07/2024
(73) **CÔNG TY CỔ PHẦN THƯƠNG MẠI VIGLACERA (VN)**
Tầng 1, tòa nhà Viglacera, số 1 Đại lộ Thăng Long, phường Mỹ Trì, quận Nam Từ
Liêm, thành phố Hà Nội
(72) Phạm Ngọc Đường (VN)
(55)



CÔNG BÁO SỞ HỮU CÔNG NGHIỆP SỐ 436 TẬP A – QUYỀN 2 (07.2024)

(11) **50849**

(21) 3-2024-00510

(28) 1

(54) **VÒI NƯỚC**

(51) **23-01**

(22) 04/03/2024

(43) 25/07/2024

(73) **CÔNG TY CỔ PHẦN THƯƠNG MẠI VIGLACERA (VN)**

Tầng 1, tòa nhà Viglacera, số 1 Đại lộ Thăng Long, phường Mỹ Trì, quận Nam Từ Liêm, thành phố Hà Nội

(72) Phạm Ngọc Đường (VN)

(55)



1.1



1.2



1.3



1.4



1.5



1.6

CÔNG BÁO SỞ HỮU CÔNG NGHIỆP SỐ 436 TẬP A – QUYỀN 2 (07.2024)

- (11) **50850**
(21) 3-2024-00511 (28) 1
(54) **VÒI NƯỚC** (51) **23-01**
(22) 04/03/2024 (43) 25/07/2024
(73) **CÔNG TY CỔ PHẦN THƯƠNG MẠI VIGLACERA (VN)**
Tầng 1, tòa nhà Viglacera, số 1 Đại lộ Thăng Long, phường Mễ Trì, quận Nam Từ
Liêm, thành phố Hà Nội
(72) Phạm Ngọc Đường (VN)
(55)



1.1



1.2



1.3



1.4



1.5



1.6

CÔNG BÁO SỞ HỮU CÔNG NGHIỆP SỐ 436 TẬP A – QUYỀN 2 (07.2024)

(11) **50851**

(21) 3-2024-00519

(28) 1

(54) **LỌ**

(51) **09-01**

(22) 04/03/2024

(43) 25/07/2024

(73) **LG H&H Co., LTD. (KR)**

58, Saemunan-ro, Jongno-gu, Seoul, Republic of Korea

(72) 1. LEE, SEUL KI (KR)

2. JUNG, MIN JEONG (KR)

3. KIM, JEONG WOO (KR)

4. LEE, JI HWAN (KR)

(74) Công ty TNHH Tâm nhìn và Liên danh (VISION & ASSOCIATES CO.LTD.)

(55)

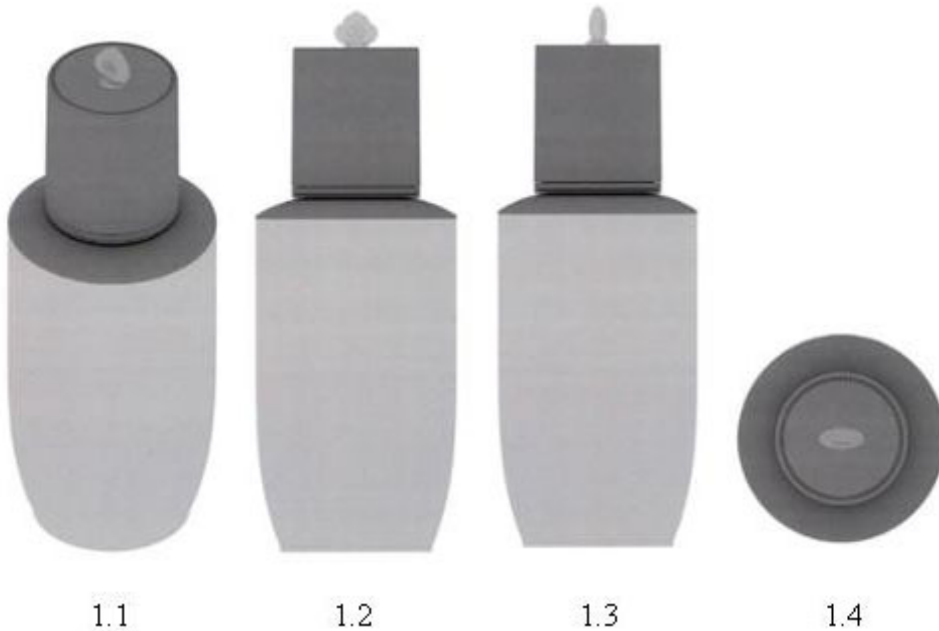

1.1

1.2

1.3

1.4



1.5



1.6

CÔNG BÁO SỞ HỮU CÔNG NGHIỆP SỐ 436 TẬP A – QUYỀN 2 (07.2024)

- (11) **50852**
(21) 3-2024-00989 (28) 1
(54) **ĐÈN TIA CỰC TÍM** (51) **28-03**
(22) 26/04/2024 (43) 25/07/2024
(73) **WANG,YUANLIN (CN)**
No. 40, Group 4, Shufangya Village, Liqiao Town, Xichong County, Sichuan
637200, China
(72) Wang,Yuanlin (CN)
(74) Công ty TNHH ADASTRA IP (VIỆT NAM) (ADASTRA IP (VIETNAM) CO.,
LTD.)
(55)



1.1



1.2



1.3



1.4



1.5



1.6



1.7

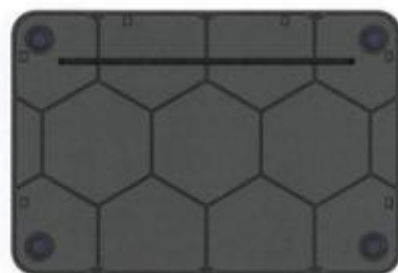

1.8

CÔNG BÁO SỞ HỮU CÔNG NGHIỆP SỐ 436 TẬP A – QUYỀN 2 (07.2024)

- (11) **50853**
- (21) 3-2024-01009 (28) 1
- (54) **NHÃN SẢN PHẨM** (51) **19-08**
- (22) 26/04/2024 (43) 25/07/2024
- (73) **CÔNG TY TNHH ĐẠI DƯƠNG Ý TƯỞNG (VN)**
Y10 Hồng Lĩnh, phường 15, quận 10, thành phố Hồ Chí Minh
- (72) Lâm Quang Thành Chung (VN)
- (74) **CÔNG TY LUẬT TNHH KHÔI NGỌC (KHOI NGOC LAW COMPANY LTD)**
- (55)



CÔNG BÁO SỞ HỮU CÔNG NGHIỆP SỐ 436 TẬP A – QUYỀN 2 (07.2024)

- (11) **50854**
(21) 3-2024-00727 (28) 1
(54) **VÒI NƯỚC** (51) **23-01**
(22) 26/03/2024 (43) 25/07/2024
(30) 113300802 20/02/2024 TW;
(73) **SHIH LEI BUSINESS CO., LTD. (TW)**
No. 293, Tayou Rd., Songshan Dist., Taipei City 105, Taiwan
(72) ZENG, ZENG-MU (TW)
(74) Công ty TNHH T&T INVENMARK Sở hữu trí tuệ Quốc tế (T&T INVENMARK CO., LTD.)
(55)



1.1

1.2

1.3



1.4

1.5



1.6



1.7

CÔNG BÁO SỞ HỮU CÔNG NGHIỆP SỐ 436 TẬP A – QUYỀN 2 (07.2024)

- (11) **50855**
(21) 3-2024-00729 (28) 1
(54) **CHAI** (51) **09-01**
(22) 26/03/2024 (43) 25/07/2024
(73) **CÔNG TY CỔ PHẦN TINGCO BÌNH ĐỊNH (VN)**
Lô A3.12+A3.13, khu công nghiệp Nhơn Hội (Khu A), khu kinh tế Nhơn Hội, xã
Nhơn Hội, thành phố Quy Nhơn, tỉnh Bình Định
(72) Võ Thị Nguyệt Nga (VN)
(74) Công ty Cổ phần Sở hữu công nghiệp INVESTIP (INVESTIP)
(55)



1.1

1.2

1.3

1.4

1.5



1.6

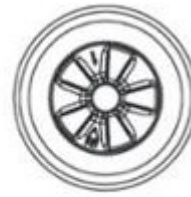

1.7

CÔNG BÁO SỞ HỮU CÔNG NGHIỆP SỐ 436 TẬP A – QUYỀN 2 (07.2024)

(11) **50856**

(21) 3-2024-01223

(28) 1

(54) **CỐC NỀN**

(51) **26-01**

(22) 29/05/2024

(43) 25/07/2024

(73) **CÔNG TY TNHH MINH LONG I (VN)**

Số 333 đường Hưng Định 24, khu phố Hưng Lộc, phường Hưng Định, thành phố Thuận An, tỉnh Bình Dương

(72) Lý Huy Sáng (VN)

(55)



1.1



1.2



1.3



1.4

CÔNG BÁO SỞ HỮU CÔNG NGHIỆP SỐ 436 TẬP A – QUYỀN 2 (07.2024)

(11) **50857**

(21) 3-2024-01224

(28) 1

(54) **NẮP**

(51) **26-01**

(22) 29/05/2024

(43) 25/07/2024

(73) **CÔNG TY TNHH MINH LONG I (VN)**

Số 333 đường Hưng Định 24, khu phố Hưng Lộc, phường Hưng Định, thành phố Thuận An, tỉnh Bình Dương

(72) Lý Huy Sáng (VN)

(55)



1.1



1.2

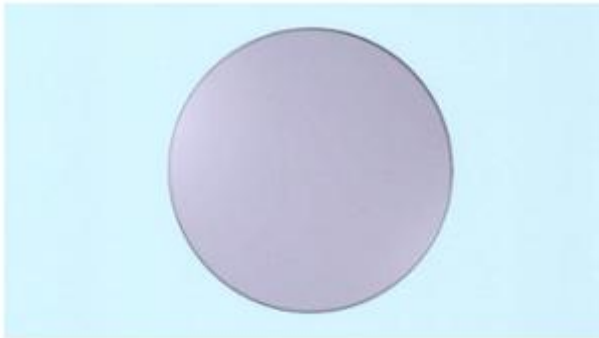

1.3



1.4

CÔNG BÁO SỞ HỮU CÔNG NGHIỆP SỐ 436 TẬP A – QUYỀN 2 (07.2024)

- (11) **50858**
- (21) 3-2024-00441
- (54) **MÀN HÌNH**
- (22) 26/02/2024
- (30) 29/911,098 29/08/2023 US;
- (73) **GOOGLE LLC (US)**
1600 Amphitheatre Parkway, Mountain View, California 94043, United States of America
- (72) 1. DANYI WANG ROBERTSON (IN)
2. JUDY ZHAO (US)
- (74) Công ty Luật TNHH ROUSE Việt Nam (ROUSE LEGAL VIETNAM LTD.)
- (55)

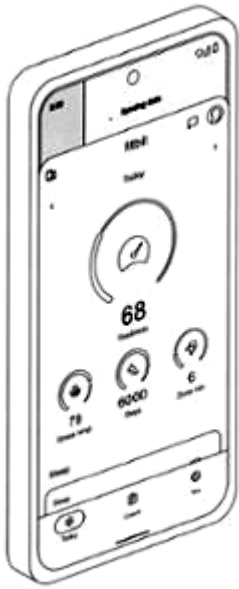

1.1



1.2



1.3



1.4



1.5



2.1



2.2

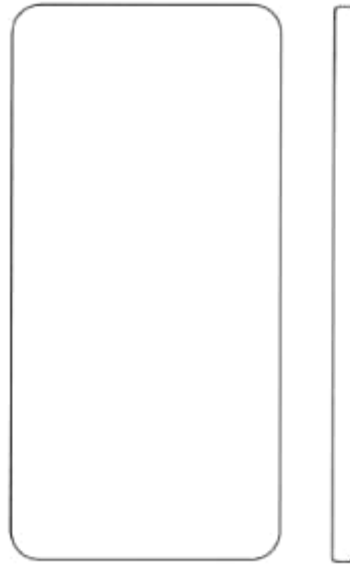

2.3



2.4

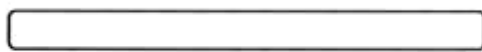

2.5



3.1

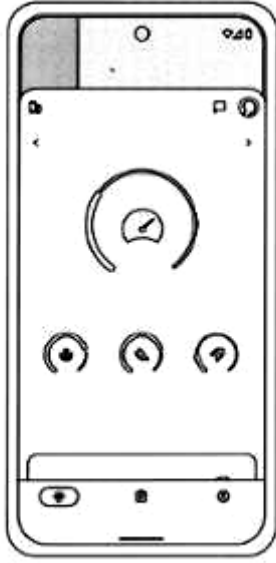

3.2

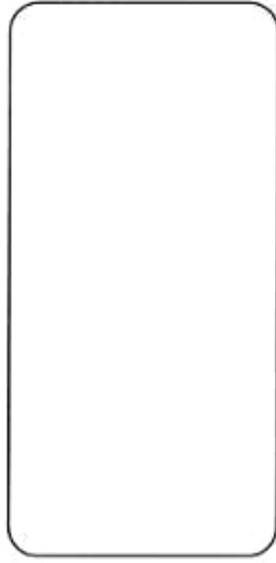

3.3



3.4



3.5

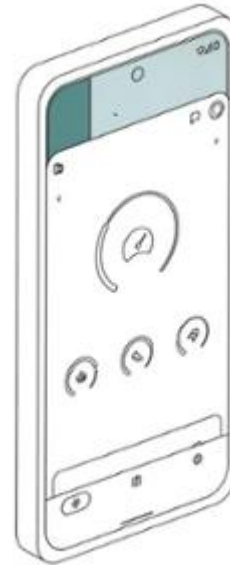

4.1



4.2



4.3



4.4



4.5

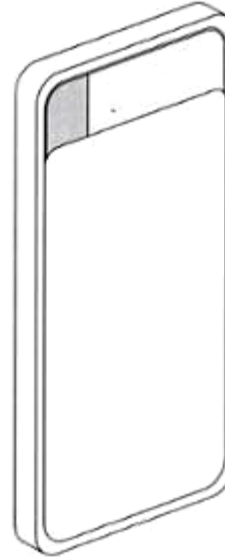

5.1

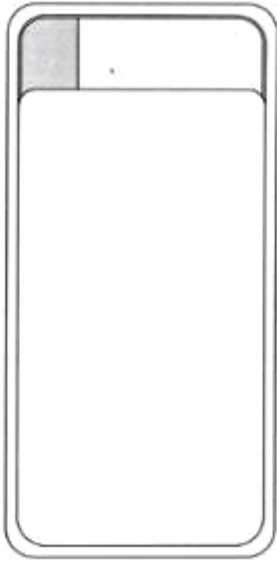

5.2



5.3



5.4



5.5

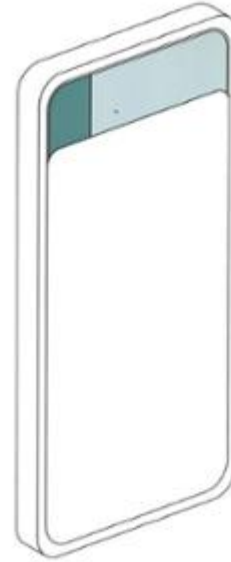

6.1



6.2



6.3



6.4



6.5

CÔNG BÁO SỞ HỮU CÔNG NGHIỆP SỐ 436 TẬP A – QUYỀN 2 (07.2024)

- (11) **50859**
(21) 3-2024-00961 (28) 5
(54) **NHÃN SẢN PHẨM** (51) **19-08**
(22) 22/04/2024 (43) 25/07/2024
(73) **CÔNG TY CỔ PHẦN GHC GLOBAL (VN)**
4-BS5C-6 khu đô thị Nam đường vành đai 3, phường Đại Kim, quận Hoàng Mai, thành phố Hà Nội
(72) Nguyễn Văn Chung (VN)
(74) Công ty Luật TNHH LEADCONSULT (LEADCONSULT)
(55)



1.1



2.1



3.1



4.1



5.1

(11) **50860**

(21) 3-2024-00964

(28) 1

(54) **BÀN NHỰA**

(51) **06-03**

(22) 22/04/2024

(43) 25/07/2024

(73) **CÔNG TY CỔ PHẦN NHỰA KHÔI NGUYỄN (VN)**

139/37 Dương Văn Dương, phường Tân Quý, quận Tân Phú, thành phố Hồ Chí Minh

(72) Nguyễn Minh Tuấn (VN)

(55)



1.1

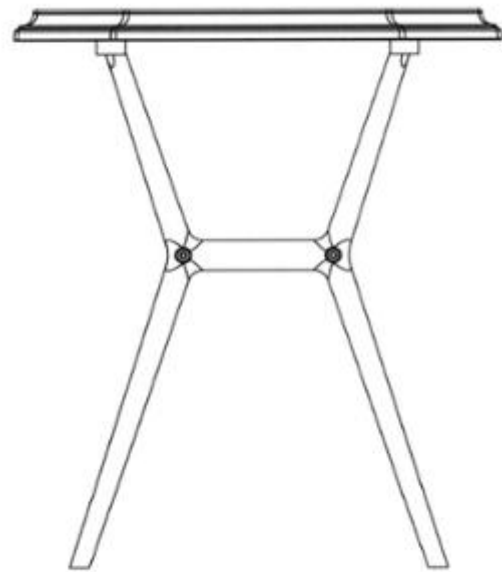

1.2

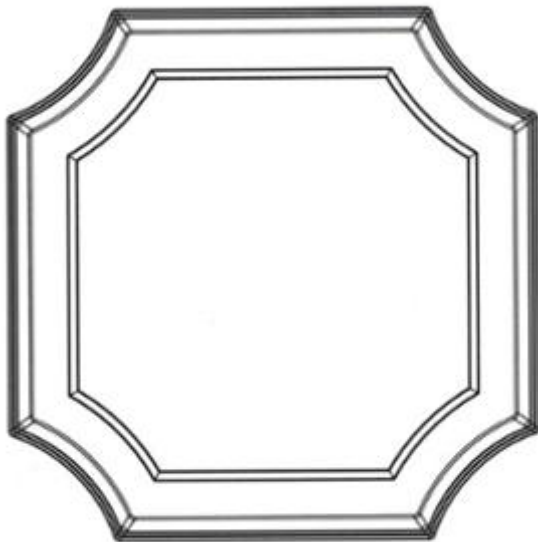

1.3

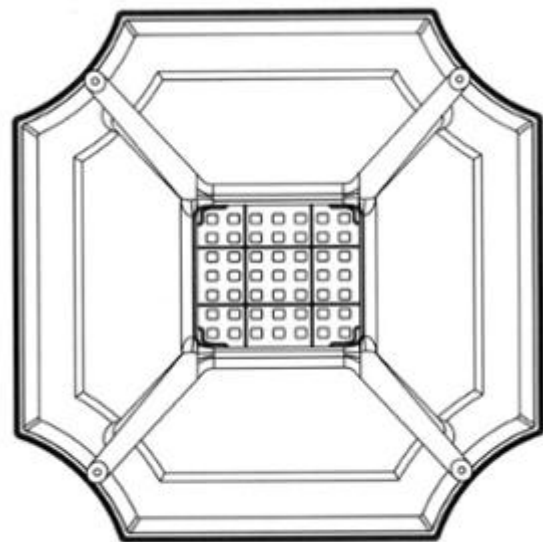

1.4

- (11) **50861**
(21) 3-2024-00019 (28) 1
(54) **MẶT ĐỒ TRANG SỨC** (51) **11-01**
(22) 04/01/2024 (43) 25/07/2024
(73) **CÔNG TY CỔ PHẦN VÀNG BẠC ĐÁ QUÝ PHÚ NHUẬN (VN)**
170E Phan Đăng Lưu, phường 03, quận Phú Nhuận, thành phố Hồ Chí Minh
(72) Võ Ngọc Thùy Anh (VN)
(74) Công ty Luật TNHH AGL (AGL LAW)
(55)



1.1

1.2

1.3



1.4

1.5

1.6

1.7

CÔNG BÁO SỞ HỮU CÔNG NGHIỆP SỐ 436 TẬP A – QUYỀN 2 (07.2024)

- (11) **50862**
(21) 3-2024-00021 (28) 1
(54) **MẶT DÂY CHUYỀN** (51) **11-01**
(22) 04/01/2024 (43) 25/07/2024
(73) **CÔNG TY CỔ PHẦN VÀNG BẠC ĐÁ QUÝ PHÚ NHUẬN (VN)**
170E Phan Đăng Lưu, phường 03, quận Phú Nhuận, thành phố Hồ Chí Minh
(72) Võ Ngọc Thùy Anh (VN)
(74) Công ty Luật TNHH AGL (AGL LAW)
(55)



1.1



1.2



1.3



1.4



1.5



1.6



1.7

CÔNG BÁO SỞ HỮU CÔNG NGHIỆP SỐ 436 TẬP A – QUYỀN 2 (07.2024)

- (11) **50863**
(21) 3-2024-00022 (28) 1
(54) **VÒNG ĐEO TAY** (51) **11-01**
(22) 04/01/2024 (43) 25/07/2024
(73) **CÔNG TY CỔ PHẦN VÀNG BẠC ĐÁ QUÝ PHÚ NHUẬN (VN)**
170E Phan Đăng Lưu, phường 03, quận Phú Nhuận, thành phố Hồ Chí Minh
(72) Võ Ngọc Thùy Anh (VN)
(74) Công ty Luật TNHH AGL (AGL LAW)
(55)



1.1



1.2



1.3



1.4

1.5



1.6



1.7

- (11) **50864**
(21) 3-2024-00023 (28) 1
(54) **DÂY CHUYỀN** (51) **11-01**
(22) 04/01/2024 (43) 25/07/2024
(73) **CÔNG TY CỔ PHẦN VÀNG BẠC ĐÁ QUÝ PHÚ NHUẬN (VN)**
170E Phan Đăng Lưu, phường 03, quận Phú Nhuận, thành phố Hồ Chí Minh
(72) Võ Ngọc Thùy Anh (VN)
(74) Công ty Luật TNHH AGL (AGL LAW)
(55)



1.1



1.2



1.3



1.4

1.5



1.6



1.7

(11) **50865**

(21) 3-2024-00024

(28) 1

(54) **VÒNG ĐEO TAY**

(51) **11-01**

(22) 04/01/2024

(43) 25/07/2024

(73) **CÔNG TY CỔ PHẦN VÀNG BẠC ĐÁ QUÝ PHÚ NHUẬN (VN)**

170E Phan Đăng Lưu, phường 03, quận Phú Nhuận, thành phố Hồ Chí Minh

(72) Võ Ngọc Thùy Anh (VN)

(74) Công ty Luật TNHH AGL (AGL LAW)

(55)



1.1



1.2



1.3



1.4



1.5



1.6



1.7

CÔNG BÁO SỞ HỮU CÔNG NGHIỆP SỐ 436 TẬP A – QUYỀN 2 (07.2024)

- (11) **50866**
(21) 3-2024-00025 (28) 1
(54) **MẶT DÂY CHUYỀN** (51) **11-01**
(22) 04/01/2024 (43) 25/07/2024
(73) **CÔNG TY CỔ PHẦN VÀNG BẠC ĐÁ QUÝ PHÚ NHUẬN (VN)**
170E Phan Đăng Lưu, phường 03, quận Phú Nhuận, thành phố Hồ Chí Minh
(72) Võ Ngọc Thùy Anh (VN)
(74) Công ty Luật TNHH AGL (AGL LAW)
(55)



1.1

1.2

1.3

1.4



1.5



1.6



1.7

CÔNG BÁO SỞ HỮU CÔNG NGHIỆP SỐ 436 TẬP A – QUYỀN 2 (07.2024)

- (11) **50867**
(21) 3-2024-00026 (28) 1
(54) **MẶT DÂY CHUYỀN** (51) **11-01**
(22) 04/01/2024 (43) 25/07/2024
(73) **CÔNG TY CỔ PHẦN VÀNG BẠC ĐÁ QUÝ PHÚ NHUẬN (VN)**
170E Phan Đăng Lưu, phường 03, quận Phú Nhuận, thành phố Hồ Chí Minh
(72) Võ Ngọc Thùy Anh (VN)
(74) Công ty Luật TNHH AGL (AGL LAW)
(55)



1.1



1.2



1.3



1.4

1.5



1.6



1.7

CÔNG BÁO SỞ HỮU CÔNG NGHIỆP SỐ 436 TẬP A – QUYỀN 2 (07.2024)

(11) **50868**

(21) 3-2024-00027

(54) **HOA TAI**

(22) 04/01/2024

(73) **CÔNG TY CỔ PHẦN VÀNG BẠC ĐÁ QUÝ PHÚ NHUẬN (VN)**

170E Phan Đăng Lưu, phường 03, quận Phú Nhuận, thành phố Hồ Chí Minh

(72) Võ Ngọc Thùy Anh (VN)

(74) Công ty Luật TNHH AGL (AGL LAW)

(55)

(28) 1

(51) **11-01**

(43) 25/07/2024



1.1



1.2



1.3

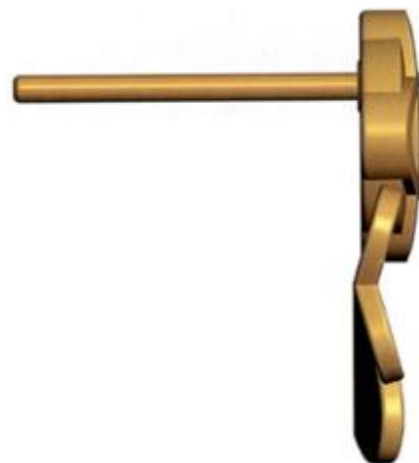

1.4



1.5



1.6



1.7

CÔNG BÁO SỞ HỮU CÔNG NGHIỆP SỐ 436 TẬP A – QUYỀN 2 (07.2024)

- (11) **50869**
(21) 3-2024-00029 (28) 1
(54) **VÒNG ĐEO TAY** (51) **11-01**
(22) 04/01/2024 (43) 25/07/2024
(73) **CÔNG TY CỔ PHẦN VÀNG BẠC ĐÁ QUÝ PHÚ NHUẬN (VN)**
170E Phan Đăng Lưu, phường 03, quận Phú Nhuận, thành phố Hồ Chí Minh
(72) Võ Ngọc Thùy Anh (VN)
(74) Công ty Luật TNHH AGL (AGL LAW)
(55)



1.1



1.2



1.3



1.4

1.5



1.6



1.7

CÔNG BÁO SỞ HỮU CÔNG NGHIỆP SỐ 436 TẬP A – QUYỀN 2 (07.2024)

- (11) **50870**
(21) 3-2024-00030 (28) 1
(54) **VÒNG ĐEO TAY** (51) **11-01**
(22) 04/01/2024 (43) 25/07/2024
(73) **CÔNG TY CỔ PHẦN VÀNG BẠC ĐÁ QUÝ PHÚ NHUẬN (VN)**
170E Phan Đăng Lưu, phường 03, quận Phú Nhuận, thành phố Hồ Chí Minh
(72) Võ Ngọc Thùy Anh (VN)
(74) Công ty Luật TNHH AGL (AGL LAW)
(55)



1.1



1.2



1.3



1.4

1.5



1.6



1.7

(11) **50871**

(21) 3-2024-00032

(28) 1

(54) **HOA TAI**

(51) **11-01**

(22) 04/01/2024

(43) 25/07/2024

(73) **CÔNG TY CỔ PHẦN VÀNG BẠC ĐÁ QUÝ PHÚ NHUẬN (VN)**

170E Phan Đăng Lưu, phường 03, quận Phú Nhuận, thành phố Hồ Chí Minh

(72) Võ Ngọc Thùy Anh (VN)

(74) Công ty Luật TNHH AGL (AGL LAW)

(55)

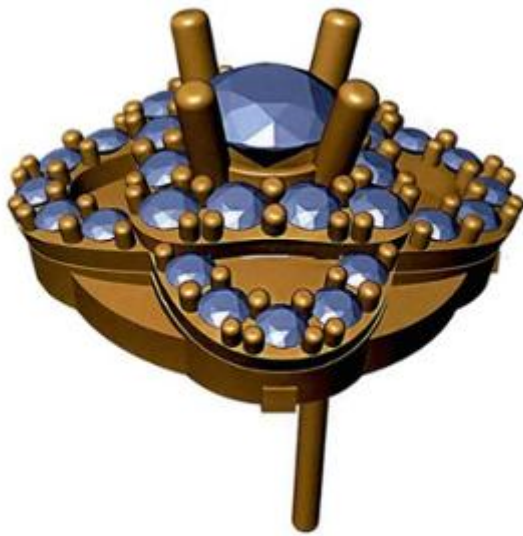

1.1

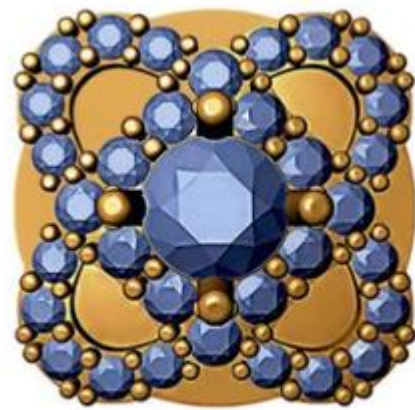

1.2



1.3

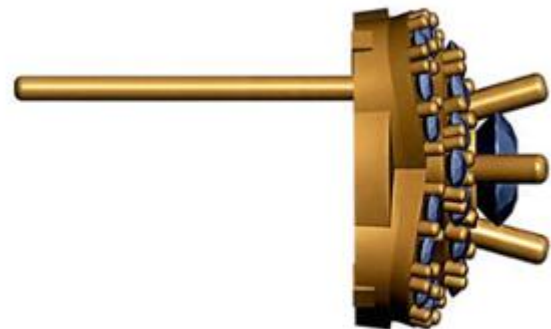

1.4



1.5

CÔNG BÁO SỞ HỮU CÔNG NGHIỆP SỐ 436 TẬP A – QUYỀN 2 (07.2024)

- (11) **50872**
(21) 3-2024-00033 (28) 1
(54) **NHÃN** (51) **11-01**
(22) 04/01/2024 (43) 25/07/2024
(73) **CÔNG TY CỔ PHẦN VÀNG BẠC ĐÁ QUÝ PHÚ NHUẬN (VN)**
170E Phan Đăng Lưu, phường 03, quận Phú Nhuận, thành phố Hồ Chí Minh
(72) Võ Ngọc Thùy Anh (VN)
(74) Công ty Luật TNHH AGL (AGL LAW)
(55)



1.1



1.2



1.3

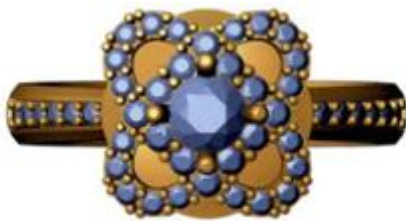

1.4



1.5

- (11) **50873**
(21) 3-2024-00035 (28) 1
(54) **DÂY CHUYỀN** (51) **11-01**
(22) 04/01/2024 (43) 25/07/2024
(73) **CÔNG TY CỔ PHẦN VÀNG BẠC ĐÁ QUÝ PHÚ NHUẬN (VN)**
170E Phan Đăng Lưu, phường 03, quận Phú Nhuận, thành phố Hồ Chí Minh
(72) Võ Ngọc Thùy Anh (VN)
(74) Công ty Luật TNHH AGL (AGL LAW)
(55)



1.1

1.2



1.3



1.4

1.5



1.6



1.7

- (11) **50874**
(21) 3-2024-00037 (28) 1
(54) **MẶT DÂY CHUYỀN** (51) **11-01**
(22) 04/01/2024 (43) 25/07/2024
(73) **CÔNG TY CỔ PHẦN VÀNG BẠC ĐÁ QUÝ PHÚ NHUẬN (VN)**
170E Phan Đăng Lưu, phường 03, quận Phú Nhuận, thành phố Hồ Chí Minh
(72) Võ Ngọc Thùy Anh (VN)
(74) Công ty Luật TNHH AGL (AGL LAW)
(55)



1.1



1.2



1.3



1.4

1.5



1.6



1.7

CÔNG BÁO SỞ HỮU CÔNG NGHIỆP SỐ 436 TẬP A – QUYỀN 2 (07.2024)

(11) **50875**

(21) 3-2024-00038

(54) **VÒNG ĐEO TAY**

(22) 04/01/2024

(73) **CÔNG TY CỔ PHẦN VÀNG BẠC ĐÁ QUÝ PHÚ NHUẬN (VN)**

170E Phan Đăng Lưu, phường 03, quận Phú Nhuận, thành phố Hồ Chí Minh

(72) Võ Ngọc Thùy Anh (VN)

(74) Công ty Luật TNHH AGL (AGL LAW)

(55)

(28) 1

(51) **11-01**

(43) 25/07/2024



1.1



1.2



1.3



1.4



1.5



1.6



1.7

- (11) **50876**
(21) 3-2024-00039 (28) 1
(54) **VÒNG ĐEO TAY** (51) **11-01**
(22) 04/01/2024 (43) 25/07/2024
(73) **CÔNG TY CỔ PHẦN VÀNG BẠC ĐÁ QUÝ PHÚ NHUẬN (VN)**
170E Phan Đăng Lưu, phường 03, quận Phú Nhuận, thành phố Hồ Chí Minh
(72) Võ Ngọc Thùy Anh (VN)
(74) Công ty Luật TNHH AGL (AGL LAW)
(55)



1.1



1.2



1.3



1.4



1.5



1.6



1.7

CÔNG BÁO SỞ HỮU CÔNG NGHIỆP SỐ 436 TẬP A – QUYỀN 2 (07.2024)

- (11) **50877**
(21) 3-2024-00187 (28) 1
(54) **CHÂN BÀN** (51) **06-03**
(22) 22/01/2024 (43) 25/07/2024
(73) **CÔNG TY TNHH A G STEEL MANUFACTURE (VN)**
27E đường 129, ấp 12, xã Tân Thạnh Đông, huyện Củ Chi, thành phố Hồ Chí Minh
(72) Joo Jae Woo (AU)
(74) Công ty Cổ phần Sở hữu trí tuệ Việt Mỹ (VIET MY IPC)
(55)



1.1



1.2



1.3



1.4



1.5

CÔNG BÁO SỞ HỮU CÔNG NGHIỆP SỐ 436 TẬP A – QUYỀN 2 (07.2024)

- (11) **50878**
(21) 3-2024-00970 (28) 1
(54) **DAO** (51) **08-03**
(22) 24/04/2024 (43) 25/07/2024
(30) 29/915,100 25/10/2023 US;
(73) **DAREX, LLC (US)**
210 East Hersey Street, Ashland, Oregon 97520 U.S.A.
(72) Daniel T. Dovel (US)
(74) Công ty TNHH Quốc tế D & N (D&N INTERNATIONAL CO.,LTD.)
(55)

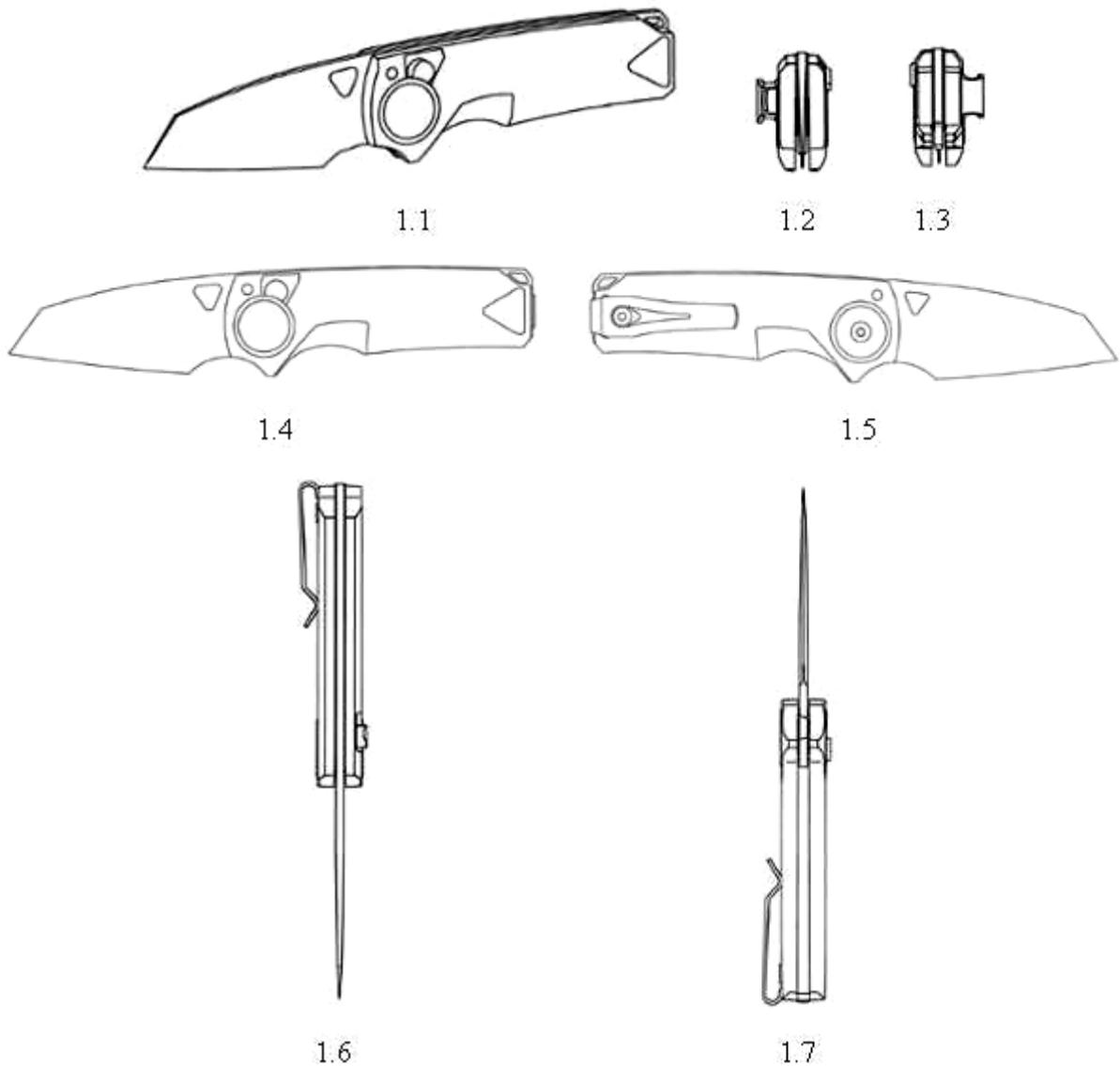

CÔNG BÁO SỞ HỮU CÔNG NGHIỆP SỐ 436 TẬP A – QUYỀN 2 (07.2024)

- (11) **50879**
(21) 3-2024-00971 (28) 1
(54) **DAO** (51) **08-03**
(22) 24/04/2024 (43) 25/07/2024
(30) 29/915,100 25/10/2023 US;
(73) **DAREX, LLC (US)**
210 East Hersey Street, Ashland, Oregon 97520 U.S.A.
(72) Daniel T. Dovel (US)
(74) Công ty TNHH Quốc tế D & N (D&N INTERNATIONAL CO.,LTD.)
(55)

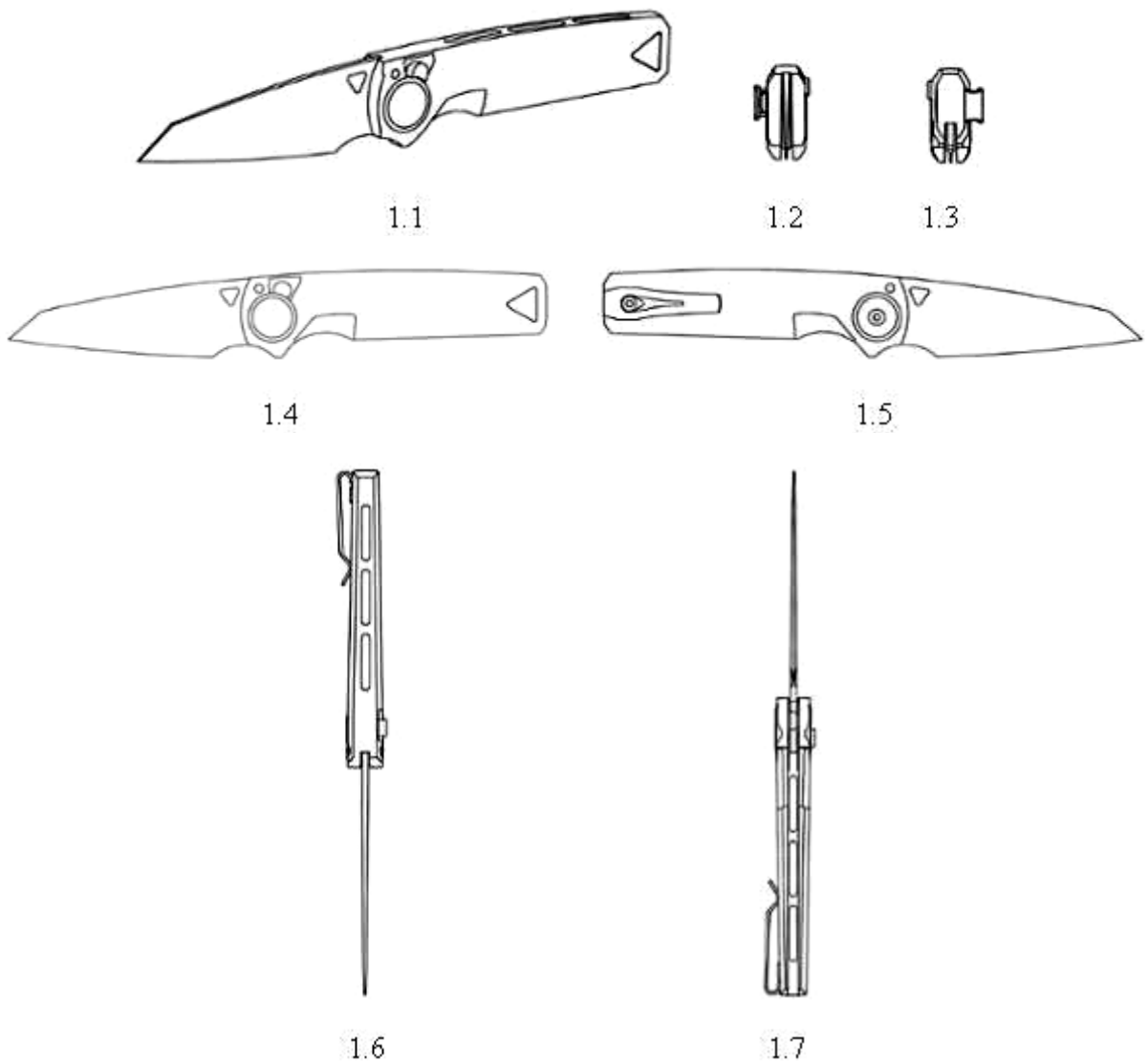

CÔNG BÁO SỞ HỮU CÔNG NGHIỆP SỐ 436 TẬP A – QUYỀN 2 (07.2024)

- (11) **50880**
- (21) 3-2024-00973
- (54) **DỤNG CỤ VỆ SINH**
- (22) 24/04/2024
- (30) 2024300896485 21/02/2024 CN;
- (73) **WANG, JIALUN (CN)**
55Jinfeng Road, Huacao Town, Minhang District, Shanghai 201100 China
- (72) WANG, Jialun (CN)
- (74) Công ty TNHH Trường Xuân (AGELESS CO.,LTD.)
- (55)



CÔNG BÁO SỞ HỮU CÔNG NGHIỆP SỐ 436 TẬP A – QUYỀN 2 (07.2024)

- (11) **50881**
- (21) 3-2024-00974 (28) 1
- (54) **DỤNG CỤ VỆ SINH** (51) **04-99**
- (22) 24/04/2024 (43) 25/07/2024
- (30) 2024300896502 21/02/2024 CN;
- (73) **CUI, TINGWEI (CN)**
No.98, Lane 55, Huazhan Road, Xuhui District, Shanghai 200231 China
- (72) CUI, Tingwei (CN)
- (74) Công ty TNHH Trường Xuân (AGELESS CO.,LTD.)
- (55)

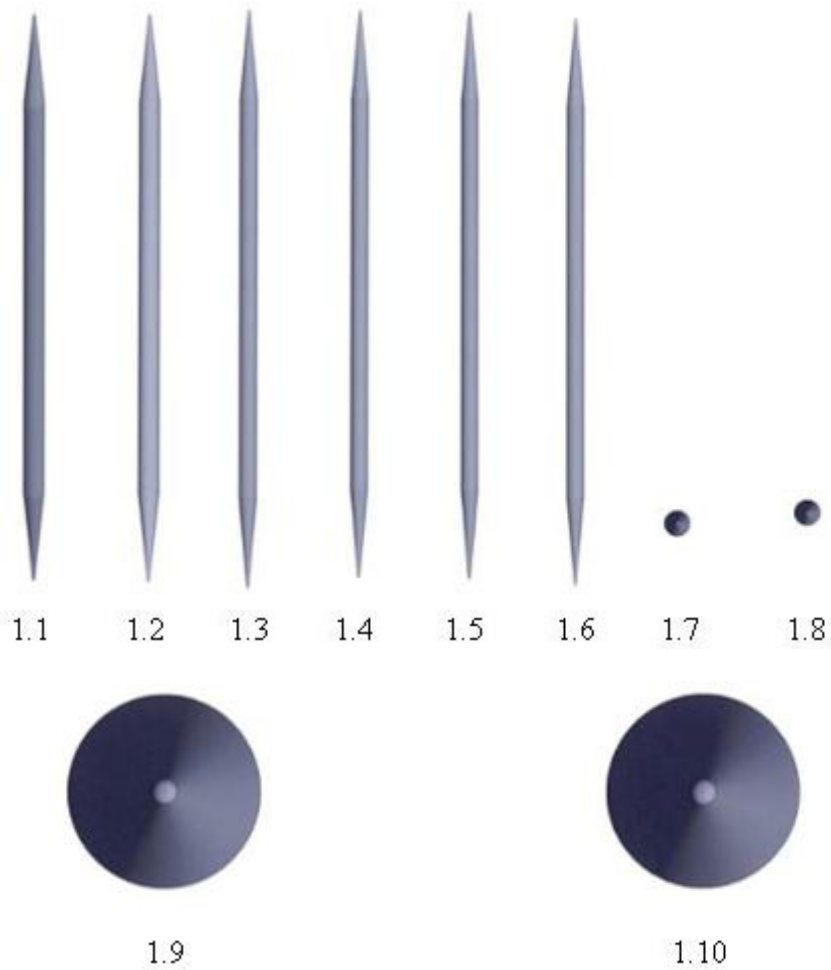

CÔNG BÁO SỞ HỮU CÔNG NGHIỆP SỐ 436 TẬP A – QUYỀN 2 (07.2024)

- (11) **50882**
(21) 3-2024-00977 (28) 1
(54) **NẤP HỘP** (51) **09-07**
(22) 24/04/2024 (43) 25/07/2024
(73) **CÔNG TY CỔ PHẦN HÀNG TIÊU DÙNG MASAN (VN)**
Số 23 Lê Duẩn, phường Bến Nghé, quận 1, thành phố Hồ Chí Minh
(72) Nguyễn Hoàng Yên (VN)
(74) Công ty cổ phần Sở hữu trí tuệ BROSS và Cộng sự (BROSS & PARTNERS., JSC)
(55)

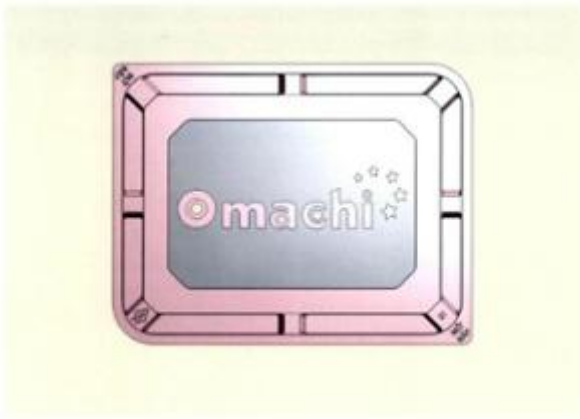

1.1

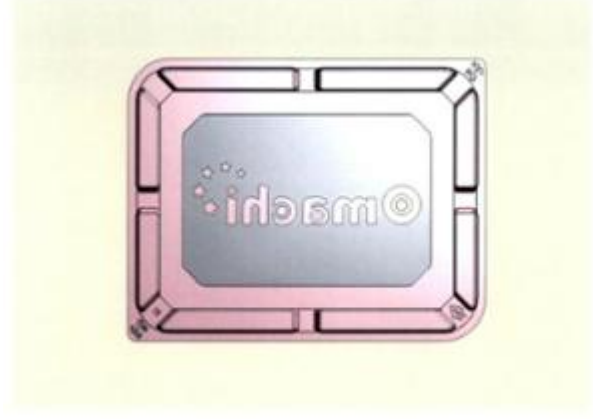

1.2



1.3

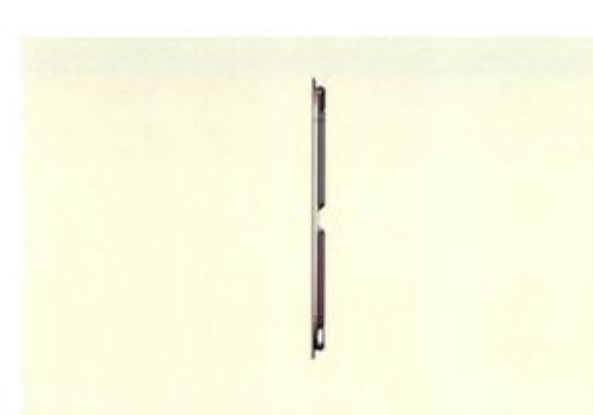

1.4



1.5



1.6



1.7

CÔNG BÁO SỞ HỮU CÔNG NGHIỆP SỐ 436 TẬP A – QUYỀN 2 (07.2024)

- (11) **50883**
- (21) 3-2024-00978
- (54) **KHAY**
- (22) 24/04/2024
- (73) **CÔNG TY CỔ PHẦN HÀNG TIÊU DÙNG MASAN (VN)**
Số 23 Lê Duẩn, phường Bến Nghé, quận 1, thành phố Hồ Chí Minh
- (72) Nguyễn Hoàng Yên (VN)
- (74) Công ty cổ phần Sở hữu trí tuệ BROSS và Cộng sự (BROSS & PARTNERS., JSC)
- (55)
- (28) 1
- (51) **09-03**
- (43) 25/07/2024



1.1



1.2



1.3



1.4



1.5



1.6



1.7

CÔNG BÁO SỞ HỮU CÔNG NGHIỆP SỐ 436 TẬP A – QUYỀN 2 (07.2024)

- (11) **50884**
(21) 3-2024-00979 (28) 1
(54) **KHAY** (51) **09-03**
(22) 24/04/2024 (43) 25/07/2024
(73) **CÔNG TY CỔ PHẦN HÀNG TIÊU DÙNG MASAN (VN)**
Số 23 Lê Duẩn, phường Bến Nghé, quận 1, thành phố Hồ Chí Minh
(72) Nguyễn Hoàng Yến (VN)
(74) Công ty cổ phần Sở hữu trí tuệ BROSS và Cộng sự (BROSS & PARTNERS., JSC)
(55)



1.1



1.2



1.3

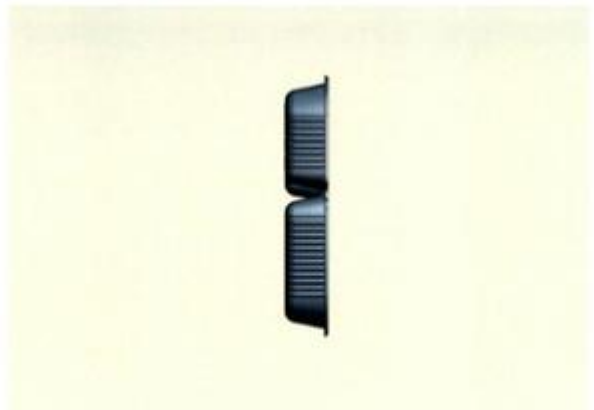

1.4



1.5



1.6



1.7

- (11) **50885**
(21) 3-2024-00969 (28) 1
(54) **BÚT MỰC NƯỚC** (51) **19-06**
(22) 24/04/2024 (43) 25/07/2024
(73) **CÔNG TY CỔ PHẦN BLUSAIGON (VN)**
129E Nguyễn Đình Chính, phường 8, quận Phú Nhuận, thành phố Hồ Chí Minh
(72) Phan Phúc Thịnh (VN)
(55)

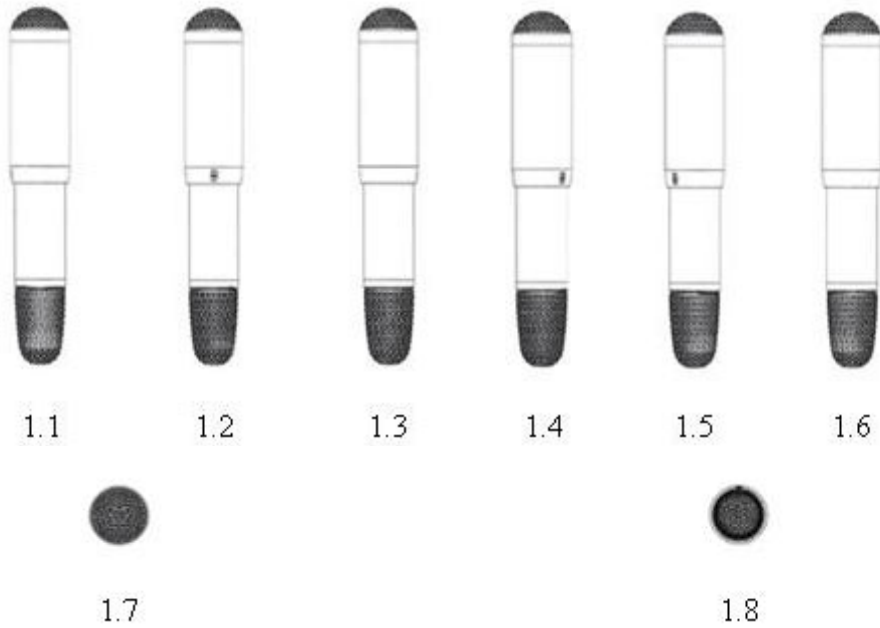

CÔNG BÁO SỞ HỮU CÔNG NGHIỆP SỐ 436 TẬP A – QUYỀN 2 (07.2024)

- (11) **50886**
- (21) 3-2024-00980 (28) 1
- (54) **NHÃN SẢN PHẨM** (51) **19-08**
- (22) 24/04/2024 (43) 25/07/2024
- (73) **CÔNG TY TNHH SẢN XUẤT PHÂN BÓN HỮU CƠ SINH HỌC NÔNG THỊNH PHÁT (VN)**
Tổ 16, ấp 2, xã Mỹ Hiệp, huyện Cao Lãnh, tỉnh Đồng Tháp
- (72) Nguyễn Thành Trung (VN)
- (74) Công ty Luật TNHH AGL (AGL LAW)
- (55)



CÔNG BÁO SỞ HỮU CÔNG NGHIỆP SỐ 436 TẬP A – QUYỀN 2 (07.2024)

- (11) **50887**
- (21) 3-2024-00981
- (54) **NHÃN SẢN PHẨM**
- (22) 24/04/2024
- (73) **CÔNG TY TNHH SẢN XUẤT PHÂN BÓN HỮU CƠ SINH HỌC NÔNG THỊNH PHÁT (VN)**
Tổ 16, ấp 2, xã Mỹ Hiệp, huyện Cao Lãnh, tỉnh Đồng Tháp
- (72) Nguyễn Thành Trung (VN)
- (74) Công ty Luật TNHH AGL (AGL LAW)
- (55)
- (28) 1
- (51) **19-08**
- (43) 25/07/2024



CÔNG BÁO SỞ HỮU CÔNG NGHIỆP SỐ 436 TẬP A – QUYỀN 2 (07.2024)

- (11) **50888**
- (21) 3-2024-00982
- (54) **NHÃN SẢN PHẨM**
- (22) 24/04/2024
- (73) **CÔNG TY TNHH SẢN XUẤT PHÂN BÓN HỮU CƠ SINH HỌC NÔNG THỊNH PHÁT (VN)**
Tổ 16, ấp 2, xã Mỹ Hiệp, huyện Cao Lãnh, tỉnh Đồng Tháp
- (72) Nguyễn Thành Trung (VN)
- (74) Công ty Luật TNHH AGL (AGL LAW)
- (55)
- (28) 1
- (51) **19-08**
- (43) 25/07/2024



CÔNG BÁO SỞ HỮU CÔNG NGHIỆP SỐ 436 TẬP A – QUYỀN 2 (07.2024)

- (11) **50889**
- (21) 3-2024-00983
- (54) **NHÃN SẴN PHẨM**
- (22) 24/04/2024
- (73) **CÔNG TY TNHH SẢN XUẤT PHÂN BÓN HỮU CƠ SINH HỌC NÔNG THỊNH PHÁT (VN)**
Tổ 16, ấp 2, xã Mỹ Hiệp, huyện Cao Lãnh, tỉnh Đồng Tháp
- (72) Nguyễn Thành Trung (VN)
- (74) Công ty Luật TNHH AGL (AGL LAW)
- (55)

- (28) 1
- (51) **19-08**
- (43) 25/07/2024



1.1

CÔNG BÁO SỞ HỮU CÔNG NGHIỆP SỐ 436 TẬP A – QUYỀN 2 (07.2024)

- (11) **50890**
(21) 3-2024-00988 (28) 2
(54) **NỒI CƠM ĐIỆN** (51) **07-02**
(22) 26/04/2024 (43) 25/07/2024
(30) 202330714746.9 02/11/2023 CN;
(73) **ZHEJIANG SUPOR ELECTRICAL APPLIANCES MANUFACTURING CO., LTD. (CN)**
3 Shiji West Street, Shaoxing, Zhejiang, CHINA
(72) Lei HUO (CN)
(74) Công ty Luật TNHH T&G (TGVN)
(55)



1.1



1.2



1.3



1.4



1.5



1.6



2.1



2.2



2.3



2.4



2.5



2.6

CÔNG BÁO SỞ HỮU CÔNG NGHIỆP SỐ 436 TẬP A – QUYỀN 2 (07.2024)

- (11) **50891**
- (21) 3-2024-00188
- (54) **HỘP**
- (22) 23/01/2024
- (73) **CÔNG TY CỔ PHẦN NƯỚC GIẢI KHÁT SANEST KHÁNH HÒA (VN)**
Quốc lộ 1A, thôn Mỹ Thanh, xã Cam Thịnh Đông, thành phố Cam Ranh, tỉnh Khánh Hòa
- (72) Lê Đức Tiến (VN)
- (74) Công ty TNHH Tư vấn sở hữu trí tuệ Việt (VIET IP CO.,LTD.)
- (55)



1.1



1.2



1.3



1.4



1.5



1.6



1.7

CÔNG BÁO SỞ HỮU CÔNG NGHIỆP SỐ 436 TẬP A – QUYỀN 2 (07.2024)

- (11) **50892**
(21) 3-2024-00097 (28) 1
(54) **NHÃN SẢN PHẨM** (51) **19-08**
(22) 11/01/2024 (43) 25/07/2024
(73) **CÔNG TY TNHH THẦN VƯƠNG (VN)**
Số 91, đường 55, khu phố 9, phường Tân Tạo, quận Bình Tân, thành phố Hồ Chí Minh
(72) Trần Quang Duy (VN)
(55)

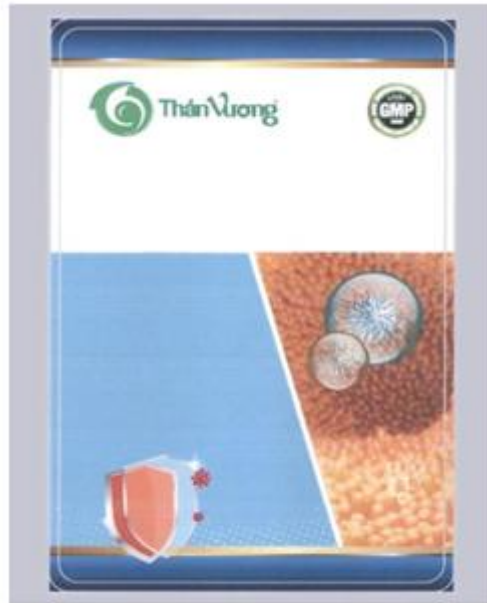

CÔNG BÁO SỞ HỮU CÔNG NGHIỆP SỐ 436 TẬP A – QUYỀN 2 (07.2024)

(11) **50893**

(21) 3-2024-00105

(28) 1

(54) **CÁN CHẢO**

(51) **07-02**

(22) 11/01/2024

(43) 25/07/2024

(73) **NGUYỄN CAO MINH (VN)**

53 đường số 4, phường Bình Hưng Hòa B, quận Bình Tân, thành phố Hồ Chí Minh

(72) Nguyễn Cao Minh (VN)

(55)

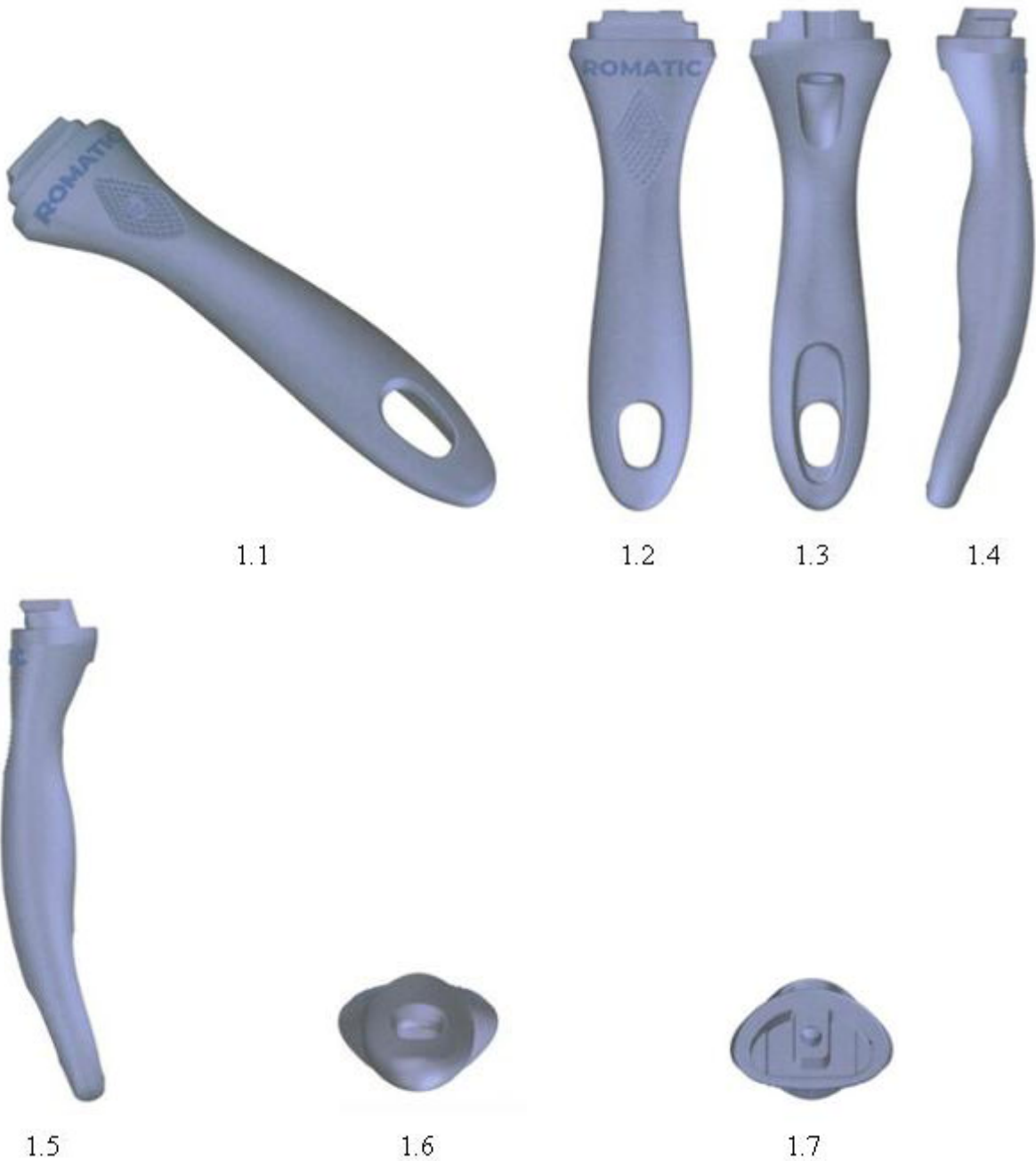

- (11) **50894**
(21) 3-2023-02717 (28) 1
(54) **THIẾT BỊ LIÊN LẠC NỘI BỘ** (51) **14-03**
(22) 13/11/2023 (43) 25/07/2024
(30) 2023-013692 03/07/2023 JP;
(73) **PANASONIC INTELLECTUAL PROPERTY MANAGEMENT CO., LTD.**
(JP)
22-6, Moto-machi, Kadoma-shi, Osaka 571-0057 Japan
(72) Miki KOBAYASHI (JP)
(74) Công ty TNHH một thành viên Sở hữu trí tuệ VCCI (VCCI-IP CO.,LTD)
(55)

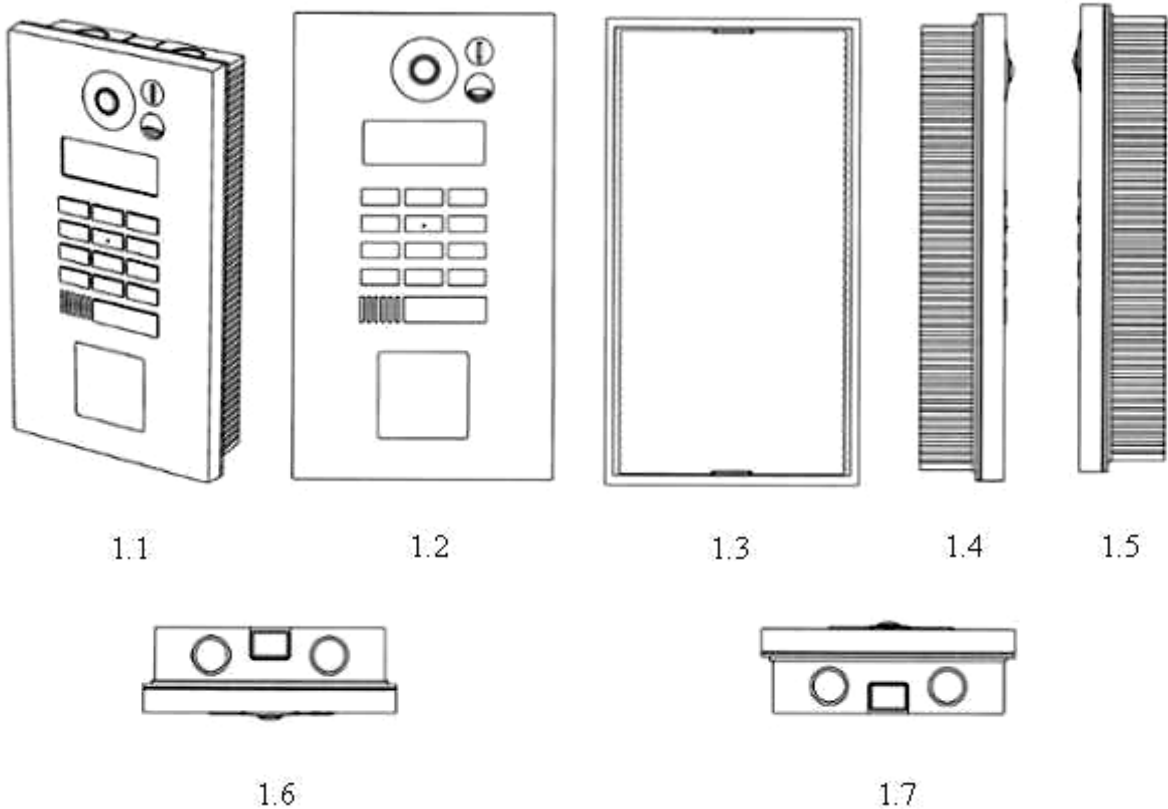

- (11) **50895**
- (21) 3-2024-00697
- (54) **LÒ NƯỚNG**
- (22) 21/03/2024
- (30) DM/232186 27/09/2023 WO;
- (73) **PI-DESIGN AG (CH)**
Altgasse 82, CH-6340 Baar, Switzerland
- (72) Jorgen BODUM (CH)
- (74) Công ty Luật TNHH T&G (TGVN)
- (55)
- (28) 1
- (51) **07-02**
- (43) 25/07/2024

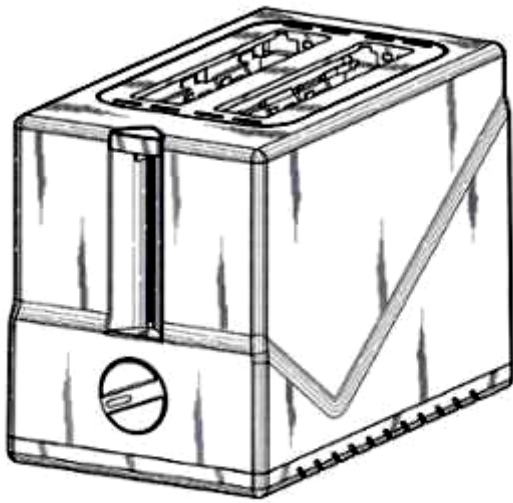

1.1

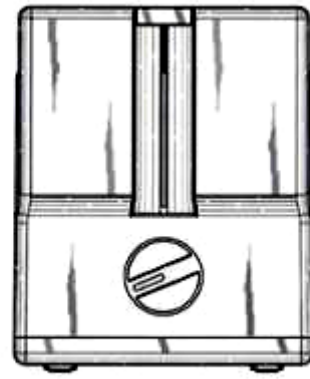

1.2

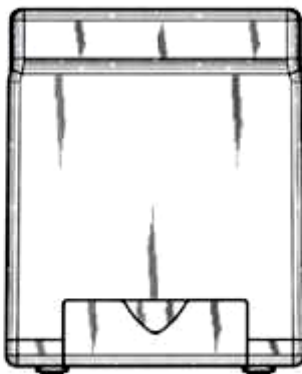

1.3

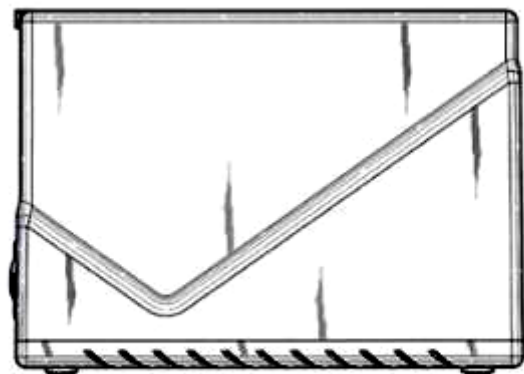

1.4

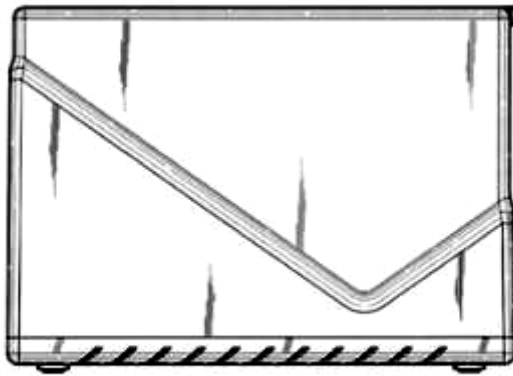

1.5

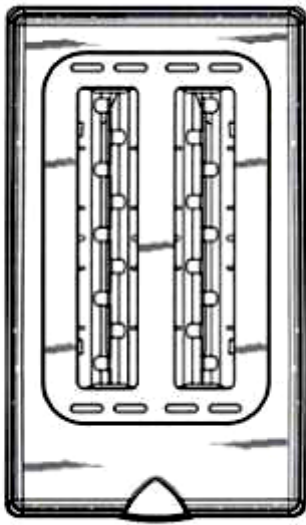

1.6



1.7

CÔNG BÁO SỞ HỮU CÔNG NGHIỆP SỐ 436 TẬP A – QUYỀN 2 (07.2024)

- (11) **50896**
(21) 3-2023-01396 (28) 1
(54) **VỎ MÁY PHÁT NHIỆT** (51) **23-03**
(22) 22/06/2023 (43) 25/07/2024
(30) 29/869,383 29/12/2022 US;
(73) **ROSEMOUNT INC. (US)**
6021 Innovation Boulevard, Shakopee, Minnesota, 55379, United States of America
(72) 1. GEORGE HAUSLER (US)
2. JEFFREY A. COTA (US)
3. JACOB D. HOLM (US)
4. CHAD M. MCGUIRE (US)
5. STEVEN J. MCCOY (US)
6. CHRISTOPHER L. ERIKSEN (US)
(74) Công ty TNHH Tầm nhìn và Liên danh (VISION & ASSOCIATES CO.LTD.)
(55)

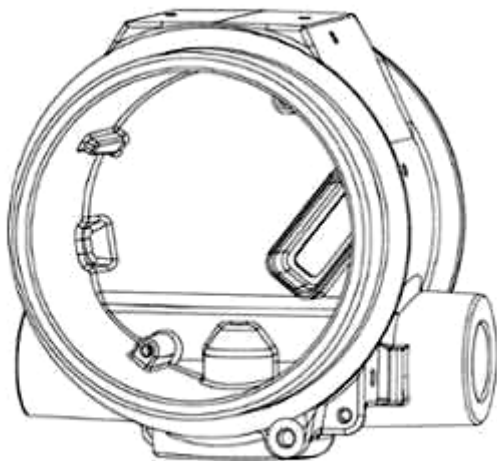

1.1

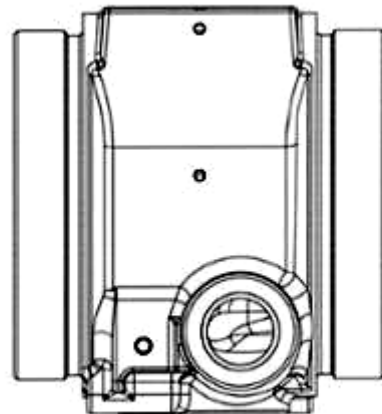

1.2

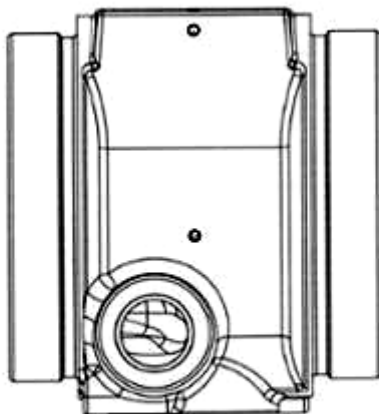

1.3

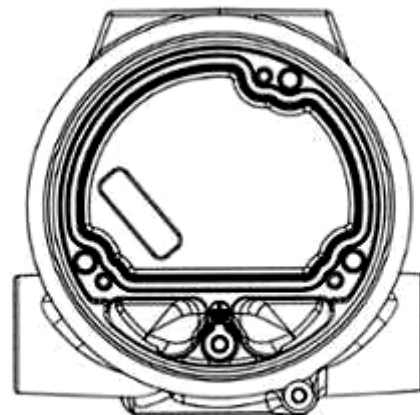

1.4

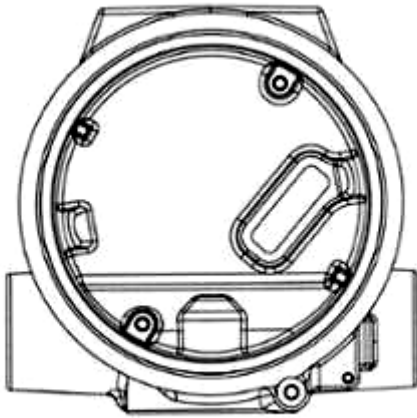

1.5

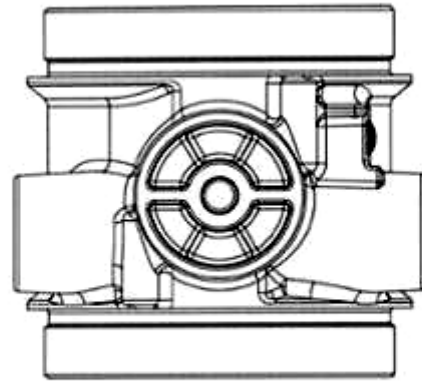

1.7

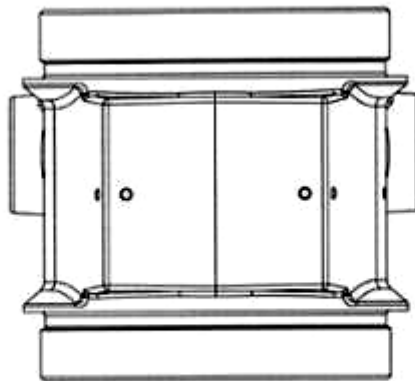

1.6

CÔNG BÁO SỞ HỮU CÔNG NGHIỆP SỐ 436 TẬP A – QUYỀN 2 (07.2024)

- (11) **50897**
(21) 3-2024-00146 (28) 1
(54) **HỘP** (51) **09-03**
(22) 18/01/2024 (43) 25/07/2024
(73) **HỘ KINH DOANH AN VĨNH PHÁT (VN)**
R23/39/36 cư xá Phú Lâm A, phường 12, quận 6, thành phố Hồ Chí Minh
(72) Khuu Sở Dinh (VN)
(55)



1.1



1.2



1.3

CÔNG BÁO SỞ HỮU CÔNG NGHIỆP SỐ 436 TẬP A – QUYỀN 2 (07.2024)

- (11) **50898**
(21) 3-2024-00147 (28) 1
(54) **HỘP** (51) **09-03**
(22) 18/01/2024 (43) 25/07/2024
(73) **HỘ KINH DOANH AN VĨNH PHÁT (VN)**
R23/39/36 cư xá Phú Lâm A, phường 12, quận 06, thành phố Hồ Chí Minh
(72) Khuu Sở Dinh (VN)
(55)



1.1



1.2



1.3



1.4



1.5



1.6



1.7

CÔNG BÁO SỞ HỮU CÔNG NGHIỆP SỐ 436 TẬP A – QUYỀN 2 (07.2024)

- (11) **50899**
(21) 3-2024-00153 (28) 1
(54) **CHAI** (51) **09-01**
(22) 18/01/2024 (43) 25/07/2024
(73) **CÔNG TY TNHH LAFRESH ĐÀ LẠT (VN)**
Tổ 87, khu biệt thự An Sơn, phường 4, thành phố Đà Lạt, tỉnh Lâm Đồng
(72) Hồ Cao Huy Bảo (VN)
(74) Công ty cổ phần FAS INVEST (FAS INVEST JSC)
(55)



1.1



1.2



1.3



1.4



1.5



1.6



1.7

CÔNG BÁO SỞ HỮU CÔNG NGHIỆP SỐ 436 TẬP A – QUYỀN 2 (07.2024)

- (11) **50900**
(21) 3-2024-00542 (28) 1
(54) **BÌNH NƯỚC** (51) **07-07**
(22) 06/03/2024 (43) 25/07/2024
(73) **CÔNG TY CỔ PHẦN SẢN XUẤT NHỰA DUY TÂN (VN)**
298 Hồ Học Lãm, phường An Lạc, quận Bình Tân, thành phố Hồ Chí Minh
(72) Trần Đức Xuyên (VN)
(74) Công ty TNHH Sở hữu trí tuệ INVENTIO (INVENTIO CO.,LTD)
(55)



1.1



1.2



1.3



1.4



1.5

CÔNG BÁO SỞ HỮU CÔNG NGHIỆP SỐ 436 TẬP A – QUYỀN 2 (07.2024)

(11) **50901**

(21) 3-2024-00543

(28) 1

(54) **BÌNH NƯỚC**

(51) **07-07**

(22) 06/03/2024

(43) 25/07/2024

(73) **CÔNG TY CỔ PHẦN SẢN XUẤT NHỰA DUY TÂN (VN)**

298 Hồ Học Lãm, phường An Lạc, quận Bình Tân, thành phố Hồ Chí Minh

(72) Trần Đức Xuyên (VN)

(74) Công ty TNHH Sở hữu trí tuệ INVENTIO (INVENTIO CO.,LTD)

(55)



1.1



1.2

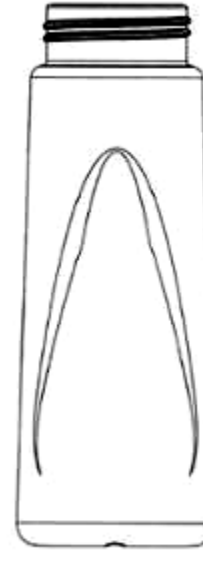

1.3



1.4



1.5

CÔNG BÁO SỞ HỮU CÔNG NGHIỆP SỐ 436 TẬP A – QUYỀN 2 (07.2024)

- (11) **50902**
(21) 3-2024-00548 (28) 1
(54) **LỌ** (51) **09-01**
(22) 06/03/2024 (43) 25/07/2024
(30) 30-2024-0008448 29/02/2024 KR;
(73) **LG H&H CO., LTD. (KR)**
58, Saemunan-ro, Jongno-gu, Seoul, Republic of Korea
(72) Lee, Ji Hwan (KR)
(74) Công ty TNHH Tầm nhìn và Liên danh (VISION & ASSOCIATES CO.LTD.)
(55)



1.1



1.2



1.3



1.4



1.5



1.6

CÔNG BÁO SỞ HỮU CÔNG NGHIỆP SỐ 436 TẬP A – QUYỀN 2 (07.2024)

(11) **50903**

(21) 3-2024-01022

(28) 1

(54) **THIẾT BỊ VẬN ĐỘNG ĐA NĂNG**

(51) **21-03**

(22) 02/05/2024

(43) 25/07/2024

(73) **CÔNG TY TNHH SẢN XUẤT MUA BÁN THIẾT BỊ TRƯỜNG HỌC TÂN TIẾN (VN)**

132 đường tx 22, khu phố 5, phường Thạnh Xuân, quận 12, thành phố Hồ Chí Minh

(72) Mai Ngọc Cường (VN)

(55)



1.1



1.2



1.3

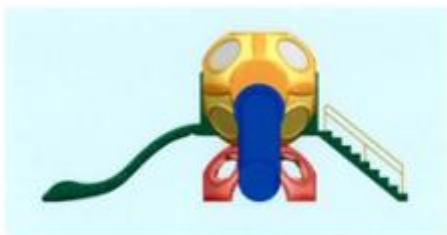

1.4



1.5

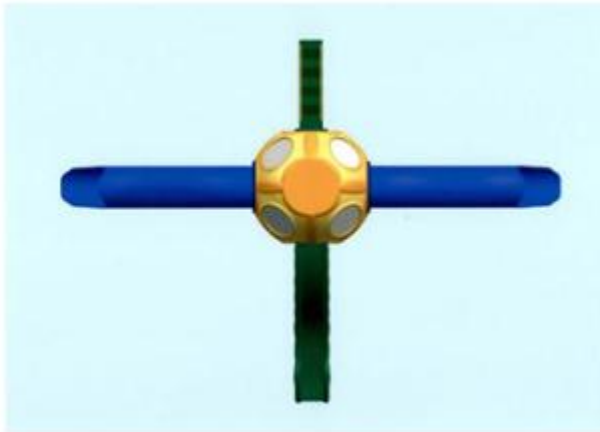

1.6

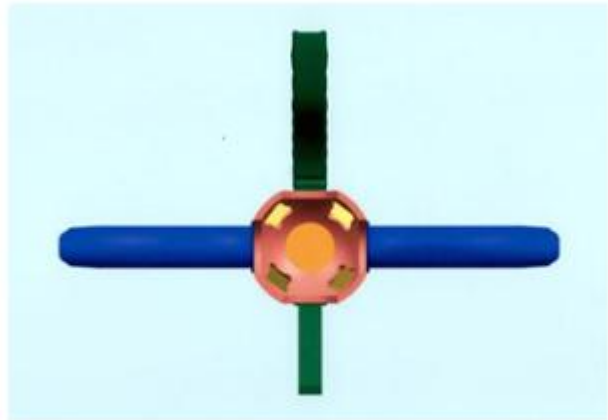

1.7

(11) **50904**

(21) 3-2024-01023

(28) 1

(54) **THIẾT BỊ VẬN ĐỘNG ĐA NĂNG**

(51) **21-03**

(22) 02/05/2024

(43) 25/07/2024

(73) **CÔNG TY TNHH SẢN XUẤT MUA BÁN THIẾT BỊ TRƯỜNG HỌC TÂN TIẾN (VN)**

132 đường tx 22, khu phố 5, phường Thạnh Xuân, quận 12, thành phố Hồ Chí Minh

(72) Mai Ngọc Cường (VN)

(55)



1.1

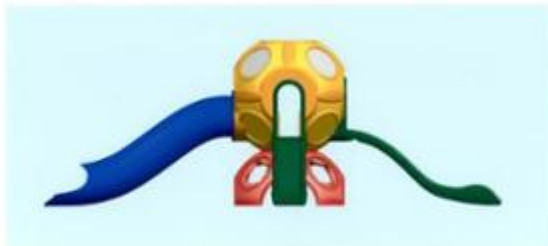

1.2



1.3



1.4



1.5

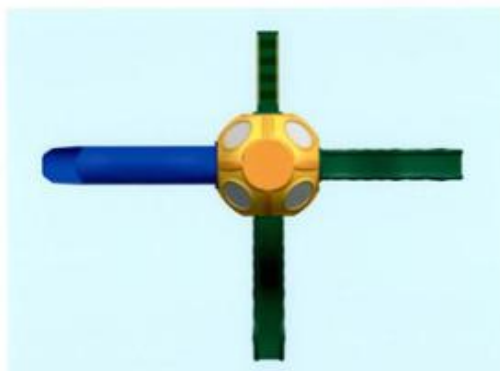

1.6

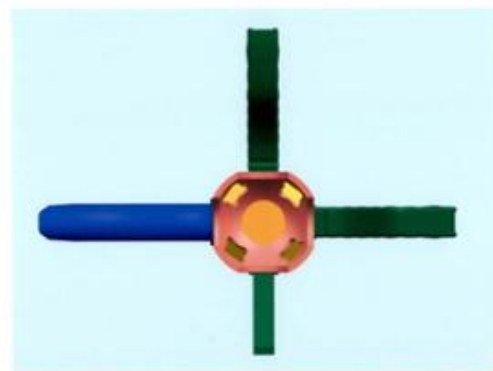

1.7

CÔNG BÁO SỞ HỮU CÔNG NGHIỆP SỐ 436 TẬP A – QUYỀN 2 (07.2024)

- (11) **50905**
(21) 3-2024-00561 (28) 1
(54) **BẢN MẪ LIÊN KẾT CHO NHÀ LẮP GHÉP** (51) **25-01; 25-02**
(22) 08/03/2024 (43) 25/07/2024
(73) **NGUYỄN XUÂN THỦY (VN)**
Tổ 3, khu 10, phường Bãi Cháy, thành phố Hạ Long, tỉnh Quảng Ninh
(72) Nguyễn Xuân Thủy (VN)
(55)



1.1



1.2

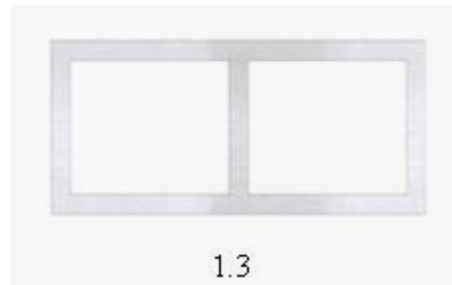

1.3

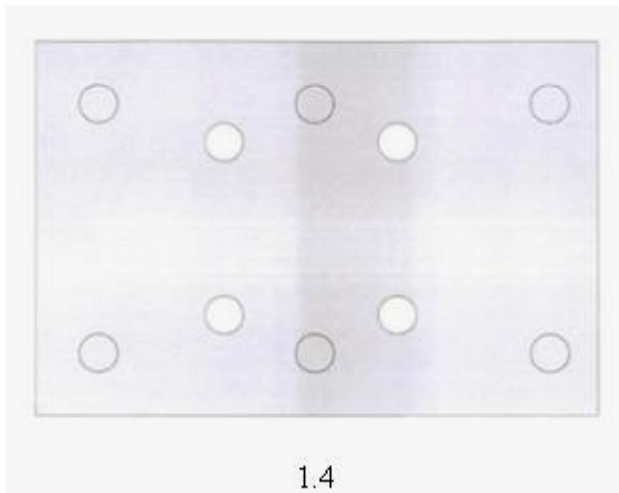

1.4

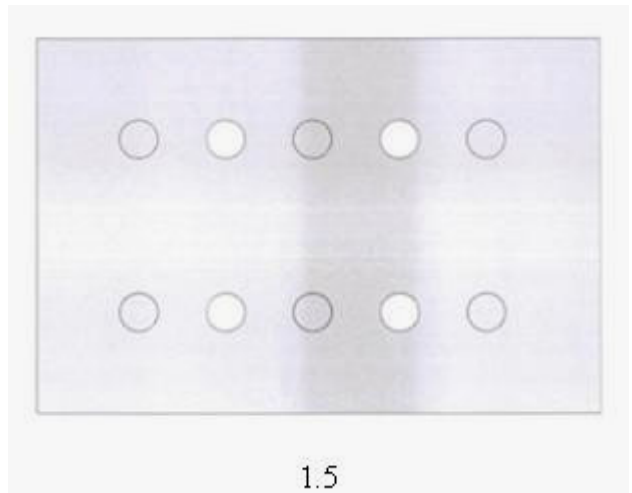

1.5

CÔNG BÁO SỞ HỮU CÔNG NGHIỆP SỐ 436 TẬP A – QUYỀN 2 (07.2024)

- (11) **50906**
(21) 3-2024-00562 (28) 1
(54) **BẢN MẪ LIÊN KẾT CHO NHÀ LẮP GHÉP** (51) **25-01; 25-02**
(22) 08/03/2024 (43) 25/07/2024
(73) **NGUYỄN XUÂN THỦY (VN)**
Tổ 3, khu 10, phường Bãi Cháy, thành phố Hạ Long, tỉnh Quảng Ninh
(72) Nguyễn Xuân Thủy (VN)
(55)

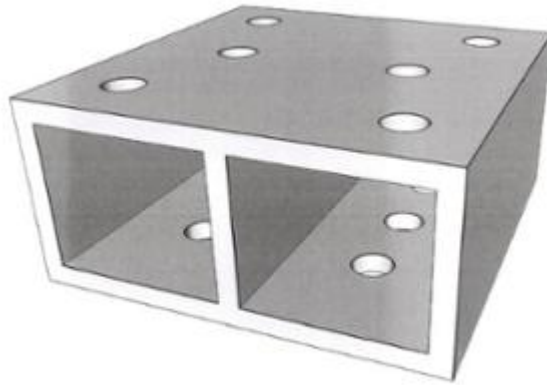

1.1

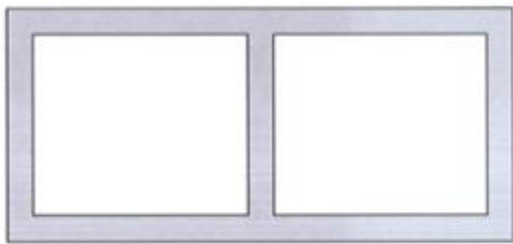

1.2



1.3

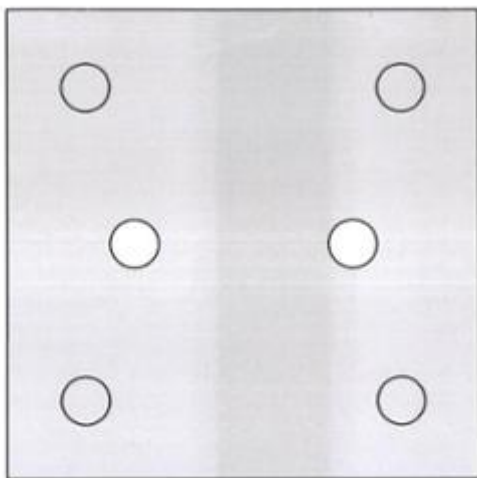

1.4

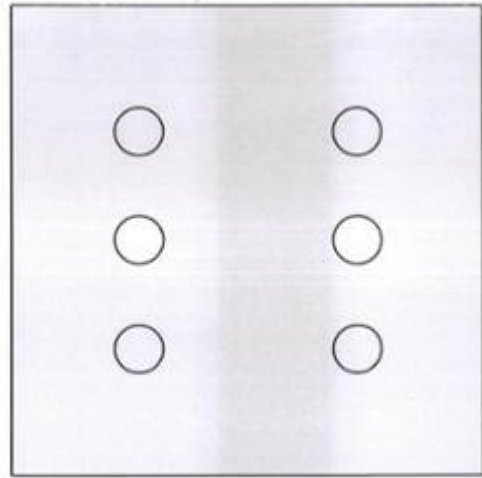

1.5

CÔNG BÁO SỞ HỮU CÔNG NGHIỆP SỐ 436 TẬP A – QUYỀN 2 (07.2024)

- (11) **50907**
(21) 3-2024-00563 (28) 1
(54) **TẤM TƯỜNG BÊ TÔNG RỖNG ĐÚC SẴN LẮP GHÉP** (51) **25-02**
(22) 08/03/2024 (43) 25/07/2024
(73) **NGUYỄN XUÂN THỦY (VN)**
Tổ 3, khu 10, phường Bãi Cháy, thành phố Hạ Long, tỉnh Quảng Ninh
(72) Nguyễn Xuân Thủy (VN)
(55)

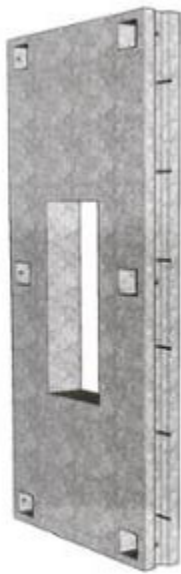

1.1

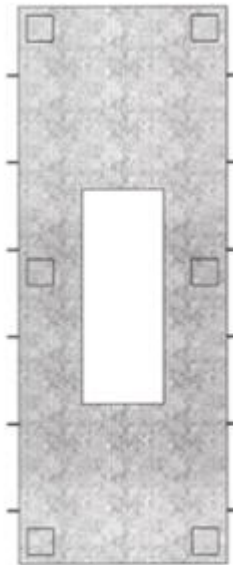

1.2

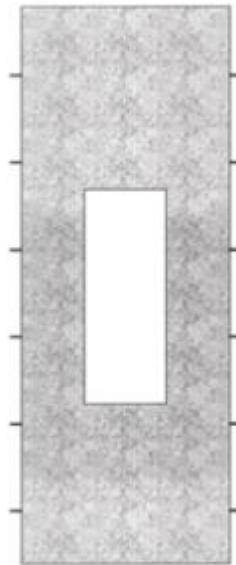

1.3



1.4



1.5

- (11) **50908**
(21) 3-2024-01040 (28) 2
(54) **HỘP VỆ SINH CHO THÚ CŨNG** (51) **30-99**
(22) 06/05/2024 (43) 25/07/2024
(30) 2023-023303 10/11/2023 JP; 2023-023302 10/11/2023 JP;
(73) **UNICHARM CORPORATION (JP)**
182, Shimobun, Kinsei-cho, Shikokuchuo-City, Ehime 799-0111, Japan
(72) 1. SATOSHI HASEGAWA (JP)
2. YASUHIRO SASANO (JP)
(74) Công ty Cổ phần Sở hữu công nghiệp INVESTIP (INVESTIP)
(55)

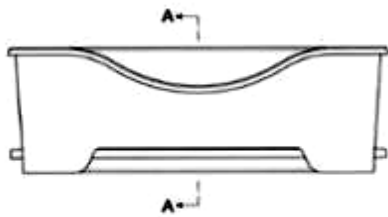

1.1



1.2



1.3



1.4

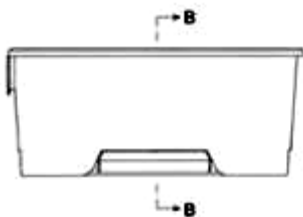

1.5



1.6



1.7

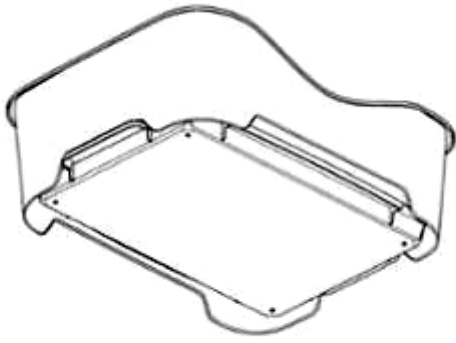

1.8

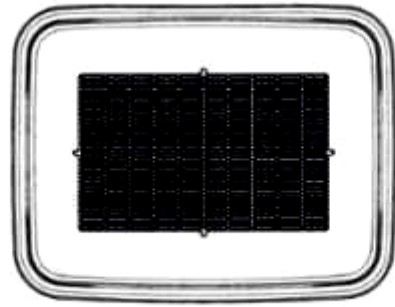

1.9



1.10



1.11



1.12



1.13



1.14



1.15



1.16



1.17

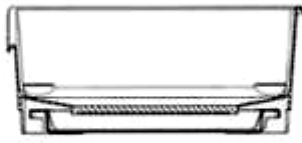

1.18



1.19



1.20



1.21

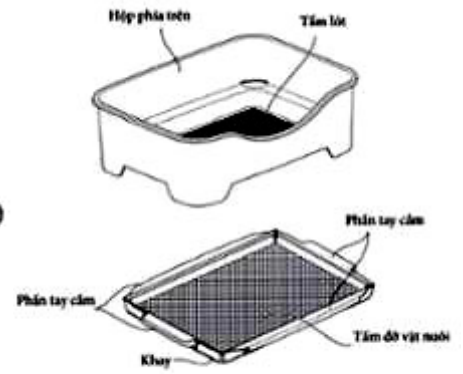

1.22

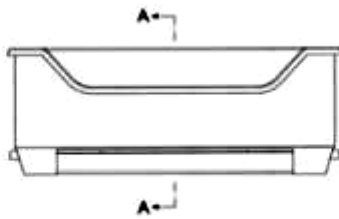

2.1

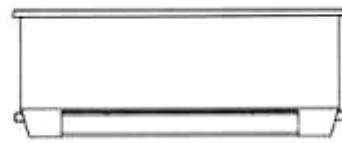

2.2



2.3

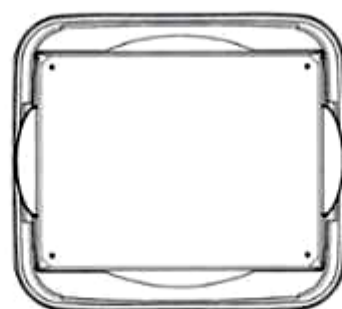

2.4

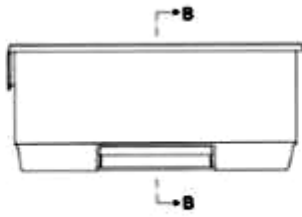

2.5



2.6

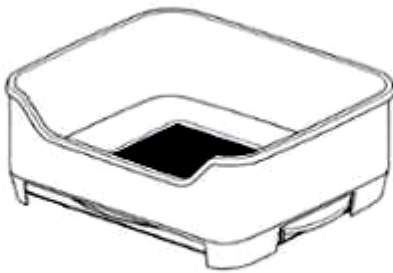

2.7

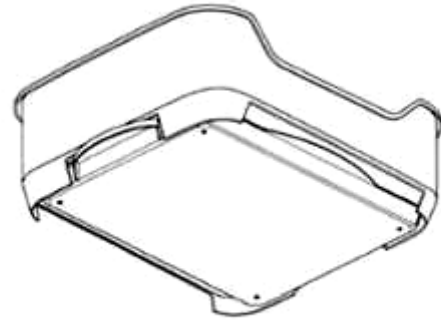

2.8

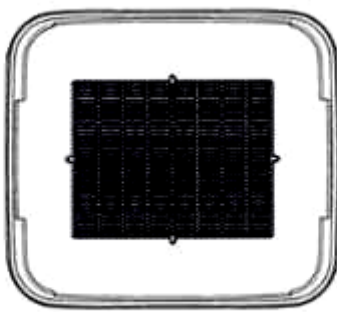

2.9



2.10



2.11



2.12



2.13



2.14



2.15



2.16



2.17



2.18

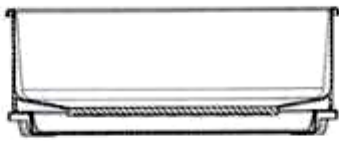

2.19



2.20



2.21

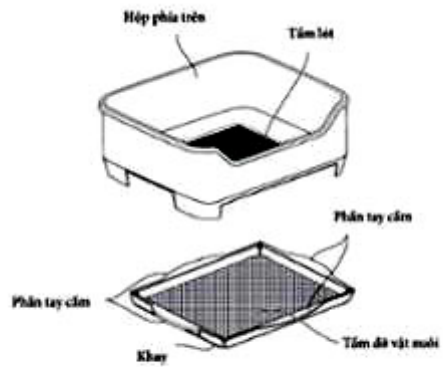

2.22

CÔNG BÁO SỞ HỮU CÔNG NGHIỆP SỐ 436 TẬP A – QUYỀN 2 (07.2024)

- (11) **50909**
(21) 3-2024-01042 (28) 1
(54) **XE MÁY ĐIỆN** (51) **12-11**
(22) 06/05/2024 (43) 25/07/2024
(30) 015040058-0001 06/11/2023 EM;
(73) **NANJING VMOTO MANUFACTURING CO, LTD (CN)**
15 Zhongxing East Road, Lishui Economic Development Zone, Lishui District,
Nanjing City, China
(72) Yiting Chen (CN)
(74) Công ty TNHH Sáng chế ACTIP (ACTIP PATENT LIMITED)
(55)



1.1



1.2



1.3



1.4



1.5



1.6



1.7



1.8

CÔNG BÁO SỞ HỮU CÔNG NGHIỆP SỐ 436 TẬP A – QUYỀN 2 (07.2024)

- (11) **50910**
(21) 3-2024-01043 (28) 1
(54) **XE MÁY ĐIỆN** (51) **12-11**
(22) 06/05/2024 (43) 25/07/2024
(30) 015040058-0002 06/11/2023 EM;
(73) **NANJING VMOTO MANUFACTURING CO, LTD (CN)**
15 Zhongxing East Road, Lishui Economic Development Zone, Lishui District,
Nanjing City, China
(72) Yiting Chen (CN)
(74) Công ty TNHH Sáng chế ACTIP (ACTIP PATENT LIMITED)
(55)



1.1



1.2



1.3



1.4



1.5



1.6



1.7



1.8

CÔNG BÁO SỞ HỮU CÔNG NGHIỆP SỐ 436 TẬP A – QUYỀN 2 (07.2024)

- (11) **50911**
(21) 3-2024-01044 (28) 1
(54) **XE MÁY ĐIỆN** (51) **12-11**
(22) 06/05/2024 (43) 25/07/2024
(30) 015040058-0003 06/11/2023 EM;
(73) **NANJING VMOTO MANUFACTURING CO, LTD (CN)**
15 Zhongxing East Road, Lishui Economic Development Zone, Lishui District,
Nanjing City, China
(72) Yiting Chen (CN)
(74) Công ty TNHH Sáng chế ACTIP (ACTIP PATENT LIMITED)
(55)



1.1



1.2



1.3



1.4



1.5



1.6



1.7



1.8

CÔNG BÁO SỞ HỮU CÔNG NGHIỆP SỐ 436 TẬP A – QUYỀN 2 (07.2024)

- (11) **50912**
(21) 3-2024-00766 (28) 1
(54) **XE SCUTO** (51) **12-11**
(22) 29/03/2024 (43) 25/07/2024
(30) 2023-020381 03/10/2023 JP;
(73) **HONDA MOTOR CO., LTD. (JP)**
1-1, Minami-Aoyama 2-chome, Minato-ku, Tokyo, 107-8556 Japan
(72) 1. SORAWIT MALIPHAN (TH)
2. TAKASHI WATANABE (JP)
(74) Công ty Luật TNHH Phạm và Liên danh (PHAM & ASSOCIATES)
(55)



1.1



1.2



1.3



1.4



1.5



1.6



1.7



1.8



1.9



1.10

CÔNG BÁO SỞ HỮU CÔNG NGHIỆP SỐ 436 TẬP A – QUYỀN 2 (07.2024)

(11) **50913**

(21) 3-2023-00969

(28) 1

(54) **HỆ THỐNG SẢN XUẤT HẠT NÊM**

(51) **15-99**

(22) 28/04/2023

(43) 25/07/2024

(73) 1. **CÔNG TY TNHH HỒ HOÀN CẦU (VN)**

Xóm 6, xã Quỳnh Văn, huyện Quỳnh Lưu, tỉnh Nghệ An

2. **CÔNG TY TNHH ABACA VIỆT NAM (VN)**

Xóm 6, xã Quỳnh Văn, huyện Quỳnh Lưu, tỉnh Nghệ An

(72) 1. **HỒ XUÂN VINH (VN)**

2. **TRẦN THỊ HỒNG THẨM (VN)**

(55)



1.1



1.2



1.3



1.4

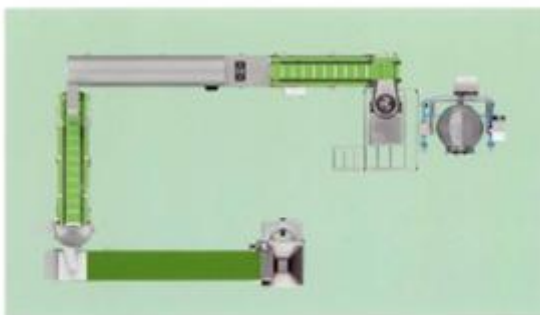

1.5



1.6

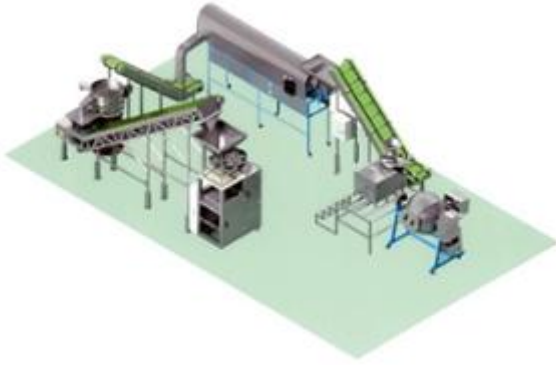

1.7

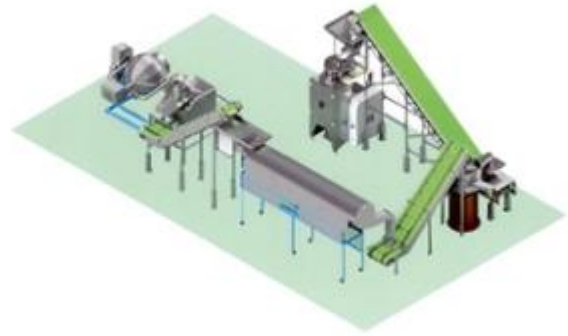

1.8

CÔNG BÁO SỞ HỮU CÔNG NGHIỆP SỐ 436 TẬP A – QUYỀN 2 (07.2024)

(11) **50914**

(21) 3-2024-00208

(28) 1

(54) **GHẾ NHỰA**

(51) **06-01**

(22) 24/01/2024

(43) 25/07/2024

(73) **CÔNG TY CỔ PHẦN NHỰA KHÔI NGUYỄN (VN)**

139/37 Dương Văn Dương, phường Tân Quý, quận Tân Phú, thành phố Hồ Chí Minh

(72) Nguyễn Minh Tuấn (VN)

(55)



1.1



1.2



1.3



1.4

CÔNG BÁO SỞ HỮU CÔNG NGHIỆP SỐ 436 TẬP A – QUYỀN 2 (07.2024)

(11) **50915**

(21) 3-2024-00209

(28) 1

(54) **GHẾ NHỰA**

(51) **06-01**

(22) 24/01/2024

(43) 25/07/2024

(73) **CÔNG TY CỔ PHẦN NHỰA KHÔI NGUYỄN (VN)**

139/37 Dương Văn Dương, phường Tân Quý, quận Tân Phú, thành phố Hồ Chí Minh

(72) Nguyễn Minh Tuấn (VN)

(55)



1.1



1.2



1.3

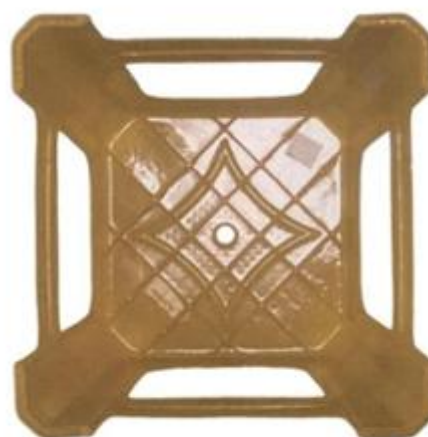

1.4

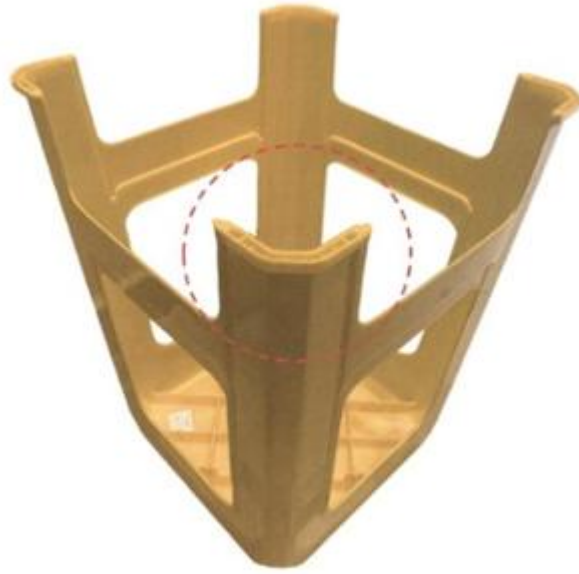

1.5

CÔNG BÁO SỞ HỮU CÔNG NGHIỆP SỐ 436 TẬP A – QUYỀN 2 (07.2024)

- (11) **50916**
(21) 3-2024-00212 (28) 1
(54) **BAO BÌ SẢN PHẨM** (51) **09-05**
(22) 24/01/2024 (43) 25/07/2024
(73) **CÔNG TY CỔ PHẦN PHÂN BÓN NA UY (VN)**
Lô A2, KCN Tân Kim mở rộng, thị trấn Cần Giuộc, huyện Cần Giuộc, tỉnh Long An
(72) Nguyễn Chí Cao (VN)
(55)



1.1



1.2

CÔNG BÁO SỞ HỮU CÔNG NGHIỆP SỐ 436 TẬP A – QUYỀN 2 (07.2024)

- (11) **50917**
(21) 3-2024-00769 (28) 1
(54) **CỤM ĐÈN PHÍA SAU XE SCUTO** (51) **26-06**
(22) 29/03/2024 (43) 25/07/2024
(30) 2023-020396 03/10/2023 JP;
(73) **HONDA MOTOR CO., LTD. (JP)**
1-1, Minami-Aoyama 2-chome, Minato-ku, Tokyo, 107-8556 Japan
(72) 1. SORAWIT MALIPHAN (TH)
2. AKIRA KATO (JP)
(74) Công ty Luật TNHH Phạm và Liên danh (PHAM & ASSOCIATES)
(55)



1.1



1.2



1.3



1.4



1.5



1.6



1.7



1.8



1.9



1.10



1.11

CÔNG BÁO SỞ HỮU CÔNG NGHIỆP SỐ 436 TẬP A – QUYỀN 2 (07.2024)

- (11) **50918**
(21) 3-2024-00770 (28) 1
(54) **DỤNG CỤ MÁT XA ĐẦU GỐI** (51) **28-03**
(22) 29/03/2024 (43) 25/07/2024
(30) 202430149019.7 21/03/2024 CN;
(73) **SHENZHEN KEEPFIT TECHNOLOGY CO., LTD. (CN)**
2F, Jingsheng Technology Bldg., No. 7 Jingsheng Industrial Zone, No. 119 Huafan Rd., Dalang St., Longhua Dist., Shenzhen, China
(72) LIJUN WAN (CN)
(74) Công ty TNHH Dịch vụ Sở hữu trí tuệ GREENIP (GREENIP CO., LTD)
(55)



1.1



1.2



1.3



1.4

1.5



1.6



1.7



1.8

CÔNG BÁO SỞ HỮU CÔNG NGHIỆP SỐ 436 TẬP A – QUYỀN 2 (07.2024)

(11) **50919**

(21) 3-2024-00782

(28) 1

(54) **ĐÈN SÀN**

(51) **26-05**

(22) 29/03/2024

(43) 25/07/2024

(73) **CÔNG TY CỔ PHẦN TƯ VẤN NHÀ ĐẸP CHÂU ÂU (VN)**

Số 36 đường Phạm Văn Đồng, phường Anh Dũng, quận Dương Kinh, thành phố Hải Phòng

(72) Nguyễn Việt Tùng (VN)

(55)



1.1



1.2



1.3



1.4

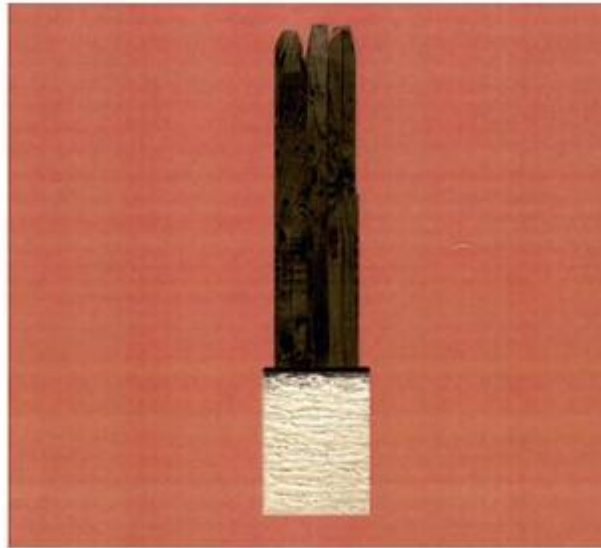

1.5



1.6



1.7

CÔNG BÁO SỞ HỮU CÔNG NGHIỆP SỐ 436 TẬP A – QUYỀN 2 (07.2024)

- (11) **50920**
- (21) 3-2024-00764 (28) 1
- (54) **NHÃN SẢN PHẨM** (51) **19-08**
- (22) 29/03/2024 (43) 25/07/2024
- (73) **CÔNG TY TNHH THỰC PHẨM ÁNH HỒNG (VN)**
21-23 đường số 1, khu dân cư Bình Phú, phường 11, quận 6, thành phố Hồ Chí Minh
- (72) Nguyễn Thị Ánh Hồng (VN)
- (74) Công ty Luật TNHH Phạm và Liên danh (PHAM & ASSOCIATES)
- (55)



CÔNG BÁO SỞ HỮU CÔNG NGHIỆP SỐ 436 TẬP A – QUYỀN 2 (07.2024)

- (11) **50921**
(21) 3-2024-00765 (28) 1
(54) **NHÃN SẢN PHẨM** (51) **19-08**
(22) 29/03/2024 (43) 25/07/2024
(73) **CÔNG TY TNHH THỰC PHẨM ÁNH HỒNG (VN)**
21-23 đường số 1, khu dân cư Bình Phú, phường 11, quận 6, thành phố Hồ Chí Minh
(72) Nguyễn Thị Ánh Hồng (VN)
(74) Công ty Luật TNHH Phạm và Liên danh (PHAM & ASSOCIATES)
(55)



1.1

CÔNG BÁO SỞ HỮU CÔNG NGHIỆP SỐ 436 TẬP A – QUYỀN 2 (07.2024)

- (11) **50922**
- (21) 3-2024-00773 (28) 2
- (54) **NHÃN SẢN PHẨM** (51) **19-08**
- (22) 29/03/2024 (43) 25/07/2024
- (73) **CÔNG TY TNHH PDA HEALTHCARE & BEAUTY (VN)**
221E/5 Trần Huy Liệu, phường 8, quận Phú Nhuận, thành phố Hồ Chí Minh
- (72) Trần Thị Thảo Nguyễn (VN)
- (55)



1.1



2.1

CÔNG BÁO SỞ HỮU CÔNG NGHIỆP SỐ 436 TẬP A – QUYỀN 2 (07.2024)

- (11) **50923**
(21) 3-2024-00774 (28) 1
(54) **NHÃN SẢN PHẨM** (51) **19-08**
(22) 29/03/2024 (43) 25/07/2024
(73) **CÔNG TY TNHH PDA HEALTHCARE & BEAUTY (VN)**
221E/5 Trần Huy Liệu, phường 8, quận Phú Nhuận, thành phố Hồ Chí Minh
(72) Trần Thị Thảo Nguyên (VN)
(55)



1.1

CÔNG BÁO SỞ HỮU CÔNG NGHIỆP SỐ 436 TẬP A – QUYỀN 2 (07.2024)

- (11) **50924**
(21) 3-2024-00779 (28) 1
(54) **BÚT** (51) **19-06**
(22) 29/03/2024 (43) 25/07/2024
(73) **CÔNG TY CỔ PHẦN TẬP ĐOÀN THIÊN LONG (VN)**
Tầng 10, Sofic Tower, số 10 đường Mai Chí Thọ, phường Thủ Thiêm, thành phố
Thủ Đức, thành phố Hồ Chí Minh
(72) Cô Gia Thọ (VN)
(74) Công ty TNHH Tư vấn sở hữu trí tuệ Việt (VIET IP CO.,LTD.)
(55)

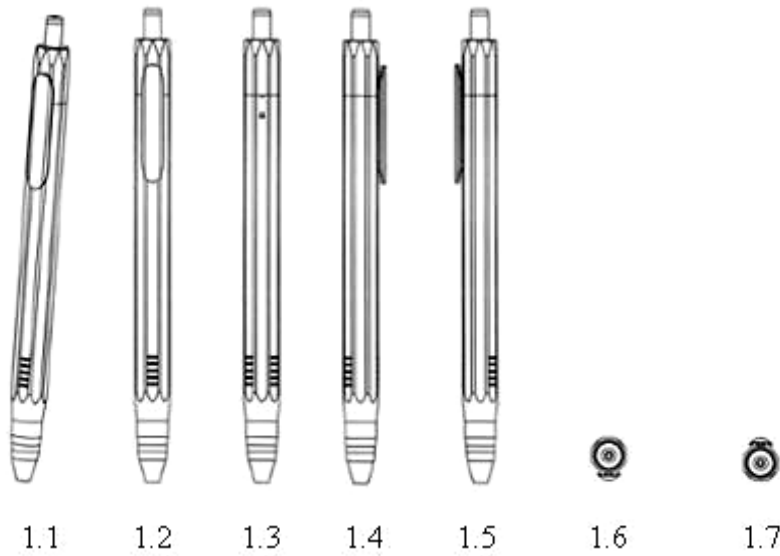

CÔNG BÁO SỞ HỮU CÔNG NGHIỆP SỐ 436 TẬP A – QUYỀN 2 (07.2024)

- (11) **50925**
(21) 3-2024-00405 (28) 1
(54) **BAO GÓI** (51) **09-05**
(22) 21/02/2024 (43) 25/07/2024
(73) **CÔNG TY TRÁCH NHIỆM HỮU HẠN CON CÒ VÀNG (VN)**
23 Lô B đường số 1, phường Phú Thuận, quận 7, thành phố Hồ Chí Minh
(72) Hoàng Mai Dẫn (VN)
(74) Công ty TNHH một thành viên Trường Luật (Trường Luật)
(55)



1.1



1.2

- (11) **50926**
- (21) 3-2024-00809
- (54) **CHAI**
- (22) 04/04/2024
- (30) DM/232443 09/10/2023 WO;
- (73) **PI-DESIGN AG (CH)**
Altgasse 82, CH-6340 Baar, Switzerland
- (72) Jorgen BODUM (CH)
- (74) Công ty Luật TNHH T&G (TGVN)
- (55)
- (28) 1
- (51) **09-01**
- (43) 25/07/2024



1.1

1.2

1.3

1.4

1.5



1.6



1.7

CÔNG BÁO SỞ HỮU CÔNG NGHIỆP SỐ 436 TẬP A – QUYỀN 2 (07.2024)

- (11) **50927**
(21) 3-2024-00820 (28) 1
(54) **THANH ĐỊNH HÌNH** (51) **25-01**
(22) 04/04/2024 (43) 25/07/2024
(73) **CÔNG TY CỔ PHẦN CÔNG NGHIỆP VĨNH TUỜNG (VN)**
Lô C23A, khu công nghiệp Hiệp Phước, xã Hiệp Phước, huyện Nhà Bè, thành phố Hồ Chí Minh
(72) Nguyễn Trung Kiên (VN)
(74) Công ty Luật TNHH Thăng Phạm và Cộng sự (IP-MARK ASIA LAW FIRM)
(55)

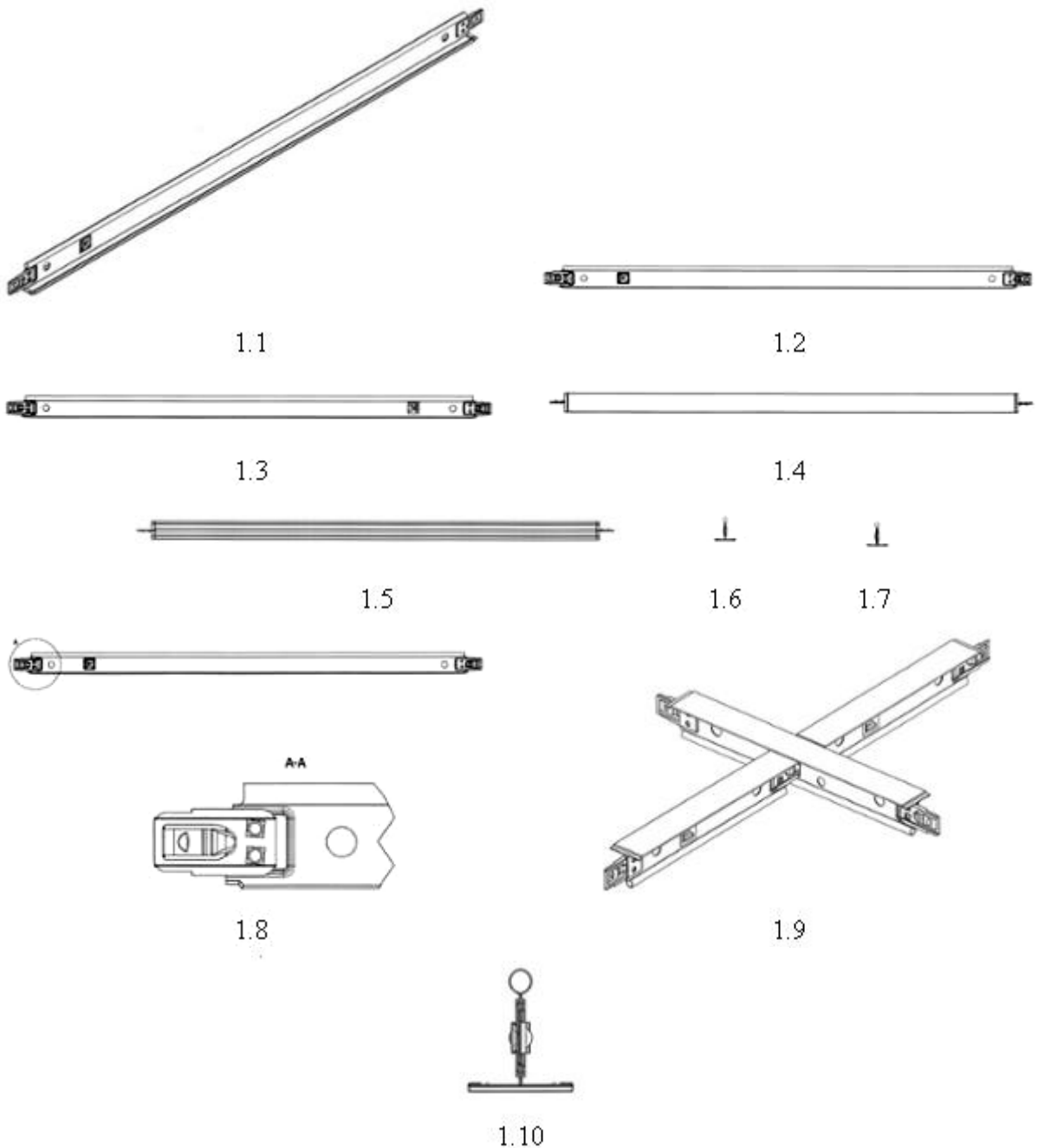

CÔNG BÁO SỞ HỮU CÔNG NGHIỆP SỐ 436 TẬP A – QUYỀN 2 (07.2024)

(11) **50928**

(21) 3-2024-00828

(28) 1

(54) **NHÃN**

(51) **11-01**

(22) 04/04/2024

(43) 25/07/2024

(73) **CÔNG TY TNHH BẢO TÍN MINH CHÂU (VN)**

Số 29 Trần Nhân Tông, phường Nguyễn Du, quận Hai Bà Trưng, thành phố Hà Nội

(72) Vũ Minh Châu (VN)

(55)



1.1



1.2



1.3



1.4



1.5



1.6

CÔNG BÁO SỞ HỮU CÔNG NGHIỆP SỐ 436 TẬP A – QUYỀN 2 (07.2024)

- (11) **50929**
(21) 3-2024-00829 (28) 1
(54) **MẶT DÂY CHUYỀN** (51) **11-01**
(22) 04/04/2024 (43) 25/07/2024
(73) **CÔNG TY TNHH BẢO TÍN MINH CHÂU (VN)**
Số 29 Trần Nhân Tông, phường Nguyễn Du, quận Hai Bà Trưng, thành phố Hà Nội
(72) Vũ Minh Châu (VN)
(55)



1.1



1.2



1.3



1.4



1.5

CÔNG BÁO SỞ HỮU CÔNG NGHIỆP SỐ 436 TẬP A – QUYỀN 2 (07.2024)

- (11) **50930**
(21) 3-2024-00830 (28) 2
(54) **THIẾT BỊ ĐÁNH DẤU MẶT ĐƯỜNG** (51) **10-05**
(22) 04/04/2024 (43) 25/07/2024
(30) 2023308292949 16/12/2023 CN; 2023308292900 16/12/2023 CN;
(73) **ZHEJIANG CHANGHUI TRAFFIC SAFETY TECHNOLOGY CO., LTD.**
(CN)
No. 668 Yingbin Avenue, Shanghua Street, Lanxi, Jinhua, Zhejiang, China
(72) 1. XIANFENG FANG (CN)
2. MING FANG (CN)
(74) Công ty TNHH Dịch vụ Sở hữu trí tuệ GREENIP (GREENIP CO., LTD)
(55)



1.1



1.2



1.3



1.4



1.5

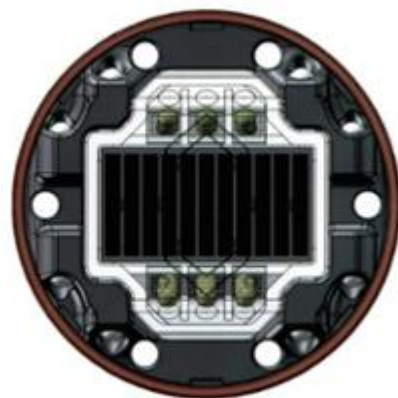

1.6

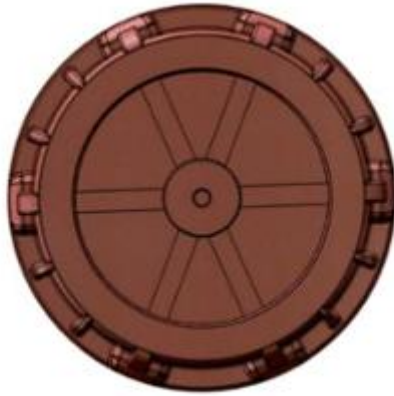

1.7



1.8



1.9

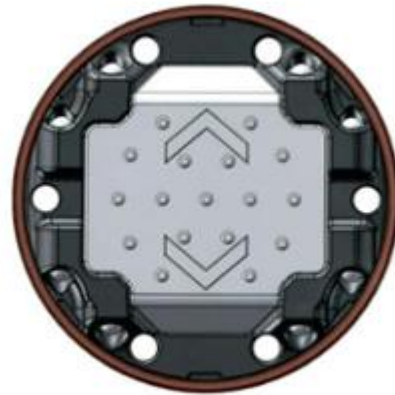

1.10



2.1



2.2



2.3



2.4



2.5

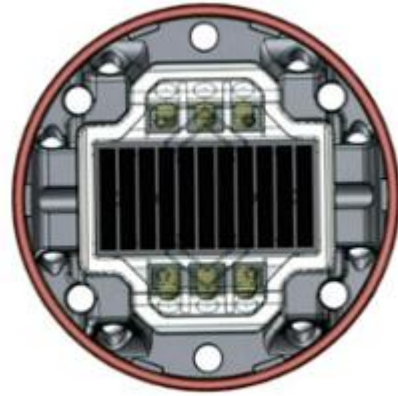

2.6



2.7



2.8



2.9

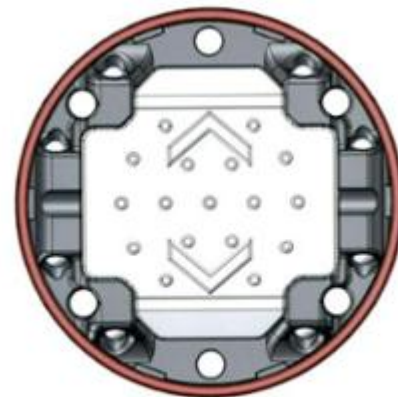

2.10

CÔNG BÁO SỞ HỮU CÔNG NGHIỆP SỐ 436 TẬP A – QUYỀN 2 (07.2024)

- (11) **50931**
(21) 3-2024-00831 (28) 2
(54) **THIẾT BỊ ĐÁNH DẤU MẶT ĐƯỜNG** (51) **10-05**
(22) 04/04/2024 (43) 25/07/2024
(30) 2023306487942 08/10/2023 CN;
(73) **MING FANG (CN)**
No. 668 Yingbin Avenue, Shanghua Street, Lanxi, Jinhua, Zhejiang, China
(72) MING FANG (CN)
(74) Công ty TNHH Dịch vụ Sở hữu trí tuệ GREENIP (GREENIP CO., LTD)
(55)

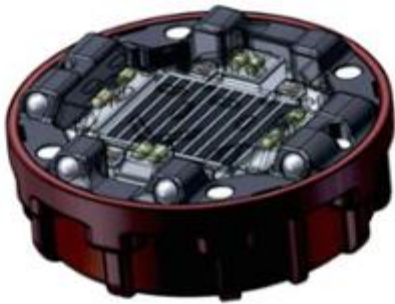

1.1



1.2



1.3



1.4



1.5

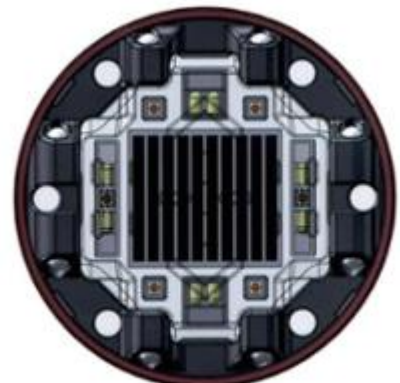

1.6



1.7



1.8



1.9



1.10



2.1



2.2



2.3



2.4



2.5

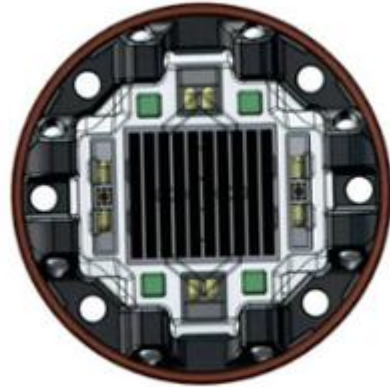

2.6



2.7



2.8



2.9



2.10

CÔNG BÁO SỞ HỮU CÔNG NGHIỆP SỐ 436 TẬP A – QUYỀN 2 (07.2024)

- (11) **50932**
(21) 3-2024-00832 (28) 2
(54) **THIẾT BỊ ĐÁNH DẤU MẶT ĐƯỜNG** (51) **10-05**
(22) 04/04/2024 (43) 25/07/2024
(30) 2023306487730 08/10/2023 CN; 2023306487656 08/10/2023 CN;
(73) **ZHEJIANG CHANGHUI TRAFFIC SAFETY TECHNOLOGY CO., LTD.**
(CN)
No. 668 Yingbin Avenue, Shanghua Street, Lanxi, Jinhua, Zhejiang, China
(72) 1. XIANFENG FANG (CN)
2. MING FANG (CN)
(74) Công ty TNHH Dịch vụ Sở hữu trí tuệ GREENIP (GREENIP CO., LTD)
(55)



1.1



1.2



1.3



1.4



1.5



1.6



1.7



1.8



1.9

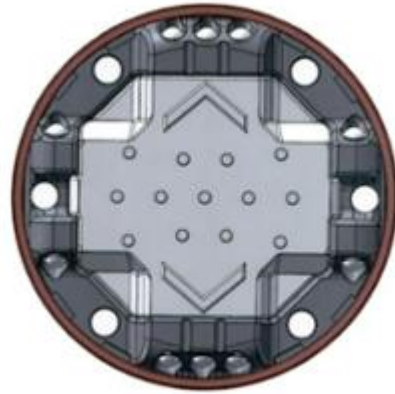

1.10



2.1



2.2



2.3



2.4



2.5

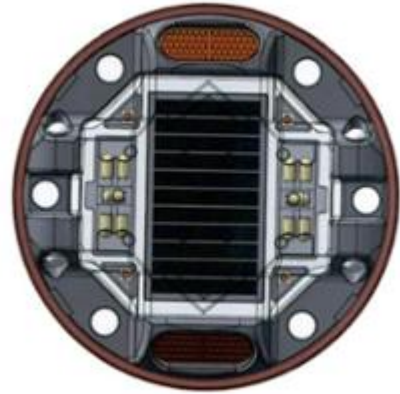

2.6



2.7



2.8



2.9

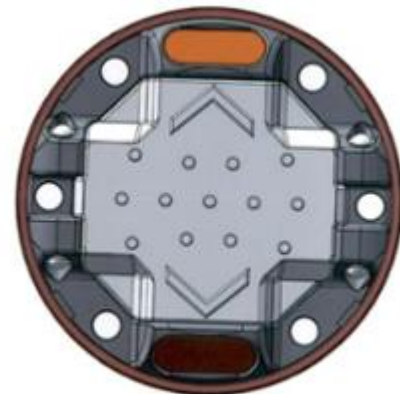

2.10

CÔNG BÁO SỞ HỮU CÔNG NGHIỆP SỐ 436 TẬP A – QUYỀN 2 (07.2024)

(11) **50933**

(21) 3-2024-00898

(28) 1

(54) **ĐÈN CHIẾU SÁNG**

(51) **26-03**

(22) 11/04/2024

(43) 25/07/2024

(73) **CÔNG TY CỔ PHẦN CHIẾU SÁNG ĐÔ THỊ HOÀNG GIA (VN)**

Phòng 403, tòa nhà Ocean Park, số 1 Đào Duy Anh, phường Phương Mai, quận
Đống Đa, thành phố Hà Nội

(72) Hoàng Song Hà (VN)

(55)



1.1



1.2



1.3



1.4



1.5



1.6



1.7

CÔNG BÁO SỞ HỮU CÔNG NGHIỆP SỐ 436 TẬP A – QUYỀN 2 (07.2024)

- (11) **50934**
(21) 3-2024-00899 (28) 1
(54) **DỤNG CỤ CHĂM SÓC CÁ NHÂN** (51) **04-02**
(22) 11/04/2024 (43) 25/07/2024
(30) 29/915,816 03/11/2023 US;
(73) **COLGATE-PALMOLIVE COMPANY (US)**
300 Park Avenue, New York, New York 10022, United States of America
(72) 1. XUQI ZHOU (CN)
2. FAN GANG XIE (CN)
(74) Văn phòng Luật sư Ân Nam (ANNAM IP & LAW)
(55)

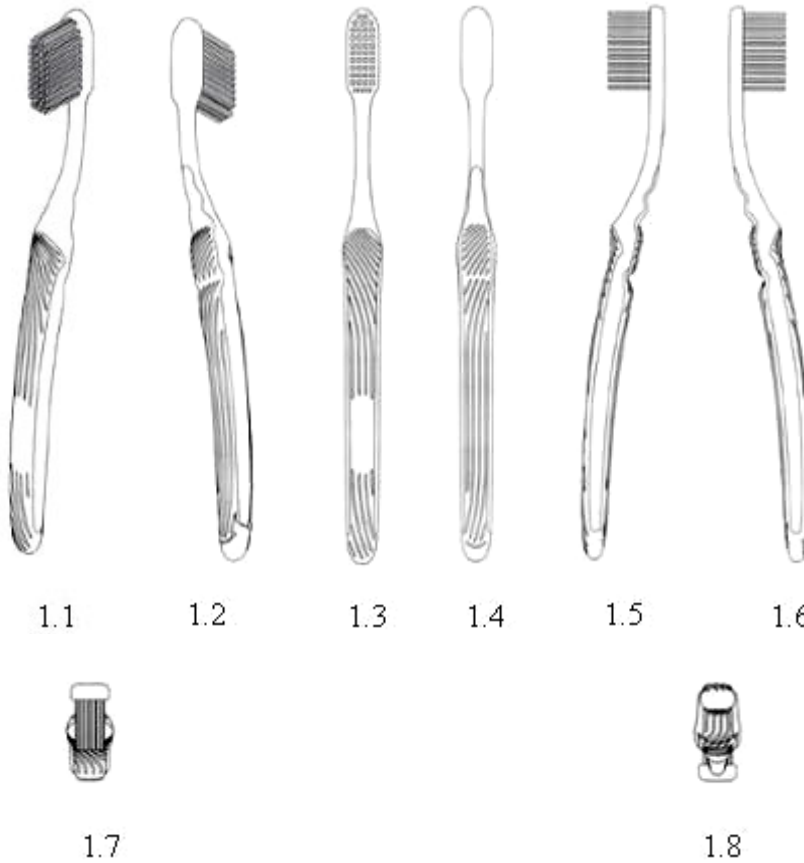

CÔNG BÁO SỞ HỮU CÔNG NGHIỆP SỐ 436 TẬP A – QUYỀN 2 (07.2024)

- (11) **50935**
- (21) 3-2024-00900 (28) 1
- (54) **NHÃN SẢN PHẨM** (51) **19-08**
- (22) 11/04/2024 (43) 25/07/2024
- (73) **CÔNG TY CỔ PHẦN SỮA VIỆT NAM (VN)**
10 Tân Trào, phường Tân Phú, quận 7, thành phố Hồ Chí Minh
- (72) Megan Nicole Bowker (US)
- (74) Công ty cổ phần Sở hữu trí tuệ BROSS và Cộng sự (BROSS & PARTNERS., JSC)
- (55)



CÔNG BÁO SỞ HỮU CÔNG NGHIỆP SỐ 436 TẬP A – QUYỀN 2 (07.2024)

(11) **50936**

(21) 3-2024-00904

(54) **ĐỒ GÁ GIA CÔNG CƠ KHÍ**

(22) 12/04/2024

(73) **NGUYỄN CHÍ LINH (VN)**

129/3 ấp An Bình, xã An Nhơn, huyện Thạnh Phú, tỉnh Bến Tre

(72) Nguyễn Chí Linh (VN)

(74) Công ty TNHH Tư vấn đầu tư và Sở hữu trí tuệ Hoàng Phi (HOANG PHI INVEST & I.P CO., LTD)

(55)

(28) 1

(51) **15-09**

(43) 25/07/2024

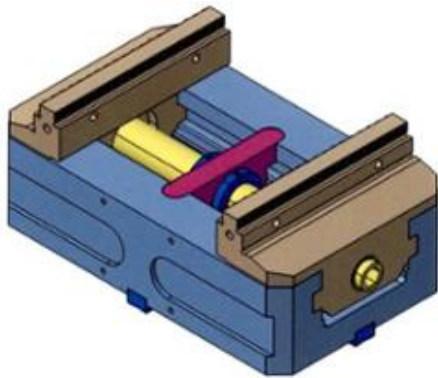

1.1



1.2

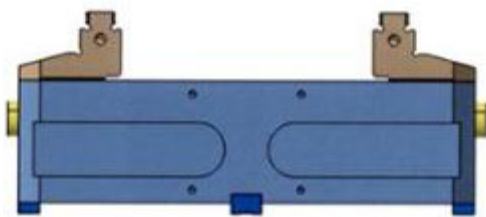

1.3

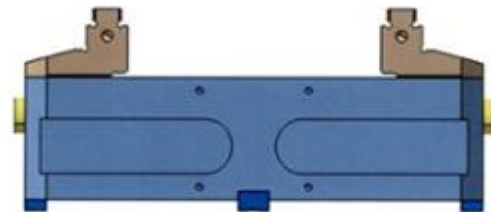

1.4

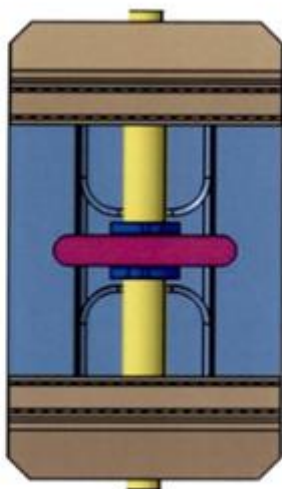

1.5

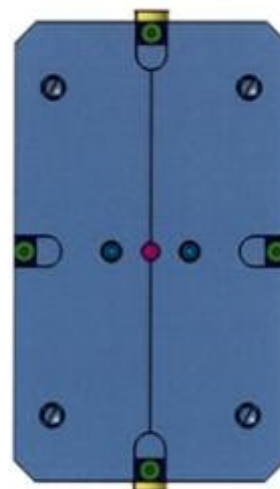

1.6

CÔNG BÁO SỞ HỮU CÔNG NGHIỆP SỐ 436 TẬP A – QUYỀN 2 (07.2024)

(11) **50937**

(21) 3-2024-00902

(28) 1

(54) **DÉP**

(51) **02-04**

(22) 12/04/2024

(43) 25/07/2024

(73) **CÔNG TY TNHH GIÀY Á CHÂU (VN)**

451/29/8 Tô Hiến Thành, phường 14, quận 10, thành phố Hồ Chí Minh

(72) Nguyễn Đình Kim (VN)

(74) Văn phòng Luật sư A Hoà (AHOA LAW OFFICE)

(55)



1.1



1.2



1.3



1.4



1.5



1.6



1.7



1.8

- (11) **50938**
(21) 3-2024-01230 (28) 1
(54) **MÒI CÂU CÁ** (51) **22-05**
(22) 30/05/2024 (43) 25/07/2024
(30) 2023-025482 06/12/2023 JP;
(73) **GLOBERIDE, INC. (JP)**
3-14-16, Maesawa, Higashi Kurume, Tokyo 203-8511, Japan
(72) Ken HAYAKAWA (JP)
(74) **CÔNG TY LUẬT TRÁCH NHIỆM HỮU HẠN AMBYS HÀ NỘI (AMBYS HANOI)**
(55)



1.1



1.2



1.3

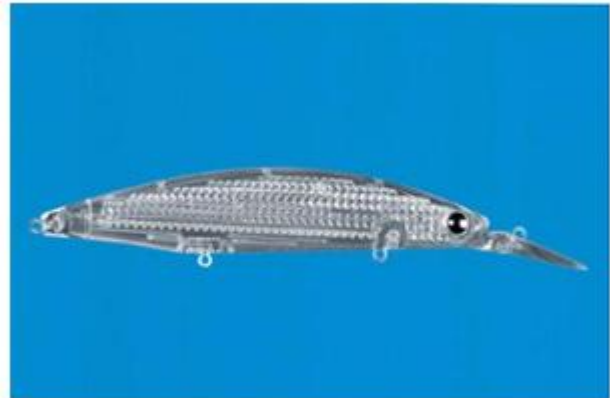

1.4



1.5



1.6

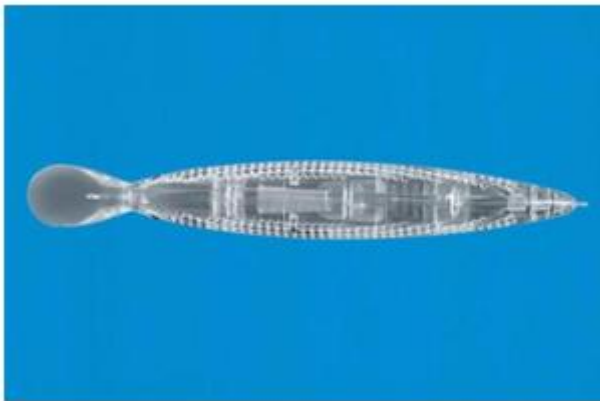

1.7

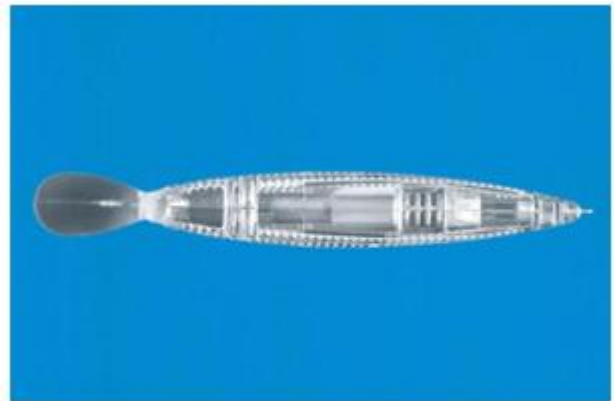

1.8

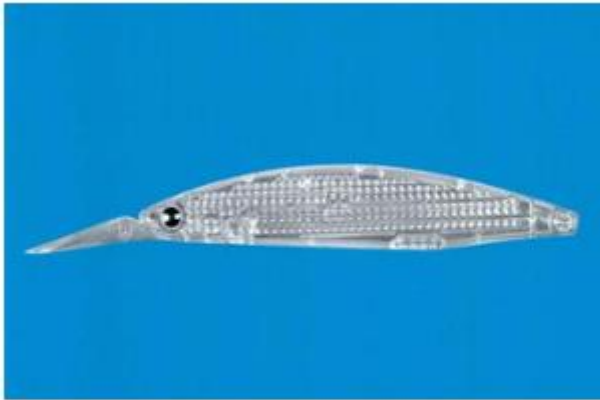

1.9

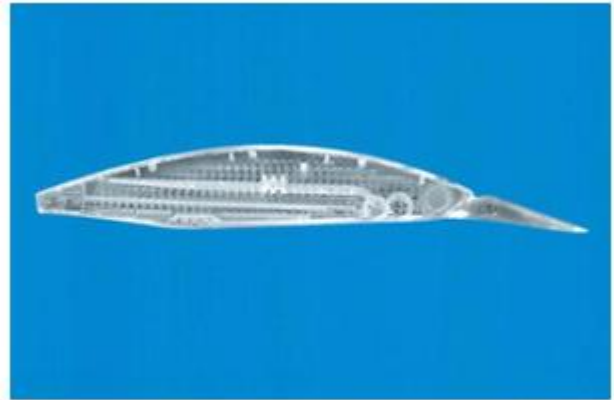

1.10

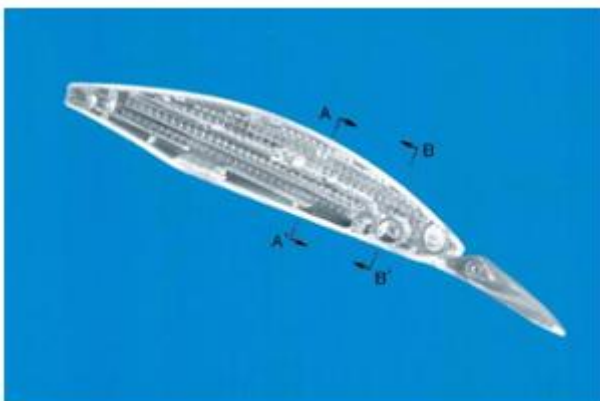

1.11



1.12

(11) **50939**

(21) 3-2024-01238

(28) 1

(54) **PHẦN MỞ RỘNG CỦA ĐUÔI GIÓ MŨ BẢO HIỂM**

(51) **02-03**

(22) 30/05/2024

(43) 25/07/2024

(73) **HENRY TEDJAKUSUMA (ID)**

Jalan Wuluh Blok II/3, RT/RW 009/006, Kota Bambu Utara, Palmerah Jakarta Barat 11420, Indonesia

(72) Henry Tedjakusuma (ID)

(74) Công ty TNHH Sở hữu trí tuệ HA VIP (HAVIP CO., LTD.)

(55)

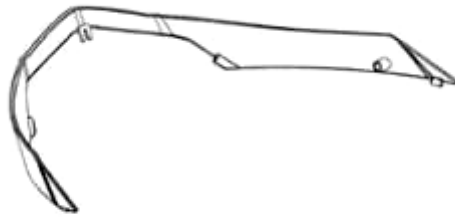

1.1



1.2



1.3



1.4



1.5



1.6



1.7

CÔNG BÁO SỞ HỮU CÔNG NGHIỆP SỐ 436 TẬP A – QUYỀN 2 (07.2024)

- (11) **50940**
- (21) 3-2024-01239
- (54) **THẺ**
- (22) 30/05/2024
- (73) **CÔNG TY CỔ PHẦN DỊCH VỤ HÀNG KHÔNG NỘI BÀI (VN)**
Tầng 4, toà nhà NTS cảng Hàng không quốc tế Nội Bài, xã Phú Cường, huyện Sóc Sơn, thành phố Hà Nội
- (72) Nguyễn Hoàng Mai Thư (VN)
- (74) Công ty TNHH Sở hữu trí tuệ Trần & Trần (TRAN & TRAN CO., LTD.)
- (55)



1.1



1.2



1.3



1.4

CÔNG BÁO SỞ HỮU CÔNG NGHIỆP SỐ 436 TẬP A – QUYỀN 2 (07.2024)

- (11) **50941**
(21) 3-2024-01240 (28) 1
(54) **THẺ** (51) **19-08**
(22) 30/05/2024 (43) 25/07/2024
(73) **CÔNG TY CỔ PHẦN DỊCH VỤ HÀNG KHÔNG NỘI BÀI (VN)**
Tầng 4, toà nhà NTS cảng Hàng không quốc tế Nội Bài, xã Phú Cường, huyện Sóc Sơn, thành phố Hà Nội
(72) Nguyễn Hoàng Mai Thu (VN)
(74) Công ty TNHH Sở hữu trí tuệ Trần & Trần (TRAN & TRAN CO., LTD.)
(55)



1.1



1.2



1.3



1.4

(11) **50942**

(21) 3-2024-01242

(28) 1

(54) **ĐÈN NĂNG LƯỢNG MẶT TRỜI**

(51) **26-03**

(22) 30/05/2024

(43) 25/07/2024

(73) **LIU CHUANLIN (CN)**

No. 42, Shiqi Lane, Gusu District, Suzhou City, Jiangsu Province, China

(72) LIU Chuanlin (CN)

(74) Công ty TNHH Sở hữu trí tuệ HA VIP (HAVIP CO., LTD.)

(55)

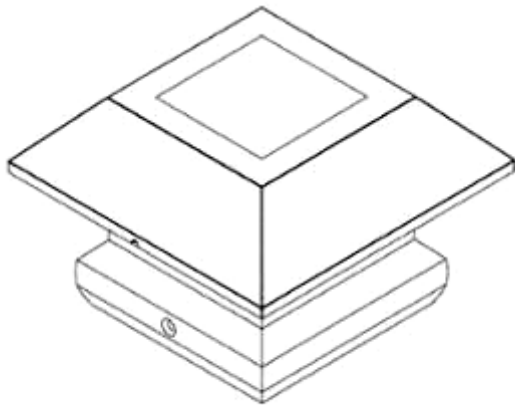

1.1

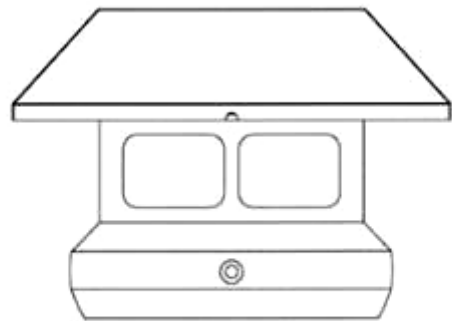

1.2

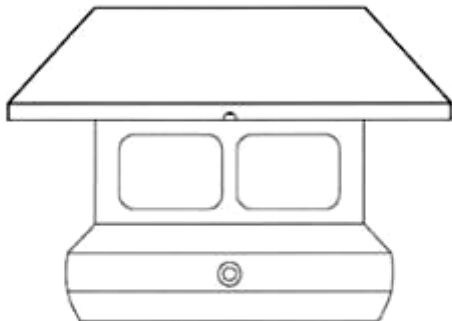

1.3

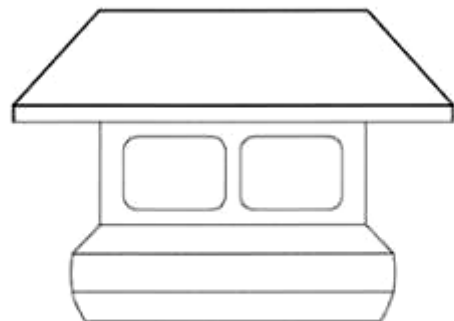

1.4

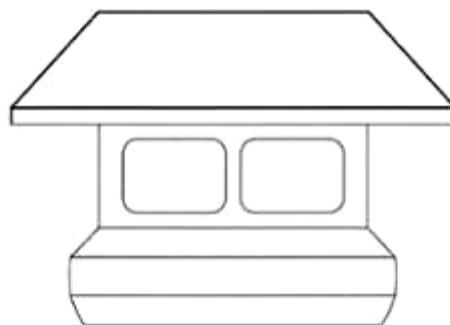

1.5

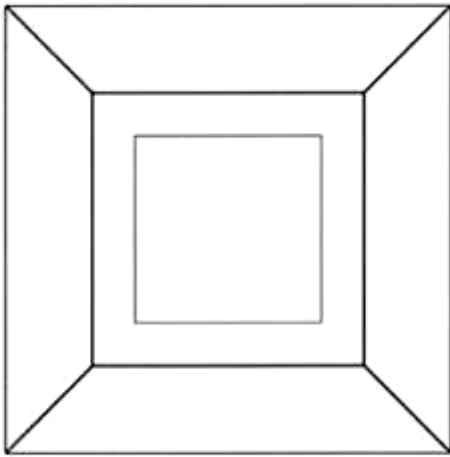

1.6

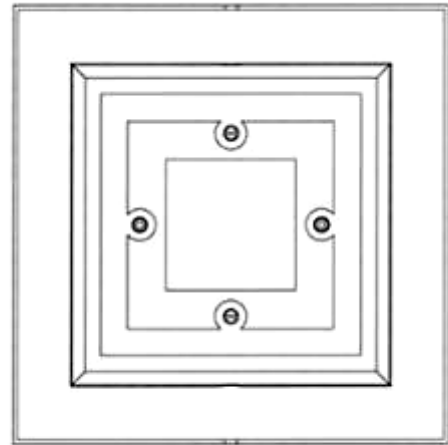

1.7

CÔNG BÁO SỞ HỮU CÔNG NGHIỆP SỐ 436 TẬP A – QUYỀN 2 (07.2024)

- (11) **50943**
(21) 3-2024-01228 (28) 1
(54) **CHAI** (51) **09-01**
(22) 30/05/2024 (43) 25/07/2024
(73) **CÔNG TY TNHH NAM PHƯƠNG V.N (VN)**
124 Lê Lai, phường 03, quận Gò Vấp, thành phố Hồ Chí Minh
(72) Hoàng Thị Minh Hiếu (VN)
(74) Công ty Luật TNHH Phạm và Liên danh (PHAM & ASSOCIATES)
(55)



1.1



1.2

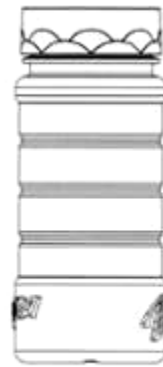

1.3



1.4



1.5

CÔNG BÁO SỞ HỮU CÔNG NGHIỆP SỐ 436 TẬP A – QUYỀN 2 (07.2024)

- (11) **50944**
- (21) 3-2024-00837
- (54) **QUE LẤY MẪU**
- (22) 05/04/2024
- (30) 2024300824400 07/02/2024 CN;
- (73) **JIALUN WANG (CN)**
Building 3, No. 189, Jinglian Road, Minhang District, Shanghai, China
- (72) Jialun Wang (CN)
- (74) Công ty TNHH Sở hữu trí tuệ Trần & Trần (TRAN & TRAN CO., LTD.)
- (55)

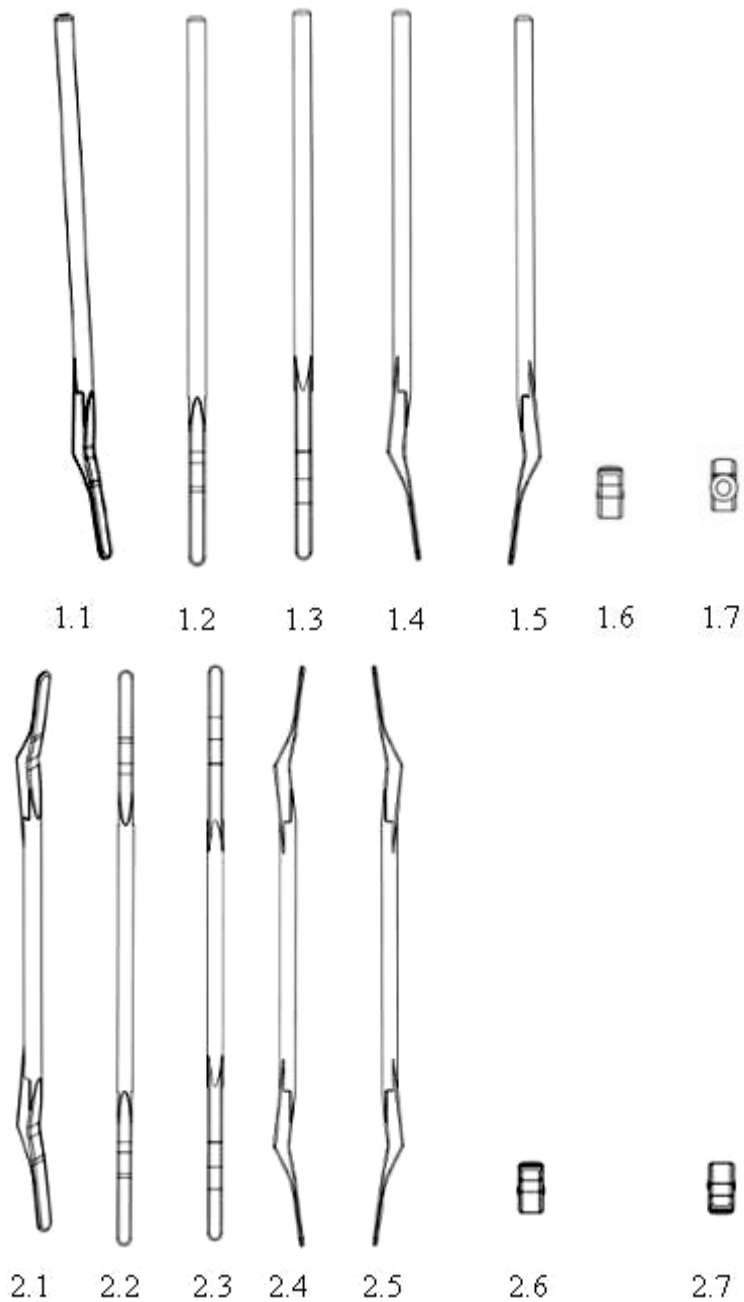

CÔNG BÁO SỞ HỮU CÔNG NGHIỆP SỐ 436 TẬP A – QUYỀN 2 (07.2024)

- (11) **50945**
(21) 3-2024-00838 (28) 1
(54) **QUE LẤY MẪU** (51) **24-02**
(22) 05/04/2024 (43) 25/07/2024
(30) 202430060379X 30/01/2024 CN;
(73) **TINGWEI CUI (CN)**
Building 3, No. 189, Jinglian Road, Minhang District, Shanghai, China
(72) Tingwei Cui (CN)
(74) Công ty TNHH Sở hữu trí tuệ Trần & Trần (TRAN & TRAN CO., LTD.)
(55)

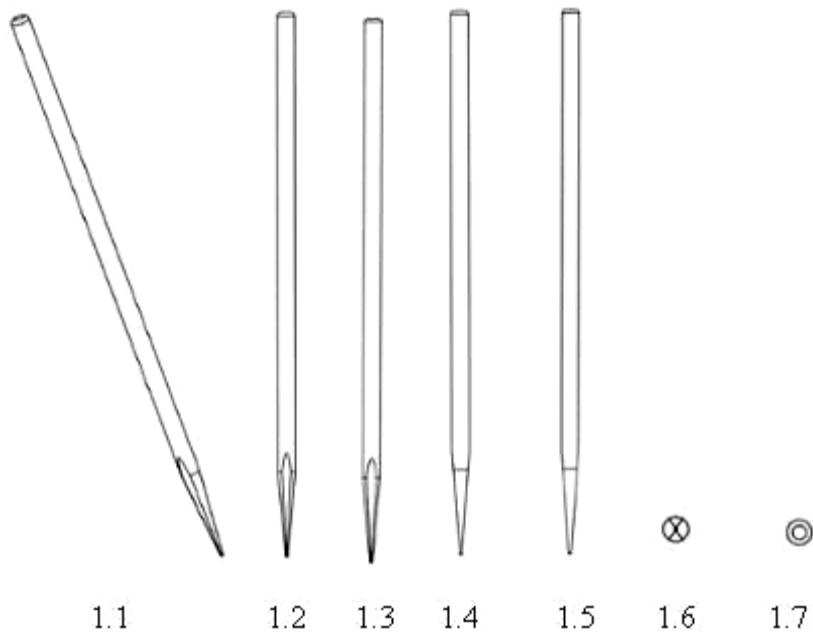

CÔNG BÁO SỞ HỮU CÔNG NGHIỆP SỐ 436 TẬP A – QUYỀN 2 (07.2024)

(11) **50946**

(21) 3-2024-00842

(28) 1

(54) **NHÃN**

(51) **11-01**

(22) 05/04/2024

(43) 25/07/2024

(73) **CÔNG TY TNHH BẢO TÍN MINH CHÂU (VN)**

Số 29 Trần Nhân Tông, phường Nguyễn Du, quận Hai Bà Trưng, thành phố Hà Nội

(72) Vũ Minh Châu (VN)

(55)



1.1



1.2



1.3



1.4



1.5

CÔNG BÁO SỞ HỮU CÔNG NGHIỆP SỐ 436 TẬP A – QUYỀN 2 (07.2024)

- (11) **50947**
(21) 3-2024-00835 (28) 1
(54) **CHAI ĐỰNG SẢN PHẨM** (51) **09-02**
(22) 05/04/2024 (43) 25/07/2024
(73) **CÔNG TY TNHH XNK NANOIL USA (VN)**
Lô Q13, đường số 11, KCN Hải Sơn mở rộng (GD 3+4), xã Đức Hòa Hạ, huyện Đức Hòa, tỉnh Long An
(72) Mai Xuân Quang (VN)
(55)



1.1



1.2



1.3



1.4



1.5



1.6



1.7

CÔNG BÁO SỞ HỮU CÔNG NGHIỆP SỐ 436 TẬP A – QUYỀN 2 (07.2024)

- (11) **50948**
(21) 3-2024-01176 (28) 1
(54) **MÁY MÀI** (51) **08-05**
(22) 23/05/2024 (43) 25/07/2024
(30) 29/919,976 07/12/2023 US;
(73) **DAREX, LLC (US)**
210 East Hersey Street, Ashland, Oregon 97520 U.S.A.
(72) 1. CONNER S. MACFARLANE (US)
2. JOEY T. ZACHARISSSEN (US)
3. DANIEL RIEGELS (US)
(74) Công ty TNHH Quốc tế D &N (D&N INTERNATIONAL CO.,LTD.)
(55)

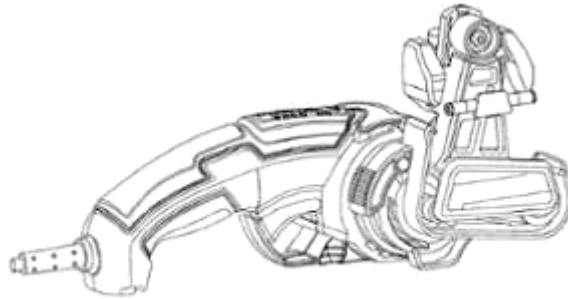

1.1

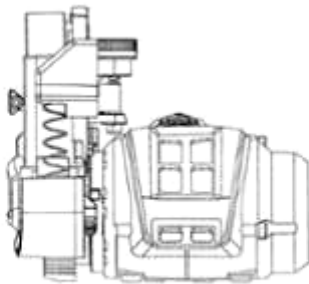

1.2

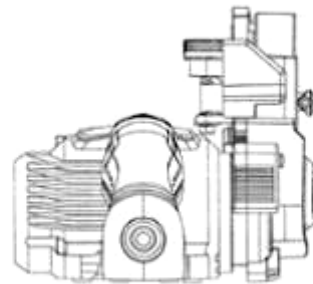

1.3

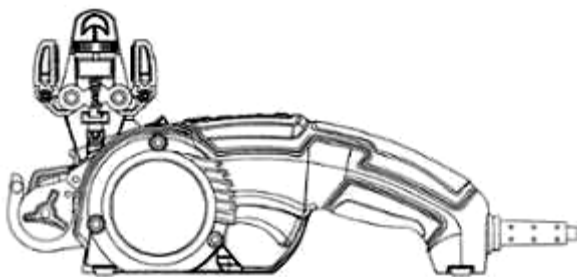

1.4

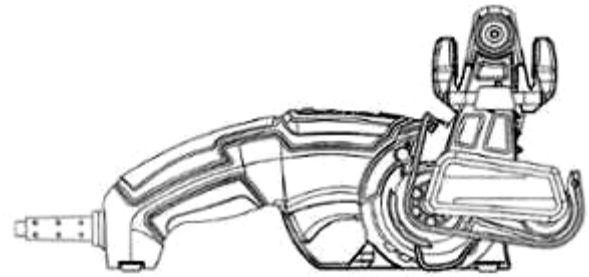

1.5

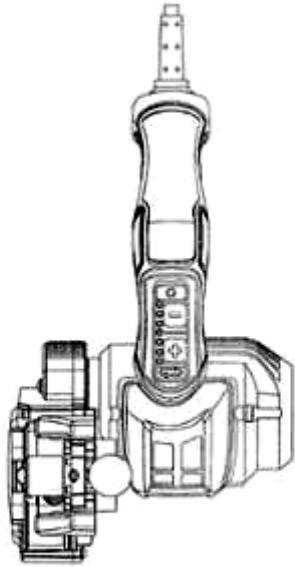

1.6

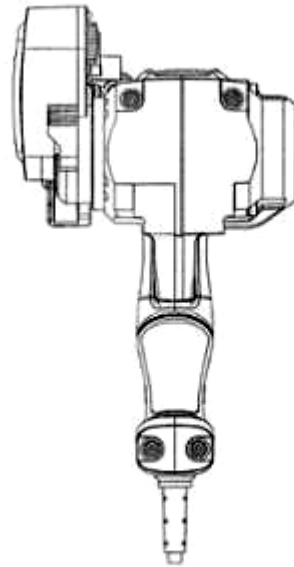

1.7

CÔNG BÁO SỞ HỮU CÔNG NGHIỆP SỐ 436 TẬP A – QUYỀN 2 (07.2024)

- (11) **50949**
(21) 3-2024-01182 (28) 1
(54) **HỘP ĐỰNG THUỐC** (51) **09-03**
(22) 23/05/2024 (43) 25/07/2024
(73) **HỢP TÁC XÃ DỊCH VỤ VÀ CHĂN NUÔI HƯƠNG SƠN DIỆM (VN)**
Thôn 4, xã Sơn Diệm, huyện Hương Sơn, tỉnh Hà Tĩnh
(72) Nguyễn Tiến Dũng (VN)
(74) Công ty TNHH Luật ALIAT (ALIAT LEGAL)
(55)



1.1



1.2

CÔNG BÁO SỞ HỮU CÔNG NGHIỆP SỐ 436 TẬP A – QUYỀN 2 (07.2024)

(11) **50950**

(21) 3-2024-00791

(28) 1

(54) **THIẾT BỊ GIÁM SÁT KHU VỰC PHÒNG NỔ**

(51) **10-05**

(22) 02/04/2024

(43) 25/07/2024

(73) **VIỆN NGHIÊN CỨU ĐIỆN TỬ, TIN HỌC, TỰ ĐỘNG HÓA (VN)**

156A đường Quán Thánh, phường Quán Thánh, quận Ba Đình, thành phố Hà Nội

(72) Nguyễn Xuân Đồng (VN)

(55)

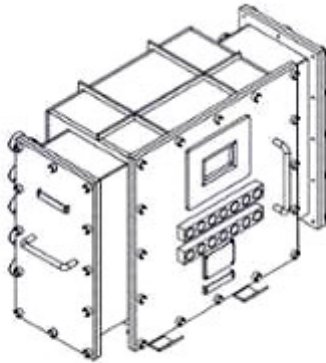

1.1

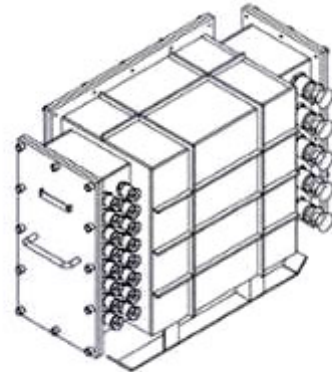

1.2

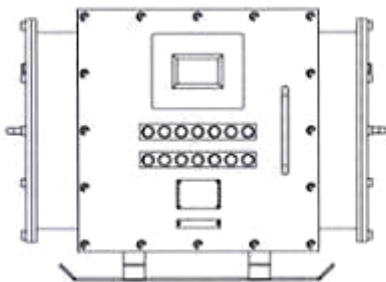

1.3

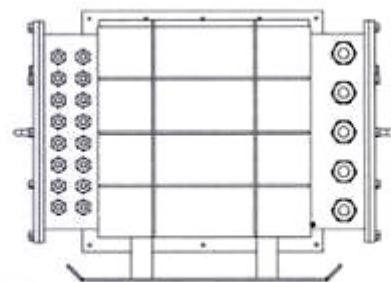

1.4

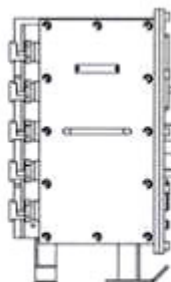

1.5

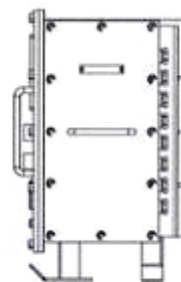

1.6

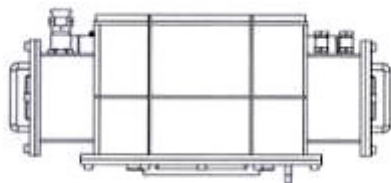

1.7

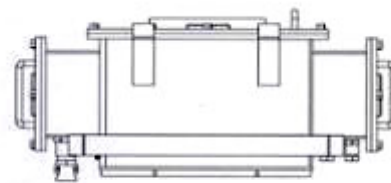

1.8

CÔNG BÁO SỞ HỮU CÔNG NGHIỆP SỐ 436 TẬP A – QUYỀN 2 (07.2024)

- (11) **50951**
(21) 3-2024-00792 (28) 1
(54) **BÀN BIDA** (51) **21-02**
(22) 02/04/2024 (43) 25/07/2024
(30) 2024301066918 04/03/2024 CN;
(73) **SHANGHAI ZHUANGCHENG HEALTH INDUSTRY GROUP CO., LTD.**
(CN)
Room 301, 3rd Floor, Building 7, No. 1688 Jinshao Road, Baoshan District,
Shanghai, China
(72) LAI, Guangkun (CN)
(74) Công ty TNHH Dịch vụ Sở hữu trí tuệ BIG5 (BIG5 IP CO.,LTD)
(55)



1.1



1.2



1.3



1.4



1.5



1.6



1.7

- (11) **50952**
(21) 3-2024-00793 (28) 1
(54) **TẮM LÓT GIÀY** (51) **02-04**
(22) 02/04/2024 (43) 25/07/2024
(30) 2024-002730 08/02/2024 JP;
(73) **SHIKAHAMA CO., LTD.** (JP)
4-22-17, Shikahama, Adachi-ku, Tokyo 123-0864, Japan
(72) Shigeru Shikahama (JP)
(74) Công ty TNHH một thành viên Sở hữu trí tuệ VCCI (VCCI-IP CO.,LTD)
(55)



1.1



1.2



1.3



1.4



1.5



1.6



1.7

- (11) **50953**
(21) 3-2024-00794 (28) 1
(54) **TẨM LÓT GIÀY** (51) **02-04**
(22) 02/04/2024 (43) 25/07/2024
(30) 2024-002709 08/02/2024 JP;
(73) **SHIKAHAMA CO., LTD.** (JP)
4-22-17, Shikahama, Adachi-ku, Tokyo 123-0864, Japan
(72) Shigeru Shikahama (JP)
(74) Công ty TNHH một thành viên Sở hữu trí tuệ VCCI (VCCI-IP CO.,LTD)
(55)



1.1



1.2



1.3



1.4



1.5



1.6



1.7

CÔNG BÁO SỞ HỮU CÔNG NGHIỆP SỐ 436 TẬP A – QUYỀN 2 (07.2024)

- (11) **50954**
(21) 3-2024-00795 (28) 1
(54) **TẮM LÓT GIÀY** (51) **02-04**
(22) 02/04/2024 (43) 25/07/2024
(73) **SHIKAHAMA CO., LTD. (JP)**
4-22-17, Shikahama, Adachi-ku, Tokyo 123-0864, Japan
(72) Shigeru Shikahama (JP)
(74) Công ty TNHH một thành viên Sở hữu trí tuệ VCCI (VCCI-IP CO.,LTD)
(55)



1.1



1.2



1.3



1.4



1.5



1.6



1.7

CÔNG BÁO SỞ HỮU CÔNG NGHIỆP SỐ 436 TẬP A – QUYỀN 2 (07.2024)

- (11) **50955**
(21) 3-2024-00796 (28) 1
(54) **KHAY NHỰA ĐA NĂNG** (51) **07-07**
(22) 02/04/2024 (43) 25/07/2024
(73) **CÔNG TY TNHH MỘT THÀNH VIÊN SẢN XUẤT THƯƠNG MẠI XUẤT NHẬP KHẨU THẮNG LỢI (VN)**
Số 334D đường Mã Lò, khu phố 6, phường Bình Trị Đông A, quận Bình Tân, thành phố Hồ Chí Minh
(72) Tô Lợi Thành (VN)
(74) Công ty Cổ phần PHANLAW VIETNAM (PHANLAW VIETNAM JSC)
(55)

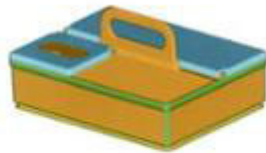

1.1



1.2



1.3

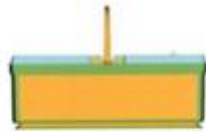

1.4

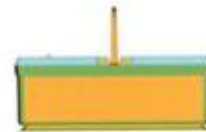

1.5

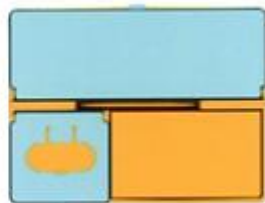

1.6



1.7

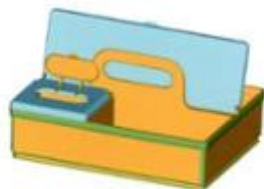

1.8



1.9

CÔNG BÁO SỞ HỮU CÔNG NGHIỆP SỐ 436 TẬP A – QUYỀN 2 (07.2024)

- (11) **50956**
(21) 3-2024-00797 (28) 1
(54) **HỘP NHỰA ĐA NĂNG** (51) **07-07**
(22) 02/04/2024 (43) 25/07/2024
(73) **CÔNG TY TNHH MỘT THÀNH VIÊN SẢN XUẤT THƯƠNG MẠI XUẤT NHẬP KHẨU THẮNG LỢI (VN)**
Số 334D đường Mã Lò, khu phố 6, phường Bình Trị Đông A, quận Bình Tân, thành phố Hồ Chí Minh
(72) Tô Lợi Thành (VN)
(74) Công ty Cổ phần PHANLAW VIETNAM (PHANLAW VIETNAM JSC)
(55)



1.1



1.2



1.3



1.4



1.5



1.6



1.7



1.8

CÔNG BÁO SỞ HỮU CÔNG NGHIỆP SỐ 436 TẬP A – QUYỀN 2 (07.2024)

- (11) **50957**
(21) 3-2024-00417 (28) 1
(54) **BAO GÓI** (51) **09-05**
(22) 22/02/2024 (43) 25/07/2024
(73) **CÔNG TY TRÁCH NHIỆM HỮU HẠN CON CÒ VÀNG (VN)**
23 Lô B đường số 1, phường Phú Thuận, quận 7, thành phố Hồ Chí Minh
(72) Hoàng Mai Dẫn (VN)
(74) Công ty TNHH một thành viên Trường Luật (Trường Luật)
(55)



1.1



1.2

CÔNG BÁO SỞ HỮU CÔNG NGHIỆP SỐ 436 TẬP A – QUYỀN 2 (07.2024)

- (11) **50958**
(21) 3-2024-00418 (28) 1
(54) **BAO GÓI** (51) **09-05**
(22) 22/02/2024 (43) 25/07/2024
(73) **CÔNG TY TRÁCH NHIỆM HỮU HẠN CON CÒ VÀNG (VN)**
23 Lô B đường số 1, phường Phú Thuận, quận 7, thành phố Hồ Chí Minh
(72) Hoàng Mai Dẫn (VN)
(74) Công ty TNHH một thành viên Trường Luật (Trường Luật)
(55)



1.1



1.2

CÔNG BÁO SỞ HỮU CÔNG NGHIỆP SỐ 436 TẬP A – QUYỀN 2 (07.2024)

- (11) **50959**
(21) 3-2024-00421 (28) 1
(54) **HỘP** (51) **09-03**
(22) 22/02/2024 (43) 25/07/2024
(73) **CÔNG TY TNHH SẢN XUẤT THƯƠNG MẠI DỊCH VỤ TÂN TUỜNG KHANG (VN)**
Lô F1 & F2, đường D2 và N5, KCN Nam Tân Uyên, phường Khánh Bình, thành phố Tân Uyên, tỉnh Bình Dương
(72) Nìm Dùng Chiếng (VN)
(74) Văn phòng Luật sư D và T (D & T LAW OFFICE)
(55)



1.1



1.2



1.3



1.4



1.5



1.6



1.7

CÔNG BÁO SỞ HỮU CÔNG NGHIỆP SỐ 436 TẬP A – QUYỀN 2 (07.2024)

- (11) **50960**
(21) 3-2024-01133 (28) 1
(54) **BÀN THỜ** (51) **99-00**
(22) 16/05/2024 (43) 25/07/2024
(73) **CÔNG TY CỔ PHẦN NỘI THẤT MANT (VN)**
Số 04, ngõ 186 Ngọc Hà, phường Ngọc Hà, quận Ba Đình, thành phố Hà Nội
(72) Nguyễn Mạnh Hùng (VN)
(74) **CÔNG TY TNHH SỞ HỮU TRÍ TUỆ ANLIS VIỆT NAM (ANLIS IP CO.,LTD)**
(55)



1.1



1.2



1.3



1.4

1.5



1.6



1.7

CÔNG BÁO SỞ HỮU CÔNG NGHIỆP SỐ 436 TẬP A – QUYỀN 2 (07.2024)

- (11) **50961**
(21) 3-2024-01134 (28) 1
(54) **BAO GÓI** (51) **09-05**
(22) 16/05/2024 (43) 25/07/2024
(73) **CÔNG TY TNHH BAO BÌ VÀ LƯƠNG THỰC AN THÁI (VN)**
Số nhà 5 dãy M khu đấu giá quyền sử dụng đất Ngõ Thì Nhậm, phường Hà Cầu,
quận Hà Đông, thành phố Hà Nội
(72) Trần Thị Kim Tuyền (VN)
(74) Công ty TNHH Sở hữu trí tuệ HA VIP (HAVIP CO., LTD.)
(55)



1.1



1.2

CÔNG BÁO SỞ HỮU CÔNG NGHIỆP SỐ 436 TẬP A – QUYỀN 2 (07.2024)

- (11) **50962**
(21) 3-2024-01297 (28) 1
(54) **XE MÁY ĐIỆN** (51) **12-11**
(22) 05/06/2024 (43) 25/07/2024
(30) 015043944-0001 11/12/2023 EM;
(73) **NANJING VMOTO MANUFACTURING CO, LTD (CN)**
15 Zhongxing East Road, Lishui Economic Development Zone, Lishui District,
Nanjing City, China
(72) Yiting Chen (CN)
(74) Công ty TNHH Sáng chế ACTIP (ACTIP PATENT LIMITED)
(55)



1.1



1.2

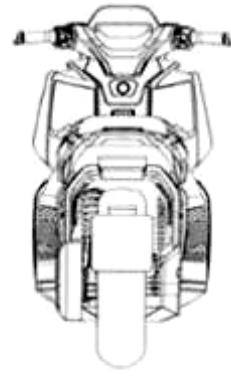

1.3

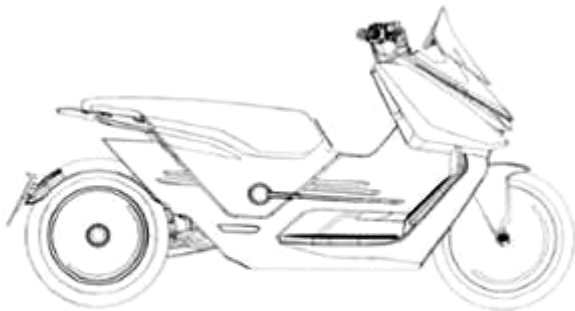

1.4



1.5

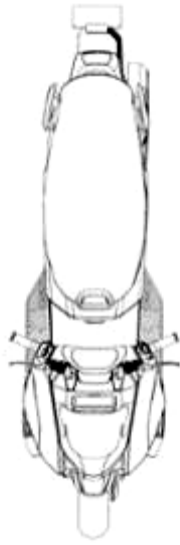

1.6

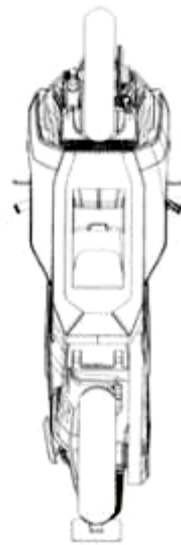

1.7

- (11) **50963**
(21) 3-2024-01333 (28) 1
(54) **VÀNH BÁNH XE** (51) **12-16**
(22) 10/06/2024 (43) 25/07/2024
(30) 24-E0486-0101 26/03/2024 MY;
(73) **MENG KAH AUTO PARTS TRADING SDN. BHD. (MY)**
No. 40, Jalan TPP 5, Taman Perindustrian Putra, 47130 Puchong, Selangor,
Malaysia
(72) LEE CONG QUAN (MY)
(74) Công ty TNHH Trường Xuân (AGELESS CO.,LTD.)
(55)



1.1



1.2



1.3



1.4



1.5



1.6



1.7



1.8

CÔNG BÁO SỞ HỮU CÔNG NGHIỆP SỐ 436 TẬP A – QUYỀN 2 (07.2024)

- (11) **50964**
(21) 3-2024-01334 (28) 1
(54) **VÀNH BÁNH XE** (51) **12-16**
(22) 10/06/2024 (43) 25/07/2024
(30) 24-E0487-0101 26/03/2024 MY;
(73) **MENG KAH AUTO PARTS TRADING SDN. BHD. (MY)**
No. 40, Jalan TPP 5, Taman Perindustrian Putra, 47130 Puchong, Selangor,
Malaysia
(72) LEE CONG QUAN (MY)
(74) Công ty TNHH Trường Xuân (AGELESS CO.,LTD.)
(55)



1.1



1.2



1.3



1.4



1.5



1.6



1.7

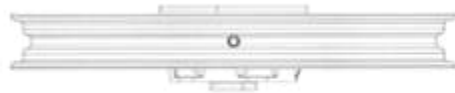

1.8

CÔNG BÁO SỞ HỮU CÔNG NGHIỆP SỐ 436 TẬP A – QUYỀN 2 (07.2024)

- (11) **50965**
(21) 3-2024-01335 (28) 1
(54) **VÀNH BÁNH XE** (51) **12-16**
(22) 10/06/2024 (43) 25/07/2024
(30) 24-E0488-0101 26/03/2024 MY;
(73) **MENG KAH AUTO PARTS TRADING SDN. BHD. (MY)**
No. 40, Jalan TPP 5, Taman Perindustrian Putra, 47130 Puchong, Selangor,
Malaysia
(72) LEE CONG QUAN (MY)
(74) Công ty TNHH Trường Xuân (AGELESS CO.,LTD.)
(55)



1.1



1.2



1.3



1.4



1.5



1.6



1.7

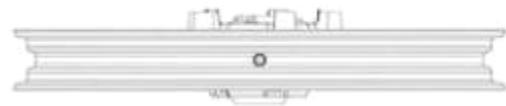

1.8

CÔNG BÁO SỞ HỮU CÔNG NGHIỆP SỐ 436 TẬP A – QUYỀN 2 (07.2024)

- (11) **50966**
(21) 3-2024-01336 (28) 1
(54) **VÀNH BÁNH XE** (51) **12-16**
(22) 10/06/2024 (43) 25/07/2024
(30) 24-E0489-0101 26/03/2024 MY;
(73) **MENG KAH AUTO PARTS TRADING SDN. BHD. (MY)**
No. 40, Jalan TPP 5, Taman Perindustrian Putra, 47130 Puchong, Selangor,
Malaysia
(72) LEE CONG QUAN (MY)
(74) Công ty TNHH Trường Xuân (AGELESS CO.,LTD.)
(55)



1.1



1.2



1.3



1.4

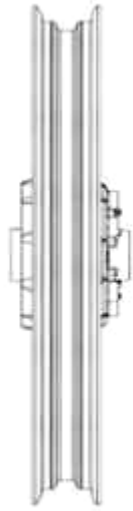

1.5



1.6

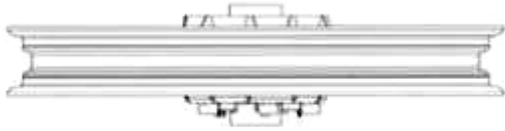

1.7

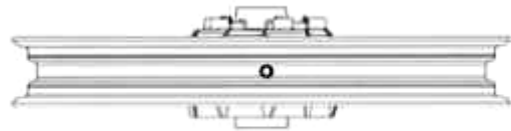

1.8

CÔNG BÁO SỞ HỮU CÔNG NGHIỆP SỐ 436 TẬP A – QUYỀN 2 (07.2024)

- (11) **50967**
(21) 3-2024-01337 (28) 1
(54) **VÀNH BÁNH XE** (51) **12-16**
(22) 10/06/2024 (43) 25/07/2024
(30) 24-E0490-0101 26/03/2024 MY;
(73) **MENG KAH AUTO PARTS TRADING SDN. BHD. (MY)**
No. 40, Jalan TPP 5, Taman Perindustrian Putra, 47130 Puchong, Selangor,
Malaysia
(72) LEE CONG QUAN (MY)
(74) Công ty TNHH Trường Xuân (AGELESS CO.,LTD.)
(55)



1.1



1.2



1.3



1.4

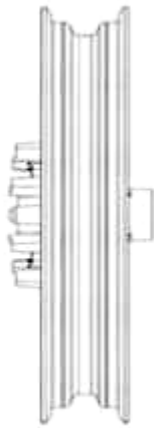

1.5

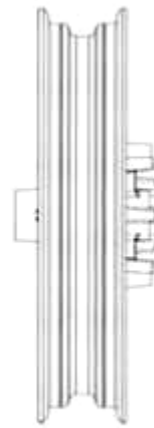

1.6

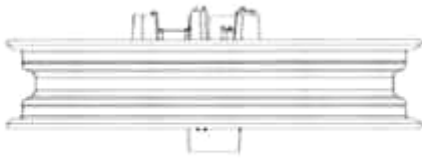

1.7

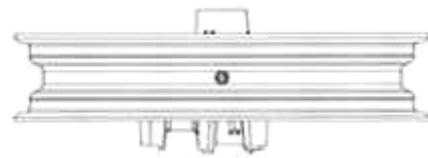

1.8

CÔNG BÁO SỞ HỮU CÔNG NGHIỆP SỐ 436 TẬP A – QUYỀN 2 (07.2024)

- (11) **50968**
(21) 3-2024-01338 (28) 1
(54) **VÀNH BÁNH XE** (51) **12-16**
(22) 10/06/2024 (43) 25/07/2024
(30) 24-E0491-0101 26/03/2024 MY;
(73) **MENG KAH AUTO PARTS TRADING SDN. BHD. (MY)**
No. 40, Jalan TPP 5, Taman Perindustrian Putra, 47130 Puchong, Selangor,
Malaysia
(72) LEE CONG QUAN (MY)
(74) Công ty TNHH Trường Xuân (AGELESS CO.,LTD.)
(55)

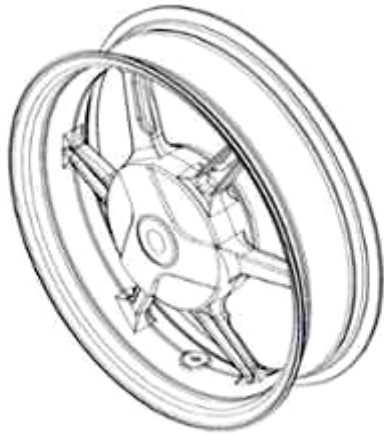

1.1



1.2

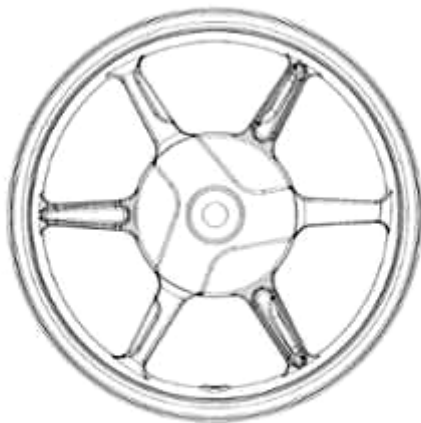

1.3



1.4



1.5



1.6



1.7



1.8

CÔNG BÁO SỞ HỮU CÔNG NGHIỆP SỐ 436 TẬP A – QUYỀN 2 (07.2024)

- (11) **50969**
(21) 3-2024-01339 (28) 1
(54) **VÀNH BÁNH XE** (51) **12-16**
(22) 10/06/2024 (43) 25/07/2024
(30) 24-E0492-0101 26/03/2024 MY;
(73) **MENG KAH AUTO PARTS TRADING SDN. BHD. (MY)**
No. 40, Jalan TPP 5, Taman Perindustrian Putra, 47130 Puchong, Selangor,
Malaysia
(72) LEE CONG QUAN (MY)
(74) Công ty TNHH Trường Xuân (AGELESS CO.,LTD.)
(55)



1.1



1.2



1.3



1.4



1.5



1.6



1.7



1.8

CÔNG BÁO SỞ HỮU CÔNG NGHIỆP SỐ 436 TẬP A – QUYỀN 2 (07.2024)

- (11) **50970**
(21) 3-2024-01340 (28) 1
(54) **VÀNH BÁNH XE** (51) **12-16**
(22) 10/06/2024 (43) 25/07/2024
(30) 24-E0493-0101 26/03/2024 MY;
(73) **MENG KAH AUTO PARTS TRADING SDN. BHD. (MY)**
No. 40, Jalan TPP 5, Taman Perindustrian Putra, 47130 Puchong, Selangor,
Malaysia
(72) LEE CONG QUAN (MY)
(74) Công ty TNHH Trường Xuân (AGELESS CO.,LTD.)
(55)



1.1



1.2



1.3



1.4



1.5



1.6



1.7

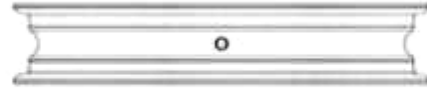

1.8

(11) **50971**

(21) 3-2024-00370

(28) 1

(54) **QUẠT TRẦN**

(51) **23-04**

(22) 16/02/2024

(43) 25/07/2024

(73) **CÔNG TY CỔ PHẦN GCOOL (VN)**

Số 158/2 phố Hồng Mai, phường Quỳnh Lôi, quận Hai Bà Trưng, thành phố Hà Nội

(72) 1. TRẦN BÌNH MINH (VN)

2. HOÀNG ANH LỘC (VN)

3. TRẦN ANH (VN)

4. NGUYỄN ĐỨC BẰNG (VN)

5. ĐẶNG ĐỨC TRUNG (VN)

6. NGUYỄN THỊ HẢI YẾN (VN)

7. TRẦN HỒNG HẢI (VN)

8. NGUYỄN ĐỨC HÒA (VN)

9. TRẦN ĐÌNH QUÂN (VN)

10. NGUYỄN TUẤN PHONG (VN)

11. PHẠM ĐỨC HIỆP (VN)

12. LÊ TUẤN SƠN (VN)

13. NGUYỄN VĂN TRỌNG (VN)

14. PHẠM VĂN NHUNG (VN)

15. PHẠM THỊ ANH (VN)

16. LÊ ĐỨC ÂN (VN)

(55)

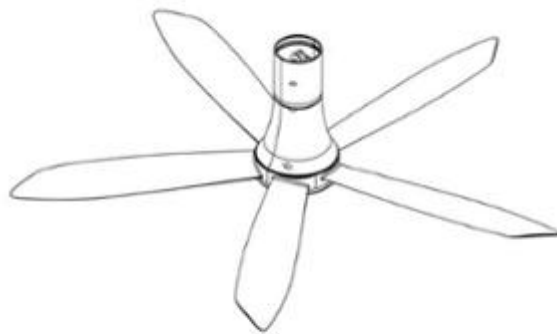

1.1



1.2



1.3



1.4



1.5

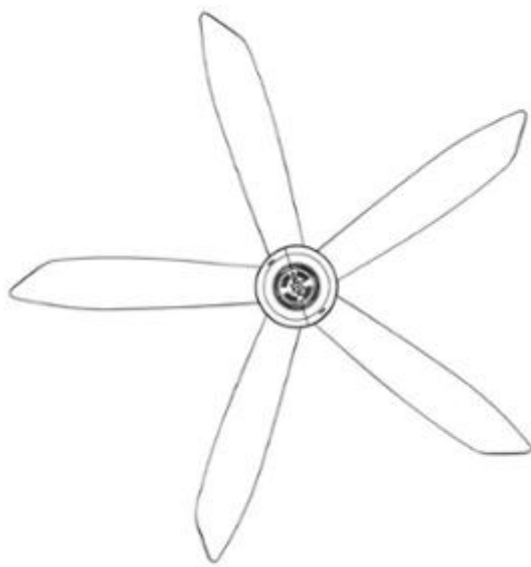

1.6

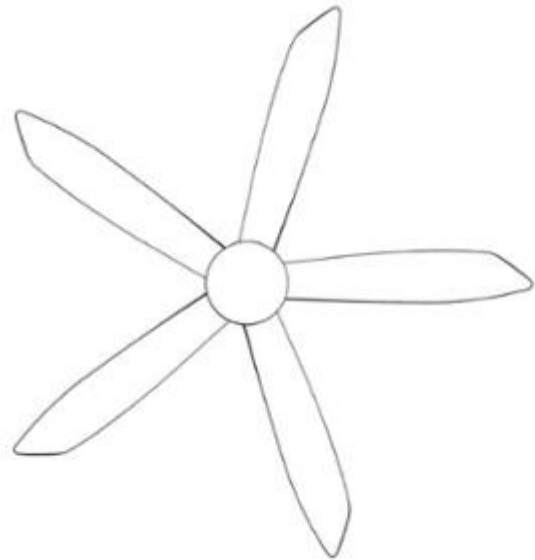

1.7

(11) **50972**

(21) 3-2024-00371

(28) 1

(54) **QUẠT TRẦN**

(51) **23-04**

(22) 16/02/2024

(43) 25/07/2024

(73) **CÔNG TY CỔ PHẦN GCOOL (VN)**

Số 158/2 phố Hồng Mai, phường Quỳnh Lôi, quận Hai Bà Trưng, thành phố Hà Nội

(72) 1. TRẦN BÌNH MINH (VN)

2. HOÀNG ANH LỘC (VN)

3. TRẦN ANH (VN)

4. NGUYỄN ĐỨC BẰNG (VN)

5. ĐẶNG ĐỨC TRUNG (VN)

6. NGUYỄN THỊ HẢI YẾN (VN)

7. TRẦN HỒNG HẢI (VN)

8. NGUYỄN ĐỨC HÒA (VN)

9. TRẦN ĐÌNH QUÂN (VN)

10. NGUYỄN TUẤN PHONG (VN)

11. PHẠM ĐỨC HIỆP (VN)

12. LÊ TUẤN SƠN (VN)

13. NGUYỄN VĂN TRỌNG (VN)

14. PHẠM VĂN NHUNG (VN)

15. PHẠM THỊ ANH (VN)

16. LÊ ĐỨC ÂN (VN)

(55)

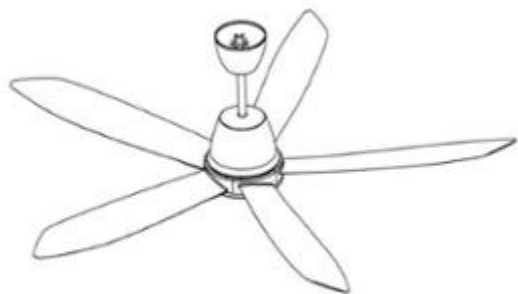

1.1



1.2



1.3



1.4



1.5

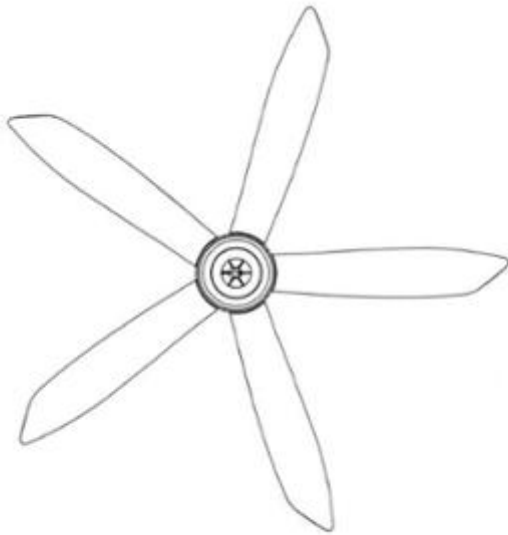

1.6

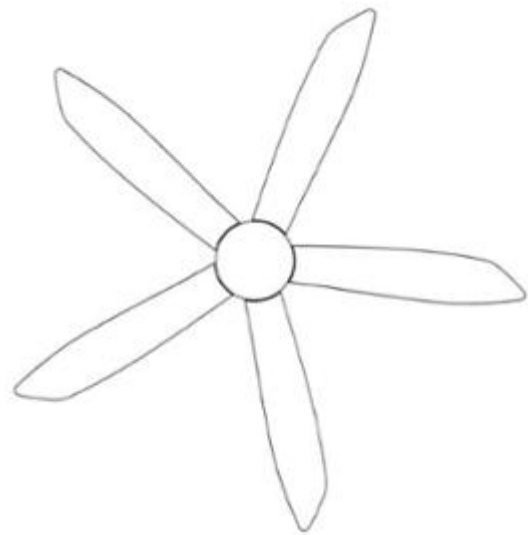

1.7

CÔNG BÁO SỞ HỮU CÔNG NGHIỆP SỐ 436 TẬP A – QUYỀN 2 (07.2024)

- (11) **50973**
(21) 3-2024-01151 (28) 1
(54) **LÒ SẤY TÀNG SÔI** (51) **15-05**
(22) 20/05/2024 (43) 25/07/2024
(73) **FOSHAN CITY WELKIN TECHNOLOGY CO., LTD. (CN)**
Xinjing Industrial Zone, Xiaotang Town, Nanhai District, Foshan City, Guangdong
Province, China
(72) Qiusheng ZHAO (CN)
(74) Công ty TNHH Dịch vụ Sở hữu trí tuệ GREENIP (GREENIP CO., LTD)
(55)

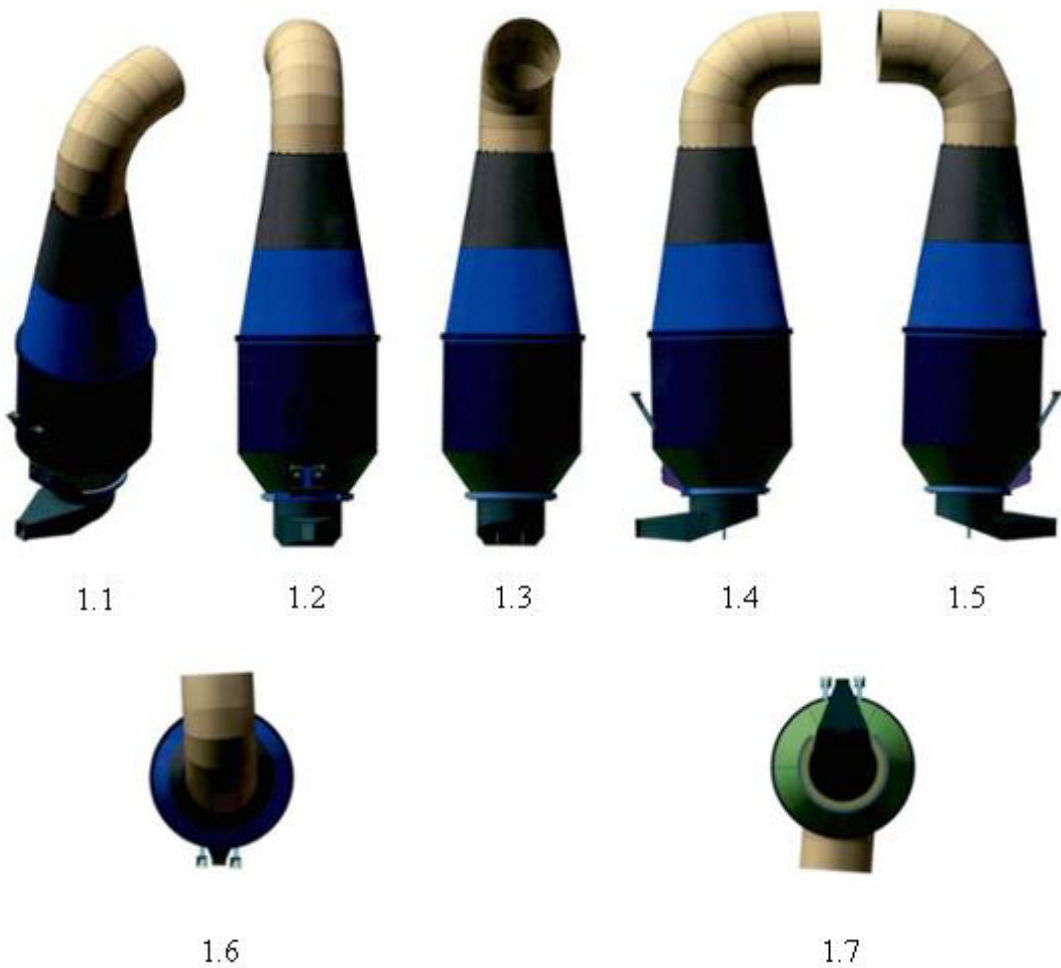

(11) **50974**

(21) 3-2024-01152

(28) 1

(54) **ỐNG XẢ**

(51) **12-16**

(22) 20/05/2024

(43) 25/07/2024

(73) **TRƯỜNG ĐẠI HỌC BÁCH KHOA - ĐẠI HỌC QUỐC GIA THÀNH PHỐ HỒ CHÍ MINH (VN)**

268 Lý Thường Kiệt, phường 14, quận 10, thành phố Hồ Chí Minh

(72) 1. NGÔ KHÁNH HIẾU (VN)

2. LÊ TRỌNG ĐẠT (VN)

3. ĐẶNG LÊ QUANG (VN)

(55)



- (11) **50975**
- (21) 3-2024-01153
- (54) **KHAY**
- (22) 20/05/2024
- (30) 2023-024145 22/11/2023 JP;
- (73) **FUJITA CORPORATION (JP)**
4-32-22, Nishi-Shinjuku, Shinjuku-ku, Tokyo 160-8378, Japan
- (72) 1. TOSHIYA KAWASAKI (JP)
2. MITSUYOSHI ISHIKAWA (JP)
- (74) Công ty TNHH một thành viên Sở hữu trí tuệ VCCI (VCCI-IP CO.,LTD)
- (55)

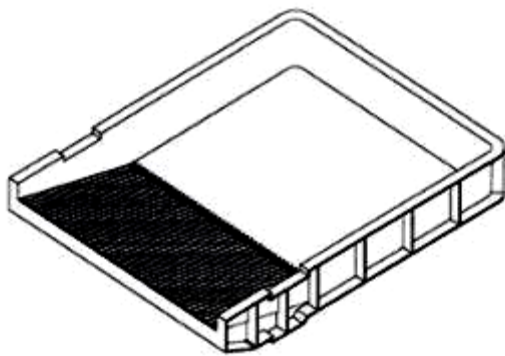

1.1

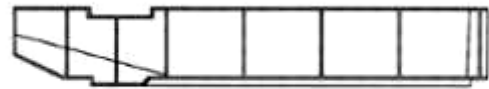

1.2



1.3

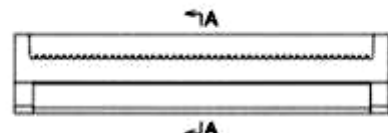

1.4



1.5

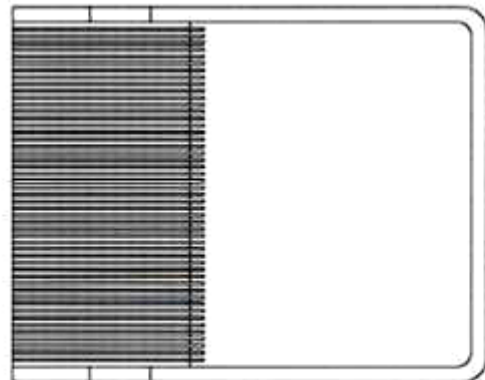

1.6

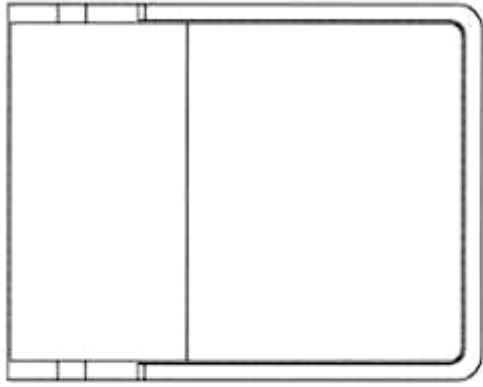

1.7



1.8



1.9

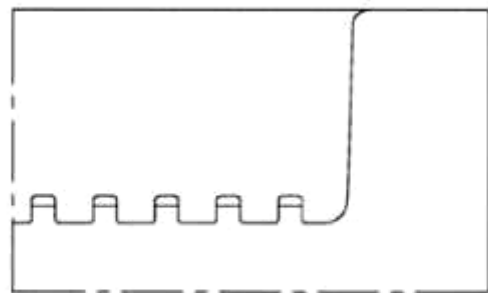

1.10

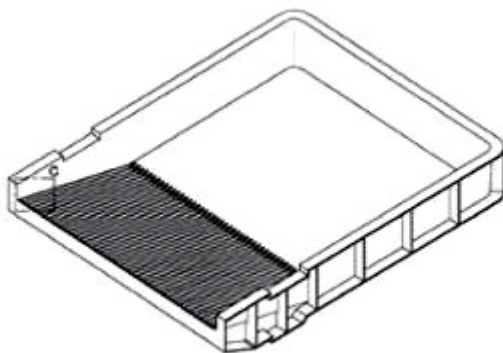

1.11

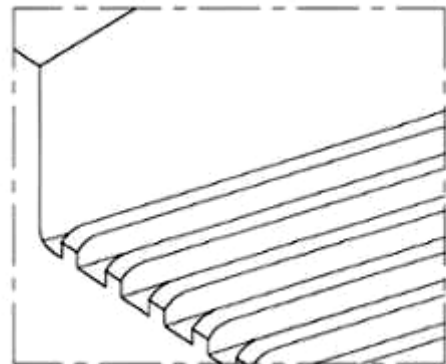

1.12

CÔNG BÁO SỞ HỮU CÔNG NGHIỆP SỐ 436 TẬP A – QUYỀN 2 (07.2024)

(11) **50976**

(21) 3-2024-01156

(28) 1

(54) **THÙNG XE MÔ TÔ**

(51) **12-16**

(22) 20/05/2024

(43) 25/07/2024

(73) **GIVI SPA (IT)**

Via G. Ungaretti, 48, 25020 Flero (BS), Italy

(72) Visenzi Giuseppe (IT)

(74) Công ty Cổ phần Sở hữu công nghiệp INVESTIP (INVESTIP)

(55)



1.1



1.2



1.3



1.4



1.5



1.6



1.7



1.8

CÔNG BÁO SỞ HỮU CÔNG NGHIỆP SỐ 436 TẬP A – QUYỀN 2 (07.2024)

- (11) **50977**
(21) 3-2024-01154 (28) 1
(54) **KHUNG XE MÁY ĐIỆN** (51) **12-16**
(22) 20/05/2024 (43) 25/07/2024
(73) **CÔNG TY TNHH NUEN MOTO (VN)**
29 Xuân Thủy, phường Thảo Điền, thành phố Thủ Đức, thành phố Hồ Chí Minh
(72) Nguyễn Hoàng Gia (VN)
(74) Công ty TNHH Nam Việt và Liên danh (VIPCO)
(55)



1.1

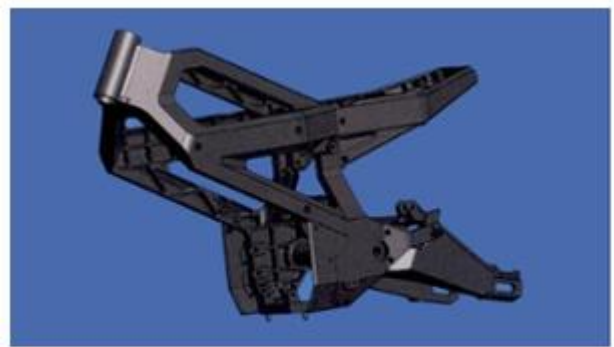

1.2

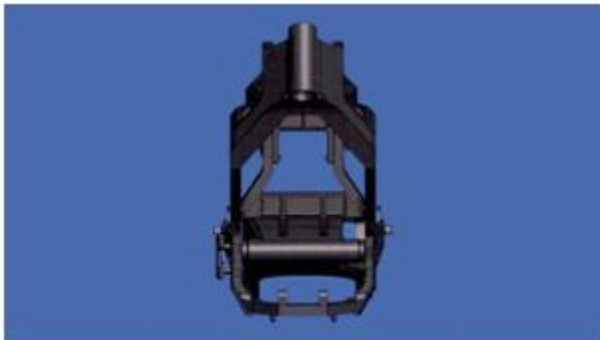

1.3

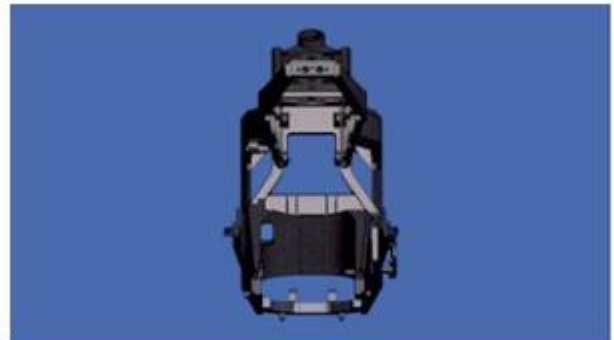

1.4

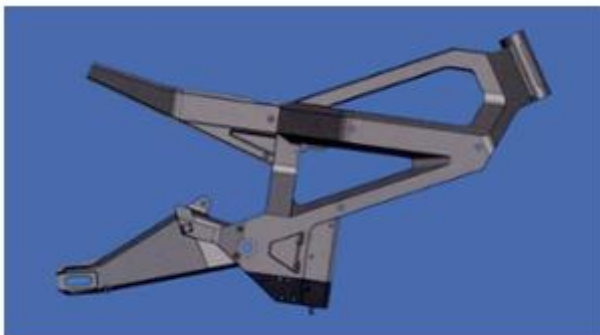

1.5

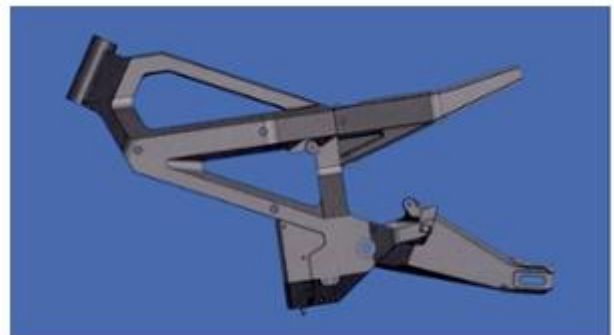

1.6

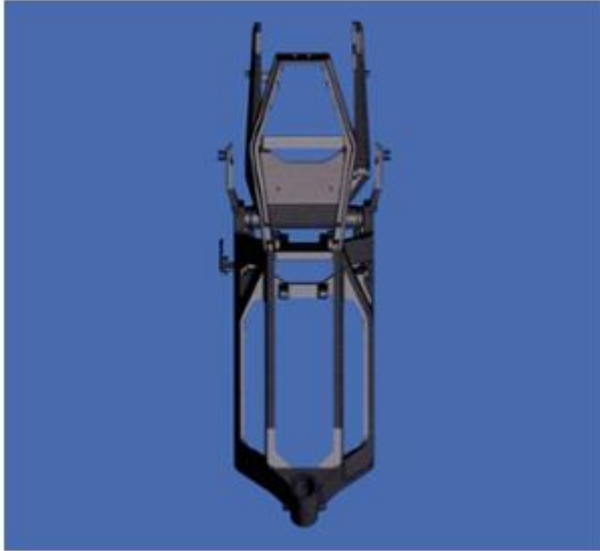

1.7



1.8

CÔNG BÁO SỞ HỮU CÔNG NGHIỆP SỐ 436 TẬP A – QUYỀN 2 (07.2024)

- (11) **50978**
(21) 3-2024-01155 (28) 1
(54) **XE MÁY ĐIỆN** (51) **12-11**
(22) 20/05/2024 (43) 25/07/2024
(73) **CÔNG TY TNHH NUEN MOTO (VN)**
29 Xuân Thủy, phường Thảo Điền, thành phố Thủ Đức, thành phố Hồ Chí Minh
(72) Nguyễn Hoàng Gia (VN)
(74) Công ty TNHH Nam Việt và Liên danh (VIPCO)
(55)



1.1



1.2



1.3



1.4



1.5



1.6

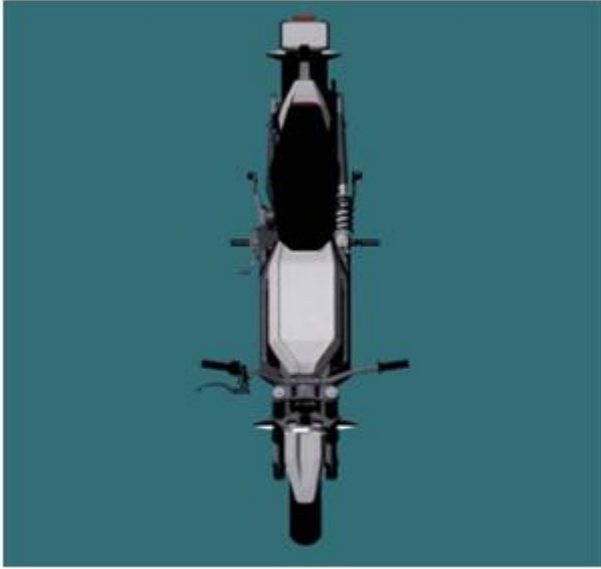

1.7

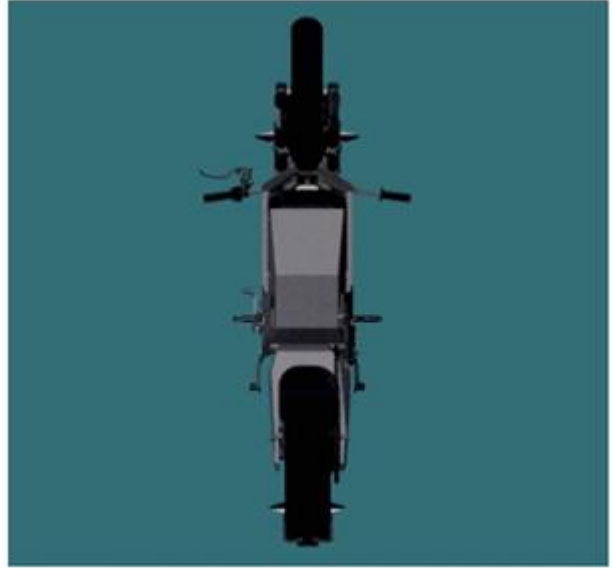

1.8

(11) **50979**

(21) 3-2024-00253

(28) 1

(54) **MÓNG ĐƠN ĐÚC SẴN LẮP GHÉP**

(51) **25-02**

(22) 29/01/2024

(43) 25/07/2024

(73) **NGUYỄN XUÂN THỦY (VN)**

Tổ 3, khu 10, phường Bãi Cháy, thành phố Hạ Long, tỉnh Quảng Ninh

(72) Nguyễn Xuân Thủy (VN)

(55)

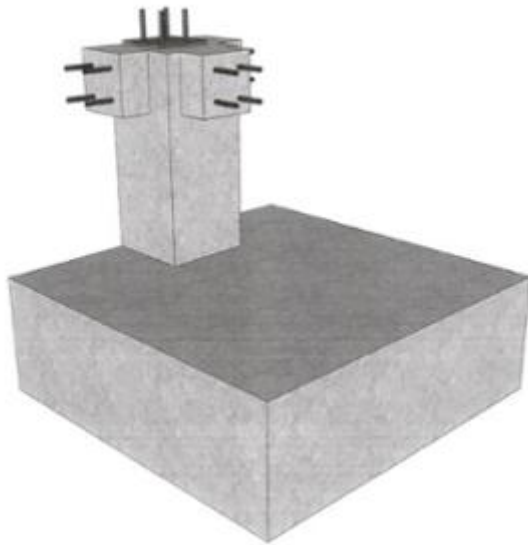

1.1

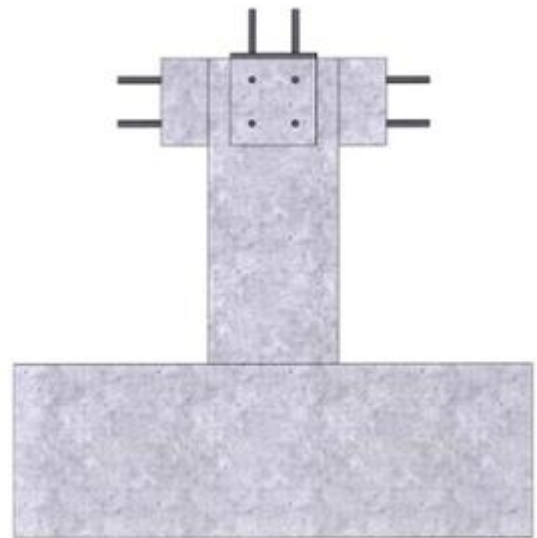

1.2

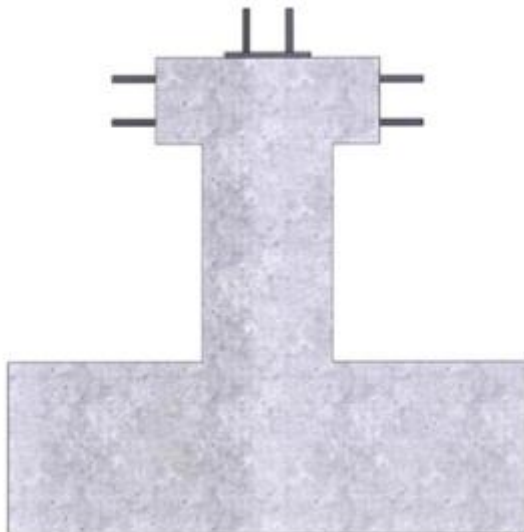

1.3

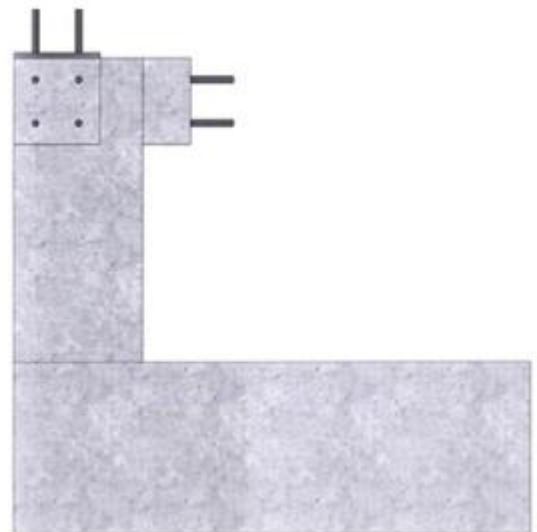

1.4

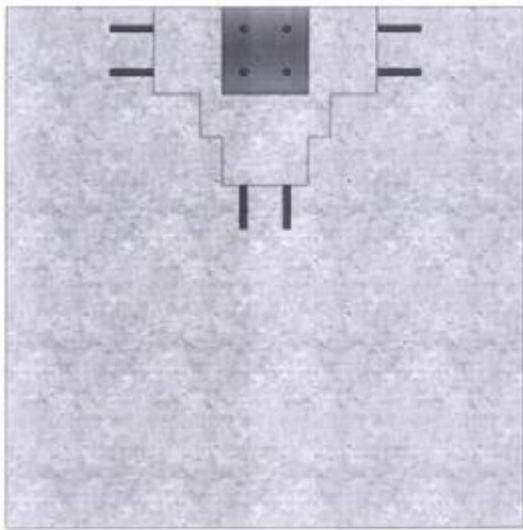

1.5

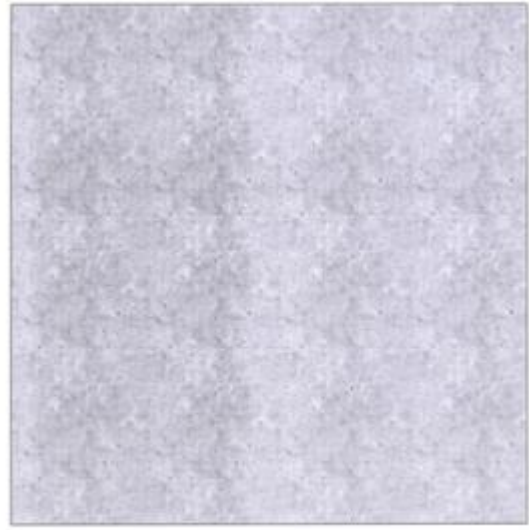

1.6

CÔNG BÁO SỞ HỮU CÔNG NGHIỆP SỐ 436 TẬP A – QUYỀN 2 (07.2024)

(11) **50980**

(21) 3-2024-00254

(28) 1

(54) **MÓNG ĐƠN ĐÚC SẴN LẮP GHÉP**

(51) **25-02**

(22) 29/01/2024

(43) 25/07/2024

(73) **NGUYỄN XUÂN THỦY (VN)**

Tổ 3, khu 10, phường Bãi Cháy, thành phố Hạ Long, tỉnh Quảng Ninh

(72) Nguyễn Xuân Thủy (VN)

(55)

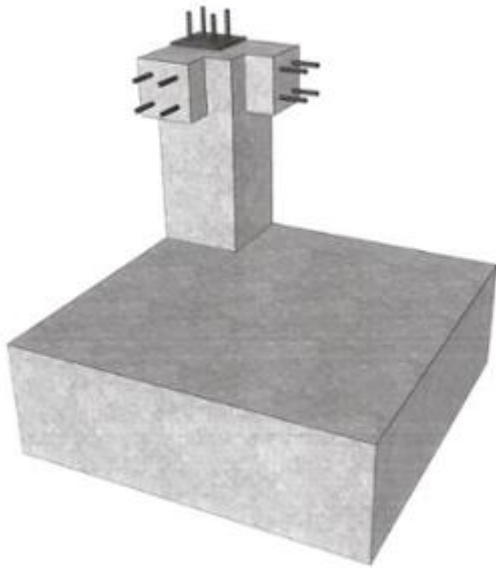

1.1

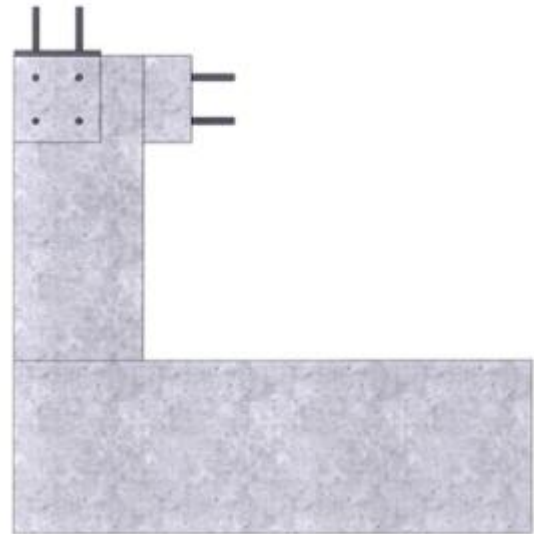

1.2

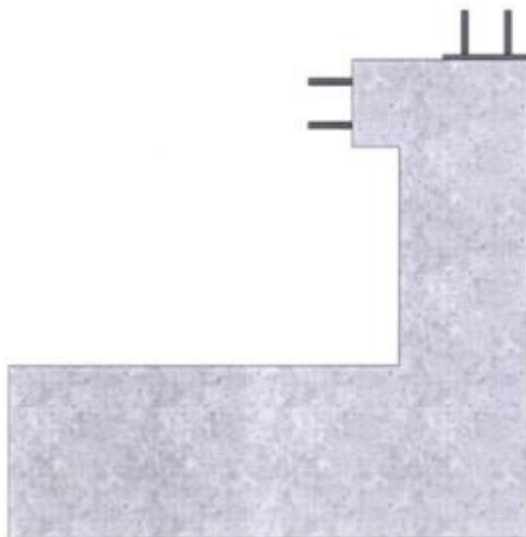

1.3

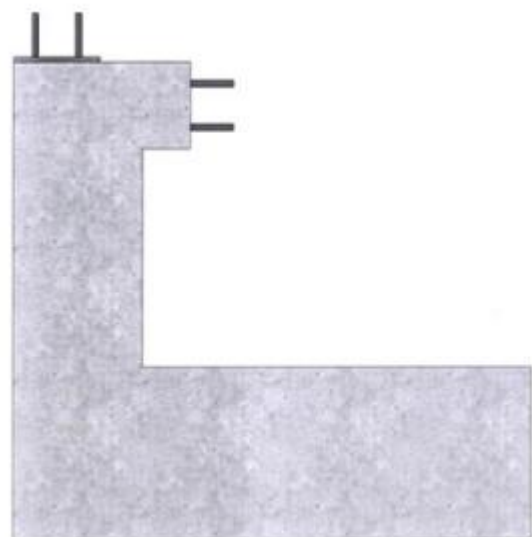

1.4

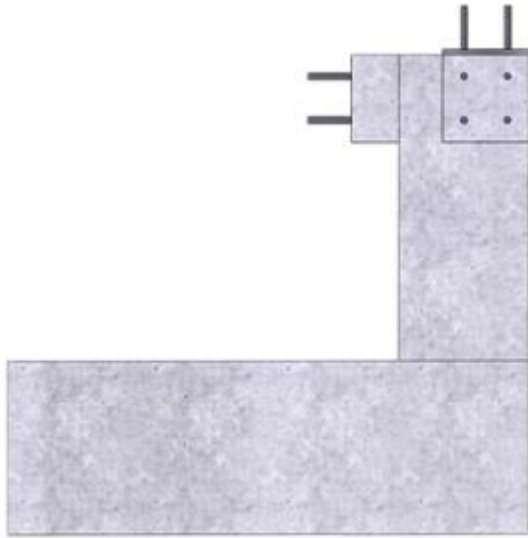

1.5

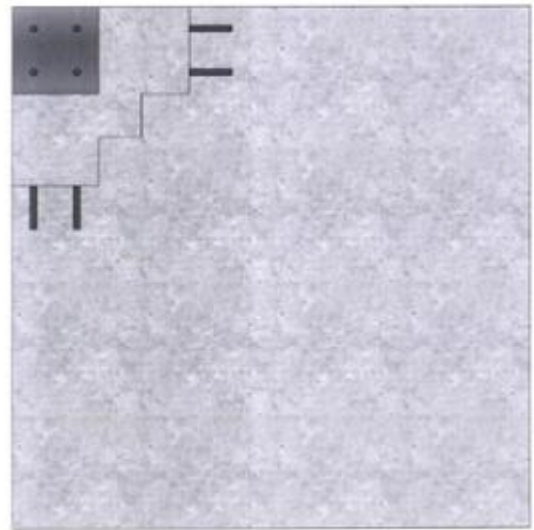

1.6

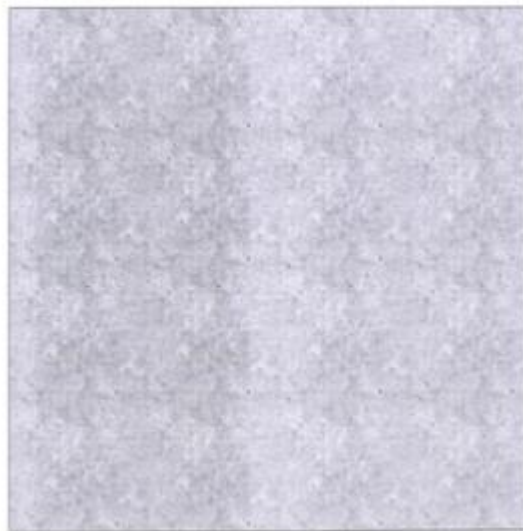

1.7

(11) **50981**

(21) 3-2024-00255

(28) 1

(54) **MÓNG ĐƠN ĐÚC SẴN LẮP GHÉP**

(51) **25-02**

(22) 29/01/2024

(43) 25/07/2024

(73) **NGUYỄN XUÂN THỦY (VN)**

Tổ 3, khu 10, phường Bãi Cháy, thành phố Hạ Long, tỉnh Quảng Ninh

(72) Nguyễn Xuân Thủy (VN)

(55)

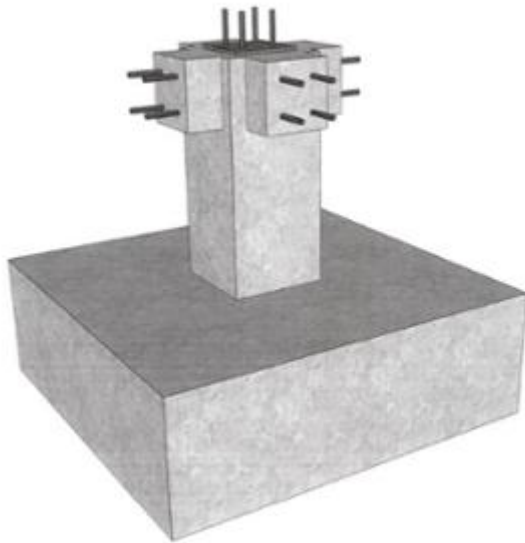

1.1

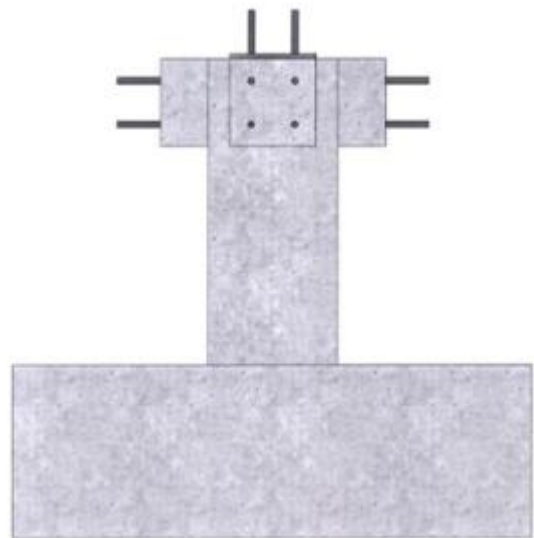

1.2

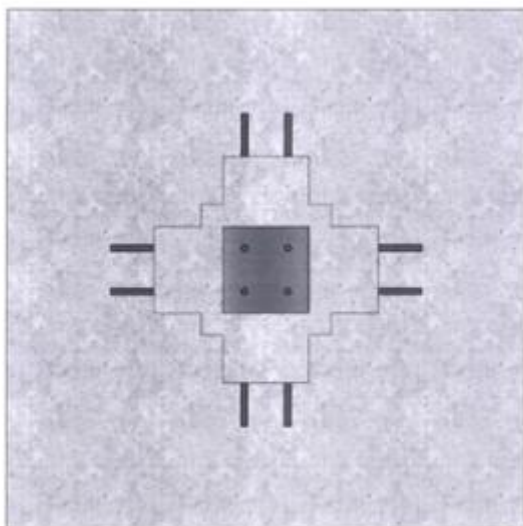

1.3



1.4

CÔNG BÁO SỞ HỮU CÔNG NGHIỆP SỐ 436 TẬP A – QUYỀN 2 (07.2024)

- (11) **50982**
(21) 3-2024-00256 (28) 1
(54) **BÚT** (51) **19-06**
(22) 29/01/2024 (43) 25/07/2024
(73) **CÔNG TY CỔ PHẦN TẬP ĐOÀN THIÊN LONG (VN)**
Tầng 10, Sofic Tower, số 10 đường Mai Chí Thọ, phường Thủ Thiêm, thành phố Thủ Đức, thành phố Hồ Chí Minh
(72) Cô Gia Thọ (VN)
(74) Công ty TNHH Tư vấn sở hữu trí tuệ Việt (VIET IP CO.,LTD.)
(55)

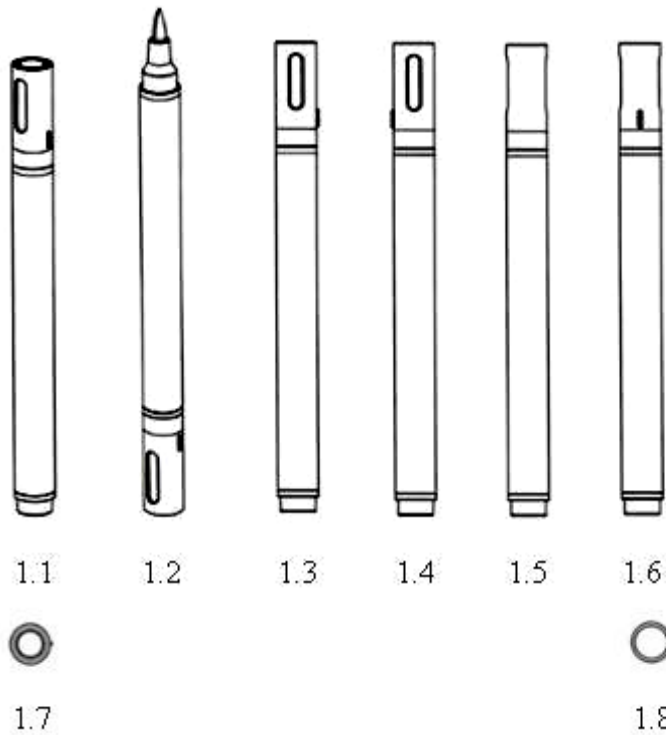

CÔNG BÁO SỞ HỮU CÔNG NGHIỆP SỐ 436 TẬP A – QUYỀN 2 (07.2024)

- (11) **50983**
(21) 3-2024-00257 (28) 1
(54) **BÚT** (51) **19-06**
(22) 29/01/2024 (43) 25/07/2024
(73) **CÔNG TY CỔ PHẦN TẬP ĐOÀN THIÊN LONG (VN)**
Tầng 10, Sofic Tower, số 10 đường Mai Chí Thọ, phường Thủ Thiêm, thành phố Thủ Đức, thành phố Hồ Chí Minh
(72) Cô Gia Thọ (VN)
(74) Công ty TNHH Tư vấn sở hữu trí tuệ Việt (VIET IP CO.,LTD.)
(55)



1.1



1.2



1.3



1.4



1.5



1.6



1.7



1.8

CÔNG BÁO SỞ HỮU CÔNG NGHIỆP SỐ 436 TẬP A – QUYỀN 2 (07.2024)

- (11) **50984**
(21) 3-2024-00258 (28) 1
(54) **BÚT** (51) **19-06**
(22) 29/01/2024 (43) 25/07/2024
(73) **CÔNG TY CỔ PHẦN TẬP ĐOÀN THIÊN LONG (VN)**
Tầng 10, Sofic Tower, số 10 đường Mai Chí Thọ, phường Thủ Thiêm, thành phố Thủ Đức, thành phố Hồ Chí Minh
(72) Cô Gia Thọ (VN)
(74) Công ty TNHH Tư vấn sở hữu trí tuệ Việt (VIET IP CO.,LTD.)
(55)

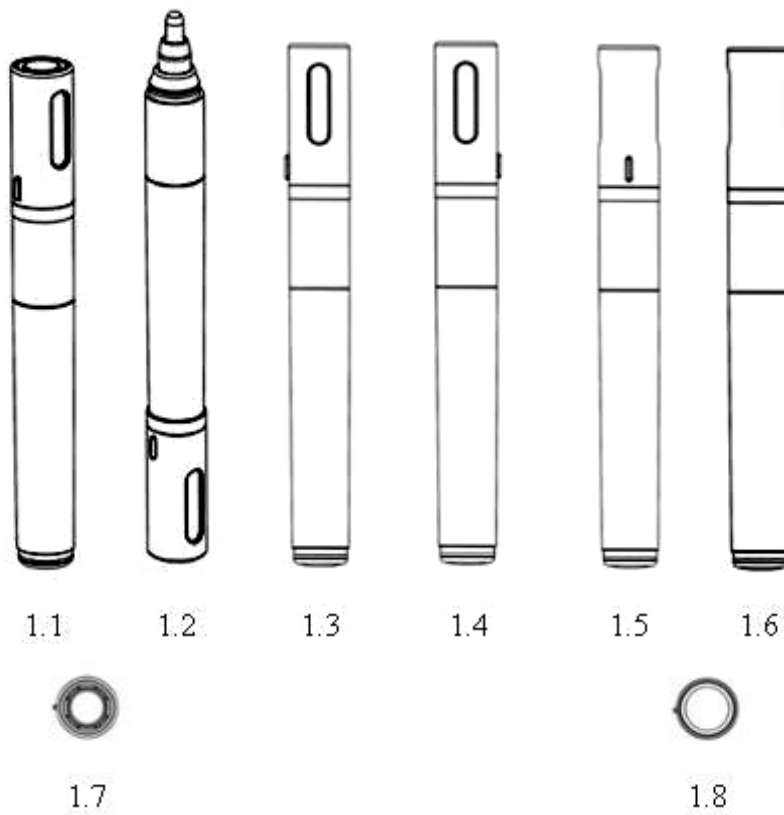

CÔNG BÁO SỞ HỮU CÔNG NGHIỆP SỐ 436 TẬP A – QUYỀN 2 (07.2024)

(11) **50985**

(21) 3-2024-00259

(28) 1

(54) **NẮP BÚT**

(51) **19-06**

(22) 29/01/2024

(43) 25/07/2024

(73) **CÔNG TY CỔ PHẦN TẬP ĐOÀN THIÊN LONG (VN)**

Tầng 10, Sofic Tower, số 10 đường Mai Chí Thọ, phường Thủ Thiêm, thành phố Thủ Đức, thành phố Hồ Chí Minh

(72) Cô Gia Thọ (VN)

(74) Công ty TNHH Tư vấn sở hữu trí tuệ Việt (VIET IP CO.,LTD.)

(55)



1.1



1.2



1.3



1.4



1.5



1.6



1.7

CÔNG BÁO SỞ HỮU CÔNG NGHIỆP SỐ 436 TẬP A – QUYỀN 2 (07.2024)

- (11) **50986**
(21) 3-2024-00260 (28) 1
(54) **BÚT** (51) **19-06**
(22) 29/01/2024 (43) 25/07/2024
(73) **CÔNG TY CỔ PHẦN TẬP ĐOÀN THIÊN LONG (VN)**
Tầng 10, Sofic Tower, số 10 đường Mai Chí Thọ, phường Thủ Thiêm, thành phố
Thủ Đức, thành phố Hồ Chí Minh
(72) Cô Gia Thọ (VN)
(74) Công ty TNHH Tư vấn sở hữu trí tuệ Việt (VIET IP CO.,LTD.)
(55)

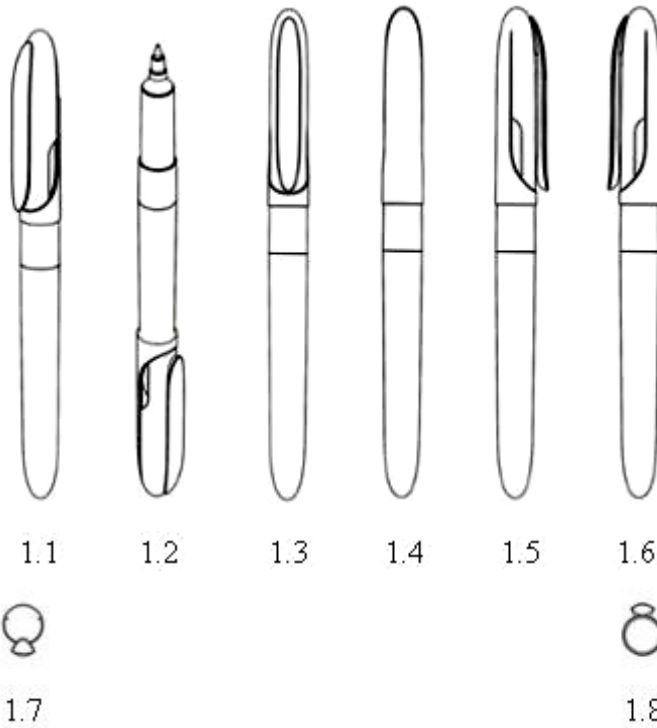

CÔNG BÁO SỞ HỮU CÔNG NGHIỆP SỐ 436 TẬP A – QUYỀN 2 (07.2024)

- (11) **50987**
(21) 3-2024-00261 (28) 1
(54) **ĐỂ CẢM KÈM BÚT** (51) **19-06**
(22) 29/01/2024 (43) 25/07/2024
(73) **CÔNG TY CỔ PHẦN TẬP ĐOÀN THIÊN LONG (VN)**
Tầng 10, Sofic Tower, số 10 đường Mai Chí Thọ, phường Thủ Thiêm, thành phố Thủ Đức, thành phố Hồ Chí Minh
(72) Cô Gia Thọ (VN)
(74) Công ty TNHH Tư vấn sở hữu trí tuệ Việt (VIET IP CO.,LTD.)
(55)

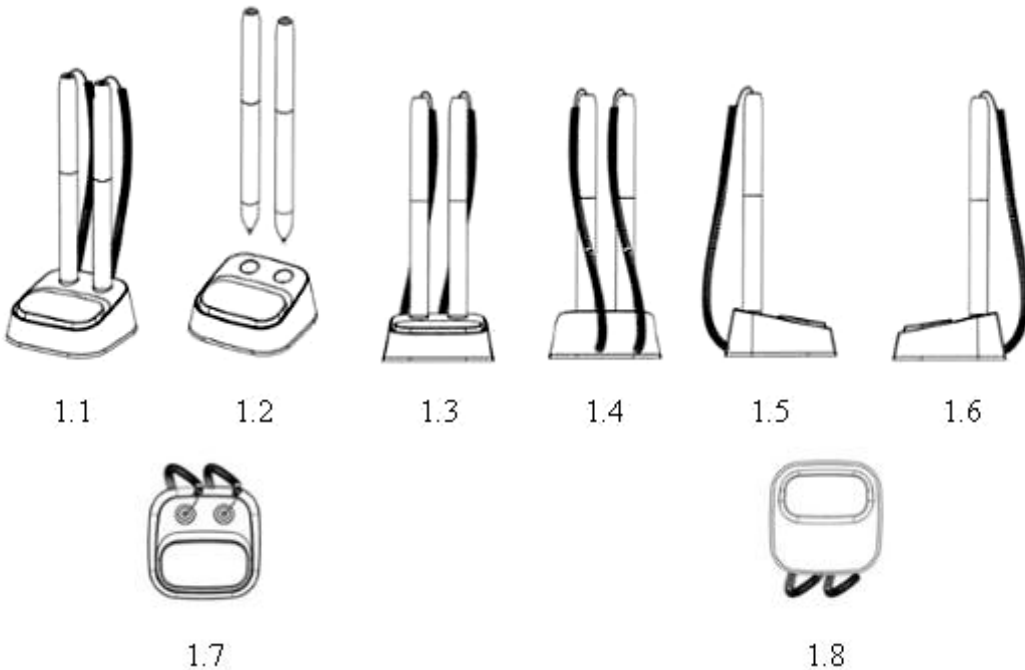

CÔNG BÁO SỞ HỮU CÔNG NGHIỆP SỐ 436 TẬP A – QUYỀN 2 (07.2024)

(11) **50988**

(21) 3-2024-00277

(28) 1

(54) **CHAI**

(51) **09-01**

(22) 31/01/2024

(43) 25/07/2024

(73) **CÔNG TY CỔ PHẦN SỮA VITADAIRY VIỆT NAM (VN)**

Tầng 5, số 37 Tôn Đức Thắng, phường Bến Nghé, quận 1, thành phố Hồ Chí Minh

(72) Nguyễn Thị Hà (VN)

(55)



1.1



1.2



1.3



1.4



1.5

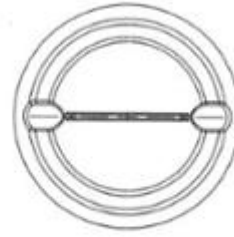

1.6

(11) **50989**

(21) 3-2024-00290

(54) **KỆ NHỰA ĐỠ HÀNG**

(22) 31/01/2024

(73) **CÔNG TY TNHH MỘT THÀNH VIÊN SẢN XUẤT THƯƠNG MẠI CƠ KHÍ TÂN HOA THỊNH LONG AN (VN)**

Đường số 1, cụm công nghiệp Liên Hưng, ấp Bình Tiên 2, xã Đức Hòa Hạ, huyện Đức Hòa, tỉnh Long An

(72) Quách Kim Long (VN)

(55)

(28) 1

(51) **09-08**

(43) 25/07/2024

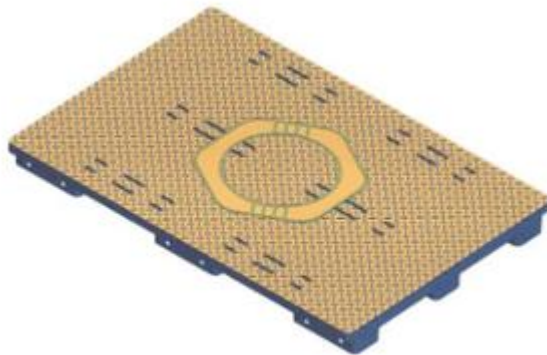

1.1



1.2



1.3

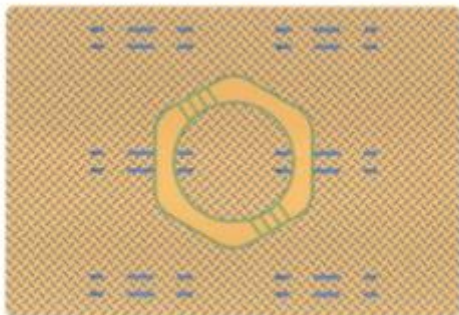

1.4

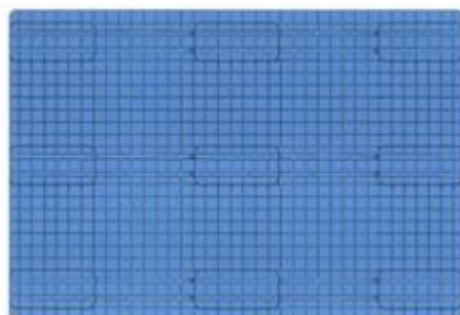

1.5

CÔNG BÁO SỞ HỮU CÔNG NGHIỆP SỐ 436 TẬP A – QUYỀN 2 (07.2024)

(11) **50990**

(21) 3-2024-00291

(54) **KỆ NHỰA ĐỠ HÀNG**

(22) 31/01/2024

(73) **CÔNG TY TNHH MỘT THÀNH VIÊN SẢN XUẤT THƯƠNG MẠI CƠ KHÍ TÂN HOA THỊNH LONG AN (VN)**

Đường số 1, cụm công nghiệp Liên Hưng, ấp Bình Tiên 2, xã Đức Hòa Hạ, huyện Đức Hòa, tỉnh Long An

(72) Quách Kim Long (VN)

(55)

(28) 1

(51) **09-08**

(43) 25/07/2024

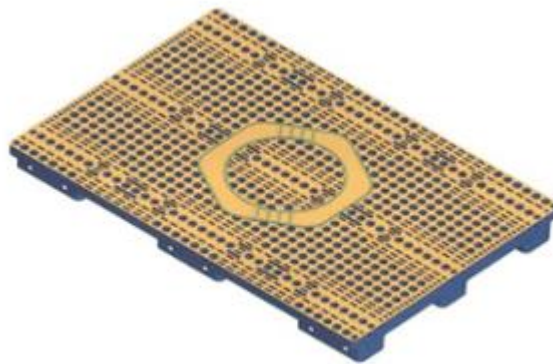

1.1



1.2



1.3

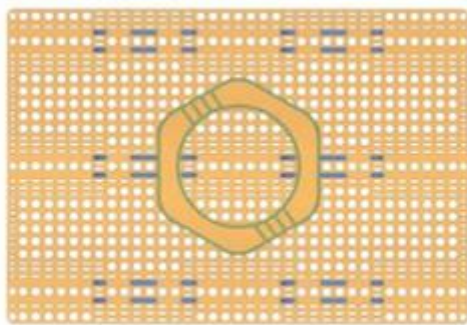

1.4

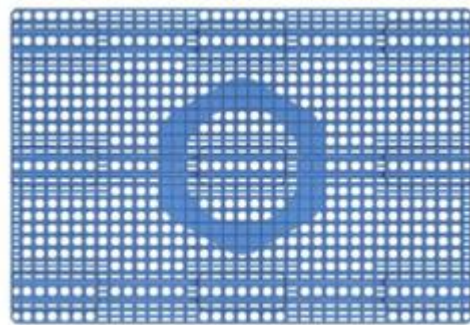

1.5

CÔNG BÁO SỞ HỮU CÔNG NGHIỆP SỐ 436 TẬP A – QUYỀN 2 (07.2024)

(11) **50991**

(21) 3-2024-00292

(28) 1

(54) **KỆ NHỰA ĐỠ HÀNG**

(51) **09-08**

(22) 31/01/2024

(43) 25/07/2024

(73) **CÔNG TY TNHH MỘT THÀNH VIÊN SẢN XUẤT THƯƠNG MẠI CƠ KHÍ TÂN HOA THỊNH LONG AN (VN)**

Đường số 1, cụm công nghiệp Liên Hưng, ấp Bình Tiên 2, xã Đức Hòa Hạ, huyện Đức Hòa, tỉnh Long An

(72) Quách Kim Long (VN)

(55)

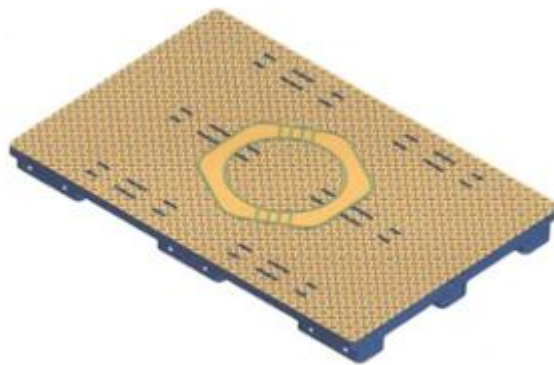

1.1



1.2



1.3

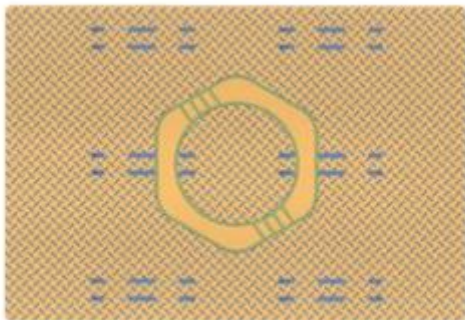

1.4

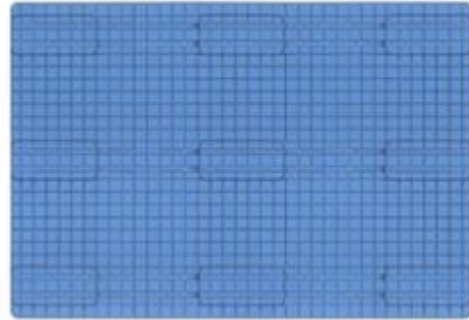

1.5

(11) **50992**

(21) 3-2024-00293

(28) 1

(54) **KỆ NHỰA ĐỠ HÀNG**

(51) **09-08**

(22) 31/01/2024

(43) 25/07/2024

(73) **CÔNG TY TNHH MỘT THÀNH VIÊN SẢN XUẤT THƯƠNG MẠI CƠ KHÍ TÂN HOA THỊNH LONG AN (VN)**

Đường số 1, cụm công nghiệp Liên Hưng, ấp Bình Tiên 2, xã Đức Hòa Hạ, huyện Đức Hòa, tỉnh Long An

(72) Quách Kim Long (VN)

(55)

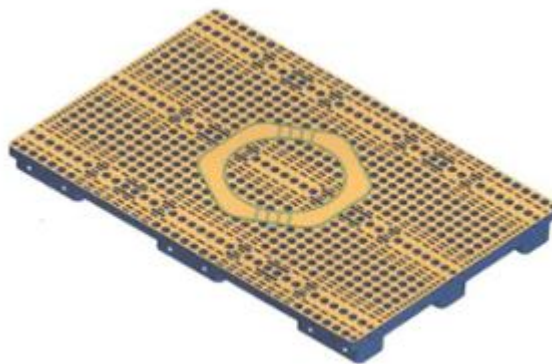

1.1



1.2



1.3

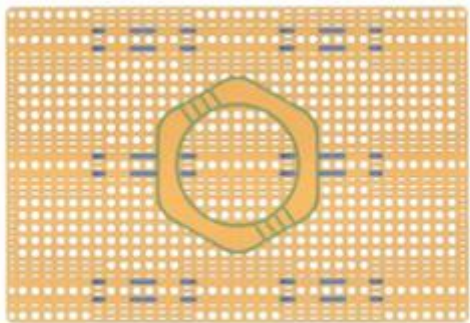

1.4

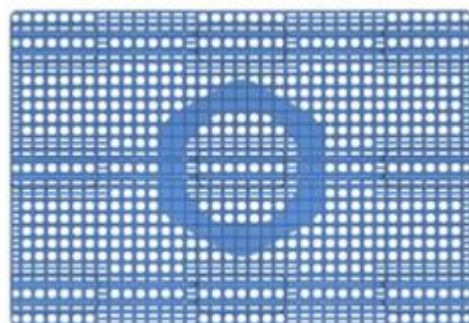

1.5

CÔNG BÁO SỞ HỮU CÔNG NGHIỆP SỐ 436 TẬP A – QUYỀN 2 (07.2024)

(11) **50993**

(21) 3-2024-00294

(28) 1

(54) **CHÂN KỆ NHỰA ĐỠ HÀNG**

(51) **09-08**

(22) 31/01/2024

(43) 25/07/2024

(73) **CÔNG TY TNHH MỘT THÀNH VIÊN SẢN XUẤT THƯƠNG MẠI CƠ KHÍ TÂN HOA THỊNH LONG AN (VN)**

Đường số 1, cụm công nghiệp Liên Hưng, ấp Bình Tiên 2, xã Đức Hòa Hạ, huyện Đức Hòa, tỉnh Long An

(72) Quách Kim Long (VN)

(55)



1.1



1.2



1.3

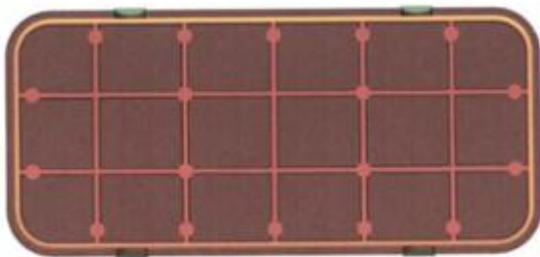

1.4



1.5

CÔNG BÁO SỞ HỮU CÔNG NGHIỆP SỐ 436 TẬP A – QUYỀN 2 (07.2024)

- (11) **50994**
(21) 3-2024-00295 (28) 1
(54) **CHÂN KỆ NHỰA ĐỠ HÀNG** (51) **09-08**
(22) 31/01/2024 (43) 25/07/2024
(73) **CÔNG TY TNHH MỘT THÀNH VIÊN SẢN XUẤT THƯƠNG MẠI CƠ KHÍ TÂN HOA THỊNH LONG AN (VN)**
Đường số 1, cụm công nghiệp Liên Hưng, ấp Bình Tiên 2, xã Đức Hòa Hạ, huyện Đức Hòa, tỉnh Long An
(72) Quách Kim Long (VN)
(55)

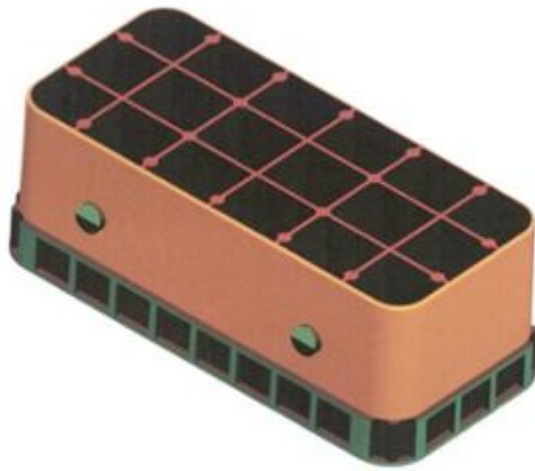

1.1



1.2

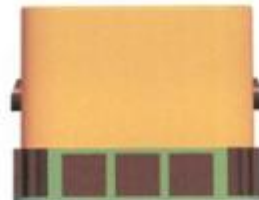

1.3

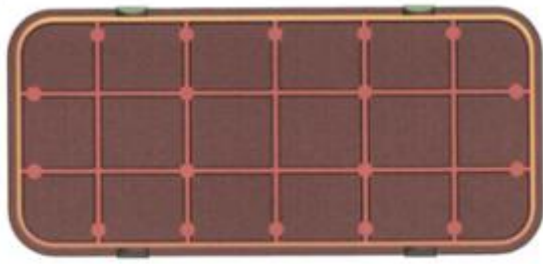

1.4



1.5

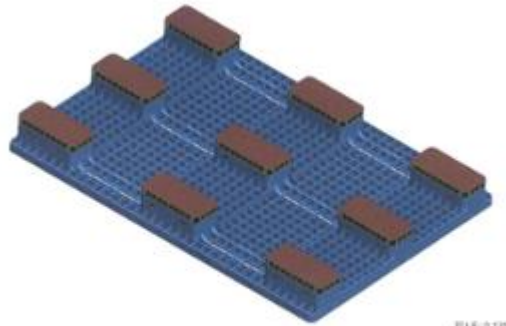

1.6

CÔNG BÁO SỞ HỮU CÔNG NGHIỆP SỐ 436 TẬP A – QUYỀN 2 (07.2024)

- (11) **50995**
(21) 3-2024-00296 (28) 1
(54) **CHÂN KỆ NHỰA ĐỠ HÀNG** (51) **09-08**
(22) 31/01/2024 (43) 25/07/2024
(73) **CÔNG TY TNHH MỘT THÀNH VIÊN SẢN XUẤT THƯƠNG MẠI CƠ KHÍ TÂN HOA THỊNH LONG AN (VN)**
Đường số 1, cụm công nghiệp Liên Hưng, ấp Bình Tiền 2, xã Đức Hòa Hạ, huyện Đức Hòa, tỉnh Long An
(72) Quách Kim Long (VN)
(55)



1.1



1.2



1.3



1.4



1.5

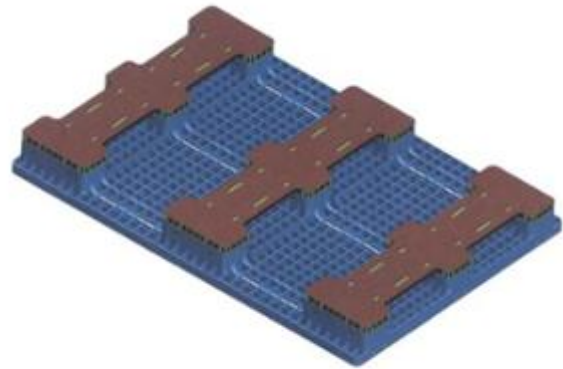

1.6

CÔNG BÁO SỞ HỮU CÔNG NGHIỆP SỐ 436 TẬP A – QUYỀN 2 (07.2024)

(11) **50996**

(21) 3-2024-00297

(28) 1

(54) **CHÂN KỆ NHỰA ĐỠ HÀNG**

(51) **09-08**

(22) 31/01/2024

(43) 25/07/2024

(73) **CÔNG TY TNHH MỘT THÀNH VIÊN SẢN XUẤT THƯƠNG MẠI CƠ KHÍ TÂN HOA THỊNH LONG AN (VN)**

Đường số 1, cụm công nghiệp Liên Hưng, ấp Bình Tiền 2, xã Đức Hòa Hạ, huyện Đức Hòa, tỉnh Long An

(72) Quách Kim Long (VN)

(55)



1.1



1.2



1.3



1.4



1.5

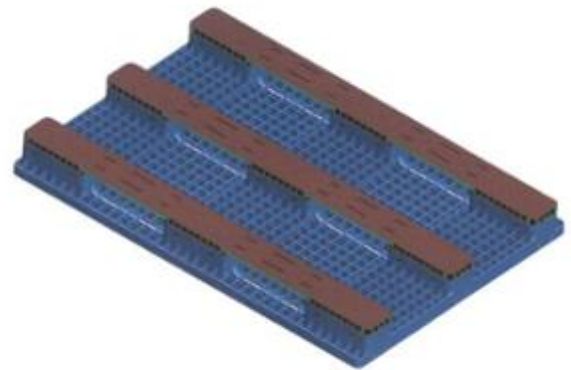

1.6

CÔNG BÁO SỞ HỮU CÔNG NGHIỆP SỐ 436 TẬP A – QUYỀN 2 (07.2024)

(11) **50997**

(21) 3-2024-00298

(28) 1

(54) **KỆ NHỰA ĐỠ HÀNG**

(51) **09-08**

(22) 31/01/2024

(43) 25/07/2024

(73) **CÔNG TY TNHH MỘT THÀNH VIÊN SẢN XUẤT THƯƠNG MẠI CƠ KHÍ TÂN HOA THỊNH LONG AN (VN)**

Đường số 1, cụm công nghiệp Liên Hưng, ấp Bình Tiên 2, xã Đức Hòa Hạ, huyện Đức Hòa, tỉnh Long An

(72) Quách Kim Long (VN)

(55)

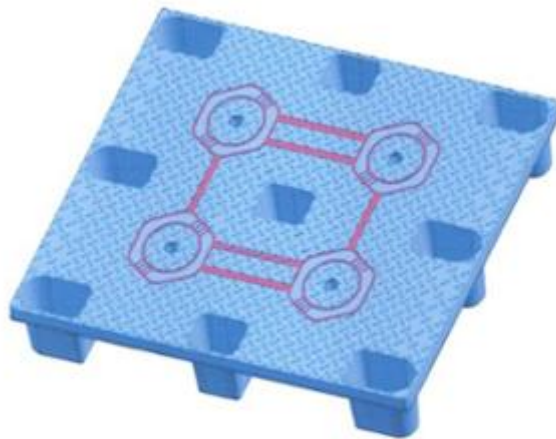

1.1



1.2



1.3



1.4



1.5

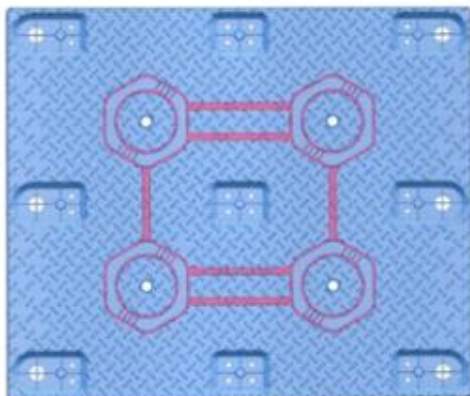

1.6

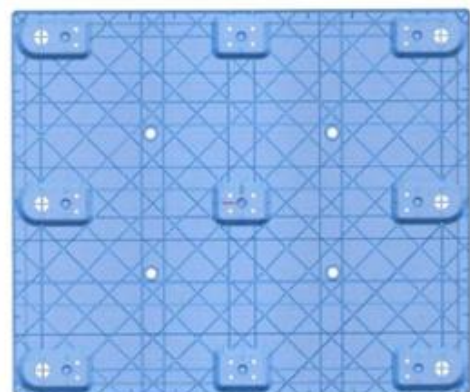

1.7

CÔNG BÁO SỞ HỮU CÔNG NGHIỆP SỐ 436 TẬP A – QUYỀN 2 (07.2024)

- (11) **50998**
(21) 3-2024-00299 (28) 1
(54) **KỆ NHỰA ĐỠ HÀNG** (51) **09-08**
(22) 31/01/2024 (43) 25/07/2024
(73) **CÔNG TY TNHH MỘT THÀNH VIÊN SẢN XUẤT THƯƠNG MẠI CƠ KHÍ TÂN HOA THỊNH LONG AN (VN)**
Đường số 1, cụm công nghiệp Liên Hưng, ấp Bình Tiên 2, xã Đức Hòa Hạ, huyện Đức Hòa, tỉnh Long An
(72) Quách Kim Long (VN)
(55)

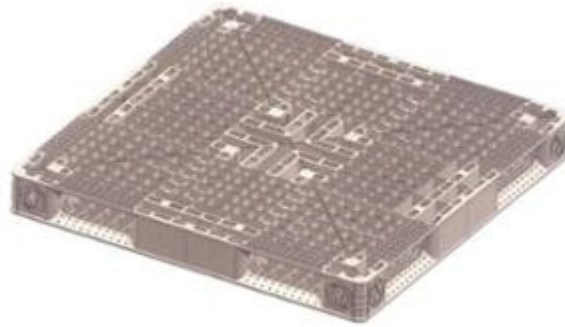

1.1



1.2



1.3



1.4



1.5

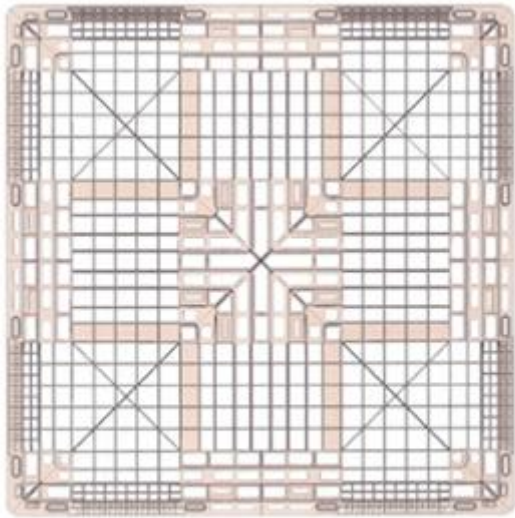

1.6

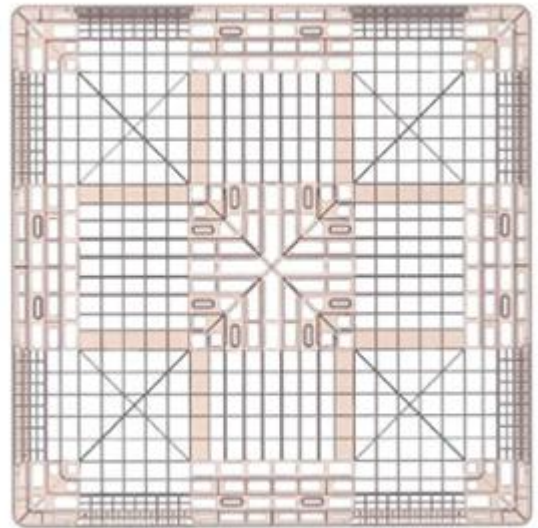

1.7

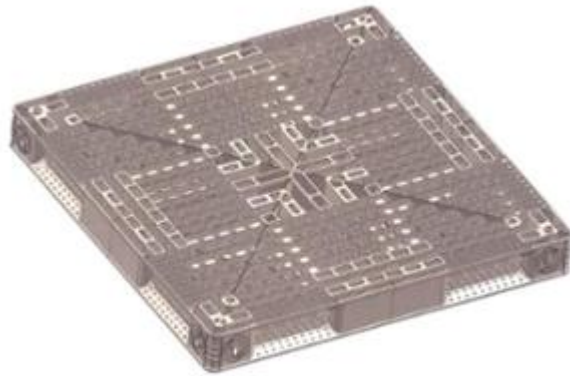

1.8

(11) **50999**

(21) 3-2024-00300

(28) 1

(54) **KỆ NHỰA ĐỠ HÀNG**

(51) **09-08**

(22) 31/01/2024

(43) 25/07/2024

(73) **CÔNG TY TNHH MỘT THÀNH VIÊN SẢN XUẤT THƯƠNG MẠI CƠ KHÍ TÂN HOA THỊNH LONG AN (VN)**

Đường số 1, cụm công nghiệp Liên Hưng, ấp Bình Tiền 2, xã Đức Hòa Hạ, huyện Đức Hòa, tỉnh Long An

(72) Quách Kim Long (VN)

(55)

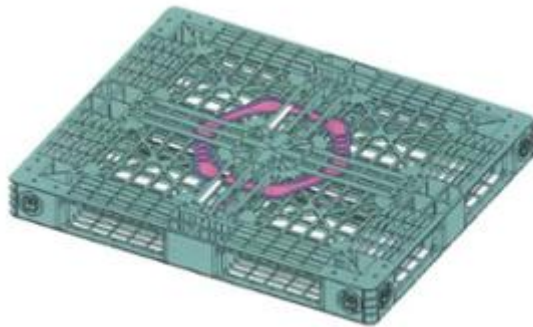

1.1



1.2



1.3



1.4



1.5

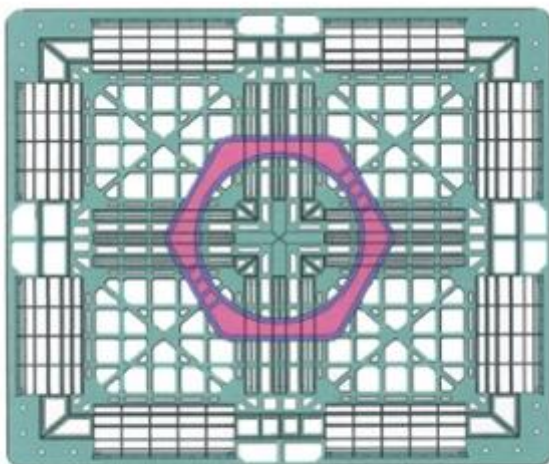

1.6

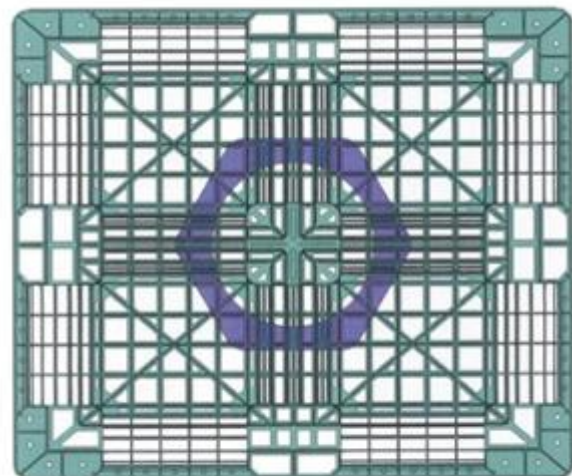

1.7

CÔNG BÁO SỞ HỮU CÔNG NGHIỆP SỐ 436 TẬP A – QUYỀN 2 (07.2024)

- (11) **51000**
(21) 3-2024-01307 (28) 1
(54) **NHÃN** (51) **11-01**
(22) 07/06/2024 (43) 25/07/2024
(30) WIPO146037 18/03/2024 WO;
(73) **VAN CLEEF & ARPELS SA (CH)**
Route des Biches 8, 1752 Villars-sur-Glâne, Switzerland
(72) Isabelle Parvex (FR)
(74) Công ty TNHH tư vấn Sở hữu trí tuệ IPFLAME (IPFLAME CO.,LTD)
(55)



1.1



1.2

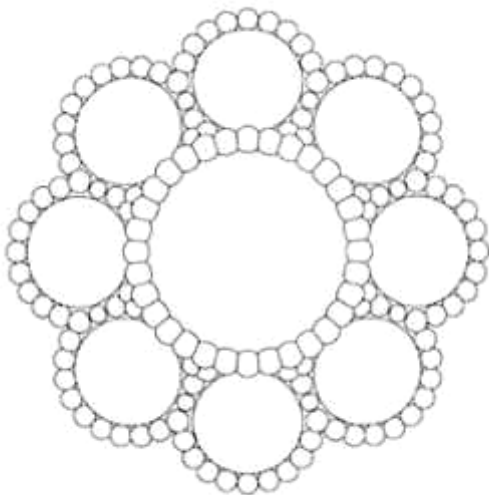

1.3

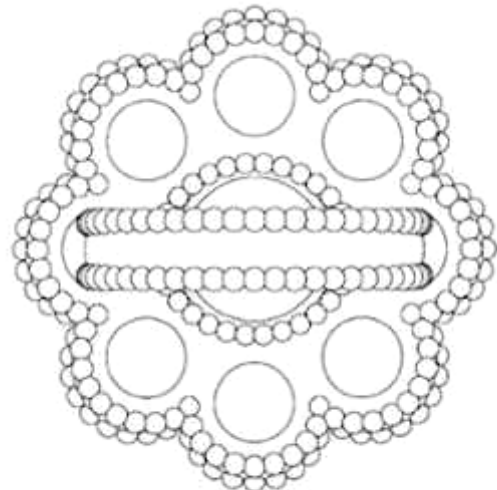

1.4

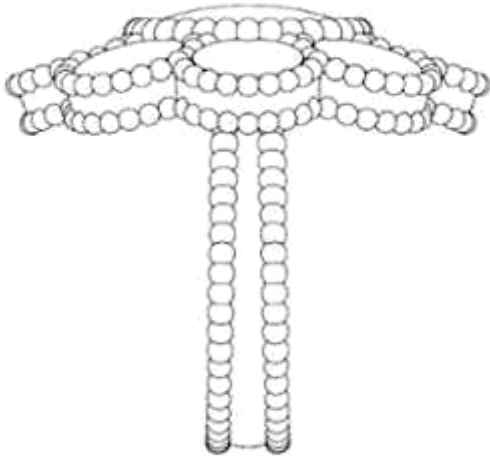

1.5

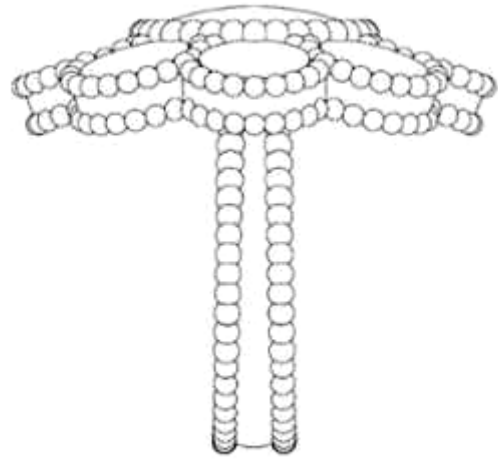

1.6



1.7



1.8

- (11) **51001**
(21) 3-2024-01308 (28) 1
(54) **BỘ PHẬN TRANG TRÍ DÙNG CHO ĐỒ TRANG SỨC** (51) **11-01**
(22) 07/06/2024 (43) 25/07/2024
(30) WIPO146036 18/03/2024 WO;
(73) **VAN CLEEF & ARPELS SA (CH)**
Route des Biches 8, 1752 Villars-sur-Glâne, Switzerland
(72) Isabelle Parvex (FR)
(74) Công ty TNHH tư vấn Sở hữu trí tuệ IPFLAME (IPFLAME CO.,LTD)
(55)

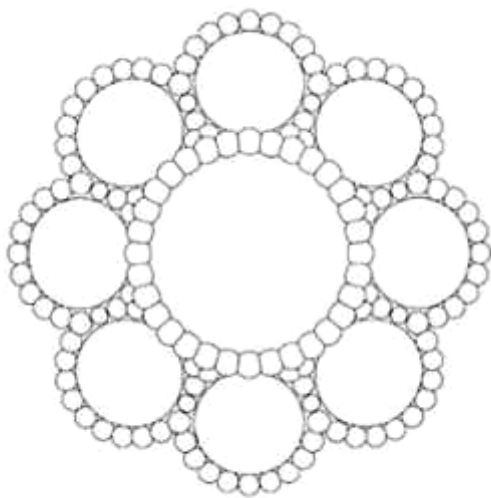

1.1

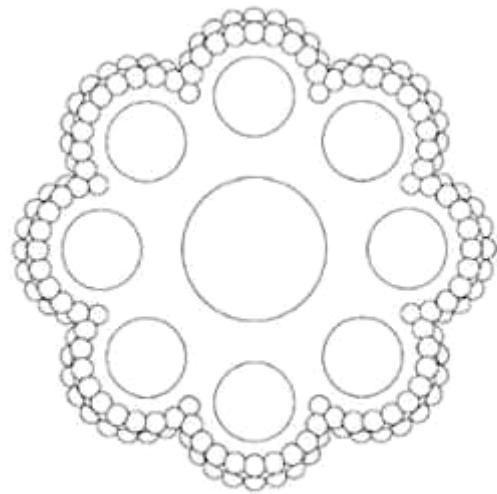

1.2

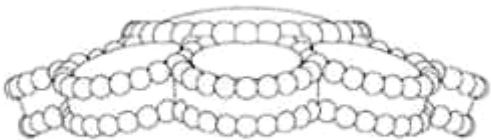

1.4

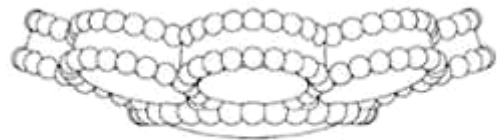

1.3



1.5



1.6

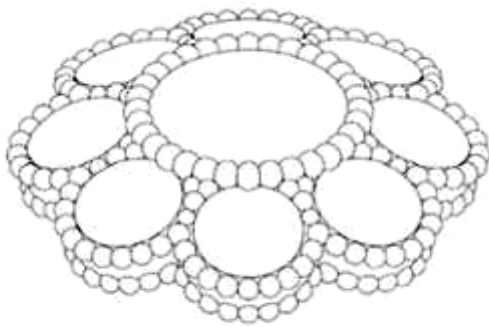

1.7

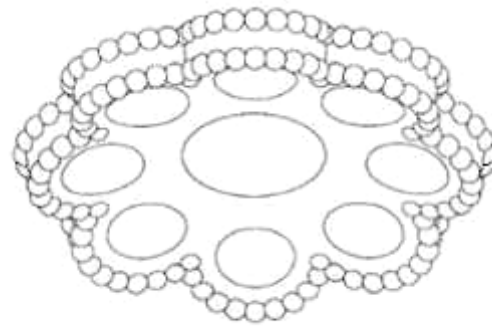

1.8

CÔNG BÁO SỞ HỮU CÔNG NGHIỆP SỐ 436 TẬP A – QUYỀN 2 (07.2024)

- (11) **51002**
(21) 3-2024-01364 (28) 1
(54) **MÁY ĐIỀU HÒA NHIỆT ĐỘ** (51) **23-04**
(22) 13/06/2024 (43) 25/07/2024
(73) **PANASONIC APPLIANCES AIR-CONDITIONING MALAYSIA SDN. BHD.**
(MY)
Lot 2, Persiaran Tengku Ampuan, Section 21, Shah Alam Industrial Site, 40300
Shah Alam, Selangor Darul Ehsan, Malaysia
(72) 1. RAY TAN CHIEN SHIUNG (MY)
2. YAP KAI WEN (MY)
(74) Công ty cổ phần tư vấn Trung Thực (TRUNG THUC.,JSC)
(55)



1.1

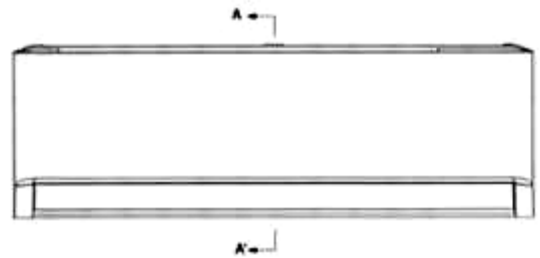

1.2



1.3



1.4

1.5

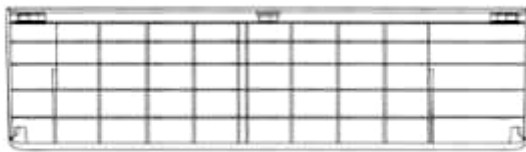

1.6



1.7



1.8

CÔNG BÁO SỞ HỮU CÔNG NGHIỆP SỐ 436 TẬP A – QUYỀN 2 (07.2024)

- (11) **51003**
(21) 3-2024-01365 (28) 1
(54) **MÁY ĐIỀU HÒA NHIỆT ĐỘ** (51) **23-04**
(22) 13/06/2024 (43) 25/07/2024
(73) **PANASONIC APPLIANCES AIR-CONDITIONING MALAYSIA SDN. BHD.**
(MY)
Lot 2, Persiaran Tengku Ampuan, Section 21, Shah Alam Industrial Site, 40300
Shah Alam, Selangor Darul Ehsan, Malaysia
(72) Ray TAN Chien Shiung (MY)
(74) Công ty cổ phần tư vấn Trung Thực (TRUNG THUC.,JSC)
(55)



1.1

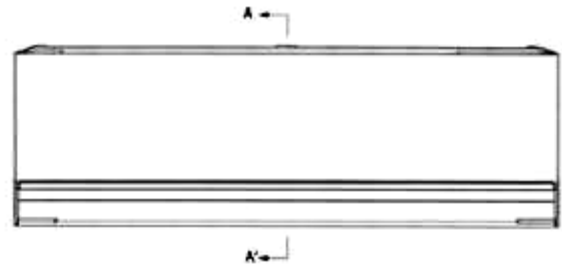

1.2



1.3



1.4

1.5

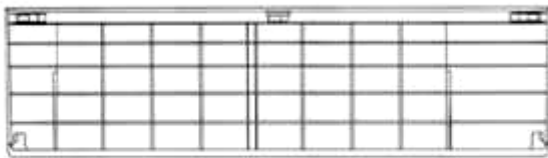

1.6

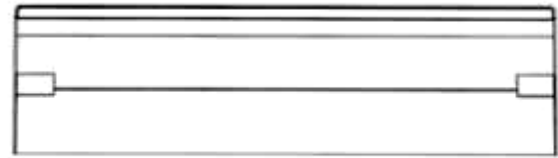

1.7



1.8

- (11) **51004**
(21) 3-2024-01372 (28) 1
(54) **MIẾNG RỬA BÁT** (51) **04-01**
(22) 13/06/2024 (43) 25/07/2024
(73) **CÔNG TY TNHH DUY NHÂN NGHĨA (VN)**
Số 47A đường số 24, phường Linh Đông, thành phố Thủ Đức, thành phố Hồ Chí Minh
(72) Nguyễn Vũ Quỳnh Ngân (VN)
(74) **CÔNG TY TNHH LUẬT SỞ HỮU TRÍ TUỆ ĐIỂM TỰA VÀNG (IPDTV CO.,LTD.)**
(55)



1.1



1.2



1.3



1.4



1.5



1.6



1.7

CÔNG BÁO SỞ HỮU CÔNG NGHIỆP SỐ 436 TẬP A – QUYỀN 2 (07.2024)

(11) **51005**

(21) 3-2024-00933

(28) 1

(54) **ĐÈN**

(51) **26-04**

(22) 17/04/2024

(43) 25/07/2024

(73) **CÔNG TY CỔ PHẦN TẬP ĐOÀN ĐIỆN QUANG (VN)**

121-123-125 Hàm Nghi, phường Nguyễn Thái Bình, quận 1, thành phố Hồ Chí Minh

(72) Hồ Quỳnh Hưng (VN)

(74) Công ty Luật TNHH AGL (AGL LAW)

(55)



1.1



1.2



1.3



1.4



1.5



1.6

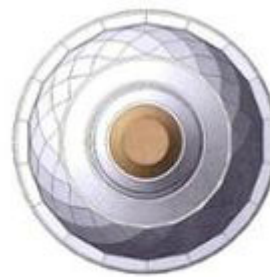

1.7

CÔNG BÁO SỞ HỮU CÔNG NGHIỆP SỐ 436 TẬP A – QUYỀN 2 (07.2024)

(11) **51006**

(21) 3-2024-00934

(28) 1

(54) **ĐÈN**

(51) **26-04**

(22) 17/04/2024

(43) 25/07/2024

(73) **CÔNG TY CỔ PHẦN TẬP ĐOÀN ĐIỆN QUANG (VN)**

121-123-125 Hàm Nghi, phường Nguyễn Thái Bình, quận 1, thành phố Hồ Chí Minh

(72) Hồ Quỳnh Hưng (VN)

(74) Công ty Luật TNHH AGL (AGL LAW)

(55)



1.1



1.2



1.3

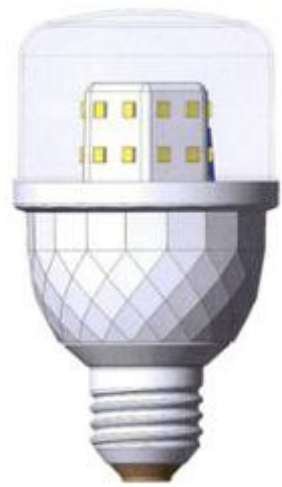

1.4

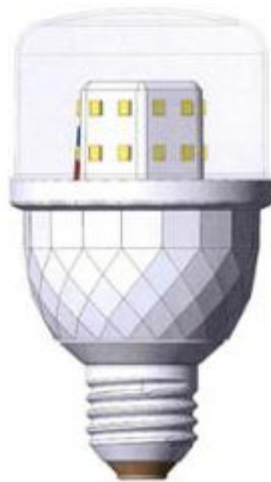

1.5



1.6

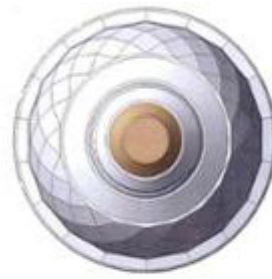

1.7

CÔNG BÁO SỞ HỮU CÔNG NGHIỆP SỐ 436 TẬP A – QUYỀN 2 (07.2024)

(11) **51007**

(21) 3-2024-00935

(28) 1

(54) **ĐÈN**

(51) **26-04**

(22) 17/04/2024

(43) 25/07/2024

(73) **CÔNG TY CỔ PHẦN TẬP ĐOÀN ĐIỆN QUANG (VN)**

121-123-125 Hàm Nghi, phường Nguyễn Thái Bình, quận 1, thành phố Hồ Chí Minh

(72) Hồ Quỳnh Hưng (VN)

(74) Công ty Luật TNHH AGL (AGL LAW)

(55)



1.1

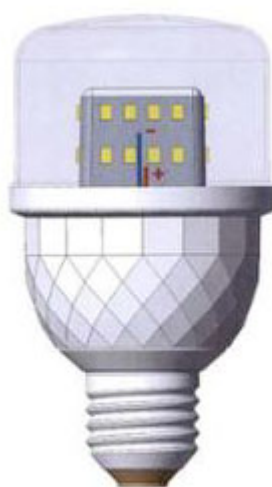

1.2

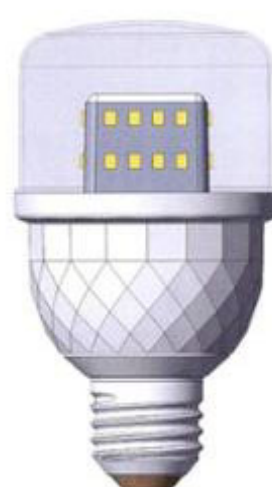

1.3

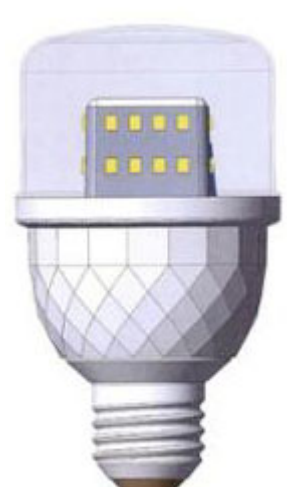

1.4

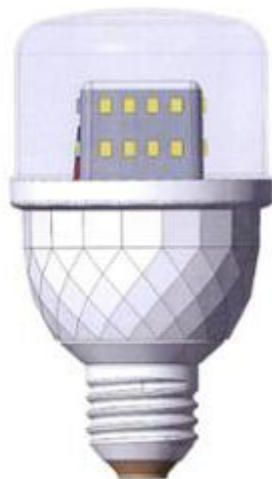

1.5

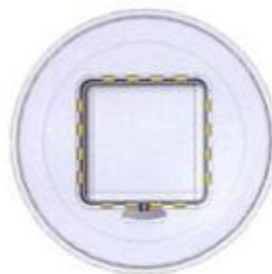

1.6

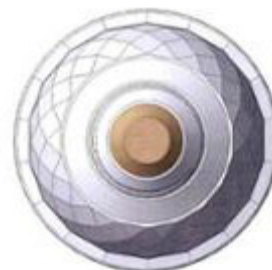

1.7

CÔNG BÁO SỞ HỮU CÔNG NGHIỆP SỐ 436 TẬP A – QUYỀN 2 (07.2024)

(11) **51008**

(21) 3-2024-00936

(28) 1

(54) **NẤP BÚT**

(51) **19-06**

(22) 17/04/2024

(43) 25/07/2024

(73) **CÔNG TY CỔ PHẦN TẬP ĐOÀN THIÊN LONG (VN)**

Tầng 10, Sofic Tower, số 10 đường Mai Chí Thọ, phường Thủ Thiêm, thành phố Thủ Đức, thành phố Hồ Chí Minh

(72) Cô Gia Thọ (VN)

(74) Công ty TNHH Tư vấn sở hữu trí tuệ Việt (VIET IP CO.,LTD.)

(55)

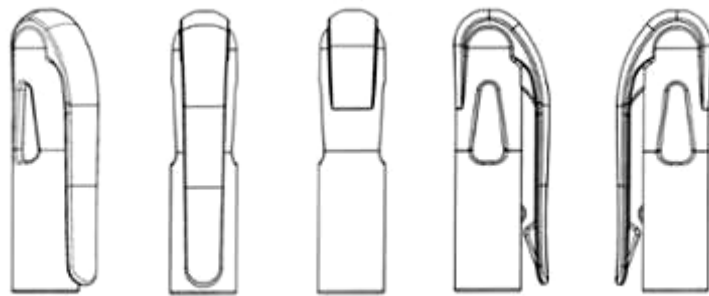

1.1

1.2

1.3

1.4

1.5



1.6



1.7

CÔNG BÁO SỞ HỮU CÔNG NGHIỆP SỐ 436 TẬP A – QUYỀN 2 (07.2024)

(11) **51009**

(21) 3-2024-00947

(54) **MÁY Ủ PHÂN HỮU CƠ**

(22) 17/04/2024

(73) **CÔNG TY CỔ PHẦN ĐẦU TƯ PHÁT TRIỂN MỸ YÊN (VN)**

59 đường tỉnh lộ 830C, ấp 7B, xã Mỹ Yên, huyện Bến Lức, tỉnh Long An

(72) Lê Thu An (VN)

(74) Công ty Cổ phần Sở hữu công nghiệp INVESTIP (INVESTIP)

(55)

(28) 1

(51) **15-99**

(43) 25/07/2024

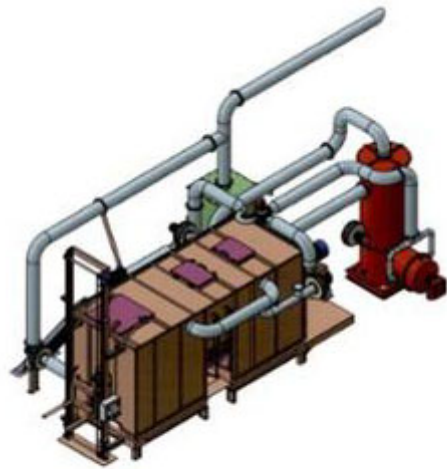

1.1

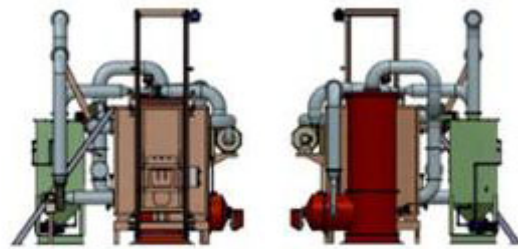

1.2

1.3

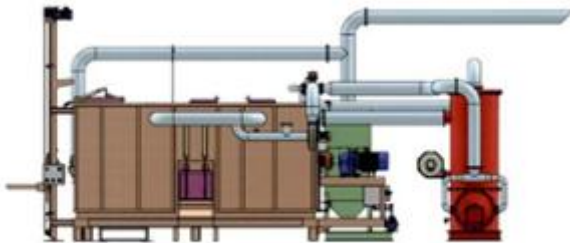

1.4

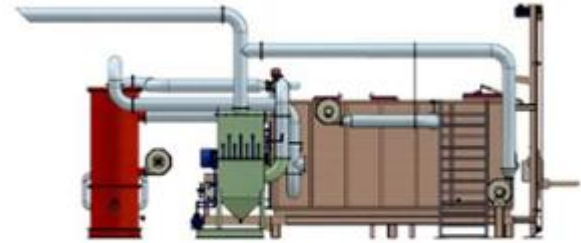

1.5

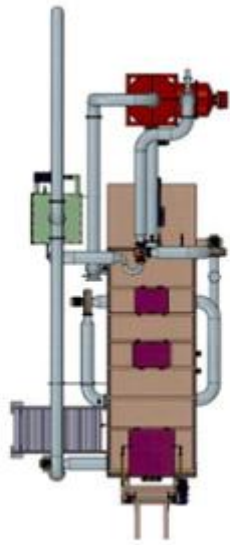

1.6



1.7

CÔNG BÁO SỞ HỮU CÔNG NGHIỆP SỐ 436 TẬP A – QUYỀN 2 (07.2024)

- (11) **51010**
(21) 3-2024-00949 (28) 1
(54) **CHAI** (51) **09-01**
(22) 17/04/2024 (43) 25/07/2024
(73) **HỘ KINH DOANH CAFÉ CHÍNH (VN)**
Số 390A đường Quang Trung, phường Xuân Hòa, thành phố Long Khánh, tỉnh
Đồng Nai
(72) Đàm Công Chính (VN)
(74) Văn phòng Luật sư D và T (D & T LAW OFFICE)
(55)

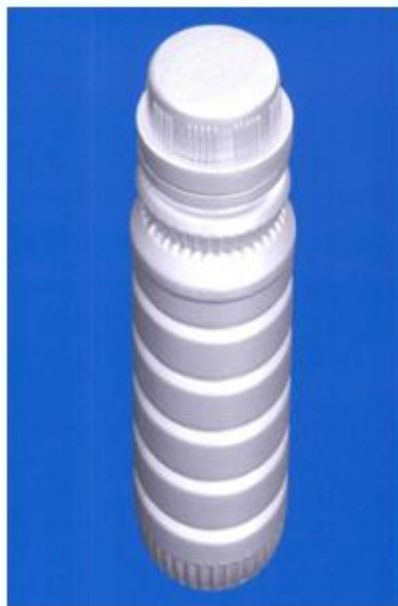

1.1



1.2



1.3



1.4

CÔNG BÁO SỞ HỮU CÔNG NGHIỆP SỐ 436 TẬP A – QUYỀN 2 (07.2024)

- (11) **51011**
(21) 3-2024-01051 (28) 1
(54) **CHẢO** (51) **07-02**
(22) 07/05/2024 (43) 25/07/2024
(30) 2023307541465 17/11/2023 CN;
(73) **JIANGMEN YISHAN METAL PRODUCTS CO., LTD. (CN)**
Jiaobeishan, Niushan, Dalingtou, Qikan, etc, Shiming village, Siqian, Xinhui,
Jiangmen City, Guangdong Province 529100, China
(72) 1. LEE CHANGHO (KR)
2. LEE WONYOUNG (KR)
(74) Công ty TNHH ASL LAW (ASL LAW CO.,LTD)
(55)



CÔNG BÁO SỞ HỮU CÔNG NGHIỆP SỐ 436 TẬP A – QUYỀN 2 (07.2024)

(11) **51012**

(21) 3-2024-01054

(28) 3

(54) **KEM**

(51) **01-01**

(22) 07/05/2024

(43) 25/07/2024

(73) **CÔNG TY CỔ PHẦN THỰC PHẨM SỮA TH (VN)**

Xã Nghĩa Sơn, huyện Nghĩa Đàn, tỉnh Nghệ An

(72) Nguyễn Văn Mạnh (VN)

(74) **CÔNG TY LUẬT TNHH IP MAX (IPMAX LAW FIRM)**

(55)



1.1

1.2

1.3

1.4

1.5

1.6

1.7



2.1

2.2

2.3

2.4

2.5



2.6

2.7



3.1

3.2

3.3

3.4

3.5



3.6



3.7



CÔNG BÁO SỞ HỮU CÔNG NGHIỆP SỐ 436 TẬP A – QUYỀN 2 (07.2024)

- (11) **51013**
(21) 3-2024-01137 (28) 1
(54) **THUỐC LÁ ĐIỆN TỬ** (51) **27-02**
(22) 17/05/2024 (43) 25/07/2024
(30) 30-2023-0046056 20/11/2023 KR;
(73) **KT & G CORPORATION (KR)**
71, Beotkkot-gil, Daedeok-gu, Daejeon 34337, Republic of Korea
(72) KIM, Min Chul (KR)
(74) Công ty Luật TNHH WINCO (WINCO LAW FIRM)
(55)

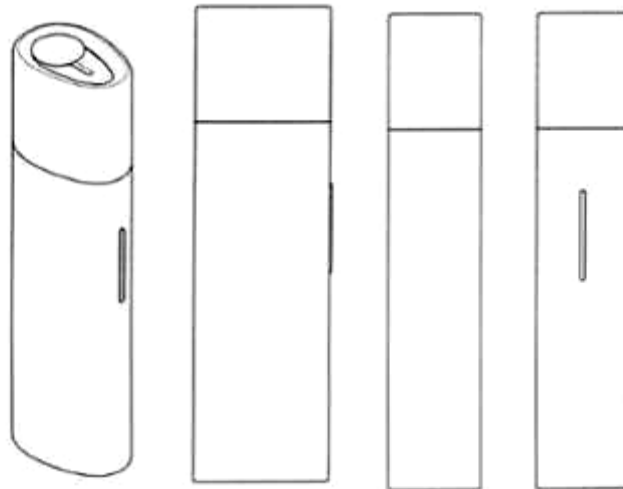

1.1

1.2

1.3

1.4

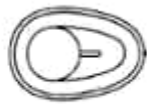

1.5



1.6

CÔNG BÁO SỞ HỮU CÔNG NGHIỆP SỐ 436 TẬP A – QUYỀN 2 (07.2024)

- (11) **51014**
(21) 3-2024-01138 (28) 1
(54) **THUỐC LÁ ĐIỆN TỬ** (51) **27-02**
(22) 17/05/2024 (43) 25/07/2024
(30) 30-2023-0046064 20/11/2023 KR;
(73) **KT & G CORPORATION (KR)**
71, Beotkkot-gil, Daedeok-gu, Daejeon 34337, Republic of Korea
(72) LEE, Sang Min (KR)
(74) Công ty Luật TNHH WINCO (WINCO LAW FIRM)
(55)

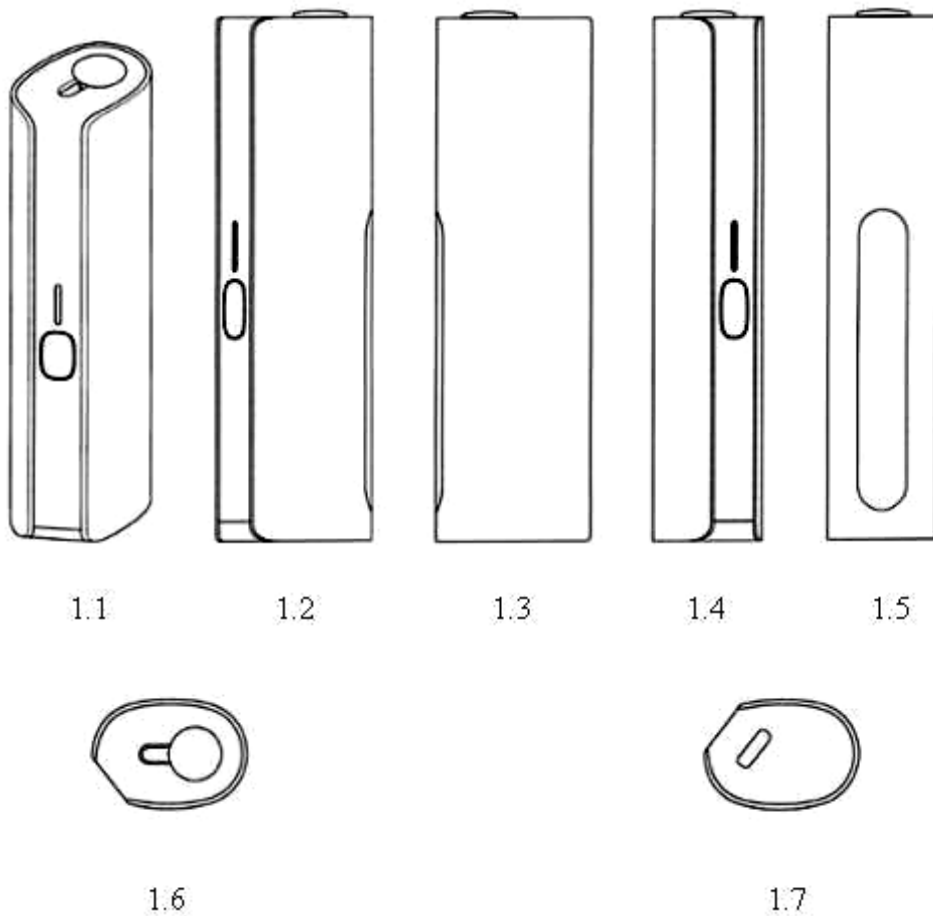

CÔNG BÁO SỞ HỮU CÔNG NGHIỆP SỐ 436 TẬP A – QUYỀN 2 (07.2024)

- (11) **51015**
(21) 3-2024-01144 (28) 2
(54) **CHAI** (51) **09-01**
(22) 17/05/2024 (43) 25/07/2024
(73) **CÔNG TY CỔ PHẦN DẦU THỰC VẬT TƯỜNG AN (VN)**
Lầu 10, tòa nhà Empress Tower, số 138 - 142 đường Hai Bà Trưng, phường Đa
Kao, quận 1, thành phố Hồ Chí Minh
(72) Trần Lê Nguyên (VN)
(74) Công ty TNHH Dịch vụ thương mại và sở hữu công nghiệp Song Ngọc (I.P.T.S.)
(55)



1.1



1.2



1.3



1.4



2.1



2.2



2.3



2.4



2.5

CÔNG BÁO SỞ HỮU CÔNG NGHIỆP SỐ 436 TẬP A – QUYỀN 2 (07.2024)

- (11) **51016**
(21) 3-2024-01150 (28) 1
(54) **CẦN TRỤC THỦY LỰC** (51) **12-05**
(22) 17/05/2024 (43) 25/07/2024
(73) **CÔNG TY TNHH CƠ KHÍ THỦY ĐỨC THỊNH (VN)**
Số 45/5A Phạm Phú Thứ, phường Hạ Lý, quận Hồng Bàng, thành phố Hải Phòng
(72) Phạm Thiện Thọ (VN)
(74) Công ty TNHH Sở hữu trí tuệ M.I.T (M.I.T IP CO., LTD)
(55)



1.1

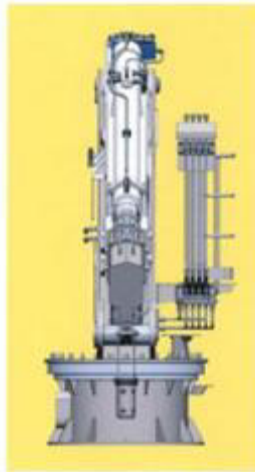

1.2

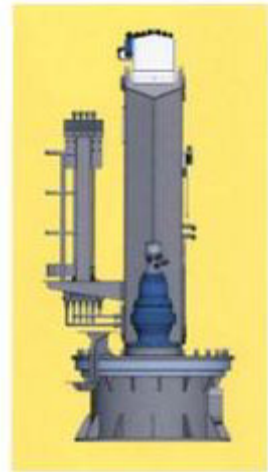

1.3



1.4



1.5

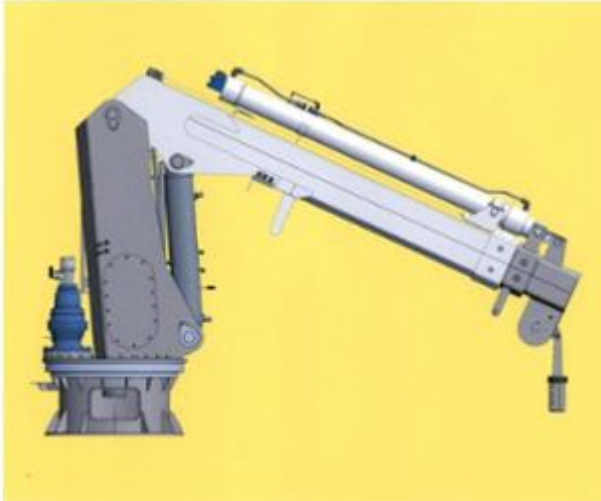

1.6

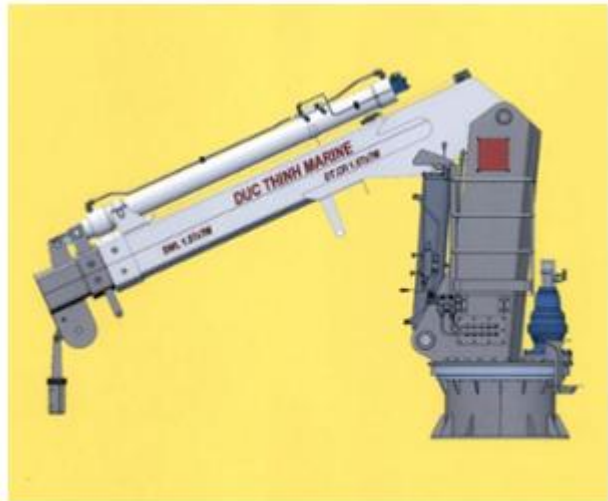

1.7

CÔNG BÁO SỞ HỮU CÔNG NGHIỆP SỐ 436 TẬP A – QUYỀN 2 (07.2024)

- (11) **51017**
(21) 3-2024-00464 (28) 1
(54) **KHẨU TRANG** (51) **29-02**
(22) 28/02/2024 (43) 25/07/2024
(30) 2023-019342 21/09/2023 JP;
(73) **UNICHARM CORPORATION (JP)**
182, Shimobun, Kinsei-cho, Shikokuchuo-City, Ehime 799-0111 Japan
(72) 1. MAKOTO SAITO (JP)
2. KAORI FURUYA (JP)
3. KEI WAKASUGI (JP)
(74) Công ty Cổ phần Sở hữu công nghiệp INVESTIP (INVESTIP)
(55)



1.1



1.2



1.3



1.4



1.5

1.6



1.7

CÔNG BÁO SỞ HỮU CÔNG NGHIỆP SỐ 436 TẬP A – QUYỀN 2 (07.2024)

- (11) **51018**
(21) 3-2024-00658 (28) 1
(54) **HỘP ĐỰNG SẢN PHẨM** (51) **09-03**
(22) 19/03/2024 (43) 25/07/2024
(73) **CÔNG TY TNHH GIẤY MYLAN (VN)**
Số 19B/5, phố Nguyễn Văn Cừ, phường Ngọc Lâm, quận Long Biên, thành phố Hà Nội
(72) Nguyễn Thị Dung (VN)
(74) Công ty TNHH Tư vấn Nhiệt tâm và Cộng sự (NT & PARTNERS CO.,LTD.)
(55)



1.1



1.2

CÔNG BÁO SỞ HỮU CÔNG NGHIỆP SỐ 436 TẬP A – QUYỀN 2 (07.2024)

- (11) **51019**
- (21) 3-2024-00662 (28) 1
- (54) **NHÃN SẢN PHẨM** (51) **19-08**
- (22) 19/03/2024 (43) 25/07/2024
- (73) **CÔNG TY TNHH GIẤY MYLAN (VN)**
Số 19B/5, phố Nguyễn Văn Cừ, phường Ngọc Lâm, quận Long Biên, thành phố Hà Nội
- (72) Nguyễn Thị Dung (VN)
- (74) Công ty TNHH Tư vấn Nhiệt tâm và Cộng sự (NT & PARTNERS CO.,LTD.)
- (55)



CÔNG BÁO SỞ HỮU CÔNG NGHIỆP SỐ 436 TẬP A – QUYỀN 2 (07.2024)

- (11) **51020**
(21) 3-2024-00663 (28) 1
(54) **HỘP ĐỰNG SẢN PHẨM** (51) **09-03**
(22) 19/03/2024 (43) 25/07/2024
(73) **CÔNG TY TNHH GIẤY MYLAN (VN)**
Số 19B/5, phố Nguyễn Văn Cừ, phường Ngọc Lâm, quận Long Biên, thành phố Hà Nội
(72) Nguyễn Thị Dung (VN)
(74) Công ty TNHH Tư vấn Nhiệt tâm và Cộng sự (NT & PARTNERS CO.,LTD.)
(55)



1.1



1.2

CÔNG BÁO SỞ HỮU CÔNG NGHIỆP SỐ 436 TẬP A – QUYỀN 2 (07.2024)

- (11) **51021**
(21) 3-2024-00665 (28) 1
(54) **NHÃN SẢN PHẨM** (51) **19-08**
(22) 19/03/2024 (43) 25/07/2024
(73) **CÔNG TY TNHH XUẤT NHẬP KHẨU VITACO (VN)**
244/29 Huỳnh Văn Bánh, phường 11, quận Phú Nhuận, thành phố Hồ Chí Minh
(72) Nguyễn Quang Hiệp (VN)
(74) Công ty cổ phần Tư vấn S&B (S&B CONSULTANT., CORP.)
(55)



CÔNG BÁO SỞ HỮU CÔNG NGHIỆP SỐ 436 TẬP A – QUYỀN 2 (07.2024)

- (11) **51022**
(21) 3-2024-00666 (28) 1
(54) **NHÃN SẢN PHẨM** (51) **19-08**
(22) 19/03/2024 (43) 25/07/2024
(73) **CÔNG TY TNHH XUẤT NHẬP KHẨU VITACO (VN)**
244/29 Huỳnh Văn Bánh, phường 11, quận Phú Nhuận, thành phố Hồ Chí Minh
(72) Nguyễn Quang Hiệp (VN)
(74) Công ty cổ phần Tư vấn S&B (S&B CONSULTANT., CORP.)
(55)



CÔNG BÁO SỞ HỮU CÔNG NGHIỆP SỐ 436 TẬP A – QUYỀN 2 (07.2024)

- (11) **51023**
(21) 3-2024-00668 (28) 1
(54) **KHOÁ TỬ** (51) **02-07**
(22) 19/03/2024 (43) 25/07/2024
(30) 202330612897.3 20/09/2023 CN;
(73) **CHARLES & KEITH INTERNATIONAL PTE. LTD. (SG)**
6 TAI SENG LINK, #08-00 CHARLES & KEITH GROUP HEADQUARTERS,
SINGAPORE 534101
(72) Kelvin Wong (SG)
(74) Công ty Luật TNHH ROUSE Việt Nam (ROUSE LEGAL VIETNAM LTD.)
(55)

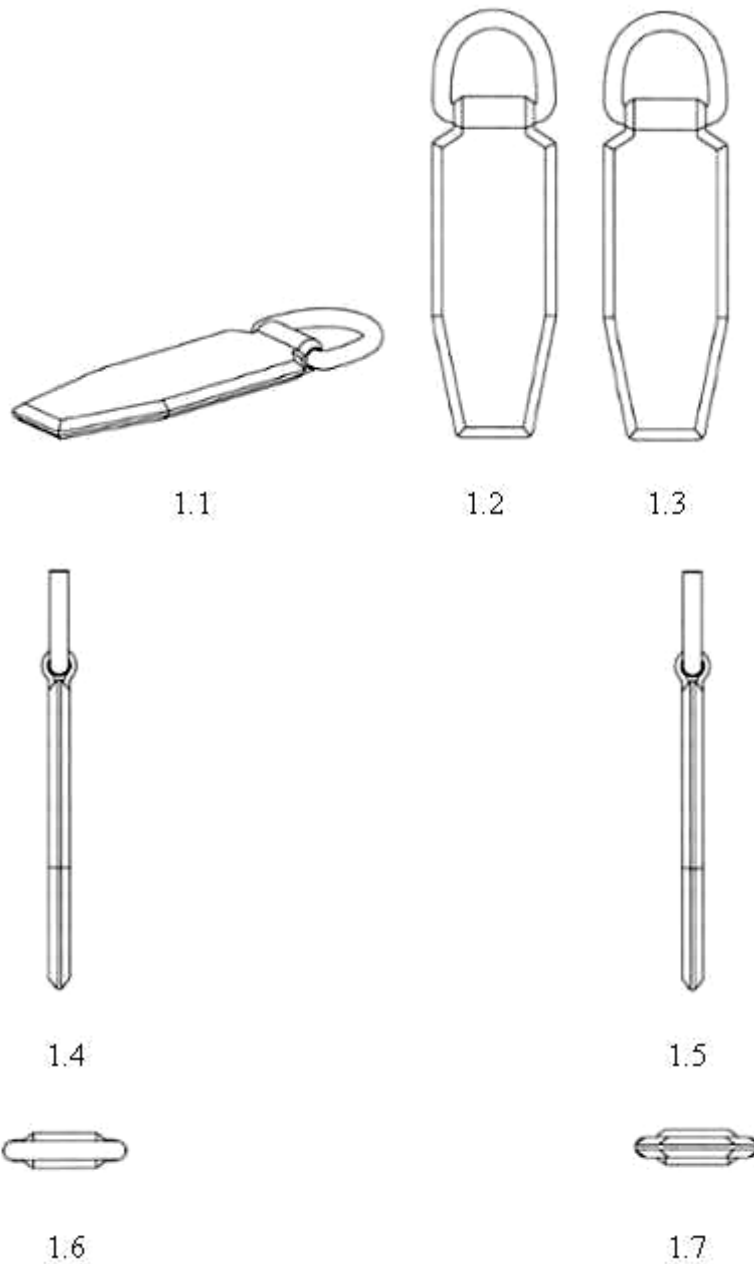

CÔNG BÁO SỞ HỮU CÔNG NGHIỆP SỐ 436 TẬP A – QUYỀN 2 (07.2024)

- (11) **51024**
(21) 3-2024-00669 (28) 1
(54) **KHOÁ TỬ** (51) **02-07**
(22) 19/03/2024 (43) 25/07/2024
(30) 202330613338.4 20/09/2023 CN;
(73) **CHARLES & KEITH INTERNATIONAL PTE. LTD. (SG)**
6 TAI SENG LINK, #08-00 CHARLES & KEITH GROUP HEADQUARTERS,
SINGAPORE 534101
(72) Kelvin Wong (SG)
(74) Công ty Luật TNHH ROUSE Việt Nam (ROUSE LEGAL VIETNAM LTD.)
(55)

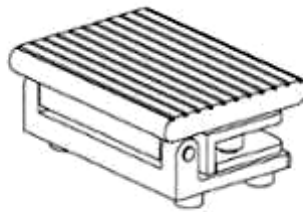

1.1



1.2

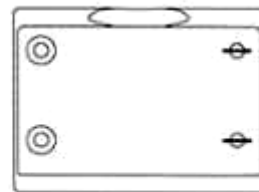

1.3

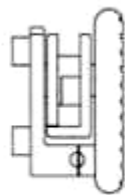

1.4

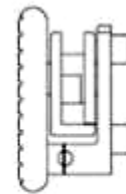

1.5

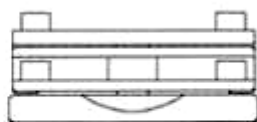

1.6

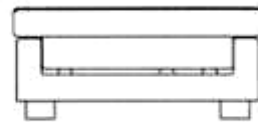

1.7

CÔNG BÁO SỞ HỮU CÔNG NGHIỆP SỐ 436 TẬP A – QUYỀN 2 (07.2024)

- (11) **51025**
(21) 3-2024-00670 (28) 1
(54) **KHOÁ TỬ** (51) **02-07**
(22) 19/03/2024 (43) 25/07/2024
(30) 202330613457.X 20/09/2023 CN;
(73) **CHARLES & KEITH INTERNATIONAL PTE. LTD. (SG)**
6 TAI SENG LINK, #08-00 CHARLES & KEITH GROUP HEADQUARTERS,
SINGAPORE 534101
(72) Kelvin Wong (SG)
(74) Công ty Luật TNHH ROUSE Việt Nam (ROUSE LEGAL VIETNAM LTD.)
(55)



1.1

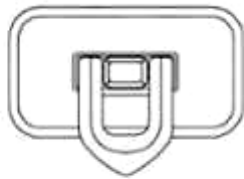

1.2

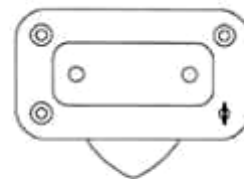

1.3



1.4



1.5

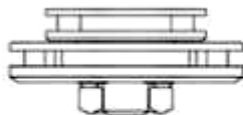

1.6



1.7

- (11) **51026**
(21) 3-2024-00672 (28) 1
(54) **MÁY MÁT XA TAY QUAY VÒNG** (51) **28-03**
(22) 19/03/2024 (43) 25/07/2024
(73) 1. **KIM CHUL KYU (KR)**
5.2, Dadae-ro 119beon-gil, Saha-gu, Busan (Sinpyeong-dong), Hàn Quốc
2. **Bùi Thị Xuân (VN)**
Thôn Đồng Xép, xã Hoàn Sơn, huyện Tiên Du, tỉnh Bắc Ninh
(72) 1. KIM CHUL KYU (KR)
2. BÙI THỊ XUÂN (VN)
(74) Công ty Luật TNHH MINH KHUÊ (MK LAW FIRM)
(55)



1.1



1.2



1.3



1.4



1.5



1.6



1.7

CÔNG BÁO SỞ HỮU CÔNG NGHIỆP SỐ 436 TẬP A – QUYỀN 2 (07.2024)

- (11) **51027**
(21) 3-2022-02185 (28) 1
(54) **NHÃN SẢN PHẨM** (51) **19-08**
(22) 10/10/2022 (43) 25/07/2024
(73) **LÊ HUỲNH MAI (VN)**
31 T1 Điện Biên Phủ, phường Đa Kao, quận 1, thành phố Hồ Chí Minh
(72) Lương Minh Nhật (VN)
(74) Công ty TNHH Sở hữu trí tuệ M.I.T (M.I.T IP CO., LTD)
(55)

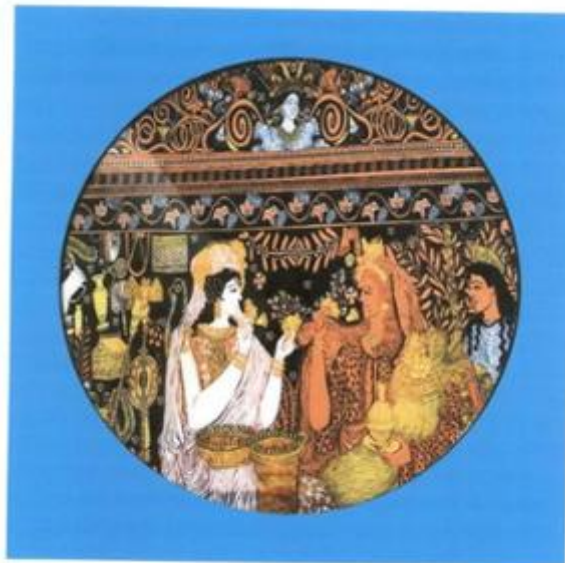

CÔNG BÁO SỞ HỮU CÔNG NGHIỆP SỐ 436 TẬP A – QUYỀN 2 (07.2024)

(11) **51028**

(21) 3-2022-02115

(28) 1

(54) **ĐÈN CHIẾU VÀNG DA**

(51) **24-01**

(22) 04/10/2022

(43) 25/07/2024

(73) **CÔNG TY TNHH VĨNH ĐẠT (LACOM CO., LTD) (VN)**

Phòng 810, tòa nhà JSC34, ngõ 164 Khuất Duy Tiến, phường Nhân Chính, quận Thanh Xuân, thành phố Hà Nội

(72) Ngô Hùng (VN)

(55)

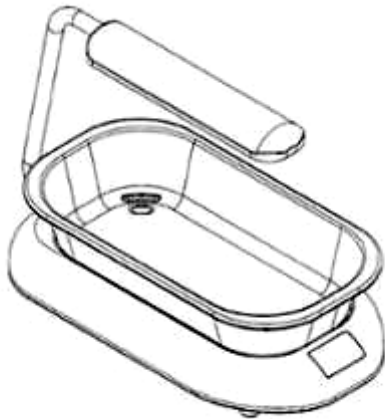

1.1

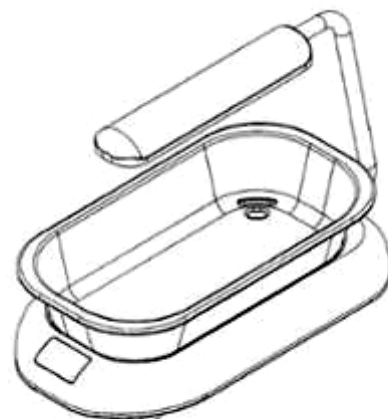

1.2



1.3

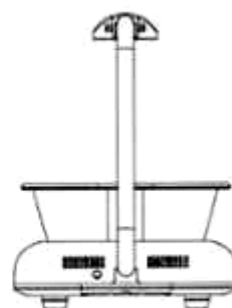

1.4

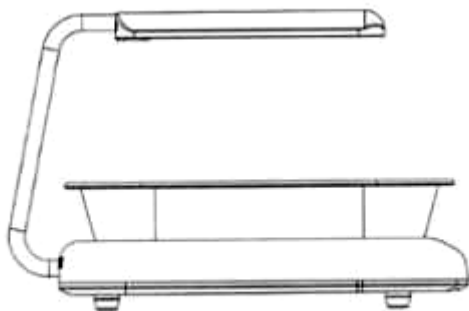

1.5

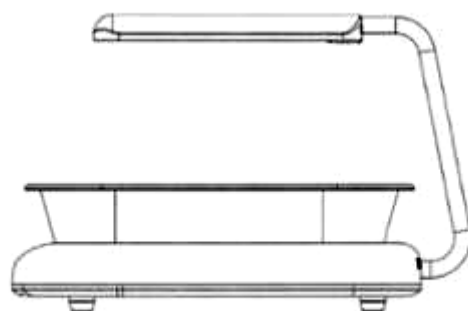

1.6

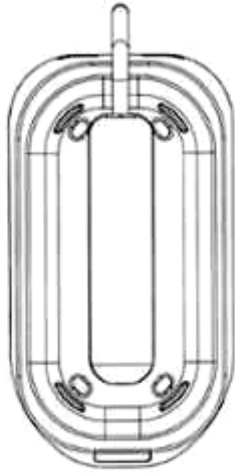

1.7

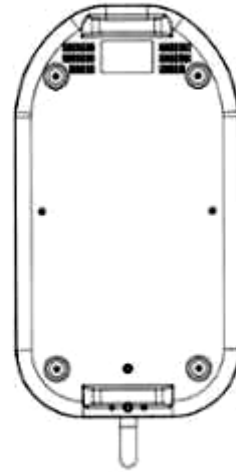

1.8

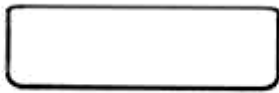

1.9

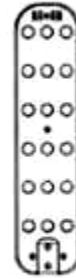

1.10

PHẦN II

SỬA ĐỔI ĐƠN

Thông báo số: 51683/TB-SHTT._{IP}, ngày 04/06/2024 về việc ghi nhận sửa đổi đơn

Số Yêu cầu: SĐ3-2021-01398 Ngày nộp: 06/07/2021

Liên quan đến đơn yêu cầu cấp Bằng độc quyền kiểu dáng công nghiệp:

(21) Số đơn	(22) Ngày nộp đơn
3-2020-00779	08/04/2020

Mục sửa đổi: Tên chủ đơn được sửa thành:

Nội dung mới: Công ty cổ phần tập đoàn Austec

Thông báo số: 51684/TB-SHTT._{IP}, ngày 04/06/2024 về việc ghi nhận sửa đổi đơn

Số Yêu cầu: SĐ3-2023-00291 Ngày nộp: 27/02/2023

Liên quan đến đơn yêu cầu cấp Bằng độc quyền kiểu dáng công nghiệp:

(21) Số đơn	(22) Ngày nộp đơn
3-2022-01247	22/06/2022

Mục sửa đổi: Bổ sung 01 Chủ đơn vào danh sách các Chủ đơn khác

Nội dung mới: Tên đầy đủ: Envases Universales de Mexico SAPI de CV
Địa chỉ: Qúbica Lomas, Volcán 150 3° piso, Colonia Lomas de Chapultepec, Ciudad de México 11000, Mexico

CÔNG BÁO SỞ HỮU CÔNG NGHIỆP

Do Cục Sở hữu trí tuệ thuộc Bộ Khoa học và Công nghệ ấn hành theo Luật Sở hữu trí tuệ số 50/2005/QH11 được Quốc hội thông qua ngày 29 tháng 11 năm 2005 và được sửa đổi bằng Luật sửa đổi, bổ sung một số điều của Luật sở hữu trí tuệ số 50/2005/QH11 được Quốc hội thông qua ngày 19 tháng 6 năm 2009.

Địa chỉ liên hệ:

384-386 đường Nguyễn Trãi, quận Thanh Xuân,
thành phố Hà Nội, Việt Nam
ĐT: 024. 38583069
Fax: 024. 38588449