

CỘNG HÒA XÃ HỘI CHỦ NGHĨA VIỆT NAM  
BỘ KHOA HỌC VÀ CÔNG NGHỆ

CỤC SỞ HỮU TRÍ TUỆ

CÔNG BÁO  
SỞ HỮU CÔNG NGHIỆP

TẬP A

QUYỂN 2: KIỂU DÁNG CÔNG NGHIỆP

06 - 2024

435

CỘNG HOÀ XÃ HỘI CHỦ NGHĨA VIỆT NAM  
BỘ KHOA HỌC VÀ CÔNG NGHỆ  
CỤC SỞ HỮU TRÍ TUỆ

---

CÔNG BÁO  
SỞ HỮU CÔNG NGHIỆP  
TẬP A

QUYỀN 2: KIỂU DÁNG CÔNG NGHIỆP

06 - 2024

435

---

HÀ NỘI

## MỤC LỤC

	Trang
<u>PHẦN I:</u> Đơn yêu cầu cấp Bằng độc quyền kiểu dáng công nghiệp	7
<u>PHẦN II:</u> Sửa đổi đơn	343
<u>PHẦN III:</u> Thay đổi chủ đơn	344

## CONTENTS

<u>PART I:</u> Applications for Industrial Design Patents	7
<u>PART II:</u> Amendment of Applications	343
<u>PART III:</u> Change of Applicants	344

MÃ SỐ HAI CHỮ CÁI THỂ HIỆN TÊN NƯỚC VÀ CÁC THỰC THỂ KHÁC TRONG CÁC TƯ LIỆU SỞ HỮU CÔNG NGHIỆP THEO TIÊU CHUẨN ST3 CỦA WIPO

AE	United Arab Emirates	CN	China	HK	Hong Kong
AF	Afganistan	CO	Colombia	HN	Honduras
AG	Antihua and Barbuda	CR	Costa Rica	HR	Croatia
AI	Anguilla	CU	Cuba	HT	Haiti
AL	Albania	CV	Cape Verde	HU	Hungary
AN	Netherlands Antilles	CY	Cyprus	ID	Indonesia
AO	Angola	CZ	Czech Republic	IE	Ireland
AR	Argentina	DE	Germany	IL	Israel
AT	Austria	DJ	Djibouti	IN	India
AU	Australia	DK	Denmark	IQ	Iraq
AW	Aruba	DM	Dominica	IR	Iran (Islamic Republic of)
BB	Barbados	DO	Dominican Republic	IS	Iceland
BD	Bangladesh	DZ	Algeria	IT	Italy
BE	Belgium	EC	Ecuador	JM	Jamaica
BF	Burkina Faso	EE	Estonia	JO	Jordan
BG	Bulgaria	EG	Egypt	JP	Japan
BH	Bahrain	ES	Spain	KE	Kenya
BI	Burundi	ET	Ethiopia	KH	Cambodia
BJ	Benin	FI	Finland	KI	Kiribati
BM	Bermuda	FJ	Fiji	KM	Comoros
BN	Brunei Darussalam	FK	Falkand Islands (Malvinas)	KN	Saint Kitts and Nevis
BO	Bolivia	FR	France	KP	Democratic People's Republic of Korea
BR	Brazil	GA	Gabon	KR	Republic of Korea
BS	Bahamas	GB	United Kingdom	KW	Kuwait
BT	Bhutan	GD	Grenada	KY	Cayman Islands
BW	Botswana	GE	Georgia	KZ	Kazakhstan
BY	Belarus	GH	Ghana	LA	Laos
BZ	Belize	GI	Gibraltar	LB	Lebanon
CA	Canada	GM	Gambia	LC	Saint Lucia
CF	Central African Republic	GN	Guinea	LI	Liechtenstein
CG	Congo	GQ	Equatorial Guinea	LK	SriLanka
CH	Switzerland	GR	Greece	LR	Liberia
CI	Côte d'Ivoire	GT	Guatemala	LS	Lesotho
CL	Chile	GW	Guinea-Bissau	LT	Lithuania
CM	Cameroon	GY	Guyana	TC	Turk and Caicos Islands
LU	Luxembourg	PA	Panama	TD	Chad
LV	Latvia	PE	Peru	TG	Togo
LY	Lybya	PG	Papua New Guinea	TH	Thailand
MA	Morocco	PH	Philippines	TN	Tunisia
MC	Monaco	PK	Pakistan	TO	Tonga
MD	Republic of Moldova	PL	Poland	TR	Turkey

**CÔNG BÁO SỞ HỮU CÔNG NGHIỆP SỐ 435 TẬP A - QUYỂN 2 (06.2024)**

MG	Madagascar	PT	Portugal	TT	Trinidad and Tobago
ML	Mali	PY	Paraguay	TV	Tuvalu
MM	Myanmar	QA	Qatar	TW	Taiwan, Province of China
MN	Mongolia	RO	Rumania	TZ	United Republic of Tanzania
MO	Macau	RU	Russian Federation	UA	Ukraine
MR	Mauritania	RW	Rwanda	UG	Uganda
MS	Montserrat	SA	Saudi Arabia	US	United States of America
MT	Malta	SB	Solomon Islands	UY	Uruguay
MU	Mauritius	SC	Seychelles	UZ	Uzbekistan
MV	Maldives	SD	Sudan	VA	Holy see
MW	Malawi	SE	Sweden	VC	Saint Vincent and the Grenadines
MX	Mexico	SG	Singapore	VE	Venezuela
MY	Malaysia	SH	Saint Helena	VG	Virgin Islands (British)
MZ	Mozambique	SL	Slovenia	VN	Vietnam
NA	Namibia	SK	Slovakia	VU	Vanuatu
NE	Niger	SL	Sierra Leone	WS	Samoa
NG	Nigeria	SM	San Marino	YE	Yemen
NJ	Nicaragua	SN	Senegal	YU	Yugoslavia
NL	Netherlands	SO	Somalia	ZA	South Africa
NO	Norway	SR	Suriname	ZM	Zambia
NP	Nepal	ST	Sao Tome and Principe	ZR	Zaire
NR	Nauru	SV	El Sanvador	ZW	Zimbabwe
NZ	New Zealand	SY	Syria		
OM	Oman	SZ	Swaziland		

**CÁC TỔ CHỨC QUỐC TẾ**

AO	African Intellectual Property Organization (OAPI)
AP	African Regional Industrial Property Organization (ARIPO)
BX	Benelux Trademark Office and Benelux Designs Office
EP	European Patent Office (EPO)
IB, WO	International Bureau of the World Intellectual Property Organization (WIPO)

**NHỮNG MÃ SỐ INID TRÍCH TỪ TIÊU CHUẨN ST80 CỦA TỔ CHỨC SỞ HỮU TRÍ TUỆ THẾ GIỚI (WIPO) ĐỂ NHẬN BIẾT CÁC DỮ LIỆU THƯ MỤC DÙNG CÔNG BỐ ĐƠN VÀ BẰNG ĐỘC QUYỀN KIỂU DÁNG CÔNG NGHIỆP**

- (11) Số bằng độc quyền kiểu dáng công nghiệp / Số công bố đơn
- (15) Ngày cấp
- (18) Ngày hết hạn hiệu lực của bằng độc quyền kiểu dáng công nghiệp
- (21) Số đơn
- (22) Ngày nộp đơn
- (23) Tên triển lãm, ngày và nơi triển lãm
- (28) Số phương án yêu cầu bảo hộ
- (30) Số đơn ưu tiên, ngày nộp đơn ưu tiên
- (43) Ngày công bố đơn
- (45) Ngày công bố bằng độc quyền kiểu dáng công nghiệp
- (51) Phân loại quốc tế kiểu dáng công nghiệp
- (54) Tên sản phẩm mang kiểu dáng công nghiệp
- (55) Ảnh chụp / hình vẽ kiểu dáng công nghiệp
- (57) Đặc điểm khác biệt yêu cầu bảo hộ của kiểu dáng công nghiệp
- (62) Số và ngày nộp đơn, số bằng độc quyền KDCN hoặc số công bố đơn liên quan đến tách đơn
- (71) Tên và địa chỉ của người nộp đơn
- (72) Tên của tác giả KDCN
- (73) Tên, địa chỉ của chủ bằng độc quyền KDCN
- (74) Tên của người đại diện SHCN

**PHẦN I**

**ĐƠN YÊU CẦU CẤP BẰNG ĐỘC QUYỀN KIỂU DÁNG CÔNG NGHIỆP**

- (11) **50339**  
(21) 3-2020-00910 (28) 2  
(54) **ĐIỆN THOẠI** (51) **14-03**  
(22) 27/04/2020 (43) 25/06/2024  
(30) 201930598898.0 31/10/2019 CN;  
(73) **VIVO MOBILE COMMUNICATION CO., LTD (CN)**  
#283, BBK Road, Wusha, Chang'an, Dongguan, Guangdong 523860, China  
(72) Junhao LIN (CN)  
(74) Công ty cổ phần Sở hữu trí tuệ BROSS và Cộng sự (BROSS & PARTNERS., JSC)  
(55)

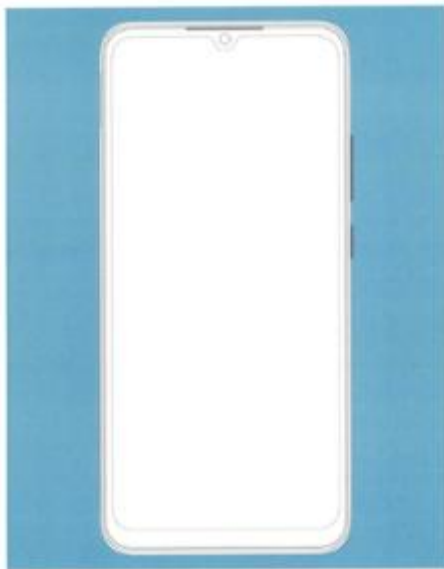

1.1

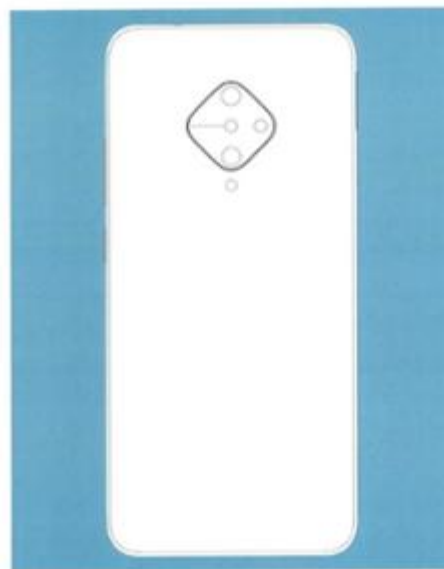

1.2



1.3



1.4



1.5



1.6

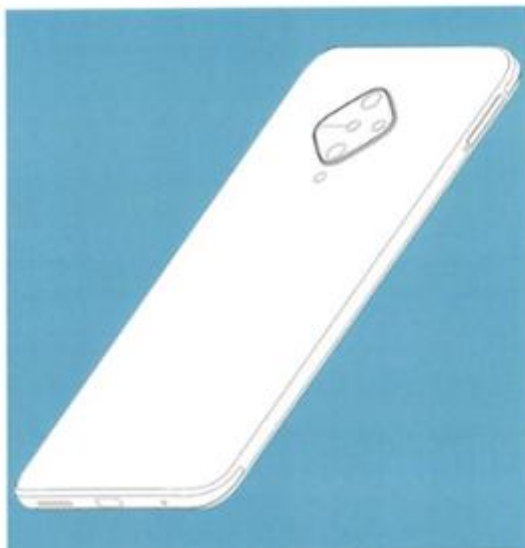

1.7



1.8





2.1



2.2

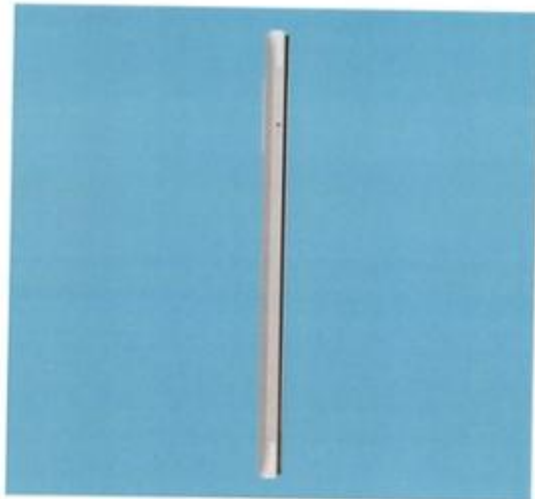

2.3



2.4



2.5



2.6



2.7



2.8

**CÔNG BÁO SỞ HỮU CÔNG NGHIỆP SỐ 435 TẬP A – QUYỀN 2 (06.2024)**

- (11) **50340**  
(21) 3-2022-01458 (28) 1  
(54) **DỤNG CỤ BẮM MÓNG** (51) **28-03**  
(22) 20/07/2022 (43) 25/06/2024  
(73) **CÔNG TY CỔ PHẦN KÈM NGHĨA (VN)**  
700/15 Lạc Long Quân, phường 9, quận Tân Bình, thành phố Hồ Chí Minh  
(72) 1. LÊ MINH ĐẠT (VN)  
2. NGUYỄN MINH KIẾT (VN)  
(74) Công ty luật TNHH APOLAT LEGAL (APOLAT LEGAL)  
(55)



1.1



1.2



1.3



1.4



1.5



1.6



1.7

**CÔNG BÁO SỞ HỮU CÔNG NGHIỆP SỐ 435 TẬP A – QUYỀN 2 (06.2024)**

- (11) **50341**  
(21) 3-2022-01459 (28) 1  
(54) **DỤNG CỤ BẮM MÓNG** (51) **28-03**  
(22) 20/07/2022 (43) 25/06/2024  
(73) **CÔNG TY CỔ PHẦN KÈM NGHĨA (VN)**  
700/15 Lạc Long Quân, phường 9, quận Tân Bình, thành phố Hồ Chí Minh  
(72) 1. LÊ MINH ĐẠT (VN)  
2. NGUYỄN MINH KIẾT (VN)  
(74) Công ty luật TNHH APOLAT LEGAL (APOLAT LEGAL)  
(55)



1.1



1.2



1.3



1.4



1.5



1.6



1.7



1.8

**CÔNG BÁO SỞ HỮU CÔNG NGHIỆP SỐ 435 TẬP A – QUYỀN 2 (06.2024)**

- (11) **50342**  
(21) 3-2022-01663 (28) 1  
(54) **PHÍCH CẢM ĐIỆN** (51) **13-03**  
(22) 12/08/2022 (43) 25/06/2024  
(30) 29/826,653 14/02/2022 US;  
(73) **TECHTRONIC CORDLESS GP (US)**  
100 Innovation Way, Anderson, SC 29621, United States of America  
(72) 1. CLINT CAGLE (US)  
2. JONATHAN R. FELDKAMP (US)  
3. RAONY BARRIOS (US)  
(74) Công ty TNHH Tầm nhìn và Liên danh (VISION & ASSOCIATES CO.LTD.)  
(55)

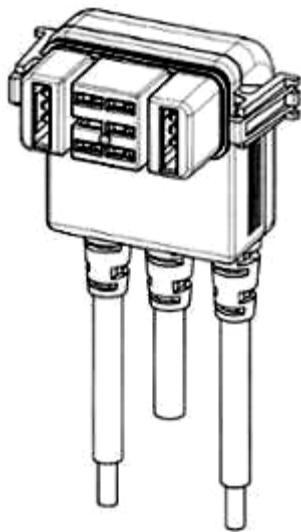

1.1

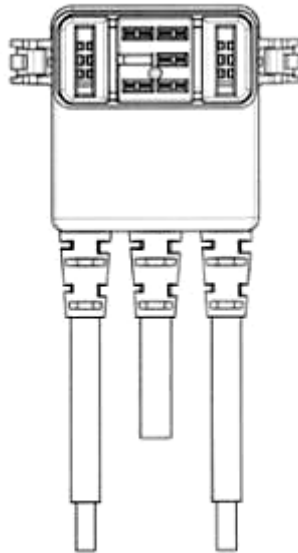

1.2

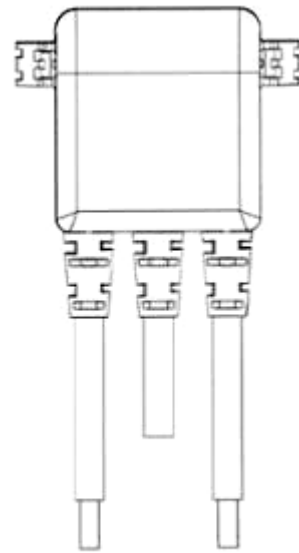

1.3

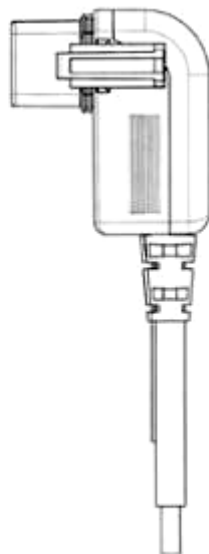

1.4

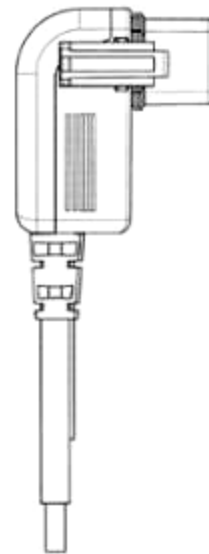

1.5

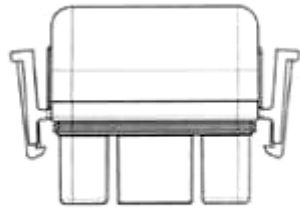

1.6

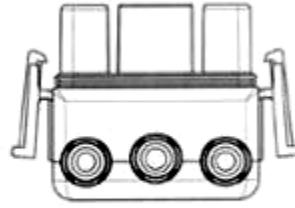

1.7



**CÔNG BÁO SỞ HỮU CÔNG NGHIỆP SỐ 435 TẬP A – QUYỀN 2 (06.2024)**

- (11) **50343**  
(21) 3-2022-01665 (28) 1  
(54) **Ổ CẮM SẠC PIN** (51) **13-03**  
(22) 12/08/2022 (43) 25/06/2024  
(30) 29/826,650 14/02/2022 US;  
(73) **TECHTRONIC CORDLESS GP (US)**  
100 Innovation Way, Anderson, SC 29621, United States of America  
(72) 1. CLINT CAGLE (US)  
2. JONATHAN R. FELDKAMP (US)  
3. RAONY BARRIOS (US)  
(74) Công ty TNHH Tầm nhìn và Liên danh (VISION & ASSOCIATES CO.LTD.)  
(55)

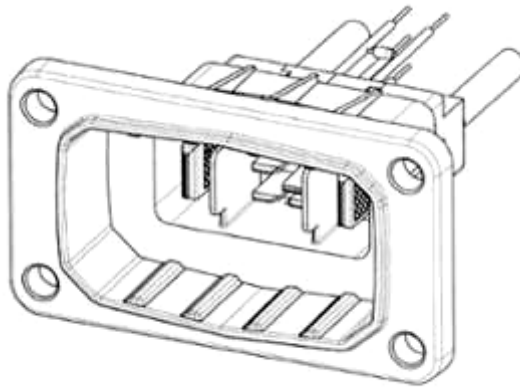

1.1

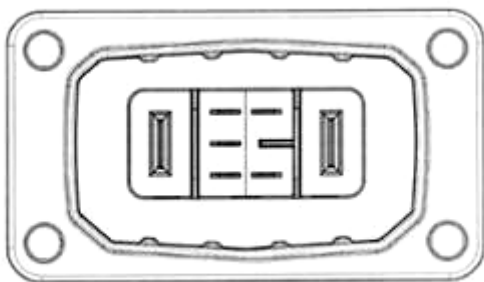

1.2

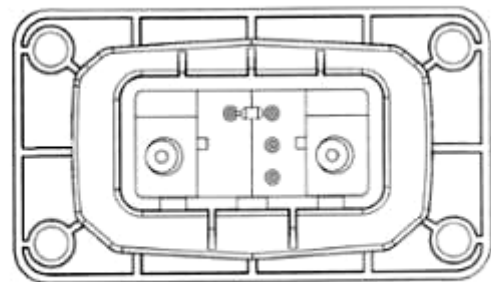

1.3

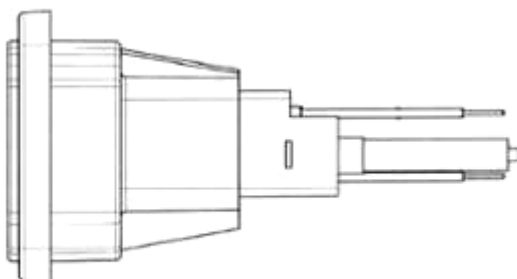

1.4

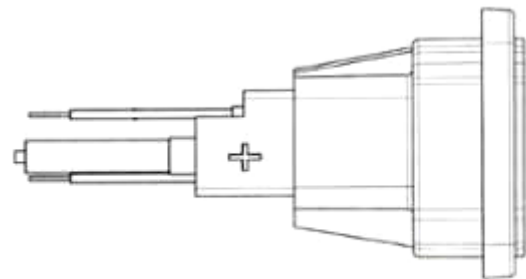

1.5

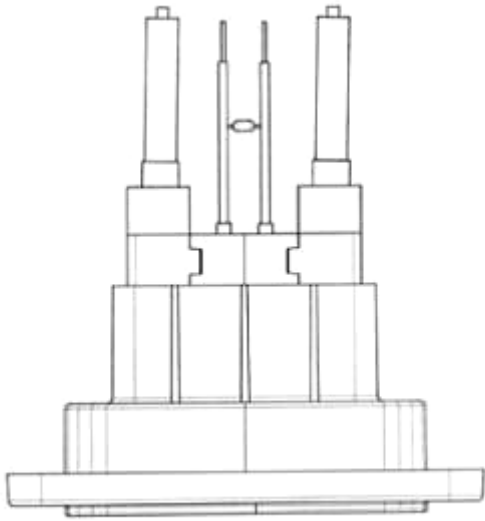

1.6

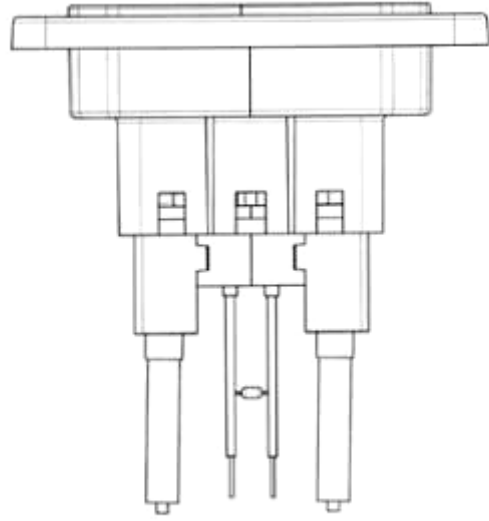

1.7

- (11) **50344**  
(21) 3-2022-01666 (28) 1  
(54) **Ổ CẮM SẠC PIN** (51) **13-03**  
(22) 12/08/2022 (43) 25/06/2024  
(30) 29/826,647 14/02/2022 US;  
(73) **TECHTRONIC CORDLESS GP (US)**  
100 Innovation Way, Anderson, SC 29621, United States of America  
(72) 1. CLINT CAGLE (US)  
2. JONATHAN R. FELDKAMP (US)  
3. RAONY BARRIOS (US)  
(74) Công ty TNHH Tầm nhìn và Liên danh (VISION & ASSOCIATES CO.LTD.)  
(55)

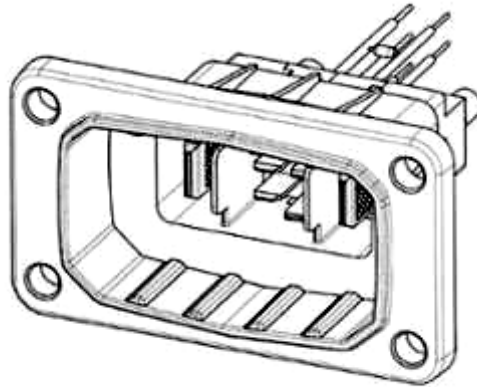

1.1

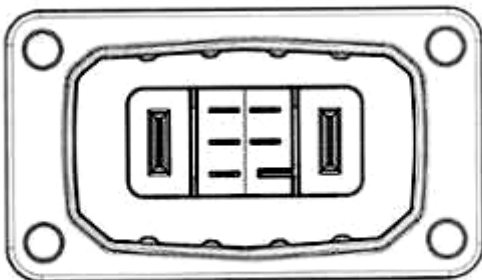

1.2

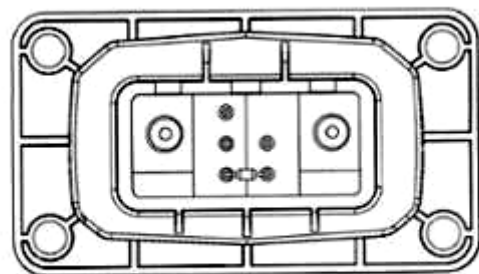

1.3

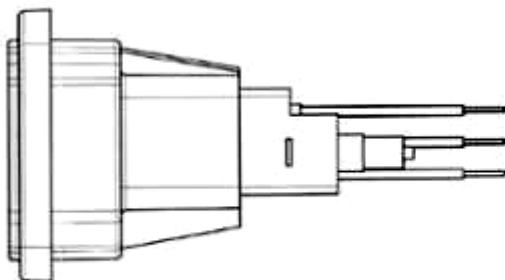

1.4

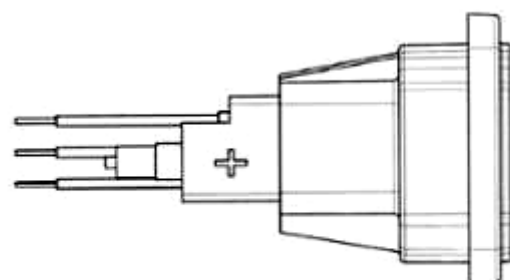

1.5

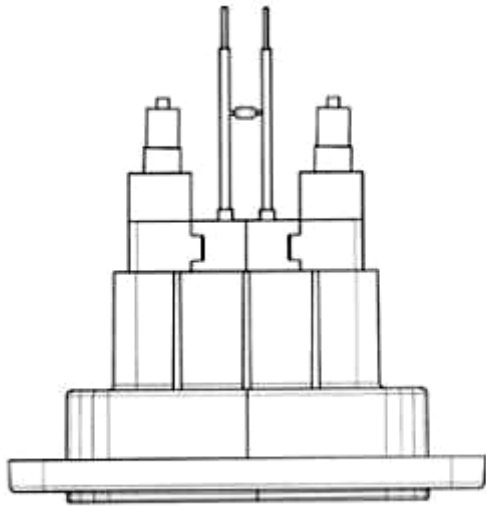

1.6

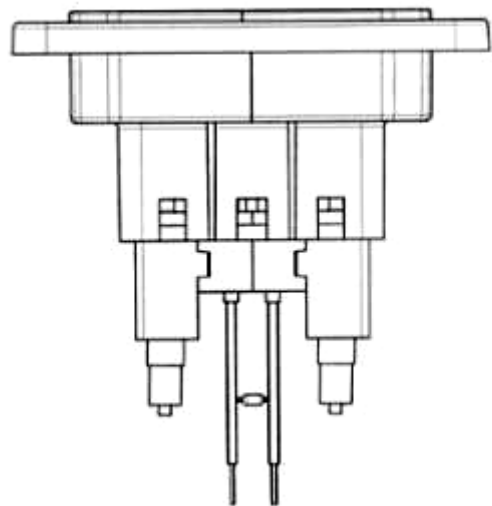

1.7

**CÔNG BÁO SỞ HỮU CÔNG NGHIỆP SỐ 435 TẬP A – QUYỀN 2 (06.2024)**

- (11) **50345**  
(21) 3-2022-02419 (28) 1  
(54) **CHAI** (51) **09-01**  
(22) 04/11/2022 (43) 25/06/2024  
(73) **CÔNG TY CỔ PHẦN VICOPHAR VIỆT NAM (VN)**  
124/59 Phan Huy Ích, quận Tân Bình, thành phố Hồ Chí Minh  
(72) Võ Ngọc Tâm (VN)  
(55)



1.1



1.2



1.3



1.4



1.5



1.6

**CÔNG BÁO SỞ HỮU CÔNG NGHIỆP SỐ 435 TẬP A – QUYỀN 2 (06.2024)**

(11) **50346**

(21) 3-2022-02689

(28) 1

(54) **CHÂN GHẾ**

(51) **06-01**

(22) 07/12/2022

(43) 25/06/2024

(73) **NGUYỄN TRẦN PHƯỚC THUẬN (VN)**

39 Lê Lai, phường 3, quận Gò Vấp, thành phố Hồ Chí Minh

(72) Nguyễn Trần Phước Thuận (VN)

(55)



1.1



1.2



1.3



1.4



1.5



1.6

**CÔNG BÁO SỞ HỮU CÔNG NGHIỆP SỐ 435 TẬP A – QUYỀN 2 (06.2024)**

(11) **50347**

(21) 3-2022-02690

(28) 1

(54) **CHÂN GHẾ**

(51) **06-01**

(22) 07/12/2022

(43) 25/06/2024

(73) **NGUYỄN TRẦN PHƯỚC THUẬN (VN)**

39 Lê Lai, phường 3, quận Gò Vấp, thành phố Hồ Chí Minh

(72) Nguyễn Trần Phước Thuận (VN)

(55)



1.1



1.2



1.3



1.4



1.5



1.6

**CÔNG BÁO SỞ HỮU CÔNG NGHIỆP SỐ 435 TẬP A – QUYỀN 2 (06.2024)**

- (11) **50348**  
(21) 3-2023-00143 (28) 1  
(54) **BẢNG HIỆU** (51) **20-03**  
(22) 13/01/2023 (43) 25/06/2024  
(30) 29/846,332 15/07/2022 US;  
(73) **DONGGUAN SHICHANG METALS FACTORY LTD. (CN)**  
ShiChang Xiang 1.2.5, XiaoBian Village, ChangAn Town, Dongguan City,  
Guangdong, 523851, China  
(72) Chen-Kang Lin (TW)  
(74) Công ty TNHH ADASTRA IP (VIỆT NAM) (ADASTRA IP (VIETNAM) CO.,  
LTD.)  
(55)

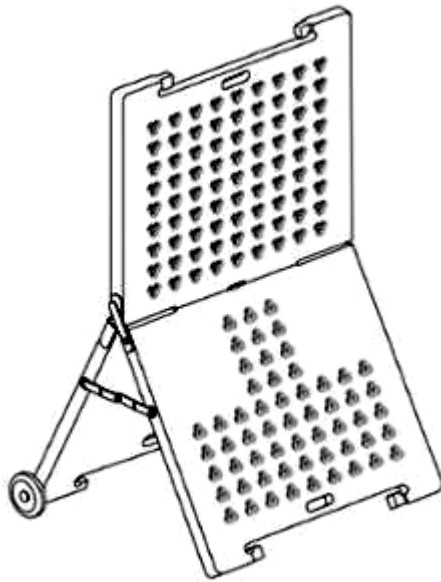

1.1

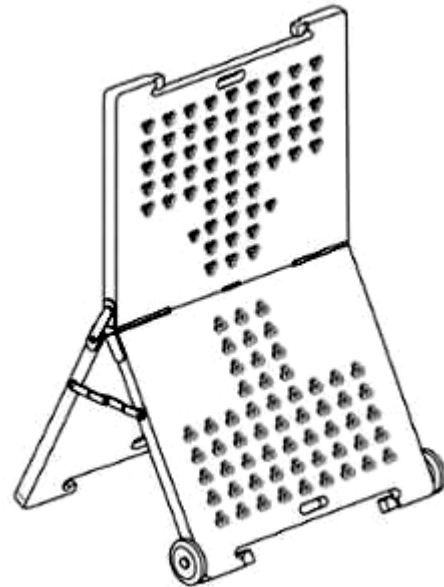

1.2



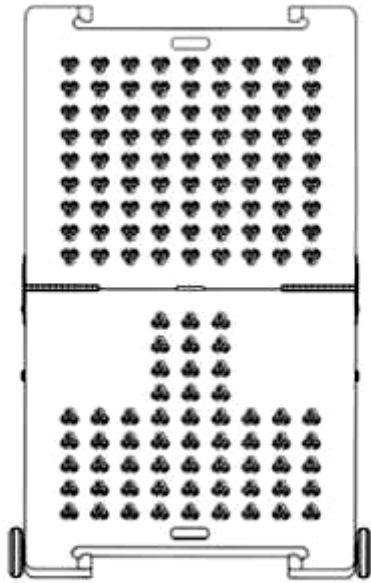

1.3

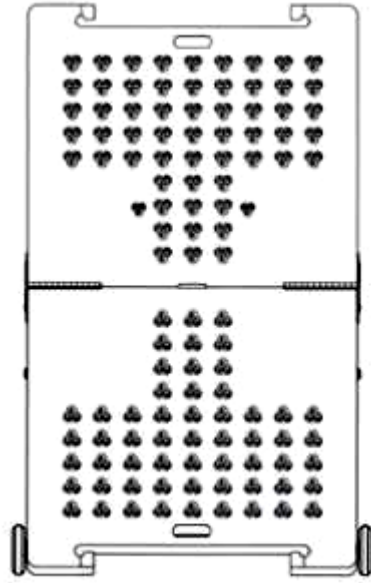

1.4

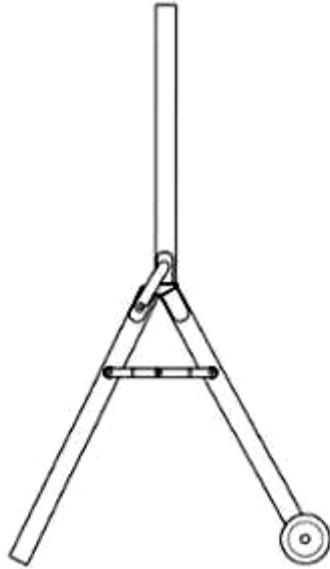

1.5

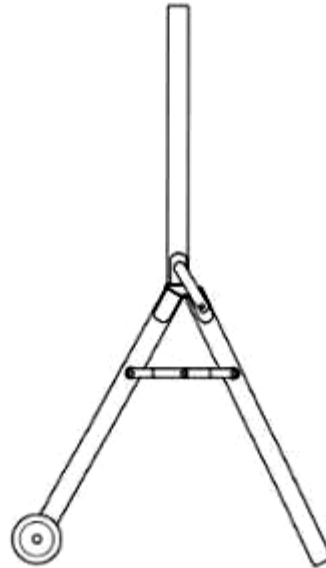

1.6

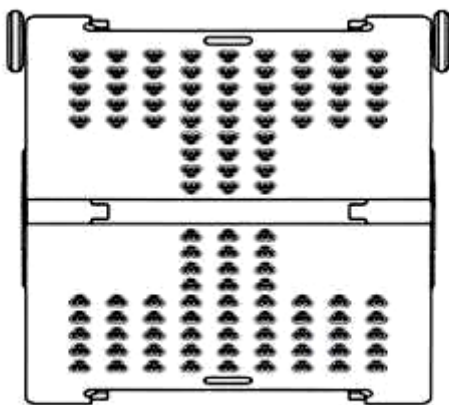

1.7

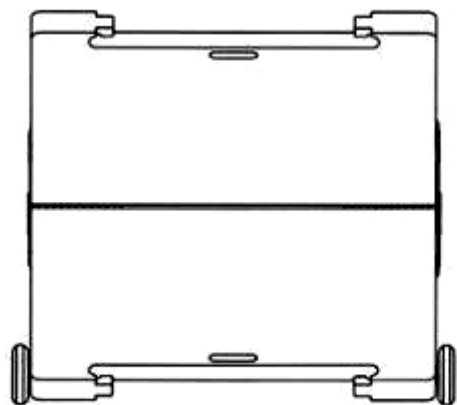

1.8

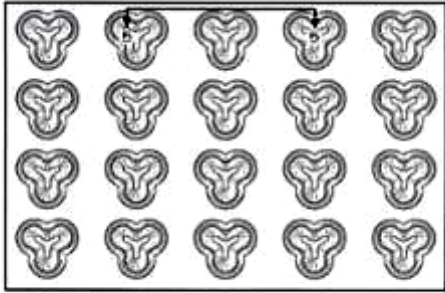

1.9

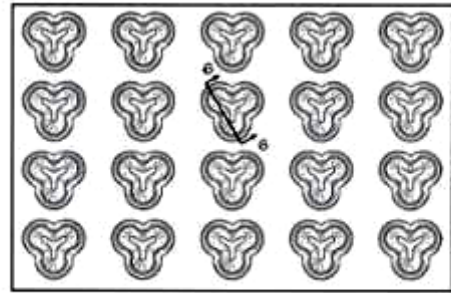

1.10

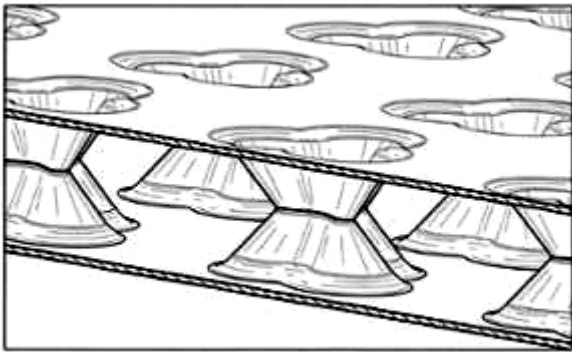

1.11

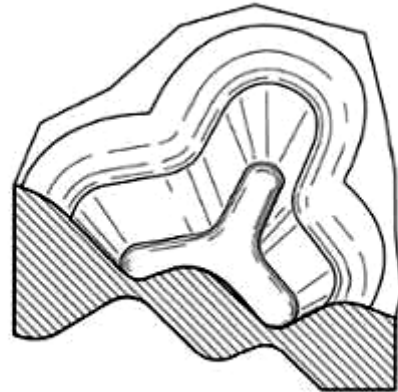

1.12

**CÔNG BÁO SỞ HỮU CÔNG NGHIỆP SỐ 435 TẬP A – QUYỀN 2 (06.2024)**

- (11) **50349**  
(21) 3-2023-00222 (28) 1  
(54) **HỘP** (51) **09-03**  
(22) 30/01/2023 (43) 25/06/2024  
(73) **ORION CORPORATION (KR)**  
13, Baekbeom-ro 90da-gil, Yongsan-gu, Seoul 04369, Republic of Korea  
(72) 1. LEE, A REUM (KR)  
2. CHOE, EUN JE (KR)  
(74) Công ty Luật TNHH quốc tế BMVN (BMVN INTERNATIONAL LLC)  
(55)



1.1



1.2

**CÔNG BÁO SỞ HỮU CÔNG NGHIỆP SỐ 435 TẬP A – QUYỀN 2 (06.2024)**

- (11) **50350**  
(21) 3-2023-01395 (28) 1  
(54) **VỎ MÁY PHÁT ÁP LỰC** (51) **13-99**  
(22) 22/06/2023 (43) 25/06/2024  
(30) 29/869,388 29/12/2022 US;  
(73) **ROSEMOUNT INC. (US)**  
6021 Innovation Boulevard, Shakopee, Minnesota, 55379, United States of America  
(72) 1. GEORGE HAUSLER (US)  
2. JEFFREY A. COTA (US)  
3. JACOB D. HOLM (US)  
4. CHAD M. MCGUIRE (US)  
5. STEVEN J. MCCOY (US)  
6. CHRISTOPHER L. ERIKSEN (US)  
(74) Công ty TNHH Tầm nhìn và Liên danh (VISION & ASSOCIATES CO.LTD.)  
(55)

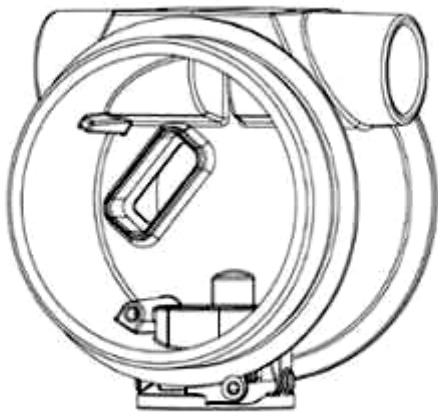

1.1

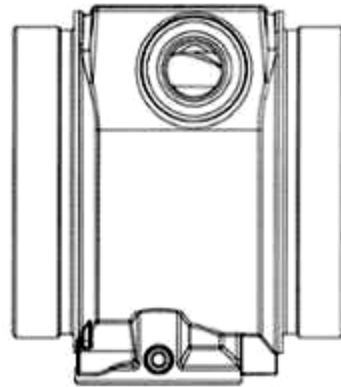

1.2

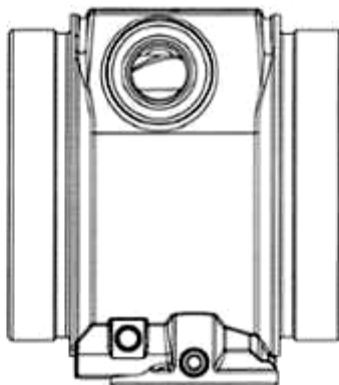

1.3

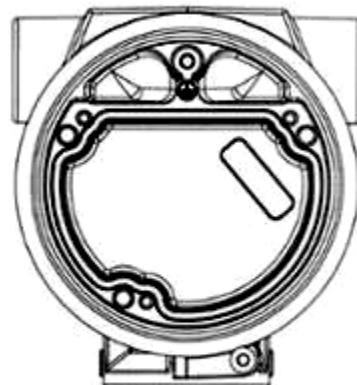

1.4

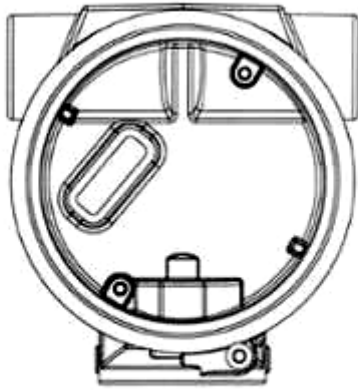

1.5

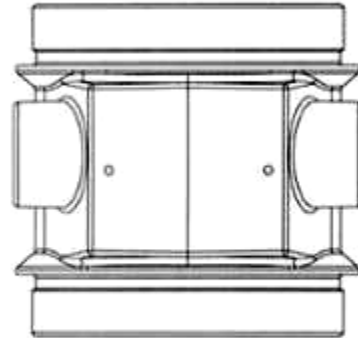

1.6

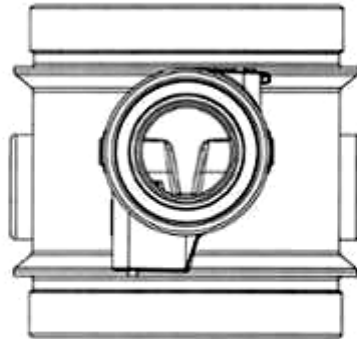

1.7

- (11) **50351**  
(21) 3-2023-01397 (28) 1  
(54) **NẮP VỎ MÁY PHÁT** (51) **13-99**  
(22) 22/06/2023 (43) 25/06/2024  
(30) 29/869,386 29/12/2022 US;  
(73) **ROSEMOUNT INC. (US)**  
6021 Innovation Boulevard, Shakopee, Minnesota, 55379, United States of America  
(72) 1. GEORGE HAUSLER (US)  
2. JEFFREY A. COTA (US)  
3. JACOB D. HOLM (US)  
4. CHAD M. MCGUIRE (US)  
5. STEVEN J. MCCOY (US)  
6. CHRISTOPHER L. ERIKSEN (US)  
(74) Công ty TNHH Tâm nhìn và Liên danh (VISION & ASSOCIATES CO.LTD.)  
(55)

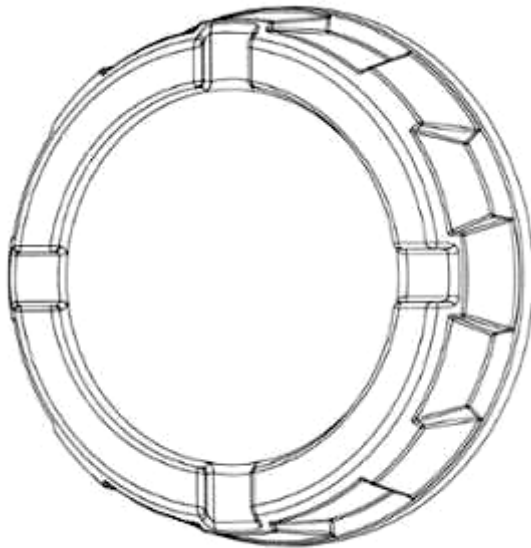

1.1

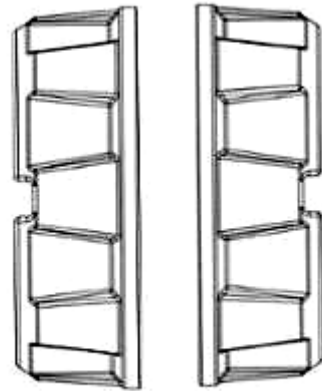

1.2

1.3

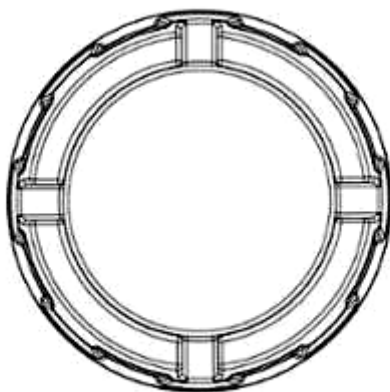

1.4

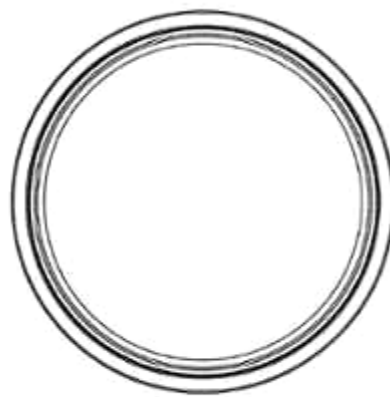

1.5

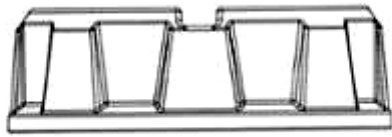

1.6

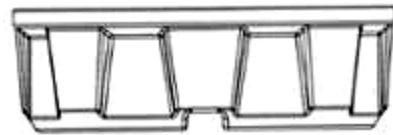

1.7

**CÔNG BÁO SỞ HỮU CÔNG NGHIỆP SỐ 435 TẬP A – QUYỀN 2 (06.2024)**

- (11) **50352**  
(21) 3-2023-01398 (28) 1  
(54) **NẮP CÔNG TƠ** (51) **10-04; 13-99**  
(22) 22/06/2023 (43) 25/06/2024  
(30) 29/869,385 29/12/2022 US;  
(73) **ROSEMOUNT INC. (US)**  
6021 Innovation Boulevard, Shakopee, Minnesota, 55379, United States of America  
(72) 1. GEORGE HAUSLER (US)  
2. JEFFREY A. COTA (US)  
3. JACOB D. HOLM (US)  
4. CHAD M. MCGUIRE (US)  
5. STEVEN J. MCCOY (US)  
6. CHRISTOPHER L. ERIKSEN (US)  
(74) Công ty TNHH Tâm nhìn và Liên danh (VISION & ASSOCIATES CO.LTD.)  
(55)

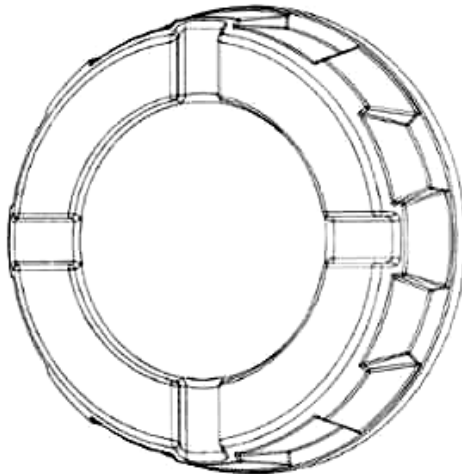

1.1

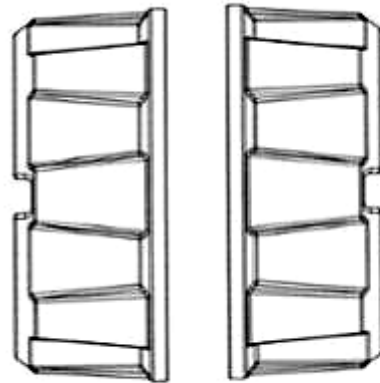

1.2

1.3

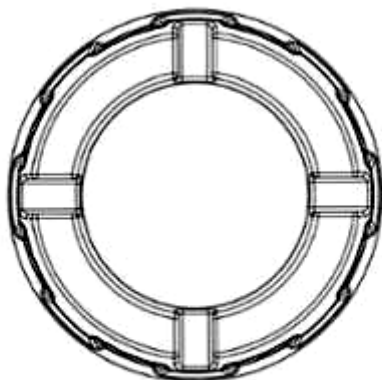

1.4

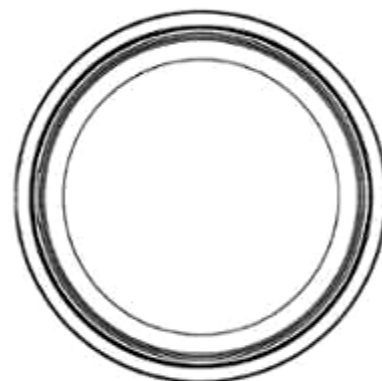

1.5



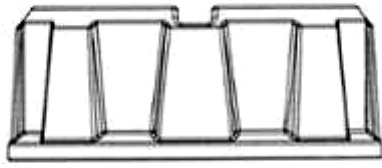

1.6

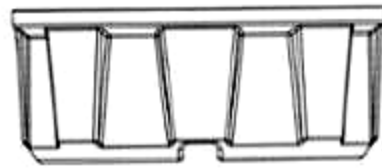

1.7

**CÔNG BÁO SỞ HỮU CÔNG NGHIỆP SỐ 435 TẬP A – QUYỀN 2 (06.2024)**

- (11) **50353**  
(21) 3-2023-01509 (28) 1  
(54) **TAY CẦM CHO NỒI** (51) **07-02**  
(22) 05/07/2023 (43) 25/06/2024  
(30) 29/881,779 06/01/2023 US;  
(73) **DART INDUSTRIES INC. (US)**  
14901 S. Orange Blossom Trail, Orlando, Florida, 32837, United States of America  
(72) Andrea Boscic (BE)  
(74) **CÔNG TY LUẬT TRÁCH NHIỆM HỮU HẠN AMBYS HÀ NỘI (AMBYS HANOI)**  
(55)



1.1



1.2

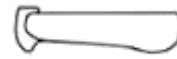

1.3

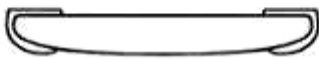

1.4



1.5

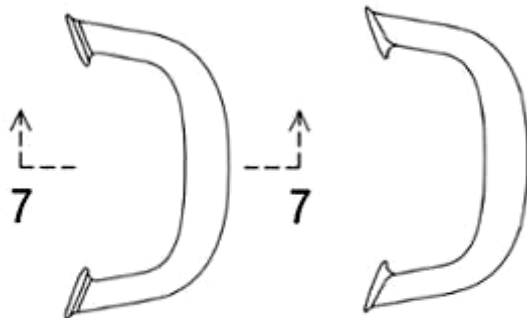

1.6

1.7



1.8

**CÔNG BÁO SỞ HỮU CÔNG NGHIỆP SỐ 435 TẬP A – QUYỀN 2 (06.2024)**

- (11) **50354**  
(21) 3-2023-01646 (28) 1  
(54) **MÁY LỌC NƯỚC** (51) **23-01**  
(22) 19/07/2023 (43) 25/06/2024  
(73) **CÔNG TY CỔ PHẦN TẬP ĐOÀN SUNHOUSE (VN)**  
Số 139, phố Nguyễn Thái Học, phường Điện Biên, quận Ba Đình, thành phố Hà Nội  
(72) Lại Văn Kiên (VN)  
(74) Công ty TNHH Sở hữu trí tuệ Bình Minh (SUNRISE IP CO.,LTD.)  
(55)



1.1



1.2



1.3



1.4



1.5

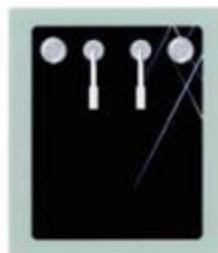

1.6



1.7

**CÔNG BÁO SỞ HỮU CÔNG NGHIỆP SỐ 435 TẬP A – QUYỀN 2 (06.2024)**

- (11) **50355**  
(21) 3-2023-01647 (28) 1  
(54) **MÁY LỌC NƯỚC** (51) **23-01**  
(22) 19/07/2023 (43) 25/06/2024  
(73) **CÔNG TY CỔ PHẦN TẬP ĐOÀN SUNHOUSE (VN)**  
Số 139, phố Nguyễn Thái Học, phường Điện Biên, quận Ba Đình, thành phố Hà Nội  
(72) Lại Văn Kiên (VN)  
(74) Công ty TNHH Sở hữu trí tuệ Bình Minh (SUNRISE IP CO.,LTD.)  
(55)



1.1



1.2



1.3



1.4



1.5



1.6



1.7

**CÔNG BÁO SỞ HỮU CÔNG NGHIỆP SỐ 435 TẬP A – QUYỀN 2 (06.2024)**

- (11) **50356**  
(21) 3-2023-01648 (28) 1  
(54) **MÁY LỌC NƯỚC** (51) **23-01**  
(22) 19/07/2023 (43) 25/06/2024  
(73) **CÔNG TY CỔ PHẦN TẬP ĐOÀN SUNHOUSE (VN)**  
Số 139, phố Nguyễn Thái Học, phường Điện Biên, quận Ba Đình, thành phố Hà Nội  
(72) Lại Văn Kiên (VN)  
(74) Công ty TNHH Sở hữu trí tuệ Bình Minh (SUNRISE IP CO.,LTD.)  
(55)



1.1



1.2



1.3



1.4



1.5

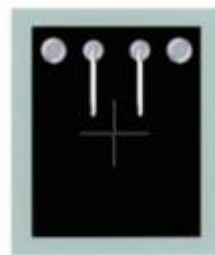

1.6



1.7

**CÔNG BÁO SỞ HỮU CÔNG NGHIỆP SỐ 435 TẬP A – QUYỀN 2 (06.2024)**

- (11) **50357**  
(21) 3-2023-01668 (28) 1  
(54) **BỘ PHẬN BẢO VỆ GÓC ĐỂ ĐÓNG GÓI** (51) **09-99**  
(22) 24/07/2023 (43) 25/06/2024  
(73) **YFY JUPITER LIMITED (TW)**  
12F., No. 51, Sec. 2, Chongqing S. Rd., Taipei City, Taiwan  
(72) 1. KU, SHIN-WEI (TW)  
2. SUNG, TING-YU (TW)  
(74) Công ty TNHH Sở hữu trí tuệ VIPATCO (VIPATCO CO., LTD.)  
(55)

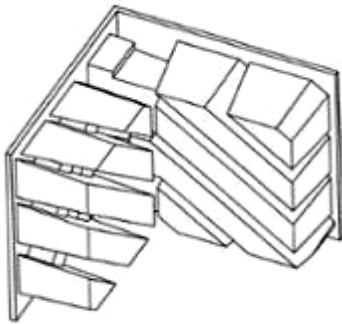

1.1

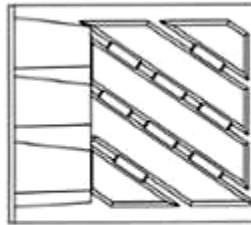

1.2

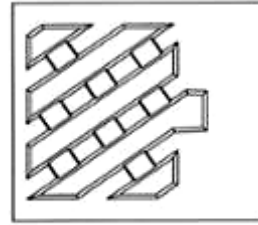

1.3

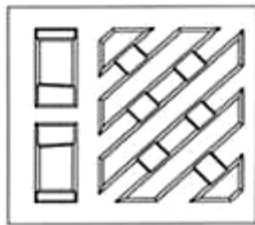

1.4

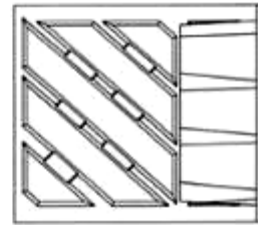

1.5

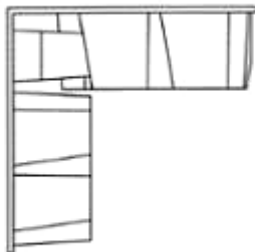

1.6

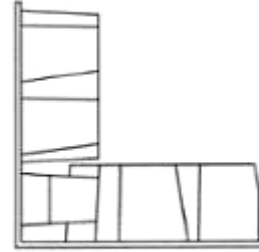

1.7

**CÔNG BÁO SỞ HỮU CÔNG NGHIỆP SỐ 435 TẬP A – QUYỀN 2 (06.2024)**

- (11) **50358**  
(21) 3-2023-01735 (28) 1  
(54) **BỘ BIẾN TẦN** (51) **13-02**  
(22) 28/07/2023 (43) 25/06/2024  
(30) 30-2023-0003557 31/01/2023 KR;  
(73) **HANWHA SOLUTIONS CORPORATION (KR)**  
(Janggyo-dong) 86, Cheonggyecheon-ro, Jung-gu, Seoul, 04541 Republic of Korea  
(72) JEON DONGJUN (KR)  
(74) Văn phòng Luật sư Ân Nam (ANNAM IP & LAW)  
(55)

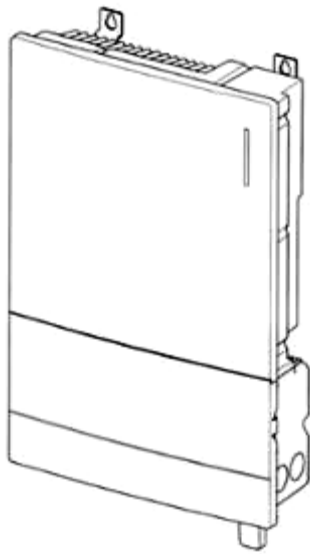

1.1



1.2

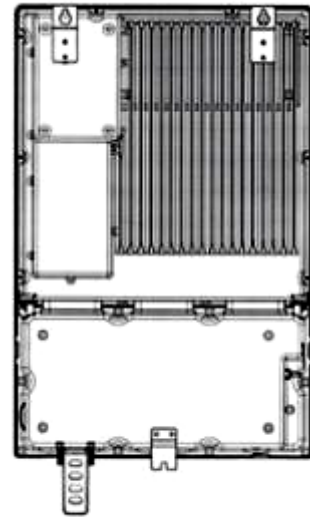

1.3

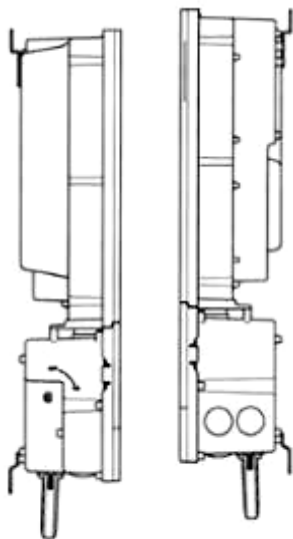

1.4

1.5

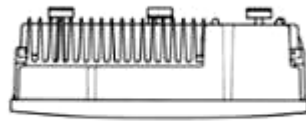

1.6

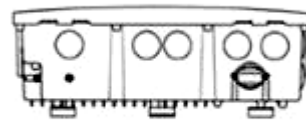

1.7

**CÔNG BÁO SỞ HỮU CÔNG NGHIỆP SỐ 435 TẬP A – QUYỀN 2 (06.2024)**

(11) **50359**

(21) 3-2023-01823

(28) 1

(54) **MÁY LỌC NƯỚC**

(51) **23-01**

(22) 08/08/2023

(43) 25/06/2024

(73) **CÔNG TY CỔ PHẦN TẬP ĐOÀN SUNHOUSE (VN)**

Số 139, phố Nguyễn Thái Học, phường Điện Biên, quận Ba Đình, thành phố Hà Nội

(72) Lại Văn Kiên (VN)

(74) Công ty TNHH Sở hữu trí tuệ Bình Minh (SUNRISE IP CO.,LTD.)

(55)

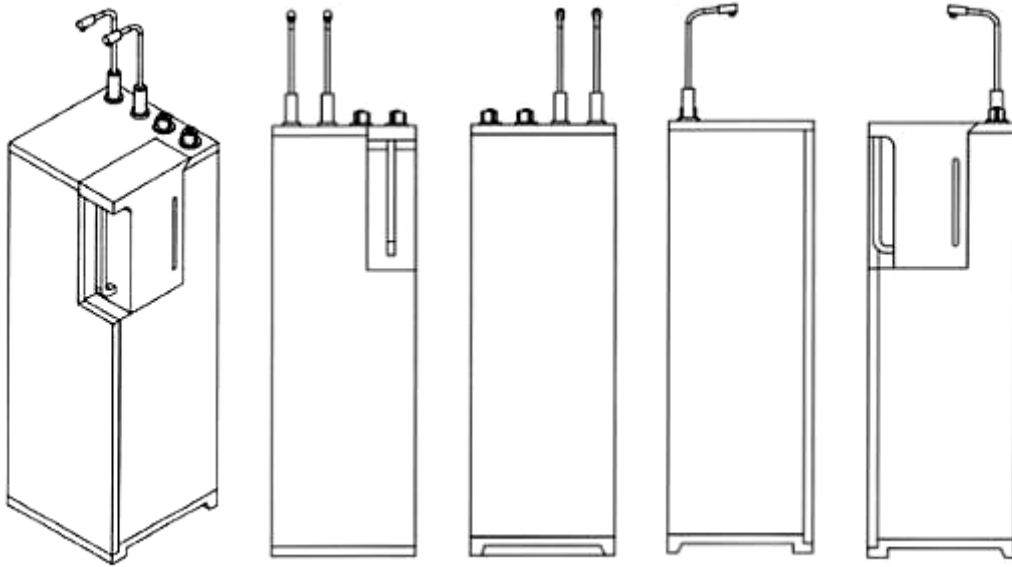

1.1

1.2

1.3

1.4

1.5

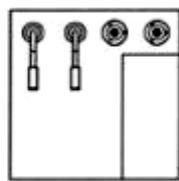

1.6

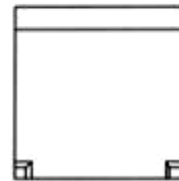

1.7



**CÔNG BÁO SỞ HỮU CÔNG NGHIỆP SỐ 435 TẬP A – QUYỀN 2 (06.2024)**

- (11) **50360**  
(21) 3-2023-01826 (28) 1  
(54) **MÁY LỌC NƯỚC** (51) **23-01**  
(22) 08/08/2023 (43) 25/06/2024  
(73) **CÔNG TY CỔ PHẦN TẬP ĐOÀN SUNHOUSE (VN)**  
Số 139, phố Nguyễn Thái Học, phường Điện Biên, quận Ba Đình, thành phố Hà Nội  
(72) Lại Văn Kiên (VN)  
(74) Công ty TNHH Sở hữu trí tuệ Bình Minh (SUNRISE IP CO.,LTD.)  
(55)

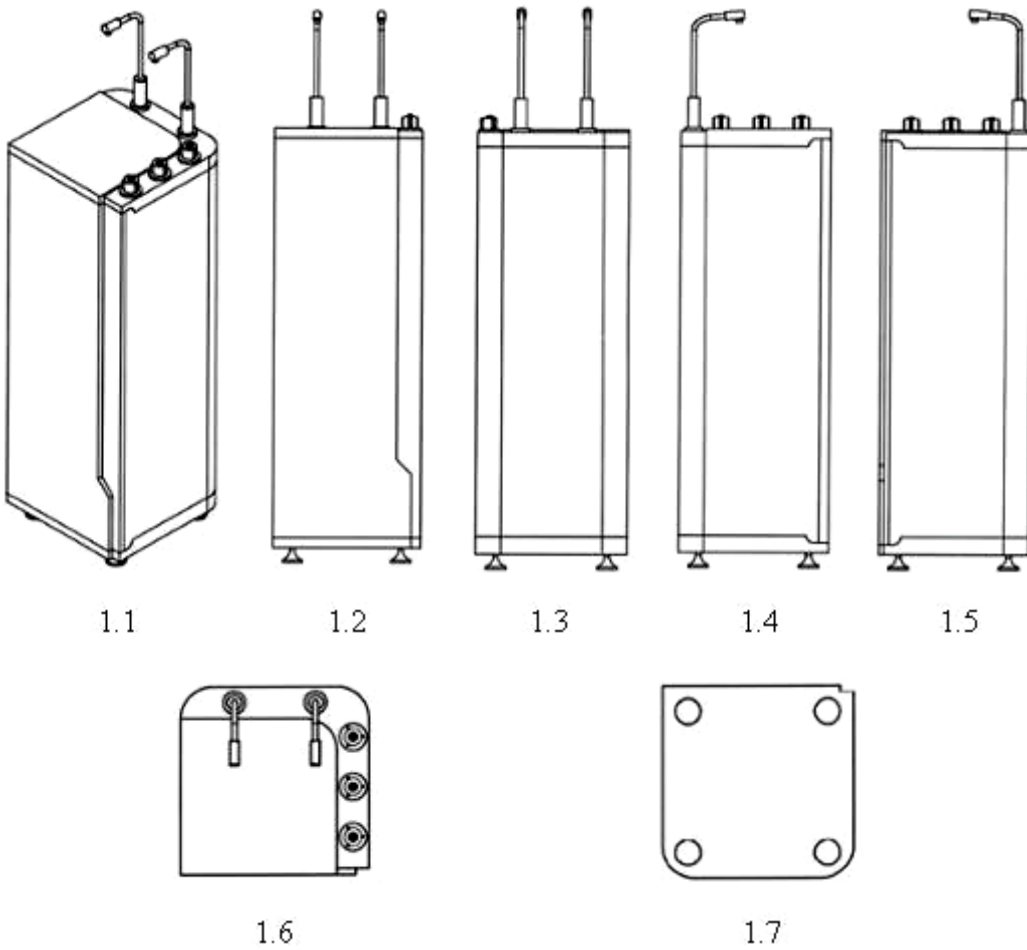

**CÔNG BÁO SỞ HỮU CÔNG NGHIỆP SỐ 435 TẬP A – QUYỀN 2 (06.2024)**

(11) **50361**

(21) 3-2023-01827

(28) 1

(54) **MÁY LỌC NƯỚC**

(51) **23-01**

(22) 08/08/2023

(43) 25/06/2024

(73) **CÔNG TY CỔ PHẦN TẬP ĐOÀN SUNHOUSE (VN)**

Số 139, phố Nguyễn Thái Học, phường Điện Biên, quận Ba Đình, thành phố Hà Nội

(72) Lại Văn Kiên (VN)

(74) Công ty TNHH Sở hữu trí tuệ Bình Minh (SUNRISE IP CO.,LTD.)

(55)

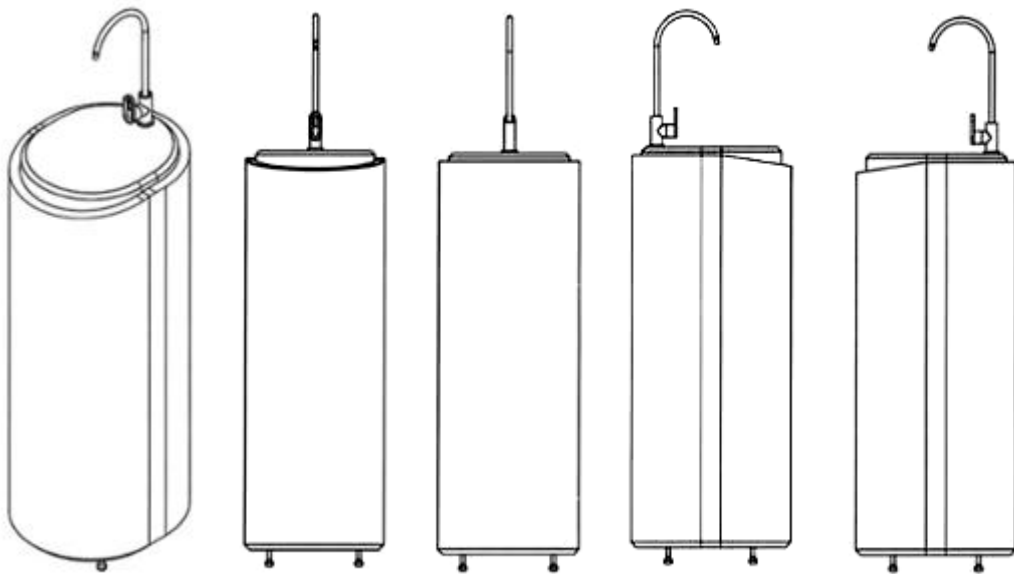

1.1

1.2

1.3

1.4

1.5



1.6



1.7

**CÔNG BÁO SỞ HỮU CÔNG NGHIỆP SỐ 435 TẬP A – QUYỀN 2 (06.2024)**

(11) **50362**

(21) 3-2023-01836

(28) 1

(54) **BỘ PIN SẠC**

(51) **13-02**

(22) 08/08/2023

(43) 25/06/2024

(73) **HANWHA SOLUTIONS CORPORATION (KR)**

(Janggyo-dong) 86, Cheonggyecheon-ro, Jung-gu, Seoul, 04541, Republic of Korea

(72) JEON DONGJUN (KR)

(74) Văn phòng Luật sư Ân Nam (ANNAM IP & LAW)

(55)

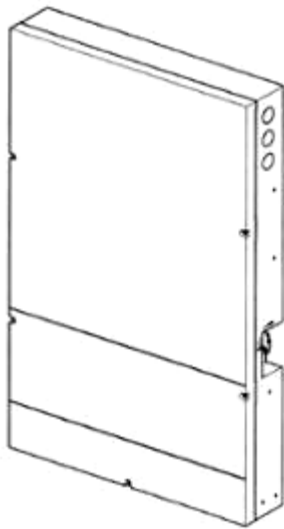

1.1

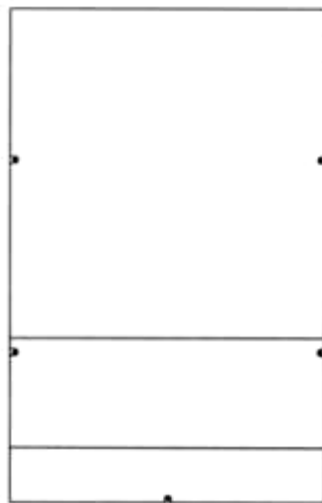

1.2

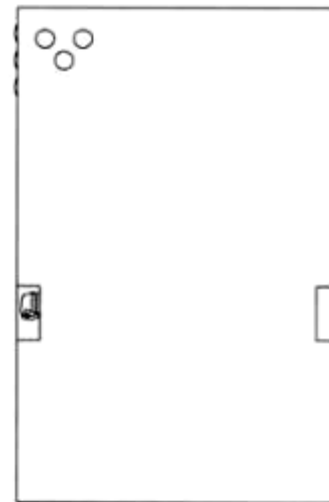

1.3

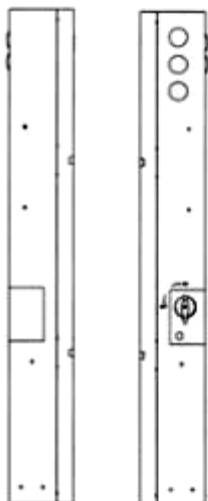

1.4

1.5



1.6

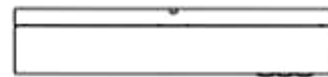

1.7

**CÔNG BÁO SỞ HỮU CÔNG NGHIỆP SỐ 435 TẬP A – QUYỀN 2 (06.2024)**

- (11) **50363**  
(21) 3-2023-01837 (28) 1  
(54) **BỘ BIẾN TẦN** (51) **13-02**  
(22) 08/08/2023 (43) 25/06/2024  
(73) **HANWHA SOLUTIONS CORPORATION (KR)**  
(Janggyo-dong) 86, Cheonggyecheon-ro, Jung-gu, Seoul, 04541, Republic of Korea  
(72) JEON DONGJUN (KR)  
(74) Văn phòng Luật sư Ân Nam (ANNAM IP & LAW)  
(55)

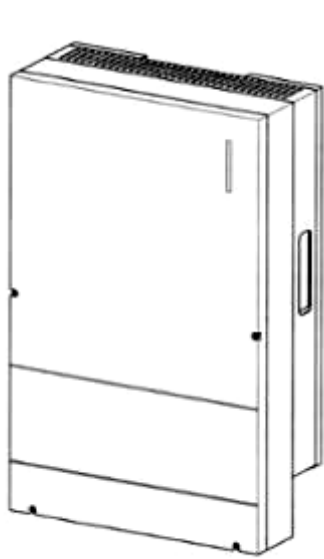

1.1

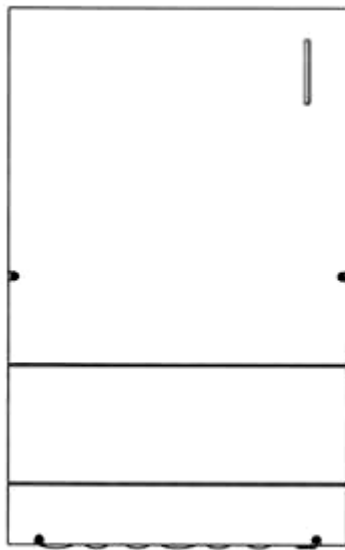

1.2

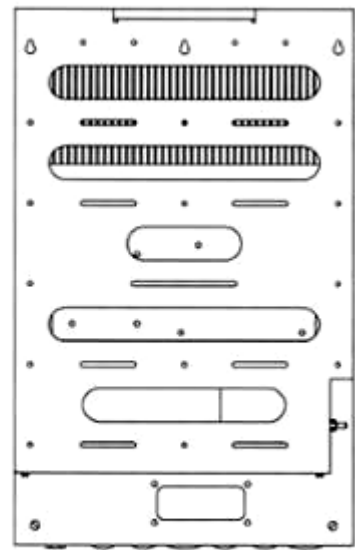

1.3

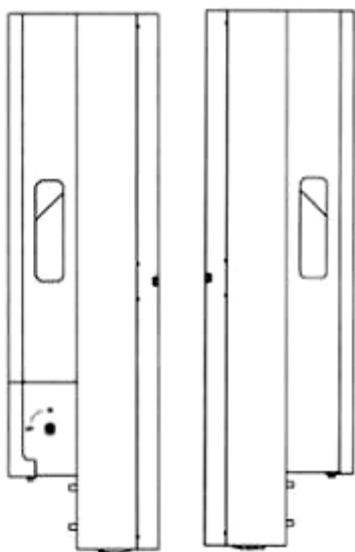

1.4

1.5

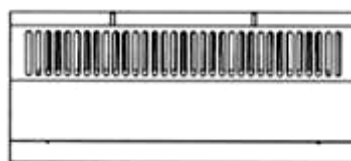

1.6

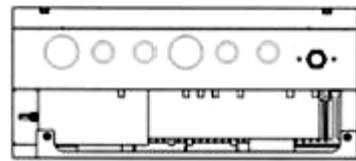

1.7

**CÔNG BÁO SỞ HỮU CÔNG NGHIỆP SỐ 435 TẬP A – QUYỀN 2 (06.2024)**

- (11) **50364**  
(21) 3-2023-01898 (28) 1  
(54) **HOA TAI** (51) **11-01**  
(22) 14/08/2023 (43) 25/06/2024  
(73) **CÔNG TY CỔ PHẦN VÀNG BẠC ĐÁ QUÝ PHÚ NHUẬN (VN)**  
170E Phan Đăng Lưu, phường 3, quận Phú Nhuận, thành phố Hồ Chí Minh  
(72) Nguyễn Khoa Hồng Thành (VN)  
(74) Công ty TNHH Sở hữu trí tuệ Việt Á (VIET A IP CO.,LTD)  
(55)



1.1



1.2



1.3



1.4



1.5



1.6



1.7

- (11) **50365**  
(21) 3-2023-01904 (28) 1  
(54) **DÂY CHUYỀN ĐEO CỔ** (51) **11-01**  
(22) 14/08/2023 (43) 25/06/2024  
(73) **CÔNG TY CỔ PHẦN VÀNG BẠC ĐÁ QUÝ PHÚ NHUẬN (VN)**  
170E Phan Đăng Lưu, phường 3, quận Phú Nhuận, thành phố Hồ Chí Minh  
(72) Nguyễn Khoa Hồng Thành (VN)  
(74) Công ty TNHH Sở hữu trí tuệ Việt Á (VIET A IP CO.,LTD)  
(55)



1.1



1.2



1.3



1.4



1.5



1.6

- (11) **50366**  
(21) 3-2023-01910 (28) 1  
(54) **NHÃN** (51) **11-01**  
(22) 14/08/2023 (43) 25/06/2024  
(73) **CÔNG TY CỔ PHẦN VÀNG BẠC ĐÁ QUÝ PHÚ NHUẬN (VN)**  
170E Phan Đăng Lưu, phường 3, quận Phú Nhuận, thành phố Hồ Chí Minh  
(72) Nguyễn Khoa Hồng Thành (VN)  
(74) Công ty TNHH Sở hữu trí tuệ Việt Á (VIET A IP CO.,LTD)  
(55)



1.1



1.2



1.3



1.4





1.5



1.6

**CÔNG BÁO SỞ HỮU CÔNG NGHIỆP SỐ 435 TẬP A – QUYỀN 2 (06.2024)**

- (11) **50367**  
(21) 3-2023-01911 (28) 1  
(54) **VÒNG ĐEO TAY** (51) **11-01**  
(22) 14/08/2023 (43) 25/06/2024  
(73) **CÔNG TY CỔ PHẦN VÀNG BẠC ĐÁ QUÝ PHÚ NHUẬN (VN)**  
170E Phan Đăng Lưu, phường 3, quận Phú Nhuận, thành phố Hồ Chí Minh  
(72) Nguyễn Khoa Hồng Thành (VN)  
(74) Công ty TNHH Sở hữu trí tuệ Việt Á (VIET A IP CO.,LTD)  
(55)



1.1



1.2



1.3



1.4



1.5



1.6



1.7

**CÔNG BÁO SỞ HỮU CÔNG NGHIỆP SỐ 435 TẬP A – QUYỀN 2 (06.2024)**

- (11) **50368**  
(21) 3-2023-01931 (28) 1  
(54) **THANH NHÔM ĐỊNH HÌNH** (51) **25-01**  
(22) 16/08/2023 (43) 25/06/2024  
(73) **CÔNG TY TNHH THANH PHÚC WINDOW (VN)**  
478 Nguyễn Thị Thập, phường Tân Quy, quận 7, thành phố Hồ Chí Minh  
(72) Nguyễn Thị Kim Hoàn (VN)  
(55)



1.1



1.2

1.3



1.4



1.5



1.6



1.7

**CÔNG BÁO SỞ HỮU CÔNG NGHIỆP SỐ 435 TẬP A – QUYỀN 2 (06.2024)**

- (11) **50369**  
(21) 3-2023-01944 (28) 1  
(54) **CHẢO NƯỚNG** (51) **07-02**  
(22) 18/08/2023 (43) 25/06/2024  
(30) 2023300642963 21/02/2023 CN;  
(73) **JIANGMEN YISHAN METAL PRODUCTS CO., LTD. (CN)**  
Jiaobeishan, Niushan, Dalingtou, Qikan, etc, Shiming village, Siqian, Xinhui,  
Jiangmen City, Guangdong Province 529100, China  
(72) 1. LEE CHANGHO (KR)  
2. LEE WONYOUNG (KR)  
(74) Công ty TNHH ASL LAW (ASL LAW CO.,LTD)  
(55)



1.1



1.2



1.3



1.4

1.5



1.6



1.7

**CÔNG BÁO SỞ HỮU CÔNG NGHIỆP SỐ 435 TẬP A – QUYỀN 2 (06.2024)**

(11) **50370**

(21) 3-2023-02001

(28) 2

(54) **HỘP GIẤY VỆ SINH**

(51) **23-02**

(22) 24/08/2023

(43) 25/06/2024

(30) 29/885,851 01/03/2023 US;

(73) **RHONDA'S ROOM, LLC (US)**

876 Kings Road, Blairsville, Georgia, 30512, United States

(72) Rhonda Kay MASON (US)

(74) Công ty TNHH Sáng chế ACTIP (ACTIP PATENT LIMITED)

(55)



1.1



1.2



1.3



1.4



1.5



1.6



1.7



1.8



2.1

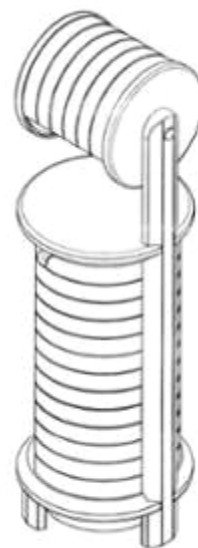

2.2



2.3



2.4



2.5

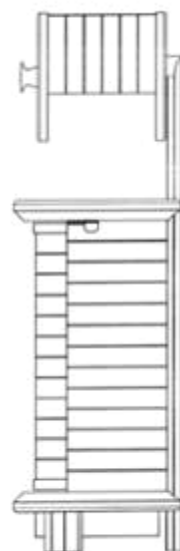

2.6



2.7



2.8



- (11) **50371**  
(21) 3-2023-02046 (28) 1  
(54) **NHANG** (51) **99-00**  
(22) 29/08/2023 (43) 25/06/2024  
(73) **WONG QUỐC MINH (VN)**  
119/47A22 Tân Hòa Đông, phường 14, quận 6, thành phố Hồ Chí Minh  
(72) Wong Quốc Minh (VN)  
(74) **CÔNG TY TNHH SỞ HỮU TRÍ TUỆ SETHACO (SETHACO IP CO.,LTD)**  
(55)

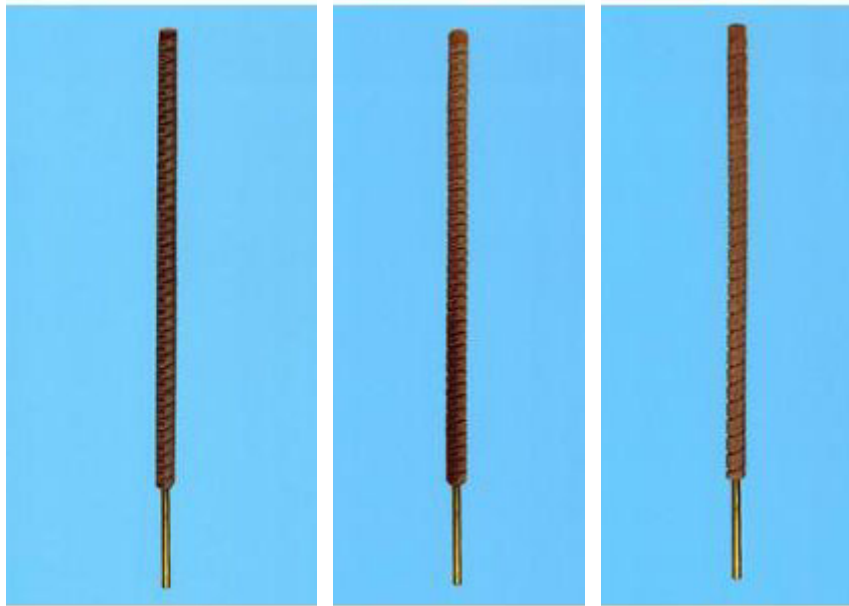

1.1

1.2

1.3



1.4



1.5

**CÔNG BÁO SỞ HỮU CÔNG NGHIỆP SỐ 435 TẬP A – QUYỀN 2 (06.2024)**

- (11) **50372**  
(21) 3-2023-02076 (28) 1  
(54) **CHẢO NƯỚNG** (51) **07-02**  
(22) 31/08/2023 (43) 25/06/2024  
(30) 202330344728.6 06/06/2023 CN;  
(73) **JIANGMEN YISHAN METAL PRODUCTS CO., LTD. (CN)**  
Jiaobeishan, Niushan, Dalingtou, Qikan, etc, Shiming village, Siqian, Xinhui,  
Jiangmen City, Guangdong Province 529100, China  
(72) 1. LEE CHANGHO (KR)  
2. LEE WONYOUNG (KR)  
(74) Công ty TNHH ASL LAW (ASL LAW CO.,LTD)  
(55)



1.1



1.2



1.3



1.4



1.5



1.6



1.7

**CÔNG BÁO SỞ HỮU CÔNG NGHIỆP SỐ 435 TẬP A – QUYỀN 2 (06.2024)**

- (11) **50373**  
(21) 3-2023-02077 (28) 1  
(54) **CHẢO NƯỚNG** (51) **07-02**  
(22) 31/08/2023 (43) 25/06/2024  
(30) 202330344721.4 06/06/2023 CN;  
(73) **JIANGMEN YISHAN METAL PRODUCTS CO., LTD. (CN)**  
Jiaobeishan, Niushan, Dalingtou, Qikan, etc, Shiming village, Siqian, Xinhui,  
Jiangmen City, Guangdong Province 529100, China  
(72) 1. LEE CHANGHO (KR)  
2. LEE WONYOUNG (KR)  
(74) Công ty TNHH ASL LAW (ASL LAW CO.,LTD)  
(55)



1.1



1.2



1.3



1.4



1.5



1.6



1.7

**CÔNG BÁO SỞ HỮU CÔNG NGHIỆP SỐ 435 TẬP A – QUYỀN 2 (06.2024)**

- (11) **50374**  
(21) 3-2023-02083 (28) 1  
(54) **CHAI NHỰA** (51) **09-01**  
(22) 31/08/2023 (43) 25/06/2024  
(73) **CÔNG TY TNHH TÂN HƯNG VIỆT NAM (VN)**  
Lô B213, đường số 5, khu công nghiệp Thái Hòa, ấp Tân Hòa, xã Đức Lập Hạ,  
huyện Đức Hòa, tỉnh Long An  
(72) Nguyễn Đức Khiêm (VN)  
(74) Công ty TNHH Sở hữu trí tuệ INNETCO-Hoàng Phúc (INNETCO CO., LTD)  
(55)



1.1



1.2



1.3



1.4

**CÔNG BÁO SỞ HỮU CÔNG NGHIỆP SỐ 435 TẬP A – QUYỀN 2 (06.2024)**

- (11) **50375**  
(21) 3-2023-02090 (28) 1  
(54) **CHẢO NƯỚNG** (51) **07-02**  
(22) 05/09/2023 (43) 25/06/2024  
(30) 202330344717.8 06/06/2023 CN;  
(73) **JIANGMEN YISHAN METAL PRODUCTS CO., LTD. (CN)**  
Jiaobeishan, Niushan, Dalingtou, Qikan, etc, Shiming village, Siqian, Xinhui,  
Jiangmen City, Guangdong Province 529100, China  
(72) 1. LEE CHANGHO (KR)  
2. LEE WONYOUNG (KR)  
(74) Công ty TNHH ASL LAW (ASL LAW CO.,LTD)  
(55)



1.1



1.2



1.3



1.4



1.5



1.6



1.7

**CÔNG BÁO SỞ HỮU CÔNG NGHIỆP SỐ 435 TẬP A – QUYỀN 2 (06.2024)**

(11) **50376**

(21) 3-2023-02139

(28) 1

(54) **BÚT BI**

(51) **19-06**

(22) 08/09/2023

(43) 25/06/2024

(73) **LI, JUNHUA (CN)**

Room 601, Wan'an Building, No. 115, Wujiang North Road, Wujiang District, Shaoguan City, Guangdong Province, China

(72) **LI, JUNHUA (CN)**

(74) Công ty TNHH một thành viên Trường Luật (Trường Luật)

(55)



1.1



1.2



1.3



1.4



1.5



1.6



1.7

**CÔNG BÁO SỞ HỮU CÔNG NGHIỆP SỐ 435 TẬP A – QUYỀN 2 (06.2024)**

- (11) **50377**  
(21) 3-2023-02279 (28) 1  
(54) **THANH KIM LOẠI ĐỊNH HÌNH** (51) **25-01**  
(22) 27/09/2023 (43) 25/06/2024  
(73) **CÔNG TY TNHH CMEDCO (VN)**  
Số 36 ngõ 41 phố Đông Tác, phường Kim Liên, quận Đống Đa, thành phố Hà Nội  
(72) Nguyễn Tiến Cường (VN)  
(74) Công ty TNHH Sở hữu trí tuệ Gia Việt (GIAVIET CO., LTD.)  
(55)

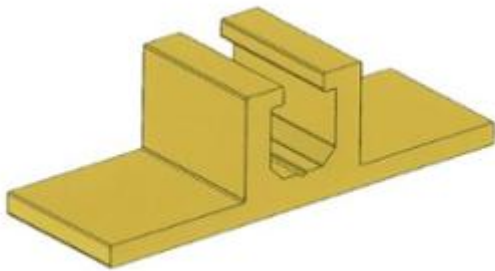

1.1



1.2



1.3

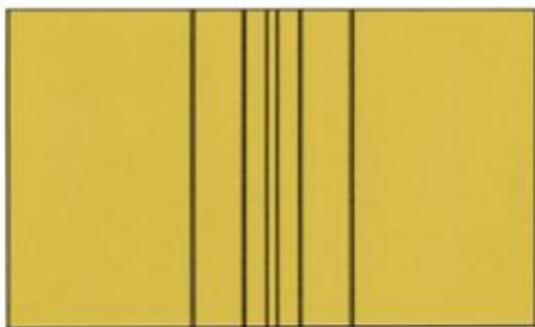

1.4



1.5

**CÔNG BÁO SỞ HỮU CÔNG NGHIỆP SỐ 435 TẬP A – QUYỀN 2 (06.2024)**

- (11) **50378**  
(21) 3-2023-02280 (28) 1  
(54) **THANH KIM LOẠI ĐỊNH HÌNH** (51) **25-01**  
(22) 27/09/2023 (43) 25/06/2024  
(73) **CÔNG TY TNHH CMEDCO (VN)**  
Số 36 ngõ 41 phố Đông Tác, phường Kim Liên, quận Đống Đa, thành phố Hà Nội  
(72) Nguyễn Tiến Cường (VN)  
(74) Công ty TNHH Sở hữu trí tuệ Gia Việt (GIAVIET CO., LTD.)  
(55)

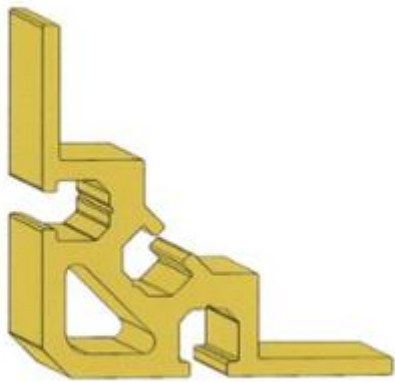

1.1



1.2



1.3



1.4



1.5

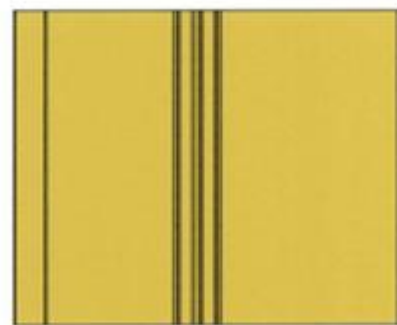

1.6



**CÔNG BÁO SỞ HỮU CÔNG NGHIỆP SỐ 435 TẬP A – QUYỀN 2 (06.2024)**

- (11) **50379**  
(21) 3-2023-02281 (28) 1  
(54) **THANH KIM LOẠI ĐỊNH HÌNH** (51) **25-01**  
(22) 27/09/2023 (43) 25/06/2024  
(73) **CÔNG TY TNHH CMEDCO (VN)**  
Số 36 ngõ 41 phố Đông Tác, phường Kim Liên, quận Đống Đa, thành phố Hà Nội  
(72) Nguyễn Tiến Cường (VN)  
(74) Công ty TNHH Sở hữu trí tuệ Gia Việt (GIAVIET CO., LTD.)  
(55)

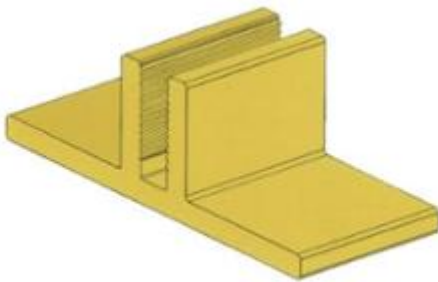

1.1

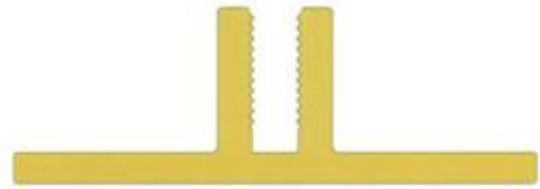

1.2



1.3

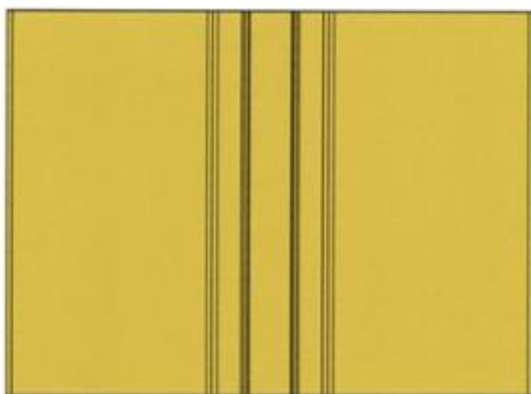

1.4



1.5

**CÔNG BÁO SỞ HỮU CÔNG NGHIỆP SỐ 435 TẬP A – QUYỀN 2 (06.2024)**

(11) **50380**

(21) 3-2023-02282

(54) **THANH KIM LOẠI ĐỊNH HÌNH**

(22) 27/09/2023

(73) **CÔNG TY TNHH CMEDCO (VN)**

Số 36 ngõ 41 phố Đông Tác, phường Kim Liên, quận Đống Đa, thành phố Hà Nội

(72) Nguyễn Tiến Cường (VN)

(74) Công ty TNHH Sở hữu trí tuệ Gia Việt (GIAVIET CO., LTD.)

(55)

(28) 1

(51) **25-01**

(43) 25/06/2024



1.1

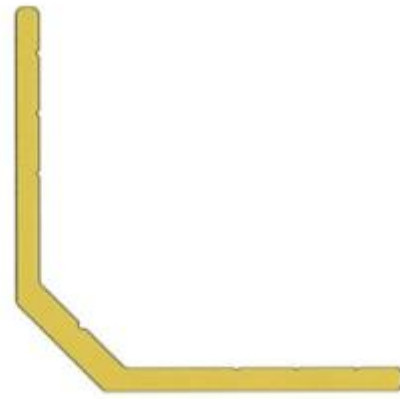

1.2

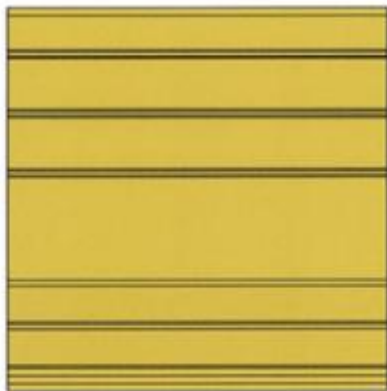

1.3

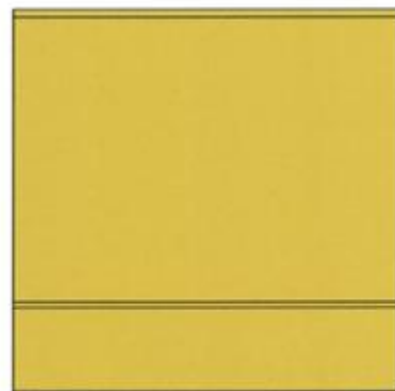

1.4

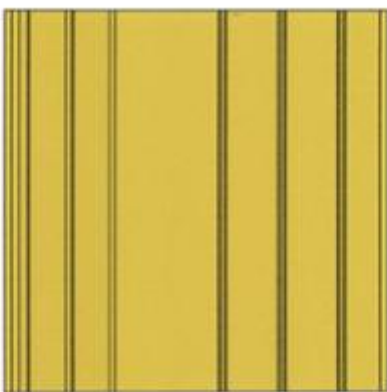

1.5

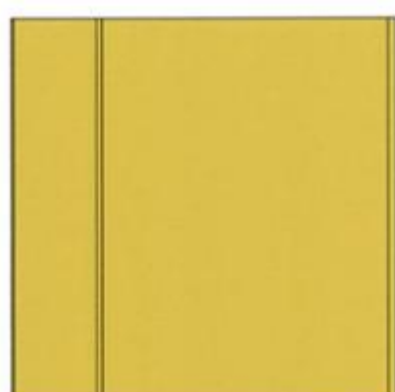

1.6

**CÔNG BÁO SỞ HỮU CÔNG NGHIỆP SỐ 435 TẬP A – QUYỀN 2 (06.2024)**

(11) **50381**

(21) 3-2023-02283

(54) **THANH KIM LOẠI ĐỊNH HÌNH**

(22) 27/09/2023

(73) **CÔNG TY TNHH CMEDCO (VN)**

Số 36 ngõ 41 phố Đông Tác, phường Kim Liên, quận Đống Đa, thành phố Hà Nội

(72) Nguyễn Tiến Cường (VN)

(74) Công ty TNHH Sở hữu trí tuệ Gia Việt (GIAVIET CO., LTD.)

(55)

(28) 1

(51) **25-01**

(43) 25/06/2024

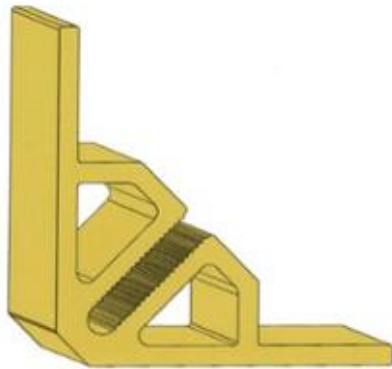

1.1

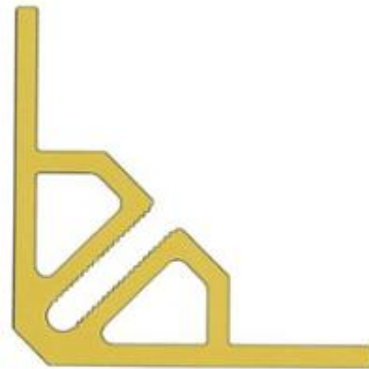

1.2



1.3

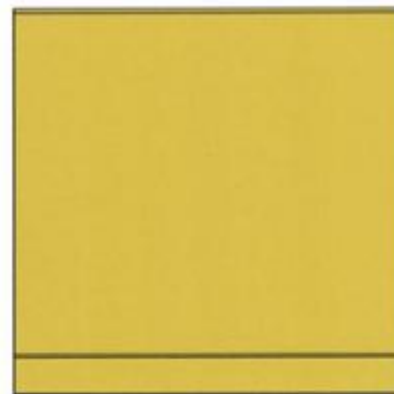

1.4



1.5

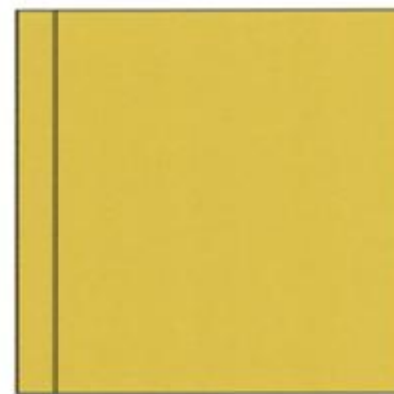

1.6

**CÔNG BÁO SỞ HỮU CÔNG NGHIỆP SỐ 435 TẬP A – QUYỀN 2 (06.2024)**

- (11) **50382**  
(21) 3-2023-02370 (28) 1  
(54) **TẮM CẢN VA PHÍA TRƯỚC XE Ô TÔ** (51) **12-16**  
(22) 09/10/2023 (43) 25/06/2024  
(30) 2023-007632 13/04/2023 JP;  
(73) **HONDA MOTOR CO., LTD. (JP)**  
1-1, Minami-Aoyama 2-Chome, Minato-ku, Tokyo, 107-8556 Japan  
(72) Kota ISHIKAWA (JP)  
(74) Công ty Luật TNHH Phạm và Liên danh (PHAM & ASSOCIATES)  
(55)



1.1



1.2



1.3



1.4



1.5



1.6



1.7



1.8

**CÔNG BÁO SỞ HỮU CÔNG NGHIỆP SỐ 435 TẬP A – QUYỀN 2 (06.2024)**

- (11) **50383**  
(21) 3-2023-02371 (28) 1  
(54) **CỤM ĐÈN PHÍA SAU XE Ô TÔ** (51) **26-06**  
(22) 09/10/2023 (43) 25/06/2024  
(30) 2023-007633 13/04/2023 JP;  
(73) **HONDA MOTOR CO., LTD. (JP)**  
1-1, Minami-Aoyama 2-Chome, Minato-ku, Tokyo, 107-8556 Japan  
(72) Kota ISHIKAWA (JP)  
(74) Công ty Luật TNHH Phạm và Liên danh (PHAM & ASSOCIATES)  
(55)



1.1



1.2



1.3



1.4



1.5



1.6



1.7



1.8

**CÔNG BÁO SỞ HỮU CÔNG NGHIỆP SỐ 435 TẬP A – QUYỀN 2 (06.2024)**

- (11) **50384**  
(21) 3-2023-02372 (28) 1  
(54) **TẮM TẢN NHIỆT DỪNG CHO XE Ô TÔ** (51) **12-16**  
(22) 09/10/2023 (43) 25/06/2024  
(30) 2023-007634 13/04/2023 JP;  
(73) **HONDA MOTOR CO., LTD. (JP)**  
1-1, Minami-Aoyama 2-Chome, Minato-ku, Tokyo, 107-8556 Japan  
(72) Kota ISHIKAWA (JP)  
(74) Công ty Luật TNHH Phạm và Liên danh (PHAM & ASSOCIATES)  
(55)



1.1



1.2



1.3



1.4



1.5



1.6



1.7



1.8

**CÔNG BÁO SỞ HỮU CÔNG NGHIỆP SỐ 435 TẬP A – QUYỀN 2 (06.2024)**

- (11) **50385**  
(21) 3-2023-02455 (28) 1  
(54) **THÂN BÀN CHẢI ĐÁNH RĂNG** (51) **04-02**  
(22) 18/10/2023 (43) 25/06/2024  
(30) 30-2023-0036834 18/09/2023 KR;  
(73) **LG H&H CO., LTD. (KR)**  
58, Saemunan-ro, Jongno-gu, Seoul, Republic of Korea  
(72) SHIN, Ho Joon (KR)  
(74) Công ty TNHH Tầm nhìn và Liên danh (VISION & ASSOCIATES CO.LTD.)  
(55)



1.1



1.2



1.3



1.4



1.5

**CÔNG BÁO SỞ HỮU CÔNG NGHIỆP SỐ 435 TẬP A – QUYỀN 2 (06.2024)**

- (11) **50386**  
(21) 3-2023-02460 (28) 1  
(54) **NGÓI** (51) **25-01**  
(22) 19/10/2023 (43) 25/06/2024  
(73) **CÔNG TY CỔ PHẦN SẢN XUẤT VẬT LIỆU XÂY DỰNG DIC (VN)**  
39/5/4 đường số 23, phường Hiệp Bình Chánh, thành phố Thủ Đức, thành phố Hồ Chí Minh  
(72) Dương Đình Thái (VN)  
(55)



1.1



1.2



1.3



1.4



1.5



1.6



1.7



**CÔNG BÁO SỞ HỮU CÔNG NGHIỆP SỐ 435 TẬP A – QUYỀN 2 (06.2024)**

- (11) **50387**  
(21) 3-2023-02461 (28) 1  
(54) **TẮM TẢN NHIỆT PHÍA TRƯỚC XE Ô TÔ** (51) **12-16**  
(22) 19/10/2023 (43) 25/06/2024  
(30) 2023-008477 25/04/2023 JP;  
(73) **HONDA MOTOR CO., LTD. (JP)**  
1-1, Minami-Aoyama 2-chome, Minato-ku, Tokyo, 107-8556 Japan  
(72) Keisuke MORIOKA (JP)  
(74) Công ty Luật TNHH Phạm và Liên danh (PHAM & ASSOCIATES)  
(55)



1.1

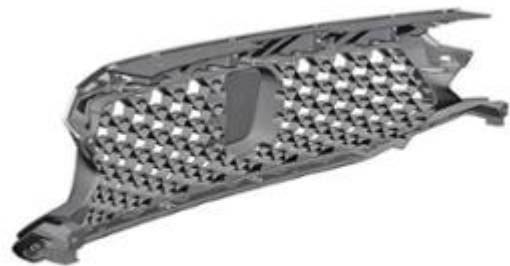

1.2



1.3

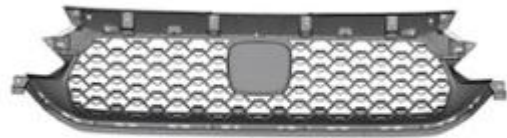

1.4



1.5



1.6



1.7



1.8



1.9



1.10

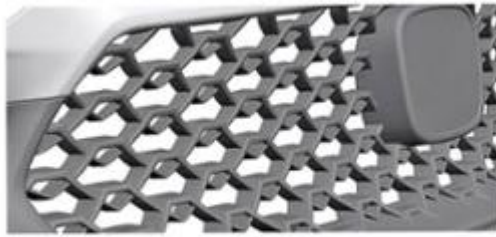

1.11

**CÔNG BÁO SỞ HỮU CÔNG NGHIỆP SỐ 435 TẬP A – QUYỀN 2 (06.2024)**

- (11) **50388**  
(21) 3-2023-02462 (28) 1  
(54) **TẮM CẢN VA PHÍA TRƯỚC XE Ô TÔ** (51) **12-16**  
(22) 19/10/2023 (43) 25/06/2024  
(30) 2023-008478 25/04/2023 JP;  
(73) **HONDA MOTOR CO., LTD. (JP)**  
1-1, Minami-Aoyama 2-chome, Minato-ku, Tokyo, 107-8556 Japan  
(72) Noriyuki ISHII (JP)  
(74) Công ty Luật TNHH Phạm và Liên danh (PHAM & ASSOCIATES)  
(55)



1.1



1.2



1.3



1.4



1.5



1.6



1.7



1.8

**CÔNG BÁO SỞ HỮU CÔNG NGHIỆP SỐ 435 TẬP A – QUYỀN 2 (06.2024)**

- (11) **50389**  
(21) 3-2023-02463 (28) 1  
(54) **TẮM TRANG TRÍ PHÍA SAU XE Ô TÔ** (51) **12-16**  
(22) 19/10/2023 (43) 25/06/2024  
(30) 2023-008479 25/04/2023 JP;  
(73) **HONDA MOTOR CO., LTD. (JP)**  
1-1, Minami-Aoyama 2-chome, Minato-ku, Tokyo, 107-8556 Japan  
(72) Keisuke MORIOKA (JP)  
(74) Công ty Luật TNHH Phạm và Liên danh (PHAM & ASSOCIATES)  
(55)



1.1

1.2



1.3



1.4



1.5



1.6



1.7



1.8

- (11) **50390**  
(21) 3-2023-02530 (28) 1  
(54) **LỚP XE** (51) **12-15**  
(22) 27/10/2023 (43) 25/06/2024  
(30) 2023-008930 28/04/2023 JP;  
(73) **THE YOKOHAMA RUBBER CO., LTD.** (JP)  
2-1, Oiwake, Hiratsuka-shi, Kanagawa 254-8601, Japan  
(72) Kentaro OBANA (JP)  
(74) **CÔNG TY LUẬT TRÁCH NHIỆM HỮU HẠN AMBYS HÀ NỘI (AMBYS HANOI)**  
(55)



1.1

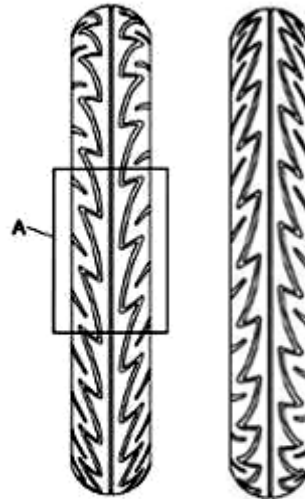

1.2

1.3



1.4



1.5



1.6



1.7

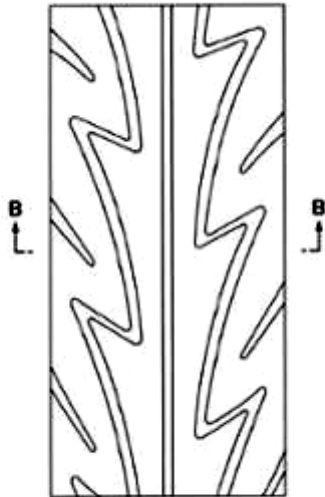

1.8



1.9

- (11) **50391**
- (21) 3-2023-02531
- (54) **LỚP XE**
- (22) 27/10/2023
- (30) 2023-008931 28/04/2023 JP;
- (73) **THE YOKOHAMA RUBBER CO., LTD. (JP)**  
2-1, Oiwake, Hiratsuka-shi, Kanagawa 254-8601, Japan
- (72) Kentaro OBANA (JP)
- (74) **CÔNG TY LUẬT TRÁCH NHIỆM HỮU HẠN AMBYS HÀ NỘI (AMBYS HANOI)**
- (55)

- (28) 1
- (51) **12-15**
- (43) 25/06/2024



1.1

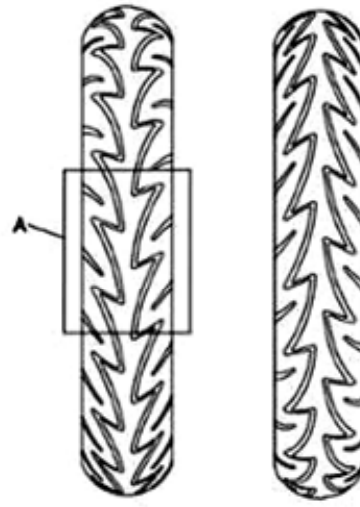

1.2

1.3



1.4



1.5



1.6



1.7

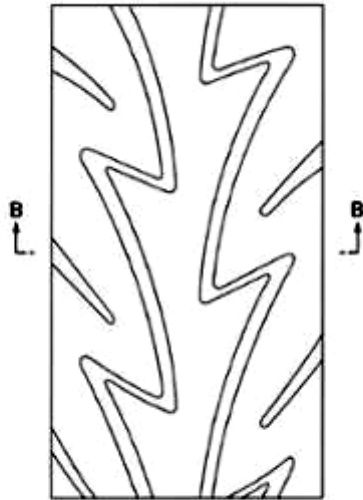

1.8



1.9



**CÔNG BÁO SỞ HỮU CÔNG NGHIỆP SỐ 435 TẬP A – QUYỀN 2 (06.2024)**

- (11) **50392**  
(21) 3-2023-02538 (28) 1  
(54) **CHAI** (51) **09-01**  
(22) 27/10/2023 (43) 25/06/2024  
(73) **CÔNG TY CỔ PHẦN TINGCO BÌNH ĐỊNH (VN)**  
Lô A3.12+A3.13 khu công nghiệp Nhơn Hội (Khu A), khu kinh tế Nhơn Hội, xã  
Nhơn Hội, thành phố Quy Nhơn, tỉnh Bình Định  
(72) Võ Thị Nguyệt Nga (VN)  
(74) Công ty Cổ phần Sở hữu công nghiệp INVESTIP (INVESTIP)  
(55)



1.1

1.2

1.3

1.4

1.5



1.6

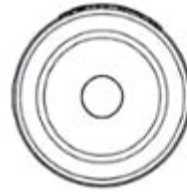

1.7

(11) **50393**

(21) 3-2023-02570

(28) 1

(54) **PHỄU HÚT SỮA**

(51) **24-02**

(22) 31/10/2023

(43) 25/06/2024

(73) **CÔNG TY TNHH JSJB VIỆT NAM (VN)**

Tầng 11, tòa nhà Zen Tower, số 12 đường Khuất Duy Tiến, phường Thanh Xuân Trung, thành phố Hà Nội

(72) Hoàng Quốc Khánh (VN)

(55)

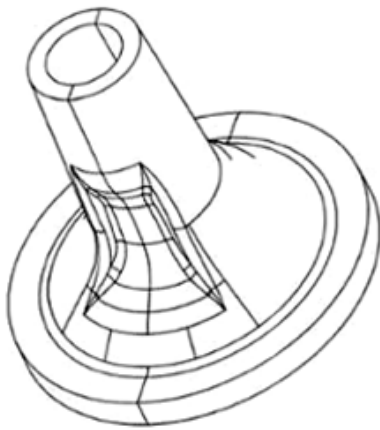

1.1

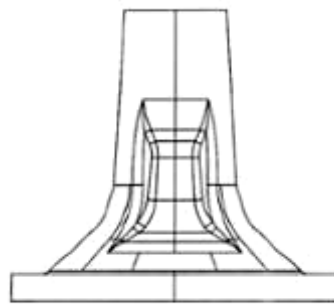

1.2

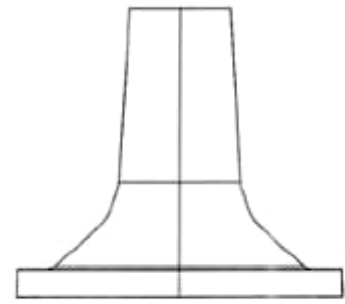

1.3

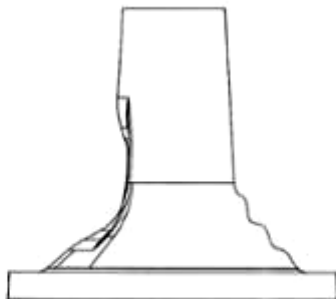

1.4

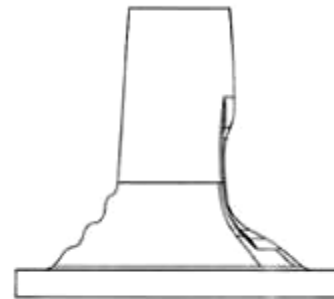

1.5

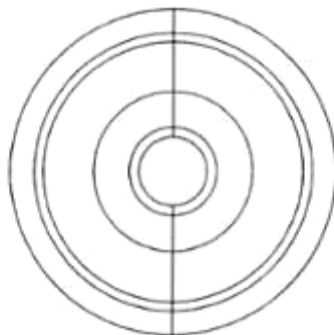

1.6

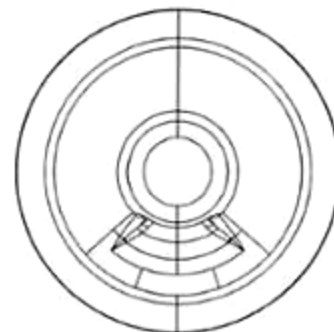

1.7

**CÔNG BÁO SỞ HỮU CÔNG NGHIỆP SỐ 435 TẬP A – QUYỀN 2 (06.2024)**

- (11) **50394**  
(21) 3-2023-02629 (28) 1  
(54) **KHUYÊN VÀNH TAI** (51) **11-01**  
(22) 07/11/2023 (43) 25/06/2024  
(30) WIPO140093 26/10/2023 WO;  
(73) **CHRISTIAN DIOR COUTURE (FR)**  
30 Avenue Montaigne, 75008 Paris, France  
(72) Victoire de Castellane (FR)  
(74) Công ty TNHH một thành viên Sở hữu trí tuệ VCCI (VCCI-IP CO.,LTD)  
(55)

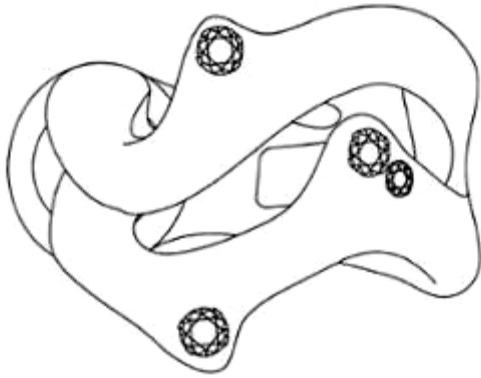

1.1

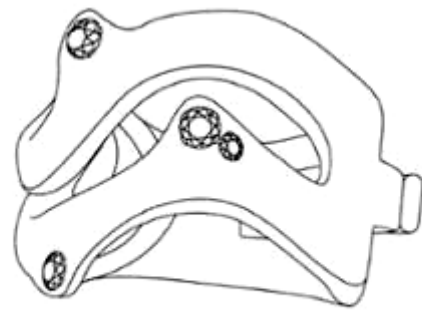

1.2



1.3



1.4

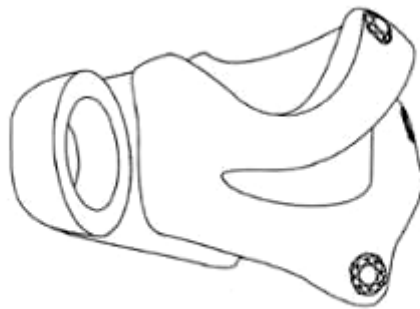

1.5



1.6



1.7

- (11) **50395**  
(21) 3-2023-02632 (28) 1  
(54) **VÒNG TAY** (51) **11-01**  
(22) 07/11/2023 (43) 25/06/2024  
(30) WIPO140093 26/10/2023 WO;  
(73) **CHRISTIAN DIOR COUTURE (FR)**  
30 Avenue Montaigne, 75008 Paris, France  
(72) Victoire de Castellane (FR)  
(74) Công ty TNHH một thành viên Sở hữu trí tuệ VCCI (VCCI-IP CO.,LTD)  
(55)

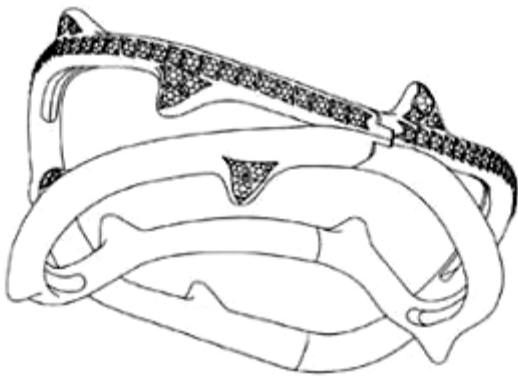

1.1

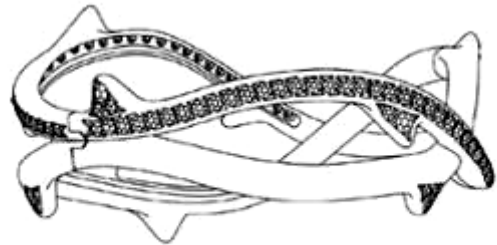

1.2



1.3

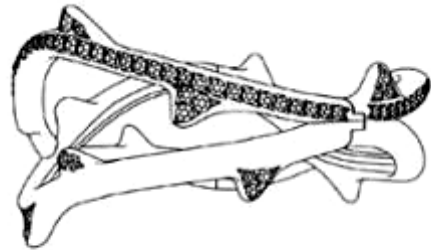

1.4



1.5

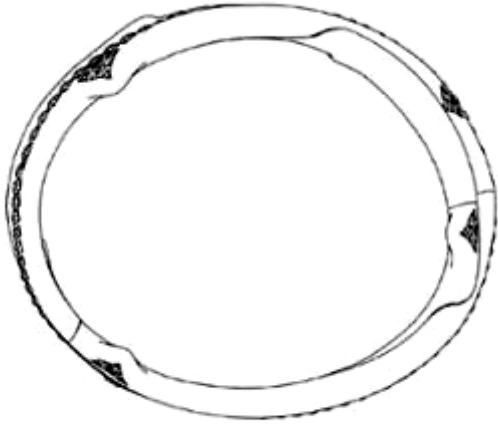

1.6

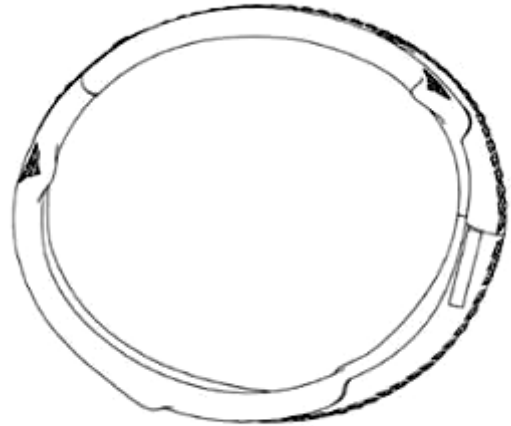

1.7

- (11) **50396**  
(21) 3-2023-02633 (28) 1  
(54) **VÒNG CỔ** (51) **11-01**  
(22) 07/11/2023 (43) 25/06/2024  
(30) WIPO140093 26/10/2023 WO;  
(73) **CHRISTIAN DIOR COUTURE (FR)**  
30 Avenue Montaigne, 75008 Paris, France  
(72) Victoire de Castellane (FR)  
(74) Công ty TNHH một thành viên Sở hữu trí tuệ VCCI (VCCI-IP CO.,LTD)  
(55)



1.1

1.2

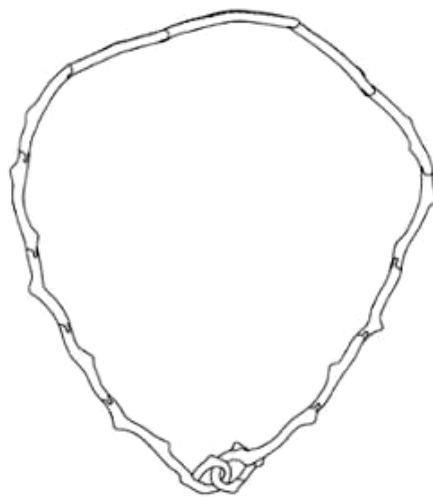

1.3

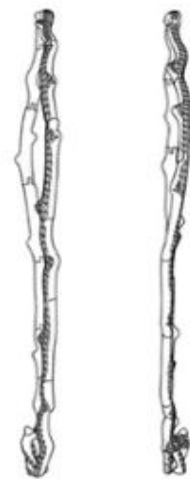

1.4

1.5



1.6



1.7

- (11) **50397**  
(21) 3-2023-02634 (28) 1  
(54) **VÒNG CỔ** (51) **11-01**  
(22) 07/11/2023 (43) 25/06/2024  
(30) WIPO140093 26/10/2023 WO;  
(73) **CHRISTIAN DIOR COUTURE (FR)**  
30 Avenue Montaigne, 75008 Paris, France  
(72) Victoire de Castellane (FR)  
(74) Công ty TNHH một thành viên Sở hữu trí tuệ VCCI (VCCI-IP CO.,LTD)  
(55)





**CÔNG BÁO SỞ HỮU CÔNG NGHIỆP SỐ 435 TẬP A – QUYỀN 2 (06.2024)**

- (11) **50398**  
(21) 3-2023-02663 (28) 1  
(54) **NHÃN** (51) **11-01**  
(22) 09/11/2023 (43) 25/06/2024  
(30) WIPO140090 26/10/2023 WO;  
(73) **CHRISTIAN DIOR COUTURE (FR)**  
30 Avenue Montaigne, 75008 Paris, France  
(72) Victoire de Castellane (FR)  
(74) Công ty TNHH một thành viên Sở hữu trí tuệ VCCI (VCCI-IP CO.,LTD)  
(55)



1.1



1.2



1.3



1.4



1.5



1.6

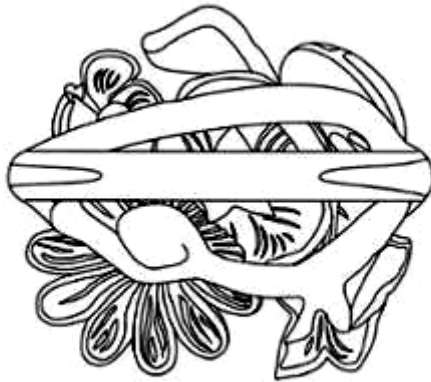

1.7

- (11) **50399**  
(21) 3-2023-02812 (28) 1  
(54) **BỘ PHẬN CỔ ĐỊNH YÊN XE ĐẠP** (51) **12-16**  
(22) 22/11/2023 (43) 25/06/2024  
(73) **CÔNG TY TNHH PRO ACTIVE GLOBAL VIỆT NAM (VN)**  
Lô A1-A7, đường N2, khu công nghiệp Đại Đăng, phường Phú Tân, thành phố Thủ Dầu Một, tỉnh Bình Dương  
(72) TSAI, SHANG - TSANG (TW)  
(74) Công ty TNHH một thành viên Trường Luật (Trường Luật)  
(55)



1.1

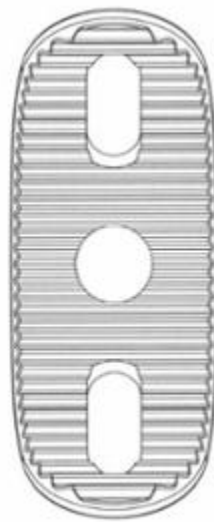

1.2

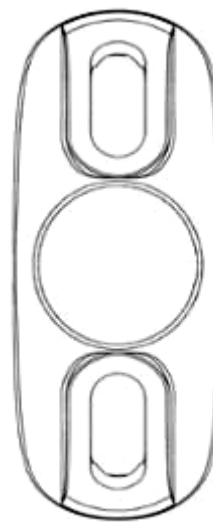

1.3



1.4



1.5



1.6

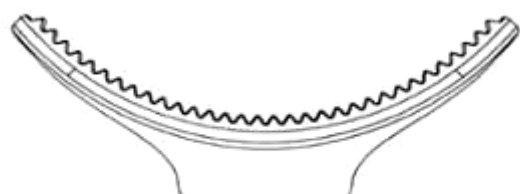

1.7

- (11) **50400**
- (21) 3-2023-02895 (28) 1
- (54) **MÀN HÌNH ĐEO ĐẦU** (51) **14-02**
- (22) 01/12/2023 (43) 25/06/2024
- (30) 29/893,885 03/06/2023 US;
- (73) **APPLE INC. (US)**  
One Apple Park Way, Cupertino, California 95014, United States of America
- (72) 1. JODY AKANA (US)  
2. MOLLY ANDERSON (GB)  
3. BARTLEY K. ANDRE (US)  
4. SHOTA AOYAGI (JP)  
5. ANTHONY MICHAEL ASHCROFT (FR)  
6. MARINE C. BATAILLE (FR)  
7. JEREMY BATAILLOU (FR)  
8. ABIBUR RAHMAN CHOWDHURY (GB)  
9. CLARA GENEVIÈVE MARINE COURTAIGNE (FR)  
10. MARKUS DIEBEL (DE)  
11. ALEXANDRE B. GIRARD (US)  
12. JONATHAN GOMEZ GARCIA (GB)  
13. M. EVANS HANKEY (US)  
14. ANNE-MARIE HECK (CH)  
15. MOISES HERNANDEZ HERNANDEZ (MX)  
16. JULIAN HOENIG (AT)  
17. RICHARD P. HOWARTH (GB)  
18. JONATHAN P. IVE (GB)  
19. JULIAN JAEDE (DE)  
20. DUNCAN ROBERT KERR (GB)  
21. KAINOA KWON-PEREZ (US)  
22. NICOLAS PEDRO LYLYK (AR)  
23. MARC A. NEWSON (AU)  
24. PETER RUSSELL-CLARKE (AU)  
25. BENJAMIN ANDREW SHAFFER (US)  
26. JOE SUNG-HO TAN (US)  
27. ROBERT V. TANG (CA)  
28. CLEMENT TISSANDIER (FR)  
29. EUGENE ANTONY WHANG (CA)
- (74) Công ty TNHH Lê & Lê (LE & LE)
- (55)



1.1



1.2



1.3



1.4



1.5



1.6



1.7



1.8



1.9

**CÔNG BÁO SỞ HỮU CÔNG NGHIỆP SỐ 435 TẬP A – QUYỀN 2 (06.2024)**

- (11) **50401**
- (21) 3-2023-02896 (28) 1
- (54) **DÂY ĐAI** (51) **14-02**
- (22) 01/12/2023 (43) 25/06/2024
- (30) 29/877,258 05/06/2023 US;
- (73) **APPLE INC. (US)**  
One Apple Park Way, Cupertino, California 95014, United States of America
- (72) 1. MOLLY ANDERSON (GB)  
2. BARTLEY K. ANDRE (US)  
3. SHOTA AOYAGI (JP)  
4. MARINE C. BATAILLE (FR)  
5. ABIBUR RAHMAN CHOWDHURY (GB)  
6. CLARA GENEVIÈVE MARINE COURTAIGNE (FR)  
7. MARKUS DIEBEL (DE)  
8. ALEXANDRE B. GIRARD (US)  
9. JONATHAN GOMEZ GARCIA (GB)  
10. M. EVANS HANKEY (US)  
11. ANNE-MARIE HECK (CH)  
12. MOISES HERNANDEZ HERNANDEZ (MX)  
13. RICHARD P. HOWARTH (GB)  
14. JULIAN JAEDE (DE)  
15. DUNCAN ROBERT KERR (GB)  
16. KAINOA KWON-PEREZ (US)  
17. NICOLAS PEDRO LYLYK (AR)  
18. PETER RUSSELL-CLARKE (AU)  
19. BENJAMIN ANDREW SHAFFER (US)  
20. ROBERT V. TANG (CA)  
21. CLEMENT TISSANDIER (FR)
- (74) Công ty TNHH Lê & Lê (LE & LE)
- (55)

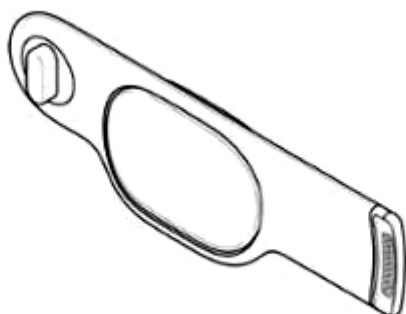

1.1

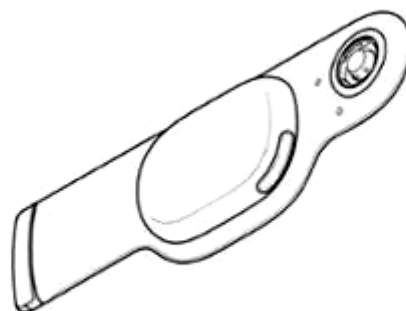

1.2



1.3



1.4

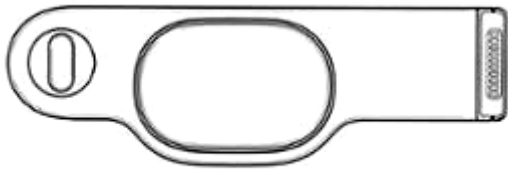

1.5



1.6



1.7



1.8



- (11) **50402**
- (21) 3-2023-02898 (28) 1
- (54) **DÂY** (51) **14-02**
- (22) 01/12/2023 (43) 25/06/2024
- (30) 29/877,215 03/06/2023 US;
- (73) **APPLE INC. (US)**  
One Apple Park Way, Cupertino, California 95014, United States of America
- (72) 1. MOLLY ANDERSON (GB)  
2. BARTLEY K. ANDRE (US)  
3. SHOTA AOYAGI (JP)  
4. MARINE C. BATAILLE (FR)  
5. ABIBUR RAHMAN CHOWDHURY (GB)  
6. CLARA GENEVIÈVE MARINE COURTAIGNE (FR)  
7. MARKUS DIEBEL (DE)  
8. ALEXANDRE B. GIRARD (US)  
9. JONATHAN GOMEZ GARCIA (GB)  
10. M. EVANS HANKEY (US)  
11. ANNE-MARIE HECK (CH)  
12. MOISES HERNANDEZ HERNANDEZ (MX)  
13. MOISES HERNANDEZ HERNANDEZ (GB)  
14. JULIAN JAEDE (DE)  
15. DUNCAN ROBERT KERR (GB)  
16. KAINOA KWON-PEREZ (US)  
17. NICOLAS PEDRO LYLYK (AR)  
18. PETER RUSSELL-CLARKE (AU)  
19. BENJAMIN ANDREW SHAFFER (US)  
20. ROBERT V. TANG (CA)  
21. CLEMENT TISSANDIER (FR)
- (74) Công ty TNHH Lê & Lê (LE & LE)
- (55)



1.1



1.2



1.3



1.4



1.5



1.6



1.7



1.8



1.9



1.10

- (11) **50403**
- (21) 3-2023-02899 (28) 1
- (54) **MÀN HÌNH ĐEO ĐẦU** (51) **14-02**
- (22) 01/12/2023 (43) 25/06/2024
- (30) 29/877,238 04/06/2023 US;
- (73) **APPLE INC. (US)**  
One Apple Park Way, Cupertino, California 95014, United States of America
- (72) 1. JODY AKANA (US)  
2. MOLLY ANDERSON (GB)  
3. BARTLEY K. ANDRE (US)  
4. SHOTA AOYAGI (JP)  
5. ANTHONY MICHAEL ASHCROFT (FR)  
6. MARINE C. BATAILLE (FR)  
7. JEREMY BATAILLOU (FR)  
8. ABIBUR RAHMAN CHOWDHURY (GB)  
9. CLARA GENEVIÈVE MARINE COURTAIGNE (FR)  
10. MARKUS DIEBEL (DE)  
11. ALEXANDRE B. GIRARD (US)  
12. JONATHAN GOMEZ GARCIA (GB)  
13. JONATHAN GOMEZ GARCIA (US)  
14. ANNE-MARIE HECK (CH)  
15. MOISES HERNANDEZ HERNANDEZ (MX)  
16. JULIAN HOENIG (AT)  
17. RICHARD P. HOWARTH (GB)  
18. JONATHAN P. IVE (GB)  
19. JULIAN JAEDE (DE)  
20. DUNCAN ROBERT KERR (GB)  
21. KAINOA KWON-PEREZ (US)  
22. NICOLAS PEDRO LYLYK (AR)  
23. MARC A. NEWSON (AU)  
24. PETER RUSSELL-CLARKE (AU)  
25. BENJAMIN ANDREW SHAFFER (US)  
26. JOE SUNG-HO TAN (US)  
27. ROBERT V. TANG (CA)  
28. CLEMENT TISSANDIER (FR)  
29. EUGENE ANTONY WHANG (CA)
- (74) Công ty TNHH Lê & Lê (LE & LE)
- (55)



1.1



1.2



1.3



1.4



1.5



1.6

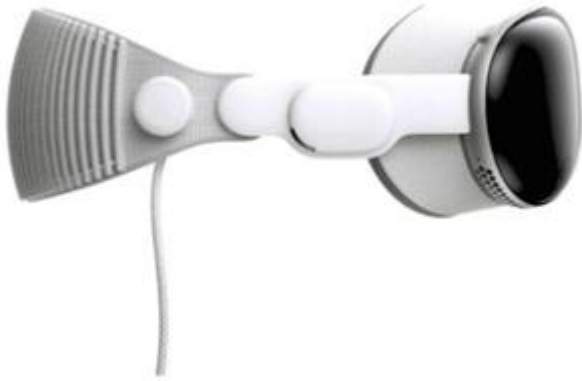

1.7



1.8



1.9

- (11) **50404**
- (21) 3-2023-02900 (28) 1
- (54) **VỎ BỌC** (51) **03-01**
- (22) 01/12/2023 (43) 25/06/2024
- (30) 29/877,253 04/06/2023 US;
- (73) **APPLE INC. (US)**  
One Apple Park Way, Cupertino, California 95014, United States of America
- (72) 1. MOLLY ANDERSON (GB)  
2. BARTLEY K. ANDRE (US)  
3. SHOTA AOYAGI (JP)  
4. MARINE C. BATAILLE (FR)  
5. ABIBUR RAHMAN CHOWDHURY (GB)  
6. CLARA GENEVIÈVE MARINE COURTAIGNE (FR)  
7. MARKUS DIEBEL (DE)  
8. ALEXANDRE B. GIRARD (US)  
9. ANNE-MARIE HECK (CH)  
10. MOISES HERNANDEZ HERNANDEZ (MX)  
11. RICHARD P. HOWARTH (GB)  
12. JULIAN JAEDE (DE)  
13. DUNCAN ROBERT KERR (GB)  
14. KAINOA KWON-PEREZ (US)  
15. NICOLAS PEDRO LYLYK (AR)  
16. PETER RIERING-CZEKALLA (DE)  
17. PETER RUSSELL-CLARKE (AU)  
18. BENJAMIN ANDREW SHAFFER (US)  
19. ROBERT V. TANG (CA)  
20. CLEMENT TISSANDIER (FR)
- (74) Công ty TNHH Lê & Lê (LE & LE)
- (55)



1.1

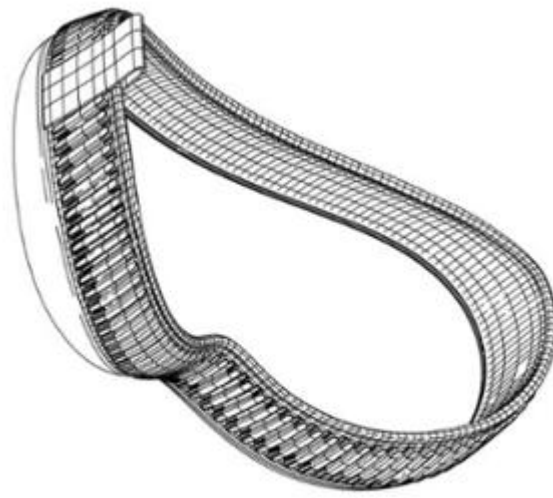

1.2



1.3

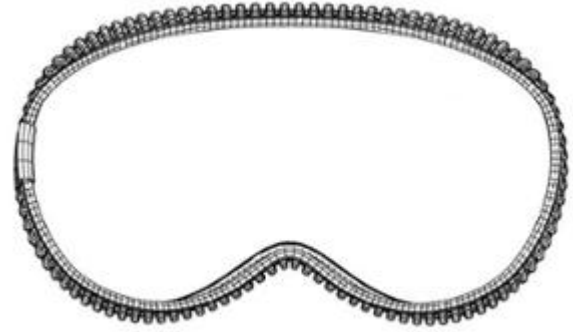

1.4



1.5



1.6

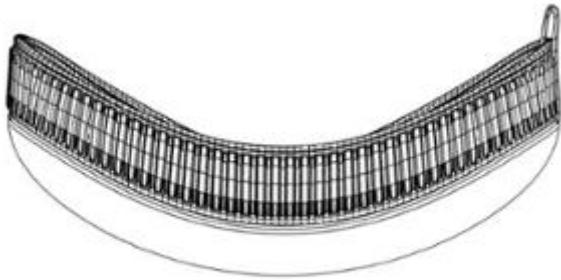

1.7

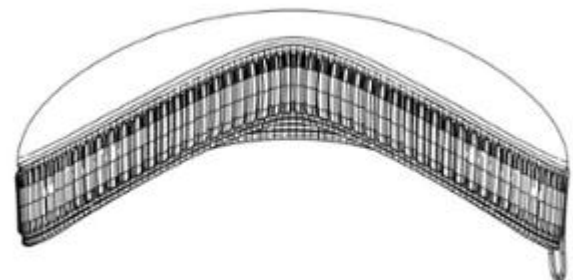

1.8

- (11) **50405**
- (21) 3-2023-02901 (28) 1
- (54) **DÂY** (51) **14-02**
- (22) 01/12/2023 (43) 25/06/2024
- (30) 29/877,247 04/06/2023 US;
- (73) **APPLE INC. (US)**  
One Apple Park Way, Cupertino, California 95014, United States of America
- (72) 1. MOLLY ANDERSON (GB)  
2. BARTLEY K. ANDRE (US)  
3. SHOTA AOYAGI (JP)  
4. MARINE C. BATAILLE (FR)  
5. ABIBUR RAHMAN CHOWDHURY (GB)  
6. CLARA GENEVIÈVE MARINE COURTAIGNE (FR)  
7. MARKUS DIEBEL (DE)  
8. ALEXANDRE B. GIRARD (US)  
9. JONATHAN GOMEZ GARCIA (GB)  
10. M. EVANS HANKEY (US)  
11. ANNE-MARIE HECK (CH)  
12. MOISES HERNANDEZ HERNANDEZ (MX)  
13. RICHARD P. HOWARTH (GB)  
14. JULIAN JAEDE (DE)  
15. DUNCAN ROBERT KERR (GB)  
16. DUNCAN ROBERT KERR (US)  
17. NICOLAS PEDRO LYLYK (AR)  
18. PETER RUSSELL-CLARKE (AU)  
19. BENJAMIN ANDREW SHAFFER (US)  
20. ROBERT V. TANG (CA)  
21. CLEMENT TISSANDIER (FR)
- (74) Công ty TNHH Lê & Lê (LE & LE)
- (55)

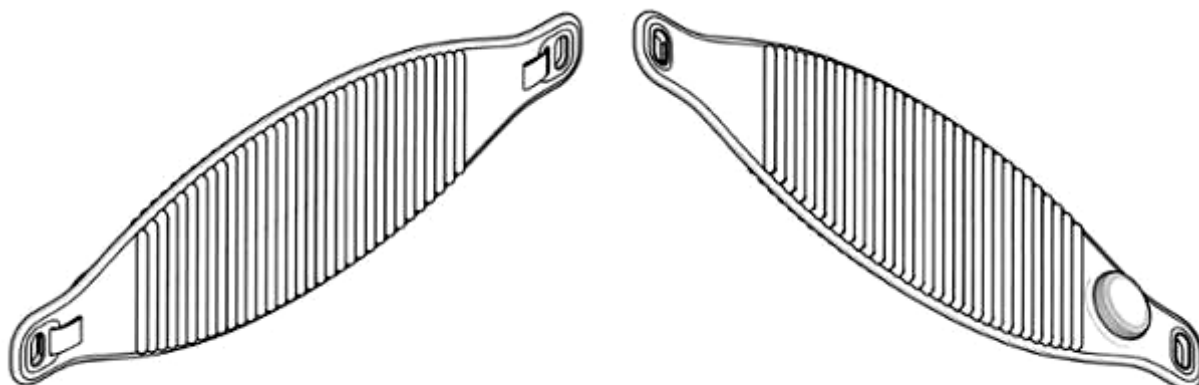

1.1

1.2



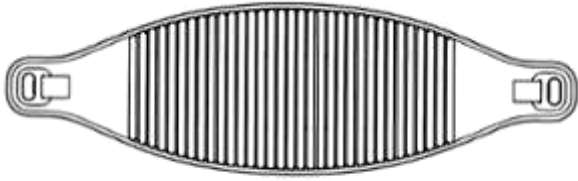

1.3

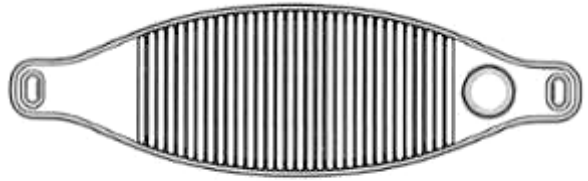

1.4



1.5



1.6



1.7

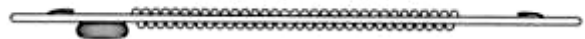

1.8

- (11) **50406**
- (21) 3-2023-02902 (28) 1
- (54) **BỘ PHẬN CHE MẶT TRƯỚC** (51) **14-02**
- (22) 01/12/2023 (43) 25/06/2024
- (30) 29/877,234 04/06/2023 US;
- (73) **APPLE INC. (US)**  
One Apple Park Way, Cupertino, California 95014, United States of America
- (72) 1. JODY AKANA (US)  
2. MOLLY ANDERSON (GB)  
3. BARTLEY K. ANDRE (US)  
4. SHOTA AOYAGI (JP)  
5. ANTHONY MICHAEL ASHCROFT (FR)  
6. MARINE C. BATAILLE (FR)  
7. JEREMY BATAILLOU (FR)  
8. ABIBUR RAHMAN CHOWDHURY (GB)  
9. CLARA GENEVIÈVE MARINE COURTAIGNE (FR)  
10. MARKUS DIEBEL (DE)  
11. ALEXANDRE B. GIRARD (US)  
12. JONATHAN GOMEZ GARCIA (GB)  
13. M. EVANS HANKEY (US)  
14. ANNE-MARIE HECK (CH)  
15. MOISES HERNANDEZ HERNANDEZ (MX)  
16. JULIAN HOENIG (AT)  
17. RICHARD P. HOWARTH (GB)  
18. JONATHAN P. IVE (GB)  
19. JULIAN JAEDE (DE)  
20. DUNCAN ROBERT KERR (GB)  
21. KAINOA KWON-PEREZ (US)  
22. NICOLAS PEDRO LYLYK (AR)  
23. MARC A. NEWSON (AU)  
24. PETER RUSSELL-CLARKE (AU)  
25. BENJAMIN ANDREW SHAFFER (US)  
26. JOE SUNG-HO TAN (US)  
27. CLEMENT TISSANDIER (FR)  
28. EUGENE ANTONY WHANG (CA)
- (74) Công ty TNHH Lê & Lê (LE & LE)
- (55)

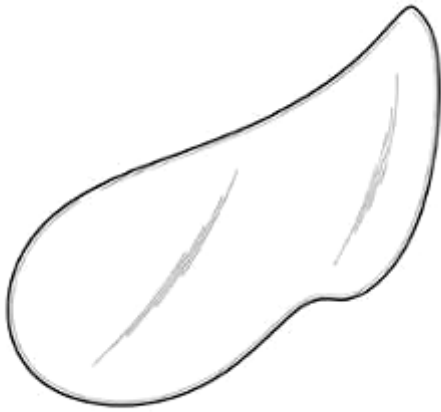

1.1

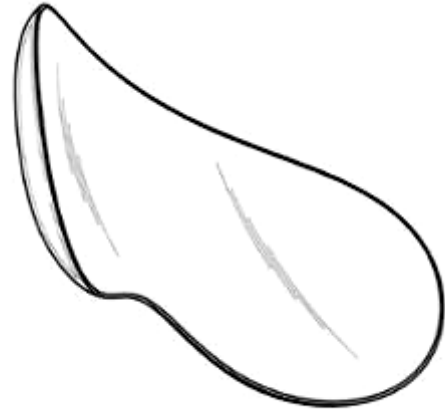

1.2



1.3



1.4



1.5



1.6



1.7



1.8

- (11) **50407**
- (21) 3-2023-02903 (28) 2
- (54) **THẤU KÍNH** (51) **16-06**
- (22) 01/12/2023 (43) 25/06/2024
- (30) 29/877,255 04/06/2023 US;
- (73) **APPLE INC. (US)**  
One Apple Park Way, Cupertino, California 95014, United States of America
- (72) 1. MOLLY ANDERSON (GB)  
2. BARTLEY K. ANDRE (US)  
3. SHOTA AOYAGI (JP)  
4. MARINE C. BATAILLE (FR)  
5. ABIBUR RAHMAN CHOWDHURY (GB)  
6. CLARA GENEVIÈVE MARINE COURTAIGNE (FR)  
7. MARKUS DIEBEL (DE)  
8. ALEXANDRE B. GIRARD (US)  
9. JONATHAN GOMEZ GARCIA (GB)  
10. M. EVANS HANKEY (US)  
11. ANNE-MARIE HECK (CH)  
12. MOISES HERNANDEZ HERNANDEZ (MX)  
13. RICHARD P. HOWARTH (GB)  
14. JULIAN JAEDE (DE)  
15. DUNCAN ROBERT KERR (GB)  
16. KAINOA KWON-PEREZ (US)  
17. NICOLAS PEDRO LYLYK (AR)  
18. PETER RUSSELL-CLARKE (AU)  
19. BENJAMIN ANDREW SHAFFER (US)  
20. CLEMENT TISSANDIER (FR)
- (74) Công ty TNHH Lê & Lê (LE & LE)
- (55)

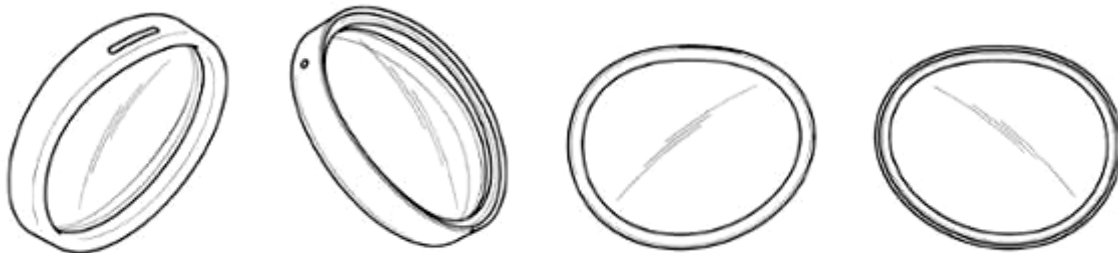

1.1

1.2

1.3

1.4



1.5



1.7



1.6



1.8



2.1



2.2



2.3



2.4



2.5



2.7



2.6



2.8

- (11) **50408**
- (21) 3-2023-02904 (28) 1
- (54) **BỘ PHẬN HIỀN THỊ** (51) **14-02**
- (22) 01/12/2023 (43) 25/06/2024
- (30) 29/877,242 04/06/2023 US;
- (73) **APPLE INC. (US)**  
One Apple Park Way, Cupertino, California 95014, United States of America
- (72) 1. JODY AKANA (US)  
2. MOLLY ANDERSON (GB)  
3. BARTLEY K. ANDRE (US)  
4. SHOTA AOYAGI (JP)  
5. ANTHONY MICHAEL ASHCROFT (FR)  
6. MARINE C. BATAILLE (FR)  
7. JEREMY BATAILLOU (FR)  
8. ABIBUR RAHMAN CHOWDHURY (GB)  
9. CLARA GENEVIÈVE MARINE COURTAIGNE (FR)  
10. MARKUS DIEBEL (DE)  
11. ALEXANDRE B. GIRARD (US)  
12. JONATHAN GOMEZ GARCIA (GB)  
13. M. EVANS HANKEY (US)  
14. ANNE-MARIE HECK (CH)  
15. MOISES HERNANDEZ HERNANDEZ (MX)  
16. JULIAN HOENIG (AT)  
17. RICHARD P. HOWARTH (GB)  
18. JONATHAN P. IVE (GB)  
19. JULIAN JAEDE (DE)  
20. DUNCAN ROBERT KERR (GB)  
21. KAINOA KWON-PEREZ (US)  
22. NICOLAS PEDRO LYLYK (AR)  
23. MARC A. NEWSON (AU)  
24. PETER RUSSELL-CLARKE (AU)  
25. BENJAMIN ANDREW SHAFFER (US)  
26. JOE SUNG-HO TAN (US)  
27. CLEMENT TISSANDIER (FR)  
28. EUGENE ANTONY WHANG (CA)
- (74) Công ty TNHH Lê & Lê (LE & LE)
- (55)



1.1



1.2

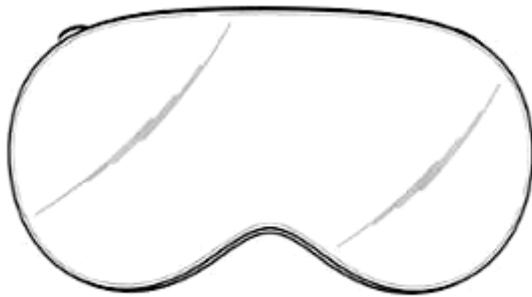

1.3



1.4



1.5



1.6



1.7

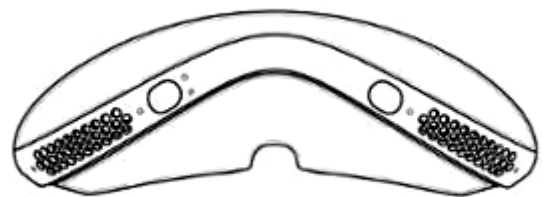

1.8

- (11) **50409**
- (21) 3-2023-02905 (28) 1
- (54) **ĐỆM** (51) **14-02**
- (22) 01/12/2023 (43) 25/06/2024
- (30) 29/877,232 04/06/2023 US;
- (73) **APPLE INC. (US)**  
One Apple Park Way, Cupertino, California 95014, United States of America
- (72) 1. MOLLY ANDERSON (GB)  
2. BARTLEY K. ANDRE (US)  
3. SHOTA AOYAGI (JP)  
4. MARINE C. BATAILLE (FR)  
5. ABIBUR RAHMAN CHOWDHURY (GB)  
6. CLARA GENEVIÈVE MARINE COURTAIGNE (FR)  
7. MARKUS DIEBEL (DE)  
8. ALEXANDRE B. GIRARD (US)  
9. JONATHAN GOMEZ GARCIA (GB)  
10. M. EVANS HANKEY (US)  
11. ANNE-MARIE HECK (CH)  
12. MOISES HERNANDEZ HERNANDEZ (MX)  
13. RICHARD P. HOWARTH (GB)  
14. JULIAN JAEDE (DE)  
15. DUNCAN ROBERT KERR (GB)  
16. KAINOA KWON-PEREZ (US)  
17. NICOLAS PEDRO LYLYK (AR)  
18. PETER RUSSELL-CLARKE (AU)  
19. BENJAMIN ANDREW SHAFFER (US)  
20. ROBERT V. TANG (CA)  
21. CLEMENT TISSANDIER (FR)
- (74) Công ty TNHH Lê & Lê (LE & LE)
- (55)

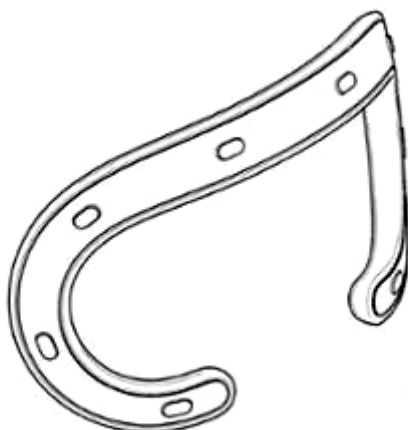

1.1



1.2



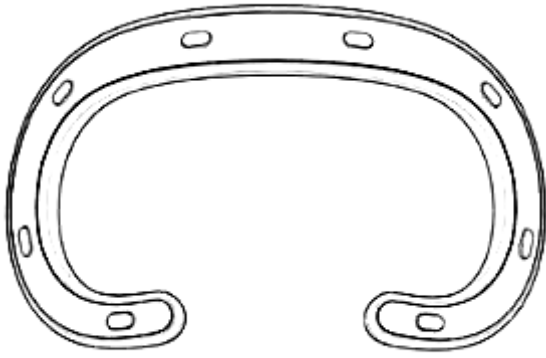

1.3

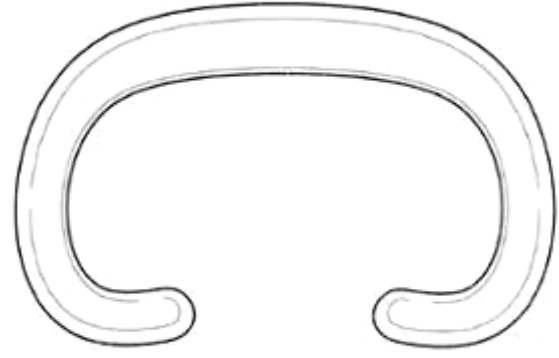

1.4



1.5



1.6



1.7

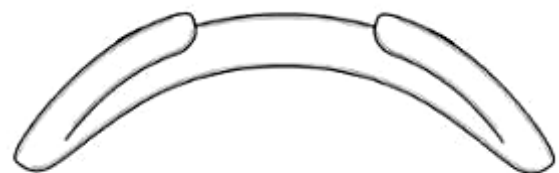

1.8

- (11) **50410**
- (21) 3-2023-02906 (28) 1
- (54) **BỘ PHẬN CHẮN SÁNG** (51) **14-02**
- (22) 01/12/2023 (43) 25/06/2024
- (30) 29/877,232 04/06/2023 US;
- (73) **APPLE INC. (US)**  
One Apple Park Way, Cupertino, California 95014, United States of America
- (72) 1. MOLLY ANDERSON (GB)  
2. BARTLEY K. ANDRE (US)  
3. SHOTA AOYAGI (JP)  
4. MARINE C. BATAILLE (FR)  
5. ABIBUR RAHMAN CHOWDHURY (GB)  
6. CLARA GENEVIÈVE MARINE COURTAIGNE (FR)  
7. MARKUS DIEBEL (DE)  
8. ALEXANDRE B. GIRARD (US)  
9. JONATHAN GOMEZ GARCIA (GB)  
10. M. EVANS HANKEY (US)  
11. ANNE-MARIE HECK (CH)  
12. MOISES HERNANDEZ HERNANDEZ (MX)  
13. RICHARD P. HOWARTH (GB)  
14. JULIAN JAEDE (DE)  
15. DUNCAN ROBERT KERR (GB)  
16. KAINOA KWON-PEREZ (US)  
17. NICOLAS PEDRO LYLYK (AR)  
18. PETER RUSSELL-CLARKE (AU)  
19. BENJAMIN ANDREW SHAFFER (US)  
20. ROBERT V. TANG (CA)  
21. CLEMENT TISSANDIER (FR)
- (74) Công ty TNHH Lê & Lê (LE & LE)
- (55)

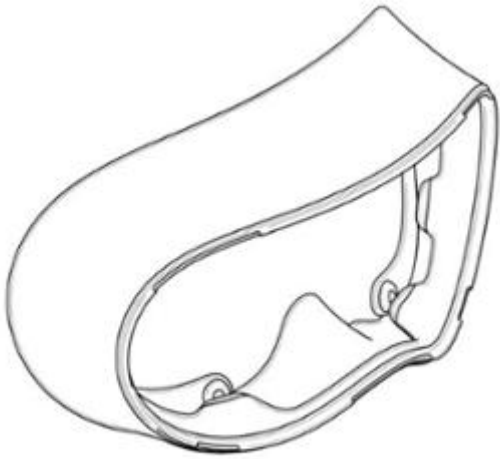

1.1

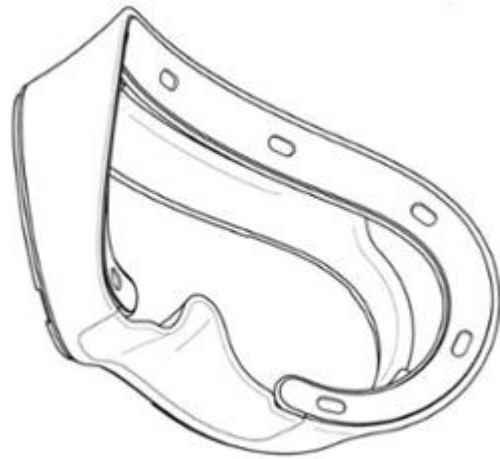

1.2



1.3



1.4



1.5



1.6



1.7

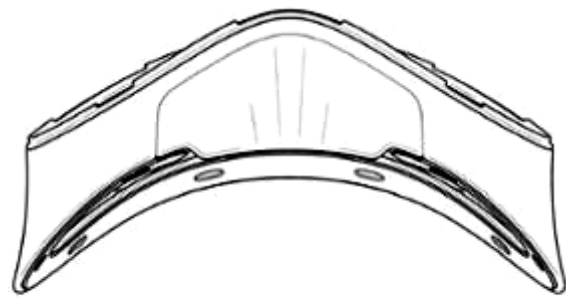

1.8

- (11) **50411**
- (21) 3-2023-02907 (28) 1
- (54) **BỘ PHẬN CHẮN SÁNG** (51) **14-02**
- (22) 01/12/2023 (43) 25/06/2024
- (30) 29/877,232 04/06/2023 US;
- (73) **APPLE INC. (US)**  
One Apple Park Way, Cupertino, California 95014, United States of America
- (72) 1. MOLLY ANDERSON (GB)  
2. BARTLEY K. ANDRE (US)  
3. SHOTA AOYAGI (JP)  
4. MARINE C. BATAILLE (FR)  
5. ABIBUR RAHMAN CHOWDHURY (GB)  
6. CLARA GENEVIÈVE MARINE COURTAIGNE (FR)  
7. MARKUS DIEBEL (DE)  
8. ALEXANDRE B. GIRARD (US)  
9. JONATHAN GOMEZ GARCIA (GB)  
10. M. EVANS HANKEY (US)  
11. ANNE-MARIE HECK (CH)  
12. MOISES HERNANDEZ HERNANDEZ (MX)  
13. RICHARD P. HOWARTH (GB)  
14. JULIAN JAEDE (DE)  
15. DUNCAN ROBERT KERR (GB)  
16. KAINOA KWON-PEREZ (US)  
17. NICOLAS PEDRO LYLYK (AR)  
18. PETER RUSSELL-CLARKE (AU)  
19. BENJAMIN ANDREW SHAFFER (US)  
20. ROBERT V. TANG (CA)  
21. CLEMENT TISSANDIER (FR)
- (74) Công ty TNHH Lê & Lê (LE & LE)
- (55)

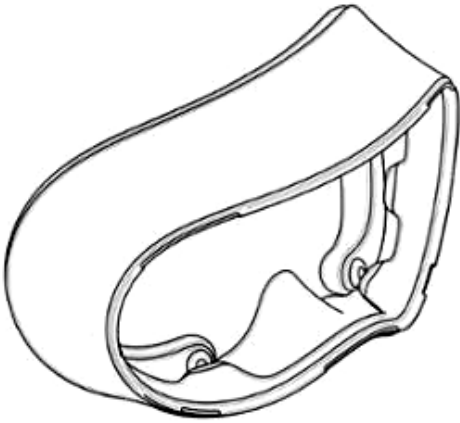

1.1

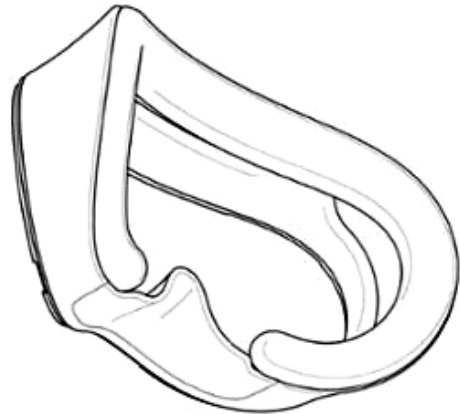

1.2



1.3

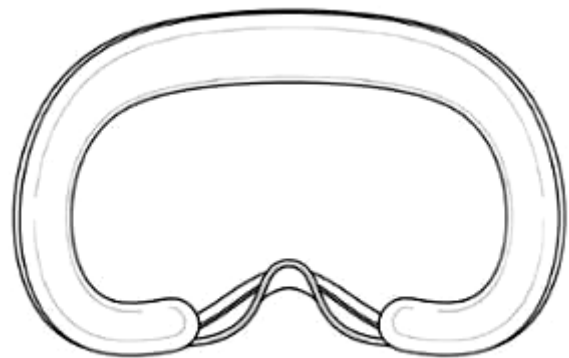

1.4



1.5



1.6

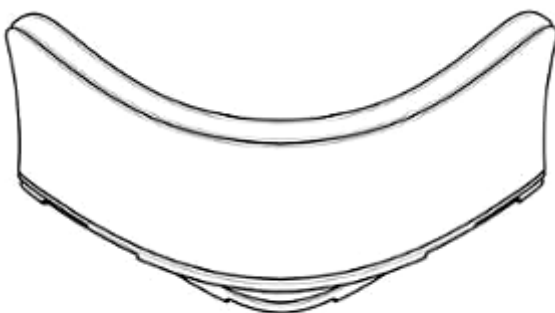

1.7

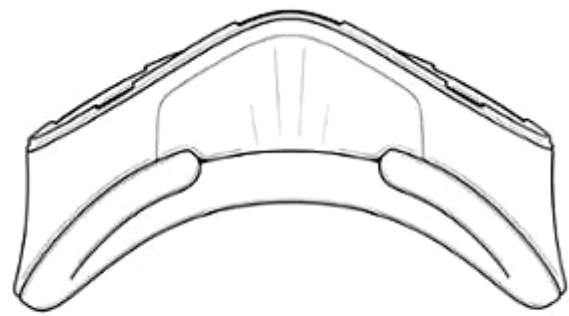

1.8

- (11) **50412**
- (21) 3-2023-02908 (28) 1
- (54) **VỎ BỌC** (51) **03-01**
- (22) 01/12/2023 (43) 25/06/2024
- (30) 29/877,214 03/06/2023 US;
- (73) **APPLE INC. (US)**  
One Apple Park Way, Cupertino, California 95014, United States of America
- (72) 1. MOLLY ANDERSON (GB)  
2. BARTLEY K. ANDRE (US)  
3. SHOTA AOYAGI (JP)  
4. MARINE C. BATAILLE (FR)  
5. ABIBUR RAHMAN CHOWDHURY (GB)  
6. CLARA GENEVIÈVE MARINE COURTAIGNE (FR)  
7. MARKUS DIEBEL (DE)  
8. ALEXANDRE B. GIRARD (US)  
9. ANNE-MARIE HECK (CH)  
10. MOISES HERNANDEZ HERNANDEZ (MX)  
11. RICHARD P. HOWARTH (GB)  
12. JULIAN JAEDE (DE)  
13. DUNCAN ROBERT KERR (GB)  
14. KAINOA KWON-PEREZ (US)  
15. NICOLAS PEDRO LYLYK (AR)  
16. PETER RIERING-CZEKALLA (DE)  
17. PETER RUSSELL-CLARKE (AU)  
18. BENJAMIN ANDREW SHAFFER (US)  
19. ROBERT V. TANG (CA)  
20. CLEMENT TISSANDIER (FR)
- (74) Công ty TNHH Lê & Lê (LE & LE)
- (55)



1.1



1.2



1.3



1.4



1.5



1.6



1.7



1.8



1.9

- (11) **50413**
- (21) 3-2023-02909 (28) 1
- (54) **ĐỆM** (51) **14-02**
- (22) 01/12/2023 (43) 25/06/2024
- (30) 29/893,889 03/06/2023 US;
- (73) **APPLE INC. (US)**  
One Apple Park Way, Cupertino, California 95014, United States of America
- (72) 1. MOLLY ANDERSON (GB)  
2. BARTLEY K. ANDRE (DE)  
3. SHOTA AOYAGI (JP)  
4. MARINE C. BATAILLE (FR)  
5. ABIBUR RAHMAN CHOWDHURY (GB)  
6. CLARA GENEVIÈVE MARINE COURTAIGNE (FR)  
7. MARKUS DIEBEL (DE)  
8. ALEXANDRE B. GIRARD (US)  
9. JONATHAN GOMEZ GARCIA (GB)  
10. M. EVANS HANKEY (US)  
11. ANNE-MARIE HECK (CH)  
12. MOISES HERNANDEZ HERNANDEZ (MX)  
13. RICHARD P. HOWARTH (GB)  
14. JULIAN JAEDE (DE)  
15. DUNCAN ROBERT KERR (GB)  
16. KAINOA KWON-PEREZ (US)  
17. NICOLAS PEDRO LYLYK (AR)  
18. PETER RUSSELL-CLARKE (AU)  
19. BENJAMIN ANDREW SHAFFER (US)  
20. ROBERT V. TANG (CA)  
21. CLEMENT TISSANDIER (FR)
- (74) Công ty TNHH Lê & Lê (LE & LE)
- (55)



1.1



1.2





1.3



1.4



1.5



1.6



1.7



1.8



1.9



1.10



1.11



1.12

- (11) **50414**
- (21) 3-2023-02910 (28) 1
- (54) **DÂY ĐAI** (51) **14-02**
- (22) 01/12/2023 (43) 25/06/2024
- (30) 29/877,278 05/06/2023 US;
- (73) **APPLE INC. (US)**  
One Apple Park Way, Cupertino, California 95014, United States of America
- (72) 1. JODY AKANA (US)  
2. MOLLY ANDERSON (GB)  
3. BARTLEY K. ANDRE (US)  
4. SHOTA AOYAGI (JP)  
5. ANTHONY MICHAEL ASHCROFT (FR)  
6. MARINE C. BATAILLE (FR)  
7. JEREMY BATAILLOU (FR)  
8. ABIBUR RAHMAN CHOWDHURY (GB)  
9. CLARA GENEVIÈVE MARINE COURTAIGNE (FR)  
10. MARKUS DIEBEL (DE)  
11. ALEXANDRE B. GIRARD (US)  
12. JONATHAN GOMEZ GARCIA (GB)  
13. M. EVANS HANKEY (US)  
14. ANNE-MARIE HECK (CH)  
15. MOISES HERNANDEZ HERNANDEZ (MX)  
16. RICHARD P. HOWARTH (GB)  
17. JONATHAN P. IVE (GB)  
18. JULIAN JAEDE (DE)  
19. DUNCAN ROBERT KERR (GB)  
20. KAINOA KWON-PEREZ (US)  
21. NICOLAS PEDRO LYLYK (AR)  
22. PETER RUSSELL-CLARKE (AU)  
23. BENJAMIN ANDREW SHAFFER (US)  
24. JOE SUNG-HO TAN (US)  
25. ROBERT V. TANG (CA)  
26. CLEMENT TISSANDIER (FR)  
27. EUGENE ANTONY WHANG (CA)
- (74) Công ty TNHH Lê & Lê (LE & LE)
- (55)

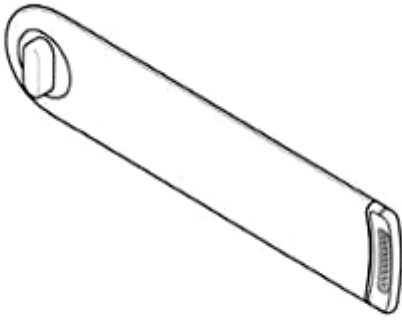

1.1

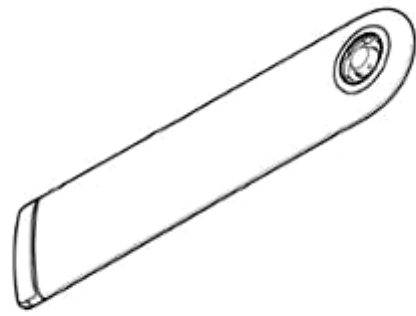

1.2



1.3



1.4



1.5



1.6



1.7



1.8

- (11) **50415**
- (21) 3-2023-02911 (28) 1
- (54) **DÂY ĐAI** (51) **14-02**
- (22) 01/12/2023 (43) 25/06/2024
- (30) 29/877,278 05/06/2023 US;
- (73) **APPLE INC. (US)**  
One Apple Park Way, Cupertino, California 95014, United States of America
- (72) 1. JODY AKANA (US)  
2. MOLLY ANDERSON (GB)  
3. BARTLEY K. ANDRE (US)  
4. SHOTA AOYAGI (JP)  
5. ANTHONY MICHAEL ASHCROFT (FR)  
6. MARINE C. BATAILLE (FR)  
7. JEREMY BATAILLOU (FR)  
8. ABIBUR RAHMAN CHOWDHURY (GB)  
9. CLARA GENEVIÈVE MARINE COURTAIGNE (FR)  
10. MARKUS DIEBEL (DE)  
11. ALEXANDRE B. GIRARD (US)  
12. JONATHAN GOMEZ GARCIA (GB)  
13. M. EVANS HANKEY (US)  
14. ANNE-MARIE HECK (CH)  
15. MOISES HERNANDEZ HERNANDEZ (MX)  
16. RICHARD P. HOWARTH (GB)  
17. JONATHAN P. IVE (GB)  
18. JULIAN JAEDE (DE)  
19. DUNCAN ROBERT KERR (GB)  
20. KAINOA KWON-PEREZ (US)  
21. NICOLAS PEDRO LYLYK (AR)  
22. PETER RUSSELL-CLARKE (AU)  
23. BENJAMIN ANDREW SHAFFER (US)  
24. JOE SUNG-HO TAN (US)  
25. ROBERT V. TANG (CA)  
26. CLEMENT TISSANDIER (FR)  
27. EUGENE ANTONY WHANG (CA)
- (74) Công ty TNHH Lê & Lê (LE & LE)
- (55)

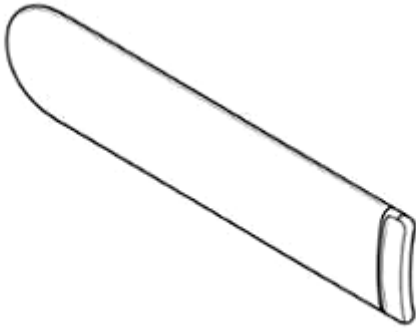

1.1

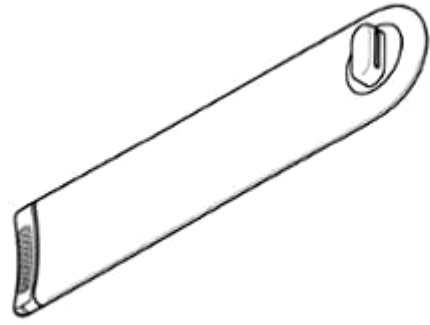

1.2



1.3



1.4



1.5



1.6



1.7



1.8

**CÔNG BÁO SỞ HỮU CÔNG NGHIỆP SỐ 435 TẬP A – QUYỀN 2 (06.2024)**

- (11) **50416**
- (21) 3-2023-02912 (28) 1
- (54) **CÁP** (51) **13-03**
- (22) 01/12/2023 (43) 25/06/2024
- (30) 29/877,344 05/06/2023 US;
- (73) **APPLE INC. (US)**  
One Apple Park Way, Cupertino, California 95014, United States of America
- (72) 1. MOLLY ANDERSON (GB)  
2. BARTLEY K. ANDRE (US)  
3. SHOTA AOYAGI (JP)  
4. MARINE C. BATAILLE (FR)  
5. ABIBUR RAHMAN CHOWDHURY (GB)  
6. CLARA GENEVIÈVE MARINE COURTAIGNE (FR)  
7. MARKUS DIEBEL (DE)  
8. ALEXANDRE B. GIRARD (US)  
9. JONATHAN GOMEZ GARCIA (GB)  
10. M. EVANS HANKEY (US)  
11. ANNE-MARIE HECK (CH)  
12. MOISES HERNANDEZ HERNANDEZ (MX)  
13. RICHARD P. HOWARTH (GB)  
14. JULIAN JAEDE (DE)  
15. DUNCAN ROBERT KERR (GB)  
16. KAINOA KWON-PEREZ (US)  
17. NICOLAS PEDRO LYLYK (AR)  
18. PETER RUSSELL-CLARKE (AU)  
19. BENJAMIN ANDREW SHAFFER (US)  
20. CLEMENT TISSANDIER (FR)
- (74) Công ty TNHH Lê & Lê (LE & LE)
- (55)

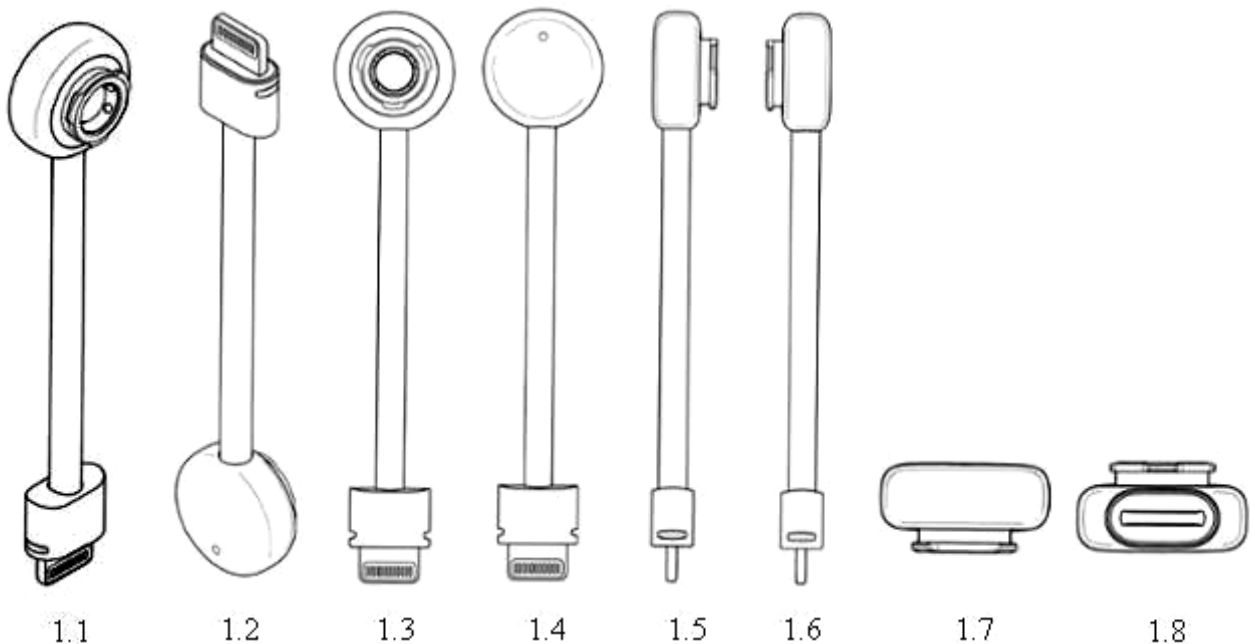

- (11) **50417**
- (21) 3-2023-02913 (28) 1
- (54) **DÂY** (51) **14-02**
- (22) 01/12/2023 (43) 25/06/2024
- (30) 29/877,298 05/06/2023 US;
- (73) **APPLE INC. (US)**  
One Apple Park Way, Cupertino, California 95014, United States of America
- (72) 1. MOLLY ANDERSON (GB)  
2. BARTLEY K. ANDRE (US)  
3. SHOTA AOYAGI (JP)  
4. MARINE C. BATAILLE (FR)  
5. ABIBUR RAHMAN CHOWDHURY (GB)  
6. CLARA GENEVIÈVE MARINE COURTAIGNE (FR)  
7. MARKUS DIEBEL (DE)  
8. ALEXANDRE B. GIRARD (US)  
9. M. EVANS HANKEY (US)  
10. ANNE-MARIE HECK (CH)  
11. MOISES HERNANDEZ HERNANDEZ (MX)  
12. RICHARD P. HOWARTH (GB)  
13. JULIAN JAEDE (DE)  
14. DUNCAN ROBERT KERR (GB)  
15. KAINOA KWON-PEREZ (US)  
16. NICOLAS PEDRO LYLYK (AR)  
17. PETER RIERING-CZEKALLA (DE)  
18. PETER RUSSELL-CLARKE (AU)  
19. BENJAMIN ANDREW SHAFFER (US)  
20. ROBERT V. TANG (CA)  
21. CLEMENT TISSANDIER (FR)
- (74) Công ty TNHH Lê & Lê (LE & LE)
- (55)

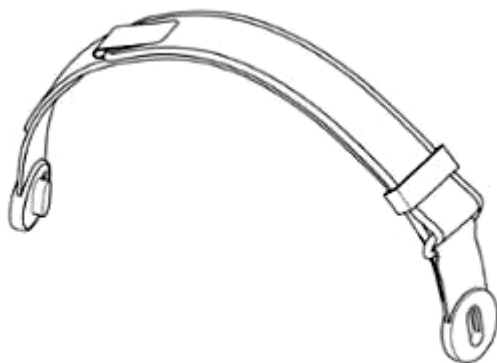

1.1

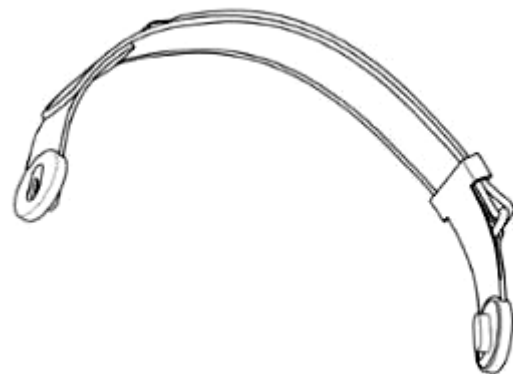

1.2





1.3



1.4



1.5



1.6



1.7



1.8

- (11) **50418**
- (21) 3-2023-02914 (28) 1
- (54) **MÀN HÌNH ĐEO ĐẦU** (51) **14-02**
- (22) 01/12/2023 (43) 25/06/2024
- (30) 29/877,231 04/06/2023 US;
- (73) **APPLE INC. (US)**  
One Apple Park Way, Cupertino, California 95014, United States of America
- (72) 1. JODY AKANA (US)  
2. MOLLY ANDERSON (GB)  
3. BARTLEY K. ANDRE (US)  
4. SHOTA AOYAGI (JP)  
5. ANTHONY MICHAEL ASHCROFT (FR)  
6. MARINE C. BATAILLE (FR)  
7. JEREMY BATAILLOU (FR)  
8. ABIBUR RAHMAN CHOWDHURY (GB)  
9. CLARA GENEVIÈVE MARINE COURTAIGNE (FR)  
10. MARKUS DIEBEL (DE)  
11. ALEXANDRE B. GIRARD (US)  
12. JONATHAN GOMEZ GARCIA (GB)  
13. M. EVANS HANKEY (US)  
14. ANNE-MARIE HECK (CH)  
15. MOISES HERNANDEZ HERNANDEZ (MX)  
16. JULIAN HOENIG (AT)  
17. RICHARD P. HOWARTH (GB)  
18. JONATHAN P. IVE (GB)  
19. JULIAN JAEDE (DE)  
20. DUNCAN ROBERT KERR (GB)  
21. KAINOA KWON-PEREZ (US)  
22. NICOLAS PEDRO LYLYK (AR)  
23. MARC A. NEWSON (AU)  
24. PETER RIERING-CZEKALLA (DE)  
25. PETER RUSSELL-CLARKE (AU)  
26. BENJAMIN ANDREW SHAFFER (US)  
27. JOE SUNG-HO TAN (US)  
28. ROBERT V. TANG (US)  
29. CLEMENT TISSANDIER (FR)  
30. EUGENE ANTONY WHANG (CA)
- (74) Công ty TNHH Lê & Lê (LE & LE)
- (55)



1.1



1.2



1.3



1.4



1.5



1.6



1.7



1.8



1.9

- (11) **50419**
- (21) 3-2023-02915 (28) 1
- (54) **PIN** (51) **13-02**
- (22) 01/12/2023 (43) 25/06/2024
- (30) 29/877,245 04/06/2023 US;
- (73) **APPLE INC. (US)**  
One Apple Park Way, Cupertino, California 95014, United States of America
- (72) 1. JODY AKANA (US)  
2. MOLLY ANDERSON (GB)  
3. BARTLEY K. ANDRE (US)  
4. SHOTA AOYAGI (JP)  
5. ANTHONY MICHAEL ASHCROFT (FR)  
6. MARINE C. BATAILLE (FR)  
7. JEREMY BATAILLOU (FR)  
8. ABIBUR RAHMAN CHOWDHURY (GB)  
9. CLARA GENEVIÈVE MARINE COURTAIGNE (FR)  
10. MARKUS DIEBEL (DE)  
11. ALEXANDRE B. GIRARD (US)  
12. JONATHAN GOMEZ GARCIA (GB)  
13. M. EVANS HANKEY (US)  
14. ANNE-MARIE HECK (CH)  
15. MOISES HERNANDEZ HERNANDEZ (MX)  
16. RICHARD P. HOWARTH (GB)  
17. JONATHAN P. IVE (GB)  
18. JULIAN JAEDE (DE)  
19. DUNCAN ROBERT KERR (GB)  
20. KAINOA KWON-PEREZ (US)  
21. NICOLAS PEDRO LYLYK (AR)  
22. PETER RUSSELL-CLARKE (AU)  
23. BENJAMIN ANDREW SHAFFER (US)  
24. JOE SUNG-HO TAN (US)  
25. CLEMENT TISSANDIER (FR)  
26. EUGENE ANTONY WHANG (CA)
- (74) Công ty TNHH Lê & Lê (LE & LE)
- (55)



1.1



1.2



1.3

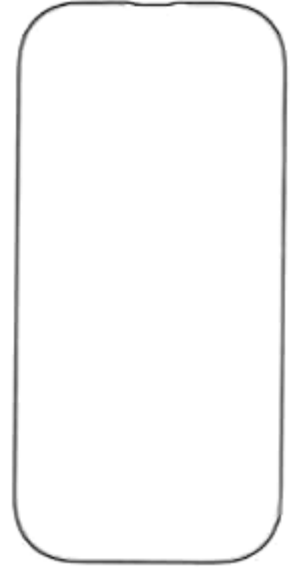

1.4

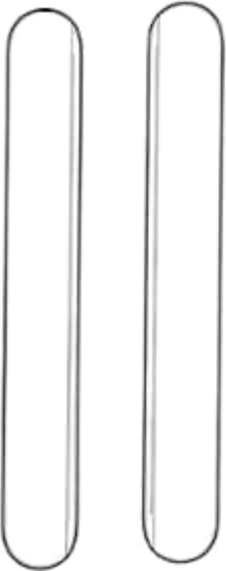

1.5

1.6



1.7

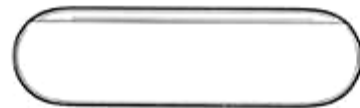

1.8

**CÔNG BÁO SỞ HỮU CÔNG NGHIỆP SỐ 435 TẬP A – QUYỀN 2 (06.2024)**

- (11) **50420**  
(21) 3-2023-02942 (28) 1  
(54) **DỤNG CỤ MASSAGE NGÓN TAY** (51) **28-03**  
(22) 04/12/2023 (43) 25/06/2024  
(73) **CÔNG TY CỔ PHẦN KHUÔN CHÍNH XÁC MINH ĐẠT (VN)**  
Quốc lộ 1A, ấp 1, xã Mỹ Yên, huyện Bến Lức, tỉnh Long An  
(72) Trịnh Hoài Sang (VN)  
(74) Công ty TNHH Sở hữu trí tuệ Thảo Thọ Quyển (INVENCO.,LTD)  
(55)



1.1



1.2



1.3



1.4



1.5



1.6



1.7

**CÔNG BÁO SỞ HỮU CÔNG NGHIỆP SỐ 435 TẬP A – QUYỀN 2 (06.2024)**

- (11) **50421**  
(21) 3-2023-02943 (28) 1  
(54) **DỤNG CỤ GIÁC HƠI** (51) **28-03**  
(22) 04/12/2023 (43) 25/06/2024  
(73) **CÔNG TY CỔ PHẦN KHUÔN CHÍNH XÁC MINH ĐẠT (VN)**  
Quốc lộ 1A, ấp 1, xã Mỹ Yên, huyện Bến Lức, tỉnh Long An  
(72) Trịnh Hoài Sang (VN)  
(74) Công ty TNHH Sở hữu trí tuệ Thảo Thọ Quyển (INVENCO.,LTD)  
(55)

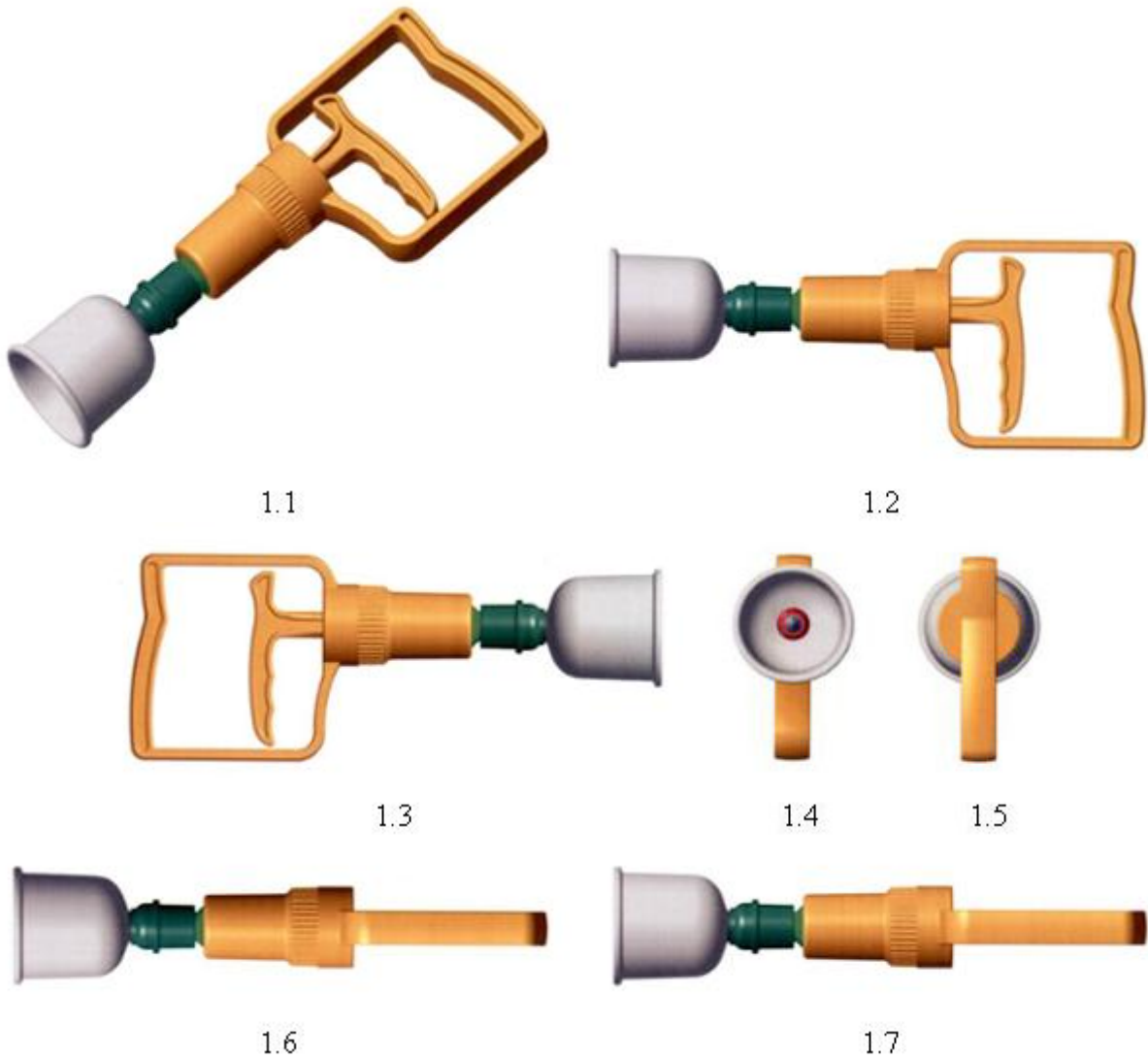



**CÔNG BÁO SỞ HỮU CÔNG NGHIỆP SỐ 435 TẬP A – QUYỀN 2 (06.2024)**

- (11) **50422**  
(21) 3-2023-02968 (28) 1  
(54) **TƯỢNG TRANG TRÍ** (51) **11-02**  
(22) 05/12/2023 (43) 25/06/2024  
(73) **CÔNG TY CỔ PHẦN GÓM CHU ĐẬU (VN)**  
Thôn Chu Đậu, xã Thái Tân, huyện Nam Sách, tỉnh Hải Dương  
(72) Nguyễn Năng Thôn (VN)  
(74) Công ty TNHH Sở hữu trí tuệ HA VIP (HAVIP CO., LTD.)  
(55)



1.1



1.2



1.3



1.4



1.5



1.6



1.7

**CÔNG BÁO SỞ HỮU CÔNG NGHIỆP SỐ 435 TẬP A – QUYỀN 2 (06.2024)**

- (11) **50423**  
(21) 3-2023-02969 (28) 1  
(54) **TƯỢNG TRANG TRÍ** (51) **11-02**  
(22) 05/12/2023 (43) 25/06/2024  
(73) **CÔNG TY CỔ PHẦN GÓM CHU ĐẬU (VN)**  
Thôn Chu Đậu, xã Thái Tân, huyện Nam Sách, tỉnh Hải Dương  
(72) Nguyễn Năng Thôn (VN)  
(74) Công ty TNHH Sở hữu trí tuệ HA VIP (HAVIP CO., LTD.)  
(55)



1.1



1.2



1.3



1.4



1.5



1.6



1.7

**CÔNG BÁO SỞ HỮU CÔNG NGHIỆP SỐ 435 TẬP A – QUYỀN 2 (06.2024)**

(11) **50424**

(21) 3-2023-03021

(28) 1

(54) **TỦ TRUNG BÀY**

(51) **06-04**

(22) 11/12/2023

(43) 25/06/2024

(73) **CÔNG TY CỔ PHẦN ĐỒ GỖ CASADORA (VN)**

Thửa đất số 165, tờ bản đồ số 35. đường ĐT 747, khu phố 7, phường Uyên Hưng, thành phố Tân Uyên, tỉnh Bình Dương

(72) CARLO ZAVAGNO (IT)

(74) Công ty TNHH Đại Tín và Liên Danh (DAITIN AND ASSOCIATES CO.,LTD)

(55)



1.1



1.2

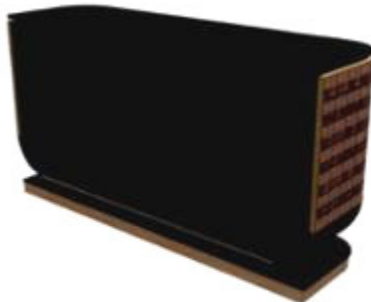

1.3



1.4

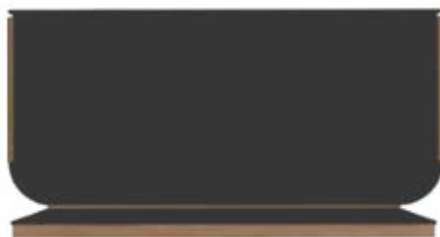

1.5

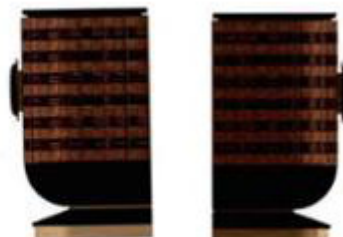

1.6

1.7



1.8



1.9

**CÔNG BÁO SỞ HỮU CÔNG NGHIỆP SỐ 435 TẬP A – QUYỀN 2 (06.2024)**

(11) **50425**

(21) 3-2023-03022

(28) 1

(54) **TỦ SÁCH**

(51) **06-04**

(22) 11/12/2023

(43) 25/06/2024

(73) **CÔNG TY CỔ PHẦN ĐỒ GỖ CASADORA (VN)**

Thửa đất số 165, tờ bản đồ số 35. đường ĐT 747, khu phố 7, phường Uyên Hưng, thành phố Tân Uyên, tỉnh Bình Dương

(72) CARLO ZAVAGNO (IT)

(74) Công ty TNHH Đại Tín và Liên Danh (DAITIN AND ASSOCIATES CO.,LTD)

(55)



1.1



1.2



1.3



1.4



1.5



1.6



1.7



1.8

**CÔNG BÁO SỞ HỮU CÔNG NGHIỆP SỐ 435 TẬP A – QUYỀN 2 (06.2024)**

- (11) **50426**  
(21) 3-2023-03023 (28) 1  
(54) **BÀN ĂN** (51) **06-03**  
(22) 11/12/2023 (43) 25/06/2024  
(73) **CÔNG TY CỔ PHẦN ĐỒ GỖ CASADORA (VN)**  
Thửa đất số 165, tờ bản đồ số 35. đường ĐT 747, khu phố 7, phường Uyên Hưng,  
thành phố Tân Uyên, tỉnh Bình Dương  
(72) CARLO ZAVAGNO (IT)  
(74) Công ty TNHH Đại Tín và Liên Danh (DAITIN AND ASSOCIATES CO.,LTD)  
(55)



1.1



1.2



1.3



1.4

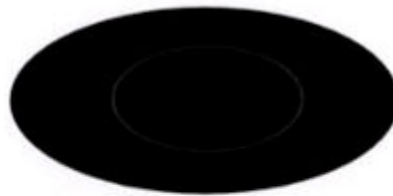

1.5

**CÔNG BÁO SỞ HỮU CÔNG NGHIỆP SỐ 435 TẬP A – QUYỀN 2 (06.2024)**

(11) **50427**

(21) 3-2023-03068

(54) **MŨ BẢO HIỂM**

(22) 15/12/2023

(73) **BÙI THANH PHƯỚC (VN)**

Đội 7, xóm Trung Hòa, thôn Vạn An 3, xã Nghĩa Thương, huyện Tư Nghĩa, tỉnh Quảng Ngãi

(72) Bùi Thanh Phước (VN)

(55)

(28) 1

(51) **02-03**

(43) 25/06/2024



1.1



1.2



1.3



1.4



1.5



1.6

**CÔNG BÁO SỞ HỮU CÔNG NGHIỆP SỐ 435 TẬP A – QUYỀN 2 (06.2024)**

- (11) **50428**  
(21) 3-2023-03089 (28) 1  
(54) **CHẢO NẤU ĂN** (51) **07-02**  
(22) 19/12/2023 (43) 25/06/2024  
(30) 015025945 26/06/2023 EM;  
(73) **JOSEPH JOSEPH LTD (GB)**  
100 Union Street, London SE1 0NL, United Kingdom  
(72) Antony Joseph (UK)  
(74) Công ty Luật TNHH ROUSE Việt Nam (ROUSE LEGAL VIETNAM LTD.)  
(55)



1.1

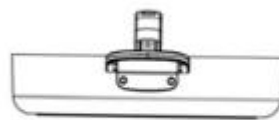

1.2

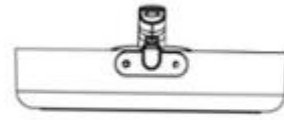

1.3



1.4

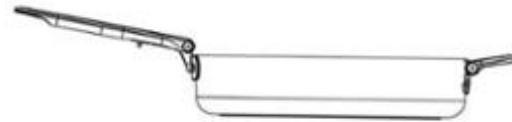

1.5



1.6



1.7



1.8



**CÔNG BÁO SỞ HỮU CÔNG NGHIỆP SỐ 435 TẬP A – QUYỀN 2 (06.2024)**

- (11) **50429**  
(21) 3-2023-03090 (28) 1  
(54) **CHẢO RÁN** (51) **07-02**  
(22) 19/12/2023 (43) 25/06/2024  
(30) 015025945 26/06/2023 EM;  
(73) **JOSEPH JOSEPH LTD** (GB)  
100 Union Street, London SE1 0NL, United Kingdom  
(72) Antony Joseph (UK)  
(74) Công ty Luật TNHH ROUSE Việt Nam (ROUSE LEGAL VIETNAM LTD.)  
(55)



1.1



1.2

1.3



1.4



1.5



1.6



1.7



1.8

**CÔNG BÁO SỞ HỮU CÔNG NGHIỆP SỐ 435 TẬP A – QUYỀN 2 (06.2024)**

- (11) **50430**  
(21) 3-2023-03091 (28) 1  
(54) **CHẢO NƯỚNG** (51) **07-02**  
(22) 19/12/2023 (43) 25/06/2024  
(30) 015025945 26/06/2023 EM;  
(73) **JOSEPH JOSEPH LTD** (GB)  
100 Union Street, London SE1 0NL, United Kingdom  
(72) Antony Joseph (UK)  
(74) Công ty Luật TNHH ROUSE Việt Nam (ROUSE LEGAL VIETNAM LTD.)  
(55)



1.1

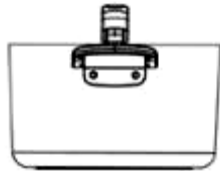

1.2

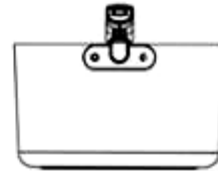

1.3

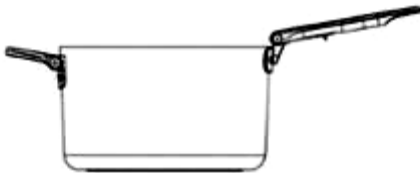

1.4

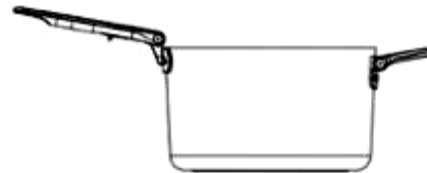

1.5



1.6



1.7



1.8

**CÔNG BÁO SỞ HỮU CÔNG NGHIỆP SỐ 435 TẬP A – QUYỀN 2 (06.2024)**

- (11) **50431**  
(21) 3-2023-03092 (28) 1  
(54) **CHẢO** (51) **07-02**  
(22) 19/12/2023 (43) 25/06/2024  
(30) 015025945 26/06/2023 EM;  
(73) **JOSEPH JOSEPH LTD** (GB)  
100 Union Street, London SE1 0NL, United Kingdom  
(72) Antony Joseph (UK)  
(74) Công ty Luật TNHH ROUSE Việt Nam (ROUSE LEGAL VIETNAM LTD.)  
(55)

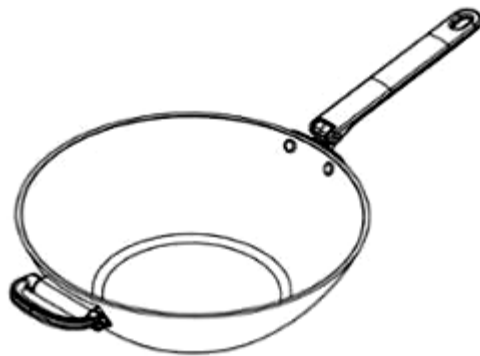

1.1

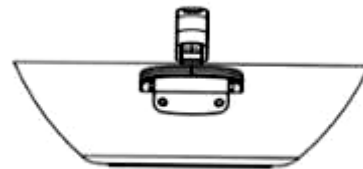

1.2

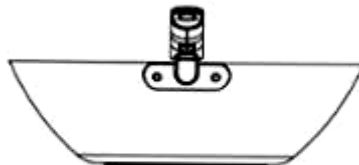

1.3



1.4



1.5

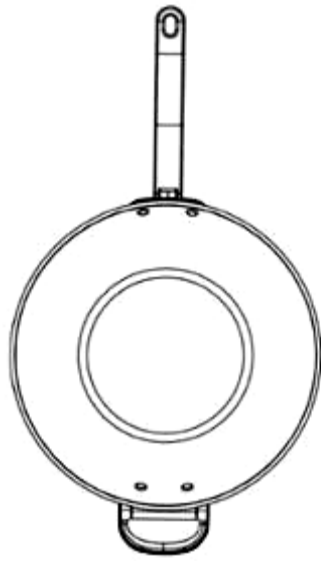

1.6



1.7



1.8

**CÔNG BÁO SỞ HỮU CÔNG NGHIỆP SỐ 435 TẬP A – QUYỀN 2 (06.2024)**

- (11) **50432**  
(21) 3-2023-03119 (28) 1  
(54) **NHÃN SẢN PHẨM BIA** (51) **19-08**  
(22) 22/12/2023 (43) 25/06/2024  
(73) **CÔNG TY TNHH TOÀN CẦU BEVERAGE (VN)**  
Số 8B đường Ngô Quyền, khu 4, phường Cẩm Thượng, thành phố Hải Dương, tỉnh Hải Dương  
(72) Nguyễn Thế Phương (VN)  
(74) Công ty TNHH Sở hữu trí tuệ M.I.T (M.I.T IP CO., LTD)  
(55)



1.1



1.2

**CÔNG BÁO SỞ HỮU CÔNG NGHIỆP SỐ 435 TẬP A – QUYỀN 2 (06.2024)**

- (11) **50433**
- (21) 3-2023-03197 (28) 1
- (54) **NHÃN SẢN PHẨM** (51) **19-08**
- (22) 29/12/2023 (43) 25/06/2024
- (73) **CÔNG TY TNHH THỰC PHẨM FACO VIỆT NAM (VN)**  
316/4 Trịnh Đình Trọng, phường Hòa Thạnh, quận Tân Phú, thành phố Hồ Chí Minh
- (72) Huỳnh Văn Hòa (VN)
- (55)



- (11) **50434**  
(21) 3-2023-03199 (28) 1  
(54) **HỘP** (51) **09-03**  
(22) 29/12/2023 (43) 25/06/2024  
(73) **HỘ KINH DOANH AN VĨNH PHÁT (VN)**  
R23/39/36 cư xá Phú Lâm A, phường 12, quận 6, thành phố Hồ Chí Minh  
(72) Khuu Sở Dinh (VN)  
(55)



1.1



1.2



1.3



1.4



1.5

**CÔNG BÁO SỞ HỮU CÔNG NGHIỆP SỐ 435 TẬP A – QUYỀN 2 (06.2024)**

- (11) **50435**
- (21) 3-2023-03201 (28) 1
- (54) **CŨ CHẶN KHE CỦA BĂNG TẢI** (51) **12-05**
- (22) 29/12/2023 (43) 25/06/2024
- (30) 29/896,322 30/06/2023 US;
- (73) **FLEXIBLE STEEL LACING COMPANY (US)**  
2525 Wisconsin Avenue, Downers Grove, Illinois, 60515, United States of America
- (72) Mark Steven Pettinga (US)
- (74) Công ty TNHH Sở hữu trí tuệ Thảo Thọ Quyển (INVENCO.,LTD)
- (55)

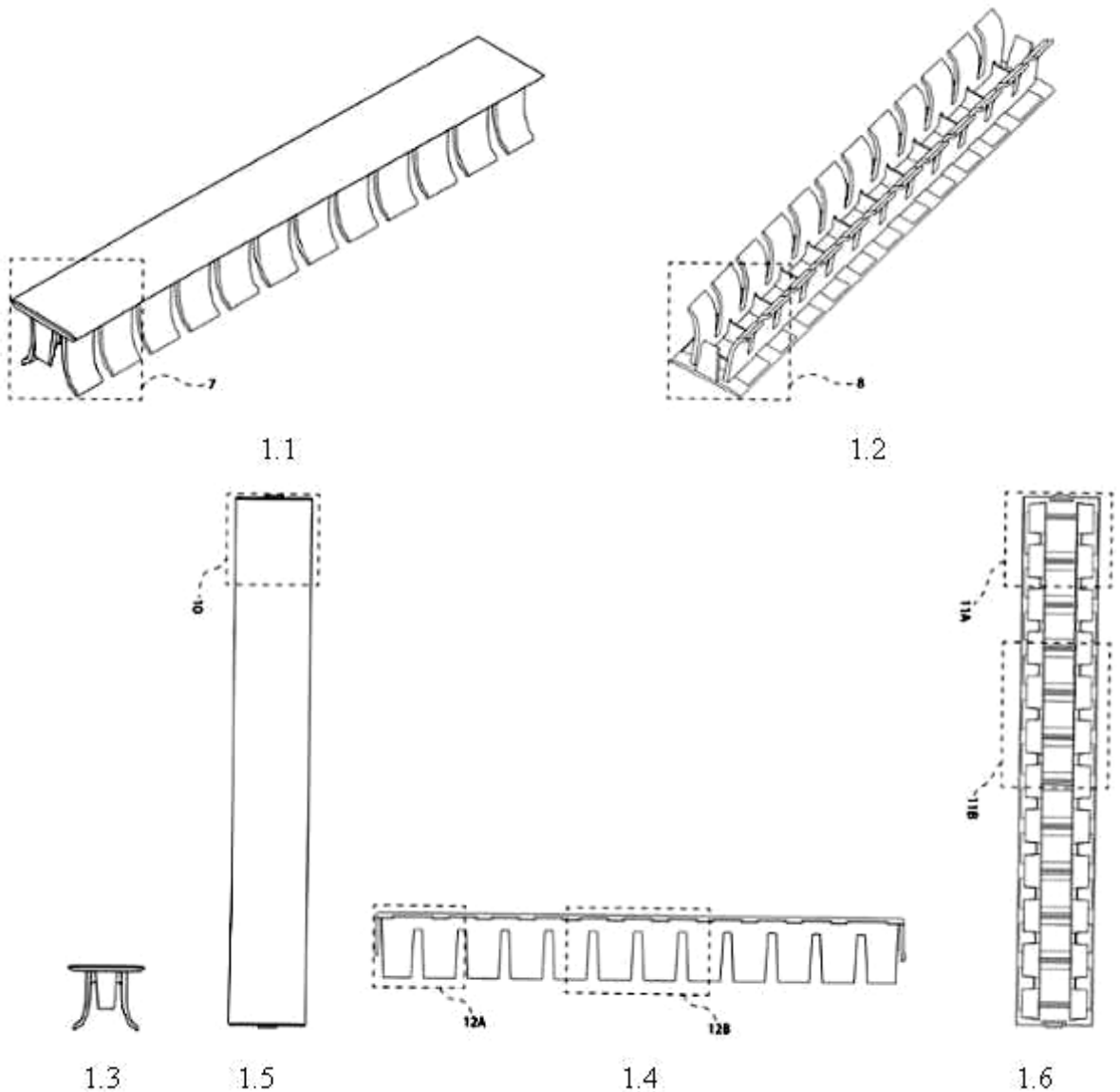





1.7

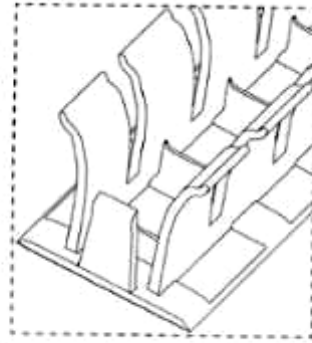

1.8



1.9

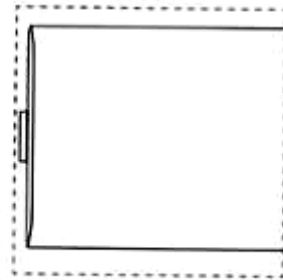

1.10

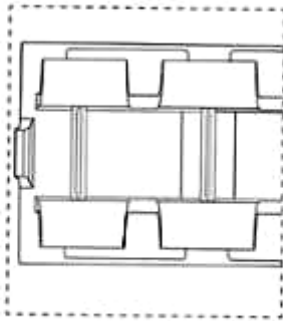

1.11

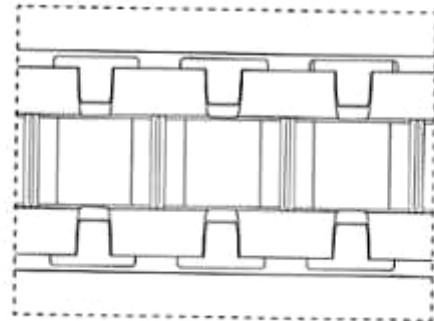

1.12

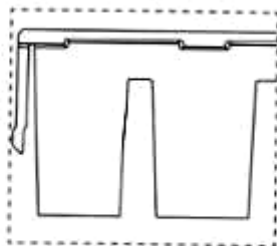

1.13

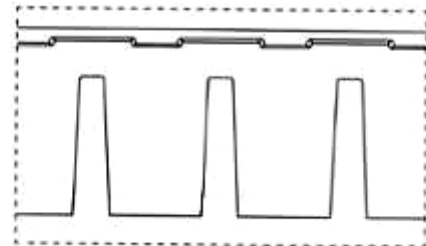

1.14

**CÔNG BÁO SỞ HỮU CÔNG NGHIỆP SỐ 435 TẬP A – QUYỀN 2 (06.2024)**

- (11) **50436**  
(21) 3-2024-00020 (28) 1  
(54) **MẶT ĐỒ TRANG SỨC** (51) **11-01**  
(22) 04/01/2024 (43) 25/06/2024  
(73) **CÔNG TY CỔ PHẦN VÀNG BẠC ĐÁ QUÝ PHÚ NHUẬN (VN)**  
170E Phan Đăng Lưu, phường 03, quận Phú Nhuận, thành phố Hồ Chí Minh  
(72) Võ Ngọc Thùy Anh (VN)  
(74) Công ty Luật TNHH AGL (AGL LAW)  
(55)

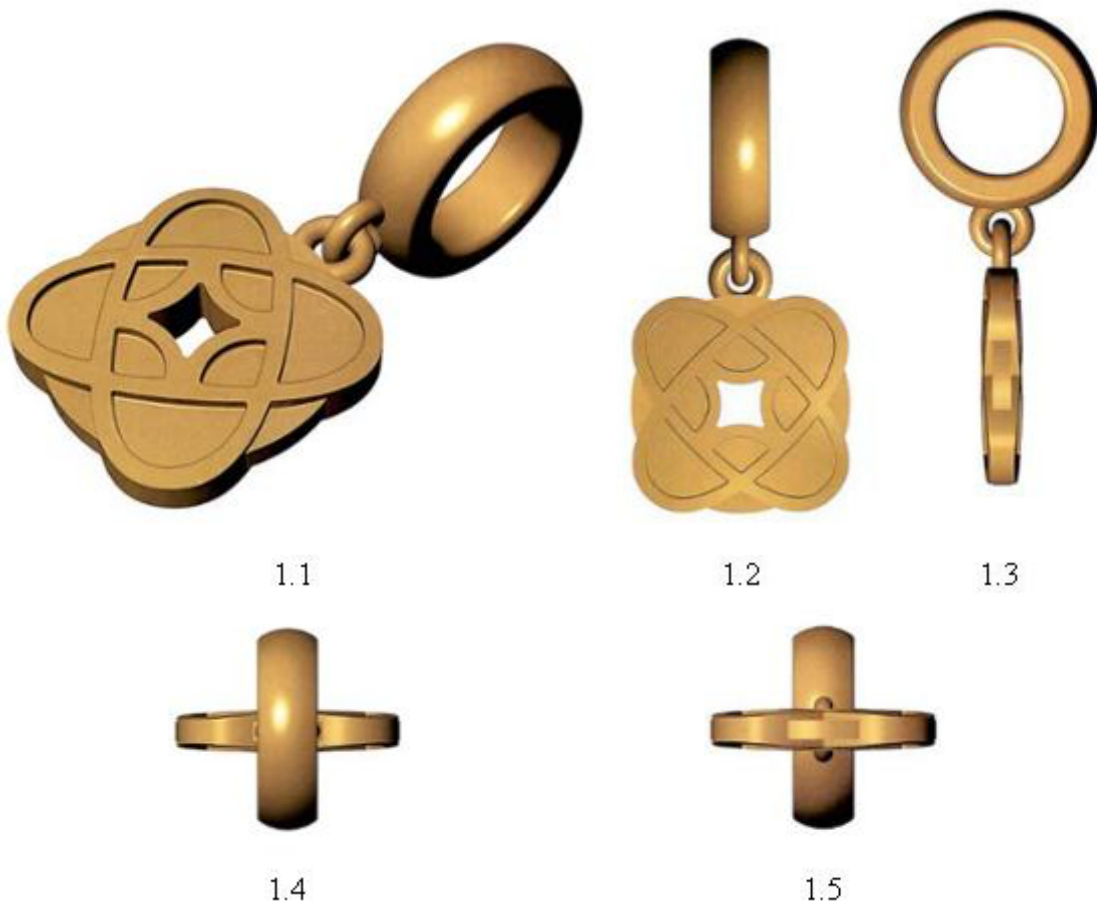

**CÔNG BÁO SỞ HỮU CÔNG NGHIỆP SỐ 435 TẬP A – QUYỀN 2 (06.2024)**

- (11) **50437**  
(21) 3-2024-00028 (28) 1  
(54) **NHÃN** (51) **11-01**  
(22) 04/01/2024 (43) 25/06/2024  
(73) **CÔNG TY CỔ PHẦN VÀNG BẠC ĐÁ QUÝ PHÚ NHUẬN (VN)**  
170E Phan Đăng Lưu, phường 03, quận Phú Nhuận, thành phố Hồ Chí Minh  
(72) Võ Ngọc Thùy Anh (VN)  
(74) Công ty Luật TNHH AGL (AGL LAW)  
(55)



1.1



1.2



1.3



1.4



1.5



1.6

**CÔNG BÁO SỞ HỮU CÔNG NGHIỆP SỐ 435 TẬP A – QUYỀN 2 (06.2024)**

- (11) **50438**  
(21) 3-2024-00031 (28) 1  
(54) **NHÃN** (51) **11-01**  
(22) 04/01/2024 (43) 25/06/2024  
(73) **CÔNG TY CỔ PHẦN VÀNG BẠC ĐÁ QUÝ PHÚ NHUẬN (VN)**  
170E Phan Đăng Lưu, phường 03, quận Phú Nhuận, thành phố Hồ Chí Minh  
(72) Võ Ngọc Thùy Anh (VN)  
(74) Công ty Luật TNHH AGL (AGL LAW)  
(55)



1.1



1.2



1.3



1.4



1.5

**CÔNG BÁO SỞ HỮU CÔNG NGHIỆP SỐ 435 TẬP A – QUYỀN 2 (06.2024)**

- (11) **50439**  
(21) 3-2024-00034 (28) 1  
(54) **NHÃN** (51) **11-01**  
(22) 04/01/2024 (43) 25/06/2024  
(73) **CÔNG TY CỔ PHẦN VÀNG BẠC ĐÁ QUÝ PHÚ NHUẬN (VN)**  
170E Phan Đăng Lưu, phường 03, quận Phú Nhuận, thành phố Hồ Chí Minh  
(72) Võ Ngọc Thùy Anh (VN)  
(74) Công ty Luật TNHH AGL (AGL LAW)  
(55)



1.1



1.2



1.3



1.4



1.5

**CÔNG BÁO SỞ HỮU CÔNG NGHIỆP SỐ 435 TẬP A – QUYỀN 2 (06.2024)**

- (11) **50440**  
(21) 3-2024-00036 (28) 1  
(54) **NHÃN** (51) **11-01**  
(22) 04/01/2024 (43) 25/06/2024  
(73) **CÔNG TY CỔ PHẦN VÀNG BẠC ĐÁ QUÝ PHÚ NHUẬN (VN)**  
170E Phan Đăng Lưu, phường 03, quận Phú Nhuận, thành phố Hồ Chí Minh  
(72) Võ Ngọc Thùy Anh (VN)  
(74) Công ty Luật TNHH AGL (AGL LAW)  
(55)



1.1



1.2



1.3



1.4



1.5

- (11) **50441**  
(21) 3-2024-00057 (28) 1  
(54) **QUAI DÉP** (51) **02-04**  
(22) 05/01/2024 (43) 25/06/2024  
(30) 2321688.0M003 06/07/2023 HK;  
(73) **DAVID FU (CA)**  
Room 2911, 29/F Tower 2, The Gateway, 25 Canton Road, Tsim Sha Tsui,  
Kowloon, Hong Kong  
(72) David FU (CA)  
(74) Công ty TNHH Tầm nhìn và Liên danh (VISION & ASSOCIATES CO.LTD.)  
(55)



1.1

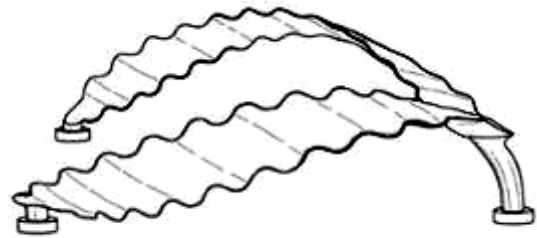

1.2

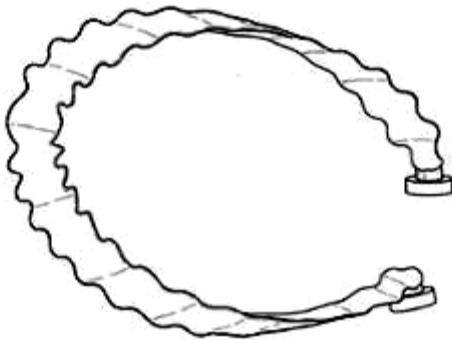

1.3



1.4

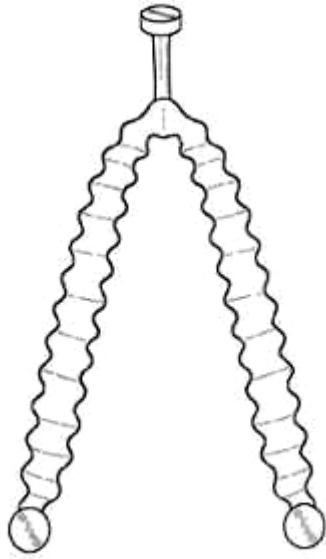

1.5



1.6



1.7



1.8

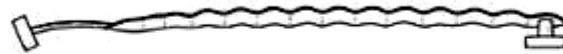

1.9



**CÔNG BÁO SỞ HỮU CÔNG NGHIỆP SỐ 435 TẬP A – QUYỀN 2 (06.2024)**

- (11) **50442**  
(21) 3-2024-00096 (28) 1  
(54) **MÁY XAY THỰC PHẨM** (51) **31-00**  
(22) 10/01/2024 (43) 25/06/2024  
(73) **CÔNG TY CỔ PHẦN ĐẦU TƯ THƯƠNG MẠI BÁCH TƯỜNG PHÁT (VN)**  
Tầng 5, N01-T4 Tower, chung cư Phú Mỹ Complex, khu Ngoại Giao Đoàn, phường  
Xuân Tảo, quận Bắc Từ Liêm, thành phố Hà Nội  
(72) Hoàng Minh Tuấn (VN)  
(55)



1.1



1.2



1.3



1.4



1.5



1.6



1.7

**CÔNG BÁO SỞ HỮU CÔNG NGHIỆP SỐ 435 TẬP A – QUYỀN 2 (06.2024)**

- (11) **50443**  
(21) 3-2024-00148 (28) 1  
(54) **GHẾ** (51) **06-01**  
(22) 18/01/2024 (43) 25/06/2024  
(73) **CÔNG TY TNHH SẢN XUẤT THƯƠNG MẠI DỊCH VỤ QUI PHÚC (VN)**  
217 Bình Long, phường Bình Hưng Hòa A, quận Bình Tân, thành phố Hồ Chí Minh  
(72) Nguyễn Thanh Hải (VN)  
(74) Công ty TNHH Sở hữu trí tuệ Thảo Thọ Quyển (INVENCO.,LTD)  
(55)



1.1



1.2



1.3



1.4



1.5



1.6



1.7

**CÔNG BÁO SỞ HỮU CÔNG NGHIỆP SỐ 435 TẬP A – QUYỀN 2 (06.2024)**

(11) **50444**

(21) 3-2024-00150

(28) 1

(54) **BÀN**

(51) **06-03**

(22) 18/01/2024

(43) 25/06/2024

(73) **CÔNG TY TNHH THƯƠNG MẠI DỊCH VỤ TỔNG HỢP HIQ THIÊN AN (VN)**

Số 33 đường 31 tháng 03, phường Lê Lợi, thành phố Quy Nhơn, tỉnh Bình Định

(72) Nguyễn Ngọc Minh (VN)

(55)



1.1



1.2

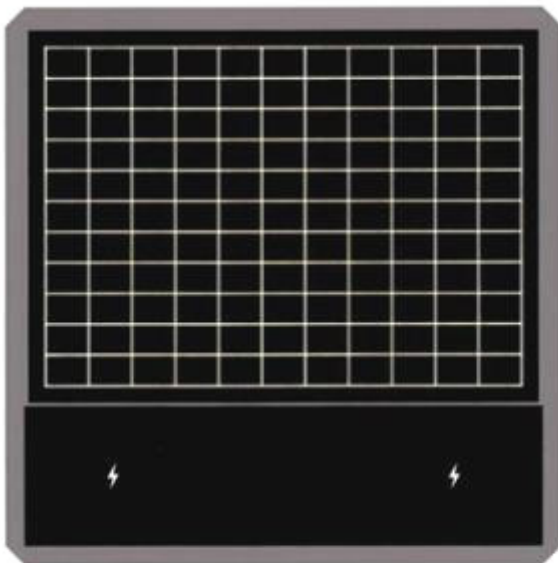

1.3

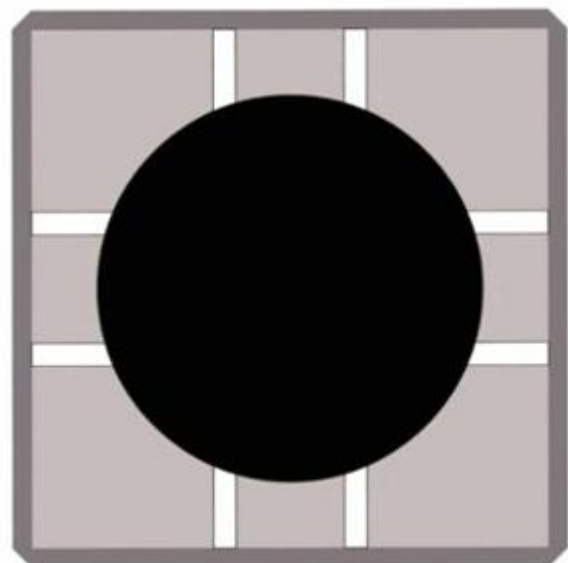

1.4

**CÔNG BÁO SỞ HỮU CÔNG NGHIỆP SỐ 435 TẬP A – QUYỀN 2 (06.2024)**

- (11) **50445**  
(21) 3-2024-00169 (28) 1  
(54) **LON** (51) **09-03**  
(22) 19/01/2024 (43) 25/06/2024  
(73) **CÔNG TY TNHH HOÀNG HƯNG LONG FOODS & DRINKS (VN)**  
255A đường Quốc lộ 13 cũ, khu phố 1, phường Hiệp Bình Phước, thành phố Thủ Đức, thành phố Hồ Chí Minh  
(72) Trần Hữu Phương (VN)  
(55)



1.1



1.2



1.3



1.4



1.5



1.6



1.7

(11) **50446**

(21) 3-2024-00203

(28) 1

(54) **VẬT MÌ**

(51) **01-01**

(22) 23/01/2024

(43) 25/06/2024

(73) **CÔNG TY CỔ PHẦN ACECOOK VIỆT NAM (VN)**

Lô số II-3, đường số 11, nhóm CN II, khu công nghiệp Tân Bình, phường Tây Thạnh, quận Tân Phú, thành phố Hồ Chí Minh

(72) KANEDA HIROKI (JP)

(74) Công ty Luật TNHH Phạm và Liên danh (PHAM & ASSOCIATES)

(55)



1.1



1.2



1.3



1.4



1.5



1.6



1.7

**CÔNG BÁO SỞ HỮU CÔNG NGHIỆP SỐ 435 TẬP A – QUYỀN 2 (06.2024)**

- (11) **50447**  
(21) 3-2024-00215 (28) 1  
(54) **KHÓA TRƯỢT DÂY CỨU SINH** (51) **08-07**  
(22) 24/01/2024 (43) 25/06/2024  
(73) **CÔNG TY CỔ PHẦN AN TOÀN SSTC (VN)**  
372/6 Dương Thị Mười, khu phố 3, phường Tân Thới Hiệp, quận 12, thành phố Hồ Chí Minh  
(72) Dương Đình Luân (VN)  
(74) Công ty Cổ phần Sở hữu công nghiệp INVESTIP (INVESTIP)  
(55)

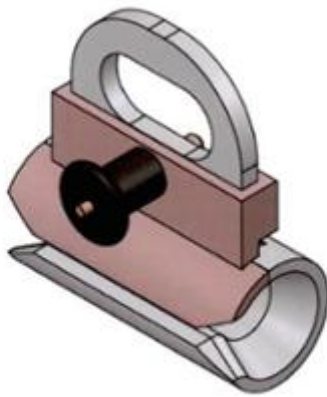

1.1

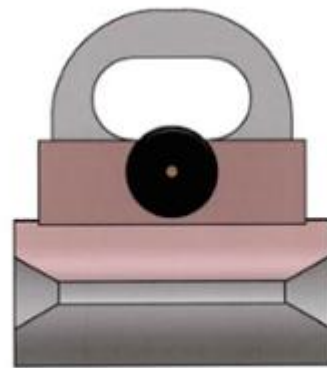

1.2

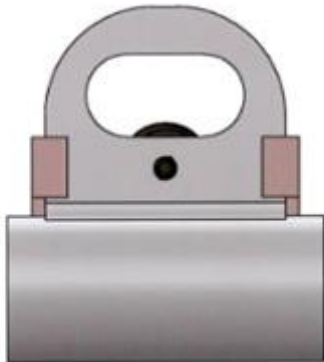

1.3



1.4

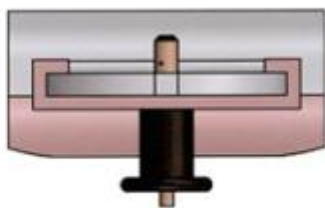

1.5



1.6



**CÔNG BÁO SỞ HỮU CÔNG NGHIỆP SỐ 435 TẬP A – QUYỀN 2 (06.2024)**

- (11) **50448**  
(21) 3-2024-00235 (28) 1  
(54) **GIƯỜNG Y TẾ** (51) **06-02**  
(22) 26/01/2024 (43) 25/06/2024  
(73) **CÔNG TY CỔ PHẦN SẢN XUẤT VÀ THƯƠNG MẠI MBH (VN)**  
Số nhà 22, ngách 197/50 đường Phúc Lợi, phường Phúc Lợi, quận Long Biên, thành phố Hà Nội  
(72) Bùi Duy Hiệp (VN)  
(55)

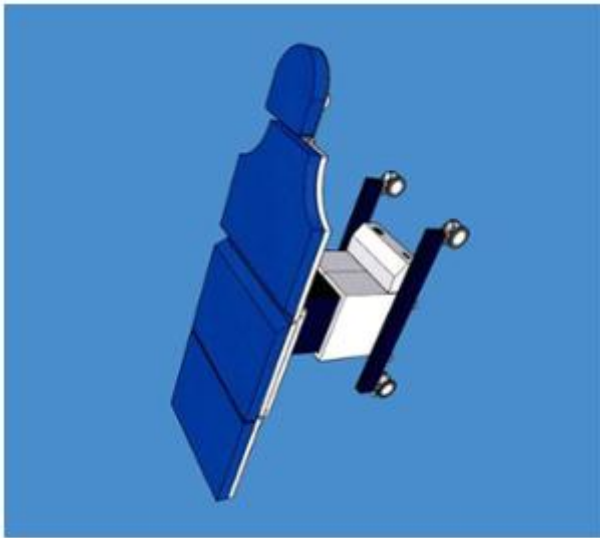

1.1



1.2



1.3



1.4



1.5

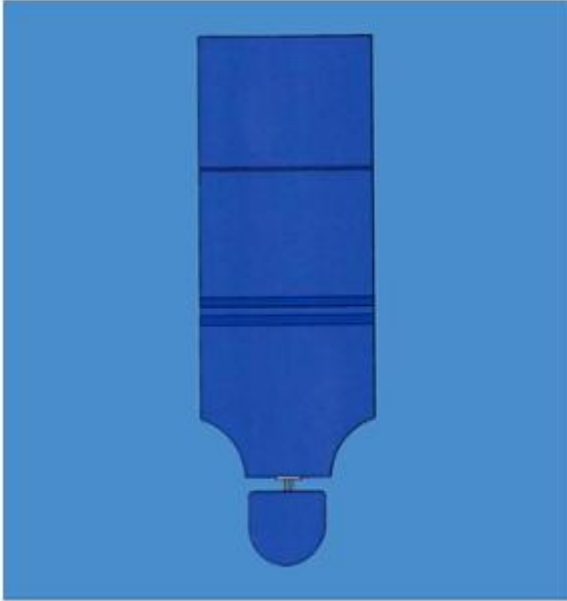

1.6

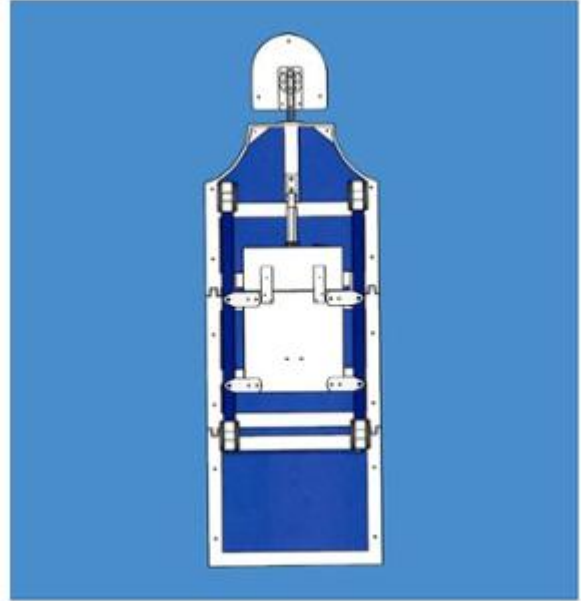

1.7

**CÔNG BÁO SỞ HỮU CÔNG NGHIỆP SỐ 435 TẬP A – QUYỀN 2 (06.2024)**

- (11) **50449**  
(21) 3-2024-00271 (28) 2  
(54) **XE Ô TÔ** (51) **12-08**  
(22) 30/01/2024 (43) 25/06/2024  
(30) 2023304854345 01/08/2023 CN;  
(73) **BYD COMPANY LIMITED (CN)**  
No.3009, BYD Road, Pingshan, Shenzhen, Guangdong 518118, China  
(72) 1. EGGER, WOLFGANG JOSEF (DE)  
2. PAN, ZILIN (CN)  
3. CHEN, MENG (CN)  
4. WANG, XI (CN)  
5. CHEN, KAISI (CN)  
(74) Công ty TNHH Sở hữu trí tuệ Thảo Thọ Quyển (INVENCO.,LTD)  
(55)



1.1



1.2



1.3



1.4

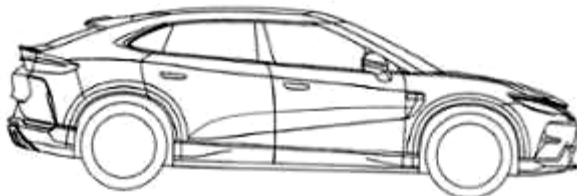

1.5

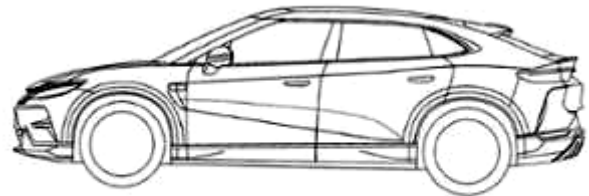

1.6

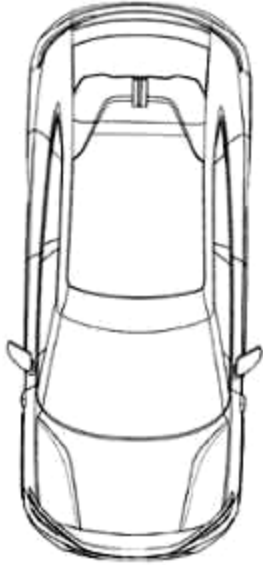

1.7



2.1



2.2



2.3



2.4



2.5



2.6



2.7

**CÔNG BÁO SỞ HỮU CÔNG NGHIỆP SỐ 435 TẬP A – QUYỀN 2 (06.2024)**

- (11) **50450**  
(21) 3-2024-00272 (28) 1  
(54) **THÂN ĐỒNG HỒ THÔNG MINH** (51) **10-02; 10-07**  
(22) 30/01/2024 (43) 25/06/2024  
(30) 202330487001.3 01/08/2023 CN;  
(73) **HUAWEI TECHNOLOGIES CO., LTD. (CN)**  
Huawei Administration Building, Bantian, Longgang District, Shenzhen,  
Guangdong 518129, P. R. China  
(72) 1. YUAN, XIANG (CN)  
2. SHEN, XIJIE (CN)  
(74) Công ty Cổ phần Sở hữu công nghiệp INVESTIP (INVESTIP)  
(55)

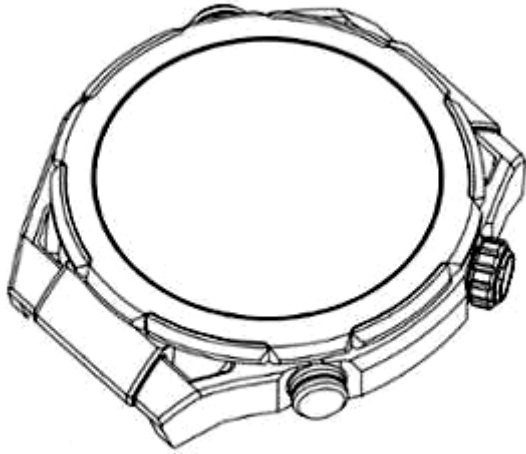

1.1

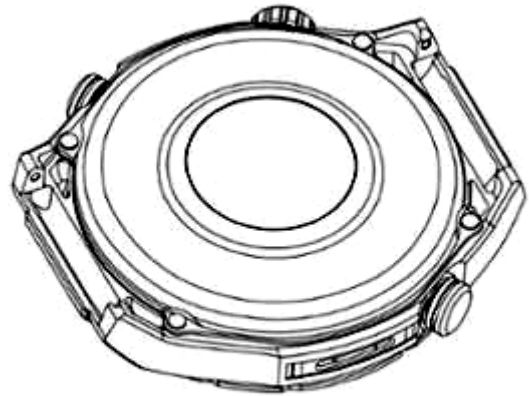

1.2

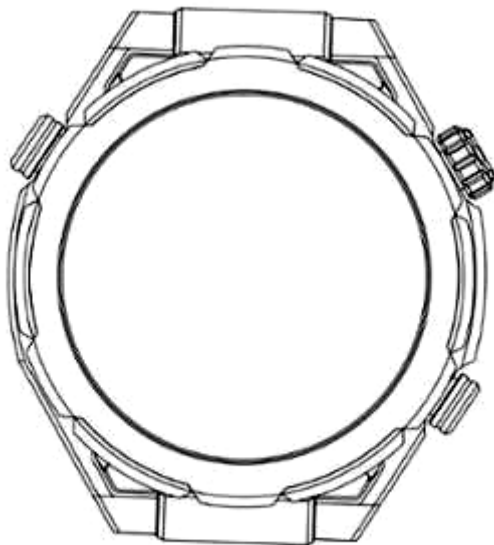

1.3

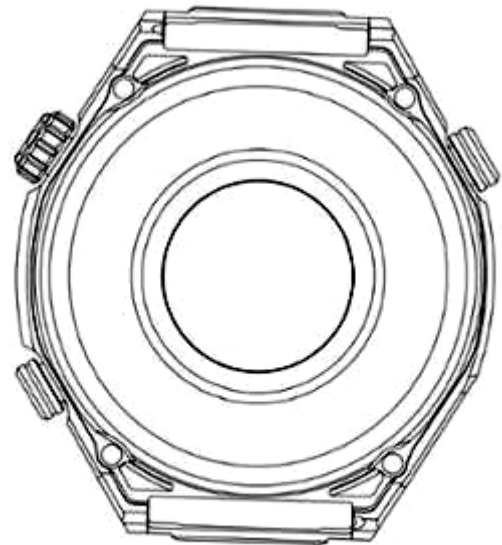

1.4

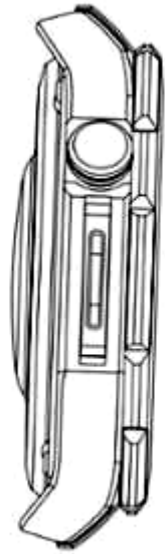

1.5

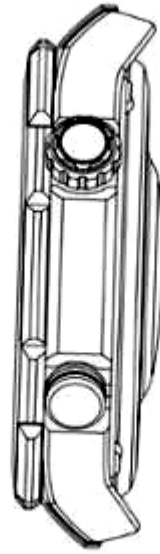

1.6

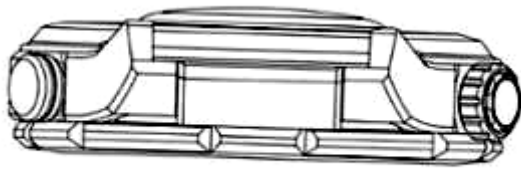

1.7

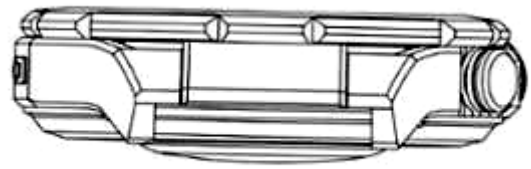

1.8

- (11) **50451**  
(21) 3-2024-00273 (28) 1  
(54) **THÂN ĐỒNG HỒ THÔNG MINH** (51) **10-02; 10-07**  
(22) 30/01/2024 (43) 25/06/2024  
(30) 202330487019.3 01/08/2023 CN;  
(73) **HUAWEI TECHNOLOGIES CO., LTD. (CN)**  
Huawei Administration Building, Bantian, Longgang District, Shenzhen,  
Guangdong 518129, P. R. China  
(72) YUAN, Xiang (CN)  
(74) Công ty Cổ phần Sở hữu công nghiệp INVESTIP (INVESTIP)  
(55)



1.1

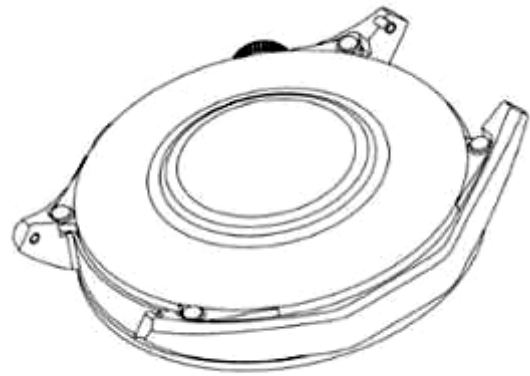

1.2



1.3

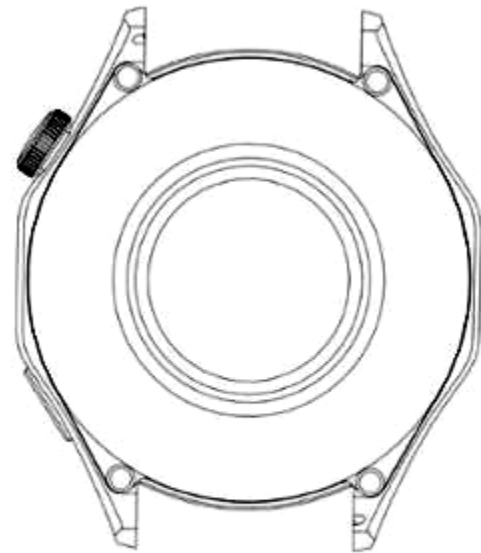

1.4





1.5



1.6



1.7



1.8

- (11) **50452**  
(21) 3-2024-00274 (28) 1  
(54) **THÂN ĐỒNG HỒ THÔNG MINH** (51) **10-02; 10-07**  
(22) 30/01/2024 (43) 25/06/2024  
(30) 202330487039.0 01/08/2023 CN;  
(73) **HUAWEI TECHNOLOGIES CO., LTD. (CN)**  
Huawei Administration Building, Bantian, Longgang District, Shenzhen,  
Guangdong 518129, P. R. China  
(72) YUAN, Xiang (CN)  
(74) Công ty Cổ phần Sở hữu công nghiệp INVESTIP (INVESTIP)  
(55)



1.1

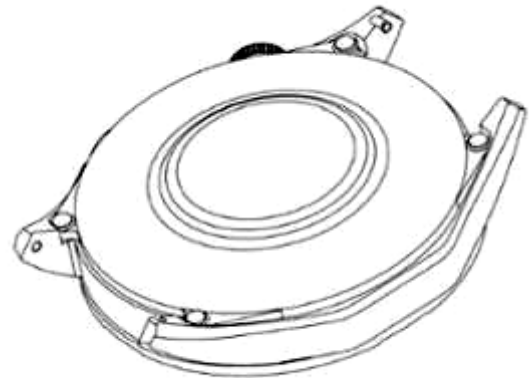

1.2

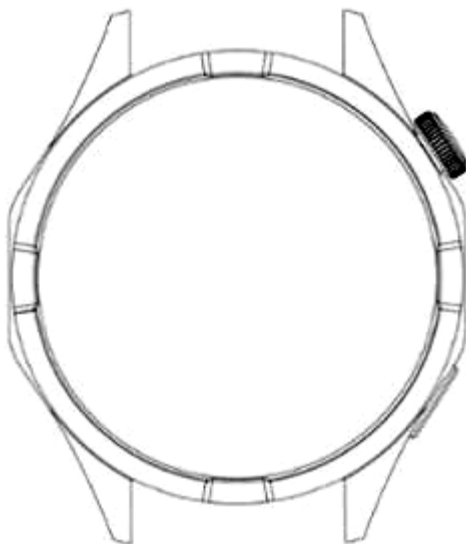

1.3

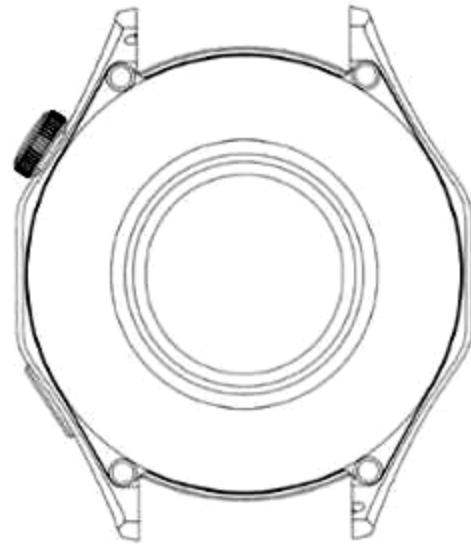

1.4



1.5

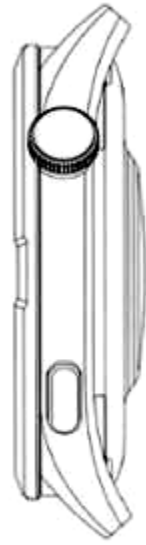

1.6

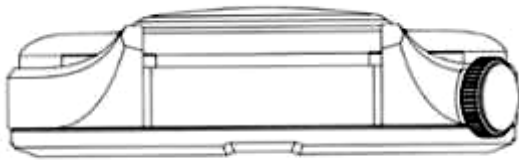

1.7



1.8

**CÔNG BÁO SỞ HỮU CÔNG NGHIỆP SỐ 435 TẬP A – QUYỀN 2 (06.2024)**

- (11) **50453**
- (21) 3-2024-00285
- (54) **BÀN CỜ**
- (22) 31/01/2024
- (73) **ĐÀO TRIỆU NGUYỄN (VN)**  
259 Võ Văn Tần, phường 5, quận 3, thành phố Hồ Chí Minh
- (72) Đào Triệu Nguyên (VN)
- (74) Văn phòng Luật sư A Hoà (AHOA LAW OFFICE)
- (55)
- (28) 1
- (51) **21-01**
- (43) 25/06/2024

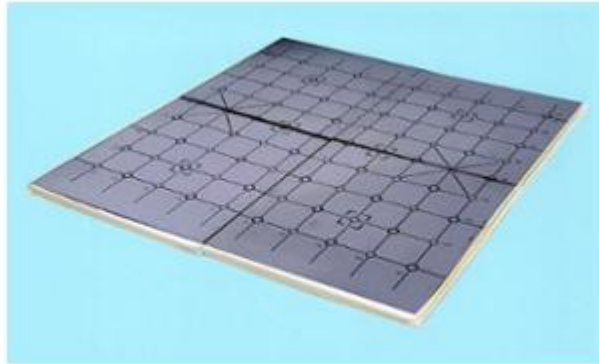

1.1



1.2



1.3

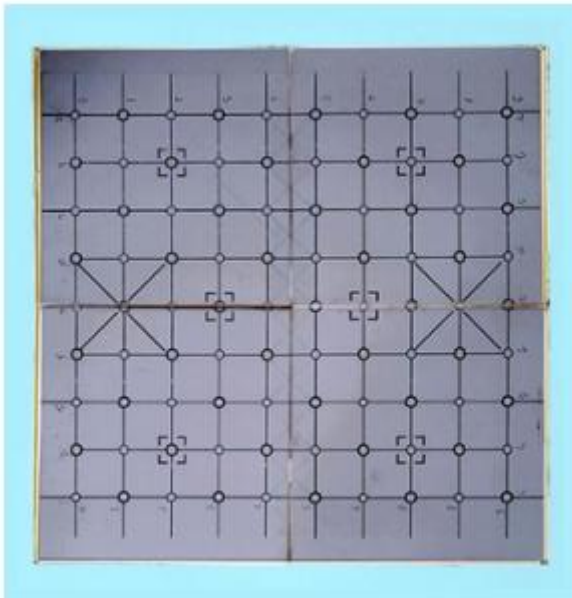

1.4



1.5

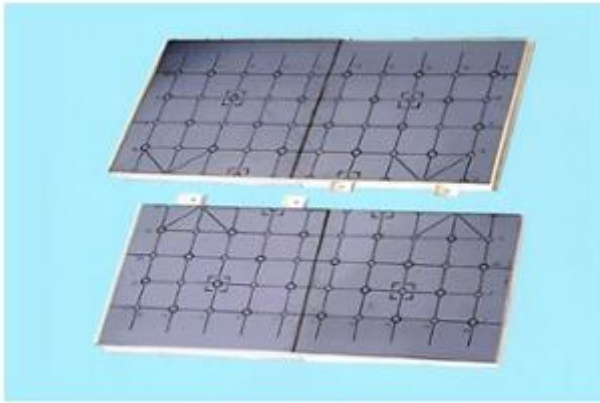

1.6

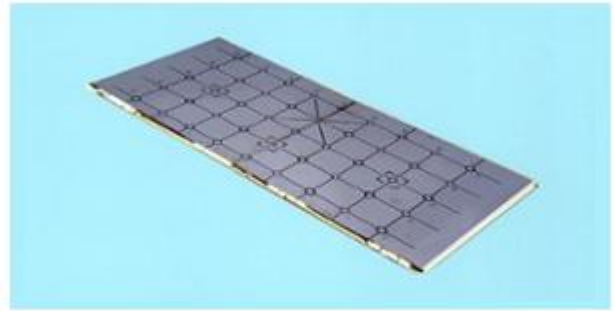

1.7

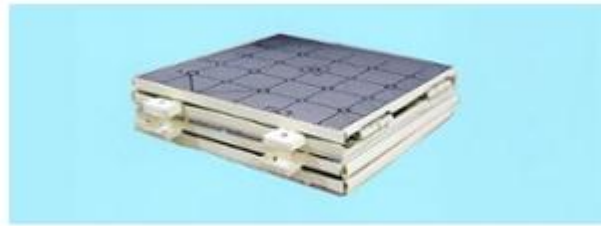

1.8

**CÔNG BÁO SỞ HỮU CÔNG NGHIỆP SỐ 435 TẬP A – QUYỀN 2 (06.2024)**

- (11) **50454**  
(21) 3-2024-00326 (28) 1  
(54) **DỤNG CỤ CHĂM SÓC CÁ NHÂN** (51) **04-02**  
(22) 02/02/2024 (43) 25/06/2024  
(30) 29/909,836 11/08/2023 US;  
(73) **COLGATE-PALMOLIVE COMPANY (US)**  
300 Park Avenue, New York, New York 10022, United States of America  
(72) 1. TAKAHIDE OKAI (JP)  
2. YANMEI JI (CN)  
3. YONGCHAO TIAN (CN)  
4. CHRISTOPHER HARSACKY (US)  
5. DYLAN FEALTMAN (US)  
6. ERAN VAUTOUR (US)  
7. ZHIZHONG CHEN (CN)  
(74) Văn phòng Luật sư Ân Nam (ANNAM IP & LAW)  
(55)



1.1

1.2

1.3

1.4

1.5

1.6



1.7



1.8

**CÔNG BÁO SỞ HỮU CÔNG NGHIỆP SỐ 435 TẬP A – QUYỀN 2 (06.2024)**

(11) **50455**

(21) 3-2024-00331

(28) 1

(54) **LỖI LỌC NƯỚC**

(51) **23-01**

(22) 05/02/2024

(43) 25/06/2024

(73) **TRẦN VĂN TÍN (VN)**

Áp 2, xã Tân Hiệp, huyện Phú Giáo, tỉnh Bình Dương

(72) Trần Văn Tín (VN)

(74) Văn phòng Luật sư A Hoà (AHOA LAW OFFICE)

(55)

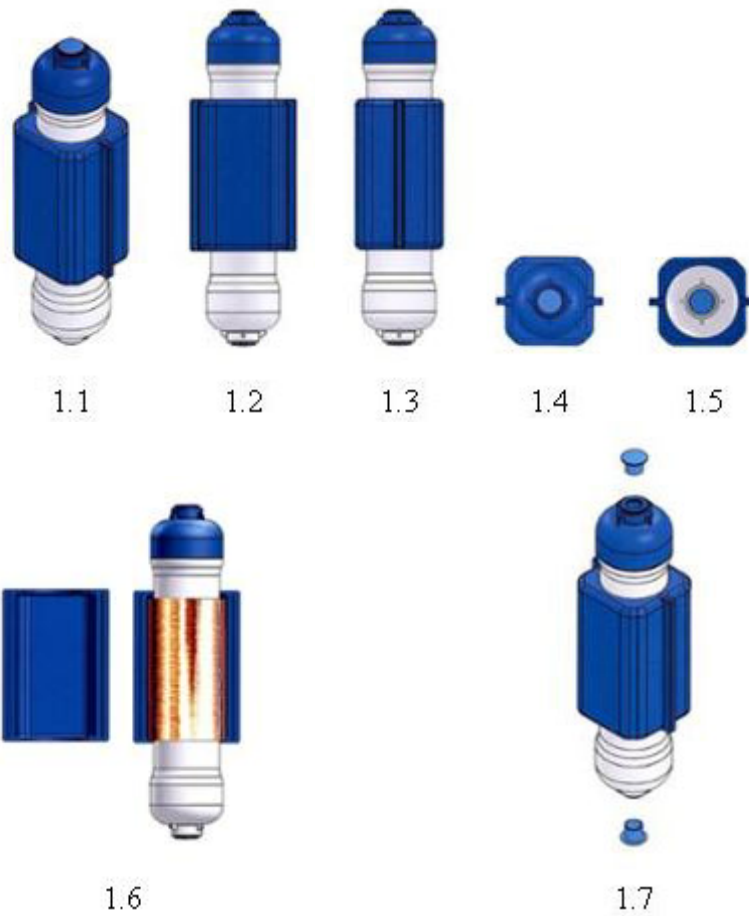

- (11) **50456**  
(21) 3-2024-00335 (28) 1  
(54) **GIÁ TREO** (51) **25-04**  
(22) 05/02/2024 (43) 25/06/2024  
(73) **CÔNG TY TNHH XÂY DỰNG FORMTECH (VN)**  
Số 1370B, đường Trường Sa, phường 3, quận Tân Bình, thành phố Hồ Chí Minh  
(72) Trần Hồng Thái (VN)  
(74) Công ty Cổ phần Sở hữu công nghiệp INVESTIP (INVESTIP)  
(55)

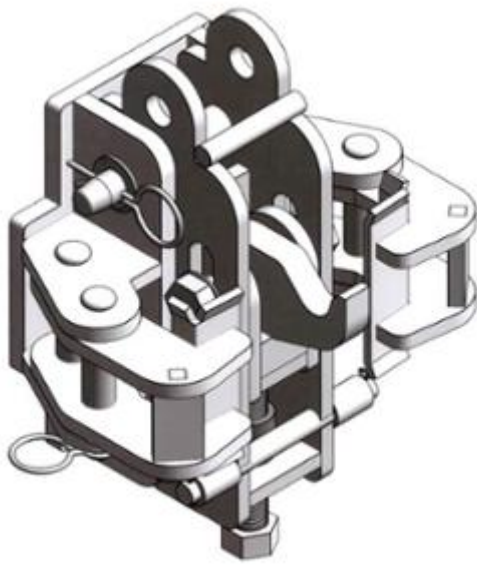

1.1

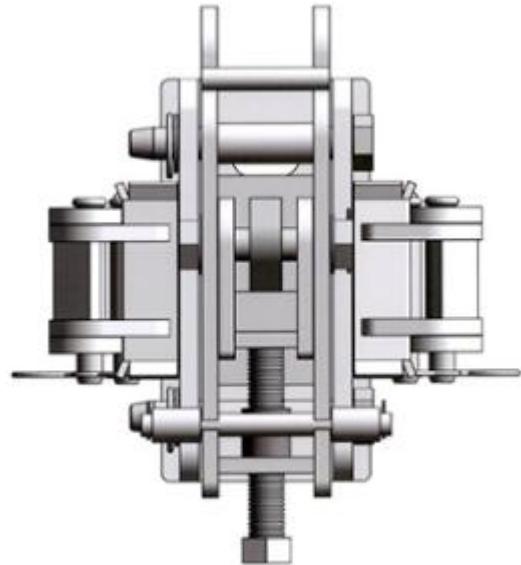

1.2

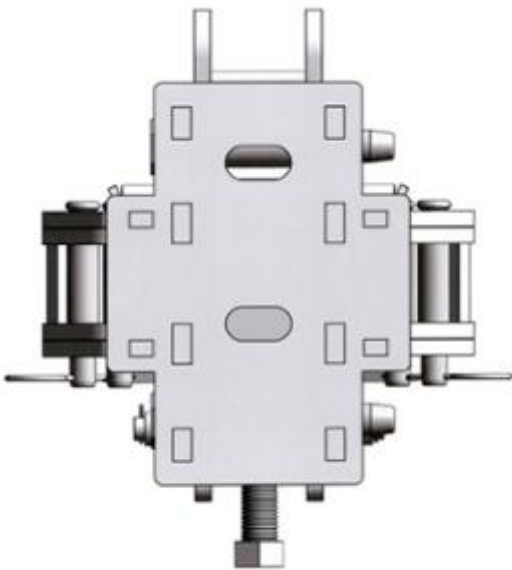

1.3

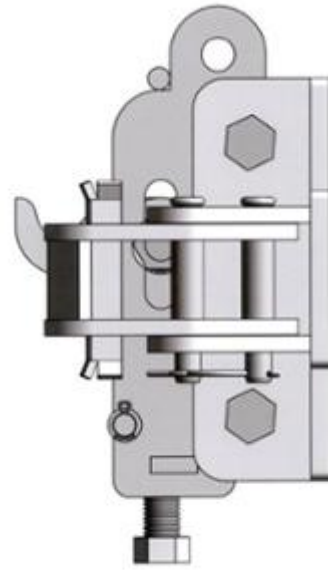

1.4



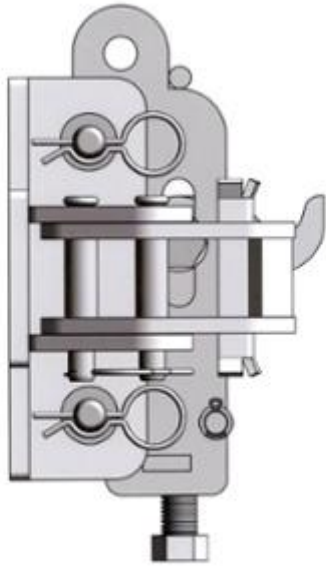

1.5

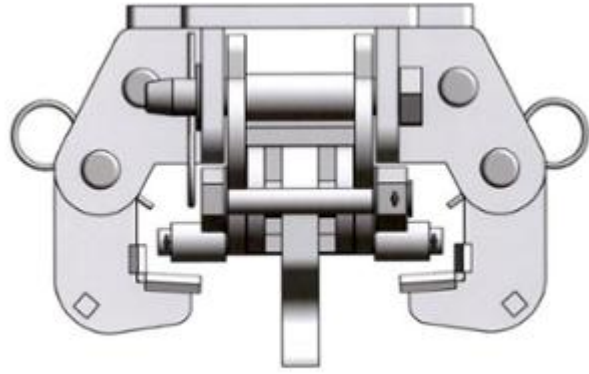

1.6

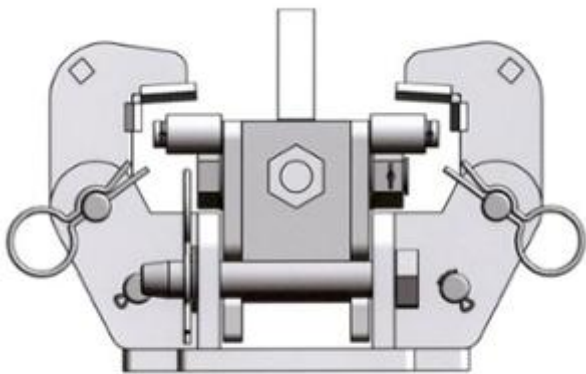

1.7

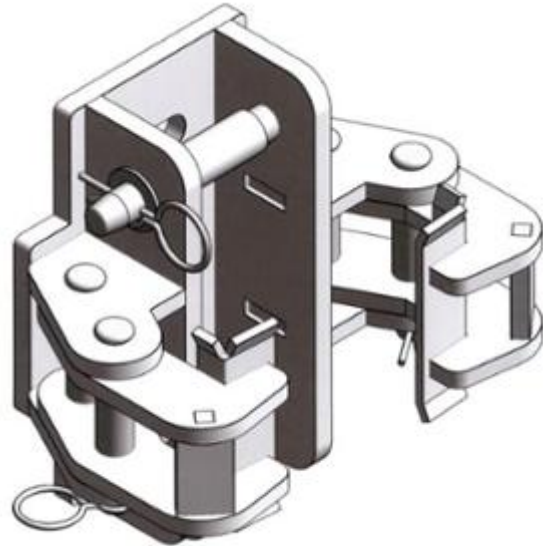

1.8



1.9



1.10

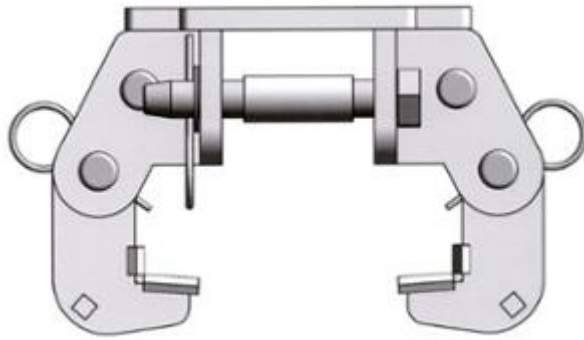

1.11



1.12

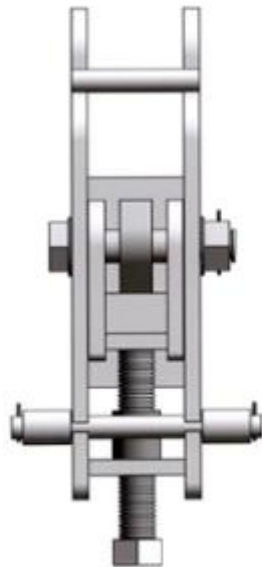

1.13

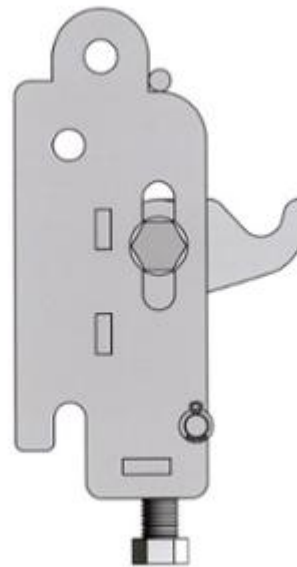

1.14



1.15

**CÔNG BÁO SỞ HỮU CÔNG NGHIỆP SỐ 435 TẬP A – QUYỀN 2 (06.2024)**

- (11) **50457**  
(21) 3-2024-00369 (28) 1  
(54) **MÁY MAY** (51) **15-06**  
(22) 16/02/2024 (43) 25/06/2024  
(30) 29/900,155 17/08/2023 US; 29/900,158 17/08/2023 US; 29/900,157 17/08/2023 US;  
(73) **SINGER SOURCING LIMITED LLC (US)**  
1714 Heil Quaker Boulevard, LaVergne, TN 37086, United States of America  
(72) 1. FRANCISCO JAVIER BARQUIN (US)  
2. JONATHAN MARK FAIRBANKS (US)  
(74) Công ty Luật TNHH T&G (TGVN)  
(55)

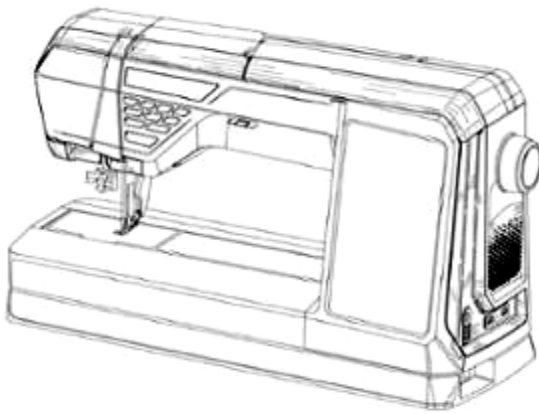

1.1

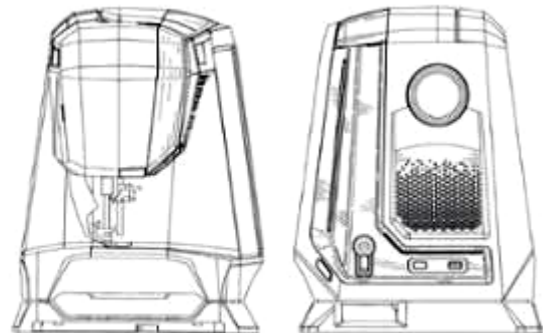

1.2



1.3

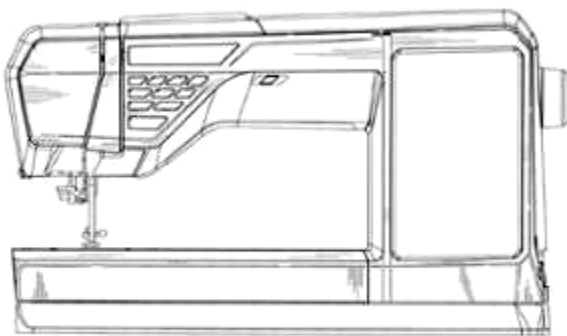

1.4

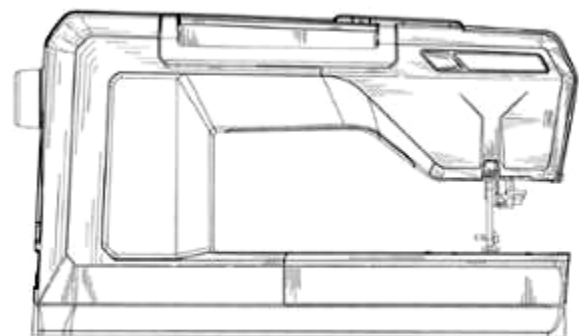

1.5

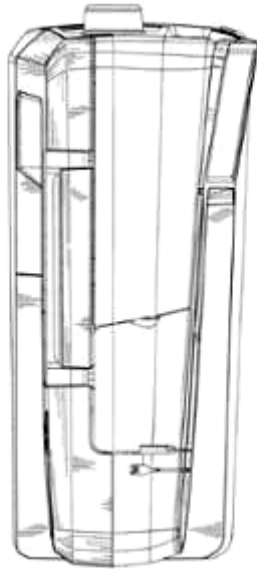

1.6



1.7

**CÔNG BÁO SỞ HỮU CÔNG NGHIỆP SỐ 435 TẬP A – QUYỀN 2 (06.2024)**

- (11) **50458**  
(21) 3-2024-00406 (28) 1  
(54) **BAO GÓI** (51) **09-05**  
(22) 21/02/2024 (43) 25/06/2024  
(73) **CÔNG TY TRÁCH NHIỆM HỮU HẠN CON CÒ VÀNG (VN)**  
23 Lô B đường số 1, phường Phú Thuận, quận 7, thành phố Hồ Chí Minh  
(72) Hoàng Mai Dẫn (VN)  
(74) Công ty TNHH một thành viên Trường Luật (Trường Luật)  
(55)



1.1



1.2

**CÔNG BÁO SỞ HỮU CÔNG NGHIỆP SỐ 435 TẬP A – QUYỀN 2 (06.2024)**

- (11) **50459**  
(21) 3-2024-00434 (28) 1  
(54) **ROBOT TỰ HÀNH** (51) **12-14**  
(22) 23/02/2024 (43) 25/06/2024  
(73) **CÔNG TY TNHH LEON LEGION (VN)**  
269 đường Liên Phường, phường Phước Long B, thành phố Thủ Đức, thành phố Hồ Chí Minh  
(72) Hoàng Xuân Thành (VN)  
(74) Công ty Luật TNHH Tư vấn Quốc tế (INDOCHINE COUNSEL)  
(55)



1.1



1.2



1.3



1.4



1.5



1.6



1.7



1.8

- (11) **50460**  
(21) 3-2024-00448 (28) 1  
(54) **KHUNG CHÍNH CỦA ĐẦU CẮT TRỘN ĐẤT XI MĂNG** (51) **15-04**  
(22) 27/02/2024 (43) 25/06/2024  
(73) **LƯƠNG PHÚ CƯỜNG (VN)**  
769/49/15 Cách Mạng Tháng Tám, phường Chánh Nghĩa, thành phố Thủ Dầu Một, tỉnh Bình Dương  
(72) Lương Phú Cường (VN)  
(74) Công ty TNHH Tư vấn - Dịch thuật - Sở hữu trí tuệ Á Đông (Á Đông IP CONSULTANCY CO.,LTD.)  
(55)

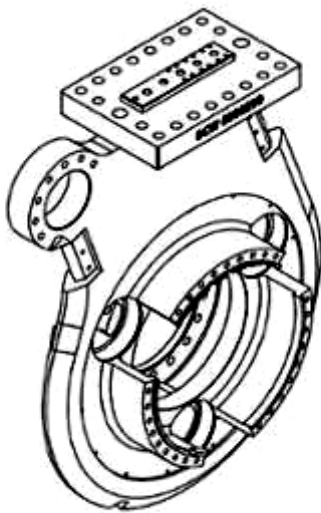

1.1

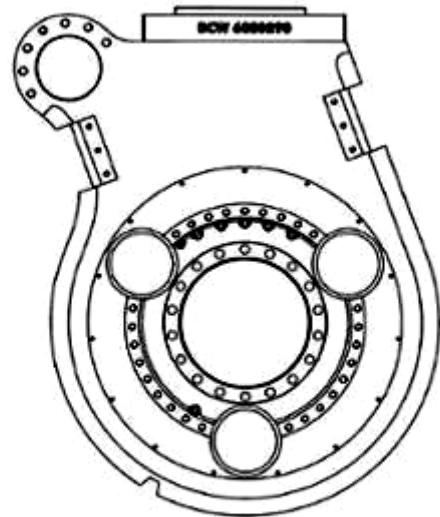

1.2

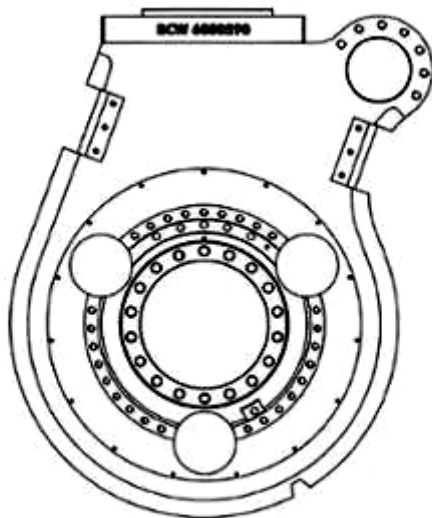

1.3

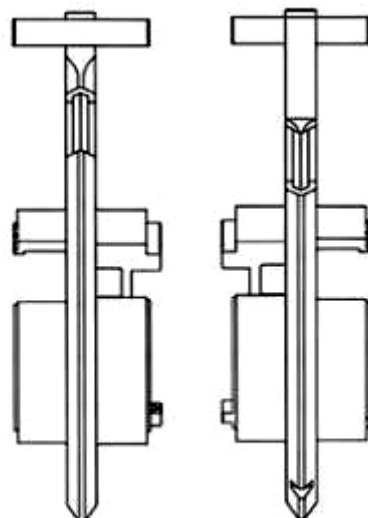

1.4

1.5

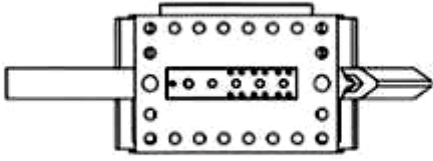

1.6

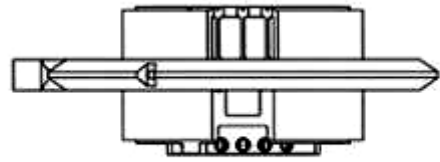

1.7



- (11) **50461**  
(21) 3-2024-00449 (28) 1  
(54) **ĐẦU CẮT TRỘN ĐẤT XI MĂNG** (51) **15-04**  
(22) 27/02/2024 (43) 25/06/2024  
(73) **LƯƠNG PHÚ CƯỜNG (VN)**  
769/49/15 Cách Mạng Tháng Tám, phường Chánh Nghĩa, thành phố Thủ Dầu Một, tỉnh Bình Dương  
(72) Lương Phú Cường (VN)  
(74) Công ty TNHH Tư vấn - Dịch thuật - Sở hữu trí tuệ Á Đông (Á Đông IP CONSULTANCY CO.,LTD.)  
(55)

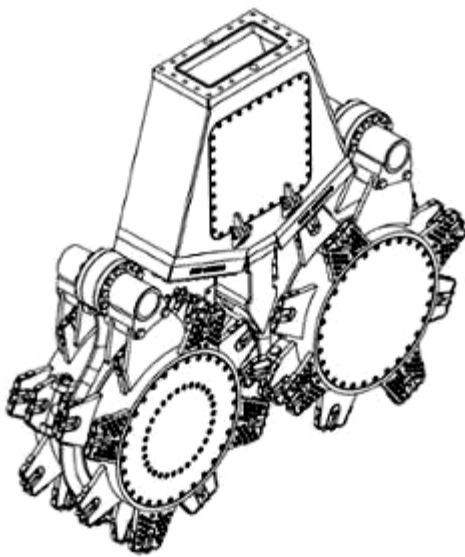

1.1

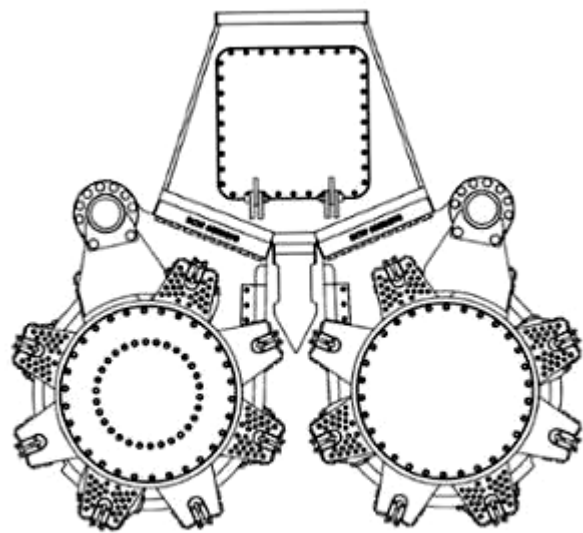

1.2

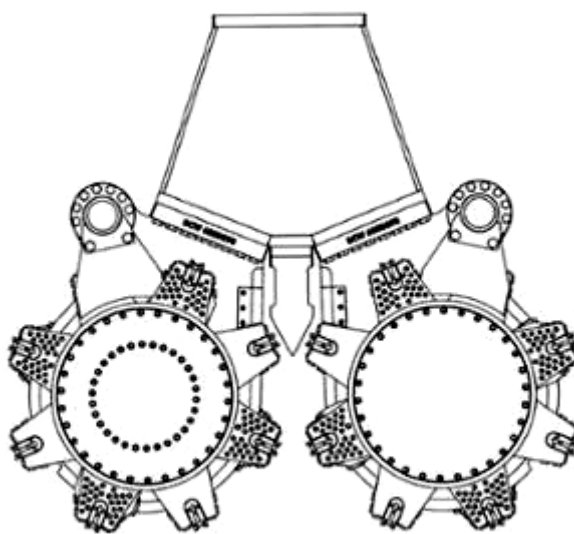

1.3

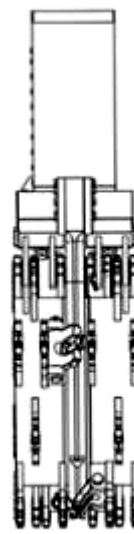

1.4

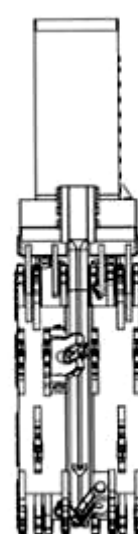

1.5

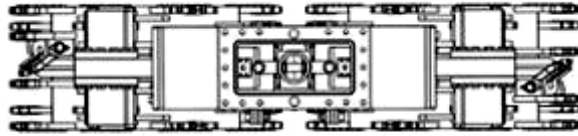

1.6

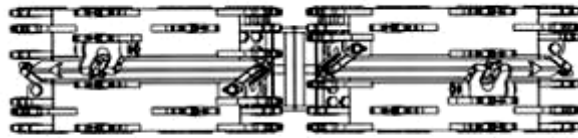

1.7

**CÔNG BÁO SỞ HỮU CÔNG NGHIỆP SỐ 435 TẬP A – QUYỀN 2 (06.2024)**

- (11) **50462**
- (21) 3-2024-00452 (28) 1
- (54) **HỘP** (51) **09-03**
- (22) 27/02/2024 (43) 25/06/2024
- (73) **ORION CORPORATION (KR)**  
13, Baekbeom-ro 90da-gil, Yongsan-gu, Seoul 04369, Republic of Korea
- (72) 1. CHOE, EUN JE (KR)  
2. OH, HYUN SUN (KR)
- (74) Công ty Luật TNHH quốc tế BMVN (BMVN INTERNATIONAL LLC)
- (55)



1.1



1.2

**CÔNG BÁO SỞ HỮU CÔNG NGHIỆP SỐ 435 TẬP A – QUYỀN 2 (06.2024)**

- (11) **50463**  
(21) 3-2024-00463 (28) 1  
(54) **KHÓA CỬA THÔNG MINH** (51) **08-07**  
(22) 28/02/2024 (43) 25/06/2024  
(73) **CÔNG TY TNHH VẬT TƯ THIẾT BỊ ĐẠI QUANG MINH (VN)**  
Số nhà 25 LK38, KĐT mới Vân Canh, xã Vân Canh, huyện Hoài Đức, thành phố Hà Nội  
(72) Trần Xuân Diệu (VN)  
(74) Công ty TNHH Sở hữu trí tuệ VIPATCO (VIPATCO CO., LTD.)  
(55)

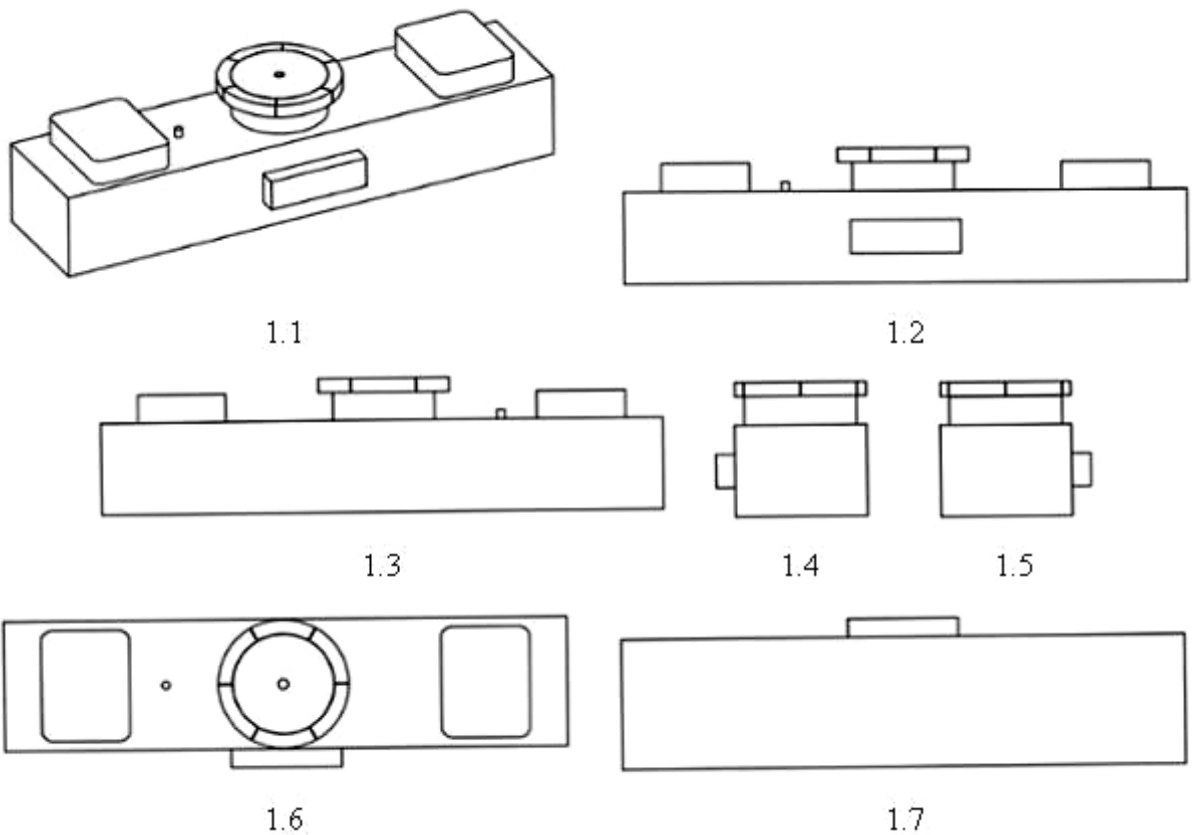

**CÔNG BÁO SỞ HỮU CÔNG NGHIỆP SỐ 435 TẬP A – QUYỀN 2 (06.2024)**

- (11) **50464**
- (21) 3-2024-00465 (28) 3
- (54) **NHÃN SẢN PHẨM** (51) **19-08**
- (22) 28/02/2024 (43) 25/06/2024
- (73) **CÔNG TY CỔ PHẦN SAO VIỆT NAM (VN)**  
Tầng 6, tòa CT4, ECO Green, khu đô thị Tây Nam Kim Giang, xã Tân Triều, huyện Thanh Trì, thành phố Hà Nội
- (72) Nguyễn Thị Nhung (VN)
- (74) Công ty Luật TNHH LEADCONSULT (LEADCONSULT)
- (55)



1.1



2.1



3.1

**CÔNG BÁO SỞ HỮU CÔNG NGHIỆP SỐ 435 TẬP A – QUYỀN 2 (06.2024)**

- (11) **50465**
- (21) 3-2024-00472
- (54) **MÁY BÁN ĐỒ UỐNG**
- (22) 29/02/2024
- (30) 29/903,130 20/09/2023 US;
- (73) **YO-KAI EXPRESS INC. (US)**  
3501 breakwater ct, Hayward, CA 94545, U.S.A.
- (72) Chih Hung Lin (US)
- (74) Công ty Luật TNHH Phạm và Liên danh (PHAM & ASSOCIATES)
- (55)

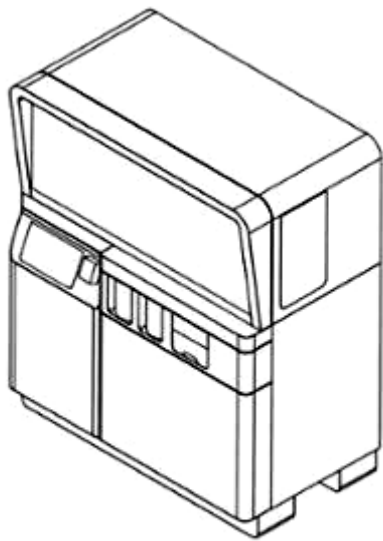

1.1

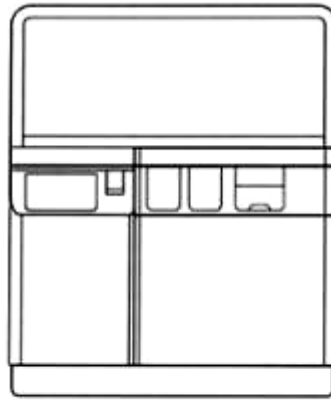

1.2

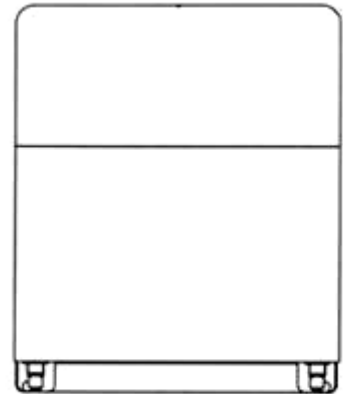

1.3

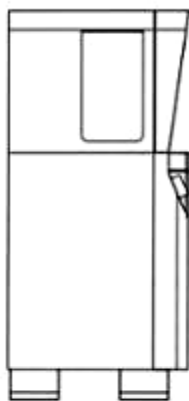

1.4

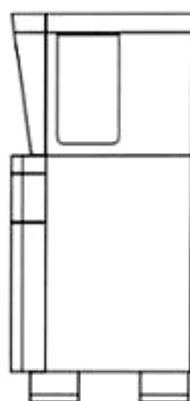

1.5

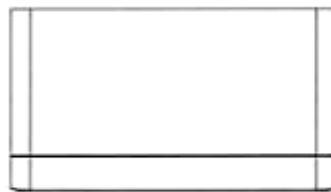

1.6



1.7

**CÔNG BÁO SỞ HỮU CÔNG NGHIỆP SỐ 435 TẬP A – QUYỀN 2 (06.2024)**

- (11) **50466**
- (21) 3-2024-00475 (28) 1
- (54) **BAO GÓI SẢN PHẨM** (51) **09-05**
- (22) 29/02/2024 (43) 25/06/2024
- (73) **CÔNG TY TNHH VIỆT THẮNG (VN)**  
Tòa nhà đa năng Việt Thắng, đường Hoàng Văn Thụ, phường Xương Giang, thành phố Bắc Giang, tỉnh Bắc Giang
- (72) Lê Văn Thịnh (VN)
- (74) Công ty Luật TNHH WINCO (WINCO LAW FIRM)
- (55)

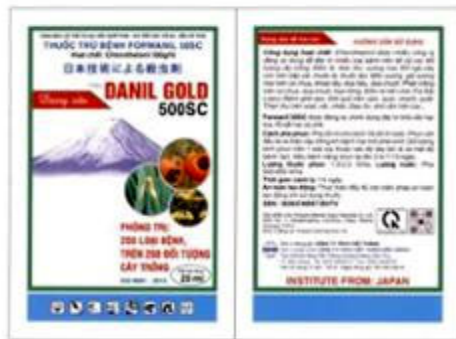

1.1



1.2

**CÔNG BÁO SỞ HỮU CÔNG NGHIỆP SỐ 435 TẬP A – QUYỀN 2 (06.2024)**

- (11) **50467**
- (21) 3-2024-00478 (28) 1
- (54) **NHÃN SẢN PHẨM** (51) **19-08**
- (22) 29/02/2024 (43) 25/06/2024
- (73) **CÔNG TY TNHH VIỆT THẮNG (VN)**  
Tòa nhà đa năng Việt Thắng, đường Hoàng Văn Thụ, phường Xương Giang, thành phố Bắc Giang, tỉnh Bắc Giang
- (72) Lê Văn Thịnh (VN)
- (74) Công ty Luật TNHH WINCO (WINCO LAW FIRM)
- (55)





**CÔNG BÁO SỞ HỮU CÔNG NGHIỆP SỐ 435 TẬP A – QUYỀN 2 (06.2024)**

- (11) **50468**
- (21) 3-2024-00482
- (54) **TAY CẦM DAO CẠO**
- (22) 29/02/2024
- (73) **KAI R&D CENTER CO., LTD. (JP)**  
1110, Oyana, Seki-shi, Gifu 5013992, Japan
- (72) Kengo Hashimoto (JP)
- (74) Công ty TNHH Ban Ca (BANCA)
- (55)
- (28) 3
- (51) **28-03**
- (43) 25/06/2024

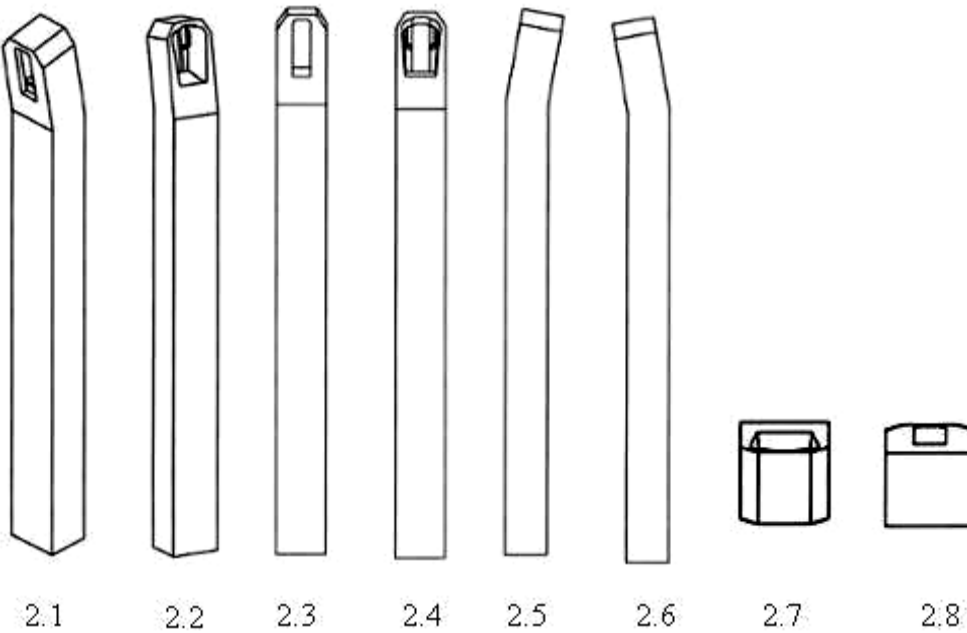
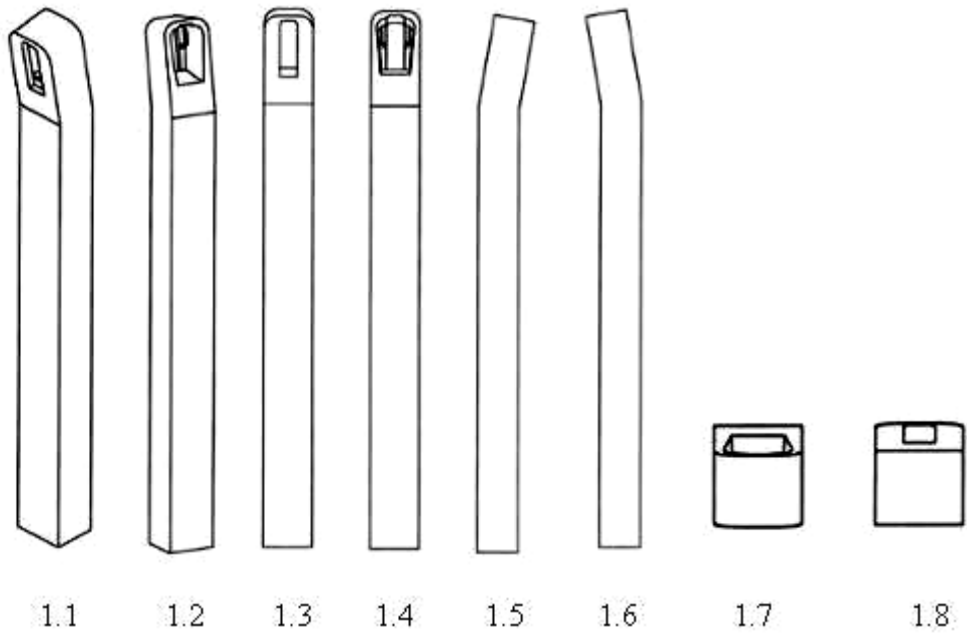



3.1



3.2



3.3



3.4



3.5



3.6



3.7

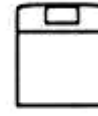

3.8

**CÔNG BÁO SỞ HỮU CÔNG NGHIỆP SỐ 435 TẬP A – QUYỀN 2 (06.2024)**

(11) **50469**

(21) 3-2024-00496

(28) 1

(54) **NHÀ THÔNG MINH**

(51) **25-03**

(22) 01/03/2024

(43) 25/06/2024

(73) **NGUYỄN VĂN GIÁP (VN)**

Tổ 1, phường Hoàng Diệu, thành phố Thái Bình, tỉnh Thái Bình

(72) Nguyễn Văn Giáp (VN)

(74) Công ty TNHH Sở hữu trí tuệ Hải Hân (HAI HAN IP CO., LTD.)

(55)



1.1

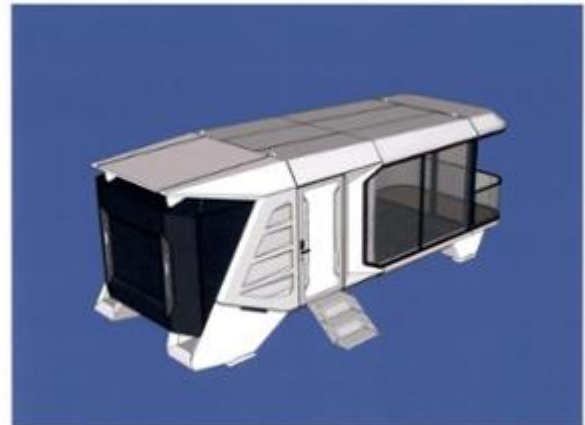

1.2



1.3

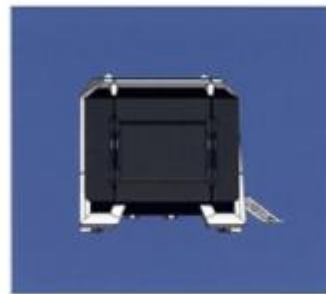

1.4

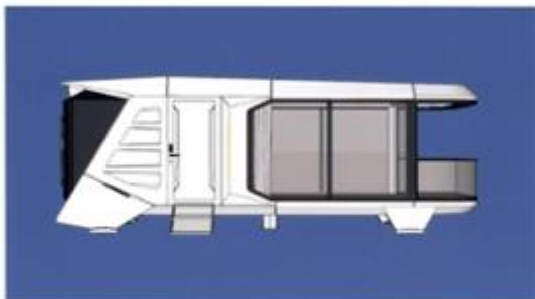

1.5

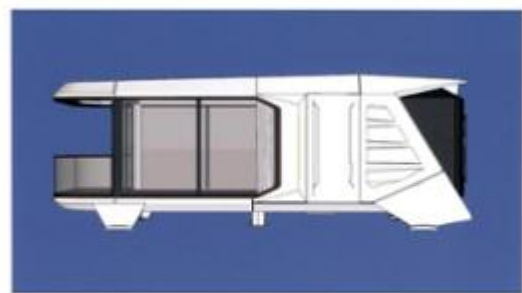

1.6

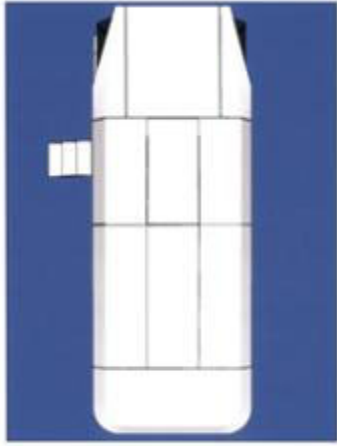

1.7

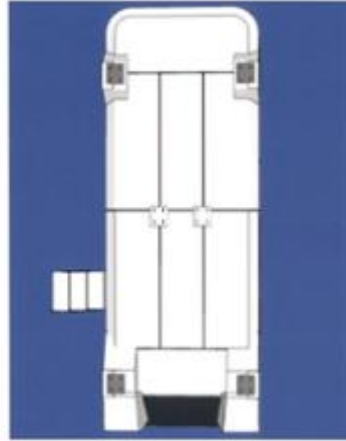

1.8

**CÔNG BÁO SỞ HỮU CÔNG NGHIỆP SỐ 435 TẬP A – QUYỀN 2 (06.2024)**

- (11) **50470**  
(21) 3-2024-00499 (28) 1  
(54) **BAO GÓI** (51) **09-05**  
(22) 01/03/2024 (43) 25/06/2024  
(73) **CÔNG TY TNHH NÔNG SẢN SONG NHI (VN)**  
Số 128, tổ 11, khóm 2, phường 6, thành phố Cao Lãnh, tỉnh Đồng Tháp  
(72) Huỳnh Thị Yến Nhi (VN)  
(74) Công ty Luật TNHH AGL (AGL LAW)  
(55)



1.1



1.2



1.3

**CÔNG BÁO SỞ HỮU CÔNG NGHIỆP SỐ 435 TẬP A – QUYỀN 2 (06.2024)**

- (11) **50471**  
(21) 3-2024-00512 (28) 1  
(54) **MÁY ĐÚC ỒNG LOA** (51) **15-09**  
(22) 04/03/2024 (43) 25/06/2024  
(73) **DOANH NGHIỆP TƯ NHÂN VĂN HỒ (VN)**  
Số 88, Nguyễn Trung Trực, phường 2, thành phố Tân An, tỉnh Long An  
(72) Nguyễn Văn Hồ (VN)  
(55)

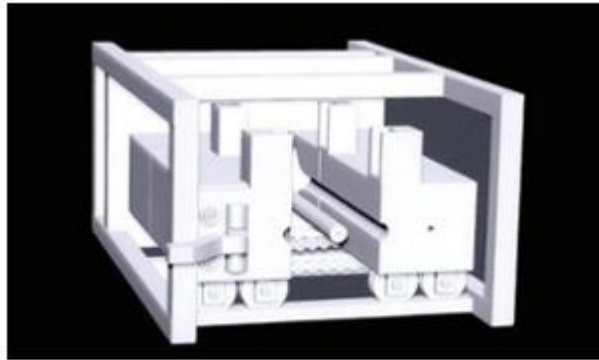

1.1

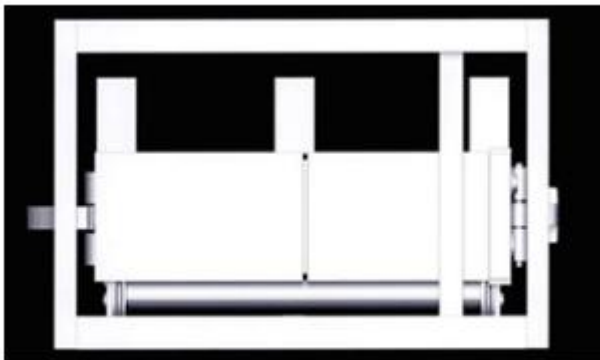

1.2

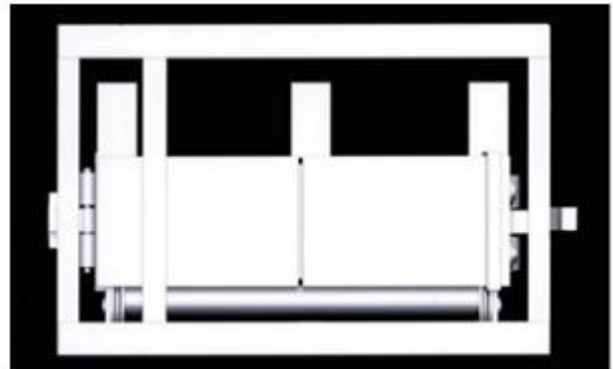

1.3

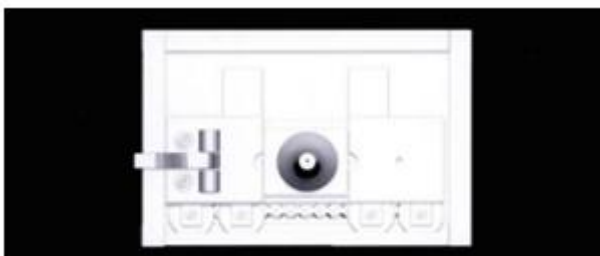

1.4

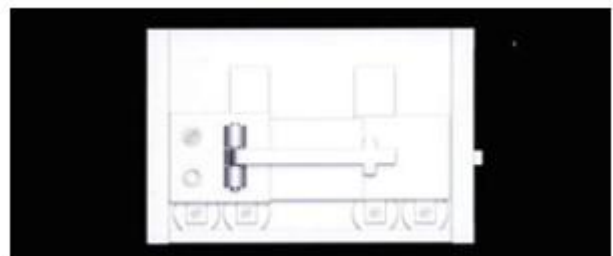

1.5

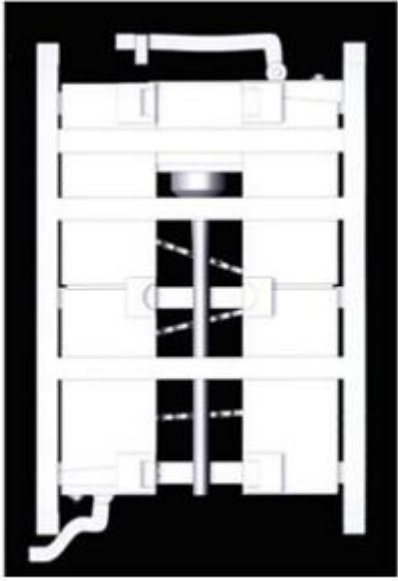

1.6

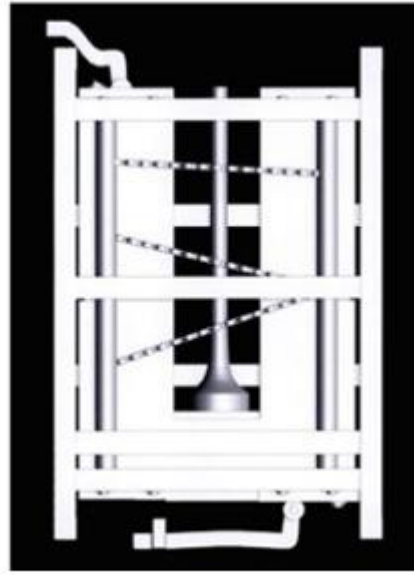

1.7

- (11) **50472**  
(21) 3-2024-00513 (28) 1  
(54) **KHUÔN ĐÚC ỐNG LOA** (51) **15-09**  
(22) 04/03/2024 (43) 25/06/2024  
(73) **DOANH NGHIỆP TƯ NHÂN VĂN HỒ (VN)**  
Số 88, Nguyễn Trung Trực, phường 2, thành phố Tân An, tỉnh Long An  
(72) Nguyễn Văn Hồ (VN)  
(55)



1.1



1.2



1.3



1.4



**CÔNG BÁO SỞ HỮU CÔNG NGHIỆP SỐ 435 TẬP A – QUYỀN 2 (06.2024)**

- (11) **50473**  
(21) 3-2024-00514 (28) 1  
(54) **KHUÔN ĐÚC ỚNG LOA** (51) **15-09**  
(22) 04/03/2024 (43) 25/06/2024  
(73) **DOANH NGHIỆP TƯ NHÂN VĂN HỒ (VN)**  
Số 88, Nguyễn Trung Trực, phường 2, thành phố Tân An, tỉnh Long An  
(72) Nguyễn Văn Hồ (VN)  
(55)



1.1



1.2



1.3



1.4

(11) **50474**

(21) 3-2024-00515

(54) **KHUÔN ĐÚC VÀNH LOA**

(22) 04/03/2024

(73) **DOANH NGHIỆP TƯ NHÂN VĂN HỒ (VN)**

Số 88, Nguyễn Trung Trực, phường 2, thành phố Tân An, tỉnh Long An

(72) Nguyễn Văn Hồ (VN)

(55)

(28) 2

(51) **15-09**

(43) 25/06/2024



1.1



1.2



1.3



1.4



2.1



2.2



2.3



2.4

**CÔNG BÁO SỞ HỮU CÔNG NGHIỆP SỐ 435 TẬP A – QUYỀN 2 (06.2024)**

(11) **50475**

(21) 3-2024-00516

(28) 2

(54) **KHUÔN ĐÚC ÔNG LOA**

(51) **15-09**

(22) 04/03/2024

(43) 25/06/2024

(73) **DOANH NGHIỆP TƯ NHÂN VĂN HỒ (VN)**

Số 88, Nguyễn Trung Trực, phường 2, thành phố Tân An, tỉnh Long An

(72) Nguyễn Văn Hồ (VN)

(55)

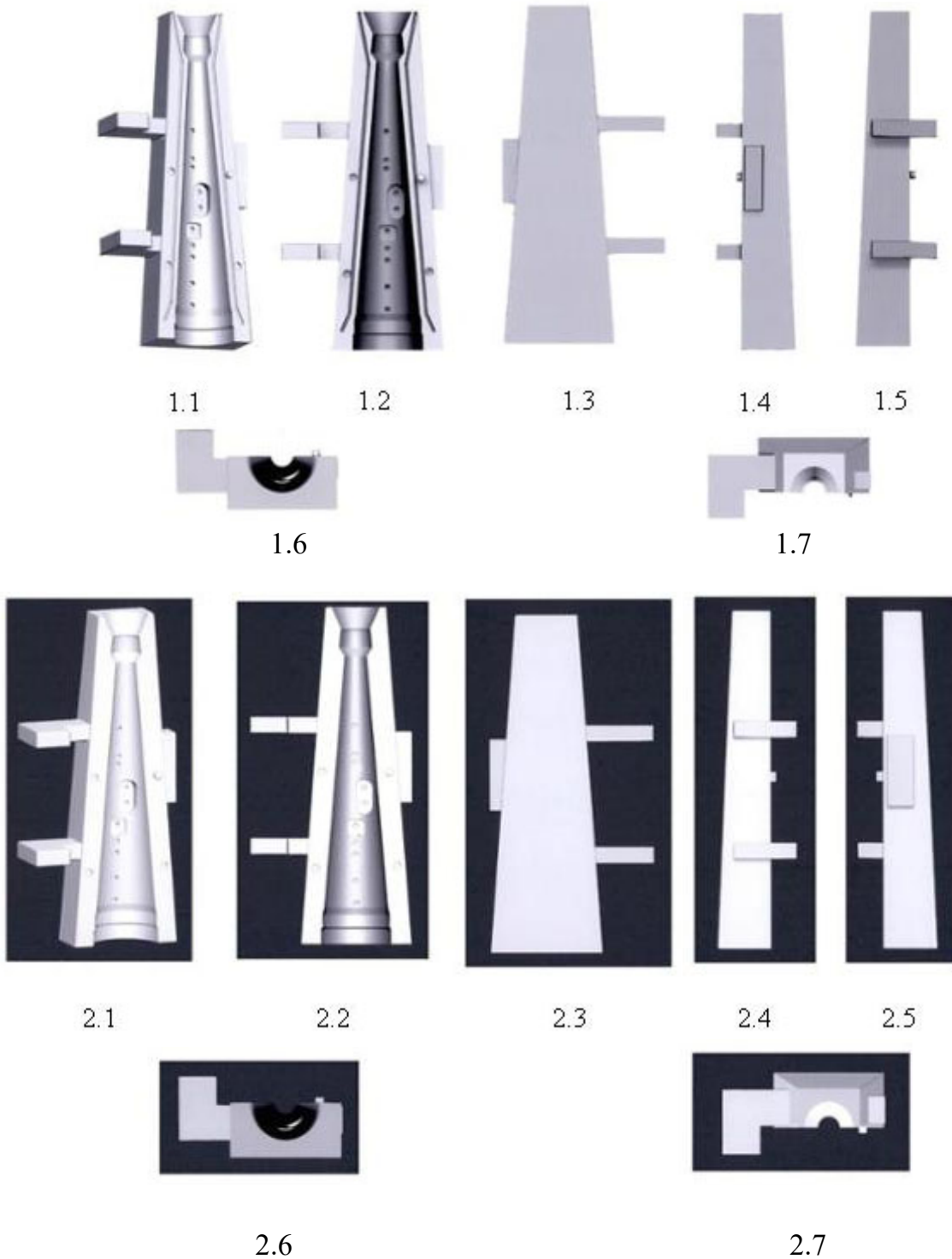

- (11) **50476**  
(21) 3-2024-00517 (28) 2  
(54) **KHUÔN ĐÚC ÔNG LOA** (51) **15-09**  
(22) 04/03/2024 (43) 25/06/2024  
(73) **DOANH NGHIỆP TƯ NHÂN VĂN VĂN HỒ (VN)**  
Số 88, Nguyễn Trung Trực, phường 2, thành phố Tân An, tỉnh Long An  
(72) Nguyễn Văn Hồ (VN)  
(55)



1.1

1.2

1.3

1.4

1.5



1.6



1.7

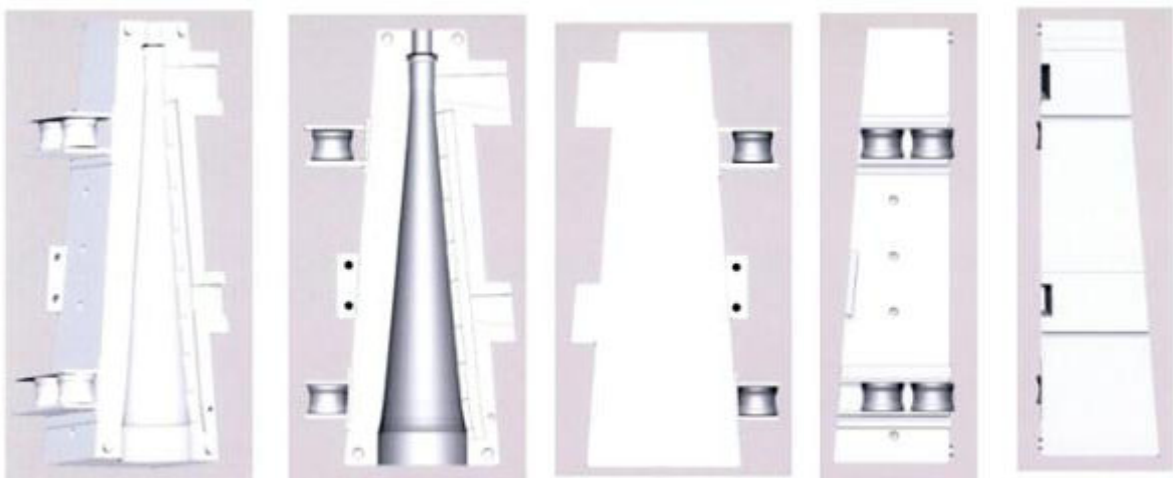

2.1

2.2

2.3

2.4

2.5



2.6



2.7

**CÔNG BÁO SỞ HỮU CÔNG NGHIỆP SỐ 435 TẬP A – QUYỀN 2 (06.2024)**

- (11) **50477**  
(21) 3-2024-00520 (28) 1  
(54) **ROBOT GIAO HÀNG TỰ HÀNH** (51) **12-14**  
(22) 04/03/2024 (43) 25/06/2024  
(73) **CÔNG TY TNHH ALPHA ASIMOV ROBOTICS (VN)**  
Tầng 3, Tòa nhà Indochina Riverside, 74 Bạch Đằng, phường Hải Châu I, quận Hải Châu, thành phố Đà Nẵng  
(72) 1. LÊ ANH SƠN (VN)  
2. ĐOÀN MINH THÔNG (VN)  
3. NGUYỄN TUẤN ANH (VN)  
(74) Công ty TNHH NACILAW (NACILAW)  
(55)

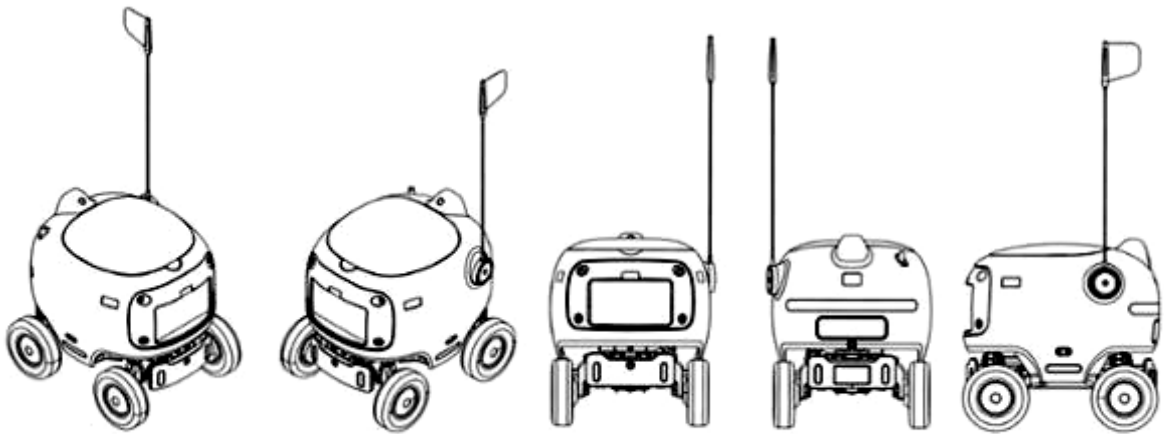

1.1

1.2

1.3

1.4

1.5

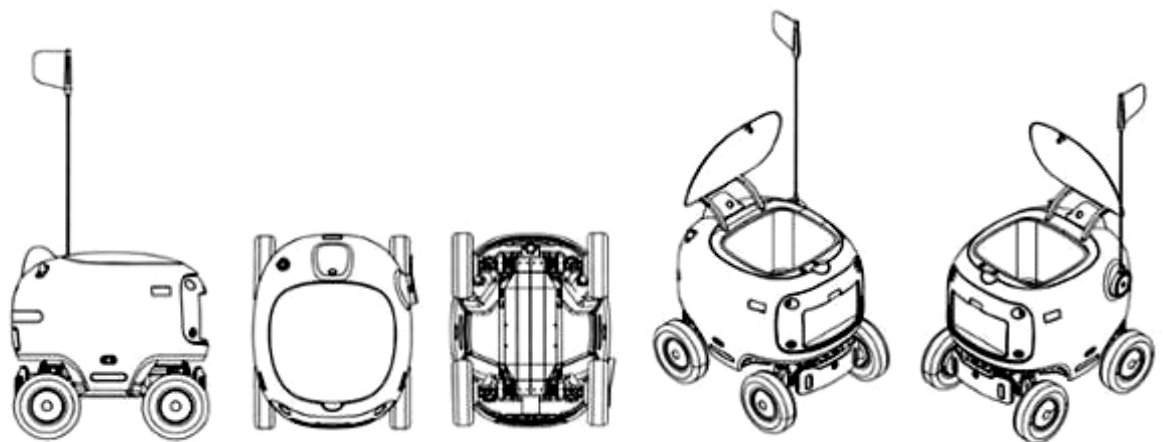

1.6

1.7

1.8

1.9

1.10

**CÔNG BÁO SỞ HỮU CÔNG NGHIỆP SỐ 435 TẬP A – QUYỀN 2 (06.2024)**

- (11) **50478**  
(21) 3-2024-00521 (28) 1  
(54) **BAO GÓI** (51) **09-05**  
(22) 04/03/2024 (43) 25/06/2024  
(73) **CÔNG TY CỔ PHẦN LIWAYWAY VIỆT NAM (VN)**  
Số 14, đường số 05, khu công nghiệp Việt Nam - Singapore, phường Bình Hòa,  
thành phố Thuận An, tỉnh Bình Dương  
(72) Robert Tan Li (PH)  
(74) Văn phòng Luật sư Tân Hà (VPLS TAN HA)  
(55)



1.1



1.2

**CÔNG BÁO SỞ HỮU CÔNG NGHIỆP SỐ 435 TẬP A – QUYỀN 2 (06.2024)**

- (11) **50479**  
(21) 3-2024-00522 (28) 1  
(54) **BAO GÓI** (51) **09-05**  
(22) 04/03/2024 (43) 25/06/2024  
(73) **CÔNG TY CỔ PHẦN LIWAYWAY VIỆT NAM (VN)**  
Số 14, đường số 05, khu công nghiệp Việt Nam - Singapore, phường Bình Hòa,  
thành phố Thuận An, tỉnh Bình Dương  
(72) Robert Tan Li (PH)  
(74) Văn phòng Luật sư Tân Hà (VPLS TAN HA)  
(55)



1.1



1.2



**CÔNG BÁO SỞ HỮU CÔNG NGHIỆP SỐ 435 TẬP A – QUYỀN 2 (06.2024)**

- (11) **50480**  
(21) 3-2024-00523 (28) 1  
(54) **BAO GÓI** (51) **09-05**  
(22) 05/03/2024 (43) 25/06/2024  
(73) **CÔNG TY CỔ PHẦN VITHAICO (VN)**  
Số 6, cụm công nghiệp Trường An, xã An Khánh, huyện Hoài Đức, thành phố Hà Nội  
(72) Nguyễn Hữu Thi (VN)  
(55)



1.1



1.2

**CÔNG BÁO SỞ HỮU CÔNG NGHIỆP SỐ 435 TẬP A – QUYỀN 2 (06.2024)**

(11) **50481**

(21) 3-2024-00524

(28) 1

(54) **BAO GÓI**

(51) **09-05**

(22) 05/03/2024

(43) 25/06/2024

(73) **CÔNG TY CỔ PHẦN VITHAICO (VN)**

Số 6, cụm công nghiệp Trường An, xã An Khánh, huyện Hoài Đức, thành phố Hà Nội

(72) Nguyễn Hữu Thi (VN)

(55)



1.1



1.2

**CÔNG BÁO SỞ HỮU CÔNG NGHIỆP SỐ 435 TẬP A – QUYỀN 2 (06.2024)**

- (11) **50482**  
(21) 3-2024-00525 (28) 1  
(54) **BAO GÓI** (51) **09-05**  
(22) 05/03/2024 (43) 25/06/2024  
(73) **CÔNG TY CỔ PHẦN VITHAICO (VN)**  
Số 6, cụm công nghiệp Trường An, xã An Khánh, huyện Hoài Đức, thành phố Hà Nội  
(72) Nguyễn Hữu Thi (VN)  
(55)



1.1



1.2

**CÔNG BÁO SỞ HỮU CÔNG NGHIỆP SỐ 435 TẬP A – QUYỀN 2 (06.2024)**

- (11) **50483**  
(21) 3-2024-00526 (28) 1  
(54) **BAO GÓI** (51) **09-05**  
(22) 05/03/2024 (43) 25/06/2024  
(73) **CÔNG TY CỔ PHẦN VITHAICO (VN)**  
Số 6, cụm công nghiệp Trường An, xã An Khánh, huyện Hoài Đức, thành phố Hà Nội  
(72) Nguyễn Hữu Thi (VN)  
(55)



1.1



1.2

**CÔNG BÁO SỞ HỮU CÔNG NGHIỆP SỐ 435 TẬP A – QUYỀN 2 (06.2024)**

- (11) **50484**
- (21) 3-2024-00541 (28) 1
- (54) **LỚP XE** (51) **12-15**
- (22) 06/03/2024 (43) 25/06/2024
- (73) **CHENG SHIN RUBBER IND. CO., LTD. (TW)**  
NO. 215, MEIGANG RD., DACUN TOWNSHIP, CHANGHUA COUNTY 51545,  
TAIWAN
- (72) 1. LIN, MIN-CHI (TW)  
2. HUANG, QI-WEN (TW)  
3. KE, JYUN-YI (TW)  
4. KUO, SSU-YU (TW)  
5. LI, CHENG-YU (TW)
- (74) Công ty TNHH một thành viên Sở hữu trí tuệ VCCI (VCCI-IP CO.,LTD)
- (55)

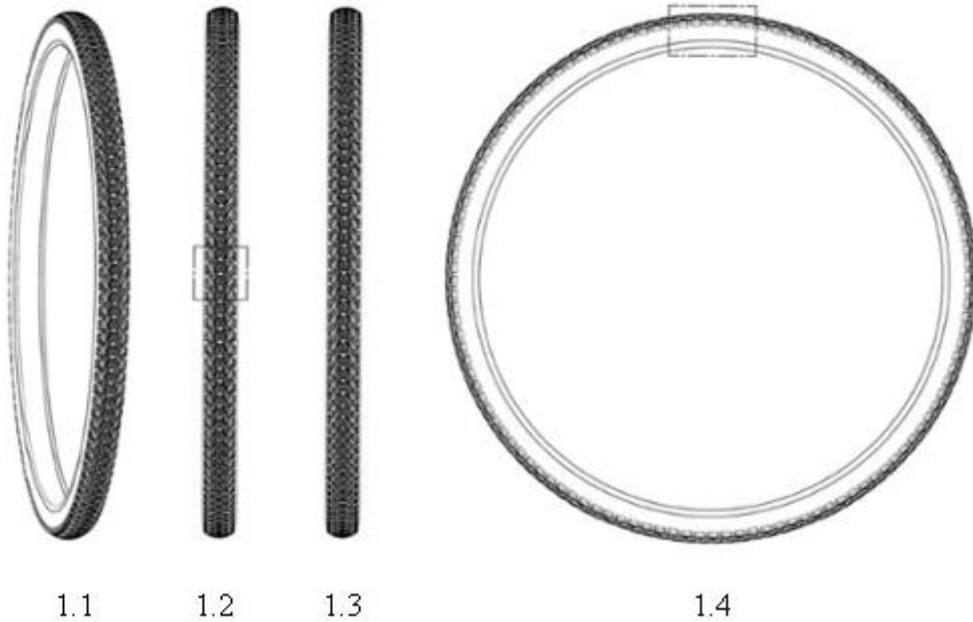



1.5



1.6

1.7



1.8

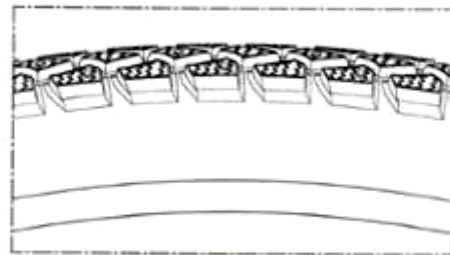

1.9

**CÔNG BÁO SỞ HỮU CÔNG NGHIỆP SỐ 435 TẬP A – QUYỀN 2 (06.2024)**

- (11) **50485**  
(21) 3-2024-00546 (28) 1  
(54) **THIẾT BỊ GIẢM XỐC** (51) **12-16**  
(22) 06/03/2024 (43) 25/06/2024  
(30) 2302005234 30/11/2023 TH;  
(73) **Y.S.S. (THAILAND) CO., LTD. (TH)**  
8/888 M.9 Thepharak Rd., Bangpla, Bangphli, Samutprakarn 10540, Thailand  
(72) Pinyo Panichgasem (TH)  
(74) Công ty TNHH Sáng chế ACTIP (ACTIP PATENT LIMITED)  
(55)



1.1

1.2

1.3

1.4

1.5

1.6



1.7



1.8

**CÔNG BÁO SỞ HỮU CÔNG NGHIỆP SỐ 435 TẬP A – QUYỀN 2 (06.2024)**

- (11) **50486**  
(21) 3-2024-00547 (28) 1  
(54) **THIẾT BỊ LASER DA LIỄU** (51) **24-01**  
(22) 06/03/2024 (43) 25/06/2024  
(73) **CÔNG TY TNHH KỸ THUẬT THIẾT BỊ Y TẾ AMED (VN)**  
28 Phạm Phú Thứ, phường 11, quận Tân Bình, thành phố Hồ Chí Minh  
(72) Lương Vũ Đăng Quang (VN)  
(74) **CÔNG TY TNHH KHANG LUẬT (KHANGLAW)**  
(55)



1.1



1.2



1.3



1.4





1.5



1.6



1.7

**CÔNG BÁO SỞ HỮU CÔNG NGHIỆP SỐ 435 TẬP A – QUYỀN 2 (06.2024)**

- (11) **50487**
- (21) 3-2024-00551
- (54) **ĐIỆN THOẠI DI ĐỘNG**
- (22) 07/03/2024
- (30) 30-2023-0037726 22/09/2023 KR;
- (73) **SAMSUNG ELECTRONICS CO., LTD. (KR)**  
129, Samsung-ro, Yeongtong-gu, Suwon-si, Gyeonggi-do 16677, Republic of Korea
- (72) 1. SONG, JISEUNG (KR)  
2. RYU, JINIE (KR)  
3. BAEK, KILHYUN (KR)  
4. SON, HYUNKEUN (KR)
- (74) Công ty Luật TNHH WINCO (WINCO LAW FIRM)
- (55)

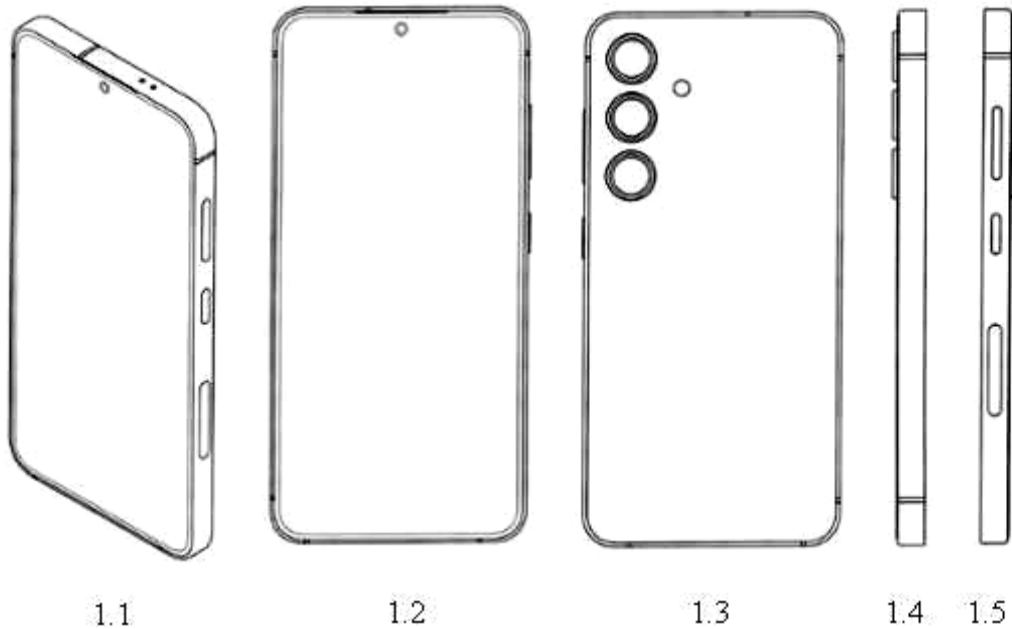

1.1

1.2

1.3

1.4

1.5

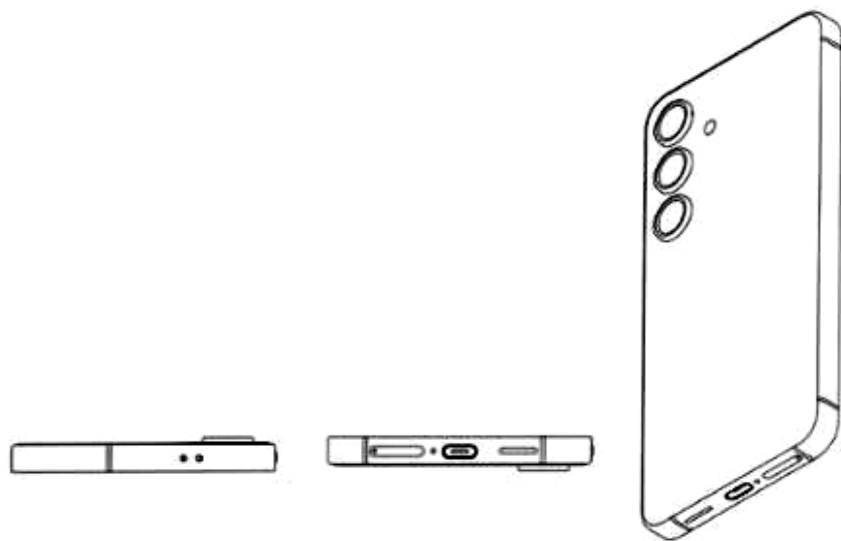

1.6

1.7

1.8

**CÔNG BÁO SỞ HỮU CÔNG NGHIỆP SỐ 435 TẬP A – QUYỀN 2 (06.2024)**

- (11) **50488**
- (21) 3-2024-00552
- (54) **ĐIỆN THOẠI DI ĐỘNG**
- (22) 07/03/2024
- (30) 30-2023-0037728 22/09/2023 KR;
- (73) **SAMSUNG ELECTRONICS CO., LTD. (KR)**  
129, Samsung-ro, Yeongtong-gu, Suwon-si, Gyeonggi-do 16677, Republic of Korea
- (72) 1. SON, HYUNKEUN (KR)  
2. RYU, JINIE (KR)  
3. BAEK, KILHYUN (KR)  
4. SONG, JISEUNG (KR)
- (74) Công ty Luật TNHH WINCO (WINCO LAW FIRM)
- (55)

- (28) 1
- (51) **14-03**
- (43) 25/06/2024



1.1



1.2



1.3



1.4



1.5



1.6



1.7

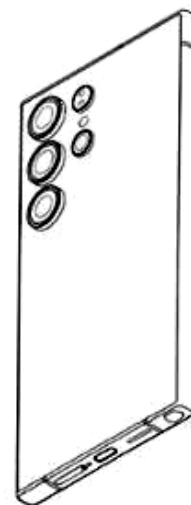

1.8

**CÔNG BÁO SỞ HỮU CÔNG NGHIỆP SỐ 435 TẬP A – QUYỀN 2 (06.2024)**

- (11) **50489**  
(21) 3-2024-00555 (28) 1  
(54) **MÁY SẤY TÓC** (51) **28-03**  
(22) 07/03/2024 (43) 25/06/2024  
(73) **GUANGDONG CONFU ELECTRICAL APPLIANCES CO., LTD. (CN)**  
North of Yu 13th Road, Tianfu Road East, Airport and Economic District, Jieyang  
City, China  
(72) Mincong Huang (CN)  
(74) **CÔNG TY TNHH SỞ HỮU TRÍ TUỆ ANLIS VIỆT NAM (ANLIS IP CO.,LTD)**  
(55)



**CÔNG BÁO SỞ HỮU CÔNG NGHIỆP SỐ 435 TẬP A – QUYỀN 2 (06.2024)**

- (11) **50490**  
(21) 3-2024-00556 (28) 1  
(54) **BAO GÓI** (51) **09-05**  
(22) 07/03/2024 (43) 25/06/2024  
(73) **CÔNG TY CỔ PHẦN KEM 35 (VN)**  
Thôn 5, xã Yên Bình, huyện Thạch Thất, thành phố Hà Nội  
(72) Hoàng Văn Nhật (VN)  
(74) Công ty TNHH Sở hữu trí tuệ HA VIP (HAVIP CO., LTD.)  
(55)



1.1



1.2

**CÔNG BÁO SỞ HỮU CÔNG NGHIỆP SỐ 435 TẬP A – QUYỀN 2 (06.2024)**

- (11) **50491**  
(21) 3-2024-00565 (28) 1  
(54) **MÁY TẮM NƯỚC** (51) **28-03**  
(22) 08/03/2024 (43) 25/06/2024  
(30) 29/902,505 13/09/2023 US;  
(73) **WATER PIK, INC. (US)**  
1730 East Prospect Road, Fort Collins, Colorado 80553, United States of America  
(72) 1. ROBERT D. WAGNER (US)  
2. JACQUELYN PHELPS (US)  
3. DYLAN A. WILLIS (US)  
4. DAVID R. HULL (US)  
(74) Công ty cổ phần tư vấn Trung Thực (TRUNG THUC.,JSC)  
(55)

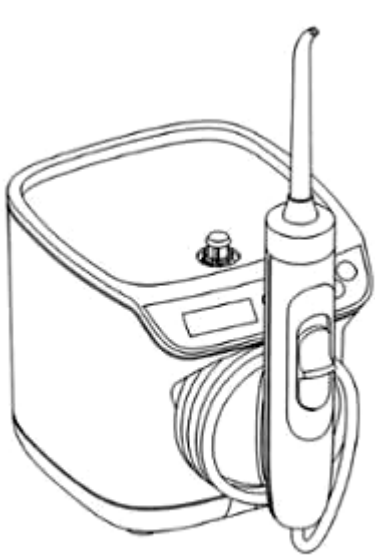

1.1

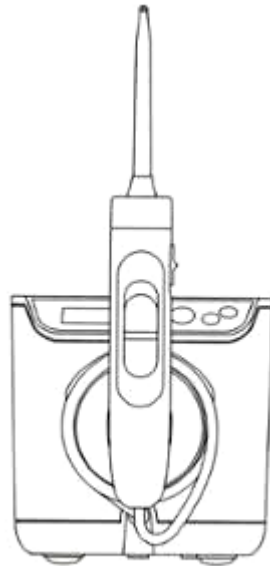

1.2

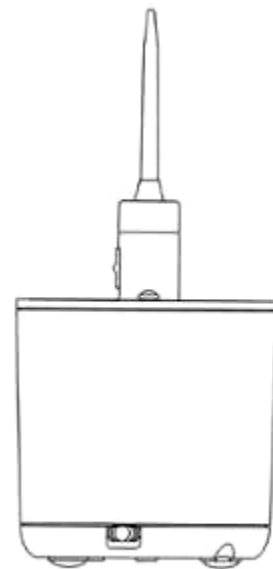

1.3

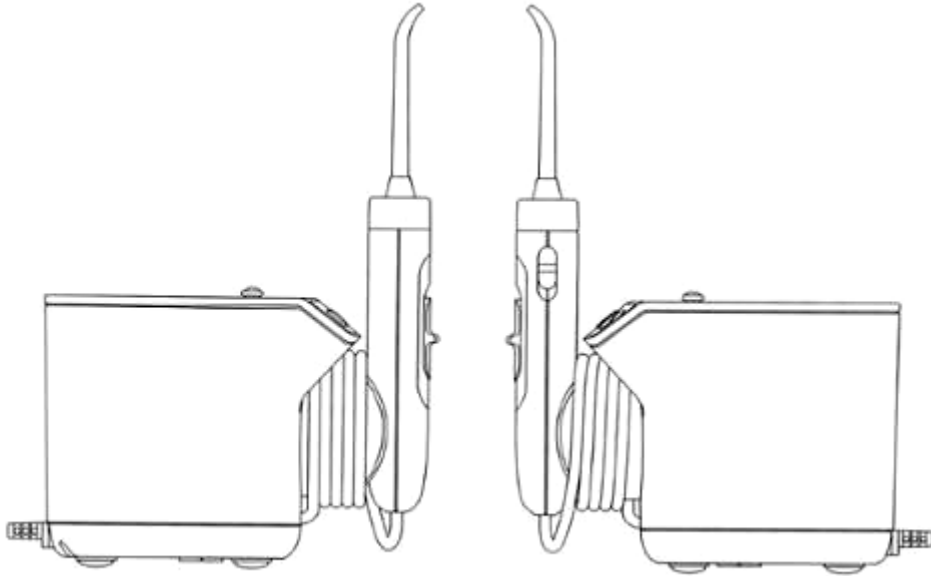

1.4

1.5

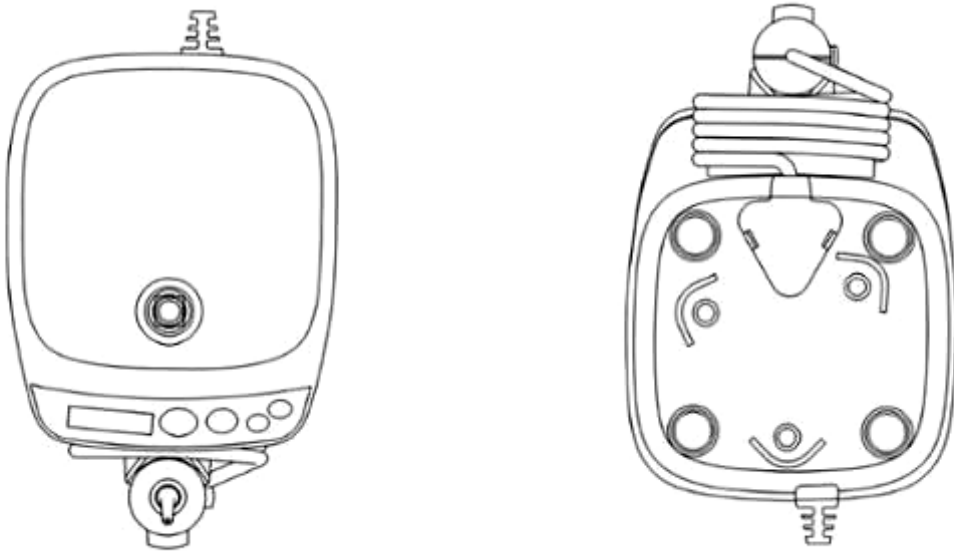

1.6

1.7

**CÔNG BÁO SỞ HỮU CÔNG NGHIỆP SỐ 435 TẬP A – QUYỀN 2 (06.2024)**

- (11) **50492**  
(21) 3-2024-00566 (28) 1  
(54) **MÁY TẮM NƯỚC** (51) **28-03**  
(22) 08/03/2024 (43) 25/06/2024  
(30) 29/902,505 13/09/2023 US;  
(73) **WATER PIK, INC. (US)**  
1730 East Prospect Road, Fort Collins, Colorado 80553, United States of America  
(72) 1. ROBERT D. WAGNER (US)  
2. JACQUELYN PHELPS (US)  
3. DYLAN A. WILLIS (US)  
4. DAVID R. HULL (US)  
(74) Công ty cổ phần tư vấn Trung Thực (TRUNG THUC.,JSC)  
(55)

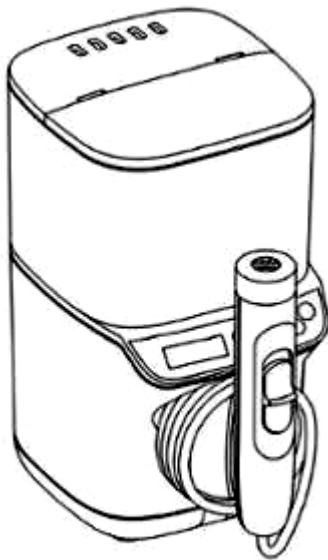

1.1

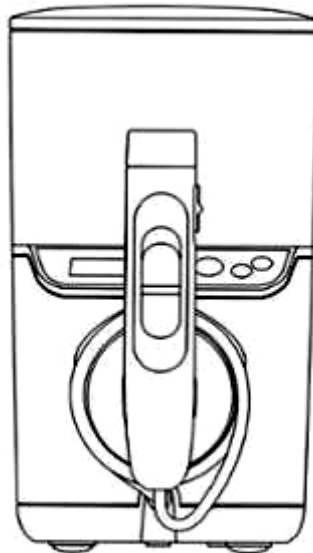

1.2

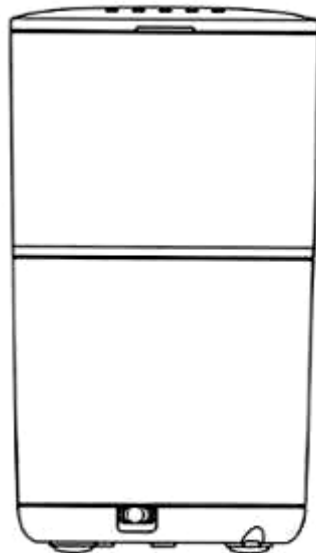

1.3



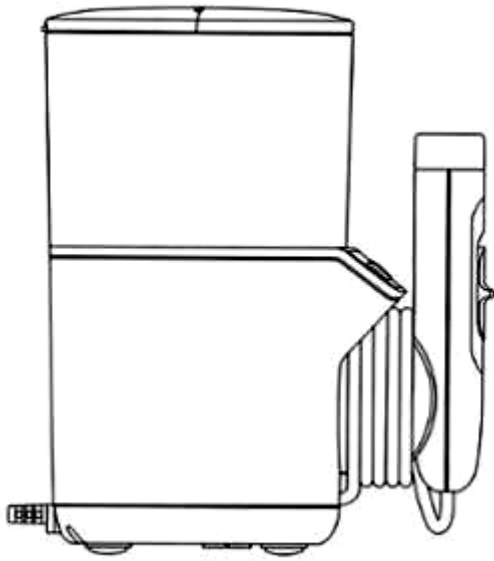

1.4

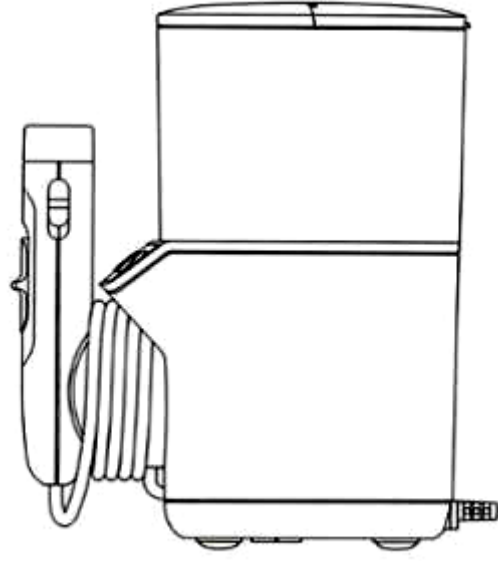

1.5

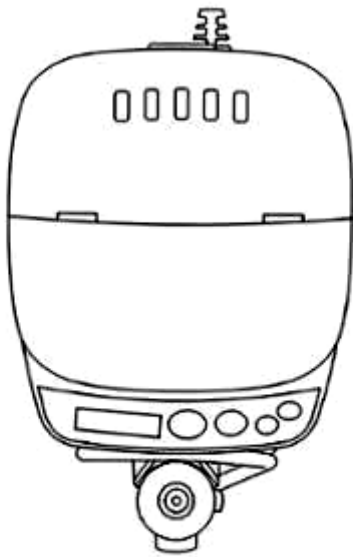

1.6



1.7

**CÔNG BÁO SỞ HỮU CÔNG NGHIỆP SỐ 435 TẬP A – QUYỀN 2 (06.2024)**

- (11) **50493**  
(21) 3-2024-00567 (28) 1  
(54) **MÁY TẮM NƯỚC** (51) **28-03**  
(22) 08/03/2024 (43) 25/06/2024  
(30) 29/902,505 13/09/2023 US;  
(73) **WATER PIK, INC. (US)**  
1730 East Prospect Road, Fort Collins, Colorado 80553, United States of America  
(72) 1. ROBERT D. WAGNER (US)  
2. JACQUELYN PHELPS (US)  
3. DYLAN A. WILLIS (US)  
4. DAVID R. HULL (US)  
(74) Công ty cổ phần tư vấn Trung Thực (TRUNG THUC.,JSC)  
(55)



1.1



1.2

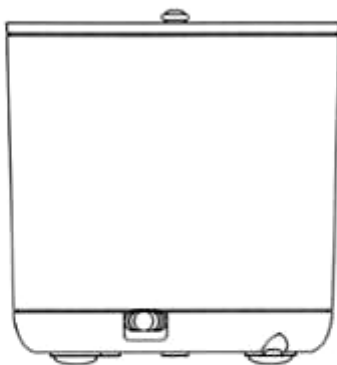

1.3

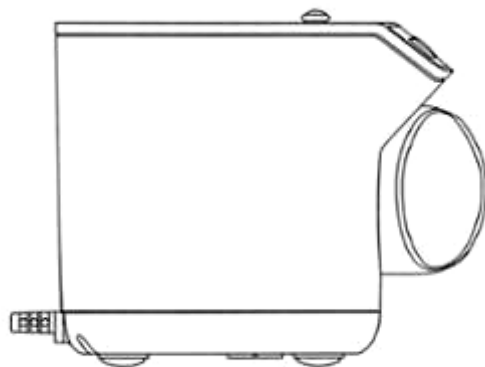

1.4

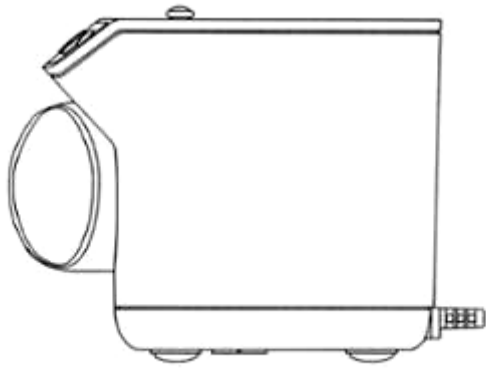

1.5



1.6



1.7

**CÔNG BÁO SỞ HỮU CÔNG NGHIỆP SỐ 435 TẬP A – QUYỀN 2 (06.2024)**

(11) **50494**

(21) 3-2024-00572

(28) 1

(54) **MÁY IN**

(51) **18-02**

(22) 08/03/2024

(43) 25/06/2024

(30) 202330645252X 07/10/2023 CN;

(73) **WUHAN JINGCHEN INTELLIGENT IDENTIFICATION TECHNOLOGY CO.,LTD (CN)**

1st Floor, No. 5, Creative Workshop, Phase III, Wuhan Creative World, Hongshan District, Wuhan City, Hubei Province 430070, China

(72) 1. XIONG LIU (CN)

2. HAIQING ZHAO (CN)

(74) Công ty TNHH Sáng chế ACTIP (ACTIP PATENT LIMITED)

(55)

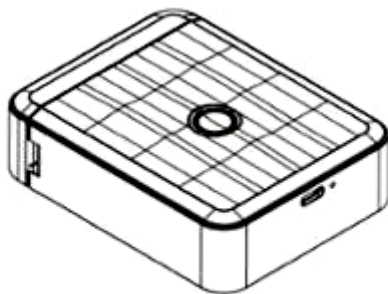

1.1

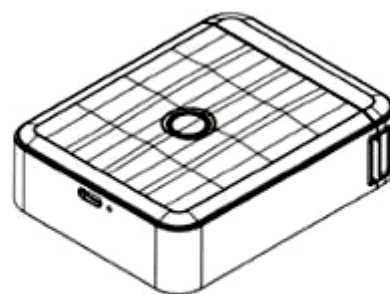

1.2

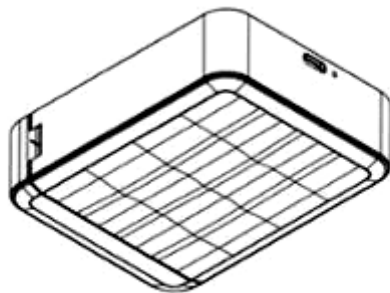

1.3



1.4



1.5



1.6



1.7

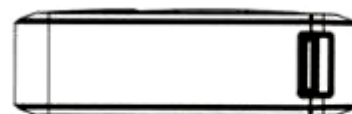

1.8

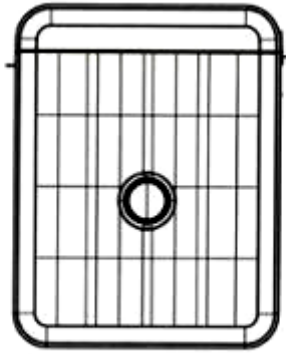

1.9

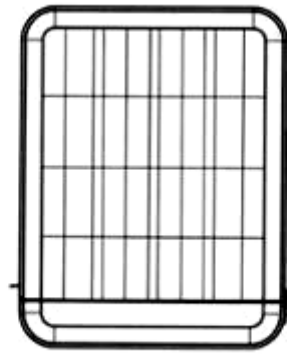

1.10

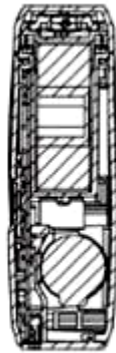

1.11



1.12

**CÔNG BÁO SỞ HỮU CÔNG NGHIỆP SỐ 435 TẬP A – QUYỀN 2 (06.2024)**

- (11) **50495**  
(21) 3-2024-00573 (28) 1  
(54) **MÁY IN** (51) **18-02**  
(22) 08/03/2024 (43) 25/06/2024  
(30) 2023306452958 07/10/2023 CN;  
(73) **WUHAN JINGCHEN INTELLIGENT IDENTIFICATION TECHNOLOGY CO.,LTD (CN)**  
1st Floor, No. 5, Creative Workshop, Phase III, Wuhan Creative World, Hongshan District, Wuhan City, Hubei Province 430070, China  
(72) 1. XIONG LIU (CN)  
2. JIE ZHOU (CN)  
(74) Công ty TNHH Sáng chế ACTIP (ACTIP PATENT LIMITED)  
(55)



1.1

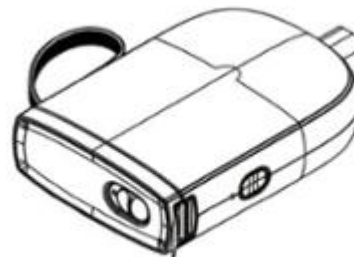

1.2

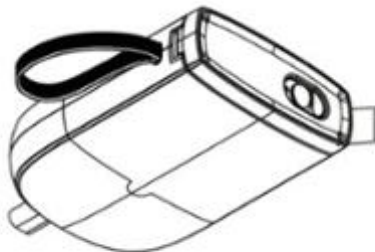

1.3

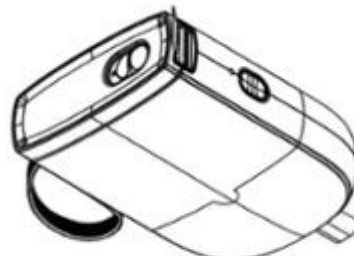

1.4



1.5

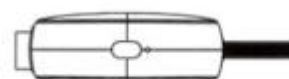

1.6

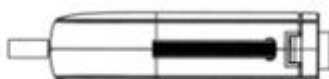

1.7

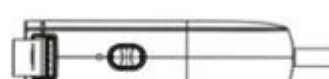

1.8



1.9

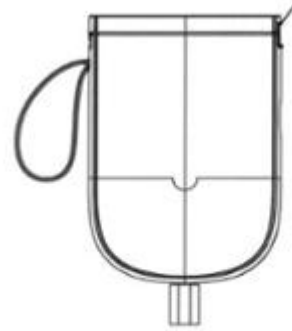

1.10

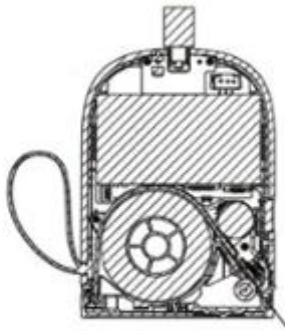

1.11

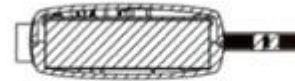

1.12

**CÔNG BÁO SỞ HỮU CÔNG NGHIỆP SỐ 435 TẬP A – QUYỀN 2 (06.2024)**

- (11) **50496**  
(21) 3-2024-00575 (28) 1  
(54) **BAO GÓI** (51) **09-05**  
(22) 11/03/2024 (43) 25/06/2024  
(73) **CÔNG TY TNHH XNK VT LOGISTICS HOÀNG QUÂN (VN)**  
Số 132-134, đường Việt Lào, TDP 1, thị trấn Tây Sơn, huyện Hương Sơn, tỉnh Hà  
Tĩnh  
(72) Nguyễn Quốc Hoàng (VN)  
(55)



1.1



1.2



**CÔNG BÁO SỞ HỮU CÔNG NGHIỆP SỐ 435 TẬP A – QUYỀN 2 (06.2024)**

- (11) **50497**  
(21) 3-2024-00576 (28) 1  
(54) **XE MÁY** (51) **12-11**  
(22) 11/03/2024 (43) 25/06/2024  
(30) 2023-018711 13/09/2023 JP;  
(73) **HONDA MOTOR CO., LTD. (JP)**  
1-1, Minami-Aoyama 2-chome, Minato-ku, Tokyo, 107-8556 Japan  
(72) 1. AYUMU TSUJI (JP)  
2. KOHEI SUZUKI (JP)  
(74) Công ty Luật TNHH Phạm và Liên danh (PHAM & ASSOCIATES)  
(55)



1.1



1.2



1.3



1.4



1.5



1.6



1.7



1.8



1.9



1.10

(11) **50498**

(21) 3-2024-00577

(28) 1

(54) **ĐÈN**

(51) **26-05**

(22) 11/03/2024

(43) 25/06/2024

(73) **CÔNG TY CỔ PHẦN BÓNG ĐÈN PHÍCH NƯỚC RẠNG ĐÔNG (VN)**

87-89 phố Hạ Đình, phường Thanh Xuân Trung, quận Thanh Xuân, thành phố Hà Nội

(72) Trần Trung Tường (VN)

(55)



1.1



1.2



1.3



1.4



1.5



1.6



1.7

**CÔNG BÁO SỞ HỮU CÔNG NGHIỆP SỐ 435 TẬP A – QUYỀN 2 (06.2024)**

(11) **50499**

(21) 3-2024-00578

(28) 1

(54) **BÌNH GIỮ NHIỆT**

(51) **07-07**

(22) 11/03/2024

(43) 25/06/2024

(73) **CÔNG TY CỔ PHẦN BÓNG ĐÈN PHÍCH NƯỚC RẠNG ĐÔNG (VN)**

87-89 phố Hạ Đình, phường Thanh Xuân Trung, quận Thanh Xuân, thành phố Hà Nội

(72) Trần Trung Tường (VN)

(55)



1.1

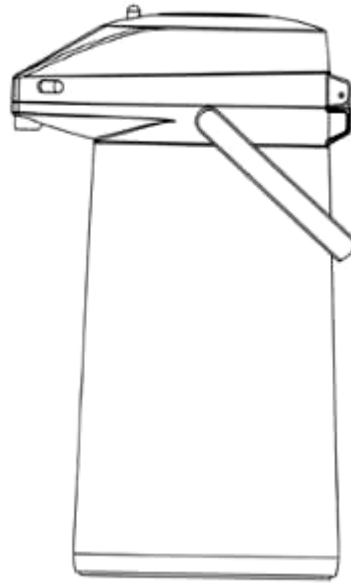

1.2

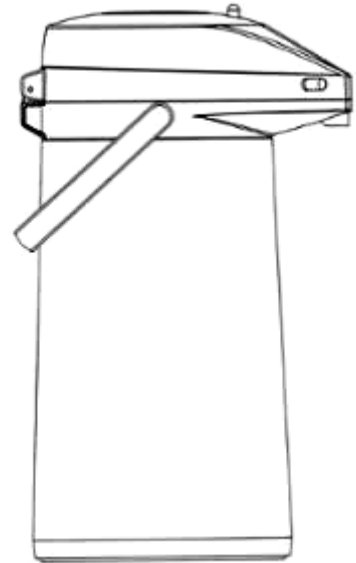

1.3

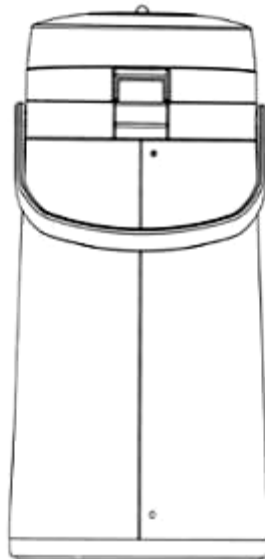

1.4



1.5

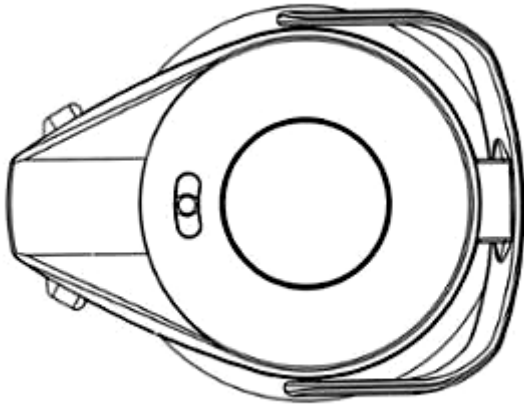

1.6

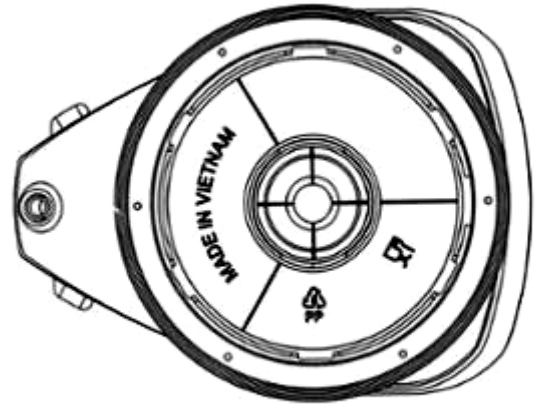

1.7

**CÔNG BÁO SỞ HỮU CÔNG NGHIỆP SỐ 435 TẬP A – QUYỀN 2 (06.2024)**

(11) **50500**

(21) 3-2024-00580

(28) 1

(54) **PHÍCH**

(51) **07-07**

(22) 11/03/2024

(43) 25/06/2024

(73) **CÔNG TY CỔ PHẦN BÓNG ĐÈN PHÍCH NƯỚC RẠNG ĐÔNG (VN)**

87-89 phố Hạ Đình, phường Thanh Xuân Trung, quận Thanh Xuân, thành phố Hà Nội

(72) Trần Trung Tường (VN)

(55)



1.1

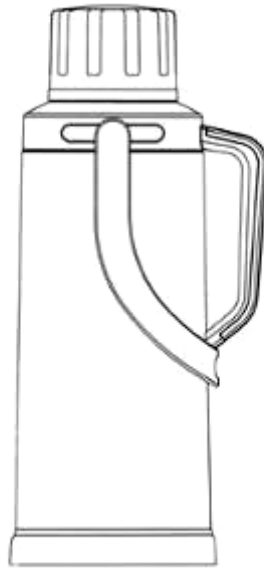

1.2

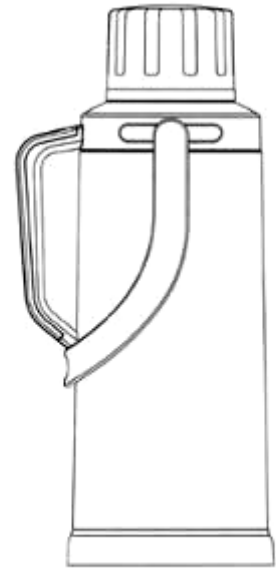

1.3



1.4



1.5

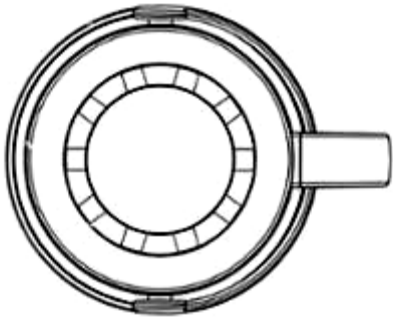

1.6

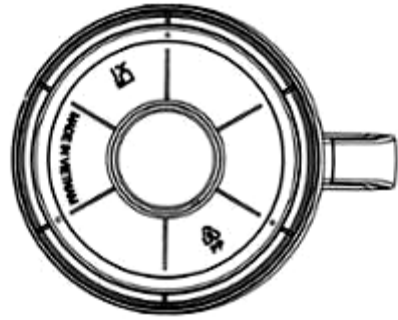

1.7

**CÔNG BÁO SỞ HỮU CÔNG NGHIỆP SỐ 435 TẬP A – QUYỀN 2 (06.2024)**

- (11) **50501**  
(21) 3-2024-00581 (28) 1  
(54) **NHÃN SẢN PHẨM** (51) **19-08**  
(22) 11/03/2024 (43) 25/06/2024  
(73) **CÔNG TY TNHH XUẤT NHẬP KHẨU THỰC PHẨM ĐÀ LẠT (VN)**  
Áp Phú Hòa, xã Phú Hội, huyện Đức Trọng, tỉnh Lâm Đồng  
(72) Lê Trọng Hưng (VN)  
(55)





**CÔNG BÁO SỞ HỮU CÔNG NGHIỆP SỐ 435 TẬP A – QUYỀN 2 (06.2024)**

- (11) **50502**
- (21) 3-2024-00589 (28) 1
- (54) **MÁY BIẾN NẠP** (51) **15-03**
- (22) 11/03/2024 (43) 25/06/2024
- (73) **CÔNG TY CỔ PHẦN RYNAN TECHNOLOGIES VIETNAM (VN)**  
Ấp Long Trị, xã Long Đức, thành phố Trà Vinh, tỉnh Trà Vinh
- (72) 1. NGUYỄN THANH MỸ (VN)  
2. HỒNG QUỐC CƯỜNG (VN)  
3. BÙI MINH CHÂU (VN)  
4. TRẦN NHẬT TRƯỜNG (VN)  
5. TRẦN QUỐC TOẢN (VN)  
6. LÊ QUỐC BẢO (VN)  
7. TRẦN THỊ LỆ TRINH (VN)  
8. NGÔ MINH TRÍ (VN)  
9. VÕ THỊ MINH THƯ (VN)  
10. NGUYỄN BÁ QUỲNH (VN)
- (74) Công ty TNHH Đại Tín và Liên Danh (DAITIN AND ASSOCIATES CO.,LTD)
- (55)



1.1

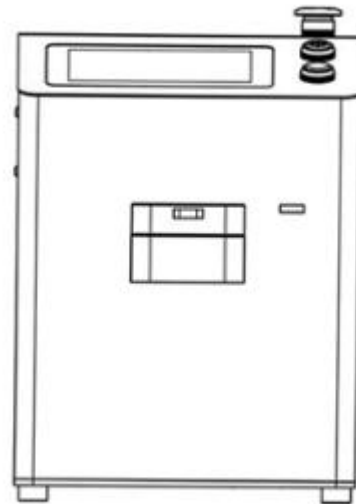

1.2

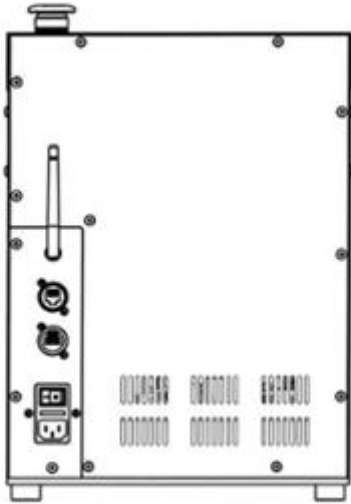

1.3

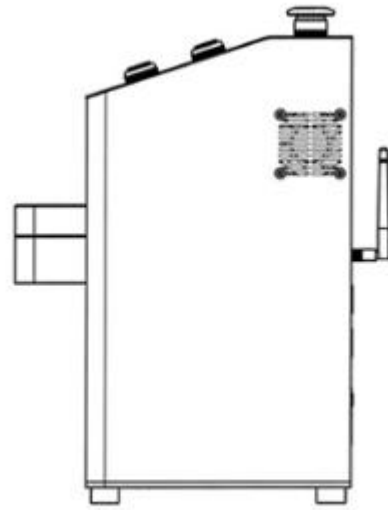

1.4

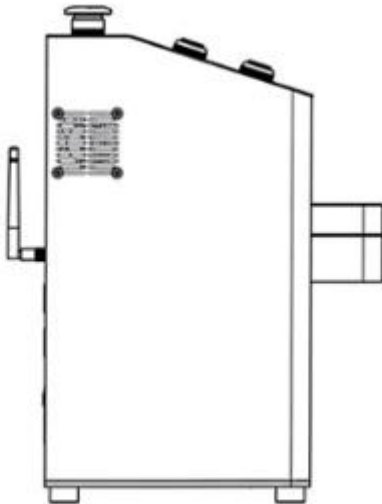

1.5

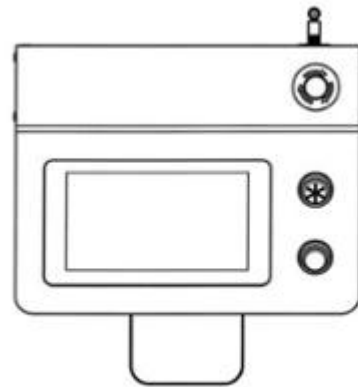

1.6

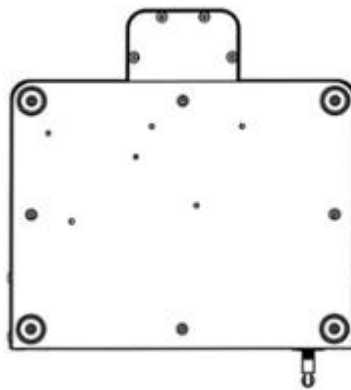

1.7

**CÔNG BÁO SỞ HỮU CÔNG NGHIỆP SỐ 435 TẬP A – QUYỀN 2 (06.2024)**

- (11) **50503**
- (21) 3-2024-00590
- (54) **VỎ BAO XI MĂNG**
- (22) 11/03/2024
- (73) **CÔNG TY TNHH MỘT THÀNH VIÊN XI MĂNG VICEM HẢI PHÒNG (VN)**  
Tràng Kênh, thị trấn Minh Đức, huyện Thủy Nguyên, thành phố Hải Phòng
- (72) Trần Văn Toàn (VN)
- (74) Công ty TNHH Sở hữu trí tuệ M.I.T (M.I.T IP CO., LTD)
- (55)
- (28) 2
- (51) **09-05**
- (43) 25/06/2024

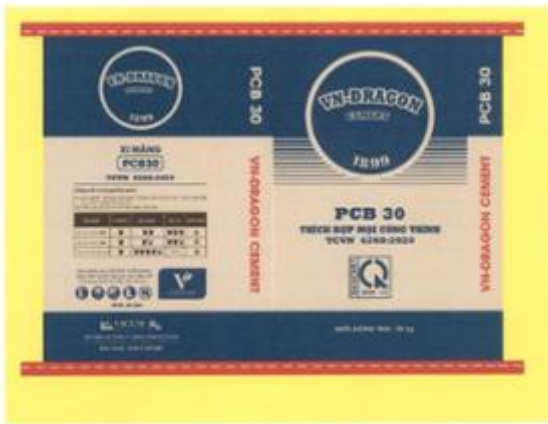

1.1



1.2



2.1



2.2

**CÔNG BÁO SỞ HỮU CÔNG NGHIỆP SỐ 435 TẬP A – QUYỀN 2 (06.2024)**

- (11) **50504**  
(21) 3-2024-00595 (28) 1  
(54) **LỢ** (51) **09-01**  
(22) 13/03/2024 (43) 25/06/2024  
(73) **CÔNG TY CỔ PHẦN METRO SÀI GÒN (VN)**  
35/21 đường TL30, phường Thạnh Lộc, quận 12, thành phố Hồ Chí Minh  
(72) Lý Thị Quy (VN)  
(74) **CÔNG TY LUẬT TNHH QUỐC TẾ ICT (ICT LAW INTERNATIONAL CO., LTD)**  
(55)



1.1

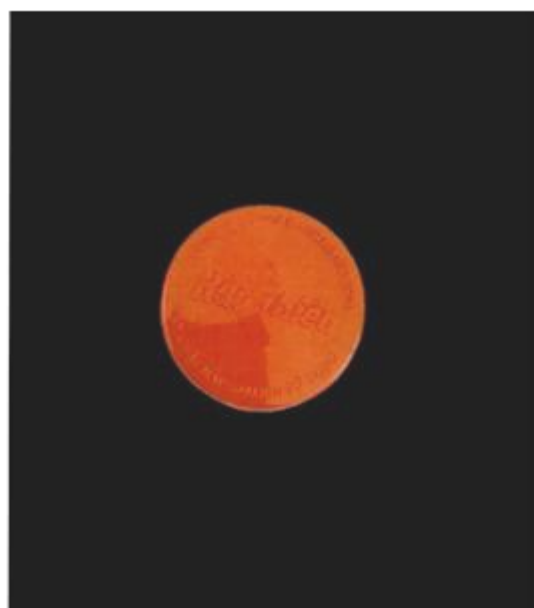

1.2



1.3



1.4

**CÔNG BÁO SỞ HỮU CÔNG NGHIỆP SỐ 435 TẬP A – QUYỀN 2 (06.2024)**

- (11) **50505**  
(21) 3-2024-00598 (28) 1  
(54) **THÙNG** (51) **09-03**  
(22) 13/03/2024 (43) 25/06/2024  
(73) **CÔNG TY CỔ PHẦN ACECOOK VIỆT NAM (VN)**  
Lô số II-3, đường số 11, nhóm CN II, khu công nghiệp Tân Bình, phường Tây  
Thạnh, quận Tân Phú, thành phố Hồ Chí Minh  
(72) KANEDA HIROKI (JP)  
(74) Công ty Luật TNHH Phạm và Liên danh (PHAM & ASSOCIATES)  
(55)



1.1



1.2

**CÔNG BÁO SỞ HỮU CÔNG NGHIỆP SỐ 435 TẬP A – QUYỀN 2 (06.2024)**

- (11) **50506**  
(21) 3-2024-00599 (28) 1  
(54) **BAO GÓI** (51) **09-05**  
(22) 13/03/2024 (43) 25/06/2024  
(73) **CÔNG TY CỔ PHẦN ACECOOK VIỆT NAM (VN)**  
Lô số II-3, đường số 11, nhóm CN II, khu công nghiệp Tân Bình, phường Tây  
Thạnh, quận Tân Phú, thành phố Hồ Chí Minh  
(72) KANEDA HIROKI (JP)  
(74) Công ty Luật TNHH Phạm và Liên danh (PHAM & ASSOCIATES)  
(55)



1.1



1.2

**CÔNG BÁO SỞ HỮU CÔNG NGHIỆP SỐ 435 TẬP A – QUYỀN 2 (06.2024)**

- (11) **50507**  
(21) 3-2024-00600 (28) 1  
(54) **THÙNG** (51) **09-03**  
(22) 13/03/2024 (43) 25/06/2024  
(73) **CÔNG TY CỔ PHẦN ACECOOK VIỆT NAM (VN)**  
Lô số II-3, đường số 11, nhóm CN II, khu công nghiệp Tân Bình, phường Tây  
Thạnh, quận Tân Phú, thành phố Hồ Chí Minh  
(72) KANEDA HIROKI (JP)  
(74) Công ty Luật TNHH Phạm và Liên danh (PHAM & ASSOCIATES)  
(55)



1.1



1.2

(11) **50508**

(21) 3-2024-00605

(28) 1

(54) **LỚP XE**

(51) **12-15**

(22) 13/03/2024

(43) 25/06/2024

(73) **CHENG SHIN RUBBER IND. CO., LTD. (TW)**

No. 215, Meigang Rd., Dacun Township, Changhua County 515, Taiwan

(72) 1. MIN-CHI LIN (TW)

2. YU-HAO HSU (TW)

3. JYUN-YI KE (TW)

4. CHEN-YANG YU (TW)

5. SHIH-WEI LIU (TW)

(74) Công ty Cổ phần Sở hữu công nghiệp INVESTIP (INVESTIP)

(55)

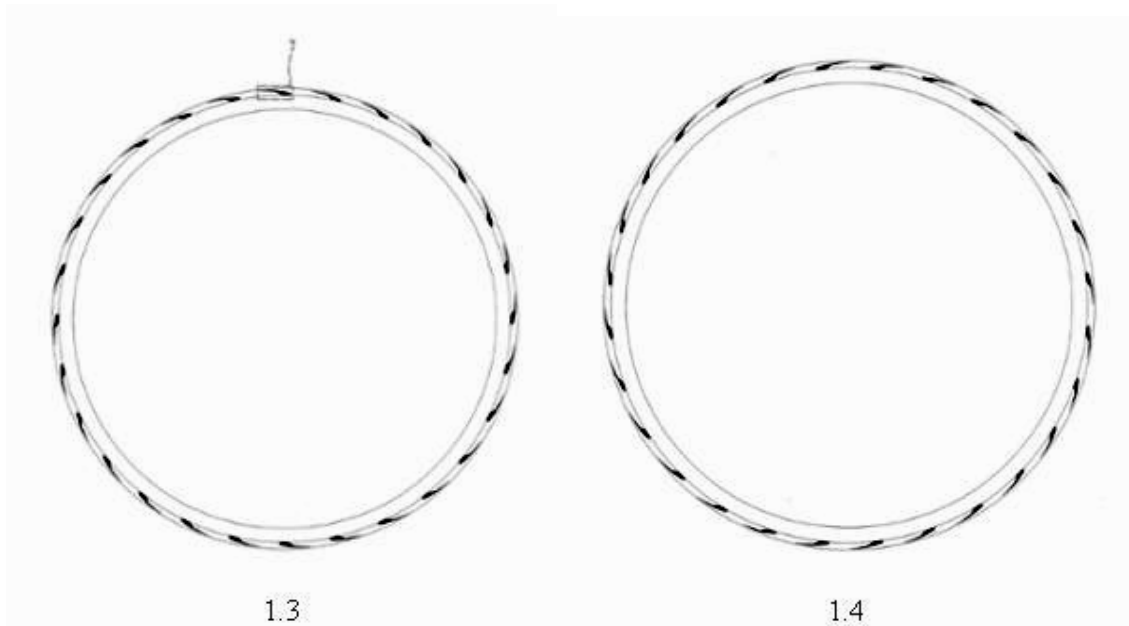
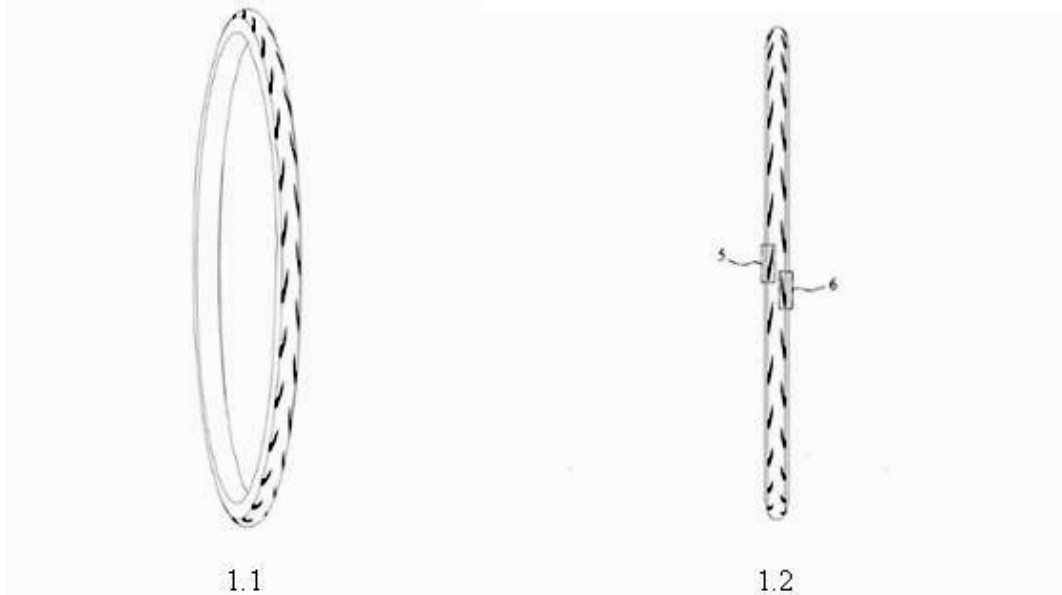





1.5



1.6

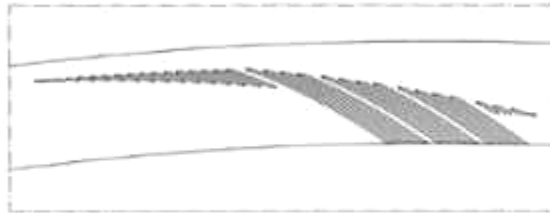

1.7

**CÔNG BÁO SỞ HỮU CÔNG NGHIỆP SỐ 435 TẬP A – QUYỀN 2 (06.2024)**

(11) **50509**

(21) 3-2024-00607

(28) 1

(54) **THANH NHÔM ĐỊNH HÌNH**

(51) **25-01**

(22) 13/03/2024

(43) 25/06/2024

(73) **CÔNG TY CỔ PHẦN NHÔM BLK VIỆT NAM (VN)**

Km 9 đường 35, thôn Thanh Hà, xã Nam Sơn, huyện Sóc Sơn, thành phố Hà Nội

(72) Vũ Bá Trường (VN)

(74) **CÔNG TY TNHH SỞ HỮU TRÍ TUỆ ANLIS VIỆT NAM (ANLIS IP CO.,LTD)**

(55)

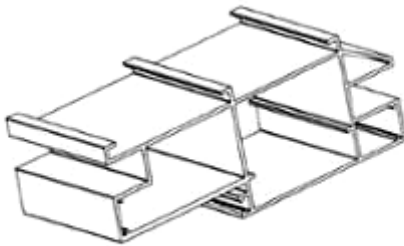

1.1

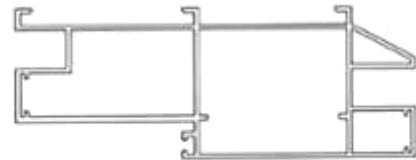

1.2



1.3



1.4

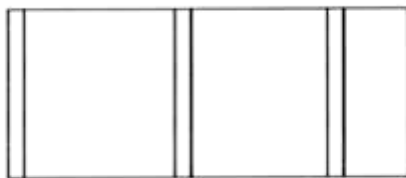

1.5



1.6

**CÔNG BÁO SỞ HỮU CÔNG NGHIỆP SỐ 435 TẬP A – QUYỀN 2 (06.2024)**

- (11) **50510**  
(21) 3-2024-00616 (28) 3  
(54) **Ổ CẮM ĐIỆN** (51) **13-03**  
(22) 14/03/2024 (43) 25/06/2024  
(30) 2023306046282 15/09/2023 CN;  
(73) **SCHNEIDER ELECTRIC INDUSTRIES SAS (FR)**  
35 Rue Joseph Monier, Rueil Malmaison, 92500 France  
(72) 1. YAO WANG (CN)  
2. YUN LI (CN)  
3. HUANBIN MENG (CN)  
4. QINGHUI MENG (CN)  
(74) Công ty TNHH Sở hữu trí tuệ Thảo Thọ Quyên (INVENCO.,LTD)  
(55)



1.1



1.2



1.3



1.4

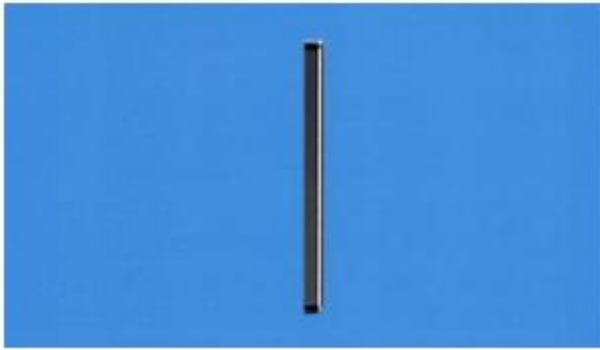

1.5



1.6



1.7



1.8



2.1

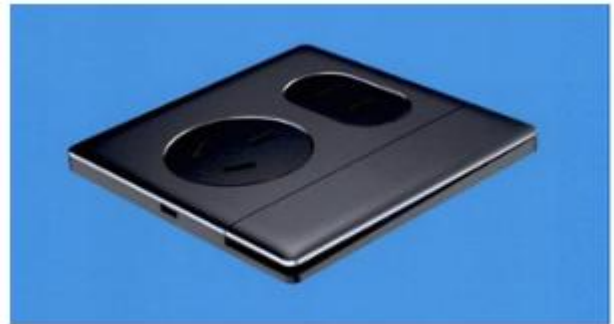

2.2



2.3



2.4



2.5



2.6



2.7



2.8



3.1



3.2



3.3



3.4



3.5



3.6



3.7

**CÔNG BÁO SỞ HỮU CÔNG NGHIỆP SỐ 435 TẬP A – QUYỀN 2 (06.2024)**

- (11) **50511**  
(21) 3-2024-00617 (28) 3  
(54) **Ổ CẮM ĐIỆN** (51) **13-03**  
(22) 14/03/2024 (43) 25/06/2024  
(30) 2023306045858 15/09/2023 CN;  
(73) **SCHNEIDER ELECTRIC INDUSTRIES SAS (FR)**  
35 Rue Joseph Monier, Rueil Malmaison, 92500 France  
(72) 1. YAO WANG (CN)  
2. YUN LI (CN)  
3. HUANBIN MENG (CN)  
4. QINGHUI MENG (CN)  
5. TO CHI WONG (HK)  
(74) Công ty TNHH Sở hữu trí tuệ Thảo Thọ Quyển (INVENCO.,LTD)  
(55)



1.1



1.2



1.3

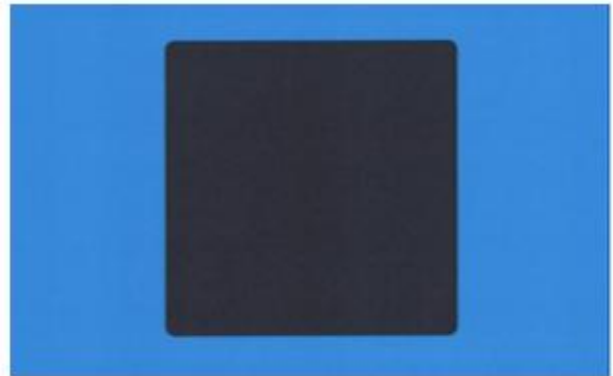

1.4



1.5



1.6



1.7



1.8



2.1



2.2

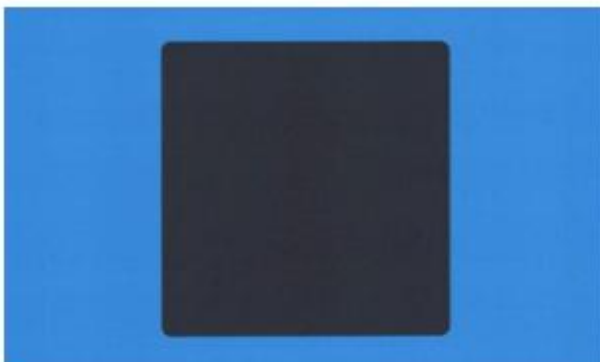

2.3



2.4



2.5



2.6



2.7



3.1



3.2



3.3

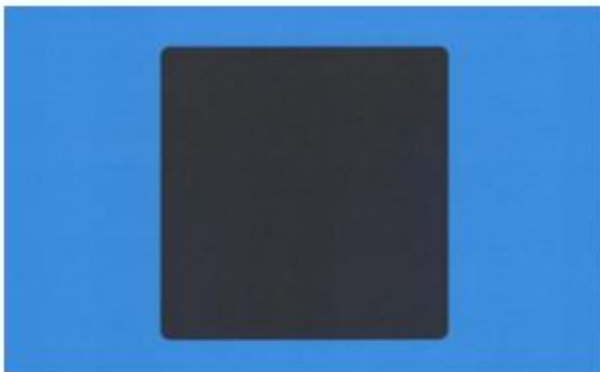

3.4



3.5





3.6



3.7



3.8

**CÔNG BÁO SỞ HỮU CÔNG NGHIỆP SỐ 435 TẬP A – QUYỀN 2 (06.2024)**

- (11) **50512**  
(21) 3-2024-00624 (28) 1  
(54) **XE MÁY** (51) **12-11**  
(22) 15/03/2024 (43) 25/06/2024  
(30) 2023-019365 21/09/2023 JP;  
(73) **HONDA MOTOR CO., LTD. (JP)**  
1-1, Minami-Aoyama 2-chome, Minato-ku, Tokyo, 107-8556 Japan  
(72) 1. AYUMU TSUJI (JP)  
2. VALERIO AIELLO (IT)  
3. HIDEKAZU IWATA (JP)  
(74) Công ty Luật TNHH Phạm và Liên danh (PHAM & ASSOCIATES)  
(55)



1.1



1.2



1.3



1.4



1.5



1.6



1.7



1.8



1.9

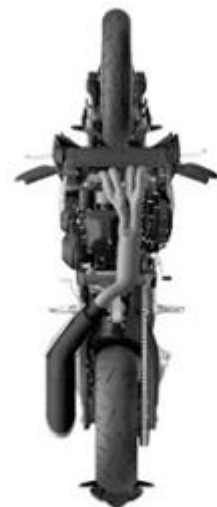

1.10

**CÔNG BÁO SỞ HỮU CÔNG NGHIỆP SỐ 435 TẬP A – QUYỀN 2 (06.2024)**

- (11) **50513**  
(21) 3-2024-00625 (28) 1  
(54) **TẮM ỐP BÌNH NHIÊN LIỆU XE MÁY** (51) **12-16**  
(22) 15/03/2024 (43) 25/06/2024  
(30) 2023-019366 21/09/2023 JP;  
(73) **HONDA MOTOR CO., LTD. (JP)**  
1-1, Minami-Aoyama 2-chome, Minato-ku, Tokyo, 107-8556 Japan  
(72) 1. AYUMU TSUJI (JP)  
2. HIDEKAZU IWATA (JP)  
(74) Công ty Luật TNHH Phạm và Liên danh (PHAM & ASSOCIATES)  
(55)



1.1



1.2



1.3



1.4



1.5



1.6



1.7



1.8



1.9



1.10



1.11

**CÔNG BÁO SỞ HỮU CÔNG NGHIỆP SỐ 435 TẬP A – QUYỀN 2 (06.2024)**

- (11) **50514**  
(21) 3-2024-00637 (28) 1  
(54) **KHUNG CHỈNH NHA KHOA** (51) **24-02**  
(22) 15/03/2024 (43) 25/06/2024  
(30) 2023306296979 26/09/2023 CN;  
(73) **GUANGZHOU OO MEDICAL SCIENTIFIC LIMITED (CN)**  
Room 316, Building G2, South China Advanced Materials Innovation Park, No.31,  
Kefeng Road, Guangzhou Development District, Guangzhou, Guangdong, China  
(72) Yuanqiang CHEN (CN)  
(74) Công ty TNHH Sáng chế ACTIP (ACTIP PATENT LIMITED)  
(55)



1.1

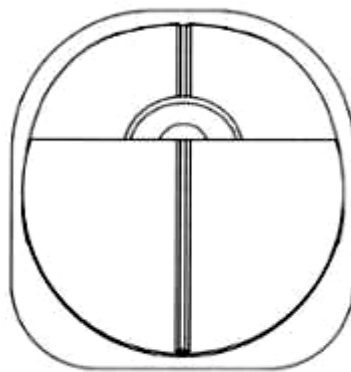

1.2

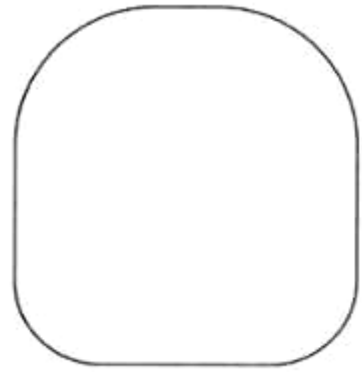

1.3



1.4



1.5

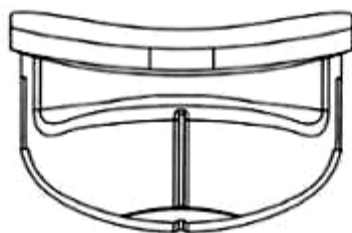

1.6

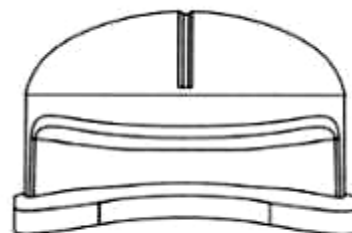

1.7

**CÔNG BÁO SỞ HỮU CÔNG NGHIỆP SỐ 435 TẬP A – QUYỀN 2 (06.2024)**

(11) **50515**

(21) 3-2024-00642

(28) 1

(54) **CÔNG TẮC**

(51) **13-03**

(22) 18/03/2024

(43) 25/06/2024

(73) **CÔNG TY CỔ PHẦN BÓNG ĐÈN PHÍCH NƯỚC RẠNG ĐÔNG (VN)**

87-89 phố Hạ Đình, phường Thanh Xuân Trung, quận Thanh Xuân, thành phố Hà Nội

(72) Trần Trung Tường (VN)

(55)

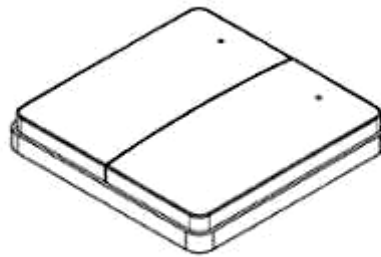

1.1

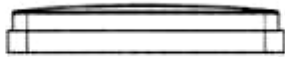

1.2

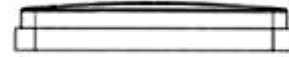

1.3

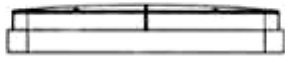

1.4

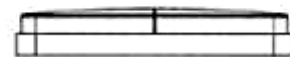

1.5

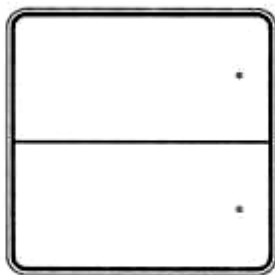

1.6

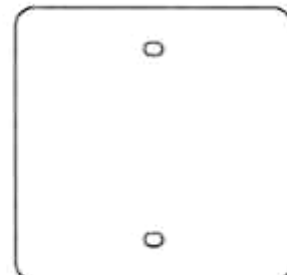

1.7

**CÔNG BÁO SỞ HỮU CÔNG NGHIỆP SỐ 435 TẬP A – QUYỀN 2 (06.2024)**

(11) **50516**

(21) 3-2024-00643

(28) 1

(54) **Ổ CẮM**

(51) **13-03**

(22) 18/03/2024

(43) 25/06/2024

(73) **CÔNG TY CỔ PHẦN BÓNG ĐÈN PHÍCH NƯỚC RẠNG ĐÔNG (VN)**  
87-89 phố Hạ Đình, phường Thanh Xuân Trung, quận Thanh Xuân, thành phố Hà Nội

(72) Trần Trung Tường (VN)

(55)

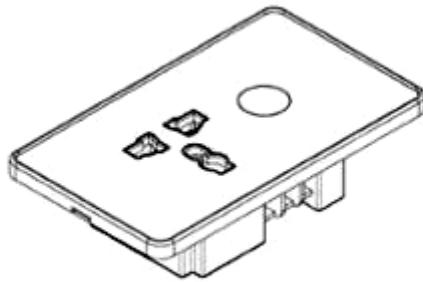

1.1

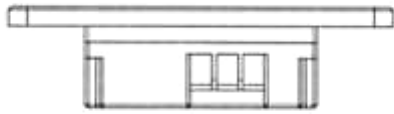

1.2

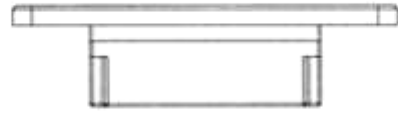

1.3

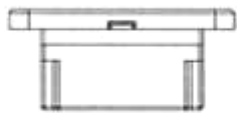

1.4



1.5

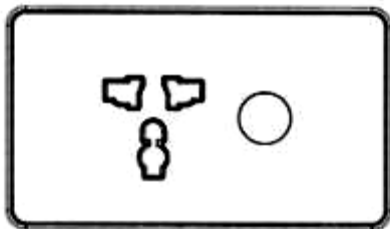

1.6

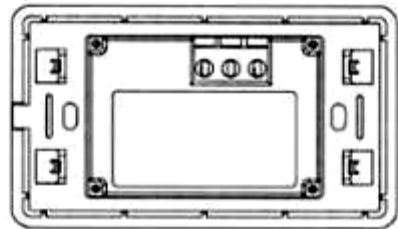

1.7



**CÔNG BÁO SỞ HỮU CÔNG NGHIỆP SỐ 435 TẬP A – QUYỀN 2 (06.2024)**

- (11) **50517**  
(21) 3-2024-00644 (28) 1  
(54) **CÔNG TẮC CHUYÊN MẠCH** (51) **13-03**  
(22) 18/03/2024 (43) 25/06/2024  
(73) **CÔNG TY CỔ PHẦN BÓNG ĐÈN PHÍCH NƯỚC RẠNG ĐÔNG (VN)**  
87-89 phố Hạ Đình, phường Thanh Xuân Trung, quận Thanh Xuân, thành phố Hà Nội  
(72) Trần Trung Tường (VN)  
(55)

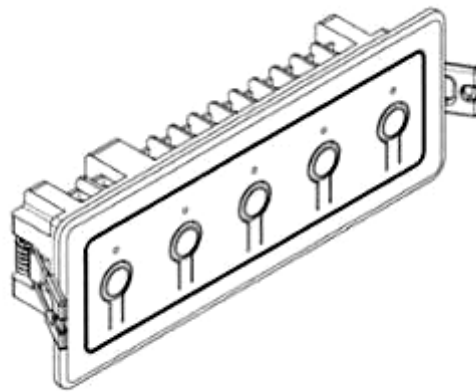

1.1



1.2



1.3

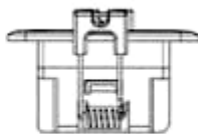

1.4

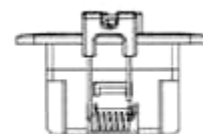

1.5

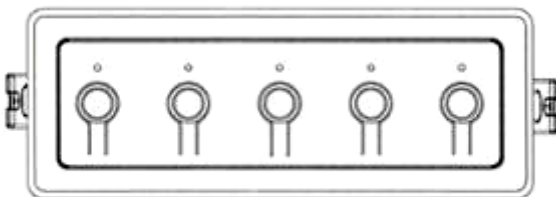

1.6

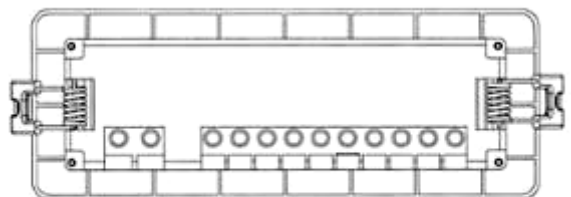

1.7

**CÔNG BÁO SỞ HỮU CÔNG NGHIỆP SỐ 435 TẬP A – QUYỀN 2 (06.2024)**

- (11) **50518**
- (21) 3-2024-00649 (28) 1
- (54) **MÁY SẤY** (51) **15-03**
- (22) 19/03/2024 (43) 25/06/2024
- (73) **TRUNG TÂM THIẾT KẾ, CHẾ TẠO VÀ THỬ NGHIỆM (VN)**  
39 Trần Hưng Đạo, phường Hàng Bài, quận Hoàn Kiếm, thành phố Hà Nội
- (72) 1. NGUYỄN VĂN THÀNH (VN)  
2. HÀ THỊ HOÀI THƯƠNG (VN)  
3. PHAN THỊ HOÀI PHƯƠNG (VN)  
4. NGUYỄN THUY DUNG (VN)  
5. NGUYỄN XUÂN THÀNH (VN)  
6. ĐẶNG HOÀNG HỢP (VN)  
7. ĐINH THỊ MINH HIỀN (VN)
- (55)

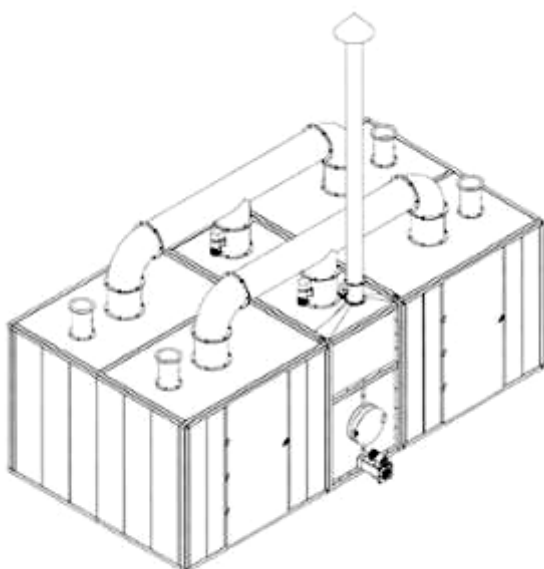

1.1

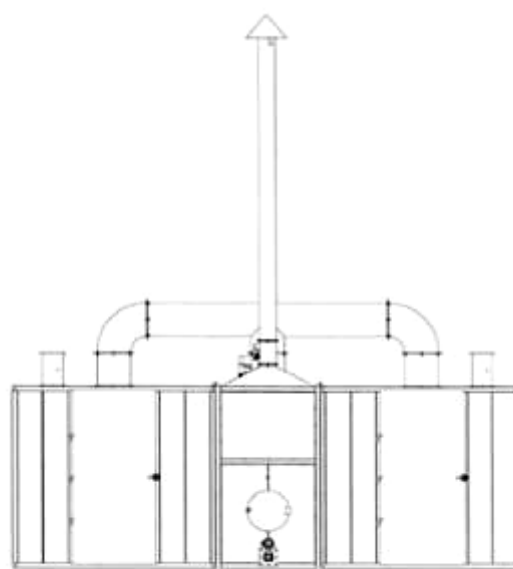

1.2

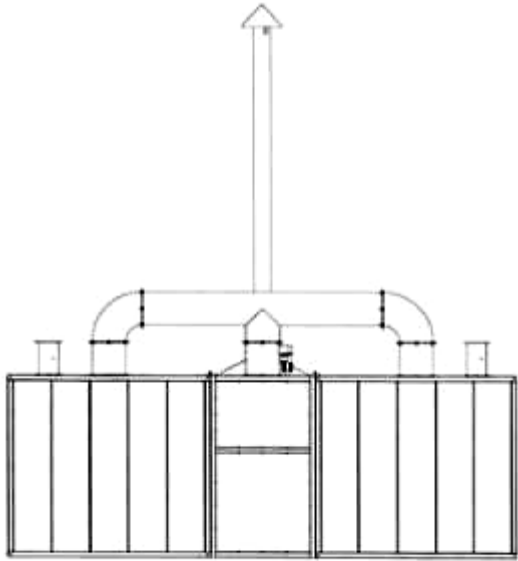

1.3

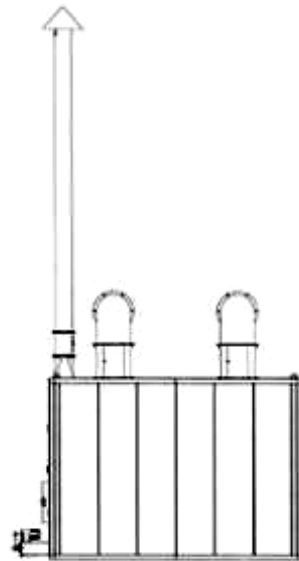

1.4

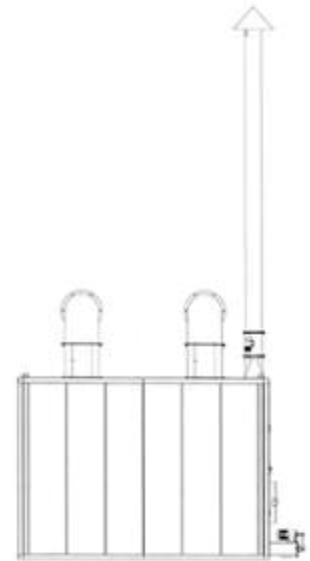

1.5

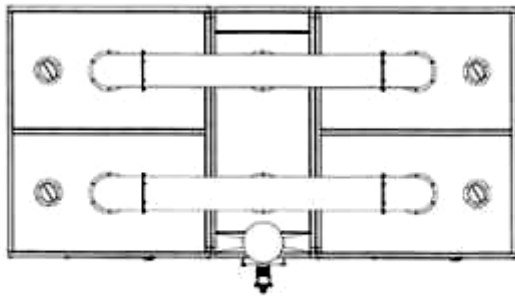

1.6

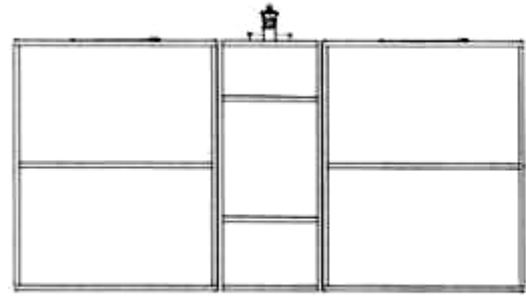

1.7

**CÔNG BÁO SỞ HỮU CÔNG NGHIỆP SỐ 435 TẬP A – QUYỀN 2 (06.2024)**

- (11) **50519**
- (21) 3-2024-00651
- (54) **BAO GÓI SẢN PHẨM**
- (22) 19/03/2024
- (73) **CÔNG TY TNHH GIẤY MYLAN (VN)**  
Số 19B/5, phố Nguyễn Văn Cừ, phường Ngọc Lâm, quận Long Biên, thành phố Hà Nội
- (72) Nguyễn Thị Dung (VN)
- (74) Công ty TNHH Tư vấn Nhiệt tâm và Cộng sự (NT & PARTNERS CO.,LTD.)
- (55)

- (28) 5
- (51) **09-05**
- (43) 25/06/2024



1.1



1.2



2.1



2.2



3.1



3.2



4.1



4.2



5.1



5.2

**CÔNG BÁO SỞ HỮU CÔNG NGHIỆP SỐ 435 TẬP A – QUYỀN 2 (06.2024)**

- (11) **50520**
  - (21) 3-2024-00652
  - (54) **BAO GÓI SẢN PHẨM**
  - (22) 19/03/2024
  - (73) **CÔNG TY TNHH GIẤY MYLAN (VN)**  
Số 19B/5, phố Nguyễn Văn Cừ, phường Ngọc Lâm, quận Long Biên, thành phố Hà Nội
  - (72) Nguyễn Thị Dung (VN)
  - (74) Công ty TNHH Tư vấn Nhiệt tâm và Cộng sự (NT & PARTNERS CO.,LTD.)
  - (55)
- (28) 1
  - (51) **09-05**
  - (43) 25/06/2024



1.1



1.2



1.3



1.4



1.5



1.6

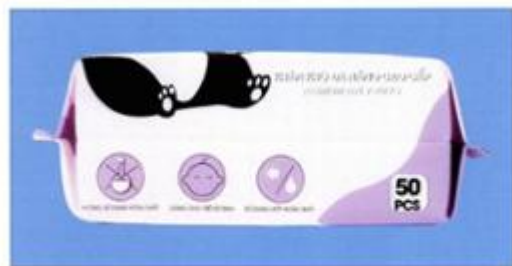

1.7

**CÔNG BÁO SỞ HỮU CÔNG NGHIỆP SỐ 435 TẬP A – QUYỀN 2 (06.2024)**

- (11) **50521**  
(21) 3-2024-00653 (28) 1  
(54) **BAO GÓI SẢN PHẨM** (51) **09-05**  
(22) 19/03/2024 (43) 25/06/2024  
(73) **CÔNG TY TNHH GIẤY MYLAN (VN)**  
Số 19B/5, phố Nguyễn Văn Cừ, phường Ngọc Lâm, quận Long Biên, thành phố Hà Nội  
(72) Nguyễn Thị Dung (VN)  
(74) Công ty TNHH Tư vấn Nhiệt tâm và Cộng sự (NT & PARTNERS CO.,LTD.)  
(55)



1.1



1.2



**CÔNG BÁO SỞ HỮU CÔNG NGHIỆP SỐ 435 TẬP A – QUYỀN 2 (06.2024)**

- (11) **50522**  
(21) 3-2024-00654 (28) 1  
(54) **BAO GÓI SẢN PHẨM** (51) **09-05**  
(22) 19/03/2024 (43) 25/06/2024  
(73) **CÔNG TY TNHH GIẤY MYLAN (VN)**  
Số 19B/5, phố Nguyễn Văn Cừ, phường Ngọc Lâm, quận Long Biên, thành phố Hà Nội  
(72) Nguyễn Thị Dung (VN)  
(74) Công ty TNHH Tư vấn Nhiệt tâm và Cộng sự (NT & PARTNERS CO.,LTD.)  
(55)



1.1



1.2

**CÔNG BÁO SỞ HỮU CÔNG NGHIỆP SỐ 435 TẬP A – QUYỀN 2 (06.2024)**

- (11) **50523**  
(21) 3-2024-00655 (28) 1  
(54) **BAO GÓI SẢN PHẨM** (51) **09-05**  
(22) 19/03/2024 (43) 25/06/2024  
(73) **CÔNG TY TNHH GIẤY MYLAN (VN)**  
Số 19B/5, phố Nguyễn Văn Cừ, phường Ngọc Lâm, quận Long Biên, thành phố Hà Nội  
(72) Nguyễn Thị Dung (VN)  
(74) Công ty TNHH Tư vấn Nhiệt tâm và Cộng sự (NT & PARTNERS CO.,LTD.)  
(55)



1.1



1.2

**CÔNG BÁO SỞ HỮU CÔNG NGHIỆP SỐ 435 TẬP A – QUYỀN 2 (06.2024)**

- (11) **50524**  
(21) 3-2024-00656 (28) 1  
(54) **BAO GÓI SẢN PHẨM** (51) **09-05**  
(22) 19/03/2024 (43) 25/06/2024  
(73) **CÔNG TY TNHH GIẤY MYLAN (VN)**  
Số 19B/5, phố Nguyễn Văn Cừ, phường Ngọc Lâm, quận Long Biên, thành phố Hà Nội  
(72) Nguyễn Thị Dung (VN)  
(74) Công ty TNHH Tư vấn Nhiệt tâm và Cộng sự (NT & PARTNERS CO.,LTD.)  
(55)



1.1



1.2

**CÔNG BÁO SỞ HỮU CÔNG NGHIỆP SỐ 435 TẬP A – QUYỀN 2 (06.2024)**

- (11) **50525**  
(21) 3-2024-00657 (28) 1  
(54) **BAO GÓI SẢN PHẨM** (51) **09-05**  
(22) 19/03/2024 (43) 25/06/2024  
(73) **CÔNG TY TNHH GIẤY MYLAN (VN)**  
Số 19B/5, phố Nguyễn Văn Cừ, phường Ngọc Lâm, quận Long Biên, thành phố Hà Nội  
(72) Nguyễn Thị Dung (VN)  
(74) Công ty TNHH Tư vấn Nhiệt tâm và Cộng sự (NT & PARTNERS CO.,LTD.)  
(55)



1.1



1.2

**CÔNG BÁO SỞ HỮU CÔNG NGHIỆP SỐ 435 TẬP A – QUYỀN 2 (06.2024)**

- (11) **50526**  
(21) 3-2024-00659 (28) 1  
(54) **BAO GÓI SẢN PHẨM** (51) **09-05**  
(22) 19/03/2024 (43) 25/06/2024  
(73) **CÔNG TY TNHH GIẤY MYLAN (VN)**  
Số 19B/5, phố Nguyễn Văn Cừ, phường Ngọc Lâm, quận Long Biên, thành phố Hà Nội  
(72) Nguyễn Thị Dung (VN)  
(74) Công ty TNHH Tư vấn Nhiệt tâm và Cộng sự (NT & PARTNERS CO.,LTD.)  
(55)



1.1



1.2

**CÔNG BÁO SỞ HỮU CÔNG NGHIỆP SỐ 435 TẬP A – QUYỀN 2 (06.2024)**

- (11) **50527**  
(21) 3-2024-00660 (28) 1  
(54) **BAO GÓI SẢN PHẨM** (51) **09-05**  
(22) 19/03/2024 (43) 25/06/2024  
(73) **CÔNG TY TNHH GIẤY MYLAN (VN)**  
Số 19B/5, phố Nguyễn Văn Cừ, phường Ngọc Lâm, quận Long Biên, thành phố Hà Nội  
(72) Nguyễn Thị Dung (VN)  
(74) Công ty TNHH Tư vấn Nhiệt tâm và Cộng sự (NT & PARTNERS CO.,LTD.)  
(55)



1.1



1.2

**CÔNG BÁO SỞ HỮU CÔNG NGHIỆP SỐ 435 TẬP A – QUYỀN 2 (06.2024)**

- (11) **50528**  
(21) 3-2024-00664 (28) 1  
(54) **BAO GÓI** (51) **09-05**  
(22) 19/03/2024 (43) 25/06/2024  
(73) **CÔNG TY TNHH FLY YOUNG (VN)**  
Số 06, đường Cầu Tiên, khu Dương Ổ, phường Phong Khê, thành phố Bắc Ninh,  
tỉnh Bắc Ninh  
(72) Ngô Thị Hoài Thu (VN)  
(74) Công ty Cổ phần ICHECK (ICHECK.,JSC)  
(55)



1.1



1.2

**CÔNG BÁO SỞ HỮU CÔNG NGHIỆP SỐ 435 TẬP A – QUYỀN 2 (06.2024)**

- (11) **50529**  
(21) 3-2024-00671 (28) 1  
(54) **BAO GÓI** (51) **09-05**  
(22) 19/03/2024 (43) 25/06/2024  
(73) **CÔNG TY TNHH NTPM (VIỆT NAM) (VN)**  
Số 22 VSIP II-A, đường số 23, khu công nghiệp Việt Nam - Singapore II-A,  
phường Vĩnh Tân, thành phố Tân Uyên, tỉnh Bình Dương  
(72) LEE KUAN PHENG (MY)  
(74) Công ty TNHH Sở hữu trí tuệ HA VIP (HAVIP CO., LTD.)  
(55)



1.1



1.2



**CÔNG BÁO SỞ HỮU CÔNG NGHIỆP SỐ 435 TẬP A – QUYỀN 2 (06.2024)**

- (11) **50530**  
(21) 3-2024-00686 (28) 1  
(54) **LỚP XE** (51) **12-15**  
(22) 20/03/2024 (43) 25/06/2024  
(73) **CHENG SHIN RUBBER IND. CO., LTD. (TW)**  
NO. 215, MEIGANG RD., DACUN TOWNSHIP, CHANGHUA COUNTY 51545,  
TAIWAN  
(72) SU, TZU-FU (TW)  
(74) Công ty TNHH một thành viên Sở hữu trí tuệ VCCI (VCCI-IP CO.,LTD)  
(55)

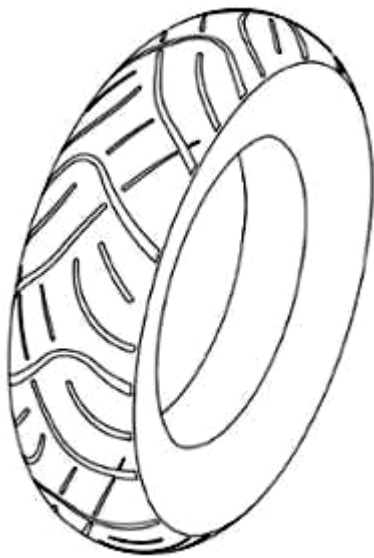

1.1

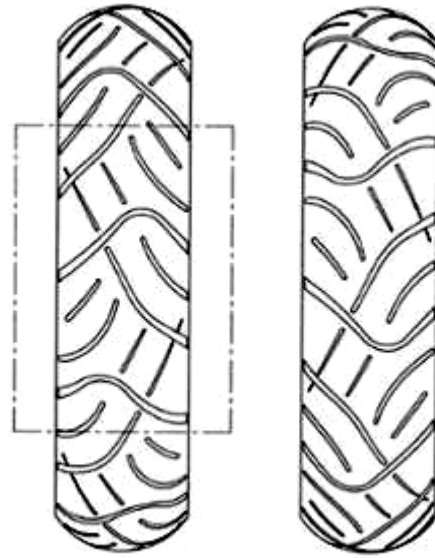

1.2

1.3

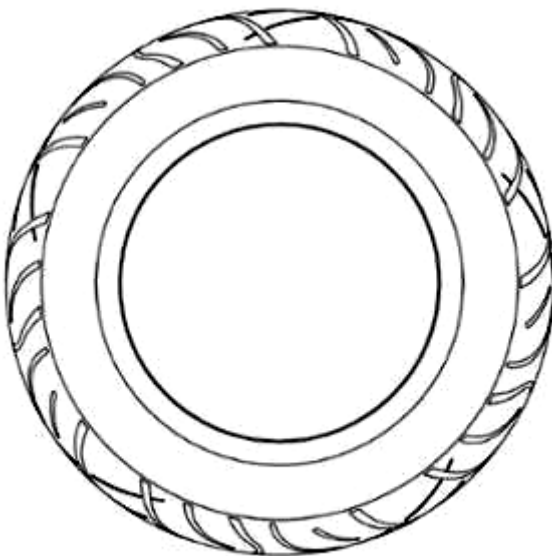

1.4



1.5

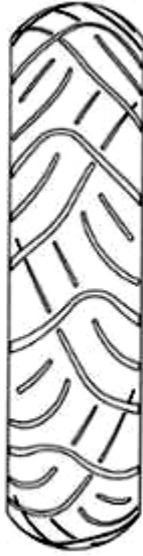

1.6



1.7

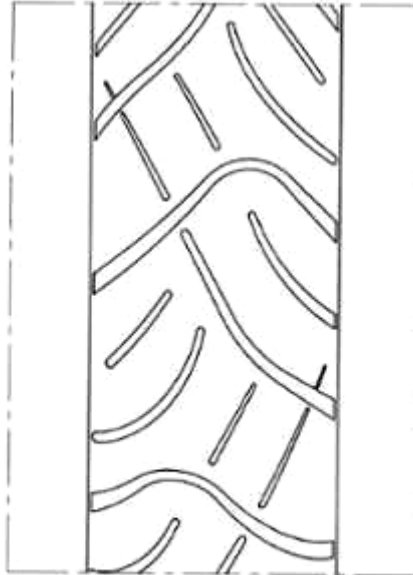

1.8

**CÔNG BÁO SỞ HỮU CÔNG NGHIỆP SỐ 435 TẬP A – QUYỀN 2 (06.2024)**

- (11) **50531**  
(21) 3-2024-00695 (28) 1  
(54) **BAO GÓI** (51) **09-05**  
(22) 20/03/2024 (43) 25/06/2024  
(73) **CÔNG TY TRÁCH NHIỆM HỮU HẠN CON CÒ VÀNG (VN)**  
23 lô B đường số 1, phường Phú Thuận, quận 7, thành phố Hồ Chí Minh  
(72) Hoàng Mai Dẫn (VN)  
(74) Công ty TNHH một thành viên Trường Luật (Trường Luật)  
(55)



1.1



1.2

**CÔNG BÁO SỞ HỮU CÔNG NGHIỆP SỐ 435 TẬP A – QUYỀN 2 (06.2024)**

- (11) **50532**  
(21) 3-2024-00698 (28) 1  
(54) **THIẾT BỊ NỔI** (51) **13-03**  
(22) 21/03/2024 (43) 25/06/2024  
(30) 2023-020574 05/10/2023 JP;  
(73) **JAPAN AVIATION ELECTRONICS INDUSTRY, LIMITED (JP)**  
21-1, Dogenzaka 1-chome, Shibuya-ku, Tokyo 150-0043 Japan  
(72) 1. KAZUNOBU NAKAMURA (JP)  
2. YUKI KASAI (JP)  
3. NAOKI IWAO (JP)  
(74) **CÔNG TY LUẬT TRÁCH NHIỆM HỮU HẠN AMBYS HÀ NỘI (AMBYS HANOI)**  
(55)

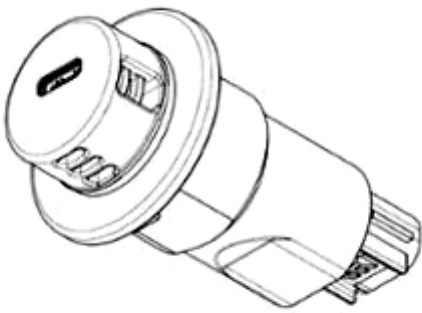

1.1

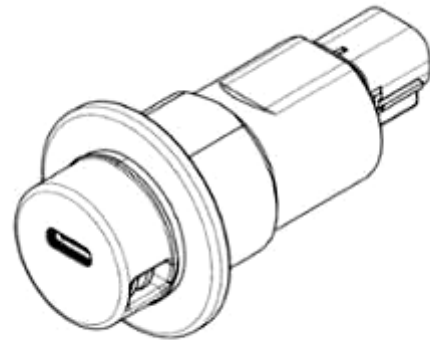

1.2

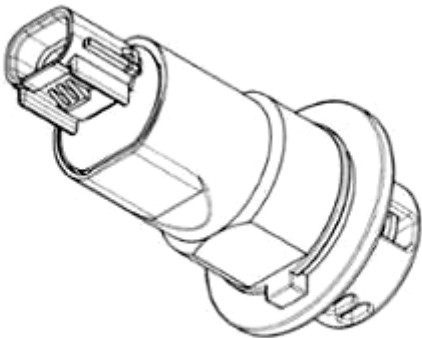

1.3

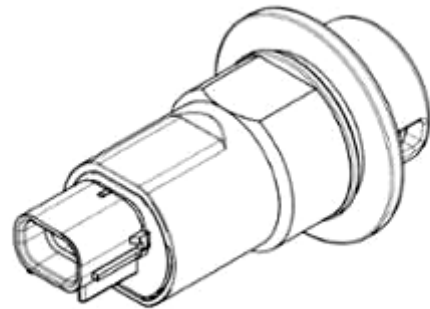

1.4



1.5

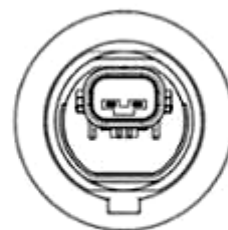

1.6

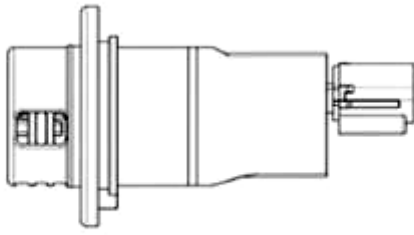

1.7

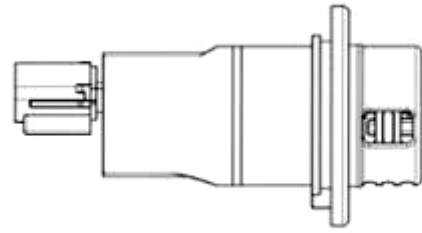

1.8

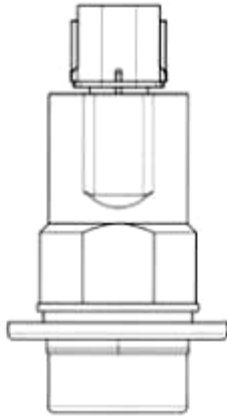

1.9

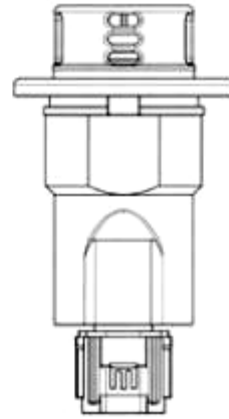

1.10

**CÔNG BÁO SỞ HỮU CÔNG NGHIỆP SỐ 435 TẬP A – QUYỀN 2 (06.2024)**

(11) **50533**

(21) 3-2024-00712

(28) 1

(54) **THIẾT BỊ VẬN ĐỘNG ĐA NĂNG**

(51) **21-03**

(22) 22/03/2024

(43) 25/06/2024

(73) **CÔNG TY TNHH SẢN XUẤT MUA BÁN THIẾT BỊ TRƯỜNG HỌC TÂN TIẾN (VN)**

354/6 đường TX 14, khu phố 7, phường Thạnh Xuân, quận 12, thành phố Hồ Chí Minh

(72) Mai Ngọc Cường (VN)

(55)



1.1



1.2



1.3



1.4



1.5

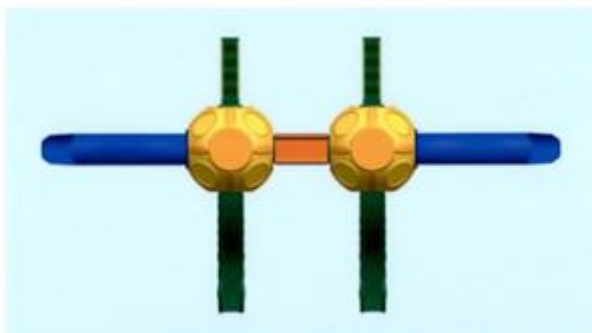

1.6

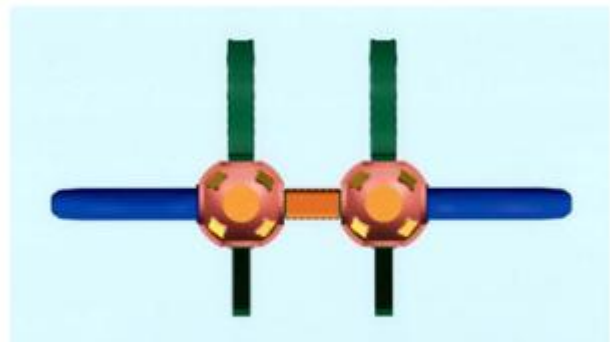

1.7

**CÔNG BÁO SỞ HỮU CÔNG NGHIỆP SỐ 435 TẬP A – QUYỀN 2 (06.2024)**

- (11) **50534**  
(21) 3-2024-00725 (28) 1  
(54) **ĐÈN** (51) **26-05**  
(22) 25/03/2024 (43) 25/06/2024  
(73) **CÔNG TY CỔ PHẦN BÓNG ĐÈN PHÍCH NƯỚC RẠNG ĐÔNG (VN)**  
87-89 phố Hạ Đình, phường Thanh Xuân Trung, quận Thanh Xuân, thành phố Hà Nội  
(72) Trần Trung Tường (VN)  
(55)

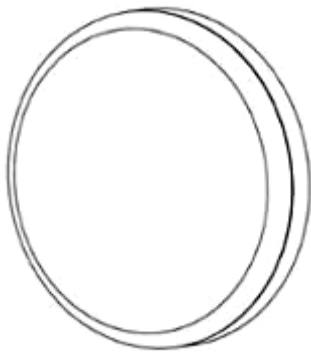

1.1



1.2

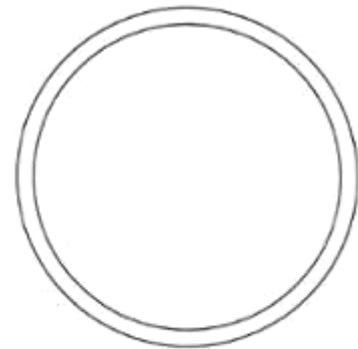

1.3

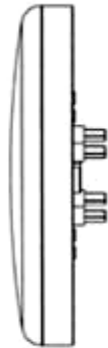

1.4



1.5



1.7



1.6

**CÔNG BÁO SỞ HỮU CÔNG NGHIỆP SỐ 435 TẬP A – QUYỀN 2 (06.2024)**

- (11) **50535**  
(21) 3-2024-00726 (28) 1  
(54) **ĐÈN** (51) **26-05**  
(22) 25/03/2024 (43) 25/06/2024  
(73) **CÔNG TY CỔ PHẦN BÓNG ĐÈN PHÍCH NƯỚC RẠNG ĐÔNG (VN)**  
87-89 phố Hạ Đình, phường Thanh Xuân Trung, quận Thanh Xuân, thành phố Hà Nội  
(72) Trần Trung Tường (VN)  
(55)

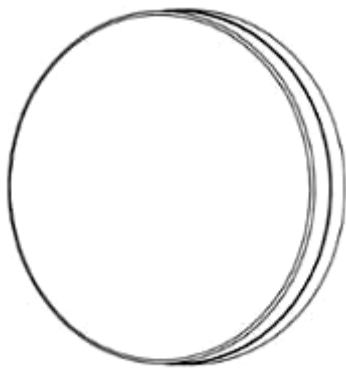

1.1

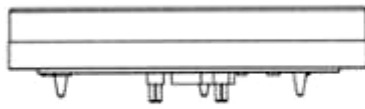

1.2

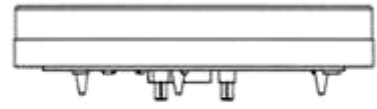

1.3

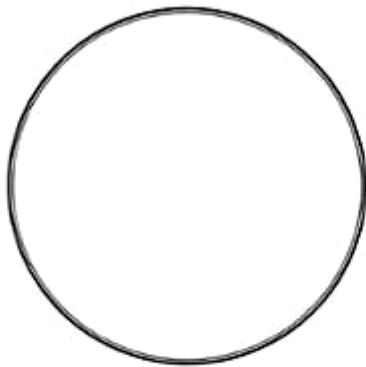

1.4

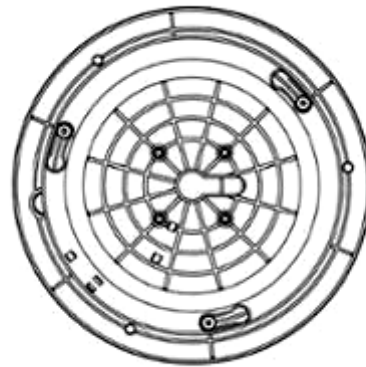

1.5

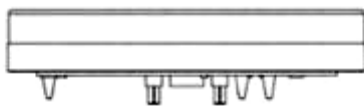

1.6



1.7



(11) **50536**

(21) 3-2024-00731

(28) 1

(54) **THIẾT BỊ CHĂM SÓC DA**

(51) **28-03**

(22) 27/03/2024

(43) 25/06/2024

(73) **SHENZHEN ULIKE SMART ELECTRONICS CO., LTD. (CN)**

Room 810, Building 1, Xunmei Technology Plaza, No. 8 Keyuan Road, Science and Technology Park Community, Yuehai Street, Nanshan District, Shenzhen, Guangdong 518000, China

(72) Lijun TAN (CN)

(74) Công ty Luật TNHH Phạm và Liên danh (PHAM & ASSOCIATES)

(55)



1.1



1.2



1.3



1.4



1.5



1.6

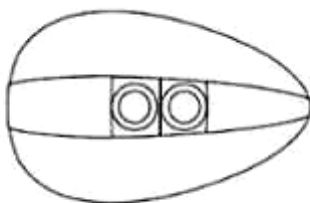

1.7

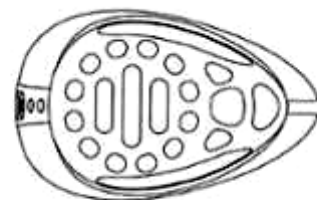

1.8

**CÔNG BÁO SỞ HỮU CÔNG NGHIỆP SỐ 435 TẬP A – QUYỀN 2 (06.2024)**

- (11) **50537**  
(21) 3-2024-00733 (28) 1  
(54) **KHAY ĐỰNG THỰC PHẨM** (51) **07-99**  
(22) 27/03/2024 (43) 25/06/2024  
(73) **CÔNG TY TNHH PHÁT TRIỂN VIỆT QUỐC TẾ (VN)**  
Phòng 102 số 11 Bis Nguyễn Gia Thiều, phường Võ Thị Sáu, quận 3, thành phố Hồ Chí Minh  
(72) Cáp Văn Thái (VN)  
(55)

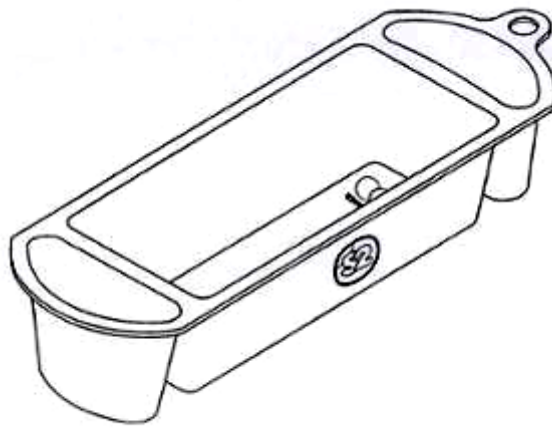

1.1



1.2

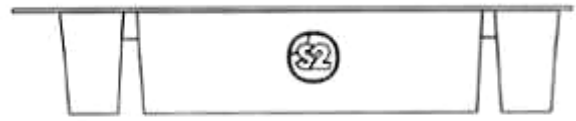

1.3

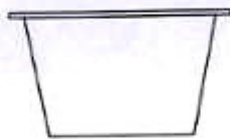

1.4

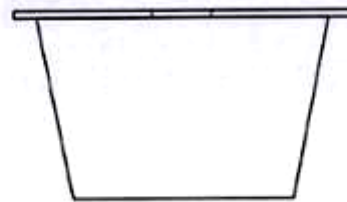

1.5

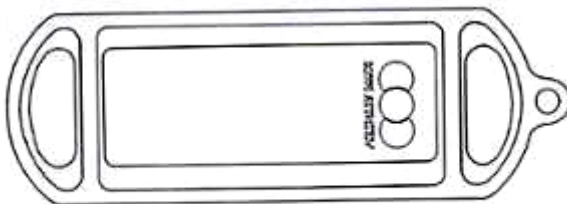

1.6

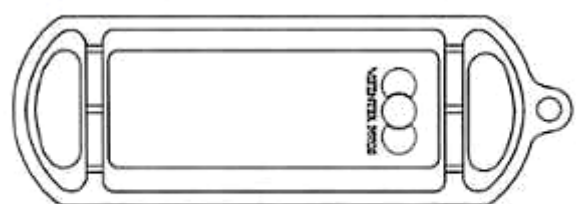

1.7

**CÔNG BÁO SỞ HỮU CÔNG NGHIỆP SỐ 435 TẬP A – QUYỀN 2 (06.2024)**

- (11) **50538**  
(21) 3-2024-00735 (28) 1  
(54) **KẸP CỬA KÍNH** (51) **08-08**  
(22) 27/03/2024 (43) 25/06/2024  
(73) **CÔNG TY TNHH SGD VIỆT NAM (VN)**  
Số 1 ngõ 32, phố Lệ Mật, phường Việt Hưng, quận Long Biên, thành phố Hà Nội  
(72) Bùi Hạnh Kiểm (VN)  
(55)



1.1



1.2

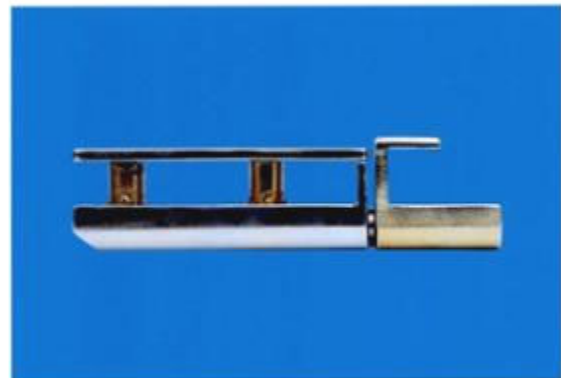

1.3



1.4



1.5

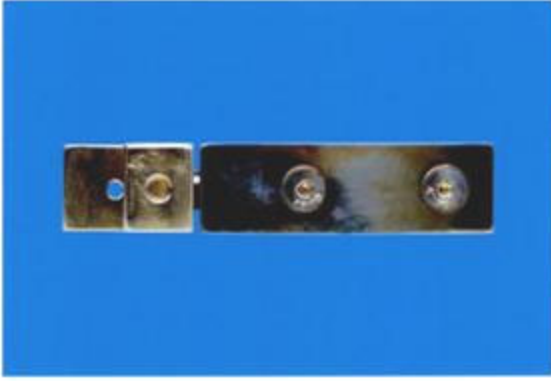

1.6



1.7

**CÔNG BÁO SỞ HỮU CÔNG NGHIỆP SỐ 435 TẬP A – QUYỀN 2 (06.2024)**

- (11) **50539**  
(21) 3-2024-00752 (28) 1  
(54) **BAO GÓI** (51) **09-05**  
(22) 28/03/2024 (43) 25/06/2024  
(73) **ORION CORPORATION (KR)**  
13, Baekbeom-ro 90da-gil, Yongsan-gu, Seoul 04369, Republic of Korea  
(72) 1. CHOE, EUN JE (KR)  
2. LEE, HYUN A (KR)  
(74) Công ty Luật TNHH quốc tế BMVN (BMVN INTERNATIONAL LLC)  
(55)



1.1



1.2

**CÔNG BÁO SỞ HỮU CÔNG NGHIỆP SỐ 435 TẬP A – QUYỀN 2 (06.2024)**

- (11) **50540**  
(21) 3-2024-00753 (28) 1  
(54) **BAO GÓI** (51) **09-05**  
(22) 28/03/2024 (43) 25/06/2024  
(73) **ORION CORPORATION (KR)**  
13, Baekbeom-ro 90da-gil, Yongsan-gu, Seoul 04369, Republic of Korea  
(72) 1. CHOE, EUN JE (KR)  
2. LEE, HYUN A (KR)  
(74) Công ty Luật TNHH quốc tế BMVN (BMVN INTERNATIONAL LLC)  
(55)



1.1



1.2

**CÔNG BÁO SỞ HỮU CÔNG NGHIỆP SỐ 435 TẬP A – QUYỀN 2 (06.2024)**

- (11) **50541**  
(21) 3-2024-00754 (28) 3  
(54) **BAO GÓI** (51) **09-05**  
(22) 28/03/2024 (43) 25/06/2024  
(73) **ORION CORPORATION (KR)**  
13, Baekbeom-ro 90da-gil, Yongsan-gu, Seoul 04369 Republic of Korea  
(72) 1. CHOE, EUN JE (KR)  
2. LEE, HYUN A (KR)  
(74) Công ty Luật TNHH quốc tế BMVN (BMVN INTERNATIONAL LLC)  
(55)



1.1



1.2



2.1



2.2



3.1



3.2



**CÔNG BÁO SỞ HỮU CÔNG NGHIỆP SỐ 435 TẬP A – QUYỀN 2 (06.2024)**

- (11) **50542**  
(21) 3-2024-00780 (28) 1  
(54) **GIÁ ĐỒ** (51) **14-99**  
(22) 29/03/2024 (43) 25/06/2024  
(73) **CÔNG TY CỔ PHẦN NESSO (VN)**  
11 Huỳnh Đình Hai, phường 14, quận Bình Thạnh, thành phố Hồ Chí Minh  
(72) 1. ĐỖ PHƯƠNG HÀ (VN)  
2. PHAN NHẬT KHOA (VN)  
(74) Công ty Luật TNHH Tư vấn Quốc tế (INDOCHINE COUNSEL)  
(55)



1.1



1.2



1.3



1.4



1.5



1.6



1.7

**CÔNG BÁO SỞ HỮU CÔNG NGHIỆP SỐ 435 TẬP A – QUYỀN 2 (06.2024)**

(11) **50543**

(21) 3-2024-00781

(28) 1

(54) **LÒ ĐỐT RÁC**

(51) **25-03**

(22) 29/03/2024

(43) 25/06/2024

(73) **CÔNG TY CỔ PHẦN THƯƠNG MẠI PHÁT TRIỂN VNS VIỆT NAM (VN)**  
Số nhà 51, ngách 299/66 đường Hoàng Mai, phường Hoàng Văn Thụ, quận Hoàng Mai, thành phố Hà Nội

(72) Phạm Văn Trí (VN)

(55)

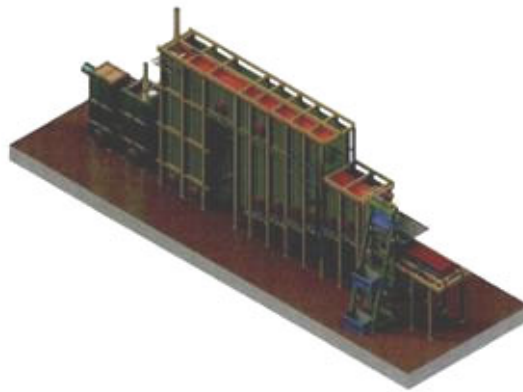

1.1

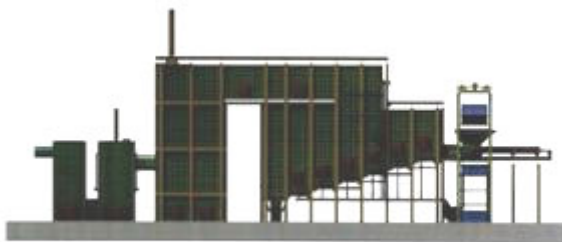

1.2

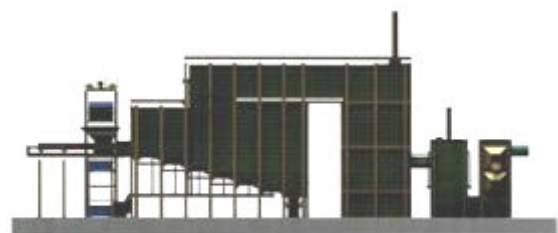

1.3



1.4



1.5

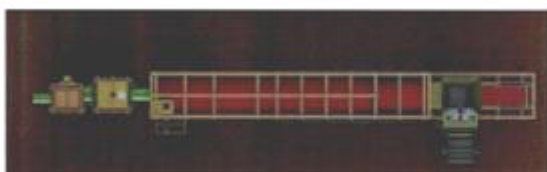

1.6



1.7

**CÔNG BÁO SỞ HỮU CÔNG NGHIỆP SỐ 435 TẬP A – QUYỀN 2 (06.2024)**

(11) **50544**

(21) 3-2024-00798

(28) 1

(54) **MÁY LỌC NƯỚC**

(51) **23-01**

(22) 03/04/2024

(43) 25/06/2024

(73) **CÔNG TY TNHH SẢN XUẤT TẬP ĐOÀN ĐẠI VIỆT (VN)**

Lô F1, đường số 10, cụm công nghiệp Hải Sơn, xã Đức Hòa Đông, huyện Đức Hoà, tỉnh Long An

(72) Ngô Xuân Mạnh (VN)

(74) Công ty TNHH Sở hữu trí tuệ Việt Á (VIET A IP CO.,LTD)

(55)

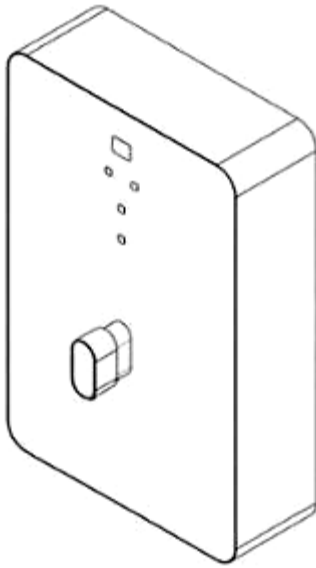

1.1

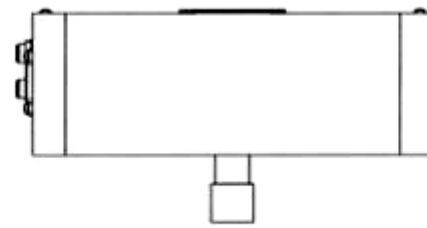

1.2

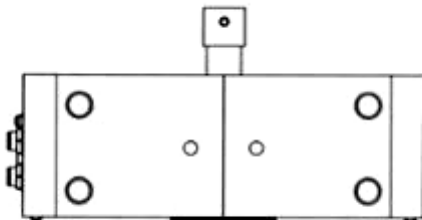

1.3

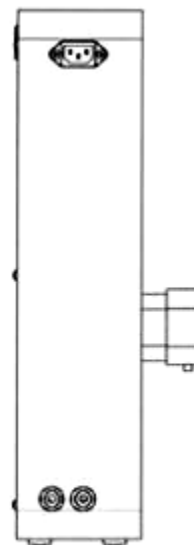

1.4

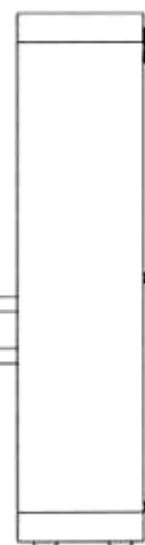

1.5

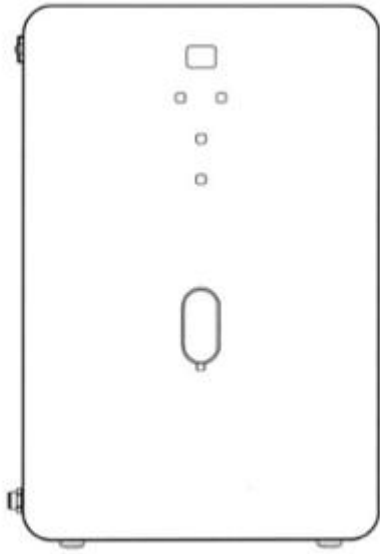

1.6

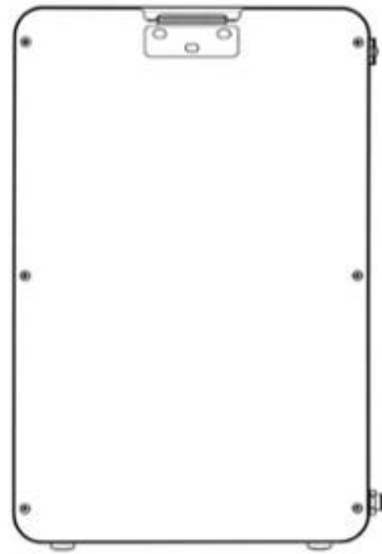

1.7

**CÔNG BÁO SỞ HỮU CÔNG NGHIỆP SỐ 435 TẬP A – QUYỀN 2 (06.2024)**

- (11) **50545**  
(21) 3-2024-00805 (28) 1  
(54) **Ổ CẮM ĐIỆN** (51) **13-03**  
(22) 03/04/2024 (43) 25/06/2024  
(73) **CÔNG TY CỔ PHẦN CHẾ TẠO THIẾT BỊ ĐIỆN OMEGA (VN)**  
Số 38 phố Bà Triệu, phường Hàng Bài, quận Hoàn Kiếm, thành phố Hà Nội  
(72) Vũ Minh Tuấn (VN)  
(74) Công ty cổ phần FAS INVEST (FAS INVEST JSC)  
(55)



1.1



1.2



1.3



1.4



1.5



1.6



1.7

**CÔNG BÁO SỞ HỮU CÔNG NGHIỆP SỐ 435 TẬP A – QUYỀN 2 (06.2024)**

- (11) **50546**  
(21) 3-2024-00819 (28) 1  
(54) **BAO GÓI** (51) **09-05**  
(22) 04/04/2024 (43) 25/06/2024  
(73) **CÔNG TY CỔ PHẦN DOSTA (VN)**  
Số 56 đường Nguyễn Đình Chiểu, phường Đa Kao, quận 1, thành phố Hồ Chí Minh  
(72) 1. NGUYỄN VĂN NAM (VN)  
2. TRẦN THỊ NHƯ NGUYỆT (VN)  
3. NGUYỄN ĐÌNH MINH HUY (VN)  
(74) Công ty Luật TNHH AGL (AGL LAW)  
(55)



1.1



1.2



1.3

**CÔNG BÁO SỞ HỮU CÔNG NGHIỆP SỐ 435 TẬP A – QUYỀN 2 (06.2024)**

- (11) **50547**  
(21) 3-2024-00824 (28) 1  
(54) **BAO GÓI** (51) **09-05**  
(22) 04/04/2024 (43) 25/06/2024  
(73) **ORION CORPORATION (KR)**  
13, Baekbeom-ro 90da-gil, Yongsan-gu, Seoul 04369 Republic of Korea  
(72) 1. CHOE, EUN JE (KR)  
2. LEE, HYUN A (KR)  
(74) Công ty Luật TNHH quốc tế BMVN (BMVN INTERNATIONAL LLC)  
(55)



1.1



1.2



**CÔNG BÁO SỞ HỮU CÔNG NGHIỆP SỐ 435 TẬP A – QUYỀN 2 (06.2024)**

- (11) **50548**  
(21) 3-2024-00826 (28) 1  
(54) **BAO GÓI** (51) **09-05**  
(22) 04/04/2024 (43) 25/06/2024  
(73) **ORION CORPORATION (KR)**  
13, Baekbeom-ro 90da-gil, Yongsan-gu, Seoul 04369 Republic of Korea  
(72) 1. CHOE, EUN JE (KR)  
2. LEE, HYUN A (KR)  
(74) Công ty Luật TNHH quốc tế BMVN (BMVN INTERNATIONAL LLC)  
(55)



1.1



1.2

**CÔNG BÁO SỞ HỮU CÔNG NGHIỆP SỐ 435 TẬP A – QUYỀN 2 (06.2024)**

- (11) **50549**  
(21) 3-2024-00836 (28) 1  
(54) **TRỤ NƯỚC CHỮA CHÁY** (51) **23-01**  
(22) 05/04/2024 (43) 25/06/2024  
(73) **CÔNG TY CỔ PHẦN VAN SHIN YI (VN)**  
Đường số 5, KCN Sông Mây, xã Bắc Sơn, huyện Trảng Bom, tỉnh Đồng Nai  
(72) Lâm Chính Hùng (VN)  
(74) **CÔNG TY TNHH KHANG LUẬT (KHANGLAW)**  
(55)

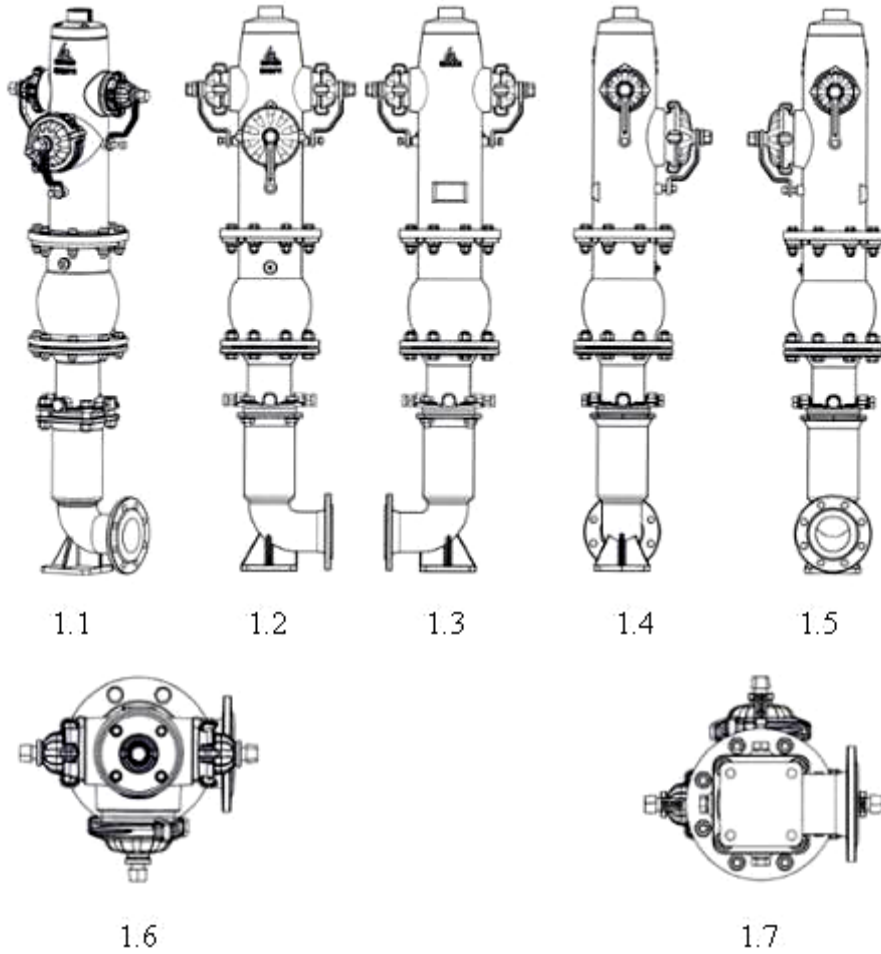

**CÔNG BÁO SỞ HỮU CÔNG NGHIỆP SỐ 435 TẬP A – QUYỀN 2 (06.2024)**

- (11) **50550**  
(21) 3-2024-00839 (28) 1  
(54) **XE MÁY ĐIỆN** (51) **12-11**  
(22) 05/04/2024 (43) 25/06/2024  
(73) **CÔNG TY CỔ PHẦN SẢN XUẤT VÀ THƯƠNG MẠI ĐỨC MINH (VN)**  
Thôn Nhuận Tháp, xã Phụng Công, huyện Văn Giang, tỉnh Hưng Yên  
(72) Nghiêm Xuân Minh (VN)  
(55)



1.1



1.2



1.3



1.4



1.5



1.6



1.7

**CÔNG BÁO SỞ HỮU CÔNG NGHIỆP SỐ 435 TẬP A – QUYỀN 2 (06.2024)**

(11) **50551**

(21) 3-2024-00843

(28) 1

(54) **CÔNG TẮC**

(51) **13-03**

(22) 08/04/2024

(43) 25/06/2024

(73) **CÔNG TY CỔ PHẦN BÓNG ĐÈN PHÍCH NƯỚC RẠNG ĐÔNG (VN)**

87-89 phố Hạ Đình, phường Thanh Xuân Trung, quận Thanh Xuân, thành phố Hà Nội

(72) Trần Trung Tường (VN)

(55)

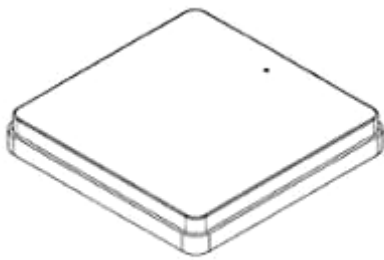

1.1



1.2



1.3



1.4



1.5

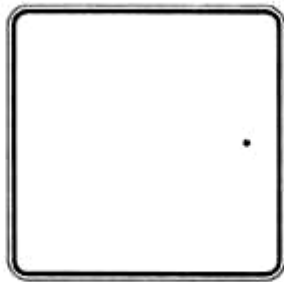

1.6

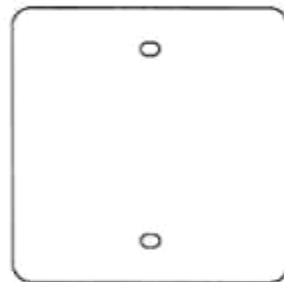

1.7

**CÔNG BÁO SỞ HỮU CÔNG NGHIỆP SỐ 435 TẬP A – QUYỀN 2 (06.2024)**

(11) **50552**

(21) 3-2024-00844

(28) 1

(54) **CÔNG TẮC**

(51) **13-03**

(22) 08/04/2024

(43) 25/06/2024

(73) **CÔNG TY CỔ PHẦN BÓNG ĐÈN PHÍCH NƯỚC RẠNG ĐÔNG (VN)**

87-89 phố Hạ Đình, phường Thanh Xuân Trung, quận Thanh Xuân, thành phố Hà Nội

(72) Trần Trung Tường (VN)

(55)

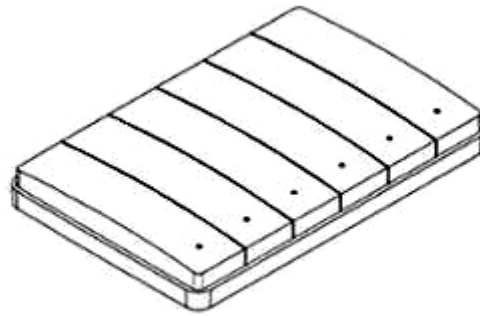

1.1



1.2



1.3



1.4

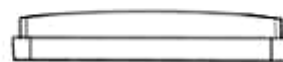

1.5

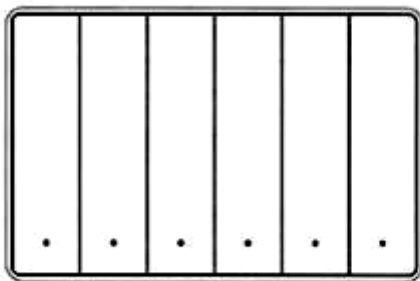

1.6

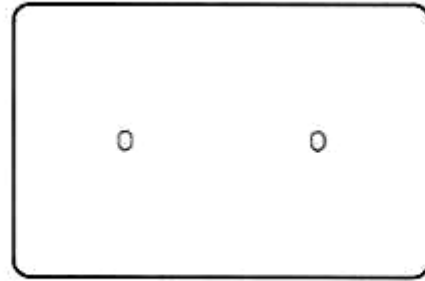

1.7

(11) **50553**

(21) 3-2024-00845

(28) 1

(54) **CÔNG TẮC**

(51) **13-03**

(22) 08/04/2024

(43) 25/06/2024

(73) **CÔNG TY CỔ PHẦN BÓNG ĐÈN PHÍCH NƯỚC RẠNG ĐÔNG (VN)**

87-89 phố Hạ Đình, phường Thanh Xuân Trung, quận Thanh Xuân, thành phố Hà Nội

(72) Trần Trung Tường (VN)

(55)

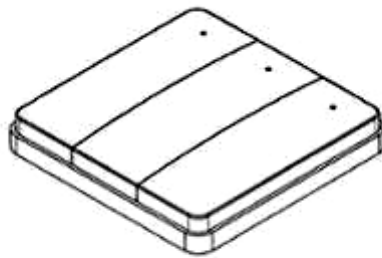

1.1



1.2

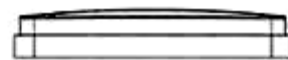

1.3

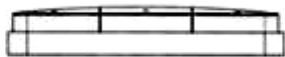

1.4

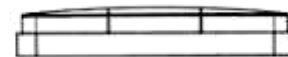

1.5

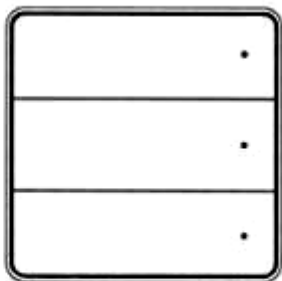

1.6

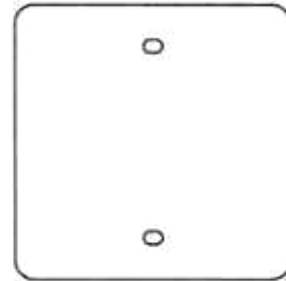

1.7

**CÔNG BÁO SỞ HỮU CÔNG NGHIỆP SỐ 435 TẬP A – QUYỀN 2 (06.2024)**

(11) **50554**

(21) 3-2024-00849

(28) 1

(54) **VÒI NƯỚC**

(51) **23-01**

(22) 08/04/2024

(43) 25/06/2024

(73) **WATERTEC (MALAYSIA) SDN BHD (MY)**

Lot 3, Jalan Halba Satu 16/16A, Section 16, 40200 Shah Alam, Selangor Darul Ehsan, Malaysia

(72) 1. AFANDI BIN HAMZAH (MY)

2. LOW HAN SIN (MY)

(74) Công ty TNHH Sở hữu trí tuệ Tầm Nhìn Mới (FRESHVIEW CO., LTD.)

(55)

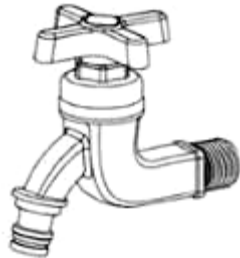

1.1



1.2



1.3

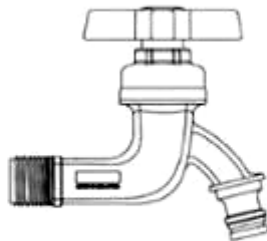

1.4

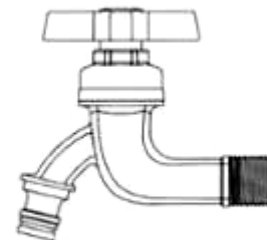

1.5

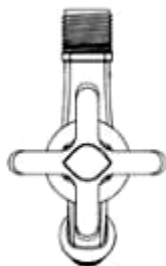

1.6

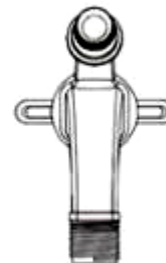

1.7



**CÔNG BÁO SỞ HỮU CÔNG NGHIỆP SỐ 435 TẬP A – QUYỀN 2 (06.2024)**

- (11) **50555**
- (21) 3-2024-00853
- (54) **VỎ BỌC DÂY ĐIỆN**
- (22) 08/04/2024
- (30) 113300525 01/02/2024 TW;
- (73) **CHANNEL WELL TECHNOLOGY CO., LTD. (TW)**  
13F., No. 208, Xingfu Rd., Taoyuan Dist., Taoyuan City 330063, Taiwan
- (72) 1. PAN, YEN-CHENG (TW)  
2. LIN, BO-LUN (TW)
- (74) CÔNG TY LUẬT TNHH IP MAX (IPMAX LAW FIRM)
- (55)

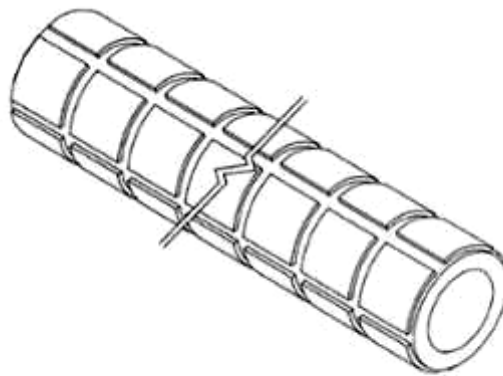

1.1

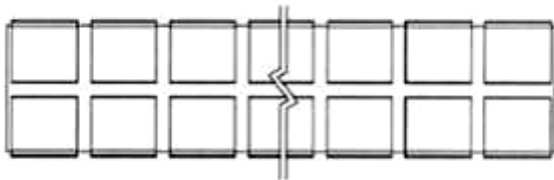

1.2

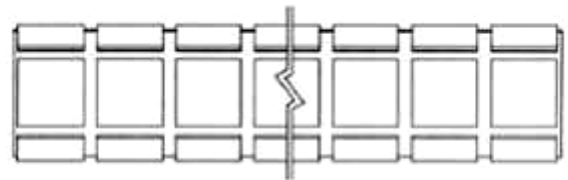

1.3

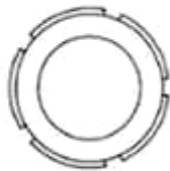

1.4

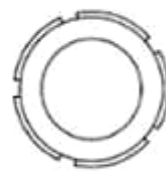

1.5

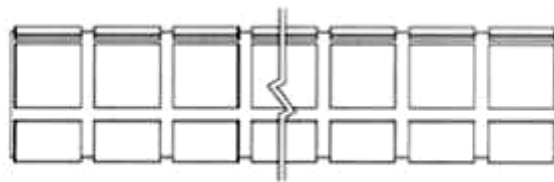

1.6

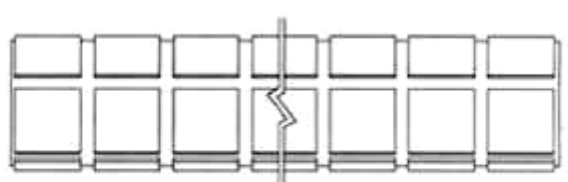

1.7

**CÔNG BÁO SỞ HỮU CÔNG NGHIỆP SỐ 435 TẬP A – QUYỀN 2 (06.2024)**

- (11) **50556**  
(21) 3-2024-00860 (28) 1  
(54) **XE MÁY** (51) **12-11**  
(22) 09/04/2024 (43) 25/06/2024  
(30) 2023-021167 13/10/2023 JP;  
(73) **HONDA MOTOR CO., LTD. (JP)**  
1-1, Minami-Aoyama 2-Chome, Minato-ku, Tokyo, 107-8556 Japan  
(72) 1. ISANA SUZUKI (JP)  
2. JUN HIROSE (JP)  
(74) Công ty Luật TNHH Phạm và Liên danh (PHAM & ASSOCIATES)  
(55)



1.1



1.2



1.3



1.4



1.5



1.6



1.7



1.8



1.9

**CÔNG BÁO SỞ HỮU CÔNG NGHIỆP SỐ 435 TẬP A – QUYỀN 2 (06.2024)**

- (11) **50557**  
(21) 3-2024-00861 (28) 1  
(54) **TẮM ỐP BÊN ĐẦU XE MÁY** (51) **12-16**  
(22) 09/04/2024 (43) 25/06/2024  
(30) 2023-021168 13/10/2023 JP;  
(73) **HONDA MOTOR CO., LTD. (JP)**  
1-1, Minami-Aoyama 2-Chome, Minato-ku, Tokyo, 107-8556 Japan  
(72) 1. ISANA SUZUKI (JP)  
2. JUN HIROSE (JP)  
(74) Công ty Luật TNHH Phạm và Liên danh (PHAM & ASSOCIATES)  
(55)



1.1



1.2



1.3



1.4



1.5



1.6



1.7



1.8



1.9

- (11) **50558**  
(21) 3-2024-00883 (28) 1  
(54) **GIÁ ĐỖ HƯƠNG VÒNG** (51) **99-00**  
(22) 10/04/2024 (43) 25/06/2024  
(73) **BÙI CÔNG TÂM (VN)**  
103 Lý Thường Kiệt, phường 4, thành phố Mỹ Tho, tỉnh Tiền Giang  
(72) Bùi Công Tâm (VN)  
(74) Công ty TNHH Sở hữu trí tuệ INVENTIO (INVENTIO CO.,LTD)  
(55)



1.1



1.2



1.3



1.4



1.5



1.6

**CÔNG BÁO SỞ HỮU CÔNG NGHIỆP SỐ 435 TẬP A – QUYỀN 2 (06.2024)**

(11) **50559**

(21) 3-2024-00921

(28) 1

(54) **TẤM CHẮN CỘP**

(51) **12-16**

(22) 15/04/2024

(43) 25/06/2024

(73) **LÊ THANH TÙNG (VN)**

Thôn Giáp Trung, xã Đức Bắc, huyện Sông Lô, tỉnh Vĩnh Phúc

(72) Lê Thanh Tùng (VN)

(55)



1.1

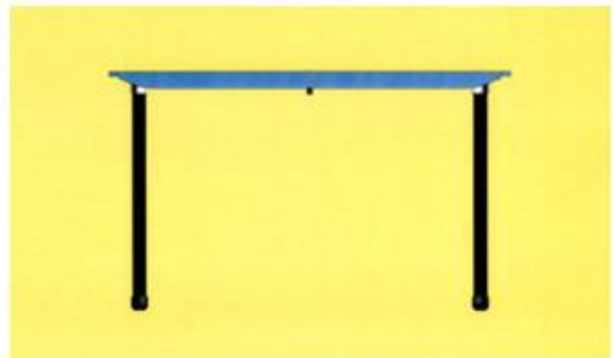

1.2

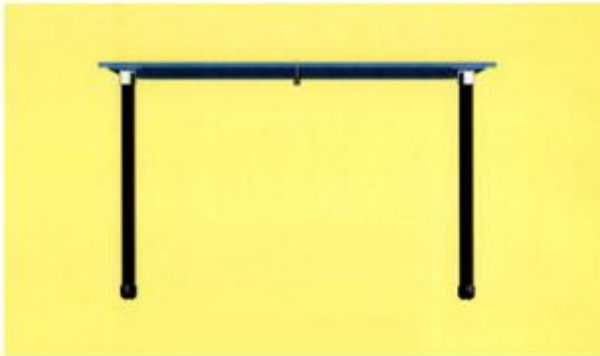

1.3



1.4



1.5



1.6

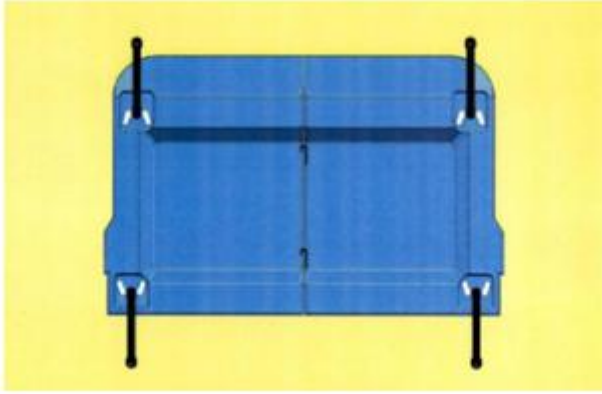

1.7

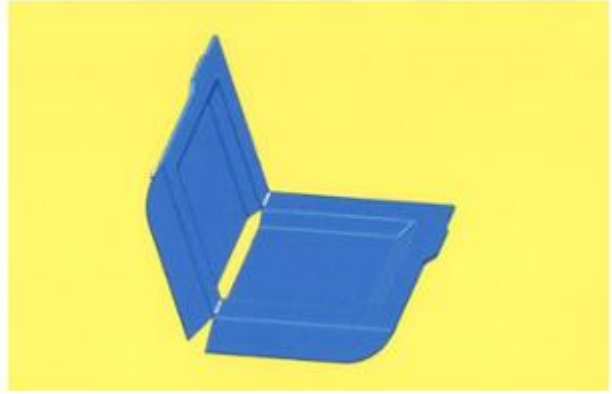

1.8



(11) **50560**

(21) 3-2024-00927

(28) 1

(54) **LỚP XE**

(51) **12-15**

(22) 16/04/2024

(43) 25/06/2024

(73) **CHENG SHIN RUBBER IND. CO., LTD. (TW)**

No. 215, Meigang Rd., Dacun Township, Changhua County 515, Taiwan

(72) TZU-FU SU (TW)

(74) Công ty Cổ phần Sở hữu công nghiệp INVESTIP (INVESTIP)

(55)



1.1



1.2



1.3

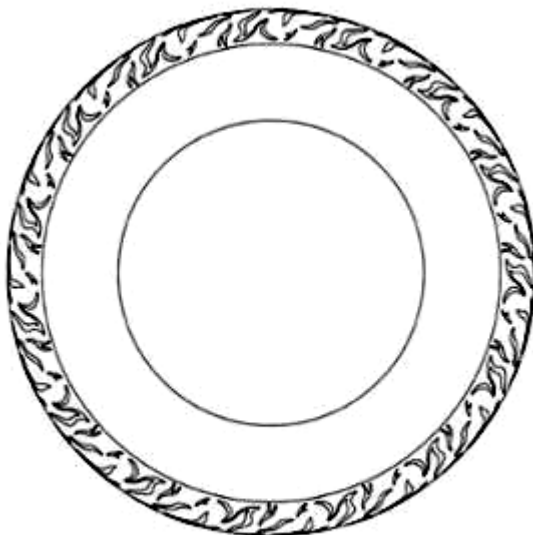

1.4



1.5



1.6

**CÔNG BÁO SỞ HỮU CÔNG NGHIỆP SỐ 435 TẬP A – QUYỀN 2 (06.2024)**

- (11) **50561**  
(21) 3-2024-00928 (28) 1  
(54) **Ô TÔ** (51) **12-08**  
(22) 17/04/2024 (43) 25/06/2024  
(30) DM/232700 18/10/2023 WO;  
(73) **FERRARI S.P.A. (IT)**  
Via Emilia Est 1163, MODENA, ITALY  
(72) 1. FLAVIO MANZONI (IT)  
2. CARLO PALAZZANI (IT)  
(74) Công ty TNHH một thành viên Sở hữu trí tuệ VCCI (VCCI-IP CO.,LTD)  
(55)

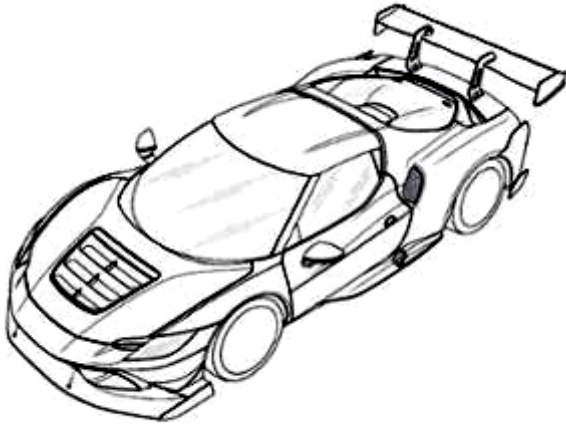

1.1

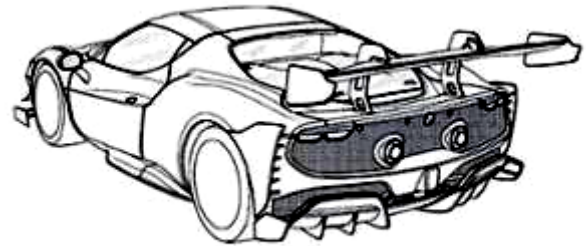

1.2



1.3

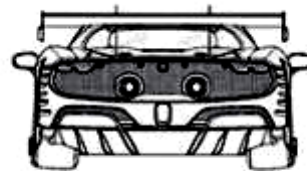

1.4

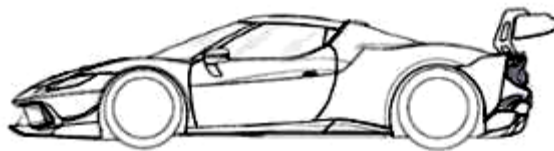

1.5

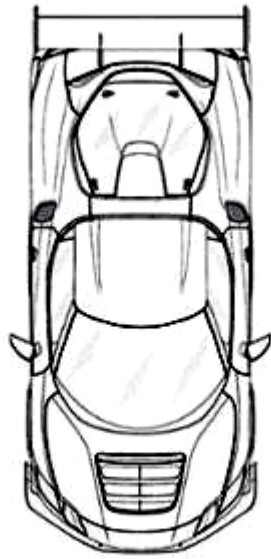

1.6

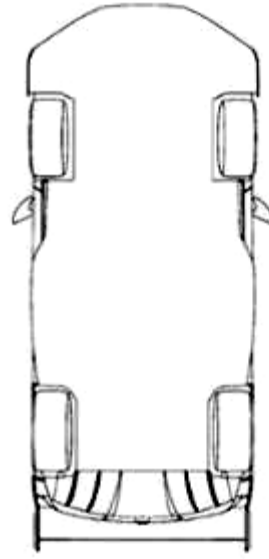

1.7

**CÔNG BÁO SỞ HỮU CÔNG NGHIỆP SỐ 435 TẬP A – QUYỀN 2 (06.2024)**

- (11) **50562**  
(21) 3-2024-00929 (28) 1  
(54) **Ô TÔ ĐỒ CHƠI** (51) **21-01**  
(22) 17/04/2024 (43) 25/06/2024  
(30) DM/232635 18/10/2023 WO;  
(73) **FERRARI S.P.A. (IT)**  
Via Emilia Est 1163, MODENA, ITALY  
(72) 1. FLAVIO MANZONI (IT)  
2. CARLO PALAZZANI (IT)  
(74) Công ty TNHH một thành viên Sở hữu trí tuệ VCCI (VCCI-IP CO.,LTD)  
(55)

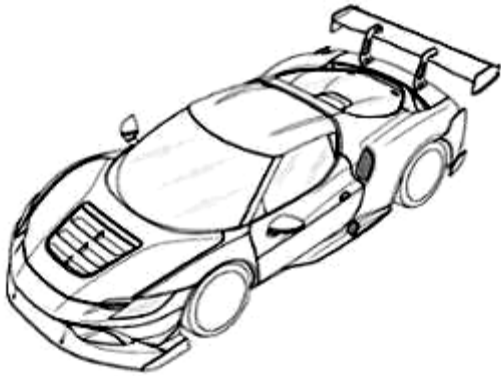

1.1

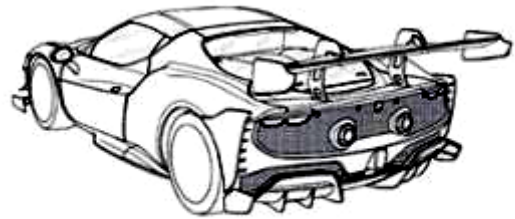

1.2



1.3

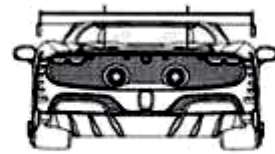

1.4

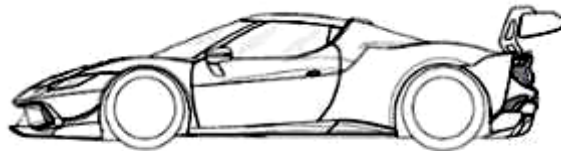

1.5

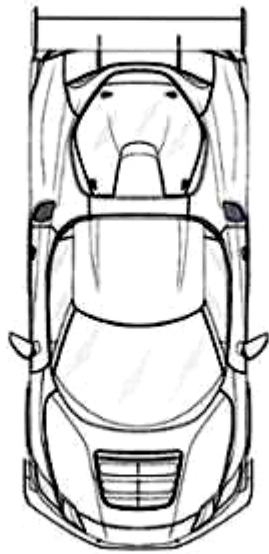

1.6

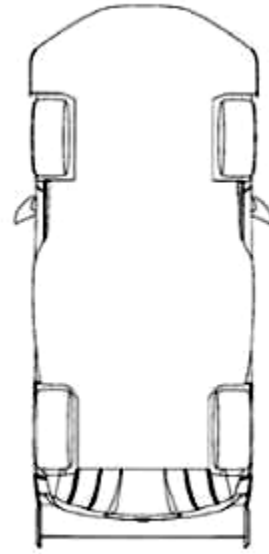

1.7

**CÔNG BÁO SỞ HỮU CÔNG NGHIỆP SỐ 435 TẬP A – QUYỀN 2 (06.2024)**

- (11) **50563**  
(21) 3-2024-00948 (28) 1  
(54) **MÁY LÀM KHÔ MÓNG TAY** (51) **28-03**  
(22) 17/04/2024 (43) 25/06/2024  
(73) **TRẦN HỒNG QUÂN (VN)**  
Tổ 18, TT Xuân Trường, Xuân Trường, tỉnh Nam Định  
(72) Trần Hồng Quân (VN)  
(74) Công ty TNHH Tư vấn IPNG (IPNG CO.,LTD)  
(55)



1.1



1.2



1.3



1.4



1.5



1.6



1.7

**CÔNG BÁO SỞ HỮU CÔNG NGHIỆP SỐ 435 TẬP A – QUYỀN 2 (06.2024)**

- (11) **50564**  
(21) 3-2024-00954 (28) 2  
(54) **XE Ô TÔ** (51) **12-08**  
(22) 19/04/2024 (43) 25/06/2024  
(30) 2023306819844 20/10/2023 CN;  
(73) **BYD COMPANY LIMITED (CN)**  
No.3009, BYD Road, Pingshan, Shenzhen, Guangdong 518118, China  
(72) 1. LIAN, YUBO (CN)  
2. EGGER, WOLFGANG JOSEF (DE)  
3. FAN, JIHAN (CN)  
4. XU, ZIYAN (CN)  
5. LI, DA (CN)  
6. PAN, PAN (CN)  
7. WEN, YAOPING (CN)  
(74) Công ty TNHH Sở hữu trí tuệ Thảo Thợ Quyển (INVENCO.,LTD)  
(55)

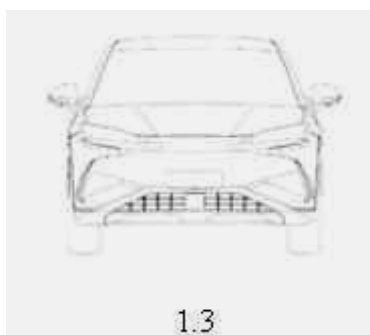
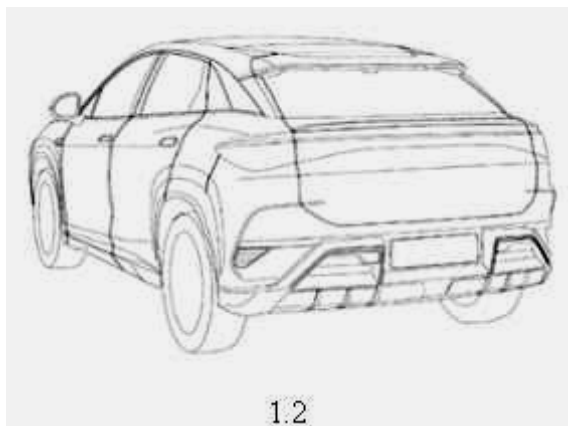
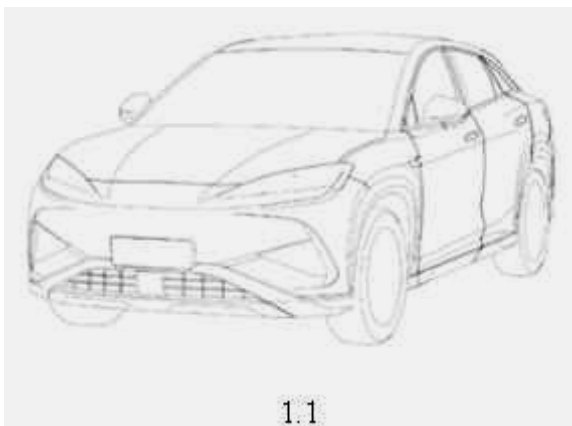



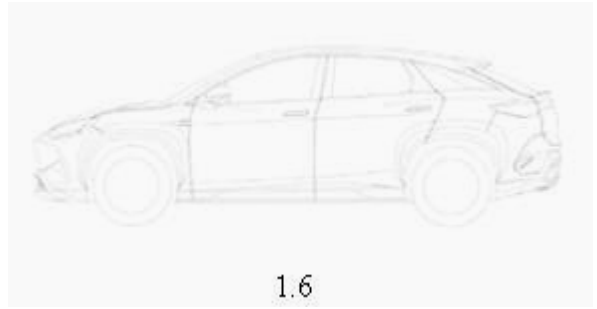
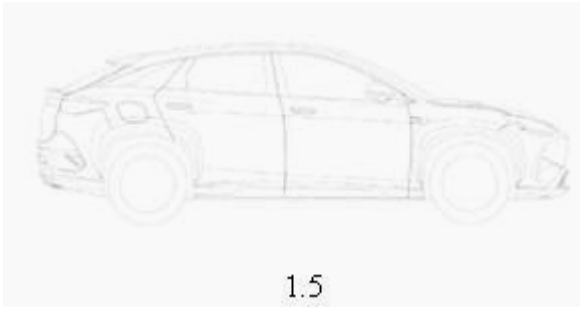



2.5



2.6



2.7

**CÔNG BÁO SỞ HỮU CÔNG NGHIỆP SỐ 435 TẬP A – QUYỀN 2 (06.2024)**

(11) **50565**

(21) 3-2024-00999

(28) 1

(54) **THÙNG XE MÔ TÔ**

(51) **12-16**

(22) 26/04/2024

(43) 25/06/2024

(73) **GIVI SPA (IT)**

Via G. Ungaretti, 48, 25020 Flero (BS), Italy

(72) Visenzi Giuseppe (IT)

(74) Công ty Cổ phần Sở hữu công nghiệp INVESTIP (INVESTIP)

(55)



1.1



1.2



1.3



1.4



1.5



1.6



1.7



1.8

**CÔNG BÁO SỞ HỮU CÔNG NGHIỆP SỐ 435 TẬP A – QUYỀN 2 (06.2024)**

- (11) **50566**  
(21) 3-2024-01024 (28) 1  
(54) **TRẠM LẮP RÁP CÔNG NGHIỆP** (51) **06-03**  
(22) 03/05/2024 (43) 25/06/2024  
(73) **PHẠM VĂN TRIỆU (VN)**  
Trường Đại học Hàng hải Việt Nam - 484 Lạch Tray, Lê Chân, thành phố Hải Phòng  
(72) 1. PHẠM VĂN TRIỆU (VN)  
2. NGÔ VƯƠNG QUỐC (VN)  
3. NGUYỄN THỊ MINH ANH (VN)  
4. PHẠM VĂN QUỲNH (VN)  
5. TRẦN TUẤN ANH (VN)  
(55)



1.1



1.2



1.3



1.4

1.5



1.6



1.7

**PHẦN II**

**SỬA ĐỔI ĐƠN**

Thông báo số: 47655/TB-SHTT.<sub>IP</sub>, ngày 28/05/2024 về việc ghi nhận sửa đổi đơn

Số Yêu cầu: SD3-2023-01539 Ngày nộp: 18/08/2023

Liên quan đến đơn yêu cầu cấp Bằng độc quyền kiểu dáng công nghiệp:

(21) Số đơn	(22) Ngày nộp đơn
3-2021-01709	29/06/2021

Mục sửa đổi: Đại diện sở hữu công nghiệp

Nội dung mới: Công ty TNHH Hùng Sơn và cộng sự(HUNG SON & PARTNERS)  
Số 6B Đông Quan, phường Quan Hoa, quận Cầu Giấy, TP. Hà Nội.

---

**PHẦN III**

**THAY ĐỔI CHỦ ĐƠN**

Thông báo số: 40891/TB-SHTT.IP, ngày 15/05/2024 về việc ghi nhận thay đổi chủ đơn

Số Yêu cầu: CD3-2022-01059 Ngày nộp: 01/12/2022

Liên quan đến đơn yêu cầu cấp bằng độc quyền kiểu dáng công nghiệp:

(21) Số đơn	(22) Ngày nộp đơn
3-2022-02490	15/11/2022

Bên chuyển nhượng: TRẦN MINH HẢO (VN)  
38 đường số 1B, Phường Bình Trị Đông B, Quận Bình Tân,  
Thành phố Hồ Chí Minh

Bên được chuyển nhượng: Trần Minh Hảo (VN)  
38 đường số 1B, phường Bình Trị Đông B, quận Bình Tân,  
thành phố Hồ Chí Minh  
Trần Phúc Thành (VN)  
15/37B khóm Đông Thạnh, phường Mỹ Thạnh, thành phố  
Long Xuyên, tỉnh An Giang  
Huỳnh Minh Đăng (VN)  
91C Lạc Long Quân, phường 5, quận 11, thành phố Hồ Chí  
Minh

---

Thông báo số: 38851/TB-SHTT.IP, ngày 06/05/2024 về việc ghi nhận thay đổi chủ đơn

Số Yêu cầu: CD3-2022-00764 Ngày nộp: 05/09/2022

Liên quan đến đơn yêu cầu cấp bằng độc quyền kiểu dáng công nghiệp:

(21) Số đơn	(22) Ngày nộp đơn
3-2021-03058	06/12/2021

Bên chuyển nhượng: HONOR DEVICE CO., LTD. (CN)  
Suite 3401, Unit A, Building 6, Shum Yip Sky Park, No.  
8089, Hongli West Road, Xiangmihu Street, Futian District,  
Shenzhen, Guangdong 518040, People's Republic of China

Bên được chuyển nhượng: Beijing Honor Device Co., Ltd. (CN)  
Floor 2-14, Building 3, Yard 5, Rendong Road, Haidian  
District, Beijing 100095, People's Republic of China

---



## **CÔNG BÁO SỞ HỮU CÔNG NGHIỆP**

*Do Cục Sở hữu trí tuệ thuộc Bộ Khoa học và Công nghệ ấn hành theo Luật Sở hữu trí tuệ số 50/2005/QH11 được Quốc hội thông qua ngày 29 tháng 11 năm 2005 và được sửa đổi bằng Luật sửa đổi, bổ sung một số điều của Luật sở hữu trí tuệ số 50/2005/QH11 được Quốc hội thông qua ngày 19 tháng 6 năm 2009.*

### ***Địa chỉ liên hệ:***

384-386 đường Nguyễn Trãi, quận Thanh Xuân,  
thành phố Hà Nội, Việt Nam  
ĐT: 024. 38583069  
Fax: 024. 38588449