

ISSN 0868 - 2534

CỘNG HÒA XÃ HỘI CHỦ NGHĨA VIỆT NAM
BỘ KHOA HỌC VÀ CÔNG NGHỆ

CỤC SỞ HỮU TRÍ TUỆ

CÔNG BÁO
SỞ HỮU CÔNG NGHIỆP

TẬP A

QUYỂN 2: KIỂU DÁNG CÔNG NGHIỆP

01 - 2024

430

HÀ NỘI

CỘNG HOÀ XÃ HỘI CHỦ NGHĨA VIỆT NAM
BỘ KHOA HỌC VÀ CÔNG NGHỆ
CỤC SỞ HỮU TRÍ TUỆ

CÔNG BÁO
SỞ HỮU CÔNG NGHIỆP
TẬP A

QUYỂN 2: KIỂU DÁNG CÔNG NGHIỆP

01 - 2024

430

HÀ NỘI

MỤC LỤC

	Trang
<u>PHẦN I:</u> Đơn yêu cầu cấp Bằng độc quyền kiểu dáng công nghiệp	7
<u>PHẦN II:</u> Sửa đổi đơn	671

CONTENTS

<u>PART I:</u> Applications for Industrial Design Patents	7
<u>PART II:</u> Amendment of Applications	671

CÔNG BÁO SỞ HỮU CÔNG NGHIỆP SỐ 430 TẬP A - QUYỂN 2 (01.2024)

MÃ SỐ HAI CHỮ CÁI THỂ HIỆN TÊN NƯỚC VÀ CÁC THỰC THỂ KHÁC TRONG CÁC TƯ LIỆU SỞ HỮU CÔNG NGHIỆP THEO TIÊU CHUẨN ST3 CỦA WIPO

AE	United Arab Emirates	CN	China	HK	Hong Kong
AF	Afganistan	CO	Colombia	HN	Honduras
AG	Antihua and Barbuda	CR	Costa Rica	HR	Croatia
AI	Anguilla	CU	Cuba	HT	Haiti
AL	Albania	CV	Cape Verde	HU	Hungary
AN	Netherlands Antilles	CY	Cyprus	ID	Indonesia
AO	Angola	CZ	Czech Republic	IE	Ireland
AR	Argentina	DE	Germany	IL	Israel
AT	Austria	DJ	Djibouti	IN	India
AU	Australia	DK	Denmark	IQ	Iraq
AW	Aruba	DM	Dominica	IR	Iran (Islamic Republic of)
BB	Barbados	DO	Dominican Republic	IS	Iceland
BD	Bangladesh	DZ	Algeria	IT	Italy
BE	Belgium	EC	Ecuador	JM	Jamaica
BF	Burkina Faso	EE	Estonia	JO	Jordan
BG	Bulgaria	EG	Egypt	JP	Japan
BH	Bahrain	ES	Spain	KE	Kenya
BI	Burundi	ET	Ethiopia	KH	Cambodia
BJ	Benin	FI	Finland	KI	Kiribati
BM	Bermuda	FJ	Fiji	KM	Comoros
BN	Brunei Darussalam	FK	Falkand Islands (Malvinas)	KN	Saint Kitts and Nevis
BO	Bolivia	FR	France	KP	Democratic People's Republic of Korea
BR	Brazil	GA	Gabon	KR	Republic of Korea
BS	Bahamas	GB	United Kingdom	KW	Kuwait
BT	Bhutan	GD	Grenada	KY	Cayman Islands
BW	Botswana	GE	Georgia	KZ	Kazakhstan
BY	Belarus	GH	Ghana	LA	Laos
BZ	Belize	GI	Gibraltar	LB	Lebanon
CA	Canada	GM	Gambia	LC	Saint Lucia
CF	Central African Republic	GN	Guinea	LI	Liechtenstein
CG	Congo	GQ	Equatorial Guinea	LK	SriLanka
CH	Switzerland	GR	Greece	LR	Liberia
CI	Côte d'Ivoire	GT	Guatemala	LS	Lesotho
CL	Chile	GW	Guinea-Bissau	LT	Lithuania
CM	Cameroon	GY	Guyana	TC	Turk and Caicos Islands
LU	Luxembourg	PA	Panama	TD	Chad
LV	Latvia	PE	Peru	TG	Togo
LY	Lybya	PG	Papua New Guinea	TH	Thailand
MA	Morocco	PH	Philippines	TN	Tunisia
MC	Monaco	PK	Pakistan	TO	Tonga
MD	Republic of Moldova	PL	Poland	TR	Turkey

CÔNG BÁO SỞ HỮU CÔNG NGHIỆP SỐ 430 TẬP A - QUYỂN 2 (01.2024)

MG	Madagascar	PT	Portugal	TT	Trinidad and Tobago
ML	Mali	PY	Paraguay	TV	Tuvalu
MM	Myanmar	QA	Qatar	TW	Taiwan, Province of China
MN	Mongolia	RO	Rumania	TZ	United Republic of Tanzania
MO	Macau	RU	Russian Federation	UA	Ukraine
MR	Mauritania	RW	Rwanda	UG	Uganda
MS	Montserrat	SA	Saudi Arabia	US	United States of America
MT	Malta	SB	Solomon Islands	UY	Uruguay
MU	Mauritius	SC	Seychelles	UZ	Uzbekistan
MV	Maldives	SD	Sudan	VA	Holy see
MW	Malawi	SE	Sweden	VC	Saint Vincent and the Grenadines
MX	Mexico	SG	Singapore	VE	Venezuela
MY	Malaysia	SH	Saint Helena	VG	Virgin Islands (British)
MZ	Mozambique	SL	Slovenia	VN	Vietnam
NA	Namibia	SK	Slovakia	VU	Vanuatu
NE	Niger	SL	Sierra Leone	WS	Samoa
NG	Nigeria	SM	San Marino	YE	Yemen
NJ	Nicaragua	SN	Senegal	YU	Yugoslavia
NL	Netherlands	SO	Somalia	ZA	South Africa
NO	Norway	SR	Suriname	ZM	Zambia
NP	Nepal	ST	Sao Tome and Principe	ZR	Zaire
NR	Nauru	SV	El Sanvador	ZW	Zimbabwe
NZ	New Zealand	SY	Syria		
OM	Oman	SZ	Swaziland		

CÁC TỔ CHỨC QUỐC TẾ

AO	African Intellectual Property Organization (OAPI)
AP	African Regional Industrial Property Organization (ARIPO)
BX	Benelux Trademark Office and Benelux Designs Office
EP	European Patent Office (EPO)
IB, WO	International Bureau of the World Intellectual Property Organization (WIPO)

NHỮNG MÃ SỐ INID TRÍCH TỪ TIÊU CHUẨN ST80 CỦA TỔ CHỨC SỞ HỮU TRÍ TUỆ THẾ GIỚI (WIPO) ĐỂ NHẬN BIẾT CÁC DỮ LIỆU THƯ MỤC DÙNG CÔNG BỐ ĐƠN VÀ BẰNG ĐỘC QUYỀN KIỂU DÁNG CÔNG NGHIỆP

- (11) Số bằng độc quyền kiểu dáng công nghiệp / Số công bố đơn
- (15) Ngày cấp
- (18) Ngày hết hạn hiệu lực của bằng độc quyền kiểu dáng công nghiệp
- (21) Số đơn
- (22) Ngày nộp đơn
- (23) Tên triển lãm, ngày và nơi triển lãm
- (28) Số phương án yêu cầu bảo hộ
- (30) Số đơn ưu tiên, ngày nộp đơn ưu tiên
- (43) Ngày công bố đơn
- (45) Ngày công bố bằng độc quyền kiểu dáng công nghiệp
- (51) Phân loại quốc tế kiểu dáng công nghiệp
- (54) Tên sản phẩm mang kiểu dáng công nghiệp
- (55) Ảnh chụp / hình vẽ kiểu dáng công nghiệp
- (57) Đặc điểm khác biệt yêu cầu bảo hộ của kiểu dáng công nghiệp
- (62) Số và ngày nộp đơn, số bằng độc quyền KDCN hoặc số công bố đơn liên quan đến tách đơn
- (71) Tên và địa chỉ của người nộp đơn
- (72) Tên của tác giả KDCN
- (73) Tên, địa chỉ của chủ bằng độc quyền KDCN
- (74) Tên của người đại diện SHCN

PHẦN I

ĐƠN YÊU CẦU CẤP BẰNG ĐỘC QUYỀN KIỂU DÁNG CÔNG NGHIỆP

- (11) **49040**
(21) 3-2021-01186
(54) **MÔ TƠ GIẢM TỐC**
(22) 12/05/2021
(73) **TRƯƠNG TRỤ HÒA (VN)**
58 đường Thiên Phước, phường 9, quận Tân Bình, thành phố Hồ Chí Minh
(72) Trương Trụ Hòa (VN)
(55)
- (28) 1
(51) **15-99**
(43) 25/01/2024

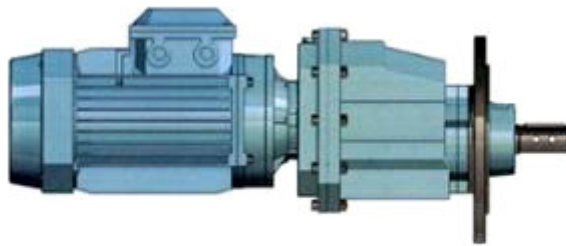

1.1



1.2



1.3



1.4



1.5



1.6

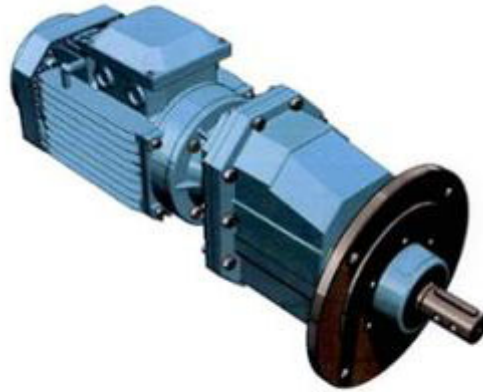

1.7

CÔNG BÁO SỞ HỮU CÔNG NGHIỆP SỐ 430 TẬP A – QUYỀN 2 (01.2024)

(11) **49041**

(21) 3-2021-01188

(28) 1

(54) **MÔ TƠ GIẢM TỐC**

(51) **15-99**

(22) 12/05/2021

(43) 25/01/2024

(73) **TRƯƠNG TRỤ HÒA (VN)**

58 đường Thiên Phước, phường 9, quận Tân Bình, thành phố Hồ Chí Minh

(72) Trương Trụ Hòa (VN)

(55)



1.1

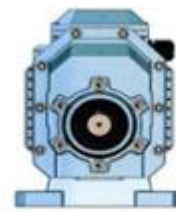

1.2



1.3



1.4



1.5

1.6



1.7

CÔNG BÁO SỞ HỮU CÔNG NGHIỆP SỐ 430 TẬP A – QUYỀN 2 (01.2024)

- (11) **49042**
(21) 3-2021-01340 (28) 1
(54) **BAO GÓI CÀ PHÊ** (51) **09-05**
(22) 21/05/2021 (43) 25/01/2024
(73) **CÔNG TY CỔ PHẦN SÀI GÒN AN THÁI (VN)**
263 Vườn Lài, phường Phú Thọ Hòa, quận Tân Phú, thành phố Hồ Chí Minh
(72) Phạm Tiến Tú (VN)
(74) Công ty TNHH Ban Ca (BANCA)
(55)



1.1



1.2

CÔNG BÁO SỞ HỮU CÔNG NGHIỆP SỐ 430 TẬP A – QUYỀN 2 (01.2024)

- (11) **49043**
(21) 3-2021-02103 (28) 2
(54) **BAO GÓI PHÂN BÓN** (51) **09-05**
(22) 19/08/2021 (43) 25/01/2024
(73) **TRUNG TÂM KHOA HỌC VÀ CÔNG NGHỆ TỈNH BÌNH PHƯỚC (VN)**
Số 825, quốc lộ 14, phường Tân Bình, thành phố Đồng Xoài, tỉnh Bình Phước
(72) Trịnh Kiều Dung (VN)
(55)



1.1



1.2



2.1



2.2

CÔNG BÁO SỞ HỮU CÔNG NGHIỆP SỐ 430 TẬP A – QUYỀN 2 (01.2024)

- (11) **49044**
(21) 3-2021-02456 (28) 1
(54) **BỘ PHẬN CỦA ĐỒNG HỒ** (51) **10-07**
(22) 08/10/2021 (43) 25/01/2024
(30) 29/810,356 04/10/2021 US;
(73) **GOOGLE LLC (US)**
1600 Amphitheatre Parkway, Mountain View, California 94043, United States of America
(72) 1. REIMANN, GINA (US)
2. OLSSON, MAJ ISABELLE (SE)
3. CAZALET, PETER MICHAEL (US)
4. CASTILLO, ALFREDO (US)
5. GREDLER, CHRISTOPH (AU)
(74) Công ty Luật TNHH ROUSE Việt Nam (ROUSE LEGAL VIETNAM LTD.)
(55)

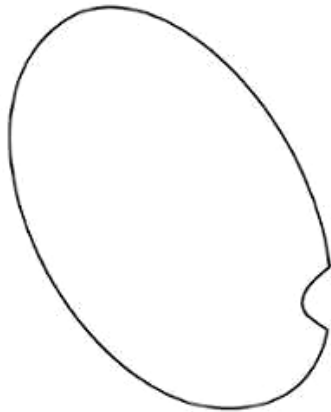

1.1

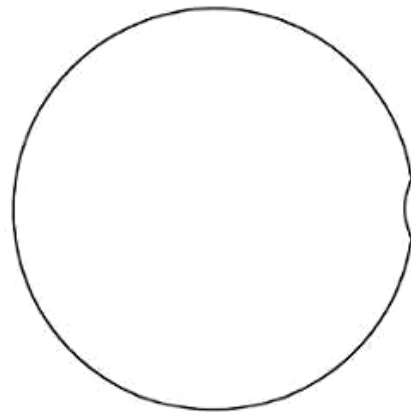

1.2

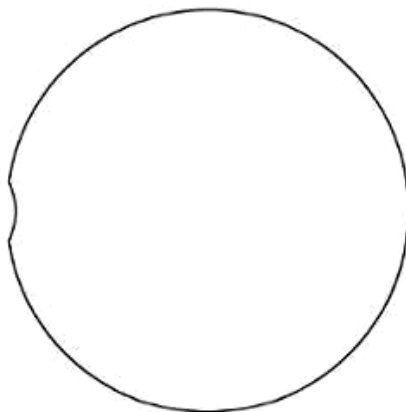

1.3



1.4



1.5

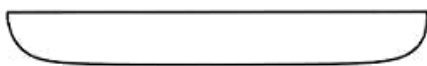

1.6



1.7

CÔNG BÁO SỞ HỮU CÔNG NGHIỆP SỐ 430 TẬP A – QUYỀN 2 (01.2024)

- (11) **49045**
(21) 3-2021-02457 (28) 1
(54) **BỘ PHẬN CỦA ĐỒNG HỒ** (51) **10-07**
(22) 08/10/2021 (43) 25/01/2024
(30) 29/810,356 04/10/2021 US;
(73) **GOOGLE LLC (US)**
1600 Amphitheatre Parkway, Mountain View, California 94043, United States of America
(72) 1. REIMANN, GINA (US)
2. OLSSON, MAJ ISABELLE (SE)
3. CAZALET, PETER MICHAEL (US)
4. CASTILLO, ALFREDO (US)
5. GREDLER, CHRISTOPH (AU)
(74) Công ty Luật TNHH ROUSE Việt Nam (ROUSE LEGAL VIETNAM LTD.)
(55)

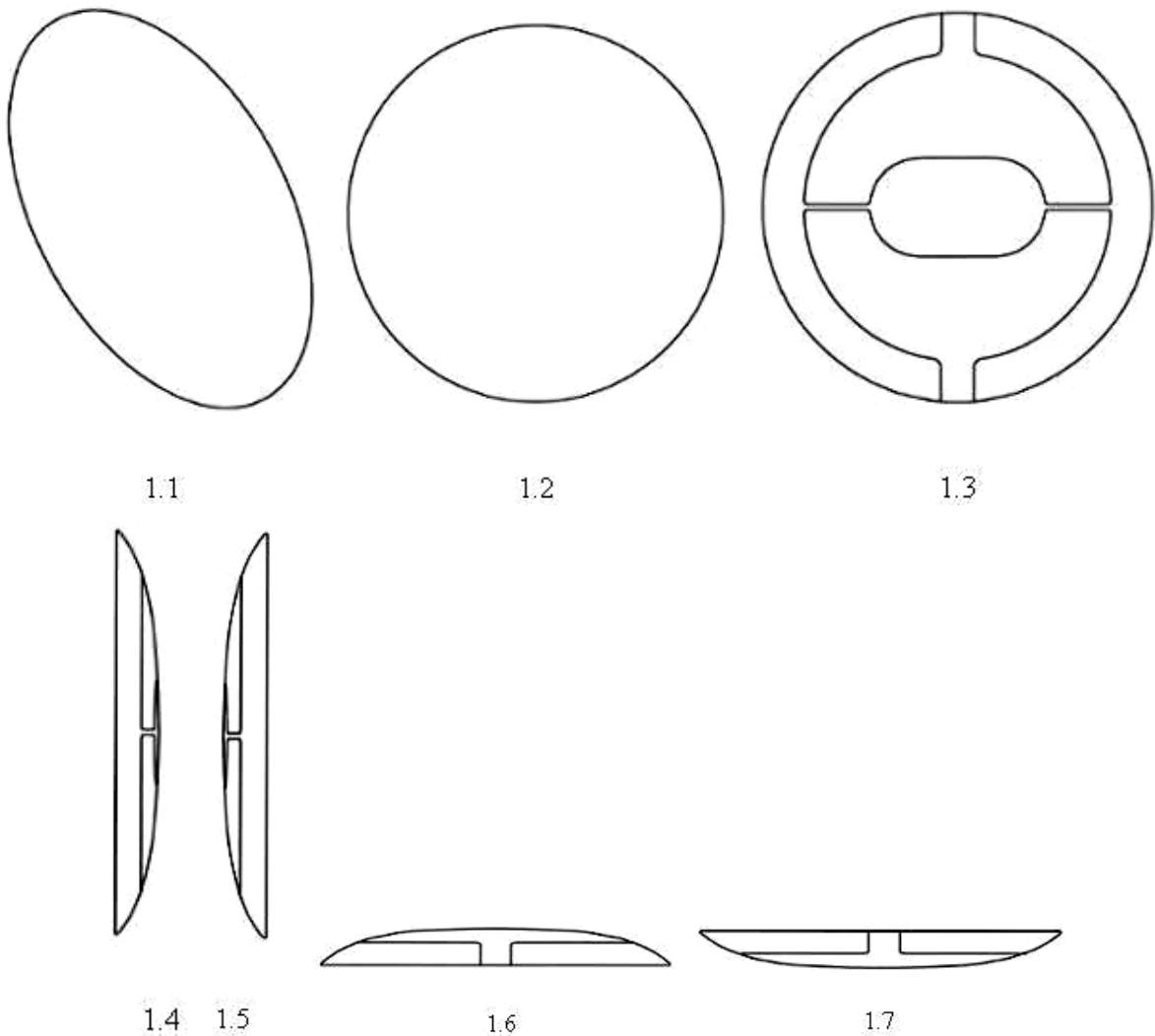

CÔNG BÁO SỞ HỮU CÔNG NGHIỆP SỐ 430 TẬP A – QUYỀN 2 (01.2024)

- (11) **49046**
(21) 3-2021-02458 (28) 1
(54) **BỘ PHẬN KẾT NỐI** (51) **10-07**
(22) 08/10/2021 (43) 25/01/2024
(30) 29/810,358 04/10/2021 US;
(73) **GOOGLE LLC (US)**
1600 Amphitheatre Parkway, Mountain View, California 94043, United States of America
(72) 1. REIMANN, GINA (US)
2. OLSSON, MAJ ISABELLE (SE)
3. CAZALET, PETER MICHAEL (US)
4. GREDLER, CHRISTOPH (AU)
(74) Công ty Luật TNHH ROUSE Việt Nam (ROUSE LEGAL VIETNAM LTD.)
(55)



1.1



1.2



1.3



1.4



1.5



1.6



1.7

CÔNG BÁO SỞ HỮU CÔNG NGHIỆP SỐ 430 TẬP A – QUYỀN 2 (01.2024)

- (11) **49047**
(21) 3-2021-02459 (28) 1
(54) **BỘ PHẬN KẾT NỐI** (51) **10-07**
(22) 08/10/2021 (43) 25/01/2024
(30) 29/810,358 04/10/2021 US;
(73) **GOOGLE LLC (US)**
1600 Amphitheatre Parkway, Mountain View, California 94043, United States of America
(72) 1. REIMANN, GINA (US)
2. OLSSON, MAJ ISABELLE (SE)
3. CAZALET, PETER MICHAEL (US)
4. GREDLER, CHRISTOPH (AU)
(74) Công ty Luật TNHH ROUSE Việt Nam (ROUSE LEGAL VIETNAM LTD.)
(55)



1.1



1.2



1.3



1.4



1.5



1.6

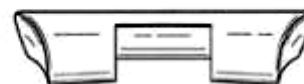

1.7

CÔNG BÁO SỞ HỮU CÔNG NGHIỆP SỐ 430 TẬP A – QUYỀN 2 (01.2024)

- (11) **49048**
(21) 3-2021-02461 (28) 1
(54) **BỘ PHẬN KẾT NỐI** (51) **10-07**
(22) 08/10/2021 (43) 25/01/2024
(30) 29/810,358 04/10/2021 US;
(73) **GOOGLE LLC (US)**
1600 Amphitheatre Parkway, Mountain View, California 94043, United States of America
(72) 1. REIMANN, GINA (US)
2. OLSSON, MAJ ISABELLE (SE)
3. CAZALET, PETER MICHAEL (US)
4. GREDLER, CHRISTOPH (AU)
(74) Công ty Luật TNHH ROUSE Việt Nam (ROUSE LEGAL VIETNAM LTD.)
(55)



1.1



1.2



1.3



1.4



1.5



1.6



1.7



1.8

CÔNG BÁO SỞ HỮU CÔNG NGHIỆP SỐ 430 TẬP A – QUYỀN 2 (01.2024)

- (11) **49049**
(21) 3-2021-02462 (28) 1
(54) **BỘ PHẬN KẾT NỐI** (51) **10-07**
(22) 08/10/2021 (43) 25/01/2024
(30) 29/810,358 04/10/2021 US;
(73) **GOOGLE LLC (US)**
1600 Amphitheatre Parkway, Mountain View, California 94043, United States of America
(72) 1. REIMANN, GINA (US)
2. OLSSON, MAJ ISABELLE (SE)
3. CAZALET, PETER MICHAEL (US)
4. GREDLER, CHRISTOPH (AU)
(74) Công ty Luật TNHH ROUSE Việt Nam (ROUSE LEGAL VIETNAM LTD.)
(55)



1.1



1.2



1.3



1.4



1.5



1.6



1.7



1.8

CÔNG BÁO SỞ HỮU CÔNG NGHIỆP SỐ 430 TẬP A – QUYỀN 2 (01.2024)

- (11) **49050**
(21) 3-2021-02488 (28) 1
(54) **HỘP ĐỰNG BÁNH** (51) **09-03**
(22) 11/10/2021 (43) 25/01/2024
(73) **CÔNG TY TNHH REPUBLIC BISCUIT CORPORATION VIỆT NAM (VN)**
Số 15 VSIP II-A, đường số 32, khu công nghiệp Việt Nam - Singapore II-A, xã Tân Bình, huyện Bắc Tân Uyên, tỉnh Bình Dương
(72) Glenie Madriñan (PH)
(55)



1.1



1.2



1.3



1.4



1.5



1.6



1.7

CÔNG BÁO SỞ HỮU CÔNG NGHIỆP SỐ 430 TẬP A – QUYỀN 2 (01.2024)

- (11) **49051**
- (21) 3-2021-02748 (28) 1
- (54) **NHÃN SẢN PHẨM** (51) **19-08**
- (22) 05/11/2021 (43) 25/01/2024
- (73) **CÔNG TY TNHH ĐẦU TƯ PHÁT TRIỂN THƯƠNG MẠI VÀ DỊCH VỤ ĐẠT LINH HƯƠNG (VN)**
Số 345 đường Nguyễn Văn Cừ, phường Võ Cường, thành phố Bắc Ninh, tỉnh Bắc Ninh
- (72) Nguyễn Hòa Hiệp (VN)
- (74) Công ty Luật TNHH LEADCONSULT (LEADCONSULT)
- (55)



CÔNG BÁO SỞ HỮU CÔNG NGHIỆP SỐ 430 TẬP A – QUYỀN 2 (01.2024)

- (11) **49052**
- (21) 3-2021-02749 (28) 1
- (54) **NHÃN SẢN PHẨM** (51) **19-08**
- (22) 05/11/2021 (43) 25/01/2024
- (73) **CÔNG TY TNHH ĐẦU TƯ PHÁT TRIỂN THƯƠNG MẠI VÀ DỊCH VỤ ĐẠT LINH HƯƠNG (VN)**
Số 345 đường Nguyễn Văn Cừ, phường Võ Cường, thành phố Bắc Ninh, tỉnh Bắc Ninh
- (72) Nguyễn Hòa Hiệp (VN)
- (74) Công ty Luật TNHH LEADCONSULT (LEADCONSULT)
- (55)



CÔNG BÁO SỞ HỮU CÔNG NGHIỆP SỐ 430 TẬP A – QUYỀN 2 (01.2024)

- (11) **49053**
- (21) 3-2021-02750 (28) 1
- (54) **NHÃN SẢN PHẨM** (51) **19-08**
- (22) 05/11/2021 (43) 25/01/2024
- (73) **CÔNG TY TNHH ĐẦU TƯ PHÁT TRIỂN THƯƠNG MẠI VÀ DỊCH VỤ ĐẠT LINH HƯƠNG (VN)**
Số 345 đường Nguyễn Văn Cừ, phường Võ Cường, thành phố Bắc Ninh, tỉnh Bắc Ninh
- (72) Nguyễn Hòa Hiệp (VN)
- (74) Công ty Luật TNHH LEADCONSULT (LEADCONSULT)
- (55)



CÔNG BÁO SỞ HỮU CÔNG NGHIỆP SỐ 430 TẬP A – QUYỀN 2 (01.2024)

- (11) **49054**
(21) 3-2021-03289 (28) 1
(54) **HỘP** (51) **09-03**
(22) 22/12/2021 (43) 25/01/2024
(73) **DƯƠNG THÁI BÌNH (VN)**
5-7 Lương Nhữ Học, phường 10, quận 5, thành phố Hồ Chí Minh
(72) Dương Thái Bình (VN)
(74) **CÔNG TY TNHH KHANG LUẬT (KHANGLAW)**
(55)



1.1



1.2



2.1



2.2

CÔNG BÁO SỞ HỮU CÔNG NGHIỆP SỐ 430 TẬP A – QUYỀN 2 (01.2024)

- (11) **49055**
(21) 3-2022-00135 (28) 1
(54) **BAO BÌ GÓI MÌ** (51) **09-05**
(22) 17/01/2022 (43) 25/01/2024
(73) **CÔNG TY CỔ PHẦN CHẾ BIẾN KINH DOANH LƯƠNG THỰC - THỰC PHẨM HÀ NỘI (VN)**
67A, đường Trương Định, phường Trương Định, quận Hai Bà Trưng, thành phố Hà Nội
(72) Phùng Ngọc Quý (VN)
(55)



1.1



1.2

CÔNG BÁO SỞ HỮU CÔNG NGHIỆP SỐ 430 TẬP A – QUYỀN 2 (01.2024)

- (11) **49056**
(21) 3-2022-00173 (28) 1
(54) **THANH KIM LOẠI ĐỊNH HÌNH** (51) **25-01**
(22) 20/01/2022 (43) 25/01/2024
(73) **CÔNG TY TNHH MTV ĐĂNG QUANG (VN)**
Đường Trường Chinh, khu phố 1, phường Phú Tài, thành phố Phan Thiết, tỉnh Bình Thuận
(72) Võ Trường Thọ (VN)
(74) **CÔNG TY TNHH KHANG LUẬT (KHANGLAW)**
(55)

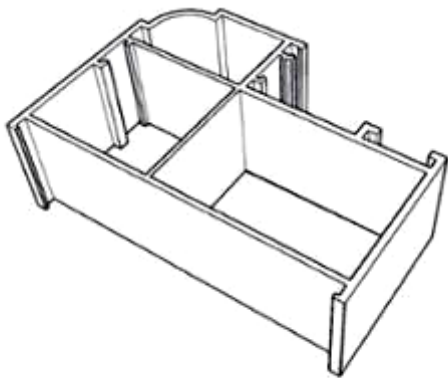

1.1



1.2

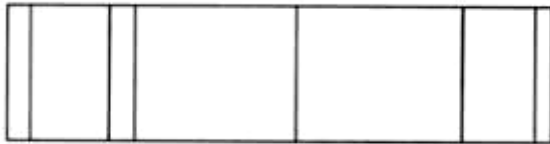

1.3



1.4



1.5

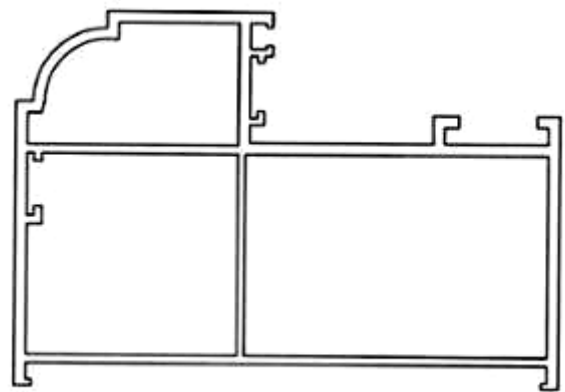

1.6

CÔNG BÁO SỞ HỮU CÔNG NGHIỆP SỐ 430 TẬP A – QUYỀN 2 (01.2024)

- (11) **49057**
(21) 3-2022-00276 (28) 1
(54) **HỘP CÁC TÔNG** (51) **09-03**
(22) 14/02/2022 (43) 25/01/2024
(30) 008652069-0001 17/08/2021 EM;
(73) **UNILEVER GLOBAL IP LIMITED (GB)**
Port Sunlight Wirral, Merseyside CH62 4ZD, United Kingdom
(72) 1. BROWN MELANIE ODETTE LILIANE (US)
2. MALHOTRA AKRITI (IN)
(74) Công ty TNHH Trần Hữu Nam và Đồng sự (TRAN H.N & ASS.)
(55)

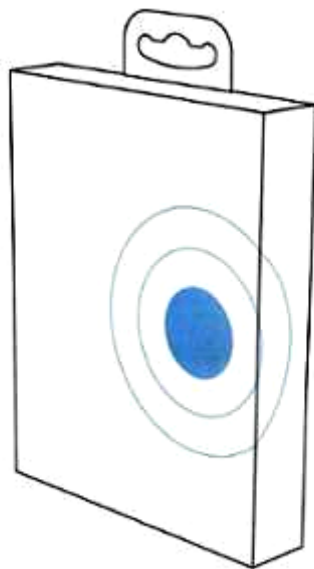

1.1

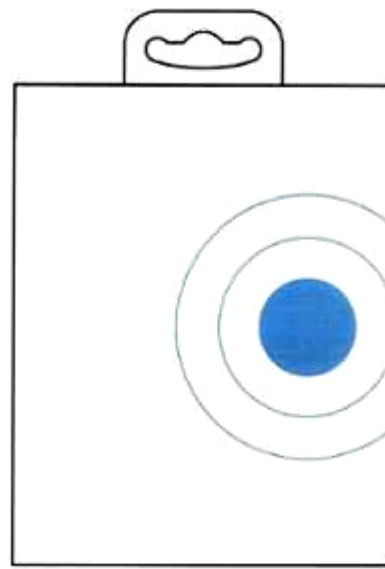

1.2

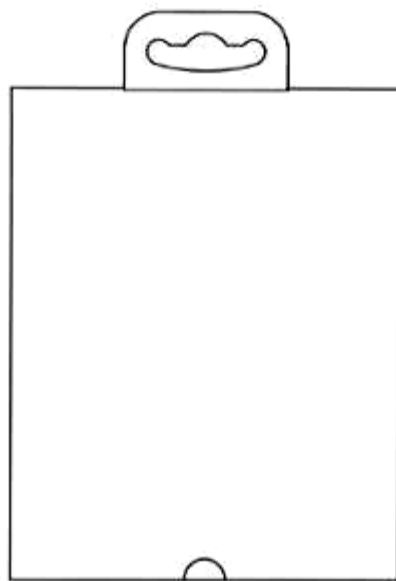

1.3

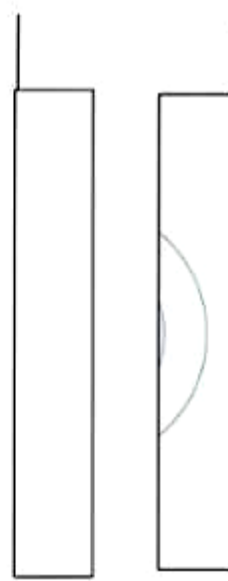

1.4

1.5

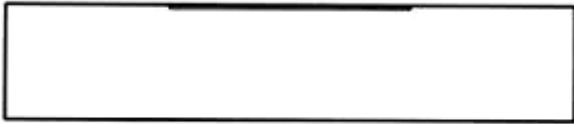

1.6



1.7

CÔNG BÁO SỞ HỮU CÔNG NGHIỆP SỐ 430 TẬP A – QUYỀN 2 (01.2024)

- (11) **49058**
- (21) 3-2022-00298 (28) 1
- (54) **BAO GÓI** (51) **09-05**
- (22) 17/02/2022 (43) 25/01/2024
- (73) **ORION CORPORATION (KR)**
13, Baekbeom-ro 90da-gil, Yongsan-gu, Seoul 04369, Republic of Korea
- (72) 1. NOH, SU BEEN (KR)
2. CHOE, EUN JE (KR)
- (74) Công ty Luật TNHH quốc tế BMVN (BMVN INTERNATIONAL LLC)
- (55)



1.1

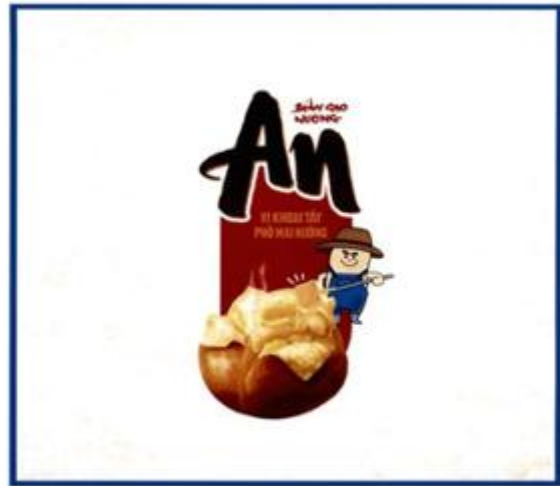

1.2

CÔNG BÁO SỞ HỮU CÔNG NGHIỆP SỐ 430 TẬP A – QUYỀN 2 (01.2024)

- (11) **49059**
- (21) 3-2022-00428
- (54) **HỘP**
- (22) 09/03/2022
- (73) **CÔNG TY CỔ PHẦN SỮA VITADAIRY VIỆT NAM (VN)**
Tầng 5, số 37 Tôn Đức Thắng, phường Bến Nghé, quận 1, thành phố Hồ Chí Minh
- (72) Nguyễn Thị Hà (VN)
- (55)
- (28) 1
- (51) **09-03**
- (43) 25/01/2024



1.1



1.2



1.3



1.4

CÔNG BÁO SỞ HỮU CÔNG NGHIỆP SỐ 430 TẬP A – QUYỀN 2 (01.2024)



1.5



1.6



1.7



1.8

CÔNG BÁO SỞ HỮU CÔNG NGHIỆP SỐ 430 TẬP A – QUYỀN 2 (01.2024)

- (11) **49060**
- (21) 3-2022-00460 (28) 1
- (54) **HỘP SỮA YẾN MẠCH** (51) **09-03**
- (22) 15/03/2022 (43) 25/01/2024
- (73) **CÔNG TY TRÁCH NHIỆM HỮU HẠN THANH AN (VN)**
P809 tầng 8, tòa nhà Plaschem, số 562 đường Nguyễn Văn Cừ, phường Gia Thụy,
quận Long Biên, thành phố Hà Nội
- (72) Tạ Bá Thuyết (VN)
- (74) Công ty TNHH Sở hữu trí tuệ và Công nghệ Thủ đô (CAPITAL IP&T CO.LTD.)
- (55)



1.1



1.2

CÔNG BÁO SỞ HỮU CÔNG NGHIỆP SỐ 430 TẬP A – QUYỀN 2 (01.2024)

- (11) **49061**
- (21) 3-2022-00461 (28) 1
- (54) **HỘP SỮA YẾN MẠCH** (51) **09-03**
- (22) 15/03/2022 (43) 25/01/2024
- (73) **CÔNG TY TRÁCH NHIỆM HỮU HẠN THANH AN (VN)**
P809 tầng 8, tòa nhà Plaschem, số 562 đường Nguyễn Văn Cừ, phường Gia Thụy,
quận Long Biên, thành phố Hà Nội
- (72) Tạ Bá Thuyết (VN)
- (74) Công ty TNHH Sở hữu trí tuệ và Công nghệ Thủ đô (CAPITAL IP&T CO.LTD.)
- (55)



1.1



1.2

(11) **49062**

(21) 3-2022-00690

(28) 1

(54) **CẤU KIỆN RỌ BÊ TÔNG CHỐNG XÓI**

(51) **25-02**

(22) 13/04/2022

(43) 25/01/2024

(73) **CÔNG TY CỔ PHẦN KHOA HỌC CÔNG NGHỆ VIỆT NAM (VN)**

Số 6, đường 3 tháng 2, phường 8, thành phố Vũng Tàu, tỉnh Bà Rịa - Vũng Tàu

(72) Hoàng Đức Thảo (VN)

(55)

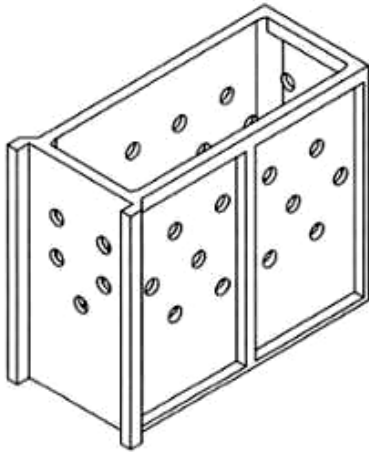

1.1

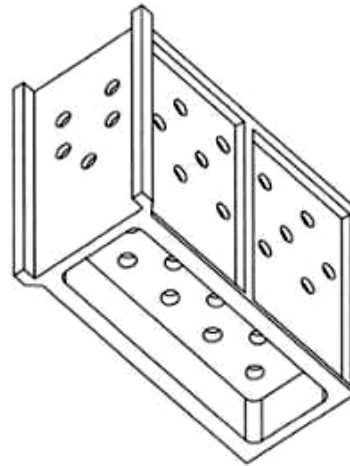

1.2

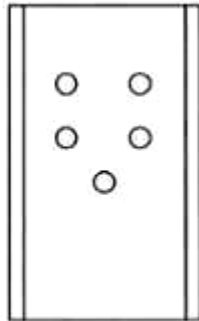

1.3

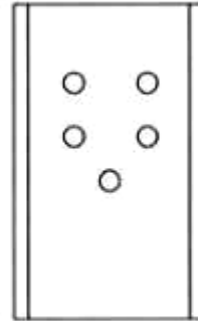

1.4

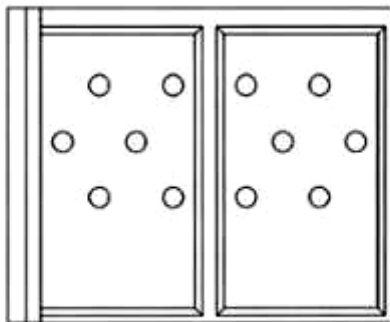

1.5

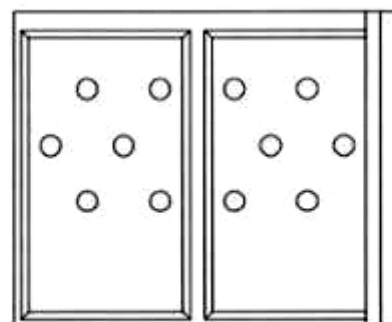

1.6

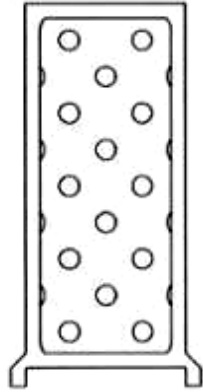

1.7

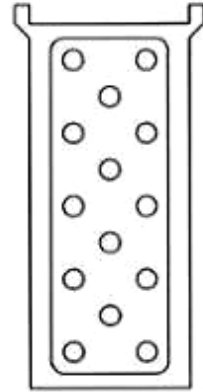

1.8

(11) **49063**

(21) 3-2022-00691

(28) 1

(54) **CẤU KIỆN RỌ BÊ TÔNG CHỐNG XÓI**

(51) **25-02**

(22) 13/04/2022

(43) 25/01/2024

(73) **CÔNG TY CỔ PHẦN KHOA HỌC CÔNG NGHỆ VIỆT NAM (VN)**

Số 6, đường 3 tháng 2, phường 8, thành phố Vũng Tàu, tỉnh Bà Rịa - Vũng Tàu

(72) Hoàng Đức Thảo (VN)

(55)

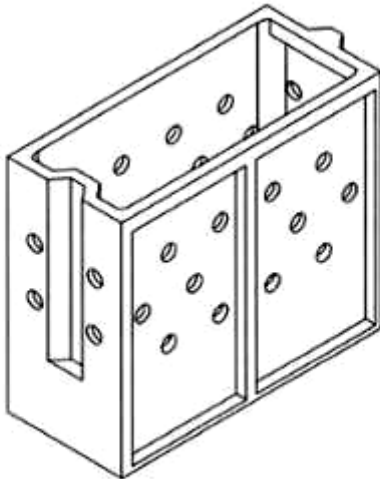

1.1

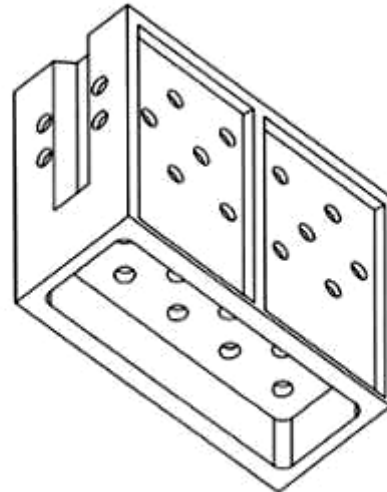

1.2

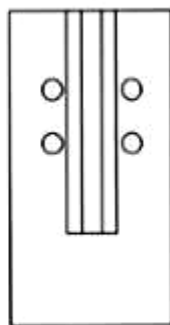

1.3

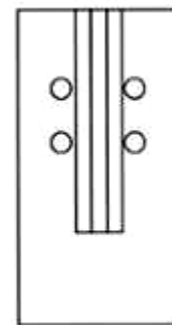

1.4

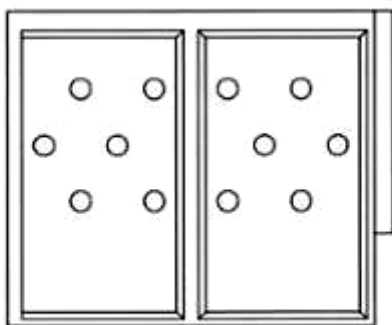

1.5

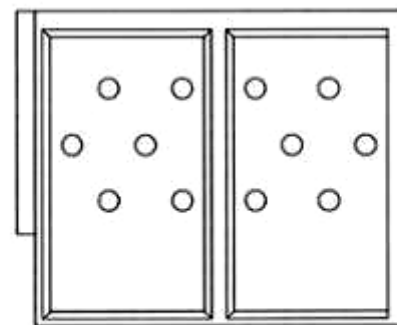

1.6

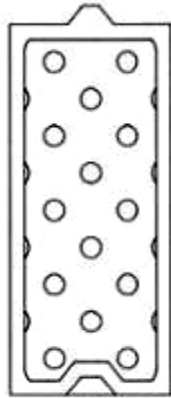

1.7

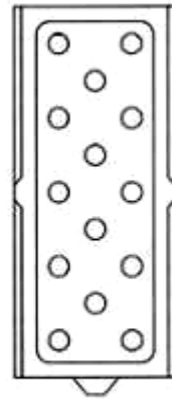

1.8

(11) **49064**

(21) 3-2022-00693

(28) 1

(54) **CẤU KIỆN RỌ BÊ TÔNG CHỐNG XÓI**

(51) **25-02**

(22) 13/04/2022

(43) 25/01/2024

(73) **CÔNG TY CỔ PHẦN KHOA HỌC CÔNG NGHỆ VIỆT NAM (VN)**

Số 6, đường 3 tháng 2, phường 8, thành phố Vũng Tàu, tỉnh Bà Rịa - Vũng Tàu

(72) Hoàng Đức Thảo (VN)

(55)

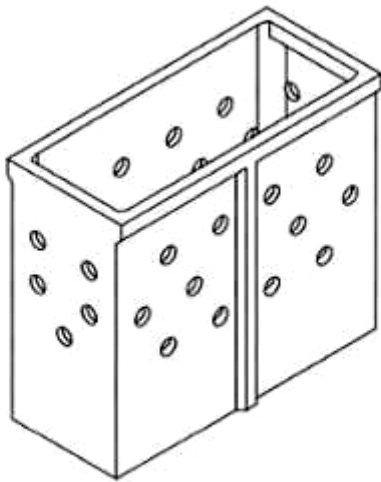

1.1

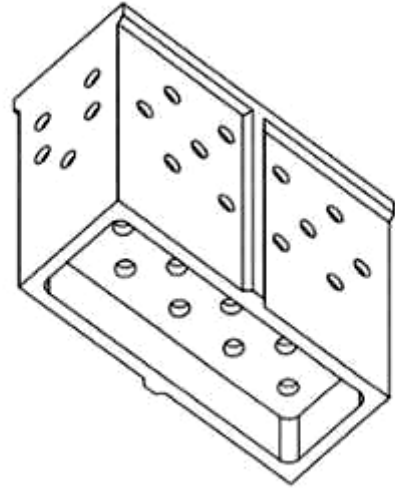

1.2

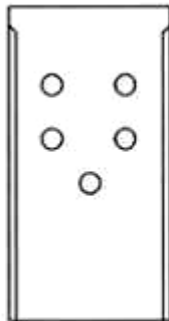

1.3

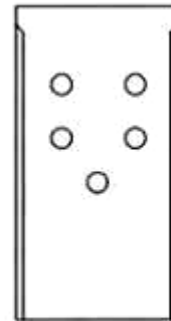

1.4

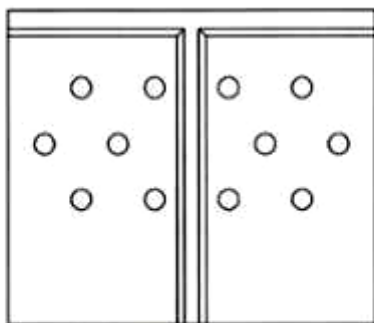

1.5

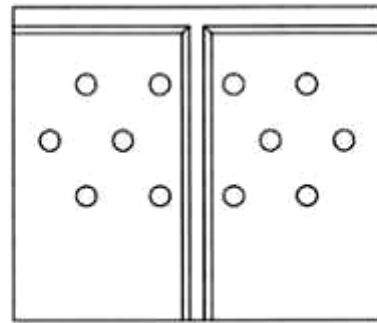

1.6

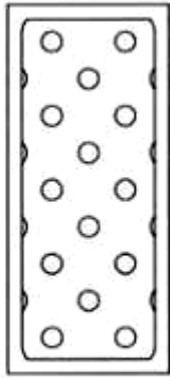

1.7

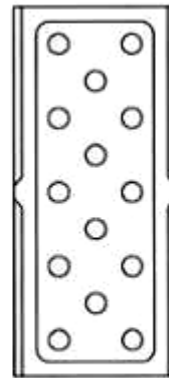

1.8

(11) **49065**

(21) 3-2022-00695

(28) 1

(54) **CẤU KIỆN RỌ BÊ TÔNG CHỐNG XÓI**

(51) **25-02**

(22) 13/04/2022

(43) 25/01/2024

(73) **CÔNG TY CỔ PHẦN KHOA HỌC CÔNG NGHỆ VIỆT NAM (VN)**

Số 6 đường 3 tháng 2, phường 8, thành phố Vũng Tàu, tỉnh Bà Rịa - Vũng Tàu

(72) Hoàng Đức Thảo (VN)

(55)

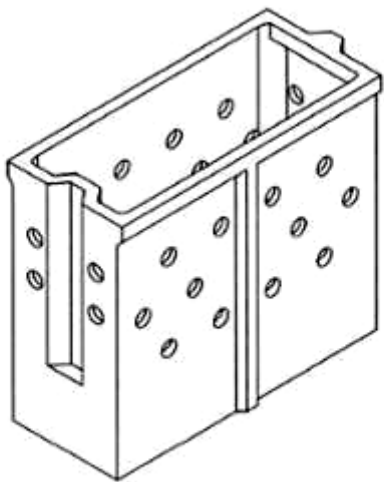

1.1

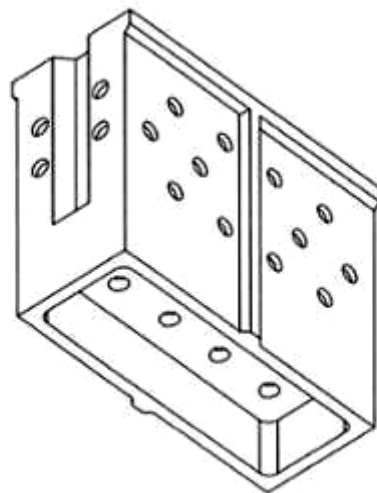

1.2

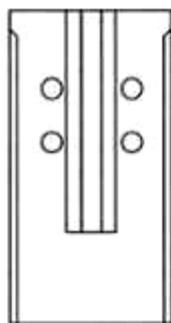

1.3

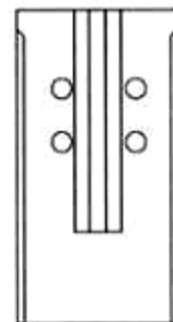

1.4

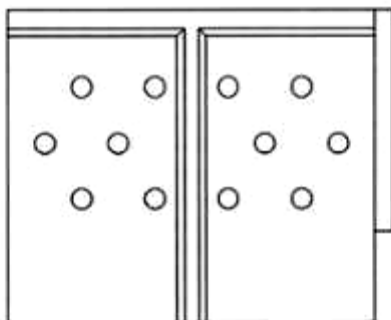

1.5

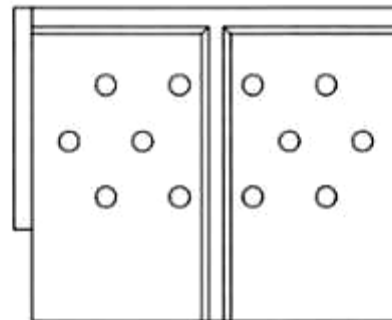

1.6

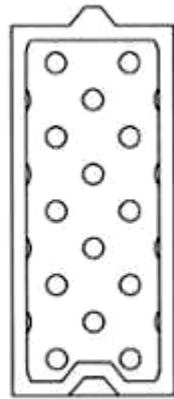

1.7

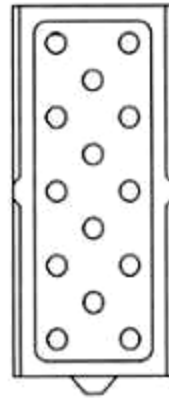

1.8

- (11) **49066**
(21) 3-2022-00697 (28) 1
(54) **CẤU KIỆN RỌ BÊ TÔNG CHỐNG XÓI** (51) **25-02**
(22) 13/04/2022 (43) 25/01/2024
(73) **CÔNG TY CỔ PHẦN KHOA HỌC CÔNG NGHỆ VIỆT NAM (VN)**
Số 6, đường 3 tháng 2, phường 8, thành phố Vũng Tàu, tỉnh Bà Rịa - Vũng Tàu
(72) Hoàng Đức Thảo (VN)
(55)

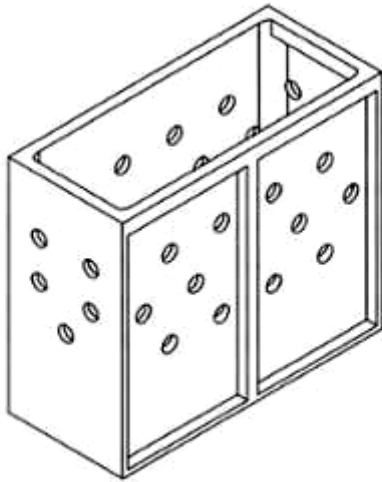

1.1

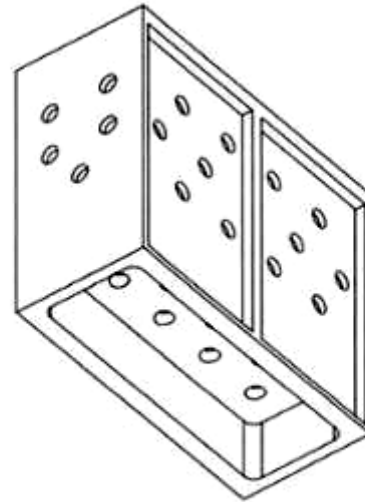

1.2

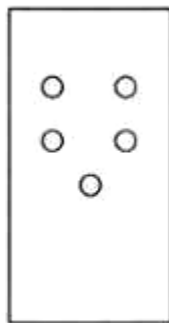

1.3

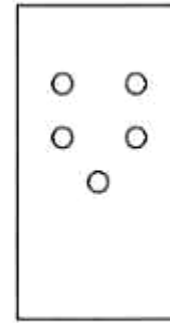

1.4

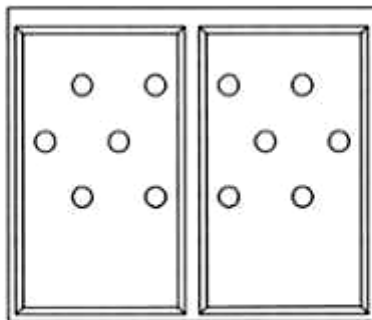

1.5

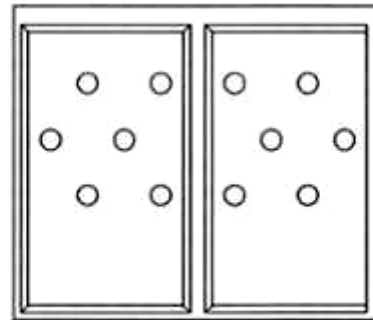

1.6

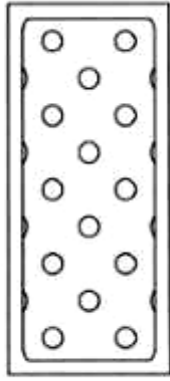

1.7

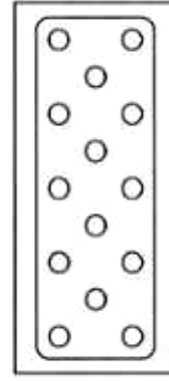

1.8

(11) **49067**

(21) 3-2022-00698

(28) 1

(54) **CẤU KIỆN RỌ BÊ TÔNG CHỐNG XÓI**

(51) **25-02**

(22) 13/04/2022

(43) 25/01/2024

(73) **CÔNG TY CỔ PHẦN KHOA HỌC CÔNG NGHỆ VIỆT NAM (VN)**

Số 6, đường 3 tháng 2, phường 8, thành phố Vũng Tàu, tỉnh Bà Rịa - Vũng Tàu

(72) Hoàng Đức Thảo (VN)

(55)

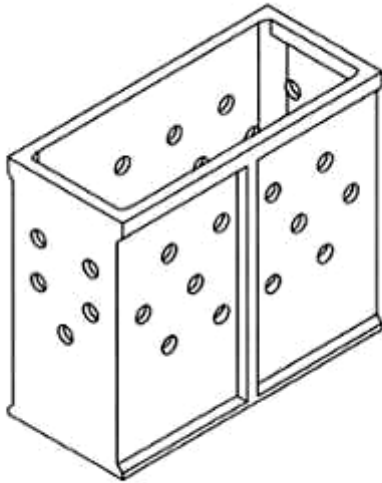

1.1

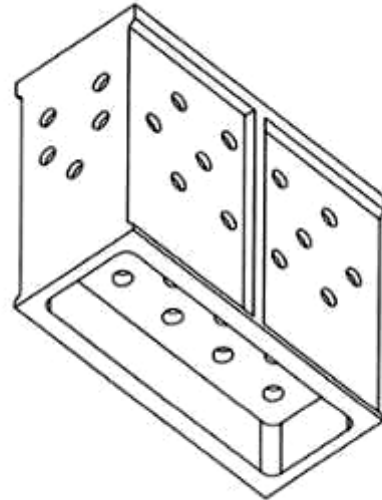

1.2

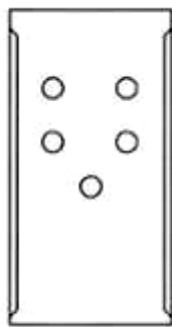

1.3

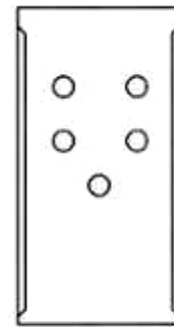

1.4

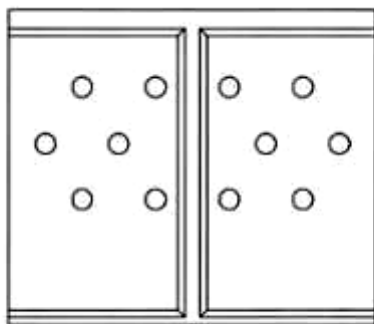

1.5

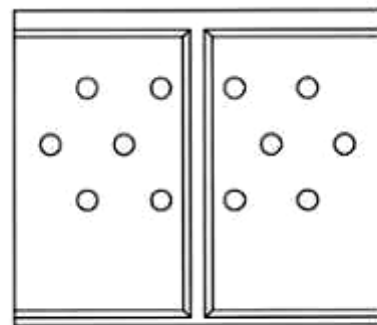

1.6

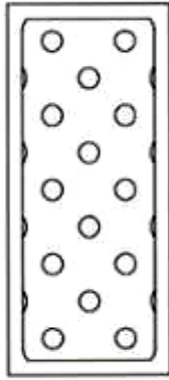

1.7

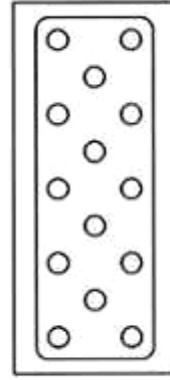

1.8

CÔNG BÁO SỞ HỮU CÔNG NGHIỆP SỐ 430 TẬP A – QUYỀN 2 (01.2024)

- (11) **49068**
(21) 3-2022-01012 (28) 1
(54) **Ô TÔ** (51) **12-08**
(22) 26/05/2022 (43) 25/01/2024
(30) 2021-026074 29/11/2021 JP;
(73) **TOYOTA JIDOSHA KABUSHIKI KAISHA (JP)**
1, Toyota-cho, Toyota-shi, Aichi-ken, 471-8571 JAPAN
(72) 1. DAICHI KIMURA (JP)
2. YUTAKA MURAKAMI (JP)
3. TSUNEO KANASUGI (JP)
(74) Công ty TNHH một thành viên Sở hữu trí tuệ VCCI (VCCI-IP CO.,LTD)
(55)



1.1



1.2



1.3



1.4



1.5



1.6



1.7

CÔNG BÁO SỞ HỮU CÔNG NGHIỆP SỐ 430 TẬP A – QUYỀN 2 (01.2024)

- (11) **49069**
- (21) 3-2022-01041 (28) 1
- (54) **NHÃN SẢN PHẨM** (51) **19-08**
- (22) 31/05/2022 (43) 25/01/2024
- (73) **CÔNG TY CỔ PHẦN CÂY TRỒNG BÌNH CHÁNH (VN)**
693A Kinh Dương Vương, khu phố 3, phường An Lạc, quận Bình Tân, thành phố Hồ Chí Minh
- (72) Trần Thị Tùng (VN)
- (55)



CÔNG BÁO SỞ HỮU CÔNG NGHIỆP SỐ 430 TẬP A – QUYỀN 2 (01.2024)

- (11) **49070**
(21) 3-2022-01045 (28) 1
(54) **NHÃN SẢN PHẨM** (51) **19-08**
(22) 31/05/2022 (43) 25/01/2024
(73) **CÔNG TY CỔ PHẦN CÂY TRỒNG BÌNH CHÁNH (VN)**
693A Kinh Dương Vương, khu phố 3, phường An Lạc, quận Bình Tân, thành phố Hồ Chí Minh
(72) Trần Thị Tùng (VN)
(55)



CÔNG BÁO SỞ HỮU CÔNG NGHIỆP SỐ 430 TẬP A – QUYỀN 2 (01.2024)

(11) **49071**

(21) 3-2022-01073

(28) 1

(54) **KHÓA**

(51) **08-07**

(22) 02/06/2022

(43) 25/01/2024

(73) **CAO BÁ QUÁT (VN)**

40/1/17D, tổ 40, Kp 9, phường Tân Phong, thành phố Biên Hòa, tỉnh Đồng Nai

(72) Cao Bá Quát (VN)

(55)

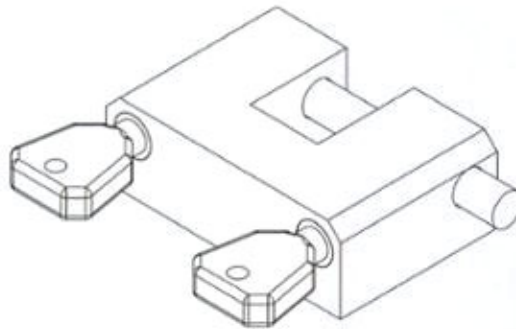

1.1



1.2

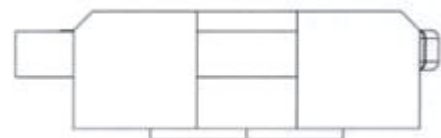

1.3

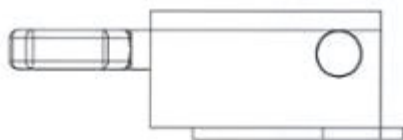

1.4

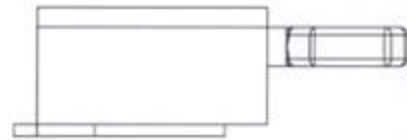

1.5

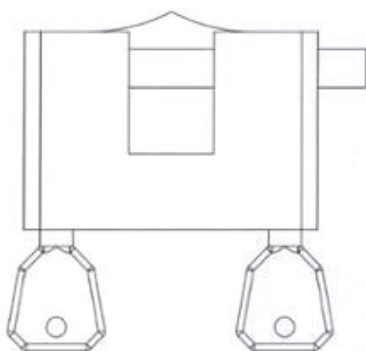

1.6

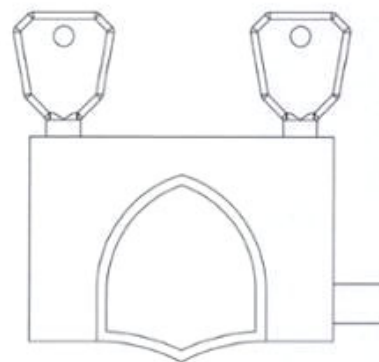

1.7

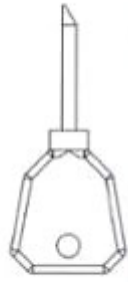

1.8

CÔNG BÁO SỞ HỮU CÔNG NGHIỆP SỐ 430 TẬP A – QUYỀN 2 (01.2024)

(11) **49072**

(21) 3-2022-01108

(28) 1

(54) **TẤM PANEN**

(51) **25-02**

(22) 08/06/2022

(43) 25/01/2024

(73) **CÔNG TY TNHH VSL VIỆT NAM (VN)**

Tòa nhà E-Town, 364 Cộng Hòa, phường 13, quận Tân Bình, thành phố Hồ Chí Minh

(72) Juan Lima (ES)

(74) Công ty TNHH Quốc tế D &N (D&N INTERNATIONAL CO.,LTD.)

(55)

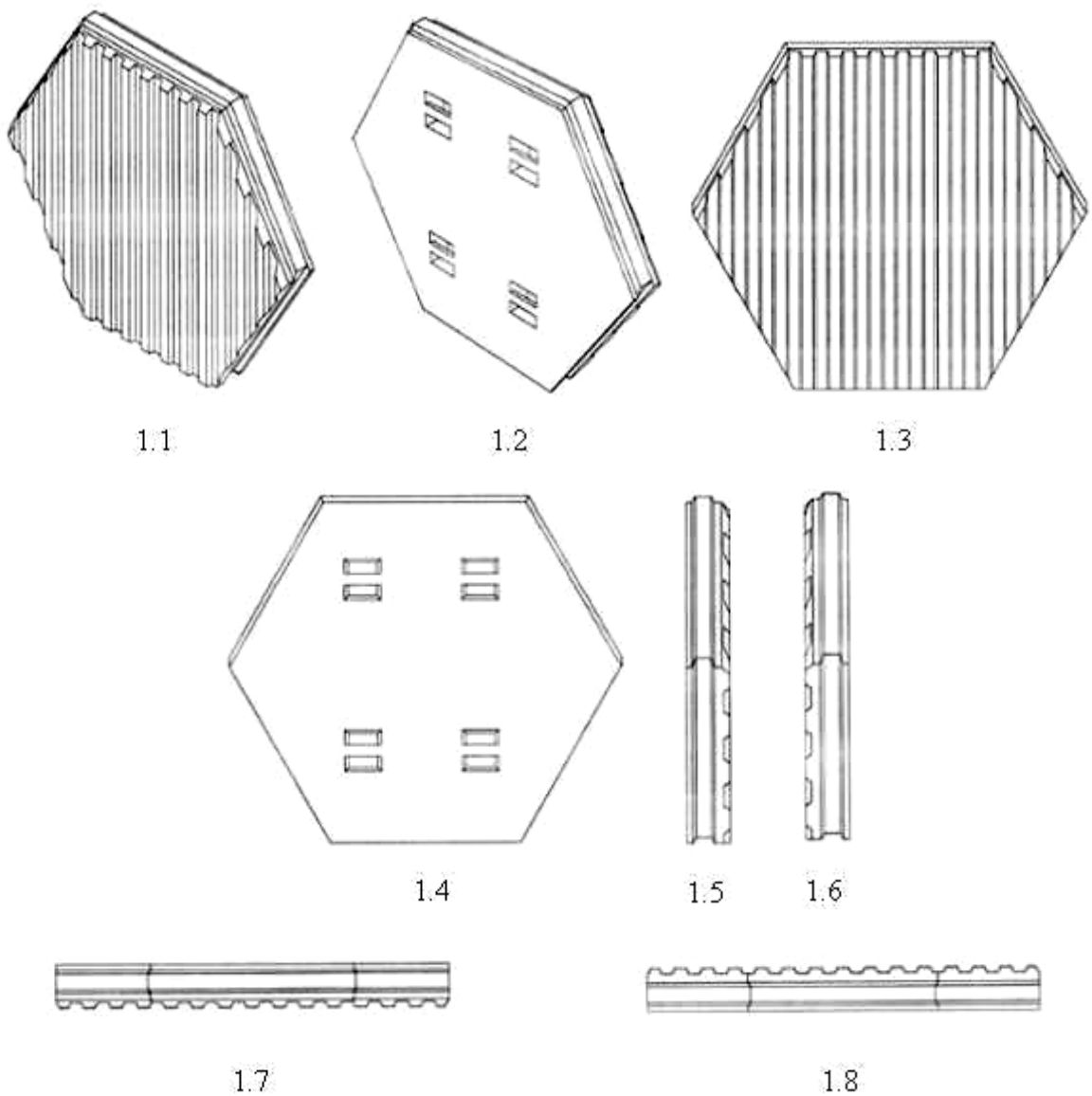

CÔNG BÁO SỞ HỮU CÔNG NGHIỆP SỐ 430 TẬP A – QUYỀN 2 (01.2024)

- (11) **49073**
- (21) 3-2022-01169
- (54) **ĐẾ ĐỖ**
- (22) 15/06/2022
- (73) **CROCODILE PRODUCTS INC. (CA)**
32227 TWP Rd, 243A Calgary, Alberta T3Z 2M8, CANADA
- (72) FORBES, Dean (CA)
- (74) Công ty Luật TNHH WINCO (WINCO LAW FIRM)
- (55)
- (28) 1
- (51) **09-08**
- (43) 25/01/2024

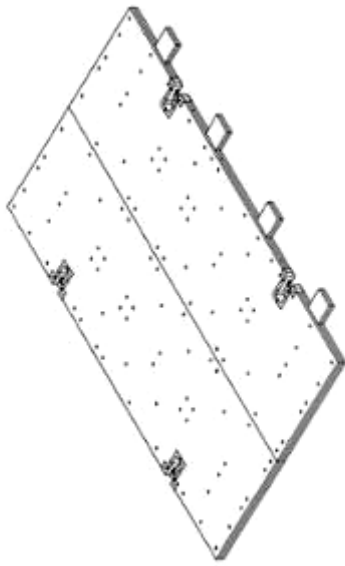

1.1

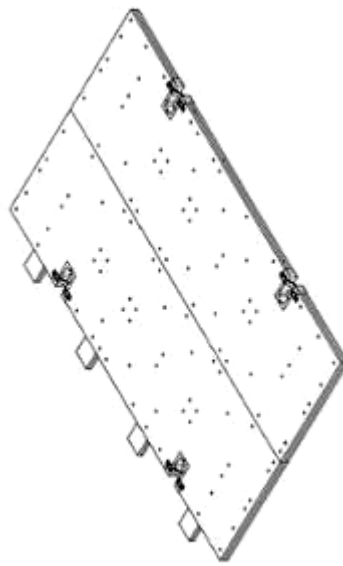

1.2

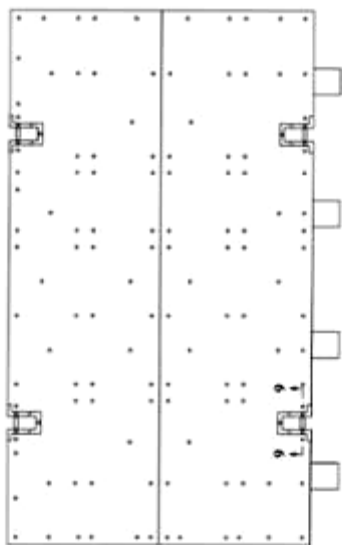

1.3

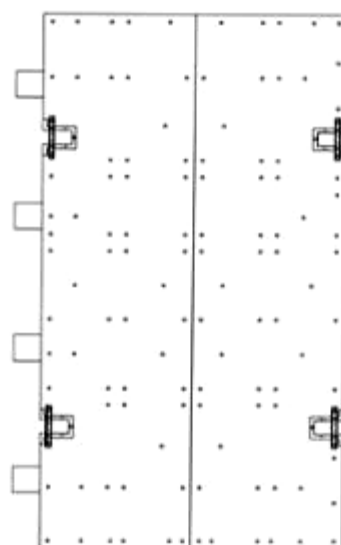

1.4



1.5



1.6



1.7



1.8



1.9

CÔNG BÁO SỞ HỮU CÔNG NGHIỆP SỐ 430 TẬP A – QUYỀN 2 (01.2024)

- (11) **49074**
(21) 3-2022-01350 (28) 1
(54) **MÁY CẮT PHỤ TẢI CHÂN KHÔNG CÓ DAO CÁCH LY** (51) **13-03; 13-99**
(22) 05/07/2022 (43) 25/01/2024
(73) **CÔNG TY CỔ PHẦN THIẾT BỊ ĐIỆN TUẤN ÂN (VN)**
Số 71 Tên Lửa, phường Bình Trị Đông B, quận Bình Tân, thành phố Hồ Chí Minh
(72) Huỳnh Tuấn Ân (VN)
(55)

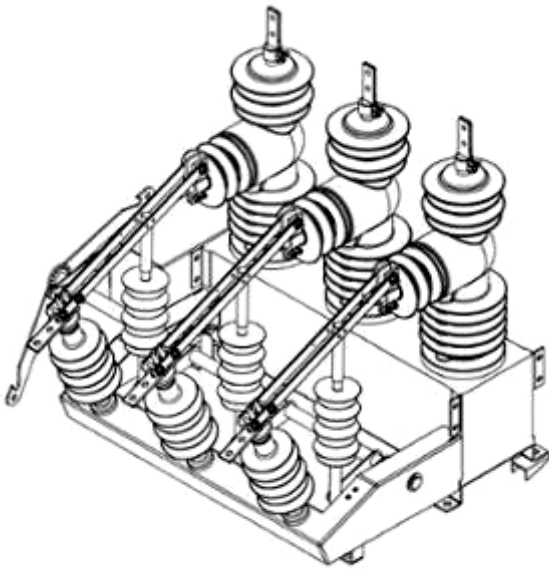

1.1

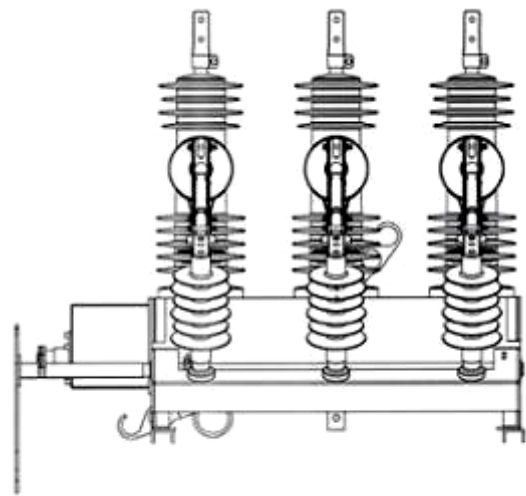

1.2

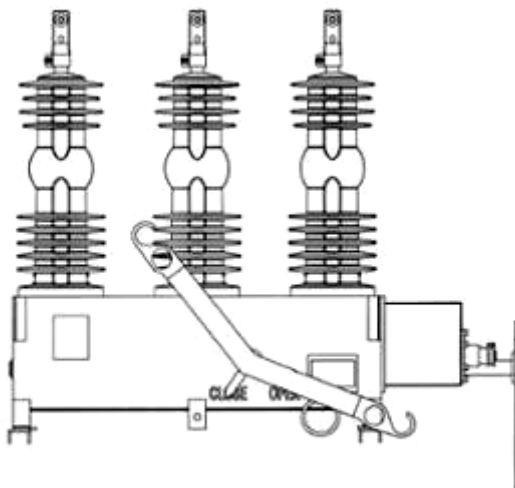

1.3

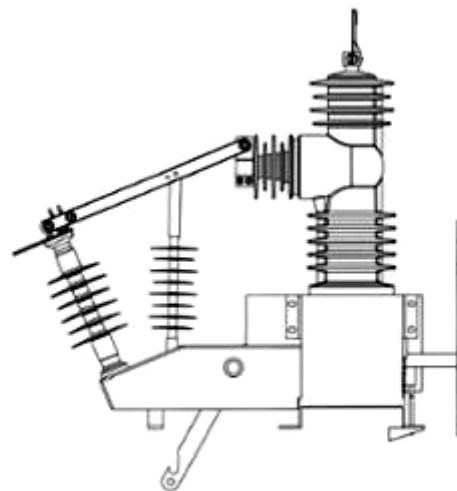

1.4

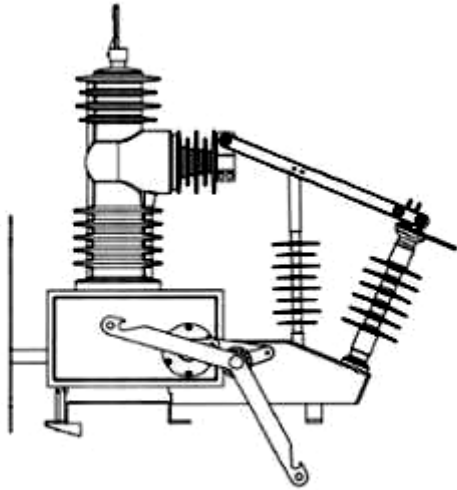

1.5

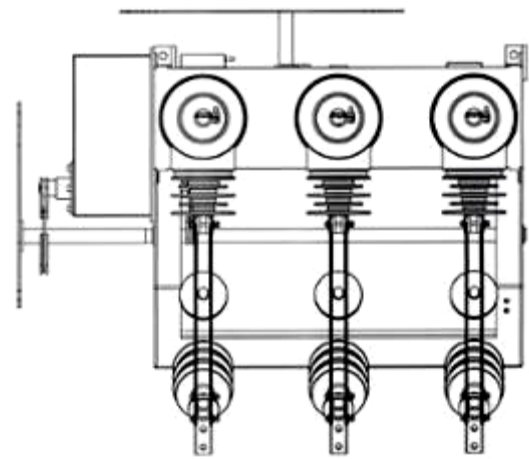

1.6

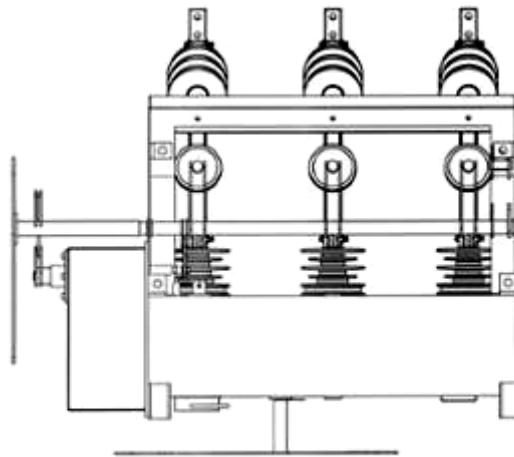

1.7

CÔNG BÁO SỞ HỮU CÔNG NGHIỆP SỐ 430 TẬP A – QUYỀN 2 (01.2024)

- (11) **49075**
(21) 3-2022-01645 (28) 2
(54) **MÁY CẮT CỎ** (51) **15-03**
(22) 11/08/2022 (43) 25/01/2024
(30) 29/826,570 14/02/2022 US; 29/826,569 14/02/2022 US;
(73) **TECHTRONIC CORDLESS GP (US)**
100 Innovation Way, Anderson, SC, 29621 United States of America
(72) 1. MATT LAMBERT (US)
2. MICHAEL FENG (CN)
(74) Công ty TNHH Tầm nhìn và Liên danh (VISION & ASSOCIATES CO.LTD.)
(55)

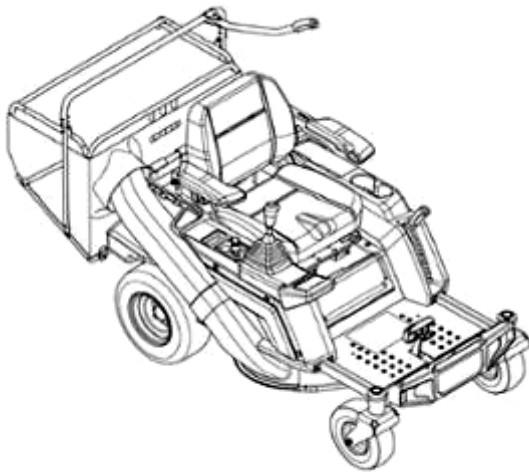

1.1

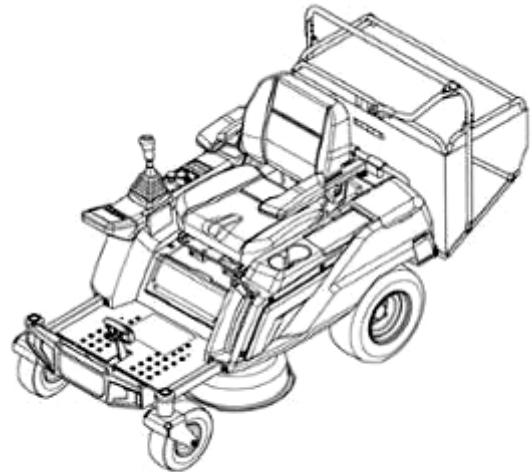

1.2

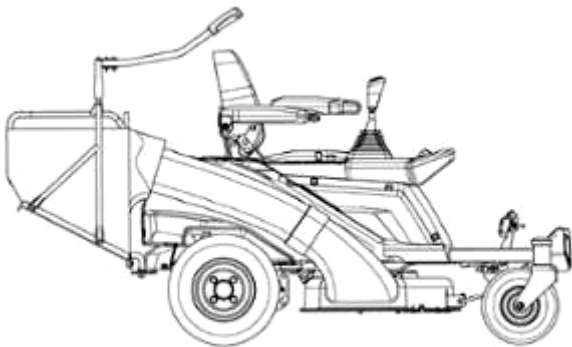

1.3

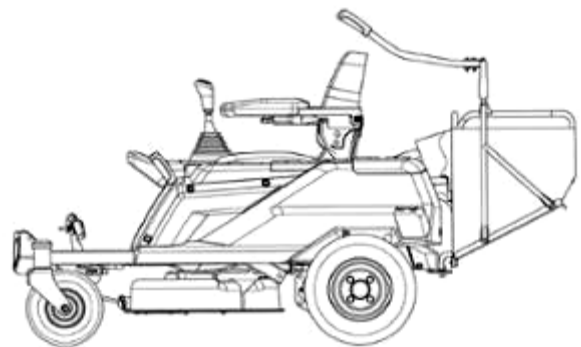

1.4

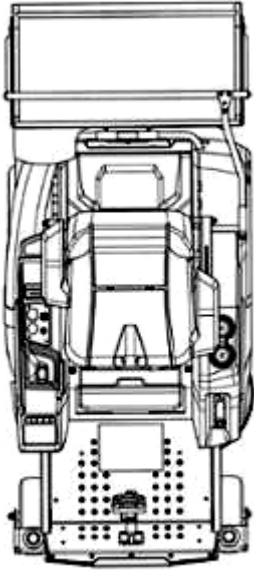

1.5

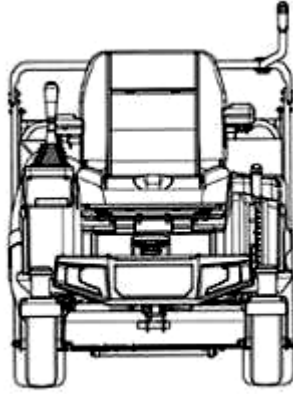

1.6

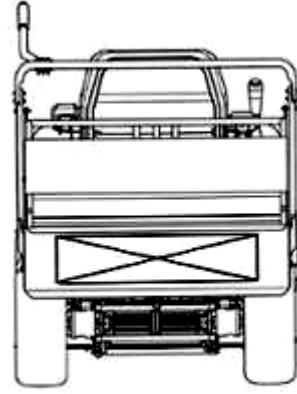

1.7

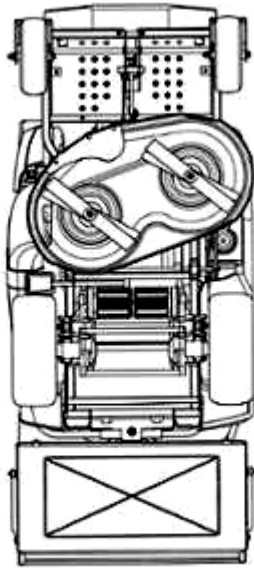

1.8

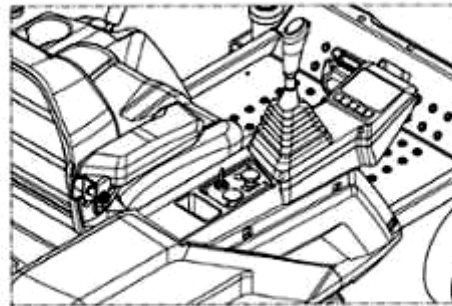

1.9

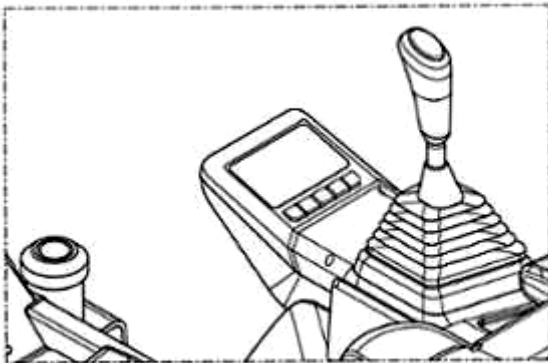

1.10

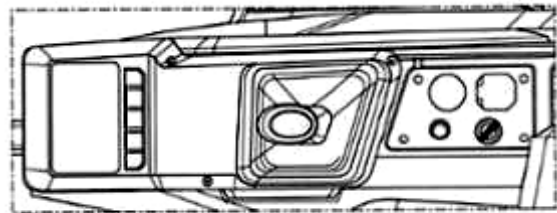

1.11

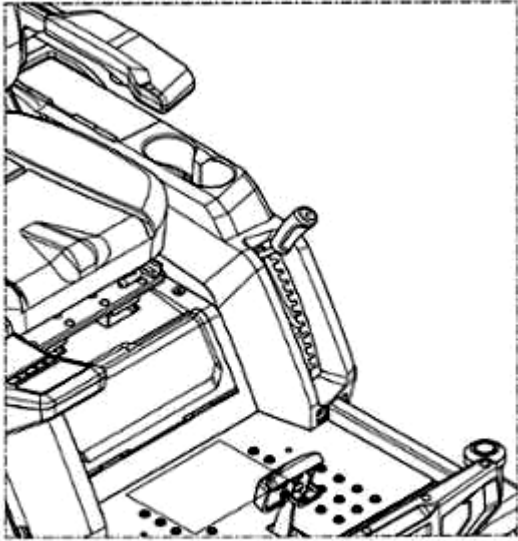

1.12

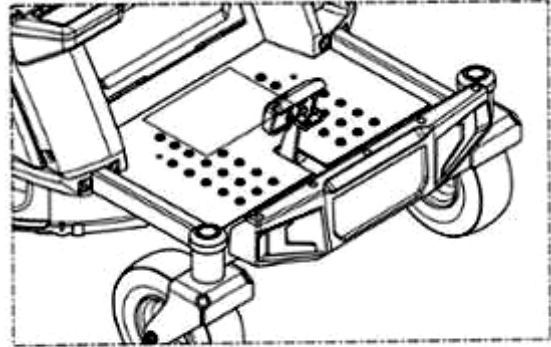

1.13

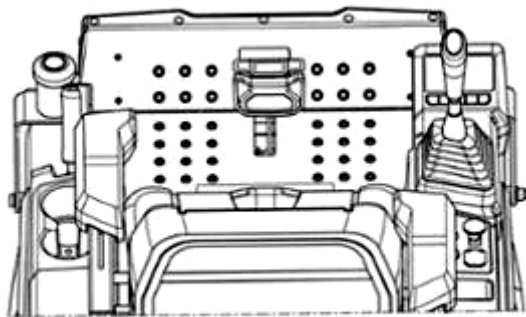

1.14

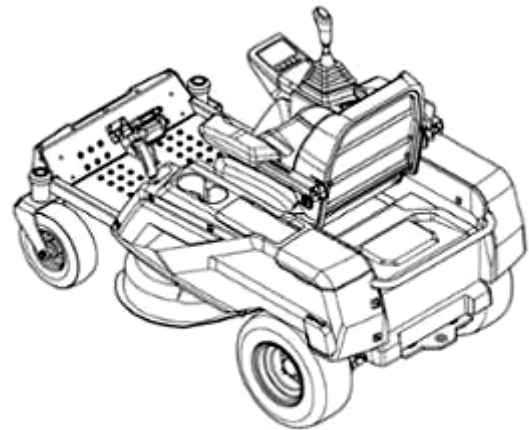

1.15

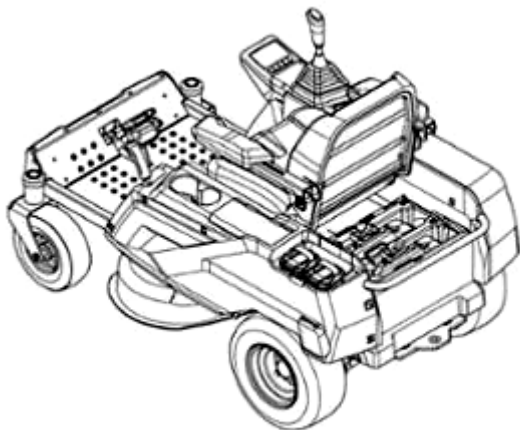

1.16

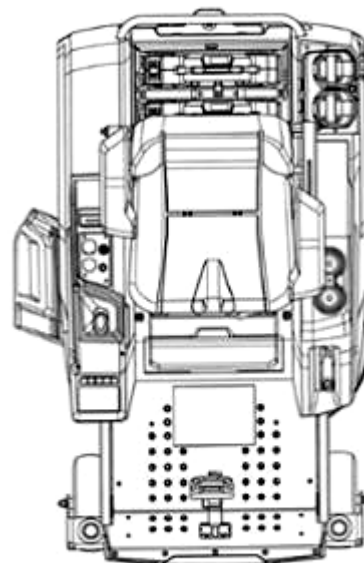

1.17

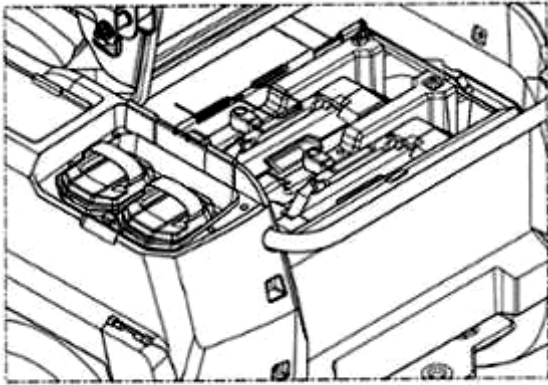

1.18

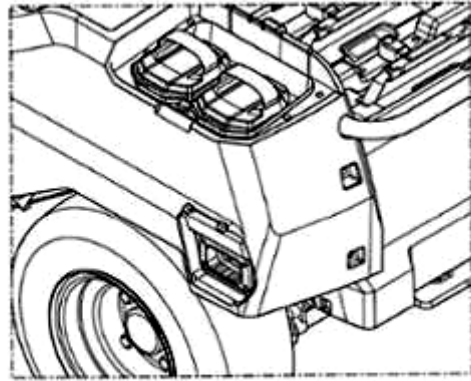

1.19

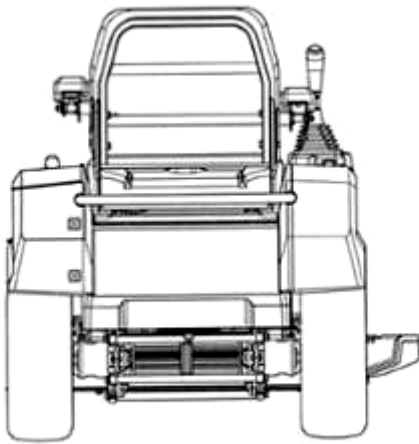

1.20

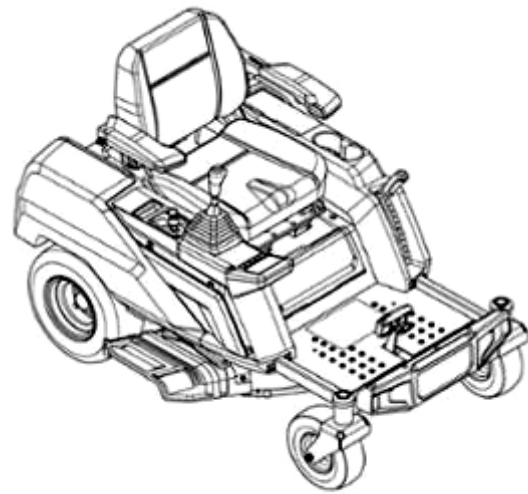

1.21

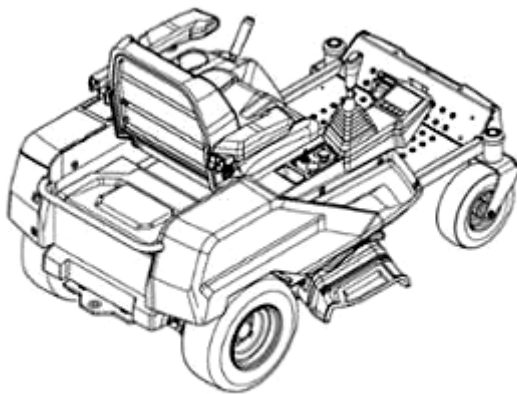

1.22

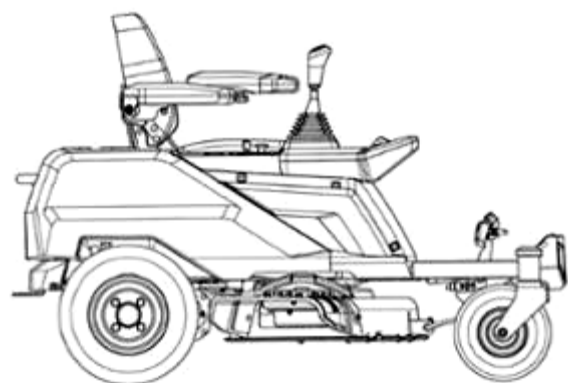

1.23

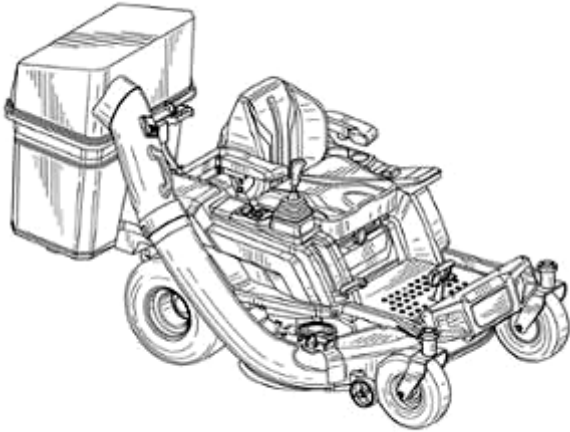

2.1

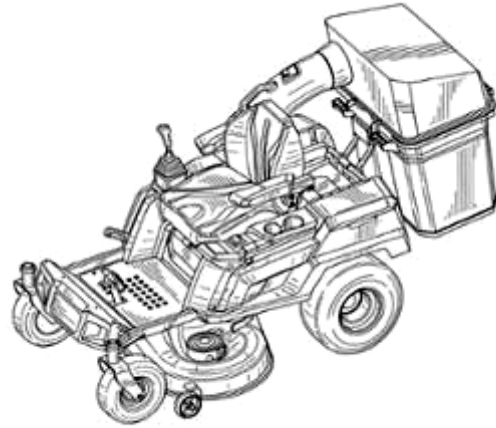

2.2

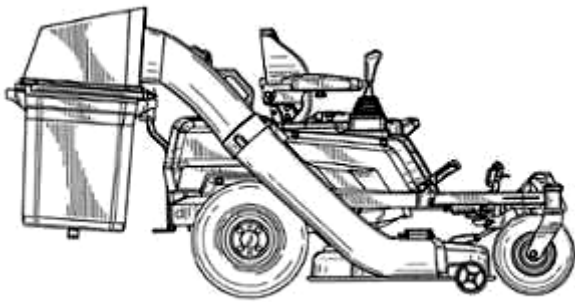

2.3

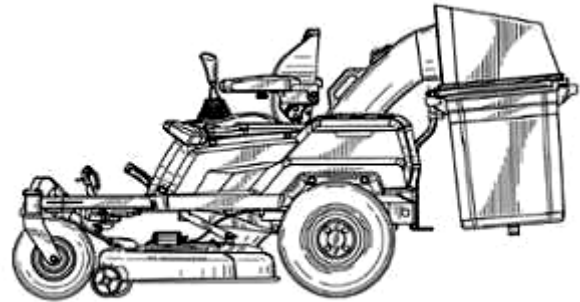

2.4

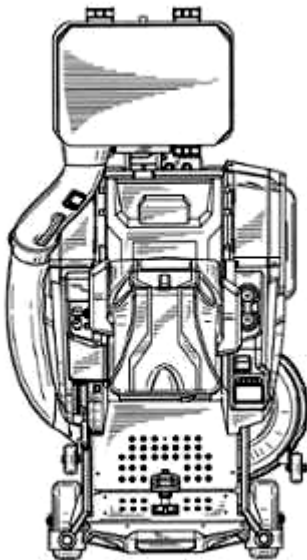

2.5

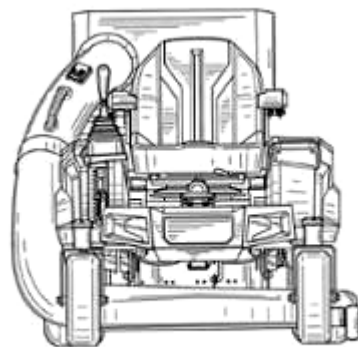

2.6

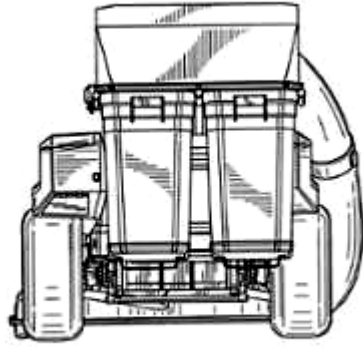

2.7

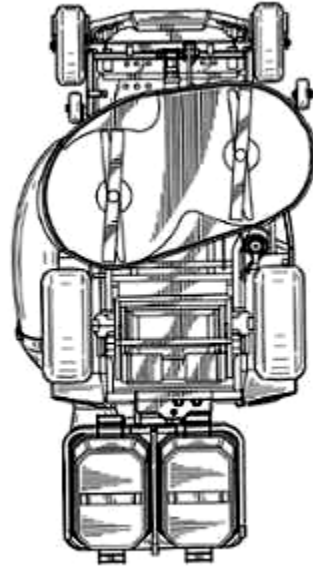

2.8

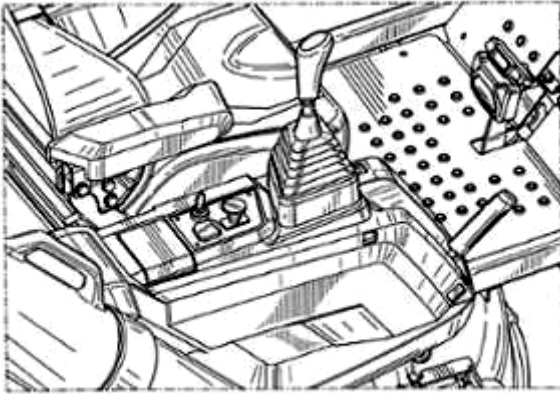

2.9

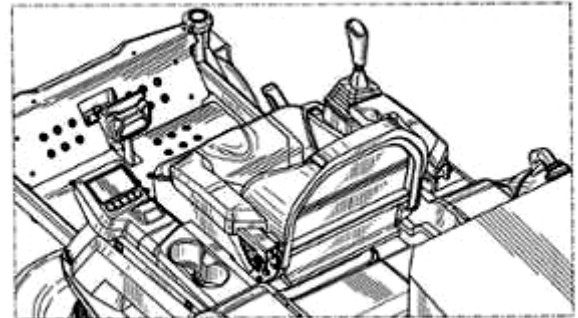

2.10

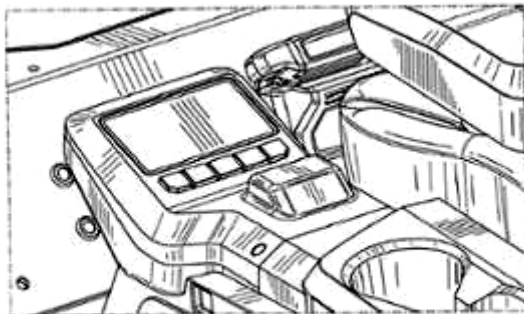

2.11

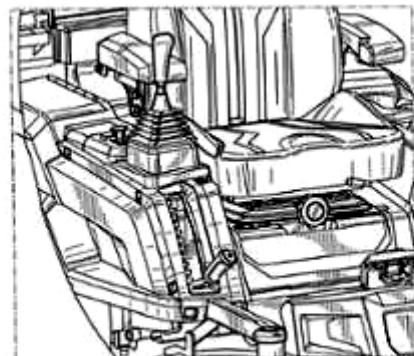

2.12

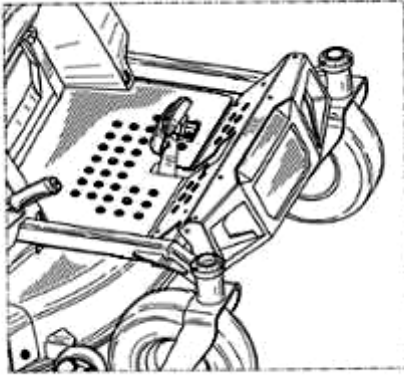

2.13

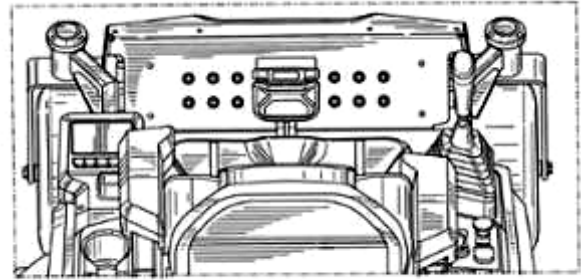

2.14

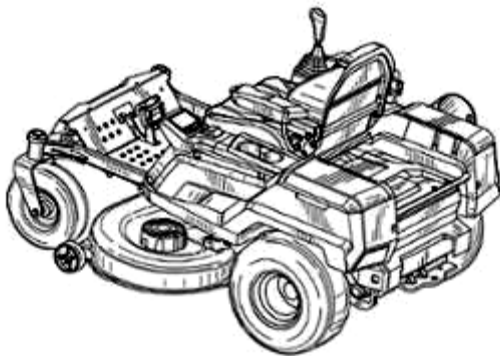

2.15

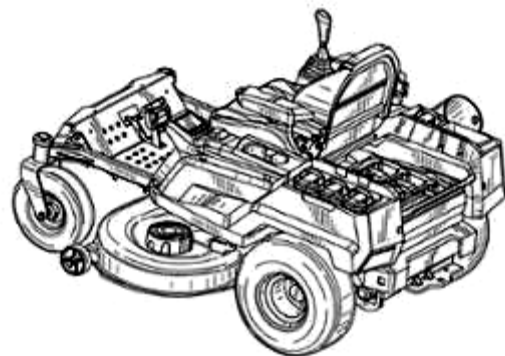

2.16

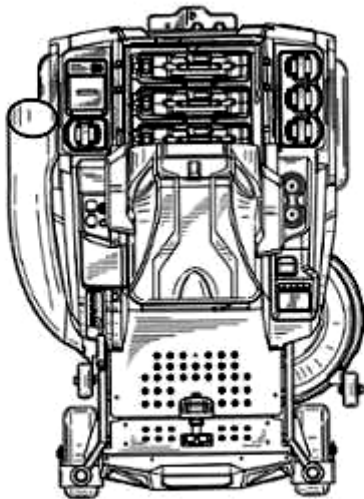

2.17

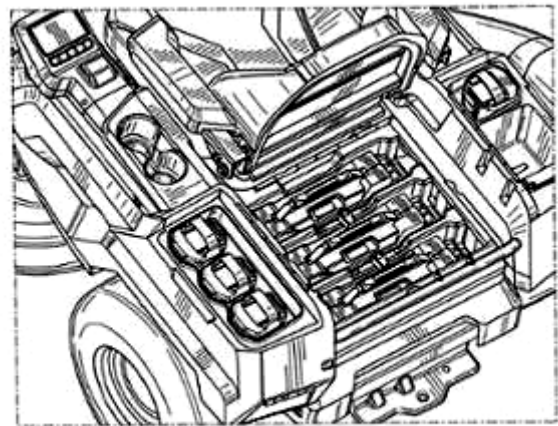

2.18

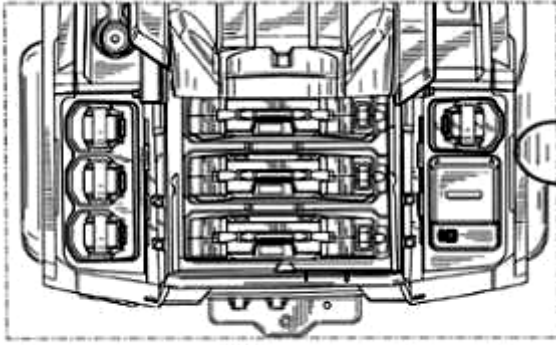

2.19

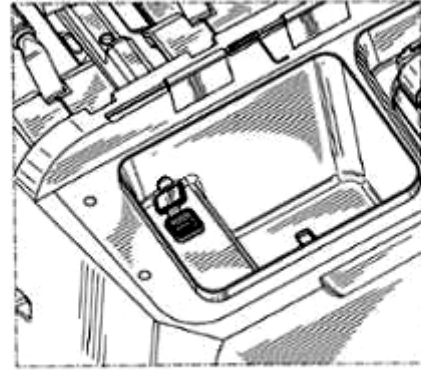

2.20

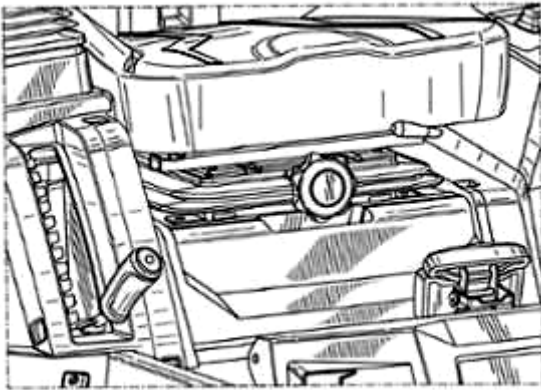

2.21

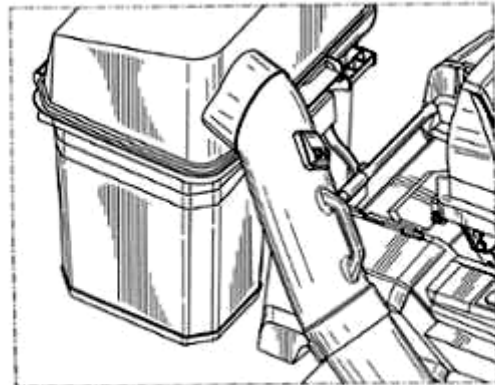

2.22

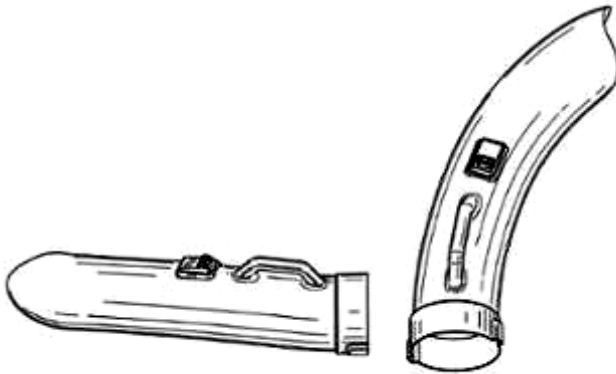

2.23

2.24

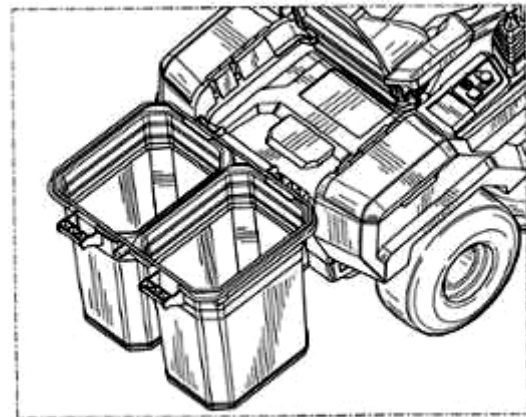

2.25

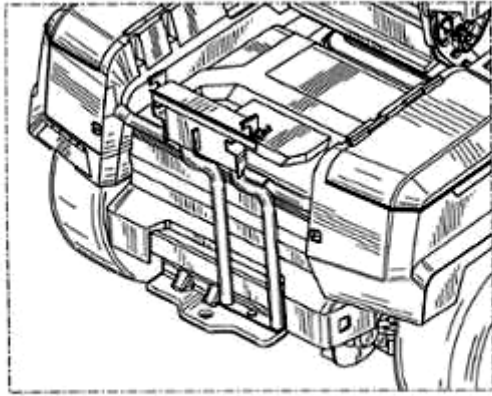

2.26

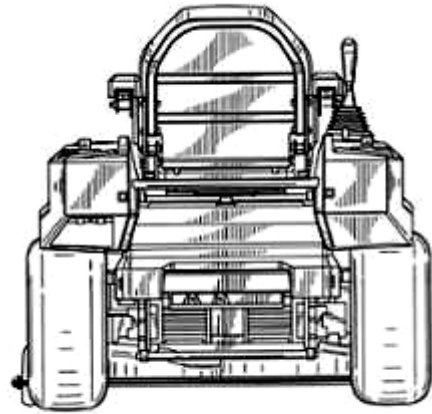

2.27

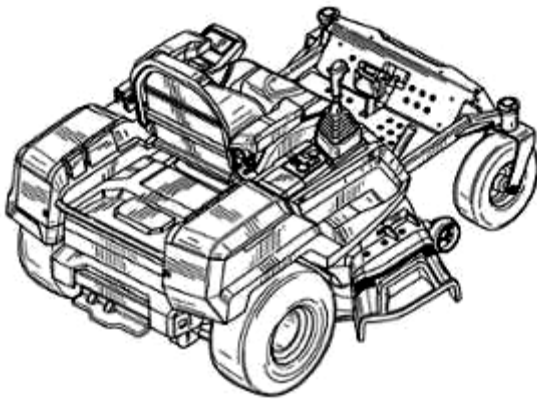

2.28

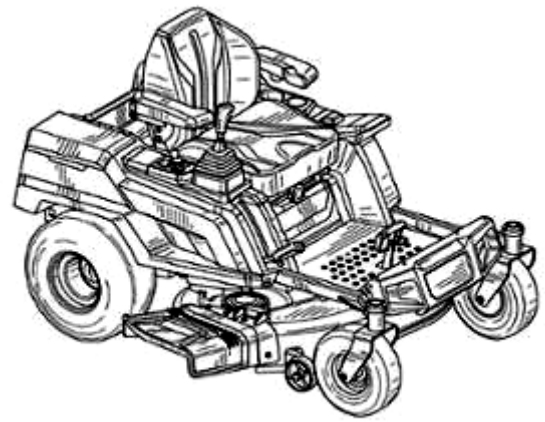

2.29

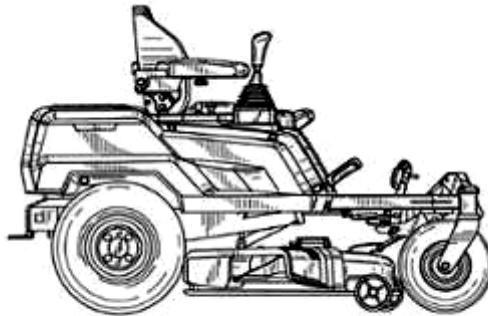

2.30

CÔNG BÁO SỞ HỮU CÔNG NGHIỆP SỐ 430 TẬP A – QUYỀN 2 (01.2024)

- (11) **49076**
(21) 3-2022-01756 (28) 1
(54) **VÍT NHỰA ĐA NĂNG** (51) **08-08**
(22) 19/08/2022 (43) 25/01/2024
(73) **CÔNG TY TNHH PHÚ CƯỜNG (VN)**
Thôn Ngọc Quỳnh, thị trấn Như Quỳnh, huyện Văn Lâm, tỉnh Hưng Yên
(72) Lê Văn Bình (VN)
(74) Công ty TNHH Tư vấn đầu tư và Sở hữu trí tuệ Hoàng Phi (HOANG PHI INVEST & I.P CO., LTD)
(55)

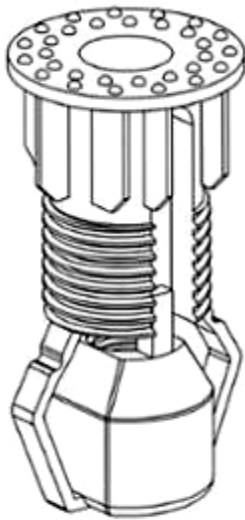

1.1

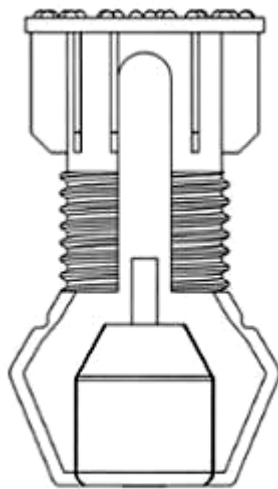

1.2

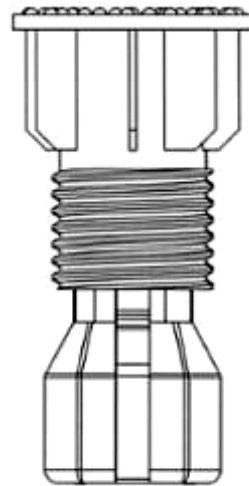

1.3

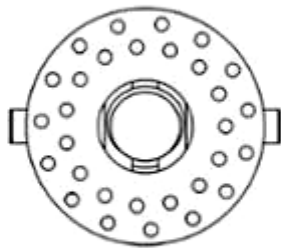

1.4

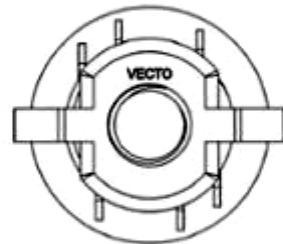

1.5

CÔNG BÁO SỞ HỮU CÔNG NGHIỆP SỐ 430 TẬP A – QUYỀN 2 (01.2024)

- (11) **49077**
(21) 3-2022-01839 (28) 1
(54) **MÁY SÁY TÓC** (51) **28-03**
(22) 30/08/2022 (43) 25/01/2024
(73) **DONGGUAN LAIFEN ELECTRONIC TECHNOLOGY CO., LTD. (CN)**
Building 1, No.14, Ningjiang Road, Humen, Dongguan, Guangdong, 523905, China
(72) Ye, Hongxin (CN)
(74) Công ty TNHH Đại Tín và Liên Danh (DAITIN AND ASSOCIATES CO.,LTD)
(55)

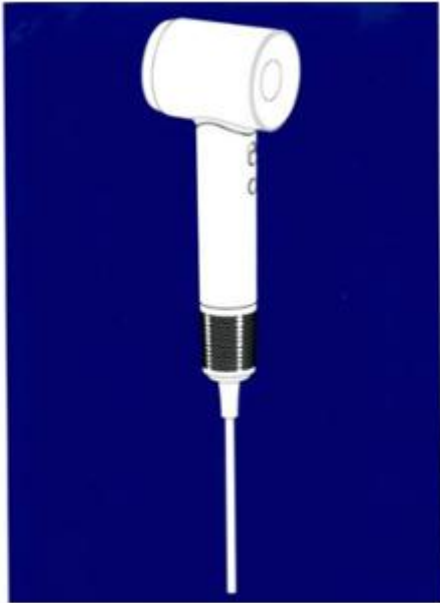

1.1

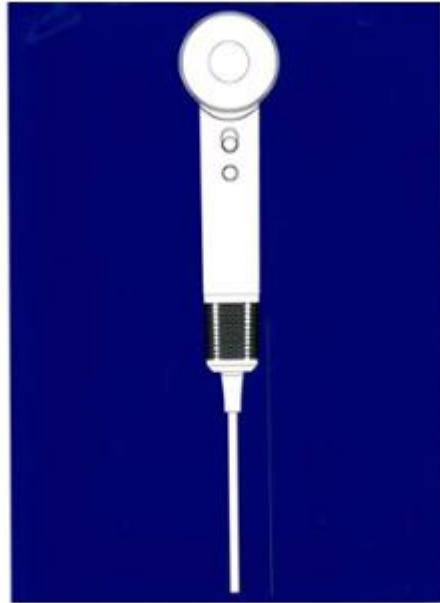

1.2



1.3

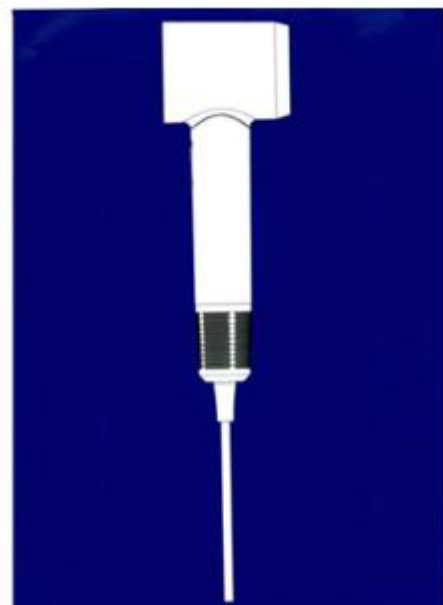

1.4

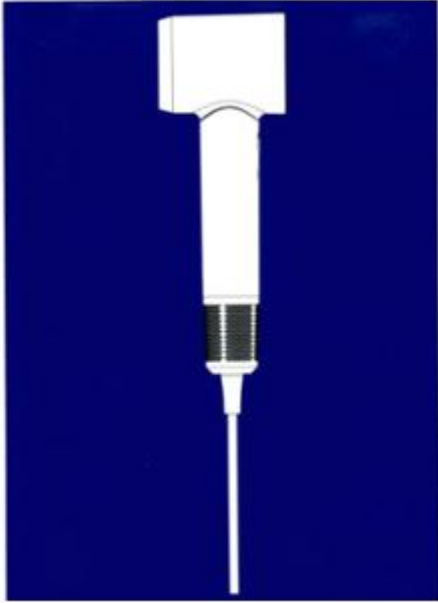

1.5



1.6

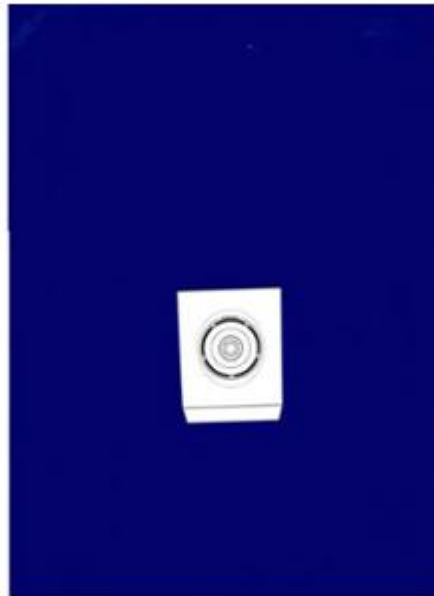

1.7

CÔNG BÁO SỞ HỮU CÔNG NGHIỆP SỐ 430 TẬP A – QUYỀN 2 (01.2024)

- (11) **49078**
(21) 3-2022-01863 (28) 1
(54) **BAO GÓI** (51) **09-05**
(22) 31/08/2022 (43) 25/01/2024
(73) **CÔNG TY TNHH THƯƠNG MẠI DỊCH VỤ XUẤT NHẬP KHẨU AUSTRALIA PLUS+TE (VN)**
295/25/34 Tân Hòa Đông, phường Bình Trị Đông, quận Bình Tân, thành phố Hồ Chí Minh
(72) Võ Thị Hồng Lệ (VN)
(74) Công ty Luật TNHH bản quyền Quốc tế (CIS LAW FIRM)
(55)



1.1



1.2

CÔNG BÁO SỞ HỮU CÔNG NGHIỆP SỐ 430 TẬP A – QUYỀN 2 (01.2024)

- (11) **49079**
(21) 3-2022-01898 (28) 1
(54) **THANH KIM LOẠI ĐỊNH HÌNH** (51) **25-01**
(22) 07/09/2022 (43) 25/01/2024
(73) **CÔNG TY CỔ PHẦN SẢN XUẤT VÀ ĐẦU TƯ HƯNG PHÁT (VN)**
Tổ dân phố Thịnh Vạn, phường Minh Đức, thị xã Mỹ Hào, tỉnh Hưng Yên
(72) Nguyễn Văn Tâm (VN)
(74) Công ty TNHH Sở hữu trí tuệ Gia Việt (GIAVIET CO., LTD.)
(55)

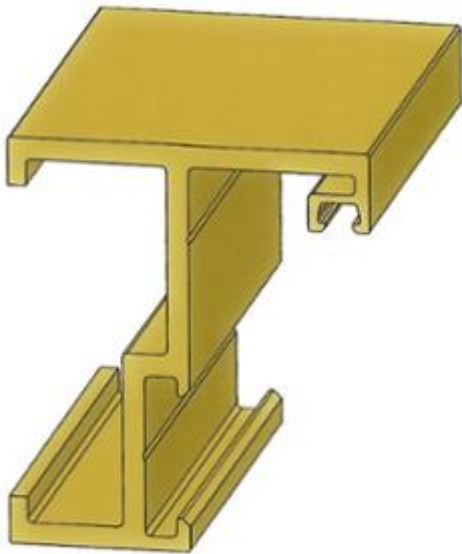

1.1

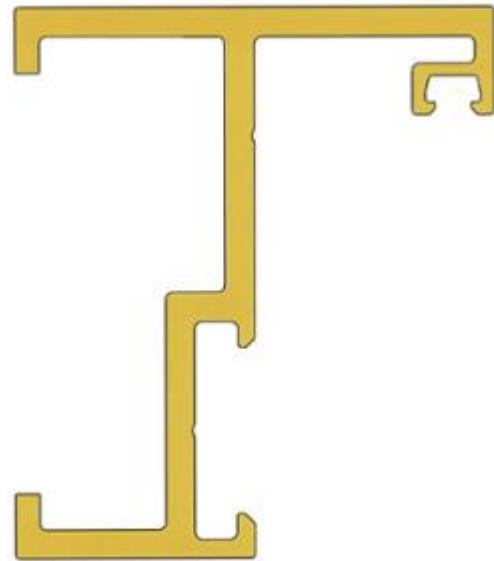

1.2



1.3



1.4



1.5



1.6

CÔNG BÁO SỞ HỮU CÔNG NGHIỆP SỐ 430 TẬP A – QUYỀN 2 (01.2024)

- (11) **49080**
(21) 3-2022-01900 (28) 1
(54) **THANH KIM LOẠI ĐỊNH HÌNH** (51) **25-01**
(22) 07/09/2022 (43) 25/01/2024
(73) **CÔNG TY CỔ PHẦN SẢN XUẤT VÀ ĐẦU TƯ HƯNG PHÁT (VN)**
Tổ dân phố Thịnh Vạn, phường Minh Đức, thị xã Mỹ Hào, tỉnh Hưng Yên
(72) Nguyễn Văn Tâm (VN)
(74) Công ty TNHH Sở hữu trí tuệ Gia Việt (GIAVIET CO., LTD.)
(55)



1.1



1.2



1.3



1.4

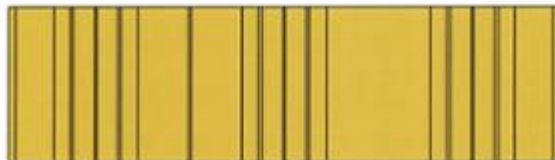

1.5

CÔNG BÁO SỞ HỮU CÔNG NGHIỆP SỐ 430 TẬP A – QUYỀN 2 (01.2024)

- (11) **49081**
(21) 3-2022-01901 (28) 1
(54) **THANH KIM LOẠI ĐỊNH HÌNH** (51) **25-01**
(22) 07/09/2022 (43) 25/01/2024
(73) **CÔNG TY CỔ PHẦN SẢN XUẤT VÀ ĐẦU TƯ HƯNG PHÁT (VN)**
Tổ dân phố Thịnh Vạn, phường Minh Đức, thị xã Mỹ Hào, tỉnh Hưng Yên
(72) Nguyễn Văn Tâm (VN)
(74) Công ty TNHH Sở hữu trí tuệ Gia Việt (GIAVIET CO., LTD.)
(55)

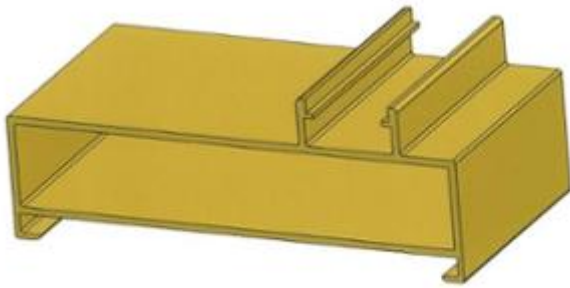

1.1

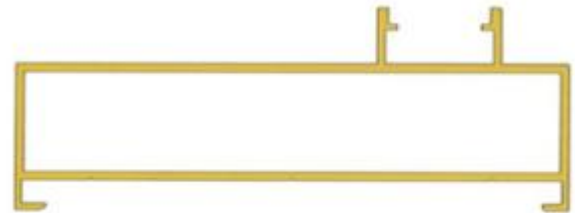

1.2



1.3

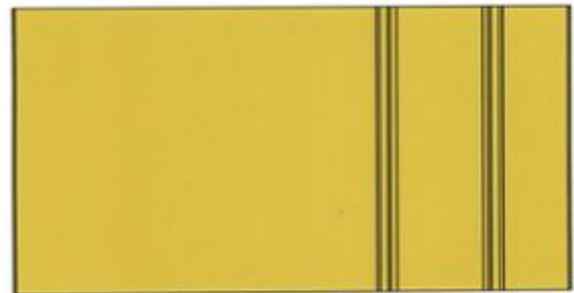

1.4

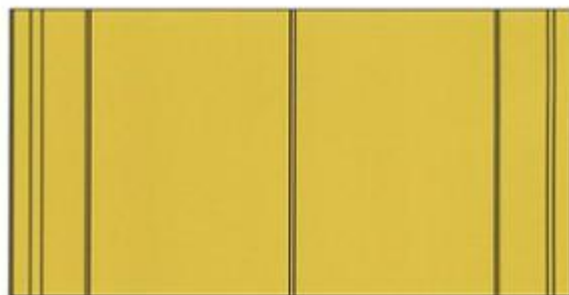

1.5

CÔNG BÁO SỞ HỮU CÔNG NGHIỆP SỐ 430 TẬP A – QUYỀN 2 (01.2024)

- (11) **49082**
(21) 3-2022-01902 (28) 1
(54) **THANH KIM LOẠI ĐỊNH HÌNH** (51) **25-01**
(22) 07/09/2022 (43) 25/01/2024
(73) **CÔNG TY CỔ PHẦN SẢN XUẤT VÀ ĐẦU TƯ HƯNG PHÁT (VN)**
Tổ dân phố Thịnh Vạn, phường Minh Đức, thị xã Mỹ Hào, tỉnh Hưng Yên
(72) Nguyễn Văn Tâm (VN)
(74) Công ty TNHH Sở hữu trí tuệ Gia Việt (GIAVIET CO., LTD.)
(55)

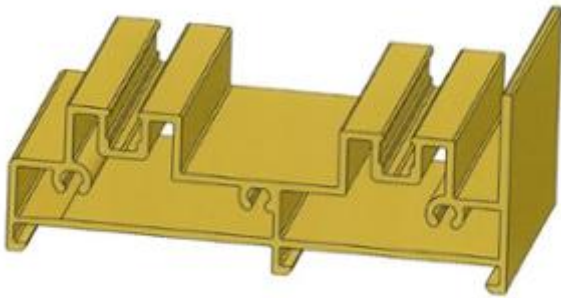

1.1

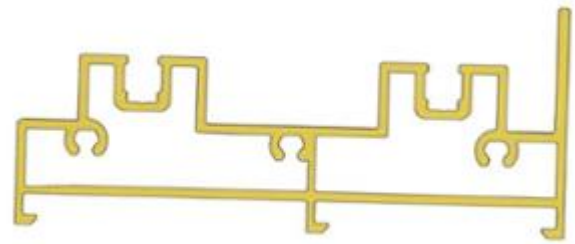

1.2



1.3

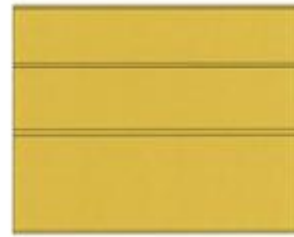

1.4

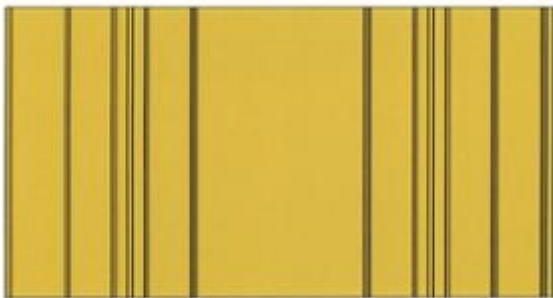

1.5



1.6

CÔNG BÁO SỞ HỮU CÔNG NGHIỆP SỐ 430 TẬP A – QUYỀN 2 (01.2024)

- (11) **49083**
(21) 3-2022-01941
(54) **XE MÁY ĐIỆN**
(22) 14/09/2022
(30) 29/830,643 14/03/2022 US;
(73) **SUPER73, INC. (US)**
16591 Noyes Ave, Irvine, CA 92606 USA
(72) 1. ERIK DUNSHEE (US)
2. LEGRAND CREWSE (US)
(74) Công ty Luật TNHH Phạm và Liên danh (PHAM & ASSOCIATES)
(55)

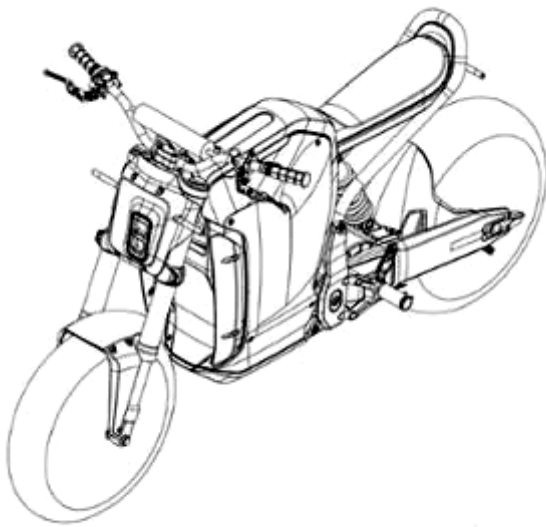

1.1

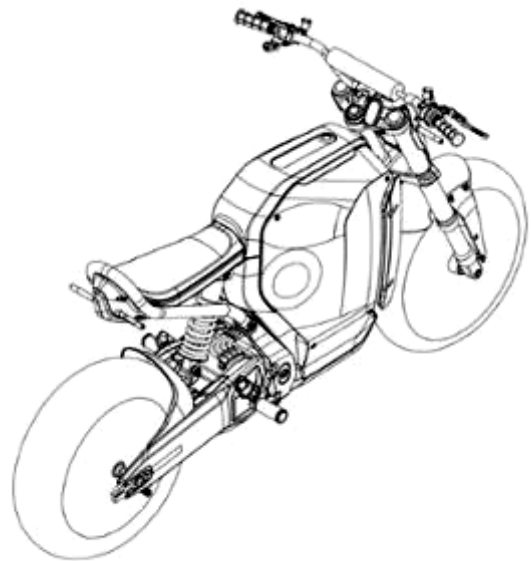

1.2

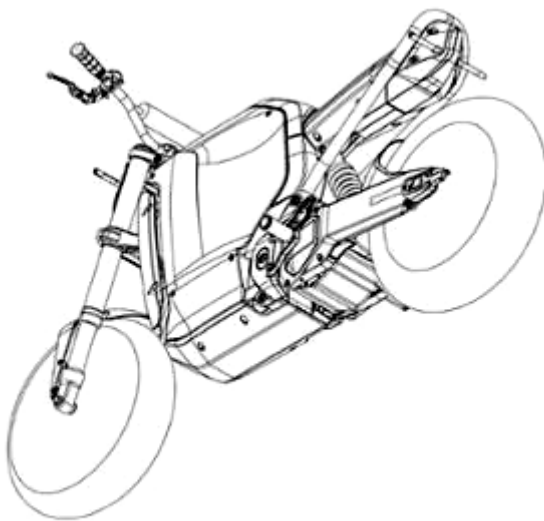

1.3

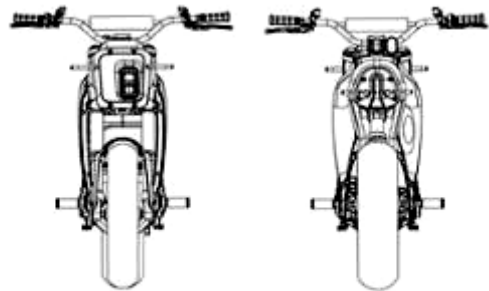

1.4

1.5

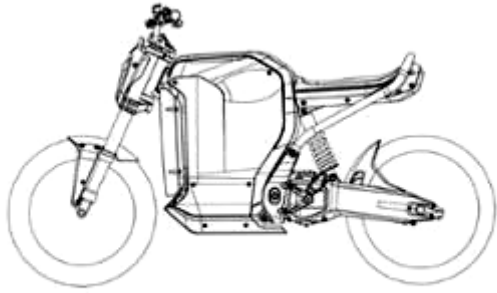

1.6

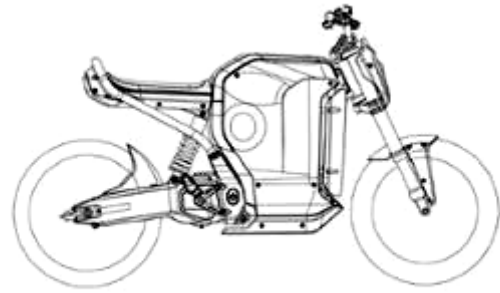

1.7

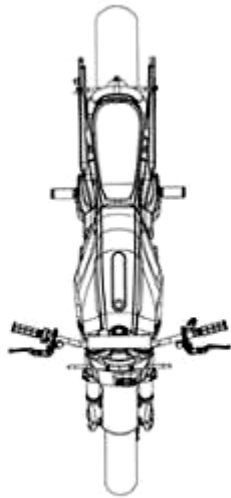

1.8

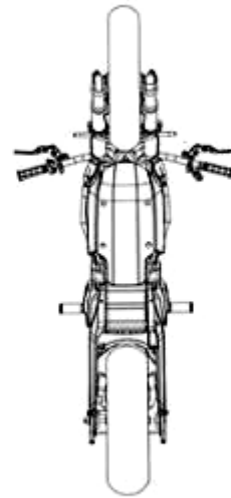

1.9

CÔNG BÁO SỞ HỮU CÔNG NGHIỆP SỐ 430 TẬP A – QUYỀN 2 (01.2024)

- (11) **49084**
(21) 3-2022-02021 (28) 1
(54) **THANH KIM LOẠI ĐỊNH HÌNH** (51) **25-01**
(22) 21/09/2022 (43) 25/01/2024
(73) **CÔNG TY CỔ PHẦN TẬP ĐOÀN AUSTDOOR (VN)**
Số 37, đường Lê Văn Thiêm, phường Nhân Chính, quận Thanh Xuân, thành phố Hà Nội
(72) Dương Thạch Nguyên (VN)
(55)

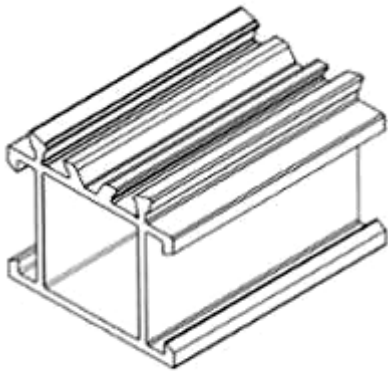

1.1

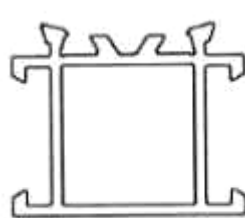

1.2

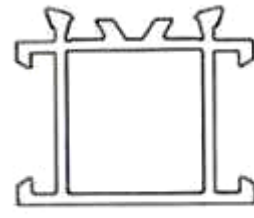

1.3

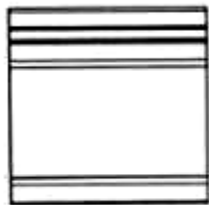

1.4



1.5

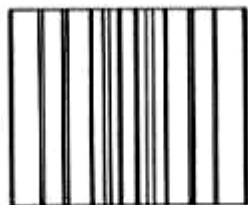

1.6



1.7

CÔNG BÁO SỞ HỮU CÔNG NGHIỆP SỐ 430 TẬP A – QUYỀN 2 (01.2024)

- (11) **49085**
(21) 3-2022-02022 (28) 1
(54) **THANH KIM LOẠI ĐỊNH HÌNH** (51) **25-01**
(22) 21/09/2022 (43) 25/01/2024
(73) **CÔNG TY CỔ PHẦN TẬP ĐOÀN AUSTDOOR (VN)**
Số 37, đường Lê Văn Thiêm, phường Nhân Chính, quận Thanh Xuân, thành phố Hà Nội
(72) Dương Thạch Nguyên (VN)
(55)

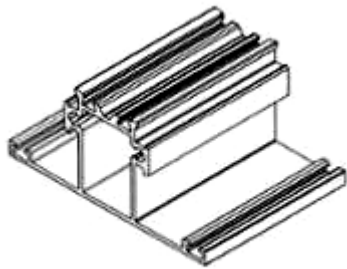

1.1

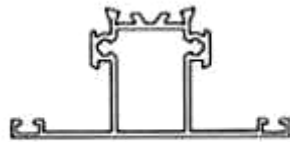

1.2

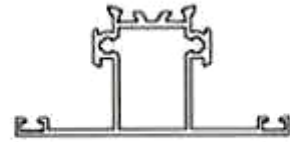

1.3



1.4



1.5



1.6



1.7

CÔNG BÁO SỞ HỮU CÔNG NGHIỆP SỐ 430 TẬP A – QUYỀN 2 (01.2024)

- (11) **49086**
(21) 3-2022-02023 (28) 1
(54) **THANH KIM LOẠI ĐỊNH HÌNH** (51) **25-01**
(22) 21/09/2022 (43) 25/01/2024
(73) **CÔNG TY CỔ PHẦN TẬP ĐOÀN AUSTDOOR (VN)**
Số 37, đường Lê Văn Thiêm, phường Nhân Chính, quận Thanh Xuân, thành phố Hà Nội
(72) Dương Thạch Nguyên (VN)
(55)



1.1

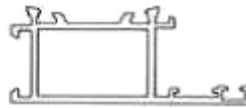

1.2

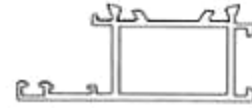

1.3

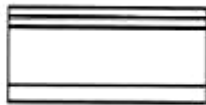

1.4



1.5

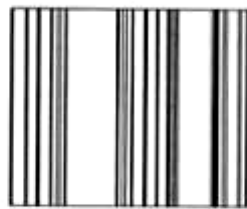

1.6



1.7

CÔNG BÁO SỞ HỮU CÔNG NGHIỆP SỐ 430 TẬP A – QUYỀN 2 (01.2024)

- (11) **49087**
(21) 3-2022-02024 (28) 1
(54) **THANH KIM LOẠI ĐỊNH HÌNH** (51) **25-01**
(22) 21/09/2022 (43) 25/01/2024
(73) **CÔNG TY CỔ PHẦN TẬP ĐOÀN AUSTDOOR (VN)**
Số 37, đường Lê Văn Thiêm, phường Nhân Chính, quận Thanh Xuân, thành phố Hà Nội
(72) Dương Thạch Nguyên (VN)
(55)

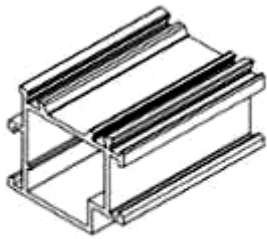

1.1

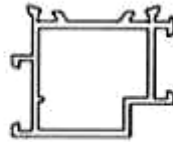

1.2

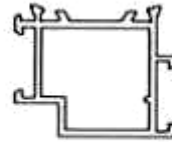

1.3



1.4



1.5

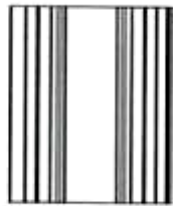

1.6

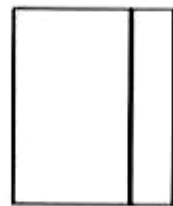

1.7

CÔNG BÁO SỞ HỮU CÔNG NGHIỆP SỐ 430 TẬP A – QUYỀN 2 (01.2024)

- (11) **49088**
(21) 3-2022-02025 (28) 1
(54) **THANH KIM LOẠI ĐỊNH HÌNH** (51) **25-01**
(22) 21/09/2022 (43) 25/01/2024
(73) **CÔNG TY CỔ PHẦN TẬP ĐOÀN AUSTDOOR (VN)**
Số 37, đường Lê Văn Thiêm, phường Nhân Chính, quận Thanh Xuân, thành phố Hà Nội
(72) Dương Thạch Nguyên (VN)
(55)

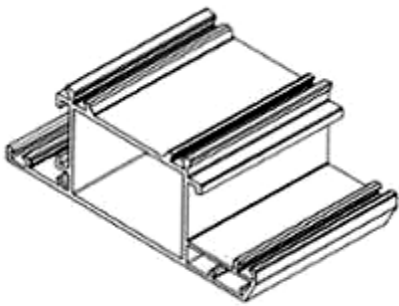

1.1

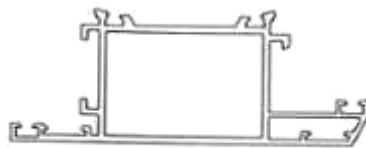

1.2

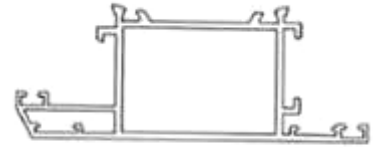

1.3



1.4



1.5

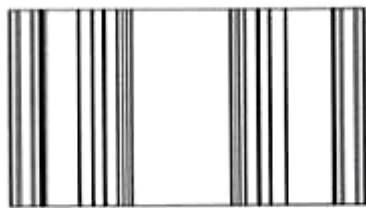

1.6



1.7

CÔNG BÁO SỞ HỮU CÔNG NGHIỆP SỐ 430 TẬP A – QUYỀN 2 (01.2024)

- (11) **49089**
(21) 3-2022-02026 (28) 1
(54) **THANH KIM LOẠI ĐỊNH HÌNH** (51) **25-01**
(22) 21/09/2022 (43) 25/01/2024
(73) **CÔNG TY CỔ PHẦN TẬP ĐOÀN AUSTDOOR (VN)**
Số 37, đường Lê Văn Thiêm, phường Nhân Chính, quận Thanh Xuân, thành phố Hà Nội
(72) Dương Thạch Nguyên (VN)
(55)

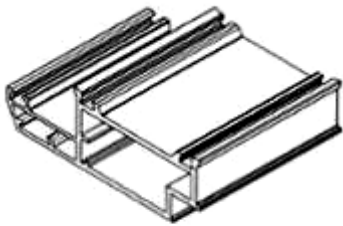

1.1

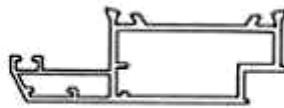

1.2

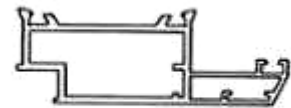

1.3

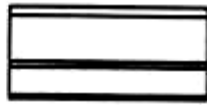

1.4

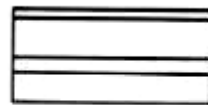

1.5

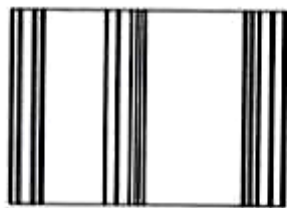

1.6



1.7

CÔNG BÁO SỞ HỮU CÔNG NGHIỆP SỐ 430 TẬP A – QUYỀN 2 (01.2024)

- (11) **49090**
(21) 3-2022-02027 (28) 1
(54) **THANH KIM LOẠI ĐỊNH HÌNH** (51) **25-01**
(22) 21/09/2022 (43) 25/01/2024
(73) **CÔNG TY CỔ PHẦN TẬP ĐOÀN AUSTDOOR (VN)**
Số 37, đường Lê Văn Thiêm, phường Nhân Chính, quận Thanh Xuân, thành phố Hà Nội
(72) Dương Thạch Nguyên (VN)
(55)

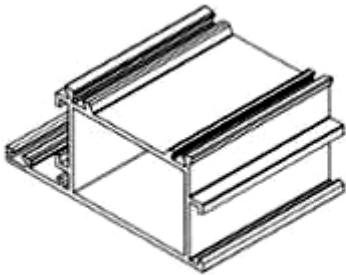

1.1

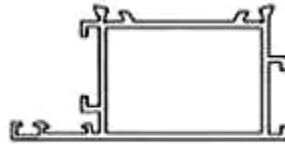

1.2

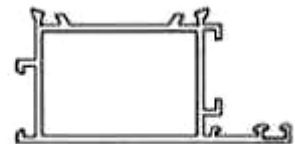

1.3



1.4

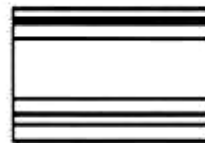

1.5

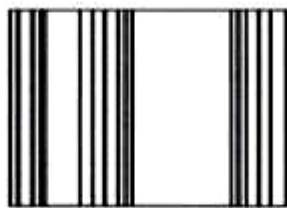

1.6



1.7

CÔNG BÁO SỞ HỮU CÔNG NGHIỆP SỐ 430 TẬP A – QUYỀN 2 (01.2024)

- (11) **49091**
(21) 3-2022-02028 (28) 1
(54) **THANH KIM LOẠI ĐỊNH HÌNH** (51) **25-01**
(22) 21/09/2022 (43) 25/01/2024
(73) **CÔNG TY CỔ PHẦN TẬP ĐOÀN AUSTDOOR (VN)**
Số 37, đường Lê Văn Thiêm, phường Nhân Chính, quận Thanh Xuân, thành phố Hà Nội
(72) Dương Thạch Nguyên (VN)
(55)



1.1

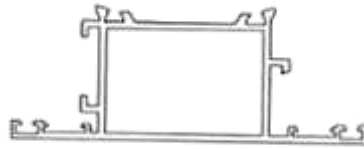

1.2

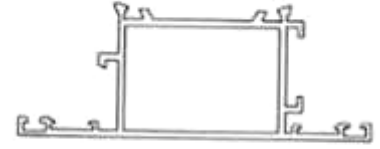

1.3



1.4



1.5

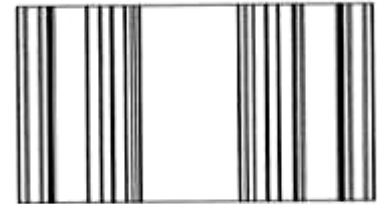

1.6



1.7

CÔNG BÁO SỞ HỮU CÔNG NGHIỆP SỐ 430 TẬP A – QUYỀN 2 (01.2024)

- (11) **49092**
(21) 3-2022-02158 (28) 1
(54) **HỘP** (51) **09-03**
(22) 06/10/2022 (43) 25/01/2024
(73) **ORION CORPORATION (KR)**
13, Baekbeom-ro 90da-gil, Yongsan-gu, Seoul 04369, Republic of Korea
(72) 1. LEE, A RUEM (KR)
2. LEE, HYUN A (KR)
(74) Công ty Luật TNHH quốc tế BMVN (BMVN INTERNATIONAL LLC)
(55)



1.1



1.2

CÔNG BÁO SỞ HỮU CÔNG NGHIỆP SỐ 430 TẬP A – QUYỀN 2 (01.2024)

- (11) **49093**
(21) 3-2022-02217 (28) 1
(54) **THÂN ĐỒNG HỒ ĐEO TAY** (51) **10-02**
(22) 13/10/2022 (43) 25/01/2024
(73) **CÔNG TY TNHH PHILIPPE MARK (VN)**
Số 801 Trần Hưng Đạo, phường Bình Khánh, thành phố Long Xuyên, tỉnh An Giang
(72) Nguyễn Hoàng Anh (VN)
(55)



1.1



1.2



1.3



1.4



1.5



1.6



1.7

CÔNG BÁO SỞ HỮU CÔNG NGHIỆP SỐ 430 TẬP A – QUYỀN 2 (01.2024)

- (11) **49094**
(21) 3-2022-02267 (28) 1
(54) **NẮP HỘP** (51) **09-07**
(22) 19/10/2022 (43) 25/01/2024
(30) 431065 05/09/2022 NZ;
(73) **THE A2 MILK COMPANY LIMITED (NZ)**
Level 10, 51 Shortland Street, Auckland 1010, New Zealand
(72) 1. JARRYD PRICE (AU)
2. ROD WIEBENGA (AU)
3. DANIEL BOOKER (AU)
(74) Công ty TNHH một thành viên Sở hữu trí tuệ VCCI (VCCI-IP CO.,LTD)
(55)

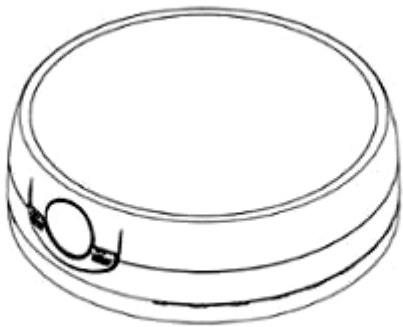

1.1

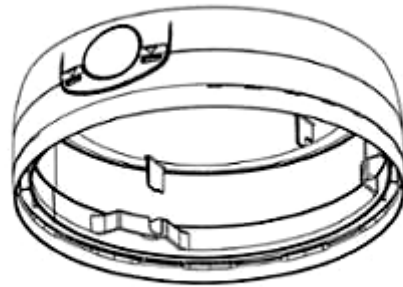

1.2



1.3

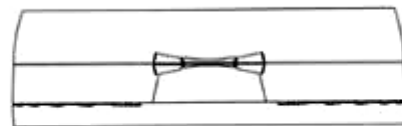

1.4

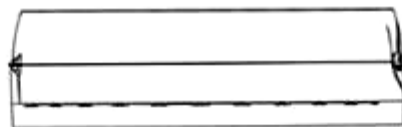

1.5

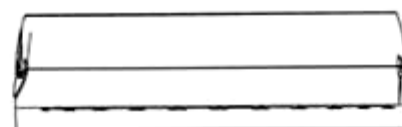

1.6

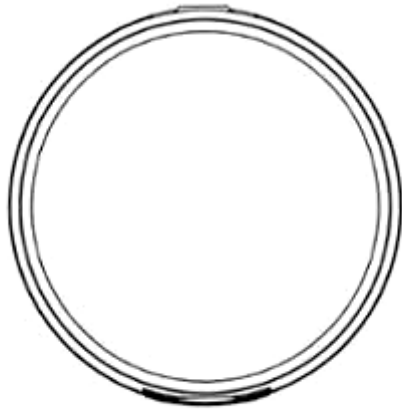

1.7

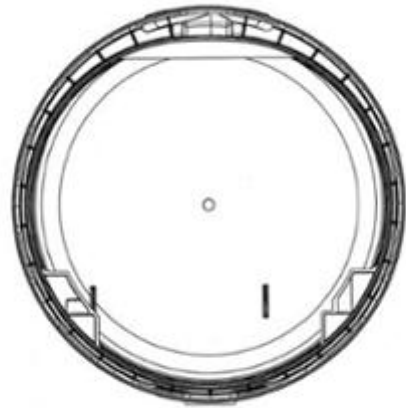

1.8

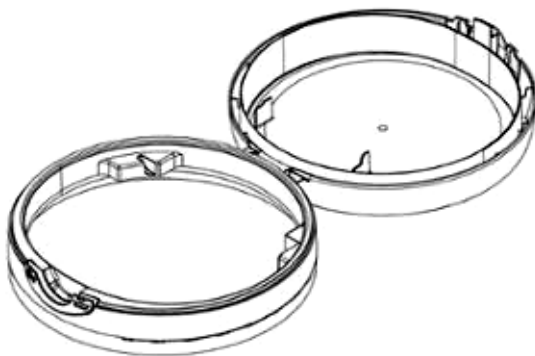

1.9

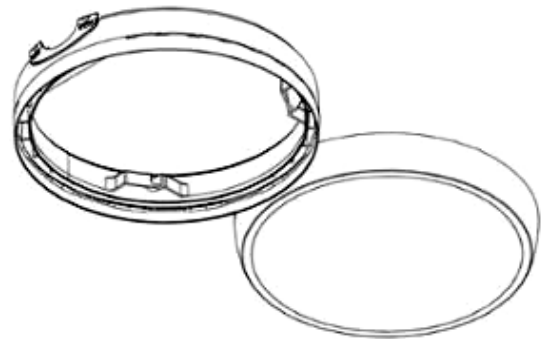

1.10



1.11



1.12

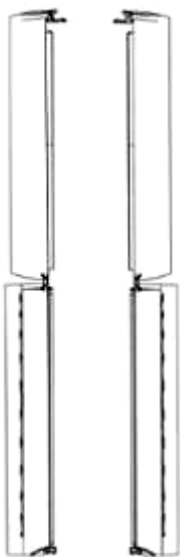

1.13

1.14

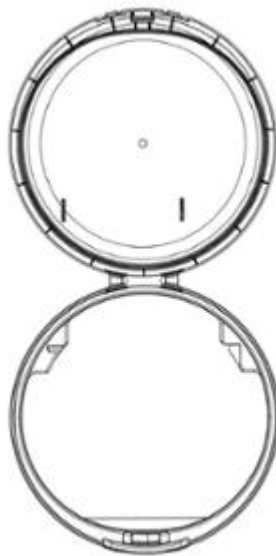

1.15



1.16

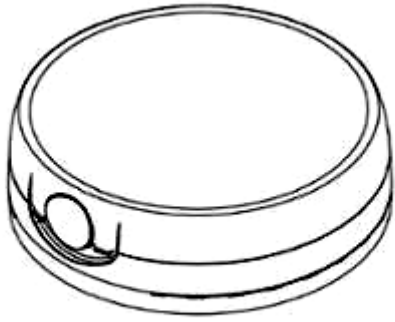

1.17

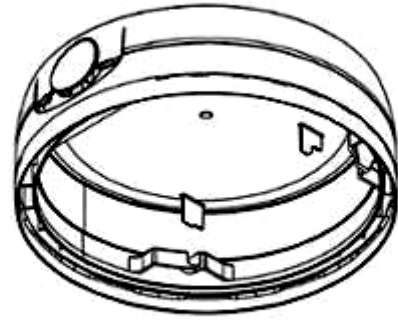

1.18



1.19

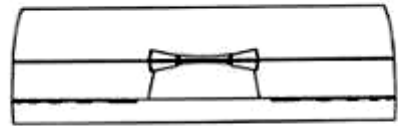

1.20

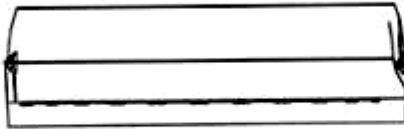

1.21

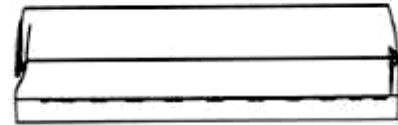

1.22

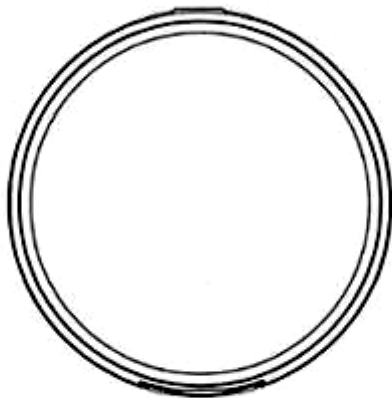

1.23

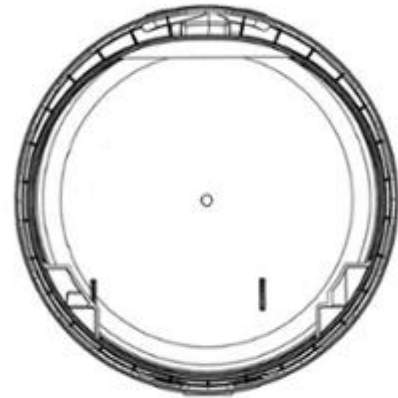

1.24

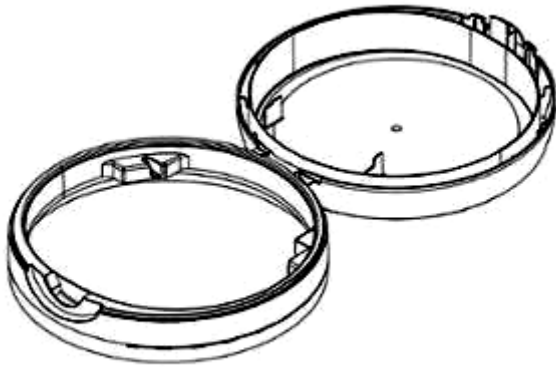

1.25

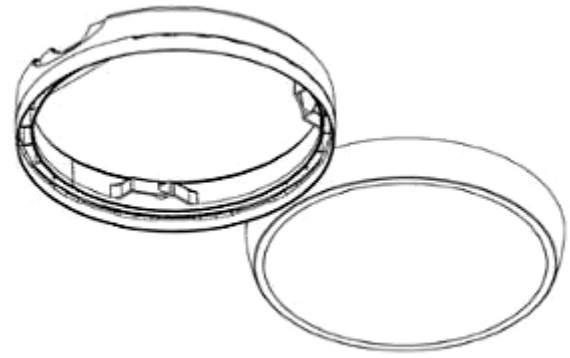

1.26

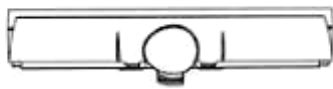

1.27



1.28



1.29



1.30

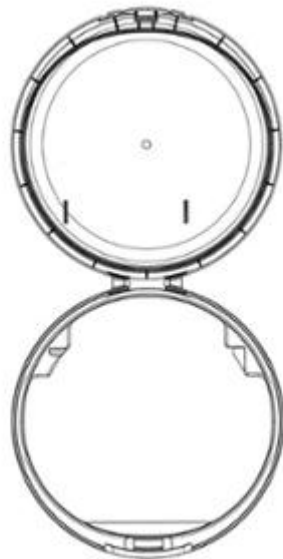

1.31



1.32

CÔNG BÁO SỞ HỮU CÔNG NGHIỆP SỐ 430 TẬP A – QUYỀN 2 (01.2024)

(11) **49095**

(21) 3-2022-02395

(28) 1

(54) **HỘP ĐỰNG**

(51) **03-01**

(22) 03/11/2022

(43) 25/01/2024

(73) **GORAN REIL (US)**

521 W. Rosecrans Avenue, Gardena, Los Angeles, California 90248, United States of America

(72) GORAN REIL (US)

(74) Công ty TNHH Ban Ca (BANCA)

(55)

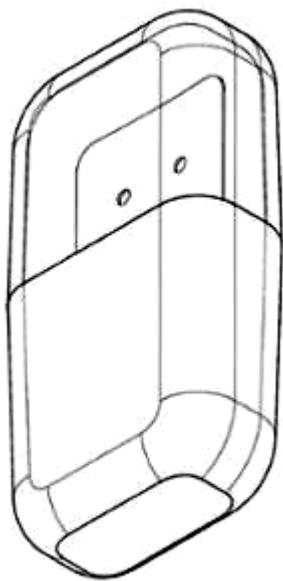

1.1

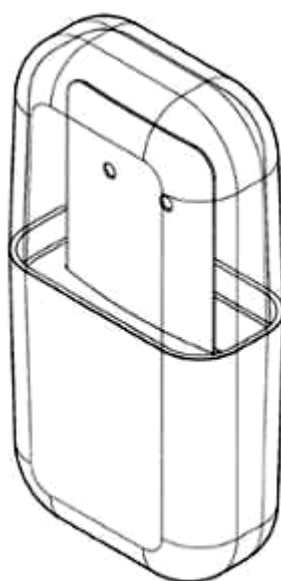

1.2

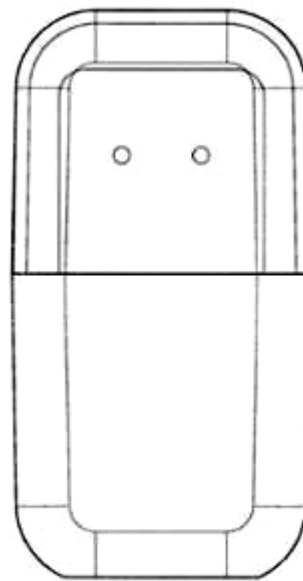

1.3

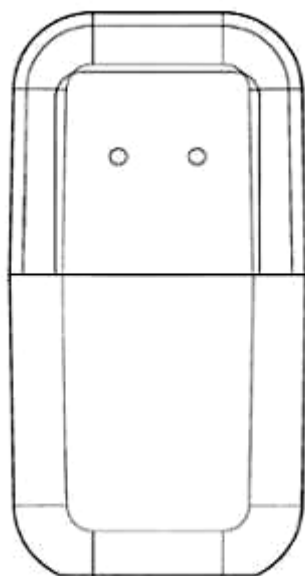

1.4



1.5



1.6

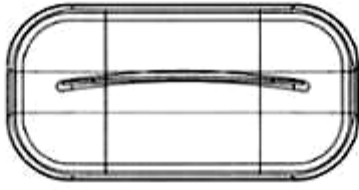

1.7

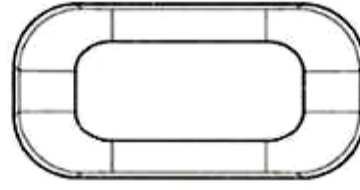

1.8

CÔNG BÁO SỞ HỮU CÔNG NGHIỆP SỐ 430 TẬP A – QUYỀN 2 (01.2024)

- (11) **49096**
(21) 3-2022-02427 (28) 2
(54) **BỘ NHÃN SẢN PHẨM** (51) **19-08**
(22) 07/11/2022 (43) 25/01/2024
(73) **CÔNG TY TNHH MTV SẢN XUẤT DỊCH VỤ VÀ THƯƠNG MẠI THĂNG LONG (VN)**
Tổ 1, khu 1, phường Yên Thanh, thành phố Uông Bí, tỉnh Quảng Ninh
(72) Khúc Đình Phương (VN)
(55)



1.1



1.2



1.3



1.4

CÔNG BÁO SỞ HỮU CÔNG NGHIỆP SỐ 430 TẬP A – QUYỀN 2 (01.2024)

- (11) **49097**
(21) 3-2022-02428 (28) 2
(54) **BỘ NHÃN SẢN PHẨM** (51) **19-08**
(22) 07/11/2022 (43) 25/01/2024
(73) **CÔNG TY TNHH MTV SẢN XUẤT DỊCH VỤ VÀ THƯƠNG MẠI THĂNG LONG (VN)**
Tổ 1, khu 1, phường Yên Thanh, thành phố Uông Bí, tỉnh Quảng Ninh
(72) Khúc Đình Phương (VN)
(55)



1.1



1.2

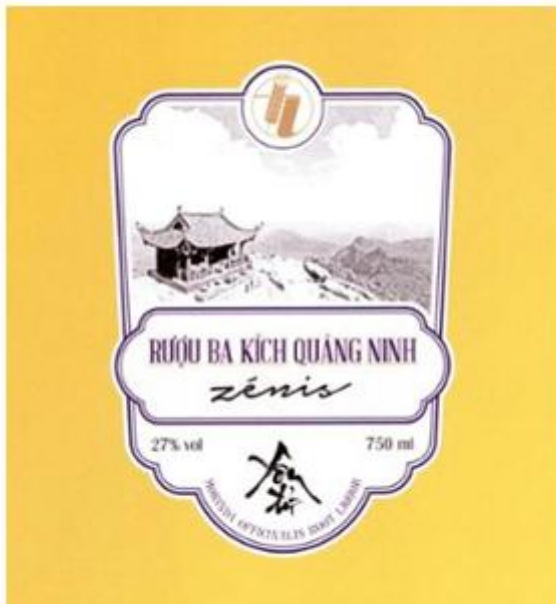

1.3



1.4

CÔNG BÁO SỞ HỮU CÔNG NGHIỆP SỐ 430 TẬP A – QUYỀN 2 (01.2024)

(11) **49098**

(21) 3-2022-02437

(28) 1

(54) **CHẬU**

(51) **07-07**

(22) 08/11/2022

(43) 25/01/2024

(73) **CÔNG TY TNHH SẢN XUẤT THƯƠNG MẠI DỊCH VỤ TÂN TƯỜNG KHANG (VN)**

Lô F1 & F2, đường D2 và N5, khu công nghiệp Nam Tân Uyên, phường Khánh Bình, thị xã Tân Uyên, tỉnh Bình Dương

(72) Nìm Dùng Chiếng (VN)

(74) Văn phòng Luật sư D và T (D & T LAW OFFICE)

(55)



1.1



1.2



1.3



1.4

CÔNG BÁO SỞ HỮU CÔNG NGHIỆP SỐ 430 TẬP A – QUYỀN 2 (01.2024)

- (11) **49099**
(21) 3-2022-02454 (28) 1
(54) **BAO GÓI** (51) **09-05**
(22) 09/11/2022 (43) 25/01/2024
(73) **CÔNG TY TNHH NTPM (VIỆT NAM) (VN)**
Số 22 VSIP II-A, đường số 23, khu công nghiệp Việt Nam - Singapore II-A,
phường Vĩnh Tân, thị xã Tân Uyên, tỉnh Bình Dương
(72) LEE KUAN PHENG (MY)
(74) Công ty TNHH Sở hữu trí tuệ HA VIP (HAVIP CO., LTD.)
(55)



1.1



1.2

CÔNG BÁO SỞ HỮU CÔNG NGHIỆP SỐ 430 TẬP A – QUYỀN 2 (01.2024)

(11) **49100**

(21) 3-2022-02488

(28) 1

(54) **GIÁ ĐỖ**

(51) **07-02**

(22) 14/11/2022

(43) 25/01/2024

(73) **ROBERT J. SKVORECZ (US)**

PO Box 723, Kinnelon, NJ 07405, United States of America

(72) Robert J. Skvorecz (US)

(74) Công ty TNHH Sáng chế ACTIP (ACTIP PATENT LIMITED)

(55)

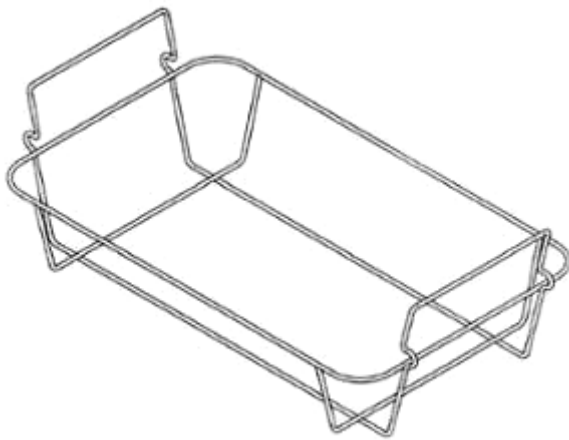

1.1

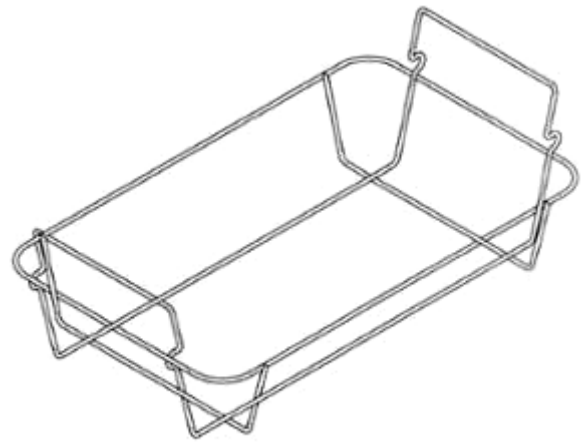

1.2



1.3



1.4

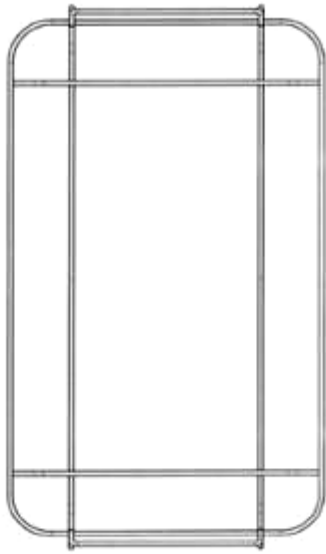

1.5

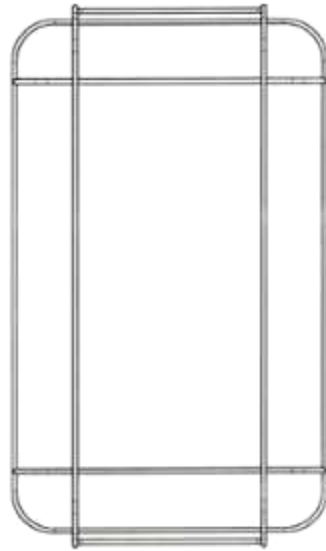

1.6

CÔNG BÁO SỞ HỮU CÔNG NGHIỆP SỐ 430 TẬP A – QUYỀN 2 (01.2024)

- (11) **49101**
(21) 3-2022-02511 (28) 1
(54) **TẦM CẢN VA PHÍA TRƯỚC XE Ô TÔ** (51) **12-16**
(22) 17/11/2022 (43) 25/01/2024
(30) 2202003330 18/08/2022 TH;
(73) **CHUSILP GROUP TRADING CO., LTD. (TH)**
3/165 Moo.3 Bangnumjude, Muang Samutsakhon, Samutsakhon, 74000 Thailand
(72) **WUTTICHAJ SRISUPRCHA (TH)**
(74) Công ty TNHH Trà và cộng sự (TRA & ASSOCIATES CO.,LTD)
(55)

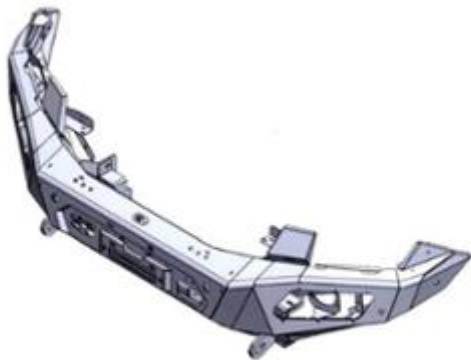

1.1



1.2



1.3



1.4

1.5

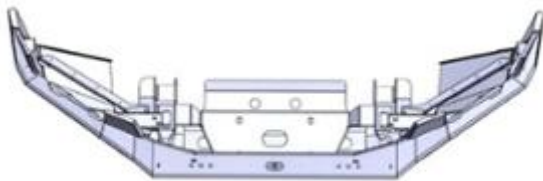

1.6



1.7

CÔNG BÁO SỞ HỮU CÔNG NGHIỆP SỐ 430 TẬP A – QUYỀN 2 (01.2024)

- (11) **49102**
(21) 3-2022-02677 (28) 1
(54) **BA LÔ Y TẾ** (51) **03-01**
(22) 06/12/2022 (43) 25/01/2024
(73) **CÔNG TY CỔ PHẦN GIẢI PHÁP CHĂM SÓC TẠI NHÀ VIỆT NAM (VN)**
Số 73/39 ngõ Đại Đồng, phường Thanh Trì, quận Hoàng Mai, thành phố Hà Nội
(72) Lê Xuân Đại (VN)
(55)



1.1



1.2



1.3



1.4



1.5



1.6

CÔNG BÁO SỞ HỮU CÔNG NGHIỆP SỐ 430 TẬP A – QUYỀN 2 (01.2024)

(11) **49103**

(21) 3-2022-02692

(54) **CHÓT LIÊN KẾT ÂM**

(22) 07/12/2022

(73) **TRẦN TRUNG HIẾU (VN)**

109 Bông Sao, phường 5, quận 8, thành phố Hồ Chí Minh

(72) Trần Trung Hiếu (VN)

(55)

(28) 1

(51) **08-08**

(43) 25/01/2024

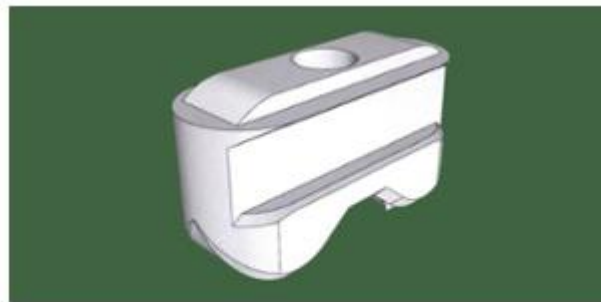

1.1



1.2



1.3

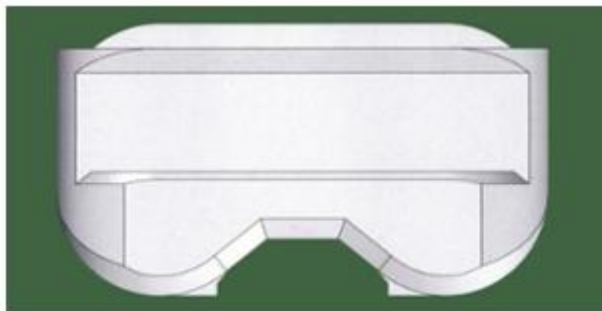

1.4

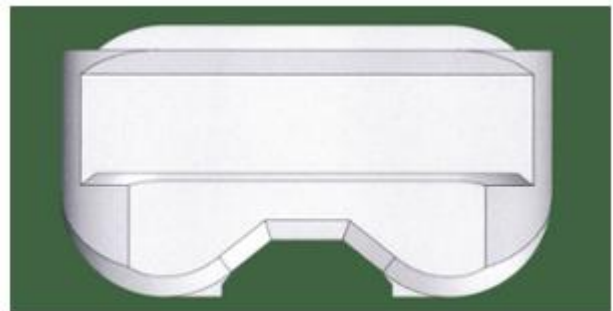

1.5



1.6

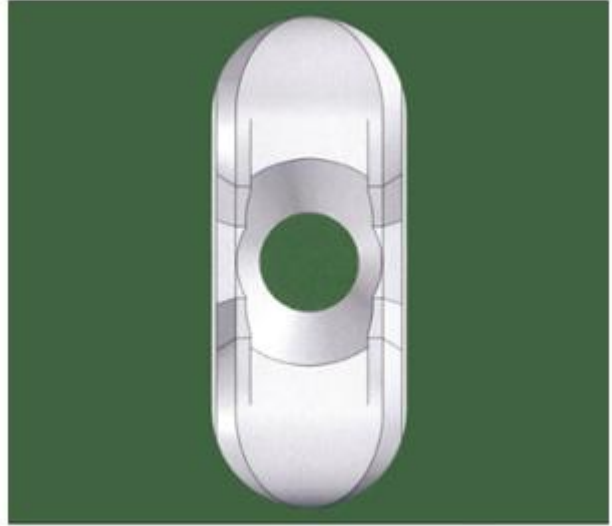

1.7

CÔNG BÁO SỞ HỮU CÔNG NGHIỆP SỐ 430 TẬP A – QUYỀN 2 (01.2024)

- (11) **49104**
(21) 3-2022-02697 (28) 1
(54) **NHÃN SẢN PHẨM** (51) **19-08**
(22) 07/12/2022 (43) 25/01/2024
(73) **CÔNG TY TNHH THƯƠNG MẠI - SẢN XUẤT HƯNG VIỆT (VN)**
166/20 Thích Quảng Đức, phường 04, quận Phú Nhuận, thành phố Hồ Chí Minh
(72) Nguyễn Thiện Hoàng Vinh (VN)
(55)



CÔNG BÁO SỞ HỮU CÔNG NGHIỆP SỐ 430 TẬP A – QUYỀN 2 (01.2024)

- (11) **49105**
(21) 3-2022-02698 (28) 1
(54) **NHÃN SẢN PHẨM** (51) **19-08**
(22) 07/12/2022 (43) 25/01/2024
(73) **CÔNG TY TNHH THƯƠNG MẠI - SẢN XUẤT HƯNG VIỆT (VN)**
166/20 Thích Quảng Đức, phường 04, quận Phú Nhuận, thành phố Hồ Chí Minh
(72) Nguyễn Thiện Hoàng Vinh (VN)
(55)



CÔNG BÁO SỞ HỮU CÔNG NGHIỆP SỐ 430 TẬP A – QUYỀN 2 (01.2024)

- (11) **49106**
(21) 3-2022-02749 (28) 1
(54) **BAO GÓI** (51) **09-05**
(22) 15/12/2022 (43) 25/01/2024
(73) **CÔNG TY TNHH MỘT THÀNH VIÊN ĐỨC THỌ SANH (VN)**
Số 4 đường Trưng Nữ Vương, phường 1, thành phố Vĩnh Long, tỉnh Vĩnh Long
(72) Lý Tấn Thành (VN)
(55)



1.1



1.2

CÔNG BÁO SỞ HỮU CÔNG NGHIỆP SỐ 430 TẬP A – QUYỀN 2 (01.2024)

- (11) **49107**
(21) 3-2022-02751 (28) 1
(54) **BAO GỐI** (51) **09-05**
(22) 15/12/2022 (43) 25/01/2024
(73) **CÔNG TY TNHH MỘT THÀNH VIÊN ĐỨC THỌ SANH (VN)**
Số 4 đường Trưng Nữ Vương, phường 1, thành phố Vĩnh Long, tỉnh Vĩnh Long
(72) Lý Tấn Thành (VN)
(55)



1.1



1.2

CÔNG BÁO SỞ HỮU CÔNG NGHIỆP SỐ 430 TẬP A – QUYỀN 2 (01.2024)

- (11) **49108**
(21) 3-2022-02806 (28) 1
(54) **BAO BÌ SẢN PHẨM** (51) **09-05**
(22) 20/12/2022 (43) 25/01/2024
(73) **CÔNG TY CỔ PHẦN THỰC PHẨM NHẤT VIỆT (VN)**
704 Nguyễn Kiệm, phường 4, quận Phú Nhuận, thành phố Hồ Chí Minh
(72) Nguyễn Thiện Hoàng Vinh (VN)
(55)



1.2



1.1

CÔNG BÁO SỞ HỮU CÔNG NGHIỆP SỐ 430 TẬP A – QUYỀN 2 (01.2024)

- (11) **49109**
(21) 3-2022-02929 (28) 1
(54) **TẮM TẢN NHIỆT** (51) **12-16**
(22) 28/12/2022 (43) 25/01/2024
(73) **QUÁCH ANH MINH (VN)**
643/75 Xô Viết Nghệ Tĩnh, phường 26, quận Bình Thạnh, thành phố Hồ Chí Minh
(72) Quách Anh Minh (VN)
(74) Công ty TNHH Dịch vụ thương mại và sở hữu công nghiệp Song Ngọc (I.P.T.S.)
(55)



1.1



1.2



1.3



1.4



1.5



1.6



1.7

CÔNG BÁO SỞ HỮU CÔNG NGHIỆP SỐ 430 TẬP A – QUYỀN 2 (01.2024)

- (11) **49110**
(21) 3-2022-02932 (28) 1
(54) **KHUNG ĐỂ CHÂN CHO NGƯỜI ĐI XE MÁY** (51) **12-16**
(22) 28/12/2022 (43) 25/01/2024
(73) **QUÁCH ANH MINH (VN)**
643/75 Xô Viết Nghệ Tĩnh, phường 26, quận Bình Thạnh, thành phố Hồ Chí Minh
(72) Quách Anh Minh (VN)
(74) Công ty TNHH Dịch vụ thương mại và sở hữu công nghiệp Song Ngọc (I.P.T.S.)
(55)



1.1



1.2



1.3



1.4



1.5

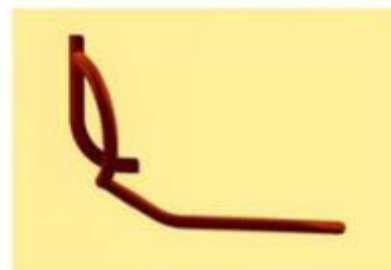

1.6

CÔNG BÁO SỞ HỮU CÔNG NGHIỆP SỐ 430 TẬP A – QUYỀN 2 (01.2024)

- (11) **49111**
- (21) 3-2023-00274
- (54) **BAO GÓI**
- (22) 09/02/2023
- (73) **NGUYỄN NGỌC LAN (VN)**
Số 05 Lý Tự Trọng, phường Bến Nghé, quận 1, thành phố Hồ Chí Minh
- (72) Nguyễn Ngọc Lan (VN)
- (74) Công ty TNHH Sở hữu trí tuệ Thảo Thọ Quyển (INVENCO.,LTD)
- (55)

- (28) 1
- (51) **09-05**
- (43) 25/01/2024



1.1



1.2



1.3



1.4



1.5



1.6

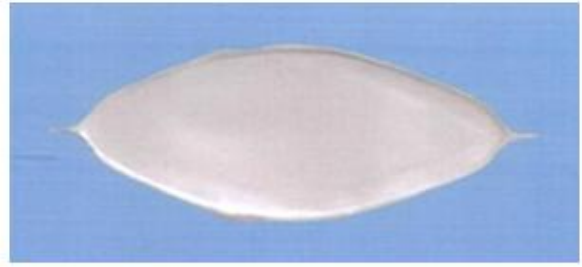

1.7

CÔNG BÁO SỞ HỮU CÔNG NGHIỆP SỐ 430 TẬP A – QUYỀN 2 (01.2024)

- (11) **49112**
(21) 3-2023-00281 (28) 1
(54) **CHAI** (51) **09-01**
(22) 10/02/2023 (43) 25/01/2024
(73) **CÔNG TY CP THỰC PHẨM DINH DƯỠNG NUTRINEST (VN)**
316 Xô Viết Nghệ Tĩnh, Phường 21, Quận Bình Thạnh, Thành phố Hồ Chí Minh
(72) Nguyễn Minh Duyên Đăng (VN)
(74) Công ty TNHH NACILAW (NACILAW)
(55)



1.1



1.2



1.3



1.4



1.5



1.6



1.7

CÔNG BÁO SỞ HỮU CÔNG NGHIỆP SỐ 430 TẬP A – QUYỀN 2 (01.2024)

- (11) **49113**
(21) 3-2023-00414 (28) 1
(54) **GHẾ** (51) **06-01**
(22) 01/03/2023 (43) 25/01/2024
(73) **NGUYỄN MINH TUẤN (VN)**
139/37 Dương Văn Dương, phường Tân Quý, quận Tân Phú, thành phố Hồ Chí Minh
(72) Nguyễn Minh Tuấn (VN)
(74) Công ty TNHH Dịch vụ thương mại và sở hữu công nghiệp Song Ngọc (I.P.T.S.)
(55)



1.1



1.2



1.3

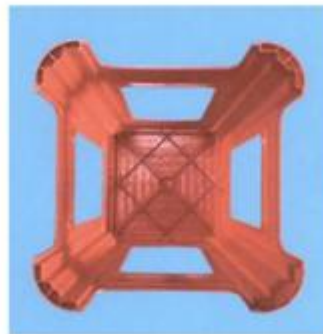

1.4

CÔNG BÁO SỞ HỮU CÔNG NGHIỆP SỐ 430 TẬP A – QUYỀN 2 (01.2024)

- (11) **49114**
- (21) 3-2023-00449 (28) 1
- (54) **NHÃN SẢN PHẨM** (51) **19-08**
- (22) 03/03/2023 (43) 25/01/2024
- (73) **CÔNG TY CỔ PHẦN CƠ KHÍ NHÔM XINGFAWINDOW - NHÀ MÁY
NHÔM XINGFA (VN)**
Ấp 4, xã Thạnh Lợi, huyện Bến Lức, tỉnh Long An
- (72) Đoàn Đức Thành (VN)
- (74) Công ty TNHH dịch vụ đại diện sở hữu công nghiệp Châu Á (ASIA SERVICE IP
CO.,LTD)
- (55)



CÔNG BÁO SỞ HỮU CÔNG NGHIỆP SỐ 430 TẬP A – QUYỀN 2 (01.2024)

(11) **49115**

(21) 3-2023-00629

(28) 1

(54) **NẮP**

(51) **07-02**

(22) 24/03/2023

(43) 25/01/2024

(73) **CÔNG TY TNHH MINH LONG I (VN)**

333 đường Hưng Định 24, khu phố Hưng Lộc, phường Hưng Định, thành phố Thuận An, tỉnh Bình Dương

(72) Lý Ngọc Minh (VN)

(55)



1.1



1.2



1.3



1.4

CÔNG BÁO SỞ HỮU CÔNG NGHIỆP SỐ 430 TẬP A – QUYỀN 2 (01.2024)

(11) **49116**

(21) 3-2023-00630

(28) 1

(54) **NỒI**

(51) **07-02**

(22) 24/03/2023

(43) 25/01/2024

(73) **CÔNG TY TNHH MINH LONG I (VN)**

333 đường Hưng Định 24, khu phố Hưng Lộc, phường Hưng Định, thành phố Thuận An, tỉnh Bình Dương

(72) Lý Ngọc Minh (VN)

(55)

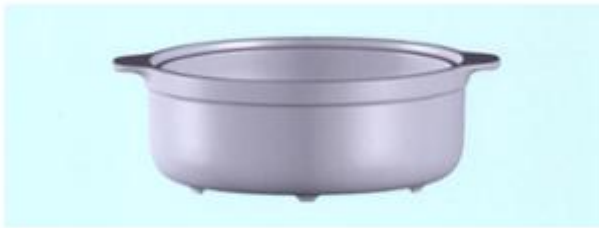

1.1



1.2



1.3



1.4

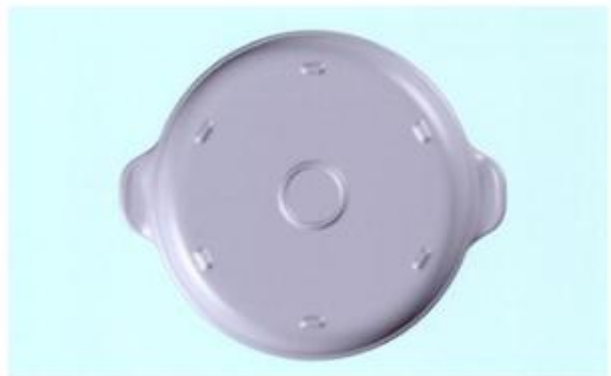

1.5

(11) **49117**

(21) 3-2023-00671

(28) 1

(54) **CỘT TRANG TRÍ**

(51) **25-02**

(22) 28/03/2023

(43) 25/01/2024

(73) **CÔNG TY CỔ PHẦN CHIẾU SÁNG ĐÔ THỊ HOÀNG GIA (VN)**

Số 226 Đê La Thành, phường Ô Chợ Dừa, quận Đống Đa, thành phố Hà Nội

(72) Hoàng Song Hà (VN)

(55)

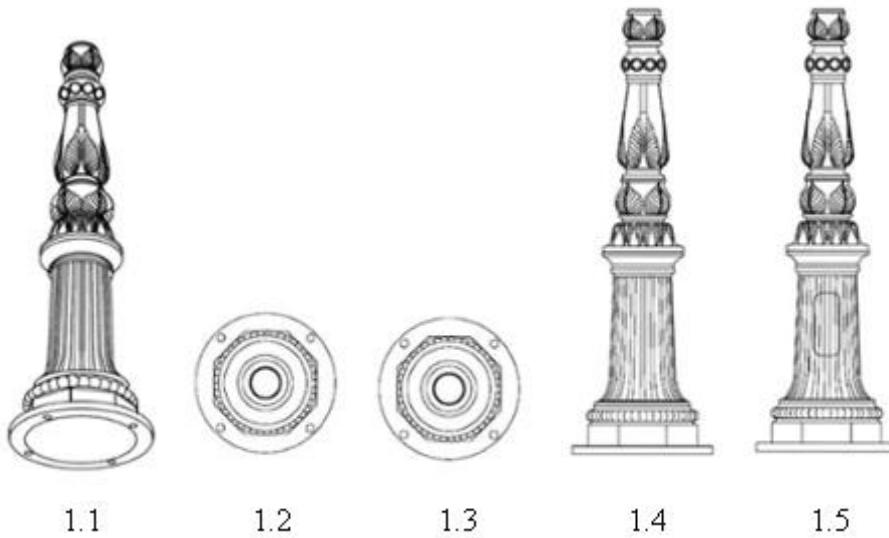

CÔNG BÁO SỞ HỮU CÔNG NGHIỆP SỐ 430 TẬP A – QUYỀN 2 (01.2024)

- (11) **49118**
(21) 3-2023-00758 (28) 1
(54) **LỌ MỸ PHẨM** (51) **09-01**
(22) 06/04/2023 (43) 25/01/2024
(73) **CÔNG TY TNHH ĐẦU TƯ THƯƠNG MẠI DỊCH VỤ BẠCH VŨ (VN)**
Căn Sor 334 đường Sorento 3, Địa Trung Hải, phường An Thới, thành phố Phú Quốc, tỉnh Kiên Giang
(72) Bạch Thanh Tùng (VN)
(55)



1.1



1.2



1.3



1.4



1.5



1.6

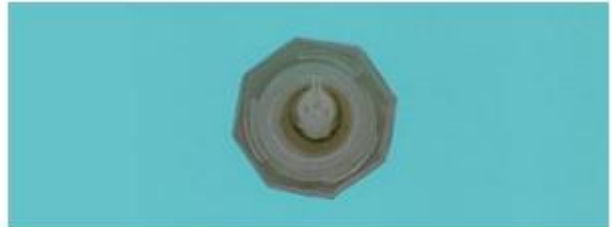

1.7

CÔNG BÁO SỞ HỮU CÔNG NGHIỆP SỐ 430 TẬP A – QUYỀN 2 (01.2024)

(11) **49119**

(21) 3-2023-00847

(28) 1

(54) **TAY NẮM CỬA**

(51) **08-06**

(22) 14/04/2023

(43) 25/01/2024

(73) **LƯU VĂN THƯỜNG (VN)**

Đội 6, thôn Đào Viên, xã Dân Tiến, huyện Khoái Châu, tỉnh Hưng Yên

(72) Lưu Văn Thường (VN)

(74) Công ty TNHH Sở hữu trí tuệ Đại Diện (IPACO.,LTD.)

(55)



1.1



1.2



1.3



1.4



1.5



1.6



1.7

CÔNG BÁO SỞ HỮU CÔNG NGHIỆP SỐ 430 TẬP A – QUYỀN 2 (01.2024)

- (11) **49120**
- (21) 3-2023-00870 (28) 1
- (54) **NHÃN SẢN PHẨM** (51) **19-08**
- (22) 17/04/2023 (43) 25/01/2024
- (73) **CÔNG TY TNHH GREENIE SCOOP (VN)**
Số 888 đại lộ Bình Dương, khu phố Bình Giao, phường Thuận Giao, thành phố Thuận An, tỉnh Bình Dương
- (72) Lý Huy Sáng (VN)
- (55)



CÔNG BÁO SỞ HỮU CÔNG NGHIỆP SỐ 430 TẬP A – QUYỀN 2 (01.2024)

- (11) **49121**
(21) 3-2023-00871 (28) 1
(54) **MÁY GIA NHIỆT** (51) **24-01**
(22) 18/04/2023 (43) 25/01/2024
(73) **CÔNG TY TNHH FORTE BIOTECH VIỆT NAM (VN)**
313/11 đường Nguyễn Trọng Tuyển, phường 10, quận Phú Nhuận, thành phố Hồ Chí Minh
(72) Nguyễn Đăng Quang Minh (VN)
(55)



1.1



1.2

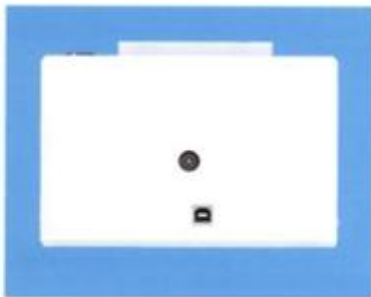

1.3

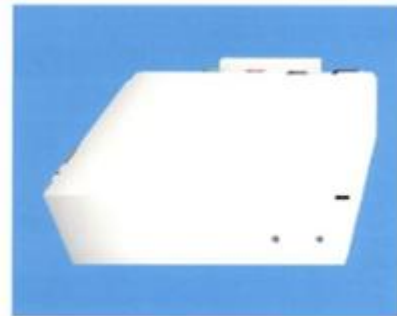

1.4

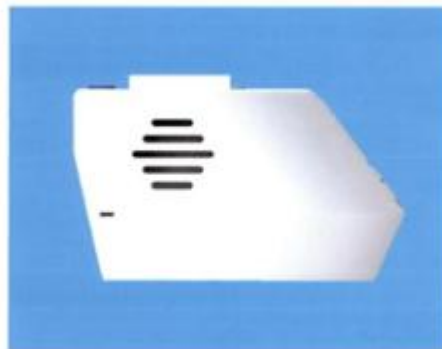

1.5



1.6



1.7

- (11) **49122**
(21) 3-2023-00886 (28) 1
(54) **ĐẾ DÉP** (51) **02-04**
(22) 19/04/2023 (43) 25/01/2024
(73) **CÔNG TY TNHH SẢN XUẤT THƯƠNG MẠI HÙ KIỆT (VN)**
Tỉnh lộ 830, ấp 8, xã Lương Hòa, huyện Bến Lức, tỉnh Long An
(72) Gíp Cao Thanh (VN)
(55)



1.1



1.2



1.3

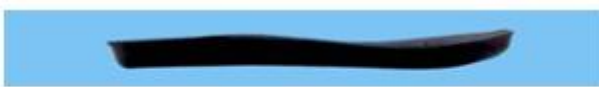

1.4



1.5



1.6



1.7

- (11) **49123**
(21) 3-2023-00887 (28) 1
(54) **ĐÉ DÉP** (51) **02-04**
(22) 19/04/2023 (43) 25/01/2024
(73) **CÔNG TY TNHH SẢN XUẤT THƯƠNG MẠI HÙ KIỆT (VN)**
Tỉnh lộ 830, ấp 8, xã Lương Hòa, huyện Bến Lức, tỉnh Long An
(72) Gịp Cao Thanh (VN)
(55)



1.1



1.2



1.3



1.4



1.5



1.6



1.7

CÔNG BÁO SỞ HỮU CÔNG NGHIỆP SỐ 430 TẬP A – QUYỀN 2 (01.2024)

- (11) **49124**
(21) 3-2023-00888 (28) 1
(54) **ĐÉ DÉP** (51) **02-04**
(22) 19/04/2023 (43) 25/01/2024
(73) **CÔNG TY TNHH SẢN XUẤT THƯƠNG MẠI HÙ KIỆT (VN)**
Tỉnh lộ 830, ấp 8, xã Lương Hòa, huyện Bến Lức, tỉnh Long An
(72) Gịp Cao Thanh (VN)
(55)



1.1



1.2



1.3



1.4



1.5



1.6



1.7

CÔNG BÁO SỞ HỮU CÔNG NGHIỆP SỐ 430 TẬP A – QUYỀN 2 (01.2024)

- (11) **49125**
(21) 3-2023-00909 (28) 1
(54) **TAY NẮM CỬA** (51) **08-06**
(22) 25/04/2023 (43) 25/01/2024
(73) **CÔNG TY CỔ PHẦN OCIMI VIỆT NAM (VN)**
Số nhà 19D, ngõ 180 Nam Dư, tổ 19, phường Lĩnh Nam, quận Hoàng Mai, thành phố Hà Nội
(72) Ngô Thọ Thịnh (VN)
(74) Công ty TNHH Sở hữu trí tuệ PADEMARK (PADEMARK CO.,LTD.)
(55)



1.1



1.2



1.3



1.4



1.5



1.6



1.7

CÔNG BÁO SỞ HỮU CÔNG NGHIỆP SỐ 430 TẬP A – QUYỀN 2 (01.2024)

- (11) **49126**
(21) 3-2023-00910 (28) 1
(54) **TAY NẮM CỬA** (51) **08-06**
(22) 25/04/2023 (43) 25/01/2024
(73) **CÔNG TY CỔ PHẦN OCIMI VIỆT NAM (VN)**
Số nhà 19D, ngõ 180 Nam Dư, tổ 19, phường Lĩnh Nam, quận Hoàng Mai, thành phố Hà Nội
(72) Ngô Thọ Thịnh (VN)
(74) Công ty TNHH Sở hữu trí tuệ PADEMARK (PADEMARK CO.,LTD.)
(55)



1.1

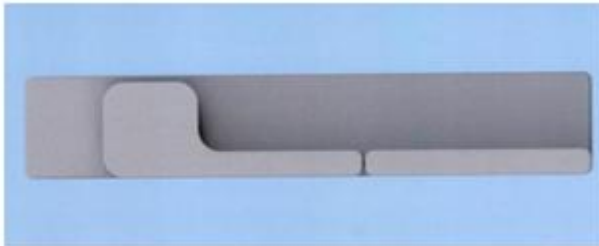

1.2



1.3



1.4



1.5



1.6



1.7

CÔNG BÁO SỞ HỮU CÔNG NGHIỆP SỐ 430 TẬP A – QUYỀN 2 (01.2024)

- (11) 49127
(21) 3-2023-00956
(54) **TÚI ĐỰNG TẤ TRẺ EM**
(22) 28/04/2023
(73) **CÔNG TY CỔ PHẦN THƯƠNG MẠI VÀ XUẤT NHẬP KHẨU MOTARO (VN)**
Số 93/253 Phủ Thượng Đoạn, phường Đông Hải 1, quận Hải An, thành phố Hải Phòng
(72) Đào Anh Tuấn (VN)
(74) Công ty TNHH tư vấn HDS (HDS ADVISORY CO.,LTD.)
(55)
- (28) 1
(51) 09-05
(43) 25/01/2024



1.1



1.2



1.3



1.4



1.5



1.6

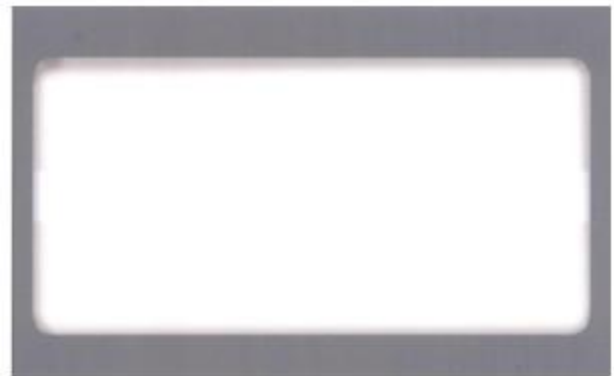

1.7

CÔNG BÁO SỞ HỮU CÔNG NGHIỆP SỐ 430 TẬP A – QUYỀN 2 (01.2024)

- (11) **49128**
(21) 3-2023-00957 (28) 1
(54) **TÚI ĐỰNG TẤ TRẺ EM** (51) **09-05**
(22) 28/04/2023 (43) 25/01/2024
(73) **CÔNG TY CỔ PHẦN THƯƠNG MẠI VÀ XUẤT NHẬP KHẨU MOTARO (VN)**
Số 93/253 Phủ Thượng Đoạn, phường Đông Hải 1, quận Hải An, thành phố Hải Phòng
(72) Đào Anh Tuấn (VN)
(74) Công ty TNHH tư vấn HDS (HDS ADVISORY CO.,LTD.)
(55)



1.1



1.2



1.3



1.4



1.5



1.6



1.7

CÔNG BÁO SỞ HỮU CÔNG NGHIỆP SỐ 430 TẬP A – QUYỀN 2 (01.2024)

- (11) **49129**
(21) 3-2023-00958 (28) 1
(54) **TÚI ĐỰNG TẤ TRẺ EM** (51) **09-05**
(22) 28/04/2023 (43) 25/01/2024
(73) **CÔNG TY CỔ PHẦN THƯƠNG MẠI VÀ XUẤT NHẬP KHẨU MOTARO (VN)**
Số 93/253 Phủ Thượng Đoạn, phường Đông Hải 1, quận Hải An, thành phố Hải Phòng
(72) Đào Anh Tuấn (VN)
(74) Công ty TNHH tư vấn HDS (HDS ADVISORY CO.,LTD.)
(55)



1.1



1.2



1.3



1.4



1.5



1.6

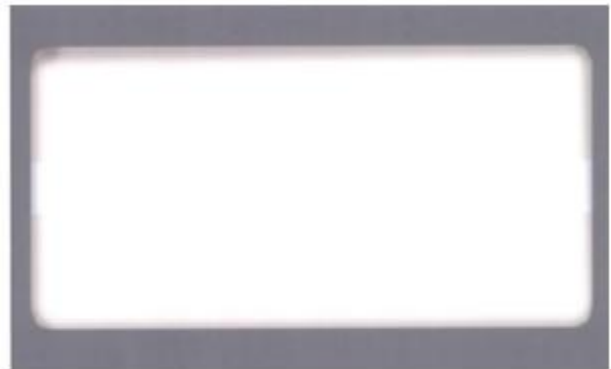

1.7

CÔNG BÁO SỞ HỮU CÔNG NGHIỆP SỐ 430 TẬP A – QUYỀN 2 (01.2024)

- (11) **49130**
(21) 3-2023-00959 (28) 1
(54) **TÚI ĐỰNG TẤ TRẺ EM** (51) **09-05**
(22) 28/04/2023 (43) 25/01/2024
(73) **CÔNG TY CỔ PHẦN THƯƠNG MẠI VÀ XUẤT NHẬP KHẨU MOTARO (VN)**
Số 93/253 Phủ Thượng Đoạn, phường Đông Hải 1, quận Hải An, thành phố Hải Phòng
(72) Đào Anh Tuấn (VN)
(74) Công ty TNHH tư vấn HDS (HDS ADVISORY CO.,LTD.)
(55)



1.1



1.2



1.3



1.4



1.5



1.6

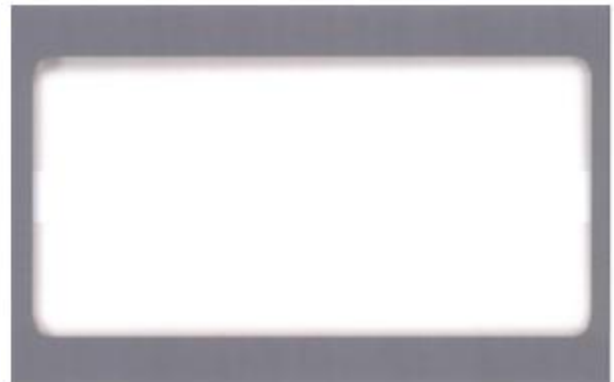

1.7

CÔNG BÁO SỞ HỮU CÔNG NGHIỆP SỐ 430 TẬP A – QUYỀN 2 (01.2024)

- (11) **49131**
(21) 3-2023-00960 (28) 1
(54) **TÚI ĐỰNG TẤ TRẺ EM** (51) **09-05**
(22) 28/04/2023 (43) 25/01/2024
(73) **CÔNG TY CỔ PHẦN THƯƠNG MẠI VÀ XUẤT NHẬP KHẨU MOTARO (VN)**
Số 93/253 Phủ Thượng Đoạn, phường Đông Hải 1, quận Hải An, thành phố Hải Phòng
(72) Đào Anh Tuấn (VN)
(74) Công ty TNHH tư vấn HDS (HDS ADVISORY CO.,LTD.)
(55)



1.1



1.2



1.3



1.4



1.5



1.6



1.7

CÔNG BÁO SỞ HỮU CÔNG NGHIỆP SỐ 430 TẬP A – QUYỀN 2 (01.2024)

- (11) **49132**
(21) 3-2023-00961 (28) 1
(54) **TÚI ĐỰNG TẤ TRẺ EM** (51) **09-05**
(22) 28/04/2023 (43) 25/01/2024
(73) **CÔNG TY CỔ PHẦN THƯƠNG MẠI VÀ XUẤT NHẬP KHẨU MOTARO (VN)**
Số 93/253 Phủ Thượng Đoạn, phường Đông Hải 1, quận Hải An, thành phố Hải Phòng
(72) Đào Anh Tuấn (VN)
(74) Công ty TNHH tư vấn HDS (HDS ADVISORY CO.,LTD.)
(55)



1.1



1.2



1.3



1.4



1.5



1.6

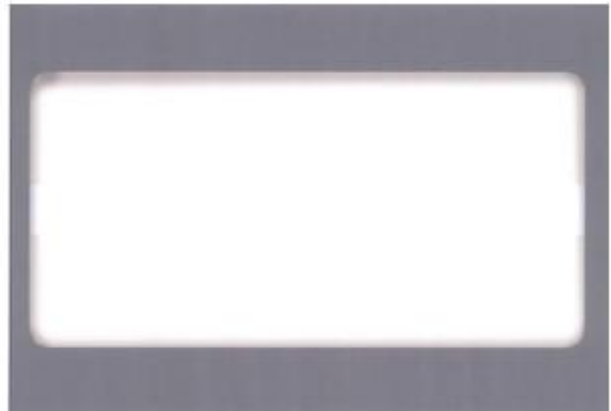

1.7

CÔNG BÁO SỞ HỮU CÔNG NGHIỆP SỐ 430 TẬP A – QUYỀN 2 (01.2024)

- (11) **49133**
(21) 3-2023-00962 (28) 1
(54) **TÚI ĐỰNG TẶNG TRẺ EM** (51) **09-05**
(22) 28/04/2023 (43) 25/01/2024
(73) **CÔNG TY CỔ PHẦN THƯƠNG MẠI VÀ XUẤT NHẬP KHẨU MOTARO (VN)**
Số 93/253 Phủ Thượng Đoạn, phường Đông Hải 1, quận Hải An, thành phố Hải Phòng
(72) Đào Anh Tuấn (VN)
(74) Công ty TNHH tư vấn HDS (HDS ADVISORY CO.,LTD.)
(55)



1.1



1.2



1.3



1.4



1.5



1.6

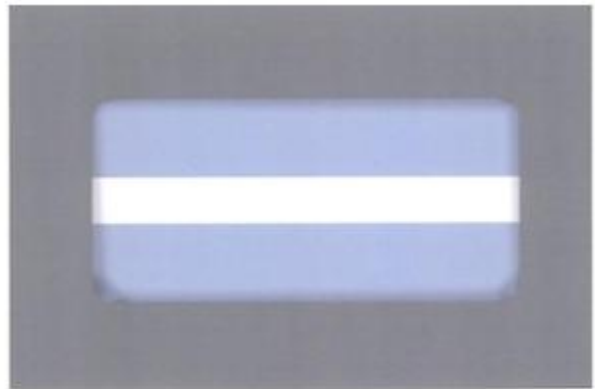

1.7

CÔNG BÁO SỞ HỮU CÔNG NGHIỆP SỐ 430 TẬP A – QUYỀN 2 (01.2024)

- (11) **49134**
(21) 3-2023-00963 (28) 1
(54) **TÚI ĐỰNG TẶNG TRẺ EM** (51) **09-05**
(22) 28/04/2023 (43) 25/01/2024
(73) **CÔNG TY CỔ PHẦN THƯƠNG MẠI VÀ XUẤT NHẬP KHẨU MOTARO (VN)**
Số 93/253 Phủ Thượng Đoạn, phường Đông Hải 1, quận Hải An, thành phố Hải Phòng
(72) Đào Anh Tuấn (VN)
(74) Công ty TNHH tư vấn HDS (HDS ADVISORY CO.,LTD.)
(55)



1.1



1.2



1.3



1.4



1.5



1.6

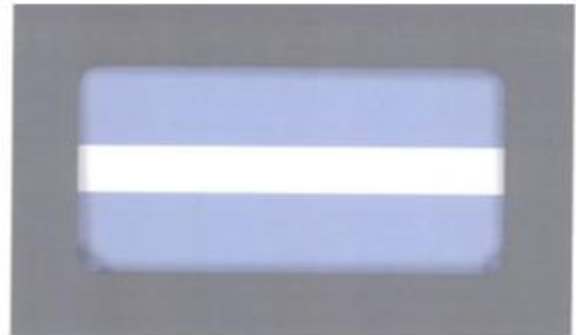

1.7

CÔNG BÁO SỞ HỮU CÔNG NGHIỆP SỐ 430 TẬP A – QUYỀN 2 (01.2024)

- (11) **49135**
(21) 3-2023-00964
(54) **TÚI ĐỰNG TẤ TRẺ EM**
(22) 28/04/2023
(73) **CÔNG TY CỔ PHẦN THƯƠNG MẠI VÀ XUẤT NHẬP KHẨU MOTARO (VN)**
Số 93/253 Phủ Thượng Đoạn, phường Đông Hải 1, quận Hải An, thành phố Hải Phòng
(72) Đào Anh Tuấn (VN)
(74) Công ty TNHH tư vấn HDS (HDS ADVISORY CO.,LTD.)
(55)
- (28) 1
(51) **09-05**
(43) 25/01/2024



1.1



1.2



1.3



1.4



1.5



1.6

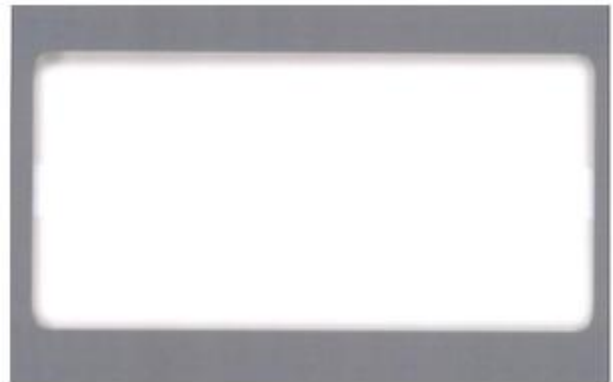

1.7

CÔNG BÁO SỞ HỮU CÔNG NGHIỆP SỐ 430 TẬP A – QUYỀN 2 (01.2024)

- (11) **49136**
- (21) 3-2023-00986 (28) 1
- (54) **NHÃN SẢN PHẨM** (51) **19-08**
- (22) 05/05/2023 (43) 25/01/2024
- (73) **CÔNG TY CỔ PHẦN CƠ KHÍ NHÔM XINGFAWINDOW - NHÀ MÁY NHÔM XINGFA (VN)**
Ấp 4, xã Thạnh Lợi, huyện Bến Lức, tỉnh Long An
- (72) Đoàn Đức Thành (VN)
- (74) Công ty TNHH dịch vụ đại diện sở hữu công nghiệp Châu Á (ASIA SERVICE IP CO.,LTD)
- (55)



CÔNG BÁO SỞ HỮU CÔNG NGHIỆP SỐ 430 TẬP A – QUYỀN 2 (01.2024)

- (11) **49137**
(21) 3-2023-00989 (28) 1
(54) **TƯỢNG TRANG TRÍ** (51) **11-02**
(22) 08/05/2023 (43) 25/01/2024
(73) **CÔNG TY TNHH MINH LONG I (VN)**
Số 333 đường Hưng Định 24, khu phố Hưng Lộc, phường Hưng Định, thành phố Thuận An, tỉnh Bình Dương
(72) Lý Huy Sáng (VN)
(55)



1.1

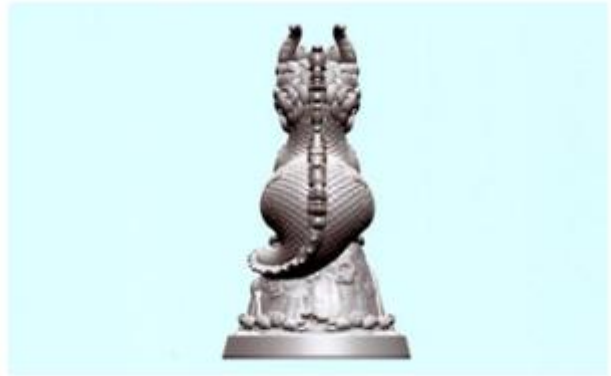

1.2



1.3

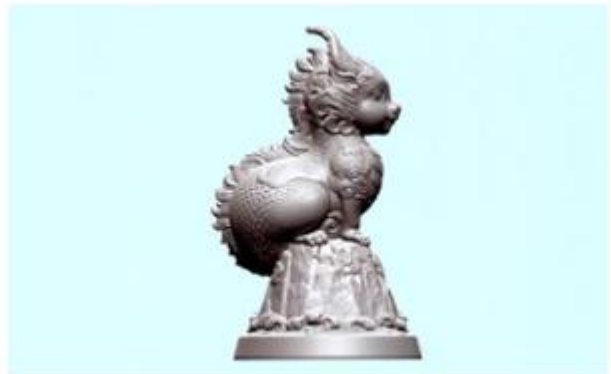

1.4



1.5



1.6

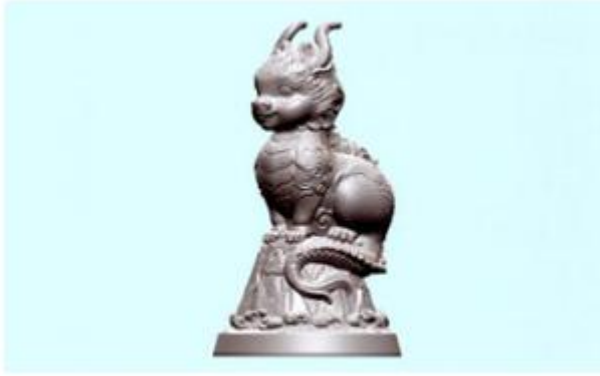

1.7



1.8

CÔNG BÁO SỞ HỮU CÔNG NGHIỆP SỐ 430 TẬP A – QUYỀN 2 (01.2024)

- (11) **49138**
(21) 3-2023-01003 (28) 1
(54) **BAO GÓI SẢN PHẨM** (51) **09-05**
(22) 09/05/2023 (43) 25/01/2024
(73) **CÔNG TY CỔ PHẦN MẶT TRỜI LỬA (VN)**
Số 209A đường Nguyễn Tri Phương, khu phố Nhị Đồng 2, phường Dĩ An, thành phố Dĩ An, tỉnh Bình Dương
(72) Trương Quang Chung (VN)
(74) Công ty TNHH Sở hữu trí tuệ PADEMARK (PADEMARK CO.,LTD.)
(55)



1.1



1.2

CÔNG BÁO SỞ HỮU CÔNG NGHIỆP SỐ 430 TẬP A – QUYỀN 2 (01.2024)

- (11) **49139**
(21) 3-2023-01007 (28) 1
(54) **BỘ NHÃN SẢN PHẨM** (51) **19-08**
(22) 10/05/2023 (43) 25/01/2024
(73) **CÔNG TY TNHH XUẤT NHẬP KHẨU WINE HOUSE (VN)**
E506 Xuân Phương Reseden, tổ 8, phố Trịnh Văn Bô, phường Xuân Phương, quận
Nam Từ Liêm, thành phố Hà Nội
(72) Lê Trọng Hưng (VN)
(55)



1.1



1.2

CÔNG BÁO SỞ HỮU CÔNG NGHIỆP SỐ 430 TẬP A – QUYỀN 2 (01.2024)

- (11) **49140**
(21) 3-2023-01063 (28) 1
(54) **MÁY TÍNH ĐIỆN TỬ** (51) **18-01**
(22) 17/03/2022 (43) 25/01/2024
(30) 2021-020571 24/09/2021 JP;
(73) **CASIO KEISANKI KABUSHIKI KAISHA D.B.A. CASIO COMPUTER CO., LTD. (JP)**
6-2, Hon-machi 1-chome, Shibuya-ku, Tokyo, Japan
(72) 1. OKA SHUNSUKE (JP)
2. ISHII KYOHEI (JP)
(74) Công ty TNHH một thành viên Sở hữu trí tuệ VCCI (VCCI-IP CO.,LTD)
(55)



1.1



1.2

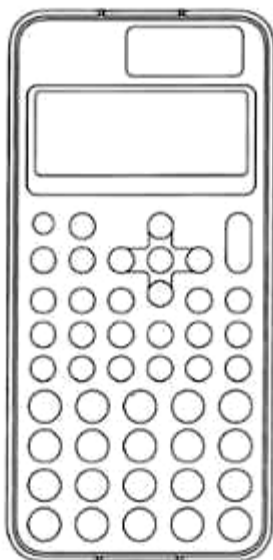

1.3



1.4



1.5



1.6

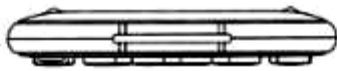

1.7

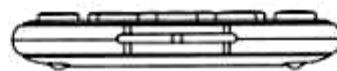

1.8

- (11) **49141**
- (21) 3-2023-01073 (28) 1
- (54) **THƯỚC ĐO** (51) **19-06**
- (22) 17/05/2023 (43) 25/01/2024
- (73) 1. **HỒ THỊ THỦY TIÊN (VN)**
Phòng 612 lô C, chung cư Cây Mai, phường 16, quận 11, thành phố Hồ Chí Minh
2. **NGUYỄN THỊ KIM ANH (VN)**
315 Hoà Hảo, phường 4, quận 10, thành phố Hồ Chí Minh
3. **LÊ THANH ĐẠT (VN)**
Phòng 612 lô C, chung cư Cây Mai, phường 16, quận 11, thành phố Hồ Chí Minh
- (72) 1. **HỒ THỊ THỦY TIÊN (VN)**
2. **NGUYỄN THỊ KIM ANH (VN)**
3. **LÊ THANH ĐẠT (VN)**
- (55)

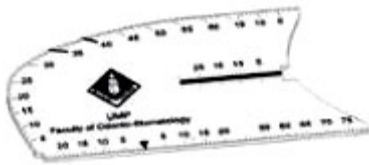

1.1



1.2



1.3

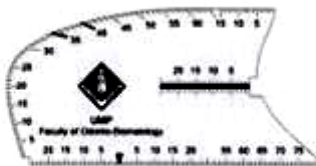

1.4



1.6

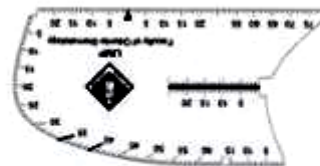

1.5



1.7

CÔNG BÁO SỞ HỮU CÔNG NGHIỆP SỐ 430 TẬP A – QUYỀN 2 (01.2024)

- (11) **49142**
(21) 3-2023-01080 (28) 1
(54) **MÁY THÙA KHUY** (51) **15-06**
(22) 18/05/2023 (43) 25/01/2024
(30) 2022-025219 22/11/2022 JP;
(73) **JUKI CORPORATION (JP)**
2-11-1, Tsurumaki, Tama-shi, Tokyo 206-8551, Japan
(72) 1. SYUUICHI SAITOU (JP)
2. SHIGEMI YAMAMOTO (JP)
3. YUUKO TAKEMOTO (JP)
4. SUMIKA SUZUKI (JP)
(74) Công ty TNHH một thành viên Sở hữu trí tuệ VCCI (VCCI-IP CO.,LTD)
(55)

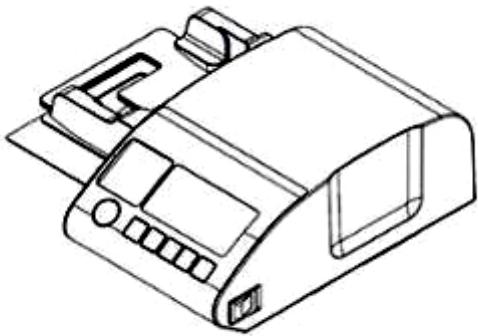

1.1

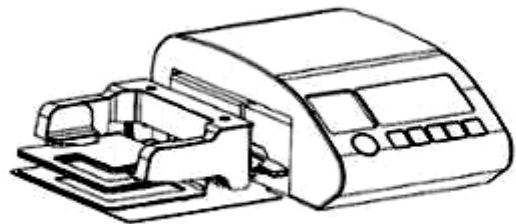

1.2

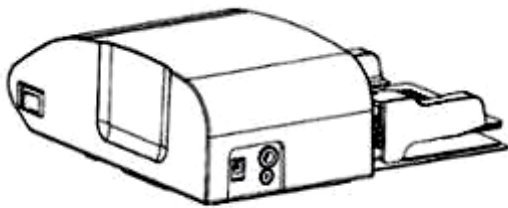

1.3

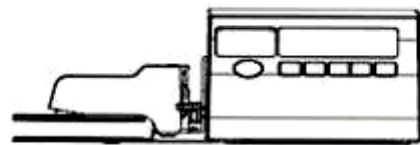

1.4

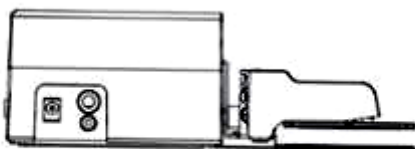

1.5

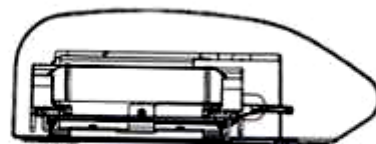

1.6



1.7

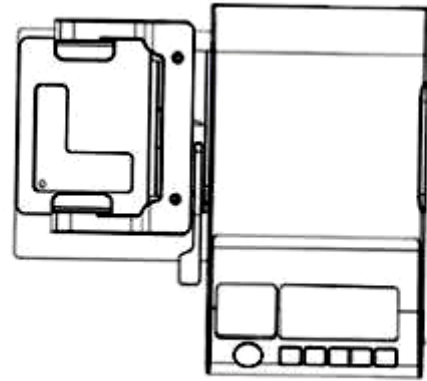

1.8

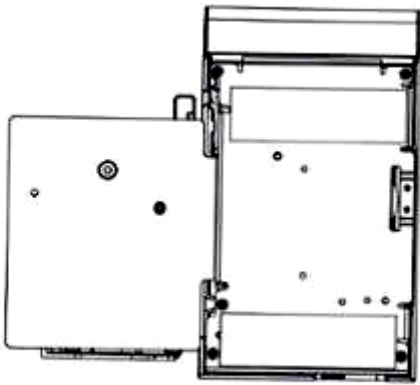

1.9

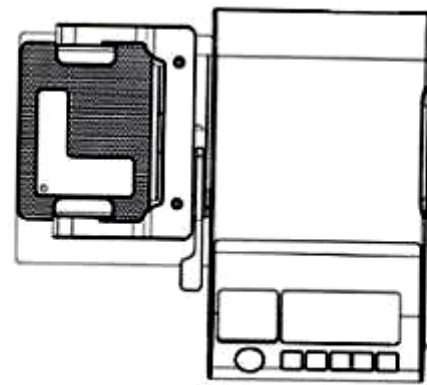

1.10

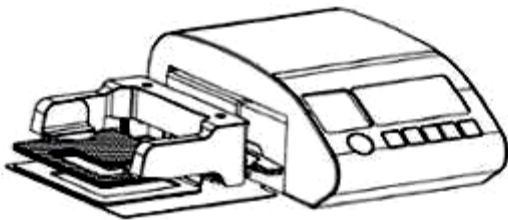

1.11

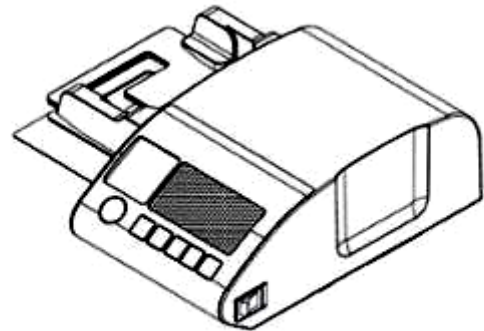

1.12

CÔNG BÁO SỞ HỮU CÔNG NGHIỆP SỐ 430 TẬP A – QUYỀN 2 (01.2024)

- (11) **49143**
(21) 3-2023-01154 (28) 1
(54) **BỘ ĐÈN PHÍA TRƯỚC CỦA Ô TÔ** (51) **26-06**
(22) 26/05/2023 (43) 25/01/2024
(30) 2022-025827 30/11/2022 JP;
(73) **DAIHATSU MOTOR CO., LTD. (JP)**
1 -1, DAIHATSU-CHO, IKEDA-SHI, OSAKA 563-8651 JAPAN
(72) Keisuke TSUKAHARA (JP)
(74) Công ty TNHH một thành viên Sở hữu trí tuệ VCCI (VCCI-IP CO.,LTD)
(55)



1.1



1.2



1.3



1.4



1.5



1.6



1.7



1.8

CÔNG BÁO SỞ HỮU CÔNG NGHIỆP SỐ 430 TẬP A – QUYỀN 2 (01.2024)

- (11) **49144**
(21) 3-2023-01155 (28) 1
(54) **BỘ ĐÈN PHÍA SAU CỦA Ô TÔ** (51) **26-06**
(22) 26/05/2023 (43) 25/01/2024
(30) 2022-025828 30/11/2022 JP;
(73) **DAIHATSU MOTOR CO., LTD. (JP)**
1-1, DAIHATSU-CHO, IKEDA-SHI, OSAKA 563-8651 JAPAN
(72) 1. SHINJI TAMURA (JP)
2. AHMAD AFFENDI BIN MUHAMMAD (MY)
(74) Công ty TNHH một thành viên Sở hữu trí tuệ VCCI (VCCI-IP CO.,LTD)
(55)



1.1



1.2



1.3



1.4



1.5



1.6



1.7



1.8

CÔNG BÁO SỞ HỮU CÔNG NGHIỆP SỐ 430 TẬP A – QUYỀN 2 (01.2024)

- (11) **49145**
(21) 3-2023-01156 (28) 1
(54) **TẮM HÃM XUNG PHÍA SAU CỦA Ô TÔ** (51) **12-16**
(22) 26/05/2023 (43) 25/01/2024
(30) 2022-025829 30/11/2022 JP;
(73) **DAIHATSU MOTOR CO., LTD. (JP)**
1-1, DAIHATSU-CHO, IKEDA-SHI, OSAKA 563-8651 JAPAN
(72) Shinji TAMURA (JP)
(74) Công ty TNHH một thành viên Sở hữu trí tuệ VCCI (VCCI-IP CO.,LTD)
(55)



1.1



1.2



1.3



1.4

1.5



1.6



1.7



1.8

CÔNG BÁO SỞ HỮU CÔNG NGHIỆP SỐ 430 TẬP A – QUYỀN 2 (01.2024)

- (11) **49146**
(21) 3-2023-01157 (28) 1
(54) **BẢNG ĐIỀU KHIỂN CỦA Ô TÔ** (51) **12-16**
(22) 26/05/2023 (43) 25/01/2024
(30) 2022-025830 30/11/2022 JP;
(73) **DAIHATSU MOTOR CO., LTD. (JP)**
1-1, DAIHATSU-CHO, IKEDA-SHI, OSAKA 563-8651 JAPAN
(72) 1. AHMAD IQTIZAR BIN AHMAD (MY)
2. SOU IKEDA (JP)
3. JIROU INOUE (JP)
(74) Công ty TNHH một thành viên Sở hữu trí tuệ VCCI (VCCI-IP CO.,LTD)
(55)



1.1



1.2



1.3



1.4



1.5



1.6



1.7

CÔNG BÁO SỞ HỮU CÔNG NGHIỆP SỐ 430 TẬP A – QUYỀN 2 (01.2024)

- (11) **49147**
(21) 3-2023-01160 (28) 1
(54) **BÌNH CHỨA** (51) **09-01**
(22) 26/05/2023 (43) 25/01/2024
(30) 015004604-0001 29/11/2022 EM;
(73) **UNILEVER GLOBAL IP LIMITED (UK)**
Port Sunlight, Wirral, Merseyside, CH62 4ZD, United Kingdom
(72) 1. JOHN HENRY NODEN (GB)
2. JESSICA FRANCES SOPHIA PEAKE (GB)
3. MARK LEE VERHAEGE (GB)
4. CHRISTOPHER PAUL WEIR (GB)
(74) Công ty TNHH Trần Hữu Nam và Đồng sự (TRAN H.N & ASS.)
(55)

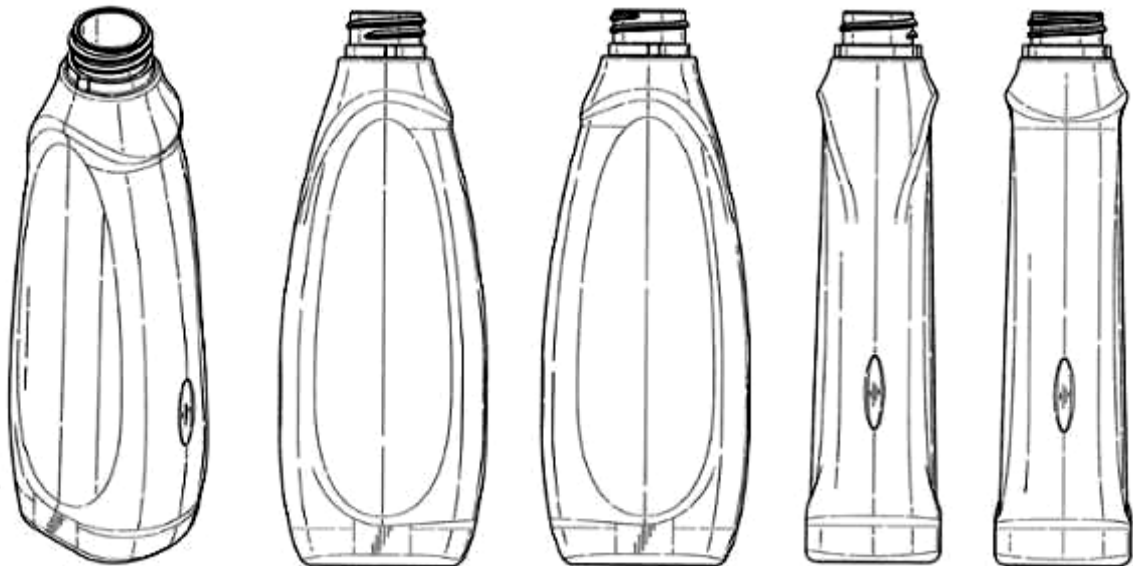

1.1

1.2

1.3

1.4

1.5

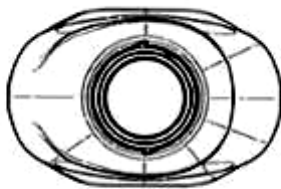

1.6



1.7

- (11) **49148**
(21) 3-2023-01202 (28) 1
(54) **CHÂN ĐỠ MÁY HÚT BỤI** (51) **15-05**
(22) 01/06/2023 (43) 25/01/2024
(30) 2023-005764 24/03/2023 JP;
(73) **SHARP KABUSHIKI KAISHA (JP)**
1 Takumi-cho, Sakai-ku, Sakai City, Osaka 590-8522, Japan
(72) **DAIJIROH TOKUNAGA (JP)**
(74) Công ty TNHH một thành viên Sở hữu trí tuệ VCCI (VCCI-IP CO.,LTD)
(55)



1.1



1.2



1.3



1.4



1.5



1.6



1.7



1.8



1.9



1.10

CÔNG BÁO SỞ HỮU CÔNG NGHIỆP SỐ 430 TẬP A – QUYỀN 2 (01.2024)

- (11) **49149**
(21) 3-2023-01224 (28) 1
(54) **MÁY GẮN PHỤ KIỆN TỰ ĐỘNG** (51) **15-99**
(22) 02/06/2023 (43) 25/01/2024
(30) 2022308551968 22/12/2022 CN;
(73) **SHENZHEN YUEHE PRECISION TECHNOLOGY CO., LTD (CN)**
301, Building 8, Hong'ao Industrial Park, Crossing of Genyu Road and Nanming
Road, Tianliao Community, Yutang Street, Guangming District, Shenzhen,
Guangdong 518107, China
(72) Li Yaoli (CN)
(74) Công ty TNHH ADAstra IP (VIỆT NAM) (ADASTRA IP (VIETNAM) CO.,
LTD.)
(55)



1.1

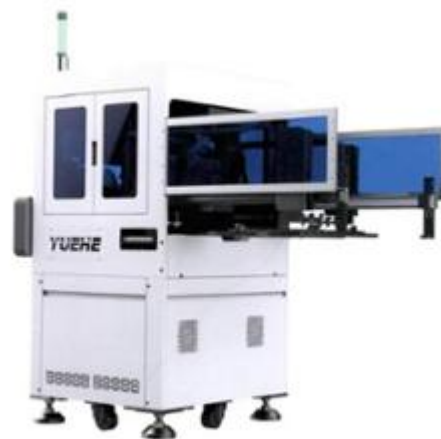

1.2



1.3



1.4



1.5



1.6



1.7



1.8

- (11) **49150**
(21) 3-2023-01290 (28) 1
(54) **LƯỢC CHẢI TÓC** (51) **28-03**
(22) 12/06/2023 (43) 25/01/2024
(30) 2022-026756 13/12/2022 JP;
(73) **MTG CO., LTD. (JP)**
2-32 Honjin-tori, Nakamura-ku, Nagoya-shi, Aichi 4530041, Japan
(72) Kei ITO (JP)
(74) **CÔNG TY LUẬT TRÁCH NHIỆM HỮU HẠN AMBYS HÀ NỘI (AMBYS HANOI)**
(55)

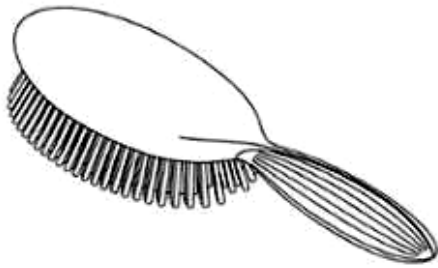

1.1

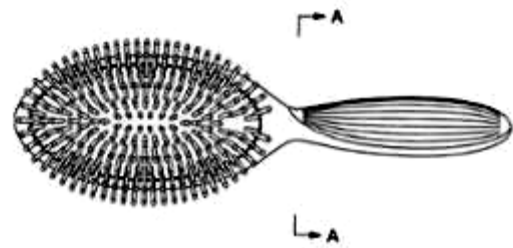

1.2

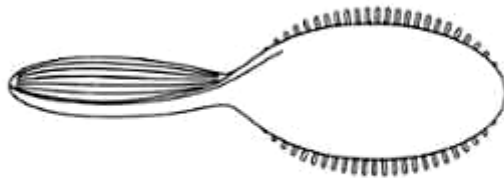

1.3



1.4



1.5



1.6

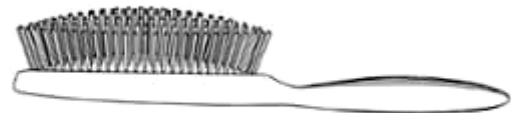

1.7



1.8

CÔNG BÁO SỞ HỮU CÔNG NGHIỆP SỐ 430 TẬP A – QUYỀN 2 (01.2024)

(11) **49151**

(21) 3-2023-01347

(28) 1

(54) **CỬ MÂY VIỀN VÀNH MŨ**

(51) **15-06**

(22) 19/06/2023

(43) 25/01/2024

(73) **CÔNG TY TNHH THÁNG TÁM (VN)**

61-63 Đỗ Quang, phường Thảo Điền, thành phố Thủ Đức, thành phố Hồ Chí Minh

(72) Nguyễn Thị Khánh Dung (VN)

(55)



1.1



1.2



1.3



1.4



1.5



1.6



1.7

CÔNG BÁO SỞ HỮU CÔNG NGHIỆP SỐ 430 TẬP A – QUYỀN 2 (01.2024)

- (11) **49152**
(21) 3-2023-01348 (28) 1
(54) **CỬ MAY VIỀN VÀNH MŨ** (51) **15-06**
(22) 19/06/2023 (43) 25/01/2024
(73) **CÔNG TY TNHH THÁNG TÁM (VN)**
61-63 Đỗ Quang, phường Thảo Điền, thành Phố Thủ Đức, thành phố Hồ Chí Minh
(72) Nguyễn Thị Khánh Dung (VN)
(55)



1.1



1.2



1.3



1.4



1.5



1.6



1.7

CÔNG BÁO SỞ HỮU CÔNG NGHIỆP SỐ 430 TẬP A – QUYỀN 2 (01.2024)

- (11) **49153**
(21) 3-2023-01353 (28) 1
(54) **TẤM ỐP LÓT SÀN XE TAY GA** (51) **12-16**
(22) 20/06/2023 (43) 25/01/2024
(73) **NGUYỄN THANH PHONG (VN)**
173/20/5A Tân Sơn Nhì, phường Tân Sơn Nhì, quận Tân Phú, thành phố Hồ Chí Minh
(72) Nguyễn Thanh Phong (VN)
(55)



1.1



1.2



1.3



1.4



1.5



1.6



1.7

CÔNG BÁO SỞ HỮU CÔNG NGHIỆP SỐ 430 TẬP A – QUYỀN 2 (01.2024)

- (11) **49154**
(21) 3-2023-01354 (28) 1
(54) **TẤM ỐP LÓT SÀN XE TAY GA** (51) **12-16**
(22) 20/06/2023 (43) 25/01/2024
(73) **NGUYỄN THANH PHONG (VN)**
173/20/5A Tân Sơn Nhì, phường Tân Sơn Nhì, quận Tân Phú, thành phố Hồ Chí Minh
(72) Nguyễn Thanh Phong (VN)
(55)



1.1



1.2



1.3



1.4



1.5



1.6



1.7

CÔNG BÁO SỞ HỮU CÔNG NGHIỆP SỐ 430 TẬP A – QUYỀN 2 (01.2024)

- (11) **49155**
(21) 3-2023-01355 (28) 1
(54) **TẤM ỐP LÓT SÀN XE TAY GA** (51) **12-16**
(22) 20/06/2023 (43) 25/01/2024
(73) **NGUYỄN THANH PHONG (VN)**
173/20/5A Tân Sơn Nhì, phường Tân Sơn Nhì, quận Tân Phú, thành phố Hồ Chí Minh
(72) Nguyễn Thanh Phong (VN)
(55)



1.1



1.2



1.3



1.4



1.5



1.6



1.7

- (11) **49156**
(21) 3-2023-01356 (28) 1
(54) **TẤM ỐP LÓT SÀN XE TAY GA** (51) **12-16**
(22) 20/06/2023 (43) 25/01/2024
(73) **NGUYỄN THANH PHONG (VN)**
173/20/5A Tân Sơn Nhì, phường Tân Sơn Nhì, quận Tân Phú, thành phố Hồ Chí Minh
(72) Nguyễn Thanh Phong (VN)
(55)



1.1



1.2



1.3



1.4



1.5



1.6



1.7

CÔNG BÁO SỞ HỮU CÔNG NGHIỆP SỐ 430 TẬP A – QUYỀN 2 (01.2024)

- (11) **49157**
(21) 3-2023-01357 (28) 1
(54) **TẤM ỐP LÓT SÀN XE TAY GA** (51) **12-16**
(22) 20/06/2023 (43) 25/01/2024
(73) **NGUYỄN THANH PHONG (VN)**
173/20/5A Tân Sơn Nhì, phường Tân Sơn Nhì, quận Tân Phú, thành phố Hồ Chí Minh
(72) Nguyễn Thanh Phong (VN)
(55)



1.1



1.2



1.3



1.4



1.5



1.6



1.7

- (11) **49158**
- (21) 3-2023-01359
- (54) **LƯỢC CHẢI TÓC**
- (22) 20/06/2023
- (30) 2022-027695 23/12/2022 JP;
- (73) **MTG CO., LTD. (JP)**
2-32 Honjin-tori, Nakamura-ku, Nagoya-shi, Aichi 4530041, Japan
- (72) Kei ITO (JP)
- (74) **CÔNG TY LUẬT TRÁCH NHIỆM HỮU HẠN AMBYS HÀ NỘI (AMBYS HANOI)**
- (55)

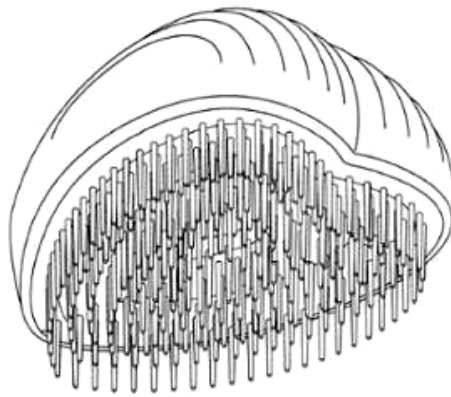

1.1

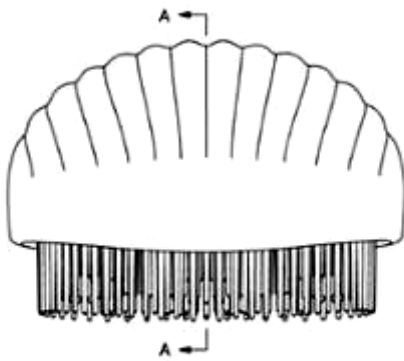

1.2

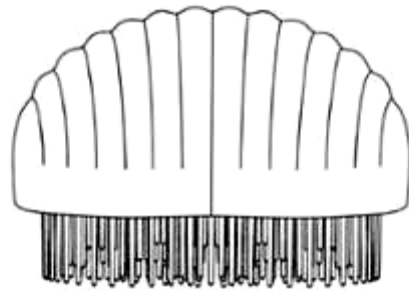

1.3

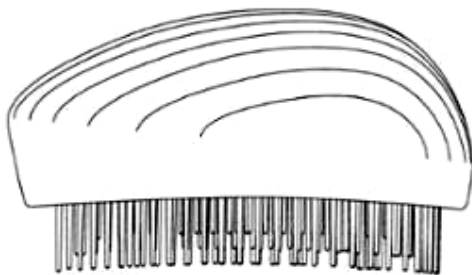

1.4

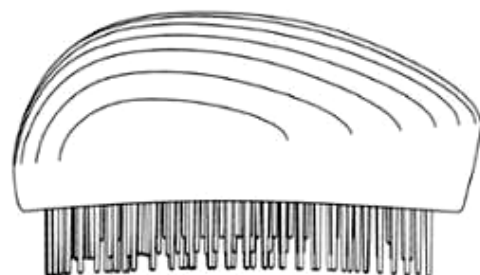

1.5

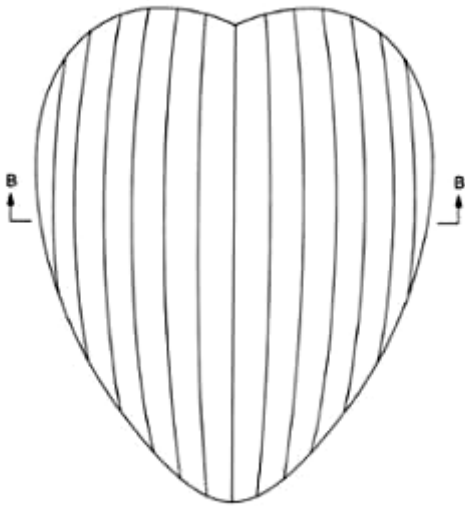

1.6

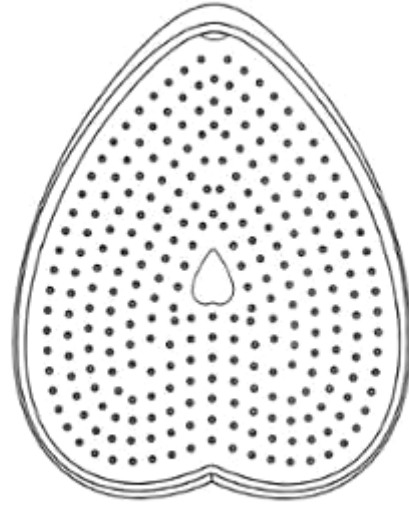

1.7

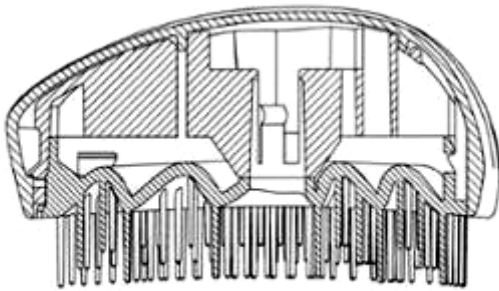

1.8

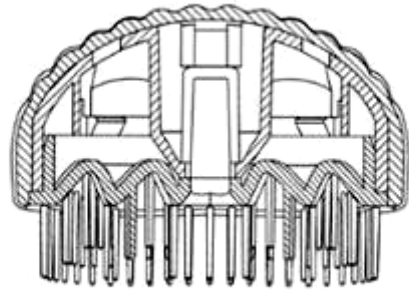

1.9

- (11) **49159**
(21) 3-2023-01360 (28) 1
(54) **LƯỢC CHẢI TÓC** (51) **28-03**
(22) 20/06/2023 (43) 25/01/2024
(30) 2022-027320 20/12/2022 JP;
(73) **MTG CO., LTD.** (JP)
2-32 Honjin-tori, Nakamura-ku, Nagoya-shi, Aichi 4530041, Japan
(72) Kei ITO (JP)
(74) **CÔNG TY LUẬT TRÁCH NHIỆM HỮU HẠN AMBYS HÀ NỘI (AMBYS HANOI)**
(55)



1.1

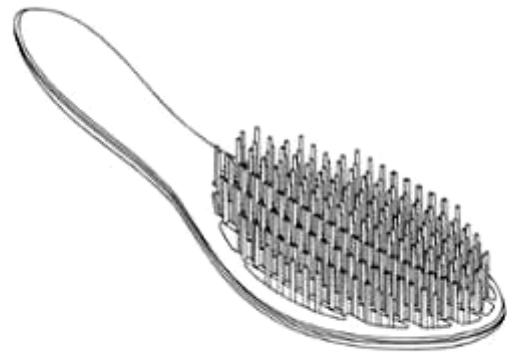

1.2

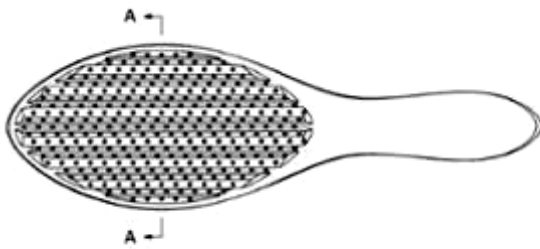

1.3



1.4

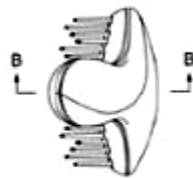

1.5



1.6



1.7



1.8

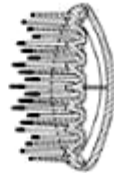

1.9

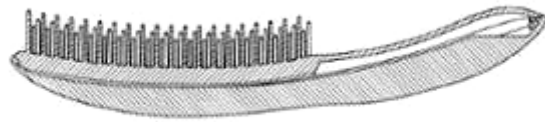

1.10

CÔNG BÁO SỞ HỮU CÔNG NGHIỆP SỐ 430 TẬP A – QUYỀN 2 (01.2024)

- (11) **49160**
(21) 3-2023-01371 (28) 1
(54) **GIƯỜNG** (51) **06-02**
(22) 21/06/2023 (43) 25/01/2024
(73) **CÔNG TY CỔ PHẦN CAO SU SÀI GÒN - KYMDAN (VN)**
28 Bình Thới, quận 11, thành phố Hồ Chí Minh
(72) Nguyễn Trí Tân (VN)
(74) Công ty TNHH Sở hữu trí tuệ Thảo Thọ Quyến (INVENCO.,LTD)
(55)



1.1



1.2



1.3



1.4



1.5

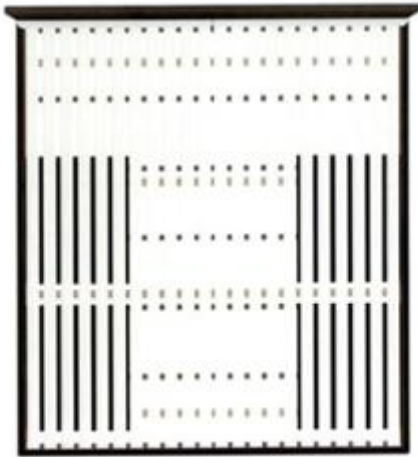

1.6

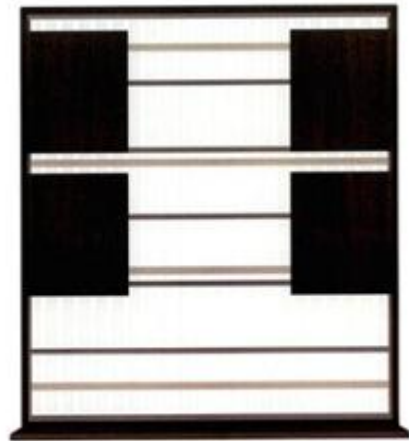

1.7

CÔNG BÁO SỞ HỮU CÔNG NGHIỆP SỐ 430 TẬP A – QUYỀN 2 (01.2024)

- (11) **49161**
(21) 3-2023-01411 (28) 1
(54) **BỘ ĐÈN PHÍA TRƯỚC CỦA Ô TÔ** (51) **26-06**
(22) 10/09/2020 (43) 25/01/2024
(30) 2020-004945 12/03/2020 JP;
(73) **TOYOTA JIDOSHA KABUSHIKI KAISHA (JP)**
1, Toyota-cho, Toyota-shi, Aichi-ken, 471-8571 JAPAN
(72) Shota ASANO (JP)
(74) Công ty TNHH một thành viên Sở hữu trí tuệ VCCI (VCCI-IP CO.,LTD)
(55)



1.1



1.2



1.3



1.4



1.5



1.6



1.7



1.8

CÔNG BÁO SỞ HỮU CÔNG NGHIỆP SỐ 430 TẬP A – QUYỀN 2 (01.2024)

- (11) **49162**
(21) 3-2023-01412 (28) 1
(54) **KÍNH MẮT** (51) **16-06**
(22) 23/06/2023 (43) 25/01/2024
(30) WIPO134606 22/06/2023 WO;
(73) **CHRISTIAN DIOR COUTURE (FR)**
30 Avenue Montaigne, 75008 Paris, France
(72) Mathieu JAMIN (FR)
(74) Công ty TNHH một thành viên Sở hữu trí tuệ VCCI (VCCI-IP CO.,LTD)
(55)



1.1



1.2



1.3



1.4



1.5



1.6



1.7

CÔNG BÁO SỞ HỮU CÔNG NGHIỆP SỐ 430 TẬP A – QUYỀN 2 (01.2024)

- (11) **49163**
(21) 3-2023-01413 (28) 1
(54) **MÁY ĐIỀU HÒA NHIỆT ĐỘ** (51) **23-04**
(22) 23/06/2023 (43) 25/01/2024
(30) 2023-001030 24/01/2023 JP;
(73) **DAIKIN INDUSTRIES, LTD. (JP)**
Osaka Umeda Twin Towers South, 1-13-1, Umeda, Kita-ku, Osaka-Shi, Osaka,
Japan
(72) Ryoichi NAKAGAWA (JP)
(74) Công ty TNHH một thành viên Sở hữu trí tuệ VCCI (VCCI-IP CO.,LTD)
(55)

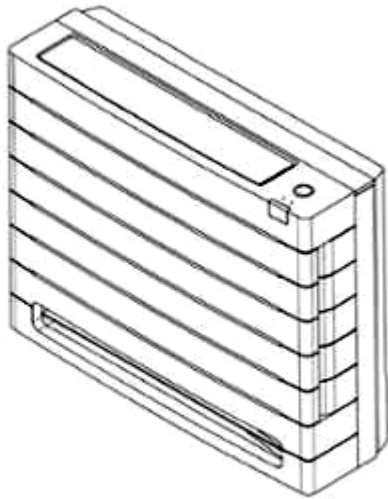

1.1

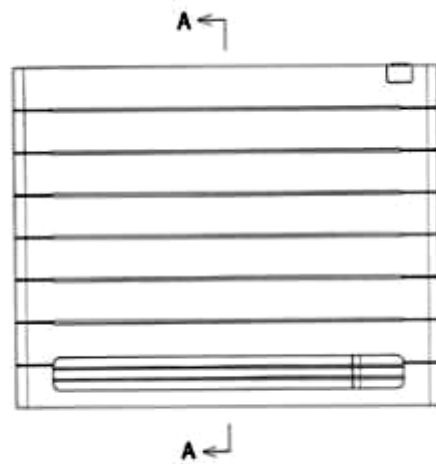

1.2



1.3

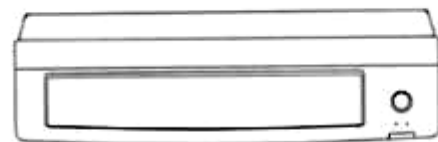

1.4



1.5



1.6

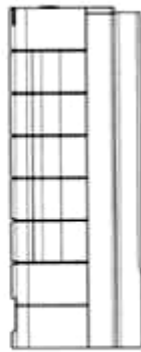

1.7

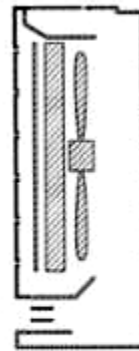

1.8

CÔNG BÁO SỞ HỮU CÔNG NGHIỆP SỐ 430 TẬP A – QUYỀN 2 (01.2024)

- (11) **49164**
(21) 3-2023-01440 (28) 1
(54) **THIẾT BỊ AN TOÀN ĐIỆN** (51) **13-03**
(22) 27/06/2023 (43) 25/01/2024
(73) **CÔNG TY CỔ PHẦN TẬP ĐOÀN TNT VINA (VN)**
Số 88 Phố Me, thị trấn Hợp Hòa, huyện Tam Dương, tỉnh Vĩnh Phúc
(72) **Kiều Văn Tuấn (VN)**
(74) Công ty TNHH Tư vấn IPNG (IPNG CO.,LTD)
(55)



1.1



1.2

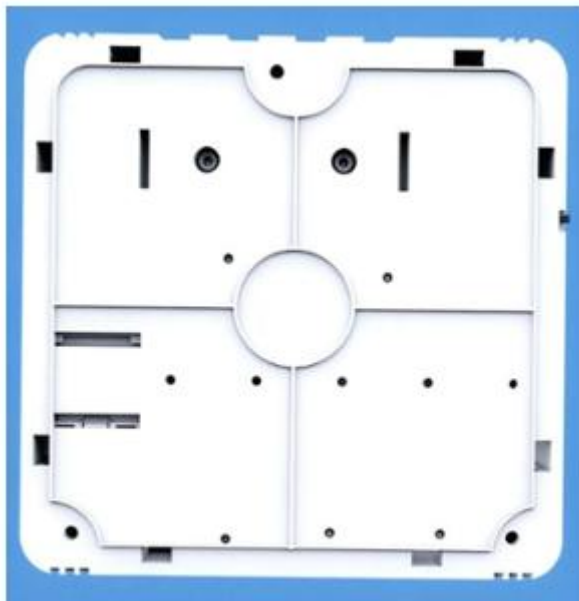

1.3



1.4



1.5

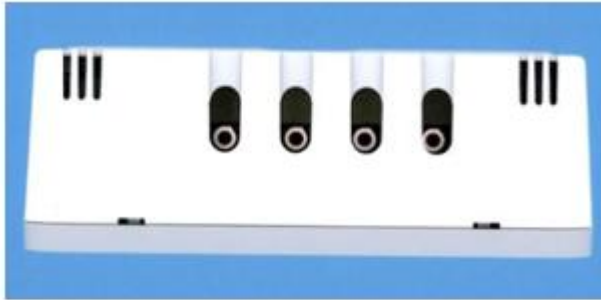

1.6



1.7

CÔNG BÁO SỞ HỮU CÔNG NGHIỆP SỐ 430 TẬP A – QUYỀN 2 (01.2024)

- (11) **49165**
(21) 3-2023-01510 (28) 1
(54) **CAN ĐỰNG SẢN PHẨM** (51) **09-02**
(22) 05/07/2023 (43) 25/01/2024
(73) **CÔNG TY TNHH XNK NANOIL USA (VN)**
Lô Q13 đường số 11, KCN Hải Sơn mở rộng (GD 3+4), xã Đức Hòa Hạ, huyện Đức
Hoà, tỉnh Long An
(72) Mai Xuân Quang (VN)
(55)



1.1



1.2



1.3



1.4



1.5

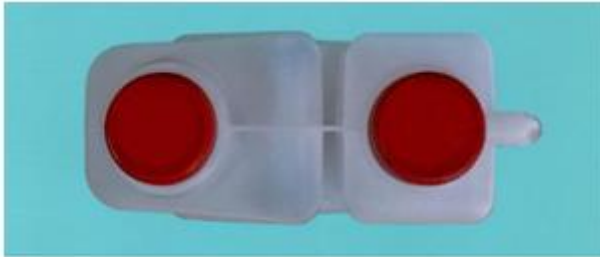

1.6



1.7

CÔNG BÁO SỞ HỮU CÔNG NGHIỆP SỐ 430 TẬP A – QUYỀN 2 (01.2024)

- (11) **49166**
(21) 3-2023-01514 (28) 1
(54) **MÁY LỌC KHÔNG KHÍ** (51) **23-04**
(22) 06/07/2023 (43) 25/01/2024
(30) 2023-000838 20/01/2023 JP;
(73) **SHARP KABUSHIKI KAISHA (JP)**
1 Takumi-cho, Sakai-ku, Sakai City, Osaka 590-8522, Japan
(72) 1. NORIYUKI TAKAHASHI (JP)
2. TATSUHIKO KUWASHIMA (JP)
3. AKIRA HARANAKA (JP)
(74) Công ty TNHH một thành viên Sở hữu trí tuệ VCCI (VCCI-IP CO.,LTD)
(55)



1.1



1.2



1.3



1.4



1.5



1.6



1.7

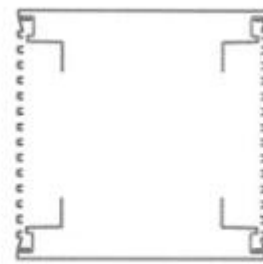

1.8

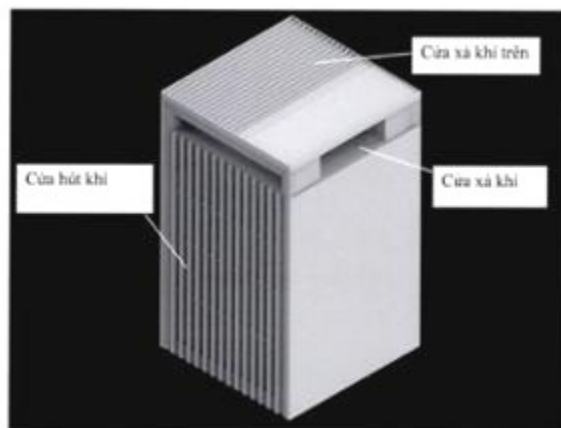

1.9

CÔNG BÁO SỞ HỮU CÔNG NGHIỆP SỐ 430 TẬP A – QUYỀN 2 (01.2024)

- (11) **49167**
(21) 3-2023-01515 (28) 1
(54) **BỘ ĐÈN PHÍA TRƯỚC CỦA Ô TÔ** (51) **26-06**
(22) 18/06/2020 (43) 25/01/2024
(30) 2019-028432 20/12/2019 JP;
(73) **TOYOTA JIDOSHA KABUSHIKI KAISHA (JP)**
1, Toyota-cho, Toyota-shi, Aichi-ken, 471-8571 JAPAN
(72) 1. CHUNG-KAI LIAO (TW)
2. TIEN-TZU LIN (TW)
(74) Công ty TNHH một thành viên Sở hữu trí tuệ VCCI (VCCI-IP CO.,LTD)
(55)



1.1



1.2



1.3



1.4



1.5



1.6



1.7

CÔNG BÁO SỞ HỮU CÔNG NGHIỆP SỐ 430 TẬP A – QUYỀN 2 (01.2024)

- (11) **49168**
(21) 3-2023-01544 (28) 1
(54) **CỘT BÊ TÔNG ĐÚC SẴN LẮP GHÉP** (51) **25-02**
(22) 10/07/2023 (43) 25/01/2024
(73) **NGUYỄN XUÂN THỦY (VN)**
Tổ 3, khu 10, phường Bãi Cháy, thành phố Hạ Long, tỉnh Quảng Ninh
(72) Nguyễn Xuân Thủy (VN)
(55)

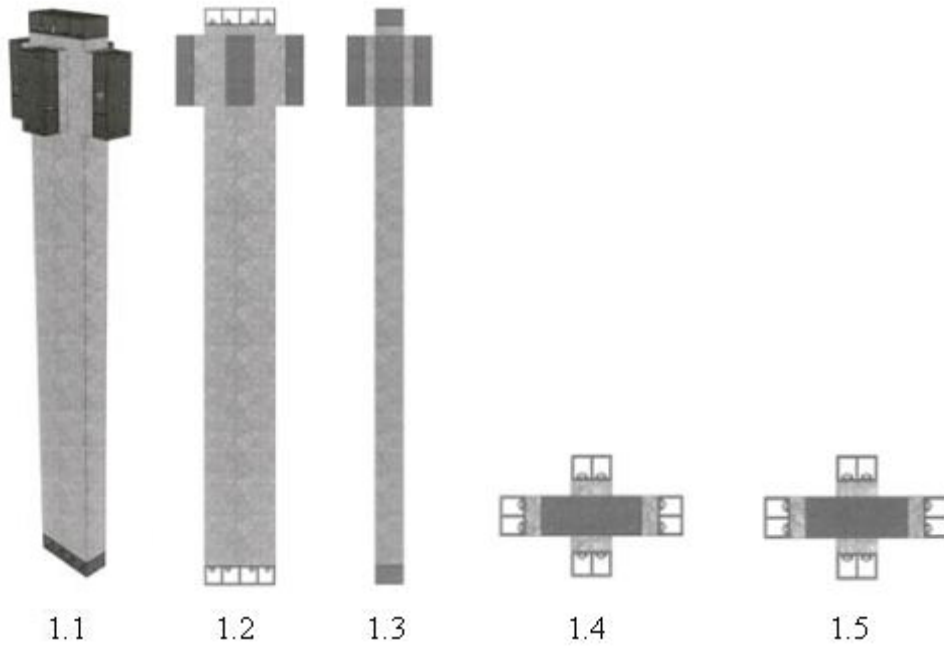

- (11) **49169**
(21) 3-2023-01549 (28) 1
(54) **TẮM ỐP ĐẦU XE MÁY** (51) **12-16**
(22) 10/07/2023 (43) 25/01/2024
(30) 2023-000512 13/01/2023 JP;
(73) **HONDA MOTOR CO., LTD. (JP)**
1-1, Minami-Aoyama 2-Chome, Minato-ku, Tokyo, 107-8556 Japan
(72) 1. YASUSHI TATEISHI (JP)
2. HIROSHI NITTA (JP)
(74) Công ty Luật TNHH Phạm và Liên danh (PHAM & ASSOCIATES)
(55)



1.1



1.2



1.3



1.4



1.5



1.6



1.7



1.8



1.9

CÔNG BÁO SỞ HỮU CÔNG NGHIỆP SỐ 430 TẬP A – QUYỀN 2 (01.2024)

- (11) **49170**
(21) 3-2023-01657 (28) 1
(54) **MÁY IN NHÃN** (51) **18-02**
(22) 20/07/2023 (43) 25/01/2024
(30) 2023300568255 17/02/2023 CN;
(73) **WUHAN JINGCHEN INTELLIGENT IDENTIFICATION TECHNOLOGY CO.,LTD (CN)**
1st Floor, No. 5, Creative Workshop, Phase III, Wuhan Creative World, Hongshan District, Wuhan City, Hubei Province 430070, China
(72) 1. XIONG LIU (CN)
2. MINGMENG LI (CN)
(74) Công ty TNHH Sáng chế ACTIP (ACTIP PATENT LIMITED)
(55)

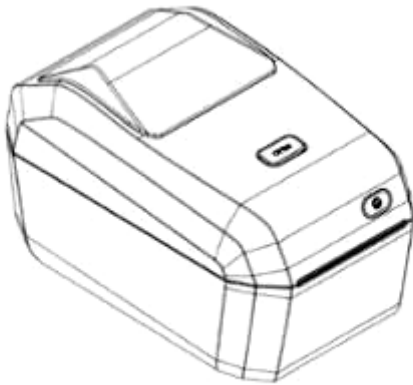

1.1



1.2



1.3



1.4



1.5

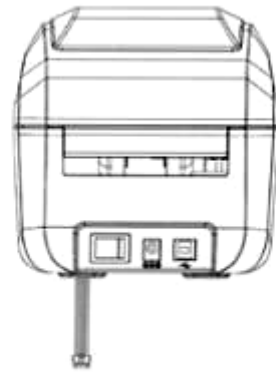

1.6

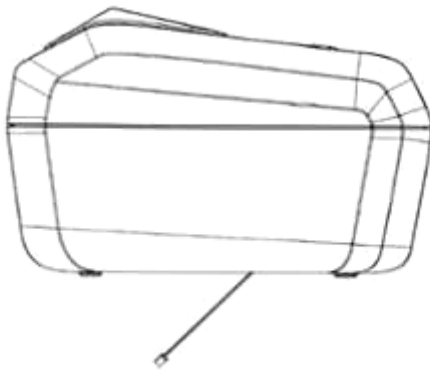

1.7

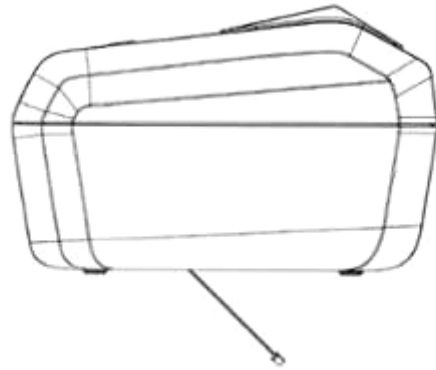

1.8

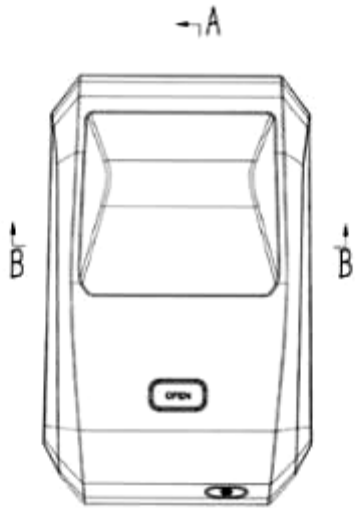

1.9

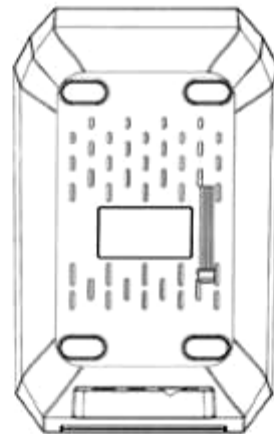

1.10

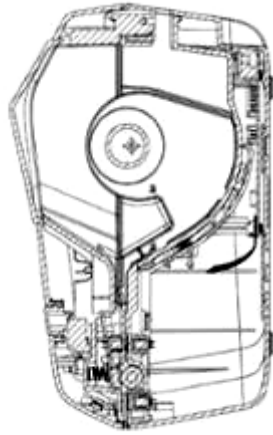

1.11

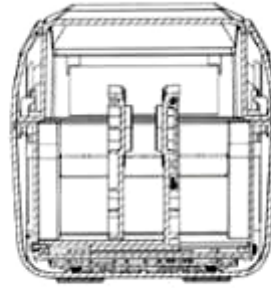

1.12

- (11) **49171**
(21) 3-2023-01696 (28) 1
(54) **LƯỢC CHẢI TÓC** (51) **28-03**
(22) 27/07/2023 (43) 25/01/2024
(30) 2023-001656 31/01/2023 JP;
(73) **MTG CO., LTD. (JP)**
2-32 Honjin-tori, Nakamura-ku, Nagoya-shi, Aichi 4530041, Japan
(72) Kei ITO (JP)
(74) **CÔNG TY LUẬT TRÁCH NHIỆM HỮU HẠN AMBYS HÀ NỘI (AMBYS HANOI)**
(55)

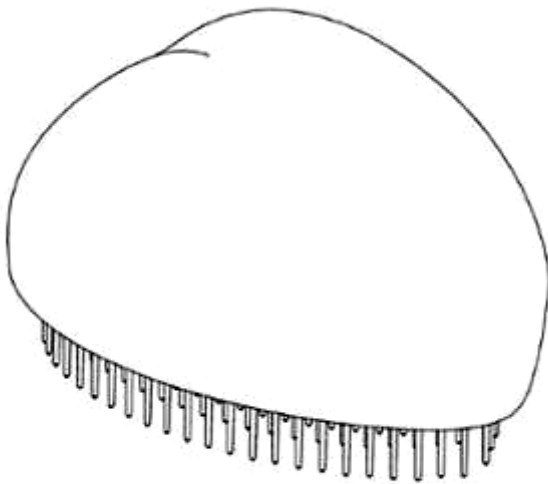

1.1

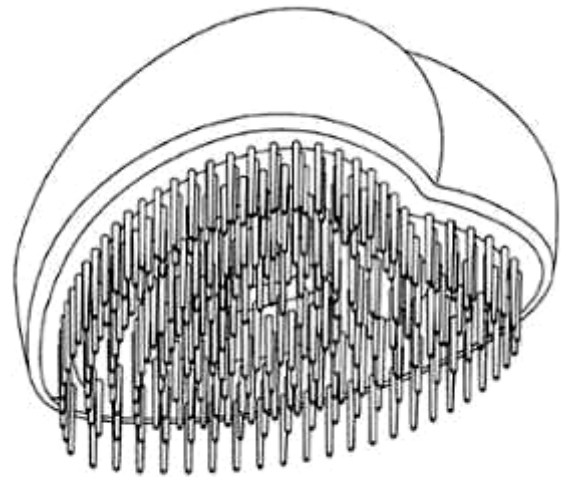

1.2

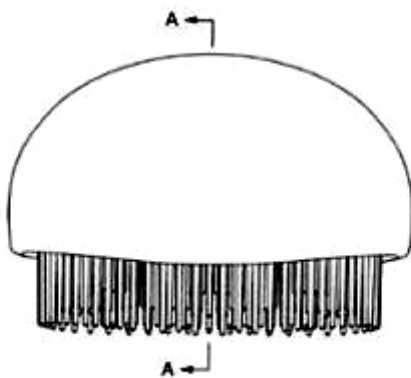

1.3

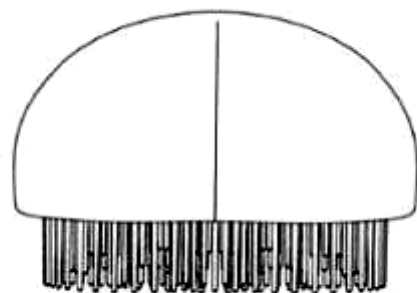

1.4

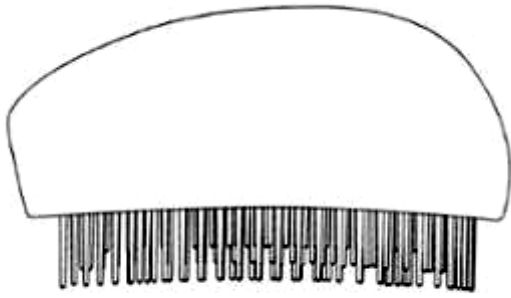

1.5

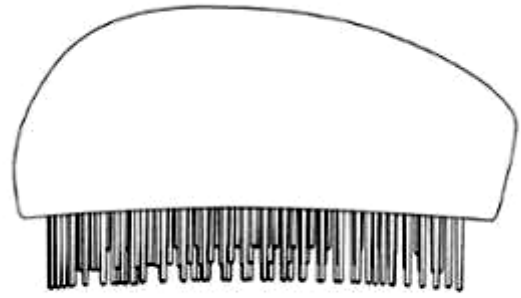

1.6

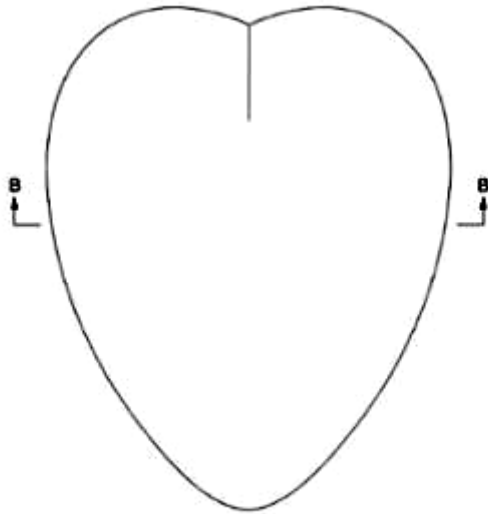

1.7

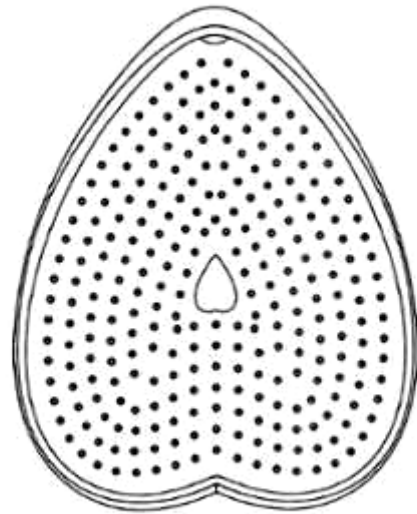

1.8

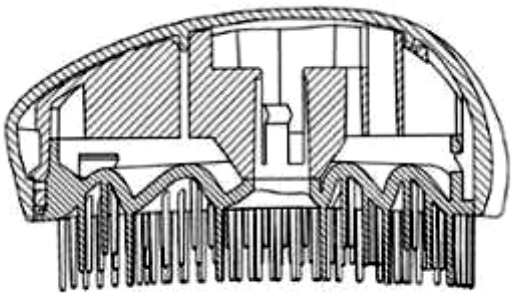

1.9

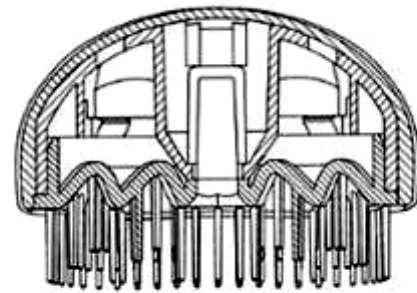

1.10

CÔNG BÁO SỞ HỮU CÔNG NGHIỆP SỐ 430 TẬP A – QUYỀN 2 (01.2024)

- (11) **49172**
(21) 3-2023-01698 (28) 1
(54) **THANH NHÔM ĐỊNH HÌNH** (51) **25-01**
(22) 27/07/2023 (43) 25/01/2024
(73) **CÔNG TY TNHH CÔNG NGHỆ AKCOME VIỆT NAM (VN)**
I2.09 Toà nhà Golden King số 15 Nguyễn Lương Bằng, phường Tân Phú, quận 7,
thành phố Hồ Chí Minh
(72) ZHOU, YUFENG (CN)
(55)

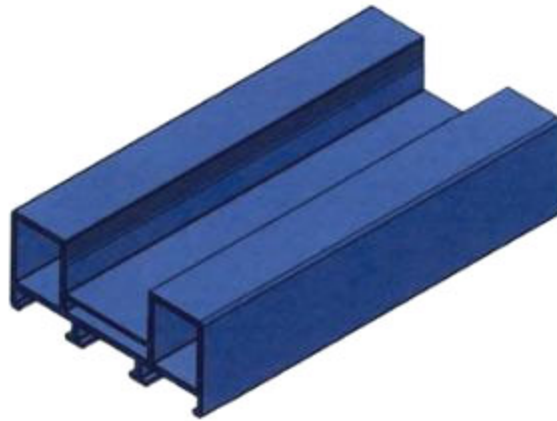

1.1



1.2

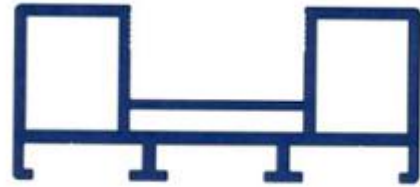

1.3



1.4



1.5



1.6



1.7

CÔNG BÁO SỞ HỮU CÔNG NGHIỆP SỐ 430 TẬP A – QUYỀN 2 (01.2024)

- (11) **49173**
(21) 3-2023-01699 (28) 1
(54) **THANH NHÔM ĐỊNH HÌNH** (51) **25-01**
(22) 27/07/2023 (43) 25/01/2024
(73) **CÔNG TY TNHH CÔNG NGHỆ AKCOME VIỆT NAM (VN)**
I2.09 Toà nhà Golden King số 15 Nguyễn Lương Bằng, phường Tân Phú, quận 7,
thành phố Hồ Chí Minh
(72) ZHOU, YUFENG (CN)
(55)



1.1

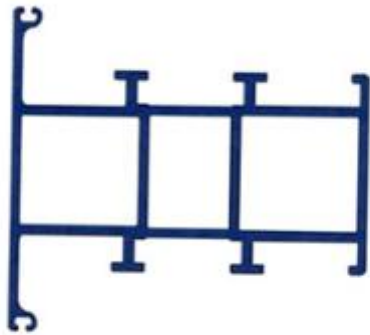

1.2

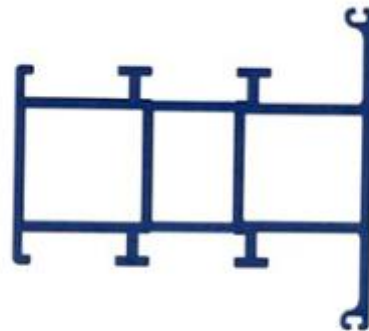

1.3



1.4



1.5



1.6



1.7

CÔNG BÁO SỞ HỮU CÔNG NGHIỆP SỐ 430 TẬP A – QUYỀN 2 (01.2024)

- (11) **49174**
(21) 3-2023-01700 (28) 1
(54) **THANH NHÔM ĐỊNH HÌNH** (51) **25-01**
(22) 27/07/2023 (43) 25/01/2024
(73) **CÔNG TY TNHH CÔNG NGHỆ AKCOME VIỆT NAM (VN)**
I2.09 Toà nhà Golden King số 15 Nguyễn Lương Bằng, phường Tân Phú, quận 7,
thành phố Hồ Chí Minh
(72) ZHOU, YUFENG (CN)
(55)

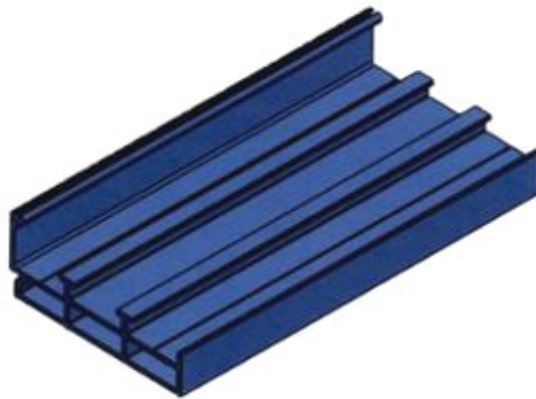

1.1



1.2



1.3



1.4



1.5

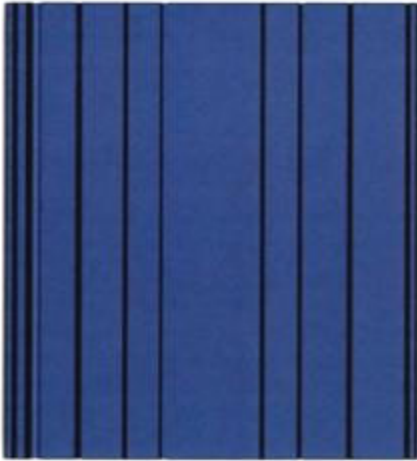

1.6



1.7

CÔNG BÁO SỞ HỮU CÔNG NGHIỆP SỐ 430 TẬP A – QUYỀN 2 (01.2024)

- (11) **49175**
(21) 3-2023-01701 (28) 1
(54) **THANH NHÔM ĐỊNH HÌNH** (51) **25-01**
(22) 27/07/2023 (43) 25/01/2024
(73) **CÔNG TY TNHH CÔNG NGHỆ AKCOME VIỆT NAM (VN)**
I2.09 Toà nhà Golden King số 15 Nguyễn Lương Bằng, phường Tân Phú, quận 7,
thành phố Hồ Chí Minh
(72) ZHOU, YUFENG (CN)
(55)

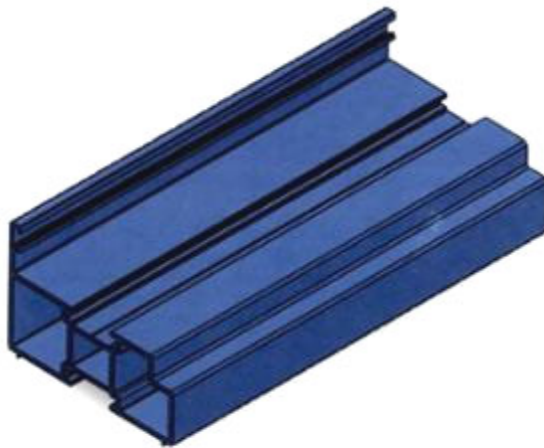

1.1

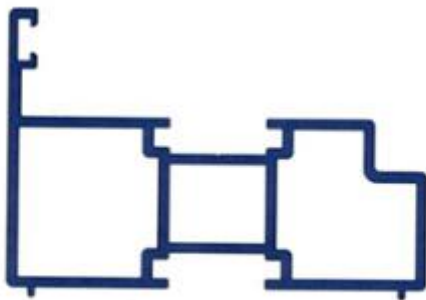

1.2

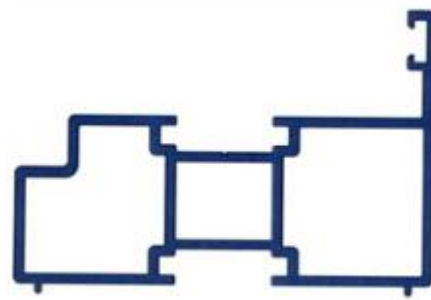

1.3

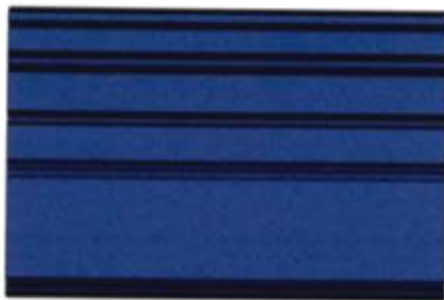

1.4



1.5



1.6



1.7

CÔNG BÁO SỞ HỮU CÔNG NGHIỆP SỐ 430 TẬP A – QUYỀN 2 (01.2024)

- (11) **49176**
(21) 3-2023-01703 (28) 1
(54) **THANH NHÔM ĐỊNH HÌNH** (51) **25-01**
(22) 27/07/2023 (43) 25/01/2024
(73) **CÔNG TY TNHH CÔNG NGHỆ AKCOME VIỆT NAM (VN)**
I2.09 Toà nhà Golden King số 15 Nguyễn Lương Bằng, phường Tân Phú, quận 7,
thành phố Hồ Chí Minh
(72) ZHOU, YUFENG (CN)
(55)

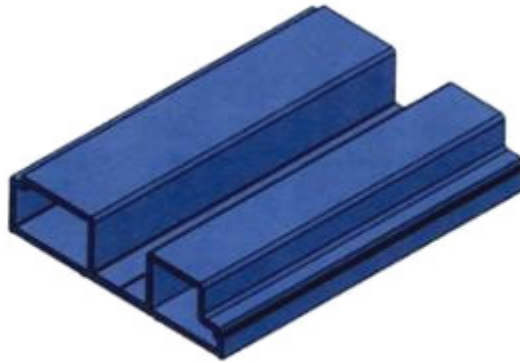

1.1



1.2



1.3



1.4



1.5



1.6



1.7

CÔNG BÁO SỞ HỮU CÔNG NGHIỆP SỐ 430 TẬP A – QUYỀN 2 (01.2024)

- (11) **49177**
(21) 3-2023-01704 (28) 1
(54) **THANH NHÔM ĐỊNH HÌNH** (51) **25-01**
(22) 27/07/2023 (43) 25/01/2024
(73) **CÔNG TY TNHH CÔNG NGHỆ AKCOME VIỆT NAM (VN)**
I2.09 Toà nhà Golden King số 15 Nguyễn Lương Bằng, phường Tân Phú, quận 7,
thành phố Hồ Chí Minh
(72) ZHOU, YUFENG (CN)
(55)



1.1



1.2



1.3



1.4



1.5



1.6

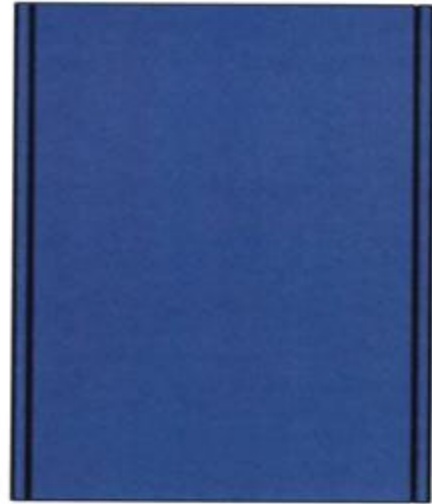

1.7

CÔNG BÁO SỞ HỮU CÔNG NGHIỆP SỐ 430 TẬP A – QUYỀN 2 (01.2024)

- (11) **49178**
(21) 3-2023-01705 (28) 1
(54) **THANH NHÔM ĐỊNH HÌNH** (51) **25-01**
(22) 27/07/2023 (43) 25/01/2024
(73) **CÔNG TY TNHH CÔNG NGHỆ AKCOME VIỆT NAM (VN)**
I2.09 Toà nhà Golden King số 15 Nguyễn Lương Bằng, phường Tân Phú, quận 7,
thành phố Hồ Chí Minh
(72) ZHOU, YUFENG (CN)
(55)

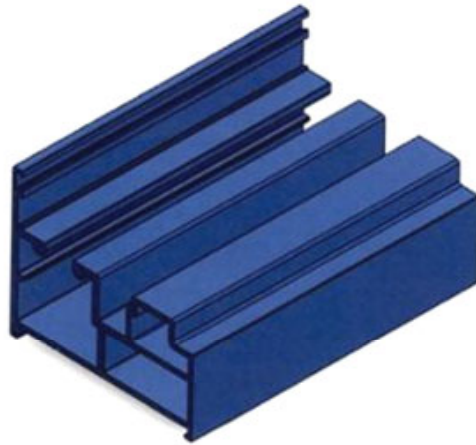

1.1

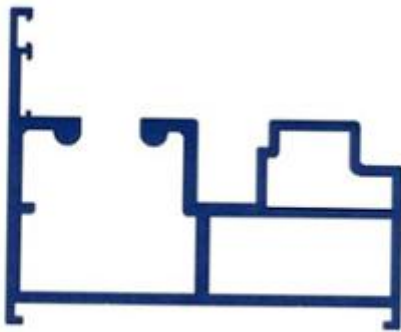

1.2

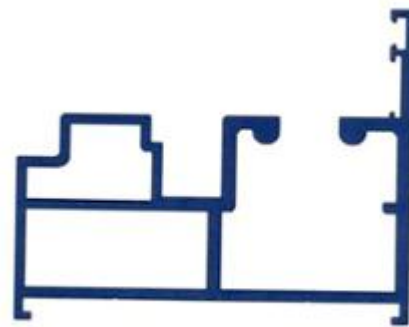

1.3



1.4



1.5

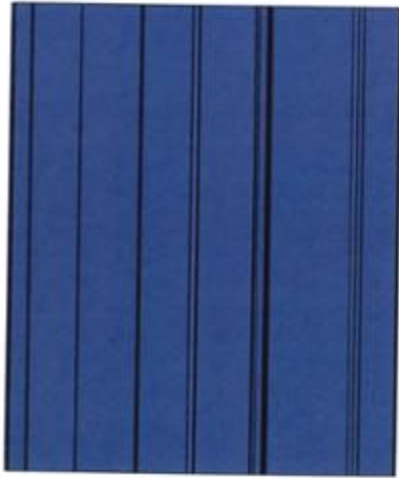

1.6



1.7

CÔNG BÁO SỞ HỮU CÔNG NGHIỆP SỐ 430 TẬP A – QUYỀN 2 (01.2024)

- (11) **49179**
(21) 3-2023-01706 (28) 1
(54) **THANH NHÔM ĐỊNH HÌNH** (51) **25-01**
(22) 27/07/2023 (43) 25/01/2024
(73) **CÔNG TY TNHH CÔNG NGHỆ AKCOME VIỆT NAM (VN)**
I2.09 Toà nhà Golden King số 15 Nguyễn Lương Bằng, phường Tân Phú, quận 7,
thành phố Hồ Chí Minh
(72) ZHOU, YUFENG (CN)
(55)



1.1

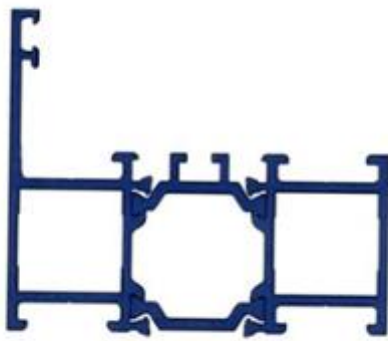

1.2

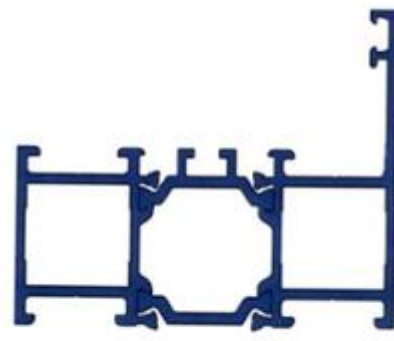

1.3



1.4



1.5



1.6



1.7

CÔNG BÁO SỞ HỮU CÔNG NGHIỆP SỐ 430 TẬP A – QUYỀN 2 (01.2024)

- (11) **49180**
(21) 3-2023-01707 (28) 1
(54) **THANH NHÔM ĐỊNH HÌNH** (51) **25-01**
(22) 27/07/2023 (43) 25/01/2024
(73) **CÔNG TY TNHH CÔNG NGHỆ AKCOME VIỆT NAM (VN)**
I2.09 Toà nhà Golden King số 15 Nguyễn Lương Bằng, phường Tân Phú, quận 7,
thành phố Hồ Chí Minh
(72) ZHOU, YUFENG (CN)
(55)

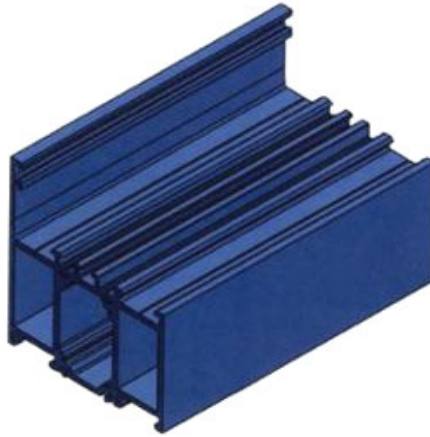

1.1

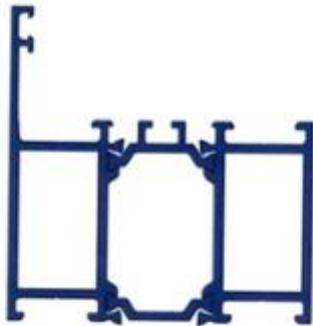

1.2

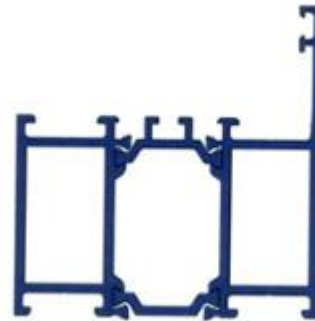

1.3



1.4



1.5



1.6



1.7

CÔNG BÁO SỞ HỮU CÔNG NGHIỆP SỐ 430 TẬP A – QUYỀN 2 (01.2024)

- (11) **49181**
(21) 3-2023-01708 (28) 1
(54) **THANH NHÔM ĐỊNH HÌNH** (51) **25-01**
(22) 27/07/2023 (43) 25/01/2024
(73) **CÔNG TY TNHH CÔNG NGHỆ AKCOME VIỆT NAM (VN)**
I2.09 Toà nhà Golden King số 15 Nguyễn Lương Bằng, phường Tân Phú, quận 7,
thành phố Hồ Chí Minh
(72) ZHOU, YUFENG (CN)
(55)



1.1



1.2



1.3



1.4



1.5



1.6



1.7

CÔNG BÁO SỞ HỮU CÔNG NGHIỆP SỐ 430 TẬP A – QUYỀN 2 (01.2024)

- (11) **49182**
(21) 3-2023-01709 (28) 1
(54) **THANH NHÔM ĐỊNH HÌNH** (51) **25-01**
(22) 27/07/2023 (43) 25/01/2024
(73) **CÔNG TY TNHH CÔNG NGHỆ AKCOME VIỆT NAM (VN)**
I2.09 Toà nhà Golden King số 15 Nguyễn Lương Bằng, phường Tân Phú, quận 7,
thành phố Hồ Chí Minh
(72) ZHOU, YUFENG (CN)
(55)



1.1

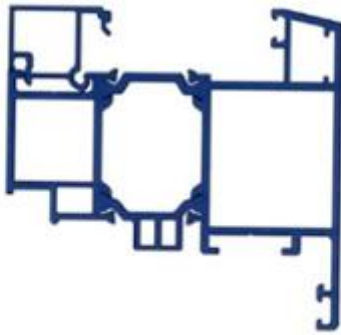

1.2

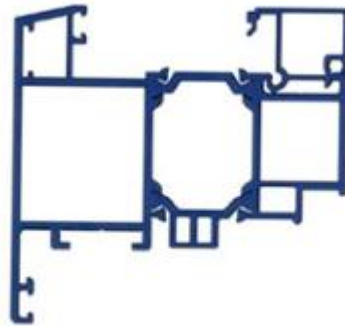

1.3



1.4



1.5



1.6



1.7

CÔNG BÁO SỞ HỮU CÔNG NGHIỆP SỐ 430 TẬP A – QUYỀN 2 (01.2024)

- (11) **49183**
(21) 3-2023-01710 (28) 1
(54) **THANH NHÔM ĐỊNH HÌNH** (51) **25-01**
(22) 27/07/2023 (43) 25/01/2024
(73) **CÔNG TY TNHH CÔNG NGHỆ AKCOME VIỆT NAM (VN)**
I2.09 Toà nhà Golden King số 15 Nguyễn Lương Bằng, phường Tân Phú, quận 7,
thành phố Hồ Chí Minh
(72) ZHOU, YUFENG (CN)
(55)

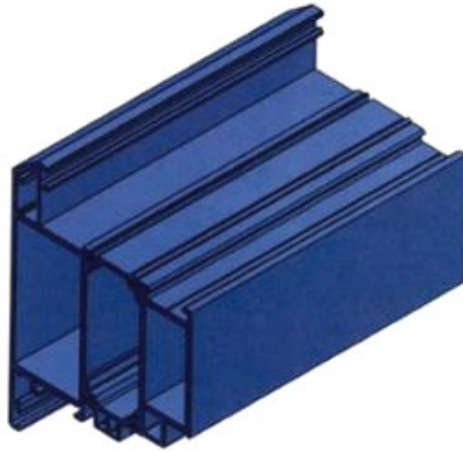

1.1

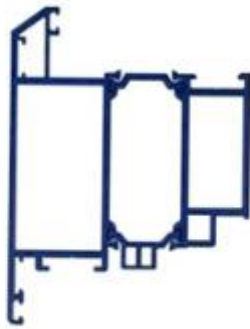

1.2

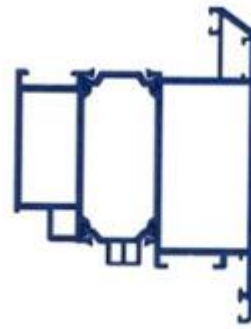

1.3



1.4



1.5



1.6



1.7

CÔNG BÁO SỞ HỮU CÔNG NGHIỆP SỐ 430 TẬP A – QUYỀN 2 (01.2024)

- (11) **49184**
(21) 3-2023-01712 (28) 1
(54) **THANH NHÔM ĐỊNH HÌNH** (51) **25-01**
(22) 27/07/2023 (43) 25/01/2024
(73) **CÔNG TY TNHH CÔNG NGHỆ AKCOME VIỆT NAM (VN)**
I2.09 Toà nhà Golden King số 15 Nguyễn Lương Bằng, phường Tân Phú, quận 7,
thành phố Hồ Chí Minh
(72) ZHOU, YUFENG (CN)
(55)



1.1

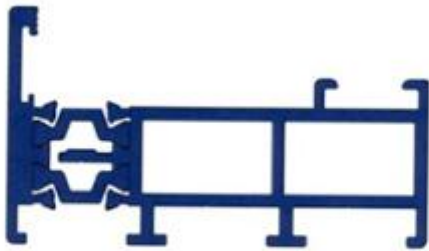

1.2

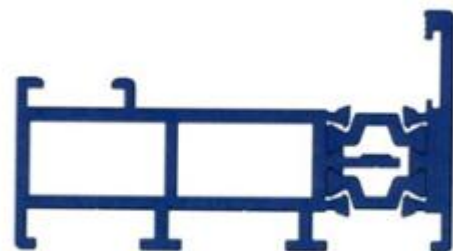

1.3



1.4



1.5

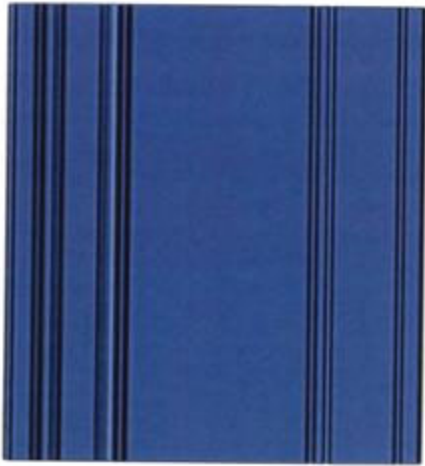

1.6



1.7

CÔNG BÁO SỞ HỮU CÔNG NGHIỆP SỐ 430 TẬP A – QUYỀN 2 (01.2024)

- (11) **49185**
(21) 3-2023-01713 (28) 1
(54) **THANH NHÔM ĐỊNH HÌNH** (51) **25-01**
(22) 27/07/2023 (43) 25/01/2024
(73) **CÔNG TY TNHH CÔNG NGHỆ AKCOME VIỆT NAM (VN)**
I2.09 Toà nhà Golden King số 15 Nguyễn Lương Bằng, phường Tân Phú, quận 7,
thành phố Hồ Chí Minh
(72) ZHOU, YUFENG (CN)
(55)

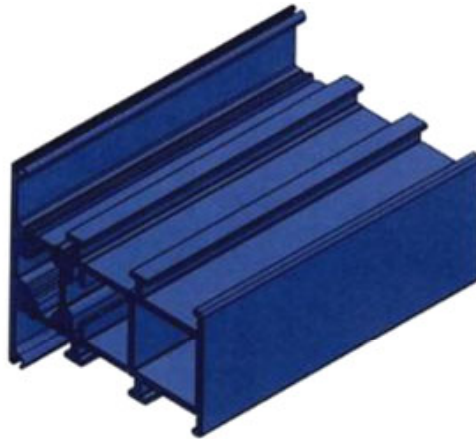

1.1

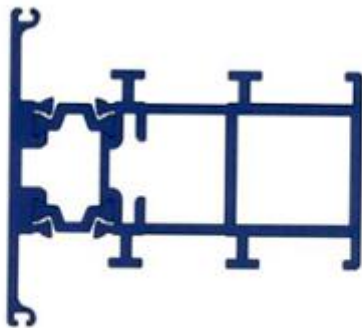

1.2

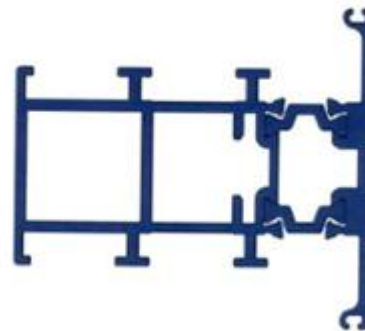

1.3



1.4



1.5



1.6



1.7

CÔNG BÁO SỞ HỮU CÔNG NGHIỆP SỐ 430 TẬP A – QUYỀN 2 (01.2024)

- (11) **49186**
(21) 3-2023-01714 (28) 1
(54) **THANH NHÔM ĐỊNH HÌNH** (51) **25-01**
(22) 27/07/2023 (43) 25/01/2024
(73) **CÔNG TY TNHH CÔNG NGHỆ AKCOME VIỆT NAM (VN)**
I2.09 Toà nhà Golden King số 15 Nguyễn Lương Bằng, phường Tân Phú, quận 7,
thành phố Hồ Chí Minh
(72) ZHOU, YUFENG (CN)
(55)

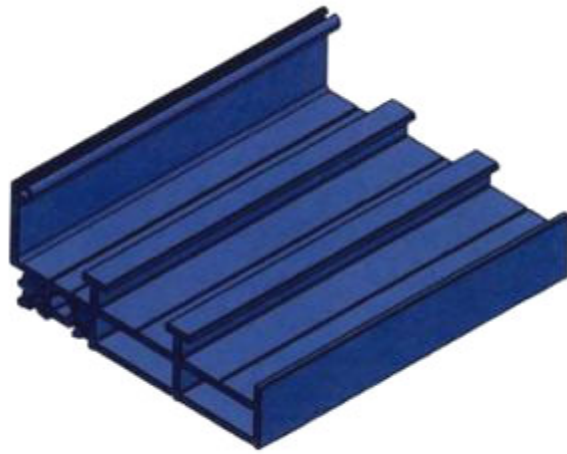

1.1



1.2



1.3



1.4



1.5



1.6



1.7

CÔNG BÁO SỞ HỮU CÔNG NGHIỆP SỐ 430 TẬP A – QUYỀN 2 (01.2024)

- (11) **49187**
(21) 3-2023-01715 (28) 1
(54) **THANH NHÔM ĐỊNH HÌNH** (51) **25-01**
(22) 27/07/2023 (43) 25/01/2024
(73) **CÔNG TY TNHH CÔNG NGHỆ AKCOME VIỆT NAM (VN)**
I2.09 Toà nhà Golden King số 15 Nguyễn Lương Bằng, phường Tân Phú, quận 7,
thành phố Hồ Chí Minh
(72) ZHOU, YUFENG (CN)
(55)



1.1



1.2



1.3



1.4



1.5



1.6



1.7

CÔNG BÁO SỞ HỮU CÔNG NGHIỆP SỐ 430 TẬP A – QUYỀN 2 (01.2024)

- (11) **49188**
(21) 3-2023-01716 (28) 1
(54) **THANH NHÔM ĐỊNH HÌNH** (51) **25-01**
(22) 27/07/2023 (43) 25/01/2024
(73) **CÔNG TY TNHH CÔNG NGHỆ AKCOME VIỆT NAM (VN)**
I2.09 Toà nhà Golden King số 15 Nguyễn Lương Bằng, phường Tân Phú, quận 7,
thành phố Hồ Chí Minh
(72) ZHOU, YUFENG (CN)
(55)

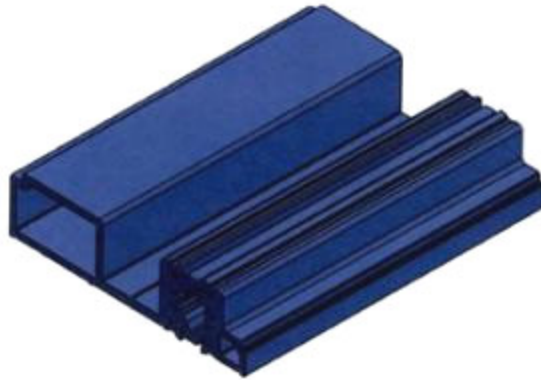

1.1



1.2



1.3



1.4



1.5



1.6



1.7

- (11) **49189**
(21) 3-2023-01719 (28) 1
(54) **THANH NHÔM ĐỊNH HÌNH** (51) **25-01**
(22) 27/07/2023 (43) 25/01/2024
(73) **CÔNG TY TNHH CÔNG NGHỆ AKCOME VIỆT NAM (VN)**
I2.09 Toà nhà Golden King số 15 Nguyễn Lương Bằng, phường Tân Phú, quận 7,
thành phố Hồ Chí Minh
(72) ZHOU, YUFENG (CN)
(55)

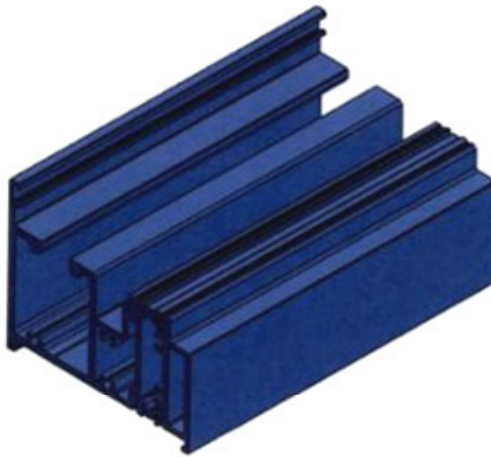

1.1



1.2

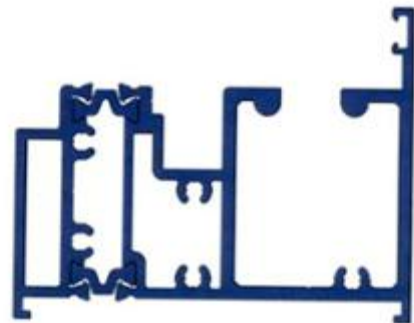

1.3



1.4



1.5

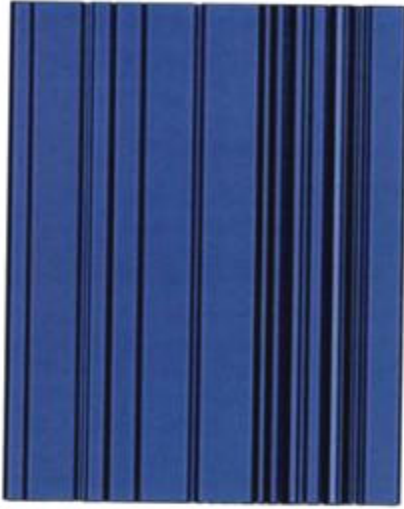

1.6



1.7

CÔNG BÁO SỞ HỮU CÔNG NGHIỆP SỐ 430 TẬP A – QUYỀN 2 (01.2024)

- (11) **49190**
(21) 3-2023-01749 (28) 1
(54) **THANH KIM LOẠI ĐỊNH HÌNH** (51) **25-01**
(22) 01/08/2023 (43) 25/01/2024
(73) **CÔNG TY CỔ PHẦN SẢN XUẤT VÀ ĐẦU TƯ HƯNG PHÁT (VN)**
Tổ dân phố Thịnh Vạn, phường Minh Đức, thị xã Mỹ Hào, tỉnh Hưng Yên
(72) Nguyễn Văn Tâm (VN)
(74) Công ty TNHH Sở hữu trí tuệ Gia Việt (GIAVIET CO., LTD.)
(55)

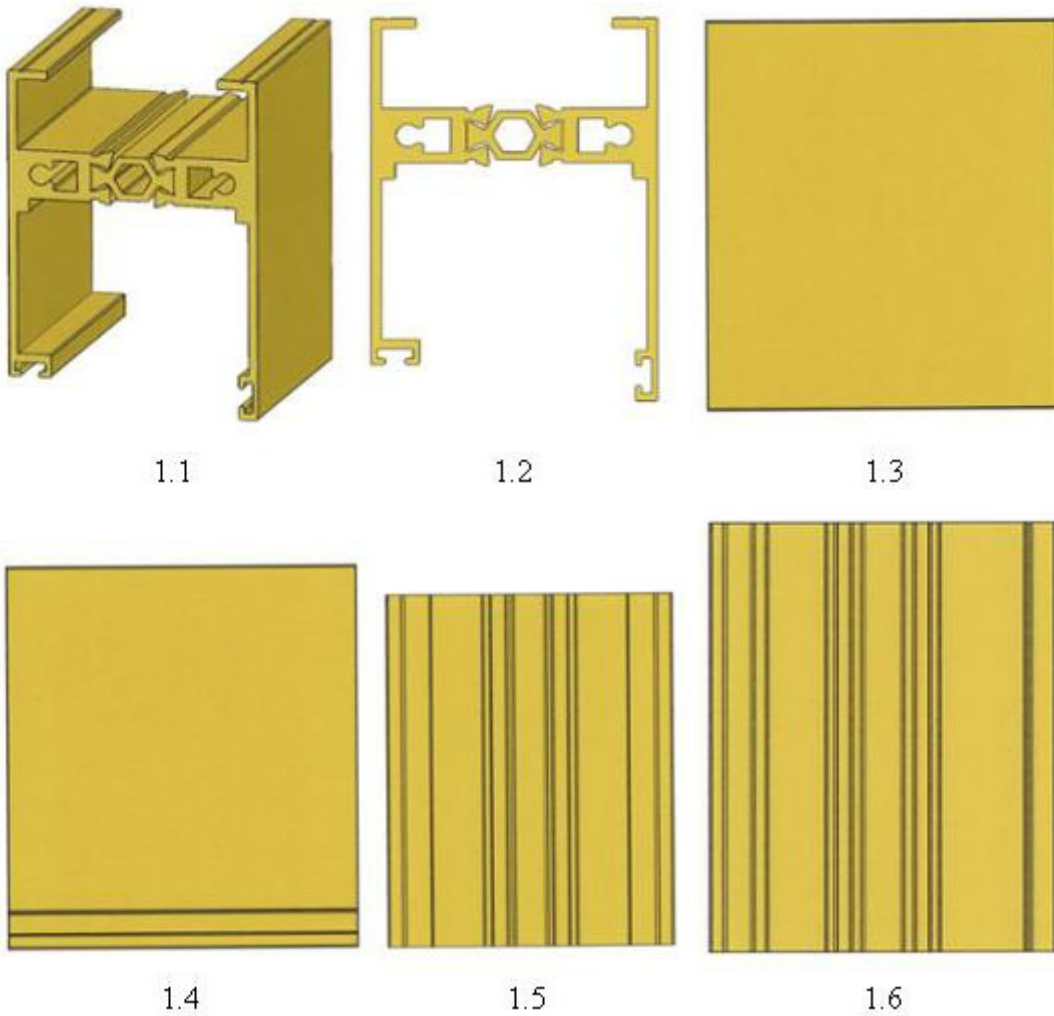

- (11) **49191**
(21) 3-2023-01753 (28) 1
(54) **THANH KIM LOẠI ĐỊNH HÌNH** (51) **25-01**
(22) 01/08/2023 (43) 25/01/2024
(73) **CÔNG TY CỔ PHẦN SẢN XUẤT VÀ ĐẦU TƯ HƯNG PHÁT (VN)**
Tổ dân phố Thịnh Vạn, phường Minh Đức, thị xã Mỹ Hào, tỉnh Hưng Yên
(72) Nguyễn Văn Tâm (VN)
(74) Công ty TNHH Sở hữu trí tuệ Gia Việt (GIAVIET CO., LTD.)
(55)

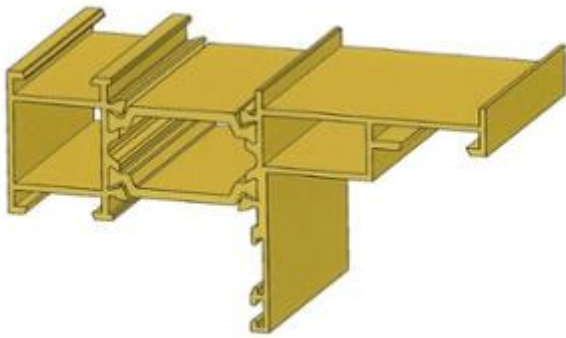

1.1

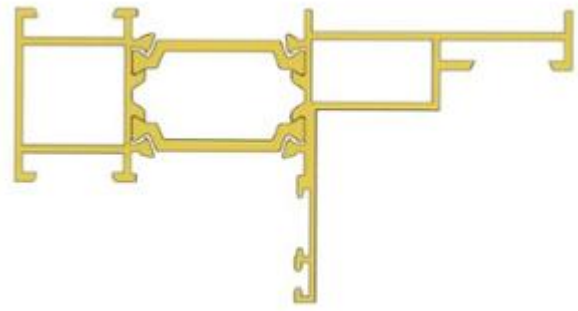

1.2



1.3

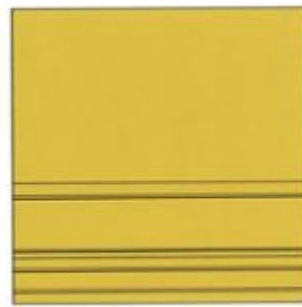

1.4



1.5



1.6

CÔNG BÁO SỞ HỮU CÔNG NGHIỆP SỐ 430 TẬP A – QUYỀN 2 (01.2024)

- (11) **49192**
(21) 3-2023-01787 (28) 1
(54) **MÁY IN** (51) **18-02**
(22) 03/08/2023 (43) 25/01/2024
(30) 2023302023972 13/04/2023 CN;
(73) **WUHAN JINGCHEN INTELLIGENT IDENTIFICATION TECHNOLOGY CO.,LTD (CN)**
1st Floor, No. 5, Creative Workshop, Phase III, Wuhan Creative World, Hongshan District, Wuhan City, Hubei Province 430070, China
(72) 1. XIONG LIU (CN)
2. PENG ZHOU (CN)
(74) Công ty TNHH Sáng chế ACTIP (ACTIP PATENT LIMITED)
(55)

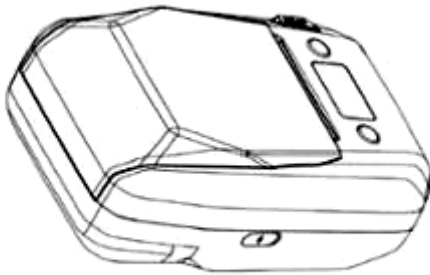

1.1

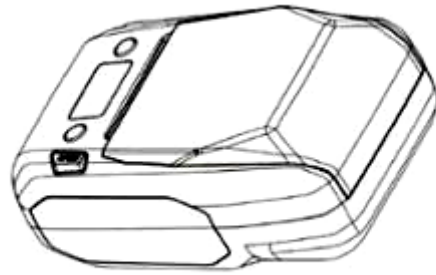

1.2

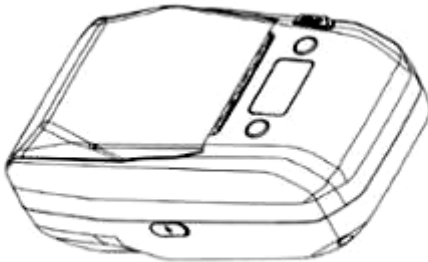

1.3

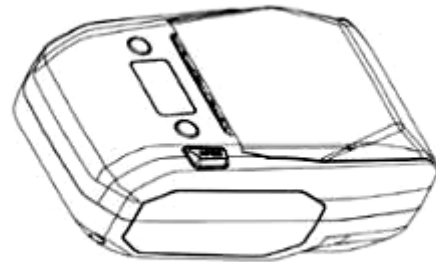

1.4

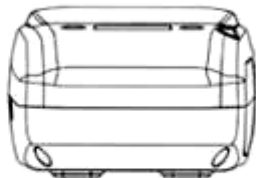

1.5

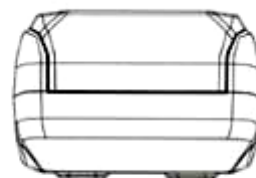

1.6

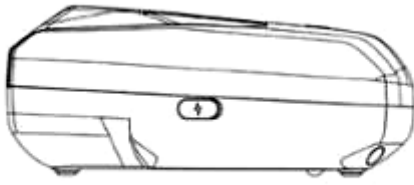

1.7

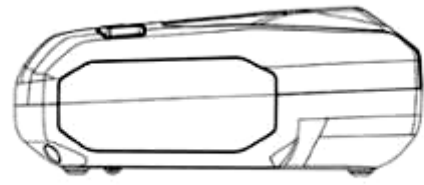

1.8

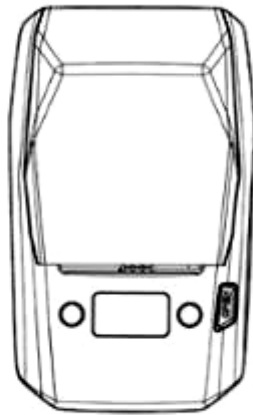

1.9

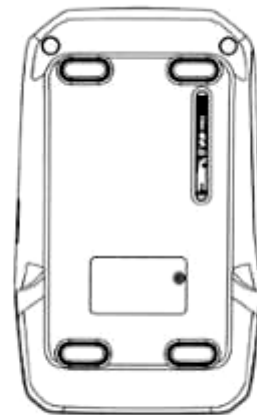

1.10

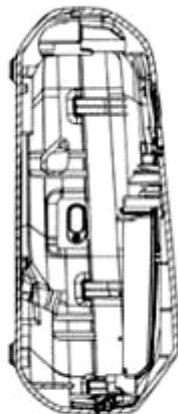

1.11

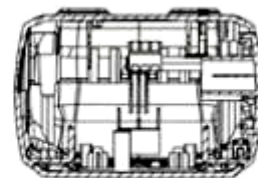

1.12

CÔNG BÁO SỞ HỮU CÔNG NGHIỆP SỐ 430 TẬP A – QUYỀN 2 (01.2024)

(11) **49193**

(21) 3-2023-01799

(28) 1

(54) **THÚ NHỒI BÔNG**

(51) **21-01**

(22) 04/08/2023

(43) 25/01/2024

(73) **PHAN THỊ HIỀN (VN)**

Thôn Tam Kiệt, xã Hữu Bằng, huyện Kiến Thụy, thành phố Hải Phòng

(72) Phan Thị Hiền (VN)

(74) Công ty TNHH ASL LAW (ASL LAW CO.,LTD)

(55)



1.1



1.2



1.3



1.4



1.5



1.6



1.7

CÔNG BÁO SỞ HỮU CÔNG NGHIỆP SỐ 430 TẬP A – QUYỀN 2 (01.2024)

- (11) **49194**
(21) 3-2023-01809 (28) 1
(54) **TỦ** (51) **06-04**
(22) 07/08/2023 (43) 25/01/2024
(73) **CÔNG TY CỔ PHẦN SẢN XUẤT NHỰA DUY TÂN (VN)**
298 Hồ Học Lãm, phường An Lạc, quận Bình Tân, thành phố Hồ Chí Minh
(72) Trần Đức Xuyên (VN)
(74) Công ty TNHH Sở hữu trí tuệ INVENTIO (INVENTIO CO.,LTD)
(55)



1.1



1.2



1.3



1.4



1.5



1.6

CÔNG BÁO SỞ HỮU CÔNG NGHIỆP SỐ 430 TẬP A – QUYỀN 2 (01.2024)

(11) **49195**

(21) 3-2023-01810

(28) 1

(54) **TỦ**

(51) **06-04**

(22) 07/08/2023

(43) 25/01/2024

(73) **CÔNG TY CỔ PHẦN SẢN XUẤT NHỰA DUY TÂN (VN)**

298 Hồ Học Lãm, phường An Lạc, quận Bình Tân, thành phố Hồ Chí Minh

(72) Trần Đức Xuyên (VN)

(74) Công ty TNHH Sở hữu trí tuệ INVENTIO (INVENTIO CO.,LTD)

(55)



1.1

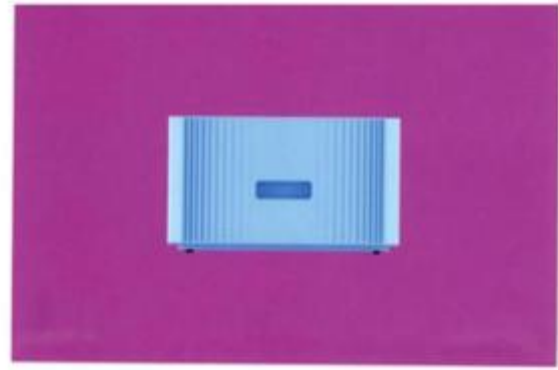

1.2

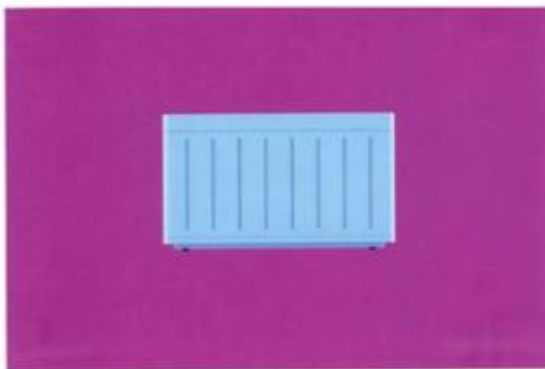

1.3



1.4



1.5



1.6

CÔNG BÁO SỞ HỮU CÔNG NGHIỆP SỐ 430 TẬP A – QUYỀN 2 (01.2024)

- (11) **49196**
(21) 3-2023-01817 (28) 1
(54) **THANH KIM LOẠI ĐỊNH HÌNH** (51) **25-01**
(22) 07/08/2023 (43) 25/01/2024
(73) **CÔNG TY TNHH DỊCH VỤ THƯƠNG MẠI VÀ XÂY DỰNG QUỐC DŨNG (VN)**
Số 372 đường Nguyễn Trãi, phường Trung Văn, quận Nam Từ Liêm, thành phố Hà Nội
(72) Đinh Văn Ba (VN)
(74) Công ty TNHH Sở hữu trí tuệ Gia Việt (GIAVIET CO., LTD.)
(55)

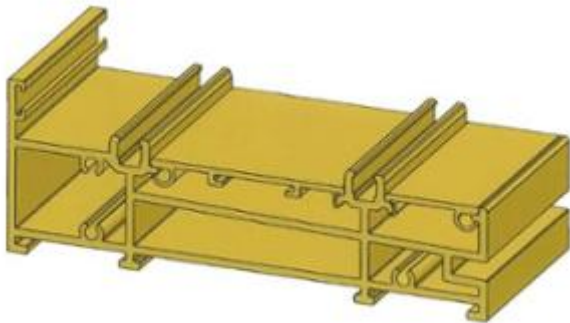

1.1

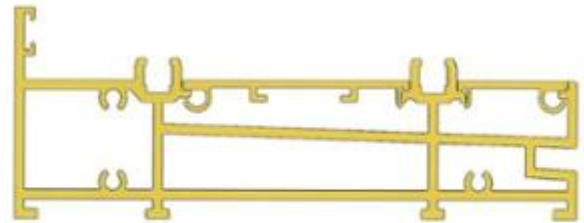

1.2

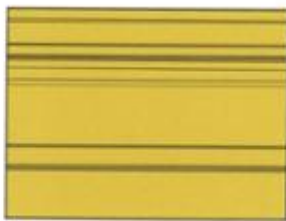

1.3



1.4



1.5

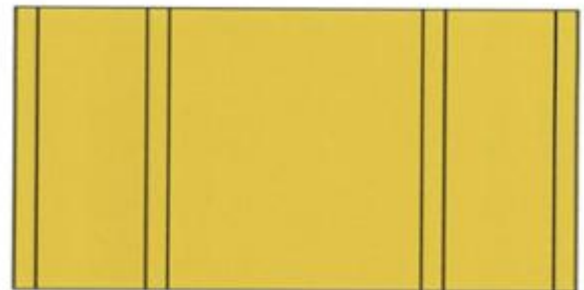

1.6

CÔNG BÁO SỞ HỮU CÔNG NGHIỆP SỐ 430 TẬP A – QUYỀN 2 (01.2024)

- (11) **49197**
(21) 3-2023-01818 (28) 1
(54) **THANH KIM LOẠI ĐỊNH HÌNH** (51) **25-01**
(22) 07/08/2023 (43) 25/01/2024
(73) **CÔNG TY TNHH DỊCH VỤ THƯƠNG MẠI VÀ XÂY DỰNG QUỐC DŨNG (VN)**
Số 372 đường Nguyễn Trãi, phường Trung Văn, quận Nam Từ Liêm, thành phố Hà Nội
(72) Đinh Văn Ba (VN)
(74) Công ty TNHH Sở hữu trí tuệ Gia Việt (GIAVIET CO., LTD.)
(55)

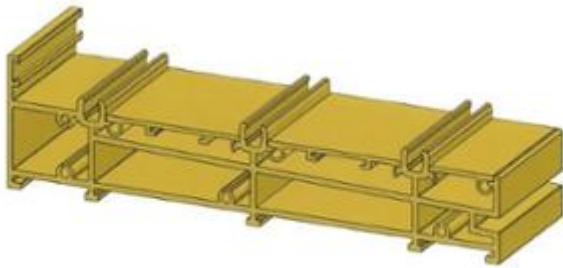

1.1

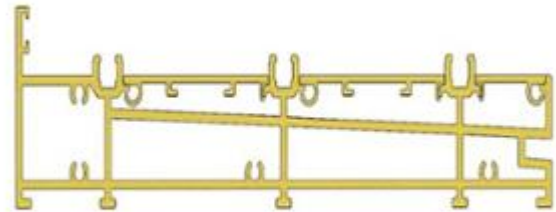

1.2



1.3



1.4



1.5



1.6

CÔNG BÁO SỞ HỮU CÔNG NGHIỆP SỐ 430 TẬP A – QUYỀN 2 (01.2024)

- (11) **49198**
(21) 3-2023-01851 (28) 1
(54) **BÚT** (51) **19-06**
(22) 08/08/2023 (43) 25/01/2024
(73) **CÔNG TY CỔ PHẦN TẬP ĐOÀN THIÊN LONG (VN)**
Tầng 10, Sofic Tower, số 10 đường Mai Chí Thọ, phường Thủ Thiêm, thành phố
Thủ Đức, thành phố Hồ Chí Minh
(72) Cô Gia Thọ (VN)
(74) Công ty TNHH Tư vấn sở hữu trí tuệ Việt (VIET IP CO.,LTD.)
(55)

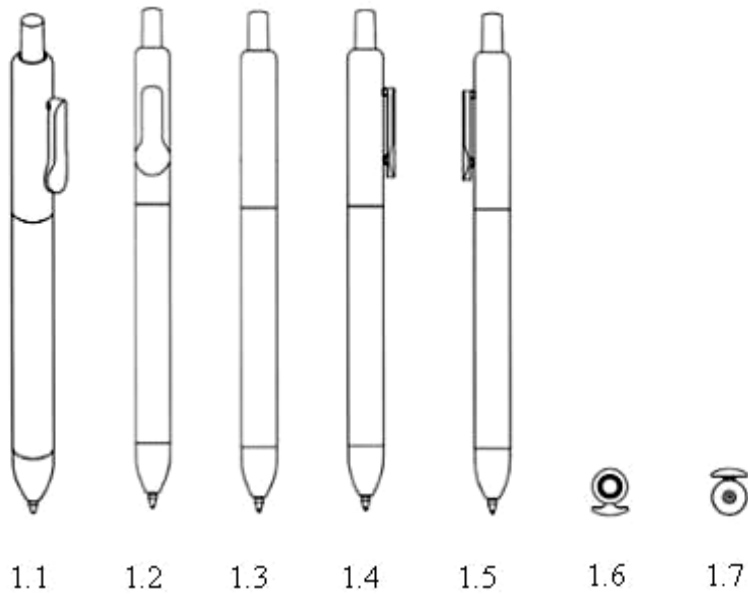

CÔNG BÁO SỞ HỮU CÔNG NGHIỆP SỐ 430 TẬP A – QUYỀN 2 (01.2024)

(11) **49199**

(21) 3-2023-01857

(28) 1

(54) **THIẾT BỊ LÀM ẤM DUNG DỊCH**

(51) **24-01**

(22) 09/08/2023

(43) 25/01/2024

(73) 1. **LAI THỊ VÂN QUYÊN (VN)**

Số 10, ngách 139/27, Nguyễn Ngọc Vũ, quận Cầu Giấy, thành phố Hà Nội

2. **NGUYỄN MẠNH THẮNG (VN)**

226 Lò Đúc, Đồng Mác, quận Hai Bà Trưng, thành phố Hà Nội

3. **CÔNG TY CỔ PHẦN ĐẦU TƯ VÀ THƯƠNG MẠI QUỐC TẾ TÂM VIỆT (VN)**

139 Đa Lộc, thôn Bàn, xã Kim Chung, huyện Đông Anh, thành phố Hà Nội

(72) 1. **LAI THỊ VÂN QUYÊN (VN)**

2. **NGUYỄN MẠNH THẮNG (VN)**

(55)



1.1



1.2



1.3



1.4



1.5



1.6



1.7

CÔNG BÁO SỞ HỮU CÔNG NGHIỆP SỐ 430 TẬP A – QUYỀN 2 (01.2024)

- (11) **49200**
(21) 3-2023-01873 (28) 1
(54) **CÔNG TẮC** (51) **13-03**
(22) 28/01/2022 (43) 25/01/2024
(30) 1317/2021 01/08/2021 EG;
(73) **SCHNEIDER ELECTRIC (AUSTRALIA) PTY LTD (AU)**
78 WATERLOO ROAD, MACQUARIE PARK, NSW 2113, AUSTRALIA
(72) 1. WANG, LI (CN)
2. ZHENG, LEIHONG (CN)
(74) Công ty TNHH Trường Xuân (AGELESS CO.,LTD.)
(55)

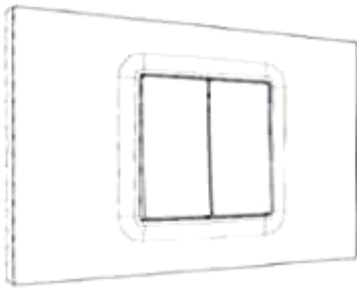

1.1

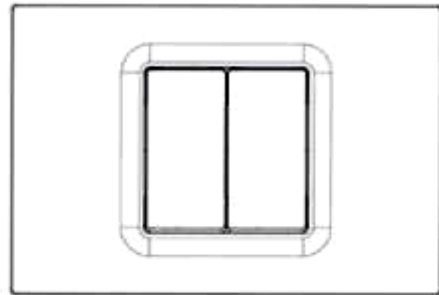

1.2

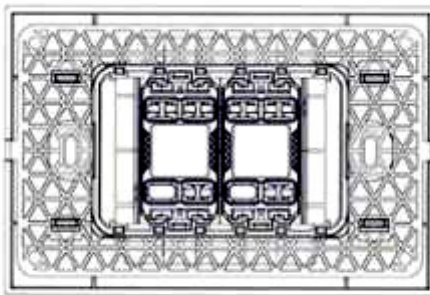

1.3

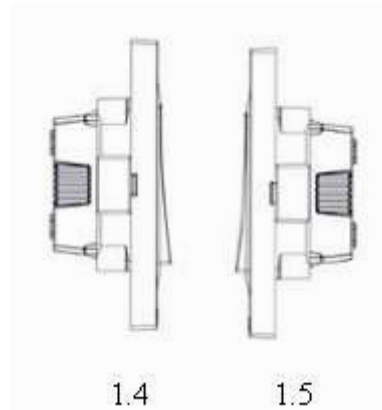

1.4

1.5

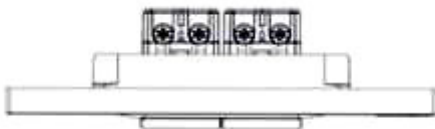

1.6

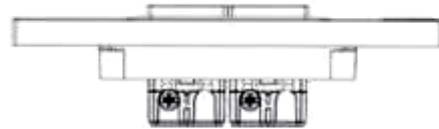

1.7

CÔNG BÁO SỞ HỮU CÔNG NGHIỆP SỐ 430 TẬP A – QUYỀN 2 (01.2024)

- (11) **49201**
(21) 3-2023-01874 (28) 1
(54) **CÔNG TẮC** (51) **13-03**
(22) 28/01/2022 (43) 25/01/2024
(30) 1317/2021 01/08/2021 EG;
(73) **SCHNEIDER ELECTRIC (AUSTRALIA) PTY LTD (AU)**
78 WATERLOO ROAD, MACQUARIE PARK, NSW 2113, AUSTRALIA
(72) 1. WANG, LI (CN)
2. ZHENG, LEIHONG (CN)
(74) Công ty TNHH Trường Xuân (AGELESS CO.,LTD.)
(55)

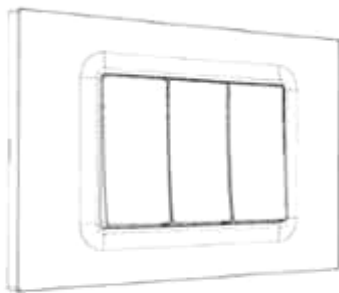

1.1

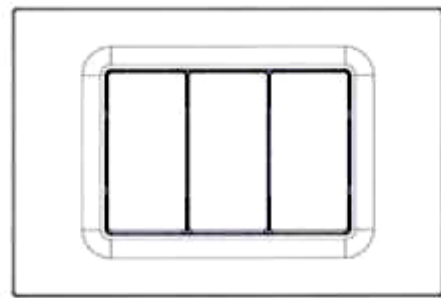

1.2

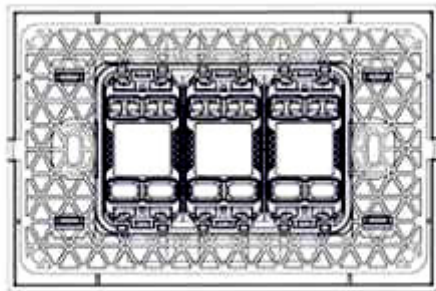

1.3

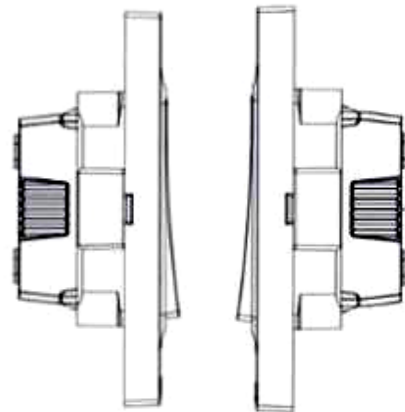

1.4

1.5

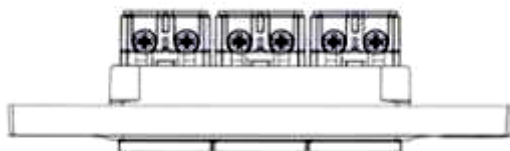

1.6

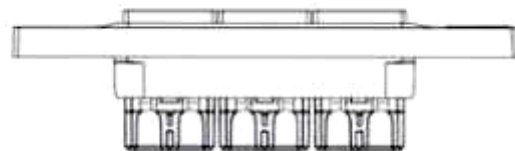

1.7

CÔNG BÁO SỞ HỮU CÔNG NGHIỆP SỐ 430 TẬP A – QUYỀN 2 (01.2024)

- (11) **49202**
(21) 3-2023-01889 (28) 1
(54) **CHAI** (51) **09-01**
(22) 11/08/2023 (43) 25/01/2024
(73) **CÔNG TY CỔ PHẦN DƯỢC PHẨM NUTIFINE (VN)**
Số 08, đường Phạm Thế Hiển, phường Mỹ Phú, thành phố Cao Lãnh, tỉnh Đồng Tháp
(72) Lê Anh Huy (VN)
(74) Công ty TNHH Tư vấn sở hữu trí tuệ Việt (VIET IP CO.,LTD.)
(55)



1.1

1.2

1.3

1.4



1.5

1.6

1.8

1.7

(11) **49203**

(21) 3-2023-01891

(54) **LỒNG KIM LOẠI**

(22) 14/08/2023

(73) **CÔNG TY CỔ PHẦN THAKE (VN)**

29/17 đường liên xã thị trấn Thới Tam Thôn, xã Thới Tam Thôn, huyện Hóc Môn, thành phố Hồ Chí Minh

(72) Chim Văn Cang (VN)

(55)

(28) 1

(51) **30-02**

(43) 25/01/2024



1.1



1.2



1.3

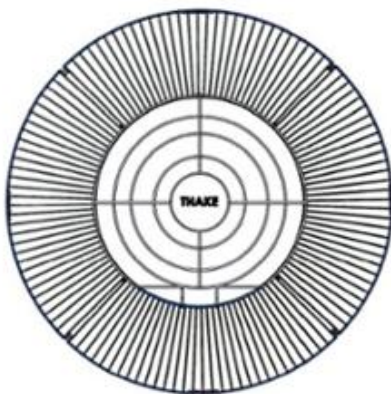

1.4

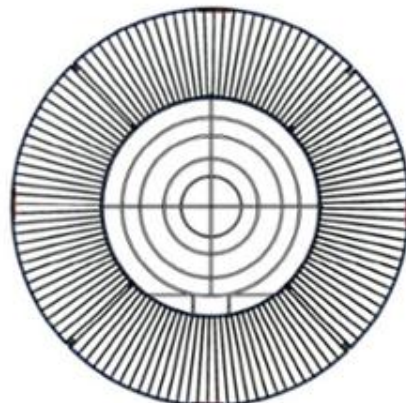

1.5

CÔNG BÁO SỞ HỮU CÔNG NGHIỆP SỐ 430 TẬP A – QUYỀN 2 (01.2024)

- (11) **49204**
(21) 3-2023-01925 (28) 1
(54) **DỤNG CỤ NÉM ĐỒ CHƠI THÚ CÙNG** (51) **30-99**
(22) 14/08/2023 (43) 25/01/2024
(73) **NGUYỄN VĂN VỮNG (VN)**
184/35, đường Lê Đình Cẩn, khu phố 10, phường Tân Tạo, quận Bình Tân, thành phố Hồ Chí Minh
(72) Nguyễn Văn Vững (VN)
(74) Công ty Cổ phần Sở hữu công nghiệp INVESTIP (INVESTIP)
(55)



1.1



1.2



1.3



1.4



1.5



1.6



1.7

- (11) **49205**
(21) 3-2023-01926 (28) 1
(54) **THỨC ĂN CHO VẬT NUÔI** (51) **01-06**
(22) 15/08/2023 (43) 25/01/2024
(30) 29/884,752 15/02/2023 US;
(73) **SPECTRUM BRANDS, INC. (US)**
3001 Deming Way, Middleton, Wisconsin 53562, United States of America
(72) SUMNERS, Lindsay (US)
(74) Công ty TNHH Sở hữu trí tuệ Thảo Thọ Quyển (INVENCO.,LTD)
(55)



1.1



1.2



1.3



1.4



1.5



1.6



1.7

CÔNG BÁO SỞ HỮU CÔNG NGHIỆP SỐ 430 TẬP A – QUYỀN 2 (01.2024)

- (11) **49206**
(21) 3-2023-01941 (28) 1
(54) **GIỎ** (51) **09-04**
(22) 18/08/2023 (43) 25/01/2024
(73) **CÔNG TY CỔ PHẦN SẢN XUẤT NHỰA DUY TÂN (VN)**
298 Hồ Học Lãm, phường An Lạc, quận Bình Tân, thành phố Hồ Chí Minh
(72) Trần Đức Xuyên (VN)
(74) Công ty TNHH Sở hữu trí tuệ INVENTIO (INVENTIO CO.,LTD)
(55)



1.1



1.2



1.3



1.4



1.5



1.6

- (11) **49207**
(21) 3-2023-01959 (28) 1
(54) **HỆ THỐNG KIỂM ĐỊNH, HIỆU CHUẨN THIẾT BỊ ĐO NỒNG ĐỘ KHỐI LƯỢNG BỤI** (51) **10-05**
(22) 22/08/2023 (43) 25/01/2024
(73) **TRUNG TÂM NGHIÊN CỨU VÀ CHUYỂN GIAO CÔNG NGHỆ (VN)**
Khu nhà ươm tạo, số 18 Hoàng Quốc Việt, quận Cầu Giấy, thành phố Hà Nội
(72) Dương Thành Nam (VN)
(55)

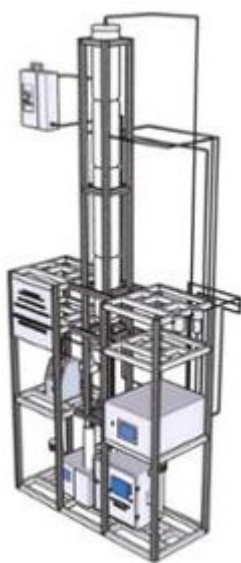

1.1



1.2

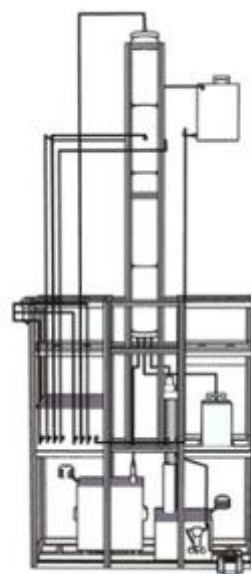

1.3

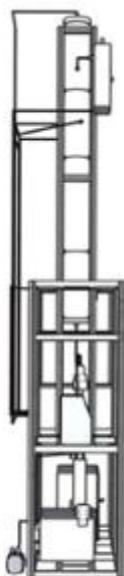

1.4

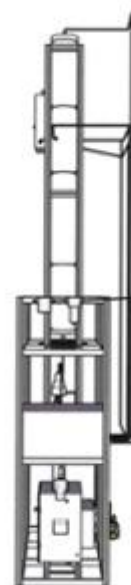

1.5

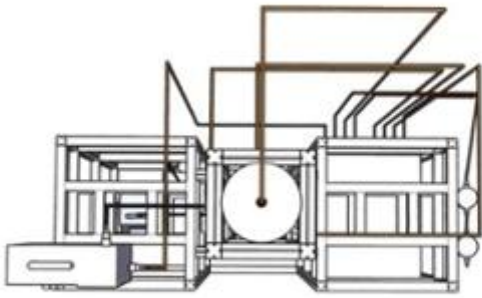

1.6

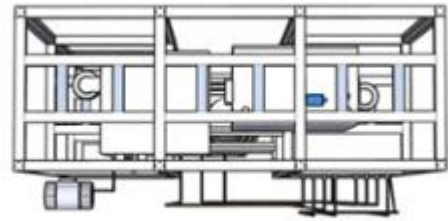

1.7

CÔNG BÁO SỞ HỮU CÔNG NGHIỆP SỐ 430 TẬP A – QUYỀN 2 (01.2024)

- (11) **49208**
(21) 3-2023-01960 (28) 1
(54) **CHAI NHỰA** (51) **09-01**
(22) 22/08/2023 (43) 25/01/2024
(73) **TRẦN MINH TUẤN (VN)**
204/27 đường Hải Phòng, tổ 27 phường Tân Chính, quận Thanh Khê, thành phố Đà Nẵng
(72) Trần Minh Tuấn (VN)
(55)



1.1

1.2

1.3

1.4

1.5



1.6



1.7

- (11) **49209**
(21) 3-2023-01963 (28) 1
(54) **HỘP ĐỰNG** (51) **07-07**
(22) 22/08/2023 (43) 25/01/2024
(30) 29/888,320 30/03/2023 US;
(73) **DART INDUSTRIES INC. (US)**
14901 S. Orange Blossom Trail, Orlando, Florida 32837, USA
(72) 1. RYAN CLAVECILLAS (PH)
2. KATELIJNE DAELMAN (BE)
3. DIMITRI M.C.J. BACKAERT (BE)
4. DONGJIN BYEON (KR)
5. ALEC VERCRUYSEN (BE)
(74) CÔNG TY LUẬT TRÁCH NHIỆM HỮU HẠN AMBYS HÀ NỘI (AMBYS HANOI)
(55)

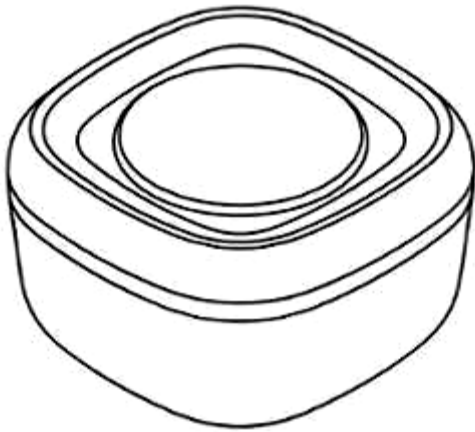

1.1

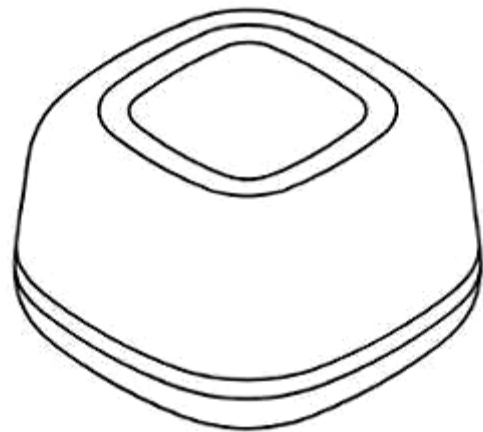

1.2

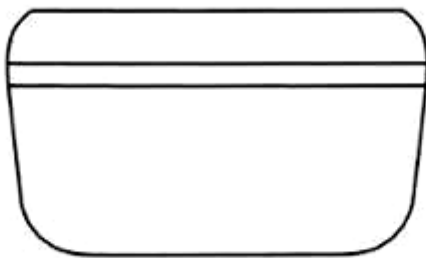

1.3

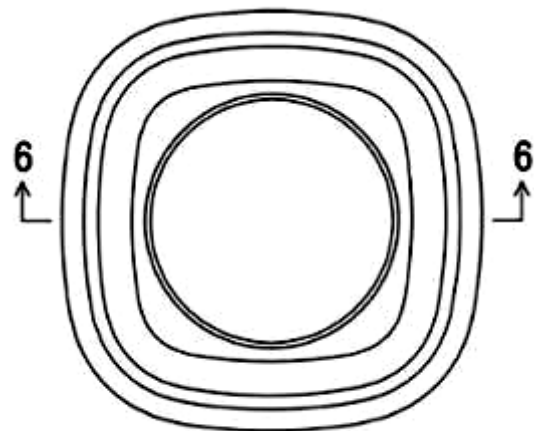

1.4

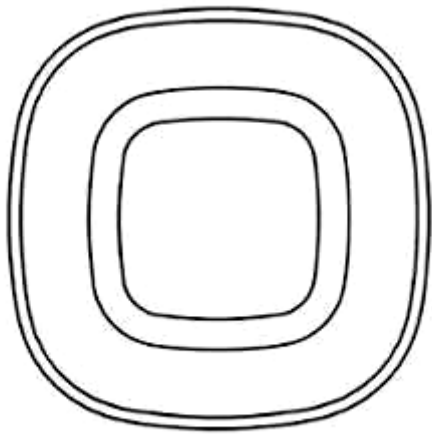

1.5

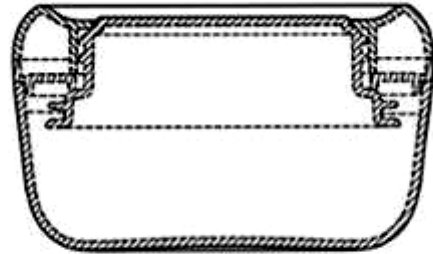

1.6

- (11) **49210**
(21) 3-2023-01965 (28) 1
(54) **NHÃN** (51) **11-01**
(22) 22/08/2023 (43) 25/01/2024
(30) WIPO129015 23/02/2023 WO;
(73) **CARTIER INTERNATIONAL AG (CH)**
Hinterbergstrasse 22, 6312 STEINHAUSEN, SWITZERLAND
(72) Emmanuelle SALLARD (FR)
(74) Công ty TNHH Tầm nhìn và Liên danh (VISION & ASSOCIATES CO.LTD.)
(55)

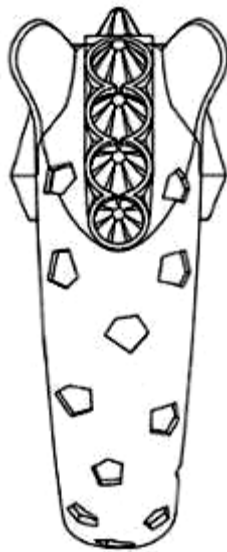

1.1



1.2

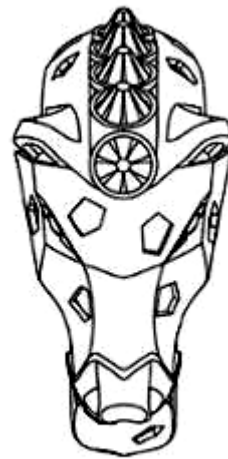

1.3

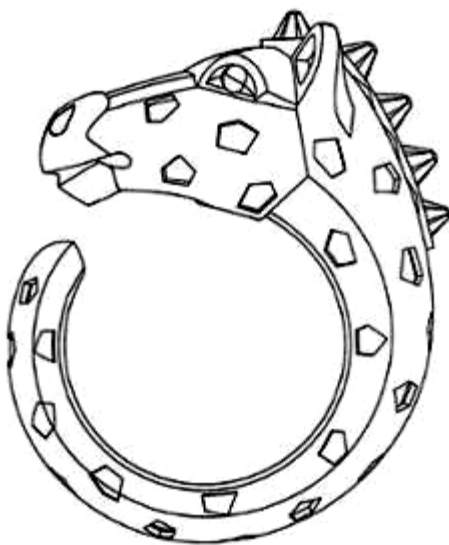

1.4

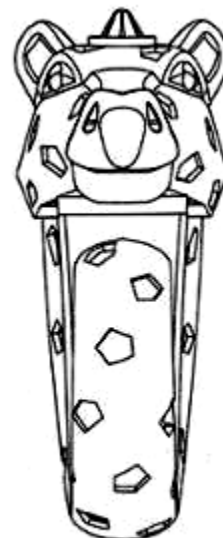

1.5

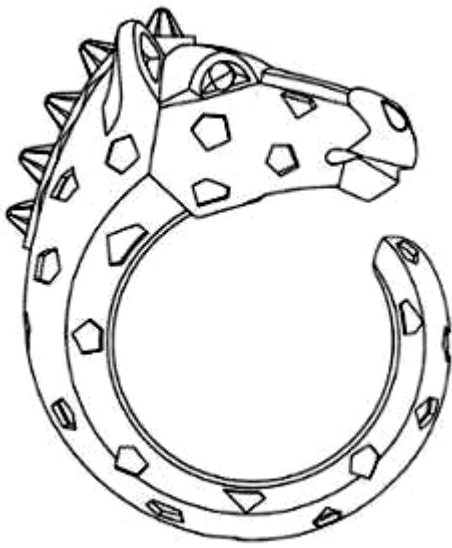

1.6

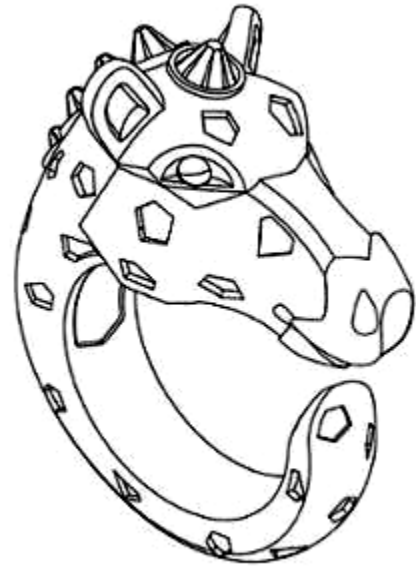

1.7

- (11) **49211**
(21) 3-2023-01966 (28) 1
(54) **NHÃN** (51) **11-01**
(22) 22/08/2023 (43) 25/01/2024
(30) WIPO129015 23/02/2023 WO;
(73) **CARTIER INTERNATIONAL AG (CH)**
Hinterbergstrasse 22, 6312 STEINHAUSEN, SWITZERLAND
(72) Emmanuelle SALLARD (FR)
(74) Công ty TNHH Tâm nhìn và Liên danh (VISION & ASSOCIATES CO.LTD.)
(55)

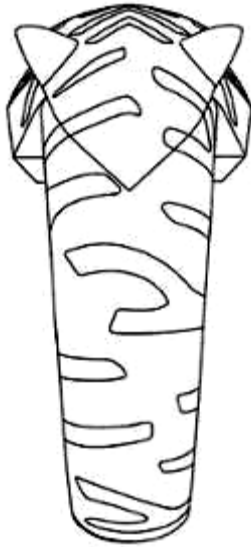

1.1

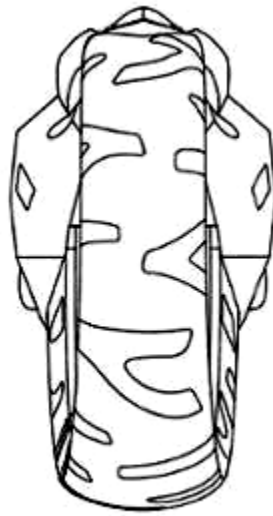

1.2



1.3

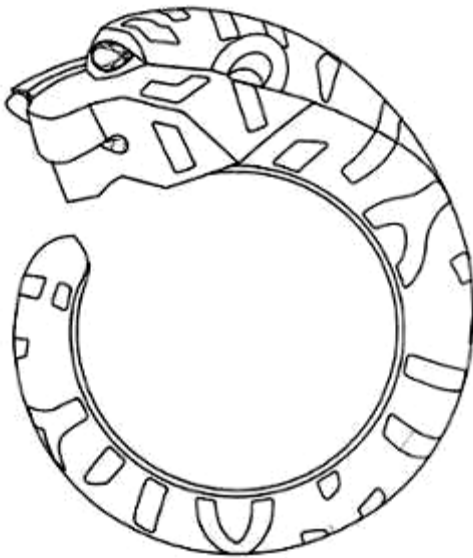

1.4

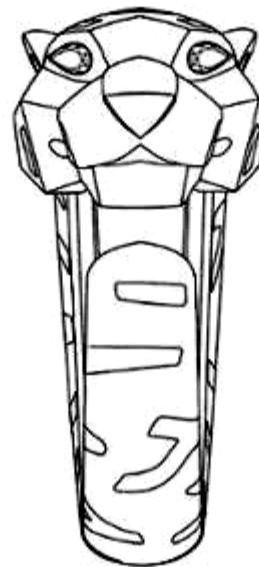

1.5



1.6

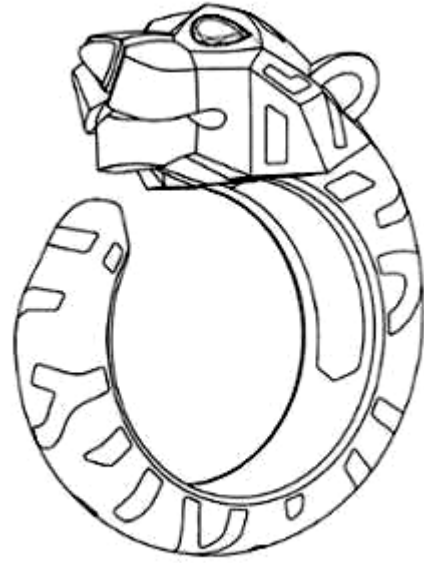

1.7

CÔNG BÁO SỞ HỮU CÔNG NGHIỆP SỐ 430 TẬP A – QUYỀN 2 (01.2024)

- (11) **49212**
- (21) 3-2023-01969
- (54) **ĐỒNG XU BẠC**
- (22) 22/08/2023
- (73) **NGUYỄN QUỐC TUẤN (VN)**
Xóm Lạc Hồng, xã Nghi Diên, huyện Nghi Lộc, tỉnh Nghệ An
- (72) Nguyễn Quốc Tuấn (VN)
- (55)



1.1

1.2

1.3

1.4



1.5

1.6

1.7

2.1



2.2

2.3

2.4

2.5



2.6

2.7

3.1

3.2



3.3

3.4

3.5



3.6



3.7



4.1



4.2



4.3



4.4



4.5



4.6



4.7

CÔNG BÁO SỞ HỮU CÔNG NGHIỆP SỐ 430 TẬP A – QUYỀN 2 (01.2024)

- (11) **49213**
(21) 3-2023-01972 (28) 1
(54) **THANH KIM LOẠI ĐỊNH HÌNH** (51) **25-01**
(22) 23/08/2023 (43) 25/01/2024
(73) **CÔNG TY CỔ PHẦN TẬP ĐOÀN KENWIN (VN)**
Tầng 4 tòa nhà VG Building, số 235 đường Nguyễn Trãi, phường Thanh Xuân
Trung, quận Thanh Xuân, thành phố Hà Nội
(72) Ngô Thọ Long (VN)
(74) Công ty TNHH Sở hữu trí tuệ PADEMARK (PADEMARK CO.,LTD.)
(55)



1.1



1.2



1.3

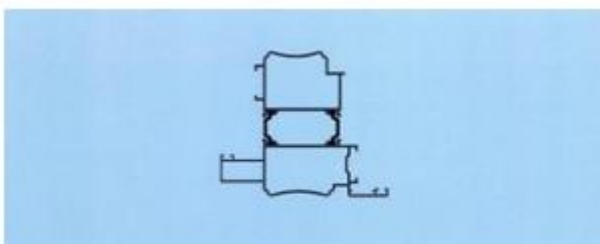

1.4

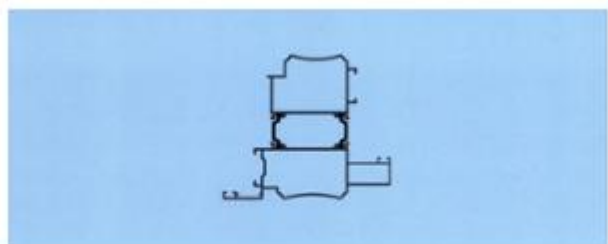

1.5



1.6



1.7

CÔNG BÁO SỞ HỮU CÔNG NGHIỆP SỐ 430 TẬP A – QUYỀN 2 (01.2024)

- (11) **49214**
(21) 3-2023-01973 (28) 1
(54) **THANH KIM LOẠI ĐỊNH HÌNH** (51) **25-01**
(22) 23/08/2023 (43) 25/01/2024
(73) **CÔNG TY CỔ PHẦN TẬP ĐOÀN KENWIN (VN)**
Tầng 4 tòa nhà VG Building, số 235 đường Nguyễn Trãi, phường Thanh Xuân
Trung, quận Thanh Xuân, thành phố Hà Nội
(72) Ngô Thọ Long (VN)
(74) Công ty TNHH Sở hữu trí tuệ PADEMARK (PADEMARK CO.,LTD.)
(55)



1.1



1.2



1.3

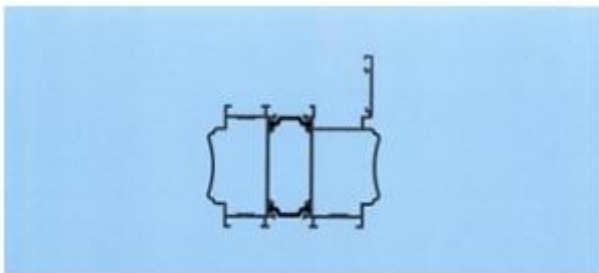

1.4

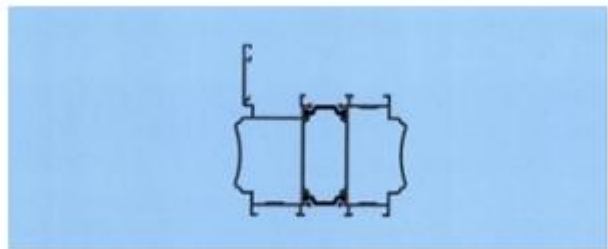

1.5



1.6



1.7

- (11) **49215**
(21) 3-2023-01976 (28) 1
(54) **NHÃN** (51) **11-01**
(22) 23/08/2023 (43) 25/01/2024
(30) WIPO129240 23/02/2023 WO;
(73) **CARTIER INTERNATIONAL AG (CH)**
Hinterbergstrasse 22, 6312 STEINHAUSEN, SWITZERLAND
(72) Emmanuelle SALLARD (FR)
(74) Công ty TNHH Tầm nhìn và Liên danh (VISION & ASSOCIATES CO.LTD.)
(55)



1.1



1.2



1.3

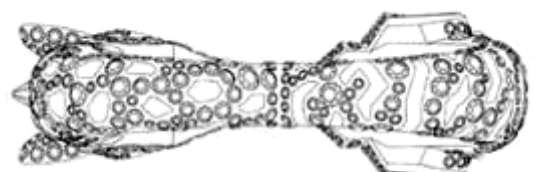

1.4



1.5



1.6



1.7

(11) **49216**

(21) 3-2023-01979

(28) 1

(54) **MÁY BÓC VỎ HẠT SEN**

(51) **15-03**

(22) 23/08/2023

(43) 25/01/2024

(73) 1. **CÔNG TY TNHH HỒ HOÀN CẦU (VN)**

Xóm 6, xã Quỳnh Văn, huyện Quỳnh Lưu, tỉnh Nghệ An

2. **CÔNG TY TNHH ABACA VIỆT NAM (VN)**

Xóm 6, xã Quỳnh Văn, huyện Quỳnh Lưu, tỉnh Nghệ An

(72) 1. **HỒ XUÂN VINH (VN)**

2. **HỒ SĨ CẦU (VN)**

3. **TRẦN THỊ HỒNG THẨM (VN)**

(55)



1.1



1.2

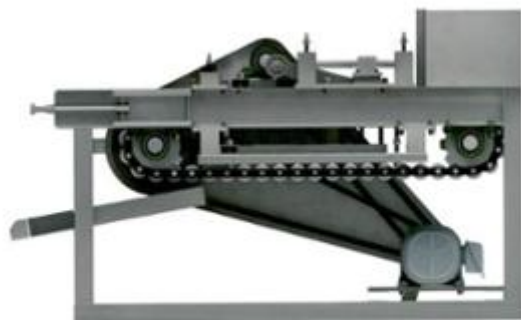

1.3

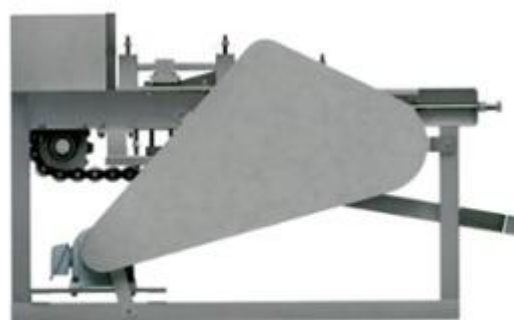

1.4



1.5



1.6



1.7



1.8

CÔNG BÁO SỞ HỮU CÔNG NGHIỆP SỐ 430 TẬP A – QUYỀN 2 (01.2024)

(11) 49217

(21) 3-2023-01980

(54) **MÁY TÁCH ĐÀI SEN**

(22) 23/08/2023

(73) 1. **CÔNG TY TNHH HỒ HOÀN CẦU (VN)**

Xóm 6, xã Quỳnh Văn, huyện Quỳnh Lưu, tỉnh Nghệ An

2. **CÔNG TY TNHH ABACA VIỆT NAM (VN)**

Xóm 6, xã Quỳnh Văn, huyện Quỳnh Lưu, tỉnh Nghệ An

(72) 1. **HỒ XUÂN VINH (VN)**

2. **HỒ SĨ CẦU (VN)**

3. **TRẦN THỊ HỒNG THẨM (VN)**

(55)

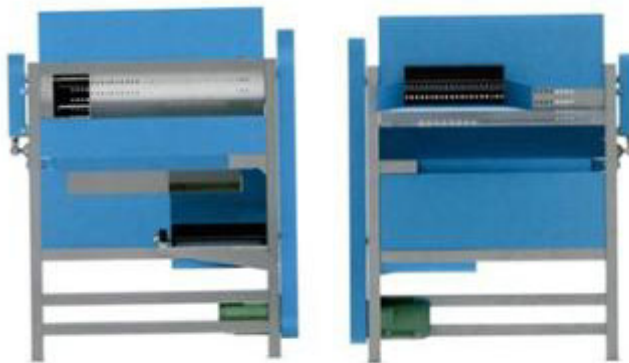

1.1

1.2



1.3

1.4

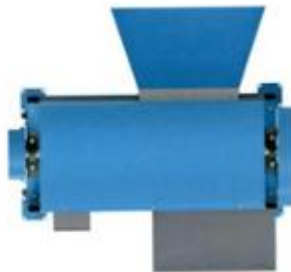

1.5



1.6



1.7



1.8

CÔNG BÁO SỞ HỮU CÔNG NGHIỆP SỐ 430 TẬP A – QUYỀN 2 (01.2024)

(11) **49218**

(21) 3-2023-01981

(28) 1

(54) **MÁY TÁCH TIM SEN**

(51) **15-03**

(22) 23/08/2023

(43) 25/01/2024

(73) **1. CÔNG TY TNHH HỒ HOÀN CẦU (VN)**

Xóm 6, xã Quỳnh Văn, huyện Quỳnh Lưu, tỉnh Nghệ An

2. CÔNG TY TNHH ABACA VIỆT NAM (VN)

Xóm 6, xã Quỳnh Văn, huyện Quỳnh Lưu, tỉnh Nghệ An

(72) **1. HỒ XUÂN VINH (VN)**

2. HỒ SĨ CẦU (VN)

3. TRẦN THỊ HỒNG THẨM (VN)

(55)



1.1



1.2

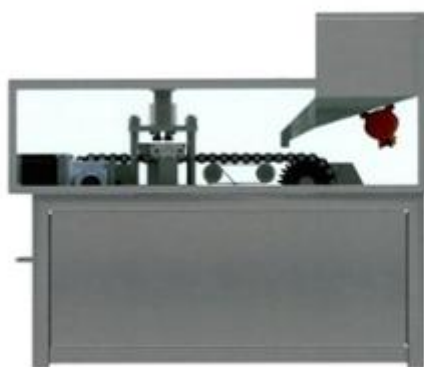

1.3

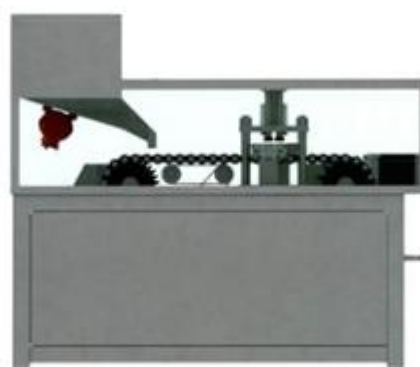

1.4



1.5



1.6



1.7



1.8

CÔNG BÁO SỞ HỮU CÔNG NGHIỆP SỐ 430 TẬP A – QUYỀN 2 (01.2024)

- (11) **49219**
(21) 3-2023-01982 (28) 1
(54) **GHẾ MÁT-XA** (51) **06-01**
(22) 23/08/2023 (43) 25/01/2024
(73) **COWAY CO., LTD (KR)**
136-23, Yugumagoksa-ro, Yugu-eup, Gongju-si, Choongcheongnam-do, Korea
(72) Hwang Seonyong (KR)
(74) Công ty TNHH Luật ALIAT (ALIAT LEGAL)
(55)

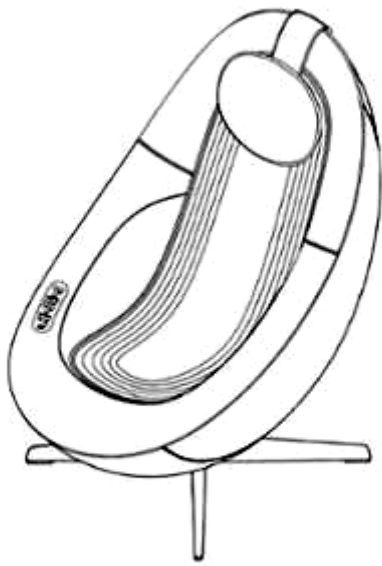

1.1

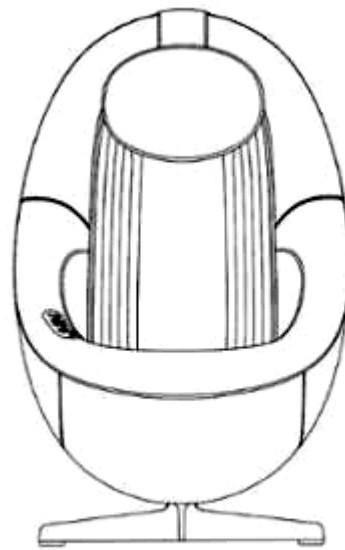

1.2

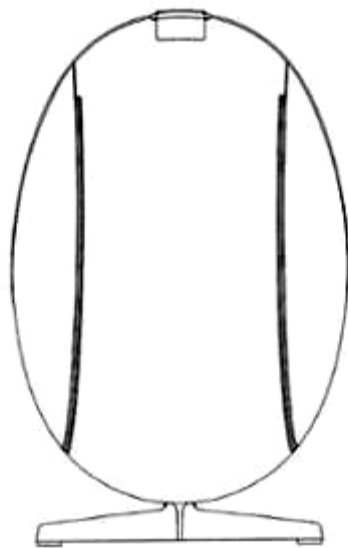

1.3

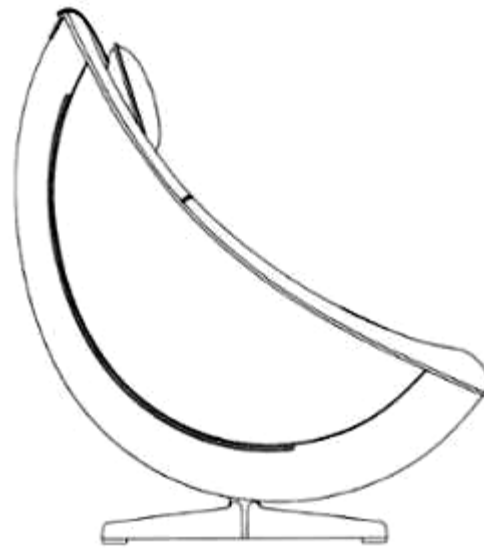

1.4

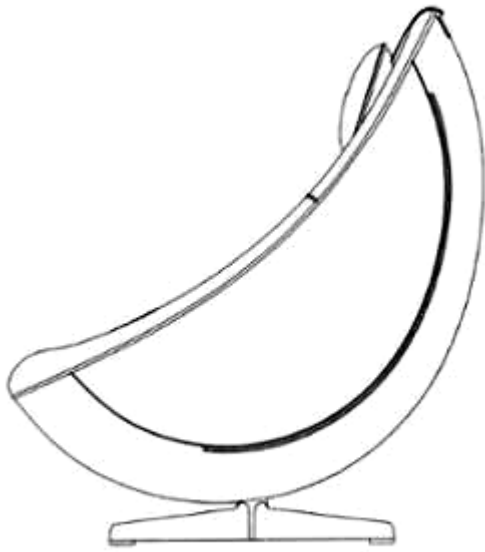

1.5

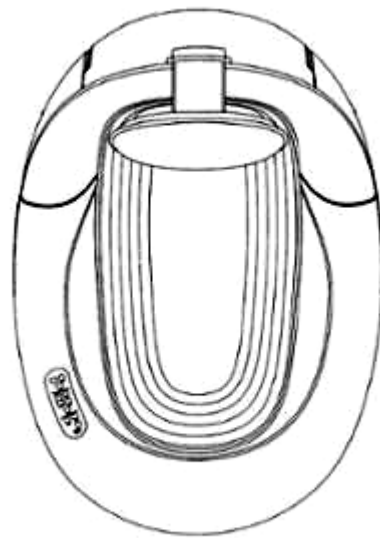

1.6

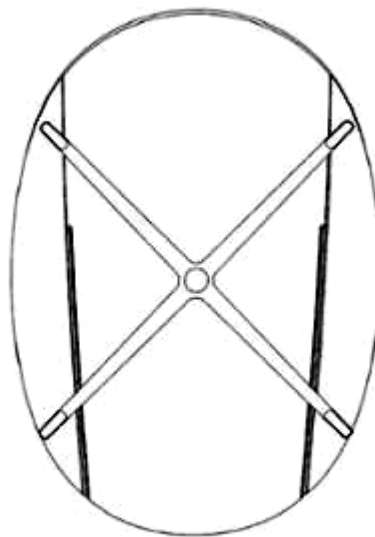

1.7

CÔNG BÁO SỞ HỮU CÔNG NGHIỆP SỐ 430 TẬP A – QUYỀN 2 (01.2024)

- (11) **49220**
(21) 3-2023-01985 (28) 1
(54) **ĐÈN** (51) **26-05**
(22) 24/08/2023 (43) 25/01/2024
(73) **CÔNG TY CỔ PHẦN BÓNG ĐÈN PHÍCH NƯỚC RẠNG ĐÔNG (VN)**
87-89 phố Hạ Đình, phường Thanh Xuân Trung, quận Thanh Xuân, thành phố Hà Nội
(72) Trần Trung Tường (VN)
(55)



1.1



1.2

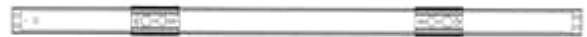

1.3



1.4



1.5



1.6



1.7

- (11) **49221**
(21) 3-2023-01986 (28) 1
(54) **THIẾT BỊ CHIẾT ÁP** (51) **13-03; 13-99**
(22) 24/08/2023 (43) 25/01/2024
(73) **CÔNG TY CỔ PHẦN BÓNG ĐÈN PHÍCH NƯỚC RẠNG ĐÔNG (VN)**
87-89 phố Hạ Đình, phường Thanh Xuân Trung, quận Thanh Xuân, thành phố Hà Nội
(72) Trần Trung Tường (VN)
(55)

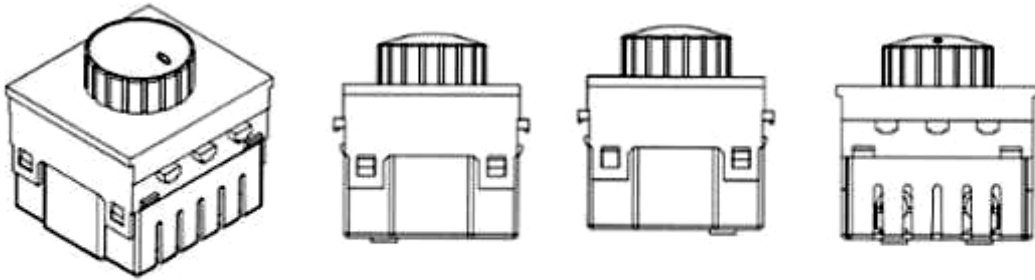

1.1

1.2

1.3

1.4

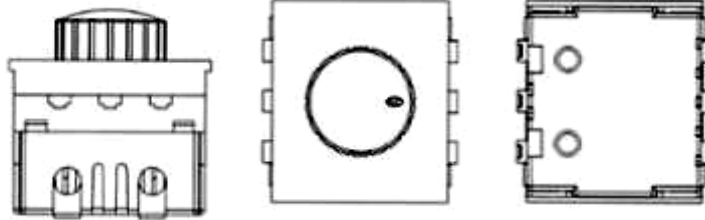

1.5

1.6

1.7

(11) **49222**

(21) 3-2023-01987

(28) 1

(54) **ĐÈN**

(51) **26-05**

(22) 24/08/2023

(43) 25/01/2024

(73) **CÔNG TY CỔ PHẦN BÓNG ĐÈN PHÍCH NƯỚC RẠNG ĐÔNG (VN)**

87-89 phố Hạ Đình, phường Thanh Xuân Trung, quận Thanh Xuân, thành phố Hà Nội

(72) Trần Trung Tường (VN)

(55)



1.1

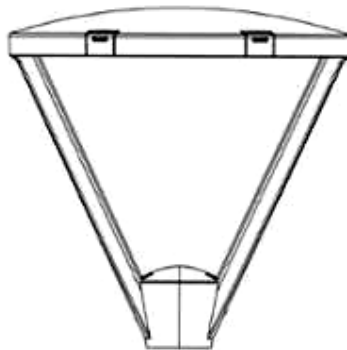

1.2

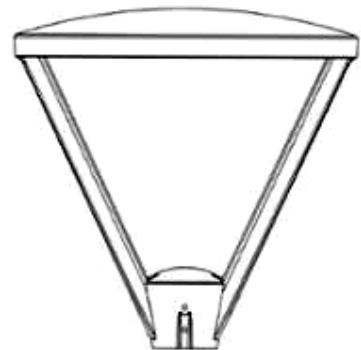

1.3



1.4



1.5



1.6

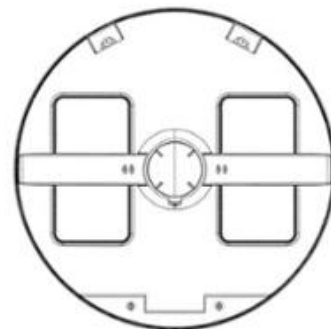

1.7

CÔNG BÁO SỞ HỮU CÔNG NGHIỆP SỐ 430 TẬP A – QUYỀN 2 (01.2024)

- (11) **49223**
- (21) 3-2023-01993
- (54) **HỘP**
- (22) 24/08/2023
- (73) **ORION CORPORATION (KR)**
13, Baekbeom-ro 90da-gil Yongsan-gu, Seoul 04369, Republic of Korea
- (72) Ngô Văn Thiện (VN)
- (74) Công ty Luật TNHH quốc tế BMVN (BMVN INTERNATIONAL LLC)
- (55)



1.1



1.2

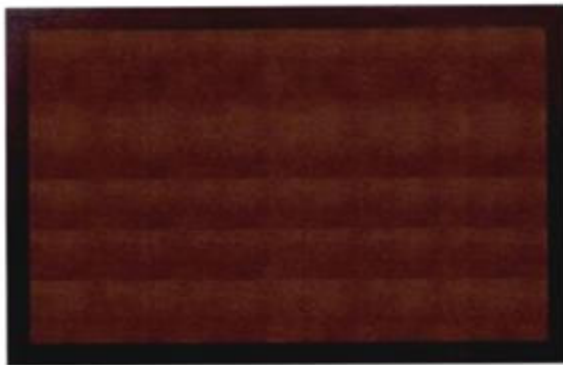

1.3



1.4



1.5

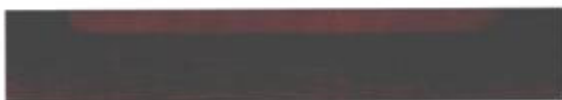

1.6



1.7

CÔNG BÁO SỞ HỮU CÔNG NGHIỆP SỐ 430 TẬP A – QUYỀN 2 (01.2024)

- (11) **49224**
(21) 3-2023-01994 (28) 1
(54) **HỘP** (51) **09-03**
(22) 24/08/2023 (43) 25/01/2024
(73) **ORION CORPORATION (KR)**
13, Baekbeom-ro 90da-gil Yongsan-gu, Seoul 04369, Republic of Korea
(72) Ngô Văn Thiện (VN)
(74) Công ty Luật TNHH quốc tế BMVN (BMVN INTERNATIONAL LLC)
(55)



1.1



1.2



1.3



1.4



1.5



1.6



1.7

CÔNG BÁO SỞ HỮU CÔNG NGHIỆP SỐ 430 TẬP A – QUYỀN 2 (01.2024)

- (11) **49225**
(21) 3-2023-01995 (28) 1
(54) **HỘP** (51) **09-03**
(22) 24/08/2023 (43) 25/01/2024
(73) **ORION CORPORATION (KR)**
13, Baekbeom-ro 90da-gil Yongsan-gu, Seoul 04369, Republic of Korea
(72) Ngô Văn Thiện (VN)
(74) Công ty Luật TNHH quốc tế BMVN (BMVN INTERNATIONAL LLC)
(55)



1.1



1.2



1.3



1.4

1.5



1.6



1.7

CÔNG BÁO SỞ HỮU CÔNG NGHIỆP SỐ 430 TẬP A – QUYỀN 2 (01.2024)

- (11) **49226**
(21) 3-2023-01996 (28) 1
(54) **HỘP** (51) **09-03**
(22) 24/08/2023 (43) 25/01/2024
(73) **ORION CORPORATION (KR)**
13, Baekbeom-ro 90da-gil Yongsan-gu, Seoul 04369, Republic of Korea
(72) Ngô Văn Thiện (VN)
(74) Công ty Luật TNHH quốc tế BMVN (BMVN INTERNATIONAL LLC)
(55)



1.1



1.2



1.3



1.4

1.5



1.6



1.7

CÔNG BÁO SỞ HỮU CÔNG NGHIỆP SỐ 430 TẬP A – QUYỀN 2 (01.2024)

- (11) 49227
(21) 3-2023-01997 (28) 1
(54) **BAO GÓI** (51) **09-05**
(22) 24/08/2023 (43) 25/01/2024
(73) **ORION CORPORATION (KR)**
13, Baekbeom-ro 90da-gil Yongsan-gu, Seoul 04369, Republic of Korea
(72) 1. LEE, SEUNG JU (KR)
2. LEE, A REUM (KR)
(74) Công ty Luật TNHH quốc tế BMVN (BMVN INTERNATIONAL LLC)
(55)



1.1



1.2

CÔNG BÁO SỞ HỮU CÔNG NGHIỆP SỐ 430 TẬP A – QUYỀN 2 (01.2024)

- (11) **49228**
(21) 3-2023-01998 (28) 1
(54) **HỘP** (51) **09-03**
(22) 24/08/2023 (43) 25/01/2024
(73) **ORION CORPORATION (KR)**
13, Baekbeom-ro 90da-gil Yongsan-gu, Seoul 04369, Republic of Korea
(72) Ngô Văn Thiện (VN)
(74) Công ty Luật TNHH quốc tế BMVN (BMVN INTERNATIONAL LLC)
(55)



1.1



1.2



1.3



1.4



1.5



1.6



1.7

- (11) **49229**
(21) 3-2023-01999 (28) 1
(54) **VIÊN GIẶT** (51) **28-02**
(22) 24/08/2023 (43) 25/01/2024
(73) **LG H&H CO., LTD. (KR)**
58, Saemunan-ro, Jongno-gu, Seoul, Republic of Korea
(72) 1. WON, JUNG HEE (KR)
2. KIM, JAE HYUN (KR)
3. GWAK, MIN JUN (KR)
4. HONG, EUN JI (KR)
(74) Công ty TNHH Tầm nhìn và Liên danh (VISION & ASSOCIATES CO.LTD.)
(55)

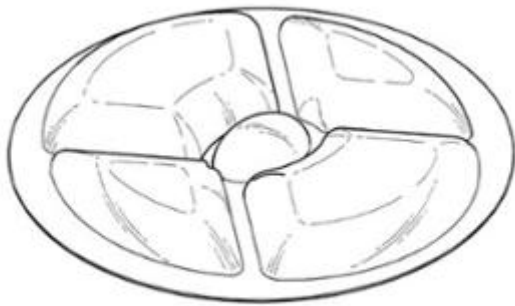

1.1

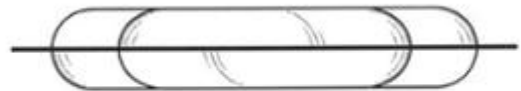

1.2

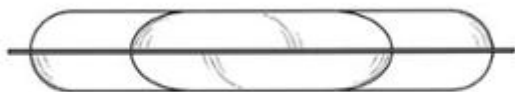

1.3



1.4

CÔNG BÁO SỞ HỮU CÔNG NGHIỆP SỐ 430 TẬP A – QUYỀN 2 (01.2024)

- (11) **49230**
(21) 3-2023-02005 (28) 1
(54) **BÀN** (51) **06-03**
(22) 25/08/2023 (43) 25/01/2024
(73) **FUKUI CHEMICAL INDUSTRY CO., LTD. (JP)**
33-66, Sanjyuhasshacho, Fukui-shi, FUKUI 918-8585 JAPAN
(72) 1. YUKI AOYAGI (JP)
2. SHUTA KAWAMATA (JP)
(74) **CÔNG TY LUẬT TRÁCH NHIỆM HỮU HẠN AMBYS HÀ NỘI (AMBYS HANOI)**
(55)

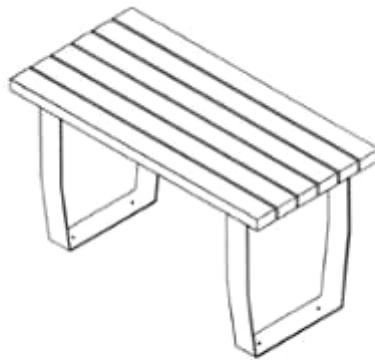

1.1



1.2

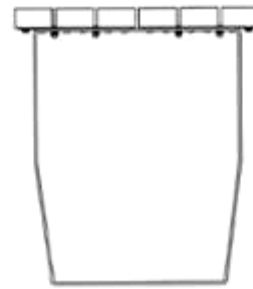

1.3



1.4

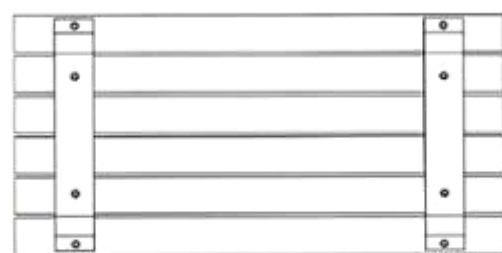

1.5

- (11) **49231**
(21) 3-2023-02006 (28) 1
(54) **GHẾ DÀI** (51) **06-01**
(22) 25/08/2023 (43) 25/01/2024
(73) **FUKUVI CHEMICAL INDUSTRY CO., LTD. (JP)**
33-66, Sanjyuhasshacho, Fukui-shi, FUKUI 918-8585 JAPAN
(72) 1. YUKI AOYAGI (JP)
2. SHUTA KAWAMATA (JP)
3. SHIORI YOSHIDA (JP)
(74) **CÔNG TY LUẬT TRÁCH NHIỆM HỮU HẠN AMBYS HÀ NỘI (AMBYS HANOI)**
(55)

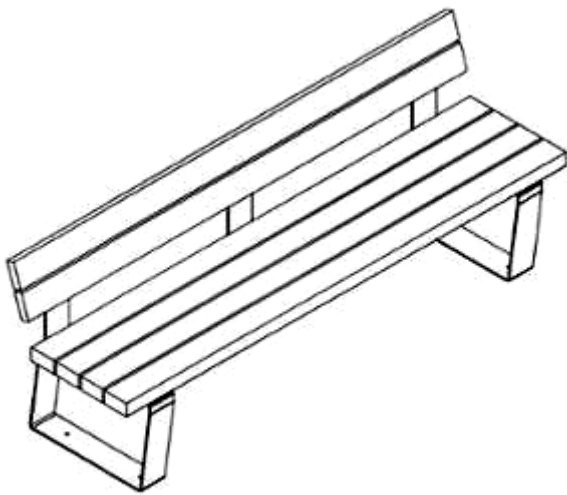

1.1



1.2

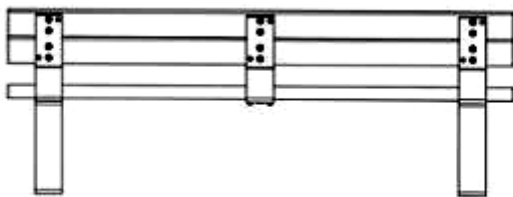

1.3



1.4



1.5

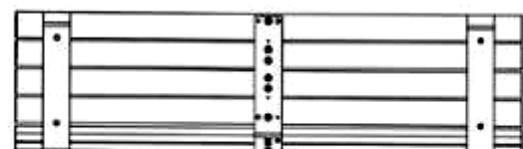

1.6

- (11) **49232**
(21) 3-2023-02007 (28) 1
(54) **GHÉ DÀI** (51) **06-01**
(22) 25/08/2023 (43) 25/01/2024
(73) **FUKUVI CHEMICAL INDUSTRY CO., LTD. (JP)**
33-66, Sanjyuhasshacho, Fukui-shi, FUKUI 918-8585 JAPAN
(72) 1. YUKI AOYAGI (JP)
2. SHUTA KAWAMATA (JP)
3. SHIORI YOSHIDA (JP)
(74) **CÔNG TY LUẬT TRÁCH NHIỆM HỮU HẠN AMBYS HÀ NỘI (AMBYS HANOI)**
(55)

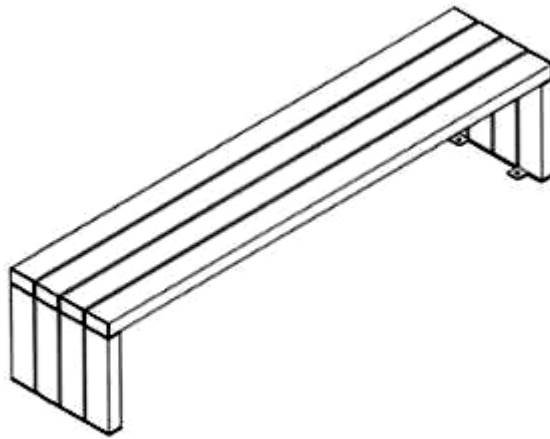

1.1



1.2

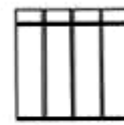

1.3

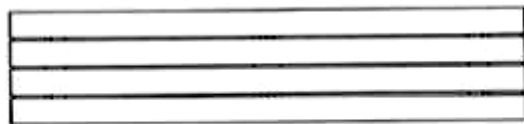

1.4



1.5

(11) **49233**

(21) 3-2023-02008

(28) 1

(54) **GHẾ DÀI**

(51) **06-01**

(22) 25/08/2023

(43) 25/01/2024

(73) **FUKUVI CHEMICAL INDUSTRY CO., LTD. (JP)**

33-66, Sanjyuhasshacho, Fukui-shi, FUKUI 918-8585 JAPAN

(72) 1. YUKI AOYAGI (JP)

2. SHUTA KAWAMATA (JP)

(74) **CÔNG TY LUẬT TRÁCH NHIỆM HỮU HẠN AMBYS HÀ NỘI (AMBYS HANOI)**

(55)

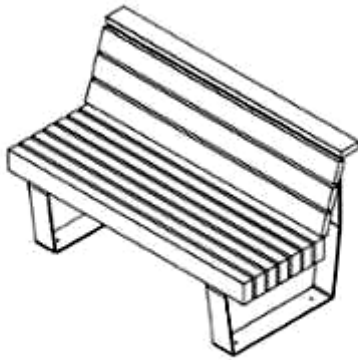

1.1



1.2

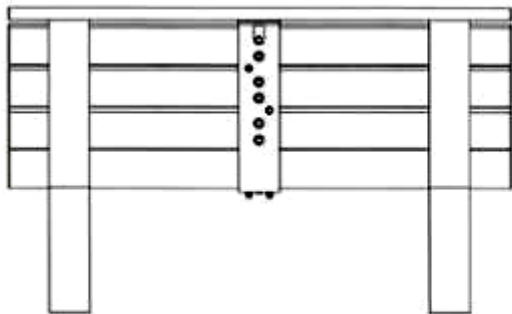

1.3

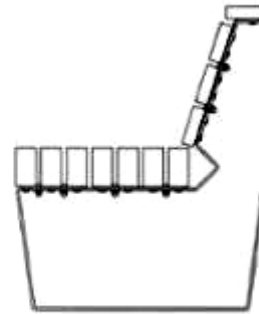

1.4

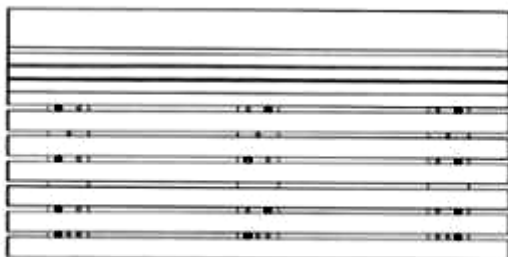

1.5

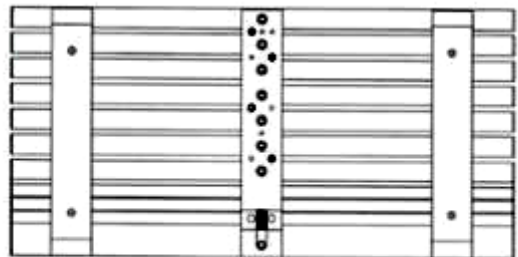

1.6

- (11) **49234**
(21) 3-2023-02010 (28) 1
(54) **GHẾ DÀI** (51) **06-01**
(22) 25/08/2023 (43) 25/01/2024
(73) **FUKUVI CHEMICAL INDUSTRY CO., LTD. (JP)**
33-66, Sanjyuhasshacho, Fukui-shi, FUKUI 918-8585 JAPAN
(72) 1. YUKI AOYAGI (JP)
2. SHUTA KAWAMATA (JP)
(74) **CÔNG TY LUẬT TRÁCH NHIỆM HỮU HẠN AMBYS HÀ NỘI (AMBYS HANOI)**
(55)

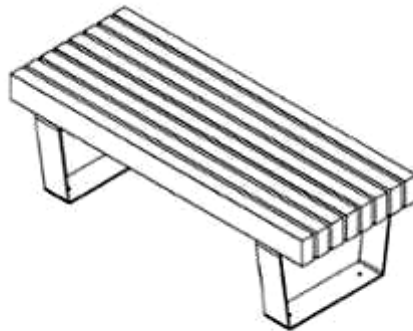

1.1



1.2

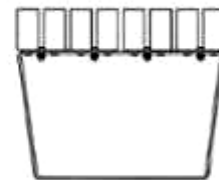

1.3

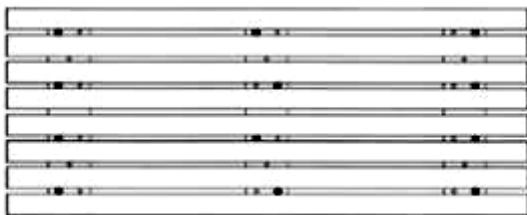

1.4

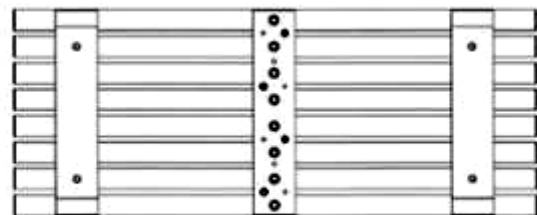

1.5

CÔNG BÁO SỞ HỮU CÔNG NGHIỆP SỐ 430 TẬP A – QUYỀN 2 (01.2024)

- (11) **49235**
(21) 3-2023-02011 (28) 1
(54) **BAO GÓI** (51) **09-05**
(22) 25/08/2023 (43) 25/01/2024
(73) **ORION CORPORATION (KR)**
13, Baekbeom-ro 90da-gil Yongsan-gu, Seoul 04369, Republic of Korea
(72) 1. HONG, MIN JEONG (KR)
2. OH, HYUN SUN (KR)
(74) Công ty Luật TNHH quốc tế BMVN (BMVN INTERNATIONAL LLC)
(55)



1.1



1.2

CÔNG BÁO SỞ HỮU CÔNG NGHIỆP SỐ 430 TẬP A – QUYỀN 2 (01.2024)

- (11) **49236**
(21) 3-2023-02012 (28) 1
(54) **HỘP** (51) **09-03**
(22) 25/08/2023 (43) 25/01/2024
(73) **ORION CORPORATION (KR)**
13, Baekbeom-ro 90da-gil Yongsan-gu, Seoul 04369, Republic of Korea
(72) 1. HONG, MIN JEONG (KR)
2. OH, HYUN SUN (KR)
(74) Công ty Luật TNHH quốc tế BMVN (BMVN INTERNATIONAL LLC)
(55)



1.1



1.2

CÔNG BÁO SỞ HỮU CÔNG NGHIỆP SỐ 430 TẬP A – QUYỀN 2 (01.2024)

- (11) **49237**
(21) 3-2023-02013 (28) 1
(54) **BAO GÓI** (51) **09-05**
(22) 25/08/2023 (43) 25/01/2024
(73) **ORION CORPORATION (KR)**
13, Baekbeom-ro 90da-gil Yongsan-gu, Seoul 04369, Republic of Korea
(72) 1. HONG, MIN JEONG (KR)
2. OH, HYUN SUN (KR)
(74) Công ty Luật TNHH quốc tế BMVN (BMVN INTERNATIONAL LLC)
(55)



1.1



1.2

CÔNG BÁO SỞ HỮU CÔNG NGHIỆP SỐ 430 TẬP A – QUYỀN 2 (01.2024)

- (11) **49238**
(21) 3-2023-02014 (28) 1
(54) **HỘP** (51) **09-03**
(22) 25/08/2023 (43) 25/01/2024
(73) **ORION CORPORATION (KR)**
13, Baekbeom-ro 90da-gil Yongsan-gu, Seoul 04369, Republic of Korea
(72) 1. HONG, MIN JEONG (KR)
2. OH, HYUN SUN (KR)
(74) Công ty Luật TNHH quốc tế BMVN (BMVN INTERNATIONAL LLC)
(55)



1.1



1.2

CÔNG BÁO SỞ HỮU CÔNG NGHIỆP SỐ 430 TẬP A – QUYỀN 2 (01.2024)

- (11) **49239**
(21) 3-2023-02017 (28) 1
(54) **NHÃN SẢN PHẨM** (51) **19-08**
(22) 25/08/2023 (43) 25/01/2024
(73) **CÔNG TY TNHH VIỆT THÁI (VN)**
Số 8 cụm CN Trường An, xã An Khánh, huyện Hoài Đức, thành phố Hà Nội
(72) Nguyễn Hữu Thi (VN)
(55)



CÔNG BÁO SỞ HỮU CÔNG NGHIỆP SỐ 430 TẬP A – QUYỀN 2 (01.2024)

- (11) **49240**
(21) 3-2023-02019 (28) 1
(54) **THANH KIM LOẠI ĐỊNH HÌNH** (51) **25-01**
(22) 25/08/2023 (43) 25/01/2024
(73) **CÔNG TY CỔ PHẦN TẬP ĐOÀN KENWIN (VN)**
Tầng 4 tòa nhà VG Building, số 235 đường Nguyễn Trãi, phường Thanh Xuân
Trung, quận Thanh Xuân, thành phố Hà Nội
(72) Ngô Thọ Long (VN)
(74) Công ty TNHH Sở hữu trí tuệ PADEMARK (PADEMARK CO.,LTD.)
(55)



1.1



1.2



1.3



1.4



1.5



1.6



1.7

CÔNG BÁO SỞ HỮU CÔNG NGHIỆP SỐ 430 TẬP A – QUYỀN 2 (01.2024)

- (11) **49241**
(21) 3-2023-02020 (28) 1
(54) **THANH KIM LOẠI ĐỊNH HÌNH** (51) **25-01**
(22) 25/08/2023 (43) 25/01/2024
(73) **CÔNG TY CỔ PHẦN TẬP ĐOÀN KENWIN (VN)**
Tầng 4 tòa nhà VG Building, số 235 đường Nguyễn Trãi, phường Thanh Xuân
Trung, quận Thanh Xuân, thành phố Hà Nội
(72) Ngô Thọ Long (VN)
(74) Công ty TNHH Sở hữu trí tuệ PADEMARK (PADEMARK CO.,LTD.)
(55)



1.1



1.2



1.3



1.4



1.5



1.6



1.7

CÔNG BÁO SỞ HỮU CÔNG NGHIỆP SỐ 430 TẬP A – QUYỀN 2 (01.2024)

- (11) **49242**
(21) 3-2023-02022 (28) 1
(54) **THANH KIM LOẠI ĐỊNH HÌNH** (51) **25-01**
(22) 25/08/2023 (43) 25/01/2024
(73) **CÔNG TY CỔ PHẦN TẬP ĐOÀN KENWIN (VN)**
Tầng 4 tòa nhà VG Building, số 235 đường Nguyễn Trãi, phường Thanh Xuân
Trung, quận Thanh Xuân, thành phố Hà Nội
(72) Ngô Thọ Long (VN)
(74) Công ty TNHH Sở hữu trí tuệ PADEMARK (PADEMARK CO.,LTD.)
(55)



1.1



1.2



1.3



1.4



1.5



1.6



1.7

CÔNG BÁO SỞ HỮU CÔNG NGHIỆP SỐ 430 TẬP A – QUYỀN 2 (01.2024)

- (11) **49243**
(21) 3-2023-02023 (28) 1
(54) **THANH KIM LOẠI ĐỊNH HÌNH** (51) **25-01**
(22) 25/08/2023 (43) 25/01/2024
(73) **CÔNG TY CỔ PHẦN TẬP ĐOÀN KENWIN (VN)**
Tầng 4 tòa nhà VG Building, số 235 đường Nguyễn Trãi, phường Thanh Xuân
Trung, quận Thanh Xuân, thành phố Hà Nội
(72) Ngô Thọ Long (VN)
(74) Công ty TNHH Sở hữu trí tuệ PADEMARK (PADEMARK CO.,LTD.)
(55)



1.1



1.2

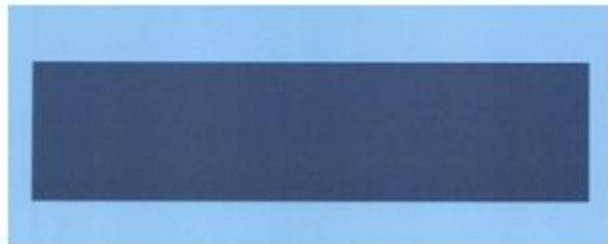

1.3

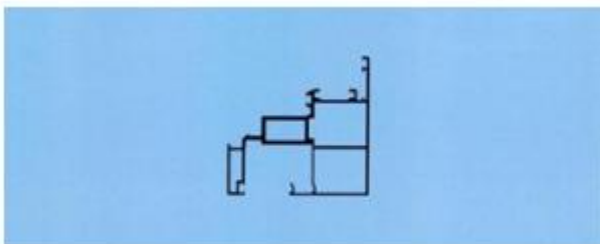

1.4

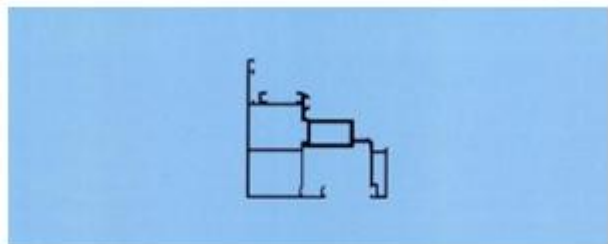

1.5



1.6



1.7

CÔNG BÁO SỞ HỮU CÔNG NGHIỆP SỐ 430 TẬP A – QUYỀN 2 (01.2024)

- (11) **49244**
(21) 3-2023-02026 (28) 1
(54) **XE ĐẠP ĐIỆN** (51) **12-11**
(22) 25/08/2023 (43) 25/01/2024
(73) **YONGQING HAOWANG HARDWARE PLASTIC PRODUCTS CO., LTD.**
(CN)
South Fanzhuang village east, Liujie Township, Yongqing County, Langfang City,
Hebei province, China
(72) ZHAO Yaoxian (CN)
(74) **CÔNG TY TRÁCH NHIỆM HỮU HẠN TƯ VẤN ĐẦU TƯ VÀ SỞ HỮU TRÍ**
TUỆ INTERFIVE (INTERFIVE CO., LTD)
(55)



1.1



1.2



1.3



1.4



1.5



1.6



1.7

CÔNG BÁO SỞ HỮU CÔNG NGHIỆP SỐ 430 TẬP A – QUYỀN 2 (01.2024)

- (11) **49245**
(21) 3-2023-02027 (28) 1
(54) **BAO GÓI** (51) **09-05**
(22) 25/08/2023 (43) 25/01/2024
(73) **NGUYỄN QUỐC CƯỜNG (VN)**
Thôn Lạc Xuân 2, xã Lạc Xuân, huyện Đơn Dương, tỉnh Lâm Đồng
(72) Nguyễn Quốc Cường (VN)
(74) Công ty TNHH Sở hữu trí tuệ Tầm Nhìn Mới (FRESHVIEW CO., LTD.)
(55)



1.1



1.2

- (11) **49246**
(21) 3-2023-02028 (28) 1
(54) **KHÓA CÀI** (51) **08-07**
(22) 25/08/2023 (43) 25/01/2024
(30) WIPO129536 03/03/2023 WO;
(73) **HERMES SELLIER (SOCIÉTÉ PAR ACTIONS SIMPLIFIÉE)** (FR)
24, Rue du Faubourg Saint-Honoré, 75008 PARIS, France
(72) Pierre-Alexis DUMAS (FR)
(74) Công ty Luật TNHH ROUSE Việt Nam (ROUSE LEGAL VIETNAM LTD.)
(55)

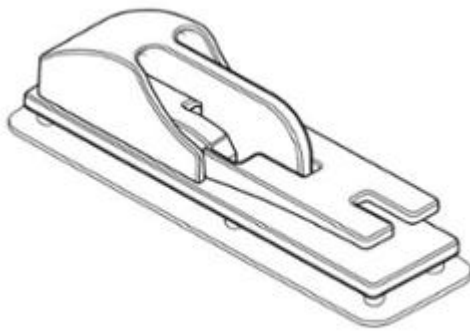

1.1



1.2



1.3



1.4

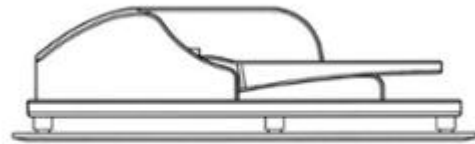

1.5

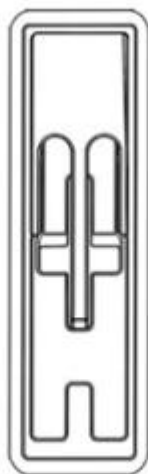

1.6

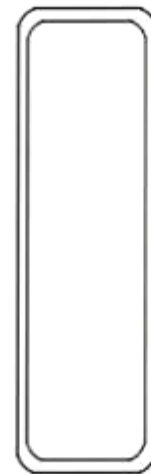

1.7

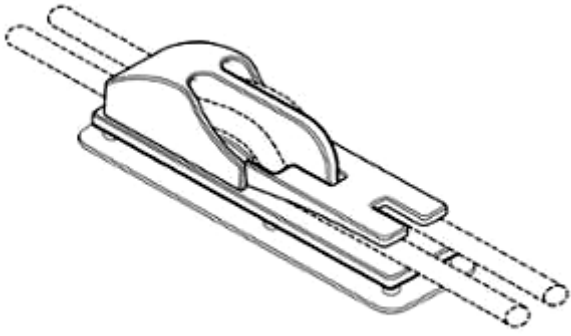

1.8

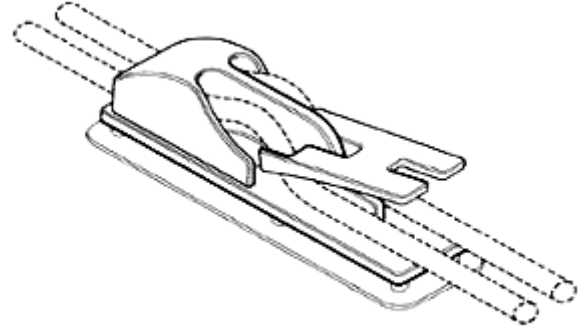

1.9

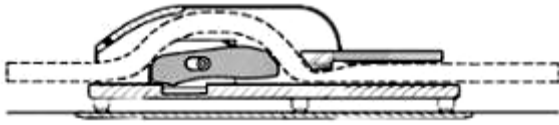

1.10

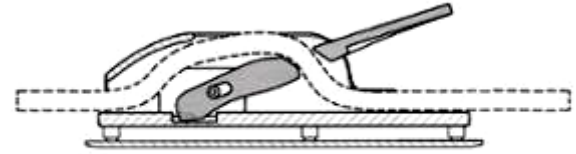

1.11

CÔNG BÁO SỞ HỮU CÔNG NGHIỆP SỐ 430 TẬP A – QUYỀN 2 (01.2024)

- (11) **49247**
(21) 3-2023-02030 (28) 1
(54) **BÚT** (51) **19-06**
(22) 25/08/2023 (43) 25/01/2024
(73) **CÔNG TY CỔ PHẦN TẬP ĐOÀN THIÊN LONG (VN)**
Tầng 10, Sofic Tower, số 10 đường Mai Chí Thọ, phường Thủ Thiêm, thành phố Thủ Đức, thành phố Hồ Chí Minh
(72) Cô Gia Thọ (VN)
(74) Công ty TNHH Tư vấn sở hữu trí tuệ Việt (VIET IP CO.,LTD.)
(55)



1.1



1.2



1.3



1.4



1.5



1.6



1.7

CÔNG BÁO SỞ HỮU CÔNG NGHIỆP SỐ 430 TẬP A – QUYỀN 2 (01.2024)

- (11) **49248**
(21) 3-2023-02033 (28) 1
(54) **CA** (51) **07-01**
(22) 28/08/2023 (43) 25/01/2024
(73) **CÔNG TY CỔ PHẦN SẢN XUẤT NHỰA DUY TÂN (VN)**
298 Hồ Học Lãm, phường An Lạc, quận Bình Tân, thành phố Hồ Chí Minh
(72) Trần Đức Xuyên (VN)
(74) Công ty TNHH Sở hữu trí tuệ INVENTIO (INVENTIO CO.,LTD)
(55)



1.1



1.2



1.3



1.4



1.5



1.6

CÔNG BÁO SỞ HỮU CÔNG NGHIỆP SỐ 430 TẬP A – QUYỀN 2 (01.2024)

(11) **49249**

(21) 3-2023-02036

(54) **MŨ BẢO HIỂM**

(22) 28/08/2023

(73) **HENRY TEDJAKUSUMA (ID)**

Jalan Wuluh Blok II/3, RT/RW 009/006, Kota Bambu Utara, Palmerah Jakarta Barat 11420, Indonesia

(72) Henry Tedjakusuma (ID)

(74) Công ty TNHH Sở hữu trí tuệ HA VIP (HAVIP CO., LTD.)

(55)

(28) 1

(51) **02-03**

(43) 25/01/2024



1.1



1.2



1.3

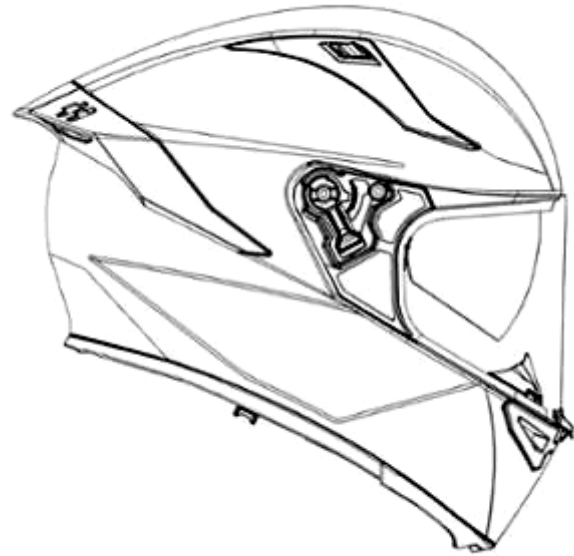

1.4

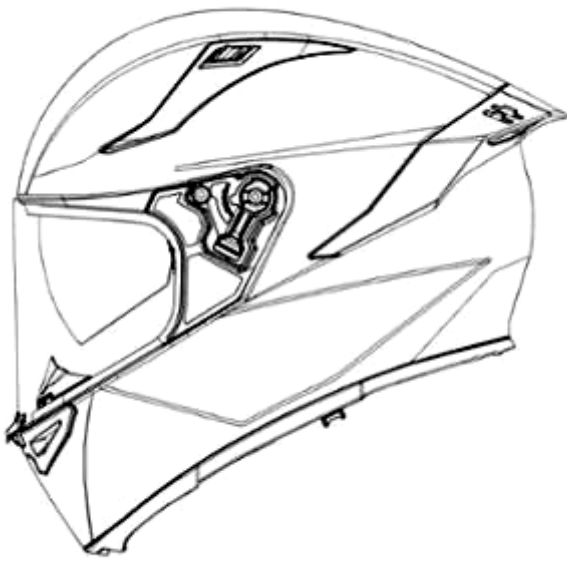

1.5



1.6

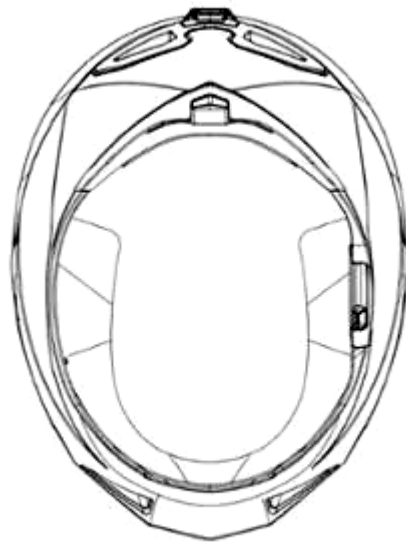

1.7

CÔNG BÁO SỞ HỮU CÔNG NGHIỆP SỐ 430 TẬP A – QUYỀN 2 (01.2024)

- (11) **49250**
(21) 3-2023-02037 (28) 1
(54) **MŨ BẢO HIỂM** (51) **02-03**
(22) 28/08/2023 (43) 25/01/2024
(73) **HENRY TEDJAKUSUMA (ID)**
Jalan Wuluh Blok II/3, RT/RW 009/006, Kota Bambu Utara, Palmerah Jakarta Barat 11420, Indonesia
(72) Henry Tedjakusuma (ID)
(74) Công ty TNHH Sở hữu trí tuệ HA VIP (HAVIP CO., LTD.)
(55)



1.1



1.2



1.3



1.4



1.5



1.6



1.7

CÔNG BÁO SỞ HỮU CÔNG NGHIỆP SỐ 430 TẬP A – QUYỀN 2 (01.2024)

- (11) **49251**
(21) 3-2023-02038 (28) 1
(54) **NHANG** (51) **99-00**
(22) 28/08/2023 (43) 25/01/2024
(73) **WONG QUỐC MINH (VN)**
119/47A22 Tân Hòa Đông, phường 14, quận 6, thành phố Hồ Chí Minh
(72) Wong Quốc Minh (VN)
(74) **CÔNG TY TNHH SỞ HỮU TRÍ TUỆ SETHACO (SETHACO IP CO.,LTD)**
(55)



1.1



1.2



1.3



1.4



1.5



1.6



1.7

CÔNG BÁO SỞ HỮU CÔNG NGHIỆP SỐ 430 TẬP A – QUYỀN 2 (01.2024)

- (11) **49252**
(21) 3-2023-02043 (28) 1
(54) **HỘP ĐỰNG SẢN PHẨM** (51) **09-03**
(22) 29/08/2023 (43) 25/01/2024
(73) **CÔNG TY TNHH DAICHI VIỆT NAM (VN)**
Số nhà 9, ngõ 444, phố Thụy Khuê, phường Bưởi, quận Tây Hồ, thành phố Hà Nội
(72) Phan Thị Điệp (VN)
(74) Công ty TNHH Sở hữu trí tuệ Bình Minh (SUNRISE IP CO.,LTD.)
(55)



1.1



1.2

CÔNG BÁO SỞ HỮU CÔNG NGHIỆP SỐ 430 TẬP A – QUYỀN 2 (01.2024)

- (11) **49253**
(21) 3-2023-02044 (28) 1
(54) **CHAI** (51) **09-01**
(22) 29/08/2023 (43) 25/01/2024
(73) **CÔNG TY CỔ PHẦN THỰC PHẨM VÀ NƯỚC GIẢI KHÁT NAM VIỆT (VN)**
Số 994/1C, đường Nguyễn Thị Minh Khai, khu phố Tân Thắng, phường Tân Bình, thành phố Dĩ An, tỉnh Bình Dương
(72) Bùi Thị Thu Hương (VN)
(74) **CÔNG TY TNHH SỞ HỮU TRÍ TUỆ ANLIS VIỆT NAM (ANLIS IP CO.,LTD)**
(55)



1.1

1.2

1.3

1.4

1.5



1.6



1.7

CÔNG BÁO SỞ HỮU CÔNG NGHIỆP SỐ 430 TẬP A – QUYỀN 2 (01.2024)

- (11) **49254**
(21) 3-2023-02045 (28) 1
(54) **NHANG** (51) **99-00**
(22) 29/08/2023 (43) 25/01/2024
(73) **WONG QUỐC MINH (VN)**
119/47A22 Tân Hòa Đông, phường 14, quận 6, thành phố Hồ Chí Minh
(72) Wong Quốc Minh (VN)
(74) **CÔNG TY TNHH SỞ HỮU TRÍ TUỆ SETHACO (SETHACO IP CO.,LTD)**
(55)



1.1



1.2



1.3



1.4



1.5



1.6



1.7

(11) **49255**

(21) 3-2023-02050

(28) 2

(54) **CẤU KIỆN KÈ LẮP GHÉP**

(51) **25-02**

(22) 30/08/2023

(43) 25/01/2024

(73) **CÔNG TY CỔ PHẦN KHOA HỌC CÔNG NGHỆ VIỆT NAM (VN)**

Số 6 đường 3 tháng 2, phường 8, thành phố Vũng Tàu, tỉnh Bà Rịa - Vũng Tàu

(72) Hoàng Đức Thảo (VN)

(55)

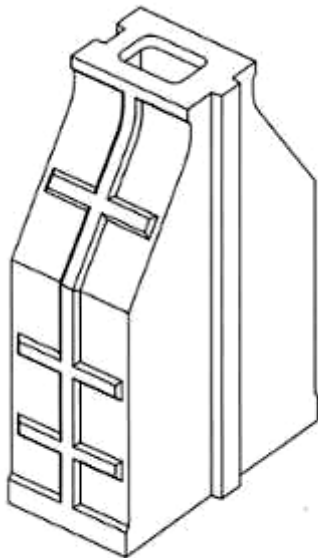

1.1

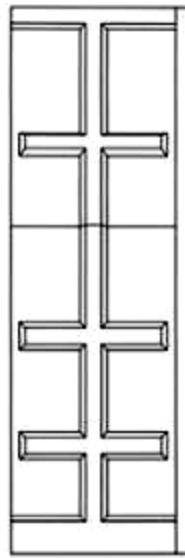

1.2

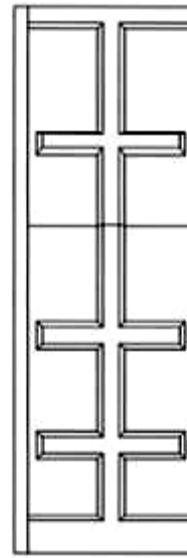

1.3

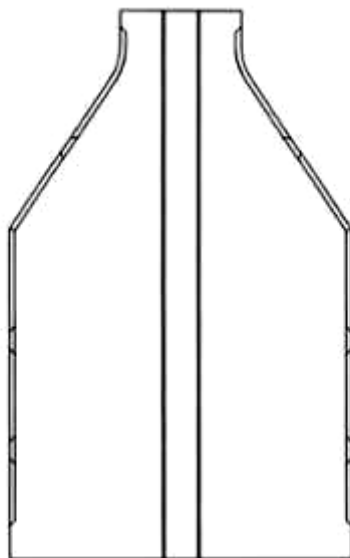

1.4

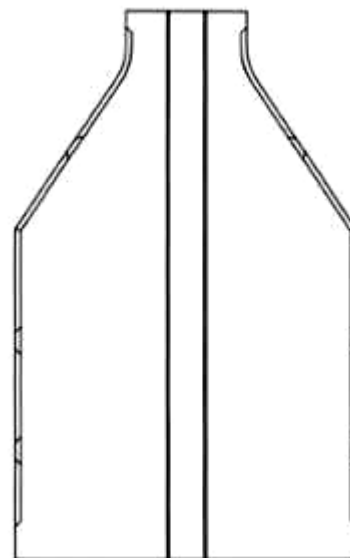

1.5

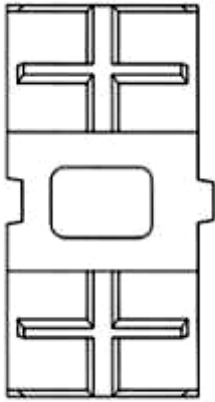

1.6

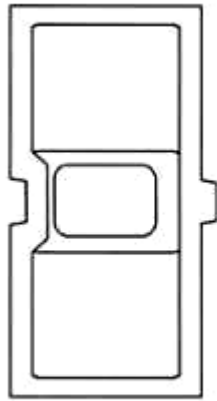

1.7

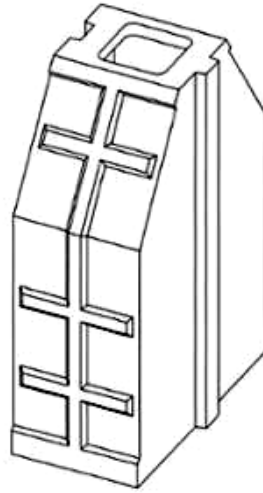

2.1

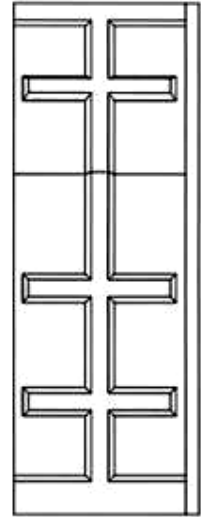

2.2

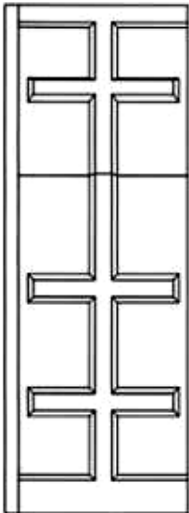

2.3

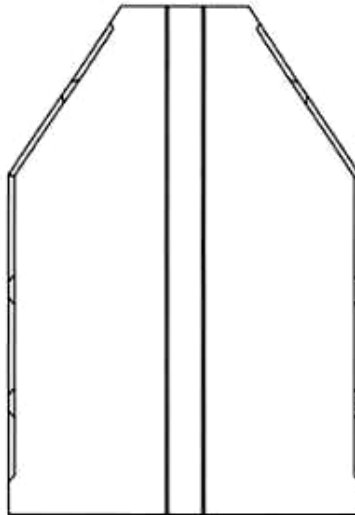

2.4

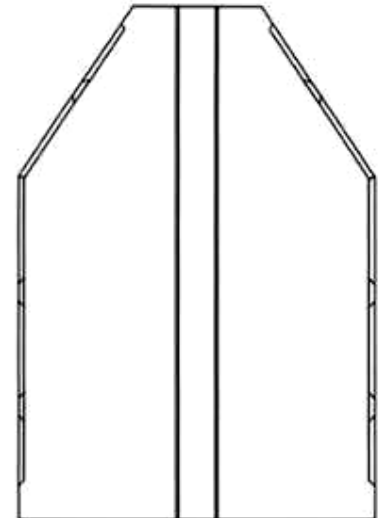

2.5

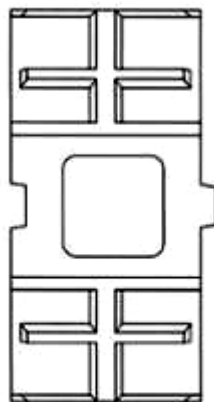

2.6

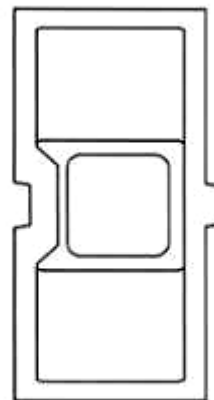

2.7

CÔNG BÁO SỞ HỮU CÔNG NGHIỆP SỐ 430 TẬP A – QUYỀN 2 (01.2024)

- (11) **49256**
- (21) 3-2023-02062 (28) 1
- (54) **NHÃN SẢN PHẨM** (51) **19-08**
- (22) 30/08/2023 (43) 25/01/2024
- (73) **CÔNG TY CỔ PHẦN CHẾ BIẾN THỰC PHẨM CAO BẰNG (VN)**
Thôn Thượng Thôn, xã Đông Tiến, huyện Yên Phong, tỉnh Bắc Ninh
- (72) Trần Thị Vượng (VN)
- (74) Công ty TNHH Sở hữu trí tuệ và Công nghệ Thủ đô (CAPITAL IP&T CO.LTD.)
- (55)



CÔNG BÁO SỞ HỮU CÔNG NGHIỆP SỐ 430 TẬP A – QUYỀN 2 (01.2024)

- (11) **49257**
(21) 3-2023-02063 (28) 1
(54) **NHÃN SẢN PHẨM** (51) **19-08**
(22) 30/08/2023 (43) 25/01/2024
(73) **CÔNG TY CỔ PHẦN CHẾ BIẾN THỰC PHẨM CAO BẰNG (VN)**
Thôn Thượng Thôn, xã Đông Tiến, huyện Yên Phong, tỉnh Bắc Ninh
(72) Trần Thị Vượng (VN)
(74) Công ty TNHH Sở hữu trí tuệ và Công nghệ Thủ đô (CAPITAL IP&T CO.LTD.)
(55)



CÔNG BÁO SỞ HỮU CÔNG NGHIỆP SỐ 430 TẬP A – QUYỀN 2 (01.2024)

- (11) **49258**
- (21) 3-2023-02064 (28) 1
- (54) **NHÃN SẢN PHẨM** (51) **19-08**
- (22) 30/08/2023 (43) 25/01/2024
- (73) **CÔNG TY TNHH SX & TM NGỌC VIỆT (VN)**
Thôn Trại, xã Tốt Động, huyện Chương Mỹ, thành phố Hà Nội
- (72) Vũ Hoàng Khánh Ngọc (VN)
- (74) Công ty TNHH Sở hữu trí tuệ và Công nghệ Thủ đô (CAPITAL IP&T CO.LTD.)
- (55)



CÔNG BÁO SỞ HỮU CÔNG NGHIỆP SỐ 430 TẬP A – QUYỀN 2 (01.2024)

- (11) **49259**
(21) 3-2023-02065 (28) 1
(54) **THIẾT BỊ ĐIỀU KHIỂN** (51) **13-03**
(22) 30/08/2023 (43) 25/01/2024
(73) **CÔNG TY TNHH CÔNG NGHỆ ITREETEK (VN)**
Số 123 đường số 6, KDC Đại Phúc, xã Bình Hưng, huyện Bình Chánh, thành phố Hồ Chí Minh
(72) Đinh Vạn Thành (VN)
(74) Công ty TNHH Sở hữu trí tuệ ALNGUYEN (ALNGUYEN IP CO.,LTD.)
(55)

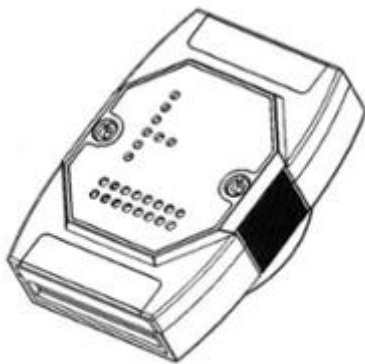

1.1

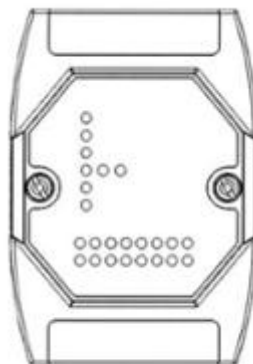

1.2

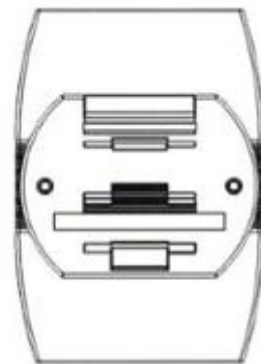

1.3

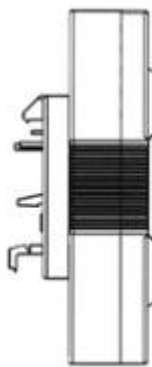

1.4

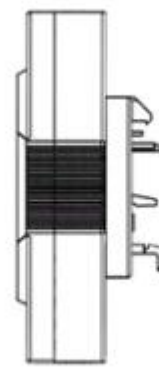

1.5

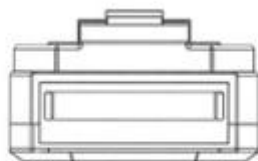

1.6



1.7

CÔNG BÁO SỞ HỮU CÔNG NGHIỆP SỐ 430 TẬP A – QUYỀN 2 (01.2024)

- (11) **49260**
(21) 3-2023-02067 (28) 1
(54) **ĐỒ CHƠI BỘ VẬN ĐỘNG ĐA NĂNG** (51) **21-03**
(22) 30/08/2023 (43) 25/01/2024
(73) **NGUYỄN ĐỨC THÀNH (VN)**
Xóm 5A, xã Lưu Phương, huyện Kim Sơn, tỉnh Ninh Bình
(72) Nguyễn Đức Thành (VN)
(74) Công ty Luật TNHH SMARTLAW (SMARTLAW LEGAL SERVICE CO.,LTD.)
(55)



1.1

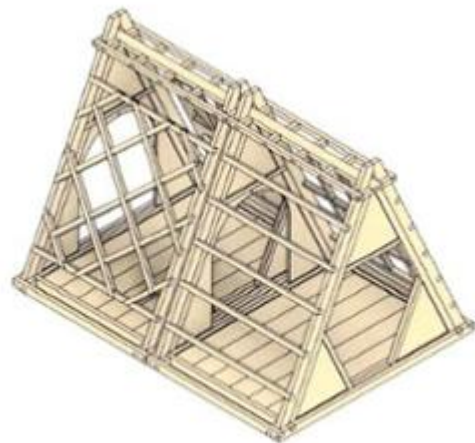

1.2

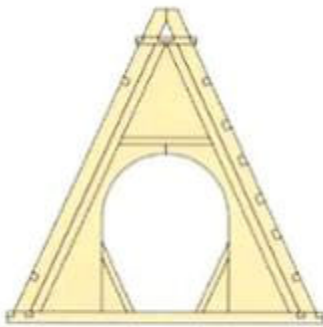

1.3

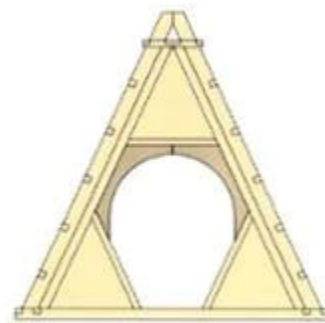

1.4

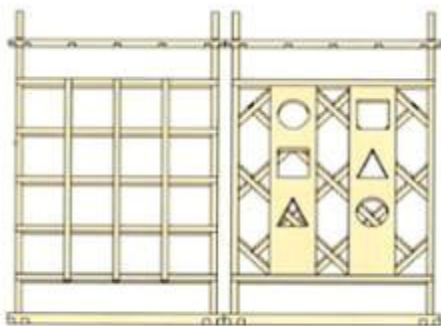

1.5

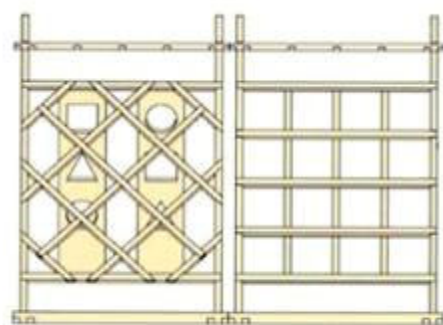

1.6

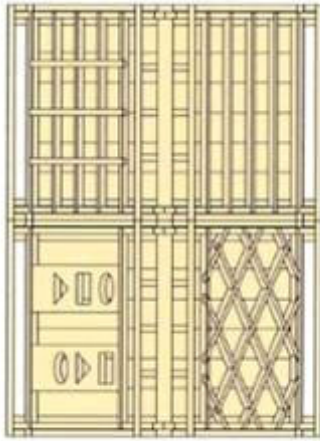

1.7

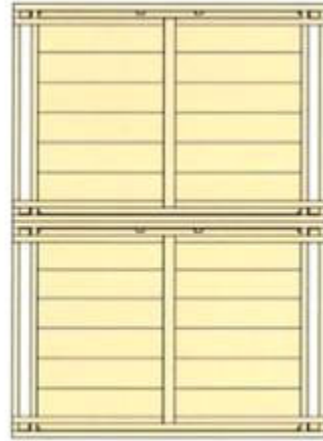

1.8

CÔNG BÁO SỞ HỮU CÔNG NGHIỆP SỐ 430 TẬP A – QUYỀN 2 (01.2024)

- (11) **49261**
(21) 3-2023-02068 (28) 1
(54) **HỘP CƠM CẢM ĐIỆN** (51) **07-02**
(22) 30/08/2023 (43) 25/01/2024
(73) **CÔNG TY CỔ PHẦN TẬP ĐOÀN BÁCH TƯỜNG PHÁT (VN)**
Tầng 5, N01-T4 Tower, chung cư Phú Mỹ Complex, khu Ngoại Giao Đoàn, phường
Xuân Tảo, quận Bắc Từ Liêm, thành phố Hà Nội
(72) Hoàng Minh Tuấn (VN)
(55)



1.1



1.2



1.3



1.4



1.5



1.6



1.7

CÔNG BÁO SỞ HỮU CÔNG NGHIỆP SỐ 430 TẬP A – QUYỀN 2 (01.2024)

- (11) **49262**
(21) 3-2023-02069 (28) 1
(54) **BÚT** (51) **19-06**
(22) 30/08/2023 (43) 25/01/2024
(73) **CÔNG TY CỔ PHẦN TẬP ĐOÀN THIÊN LONG (VN)**
Tầng 10, Sofic Tower, số 10 đường Mai Chí Thọ, phường Thủ Thiêm, thành phố
Thủ Đức, thành phố Hồ Chí Minh
(72) Cô Gia Thọ (VN)
(74) Công ty TNHH Tư vấn sở hữu trí tuệ Việt (VIET IP CO.,LTD.)
(55)

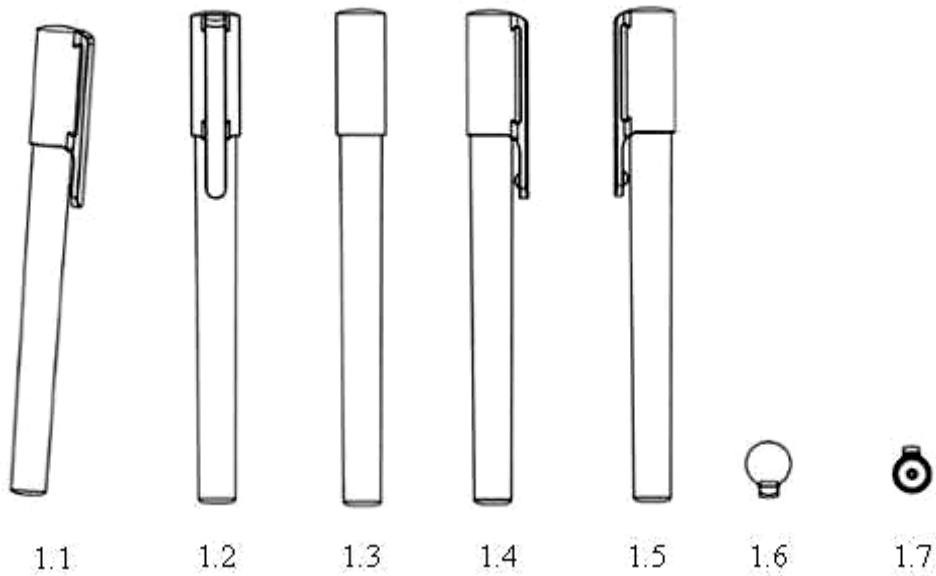

CÔNG BÁO SỞ HỮU CÔNG NGHIỆP SỐ 430 TẬP A – QUYỀN 2 (01.2024)

- (11) **49263**
(21) 3-2023-02092 (28) 1
(54) **THANH KIM LOẠI ĐỊNH HÌNH** (51) **25-01**
(22) 06/09/2023 (43) 25/01/2024
(73) **CÔNG TY TNHH CMEDCO (VN)**
Số 36 ngõ 41 phố Đông Tác, phường Kim Liên, quận Đống Đa, thành phố Hà Nội
(72) Nguyễn Tiến Cường (VN)
(74) Công ty TNHH Sở hữu trí tuệ Gia Việt (GIAVIET CO., LTD.)
(55)

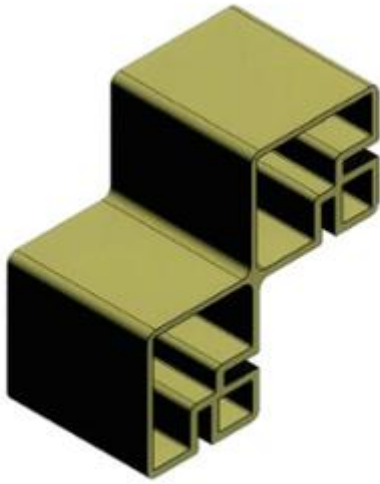

1.1

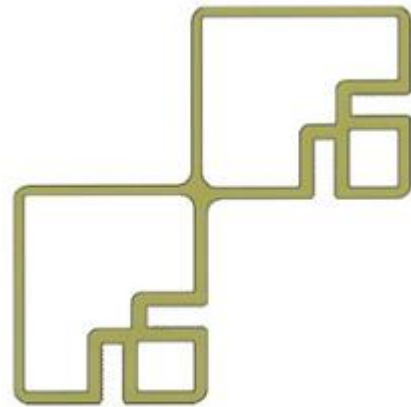

1.2

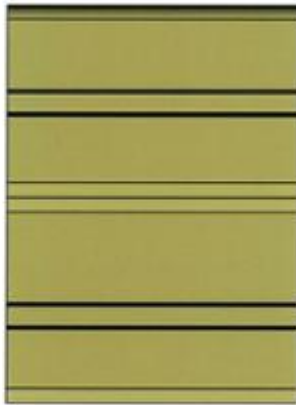

1.3



1.4



1.5

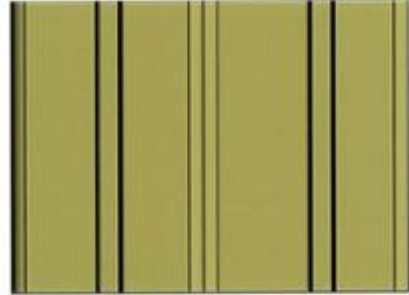

1.6

CÔNG BÁO SỞ HỮU CÔNG NGHIỆP SỐ 430 TẬP A – QUYỀN 2 (01.2024)

- (11) **49264**
(21) 3-2023-02093 (28) 1
(54) **THANH KIM LOẠI ĐỊNH HÌNH** (51) **25-01**
(22) 06/09/2023 (43) 25/01/2024
(73) **CÔNG TY TNHH CMEDCO (VN)**
Số 36 ngõ 41 phố Đông Tác, phường Kim Liên, quận Đống Đa, thành phố Hà Nội
(72) Nguyễn Tiến Cường (VN)
(74) Công ty TNHH Sở hữu trí tuệ Gia Việt (GIAVIET CO., LTD.)
(55)

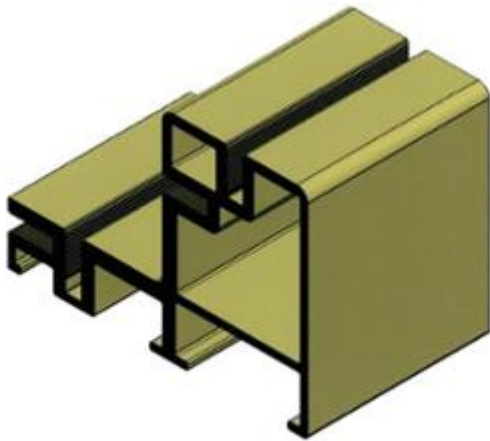

1.1

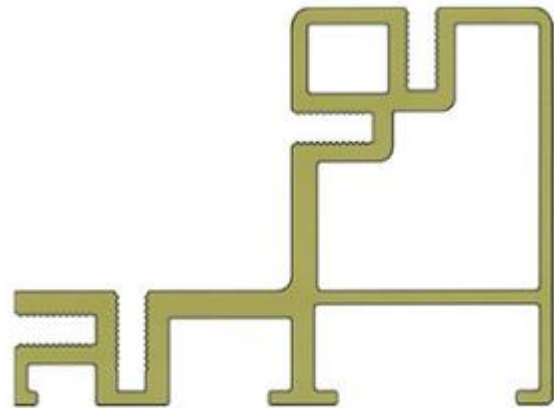

1.2



1.3



1.4



1.5



1.6

CÔNG BÁO SỞ HỮU CÔNG NGHIỆP SỐ 430 TẬP A – QUYỀN 2 (01.2024)

- (11) **49265**
(21) 3-2023-02094 (28) 1
(54) **THANH KIM LOẠI ĐỊNH HÌNH** (51) **25-01**
(22) 06/09/2023 (43) 25/01/2024
(73) **CÔNG TY TNHH CMEDCO (VN)**
Số 36 ngõ 41 phố Đông Tác, phường Kim Liên, quận Đống Đa, thành phố Hà Nội
(72) Nguyễn Tiến Cường (VN)
(74) Công ty TNHH Sở hữu trí tuệ Gia Việt (GIAVIET CO., LTD.)
(55)



1.1

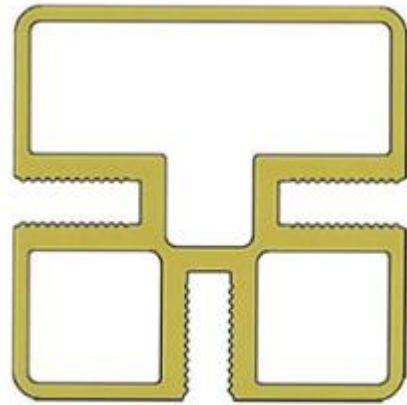

1.2



1.3



1.4



1.5

CÔNG BÁO SỞ HỮU CÔNG NGHIỆP SỐ 430 TẬP A – QUYỀN 2 (01.2024)

- (11) **49266**
(21) 3-2023-02095 (28) 1
(54) **THANH KIM LOẠI ĐỊNH HÌNH** (51) **25-01**
(22) 06/09/2023 (43) 25/01/2024
(73) **CÔNG TY TNHH CMEDCO (VN)**
Số 36 ngõ 41 phố Đông Tác, phường Kim Liên, quận Đống Đa, thành phố Hà Nội
(72) Nguyễn Tiến Cường (VN)
(74) Công ty TNHH Sở hữu trí tuệ Gia Việt (GIAVIET CO., LTD.)
(55)

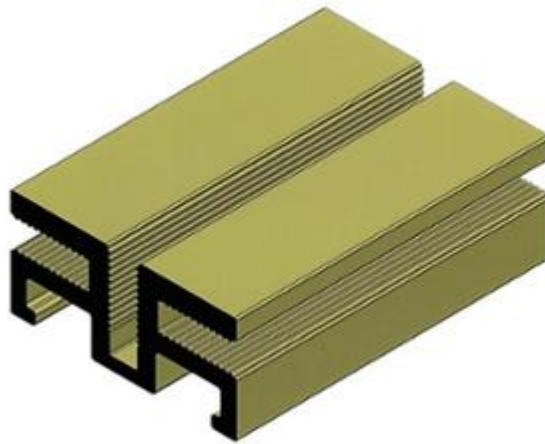

1.1



1.2



1.3



1.4



1.5

- (11) **49267**
(21) 3-2023-02096 (28) 1
(54) **DỤNG CỤ BÔI THUỐC** (51) **24-02**
(22) 06/09/2023 (43) 25/01/2024
(30) 2023-004355 06/03/2023 JP;
(73) **KOBAYASHI PHARMACEUTICAL CO., LTD. (JP)**
4-4-10 Doshomachi, Chuo-ku, Osaka, 541-0045, Japan
(72) 1. HIROSHI HASHIMOTO (JP)
2. YUKI MIMURA (JP)
(74) Công ty Luật TNHH Phạm và Liên danh (PHAM & ASSOCIATES)
(55)

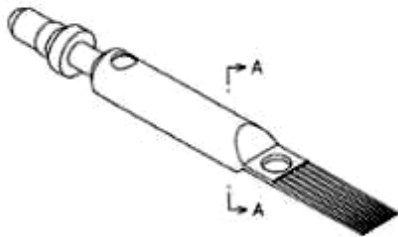

1.1



1.2

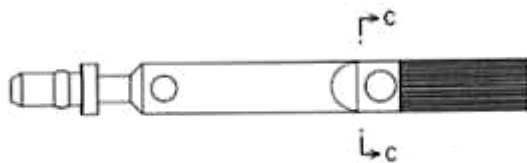

1.3



1.4



1.5



1.6

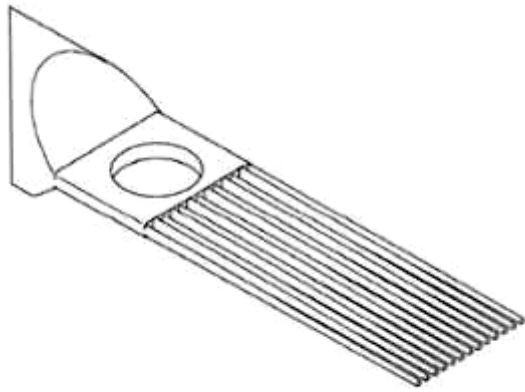

1.7



1.8

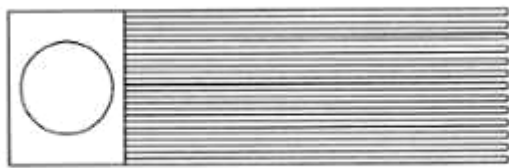

1.9



1.10



1.11

CÔNG BÁO SỞ HỮU CÔNG NGHIỆP SỐ 430 TẬP A – QUYỀN 2 (01.2024)

- (11) **49268**
(21) 3-2023-02100 (28) 1
(54) **DAO CẮT** (51) **08-03**
(22) 06/09/2023 (43) 25/01/2024
(30) 2023304456189 17/07/2023 CN;
(73) **WU, Yuewei (CN)**
No. 2, Xinyuan 1st Road, Xidian Town, Ninghai County, Ningbo, Zhejiang, China
(72) WU, Yuewei (CN)
(74) Công ty TNHH ADASTRA IP (VIỆT NAM) (ADASTRA IP (VIETNAM) CO., LTD.)
(55)

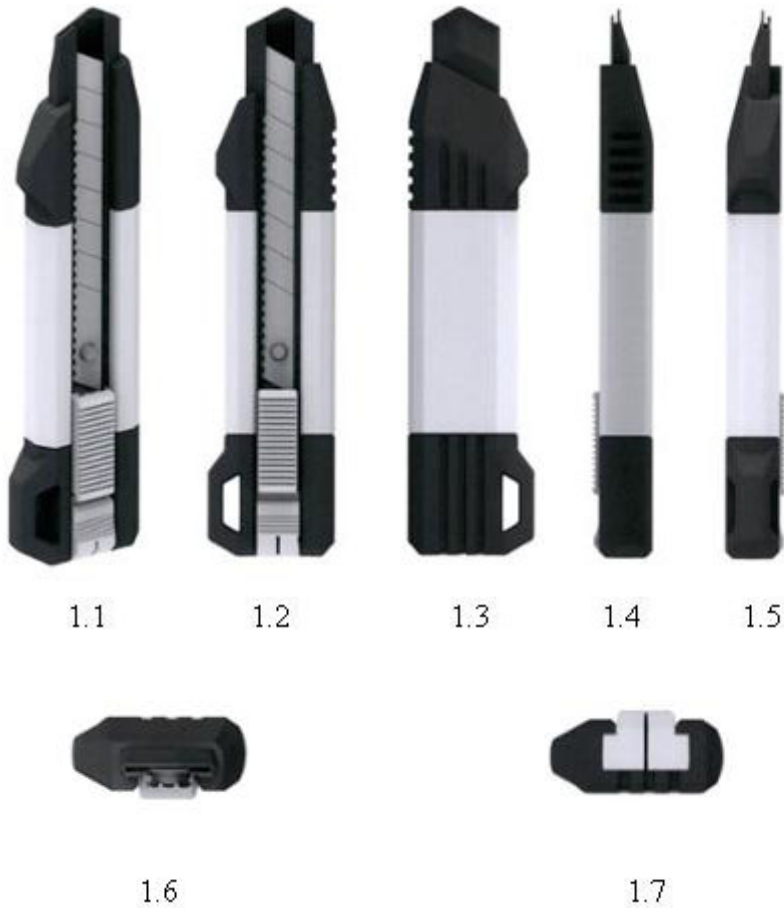

CÔNG BÁO SỞ HỮU CÔNG NGHIỆP SỐ 430 TẬP A – QUYỀN 2 (01.2024)

- (11) **49269**
(21) 3-2023-02101 (28) 1
(54) **HỘP** (51) **09-03**
(22) 06/09/2023 (43) 25/01/2024
(73) **CÔNG TY CỔ PHẦN PHÁT TRIỂN THƯƠNG MẠI TRÀNG TIỀN 35 (VN)**
Số 1, ngõ 34 Nguyễn Khiết, phường Phúc Tân, quận Hoàn Kiếm, thành phố Hà Nội
(72) Nguyễn Thị Hồng Vân (VN)
(74) **CÔNG TY TNHH SỞ HỮU TRÍ TUỆ SETHACO (SETHACO IP CO.,LTD)**
(55)



1.1



1.2

CÔNG BÁO SỞ HỮU CÔNG NGHIỆP SỐ 430 TẬP A – QUYỀN 2 (01.2024)

- (11) **49270**
(21) 3-2023-02102 (28) 1
(54) **KHAY CẨM BÚT** (51) **19-06**
(22) 06/09/2023 (43) 25/01/2024
(73) **HỘ KINH DOANH BẠCH NGỌC (VN)**
998 Lò Gốm, phường 8, quận 6, thành phố Hồ Chí Minh
(72) Trần Huệ Ngọc (VN)
(74) **CÔNG TY TNHH SỞ HỮU TRÍ TUỆ SETHACO (SETHACO IP CO.,LTD)**
(55)

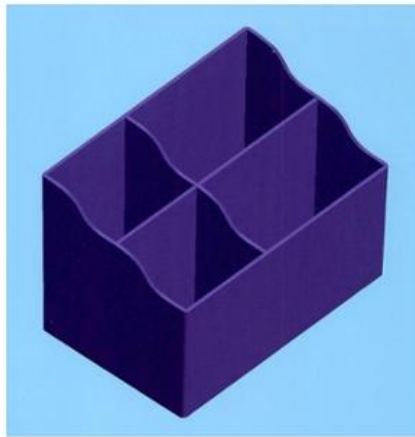

1.1



1.2



1.3



1.4



1.5

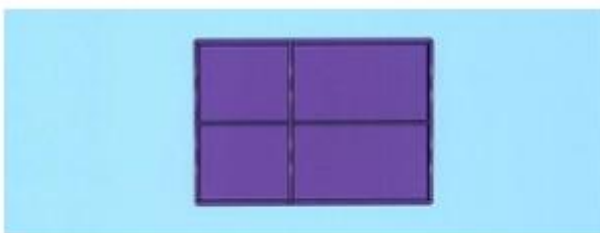

1.6



1.7

- (11) **49271**
- (21) 3-2023-02106 (28) 1
- (54) **MÀN HÌNH ĐEO ĐẦU** (51) **14-99**
- (22) 06/09/2023 (43) 25/01/2024
- (30) 29/886,191 06/03/2023 US;
- (73) **APPLE INC. (US)**
One Apple Park Way, Cupertino, California 95014, United States of America
- (72) 1. JODY AKANA (US)
2. MOLLY ANDERSON (GB)
3. BARTLEY K. ANDRE (US)
4. SHOTA AOYAGI (JP)
5. ANTHONY MICHAEL ASHCROFT (FR)
6. MARINE C. BATAILLE (FR)
7. JEREMY BATAILLOU (FR)
8. ABIDUR RAHMAN CHOWDHURY (GB)
9. CLARA GENEVIÈVE MARINE COURTAIGNE (FR)
10. MARKUS DIEBEL (DE)
11. JONATHAN GOMEZ GARCIA (GB)
12. M. EVANS HANKEY (US)
13. MOISES HERNANDEZ HERNANDEZ (MX)
14. JULIAN HOENIG (AT)
15. RICHARD P. HOWARTH (GB)
16. JONATHAN P. IVE (GB)
17. JULIAN JAEDE (DE)
18. DUNCAN ROBERT KERR (GB)
19. NICOLAS PEDRO LYLYK (AR)
20. MARC A. NEWSON (AU)
21. PETER RUSSELL-CLARKE (AU)
22. BENJAMIN ANDREW SHAFFER (US)
23. JOE SUNG-HO TAN (US)
24. CLEMENT TISSANDIER (FR)
25. EUGENE ANTONY WHANG (CA)
- (74) Công ty TNHH Lê & Lê (LE & LE)
- (55)

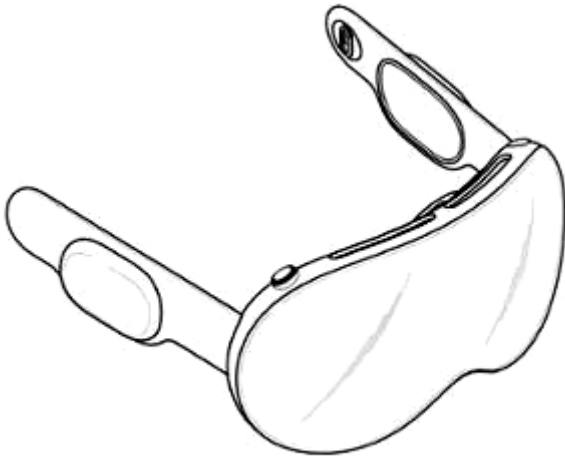

1.1

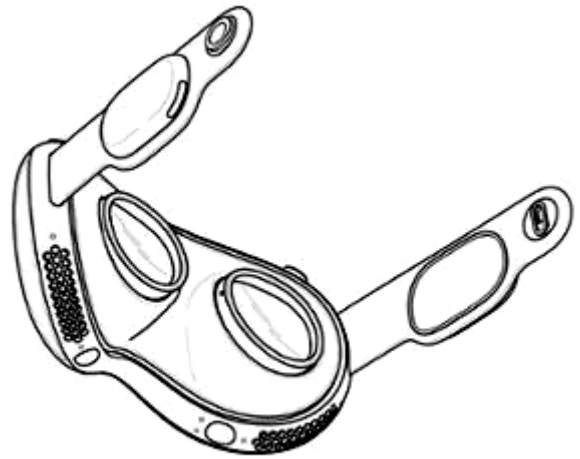

1.2



1.3



1.4

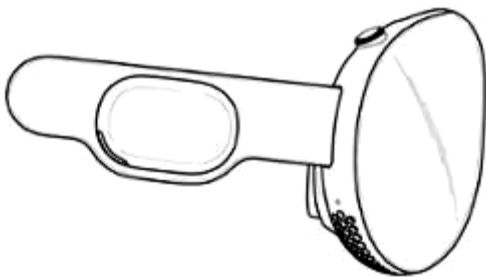

1.5

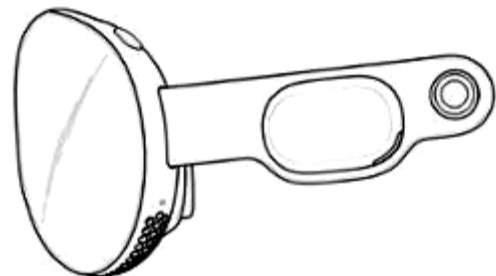

1.6

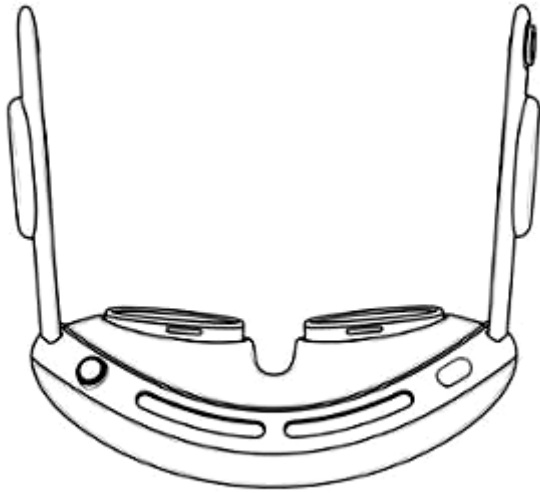

1.7

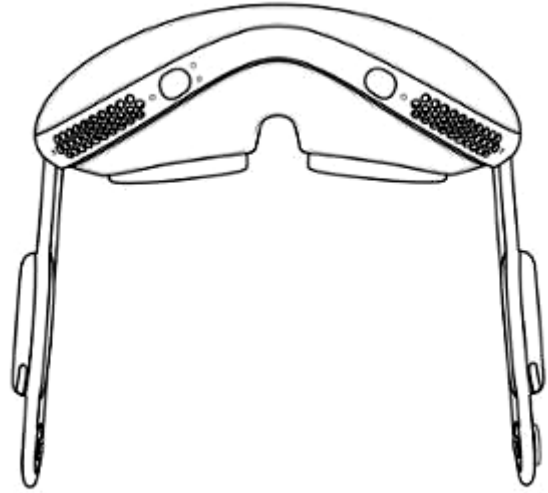

1.8

- (11) **49272**
- (21) 3-2023-02109 (28) 1
- (54) **DÂY** (51) **14-99**
- (22) 06/09/2023 (43) 25/01/2024
- (30) 29/886,193 06/03/2023 US;
- (73) **APPLE INC. (US)**
One Apple Park Way, Cupertino, California 95014, United States of America
- (72) 1. JODY AKANA (US)
2. MOLLY ANDERSON (GB)
3. BARTLEY K. ANDRE (US)
4. SHOTA AOYAGI (JP)
5. ANTHONY MICHAEL ASHCROFT (FR)
6. MARINE C. BATAILLE (FR)
7. JEREMY BATAILLOU (FR)
8. ABIDUR RAHMAN CHOWDHURY (GB)
9. CLARA GENEVIÈVE MARINE COURTAIGNE (FR)
10. MARKUS DIEBEL (DE)
11. JONATHAN GOMEZ GARCIA (GB)
12. M. EVANS HANKEY (US)
13. MOISES HERNANDEZ HERNANDEZ (MX)
14. JULIAN HOENIG (AT)
15. RICHARD P. HOWARTH (GB)
16. JONATHAN P. IVE (GB)
17. JULIAN JAEDE (DE)
18. DUNCAN ROBERT KERR (GB)
19. NICOLAS PEDRO LYLYK (AR)
20. MARC A. NEWSON (AU)
21. PETER RUSSELL-CLARKE (AU)
22. BENJAMIN ANDREW SHAFFER (US)
23. JOE SUNG-HO TAN (US)
24. CLEMENT TISSANDIER (FR)
25. EUGENE ANTONY WHANG (CA)
- (74) Công ty TNHH Lê & Lê (LE & LE)
- (55)

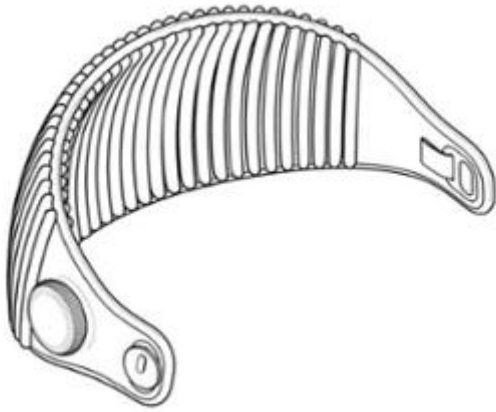

1.1

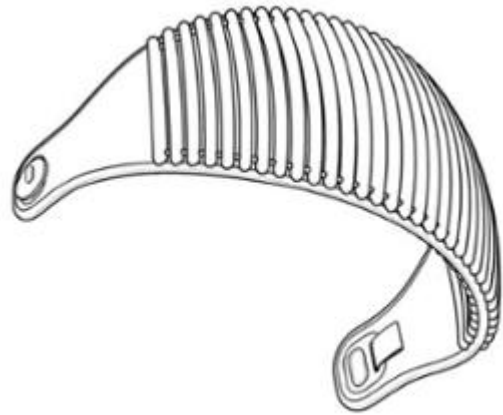

1.2

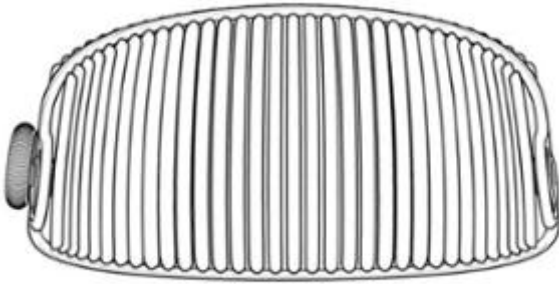

1.3

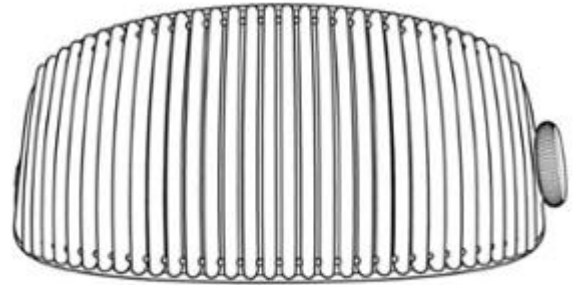

1.4

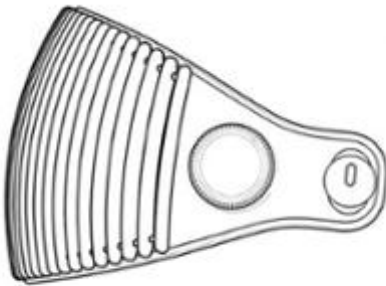

1.5

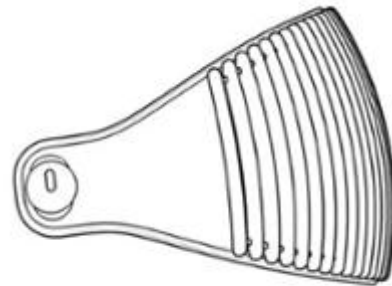

1.6



1.7



1.8

CÔNG BÁO SỞ HỮU CÔNG NGHIỆP SỐ 430 TẬP A – QUYỀN 2 (01.2024)

- (11) **49273**
(21) 3-2023-02110 (28) 1
(54) **HỘP** (51) **09-03**
(22) 06/09/2023 (43) 25/01/2024
(73) **CÔNG TY TNHH IGG VIỆT NAM (VN)**
44/8 đường số 16, khu phố 4, phường Bình Hưng Hòa, quận Bình Tân, thành phố Hồ Chí Minh
(72) Huỳnh Thị Thu Thảo (VN)
(74) Công ty TNHH một thành viên Trường Luật (Trường Luật)
(55)



1.1



1.2

CÔNG BÁO SỞ HỮU CÔNG NGHIỆP SỐ 430 TẬP A – QUYỀN 2 (01.2024)

(11) **49274**

(21) 3-2023-02111

(54) **CA**

(22) 07/09/2023

(73) **CÔNG TY TNHH MINH LONG I (VN)**

Số 333 đường Hưng Định 24, khu phố Hưng Lộc, phường Hưng Định, thành phố Thuận An, tỉnh Bình Dương

(72) Lý Ngọc Minh (VN)

(55)

(28) 1

(51) **07-01**

(43) 25/01/2024

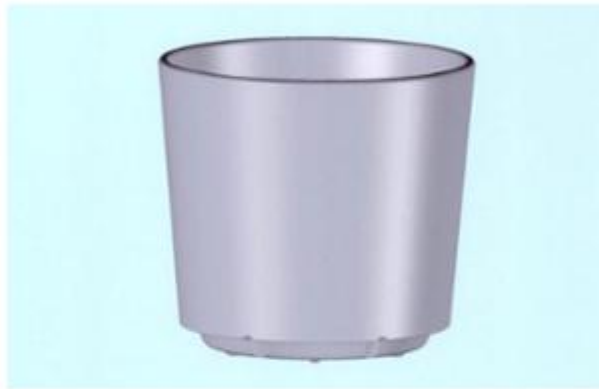

1.1



1.2



1.3



1.4

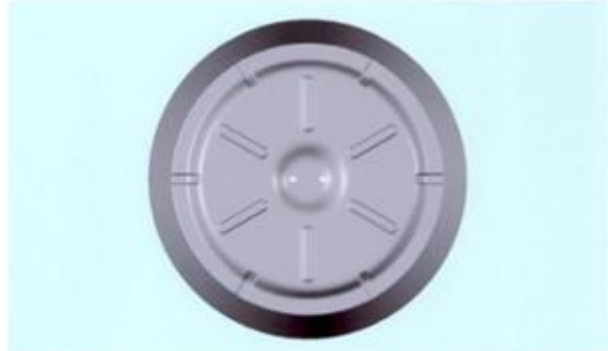

1.5

CÔNG BÁO SỞ HỮU CÔNG NGHIỆP SỐ 430 TẬP A – QUYỀN 2 (01.2024)

(11) **49275**

(21) 3-2023-02113

(28) 1

(54) **NẮP**

(51) **07-02**

(22) 07/09/2023

(43) 25/01/2024

(73) **CÔNG TY TNHH MINH LONG I (VN)**

Số 333 đường Hưng Định 24, khu phố Hưng Lộc, phường Hưng Định, thành phố Thuận An, tỉnh Bình Dương

(72) Lý Ngọc Minh (VN)

(55)



1.1



1.2



1.3



1.4



1.5

CÔNG BÁO SỞ HỮU CÔNG NGHIỆP SỐ 430 TẬP A – QUYỀN 2 (01.2024)

(11) **49276**

(21) 3-2023-02114

(28) 1

(54) **PHIN CHỨA**

(51) **07-02**

(22) 07/09/2023

(43) 25/01/2024

(73) **CÔNG TY TNHH MINH LONG I (VN)**

Số 333 đường Hưng Định 24, khu phố Hưng Lộc, phường Hưng Định, thành phố Thuận An, tỉnh Bình Dương

(72) Lý Ngọc Minh (VN)

(55)



1.1



1.2



1.3



1.4



1.5

- (11) **49277**
(21) 3-2023-02115 (28) 1
(54) **VIÊN GIẶT** (51) **28-99**
(22) 07/09/2023 (43) 25/01/2024
(30) 23-E0930-0101 06/07/2023 MY;
(73) **NEUTROVIS SDN BHD (MY)**
Block C, PJ City Development, 15A, Jalan 51a/219, Seksyen 51a, 46100 Petaling
Jaya, Selangor, Malaysia
(72) Lee William (MY)
(74) Công ty TNHH Dịch vụ Sở hữu trí tuệ KASS Việt Nam (KASS VIETNAM
CO.,LTD.)
(55)

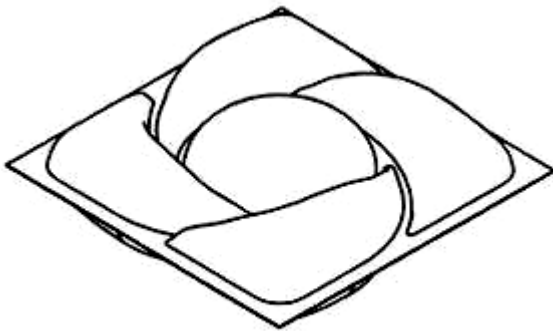

1.1

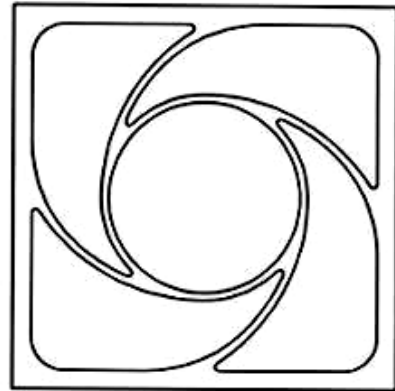

1.2



1.3



1.4

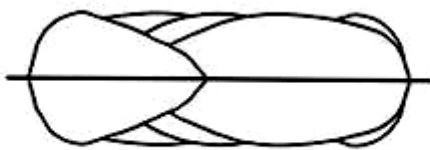

1.5

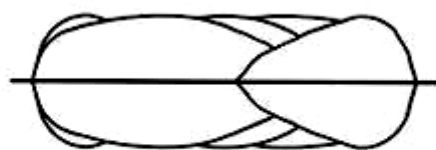

1.6

- (11) **49278**
(21) 3-2023-02116 (28) 1
(54) **VIÊN GIẶT** (51) **28-99**
(22) 07/09/2023 (43) 25/01/2024
(30) 23-E0931-0101 06/07/2023 MY;
(73) **NEUTROVIS SDN BHD (MY)**
Block C, PJ City Development, 15A, Jalan 51a/219, Seksyen 51a, 46100 Petaling
Jaya, Selangor, Malaysia
(72) Lee William (MY)
(74) Công ty TNHH Dịch vụ Sở hữu trí tuệ KASS Việt Nam (KASS VIETNAM
CO.,LTD.)
(55)

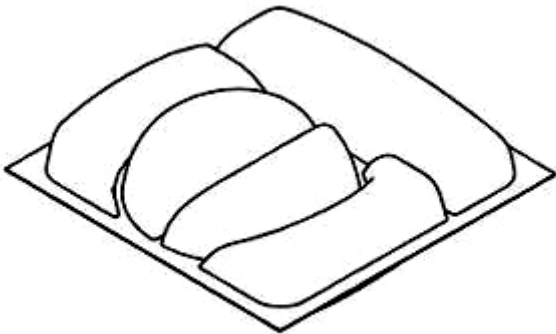

1.1

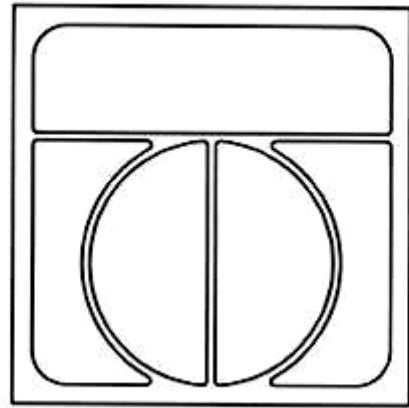

1.2



1.3



1.4



1.5

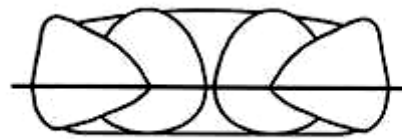

1.6

CÔNG BÁO SỞ HỮU CÔNG NGHIỆP SỐ 430 TẬP A – QUYỀN 2 (01.2024)

- (11) **49279**
(21) 3-2023-02117 (28) 1
(54) **NHÃN SẢN PHẨM** (51) **19-08**
(22) 07/09/2023 (43) 25/01/2024
(73) **CÔNG TY TNHH XUẤT NHẬP KHẨU THỰC PHẨM ĐÀ LẠT (VN)**
Ấp Phú Hòa, xã Phú Hội, huyện Đức Trọng, tỉnh Lâm Đồng
(72) Lê Trọng Hưng (VN)
(55)

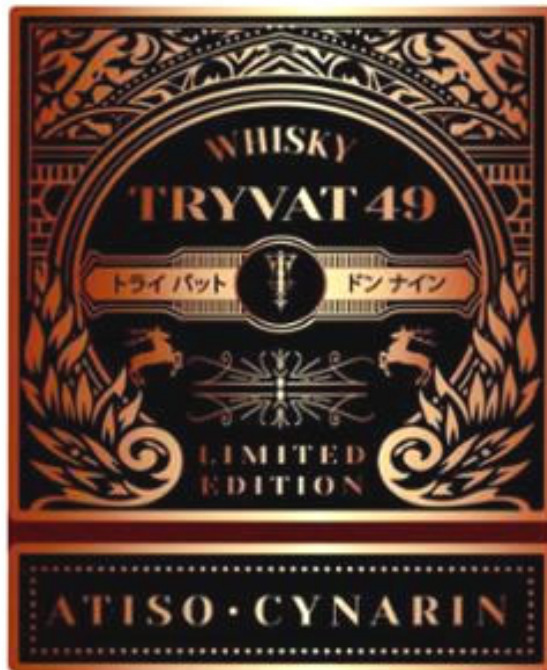

CÔNG BÁO SỞ HỮU CÔNG NGHIỆP SỐ 430 TẬP A – QUYỀN 2 (01.2024)

- (11) **49280**
(21) 3-2023-02119 (28) 2
(54) **MÁY LỌC KHÔNG KHÍ** (51) **23-04**
(22) 07/09/2023 (43) 25/01/2024
(73) **VISSMANN CLIMATE SOLUTIONS SE (DE)**
Viessmannstrasse 1, 35108 Allendorf, Federal Republic of Germany
(72) 1. LORENZO SCAZZIGA (CH)
2. BENJAMIN BECK (DE)
(74) Công ty TNHH Tâm nhìn và Liên danh (VISION & ASSOCIATES CO.LTD.)
(55)

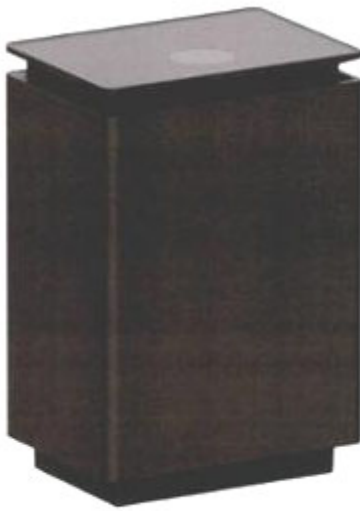

1.1



1.2



1.3



1.4



1.5



1.6



1.7



2.1



2.2

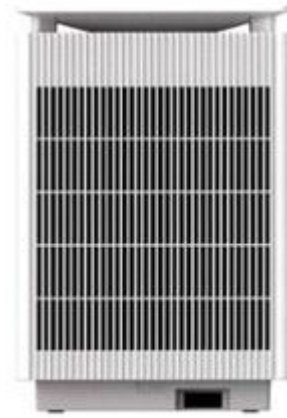

2.3



2.4



2.5

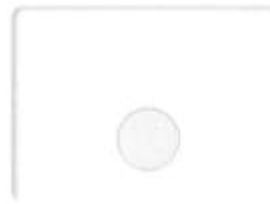

2.6

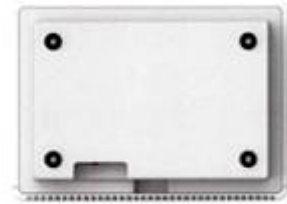

2.7

CÔNG BÁO SỞ HỮU CÔNG NGHIỆP SỐ 430 TẬP A – QUYỀN 2 (01.2024)

- (11) **49281**
(21) 3-2023-02120 (28) 2
(54) **MÁY LỌC KHÔNG KHÍ** (51) **23-04**
(22) 07/09/2023 (43) 25/01/2024
(73) **VISSMANN CLIMATE SOLUTIONS SE (DE)**
Viessmannstrasse 1, 35108 Allendorf, Federal Republic of Germany
(72) 1. LORENZO SCAZZIGA (CH)
2. BENJAMIN BECK (DE)
(74) Công ty TNHH Tâm nhìn và Liên danh (VISION & ASSOCIATES CO.LTD.)
(55)

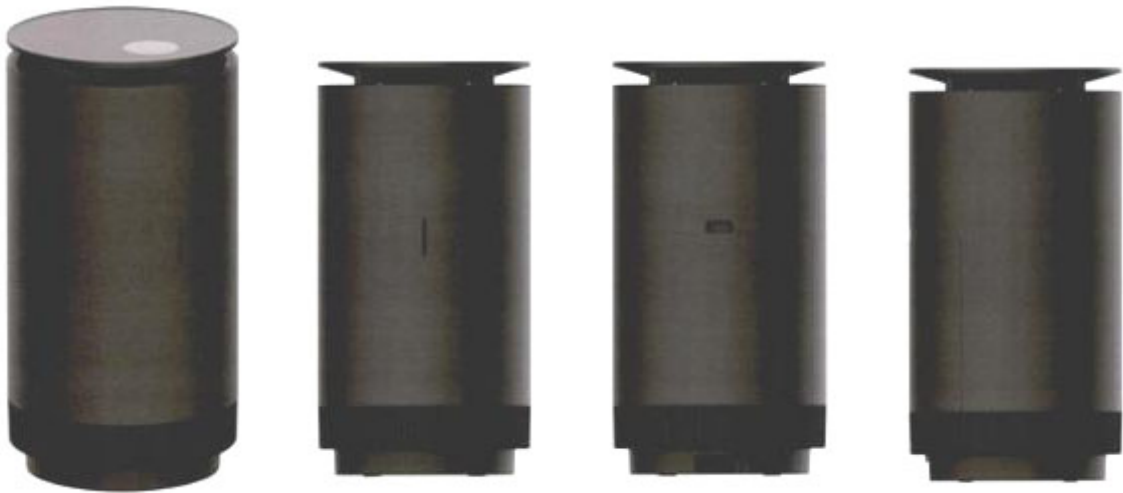

1.1

1.2

1.3

1.4



1.5



1.6



1.7



2.1



2.2



2.3



2.4



2.5



2.6



2.7

CÔNG BÁO SỞ HỮU CÔNG NGHIỆP SỐ 430 TẬP A – QUYỀN 2 (01.2024)

- (11) **49282**
(21) 3-2023-02121 (28) 2
(54) **MÁY LỌC KHÔNG KHÍ** (51) **23-04**
(22) 07/09/2023 (43) 25/01/2024
(73) **VISSMANN CLIMATE SOLUTIONS SE (DE)**
Viessmannstrasse 1, 35108 Allendorf, Federal Republic of Germany
(72) 1. LORENZO SCAZZIGA (CH)
2. BENJAMIN BECK (DE)
(74) Công ty TNHH Tâm nhìn và Liên danh (VISION & ASSOCIATES CO.LTD.)
(55)



1.1



1.2



1.3



1.4



1.5



1.6



1.7



2.1



2.2



2.3



2.4



2.5



2.6

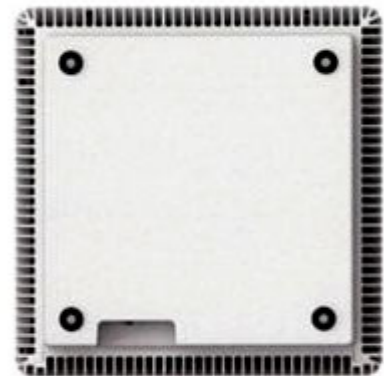

2.7

CÔNG BÁO SỞ HỮU CÔNG NGHIỆP SỐ 430 TẬP A – QUYỀN 2 (01.2024)

- (11) **49283**
(21) 3-2023-02124 (28) 1
(54) **KHÓA CỬA DỤNG CỤ KHOAN DỪA** (51) **07-04**
(22) 07/09/2023 (43) 25/01/2024
(30) 2302001013 10/03/2023 TH;
(73) **K-FRESH CO., Ltd. (TH)**
No. 234 moo 2, Suan Som sub-district, Ban Phaeo district, Samut Sakhon province,
74120, Thailand
(72) 1. KEMTAS MANUSRUNGSRI (TH)
2. WARAPORN MANUSRUNGSRI (TH)
(74) Công ty TNHH Trà và cộng sự (TRA & ASSOCIATES CO.,LTD)
(55)

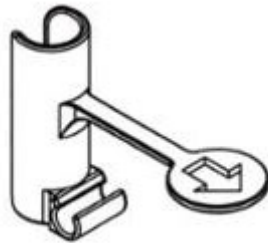

1.1



1.2



1.3

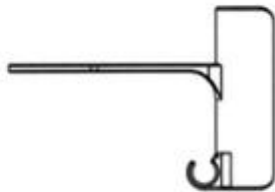

1.4

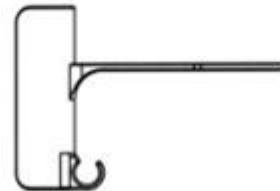

1.5



1.6



1.7

- (11) **49284**
(21) 3-2023-02125 (28) 1
(54) **BỘ PHẬN CỦA DỤNG CỤ KHOAN DỪA** (51) **07-04**
(22) 07/09/2023 (43) 25/01/2024
(30) 2302001014 10/03/2023 TH;
(73) **K-FRESH CO., Ltd. (TH)**
No. 234 moo 2, Suan Som sub-district, Ban Phaeo district, Samut Sakhon province,
74120, Thailand
(72) 1. KEMTAS MANUSRUNGSRI (TH)
2. WARAPORN MANUSRUNGSRI (TH)
(74) Công ty TNHH Trà và cộng sự (TRA & ASSOCIATES CO.,LTD)
(55)



1.1

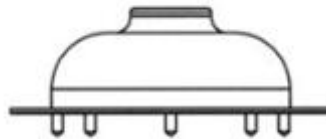

1.2

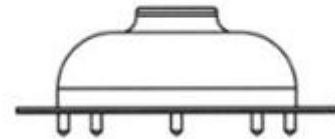

1.3

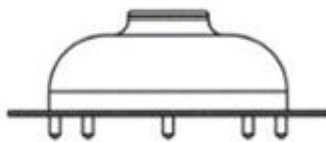

1.4

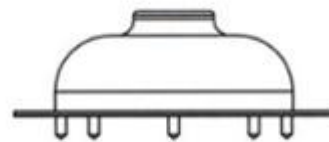

1.5

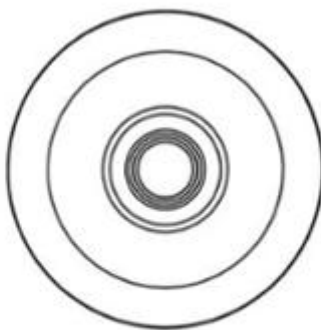

1.6

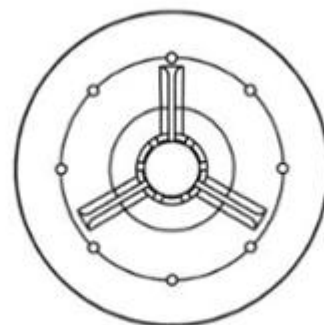

1.7

CÔNG BÁO SỞ HỮU CÔNG NGHIỆP SỐ 430 TẬP A – QUYỀN 2 (01.2024)

- (11) **49285**
(21) 3-2023-02126 (28) 1
(54) **DỤNG CỤ KHOAN DỪA** (51) **07-04**
(22) 07/09/2023 (43) 25/01/2024
(30) 2302001015 10/03/2023 TH;
(73) **K-FRESH CO., Ltd. (TH)**
No. 234 moo 2, Suan Som sub-district, Ban Phaeo district, Samut Sakhon province,
74120, Thailand
(72) 1. KEMTAS MANUSRUNGSRI (TH)
2. WARAPORN MANUSRUNGSRI (TH)
(74) Công ty TNHH Trà và cộng sự (TRA & ASSOCIATES CO.,LTD)
(55)



1.1

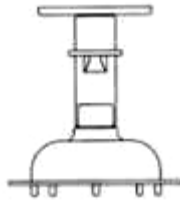

1.2

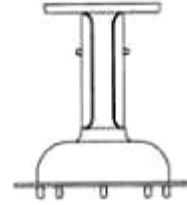

1.3

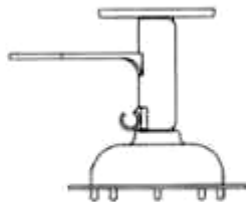

1.4

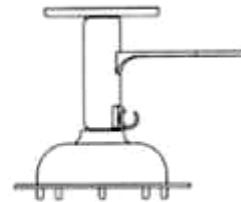

1.5



1.6

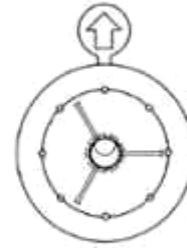

1.7

CÔNG BÁO SỞ HỮU CÔNG NGHIỆP SỐ 430 TẬP A – QUYỀN 2 (01.2024)

- (11) **49286**
(21) 3-2023-02127 (28) 1
(54) **BAO BÌ ĐỰNG QUẢ DỪA** (51) **09-03**
(22) 07/09/2023 (43) 25/01/2024
(30) 2302001016 10/03/2023 TH;
(73) **K-FRESH CO., Ltd. (TH)**
No. 234 moo 2, Suan Som sub-district, Ban Phaeo district, Samut Sakhon province,
74120, Thailand
(72) 1. KEMTAS MANUSRUNGSRI (TH)
2. WARAPORN MANUSRUNGSRI (TH)
(74) Công ty TNHH Trà và cộng sự (TRA & ASSOCIATES CO.,LTD)
(55)



1.1

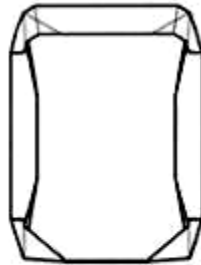

1.2



1.3

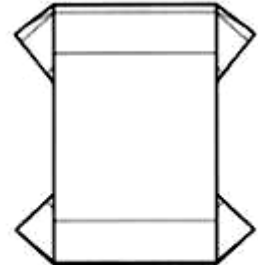

1.4

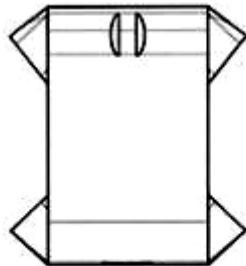

1.5

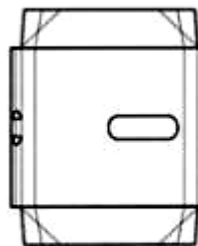

1.6

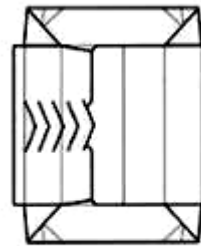

1.7

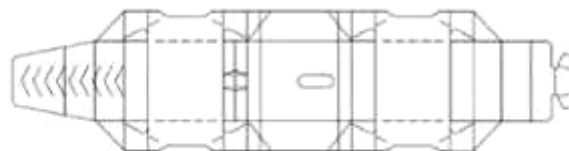

1.8

(11) **49287**

(21) 3-2023-02142

(28) 1

(54) **BÀN**

(51) **06-03**

(22) 11/09/2023

(43) 25/01/2024

(73) **CÔNG TY TNHH ATRIUM DESIGN AND BUILD (VN)**

L3-19, tầng 3, khu Cao ốc Văn phòng - Thương mại - Dịch vụ tổng hợp lô 5.5, số 8-10, đường Mai Chí Thọ, phường Thủ Thiêm, thành phố Thủ Đức, thành phố Hồ Chí Minh

(72) Trần Viên Ngọc Trân (VN)

(55)



1.1

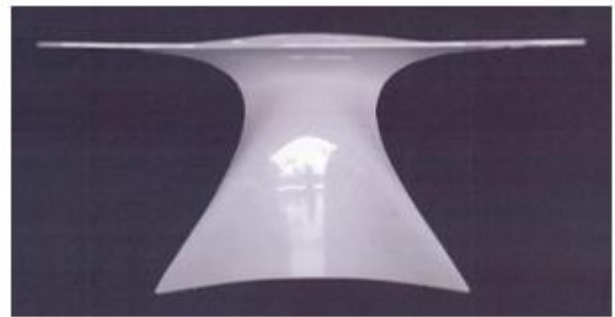

1.2



1.3



1.4



1.5



1.6



1.7

(11) **49288**

(21) 3-2023-02150

(54) **KHUNG VÕNG**

(22) 12/09/2023

(73) **CÔNG TY CỔ PHẦN TƯỞNG LAI VIỆT (VN)**

Số 43 đường 85, xã Tân Phú Trung, huyện Củ Chi, thành phố Hồ Chí Minh

(72) 1. HUỖNH NGỌC GIÀU (VN)

2. LÊ MINH HIẾU (VN)

(55)

(28) 1

(51) **06-02**

(43) 25/01/2024



1.1



1.2



1.3

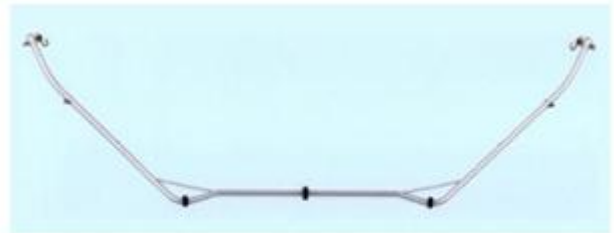

1.4



1.5



1.6

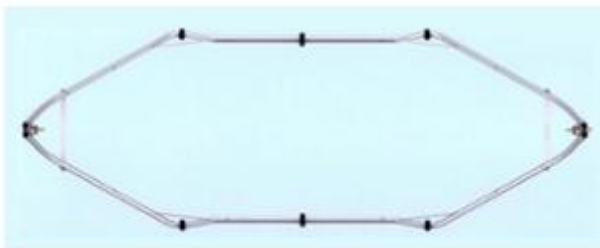

1.7

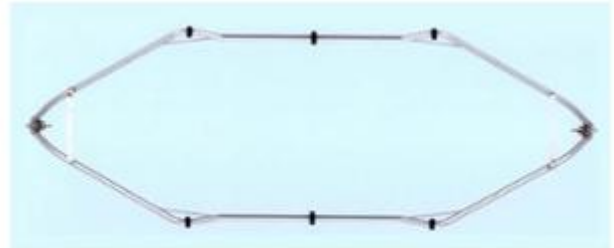

1.8

CÔNG BÁO SỞ HỮU CÔNG NGHIỆP SỐ 430 TẬP A – QUYỀN 2 (01.2024)

- (11) **49289**
(21) 3-2023-02166 (28) 1
(54) **THANH KIM LOẠI ĐỊNH HÌNH** (51) **25-01**
(22) 13/09/2023 (43) 25/01/2024
(73) **CÔNG TY TNHH MTV ĐĂNG QUANG (VN)**
Đường Trường Chinh, khu phố 1, phường Phú Tài, thành phố Phan Thiết, tỉnh Bình Thuận
(72) Võ Trường Thọ (VN)
(74) **CÔNG TY TNHH KHANG LUẬT (KHANGLAW)**
(55)

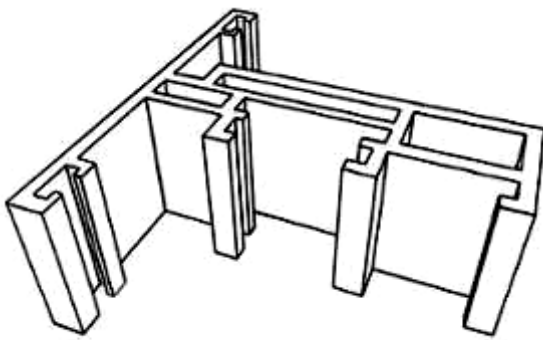

1.1



1.2

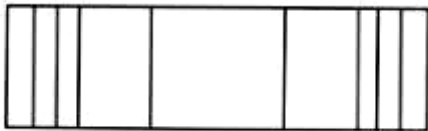

1.3



1.4

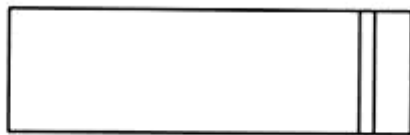

1.5

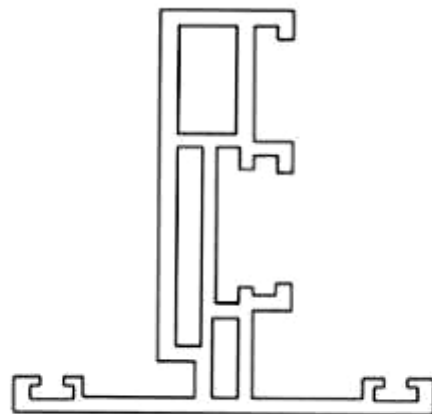

1.6

CÔNG BÁO SỞ HỮU CÔNG NGHIỆP SỐ 430 TẬP A – QUYỀN 2 (01.2024)

- (11) **49290**
(21) 3-2023-02175 (28) 1
(54) **BAO GÓI** (51) **09-05**
(22) 15/09/2023 (43) 25/01/2024
(73) **CÔNG TY CỔ PHẦN ONG MẬT TIỀN GIANG (VN)**
Tầng 5, tòa nhà Songdo, 62A Phạm Ngọc Thạch, phường Võ Thị Sáu, quận 3, thành phố Hồ Chí Minh
(72) Lê Thị Kim Phượng (VN)
(55)



1.1



1.2

CÔNG BÁO SỞ HỮU CÔNG NGHIỆP SỐ 430 TẬP A – QUYỀN 2 (01.2024)

- (11) **49291**
(21) 3-2023-02176 (28) 1
(54) **BAO GÓI** (51) **09-05**
(22) 15/09/2023 (43) 25/01/2024
(73) **CÔNG TY CỔ PHẦN ONG MẬT TIỀN GIANG (VN)**
Tầng 5, tòa nhà Songdo, 62A Phạm Ngọc Thạch, phường Võ Thị Sáu, quận 3, thành phố Hồ Chí Minh
(72) Lê Thị Kim Phượng (VN)
(55)



1.1



1.2

CÔNG BÁO SỞ HỮU CÔNG NGHIỆP SỐ 430 TẬP A – QUYỀN 2 (01.2024)

(11) **49292**

(21) 3-2023-02180

(28) 1

(54) **MÁY BÀO VỎ QUẾ**

(51) **15-03**

(22) 15/09/2023

(43) 25/01/2024

(73) **PHẠM VĂN HƯNG (VN)**

Thôn Làng Chẹo, xã An Thịnh, huyện Văn Yên, tỉnh Yên Bái

(72) Phạm Văn Hưng (VN)

(74) Công ty Cổ phần Sở hữu trí tuệ Việt Mỹ (VIET MY IPC)

(55)



1.1



1.2



1.3



1.4



1.5



1.6



1.7

CÔNG BÁO SỞ HỮU CÔNG NGHIỆP SỐ 430 TẬP A – QUYỀN 2 (01.2024)

- (11) **49293**
(21) 3-2023-02182 (28) 1
(54) **HỘP** (51) **09-03**
(22) 15/09/2023 (43) 25/01/2024
(73) **CÔNG TY TNHH THƯƠNG MẠI 3H GLOBAL (VN)**
237B An Dương Vương, phường An Lạc, quận Bình Tân, thành phố Hồ Chí Minh
(72) Lê Văn Thạch (VN)
(74) Công ty TNHH Sở hữu trí tuệ Đông Dương (DONG DUONG IP CO.,LTD)
(55)



1.1



1.2

CÔNG BÁO SỞ HỮU CÔNG NGHIỆP SỐ 430 TẬP A – QUYỀN 2 (01.2024)

- (11) **49294**
(21) 3-2023-02184 (28) 1
(54) **CHAI** (51) **09-01**
(22) 15/09/2023 (43) 25/01/2024
(73) **CÔNG TY TNHH URC VIỆT NAM (VN)**
Số 42 VSIP Đại lộ Tự Do, khu công nghiệp Việt Nam-Singapore, phường An Phú,
thành phố Thuận An, tỉnh Bình Dương
(72) JEAN PIERRE SANCHEZ GAMBOA (PH)
(74) Công ty TNHH Dương và Đồng sự (DUONG & PARTNERS CO.,LTD.)
(55)



1.1



1.2



1.3



1.4



1.5



1.6



1.7

CÔNG BÁO SỞ HỮU CÔNG NGHIỆP SỐ 430 TẬP A – QUYỀN 2 (01.2024)

- (11) **49295**
(21) 3-2023-02188 (28) 1
(54) **HỘP** (51) **09-03**
(22) 18/09/2023 (43) 25/01/2024
(73) **CÔNG TY TNHH SẢN XUẤT THƯƠNG MẠI DỊCH VỤ TÂN TƯỜNG KHANG (VN)**
Lô F1&F2, đường D2 và N5, KCN Nam Tân Uyên, phường Khánh Bình, thành phố Tân Uyên, tỉnh Bình Dương
(72) Nìm Dùng Chiếng (VN)
(74) Văn phòng Luật sư D và T (D & T LAW OFFICE)
(55)





1.7



1.8

CÔNG BÁO SỞ HỮU CÔNG NGHIỆP SỐ 430 TẬP A – QUYỀN 2 (01.2024)

(11) **49296**

(21) 3-2023-02191

(28) 1

(54) **VỈ LƯỢC**

(51) **07-02**

(22) 18/09/2023

(43) 25/01/2024

(73) **CÔNG TY TNHH MINH LONG I (VN)**

Số 333 đường Hưng Định 24, khu phố Hưng Lộc, phường Hưng Định, thành phố Thuận An, tỉnh Bình Dương

(72) Lý Ngọc Minh (VN)

(55)



1.1



1.2



1.3



1.4



1.5

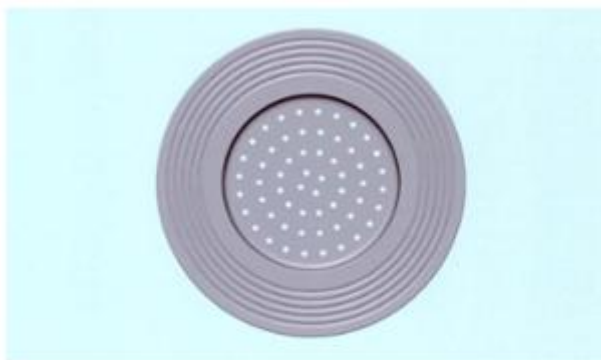

1.6

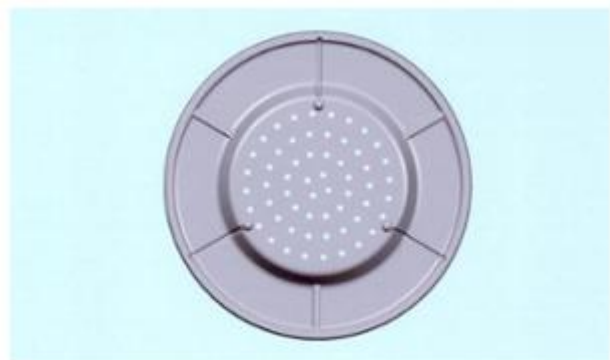

1.7

CÔNG BÁO SỞ HỮU CÔNG NGHIỆP SỐ 430 TẬP A – QUYỀN 2 (01.2024)

(11) **49297**

(21) 3-2023-02192

(28) 1

(54) **THIẾT BỊ TẢN DÒNG**

(51) **07-01; 07-02**

(22) 18/09/2023

(43) 25/01/2024

(73) **CÔNG TY TNHH MINH LONG I (VN)**

Số 333 đường Hưng Định 24, khu phố Hưng Lộc, phường Hưng Định, thành phố Thuận An, tỉnh Bình Dương

(72) Lý Ngọc Minh (VN)

(55)

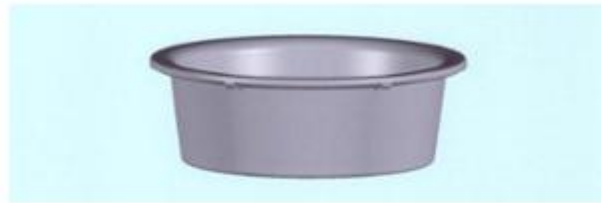

1.1



1.2



1.3



1.4

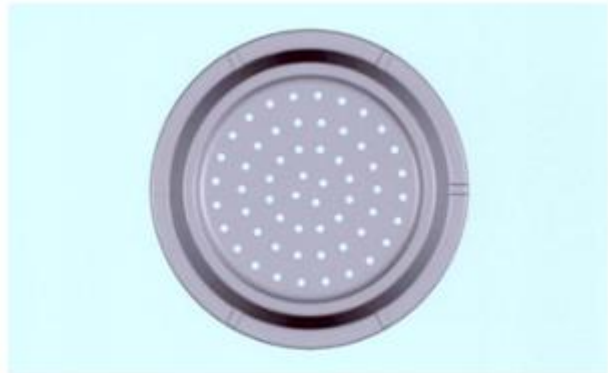

1.5

(11) **49298**

(21) 3-2023-02193

(54) **THANH CHẶN**

(22) 18/09/2023

(73) **CÔNG TY TNHH MINH LONG I (VN)**

Số 333 đường Hưng Định 24, khu phố Hưng Lộc, phường Hưng Định, thành phố Thuận An, tỉnh Bình Dương

(72) Lý Ngọc Minh (VN)

(55)

(28) 1

(51) **07-02**

(43) 25/01/2024



1.1



1.2



1.3

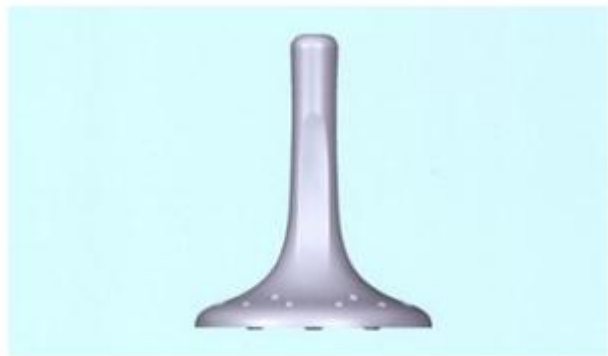

1.4

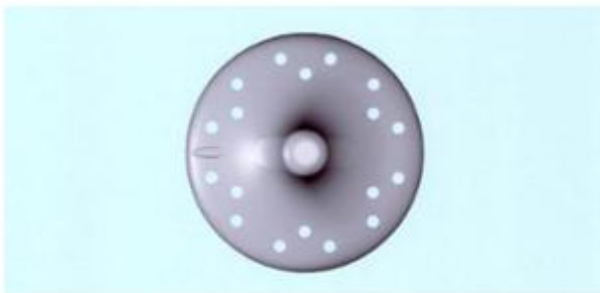

1.5

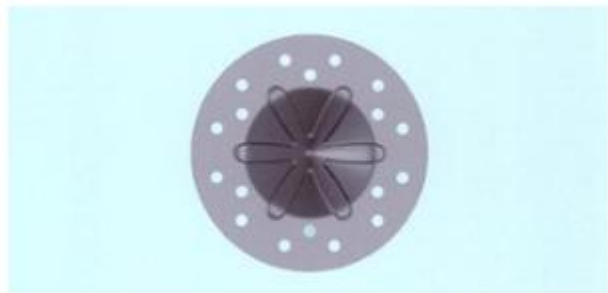

1.6

CÔNG BÁO SỞ HỮU CÔNG NGHIỆP SỐ 430 TẬP A – QUYỀN 2 (01.2024)

- (11) **49299**
(21) 3-2023-02203 (28) 1
(54) **BÌNH GIỮ NHIỆT** (51) **07-07**
(22) 20/09/2023 (43) 25/01/2024
(73) **CÔNG TY CỔ PHẦN SẢN XUẤT NHỰA DUY TÂN (VN)**
298 Hồ Học Lãm, phường An Lạc, quận Bình Tân, thành phố Hồ Chí Minh
(72) Trần Đức Xuyên (VN)
(74) Công ty TNHH Sở hữu trí tuệ INVENTIO (INVENTIO CO.,LTD)
(55)



1.1



1.2



1.3



1.4



1.5



1.6

CÔNG BÁO SỞ HỮU CÔNG NGHIỆP SỐ 430 TẬP A – QUYỀN 2 (01.2024)

- (11) **49300**
(21) 3-2023-02211 (28) 1
(54) **BỒN CHỨA NƯỚC** (51) **23-01**
(22) 21/09/2023 (43) 25/01/2024
(73) **CÔNG TY CỔ PHẦN NHỰA SAO VIỆT (VN)**
Tổ 12, ấp Hội Thạnh, xã Xuân Hiệp, huyện Trà Ôn, tỉnh Vĩnh Long
(72) Nguyễn Phú Thi (VN)
(74) Công ty TNHH Tư vấn - Dịch thuật - Sở hữu trí tuệ Á Đông (Á Đông IP CONSULTANCY CO.,LTD.)
(55)



1.1

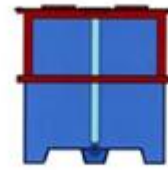

1.2



1.3

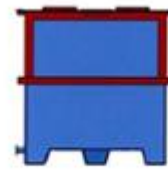

1.4



1.5

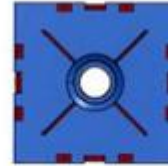

1.6

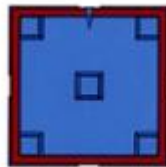

1.7

CÔNG BÁO SỞ HỮU CÔNG NGHIỆP SỐ 430 TẬP A – QUYỀN 2 (01.2024)

(11) **49301**

(21) 3-2023-02213

(28) 1

(54) **BẦU NHỎ GIỌT**

(51) **24-02**

(22) 21/09/2023

(43) 25/01/2024

(73) **CÔNG TY CỔ PHẦN NHÀ MÁY TRANG THIẾT BỊ Y TẾ USM
HEALTHCARE (VN)**

Lô I-4b-1.3, đường N3, khu Công nghệ cao, phường Long Thạnh Mỹ, thành phố
Thủ Đức, thành phố Hồ Chí Minh

(72) 1. **VÕ XUÂN BỘI LÂM (VN)**

2. **NGUYỄN VĂN THUẬN (VN)**

3. **PHẠM MINH NHỰT (VN)**

4. **VÕ VĂN THI (VN)**

5. **NGUYỄN VĂN DŨNG (VN)**

6. **NGUYỄN HOÀNG MINH QUÂN (VN)**

(74) **CÔNG TY TNHH SỞ HỮU TRÍ TUỆ ANLIS VIỆT NAM (ANLIS IP CO.,LTD)**

(55)

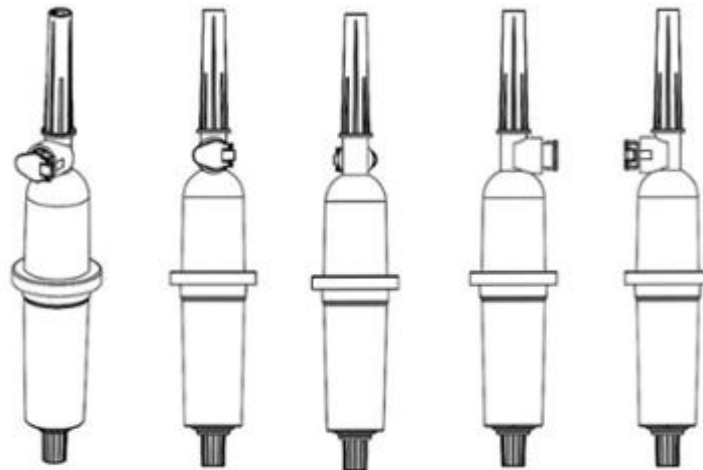

1.1

1.2

1.3

1.4

1.5



1.6



1.7

CÔNG BÁO SỞ HỮU CÔNG NGHIỆP SỐ 430 TẬP A – QUYỀN 2 (01.2024)

- (11) **49302**
- (21) 3-2023-02216 (28) 1
- (54) **NHÃN SẢN PHẨM** (51) **19-08**
- (22) 22/09/2023 (43) 25/01/2024
- (73) **CÔNG TY TNHH ASIAN VN GROUP (VN)**
Số 93, đường N1, KDC Hiệp Thành, phường Hiệp Thành, quận 12, thành phố Hồ Chí Minh
- (72) Phạm Văn Phong (VN)
- (55)



CÔNG BÁO SỞ HỮU CÔNG NGHIỆP SỐ 430 TẬP A – QUYỀN 2 (01.2024)

(11) **49303**

(21) 3-2023-02219

(28) 1

(54) **CHI TIẾT HÃM CHÓT CỬA**

(51) **08-07**

(22) 22/09/2023

(43) 25/01/2024

(73) **ĐÀO THỦY TIÊN (VN)**

Số 11 ngõ Trung Yên, phường Hàng Bạc, quận Hoàn Kiếm, thành phố Hà Nội

(72) Đào Thủy Tiên (VN)

(55)



1.1



1.2



1.3



1.4



1.5



1.6



1.7

CÔNG BÁO SỞ HỮU CÔNG NGHIỆP SỐ 430 TẬP A – QUYỀN 2 (01.2024)

(11) **49304**

(21) 3-2023-02220

(28) 1

(54) **CHI TIẾT HÃM CHÓT CỬA**

(51) **08-07**

(22) 22/09/2023

(43) 25/01/2024

(73) **ĐÀO THỦY TIÊN (VN)**

Số 11 ngõ Trung Yên, phường Hàng Bạc, quận Hoàn Kiếm, thành phố Hà Nội

(72) Đào Thủy Tiên (VN)

(55)



1.1



1.2



1.3



1.4



1.5



1.6



1.7

- (11) **49305**
(21) 3-2023-02244 (28) 1
(54) **VIÊN GIẶT** (51) **28-99**
(22) 22/09/2023 (43) 25/01/2024
(30) 23-E1129-0101 17/08/2023 MY;
(73) **NEUTROVIS SDN. BHD.** (MY)
Block C, PJ City Development, 15A, Jalan 51a/219, Seksyen 51a, 46100 Petaling
Jaya, Selangor, Malaysia
(72) William Lee (MY)
(74) Công ty TNHH Dịch vụ Sở hữu trí tuệ KASS Việt Nam (KASS VIETNAM
CO.,LTD.)
(55)

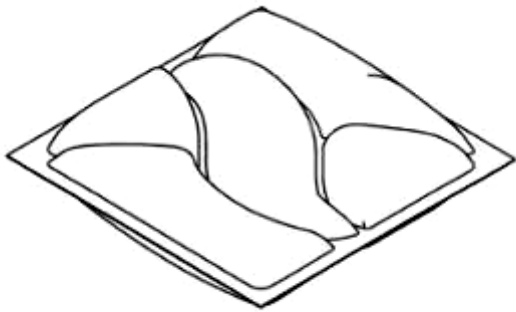

1.1

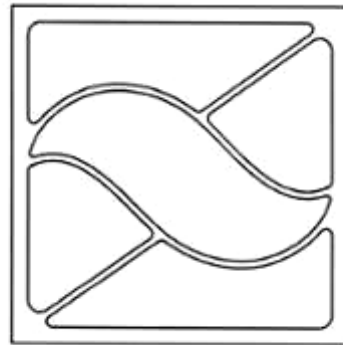

1.2

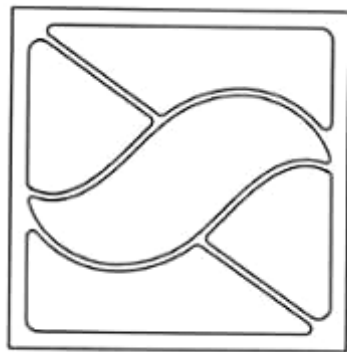

1.3



1.4



1.5



1.6



1.7

CÔNG BÁO SỞ HỮU CÔNG NGHIỆP SỐ 430 TẬP A – QUYỀN 2 (01.2024)

- (11) **49306**
(21) 3-2023-02245 (28) 1
(54) **BÚT** (51) **19-06**
(22) 22/09/2023 (43) 25/01/2024
(73) **CÔNG TY CỔ PHẦN TẬP ĐOÀN THIÊN LONG (VN)**
Tầng 10, Sofic Tower, số 10 đường Mai Chí Thọ, phường Thủ Thiêm, thành phố
Thủ Đức, thành phố Hồ Chí Minh
(72) Cô Gia Thọ (VN)
(74) Công ty TNHH Tư vấn sở hữu trí tuệ Việt (VIET IP CO.,LTD.)
(55)

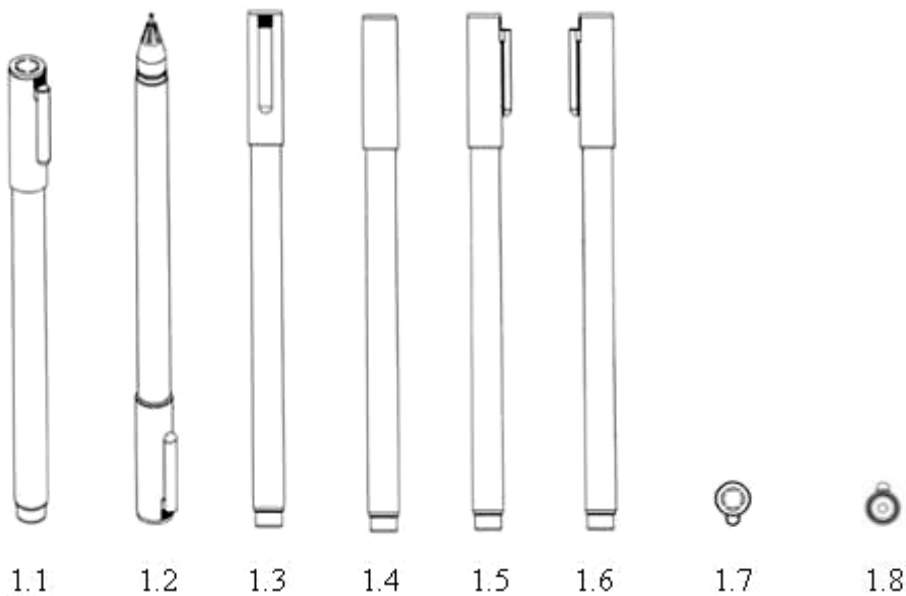

CÔNG BÁO SỞ HỮU CÔNG NGHIỆP SỐ 430 TẬP A – QUYỀN 2 (01.2024)

- (11) **49307**
(21) 3-2023-02246 (28) 1
(54) **THIẾT BỊ GIÁM SÁT TẬP TRUNG** (51) **14-02**
(22) 25/09/2023 (43) 25/01/2024
(73) **CÔNG TY CỔ PHẦN SMATEC (VN)**
TT17 - B24, khu đô thị Văn Quán - Yên Phúc, phường Phúc La, quận Hà Đông,
thành phố Hà Nội
(72) 1. NGUYỄN HỒNG SƠN (VN)
2. LÊ BÌNH DẦN (VN)
(55)

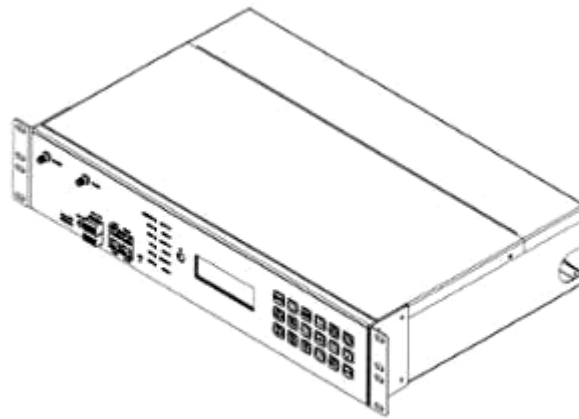

1.1



1.2



1.3



1.4



1.5

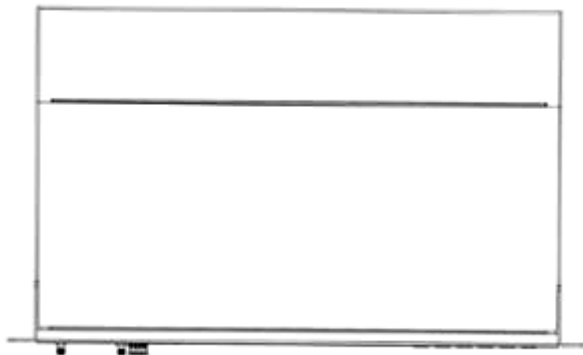

1.6



1.7

CÔNG BÁO SỞ HỮU CÔNG NGHIỆP SỐ 430 TẬP A – QUYỀN 2 (01.2024)

- (11) **49308**
- (21) 3-2023-02247
- (54) **THIẾT BỊ ĐIỀU KHIỂN SỐ HÓA**
- (22) 25/09/2023
- (73) **CÔNG TY CỔ PHẦN SMATEC (VN)**
TT17 - B24, khu đô thị Văn Quán - Yên Phúc, phường Phúc La, quận Hà Đông, thành phố Hà Nội
- (72) 1. NGUYỄN HỒNG SƠN (VN)
2. LÊ BÌNH DẦN (VN)
- (55)

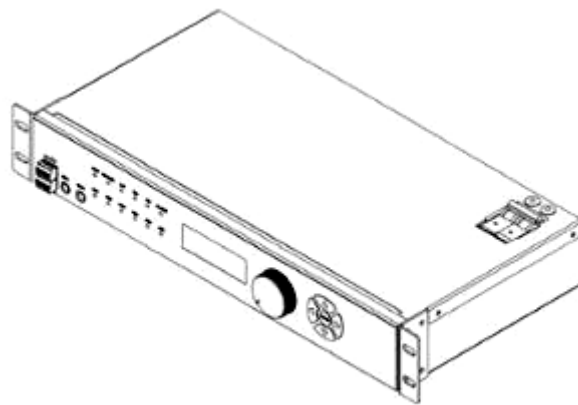

1.1



1.2



1.3



1.4



1.5



1.6



1.7

CÔNG BÁO SỞ HỮU CÔNG NGHIỆP SỐ 430 TẬP A – QUYỀN 2 (01.2024)

- (11) **49309**
(21) 3-2023-02249 (28) 1
(54) **THIẾT BỊ TRUYỀN THANH THÔNG MINH** (51) **14-03**
(22) 25/09/2023 (43) 25/01/2024
(73) **CÔNG TY CỔ PHẦN SMATEC (VN)**
TT17 - B24, khu đô thị Văn Quán - Yên Phúc, phường Phúc La, quận Hà Đông,
thành phố Hà Nội
(72) 1. NGUYỄN HỒNG SƠN (VN)
2. LÊ BÌNH DẦN (VN)
(55)

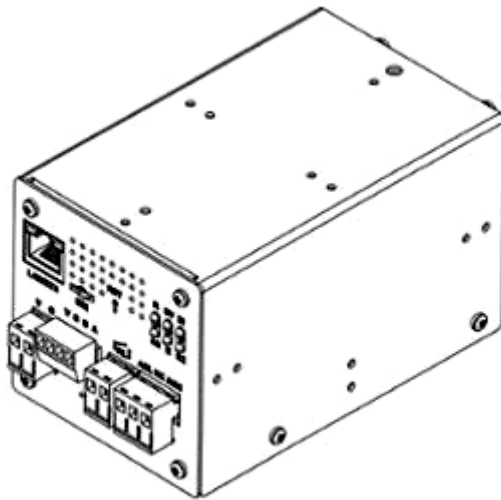

1.1

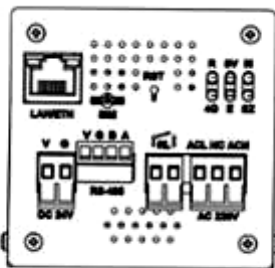

1.2

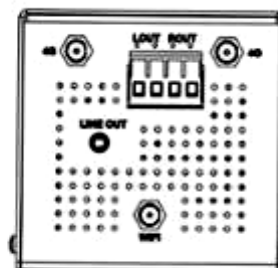

1.3

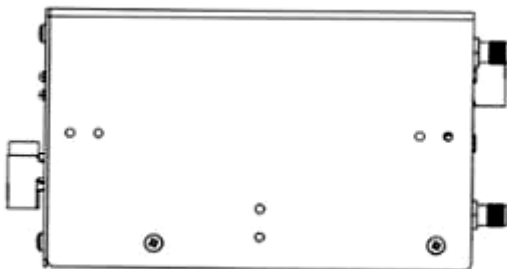

1.4

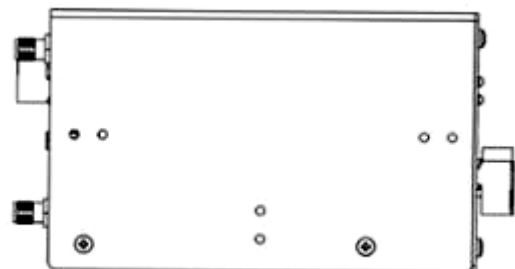

1.5



1.6



1.7

CÔNG BÁO SỞ HỮU CÔNG NGHIỆP SỐ 430 TẬP A – QUYỀN 2 (01.2024)

- (11) **49310**
(21) 3-2023-02250 (28) 1
(54) **THIẾT BỊ TRUYỀN THANH THÔNG MINH** (51) **14-03**
(22) 25/09/2023 (43) 25/01/2024
(73) **CÔNG TY CỔ PHẦN SMATEC (VN)**
TT17 - B24, khu đô thị Văn Quán - Yên Phúc, phường Phúc La, quận Hà Đông,
thành phố Hà Nội
(72) 1. NGUYỄN HỒNG SƠN (VN)
2. LÊ BÌNH DẦN (VN)
(55)

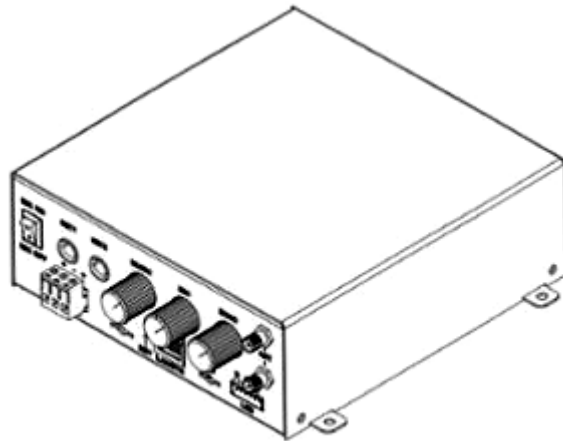

1.1

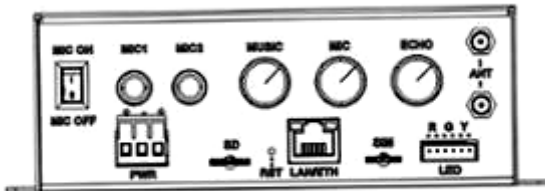

1.2

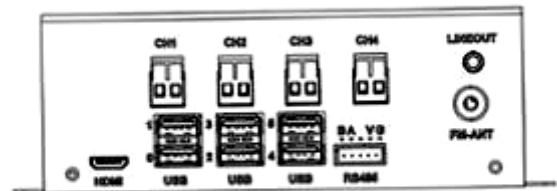

1.3



1.4



1.5

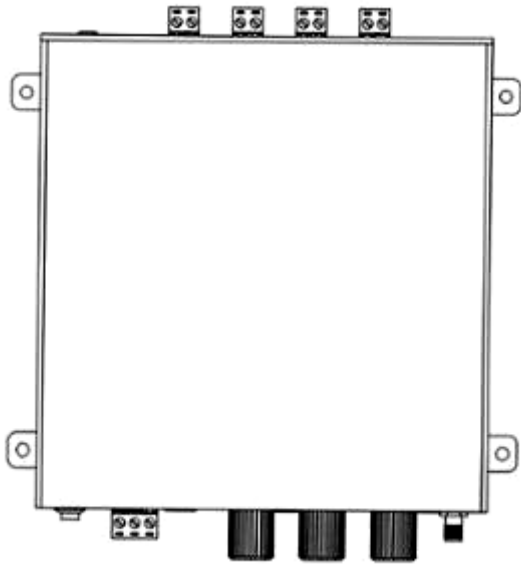

1.6

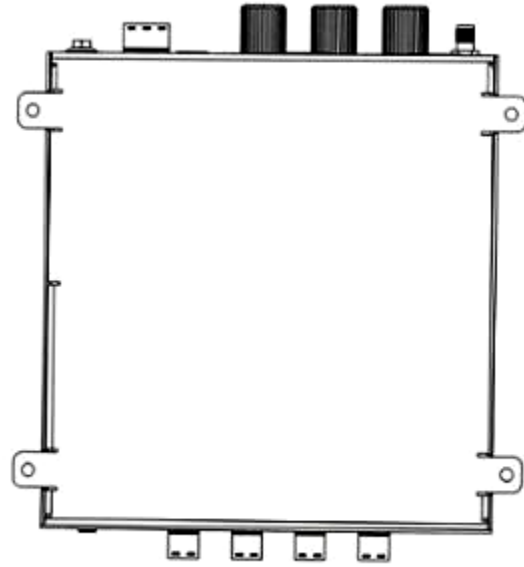

1.7

CÔNG BÁO SỞ HỮU CÔNG NGHIỆP SỐ 430 TẬP A – QUYỀN 2 (01.2024)

- (11) **49311**
(21) 3-2023-02251 (28) 1
(54) **THIẾT BỊ SỐ HÓA ÂM THANH** (51) **14-03**
(22) 25/09/2023 (43) 25/01/2024
(73) **CÔNG TY CỔ PHẦN SMATEC (VN)**
TT17 - B24, khu đô thị Văn Quán - Yên Phúc, phường Phúc La, quận Hà Đông,
thành phố Hà Nội
(72) 1. NGUYỄN HỒNG SƠN (VN)
2. LÊ BÌNH DẦN (VN)
(55)

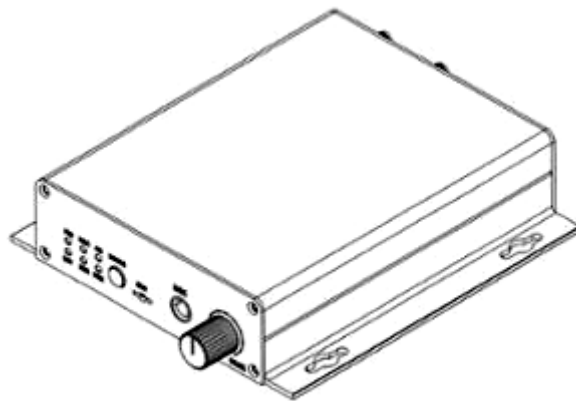

1.1

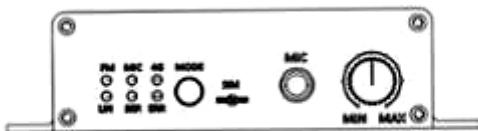

1.2

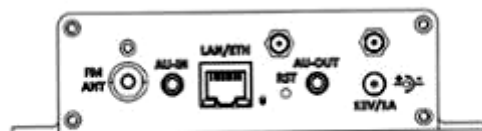

1.3



1.4



1.5

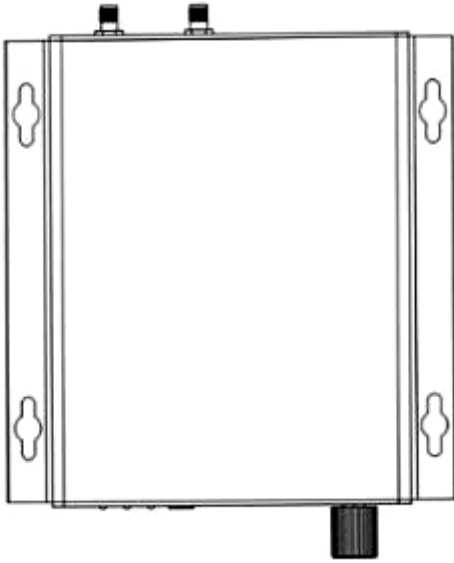

1.6

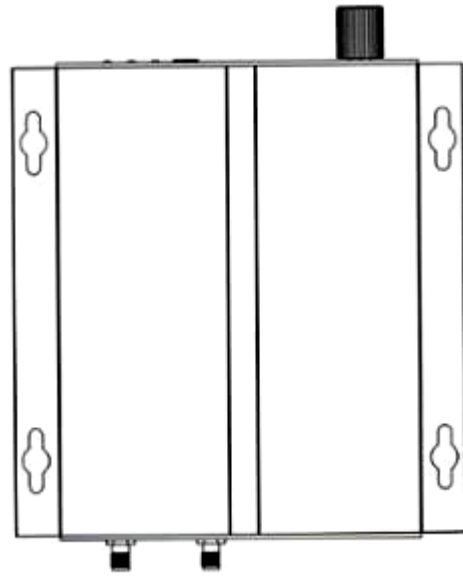

1.7

CÔNG BÁO SỞ HỮU CÔNG NGHIỆP SỐ 430 TẬP A – QUYỀN 2 (01.2024)

- (11) **49312**
(21) 3-2023-02252 (28) 1
(54) **ĐIỆN THOẠI DI ĐỘNG** (51) **14-03**
(22) 25/09/2023 (43) 25/01/2024
(30) 30-2023-0015102 19/04/2023 KR;
(73) **SAMSUNG ELECTRONICS CO., LTD. (KR)**
129, Samsung-ro, Yeongtong-gu, Suwon-si, Gyeonggi-do 16677, Republic of Korea
(72) 1. LEE, MIRI (KR)
2. KWON, KIHWAN (KR)
3. KIM, NAMSU (KR)
4. LEE, JUNWON (KR)
5. CHOI, DUYEONG (KR)
6. LEE, DAHYUN (KR)
7. MYUNG, JIEUN (KR)
8. LIM, JIYUN (KR)
9. LEE, SUNGWOOK (KR)
(74) Công ty Luật TNHH WINCO (WINCO LAW FIRM)
(55)

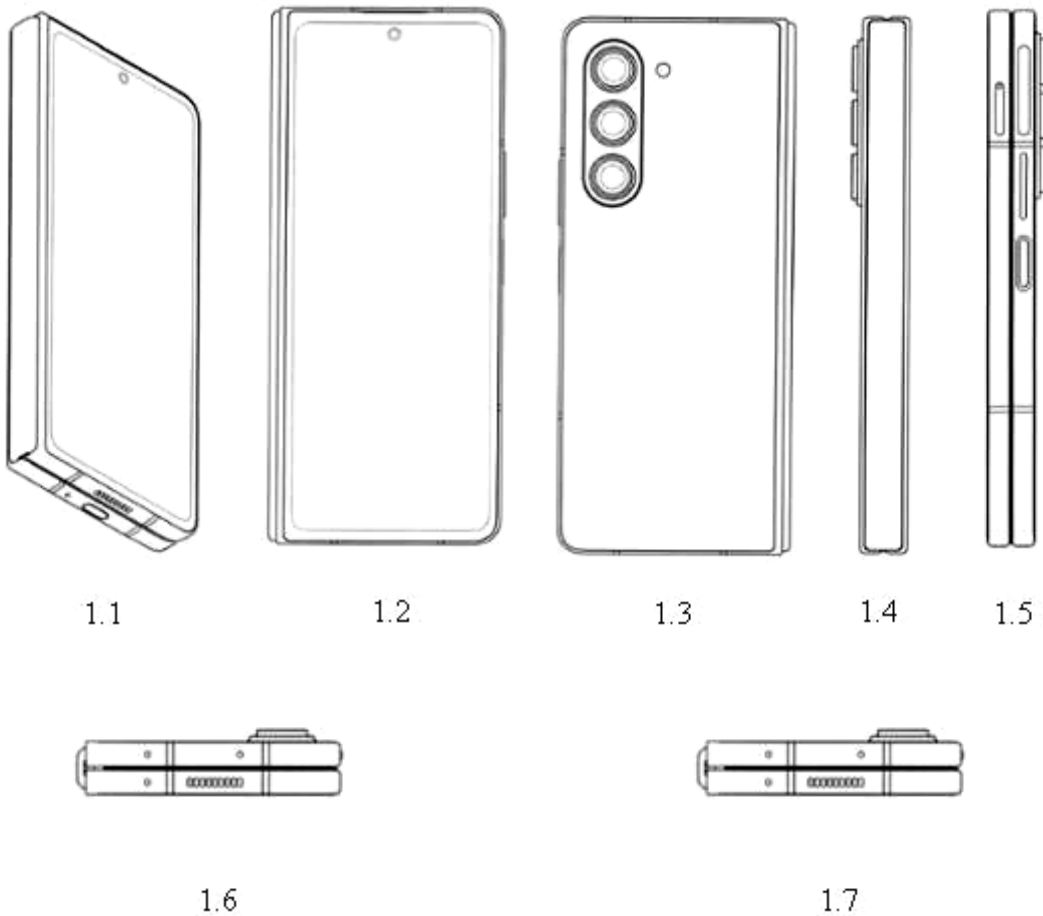

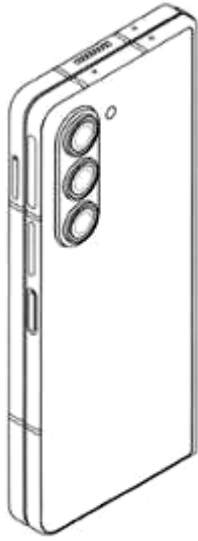

1.8

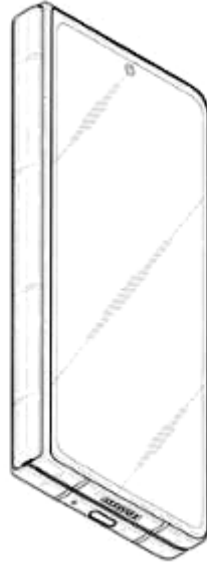

1.9



1.10

CÔNG BÁO SỞ HỮU CÔNG NGHIỆP SỐ 430 TẬP A – QUYỀN 2 (01.2024)

- (11) **49313**
- (21) 3-2023-02253 (28) 1
- (54) **ĐIỆN THOẠI DI ĐỘNG** (51) **14-03**
- (22) 25/09/2023 (43) 25/01/2024
- (30) 30-2023-0015101 19/04/2023 KR;
- (73) **SAMSUNG ELECTRONICS CO., LTD. (KR)**
129, Samsung-ro, Yeongtong-gu, Suwon-si, Gyeonggi-do 16677, Republic of Korea
- (72) 1. LEE, MIRI (KR)
2. KWON, KIHWAN (KR)
3. KIM, NAMSU (KR)
4. LEE, JUNWON (KR)
5. CHOI, DUYEONG (KR)
6. LEE, DAHYUN (KR)
7. MYUNG, JIEUN (KR)
8. LIM, JIYUN (KR)
9. LEE, SUNGWOOK (KR)
- (74) Công ty Luật TNHH WINCO (WINCO LAW FIRM)
- (55)



1.1

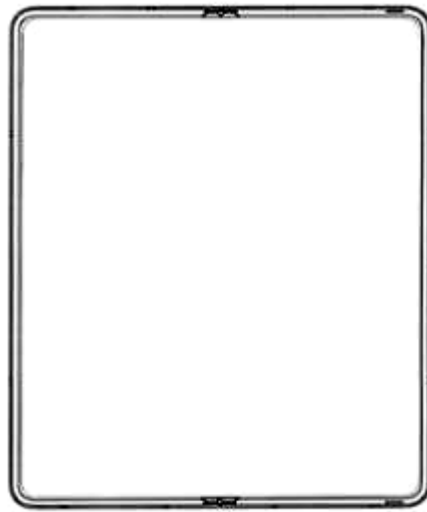

1.2

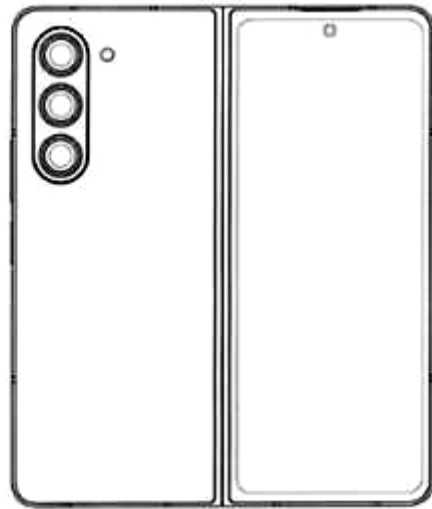

1.3



1.4



1.5

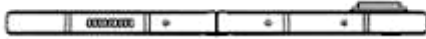

1.6



1.7



1.8



1.9



1.10

CÔNG BÁO SỞ HỮU CÔNG NGHIỆP SỐ 430 TẬP A – QUYỀN 2 (01.2024)

- (11) **49314**
(21) 3-2023-02254 (28) 1
(54) **ĐIỆN THOẠI DI ĐỘNG** (51) **14-03**
(22) 25/09/2023 (43) 25/01/2024
(30) 30-2023-0015088 19/04/2023 KR;
(73) **SAMSUNG ELECTRONICS CO., LTD. (KR)**
129, Samsung-ro, Yeongtong-gu, Suwon-si, Gyeonggi-do 16677, Republic of Korea
(72) 1. LEE, DAHYUN (KR)
2. KWON, KIHWAN (KR)
3. KIM, NAMSU (KR)
4. LEE, JINHOO (KR)
5. CHOI, DUYEONG (KR)
6. LEE, MIRI (KR)
7. MYUNG, JIEUN (KR)
8. LIM, JIYUN (KR)
9. LEE, SUNGWOOK (KR)
(74) Công ty Luật TNHH WINCO (WINCO LAW FIRM)
(55)

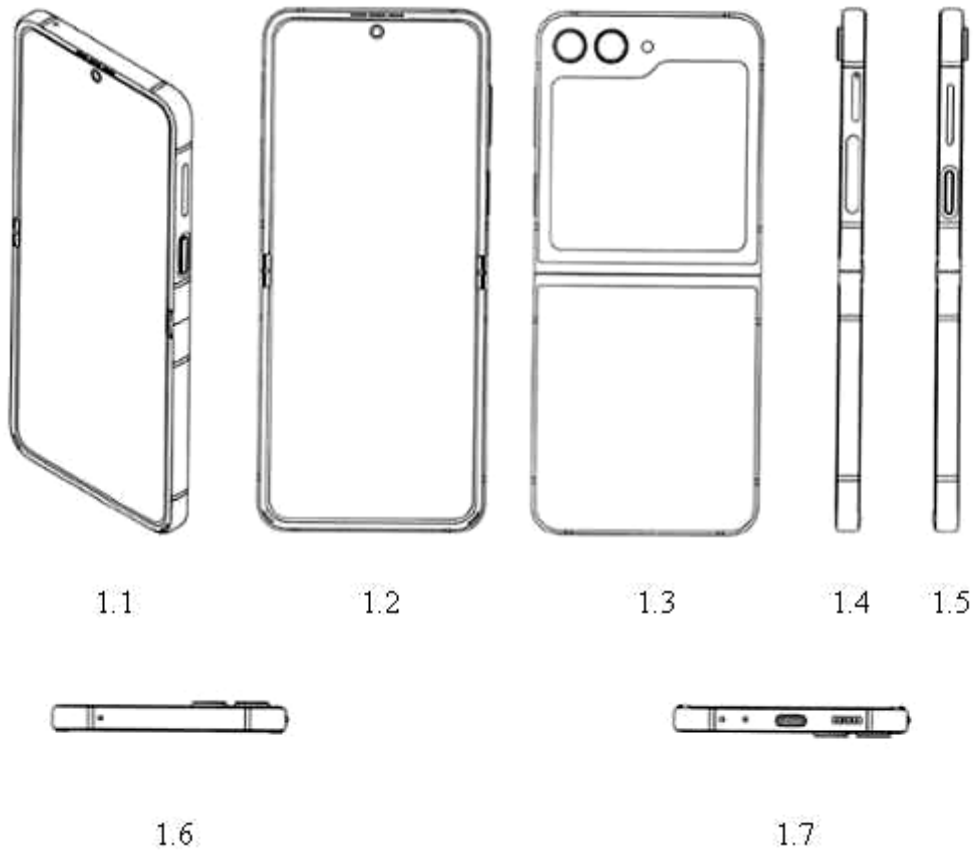

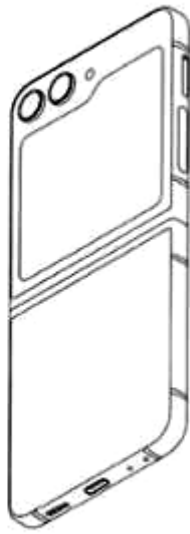

1.8



1.9



1.10

CÔNG BÁO SỞ HỮU CÔNG NGHIỆP SỐ 430 TẬP A – QUYỀN 2 (01.2024)

- (11) **49315**
(21) 3-2023-02255 (28) 1
(54) **ĐIỆN THOẠI DI ĐỘNG** (51) **14-03**
(22) 25/09/2023 (43) 25/01/2024
(30) 30-2023-0015089 19/04/2023 KR;
(73) **SAMSUNG ELECTRONICS CO., LTD. (KR)**
129, Samsung-ro, Yeongtong-gu, Suwon-si, Gyeonggi-do 16677, Republic of Korea
(72) 1. LEE, DAHYUN (KR)
2. KWON, KIHWAN (KR)
3. KIM, NAMSU (KR)
4. LEE, JINHOO (KR)
5. CHOI, DUYEONG (KR)
6. LEE, MIRI (KR)
7. MYUNG, JIEUN (KR)
8. LIM, JIYUN (KR)
9. LEE, SUNGWOOK (KR)
(74) Công ty Luật TNHH WINCO (WINCO LAW FIRM)
(55)

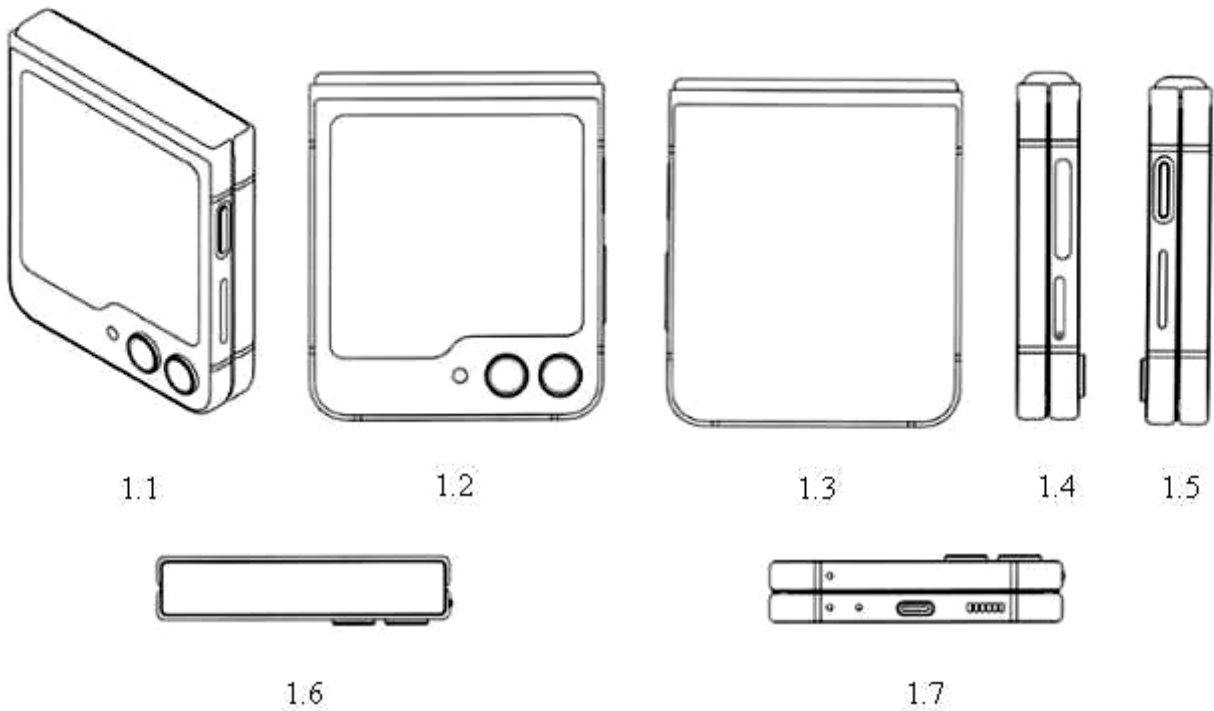

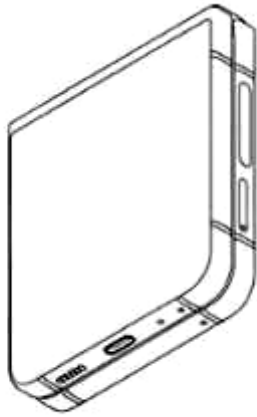

1.8

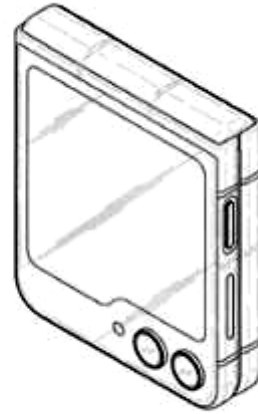

1.9

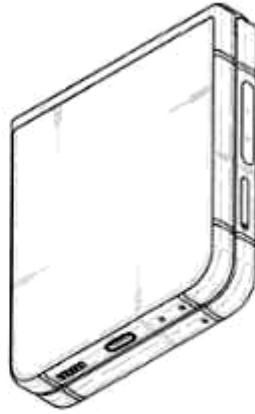

1.10

CÔNG BÁO SỞ HỮU CÔNG NGHIỆP SỐ 430 TẬP A – QUYỀN 2 (01.2024)

- (11) **49316**
(21) 3-2023-02262 (28) 2
(54) **BAO GÓI** (51) **09-05**
(22) 25/09/2023 (43) 25/01/2024
(73) **CÔNG TY TNHH SƠN TISON (VN)**
Khu phố Bình Đáng, phường Bình Hòa, thành phố Thuận An, tỉnh Bình Dương
(72) Lưu Tấn Tiến (VN)
(74) Công ty Luật TNHH Phạm và Liên danh (PHAM & ASSOCIATES)
(55)



1.1



1.2



2.1



2.2

CÔNG BÁO SỞ HỮU CÔNG NGHIỆP SỐ 430 TẬP A – QUYỀN 2 (01.2024)

(11) **49317**

(21) 3-2023-02263

(28) 2

(54) **BÀN BI-A**

(51) **21-02**

(22) 25/09/2023

(43) 25/01/2024

(73) **CÔNG TY TNHH BILLIARDS PHÚC THỊNH (VN)**

335 Lê Văn Thọ, Phường 9, Quận Gò Vấp, Thành phố Hồ Chí Minh

(72) Lương Khắc Tâm (VN)

(55)

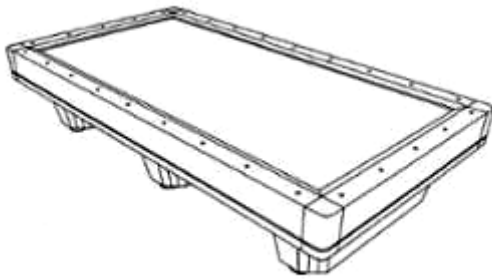

1.1

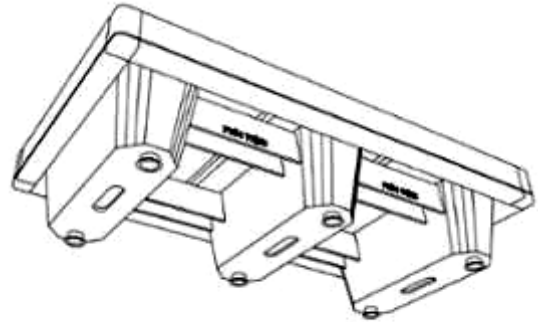

1.2

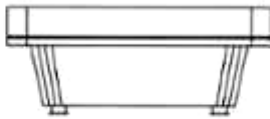

1.3

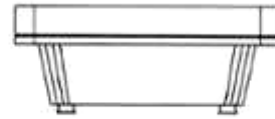

1.4

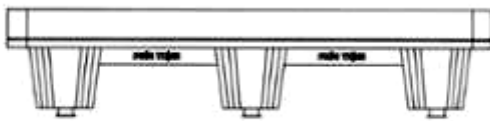

1.5



1.6

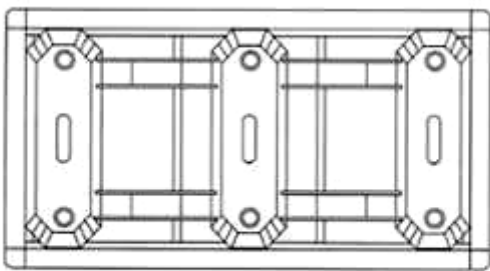

1.7

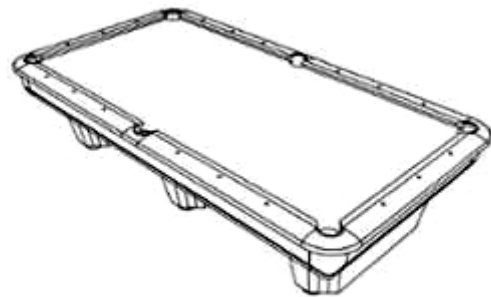

2.1

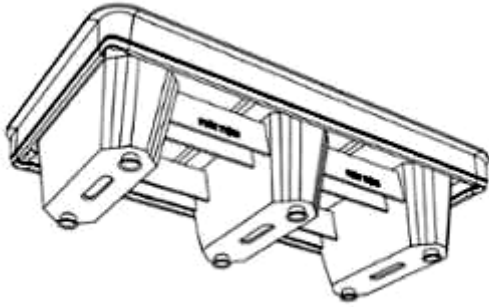

2.2

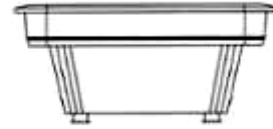

2.3

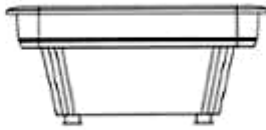

2.4

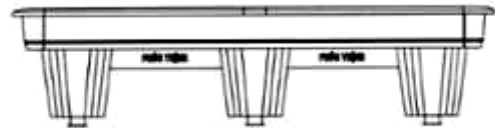

2.5

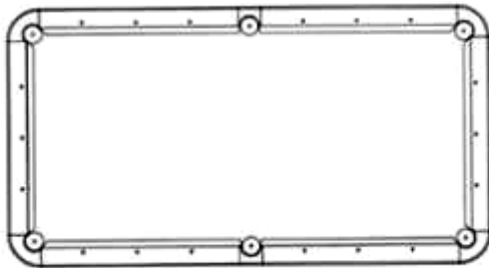

2.6

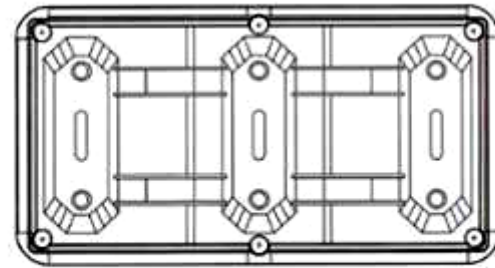

2.7

CÔNG BÁO SỞ HỮU CÔNG NGHIỆP SỐ 430 TẬP A – QUYỀN 2 (01.2024)

- (11) **49318**
(21) 3-2023-02264 (28) 1
(54) **BÚT** (51) **19-06**
(22) 25/09/2023 (43) 25/01/2024
(73) **CÔNG TY CỔ PHẦN TẬP ĐOÀN THIÊN LONG (VN)**
Tầng 10, Sofic Tower, số 10 đường Mai Chí Thọ, phường Thủ Thiêm, thành phố
Thủ Đức, thành phố Hồ Chí Minh
(72) Cô Gia Thọ (VN)
(74) Công ty TNHH Tư vấn sở hữu trí tuệ Việt (VIET IP CO.,LTD.)
(55)

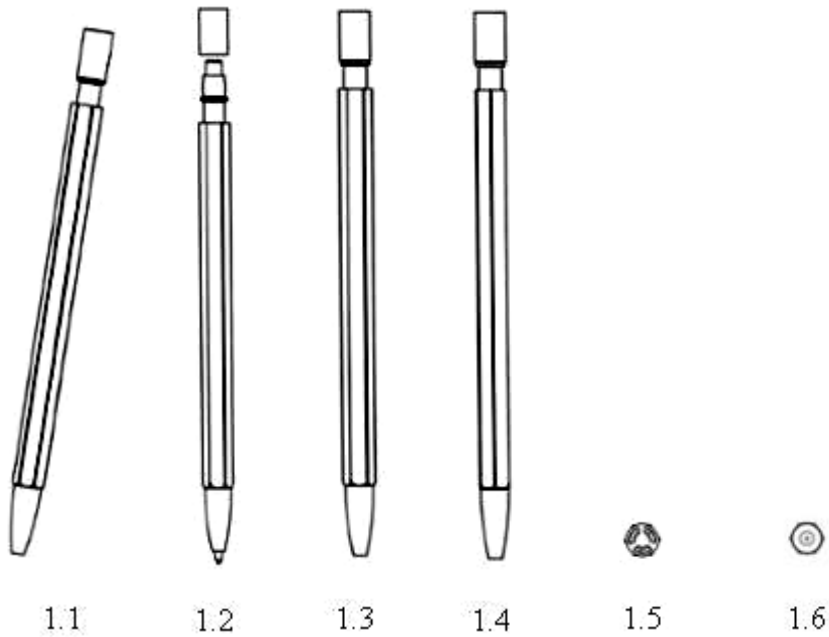

CÔNG BÁO SỞ HỮU CÔNG NGHIỆP SỐ 430 TẬP A – QUYỀN 2 (01.2024)

- (11) **49319**
(21) 3-2023-02265 (28) 1
(54) **HỘP** (51) **19-06**
(22) 25/09/2023 (43) 25/01/2024
(73) **CÔNG TY CỔ PHẦN TẬP ĐOÀN THIÊN LONG (VN)**
Tầng 10, Sofic Tower, số 10 đường Mai Chí Thọ, phường Thủ Thiêm, thành phố Thủ Đức, thành phố Hồ Chí Minh
(72) Cô Gia Thọ (VN)
(74) Công ty TNHH Tư vấn sở hữu trí tuệ Việt (VIET IP CO.,LTD.)
(55)

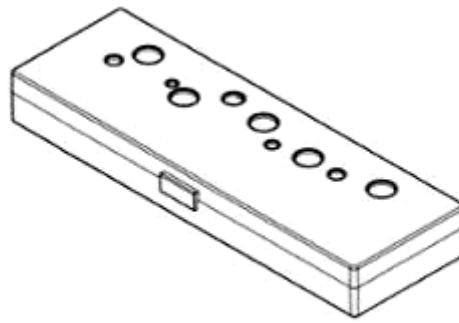

1.1

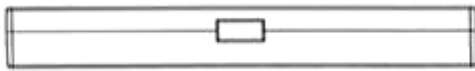

1.2



1.3



1.4



1.5

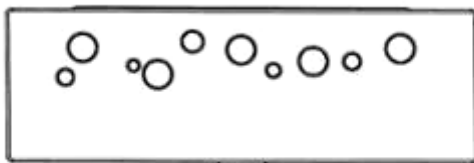

1.6



1.7

CÔNG BÁO SỞ HỮU CÔNG NGHIỆP SỐ 430 TẬP A – QUYỀN 2 (01.2024)

- (11) **49320**
(21) 3-2023-02272 (28) 8
(54) **THIẾT BỊ CHUYỂN MẠCH** (51) **13-03**
(22) 26/09/2023 (43) 25/01/2024
(30) 2023302327658 24/04/2023 CN;
(73) **SCHNEIDER ELECTRIC INDUSTRIES SAS (FR)**
35 Rue Joseph Monier, Rueil Malmaison, 92500 France
(72) 1. SHI, HONGQIONG (CN)
2. ZHENG, LEIHONG (CN)
(74) Công ty TNHH Sở hữu trí tuệ Thảo Thọ Quyên (INVENCO.,LTD)
(55)



1.1



1.2

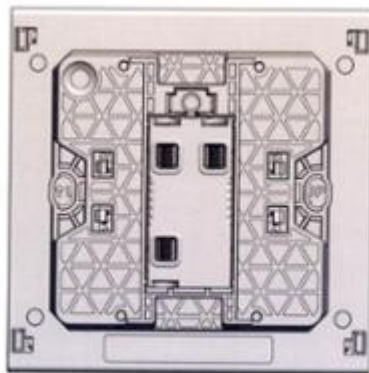

1.3



1.4

1.5

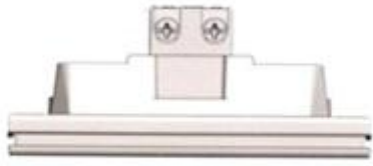

1.6



1.7



2.1



2.2

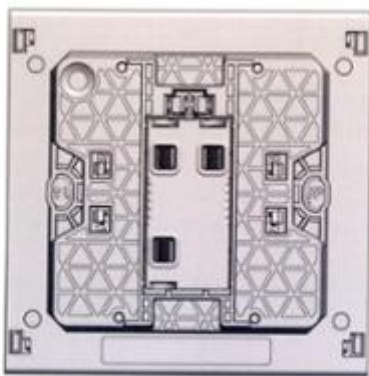

2.3



2.4



2.5



2.6



2.7



3.1



3.2

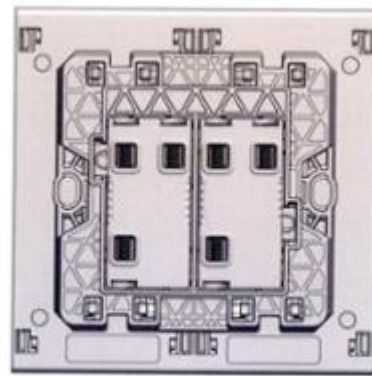

3.3



3.4



3.5

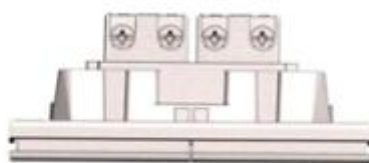

3.6



3.7



4.1



4.2

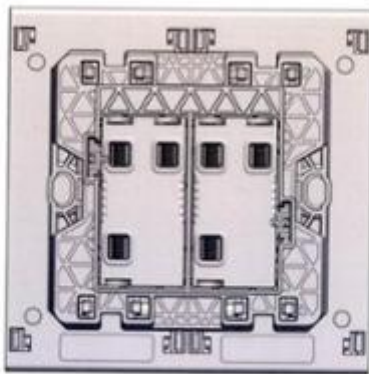

4.3

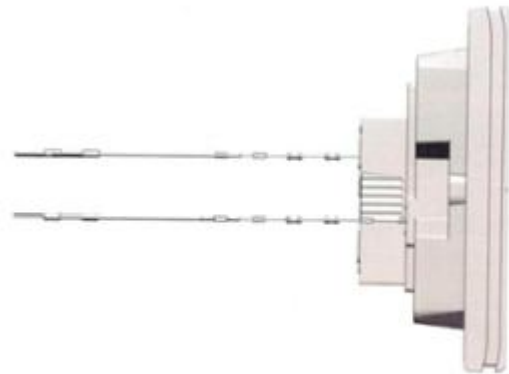

4.4

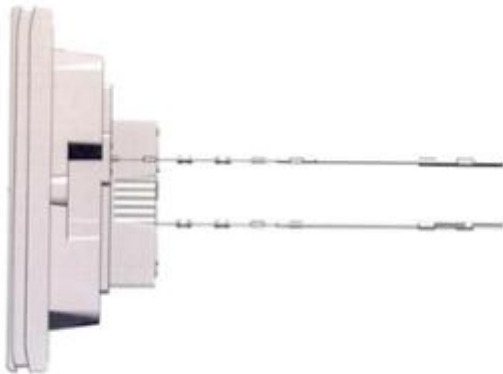

4.5



4.6



4.7



5.1



5.2

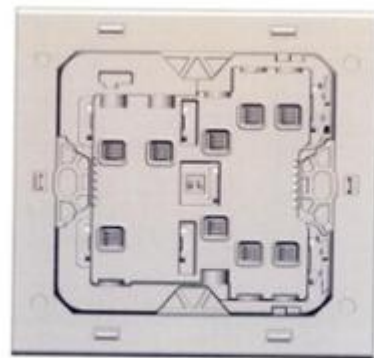

5.3



5.4



5.5



5.6



5.7

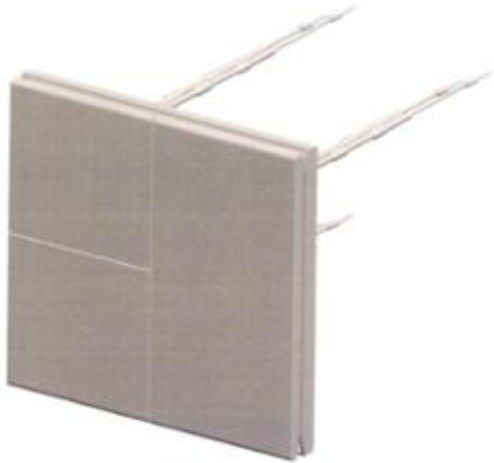

6.1



6.2

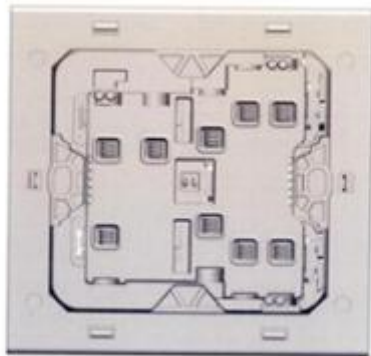

6.3



6.4



6.5



6.6



6.7



7.1



7.2

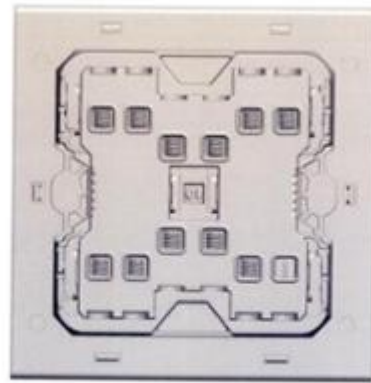

7.3



7.4



7.5



7.6



7.7



8.1



8.2

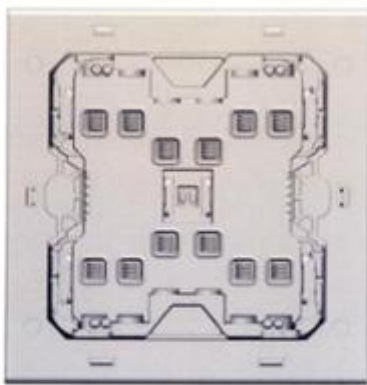

8.3



8.4



8.5



8.6



8.7

CÔNG BÁO SỞ HỮU CÔNG NGHIỆP SỐ 430 TẬP A – QUYỀN 2 (01.2024)

- (11) **49321**
(21) 3-2023-02273 (28) 1
(54) **NHÃN SẢN PHẨM** (51) **19-08**
(22) 27/09/2023 (43) 25/01/2024
(73) **CÔNG TY TNHH THẦN VƯƠNG (VN)**
Số 91, đường 55, khu phố 9, phường Tân Tạo, quận Bình Tân, thành phố Hồ Chí Minh
(72) Trần Quang Duy (VN)
(55)



CÔNG BÁO SỞ HỮU CÔNG NGHIỆP SỐ 430 TẬP A – QUYỀN 2 (01.2024)

- (11) **49322**
(21) 3-2023-02274 (28) 1
(54) **NHÃN SẢN PHẨM** (51) **19-08**
(22) 27/09/2023 (43) 25/01/2024
(73) **CÔNG TY TNHH THẦN VƯƠNG (VN)**
Số 91, đường 55, khu phố 9, phường Tân Tạo, quận Bình Tân, thành phố Hồ Chí Minh
(72) Trần Quang Duy (VN)
(55)



CÔNG BÁO SỞ HỮU CÔNG NGHIỆP SỐ 430 TẬP A – QUYỀN 2 (01.2024)

- (11) **49323**
(21) 3-2023-02292 (28) 1
(54) **TẮM CHẮN PHÍA TRƯỚC CỦA Ô TÔ** (51) **12-16**
(22) 28/09/2023 (43) 25/01/2024
(30) 2023-006616 31/03/2023 JP;
(73) **DAIHATSU MOTOR CO., LTD. (JP)**
1-1, DAIHATSU-CHO, IKEDA-SHI, OSAKA 563-8651 JAPAN
(72) 1. ATSUSHI IKEUCHI (JP)
2. EISHI ARAKI (JP)
3. SHUN OHOKA (JP)
(74) Công ty TNHH một thành viên Sở hữu trí tuệ VCCI (VCCI-IP CO.,LTD)
(55)



1.1



1.2



1.3



1.4

1.5



1.6



1.7



1.8

CÔNG BÁO SỞ HỮU CÔNG NGHIỆP SỐ 430 TẬP A – QUYỀN 2 (01.2024)

- (11) **49324**
(21) 3-2023-02293 (28) 1
(54) **BỘ ĐÈN PHÍA TRƯỚC CỦA Ô TÔ** (51) **26-06**
(22) 28/09/2023 (43) 25/01/2024
(30) 2023-006617 31/03/2023 JP;
(73) **DAIHATSU MOTOR CO., LTD. (JP)**
1-1, DAIHATSU-CHO, IKEDA-SHI, OSAKA 563-8651 JAPAN
(72) Eishi ARAKI (JP)
(74) Công ty TNHH một thành viên Sở hữu trí tuệ VCCI (VCCI-IP CO.,LTD)
(55)



1.1



1.2



1.3



1.4



1.5



1.6



1.7



1.8

CÔNG BÁO SỞ HỮU CÔNG NGHIỆP SỐ 430 TẬP A – QUYỀN 2 (01.2024)

- (11) **49325**
(21) 3-2023-02294 (28) 1
(54) **BỘ ĐÈN PHÍA SAU CỦA Ô TÔ** (51) **26-06**
(22) 28/09/2023 (43) 25/01/2024
(30) 2023-006618 31/03/2023 JP;
(73) **DAIHATSU MOTOR CO., LTD. (JP)**
1-1, DAIHATSU-CHO, IKEDA-SHI, OSAKA 563-8651 JAPAN
(72) Yoshihiko SAKURAI (JP)
(74) Công ty TNHH một thành viên Sở hữu trí tuệ VCCI (VCCI-IP CO.,LTD)
(55)



1.1



1.2



1.3



1.4



1.5



1.6



1.7



1.8

CÔNG BÁO SỞ HỮU CÔNG NGHIỆP SỐ 430 TẬP A – QUYỀN 2 (01.2024)

- (11) **49326**
(21) 3-2023-02296 (28) 1
(54) **BẢNG ĐIỀU KHIỂN CỦA Ô TÔ** (51) **12-16**
(22) 28/09/2023 (43) 25/01/2024
(30) 2023-006620 31/03/2023 JP;
(73) **DAIHATSU MOTOR CO., LTD. (JP)**
1-1, DAIHATSU-CHO, IKEDA-SHI, OSAKA 563-8651 JAPAN
(72) 1. AYUMI KADOTA (JP)
2. KOJI NAGAI (JP)
(74) Công ty TNHH một thành viên Sở hữu trí tuệ VCCI (VCCI-IP CO.,LTD)
(55)



1.1



1.2



1.3



1.4



1.5



1.6



1.7

CÔNG BÁO SỞ HỮU CÔNG NGHIỆP SỐ 430 TẬP A – QUYỀN 2 (01.2024)

- (11) **49327**
(21) 3-2023-02300 (28) 1
(54) **LỌ** (51) **09-01**
(22) 28/09/2023 (43) 25/01/2024
(73) **LG H&H Co., LTD. (KR)**
58, Saemunan-ro, Jongno-gu, Seoul, Republic of Korea
(72) **PARK, Jin Won (KR)**
(74) Công ty TNHH Tầm nhìn và Liên danh (VISION & ASSOCIATES CO.LTD.)
(55)



1.1

1.2

1.3

1.4

1.5



1.6



1.7



1.8

CÔNG BÁO SỞ HỮU CÔNG NGHIỆP SỐ 430 TẬP A – QUYỀN 2 (01.2024)

(11) **49328**

(21) 3-2023-02301

(28) 1

(54) **LỌ**

(51) **09-01**

(22) 28/09/2023

(43) 25/01/2024

(73) **LG H&H Co., LTD. (KR)**

58, Saemunan-ro, Jongno-gu, Seoul, Republic of Korea

(72) SHIN, Ji Won (KR)

(74) Công ty TNHH Tâm nhìn và Liên danh (VISION & ASSOCIATES CO.LTD.)

(55)



1.1

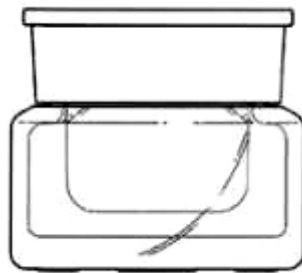

1.2

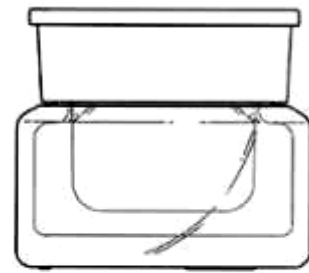

1.3

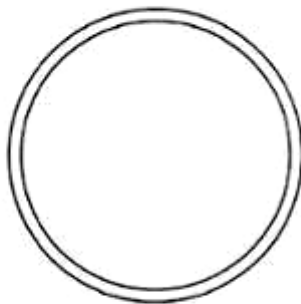

1.4



1.5

CÔNG BÁO SỞ HỮU CÔNG NGHIỆP SỐ 430 TẬP A – QUYỀN 2 (01.2024)

- (11) **49329**
(21) 3-2023-02303 (28) 1
(54) **LỌ** (51) **09-01**
(22) 28/09/2023 (43) 25/01/2024
(73) **LG H&H Co., LTD. (KR)**
58, Saemunan-ro, Jongno-gu, Seoul, Republic of Korea
(72) PARK, Jin Won (KR)
(74) Công ty TNHH Tâm nhìn và Liên danh (VISION & ASSOCIATES CO.LTD.)
(55)



1.1



1.2



1.3



1.4



1.5



1.6



1.7



1.8

CÔNG BÁO SỞ HỮU CÔNG NGHIỆP SỐ 430 TẬP A – QUYỀN 2 (01.2024)

- (11) **49330**
(21) 3-2023-02304 (28) 1
(54) **LỌ** (51) **09-01**
(22) 28/09/2023 (43) 25/01/2024
(73) **LG H&H Co., LTD. (KR)**
58, Saemunan-ro, Jongno-gu, Seoul, Republic of Korea
(72) PARK, Jin Won (KR)
(74) Công ty TNHH Tầm nhìn và Liên danh (VISION & ASSOCIATES CO.LTD.)
(55)



1.1



1.2



1.3



1.4



1.5



1.6



1.7



1.8

- (11) **49331**
(21) 3-2023-02306 (28) 1
(54) **HỘP** (51) **09-01**
(22) 29/09/2023 (43) 25/01/2024
(30) 30-2023-0030855 08/08/2023 KR;
(73) **AMOREPACIFIC CORPORATION (KR)**
100, Hangang-daero, Yongsan-gu, Seoul, Republic of Korea
(72) 1. LEE, SEUNGWON (KR)
2. SEO, WOONKYUNG (KR)
3. LEE, JI MIN (KR)
(74) Công ty Luật TNHH T&G (TGVN)
(55)

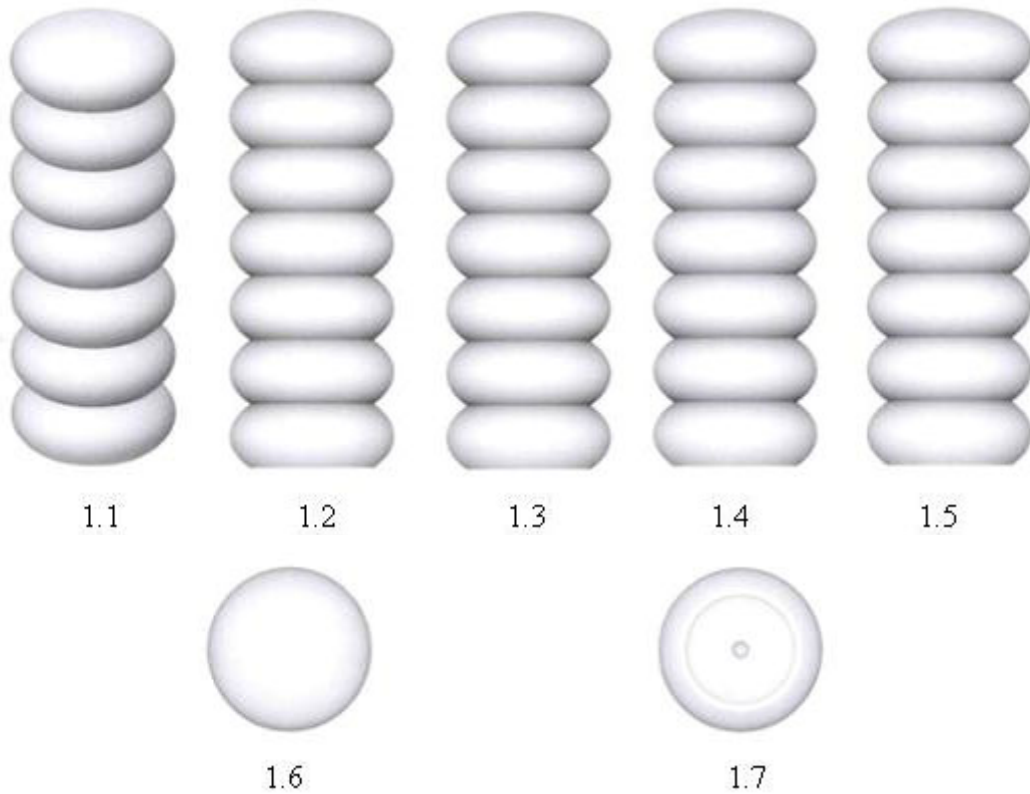

- (11) **49332**
(21) 3-2023-02307 (28) 1
(54) **HỘP** (51) **09-01**
(22) 29/09/2023 (43) 25/01/2024
(30) 30-2023-0030036 01/08/2023 KR;
(73) **AMOREPACIFIC CORPORATION (KR)**
100, Hangang-daero, Yongsan-gu, Seoul, Republic of Korea
(72) 1. LEE, SEUNGWON (KR)
2. SEO, WOONKYUNG (KR)
3. LEE, JI MIN (KR)
(74) Công ty Luật TNHH T&G (TGVN)
(55)

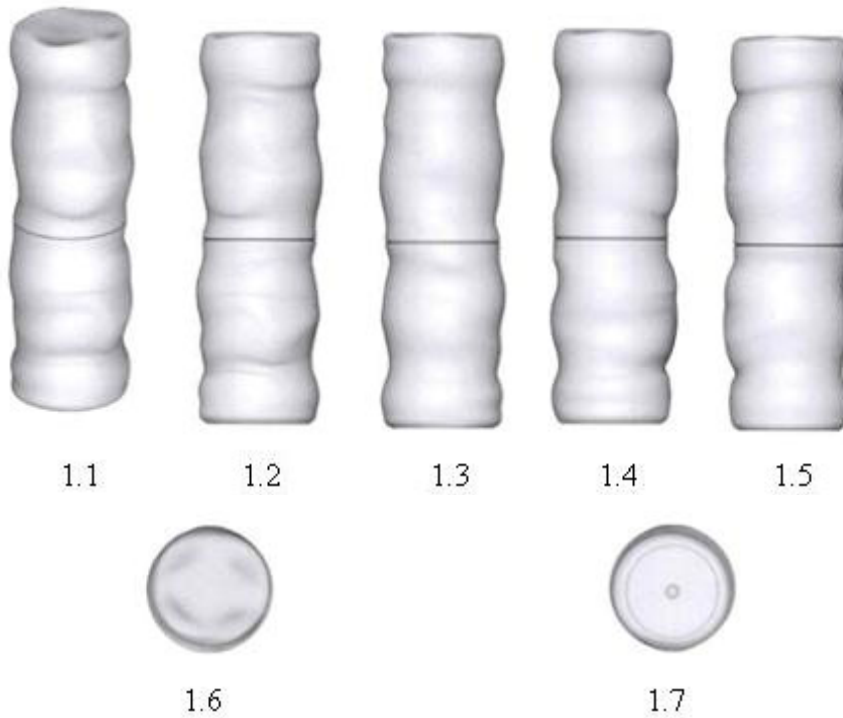

CÔNG BÁO SỞ HỮU CÔNG NGHIỆP SỐ 430 TẬP A – QUYỀN 2 (01.2024)

- (11) **49333**
(21) 3-2023-02308 (28) 1
(54) **HỘP** (51) **09-03**
(22) 29/09/2023 (43) 25/01/2024
(30) 30-2023-0030856 08/08/2023 KR;
(73) **AMOREPACIFIC CORPORATION (KR)**
100, Hangang-daero, Yongsan-gu, Seoul, Republic of Korea
(72) 1. SEO, WOONKYUNG (KR)
2. LEE, SEUNGWON (KR)
3. LEE, JI MIN (KR)
4. JEON, KYOUNGHEE (KR)
(74) Công ty Luật TNHH T&G (TGVN)
(55)



1.1



1.2



1.3



1.4



1.5



1.6



1.7

CÔNG BÁO SỞ HỮU CÔNG NGHIỆP SỐ 430 TẬP A – QUYỀN 2 (01.2024)

- (11) 49334
(21) 3-2023-02316 (28) 1
(54) BAO GÓI (51) 09-05
(22) 29/09/2023 (43) 25/01/2024
(73) **CÔNG TY CỔ PHẦN ACECOOK VIỆT NAM (VN)**
Lô số II-3, đường số 11, nhóm CN II, Khu công nghiệp Tân Bình, phường Tây Thạnh, quận Tân Phú, thành phố Hồ Chí Minh
(72) Kaneda Hiroki (JP)
(74) Công ty Luật TNHH Phạm và Liên danh (PHAM & ASSOCIATES)
(55)



1.1



1.2

CÔNG BÁO SỞ HỮU CÔNG NGHIỆP SỐ 430 TẬP A – QUYỀN 2 (01.2024)

- (11) **49335**
(21) 3-2023-02318 (28) 1
(54) **QUÂN CHƠI Ô ĂN QUAN** (51) **21-01**
(22) 29/09/2023 (43) 25/01/2024
(73) **VŨ HẢI NAM (VN)**
P119-A6 Tập thể Giảng Võ, phường Giảng Võ, quận Ba Đình, thành phố Hà Nội
(72) Vũ Hải Nam (VN)
(74) Công ty TNHH Sở hữu trí tuệ HA VIP (HAVIP CO., LTD.)
(55)



1.1



1.2



1.3

CÔNG BÁO SỞ HỮU CÔNG NGHIỆP SỐ 430 TẬP A – QUYỀN 2 (01.2024)

- (11) **49336**
(21) 3-2023-02320 (28) 1
(54) **BÀN CHƠI Ô ĂN QUAN** (51) **21-01**
(22) 29/09/2023 (43) 25/01/2024
(73) **VŨ HẢI NAM (VN)**
P119-A6 Tập thể Giảng Võ, phường Giảng Võ, quận Ba Đình, thành phố Hà Nội
(72) Vũ Hải Nam (VN)
(74) Công ty TNHH Sở hữu trí tuệ HA VIP (HAVIP CO., LTD.)
(55)



1.1



1.2



1.3



1.4

1.5



1.6



1.7



1.8

CÔNG BÁO SỞ HỮU CÔNG NGHIỆP SỐ 430 TẬP A – QUYỀN 2 (01.2024)

- (11) **49337**
(21) 3-2023-02321 (28) 1
(54) **BÀN CHƠI Ô ĂN QUAN** (51) **21-01**
(22) 29/09/2023 (43) 25/01/2024
(73) **VŨ HẢI NAM (VN)**
P119-A6 Tập thể Giảng Võ, phường Giảng Võ, quận Ba Đình, thành phố Hà Nội
(72) Vũ Hải Nam (VN)
(74) Công ty TNHH Sở hữu trí tuệ HA VIP (HAVIP CO., LTD.)
(55)



1.1



1.2



1.3



1.4



1.5



1.6



1.7



1.8



1.9



1.10

CÔNG BÁO SỞ HỮU CÔNG NGHIỆP SỐ 430 TẬP A – QUYỀN 2 (01.2024)

- (11) **49338**
(21) 3-2023-02323 (28) 1
(54) **BÀN CỜ CARO** (51) **21-01**
(22) 29/09/2023 (43) 25/01/2024
(73) **VŨ HẢI NAM (VN)**
P119-A6 Tập thể Giảng Võ, phường Giảng Võ, quận Ba Đình, thành phố Hà Nội
(72) Vũ Hải Nam (VN)
(74) Công ty TNHH Sở hữu trí tuệ HA VIP (HAVIP CO., LTD.)
(55)



1.1



1.2

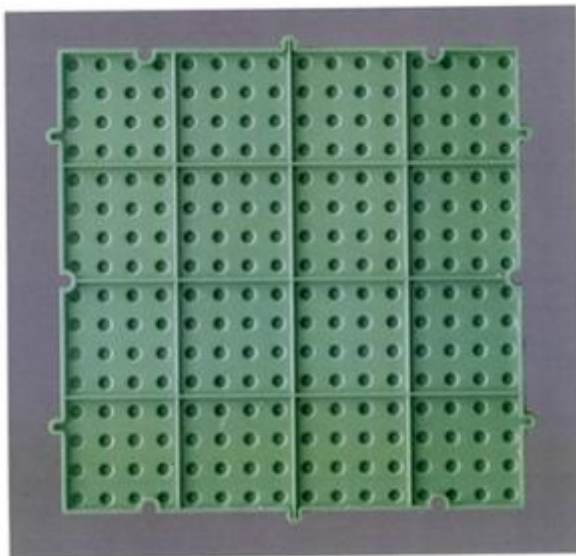

1.3



1.4



1.5

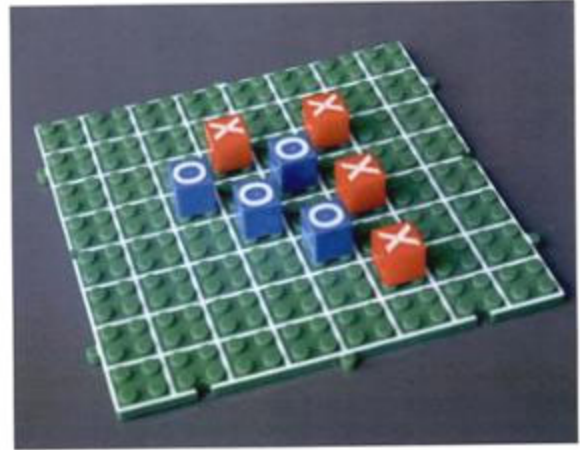

1.6

CÔNG BÁO SỞ HỮU CÔNG NGHIỆP SỐ 430 TẬP A – QUYỀN 2 (01.2024)

- (11) **49339**
- (21) 3-2023-02325 (28) 1
- (54) **BAO GÓI** (51) **09-05**
- (22) 29/09/2023 (43) 25/01/2024
- (73) **CÔNG TY TNHH XUẤT NHẬP KHẨU KỸ THUẬT NÔNG NGHIỆP YAKARA (VN)**
 144B đường Ấp Đông 3, Ấp Đông 1, xã Thới Tam Thôn, huyện Hóc Môn, thành phố Hồ Chí Minh
- (72) Nguyễn Trung Khương (VN)
- (74) Công ty Cổ phần Sở hữu công nghiệp INVESTIP (INVESTIP)
- (55)



1.1



1.2

CÔNG BÁO SỞ HỮU CÔNG NGHIỆP SỐ 430 TẬP A – QUYỀN 2 (01.2024)

- (11) **49340**
(21) 3-2023-02326 (28) 1
(54) **HỘP** (51) **09-03**
(22) 02/10/2023 (43) 25/01/2024
(73) **CÔNG TY CỔ PHẦN DƯỢC KHOA (VN)**
Số 9 Nguyễn Công Trứ, phường Phạm Đình Hổ, quận Hai Bà Trưng, thành phố Hà Nội
(72) Hà Đăng Thành (VN)
(74) **CÔNG TY LUẬT TNHH LEGOS (CÔNG TY LUẬT TNHH LEGOS)**
(55)



1.1



1.2

CÔNG BÁO SỞ HỮU CÔNG NGHIỆP SỐ 430 TẬP A – QUYỀN 2 (01.2024)

- (11) **49341**
(21) 3-2023-02328 (28) 1
(54) **HỘP** (51) **09-03**
(22) 02/10/2023 (43) 25/01/2024
(73) **CÔNG TY CỔ PHẦN DƯỢC KHOA (VN)**
Số 9 Nguyễn Công Trứ, phường Phạm Đình Hổ, quận Hai Bà Trưng, thành phố Hà Nội
(72) Hà Đăng Thành (VN)
(74) **CÔNG TY LUẬT TNHH LEGOS (CÔNG TY LUẬT TNHH LEGOS)**
(55)



1.1



1.2

- (11) **49342**
(21) 3-2023-02331 (28) 1
(54) **HỘP** (51) **09-03**
(22) 03/10/2023 (43) 25/01/2024
(73) **HỘ KINH DOANH AN VĨNH PHÁT (VN)**
R23/39/36 cư xá Phú Lâm A, phường 12, quận 6, thành phố Hồ Chí Minh
(72) Khuu Sở Dinh (VN)
(55)



1.1



1.2



1.3



1.4



1.5

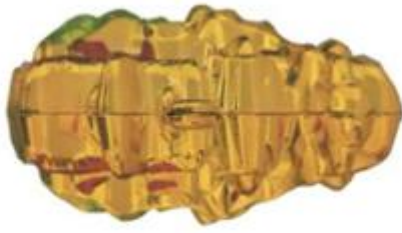

1.6



1.7

CÔNG BÁO SỞ HỮU CÔNG NGHIỆP SỐ 430 TẬP A – QUYỀN 2 (01.2024)

(11) **49343**

(21) 3-2023-02354

(54) **THANH KIM LOẠI ĐỊNH HÌNH**

(22) 04/10/2023

(73) **CÔNG TY TNHH MTV ĐĂNG QUANG (VN)**

Đường Trường Chinh, khu phố 1, phường Phú Tài, thành phố Phan Thiết, tỉnh Bình Thuận

(72) Võ Trường Thọ (VN)

(74) **CÔNG TY TNHH KHANG LUẬT (KHANGLAW)**

(55)

(28) 1

(51) **25-01**

(43) 25/01/2024

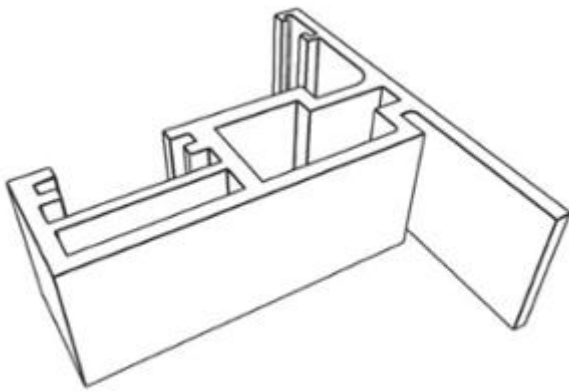

1.1



1.2



1.3



1.4



1.5

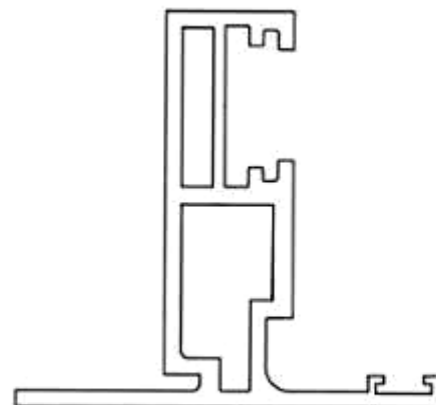

1.6

CÔNG BÁO SỞ HỮU CÔNG NGHIỆP SỐ 430 TẬP A – QUYỀN 2 (01.2024)

- (11) **49344**
(21) 3-2023-02355 (28) 1
(54) **THANH KIM LOẠI ĐỊNH HÌNH** (51) **25-01**
(22) 04/10/2023 (43) 25/01/2024
(73) **CÔNG TY TNHH MTV ĐĂNG QUANG (VN)**
Đường Trường Chinh, khu phố 1, phường Phú Tài, thành phố Phan Thiết, tỉnh Bình Thuận
(72) Võ Trường Thọ (VN)
(74) **CÔNG TY TNHH KHANG LUẬT (KHANGLAW)**
(55)

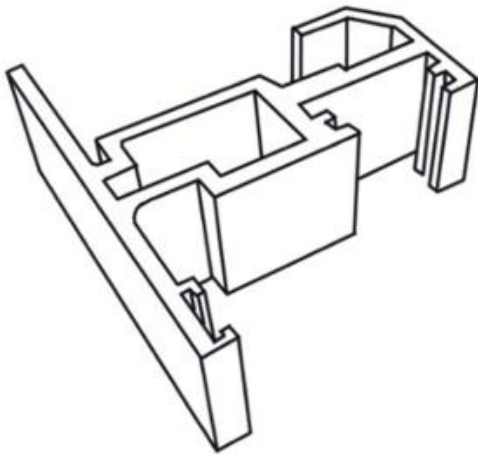

1.1



1.2



1.3



1.4

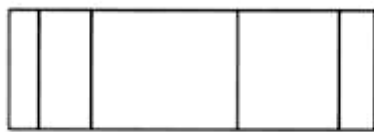

1.5

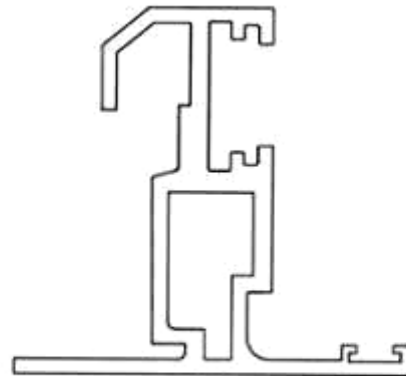

1.6

CÔNG BÁO SỞ HỮU CÔNG NGHIỆP SỐ 430 TẬP A – QUYỀN 2 (01.2024)

- (11) **49345**
(21) 3-2023-02360 (28) 1
(54) **HỘP ĐỰNG CHAI RƯỢU** (51) **09-03**
(22) 05/10/2023 (43) 25/01/2024
(73) **HỢP TÁC XÃ SẢN XUẤT VÀ KINH DOANH HUY HOÀNG (VN)**
Thôn Đồng Ý, xã Việt Dân, thị xã Đông Triều, tỉnh Quảng Ninh
(72) Nguyễn Lê Huy Hoàng (VN)
(74) Công ty TNHH Sở hữu trí tuệ VIPATCO (VIPATCO CO., LTD.)
(55)



1.1

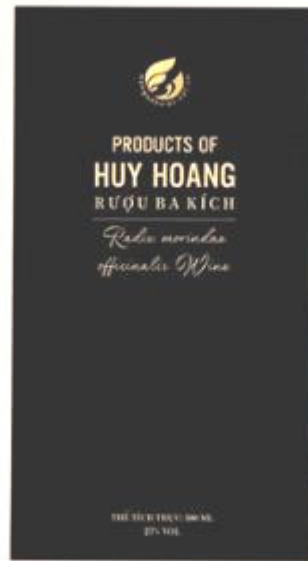

1.2



1.3



1.4



1.5



1.6



1.7

CÔNG BÁO SỞ HỮU CÔNG NGHIỆP SỐ 430 TẬP A – QUYỀN 2 (01.2024)

- (11) **49346**
(21) 3-2023-02373 (28) 1
(54) **LÒ VI SÓNG** (51) **07-02**
(22) 13/04/2022 (43) 25/01/2024
(73) **PANASONIC INTELLECTUAL PROPERTY MANAGEMENT CO., LTD.**
(JP)
1-61, Shiromi 2-chome, Chuo-ku, Osaka-shi, Osaka 540-6207 Japan
(72) 1. HITOMI NISHIO (JP)
2. YURINA KATAOKA (JP)
3. NAOKI FUDETANI (JP)
(74) Công ty TNHH một thành viên Sở hữu trí tuệ VCCI (VCCI-IP CO.,LTD)
(55)

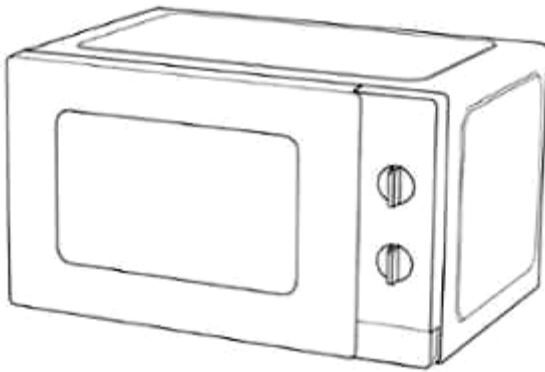

1.1

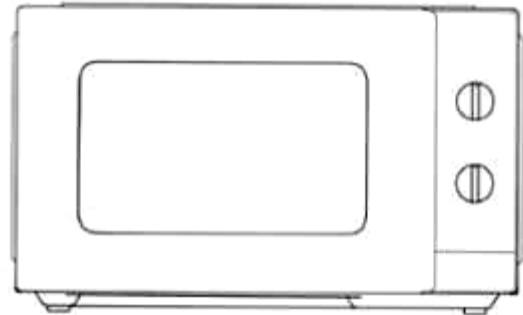

1.2

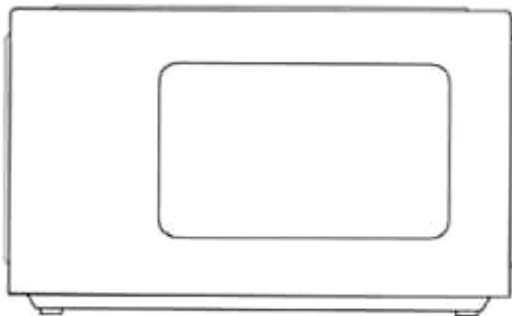

1.3

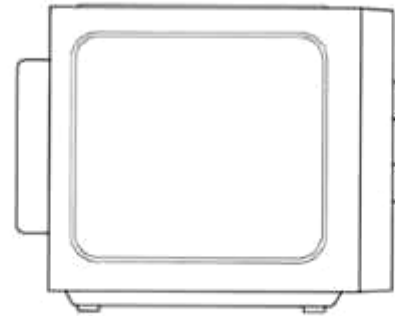

1.4

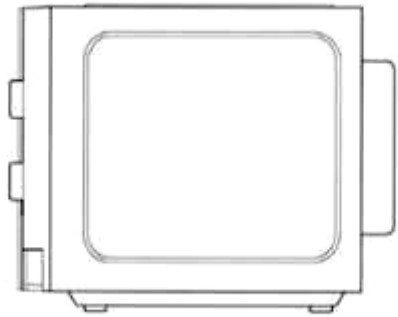

1.5

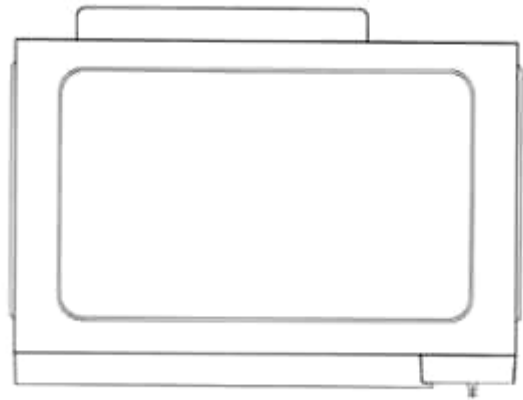

1.6

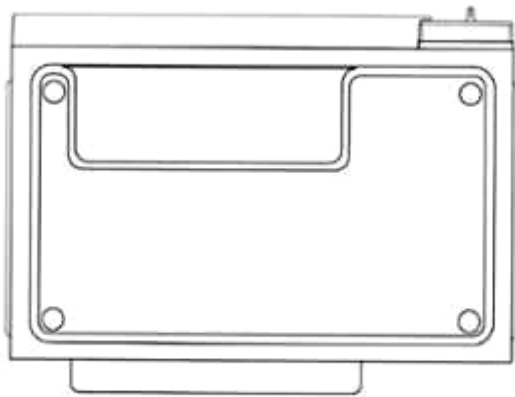

1.7

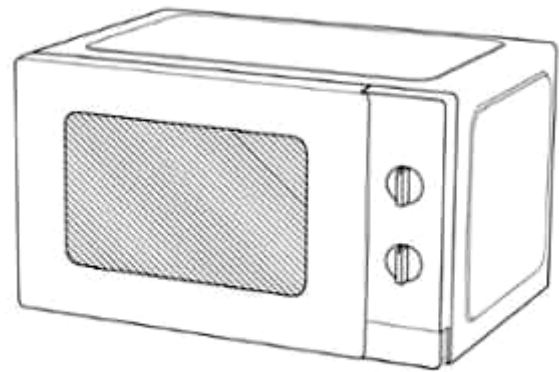

1.8

CÔNG BÁO SỞ HỮU CÔNG NGHIỆP SỐ 430 TẬP A – QUYỀN 2 (01.2024)

- (11) **49347**
(21) 3-2023-02376 (28) 1
(54) **THANH KIM LOẠI ĐỊNH HÌNH** (51) **25-01**
(22) 09/10/2023 (43) 25/01/2024
(73) **CÔNG TY CỔ PHẦN TẬP ĐOÀN KENWIN (VN)**
Tầng 4 tòa nhà VG Building, số 235 đường Nguyễn Trãi, phường Thanh Xuân
Trung, quận Thanh Xuân, thành phố Hà Nội
(72) Ngô Thọ Long (VN)
(74) Công ty TNHH Sở hữu trí tuệ PADEMARK (PADEMARK CO.,LTD.)
(55)

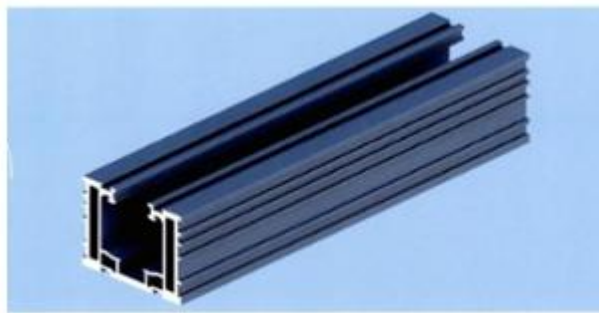

1.1



1.2



1.3



1.4



1.5



1.6



1.7

CÔNG BÁO SỞ HỮU CÔNG NGHIỆP SỐ 430 TẬP A – QUYỀN 2 (01.2024)

- (11) **49348**
- (21) 3-2023-02387 (28) 1
- (54) **NHÃN SẢN PHẨM** (51) **19-08**
- (22) 10/10/2023 (43) 25/01/2024
- (73) **TỔNG CÔNG TY CỔ PHẦN BIA - RƯỢU - NƯỚC GIẢI KHÁT HÀ NỘI**
(VN)
Số 183, phố Hoàng Hoa Thám, phường Ngọc Hà, quận Ba Đình, thành phố Hà Nội
- (72) Đặng Nguyên Phương (VN)
- (74) Công ty TNHH tư vấn Sở hữu trí tuệ IPFLAME (IPFLAME CO.,LTD)
- (55)



CÔNG BÁO SỞ HỮU CÔNG NGHIỆP SỐ 430 TẬP A – QUYỀN 2 (01.2024)

- (11) **49349**
- (21) 3-2023-02388 (28) 1
- (54) **NHÃN SẢN PHẨM** (51) **19-08**
- (22) 10/10/2023 (43) 25/01/2024
- (73) **TỔNG CÔNG TY CỔ PHẦN BIA - RƯỢU - NƯỚC GIẢI KHÁT HÀ NỘI**
(VN)
Số 183, phố Hoàng Hoa Thám, phường Ngọc Hà, quận Ba Đình, thành phố Hà Nội
- (72) Đặng Nguyên Phương (VN)
- (74) Công ty TNHH tư vấn Sở hữu trí tuệ IPFLAME (IPFLAME CO.,LTD)
- (55)



CÔNG BÁO SỞ HỮU CÔNG NGHIỆP SỐ 430 TẬP A – QUYỀN 2 (01.2024)

- (11) **49350**
(21) 3-2023-02389 (28) 1
(54) **GẠCH** (51) **25-01**
(22) 10/10/2023 (43) 25/01/2024
(73) **CÔNG TY CỔ PHẦN VIỆT TILES (VN)**
17 đường số 40, khu phố 1, phường An Khánh, thành phố Thủ Đức, thành phố Hồ Chí Minh
(72) Nguyễn Thị Hiền (VN)
(74) **CÔNG TY TNHH TRUNG TÂM TƯ VẤN PHÁT TRIỂN THƯƠNG HIỆU ĐIỂM TỰA VÀNG (TRUNG TÂM TƯ VẤN PHÁT TRIỂN THƯƠNG HIỆU ĐIỂM TỰA VÀNG)**
(55)



1.1



1.2

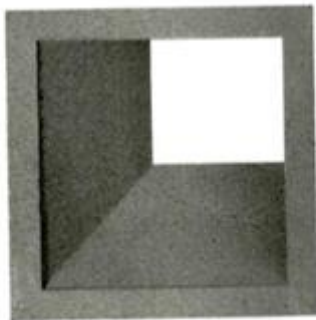

1.3

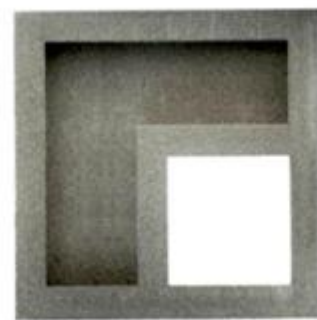

1.4



1.5

CÔNG BÁO SỞ HỮU CÔNG NGHIỆP SỐ 430 TẬP A – QUYỀN 2 (01.2024)

- (11) **49351**
(21) 3-2023-02390 (28) 1
(54) **THIẾT BỊ Y TẾ** (51) **24-01**
(22) 10/10/2023 (43) 25/01/2024
(30) 2023301926604 11/04/2023 CN;
(73) **INVENTEC EASY DOCTOR CORPORATION (CN)**
Building 3, No. 789, Puxing Road, Shanghai, P.R.C.
(72) 1. YANG ANPING (CN)
2. TSENG SHIH-CHIN (TW)
3. SHEN YONG-TAO (CN)
(74) **CÔNG TY LUẬT TNHH IP MAX (IPMAX LAW FIRM)**
(55)

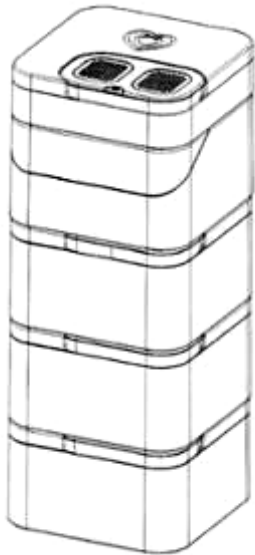

1.1

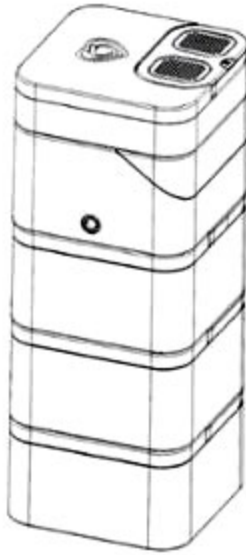

1.2

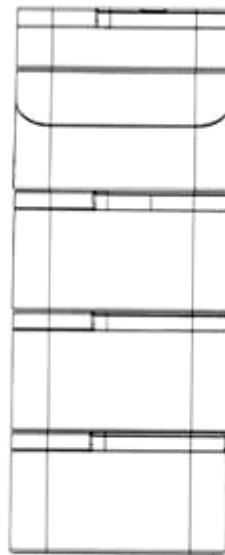

1.3

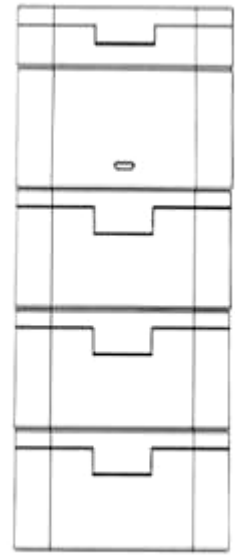

1.4

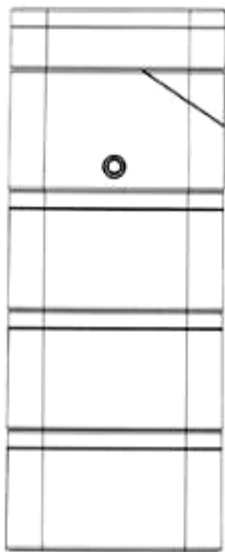

1.5

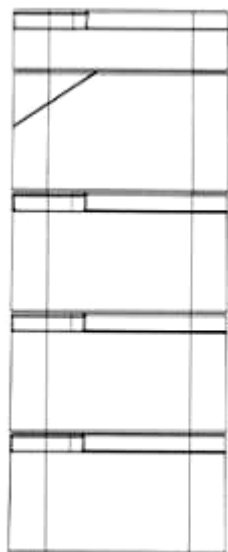

1.6



1.7



1.8



1.9



1.10



1.11



1.12



1.13



1.14



1.15



1.16



1.17



1.18

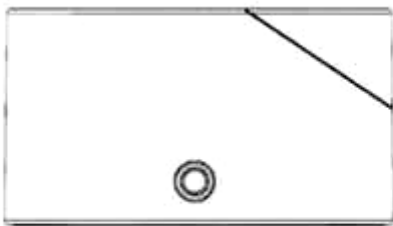

1.19

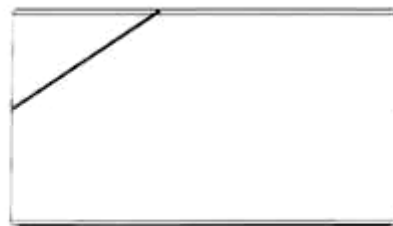

1.20

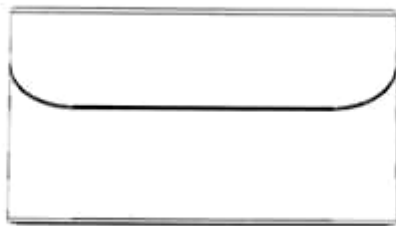

1.21



1.22



1.23



1.24



1.25



1.26



1.27

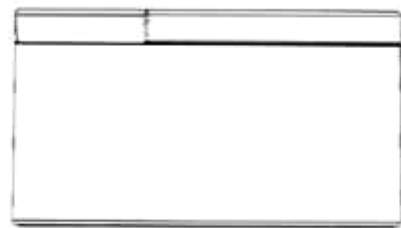

1.28



1.29

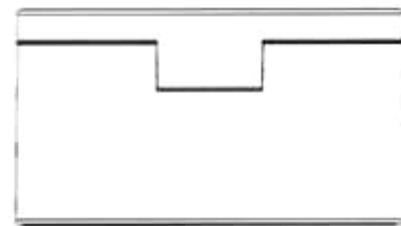

1.30



1.31



1.32



1.33



1.34

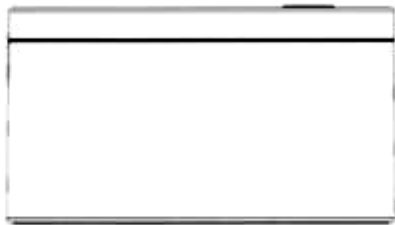

1.35



1.36

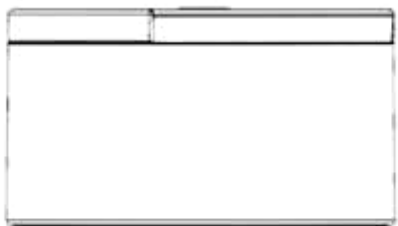

1.37

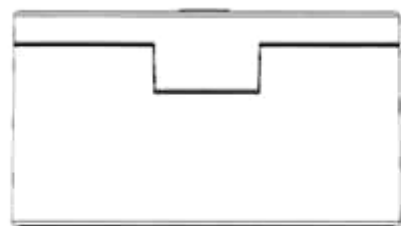

1.38



1.39

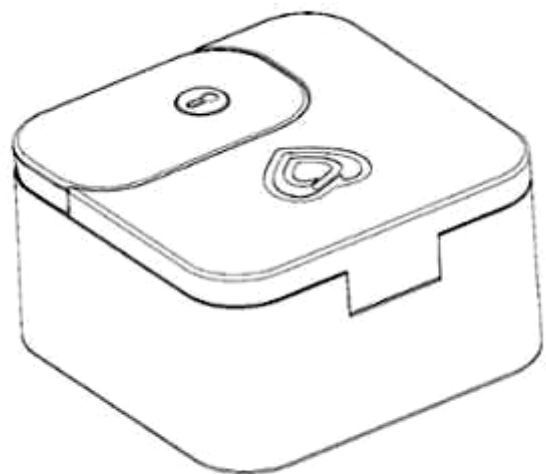

1.40



1.41



1.42



1.43



1.44

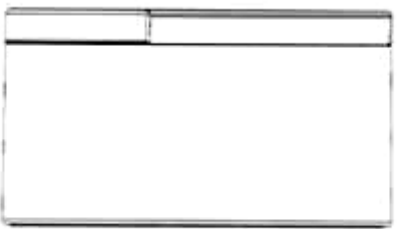

1.45

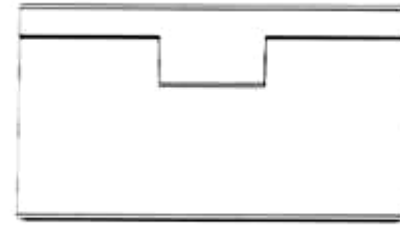

1.46



1.47

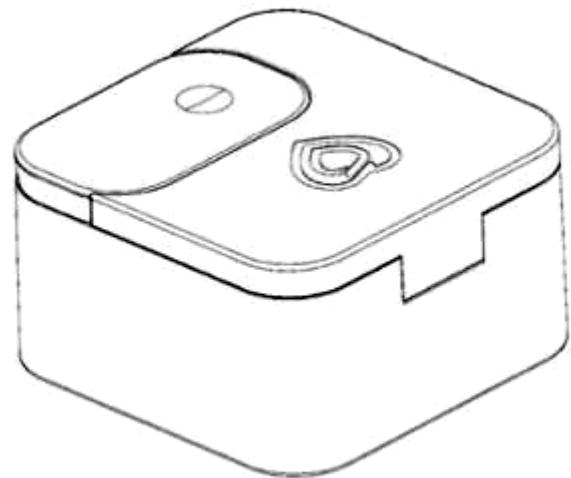

1.48

- (11) **49352**
- (21) 3-2023-02391
- (54) **LÒ NƯỚNG**
- (22) 30/03/2022
- (30) 29/809,967 30/09/2021 US;
- (73) **SOLO BRANDS, LLC (US)**
1001 Mustang Dr. Grapevine, TX 76051, United States of America
- (72) 1. JEFFREY R. WEILERT (US)
2. ALEXANDER K. MAGHSADI (US)
- (74) Công ty Luật TNHH T&G (TGVN)
- (55)

- (28) 1
- (51) **07-02**
- (43) 25/01/2024

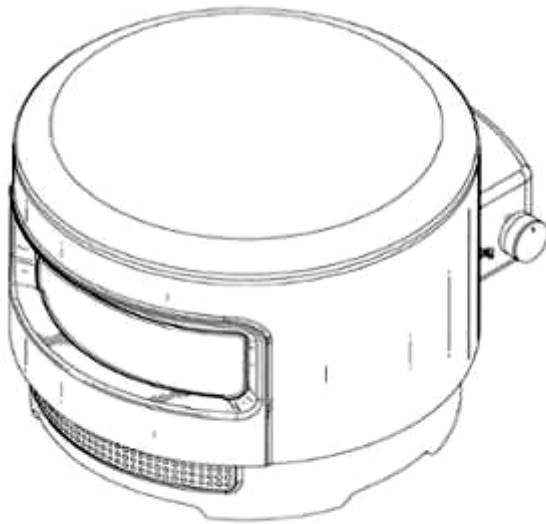

1.1

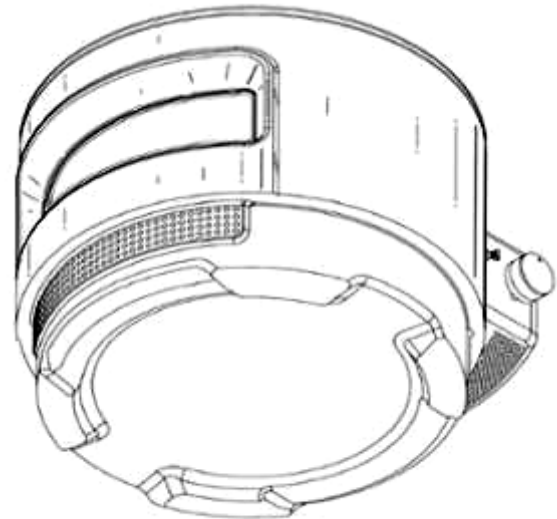

1.2

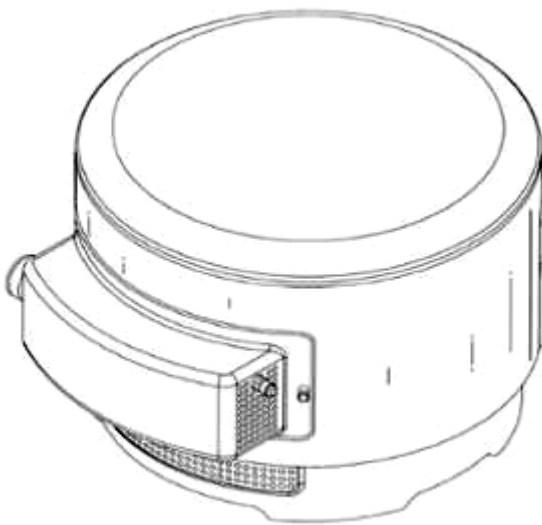

1.3

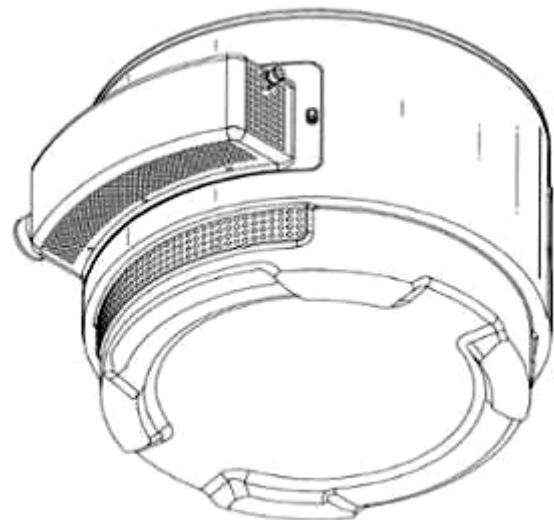

1.4

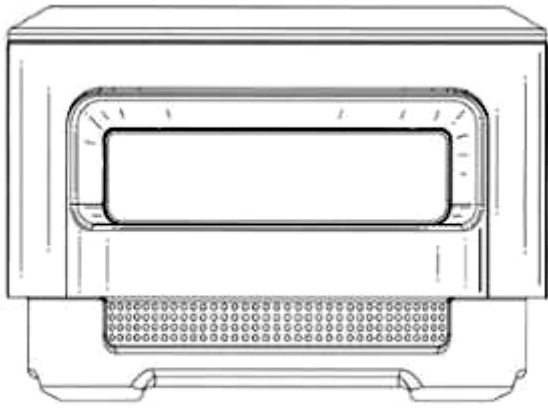

1.5

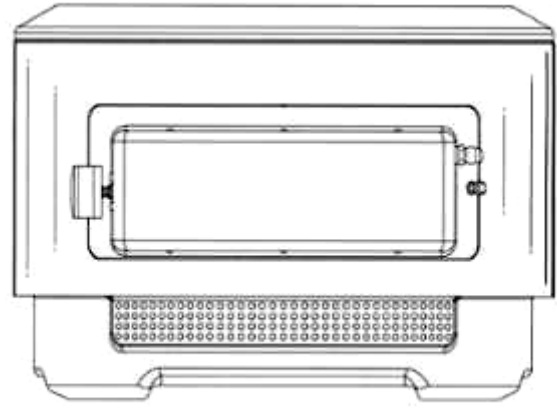

1.6

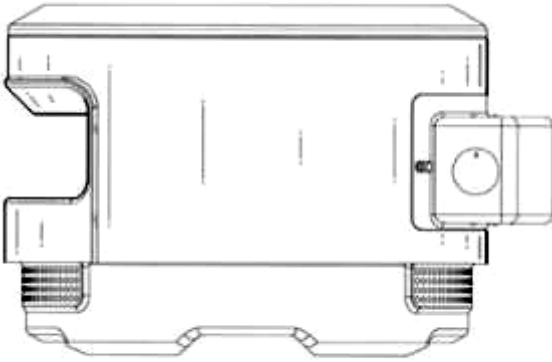

1.7

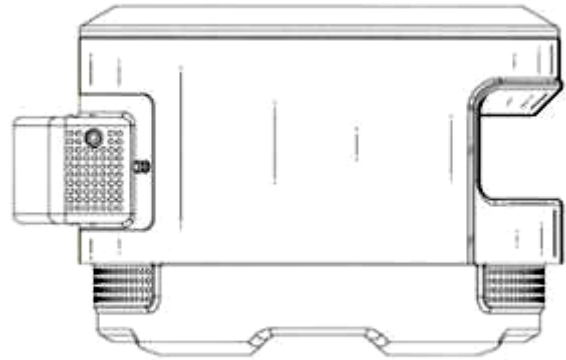

1.8

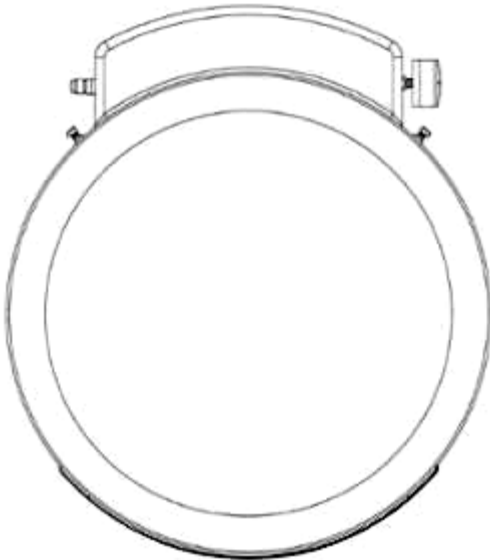

1.9

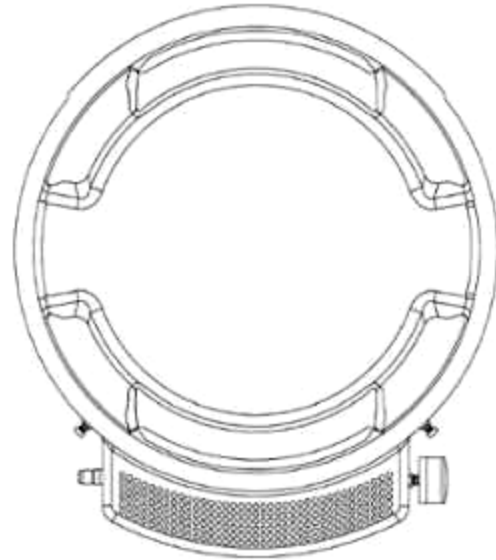

1.10

CÔNG BÁO SỞ HỮU CÔNG NGHIỆP SỐ 430 TẬP A – QUYỀN 2 (01.2024)

(11) **49353**

(21) 3-2023-02393

(28) 1

(54) **HỘP**

(51) **09-03**

(22) 11/10/2023

(43) 25/01/2024

(73) **LG H&H CO., LTD. (KR)**

58, Saemunan-ro, Jongno-gu, Seoul, Republic of Korea

(72) PARK, Suk Young (KR)

(74) Công ty TNHH Tầm nhìn và Liên danh (VISION & ASSOCIATES CO.LTD.)

(55)

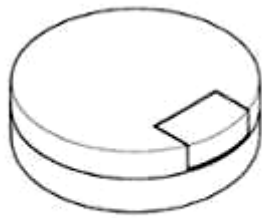

1.1

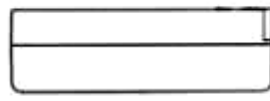

1.2

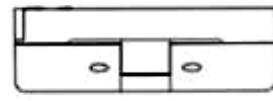

1.3

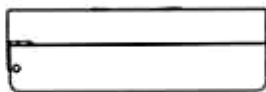

1.4

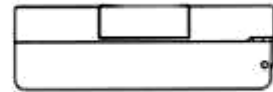

1.5

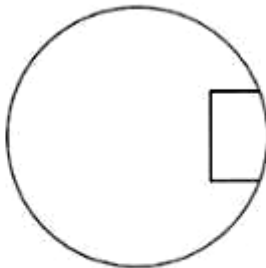

1.6

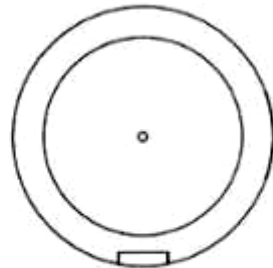

1.7



1.8

CÔNG BÁO SỞ HỮU CÔNG NGHIỆP SỐ 430 TẬP A – QUYỀN 2 (01.2024)

- (11) **49354**
(21) 3-2023-02395 (28) 1
(54) **NẮP CHAI** (51) **09-07**
(22) 11/10/2023 (43) 25/01/2024
(73) **CÔNG TY CỔ PHẦN CẤP NƯỚC ĐỒNG NAI (VN)**
Số 48 đường Cách Mạng Tháng Tám, phường Quyết Thắng, thành phố Biên Hoà,
tỉnh Đồng Nai
(72) Phạm Thị Hồng (VN)
(74) **CÔNG TY TNHH KHANG LUẬT (KHANGLAW)**
(55)



1.1



1.2



1.3



1.4



1.5

CÔNG BÁO SỞ HỮU CÔNG NGHIỆP SỐ 430 TẬP A – QUYỀN 2 (01.2024)

- (11) **49355**
(21) 3-2023-02399 (28) 1
(54) **LỌ** (51) **09-01**
(22) 12/10/2023 (43) 25/01/2024
(73) **LG H&H CO., LTD. (KR)**
58, Saemunan-ro, Jongno-gu, Seoul, Republic of Korea
(72) PARK, Suk Young (KR)
(74) Công ty TNHH Tâm nhìn và Liên danh (VISION & ASSOCIATES CO.LTD.)
(55)



1.1



1.2

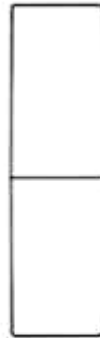

1.3



1.4



1.5



1.6



1.7



1.8

CÔNG BÁO SỞ HỮU CÔNG NGHIỆP SỐ 430 TẬP A – QUYỀN 2 (01.2024)

- (11) **49356**
(21) 3-2023-02400 (28) 2
(54) **BAO GÓI** (51) **09-05**
(22) 12/10/2023 (43) 25/01/2024
(73) **CÔNG TY TNHH KHÁNH NGUYỄN (VN)**
Số 522 Nguyễn Đình Chiểu, phường 3, thành phố Tân An, tỉnh Long An
(72) Tạ Quốc Tuấn (VN)
(74) Công ty Cổ phần Sở hữu công nghiệp INVESTIP (INVESTIP)
(55)



1.1



1.2



2.1



2.2

CÔNG BÁO SỞ HỮU CÔNG NGHIỆP SỐ 430 TẬP A – QUYỀN 2 (01.2024)

(11) 49357

(21) 3-2023-02405

(28) 4

(54) BAO GÓI

(51) 09-05

(22) 13/10/2023

(43) 25/01/2024

(73) CÔNG TY TNHH NHỰA MMA (VN)

Lô E23-E24 đường số 10, cụm công nghiệp Hải Sơn, xã Đức Hòa Đông, huyện Đức Hoà, tỉnh Long An

(72) Đinh Thế Huy (VN)

(55)



1.1

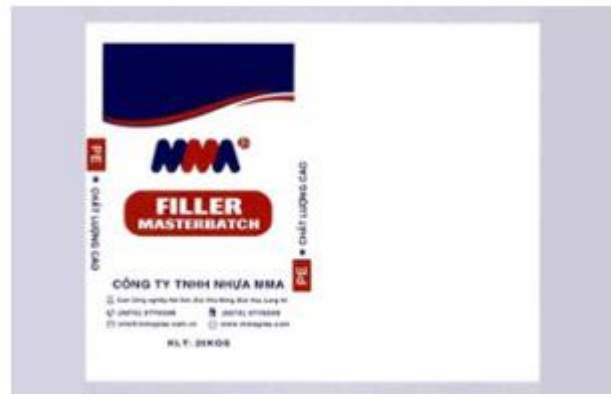

1.2



2.1



2.2



3.1



3.2



4.1



4.2

CÔNG BÁO SỞ HỮU CÔNG NGHIỆP SỐ 430 TẬP A – QUYỀN 2 (01.2024)

- (11) **49358**
(21) 3-2023-02406 (28) 1
(54) **NHÃN SẢN PHẨM** (51) **19-08**
(22) 13/10/2023 (43) 25/01/2024
(73) **CÔNG TY TNHH XUẤT NHẬP KHẨU THỰC PHẨM ĐÀ LẠT (VN)**
Ấp Phú Hòa, xã Phú Hội, huyện Đức Trọng, tỉnh Lâm Đồng
(72) Lê Trọng Hưng (VN)
(55)

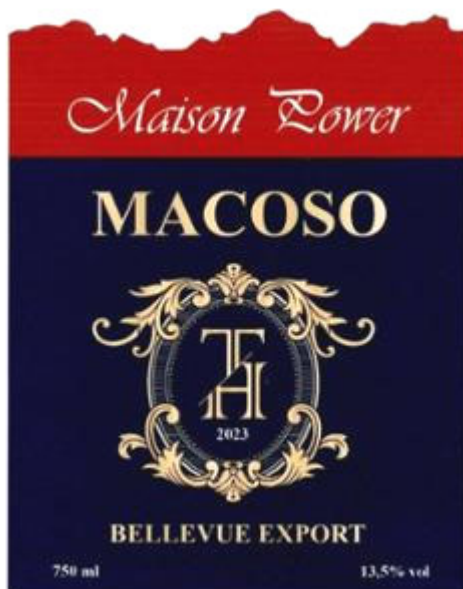

CÔNG BÁO SỞ HỮU CÔNG NGHIỆP SỐ 430 TẬP A – QUYỀN 2 (01.2024)

(11) **49359**

(21) 3-2023-02411

(28) 1

(54) **LỌ KEO DÁN**

(51) **19-06**

(22) 13/10/2023

(43) 25/01/2024

(73) **CÔNG TY CỔ PHẦN TẬP ĐOÀN THIÊN LONG (VN)**

Tầng 10, Sofic Tower, số 10 đường Mai Chí Thọ, phường Thủ Thiêm, thành phố Thủ Đức, thành phố Hồ Chí Minh

(72) Cô Gia Thọ (VN)

(74) Công ty TNHH Tư vấn sở hữu trí tuệ Việt (VIET IP CO.,LTD.)

(55)

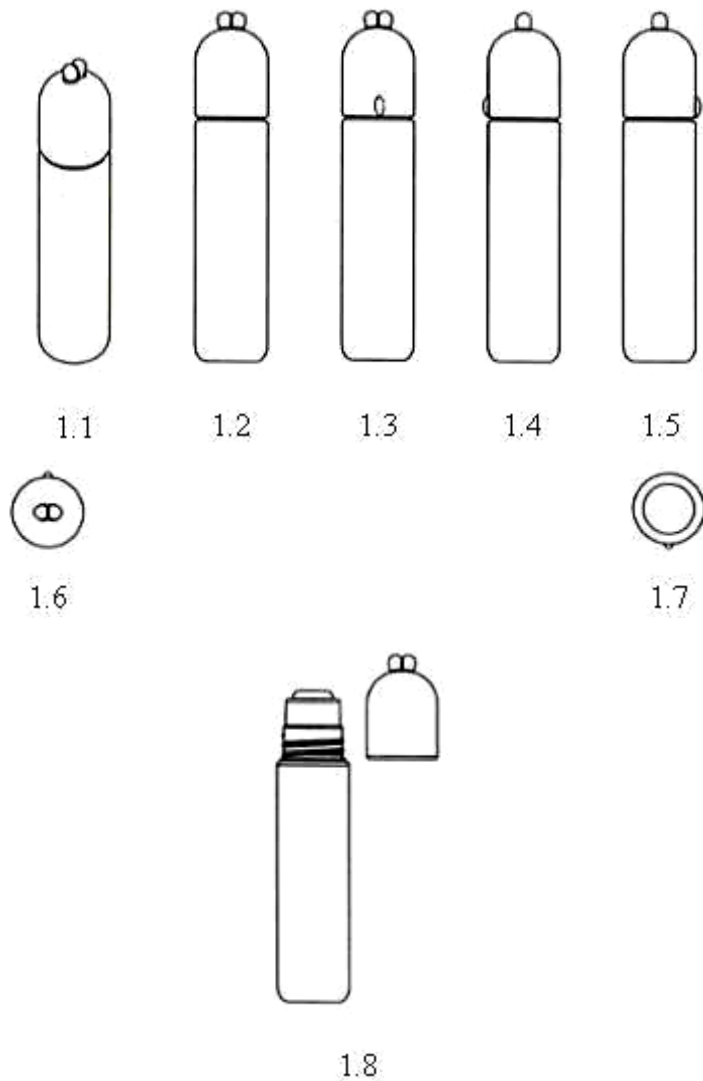

CÔNG BÁO SỞ HỮU CÔNG NGHIỆP SỐ 430 TẬP A – QUYỀN 2 (01.2024)

(11) **49360**

(21) 3-2023-02412

(28) 1

(54) **NẤP BÚT**

(51) **19-06**

(22) 13/10/2023

(43) 25/01/2024

(73) **CÔNG TY CỔ PHẦN TẬP ĐOÀN THIÊN LONG (VN)**

Tầng 10, Sofic Tower, số 10 đường Mai Chí Thọ, phường Thủ Thiêm, thành phố Thủ Đức, thành phố Hồ Chí Minh

(72) Cô Gia thọ (VN)

(74) Công ty TNHH Tư vấn sở hữu trí tuệ Việt (VIET IP CO.,LTD.)

(55)



1.1



1.2



1.3



1.4



1.5



1.6



1.7



1.8

CÔNG BÁO SỞ HỮU CÔNG NGHIỆP SỐ 430 TẬP A – QUYỀN 2 (01.2024)

- (11) **49361**
(21) 3-2023-02413 (28) 2
(54) **DỤNG CỤ GỌT BÚT CHÌ** (51) **19-06**
(22) 13/10/2023 (43) 25/01/2024
(73) **CÔNG TY CỔ PHẦN TẬP ĐOÀN THIÊN LONG (VN)**
Tầng 10, Sofic Tower, số 10 đường Mai Chí Thọ, phường Thủ Thiêm, thành phố Thủ Đức, thành phố Hồ Chí Minh
(72) Cô Gia Thọ (VN)
(74) Công ty TNHH Tư vấn sở hữu trí tuệ Việt (VIET IP CO.,LTD.)
(55)

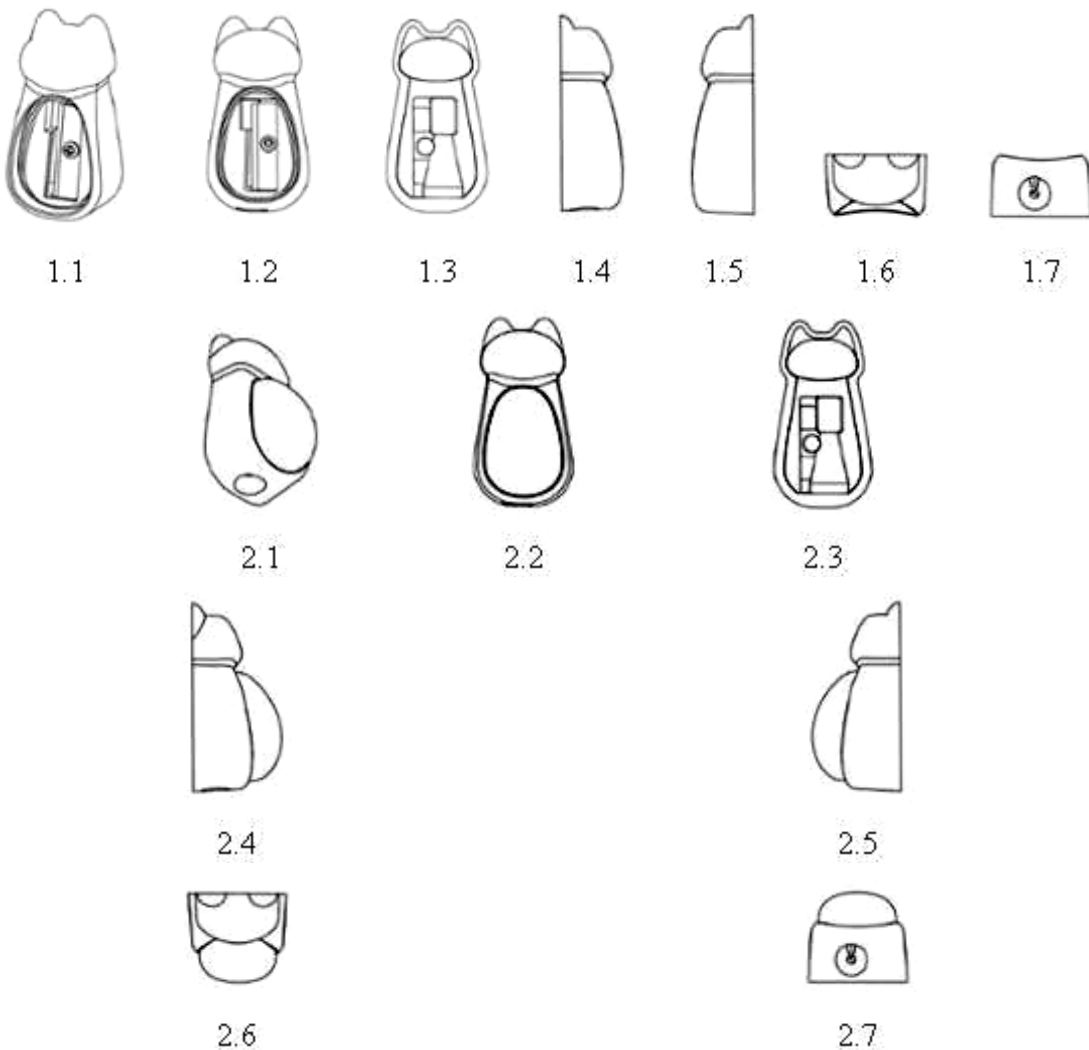

- (11) **49362**
(21) 3-2023-02414 (28) 1
(54) **ĐÁ ỐP LÁT** (51) **25-01**
(22) 16/10/2023 (43) 25/01/2024
(73) **CÔNG TY CỔ PHẦN TẬP ĐOÀN PHƯỢNG HOÀNG XANH A&A (VN)**
Số 167, phố Hoàng Ngân, phường Trung Hòa, quận Cầu Giấy, thành phố Hà Nội
(72) Hồ Xuân Năng (VN)
(55)



1.1



1.2



1.3



1.4



1.5



1.6



1.7

CÔNG BÁO SỞ HỮU CÔNG NGHIỆP SỐ 430 TẬP A – QUYỀN 2 (01.2024)

- (11) **49363**
(21) 3-2023-02416 (28) 1
(54) **ĐÁ ỐP LÁT** (51) **25-01**
(22) 16/10/2023 (43) 25/01/2024
(73) **CÔNG TY CỔ PHẦN TẬP ĐOÀN PHƯỢNG HOÀNG XANH A&A (VN)**
Số 167, phố Hoàng Ngân, phường Trung Hòa, quận Cầu Giấy, thành phố Hà Nội
(72) Hồ Xuân Năng (VN)
(55)



1.1



1.2



1.3



1.4



1.5



1.6

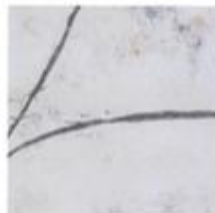

1.7

CÔNG BÁO SỞ HỮU CÔNG NGHIỆP SỐ 430 TẬP A – QUYỀN 2 (01.2024)

(11) **49364**

(21) 3-2023-02418

(28) 1

(54) **ĐÁ ỐP LÁT**

(51) **25-01**

(22) 16/10/2023

(43) 25/01/2024

(73) **CÔNG TY CỔ PHẦN TẬP ĐOÀN PHƯỢNG HOÀNG XANH A&A (VN)**

Số 167, phố Hoàng Ngân, phường Trung Hòa, quận Cầu Giấy, thành phố Hà Nội

(72) Hồ Xuân Năng (VN)

(55)



1.1



1.2



1.3



1.4



1.5



1.6



1.7

CÔNG BÁO SỞ HỮU CÔNG NGHIỆP SỐ 430 TẬP A – QUYỀN 2 (01.2024)

- (11) **49365**
(21) 3-2023-02419 (28) 1
(54) **XE SCUTO** (51) **12-11**
(22) 16/10/2023 (43) 25/01/2024
(30) 2023-007981 17/04/2023 JP;
(73) **HONDA MOTOR CO., LTD. (JP)**
1-1, Minami-Aoyama 2-Chome, Minato-ku, Tokyo, 107-8556 Japan
(72) 1. WONGSAKORN WATTANAVEKIN (TH)
2. TAKASHI WATANABE (JP)
(74) Công ty Luật TNHH Phạm và Liên danh (PHAM & ASSOCIATES)
(55)



1.1



1.2



1.3



1.4



1.5



1.6



1.7



1.8



1.9

CÔNG BÁO SỞ HỮU CÔNG NGHIỆP SỐ 430 TẬP A – QUYỀN 2 (01.2024)

- (11) **49366**
(21) 3-2023-02421 (28) 1
(54) **LỌ** (51) **09-01**
(22) 16/10/2023 (43) 25/01/2024
(73) **LG H&H Co., LTD. (KR)**
58, Saemunan-ro, Jongno-gu, Seoul, Republic of Korea
(72) LEE, Seul Ki (KR)
(74) Công ty TNHH Tâm nhìn và Liên danh (VISION & ASSOCIATES CO.LTD.)
(55)



1.1



1.2



1.3



1.4

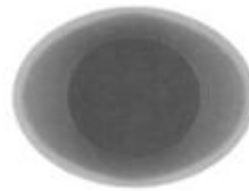

1.5

CÔNG BÁO SỞ HỮU CÔNG NGHIỆP SỐ 430 TẬP A – QUYỀN 2 (01.2024)

- (11) **49367**
(21) 3-2023-02422 (28) 1
(54) **THÙNG BIA** (51) **09-03**
(22) 16/10/2023 (43) 25/01/2024
(73) **TỔNG CÔNG TY CỔ PHẦN BIA-RƯỢU-NƯỚC GIẢI KHÁT SÀI GÒN (VN)**
187 Nguyễn Chí Thanh, phường 12, quận 5, thành phố Hồ Chí Minh
(72) Tan Teck Chuan Lester (SG)
(74) Công ty TNHH Luật ALIAT (ALIAT LEGAL)
(55)



1.1



1.2

CÔNG BÁO SỞ HỮU CÔNG NGHIỆP SỐ 430 TẬP A – QUYỀN 2 (01.2024)

- (11) **49368**
(21) 3-2023-02423 (28) 1
(54) **THÙNG BIA** (51) **09-03**
(22) 16/10/2023 (43) 25/01/2024
(73) **TỔNG CÔNG TY CỔ PHẦN BIA-RƯỢU-NƯỚC GIẢI KHÁT SÀI GÒN (VN)**
187 Nguyễn Chí Thanh, phường 12, quận 5, thành phố Hồ Chí Minh
(72) Tan Teck Chuan Lester (SG)
(74) Công ty TNHH Luật ALIAT (ALIAT LEGAL)
(55)



1.1



1.2

CÔNG BÁO SỞ HỮU CÔNG NGHIỆP SỐ 430 TẬP A – QUYỀN 2 (01.2024)

- (11) **49369**
(21) 3-2023-02424 (28) 1
(54) **THÙNG BIA** (51) **09-03**
(22) 16/10/2023 (43) 25/01/2024
(73) **TỔNG CÔNG TY CỔ PHẦN BIA-RƯỢU-NƯỚC GIẢI KHÁT SÀI GÒN (VN)**
187 Nguyễn Chí Thanh, phường 12, quận 5, thành phố Hồ Chí Minh
(72) Tan Teck Chuan Lester (SG)
(74) Công ty TNHH Luật ALIAT (ALIAT LEGAL)
(55)



1.1



1.2

CÔNG BÁO SỞ HỮU CÔNG NGHIỆP SỐ 430 TẬP A – QUYỀN 2 (01.2024)

- (11) **49370**
(21) 3-2023-02425 (28) 1
(54) **THÙNG BIA** (51) **09-03**
(22) 16/10/2023 (43) 25/01/2024
(73) **TỔNG CÔNG TY CỔ PHẦN BIA-RƯỢU-NƯỚC GIẢI KHÁT SÀI GÒN (VN)**
187 Nguyễn Chí Thanh, phường 12, quận 5, thành phố Hồ Chí Minh
(72) Tan Teck Chuan Lester (SG)
(74) Công ty TNHH Luật ALIAT (ALIAT LEGAL)
(55)



1.1



1.2

CÔNG BÁO SỞ HỮU CÔNG NGHIỆP SỐ 430 TẬP A – QUYỀN 2 (01.2024)

- (11) **49371**
(21) 3-2023-02426 (28) 1
(54) **THÙNG BIA** (51) **09-03**
(22) 16/10/2023 (43) 25/01/2024
(73) **TỔNG CÔNG TY CỔ PHẦN BIA-RƯỢU-NƯỚC GIẢI KHÁT SÀI GÒN (VN)**
187 Nguyễn Chí Thanh, phường 12, quận 5, thành phố Hồ Chí Minh
(72) Tan Teck Chuan Lester (SG)
(74) Công ty TNHH Luật ALIAT (ALIAT LEGAL)
(55)



1.1



1.2

CÔNG BÁO SỞ HỮU CÔNG NGHIỆP SỐ 430 TẬP A – QUYỀN 2 (01.2024)

- (11) **49372**
(21) 3-2023-02427 (28) 1
(54) **THÙNG BIA** (51) **09-03**
(22) 16/10/2023 (43) 25/01/2024
(73) **TỔNG CÔNG TY CỔ PHẦN BIA-RƯỢU-NƯỚC GIẢI KHÁT SÀI GÒN (VN)**
187 Nguyễn Chí Thanh, phường 12, quận 5, thành phố Hồ Chí Minh
(72) Tan Teck Chuan Lester (SG)
(74) Công ty TNHH Luật ALIAT (ALIAT LEGAL)
(55)



1.1



1.2

CÔNG BÁO SỞ HỮU CÔNG NGHIỆP SỐ 430 TẬP A – QUYỀN 2 (01.2024)

- (11) **49373**
(21) 3-2023-02428 (28) 1
(54) **THÙNG BIA** (51) **09-03**
(22) 16/10/2023 (43) 25/01/2024
(73) **TỔNG CÔNG TY CỔ PHẦN BIA-RƯỢU-NƯỚC GIẢI KHÁT SÀI GÒN (VN)**
187 Nguyễn Chí Thanh, phường 12, quận 5, thành phố Hồ Chí Minh
(72) Tan Teck Chuan Lester (SG)
(74) Công ty TNHH Luật ALIAT (ALIAT LEGAL)
(55)



1.1



1.2

CÔNG BÁO SỞ HỮU CÔNG NGHIỆP SỐ 430 TẬP A – QUYỀN 2 (01.2024)

- (11) **49374**
- (21) 3-2023-02437 (28) 1
- (54) **NHÃN SẢN PHẨM** (51) **19-08**
- (22) 27/01/2021 (43) 25/01/2024
- (73) **CERIOTI HOLDING S.A. (LU)**
23, Rue Aldringen L-1118 Luxembourg
- (72) Lê Thị Ánh Phương (VN)
- (74) Công ty TNHH Tầm nhìn và Liên danh (VISION & ASSOCIATES CO.LTD.)
- (55)



CÔNG BÁO SỞ HỮU CÔNG NGHIỆP SỐ 430 TẬP A – QUYỀN 2 (01.2024)

- (11) **49375**
- (21) 3-2023-02438 (28) 1
- (54) **NHÃN SẢN PHẨM** (51) **19-08**
- (22) 27/01/2021 (43) 25/01/2024
- (73) **CERIOTI HOLDING S.A. (LU)**
23, Rue Aldringen L-1118 Luxembourg
- (72) Lê Thị Ánh Phương (VN)
- (74) Công ty TNHH Tầm nhìn và Liên danh (VISION & ASSOCIATES CO.LTD.)
- (55)



(11) **49376**

(21) 3-2023-02442

(28) 1

(54) **QUẠT TRẦN**

(51) **23-04**

(22) 17/10/2023

(43) 25/01/2024

(73) **CÔNG TY TNHH ÁNH DƯƠNG (VN)**

Khu tập thể thức ăn gia súc, xã An Khánh, huyện Hoài Đức, thành phố Hà Nội

(72) Nguyễn Duy Trinh (VN)

(55)



1.1



1.2

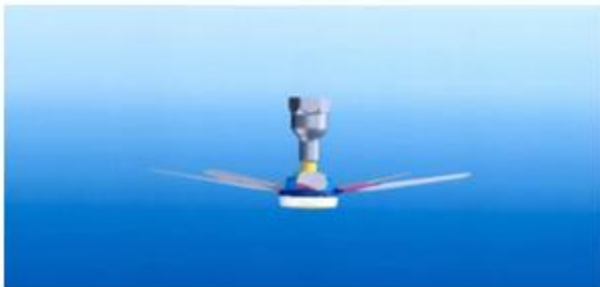

1.3

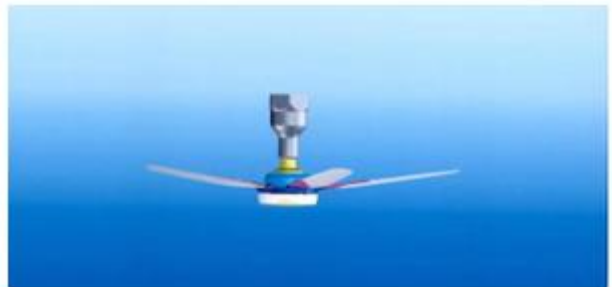

1.4

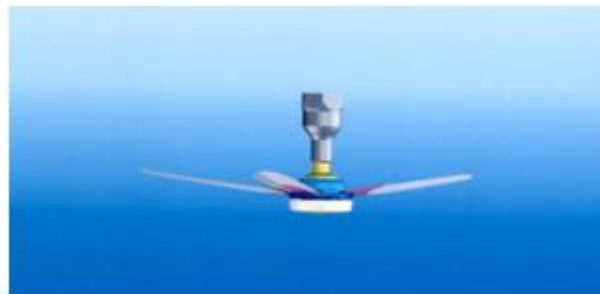

1.5



1.6



1.7

CÔNG BÁO SỞ HỮU CÔNG NGHIỆP SỐ 430 TẬP A – QUYỀN 2 (01.2024)

(11) **49377**

(21) 3-2023-02443

(28) 1

(54) **QUẠT TRẦN**

(51) **23-04**

(22) 17/10/2023

(43) 25/01/2024

(73) **CÔNG TY TNHH ÁNH DƯƠNG (VN)**

Khu tập thể thức ăn gia súc, xã An Khánh, huyện Hoài Đức, thành phố Hà Nội

(72) Nguyễn Duy Trinh (VN)

(55)



1.1

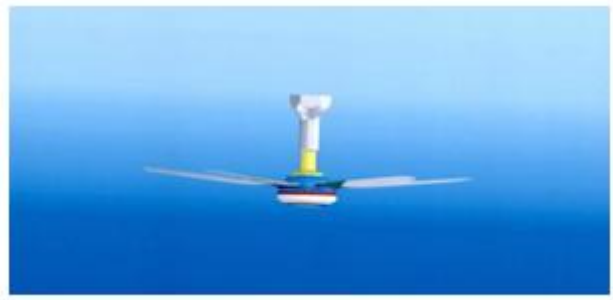

1.2



1.3

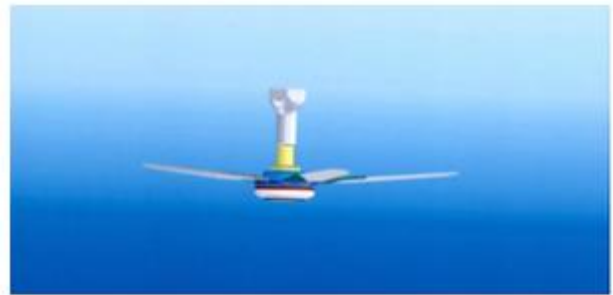

1.4

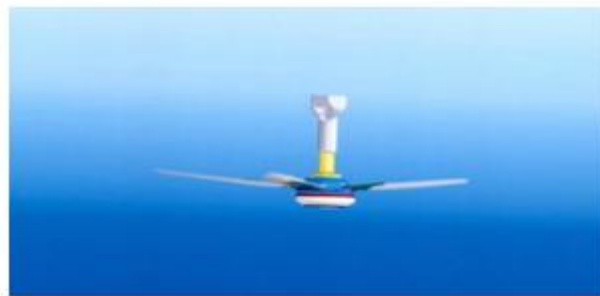

1.5



1.6



1.7

(11) **49378**

(21) 3-2023-02444

(28) 2

(54) **QUẠT TRẦN**

(51) **23-04**

(22) 17/10/2023

(43) 25/01/2024

(73) **CÔNG TY TNHH ÁNH DƯƠNG (VN)**

Khu tập thể thức ăn gia súc, xã An Khánh, huyện Hoài Đức, thành phố Hà Nội

(72) Nguyễn Duy Trinh (VN)

(55)



1.1



1.2

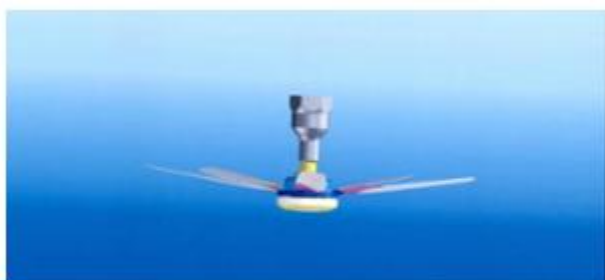

1.3

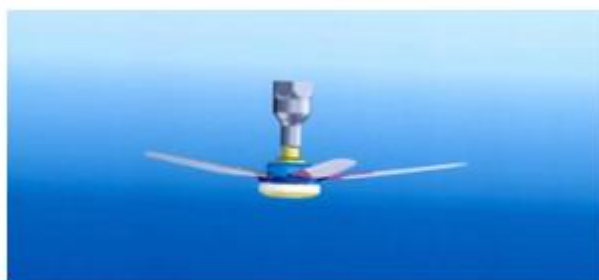

1.4

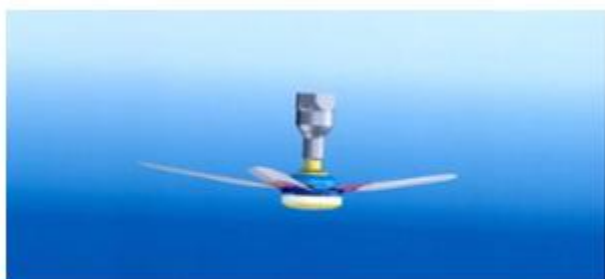

1.5



1.6



1.7



2.1

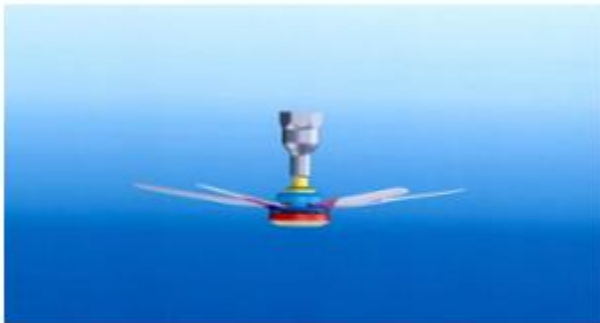

2.2



2.3

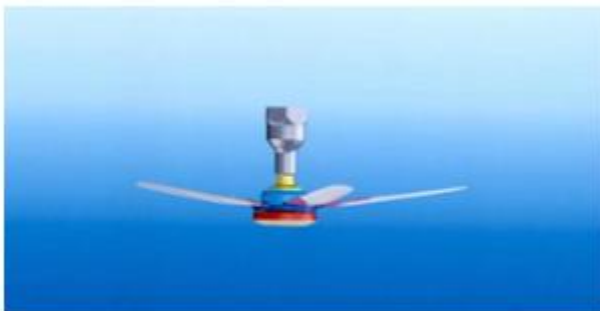

2.4



2.5



2.6



2.7

CÔNG BÁO SỞ HỮU CÔNG NGHIỆP SỐ 430 TẬP A – QUYỀN 2 (01.2024)

- (11) **49379**
(21) 3-2023-02445 (28) 1
(54) **HỘP BÚT** (51) **09-03**
(22) 17/10/2023 (43) 25/01/2024
(73) **CÔNG TY CỔ PHẦN TẬP ĐOÀN THIÊN LONG (VN)**
Tầng 10, Sofic Tower, số 10 đường Mai Chí Thọ, phường Thủ Thiêm, thành phố Thủ Đức, thành phố Hồ Chí Minh
(72) Cô Gia Thọ (VN)
(74) Công ty TNHH Tư vấn sở hữu trí tuệ Việt (VIET IP CO.,LTD.)
(55)



1.1



1.2

CÔNG BÁO SỞ HỮU CÔNG NGHIỆP SỐ 430 TẬP A – QUYỀN 2 (01.2024)

- (11) **49380**
(21) 3-2023-02447 (28) 1
(54) **LỚP XE** (51) **12-15**
(22) 18/10/2023 (43) 25/01/2024
(73) **CHENG SHIN RUBBER IND. CO., LTD. (TW)**
NO. 215, MEIGANG RD., DACUN TOWNSHIP, CHANGHUA COUNTY 51545,
TAIWAN
(72) HSIAO, CHIEN-MIN (TW)
(74) Công ty TNHH một thành viên Sở hữu trí tuệ VCCI (VCCI-IP CO.,LTD)
(55)



1.1

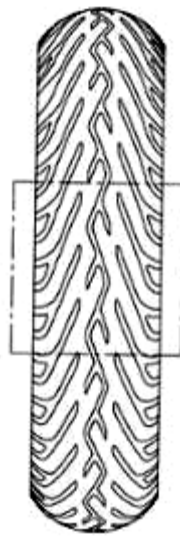

1.2



1.3

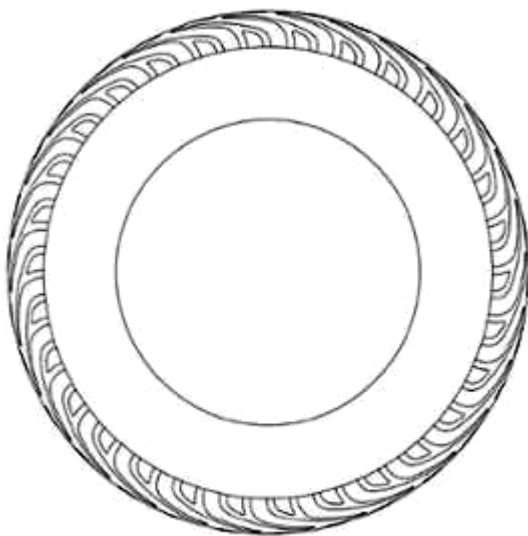

1.4

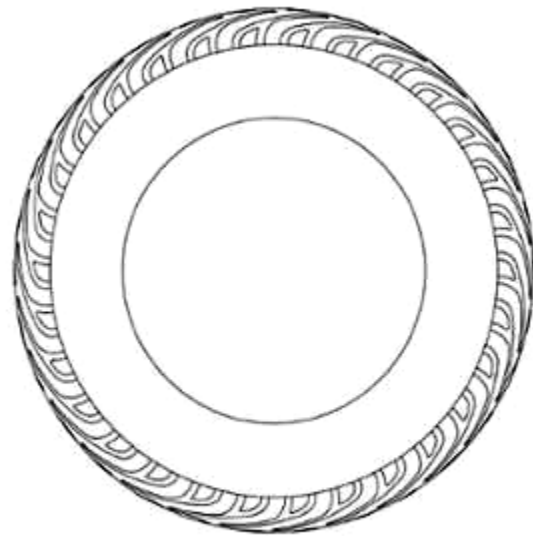

1.5



1.6



1.7

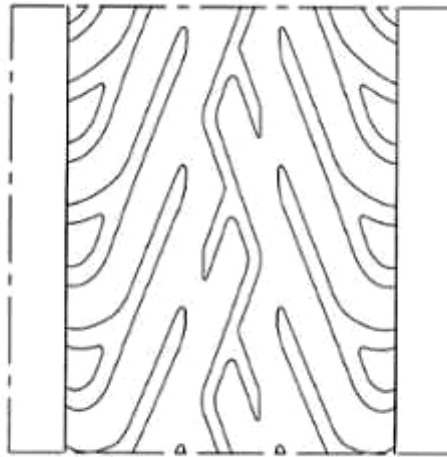

1.8

CÔNG BÁO SỞ HỮU CÔNG NGHIỆP SỐ 430 TẬP A – QUYỀN 2 (01.2024)

- (11) **49381**
- (21) 3-2023-02449 (28) 1
- (54) **HỢP ĐỰNG BỘT THANH LONG** (51) **09-03**
- (22) 18/10/2023 (43) 25/01/2024
- (73) **HỢP TÁC XÃ NÔNG NGHIỆP CÔNG NGHỆ CAO BÀ RỊA VŨNG TÀU (VN)**
QL 56, tổ 4, ấp Bình Mỹ, xã Bình Ba, huyện Châu Đức, tỉnh Bà Rịa - Vũng Tàu
- (72) Lê Hòa Bình (VN)
- (74) Văn phòng Luật sư D và T (D & T LAW OFFICE)
- (55)



1.1



1.2

CÔNG BÁO SỞ HỮU CÔNG NGHIỆP SỐ 430 TẬP A – QUYỀN 2 (01.2024)

- (11) **49382**
(21) 3-2023-02451 (28) 1
(54) **THANH KIM LOẠI ĐỊNH HÌNH** (51) **25-01**
(22) 18/10/2023 (43) 25/01/2024
(73) **CÔNG TY CỔ PHẦN TẬP ĐOÀN KENWIN (VN)**
Tầng 4 tòa nhà VG Building, số 235 đường Nguyễn Trãi, phường Thanh Xuân
Trung, quận Thanh Xuân, thành phố Hà Nội
(72) Ngô Thọ Long (VN)
(74) Công ty TNHH Sở hữu trí tuệ PADEMARK (PADEMARK CO.,LTD.)
(55)



1.1



1.2



1.3

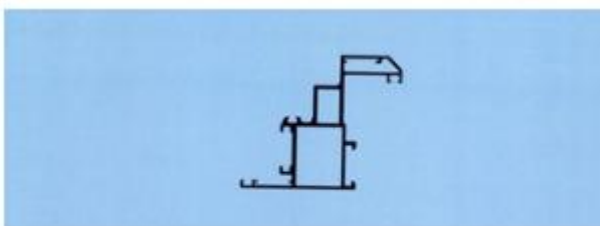

1.4

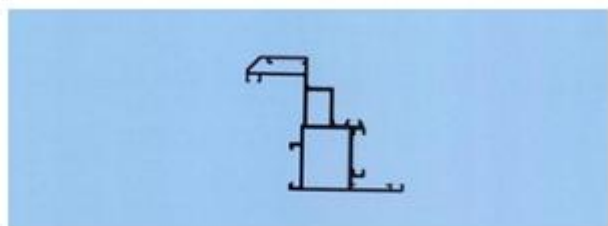

1.5



1.6



1.7

CÔNG BÁO SỞ HỮU CÔNG NGHIỆP SỐ 430 TẬP A – QUYỀN 2 (01.2024)

- (11) **49383**
(21) 3-2023-02459 (28) 1
(54) **HỘP** (51) **09-03**
(22) 18/10/2023 (43) 25/01/2024
(73) **CÔNG TY TNHH MỘT THÀNH VIÊN NAM HUY ĐỒNG THÁP (VN)**
Số 180, ấp Hòa Bình, xã Hòa Tân, huyện Châu Thành, tỉnh Đồng Tháp
(72) Nguyễn Phạm Quốc Tùng (VN)
(74) Công ty Luật TNHH AGL (AGL LAW)
(55)



1.1



1.2



1.3

CÔNG BÁO SỞ HỮU CÔNG NGHIỆP SỐ 430 TẬP A – QUYỀN 2 (01.2024)

- (11) **49384**
(21) 3-2023-02464 (28) 1
(54) **XE BÁN HÀNG LƯU ĐỘNG** (51) **12-02**
(22) 19/10/2023 (43) 25/01/2024
(73) **CÔNG TY CỔ PHẦN THỰC PHẨM QUỐC TẾ TORKI (VN)**
120/5 Lê Văn Quới, phường Bình Hưng Hòa A, quận Bình Tân, thành phố Hồ Chí Minh
(72) Lê Quốc Thạch (VN)
(74) Công ty Luật TNHH Phạm và Liên danh (PHAM & ASSOCIATES)
(55)



1.1

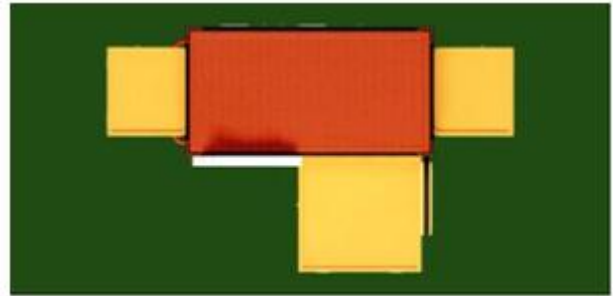

1.2

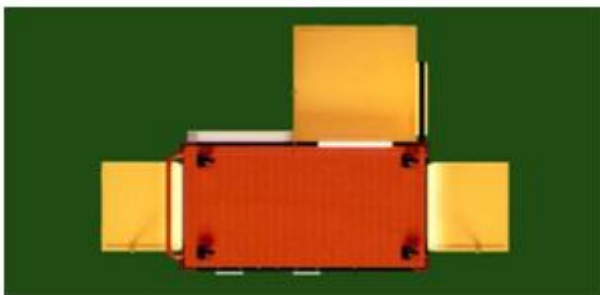

1.3



1.4



1.5



1.6



1.7

CÔNG BÁO SỞ HỮU CÔNG NGHIỆP SỐ 430 TẬP A – QUYỀN 2 (01.2024)

- (11) **49385**
(21) 3-2023-02465 (28) 1
(54) **QUẦY BÁN HÀNG** (51) **25-03**
(22) 19/10/2023 (43) 25/01/2024
(73) **CÔNG TY CỔ PHẦN THỰC PHẨM QUỐC TẾ TORKI (VN)**
120/5 Lê Văn Quới, phường Bình Hưng Hòa A, quận Bình Tân, thành phố Hồ Chí Minh
(72) Lê Quốc Thạch (VN)
(74) Công ty Luật TNHH Phạm và Liên danh (PHAM & ASSOCIATES)
(55)



1.1



1.2



1.3



1.4

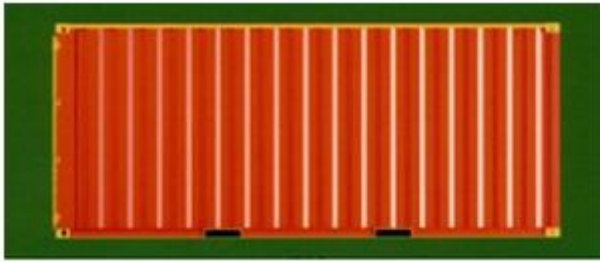

1.5



1.6

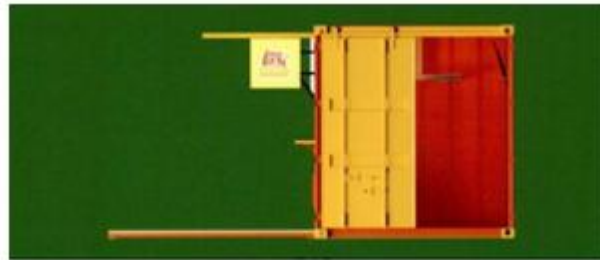

1.7

CÔNG BÁO SỞ HỮU CÔNG NGHIỆP SỐ 430 TẬP A – QUYỀN 2 (01.2024)

- (11) **49386**
(21) 3-2023-02472 (28) 1
(54) **NHÃN SẢN PHẨM** (51) **19-08**
(22) 19/10/2023 (43) 25/01/2024
(73) **CÔNG TY TNHH MAGICSEAL VIỆT NAM (VN)**
Khu phố Tân Xuân, thị trấn Cần Giuộc, huyện Cần Giuộc, tỉnh Long An
(72) Nguyễn Huy Văn (VN)
(74) Công ty TNHH Sở hữu trí tuệ INVENTIO (INVENTIO CO.,LTD)
(55)



1.1



1.2

CÔNG BÁO SỞ HỮU CÔNG NGHIỆP SỐ 430 TẬP A – QUYỀN 2 (01.2024)

- (11) **49387**
(21) 3-2023-02475 (28) 1
(54) **HỘP ĐỰNG VIÊN GIẶT** (51) **09-03**
(22) 19/10/2023 (43) 25/01/2024
(30) 23-E0658-0101 08/05/2023 MY;
(73) **NEUTROVIS SDN. BHD.** (MY)
Block C, PJ City Development, 15A, Jalan 51a/219, Seksyen 51a, 46100 Petaling
Jaya, Selangor, Malaysia
(72) Tan Chui Yen (MY)
(74) Công ty TNHH Dịch vụ Sở hữu trí tuệ KASS Việt Nam (KASS VIETNAM
CO.,LTD.)
(55)



1.1

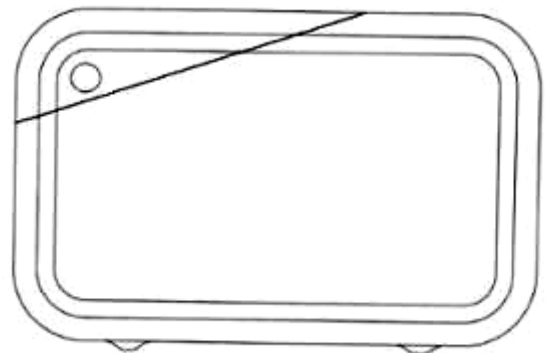

1.2

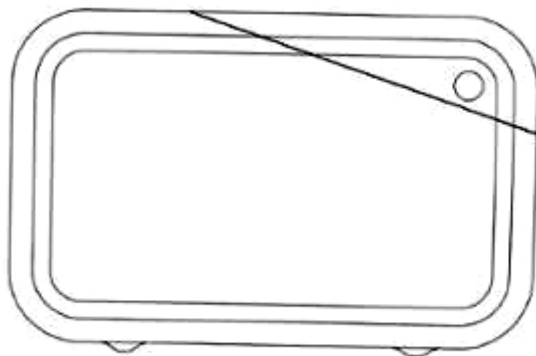

1.3

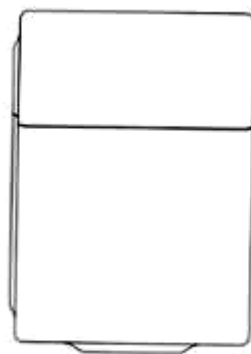

1.4



1.5

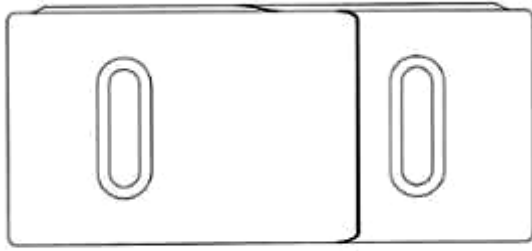

1.6



1.7

CÔNG BÁO SỞ HỮU CÔNG NGHIỆP SỐ 430 TẬP A – QUYỀN 2 (01.2024)

(11) **49388**

(21) 3-2023-02477

(28) 1

(54) **ĐÉ GIẦY**

(51) **02-04**

(22) 19/10/2023

(43) 25/01/2024

(73) **CÔNG TY TNHH BÌNH TIÊN BIÊN HÒA (VN)**

Lô 101/2 khu công nghiệp Amata, phường Long Bình, thành phố Biên Hòa, tỉnh Đồng Nai

(72) Lai Khiêm (VN)

(74) Công ty TNHH Tư vấn sở hữu trí tuệ Việt (VIET IP CO.,LTD.)

(55)



1.1



1.2



1.3



1.4



1.5



1.6



1.7

CÔNG BÁO SỞ HỮU CÔNG NGHIỆP SỐ 430 TẬP A – QUYỀN 2 (01.2024)

(11) **49389**

(21) 3-2023-02478

(28) 1

(54) **GIÀY**

(51) **02-04**

(22) 19/10/2023

(43) 25/01/2024

(73) **CÔNG TY TNHH BÌNH TIÊN BIÊN HÒA (VN)**

Lô 101/2 khu công nghiệp Amata, phường Long Bình, thành phố Biên Hòa, tỉnh Đồng Nai

(72) Lai Khiêm (VN)

(74) Công ty TNHH Tư vấn sở hữu trí tuệ Việt (VIET IP CO.,LTD.)

(55)



1.1



1.2



1.3



1.4



1.5



1.6

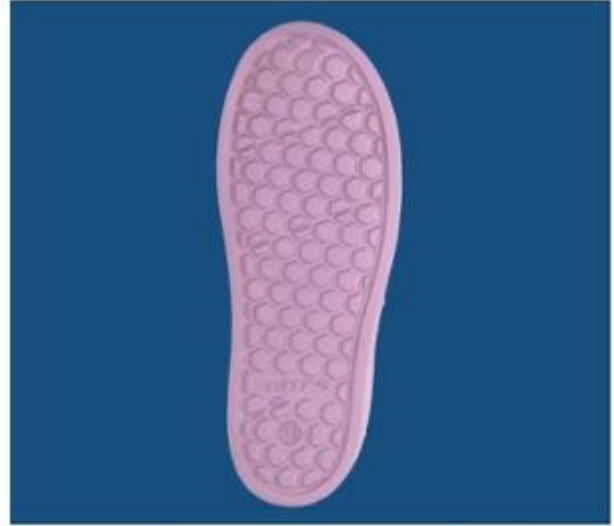

1.7

CÔNG BÁO SỞ HỮU CÔNG NGHIỆP SỐ 430 TẬP A – QUYỀN 2 (01.2024)

(11) **49390**

(21) 3-2023-02479

(28) 1

(54) **ĐÉ GIẦY**

(51) **02-04**

(22) 19/10/2023

(43) 25/01/2024

(73) **CÔNG TY TNHH BÌNH TIÊN BIÊN HÒA (VN)**

Lô 101/2 khu công nghiệp Amata, phường Long Bình, thành phố Biên Hòa, tỉnh Đồng Nai

(72) Lai Khiêm (VN)

(74) Công ty TNHH Tư vấn sở hữu trí tuệ Việt (VIET IP CO.,LTD.)

(55)



1.1



1.2



1.3



1.4



1.5



1.6



1.7

CÔNG BÁO SỞ HỮU CÔNG NGHIỆP SỐ 430 TẬP A – QUYỀN 2 (01.2024)

(11) **49391**

(21) 3-2023-02480

(28) 1

(54) **ĐÉ GIÀY**

(51) **02-04**

(22) 19/10/2023

(43) 25/01/2024

(73) **CÔNG TY TNHH BÌNH TIÊN BIÊN HÒA (VN)**

Lô 101/2 Khu công nghiệp Amata, phường Long Bình, thành phố Biên Hòa, tỉnh Đồng Nai

(72) Lai Khiêm (VN)

(74) Công ty TNHH Tư vấn sở hữu trí tuệ Việt (VIET IP CO.,LTD.)

(55)



1.1



1.2



1.3



1.4



1.5



1.6



1.7

CÔNG BÁO SỞ HỮU CÔNG NGHIỆP SỐ 430 TẬP A – QUYỀN 2 (01.2024)

- | | | | |
|------|--|------|--------------|
| (11) | 49392 | | |
| (21) | 3-2023-02481 | (28) | 1 |
| (54) | NHÃN SẢN PHẨM | (51) | 19-08 |
| (22) | 20/10/2023 | (43) | 25/01/2024 |
| (73) | LÊ THỊ HỖ (VN)
1300 đường 2 tháng 4, phường Vạn Thắng, thành phố Nha Trang, tỉnh Khánh Hòa | | |
| (72) | Lê Thị Hỷ (VN) | | |
| (55) | | | |



CÔNG BÁO SỞ HỮU CÔNG NGHIỆP SỐ 430 TẬP A – QUYỀN 2 (01.2024)

- (11) **49393**
(21) 3-2023-02482 (28) 1
(54) **NHÃN SẢN PHẨM** (51) **19-08**
(22) 20/10/2023 (43) 25/01/2024
(73) **CÔNG TY CỔ PHẦN FALCON COATINGS VIỆT NAM (VN)**
Số 30, ngõ 67, đường Tô Ngọc Vân, phường Quảng An, quận Tây Hồ, thành phố Hà Nội
(72) Ngô Thị Hồng Vân (VN)
(55)



CÔNG BÁO SỞ HỮU CÔNG NGHIỆP SỐ 430 TẬP A – QUYỀN 2 (01.2024)

- (11) **49394**
- (21) 3-2023-02483 (28) 1
- (54) **NHÃN SẢN PHẨM** (51) **19-08**
- (22) 20/10/2023 (43) 25/01/2024
- (73) **CÔNG TY CỔ PHẦN FALCON COATINGS VIỆT NAM (VN)**
Số 30, ngõ 67, đường Tô Ngọc Vân, phường Quảng An, quận Tây Hồ, thành phố Hà Nội
- (72) Ngô Thị Hồng Vân (VN)
- (55)



CÔNG BÁO SỞ HỮU CÔNG NGHIỆP SỐ 430 TẬP A – QUYỀN 2 (01.2024)

- (11) **49395**
- (21) 3-2023-02484 (28) 1
- (54) **NHÃN SẢN PHẨM** (51) **19-08**
- (22) 20/10/2023 (43) 25/01/2024
- (73) **CÔNG TY CỔ PHẦN FALCON COATINGS VIỆT NAM (VN)**
Số 30, ngõ 67, đường Tô Ngọc Vân, phường Quảng An, quận Tây Hồ, thành phố Hà Nội
- (72) Ngô Thị Hồng Vân (VN)
- (55)



CÔNG BÁO SỞ HỮU CÔNG NGHIỆP SỐ 430 TẬP A – QUYỀN 2 (01.2024)

- (11) **49396**
- (21) 3-2023-02485 (28) 1
- (54) **NHÃN SẢN PHẨM** (51) **19-08**
- (22) 20/10/2023 (43) 25/01/2024
- (73) **CÔNG TY CỔ PHẦN FALCON COATINGS VIỆT NAM (VN)**
Số 30, ngõ 67, đường Tô Ngọc Vân, phường Quảng An, quận Tây Hồ, thành phố Hà Nội
- (72) Ngô Thị Hồng Vân (VN)
- (55)



CÔNG BÁO SỞ HỮU CÔNG NGHIỆP SỐ 430 TẬP A – QUYỀN 2 (01.2024)

- (11) **49397**
(21) 3-2023-02486 (28) 1
(54) **NHÃN SẢN PHẨM** (51) **19-08**
(22) 20/10/2023 (43) 25/01/2024
(73) **CÔNG TY CỔ PHẦN FALCON COATINGS VIỆT NAM (VN)**
Số 30, ngõ 67, đường Tô Ngọc Vân, phường Quảng An, quận Tây Hồ, thành phố Hà Nội
(72) Ngô Thị Hồng Vân (VN)
(55)



CÔNG BÁO SỞ HỮU CÔNG NGHIỆP SỐ 430 TẬP A – QUYỀN 2 (01.2024)

- (11) **49398**
(21) 3-2023-02488 (28) 1
(54) **THIẾT BỊ ĐIỀU KHIỂN CÓ MÀN HÌNH HIỂN THỊ** (51) **14-03**
(22) 20/10/2023 (43) 25/01/2024
(30) 2023-008982 28/04/2023 JP;
(73) **SONY INTERACTIVE ENTERTAINMENT INC. (JP)**
1-7-1 Konan, Minato-ku, Tokyo, Japan
(72) Ikuo KOBAYASHI (JP)
(74) Công ty Luật TNHH Phạm và Liên danh (PHAM & ASSOCIATES)
(55)

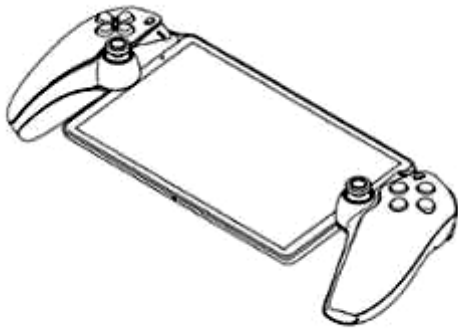

1.1

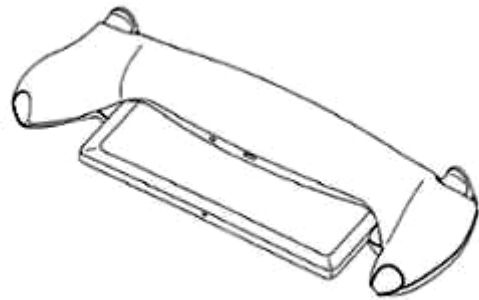

1.2



1.3



1.4

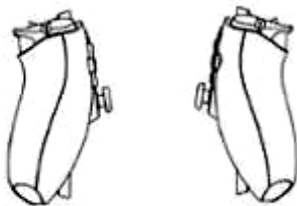

1.5

1.6



1.7



1.8

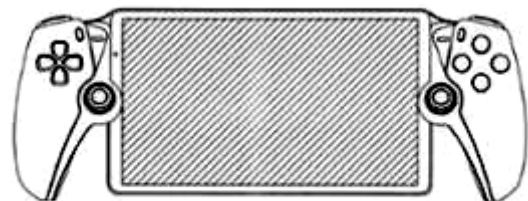

1.9

CÔNG BÁO SỞ HỮU CÔNG NGHIỆP SỐ 430 TẬP A – QUYỀN 2 (01.2024)

- (11) **49399**
(21) 3-2023-02493 (28) 3
(54) **BAO BÌ** (51) **09-05**
(22) 20/10/2023 (43) 25/01/2024
(73) **CÔNG TY TNHH MỘT THÀNH VIÊN BÒ SỮA VIỆT NAM (VN)**
10 Tân Trào, phường Tân Phú, quận 7, thành phố Hồ Chí Minh
(72) 1. NGUYỄN NGỌC TRÂN (VN)
2. MEGAN BOWKER (US)
(74) Công ty Cổ phần Sở hữu công nghiệp INVESTIP (INVESTIP)
(55)



1.1



1.2



2.1



2.2



3.1



3.2

CÔNG BÁO SỞ HỮU CÔNG NGHIỆP SỐ 430 TẬP A – QUYỀN 2 (01.2024)

- (11) **49400**
- (21) 3-2023-02494
- (54) **MÁY CÀO BÙN PHẪNG**
- (22) 23/10/2023
- (73) **CÔNG TY CỔ PHẦN KỸ NGHỆ HOÀNG MAI (VN)**
Số nhà 24A ngõ 629, đường Giải Phóng, phường Giáp Bát, quận Hoàng Mai, thành phố Hà Nội
- (72) Nguyễn Viết Phong (VN)
- (74) Công ty TNHH MASTERBRAND (MASTERBRAND)
- (55)



1.1

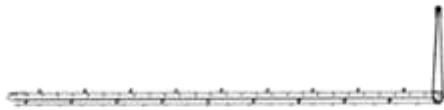

1.2

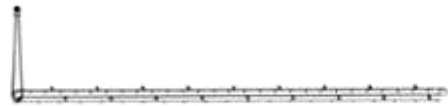

1.3



1.4



1.5

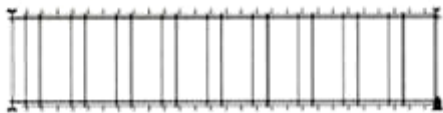

1.6

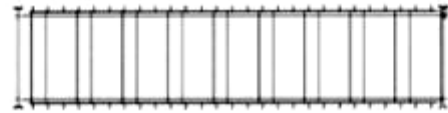

1.7

CÔNG BÁO SỞ HỮU CÔNG NGHIỆP SỐ 430 TẬP A – QUYỀN 2 (01.2024)

- (11) **49401**
(21) 3-2023-02498 (28) 2
(54) **THANH KIM LOẠI ĐỊNH HÌNH** (51) **25-01**
(22) 23/10/2023 (43) 25/01/2024
(73) **CÔNG TY TNHH CỬA CUỐN ÚC VINH QUANG (VN)**
Số 180 Tô Hiệu, phường Trại Cau, quận Lê Chân, thành phố Hải Phòng
(72) Lê Mạnh Đức (VN)
(74) Công ty TNHH Sở hữu trí tuệ Gia Việt (GIAVIET CO., LTD.)
(55)

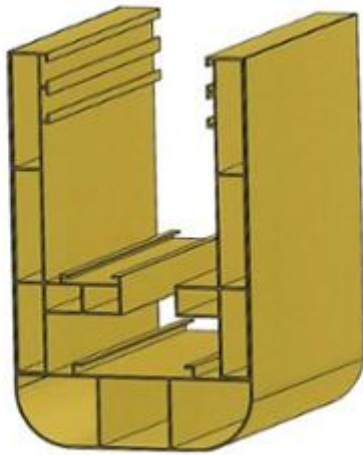

1.1

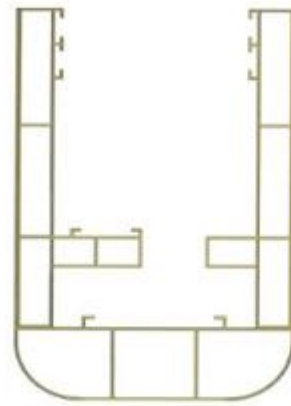

1.2



1.3

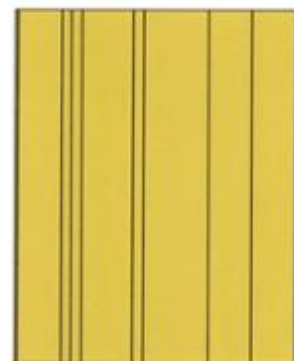

1.4

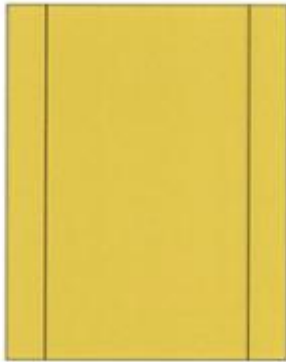

1.5

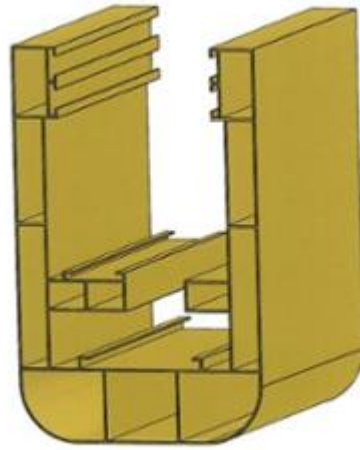

2.1

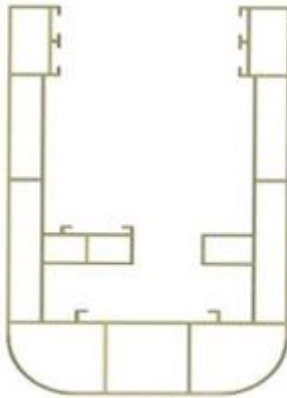

2.2



2.3

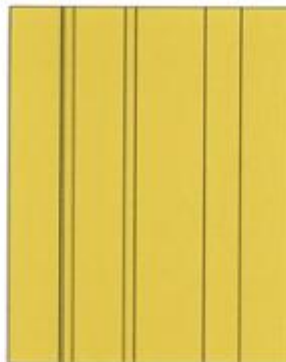

2.4



2.5

CÔNG BÁO SỞ HỮU CÔNG NGHIỆP SỐ 430 TẬP A – QUYỀN 2 (01.2024)

- (11) **49402**
(21) 3-2023-02499 (28) 1
(54) **THANH NỐI CỬA CUỐN** (51) **25-01**
(22) 23/10/2023 (43) 25/01/2024
(73) **CÔNG TY TNHH CỬA CUỐN ÚC VINH QUANG (VN)**
Số 180 Tô Hiệu, phường Trại Cau, quận Lê Chân, thành phố Hải Phòng
(72) Lê Mạnh Đức (VN)
(74) Công ty TNHH Sở hữu trí tuệ Gia Việt (GIAVIET CO., LTD.)
(55)



1.1



1.2



1.3



1.4

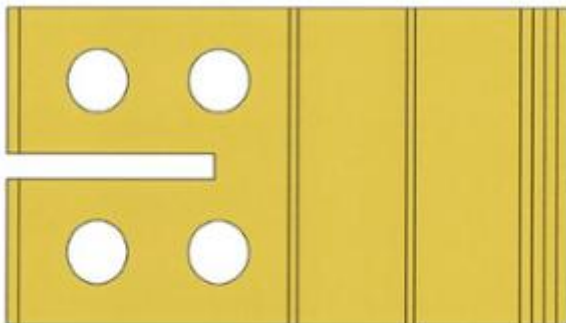

1.5

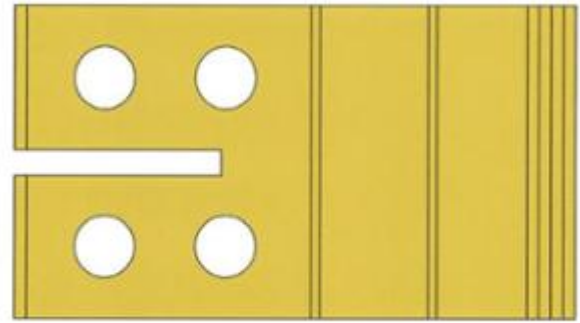

1.6

CÔNG BÁO SỞ HỮU CÔNG NGHIỆP SỐ 430 TẬP A – QUYỀN 2 (01.2024)

- (11) **49403**
(21) 3-2023-02503 (28) 1
(54) **GUỖNG CHIẾU HẬU XE GẮN MÁY** (51) **12-16**
(22) 23/10/2023 (43) 25/01/2024
(73) **HỘ KINH DOANH HÙNG CƯỜNG (VN)**
Số 71/33, Lãn Bình Thăng, phường 12, quận 11, thành phố Hồ Chí Minh
(72) Lưu Chí Hùng (VN)
(74) Công ty Cổ phần Sở hữu công nghiệp INVESTIP (INVESTIP)
(55)



1.1

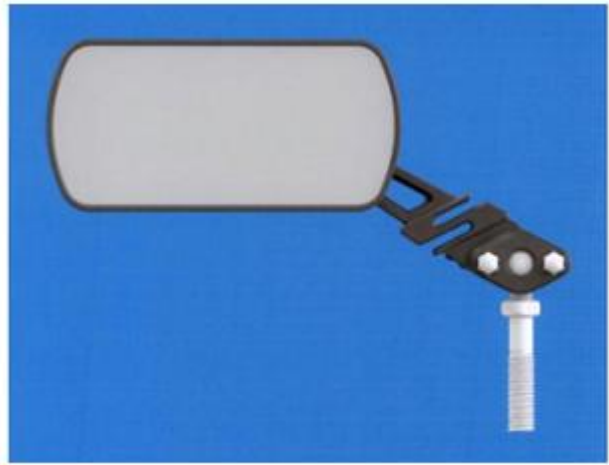

1.2



1.3



1.4



1.5

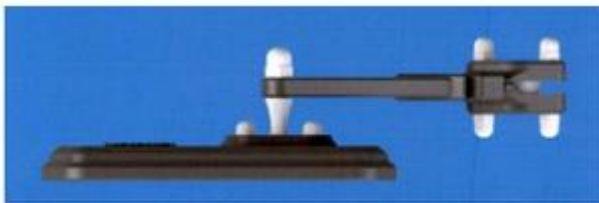

1.6



1.7

CÔNG BÁO SỞ HỮU CÔNG NGHIỆP SỐ 430 TẬP A – QUYỀN 2 (01.2024)

- (11) **49404**
(21) 3-2023-02505 (28) 1
(54) **BAO GÓI YẾN MẠCH** (51) **09-05**
(22) 24/10/2023 (43) 25/01/2024
(73) **CÔNG TY TRÁCH NHIỆM HỮU HẠN THANH AN (VN)**
P809 tầng 8, tòa nhà Plaschem, số 562 đường Nguyễn Văn Cừ, phường Gia Thụy,
quận Long Biên, thành phố Hà Nội
(72) Tạ Bá Thuyết (VN)
(74) Công ty TNHH Sở hữu trí tuệ và Công nghệ Thủ đô (CAPITAL IP&T CO.LTD.)
(55)



1.1



1.2

CÔNG BÁO SỞ HỮU CÔNG NGHIỆP SỐ 430 TẬP A – QUYỀN 2 (01.2024)

- (11) **49405**
(21) 3-2023-02507 (28) 1
(54) **MÁY ĐIỀU HÒA KHÔNG KHÍ** (51) **23-04**
(22) 24/10/2023 (43) 25/01/2024
(30) 2023-014871 20/07/2023 JP;
(73) **FUJITSU GENERAL LIMITED (JP)**
3-3-17, Suenaga, Takatsu-ku, Kawasaki 213-8502, Japan
(72) Shingo IWASA (JP)
(74) **CÔNG TY LUẬT TRÁCH NHIỆM HỮU HẠN AMBYS HÀ NỘI (AMBYS HANOI)**
(55)



1.1



1.2



1.3



1.4



1.5

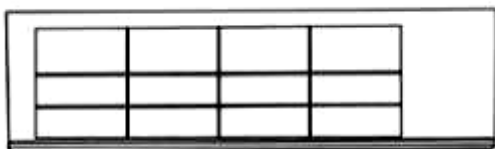

1.6



1.7

(11) **49406**

(21) 3-2023-02508

(28) 1

(54) **KHUNG NỆP**

(51) **25-01**

(22) 24/10/2023

(43) 25/01/2024

(73) **CÔNG TY TNHH ĐẦU TƯ XÂY DỰNG THƯƠNG MẠI DỊCH VỤ TRƯỜNG THỊNH (VN)**

36 Đường Xuân Thới Sơn 15, ấp 4, xã Xuân Thới Sơn, huyện Hóc Môn, thành phố Hồ Chí Minh

(72) Lê Văn Giang (VN)

(74) Công ty TNHH một thành viên Trường Luật (Trường Luật)

(55)

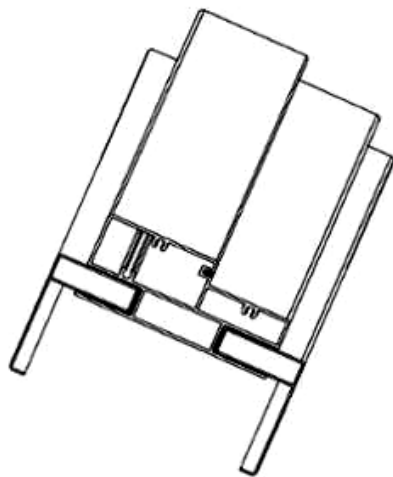

1.1

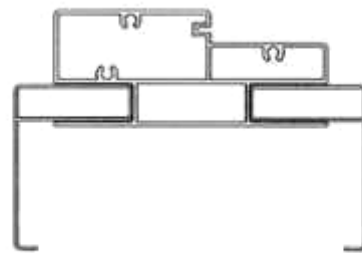

1.2

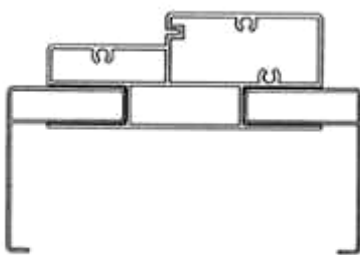

1.3

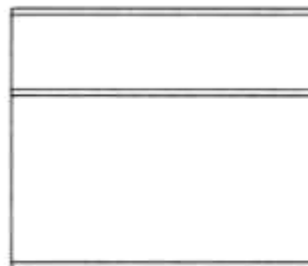

1.4



1.5

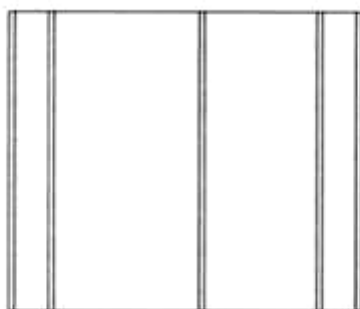

1.6

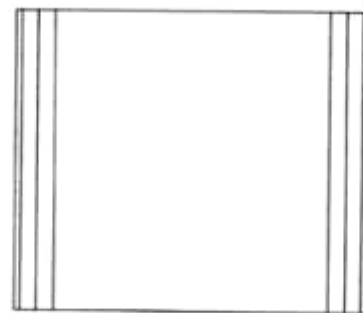

1.7

CÔNG BÁO SỞ HỮU CÔNG NGHIỆP SỐ 430 TẬP A – QUYỀN 2 (01.2024)

- (11) **49407**
(21) 3-2023-02511 (28) 1
(54) **HỆ THỐNG GIÁM SÁT CÔN TRÙNG** (51) **22-06**
(22) 24/10/2023 (43) 25/01/2024
(73) **CÔNG TY CỔ PHẦN RYNAN TECHNOLOGIES VIETNAM (VN)**
Ấp Long Trị, xã Long Đức, thành phố Trà Vinh, tỉnh Trà Vinh
(72) 1. NGUYỄN THANH MỸ (VN)
2. MẠC HOÀNG QUÍ (VN)
3. LÂM THANH TUẤN (VN)
4. NGUYỄN HỮU ĐỨC (VN)
5. TRẦN QUỐC TOẢN (VN)
(74) Công ty TNHH Đại Tín và Liên Danh (DAITIN AND ASSOCIATES CO.,LTD)
(55)



1.1



1.2

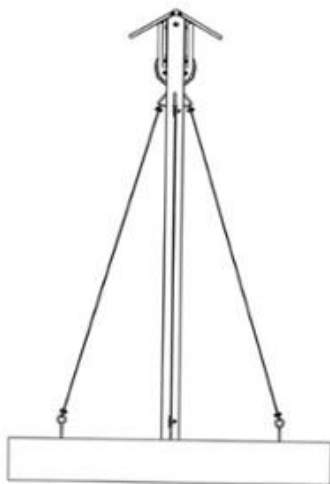

1.3



1.4



1.5

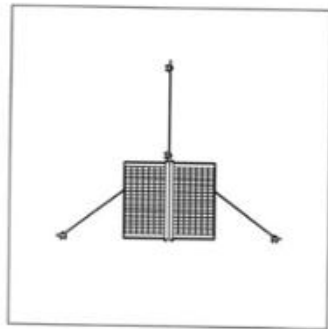

1.6



1.7

CÔNG BÁO SỞ HỮU CÔNG NGHIỆP SỐ 430 TẬP A – QUYỀN 2 (01.2024)

- (11) **49408**
(21) 3-2023-02517 (28) 1
(54) **KHUNG CHIA NGĂN GẤP GỌN CÓ TRỤ ĐỨNG** (51) **09-03**
(22) 25/10/2023 (43) 25/01/2024
(73) **CÔNG TY CỔ PHẦN BAO BÌ FUJI (VN)**
Thôn 1 (thuê của Công ty TNHH Phước Hồng), xã Bắc Sơn, huyện An Dương,
thành phố Hải Phòng
(72) Fujiwara Ryohsuke (JP)
(74) **CÔNG TY LUẬT TRÁCH NHIỆM HỮU HẠN AMBYS HÀ NỘI (AMBYS
HANOI)**
(55)

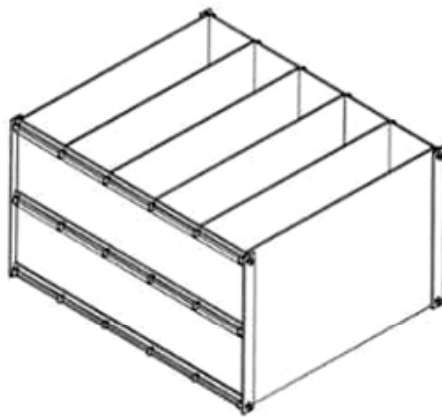

1.1



1.2



1.3



1.4



1.5

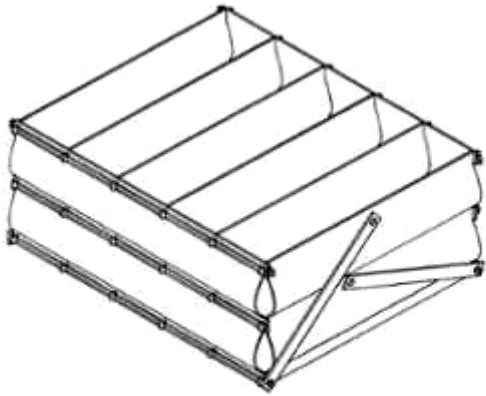

1.6

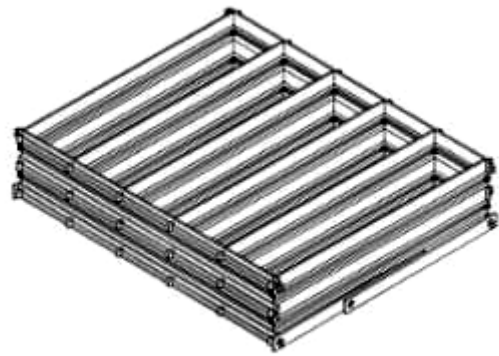

1.7

CÔNG BÁO SỞ HỮU CÔNG NGHIỆP SỐ 430 TẬP A – QUYỀN 2 (01.2024)

- (11) **49409**
(21) 3-2023-02518 (28) 1
(54) **GIẤY GÓI** (51) **09-05**
(22) 25/10/2023 (43) 25/01/2024
(30) 30-2023-0026723 12/07/2023 KR;
(73) **CHEONGSONG COUNTY OFFICE (KR)**
51, Guncheong-ro, Cheongsong-eup, Cheongsong-gun, Gyeongsangbuk-do, 37427,
Republic of Korea
(72) Jeong Ki SHIN (KR)
(74) Công ty TNHH Tầm nhìn và Liên danh (VISION & ASSOCIATES CO.LTD.)
(55)



1.1



1.2

CÔNG BÁO SỞ HỮU CÔNG NGHIỆP SỐ 430 TẬP A – QUYỀN 2 (01.2024)

- (11) **49410**
(21) 3-2023-02519 (28) 1
(54) **GIẤY GÓI** (51) **05-06; 09-05**
(22) 25/10/2023 (43) 25/01/2024
(30) 30-2023-0026724 12/07/2023 KR;
(73) **CHEONGSONG COUNTY OFFICE (KR)**
51, Guncheong-ro, Cheongsong-eup, Cheongsong-gun, Gyeongsangbuk-do, 37427,
Republic of Korea
(72) Jeong Ki SHIN (KR)
(74) Công ty TNHH Tầm nhìn và Liên danh (VISION & ASSOCIATES CO.LTD.)
(55)



1.1



1.2

CÔNG BÁO SỞ HỮU CÔNG NGHIỆP SỐ 430 TẬP A – QUYỀN 2 (01.2024)

- (11) **49411**
(21) 3-2023-02520 (28) 1
(54) **GIẤY GÓI** (51) **05-06; 09-05**
(22) 25/10/2023 (43) 25/01/2024
(30) 30-2023-0026725 12/07/2023 KR;
(73) **CHEONGSONG COUNTY OFFICE (KR)**
51, Guncheong-ro, Cheongsong-eup, Cheongsong-gun, Gyeongsangbuk-do, 37427,
Republic of Korea
(72) Jeong Ki SHIN (KR)
(74) Công ty TNHH Tầm nhìn và Liên danh (VISION & ASSOCIATES CO.LTD.)
(55)

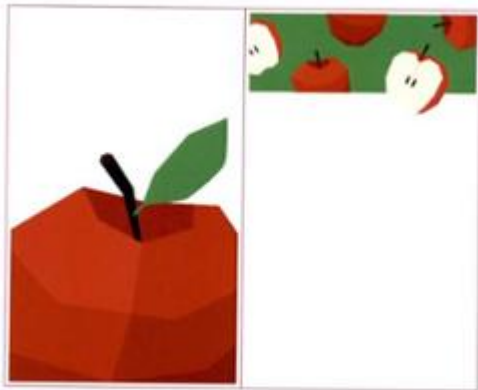

1.1



1.2

CÔNG BÁO SỞ HỮU CÔNG NGHIỆP SỐ 430 TẬP A – QUYỀN 2 (01.2024)

- (11) **49412**
- (21) 3-2023-02521 (28) 1
- (54) **GIẤY GÓI** (51) **05-06; 09-05**
- (22) 25/10/2023 (43) 25/01/2024
- (30) 30-2023-0026726 12/07/2023 KR;
- (73) **CHEONGSONG COUNTY OFFICE (KR)**
51, Guncheong-ro, Cheongsong-eup, Cheongsong-gun, Gyeongsangbuk-do, 37427,
Republic of Korea
- (72) Jeong Ki SHIN (KR)
- (74) Công ty TNHH Tầm nhìn và Liên danh (VISION & ASSOCIATES CO.LTD.)
- (55)

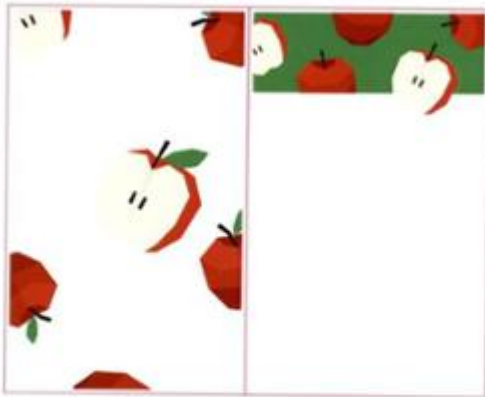

1.1



1.2

CÔNG BÁO SỞ HỮU CÔNG NGHIỆP SỐ 430 TẬP A – QUYỀN 2 (01.2024)

(11) **49413**

(21) 3-2023-02522

(28) 1

(54) **CHAI**

(51) **09-01**

(22) 25/10/2023

(43) 25/01/2024

(73) **CÔNG TY TNHH SẢN XUẤT NHỰA HOÀNG NGUYỄN (VN)**

301 Bình Long, phường Bình Hưng Hòa A, quận Bình Tân, thành phố Hồ Chí Minh

(72) Trương Trần Hoàng Sơn (VN)

(74) Công ty TNHH NACILAW (NACILAW)

(55)



1.1



1.2



1.3

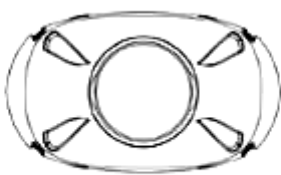

1.4

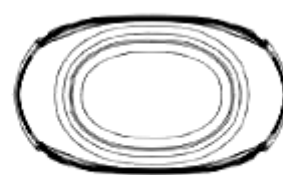

1.5

CÔNG BÁO SỞ HỮU CÔNG NGHIỆP SỐ 430 TẬP A – QUYỀN 2 (01.2024)

- (11) **49414**
(21) 3-2023-02525 (28) 1
(54) **NHÃN SẢN PHẨM** (51) **19-08**
(22) 26/10/2023 (43) 25/01/2024
(73) **CÔNG TY TNHH XUẤT NHẬP KHẨU VITACO (VN)**
244/29 Huỳnh Văn Bánh, phường 11, quận Phú Nhuận, thành phố Hồ Chí Minh
(72) Nguyễn Quang Hiệp (VN)
(74) Công ty cổ phần Tư vấn S&B (S&B CONSULTANT., CORP.)
(55)

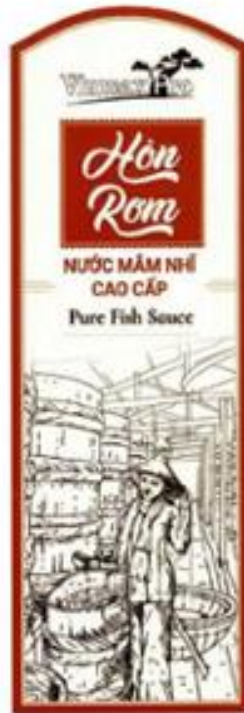

CÔNG BÁO SỞ HỮU CÔNG NGHIỆP SỐ 430 TẬP A – QUYỀN 2 (01.2024)

- (11) **49415**
(21) 3-2023-02532 (28) 2
(54) **GIÀY** (51) **02-04**
(22) 27/10/2023 (43) 25/01/2024
(30) 29/879,255 05/07/2023 US;
(73) **SKECHERS U.S.A., INC. II (US)**
228 Manhattan Beach Blvd., Manhattan Beach, CA 90266, United States of America
(72) Jung Yol Kim (US)
(74) Công ty Luật TNHH T&G (TGVN)
(55)

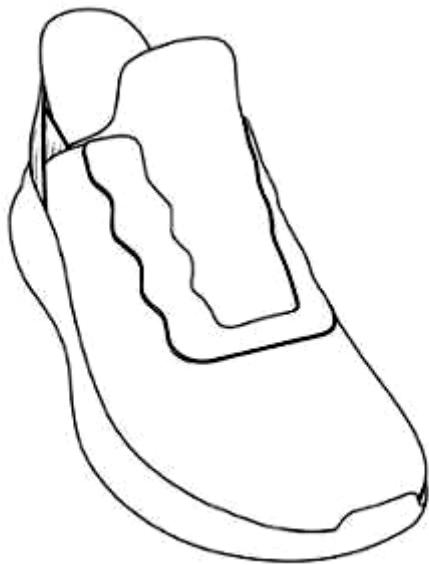

1.1

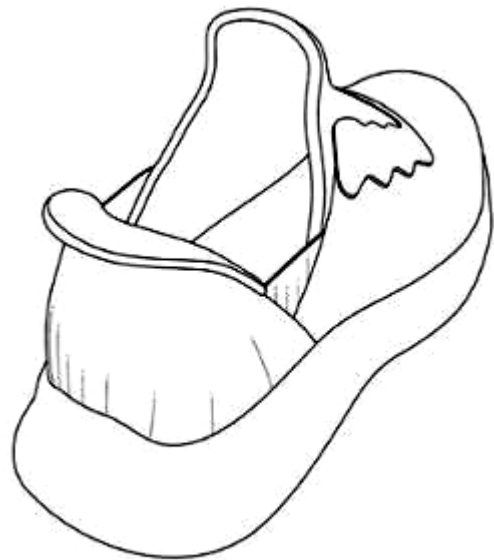

1.2

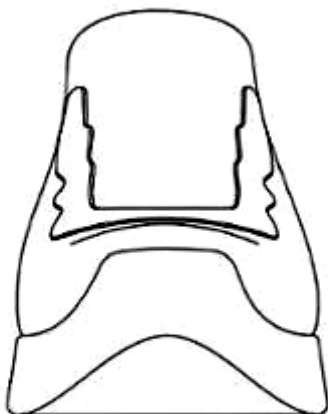

1.3

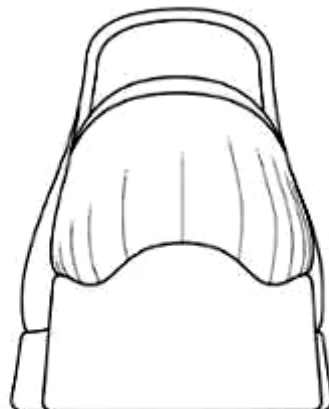

1.4

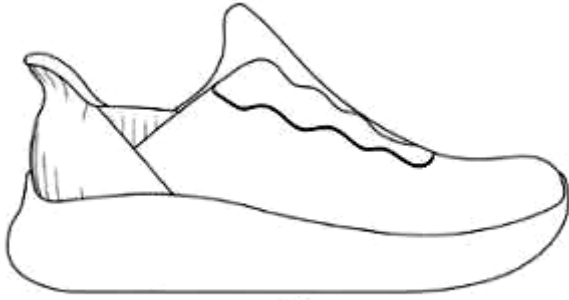

1.5

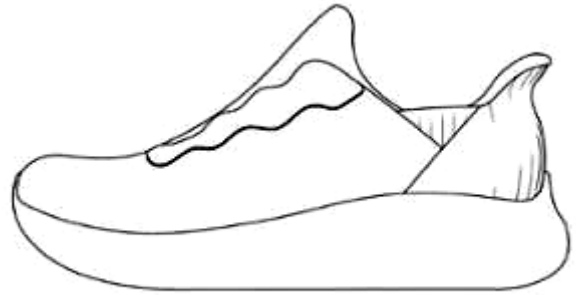

1.6

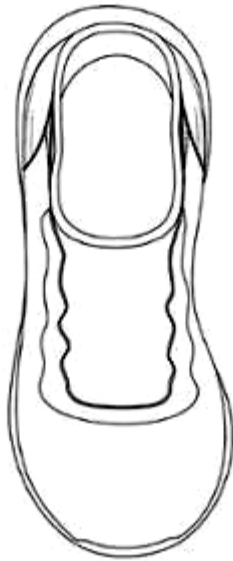

1.7



1.8

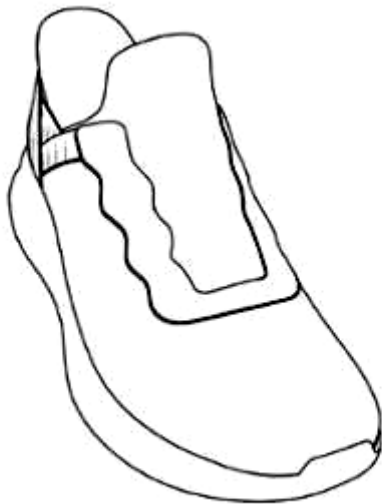

2.1

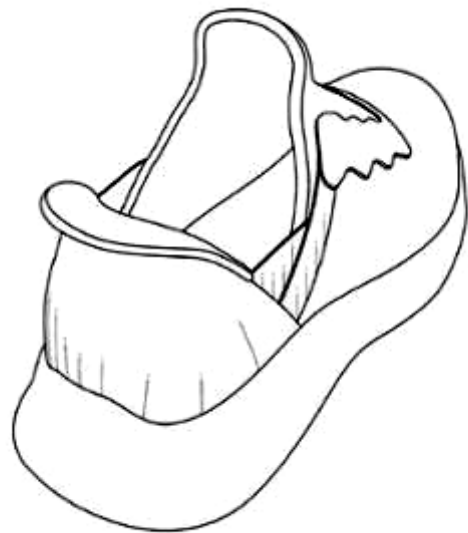

2.2

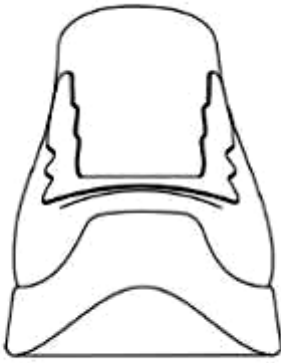

2.3

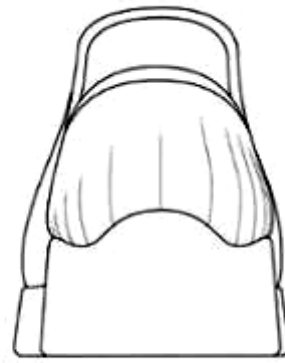

2.4

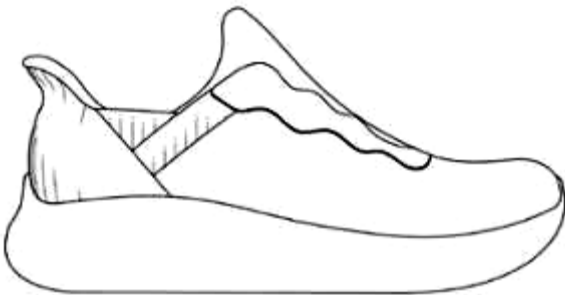

2.5

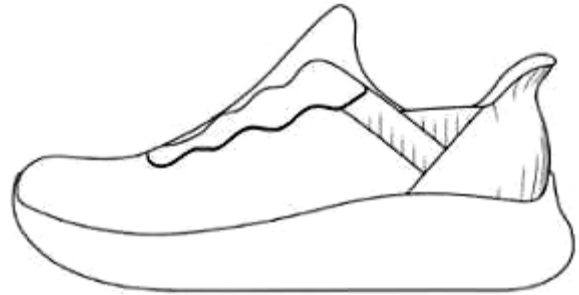

2.6

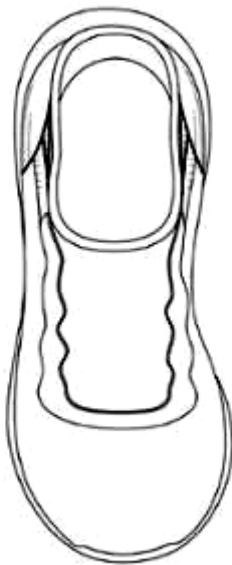

2.7



2.8

CÔNG BÁO SỞ HỮU CÔNG NGHIỆP SỐ 430 TẬP A – QUYỀN 2 (01.2024)

- (11) **49416**
(21) 3-2023-02535 (28) 1
(54) **XE ĐẨY** (51) **12-02**
(22) 27/10/2023 (43) 25/01/2024
(73) **CÔNG TY CỔ PHẦN SẢN XUẤT NHỰA DUY TÂN (VN)**
298 Hồ Học Lãm, phường An Lạc, quận Bình Tân, thành phố Hồ Chí Minh
(72) Trần Đức Xuyên (VN)
(74) Công ty TNHH Sở hữu trí tuệ INVENTIO (INVENTIO CO.,LTD)
(55)



1.1



1.2



1.3



1.4



1.5



1.6

CÔNG BÁO SỞ HỮU CÔNG NGHIỆP SỐ 430 TẬP A – QUYỀN 2 (01.2024)

- (11) **49417**
(21) 3-2023-02541 (28) 1
(54) **TƯỢNG TRANG TRÍ** (51) **11-02**
(22) 30/10/2023 (43) 25/01/2024
(73) **CÔNG TY TNHH MINH LONG I (VN)**
Số 333, đường Hưng Định 24, khu phố Hưng Lộc, phường Hưng Định, thành phố Thuận An, tỉnh Bình Dương
(72) Lý Huy Sáng (VN)
(55)



1.1



1.2



1.3



1.4



1.5



1.6



1.7



1.8

CÔNG BÁO SỞ HỮU CÔNG NGHIỆP SỐ 430 TẬP A – QUYỀN 2 (01.2024)

- (11) **49418**
(21) 3-2023-02556 (28) 1
(54) **THANH NHÔM ĐỊNH HÌNH** (51) **25-01**
(22) 30/10/2023 (43) 25/01/2024
(73) **CÔNG TY CỔ PHẦN VIỆT - SÉC (VN)**
Đường số 2, KCN Hòa Cầm, phường Hòa Thọ Tây, quận Cẩm Lệ, thành phố Đà Nẵng
(72) Nguyễn Thanh Trường (VN)
(74) Công ty Luật TNHH SMARTLAW (SMARTLAW LEGAL SERVICE CO.,LTD.)
(55)



1.1



1.2



1.3



1.4



1.5

CÔNG BÁO SỞ HỮU CÔNG NGHIỆP SỐ 430 TẬP A – QUYỀN 2 (01.2024)

- (11) **49419**
(21) 3-2023-02557 (28) 1
(54) **THANH NHÔM ĐỊNH HÌNH** (51) **25-01**
(22) 30/10/2023 (43) 25/01/2024
(73) **CÔNG TY CỔ PHẦN VIỆT – SÉC (VN)**
Đường số 2, KCN Hòa Cầm, phường Hòa Thọ Tây, quận Cẩm Lệ, thành phố Đà Nẵng
(72) Nguyễn Thanh Trường (VN)
(74) Công ty Luật TNHH SMARTLAW (SMARTLAW LEGAL SERVICE CO.,LTD.)
(55)



1.1



1.2



1.3



1.4



1.5



1.6



1.7

CÔNG BÁO SỞ HỮU CÔNG NGHIỆP SỐ 430 TẬP A – QUYỀN 2 (01.2024)

- (11) **49420**
(21) 3-2023-02559 (28) 1
(54) **THANH NHÔM ĐỊNH HÌNH** (51) **25-01**
(22) 30/10/2023 (43) 25/01/2024
(73) **CÔNG TY CỔ PHẦN VIỆT – SÉC (VN)**
Đường số 2, KCN Hòa Cầm, phường Hòa Thọ Tây, quận Cẩm Lệ, thành phố Đà Nẵng
(72) Nguyễn Thanh Trường (VN)
(74) Công ty Luật TNHH SMARTLAW (SMARTLAW LEGAL SERVICE CO.,LTD.)
(55)



1.1



1.2



1.3



1.4



1.5



1.6

CÔNG BÁO SỞ HỮU CÔNG NGHIỆP SỐ 430 TẬP A – QUYỀN 2 (01.2024)

- (11) **49421**
(21) 3-2023-02560 (28) 1
(54) **THANH NHÔM ĐỊNH HÌNH** (51) **25-01**
(22) 30/10/2023 (43) 25/01/2024
(73) **CÔNG TY CỔ PHẦN VIỆT – SÉC (VN)**
Đường số 2, KCN Hòa Cầm, phường Hòa Thọ Tây, quận Cẩm Lệ, thành phố Đà Nẵng
(72) Nguyễn Thanh Trường (VN)
(74) Công ty Luật TNHH SMARTLAW (SMARTLAW LEGAL SERVICE CO.,LTD.)
(55)



1.1



1.2



1.3



1.4



1.5



1.6



1.7

CÔNG BÁO SỞ HỮU CÔNG NGHIỆP SỐ 430 TẬP A – QUYỀN 2 (01.2024)

- (11) **49422**
(21) 3-2023-02562 (28) 1
(54) **THANH NHÔM ĐỊNH HÌNH** (51) **25-01**
(22) 30/10/2023 (43) 25/01/2024
(73) **CÔNG TY CỔ PHẦN VIỆT – SÉC (VN)**
Đường số 2, KCN Hòa Cầm, phường Hòa Thọ Tây, quận Cẩm Lệ, thành phố Đà Nẵng
(72) Nguyễn Thanh Trường (VN)
(74) Công ty Luật TNHH SMARTLAW (SMARTLAW LEGAL SERVICE CO.,LTD.)
(55)



1.1



1.2



1.3



1.4

CÔNG BÁO SỞ HỮU CÔNG NGHIỆP SỐ 430 TẬP A – QUYỀN 2 (01.2024)

- (11) **49423**
(21) 3-2023-02564 (28) 1
(54) **THANH NHÔM ĐỊNH HÌNH** (51) **25-01**
(22) 30/10/2023 (43) 25/01/2024
(73) **CÔNG TY CỔ PHẦN VIỆT – SÉC (VN)**
Đường số 2, KCN Hòa Cầm, phường Hòa Thọ Tây, quận Cẩm Lệ, thành phố Đà Nẵng
(72) Nguyễn Thanh Trường (VN)
(74) Công ty Luật TNHH SMARTLAW (SMARTLAW LEGAL SERVICE CO.,LTD.)
(55)



1.1



1.2



1.3



1.4



1.5



1.6

CÔNG BÁO SỞ HỮU CÔNG NGHIỆP SỐ 430 TẬP A – QUYỀN 2 (01.2024)

- (11) **49424**
(21) 3-2023-02575 (28) 1
(54) **BÌNH DẦU PHUỘC** (51) **12-16**
(22) 31/10/2023 (43) 25/01/2024
(73) **SUPERFLY MOTORSPORTS SDN BHD (MY)**
NO 6 JALAN TIONG EMAS 3, KAWASAN PERINDUSTRIAN TIONG NAM,
JOHOR BAHRU 81100, JOHOR, MALAYSIA
(72) NG PUH JINN (MY)
(74) Công ty TNHH Dịch vụ Sở hữu trí tuệ KENFOX (KENFOX IP SERVICE
CO.,LTD.)
(55)



1.1

1.2

1.3

1.4



1.5

1.6

1.7

CÔNG BÁO SỞ HỮU CÔNG NGHIỆP SỐ 430 TẬP A – QUYỀN 2 (01.2024)

- (11) **49425**
(21) 3-2023-02576 (28) 1
(54) **CHAI** (51) **09-01**
(22) 31/10/2023 (43) 25/01/2024
(73) **CÔNG TY CỔ PHẦN NOSAFOOD (VN)**
E4/20 Nguyễn Hữu Trí, thị trấn Tân Túc, huyện Bình Chánh, thành phố Hồ Chí Minh
(72) Ho Joong (KR)
(74) Công ty TNHH Tâm nhìn và Liên danh (VISION & ASSOCIATES CO.LTD.)
(55)



1.1



1.2



1.3

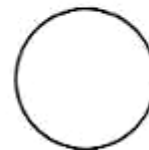

1.4

CÔNG BÁO SỞ HỮU CÔNG NGHIỆP SỐ 430 TẬP A – QUYỀN 2 (01.2024)

(11) **49426**

(21) 3-2023-02577

(28) 1

(54) **XE MÔ TÔ**

(51) **12-11**

(22) 31/10/2023

(43) 25/01/2024

(73) **SANYANG MOTOR CO., LTD. (TW)**

No. 184, Keng Tzu Kou, Shang Keng Village, Hsin Fong Shiang, Hsinchu County
304, Taiwan

(72) Wen-Pin CHAN (TW)

(74) Công ty TNHH Trường Xuân (AGELESS CO.,LTD.)

(55)



1.1



1.2



1.3



1.4



1.5



1.6



1.7



1.8



1.9



1.10

CÔNG BÁO SỞ HỮU CÔNG NGHIỆP SỐ 430 TẬP A – QUYỀN 2 (01.2024)

- (11) **49427**
(21) 3-2023-02578 (28) 1
(54) **XE MÔ TÔ** (51) **12-11**
(22) 31/10/2023 (43) 25/01/2024
(73) **SANYANG MOTOR CO., LTD. (TW)**
No. 184, Keng Tzu Kou, Shang Keng Village, Hsin Fong Shiang, Hsinchu County
304, Taiwan
(72) Der-Kuang HONG (TW)
(74) Công ty TNHH Trường Xuân (AGELESS CO.,LTD.)
(55)



1.1



1.2



1.3



1.4



1.5



1.6



1.7



1.8



1.9



1.10

CÔNG BÁO SỞ HỮU CÔNG NGHIỆP SỐ 430 TẬP A – QUYỀN 2 (01.2024)

- (11) **49428**
- (21) 3-2023-02580 (28) 1
- (54) **BAO GÓI KẸO** (51) **09-05**
- (22) 31/10/2023 (43) 25/01/2024
- (73) **HỘ KINH DOANH DƯƠNG GIA LONG (VN)**
Thôn 7, xã Cát Quế, huyện Hoài Đức, thành phố Hà Nội
- (72) Nguyễn Hữu Sơn (VN)
- (74) Công ty TNHH Tư vấn đầu tư và Sở hữu trí tuệ Hoàng Phi (HOANG PHI INVEST & I.P CO., LTD)
- (55)



1.1



1.2

CÔNG BÁO SỞ HỮU CÔNG NGHIỆP SỐ 430 TẬP A – QUYỀN 2 (01.2024)

- (11) **49429**
(21) 3-2023-02584
(54) **THÙNG ĐỰNG ĐỒ**
(22) 01/11/2023
(30) 015020470-0001 04/05/2023 EM;
(73) **UNILEVER GLOBAL IP LIMITED (GB)**
Port Sunlight, Wirral, Merseyside, CH62 4ZD, United Kingdom
(72) 1. ZHIJIAN HU (CN)
2. XIAOMO OU (CN)
3. JUN SHEN (CN)
4. YANG ZHOU (CN)
(74) Công ty TNHH Trần Hữu Nam và Đồng sự (TRAN H.N & ASS.)
(55)

- (28) 1
(51) **07-07**
(43) 25/01/2024



1.1

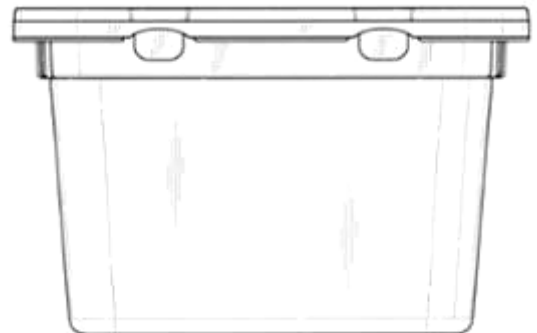

1.2

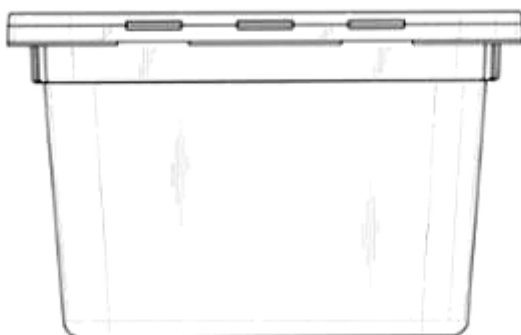

1.3

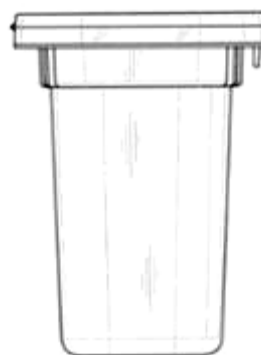

1.4

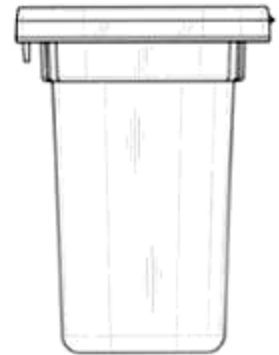

1.5



1.6



1.7

CÔNG BÁO SỞ HỮU CÔNG NGHIỆP SỐ 430 TẬP A – QUYỀN 2 (01.2024)

- (11) **49430**
(21) 3-2023-02585 (28) 1
(54) **THÙNG ĐỰNG ĐỒ** (51) **07-07**
(22) 01/11/2023 (43) 25/01/2024
(30) 015020221-0001 04/05/2023 EM;
(73) **UNILEVER GLOBAL IP LIMITED (GB)**
Port Sunlight, Wirral, Merseyside, CH62 4ZD, United Kingdom
(72) 1. XIAOMO OU (CN)
2. JUN SHEN (CN)
3. YANG ZHOU (CN)
(74) Công ty TNHH Trần Hữu Nam và Đồng sự (TRAN H.N & ASS.)
(55)



1.1

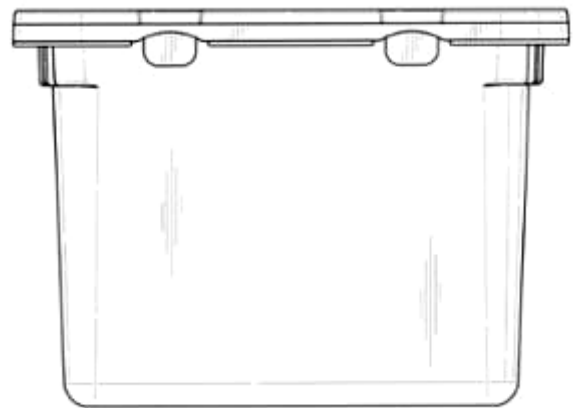

1.2

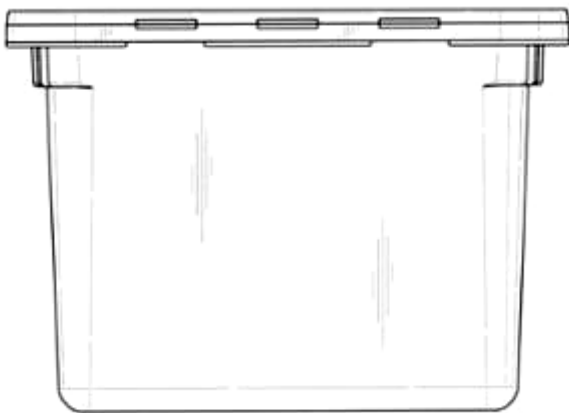

1.3



1.4

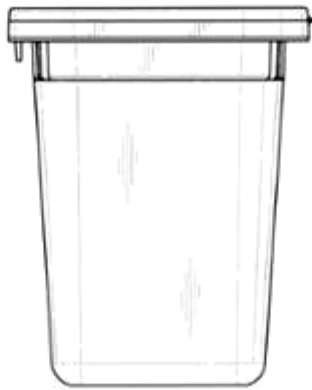

1.5

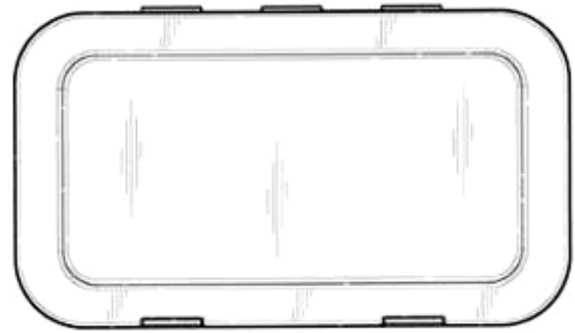

1.6

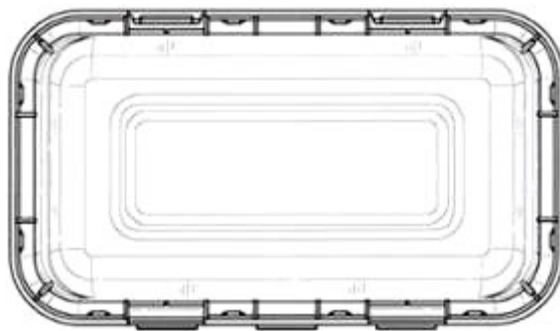

1.7

- (11) **49431**
(21) 3-2023-02586 (28) 1
(54) **ĐỒ CHƠI** (51) **21-01**
(22) 01/11/2023 (43) 25/01/2024
(73) **VŨ QUỐC PHONG (VN)**
Thôn Đông Mai, xã Khánh Hải, huyện Yên Khánh, tỉnh Ninh Bình
(72) Vũ Quốc Phong (VN)
(74) CÔNG TY TNHH SỞ HỮU TRÍ TUỆ ANLIS VIỆT NAM (ANLIS IP CO.,LTD)
(55)

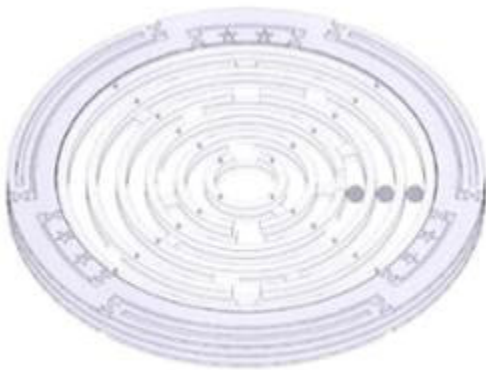

1.1



1.2



1.3



1.4



1.5



1.6

- (11) **49432**
(21) 3-2023-02587 (28) 1
(54) **ĐỒ CHƠI** (51) **21-01**
(22) 01/11/2023 (43) 25/01/2024
(73) **VŨ QUỐC PHONG (VN)**
Thôn Đông Mai, xã Khánh Hải, huyện Yên Khánh, tỉnh Ninh Bình
(72) Vũ Quốc Phong (VN)
(74) **CÔNG TY TNHH SỞ HỮU TRÍ TUỆ ANLIS VIỆT NAM (ANLIS IP CO.,LTD)**
(55)

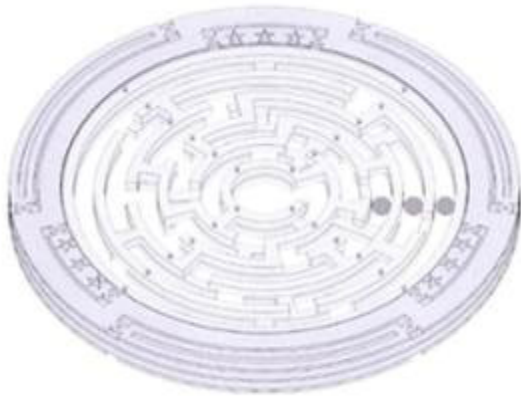

1.1



1.2



1.3



1.4



1.5



1.6

CÔNG BÁO SỞ HỮU CÔNG NGHIỆP SỐ 430 TẬP A – QUYỀN 2 (01.2024)

- (11) **49433**
(21) 3-2023-02595 (28) 1
(54) **KHAY CÁP** (51) **13-03**
(22) 01/11/2023 (43) 25/01/2024
(73) **CÔNG TY CỔ PHẦN BESTRAY (VN)**
180/7B, ấp Tân Thới 3, xã Tân Hiệp, huyện Hóc Môn, thành phố Hồ Chí Minh
(72) Đồng Công Quốc (VN)
(55)



1.1

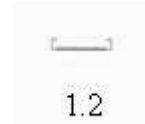

1.2



1.3



1.4



1.5

CÔNG BÁO SỞ HỮU CÔNG NGHIỆP SỐ 430 TẬP A – QUYỀN 2 (01.2024)

- (11) **49434**
(21) 3-2023-02596 (28) 1
(54) **KHAY CÁP** (51) **13-03**
(22) 01/11/2023 (43) 25/01/2024
(73) **CÔNG TY CỔ PHẦN BESTRAY (VN)**
180/7B, ấp Tân Thới 3, xã Tân Hiệp, huyện Hóc Môn, thành phố Hồ Chí Minh
(72) Đồng Công Quốc (VN)
(55)

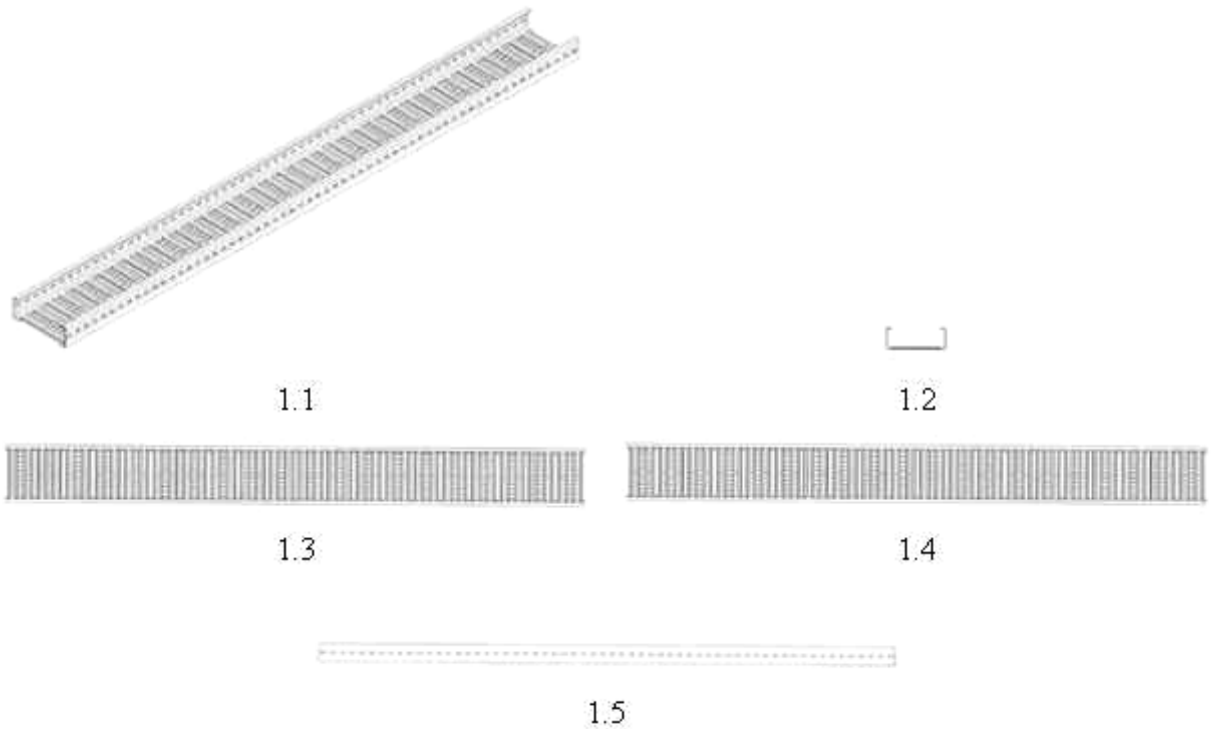

CÔNG BÁO SỞ HỮU CÔNG NGHIỆP SỐ 430 TẬP A – QUYỀN 2 (01.2024)

- (11) **49435**
(21) 3-2023-02597 (28) 1
(54) **NẮP HỘP ĐỰNG** (51) **09-07**
(22) 30/03/2022 (43) 25/01/2024
(30) 29/814,609 08/11/2021 US;
(73) **DART INDUSTRIES INC. (US)**
14901 S. Orange Blossom Trail, Orlando, Florida, 32837, United States of America
(72) Dongjin Byeon (KR)
(74) **CÔNG TY LUẬT TRÁCH NHIỆM HỮU HẠN AMBYS HÀ NỘI (AMBYS HANOI)**
(55)

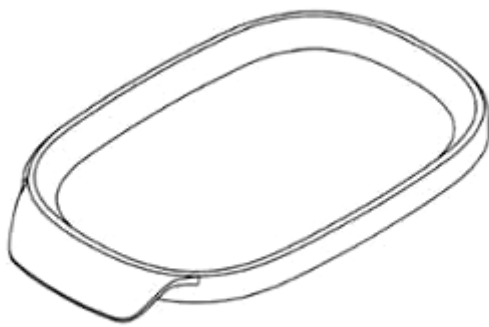

1.1

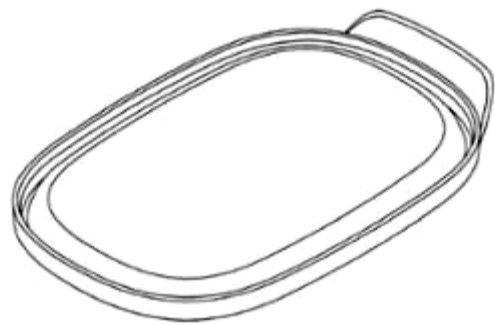

1.2



1.3



1.4



1.5

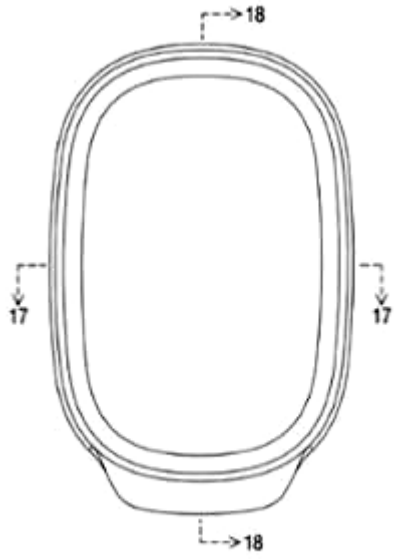

1.6

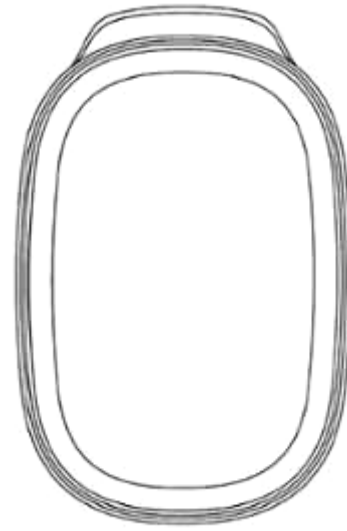

1.7



1.8



1.9

- (11) **49436**
- (21) 3-2023-02598
- (54) **NẮP HỘP ĐỰNG**
- (22) 30/03/2022
- (30) 29/814,609 08/11/2021 US;
- (73) **DART INDUSTRIES INC. (US)**
14901 S. Orange Blossom Trail, Orlando, Florida, 32837, United States of America
- (72) Dongjin Byeon (KR)
- (74) CÔNG TY LUẬT TRÁCH NHIỆM HỮU HẠN AMBYS HÀ NỘI (AMBYS HANOI)
- (55)

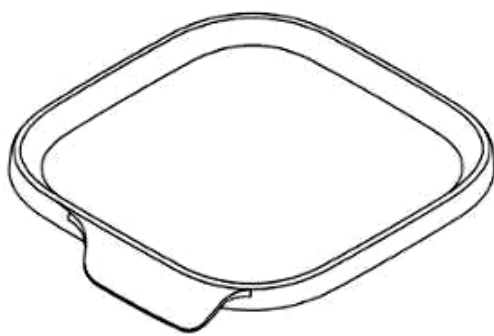

1.1

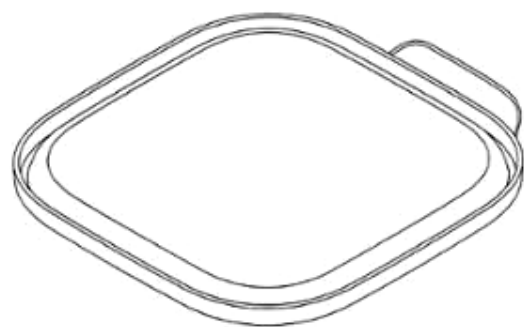

1.2



1.3



1.4



1.5

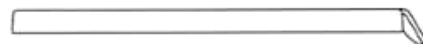

1.6

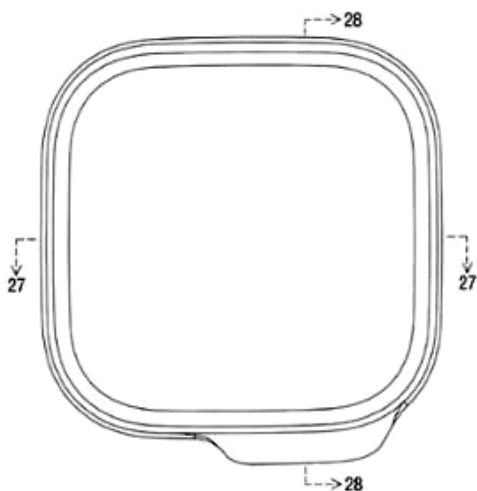

1.7

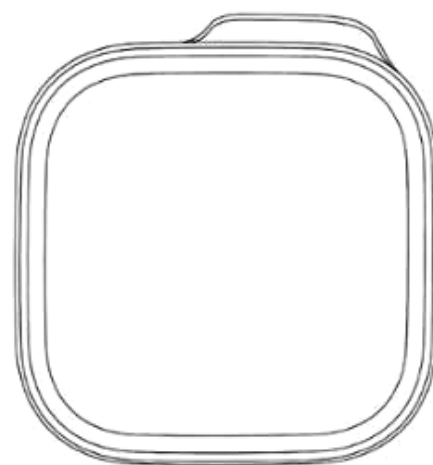

1.8



1.9



1.10

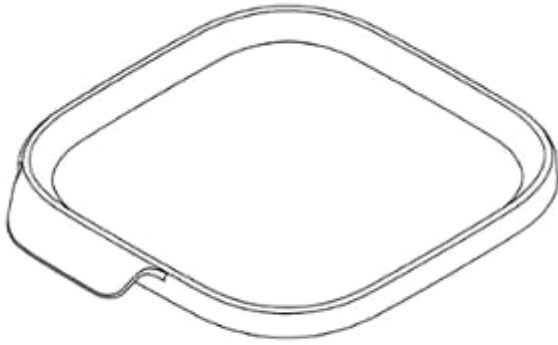

2.1

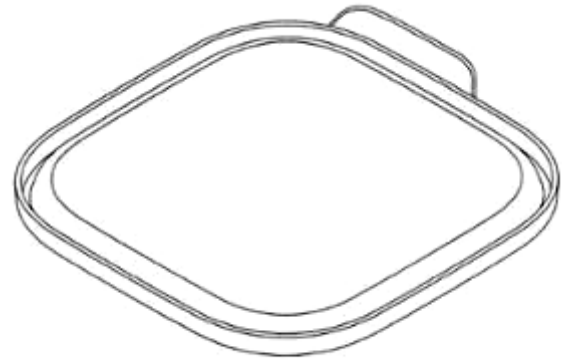

2.2



2.3



2.4

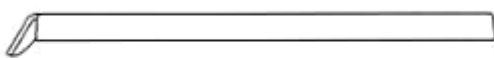

2.5



2.6

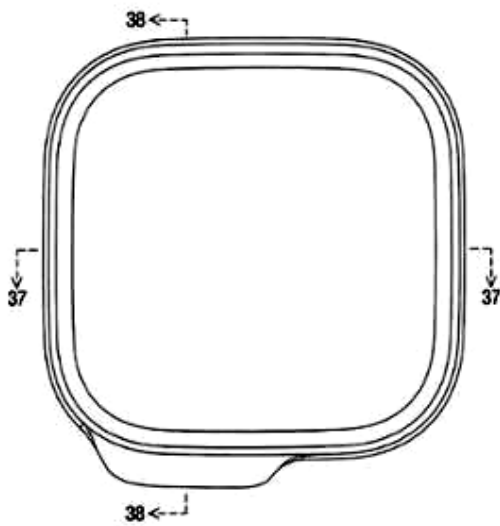

2.7

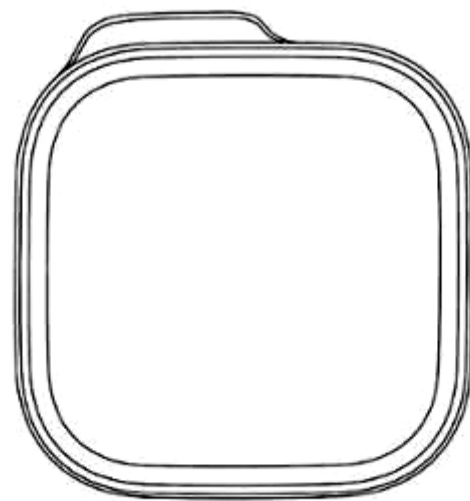

2.8



2.9



2.10

CÔNG BÁO SỞ HỮU CÔNG NGHIỆP SỐ 430 TẬP A – QUYỀN 2 (01.2024)

- (11) **49437**
- (21) 3-2023-02599
- (54) **NẮP HỘP ĐỰNG**
- (22) 30/03/2022
- (30) 29/814,609 08/11/2021 US;
- (73) **DART INDUSTRIES INC. (US)**
14901 S. Orange Blossom Trail, Orlando, Florida, 32837, United States of America
- (72) Dongjin Byeon (KR)
- (74) **CÔNG TY LUẬT TRÁCH NHIỆM HỮU HẠN AMBYS HÀ NỘI (AMBYS HANOI)**
- (55)

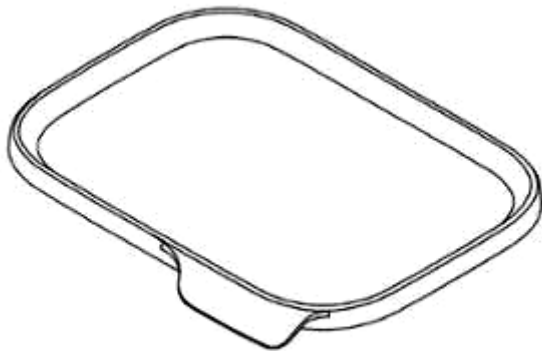

1.1

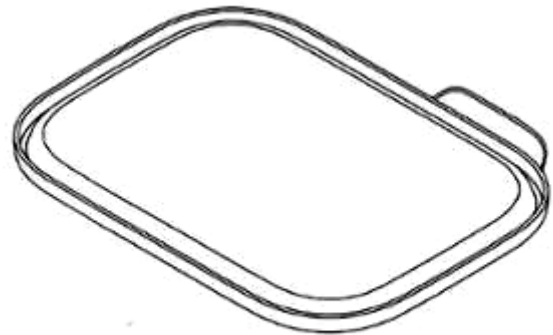

1.2



1.3



1.4



1.5



1.6

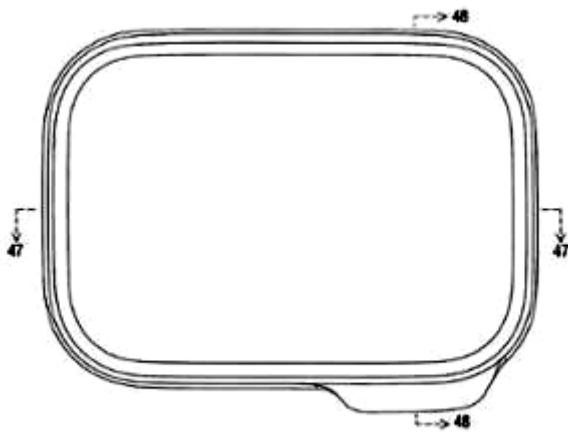

1.7

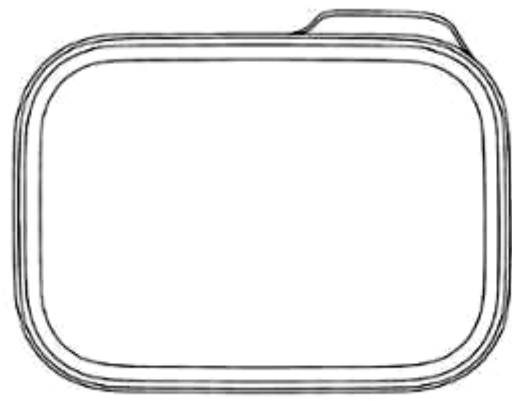

1.8



1.9



1.10

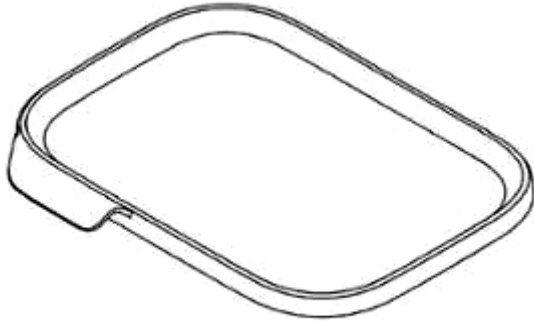

2.1

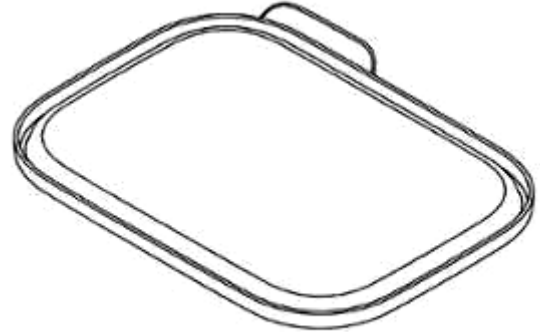

2.2



2.3



2.4



2.5



2.6

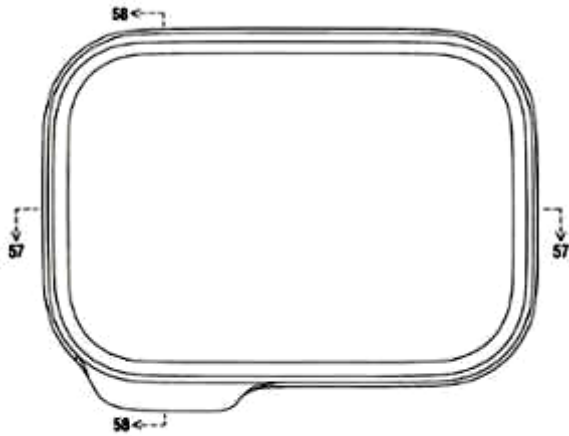

2.7

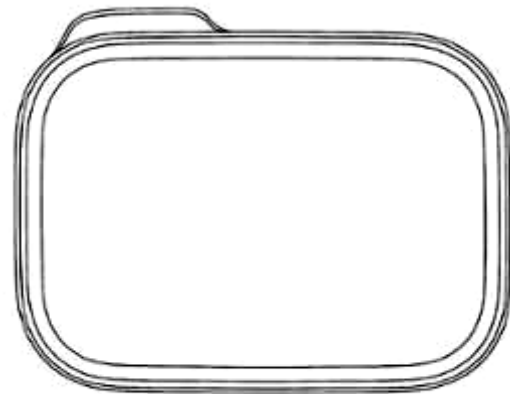

2.8



2.9



2.10

CÔNG BÁO SỞ HỮU CÔNG NGHIỆP SỐ 430 TẬP A – QUYỀN 2 (01.2024)

- (11) **49438**
(21) 3-2023-02600 (28) 1
(54) **NẮP VẬT CHỨA** (51) **09-07**
(22) 02/11/2023 (43) 25/01/2024
(73) **MIKASA INDUSTRY CO., LTD. (JP)**
53, Oaza Terado, Koryo-cho, Kitakatsuragi-gun, Nara 635-0817, Japan
(72) Satoshi HIDESHIMA (JP)
(74) Công ty TNHH Tầm nhìn và Liên danh (VISION & ASSOCIATES CO.LTD.)
(55)



1.1

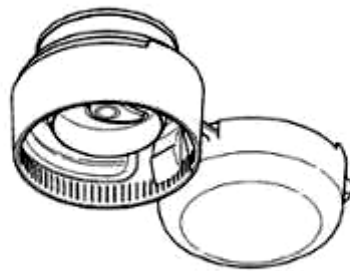

1.2

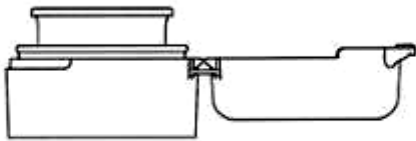

1.3

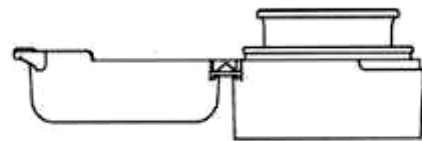

1.4

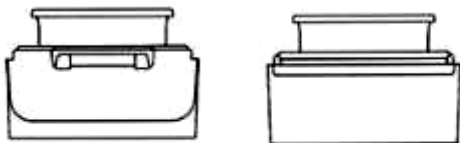

1.5

1.6

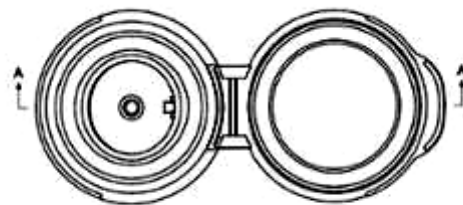

1.7

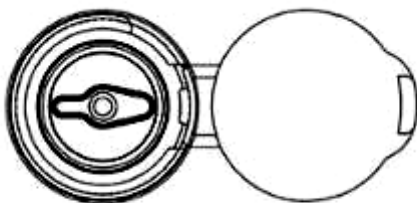

1.8

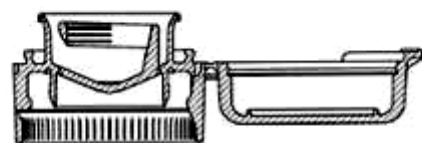

1.9

CÔNG BÁO SỞ HỮU CÔNG NGHIỆP SỐ 430 TẬP A – QUYỀN 2 (01.2024)

- (11) **49439**
(21) 3-2023-02603 (28) 2
(54) **HỘP CÀ PHÊ** (51) **09-03**
(22) 03/11/2023 (43) 25/01/2024
(73) **CÔNG TY TNHH VÂN NGUYỄN NGUYỄN (VN)**
Số 01 Hùng Vương, phường Lộc Thọ, thành phố Nha Trang, tỉnh Khánh Hòa
(72) Ngô Thị Thanh Huyền (VN)
(74) Công ty TNHH ADASTRA IP (VIỆT NAM) (ADASTRA IP (VIETNAM) CO., LTD.)
(55)



1.1



1.2



1.3



1.4



1.5



1.6



1.7



2.1



2.2



2.3



2.4



2.5



2.6



2.7

CÔNG BÁO SỞ HỮU CÔNG NGHIỆP SỐ 430 TẬP A – QUYỀN 2 (01.2024)

- (11) **49440**
(21) 3-2023-02604 (28) 1
(54) **HỘP ĐỰNG BÁNH** (51) **09-03**
(22) 03/11/2023 (43) 25/01/2024
(73) **CÔNG TY CỔ PHẦN THƯƠNG MẠI RỒNG VÀNG MINH NGỌC (VN)**
Khu 6 phường Cẩm Thượng, thành phố Hải Dương, tỉnh Hải Dương
(72) Thái Thị Vân Anh (VN)
(74) Công ty TNHH Sở hữu trí tuệ M.I.T (M.I.T IP CO., LTD)
(55)



1.1

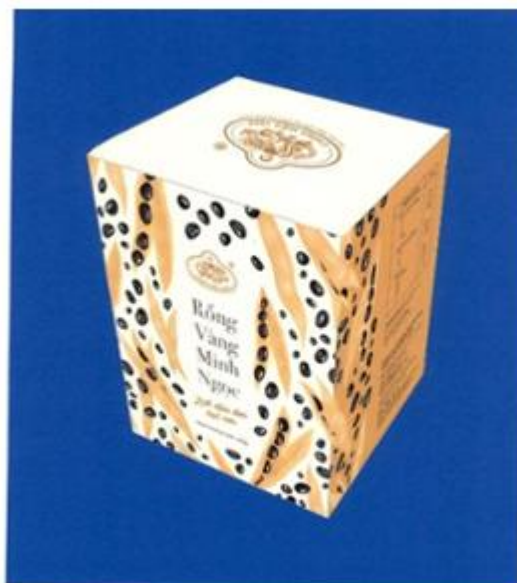

1.2

CÔNG BÁO SỞ HỮU CÔNG NGHIỆP SỐ 430 TẬP A – QUYỀN 2 (01.2024)

- (11) **49441**
(21) 3-2023-02605 (28) 2
(54) **HỘP ĐỰNG BÁNH** (51) **09-03**
(22) 03/11/2023 (43) 25/01/2024
(73) **CÔNG TY CỔ PHẦN THƯƠNG MẠI RỒNG VÀNG MINH NGỌC (VN)**
Khu 6 phường Cẩm Thượng, thành phố Hải Dương, tỉnh Hải Dương
(72) Thái Thị Vân Anh (VN)
(74) Công ty TNHH Sở hữu trí tuệ M.I.T (M.I.T IP CO., LTD)
(55)



1.1

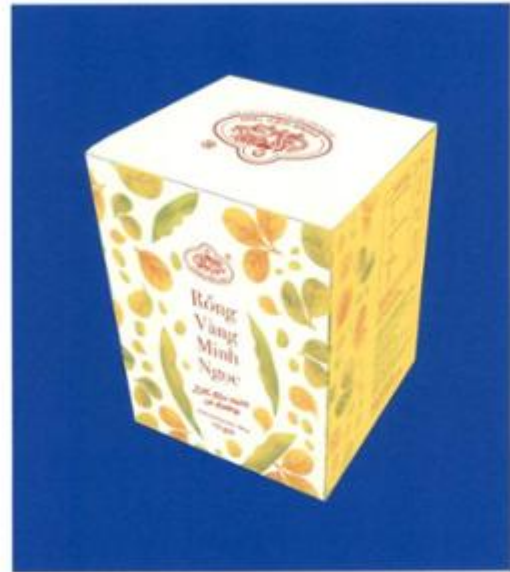

1.2



2.1

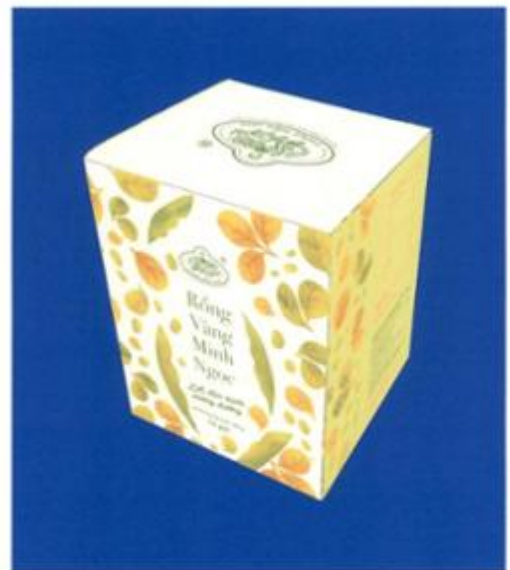

2.2

CÔNG BÁO SỞ HỮU CÔNG NGHIỆP SỐ 430 TẬP A – QUYỀN 2 (01.2024)

- (11) **49442**
(21) 3-2023-02607 (28) 1
(54) **THANH ĐỊNH HÌNH** (51) **25-01**
(22) 03/11/2023 (43) 25/01/2024
(73) **CÔNG TY TNHH XUẤT NHẬP KHẨU TRUNG CHÍNH (VN)**
Số 100, quốc lộ 51, khu phố Bình Dương, phường Long Bình Tân, thành phố Biên
Hoà, tỉnh Đồng Nai
(72) Nguyễn Trung Chính (VN)
(74) Công ty TNHH Tư vấn sở hữu trí tuệ Việt (VIET IP CO.,LTD.)
(55)

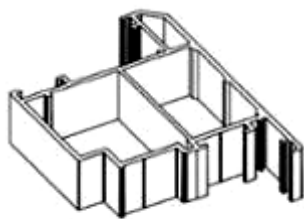

1.1



1.2



1.3



1.4



1.5

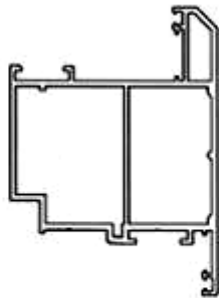

1.6

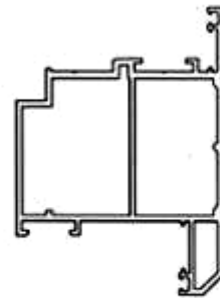

1.7

CÔNG BÁO SỞ HỮU CÔNG NGHIỆP SỐ 430 TẬP A – QUYỀN 2 (01.2024)

- (11) **49443**
(21) 3-2023-02608 (28) 1
(54) **THANH ĐỊNH HÌNH** (51) **25-01**
(22) 03/11/2023 (43) 25/01/2024
(73) **CÔNG TY TNHH XUẤT NHẬP KHẨU TRUNG CHÍNH (VN)**
Số 100, quốc lộ 51, khu phố Bình Dương, phường Long Bình Tân, thành phố Biên
Hoà, tỉnh Đồng Nai
(72) Nguyễn Trung Chính (VN)
(74) Công ty TNHH Tư vấn sở hữu trí tuệ Việt (VIET IP CO.,LTD.)
(55)

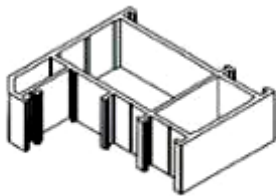

1.1



1.2



1.3



1.4

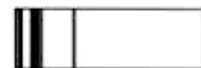

1.5

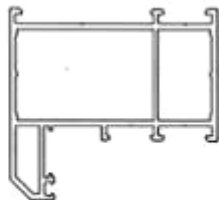

1.6

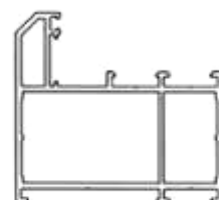

1.7

CÔNG BÁO SỞ HỮU CÔNG NGHIỆP SỐ 430 TẬP A – QUYỀN 2 (01.2024)

- (11) **49444**
(21) 3-2023-02609 (28) 1
(54) **THANH ĐỊNH HÌNH** (51) **25-01**
(22) 03/11/2023 (43) 25/01/2024
(73) **CÔNG TY TNHH XUẤT NHẬP KHẨU TRUNG CHÍNH (VN)**
Số 100, quốc lộ 51, khu phố Bình Dương, phường Long Bình Tân, thành phố Biên
Hoà, tỉnh Đồng Nai
(72) Nguyễn Trung Chính (VN)
(74) Công ty TNHH Tư vấn sở hữu trí tuệ Việt (VIET IP CO.,LTD.)
(55)

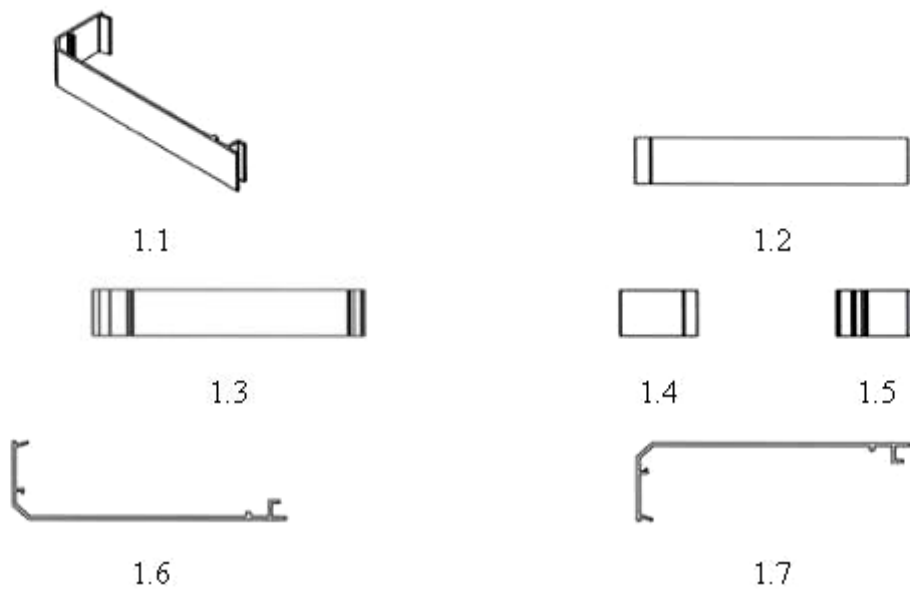

CÔNG BÁO SỞ HỮU CÔNG NGHIỆP SỐ 430 TẬP A – QUYỀN 2 (01.2024)

- (11) **49445**
(21) 3-2023-02610 (28) 1
(54) **THANH ĐỊNH HÌNH** (51) **25-01**
(22) 03/11/2023 (43) 25/01/2024
(73) **CÔNG TY TNHH XUẤT NHẬP KHẨU TRUNG CHÍNH (VN)**
Số 100, quốc lộ 51, khu phố Bình Dương, phường Long Bình Tân, thành phố Biên
Hoà, tỉnh Đồng Nai
(72) Nguyễn Trung Chính (VN)
(74) Công ty TNHH Tư vấn sở hữu trí tuệ Việt (VIET IP CO.,LTD.)
(55)

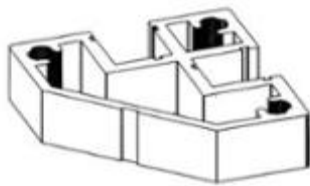

1.1



1.2



1.3



1.4



1.5

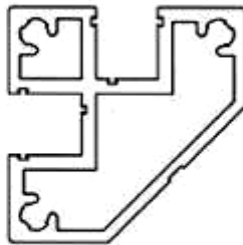

1.6

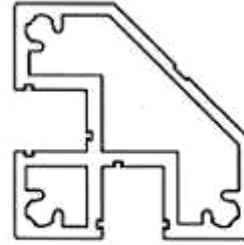

1.7

CÔNG BÁO SỞ HỮU CÔNG NGHIỆP SỐ 430 TẬP A – QUYỀN 2 (01.2024)

- (11) **49446**
(21) 3-2023-02611 (28) 1
(54) **THANH ĐỊNH HÌNH** (51) **25-01**
(22) 03/11/2023 (43) 25/01/2024
(73) **CÔNG TY TNHH XUẤT NHẬP KHẨU TRUNG CHÍNH (VN)**
Số 100, quốc lộ 51, khu phố Bình Dương, phường Long Bình Tân, thành phố Biên
Hoà, tỉnh Đồng Nai
(72) Nguyễn Trung Chính (VN)
(74) Công ty TNHH Tư vấn sở hữu trí tuệ Việt (VIET IP CO.,LTD.)
(55)



1.1



1.3



1.5

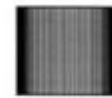

1.2



1.4



1.6



1.7

CÔNG BÁO SỞ HỮU CÔNG NGHIỆP SỐ 430 TẬP A – QUYỀN 2 (01.2024)

- (11) **49447**
(21) 3-2023-02612 (28) 1
(54) **THANH ĐỊNH HÌNH** (51) **25-01**
(22) 03/11/2023 (43) 25/01/2024
(73) **CÔNG TY TNHH XUẤT NHẬP KHẨU TRUNG CHÍNH (VN)**
Số 100, quốc lộ 51, khu phố Bình Dương, phường Long Bình Tân, thành phố Biên
Hoà, tỉnh Đồng Nai
(72) Nguyễn Trung Chính (VN)
(74) Công ty TNHH Tư vấn sở hữu trí tuệ Việt (VIET IP CO.,LTD.)
(55)

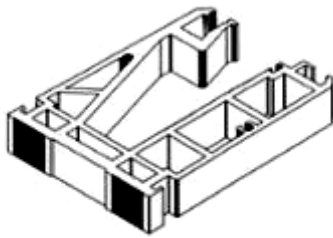

1.1



1.2



1.3



1.4

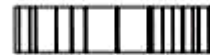

1.5

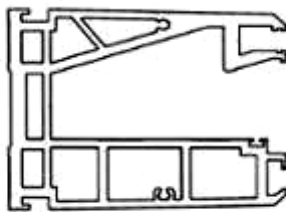

1.6

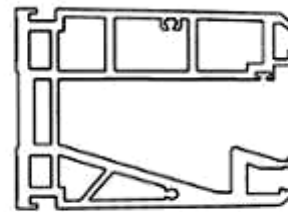

1.7

CÔNG BÁO SỞ HỮU CÔNG NGHIỆP SỐ 430 TẬP A – QUYỀN 2 (01.2024)

- (11) **49448**
(21) 3-2023-02613 (28) 1
(54) **THANH ĐỊNH HÌNH** (51) **25-01**
(22) 03/11/2023 (43) 25/01/2024
(73) **CÔNG TY TNHH XUẤT NHẬP KHẨU TRUNG CHÍNH (VN)**
Số 100, quốc lộ 51, khu phố Bình Dương, phường Long Bình Tân, thành phố Biên
Hoà, tỉnh Đồng Nai
(72) Nguyễn Trung Chính (VN)
(74) Công ty TNHH Tư vấn sở hữu trí tuệ Việt (VIET IP CO.,LTD.)
(55)

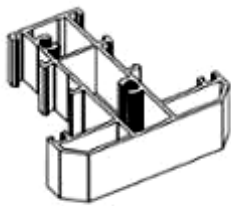

1.1



1.2



1.3



1.4



1.5

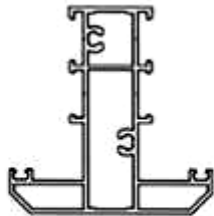

1.6

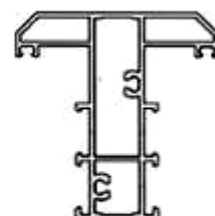

1.7

CÔNG BÁO SỞ HỮU CÔNG NGHIỆP SỐ 430 TẬP A – QUYỀN 2 (01.2024)

- (11) **49449**
(21) 3-2023-02614 (28) 1
(54) **THANH ĐỊNH HÌNH** (51) **25-01**
(22) 03/11/2023 (43) 25/01/2024
(73) **CÔNG TY TNHH XUẤT NHẬP KHẨU TRUNG CHÍNH (VN)**
Số 100, quốc lộ 51, khu phố Bình Dương, phường Long Bình Tân, thành phố Biên
Hoà, tỉnh Đồng Nai
(72) Nguyễn Trung Chính (VN)
(74) Công ty TNHH Tư vấn sở hữu trí tuệ Việt (VIET IP CO.,LTD.)
(55)

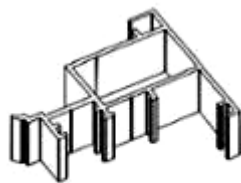

1.1



1.2

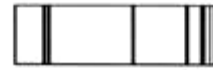

1.3



1.4



1.5

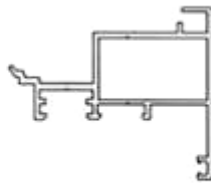

1.6

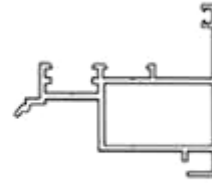

1.7

CÔNG BÁO SỞ HỮU CÔNG NGHIỆP SỐ 430 TẬP A – QUYỀN 2 (01.2024)

- (11) **49450**
(21) 3-2023-02615 (28) 1
(54) **THANH ĐỊNH HÌNH** (51) **25-01**
(22) 03/11/2023 (43) 25/01/2024
(73) **CÔNG TY TNHH XUẤT NHẬP KHẨU TRUNG CHÍNH (VN)**
Số 100, quốc lộ 51, khu phố Bình Dương, phường Long Bình Tân, thành phố Biên
Hoà, tỉnh Đồng Nai
(72) Nguyễn Trung Chính (VN)
(74) Công ty TNHH Tư vấn sở hữu trí tuệ Việt (VIET IP CO.,LTD.)
(55)

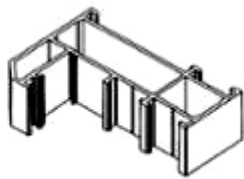

1.1



1.2



1.3



1.4



1.5

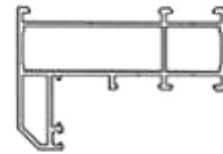

1.6

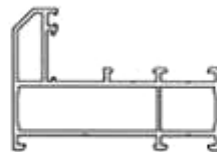

1.7

CÔNG BÁO SỞ HỮU CÔNG NGHIỆP SỐ 430 TẬP A – QUYỀN 2 (01.2024)

- (11) **49451**
(21) 3-2023-02616 (28) 1
(54) **THANH ĐỊNH HÌNH** (51) **25-01**
(22) 03/11/2023 (43) 25/01/2024
(73) **CÔNG TY TNHH XUẤT NHẬP KHẨU TRUNG CHÍNH (VN)**
Số 100, quốc lộ 51, khu phố Bình Dương, phường Long Bình Tân, thành phố Biên
Hoà, tỉnh Đồng Nai
(72) Nguyễn Trung Chính (VN)
(74) Công ty TNHH Tư vấn sở hữu trí tuệ Việt (VIET IP CO.,LTD.)
(55)

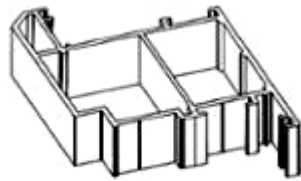

1.1



1.2



1.3



1.4



1.5

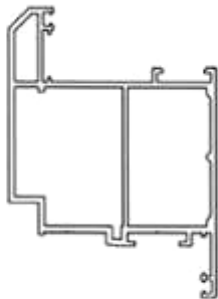

1.6

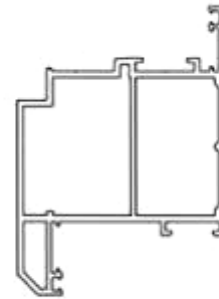

1.7

CÔNG BÁO SỞ HỮU CÔNG NGHIỆP SỐ 430 TẬP A – QUYỀN 2 (01.2024)

- (11) **49452**
(21) 3-2023-02617 (28) 1
(54) **THANH ĐỊNH HÌNH** (51) **25-01**
(22) 03/11/2023 (43) 25/01/2024
(73) **CÔNG TY TNHH XUẤT NHẬP KHẨU TRUNG CHÍNH (VN)**
Số 100, quốc lộ 51, khu phố Bình Dương, phường Long Bình Tân, thành phố Biên
Hoà, tỉnh Đồng Nai
(72) Nguyễn Trung Chính (VN)
(74) Công ty TNHH Tư vấn sở hữu trí tuệ Việt (VIET IP CO.,LTD.)
(55)

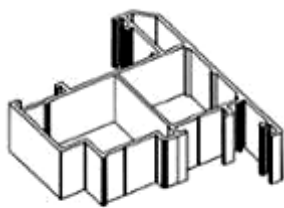

1.1



1.2



1.3



1.4



1.5

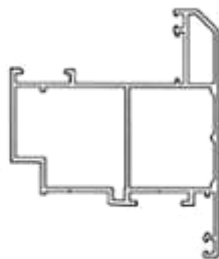

1.6

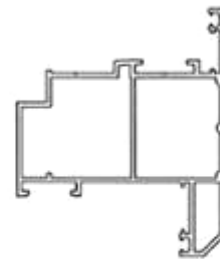

1.7

CÔNG BÁO SỞ HỮU CÔNG NGHIỆP SỐ 430 TẬP A – QUYỀN 2 (01.2024)

- (11) **49453**
(21) 3-2023-02618 (28) 1
(54) **THANH ĐỊNH HÌNH** (51) **25-01**
(22) 03/11/2023 (43) 25/01/2024
(73) **CÔNG TY TNHH XUẤT NHẬP KHẨU TRUNG CHÍNH (VN)**
Số 100, quốc lộ 51, khu phố Bình Dương, phường Long Bình Tân, thành phố Biên
Hoà, tỉnh Đồng Nai
(72) Nguyễn Trung Chính (VN)
(74) Công ty TNHH Tư vấn sở hữu trí tuệ Việt (VIET IP CO.,LTD.)
(55)

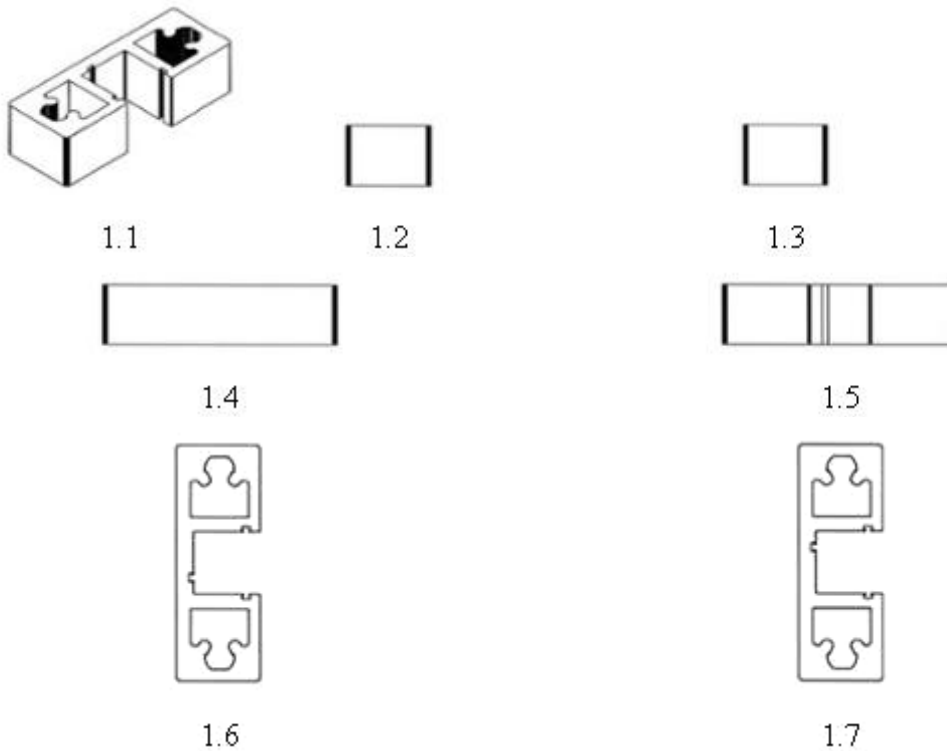

CÔNG BÁO SỞ HỮU CÔNG NGHIỆP SỐ 430 TẬP A – QUYỀN 2 (01.2024)

- (11) **49454**
(21) 3-2023-02619 (28) 1
(54) **THANH ĐỊNH HÌNH** (51) **25-01**
(22) 03/11/2023 (43) 25/01/2024
(73) **CÔNG TY TNHH XUẤT NHẬP KHẨU TRUNG CHÍNH (VN)**
Số 100, quốc lộ 51, khu phố Bình Dương, phường Long Bình Tân, thành phố Biên
Hoà, tỉnh Đồng Nai
(72) Nguyễn Trung Chính (VN)
(74) Công ty TNHH Tư vấn sở hữu trí tuệ Việt (VIET IP CO.,LTD.)
(55)

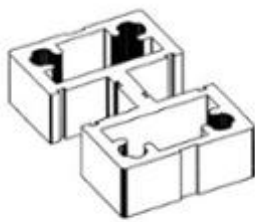

1.1



1.2

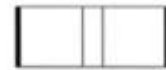

1.3



1.4



1.5

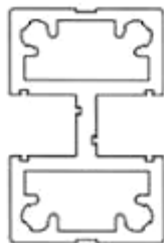

1.6

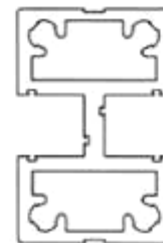

1.7

CÔNG BÁO SỞ HỮU CÔNG NGHIỆP SỐ 430 TẬP A – QUYỀN 2 (01.2024)

(11) **49455**

(21) 3-2023-02624

(28) 1

(54) **MÔ-TƠ CUỐN BẠT**

(51) **15-99**

(22) 07/11/2023

(43) 25/01/2024

(73) **PHẠM VĂN HIỂN (VN)**

Thôn Kim Thành, Kim Thư, huyện Thanh Oai, thành phố Hà Nội

(72) Phạm Văn Hiến (VN)

(55)



1.1



1.2



1.3



1.4



1.5



1.6



1.7

CÔNG BÁO SỞ HỮU CÔNG NGHIỆP SỐ 430 TẬP A – QUYỀN 2 (01.2024)

- (11) **49456**
(21) 3-2023-02625 (28) 1
(54) **XE MÁY** (51) **12-11**
(22) 07/11/2023 (43) 25/01/2024
(30) 2023-009616 12/05/2023 JP;
(73) **HONDA MOTOR CO., LTD. (JP)**
1-1, Minami-Aoyama 2-chome, Minato-ku, Tokyo, 107-8556 Japan
(72) 1. MAURIZIO CARBONARA (IT)
2. SATOSHI ITO (JP)
(74) Công ty Luật TNHH Phạm và Liên danh (PHAM & ASSOCIATES)
(55)



1.1



1.2



1.3



1.4



1.5



1.6



1.7



1.8



1.9



1.10

CÔNG BÁO SỞ HỮU CÔNG NGHIỆP SỐ 430 TẬP A – QUYỀN 2 (01.2024)

- (11) **49457**
(21) 3-2023-02626 (28) 1
(54) **TẮM ỐP BÊN ĐẦU XE MÁY** (51) **12-16**
(22) 07/11/2023 (43) 25/01/2024
(30) 2023-009617 12/05/2023 JP;
(73) **HONDA MOTOR CO., LTD. (JP)**
1-1, Minami-Aoyama 2-chome, Minato-ku, Tokyo, 107-8556 Japan
(72) 1. MAURIZIO CARBONARA (IT)
2. SATOSHI ITO (JP)
(74) Công ty Luật TNHH Phạm và Liên danh (PHAM & ASSOCIATES)
(55)



1.1



1.2



1.3



1.4



1.5



1.6



1.7



1.8



1.9



1.10



1.11

- (11) **49458**
(21) 3-2023-02627 (28) 1
(54) **TẮM ỐP BÊN ĐẦU XE MÁY** (51) **12-16**
(22) 07/11/2023 (43) 25/01/2024
(30) 2023-009618 12/05/2023 JP;
(73) **HONDA MOTOR CO., LTD. (JP)**
1-1, Minami-Aoyama 2-chome, Minato-ku, Tokyo, 107-8556 Japan
(72) 1. MAURIZIO CARBONARA (IT)
2. KAZUTERU ISHIKAWA (JP)
(74) Công ty Luật TNHH Phạm và Liên danh (PHAM & ASSOCIATES)
(55)



1.1

1.2

1.3

1.4



1.5

1.6

1.7

1.8



1.9



1.10

CÔNG BÁO SỞ HỮU CÔNG NGHIỆP SỐ 430 TẬP A – QUYỀN 2 (01.2024)

- (11) **49459**
(21) 3-2023-02635 (28) 1
(54) **HỘP** (51) **09-03**
(22) 07/11/2023 (43) 25/01/2024
(73) **CÔNG TY CỔ PHẦN SẢN XUẤT NHỰA DUY TÂN (VN)**
298 Hồ Học Lãm, phường An Lạc, quận Bình Tân, thành phố Hồ Chí Minh
(72) Trần Đức Xuyên (VN)
(74) Công ty TNHH Sở hữu trí tuệ INVENTIO (INVENTIO CO.,LTD)
(55)



1.1



1.2



1.3



1.4



1.5

CÔNG BÁO SỞ HỮU CÔNG NGHIỆP SỐ 430 TẬP A – QUYỀN 2 (01.2024)

- (11) **49460**
- (21) 3-2023-02637 (28) 1
- (54) **HỘP ĐỰNG** (51) **09-03**
- (22) 07/11/2023 (43) 25/01/2024
- (73) **CÔNG TY TNHH MỘT THÀNH VIÊN DƯỢC PHẨM PV HEALTHCARE (VN)**
4/5 Khu dân cư Vạn Xuân Đất Việt, đường số 5, phường Bình Hưng Hòa, quận Bình Tân, thành phố Hồ Chí Minh
- (72) Nguyễn Thị Ngọc Phương (VN)
- (74) Công ty TNHH Đại Tín và Liên Danh (DAITIN AND ASSOCIATES CO.,LTD)
- (55)



1.1



1.2

CÔNG BÁO SỞ HỮU CÔNG NGHIỆP SỐ 430 TẬP A – QUYỀN 2 (01.2024)

- (11) **49461**
(21) 3-2023-02638 (28) 1
(54) **HỘP ĐỰNG** (51) **09-03**
(22) 07/11/2023 (43) 25/01/2024
(73) **CÔNG TY TNHH MỘT THÀNH VIÊN DƯỢC PHẨM PV HEALTHCARE (VN)**
4/5 Khu dân cư Vạn Xuân Đất Việt, đường số 5, phường Bình Hưng Hòa, quận Bình Tân, thành phố Hồ Chí Minh
(72) Nguyễn Thị Ngọc Phương (VN)
(74) Công ty TNHH Đại Tín và Liên Danh (DAITIN AND ASSOCIATES CO.,LTD)
(55)

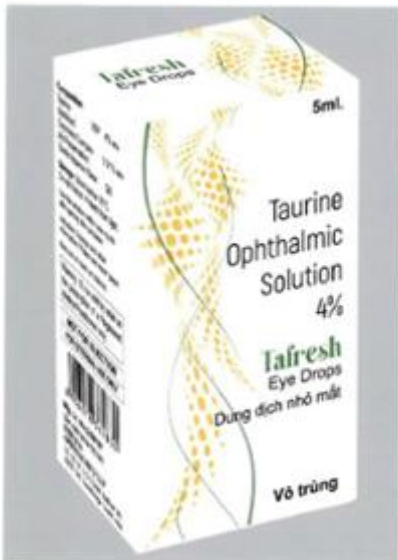

1.1



1.2

CÔNG BÁO SỞ HỮU CÔNG NGHIỆP SỐ 430 TẬP A – QUYỀN 2 (01.2024)

- (11) **49462**
(21) 3-2023-02639 (28) 1
(54) **HỘP ĐỰNG THUỐC** (51) **09-03**
(22) 07/11/2023 (43) 25/01/2024
(73) **CÔNG TY CỔ PHẦN HOÁ - DƯỢC PHẨM MEKOPHAR (VN)**
297/5 Lý Thường Kiệt, phường 15, quận 11, thành phố Hồ Chí Minh
(72) Huỳnh Thị Lan (VN)
(74) Công ty TNHH Luật ALIAT (ALIAT LEGAL)
(55)



1.1



1.2

CÔNG BÁO SỞ HỮU CÔNG NGHIỆP SỐ 430 TẬP A – QUYỀN 2 (01.2024)

- (11) **49463**
- (21) 3-2023-02640 (28) 1
- (54) **QUẠT TRẦN** (51) **23-04**
- (22) 07/11/2023 (43) 25/01/2024
- (73) **CÔNG TY CỔ PHẦN GCOOL (VN)**
Số 158/2 phố Hồng Mai, phường Quỳnh Lôi, quận Hai Bà Trưng, thành phố Hà Nội
- (72) 1. TRẦN BÌNH MINH (VN)
2. ĐẶNG ĐỨC TRUNG (VN)
3. TRẦN HỒNG HẢI (VN)
4. PHẠM ĐỨC HIỆP (VN)
5. NGUYỄN TUẤN PHONG (VN)
6. LÊ TUẤN SƠN (VN)
7. NGUYỄN VĂN TRỌNG (VN)
8. NGUYỄN ĐÌNH THẮNG (VN)
9. TRẦN ĐÌNH QUÂN (VN)
10. NGUYỄN HỒNG THẮNG (VN)
11. LÊ ĐỨC ÂN (VN)
12. NGUYỄN THỊ HẢI YẾN (VN)
- (74) Văn phòng Luật sư Tân Hà (VPLS TAN HA)
- (55)



1.1



1.2

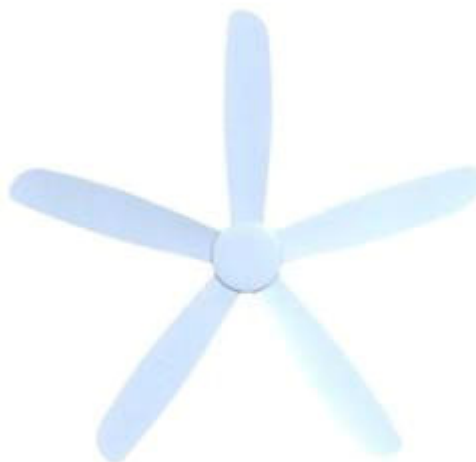

1.3



1.4



1.5



1.6



1.7

- (11) **49464**
- (21) 3-2023-02641 (28) 1
- (54) **QUẠT TRẦN** (51) **23-04**
- (22) 07/11/2023 (43) 25/01/2024
- (73) **CÔNG TY CỔ PHẦN GCOOL (VN)**
Số 158/2 phố Hồng Mai, phường Quỳnh Lôi, quận Hai Bà Trưng, thành phố Hà Nội
- (72) 1. TRẦN BÌNH MINH (VN)
2. ĐẶNG ĐỨC TRUNG (VN)
3. TRẦN HỒNG HẢI (VN)
4. PHẠM ĐỨC HIỆP (VN)
5. NGUYỄN TUẤN PHONG (VN)
6. LÊ TUẤN SƠN (VN)
7. NGUYỄN VĂN TRỌNG (VN)
8. NGUYỄN ĐÌNH THẮNG (VN)
9. TRẦN ĐÌNH QUÂN (VN)
10. NGUYỄN HỒNG THẮNG (VN)
11. LÊ ĐỨC ÂN (VN)
12. NGUYỄN THỊ HẢI YẾN (VN)
- (74) Văn phòng Luật sư Tân Hà (VPLS TAN HA)
- (55)



1.1



1.2

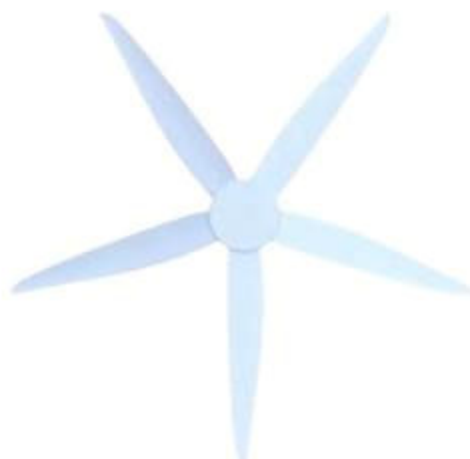

1.3



1.4



1.5



1.6



1.7

CÔNG BÁO SỞ HỮU CÔNG NGHIỆP SỐ 430 TẬP A – QUYỀN 2 (01.2024)

- (11) **49465**
(21) 3-2023-02644 (28) 1
(54) **BAO GÓI THỰC PHẨM** (51) **09-05**
(22) 08/11/2023 (43) 25/01/2024
(73) **LÊ ĐÌNH HÙNG (VN)**
Số 14 phố Trần Văn Chuông, phường Yết Kiêu, quận Hà Đông, thành phố Hà Nội
(72) Lê Đình Hùng (VN)
(55)



1.1



1.2

CÔNG BÁO SỞ HỮU CÔNG NGHIỆP SỐ 430 TẬP A – QUYỀN 2 (01.2024)

- (11) **49466**
(21) 3-2023-02645 (28) 1
(54) **BAO GÓI THỰC PHẨM** (51) **09-05**
(22) 08/11/2023 (43) 25/01/2024
(73) **LÊ ĐÌNH HÙNG (VN)**
Số 14 phố Trần Văn Chuông, phường Yết Kiêu, quận Hà Đông, thành phố Hà Nội
(72) Lê Đình Hùng (VN)
(55)



1.1



1.2

CÔNG BÁO SỞ HỮU CÔNG NGHIỆP SỐ 430 TẬP A – QUYỀN 2 (01.2024)

- (11) **49467**
(21) 3-2023-02646 (28) 1
(54) **BAO GÓI THỰC PHẨM** (51) **09-05**
(22) 08/11/2023 (43) 25/01/2024
(73) **LÊ ĐÌNH HÙNG (VN)**
Số 14 phố Trần Văn Chuông, phường Yết Kiêu, quận Hà Đông, thành phố Hà Nội
(72) Lê Đình Hùng (VN)
(55)



1.1



1.2

CÔNG BÁO SỞ HỮU CÔNG NGHIỆP SỐ 430 TẬP A – QUYỀN 2 (01.2024)

(11) **49468**

(21) 3-2023-02670

(54) **DỤNG CỤ DẬP GHIM**

(22) 09/11/2023

(30) 2023-009418 10/05/2023 JP;

(73) **MAX CO., LTD. (JP)**

6-6, Nihonbashi Hakozaiki-cho, Chuo-ku, Tokyo 103-8502, Japan

(72) Tomohiro IRAGO (JP)

(74) Công ty Cổ phần Sở hữu công nghiệp INVESTIP (INVESTIP)

(55)

(28) 1

(51) **19-02**

(43) 25/01/2024

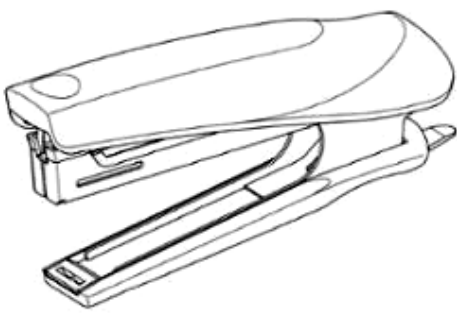

1.1

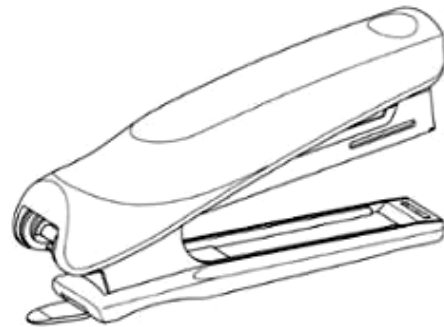

1.2

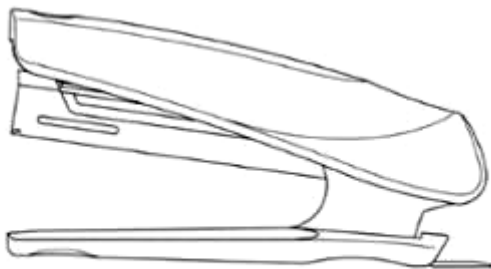

1.3



1.4

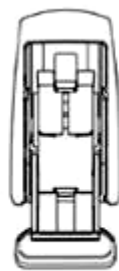

1.5



1.6



1.7



1.8

CÔNG BÁO SỞ HỮU CÔNG NGHIỆP SỐ 430 TẬP A – QUYỀN 2 (01.2024)

- (11) **49469**
(21) 3-2023-02671 (28) 1
(54) **BỘ PHẬN THIẾT BỊ XỬ LÝ NƯỚC THẢI** (51) **23-01; 23-99**
(22) 09/11/2023 (43) 25/01/2024
(30) 112302549 23/05/2023 TW;
(73) **EVER CLEAR ENVIRONMENTAL ENGINEERING CORPORATION (TW)**
No. 261, Sec. 5, Longfu Rd., Xitun Dist., Taichung City 407028, Taiwan
(72) 1. HO, CHIA-CHIN (TW)
2. TSOU, CHIEN-WEI (TW)
3. ZENG, JHIH-CIANG (TW)
4. CHIU, CHI-CHIH (TW)
5. HSIEH, PING-HENG (TW)
(74) Công ty TNHH Tầm nhìn và Liên danh (VISION & ASSOCIATES CO.LTD.)
(55)

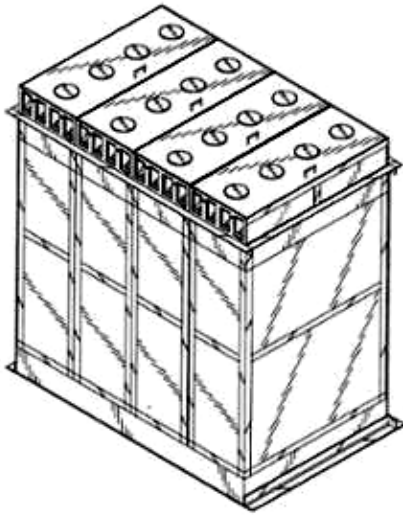

1.1

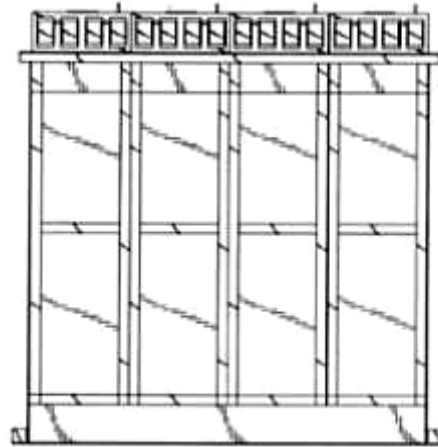

1.2

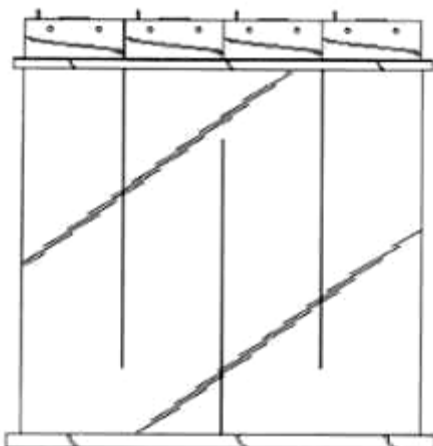

1.3

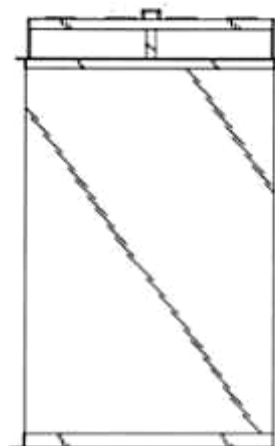

1.4

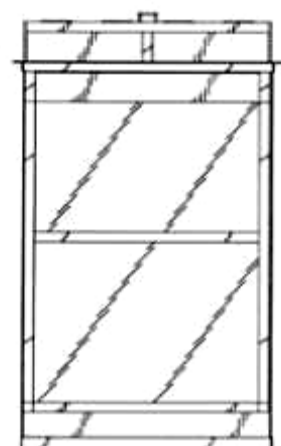

1.5

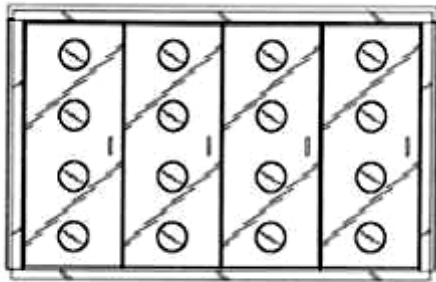

1.6

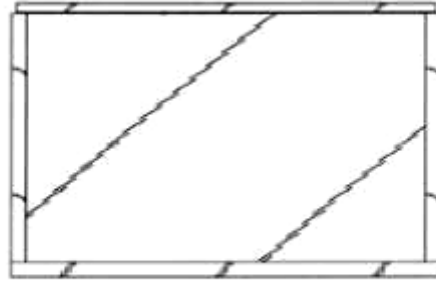

1.7

CÔNG BÁO SỞ HỮU CÔNG NGHIỆP SỐ 430 TẬP A – QUYỀN 2 (01.2024)

- (11) **49470**
(21) 3-2023-02725 (28) 1
(54) **BAO GÓI** (51) **09-05**
(22) 13/11/2023 (43) 25/01/2024
(73) **CÔNG TY CỔ PHẦN LIWAYWAY VIỆT NAM (VN)**
Số 14, đường số 05, khu công nghiệp Việt Nam - Singapore, phường Bình Hòa,
thành phố Thuận An, tỉnh Bình Dương
(72) Robert Tan Li (PH)
(74) Văn phòng Luật sư Tân Hà (VPLS TAN HA)
(55)



1.1



1.2

(11) **49471**

(21) 3-2023-02758

(28) 1

(54) **QUẠT TRẦN**

(51) **23-04**

(22) 15/11/2023

(43) 25/01/2024

(73) **CÔNG TY CỔ PHẦN GCOOL (VN)**

Số 158/2 phố Hồng Mai, phường Quỳnh Lôi, quận Hai Bà Trưng, thành phố Hà Nội

(72) 1. **TRẦN BÌNH MINH (VN)**

2. **ĐẶNG ĐỨC TRUNG (VN)**

3. **TRẦN HỒNG HẢI (VN)**

4. **LÊ TUẤN SƠN (VN)**

5. **NGUYỄN ĐÌNH THẮNG (VN)**

6. **TRẦN ĐÌNH QUÂN (VN)**

(74) Văn phòng Luật sư Tân Hà (VPLS TAN HA)

(55)



1.1



1.2

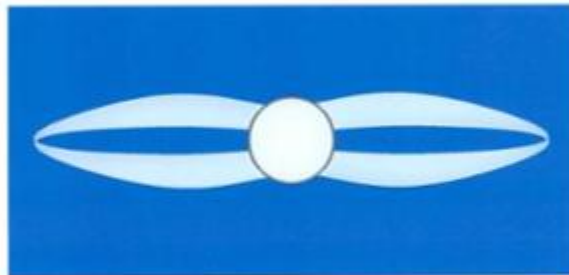

1.3



1.4



1.5

CÔNG BÁO SỞ HỮU CÔNG NGHIỆP SỐ 430 TẬP A – QUYỀN 2 (01.2024)

- (11) **49472**
(21) 3-2023-02775 (28) 1
(54) **THÙNG ĐỰNG** (51) **09-03**
(22) 17/11/2023 (43) 25/01/2024
(73) **TỔNG CÔNG TY CỔ PHẦN BIA - RƯỢU - NƯỚC GIẢI KHÁT HÀ NỘI**
(VN)
Số 183, phố Hoàng Hoa Thám, phường Ngọc Hà, quận Ba Đình, thành phố Hà Nội
(72) Đặng Nguyên Phương (VN)
(74) Công ty TNHH tư vấn Sở hữu trí tuệ IPFLAME (IPFLAME CO.,LTD)
(55)



1.1



1.2

CÔNG BÁO SỞ HỮU CÔNG NGHIỆP SỐ 430 TẬP A – QUYỀN 2 (01.2024)

- (11) **49473**
(21) 3-2023-02803 (28) 1
(54) **TÚI ĐỰNG** (51) **09-05**
(22) 21/11/2023 (43) 25/01/2024
(73) **DAIO PAPER CORPORATION (JP)**
2-60, Mishimakamiya-cho, Shikokuchuo-shi, Ehime 799-0492 Japan
(72) Azizah Ayuningtias (ID)
(74) Công ty TNHH Đại Tín và Liên Danh (DAITIN AND ASSOCIATES CO.,LTD)
(55)



1.1



1.2



1.3



1.4



1.5



1.6



1.7

CÔNG BÁO SỞ HỮU CÔNG NGHIỆP SỐ 430 TẬP A – QUYỀN 2 (01.2024)

- (11) **49474**
- (21) 3-2023-02805 (28) 1
- (54) **BAO GÓI** (51) **09-05**
- (22) 21/11/2023 (43) 25/01/2024
- (73) **CÔNG TY TNHH NTPM (VIỆT NAM) (VN)**
Số 22 VSIP II-A, đường 23, KCN Việt Nam-Singapore II-A, phường Vĩnh Tân,
thành phố Tân Uyên, tỉnh Bình Dương
- (72) LEE KUAN PHENG (MY)
- (74) Công ty TNHH Sở hữu trí tuệ HA VIP (HAVIP CO., LTD.)
- (55)



1.1



1.2

CÔNG BÁO SỞ HỮU CÔNG NGHIỆP SỐ 430 TẬP A – QUYỀN 2 (01.2024)

- (11) **49475**
(21) 3-2023-02810 (28) 1
(54) **TÚI ĐỰNG** (51) **09-05**
(22) 22/11/2023 (43) 25/01/2024
(73) **DAIO PAPER CORPORATION (JP)**
2-60, Mishimakamiya-cho, Shikokuchuo-shi, Ehime 799-0492 Japan
(72) Benchawan Ghoumeddin (TH)
(74) Công ty TNHH Đại Tín và Liên Danh (DAITIN AND ASSOCIATES CO.,LTD)
(55)



1.1



1.2



1.3



1.4



1.5



1.6



1.7

CÔNG BÁO SỞ HỮU CÔNG NGHIỆP SỐ 430 TẬP A – QUYỀN 2 (01.2024)

- (11) **49476**
(21) 3-2023-02829 (28) 1
(54) **HỘP ĐỰNG** (51) **09-03**
(22) 23/11/2023 (43) 25/01/2024
(30) 202330329185.0 31/05/2023 CN;
(73) **WL CENTRALIN DAVID APAC PTE. LTD. (SG)**
6 HARPER ROAD #01-09, LEONG HUAT BUILDING, SINGAPORE
(72) CHO Ping Joyce (CN)
(74) Công ty TNHH Trường Xuân (AGELESS CO.,LTD.)
(55)



1.1



1.2



1.3



1.4



1.5

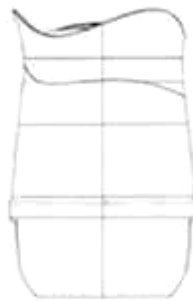

1.6



1.7



1.8

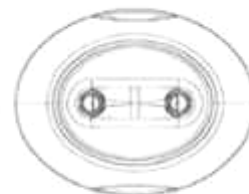

1.9

CÔNG BÁO SỞ HỮU CÔNG NGHIỆP SỐ 430 TẬP A – QUYỀN 2 (01.2024)

- (11) **49477**
- (21) 3-2023-02841 (28) 1
- (54) **HỘP ĐỰNG** (51) **09-03**
- (22) 27/11/2023 (43) 25/01/2024
- (73) 1. **CÔNG TY TNHH SỨC KHỎE HOÀN HẢO THANH HUẾ (VN)**
Khu dân cư mới, thôn An Nhân Đông, thị trấn Tứ Kỳ, huyện Tứ Kỳ, tỉnh Hải Dương
2. **TRƯỜNG ĐẠI HỌC THÀNH ĐÔ (VN)**
Lai Xá, Kim Chung, huyện Hoài Đức, thành phố Hà Nội
- (72) 1. **PHẠM THỊ THANH HUẾ (VN)**
2. **PHAN THỊ THANH THẢO (VN)**
- (55)



1.1



1.2

CÔNG BÁO SỞ HỮU CÔNG NGHIỆP SỐ 430 TẬP A – QUYỀN 2 (01.2024)

- (11) **49478**
- (21) 3-2023-02842 (28) 1
- (54) **HỘP ĐỰNG** (51) **09-03**
- (22) 27/11/2023 (43) 25/01/2024
- (73) 1. **CÔNG TY TNHH SỨC KHỎE HOÀN HẢO THANH HUẾ (VN)**
Khu dân cư mới, thôn An Nhân Đông, thị trấn Tứ Kỳ, huyện Tứ Kỳ, tỉnh Hải Dương
2. **TRƯỜNG ĐẠI HỌC THÀNH ĐÔ (VN)**
Lai Xá, Kim Chung, huyện Hoài Đức, thành phố Hà Nội
- (72) 1. **PHẠM THỊ THANH HUẾ (VN)**
2. **PHAN THỊ THANH THẢO (VN)**
- (55)



1.1



1.2

CÔNG BÁO SỞ HỮU CÔNG NGHIỆP SỐ 430 TẬP A – QUYỀN 2 (01.2024)

- (11) **49479**
- (21) 3-2023-02843 (28) 1
- (54) **HỘP ĐỰNG** (51) **09-03**
- (22) 27/11/2023 (43) 25/01/2024
- (73) 1. **CÔNG TY TNHH SỨC KHỎE HOÀN HẢO THANH HUẾ (VN)**
Khu dân cư mới, thôn An Nhân Đông, thị trấn Tứ Kỳ, huyện Tứ Kỳ, tỉnh Hải Dương
2. **TRƯỜNG ĐẠI HỌC THÀNH ĐÔ (VN)**
Lai Xá, Kim Chung, huyện Hoài Đức, thành phố Hà Nội
- (72) 1. **PHẠM THỊ THANH HUẾ (VN)**
2. **PHAN THỊ THANH THẢO (VN)**
- (55)



1.1



1.2

CÔNG BÁO SỞ HỮU CÔNG NGHIỆP SỐ 430 TẬP A – QUYỀN 2 (01.2024)

- (11) **49480**
- (21) 3-2023-02844 (28) 1
- (54) **HỘP ĐỰNG** (51) **09-03**
- (22) 27/11/2023 (43) 25/01/2024
- (73) 1. **CÔNG TY TNHH SỨC KHỎE HOÀN HẢO THANH HUẾ (VN)**
Khu dân cư mới, thôn An Nhân Đông, thị trấn Tứ Kỳ, huyện Tứ Kỳ, tỉnh Hải Dương
2. **TRƯỜNG ĐẠI HỌC THÀNH ĐÔ (VN)**
Lai Xá, Kim Chung, huyện Hoài Đức, thành phố Hà Nội
- (72) 1. **PHẠM THỊ THANH HUẾ (VN)**
2. **PHAN THỊ THANH THẢO (VN)**
- (55)



1.1



1.2

CÔNG BÁO SỞ HỮU CÔNG NGHIỆP SỐ 430 TẬP A – QUYỀN 2 (01.2024)

- (11) **49481**
- (21) 3-2023-02845 (28) 1
- (54) **HỘP ĐỰNG** (51) **09-03**
- (22) 27/11/2023 (43) 25/01/2024
- (73) 1. **CÔNG TY TNHH SỨC KHỎE HOÀN HẢO THANH HUẾ (VN)**
Khu dân cư mới, thôn An Nhân Đông, thị trấn Tứ Kỳ, huyện Tứ Kỳ, tỉnh Hải Dương
2. **TRƯỜNG ĐẠI HỌC THÀNH ĐÔ (VN)**
Lai Xá, Kim Chung, huyện Hoài Đức, thành phố Hà Nội
- (72) 1. **PHẠM THỊ THANH HUẾ (VN)**
2. **PHAN THỊ THANH THẢO (VN)**
- (55)



1.1



1.2

CÔNG BÁO SỞ HỮU CÔNG NGHIỆP SỐ 430 TẬP A – QUYỀN 2 (01.2024)

- (11) **49482**
(21) 3-2023-02934 (28) 1
(54) **HỘP BỘT ĐẬU XANH UỐNG LIỀN** (51) **09-03**
(22) 04/12/2023 (43) 25/01/2024
(73) **CÔNG TY CỔ PHẦN QUÊ HƯƠNG (VN)**
Ngã tư Bến Hàn, phường Bình Hàn, thành phố Hải Dương, tỉnh Hải Dương
(72) Nguyễn Cảnh Thịnh (VN)
(74) Công ty TNHH Sở hữu trí tuệ và Công nghệ Thủ đô (CAPITAL IP&T CO.LTD.)
(55)



1.1



1.2

CÔNG BÁO SỞ HỮU CÔNG NGHIỆP SỐ 430 TẬP A – QUYỀN 2 (01.2024)

- (11) **49483**
(21) 3-2023-02935 (28) 1
(54) **HỘP BỘT ĐẬU XANH UỐNG LIỀN** (51) **09-03**
(22) 04/12/2023 (43) 25/01/2024
(73) **CÔNG TY CỔ PHẦN QUÊ HƯƠNG (VN)**
Ngã tư Bến Hàn, phường Bình Hàn, thành phố Hải Dương, tỉnh Hải Dương
(72) Nguyễn Cảnh Thịnh (VN)
(74) Công ty TNHH Sở hữu trí tuệ và Công nghệ Thủ đô (CAPITAL IP&T CO.LTD.)
(55)



1.1



1.2

CÔNG BÁO SỞ HỮU CÔNG NGHIỆP SỐ 430 TẬP A – QUYỀN 2 (01.2024)

- (11) **49484**
(21) 3-2023-02936 (28) 1
(54) **HỘP ĐỰNG SẢN PHẨM** (51) **09-03**
(22) 04/12/2023 (43) 25/01/2024
(73) **NGUYỄN TOÀN QUYỀN (VN)**
Thôn Vĩnh Mộ, xã Nguyễn Trãi, huyện Thường Tín, thành phố Hà Nội
(72) Nguyễn Toàn Quyền (VN)
(74) Công ty Luật TNHH WINCO (WINCO LAW FIRM)
(55)



1.1



1.2

CÔNG BÁO SỞ HỮU CÔNG NGHIỆP SỐ 430 TẬP A – QUYỀN 2 (01.2024)

- (11) **49485**
(21) 3-2023-02937 (28) 1
(54) **HỘP ĐỰNG SẢN PHẨM** (51) **09-03**
(22) 04/12/2023 (43) 25/01/2024
(73) **NGUYỄN TOÀN QUYỀN (VN)**
Thôn Vĩnh Mộ, xã Nguyễn Trãi, huyện Thường Tín, thành phố Hà Nội
(72) Nguyễn Toàn Quyền (VN)
(74) Công ty Luật TNHH WINCO (WINCO LAW FIRM)
(55)



1.1



1.2



1.3



1.4



1.5



1.6

CÔNG BÁO SỞ HỮU CÔNG NGHIỆP SỐ 430 TẬP A – QUYỀN 2 (01.2024)

- (11) **49486**
(21) 3-2023-02983 (28) 1
(54) **HỘP** (51) **09-03**
(22) 07/12/2023 (43) 25/01/2024
(73) **NGUYỄN NGỌC MINH (VN)**
Số 502, đường Điện Biên Phủ, thành phố Hải Dương, tỉnh Hải Dương
(72) Nguyễn Ngọc Minh (VN)
(55)



1.1



1.2

CÔNG BÁO SỞ HỮU CÔNG NGHIỆP SỐ 430 TẬP A – QUYỀN 2 (01.2024)

- (11) **49487**
(21) 3-2023-02986 (28) 1
(54) **BÌNH XỊT MỬI** (51) **09-01**
(22) 31/03/2022 (43) 25/01/2024
(30) 29/810,218 01/10/2021 US;
(73) **SANOTIZE RESEARCH AND DEVELOPMENT CORP. (CA)**
25th Floor, 700 West Georgia, Vancouver, British Columbia, V7Y-1B3, Canada
(72) 1. GILLY REGEV (CA)
2. CHRISTOPHER C. MILLER (CA)
3. NIR NAGAR (IL)
(74) Văn phòng Luật sư Ân Nam (ANNAM IP & LAW)
(55)

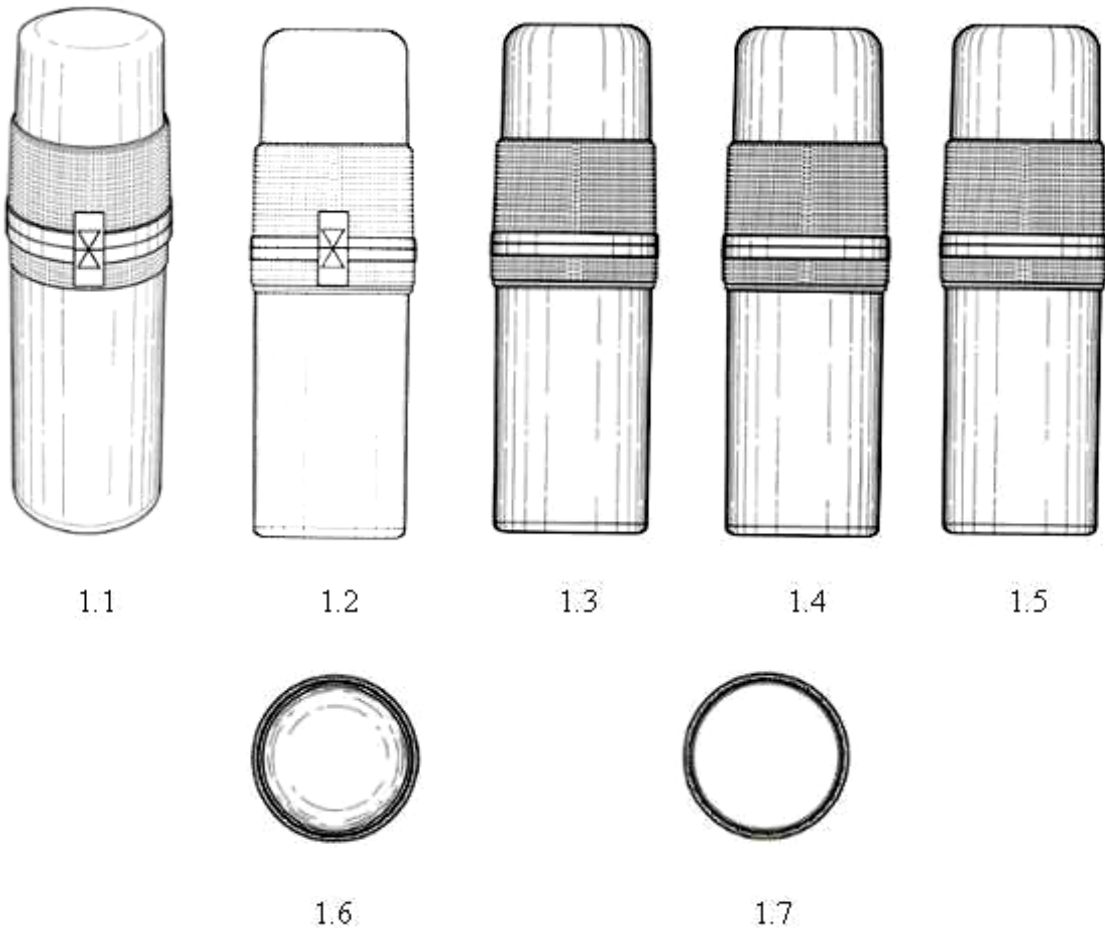



Hình 8

1.8



1.9



1.10



1.11

CÔNG BÁO SỞ HỮU CÔNG NGHIỆP SỐ 430 TẬP A – QUYỀN 2 (01.2024)

- (11) **49488**
- (21) 3-2023-02989 (28) 1
- (54) **HỘP ĐỰNG** (51) **09-03**
- (22) 07/12/2023 (43) 25/01/2024
- (73) **CÔNG TY CỔ PHẦN TẬP ĐOÀN ĐẦU TƯ THƯƠNG MẠI VĂN LANG (VN)**
Số D56, khu X361 tổ dân phố Tân Xuân 1, phường Xuân Đình, quận Bắc Từ Liêm, thành phố Hà Nội
- (72) Tạ Thị Việt Hà (VN)
- (74) Công ty TNHH Sở hữu trí tuệ HA VIP (HAVIP CO., LTD.)
- (55)



1.1



1.2

CÔNG BÁO SỞ HỮU CÔNG NGHIỆP SỐ 430 TẬP A – QUYỀN 2 (01.2024)

- (11) **49489**
(21) 3-2023-03038 (28) 1
(54) **HỘP ĐỰNG** (51) **09-03**
(22) 12/12/2023 (43) 25/01/2024
(73) **CÔNG TY CỔ PHẦN RICHY GROUP (VN)**
Tầng 15, tòa nhà Richy, tổ 32, phường Yên Hòa, quận Cầu Giấy, thành phố Hà Nội
(72) Trần Sỹ Trực (VN)
(74) Công ty TNHH Sở hữu trí tuệ HA VIP (HAVIP CO., LTD.)
(55)



1.1



1.2

CÔNG BÁO SỞ HỮU CÔNG NGHIỆP SỐ 430 TẬP A – QUYỀN 2 (01.2024)

- (11) **49490**
(21) 3-2023-03039 (28) 1
(54) **HỘP ĐỰNG** (51) **09-03**
(22) 12/12/2023 (43) 25/01/2024
(73) **CÔNG TY CỔ PHẦN RICHY GROUP (VN)**
Tầng 15, tòa nhà Richy, tổ 32, phường Yên Hòa, quận Cầu Giấy, thành phố Hà Nội
(72) Trần Sỹ Trực (VN)
(74) Công ty TNHH Sở hữu trí tuệ HA VIP (HAVIP CO., LTD.)
(55)



1.1



1.2

PHẦN II

SỬA ĐỔI ĐƠN

Thông báo số: 101207/TB-SHTT.IP, ngày 13/12/2023 về việc ghi nhận sửa đổi đơn

Số Yêu cầu: SĐ3-2022-01994 Ngày nộp: 24/10/2022

Liên quan đến đơn yêu cầu cấp Bằng độc quyền kiểu dáng công nghiệp:

(21) Số đơn	(22) Ngày nộp đơn
3-2021-01690	25/06/2021
3-2022-01404	14/07/2022

Mục sửa đổi: Tên, địa chỉ chủ đơn

Nội dung mới: Công ty TNHH cơ khí thương mại Hoàng Huy (VN)
Thôn 6, xã Phú Cát, huyện Quốc Oai, thành phố Hà Nội

Thông báo số: 101239/TB-SHTT.IP, ngày 13/12/2023 về việc ghi nhận sửa đổi đơn

Số Yêu cầu: SĐ3-2022-00921 Ngày nộp: 31/05/2022

Liên quan đến đơn yêu cầu cấp Bằng độc quyền kiểu dáng công nghiệp:

(21) Số đơn	(22) Ngày nộp đơn
3-2019-02312	12/09/2019
3-2019-02313	12/09/2019

Mục sửa đổi: Tên, địa chỉ chủ đơn

Nội dung mới: Công ty cổ phần xuất nhập khẩu Bến Tre (VN)
Lô K, CCN-TTCN Phong Năm, xã Phong Năm, huyện Giồng Trôm,
tỉnh Bến Tre

CÔNG BÁO SỞ HỮU CÔNG NGHIỆP SỐ 430 TẬP A – QUYỀN 2 (01.2024)

Thông báo số: 101265/TB-SHTT.IP, ngày 13/12/2023 về việc ghi nhận sửa đổi đơn

Số Yêu cầu: SĐ3-2023-01348 Ngày nộp: 18/07/2023

Liên quan đến đơn yêu cầu cấp Bằng độc quyền kiểu dáng công nghiệp:

(21) Số đơn	(22) Ngày nộp đơn
3-2022-02029	21/09/2022

Mục sửa đổi: Đại diện sở hữu công nghiệp

Nội dung mới: Công ty TNHH IPCELLS & Cộng Sự (IPCELLS & ASSOCIATED CO.,LTD)
Tầng 4, số 229 đường Quang Trung, phường Quang Trung, Quận Hà Đông, TP. Hà Nội

CÔNG BÁO SỞ HỮU CÔNG NGHIỆP

Do Cục Sở hữu trí tuệ thuộc Bộ Khoa học và Công nghệ ấn hành theo Luật Sở hữu trí tuệ số 50/2005/QH11 được Quốc hội thông qua ngày 29 tháng 11 năm 2005 và được sửa đổi bằng Luật sửa đổi, bổ sung một số điều của Luật sở hữu trí tuệ số 50/2005/QH11 được Quốc hội thông qua ngày 19 tháng 6 năm 2009.

Địa chỉ liên hệ:

384-386 đường Nguyễn Trãi, quận Thanh Xuân,
thành phố Hà Nội, Việt Nam
ĐT: 024. 38583069
Fax: 024. 38588449