

CỘNG HÒA XÃ HỘI CHỦ NGHĨA VIỆT NAM
BỘ KHOA HỌC VÀ CÔNG NGHỆ

CỤC SỞ HỮU TRÍ TUỆ

CÔNG BÁO
SỞ HỮU CÔNG NGHIỆP

TẬP A

QUYỂN 2: KIỂU DÁNG CÔNG NGHIỆP

12 - 2023

429

CỘNG HOÀ XÃ HỘI CHỦ NGHĨA VIỆT NAM
BỘ KHOA HỌC VÀ CÔNG NGHỆ
CỤC SỞ HỮU TRÍ TUỆ

CÔNG BÁO
SỞ HỮU CÔNG NGHIỆP
TẬP A

QUYỂN 2: KIỂU DÁNG CÔNG NGHIỆP

12 - 2023

429

HÀ NỘI

MỤC LỤC

	Trang
<u>PHẦN I:</u> Đơn yêu cầu cấp Bằng độc quyền kiểu dáng công nghiệp	7
<u>PHẦN II:</u> Sửa đổi đơn	781
<u>PHẦN III:</u> Thay đổi chủ đơn	790

CONTENTS

<u>PART I:</u> Applications for Industrial Design Patents	7
<u>PART II:</u> Amendment of Applications	781
<u>PART III:</u> Change of Applicants	790

CÔNG BÁO SỞ HỮU CÔNG NGHIỆP SỐ 429 TẬP A - QUYỂN 2 (12.2023)

MÃ SỐ HAI CHỮ CÁI THỂ HIỆN TÊN NƯỚC VÀ CÁC THỰC THỂ KHÁC TRONG CÁC TƯ LIỆU SỞ HỮU CÔNG NGHIỆP THEO TIÊU CHUẨN ST3 CỦA WIPO

AE	United Arab Emirates	CN	China	HK	Hong Kong
AF	Afganistan	CO	Colombia	HN	Honduras
AG	Antihua and Barbuda	CR	Costa Rica	HR	Croatia
AI	Anguilla	CU	Cuba	HT	Haiti
AL	Albania	CV	Cape Verde	HU	Hungary
AN	Netherlands Antilles	CY	Cyprus	ID	Indonesia
AO	Angola	CZ	Czech Republic	IE	Ireland
AR	Argentina	DE	Germany	IL	Israel
AT	Austria	DJ	Djibouti	IN	India
AU	Australia	DK	Denmark	IQ	Iraq
AW	Aruba	DM	Dominica	IR	Iran (Islamic Republic of)
BB	Barbados	DO	Dominican Republic	IS	Iceland
BD	Bangladesh	DZ	Algeria	IT	Italy
BE	Belgium	EC	Ecuador	JM	Jamaica
BF	Burkina Faso	EE	Estonia	JO	Jordan
BG	Bulgaria	EG	Egypt	JP	Japan
BH	Bahrain	ES	Spain	KE	Kenya
BI	Burundi	ET	Ethiopia	KH	Cambodia
BJ	Benin	FI	Finland	KI	Kiribati
BM	Bermuda	FJ	Fiji	KM	Comoros
BN	Brunei Darussalam	FK	Falkand Islands (Malvinas)	KN	Saint Kitts and Nevis
BO	Bolivia	FR	France	KP	Democratic People's Republic of Korea
BR	Brazil	GA	Gabon	KR	Republic of Korea
BS	Bahamas	GB	United Kingdom	KW	Kuwait
BT	Bhutan	GD	Grenada	KY	Cayman Islands
BW	Botswana	GE	Georgia	KZ	Kazakhstan
BY	Belarus	GH	Ghana	LA	Laos
BZ	Belize	GI	Gibraltar	LB	Lebanon
CA	Canada	GM	Gambia	LC	Saint Lucia
CF	Central African Republic	GN	Guinea	LI	Liechtenstein
CG	Congo	GQ	Equatorial Guinea	LK	SriLanka
CH	Switzerland	GR	Greece	LR	Liberia
CI	Côte d'Ivoire	GT	Guatemala	LS	Lesotho
CL	Chile	GW	Guinea-Bissau	LT	Lithuania
CM	Cameroon	GY	Guyana	TC	Turk and Caicos Islands
LU	Luxembourg	PA	Panama	TD	Chad
LV	Latvia	PE	Peru	TG	Togo
LY	Lybya	PG	Papua New Guinea	TH	Thailand
MA	Morocco	PH	Philippines	TN	Tunisia
MC	Monaco	PK	Pakistan	TO	Tonga
MD	Republic of Moldova	PL	Poland	TR	Turkey

CÔNG BÁO SỞ HỮU CÔNG NGHIỆP SỐ 429 TẬP A - QUYỂN 2 (12.2023)

MG	Madagascar	PT	Portugal	TT	Trinidad and Tobago
ML	Mali	PY	Paraguay	TV	Tuvalu
MM	Myanmar	QA	Qatar	TW	Taiwan, Province of China
MN	Mongolia	RO	Rumania	TZ	United Republic of Tanzania
MO	Macau	RU	Russian Federation	UA	Ukraine
MR	Mauritania	RW	Rwanda	UG	Uganda
MS	Montserrat	SA	Saudi Arabia	US	United States of America
MT	Malta	SB	Solomon Islands	UY	Uruguay
MU	Mauritius	SC	Seychelles	UZ	Uzbekistan
MV	Maldives	SD	Sudan	VA	Holy see
MW	Malawi	SE	Sweden	VC	Saint Vincent and the Grenadines
MX	Mexico	SG	Singapore	VE	Venezuela
MY	Malaysia	SH	Saint Helena	VG	Virgin Islands (British)
MZ	Mozambique	SL	Slovenia	VN	Vietnam
NA	Namibia	SK	Slovakia	VU	Vanuatu
NE	Niger	SL	Sierra Leone	WS	Samoa
NG	Nigeria	SM	San Marino	YE	Yemen
NJ	Nicaragua	SN	Senegal	YU	Yugoslavia
NL	Netherlands	SO	Somalia	ZA	South Africa
NO	Norway	SR	Suriname	ZM	Zambia
NP	Nepal	ST	Sao Tome and Principe	ZR	Zaire
NR	Nauru	SV	El Sanvador	ZW	Zimbabwe
NZ	New Zealand	SY	Syria		
OM	Oman	SZ	Swaziland		

CÁC TỔ CHỨC QUỐC TẾ

AO	African Intellectual Property Organization (OAPI)
AP	African Regional Industrial Property Organization (ARIPO)
BX	Benelux Trademark Office and Benelux Designs Office
EP	European Patent Office (EPO)
IB, WO	International Bureau of the World Intellectual Property Organization (WIPO)

NHỮNG MÃ SỐ INID TRÍCH TỪ TIÊU CHUẨN ST80 CỦA TỔ CHỨC SỞ HỮU TRÍ TUỆ THẾ GIỚI (WIPO) ĐỂ NHẬN BIẾT CÁC DỮ LIỆU THƯ MỤC DÙNG CÔNG BỐ ĐƠN VÀ BẰNG ĐỘC QUYỀN KIỂU DÁNG CÔNG NGHIỆP

- (11) Số bằng độc quyền kiểu dáng công nghiệp / Số công bố đơn
- (15) Ngày cấp
- (18) Ngày hết hạn hiệu lực của bằng độc quyền kiểu dáng công nghiệp
- (21) Số đơn
- (22) Ngày nộp đơn
- (23) Tên triển lãm, ngày và nơi triển lãm
- (28) Số phương án yêu cầu bảo hộ
- (30) Số đơn ưu tiên, ngày nộp đơn ưu tiên
- (43) Ngày công bố đơn
- (45) Ngày công bố bằng độc quyền kiểu dáng công nghiệp
- (51) Phân loại quốc tế kiểu dáng công nghiệp
- (54) Tên sản phẩm mang kiểu dáng công nghiệp
- (55) Ảnh chụp / hình vẽ kiểu dáng công nghiệp
- (57) Đặc điểm khác biệt yêu cầu bảo hộ của kiểu dáng công nghiệp
- (62) Số và ngày nộp đơn, số bằng độc quyền KDCN hoặc số công bố đơn liên quan đến tách đơn
- (71) Tên và địa chỉ của người nộp đơn
- (72) Tên của tác giả KDCN
- (73) Tên, địa chỉ của chủ bằng độc quyền KDCN
- (74) Tên của người đại diện SHCN

PHẦN I

ĐƠN YÊU CẦU CẤP BẰNG ĐỘC QUYỀN KIỂU DÁNG CÔNG NGHIỆP

- (11) **48500**
(21) 3-2020-00510 (28) 1
(54) **VIÊN NGÓI** (51) **25-01**
(22) 06/03/2020 (43) 25/12/2023
(73) **CÔNG TY TNHH COTTO QUẢNG NINH (VN)**
Cụm công nghiệp Kim Sơn, phường Kim Sơn, thị xã Đông Triều, tỉnh Quảng Ninh
(72) Nguyễn Đức Lợi (VN)
(74) Công ty TNHH Tư vấn đầu tư và Sở hữu trí tuệ Hoàng Phi (HOANG PHI INVEST & I.P CO., LTD)
(55)



1.1



1.2



1.3



1.4



1.5



1.6



1.7

CÔNG BÁO SỞ HỮU CÔNG NGHIỆP SỐ 429 TẬP A – QUYỀN 2 (12.2023)

- (11) **48501**
(21) 3-2020-01123 (28) 1
(54) **BAO BÌ** (51) **09-05**
(22) 15/05/2020 (43) 25/12/2023
(73) **CÔNG TY TNHH SUMI&SUKI (VN)**
Lô 90-92 đường Trần Nam Trung, phường Hòa Xuân, quận Cẩm Lệ, thành phố Đà Nẵng
(72) Lê Văn Đông (VN)
(55)



1.1



1.2

CÔNG BÁO SỞ HỮU CÔNG NGHIỆP SỐ 429 TẬP A – QUYỀN 2 (12.2023)

- (11) **48502**
(21) 3-2020-02811 (28) 3
(54) **HỘP CHỨA** (51) **09-03**
(22) 20/11/2020 (43) 25/12/2023
(30) 007958459-0001 20/05/2020 EM; 007958459-0003 20/05/2020 EM; 007958459-0002 20/05/2020 EM;
(73) **UNILEVER GLOBAL IP LIMITED (UK)**
Port Sunlight, Wirral, Merseyside, CH62 4ZD, United Kingdom
(72) 1. BOULTON OLIVER JAMES (GB)
2. BRZEZINKA HANNAH (GB)
(74) Công ty TNHH Trần Hữu Nam và Đồng sự (TRAN H.N & ASS.)
(55)

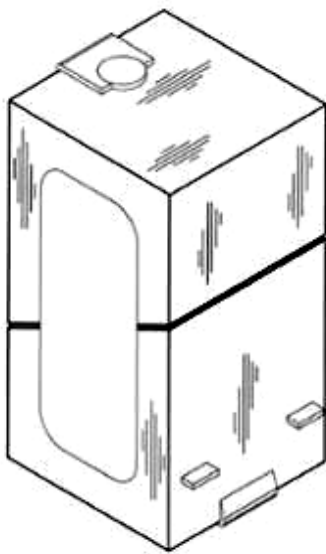

1.1

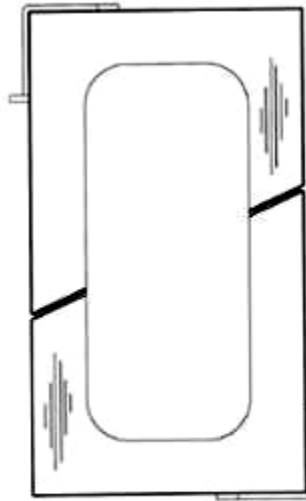

1.2



1.3

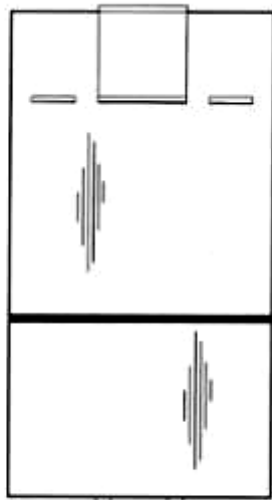

1.4

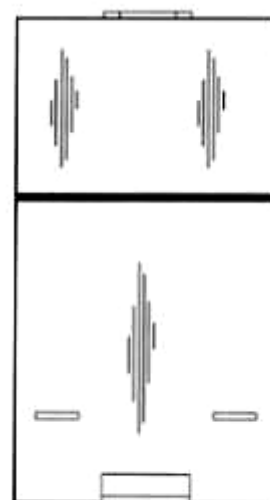

1.5

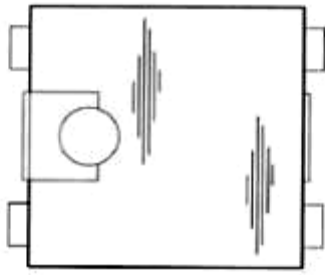

1.6

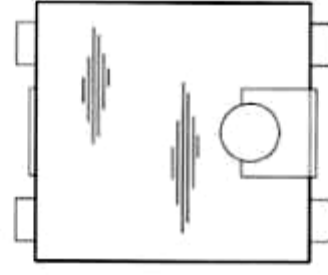

1.7

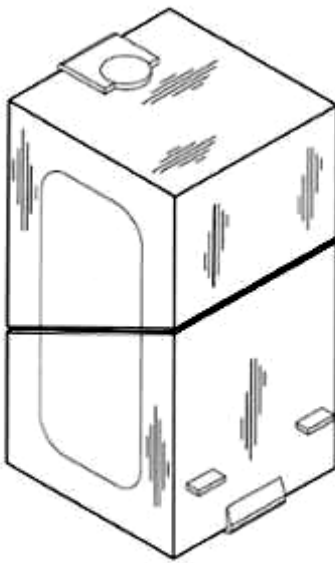

2.1

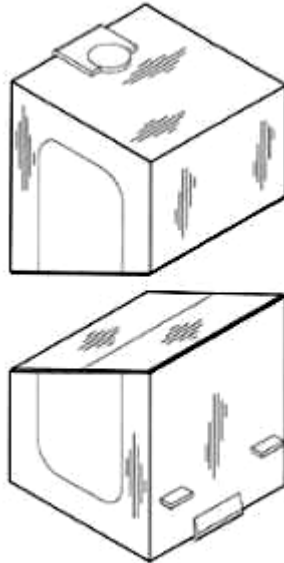

2.2

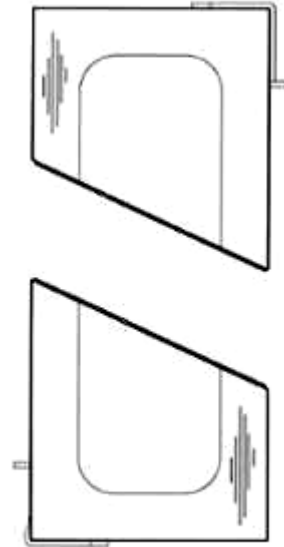

2.3

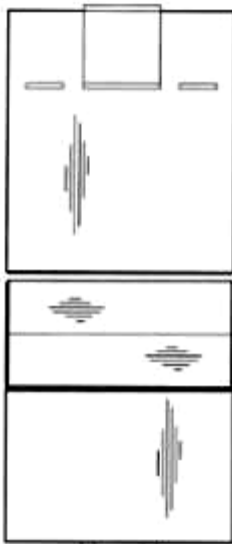

2.4

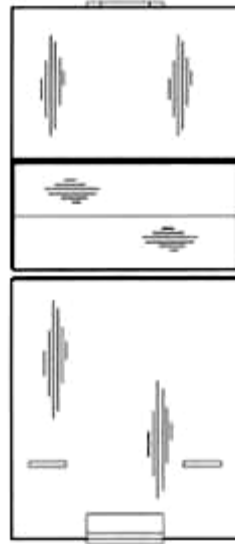

2.5

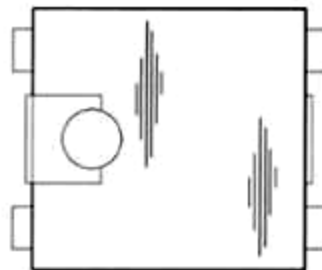

2.6

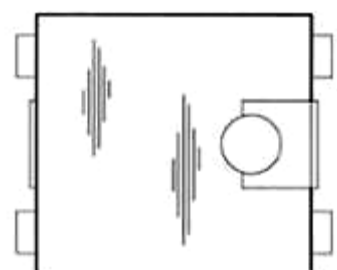

2.7

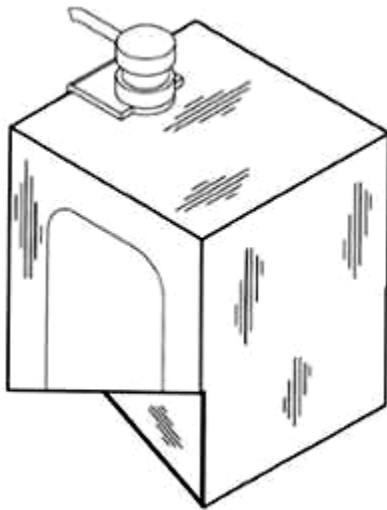

3.1

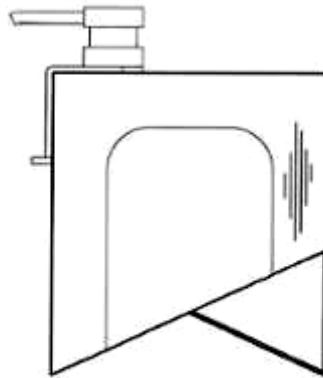

3.2

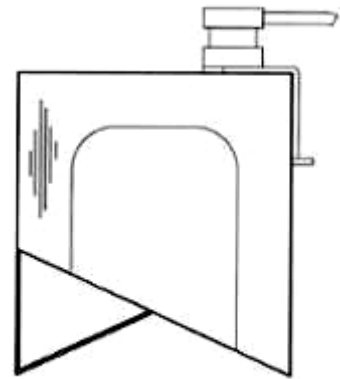

3.3

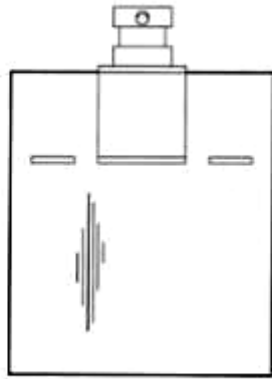

3.4

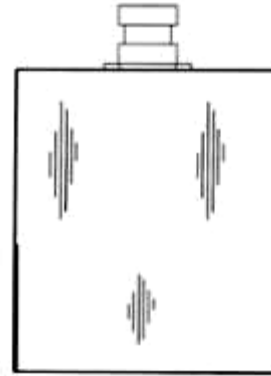

3.5

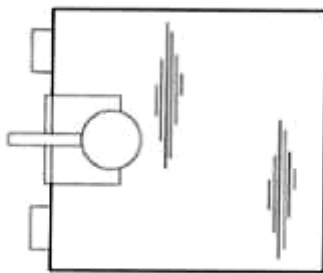

3.6

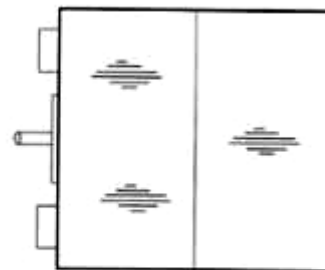

3.7

CÔNG BÁO SỞ HỮU CÔNG NGHIỆP SỐ 429 TẬP A – QUYỀN 2 (12.2023)

- (11) **48503**
(21) 3-2021-00009 (28) 1
(54) **HỘP ĐỰNG SẢN PHẨM** (51) **09-03**
(22) 05/01/2021 (43) 25/12/2023
(73) **CÔNG TY TNHH QUỐC TẾ LUXURY PHARMA (VN)**
Đội 1, thôn Đoài Khê, xã Đan Phượng, huyện Đan Phượng, thành phố Hà Nội
(72) Nguyễn Văn Duân (VN)
(74) Công ty TNHH Sở hữu trí tuệ Bình Minh (SUNRISE IP CO.,LTD.)
(55)



1.1



1.2

CÔNG BÁO SỞ HỮU CÔNG NGHIỆP SỐ 429 TẬP A – QUYỀN 2 (12.2023)

- (11) **48504**
(21) 3-2021-00525 (28) 1
(54) **MÁY LỌC KHÔNG KHÍ** (51) **23-04**
(22) 17/03/2021 (43) 25/12/2023
(73) **CÔNG TY TNHH CÔNG NGHỆ TECOMEN (VN)**
Thôn Từ Hồ, xã Yên Phú, huyện Yên Mỹ, tỉnh Hưng Yên
(72) Bùi Hữu Kiên (VN)
(55)



1.1



1.2



1.3



1.4



1.5



1.6

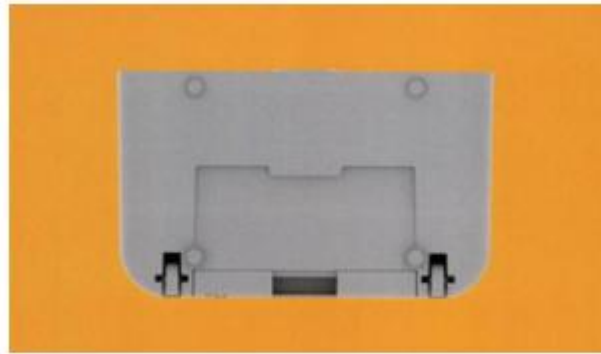

1.7

CÔNG BÁO SỞ HỮU CÔNG NGHIỆP SỐ 429 TẬP A – QUYỀN 2 (12.2023)

- (11) **48505**
- (21) 3-2021-00882 (28) 1
- (54) **NHÃN SẢN PHẨM** (51) **19-08**
- (22) 14/04/2021 (43) 25/12/2023
- (73) **CÔNG TY CỔ PHẦN THỰC PHẨM DINH DƯỠNG ĐẠI VIỆT (VN)**
579/25 Quang Trung, phường 11, quận Gò Vấp, thành phố Hồ Chí Minh
- (72) Nguyễn Quang Hồng Phúc (VN)
- (55)



CÔNG BÁO SỞ HỮU CÔNG NGHIỆP SỐ 429 TẬP A – QUYỀN 2 (12.2023)

- (11) **48506**
(21) 3-2021-02437 (28) 1
(54) **HỘP SẢN PHẨM** (51) **09-03**
(22) 08/10/2021 (43) 25/12/2023
(73) **CÔNG TY CP KING ATTORNEY (VN)**
28D Lý Chiêu Hoàng, phường 10, quận 6, thành phố Hồ Chí Minh
(72) Đỗ Hữu Chiến (VN)
(74) **CÔNG TY TNHH KHANG LUẬT (KHANGLAW)**
(55)



1.1

1.2

1.3

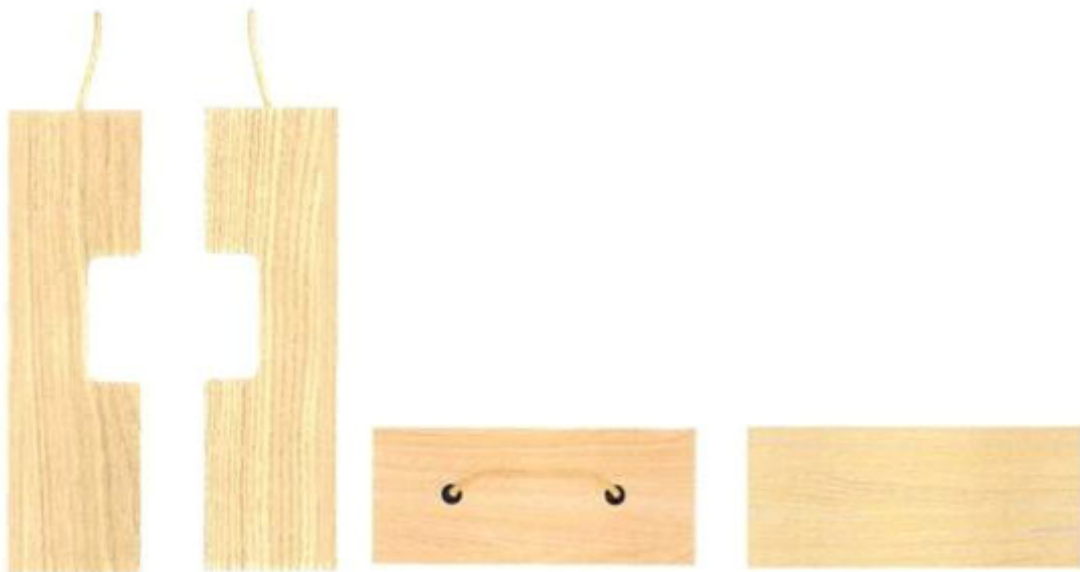

1.4

1.5

1.6

1.7

CÔNG BÁO SỞ HỮU CÔNG NGHIỆP SỐ 429 TẬP A – QUYỀN 2 (12.2023)

(11) **48507**

(21) 3-2021-02501

(28) 1

(54) **MÓNG BÈ NỔI**

(51) **25-02**

(22) 12/10/2021

(43) 25/12/2023

(73) **CÔNG TY CỔ PHẦN KHOA HỌC CÔNG NGHỆ VIỆT NAM (VN)**

Số 6 đường 3 tháng 2, phường 8, thành phố Vũng Tàu, tỉnh Bà Rịa - Vũng Tàu

(72) Hoàng Đức Thảo (VN)

(55)

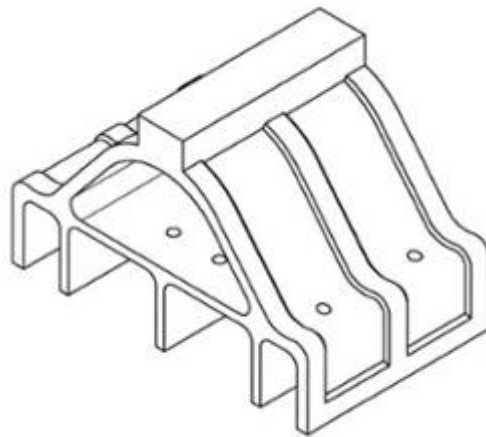

1.1

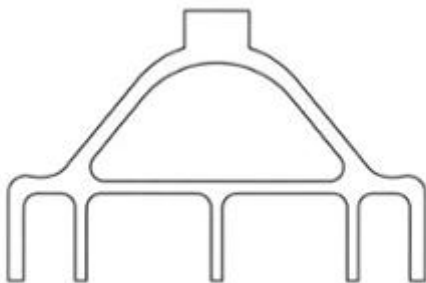

1.2

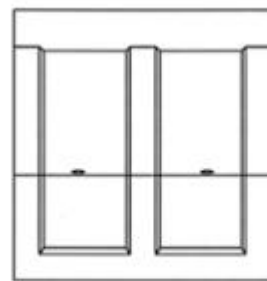

1.3

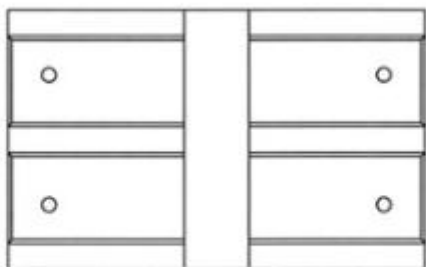

1.4

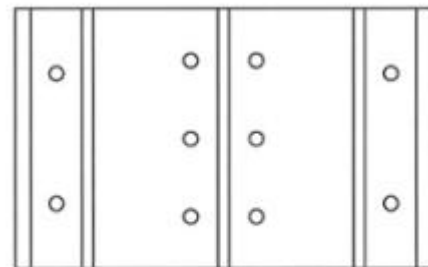

1.5

(11) **48508**

(21) 3-2021-02503

(28) 1

(54) **MÓNG BÈ NỔI**

(51) **25-02**

(22) 12/10/2021

(43) 25/12/2023

(73) **CÔNG TY CỔ PHẦN KHOA HỌC CÔNG NGHỆ VIỆT NAM (VN)**

Số 6 đường 3 tháng 2, phường 8, thành phố Vũng Tàu, tỉnh Bà Rịa - Vũng Tàu

(72) Hoàng Đức Thảo (VN)

(55)

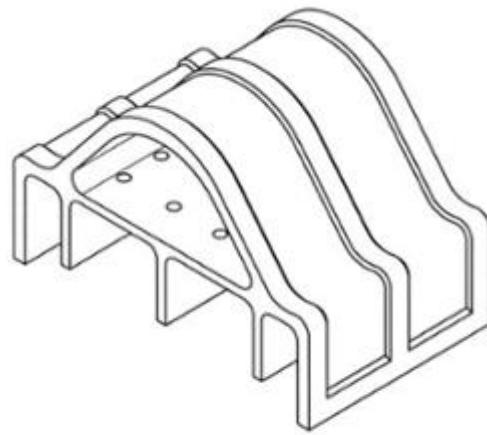

1.1

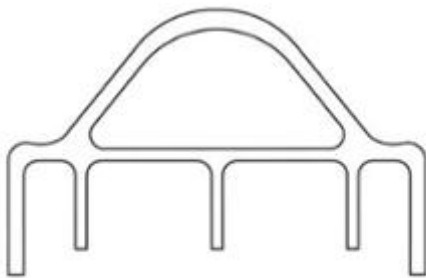

1.2

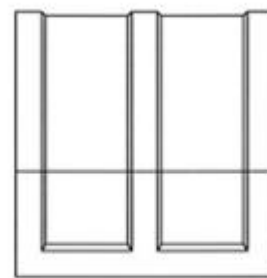

1.3

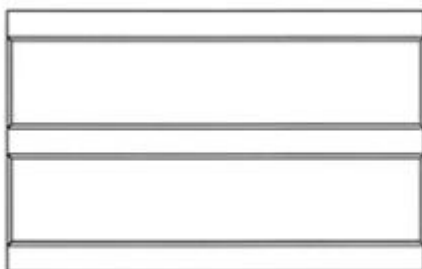

1.4

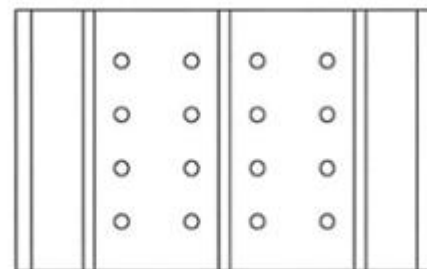

1.5

(11) **48509**

(21) 3-2021-02504

(28) 1

(54) **MÓNG BÈ NỔI**

(51) **25-02**

(22) 12/10/2021

(43) 25/12/2023

(73) **CÔNG TY CỔ PHẦN KHOA HỌC CÔNG NGHỆ VIỆT NAM (VN)**

Số 6 đường 3 tháng 2, phường 8, thành phố Vũng Tàu, tỉnh Bà Rịa - Vũng Tàu

(72) Hoàng Đức Thảo (VN)

(55)

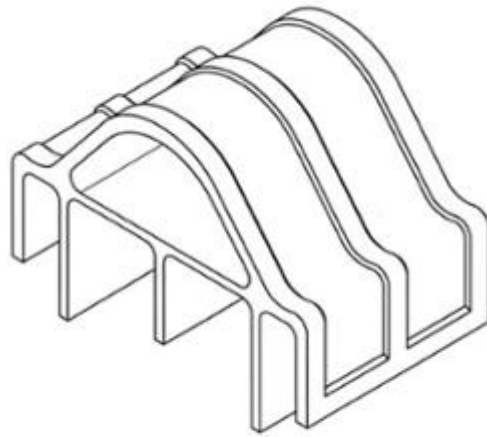

1.1

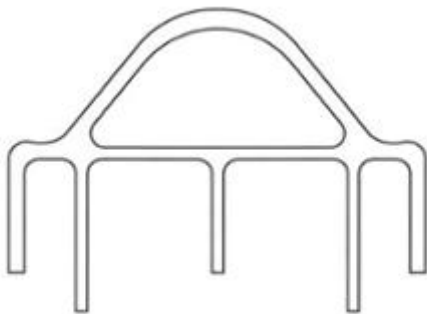

1.2

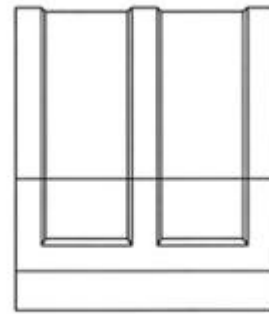

1.3

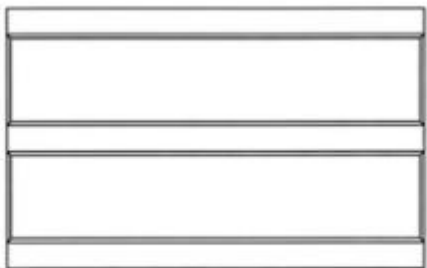

1.4

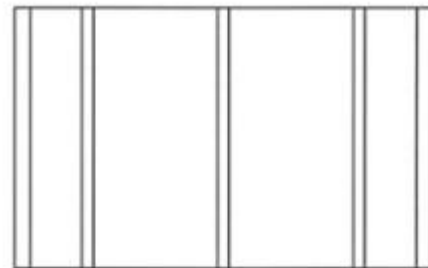

1.5

CÔNG BÁO SỞ HỮU CÔNG NGHIỆP SỐ 429 TẬP A – QUYỀN 2 (12.2023)

- (11) **48510**
(21) 3-2021-02715 (28) 1
(54) **BAO GÓI SẢN PHẨM** (51) **09-05**
(22) 03/11/2021 (43) 25/12/2023
(73) **CƠ SỞ PHÚC MƠ (VN)**
Thôn Hoàng Trung, xã Hồng Dương, huyện Thanh Oai, thành phố Hà Nội
(72) Lê Văn Bình (VN)
(74) Công ty Luật TNHH WINCO (WINCO LAW FIRM)
(55)



1.1



1.2

CÔNG BÁO SỞ HỮU CÔNG NGHIỆP SỐ 429 TẬP A – QUYỀN 2 (12.2023)

- (11) **48511**
(21) 3-2021-02933 (28) 2
(54) **BỘ NHÃN SẢN PHẨM** (51) **19-08**
(22) 24/11/2021 (43) 25/12/2023
(73) **CÔNG TY CỔ PHẦN DẦU THỰC VẬT TƯỜNG AN (VN)**
Lầu 10, tòa nhà Empress Tower, số 138-142 đường Hai Bà Trưng, phường Đa Kao, quận 1, thành phố Hồ Chí Minh
(72) Nguyễn Thị Hạnh (VN)
(74) Công ty TNHH Dịch vụ thương mại và sở hữu công nghiệp Song Ngọc (I.P.T.S.)
(55)



a.1

a.2

1.1

1.2

CÔNG BÁO SỞ HỮU CÔNG NGHIỆP SỐ 429 TẬP A – QUYỀN 2 (12.2023)

- (11) **48512**
(21) 3-2021-02990 (28) 5
(54) **NHÃN SẢN PHẨM** (51) **19-08**
(22) 29/11/2021 (43) 25/12/2023
(73) **CÔNG TY CỔ PHẦN KINGFOODS (VN)**
Số 1 đường 24B, phường An Phú, thành phố Thủ Đức, thành phố Hồ Chí Minh
(72) Nguyễn Mạnh Cường (VN)
(74) Công ty Luật TNHH quốc tế BMVN (BMVN INTERNATIONAL LLC)
(55)



1.1



2.1



3.1



4.1



5.1

CÔNG BÁO SỞ HỮU CÔNG NGHIỆP SỐ 429 TẬP A – QUYỀN 2 (12.2023)

- (11) **48513**
(21) 3-2021-03210 (28) 1
(54) **THÙNG ĐỰNG SƠN** (51) **09-02**
(22) 16/12/2021 (43) 25/12/2023
(73) **CÔNG TY CỔ PHẦN PAINT & MORE (VN)**
135/37/71 Nguyễn Hữu Cảnh, phường 22, quận Bình Thạnh, thành phố Hồ Chí Minh
(72) 1. TRẦN VĂN CHÂU (DE)
2. TRẦN HOÀNG VÂN (US)
(55)



1.1



1.2



1.3



1.4



1.5



1.6



1.7

CÔNG BÁO SỞ HỮU CÔNG NGHIỆP SỐ 429 TẬP A – QUYỀN 2 (12.2023)

- (11) **48514**
- (21) 3-2021-03381 (28) 6
- (54) **THIẾT BỊ THEO DÕI SỨC KHỎE ĐEO ĐƯỢC** (51) **10-04**
- (22) 31/12/2021 (43) 25/12/2023
- (30) US 29/797,847 02/07/2021 US;
- (73) **GOOGLE LLC (US)**
1600 Amphitheatre Parkway, Mountain View, California 94043, United States of America
- (72) 1. PARK, JUNYONG (KR)
2. RIOT, BENJAMIN PATRICK ROBERT JEAN (FR)
3. KOZLOVSKAYA, IRINA IGOREVNA (US)
4. FAIRBANKS, ERIC JOHN (US)
5. PASCHKE BRIAN DENNIS (CA)
6. BERNARD, CÉDRIC ERIC JEAN-EDOUARD (FR)
7. BECKER, JONAH AVRAM (US)
8. VANDENBUSSCHE, GREGOIRE LUDOVIC VINCENT (FR)
- (74) Công ty Luật TNHH ROUSE Việt Nam (ROUSE LEGAL VIETNAM LTD.)
- (55)



1.1



1.2



1.3



1.4



1.5



1.6



1.7



1.8

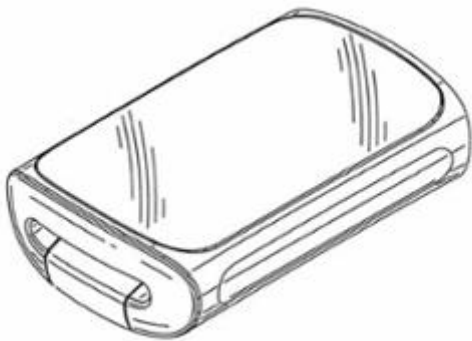

2.1



2.2

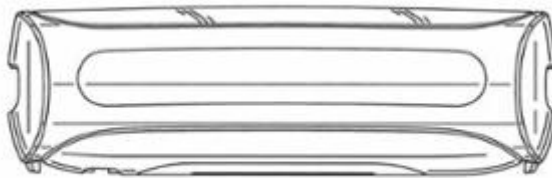

2.3



2.4



2.5



2.6

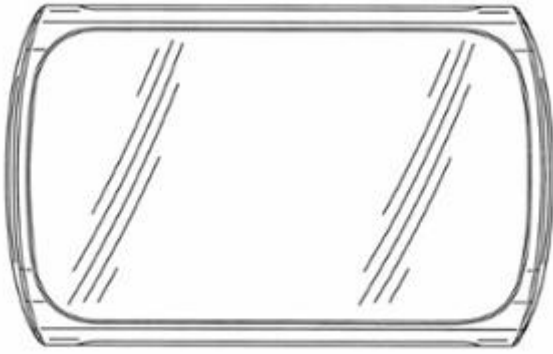

2.7

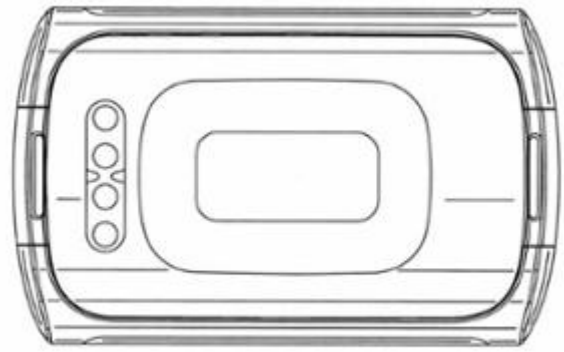

2.8

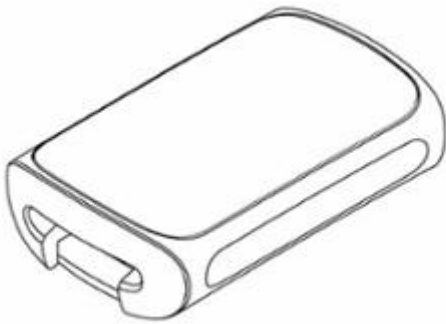

3.1



3.2

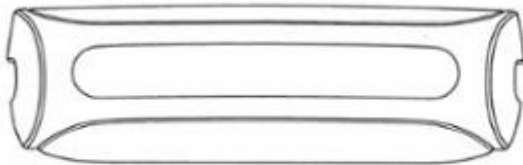

3.3



3.4

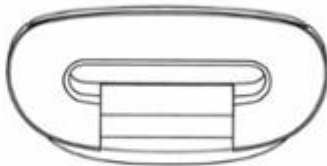

3.5

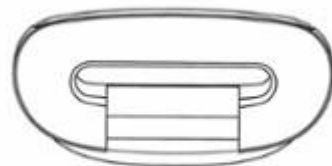

3.6



3.7



3.8

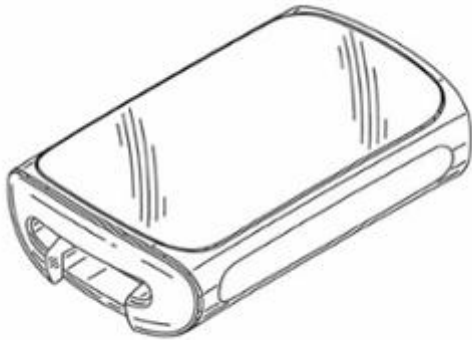

4.1



4.2



4.3



4.4



4.5



4.6

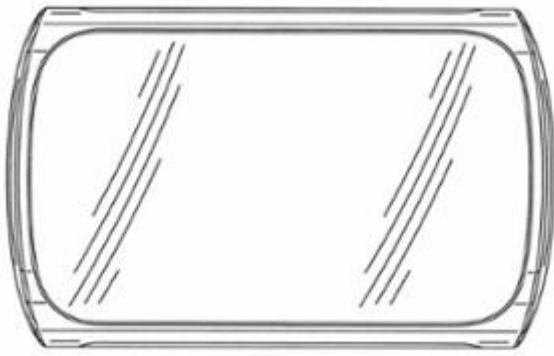

4.7

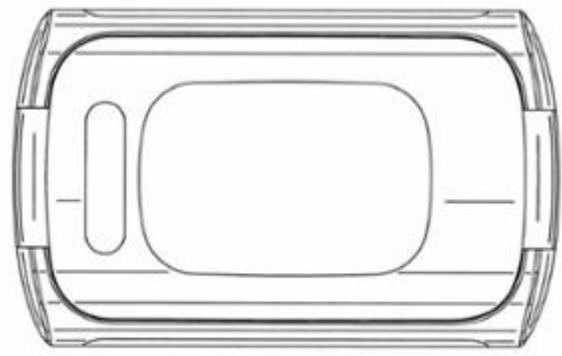

4.8



5.1



5.2



5.3



5.4



5.5



5.6



5.7



5.8

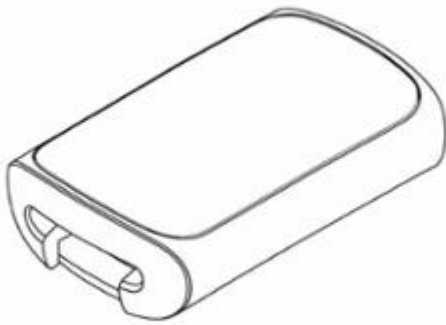

6.1

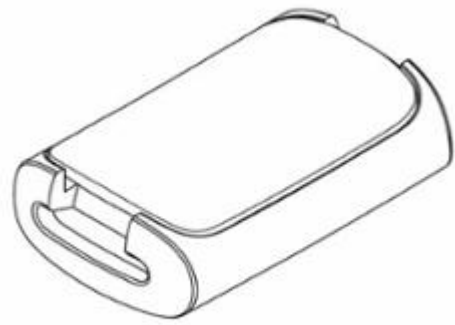

6.2



6.3

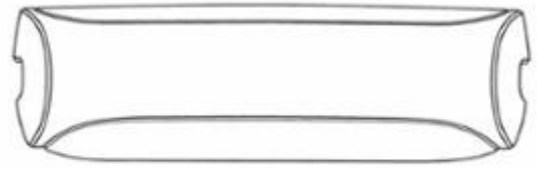

6.4

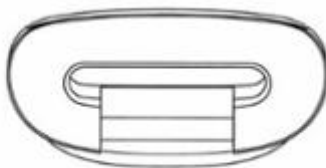

6.5

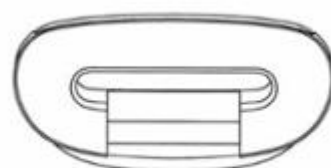

6.6



6.7



6.8

CÔNG BÁO SỞ HỮU CÔNG NGHIỆP SỐ 429 TẬP A – QUYỀN 2 (12.2023)

- (11) **48515**
- (21) 3-2021-03382 (28) 4
- (54) **THIẾT BỊ THEO DÕI SỨC KHỎE ĐEO ĐƯỢC** (51) **10-04**
- (22) 31/12/2021 (43) 25/12/2023
- (30) US 29/797,846 02/07/2021 US;
- (73) **GOOGLE LLC (US)**
1600 Amphitheatre Parkway, Mountain View, California 94043, United States of America
- (72) 1. PARK, JUNYONG (KR)
2. RIOT, BENJAMIN PATRICK ROBERT JEAN (FR)
3. KOZLOVSKAYA, IRINA IGOREVNA (US)
4. FAIRBANKS, ERIC JOHN (US)
5. PASCHKE BRIAN DENNIS (CA)
6. BERNARD, CÉDRIC ERIC JEAN-EDOUARD (FR)
7. BECKER, JONAH AVRAM (US)
8. VANDENBUSSCHE, GREGOIRE LUDOVIC VINCENT (FR)
- (74) Công ty Luật TNHH ROUSE Việt Nam (ROUSE LEGAL VIETNAM LTD.)
- (55)



1.1

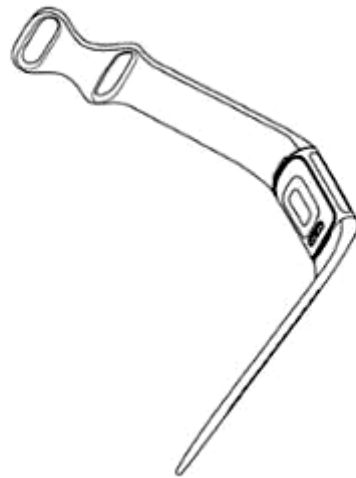

1.2

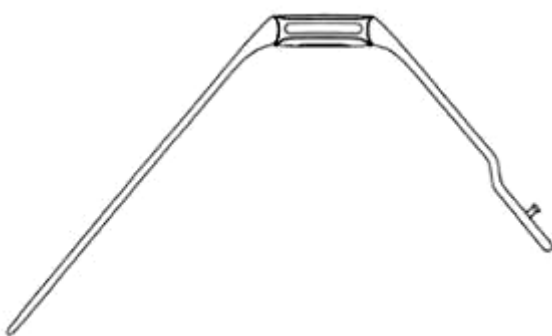

1.3

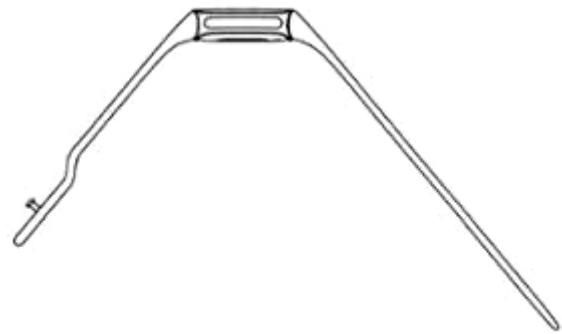

1.4



1.5



1.6



1.7



1.8



2.1



2.2



2.3



2.4



2.5



2.6



2.7



2.8



3.1



3.2



3.3



3.4



3.5



3.6



3.7



3.8



4.1



4.2



4.3



4.4



4.5



4.6



4.7



4.8

CÔNG BÁO SỞ HỮU CÔNG NGHIỆP SỐ 429 TẬP A – QUYỀN 2 (12.2023)

- (11) **48516**
(21) 3-2022-00132 (28) 1
(54) **HỘP SẢN PHẨM** (51) **09-03**
(22) 17/01/2022 (43) 25/12/2023
(73) **CÔNG TY TNHH XUẤT NHẬP KHẨU VÀ KINH DOANH VHP (VN)**
Số 17/331 phố Trần Khát Trân, phường Thanh Nhân, quận Hai Bà Trưng, thành phố Hà Nội
(72) Đào Thị Gấm (VN)
(55)



1.1



1.2

CÔNG BÁO SỞ HỮU CÔNG NGHIỆP SỐ 429 TẬP A – QUYỀN 2 (12.2023)

- (11) **48517**
(21) 3-2022-00133 (28) 1
(54) **HỘP ĐỰNG SỮA ĐẬU ĐỎ** (51) **09-03**
(22) 17/01/2022 (43) 25/12/2023
(73) **CÔNG TY CỔ PHẦN MÍA ĐƯỜNG LAM SƠN (VN)**
Thị trấn Lam Sơn, huyện Thọ Xuân, tỉnh Thanh Hóa
(72) Lê Văn Tân (VN)
(74) Công ty Luật TNHH Phạm và Liên danh (PHAM & ASSOCIATES)
(55)



1.1



1.2



1.3



1.4



1.5



1.6



1.7

CÔNG BÁO SỞ HỮU CÔNG NGHIỆP SỐ 429 TẬP A – QUYỀN 2 (12.2023)

- (11) **48518**
(21) 3-2022-00232 (28) 1
(54) **BÀN CHẢI** (51) **04-02**
(22) 28/01/2022 (43) 25/12/2023
(30) 008637441-0001 02/08/2021 EM;
(73) **UNILEVER GLOBAL IP LIMITED (GB)**
Port Sunlight Wirral, Merseyside CH62 4ZD, United Kingdom
(72) 1. KING JAMIE MARK (GB)
2. NEELY DEBORAH ELIZABETH (GB)
3. SHAIKH FEHMIDA BEGUM (IN)
(74) Công ty TNHH Trần Hữu Nam và Đồng sự (TRAN H.N & ASS.)
(55)

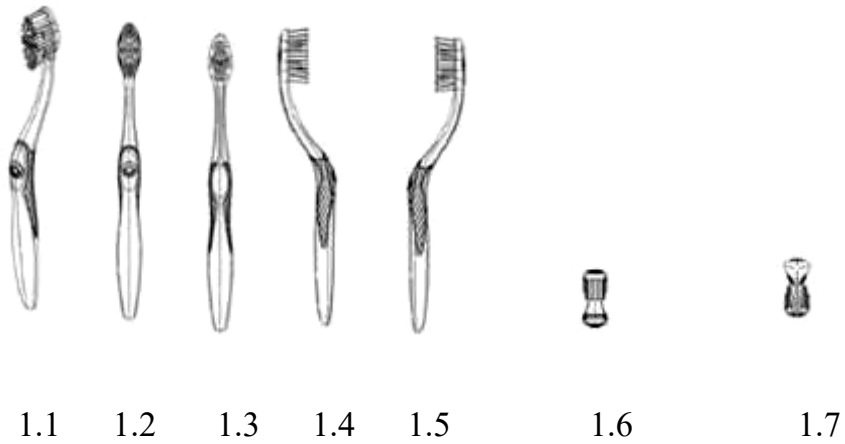

- (11) **48519**
(21) 3-2022-00234 (28) 1
(54) **BÀN CHẢI** (51) **04-02**
(22) 28/01/2022 (43) 25/12/2023
(30) 008637441-0002 02/08/2021 EM;
(73) **UNILEVER GLOBAL IP LIMITED (GB)**
Port Sunlight Wirral, Merseyside CH62 4ZD, United Kingdom
(72) 1. KING JAMIE MARK (GB)
2. NEELY DEBORAH ELIZABETH (GB)
3. SHAIKH FEHMIDA BEGUM (IN)
(74) Công ty TNHH Trần Hữu Nam và Đồng sự (TRAN H.N & ASS.)
(55)

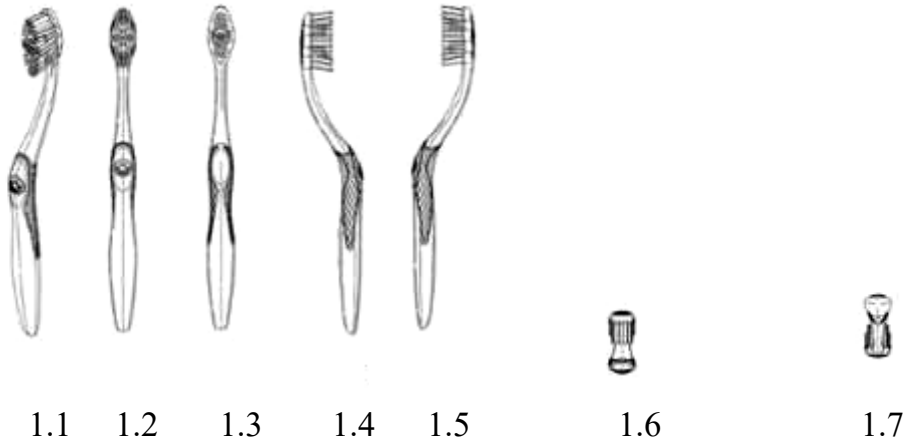

CÔNG BÁO SỞ HỮU CÔNG NGHIỆP SỐ 429 TẬP A – QUYỀN 2 (12.2023)

- (11) **48520**
(21) 3-2022-00258 (28) 1
(54) **HỘP CÁC TÔNG** (51) **09-03**
(22) 08/02/2022 (43) 25/12/2023
(30) 008646533-0001 09/08/2021 EM;
(73) **UNILEVER GLOBAL IP LIMITED** (GB)
Port Sunlight Wirral, Merseyside CH62 4ZD, United Kingdom
(72) 1. CREBO JULIE KATHLEEN MARY (GB)
2. SPENCE ALLISON FAY (GB)
3. TRACEY CHANEL EMILY (GB)
(74) Công ty TNHH Trần Hữu Nam và Đồng sự (TRAN H.N & ASS.)
(55)



1.1

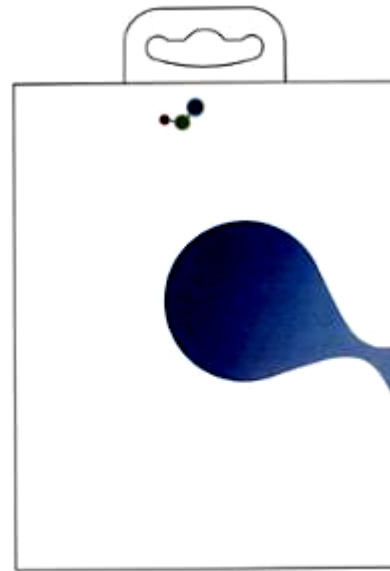

1.2



1.3



1.4

1.5



1.6



1.7

CÔNG BÁO SỞ HỮU CÔNG NGHIỆP SỐ 429 TẬP A – QUYỀN 2 (12.2023)

- (11) **48521**
(21) 3-2022-00377 (28) 1
(54) **ỐNG NHỰA** (51) **25-99**
(22) 25/02/2022 (43) 25/12/2023
(73) **CÔNG TY TNHH MỘT THÀNH VIÊN KIM TỰ THÁP (VN)**
Lô B8, cụm công nghiệp Phú Mỹ, xã Tam Phước, huyện Phú Ninh, tỉnh Quảng Nam
(72) Lê Văn Trọng (VN)
(74) Công ty TNHH T&T INVENMARK Sở hữu trí tuệ Quốc tế (T&T INVENMARK CO., LTD.)
(55)

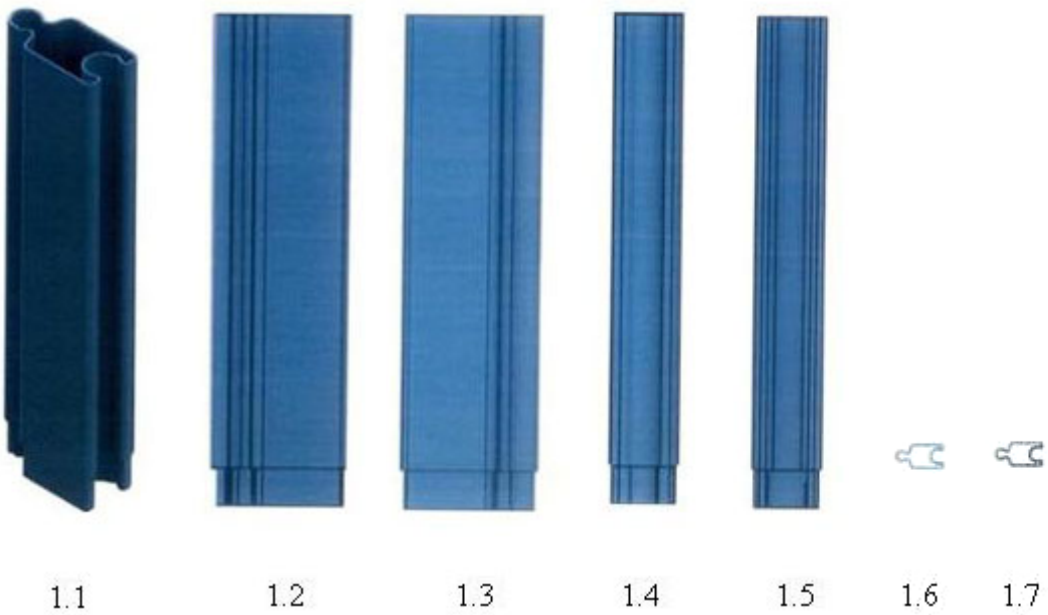

CÔNG BÁO SỞ HỮU CÔNG NGHIỆP SỐ 429 TẬP A – QUYỀN 2 (12.2023)

- (11) **48522**
- (21) 3-2022-00427
- (54) **HỘP**
- (22) 09/03/2022
- (73) **CÔNG TY CỔ PHẦN SỮA VITADAIRY VIỆT NAM (VN)**
Tầng 5, số 37 Tôn Đức Thắng, phường Bến Nghé, quận 1, thành phố Hồ Chí Minh
- (72) Nguyễn Thị Hà (VN)
- (55)
- (28) 1
- (51) **09-03**
- (43) 25/12/2023



1.1



1.2



1.3



1.4



1.5



1.6



1.7

CÔNG BÁO SỞ HỮU CÔNG NGHIỆP SỐ 429 TẬP A – QUYỀN 2 (12.2023)

- (11) **48523**
(21) 3-2022-00535 (28) 1
(54) **HỘP TRÀ** (51) **09-03**
(22) 24/03/2022 (43) 25/12/2023
(73) **CÔNG TY TNHH MỘT THÀNH VIÊN VĂN THỊNH PHÁT (VN)**
Số 53 đường Thành Thái, phường Long Hoa, thị xã Hòa Thành, tỉnh Tây Ninh
(72) Nguyễn Anh Tuấn (VN)
(55)



1.1



1.2

CÔNG BÁO SỞ HỮU CÔNG NGHIỆP SỐ 429 TẬP A – QUYỀN 2 (12.2023)

(11) **48524**

(21) 3-2022-00614

(28) 1

(54) **QUẠT**

(51) **23-04**

(22) 04/04/2022

(43) 25/12/2023

(73) **CÔNG TY TNHH HÀ NỘI CHING HAI (VN)**

KCN Đại Đồng - Hoàn Sơn, xã Đại Đồng, huyện Tiên Du, tỉnh Bắc Ninh

(72) LIN HSIEN TSUNG (TW)

(55)



1.1



1.2



1.3



1.4



1.5



1.6



1.7

CÔNG BÁO SỞ HỮU CÔNG NGHIỆP SỐ 429 TẬP A – QUYỀN 2 (12.2023)

- (11) **48525**
(21) 3-2022-00628 (28) 1
(54) **HỘP** (51) **09-03**
(22) 05/04/2022 (43) 25/12/2023
(73) **NGÔ VĨNH PHONG (VN)**
90 Hải Thượng Lãn Ông, phường 10, quận 5, thành phố Hồ Chí Minh
(72) Ngô Vĩnh Phong (VN)
(74) Công ty TNHH một thành viên Trường Luật (Trường Luật)
(55)



1.1



1.2

CÔNG BÁO SỞ HỮU CÔNG NGHIỆP SỐ 429 TẬP A – QUYỀN 2 (12.2023)

- (11) **48526**
(21) 3-2022-00754 (28) 1
(54) **BAO GÓI** (51) **09-05**
(22) 18/04/2022 (43) 25/12/2023
(73) **CÔNG TY TNHH THƯƠNG MẠI XUẤT NHẬP KHẨU NGUYỄN HỮU THẮNG (VN)**
Số 36B/14 đường 762 Hồng Bàng, phường 1, quận 11, thành phố Hồ Chí Minh
(72) Nguyễn Đình Thái (VN)
(74) Công ty TNHH một thành viên Trường Luật (Trường Luật)
(55)



1.1



1.2



1.3



1.4



1.5



1.6



1.7



2.1



2.2



2.3



2.4



2.5



2.6



2.7

CÔNG BÁO SỞ HỮU CÔNG NGHIỆP SỐ 429 TẬP A – QUYỀN 2 (12.2023)

- (11) **48527**
(21) 3-2022-00820 (28) 1
(54) **TÚI ĐỰNG SẢN PHẨM** (51) **09-05**
(22) 26/04/2022 (43) 25/12/2023
(73) **LÊ HUYỀN TÂY THỦY (VN)**
128 đường Trương Định, phường Phước Hòa, thành phố Nha Trang, tỉnh Khánh Hòa
(72) Lê Huyền Tây Thủy (VN)
(55)



1.1



1.2

CÔNG BÁO SỞ HỮU CÔNG NGHIỆP SỐ 429 TẬP A – QUYỀN 2 (12.2023)

(11) **48528**

(21) 3-2022-00958

(28) 1

(54) **TỦ ĐIỆN ĐIỀU KHIỂN TỰ ĐỘNG**

(51) **13-03**

(22) 16/05/2022

(43) 25/12/2023

(73) **CÔNG TY TNHH ĐẦU TƯ IKON (VN)**

208 Bạch Đằng, phường 24, quận Bình Thạnh, thành phố Hồ Chí Minh

(72) 1. NGUYỄN ĐĂNG TẤN QUÝ (VN)

2. DƯƠNG MIÊN KA (VN)

3. NGUYỄN DUY KHANH (VN)

4. PHẠM ĐỨC HIỀN (VN)

(55)



1.1



1.2



1.3



1.4



1.5

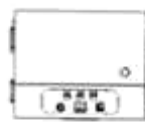

1.6



1.7

CÔNG BÁO SỞ HỮU CÔNG NGHIỆP SỐ 429 TẬP A – QUYỀN 2 (12.2023)

- (11) **48529**
- (21) 3-2022-01026 (28) 1
- (54) **MÔ ĐUN TỬ ĐIỆN ĐIỀU KHIỂN TỰ ĐỘNG** (51) **13-03**
- (22) 30/05/2022 (43) 25/12/2023
- (73) **CÔNG TY TNHH ĐẦU TƯ IKON (VN)**
208 Bạch Đằng, phường 24, quận Bình Thạnh, thành phố Hồ Chí Minh
- (72) 1. NGUYỄN ĐĂNG TẤN QUÝ (VN)
2. DƯƠNG MIÊN KA (VN)
3. NGUYỄN DUY KHANH (VN)
4. PHẠM ĐỨC HIỀN (VN)
- (55)



1.1



1.2



1.3



1.4



1.5



1.6



1.7

(11) **48530**

(21) 3-2022-01079

(54) **BỘ BI CHƠI GÔN**

(22) 03/06/2022

(73) **TẠ VĂN HIỂN (VN)**

09 Nguyễn Huệ, phường 1, thị xã Vĩnh Châu, tỉnh Sóc Trăng

(72) Tạ Văn Hiến (VN)

(55)

(28) 3

(51) **21-01**

(43) 25/12/2023



1.1



1.2



1.3



1.4



1.5



1.6

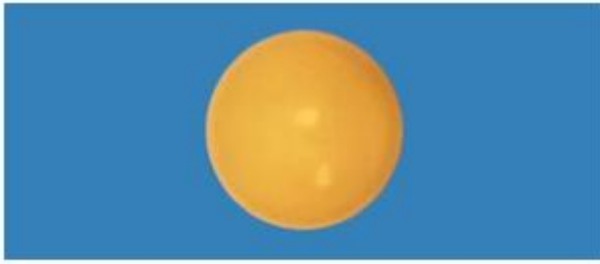

1.7



1.8



1.9



1.10



1.11



1.12



1.13

CÔNG BÁO SỞ HỮU CÔNG NGHIỆP SỐ 429 TẬP A – QUYỀN 2 (12.2023)

- (11) **48531**
(21) 3-2022-01167 (28) 1
(54) **ĐẾ ĐỖ** (51) **09-08**
(22) 15/06/2022 (43) 25/12/2023
(73) **CROCODILE PRODUCTS INC. (CA)**
32227 TWP Rd, 243A Calgary, Alberta T3Z 2M8, CANADA
(72) FORBES, Dean (CA)
(74) Công ty Luật TNHH WINCO (WINCO LAW FIRM)
(55)

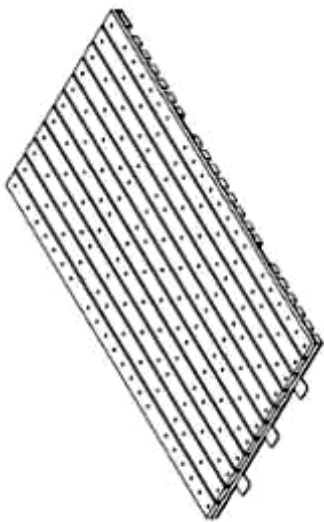

1.1



1.2



1.3

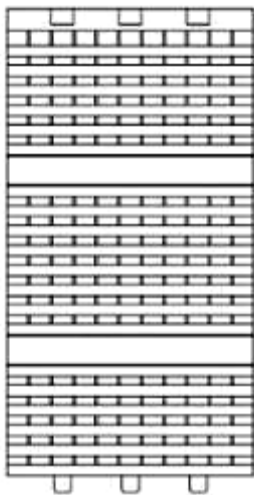

1.4



1.5

1.6



1.7



1.8

CÔNG BÁO SỞ HỮU CÔNG NGHIỆP SỐ 429 TẬP A – QUYỀN 2 (12.2023)

- (11) **48532**
- (21) 3-2022-01168
- (54) **ĐẾ ĐỖ**
- (22) 15/06/2022
- (73) **CROCODILE PRODUCTS INC. (CA)**
32227 TWP Rd, 243A Calgary, Alberta T3Z 2M8, CANADA
- (72) FORBES, Dean (CA)
- (74) Công ty Luật TNHH WINCO (WINCO LAW FIRM)
- (55)

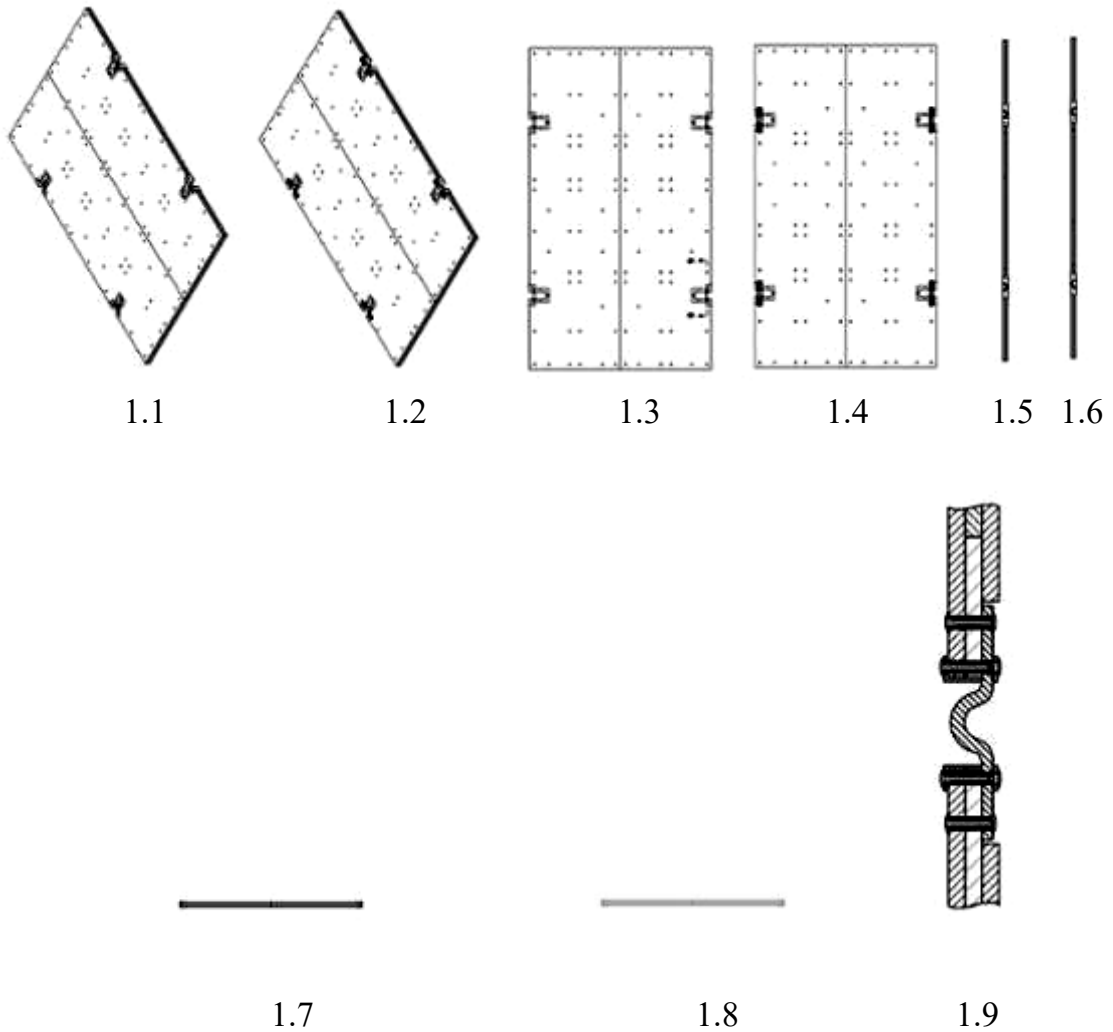

- (11) **48533**
- (21) 3-2022-01170
- (54) **ĐẾ ĐỖ**
- (22) 15/06/2022
- (73) **CROCODILE PRODUCTS INC. (CA)**
32227 TWP Rd, 243A Calgary, Alberta T3Z 2M8, CANADA
- (72) FORBES, Dean (CA)
- (74) Công ty Luật TNHH WINCO (WINCO LAW FIRM)
- (55)
- (28) 1
- (51) **09-08**
- (43) 25/12/2023

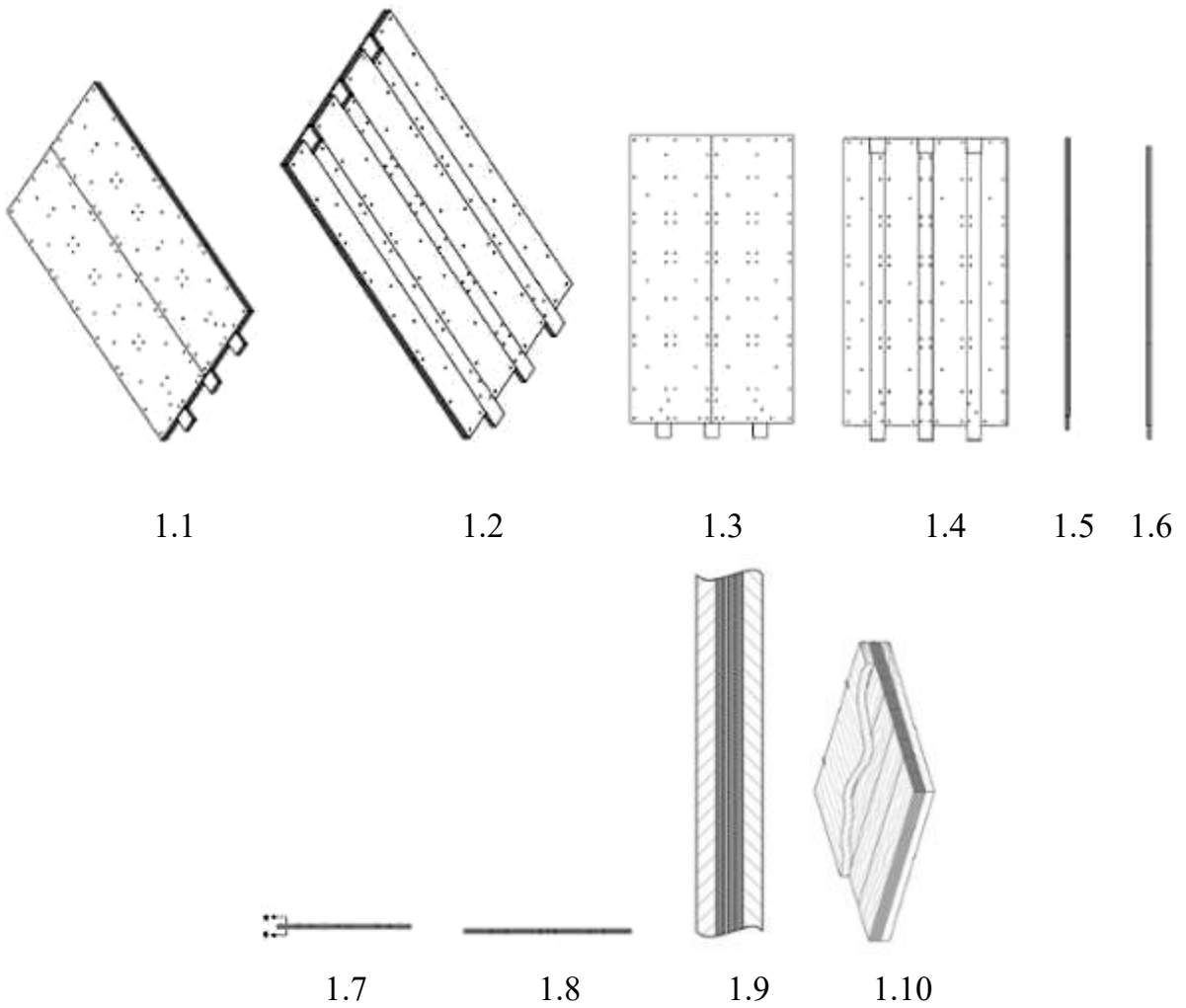

CÔNG BÁO SỞ HỮU CÔNG NGHIỆP SỐ 429 TẬP A – QUYỀN 2 (12.2023)

- (11) **48534**
(21) 3-2022-01171 (28) 1
(54) **ĐẾ ĐỖ** (51) **09-08**
(22) 15/06/2022 (43) 25/12/2023
(73) **CROCODILE PRODUCTS INC. (CA)**
32227 TWP Rd, 243A Calgary, Alberta T3Z 2M8, CANADA
(72) FORBES, Dean (CA)
(74) Công ty Luật TNHH WINCO (WINCO LAW FIRM)
(55)

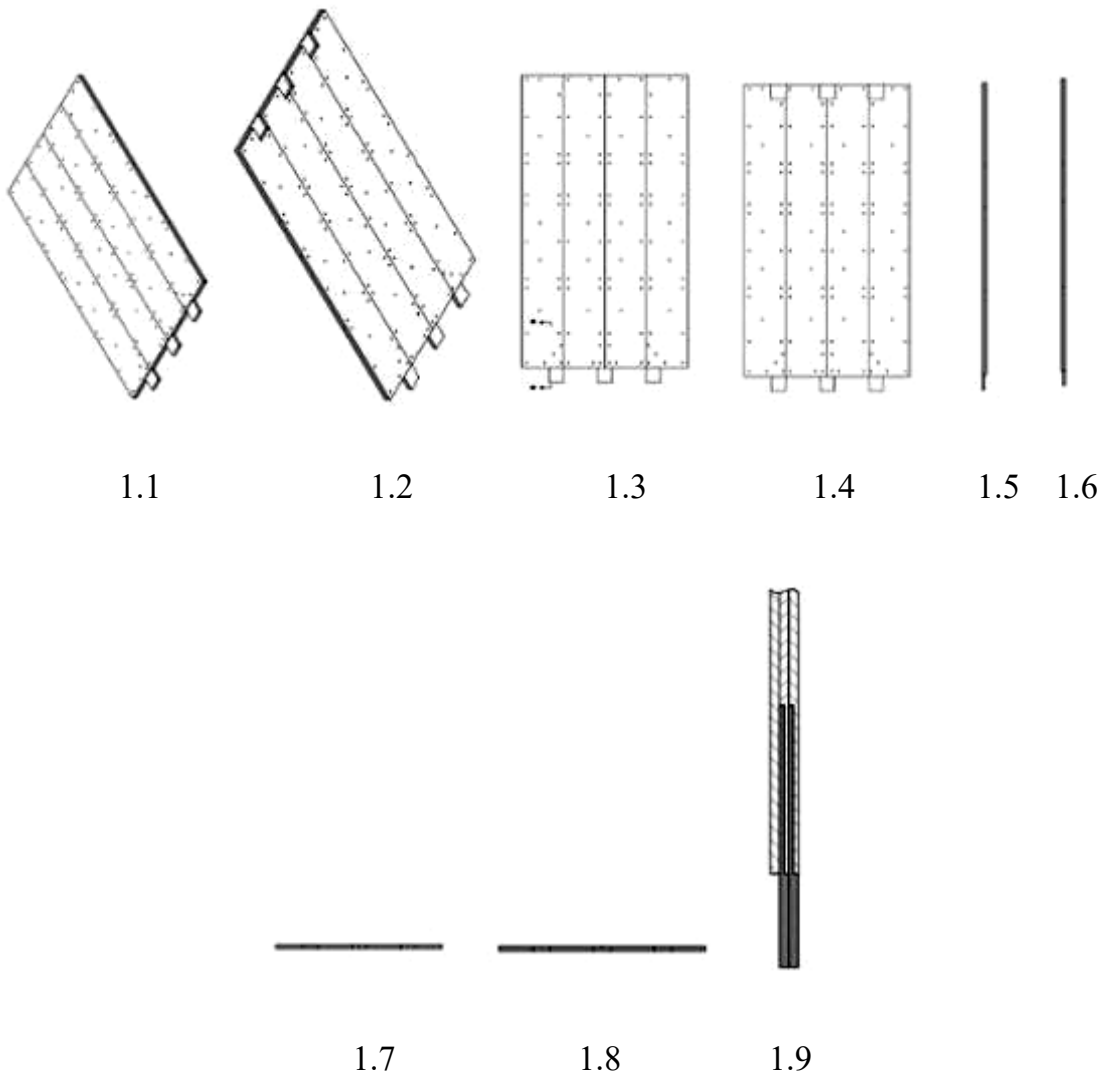

CÔNG BÁO SỞ HỮU CÔNG NGHIỆP SỐ 429 TẬP A – QUYỀN 2 (12.2023)

- (11) **48535**
(21) 3-2022-01331 (28) 1
(54) **HỘP ĐỰNG SẢN PHẨM** (51) **09-03**
(22) 30/06/2022 (43) 25/12/2023
(73) **CÔNG TY TNHH DƯỢC MỸ PHẨM SOO YOUNG KOREA (VN)**
49/48 đường số 4, phường Bình Hưng Hòa A, quận Bình Tân, thành phố Hồ Chí Minh
(72) Nguyễn Thị Kim Ngân (VN)
(74) Công ty TNHH Sở hữu trí tuệ A&Z (A&Z IP)
(55)



1.1



1.2



1.3



1.4

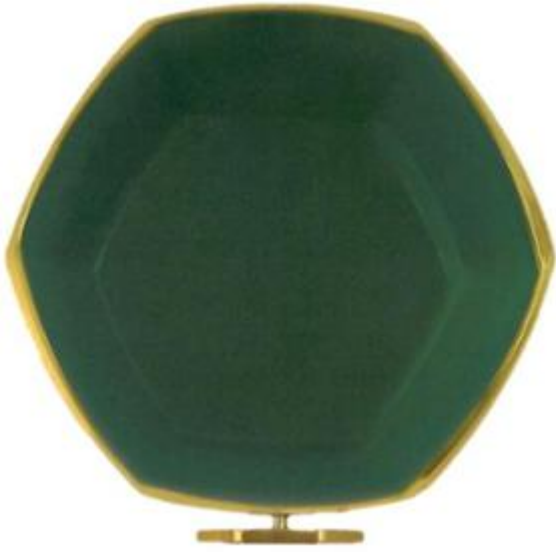

1.5



1.6



1.7

CÔNG BÁO SỞ HỮU CÔNG NGHIỆP SỐ 429 TẬP A – QUYỀN 2 (12.2023)

- (11) **48536**
(21) 3-2022-01411 (28) 1
(54) **HỘP** (51) **09-03**
(22) 14/07/2022 (43) 25/12/2023
(73) **CÔNG TY TNHH THƯƠNG MẠI VÀ DƯỢC PHẨM TÂY ĐỨC VIỆT (VN)**
Số 1 ngách 35/81 Đặng Thai Mai, phường Quảng An, quận Tây Hồ, thành phố Hà Nội
(72) Lê Hữu Thanh (VN)
(74) Công ty TNHH NACILAW (NACILAW)
(55)



1.1



1.2

CÔNG BÁO SỞ HỮU CÔNG NGHIỆP SỐ 429 TẬP A – QUYỀN 2 (12.2023)

- (11) **48537**
- (21) 3-2022-01463 (28) 2
- (54) **TẦM LÁT SÀN** (51) **25-01**
- (22) 21/07/2022 (43) 25/12/2023
- (30) 29/824,050 21/01/2022 US;
- (73) **SHAW INDUSTRIES GROUP, INC. (US)**
616 East Walnut Avenue, Dalton, GA 30720 United States of America
- (72) Jason SHAW (US)
- (74) Công ty TNHH Tầm nhìn và Liên danh (VISION & ASSOCIATES CO.LTD.)
- (55)

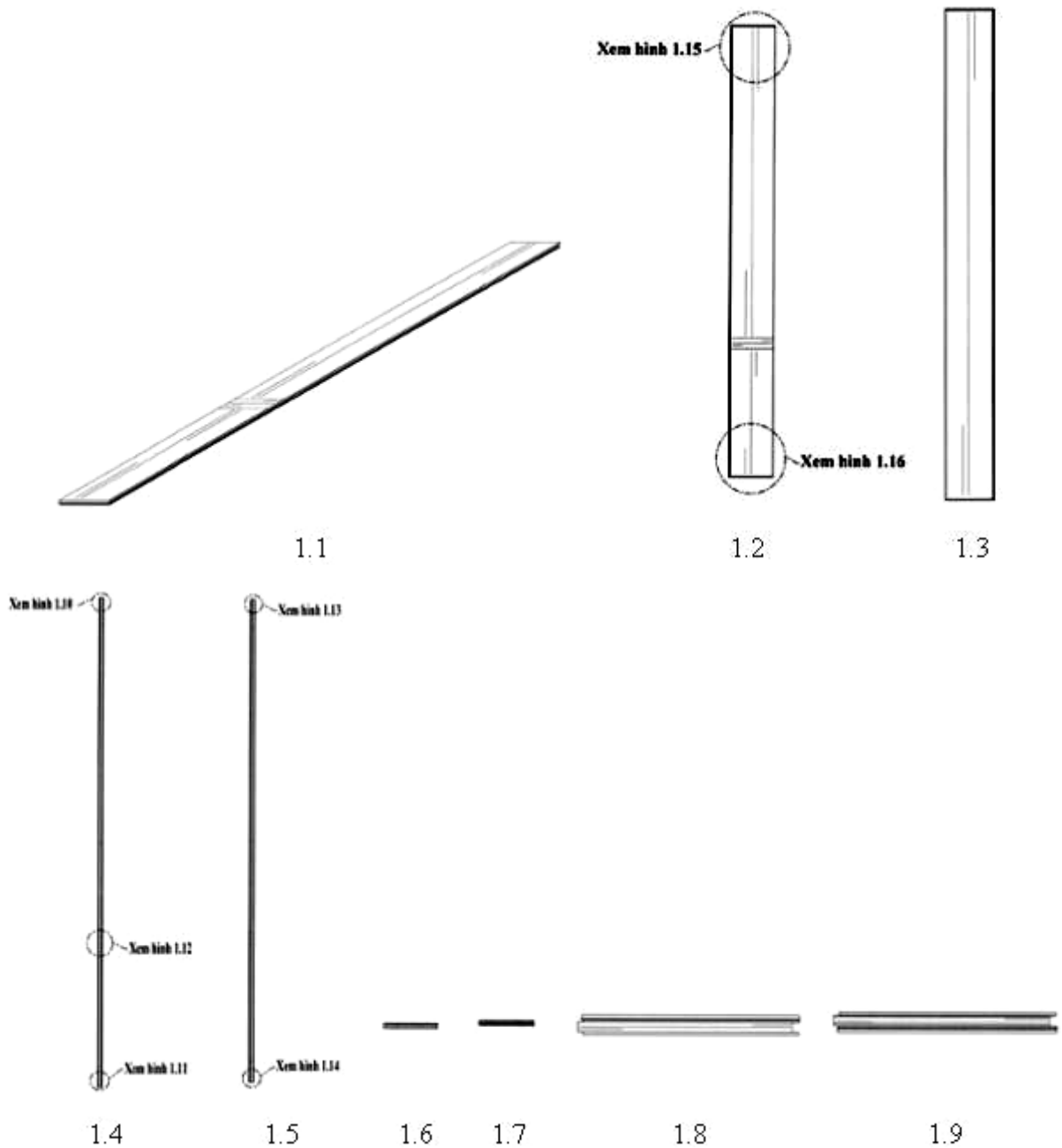



1.10



1.11



1.12



1.13



1.14

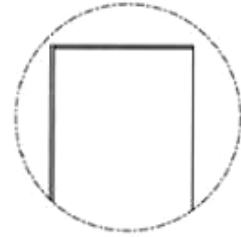

1.15



1.16



2.1

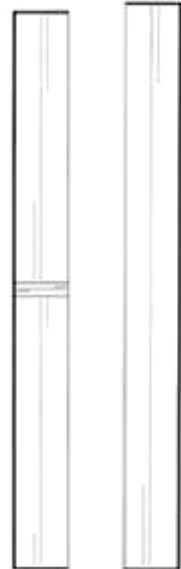

2.2

2.3



Xem hình 2.10

2.4

2.5



2.6



2.7



2.8



2.9



2.10

CÔNG BÁO SỞ HỮU CÔNG NGHIỆP SỐ 429 TẬP A – QUYỀN 2 (12.2023)

- (11) **48538**
(21) 3-2022-01539 (28) 1
(54) **LÒ ĐỐT RÁC DI ĐỘNG** (51) **23-99**
(22) 29/07/2022 (43) 25/12/2023
(73) **CÔNG TY CỔ PHẦN AIPT VIỆT NAM (VN)**
Số 86, đường 3.6, khu đô thị Gamuda Gardens, phường Trần Phú, quận Hoàng Mai,
thành phố Hà Nội
(72) Nguyễn Trung Ái (VN)
(55)



1.1



1.2



1.3



1.4

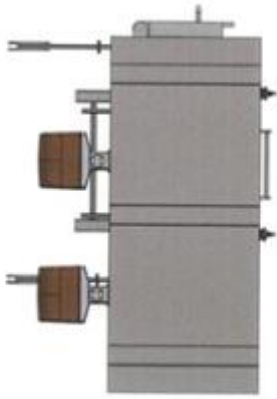

1.5

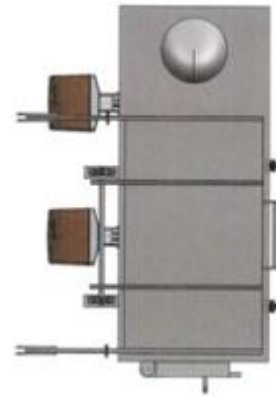

1.6

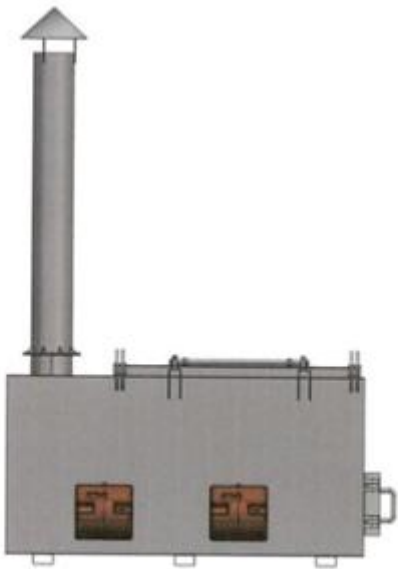

1.7



1.8

CÔNG BÁO SỞ HỮU CÔNG NGHIỆP SỐ 429 TẬP A – QUYỀN 2 (12.2023)

- (11) **48539**
(21) 3-2022-01630 (28) 1
(54) **TAY CẦM DỤNG CỤ LÀM VƯỜN** (51) **08-06**
(22) 11/08/2022 (43) 25/12/2023
(73) **CÔNG TY TNHH UNITED JUMBO (VN)**
Đường số 10, KCN Suối Tre, phường Suối Tre, thành phố Long Khánh, tỉnh Đồng Nai
(72) Wang, Jui-Fu (TW)
(74) **CÔNG TY TNHH SỞ HỮU TRÍ TUỆ SETHACO (SETHACO IP CO.,LTD)**
(55)



Hình 1: hình phối cảnh

1.1



Hình 2: hình chiếu phía trước

1.2



Hình 3: hình chiếu phía sau

1.3



Hình 4: hình chiếu bên trái

1.4



Hình 5: hình chiếu bên phải

1.5



Hình 6: hình chiếu phía trên

1.6



Hình 7: hình chiếu phía dưới

1.7

- (11) **48540**
(21) 3-2022-01646 (28) 1
(54) **DỤNG CỤ XOA BÓP LẮP RÁP** (51) **28-03**
(22) 12/08/2022 (43) 25/12/2023
(73) **BÙI MINH TÂM (VN)**
16 Ký Con, phường 7, quận Phú Nhuận, thành phố Hồ Chí Minh
(72) Bùi Minh Tâm (VN)
(74) Công ty Luật TNHH bản quyền Quốc tế (CIS LAW FIRM)
(55)

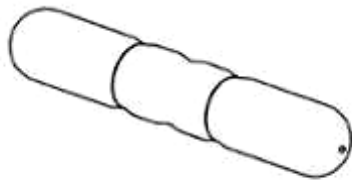

1.1



1.2



1.3



1.4

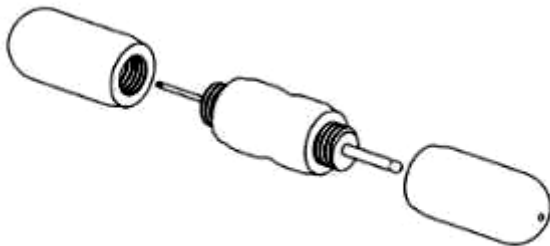

...

1.5



1.6



1.7



1.8

CÔNG BÁO SỞ HỮU CÔNG NGHIỆP SỐ 429 TẬP A – QUYỀN 2 (12.2023)

- (11) **48541**
(21) 3-2022-01755 (28) 1
(54) **NỒI ÁP SUẤT** (51) **07-02**
(22) 19/08/2022 (43) 25/12/2023
(30) 2022-004246 02/03/2022 JP;
(73) **PANASONIC INTELLECTUAL PROPERTY MANAGEMENT CO., LTD.**
(JP)
1-61, Shiromi 2-chome, Chuo-ku, Osaka-shi, Osaka 540-6207 Japan
(72) 1. SAKIKO UCHIYAMA (JP)
2. TSUYOSHI YOSHIYAMA (JP)
(74) Công ty TNHH một thành viên Sở hữu trí tuệ VCCI (VCCI-IP CO.,LTD)
(55)

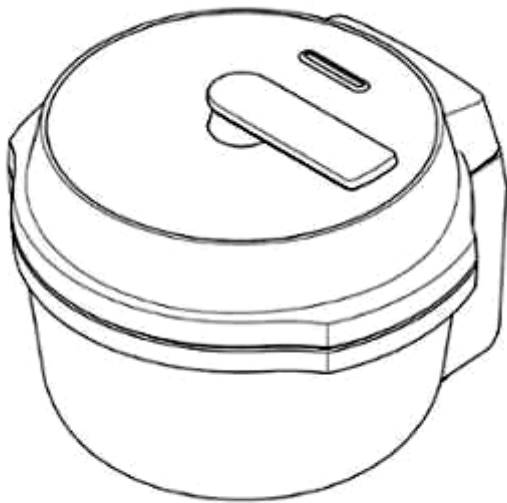

1.1

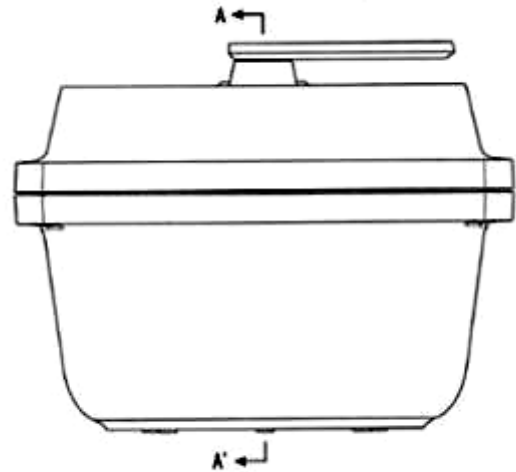

1.2

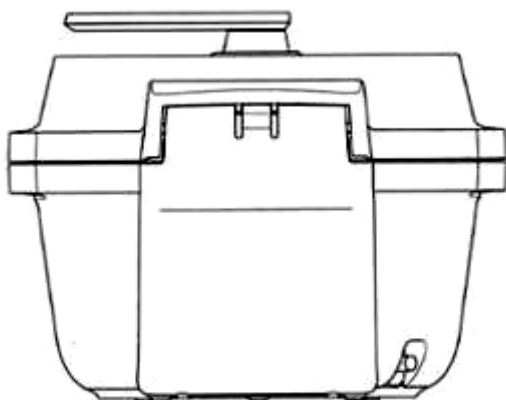

1.3

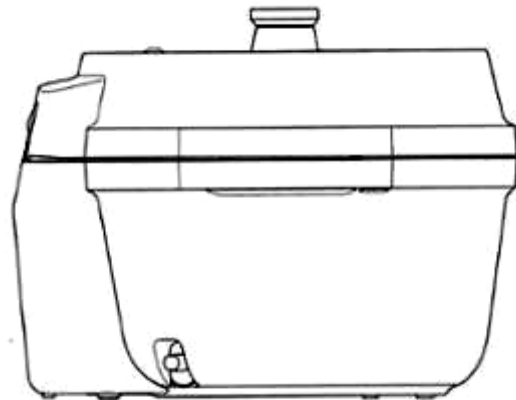

1.4

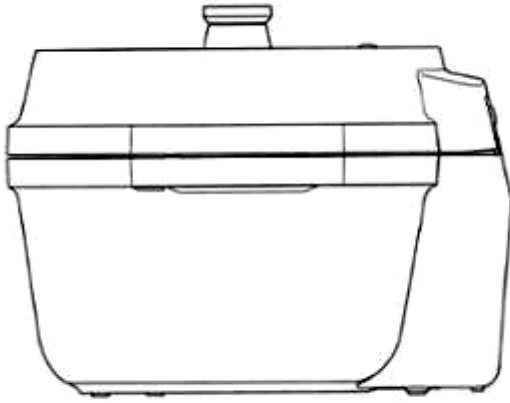

1.5



1.6

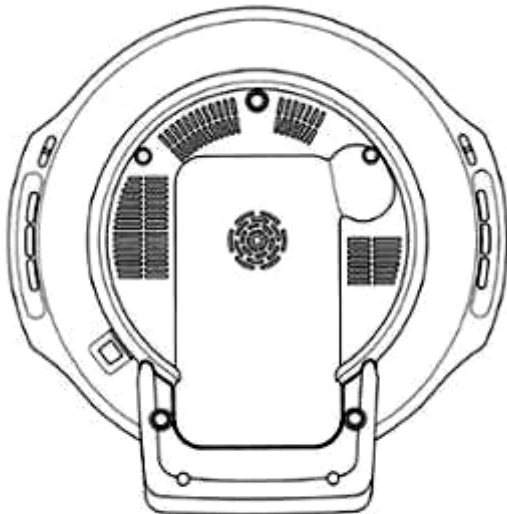

1.7

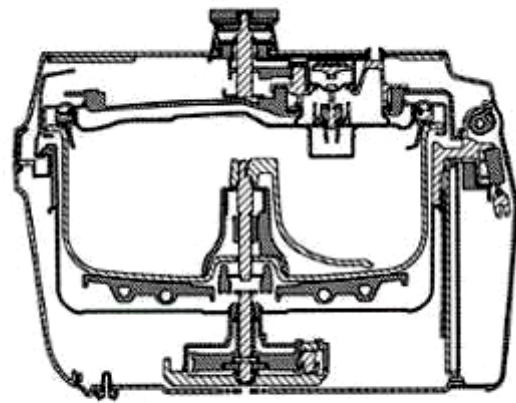

1.8



1.9

CÔNG BÁO SỞ HỮU CÔNG NGHIỆP SỐ 429 TẬP A – QUYỀN 2 (12.2023)

- (11) **48542**
(21) 3-2022-01767 (28) 1
(54) **CAMERA** (51) **16-01**
(22) 22/08/2022 (43) 25/12/2023
(73) **CÔNG TY CỔ PHẦN MK VISION (VN)**
Lô C-1B, khu công nghiệp Thăng Long Vĩnh Phúc, xã Thiện Kê, huyện Bình Xuyên, tỉnh Vĩnh Phúc
(72) Nguyễn Trọng Khang (VN)
(74) Công ty TNHH Sở hữu trí tuệ PADEMARK (PADEMARK CO.,LTD.)
(55)



1.1



1.2



1.3



1.4



1.5



1.6



1.7



1.8

CÔNG BÁO SỞ HỮU CÔNG NGHIỆP SỐ 429 TẬP A – QUYỀN 2 (12.2023)

- (11) **48543**
(21) 3-2022-01768 (28) 1
(54) **CAMERA** (51) **16-01**
(22) 22/08/2022 (43) 25/12/2023
(73) **CÔNG TY CỔ PHẦN MK VISION (VN)**
Lô C-1B, khu công nghiệp Thăng Long Vĩnh Phúc, xã Thiện Kê, huyện Bình Xuyên, tỉnh Vĩnh Phúc
(72) Nguyễn Trọng Khang (VN)
(74) Công ty TNHH Sở hữu trí tuệ PADEMARK (PADEMARK CO.,LTD.)
(55)



1.1



1.2



1.3



1.4

1.5



1.6



1.7

CÔNG BÁO SỞ HỮU CÔNG NGHIỆP SỐ 429 TẬP A – QUYỀN 2 (12.2023)

- (11) **48544**
(21) 3-2022-01773 (28) 1
(54) **BỘ ĐÈN PHÍA SAU CỦA Ô TÔ** (51) **26-06**
(22) 22/08/2022 (43) 25/12/2023
(30) DM/221148 22/02/2022 WO;
(73) **FERRARI S.p.A. (IT)**
Via Emilia Est 1163, Modena, Italy
(72) Flavio MANZONI (IT)
(74) Công ty TNHH một thành viên Sở hữu trí tuệ VCCI (VCCI-IP CO.,LTD)
(55)



1.1



1.2



1.3



1.4



1.5



1.6



1.7

CÔNG BÁO SỞ HỮU CÔNG NGHIỆP SỐ 429 TẬP A – QUYỀN 2 (12.2023)

- (11) **48545**
(21) 3-2022-01778 (28) 1
(54) **TÚI CHỨA** (51) **28-02**
(22) 22/08/2022 (43) 25/12/2023
(30) 008871537-0001 25/02/2022 EM;
(73) **UNILEVER GLOBAL IP LIMITED (GB)**
Port Sunlight, Wirral, Merseyside, CH62 4ZD, United Kingdom
(72) TOH Meng Lee (SG)
(74) Công ty TNHH Trần Hữu Nam và Đồng sự (TRAN H.N & ASS.)
(55)



1.1

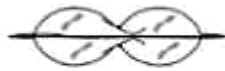

1.2

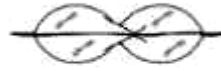

1.3



1.4



1.5

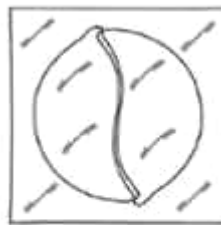

1.6



1.7

CÔNG BÁO SỞ HỮU CÔNG NGHIỆP SỐ 429 TẬP A – QUYỀN 2 (12.2023)

- (11) **48546**
(21) 3-2022-01779 (28) 1
(54) **TÚI CHỨA** (51) **28-02**
(22) 22/08/2022 (43) 25/12/2023
(30) 008869861-0001 25/02/2022 EM;
(73) **UNILEVER GLOBAL IP LIMITED (GB)**
Port Sunlight, Wirral, Merseyside, CH62 4ZD, United Kingdom
(72) TOH Meng Lee (SG)
(74) Công ty TNHH Trần Hữu Nam và Đồng sự (TRAN H.N & ASS.)
(55)



1.1



1.2



1.3



1.4



1.5



1.6



1.7

CÔNG BÁO SỞ HỮU CÔNG NGHIỆP SỐ 429 TẬP A – QUYỀN 2 (12.2023)

- (11) **48547**
(21) 3-2022-01805 (28) 1
(54) **THANH NHÔM ĐỊNH HÌNH** (51) **25-01**
(22) 25/08/2022 (43) 25/12/2023
(73) **CÔNG TY TNHH XUẤT NHẬP KHẨU THANH PHÚC (VN)**
317 Nguyễn Thị Thập, phường Tân Phú, quận 7, thành phố Hồ Chí Minh
(72) Nguyễn Văn Phúc (VN)
(55)

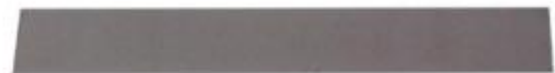

1.1



1.2



1.3



1.4



1.6

1.5

CÔNG BÁO SỞ HỮU CÔNG NGHIỆP SỐ 429 TẬP A – QUYỀN 2 (12.2023)

- (11) **48548**
(21) 3-2022-01840 (28) 1
(54) **CHAI** (51) **09-01**
(22) 31/08/2022 (43) 25/12/2023
(30) 2022-004169 01/03/2022 JP;
(73) **ALBION CO., LTD (JP)**
1-7-10, Ginza, Chuo-Ku, Tokyo 104-0061, Japan
(72) Sayo IZURU (JP)
(74) Công ty Luật TNHH Phạm và Liên danh (PHAM & ASSOCIATES)
(55)



1.1



1.2



1.3



1.4



1.5



1.6



1.7



1.8

CÔNG BÁO SỞ HỮU CÔNG NGHIỆP SỐ 429 TẬP A – QUYỀN 2 (12.2023)

- (11) **48549**
(21) 3-2022-01841 (28) 1
(54) **CHAI** (51) **09-01**
(22) 31/08/2022 (43) 25/12/2023
(30) 2022-004170 01/03/2022 JP;
(73) **ALBION CO., LTD (JP)**
1-7-10, Ginza, Chuo-Ku, Tokyo 104-0061, Japan
(72) Sayo IZURU (JP)
(74) Công ty Luật TNHH Phạm và Liên danh (PHAM & ASSOCIATES)
(55)



CÔNG BÁO SỞ HỮU CÔNG NGHIỆP SỐ 429 TẬP A – QUYỀN 2 (12.2023)

- (11) **48550**
(21) 3-2022-01883 (28) 2
(54) **ỐNG XI PHÔNG VỆ SINH** (51) **23-01**
(22) 05/09/2022 (43) 25/12/2023
(30) 2022-007931 12/04/2022 JP;
(73) **LIXIL CORPORATION (JP)**
Osaki Garden Tower, 1-1-1 Nishishinagawa, Shinagawa-ku, Tokyo 141-0033, Japan
(72) 1. DAIGO ISHIYAMA (JP)
2. GUNJAN MANU PATEL (US)
(74) Công ty TNHH Tầm nhìn và Liên danh (VISION & ASSOCIATES CO.LTD.)
(55)

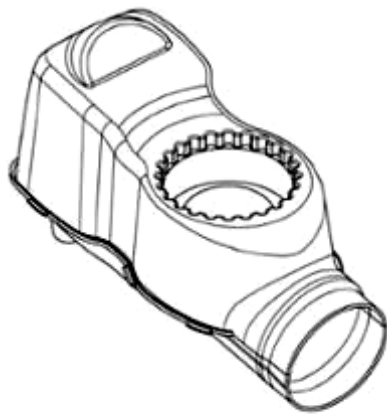

1.1

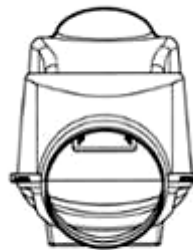

1.2



1.3

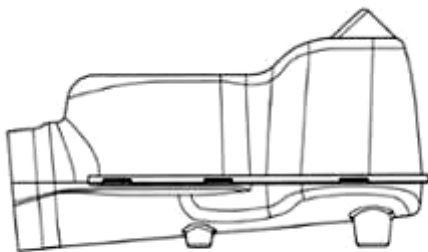

1.4

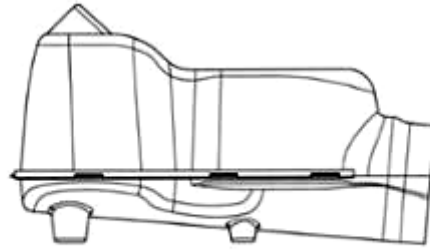

1.5



1.6

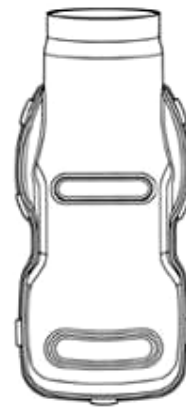

1.7



2.1

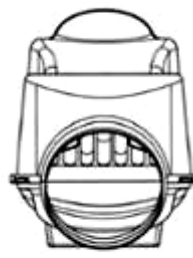

2.2



2.3

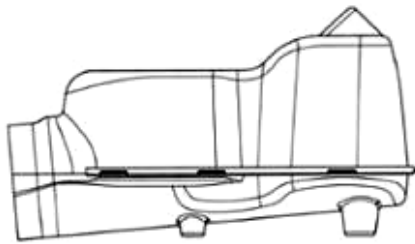

2.4

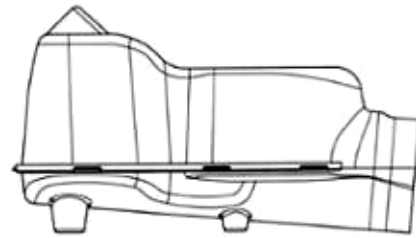

2.5

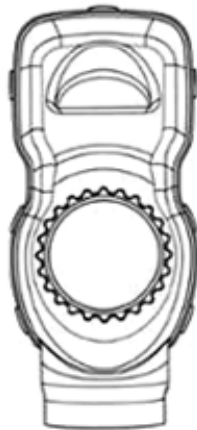

2.6



2.7

CÔNG BÁO SỞ HỮU CÔNG NGHIỆP SỐ 429 TẬP A – QUYỀN 2 (12.2023)

- (11) **48551**
(21) 3-2022-01899 (28) 1
(54) **THANH KIM LOẠI ĐỊNH HÌNH** (51) **25-01**
(22) 07/09/2022 (43) 25/12/2023
(73) **CÔNG TY CỔ PHẦN SẢN XUẤT VÀ ĐẦU TƯ HƯNG PHÁT (VN)**
Tổ dân phố Thịnh Vạn, phường Minh Đức, thị xã Mỹ Hào, tỉnh Hưng Yên
(72) Nguyễn Văn Tâm (VN)
(74) Công ty TNHH Sở hữu trí tuệ Gia Việt (GIAVIET CO., LTD.)
(55)

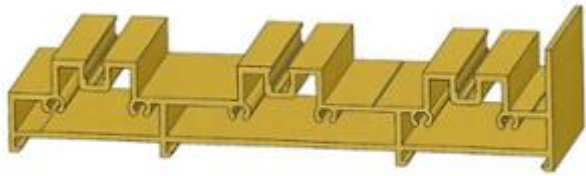

1.1

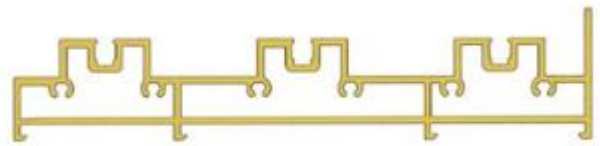

1.2



1.3

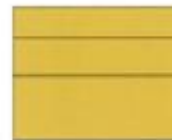

1.4



1.5

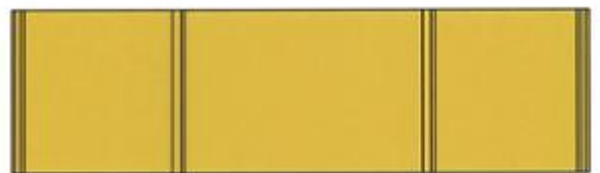

1.6

CÔNG BÁO SỞ HỮU CÔNG NGHIỆP SỐ 429 TẬP A – QUYỀN 2 (12.2023)

- (11) **48552**
(21) 3-2022-01903 (28) 1
(54) **THANH KIM LOẠI ĐỊNH HÌNH** (51) **25-01**
(22) 07/09/2022 (43) 25/12/2023
(73) **CÔNG TY CỔ PHẦN SẢN XUẤT VÀ ĐẦU TƯ HƯNG PHÁT (VN)**
Tổ dân phố Thịnh Vạn, phường Minh Đức, thị xã Mỹ Hào, tỉnh Hưng Yên
(72) Nguyễn Văn Tâm (VN)
(74) Công ty TNHH Sở hữu trí tuệ Gia Việt (GIAVIET CO., LTD.)
(55)



1.1



1.2



1.3

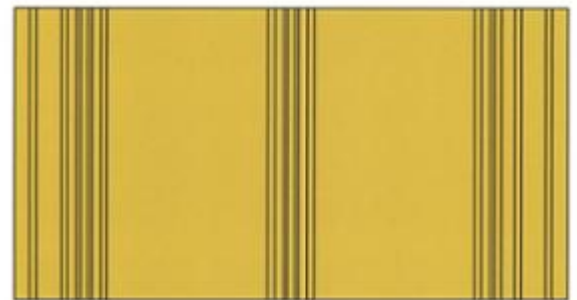

1.4



1.5

CÔNG BÁO SỞ HỮU CÔNG NGHIỆP SỐ 429 TẬP A – QUYỀN 2 (12.2023)

- (11) **48553**
(21) 3-2022-01919 (28) 4
(54) **BÚA** (51) **08-02**
(22) 09/09/2022 (43) 25/12/2023
(30) 29/830,181 10/03/2022 US; 29/830,180 10/03/2022 US;
(73) **JS PRODUCTS, INC. (US)**
6445 Montessouri Street, Las Vegas, NV 89113, United States of America
(72) 1. CRAIG STEINFELS (US)
2. JAMES MOORE (US)
(74) Công ty TNHH Quốc tế D &N (D&N INTERNATIONAL CO.,LTD.)
(55)

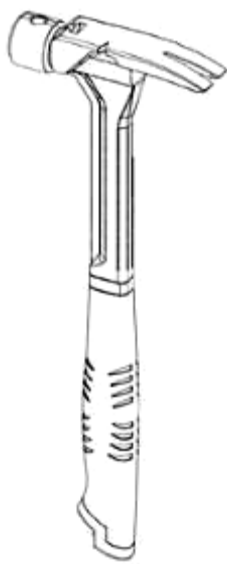

1.1

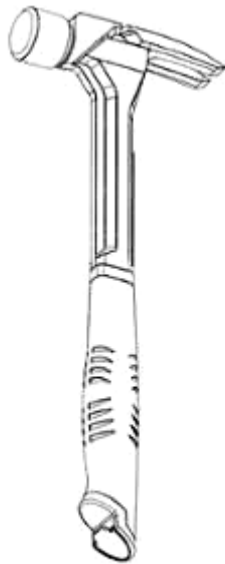

1.2

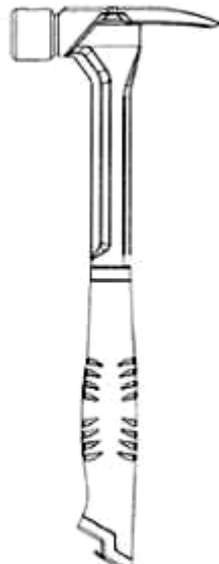

1.3

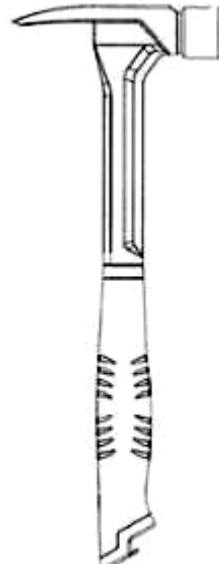

1.4



1.5



1.6



1.7



1.8

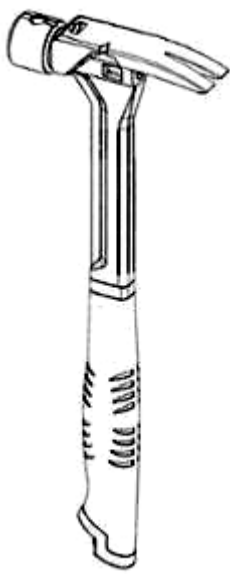

2.1

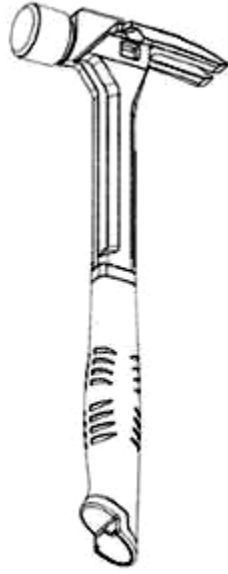

2.2

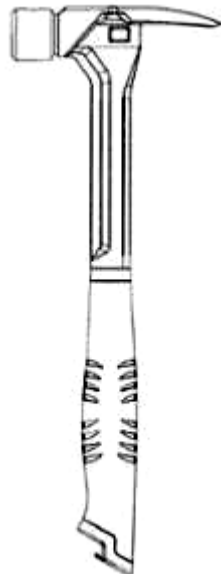

2.3

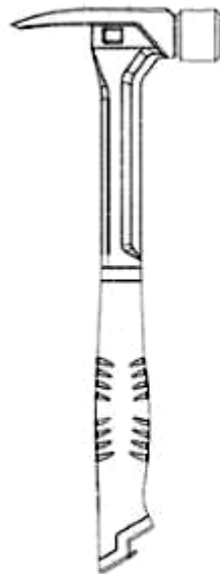

2.4



2.5



2.6



2.7



2.8

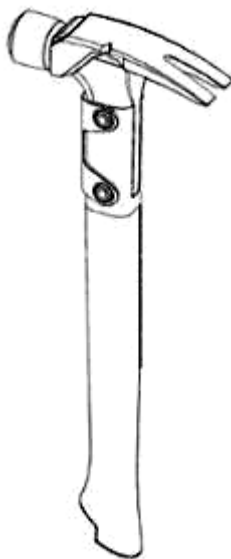

3.1

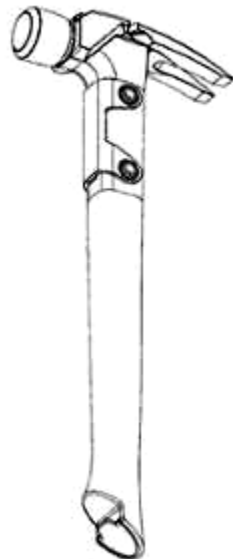

3.2

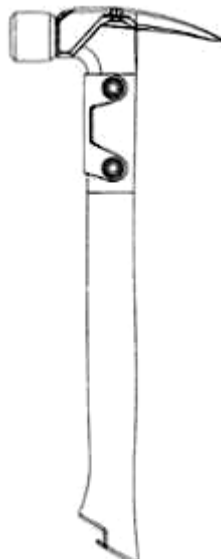

3.3

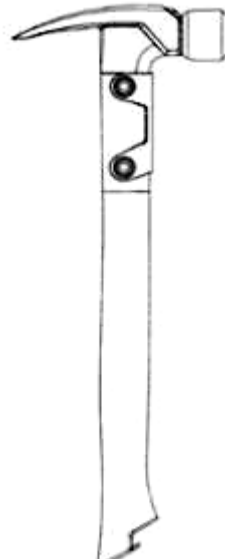

3.4



3.5



3.6



3.7



3.8

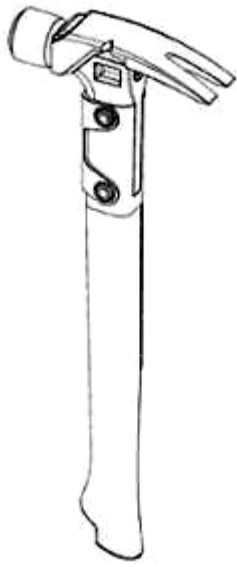

4.1

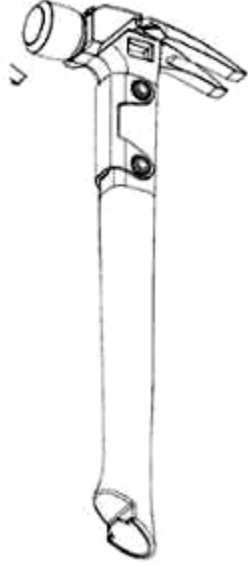

4.2

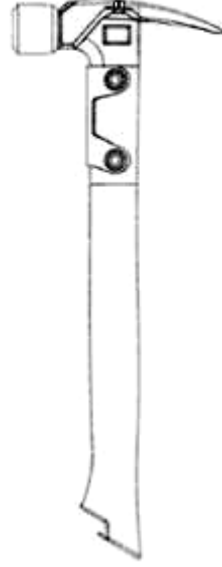

4.3

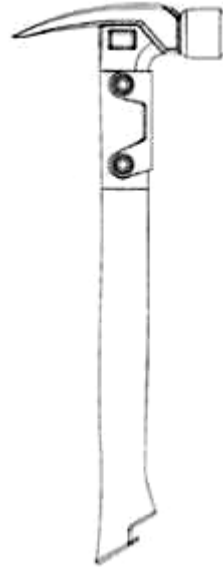

4.4



4.5



4.6



4.7



4.8

CÔNG BÁO SỞ HỮU CÔNG NGHIỆP SỐ 429 TẬP A – QUYỀN 2 (12.2023)

(11) **48554**

(21) 3-2022-01948

(28) 1

(54) **TAY ĐÒN BẦY**

(51) **08-08**

(22) 15/09/2022

(43) 25/12/2023

(73) **TSAN-JEE CHEN (TW)**

7F., No. 36, Ln. 358, Ruiguang Rd., Neihu Dist., Taipei City, 114, Taiwan

(72) Tsan-Jee CHEN (TW)

(74) Công ty Luật TNHH WINCO (WINCO LAW FIRM)

(55)



1.1



1.2



1.3



1.4



1.5



1.6



1.7



1.8



1.9

CÔNG BÁO SỞ HỮU CÔNG NGHIỆP SỐ 429 TẬP A – QUYỀN 2 (12.2023)

- (11) **48555**
(21) 3-2022-01955 (28) 1
(54) **HỘP** (51) **09-03**
(22) 15/09/2022 (43) 25/12/2023
(73) **CÔNG TY TNHH PHỤ LIỆU MAY MÂY (VN)**
6/4B Lầu 1, đường Tống Duy Tân, phường 14, quận 5, thành phố Hồ Chí Minh
(72) Huỳnh Kim Tuyên (VN)
(74) Công ty TNHH Sở hữu trí tuệ Đông Dương (DONG DUONG IP CO.,LTD)
(55)



1.1



1.2

CÔNG BÁO SỞ HỮU CÔNG NGHIỆP SỐ 429 TẬP A – QUYỀN 2 (12.2023)

- (11) **48556**
(21) 3-2022-01968 (28) 1
(54) **BỆ MICRÔ HỘI THẢO** (51) **14-01**
(22) 16/09/2022 (43) 25/12/2023
(73) **CÔNG TY TNHH CÔNG NGHỆ HAN (VN)**
Số 5, ngõ 444 Thụy Khuê, phường Bưởi, quận Tây Hồ, thành phố Hà Nội
(72) 1. HOÀNG ANH (VN)
2. ĐẶNG THỊ HIỀN (VN)
(74) **CÔNG TY LUẬT TRÁCH NHIỆM HỮU HẠN AMBYS HÀ NỘI (AMBYS HANOI)**
(55)



1.1

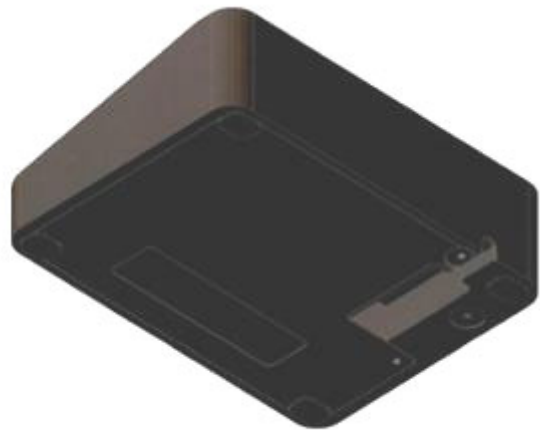

1.2



1.3



1.4



1.5



1.6



1.7



1.8



1.9

CÔNG BÁO SỞ HỮU CÔNG NGHIỆP SỐ 429 TẬP A – QUYỀN 2 (12.2023)

- | | | | |
|------|---|------|--------------|
| (11) | 48557 | | |
| (21) | 3-2022-01976 | (28) | 1 |
| (54) | BAO GÓI SẢN PHẨM | (51) | 09-05 |
| (22) | 19/09/2022 | (43) | 25/12/2023 |
| (73) | CƠ SỞ CHẾ BIẾN MEN RƯỢU TRUNG TIẾN (VN)
Thôn Tam Đồng, xã Thụy Hải, huyện Thái Thụy, tỉnh Thái Bình | | |
| (72) | Nguyễn Thành Trung (VN) | | |
| (55) | | | |



1.1

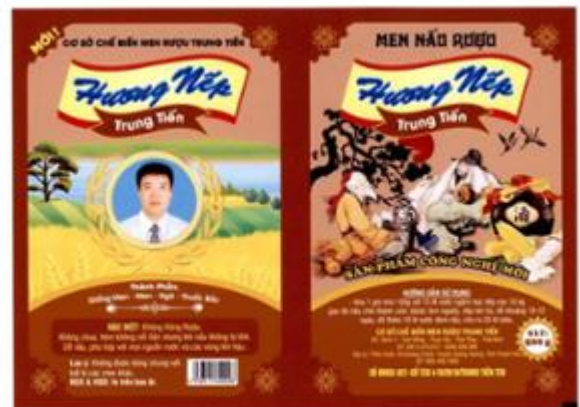

1.2

CÔNG BÁO SỞ HỮU CÔNG NGHIỆP SỐ 429 TẬP A – QUYỀN 2 (12.2023)

- (11) **48558**
- (21) 3-2022-01977
- (54) **BAO GÓI SẢN PHẨM**
- (22) 19/09/2022
- (73) **CƠ SỞ CHẾ BIẾN MEN RƯỢU TRUNG TIẾN (VN)**
Thôn Tam Đồng, xã Thụy Hải, huyện Thái Thụy, tỉnh Thái Bình
- (72) Nguyễn Thành Trung (VN)
- (55)

(28) 1

(51) **09-05**

(43) 25/12/2023



1.1



1.2

- (11) **48559**
(21) 3-2022-02005 (28) 8
(54) **CHAI** (51) **09-01**
(22) 20/09/2022 (43) 25/12/2023
(30) 146770 06/05/2022 CH;
(73) **ALPLA WERKE ALWIN LEHNER GMBH & CO. KG (AT)**
Allmendstrasse 81, A-6971 Hard, Austria
(72) 1. CHRISTIAN SCHARINGER (AT)
2. FLORIAN HEIDER (AT)
3. KLEMENS BÖSCH (AT)
4. OLIVER UNTERLECHNER (AT)
5. THOMAS BOHLE (AT)
(74) Công ty TNHH Sở hữu trí tuệ ALNGUYEN (ALNGUYEN IP CO.,LTD.)
(55)

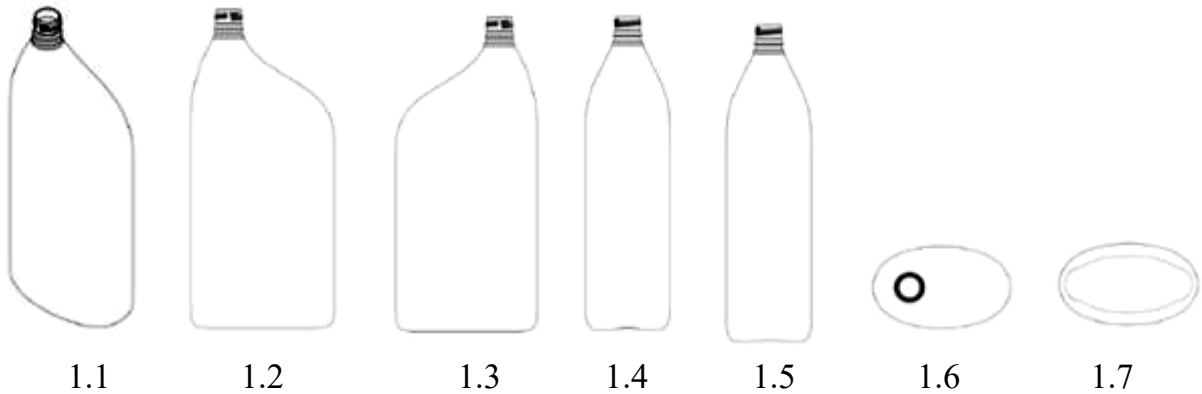



3.1



3.2



3.3



3.4



3.5



3.6



3.7



4.1



4.2



4.3



4.4



4.5



4.6



4.7



5.1



5.2



5.3



5.4



5.5



5.6



5.7



6.1



6.2



6.3



6.4



6.5



6.6



6.7



7.1



7.2



7.3



7.4



7.5



7.6



7.7



8.1



8.2



8.3



8.4



8.5



8.6



8.7

- (11) **48560**
- (21) 3-2022-02014
- (54) **KẸP ỐNG**
- (22) 20/09/2022
- (30) 2022-006064 23/03/2022 JP;
- (73) **SK-KAWANISHI CO., LTD. (JP)**
7188-1, Sue, Ayagawa-cho, Ayauta-gun, Kagawa 761-2103 Japan
- (72) Hidehito KAWANISHI (JP)
- (74) CÔNG TY LUẬT TRÁCH NHIỆM HỮU HẠN AMBYS HÀ NỘI (AMBYS HANOI)
- (55)

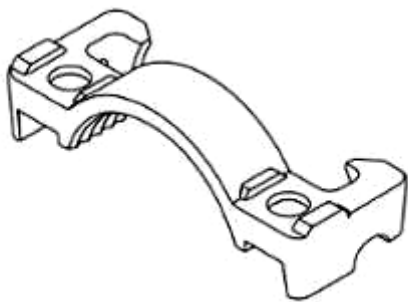

1.1



1.2



1.3

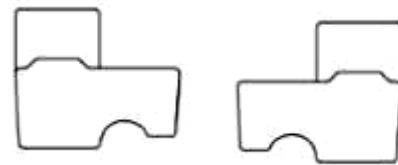

1.4

1.5

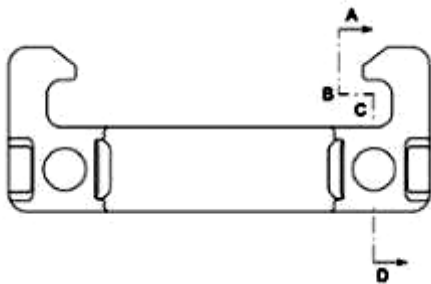

1.6

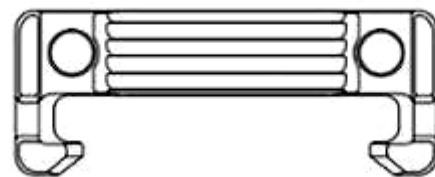

1.7



1.8

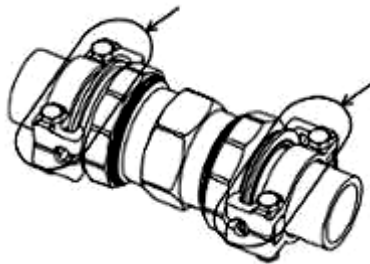

1.9

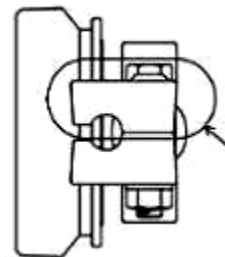

1.10

- (11) **48561**
(21) 3-2022-02057 (28) 1
(54) **TẮM ỐP PHÍA SAU XE MÁY** (51) **12-16**
(22) 26/09/2022 (43) 25/12/2023
(30) 2022-006939 31/03/2022 JP;
(73) **HONDA MOTOR CO., LTD. (JP)**
1-1, Minami-Aoyama 2-chome, Minato-ku, Tokyo, 107-8556 Japan
(72) 1. NUTTAPON SANGRAWEE (TH)
2. TANAT LOTHIM (TH)
3. CHALERMPOL THEPPRAPAN (TH)
(74) Công ty Luật TNHH Phạm và Liên danh (PHAM & ASSOCIATES)
(55)



1.1



1.2



1.3



1.4



1.5



1.6



1.7



1.8



1.9



1.10



1.11

CÔNG BÁO SỞ HỮU CÔNG NGHIỆP SỐ 429 TẬP A – QUYỀN 2 (12.2023)

- (11) **48562**
(21) 3-2022-02058 (28) 1
(54) **XE MÁY** (51) **12-11**
(22) 26/09/2022 (43) 25/12/2023
(30) 2022-006936 31/03/2022 JP;
(73) **HONDA MOTOR CO., LTD. (JP)**
1-1, Minami-Aoyama 2-chome, Minato-ku, Tokyo, 107-8556 Japan
(72) 1. THANAPON HARNPATTANAPANICH (TH)
2. PATIPOL KHEMPIMOOK (TH)
3. CHINNAWAT KUNCHONPANGA (TH)
4. TANAT LOTHIM (TH)
5. CHALERMPOL THEPPRAPAN (TH)
(74) Công ty Luật TNHH Phạm và Liên danh (PHAM & ASSOCIATES)
(55)



1.1



1.2



1.3



1.4



1.5



1.6



1.7



1.8



1.9



1.10

CÔNG BÁO SỞ HỮU CÔNG NGHIỆP SỐ 429 TẬP A – QUYỀN 2 (12.2023)

- (11) **48563**
(21) 3-2022-02077 (28) 1
(54) **HỘP** (51) **09-03**
(22) 28/09/2022 (43) 25/12/2023
(73) **CÔNG TY CỔ PHẦN K PRODUCTS (VN)**
828/10/24 đường Bình Giã, phường 11, thành phố Vũng Tàu, tỉnh Bà Rịa - Vũng Tàu
(72) Nguyễn Trung Hiếu (VN)
(74) Công ty Cổ phần Sở hữu công nghiệp INVESTIP (INVESTIP)
(55)



1.1



1.2

CÔNG BÁO SỞ HỮU CÔNG NGHIỆP SỐ 429 TẬP A – QUYỀN 2 (12.2023)

(11) **48564**

(21) 3-2022-02116

(28) 1

(54) **ĐÈN CHIẾU VÀNG DA CHO TRẺ SƠ SINH**

(51) **24-01**

(22) 04/10/2022

(43) 25/12/2023

(73) **CÔNG TY TNHH VĨNH ĐẠT (LACOM CO., LTD) (VN)**

Phòng 810, tòa nhà JSC34, ngõ 164 Khuất Duy Tiến, phường Nhân Chính, quận Thanh Xuân, thành phố Hà Nội

(72) Ngô Hùng (VN)

(55)

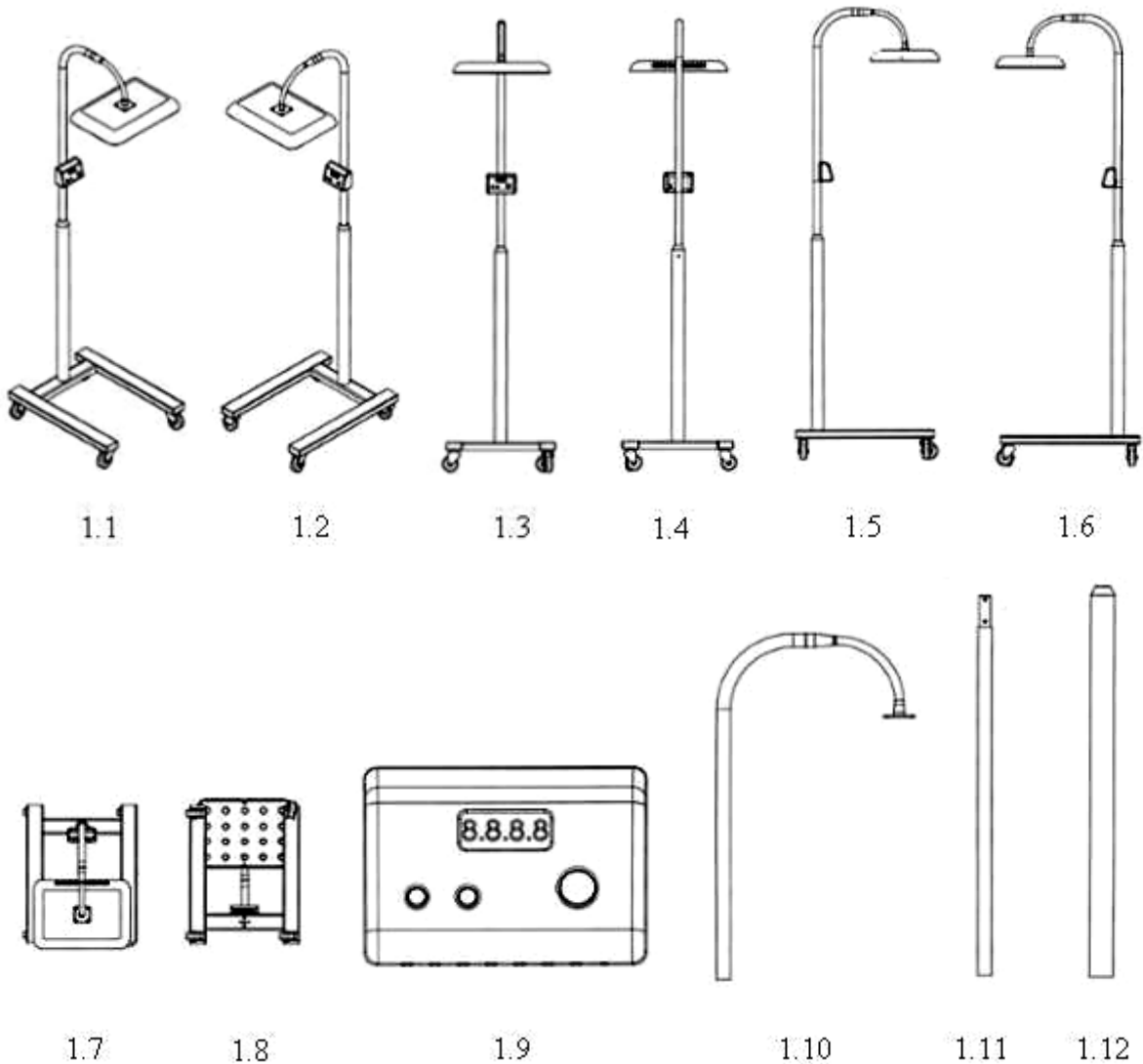

- (11) **48565**
(21) 3-2022-02126 (28) 2
(54) **THIẾT BỊ BUỘC DÂY TÀU KÉO** (51) **12-06**
(22) 04/10/2022 (43) 25/12/2023
(30) 008927719 05/04/2022 EM;
(73) **SVITZER A/S (DK)**
Esplanaden 50, 1263 Copenhagen K, Denmark
(72) 1. THOMAS BANGLUND (DK)
2. THOMAS NØRMØLLE (DK)
3. JONAS BECHMANN (DK)
(74) Công ty TNHH Sở hữu trí tuệ Thảo Thọ Quyển (INVENCO.,LTD)
(55)

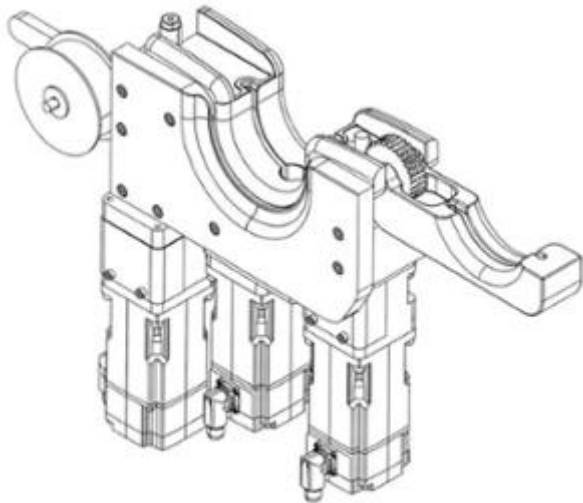

1.1

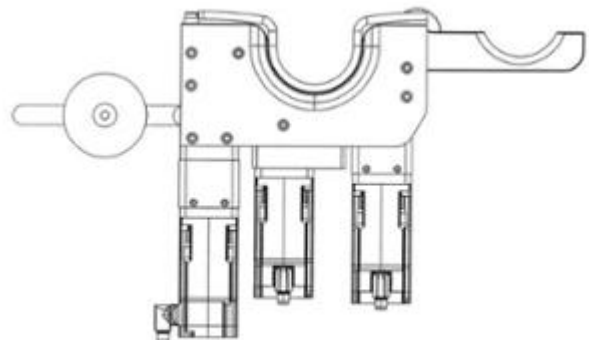

1.2

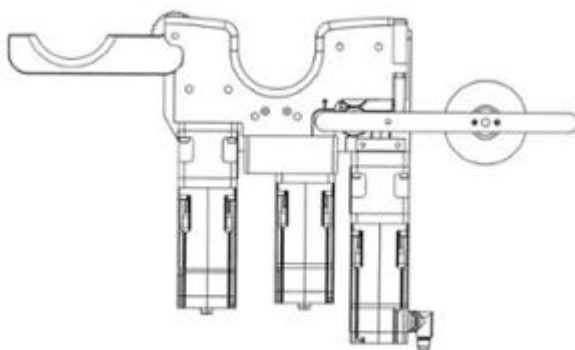

1.3

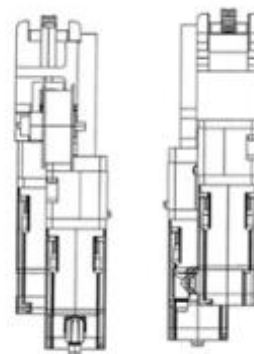

1.4

1.5

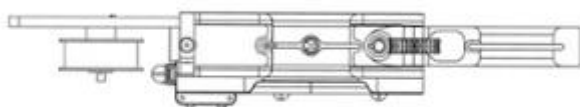

1.6

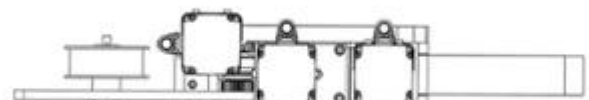

1.7

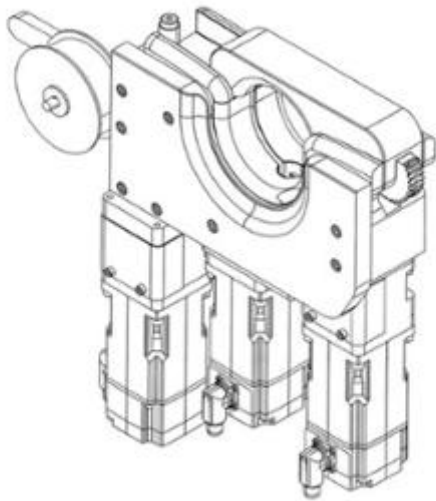

2.1

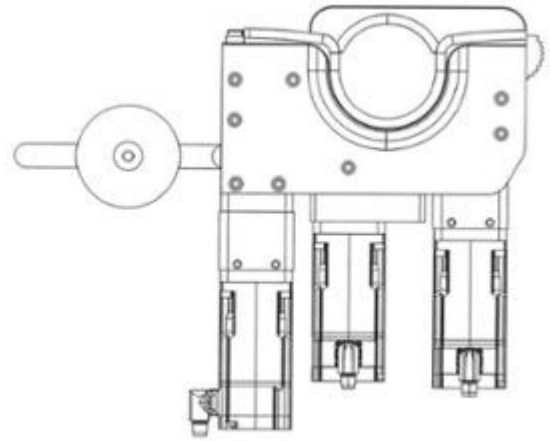

2.2

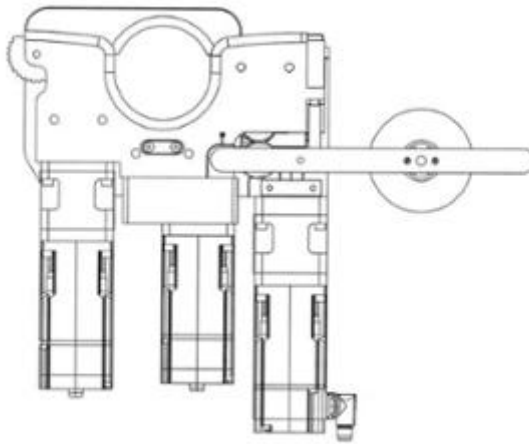

2.3

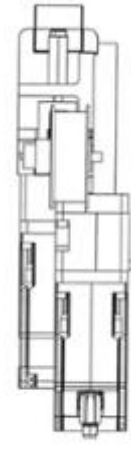

2.4

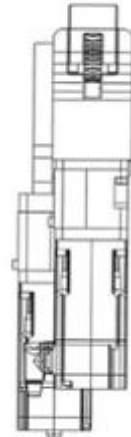

2.5

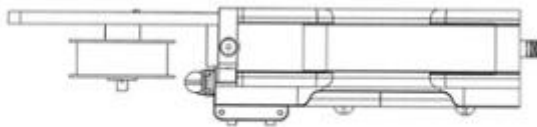

2.6

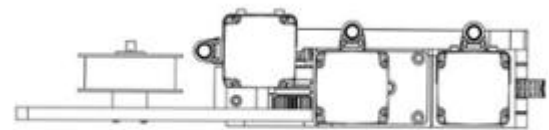

2.7

- (11) **48566**
(21) 3-2022-02127 (28) 6
(54) **CHÂN TIẾP XÚC** (51) **10-05**
(22) 04/10/2022 (43) 25/12/2023
(30) 29/833,520 05/04/2022 US; 29/843,097 17/06/2022 US;
(73) **JOHNSTECH INTERNATIONAL CORPORATION (US)**
1210 New Brighton Boulevard, Minneapolis, Minnesota 55413, United States of America
(72) 1. MELISSA HASSKAMP (US)
2. DAVID SKODJE (US)
3. MIKE ANDRES (US)
(74) Công ty TNHH Lê & Lê (LE & LE)
(55)

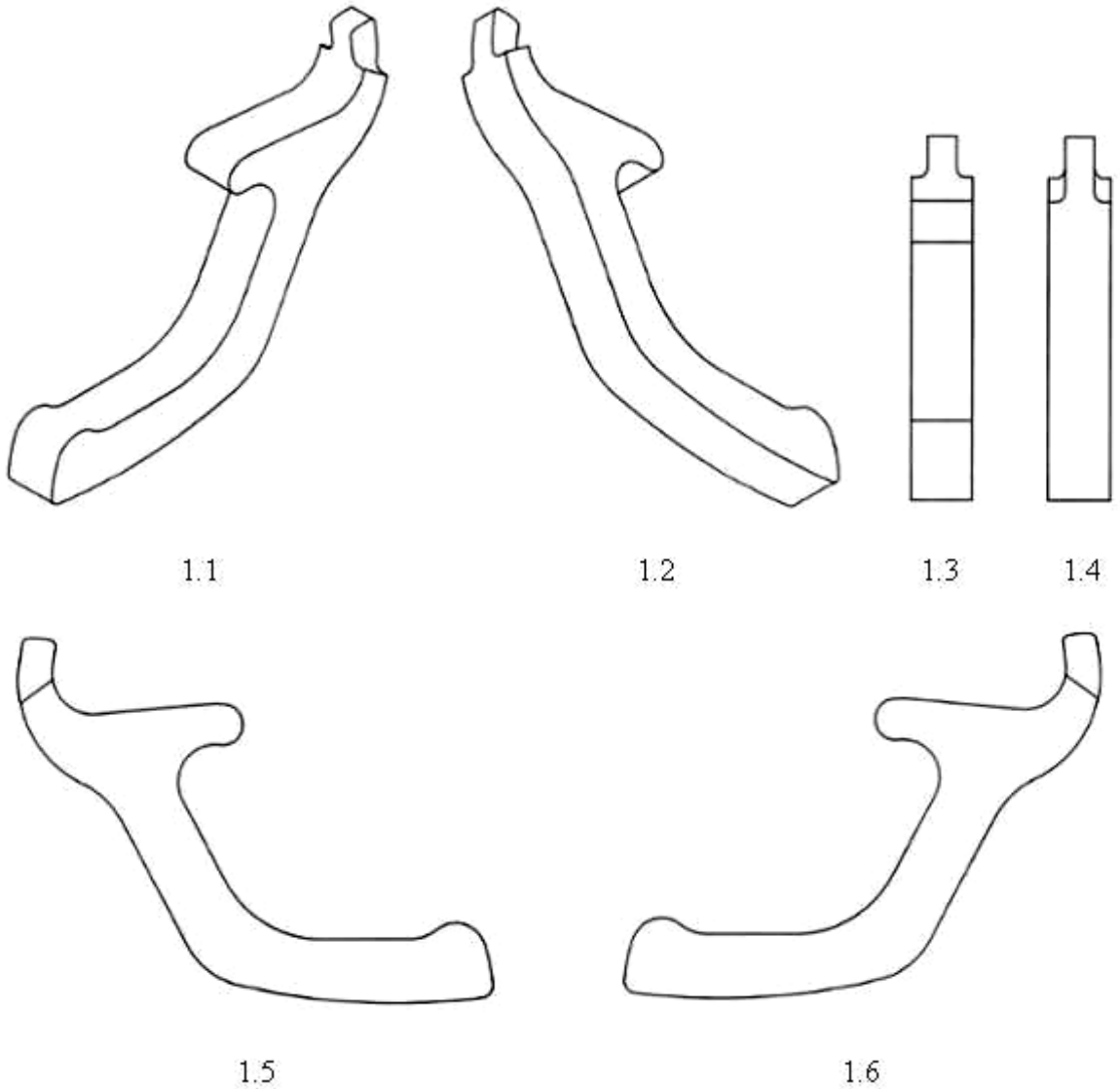

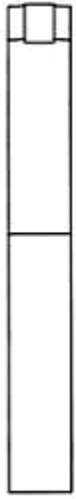

1.7



1.8

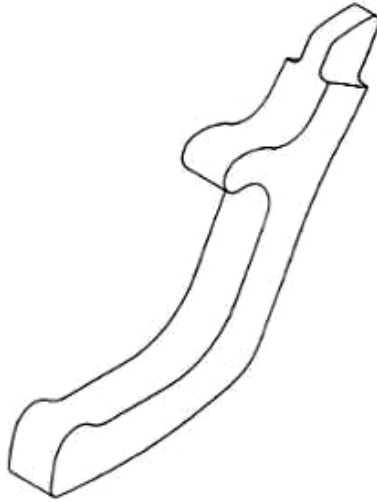

2.1

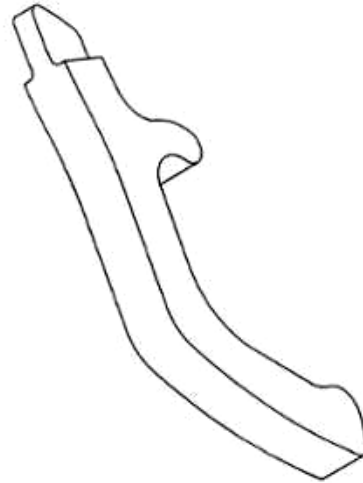

2.2



2.3



2.4

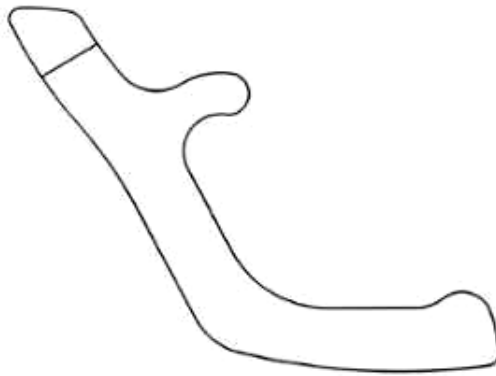

2.5

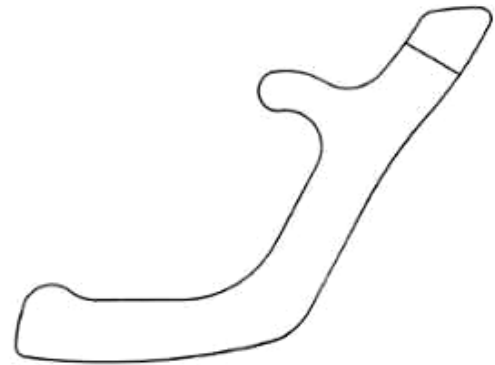

2.6

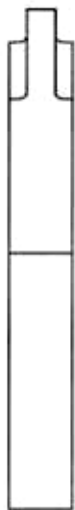

2.7



2.8



3.1

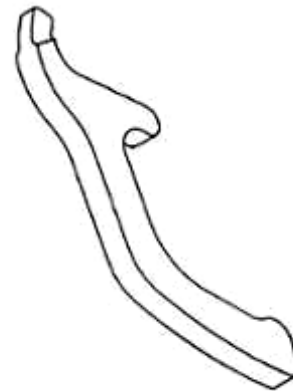

3.2

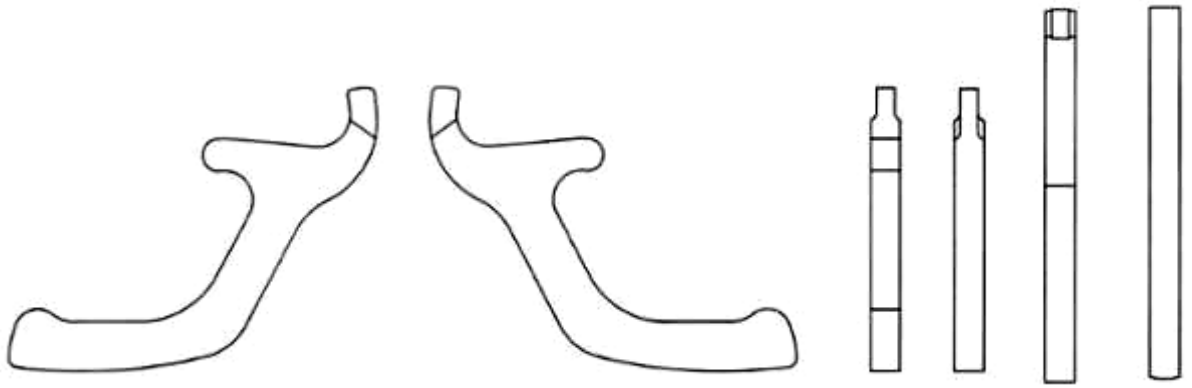

3.3

3.4

3.5

3.6

3.7

3.8

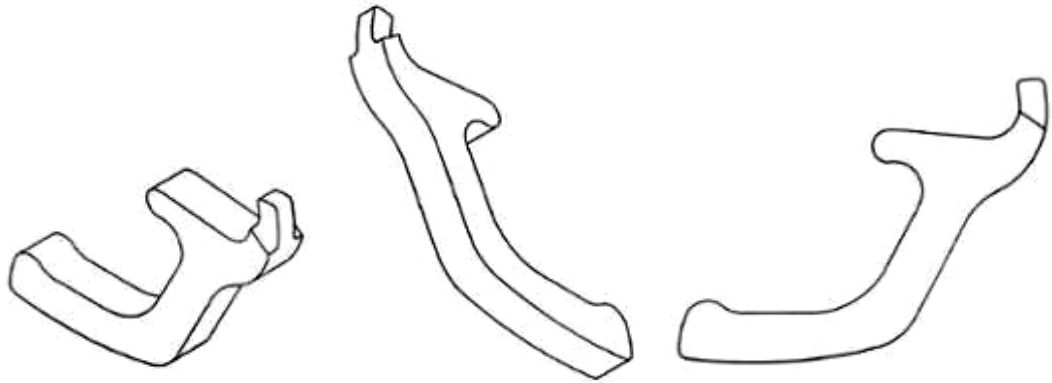

4.1

4.2

4.3

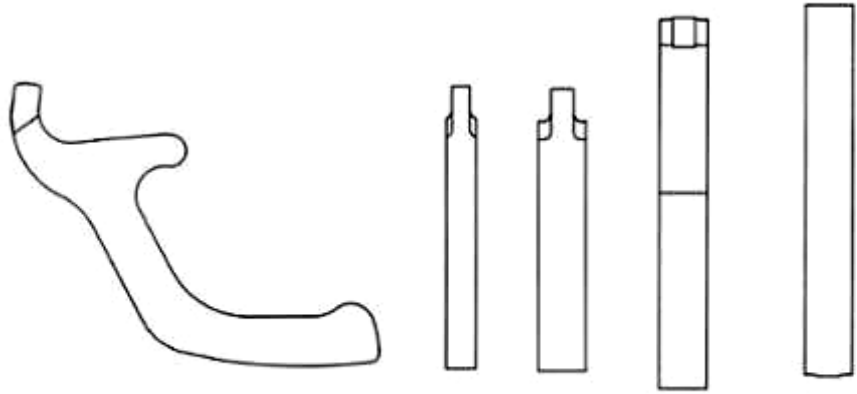

4.4

4.5

4.6

4.7

4.8

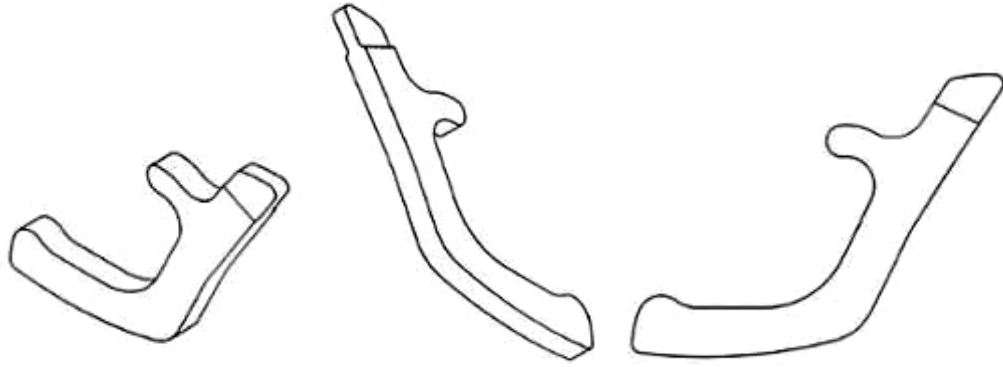

5.1

5.2

5.3

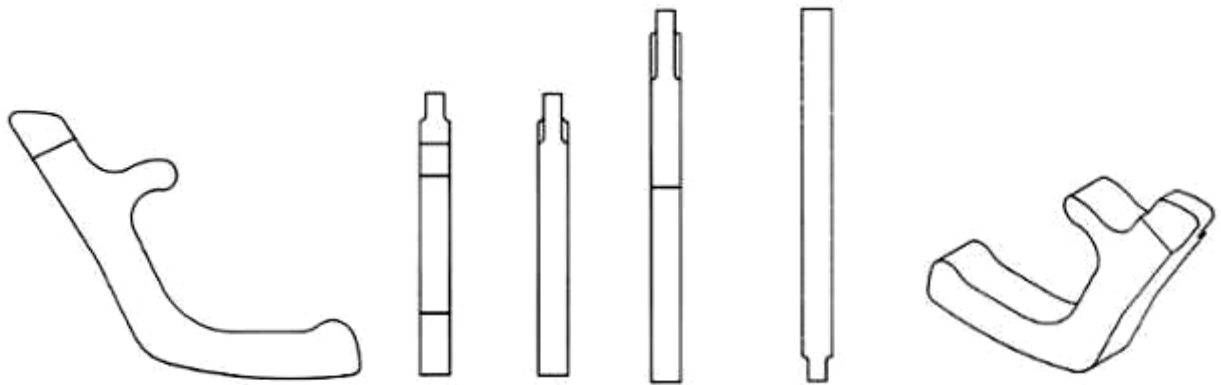

5.4

5.5

5.6

5.7

5.8

6.1

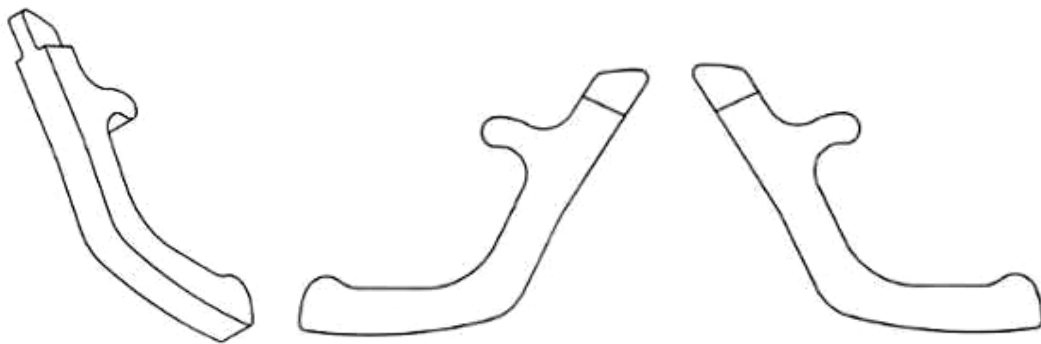

6.2

6.3

6.4

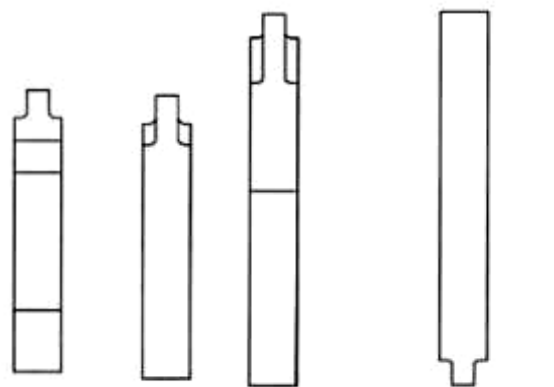

6.5

6.6

6.6

6.8

CÔNG BÁO SỞ HỮU CÔNG NGHIỆP SỐ 429 TẬP A – QUYỀN 2 (12.2023)

- (11) **48567**
- (21) 3-2022-02145
- (54) **HỘP**
- (22) 06/10/2022
- (73) **CÔNG TY CỔ PHẦN SỮA VITADAIRY VIỆT NAM (VN)**
99 Nguyễn Thị Minh Khai, phường Bến Thành, quận 1, thành phố Hồ Chí Minh
- (72) Nguyễn Thị Hà (VN)
- (55)

(28) 1

(51) **09-03**

(43) 25/12/2023



1.1



1.2



1.3



1.4



1.5



1.6



1.7

CÔNG BÁO SỞ HỮU CÔNG NGHIỆP SỐ 429 TẬP A – QUYỀN 2 (12.2023)

- (11) **48568**
(21) 3-2022-02218 (28) 1
(54) **BAO GÓI SẢN PHẨM** (51) **09-05**
(22) 13/10/2022 (43) 25/12/2023
(73) **CÔNG TY CỔ PHẦN MẶT TRỜI LỬA (VN)**
Số 209A đường Nguyễn Tri Phương, khu phố Nhị Đồng 2, phường Dĩ An, thành phố Dĩ An, tỉnh Bình Dương
(72) Trương Quang Chung (VN)
(74) Công ty TNHH Sở hữu trí tuệ PADEMARK (PADEMARK CO.,LTD.)
(55)



1.1



1.2

CÔNG BÁO SỞ HỮU CÔNG NGHIỆP SỐ 429 TẬP A – QUYỀN 2 (12.2023)

- (11) **48569**
- (21) 3-2022-02241 (28) 1
- (54) **BAO BÌ SẢN PHẨM** (51) **09-05**
- (22) 14/10/2022 (43) 25/12/2023
- (73) **CÔNG TY CỔ PHẦN PHÂN BÓN NA UY (VN)**
Lô A2, KCN Tân Kim mở rộng, thị trấn Cần Giuộc, huyện Cần Giuộc, tỉnh Long An
- (72) Nguyễn Chí Cao (VN)
- (55)



1.2



1.1

- (11) **48570**
(21) 3-2022-02260 (28) 1
(54) **TÚI CHỨA** (51) **28-02**
(22) 19/10/2022 (43) 25/12/2023
(30) 008962914-0001 22/04/2022 EM;
(73) **UNILEVER GLOBAL IP LIMITED (GB)**
Port Sunlight, Wirral, Merseyside, CH62 4ZD, United Kingdom
(72) 1. CAO WEI (CN)
2. CHEN YANCHAO (CN)
3. QUE CHUQIN (CN)
(74) Công ty TNHH Trần Hữu Nam và Đồng sự (TRAN H.N & ASS.)
(55)

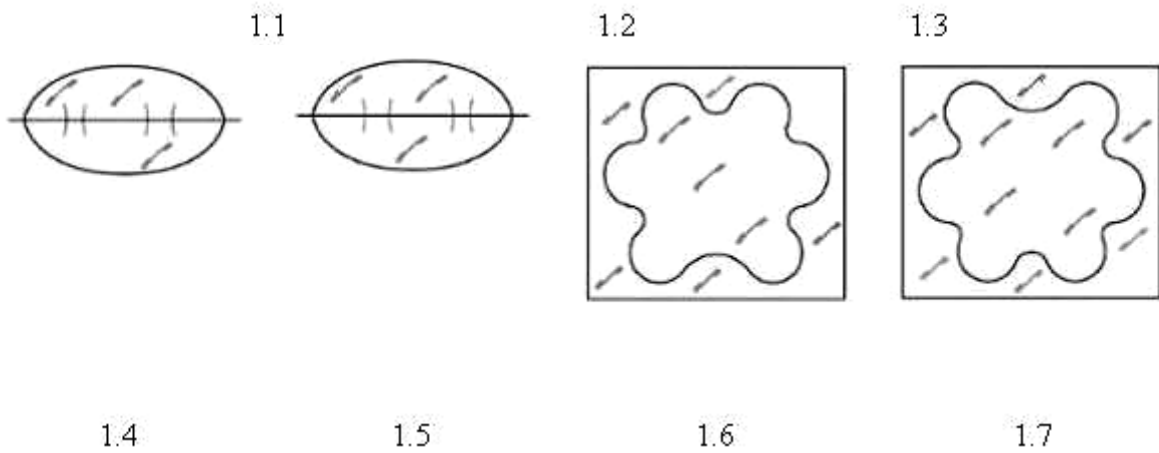
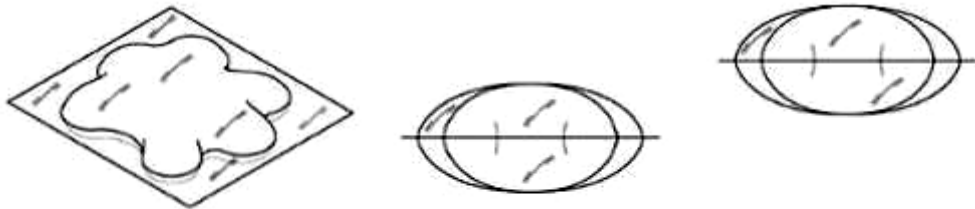

CÔNG BÁO SỞ HỮU CÔNG NGHIỆP SỐ 429 TẬP A – QUYỀN 2 (12.2023)

- (11) **48571**
(21) 3-2022-02331 (28) 1
(54) **TAI NGHE** (51) **14-01**
(22) 27/10/2022 (43) 25/12/2023
(30) 29/836,998 29/04/2022 us;
(73) **BOSE CORPORATION (US)**
The Mountain, Framingham, Massachusetts 01701-9168, United States of America
(72) 1. PAUL C. WILLIAMSON (US)
2. ETHAN FRANCES NORTON (US)
(74) Công ty Luật TNHH Phạm và Liên danh (PHAM & ASSOCIATES)
(55)



1.1



1.2



1.3

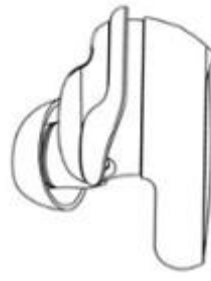

1.4

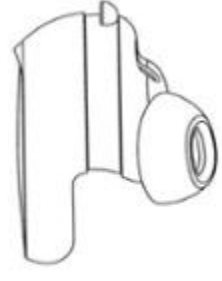

1.5



1.6



1.7

CÔNG BÁO SỞ HỮU CÔNG NGHIỆP SỐ 429 TẬP A – QUYỀN 2 (12.2023)

- (11) **48572**
(21) 3-2022-02332 (28) 1
(54) **HỘP SẠC TAI NGHE** (51) **13-02**
(22) 27/10/2022 (43) 25/12/2023
(30) 29/837,000 29/04/2022 US;
(73) **BOSE CORPORATION (US)**
The Mountain, Framingham, Massachusetts 01701-9168, United States of America
(72) 1. PAUL C. WILLIAMSON (US)
2. ETHAN FRANCES NORTON (US)
(74) Công ty Luật TNHH Phạm và Liên danh (PHAM & ASSOCIATES)
(55)



1.1

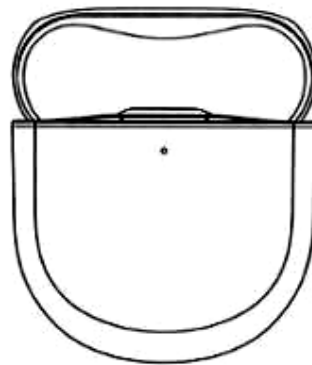

1.2

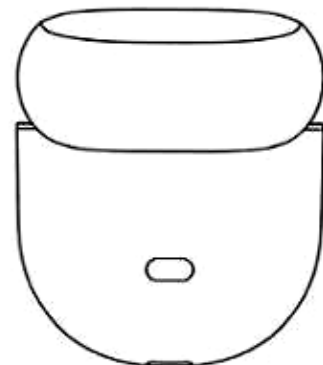

1.3



1.4



1.5



1.6

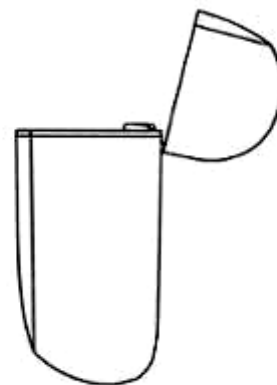

1.7

- (11) **48573**
(21) 3-2022-02342 (28) 4
(54) **HỘP** (51) **09-03**
(22) 31/10/2022 (43) 25/12/2023
(30) 29/850,400 19/08/2022 US;
(73) **KOLACANS MANUFACTURING, LLC (US)**
20 Boulder Crescent St., Colorado Springs, CO 80903, US
(72) 1. TRAVIS LANTZ (US)
2. KATHERINE IRWIN (US)
3. JONATHAN CARFIELD (US)
4. DORIAN RIEGER (US)
5. DAVID WU (US)
(74) Công ty Luật TNHH Phạm và Liên danh (PHAM & ASSOCIATES)
(55)

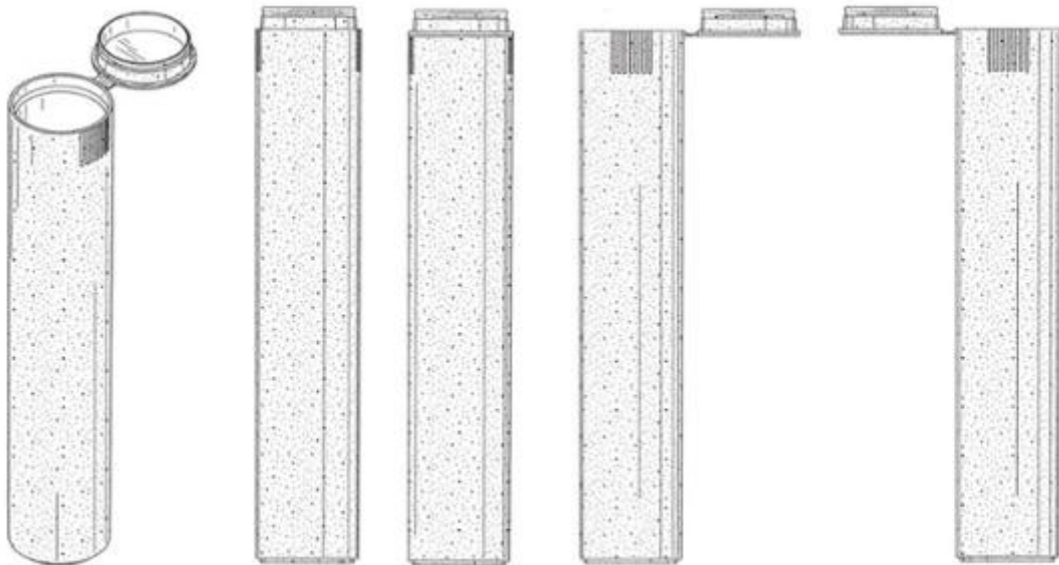

1.1

1.2

1.3

1.4

1.5



1.6



1.7

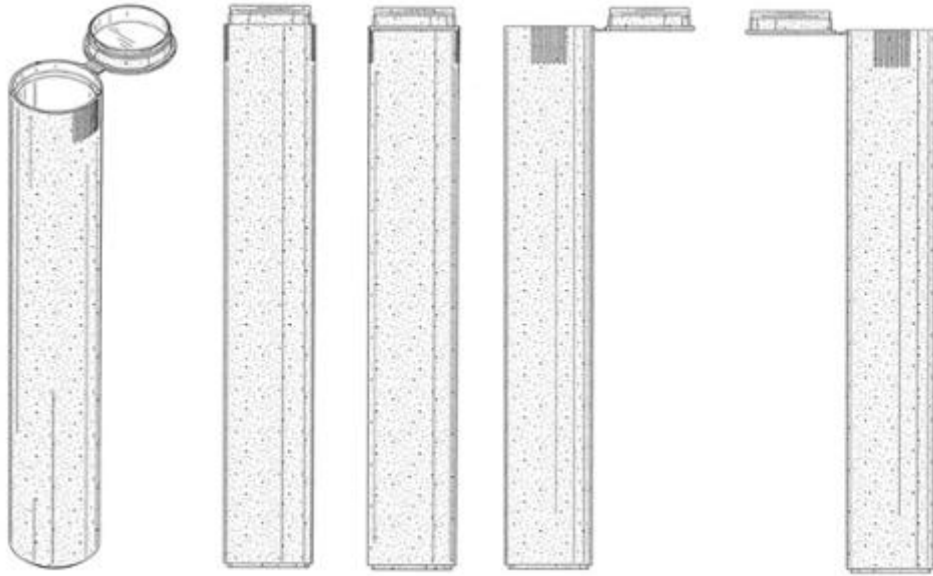

2.1

2.2

2.3

2.4

2.5



2.6



2.7



3.1

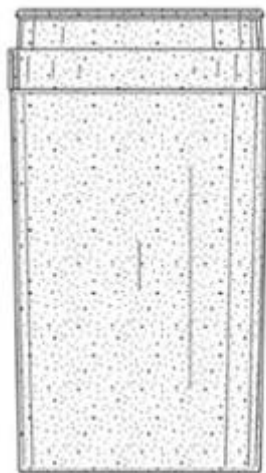

3.2

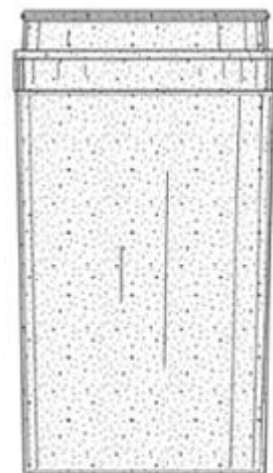

3.3

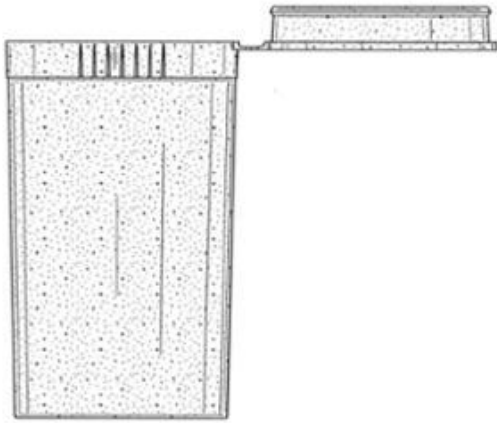

3.4

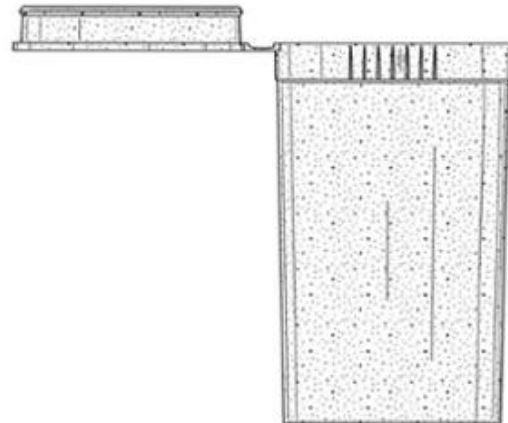

3.5

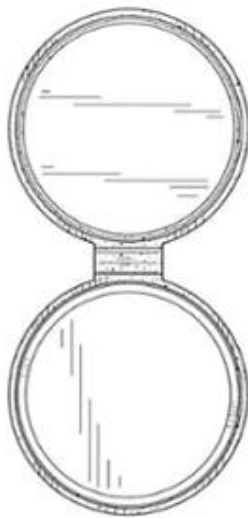

3.6

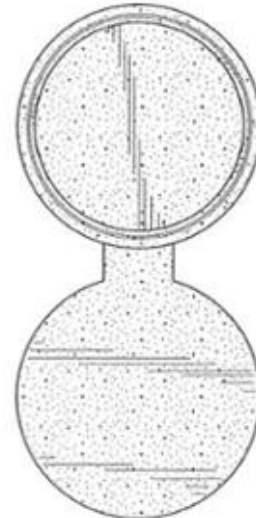

3.7

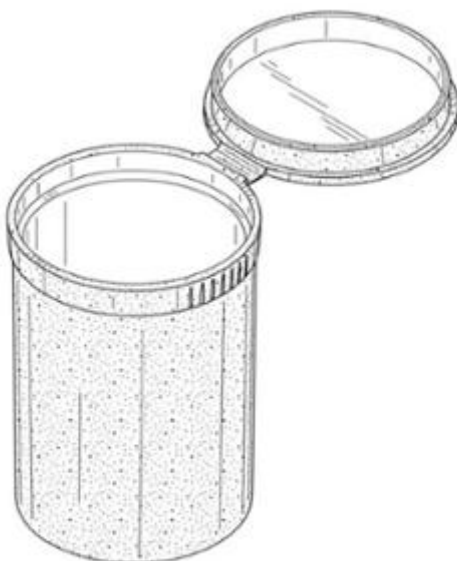

4.1

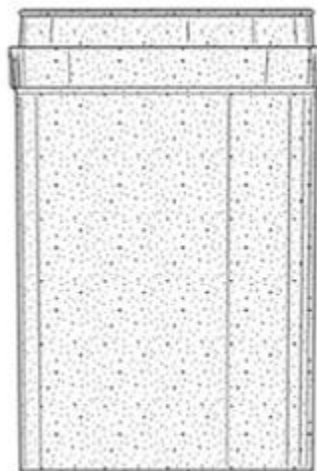

4.2

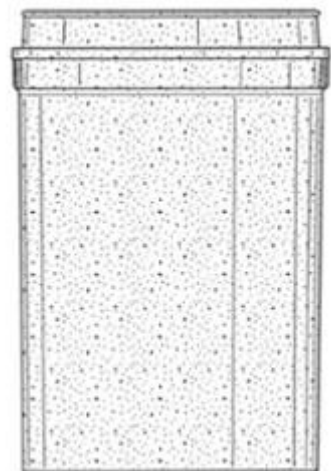

4.3

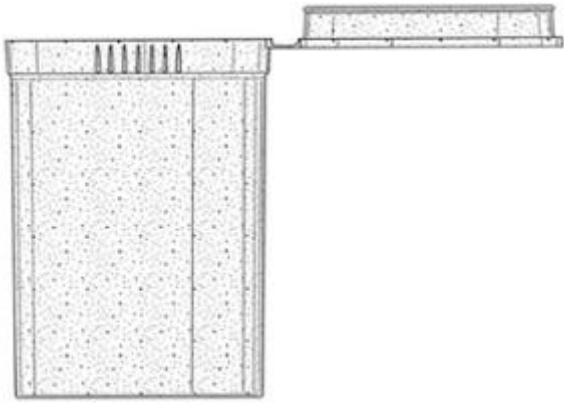

4.4

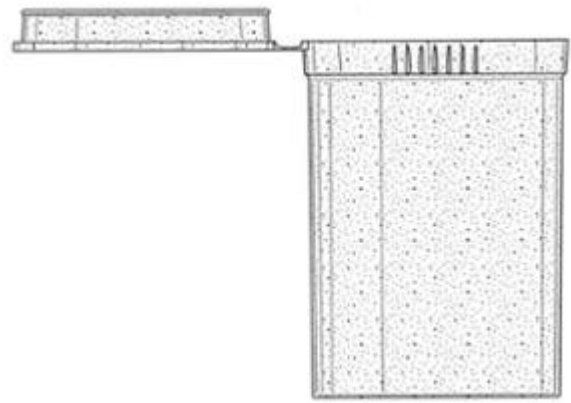

4.5

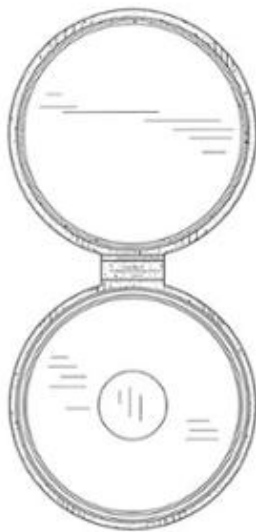

4.6

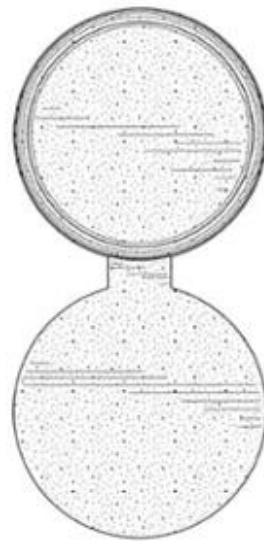

4.7

CÔNG BÁO SỞ HỮU CÔNG NGHIỆP SỐ 429 TẬP A – QUYỀN 2 (12.2023)

- (11) **48574**
(21) 3-2022-02359 (28) 1
(54) **ĐIỆN THOẠI DI ĐỘNG** (51) **14-03**
(22) 01/11/2022 (43) 25/12/2023
(30) 30-2022-0020978 26/05/2022 KR;
(73) **SAMSUNG ELECTRONICS CO., LTD. (KR)**
129, Samsung-ro, Yeongtong-gu, Suwon-si, Gyeonggi-do 16677, Republic of Korea
(72) 1. CHOI, JUNGHYUN (KR)
2. KANG, BOSOON (KR)
3. KIM, BYOUNGJIN (KR)
4. KIM, TAEHO (KR)
5. SONG, JUNYONG (KR)
6. JEONG, WOOHYEOK (KR)
(74) Công ty Luật TNHH WINCO (WINCO LAW FIRM)
(55)

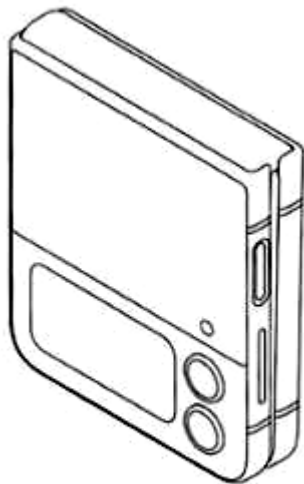

1.1

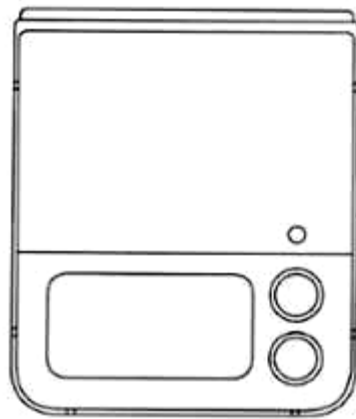

1.2

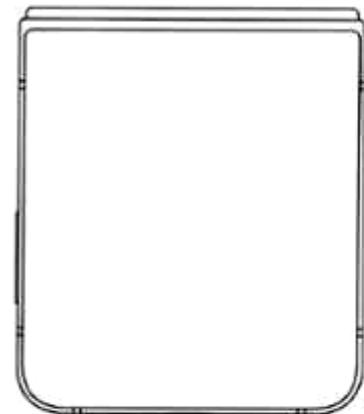

1.3

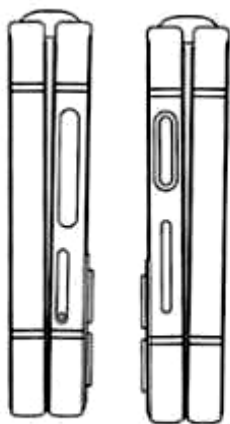

1.4

1.5



1.6



1.7

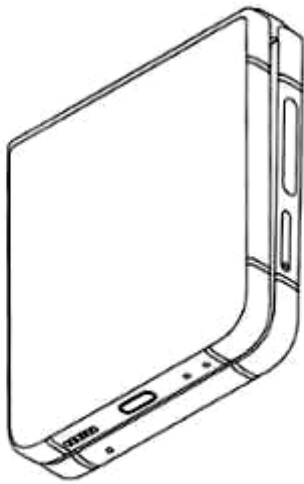

1.8

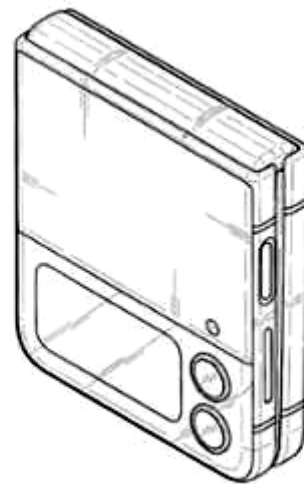

1.9

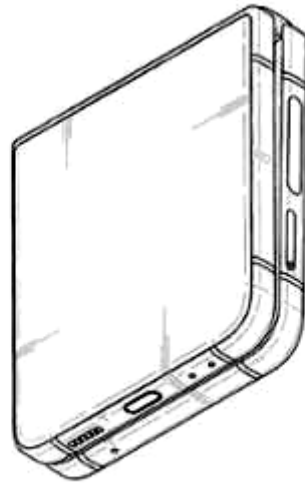

1.10

(11) **48575**

(21) 3-2022-02374

(54) **MÁY RANG MUỐI TÔM**

(22) 01/11/2022

(73) **CÔNG TY TNHH HỒ HOÀN CẦU (VN)**

Xóm 6, xã Quỳnh Văn, huyện Quỳnh Lưu, tỉnh Nghệ An

(72) Hồ Xuân Vinh (VN)

(55)

(28) 1

(51) **15-03**

(43) 25/12/2023



1.1



1.2



1.3



1.4



1.5



1.6



1.7

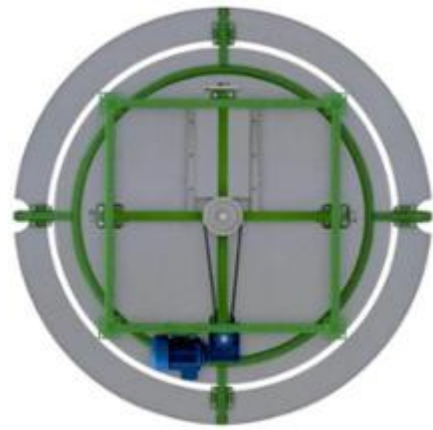

1.8

CÔNG BÁO SỞ HỮU CÔNG NGHIỆP SỐ 429 TẬP A – QUYỀN 2 (12.2023)

- (11) **48576**
(21) 3-2022-02400 (28) 1
(54) **DÉP** (51) **02-04**
(22) 03/11/2022 (43) 25/12/2023
(30) 29/837,650 06/05/2022 US;
(73) **CROCS, INC. (US)**
13601 Via Varra, Broomfield, Colorado 80020, United States of America
(72) Catherine LAM (US)
(74) Công ty Luật TNHH quốc tế BMVN (BMVN INTERNATIONAL LLC)
(55)

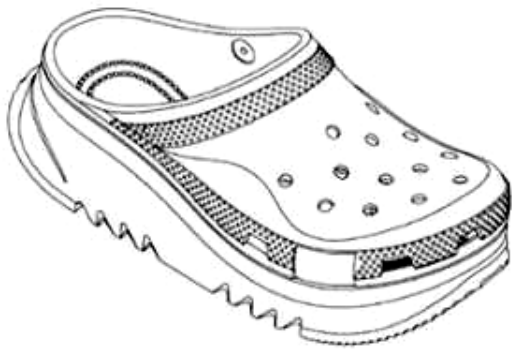

1.1



1.2



1.3

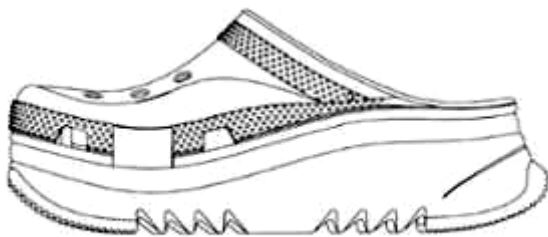

1.4



1.5

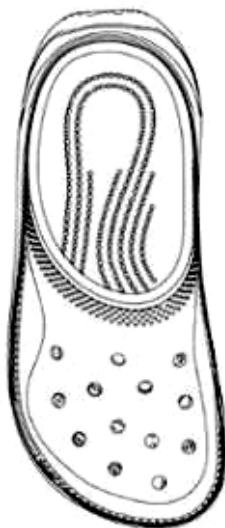

1.6



1.7

CÔNG BÁO SỞ HỮU CÔNG NGHIỆP SỐ 429 TẬP A – QUYỀN 2 (12.2023)

- (11) **48577**
- (21) 3-2022-02409 (28) 2
- (54) **THIẾT BỊ MẠNG GẮN TRÊN TƯỜNG** (51) **14-03**
- (22) 04/11/2022 (43) 25/12/2023
- (30) 29/837,355 04/05/2022 US;
- (73) **UBIQUITI INC. (US)**
685 Third Avenue, 27th Floor, New York NY 10017 Delaware, United States of America
- (72) 1. ROBERT J. PERA (US)
2. TSUNG HWA YANG (TW)
3. TE-HO CHEN (TW)
4. CHI-SHEN WANG (TW)
5. PIN-TA TSAI (TW)
6. YONG-RUEI YANG (TW)
7. PANG-LEI HSU (TW)
8. SIANGTING LI (TW)
- (74) Công ty Luật TNHH T&G (TGVN)
- (55)

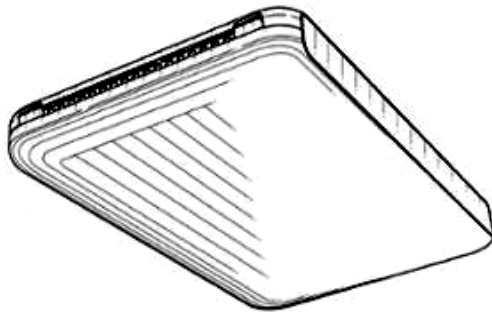

1.1

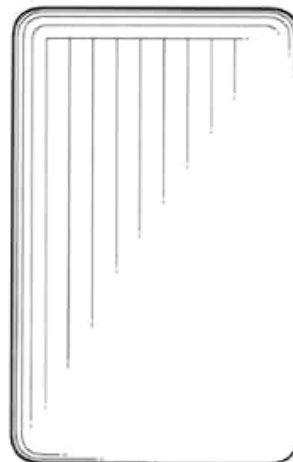

1.2

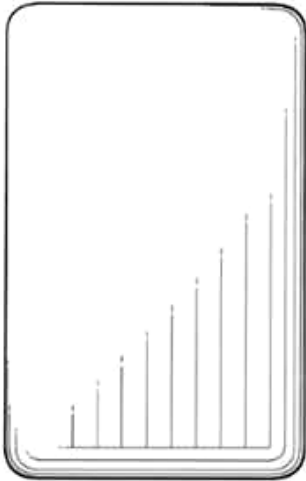

1.3



1.4



1.5

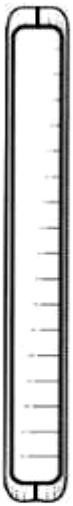

1.6



1.7

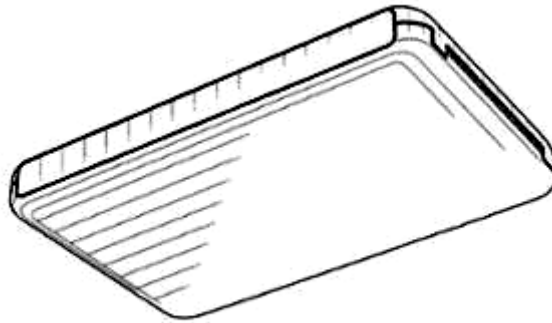

1.8

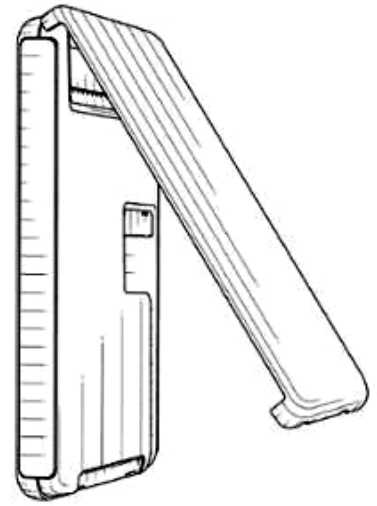

1.9

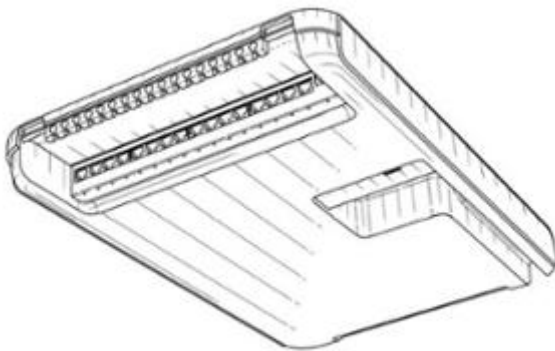

2.1

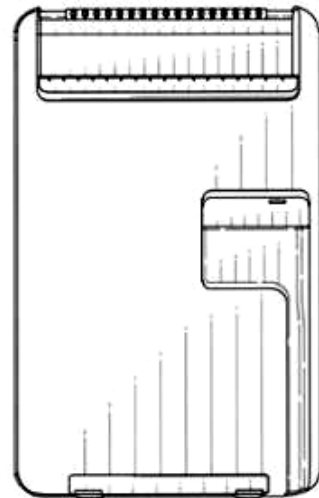

2.2

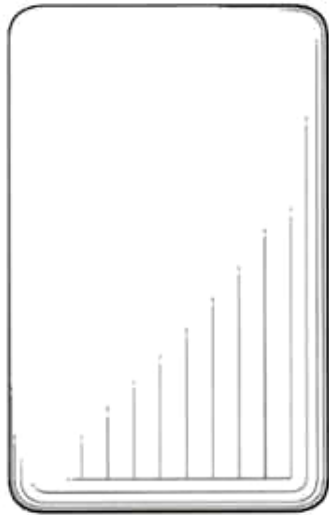

2.3

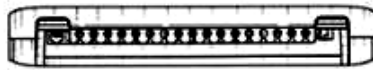

2.4



2.5

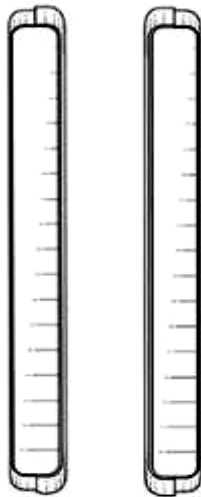

2.6

2.7

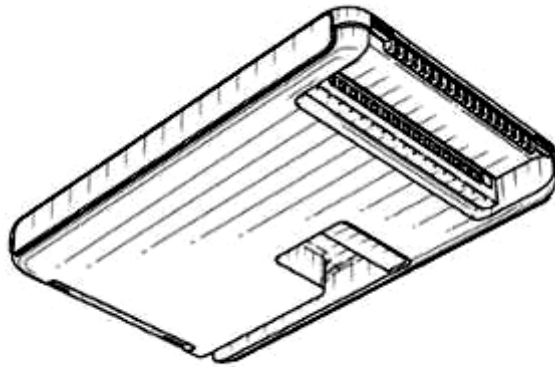

2.8

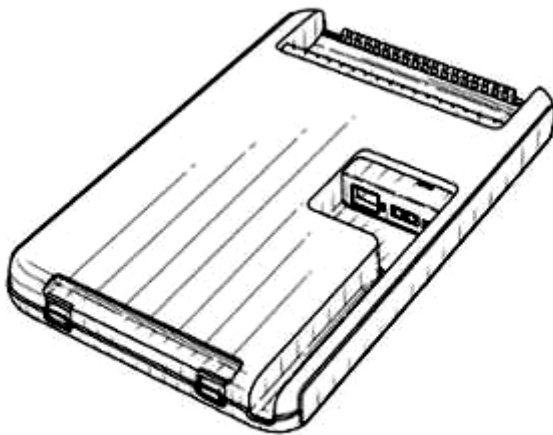

2.9

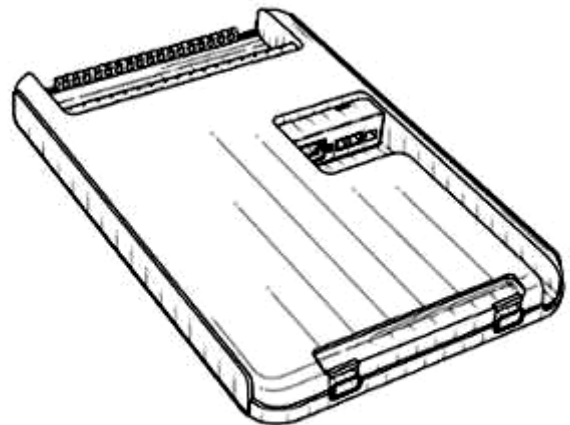

2.10

CÔNG BÁO SỞ HỮU CÔNG NGHIỆP SỐ 429 TẬP A – QUYỀN 2 (12.2023)

- (11) **48578**
- (21) 3-2022-02410 (28) 1
- (54) **THIẾT BỊ MẠNG GẮN TRÊN TƯỜNG** (51) **14-03**
- (22) 04/11/2022 (43) 25/12/2023
- (30) 29/837,664 06/05/2022 US;
- (73) **UBIQUITI INC. (US)**
685 Third Avenue, 27th Floor, New York NY 10017 Delaware, United States of America
- (72) 1. ROBERT J. PERA (US)
2. TSUNG HWA YANG (TW)
3. TE-HO CHEN (TW)
4. CHI-SHEN WANG (TW)
5. YING-JHANG CHEN (TW)
6. SHU-JEN CHOU (TW)
7. CHU-CHI LIN (TW)
8. YONG-RUEI YANG (TW)
9. PANG-LEI HSU (TW)
10. SIANGTING LI (TW)
- (74) Công ty Luật TNHH T&G (TGVN)
- (55)

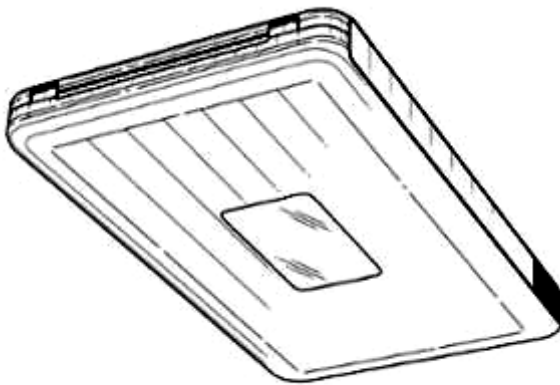

1.1

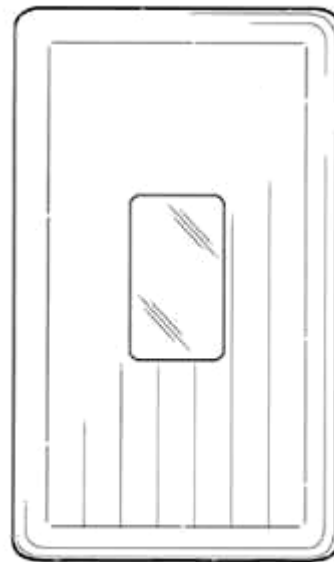

1.2

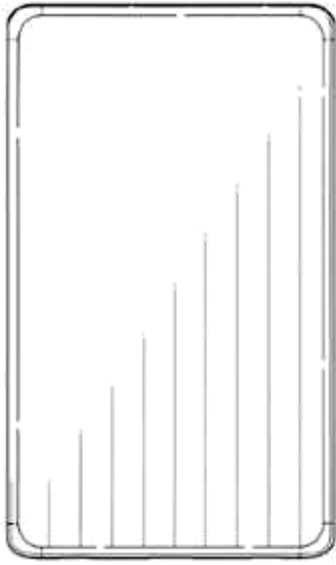

1.3



1.4



1.5

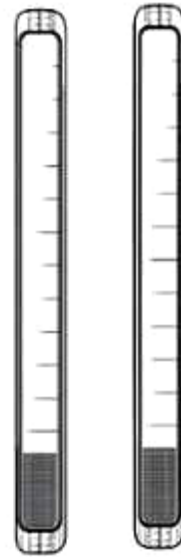

1.6

1.7

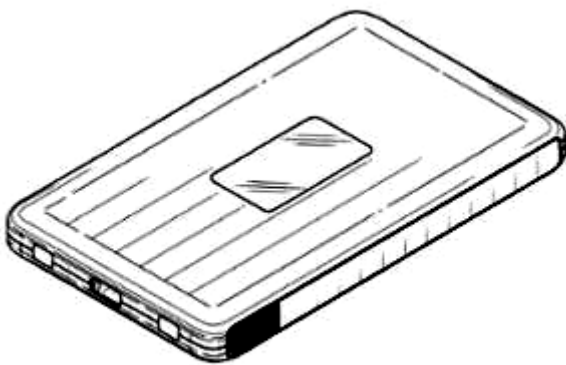

1.8

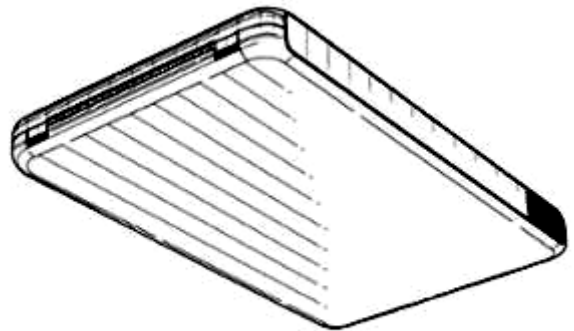

1.9

CÔNG BÁO SỞ HỮU CÔNG NGHIỆP SỐ 429 TẬP A – QUYỀN 2 (12.2023)

- (11) **48579**
(21) 3-2022-02465 (28) 1
(54) **GIÀY** (51) **02-04**
(22) 10/11/2022 (43) 25/12/2023
(30) 29/864,245 16/05/2022 US;
(73) **FULL FORTUNE INTELLECTUAL LIMITED (CN)**
6/F., The Annex, Central Plaza, 18 Harbour Road, Hong Kong
(72) Dario Leonardo Michael Donatello KAUTE (DE)
(74) Công ty TNHH Tầm nhìn và Liên danh (VISION & ASSOCIATES CO.LTD.)
(55)



1.1

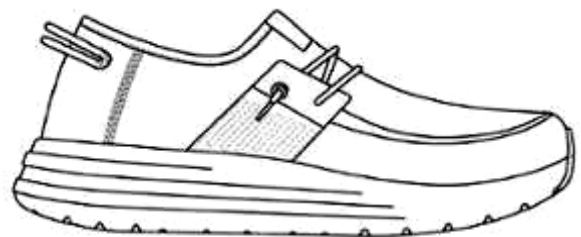

1.2

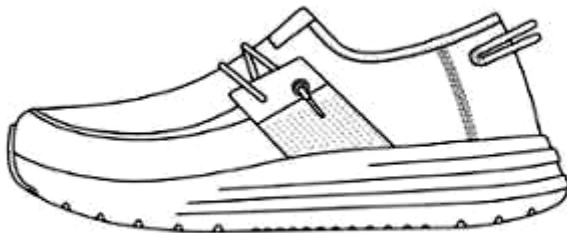

1.3



1.4



1.5

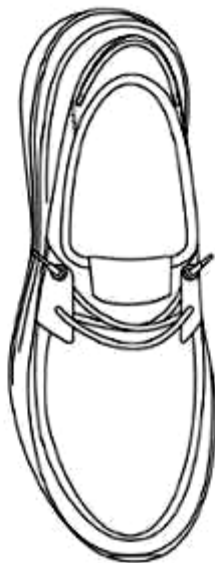

1.6



1.7

CÔNG BÁO SỞ HỮU CÔNG NGHIỆP SỐ 429 TẬP A – QUYỀN 2 (12.2023)

- (11) **48580**
(21) 3-2022-02472 (28) 1
(54) **HỘP** (51) **09-01**
(22) 14/11/2022 (43) 25/12/2023
(30) 2022-010479 17/05/2022 JP;
(73) **ALBION CO., LTD (JP)**
1-7-10, Ginza, Chuo-Ku, Tokyo 104-0061, Japan
(72) Yoko NISHIYAMA (JP)
(74) Công ty Luật TNHH Phạm và Liên danh (PHAM & ASSOCIATES)
(55)



1.1

1.2

1.3

1.4

1.5



1.6



1.7



1.8

CÔNG BÁO SỞ HỮU CÔNG NGHIỆP SỐ 429 TẬP A – QUYỀN 2 (12.2023)

- (11) **48581**
(21) 3-2022-02473 (28) 1
(54) **HỘP** (51) **09-01**
(22) 14/11/2022 (43) 25/12/2023
(30) 2022-010478 17/05/2022 JP;
(73) **ALBION CO., LTD (JP)**
1-7-10, Ginza, Chuo-Ku, Tokyo 104-0061, Japan
(72) Yoko NISHIYAMA (JP)
(74) Công ty Luật TNHH Phạm và Liên danh (PHAM & ASSOCIATES)
(55)



1.1



1.2



1.3



1.4



1.5



1.6



1.7



1.8

CÔNG BÁO SỞ HỮU CÔNG NGHIỆP SỐ 429 TẬP A – QUYỀN 2 (12.2023)

- (11) **48582**
(21) 3-2022-02474 (28) 1
(54) **HỘP** (51) **09-01**
(22) 14/11/2022 (43) 25/12/2023
(30) 2022-010480 17/05/2022 JP;
(73) **ALBION CO., LTD (JP)**
1-7-10, Ginza, Chuo-Ku, Tokyo 104-0061, Japan
(72) Yoko NISHIYAMA (JP)
(74) Công ty Luật TNHH Phạm và Liên danh (PHAM & ASSOCIATES)
(55)



1.1



1.2



1.3



1.4



1.5



1.6



1.7



1.8

CÔNG BÁO SỞ HỮU CÔNG NGHIỆP SỐ 429 TẬP A – QUYỀN 2 (12.2023)

- (11) **48583**
(21) 3-2022-02475 (28) 1
(54) **HỘP** (51) **09-01**
(22) 14/11/2022 (43) 25/12/2023
(30) 2022-010481 17/05/2022 JP;
(73) **ALBION CO., LTD (JP)**
1-7-10, Ginza, Chuo-Ku, Tokyo 104-0061, Japan
(72) Yoko NISHIYAMA (JP)
(74) Công ty Luật TNHH Phạm và Liên danh (PHAM & ASSOCIATES)
(55)



1.1



1.2



1.3



1.4



1.5



1.6



1.7



1.8

CÔNG BÁO SỞ HỮU CÔNG NGHIỆP SỐ 429 TẬP A – QUYỀN 2 (12.2023)

- (11) **48584**
(21) 3-2022-02500 (28) 1
(54) **NẮP CHAI** (51) **09-07**
(22) 16/11/2022 (43) 25/12/2023
(73) **CÔNG TY CỔ PHẦN HÀNG TIÊU DÙNG MASAN (VN)**
Tầng 12, tòa nhà MPlaza Saigon, số 39 Lê Duẩn, phường Bến Nghé, quận 1, thành phố Hồ Chí Minh
(72) Nguyễn Hoàng Yên (VN)
(74) Công ty cổ phần Sở hữu trí tuệ BROSS và Cộng sự (BROSS & PARTNERS., JSC)
(55)

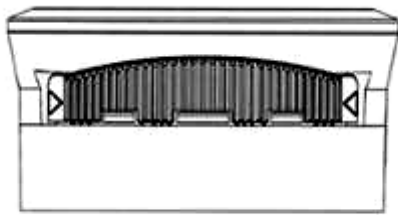

1.1

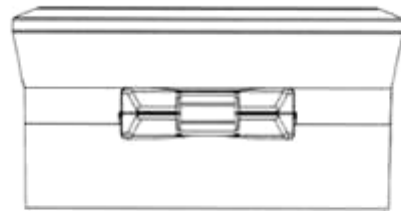

1.2

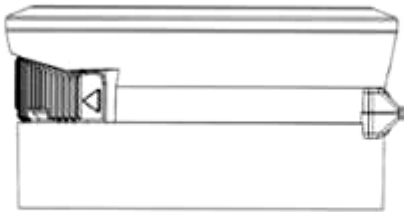

1.3



1.4



1.5

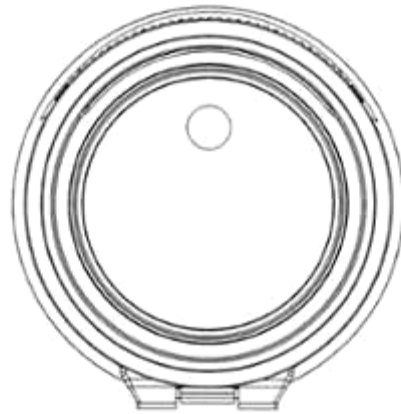

1.6



1.7

CÔNG BÁO SỞ HỮU CÔNG NGHIỆP SỐ 429 TẬP A – QUYỀN 2 (12.2023)

- (11) **48585**
(21) 3-2022-02501 (28) 1
(54) **NẤP CHAI** (51) **09-07**
(22) 16/11/2022 (43) 25/12/2023
(73) **CÔNG TY CỔ PHẦN HÀNG TIÊU DÙNG MASAN (VN)**
Tầng 12, tòa nhà MPlaza Saigon, số 39 Lê Duẩn, phường Bến Nghé, quận 1, thành phố Hồ Chí Minh
(72) Nguyễn Hoàng Yên (VN)
(74) Công ty cổ phần Sở hữu trí tuệ BROSS và Cộng sự (BROSS & PARTNERS., JSC)
(55)

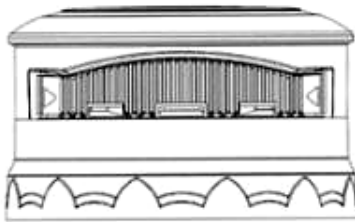

1.1

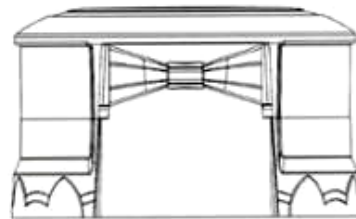

1.2

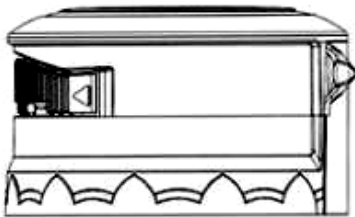

1.3

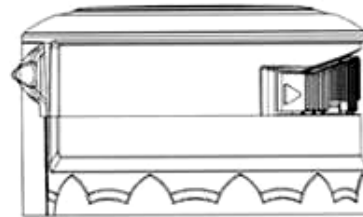

1.4



1.5



1.6



1.7

CÔNG BÁO SỞ HỮU CÔNG NGHIỆP SỐ 429 TẬP A – QUYỀN 2 (12.2023)

- (11) **48586**
(21) 3-2022-02519 (28) 2
(54) **THÙNG MÌ** (51) **09-03**
(22) 18/11/2022 (43) 25/12/2023
(73) **CÔNG TY CỔ PHẦN ACECOOK VIỆT NAM (VN)**
Lô số II-3, đường số 11, nhóm CN II, khu công nghiệp Tân Bình, phường Tây
Thạnh, quận Tân Phú, thành phố Hồ Chí Minh
(72) Kajiwara Junichi (JP)
(74) Công ty Luật TNHH Phạm và Liên danh (PHAM & ASSOCIATES)
(55)



1.1



1.2



2.1



2.2

CÔNG BÁO SỞ HỮU CÔNG NGHIỆP SỐ 429 TẬP A – QUYỀN 2 (12.2023)

- (11) **48587**
(21) 3-2022-02589 (28) 1
(54) **THIẾT BỊ LỌC** (51) **23-01**
(22) 24/11/2022 (43) 25/12/2023
(30) 29/865,850 16/08/2022 US;
(73) **AQUA TRU, LLC (US)**
14724 Ventura Blvd., Suite 200, Sherman Oaks, California 91403, United States of America
(72) 1. PETER SPIEGEL (US)
2. VOYTEK SIWIEC (US)
(74) Công ty TNHH Tầm nhìn và Liên danh (VISION & ASSOCIATES CO.LTD.)
(55)

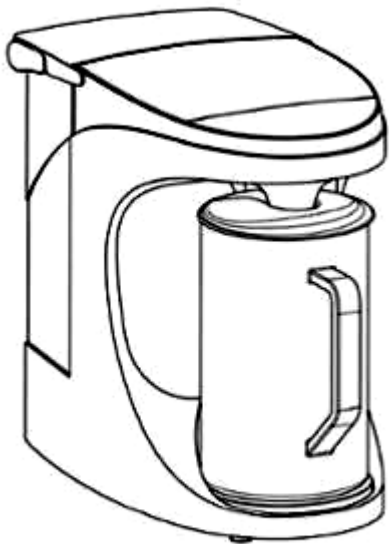

1.1



1.2

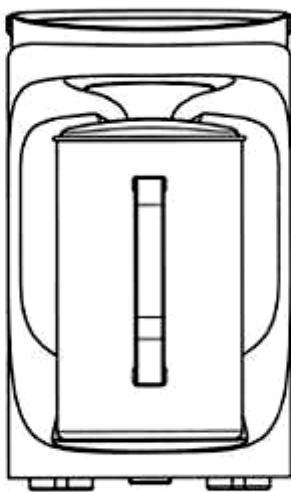

1.3

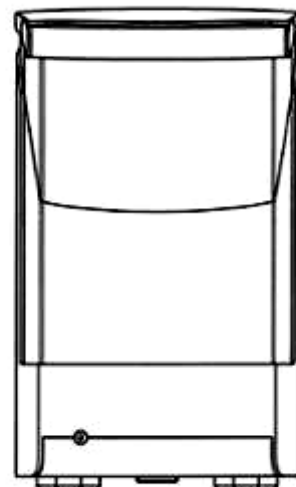

1.4

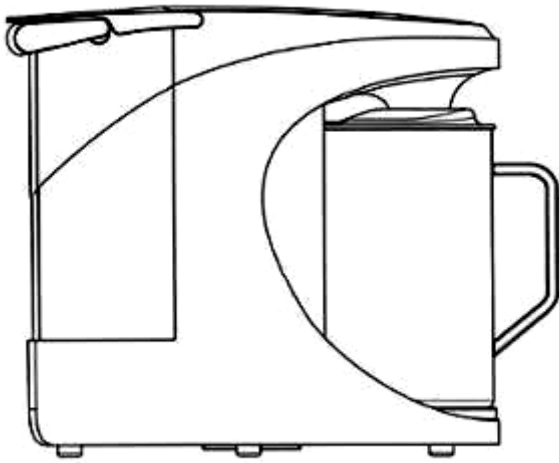

1.5

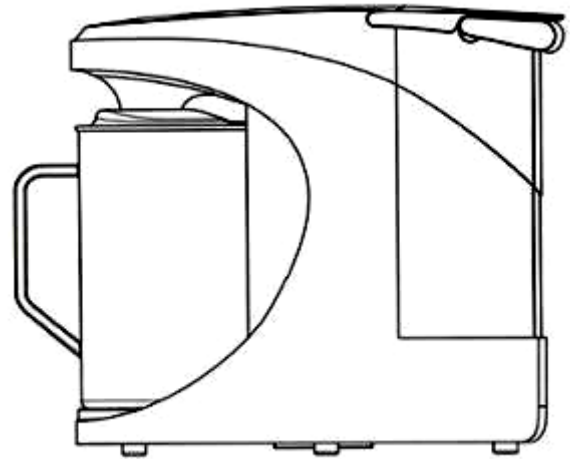

1.6

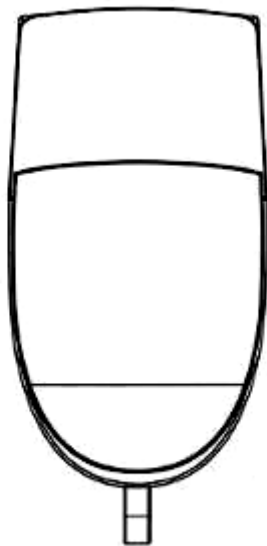

1.7

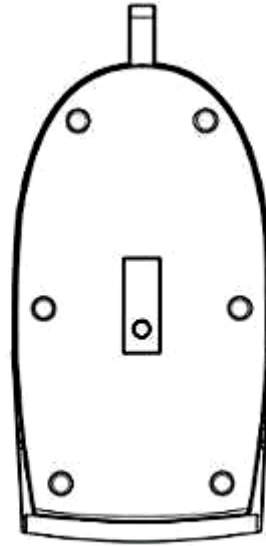

1.8

CÔNG BÁO SỞ HỮU CÔNG NGHIỆP SỐ 429 TẬP A – QUYỀN 2 (12.2023)

- (11) **48588**
(21) 3-2022-02684 (28) 2
(54) **THÂN VÒI HOA SEN** (51) **23-01**
(22) 07/12/2022 (43) 25/12/2023
(30) 202230357710.5 13/06/2022 CN;
(73) **LIXIL INTERNATIONAL PTE. LTD. (SG)**
180 Clemenceau Avenue, Haw Par Centre, #06-02 Singapore 239922 Singapore
(72) 1. ANTOINE BESSEYRE DES HORTS (FR)
2. MINSEONG KIM (KR)
3. HELDER FILIPOV (BR)
(74) Công ty Luật TNHH Phạm và Liên danh (PHAM & ASSOCIATES)
(55)



1.1



1.2



1.3



1.4



1.5



1.6



1.7



2.1



2.2



2.3



2.4



2.5



2.6



2.7

CÔNG BÁO SỞ HỮU CÔNG NGHIỆP SỐ 429 TẬP A – QUYỀN 2 (12.2023)

(11) **48589**

(21) 3-2022-02687

(28) 2

(54) **GHẾ DÀI**

(51) **06-01**

(22) 07/12/2022

(43) 25/12/2023

(73) **NGUYỄN TRẦN PHƯỚC THUẬN (VN)**

39 Lê Lai, phường 3, quận Gò Vấp, thành phố Hồ Chí Minh

(72) Nguyễn Trần Phước Thuận (VN)

(55)



1.1



1.2



1.3



1.4



1.5



1.6



2.1



2.2



2.3



2.4



2.5



2.6

CÔNG BÁO SỞ HỮU CÔNG NGHIỆP SỐ 429 TẬP A – QUYỀN 2 (12.2023)

(11) **48590**

(21) 3-2022-02691

(28) 1

(54) **ĐỒNG HỒ ĐEO TAY**

(51) **10-02**

(22) 07/12/2022

(43) 25/12/2023

(73) **CÔNG TY TNHH PHILIPPE MARK (VN)**

Số 801 Trần Hưng Đạo, phường Bình Khánh, thành phố Long Xuyên, tỉnh An Giang

(72) Nguyễn Hoàng Anh (VN)

(55)

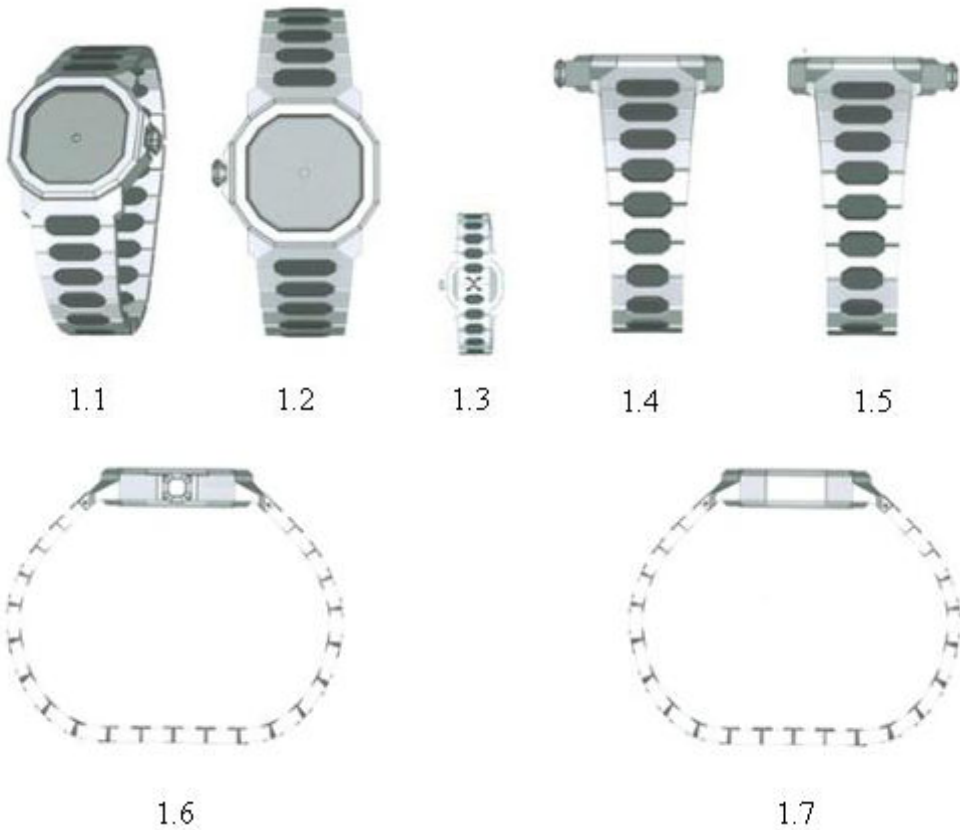

CÔNG BÁO SỞ HỮU CÔNG NGHIỆP SỐ 429 TẬP A – QUYỀN 2 (12.2023)

- (11) **48591**
(21) 3-2022-02693 (28) 1
(54) **MÁY SỬỞI BẰNG GA DI ĐỘNG** (51) **23-03**
(22) 07/12/2022 (43) 25/12/2023
(30) 2022-014193 01/07/2022 JP;
(73) **IWATANI CORPORATION (JP)**
6-4, Hommachi 3-chome, Chuo-ku, Osaka-shi, Osaka, Japan
(72) Tsuyoshi TADA (JP)
(74) Công ty TNHH Đại Tín và Liên Danh (DAITIN AND ASSOCIATES CO.,LTD)
(55)



1.1



1.2



1.3



1.4



1.5



1.6



1.7



1.8



1.9



1.10

(11) **48592**

(21) 3-2022-02695

(28) 1

(54) **CHAI**

(51) **09-01**

(22) 07/12/2022

(43) 25/12/2023

(73) **CÔNG TY CỔ PHẦN THỰC PHẨM NHẤT VIỆT (VN)**

704 Nguyễn Kiệm, phường 04, quận Phú Nhuận, thành phố Hồ Chí Minh

(72) Nguyễn Thiện Hoàng Vinh (VN)

(55)



1.1

1.2

1.3

1.4



1.5

1.6

1.7

- (11) **48593**
(21) 3-2022-02696 (28) 1
(54) **CHAI** (51) **09-01**
(22) 07/12/2022 (43) 25/12/2023
(73) **CÔNG TY CỔ PHẦN THỰC PHẨM NHẤT VIỆT (VN)**
704 Nguyễn Kiệm, phường 04, quận Phú Nhuận, thành phố Hồ Chí Minh
(72) Nguyễn Thiện Hoàng Vinh (VN)
(55)



1.1

1.2

1.3

1.4

1.5



1.6



1.7

CÔNG BÁO SỞ HỮU CÔNG NGHIỆP SỐ 429 TẬP A – QUYỀN 2 (12.2023)

(11) **48594**

(21) 3-2022-02707

(28) 1

(54) **HỘP**

(51) **09-03**

(22) 12/12/2022

(43) 25/12/2023

(73) **CÔNG TY TNHH ĐÔNG Y TOÀN MAI (VN)**

19 đường 14, KP4, phường Linh Đông, quận Thủ Đức, thành phố Hồ Chí Minh

(72) Phạm Đức Toàn (VN)

(55)



1.1



1.2

CÔNG BÁO SỞ HỮU CÔNG NGHIỆP SỐ 429 TẬP A – QUYỀN 2 (12.2023)

- (11) **48595**
(21) 3-2022-02726 (28) 9
(54) **NHÃN SẢN PHẨM** (51) **19-08**
(22) 13/12/2022 (43) 25/12/2023
(73) **CÔNG TY CỔ PHẦN THUỐC LÁ SUNRISE (VN)**
74/24 Thân Văn Nhiếp, phường An Phú, thành phố Thủ Đức, thành phố Hồ Chí Minh
(72) Nguyễn Vũ Minh Hoàng (VN)
(55)



1.1



2.1



3.1



4.1



5.1



6.1



7.1



8.1



9.1

CÔNG BÁO SỞ HỮU CÔNG NGHIỆP SỐ 429 TẬP A – QUYỀN 2 (12.2023)

- (11) **48596**
(21) 3-2022-02727 (28) 10
(54) **BAO GÓI SẢN PHẨM** (51) **09-03**
(22) 13/12/2022 (43) 25/12/2023
(73) **CÔNG TY CỔ PHẦN THUỐC LÁ SUNRISE (VN)**
74/24 Thân Văn Nhiếp, phường An Phú, thành phố Thủ Đức, thành phố Hồ Chí Minh
(72) Nguyễn Vũ Minh Hoàng (VN)
(55)



1.1



1.2



2.1



2.2



3.1



3.2



4.1



4.2



5.1



5.2



6.1



6.2



7.1



7.2



8.1



8.2



9.1



9.2



10.1



10.2

CÔNG BÁO SỞ HỮU CÔNG NGHIỆP SỐ 429 TẬP A – QUYỀN 2 (12.2023)

- (11) **48597**
(21) 3-2022-02741 (28) 1
(54) **HỘP ĐỰNG KẸO** (51) **09-03**
(22) 15/12/2022 (43) 25/12/2023
(73) **CÔNG TY TNHH VĨNH TIẾN (VN)**
Số 60A4, khu phố 1, phường Phú Tân, thành phố Bến Tre, tỉnh Bến Tre
(72) Đặng Thị Trúc Lan Chi (VN)
(55)



1.1



1.2

CÔNG BÁO SỞ HỮU CÔNG NGHIỆP SỐ 429 TẬP A – QUYỀN 2 (12.2023)

- (11) **48598**
(21) 3-2022-02798 (28) 1
(54) **HỮ** (51) **09-01**
(22) 19/12/2022 (43) 25/12/2023
(30) 29/848,137 29/07/2022 US;
(73) **OWENS-BROCKWAY GLASS CONTAINER INC. (US)**
One Michael Owens Way, Perrysburg, Ohio 43551, United States of America
(72) 1. PAUL HARRIS (US)
2. DOUGLAS LAIB (US)
3. CAROLINE BUSSICK (US)
(74) Công ty TNHH Tầm nhìn và Liên danh (VISION & ASSOCIATES CO.LTD.)
(55)



1.1



1.2



1.3

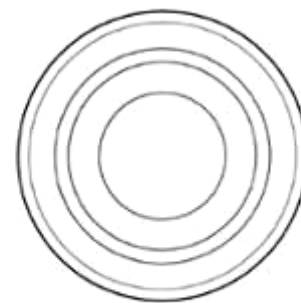

1.4

- (11) **48599**
(21) 3-2022-02817 (28) 1
(54) **HỆ THỐNG TREO GHẾ NGỒI NGƯỜI LÁI XE BUÝT** (51) **15-99**
(22) 20/12/2022 (43) 25/12/2023
(73) **TRƯỜNG ĐẠI HỌC BÁCH KHOA - ĐẠI HỌC QUỐC GIA THÀNH PHỐ HỒ CHÍ MINH (VN)**
268 Lý Thường Kiệt, phường 14, quận 10, thành phố Hồ Chí Minh
(72) Trần Hữu Nhân (VN)
(55)



1.1



1.2



1.3



1.4



1.5



1.6



1.7



1.8

CÔNG BÁO SỞ HỮU CÔNG NGHIỆP SỐ 429 TẬP A – QUYỀN 2 (12.2023)

- (11) **48600**
- (21) 3-2022-02818 (28) 1
- (54) **THIẾT BỊ CHUYỂN MẠCH ĐIỆN LƯỚI VÀ MÁY PHÁT ĐIỆN** (51) **13-01; 13-03**
- (22) 20/12/2022 (43) 25/12/2023
- (73) **MAI HỒNG ANH (VN)**
P.216 - C11, khu tập thể Thanh Xuân Bắc, phường Thanh Xuân Bắc, quận Thanh Xuân, thành phố Hà Nội
- (72) Mai Hồng Anh (VN)
- (74) Công ty TNHH Tư vấn đầu tư và Sở hữu trí tuệ Hoàng Phi (HOANG PHI INVEST & I.P CO., LTD)
- (55)



1.1



1.2



1.3



1.4



1.5



1.6



1.7

- (11) **48601**
(21) 3-2022-02822 (28) 1
(54) **VỎ CHỨA MÁY QUAY PHIM ĐỘ PHÂN GIẢI CAO** (51) **16-01**
(22) 21/12/2022 (43) 25/12/2023
(30) 29/843,477 21/06/2022 US;
(73) **UBIQUITI INC. (US)**
685 Third Avenue, 27th Floor, New York NY 10017, United States of America
(72) 1. ROBERT J. PERA (US)
2. TSUNG HWA YANG (TW)
3. HONG WEI LIN (TW)
(74) Công ty Luật TNHH T&G (TGVN)
(55)

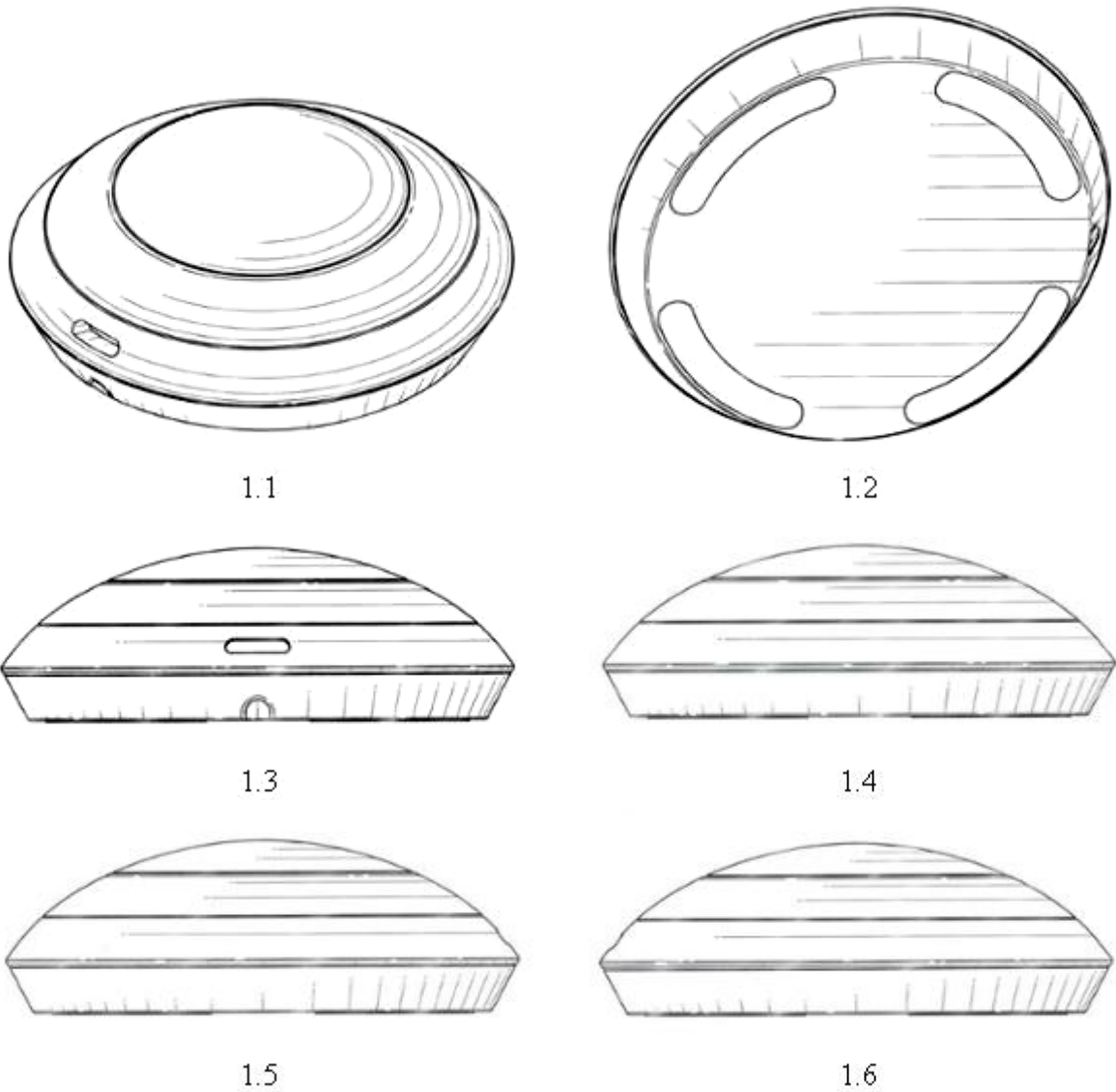

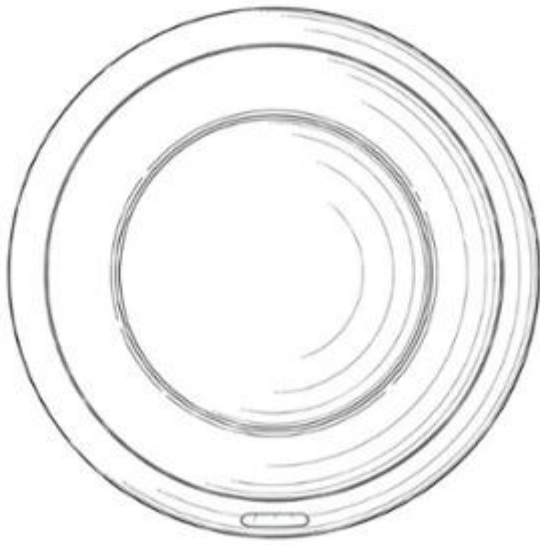

1.7



1.8

CÔNG BÁO SỞ HỮU CÔNG NGHIỆP SỐ 429 TẬP A – QUYỀN 2 (12.2023)

- (11) **48602**
(21) 3-2022-02871 (28) 1
(54) **CAN** (51) **09-02**
(22) 26/12/2022 (43) 25/12/2023
(73) **CÔNG TY TNHH VIDAN (VN)**
Lô C5b đường số 3, khu công nghiệp Hiệp Phước, xã Hiệp Phước, huyện Nhà Bè,
thành phố Hồ Chí Minh
(72) Lê Anh (VN)
(55)



1.1



1.2



1.3



1.4



1.5



1.6



1.7

- (11) **48603**
(21) 3-2022-02898 (28) 2
(54) **CHAI** (51) **09-01**
(22) 27/12/2022 (43) 25/12/2023
(30) 29/844,381 28/06/2022 US;
(73) **COURVOISIER S.A.S. (FR)**
2 Place du Château, Jarnac, FR 16200, France
(72) Daniela Mihranian (GB)
(74) Công ty Luật TNHH T&G (TGVN)
(55)

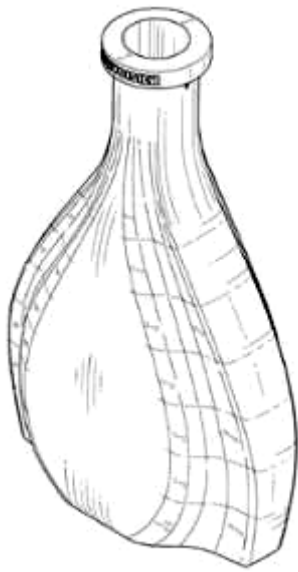

1.1

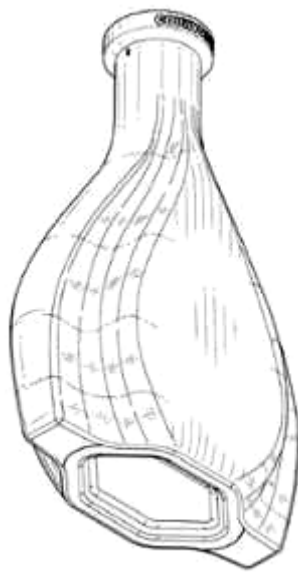

1.2



1.3

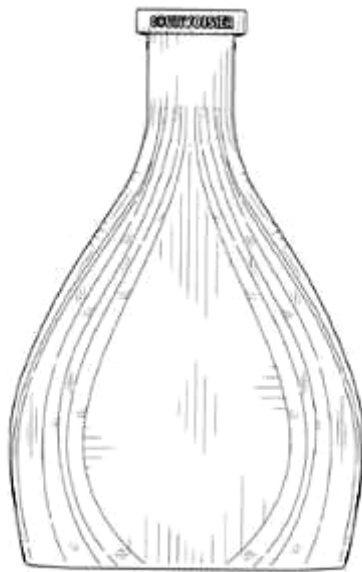

1.4



1.5



1.6

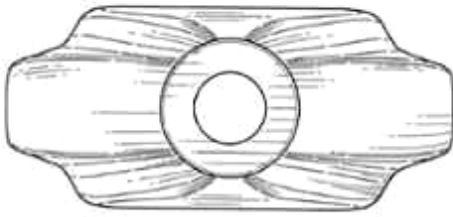

1.7

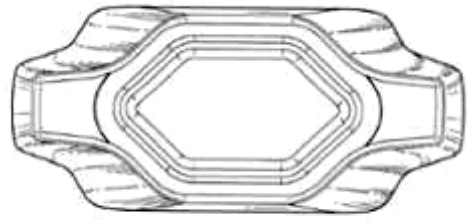

1.8

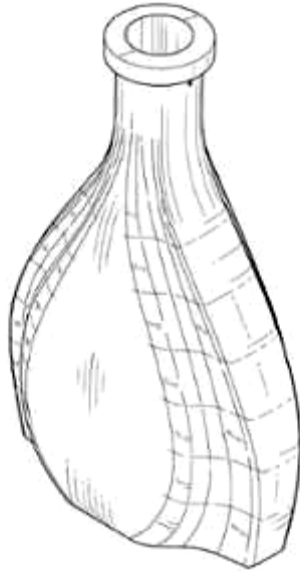

2.1

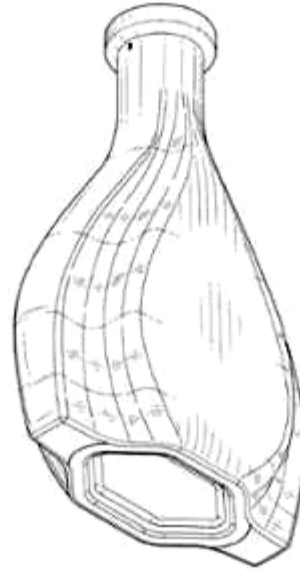

2.2

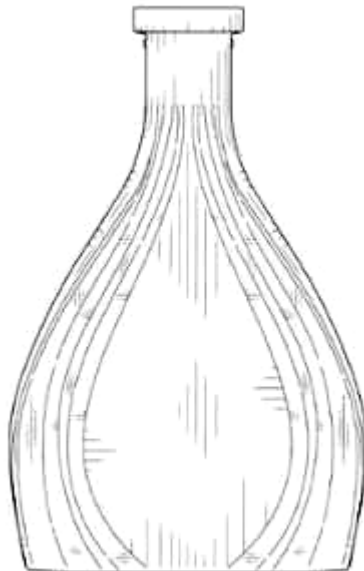

2.3

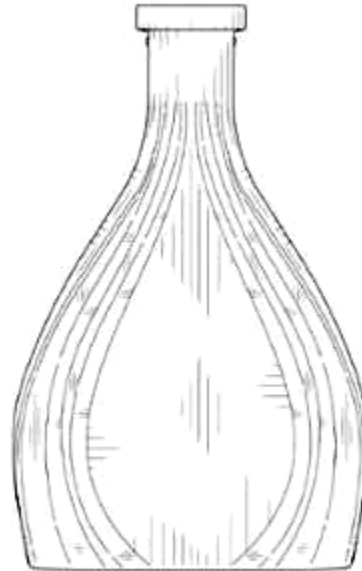

2.4



2.5



2.6

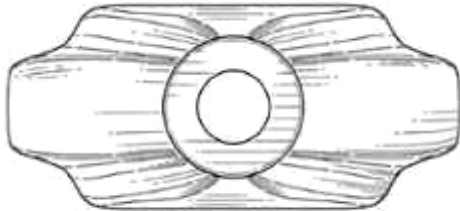

2.7

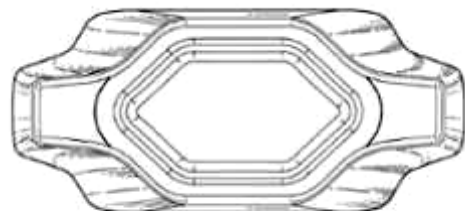

2.8

CÔNG BÁO SỞ HỮU CÔNG NGHIỆP SỐ 429 TẬP A – QUYỀN 2 (12.2023)

- (11) **48604**
(21) 3-2022-02931 (28) 1
(54) **THẨM** (51) **06-11**
(22) 28/12/2022 (43) 25/12/2023
(73) **ZHEJIANG HUAYANG LEISURE PRODUCTS CO., LTD (CN)**
Guanzhuang Industrial Zone, Ruoheng Town, Wenling City, Zhejiang, China
(72) 1. CHENGLONG LIN (CN)
2. HUIMING JIANG (CN)
(74) Công ty Luật TNHH LEADCONSULT (LEADCONSULT)
(55)

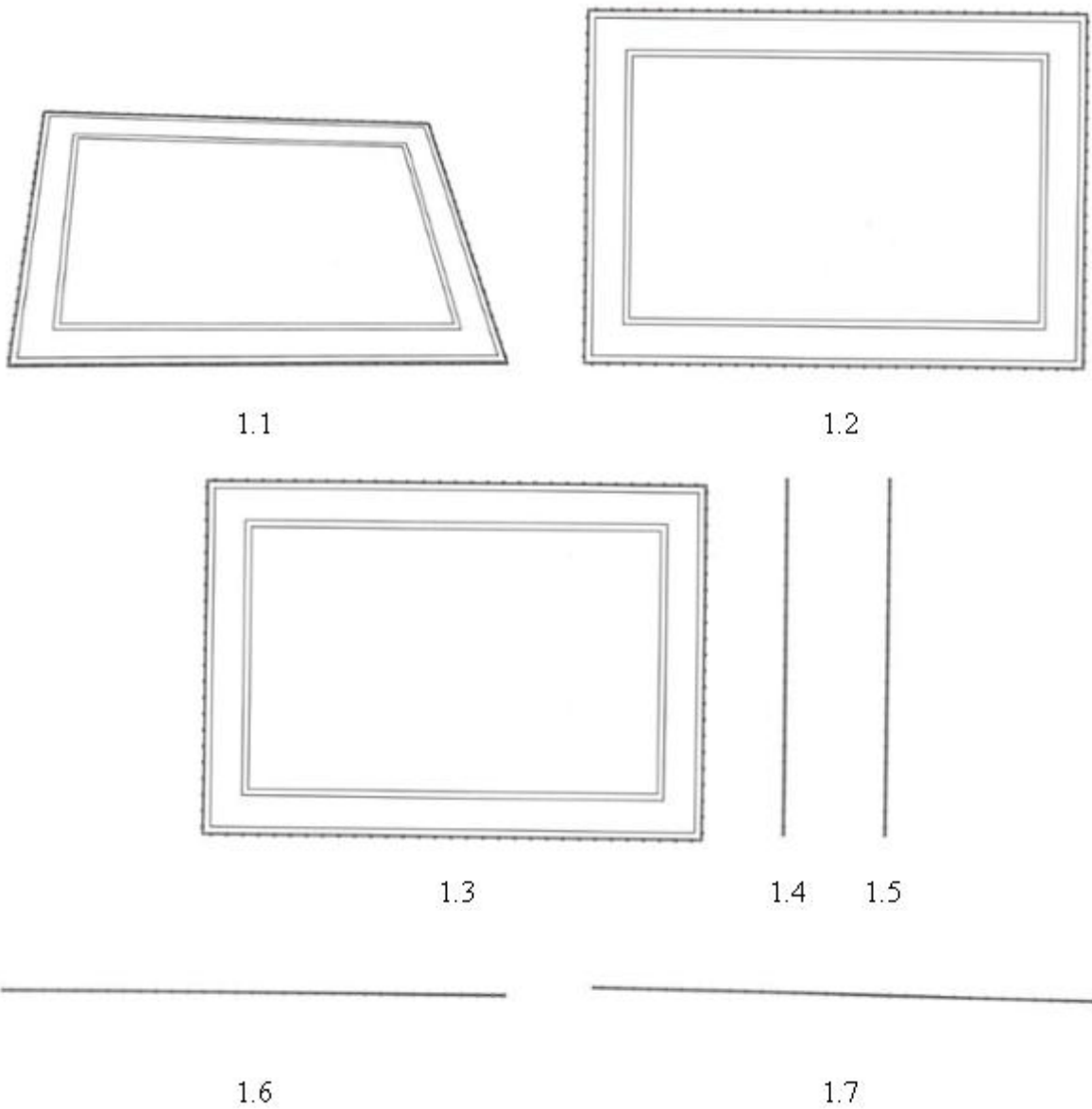

CÔNG BÁO SỞ HỮU CÔNG NGHIỆP SỐ 429 TẬP A – QUYỀN 2 (12.2023)

- (11) **48605**
(21) 3-2022-02971 (28) 1
(54) **KHUNG LỀU TRÊN NÓC XE** (51) **21-04**
(22) 30/12/2022 (43) 25/12/2023
(30) 202230813220.1 05/12/2022 CN;
(73) **TIANJIN HUANQIU RECREATION PRODUCTS CO., LTD (CN)**
TianBao Industrial Park, Baodi District, Tianjin, China
(72) LI Jian (CN)
(74) Công ty TNHH Dịch vụ Sở hữu trí tuệ BIG5 (BIG5 IP CO.,LTD)
(55)

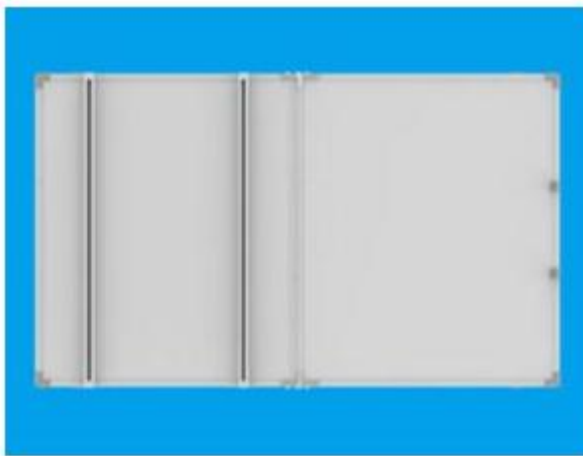

1.1



1.2

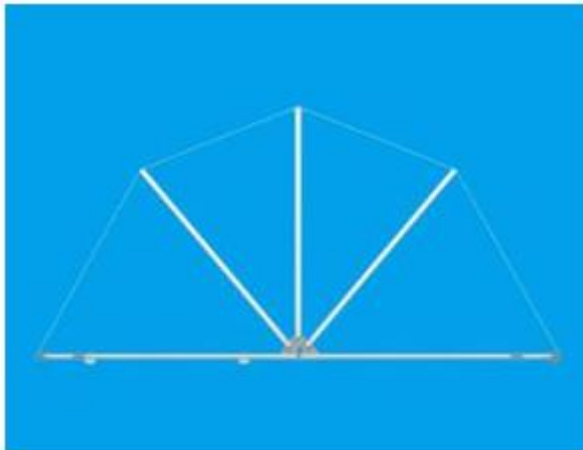

1.3

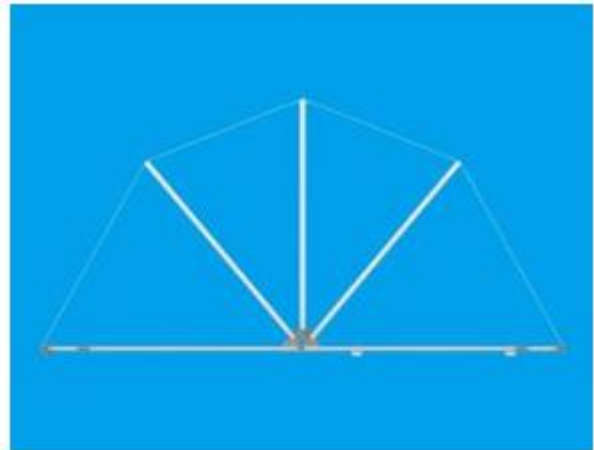

1.4

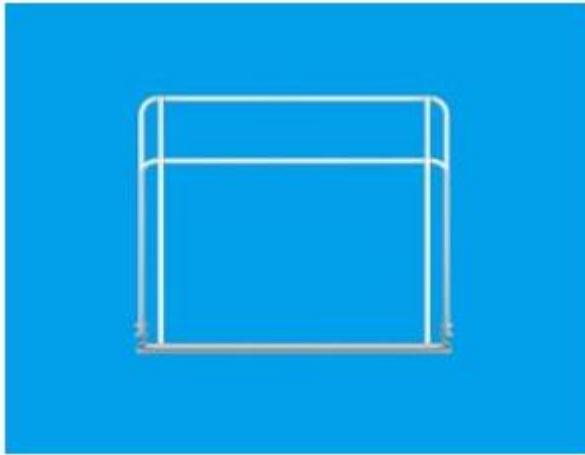

1.5

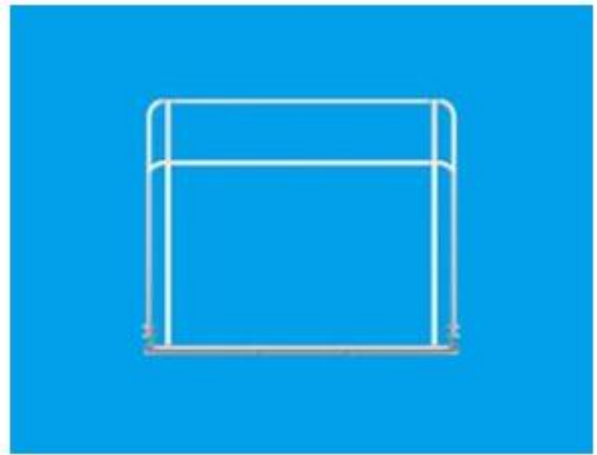

1.6

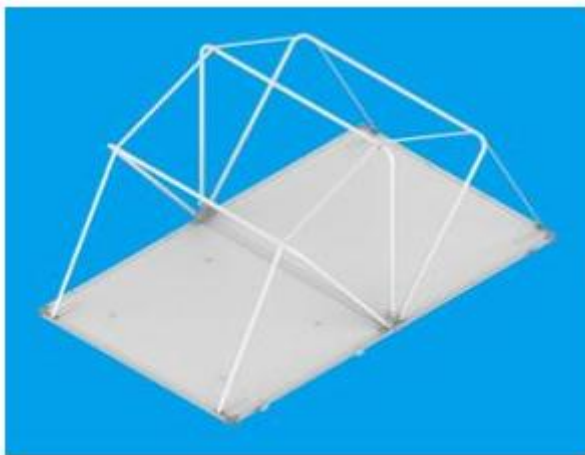

1.7

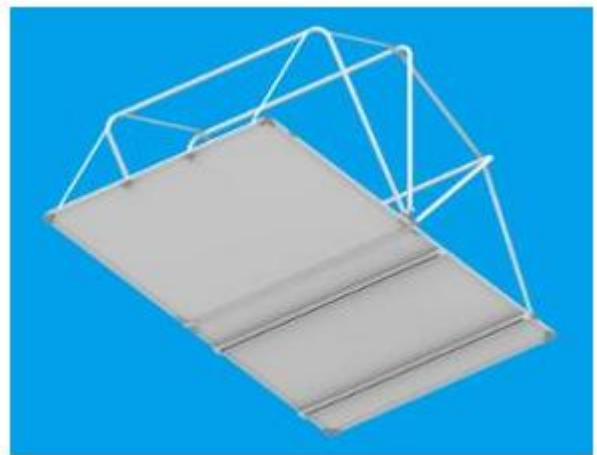

1.8

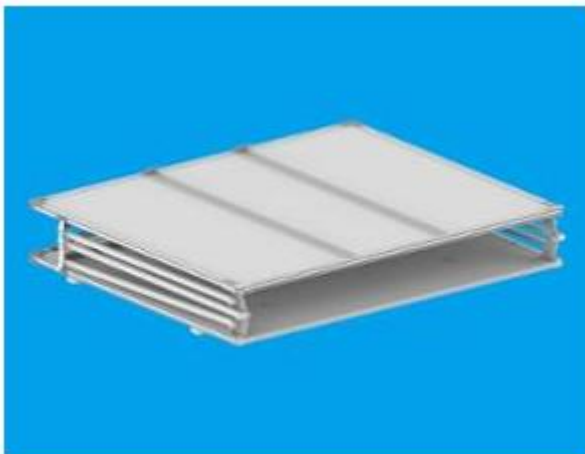

1.9

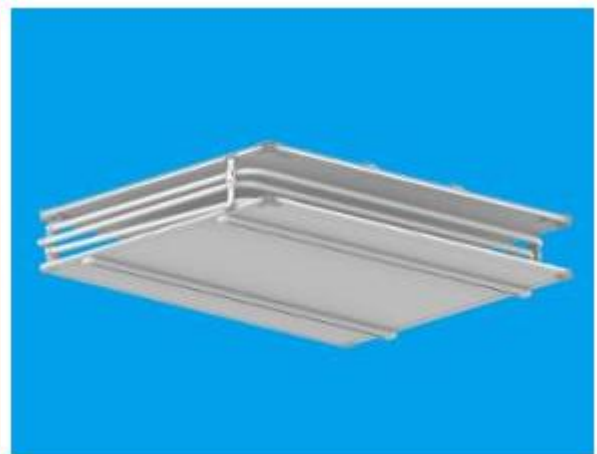

1.10

CÔNG BÁO SỞ HỮU CÔNG NGHIỆP SỐ 429 TẬP A – QUYỀN 2 (12.2023)

- (11) **48606**
(21) 3-2022-02972 (28) 1
(54) **GIÁ ĐỖ KHUNG LỀU TRÊN NÓC XE** (51) **21-04**
(22) 30/12/2022 (43) 25/12/2023
(30) 202230813217.X 05/12/2022 CN;
(73) **TIANJIN HUANQIU RECREATION PRODUCTS CO., LTD (CN)**
TianBao Industrial Park, Baodi District, Tianjin, China
(72) LI Jian (CN)
(74) Công ty TNHH Dịch vụ Sở hữu trí tuệ BIG5 (BIG5 IP CO.,LTD)
(55)

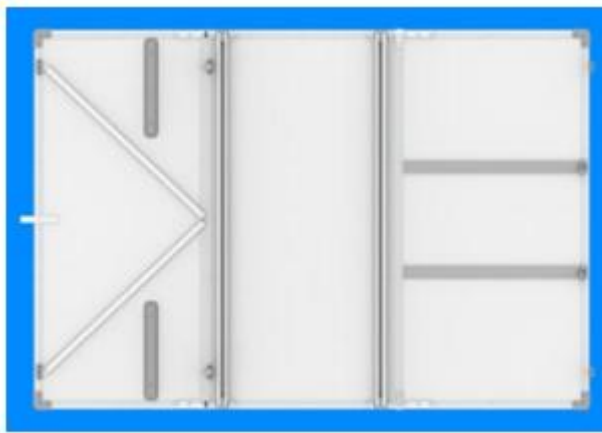

1.1



1.2

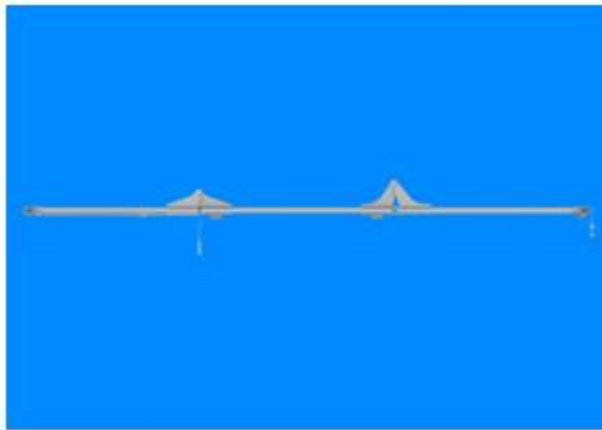

1.3

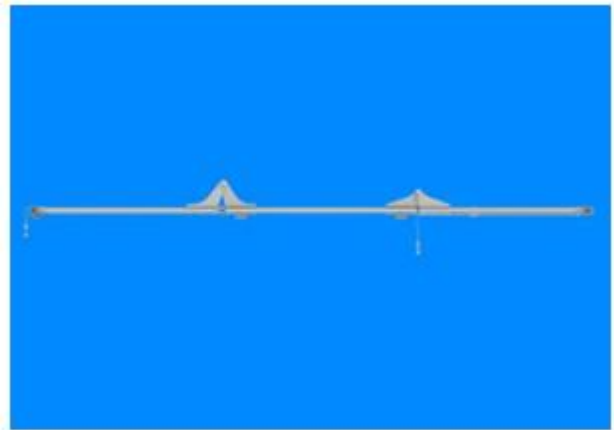

1.4

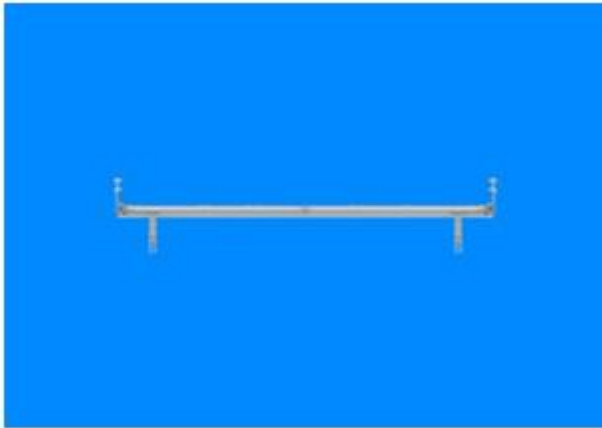

1.5

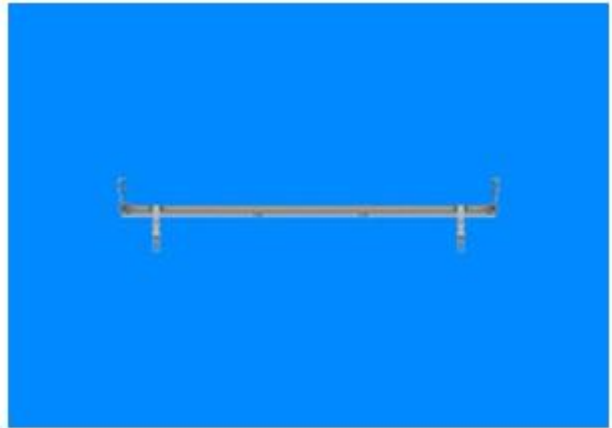

1.6

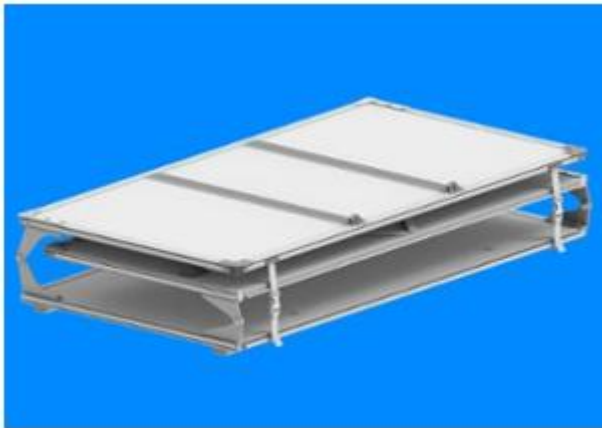

1.7

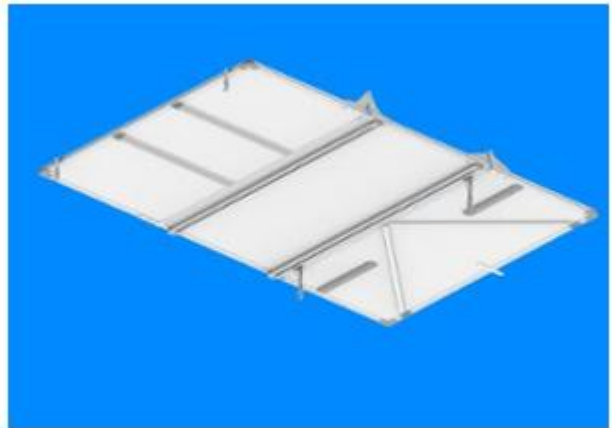

1.8

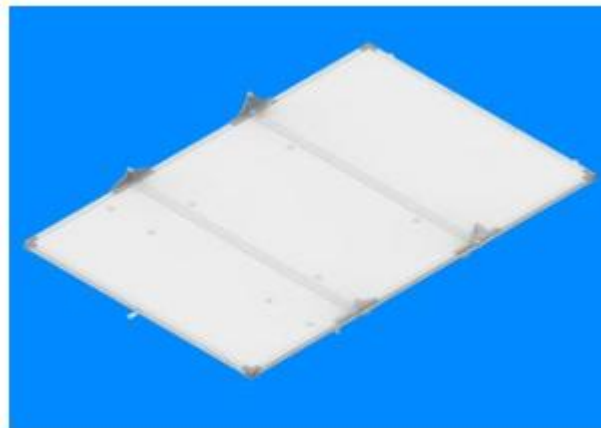

1.9

CÔNG BÁO SỞ HỮU CÔNG NGHIỆP SỐ 429 TẬP A – QUYỀN 2 (12.2023)

- (11) **48607**
(21) 3-2023-00001 (28) 1
(54) **TẮM TẢN NHIỆT PHÍA TRƯỚC XE Ô TÔ** (51) **12-16**
(22) 03/01/2023 (43) 25/12/2023
(30) 2022-014408 05/07/2022 JP;
(73) **HONDA MOTOR CO., LTD. (JP)**
1-1, Minami-Aoyama 2-chome, Minato-ku, Tokyo, 107-8556 Japan
(72) Noriyuki ISHII (JP)
(74) Công ty Luật TNHH Phạm và Liên danh (PHAM & ASSOCIATES)
(55)



1.1



1.2



1.3



1.4



1.5



1.6



1.7



1.8

CÔNG BÁO SỞ HỮU CÔNG NGHIỆP SỐ 429 TẬP A – QUYỀN 2 (12.2023)

- (11) **48608**
(21) 3-2023-00002 (28) 1
(54) **TẮM CẢN VA PHÍA TRƯỚC XE Ô TÔ** (51) **12-16**
(22) 03/01/2023 (43) 25/12/2023
(30) 2022-014406 05/07/2022 JP;
(73) **HONDA MOTOR CO., LTD. (JP)**
1-1, Minami-Aoyama 2-chome, Minato-ku, Tokyo, 107-8556 Japan
(72) Tabito SUGIYAMA (JP)
(74) Công ty Luật TNHH Phạm và Liên danh (PHAM & ASSOCIATES)
(55)



1.1



1.2



1.3



1.4



1.5



1.6



1.7



1.8

CÔNG BÁO SỞ HỮU CÔNG NGHIỆP SỐ 429 TẬP A – QUYỀN 2 (12.2023)

- (11) **48609**
(21) 3-2023-00003 (28) 1
(54) **TẮM TẢN NHIỆT PHÍA TRƯỚC XE Ô TÔ** (51) **12-16**
(22) 03/01/2023 (43) 25/12/2023
(30) 2022-014407 05/07/2022 JP;
(73) **HONDA MOTOR CO., LTD. (JP)**
1-1, Minami-Aoyama 2-chome, Minato-ku, Tokyo, 107-8556 Japan
(72) Noriyuki ISHII (JP)
(74) Công ty Luật TNHH Phạm và Liên danh (PHAM & ASSOCIATES)
(55)



1.1



1.2



1.3



1.4



1.5



1.6



1.7



1.8

CÔNG BÁO SỞ HỮU CÔNG NGHIỆP SỐ 429 TẬP A – QUYỀN 2 (12.2023)

- (11) **48610**
(21) 3-2023-00026 (28) 1
(54) **CAN** (51) **09-02**
(22) 04/01/2023 (43) 25/12/2023
(73) **CÔNG TY TNHH XUẤT NHẬP KHẨU THƯƠNG MẠI JAPAN ONE (VN)**
Số 43/15 - 43/17 đường số 38, khu phố 1, phường An Khánh, thành phố Thủ Đức,
thành phố Hồ Chí Minh
(72) Trần Ngọc Kiên (VN)
(74) **CÔNG TY TNHH KHANG LUẬT (KHANGLAW)**
(55)



1.1



1.2



1.3



1.4



1.5



1.6



1.7

CÔNG BÁO SỞ HỮU CÔNG NGHIỆP SỐ 429 TẬP A – QUYỀN 2 (12.2023)

- (11) **48611**
(21) 3-2023-00045 (28) 1
(54) **BÚT BI** (51) **19-06**
(22) 06/01/2023 (43) 25/12/2023
(73) **CÔNG TY CỔ PHẦN BLUSAIGON (VN)**
129E Nguyễn Đình Chính, phường 8, quận Phú Nhuận, thành phố Hồ Chí Minh
(72) Phan Phúc Thịnh (VN)
(55)

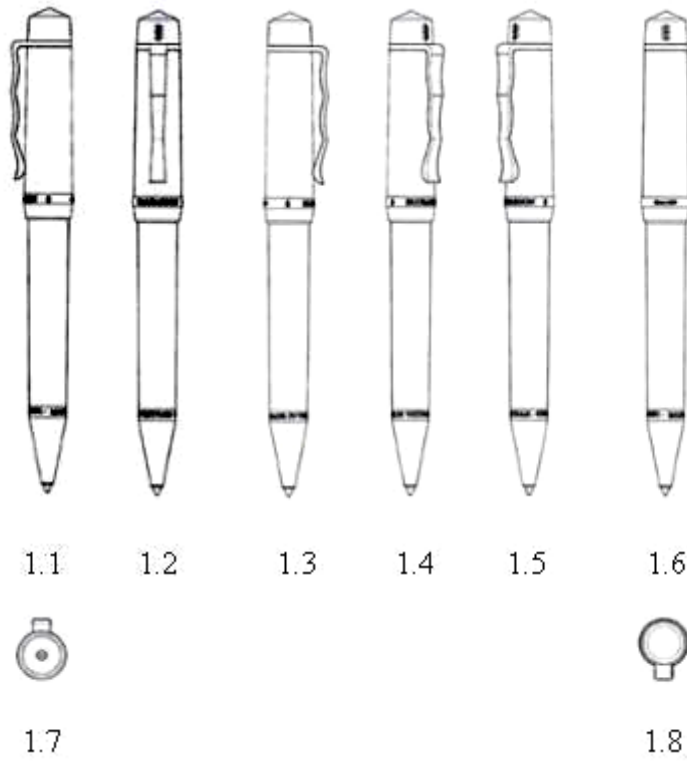

CÔNG BÁO SỞ HỮU CÔNG NGHIỆP SỐ 429 TẬP A – QUYỀN 2 (12.2023)

- (11) **48612**
(21) 3-2023-00056 (28) 1
(54) **THANH KIM LOẠI ĐỊNH HÌNH** (51) **25-01**
(22) 06/01/2023 (43) 25/12/2023
(73) **CÔNG TY CỔ PHẦN TẬP ĐOÀN KENWIN (VN)**
Tầng 4 tòa nhà VG Building, số 235 đường Nguyễn Trãi, phường Thanh Xuân
Trung, quận Thanh Xuân, thành phố Hà Nội
(72) Ngô Thọ Long (VN)
(74) Công ty TNHH Sở hữu trí tuệ PADEMARK (PADEMARK CO.,LTD.)
(55)



1.1



1.2



1.3

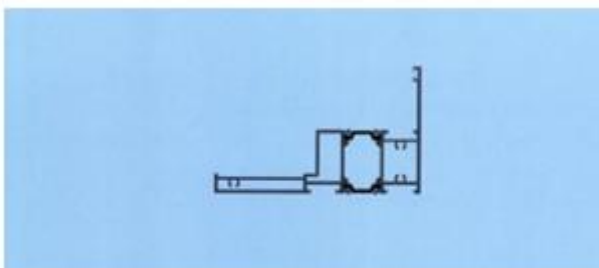

1.4

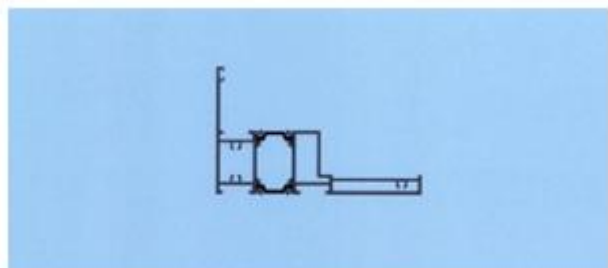

1.5



1.6



1.7

CÔNG BÁO SỞ HỮU CÔNG NGHIỆP SỐ 429 TẬP A – QUYỀN 2 (12.2023)

- (11) **48613**
(21) 3-2023-00057 (28) 1
(54) **THANH KIM LOẠI ĐỊNH HÌNH** (51) **25-01**
(22) 06/01/2023 (43) 25/12/2023
(73) **CÔNG TY CỔ PHẦN TẬP ĐOÀN KENWIN (VN)**
Tầng 4 tòa nhà VG Building, số 235 đường Nguyễn Trãi, phường Thanh Xuân
Trung, quận Thanh Xuân, thành phố Hà Nội
(72) Ngô Thọ Long (VN)
(74) Công ty TNHH Sở hữu trí tuệ PADEMARK (PADEMARK CO.,LTD.)
(55)



1.1



1.2



1.3



1.4

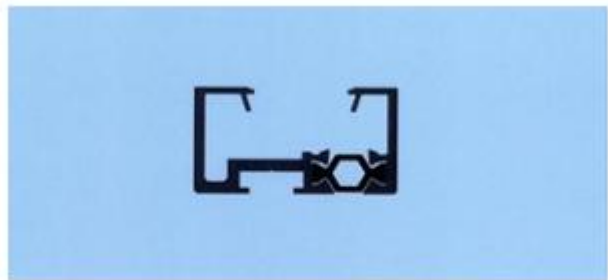

1.5



1.6



1.7

- (11) **48614**
(21) 3-2023-00070 (28) 1
(54) **LƯỢC CHẢI TÓC** (51) **28-03**
(22) 09/01/2023 (43) 25/12/2023
(30) 2022-014941 12/07/2022 JP;
(73) **MTG CO., LTD. (JP)**
2-32 Honjin-tori, Nakamura-ku, Nagoya, Aichi 453-0041, Japan
(72) Kei ITO (JP)
(74) **CÔNG TY LUẬT TRÁCH NHIỆM HỮU HẠN AMBYS HÀ NỘI (AMBYS HANOI)**
(55)

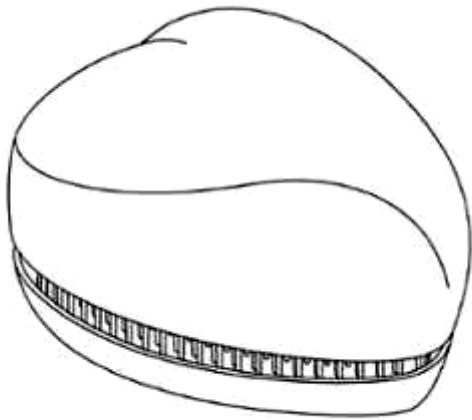

1.1

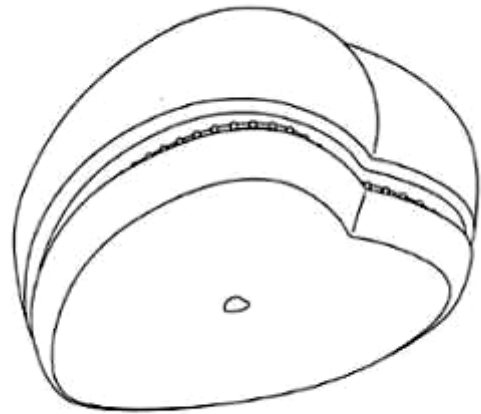

1.2

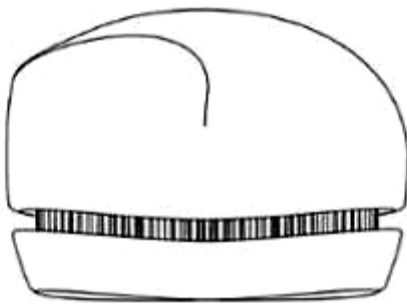

1.3

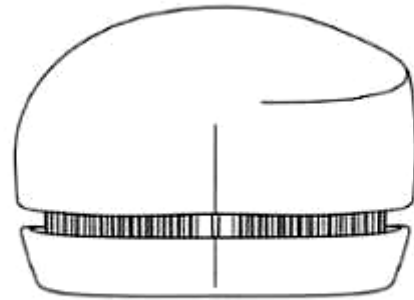

1.4

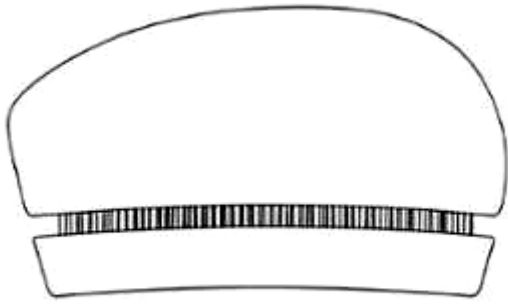

1.5

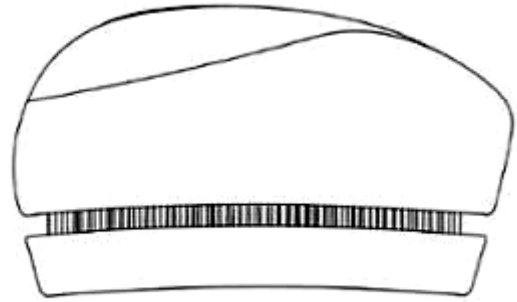

1.6

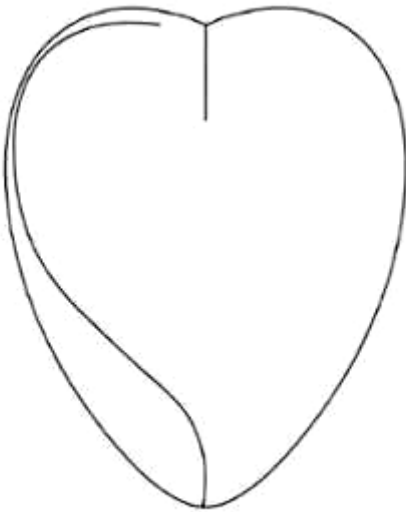

1.7

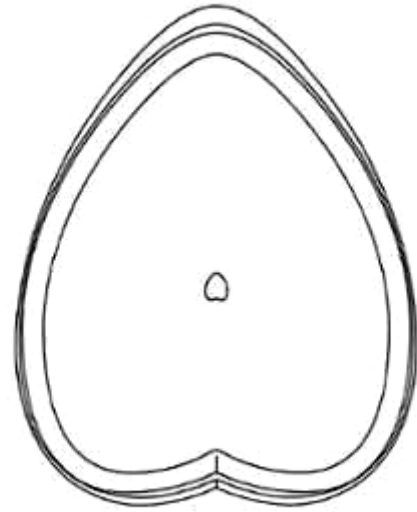

1.8

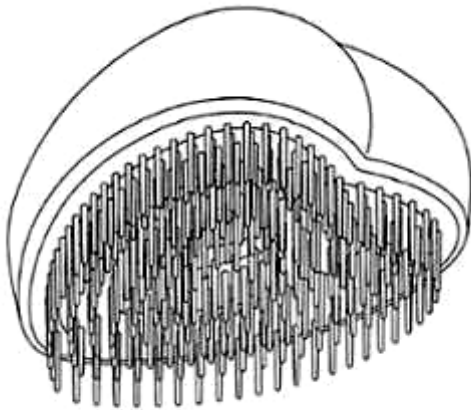

1.9

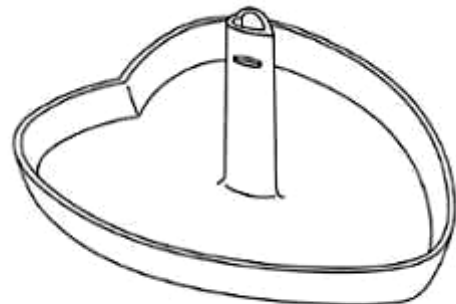

1.10

- (11) **48615**
(21) 3-2023-00082 (28) 2
(54) **GIÁ ĐỀ CHỈ NHA KHOA** (51) **28-03**
(22) 10/01/2023 (43) 25/12/2023
(73) **CÔNG TY TNHH KI. WORKS (VIỆT NAM) (VN)**
Số 40 Đại lộ Độc Lập, Khu công nghiệp Việt Nam-Singapore, Phường Bình Hòa,
Thành phố Thuận An, Tỉnh Bình Dương
(72) Huang, Chiu - Lin (CN)
(55)



1.1



1.2



1.3



1.4



1.5



1.6



1.7



1.8



2.1



2.2



2.3



2.4

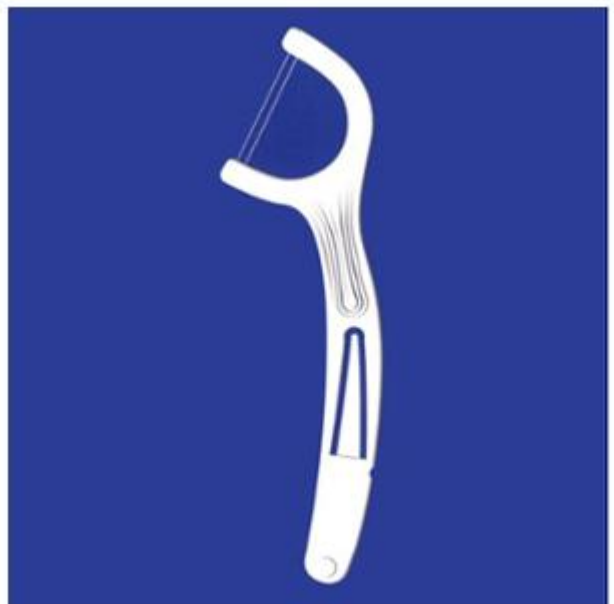

2.5



2.6



2.7



2.8

CÔNG BÁO SỞ HỮU CÔNG NGHIỆP SỐ 429 TẬP A – QUYỀN 2 (12.2023)

- (11) **48616**
(21) 3-2023-00093 (28) 1
(54) **GIƯỜNG KIM LOẠI** (51) **06-02**
(22) 10/01/2023 (43) 25/12/2023
(73) **XIA MEN MINT FURNITURE CO., LTD. (CN)**
No. 200, Zhuangshangli, Silin Village, Wuxian Town, TongAn District, Xiamen,
Fujian, China
(72) Aihua HOU (CN)
(74) Công ty cổ phần Sở hữu trí tuệ BROSS và Cộng sự (BROSS & PARTNERS., JSC)
(55)

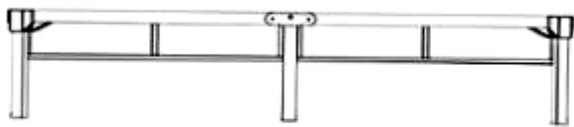

1.1

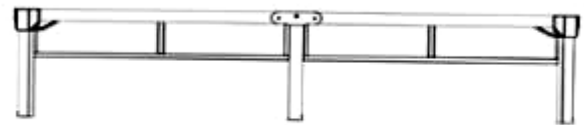

1.2



1.3



1.4

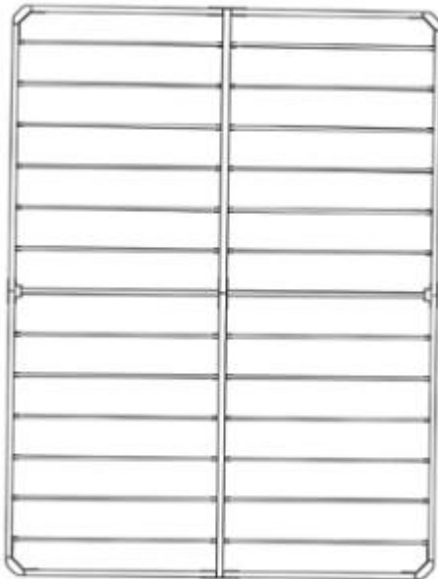

1.5



1.6



1.7

CÔNG BÁO SỞ HỮU CÔNG NGHIỆP SỐ 429 TẬP A – QUYỀN 2 (12.2023)

- (11) **48617**
(21) 3-2023-00110 (28) 1
(54) **THANH NHÔM ĐỊNH HÌNH** (51) **25-01**
(22) 11/01/2023 (43) 25/12/2023
(73) **CÔNG TY TNHH THANH PHÚC WINDOW (VN)**
478 Nguyễn Thị Thập, phường Tân Quy, quận 7, thành phố Hồ Chí Minh
(72) Nguyễn Thị Kim Hoàn (VN)
(55)



1.1

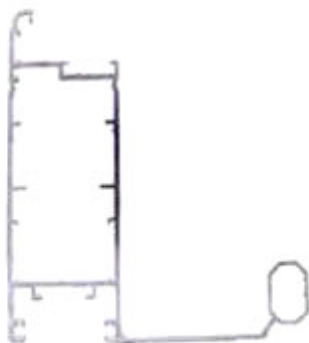

1.2



1.3

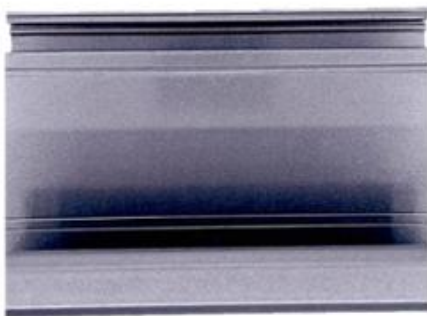

1.4



1.5



1.6



1.7

(11) **48618**

(21) 3-2023-00120

(54) **CẤU KIỆN KÈ LẮP GHÉP**

(22) 12/01/2023

(73) **CÔNG TY CỔ PHẦN KHOA HỌC CÔNG NGHỆ VIỆT NAM (VN)**

Số 6 đường 3 tháng 2, phường 8, thành phố Vũng Tàu, tỉnh Bà Rịa - Vũng Tàu

(72) Hoàng Đức Thảo (VN)

(55)

(28) 1

(51) **25-02**

(43) 25/12/2023

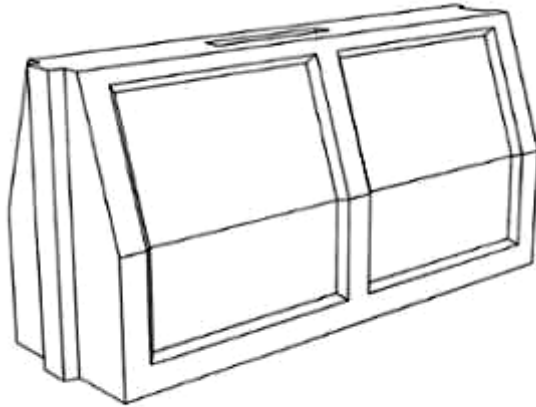

1.1



1.2



1.3

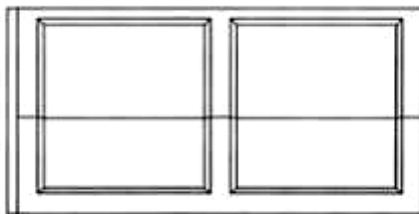

1.4

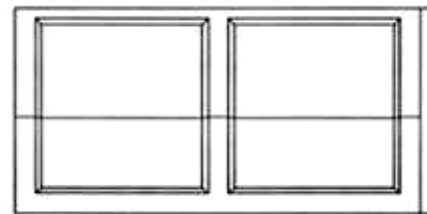

1.5



1.6



1.7

CÔNG BÁO SỞ HỮU CÔNG NGHIỆP SỐ 429 TẬP A – QUYỀN 2 (12.2023)

- | | | | |
|------|---|------|--------------|
| (11) | 48619 | | |
| (21) | 3-2023-00126 | (28) | 1 |
| (54) | NHÃN SẢN PHẨM | (51) | 19-08 |
| (22) | 12/01/2023 | (43) | 25/12/2023 |
| (73) | CÔNG TY TNHH THƯƠNG MẠI SẢN XUẤT DỊCH VỤ HÒA AN ORGANIC (VN)
Số 91, Nguyễn Văn Bạch, khu phố 5, phường 3, thành phố Tây Ninh, tỉnh Tây Ninh | | |
| (72) | Nguyễn Thị Mai Trâm (VN) | | |
| (74) | Công ty TNHH Đại Tín và Liên Danh (DAITIN AND ASSOCIATES CO.,LTD) | | |
| (55) | | | |



CÔNG BÁO SỞ HỮU CÔNG NGHIỆP SỐ 429 TẬP A – QUYỀN 2 (12.2023)

- (11) **48620**
- (21) 3-2023-00127 (28) 1
- (54) **NHÃN SẢN PHẨM** (51) **19-08**
- (22) 12/01/2023 (43) 25/12/2023
- (73) **CÔNG TY TNHH THƯƠNG MẠI SẢN XUẤT DỊCH VỤ HÒA AN ORGANIC (VN)**
Số 91, Nguyễn Văn Bạch, khu phố 5, phường 3, thành phố Tây Ninh, tỉnh Tây Ninh
- (72) Nguyễn Thị Mai Trâm (VN)
- (74) Công ty TNHH Đại Tín và Liên Danh (DAITIN AND ASSOCIATES CO.,LTD)
- (55)



CÔNG BÁO SỞ HỮU CÔNG NGHIỆP SỐ 429 TẬP A – QUYỀN 2 (12.2023)

- (11) **48621**
- (21) 3-2023-00128 (28) 1
- (54) **NHÃN SẢN PHẨM** (51) **19-08**
- (22) 12/01/2023 (43) 25/12/2023
- (73) **CÔNG TY TNHH THƯƠNG MẠI SẢN XUẤT DỊCH VỤ HÒA AN ORGANIC (VN)**
Số 91, Nguyễn Văn Bạch, khu phố 5, phường 3, thành phố Tây Ninh, tỉnh Tây Ninh
- (72) Nguyễn Thị Mai Trâm (VN)
- (74) Công ty TNHH Đại Tín và Liên Danh (DAITIN AND ASSOCIATES CO.,LTD)
- (55)



CÔNG BÁO SỞ HỮU CÔNG NGHIỆP SỐ 429 TẬP A – QUYỀN 2 (12.2023)

- (11) **48622**
- (21) 3-2023-00129 (28) 1
- (54) **NHÃN SẢN PHẨM** (51) **19-08**
- (22) 12/01/2023 (43) 25/12/2023
- (73) **CÔNG TY TNHH THƯƠNG MẠI SẢN XUẤT DỊCH VỤ HÒA AN ORGANIC (VN)**
Số 91, Nguyễn Văn Bạch, khu phố 5, phường 3, thành phố Tây Ninh, tỉnh Tây Ninh
- (72) Nguyễn Thị Mai Trâm (VN)
- (74) Công ty TNHH Đại Tín và Liên Danh (DAITIN AND ASSOCIATES CO.,LTD)
- (55)



CÔNG BÁO SỞ HỮU CÔNG NGHIỆP SỐ 429 TẬP A – QUYỀN 2 (12.2023)

- (11) **48623**
- (21) 3-2023-00130 (28) 1
- (54) **NHÃN SẢN PHẨM** (51) **19-08**
- (22) 12/01/2023 (43) 25/12/2023
- (73) **CÔNG TY TNHH THƯƠNG MẠI SẢN XUẤT DỊCH VỤ HÒA AN ORGANIC (VN)**
Số 91, Nguyễn Văn Bạch, khu phố 5, phường 3, thành phố Tây Ninh, tỉnh Tây Ninh
- (72) Nguyễn Thị Mai Trâm (VN)
- (74) Công ty TNHH Đại Tín và Liên Danh (DAITIN AND ASSOCIATES CO.,LTD)
- (55)



CÔNG BÁO SỞ HỮU CÔNG NGHIỆP SỐ 429 TẬP A – QUYỀN 2 (12.2023)

- (11) **48624**
- (21) 3-2023-00131 (28) 1
- (54) **NHÃN SẢN PHẨM** (51) **19-08**
- (22) 12/01/2023 (43) 25/12/2023
- (73) **CÔNG TY TNHH THƯƠNG MẠI SẢN XUẤT DỊCH VỤ HÒA AN ORGANIC (VN)**
Số 91, Nguyễn Văn Bạch, khu phố 5, phường 3, thành phố Tây Ninh, tỉnh Tây Ninh
- (72) Nguyễn Thị Mai Trâm (VN)
- (74) Công ty TNHH Đại Tín và Liên Danh (DAITIN AND ASSOCIATES CO.,LTD)
- (55)



CÔNG BÁO SỞ HỮU CÔNG NGHIỆP SỐ 429 TẬP A – QUYỀN 2 (12.2023)

- (11) **48625**
(21) 3-2023-00132 (28) 2
(54) **NHÃN SẢN PHẨM** (51) **19-08**
(22) 12/01/2023 (43) 25/12/2023
(73) **CÔNG TY TNHH THƯƠNG MẠI SẢN XUẤT DỊCH VỤ HÒA AN ORGANIC (VN)**
Số 91, Nguyễn Văn Bạch, khu phố 5, phường 3, thành phố Tây Ninh, tỉnh Tây Ninh
(72) Nguyễn Thị Mai Trâm (VN)
(74) Công ty TNHH Đại Tín và Liên Danh (DAITIN AND ASSOCIATES CO.,LTD)
(55)



1.1



2.1

CÔNG BÁO SỞ HỮU CÔNG NGHIỆP SỐ 429 TẬP A – QUYỀN 2 (12.2023)

- (11) **48626**
- (21) 3-2023-00136 (28) 1
- (54) **NHÃN SẢN PHẨM** (51) **19-08**
- (22) 13/01/2023 (43) 25/12/2023
- (73) **CÔNG TY CỔ PHẦN THỰC PHẨM NHẤT VIỆT (VN)**
704 Nguyễn Kiệm, phường 4, quận Phú Nhuận, thành phố Hồ Chí Minh
- (72) Nguyễn Thiện Hoàng Vinh (VN)
- (55)



CÔNG BÁO SỞ HỮU CÔNG NGHIỆP SỐ 429 TẬP A – QUYỀN 2 (12.2023)

- (11) **48627**
(21) 3-2023-00137 (28) 1
(54) **NHÃN SẢN PHẨM** (51) **19-08**
(22) 13/01/2023 (43) 25/12/2023
(73) **CÔNG TY CỔ PHẦN THỰC PHẨM NHẤT VIỆT (VN)**
704 Nguyễn Kiệm, phường 4, quận Phú Nhuận, thành phố Hồ Chí Minh
(72) Nguyễn Thiện Hoàng Vinh (VN)
(55)



CÔNG BÁO SỞ HỮU CÔNG NGHIỆP SỐ 429 TẬP A – QUYỀN 2 (12.2023)

- (11) **48628**
(21) 3-2023-00138 (28) 1
(54) **CHAI** (51) **09-01**
(22) 13/01/2023 (43) 25/12/2023
(73) **CÔNG TY CỔ PHẦN DẦU THỰC VẬT TƯỜNG AN (VN)**
Lầu 10, tòa nhà Empress Tower, số 138 - 142 đường Hai Bà Trưng, phường Đa
Kao, quận 1, thành phố Hồ Chí Minh
(72) Trần Lê Nguyên (VN)
(74) Công ty TNHH Dịch vụ Thương mại và Sở hữu công nghiệp Song Ngọc (I.P.T.S.)
(55)



1.1

1.2

1.3

1.4



1.5



1.6

CÔNG BÁO SỞ HỮU CÔNG NGHIỆP SỐ 429 TẬP A – QUYỀN 2 (12.2023)

- (11) **48629**
(21) 3-2023-00171 (28) 1
(54) **BAO BÌ SẢN PHẨM** (51) **09-05**
(22) 17/01/2023 (43) 25/12/2023
(73) **CÔNG TY CỔ PHẦN PHÂN BÓN NA UY (VN)**
Lô A2, KCN Tân Kim mở rộng, thị trấn Cần Giuộc, huyện Cần Giuộc, tỉnh Long An
(72) Nguyễn Chí Cao (VN)
(55)



1.1



1.2

CÔNG BÁO SỞ HỮU CÔNG NGHIỆP SỐ 429 TẬP A – QUYỀN 2 (12.2023)

- (11) **48630**
(21) 3-2023-00178 (28) 1
(54) **HỒ LÔ HÓA VÀNG** (51) **23-03**
(22) 17/01/2023 (43) 25/12/2023
(73) **CÔNG TY TNHH TRANG ĐIỂM ĐÔ THỊ HỮU ĐỨC (VN)**
Số 37, ngõ 67, phố Thái Thịnh, phường Thịnh Quang, quận Đống Đa, thành phố Hà Nội
(72) Lê Hữu Đức (VN)
(74) Công ty TNHH Sở hữu trí tuệ Hải Hân (HAI HAN IP CO., LTD.)
(55)



1.1



1.2



1.3



1.4



1.5



1.6

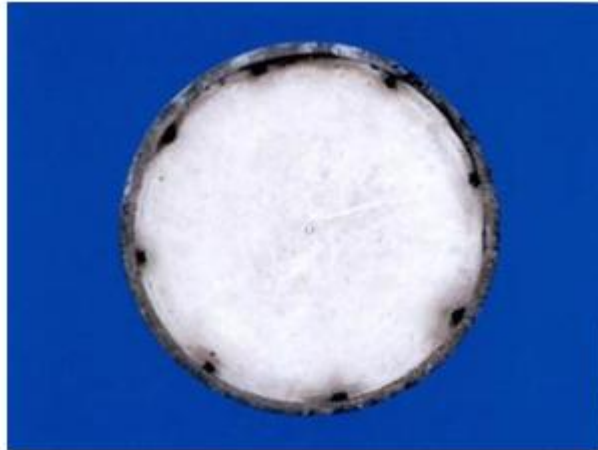

1.7

CÔNG BÁO SỞ HỮU CÔNG NGHIỆP SỐ 429 TẬP A – QUYỀN 2 (12.2023)

- (11) **48631**
(21) 3-2023-00180 (28) 1
(54) **XE MÁY ĐIỆN** (51) **12-11**
(22) 18/01/2023 (43) 25/12/2023
(30) 29/846,839 19/07/2022 US;
(73) **RYVID, INC. (US)**
Suite A16 2323 Main Street, Irvine, California 92614, U.S.A
(72) Dong Tran (US)
(74) Công ty TNHH Quốc tế D &N (D&N INTERNATIONAL CO.,LTD.)
(55)



1.1



1.2



1.3



1.4



1.5



1.6



1.7



1.8



1.9



1.10

CÔNG BÁO SỞ HỮU CÔNG NGHIỆP SỐ 429 TẬP A – QUYỀN 2 (12.2023)

- (11) **48632**
(21) 3-2023-00195 (28) 1
(54) **NẮP VẬT CHỨA** (51) **09-07**
(22) 19/01/2023 (43) 25/12/2023
(73) **LG HOUSEHOLD & HEALTH CARE LTD. (KR)**
58, Saemunan-ro, Jongno-gu, Seoul, Republic of Korea
(72) SHIN, Ho Jun (KR)
(74) Công ty TNHH Tâm nhìn và Liên danh (VISION & ASSOCIATES CO.LTD.)
(55)



1.1



1.2



1.3



1.4



1.5

- (11) **48633**
(21) 3-2023-00196 (28) 1
(54) **NÚM ĐIỀU KHIỂN DÙNG CHO BỘ ĐIỀU KHIỂN THIẾT BỊ ĐIỆN TỬ** (51) **14-03**
(22) 27/01/2023 (43) 25/12/2023
(30) 2022-016801 05/08/2022 JP;
(73) **SONY INTERACTIVE ENTERTAINMENT INC. (JP)**
1-7-1 Konan, Minato-ku, Tokyo, Japan
(72) 1. MASAHO MORITA (JP)
2. KENTA KIDOBA (JP)
(74) Công ty Luật TNHH Phạm và Liên danh (PHAM & ASSOCIATES)
(55)

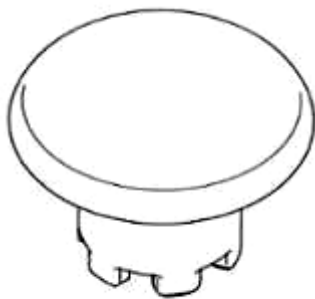

1.1

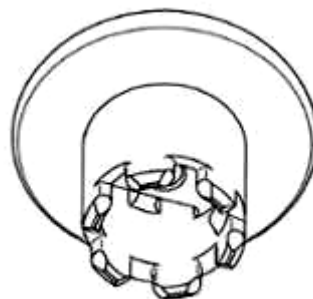

1.2

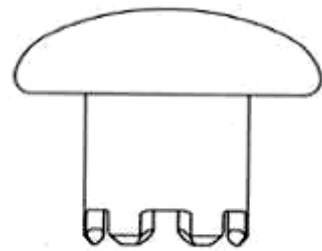

1.3

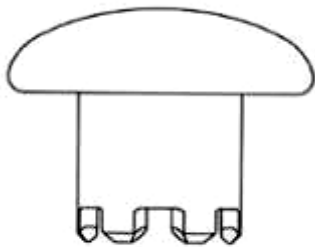

1.4

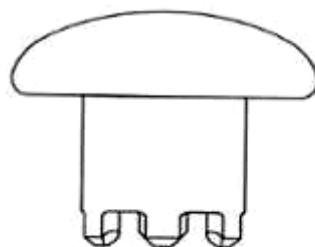

1.5

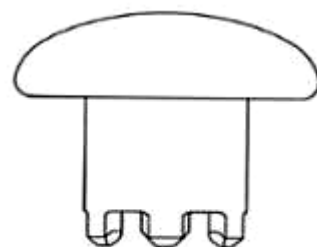

1.6

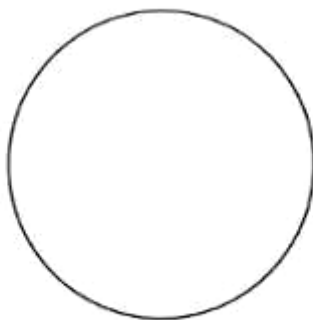

1.7

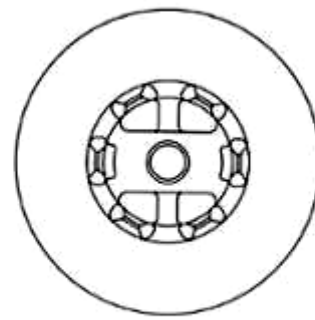

1.8

CÔNG BÁO SỞ HỮU CÔNG NGHIỆP SỐ 429 TẬP A – QUYỀN 2 (12.2023)

- (11) **48634**
(21) 3-2023-00197 (28) 1
(54) **VỎ BỘ ĐIỀU KHIỂN THIẾT BỊ ĐIỆN TỬ** (51) **14-03**
(22) 27/01/2023 (43) 25/12/2023
(30) 2022-016803 05/08/2022 JP;
(73) **SONY INTERACTIVE ENTERTAINMENT INC. (JP)**
1-7-1 Konan, Minato-ku, Tokyo, Japan
(72) Daisuke KURIHARA (JP)
(74) Công ty Luật TNHH Phạm và Liên danh (PHAM & ASSOCIATES)
(55)

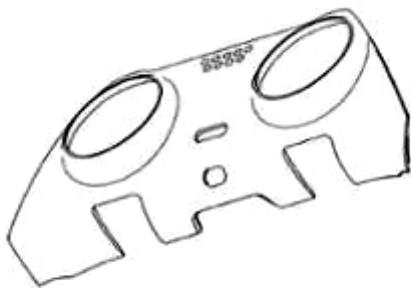

1.1

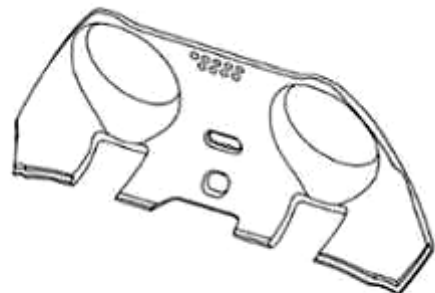

1.2

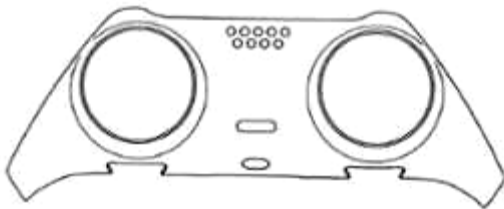

1.3



1.4



1.5



1.6



1.7



1.8

CÔNG BÁO SỞ HỮU CÔNG NGHIỆP SỐ 429 TẬP A – QUYỀN 2 (12.2023)

- (11) **48635**
(21) 3-2023-00198 (28) 1
(54) **VỎ BỘ ĐIỀU KHIỂN THIẾT BỊ ĐIỆN TỬ** (51) **14-03**
(22) 27/01/2023 (43) 25/12/2023
(30) 2022-016804 05/08/2022 JP;
(73) **SONY INTERACTIVE ENTERTAINMENT INC. (JP)**
1-7-1 Konan, Minato-ku, Tokyo, Japan
(72) Daisuke KURIHARA (JP)
(74) Công ty Luật TNHH Phạm và Liên danh (PHAM & ASSOCIATES)
(55)

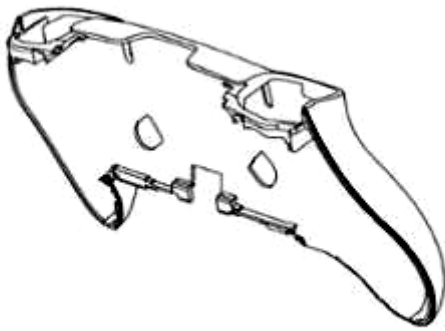

1.1

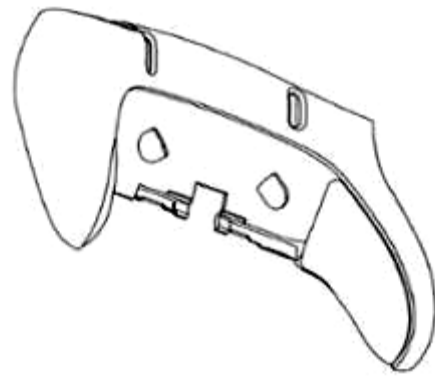

1.2

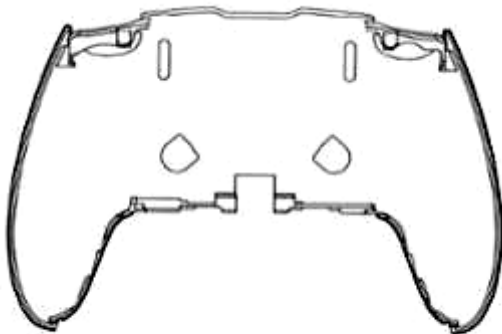

1.3

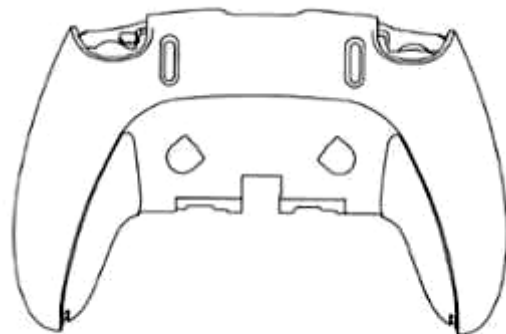

1.4



1.5



1.6



1.7

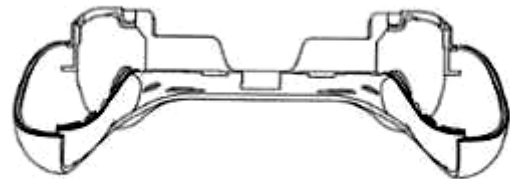

1.8

- (11) **48636**
(21) 3-2023-00199 (28) 1
(54) **VỎ BỘ ĐIỀU KHIỂN THIẾT BỊ ĐIỆN TỬ** (51) **14-03**
(22) 27/01/2023 (43) 25/12/2023
(30) 2022-016805 05/08/2022 JP;
(73) **SONY INTERACTIVE ENTERTAINMENT INC. (JP)**
1-7-1 Konan, Minato-ku, Tokyo, Japan
(72) Daisuke KURIHARA (JP)
(74) Công ty Luật TNHH Phạm và Liên danh (PHAM & ASSOCIATES)
(55)

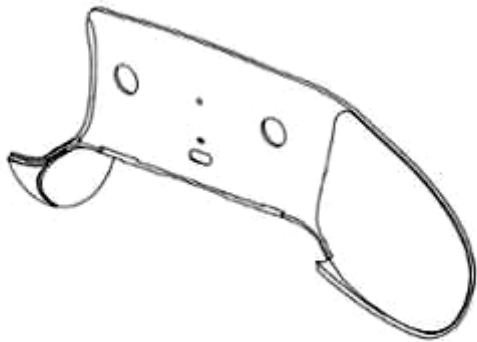

1.1

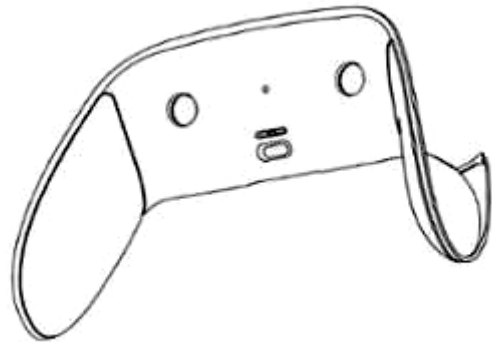

1.2

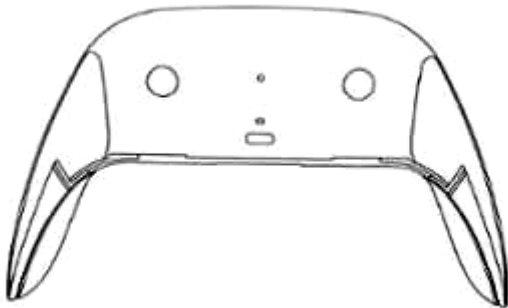

1.3

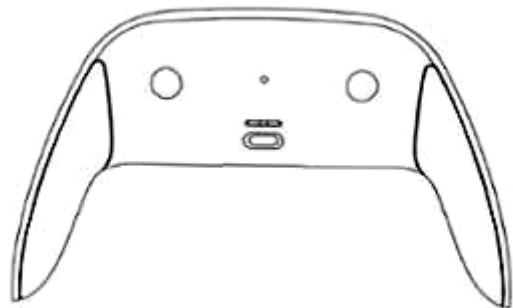

1.4



1.5



1.6



1.7



1.8

CÔNG BÁO SỞ HỮU CÔNG NGHIỆP SỐ 429 TẬP A – QUYỀN 2 (12.2023)

- (11) **48637**
(21) 3-2023-00200 (28) 1
(54) **NÚT ĐIỀU KHIỂN DÙNG CHO BỘ ĐIỀU KHIỂN THIẾT BỊ ĐIỆN TỬ** (51) **14-03**
(22) 27/01/2023 (43) 25/12/2023
(30) 2022-016806 05/08/2022 JP;
(73) **SONY INTERACTIVE ENTERTAINMENT INC. (JP)**
1-7-1 Konan, Minato-ku, Tokyo, Japan
(72) 1. DAISUKE KURIHARA (JP)
2. MASAO MORITA (JP)
3. TAKASHI ONDA (JP)
(74) Công ty Luật TNHH Phạm và Liên danh (PHAM & ASSOCIATES)
(55)

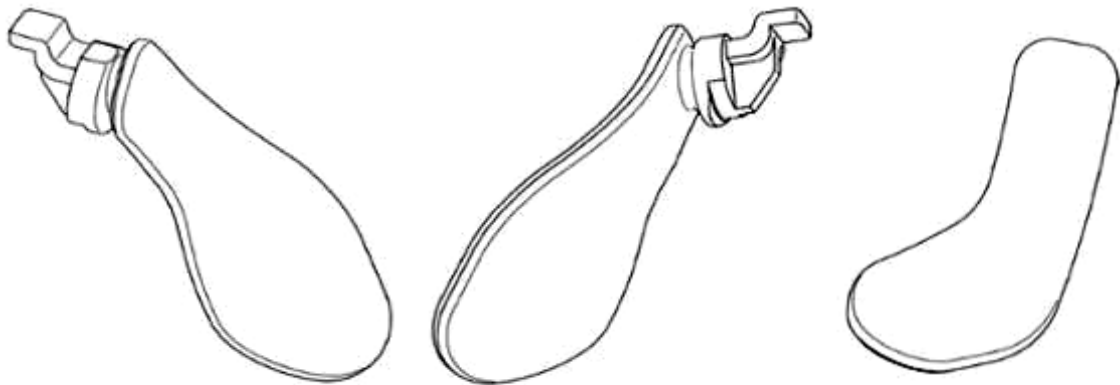

1.1

1.2

1.3



1.4

1.5

1.6



1.7

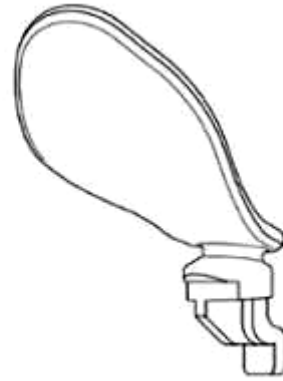

1.8

- (11) **48638**
(21) 3-2023-00204 (28) 1
(54) **NÚT ĐIỀU KHIỂN DÙNG CHO BỘ ĐIỀU KHIỂN THIẾT BỊ ĐIỆN TỬ** (51) **14-03**
(22) 27/01/2023 (43) 25/12/2023
(30) 2022-016807 05/08/2022 JP;
(73) **SONY INTERACTIVE ENTERTAINMENT INC. (JP)**
1-7-1 Konan, Minato-ku, Tokyo, Japan
(72) 1. DAISUKE KURIHARA (JP)
2. MASAO MORITA (JP)
3. TAKASHI ONDA (JP)
(74) Công ty Luật TNHH Phạm và Liên danh (PHAM & ASSOCIATES)
(55)

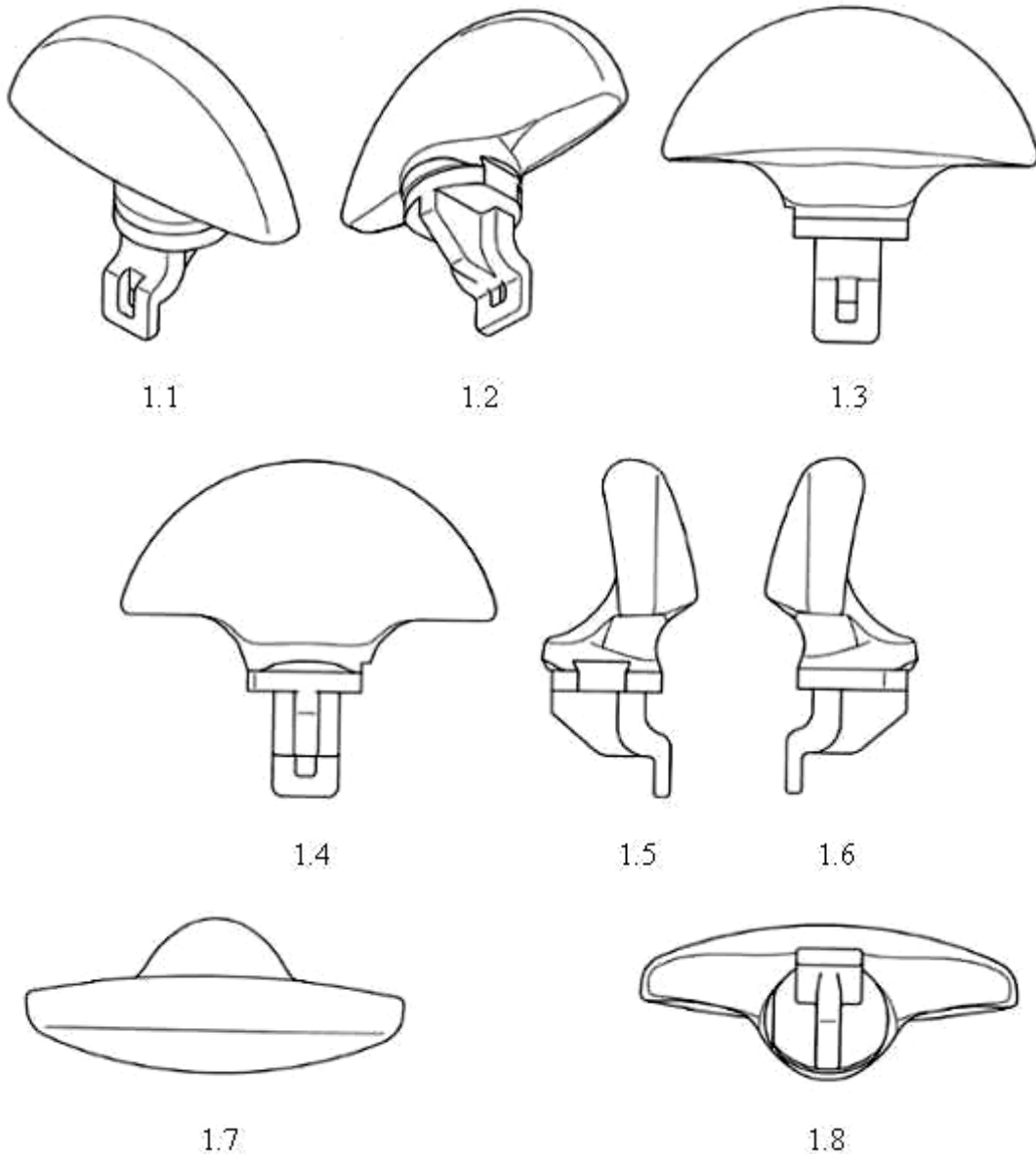

- (11) **48639**
(21) 3-2023-00205 (28) 1
(54) **KHỐI KẾT CẤU CỦA NÚM ĐIỀU KHIỂN THIẾT BỊ ĐIỆN TỬ** (51) **14-03**
(22) 27/01/2023 (43) 25/12/2023
(30) 2022-016799 05/08/2022 JP;
(73) **SONY INTERACTIVE ENTERTAINMENT INC. (JP)**
1-7-1 Konan, Minato-ku, Tokyo, Japan
(72) 1. DAISUKE KURIHARA (JP)
2. KAZUYUKI SUZUKI (JP)
(74) Công ty Luật TNHH Phạm và Liên danh (PHAM & ASSOCIATES)
(55)



1.1



1.2

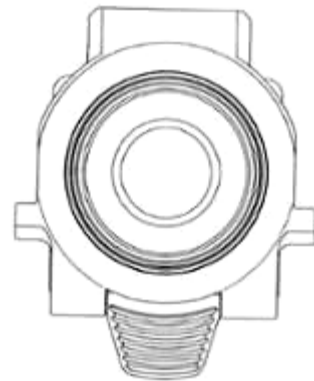

1.3

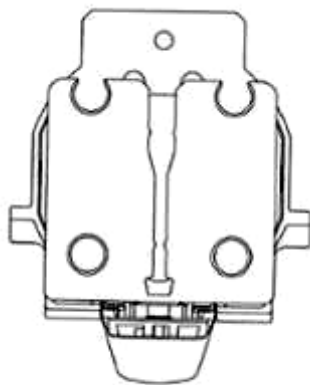

1.4

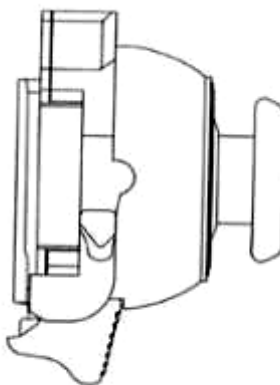

1.5

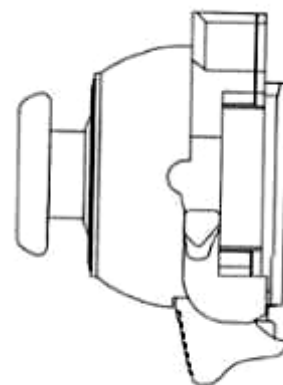

1.6

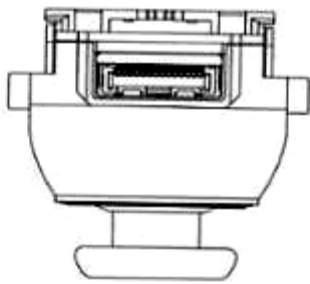

1.7

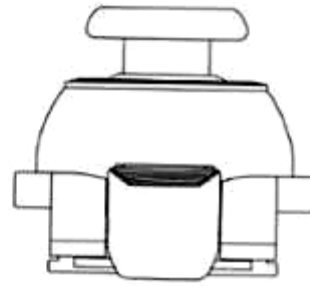

1.8

CÔNG BÁO SỞ HỮU CÔNG NGHIỆP SỐ 429 TẬP A – QUYỀN 2 (12.2023)

- (11) **48640**
(21) 3-2023-00206
(54) **HỘP ĐỰNG**
(22) 27/01/2023
(30) 29/847,500 25/07/2022 US;
(73) **GREGG GORSKI (US)**
5915 Al Fresco Ave, Pahrump, NV 89061, United States of America
(72) GREGG GORSKI (US)
(74) Công ty Luật TNHH T&G (TGVN)
(55)
- (28) 1
(51) **09-03**
(43) 25/12/2023

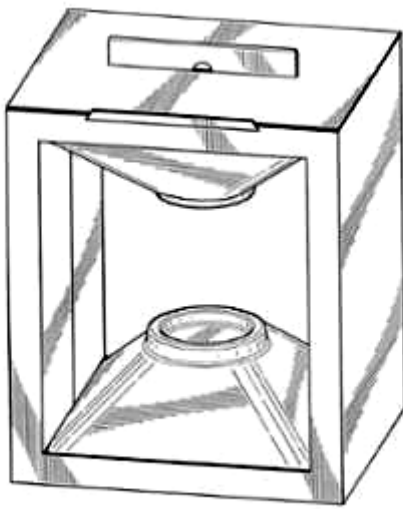

1.1

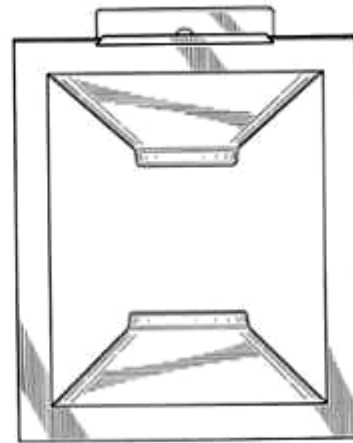

1.2

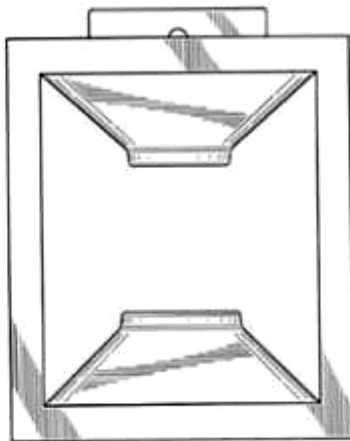

1.3



1.4



1.5

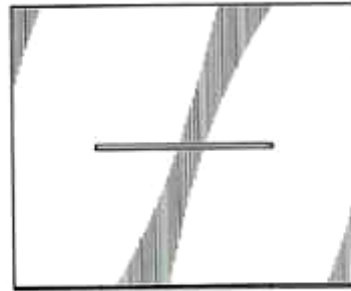

1.6

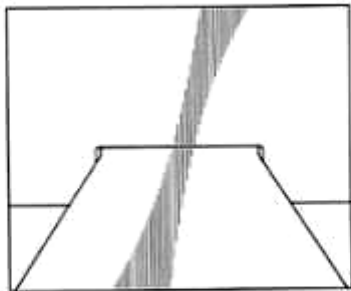

1.7

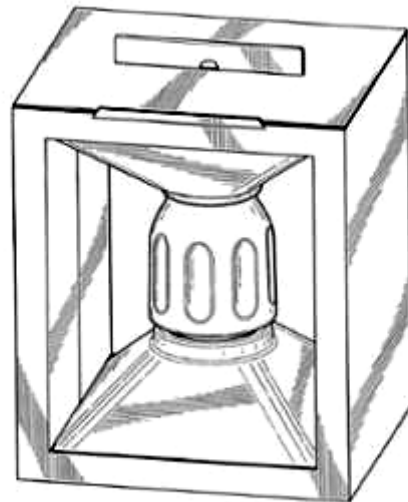

1.8

- (11) **48641**
- (21) 3-2023-00214 (28) 1
- (54) **VỎ** (51) **14-02**
- (22) 27/01/2023 (43) 25/12/2023
- (30) 29/848,134 29/07/2022 US;
- (73) **APPLE INC. (US)**
One Apple Park Way, Cupertino, California 95014, United States of America
- (72) 1. MOLLY ANDERSON (GB)
2. BARTLEY K. ANDRE (US)
3. SHOTA AOYAGI (JP)
4. MARINE C. BATAILLE (FR)
5. ABIDUR RAHMAN CHOWDHURY (GB)
6. CLARA GENEVIÈVE MARINE COURTAIGNE (FR)
7. MARKUS DIEBEL (DE)
8. JONATHAN GOMEZ GARCIA (GB)
9. M. EVANS HANKEY (US)
10. ANNE-MARIE HECK (CH)
11. MOISES HERNANDEZ HERNANDEZ (MX)
12. RICHARD P. HOWARTH (GB)
13. JULIAN JAEDE (DE)
14. DUNCAN ROBERT KERR (GB)
15. KAINOA KWON-PEREZ (US)
16. NICOLAS PEDRO LYLYK (AR)
17. PETER RUSSELL-CLARKE (AU)
18. BENJAMIN ANDREW SHAFFER (US)
19. CLEMENT TISSANDIER (FR)
- (74) Công ty TNHH Lê & Lê (LE & LE)
- (55)

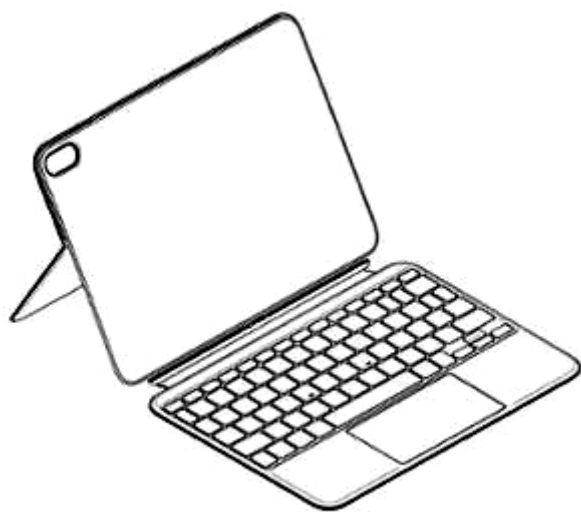

1.1

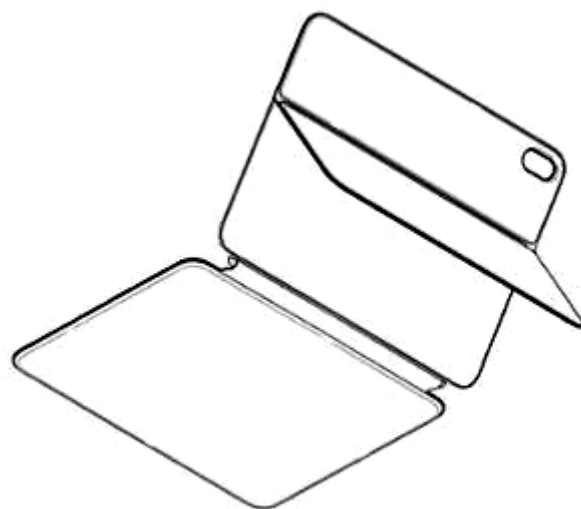

1.2

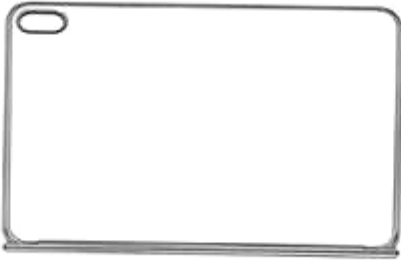

1.3

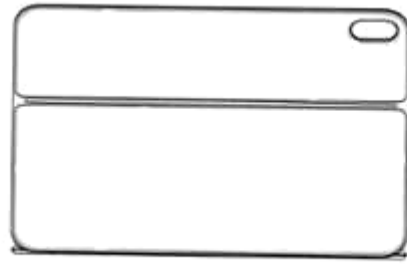

1.4



1.5



1.6



1.7

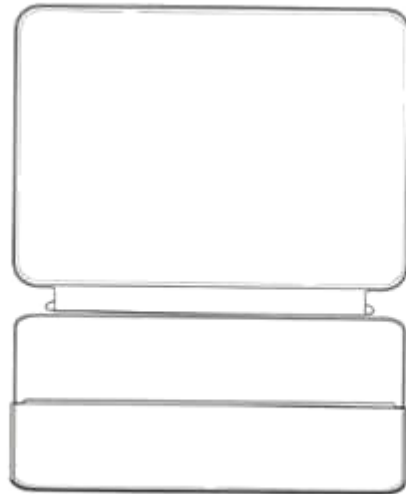

1.8



1.9

- (11) **48642**
(21) 3-2023-00216 (28) 1
(54) **NẮP ĐỒ CHỨA** (51) **09-07**
(22) 27/01/2023 (43) 25/12/2023
(30) GB 6221948 28/07/2022 GB;
(73) **CROWN PACKAGING TECHNOLOGY, INC. (US)**
18410 Crossing Drive, Suite A, Tinley Park, IL 60487, U.S.A.
(72) CHISLETT, Hannah (GB)
(74) CÔNG TY LUẬT TNHH IP MAX (IPMAX LAW FIRM)
(55)



1.1

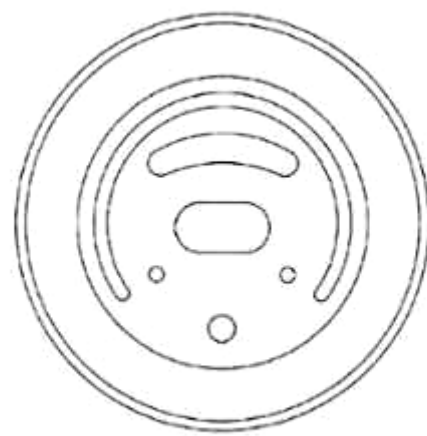

1.2

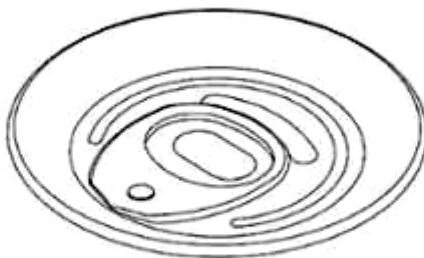

1.3



1.4



1.5

CÔNG BÁO SỞ HỮU CÔNG NGHIỆP SỐ 429 TẬP A – QUYỀN 2 (12.2023)

- (11) **48643**
(21) 3-2023-00217 (28) 1
(54) **ĐẦU NỔI** (51) **13-03**
(22) 30/01/2023 (43) 25/12/2023
(30) 2022-017161 10/08/2022 JP;
(73) **SONY INTERACTIVE ENTERTAINMENT INC. (JP)**
1-7-1 Konan, Minato-ku, Tokyo, Japan
(72) Daisuke KURIHARA (JP)
(74) Công ty Luật TNHH Phạm và Liên danh (PHAM & ASSOCIATES)
(55)

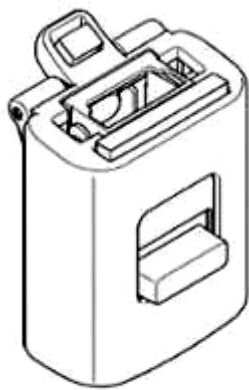

1.1



1.2

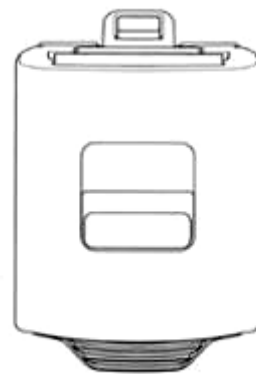

1.3

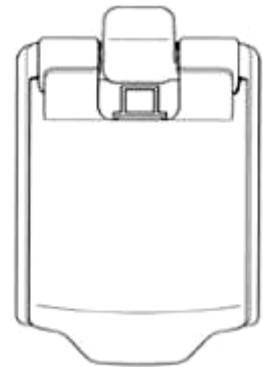

1.4

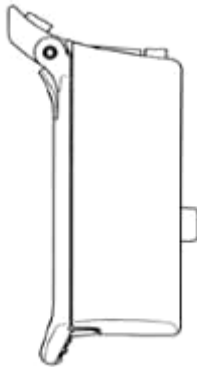

1.5

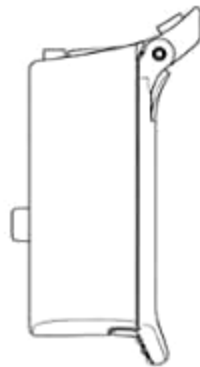

1.6

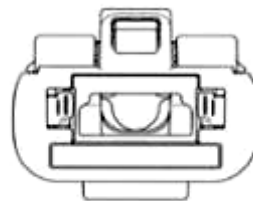

1.7



1.8

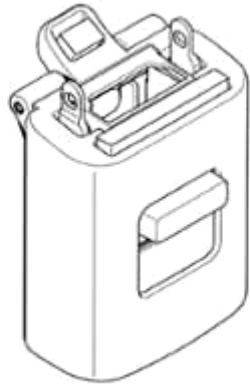

1.9



1.10

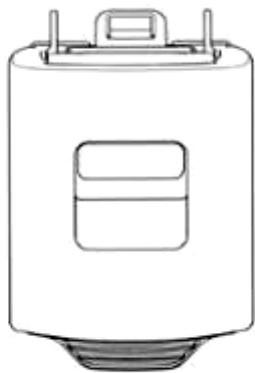

1.11

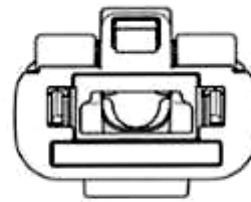

1.12

- (11) **48644**
(21) 3-2023-00218 (28) 1
(54) **KẸP TÀI LIỆU** (51) **19-02**
(22) 30/01/2023 (43) 25/12/2023
(30) 2022-017190 10/08/2022 JP;
(73) **KING JIM CO., LTD (JP)**
10-18, Higashi Kanda 2-chome, Chiyoda-ku, Tokyo, Japan
(72) 1. FUDO, TOMOHIRO (JP)
2. TANIMOTO, KOICHI (JP)
3. KURIYAMA, TOMOYUKI (JP)
(74) Công ty Cổ phần Sở hữu công nghiệp INVESTIP (INVESTIP)
(55)



1.1

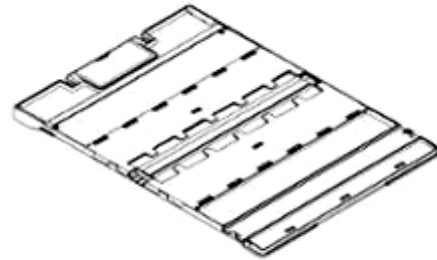

1.2



1.3

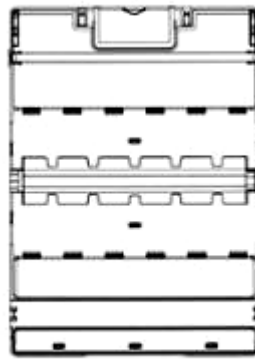

1.4



1.5 1.6



1.7



1.8

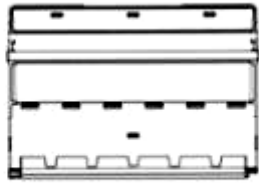

1.9

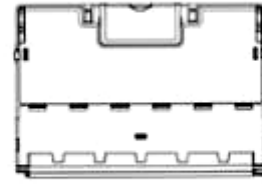

1.10



1.11



1.12



1.13



1.14

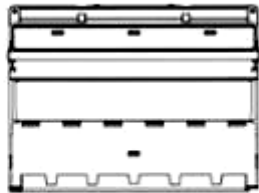

1.15

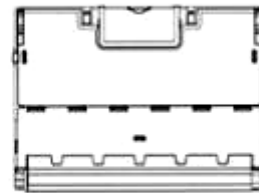

1.16



1.17



1.18



1.19



1.20

CÔNG BÁO SỞ HỮU CÔNG NGHIỆP SỐ 429 TẬP A – QUYỀN 2 (12.2023)

- (11) **48645**
(21) 3-2023-00264 (28) 1
(54) **ĐẠI KIỆP TÔN** (51) **08-08**
(22) 07/02/2023 (43) 25/12/2023
(73) **CÔNG TY TNHH EBADA VINA (VN)**
Lô số 10-2C đường số 3A, khu công nghiệp quốc tế Protrade, xã An Tây, thị xã Bến Cát, tỉnh Bình Dương
(72) KIM SANG GE (KR)
(74) Công ty TNHH Tư vấn đầu tư và Sở hữu trí tuệ Hoàng Phi (HOANG PHI INVEST & I.P CO., LTD)
(55)



1.1



1.2



1.3



1.4



1.5



1.6



1.7

CÔNG BÁO SỞ HỮU CÔNG NGHIỆP SỐ 429 TẬP A – QUYỀN 2 (12.2023)

- (11) **48646**
(21) 3-2023-00266 (28) 1
(54) **CHÓT HẮM KÍNH MŨ BẢO HIỂM** (51) **02-03**
(22) 07/02/2023 (43) 25/12/2023
(73) **HENRY TEDJAKUSUMA (ID)**
Jalan Wuluh Blok II/3, RT/RW 009/006, Kota Bambu Utara, Palmerah Jakarta Barat 11420, Indonesia
(72) Henry Tedjakusuma (ID)
(74) Công ty TNHH Sở hữu trí tuệ HA VIP (HAVIP CO., LTD.)
(55)

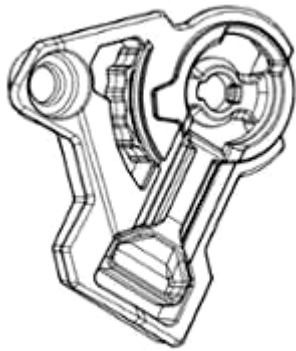

1.1



1.2



1.3



1.4



1.5



1.6



1.7

CÔNG BÁO SỞ HỮU CÔNG NGHIỆP SỐ 429 TẬP A – QUYỀN 2 (12.2023)

- (11) **48647**
(21) 3-2023-00269 (28) 1
(54) **BÚT MÁY** (51) **19-06**
(22) 08/02/2023 (43) 25/12/2023
(73) **CÔNG TY CỔ PHẦN BLUSAIGON (VN)**
129E Nguyễn Đình Chính, phường 8, quận Phú Nhuận, thành phố Hồ Chí Minh
(72) Phan Phúc Thịnh (VN)
(55)

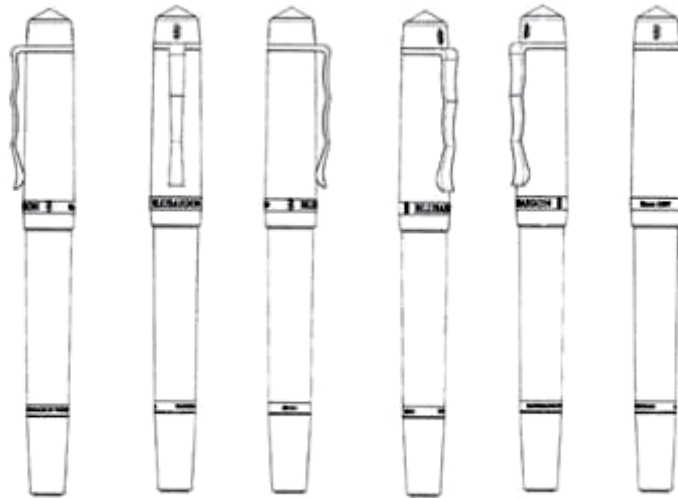

1.1

1.2

1.3

1.4

1.5

1.6



1.7



1.8

CÔNG BÁO SỞ HỮU CÔNG NGHIỆP SỐ 429 TẬP A – QUYỀN 2 (12.2023)

(11) **48648**

(21) 3-2023-00276

(54) **QUAI XÁCH ĐỒ UỐNG**

(22) 10/02/2023

(73) **HUỶNH NGHIÊM (VN)**

14.01 lô B c/c 163 Phan Đăng Lưu, phường 01, quận Phú Nhuận, thành phố Hồ Chí Minh

(72) Huỳnh Nghiêm (VN)

(55)

(28) 1

(51) **09-07**

(43) 25/12/2023



1.1



1.2



1.3



1.4



1.5



1.6



1.7



1.8

CÔNG BÁO SỞ HỮU CÔNG NGHIỆP SỐ 429 TẬP A – QUYỀN 2 (12.2023)

- (11) **48649**
(21) 3-2023-00285 (28) 2
(54) **TẨM TRẦN TRANG TRÍ** (51) **25-01**
(22) 14/02/2023 (43) 25/12/2023
(73) **CÔNG TY CỔ PHẦN CÔNG NGHIỆP VĨNH TƯỜNG (VN)**
Lô C23a, khu công nghiệp Hiệp Phước, xã Hiệp Phước, huyện Nhà Bè, thành phố Hồ Chí Minh
(72) 1. NGUYỄN HỮU DƯƠNG (VN)
2. DƯƠNG ANH THƯ (VN)
(74) Văn phòng Luật sư A Hoà (AHOA LAW OFFICE)
(55)

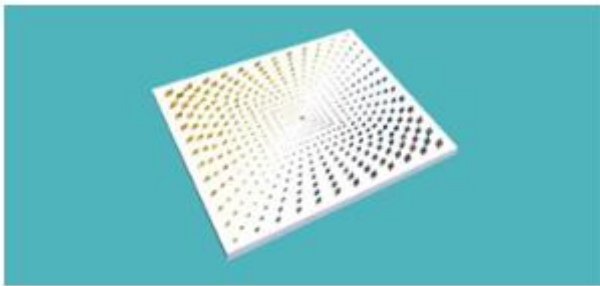

1.1



1.2

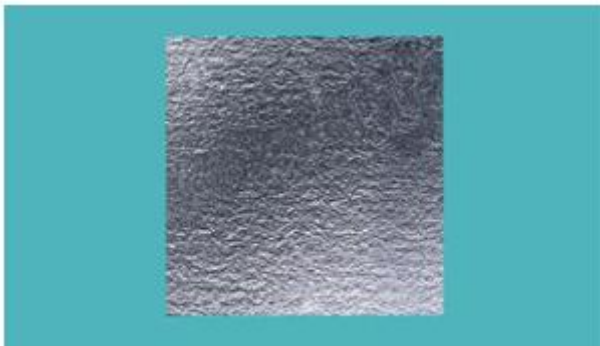

1.3



1.4

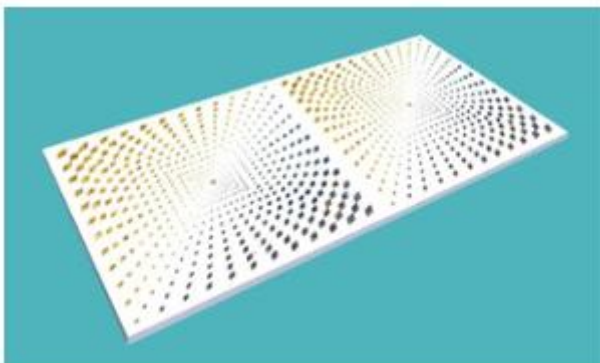

2.1

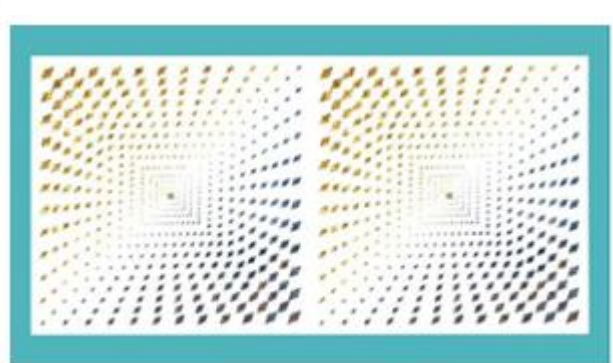

2.2



2.3



2.4



2.5

CÔNG BÁO SỞ HỮU CÔNG NGHIỆP SỐ 429 TẬP A – QUYỀN 2 (12.2023)

- (11) **48650**
(21) 3-2023-00286 (28) 2
(54) **TẨM TRẦN TRANG TRÍ** (51) **25-01**
(22) 14/02/2023 (43) 25/12/2023
(73) **CÔNG TY CỔ PHẦN CÔNG NGHIỆP VĨNH TƯỜNG (VN)**
Lô C23a, khu công nghiệp Hiệp Phước, xã Hiệp Phước, huyện Nhà Bè, thành phố Hồ Chí Minh
(72) 1. NGUYỄN HỮU DƯƠNG (VN)
2. DƯƠNG ANH THƯ (VN)
(74) Văn phòng Luật sư A Hoà (AHOA LAW OFFICE)
(55)



1.1



1.2

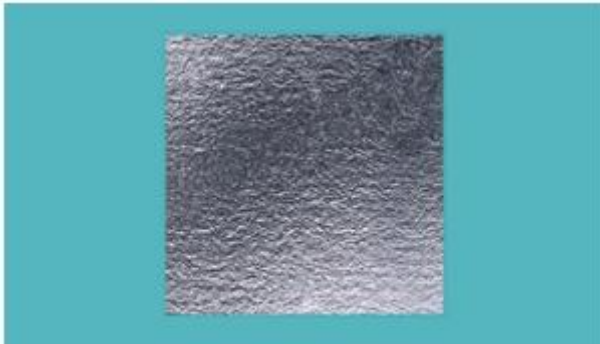

1.3



1.4



2.1



2.2



2.3



2.4



2.5

CÔNG BÁO SỞ HỮU CÔNG NGHIỆP SỐ 429 TẬP A – QUYỀN 2 (12.2023)

- (11) **48651**
(21) 3-2023-00287 (28) 2
(54) **TẨM TRẦN TRANG TRÍ** (51) **25-01**
(22) 14/02/2023 (43) 25/12/2023
(73) **CÔNG TY CỔ PHẦN CÔNG NGHIỆP VĨNH TUỜNG (VN)**
Lô C23a, khu công nghiệp Hiệp Phước, xã Hiệp Phước, huyện Nhà Bè, thành phố Hồ Chí Minh
(72) 1. NGUYỄN HỮU DƯƠNG (VN)
2. DƯƠNG ANH THƯ (VN)
(74) Văn phòng Luật sư A Hoà (AHOA LAW OFFICE)
(55)

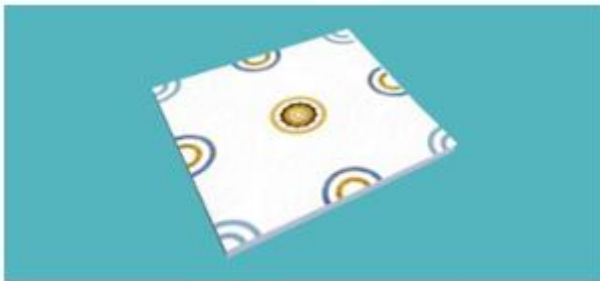

1.1



1.2

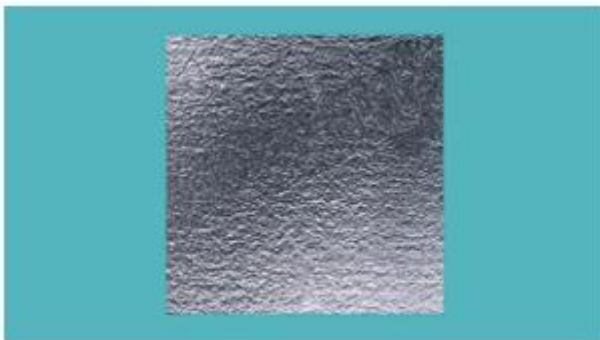

1.3



1.4

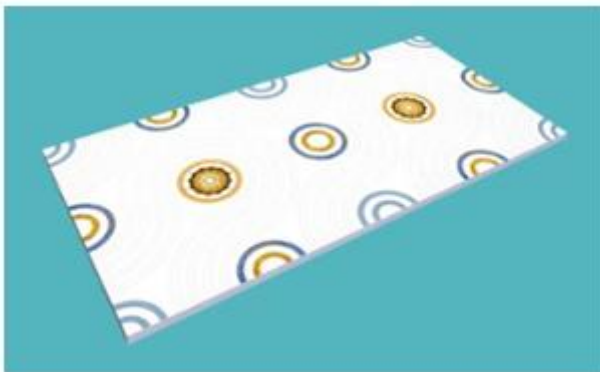

2.1



2.2



2.3



2.4



2.5

CÔNG BÁO SỞ HỮU CÔNG NGHIỆP SỐ 429 TẬP A – QUYỀN 2 (12.2023)

- (11) **48652**
(21) 3-2023-00288 (28) 2
(54) **TẨM TRẦN TRANG TRÍ** (51) **25-01**
(22) 14/02/2023 (43) 25/12/2023
(73) **CÔNG TY CỔ PHẦN CÔNG NGHIỆP VĨNH TƯỜNG (VN)**
Lô C23a, Khu công nghiệp Hiệp Phước, xã Hiệp Phước, huyện Nhà Bè, thành phố Hồ Chí Minh
(72) 1. NGUYỄN HỮU DƯƠNG (VN)
2. DƯƠNG ANH THƯ (VN)
(74) Văn phòng Luật sư A Hoà (AHOA LAW OFFICE)
(55)

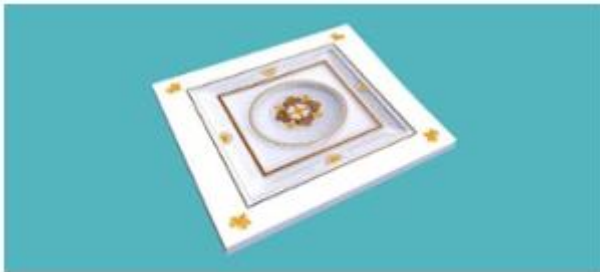

1.1



1.2

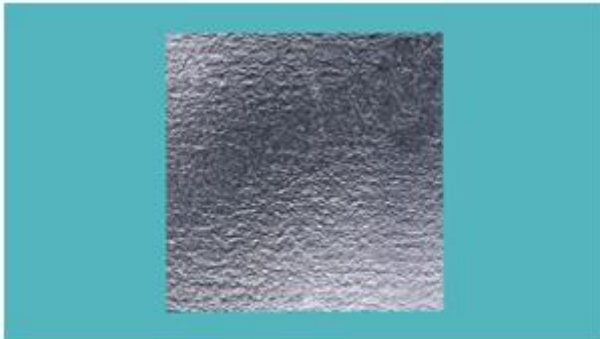

1.3



1.4

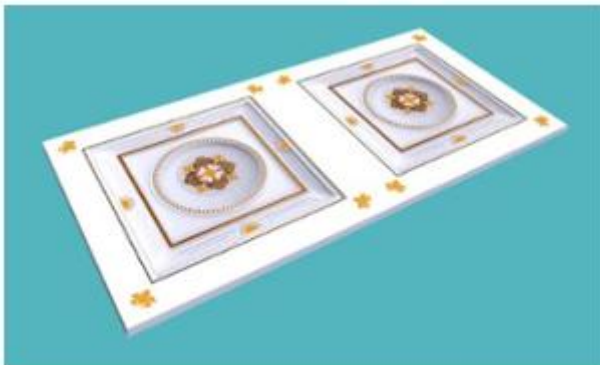

2.1



2.2



2.3



2.4



2.5

CÔNG BÁO SỞ HỮU CÔNG NGHIỆP SỐ 429 TẬP A – QUYỀN 2 (12.2023)

- (11) **48653**
(21) 3-2023-00289 (28) 2
(54) **TẨM TRẦN TRANG TRÍ** (51) **25-01**
(22) 14/02/2023 (43) 25/12/2023
(73) **CÔNG TY CỔ PHẦN CÔNG NGHIỆP VĨNH TƯỜNG (VN)**
Lô C23a, khu công nghiệp Hiệp Phước, xã Hiệp Phước, huyện Nhà Bè, thành phố Hồ Chí Minh
(72) 1. NGUYỄN HỮU DƯƠNG (VN)
2. DƯƠNG ANH THƯ (VN)
(74) Văn phòng Luật sư A Hoà (AHOA LAW OFFICE)
(55)



1.1



1.2

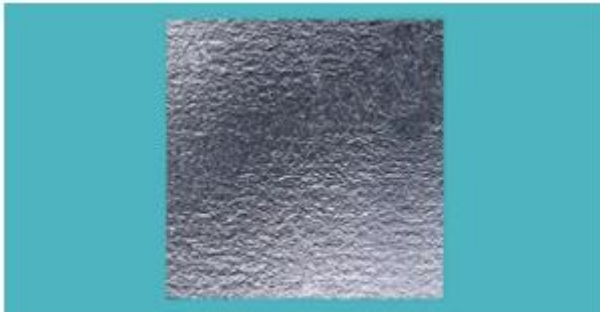

1.3



1.4



2.1



2.2

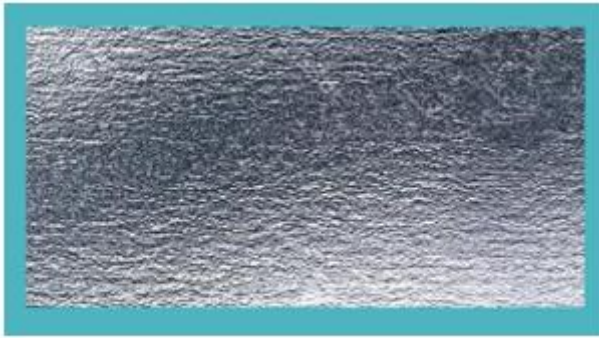

2.3



2.4



2.5

CÔNG BÁO SỞ HỮU CÔNG NGHIỆP SỐ 429 TẬP A – QUYỀN 2 (12.2023)

- (11) **48654**
(21) 3-2023-00293 (28) 2
(54) **KHUNG GẤP** (51) **13-99**
(22) 14/02/2023 (43) 25/12/2023
(30) 015009273 18/01/2023 EM;
(73) **SHENZHEN QINYIHE INDUSTRY CO., LTD. (CN)**
302, Block C, No. 9, Songbai Road, Shanmen Community, Yanluo Street, Bao'an District, Shenzhen City, Guangdong Province, China
(72) LIUGEN HUANG (CN)
(74) Công ty TNHH Trường Xuân (AGELESS CO.,LTD.)
(55)

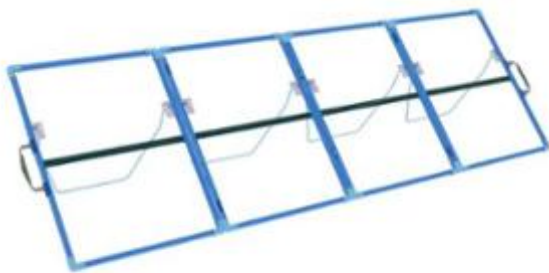

1.1

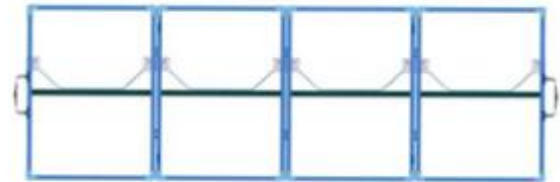

1.2

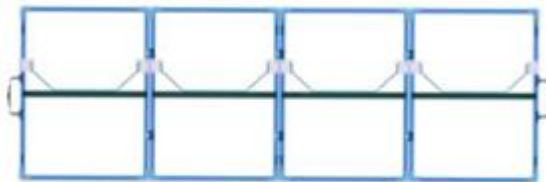

1.3

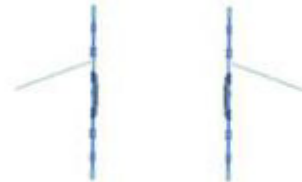

1.4



1.5



1.6



1.7

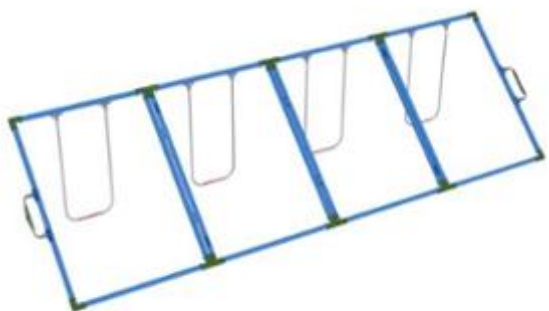

2.1

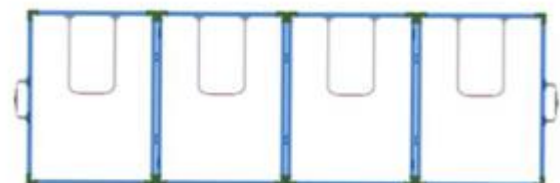

2.2

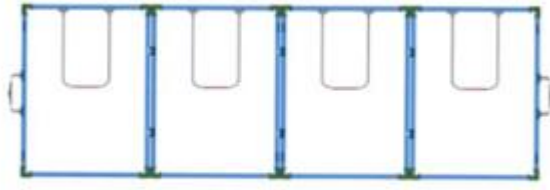

2.3

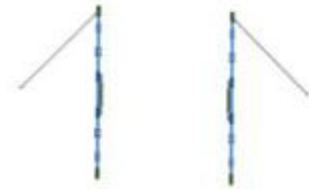

2.4

2.5



2.6

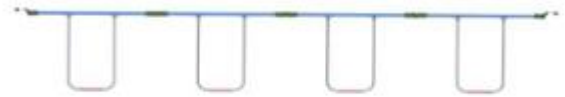

2.7

CÔNG BÁO SỞ HỮU CÔNG NGHIỆP SỐ 429 TẬP A – QUYỀN 2 (12.2023)

- (11) **48655**
(21) 3-2023-00308 (28) 1
(54) **CHAI** (51) **09-01**
(22) 16/02/2023 (43) 25/12/2023
(73) **CÔNG TY CỔ PHẦN HÀNG TIÊU DÙNG MASAN (VN)**
Tầng 12, tòa nhà MPIaza Saigon, số 39 Lê Duẩn, phường Bến Nghé, quận 1, thành phố Hồ Chí Minh
(72) Nguyễn Hoàng Yên (VN)
(74) Công ty cổ phần Sở hữu trí tuệ BROSS và Cộng sự (BROSS & PARTNERS., JSC)
(55)



1.1



1.2



1.3



1.4



1.5

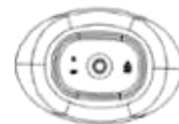

1.6



1.7

CÔNG BÁO SỞ HỮU CÔNG NGHIỆP SỐ 429 TẬP A – QUYỀN 2 (12.2023)

- (11) **48656**
- (21) 3-2023-00313 (28) 1
- (54) **HỘP ĐỰNG SẢN PHẨM NHANG** (51) **09-03**
- (22) 17/02/2023 (43) 25/12/2023
- (73) **CÔNG TY TNHH THANATKORN VIỆT NAM (VN)**
Tầng 9, tòa nhà Viễn Đông, số 14 Phan Tôn, phường Đa Kao, quận 1, thành phố Hồ Chí Minh
- (72) Trịnh Văn Khoa (VN)
- (74) Công ty TNHH Luật Quốc tế Nguyễn và Cộng sự (NVCS GENERAL TRADING SERVICES CO.,LTD)
- (55)



1.1



1.2

CÔNG BÁO SỞ HỮU CÔNG NGHIỆP SỐ 429 TẬP A – QUYỀN 2 (12.2023)

- (11) **48657**
- (21) 3-2023-00314 (28) 1
- (54) **HỘP ĐỰNG SẢN PHẨM NHANG** (51) **09-03**
- (22) 17/02/2023 (43) 25/12/2023
- (73) **CÔNG TY TNHH THANATKORN VIỆT NAM (VN)**
Tầng 9, tòa nhà Viễn Đông, số 14 Phan Tôn, phường Đa Kao, quận 1, thành phố Hồ Chí Minh
- (72) Trịnh Văn Khoa (VN)
- (74) Công ty TNHH Luật Quốc tế Nguyễn và Cộng sự (NVCS GENERAL TRADING SERVICES CO.,LTD)
- (55)



1.1



1.2

CÔNG BÁO SỞ HỮU CÔNG NGHIỆP SỐ 429 TẬP A – QUYỀN 2 (12.2023)

- (11) **48658**
(21) 3-2023-00338 (28) 1
(54) **HỘP** (51) **09-03**
(22) 22/02/2023 (43) 25/12/2023
(73) **CÔNG TY CỔ PHẦN METRO SÀI GÒN (VN)**
35/21 đường TL30, phường Thạnh Lộc, quận 12, thành phố Hồ Chí Minh
(72) Lý Thị Quy (VN)
(74) **CÔNG TY LUẬT TNHH QUỐC TẾ ICT (ICT LAW INTERNATIONAL CO., LTD)**
(55)



1.1



1.2



1.3

CÔNG BÁO SỞ HỮU CÔNG NGHIỆP SỐ 429 TẬP A – QUYỀN 2 (12.2023)

- (11) **48659**
(21) 3-2023-00339 (28) 1
(54) **HỘP** (51) **09-03**
(22) 22/02/2023 (43) 25/12/2023
(73) **CÔNG TY CỔ PHẦN METRO SÀI GÒN (VN)**
35/21 đường TL30, phường Thạnh Lộc, quận 12, thành phố Hồ Chí Minh
(72) Lý Thị Quy (VN)
(74) **CÔNG TY LUẬT TNHH QUỐC TẾ ICT (ICT LAW INTERNATIONAL CO., LTD)**
(55)



1.1



1.2



1.3

CÔNG BÁO SỞ HỮU CÔNG NGHIỆP SỐ 429 TẬP A – QUYỀN 2 (12.2023)

- (11) **48660**
(21) 3-2023-00346 (28) 1
(54) **ỐNG NHÒM CẦM TAY** (51) **16-06**
(22) 23/02/2023 (43) 25/12/2023
(73) **NGUYỄN ANH TUẤN (VN)**
Viện Vật lý Kỹ thuật, số 17 phố Hoàng Sâm, phường Nghĩa Đô, quận Cầu Giấy, thành phố Hà Nội
(72) 1. NGUYỄN ANH TUẤN (VN)
2. MAI NGUYỆT CÔNG (VN)
3. PHẠM ĐÌNH QUÝ (VN)
4. TRỊNH VIỆT HÀ (VN)
(74) Công ty TNHH Sở hữu trí tuệ HA VIP (HAVIP CO., LTD.)
(55)

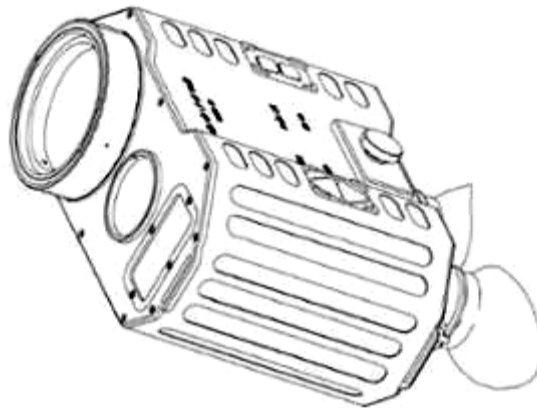

1.1



1.2

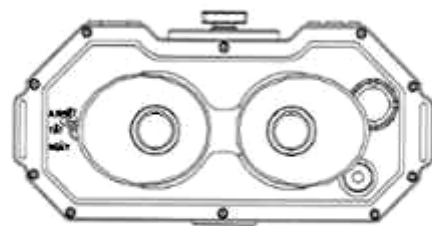

1.3

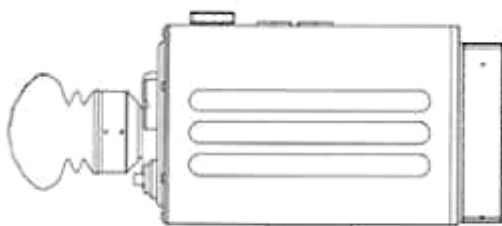

1.4

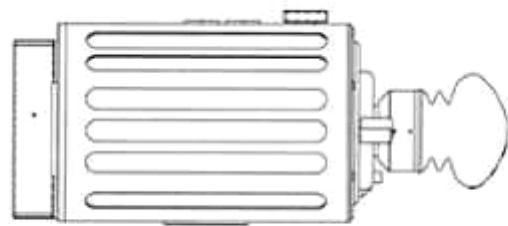

1.5

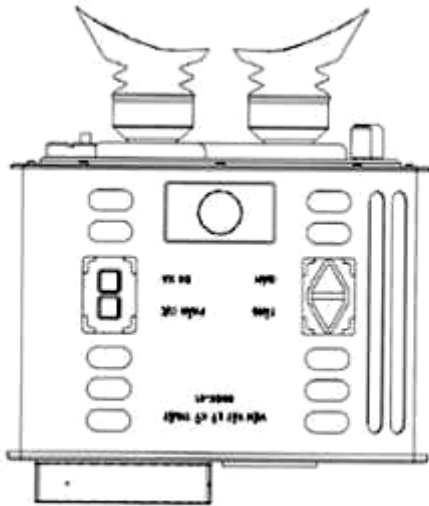

1.6

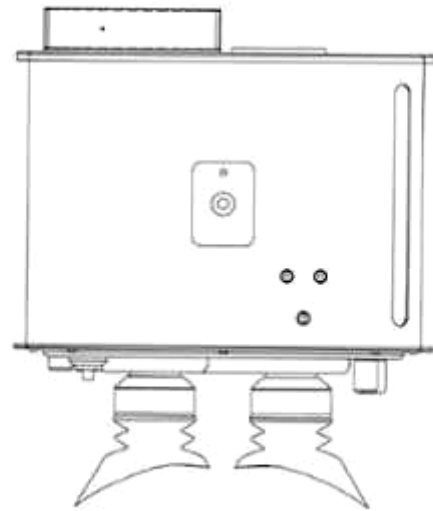

1.7

CÔNG BÁO SỞ HỮU CÔNG NGHIỆP SỐ 429 TẬP A – QUYỀN 2 (12.2023)

- (11) **48661**
(21) 3-2023-00348 (28) 1
(54) **HỘP** (51) **09-03**
(22) 24/02/2023 (43) 25/12/2023
(73) **CÔNG TY CỔ PHẦN METRO SÀI GÒN (VN)**
35/21 đường TL30, phường Thạnh Lộc, quận 12, thành phố Hồ Chí Minh
(72) Lý Thị Quy (VN)
(74) **CÔNG TY LUẬT TNHH QUỐC TẾ ICT (ICT LAW INTERNATIONAL CO., LTD)**
(55)



1.1



1.2



1.3

CÔNG BÁO SỞ HỮU CÔNG NGHIỆP SỐ 429 TẬP A – QUYỀN 2 (12.2023)

- (11) **48662**
(21) 3-2023-00349 (28) 1
(54) **HỘP** (51) **09-03**
(22) 24/02/2023 (43) 25/12/2023
(73) **CÔNG TY CỔ PHẦN METRO SÀI GÒN (VN)**
35/21 đường TL30, phường Thạnh Lộc, quận 12, thành phố Hồ Chí Minh
(72) Lý Thị Quy (VN)
(74) **CÔNG TY LUẬT TNHH QUỐC TẾ ICT (ICT LAW INTERNATIONAL CO., LTD)**
(55)



1.1



1.2



1.3

CÔNG BÁO SỞ HỮU CÔNG NGHIỆP SỐ 429 TẬP A – QUYỀN 2 (12.2023)

- (11) **48663**
- (21) 3-2023-00350 (28) 1
- (54) **HỘP** (51) **09-03**
- (22) 24/02/2023 (43) 25/12/2023
- (73) **CÔNG TY TNHH CHẾ BIẾN VÀ SẢN XUẤT SA TẾ TÔM NGON THUẬN PHÁT (VN)**
35/21 đường TL30, phường Thạnh Lộc, quận 12, thành phố Hồ Chí Minh
- (72) Lý Thị Quy (VN)
- (74) **CÔNG TY LUẬT TNHH QUỐC TẾ ICT (ICT LAW INTERNATIONAL CO., LTD)**
- (55)



1.1



1.2



1.3

CÔNG BÁO SỞ HỮU CÔNG NGHIỆP SỐ 429 TẬP A – QUYỀN 2 (12.2023)

- (11) **48664**
- (21) 3-2023-00351 (28) 1
- (54) **HỘP** (51) **09-03**
- (22) 24/02/2023 (43) 25/12/2023
- (73) **CÔNG TY TNHH CHẾ BIẾN VÀ SẢN XUẤT SA TẾ TÔM NGON THUẬN PHÁT (VN)**
35/21 đường TL30, phường Thạnh Lộc, quận 12, thành phố Hồ Chí Minh
- (72) Lý Thị Quy (VN)
- (74) **CÔNG TY LUẬT TNHH QUỐC TẾ ICT (ICT LAW INTERNATIONAL CO., LTD)**
- (55)



1.1



1.2



1.3

CÔNG BÁO SỞ HỮU CÔNG NGHIỆP SỐ 429 TẬP A – QUYỀN 2 (12.2023)

- (11) **48665**
(21) 3-2023-00360 (28) 1
(54) **BAO GÓI** (51) **09-05**
(22) 24/02/2023 (43) 25/12/2023
(73) **CÔNG TY TNHH XUẤT NHẬP KHẨU THUẬN HƯNG PHÁT (VN)**
Tổ dân phố Hưng Long, thị trấn Tà Lùng, huyện Quảng Hòa, tỉnh Cao Bằng
(72) Nguyễn Xuân Hòa (VN)
(74) Công ty TNHH NACILAW (NACILAW)
(55)



1.1



1.2

CÔNG BÁO SỞ HỮU CÔNG NGHIỆP SỐ 429 TẬP A – QUYỀN 2 (12.2023)

- (11) **48666**
(21) 3-2023-00391 (28) 1
(54) **THANH TREO VÒI SEN** (51) **23-02**
(22) 28/02/2023 (43) 25/12/2023
(30) 202215147 31/08/2022 AU;
(73) **PHOENIX INDUSTRIES PTY LTD (AU)**
926 Mountain Hwy, Bayswater, Victoria, 3153, Australia
(72) Alexander Tomlinson (AU)
(74) Công ty TNHH Tầm nhìn và Liên danh (VISION & ASSOCIATES CO.LTD.)
(55)

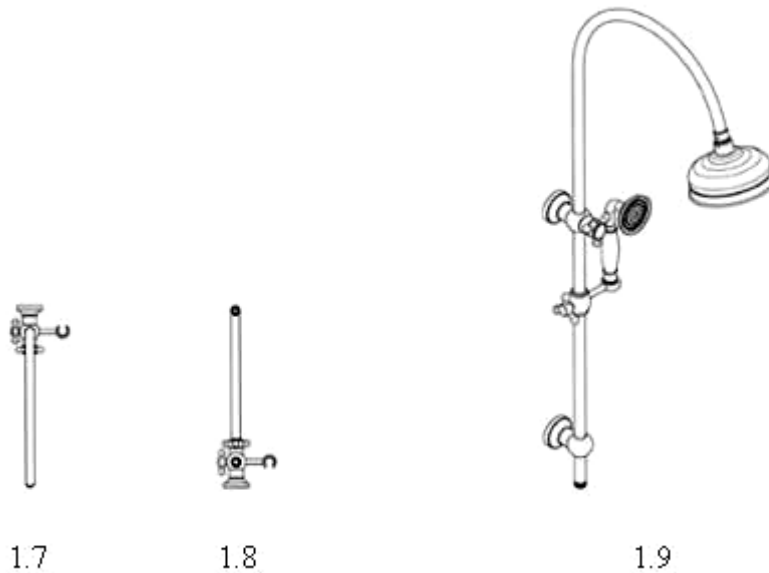
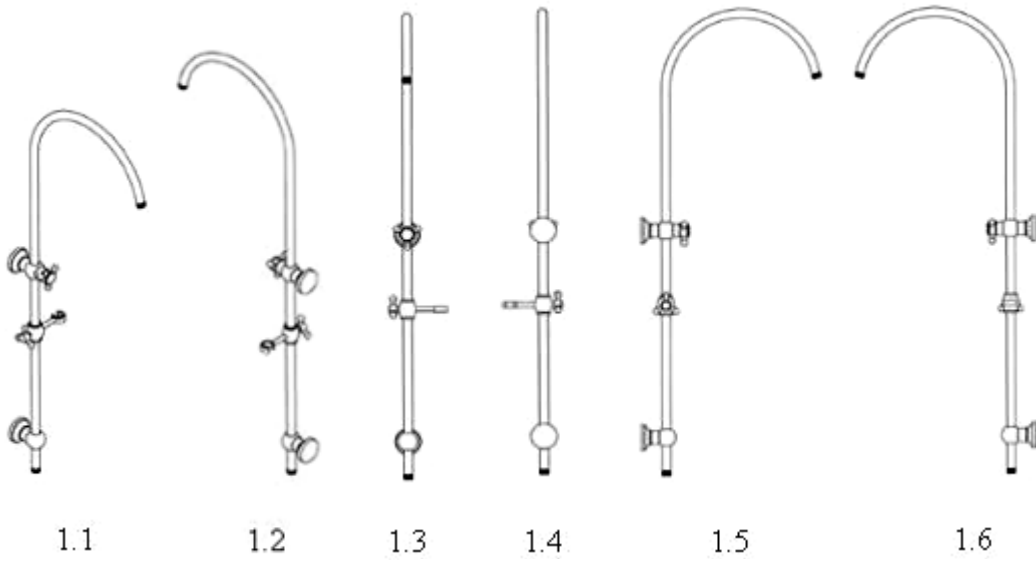

CÔNG BÁO SỞ HỮU CÔNG NGHIỆP SỐ 429 TẬP A – QUYỀN 2 (12.2023)

- (11) **48667**
(21) 3-2023-00393 (28) 1
(54) **THANH TREO VÒI SEN** (51) **23-02**
(22) 28/02/2023 (43) 25/12/2023
(30) 202215149 31/08/2022 AU;
(73) **PHOENIX INDUSTRIES PTY LTD (AU)**
926 Mountain Hwy, Bayswater, Victoria, 3153, Australia
(72) Alexander Tomlinson (AU)
(74) Công ty TNHH Tầm nhìn và Liên danh (VISION & ASSOCIATES CO.LTD.)
(55)

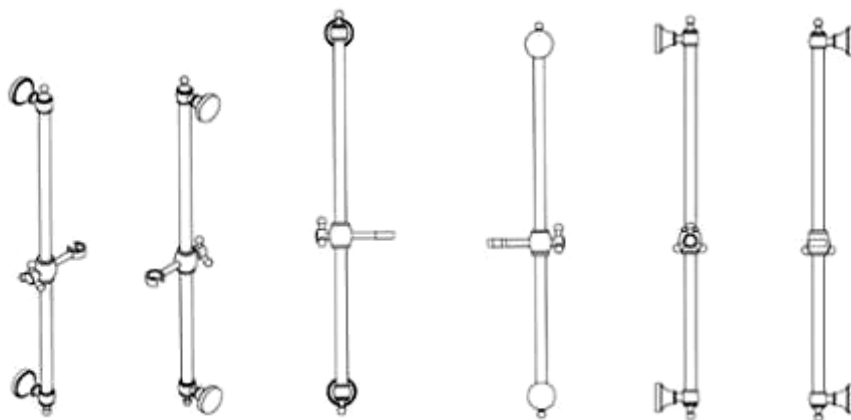

1.1

1.2

1.3

1.4

1.5

1.6



1.7



1.8

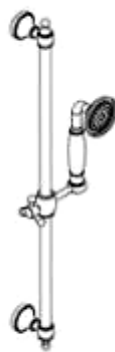

1.9

- (11) **48668**
(21) 3-2023-00402 (28) 2
(54) **NẮP CHE ĐỘNG CƠ XE ĐIỆN** (51) **12-16**
(22) 01/03/2023 (43) 25/12/2023
(30) 202230575873.0 01/09/2022 CN;
(73) **BOSCH (NINGBO) E-SCOOTER MOTOR CO. LTD. (CN)**
18 Qiyuan Road Hangzhou Bay New Zone Ningbo City 315336, P.R.China
1. SVEN DIGELE (DE)
(72) 2. DAISY ZHANG (CN)
3. YAO PAN (CN)
(74) Công ty Luật TNHH Phạm và Liên danh (PHAM & ASSOCIATES)
(55)

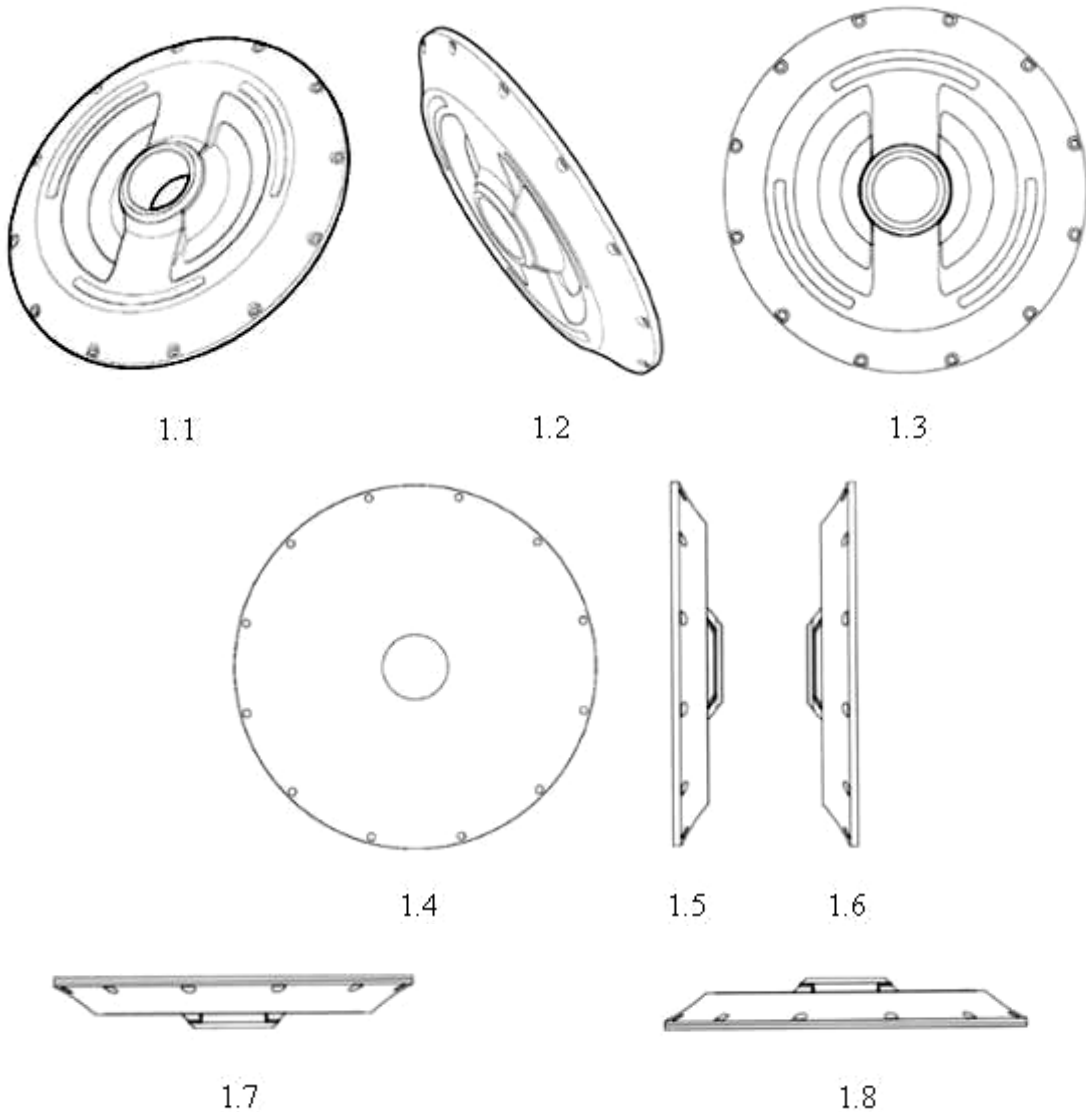



2.1

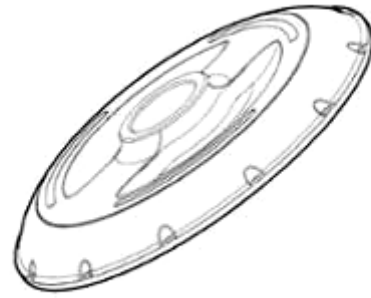

2.2

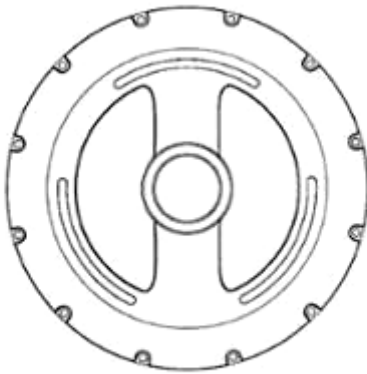

2.3

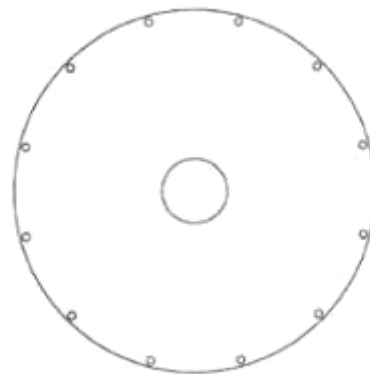

2.4



2.5



2.6



2.7

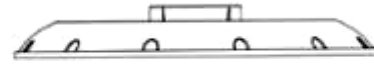

2.8

- (11) **48669**
- (21) 3-2023-00406 (28) 1
- (54) **THIẾT BỊ ĐEO ĐƯỢC** (51) **10-02; 10-03; 10-04; 14-01; 14-02; 14-03; 24-01**
- (22) 01/03/2023 (43) 25/12/2023
- (30) 29/852,192 04/09/2022 US;
- (73) **APPLE INC. (US)**
One Apple Park Way, Cupertino, California 95014, United States of America
- (72) 1. JODY AKANA (US)
2. MOLLY ANDERSON (GB)
3. BARTLEY K. ANDRE (US)
4. SHOTA AOYAGI (JP)
5. ANTHONY MICHAEL ASHCROFT (FR)
6. MARINE C. BATAILLE (FR)
7. JEREMY BATAILLOU (FR)
8. ABIDUR RAHMAN CHOWDHURY (GB)
9. CLARA GENEVIÈVE MARINE COURTAIGNE (FR)
10. MARKUS DIEBEL (DE)
11. JONATHAN GOMEZ GARCIA (GB)
12. M. EVANS HANKEY (US)
13. ANNE-MARIE HECK (CH)
14. MOISES HERNANDEZ HERNANDEZ (MX)
15. RICHARD P. HOWARTH (GB)
16. JONATHAN P. IVE (GB)
17. JULIAN JAEDE (DE)
18. DUNCAN ROBERT KERR (GB)
19. KAINOA KWON-PEREZ (US)
20. NICOLAS PEDRO LYLYK (AR)
21. PETER RUSSELL-CLARKE (AU)
22. BENJAMIN ANDREW SHAFFER (US)
23. CLEMENT TISSANDIER (FR)
24. EUGENE ANTONY WHANG (CA)
- (74) Công ty TNHH Lê & Lê (LE & LE)
- (55)



1.1



1.2



1.3



1.4



1.5



1.6



1.7



1.8



1.9



1.10

- (11) **48670**
- (21) 3-2023-00413 (28) 1
- (54) **THIẾT BỊ ĐEO ĐƯỢC** (51) **10-02; 10-03; 10-04; 14-01; 14-02; 14-03; 24-01**
- (22) 01/03/2023 (43) 25/12/2023
- (30) 29/852,193 04/09/2022 US;
- (73) **APPLE INC. (US)**
One Apple Park Way, Cupertino, California 95014, United States of America
- (72) 1. JODY AKANA (US)
2. MOLLY ANDERSON (GB)
3. BARTLEY K. ANDRE (US)
4. SHOTA AOYAGI (JP)
5. ANTHONY MICHAEL ASHCROFT (FR)
6. MARINE C. BATAILLE (FR)
7. JEREMY BATAILLOU (FR)
8. ABIDUR RAHMAN CHOWDHURY (GB)
9. CLARA GENEVIÈVE MARINE COURTAIGNE (FR)
10. MARKUS DIEBEL (DE)
11. JONATHAN GOMEZ GARCIA (GB)
12. M. EVANS HANKEY (US)
13. ANNE-MARIE HECK (CH)
14. MOISES HERNANDEZ HERNANDEZ (MX)
15. RICHARD P. HOWARTH (GB)
16. JONATHAN P. IVE (GB)
17. JULIAN JAEDE (DE)
18. DUNCAN ROBERT KERR (GB)
19. KAINOA KWON-PEREZ (US)
20. NICOLAS PEDRO LYLYK (AR)
21. PETER RUSSELL-CLARKE (AU)
22. BENJAMIN ANDREW SHAFFER (US)
23. CLEMENT TISSANDIER (FR)
24. EUGENE ANTONY WHANG (CA)
- (74) Công ty TNHH Lê & Lê (LE & LE)
- (55)



1.1



1.2



1.3



1.4



1.5

1.6



1.7



1.8



1.9



1.10

- (11) **48671**
(21) 3-2023-00418 (28) 1
(54) **TẮM BẢO VỆ CACTE ĐỘNG CƠ** (51) **12-16**
(22) 02/03/2023 (43) 25/12/2023
(30) 009184237-0006 23/09/2022 EM;
(73) **DECATHLON (FR)**
4, Boulevard de Mons, F-59650 Villeneuve d’Ascq, France
(72) Charles Hermant (FR)
(74) Công ty Luật TNHH T&G (TGVN)
(55)

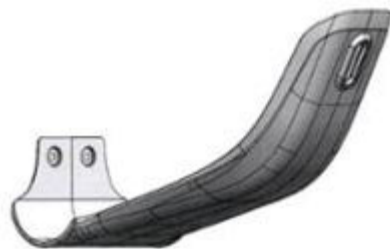

1.1



1.2

1.3



1.4



1.5



1.6



1.7

CÔNG BÁO SỞ HỮU CÔNG NGHIỆP SỐ 429 TẬP A – QUYỀN 2 (12.2023)

(11) **48672**

(21) 3-2023-00422

(28) 1

(54) **GHẾ**

(51) **06-01**

(22) 02/03/2023

(43) 25/12/2023

(73) **PHẠM THỊ KIM LOAN (VN)**

04 Trương Định, phường 06, quận 3, thành phố Hồ Chí Minh

(72) Phạm Thị Kim Loan (VN)

(74) Công ty TNHH Sở hữu trí tuệ PADEMARK (PADEMARK CO.,LTD.)

(55)



1.1



1.2



1.3



1.4



1.5

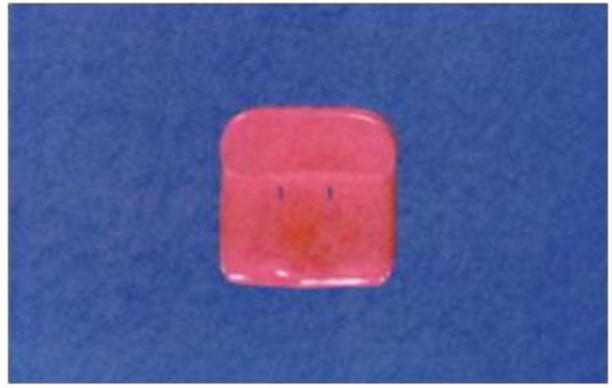

1.6

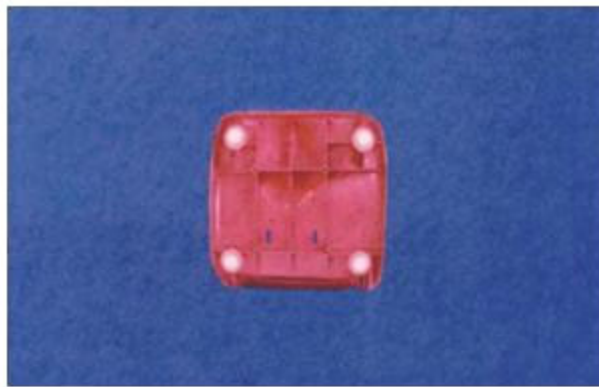

1.7

CÔNG BÁO SỞ HỮU CÔNG NGHIỆP SỐ 429 TẬP A – QUYỀN 2 (12.2023)

- (11) **48673**
(21) 3-2023-00440 (28) 1
(54) **THIẾT BỊ GIẢM XÓC** (51) **12-16**
(22) 02/03/2023 (43) 25/12/2023
(73) **SOLFILI PERFORMANCE PARTS SDN. BHD. (MY)**
No.40, Jalan TPP5, Taman Perindustrian Putra, 47130 Puchong, Selangor Darul
Ehsan, Malaysia
(72) LEE CONG QUAN (MY)
(74) Công ty TNHH Sáng chế ACTIP (ACTIP PATENT LIMITED)
(55)



1.1

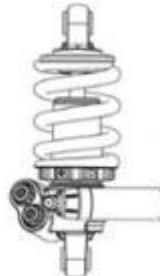

1.2

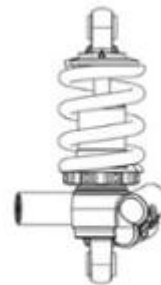

1.3



1.4



1.5



1.6



1.7

CÔNG BÁO SỞ HỮU CÔNG NGHIỆP SỐ 429 TẬP A – QUYỀN 2 (12.2023)

- (11) **48674**
(21) 3-2023-00441 (28) 1
(54) **THIẾT BỊ GIẢM XÓC** (51) **12-16**
(22) 02/03/2023 (43) 25/12/2023
(73) **SOLFILI PERFORMANCE PARTS SDN. BHD. (MY)**
No.40, Jalan TPP5, Taman Perindustrian Putra, 47130 Puchong, Selangor Darul
Ehsan, Malaysia
(72) LEE CONG QUAN (MY)
(74) Công ty TNHH Sáng chế ACTIP (ACTIP PATENT LIMITED)
(55)



1.1



1.2



1.3



1.4



1.5



1.6



1.7

- (11) **48675**
(21) 3-2023-00453 (28) 1
(54) **THIẾT BỊ PHẠO** (51) **10-05**
(22) 03/03/2023 (43) 25/12/2023
(73) **EDDY PUMP CORPORATION (US)**
15405 Olde Hwy 80, El Cajon, CA 92021, United States of America
(72) Daniel WAHLGREN (US)
(74) Công ty TNHH Trà và cộng sự (TRA & ASSOCIATES CO.,LTD)
(55)

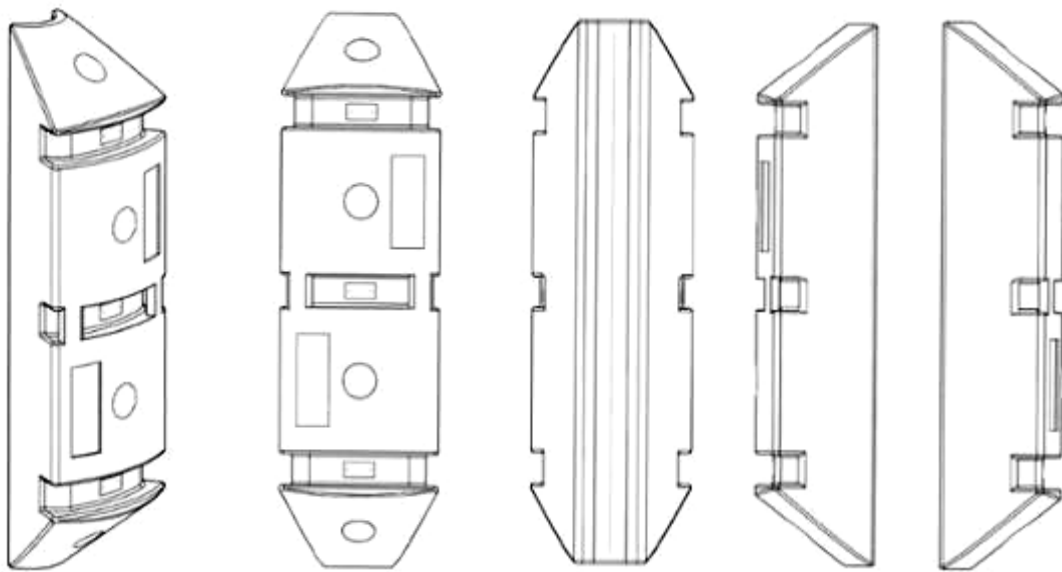

1.1

1.2

1.3

1.4

1.5



1.6



1.7

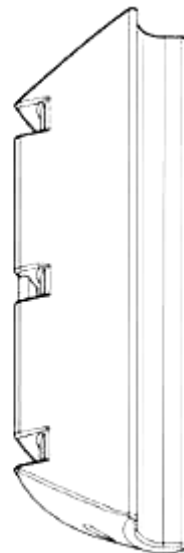

1.8

(11) **48676**

(21) 3-2023-00465

(54) **KHUNG GHẾ TỰ HÀNH**

(22) 06/03/2023

(73) 1. **HỒNG ĐỨC THÔNG (VN)**

Đại học Bách Khoa thành phố Hồ Chí Minh, 268 Lý Thường Kiệt, phường 14, quận 10, thành phố Hồ Chí Minh

2. **NGUYỄN TRƯỜNG SƠN (VN)**

Đại học Bách Khoa thành phố Hồ Chí Minh, 268 Lý Thường Kiệt, phường 14, quận 10, thành phố Hồ Chí Minh

(72) 1. **HỒNG ĐỨC THÔNG (VN)**

2. **PHẠM HUY HOÀNG (VN)**

(55)

(28) 1

(51) **06-01**

(43) 25/12/2023

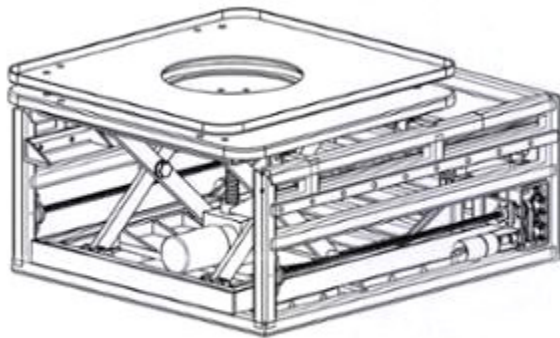

1.1

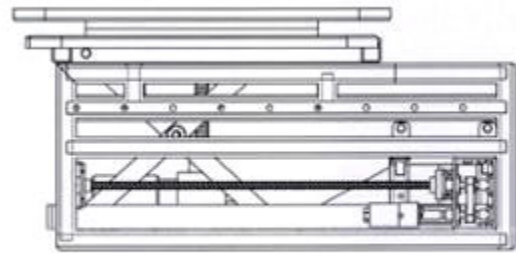

1.2

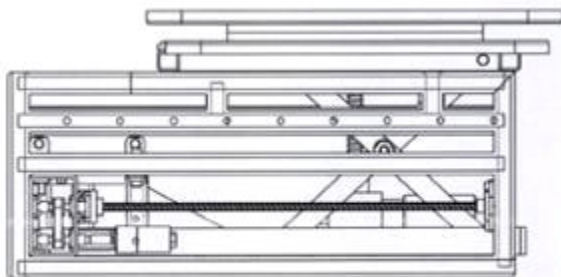

1.3

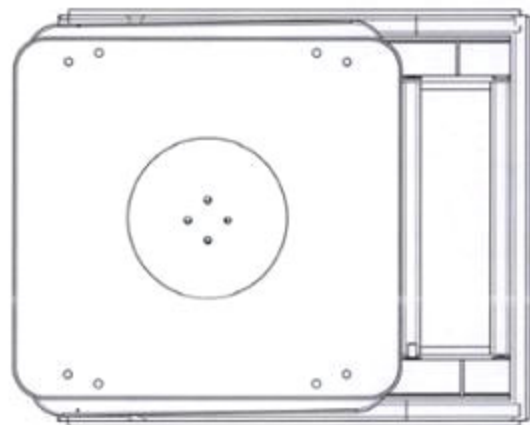

1.4

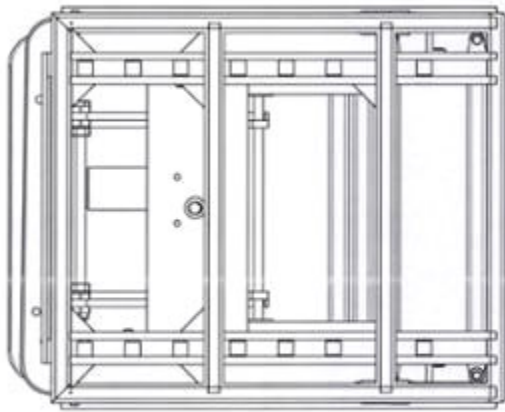

1.5

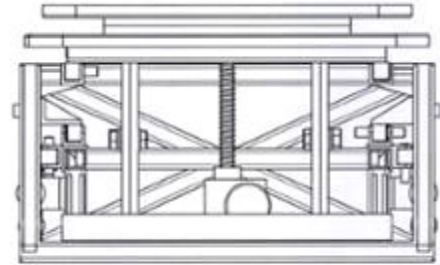

1.6

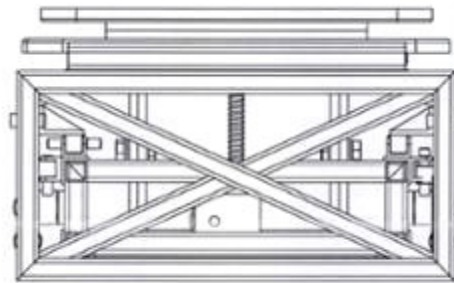

1.7

CÔNG BÁO SỞ HỮU CÔNG NGHIỆP SỐ 429 TẬP A – QUYỀN 2 (12.2023)

- (11) **48677**
(21) 3-2023-00473 (28) 1
(54) **XE Ô TÔ** (51) **12-08**
(22) 06/03/2023 (43) 25/12/2023
(30) DM/224017 28/09/2022 WO;
(73) **SC AUTO INDUSTRIES (S) PTE LTD (SG)**
51 SENOKO ROAD, 758133 SINGAPORE
(72) SIOW CHUA TAN (SG)
(74) Công ty TNHH Trường Xuân (AGELESS CO.,LTD.)
(55)



1.1



1.2



1.3



1.4

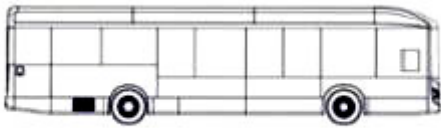

1.5

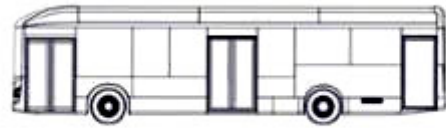

1.6



1.7



1.8

CÔNG BÁO SỞ HỮU CÔNG NGHIỆP SỐ 429 TẬP A – QUYỀN 2 (12.2023)

- (11) **48678**
(21) 3-2023-00474 (28) 1
(54) **KÍNH CHẮN GIÓ** (51) **12-16**
(22) 06/03/2023 (43) 25/12/2023
(30) DM/224017 28/09/2022 WO;
(73) **SC AUTO INDUSTRIES (S) PTE LTD (SG)**
51 SENOKO ROAD, 758133 SINGAPORE
(72) SIOW CHUA TAN (SG)
(74) Công ty TNHH Trường Xuân (AGELESS CO.,LTD.)
(55)



1.1

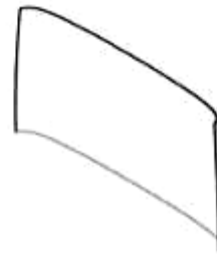

1.2



1.3



1.4



1.5



1.6



1.7



1.8

CÔNG BÁO SỞ HỮU CÔNG NGHIỆP SỐ 429 TẬP A – QUYỀN 2 (12.2023)

- (11) **48679**
(21) 3-2023-00475 (28) 1
(54) **CABIN** (51) **12-16**
(22) 06/03/2023 (43) 25/12/2023
(30) DM/224017 28/09/2022 WO;
(73) **SC AUTO INDUSTRIES (S) PTE LTD (SG)**
51 SENOKO ROAD, 758133 SINGAPORE
(72) SIOW CHUA TAN (SG)
(74) Công ty TNHH Trường Xuân (AGELESS CO.,LTD.)
(55)

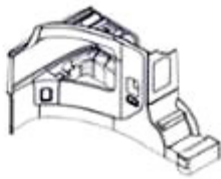

1.1

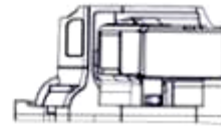

1.2

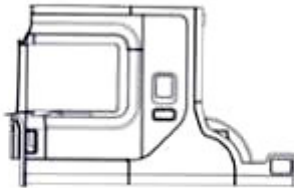

1.3

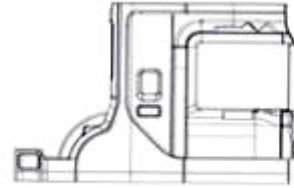

1.4



1.5



1.6

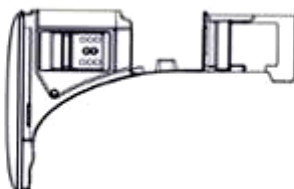

1.7

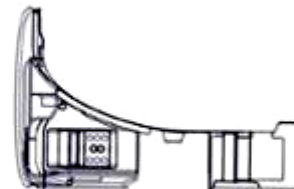

1.8

CÔNG BÁO SỞ HỮU CÔNG NGHIỆP SỐ 429 TẬP A – QUYỀN 2 (12.2023)

- (11) **48680**
- (21) 3-2023-00506 (28) 1
- (54) **NHÃN SẢN PHẨM** (51) **19-08**
- (22) 09/03/2023 (43) 25/12/2023
- (73) **AUSTRALASIAN IMPORT EXPORT PTY LTD (AU)**
11A Valley Road, Campbelltown, NSW, Australia, 2560
- (72) Trương Thị Nhạn (VN)
- (74) Công ty TNHH tư vấn Sở hữu trí tuệ IPFLAME (IPFLAME CO.,LTD)
- (55)



CÔNG BÁO SỞ HỮU CÔNG NGHIỆP SỐ 429 TẬP A – QUYỀN 2 (12.2023)

- (11) **48681**
- (21) 3-2023-00507 (28) 1
- (54) **NHÃN SẢN PHẨM** (51) **19-08**
- (22) 09/03/2023 (43) 25/12/2023
- (73) **AUSTRALASIAN IMPORT EXPORT PTY LTD (AU)**
11A Valley Road, Campbelltown, NSW, Australia, 2560
- (72) Trương Thị Nhạn (VN)
- (74) Công ty TNHH tư vấn Sở hữu trí tuệ IPFLAME (IPFLAME CO.,LTD)
- (55)

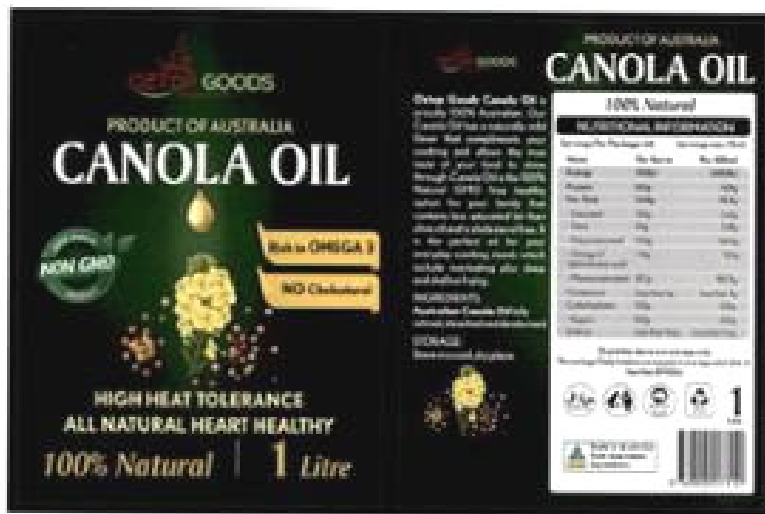

CÔNG BÁO SỞ HỮU CÔNG NGHIỆP SỐ 429 TẬP A – QUYỀN 2 (12.2023)

- (11) **48682**
- (21) 3-2023-00508 (28) 1
- (54) **NHÃN SẢN PHẨM** (51) **19-08**
- (22) 09/03/2023 (43) 25/12/2023
- (73) **AUSTRALASIAN IMPORT EXPORT PTY LTD (AU)**
11A Valley Road, Campbelltown, NSW, Australia, 2560
- (72) Trương Thị Nhạn (VN)
- (74) Công ty TNHH tư vấn Sở hữu trí tuệ IPFLAME (IPFLAME CO.,LTD)
- (55)

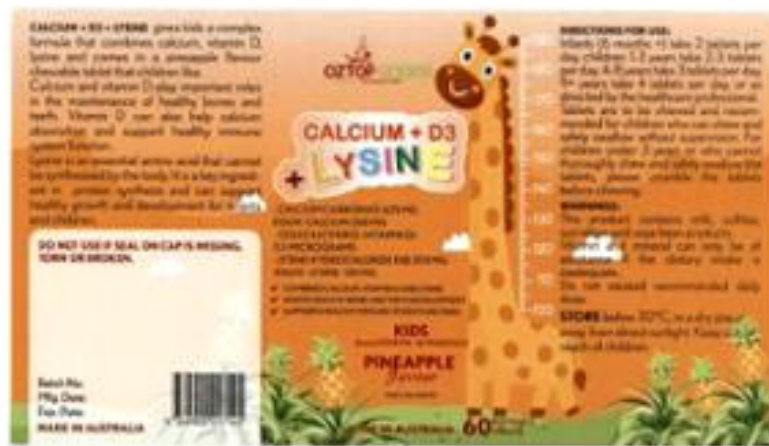

CÔNG BÁO SỞ HỮU CÔNG NGHIỆP SỐ 429 TẬP A – QUYỀN 2 (12.2023)

- (11) **48683**
(21) 3-2023-00511 (28) 1
(54) **ĐIỆN THOẠI DI ĐỘNG** (51) **14-03**
(22) 10/03/2023 (43) 25/12/2023
(30) 30-2022-0038424 20/09/2022 KR;
(73) **SAMSUNG ELECTRONICS CO., LTD. (KR)**
129, Samsung-ro, Yeongtong-gu, Suwon-si, Gyeonggi-do 16677, Republic of Korea
(72) 1. KIM, CHUNGHA (KR)
2. SON, HYENKEUN (KR)
3. KIM, HEESUN (KR)
4. JANG, SEUNGHO (KR)
5. JUNG, JONGBO (KR)
6. KIM, HAN (KR)
(74) Công ty Luật TNHH WINCO (WINCO LAW FIRM)
(55)

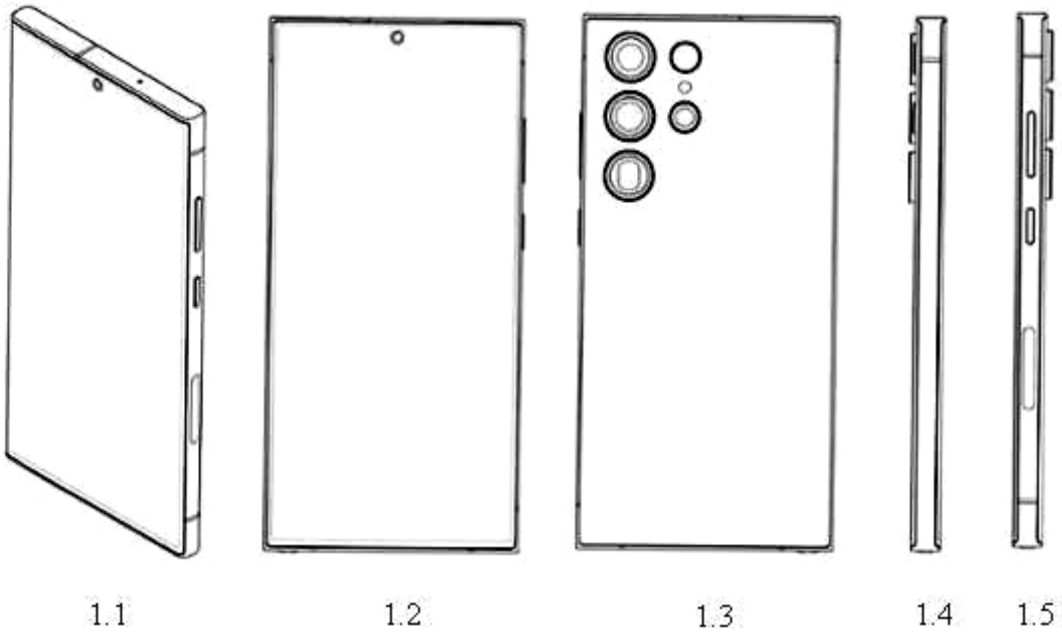



1.6



1.7

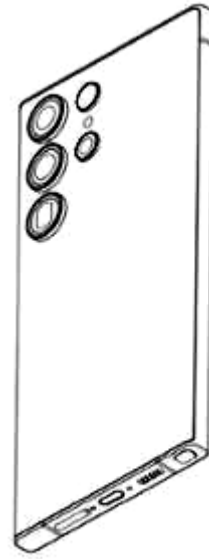

1.8

CÔNG BÁO SỞ HỮU CÔNG NGHIỆP SỐ 429 TẬP A – QUYỀN 2 (12.2023)

- (11) **48684**
- (21) 3-2023-00512 (28) 1
- (54) **ĐIỆN THOẠI DI ĐỘNG** (51) **14-03**
- (22) 10/03/2023 (43) 25/12/2023
- (30) 30-2022-0038422 20/09/2022 KR;
- (73) **SAMSUNG ELECTRONICS CO., LTD. (KR)**
129, Samsung-ro, Yeongtong-gu, Suwon-si, Gyeonggi-do 16677, Republic of Korea
- (72) 1. KIM, HEESUN (KR)
2. SON, HYENKEUN (KR)
3. KIM, CHUNGHA (KR)
4. JANG, SEUNGHO (KR)
5. JUNG, JONGBO (KR)
6. KIM, HAN (KR)
- (74) Công ty Luật TNHH WINCO (WINCO LAW FIRM)
- (55)



1.1



1.2



1.3



1.4



1.5



1.6



1.7

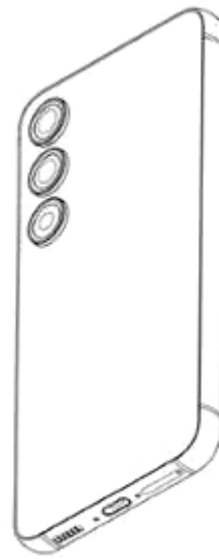

1.8

CÔNG BÁO SỞ HỮU CÔNG NGHIỆP SỐ 429 TẬP A – QUYỀN 2 (12.2023)

- (11) **48685**
- (21) 3-2023-00513 (28) 1
- (54) **ĐIỆN THOẠI DI ĐỘNG** (51) **14-03**
- (22) 10/03/2023 (43) 25/12/2023
- (30) 30-2022-0038423 20/09/2022 KR;
- (73) **SAMSUNG ELECTRONICS CO., LTD. (KR)**
129, Samsung-ro, Yeongtong-gu, Suwon-si, Gyeonggi-do 16677, Republic of Korea
- (72) 1. SON, HYUN-KEUN (KR)
2. KIM, CHUNG-HA (KR)
3. KIM, HEESUN (KR)
4. JANG, SEUNG-HO (KR)
5. JUNG, JONG-BO (KR)
6. KIM, HAN (KR)
- (74) Công ty Luật TNHH WINCO (WINCO LAW FIRM)
- (55)



1.1



1.2



1.3



1.4



1.5



1.6



1.7

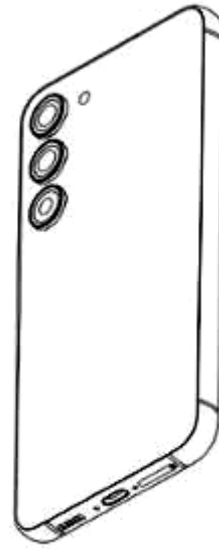

1.8

CÔNG BÁO SỞ HỮU CÔNG NGHIỆP SỐ 429 TẬP A – QUYỀN 2 (12.2023)

- (11) **48686**
(21) 3-2023-00544 (28) 1
(54) **CAN ĐỰNG DẦU NHỚT** (51) **09-02**
(22) 14/03/2023 (43) 25/12/2023
(73) **CÔNG TY TNHH XNK NANOIL USA (VN)**
Lô Q13, đường số 11, KCN Hải Sơn mở rộng (GD 3+4), xã Đức Hòa Hạ, huyện Đức Hòa, tỉnh Long An
(72) Mai Xuân Quang (VN)
(55)



1.1



1.2



1.3



1.4

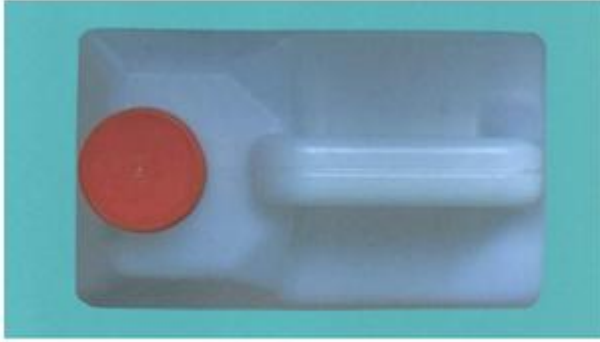

1.5



1.6

- (11) **48687**
(21) 3-2023-00558 (28) 1
(54) **THƯỚC** (51) **19-06**
(22) 16/03/2023 (43) 25/12/2023
(73) **HOÀNG TĂNG MẠNH (VN)**
D103 Chung cư Đào Duy Từ, phường 14, quận 10, thành phố Hồ Chí Minh
(72) Hoàng Tăng Mạnh (VN)
(74) Công ty TNHH Tư vấn công nghệ và Sở hữu trí tuệ IP GROUP (IP GROUP CO.,LTD.)
(55)

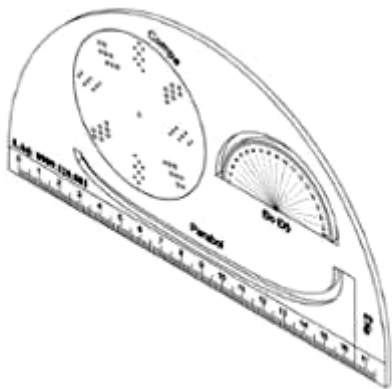

1.1

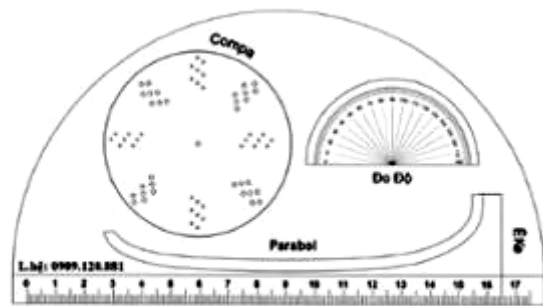

1.2

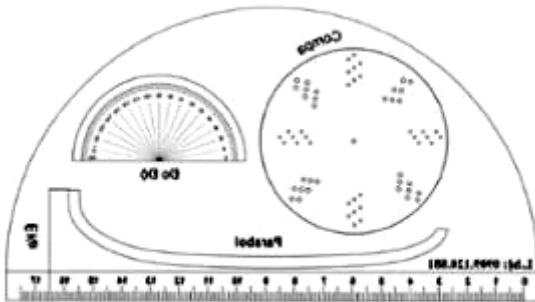

1.3



1.4



1.5

CÔNG BÁO SỞ HỮU CÔNG NGHIỆP SỐ 429 TẬP A – QUYỀN 2 (12.2023)

- (11) **48688**
(21) 3-2023-00560 (28) 1
(54) **THANH GIỮ NỆM** (51) **06-02**
(22) 16/03/2023 (43) 25/12/2023
(73) **XIA MEN MINT FURNITURE CO., LTD. (CN)**
No. 200, Zhuangshangli, Silin Village, Wuxian Town, TongAn District, Xiamen,
Fujian, China
(72) Aihua HOU (CN)
(74) Công ty cổ phần Sở hữu trí tuệ BROSS và Cộng sự (BROSS & PARTNERS., JSC)
(55)

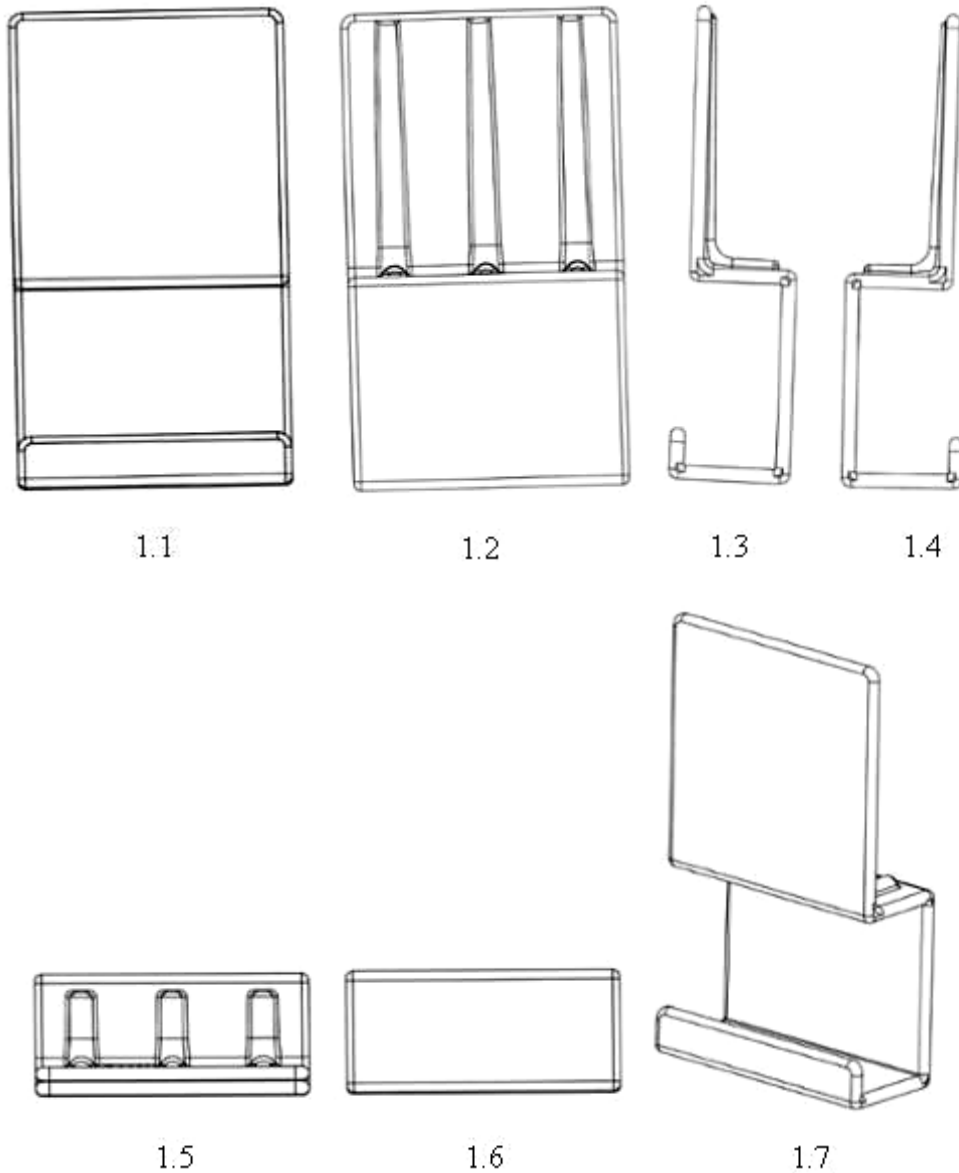

- (11) **48689**
(21) 3-2023-00573 (28) 1
(54) **GIỎ DÂY BUỘC DỪNG CHO TUABIN GIÓ** (51) **12-05**
(22) 20/03/2023 (43) 25/12/2023
(30) 371825-001 30/09/2022 IN;
(73) **WINDCARE INDIA PRIVATE LIMITED (IN)**
3/241 A, Thirumalai Nagar, Nall Road, Gudimangalam (Po), Udumalpet - 642 201,
Tiruppur Dt, Tamil Nadu, India
(72) S.Anthonyraj Premkumar (IN)
(74) Công ty TNHH Sở hữu trí tuệ Toàn Cầu (GLOBAL IP CO., LTD.)
(55)

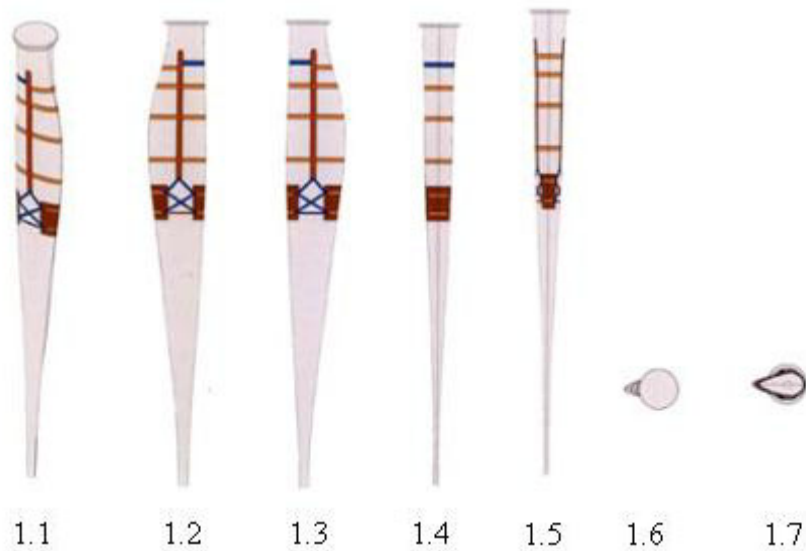

CÔNG BÁO SỞ HỮU CÔNG NGHIỆP SỐ 429 TẬP A – QUYỀN 2 (12.2023)

- (11) **48690**
(21) 3-2023-00578 (28) 1
(54) **CHAI** (51) **09-01**
(22) 20/03/2023 (43) 25/12/2023
(73) **CÔNG TY TNHH HÓA MỸ PHẨM NGỌC THỦY (VN)**
101/31 Phạm Đình Hồ, phường 6, quận 6, thành phố Hồ Chí Minh
(72) Trịnh Gia Phú (VN)
(55)



1.1



1.2



1.4



1.3

CÔNG BÁO SỞ HỮU CÔNG NGHIỆP SỐ 429 TẬP A – QUYỀN 2 (12.2023)

(11) **48691**

(21) 3-2023-00581

(54) **LỌ NƯỚC HOA**

(22) 20/03/2023

(73) **CÔNG TY CỔ PHẦN CLEOPATRAPERFUME (VN)**

Số 81 ngõ 16 Hoàng Cầu, phường Ô Chợ Dừa, quận Đống Đa, thành phố Hà Nội

(72) Vũ Lan Phương (VN)

(55)

(28) 1

(51) **09-01**

(43) 25/12/2023



1.1



1.2

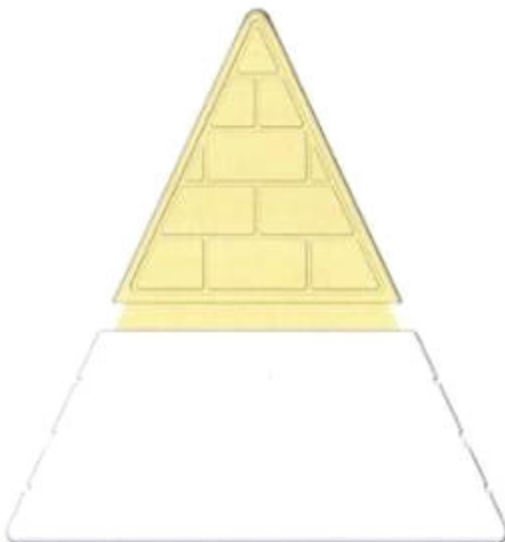

1.3

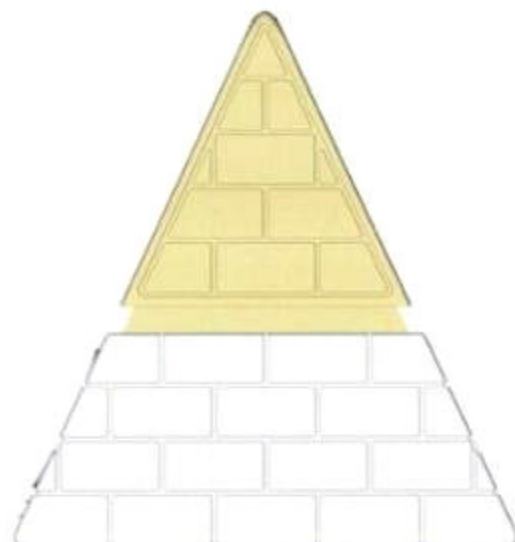

1.4

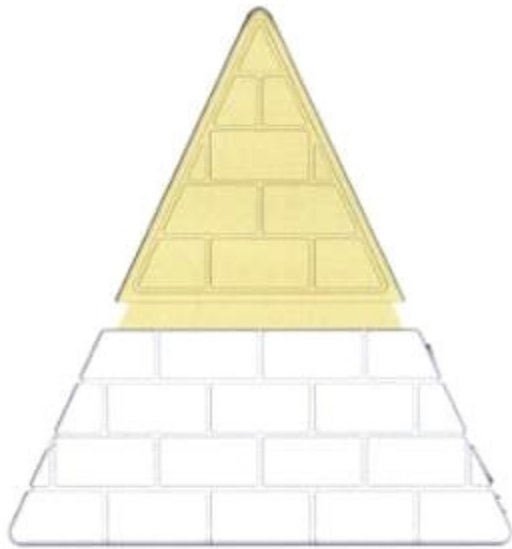

1.5



1.6



1.7

CÔNG BÁO SỞ HỮU CÔNG NGHIỆP SỐ 429 TẬP A – QUYỀN 2 (12.2023)

- (11) **48692**
(21) 3-2023-00584 (28) 1
(54) **CA BIN XE TẢI** (51) **12-16**
(22) 21/03/2023 (43) 25/12/2023
(30) 2022-020698 28/09/2022 JP;
(73) **ISUZU MOTORS LIMITED (JP)**
2-5, Takashima 1-chome, Nishi-ku, Yokohama-shi, Kanagawa, 220-8720, JAPAN
(72) 1. JUNICHI SHIINA (JP)
2. NOBUYUKI HORISAWA (JP)
3. RYOU KAWAHARA (JP)
4. YUI IWAMA (JP)
5. YASUHIRO MORIFUJI (JP)
6. KENJI TASHIRO (JP)
7. YOSHIKI TANAKA (JP)
(74) Công ty Luật TNHH Phạm và Liên danh (PHAM & ASSOCIATES)
(55)



1.1



1.2



1.3



1.4



1.5



1.6

CÔNG BÁO SỞ HỮU CÔNG NGHIỆP SỐ 429 TẬP A – QUYỀN 2 (12.2023)

- (11) **48693**
(21) 3-2023-00585 (28) 1
(54) **TẮM TẢN NHIỆT PHÍA TRƯỚC XE Ô TÔ** (51) **12-16**
(22) 21/03/2023 (43) 25/12/2023
(30) 2022-020699 28/09/2022 JP;
(73) **ISUZU MOTORS LIMITED (JP)**
2-5, Takashima 1-chome, Nishi-ku, Yokohama-shi, Kanagawa, 220-8720, JAPAN
(72) 1. MOTOO WATANABE (JP)
2. RYOU KAWAHARA (JP)
3. JUNICHI SHIINA (JP)
4. KATSUMI TAJIMA (JP)
5. DAIKI WATANABE (JP)
6. KENJI TASHIRO (JP)
7. MAKOTO KIMURA (JP)
(74) Công ty Luật TNHH Phạm và Liên danh (PHAM & ASSOCIATES)
(55)



1.1



1.2



1.3



1.4



1.5



1.6



1.7



1.8

CÔNG BÁO SỞ HỮU CÔNG NGHIỆP SỐ 429 TẬP A – QUYỀN 2 (12.2023)

- (11) **48694**
(21) 3-2023-00586 (28) 1
(54) **ĐÈN PHA XE Ô TÔ** (51) **26-06**
(22) 21/03/2023 (43) 25/12/2023
(30) 2022-020700 28/09/2022 JP;
(73) **ISUZU MOTORS LIMITED (JP)**
2-5, Takashima 1-chome, Nishi-ku, Yokohama-shi, Kanagawa, 220-8720, JAPAN
(72) 1. MOTOO WATANABE (JP)
2. NOBUYUKI HORISAWA (JP)
3. RYOU KAWAHARA (JP)
4. KATSUMI TAJIMA (JP)
5. DAIKI WATANABE (JP)
6. HIROYUKI KURASAKO (JP)
7. YOSHIKI TANAKA (JP)
(74) Công ty Luật TNHH Phạm và Liên danh (PHAM & ASSOCIATES)
(55)

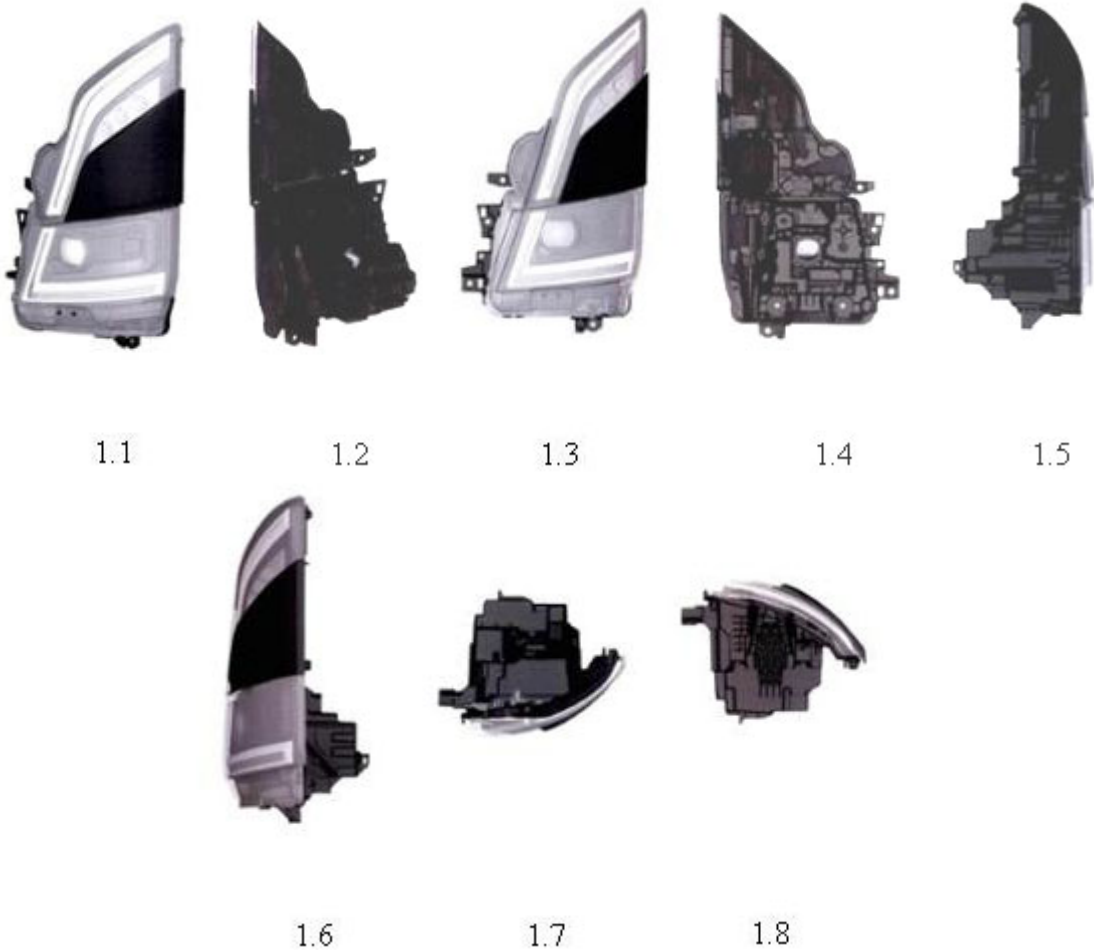

CÔNG BÁO SỞ HỮU CÔNG NGHIỆP SỐ 429 TẬP A – QUYỀN 2 (12.2023)

- (11) **48695**
- (21) 3-2023-00587 (28) 1
- (54) **TẮM CẢN VA PHÍA TRƯỚC XE Ô TÔ** (51) **12-16**
- (22) 21/03/2023 (43) 25/12/2023
- (30) 2022-020702 28/09/2022 JP;
- (73) **ISUZU MOTORS LIMITED (JP)**
2-5, Takashima 1-chome, Nishi-ku, Yokohama-shi, Kanagawa, 220-8720, JAPAN
- (72) 1. MOTOO WATANABE (JP)
2. RYOU KAWAHARA (JP)
3. JUNICHI SHIINA (JP)
4. DAIKI WATANABE (JP)
5. YUUKI ISHII (JP)
6. KENJI TASHIRO (JP)
7. MAKOTO KIMURA (JP)
- (74) Công ty Luật TNHH Phạm và Liên danh (PHAM & ASSOCIATES)
- (55)



1.1



1.2



1.3



1.4



1.5



1.6



1.7



1.8

CÔNG BÁO SỞ HỮU CÔNG NGHIỆP SỐ 429 TẬP A – QUYỀN 2 (12.2023)

- (11) **48696**
(21) 3-2023-00588 (28) 1
(54) **BẢNG GẮN CHI TIẾT ĐIỀU KHIỂN XE Ô TÔ** (51) **12-16**
(22) 21/03/2023 (43) 25/12/2023
(30) 2022-020704 28/09/2022 JP;
(73) **ISUZU MOTORS LIMITED (JP)**
2-5, Takashima 1-chome, Nishi-ku, Yokohama-shi, Kanagawa, 220-8720, JAPAN
(72) 1. MIKIO YAJIMA (JP)
2. NOBUYUKI HORISAWA (JP)
3. TOMOYOSHI ASO (JP)
4. SUSUMU MATSUDA (JP)
5. YOSHIHISA FUJITA (JP)
6. YUUTA YAMAMOTO (JP)
7. NORIAKI NAKANE (JP)
(74) Công ty Luật TNHH Phạm và Liên danh (PHAM & ASSOCIATES)
(55)



1.1



1.2



1.3



1.4



1.5



1.6



1.7



1.8

CÔNG BÁO SỞ HỮU CÔNG NGHIỆP SỐ 429 TẬP A – QUYỀN 2 (12.2023)

- (11) **48697**
(21) 3-2023-00590 (28) 1
(54) **NHÃN SẢN PHẨM** (51) **19-08**
(22) 21/03/2023 (43) 25/12/2023
(73) **CÔNG TY TNHH THƯƠNG MẠI DỊCH VỤ FRUITSCO VN (VN)**
319/B10 Lý Thường Kiệt, phường 15, quận 11, thành phố Hồ Chí Minh
(72) Nguyễn Anh Hòa (VN)
(55)



CÔNG BÁO SỞ HỮU CÔNG NGHIỆP SỐ 429 TẬP A – QUYỀN 2 (12.2023)

- (11) **48698**
- (21) 3-2023-00591 (28) 1
- (54) **NHÃN SẢN PHẨM** (51) **19-08**
- (22) 21/03/2023 (43) 25/12/2023
- (73) **CÔNG TY TNHH THƯƠNG MẠI DỊCH VỤ FRUITSCO VN (VN)**
319/B10 Lý Thường Kiệt, phường 15, quận 11, thành phố Hồ Chí Minh
- (72) Nguyễn Anh Hòa (VN)
- (55)



CÔNG BÁO SỞ HỮU CÔNG NGHIỆP SỐ 429 TẬP A – QUYỀN 2 (12.2023)

- (11) **48699**
(21) 3-2023-00592 (28) 1
(54) **NHÃN SẢN PHẨM** (51) **19-08**
(22) 21/03/2023 (43) 25/12/2023
(73) **CÔNG TY TNHH THƯƠNG MẠI DỊCH VỤ FRUITSCO VN (VN)**
319/B10 Lý Thường Kiệt, phường 15, quận 11, thành phố Hồ Chí Minh
(72) Nguyễn Anh Hòa (VN)
(55)



CÔNG BÁO SỞ HỮU CÔNG NGHIỆP SỐ 429 TẬP A – QUYỀN 2 (12.2023)

- (11) **48700**
- (21) 3-2023-00593 (28) 1
- (54) **NHÃN SẢN PHẨM** (51) **19-08**
- (22) 21/03/2023 (43) 25/12/2023
- (73) **CÔNG TY TNHH THƯƠNG MẠI DỊCH VỤ FRUITSCO VN (VN)**
319/B10 Lý Thường Kiệt, phường 15, quận 11, thành phố Hồ Chí Minh
- (72) Nguyễn Anh Hòa (VN)
- (55)



CÔNG BÁO SỞ HỮU CÔNG NGHIỆP SỐ 429 TẬP A – QUYỀN 2 (12.2023)

- (11) **48701**
(21) 3-2023-00615 (28) 1
(54) **HỆ THỐNG BĂNG CHUYỀN VẬN CHUYỂN TÚI HÀNG TRÊN CAO TẠI SIÊU THỊ** (51) **12-05**
(22) 23/03/2023 (43) 25/12/2023
(73) **CÔNG TY TNHH TẬP ĐOÀN CÔNG NGHIỆP TRƯỜNG HẢI (VN)**
KCN cơ khí ô tô Chu Lai Trường Hải, xã Tam Hiệp, huyện Núi Thành, tỉnh Quảng Nam
(72) Đỗ Minh Tâm (VN)
(74) Công ty TNHH Luật ALIAT (ALIAT LEGAL)
(55)

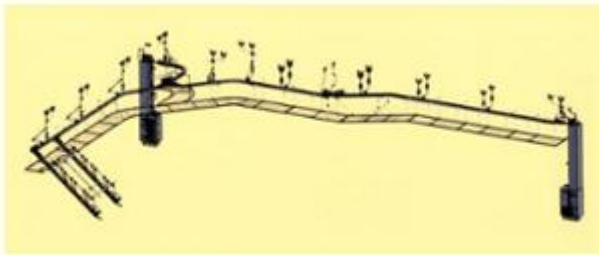

1.1

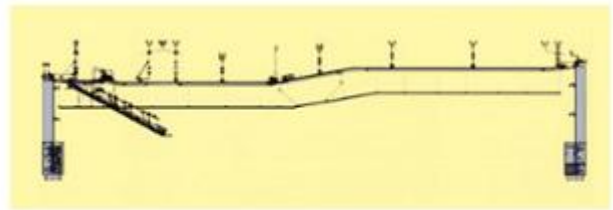

1.2

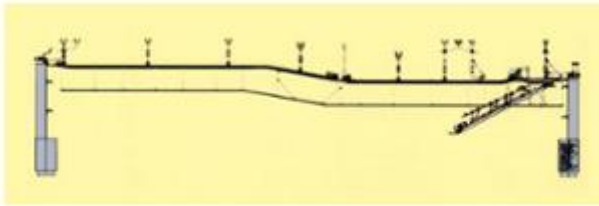

1.3

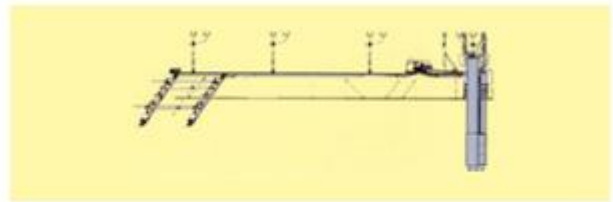

1.4

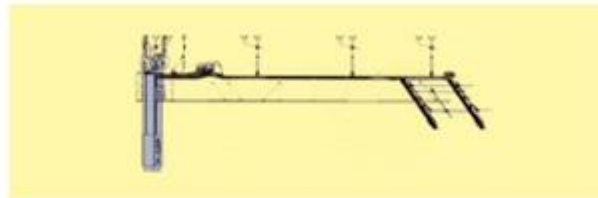

1.5

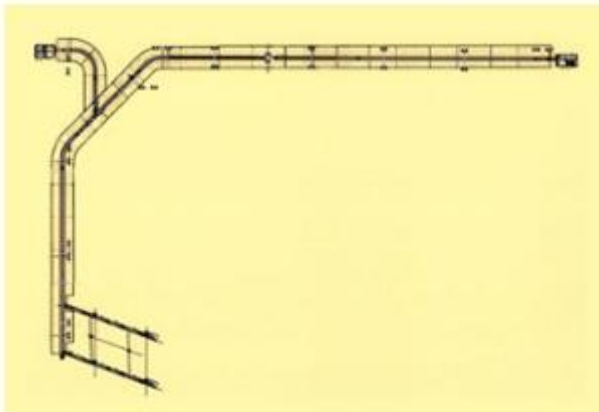

1.6

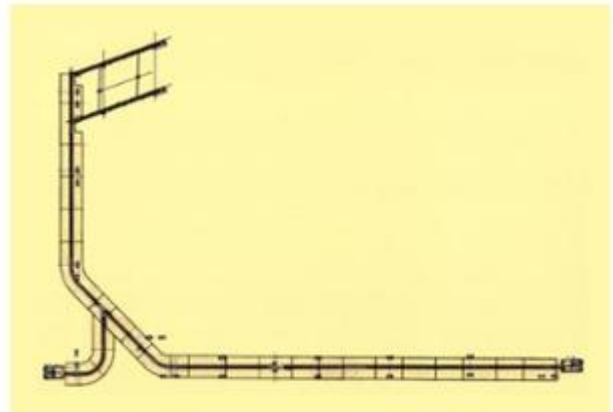

1.7

CÔNG BÁO SỞ HỮU CÔNG NGHIỆP SỐ 429 TẬP A – QUYỀN 2 (12.2023)

- (11) **48702**
(21) 3-2023-00631 (28) 1
(54) **BỘ ĐỊNH TUYẾN** (51) **14-03**
(22) 24/03/2023 (43) 25/12/2023
(30) 30-2022-0039275 26/09/2022 KR;
(73) **SAMSUNG ELECTRONICS CO., LTD. (KR)**
129, Samsung-ro, Yeongtong-gu, Suwon-si, Gyeonggi-do 16677, Republic of Korea
(72) JEON, Soyeon (KR)
(74) Công ty Luật TNHH WINCO (WINCO LAW FIRM)
(55)

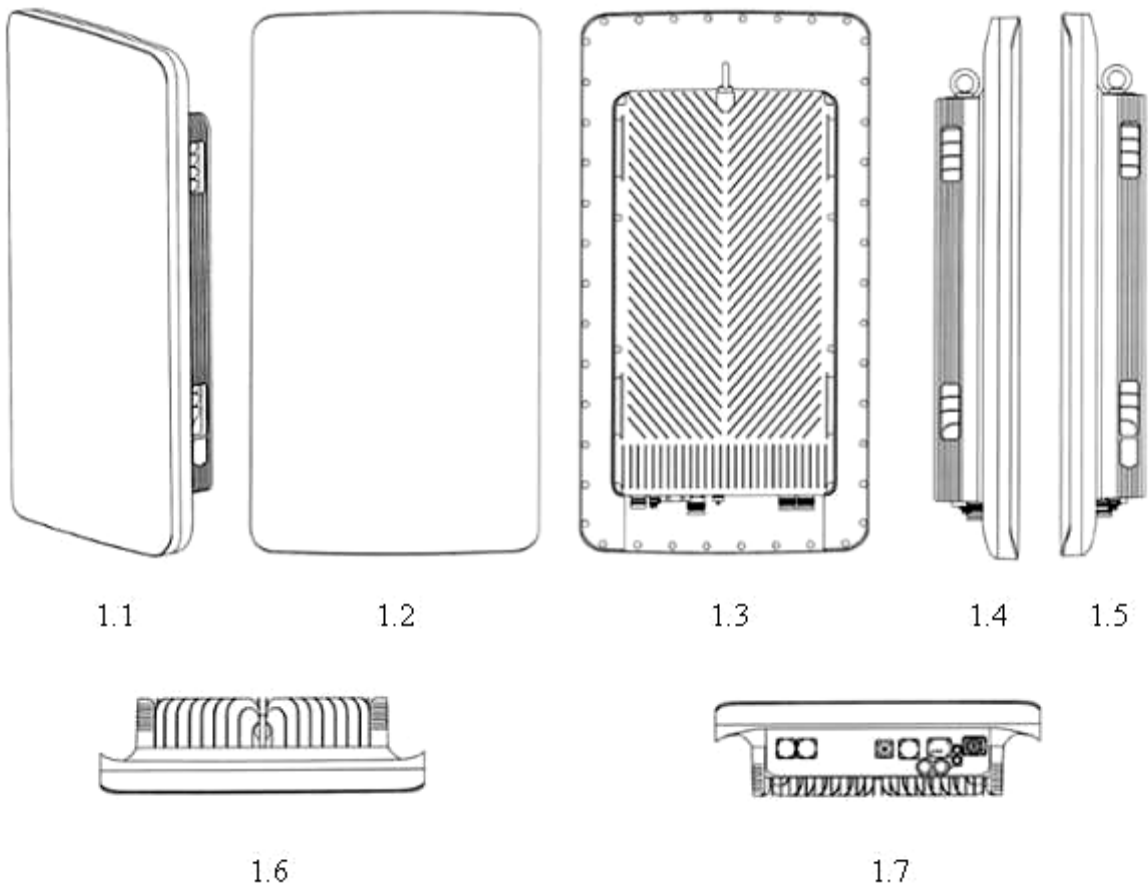

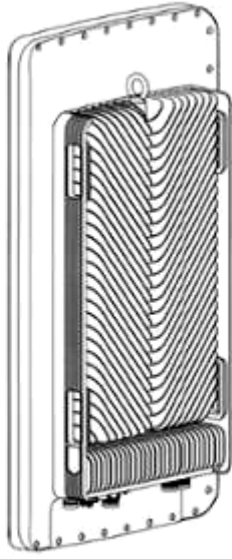

1.8

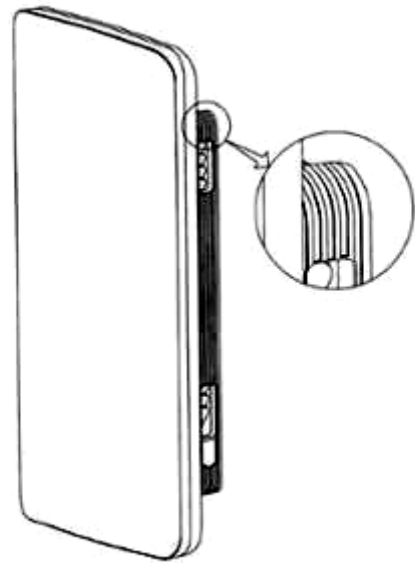

1.9

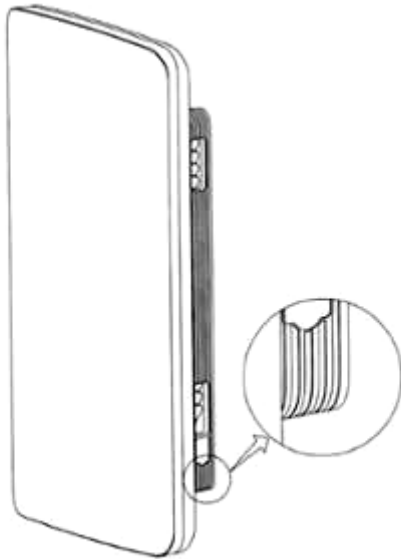

1.10

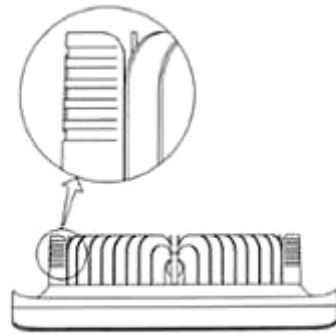

1.11

- (11) **48703**
(21) 3-2023-00632 (28) 1
(54) **HỘP SẠC TAI NGHE** (51) **13-02**
(22) 24/03/2023 (43) 25/12/2023
(30) 29/854,525 26/09/2022 US;
(73) **BOSE CORPORATION (US)**
The Mountain, Framingham, Massachusetts 01701-9168, United States of America
(72) 1. PAUL C. WILLIAMSON (US)
2. ETHAN FRANCES NORTON (US)
(74) Công ty Luật TNHH Phạm và Liên danh (PHAM & ASSOCIATES)
(55)

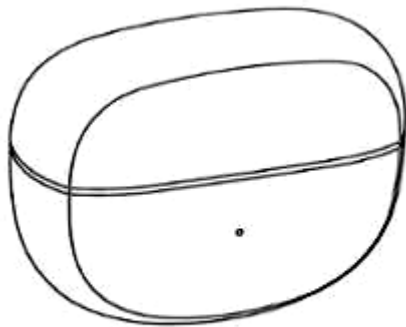

1.1

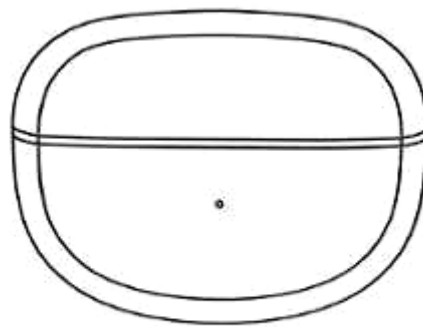

1.2

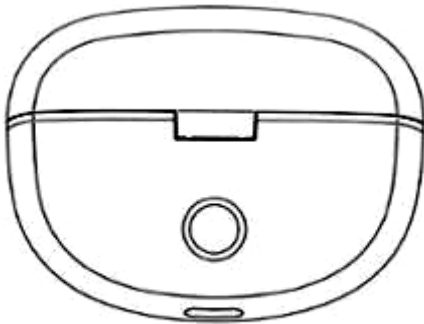

1.3

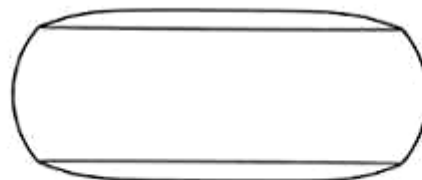

1.4



1.5



1.6



1.7

CÔNG BÁO SỞ HỮU CÔNG NGHIỆP SỐ 429 TẬP A – QUYỀN 2 (12.2023)

- (11) **48704**
(21) 3-2023-00633 (28) 1
(54) **HỘP SẠC TAI NGHE** (51) **13-02**
(22) 24/03/2023 (43) 25/12/2023
(30) 29/854,531 26/09/2022 US;
(73) **BOSE CORPORATION (US)**
The Mountain, Framingham, Massachusetts 01701-9168, United States of America
(72) 1. PAUL C. WILLIAMSON (US)
2. ETHAN FRANCES NORTON (US)
(74) Công ty Luật TNHH Phạm và Liên danh (PHAM & ASSOCIATES)
(55)

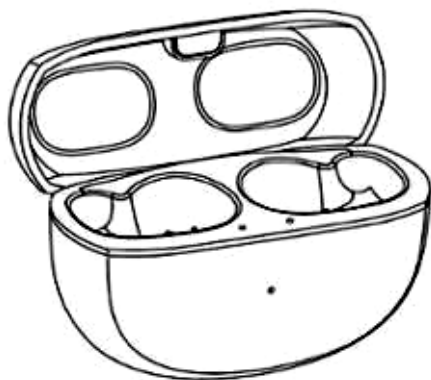

1.1

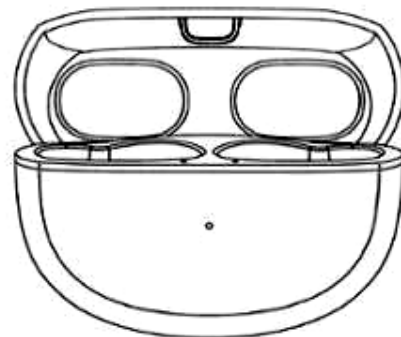

1.2



1.3

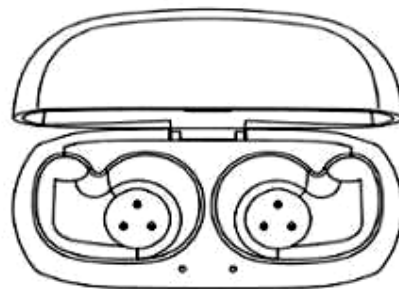

1.4



1.5



1.6



1.7

CÔNG BÁO SỞ HỮU CÔNG NGHIỆP SỐ 429 TẬP A – QUYỀN 2 (12.2023)

- (11) **48705**
(21) 3-2023-00634 (28) 1
(54) **HỘP SẠC CÓ TAI NGHE** (51) **13-02**
(22) 24/03/2023 (43) 25/12/2023
(30) 29/854,532 26/09/2022 US;
(73) **BOSE CORPORATION (US)**
The Mountain, Framingham, Massachusetts 01701-9168, United States of America
(72) 1. PAUL C. WILLIAMSON (US)
2. ETHAN FRANCES NORTON (US)
(74) Công ty Luật TNHH Phạm và Liên danh (PHAM & ASSOCIATES)
(55)

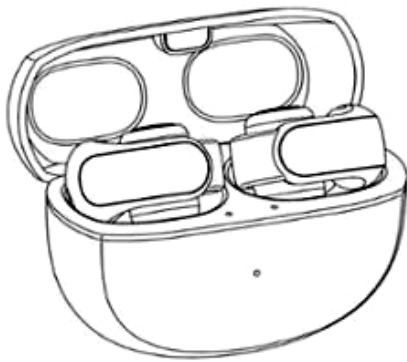

1.1



1.2



1.3

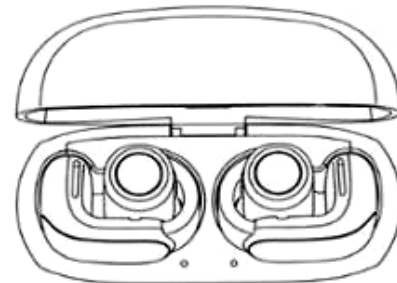

1.4



1.5



1.6



1.7

CÔNG BÁO SỞ HỮU CÔNG NGHIỆP SỐ 429 TẬP A – QUYỀN 2 (12.2023)

- (11) **48706**
(21) 3-2023-00635 (28) 1
(54) **TAI NGHE** (51) **14-01**
(22) 24/03/2023 (43) 25/12/2023
(30) 29/854,569 26/09/2022 US;
(73) **BOSE CORPORATION (US)**
The Mountain, Framingham, Massachusetts 01701-9168, United States of America
(72) 1. PAUL C. WILLIAMSON (US)
2. ETHAN FRANCES NORTON (US)
3. JOSHUA KEVIN DRYDEN (US)
(74) Công ty Luật TNHH Phạm và Liên danh (PHAM & ASSOCIATES)
(55)



1.1



1.2

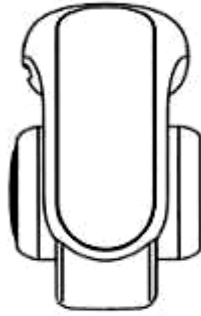

1.3



1.4



1.5



1.6

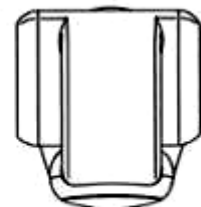

1.7

CÔNG BÁO SỞ HỮU CÔNG NGHIỆP SỐ 429 TẬP A – QUYỀN 2 (12.2023)

- (11) **48707**
(21) 3-2023-00639 (28) 1
(54) **XE Ô TÔ** (51) **12-08**
(22) 24/03/2023 (43) 25/12/2023
(30) 2022-021785 07/10/2022 JP;
(73) **mitsubishi JIDOSHA KOGYO KABUSHIKI KAISHA (JP)**
1-21, Shibaura 3-chome, Minato-ku, Tokyo, 108-8410 Japan
(72) 1. SHINYA NISHIKADO (JP)
2. TAKASHI MOGAMI (JP)
(74) **CÔNG TY LUẬT TRÁCH NHIỆM HỮU HẠN AMBYS HÀ NỘI (AMBYS HANOI)**
(55)



1.1



1.2



1.3



1.4



1.5



1.6



1.7

CÔNG BÁO SỞ HỮU CÔNG NGHIỆP SỐ 429 TẬP A – QUYỀN 2 (12.2023)

- (11) **48708**
- (21) 3-2023-00675 (28) 1
- (54) **NHÃN SẢN PHẨM** (51) **19-08**
- (22) 28/03/2023 (43) 25/12/2023
- (73) **CÔNG TY TNHH SẢN XUẤT THƯƠNG MẠI XUẤT NHẬP KHẨU DR. MAN (VN)**
131/17 Kinh Dương Vương, phường 12, quận 6, thành phố Hồ Chí Minh
- (72) Nguyễn Thị Mai Dung (VN)
- (55)

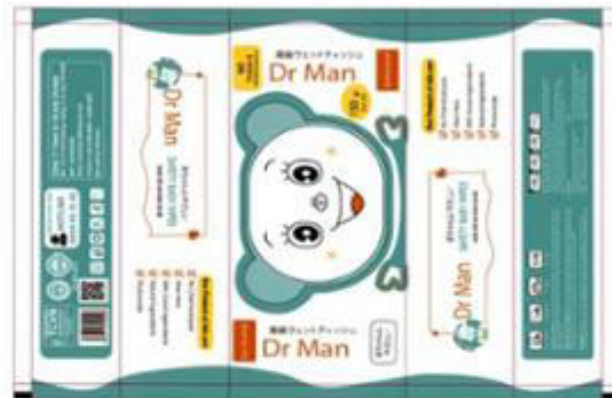

CÔNG BÁO SỞ HỮU CÔNG NGHIỆP SỐ 429 TẬP A – QUYỀN 2 (12.2023)

- (11) **48709**
- (21) 3-2023-00698 (28) 1
- (54) **NHÃN SẢN PHẨM** (51) **19-08**
- (22) 30/03/2023 (43) 25/12/2023
- (73) **CÔNG TY TNHH NĂNG LƯỢNG XANH THIÊN THANH (VN)**
Số 92, đường Trần Hưng Đạo, khu phố Đông A, phường Đông Hòa, thành phố Dĩ An, tỉnh Bình Dương
- (72) Lê Văn Thanh (VN)
- (74) Công ty TNHH một thành viên Trường Luật (Trường Luật)
- (55)



CÔNG BÁO SỞ HỮU CÔNG NGHIỆP SỐ 429 TẬP A – QUYỀN 2 (12.2023)

- (11) **48710**
- (21) 3-2023-00699 (28) 1
- (54) **NHÃN SẢN PHẨM** (51) **19-08**
- (22) 30/03/2023 (43) 25/12/2023
- (73) **CÔNG TY TNHH NĂNG LƯỢNG XANH THIÊN THANH (VN)**
Số 92, đường Trần Hưng Đạo, khu phố Đông A, phường Đông Hòa, thành phố Dĩ An, tỉnh Bình Dương
- (72) Lê Văn Thanh (VN)
- (74) Công ty TNHH một thành viên Trường Luật (Trường Luật)
- (55)



CÔNG BÁO SỞ HỮU CÔNG NGHIỆP SỐ 429 TẬP A – QUYỀN 2 (12.2023)

- (11) **48711**
(21) 3-2023-00701 (28) 1
(54) **THANH NHÔM ĐỊNH HÌNH** (51) **25-01**
(22) 30/03/2023 (43) 25/12/2023
(73) **CÔNG TY TNHH THANH PHÚC WINDOW (VN)**
478 Nguyễn Thị Thập, phường Tân Quy, quận 7, thành phố Hồ Chí Minh
(72) Nguyễn Thị Kim Hoàn (VN)
(55)



1.1



1.2

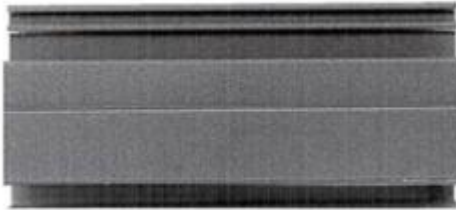

1.3

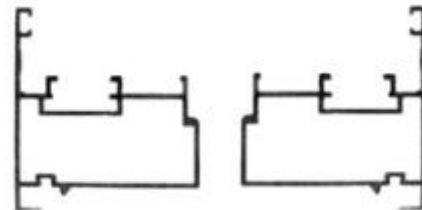

1.4

1.5



1.6



1.7

- (11) **48712**
(21) 3-2023-00704 (28) 1
(54) **THANH NHÔM ĐỊNH HÌNH** (51) **25-01**
(22) 30/03/2023 (43) 25/12/2023
(73) **CÔNG TY TNHH THANH PHÚC WINDOW (VN)**
478 Nguyễn Thị Thập, phường Tân Quy, quận 7, thành phố Hồ Chí Minh
(72) Nguyễn Thị Kim Hoàn (VN)
(55)



1.1



1.2



1.3



1.4

1.5



1.6



1.7

CÔNG BÁO SỞ HỮU CÔNG NGHIỆP SỐ 429 TẬP A – QUYỀN 2 (12.2023)

- (11) **48713**
(21) 3-2023-00705 (28) 1
(54) **THANH NHÔM ĐỊNH HÌNH** (51) **25-01**
(22) 30/03/2023 (43) 25/12/2023
(73) **CÔNG TY TNHH THANH PHÚC WINDOW (VN)**
478 Nguyễn Thị Thập, phường Tân Quy, quận 7, thành phố Hồ Chí Minh
(72) Nguyễn Thị Kim Thoán (VN)
(55)

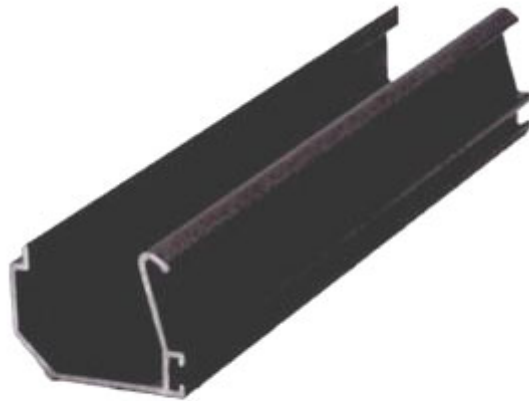

1.1



1.2



1.3

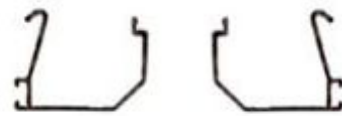

1.4

1.5



1.6



1.7

CÔNG BÁO SỞ HỮU CÔNG NGHIỆP SỐ 429 TẬP A – QUYỀN 2 (12.2023)

- (11) **48714**
(21) 3-2023-00729 (28) 1
(54) **THANH NHÔM ĐỊNH HÌNH** (51) **25-01**
(22) 31/03/2023 (43) 25/12/2023
(73) **CÔNG TY TNHH THANH PHÚC WINDOW (VN)**
478 Nguyễn Thị Thập, phường Tân Quy, quận 7, thành phố Hồ Chí Minh
(72) Nguyễn Thị Kim Hoàn (VN)
(55)



1.1

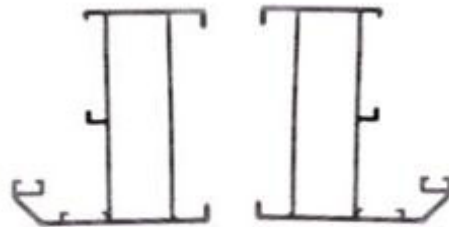

1.2

1.3



1.4

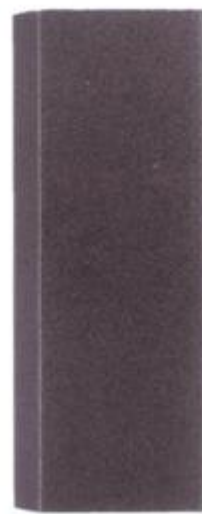

1.5



1.6



1.7

CÔNG BÁO SỞ HỮU CÔNG NGHIỆP SỐ 429 TẬP A – QUYỀN 2 (12.2023)

- (11) **48715**
(21) 3-2023-00732 (28) 1
(54) **THANH NHÔM ĐỊNH HÌNH** (51) **25-01**
(22) 31/03/2023 (43) 25/12/2023
(73) **CÔNG TY TNHH THANH PHÚC WINDOW (VN)**
478 Nguyễn Thị Thập, phường Tân Quy, quận 7, thành phố Hồ Chí Minh
(72) Nguyễn Thị Kim Hoàn (VN)
(55)



1.1



1.2



1.3



1.4

CÔNG BÁO SỞ HỮU CÔNG NGHIỆP SỐ 429 TẬP A – QUYỀN 2 (12.2023)

- (11) **48716**
(21) 3-2023-00751 (28) 1
(54) **HỘP** (51) **09-03**
(22) 05/04/2023 (43) 25/12/2023
(73) **ORION CORPORATION (KR)**
13, Baekbeom-ro 90da-gil, Yongsan-gu, Seoul 04369, Republic of Korea
(72) 1. LEE, A REUM (KR)
2. CHOE, EUN JE (KR)
(74) Công ty Luật TNHH quốc tế BMVN (BMVN INTERNATIONAL LLC)
(55)



1.1



1.2



1.3



1.4



1.5



1.6



1.7

CÔNG BÁO SỞ HỮU CÔNG NGHIỆP SỐ 429 TẬP A – QUYỀN 2 (12.2023)

- (11) **48717**
(21) 3-2023-00752 (28) 1
(54) **HỘP** (51) **09-03**
(22) 05/04/2023 (43) 25/12/2023
(73) **ORION CORPORATION (KR)**
13, Baekbeom-ro 90da-gil, Yongsan-gu, Seoul 04369, Republic of Korea
(72) 1. LEE, A REUM (KR)
2. CHOE, EUN JE (KR)
(74) Công ty Luật TNHH quốc tế BMVN (BMVN INTERNATIONAL LLC)
(55)



1.1



1.2



1.3



1.4



1.5



1.6

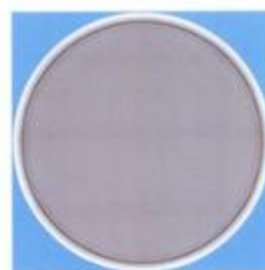

1.7

CÔNG BÁO SỞ HỮU CÔNG NGHIỆP SỐ 429 TẬP A – QUYỀN 2 (12.2023)

- (11) **48718**
(21) 3-2023-00763 (28) 1
(54) **HỘP ĐỰNG** (51) **09-03**
(22) 06/04/2023 (43) 25/12/2023
(30) 29/855,714 06/10/2022 US;
(73) **STASHER, INC. (US)**
1310 63rd Street, Emeryville, California, 94608, United States of America
(72) Angelo CARPINELLI (US)
(74) Công ty TNHH Đại Tín và Liên Danh (DAITIN AND ASSOCIATES CO.,LTD)
(55)

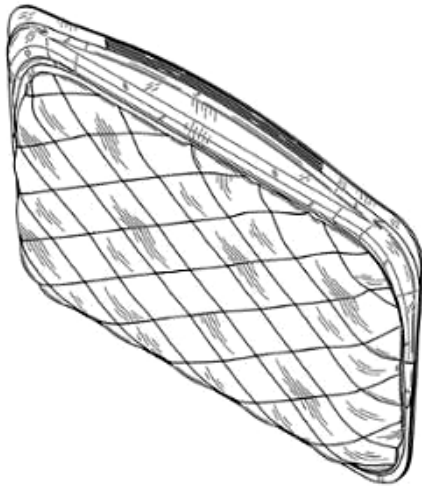

1.1



1.2

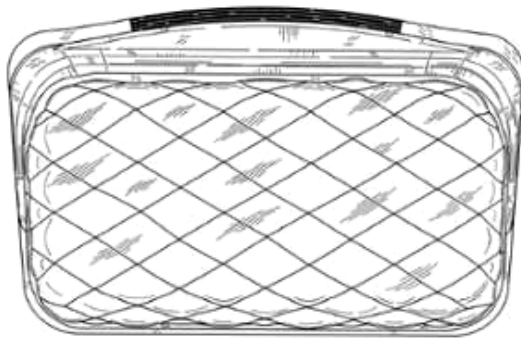

1.3

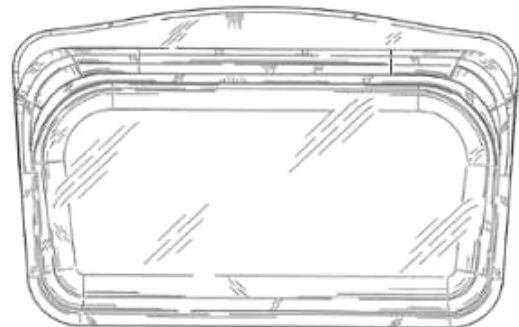

1.4



1.5



1.6



1.7

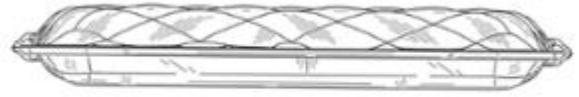

1.8



1.9



1.10

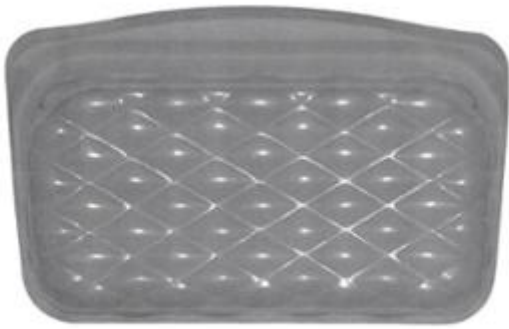

1.11



1.12



1.13



1.14



1.15



1.16

CÔNG BÁO SỞ HỮU CÔNG NGHIỆP SỐ 429 TẬP A – QUYỀN 2 (12.2023)

- (11) **48719**
(21) 3-2023-00764 (28) 1
(54) **HỘP ĐỰNG** (51) **09-03**
(22) 06/04/2023 (43) 25/12/2023
(30) 29/855,718 06/10/2022 US;
(73) **STASHER, INC. (US)**
1310 63rd Street, Emeryville, California, 94608, United States of America
(72) Angelo CARPINELLI (US)
(74) Công ty TNHH Đại Tín và Liên Danh (DAITIN AND ASSOCIATES CO.,LTD)
(55)

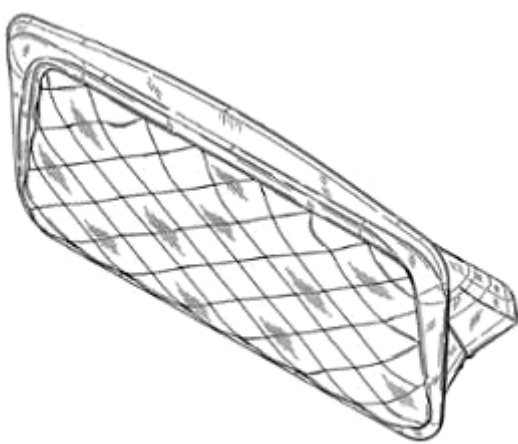

1.1



1.2

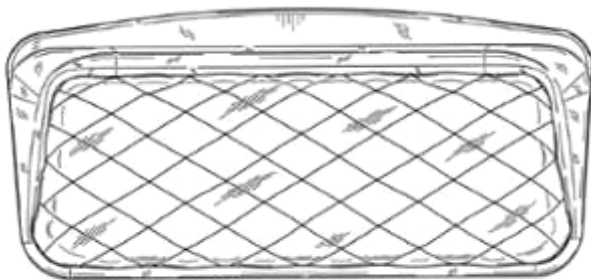

1.3

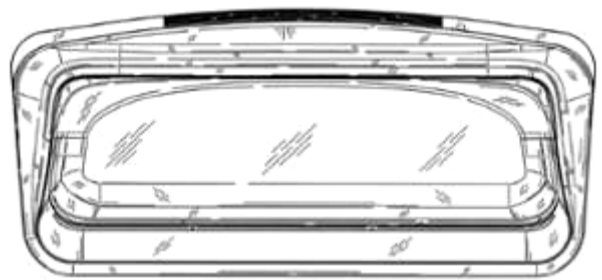

1.4



1.5



1.6

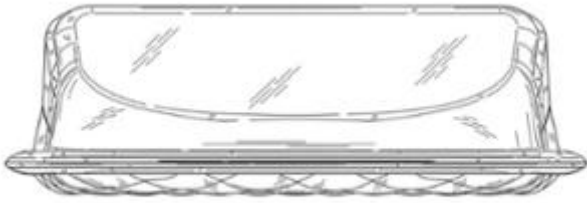

1.7

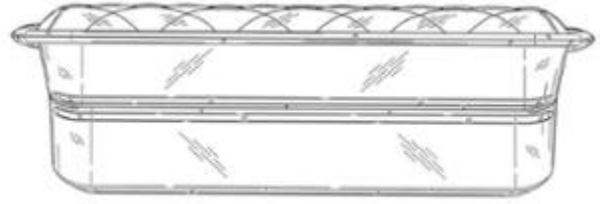

1.8



1.9



1.10

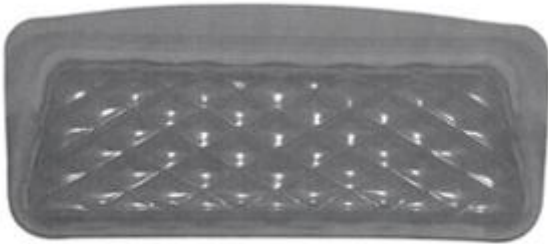

1.11



1.12



1.13



1.14



1.15



1.16

CÔNG BÁO SỞ HỮU CÔNG NGHIỆP SỐ 429 TẬP A – QUYỀN 2 (12.2023)

- (11) **48720**
(21) 3-2023-00765 (28) 1
(54) **HỘP ĐỰNG** (51) **09-03**
(22) 06/04/2023 (43) 25/12/2023
(30) 29/855,715 06/10/2022 US;
(73) **STASHER, INC. (US)**
1310 63rd Street, Emeryville, California, 94608, United States of America
(72) Angelo CARPINELLI (US)
(74) Công ty TNHH Đại Tín và Liên Danh (DAITIN AND ASSOCIATES CO.,LTD)
(55)



1.1

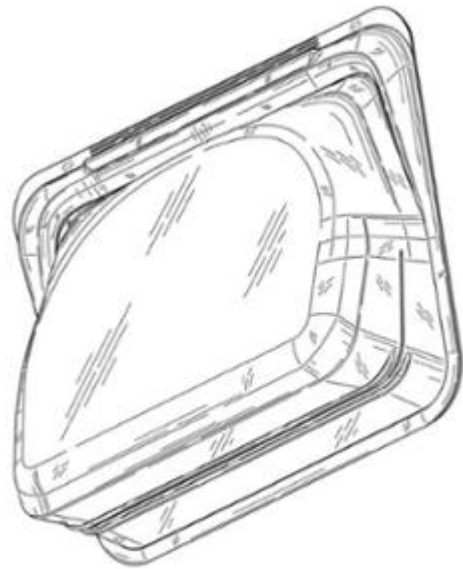

1.2

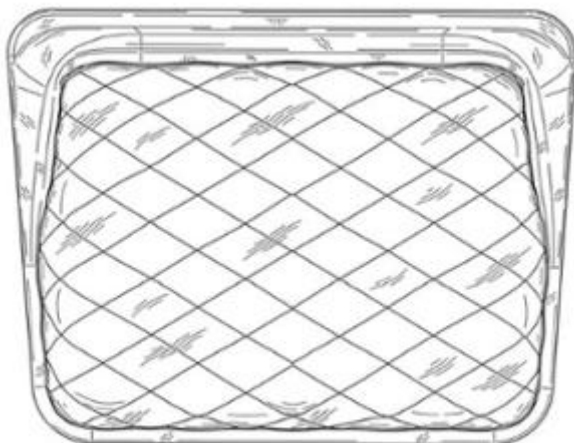

1.3

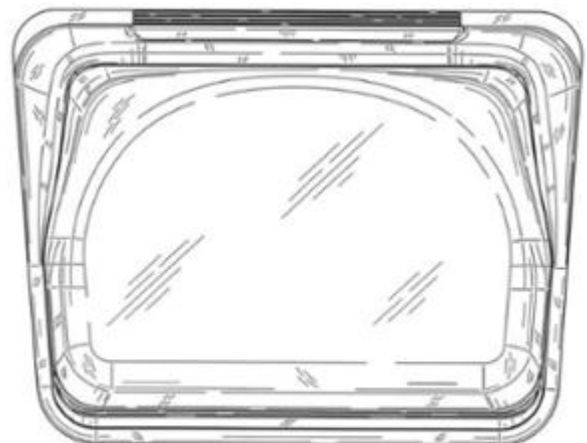

1.4

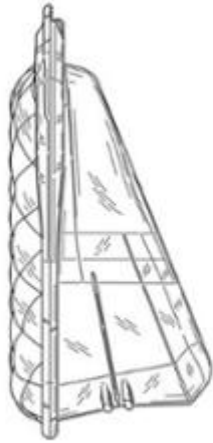

1.5



1.6

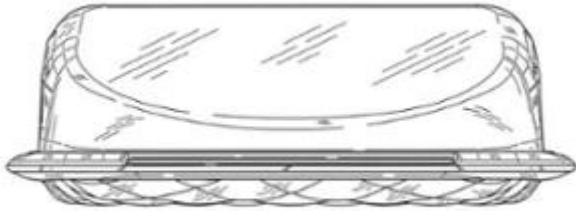

1.7

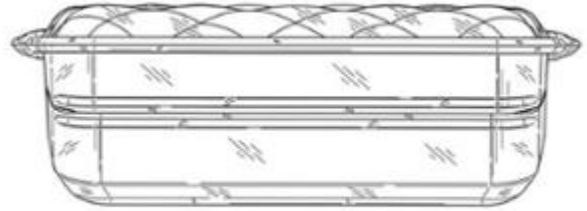

1.8



1.9



1.10

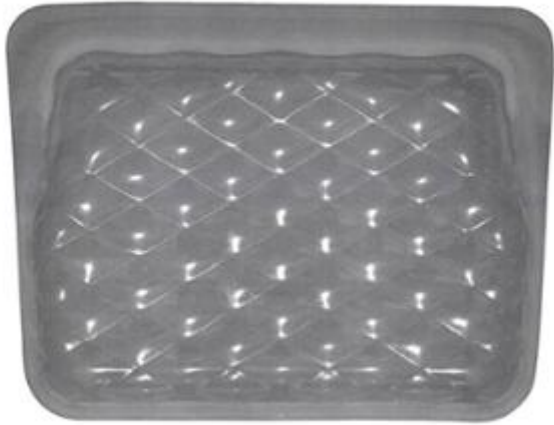

1.11



1.12



1.13



1.14



1.15



1.16

- (11) **48721**
(21) 3-2023-00768 (28) 1
(54) **DỤNG CỤ CHĂM SÓC CÁ NHÂN** (51) **24-02**
(22) 06/04/2023 (43) 25/12/2023
(30) 29/856,380 13/10/2022 US;
(73) **COLGATE-PALMOLIVE COMPANY (US)**
300 Park Avenue, New York, New York 10022, United States of America
(72) 1. DANIEL WAINLESS (US)
2. EDUARDO JIMENEZ (US)
(74) Văn phòng Luật sư Ân Nam (ANNAM IP & LAW)
(55)

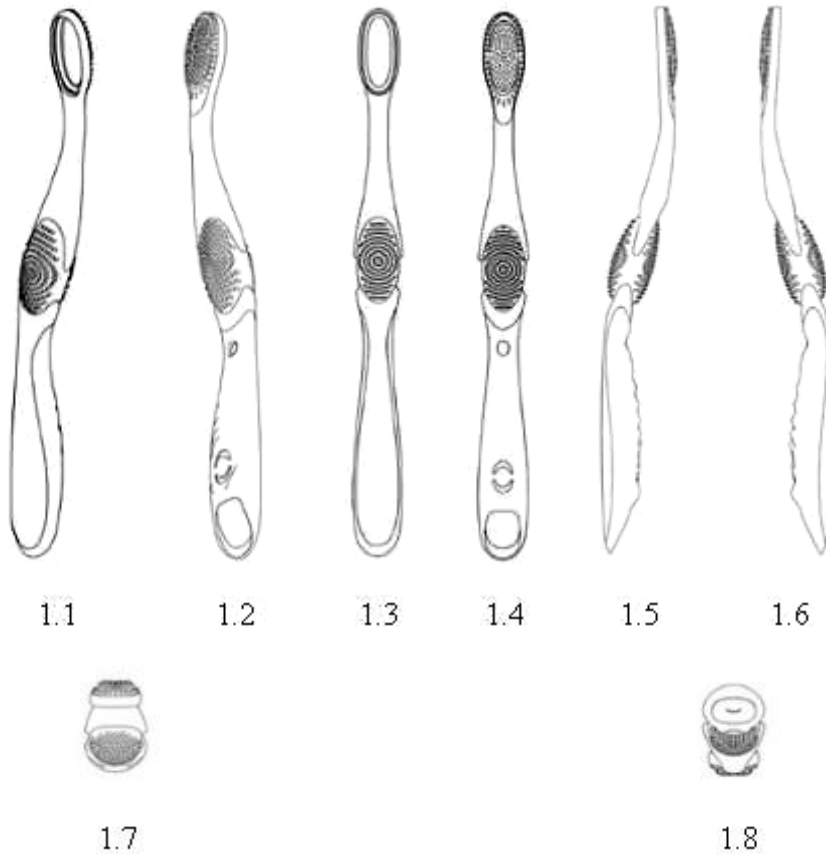

CÔNG BÁO SỞ HỮU CÔNG NGHIỆP SỐ 429 TẬP A – QUYỀN 2 (12.2023)

- (11) **48722**
(21) 3-2023-00773 (28) 1
(54) **CAN** (51) **09-02**
(22) 07/04/2023 (43) 25/12/2023
(73) **CÔNG TY TNHH SẢN XUẤT THƯƠNG MẠI DỊCH VỤ HÓA MỸ PHẨM
THIÊN LỘC THÀNH (VN)**
127/39 đường TA13, khu phố 3, phường Thới An, quận 12, thành phố Hồ Chí Minh
(72) Huỳnh Thị Đức Như (VN)
(55)



1.1



1.2



1.3



1.4



1.5



1.6

CÔNG BÁO SỞ HỮU CÔNG NGHIỆP SỐ 429 TẬP A – QUYỀN 2 (12.2023)

- (11) **48723**
(21) 3-2023-00781 (28) 1
(54) **HỘP ĐỰNG** (51) **09-03**
(22) 07/04/2023 (43) 25/12/2023
(73) **CÔNG TY CỔ PHẦN CÔNG NGHỆ DƯỢC LIỆU BẮC HÀ (VN)**
Thôn Nam Đội Nhân, xã Nông Thượng, thành phố Bắc Kạn, tỉnh Bắc Kạn
(72) 1. PHẠM TIỀN ĐẠT (VN)
2. NÔNG THỊ KIM CHI (VN)
(74) Công ty TNHH Sở hữu trí tuệ HA VIP (HAVIP CO., LTD.)
(55)



1.1



1.2

CÔNG BÁO SỞ HỮU CÔNG NGHIỆP SỐ 429 TẬP A – QUYỀN 2 (12.2023)

- (11) **48724**
- (21) 3-2023-00782 (28) 1
- (54) **HỘP ĐỰNG** (51) **09-03**
- (22) 07/04/2023 (43) 25/12/2023
- (73) **CÔNG TY CỔ PHẦN CÔNG NGHỆ DƯỢC LIỆU BẮC HÀ (VN)**
Thôn Nam Đội Nhân, xã Nông Thượng, thành phố Bắc Kạn, tỉnh Bắc Kạn
- (72) 1. PHẠM TIỀN ĐẠT (VN)
2. NÔNG THỊ KIM CHI (VN)
- (74) Công ty TNHH Sở hữu trí tuệ HA VIP (HAVIP CO., LTD.)
- (55)



1.1



1.2

CÔNG BÁO SỞ HỮU CÔNG NGHIỆP SỐ 429 TẬP A – QUYỀN 2 (12.2023)

- (11) **48725**
(21) 3-2023-00785 (28) 1
(54) **ĐAI NỊT BỤNG** (51) **02-01**
(22) 07/04/2023 (43) 25/12/2023
(73) **CÔNG TY TNHH XUẤT NHẬP KHẨU AMERICAN RUBY'S (VN)**
LK 16-17, đường N1, KP7, phường Thống Nhất, thành phố Biên Hoà, tỉnh Đồng Nai
(72) Nguyễn Võ Anh Thư (VN)
(74) Công ty TNHH Tư vấn IPNG (IPNG CO.,LTD)
(55)



1.1



1.2



1.3



1.4



1.5



1.6



1.7

CÔNG BÁO SỞ HỮU CÔNG NGHIỆP SỐ 429 TẬP A – QUYỀN 2 (12.2023)

- (11) **48726**
(21) 3-2023-00794 (28) 1
(54) **BẾP GA MINI** (51) **07-02**
(22) 10/04/2023 (43) 25/12/2023
(73) **CÔNG TY TNHH SẢN XUẤT THƯƠNG MẠI DỊCH VỤ CƠ HÙNG PHÁT (VN)**
9/30F đường T14 ấp 4, xã Tân Quy Tây, huyện Bình Chánh, thành phố Hồ Chí Minh
(72) Lâm Trần Cơ (VN)
(74) **CÔNG TY TNHH SỞ HỮU TRÍ TUỆ SETHACO (SETHACO IP CO.,LTD)**
(55)



1.1



1.2



1.3



1.4



1.5



1.6



1.7

CÔNG BÁO SỞ HỮU CÔNG NGHIỆP SỐ 429 TẬP A – QUYỀN 2 (12.2023)

(11) **48727**

(21) 3-2023-00821

(54) **KHUÔN ĐÚC CỘT XÂY DỰNG**

(22) 11/04/2023

(73) **NGUYỄN XUÂN THỦY (VN)**

Tổ 3, khu 10, phường Bãi Cháy, thành phố Hạ Long, tỉnh Quảng Ninh

(72) Nguyễn Xuân Thủy (VN)

(55)

(28) 1

(51) **25-02**

(43) 25/12/2023

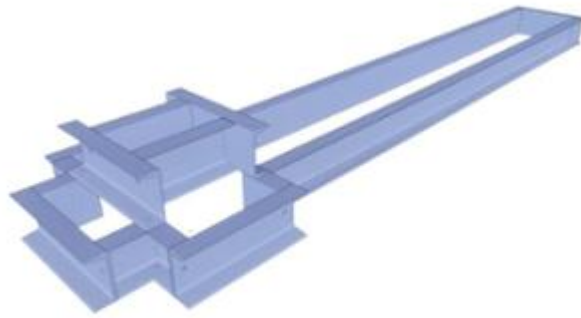

1.1



1.2



1.3



1.4



1.5

CÔNG BÁO SỞ HỮU CÔNG NGHIỆP SỐ 429 TẬP A – QUYỀN 2 (12.2023)

(11) **48728**

(21) 3-2023-00822

(28) 1

(54) **CỘT XÂY DỰNG**

(51) **25-02**

(22) 11/04/2023

(43) 25/12/2023

(73) **NGUYỄN XUÂN THỦY (VN)**

Tổ 3, khu 10, phường Bãi Cháy, thành phố Hạ Long, tỉnh Quảng Ninh

(72) Nguyễn Xuân Thủy (VN)

(55)



1.1



1.2



1.3



1.4

CÔNG BÁO SỞ HỮU CÔNG NGHIỆP SỐ 429 TẬP A – QUYỀN 2 (12.2023)

- (11) **48729**
(21) 3-2023-00831 (28) 2
(54) **ĐÈN PHA CHO XE CỘ** (51) **26-06**
(22) 12/04/2023 (43) 25/12/2023
(30) 2022308344544 13/12/2022 CN;
(73) **FORD GLOBAL TECHNOLOGIES, LLC (US)**
1 American Rd FL4, Dearborn, MI, United State of America, 48126-2701
(72) 1. MAX WOLFF (AU)
2. MAX TRAN (AU)
3. LEIGH HENDRIK COSENTINO (AU)
4. NONTHAWAT KONGSARI (TH)
5. BEN EYERS (AU)
(74) Công ty TNHH Sở hữu trí tuệ HA VIP (HAVIP CO., LTD.)
(55)



1.1



1.2

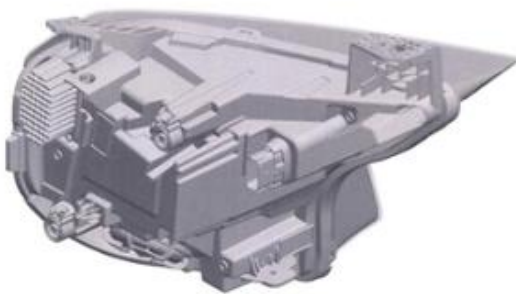

1.3



1.4



1.5



1.6



1.7



1.8



1.9



2.1



2.2

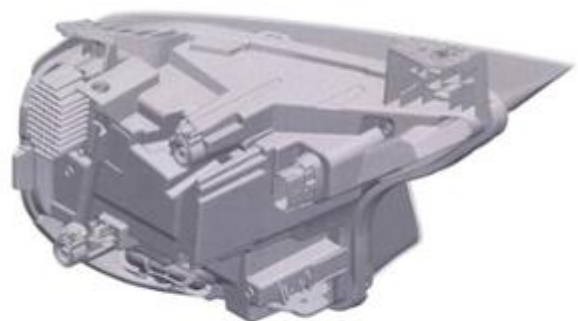

2.3



2.4



2.5



2.6



2.7



2.8



2.9

CÔNG BÁO SỞ HỮU CÔNG NGHIỆP SỐ 429 TẬP A – QUYỀN 2 (12.2023)

- (11) **48730**
(21) 3-2023-00832 (28) 2
(54) **LƯỚI TẢN NHIỆT TRÊN MẶT TRƯỚC XE CỘ** (51) **12-16**
(22) 12/04/2023 (43) 25/12/2023
(30) 2022308349834 13/12/2022 CN;
(73) **FORD GLOBAL TECHNOLOGIES, LLC (US)**
1 American Rd FL4, Dearborn, MI, United State of America, 48126-2701
(72) 1. MAX WOLFF (AU)
2. MAX TRAN (AU)
3. LEIGH HENDRIK COSENTINO (AU)
4. NONTHAWAT KONGSARI (TH)
(74) Công ty TNHH Sở hữu trí tuệ HA VIP (HAVIP CO., LTD.)
(55)



1.1



1.2



1.3



1.4



1.5



1.6



1.7



1.8



1.9



2.1



2.2



2.3



2.4

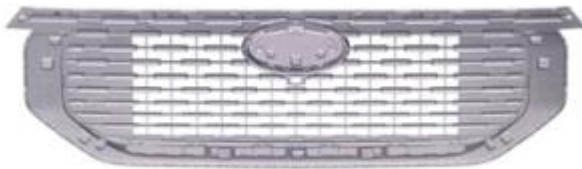

2.5



2.6



2.7



2.8



2.9

CÔNG BÁO SỞ HỮU CÔNG NGHIỆP SỐ 429 TẬP A – QUYỀN 2 (12.2023)

- (11) **48731**
- (21) 3-2023-00833 (28) 1
- (54) **TẦM ỐP CẢN TRÊN MẶT TRƯỚC XE CỘ** (51) **12-16**
- (22) 12/04/2023 (43) 25/12/2023
- (30) 2022308356429 13/12/2022 CN;
- (73) **FORD GLOBAL TECHNOLOGIES, LLC (US)**
1 American Rd FL4, Dearborn, MI, United State of America, 48126-2701
- (72) 1. MAX WOLFF (AU)
2. MAX TRAN (AU)
3. LEIGH HENDRIK COSENTINO (AU)
4. NONTHAWAT KONGSARI (TH)
- (74) Công ty TNHH Sở hữu trí tuệ HA VIP (HAVIP CO., LTD.)
- (55)



1.1

1.2



1.3



1.4



1.5



1.6

1.7



1.8



1.9

CÔNG BÁO SỞ HỮU CÔNG NGHIỆP SỐ 429 TẬP A – QUYỀN 2 (12.2023)

- (11) **48732**
(21) 3-2023-00834 (28) 1
(54) **TẦM ỐP CẢN DƯỚI MẶT TRƯỚC XE CỘ** (51) **12-16**
(22) 12/04/2023 (43) 25/12/2023
(30) 2022308344559 13/12/2022 CN;
(73) **FORD GLOBAL TECHNOLOGIES, LLC (US)**
1 American Rd FL4, Dearborn, MI, United State of America, 48126-2701
(72) 1. MAX WOLFF (AU)
2. MAX TRAN (AU)
3. LEIGH HENDRIK COSENTINO (AU)
4. NONTHAWAT KONGSARI (TH)
(74) Công ty TNHH Sở hữu trí tuệ HA VIP (HAVIP CO., LTD.)
(55)



1.1



1.2



1.3



1.4



1.5



1.6



1.7



1.8



1.9

CÔNG BÁO SỞ HỮU CÔNG NGHIỆP SỐ 429 TẬP A – QUYỀN 2 (12.2023)

- (11) **48733**
- (21) 3-2023-00835 (28) 1
- (54) **Ô TÔ** (51) **12-08**
- (22) 12/04/2023 (43) 25/12/2023
- (30) 2022308382584 14/12/2022 CN;
- (73) **FORD GLOBAL TECHNOLOGIES, LLC (US)**
1 American Rd FL4, Dearborn, MI, United State of America, 48126-2701
- (72) 1. MAX WOLFF (AU)
2. MAX TRAN (AU)
3. LEIGH HENDRIK COSENTINO (AU)
4. NICK DAVID ETEROVIC (AU)
5. NONTHAWAT KONGSARI (TH)
6. ANDY BEARD (AU)
7. JEFFREY LIU (CN)
8. BEN EYERS (AU)
9. TAEHOON KANG (KR)
- (74) Công ty TNHH Sở hữu trí tuệ HA VIP (HAVIP CO., LTD.)
- (55)



1.1



1.2



1.3



1.4



1.5



1.6



1.7

CÔNG BÁO SỞ HỮU CÔNG NGHIỆP SỐ 429 TẬP A – QUYỀN 2 (12.2023)

- (11) **48734**
(21) 3-2023-00857 (28) 1
(54) **ROBOT TỰ HÀNH** (51) **12-14**
(22) 14/04/2023 (43) 25/12/2023
(73) **CÔNG TY CỔ PHẦN KỸ THUẬT TEMAS (VN)**
Số 17, khu X5, ngõ 60, phố Dương Khuê, phường Mỹ Đình 2, quận Nam Từ Liêm,
thành phố Hà Nội
(72) 1. TRẦN ĐỨC HIẾU (VN)
2. TRẦN MINH NHẬT (VN)
(74) Công ty TNHH Sở hữu trí tuệ HA VIP (HAVIP CO., LTD.)
(55)

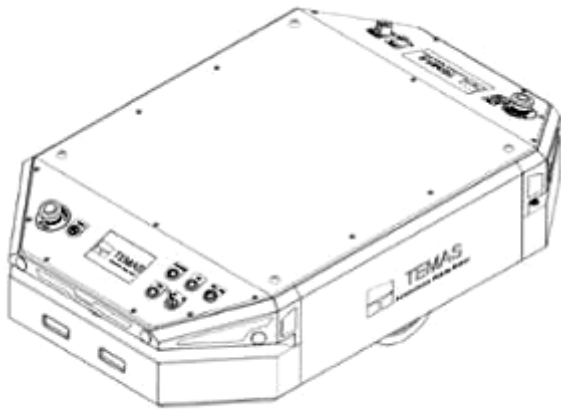

1.1

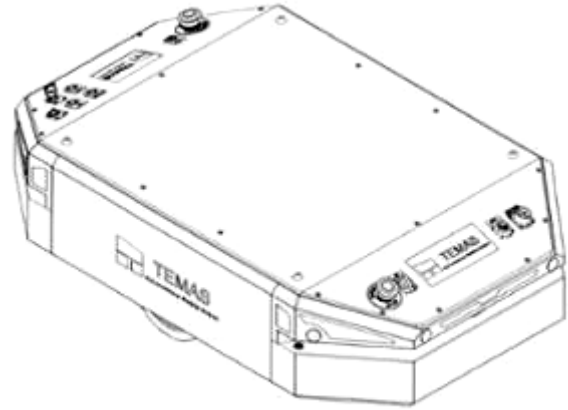

1.2



1.3



1.4

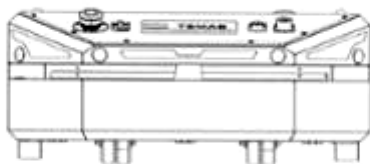

1.5

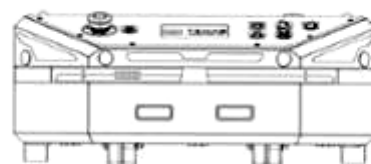

1.6

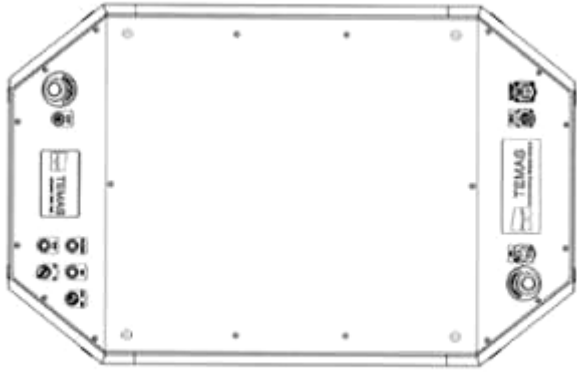

1.7

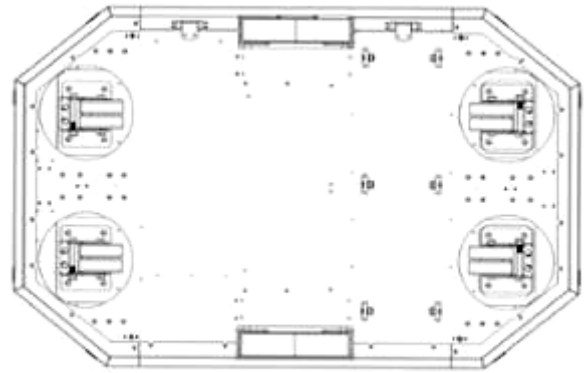

1.8

CÔNG BÁO SỞ HỮU CÔNG NGHIỆP SỐ 429 TẬP A – QUYỀN 2 (12.2023)

- (11) **48735**
(21) 3-2023-00889 (28) 1
(54) **MÁY KÍCH THÍCH ĐIỆN** (51) **24-01**
(22) 19/04/2023 (43) 25/12/2023
(30) 111306708 30/12/2022 TW;
(73) **GIMER MEDICAL COMPANY LIMITED (TW)**
9F.-5, No. 97, Sec. 1, Xintai 5th Rd., Xizhi Disc, New Taipei City 22175, Taiwan
(72) 1. CHENG-YUNG TUNG (TW)
2. CHING-TAI WANG (TW)
3. CHI-HENG CHANG (TW)
4. PEI-YI LIN (TW)
5. CHIA-HSIUNG PENG (TW)
(74) Công ty TNHH Trường Xuân (AGELESS CO.,LTD.)
(55)

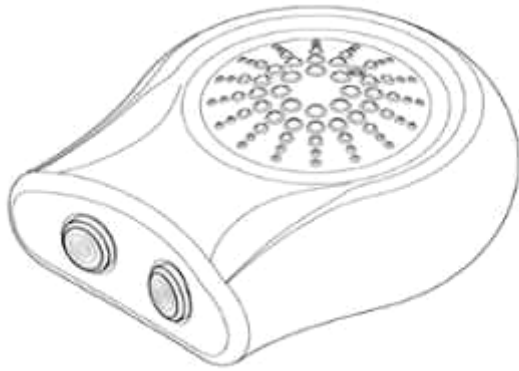

1.1

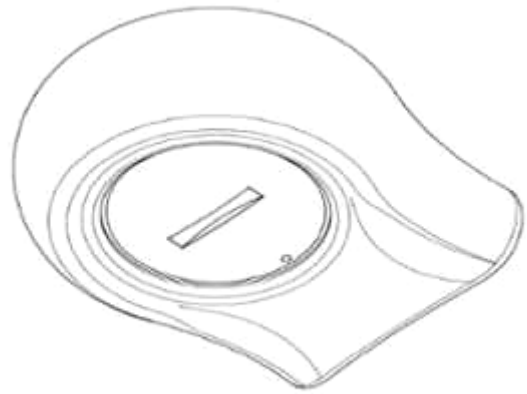

1.2

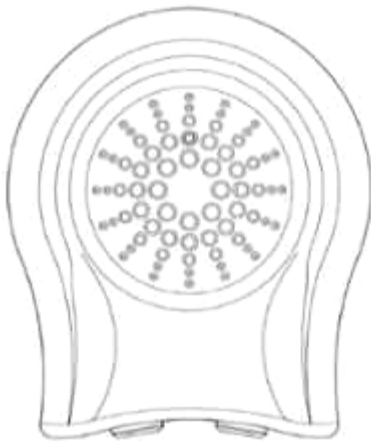

1.3

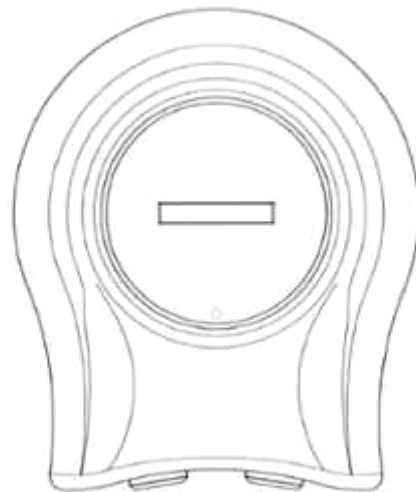

1.4



1.5



1.6



1.7



1.8

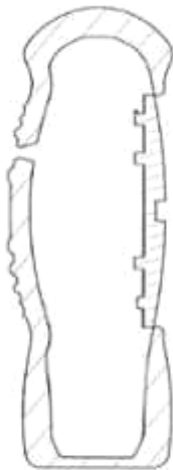

1.9

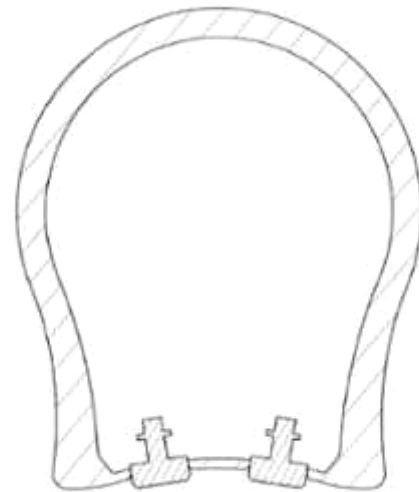

1.10

- (11) **48736**
(21) 3-2023-00914 (28) 2
(54) **THIẾT BỊ THỬ ĐỘNG CƠ ĐIỆN** (51) **10-05**
(22) 26/04/2023 (43) 25/12/2023
(73) **TRƯỜNG ĐẠI HỌC BÁCH KHOA - ĐẠI HỌC QUỐC GIA THÀNH PHỐ HỒ CHÍ MINH (VN)**
268 Lý Thường Kiệt, phường 14, quận 10, thành phố Hồ Chí Minh
(72) 1. HỒNG ĐỨC THÔNG (VN)
2. TRƯƠNG TẤN PHÁT (VN)
3. PHẠM QUANG MINH (VN)
4. HỒ NAM HOA (VN)
5. LÊ ĐỖ MINH HOÀNG (VN)
(55)

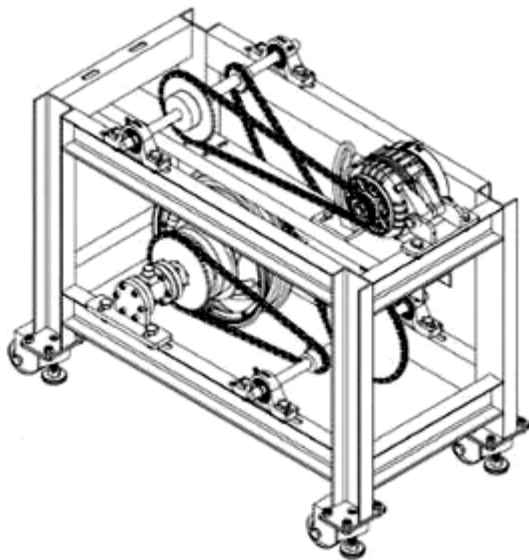

1.1

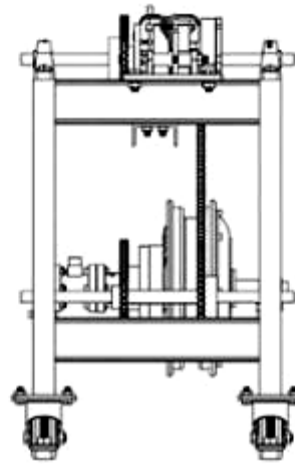

1.2

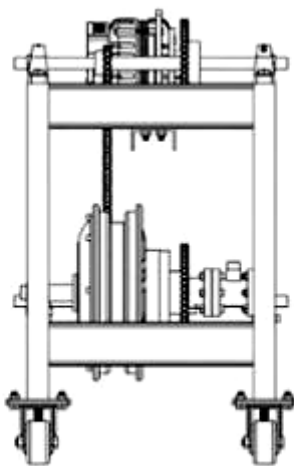

1.3

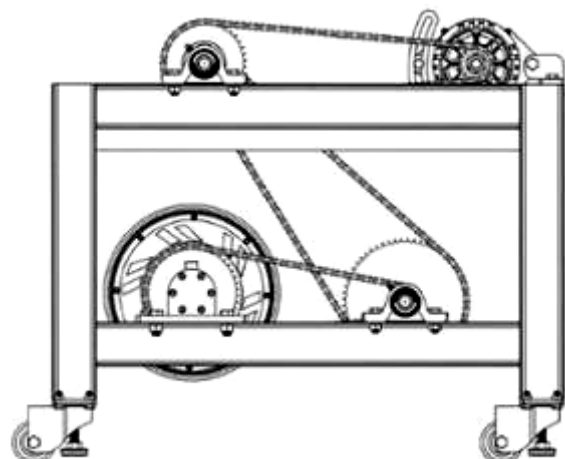

1.4

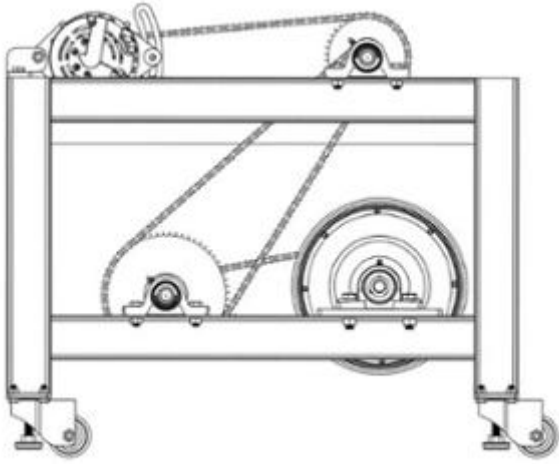

1.5

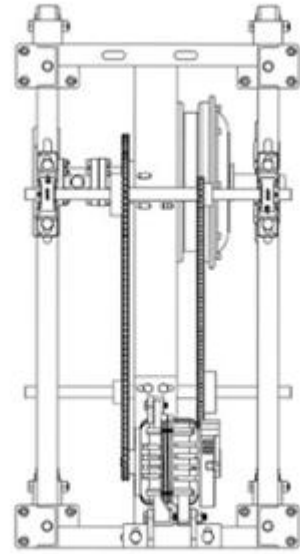

1.6

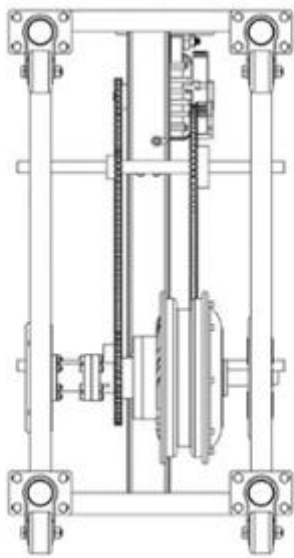

1.7

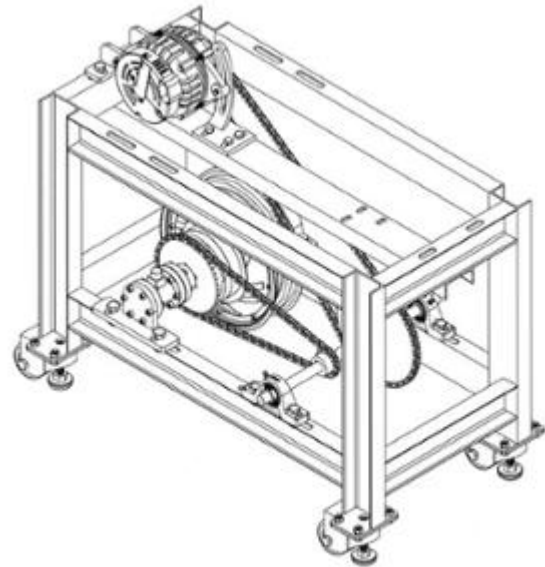

2.1

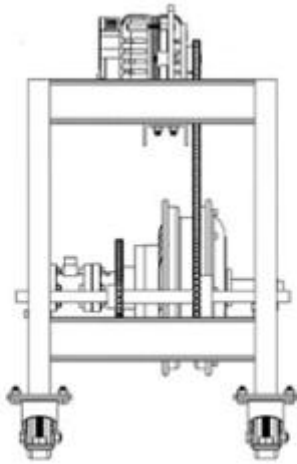

2.2

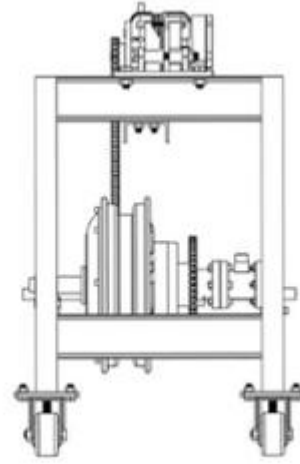

2.3

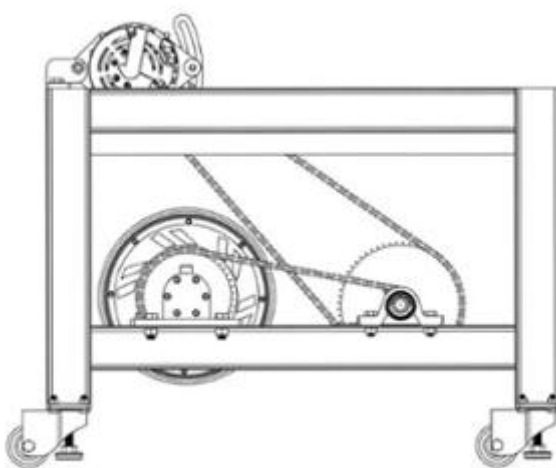

2.4

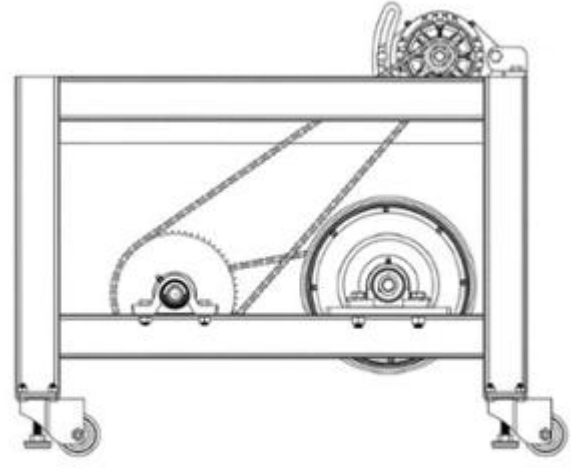

2.5

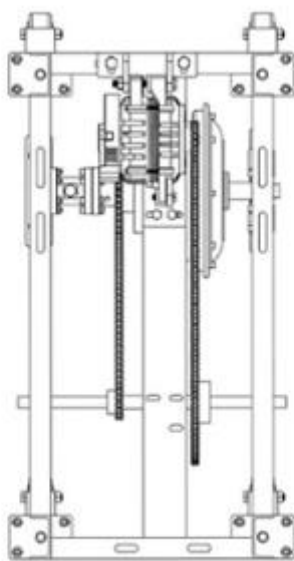

2.6

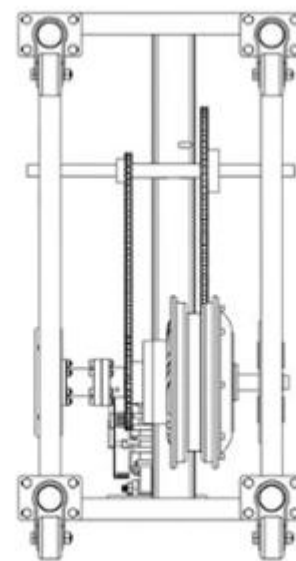

2.7

- (11) **48737**
(21) 3-2023-00915 (28) 1
(54) **DÂY CÁP TÍN HIỆU** (51) **13-03**
(22) 26/04/2023 (43) 25/12/2023
(30) 30-2022-0046021 09/11/2022 KR;
(73) **MOON, GEON HYEONG (KR)**
703-103, 5 Haesol-ro, Paju-si, Gyeonggi-do, 10893, Republic of Korea
(72) Moon, Geon Hyeong (KR)
(74) **CÔNG TY TRÁCH NHIỆM HỮU HẠN TƯ VẤN ĐẦU TƯ VÀ SỞ HỮU TRÍ TUỆ INTERFIVE (INTERFIVE CO., LTD)**
(55)

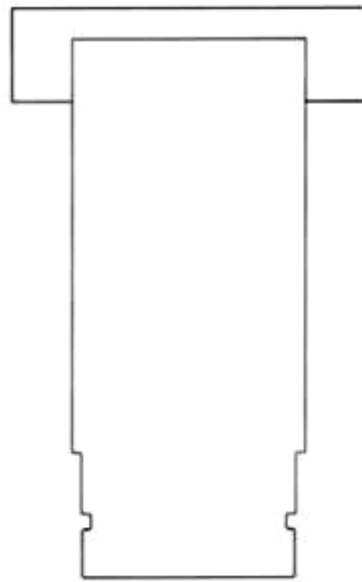

1.3



1.4

1.5



1.6



1.7



1.8

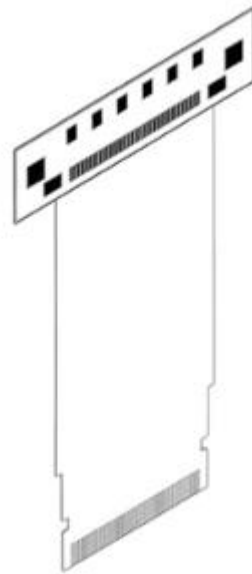

1.1

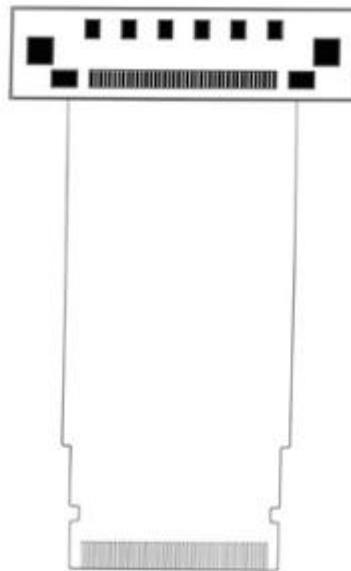

1.2

- (11) **48738**
(21) 3-2023-00916 (28) 1
(54) **VIÊN GIẶT** (51) **28-99**
(22) 26/04/2023 (43) 25/12/2023
(30) 111306172 08/12/2022 TW;
(73) **YUEN FOONG YU CONSUMER PRODUCTS CO., LTD. (TW)**
16Fl., No. 51, Sec. 2, Chung Ching South Rd., Taipei City, Taiwan
(72) 1. YI-DA HO (TW)
2. HSING-NAN CHEN (TW)
3. CHING-WEN YEN (TW)
(74) Công ty TNHH một thành viên Sở hữu trí tuệ VCCI (VCCI-IP CO.,LTD)
(55)



1.1

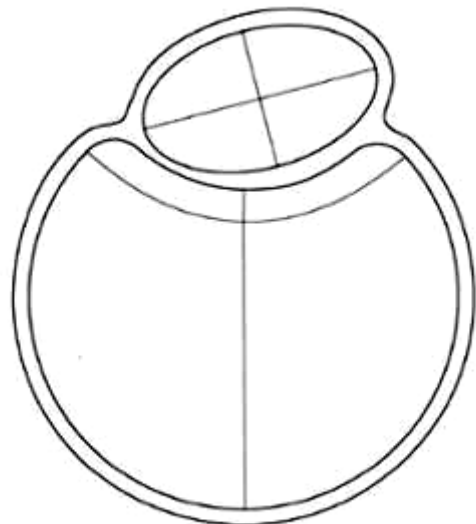

1.2

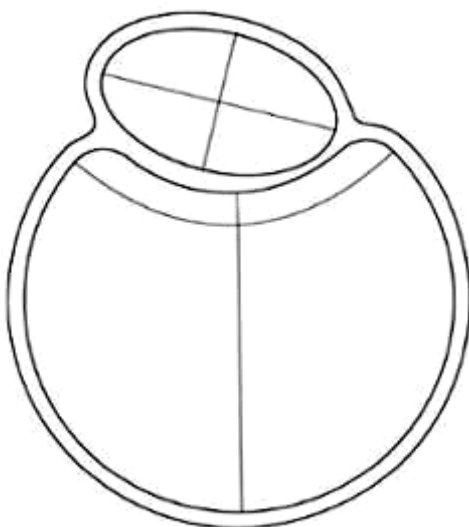

1.3

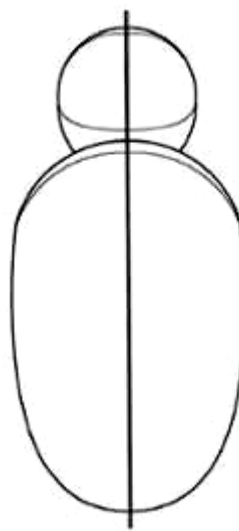

1.4

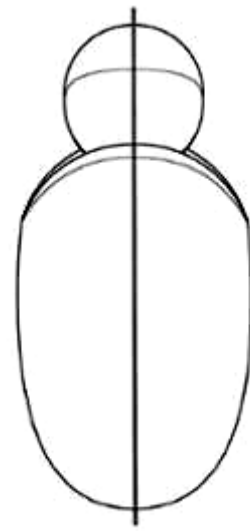

1.5

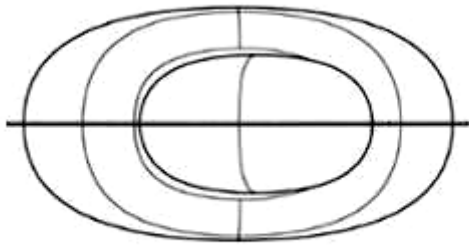

1.6

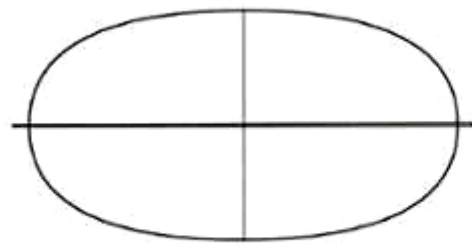

1.7

CÔNG BÁO SỞ HỮU CÔNG NGHIỆP SỐ 429 TẬP A – QUYỀN 2 (12.2023)

- (11) **48739**
(21) 3-2023-00938 (28) 1
(54) **NHÃN SẢN PHẨM** (51) **19-08**
(22) 27/04/2023 (43) 25/12/2023
(73) **CÔNG TY CỔ PHẦN THÁI SƠN PAINT (VN)**
Số 63, đường số 61, phường 10, quận 6, thành phố Hồ Chí Minh
(72) Lê Thái Nhuận (VN)
(74) Công ty TNHH Sở hữu trí tuệ VIPATCO (VIPATCO CO., LTD.)
(55)



CÔNG BÁO SỞ HỮU CÔNG NGHIỆP SỐ 429 TẬP A – QUYỀN 2 (12.2023)

- (11) **48740**
(21) 3-2023-00940 (28) 1
(54) **THIẾT BỊ ĐIỀU KHIỂN CÁNH LÁI DẠNG CƠ ĐIỆN** (51) **12-16**
(22) 27/04/2023 (43) 25/12/2023
(73) **TẬP ĐOÀN CÔNG NGHIỆP - VIỆN THÔNG QUÂN ĐỘI (VN)**
Lô D26 khu đô thị mới Cầu Giấy, phường Yên Hoà, quận Cầu Giấy, thành phố Hà Nội
(72) Hà Thị Hồng Yến (VN)
(74) Công ty TNHH NACILAW (NACILAW)
(55)

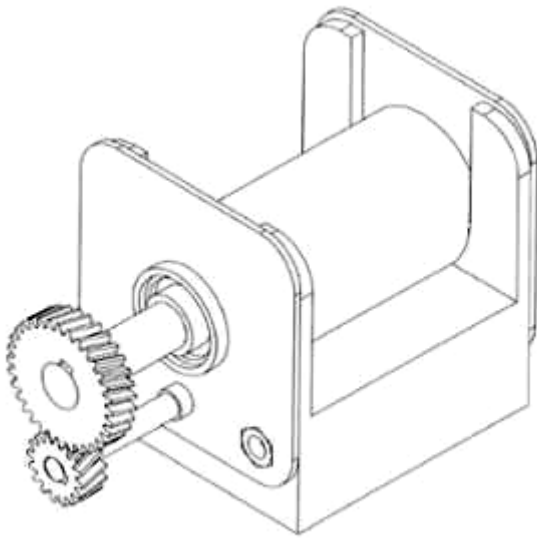

1.1

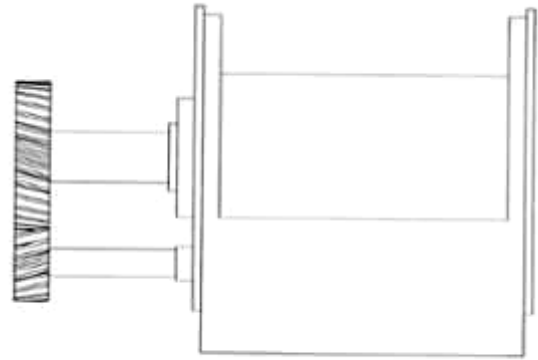

1.2

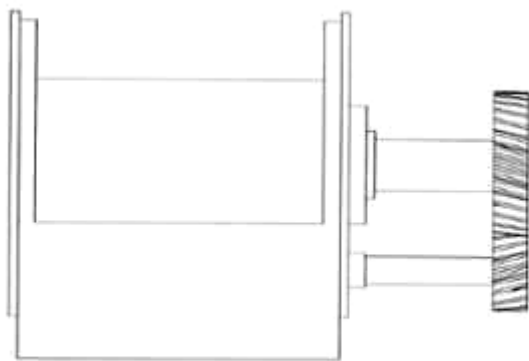

1.3

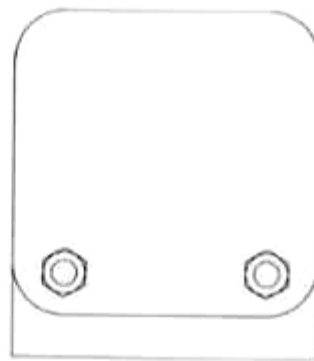

1.4

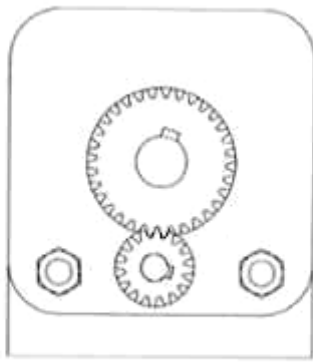

1.5

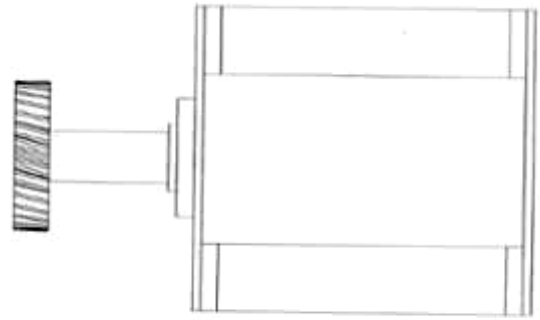

1.6

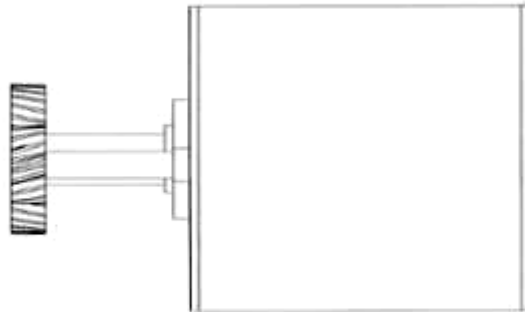

1.7

CÔNG BÁO SỞ HỮU CÔNG NGHIỆP SỐ 429 TẬP A – QUYỀN 2 (12.2023)

- (11) **48741**
- (21) 3-2023-00948 (28) 1
- (54) **BỘ PHẬN DẬP DÙNG CHO THIẾT BỊ GẮN VÀ SỬA CHỮA CHÍP** (51) **15-99**
- (22) 28/04/2023 (43) 25/12/2023
- (30) 2022-023936 04/11/2022 JP;
- (73) **SHIN-ETSU CHEMICAL CO., LTD. (JP)**
4-1, Marunouchi 1-chome, Chiyoda-ku, Tokyo 100-0005, JAPAN
- (72) 1. YOSHINORI OGAWA (JP)
2. KAZUNORI KONDO (JP)
3. NOBUAKI MATSUMOTO (JP)
4. NOBUAKI TOMURA (JP)
5. AKIRA SAKAMOTO (JP)
6. TAICHI KITAGAWA (JP)
- (74) Công ty TNHH Tư vấn - Dịch thuật - Sở hữu trí tuệ Á Đông (Á Đông IP CONSULTANCY CO.,LTD.)
- (55)

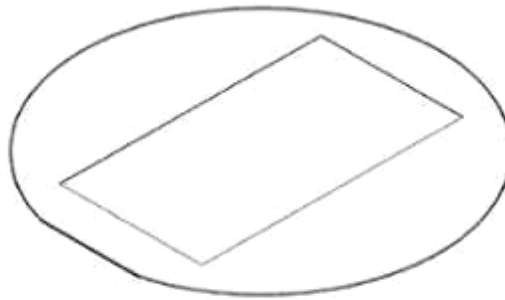

1.1



1.2



1.3



1.4



1.5

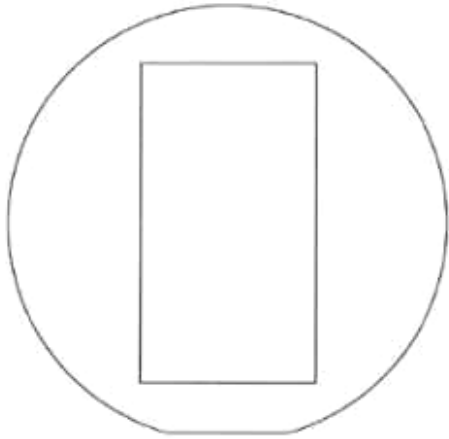

1.6

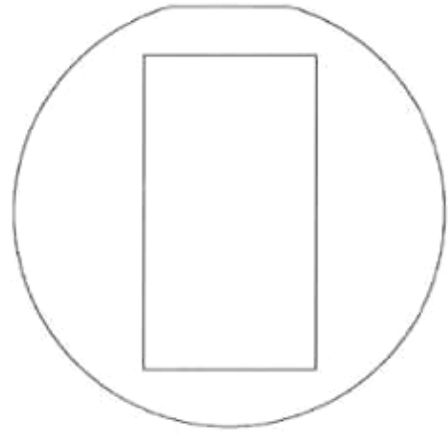

1.7

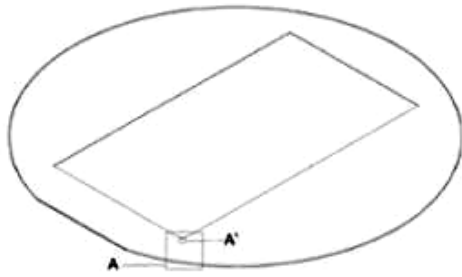

1.8



1.9

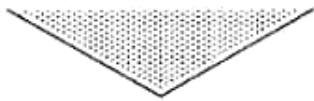

1.10

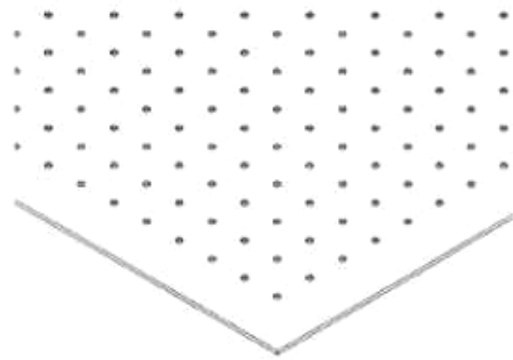

1.11



1.12



1.13

CÔNG BÁO SỞ HỮU CÔNG NGHIỆP SỐ 429 TẬP A – QUYỀN 2 (12.2023)

- (11) **48742**
- (21) 3-2023-00949 (28) 1
- (54) **BỘ PHẬN DẬP DỪNG CHO THIẾT BỊ GẮN VÀ SỬA CHỮA CHÍP** (51) **15-99**
- (22) 28/04/2023 (43) 25/12/2023
- (30) 2022-023937 04/11/2022 JP;
- (73) **SHIN-ETSU CHEMICAL CO., LTD. (JP)**
4-1, Marunouchi 1-chome, Chiyoda-ku, Tokyo 100-0005, JAPAN
- (72) 1. YOSHINORI OGAWA (JP)
2. KAZUNORI KONDO (JP)
3. NOBUAKI MATSUMOTO (JP)
4. NOBUAKI TOMURA (JP)
5. AKIRA SAKAMOTO (JP)
6. TAICHI KITAGAWA (JP)
- (74) Công ty TNHH Tư vấn - Dịch thuật - Sở hữu trí tuệ Á Đông (Á Đông IP CONSULTANCY CO.,LTD.)
- (55)

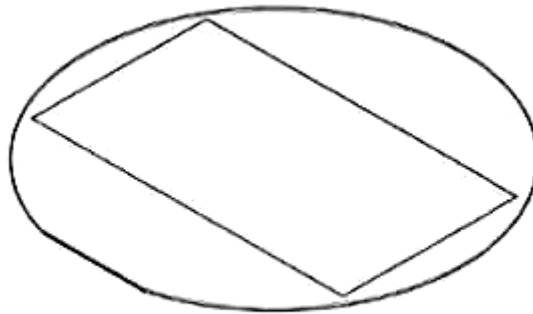

1.1



1.2



1.3



1.4



1.5

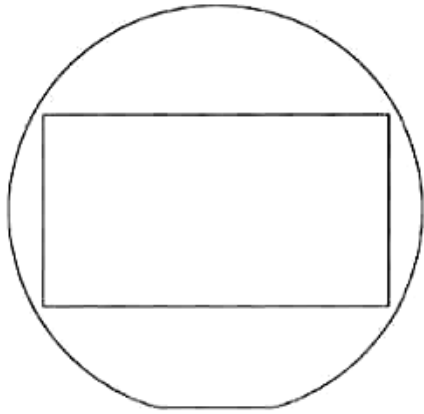

1.6

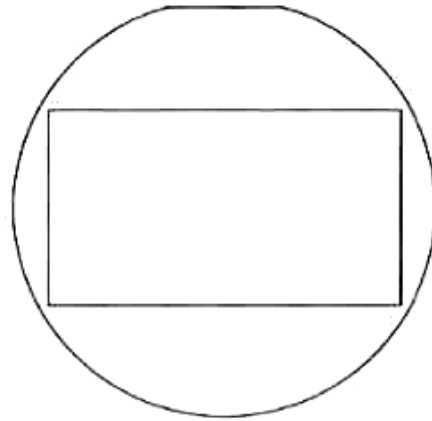

1.7

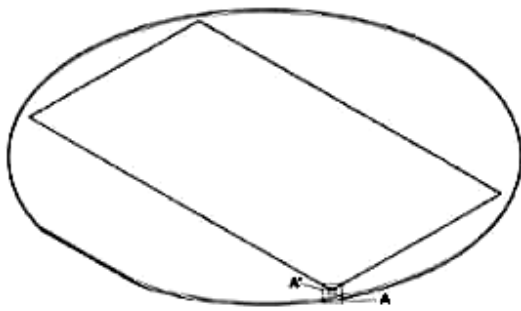

1.8



1.9

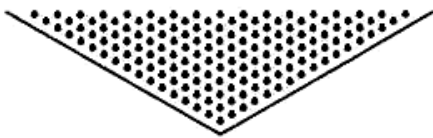

1.10

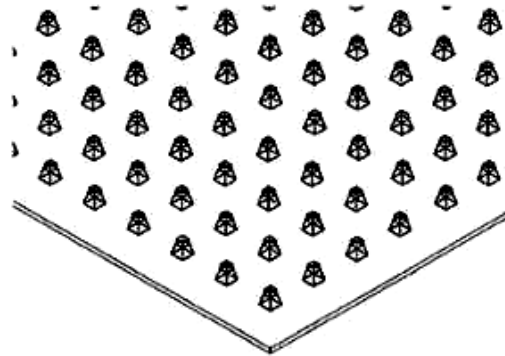

1.11

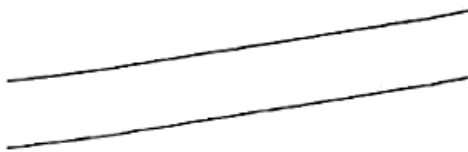

1.12



1.13

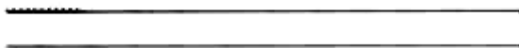

CÔNG BÁO SỞ HỮU CÔNG NGHIỆP SỐ 429 TẬP A – QUYỀN 2 (12.2023)

- (11) **48743**
- (21) 3-2023-00950 (28) 1
- (54) **BỘ PHẬN DẬP DÙNG CHO THIẾT BỊ GẮN VÀ SỬA CHỮA CHÍP** (51) **15-99**
- (22) 28/04/2023 (43) 25/12/2023
- (30) 2022-023938 04/11/2022 JP;
- (73) **SHIN-ETSU CHEMICAL CO., LTD. (JP)**
4-1, Marunouchi 1-chome, Chiyoda-ku, Tokyo 100-0005, JAPAN
- (72) 1. YOSHINORI OGAWA (JP)
2. KAZUNORI KONDO (JP)
3. NOBUAKI MATSUMOTO (JP)
4. NOBUAKI TOMURA (JP)
5. AKIRA SAKAMOTO (JP)
6. TAICHI KITAGAWA (JP)
- (74) Công ty TNHH Tư vấn - Dịch thuật - Sở hữu trí tuệ Á Đông (Á Đông IP CONSULTANCY CO.,LTD.)
- (55)

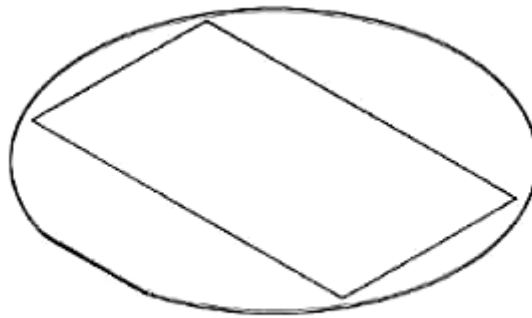

1.1



1.2



1.3



1.4



1.5

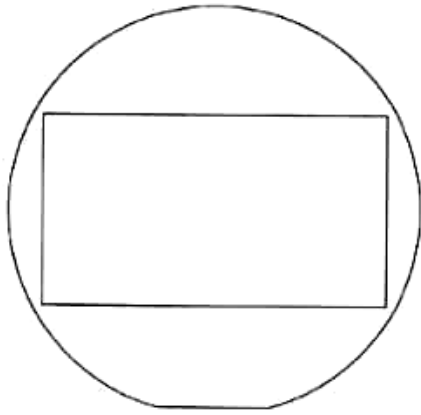

1.6

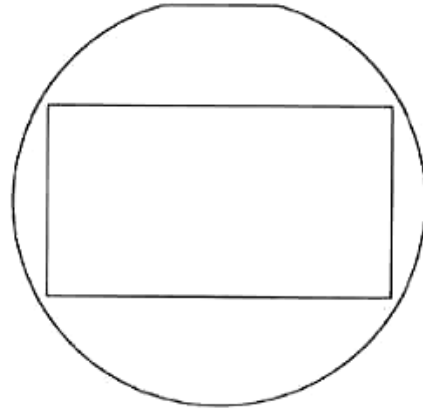

1.7

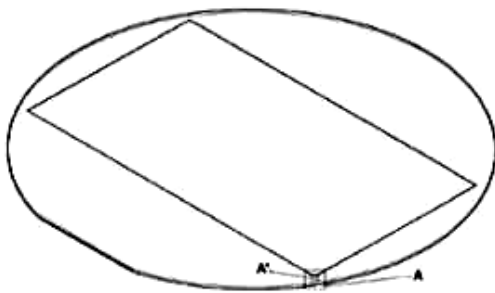

1.8



1.9

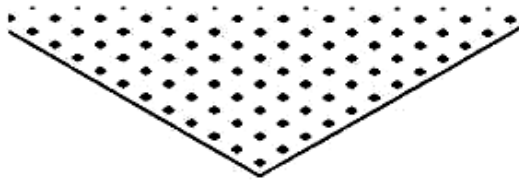

1.10

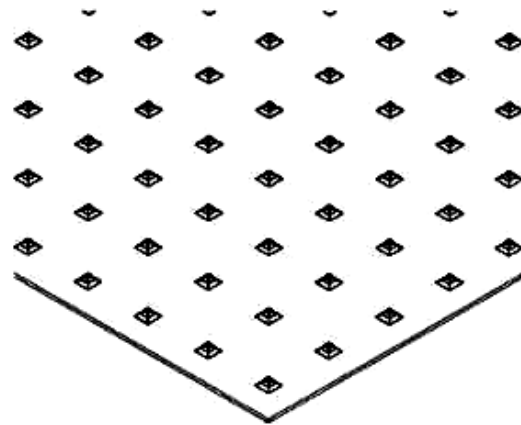

1.11



1.12



1.13

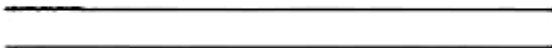

CÔNG BÁO SỞ HỮU CÔNG NGHIỆP SỐ 429 TẬP A – QUYỀN 2 (12.2023)

- (11) **48744**
- (21) 3-2023-00951 (28) 1
- (54) **BỘ PHẬN DẬP DÙNG CHO THIẾT BỊ GẮN VÀ SỬA CHỮA CHÍP** (51) **15-99**
- (22) 28/04/2023 (43) 25/12/2023
- (30) 2022-023941 04/11/2022 JP;
- (73) **SHIN-ETSU CHEMICAL CO., LTD. (JP)**
4-1, Marunouchi 1-chome, Chiyoda-ku, Tokyo 100-0005, JAPAN
- (72) 1. YOSHINORI OGAWA (JP)
2. KAZUNORI KONDO (JP)
3. NOBUAKI MATSUMOTO (JP)
4. NOBUAKI TOMURA (JP)
5. AKIRA SAKAMOTO (JP)
6. TAICHI KITAGAWA (JP)
- (74) Công ty TNHH Tư vấn - Dịch thuật - Sở hữu trí tuệ Á Đông (Á Đông IP CONSULTANCY CO.,LTD.)
- (55)

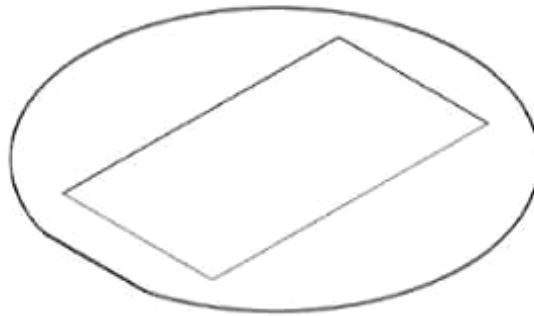

1.1

1.2

1.3

1.4

1.5

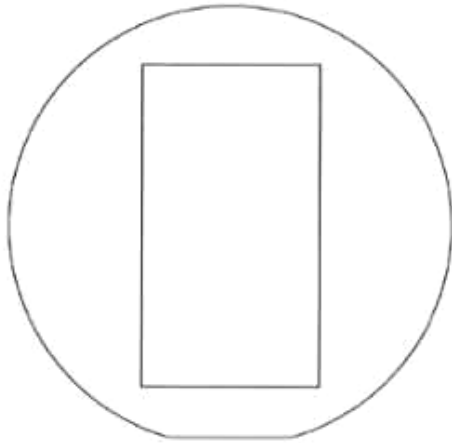

1.6

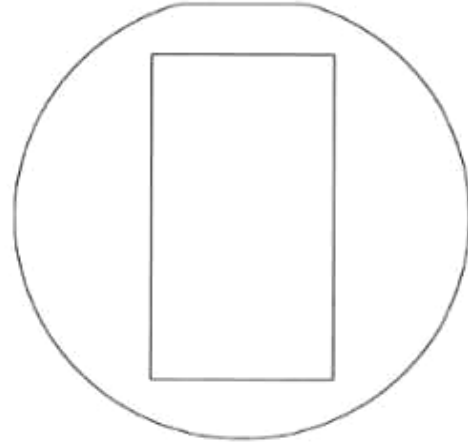

1.7

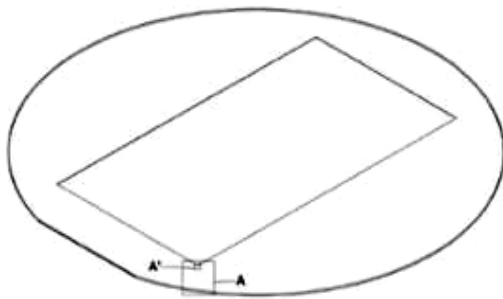

1.8



1.9



1.10

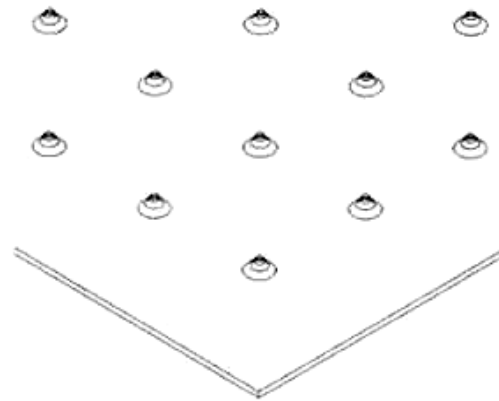

1.11



1.12



1.13

CÔNG BÁO SỞ HỮU CÔNG NGHIỆP SỐ 429 TẬP A – QUYỀN 2 (12.2023)

- (11) **48745**
- (21) 3-2023-00952 (28) 1
- (54) **BỘ PHẬN DẬP DÙNG CHO THIẾT BỊ GẮN VÀ SỬA CHỮA CHÍP** (51) **15-99**
- (22) 28/04/2023 (43) 25/12/2023
- (30) 2022-023944 04/11/2022 JP;
- (73) **SHIN-ETSU CHEMICAL CO., LTD. (JP)**
4-1, Marunouchi 1-chome, Chiyoda-ku, Tokyo 100-0005, JAPAN
- (72) 1. YOSHINORI OGAWA (JP)
2. KAZUNORI KONDO (JP)
3. NOBUAKI MATSUMOTO (JP)
4. NOBUAKI TOMURA (JP)
5. AKIRA SAKAMOTO (JP)
6. TAICHI KITAGAWA (JP)
- (74) Công ty TNHH Tư vấn - Dịch thuật - Sở hữu trí tuệ Á Đông (Á Đông IP CONSULTANCY CO.,LTD.)
- (55)

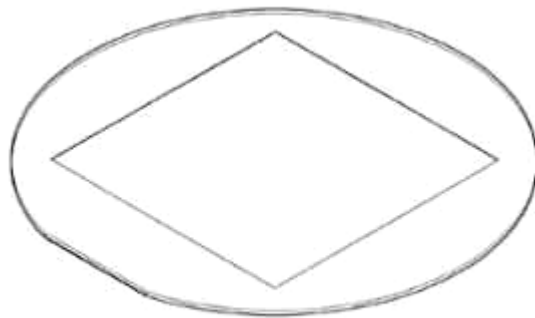

1.1



1.2



1.3



1.4



1.5

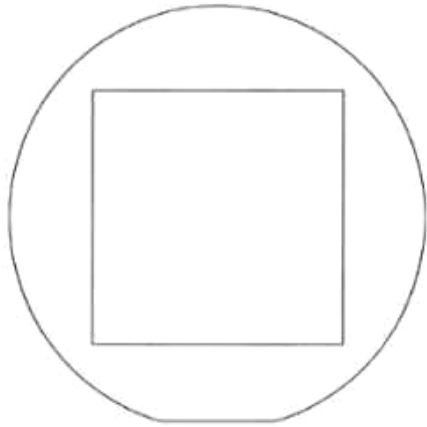

1.6

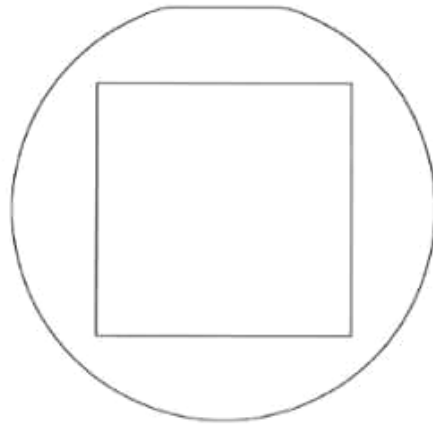

1.7

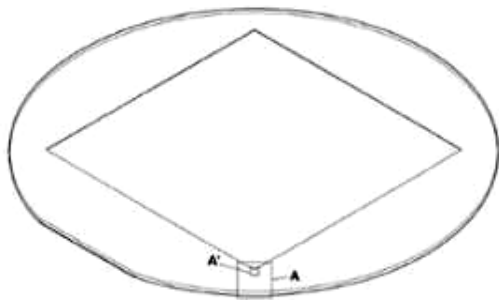

1.8

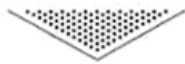

1.10



1.12



1.11

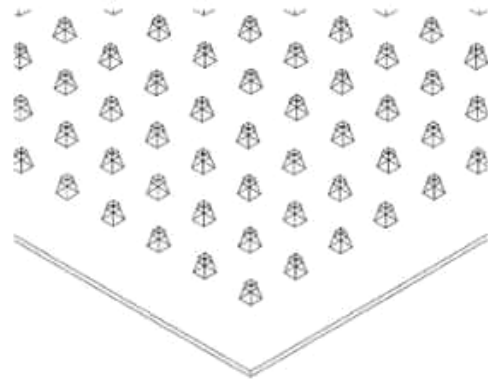

1.13



1.13



CÔNG BÁO SỞ HỮU CÔNG NGHIỆP SỐ 429 TẬP A – QUYỀN 2 (12.2023)

- (11) **48746**
- (21) 3-2023-00953 (28) 1
- (54) **BỘ PHẬN DẬP DÙNG CHO THIẾT BỊ GẮN VÀ SỬA CHỮA CHÍP** (51) **15-99**
- (22) 28/04/2023 (43) 25/12/2023
- (30) 2022-023945 04/11/2022 JP;
- (73) **SHIN-ETSU CHEMICAL CO., LTD. (JP)**
4-1, Marunouchi 1-chome, Chiyoda-ku, Tokyo 100-0005, JAPAN
- (72) 1. YOSHINORI OGAWA (JP)
2. KAZUNORI KONDO (JP)
3. NOBUAKI MATSUMOTO (JP)
4. NOBUAKI TOMURA (JP)
5. AKIRA SAKAMOTO (JP)
6. TAICHI KITAGAWA (JP)
- (74) Công ty TNHH Tư vấn - Dịch thuật - Sở hữu trí tuệ Á Đông (Á Đông IP CONSULTANCY CO.,LTD.)
- (55)

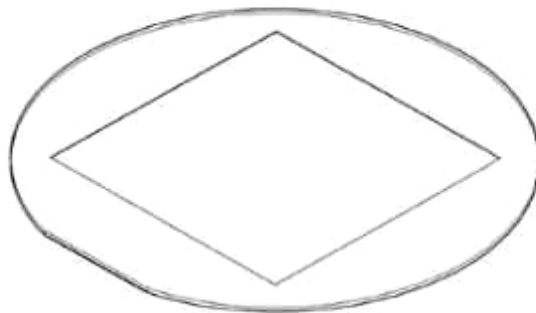

1.1



1.2



1.3



1.4



1.5

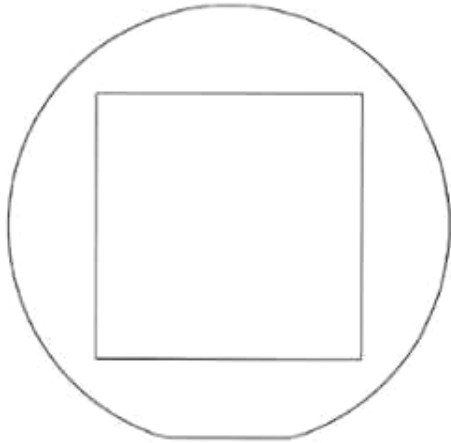

1.6

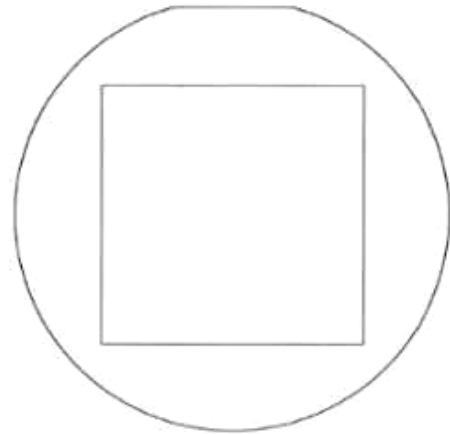

1.7

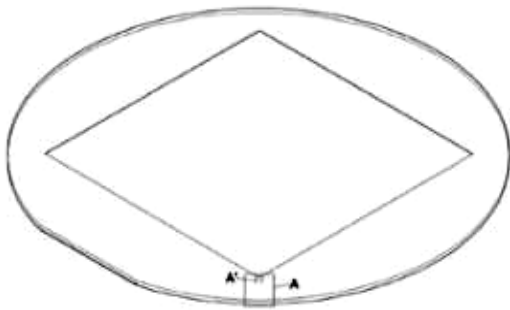

1.8



1.9

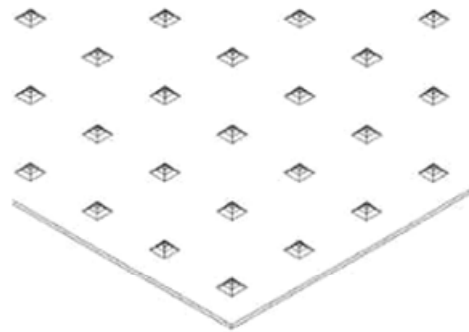

1.10



1.11



1.12



1.13

CÔNG BÁO SỞ HỮU CÔNG NGHIỆP SỐ 429 TẬP A – QUYỀN 2 (12.2023)

- (11) **48747**
(21) 3-2023-00970 (28) 1
(54) **THANH NHÔM ĐỊNH HÌNH** (51) **25-01**
(22) 28/04/2023 (43) 25/12/2023
(73) **TRẦN VĂN PHI (VN)**
Lô A- A6, cụm công nghiệp Phùng, thị trấn Phùng, huyện Đan Phượng, thành phố Hà Nội
(72) Trần Văn Phi (VN)
(55)



1.1

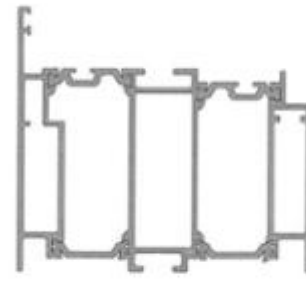

1.2

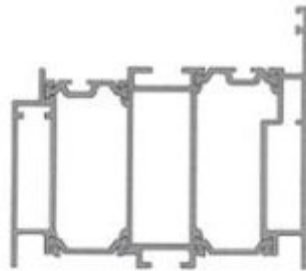

1.3



1.4



1.5



1.6



1.7

CÔNG BÁO SỞ HỮU CÔNG NGHIỆP SỐ 429 TẬP A – QUYỀN 2 (12.2023)

(11) **48748**

(21) 3-2023-00971

(54) **THANH NHÔM ĐỊNH HÌNH**

(22) 28/04/2023

(73) **TRẦN VĂN PHI (VN)**

Lô A- A6, cụm công nghiệp Phùng, thị trấn Phùng, huyện Đan Phượng, thành phố Hà Nội

(72) Trần Văn Phi (VN)

(55)

(28) 1

(51) **25-01**

(43) 25/12/2023

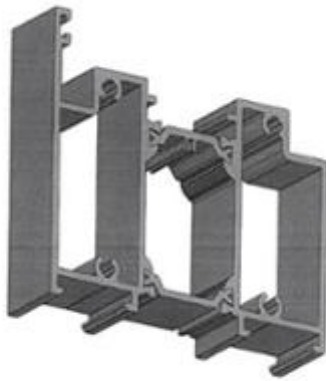

1.1

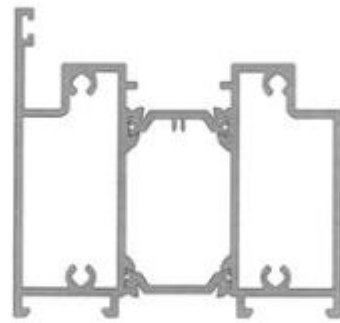

1.2

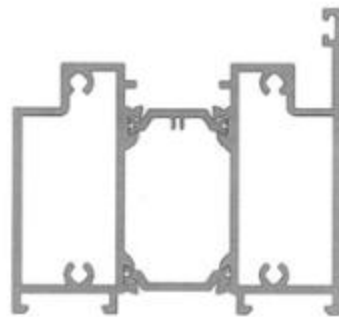

1.3



1.4



1.5



1.6



1.7

CÔNG BÁO SỞ HỮU CÔNG NGHIỆP SỐ 429 TẬP A – QUYỀN 2 (12.2023)

(11) **48749**

(21) 3-2023-00972

(54) **THANH NHÔM ĐỊNH HÌNH**

(22) 28/04/2023

(73) **TRẦN VĂN PHI (VN)**

Lô A- A6, cụm công nghiệp Phùng, thị trấn Phùng, huyện Đan Phượng, thành phố Hà Nội

(72) Trần Văn Phi (VN)

(55)

(28) 1

(51) **25-01**

(43) 25/12/2023

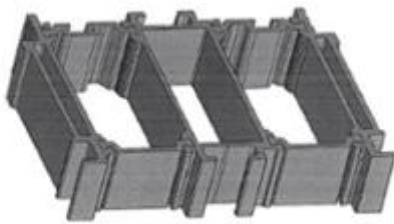

1.1

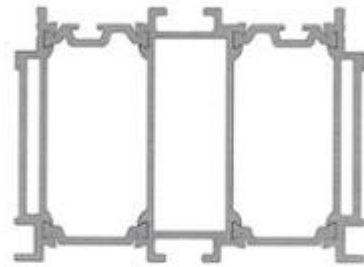

1.2

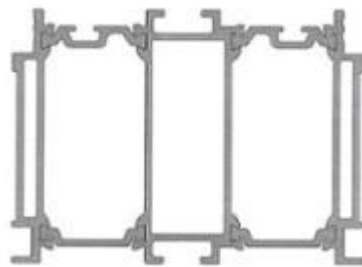

1.3



1.4



1.5



1.6



1.7

CÔNG BÁO SỞ HỮU CÔNG NGHIỆP SỐ 429 TẬP A – QUYỀN 2 (12.2023)

- (11) **48750**
(21) 3-2023-00973 (28) 1
(54) **THANH NHÔM ĐỊNH HÌNH** (51) **25-01**
(22) 28/04/2023 (43) 25/12/2023
(73) **TRẦN VĂN PHI (VN)**
Lô A- A6, cụm công nghiệp Phùng, thị trấn Phùng, huyện Đan Phượng, thành phố Hà Nội
(72) Trần Văn Phi (VN)
(55)

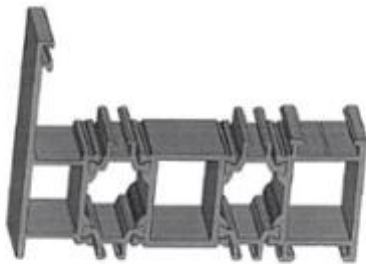

1.1

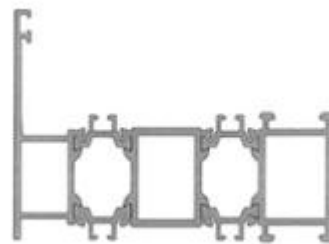

1.2

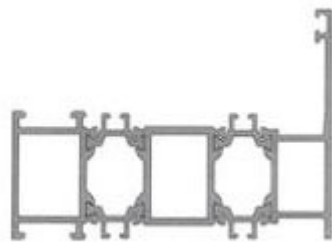

1.3



1.4



1.5



1.6



1.7

CÔNG BÁO SỞ HỮU CÔNG NGHIỆP SỐ 429 TẬP A – QUYỀN 2 (12.2023)

- (11) **48751**
(21) 3-2023-00974 (28) 1
(54) **THANH NHÔM ĐỊNH HÌNH** (51) **25-01**
(22) 28/04/2023 (43) 25/12/2023
(73) **TRẦN VĂN PHI (VN)**
Lô A- A6, cụm công nghiệp Phùng, thị trấn Phùng, huyện Đan Phượng, thành phố Hà Nội
(72) Trần Văn Phi (VN)
(55)

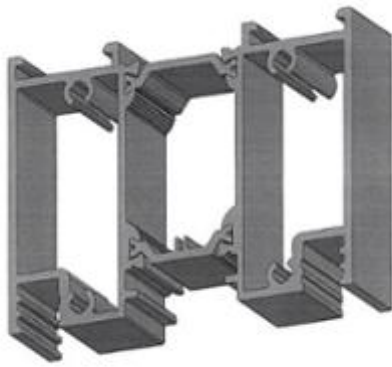

1.1

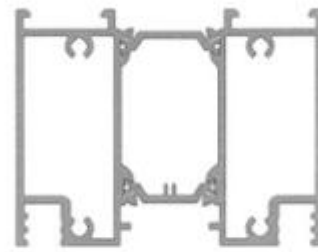

1.2

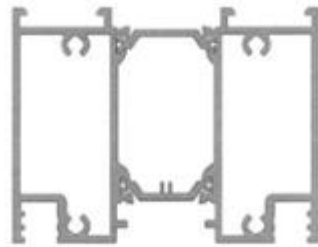

1.3



1.4



1.5



1.6



1.7

CÔNG BÁO SỞ HỮU CÔNG NGHIỆP SỐ 429 TẬP A – QUYỀN 2 (12.2023)

(11) **48752**

(21) 3-2023-00976

(54) **THANH NHÔM ĐỊNH HÌNH**

(22) 28/04/2023

(73) **TRẦN VĂN PHI (VN)**

Lô A- A6, cụm công nghiệp Phùng, thị trấn Phùng, huyện Đan Phượng, thành phố Hà Nội

(72) Trần Văn Phi (VN)

(55)

(28) 1

(51) **25-01**

(43) 25/12/2023

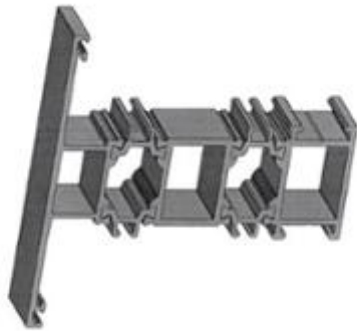

1.1

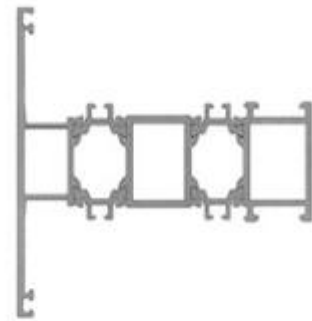

1.2

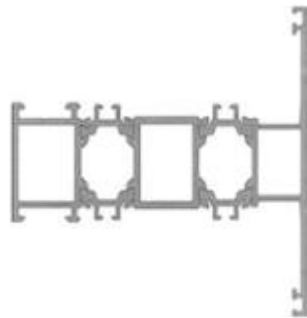

1.3



1.4



1.5



1.6



1.7

CÔNG BÁO SỞ HỮU CÔNG NGHIỆP SỐ 429 TẬP A – QUYỀN 2 (12.2023)

- (11) **48753**
(21) 3-2023-00999 (28) 1
(54) **CHAI ĐỰNG NƯỚC** (51) **09-01**
(22) 09/05/2023 (43) 25/12/2023
(73) **CÔNG TY CỔ PHẦN NƯỚC TINH KHIẾT ỐC ĐẢO XANH (VN)**
Lô 101/2-1, đường 3B, KCN Long Bình (Amata), phường Long Bình, thành phố Biên Hoà, tỉnh Đồng Nai
(72) Hoàng Tuấn Anh (VN)
(74) Công ty Luật TNHH Việt An (VIET AN LAW FIRM)
(55)



1.1

1.2

1.3

1.4

1.5



1.6



1.7

CÔNG BÁO SỞ HỮU CÔNG NGHIỆP SỐ 429 TẬP A – QUYỀN 2 (12.2023)

- (11) **48754**
(21) 3-2023-01012 (28) 1
(54) **MÔ ĐUN PHUN** (51) **28-03**
(22) 10/05/2023 (43) 25/12/2023
(30) 30-2022-0046735 11/11/2022 KR;
(73) **RECENSMEDICAL.INC (KR)**
301-1ho, 110dong, 50 UNIST-gil, Eonyang-eup, Ulju-gun, Ulsan 44919 Republic of Korea
(72) 1. KIM, KYUNGBAE (KR)
2. KIM, DAEHYUN (KR)
3. LEE, CHULHO (KR)
4. JOO, HOYOUNG (KR)
5. LEE, SEUNGYEOL (KR)
(74) Công ty TNHH Luật ALIAT (ALIAT LEGAL)
(55)

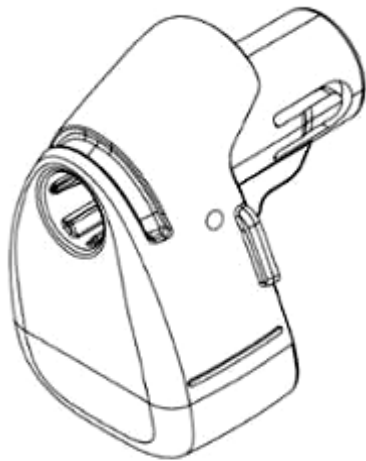

1.1

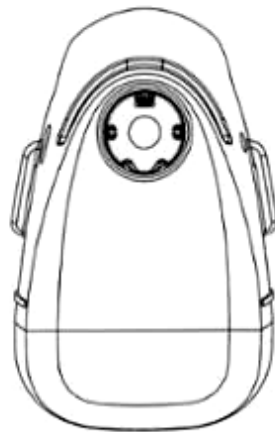

1.2

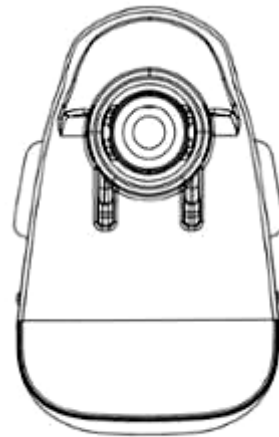

1.3

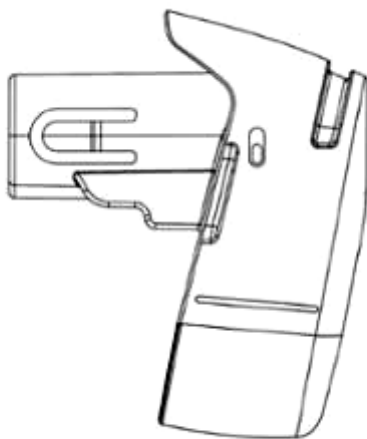

1.4

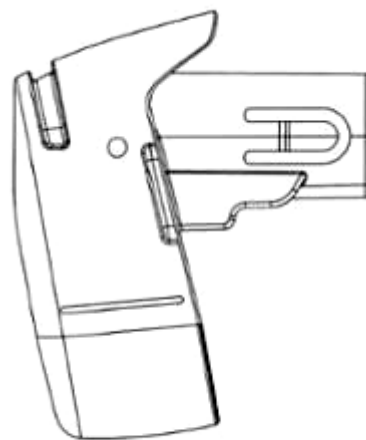

1.5

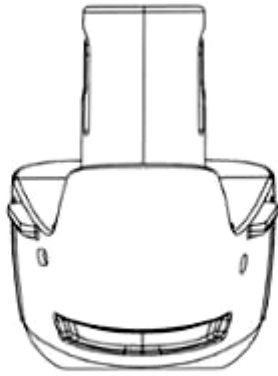

1.6

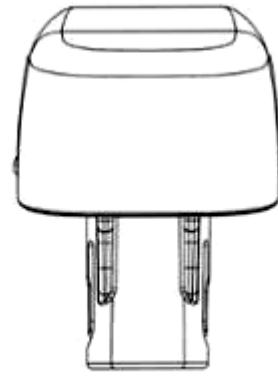

1.7

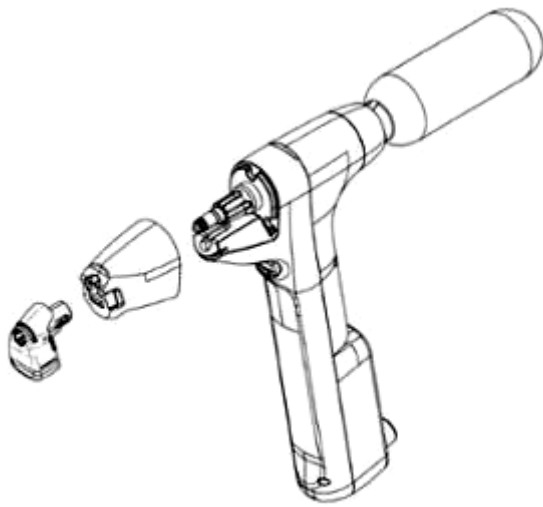

1.8

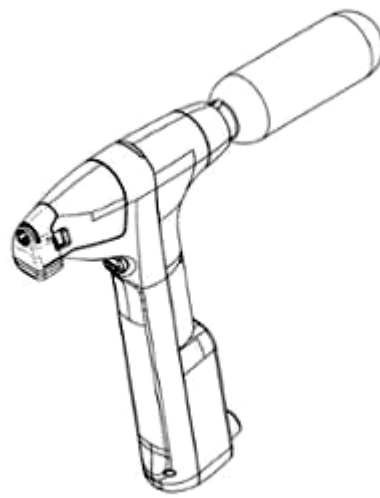

1.9

CÔNG BÁO SỞ HỮU CÔNG NGHIỆP SỐ 429 TẬP A – QUYỀN 2 (12.2023)

- (11) **48755**
(21) 3-2023-01016 (28) 3
(54) **TẤM CỬA XẾP LỚP** (51) **25-01**
(22) 11/05/2023 (43) 25/12/2023
(73) **CÔNG TY CỔ PHẦN ĐẦU TƯ VÀ THƯƠNG MẠI QUEENVIET (VN)**
Tầng 1, số 530 đường Trường Chinh, phường Ngã Tư Sở, quận Đống Đa, thành phố Hà Nội
(72) Nguyễn Mạnh Cường (VN)
(74) Công ty Luật TNHH SMARTLAW (SMARTLAW LEGAL SERVICE CO.,LTD.)
(55)



1.1



1.2



1.3



1.4



1.5

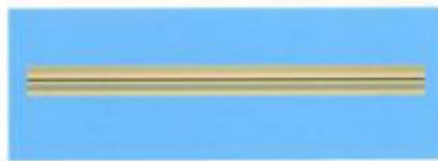

1.6



1.7

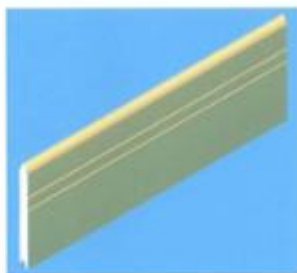

2.1

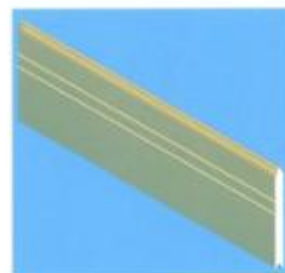

2.2



2.3

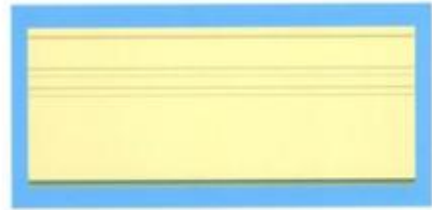

2.4



2.5



2.6



2.7



3.1



3.2



3.3



3.4



3.5



3.6



3.7

- (11) **48756**
(21) 3-2023-01017 (28) 1
(54) **NHÃN SẢN PHẨM** (51) **19-08**
(22) 11/05/2023 (43) 25/12/2023
(73) **CÔNG TY TNHH THƯƠNG MẠI LOVEWINE (VN)**
41/28 Nguyễn Oanh, phường 10, quận Gò Vấp, thành phố Hồ Chí Minh
(72) Huỳnh Thu Vân (VN)
(55)

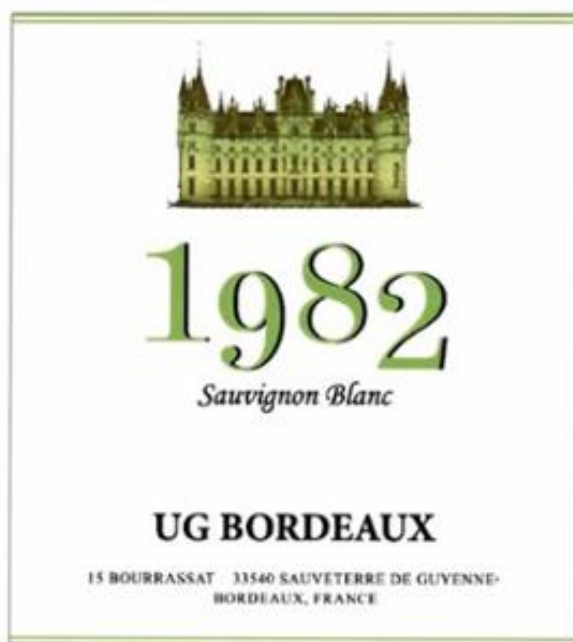

CÔNG BÁO SỞ HỮU CÔNG NGHIỆP SỐ 429 TẬP A – QUYỀN 2 (12.2023)

- (11) **48757**
(21) 3-2023-01021 (28) 1
(54) **NHÃN SẢN PHẨM BIA** (51) **19-08**
(22) 11/05/2023 (43) 25/12/2023
(73) **CÔNG TY TNHH TOÀN CẦU BEVERAGE (VN)**
Số 8B đường Ngô Quyền, khu 4, phường Cẩm Thượng, thành phố Hải Dương, tỉnh Hải Dương
(72) Nguyễn Thế Phương (VN)
(74) Công ty TNHH Sở hữu trí tuệ M.I.T (M.I.T IP CO., LTD)
(55)



1.1



1.2

CÔNG BÁO SỞ HỮU CÔNG NGHIỆP SỐ 429 TẬP A – QUYỀN 2 (12.2023)

- (11) **48758**
(21) 3-2023-01022 (28) 1
(54) **NHÃN SẢN PHẨM BIA** (51) **19-08**
(22) 11/05/2023 (43) 25/12/2023
(73) **CÔNG TY TNHH TOÀN CẦU BEVERAGE (VN)**
Số 8B đường Ngô Quyền, khu 4, phường Cẩm Thượng, thành phố Hải Dương, tỉnh Hải Dương
(72) Nguyễn Thế Phương (VN)
(74) Công ty TNHH Sở hữu trí tuệ M.I.T (M.I.T IP CO., LTD)
(55)



1.1



1.2

- (11) **48759**
(21) 3-2023-01026 (28) 1
(54) **HỌNG NẤU CỦA BẾP GA** (51) **07-02**
(22) 12/05/2023 (43) 25/12/2023
(73) **CÔNG TY CỔ PHẦN CƠ KHÍ 27-7 HỒNG ĐỨC (VN)**
Thôn Thiên Đông, xã Mỹ Hưng, huyện Thanh Oai, thành phố Hà Nội
(72) Bùi Văn Hồng (VN)
(55)



1.1



1.2



1.3



1.4



1.5



1.6



1.7

- (11) **48760**
(21) 3-2023-01036 (28) 1
(54) **CHAI NHỰA** (51) **09-01**
(22) 12/05/2023 (43) 25/12/2023
(73) **ĐINH THỊ NGỌC HƯƠNG (VN)**
Áp Hội Thạnh, xã Xuân Hiệp, huyện Trà Ôn, tỉnh Vĩnh Long
(72) Đinh Thị Ngọc Hương (VN)
(74) **CÔNG TY TNHH KHANG LUẬT (KHANGLAW)**
(55)



1.1



1.2



1.3



1.4



1.5

- (11) **48761**
(21) 3-2023-01050 (28) 1
(54) **THANH KIM LOẠI ĐỊNH HÌNH** (51) **25-01**
(22) 15/05/2023 (43) 25/12/2023
(73) **CÔNG TY CỔ PHẦN SẢN XUẤT VÀ ĐẦU TƯ HƯNG PHÁT (VN)**
Tổ dân phố Thịnh Vạn, phường Minh Đức, thị xã Mỹ Hào, tỉnh Hưng Yên
(72) Nguyễn Văn Tâm (VN)
(74) Công ty TNHH Sở hữu trí tuệ Gia Việt (GIAVIET CO., LTD.)
(55)

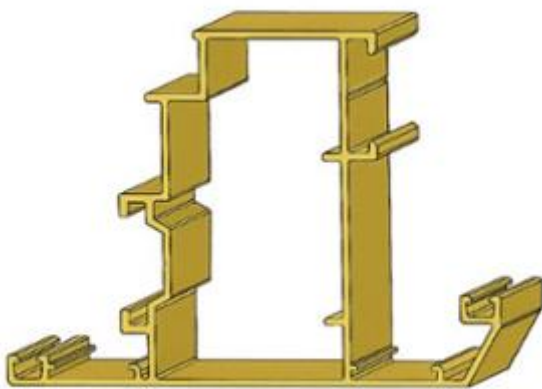

1.1

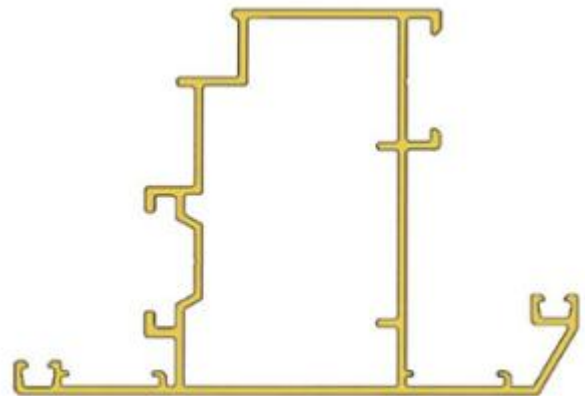

1.2



1.3



1.4

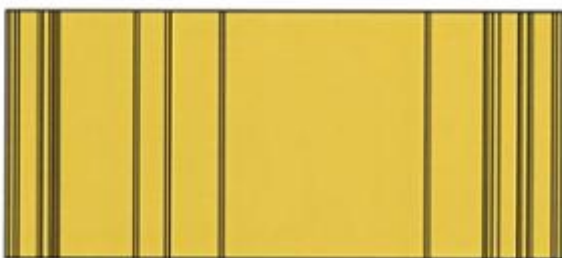

1.5



1.6

CÔNG BÁO SỞ HỮU CÔNG NGHIỆP SỐ 429 TẬP A – QUYỀN 2 (12.2023)

- (11) **48762**
(21) 3-2023-01053 (28) 2
(54) **NHÃN SẢN PHẨM** (51) **19-08**
(22) 15/05/2023 (43) 25/12/2023
(73) **CÔNG TY CỔ PHẦN HÀNG TIÊU DÙNG NATURAL LIFE (VN)**
Tòa nhà Centre Point, phòng 1501B, tầng 15, số 106 Nguyễn Văn Trỗi, phường 08,
quận Phú Nhuận, thành phố Hồ Chí Minh
(72) Phan Hồng Việt (VN)
(74) Công ty TNHH Tâm nhìn và Liên danh (VISION & ASSOCIATES CO.LTD.)
(55)



1.1

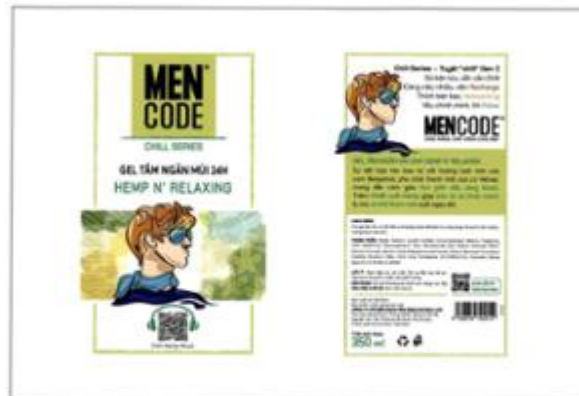

2.1

CÔNG BÁO SỞ HỮU CÔNG NGHIỆP SỐ 429 TẬP A – QUYỀN 2 (12.2023)

- (11) **48763**
- (21) 3-2023-01054 (28) 2
- (54) **NHÃN SẢN PHẨM** (51) **19-08**
- (22) 15/05/2023 (43) 25/12/2023
- (73) **CÔNG TY CỔ PHẦN HÀNG TIÊU DÙNG NATURAL LIFE (VN)**
Tòa nhà Centre Point, phòng 1501B, tầng 15, số 106 Nguyễn Văn Trỗi, phường 08,
quận Phú Nhuận, thành phố Hồ Chí Minh
- (72) Phan Hồng Việt (VN)
- (74) Công ty TNHH Tâm nhìn và Liên danh (VISION & ASSOCIATES CO.LTD.)
- (55)

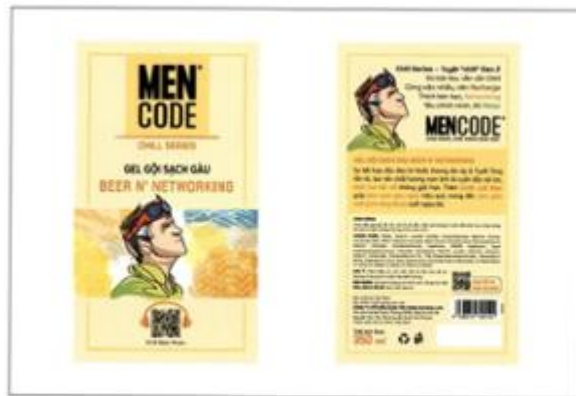

1.1

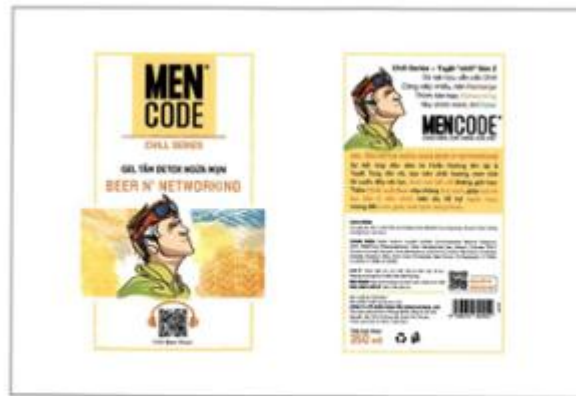

2.1

CÔNG BÁO SỞ HỮU CÔNG NGHIỆP SỐ 429 TẬP A – QUYỀN 2 (12.2023)

- (11) **48764**
(21) 3-2023-01055 (28) 2
(54) **NHÃN SẢN PHẨM** (51) **19-08**
(22) 15/05/2023 (43) 25/12/2023
(73) **CÔNG TY CỔ PHẦN HÀNG TIÊU DÙNG NATURAL LIFE (VN)**
Tòa nhà Centre Point, phòng 1501B, tầng 15, số 106 Nguyễn Văn Trỗi, phường 08,
quận Phú Nhuận, thành phố Hồ Chí Minh
(72) Phan Hồng Việt (VN)
(74) Công ty TNHH Tâm nhìn và Liên danh (VISION & ASSOCIATES CO.LTD.)
(55)



1.1



2.1

CÔNG BÁO SỞ HỮU CÔNG NGHIỆP SỐ 429 TẬP A – QUYỀN 2 (12.2023)

(11) **48765**

(21) 3-2023-01061

(28) 1

(54) **KỆ**

(51) **06-04**

(22) 16/05/2023

(43) 25/12/2023

(73) **CÔNG TY TNHH DAIJIN VINA (VN)**

Lô U1-U3 đường số 10B và đường ven DT 602, khu công nghiệp Hòa Khánh mở rộng, phường Hòa Khánh Bắc, quận Liên Chiểu, thành phố Đà Nẵng

(72) Nguyễn Đình Tiệp (VN)

(55)



1.1



1.2

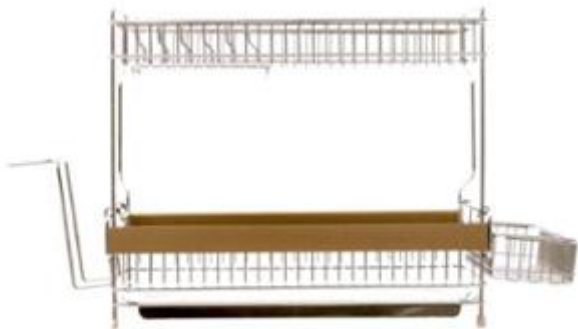

1.3



1.4



1.5



1.6



1.7

CÔNG BÁO SỞ HỮU CÔNG NGHIỆP SỐ 429 TẬP A – QUYỀN 2 (12.2023)

- (11) **48766**
(21) 3-2023-01064 (28) 1
(54) **MÁY RỬA BÁT CÔNG NGHIỆP** (51) **15-05**
(22) 16/05/2023 (43) 25/12/2023
(73) **CÔNG TY TNHH CÔNG NGHỆ MỚI VINH SƠN (VN)**
Số 961 đường Phúc Diễn, phường Xuân Phương, quận Nam Từ Liêm, thành phố Hà Nội
(72) Võ Kim Sơn (VN)
(74) Công ty TNHH Tư vấn đầu tư và Sở hữu trí tuệ Hoàng Phi (HOANG PHI INVEST & I.P CO., LTD)
(55)

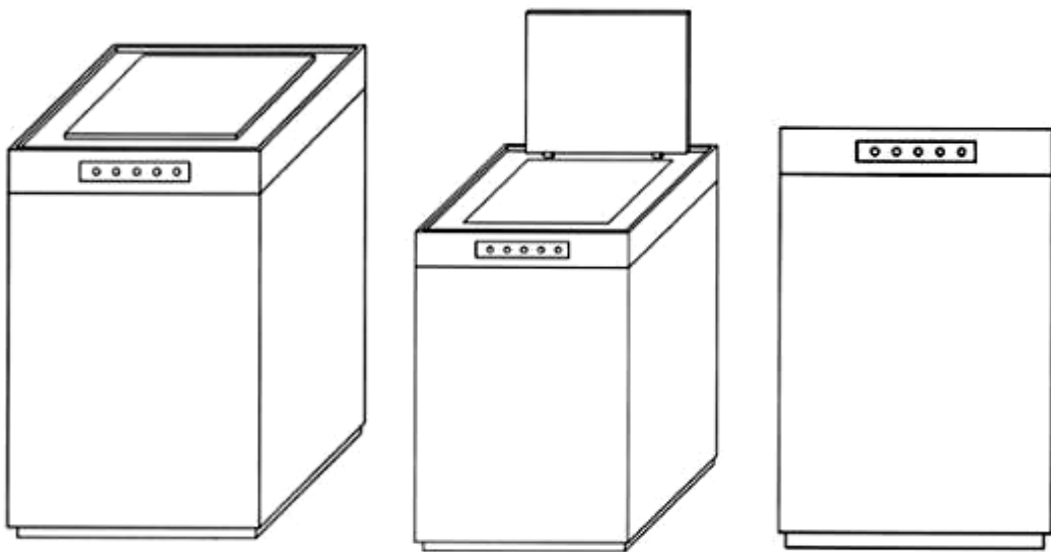

1.1

1.2

1.3

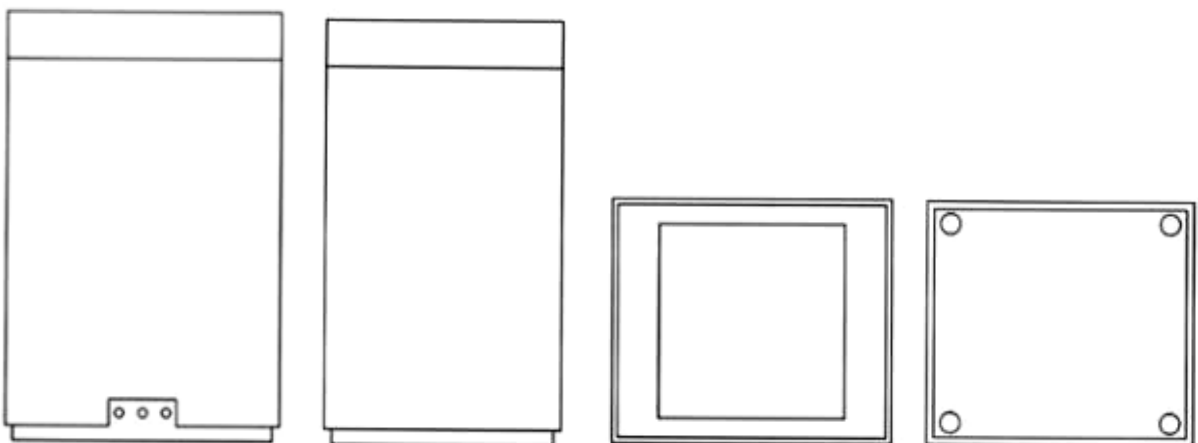

1.4

1.5

1.6

1.7

CÔNG BÁO SỞ HỮU CÔNG NGHIỆP SỐ 429 TẬP A – QUYỀN 2 (12.2023)

- (11) **48767**
(21) 3-2023-01072 (28) 33
(54) **THIẾT BỊ PHÂN PHỐI THUỐC** (51) **24-02**
(22) 17/05/2023 (43) 25/12/2023
(30) 29/868,089 30/11/2022 US;
(73) **REGENERON PHARMACEUTICALS, INC. (US)**
777 Old Saw Mill River Road, Tarrytown, NY 10591, United States of America
(72) Trevor Langley (US)
(74) Công ty TNHH Sở hữu trí tuệ Thảo Thọ Quyển (INVENCO.,LTD)
(55)



1.1



1.2



1.3



1.4

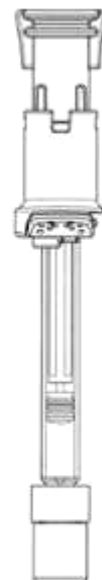

1.5

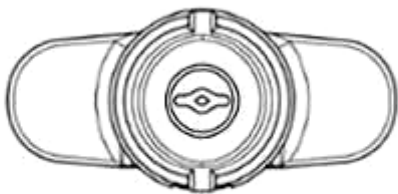

1.6

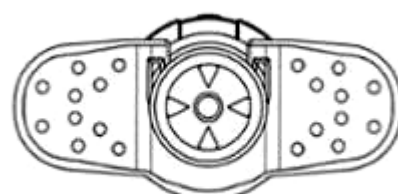

1.7



2.1



2.2



2.3

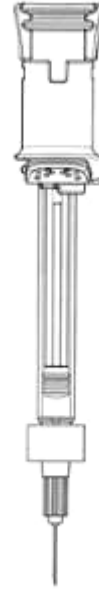

2.4

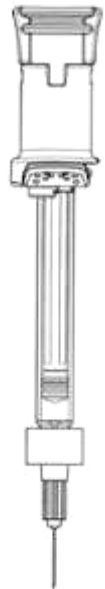

2.5



2.6

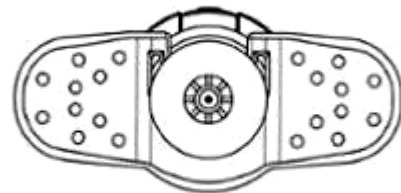

2.7



3.1



3.2



3.3

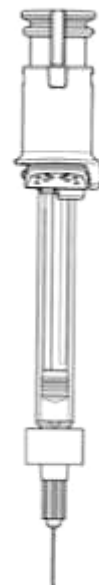

3.4



3.5



3.6

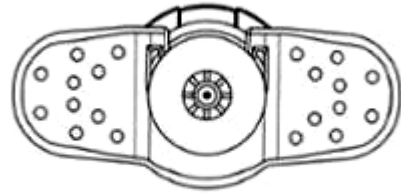

3.7



4.1



4.2



4.3

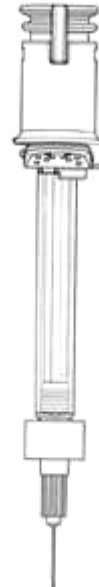

4.4

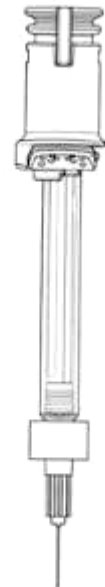

4.5

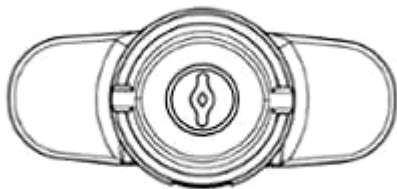

4.6

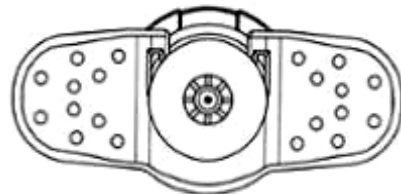

4.7



5.1



5.2



5.3



5.4



5.5

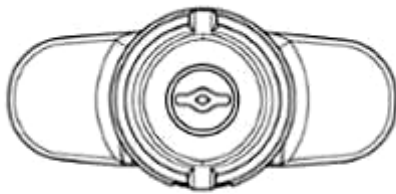

5.6

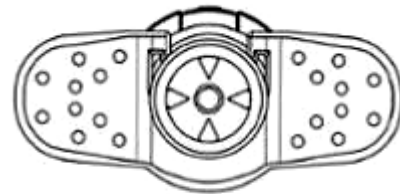

5.7



6.1



6.2



6.3



6.4



6.5



6.6

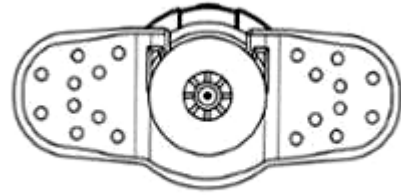

6.7



7.1



7.2



7.3

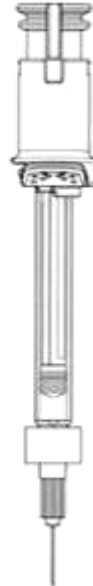

7.4

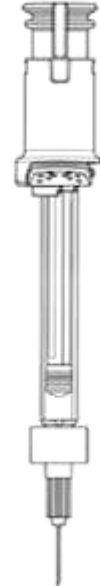

7.5



7.6

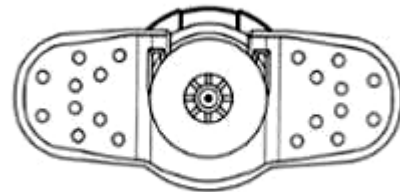

7.7



8.1

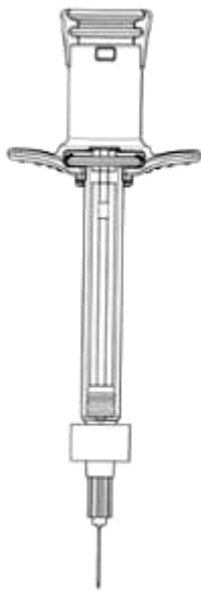

8.2



8.3

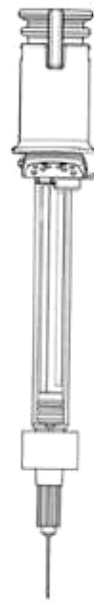

8.4



8.5

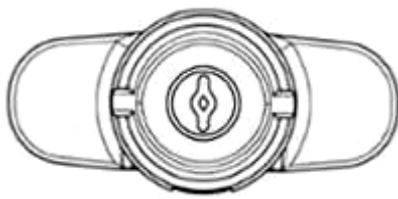

8.6

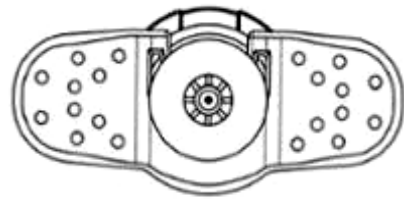

8.7

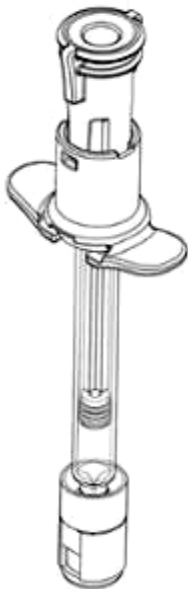

9.1



9.2



9.3



9.4



9.5



9.6

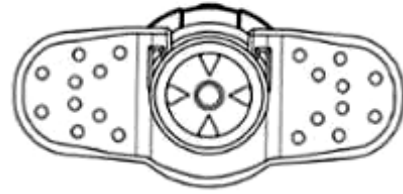

9.7



10.1



10.2

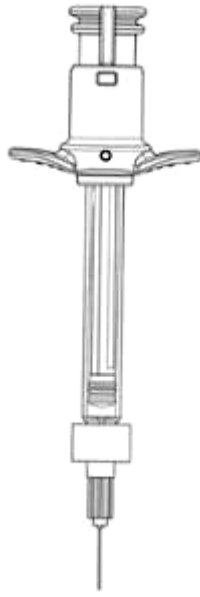

10.3



10.4

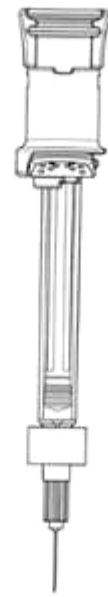

10.5

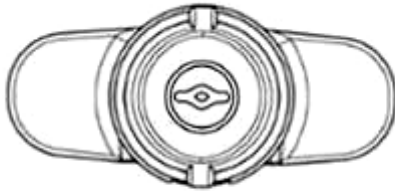

10.6

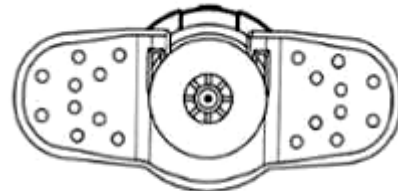

10.7



11.1

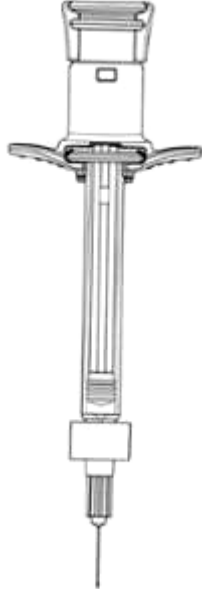

11.2



11.3



11.4



11.5



11.6

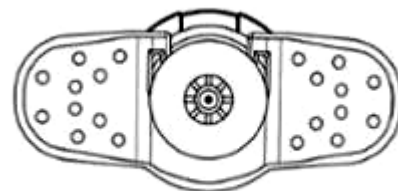

11.7



12.1



12.2



12.3



12.4

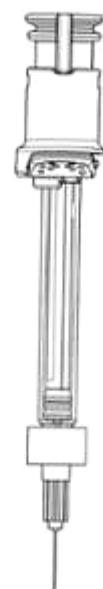

12.5

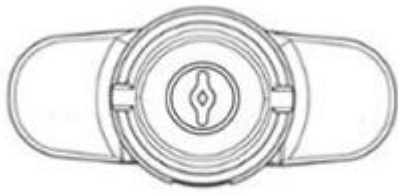

12.6

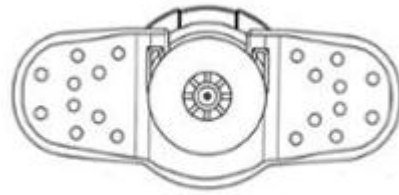

12.7

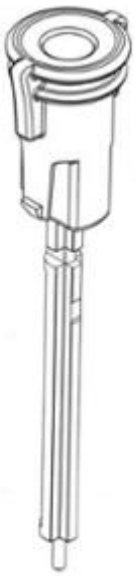

13.1

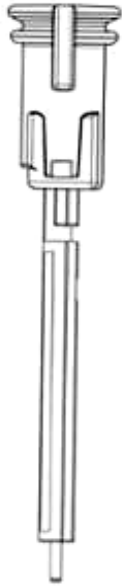

13.2

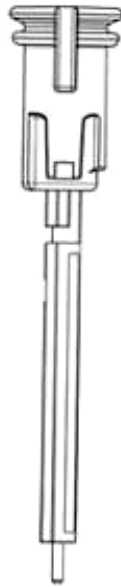

13.3

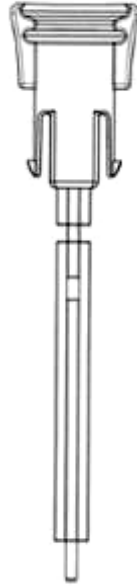

13.4

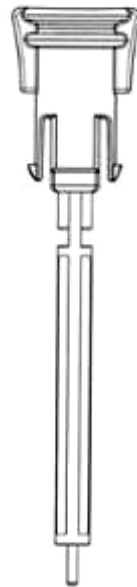

13.5



13.6



13.7

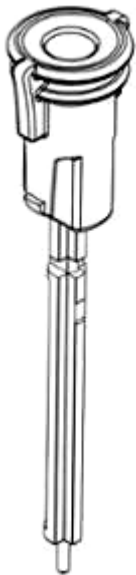

14.1

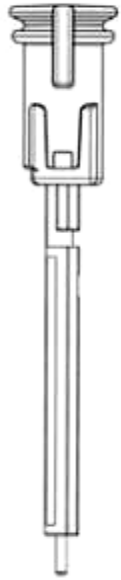

14.2

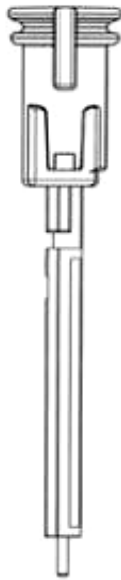

14.3

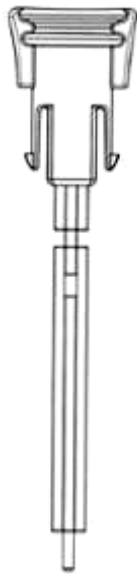

14.4

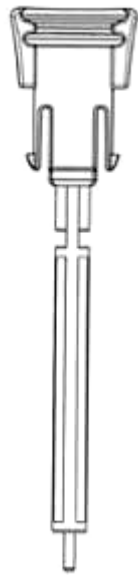

14.5



14.6



14.7

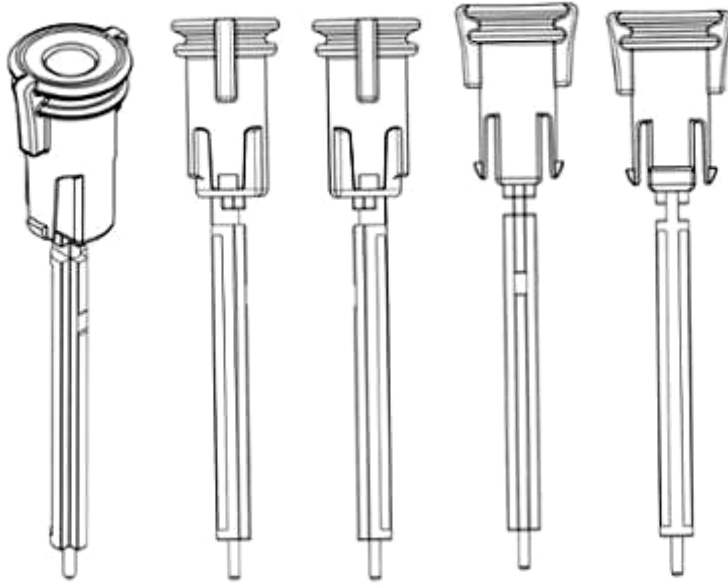

15.1

15.2

15.3

15.4

15.5

15.6

15.7

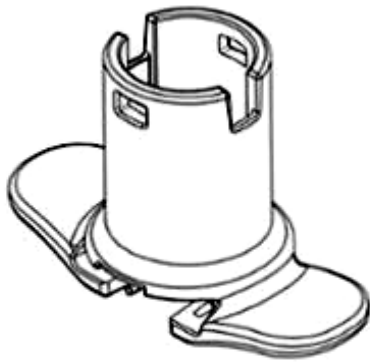

16.1

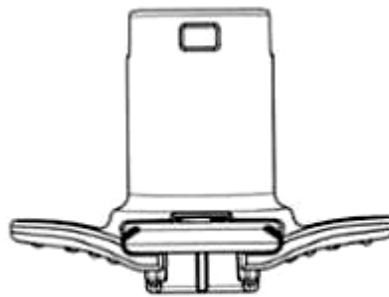

16.2

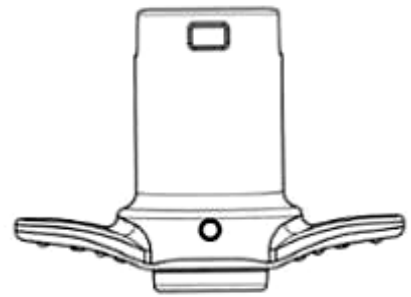

16.3



16.4



16.5

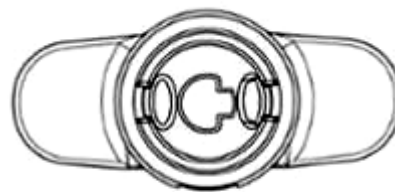

16.6

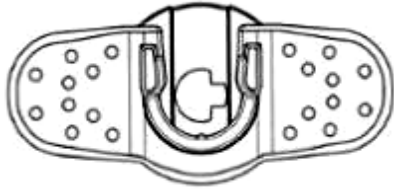

16.7

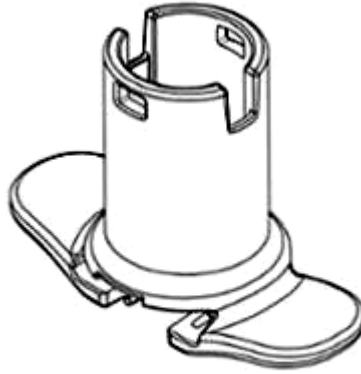

17.1

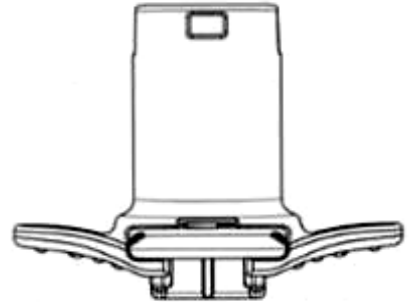

17.2

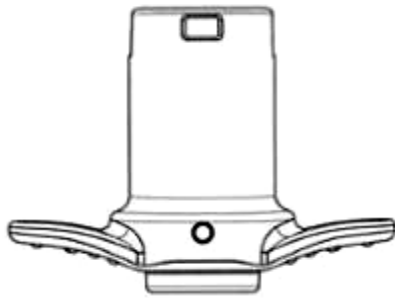

17.3



17.4



17.5



17.6

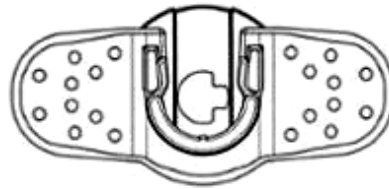

17.7

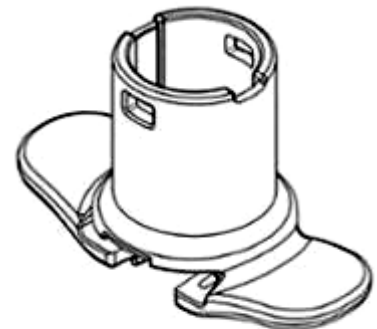

18.1

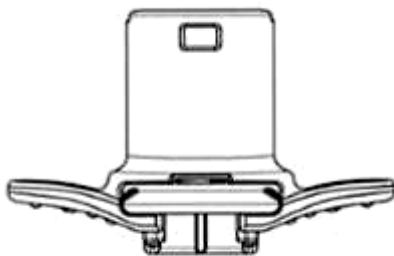

18.2

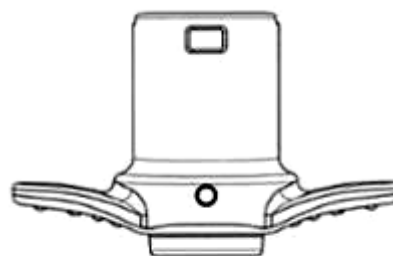

18.3

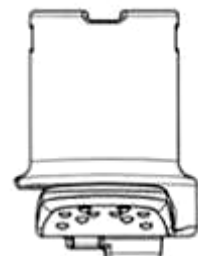

18.4



18.5



18.6

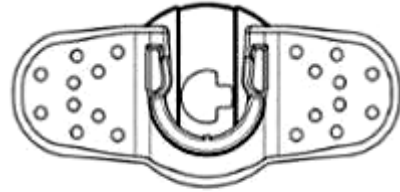

18.7



19.1



19.2



19.3



19.4

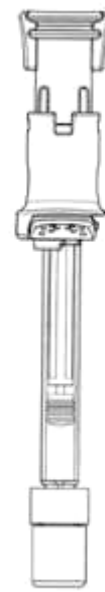

19.5

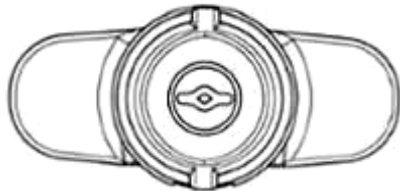

19.6

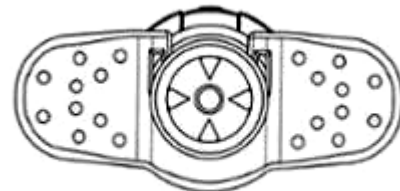

19.7



20.1



20.2



20.3



20.4



20.5

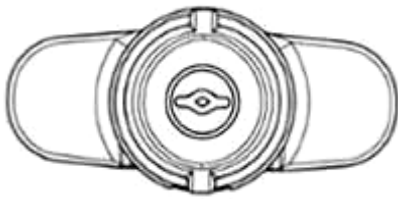

20.6

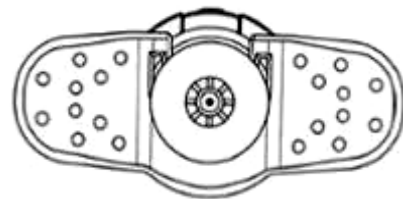

20.7



21.1

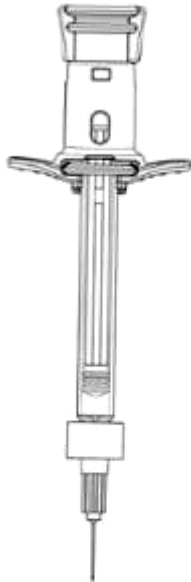

21.2



21.3



21.4



21.5

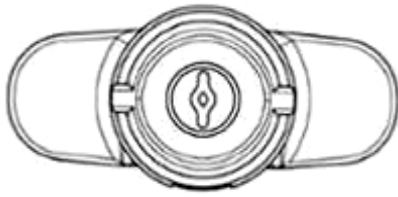

21.6

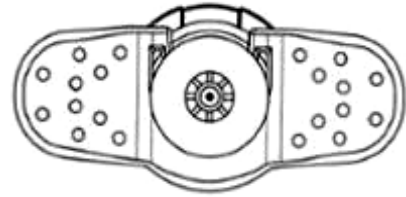

21.7



22.1



22.2



22.3

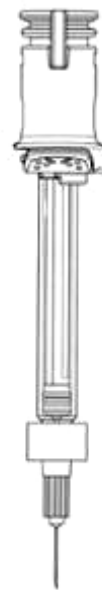

22.4

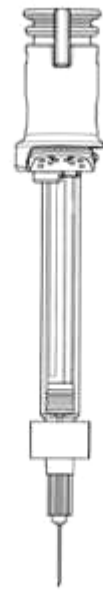

22.5



22.6

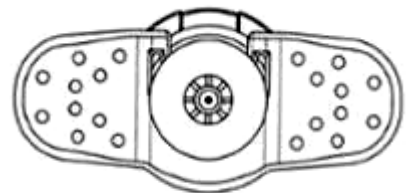

22.7



23.1



23.2



23.3



23.4

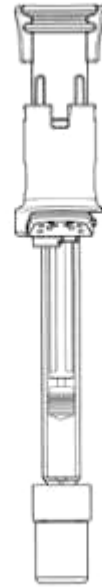

23.5



23.6

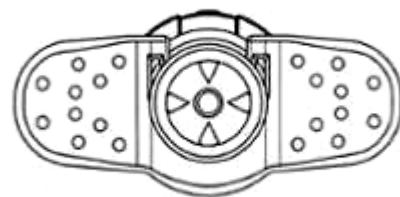

23.7



24.1



24.2

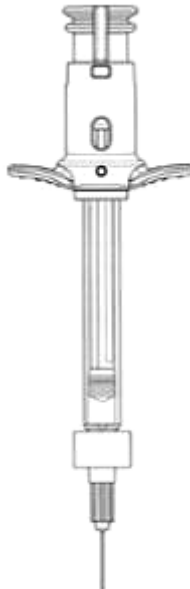

24.3

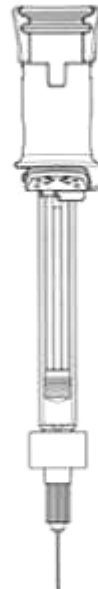

24.4



24.5

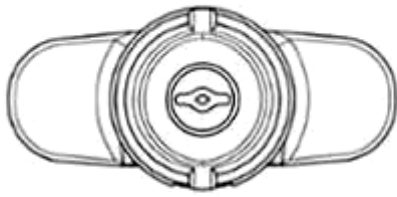

24.6

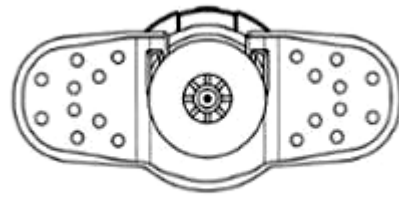

24.7



25.1



25.2

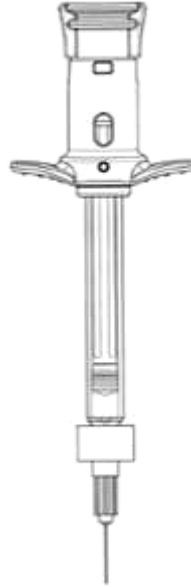

25.3

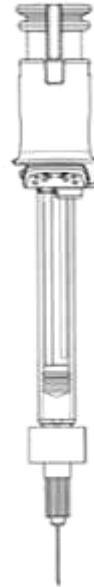

25.4



25.5

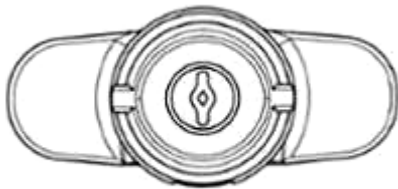

25.6

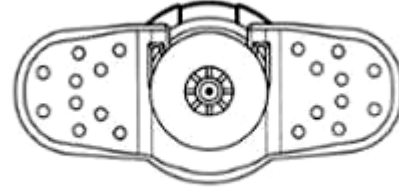

25.7



26.1



26.2

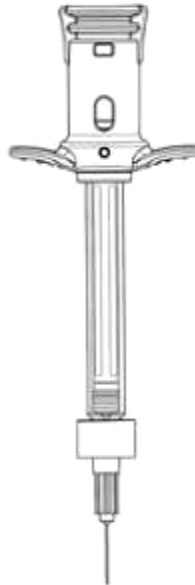

26.3

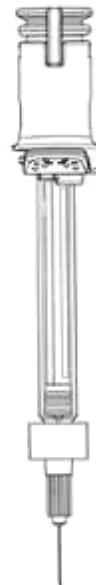

26.4

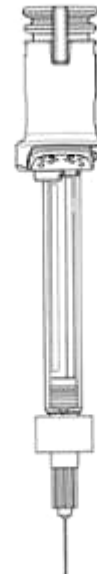

26.5



26.6

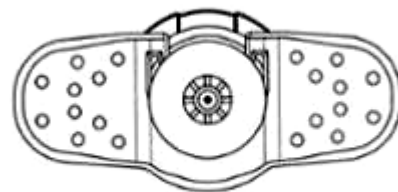

26.7

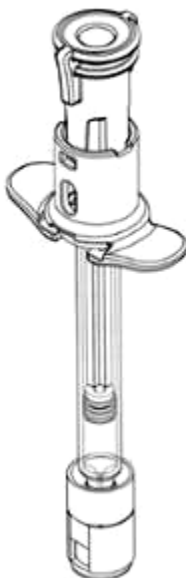

27.1



27.2



27.3



27.4



27.5



27.6

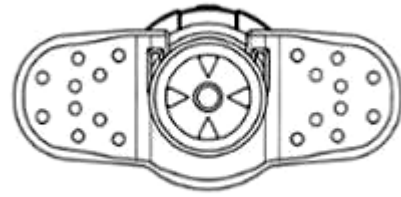

27.7

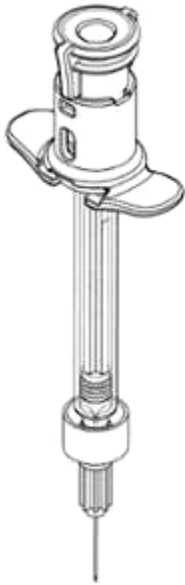

28.1

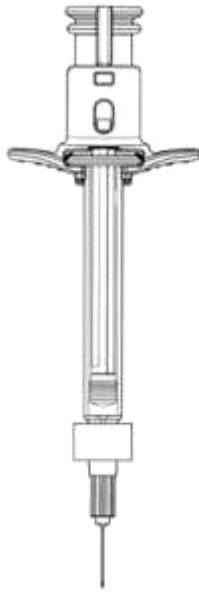

28.2



28.3



28.4

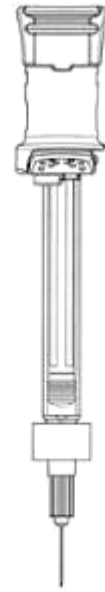

28.5

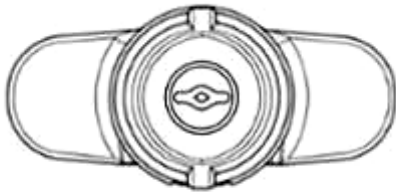

28.6

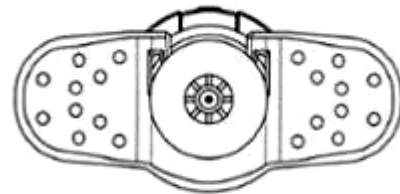

28.7



29.1

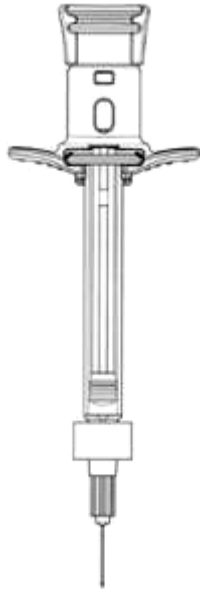

29.2

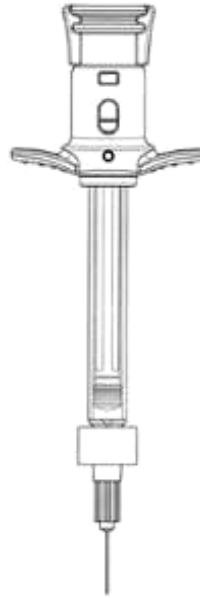

29.3

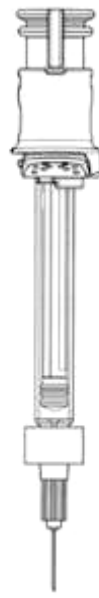

29.4

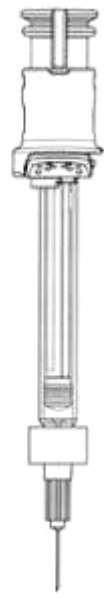

29.5

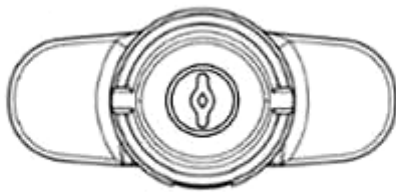

29.6

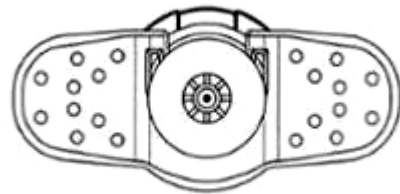

29.7



30.1



30.2



30.3

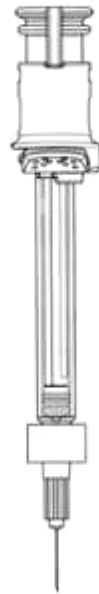

30.4

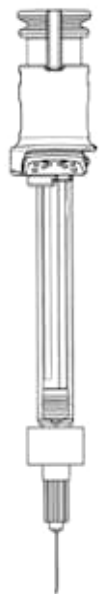

30.5



30.6

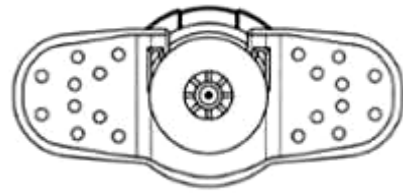

30.7

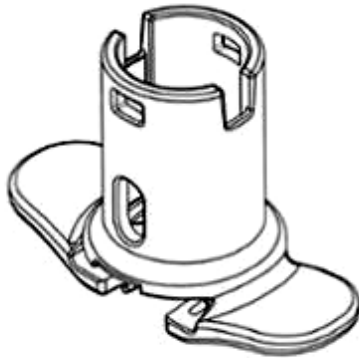

31.1

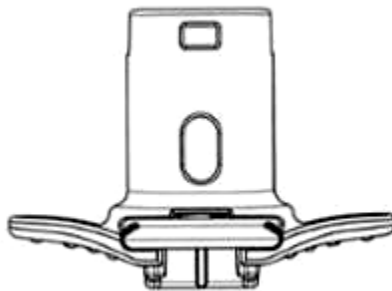

31.2

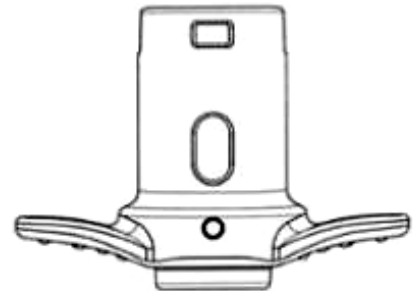

31.3



31.4



31.5



31.6

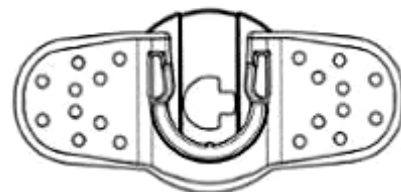

31.7

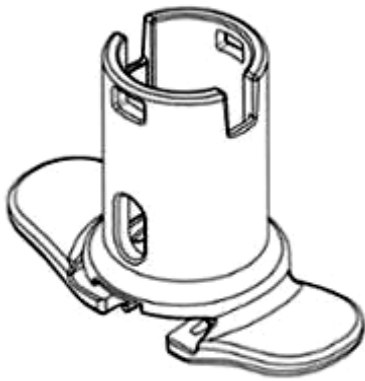

32.1

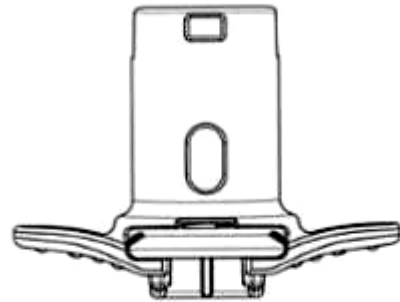

32.2

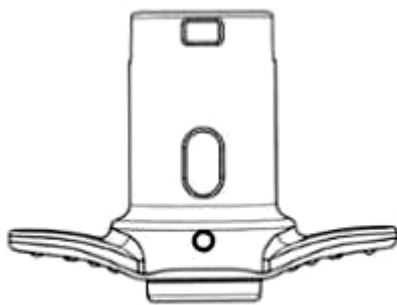

32.3



32.4



32.5

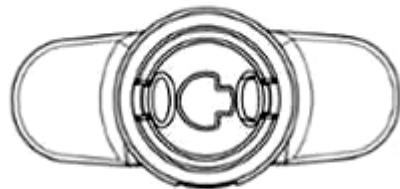

32.6

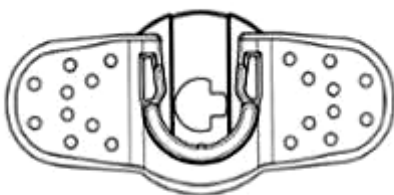

32.7

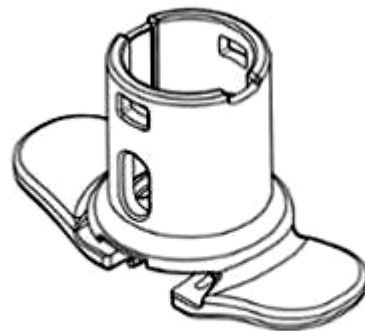

33.1

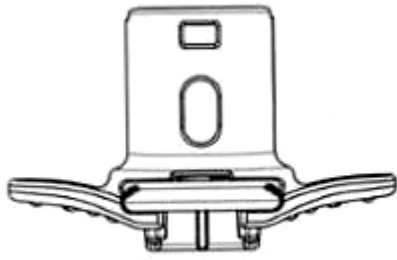

33.2

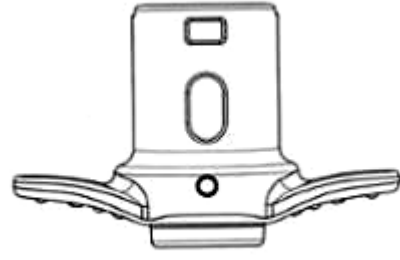

33.3



33.4

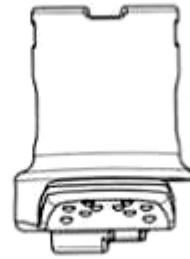

33.5



33.6

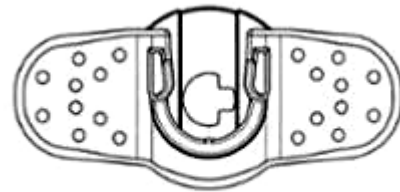

33.7

CÔNG BÁO SỞ HỮU CÔNG NGHIỆP SỐ 429 TẬP A – QUYỀN 2 (12.2023)

- (11) **48768**
(21) 3-2023-01078 (28) 1
(54) **HỘP ĐỰNG** (51) **09-03**
(22) 17/05/2023 (43) 25/12/2023
(30) 29/860,291 17/11/2022 US;
(73) **STASHER, INC. (US)**
1310 63rd Street, Emeryville, California, 94608, United States of America
(72) Angelo CARPINELLI (US)
(74) Công ty TNHH Đại Tín và Liên Danh (DAITIN AND ASSOCIATES CO.,LTD)
(55)

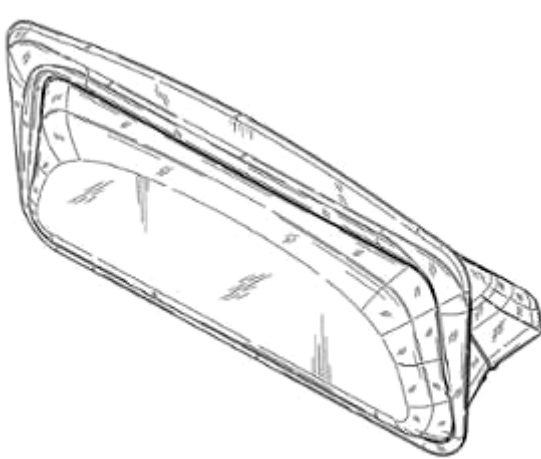

1.1

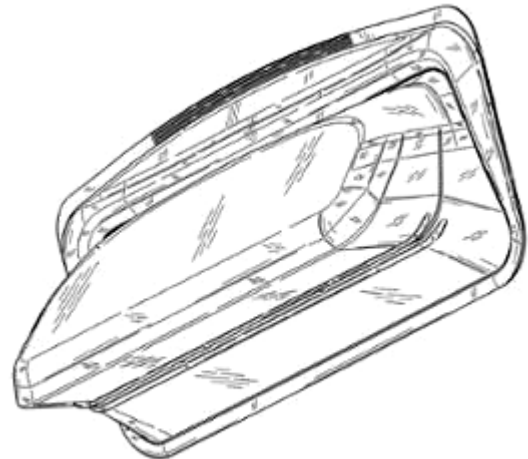

1.2

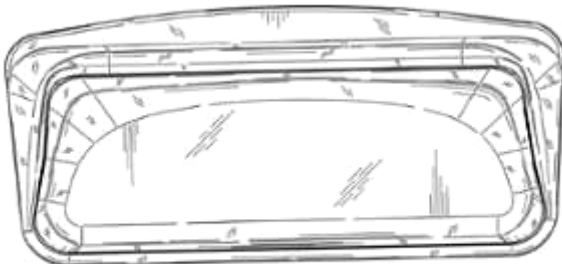

1.3

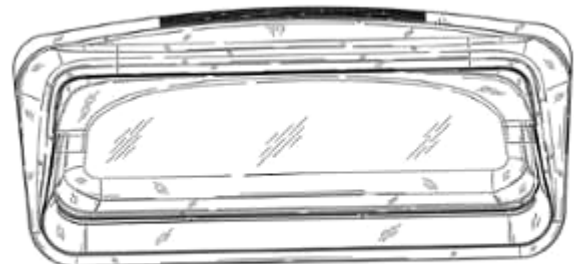

1.4



1.5



1.6



1.7



1.8



1.9



1.10

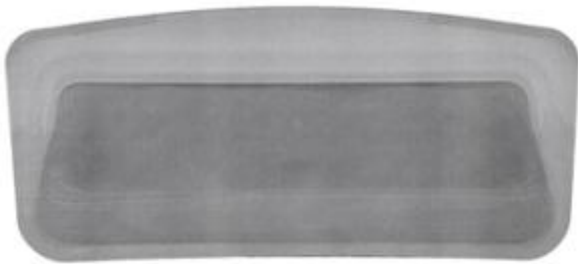

1.11

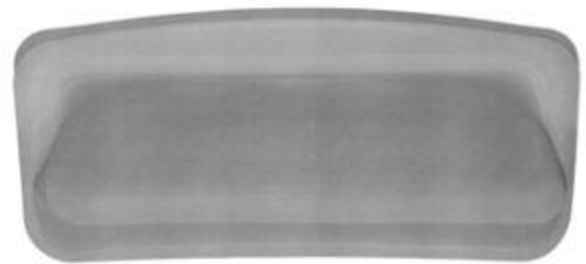

1.12



1.13



1.14



1.15



1.16

CÔNG BÁO SỞ HỮU CÔNG NGHIỆP SỐ 429 TẬP A – QUYỀN 2 (12.2023)

- (11) **48769**
(21) 3-2023-01088 (28) 1
(54) **GHÉ** (51) **06-01**
(22) 19/05/2023 (43) 25/12/2023
(30) 29/868,126 21/11/2022 US;
(73) **CLIQ PRODUCTS, INC. (US)**
1114 State St, Suite 303, Santa Barbara, CA 93101, United States of America
(72) 1. WAI-LOONG LIM (US)
2. KUMIKO FURUKAWA (US)
3. JOHN GEE TANG (US)
4. MICHAEL ZAPATA (US)
5. MIEKO KUSANO (US)
(74) Công ty TNHH Quốc tế D & N (D&N INTERNATIONAL CO.,LTD.)
(55)



1.1

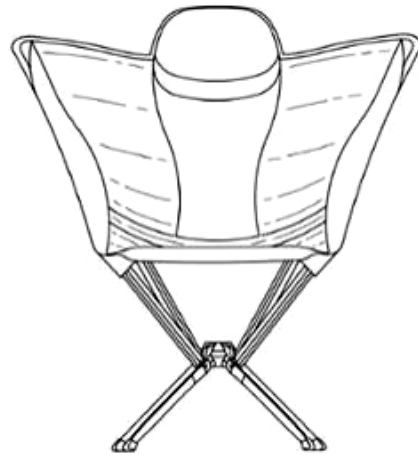

1.2



1.3



1.4

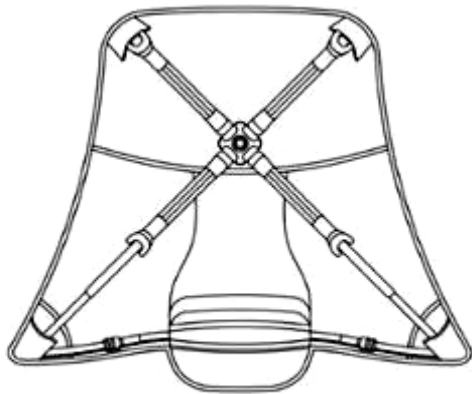

1.5

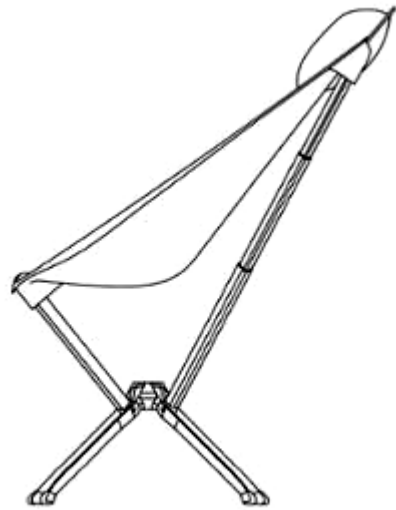

1.6

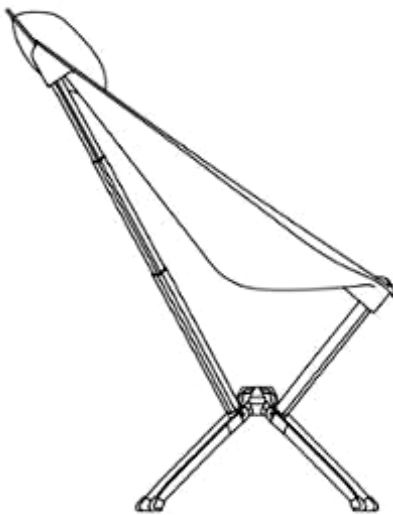

1.7



1.8

CÔNG BÁO SỞ HỮU CÔNG NGHIỆP SỐ 429 TẬP A – QUYỀN 2 (12.2023)

- (11) **48770**
(21) 3-2023-01101 (28) 1
(54) **BÌNH** (51) **09-02**
(22) 19/05/2023 (43) 25/12/2023
(30) 6255214 13/01/2023 GB;
(73) **CASTROL LIMITED (GB)**
Technology Centre, Whitchurch Hill, Pangbourne, Reading RG8 7QR, United Kingdom
(72) 1. SULISTYO SANTOSO (ID)
2. CHRISTOPHER JENKINS (AU)
3. DARREN TEE HING WEE (MY)
4. SENER KARAGULLE (TR)
5. AMZAR YEE CHEE SENG (THONG CHEE SENG) (SG)
6. BARIS GUNAL (CY)
7. ZABEEN AHMED (GB)
(74) Công ty TNHH Tư vấn sở hữu trí tuệ Việt (VIET IP CO.,LTD.)
(55)



1.1



1.2



1.3



1.4



1.5

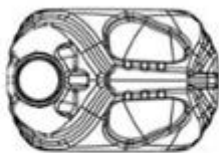

1.6

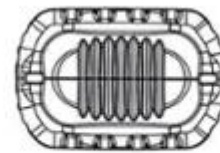

1.7

CÔNG BÁO SỞ HỮU CÔNG NGHIỆP SỐ 429 TẬP A – QUYỀN 2 (12.2023)

- (11) **48771**
(21) 3-2023-01102 (28) 1
(54) **BÌNH** (51) **09-02**
(22) 19/05/2023 (43) 25/12/2023
(30) 6255213 13/01/2023 GB;
(73) **CASTROL LIMITED (GB)**
Technology Centre, Whitchurch Hill, Pangbourne, Reading RG8 7QR, United Kingdom
(72) 1. SULISTYO SANTOSO (ID)
2. CHRISTOPHER JENKINS (AU)
3. DARREN TEE HING WEE (MY)
4. SENER KARAGULLE (TR)
5. AMZAR YEE CHEE SENG (THONG CHEE SENG) (SG)
6. BARIS GUNAL (CY)
7. ZABEEN AHMED (GB)
(74) Công ty TNHH Tư vấn sở hữu trí tuệ Việt (VIET IP CO.,LTD.)
(55)



1.1

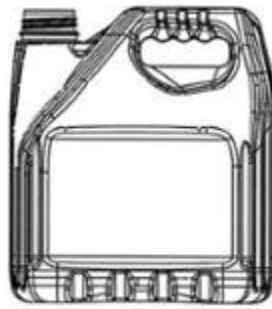

1.2

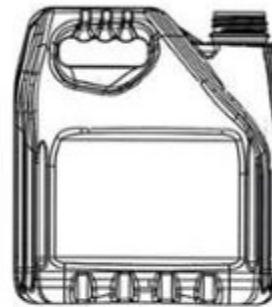

1.3

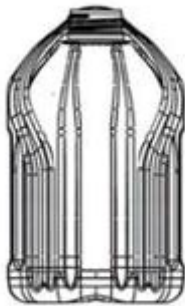

1.4

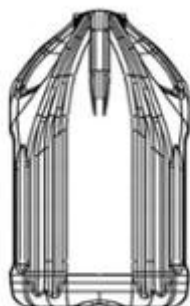

1.5

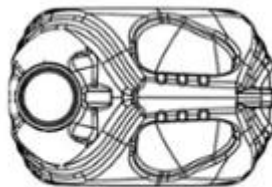

1.6

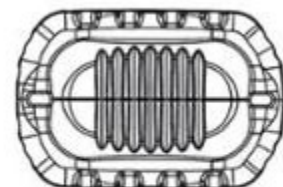

1.7

CÔNG BÁO SỞ HỮU CÔNG NGHIỆP SỐ 429 TẬP A – QUYỀN 2 (12.2023)

- (11) **48772**
(21) 3-2023-01103 (28) 1
(54) **TỦ GIÁM SÁT ĐIỀU KHIỂN HIỆN TRƯỜNG TRẠM BIẾN ÁP** (51) **13-03**
(22) 22/05/2023 (43) 25/12/2023
(73) **VIỆN NGHIÊN CỨU ĐIỆN TỬ, TIN HỌC, TỰ ĐỘNG HÓA (VN)**
156A đường Quán Thánh, phường Quán Thánh, quận Ba Đình, thành phố Hà Nội
(72) Nguyễn Thế Truyen (VN)
(55)

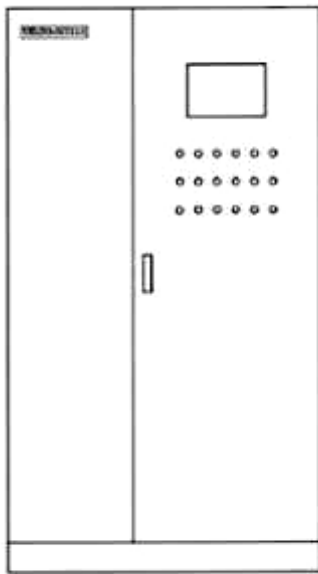

1.1

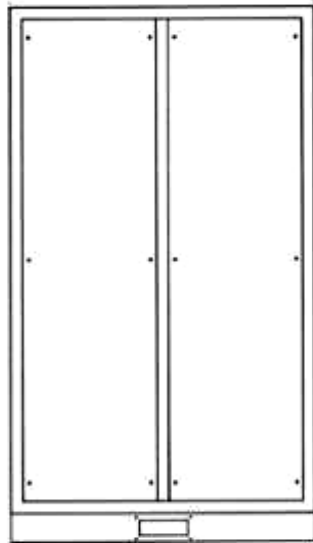

1.2



1.3



1.4



1.5



1.6



1.7

CÔNG BÁO SỞ HỮU CÔNG NGHIỆP SỐ 429 TẬP A – QUYỀN 2 (12.2023)

(11) **48773**

(21) 3-2023-01104

(28) 1

(54) **TỦ GIÁM SÁT CẢNH BÁO SỰ CỐ ĐƯỜNG DÂY**

(51) **13-03**

(22) 22/05/2023

(43) 25/12/2023

(73) **VIỆN NGHIÊN CỨU ĐIỆN TỬ, TIN HỌC, TỰ ĐỘNG HÓA (VN)**

156A đường Quán Thánh, phường Quán Thánh, quận Ba Đình, thành phố Hà Nội

(72) Nguyễn Xuân Đồng (VN)

(55)

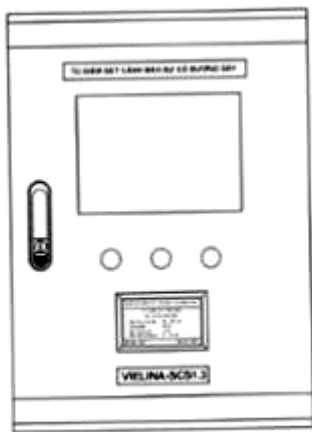

1.1

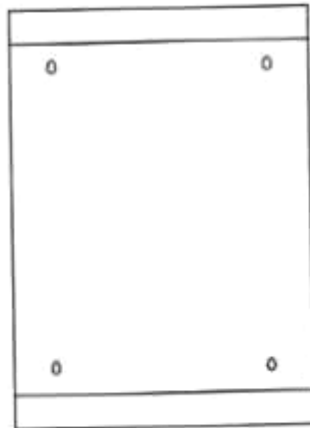

1.2



1.3



1.4



1.5

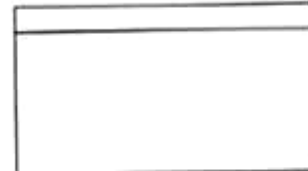

1.6

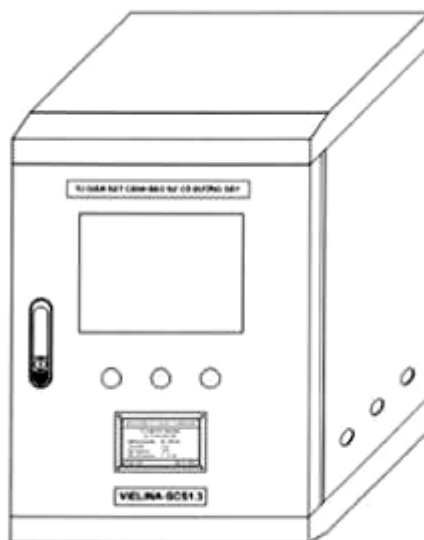

1.7

(11) **48774**

(21) 3-2023-01119

(28) 1

(54) **TAY NẮM CỬA**

(51) **08-06**

(22) 24/05/2023

(43) 25/12/2023

(73) **LƯU VĂN THƯỜNG (VN)**

Đội 6, thôn Đào Viên, xã Dân Tiến, huyện Khoái Châu, tỉnh Hưng Yên

(72) Lưu Văn Thường (VN)

(74) Công ty TNHH Sở hữu trí tuệ Đại Diện (IPACO.,LTD.)

(55)



1.1



1.2



1.3



1.4



1.5



1.6

CÔNG BÁO SỞ HỮU CÔNG NGHIỆP SỐ 429 TẬP A – QUYỀN 2 (12.2023)

- (11) **48775**
(21) 3-2023-01130 (28) 1
(54) **BÀN NÂNG HẠ** (51) **06-03**
(22) 25/05/2023 (43) 25/12/2023
(73) **CÔNG TY TNHH CÔNG NGHIỆP KINGTEC VIỆT NAM (VN)**
Lô C-4A-CN, khu công nghiệp Mỹ Phước 3, phường Thới Hòa, thị xã Bến Cát, tỉnh Bình Dương
(72) HUANG, WEI-HAN (TW)
(74) Công ty TNHH Tư vấn - Dịch thuật - Sở hữu trí tuệ Á Đông (Á Đông IP CONSULTANCY CO.,LTD.)
(55)



1.1

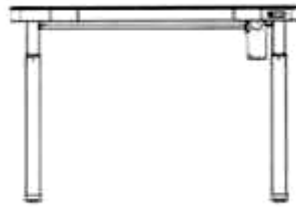

1.2

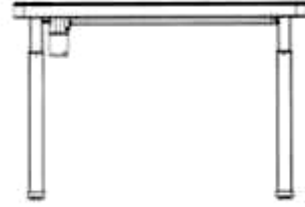

1.3



1.4



1.5



1.6

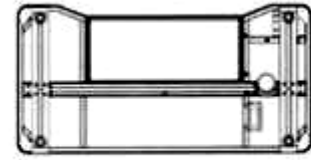

1.7

CÔNG BÁO SỞ HỮU CÔNG NGHIỆP SỐ 429 TẬP A – QUYỀN 2 (12.2023)

- (11) **48776**
(21) 3-2023-01131 (28) 1
(54) **BÀN NÂNG HẠ** (51) **06-03**
(22) 25/05/2023 (43) 25/12/2023
(73) **CÔNG TY TNHH CÔNG NGHIỆP KINGTEC VIỆT NAM (VN)**
Lô C-4A-CN, khu công nghiệp Mỹ Phước 3, phường Thới Hòa, thị xã Bến Cát, tỉnh Bình Dương
(72) HUANG, WEI-HAN (TW)
(74) Công ty TNHH Tư vấn - Dịch thuật - Sở hữu trí tuệ Á Đông (Á Đông IP CONSULTANCY CO.,LTD.)
(55)

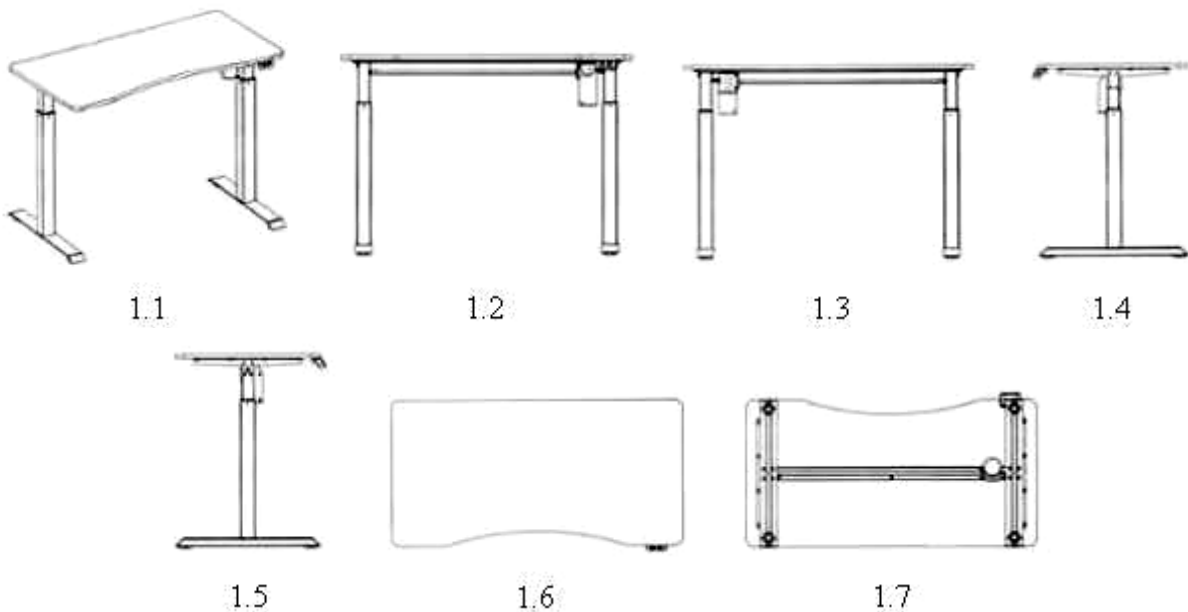

CÔNG BÁO SỞ HỮU CÔNG NGHIỆP SỐ 429 TẬP A – QUYỀN 2 (12.2023)

- (11) **48777**
(21) 3-2023-01132 (28) 1
(54) **BÀN NÂNG HẠ** (51) **06-03**
(22) 25/05/2023 (43) 25/12/2023
(73) **CÔNG TY TNHH CÔNG NGHIỆP KINGTEC VIỆT NAM (VN)**
Lô C-4A-CN, khu công nghiệp Mỹ Phước 3, phường Thới Hòa, thị xã Bến Cát, tỉnh Bình Dương
(72) HUANG, WEI-HAN (TW)
(74) Công ty TNHH Tư vấn - Dịch thuật - Sở hữu trí tuệ Á Đông (Á Đông IP CONSULTANCY CO.,LTD.)
(55)



1.1

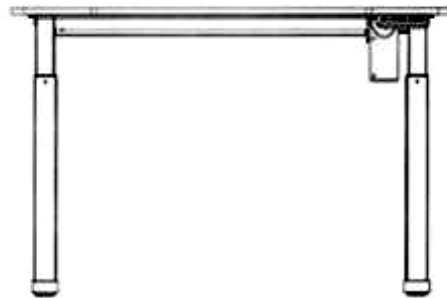

1.2

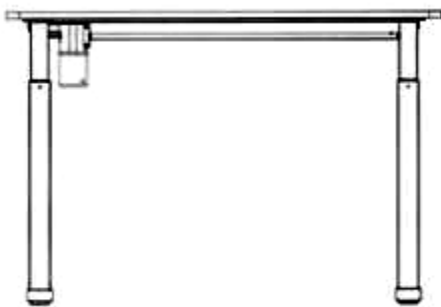

1.3

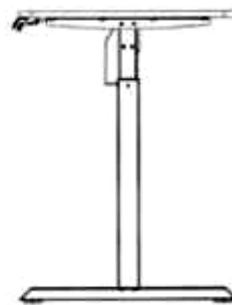

1.4



1.5

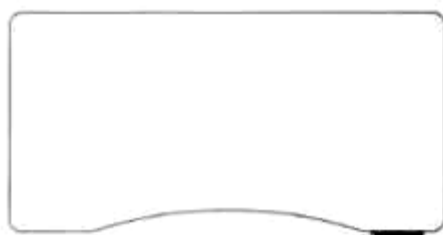

1.6

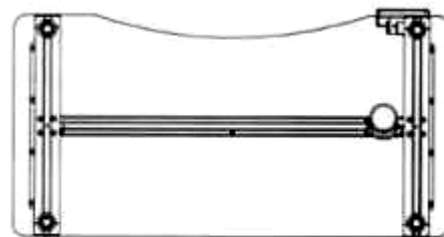

1.7

CÔNG BÁO SỞ HỮU CÔNG NGHIỆP SỐ 429 TẬP A – QUYỀN 2 (12.2023)

- (11) **48778**
(21) 3-2023-01133 (28) 1
(54) **BÀN NÂNG HẠ** (51) **06-03**
(22) 25/05/2023 (43) 25/12/2023
(73) **CÔNG TY TNHH CÔNG NGHIỆP KINGTEC VIỆT NAM (VN)**
Lô C-4A-CN, khu công nghiệp Mỹ Phước 3, phường Thới Hòa, thị xã Bến Cát, tỉnh Bình Dương
(72) HUANG, WEI-HAN (TW)
(74) Công ty TNHH Tư vấn - Dịch thuật - Sở hữu trí tuệ Á Đông (Á Đông IP CONSULTANCY CO.,LTD.)
(55)

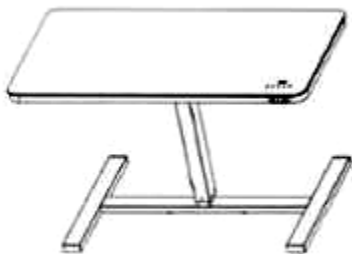

1.1

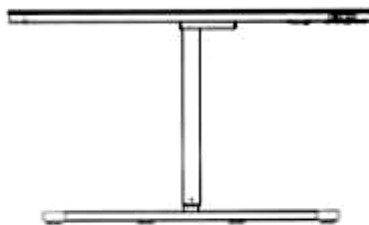

1.2

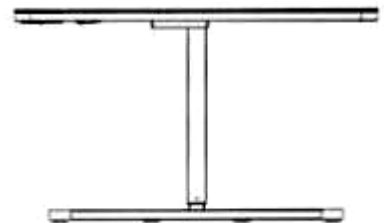

1.3

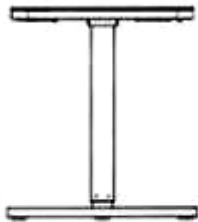

1.4

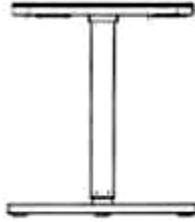

1.5



1.6

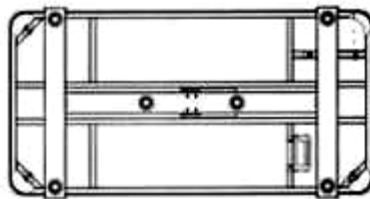

1.7

CÔNG BÁO SỞ HỮU CÔNG NGHIỆP SỐ 429 TẬP A – QUYỀN 2 (12.2023)

- (11) **48779**
(21) 3-2023-01149 (28) 1
(54) **THANH KIM LOẠI ĐỊNH HÌNH** (51) **25-01**
(22) 25/05/2023 (43) 25/12/2023
(73) **CÔNG TY TNHH MTV ĐĂNG QUANG (VN)**
Đường Trường Chinh, khu phố 1, phường Phú Tài, thành phố Phan Thiết, tỉnh Bình Thuận
(72) Võ Trường Thọ (VN)
(74) **CÔNG TY TNHH KHANG LUẬT (KHANGLAW)**
(55)

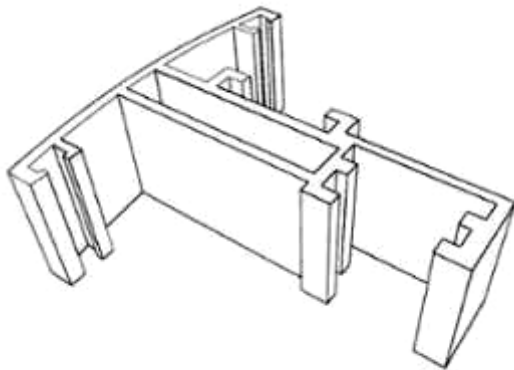

1.1

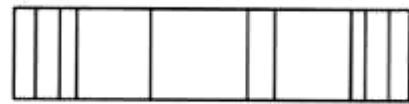

1.2



1.3



1.4



1.5

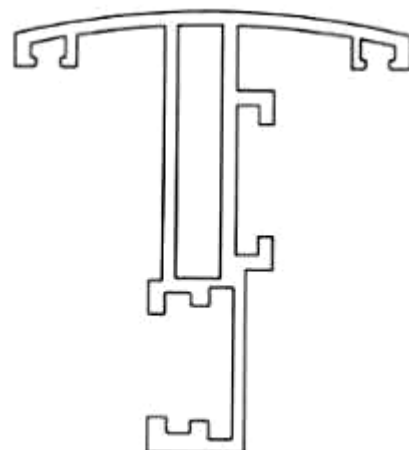

1.6

CÔNG BÁO SỞ HỮU CÔNG NGHIỆP SỐ 429 TẬP A – QUYỀN 2 (12.2023)

(11) **48780**

(21) 3-2023-01150

(54) **THANH KIM LOẠI ĐỊNH HÌNH**

(22) 25/05/2023

(73) **CÔNG TY TNHH MTV ĐĂNG QUANG (VN)**

Đường Trường Chinh, khu phố 1, phường Phú Tài, thành phố Phan Thiết, tỉnh Bình Thuận

(72) Võ Trường Thọ (VN)

(74) **CÔNG TY TNHH KHANG LUẬT (KHANGLAW)**

(55)

(28) 1

(51) **25-01**

(43) 25/12/2023

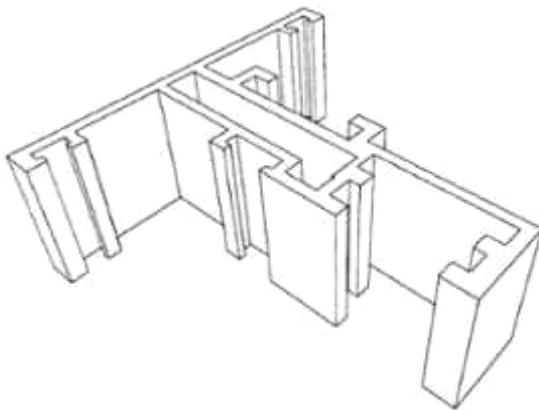

1.1



1.2



1.3



1.4

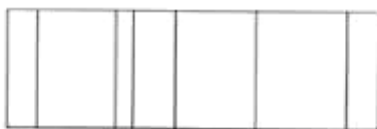

1.5

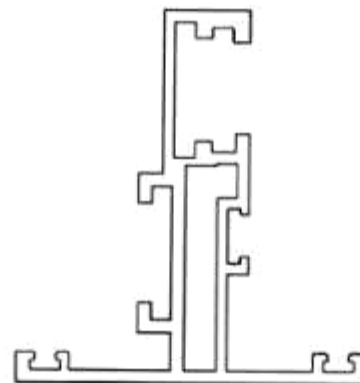

1.6

CÔNG BÁO SỞ HỮU CÔNG NGHIỆP SỐ 429 TẬP A – QUYỀN 2 (12.2023)

(11) **48781**

(21) 3-2023-01151

(54) **NGĂN KÉO TỬ BẾP**

(22) 25/05/2023

(73) **CÔNG TY TNHH ONP - VIỆT NAM (VN)**

Số 38 đường Hàm Nghi, khu phố Thiên Bình, phường Tam Phước, thành phố Biên Hoà, tỉnh Đồng Nai

(72) Patrick Floyd Mcneal (US)

(74) Công ty TNHH Tư vấn sở hữu trí tuệ Việt (VIET IP CO.,LTD.)

(55)

(28) 1

(51) **06-04**

(43) 25/12/2023

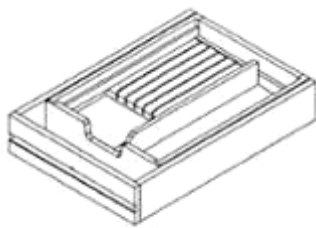

1.1

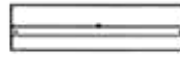

1.2



1.3



1.4



1.5

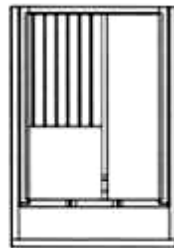

1.6



1.7

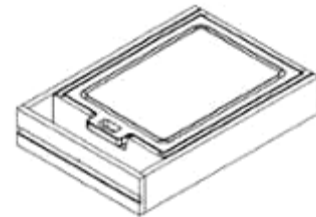

1.8

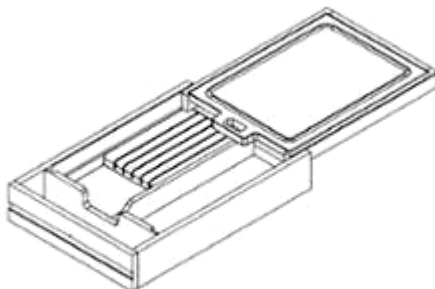

1.9

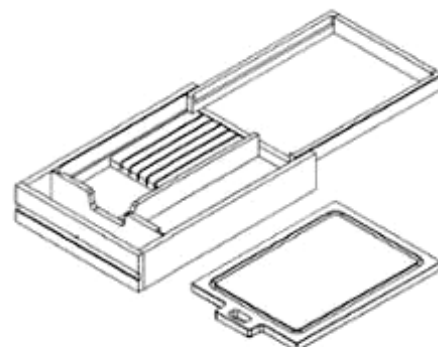

1.10

CÔNG BÁO SỞ HỮU CÔNG NGHIỆP SỐ 429 TẬP A – QUYỀN 2 (12.2023)

- (11) **48782**
(21) 3-2023-01152 (28) 2
(54) **Ô TÔ** (51) **12-08**
(22) 26/05/2023 (43) 25/12/2023
(30) 2022-025823 30/11/2022 JP; 2022-025822 30/11/2022 JP;
(73) **DAIHATSU MOTOR CO., LTD. (JP)**
1-1, DAIHATSU-CHO, IKEDA-SHI, OSAKA 563-8651 JAPAN
(72) 1. YOSHIHISA OKUNO (JP)
2. TOSHIAKI OKAMOTO (JP)
3. KATSUTARO KIMURA (JP)
(74) Công ty TNHH một thành viên Sở hữu trí tuệ VCCI (VCCI-IP CO.,LTD)
(55)



1.1



1.2



1.3



1.4



1.5



1.6



1.7



2.1



2.2



2.3



2.4



2.5



2.6



2.7

CÔNG BÁO SỞ HỮU CÔNG NGHIỆP SỐ 429 TẬP A – QUYỀN 2 (12.2023)

- (11) **48783**
(21) 3-2023-01167 (28) 1
(54) **CÔNG TẮC** (51) **13-03**
(22) 26/02/2019 (43) 25/12/2023
(30) 201830490056.9 31/08/2018 CN;
(73) **SCHNEIDER ELECTRIC (AUSTRALIA) PTY LTD (AU)**
78 WATERLOO ROAD, MACQUARIE PARK, New South Wales NSW 2113,
AUSTRALIA
(72) 1. WANG, LI (CN)
2. ZHENG, LEIHONG (CN)
(74) Công ty TNHH Trường Xuân (AGELESS CO.,LTD.)
(55)

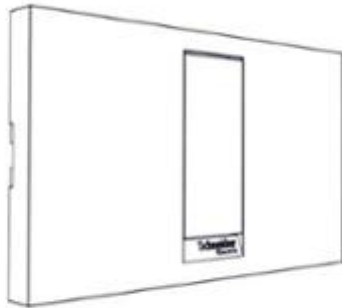

1.1

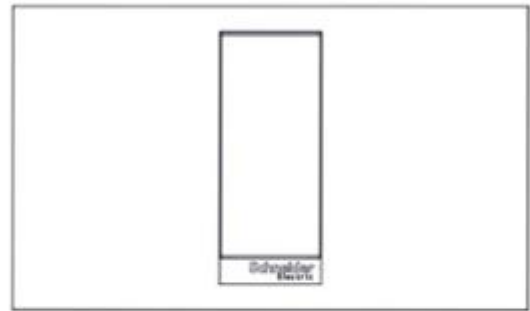

1.2

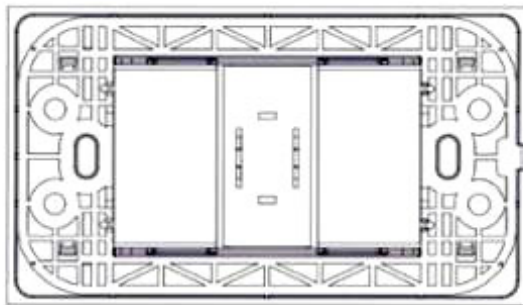

1.3

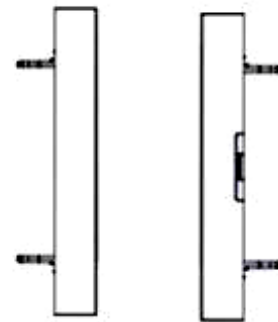

1.4

1.5



1.6



1.7

CÔNG BÁO SỞ HỮU CÔNG NGHIỆP SỐ 429 TẬP A – QUYỀN 2 (12.2023)

- (11) **48784**
(21) 3-2023-01168 (28) 1
(54) **CÔNG TẮC** (51) **13-03**
(22) 26/02/2019 (43) 25/12/2023
(30) 201830490056.9 31/08/2018 CN;
(73) **SCHNEIDER ELECTRIC (AUSTRALIA) PTY LTD (AU)**
78 WATERLOO ROAD, MACQUARIE PARK, New South Wales NSW 2113,
AUSTRALIA
(72) 1. WANG, LI (CN)
2. ZHENG, LEIHONG (CN)
(74) Công ty TNHH Trường Xuân (AGELESS CO.,LTD.)
(55)

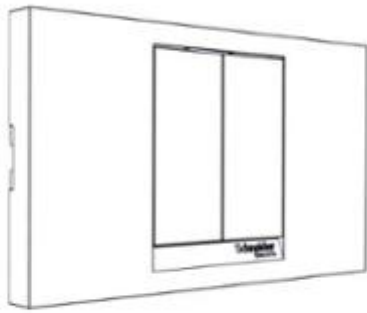

1.1

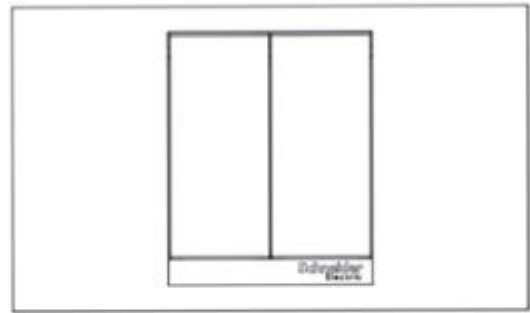

1.2

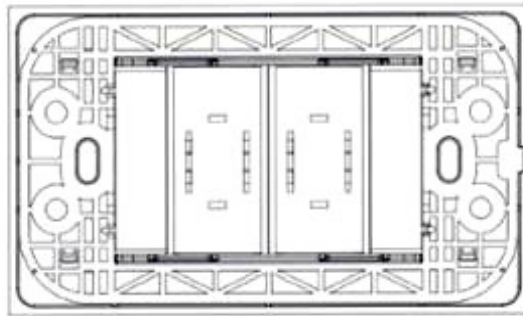

1.3

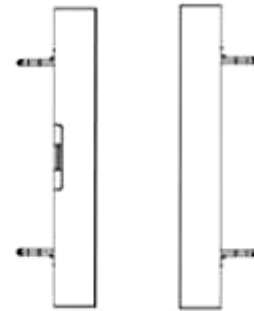

1.4

1.5



1.6



1.7

CÔNG BÁO SỞ HỮU CÔNG NGHIỆP SỐ 429 TẬP A – QUYỀN 2 (12.2023)

- (11) **48785**
(21) 3-2023-01176 (28) 1
(54) **Ổ CẮM ĐIỆN** (51) **13-03**
(22) 14/02/2020 (43) 25/12/2023
(30) 201930442270.1 14/08/2019 CN;
(73) **SCHNEIDER ELECTRIC (AUSTRALIA) PTY LTD (AU)**
78 WATERLOO ROAD, MACQUARIE PARK, New South Wales NSW 2113,
AUSTRALIA
(72) 1. JI, XIANG (CN)
2. ZHONG, JIAYIN (CN)
3. WANG, YONGGANG (CN)
(74) Công ty TNHH Trường Xuân (AGELESS CO.,LTD.)
(55)



1.1



1.2



1.3



1.4

1.5



1.6



1.7

CÔNG BÁO SỞ HỮU CÔNG NGHIỆP SỐ 429 TẬP A – QUYỀN 2 (12.2023)

- (11) **48786**
(21) 3-2023-01177 (28) 1
(54) **HỘP ĐỰNG SẢN PHẨM** (51) **09-03**
(22) 30/05/2023 (43) 25/12/2023
(73) **CÔNG TY CỔ PHẦN LONG HÙNG HOLDINGS (VN)**
D2 Lô C, phố Duy Tân, phường Dịch Vọng Hậu, quận Cầu Giấy, thành phố Hà Nội
(72) Trần Thị Ngọc Bích (VN)
(55)



1.1



1.2



2.1



2.2



3.1



3.2

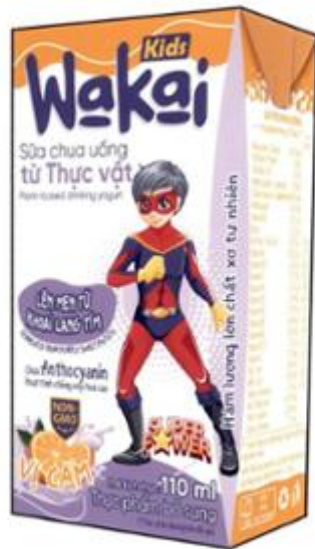

4.1



4.2

CÔNG BÁO SỞ HỮU CÔNG NGHIỆP SỐ 429 TẬP A – QUYỀN 2 (12.2023)

- (11) **48787**
(21) 3-2023-01179 (28) 2
(54) **BỘ NHÃN SẢN PHẨM** (51) **19-08**
(22) 30/05/2023 (43) 25/12/2023
(73) **CÔNG TY CỔ PHẦN HÀNG TIÊU DÙNG MASAN (VN)**
Tầng 12, tòa nhà MPlaza Saigon, số 39 Lê Duẩn, phường Bến Nghé, quận 1, thành phố Hồ Chí Minh
(72) Nguyễn Hoàng Yên (VN)
(74) Công ty cổ phần Sở hữu trí tuệ BROSS và Cộng sự (BROSS & PARTNERS., JSC)
(55)



1.1



1.2

CÔNG BÁO SỞ HỮU CÔNG NGHIỆP SỐ 429 TẬP A – QUYỀN 2 (12.2023)

- (11) **48788**
(21) 3-2023-01186 (28) 1
(54) **Ổ CẮM** (51) **13-03**
(22) 26/02/2019 (43) 25/12/2023
(30) 201830490316.2 31/08/2018 CN;
(73) **SCHNEIDER ELECTRIC (AUSTRALIA) PTY LTD (AU)**
78 WATERLOO ROAD, MACQUARIE PARK, New South Wales NSW 2113,
AUSTRALIA
(72) 1. WANG, LI (CN)
2. ZHENG, LEIHONG (CN)
(74) Công ty TNHH Trường Xuân (AGELESS CO.,LTD.)
(55)

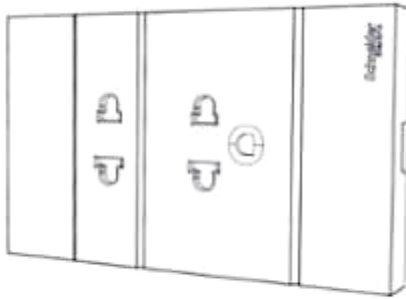

1.1

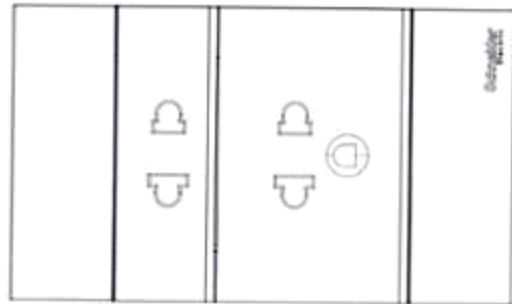

1.2

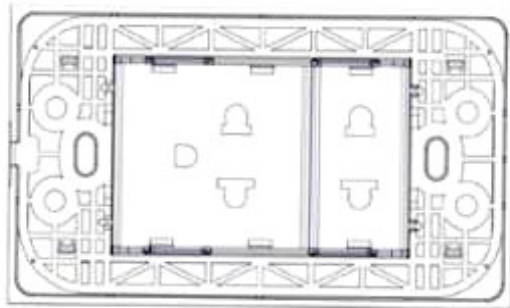

1.3

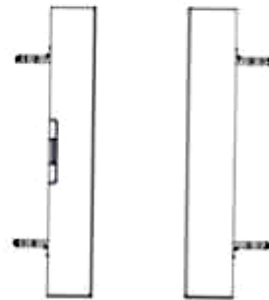

1.4

1.5

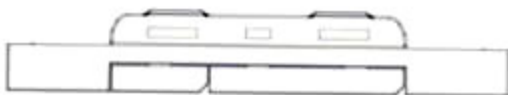

1.6



1.7

CÔNG BÁO SỞ HỮU CÔNG NGHIỆP SỐ 429 TẬP A – QUYỀN 2 (12.2023)

- (11) **48789**
(21) 3-2023-01187 (28) 1
(54) **Ổ CẮM** (51) **13-03**
(22) 26/02/2019 (43) 25/12/2023
(30) 201830490316.2 31/08/2018 CN;
(73) **SCHNEIDER ELECTRIC (AUSTRALIA) PTY LTD (AU)**
78 Waterloo Road, Macquarie Park, New South Wales NSW 2113, Australia
(72) 1. WANG, LI (CN)
2. ZHENG, LEIHONG (CN)
(74) Công ty TNHH Trường Xuân (AGELESS CO.,LTD.)
(55)

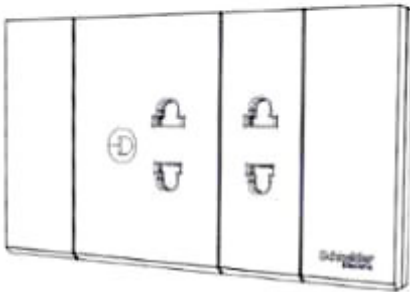

1.1

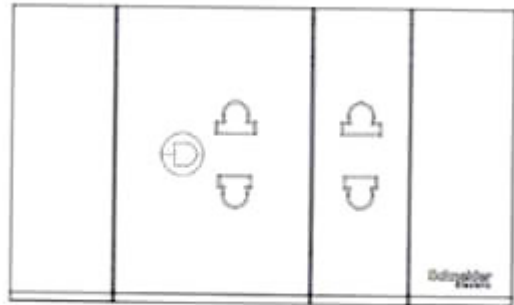

1.2

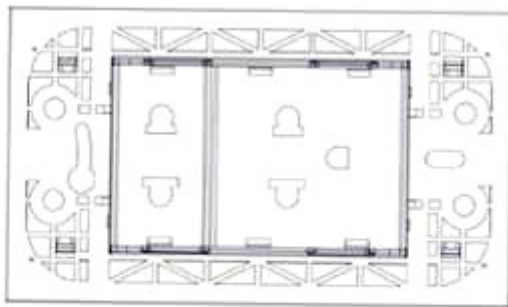

1.3

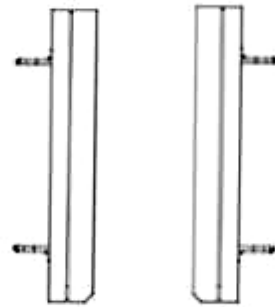

1.4

1.5



1.6

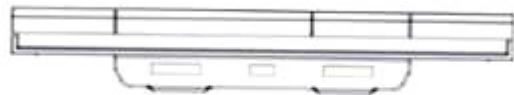

1.7

CÔNG BÁO SỞ HỮU CÔNG NGHIỆP SỐ 429 TẬP A – QUYỀN 2 (12.2023)

- (11) **48790**
(21) 3-2023-01188 (28) 1
(54) **CỤM Ổ CẮM VÀ CÔNG TẮC** (51) **13-03**
(22) 18/06/2019 (43) 25/12/2023
(30) 201830736034.6 18/12/2018 CN;
(73) **SCHNEIDER ELECTRIC (AUSTRALIA) PTY LTD (AU)**
78 Waterloo Road, Macquarie Park, New South Wales NSW 2113, Australia
(72) 1. WANG, LI (CN)
2. ZHENG, LEIHONG (CN)
(74) Công ty TNHH Trường Xuân (AGELESS CO.,LTD.)
(55)

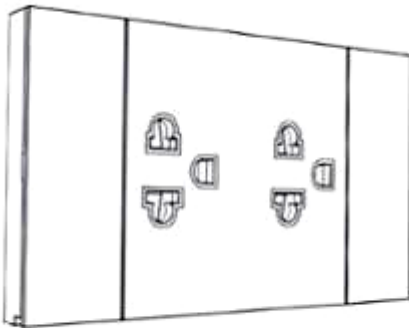

1.1

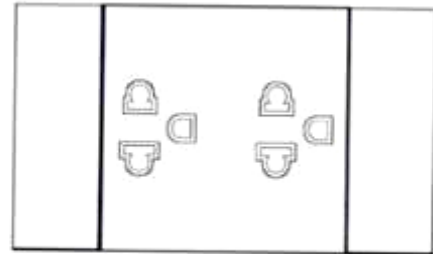

1.2

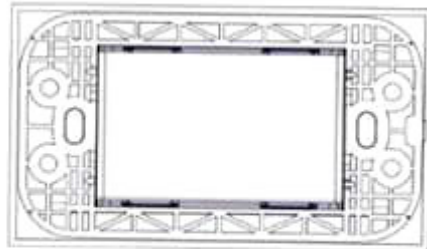

1.3

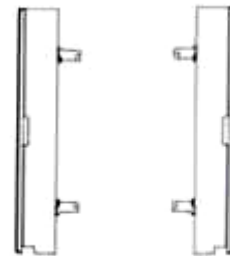

1.4

1.5



1.6



1.7

CÔNG BÁO SỞ HỮU CÔNG NGHIỆP SỐ 429 TẬP A – QUYỀN 2 (12.2023)

- (11) **48791**
(21) 3-2023-01189 (28) 1
(54) **CỤM Ổ CẮM VÀ CÔNG TẮC** (51) **13-03**
(22) 18/06/2019 (43) 25/12/2023
(30) 201830736034.6 18/12/2018 CN;
(73) **SCHNEIDER ELECTRIC (AUSTRALIA) PTY LTD (AU)**
78 Waterloo Road, Macquarie Park, New South Wales NSW 2113, Australia
(72) 1. WANG, LI (CN)
2. ZHENG, LEIHONG (CN)
(74) Công ty TNHH Trường Xuân (AGELESS CO.,LTD.)
(55)

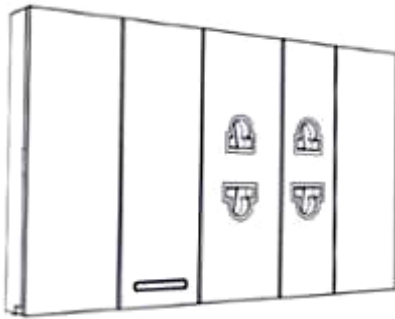

1.1

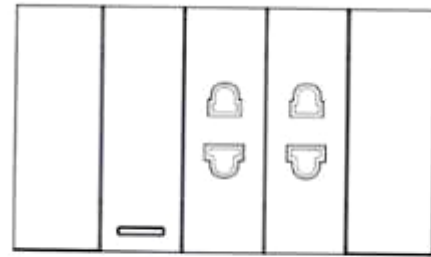

1.2

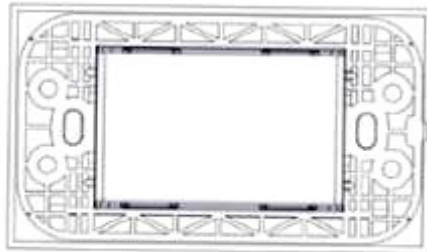

1.3

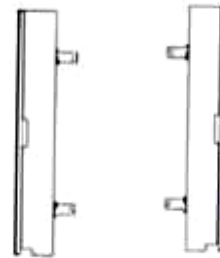

1.4



1.5



1.6



1.7

CÔNG BÁO SỞ HỮU CÔNG NGHIỆP SỐ 429 TẬP A – QUYỀN 2 (12.2023)

- (11) **48792**
(21) 3-2023-01190 (28) 1
(54) **CỤM Ổ CẮM VÀ CÔNG TẮC** (51) **13-03**
(22) 18/06/2019 (43) 25/12/2023
(30) 201830736034.6 18/12/2018 CN;
(73) **SCHNEIDER ELECTRIC (AUSTRALIA) PTY LTD (AU)**
78 Waterloo Road, Macquarie Park, New South Wales Nsw 2113, Australia
(72) 1. WANG, LI (CN)
2. ZHENG, LEIHONG (CN)
(74) Công ty TNHH Trường Xuân (AGELESS CO.,LTD.)
(55)

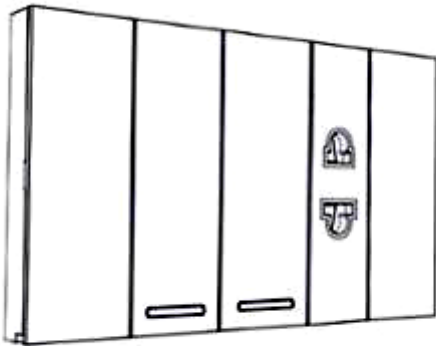

1.1

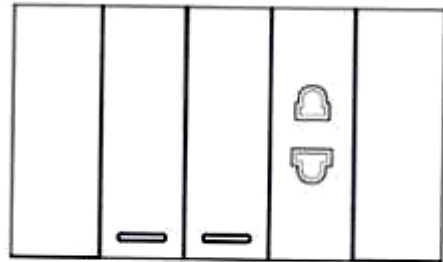

1.2

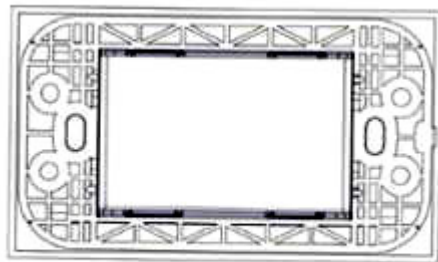

1.3

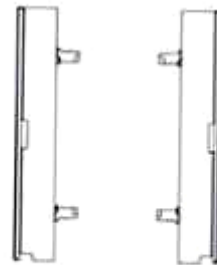

1.4

1.5



1.6



1.7

CÔNG BÁO SỞ HỮU CÔNG NGHIỆP SỐ 429 TẬP A – QUYỀN 2 (12.2023)

- (11) **48793**
(21) 3-2023-01211 (28) 1
(54) **HỘP BAO GÓI SẢN PHẨM** (51) **09-03**
(22) 01/06/2023 (43) 25/12/2023
(73) **CÔNG TY CỔ PHẦN DƯỢC PHẨM IMOCHILD VIỆT NAM (VN)**
Thôn Đỗ Xá, xã Vạn Diêm, huyện Thường Tín, thành phố Hà Nội
(72) Nguyễn Đức Cường (VN)
(55)



1.1



1.2

CÔNG BÁO SỞ HỮU CÔNG NGHIỆP SỐ 429 TẬP A – QUYỀN 2 (12.2023)

- (11) **48794**
(21) 3-2023-01212 (28) 1
(54) **BAO GÓI SẢN PHẨM** (51) **09-05**
(22) 02/06/2023 (43) 25/12/2023
(73) **CƠ SỞ CHẾ BIẾN MEN RƯỢU THÊ DUY (VN)**
Thôn Tam Đồng, xã Thụy Hải, huyện Thái Thụy, tỉnh Thái Bình
(72) Phạm Văn Thủ (VN)
(55)



1.1



1.2

CÔNG BÁO SỞ HỮU CÔNG NGHIỆP SỐ 429 TẬP A – QUYỀN 2 (12.2023)

- (11) **48795**
(21) 3-2023-01216 (28) 1
(54) **MÁY MÀI DỬA MÓNG** (51) **28-03**
(22) 02/06/2023 (43) 25/12/2023
(73) **GUANGZHOU YADA NAIL PRODUCTS CO., LTD (CN)**
Room 412, No.2 Airport East Gate Street, Baiyun District, Guangzhou, China.
(72) BINGNA ZHANG (CN)
(74) Công ty cổ phần tư vấn Sở hữu trí tuệ IPAC (IPAC IP.,JSC.)
(55)



1.1



1.2



1.3



1.4



1.5



1.6



1.7



1.8

CÔNG BÁO SỞ HỮU CÔNG NGHIỆP SỐ 429 TẬP A – QUYỀN 2 (12.2023)

- (11) **48796**
(21) 3-2023-01218 (28) 1
(54) **LỌ** (51) **09-01**
(22) 02/06/2023 (43) 25/12/2023
(73) **LG H&H Co., LTD. (KR)**
58, Saemunan-ro, Jongno-gu, Seoul, Republic of Korea
(72) LEE, Hye Min (KR)
(74) Công ty TNHH Tầm nhìn và Liên danh (VISION & ASSOCIATES CO.LTD.)
(55)



1.1

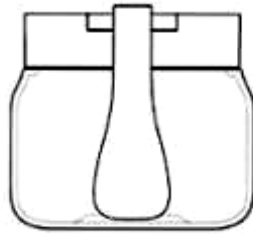

1.2



1.3



1.4

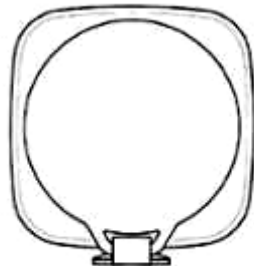

1.5



1.6

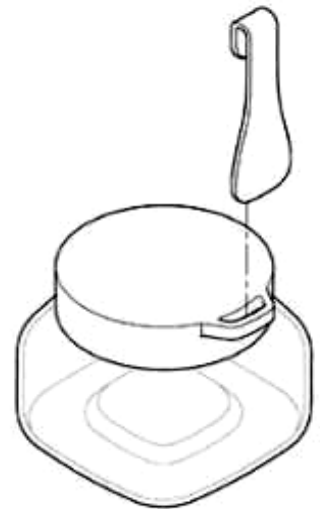

1.7

CÔNG BÁO SỞ HỮU CÔNG NGHIỆP SỐ 429 TẬP A – QUYỀN 2 (12.2023)

- (11) **48797**
- (21) 3-2023-01219 (28) 1
- (54) **NHÃN SẢN PHẨM** (51) **19-08**
- (22) 02/06/2023 (43) 25/12/2023
- (73) **HỘ KINH DOANH HOA KIM TIÊN (VN)**
Số 589, tổ NDTQ số 14, ấp Hưng Phú, xã Hưng Phong, huyện Giồng Tôm, tỉnh Bến Tre
- (72) Nguyễn Văn Việt (VN)
- (55)



CÔNG BÁO SỞ HỮU CÔNG NGHIỆP SỐ 429 TẬP A – QUYỀN 2 (12.2023)

- (11) **48798**
(21) 3-2023-01221 (28) 2
(54) **BỘ NHÃN SẢN PHẨM** (51) **19-08**
(22) 02/06/2023 (43) 25/12/2023
(73) **TỔNG CÔNG TY CỔ PHẦN BIA-RƯỢU-NƯỚC GIẢI KHÁT SÀI GÒN (VN)**
187 Nguyễn Chí Thanh, phường 12, quận 5, thành phố Hồ Chí Minh
(72) Neo Gim Siong Bennett (SG)
(74) Công ty TNHH Luật ALIAT (ALIAT LEGAL)
(55)

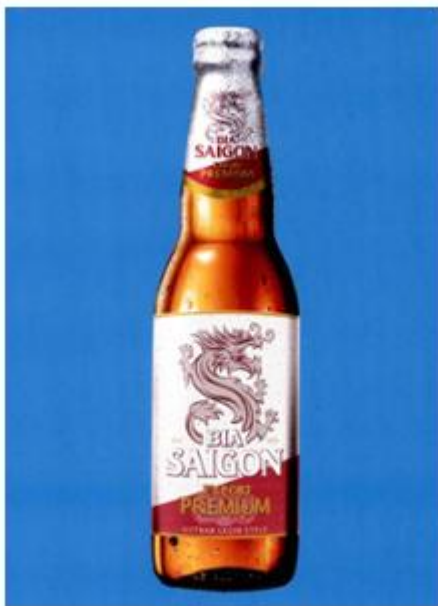

1.1



1.2



1.3

CÔNG BÁO SỞ HỮU CÔNG NGHIỆP SỐ 429 TẬP A – QUYỀN 2 (12.2023)

- (11) **48799**
(21) 3-2023-01223 (28) 1
(54) **KẾT ĐỰNG CHAI** (51) **09-04**
(22) 02/06/2023 (43) 25/12/2023
(73) **TỔNG CÔNG TY CỔ PHẦN BIA-RƯỢU-NƯỚC GIẢI KHÁT SÀI GÒN (VN)**
187 Nguyễn Chí Thanh, phường 12, quận 5, thành phố Hồ Chí Minh
(72) Neo Gim Siong Bennett (SG)
(74) Công ty TNHH Luật ALIAT (ALIAT LEGAL)
(55)



1.1



1.2



1.3

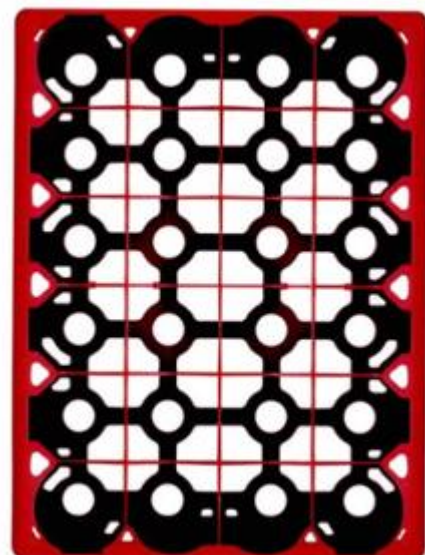

1.4

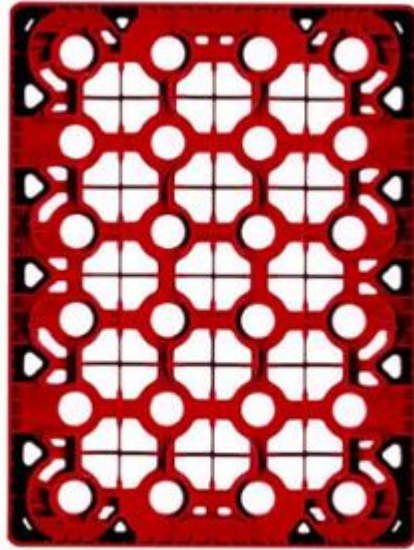

1.5

CÔNG BÁO SỞ HỮU CÔNG NGHIỆP SỐ 429 TẬP A – QUYỀN 2 (12.2023)

- (11) **48800**
(21) 3-2023-01231 (28) 2
(54) **BÌNH NƯỚC NÓNG** (51) **23-03**
(22) 05/06/2023 (43) 25/12/2023
(73) **CÔNG TY CỔ PHẦN ĐẦU TƯ TẬP ĐOÀN TÂN Á ĐẠI THÀNH (VN)**
Số 124 đường Tôn Đức Thắng, phường Quốc Tử Giám, quận Đống Đa, thành phố Hà Nội
(72) Nguyễn Duy Chính (VN)
(55)



1.1

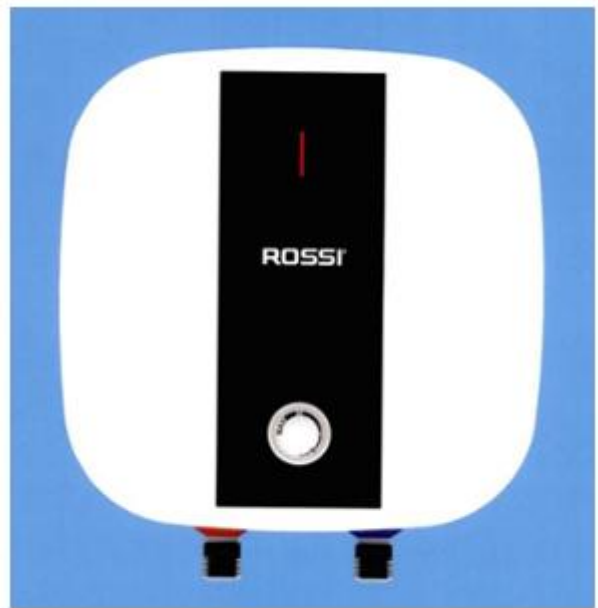

1.2



1.3



1.4



1.5

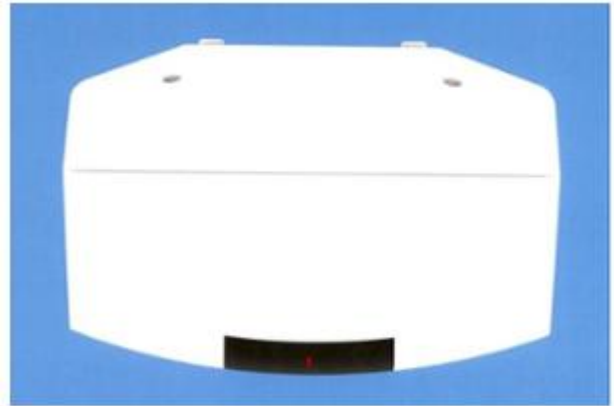

1.6

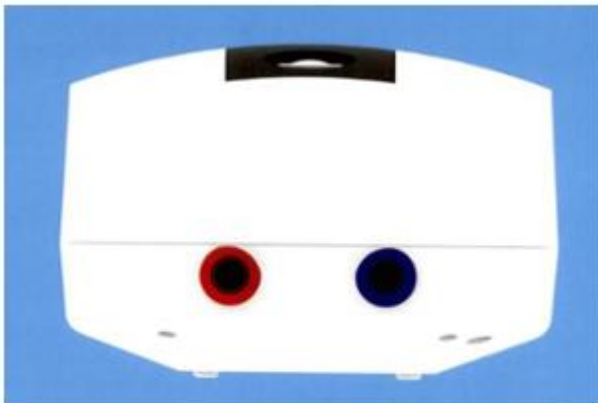

1.7



2.1

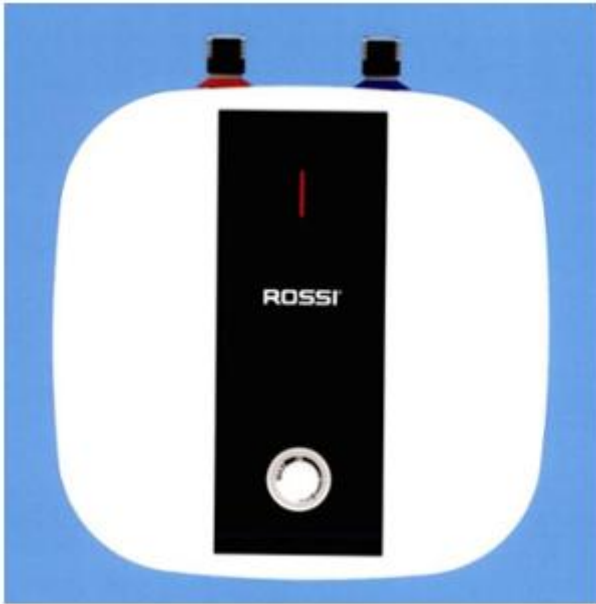

2.2

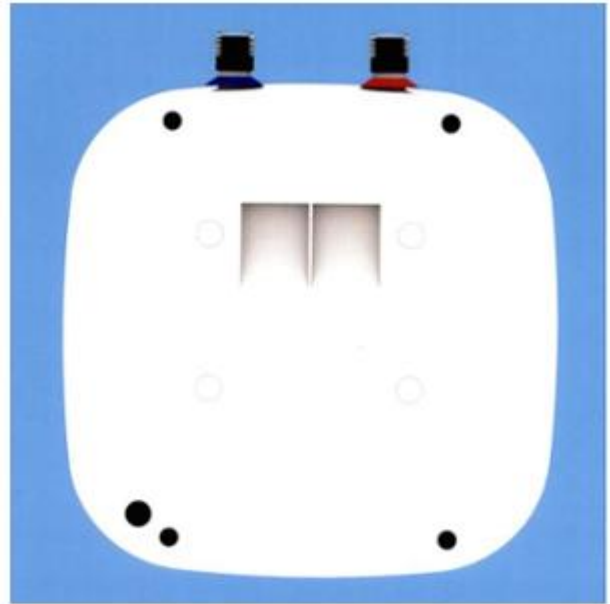

2.3



2.4



2.5

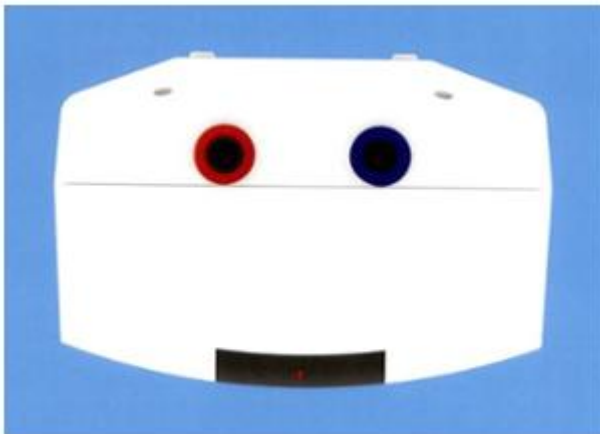

2.6

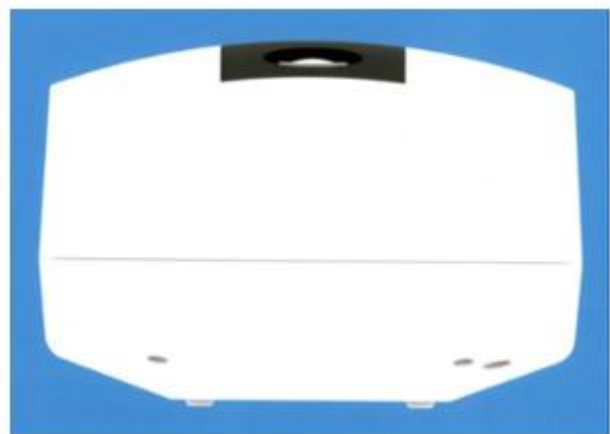

2.7

CÔNG BÁO SỞ HỮU CÔNG NGHIỆP SỐ 429 TẬP A – QUYỀN 2 (12.2023)

(11) **48801**

(21) 3-2023-01236

(28) 1

(54) **KẸP ĐẦU RỄ CÁP TRUNG THỂ CHO CÁP TRẦN**

(51) **13-03**

(22) 06/06/2023

(43) 25/12/2023

(73) **CÔNG TY CỔ PHẦN THIẾT BỊ ĐIỆN SÀI GÒN (VN)**

199 đường 16, khu dân cư An Lạc, phường Bình Trị Đông B, quận Bình Tân, thành phố Hồ Chí Minh

(72) Nguyễn Thành Thuận (VN)

(55)

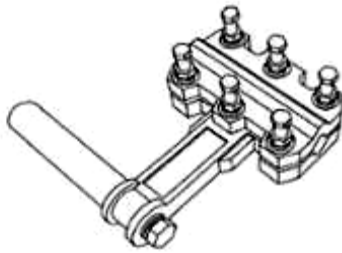

1.1

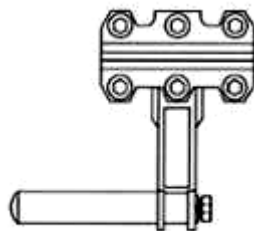

1.2

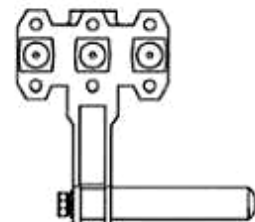

1.3

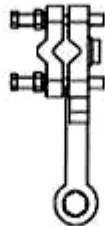

1.4

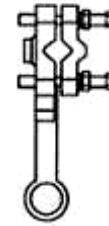

1.5

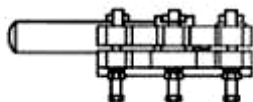

1.6

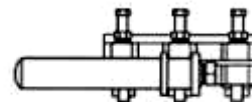

1.7

CÔNG BÁO SỞ HỮU CÔNG NGHIỆP SỐ 429 TẬP A – QUYỀN 2 (12.2023)

(11) **48802**

(21) 3-2023-01237

(28) 1

(54) **KẸP ĐẦU RỄ CÁP TRUNG THỂ CHO CÁP BỌC**

(51) **13-03**

(22) 06/06/2023

(43) 25/12/2023

(73) **CÔNG TY CỔ PHẦN THIẾT BỊ ĐIỆN SÀI GÒN (VN)**

199 đường 16, khu dân cư An Lạc, phường Bình Trị Đông B, quận Bình Tân, thành phố Hồ Chí Minh

(72) Nguyễn Thành Thuận (VN)

(55)

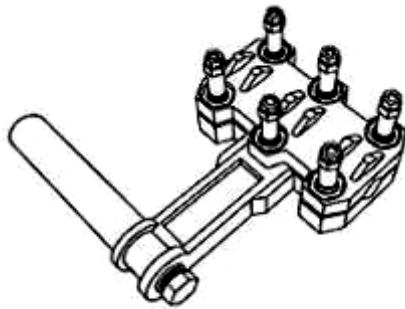

1.1

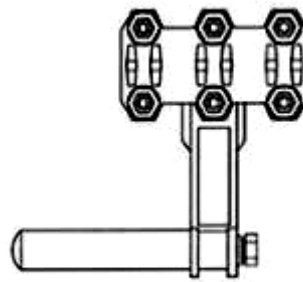

1.2

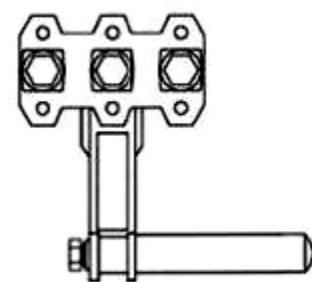

1.3

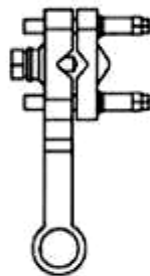

1.4

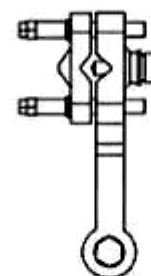

1.5

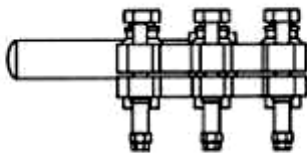

1.6

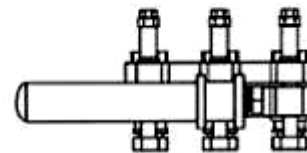

1.7

CÔNG BÁO SỞ HỮU CÔNG NGHIỆP SỐ 429 TẬP A – QUYỀN 2 (12.2023)

- (11) **48803**
(21) 3-2023-01242 (28) 1
(54) **HỘP** (51) **09-03**
(22) 06/06/2023 (43) 25/12/2023
(73) **CÔNG TY CỔ PHẦN THỰC PHẨM Á LONG (VN)**
175-177 Xô Viết Nghệ Tĩnh, phường 17, quận Bình Thạnh, thành phố Hồ Chí Minh
(72) Phạm Quang Huy (VN)
(74) Công ty TNHH Sở hữu trí tuệ Tầm Nhìn Mới (FRESHVIEW CO., LTD.)
(55)



1.1



1.2



1.3



1.4



1.5



1.6



1.7

CÔNG BÁO SỞ HỮU CÔNG NGHIỆP SỐ 429 TẬP A – QUYỀN 2 (12.2023)

- (11) **48804**
(21) 3-2023-01254 (28) 1
(54) **BAO GÓI** (51) **09-05**
(22) 07/06/2023 (43) 25/12/2023
(73) **LƯ HOÀNG THANH (VN)**
98 TA11, khu phố 3, phường Thới An, quận 12, thành phố Hồ Chí Minh
(72) Lư Hoàng Thanh (VN)
(74) Công ty TNHH Sở hữu trí tuệ INVENTIO (INVENTIO CO.,LTD)
(55)



1.1



1.2



1.3



1.4



1.5



1.6



1.7

CÔNG BÁO SỞ HỮU CÔNG NGHIỆP SỐ 429 TẬP A – QUYỀN 2 (12.2023)

- (11) **48805**
(21) 3-2023-01265 (28) 1
(54) **CÔNG TẮC** (51) **13-03**
(22) 25/02/2019 (43) 25/12/2023
(30) 201830488683.9 31/08/2018 CN;
(73) **SCHNEIDER ELECTRIC (AUSTRALIA) PTY LTD (AU)**
78 WATERLOO ROAD, MACQUARIE PARK, New South Wales NSW 2113,
AUSTRALIA
(72) 1. WANG, LI (CN)
2. ZHENG, LEIHONG (CN)
(74) Công ty TNHH Trường Xuân (AGELESS CO.,LTD.)
(55)

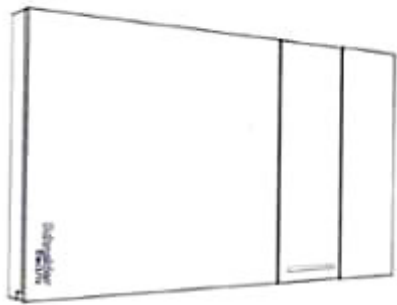

1.1



1.2

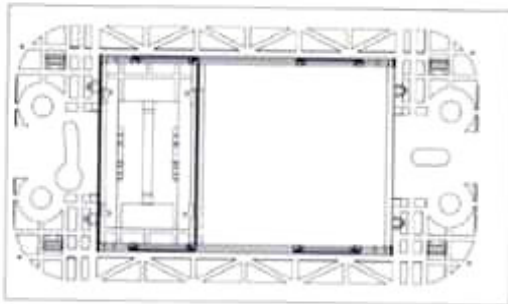

1.3

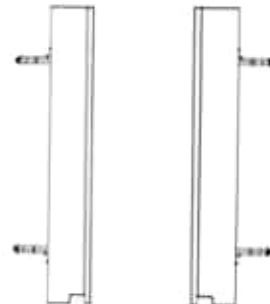

1.4

1.5

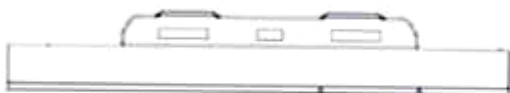

1.6



1.7

CÔNG BÁO SỞ HỮU CÔNG NGHIỆP SỐ 429 TẬP A – QUYỀN 2 (12.2023)

- (11) **48806**
(21) 3-2023-01266 (28) 2
(54) **CÔNG TẮC** (51) **13-03**
(22) 25/02/2019 (43) 25/12/2023
(30) 201830488683.9 31/08/2018 CN;
(73) **SCHNEIDER ELECTRIC (AUSTRALIA) PTY LTD (AU)**
78 WATERLOO ROAD, MACQUARIE PARK, New South Wales NSW 2113,
AUSTRALIA
(72) 1. WANG, LI (CN)
2. ZHENG, LEIHONG (CN)
(74) Công ty TNHH Trường Xuân (AGELESS CO.,LTD.)
(55)

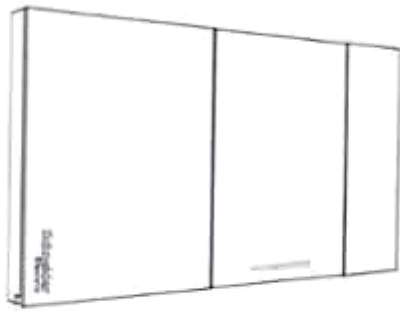

1.1



1.2

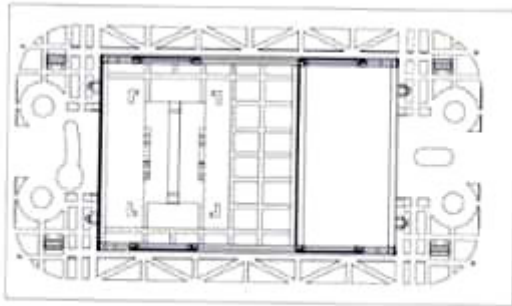

1.3

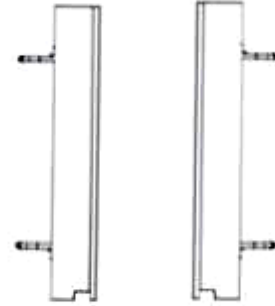

1.4

1.5



1.6



1.7

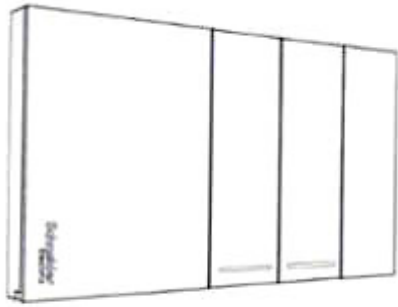

2.1

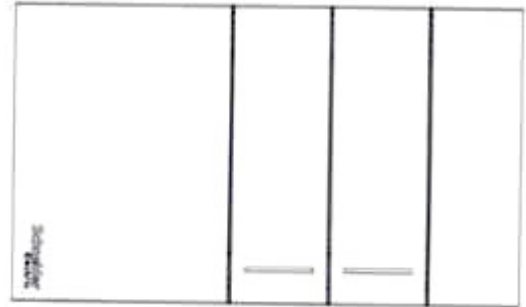

2.2

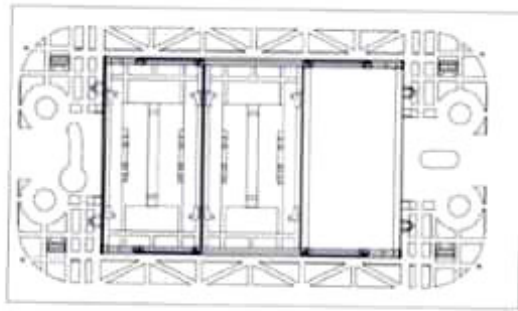

2.3

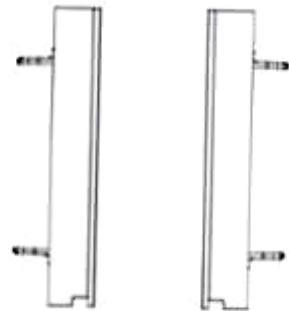

2.4

2.5



2.6



2.7

CÔNG BÁO SỞ HỮU CÔNG NGHIỆP SỐ 429 TẬP A – QUYỀN 2 (12.2023)

- (11) **48807**
(21) 3-2023-01267 (28) 1
(54) **BỒN CẦU THÔNG MINH** (51) **23-02**
(22) 08/06/2023 (43) 25/12/2023
(73) **HUANG, XIAOYUE (CN)**
No. 7, Fuli District, Fuzhong Village, Guxiang Town, Chaoan District, Chaozhou
City, Guangdong Province, China
(72) HUANG, Xiaoyue (CN)
(74) Công ty TNHH Dịch vụ Sở hữu trí tuệ BIG5 (BIG5 IP CO.,LTD)
(55)



1.1



1.2



1.3



1.4



1.5



1.6



1.7

- (11) **48808**
(21) 3-2023-01268 (28) 2
(54) **VÒNG ĐEO CỔ LÀM MÁT** (51) **02-05**
(22) 08/06/2023 (43) 25/12/2023
(30) 2023300932326 06/03/2023 CN; 2023300932275 06/03/2023 CN;
(73) **GUANGZHOU CICIBELLA INFORMATION TECHNOLOGY CO., LTD**
(CN)
Self-made part A2-51 of ABCD 1H1, Room 1901, No. 1 Hanjing Road, Tianhe District, Guangzhou, 510630 China
(72) 1. LINFENG CHEN (CN)
2. XUGUANG XU (CN)
(74) Công ty TNHH Dịch vụ Sở hữu trí tuệ BIG5 (BIG5 IP CO.,LTD)
(55)

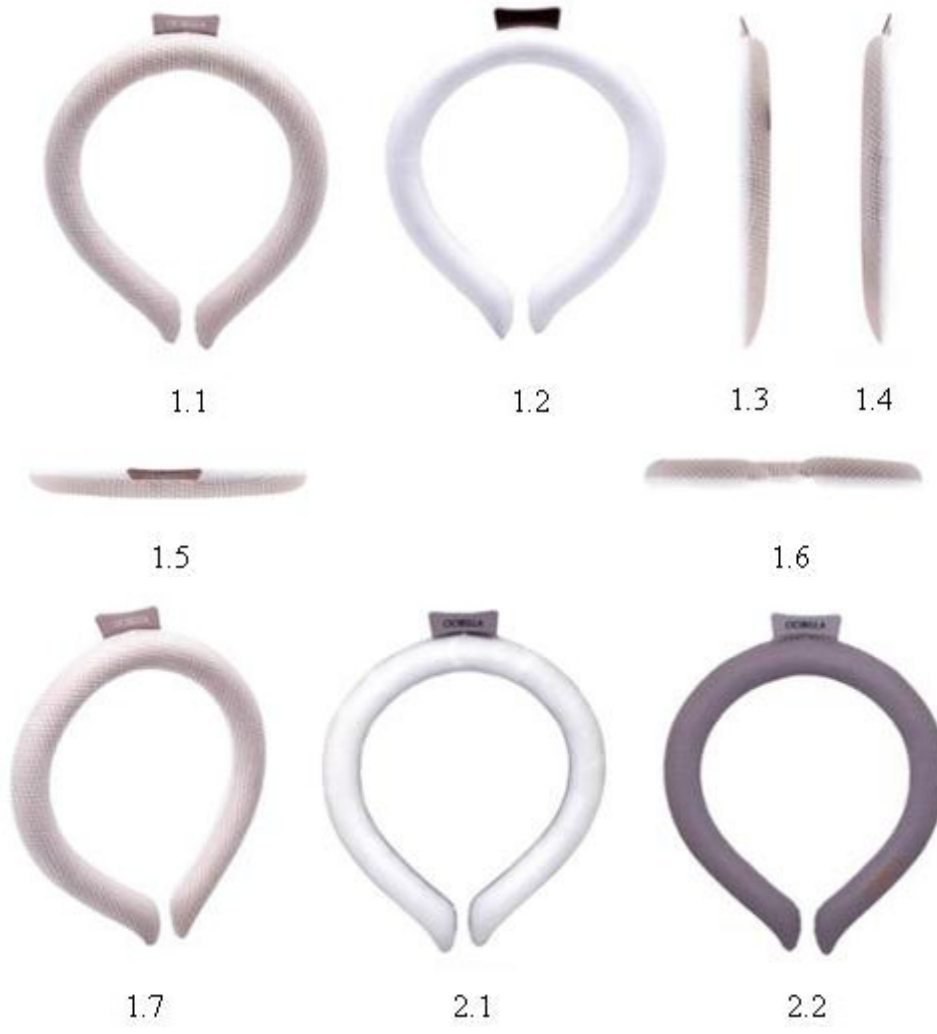



2.3



2.4



2.5



2.6



2.7

CÔNG BÁO SỞ HỮU CÔNG NGHIỆP SỐ 429 TẬP A – QUYỀN 2 (12.2023)

(11) **48809**

(21) 3-2023-01291

(28) 1

(54) **TẮT**

(51) **02-04**

(22) 12/06/2023

(43) 25/12/2023

(30) 015008191 09/01/2023 EM;

(73) **HENGSHUI YIQINGSHU HOSIERY CO., LTD. (CN)**

No. 89, Chunfeng West Street, Jizhou District, Hengshui, Hebei, China

(72) Du Guiyong (CN)

(74) Công ty TNHH Trà và cộng sự (TRA & ASSOCIATES CO.,LTD)

(55)



1.1



1.2



1.3



1.4



1.5



1.6



1.7



1.8

CÔNG BÁO SỞ HỮU CÔNG NGHIỆP SỐ 429 TẬP A – QUYỀN 2 (12.2023)

- (11) **48810**
- (21) 3-2023-01303 (28) 1
- (54) **XE Ô TÔ** (51) **12-08**
- (22) 14/06/2023 (43) 25/12/2023
- (30) 2022308363899 14/12/2022 CN;
- (73) **GREAT WALL MOTOR COMPANY LIMITED (CN)**
2266 Chaoyang South Street, Lianchi District, Baoding, Hebei, 071000, CHINA
- (72) 1. JI YUMING (CN)
2. WANG WEIYE (CN)
3. LU WEILONG (CN)
4. TANG LILI (CN)
5. LI YANKAI (CN)
6. WANG HAO (CN)
7. YANG ZELIN (CN)
8. LI BAOWANG (CN)
9. LI HUIXIAN (CN)
10. MO BAOQIANG (CN)
- (74) **CÔNG TY TRÁCH NHIỆM HỮU HẠN TƯ VẤN ĐẦU TƯ VÀ SỞ HỮU TRÍ TUỆ INTERFIVE (INTERFIVE CO., LTD)**
- (55)



1.1



1.2



1.3



1.4



1.5



1.6



1.7

CÔNG BÁO SỞ HỮU CÔNG NGHIỆP SỐ 429 TẬP A – QUYỀN 2 (12.2023)

- (11) **48811**
- (21) 3-2023-01305
- (54) **HỘP**
- (22) 14/06/2023
- (73) **CÔNG TY CỔ PHẦN NƯỚC GIẢI KHÁT SANEST KHÁNH HÒA (VN)**
Quốc lộ 1A, thôn Mỹ Thanh, xã Cam Thịnh Đông, thành phố Cam Ranh, tỉnh Khánh Hòa
- (72) Lê Đức Tiến (VN)
- (74) Công ty TNHH Tư vấn sở hữu trí tuệ Việt (VIET IP CO.,LTD.)
- (55)



1.1



1.2



1.3



1.4



1.5



1.6



1.7



1.8

CÔNG BÁO SỞ HỮU CÔNG NGHIỆP SỐ 429 TẬP A – QUYỀN 2 (12.2023)

- (11) **48812**
(21) 3-2023-01306 (28) 1
(54) **HỘP** (51) **09-03**
(22) 14/06/2023 (43) 25/12/2023
(73) **CÔNG TY CỔ PHẦN NƯỚC GIẢI KHÁT SANEST KHÁNH HÒA (VN)**
Quốc lộ 1A, thôn Mỹ Thanh, xã Cam Thịnh Đông, thành phố Cam Ranh, tỉnh
Khánh Hòa
(72) Lê Đức Tiến (VN)
(74) Công ty TNHH Tư vấn sở hữu trí tuệ Việt (VIET IP CO.,LTD.)
(55)



1.1



1.2



1.3



1.4



1.5



1.6



1.7



1.8

CÔNG BÁO SỞ HỮU CÔNG NGHIỆP SỐ 429 TẬP A – QUYỀN 2 (12.2023)

- (11) **48813**
- (21) 3-2023-01307
- (54) **HỘP**
- (22) 14/06/2023
- (73) **CÔNG TY CỔ PHẦN NƯỚC GIẢI KHÁT SANEST KHÁNH HÒA (VN)**
Quốc lộ 1A, thôn Mỹ Thanh, xã Cam Thịnh Đông, thành phố Cam Ranh, tỉnh Khánh Hòa
- (72) Lê Đức Tiến (VN)
- (74) Công ty TNHH Tư vấn sở hữu trí tuệ Việt (VIET IP CO.,LTD.)
- (55)



1.1



1.2



1.3



1.4



1.5



1.6



1.7



1.8

CÔNG BÁO SỞ HỮU CÔNG NGHIỆP SỐ 429 TẬP A – QUYỀN 2 (12.2023)

- (11) **48814**
(21) 3-2023-01313 (28) 1
(54) **LON ĐỰNG SẢN PHẨM** (51) **09-03**
(22) 15/06/2023 (43) 25/12/2023
(73) **CÔNG TY TNHH XNK NANOIL USA (VN)**
Lô Q13 đường số 11, KCN Hải Sơn mở rộng (GD 3+4), xã Đức Hòa Hạ, huyện Đức
Hoà, tỉnh Long An
(72) Mai Xuân Quang (VN)
(55)



1.1



1.2



1.3



1.4



1.5



1.6

CÔNG BÁO SỞ HỮU CÔNG NGHIỆP SỐ 429 TẬP A – QUYỀN 2 (12.2023)

- (11) **48815**
(21) 3-2023-01314 (28) 1
(54) **CẤU KIỆN TẠO RỔNG CHO SÀN BÊ TÔNG** (51) **25-01; 25-02**
(22) 15/06/2023 (43) 25/12/2023
(73) **CÔNG TY CỔ PHẦN TƯ VẤN VÀ ĐẦU TƯ XÂY DỰNG 304 (VN)**
Số 8 tổ 25B khu 3, phường Cao Thắng, thành phố Hạ Long, tỉnh Quảng Ninh
(72) Nguyễn Văn Nam (VN)
(55)



1.1



1.2

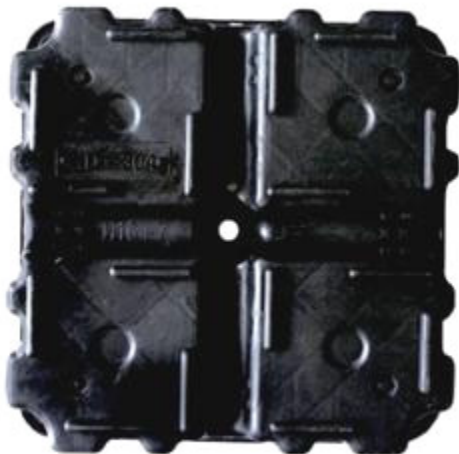

1.3

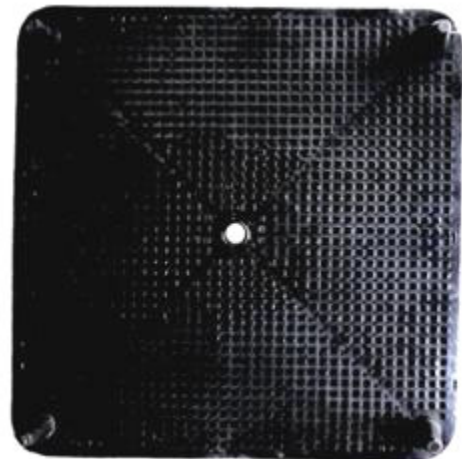

1.4



1.5



1.6

- (11) **48816**
(21) 3-2023-01317 (28) 1
(54) **TÚI ĐỰNG SẢN PHẨM** (51) **09-05**
(22) 15/06/2023 (43) 25/12/2023
(73) **DƯƠNG TUẤN ANH (VN)**
Tổ 2, phường Tây Sơn, thành phố Tam Điệp, tỉnh Ninh Bình
(72) Dương Tuấn Anh (VN)
(55)



1.1



1.2

CÔNG BÁO SỞ HỮU CÔNG NGHIỆP SỐ 429 TẬP A – QUYỀN 2 (12.2023)

(11) **48817**

(21) 3-2023-01332

(28) 2

(54) **GHẾ SOFA**

(51) **06-01**

(22) 16/06/2023

(43) 25/12/2023

(73) **CÔNG TY TNHH NỘI THẤT TIVANY (VIỆT NAM) (VN)**

Số 304/16, đường Đồng Khởi, khu 3, phường Hòa Phú, thành phố Thủ Dầu Một, tỉnh Bình Dương

(72) 1. JIANG PING (CN)

2. ZHOU XIAO MING (CN)

3. KUMARAN ARUMUGAM KRISHNADAS (LK)

4. ANAGHA YOGESH PADGAOKAR (US)

(55)



1.1



1.2



1.3



1.4



1.5

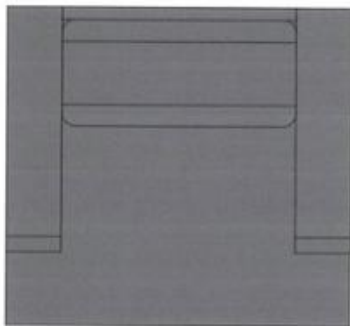

1.6

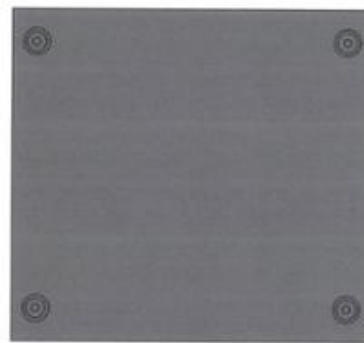

1.7

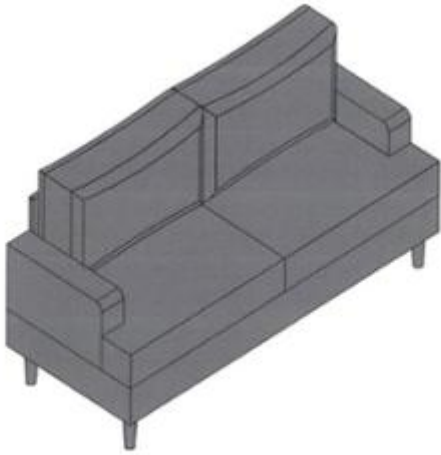

2.1

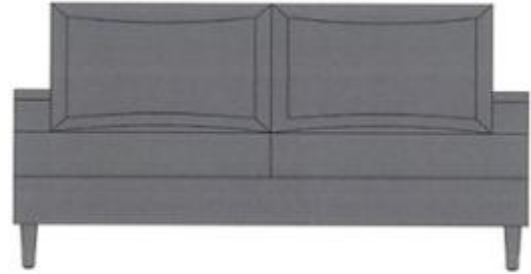

2.2



2.3



2.4

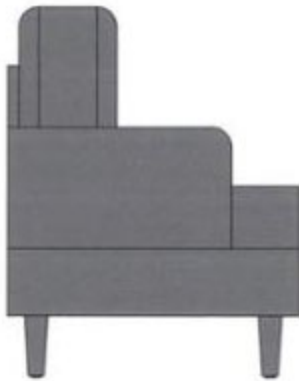

2.5



2.6



2.7

CÔNG BÁO SỞ HỮU CÔNG NGHIỆP SỐ 429 TẬP A – QUYỀN 2 (12.2023)

- (11) **48818**
(21) 3-2023-01342 (28) 1
(54) **ĐÈN XE MÁY** (51) **26-06**
(22) 16/06/2023 (43) 25/12/2023
(30) 202230845565.5 17/12/2022 CN;
(73) **DONGGUANSHI ZHUOSHI INTELLIGENT TECH CO., LTD (CN)**
Room 301, No.3 Hongmian Road, Shangjiao, Chang'an Town, Dongguan City,
Guangdong Province 523841, China
(72) WenShu ZHOU (CN)
(74) Công ty TNHH Dịch vụ Sở hữu trí tuệ BIG5 (BIG5 IP CO.,LTD)
(55)

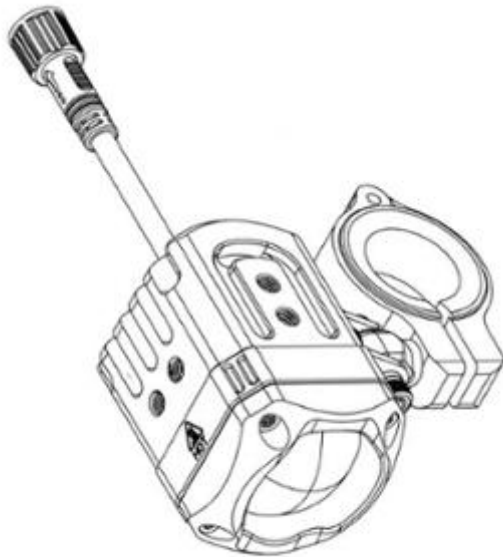

1.1



1.2



1.3

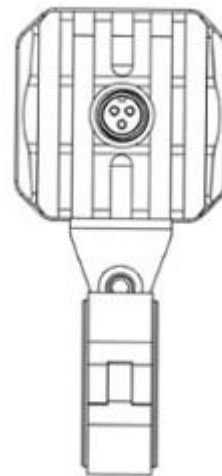

1.4

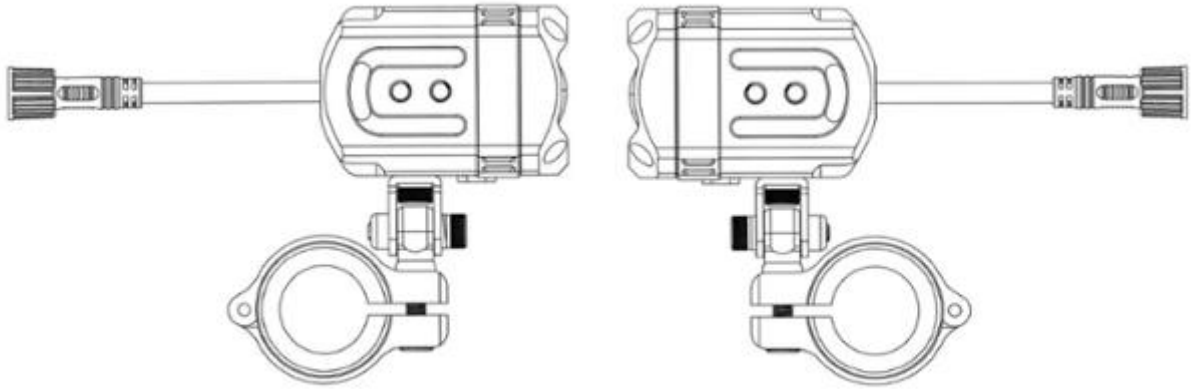

1.5

1.6

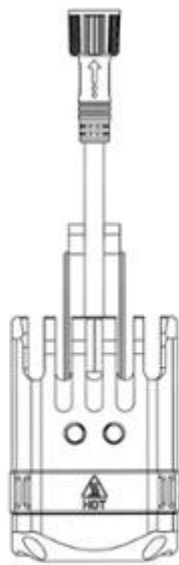

1.7

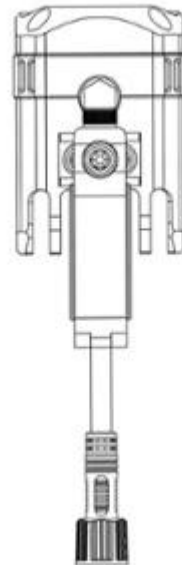

1.8

CÔNG BÁO SỞ HỮU CÔNG NGHIỆP SỐ 429 TẬP A – QUYỀN 2 (12.2023)

- (11) **48819**
(21) 3-2023-01349 (28) 1
(54) **BỘ ĐÈN PHÍA TRƯỚC CỦA Ô TÔ** (51) **26-06**
(22) 18/06/2020 (43) 25/12/2023
(30) 2019-028436 20/12/2019 JP;
(73) **TOYOTA JIDOSHA KABUSHIKI KAISHA (JP)**
1, Toyota-cho, Toyota-shi, Aichi-ken, 471-8571 JAPAN
(72) Peter Anthony Elliott (AU)
(74) Công ty TNHH một thành viên Sở hữu trí tuệ VCCI (VCCI-IP CO.,LTD)
(55)



1.1



1.2



1.3



1.4



1.5



1.6



1.7

CÔNG BÁO SỞ HỮU CÔNG NGHIỆP SỐ 429 TẬP A – QUYỀN 2 (12.2023)

- (11) **48820**
(21) 3-2023-01351 (28) 1
(54) **BAO GÓI** (51) **09-05**
(22) 19/06/2023 (43) 25/12/2023
(73) **ORION CORPORATION (KR)**
13, Baekbeom-ro 90da-gil, Yongsan-gu, Seoul 04369, Republic of Korea
(72) 1. CHOE, EUN JE (KR)
2. OH, HYUN SUN (KR)
(74) Công ty Luật TNHH quốc tế BMVN (BMVN INTERNATIONAL LLC)
(55)



1.1



1.2

CÔNG BÁO SỞ HỮU CÔNG NGHIỆP SỐ 429 TẬP A – QUYỀN 2 (12.2023)

- (11) **48821**
- (21) 3-2023-01352 (28) 1
- (54) **NHÃN SẢN PHẨM** (51) **19-08**
- (22) 19/06/2023 (43) 25/12/2023
- (73) **CÔNG TY TNHH CHẾ BIẾN HẢI SẢN BA LÀNG (VN)**
Nhà ông Nguyễn Văn Tuyên, thôn Quang Minh, phường Hải Thanh, thị xã Nghi Sơn, tỉnh Thanh Hoá
- (72) Nguyễn Văn Tuyên (VN)
- (74) Công ty TNHH NACILAW (NACILAW)
- (55)



(11) **48822**

(21) 3-2023-01358

(28) 1

(54) **BỒN CHỨA**

(51) **23-01; 23-99**

(22) 20/06/2023

(43) 25/12/2023

(73) **CÔNG TY CỔ PHẦN QUỐC TẾ SATA (VN)**

Số 9, ngách 43/98, TDP Đống 6, đường Cổ Nhuế, phường Cổ Nhuế 2, quận Bắc Từ Liêm, thành phố Hà Nội

(72) 1. BIÊN VĂN BẢY (VN)

2. NGUYỄN VĂN THANH (VN)

3. TRỊNH THỊ PHƯƠNG (VN)

4. LÊ THỊ HẰNG (VN)

(74) Công ty TNHH Nghiên cứu và Tư vấn chuyển giao công nghệ và đầu tư (CONCETTI)

(55)



1.1



1.2



1.3



1.4



1.5



1.6



1.7

CÔNG BÁO SỞ HỮU CÔNG NGHIỆP SỐ 429 TẬP A – QUYỀN 2 (12.2023)

- (11) **48823**
(21) 3-2023-01363 (28) 3
(54) **BÚT** (51) **19-06**
(22) 20/06/2023 (43) 25/12/2023
(73) **CÔNG TY CỔ PHẦN VĂN PHÒNG PHẨM HỒNG HÀ (VN)**
25 Lý Thường Kiệt, phường Phan Chu Trinh, quận Hoàn Kiếm, thành phố Hà Nội
(72) Phạm Trung Kiên (VN)
(55)

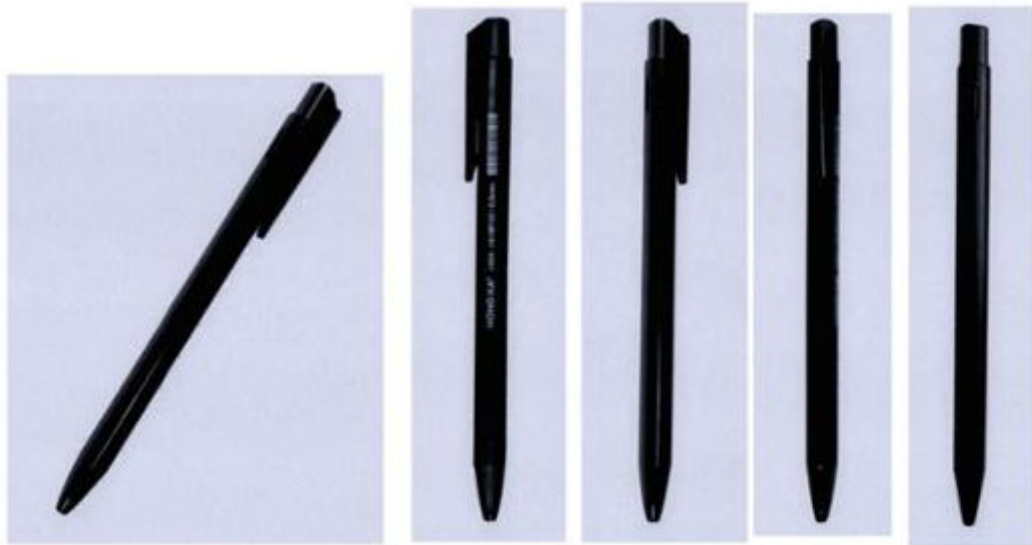

1.1

1.2

1.3

1.4

1.5



1.6



1.7

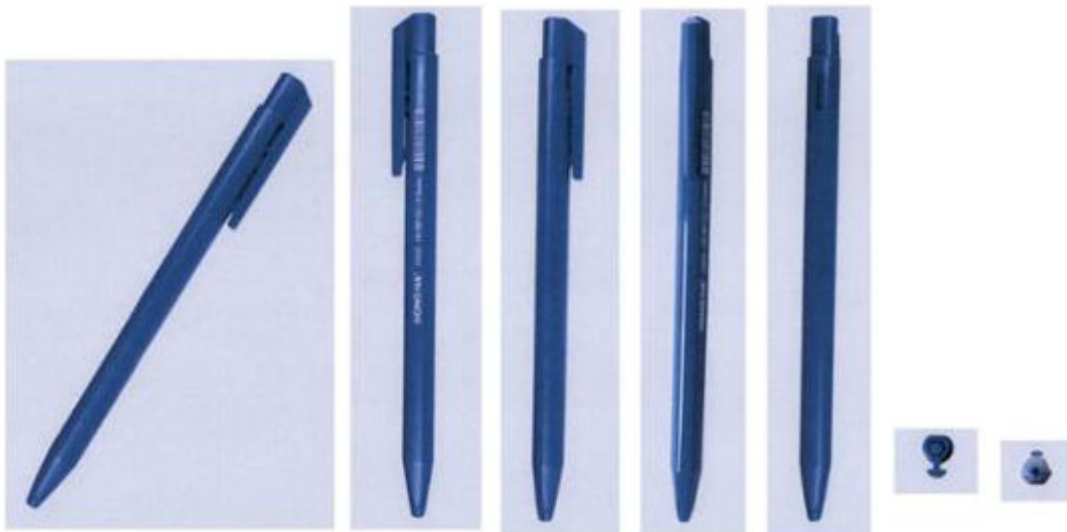

2.1

2.2

2.3

2.4

2.5

2.6

2.7



3.1



3.2



3.3



3.4



3.5



3.6



3.7

CÔNG BÁO SỞ HỮU CÔNG NGHIỆP SỐ 429 TẬP A – QUYỀN 2 (12.2023)

- (11) **48824**
(21) 3-2023-01364 (28) 3
(54) **BÚT** (51) **19-06**
(22) 20/06/2023 (43) 25/12/2023
(73) **CÔNG TY CỔ PHẦN VĂN PHÒNG PHẨM HỒNG HÀ (VN)**
25 Lý Thường Kiệt, phường Phan Chu Trinh, quận Hoàn Kiếm, thành phố Hà Nội
(72) Phạm Trung Kiên (VN)
(55)



1.1 1.2 1.3 1.4 1.5 1.6 1.7



2.1 2.2 2.3 2.4 2.5



2.6



2.7



3.1



3.2



3.3



3.4



3.5



3.6



3.7

CÔNG BÁO SỞ HỮU CÔNG NGHIỆP SỐ 429 TẬP A – QUYỀN 2 (12.2023)

- (11) **48825**
- (21) 3-2023-01365 (28) 2
- (54) **BÚT** (51) **19-06**
- (22) 20/06/2023 (43) 25/12/2023
- (73) **CÔNG TY CỔ PHẦN VĂN PHÒNG PHẨM HỒNG HÀ (VN)**
25 Lý Thường Kiệt, phường Phan Chu Trinh, quận Hoàn Kiếm, thành phố Hà Nội
- (72) Phạm Trung Kiên (VN)
- (55)



1.1

1.2

1.3

1.4

1.5

1.6

1.7



2.1

2.2

2.3

2.4

2.5



2.6



2.7

CÔNG BÁO SỞ HỮU CÔNG NGHIỆP SỐ 429 TẬP A – QUYỀN 2 (12.2023)

(11) **48826**

(21) 3-2023-01366

(28) 4

(54) **BÚT**

(51) **19-06**

(22) 20/06/2023

(43) 25/12/2023

(73) **CÔNG TY CỔ PHẦN VĂN PHÒNG PHẨM HỒNG HÀ (VN)**

25 Lý Thường Kiệt, phường Phan Chu Trinh, quận Hoàn Kiếm, thành phố Hà Nội

(72) Phạm Trung Kiên (VN)

(55)

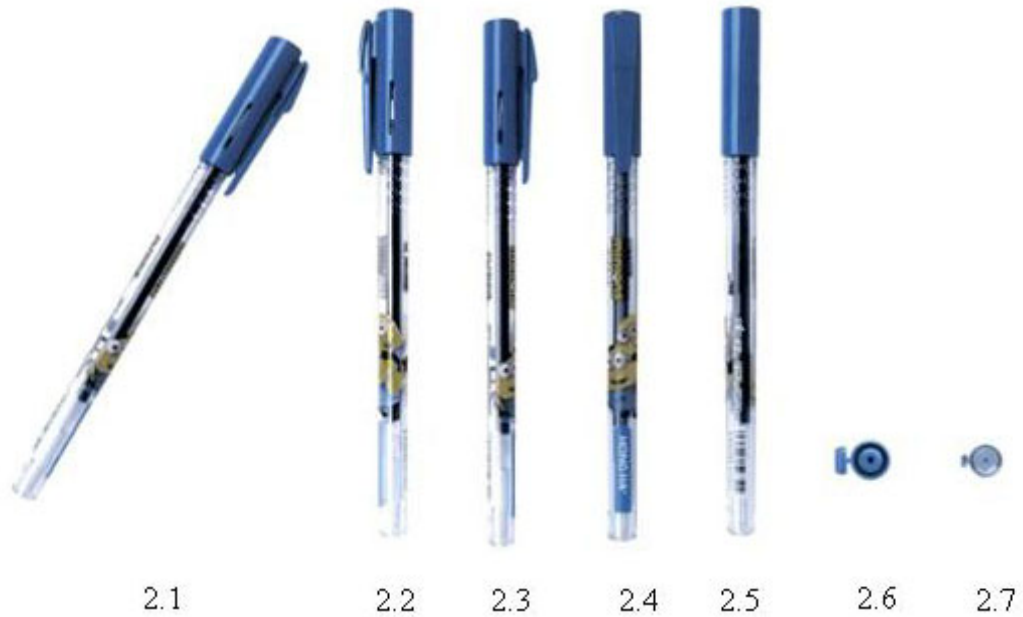



3.1



3.2



3.3



3.4



3.5



3.6



3.7



4.1



4.2



4.3



4.4



4.5



4.6



4.7

CÔNG BÁO SỞ HỮU CÔNG NGHIỆP SỐ 429 TẬP A – QUYỀN 2 (12.2023)

- (11) **48827**
(21) 3-2023-01367 (28) 4
(54) **BÚT** (51) **19-06**
(22) 20/06/2023 (43) 25/12/2023
(73) **CÔNG TY CỔ PHẦN VĂN PHÒNG PHẨM HỒNG HÀ (VN)**
25 Lý Thường Kiệt, phường Phan Chu Trinh, quận Hoàn Kiếm, thành phố Hà Nội
(72) Phạm Trung Kiên (VN)
(55)



1.1 1.2 1.3 1.4 1.5 1.6 1.7



2.1 2.2 2.3 2.4 2.5 2.6 2.7



3.1



3.2



3.3



3.4



3.5



3.6



3.7



4.1



4.2



4.3

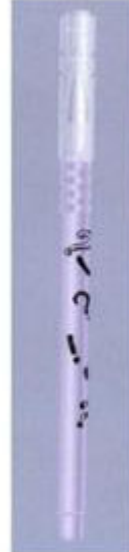

4.4



4.5



4.6



4.7

CÔNG BÁO SỞ HỮU CÔNG NGHIỆP SỐ 429 TẬP A – QUYỀN 2 (12.2023)

- (11) **48828**
(21) 3-2023-01368 (28) 4
(54) **BÚT** (51) **19-06**
(22) 20/06/2023 (43) 25/12/2023
(73) **CÔNG TY CỔ PHẦN VĂN PHÒNG PHẨM HỒNG HÀ (VN)**
25 Lý Thường Kiệt, phường Phan Chu Trinh, quận Hoàn Kiếm, thành phố Hà Nội
(72) Phạm Trung Kiên (VN)
(55)

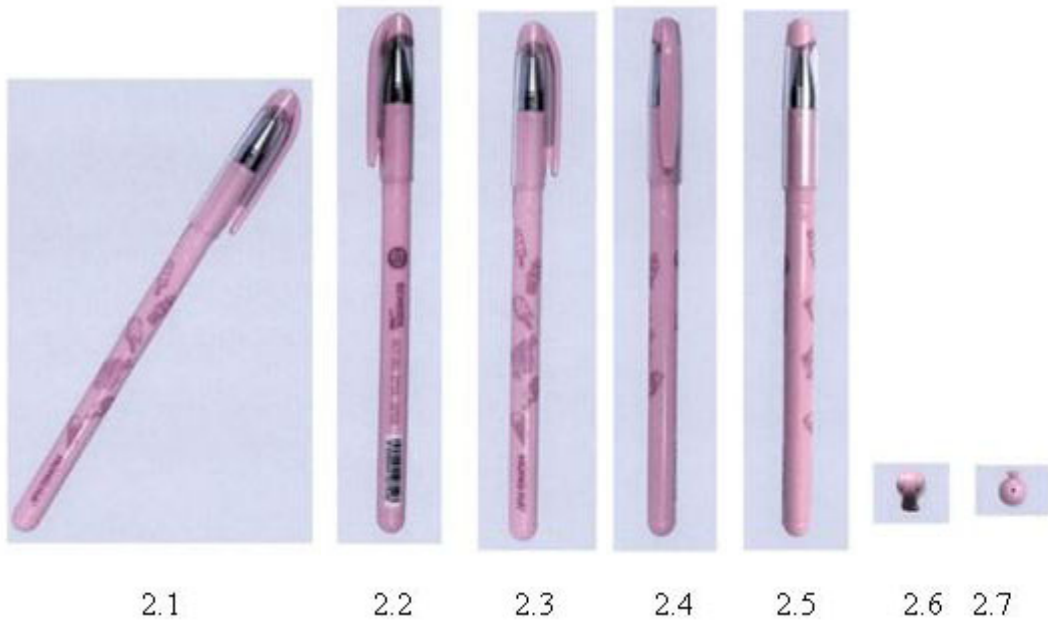



3.1



3.2



3.3



3.4



3.5



3.6



3.7



4.1



4.2



4.3



4.4



4.5



4.6



4.7

CÔNG BÁO SỞ HỮU CÔNG NGHIỆP SỐ 429 TẬP A – QUYỀN 2 (12.2023)

- (11) **48829**
(21) 3-2023-01372 (28) 1
(54) **HỆ THỐNG TỰ ĐỘNG XỬ LÝ NƯỚC** (51) **23-01**
(22) 21/06/2023 (43) 25/12/2023
(73) **CÔNG TY CỔ PHẦN CÔNG NGHỆ MÔI TRƯỜNG VTECH VIỆT NAM**
(VN)
Số 7, phố Vân Hồ 3, phường Lê Đại Hành, quận Hai Bà Trưng, thành phố Hà Nội
(72) Trần Xuân Tiến (VN)
(74) Công ty TNHH Lê & Lê (LE & LE)
(55)

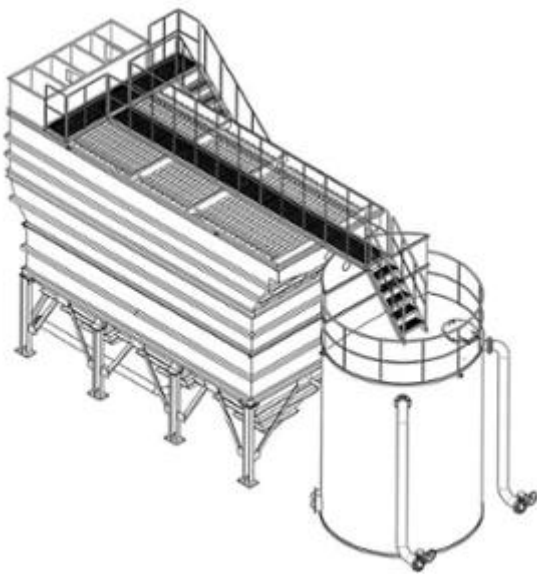

1.1

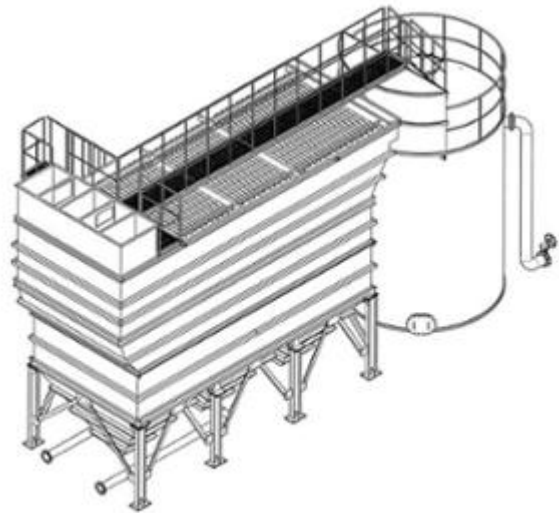

1.2

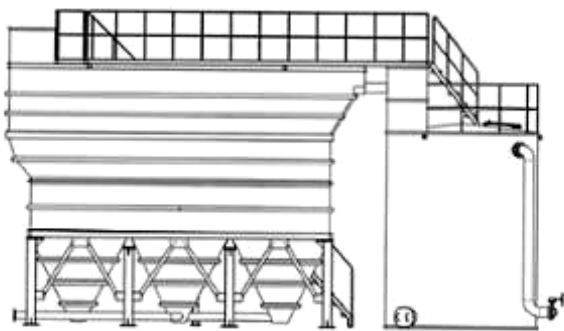

1.3

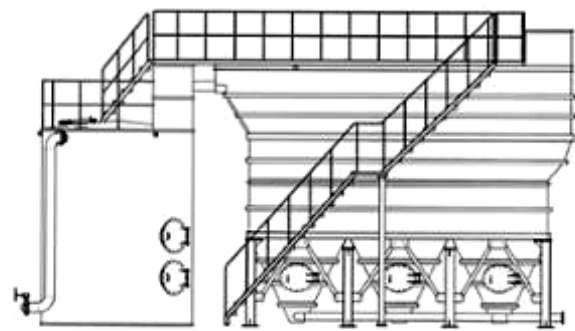

1.4

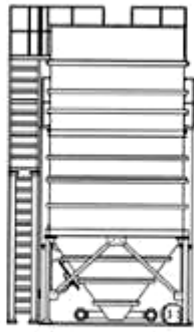

1.5

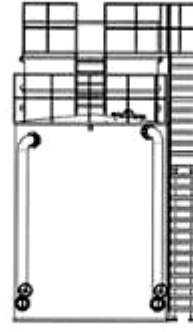

1.6

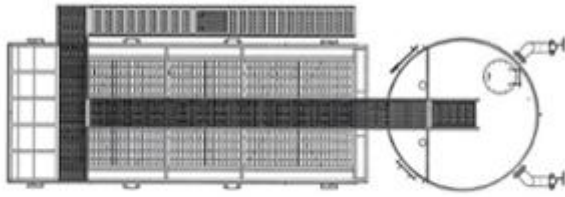

1.7

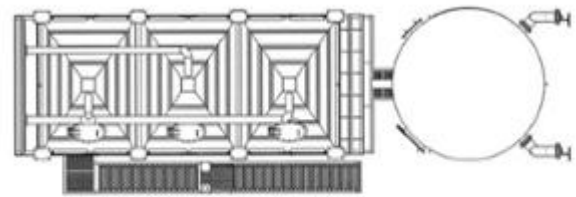

1.8

CÔNG BÁO SỞ HỮU CÔNG NGHIỆP SỐ 429 TẬP A – QUYỀN 2 (12.2023)

- (11) **48830**
(21) 3-2023-01373 (28) 1
(54) **GẠCH** (51) **25-01**
(22) 21/06/2023 (43) 25/12/2023
(73) **HÀ NGỌC TUÂN (VN)**
Tổ 1, thị trấn Chi Đông, huyện Mê Linh, thành phố Hà Nội
(72) Hà Ngọc Tuân (VN)
(74) Công ty Luật TNHH ELITE (ELITE LAW FIRM)
(55)

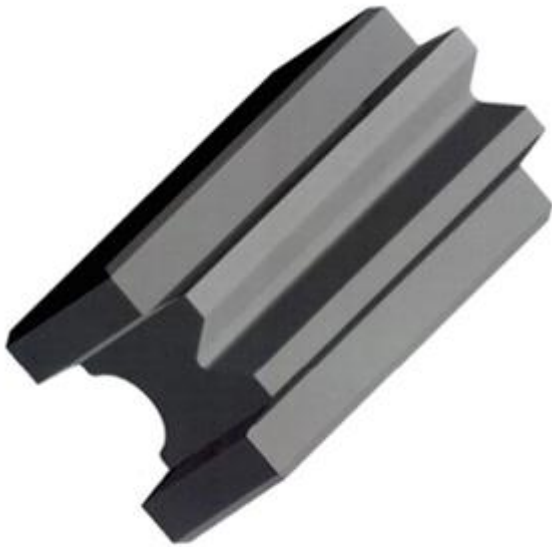

1.1



1.2

1.3



1.4



1.5



1.6



1.7

CÔNG BÁO SỞ HỮU CÔNG NGHIỆP SỐ 429 TẬP A – QUYỀN 2 (12.2023)

- (11) **48831**
(21) 3-2023-01374 (28) 1
(54) **GẠCH** (51) **25-01**
(22) 21/06/2023 (43) 25/12/2023
(73) **HÀ NGỌC TUÂN (VN)**
Tổ 1, thị trấn Chi Đông, huyện Mê Linh, thành phố Hà Nội
(72) Hà Ngọc Tuân (VN)
(74) Công ty Luật TNHH ELITE (ELITE LAW FIRM)
(55)



1.1

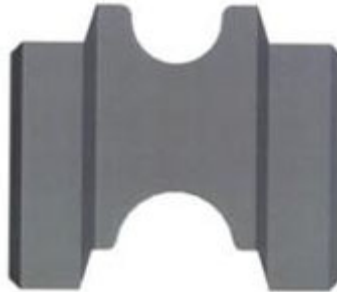

1.2



1.3



1.4



1.5



1.6



1.7

CÔNG BÁO SỞ HỮU CÔNG NGHIỆP SỐ 429 TẬP A – QUYỀN 2 (12.2023)

- (11) **48832**
(21) 3-2023-01375 (28) 1
(54) **DÂY NHỰA ĐÚC** (51) **09-06**
(22) 21/06/2023 (43) 25/12/2023
(73) **SUN HSIEN - WEI (TW)**
Thửa đất 2588, tờ bản đồ 14, tổ 4, ấp Phú Thuận, xã Phú An, thị xã Bến Cát, tỉnh Bình Dương
(72) Sun Hsien - Wei (TW)
(74) Công ty Cổ phần Sở hữu công nghiệp INVESTIP (INVESTIP)
(55)



1.1



1.2



1.3

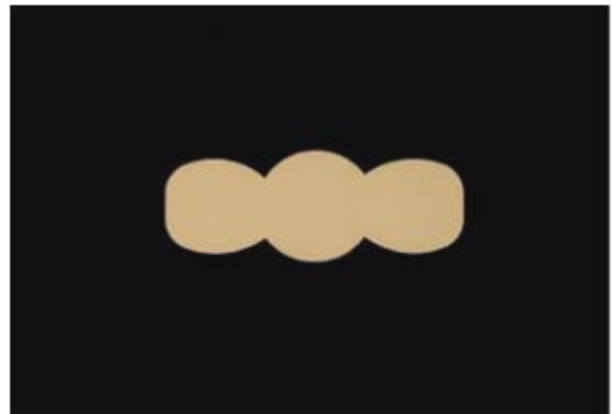

1.4

CÔNG BÁO SỞ HỮU CÔNG NGHIỆP SỐ 429 TẬP A – QUYỀN 2 (12.2023)

- (11) **48833**
(21) 3-2023-01376 (28) 1
(54) **DÂY NHỰA ĐÚC** (51) **09-06**
(22) 21/06/2023 (43) 25/12/2023
(73) **SUN HSIEN - WEI (TW)**
Thửa đất 2588, tờ bản đồ 14, tổ 4, ấp Phú Thuận, xã Phú An, thị xã Bến Cát, tỉnh Bình Dương
(72) Sun Hsien - Wei (TW)
(74) Công ty Cổ phần Sở hữu công nghiệp INVESTIP (INVESTIP)
(55)



1.1

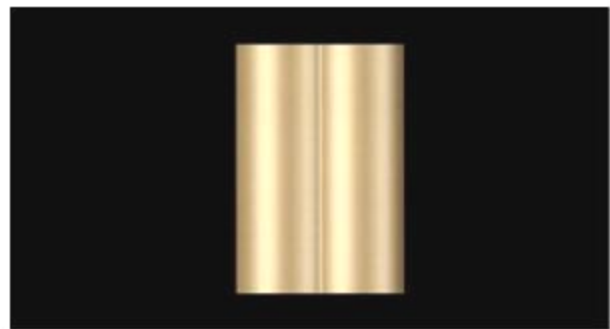

1.2

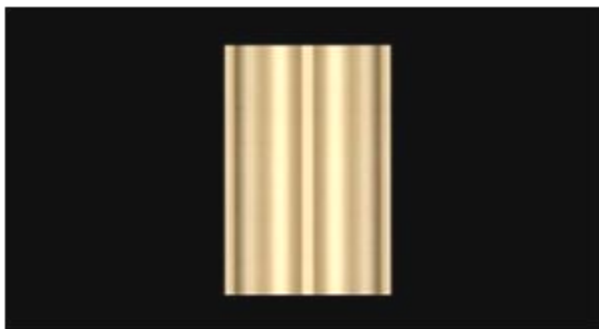

1.3



1.4

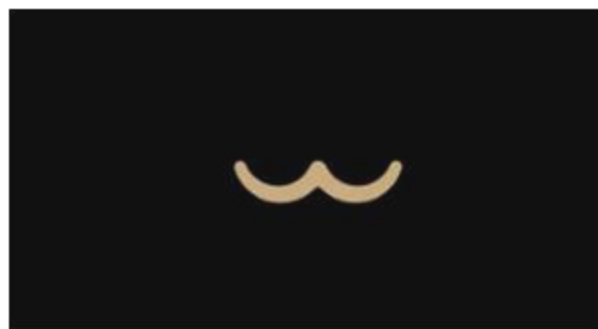

1.5

CÔNG BÁO SỞ HỮU CÔNG NGHIỆP SỐ 429 TẬP A – QUYỀN 2 (12.2023)

- (11) **48834**
(21) 3-2023-01377 (28) 1
(54) **DÂY NHỰA ĐÚC** (51) **09-06**
(22) 21/06/2023 (43) 25/12/2023
(73) **SUN HSIEN - WEI (TW)**
Thửa đất 2588, tờ bản đồ 14, tổ 4, ấp Phú Thuận, xã Phú An, thị xã Bến Cát, tỉnh Bình Dương
(72) Sun Hsien - Wei (TW)
(74) Công ty Cổ phần Sở hữu công nghiệp INVESTIP (INVESTIP)
(55)



1.1



1.2



1.3

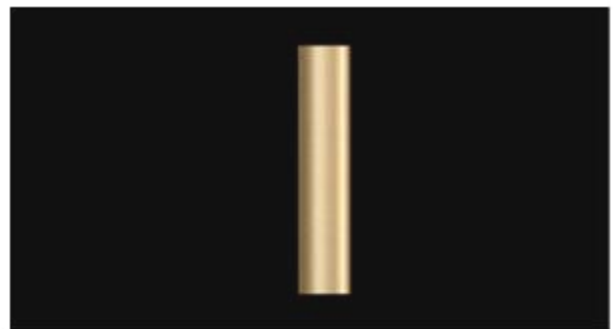

1.4

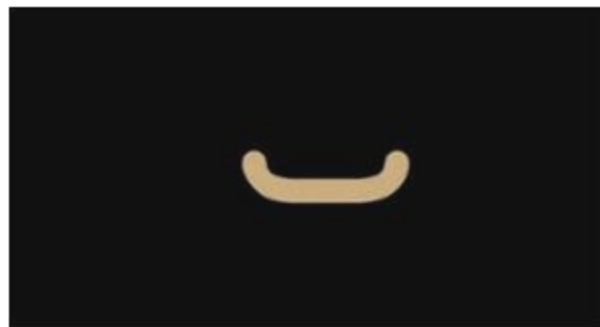

1.5

CÔNG BÁO SỞ HỮU CÔNG NGHIỆP SỐ 429 TẬP A – QUYỀN 2 (12.2023)

- (11) **48835**
(21) 3-2023-01378 (28) 1
(54) **DÂY NHỰA ĐÚC** (51) **09-06**
(22) 21/06/2023 (43) 25/12/2023
(73) **SUN HSIEN - WEI (TW)**
Thửa đất 2588, tờ bản đồ 14, tổ 4, ấp Phú Thuận, xã Phú An, thị xã Bến Cát, tỉnh Bình Dương
(72) Sun Hsien - Wei (TW)
(74) Công ty Cổ phần Sở hữu công nghiệp INVESTIP (INVESTIP)
(55)



1.1



1.2

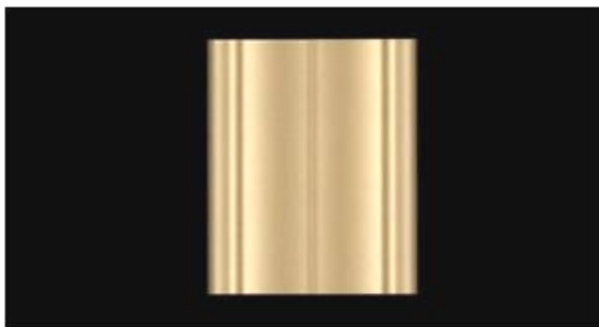

1.3

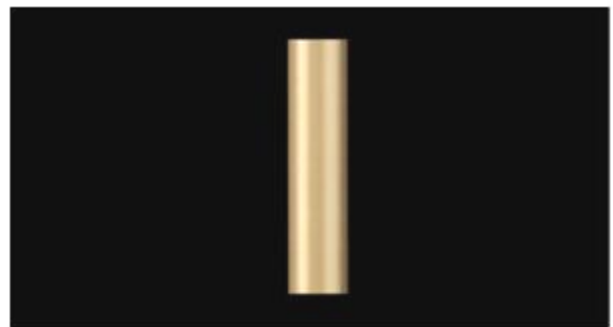

1.4

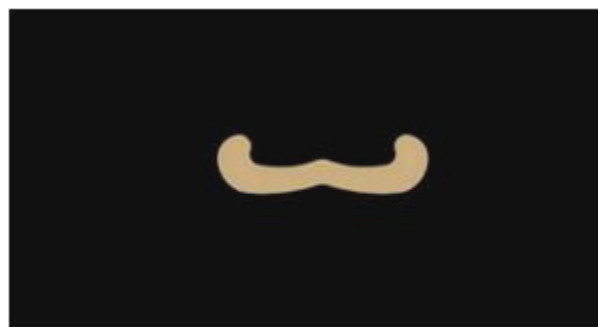

1.5

CÔNG BÁO SỞ HỮU CÔNG NGHIỆP SỐ 429 TẬP A – QUYỀN 2 (12.2023)

- (11) **48836**
(21) 3-2023-01379 (28) 1
(54) **DÂY NHỰA ĐÚC** (51) **09-06**
(22) 21/06/2023 (43) 25/12/2023
(73) **SUN HSIEN - WEI (TW)**
Thửa đất 2588, tờ bản đồ 14, tổ 4, ấp Phú Thuận, xã Phú An, thị xã Bến Cát, tỉnh Bình Dương
(72) Sun Hsien - Wei (TW)
(74) Công ty Cổ phần Sở hữu công nghiệp INVESTIP (INVESTIP)
(55)

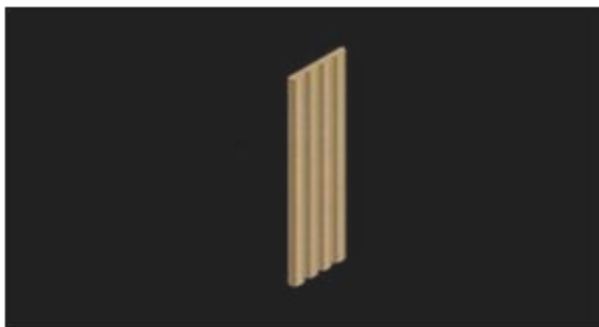

1.1



1.2



1.3



1.4

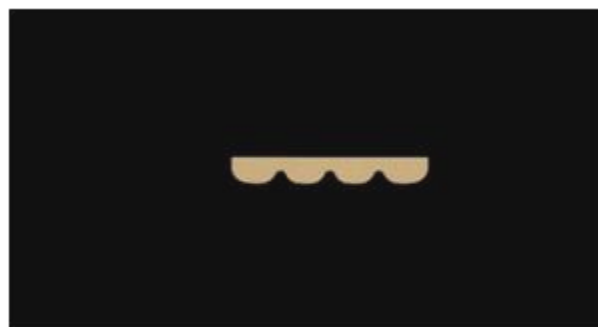

1.5

CÔNG BÁO SỞ HỮU CÔNG NGHIỆP SỐ 429 TẬP A – QUYỀN 2 (12.2023)

- (11) **48837**
(21) 3-2023-01380 (28) 1
(54) **DÂY NHỰA ĐÚC** (51) **09-06**
(22) 21/06/2023 (43) 25/12/2023
(73) **SUN HSIEN - WEI (TW)**
Thửa đất 2588, tờ bản đồ 14, tổ 4, ấp Phú Thuận, xã Phú An, thị xã Bến Cát, tỉnh Bình Dương
(72) Sun Hsien - Wei (TW)
(74) Công ty Cổ phần Sở hữu công nghiệp INVESTIP (INVESTIP)
(55)



1.1



1.2



1.3



1.4

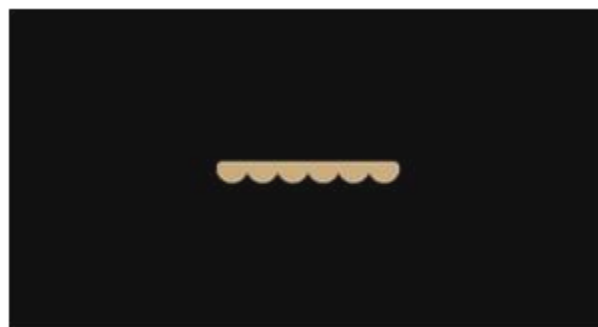

1.5

CÔNG BÁO SỞ HỮU CÔNG NGHIỆP SỐ 429 TẬP A – QUYỀN 2 (12.2023)

- (11) **48838**
(21) 3-2023-01381 (28) 1
(54) **DÂY NHỰA ĐÚC** (51) **09-06**
(22) 21/06/2023 (43) 25/12/2023
(73) **SUN HSIEN - WEI (TW)**
Thửa đất 2588, tờ bản đồ 14, tổ 4, ấp Phú Thuận, xã Phú An, thị xã Bến Cát, tỉnh Bình Dương
(72) Sun Hsien - Wei (TW)
(74) Công ty Cổ phần Sở hữu công nghiệp INVESTIP (INVESTIP)
(55)



1.1



1.2



1.3

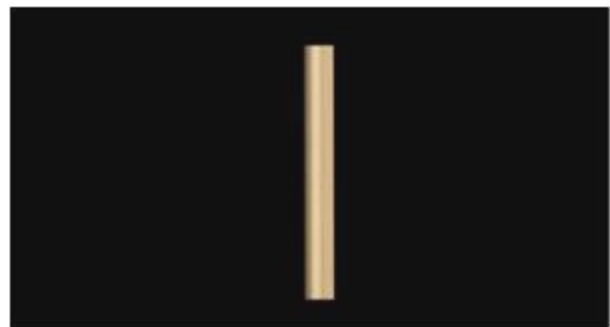

1.4

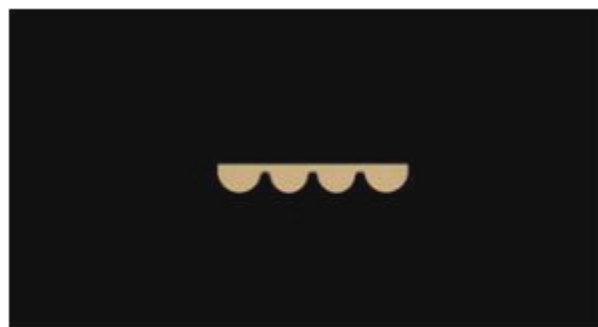

1.5

CÔNG BÁO SỞ HỮU CÔNG NGHIỆP SỐ 429 TẬP A – QUYỀN 2 (12.2023)

- (11) **48839**
(21) 3-2023-01382 (28) 1
(54) **DÂY NHỰA ĐÚC** (51) **09-06**
(22) 21/06/2023 (43) 25/12/2023
(73) **SUN HSIEN - WEI (TW)**
Thửa đất 2588, tờ bản đồ 14, tổ 4, ấp Phú Thuận, xã Phú An, thị xã Bến Cát, tỉnh Bình Dương
(72) Sun Hsien - Wei (TW)
(74) Công ty Cổ phần Sở hữu công nghiệp INVESTIP (INVESTIP)
(55)



1.1

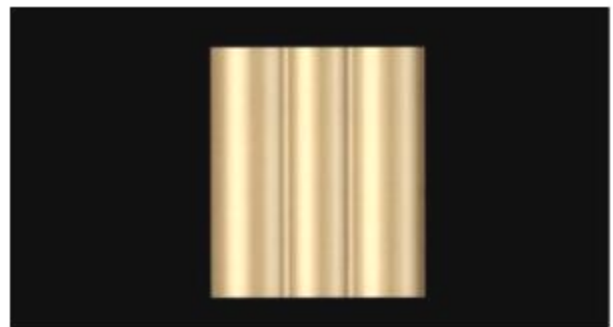

1.2

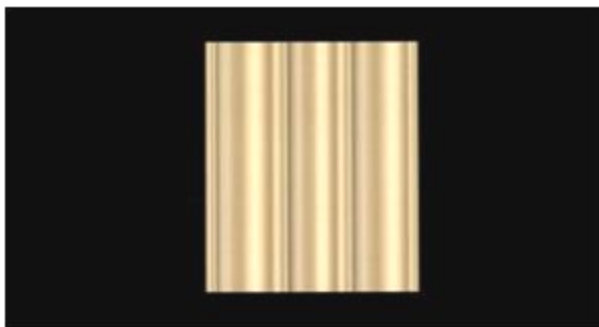

1.3

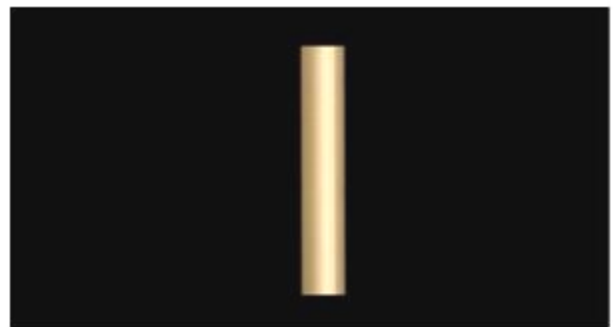

1.4

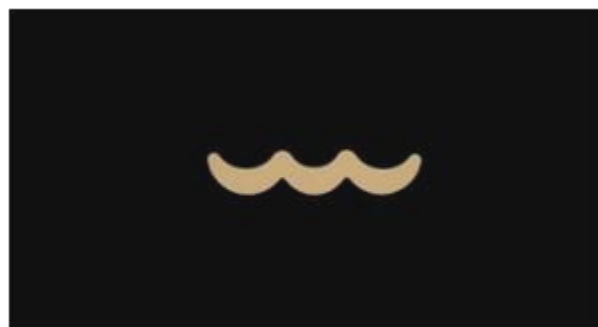

1.5

CÔNG BÁO SỞ HỮU CÔNG NGHIỆP SỐ 429 TẬP A – QUYỀN 2 (12.2023)

- (11) **48840**
(21) 3-2023-01383 (28) 1
(54) **DÂY NHỰA ĐÚC** (51) **09-06**
(22) 21/06/2023 (43) 25/12/2023
(73) **SUN HSIEN - WEI (TW)**
Thửa đất 2588, tờ bản đồ 14, tổ 4, ấp Phú Thuận, xã Phú An, thị xã Bến Cát, tỉnh Bình Dương
(72) Sun Hsien - Wei (TW)
(74) Công ty Cổ phần Sở hữu công nghiệp INVESTIP (INVESTIP)
(55)



1.1



1.2

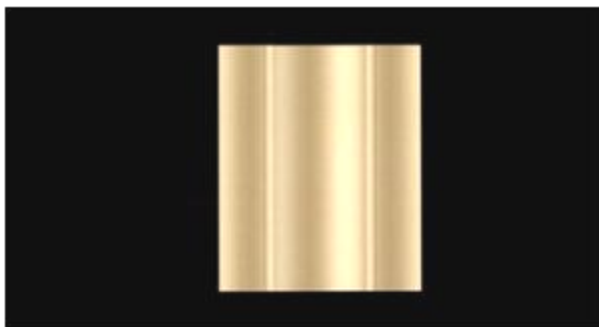

1.3

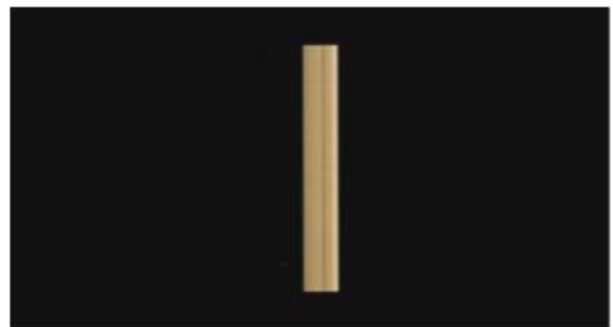

1.4



1.5

CÔNG BÁO SỞ HỮU CÔNG NGHIỆP SỐ 429 TẬP A – QUYỀN 2 (12.2023)

- (11) **48841**
(21) 3-2023-01384 (28) 1
(54) **DÂY NHỰA ĐÚC** (51) **09-06**
(22) 21/06/2023 (43) 25/12/2023
(73) **SUN HSIEN - WEI (TW)**
Thửa đất 2588, tờ bản đồ 14, tổ 4, ấp Phú Thuận, xã Phú An, thị xã Bến Cát, tỉnh Bình Dương
(72) Sun Hsien - Wei (TW)
(74) Công ty Cổ phần Sở hữu công nghiệp INVESTIP (INVESTIP)
(55)



1.1

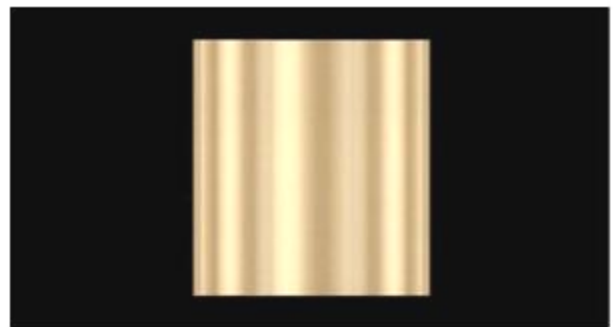

1.2

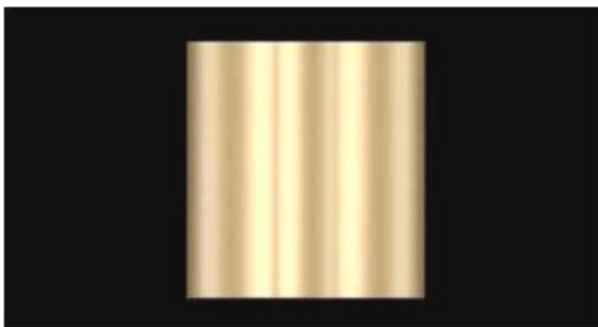

1.3



1.4

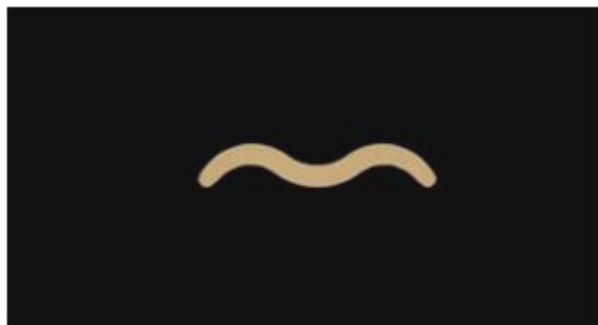

1.5

CÔNG BÁO SỞ HỮU CÔNG NGHIỆP SỐ 429 TẬP A – QUYỀN 2 (12.2023)

- (11) **48842**
(21) 3-2023-01385 (28) 1
(54) **DÂY NHỰA ĐÚC** (51) **09-06**
(22) 21/06/2023 (43) 25/12/2023
(73) **SUN HSIEN - WEI (TW)**
Thửa đất 2588, tờ bản đồ 14, tổ 4, ấp Phú Thuận, xã Phú An, thị xã Bến Cát, tỉnh Bình Dương
(72) Sun Hsien - Wei (TW)
(74) Công ty Cổ phần Sở hữu công nghiệp INVESTIP (INVESTIP)
(55)

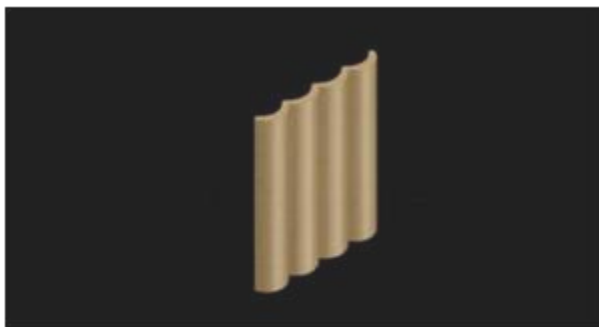

1.1

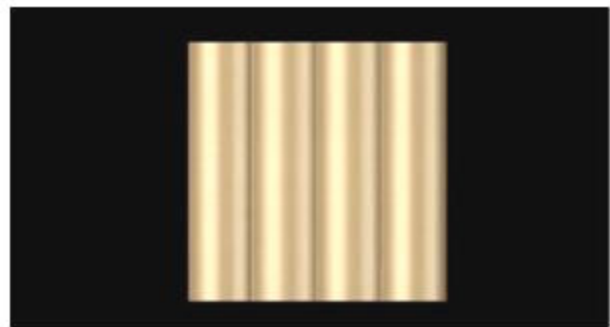

1.2

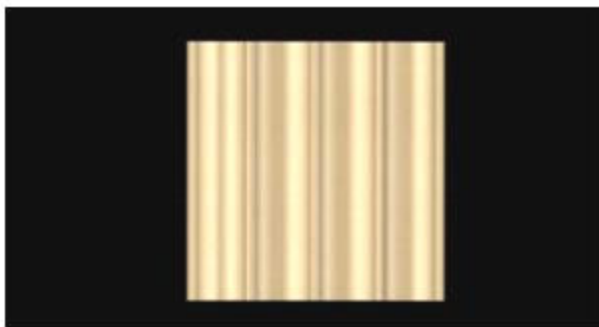

1.3

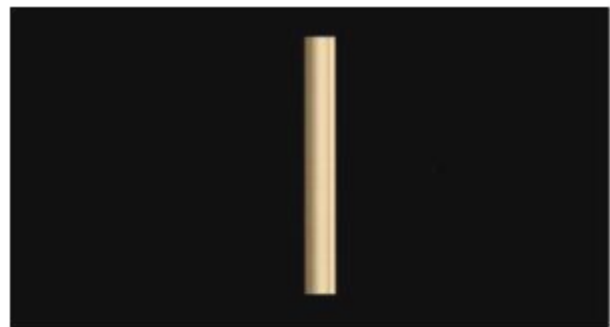

1.4

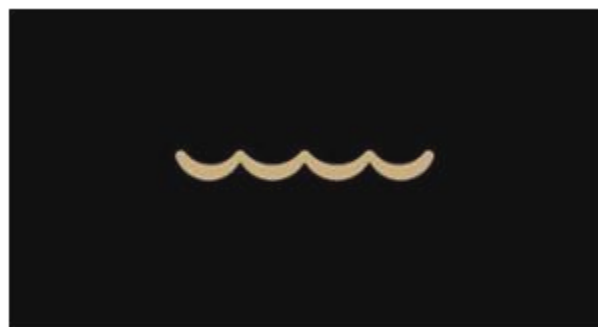

1.5

CÔNG BÁO SỞ HỮU CÔNG NGHIỆP SỐ 429 TẬP A – QUYỀN 2 (12.2023)

- (11) **48843**
(21) 3-2023-01386 (28) 1
(54) **DÂY NHỰA ĐÚC** (51) **09-06**
(22) 21/06/2023 (43) 25/12/2023
(73) **SUN HSIEN - WEI (TW)**
Thửa đất 2588, tờ bản đồ 14, tổ 4, ấp Phú Thuận, xã Phú An, thị xã Bến Cát, tỉnh Bình Dương
(72) Sun Hsien - Wei (TW)
(74) Công ty Cổ phần Sở hữu công nghiệp INVESTIP (INVESTIP)
(55)



1.1



1.2



1.3



1.4



1.5

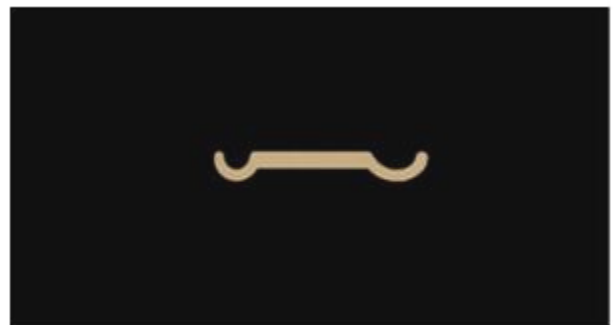

1.6

CÔNG BÁO SỞ HỮU CÔNG NGHIỆP SỐ 429 TẬP A – QUYỀN 2 (12.2023)

- (11) **48844**
(21) 3-2023-01387 (28) 2
(54) **DÂY NHỰA ĐÚC** (51) **09-06**
(22) 21/06/2023 (43) 25/12/2023
(73) **SUN HSIEN - WEI (TW)**
Thửa đất 2588, tờ bản đồ 14, tổ 4, ấp Phú Thuận, xã Phú An, thị xã Bến Cát, tỉnh Bình Dương
(72) Sun Hsien - Wei (TW)
(74) Công ty Cổ phần Sở hữu công nghiệp INVESTIP (INVESTIP)
(55)

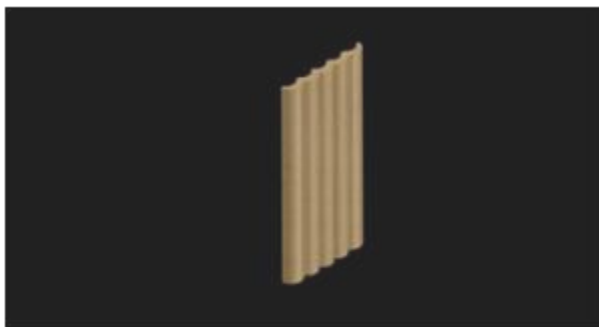

1.1



1.2

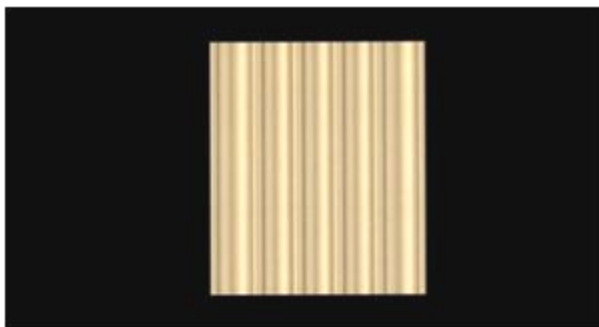

1.3

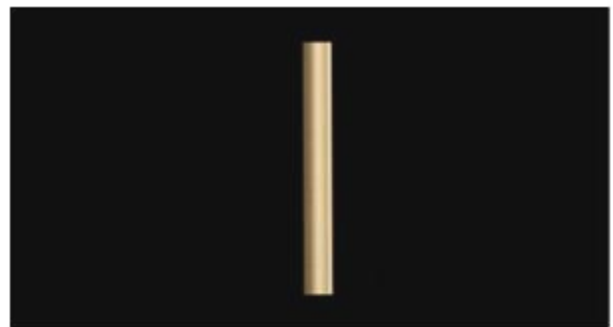

1.4

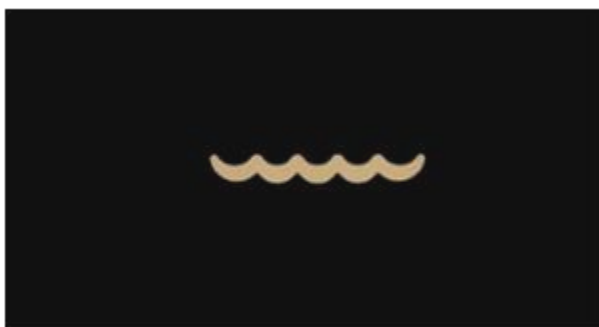

1.5

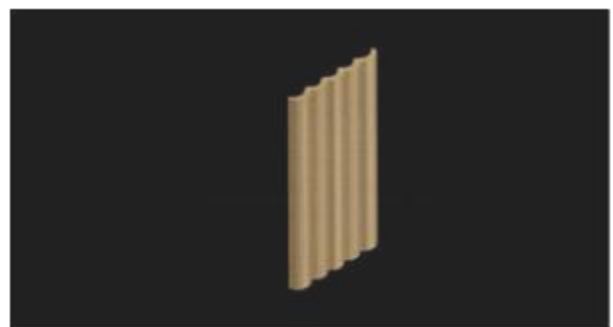

2.1



2.2



2.3



2.4



2.5

CÔNG BÁO SỞ HỮU CÔNG NGHIỆP SỐ 429 TẬP A – QUYỀN 2 (12.2023)

- (11) **48845**
(21) 3-2023-01388 (28) 5
(54) **BAO GÓI SẢN PHẨM** (51) **09-05**
(22) 21/06/2023 (43) 25/12/2023
(73) **CÔNG TY CỔ PHẦN SỮA VIỆT NAM (VN)**
10 Tân Trào, phường Tân Phú, quận 7, thành phố Hồ Chí Minh
(72) Đào Đức Duy (VN)
(74) Công ty cổ phần Sở hữu trí tuệ BROSS và Cộng sự (BROSS & PARTNERS., JSC)
(55)



1.1



1.2



2.1



2.2



3.1



3.2



4.1



4.2



5.1



5.2

CÔNG BÁO SỞ HỮU CÔNG NGHIỆP SỐ 429 TẬP A – QUYỀN 2 (12.2023)

- (11) **48846**
(21) 3-2023-01389 (28) 1
(54) **DÂY NHỰA ĐÚC** (51) **09-06**
(22) 21/06/2023 (43) 25/12/2023
(73) **SUN HSIEN - WEI (TW)**
Thửa đất 2588, tờ bản đồ 14, tổ 4, ấp Phú Thuận, xã Phú An, thị xã Bến Cát, tỉnh Bình Dương
(72) Sun Hsien - Wei (VN)
(74) Công ty Cổ phần Sở hữu công nghiệp INVESTIP (INVESTIP)
(55)

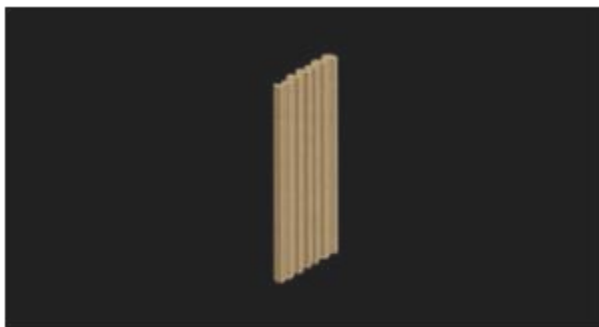

1.1



1.2



1.3



1.4

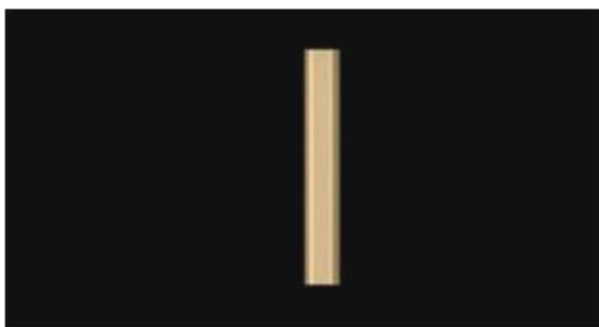

1.5

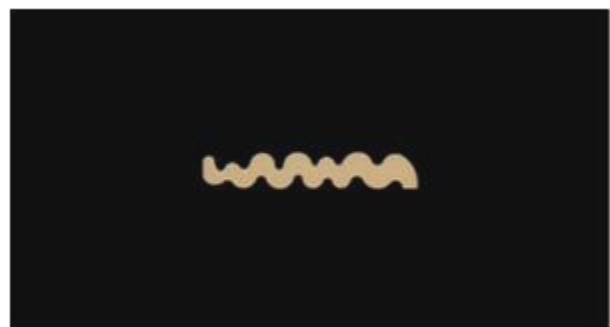

1.6



1.7

- (11) **48847**
(21) 3-2023-01405 (28) 1
(54) **THANH NHÔM ĐỊNH HÌNH** (51) **25-01**
(22) 23/06/2023 (43) 25/12/2023
(73) **CÔNG TY TNHH THANH PHÚC WINDOW (VN)**
478 Nguyễn Thị Thập, phường Tân Quy, quận 7, Thành phố Hồ Chí Minh
(72) Nguyễn Thị Kim Hoàn (VN)
(55)



1.1

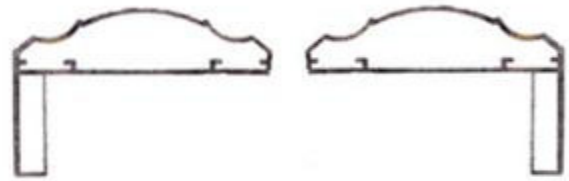

1.2

1.3



1.4



1.5



1.6



1.7

(11) **48848**

(21) 3-2023-01406

(28) 1

(54) **ĐÈN CHIẾU SÁNG ĐƯỜNG PHỐ**

(51) **26-03**

(22) 23/06/2023

(43) 25/12/2023

(73) **CÔNG TY CỔ PHẦN ĐIỆN VÀ CHIẾU SÁNG PHÚ THẮNG (VN)**

Lô số CN1, KCN Thạch Thất, Quốc Oai, huyện Thạch Thất, thành phố Hà Nội

(72) Phùng Hữu Thắng (VN)

(55)

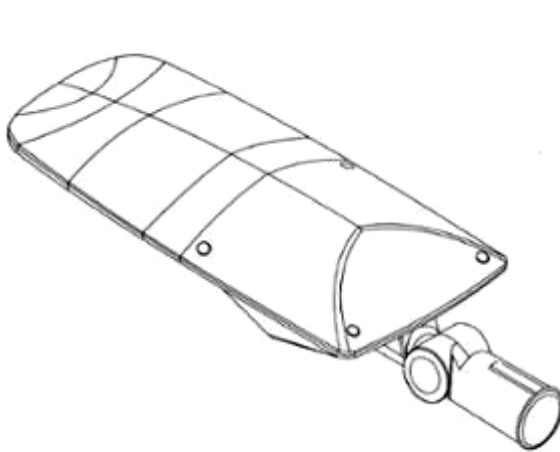

1.1

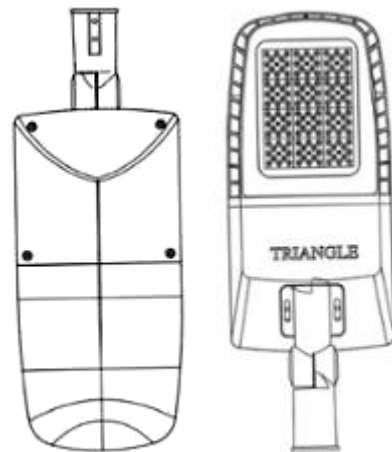

1.2

1.3



1.4



1.5



1.6



1.7

- (11) **48849**
(21) 3-2023-01407 (28) 1
(54) **ĐÈN CHIẾU SÁNG ĐƯỜNG PHỐ** (51) **26-03**
(22) 23/06/2023 (43) 25/12/2023
(73) **CÔNG TY CỔ PHẦN ĐIỆN VÀ CHIẾU SÁNG PHÚ THẮNG (VN)**
Lô số CN1, KCN Thạch Thất, Quốc Oai, huyện Thạch Thất, thành phố Hà Nội
(72) Phùng Hữu Thắng (VN)
(55)

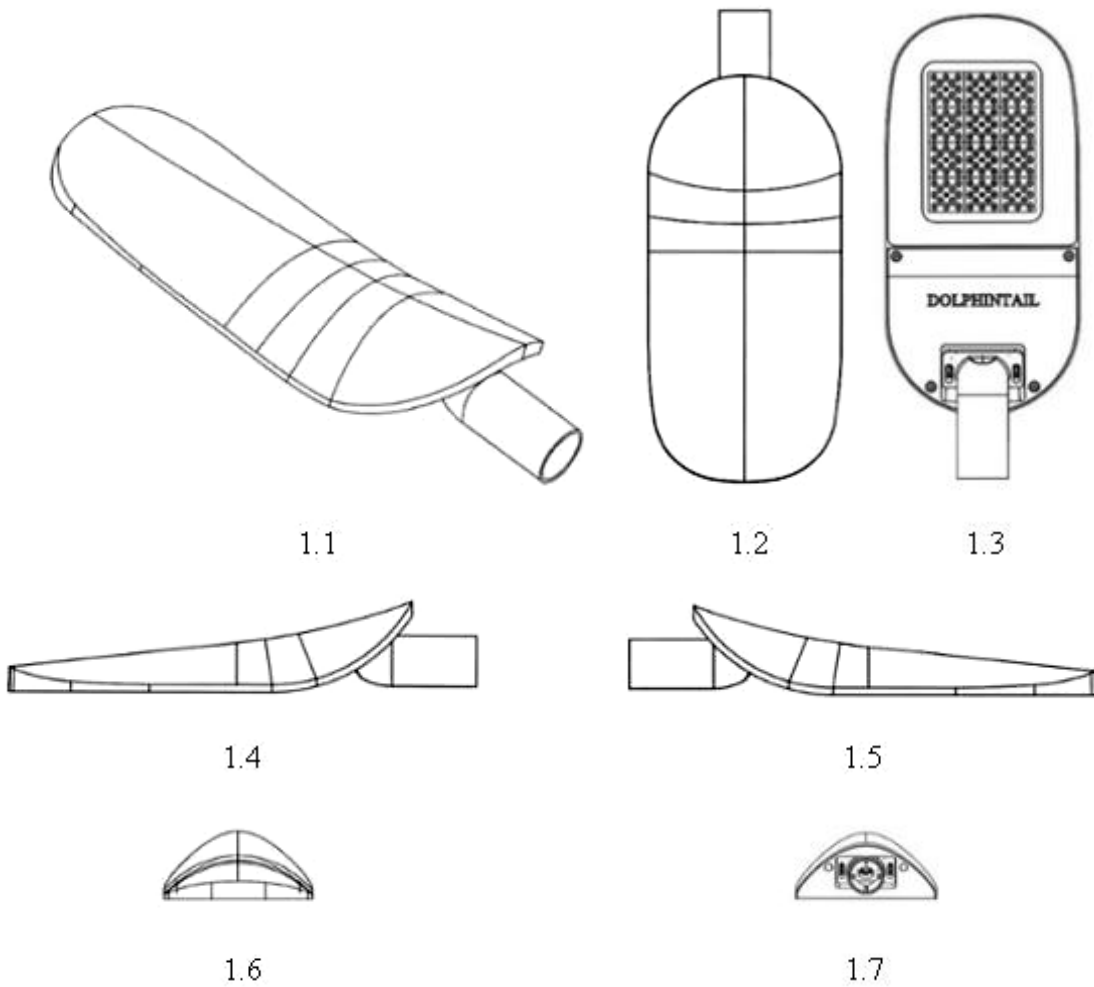

CÔNG BÁO SỞ HỮU CÔNG NGHIỆP SỐ 429 TẬP A – QUYỀN 2 (12.2023)

- (11) **48850**
(21) 3-2023-01416 (28) 1
(54) **LỌ** (51) **09-01**
(22) 23/06/2023 (43) 25/12/2023
(73) **LG H&H CO., LTD. (KR)**
58, Saemunan-ro, Jongno-gu, Seoul, Republic of Korea
(72) YUN, Tae Ung (KR)
(74) Công ty TNHH Tầm nhìn và Liên danh (VISION & ASSOCIATES CO.LTD.)
(55)



1.1

1.2

1.3

1.4

1.5



1.6



1.7

- (11) **48851**
(21) 3-2023-01421 (28) 1
(54) **KẸO CARAMEN** (51) **01-01**
(22) 26/06/2023 (43) 25/12/2023
(73) **PERFETTI VAN MELLE S.P.A. (IT)**
Via XXV Aprile, 7 - 20045 Lainate (MI) - Italy
(72) Lucia Manzoni (IT)
(74) Công ty Luật TNHH Phạm và Liên danh (PHAM & ASSOCIATES)
(55)



1.1



1.2



1.3



1.4



1.5



1.6



1.7

CÔNG BÁO SỞ HỮU CÔNG NGHIỆP SỐ 429 TẬP A – QUYỀN 2 (12.2023)

- (11) **48852**
(21) 3-2023-01428 (28) 1
(54) **HỘP** (51) **09-03**
(22) 26/06/2023 (43) 25/12/2023
(73) **ORION CORPORATION (KR)**
13, Baekbeom-ro 90da-gil, Yongsan-gu, Seoul 04369, Republic of Korea
(72) 1. CHOE, EUN JE (KR)
2. OH, HYUN SUN (KR)
(74) Công ty Luật TNHH quốc tế BMVN (BMVN INTERNATIONAL LLC)
(55)



1.1



1.2

CÔNG BÁO SỞ HỮU CÔNG NGHIỆP SỐ 429 TẬP A – QUYỀN 2 (12.2023)

- (11) **48853**
- (21) 3-2023-01432 (28) 1
- (54) **THIẾT BỊ XỬ LÝ CHẤT THẢI RẮN Y TẾ LÂY NHIỄM SINH HỌC** (51) **23-99**
- (22) 27/06/2023 (43) 25/12/2023
- (73) **CÔNG TY TNHH CÔNG NGHỆ Y TẾ MÔI TRƯỜNG SENVIMED (VN)**
Số nhà 82 ngõ 387 phố Vũ Tông Phan, phường Khương Đình, quận Thanh Xuân,
thành phố Hà Nội
- (72) Đặng Xuân Hoàng (VN)
- (74) Công ty TNHH Sở hữu trí tuệ Gia Việt (GIAVIET CO., LTD.)
- (55)

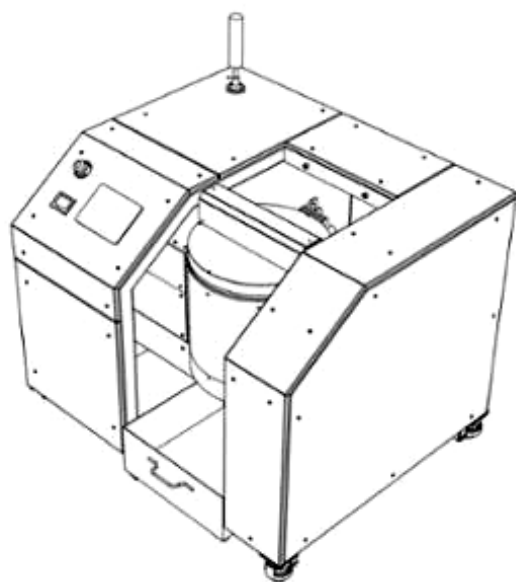

1.1

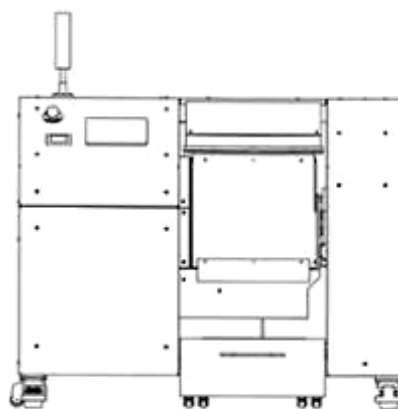

1.2

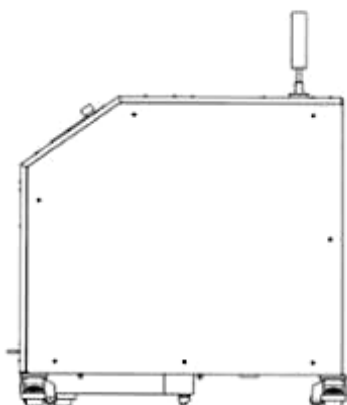

1.3

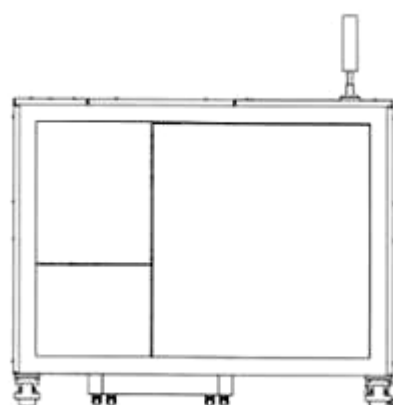

1.4

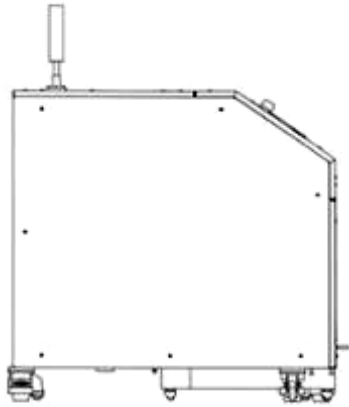

1.5

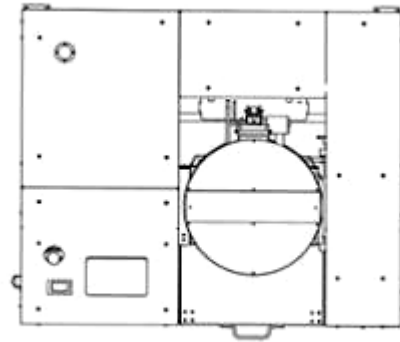

1.6

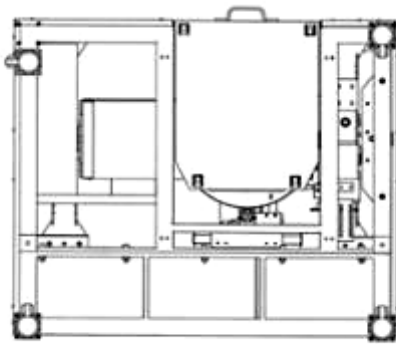

1.7

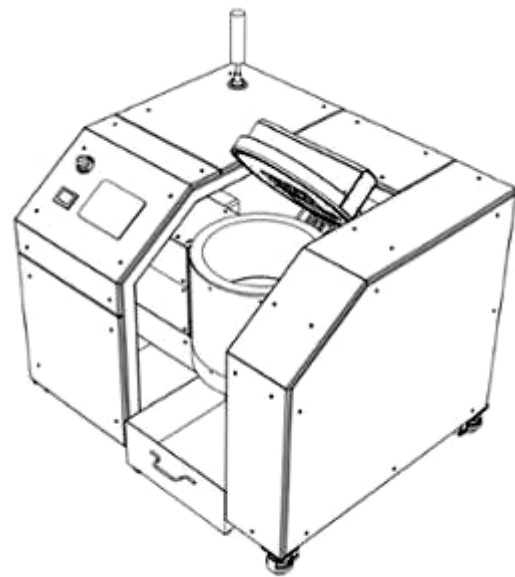

1.8

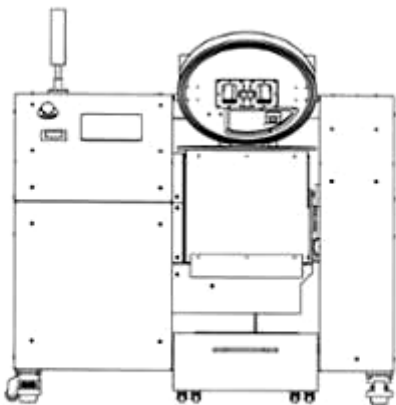

1.9

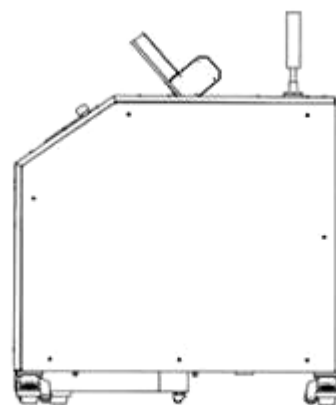

1.10

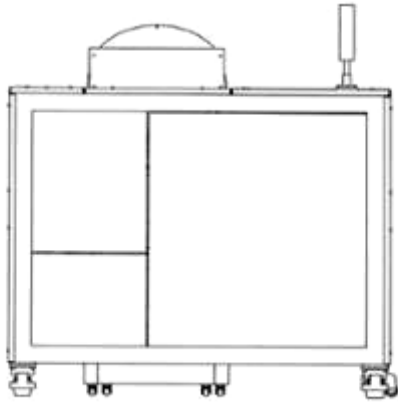

1.11

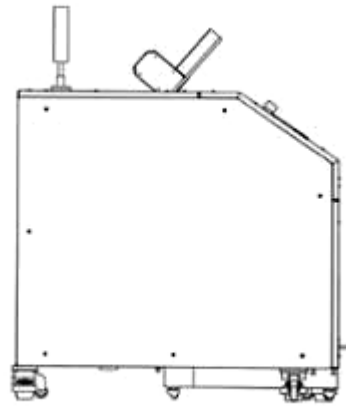

1.12

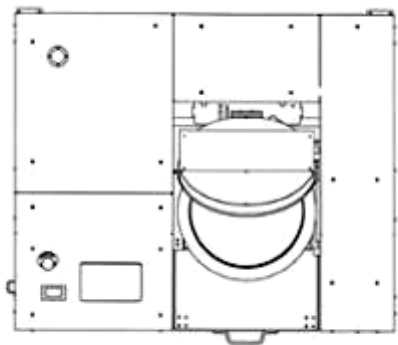

1.13

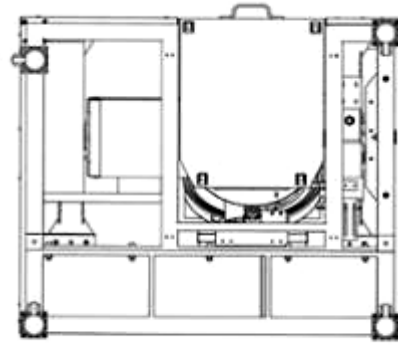

1.14

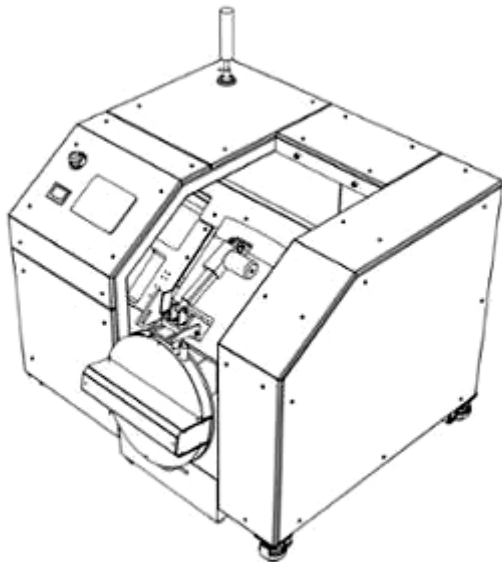

1.15

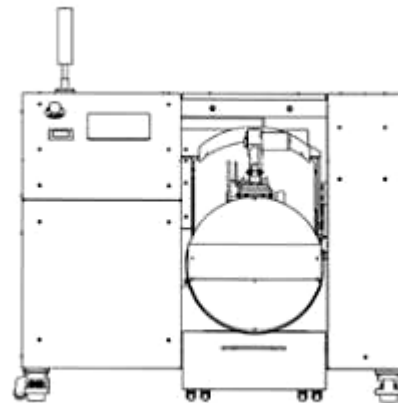

1.16

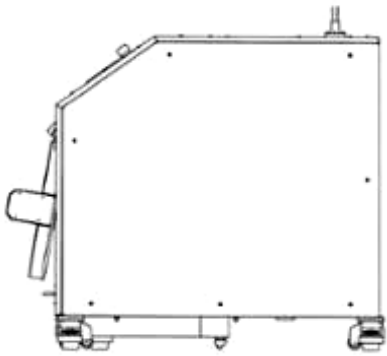

1.17

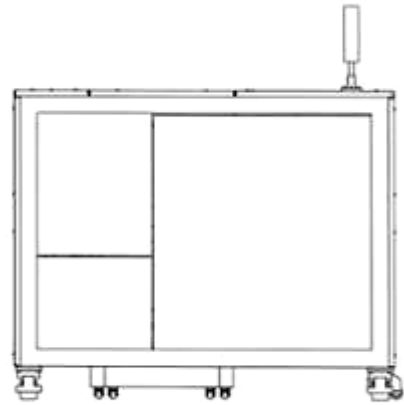

1.18

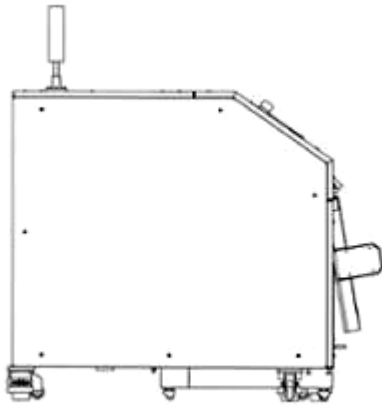

1.19

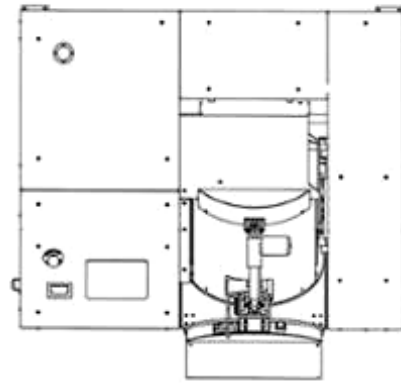

1.20

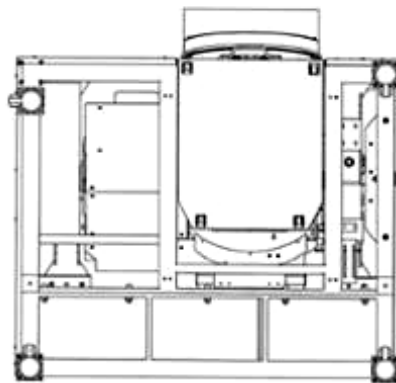

1.21

CÔNG BÁO SỞ HỮU CÔNG NGHIỆP SỐ 429 TẬP A – QUYỀN 2 (12.2023)

- (11) **48854**
(21) 3-2023-01439 (28) 1
(54) **KHÓA TÚI** (51) **08-07**
(22) 27/06/2023 (43) 25/12/2023
(30) 2022308727772 30/12/2022 CN;
(73) **CHARLES & KEITH INTERNATIONAL PTE. LTD. (SG)**
6 Tai Seng Link, #08-00 Charles & Keith Group Headquarters, Singapore 534101
(72) Kelvin Wong (SG)
(74) Công ty Luật TNHH ROUSE Việt Nam (ROUSE LEGAL VIETNAM LTD.)
(55)

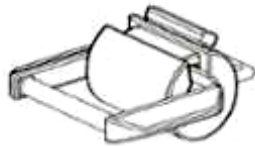

1.1



1.2

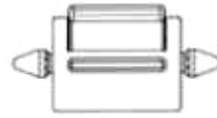

1.3



1.4



1.5



1.6

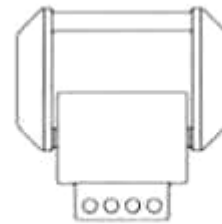

1.7

CÔNG BÁO SỞ HỮU CÔNG NGHIỆP SỐ 429 TẬP A – QUYỀN 2 (12.2023)

- (11) **48855**
(21) 3-2023-01451 (28) 1
(54) **KHÓA TÚI** (51) **08-07**
(22) 28/06/2023 (43) 25/12/2023
(30) 202230872801.2 30/12/2022 CN;
(73) **CHARLES & KEITH INTERNATIONAL PTE. LTD. (SG)**
6 Tai Seng Link, #08-00 Charles & Keith Group Headquarters, Singapore 534101
(72) Kelvin Wong (SG)
(74) Công ty Luật TNHH ROUSE Việt Nam (ROUSE LEGAL VIETNAM LTD.)
(55)



1.1

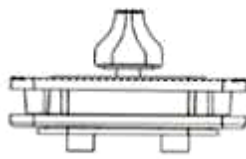

1.2

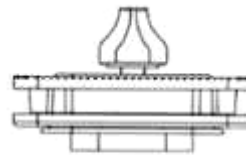

1.3



1.4

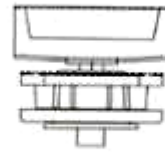

1.5



1.6

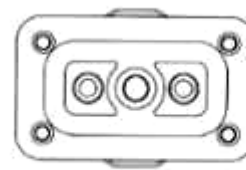

1.7

CÔNG BÁO SỞ HỮU CÔNG NGHIỆP SỐ 429 TẬP A – QUYỀN 2 (12.2023)

- (11) **48856**
(21) 3-2023-01452 (28) 1
(54) **KHÓA TỬ** (51) **08-07**
(22) 28/06/2023 (43) 25/12/2023
(30) 202230872819.2 30/12/2022 CN;
(73) **CHARLES & KEITH INTERNATIONAL PTE. LTD. (SG)**
6 Tai Seng Link, #08-00 Charles & Keith Group Headquarters, Singapore 534101
(72) Kelvin Wong (SG)
(74) Công ty Luật TNHH ROUSE Việt Nam (ROUSE LEGAL VIETNAM LTD.)
(55)



1.1



1.2

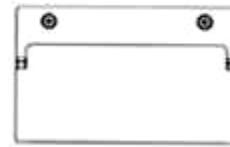

1.3



1.4

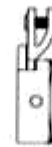

1.5



1.6

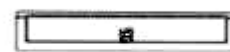

1.7

CÔNG BÁO SỞ HỮU CÔNG NGHIỆP SỐ 429 TẬP A – QUYỀN 2 (12.2023)

- (11) **48857**
- (21) 3-2023-01453
- (54) **KHÓA TÚI**
- (22) 28/06/2023
- (30) 202230872896.8 30/12/2022 CN;
- (73) **CHARLES & KEITH INTERNATIONAL PTE. LTD. (SG)**
6 Tai Seng Link, #08-00 Charles & Keith Group Headquarters, Singapore 534101
- (72) Kelvin Wong (SG)
- (74) Công ty Luật TNHH ROUSE Việt Nam (ROUSE LEGAL VIETNAM LTD.)
- (55)

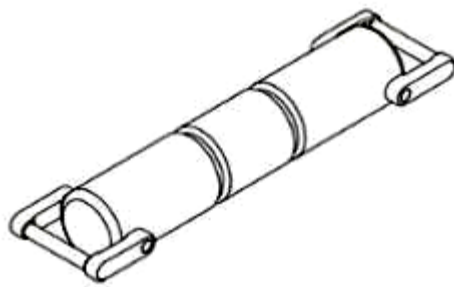

1.1

1.2

1.3

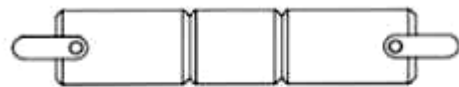
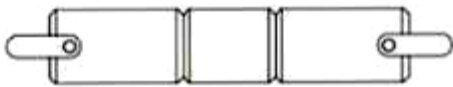

1.4

1.5

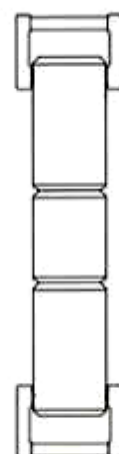
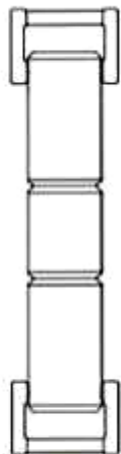

1.6

1.7

CÔNG BÁO SỞ HỮU CÔNG NGHIỆP SỐ 429 TẬP A – QUYỀN 2 (12.2023)

- (11) **48858**
(21) 3-2023-01454 (28) 1
(54) **KHÓA TỬ** (51) **08-07**
(22) 28/06/2023 (43) 25/12/2023
(30) 202230872968.9 30/12/2022 CN;
(73) **CHARLES & KEITH INTERNATIONAL PTE. LTD. (SG)**
6 Tai Seng Link, #08-00 Charles & Keith Group Headquarters, Singapore 534101
(72) Kelvin Wong (SG)
(74) Công ty Luật TNHH ROUSE Việt Nam (ROUSE LEGAL VIETNAM LTD.)
(55)

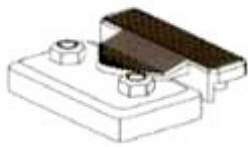

1.1



1.2



1.3



1.4

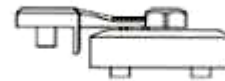

1.5

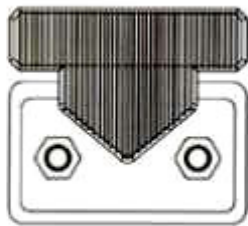

1.6

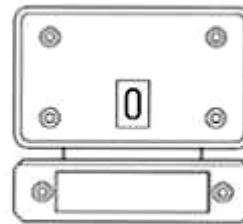

1.7

CÔNG BÁO SỞ HỮU CÔNG NGHIỆP SỐ 429 TẬP A – QUYỀN 2 (12.2023)

- (11) **48859**
(21) 3-2023-01455 (28) 1
(54) **KHÓA TỬ** (51) **08-07**
(22) 28/06/2023 (43) 25/12/2023
(30) 202230872873.7 30/12/2022 CN;
(73) **CHARLES & KEITH INTERNATIONAL PTE. LTD. (SG)**
6 Tai Seng Link, #08-00 Charles & Keith Group Headquarters, Singapore 534101
(72) Kelvin Wong (SG)
(74) Công ty Luật TNHH ROUSE Việt Nam (ROUSE LEGAL VIETNAM LTD.)
(55)

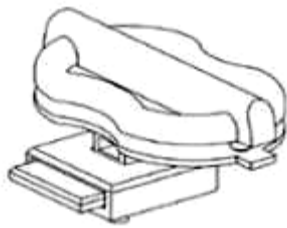

1.1

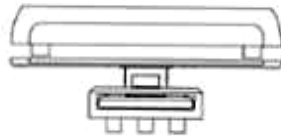

1.2

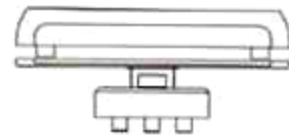

1.3

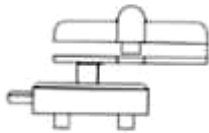

1.4

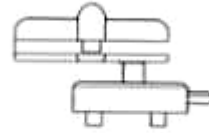

1.5

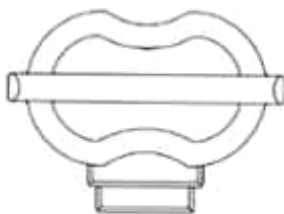

1.6

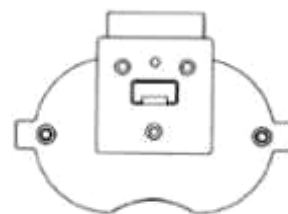

1.7

CÔNG BÁO SỞ HỮU CÔNG NGHIỆP SỐ 429 TẬP A – QUYỀN 2 (12.2023)

- (11) **48860**
(21) 3-2023-01456 (28) 1
(54) **KHÓA TÚI** (51) **08-07**
(22) 28/06/2023 (43) 25/12/2023
(30) 202230872830.9 30/12/2022 CN;
(73) **CHARLES & KEITH INTERNATIONAL PTE. LTD. (SG)**
6 Tai Seng Link, #08-00 Charles & Keith Group Headquarters, Singapore 534101
(72) Kelvin Wong (SG)
(74) Công ty Luật TNHH ROUSE Việt Nam (ROUSE LEGAL VIETNAM LTD.)
(55)



1.1

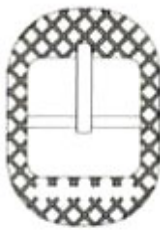

1.2

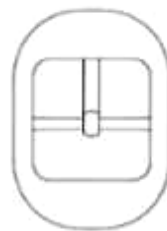

1.3



1.4

1.5



1.6



1.7

CÔNG BÁO SỞ HỮU CÔNG NGHIỆP SỐ 429 TẬP A – QUYỀN 2 (12.2023)

(11) **48861**

(21) 3-2023-01459

(28) 1

(54) **CAN**

(51) **09-02**

(22) 29/06/2023

(43) 25/12/2023

(73) **CÔNG TY TNHH KIM LÂM (VN)**

Lô A2.CN7 - Cụm công nghiệp tập trung vừa và nhỏ Từ Liêm, phường Phương Canh, quận Nam Từ Liêm, thành phố Hà Nội

(72) **Võ Thị Liễu Trâm (VN)**

(55)



1.1



1.2



1.3



1.4



1.5



1.6



1.7

CÔNG BÁO SỞ HỮU CÔNG NGHIỆP SỐ 429 TẬP A – QUYỀN 2 (12.2023)

- (11) **48862**
- (21) 3-2023-01460 (28) 1
- (54) **NHÃN SẢN PHẨM** (51) **19-08**
- (22) 29/06/2023 (43) 25/12/2023
- (73) **HỘ KINH DOANH SẢN XUẤT VÀ KINH DOANH BÁNH NGỌT THÚY QUYÊN (VN)**
Tại nhà, thôn Đông Ngàn, xã Đông Hội, huyện Đông Anh, thành phố Hà Nội
- (72) Nguyễn Trọng Thăng (VN)
- (74) **CÔNG TY LUẬT TNHH KHÔI NGỌC (KHOI NGOC LAW COMPANY LTD)**
- (55)

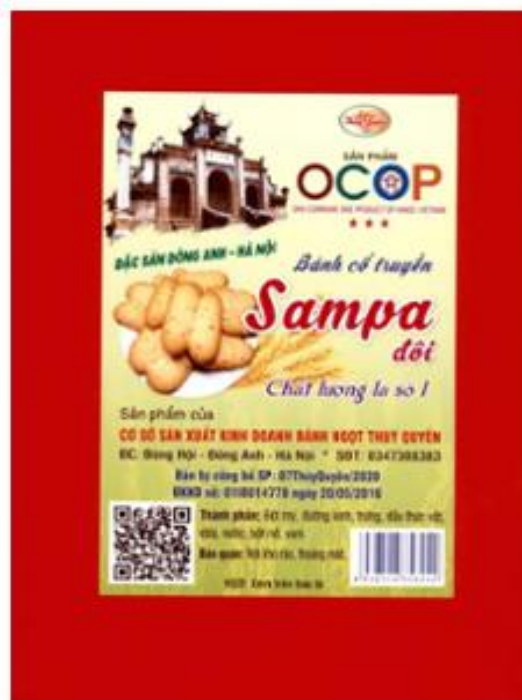

CÔNG BÁO SỞ HỮU CÔNG NGHIỆP SỐ 429 TẬP A – QUYỀN 2 (12.2023)

- (11) **48863**
- (21) 3-2023-01461 (28) 1
- (54) **NHÃN SẢN PHẨM** (51) **19-08**
- (22) 29/06/2023 (43) 25/12/2023
- (73) **HỘ KINH DOANH SẢN XUẤT VÀ KINH DOANH BÁNH NGỌT THÚY QUYÊN (VN)**
Tại nhà, thôn Đông Ngàn, xã Đông Hội, huyện Đông Anh, thành phố Hà Nội
- (72) Nguyễn Trọng Thăng (VN)
- (74) **CÔNG TY LUẬT TNHH KHÔI NGỌC (KHOI NGOC LAW COMPANY LTD)**
- (55)



CÔNG BÁO SỞ HỮU CÔNG NGHIỆP SỐ 429 TẬP A – QUYỀN 2 (12.2023)

- (11) **48864**
- (21) 3-2023-01462 (28) 1
- (54) **NHÃN SẢN PHẨM** (51) **19-08**
- (22) 29/06/2023 (43) 25/12/2023
- (73) **HỘ KINH DOANH SẢN XUẤT VÀ KINH DOANH BÁNH NGỌT THÚY QUYÊN (VN)**
Tại nhà, thôn Đông Ngàn, xã Đông Hội, huyện Đông Anh, thành phố Hà Nội
- (72) Nguyễn Trọng Thăng (VN)
- (74) CÔNG TY LUẬT TNHH KHÔI NGỌC (KHOI NGOC LAW COMPANY LTD)
- (55)



CÔNG BÁO SỞ HỮU CÔNG NGHIỆP SỐ 429 TẬP A – QUYỀN 2 (12.2023)

- (11) **48865**
- (21) 3-2023-01465 (28) 1
- (54) **NHÃN SẢN PHẨM** (51) **19-08**
- (22) 29/06/2023 (43) 25/12/2023
- (73) **CÔNG TY CỔ PHẦN THÁI SƠN PAINT (VN)**
Số 63, đường số 61, phường 10, quận 6, thành phố Hồ Chí Minh
- (72) Lê Thái Nhuận (VN)
- (74) Công ty TNHH Sở hữu trí tuệ VIPATCO (VIPATCO CO., LTD.)
- (55)



CÔNG BÁO SỞ HỮU CÔNG NGHIỆP SỐ 429 TẬP A – QUYỀN 2 (12.2023)

- (11) **48866**
- (21) 3-2023-01466 (28) 1
- (54) **NHÃN SẢN PHẨM** (51) **19-08**
- (22) 29/06/2023 (43) 25/12/2023
- (73) **CÔNG TY CỔ PHẦN LITA FOODS (VN)**
Phố Ba Mỏ, thị trấn Thanh Sơn, huyện Thanh Sơn, tỉnh Phú Thọ
- (72) Nguyễn Thị Thu Hoa (VN)
- (74) Công ty TNHH Sở hữu trí tuệ WITIP Việt Nam (WITIP CO., LTD.)
- (55)



CÔNG BÁO SỞ HỮU CÔNG NGHIỆP SỐ 429 TẬP A – QUYỀN 2 (12.2023)

- (11) **48867**
(21) 3-2023-01467 (28) 1
(54) **NHÃN SẢN PHẨM** (51) **19-08**
(22) 29/06/2023 (43) 25/12/2023
(73) **CÔNG TY CỔ PHẦN LITA FOODS (VN)**
Phố Ba Mỏ, thị trấn Thanh Sơn, huyện Thanh Sơn, tỉnh Phú Thọ
(72) Nguyễn Thị Thu Hoa (VN)
(74) Công ty TNHH Sở hữu trí tuệ WITIP Việt Nam (WITIP CO., LTD.)
(55)



CÔNG BÁO SỞ HỮU CÔNG NGHIỆP SỐ 429 TẬP A – QUYỀN 2 (12.2023)

- (11) **48868**
(21) 3-2023-01469 (28) 1
(54) **KHÓA TỬ** (51) **08-07**
(22) 29/06/2023 (43) 25/12/2023
(30) 202330000579.1 03/01/2023 CN;
(73) **CHARLES & KEITH INTERNATIONAL PTE. LTD. (SG)**
6 Tai Seng Link, #08-00 Charles & Keith Group Headquarters, Singapore 534101
(72) Kelvin Wong (SG)
(74) Công ty Luật TNHH ROUSE Việt Nam (ROUSE LEGAL VIETNAM LTD.)
(55)



1.1

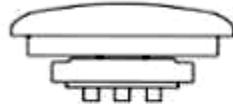

1.2

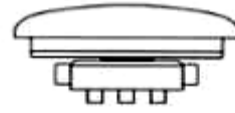

1.3

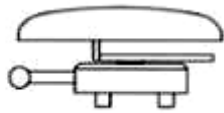

1.4

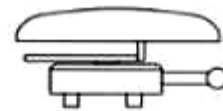

1.5

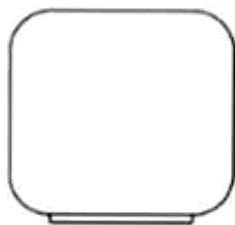

1.6

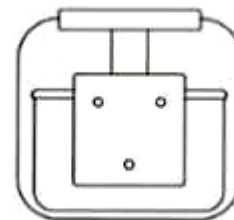

1.7

CÔNG BÁO SỞ HỮU CÔNG NGHIỆP SỐ 429 TẬP A – QUYỀN 2 (12.2023)

(11) **48869**

(21) 3-2023-01471

(28) 1

(54) **LỌ ĐỪNG KEM**

(51) **09-01**

(22) 30/06/2023

(43) 25/12/2023

(73) **CÔNG TY CỔ PHẦN XUẤT NHẬP KHẨU NT BEAUTY (VN)**

Tầng 19, khu văn phòng Indochina Park Tower, số 4 Nguyễn Đình Chiểu, phường Đa Kao, quận 1, thành phố Hồ Chí Minh

(72) Nguyễn Thị Minh Phương (VN)

(74) **CÔNG TY TNHH KHANG LUẬT (KHANGLAW)**

(55)



1.1



1.2



1.3



1.4



1.5



1.6



1.7

CÔNG BÁO SỞ HỮU CÔNG NGHIỆP SỐ 429 TẬP A – QUYỀN 2 (12.2023)

- (11) **48870**
(21) 3-2023-01480 (28) 1
(54) **THANH KIM LOẠI ĐỊNH HÌNH** (51) **25-01**
(22) 03/07/2023 (43) 25/12/2023
(73) **CÔNG TY CỔ PHẦN SẢN XUẤT VÀ ĐẦU TƯ HƯNG PHÁT (VN)**
Tổ dân phố Thịnh Vạn, phường Minh Đức, thị xã Mỹ Hào, tỉnh Hưng Yên
(72) Nguyễn Văn Tâm (VN)
(74) Công ty TNHH Sở hữu trí tuệ Gia Việt (GIAVIET CO., LTD.)
(55)

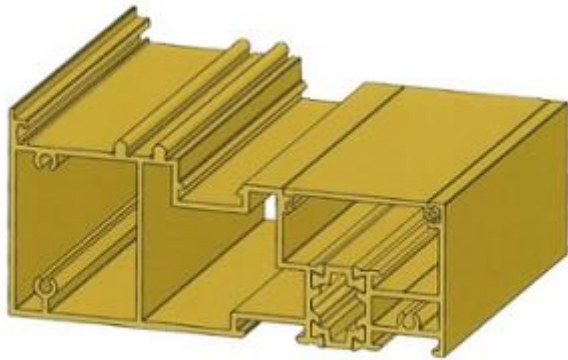

1.1

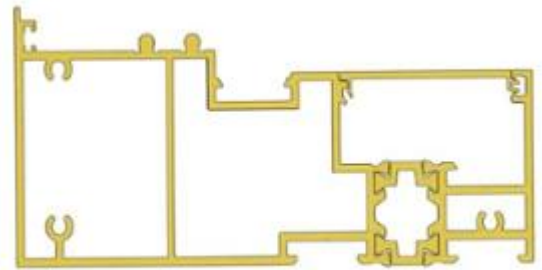

1.2



1.3



1.4

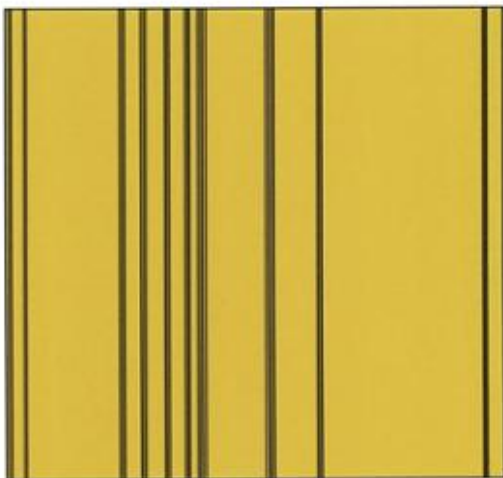

1.5

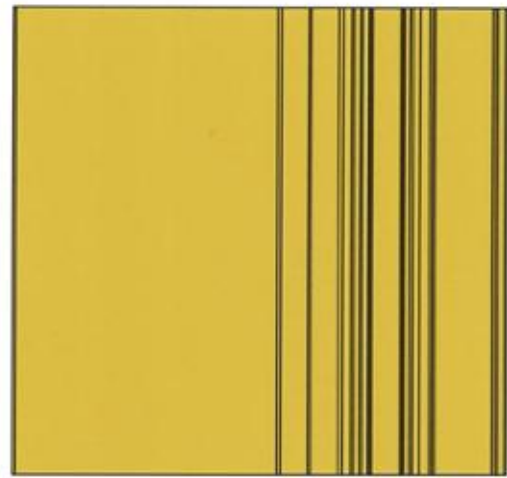

1.6

- (11) **48871**
(21) 3-2023-01481 (28) 1
(54) **THANH KIM LOẠI ĐỊNH HÌNH** (51) **25-01**
(22) 03/07/2023 (43) 25/12/2023
(73) **CÔNG TY CỔ PHẦN SẢN XUẤT VÀ ĐẦU TƯ HƯNG PHÁT (VN)**
Tổ dân phố Thịnh Vạn, phường Minh Đức, thị xã Mỹ Hào, tỉnh Hưng Yên
(72) Nguyễn Văn Tâm (VN)
(74) Công ty TNHH Sở hữu trí tuệ Gia Việt (GIAVIET CO., LTD.)
(55)



1.1



1.2

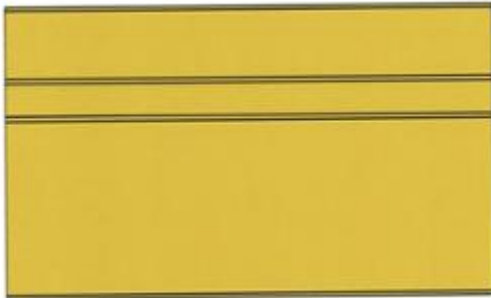

1.3



1.4

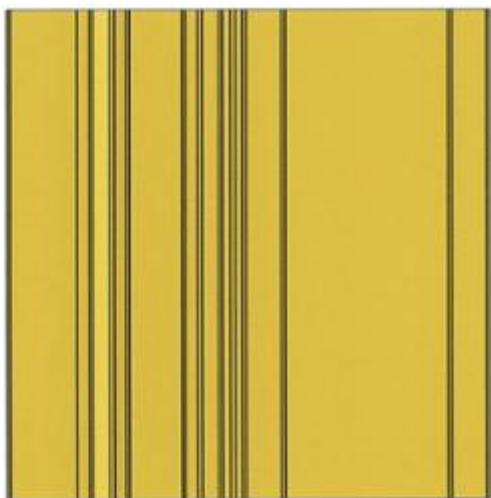

1.5

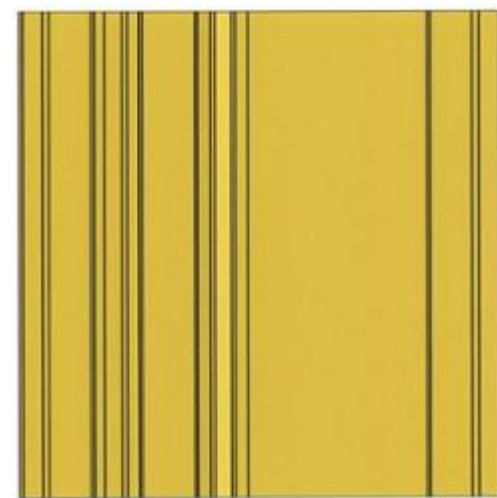

1.6

CÔNG BÁO SỞ HỮU CÔNG NGHIỆP SỐ 429 TẬP A – QUYỀN 2 (12.2023)

- (11) **48872**
(21) 3-2023-01482 (28) 1
(54) **THANH KIM LOẠI ĐỊNH HÌNH** (51) **25-01**
(22) 03/07/2023 (43) 25/12/2023
(73) **CÔNG TY CỔ PHẦN SẢN XUẤT VÀ ĐẦU TƯ HƯNG PHÁT (VN)**
Tổ dân phố Thịnh Vạn, phường Minh Đức, thị xã Mỹ Hào, tỉnh Hưng Yên
(72) Nguyễn Văn Tâm (VN)
(74) Công ty TNHH Sở hữu trí tuệ Gia Việt (GIAVIET CO., LTD.)
(55)

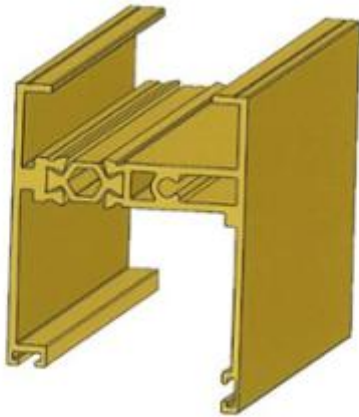

1.1

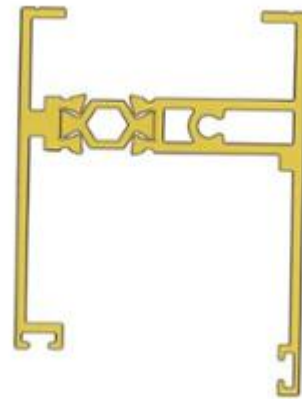

1.2



1.3



1.4

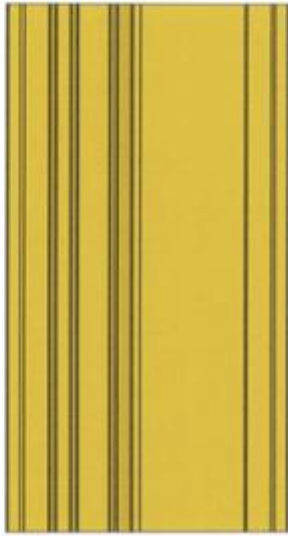

1.5



1.6

CÔNG BÁO SỞ HỮU CÔNG NGHIỆP SỐ 429 TẬP A – QUYỀN 2 (12.2023)

- (11) **48873**
(21) 3-2023-01483 (28) 1
(54) **THANH KIM LOẠI ĐỊNH HÌNH** (51) **25-01**
(22) 03/07/2023 (43) 25/12/2023
(73) **CÔNG TY CỔ PHẦN SẢN XUẤT VÀ ĐẦU TƯ HƯNG PHÁT (VN)**
Tổ dân phố Thịnh Vạn, phường Minh Đức, thị xã Mỹ Hào, tỉnh Hưng Yên
(72) Nguyễn Văn Tâm (VN)
(74) Công ty TNHH Sở hữu trí tuệ Gia Việt (GIAVIET CO., LTD.)
(55)

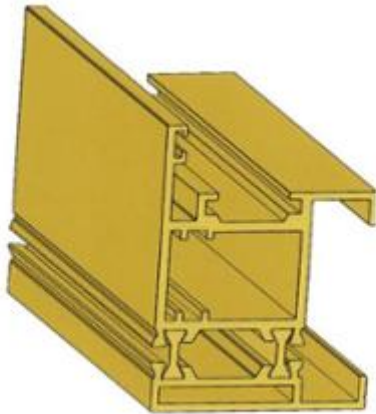

1.1

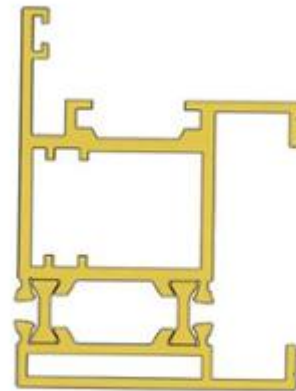

1.2

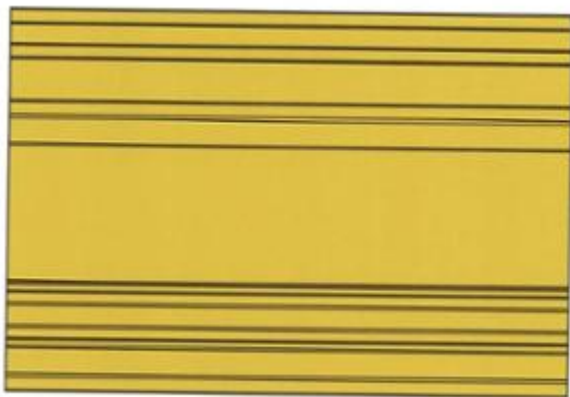

1.3

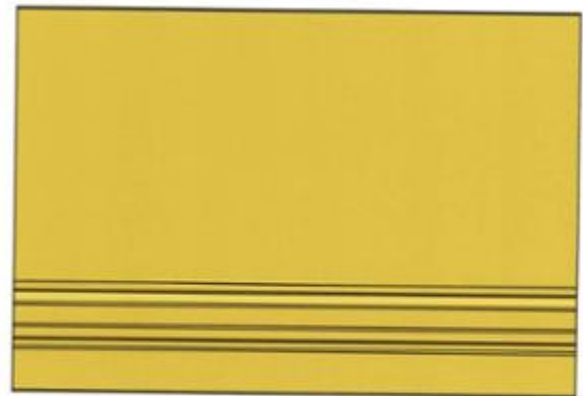

1.4

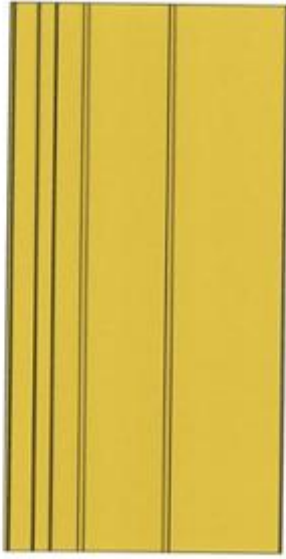

1.5



1.6

CÔNG BÁO SỞ HỮU CÔNG NGHIỆP SỐ 429 TẬP A – QUYỀN 2 (12.2023)

- (11) **48874**
(21) 3-2023-01484 (28) 1
(54) **THANH KIM LOẠI ĐỊNH HÌNH** (51) **25-01**
(22) 03/07/2023 (43) 25/12/2023
(73) **CÔNG TY CỔ PHẦN SẢN XUẤT VÀ ĐẦU TƯ HƯNG PHÁT (VN)**
Tổ dân phố Thịnh Vạn, phường Minh Đức, thị xã Mỹ Hào, tỉnh Hưng Yên
(72) Nguyễn Văn Tâm (VN)
(74) Công ty TNHH Sở hữu trí tuệ Gia Việt (GIAVIET CO., LTD.)
(55)



1.1

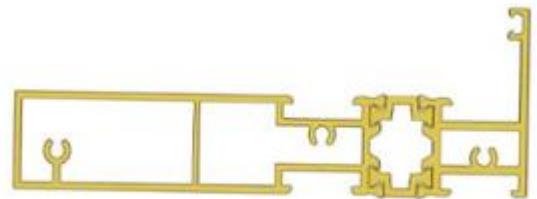

1.2



1.3



1.4

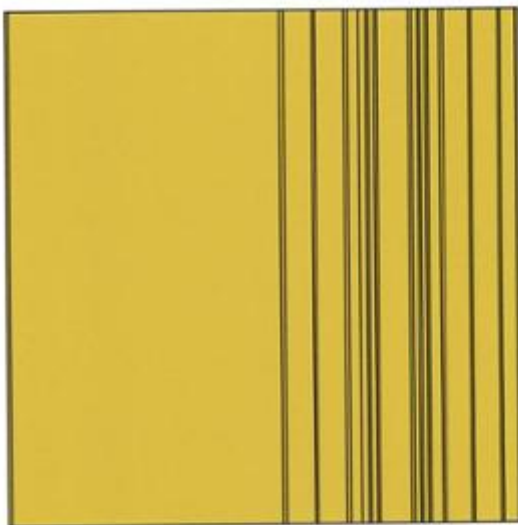

1.5

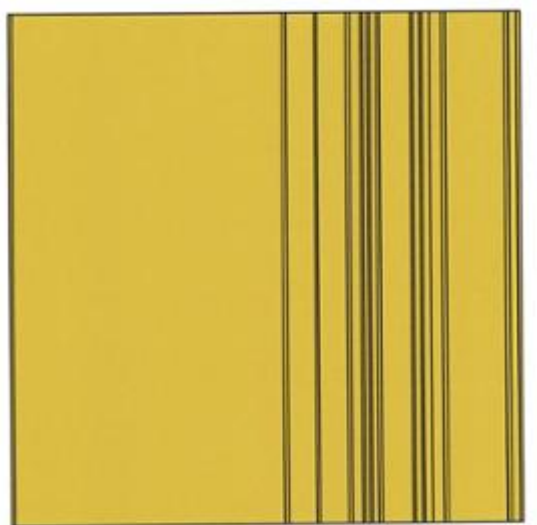

1.6

CÔNG BÁO SỞ HỮU CÔNG NGHIỆP SỐ 429 TẬP A – QUYỀN 2 (12.2023)

- (11) **48875**
(21) 3-2023-01485 (28) 1
(54) **THANH KIM LOẠI ĐỊNH HÌNH** (51) **25-01**
(22) 03/07/2023 (43) 25/12/2023
(73) **CÔNG TY CỔ PHẦN SẢN XUẤT VÀ ĐẦU TƯ HƯNG PHÁT (VN)**
Tổ dân phố Thịnh Vạn, phường Minh Đức, thị xã Mỹ Hào, tỉnh Hưng Yên
(72) Nguyễn Văn Tâm (VN)
(74) Công ty TNHH Sở hữu trí tuệ Gia Việt (GIAVIET CO., LTD.)
(55)

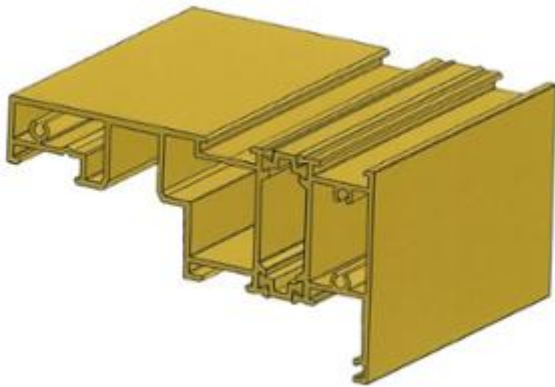

1.1

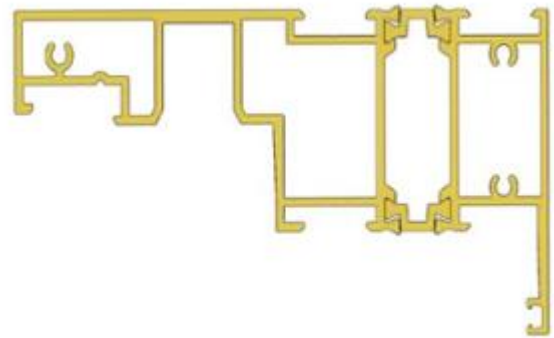

1.2



1.3



1.4

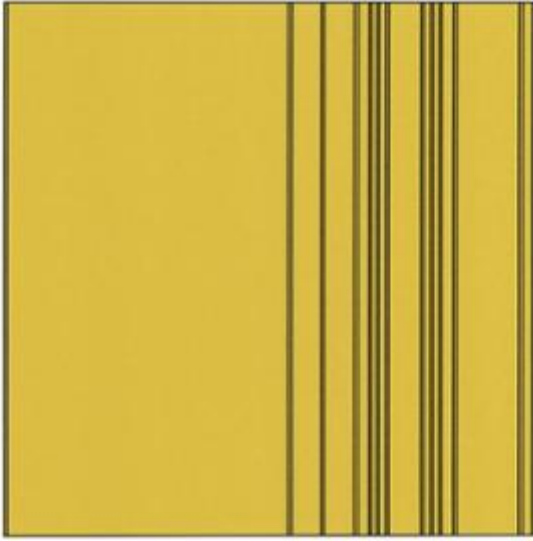

1.5

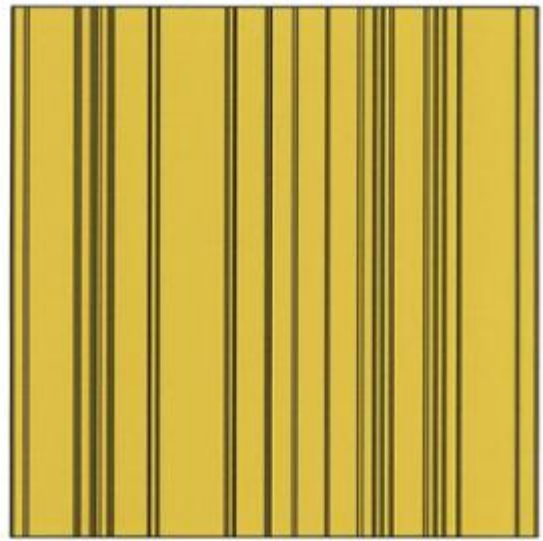

1.6

CÔNG BÁO SỞ HỮU CÔNG NGHIỆP SỐ 429 TẬP A – QUYỀN 2 (12.2023)

- (11) **48876**
(21) 3-2023-01486 (28) 1
(54) **THANH KIM LOẠI ĐỊNH HÌNH** (51) **25-01**
(22) 03/07/2023 (43) 25/12/2023
(73) **CÔNG TY CỔ PHẦN SẢN XUẤT VÀ ĐẦU TƯ HƯNG PHÁT (VN)**
Tổ dân phố Thịnh Vạn, phường Minh Đức, thị xã Mỹ Hào, tỉnh Hưng Yên
(72) Nguyễn Văn Tâm (VN)
(74) Công ty TNHH Sở hữu trí tuệ Gia Việt (GIAVIET CO., LTD.)
(55)



1.1



1.2



1.3

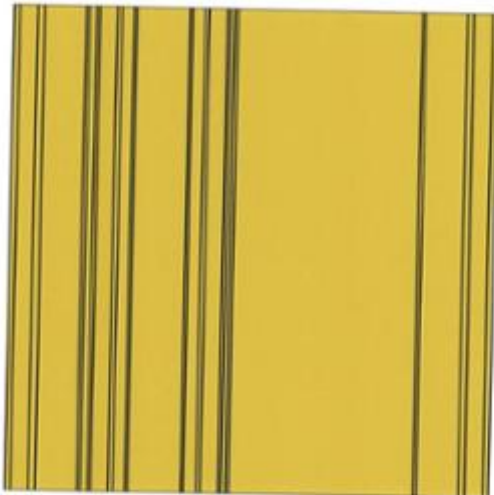

1.4

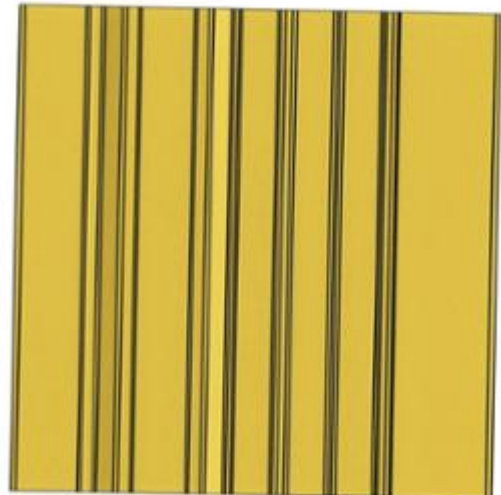

1.5

CÔNG BÁO SỞ HỮU CÔNG NGHIỆP SỐ 429 TẬP A – QUYỀN 2 (12.2023)

- (11) **48877**
(21) 3-2023-01487 (28) 1
(54) **THANH KIM LOẠI ĐỊNH HÌNH** (51) **25-01**
(22) 03/07/2023 (43) 25/12/2023
(73) **CÔNG TY CỔ PHẦN SẢN XUẤT VÀ ĐẦU TƯ HƯNG PHÁT (VN)**
Tổ dân phố Thịnh Vạn, phường Minh Đức, thị xã Mỹ Hào, tỉnh Hưng Yên
(72) Nguyễn Văn Tâm (VN)
(74) Công ty TNHH Sở hữu trí tuệ Gia Việt (GIAVIET CO., LTD.)
(55)

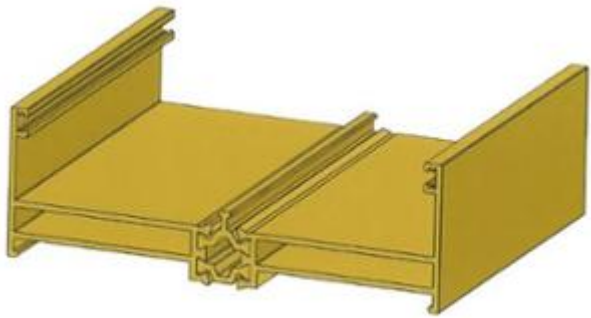

1.1



1.2



1.3

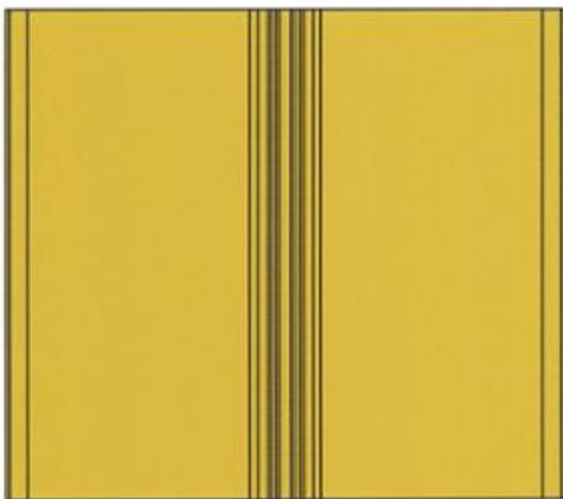

1.4



1.5

CÔNG BÁO SỞ HỮU CÔNG NGHIỆP SỐ 429 TẬP A – QUYỀN 2 (12.2023)

- (11) **48878**
- (21) 3-2023-01488
- (54) **HỘP**
- (22) 03/07/2023
- (73) **ORION CORPORATION (KR)**
13, Baekbeom-ro 90da-gil, Yongsan-gu, Seoul 04369, Republic of Korea
- (72) 1. CHOE, EUN JE (KR)
2. OH, HYUN SUN (KR)
- (74) Công ty Luật TNHH quốc tế BMVN (BMVN INTERNATIONAL LLC)
- (55)



1.1



1.2



2.1



2.2

CÔNG BÁO SỞ HỮU CÔNG NGHIỆP SỐ 429 TẬP A – QUYỀN 2 (12.2023)

- (11) **48879**
- (21) 3-2023-01489 (28) 2
- (54) **HỘP** (51) **09-03**
- (22) 03/07/2023 (43) 25/12/2023
- (73) **ORION CORPORATION (KR)**
13, Baekbeom-ro 90da-gil, Yongsan-gu, Seoul 04369, Republic of Korea
- (72) 1. CHOE, EUN JE (KR)
2. OH, HYUN SUN (KR)
- (74) Công ty Luật TNHH quốc tế BMVN (BMVN INTERNATIONAL LLC)
- (55)



1.1



1.2



2.1



2.2

CÔNG BÁO SỞ HỮU CÔNG NGHIỆP SỐ 429 TẬP A – QUYỀN 2 (12.2023)

- (11) **48880**
(21) 3-2023-01490 (28) 2
(54) **HỘP** (51) **09-03**
(22) 03/07/2023 (43) 25/12/2023
(73) **ORION CORPORATION (KR)**
13, Baekbeom-ro 90da-gil, Yongsan-gu, Seoul 04369, Republic of Korea
(72) 1. CHOE, EUN JE (KR)
2. OH, HYUN SUN (KR)
(74) Công ty Luật TNHH quốc tế BMVN (BMVN INTERNATIONAL LLC)
(55)



1.1



1.2



2.1



2.2

CÔNG BÁO SỞ HỮU CÔNG NGHIỆP SỐ 429 TẬP A – QUYỀN 2 (12.2023)

- (11) **48881**
(21) 3-2023-01493 (28) 1
(54) **KÍNH MẮT** (51) **16-06**
(22) 04/07/2023 (43) 25/12/2023
(30) DM/229441 01/06/2023 WO;
(73) **CHRISTIAN DIOR COUTURE (FR)**
30 Avenue Montaigne, 75008 Paris, France
(72) Mathieu JAMIN (FR)
(74) Công ty TNHH một thành viên Sở hữu trí tuệ VCCI (VCCI-IP CO.,LTD)
(55)



1.1



1.2



1.3



1.4



1.5



1.6



1.7

CÔNG BÁO SỞ HỮU CÔNG NGHIỆP SỐ 429 TẬP A – QUYỀN 2 (12.2023)

- (11) **48882**
(21) 3-2023-01494 (28) 1
(54) **KÍNH MẮT** (51) **16-06**
(22) 04/07/2023 (43) 25/12/2023
(30) DM/229441 01/06/2023 WO;
(73) **CHRISTIAN DIOR COUTURE (FR)**
30 Avenue Montaigne, 75008 Paris, France
(72) Mathieu JAMIN (FR)
(74) Công ty TNHH một thành viên Sở hữu trí tuệ VCCI (VCCI-IP CO.,LTD)
(55)



1.1



1.2



1.3



1.4



1.5



1.6



1.7

CÔNG BÁO SỞ HỮU CÔNG NGHIỆP SỐ 429 TẬP A – QUYỀN 2 (12.2023)

(11) **48883**

(21) 3-2023-01513

(28) 1

(54) **LỢ**

(51) **09-01**

(22) 06/07/2023

(43) 25/12/2023

(73) **NGUYỄN THỊ THANH HUYỀN (VN)**

Liên kê 16-19, khu đô thị An Hưng, phường La Khê, quận Hà Đông, thành phố Hà Nội

(72) Nguyễn Thị Thanh Huyền (VN)

(55)



1.1



1.2



1.3



1.4



1.5

CÔNG BÁO SỞ HỮU CÔNG NGHIỆP SỐ 429 TẬP A – QUYỀN 2 (12.2023)

- (11) **48884**
(21) 3-2023-01521 (28) 1
(54) **DÂY NHỰA ĐÚC** (51) **09-06**
(22) 06/07/2023 (43) 25/12/2023
(73) **SUN HSIEN - WEI (TW)**
Thửa đất 2588, tờ bản đồ 14, tổ 4, ấp Phú Thuận, xã Phú An, thị xã Bến Cát, tỉnh Bình Dương
(72) Sun Hsien - Wei (TW)
(74) Công ty Cổ phần Sở hữu công nghiệp INVESTIP (INVESTIP)
(55)



1.1



1.2



1.3



1.4



1.5



1.6



1.7

CÔNG BÁO SỞ HỮU CÔNG NGHIỆP SỐ 429 TẬP A – QUYỀN 2 (12.2023)

- (11) **48885**
(21) 3-2023-01527 (28) 1
(54) **CHAI** (51) **09-01**
(22) 07/07/2023 (43) 25/12/2023
(73) **CÔNG TY CỔ PHẦN THỰC PHẨM BAN MAI XANH LONG AN (VN)**
Lô B4-2 Và B5-1, đường Dọc 3, KCN Phú An Thạnh, xã An Thạnh, huyện Bến
Lức, tỉnh Long An
(72) Nguyễn Minh Phúc (VN)
(55)

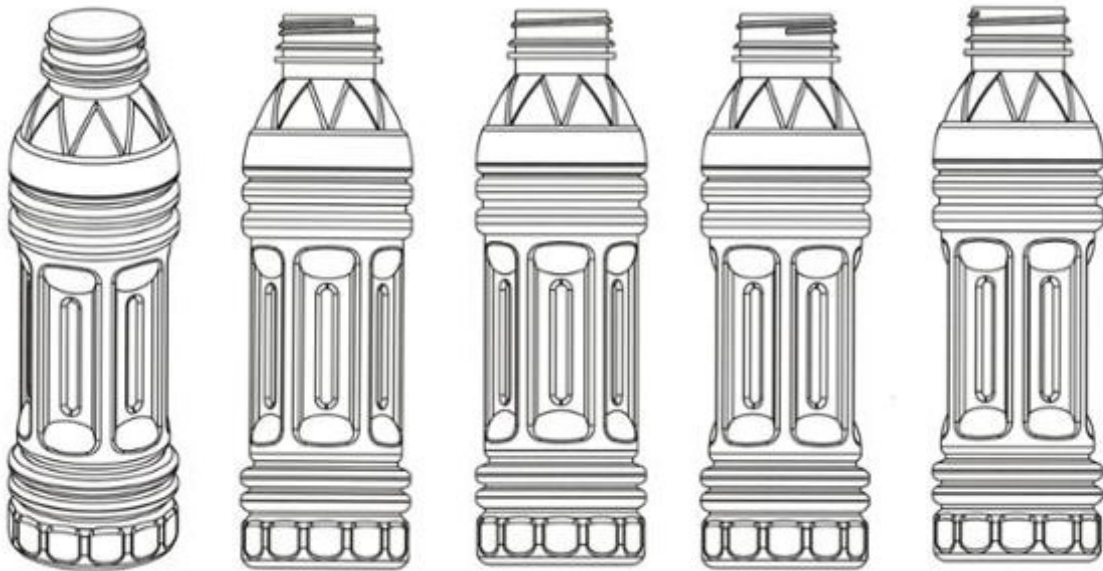

1.1

1.2

1.3

1.4

1.5



1.6



1.7

CÔNG BÁO SỞ HỮU CÔNG NGHIỆP SỐ 429 TẬP A – QUYỀN 2 (12.2023)

- (11) **48886**
(21) 3-2023-01538 (28) 1
(54) **THIẾT BỊ ĐỊNH LƯỢNG VÀ ĐÓNG GÓI THỰC PHẨM** (51) **15-99**
(22) 07/07/2023 (43) 25/12/2023
(73) **CÔNG TY TNHH THƯƠNG MẠI SẢN XUẤT DỊCH VỤ NHƠN DŨNG HOÀNG (VN)**
174/33/20 Nguyễn Tư Giản, phường 12, quận Gò Vấp, thành phố Hồ Chí Minh
(72) Nguyễn Ngọc Hoàng (VN)
(74) Công ty Cổ phần Sở hữu công nghiệp INVESTIP (INVESTIP)
(55)

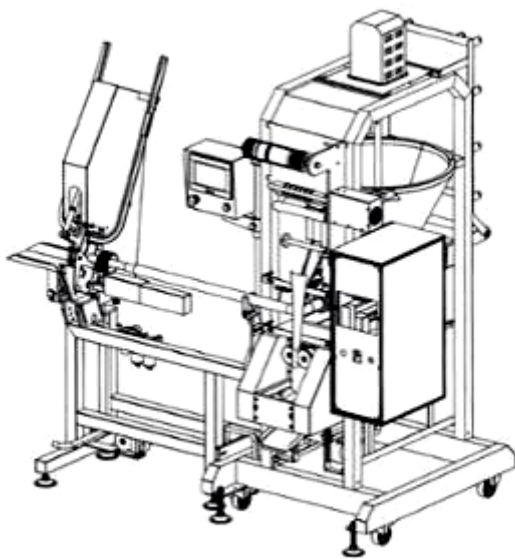

1.1

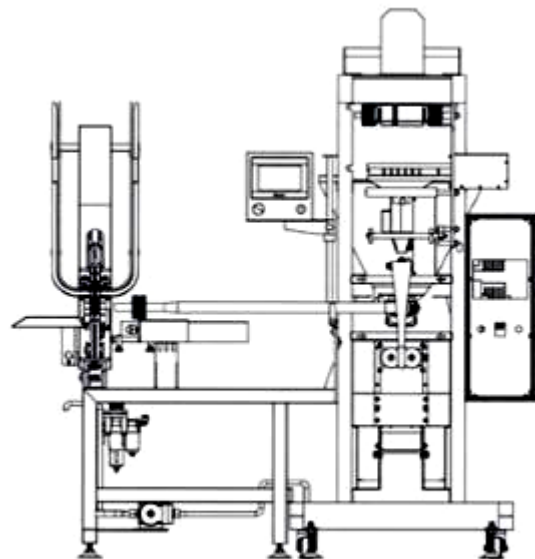

1.2

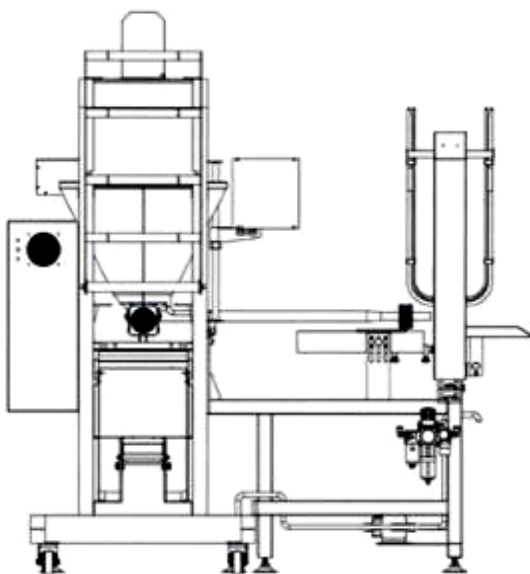

1.3

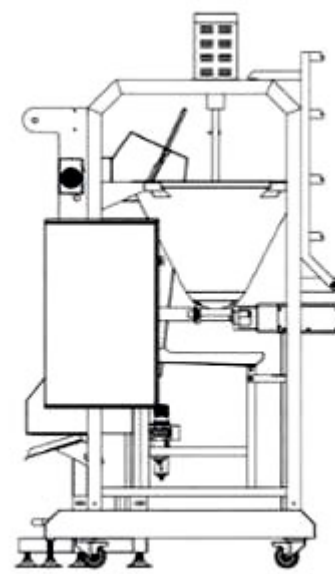

1.4

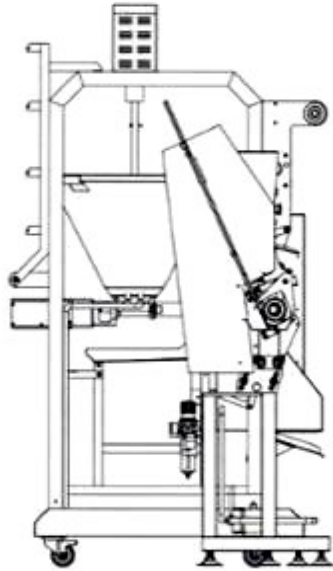

1.5

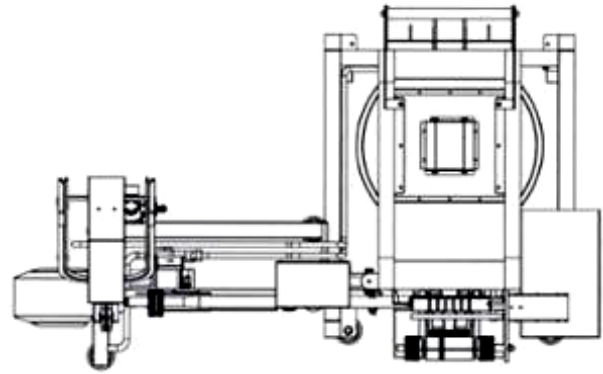

1.6

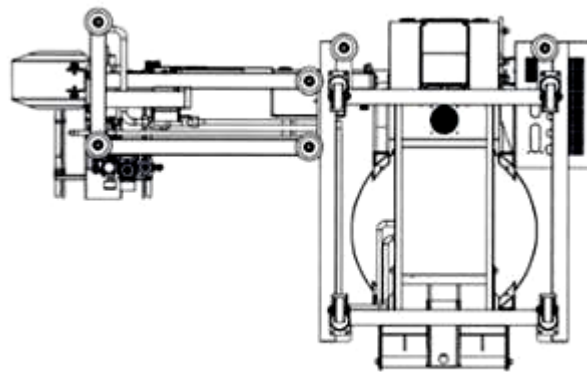

1.7

CÔNG BÁO SỞ HỮU CÔNG NGHIỆP SỐ 429 TẬP A – QUYỀN 2 (12.2023)

- (11) **48887**
(21) 3-2023-01539 (28) 1
(54) **THIẾT BỊ KẸP CHÌ BAO GÓI** (51) **15-99**
(22) 07/07/2023 (43) 25/12/2023
(73) **CÔNG TY TNHH THƯƠNG MẠI SẢN XUẤT DỊCH VỤ NHƠN DŨNG HOÀNG (VN)**
174/33/20 Nguyễn Tư Giản, phường 12, quận Gò Vấp, thành phố Hồ Chí Minh
(72) Nguyễn Ngọc Hoàng (VN)
(74) Công ty Cổ phần Sở hữu công nghiệp INVESTIP (INVESTIP)
(55)



1.1

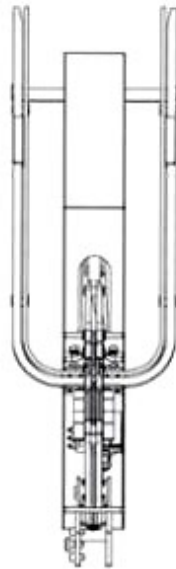

1.2



1.3

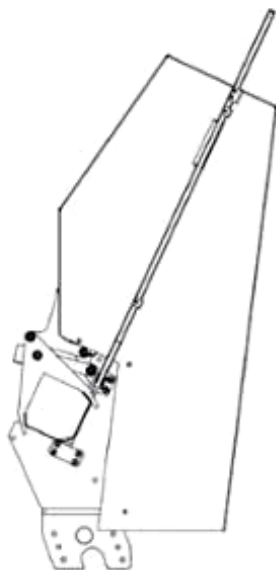

1.4



1.5

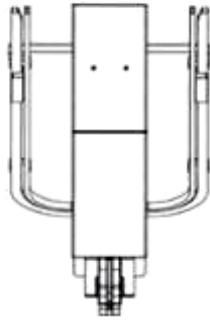

1.6

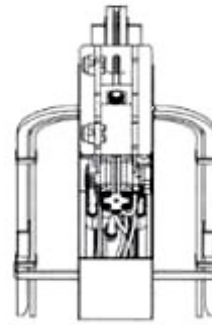

1.7

CÔNG BÁO SỞ HỮU CÔNG NGHIỆP SỐ 429 TẬP A – QUYỀN 2 (12.2023)

- (11) **48888**
(21) 3-2023-01540 (28) 1
(54) **THIẾT BỊ CẤP NGUYÊN LIỆU** (51) **15-99**
(22) 07/07/2023 (43) 25/12/2023
(73) **CÔNG TY TNHH THƯƠNG MẠI SẢN XUẤT DỊCH VỤ NHƠN DŨNG HOÀNG (VN)**
174/33/20 Nguyễn Tư Giản, phường 12, quận Gò Vấp, thành phố Hồ Chí Minh
(72) Nguyễn Ngọc Hoàng (VN)
(74) Công ty Cổ phần Sở hữu công nghiệp INVESTIP (INVESTIP)
(55)

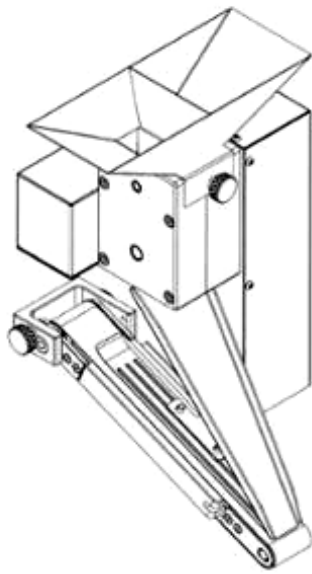

1.1



1.2

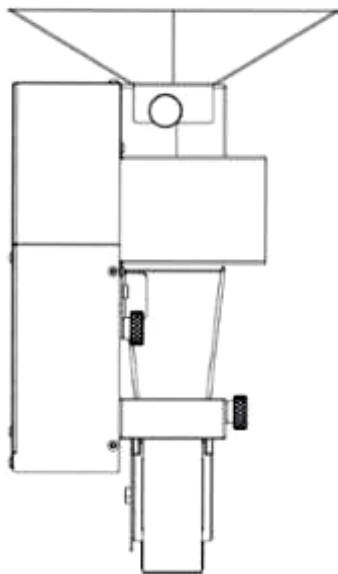

1.3

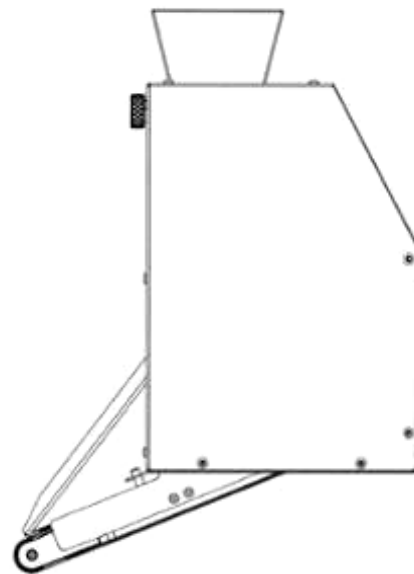

1.4

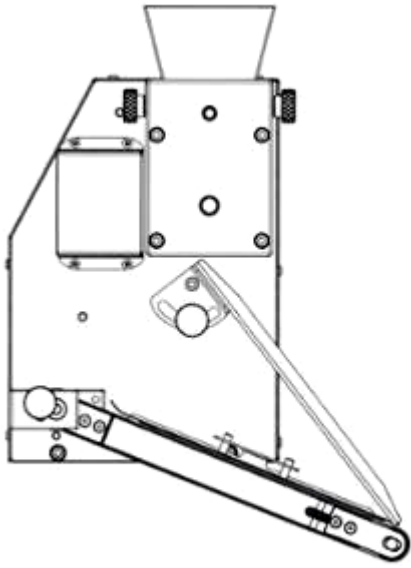

1.5

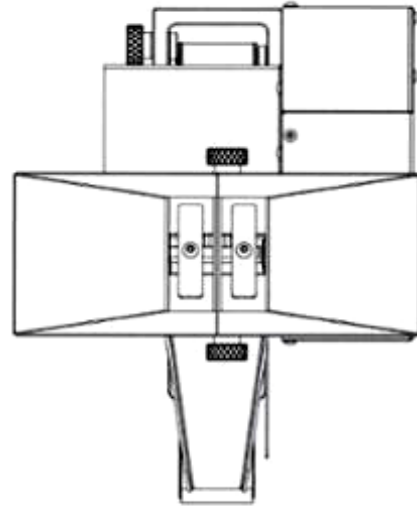

1.6

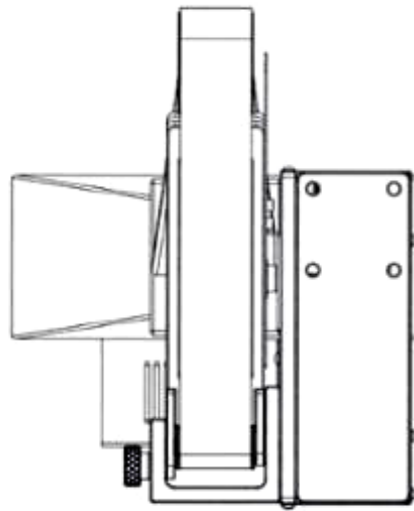

1.7

CÔNG BÁO SỞ HỮU CÔNG NGHIỆP SỐ 429 TẬP A – QUYỀN 2 (12.2023)

- (11) **48889**
(21) 3-2023-01576 (28) 1
(54) **NHÃN SẢN PHẨM** (51) **19-08**
(22) 11/07/2023 (43) 25/12/2023
(73) **CÔNG TY CỔ PHẦN THỰC PHẨM VÀ NƯỚC GIẢI KHÁT NAM VIỆT (VN)**
Số 994/1C, đường Nguyễn Thị Minh Khai, khu phố Tân Thắng, phường Tân Bình, thành phố Dĩ An, tỉnh Bình Dương
(72) Bùi Thị Thu Hương (VN)
(74) **CÔNG TY TNHH SỞ HỮU TRÍ TUỆ ANLIS VIỆT NAM (ANLIS IP CO.,LTD)**
(55)

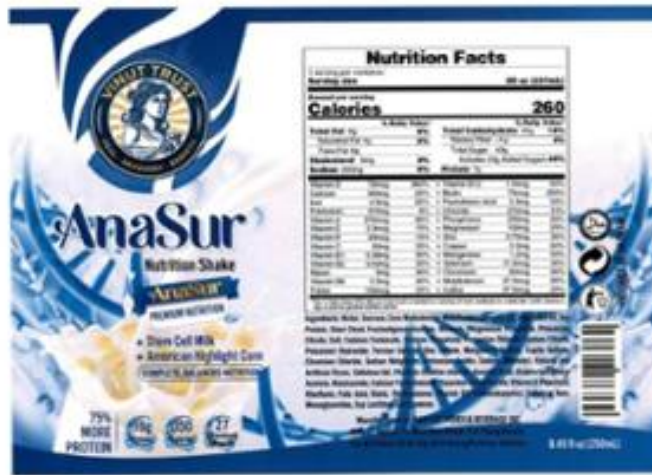

CÔNG BÁO SỞ HỮU CÔNG NGHIỆP SỐ 429 TẬP A – QUYỀN 2 (12.2023)

- (11) **48890**
- (21) 3-2023-01577
- (54) **LON**
- (22) 11/07/2023
- (73) **CÔNG TY CỔ PHẦN THỰC PHẨM VÀ NƯỚC GIẢI KHÁT NAM VIỆT (VN)**
Số 994/1C, đường Nguyễn Thị Minh Khai, khu phố Tân Thắng, phường Tân Bình, thành phố Dĩ An, tỉnh Bình Dương
- (72) Bùi Thị Thu Hương (VN)
- (74) **CÔNG TY TNHH SỞ HỮU TRÍ TUỆ ANLIS VIỆT NAM (ANLIS IP CO.,LTD)**
- (55)



1.1



1.2



1.3



1.4



1.5



1.6



1.7

CÔNG BÁO SỞ HỮU CÔNG NGHIỆP SỐ 429 TẬP A – QUYỀN 2 (12.2023)

- (11) **48891**
(21) 3-2023-01584 (28) 1
(54) **MÁY LỌC NƯỚC** (51) **23-01**
(22) 12/07/2023 (43) 25/12/2023
(73) **CÔNG TY CỔ PHẦN TẬP ĐOÀN SUNHOUSE (VN)**
Số 139, phố Nguyễn Thái Học, phường Điện Biên, quận Ba Đình, thành phố Hà Nội
(72) 1. LÊ TÙNG (VN)
2. TRẦN VĂN QUÂN (VN)
3. TRỊNH ĐỖ TRỌNG (VN)
4. ĐẶNG LÊ HÙNG (VN)
5. ĐINH VĂN VẠN (VN)
(74) Công ty TNHH Sở hữu trí tuệ Bình Minh (SUNRISE IP CO.,LTD.)
(55)



1.1



1.2



1.3



1.4



1.5



1.6



1.7

CÔNG BÁO SỞ HỮU CÔNG NGHIỆP SỐ 429 TẬP A – QUYỀN 2 (12.2023)

- (11) **48892**
(21) 3-2023-01585 (28) 2
(54) **BỘ PIN** (51) **13-02**
(22) 12/07/2023 (43) 25/12/2023
(30) 2023300833053 13/01/2023 CN;
(73) **TECHTRONIC CORDLESS GP (US)**
100 Innovation Way, Anderson, SC 29621, United States of America
(72) Ryan ALTENBURGER (US)
(74) Công ty TNHH Tầm nhìn và Liên danh (VISION & ASSOCIATES CO.LTD.)
(55)

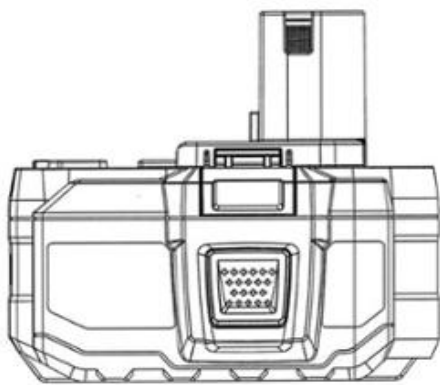

1.1

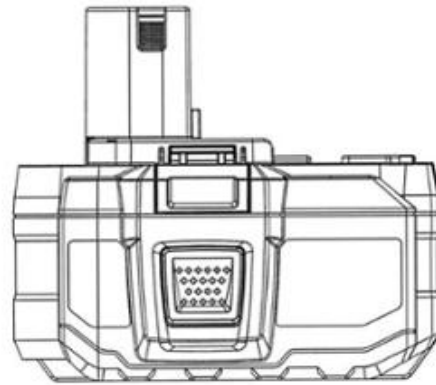

1.2



1.3

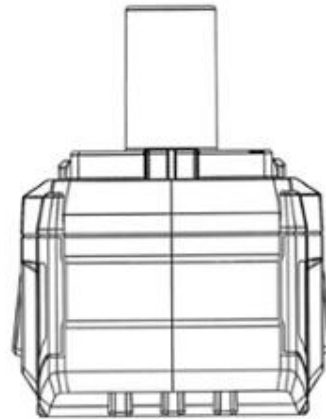

1.4

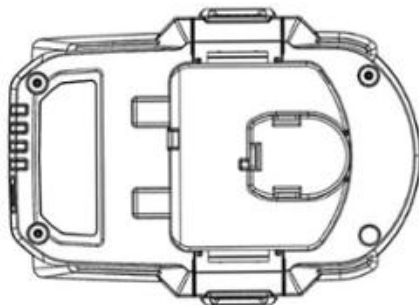

1.5

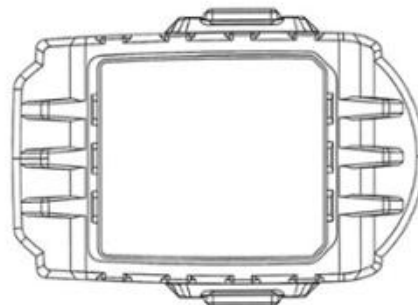

1.6

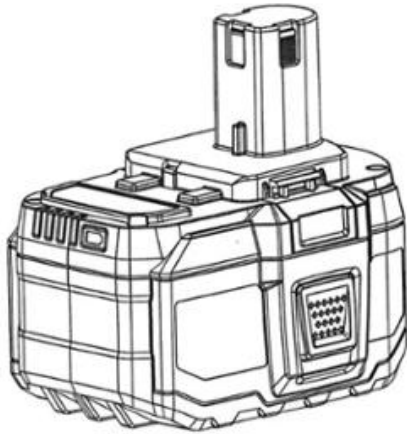

1.7

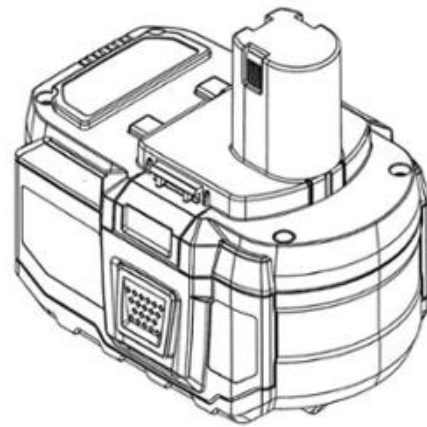

1.8



1.9

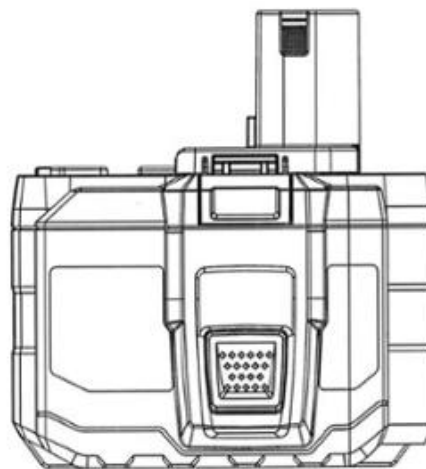

2.1

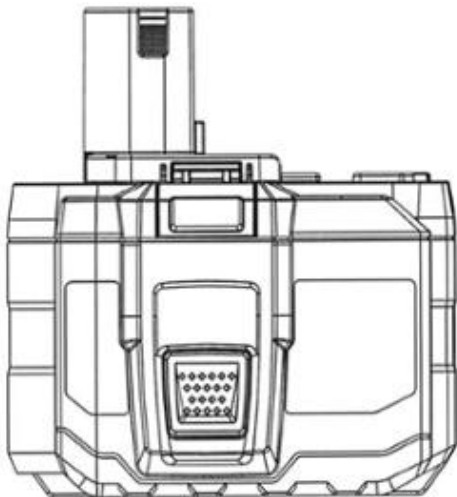

2.2

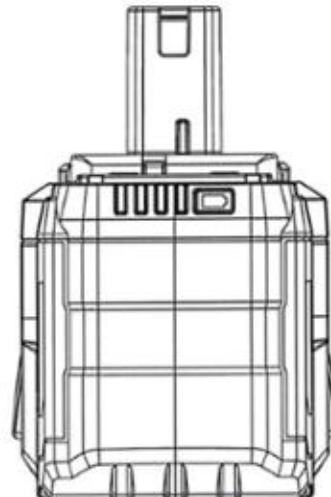

2.3



2.4

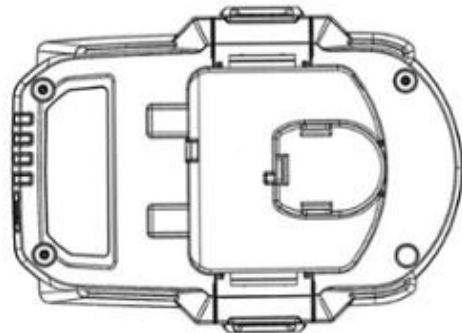

2.5

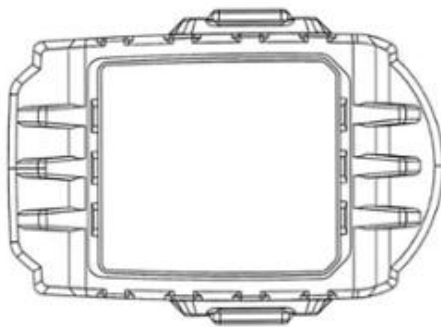

2.6

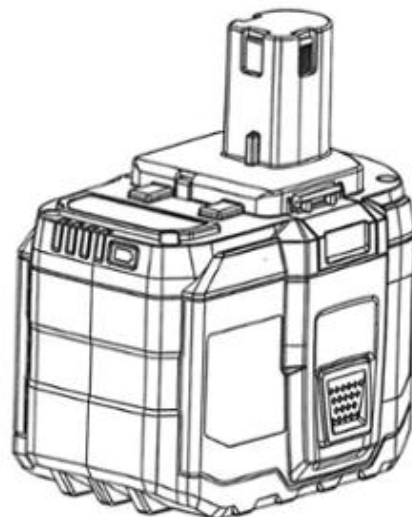

2.7

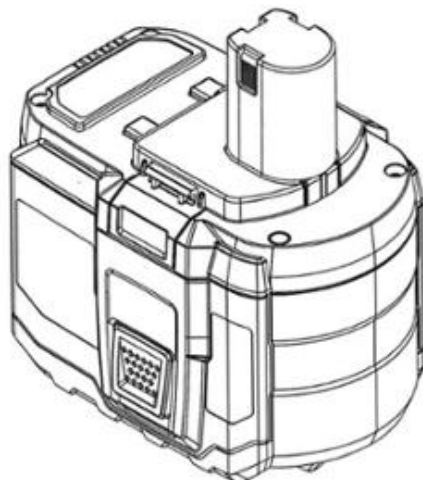

2.8



2.9

CÔNG BÁO SỞ HỮU CÔNG NGHIỆP SỐ 429 TẬP A – QUYỀN 2 (12.2023)

(11) **48893**

(21) 3-2023-01589

(28) 1

(54) **NẮP**

(51) **07-01**

(22) 13/07/2023

(43) 25/12/2023

(73) **CÔNG TY TNHH MINH LONG I (VN)**

333 đường Hưng Định 24, khu phố Hưng Lộc, phường Hưng Định, thành phố Thuận An, tỉnh Bình Dương

(72) Lý Huy Sáng (VN)

(55)

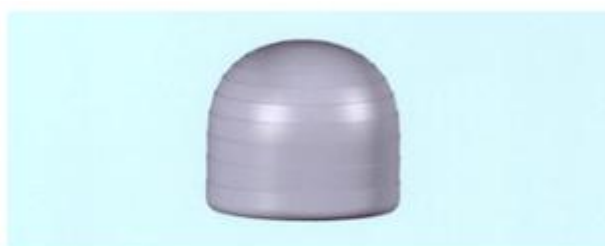

1.1



1.2

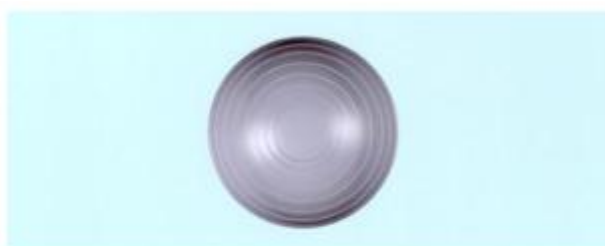

1.3



1.4

CÔNG BÁO SỞ HỮU CÔNG NGHIỆP SỐ 429 TẬP A – QUYỀN 2 (12.2023)

(11) **48894**

(21) 3-2023-01590

(28) 1

(54) **THANH KIM LOẠI ĐỊNH HÌNH**

(51) **25-01**

(22) 13/07/2023

(43) 25/12/2023

(73) **CÔNG TY TNHH MTV ĐĂNG QUANG (VN)**

Đường Trường Chinh, khu phố 1, phường Phú Tài, thành phố Phan Thiết, tỉnh Bình Thuận

(72) Võ Trường Thọ (VN)

(74) **CÔNG TY TNHH KHANG LUẬT (KHANGLAW)**

(55)

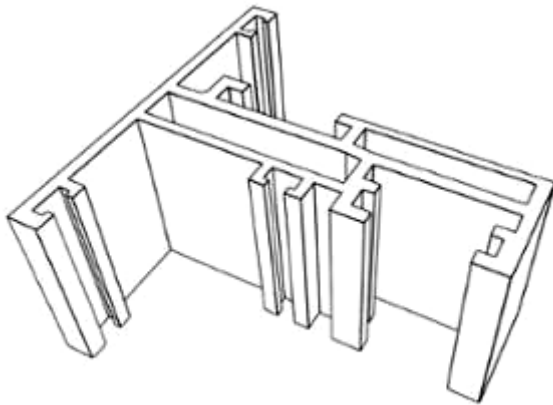

1.1



1.2



1.3



1.4



1.5

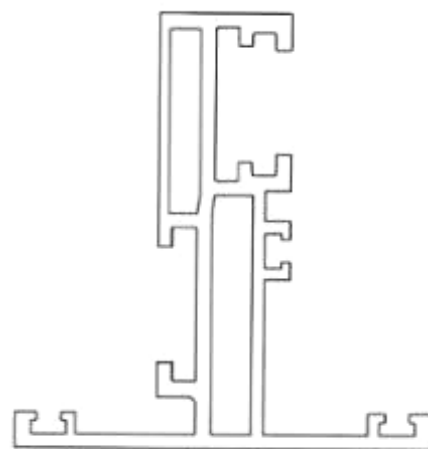

1.6

CÔNG BÁO SỞ HỮU CÔNG NGHIỆP SỐ 429 TẬP A – QUYỀN 2 (12.2023)

- (11) **48895**
(21) 3-2023-01591 (28) 1
(54) **HỘP** (51) **09-03**
(22) 13/07/2023 (43) 25/12/2023
(73) **HỘ KINH DOANH AN VĨNH PHÁT (VN)**
R23/39/36 cư xá Phú Lâm A, phường 12, quận 6, thành phố Hồ Chí Minh
(72) Khuu Sở Dinh (VN)
(55)



1.1



1.2



1.3



1.4



1.5

CÔNG BÁO SỞ HỮU CÔNG NGHIỆP SỐ 429 TẬP A – QUYỀN 2 (12.2023)

- (11) **48896**
- (21) 3-2023-01592
- (54) **THANH KIM LOẠI ĐỊNH HÌNH**
- (22) 13/07/2023
- (73) **CÔNG TY CỔ PHẦN TẬP ĐOÀN KENWIN (VN)**
Tầng 4 tòa nhà VG Building, số 235 đường Nguyễn Trãi, phường Thanh Xuân
Trung, quận Thanh Xuân, thành phố Hà Nội
- (72) Ngô Thọ Long (VN)
- (74) Công ty TNHH Sở hữu trí tuệ PADEMARK (PADEMARK CO.,LTD.)
- (55)

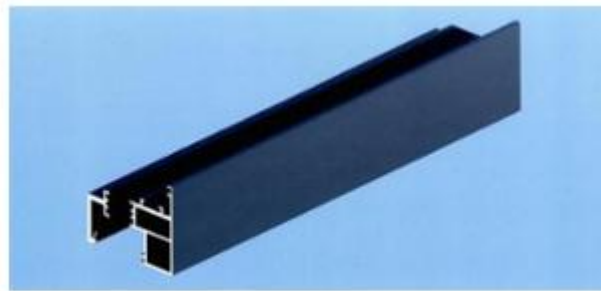

1.1



1.2



1.3

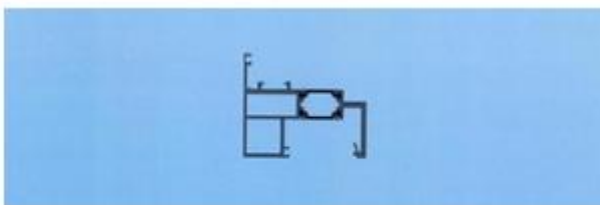

1.4

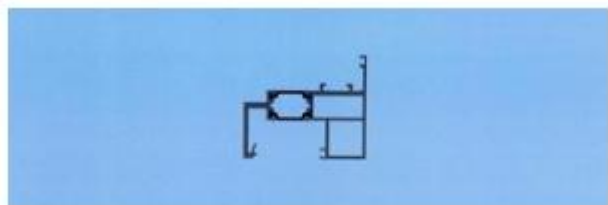

1.5



1.6



1.7

CÔNG BÁO SỞ HỮU CÔNG NGHIỆP SỐ 429 TẬP A – QUYỀN 2 (12.2023)

- (11) **48897**
(21) 3-2023-01593 (28) 1
(54) **THANH KIM LOẠI ĐỊNH HÌNH** (51) **25-01**
(22) 13/07/2023 (43) 25/12/2023
(73) **CÔNG TY CỔ PHẦN TẬP ĐOÀN KENWIN (VN)**
Tầng 4 tòa nhà VG Building, số 235 đường Nguyễn Trãi, phường Thanh Xuân
Trung, quận Thanh Xuân, thành phố Hà Nội
(72) Ngô Thọ Long (VN)
(74) Công ty TNHH Sở hữu trí tuệ PADEMARK (PADEMARK CO.,LTD.)
(55)



1.1



1.2



1.3

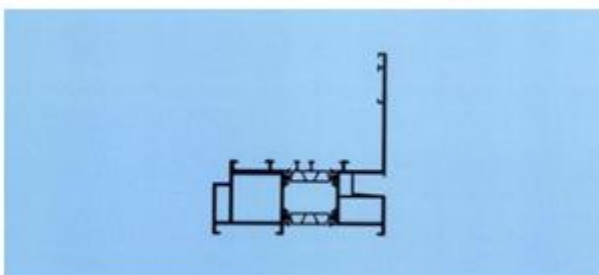

1.4

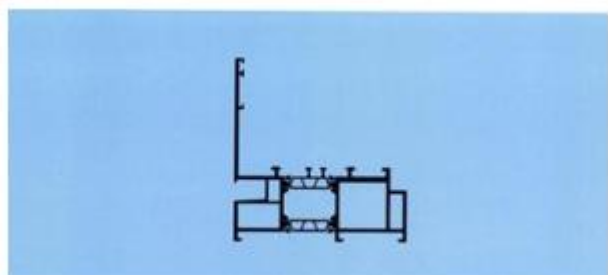

1.5



1.6



1.7

CÔNG BÁO SỞ HỮU CÔNG NGHIỆP SỐ 429 TẬP A – QUYỀN 2 (12.2023)

- (11) **48898**
(21) 3-2023-01595 (28) 1
(54) **THÙNG BIA** (51) **09-03**
(22) 13/07/2023 (43) 25/12/2023
(73) **CÔNG TY TNHH TOÀN CẦU BEVERAGE (VN)**
Số 8B đường Ngô Quyền, khu 4, phường Cẩm Thượng, thành phố Hải Dương, tỉnh Hải Dương
(72) Nguyễn Thế Phương (VN)
(74) Công ty TNHH Sở hữu trí tuệ M.I.T (M.I.T IP CO., LTD)
(55)



1.1



1.2

CÔNG BÁO SỞ HỮU CÔNG NGHIỆP SỐ 429 TẬP A – QUYỀN 2 (12.2023)

- (11) **48899**
(21) 3-2023-01596 (28) 1
(54) **THÙNG BIA** (51) **09-03**
(22) 13/07/2023 (43) 25/12/2023
(73) **CÔNG TY TNHH TOÀN CẦU BEVERAGE (VN)**
Số 8B đường Ngô Quyền, khu 4, phường Cẩm Thượng, thành phố Hải Dương, tỉnh Hải Dương
(72) Nguyễn Thế Phương (VN)
(74) Công ty TNHH Sở hữu trí tuệ M.I.T (M.I.T IP CO., LTD)
(55)



1.1



1.2

CÔNG BÁO SỞ HỮU CÔNG NGHIỆP SỐ 429 TẬP A – QUYỀN 2 (12.2023)

(11) **48900**

(21) 3-2023-01598

(28) 1

(54) **MÁY XI**

(51) **15-09**

(22) 14/07/2023

(43) 25/12/2023

(73) **CÔNG TY CỔ PHẦN THƯƠNG MẠI DỊCH VỤ IBC (VN)**

37/2 Nguyễn Minh Hoàng, phường 12, quận Tân Bình, thành phố Hồ Chí Minh

(72) Lưu Đình Ngọc Long (VN)

(74) **CÔNG TY TNHH MASTERBRAND (MASTERBRAND)**

(55)



1.1



1.2



1.3



1.4

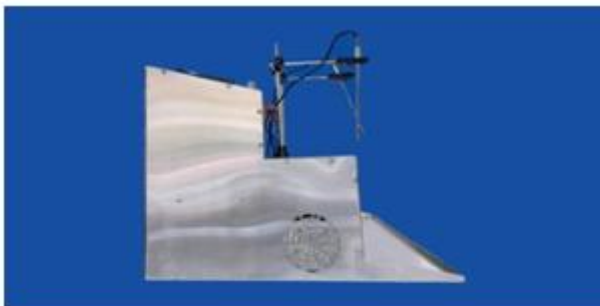

1.5



1.6



1.7

CÔNG BÁO SỞ HỮU CÔNG NGHIỆP SỐ 429 TẬP A – QUYỀN 2 (12.2023)

(11) **48901**

(21) 3-2023-01623

(54) **CHUÔNG GIA CẦM**

(22) 14/07/2023

(73) **HỘ KINH DOANH VÕ THỊ TUYẾT PHƯƠNG (VN)**

331, đường Sông Lu, tổ 4, ấp An Hòa, xã Trung An, huyện Củ Chi, thành phố Hồ Chí Minh

(72) Lê Thanh Sơn (VN)

(74) Công ty TNHH Tư vấn - Dịch thuật - Sở hữu trí tuệ Á Đông (Á Đông IP CONSULTANCY CO.,LTD.)

(55)



1.1

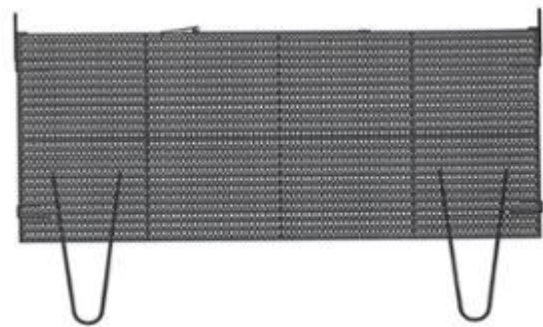

1.2

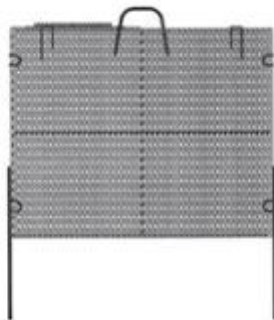

1.3

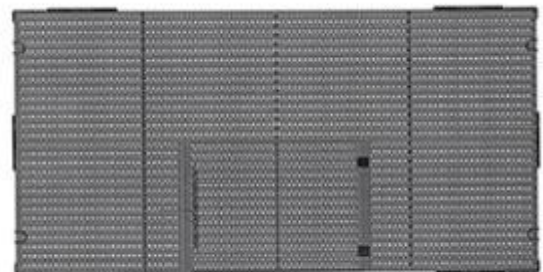

1.4

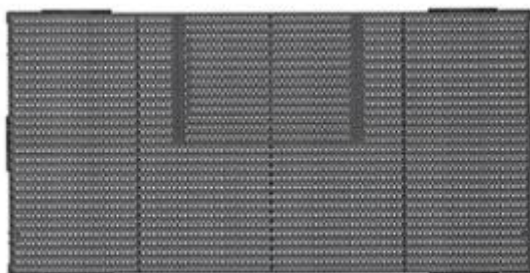

1.5



2.1

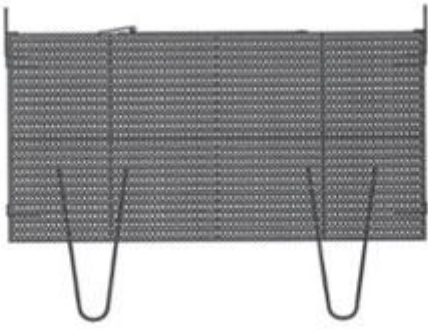

2.2



2.3

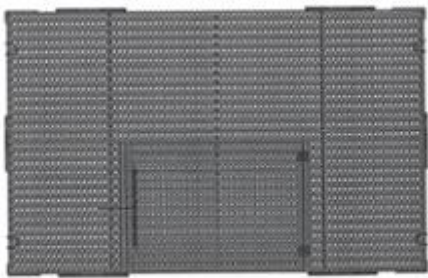

2.4

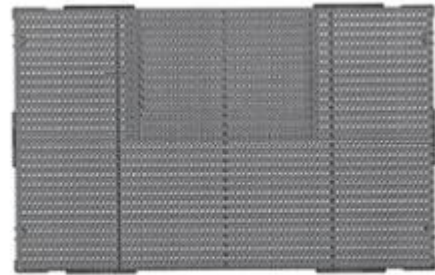

2.5



3.1

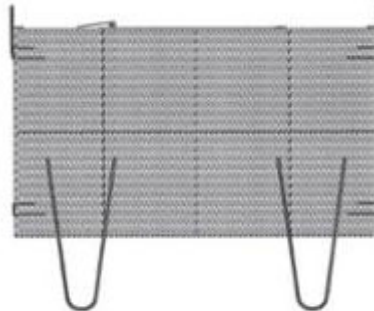

3.2

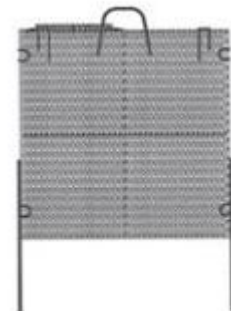

3.3

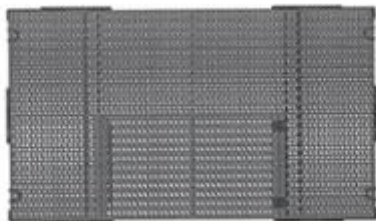

3.4

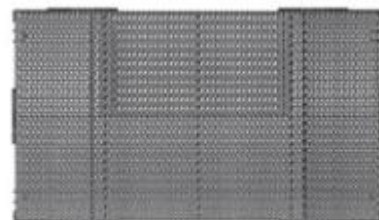

3.5

CÔNG BÁO SỞ HỮU CÔNG NGHIỆP SỐ 429 TẬP A – QUYỀN 2 (12.2023)

- (11) **48902**
(21) 3-2023-01624 (28) 2
(54) **MÁNG ĐỰNG THỨC ĂN CHO GIA CẦM** (51) **30-03**
(22) 14/07/2023 (43) 25/12/2023
(73) **HỘ KINH DOANH VÕ THỊ TUYẾT PHƯƠNG (VN)**
331, đường Sông Lu, tổ 4, ấp An Hòa, xã Trung An, huyện Củ Chi, thành phố Hồ Chí Minh
(72) Lê Thanh Sơn (VN)
(74) Công ty TNHH Tư vấn - Dịch thuật - Sở hữu trí tuệ Á Đông (Á Đông IP CONSULTANCY CO.,LTD.)
(55)



1.1



1.2



1.3



1.4



1.5



2.1



2.2



2.3



2.4



2.5

CÔNG BÁO SỞ HỮU CÔNG NGHIỆP SỐ 429 TẬP A – QUYỀN 2 (12.2023)

- (11) **48903**
(21) 3-2023-01634 (28) 2
(54) **PHÍCH CẮM ĐIỆN** (51) **13-03**
(22) 17/07/2023 (43) 25/12/2023
(73) **CÔNG TY CỔ PHẦN CHẾ TẠO THIẾT BỊ ĐIỆN OMEGA (VN)**
Số 38 phố Bà Triệu, phường Hàng Bài, quận Hoàn Kiếm, thành phố Hà Nội
(72) Vũ Minh Tuấn (VN)
(74) Công ty cổ phần FAS INVEST (FAS INVEST JSC)
(55)



1.1



1.2



1.3



1.4



1.5



1.6



2.1



2.2



2.3



2.4



2.5



2.6

CÔNG BÁO SỞ HỮU CÔNG NGHIỆP SỐ 429 TẬP A – QUYỀN 2 (12.2023)

(11) **48904**

(21) 3-2023-01637

(28) 1

(54) **MÁNG ĐÈN**

(51) **26-05**

(22) 18/07/2023

(43) 25/12/2023

(73) **CÔNG TY CỔ PHẦN PCS VIỆT NAM (VN)**

Số 15, ngách 99/85/6 đường Đức Giang, phường Thượng Thanh, quận Long Biên, thành phố Hà Nội

(72) Trần Văn Nguyên (VN)

(74) Công ty TNHH Sở hữu trí tuệ Toàn Cầu (GLOBAL IP CO., LTD.)

(55)



1.1

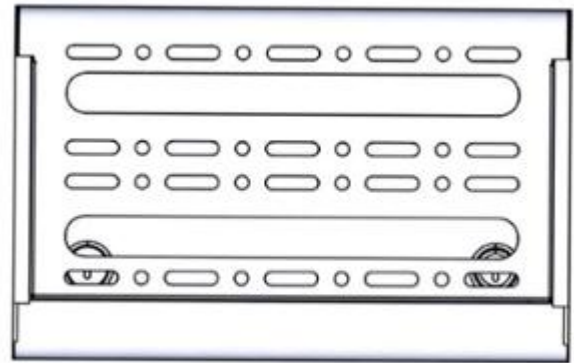

1.2

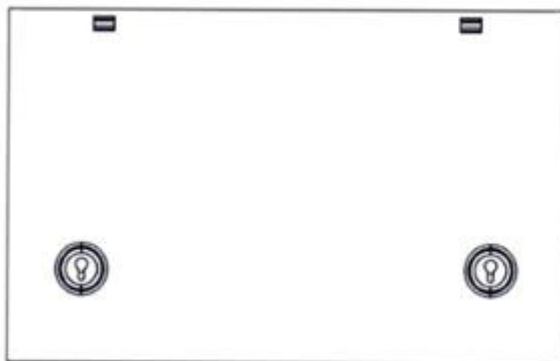

1.3



1.4



1.5



1.6

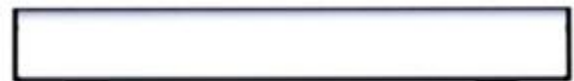

1.7

CÔNG BÁO SỞ HỮU CÔNG NGHIỆP SỐ 429 TẬP A – QUYỀN 2 (12.2023)

- (11) **48905**
(21) 3-2023-01639 (28) 1
(54) **NẮP HỘP ĐỰNG THỰC PHẨM** (51) **07-07; 09-07**
(22) 18/07/2023 (43) 25/12/2023
(30) 30-2023-0004461 07/02/2023 KR;
(73) **LOCK & LOCK CO., LTD.** (KR)
1260, Manse-ro, Wongok-myeon, Anseong-si, Gyeonggi-do, Republic of Korea
(72) NAM, Soo Jung (KR)
(74) Công ty TNHH Tầm nhìn và Liên danh (VISION & ASSOCIATES CO.LTD.)
(55)

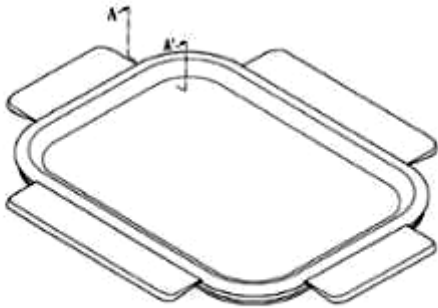

1.1



1.2



1.3



1.4



1.5



1.6

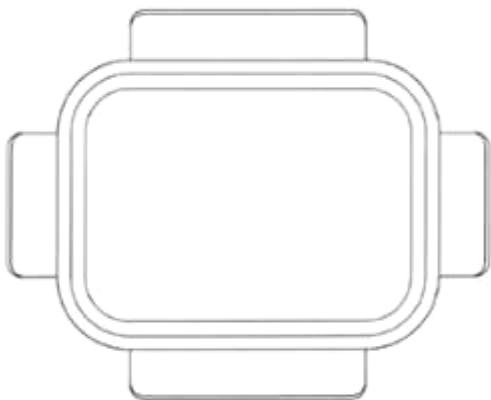

1.7



1.8

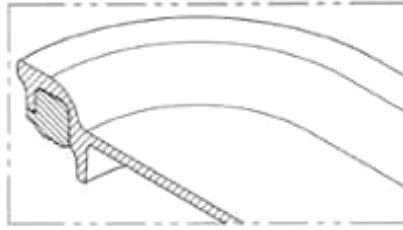

1.9

CÔNG BÁO SỞ HỮU CÔNG NGHIỆP SỐ 429 TẬP A – QUYỀN 2 (12.2023)

- (11) **48906**
(21) 3-2023-01640 (28) 1
(54) **NẮP HỘP ĐỰNG THỰC PHẨM** (51) **07-07; 09-07**
(22) 18/07/2023 (43) 25/12/2023
(30) 30-2023-0004462 07/02/2023 KR;
(73) **LOCK & LOCK CO., LTD.** (KR)
1260, Manse-ro, Wongok-myeon, Anseong-si, Gyeonggi-do, Republic of Korea
(72) SHIM, Dong Seop (KR)
(74) Công ty TNHH Tầm nhìn và Liên danh (VISION & ASSOCIATES CO.LTD.)
(55)

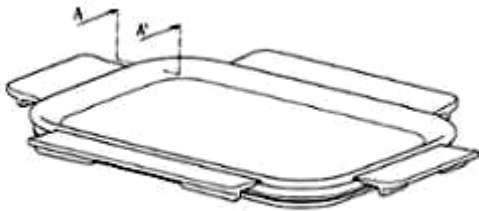

1.1



1.2



1.3



1.4



1.5



1.6

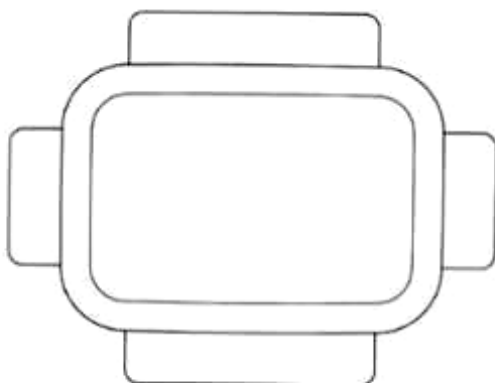

1.7



1.8

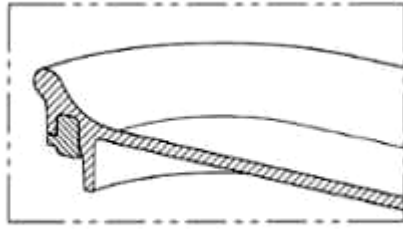

1.9

CÔNG BÁO SỞ HỮU CÔNG NGHIỆP SỐ 429 TẬP A – QUYỀN 2 (12.2023)

- (11) **48907**
(21) 3-2023-01642 (28) 1
(54) **THUYỀN MÁY** (51) **12-06**
(22) 19/07/2023 (43) 25/12/2023
(73) **CÔNG TY CP VIETBOAT (VN)**
Tổ 95 khu Đồn Điền, phường Hà Khẩu, thành phố Hạ Long, tỉnh Quảng Ninh
(72) **Bùi Mạnh Cường (VN)**
(74) Công ty Luật TNHH Phạm và Liên danh (PHAM & ASSOCIATES)
(55)



1.1



1.2



1.3



1.4

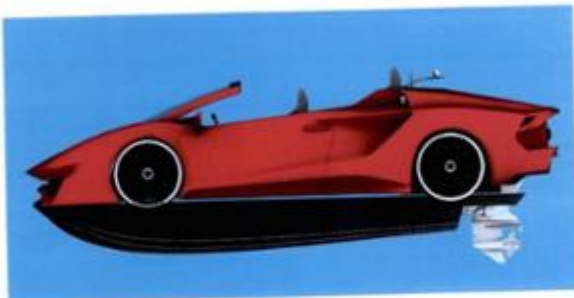

1.5



1.6



1.7

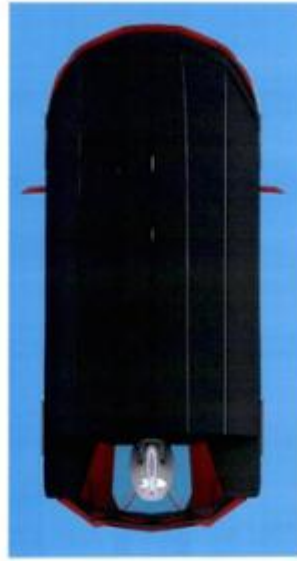

1.8

CÔNG BÁO SỞ HỮU CÔNG NGHIỆP SỐ 429 TẬP A – QUYỀN 2 (12.2023)

- (11) **48908**
- (21) 3-2023-01651 (28) 1
- (54) **NHÃN SẢN PHẨM** (51) **19-08**
- (22) 19/07/2023 (43) 25/12/2023
- (73) **CÔNG TY TNHH VKT VIỆT THÁI (VN)**
27A đường TCH08, khu phố 11, phường Tân Chánh Hiệp, quận 12, thành phố Hồ Chí Minh
- (72) Lê Nguyên Khải (VN)
- (74) **CÔNG TY TNHH KHANG LUẬT (KHANGLAW)**
- (55)



CÔNG BÁO SỞ HỮU CÔNG NGHIỆP SỐ 429 TẬP A – QUYỀN 2 (12.2023)

- (11) **48909**
- (21) 3-2023-01660 (28) 1
- (54) **VỎ BỌC ĐỒNG HỒ ĐEO TAY** (51) **10-07**
- (22) 20/07/2023 (43) 25/12/2023
- (30) DM/226741 10/02/2023 WO;
- (73) **RICHEMONT INTERNATIONAL SA (CH)**
10 Route des Biches, 1752 Villars-sur-Glane, Switzerland
- (72) Julien Gurtner (CH)
- (74) Công ty TNHH Luật ALIAT (ALIAT LEGAL)
- (55)

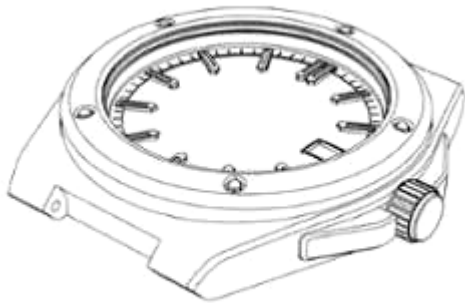

1.1

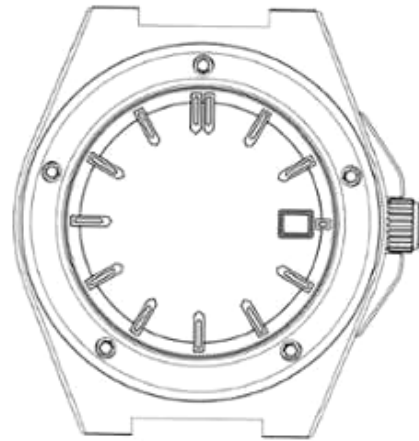

1.2

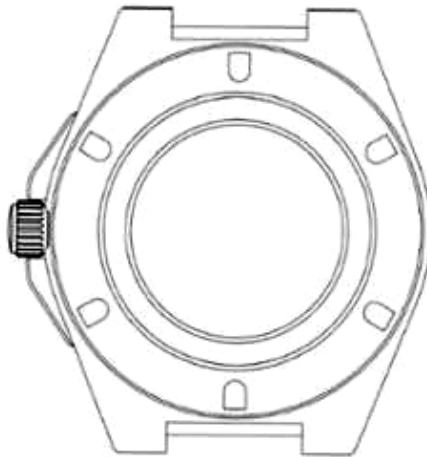

1.3

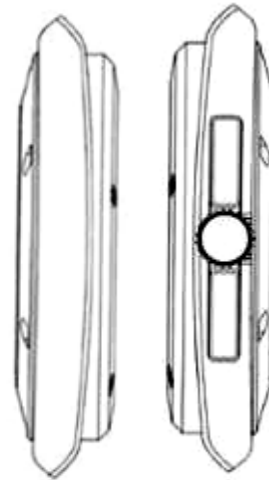

1.4

1.5



1.6



1.7

CÔNG BÁO SỞ HỮU CÔNG NGHIỆP SỐ 429 TẬP A – QUYỀN 2 (12.2023)

- (11) **48910**
 - (21) 3-2023-01661
 - (54) **VỎ BỌC ĐỒNG HỒ ĐEO TAY**
 - (22) 20/07/2023
 - (30) DM/226741 10/02/2023 WO;
 - (73) **RICHEMONT INTERNATIONAL SA (CH)**
10 Route des Biches, 1752 Villars-sur-Glane, Switzerland
 - (72) Julien Gurtner (CH)
 - (74) Công ty TNHH Luật ALIAT (ALIAT LEGAL)
 - (55)
- (28) 1
- (51) **10-07**
- (43) 25/12/2023

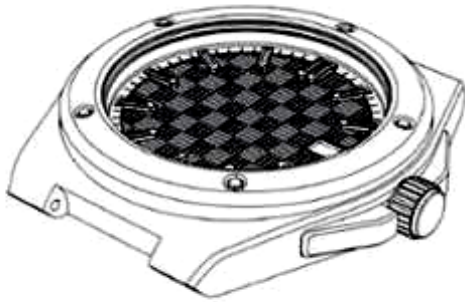

1.1

1.2

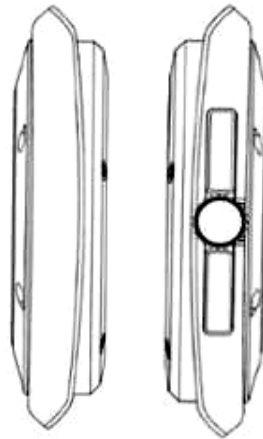
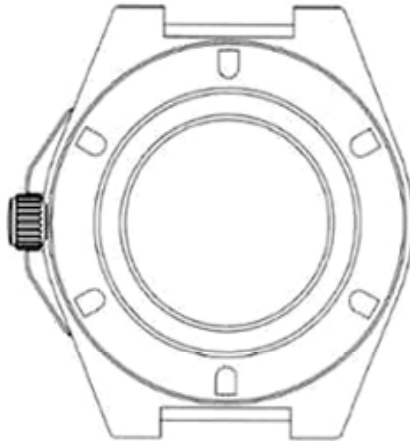

1.3

1.4

1.5

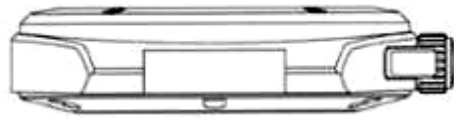

1.6

1.7

- (11) **48911**
- (21) 3-2023-01662 (28) 1
- (54) **MẶT ĐỒNG HỒ ĐEO TAY** (51) **10-07**
- (22) 20/07/2023 (43) 25/12/2023
- (30) DM/226741 10/02/2023 WO;
- (73) **RICHEMONT INTERNATIONAL SA (CH)**
10 Route des Biches, 1752 Villars-sur-Glane, Switzerland
- (72) Julien Gurtner (CH)
- (74) Công ty TNHH Luật ALIAT (ALIAT LEGAL)
- (55)

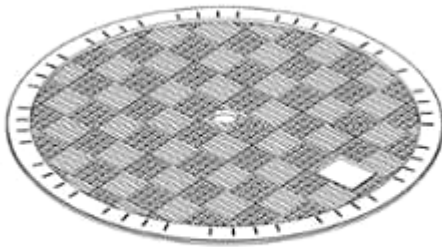

1.1

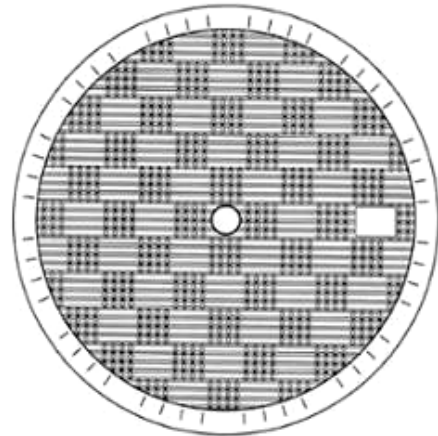

1.2

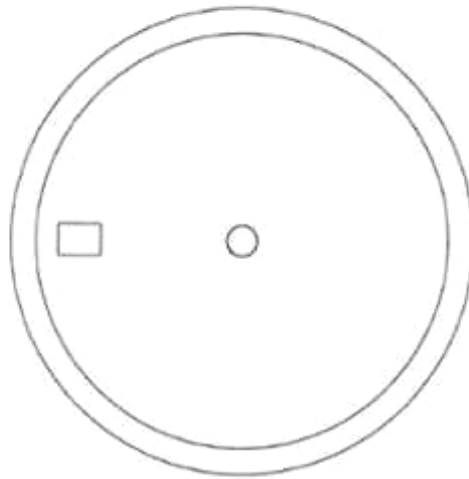

1.3



1.4

1.5



1.6



1.7

CÔNG BÁO SỞ HỮU CÔNG NGHIỆP SỐ 429 TẬP A – QUYỀN 2 (12.2023)

(11) **48912**

(21) 3-2023-01665

(54) **SỢT ĐỰNG**

(22) 24/07/2023

(73) **CÔNG TY CỔ PHẦN THAKE (VN)**

29/17 đường liên xã thị trấn Thới Tam Thôn, xã Thới Tam Thôn, huyện Hóc Môn, thành phố Hồ Chí Minh

(72) Chim Văn Càng (VN)

(55)

(28) 1

(51) **09-04**

(43) 25/12/2023



1.1



1.2



1.3

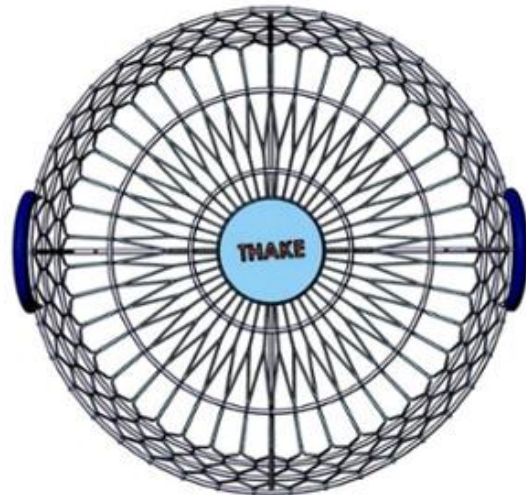

1.4

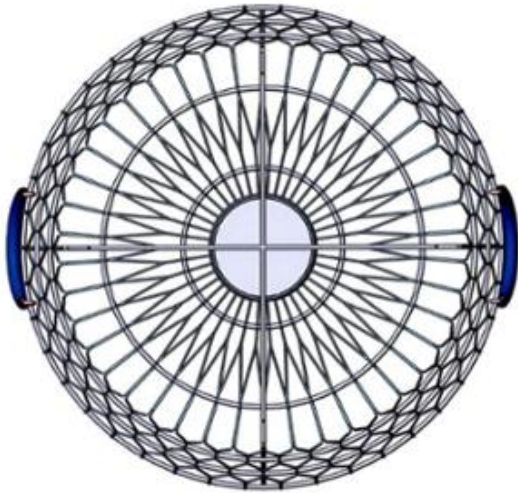

1.5



1.6

CÔNG BÁO SỞ HỮU CÔNG NGHIỆP SỐ 429 TẬP A – QUYỀN 2 (12.2023)

- (11) **48913**
(21) 3-2023-01666 (28) 2
(54) **GIÀY** (51) **02-04**
(22) 24/07/2023 (43) 25/12/2023
(30) 29/896,383 03/07/2023 US;
(73) **HALF PIPE II, LLC (US)**
100 East Sandreed Road, Jackson, WY 83001, USA
(72) 1. WAYNE KULKIN (US)
2. JOSEPH AMORUSO (IT)
(74) Công ty TNHH Ban Ca (BANCA)
(55)



1.1



1.2

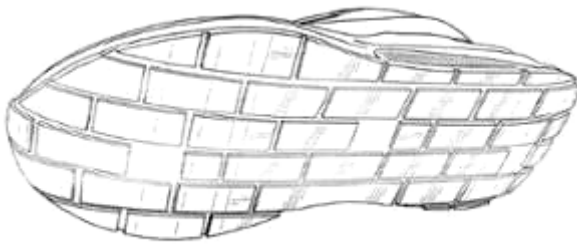

1.3

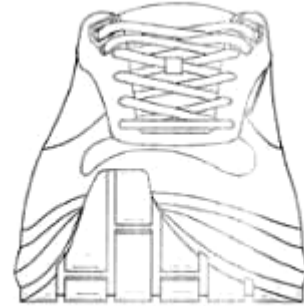

1.4

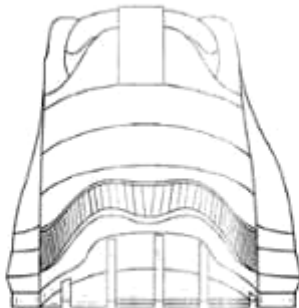

1.5



1.6



1.7



1.8

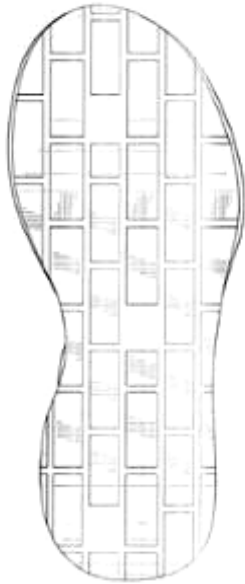

1.9



2.1



2.2

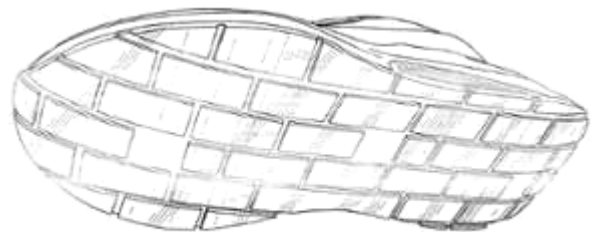

2.3

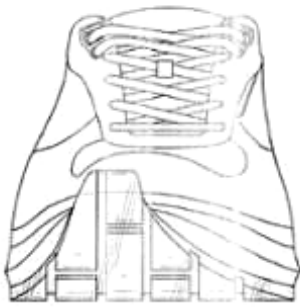

2.4

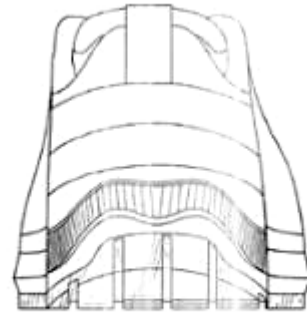

2.5



2.6



2.7



2.8

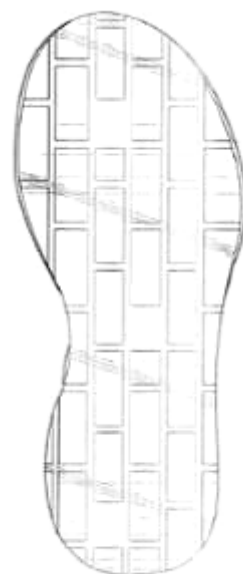

2.9

CÔNG BÁO SỞ HỮU CÔNG NGHIỆP SỐ 429 TẬP A – QUYỀN 2 (12.2023)

- (11) **48914**
(21) 3-2023-01669 (28) 1
(54) **LỌ** (51) **09-01**
(22) 24/07/2023 (43) 25/12/2023
(73) **LG H&H CO., LTD. (KR)**
58, Saemunan-ro, Jongno-gu, Seoul, Republic of Korea
(72) KIM, Ja Young (KR)
(74) Công ty TNHH Tâm nhìn và Liên danh (VISION & ASSOCIATES CO.LTD.)
(55)



1.1



1.2



1.3



1.4



1.5



1.6



1.7

CÔNG BÁO SỞ HỮU CÔNG NGHIỆP SỐ 429 TẬP A – QUYỀN 2 (12.2023)

- (11) **48915**
(21) 3-2023-01673 (28) 1
(54) **ĐỂ ĐẶT TƯỢNG** (51) **99-00**
(22) 25/07/2023 (43) 25/12/2023
(73) **NGUYỄN NGỌC PHƯƠNG (VN)**
Phòng 414-P70-D6 phường Giảng Võ, quận Ba Đình, thành phố Hà Nội
(72) Nguyễn Ngọc Phương (VN)
(74) Công ty TNHH Hùng Sơn và Cộng sự (HUNG SON & PARTNERS)
(55)



1.1



1.2



1.3



1.4



1.5



1.6

CÔNG BÁO SỞ HỮU CÔNG NGHIỆP SỐ 429 TẬP A – QUYỀN 2 (12.2023)

- (11) **48916**
(21) 3-2023-01674 (28) 1
(54) **QUẠT** (51) **23-04**
(22) 25/07/2023 (43) 25/12/2023
(73) **KANG YONG ELECTRIC PUBLIC COMPANY LIMITED (TH)**
67 Moo 11, Debaratana Road, Km.20., Bang Cha long, Bang Plee, Samut Prakan
Province, 10540, Thailand
(72) Anek Songsrisawad (TH)
(74) Công ty TNHH Tâm nhìn và Liên danh (VISION & ASSOCIATES CO.LTD.)
(55)



1.1



1.2



1.3



1.4



1.5



1.6



1.7

CÔNG BÁO SỞ HỮU CÔNG NGHIỆP SỐ 429 TẬP A – QUYỀN 2 (12.2023)

- (11) **48917**
(21) 3-2023-01675 (28) 1
(54) **BỒN CHỨA NƯỚC** (51) **23-01**
(22) 25/07/2023 (43) 25/12/2023
(73) **CÔNG TY CỔ PHẦN NHỰA SAO VIỆT (VN)**
Tổ 12, ấp Hội Thạnh, xã Xuân Hiệp, huyện Trà Ôn, tỉnh Vĩnh Long
(72) Nguyễn Phú Thi (VN)
(74) Công ty TNHH Tư vấn - Dịch thuật - Sở hữu trí tuệ Á Đông (Á Đông IP
CONSULTANCY CO.,LTD.)
(55)



1.1

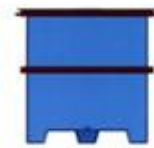

1.2



1.3



1.4



1.5



1.6



1.7

CÔNG BÁO SỞ HỮU CÔNG NGHIỆP SỐ 429 TẬP A – QUYỀN 2 (12.2023)

- (11) **48918**
(21) 3-2023-01682 (28) 1
(54) **TẤM TRANG TRÍ DÀNH CHO CỬA TỬ** (51) **06-04**
(22) 26/07/2023 (43) 25/12/2023
(73) **ĐÀO HIỆU ĐÔNG (VN)**
259 Võ Văn Tần, phường 5, quận 3, thành phố Hồ Chí Minh
(72) Đào Hiếu Đông (VN)
(74) Văn phòng Luật sư A Hoà (AHOA LAW OFFICE)
(55)



1.1



1.2



1.3



1.4

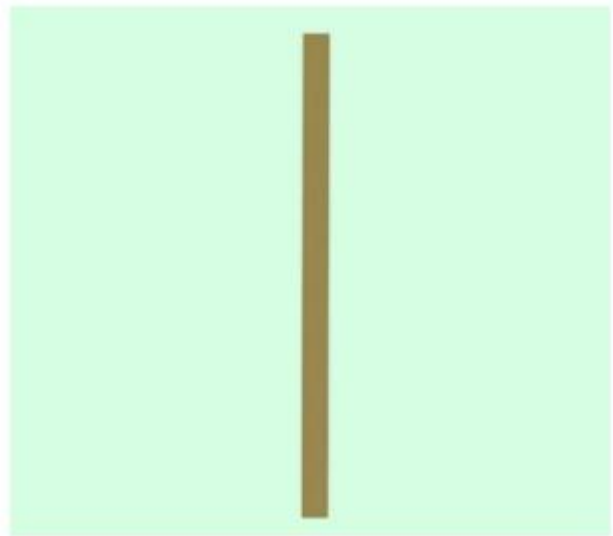

1.5



1.6

CÔNG BÁO SỞ HỮU CÔNG NGHIỆP SỐ 429 TẬP A – QUYỀN 2 (12.2023)

- (11) **48919**
(21) 3-2023-01683 (28) 1
(54) **TẤM TRANG TRÍ DÀNH CHO CỬA TỬ** (51) **06-04**
(22) 26/07/2023 (43) 25/12/2023
(73) **ĐÀO HIỆU ĐÔNG (VN)**
259 Võ Văn Tần, phường 5, quận 3, thành phố Hồ Chí Minh
(72) Đào Hiệu Đông (VN)
(74) Văn phòng Luật sư A Hoà (AHOA LAW OFFICE)
(55)



1.1



1.2



1.3



1.4

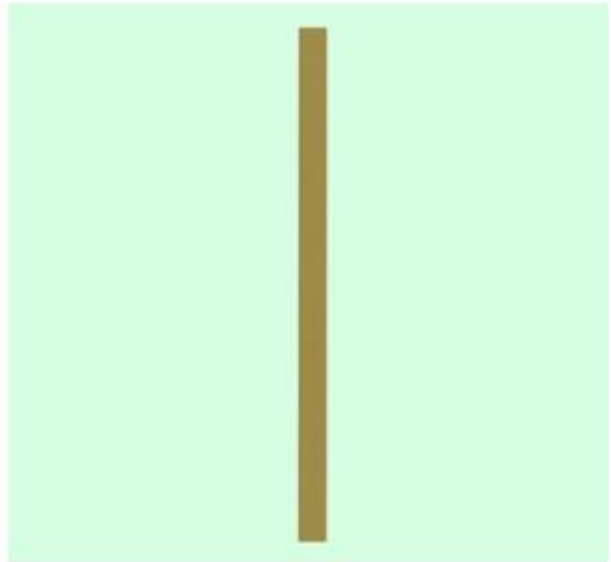

1.5

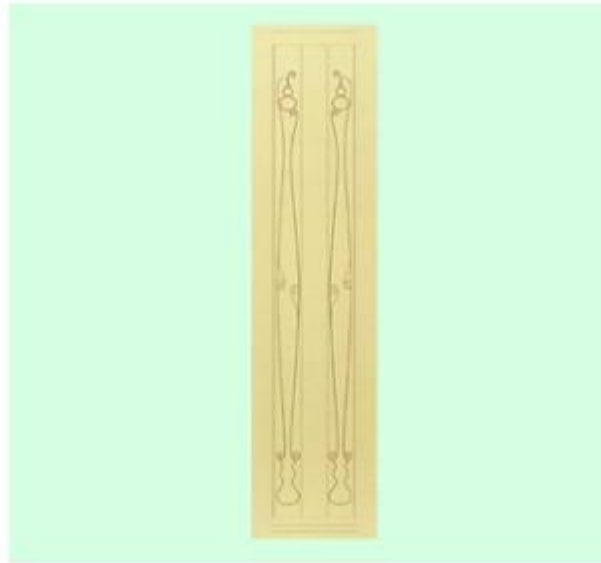

1.6

CÔNG BÁO SỞ HỮU CÔNG NGHIỆP SỐ 429 TẬP A – QUYỀN 2 (12.2023)

- (11) **48920**
(21) 3-2023-01688 (28) 1
(54) **DÉP** (51) **02-04**
(22) 26/07/2023 (43) 25/12/2023
(30) 29/883,517 30/01/2023 US;
(73) **CROCS, INC. (US)**
13601 Via Varra, Broomfield, Colorado 80020, United States of America
(72) Salehe BEMBURY (US)
(74) Công ty Luật TNHH quốc tế BMVN (BMVN INTERNATIONAL LLC)
(55)



1.1



1.2



1.3



1.4



1.5



1.6



1.7

CÔNG BÁO SỞ HỮU CÔNG NGHIỆP SỐ 429 TẬP A – QUYỀN 2 (12.2023)

- (11) **48921**
(21) 3-2023-01689 (28) 2
(54) **KẸO** (51) **01-01**
(22) 26/07/2023 (43) 25/12/2023
(30) 015022241-0004 22/05/2023 EM; 015022241-0003 22/05/2023 EM;
(73) **ZURU (SINGAPORE) PTE. LTD. (SG)**
1003 Bukit Merah Central #06-07, Singapore
(72) MOWBRAY, Mathew Peter (NZ)
(74) Công ty TNHH Dịch vụ Sở hữu trí tuệ KENFOX (KENFOX IP SERVICE CO.,LTD.)
(55)



1.1



1.2



1.3



1.4



1.5



1.6



1.7



2.1



2.2



2.3



2.4



2.5



2.6



2.7

CÔNG BÁO SỞ HỮU CÔNG NGHIỆP SỐ 429 TẬP A – QUYỀN 2 (12.2023)

- (11) **48922**
(21) 3-2023-01695 (28) 1
(54) **TĂNG ĐỘ CẤP** (51) **08-99**
(22) 26/07/2023 (43) 25/12/2023
(73) **CÔNG TY CỔ PHẦN AN TOÀN SSTC (VN)**
372/6 Dương Thị Mười, khu phố 3, phường Tân Thới Hiệp, quận 12, thành phố Hồ Chí Minh
(72) Dương Đình Luân (VN)
(74) Công ty Cổ phần Sở hữu công nghiệp INVESTIP (INVESTIP)
(55)



1.1



1.3



1.2



1.4

CÔNG BÁO SỞ HỮU CÔNG NGHIỆP SỐ 429 TẬP A – QUYỀN 2 (12.2023)

- (11) **48923**
- (21) 3-2023-01720 (28) 1
- (54) **NHÃN SẢN PHẨM** (51) **19-08**
- (22) 27/07/2023 (43) 25/12/2023
- (73) **CÔNG TY TNHH SẢN XUẤT THƯƠNG MẠI DR HIẾU (VN)**
896A/59 Hậu Giang, phường 12, quận 6, thành phố Hồ Chí Minh
- (72) Nguyễn Chánh Trung (VN)
- (74) Công ty TNHH một thành viên Trường Luật (Trường Luật)
- (55)



CÔNG BÁO SỞ HỮU CÔNG NGHIỆP SỐ 429 TẬP A – QUYỀN 2 (12.2023)

- (11) **48924**
(21) 3-2023-01727 (28) 1
(54) **TUÝP ĐỰNG MỸ PHẨM** (51) **09-05**
(22) 28/07/2023 (43) 25/12/2023
(73) **LG H&H CO., LTD. (KR)**
58, Saemunan-ro, Jongno-gu, Seoul, Republic of Korea
(72) KIM, Jeong Woo (KR)
(74) Công ty TNHH Tâm nhìn và Liên danh (VISION & ASSOCIATES CO.LTD.)
(55)



1.1

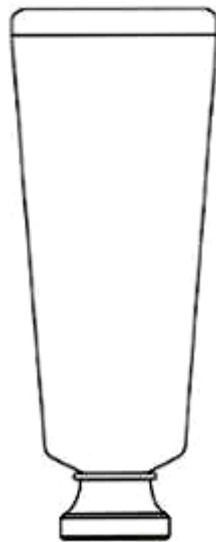

1.2



1.3

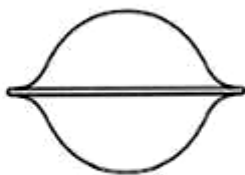

1.4

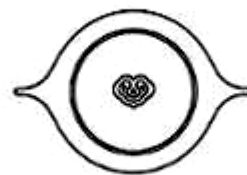

1.5

CÔNG BÁO SỞ HỮU CÔNG NGHIỆP SỐ 429 TẬP A – QUYỀN 2 (12.2023)

- (11) **48925**
(21) 3-2023-01739 (28) 1
(54) **KHỐI ĐỒ CHƠI** (51) **21-01**
(22) 31/07/2023 (43) 25/12/2023
(30) 30-2023-0003947 02/02/2023 KR;
(73) **IRINGO CO., LTD** (KR)
403, Hambangmoe-ro, Namdong-gu, Incheon, Republic of Korea
(72) KIM Kwan-Young (KR)
(74) Công ty Luật TNHH Phạm và Liên danh (PHAM & ASSOCIATES)
(55)

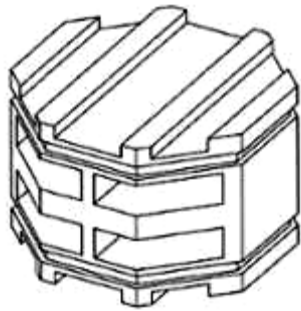

1.1

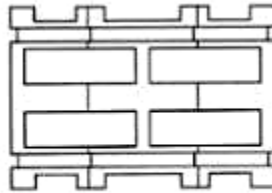

1.2

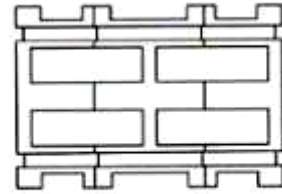

1.3

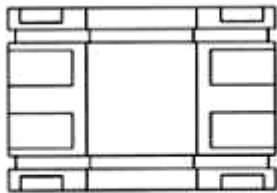

1.4

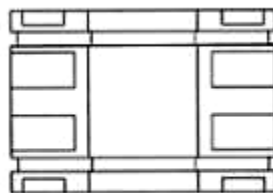

1.5

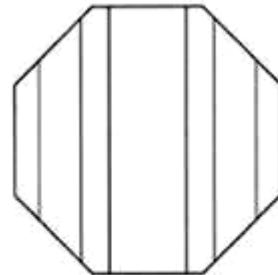

1.6

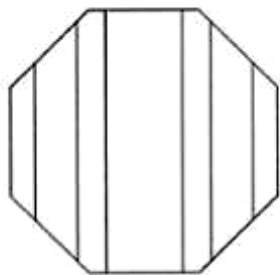

1.7

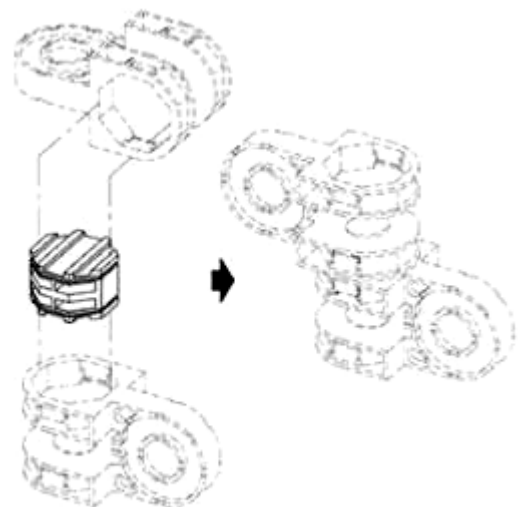

1.8

CÔNG BÁO SỞ HỮU CÔNG NGHIỆP SỐ 429 TẬP A – QUYỀN 2 (12.2023)

- (11) **48926**
- (21) 3-2023-01740 (28) 1
- (54) **BAO GÓI** (51) **09-05**
- (22) 31/07/2023 (43) 25/12/2023
- (73) **CÔNG TY TNHH MTK (VN)**
L5.05.OT.05 Landmark 5, Vinhomes Central Park, 720A Điện Biên Phủ, phường
22, quận Bình Thạnh, thành phố Hồ Chí Minh
- (72) Trương Thành Trung (VN)
- (74) Công ty Luật TNHH Phạm và Liên danh (PHAM & ASSOCIATES)
- (55)



1.1



1.2

- (11) **48927**
- (21) 3-2023-01741
- (54) **LỌ**
- (22) 31/07/2023
- (30) 2023-002615 13/02/2023 JP; 2023-002614 13/02/2023 JP;
- (73) **HISAMITSU PHARMACEUTICAL CO., INC. (JP)**
408, Tashirodaikan-machi, Tosu-shi, Saga 841-0017 Japan
- (72) Tatsuaki SAKAI (JP)
- (74) Công ty TNHH Một thành viên Sở hữu trí tuệ VCCI (VCCI-IP CO.,LTD)
- (55)

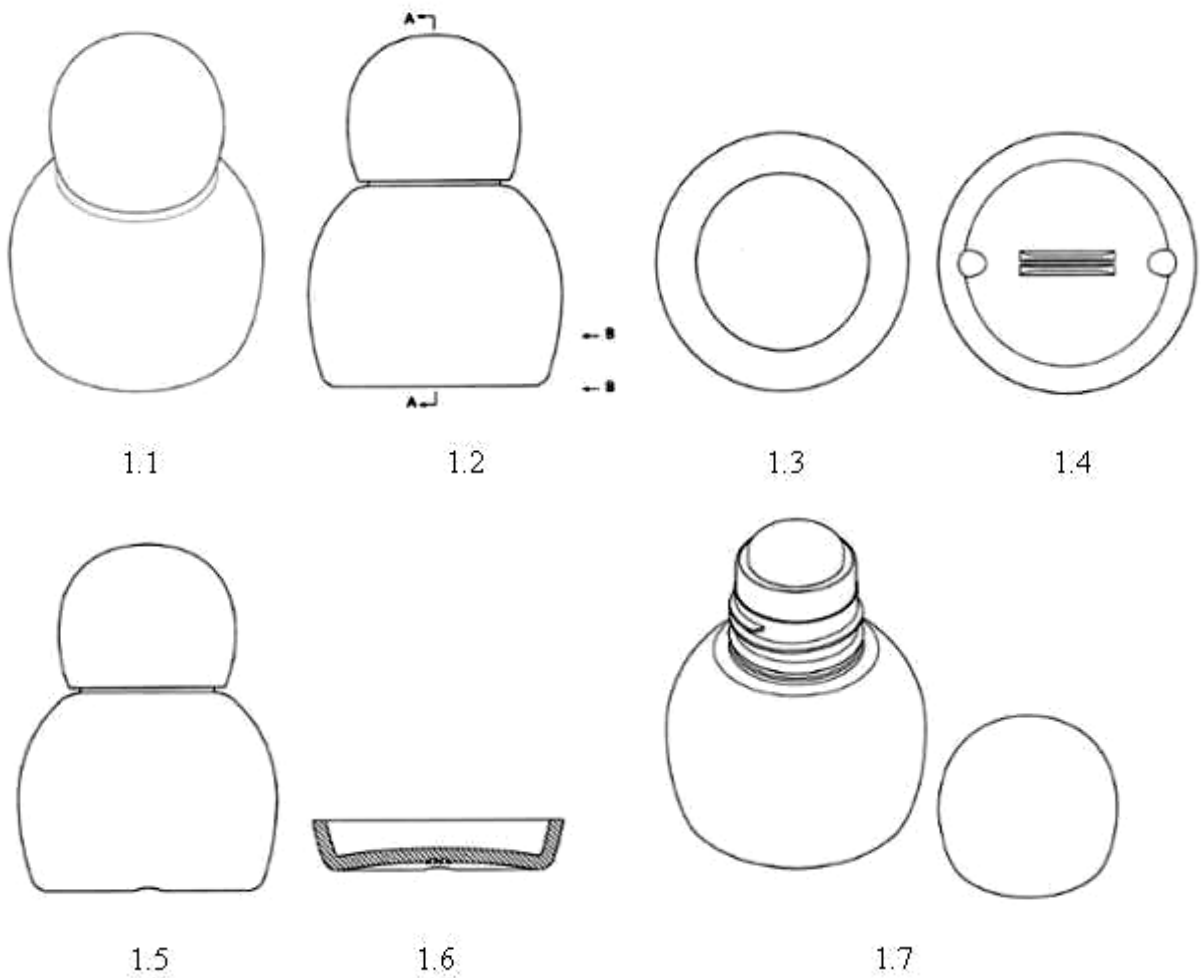



1.8



1.9

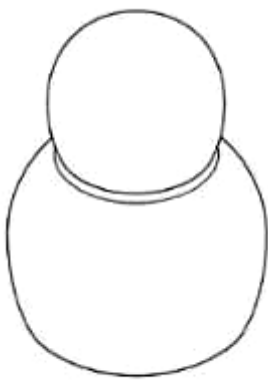

2.1

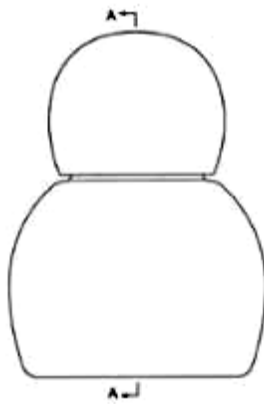

2.2

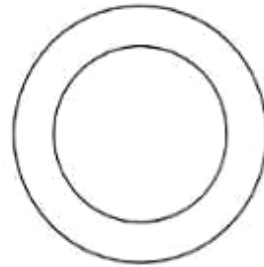

2.3

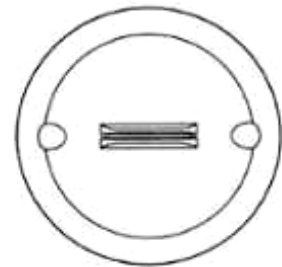

2.4

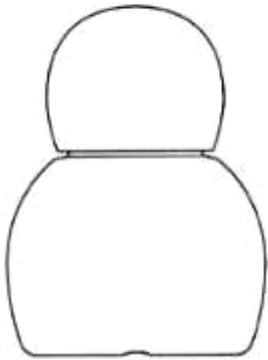

2.5

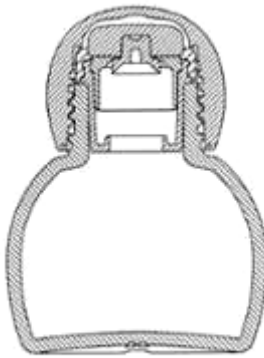

2.6



2.7



2.8



2.9

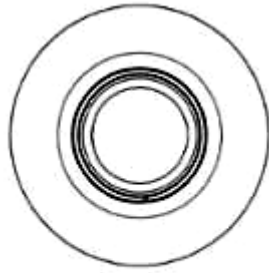

2.10

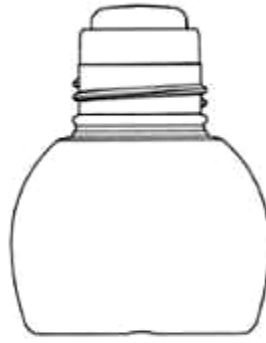

2.11



2.12

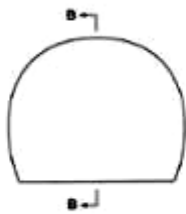

2.13

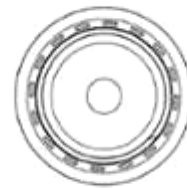

2.14



2.15

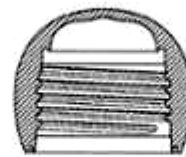

2.16



2.17



2.18

CÔNG BÁO SỞ HỮU CÔNG NGHIỆP SỐ 429 TẬP A – QUYỀN 2 (12.2023)

- (11) **48928**
(21) 3-2023-01744 (28) 2
(54) **BỘ NHÃN SẢN PHẨM** (51) **19-08**
(22) 01/08/2023 (43) 25/12/2023
(73) **CÔNG TY TNHH NAK VIỆT NAM (VN)**
45 đường D4A, khu dân cư Hưng Phú, phường Phước Long B, thành phố Thủ Đức,
thành phố Hồ Chí Minh
(72) Nguyễn Thị Bích Ly (VN)
(74) Công ty Luật TNHH AGL (AGL LAW)
(55)



1.1



1.2

CÔNG BÁO SỞ HỮU CÔNG NGHIỆP SỐ 429 TẬP A – QUYỀN 2 (12.2023)

- (11) **48929**
(21) 3-2023-01745 (28) 2
(54) **BỘ NHÃN SẢN PHẨM** (51) **19-08**
(22) 01/08/2023 (43) 25/12/2023
(73) **CÔNG TY TNHH NAK VIỆT NAM (VN)**
45 đường D4A, khu dân cư Hưng Phú, phường Phước Long B, thành phố Thủ Đức,
thành phố Hồ Chí Minh
(72) Nguyễn Thị Bích Ly (VN)
(74) Công ty Luật TNHH AGL (AGL LAW)
(55)



1.1



1.2

CÔNG BÁO SỞ HỮU CÔNG NGHIỆP SỐ 429 TẬP A – QUYỀN 2 (12.2023)

- (11) **48930**
(21) 3-2023-01746 (28) 1
(54) **THANH KIM LOẠI ĐỊNH HÌNH** (51) **25-01**
(22) 01/08/2023 (43) 25/12/2023
(73) **CÔNG TY CỔ PHẦN SẢN XUẤT VÀ ĐẦU TƯ HƯNG PHÁT (VN)**
Tổ dân phố Thịnh Vạn, phường Minh Đức, thị xã Mỹ Hào, tỉnh Hưng Yên
(72) Nguyễn Văn Tâm (VN)
(74) Công ty TNHH Sở hữu trí tuệ Gia Việt (GIAVIET CO., LTD.)
(55)

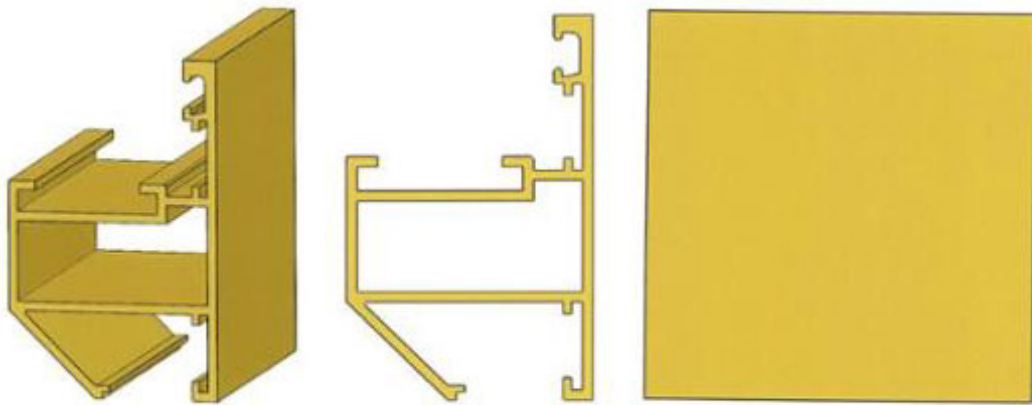

1.1

1.2

1.3



1.4

1.5

1.6

CÔNG BÁO SỞ HỮU CÔNG NGHIỆP SỐ 429 TẬP A – QUYỀN 2 (12.2023)

- (11) **48931**
(21) 3-2023-01747 (28) 1
(54) **THANH KIM LOẠI ĐỊNH HÌNH** (51) **25-01**
(22) 01/08/2023 (43) 25/12/2023
(73) **CÔNG TY CỔ PHẦN SẢN XUẤT VÀ ĐẦU TƯ HƯNG PHÁT (VN)**
Tổ dân phố Thịnh Vạn, phường Minh Đức, thị xã Mỹ Hào, tỉnh Hưng Yên
(72) Nguyễn Văn Tâm (VN)
(74) Công ty TNHH Sở hữu trí tuệ Gia Việt (GIAVIET CO., LTD.)
(55)



1.1

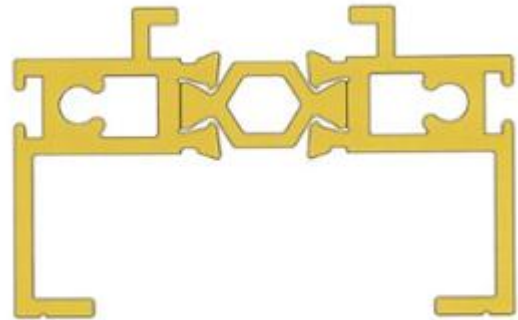

1.2

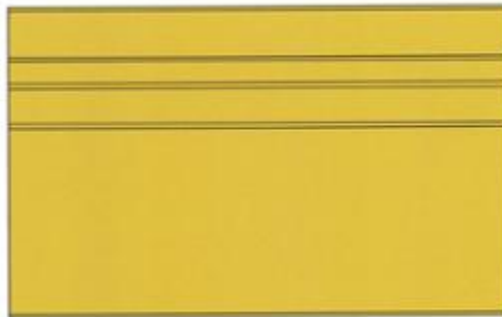

1.3

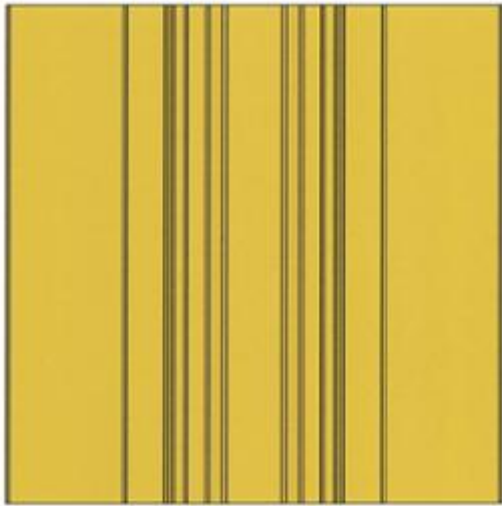

1.4

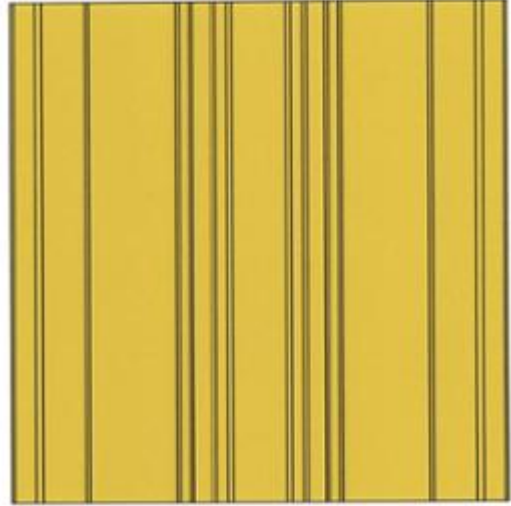

1.5

CÔNG BÁO SỞ HỮU CÔNG NGHIỆP SỐ 429 TẬP A – QUYỀN 2 (12.2023)

- (11) **48932**
(21) 3-2023-01748 (28) 1
(54) **THANH KIM LOẠI ĐỊNH HÌNH** (51) **25-01**
(22) 01/08/2023 (43) 25/12/2023
(73) **CÔNG TY CỔ PHẦN SẢN XUẤT VÀ ĐẦU TƯ HƯNG PHÁT (VN)**
Tổ dân phố Thịnh Vạn, phường Minh Đức, thị xã Mỹ Hào, tỉnh Hưng Yên
(72) Nguyễn Văn Tâm (VN)
(74) Công ty TNHH Sở hữu trí tuệ Gia Việt (GIAVIET CO., LTD.)
(55)

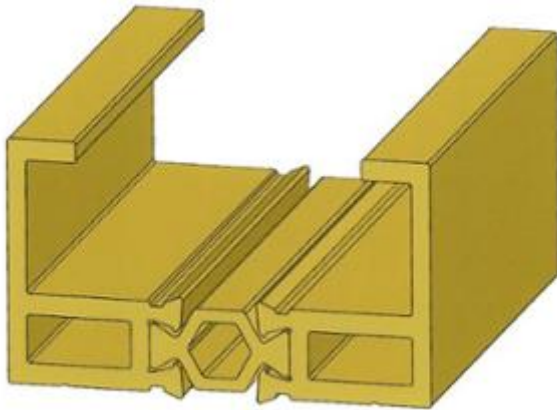

1.1

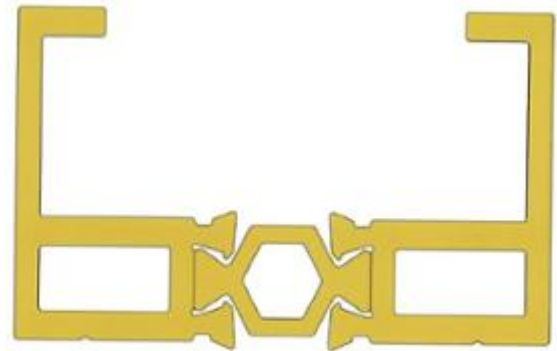

1.2



1.3

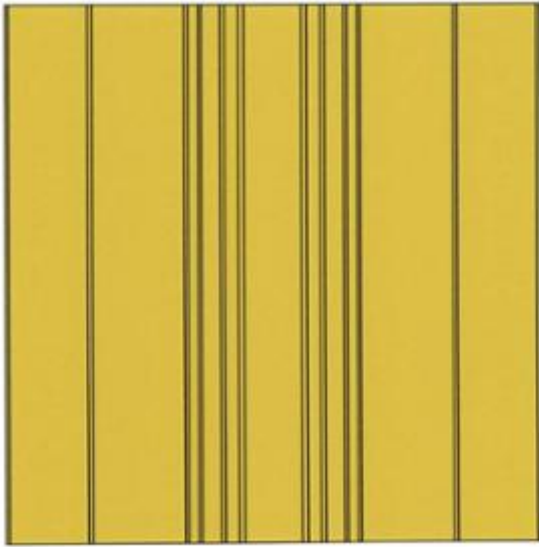

1.4

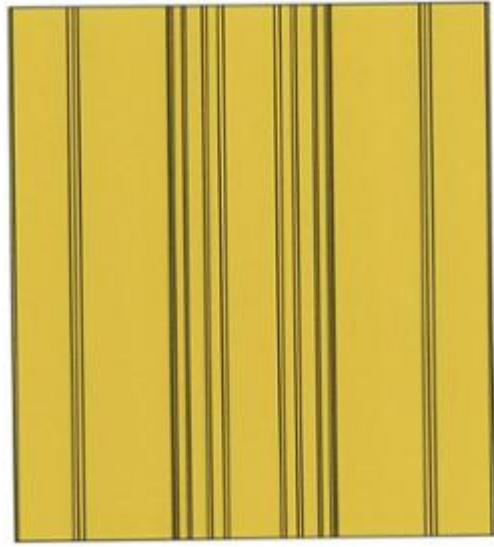

1.5

CÔNG BÁO SỞ HỮU CÔNG NGHIỆP SỐ 429 TẬP A – QUYỀN 2 (12.2023)

- (11) **48933**
(21) 3-2023-01750 (28) 1
(54) **THANH KIM LOẠI ĐỊNH HÌNH** (51) **25-01**
(22) 01/08/2023 (43) 25/12/2023
(73) **CÔNG TY CỔ PHẦN SẢN XUẤT VÀ ĐẦU TƯ HƯNG PHÁT (VN)**
Tổ dân phố Thịnh Vạn, phường Minh Đức, thị xã Mỹ Hào, tỉnh Hưng Yên
(72) Nguyễn Văn Tâm (VN)
(74) Công ty TNHH Sở hữu trí tuệ Gia Việt (GIAVIET CO., LTD.)
(55)

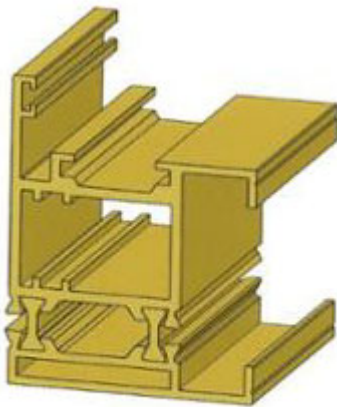

1.1

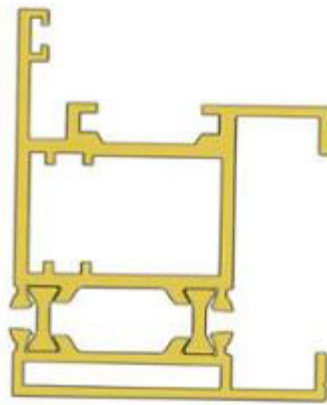

1.2



1.3



1.4



1.5



1.6

CÔNG BÁO SỞ HỮU CÔNG NGHIỆP SỐ 429 TẬP A – QUYỀN 2 (12.2023)

- (11) **48934**
(21) 3-2023-01751 (28) 1
(54) **THANH KIM LOẠI ĐỊNH HÌNH** (51) **25-01**
(22) 01/08/2023 (43) 25/12/2023
(73) **CÔNG TY CỔ PHẦN SẢN XUẤT VÀ ĐẦU TƯ HƯNG PHÁT (VN)**
Tổ dân phố Thịnh Vạn, phường Minh Đức, thị xã Mỹ Hào, tỉnh Hưng Yên
(72) Nguyễn Văn Tâm (VN)
(74) Công ty TNHH Sở hữu trí tuệ Gia Việt (GIAVIET CO., LTD.)
(55)

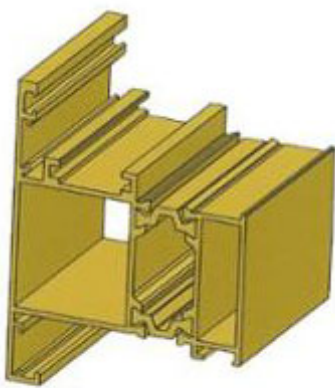

1.1

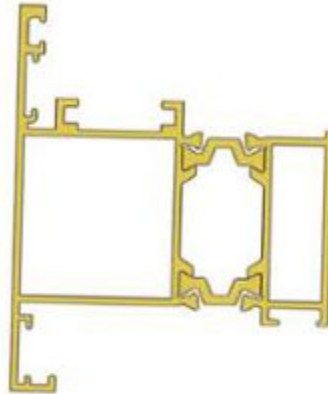

1.2



1.3



1.4

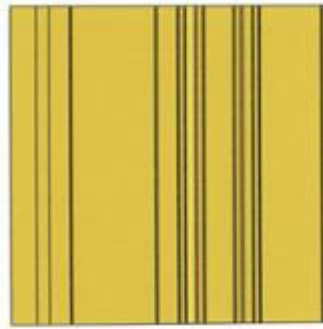

1.5

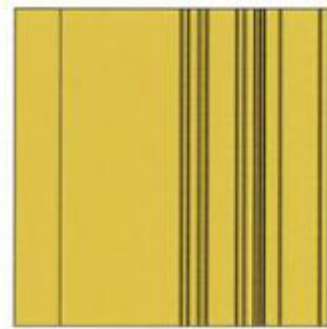

1.6

CÔNG BÁO SỞ HỮU CÔNG NGHIỆP SỐ 429 TẬP A – QUYỀN 2 (12.2023)

- (11) **48935**
(21) 3-2023-01752 (28) 1
(54) **THANH KIM LOẠI ĐỊNH HÌNH** (51) **25-01**
(22) 01/08/2023 (43) 25/12/2023
(73) **CÔNG TY CỔ PHẦN SẢN XUẤT VÀ ĐẦU TƯ HƯNG PHÁT (VN)**
Tổ dân phố Thịnh Vạn, phường Minh Đức, thị xã Mỹ Hào, tỉnh Hưng Yên
(72) Nguyễn Văn Tâm (VN)
(74) Công ty TNHH Sở hữu trí tuệ Gia Việt (GIAVIET CO., LTD.)
(55)



1.1

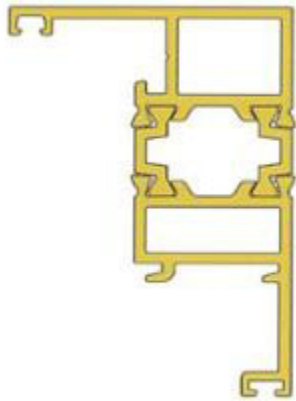

1.2



1.3

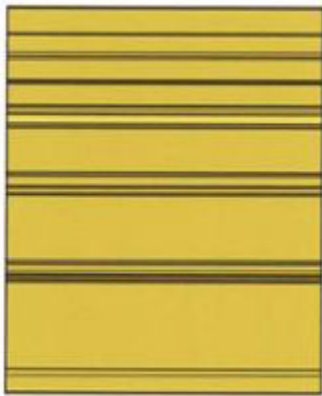

1.4



1.5



1.6

CÔNG BÁO SỞ HỮU CÔNG NGHIỆP SỐ 429 TẬP A – QUYỀN 2 (12.2023)

- (11) **48936**
(21) 3-2023-01754 (28) 1
(54) **THANH KIM LOẠI ĐỊNH HÌNH** (51) **25-01**
(22) 01/08/2023 (43) 25/12/2023
(73) **CÔNG TY CỔ PHẦN SẢN XUẤT VÀ ĐẦU TƯ HƯNG PHÁT (VN)**
Tổ dân phố Thịnh Vạn, phường Minh Đức, thị xã Mỹ Hào, tỉnh Hưng Yên
(72) Nguyễn Văn Tâm (VN)
(74) Công ty TNHH Sở hữu trí tuệ Gia Việt (GIAVIET CO., LTD.)
(55)

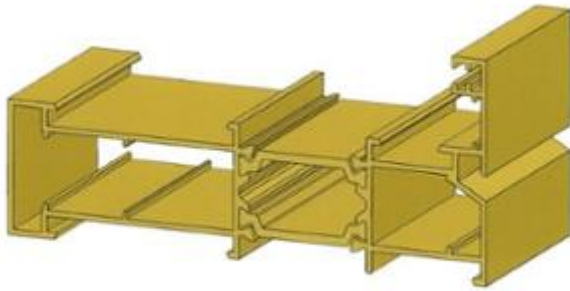

1.1

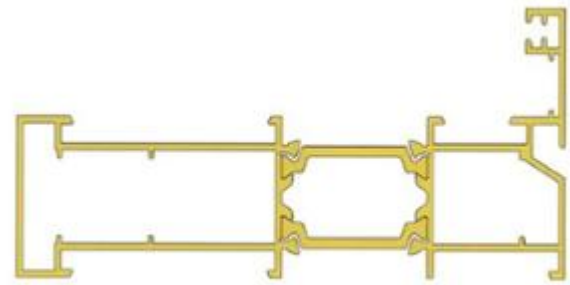

1.2



1.3



1.4



1.5



1.6

- (11) **48937**
(21) 3-2023-01755 (28) 1
(54) **THANH KIM LOẠI ĐỊNH HÌNH** (51) **25-01**
(22) 01/08/2023 (43) 25/12/2023
(73) **CÔNG TY CỔ PHẦN SẢN XUẤT VÀ ĐẦU TƯ HƯNG PHÁT (VN)**
Tổ dân phố Thịnh Vạn, phường Minh Đức, thị xã Mỹ Hào, tỉnh Hưng Yên
(72) Nguyễn Văn Tâm (VN)
(74) Công ty TNHH Sở hữu trí tuệ Gia Việt (GIAVIET CO., LTD.)
(55)

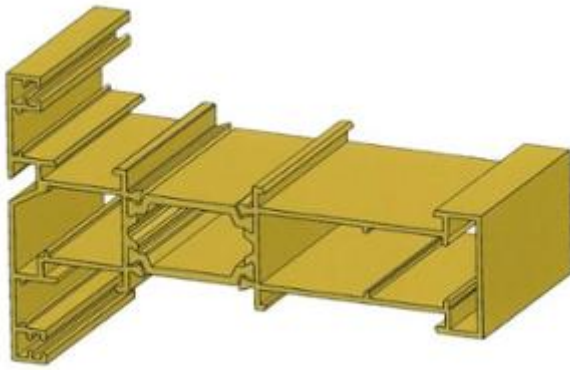

1.1

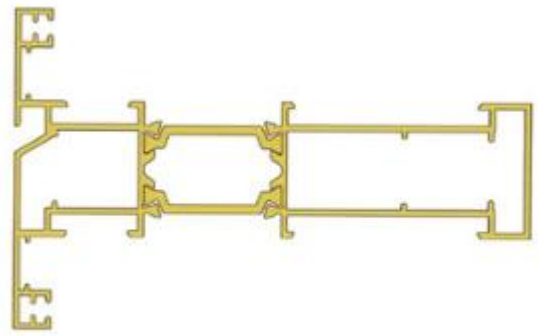

1.2



1.3



1.4



1.5

(11) **48938**

(21) 3-2023-01756

(28) 1

(54) **THANH KIM LOẠI ĐỊNH HÌNH**

(51) **25-01**

(22) 01/08/2023

(43) 25/12/2023

(73) **CÔNG TY CỔ PHẦN SẢN XUẤT VÀ ĐẦU TƯ HƯNG PHÁT (VN)**

Tổ dân phố Thịnh Vạn, phường Minh Đức, thị xã Mỹ Hào, tỉnh Hưng Yên

(72) Nguyễn Văn Tâm (VN)

(74) Công ty TNHH Sở hữu trí tuệ Gia Việt (GIAVIET CO., LTD.)

(55)

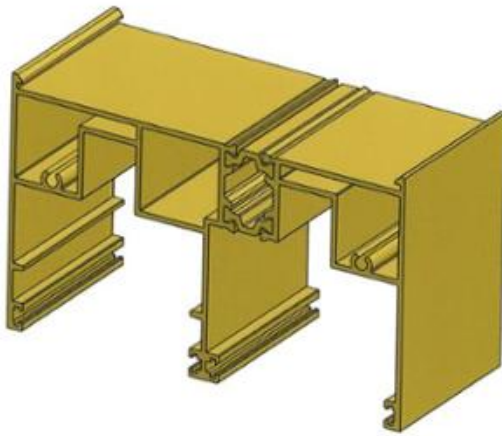

1.1

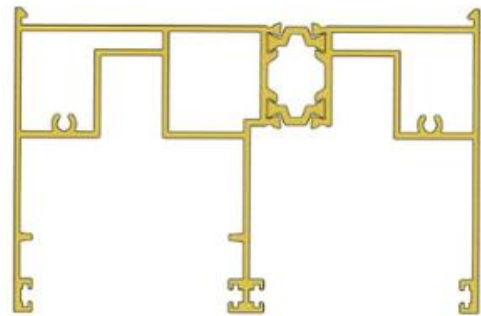

1.2



1.3

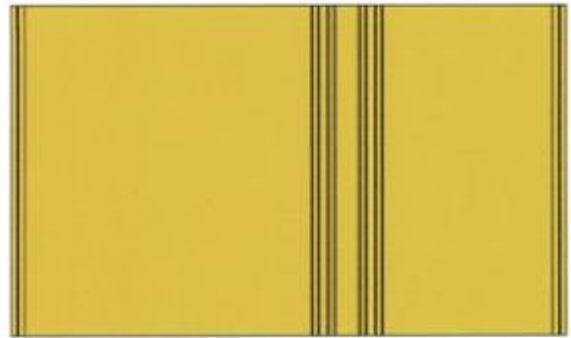

1.4

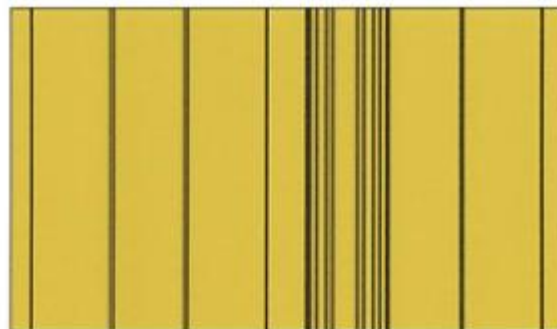

1.5

- (11) **48939**
(21) 3-2023-01757 (28) 1
(54) **THANH KIM LOẠI ĐỊNH HÌNH** (51) **25-01**
(22) 01/08/2023 (43) 25/12/2023
(73) **CÔNG TY CỔ PHẦN SẢN XUẤT VÀ ĐẦU TƯ HƯNG PHÁT (VN)**
Tổ dân phố Thịnh Vạn, phường Minh Đức, thị xã Mỹ Hào, tỉnh Hưng Yên
(72) Nguyễn Văn Tâm (VN)
(74) Công ty TNHH Sở hữu trí tuệ Gia Việt (GIAVIET CO., LTD.)
(55)

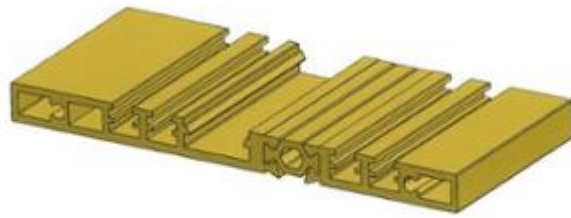

1.1



1.2



1.3



1.4

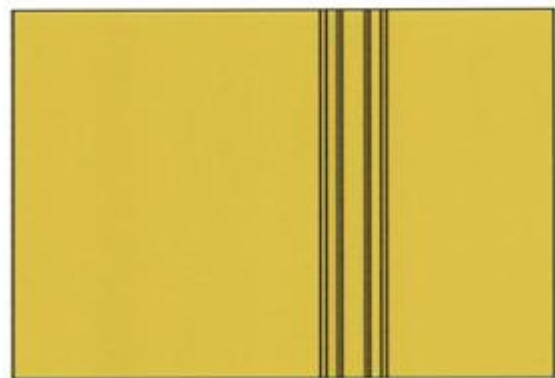

1.5

CÔNG BÁO SỞ HỮU CÔNG NGHIỆP SỐ 429 TẬP A – QUYỀN 2 (12.2023)

- (11) **48940**
(21) 3-2023-01758 (28) 1
(54) **THANH KIM LOẠI ĐỊNH HÌNH** (51) **25-01**
(22) 01/08/2023 (43) 25/12/2023
(73) **CÔNG TY CỔ PHẦN SẢN XUẤT VÀ ĐẦU TƯ HƯNG PHÁT (VN)**
Tổ dân phố Thịnh Vạn, phường Minh Đức, thị xã Mỹ Hào, tỉnh Hưng Yên
(72) Nguyễn Văn Tâm (VN)
(74) Công ty TNHH Sở hữu trí tuệ Gia Việt (GIAVIET CO., LTD.)
(55)



1.1



1.2



1.3



1.4

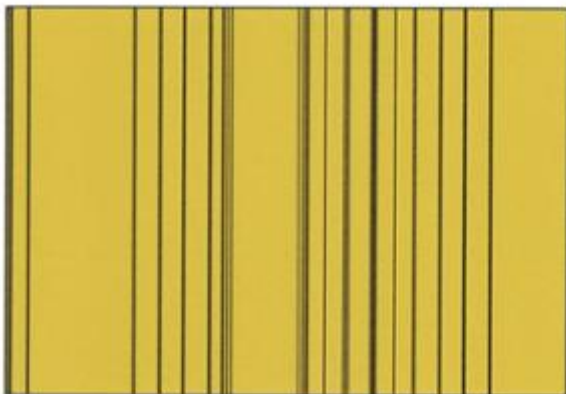

1.5

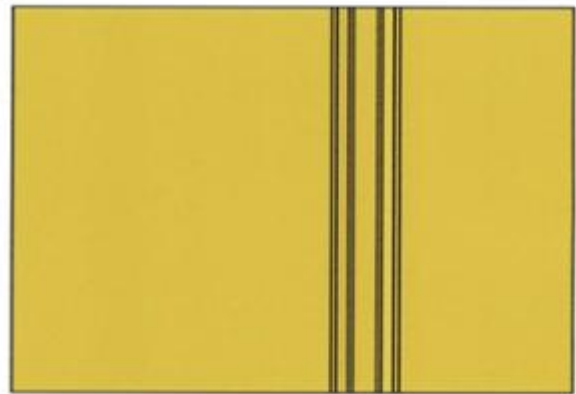

1.6

(11) **48941**

(21) 3-2023-01759

(28) 1

(54) **CỘT ĐỖ CÂY TRỒNG**

(51) **08-08**

(22) 01/08/2023

(43) 25/12/2023

(73) **CÔNG TY CỔ PHẦN PHÁT TRIỂN CÔNG VIÊN CÂY XANH VÀ ĐÔ THỊ VŨNG TÀU (UPC) (VN)**

Số 221 Võ Thị Sáu, phường Thắng Tam, thành phố Vũng Tàu, tỉnh Bà Rịa - Vũng Tàu

(72) Lê Huy Hữu Hiệp (VN)

(74) Công ty Luật TNHH ELITE (ELITE LAW FIRM)

(55)



1.1



1.2



1.3



1.4



1.5



1.6



1.7

CÔNG BÁO SỞ HỮU CÔNG NGHIỆP SỐ 429 TẬP A – QUYỀN 2 (12.2023)

- (11) **48942**
(21) 3-2023-01760 (28) 1
(54) **HỘP** (51) **09-03**
(22) 01/08/2023 (43) 25/12/2023
(73) **CÔNG TY TNHH THỰC PHẨM DELTA D’ASIA (VN)**
107 đường 2, tổ 3, KP 1, phường Tăng Nhơn Phú B, thành phố Thủ Đức, thành phố Hồ Chí Minh
(72) Lương Thị Thanh (VN)
(74) **CÔNG TY TNHH SỞ HỮU TRÍ TUỆ SETHACO (SETHACO IP CO.,LTD)**
(55)



1.1



1.2

CÔNG BÁO SỞ HỮU CÔNG NGHIỆP SỐ 429 TẬP A – QUYỀN 2 (12.2023)

- (11) **48943**
(21) 3-2023-01761 (28) 1
(54) **HỘP** (51) **09-03**
(22) 01/08/2023 (43) 25/12/2023
(73) **CÔNG TY TNHH THỰC PHẨM DELTA D'ASIA (VN)**
107 đường 2, tổ 3, KP 1, phường Tăng Nhơn Phú B, thành phố Thủ Đức, thành phố Hồ Chí Minh
(72) Lương Thị Thanh (VN)
(74) **CÔNG TY TNHH SỞ HỮU TRÍ TUỆ SETHACO (SETHACO IP CO.,LTD)**
(55)



1.1



1.2

CÔNG BÁO SỞ HỮU CÔNG NGHIỆP SỐ 429 TẬP A – QUYỀN 2 (12.2023)

- (11) **48944**
(21) 3-2023-01762 (28) 1
(54) **HỘP** (51) **09-03**
(22) 01/08/2023 (43) 25/12/2023
(73) **CÔNG TY TNHH THỰC PHẨM DELTA D'ASIA (VN)**
107 đường 2, tổ 3, KP 1, phường Tăng Nhơn Phú B, thành phố Thủ Đức, thành phố Hồ Chí Minh
(72) Lương Thị Thanh (VN)
(74) **CÔNG TY TNHH SỞ HỮU TRÍ TUỆ SETHACO (SETHACO IP CO.,LTD)**
(55)



1.1



1.2

CÔNG BÁO SỞ HỮU CÔNG NGHIỆP SỐ 429 TẬP A – QUYỀN 2 (12.2023)

- (11) **48945**
- (21) 3-2023-01764 (28) 1
- (54) **NHÃN SẢN PHẨM** (51) **19-08**
- (22) 01/08/2023 (43) 25/12/2023
- (73) **HỢP TÁC XÃ DỊCH VỤ TỔNG HỢP NÔNG NGHIỆP VÀ THƯƠNG MẠI LÀNG CHẾU (VN)**
Bản Cáo A, xã Làng Chếu, huyện Bắc Yên, tỉnh Sơn La
- (72) Sông A Mang (VN)
- (74) **CÔNG TY LUẬT TNHH KHÔI NGỌC (KHOI NGOC LAW COMPANY LTD)**
- (55)



CÔNG BÁO SỞ HỮU CÔNG NGHIỆP SỐ 429 TẬP A – QUYỀN 2 (12.2023)

- (11) **48946**
- (21) 3-2023-01765 (28) 1
- (54) **NHÃN SẢN PHẨM** (51) **19-08**
- (22) 01/08/2023 (43) 25/12/2023
- (73) **HỢP TÁC XÃ DỊCH VỤ TỔNG HỢP NÔNG NGHIỆP VÀ THƯƠNG MẠI LÀNG CHẾU (VN)**
Bản Cáo A, xã Làng Chếu, huyện Bắc Yên, tỉnh Sơn La
- (72) Sông A Mang (VN)
- (74) **CÔNG TY LUẬT TNHH KHÔI NGỌC (KHOI NGOC LAW COMPANY LTD)**
- (55)



CÔNG BÁO SỞ HỮU CÔNG NGHIỆP SỐ 429 TẬP A – QUYỀN 2 (12.2023)

- (11) **48947**
(21) 3-2023-01766 (28) 1
(54) **MÁY ĐIỆN XUNG** (51) **24-01**
(22) 02/08/2023 (43) 25/12/2023
(73) **WATSON & COMPANY CORP. (KR)**
#505, Office-dong, 17 Seobinggo-ro, Yongsan-gu, Seoul, 04387, Republic of Korea
(72) KIM Min Gyu (KR)
(74) Công ty TNHH một thành viên Sở hữu trí tuệ VCCI (VCCI-IP CO.,LTD)
(55)



1.1



1.2



1.3

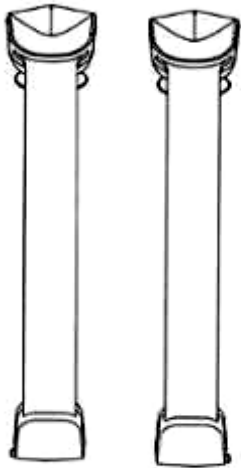

1.4

1.5



1.6



1.7

CÔNG BÁO SỞ HỮU CÔNG NGHIỆP SỐ 429 TẬP A – QUYỀN 2 (12.2023)

- (11) **48948**
(21) 3-2023-01767 (28) 1
(54) **KẸP PHANH** (51) **12-16**
(22) 02/08/2023 (43) 25/12/2023
(73) **SUPERFLY MOTORSPORTS SDN BHD (MY)**
6, JALAN TIONG EMAS 3, TAMAN MOUNT AUSTIN 81100 JOHOR BAHRU
JOHOR MALAYSIA
(72) Ng Puh Jinn (MY)
(74) Công ty TNHH Dịch vụ Sở hữu trí tuệ KENFOX (KENFOX IP SERVICE
CO.,LTD.)
(55)



1.1



1.2



1.3



1.4



1.5



1.6



1.7

CÔNG BÁO SỞ HỮU CÔNG NGHIỆP SỐ 429 TẬP A – QUYỀN 2 (12.2023)

- (11) **48949**
(21) 3-2023-01768 (28) 3
(54) **NHÃN SẢN PHẨM** (51) **19-08**
(22) 02/08/2023 (43) 25/12/2023
(73) **CÔNG TY TNHH NAK VIỆT NAM (VN)**
45 đường D4A, khu dân cư Hưng Phú, phường Phước Long B, thành phố Thủ Đức,
thành phố Hồ Chí Minh
(72) Nguyễn Thị Bích Ly (VN)
(74) Công ty Luật TNHH AGL (AGL LAW)
(55)



1.1



2.1



3.1

CÔNG BÁO SỞ HỮU CÔNG NGHIỆP SỐ 429 TẬP A – QUYỀN 2 (12.2023)

- (11) **48950**
(21) 3-2023-01775 (28) 1
(54) **HỘP ĐỰNG GIẤY VỆ SINH** (51) **03-01**
(22) 03/08/2023 (43) 25/12/2023
(30) 29/873,583 04/04/2023 US;
(73) **MANSCAPED, LLC (US)**
3753 Howard Hughes Parkway, Suite 200, Las Vegas, NV 89169, United States of America
(72) 1. ANH HAO TRAN (US)
2. ANDRE GALLARDO (PH)
3. EDILBERT NERI ABILLAR (US)
4. MARCELO KERTESZ (US)
5. RACHELLE MINYARD (US)
(74) Công ty cổ phần tư vấn Trung Thực (TRUNG THUC.,JSC)
(55)

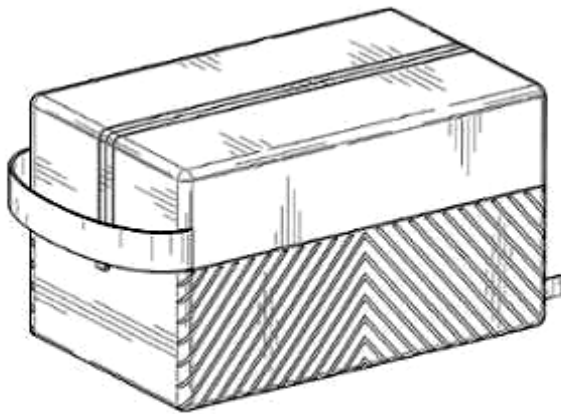

1.1

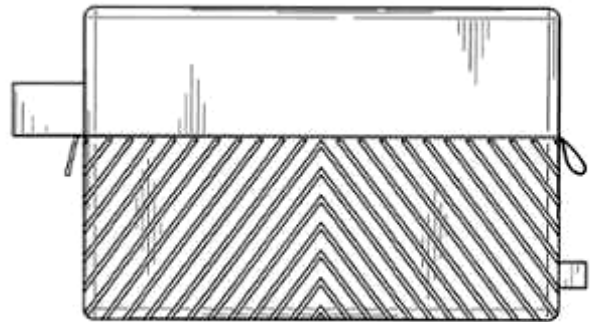

1.2

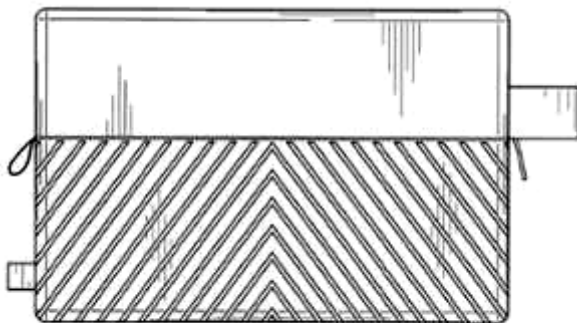

1.3

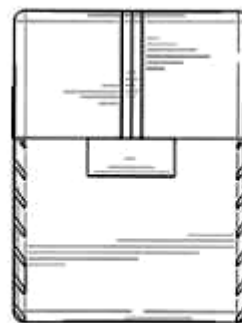

1.4

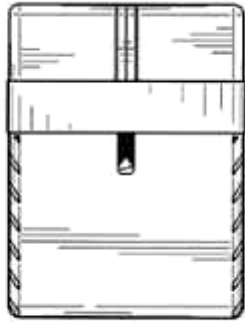

1.5

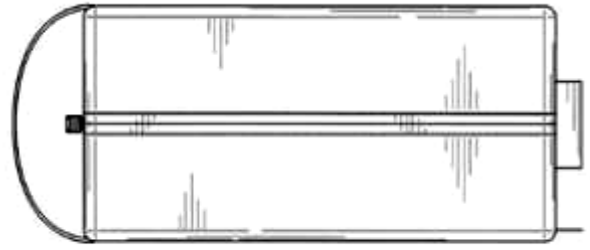

1.6

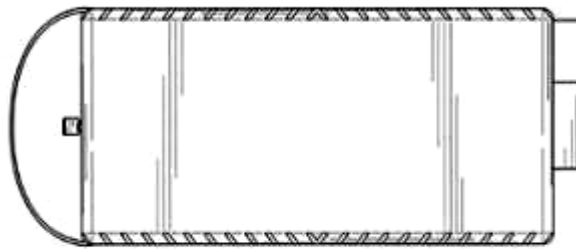

1.7

- (11) **48951**
(21) 3-2023-01782 (28) 1
(54) **MÓC THANH NAN CỬA CUỐN** (51) **08-07**
(22) 03/08/2023 (43) 25/12/2023
(73) **TRẦN THỊ THỦY TIÊN (VN)**
1/1 Sơn Kỳ, phường Sơn Kỳ, quận Tân Phú, thành phố Hồ Chí Minh
(72) Trần Thị Thủy Tiên (VN)
(74) Công ty TNHH Sở hữu trí tuệ PADEMARK (PADEMARK CO.,LTD.)
(55)

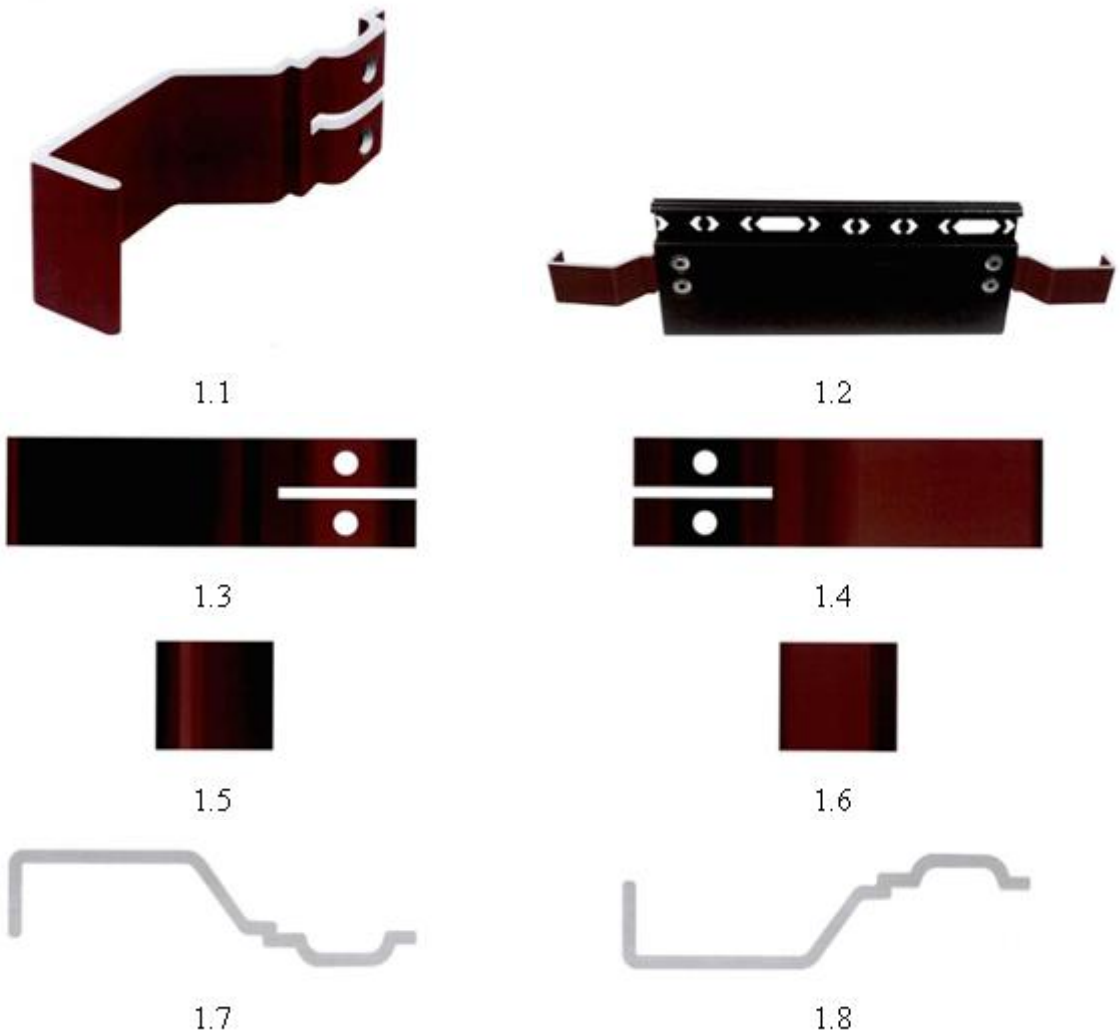

CÔNG BÁO SỞ HỮU CÔNG NGHIỆP SỐ 429 TẬP A – QUYỀN 2 (12.2023)

- (11) **48952**
(21) 3-2023-01783 (28) 1
(54) **CON LĂN DÙNG CHO CỬA CUỐN** (51) **25-02**
(22) 03/08/2023 (43) 25/12/2023
(73) **TRẦN THỊ THỦY TIÊN (VN)**
1/1 Sơn Kỳ, phường Sơn Kỳ, quận Tân Phú, thành phố Hồ Chí Minh
(72) Trần Thị Thủy Tiên (VN)
(74) Công ty TNHH Sở hữu trí tuệ PADEMARK (PADEMARK CO.,LTD.)
(55)



1.1



1.2



1.3



1.4



1.5



1.6



1.7



1.8

- (11) **48953**
(21) 3-2023-01784 (28) 1
(54) **CỤC CHỐNG XÔ NAN CỬA CUỐN** (51) **25-02**
(22) 03/08/2023 (43) 25/12/2023
(73) **TRẦN THỊ THỦY TIÊN (VN)**
1/1 Sơn Kỳ, phường Sơn Kỳ, quận Tân Phú, thành phố Hồ Chí Minh
(72) Trần Thị Thủy Tiên (VN)
(74) Công ty TNHH Sở hữu trí tuệ PADEMARK (PADEMARK CO.,LTD.)
(55)

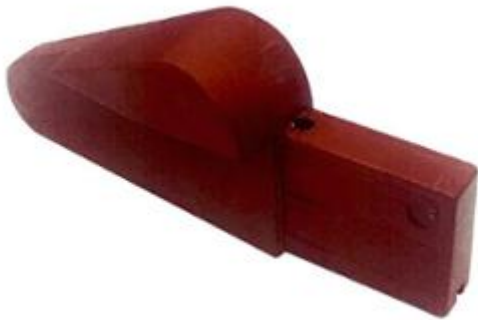

1.1



1.2



1.3



1.4



1.5



1.6



1.7



1.8

CÔNG BÁO SỞ HỮU CÔNG NGHIỆP SỐ 429 TẬP A – QUYỀN 2 (12.2023)

- (11) **48954**
(21) 3-2023-01785 (28) 1
(54) **BẾP NƯỚNG NGOÀI TRỜI** (51) **07-02**
(22) 03/08/2023 (43) 25/12/2023
(30) 29/871,686 24/02/2023 US;
(73) **TRAEGER PELLET GRILLS, LLC (US)**
1215 East Wilmington Avenue, Suite 200, Salt Lake City, UT 84016, United States of America
(72) 1. MARGARET A. GOERTZEN (US)
2. KEVIN ALEXANDER (US)
3. PATRICK FRATESI (US)
(74) Công ty TNHH Tâm nhìn và Liên danh (VISION & ASSOCIATES CO.LTD.)
(55)

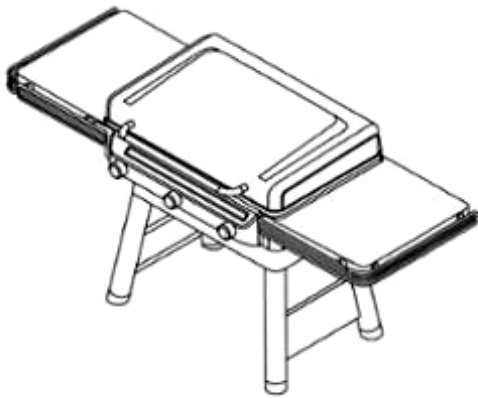

1.1

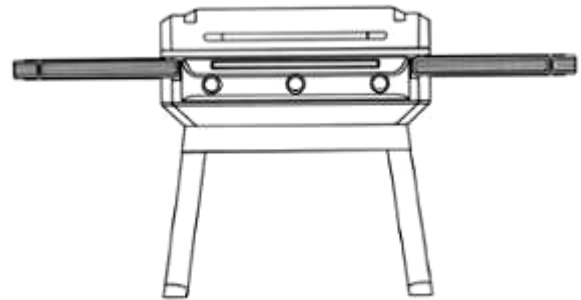

1.2



1.3

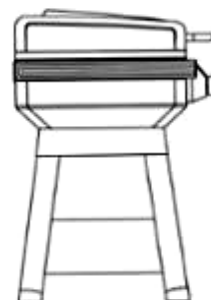

1.4

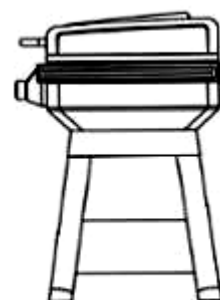

1.5



1.6

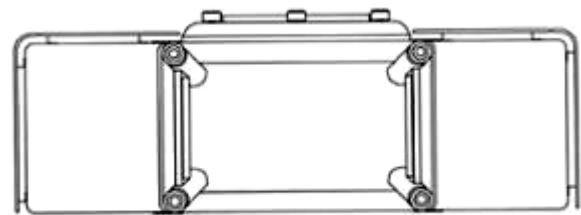

1.7

CÔNG BÁO SỞ HỮU CÔNG NGHIỆP SỐ 429 TẬP A – QUYỀN 2 (12.2023)

- (11) **48955**
- (21) 3-2023-01786
- (54) **QUẠT**
- (22) 03/08/2023
- (73) **ECOTEK CANADA PROMOTION TRADE CORPORATION (CA)**
1188 West Georgia Street, Unit 1440, Vancouver, British Columbia, Canada V6E 4A2
- (72) Nguyễn Châu (CA)
- (74) Công ty TNHH Trường Xuân (AGELESS CO.,LTD.)
- (55)



1.1



1.2



1.3



1.4



1.5



1.6



1.7

CÔNG BÁO SỞ HỮU CÔNG NGHIỆP SỐ 429 TẬP A – QUYỀN 2 (12.2023)

- (11) **48956**
(21) 3-2023-01795 (28) 1
(54) **HỘP ĐỰNG CÀ PHÊ** (51) **09-03**
(22) 04/08/2023 (43) 25/12/2023
(73) **PHAN THỊ LỢI (VN)**
Đội 5, thôn Phụ Khang, xã Đường Lâm, thị xã Sơn Tây, thành phố Hà Nội
(72) Phan Thị Lợi (VN)
(55)



1.1



1.2

CÔNG BÁO SỞ HỮU CÔNG NGHIỆP SỐ 429 TẬP A – QUYỀN 2 (12.2023)

- (11) **48957**
- (21) 3-2023-01796 (28) 1
- (54) **BAO GÓI** (51) **09-05**
- (22) 04/08/2023 (43) 25/12/2023
- (73) **ORION CORPORATION (KR)**
13, Baekbeom-ro 90da-gil, Yongsan-gu, Seoul 04369, Republic of Korea
- (72) 1. LEE, HYUN A (KR)
2. OH HYUN SUN (KR)
- (74) Công ty Luật TNHH quốc tế BMVN (BMVN INTERNATIONAL LLC)
- (55)



1.1



1.2

CÔNG BÁO SỞ HỮU CÔNG NGHIỆP SỐ 429 TẬP A – QUYỀN 2 (12.2023)

- (11) **48958**
(21) 3-2023-01797 (28) 1
(54) **BAO GÓI** (51) **09-05**
(22) 04/08/2023 (43) 25/12/2023
(73) **ORION CORPORATION (KR)**
13, Baekbeom-ro 90da-gil, Yongsan-gu, Seoul 04369, Republic of Korea
(72) 1. LEE, HYUN A (KR)
2. OH, HYUN SUN (KR)
(74) Công ty Luật TNHH quốc tế BMVN (BMVN INTERNATIONAL LLC)
(55)



1.1



1.2

CÔNG BÁO SỞ HỮU CÔNG NGHIỆP SỐ 429 TẬP A – QUYỀN 2 (12.2023)

- (11) **48959**
(21) 3-2023-01801 (28) 1
(54) **BAO GÓI** (51) **09-05**
(22) 07/08/2023 (43) 25/12/2023
(73) **CÔNG TY CỔ PHẦN CÔNG NÔNG NGHIỆP TIẾN NÔNG (VN)**
274B, đường Bà Triệu, phường Đông Thọ, thành phố Thanh Hoá, tỉnh Thanh Hoá
(72) Nguyễn Hồng Phong (VN)
(55)



1.1



1.2



1.3

CÔNG BÁO SỞ HỮU CÔNG NGHIỆP SỐ 429 TẬP A – QUYỀN 2 (12.2023)

- (11) **48960**
(21) 3-2023-01802 (28) 1
(54) **BAO GÓI** (51) **09-05**
(22) 07/08/2023 (43) 25/12/2023
(73) **CÔNG TY CỔ PHẦN CÔNG NÔNG NGHIỆP TIẾN NÔNG (VN)**
274B, đường Bà Triệu, phường Đông Thọ, thành phố Thanh Hoá, tỉnh Thanh Hoá
(72) Nguyễn Hồng Phong (VN)
(55)



1.1



1.2

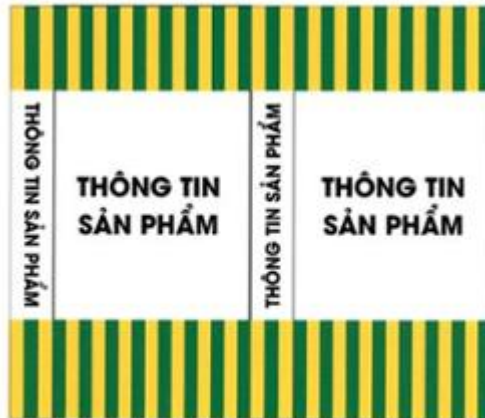

1.3

CÔNG BÁO SỞ HỮU CÔNG NGHIỆP SỐ 429 TẬP A – QUYỀN 2 (12.2023)

- (11) **48961**
(21) 3-2023-01804 (28) 1
(54) **BAO GÓI** (51) **09-05**
(22) 07/08/2023 (43) 25/12/2023
(73) **CÔNG TY CỔ PHẦN CÔNG NÔNG NGHIỆP TIẾN NÔNG (VN)**
274B, đường Bà Triệu, phường Đông Thọ, thành phố Thanh Hoá, tỉnh Thanh Hoá
(72) Nguyễn Hồng Phong (VN)
(55)



1.1

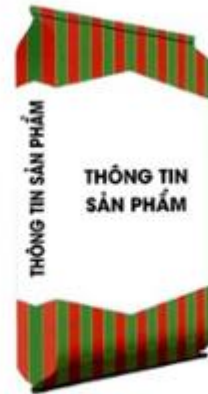

1.2



1.3

CÔNG BÁO SỞ HỮU CÔNG NGHIỆP SỐ 429 TẬP A – QUYỀN 2 (12.2023)

- (11) **48962**
(21) 3-2023-01805 (28) 1
(54) **BAO GÓI** (51) **09-05**
(22) 07/08/2023 (43) 25/12/2023
(73) **CÔNG TY CỔ PHẦN CÔNG NÔNG NGHIỆP TIẾN NÔNG (VN)**
274B, đường Bà Triệu, phường Đông Thọ, thành phố Thanh Hoá, tỉnh Thanh Hoá
(72) Nguyễn Hồng Phong (VN)
(55)

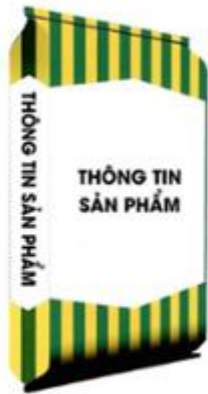

1.1

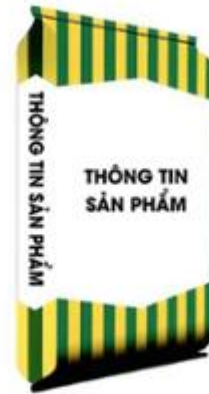

1.2

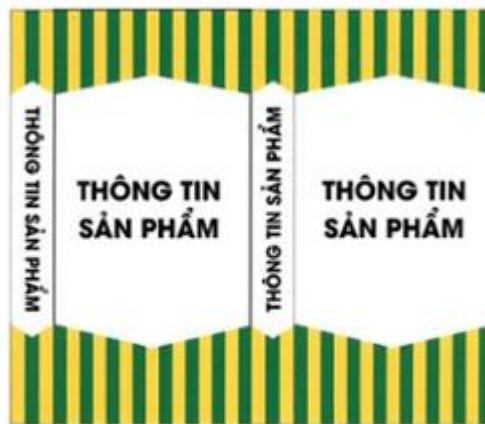

1.3

CÔNG BÁO SỞ HỮU CÔNG NGHIỆP SỐ 429 TẬP A – QUYỀN 2 (12.2023)

(11) **48963**

(21) 3-2023-01811

(28) 1

(54) **KỆ**

(51) **06-04**

(22) 07/08/2023

(43) 25/12/2023

(73) **CÔNG TY CỔ PHẦN SẢN XUẤT NHỰA DUY TÂN (VN)**

298 Hồ Học Lãm, phường An Lạc, quận Bình Tân, thành phố Hồ Chí Minh

(72) Trần Đức Xuyên (VN)

(74) Công ty TNHH Sở hữu trí tuệ INVENTIO (INVENTIO CO.,LTD)

(55)



1.1



1.2

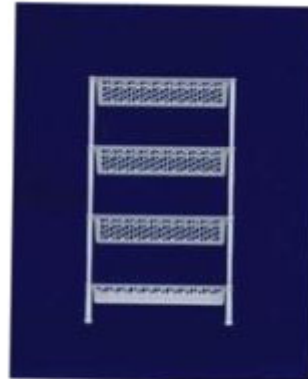

1.3



1.4



1.5



1.6

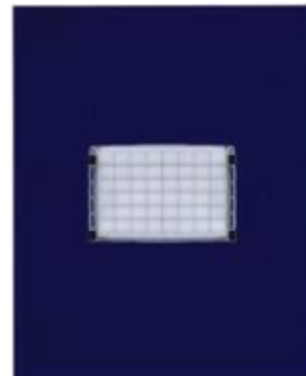

1.7

CÔNG BÁO SỞ HỮU CÔNG NGHIỆP SỐ 429 TẬP A – QUYỀN 2 (12.2023)

- (11) **48964**
(21) 3-2023-01812 (28) 1
(54) **THANH KIM LOẠI ĐỊNH HÌNH** (51) **25-01**
(22) 07/08/2023 (43) 25/12/2023
(73) **CÔNG TY CỔ PHẦN TẬP ĐOÀN KENWIN (VN)**
Tầng 4 tòa nhà VG Building, số 235 đường Nguyễn Trãi, phường Thanh Xuân
Trung, quận Thanh Xuân, thành phố Hà Nội
(72) Ngô Thọ Long (VN)
(74) Công ty TNHH Sở hữu trí tuệ PADEMARK (PADEMARK CO.,LTD.)
(55)



1.1



1.2



1.3

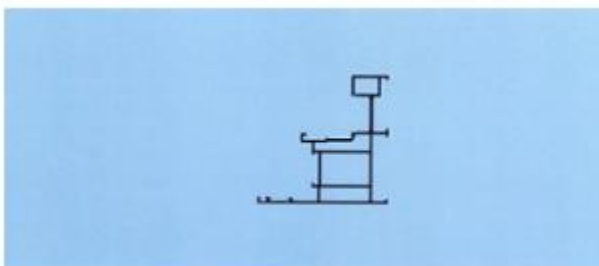

1.4

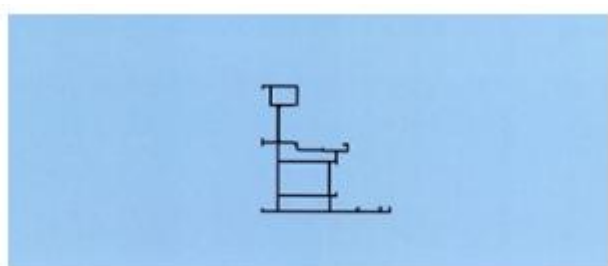

1.5



1.6



1.7

CÔNG BÁO SỞ HỮU CÔNG NGHIỆP SỐ 429 TẬP A – QUYỀN 2 (12.2023)

- (11) **48965**
(21) 3-2023-01813 (28) 1
(54) **THANH KIM LOẠI ĐỊNH HÌNH** (51) **25-01**
(22) 07/08/2023 (43) 25/12/2023
(73) **CÔNG TY CỔ PHẦN TẬP ĐOÀN KENWIN (VN)**
Tầng 4 tòa nhà VG Building, số 235 đường Nguyễn Trãi, phường Thanh Xuân
Trung, quận Thanh Xuân, thành phố Hà Nội
(72) Ngô Thọ Long (VN)
(74) Công ty TNHH Sở hữu trí tuệ PADEMARK (PADEMARK CO.,LTD.)
(55)



1.1



1.2



1.3

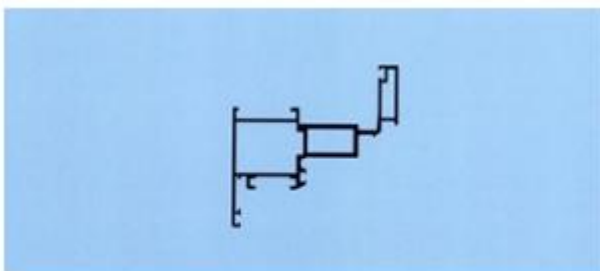

1.4

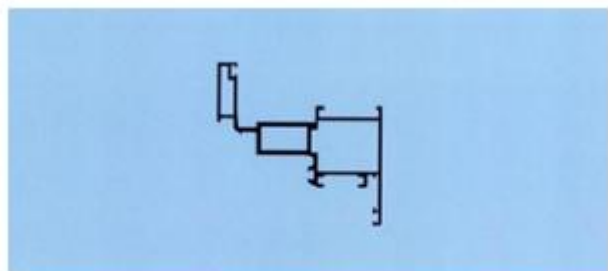

1.5



1.6



1.7

CÔNG BÁO SỞ HỮU CÔNG NGHIỆP SỐ 429 TẬP A – QUYỀN 2 (12.2023)

- (11) **48966**
(21) 3-2023-01814 (28) 1
(54) **THANH KIM LOẠI ĐỊNH HÌNH** (51) **25-01**
(22) 07/08/2023 (43) 25/12/2023
(73) **CÔNG TY CỔ PHẦN TẬP ĐOÀN KENWIN (VN)**
Tầng 4 tòa nhà VG Building, số 235 đường Nguyễn Trãi, phường Thanh Xuân
Trung, quận Thanh Xuân, thành phố Hà Nội
(72) Ngô Thọ Long (VN)
(74) Công ty TNHH Sở hữu trí tuệ PADEMARK (PADEMARK CO.,LTD.)
(55)



1.1



1.2



1.3



1.4

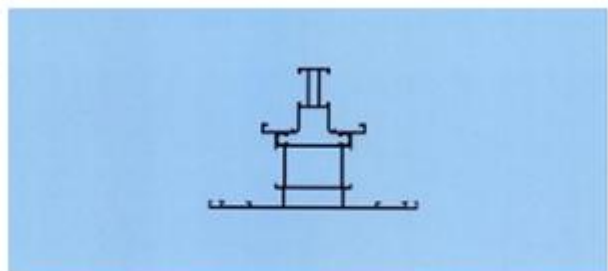

1.5



1.6



1.7

CÔNG BÁO SỞ HỮU CÔNG NGHIỆP SỐ 429 TẬP A – QUYỀN 2 (12.2023)

- (11) **48967**
(21) 3-2023-01815 (28) 1
(54) **THANH KIM LOẠI ĐỊNH HÌNH** (51) **25-01**
(22) 07/08/2023 (43) 25/12/2023
(73) **CÔNG TY CỔ PHẦN TẬP ĐOÀN KENWIN (VN)**
Tầng 4 tòa nhà VG Building, số 235 đường Nguyễn Trãi, phường Thanh Xuân
Trung, quận Thanh Xuân, thành phố Hà Nội
(72) Ngô Thọ Long (VN)
(74) Công ty TNHH Sở hữu trí tuệ PADEMARK (PADEMARK CO.,LTD.)
(55)



1.1



1.2



1.3

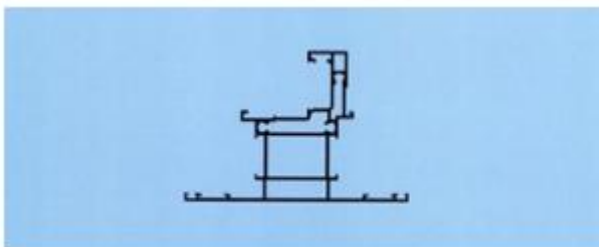

1.4



1.5



1.6



1.7

CÔNG BÁO SỞ HỮU CÔNG NGHIỆP SỐ 429 TẬP A – QUYỀN 2 (12.2023)

- (11) **48968**
- (21) 3-2023-01820
- (54) **BAO GÓI**
- (22) 07/08/2023
- (73) **CÔNG TY CỔ PHẦN THƯƠNG MẠI XUẤT NHẬP KHẨU VINDRINK (VN)**
Số 275 đường Phan Đình Giót, đội 4, tổ dân phố 4, phường La Khê, quận Hà Đông, thành phố Hà Nội
- (72) Mai Ngọc Dương (VN)
- (74) Công ty TNHH IPCOM Việt Nam (IPCOM CO., LTD.)
- (55)



1.1

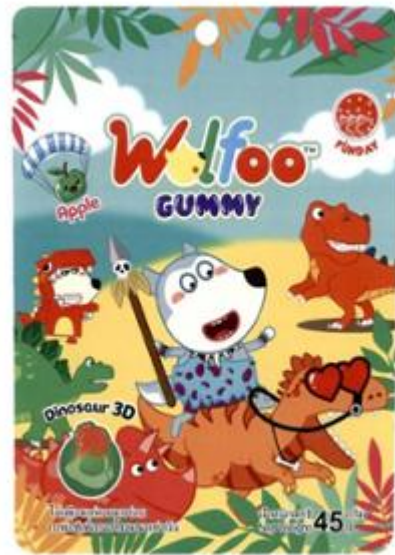

1.2



1.3



1.4

1.5



1.6



1.7

CÔNG BÁO SỞ HỮU CÔNG NGHIỆP SỐ 429 TẬP A – QUYỀN 2 (12.2023)

- (11) **48969**
(21) 3-2023-01831
(54) **BỘ NHÃN SẢN PHẨM**
(22) 08/08/2023
(73) **CÔNG TY TNHH NAK VIỆT NAM (VN)**
45 đường D4A, khu dân cư Hưng Phú, phường Phước Long B, thành phố Thủ Đức, thành phố Hồ Chí Minh
(72) Nguyễn Thị Bích Ly (VN)
(74) Công ty Luật TNHH AGL (AGL LAW)
(55)
- (28) 2
(51) **19-08**
(43) 25/12/2023



1.1



1.2

CÔNG BÁO SỞ HỮU CÔNG NGHIỆP SỐ 429 TẬP A – QUYỀN 2 (12.2023)

- (11) **48970**
- (21) 3-2023-01832 (28) 1
- (54) **NHÃN SẢN PHẨM** (51) **19-08**
- (22) 08/08/2023 (43) 25/12/2023
- (73) **CÔNG TY TNHH NAK VIỆT NAM (VN)**
45 đường D4A, khu dân cư Hưng Phú, phường Phước Long B, thành phố Thủ Đức,
thành phố Hồ Chí Minh
- (72) Nguyễn Thị Bích Ly (VN)
- (74) Công ty Luật TNHH AGL (AGL LAW)
- (55)



CÔNG BÁO SỞ HỮU CÔNG NGHIỆP SỐ 429 TẬP A – QUYỀN 2 (12.2023)

- (11) **48971**
(21) 3-2023-01833 (28) 2
(54) **NHÃN SẢN PHẨM** (51) **19-08**
(22) 08/08/2023 (43) 25/12/2023
(73) **CÔNG TY TNHH NAK VIỆT NAM (VN)**
45 đường D4A, khu dân cư Hưng Phú, phường Phước Long B, thành phố Thủ Đức,
thành phố Hồ Chí Minh
(72) Nguyễn Thị Bích Ly (VN)
(74) Công ty Luật TNHH AGL (AGL LAW)
(55)



1.1



2.1

CÔNG BÁO SỞ HỮU CÔNG NGHIỆP SỐ 429 TẬP A – QUYỀN 2 (12.2023)

- (11) **48972**
(21) 3-2023-01838 (28) 2
(54) **THIẾT BỊ NỔI TẮT CẦU CHÌ TỰ RƠI** (51) **13-03**
(22) 08/08/2023 (43) 25/12/2023
(73) **CÔNG TY CỔ PHẦN ĐẦU TƯ VÀ CÔNG NGHỆ HC TOÀN CẦU (VN)**
Lô 3 - 4, khu BT1, khu nhà ở Trung Văn, phường Trung Văn, quận Nam Từ Liêm,
thành phố Hà Nội
(72) Nguyễn Văn Hà (VN)
(74) Công ty TNHH Sở hữu trí tuệ HAVIP (HAVIP CO., LTD.)
(55)



1.1



1.2



1.3



1.4



1.5



2.1



2.2



2.3



2.4



2.5

CÔNG BÁO SỞ HỮU CÔNG NGHIỆP SỐ 429 TẬP A – QUYỀN 2 (12.2023)

(11) **48973**

(21) 3-2023-01839

(28) 1

(54) **BÀN**

(51) **06-03**

(22) 08/08/2023

(43) 25/12/2023

(73) **CÔNG TY CỔ PHẦN SEMA GROUP (VN)**

Số 69, đường 23, khu đô thị thành phố Giao lưu, phường Cổ Nhuế 1, quận Bắc Từ Liêm, thành phố Hà Nội

(72) 1. NGUYỄN PHƯƠNG CHI (VN)

2. PHẠM TUẤN ANH (VN)

3. NGUYỄN ĐÌNH PHÚC (VN)

4. TRẦN VĂN LINH (VN)

(74) Công ty TNHH NACILAW (NACILAW)

(55)



1.1



1.2

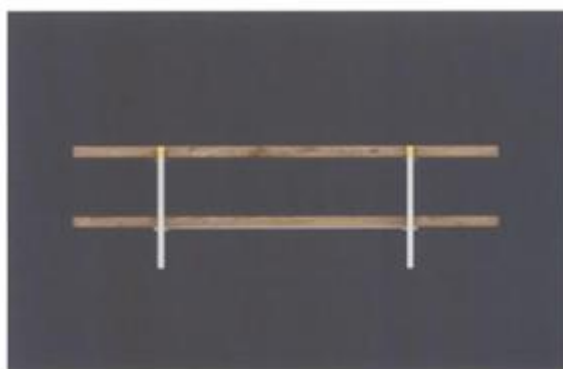

1.3



1.4



1.5

CÔNG BÁO SỞ HỮU CÔNG NGHIỆP SỐ 429 TẬP A – QUYỀN 2 (12.2023)

- (11) **48974**
(21) 3-2023-01840 (28) 1
(54) **BÀN** (51) **06-03**
(22) 08/08/2023 (43) 25/12/2023
(73) **CÔNG TY CỔ PHẦN SEMA GROUP (VN)**
Số 69, đường 23, khu đô thị thành phố Giao lưu, phường Cổ Nhuế 1, quận Bắc Từ Liêm, thành phố Hà Nội
(72) 1. NGUYỄN PHƯƠNG CHI (VN)
2. PHẠM TUẤN ANH (VN)
3. NGUYỄN ĐÌNH PHÚC (VN)
4. TRẦN VĂN LINH (VN)
(74) Công ty TNHH NACILAW (NACILAW)
(55)



1.1



1.2



1.3

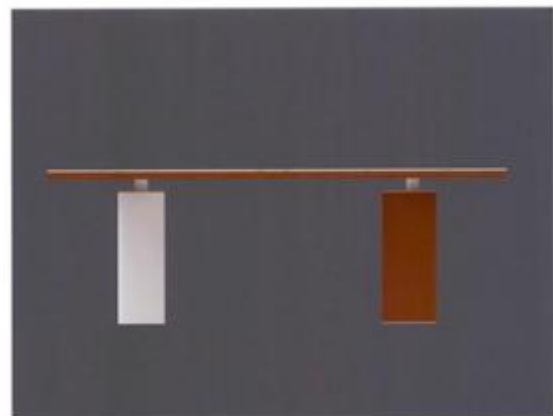

1.4



1.5



1.6

CÔNG BÁO SỞ HỮU CÔNG NGHIỆP SỐ 429 TẬP A – QUYỀN 2 (12.2023)

(11) **48975**

(21) 3-2023-01841

(28) 1

(54) **GHẾ**

(51) **06-01**

(22) 08/08/2023

(43) 25/12/2023

(73) **CÔNG TY CỔ PHẦN SEMA GROUP (VN)**

Số 69, đường 23, khu đô thị thành phố Giao lưu, phường Cổ Nhuế 1, quận Bắc Từ Liêm, thành phố Hà Nội

(72) 1. NGUYỄN PHƯƠNG CHI (VN)

2. PHẠM TUẤN ANH (VN)

3. NGUYỄN ĐÌNH PHÚC (VN)

4. TRẦN VĂN LINH (VN)

(74) Công ty TNHH NACILAW (NACILAW)

(55)



1.1



1.2



1.3



1.4



1.5



1.6

CÔNG BÁO SỞ HỮU CÔNG NGHIỆP SỐ 429 TẬP A – QUYỀN 2 (12.2023)

(11) **48976**

(21) 3-2023-01842

(28) 1

(54) **GHẾ**

(51) **06-01**

(22) 08/08/2023

(43) 25/12/2023

(73) **CÔNG TY CỔ PHẦN SEMA GROUP (VN)**

Số 69, đường 23, khu đô thị thành phố Giao lưu, phường Cổ Nhuế 1, quận Bắc Từ Liêm, thành phố Hà Nội

(72) 1. NGUYỄN PHƯƠNG CHI (VN)

2. PHẠM TUẤN ANH (VN)

3. NGUYỄN ĐÌNH PHÚC (VN)

4. TRẦN VĂN LINH (VN)

(74) Công ty TNHH NACILAW (NACILAW)

(55)



1.1

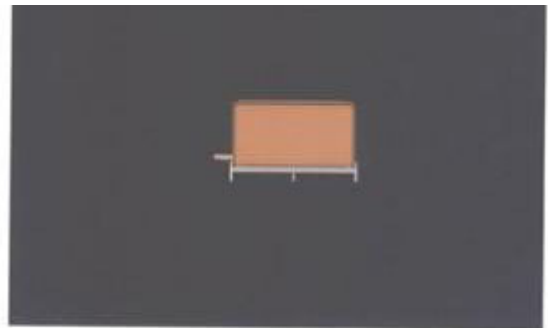

1.2



1.3



1.4



1.5

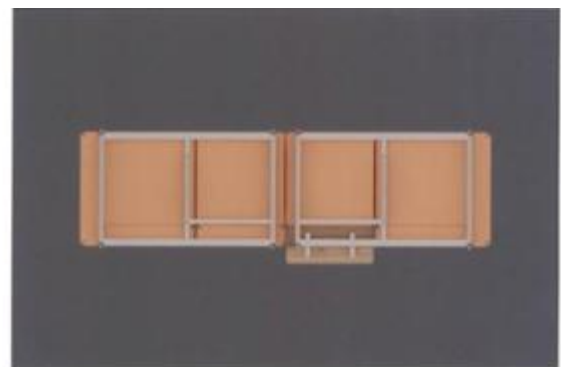

1.6

CÔNG BÁO SỞ HỮU CÔNG NGHIỆP SỐ 429 TẬP A – QUYỀN 2 (12.2023)

(11) **48977**

(21) 3-2023-01843

(28) 1

(54) **GHẾ**

(51) **06-01**

(22) 08/08/2023

(43) 25/12/2023

(73) **CÔNG TY CỔ PHẦN SEMA GROUP (VN)**

Số 69, đường 23, khu đô thị thành phố Giao lưu, phường Cổ Nhuế 1, quận Bắc Từ Liêm, thành phố Hà Nội

(72) 1. NGUYỄN PHƯƠNG CHI (VN)

2. PHẠM TUẤN ANH (VN)

3. NGUYỄN ĐÌNH PHÚC (VN)

4. TRẦN VĂN LINH (VN)

(74) Công ty TNHH NACILAW (NACILAW)

(55)



1.1



1.2



1.3



1.4

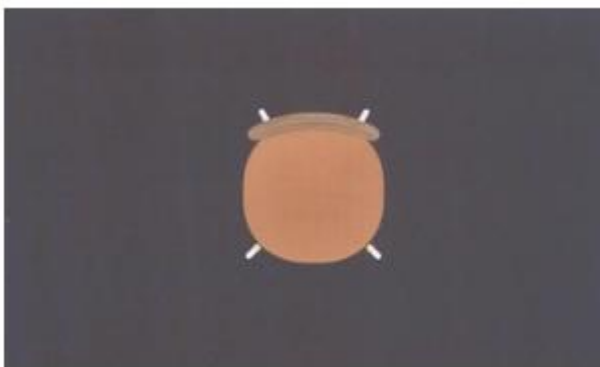

1.5



1.6

CÔNG BÁO SỞ HỮU CÔNG NGHIỆP SỐ 429 TẬP A – QUYỀN 2 (12.2023)

(11) **48978**

(21) 3-2023-01844

(28) 1

(54) **GIƯỜNG**

(51) **06-02**

(22) 08/08/2023

(43) 25/12/2023

(73) **CÔNG TY CỔ PHẦN SEMA GROUP (VN)**

Số 69, đường 23, khu đô thị thành phố Giao lưu, phường Cổ Nhuế 1, quận Bắc Từ Liêm, thành phố Hà Nội

(72) 1. NGUYỄN PHƯƠNG CHI (VN)

2. PHẠM TUẤN ANH (VN)

3. NGUYỄN ĐÌNH PHÚC (VN)

4. TRẦN VĂN LINH (VN)

(74) Công ty TNHH NACILAW (NACILAW)

(55)



1.1



1.2

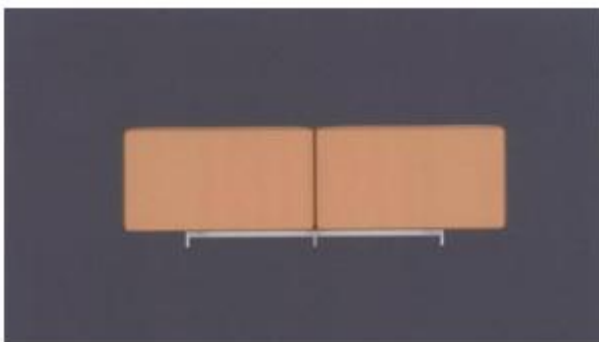

1.3



1.4



1.5



1.6

CÔNG BÁO SỞ HỮU CÔNG NGHIỆP SỐ 429 TẬP A – QUYỀN 2 (12.2023)

- (11) **48979**
(21) 3-2023-01845 (28) 1
(54) **BÚT** (51) **19-06**
(22) 08/08/2023 (43) 25/12/2023
(73) **CÔNG TY CỔ PHẦN TẬP ĐOÀN THIÊN LONG (VN)**
Tầng 10, Sofic Tower, số 10 đường Mai Chí Thọ, phường Thủ Thiêm, thành phố
Thủ Đức, thành phố Hồ Chí Minh
(72) Cô Gia Thọ (VN)
(74) Công ty TNHH Tư vấn sở hữu trí tuệ Việt (VIET IP CO.,LTD.)
(55)



1.1



1.2



1.3



1.4

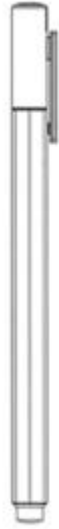

1.5



1.7



1.6



1.8

CÔNG BÁO SỞ HỮU CÔNG NGHIỆP SỐ 429 TẬP A – QUYỀN 2 (12.2023)

- (11) **48980**
(21) 3-2023-01846 (28) 1
(54) **BÚT** (51) **19-06**
(22) 08/08/2023 (43) 25/12/2023
(73) **CÔNG TY CỔ PHẦN TẬP ĐOÀN THIÊN LONG (VN)**
Tầng 10, Sofic Tower, số 10 đường Mai Chí Thọ, phường Thủ Thiêm, thành phố
Thủ Đức, thành phố Hồ Chí Minh
(72) Cô Gia Thọ (VN)
(74) Công ty TNHH Tư vấn sở hữu trí tuệ Việt (VIET IP CO.,LTD.)
(55)

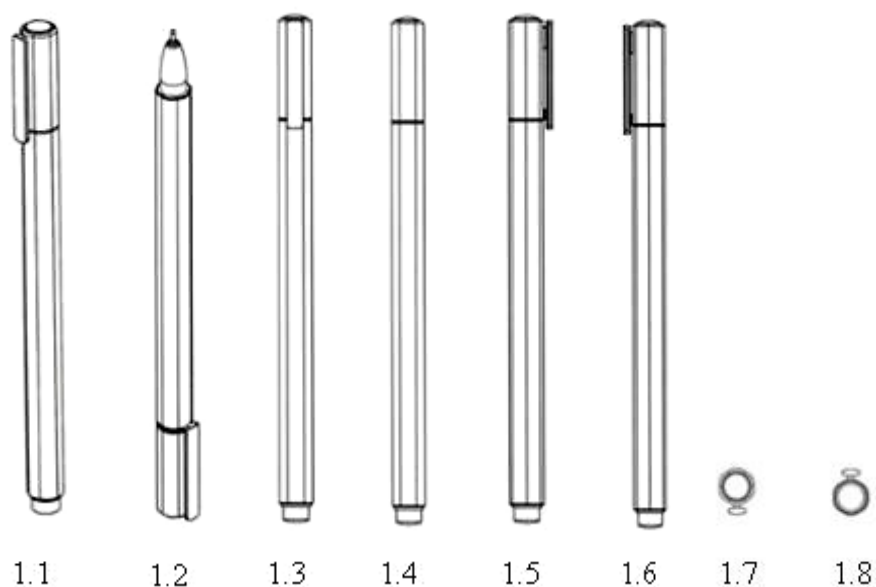

CÔNG BÁO SỞ HỮU CÔNG NGHIỆP SỐ 429 TẬP A – QUYỀN 2 (12.2023)

- (11) **48981**
(21) 3-2023-01847 (28) 1
(54) **CHI TIẾT TRANG TRÍ TRÊN THANH CÀI CỦA BÚT** (51) **19-06**
(22) 08/08/2023 (43) 25/12/2023
(73) **CÔNG TY CỔ PHẦN TẬP ĐOÀN THIÊN LONG (VN)**
Tầng 10, Sofic Tower, số 10 đường Mai Chí Thọ, phường Thủ Thiêm, thành phố Thủ Đức, thành phố Hồ Chí Minh
(72) Cô Gia Thọ (VN)
(74) Công ty TNHH Tư vấn sở hữu trí tuệ Việt (VIET IP CO.,LTD.)
(55)



1.1

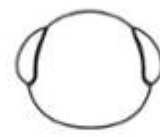

1.2

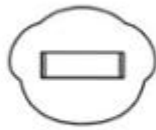

1.3



1.4



1.5



1.6



1.7



1.8

CÔNG BÁO SỞ HỮU CÔNG NGHIỆP SỐ 429 TẬP A – QUYỀN 2 (12.2023)

- (11) **48982**
(21) 3-2023-01848 (28) 1
(54) **BÚT** (51) **19-06**
(22) 08/08/2023 (43) 25/12/2023
(73) **CÔNG TY CỔ PHẦN TẬP ĐOÀN THIÊN LONG (VN)**
Tầng 10, Sofic Tower, số 10 đường Mai Chí Thọ, phường Thủ Thiêm, thành phố
Thủ Đức, thành phố Hồ Chí Minh
(72) Cô Gia Thọ (VN)
(74) Công ty TNHH Tư vấn sở hữu trí tuệ Việt (VIET IP CO.,LTD.)
(55)

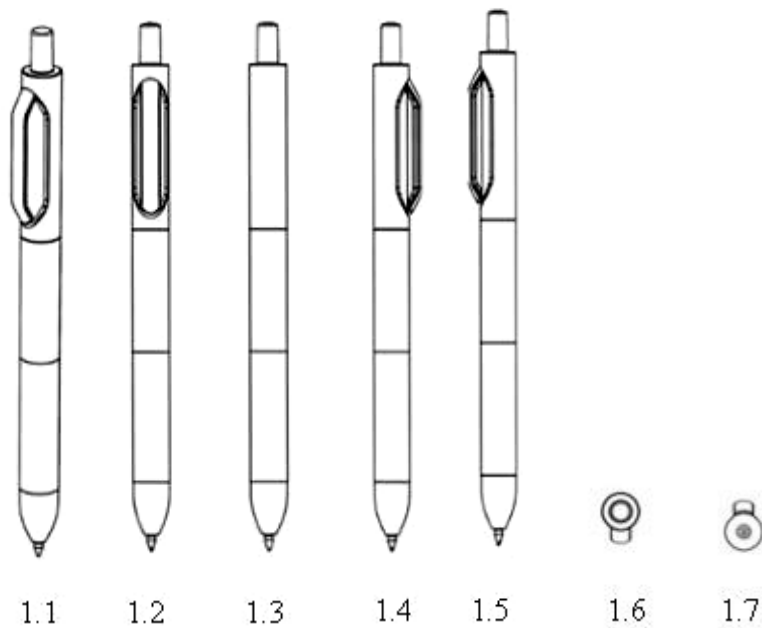

CÔNG BÁO SỞ HỮU CÔNG NGHIỆP SỐ 429 TẬP A – QUYỀN 2 (12.2023)

(11) **48983**

(21) 3-2023-01849

(28) 1

(54) **BÚT**

(51) **19-06**

(22) 08/08/2023

(43) 25/12/2023

(73) **CÔNG TY CỔ PHẦN TẬP ĐOÀN THIÊN LONG (VN)**

Tầng 10, Sofic Tower, số 10 đường Mai Chí Thọ, phường Thủ Thiêm, thành phố Thủ Đức, thành phố Hồ Chí Minh

(72) Cô Gia Thọ (VN)

(74) Công ty TNHH Tư vấn sở hữu trí tuệ Việt (VIET IP CO.,LTD.)

(55)

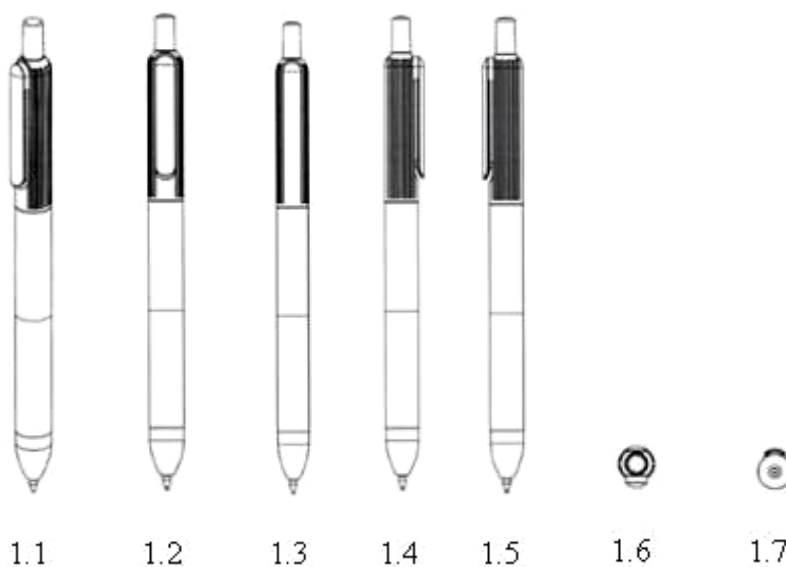

CÔNG BÁO SỞ HỮU CÔNG NGHIỆP SỐ 429 TẬP A – QUYỀN 2 (12.2023)

- (11) **48984**
(21) 3-2023-01850 (28) 1
(54) **BÚT** (51) **19-06**
(22) 08/08/2023 (43) 25/12/2023
(73) **CÔNG TY CỔ PHẦN TẬP ĐOÀN THIÊN LONG (VN)**
Tầng 10, Sofic Tower, số 10 đường Mai Chí Thọ, phường Thủ Thiêm, thành phố
Thủ Đức, thành phố Hồ Chí Minh
(72) Cô Gia Thọ (VN)
(74) Công ty TNHH Tư vấn sở hữu trí tuệ Việt (VIET IP CO.,LTD.)
(55)

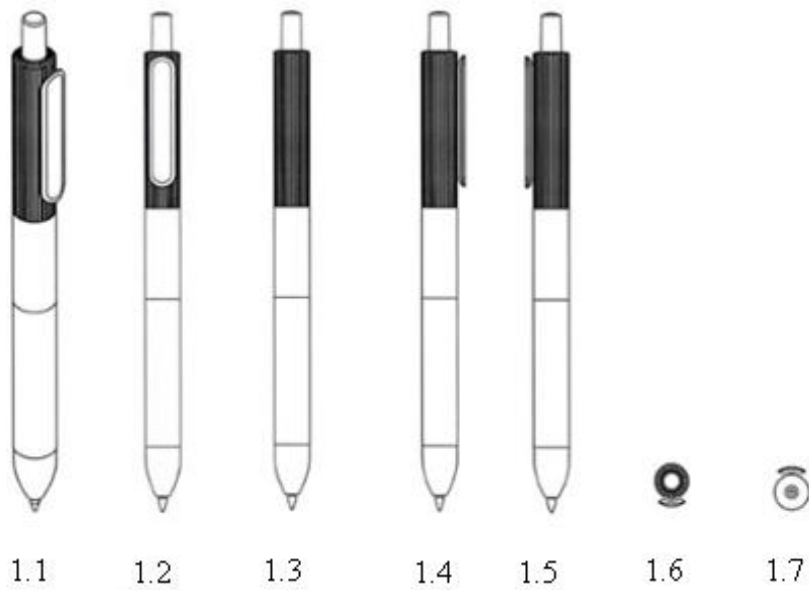

CÔNG BÁO SỞ HỮU CÔNG NGHIỆP SỐ 429 TẬP A – QUYỀN 2 (12.2023)

(11) **48985**

(21) 3-2023-01852

(28) 3

(54) **BÚT**

(51) **19-06**

(22) 08/08/2023

(43) 25/12/2023

(73) **CÔNG TY CỔ PHẦN TẬP ĐOÀN THIÊN LONG (VN)**

Tầng 10, Sofic Tower, số 10 đường Mai Chí Thọ, phường Thủ Thiêm, thành phố Thủ Đức, thành phố Hồ Chí Minh

(72) Cô Gia Thọ (VN)

(74) Công ty TNHH Tư vấn sở hữu trí tuệ Việt (VIET IP CO.,LTD.)

(55)

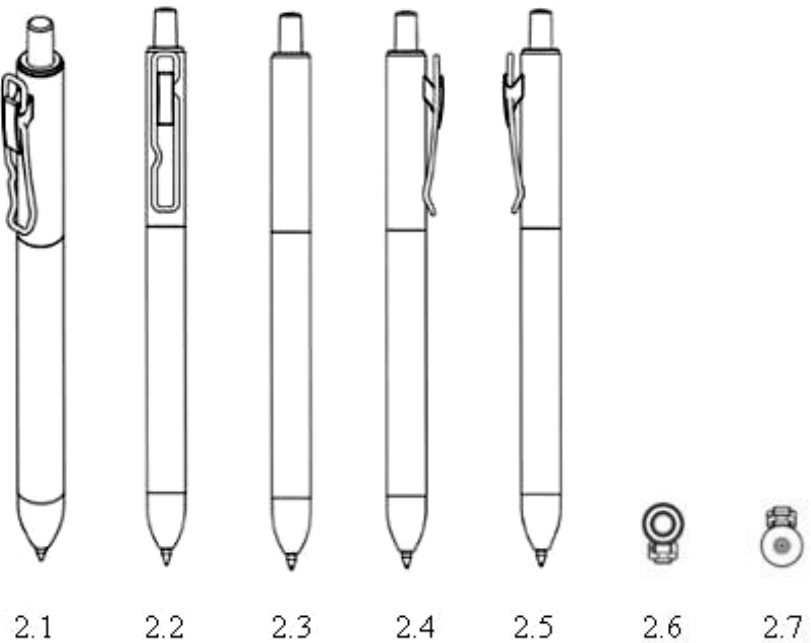
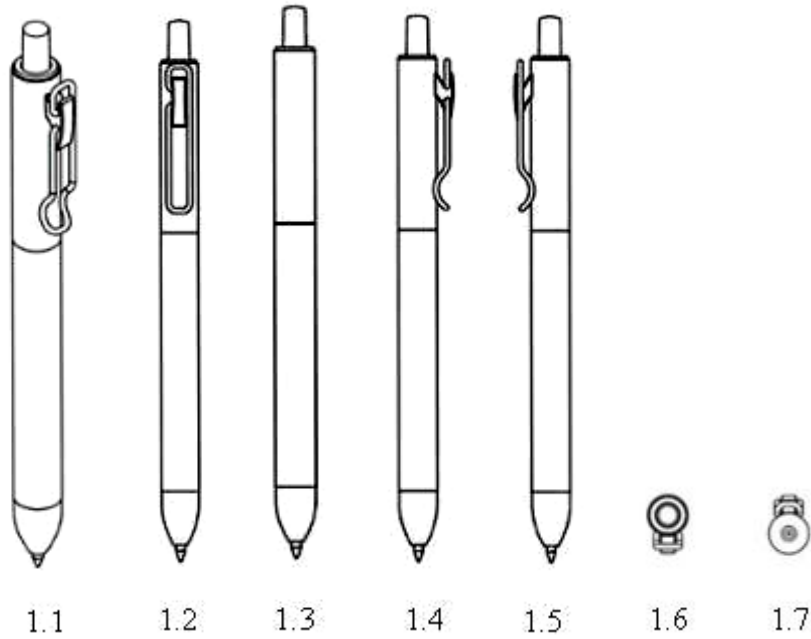



3.1



3.2



3.3



3.4



3.5



3.6



3.7

CÔNG BÁO SỞ HỮU CÔNG NGHIỆP SỐ 429 TẬP A – QUYỀN 2 (12.2023)

- (11) **48986**
(21) 3-2023-01853 (28) 1
(54) **BÚT** (51) **19-06**
(22) 08/08/2023 (43) 25/12/2023
(73) **CÔNG TY CỔ PHẦN TẬP ĐOÀN THIÊN LONG (VN)**
Tầng 10, Sofic Tower, số 10 đường Mai Chí Thọ, phường Thủ Thiêm, thành phố
Thủ Đức, thành phố Hồ Chí Minh
(72) Cô Gia Thọ (VN)
(74) Công ty TNHH Tư vấn sở hữu trí tuệ Việt (VIET IP CO.,LTD.)
(55)

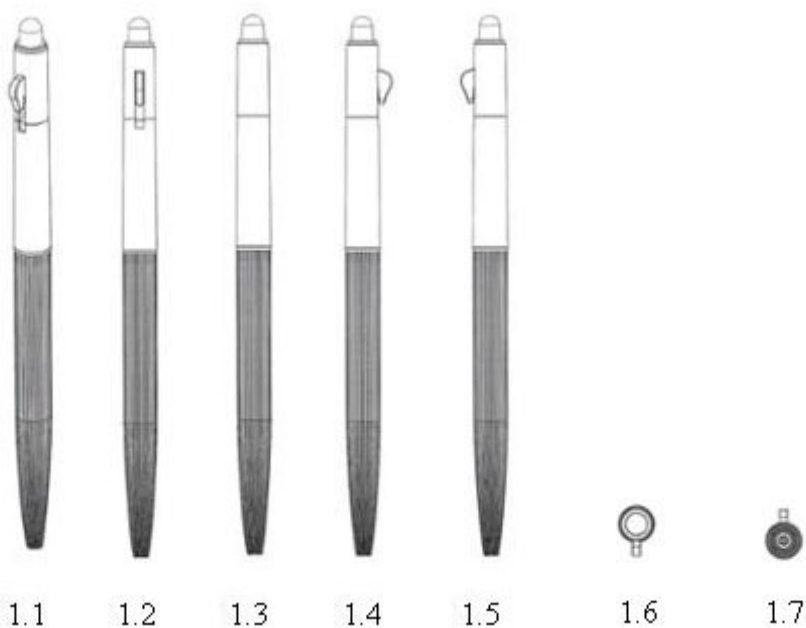

CÔNG BÁO SỞ HỮU CÔNG NGHIỆP SỐ 429 TẬP A – QUYỀN 2 (12.2023)

- (11) **48987**
(21) 3-2023-01854 (28) 1
(54) **BÚT** (51) **19-06**
(22) 08/08/2023 (43) 25/12/2023
(73) **CÔNG TY CỔ PHẦN TẬP ĐOÀN THIÊN LONG (VN)**
Tầng 10, Sofic Tower, số 10 đường Mai Chí Thọ, phường Thủ Thiêm, thành phố
Thủ Đức, thành phố Hồ Chí Minh
(72) Cô Gia Thọ (VN)
(74) Công ty TNHH Tư vấn sở hữu trí tuệ Việt (VIET IP CO.,LTD.)
(55)

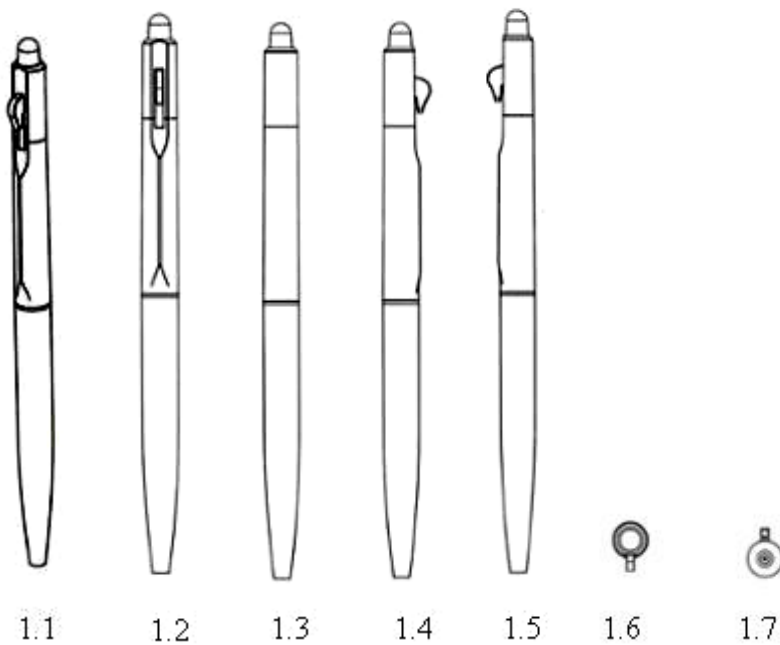

CÔNG BÁO SỞ HỮU CÔNG NGHIỆP SỐ 429 TẬP A – QUYỀN 2 (12.2023)

- (11) **48988**
(21) 3-2023-01855 (28) 1
(54) **BÚT** (51) **19-06**
(22) 08/08/2023 (43) 25/12/2023
(73) **CÔNG TY CỔ PHẦN TẬP ĐOÀN THIÊN LONG (VN)**
Tầng 10, Sofic Tower, số 10 đường Mai Chí Thọ, phường Thủ Thiêm, thành phố
Thủ Đức, thành phố Hồ Chí Minh
(72) Cô Gia Thọ (VN)
(74) Công ty TNHH Tư vấn sở hữu trí tuệ Việt (VIET IP CO.,LTD.)
(55)

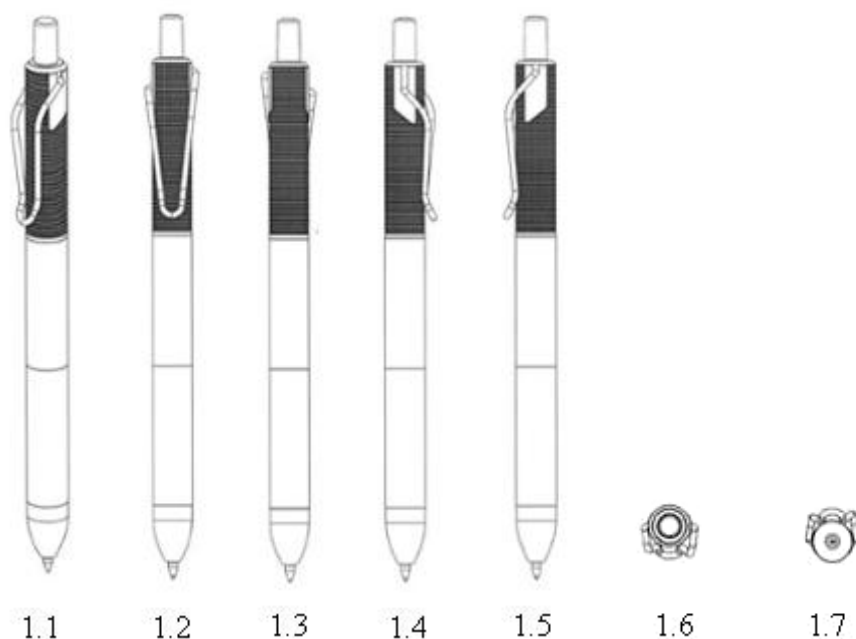

CÔNG BÁO SỞ HỮU CÔNG NGHIỆP SỐ 429 TẬP A – QUYỀN 2 (12.2023)

- (11) **48989**
(21) 3-2023-01856 (28) 1
(54) **BÚT** (51) **19-06**
(22) 08/08/2023 (43) 25/12/2023
(73) **CÔNG TY CỔ PHẦN TẬP ĐOÀN THIÊN LONG (VN)**
Tầng 10, Sofic Tower, số 10 đường Mai Chí Thọ, phường Thủ Thiêm, thành phố Thủ Đức, thành phố Hồ Chí Minh
(72) Cô Gia Thọ (VN)
(74) Công ty TNHH Tư vấn sở hữu trí tuệ Việt (VIET IP CO.,LTD.)
(55)

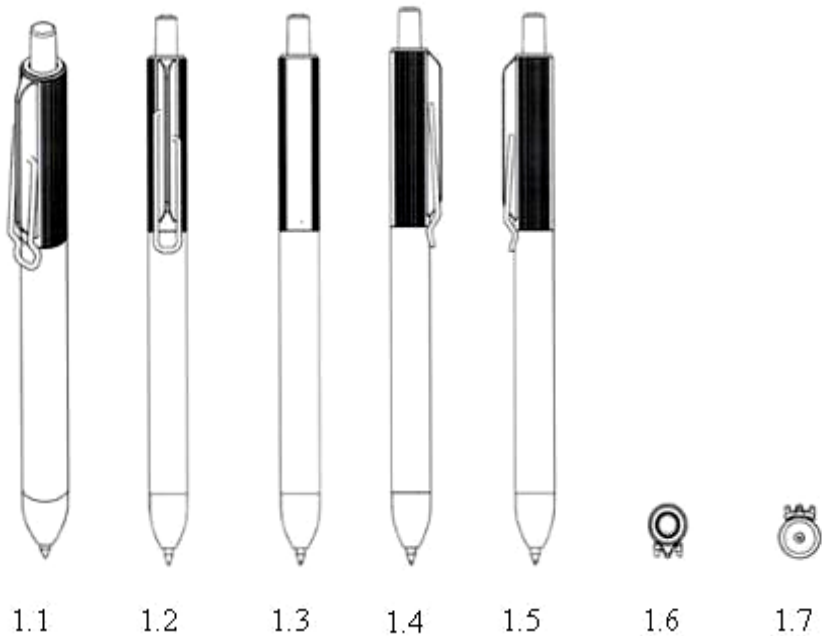

CÔNG BÁO SỞ HỮU CÔNG NGHIỆP SỐ 429 TẬP A – QUYỀN 2 (12.2023)

- (11) **48990**
(21) 3-2023-01861 (28) 1
(54) **THANH KIM LOẠI ĐỊNH HÌNH** (51) **25-01**
(22) 09/08/2023 (43) 25/12/2023
(73) **TRẦN THỊ THỦY TIÊN (VN)**
1/1 Sơn Kỳ, phường Sơn Kỳ, quận Tân Phú, thành phố Hồ Chí Minh
(72) Trần Thị Thủy Tiên (VN)
(74) Công ty TNHH Sở hữu trí tuệ PADEMARK (PADEMARK CO.,LTD.)
(55)

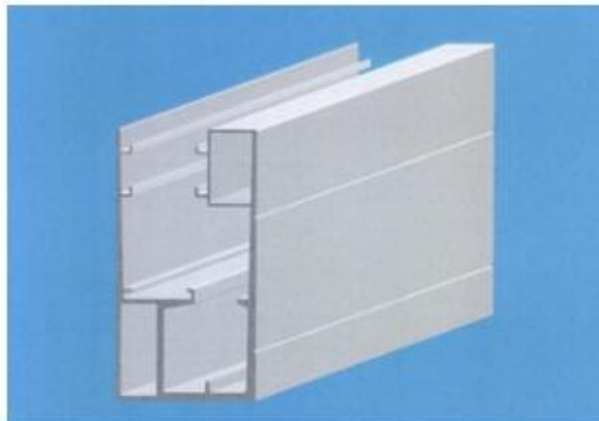

1.1



1.2



1.3



1.4

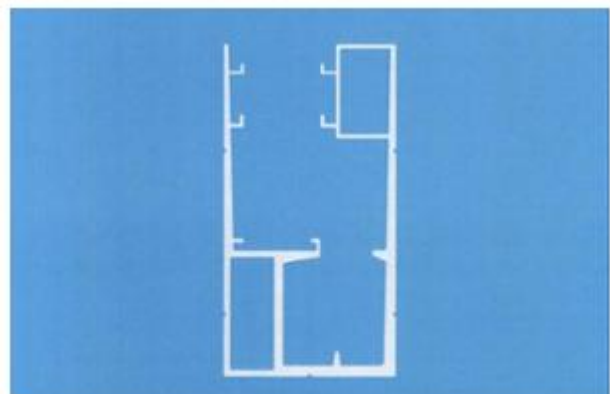

1.5

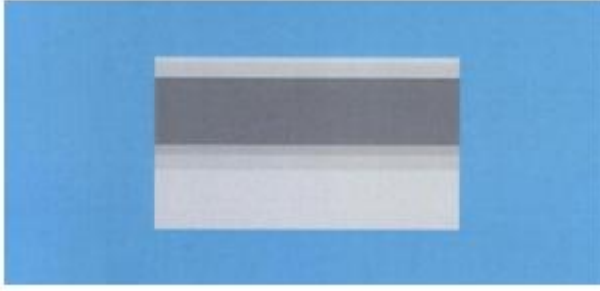

1.6

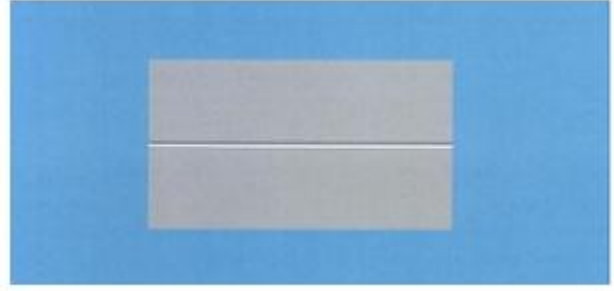

1.7

CÔNG BÁO SỞ HỮU CÔNG NGHIỆP SỐ 429 TẬP A – QUYỀN 2 (12.2023)

- (11) **48991**
(21) 3-2023-01862 (28) 1
(54) **LỘ ĐỰNG SON BÓNG** (51) **28-02**
(22) 10/08/2023 (43) 25/12/2023
(73) **SHANTOU LICAI PLASTIC CO., LTD (CN)**
No. 15, Zhaitou Outer Workshop, Qishan Street, Jinping District, Shantou City,
Guangdong Province, 515135, China
(72) Junqing Hong (CN)
(74) Công ty TNHH ADASTRA IP (VIỆT NAM) (ADASTRA IP (VIETNAM) CO.,
LTD.)
(55)

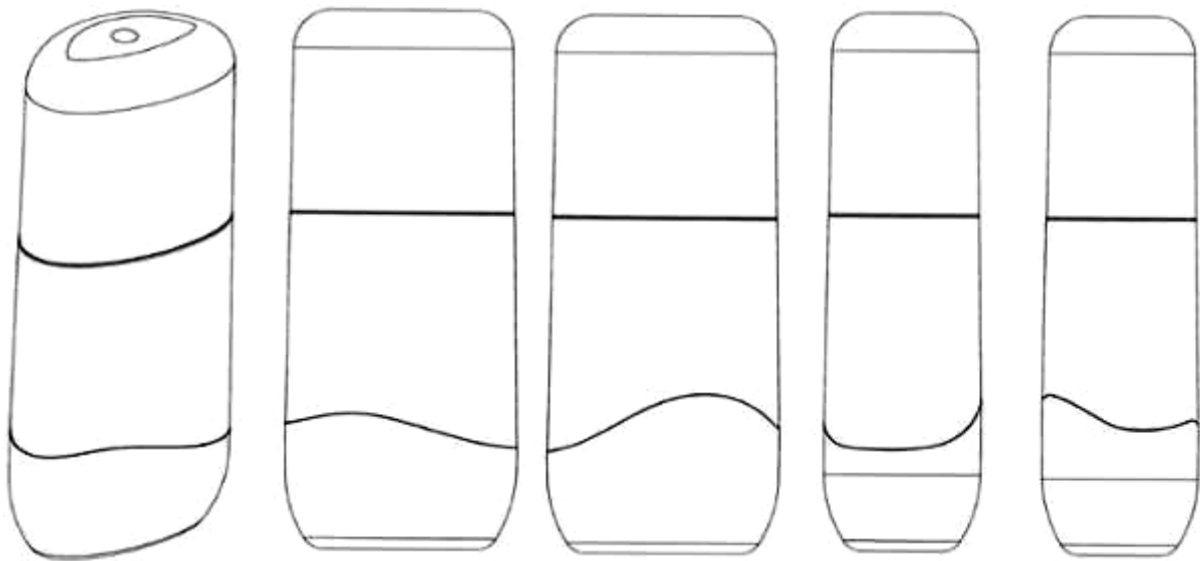

1.1

1.2

1.3

1.4

1.5



1.6

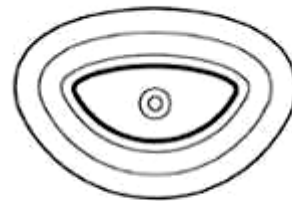

1.7

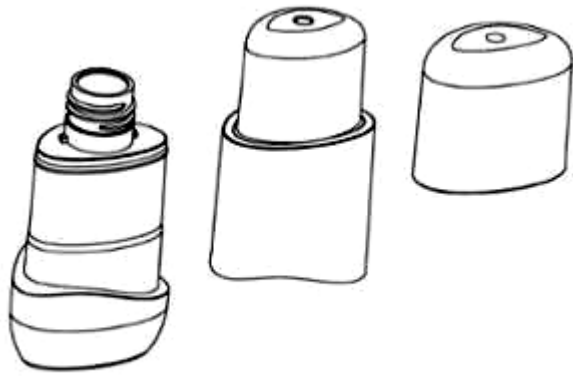

1.8

CÔNG BÁO SỞ HỮU CÔNG NGHIỆP SỐ 429 TẬP A – QUYỀN 2 (12.2023)

- (11) **48992**
(21) 3-2023-01871 (28) 1
(54) **THIẾT BỊ SẢN XUẤT KHÍ HYDRO** (51) **23-01**
(22) 10/08/2023 (43) 25/12/2023
(73) **LIN, HSIN-YUNG (CN)**
No.758, Jiaxin Highway, Jiading District, Shanghai, China
(72) LIN, Hsin-Yung (TW)
(74) Công ty TNHH Tâm nhìn và Liên danh (VISION & ASSOCIATES CO.LTD.)
(55)



1.1



1.2



1.3



1.4

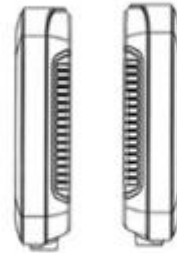

1.5

1.6



1.7



1.8

CÔNG BÁO SỞ HỮU CÔNG NGHIỆP SỐ 429 TẬP A – QUYỀN 2 (12.2023)

- (11) **48993**
(21) 3-2023-01877 (28) 2
(54) **BAO GÓI** (51) **09-05**
(22) 11/08/2023 (43) 25/12/2023
(73) **CÔNG TY CỔ PHẦN ACECOOK VIỆT NAM (VN)**
Lô số II-3, đường số 11, nhóm CN II, Khu công nghiệp Tân Bình, phường Tây
Thạnh, quận Tân Phú, thành phố Hồ Chí Minh
(72) KANEDA HIROKI (JP)
(74) Công ty Luật TNHH Phạm và Liên danh (PHAM & ASSOCIATES)
(55)



1.1



1.2



2.1



2.2

CÔNG BÁO SỞ HỮU CÔNG NGHIỆP SỐ 429 TẬP A – QUYỀN 2 (12.2023)

- (11) **48994**
- (21) 3-2023-01878
- (54) **THÙNG**
- (22) 11/08/2023
- (73) **CÔNG TY CỔ PHẦN ACECOOK VIỆT NAM (VN)**
Lô số II-3, đường số 11, nhóm CN II, khu công nghiệp Tân Bình, phường Tây Thạnh, quận Tân Phú, thành phố Hồ Chí Minh
- (72) KANEDA HIROKI (JP)
- (74) Công ty Luật TNHH Phạm và Liên danh (PHAM & ASSOCIATES)
- (55)



1.1



1.2



2.1



2.2

CÔNG BÁO SỞ HỮU CÔNG NGHIỆP SỐ 429 TẬP A – QUYỀN 2 (12.2023)

- (11) **48995**
(21) 3-2023-01879 (28) 1
(54) **THIẾT BỊ NÂNG HẠ** (51) **12-05**
(22) 11/08/2023 (43) 25/12/2023
(73) **CÔNG TY TNHH ATS VIETNAM (VN)**
Số 192 đường Đoàn Văn Bơ, phường 09, quận 4, thành phố Hồ Chí Minh
(72) Lê Ngọc Danh (VN)
(55)

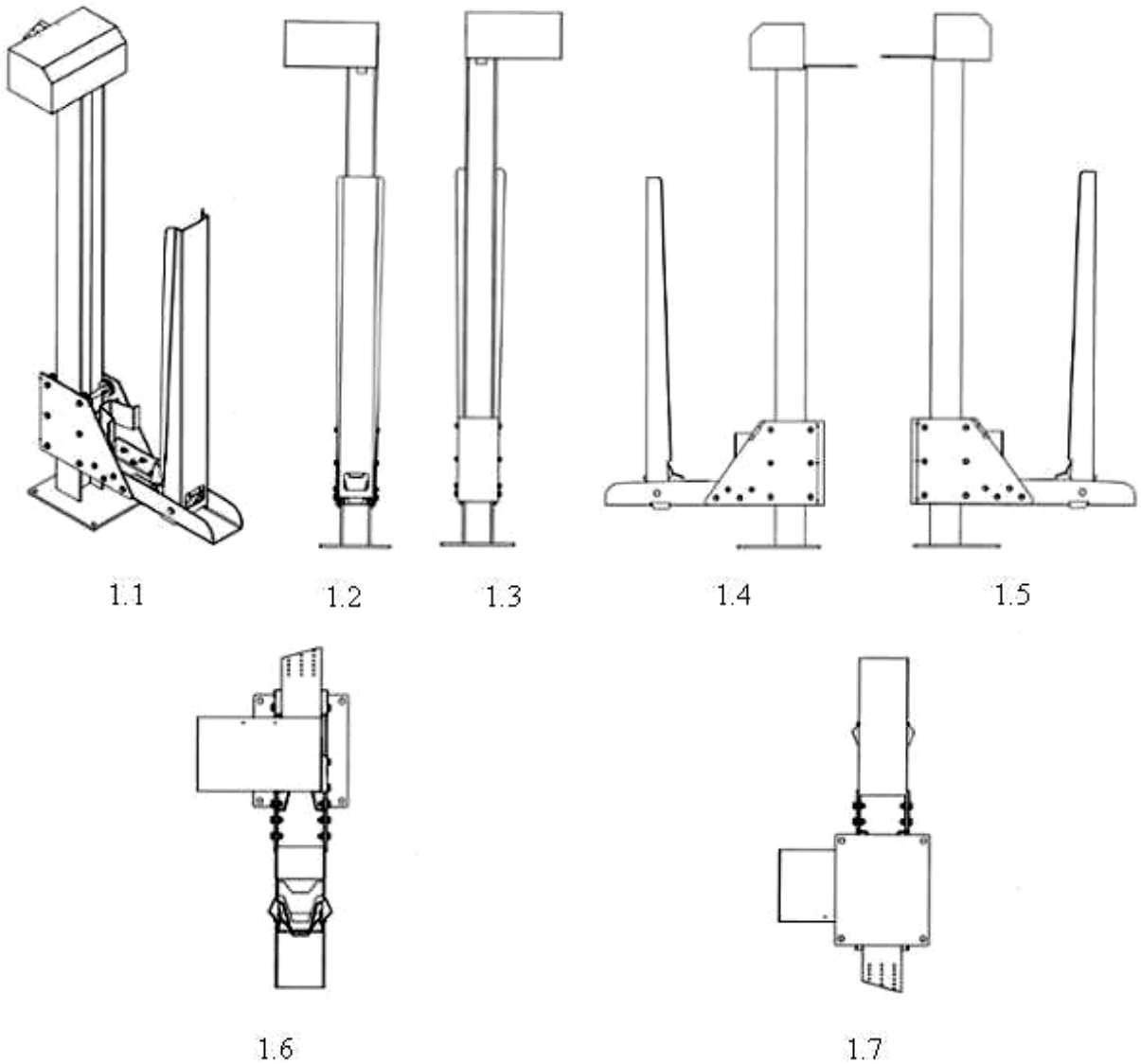

CÔNG BÁO SỞ HỮU CÔNG NGHIỆP SỐ 429 TẬP A – QUYỀN 2 (12.2023)

- (11) **48996**
- (21) 3-2023-01880
- (54) **Ô TÔ**
- (22) 11/08/2023
- (30) DM/226869 13/02/2023 WO;
- (73) **FERRARI S.P.A (IT)**
Via Emilia Est 1163, Modena, Italy
- (72) ENRICO CARDILE (IT)
- (74) Công ty TNHH một thành viên Sở hữu trí tuệ VCCI (VCCI-IP CO.,LTD)
- (55)

- (28) 1
- (51) **12-08**
- (43) 25/12/2023

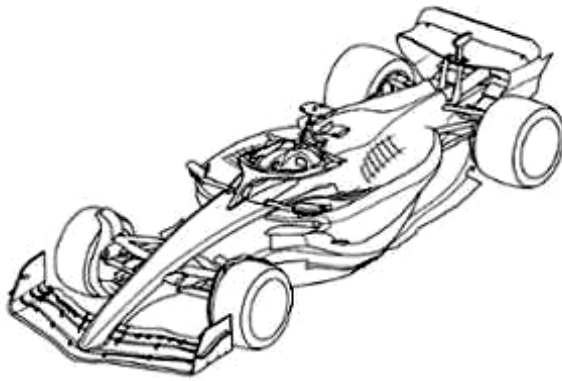

1.1

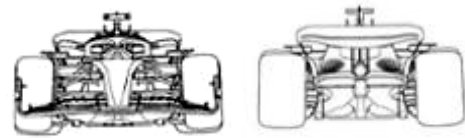

1.2

1.3

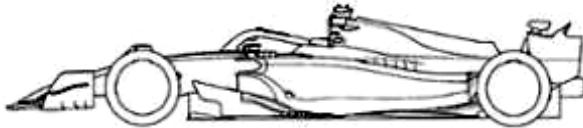

1.4



1.5

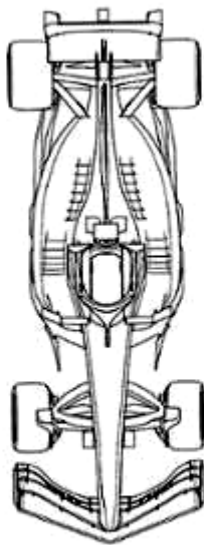

1.6

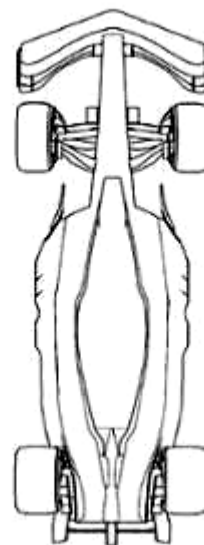

1.7

CÔNG BÁO SỞ HỮU CÔNG NGHIỆP SỐ 429 TẬP A – QUYỀN 2 (12.2023)

- (11) **48997**
(21) 3-2023-01881 (28) 1
(54) **Ô TÔ ĐỒ CHƠI** (51) **21-01**
(22) 11/08/2023 (43) 25/12/2023
(30) DM/226870 13/02/2023 WO;
(73) **FERRARI S.P.A. (IT)**
Via Emilia Est 1163, Modena, Italy
(72) ENRICO CARDILE (IT)
(74) Công ty TNHH một thành viên Sở hữu trí tuệ VCCI (VCCI-IP CO.,LTD)
(55)

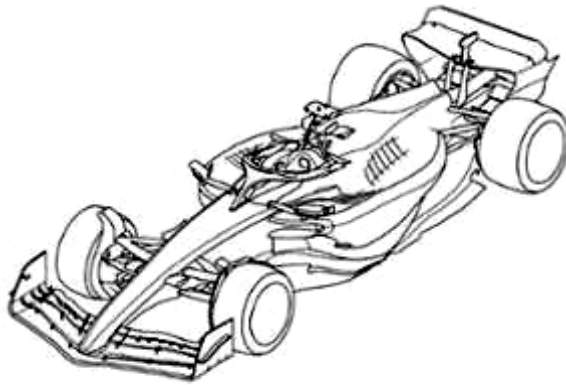

1.1



1.2

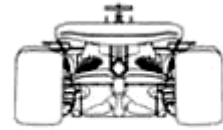

1.3

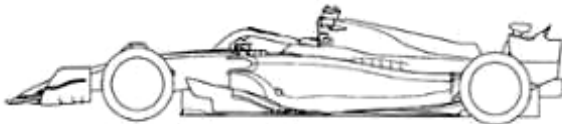

1.4



1.5

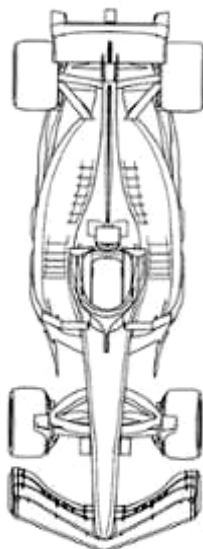

1.6



1.7

CÔNG BÁO SỞ HỮU CÔNG NGHIỆP SỐ 429 TẬP A – QUYỀN 2 (12.2023)

- (11) **48998**
(21) 3-2023-01883 (28) 1
(54) **HỘP** (51) **09-03**
(22) 11/08/2023 (43) 25/12/2023
(73) **CÔNG TY TNHH MỘT THÀNH VIÊN MỸ PHẨM MỸ HẠNH (VN)**
Số 240, tổ 6, ấp Long Hạ, Kiên An, huyện Chợ Mới, tỉnh An Giang
(72) Lê Thị Lành (VN)
(55)



1.1



1.2



1.3

CÔNG BÁO SỞ HỮU CÔNG NGHIỆP SỐ 429 TẬP A – QUYỀN 2 (12.2023)

- (11) **48999**
(21) 3-2023-01885 (28) 1
(54) **TỦ LẠNH ĐỪNG KIM CHI** (51) **15-07**
(22) 11/08/2023 (43) 25/12/2023
(30) 30-2023-0030464 04/08/2023 KR;
(73) **LOCK & LOCK CO., LTD.** (KR)
1260, Manse-ro, Wongok-myeon, Anseong-si, Gyeonggi-do, Republic of Korea
(72) SHIM, Dong Seop (KR)
(74) Công ty TNHH Tâm nhìn và Liên danh (VISION & ASSOCIATES CO.LTD.)
(55)



1.1



1.2

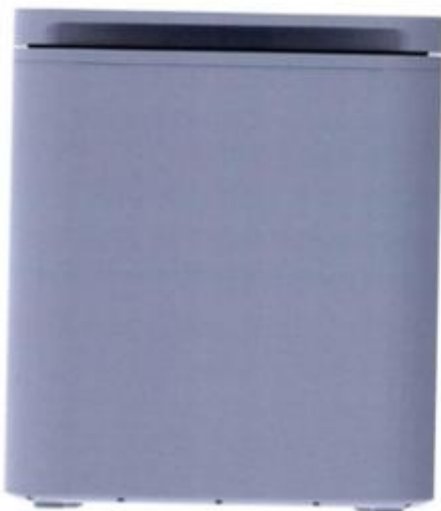

1.3



1.4



1.5



1.6



1.7



1.8



1.9

CÔNG BÁO SỞ HỮU CÔNG NGHIỆP SỐ 429 TẬP A – QUYỀN 2 (12.2023)

- (11) **49000**
(21) 3-2023-01886 (28) 1
(54) **BÌNH** (51) **07-07**
(22) 11/08/2023 (43) 25/12/2023
(30) 30-2023-0030465 04/08/2023 KR;
(73) **LOCK & LOCK CO., LTD.** (KR)
1260, Manse-ro, Wongok-myeon, Anseong-si, Gyeonggi-do, Republic of Korea
(72) KIM, Kwang Ik (KR)
(74) Công ty TNHH Tầm nhìn và Liên danh (VISION & ASSOCIATES CO.LTD.)
(55)



1.1



1.2



1.3



1.4



1.5



1.6



1.7



1.8

CÔNG BÁO SỞ HỮU CÔNG NGHIỆP SỐ 429 TẬP A – QUYỀN 2 (12.2023)

- (11) **49001**
(21) 3-2023-01887 (28) 1
(54) **GIƯỜNG** (51) **06-02**
(22) 11/08/2023 (43) 25/12/2023
(73) **CÔNG TY CỔ PHẦN CAO SU SÀI GÒN - KYMDAN (VN)**
28 Bình Thới, quận 11, thành phố Hồ Chí Minh
(72) Nguyễn Trí Tân (VN)
(74) Công ty TNHH Sở hữu trí tuệ Thảo Thọ Quyển (INVENCO.,LTD)
(55)



1.1

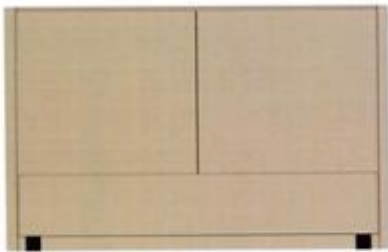

1.2



1.3



1.4



1.5



1.6



1.7

CÔNG BÁO SỞ HỮU CÔNG NGHIỆP SỐ 429 TẬP A – QUYỀN 2 (12.2023)

- (11) **49002**
(21) 3-2023-01890 (28) 1
(54) **THÂN BÚT** (51) **19-06**
(22) 11/08/2023 (43) 25/12/2023
(73) **CÔNG TY CỔ PHẦN TẬP ĐOÀN THIÊN LONG (VN)**
Tầng 10, Sofic Tower, số 10 đường Mai Chí Thọ, phường Thủ Thiêm, thành phố
Thủ Đức, thành phố Hồ Chí Minh
(72) Cô Gia Thọ (VN)
(74) Công ty TNHH Tư vấn sở hữu trí tuệ Việt (VIET IP CO.,LTD.)
(55)

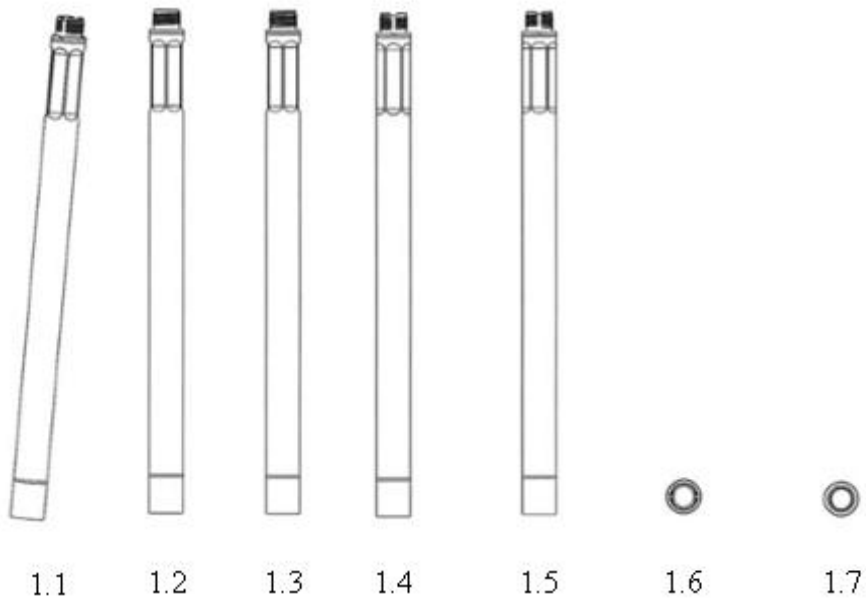

CÔNG BÁO SỞ HỮU CÔNG NGHIỆP SỐ 429 TẬP A – QUYỀN 2 (12.2023)

- (11) **49003**
(21) 3-2023-01894 (28) 1
(54) **CA BIN XE TẢI** (51) **12-16**
(22) 14/08/2023 (43) 25/12/2023
(30) 2023-003477 22/02/2023 JP;
(73) **ISUZU MOTORS LIMITED (JP)**
2-5, Takashima 1-chome, Nishi-ku, Yokohama-shi, Kanagawa, 220-8720, JAPAN
(72) 1. TAKUYA HIRAKAWA (JP)
2. NOBUYUKI HORISAWA (JP)
3. RYOU KAWAHARA (JP)
4. EIJI NAKAJIMA (JP)
5. NOBORU KUDOU (JP)
6. DAIKI WATANABE (JP)
7. YOSHIKI TANAKA (JP)
(74) Công ty Luật TNHH Phạm và Liên danh (PHAM & ASSOCIATES)
(55)



1.1



1.2



1.3



1.4



1.5



1.6

CÔNG BÁO SỞ HỮU CÔNG NGHIỆP SỐ 429 TẬP A – QUYỀN 2 (12.2023)

- (11) **49004**
(21) 3-2023-01896 (28) 1
(54) **CA BIN XE TẢI** (51) **12-16**
(22) 14/08/2023 (43) 25/12/2023
(30) 2023-003454 22/02/2023 JP;
(73) **ISUZU MOTORS LIMITED (JP)**
2-5, Takashima 1-chome, Nishi-ku, Yokohama-shi, Kanagawa, 220-8720, JAPAN
(72) 1. JUNICHI SHIINA (JP)
2. NOBUYUKI HORISAWA (JP)
3. KATSUMI TAJIMA (JP)
4. YASUHIRO MORIFUJI (JP)
5. KENJI TASHIRO (JP)
6. KOUICHI KAWASUMI (JP)
7. DAIKI WATANABE (JP)
(74) Công ty Luật TNHH Phạm và Liên danh (PHAM & ASSOCIATES)
(55)



1.1



1.2



1.3



1.4



1.5



1.6



1.7

- (11) **49005**
(21) 3-2023-01897 (28) 1
(54) **HOA TAI** (51) **11-01**
(22) 14/08/2023 (43) 25/12/2023
(73) **CÔNG TY CỔ PHẦN VÀNG BẠC ĐÁ QUÝ PHÚ NHUẬN (VN)**
170E Phan Đăng Lưu, phường 3, quận Phú Nhuận, thành phố Hồ Chí Minh
(72) Nguyễn Khoa Hồng Thành (VN)
(74) Công ty TNHH Sở hữu trí tuệ Việt Á (VIET A IP CO.,LTD)
(55)



1.1

1.2

1.3



1.4

1.5

1.6

CÔNG BÁO SỞ HỮU CÔNG NGHIỆP SỐ 429 TẬP A – QUYỀN 2 (12.2023)

- (11) **49006**
(21) 3-2023-01899 (28) 1
(54) **DÂY CHUYỀN ĐEO CỔ** (51) **11-01**
(22) 14/08/2023 (43) 25/12/2023
(73) **CÔNG TY CỔ PHẦN VÀNG BẠC ĐÁ QUÝ PHÚ NHUẬN (VN)**
170E Phan Đăng Lưu, phường 3, quận Phú Nhuận, thành phố Hồ Chí Minh
(72) Nguyễn Khoa Hồng Thành (VN)
(74) Công ty TNHH Sở hữu trí tuệ Việt Á (VIET A IP CO.,LTD)
(55)



1.1



1.2



1.3



1.4



1.5



1.6

CÔNG BÁO SỞ HỮU CÔNG NGHIỆP SỐ 429 TẬP A – QUYỀN 2 (12.2023)

- (11) **49007**
(21) 3-2023-01900 (28) 1
(54) **DÂY CHUYỀN ĐEO CỔ** (51) **11-01**
(22) 14/08/2023 (43) 25/12/2023
(73) **CÔNG TY CỔ PHẦN VÀNG BẠC ĐÁ QUÝ PHÚ NHUẬN (VN)**
170E Phan Đăng Lưu, phường 3, quận Phú Nhuận, thành phố Hồ Chí Minh
(72) Nguyễn Khoa Hồng Thành (VN)
(74) Công ty TNHH Sở hữu trí tuệ Việt Á (VIET A IP CO.,LTD)
(55)



1.1



1.2



1.3



1.4



1.5



1.6

CÔNG BÁO SỞ HỮU CÔNG NGHIỆP SỐ 429 TẬP A – QUYỀN 2 (12.2023)

- (11) **49008**
(21) 3-2023-01901 (28) 1
(54) **DÂY CHUYỀN ĐEO CỔ** (51) **11-01**
(22) 14/08/2023 (43) 25/12/2023
(73) **CÔNG TY CỔ PHẦN VÀNG BẠC ĐÁ QUÝ PHÚ NHUẬN (VN)**
170E Phan Đăng Lưu, phường 3, quận Phú Nhuận, thành phố Hồ Chí Minh
(72) Nguyễn Khoa Hồng Thành (VN)
(74) Công ty TNHH Sở hữu trí tuệ Việt Á (VIET A IP CO.,LTD)
(55)



1.1



1.2



1.3



1.4



1.5



1.6

CÔNG BÁO SỞ HỮU CÔNG NGHIỆP SỐ 429 TẬP A – QUYỀN 2 (12.2023)

- (11) **49009**
(21) 3-2023-01903 (28) 1
(54) **DÂY CHUYỀN ĐEO CỔ** (51) **11-01**
(22) 14/08/2023 (43) 25/12/2023
(73) **CÔNG TY CỔ PHẦN VÀNG BẠC ĐÁ QUÝ PHÚ NHUẬN (VN)**
170E Phan Đăng Lưu, phường 3, quận Phú Nhuận, thành phố Hồ Chí Minh
(72) Nguyễn Khoa Hồng Thành (VN)
(74) Công ty TNHH Sở hữu trí tuệ Việt Á (VIET A IP CO.,LTD)
(55)



1.1



1.2



1.3



1.4



1.5



1.6

CÔNG BÁO SỞ HỮU CÔNG NGHIỆP SỐ 429 TẬP A – QUYỀN 2 (12.2023)

- (11) **49010**
(21) 3-2023-01905
(54) **DÂY CHUYỀN ĐEO CỔ**
(22) 14/08/2023
(73) **CÔNG TY CỔ PHẦN VÀNG BẠC ĐÁ QUÝ PHÚ NHUẬN (VN)**
170E Phan Đăng Lưu, phường 3, quận Phú Nhuận, thành phố Hồ Chí Minh
(72) Nguyễn Khoa Hồng Thành (VN)
(74) Công ty TNHH Sở hữu trí tuệ Việt Á (VIET A IP CO.,LTD)
(55)
- (28) 1
(51) **11-01**
(43) 25/12/2023



1.1



1.2



1.3



1.4



1.5



1.6

CÔNG BÁO SỞ HỮU CÔNG NGHIỆP SỐ 429 TẬP A – QUYỀN 2 (12.2023)

- (11) **49011**
(21) 3-2023-01906 (28) 1
(54) **DÂY CHUYỀN ĐEO CỔ** (51) **11-01**
(22) 14/08/2023 (43) 25/12/2023
(73) **CÔNG TY CỔ PHẦN VÀNG BẠC ĐÁ QUÝ PHÚ NHUẬN (VN)**
170E Phan Đăng Lưu, phường 3, quận Phú Nhuận, thành phố Hồ Chí Minh
(72) Nguyễn Khoa Hồng Thành (VN)
(74) Công ty TNHH Sở hữu trí tuệ Việt Á (VIET A IP CO.,LTD)
(55)



1.1



1.2



1.3



1.4



1.5



1.6

CÔNG BÁO SỞ HỮU CÔNG NGHIỆP SỐ 429 TẬP A – QUYỀN 2 (12.2023)

- (11) **49012**
(21) 3-2023-01907 (28) 1
(54) **DÂY CHUYỀN ĐEO CỔ** (51) **11-01**
(22) 14/08/2023 (43) 25/12/2023
(73) **CÔNG TY CỔ PHẦN VÀNG BẠC ĐÁ QUÝ PHÚ NHUẬN (VN)**
170E Phan Đăng Lưu, phường 3, quận Phú Nhuận, thành phố Hồ Chí Minh
(72) Nguyễn Khoa Hồng Thành (VN)
(74) Công ty TNHH Sở hữu trí tuệ Việt Á (VIET A IP CO.,LTD)
(55)



1.1



1.2



1.3



1.4



1.5



1.6

CÔNG BÁO SỞ HỮU CÔNG NGHIỆP SỐ 429 TẬP A – QUYỀN 2 (12.2023)

- (11) **49013**
(21) 3-2023-01909 (28) 1
(54) **VÒNG ĐEO TAY** (51) **11-01**
(22) 14/08/2023 (43) 25/12/2023
(73) **CÔNG TY CỔ PHẦN VÀNG BẠC ĐÁ QUÝ PHÚ NHUẬN (VN)**
170E Phan Đăng Lưu, phường 3, quận Phú Nhuận, thành phố Hồ Chí Minh
(72) Nguyễn Khoa Hồng Thành (VN)
(74) Công ty TNHH Sở hữu trí tuệ Việt Á (VIET A IP CO.,LTD)
(55)



1.1



1.2



1.3



1.4



1.5



1.6

CÔNG BÁO SỞ HỮU CÔNG NGHIỆP SỐ 429 TẬP A – QUYỀN 2 (12.2023)

- (11) **49014**
(21) 3-2023-01915 (28) 1
(54) **BAO GÓI SẢN PHẨM** (51) **09-05**
(22) 14/08/2023 (43) 25/12/2023
(73) **CÔNG TY TNHH CAFE CAO NGUYÊN VIỆT NAM (VN)**
Số 6 đường E, thôn 2, xã Cư Êbur, thành phố Buôn Ma Thuột, tỉnh Đắk Lắk
(72) Nguyễn Đỗ Phượng Vỹ (VN)
(74) Công ty TNHH BUD & PRAIRIE (BUD & PRAIRIE LLC.)
(55)



1.1

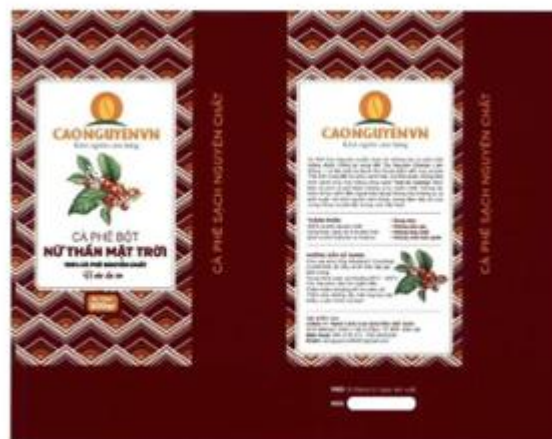

1.2

CÔNG BÁO SỞ HỮU CÔNG NGHIỆP SỐ 429 TẬP A – QUYỀN 2 (12.2023)

- (11) **49015**
(21) 3-2023-01917 (28) 1
(54) **BAO GÓI SẢN PHẨM** (51) **09-05**
(22) 14/08/2023 (43) 25/12/2023
(73) **CÔNG TY TNHH CAFE CAO NGUYÊN VIỆT NAM (VN)**
Số 6 đường E, thôn 2, xã Cư Êbur, thành phố Buôn Ma Thuột, tỉnh Đắk Lắk
(72) Nguyễn Đỗ Phượng Vỹ (VN)
(74) Công ty TNHH BUD & PRAIRIE (BUD & PRAIRIE LLC.)
(55)



1.1



1.2

CÔNG BÁO SỞ HỮU CÔNG NGHIỆP SỐ 429 TẬP A – QUYỀN 2 (12.2023)

(11) **49016**

(21) 3-2023-01919

(54) **THÙNG XE MÔ TÔ**

(22) 14/08/2023

(73) **GIVI SPA (IT)**

Via G. Ungaretti, 48, 25020 Flero (BS), Italy

(72) Visenzi Giuseppe (IT)

(74) Công ty Cổ phần Sở hữu công nghiệp INVESTIP (INVESTIP)

(55)

(28) 1

(51) **12-16**

(43) 25/12/2023



1.1



1.2



1.3



1.4



1.5



1.6



1.7

CÔNG BÁO SỞ HỮU CÔNG NGHIỆP SỐ 429 TẬP A – QUYỀN 2 (12.2023)

(11) **49017**

(21) 3-2023-01920

(28) 1

(54) **THÙNG XE MÔ TÔ**

(51) **12-16**

(22) 14/08/2023

(43) 25/12/2023

(73) **GIVI SPA (IT)**

Via G. Ungaretti, 48. 25020 Flero (BS), Italy

(72) Visenzi Giuseppe (IT)

(74) Công ty Cổ phần Sở hữu công nghiệp INVESTIP (INVESTIP)

(55)



1.1



1.2



1.3



1.4



1.5



1.6



1.7

CÔNG BÁO SỞ HỮU CÔNG NGHIỆP SỐ 429 TẬP A – QUYỀN 2 (12.2023)

(11) **49018**

(21) 3-2023-01923

(28) 1

(54) **BỒN CHỨA**

(51) **23-01; 23-99**

(22) 14/08/2023

(43) 25/12/2023

(73) **CÔNG TY CỔ PHẦN QUỐC TẾ SATA (VN)**

Số 9, ngách 43/98, TDP Đống 6, đường Cổ Nhuế, phường Cổ Nhuế 2, quận Bắc Từ Liêm, thành phố Hà Nội

(72) 1. NGUYỄN VĂN THANH (VN)

2. VŨ NGỌC ĐIỆP (VN)

3. TRỊNH DUY DŨNG (VN)

4. HOÀNG QUỐC VƯƠNG (VN)

(74) Công ty TNHH Nghiên cứu và Tư vấn chuyển giao công nghệ và đầu tư (CONCETTI)

(55)



1.1



1.2



1.3



1.4



1.5



1.6



1.7

CÔNG BÁO SỞ HỮU CÔNG NGHIỆP SỐ 429 TẬP A – QUYỀN 2 (12.2023)

(11) **49019**

(21) 3-2023-01924

(28) 1

(54) **BỒN CHỨA**

(51) **23-01; 23-99**

(22) 14/08/2023

(43) 25/12/2023

(73) **CÔNG TY CỔ PHẦN QUỐC TẾ SATA (VN)**

Số 9, ngách 43/98, TDP Đống 6, đường Cổ Nhuế, phường Cổ Nhuế 2, quận Bắc Từ Liêm, thành phố Hà Nội

(72) 1. NGUYỄN VĂN THANH (VN)

2. VŨ NGỌC ĐIỆP (VN)

3. TRỊNH DUY DŨNG (VN)

4. HOÀNG QUỐC VƯƠNG (VN)

(74) Công ty TNHH Nghiên cứu và Tư vấn chuyển giao công nghệ và đầu tư (CONCETTI)

(55)



1.1



1.2



1.3



1.4



1.5



1.6



1.7

CÔNG BÁO SỞ HỮU CÔNG NGHIỆP SỐ 429 TẬP A – QUYỀN 2 (12.2023)

- (11) **49020**
- (21) 3-2023-01933 (28) 1
- (54) **BAO GÓI SẢN PHẨM** (51) **09-05**
- (22) 16/08/2023 (43) 25/12/2023
- (73) **CÔNG TY TNHH SẢN XUẤT PHÁT TRIỂN TỰ CƯỜNG (VN)**
Số nhà 13, ngõ 91/109 đường Quán Trữ, phường Lãm Hà, quận Kiến An, thành phố Hải Phòng
- (72) Nguyễn Văn Phương (VN)
- (74) Công ty TNHH Nghiên cứu và Tư vấn chuyên giao công nghệ và đầu tư (CONCETTI)
- (55)



1.1



1.2

CÔNG BÁO SỞ HỮU CÔNG NGHIỆP SỐ 429 TẬP A – QUYỀN 2 (12.2023)

- (11) **49021**
(21) 3-2023-01935 (28) 1
(54) **HỘP** (51) **09-03**
(22) 17/08/2023 (43) 25/12/2023
(73) **ORION CORPORATION (KR)**
13, Baekbeom-ro 90da-gil, Yongsan-gu, Seoul 04369, Republic of Korea
(72) 1. LEE, HYUN A (KR)
2. OH, HYUN SUN (KR)
(74) Công ty Luật TNHH quốc tế BMVN (BMVN INTERNATIONAL LLC)
(55)



1.1



1.2

CÔNG BÁO SỞ HỮU CÔNG NGHIỆP SỐ 429 TẬP A – QUYỀN 2 (12.2023)

(11) **49022**

(21) 3-2023-01936

(28) 1

(54) **HỘP**

(51) **09-03**

(22) 17/08/2023

(43) 25/12/2023

(73) **ORION CORPORATION (KR)**

13, Baekbeom-ro 90da-gil, Yongsan-gu, Seoul 04369, Republic of Korea

(72) 1. LEE, HYUN A (KR)

2. OH, HYUN SUN (KR)

(74) Công ty Luật TNHH quốc tế BMVN (BMVN INTERNATIONAL LLC)

(55)



1.1



1.2

- (11) **49023**
 - (21) 3-2023-01938
 - (54) **NẮP HỘP**
 - (22) 18/08/2023
 - (30) 30-2023-0027877 19/07/2023 KR;
 - (73) **AEKYUNG INDUSTRIAL CO., LTD. (KR)**
188, Yanghwa-ro, Mapo-gu, Seoul, Republic of Korea
 - (72) **PARK NURI (KR)**
 - (74) **Công ty Luật TNHH WINCO (WINCO LAW FIRM)**
 - (55)
- (28) 1
 - (51) **09-07**
 - (43) 25/12/2023

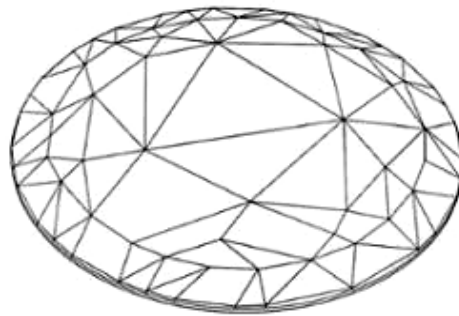

1.1



1.2



1.3



1.4



1.5

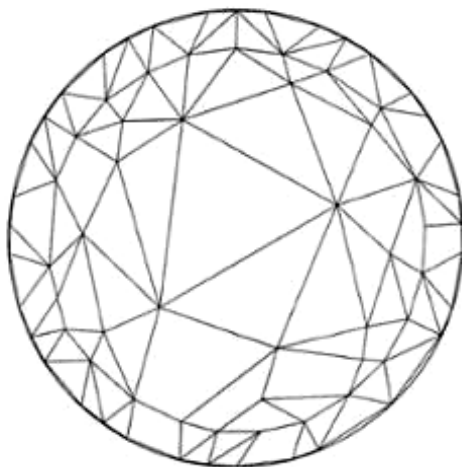

1.6

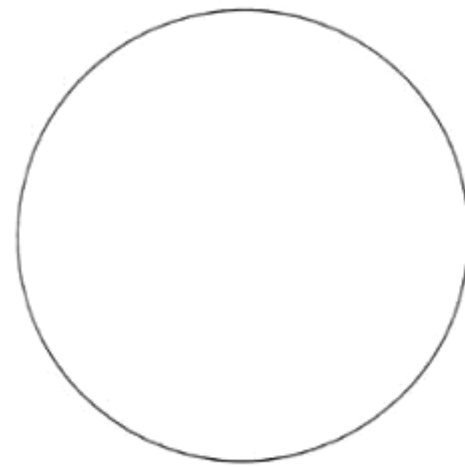

1.7



1.8

CÔNG BÁO SỞ HỮU CÔNG NGHIỆP SỐ 429 TẬP A – QUYỀN 2 (12.2023)

- (11) **49024**
(21) 3-2023-01939 (28) 1
(54) **Ô TÔ** (51) **12-08**
(22) 18/08/2023 (43) 25/12/2023
(30) DM/227127 20/02/2023 WO;
(73) **FERRARI S.P.A. (IT)**
Via Emilia Est 1163, Modena, Italy
(72) FLAVIO MANZONI (IT)
(74) Công ty TNHH một thành viên Sở hữu trí tuệ VCCI (VCCI-IP CO.,LTD)
(55)

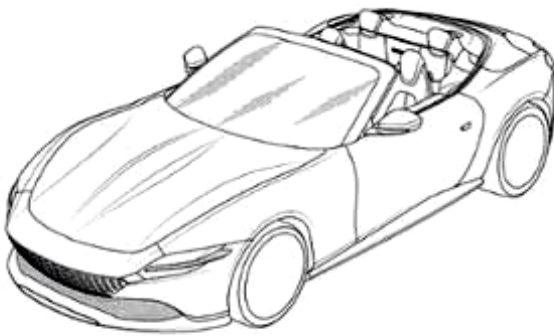

1.1

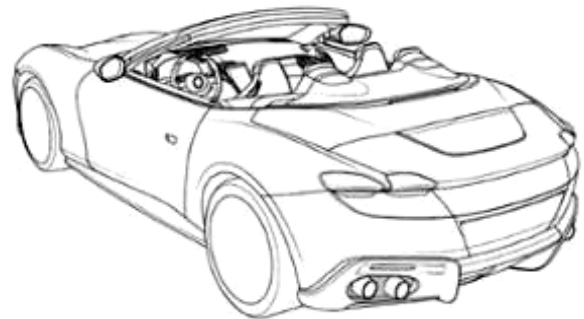

1.2



1.3

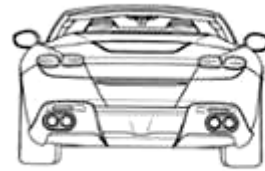

1.4

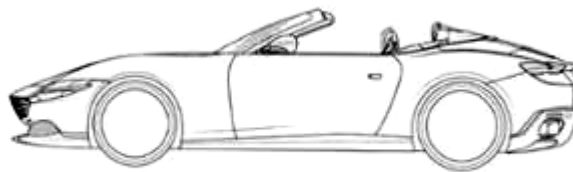

1.5



1.6

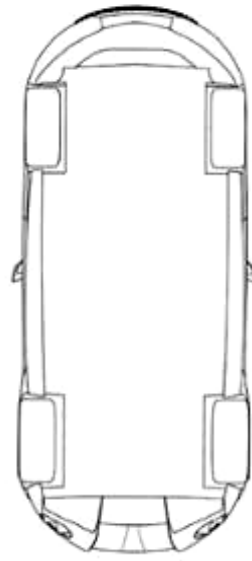

1.7

CÔNG BÁO SỞ HỮU CÔNG NGHIỆP SỐ 429 TẬP A – QUYỀN 2 (12.2023)

- (11) **49025**
(21) 3-2023-01940 (28) 1
(54) **Ô TÔ ĐỒ CHƠI** (51) **21-01**
(22) 18/08/2023 (43) 25/12/2023
(30) DM/227131 20/02/2023 WO;
(73) **FERRARI S.P.A. (IT)**
Via Emilia Est 1163, Modena, Italy
(72) FLAVIO MANZONI (IT)
(74) Công ty TNHH một thành viên Sở hữu trí tuệ VCCI (VCCI-IP CO.,LTD)
(55)

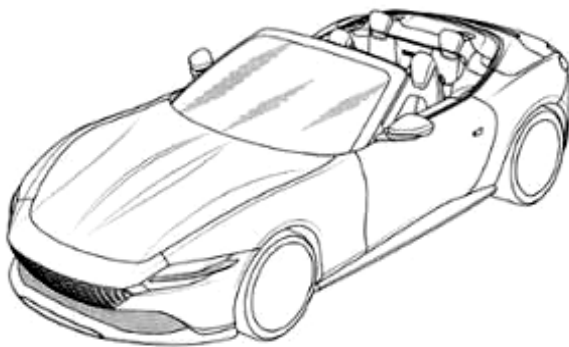

1.1



1.2



1.3



1.4



1.5



1.6

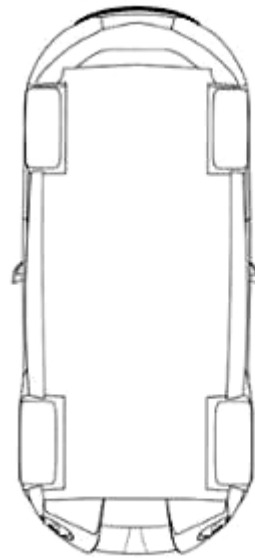

1.7

CÔNG BÁO SỞ HỮU CÔNG NGHIỆP SỐ 429 TẬP A – QUYỀN 2 (12.2023)

- (11) **49026**
(21) 3-2023-01945 (28) 1
(54) **NHÃN SẢN PHẨM** (51) **19-08**
(22) 18/08/2023 (43) 25/12/2023
(73) **NGUYỄN THỊ THU HOA (VN)**
Phố Ba Mỏ, thị trấn Thanh Sơn, huyện Thanh Sơn, tỉnh Phú Thọ
(72) Nguyễn Thị Thu Hoa (VN)
(74) Công ty TNHH Sở hữu trí tuệ WITIP Việt Nam (WITIP CO., LTD.)
(55)



CÔNG BÁO SỞ HỮU CÔNG NGHIỆP SỐ 429 TẬP A – QUYỀN 2 (12.2023)

- (11) **49027**
- (21) 3-2023-01946 (28) 1
- (54) **NHÃN SẢN PHẨM** (51) **19-08**
- (22) 18/08/2023 (43) 25/12/2023
- (73) **NGUYỄN THỊ THU HOA (VN)**
Phố Ba Mỏ, thị trấn Thanh Sơn, huyện Thanh Sơn, tỉnh Phú Thọ
- (72) Nguyễn Thị Thu Hoa (VN)
- (74) Công ty TNHH Sở hữu trí tuệ WITIP Việt Nam (WITIP CO., LTD.)
- (55)



CÔNG BÁO SỞ HỮU CÔNG NGHIỆP SỐ 429 TẬP A – QUYỀN 2 (12.2023)

- (11) **49028**
(21) 3-2023-01947 (28) 1
(54) **THIẾT BỊ ĐỌC THẺ SINH TRẮC HỌC** (51) **14-02**
(22) 21/08/2023 (43) 25/12/2023
(73) **CÔNG TY CỔ PHẦN CÔNG NGHỆ CAO MK (VN)**
Lô C-1A, khu công nghiệp Thăng Long Vĩnh Phúc, xã Thiện Kê, huyện Bình Xuyên, tỉnh Vĩnh Phúc
(72) Nguyễn Trọng Khang (VN)
(74) Công ty TNHH Sở hữu trí tuệ PADEMARK (PADEMARK CO.,LTD.)
(55)



1.1



1.2



1.3



1.4



1.5



1.6



1.7

- (11) **49029**
(21) 3-2023-01948 (28) 1
(54) **MŨ BẢO HIỂM** (51) **02-03**
(22) 21/08/2023 (43) 25/12/2023
(30) 015018800 19/04/2023 EM;
(73) **ABUS AUGUST BREMICKER SÖHNE KG (DE)**
Altenhofer Weg 25, D-58300 Wetter/Volmarstein, Germany
(72) Stefan RICHERT (DE)
(74) Công ty TNHH Đại Tín và Liên Danh (DAITIN AND ASSOCIATES CO.,LTD)
(55)



1.1

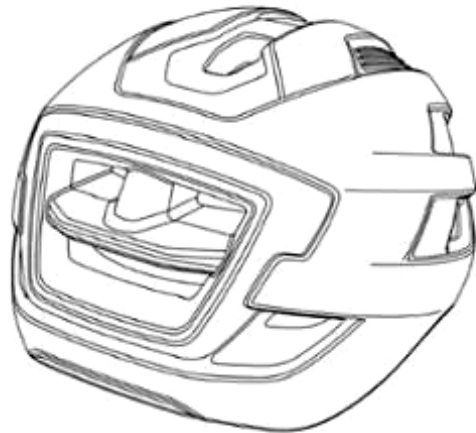

1.2



1.3



1.4



1.5



1.6



1.7



1.8

CÔNG BÁO SỞ HỮU CÔNG NGHIỆP SỐ 429 TẬP A – QUYỀN 2 (12.2023)

- (11) **49030**
(21) 3-2023-01949 (28) 1
(54) **MŨ BẢO HIỂM** (51) **02-03**
(22) 21/08/2023 (43) 25/12/2023
(30) 015018801 19/04/2023 EM;
(73) **ABUS AUGUST BREMICKER SÖHNE KG (DE)**
Altenhofer Weg 25, D-58300 Wetter/Volmarstein, GERMANY
(72) Stefan RICHERT (DE)
(74) Công ty TNHH Đại Tín và Liên Danh (DAITIN AND ASSOCIATES CO.,LTD)
(55)



1.1



1.2



1.3



1.4

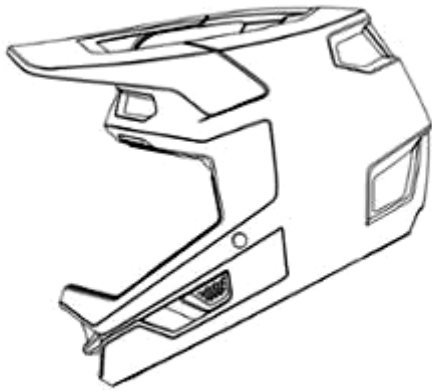

1.5

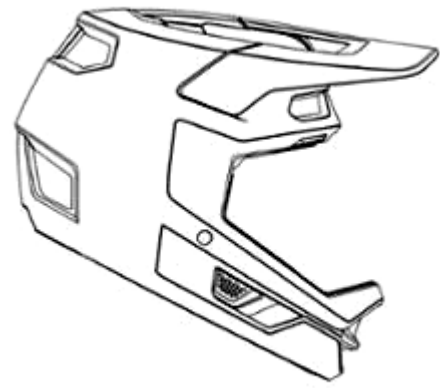

1.6



1.7

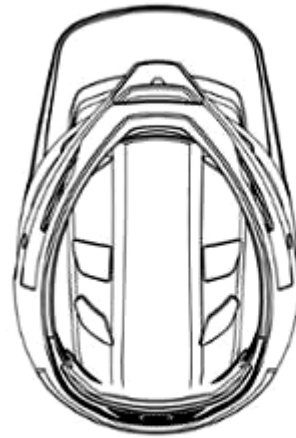

1.8

- (11) **49031**
(21) 3-2023-01950 (28) 1
(54) **MŨ BẢO HIỂM** (51) **02-03**
(22) 21/08/2023 (43) 25/12/2023
(30) 015017215 06/04/2023 EM;
(73) **ABUS AUGUST BREMICKER SÖHNE KG (DE)**
Altenhofer Weg 25, D-58300 Wetter/Volmarstein, GERMANY
(72) Matthias Ocklenburg (DE)
(74) Công ty TNHH Đại Tín và Liên Danh (DAITIN AND ASSOCIATES CO.,LTD)
(55)



1.1



1.2

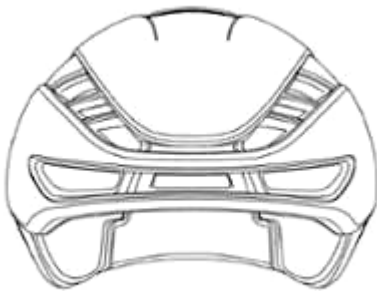

1.3



1.4



1.5



1.6



1.7



1.8

CÔNG BÁO SỞ HỮU CÔNG NGHIỆP SỐ 429 TẬP A – QUYỀN 2 (12.2023)

- (11) **49032**
(21) 3-2023-01951 (28) 1
(54) **MŨ BẢO HIỂM** (51) **02-03**
(22) 21/08/2023 (43) 25/12/2023
(30) 015018805 19/04/2023 EM;
(73) **ABUS AUGUST BREMICKER SÖHNE KG (DE)**
Altenhofer Weg 25, D-58300 Wetter/Volmarstein, GERMANY
(72) Stefan RICHERT (DE)
(74) Công ty TNHH Đại Tín và Liên Danh (DAITIN AND ASSOCIATES CO.,LTD)
(55)

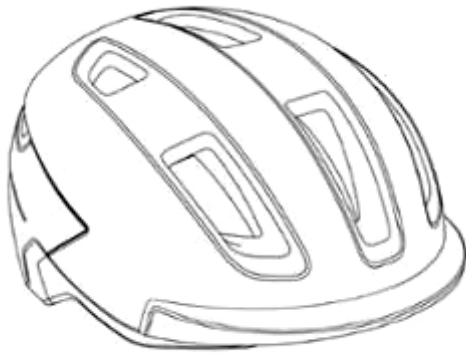

1.1



1.2



1.3



1.4



1.5



1.6



1.7



1.8

CÔNG BÁO SỞ HỮU CÔNG NGHIỆP SỐ 429 TẬP A – QUYỀN 2 (12.2023)

- (11) **49033**
- (21) 3-2023-01952
- (54) **ĐĨA**
- (22) 21/08/2023
- (30) 30-2023-0028036 20/07/2023 KR;
- (73) **GREEN PACKAGE SOLUTION CO., LTD. (KR)**
85 Igongdan-ro 10-gil, Gumi-si, Gyeongsangbuk-do, Republic of Korea
- (72) AHN, Sung Hun (KR)
- (74) Công ty TNHH Trường Xuân (AGELESS CO.,LTD.)
- (55)

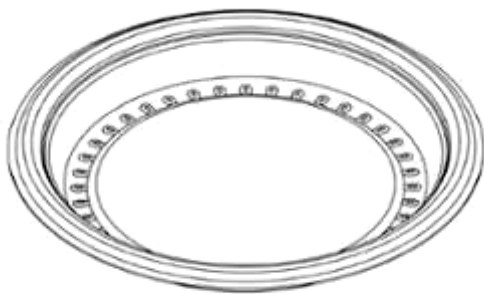

1.1



1.2



1.3



1.4



1.5



1.6

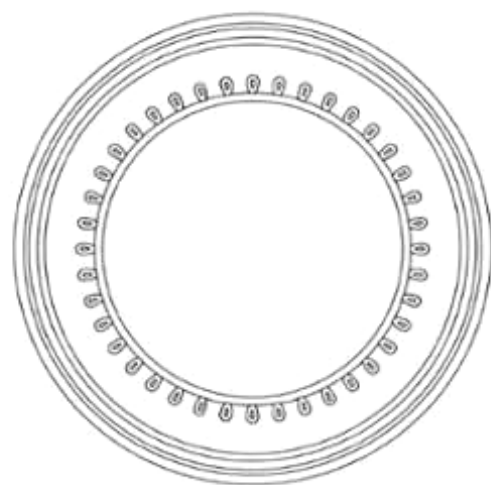

1.7

CÔNG BÁO SỞ HỮU CÔNG NGHIỆP SỐ 429 TẬP A – QUYỀN 2 (12.2023)

- (11) **49034**
- (21) 3-2023-01953
- (54) **HỘP ĐỰNG**
- (22) 21/08/2023
- (30) 30-2023-0029510 28/07/2023 KR;
- (73) **GREEN PACKAGE SOLUTION CO., LTD. (KR)**
85 1gongdan-ro 10-gil, Gumi-si, Gyeongsangbuk-do, Republic of Korea
- (72) AHN, Sung Hun (KR)
- (74) Công ty TNHH Trường Xuân (AGELESS CO.,LTD.)
- (55)



1.1



1.2

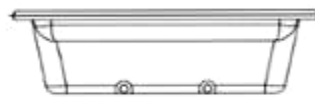

1.3



1.4



1.5

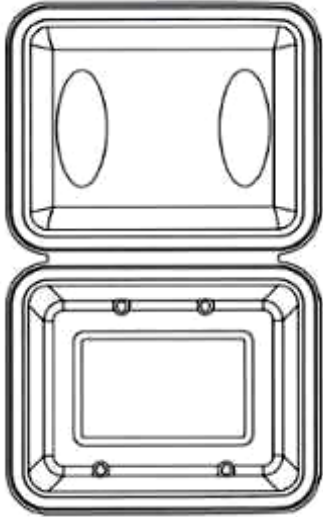

1.6

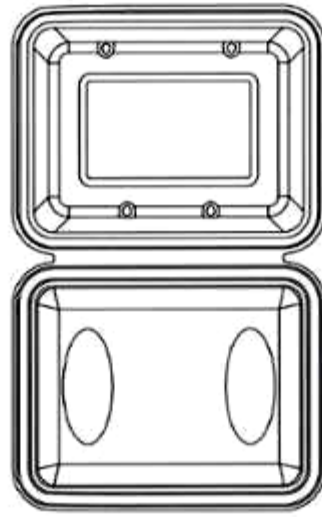

1.7

CÔNG BÁO SỞ HỮU CÔNG NGHIỆP SỐ 429 TẬP A – QUYỀN 2 (12.2023)

- (11) **49035**
(21) 3-2023-01954 (28) 1
(54) **ĐĨA** (51) **07-01**
(22) 21/08/2023 (43) 25/12/2023
(30) 30-2023-0028032 20/07/2023 KR;
(73) **GREEN PACKAGE SOLUTION CO., LTD. (KR)**
85 1gongdan-ro 10-gil, Gumi-si, Gyeongsangbuk-do, Republic of Korea
(72) AHN, Sung Hun (KR)
(74) Công ty TNHH Trường Xuân (AGELESS CO.,LTD.)
(55)



1.1



1.2



1.3



1.4



1.5



1.6

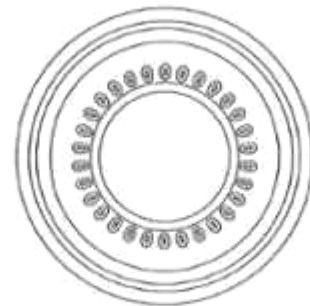

1.7

CÔNG BÁO SỞ HỮU CÔNG NGHIỆP SỐ 429 TẬP A – QUYỀN 2 (12.2023)

- (11) **49036**
(21) 3-2023-01967 (28) 1
(54) **VÀNH BÁNH XE MÁY** (51) **12-16**
(22) 22/08/2023 (43) 25/12/2023
(73) **MENG KAH AUTO PARTS TRADING SDN BHD (MY)**
No. 40, Jalan TPP 5, Taman Perindustrian Putra, 47130 Puchong, Selangor Darul
Ehsan, Malaysia
(72) LEE CONG QUAN (MY)
(74) Công ty TNHH ASL LAW (ASL LAW CO.,LTD)
(55)

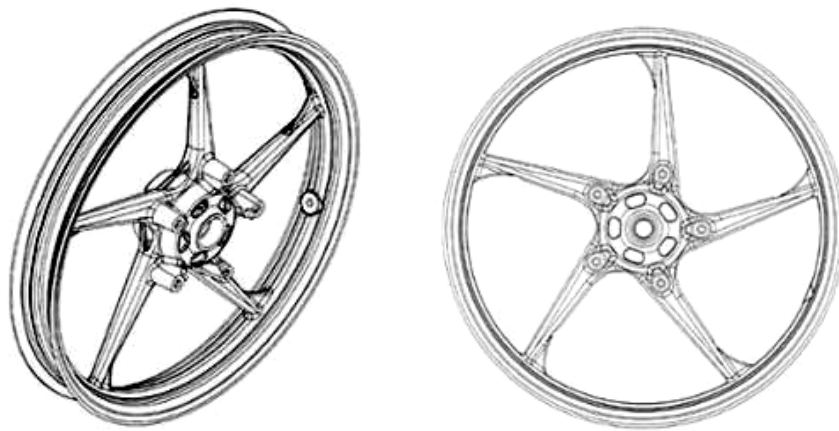

1.1

1.2



1.3

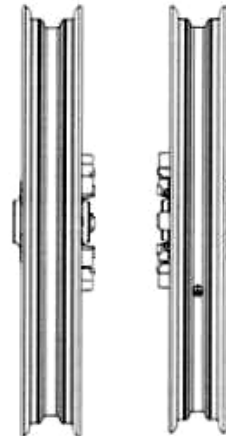

1.4

1.5



1.6



1.7

CÔNG BÁO SỞ HỮU CÔNG NGHIỆP SỐ 429 TẬP A – QUYỀN 2 (12.2023)

- (11) **49037**
(21) 3-2023-01968 (28) 1
(54) **VÀNH BÁNH XE MÁY** (51) **12-16**
(22) 22/08/2023 (43) 25/12/2023
(73) **MENG KAH AUTO PARTS TRADING SDN BHD (MY)**
No. 40, Jalan TPP 5, Taman Perindustrian Putra, 47130 Puchong, Selangor Darul
Ehsan, Malaysia
(72) LEE CONG QUAN (MY)
(74) Công ty TNHH ASL LAW (ASL LAW CO.,LTD)
(55)



1.1



1.2

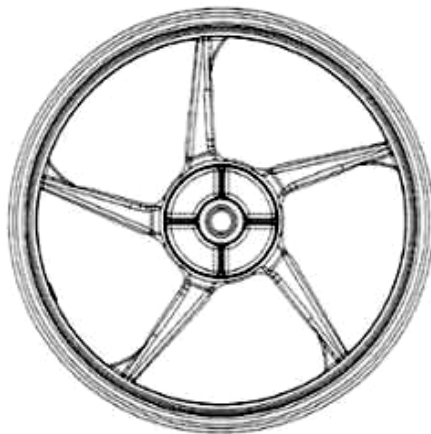

1.3

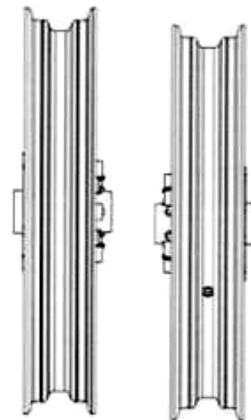

1.4

1.5

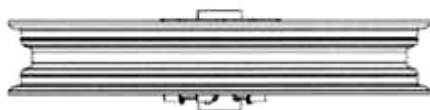

1.6

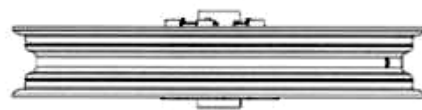

1.7

CÔNG BÁO SỞ HỮU CÔNG NGHIỆP SỐ 429 TẬP A – QUYỀN 2 (12.2023)

- (11) **49038**
- (21) 3-2023-01974 (28) 1
- (54) **NHÃN SẢN PHẨM** (51) **19-08**
- (22) 31/03/2022 (43) 25/12/2023
- (73) **CÔNG TY TNHH TRÍ MINH (VN)**
Số 65, phố Hàng Bông, phường Hàng Gai, quận Hoàn Kiếm, thành phố Hà Nội
- (72) Trương Tuấn Nghĩa (VN)
- (74) Công ty TNHH Sở hữu trí tuệ VIPATCO (VIPATCO CO., LTD.)
- (55)



CÔNG BÁO SỞ HỮU CÔNG NGHIỆP SỐ 429 TẬP A – QUYỀN 2 (12.2023)

- (11) **49039**
- (21) 3-2023-01975 (28) 1
- (54) **NHÃN SẢN PHẨM** (51) **19-08**
- (22) 31/03/2022 (43) 25/12/2023
- (73) **CÔNG TY TNHH TRÍ MINH (VN)**
Số 65, phố Hàng Bông, phường Hàng Gai, quận Hoàn Kiếm, thành phố Hà Nội
- (72) Trương Tuấn Nghĩa (VN)
- (74) Công ty TNHH Sở hữu trí tuệ VIPATCO (VIPATCO CO., LTD.)
- (55)



PHẦN II

SỬA ĐỔI ĐƠN

Thông báo số: 87366/TB-SHTT._{IP}, ngày 09/11/2023 về việc ghi nhận sửa đổi đơn

Số Yêu cầu: SĐ3-2023-00236 Ngày nộp: 17/02/2023

Liên quan đến đơn yêu cầu cấp Bằng độc quyền kiểu dáng công nghiệp:

(21) Số đơn	(22) Ngày nộp đơn
3-2022-01883	05/09/2022

Mục sửa đổi: Tên, địa chỉ chủ đơn

Nội dung mới: LIXIL Corporation (JP)

Osaki Garden Tower, 1-1-1 Nishishinagawa, Shinagawa-ku, Tokyo
141-0033, Japan

Thông báo số: 87653w/QĐ-SHTT, ngày 09/11/2023 về việc ghi nhận sửa đổi đơn

Số Yêu cầu: SĐ3-2021-02381 Ngày nộp: 14/12/2021

Liên quan đến đơn yêu cầu cấp Bằng độc quyền kiểu dáng công nghiệp:

(21) Số đơn	(22) Ngày nộp đơn
3-2018-02845	26/12/2018

Mục sửa đổi: Bổ sung phương án

Nội dung mới: Bổ sung thêm 02 phương án của kiểu dáng công nghiệp

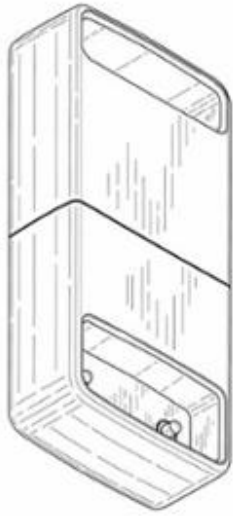

2.1



2.2



2.3



2.4



2.5



2.6



2.7



2.8

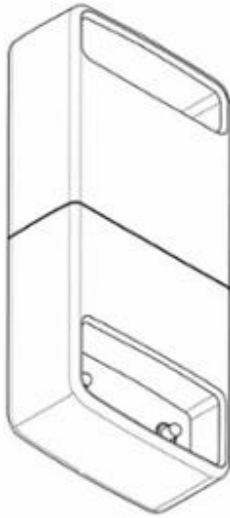

3.1

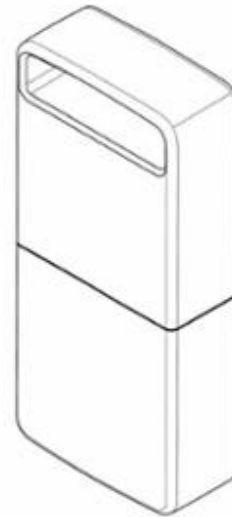

3.2



3.3



3.4



3.5

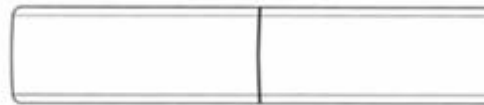

3.6



3.7



3.8

Thông báo số: 87654/TB-SHTT._{IP}, ngày 09/11/2023 về việc ghi nhận sửa đổi đơn

Số Yêu cầu: SĐ3-2022-01578 Ngày nộp: 24/08/2022

Liên quan đến đơn yêu cầu cấp Bằng độc quyền kiểu dáng công nghiệp:

(21) Số đơn	(22) Ngày nộp đơn
3-2021-00692	23/03/2021

Mục sửa đổi: Tên, địa chỉ chủ đơn

Nội dung mới: PLINICLABS CO., LTD (KR)
A/707, 30, Songdomirae-ro, Yeonsu-gu, Incheon, Republic of Korea

Thông báo số: 87655/TB-SHTT._{IP}, ngày 09/11/2023 về việc ghi nhận sửa đổi đơn

Số Yêu cầu: SĐ3-2023-00222 Ngày nộp: 15/02/2023

Liên quan đến đơn yêu cầu cấp Bằng độc quyền kiểu dáng công nghiệp:

(21) Số đơn	(22) Ngày nộp đơn
3-2021-02625	22/10/2021

CÔNG BÁO SỞ HỮU CÔNG NGHIỆP SỐ 429 TẬP A – QUYỀN 2 (12.2023)

Mục sửa đổi: Đại diện Sở hữu công nghiệp

Nội dung mới: **Công ty cổ phần Sở hữu trí tuệ BROSS và Cộng sự (BROSS & PARTNERS)**

Địa chỉ: Tầng 21, tòa nhà Charmvit Tower, 117 Trần Duy Hưng, phường Trung Hòa, quận Cầu Giấy, thành phố Hà Nội

Thông báo số: 87656w/QĐ-SHTT, ngày 09/11/2023 về việc ghi nhận sửa đổi đơn

Số Yêu cầu: SĐ3-2021-00199 Ngày nộp: 14/01/2021

Liên quan đến đơn yêu cầu cấp Bằng độc quyền kiểu dáng công nghiệp:

(21) Số đơn	(22) Ngày nộp đơn
3-2019-02984	20/11/2019

Mục sửa đổi: Tên, địa chỉ chủ đơn

Nội dung mới: Công ty cổ phần Liwayway Việt Nam (VN)

Số 14 đường số 05, khu công nghiệp Việt Nam - Singapore, phường Bình Hòa, thành phố Thuận An, tỉnh Bình Dương

Thông báo số: 87669/TB-SHTT.IP, ngày 09/11/2023 về việc ghi nhận sửa đổi đơn

Số Yêu cầu: SĐ3-2023-00149 Ngày nộp: 02/02/2023

Liên quan đến đơn yêu cầu cấp Bằng độc quyền kiểu dáng công nghiệp:

(21) Số đơn	(22) Ngày nộp đơn
3-2021-01558	15/06/2021
3-2021-01559	15/06/2021
3-2021-01560	15/06/2021
3-2021-01561	15/06/2021
3-2021-01930	27/07/2021

CÔNG BÁO SỞ HỮU CÔNG NGHIỆP SỐ 429 TẬP A – QUYỀN 2 (12.2023)

3-2021-02376	28/09/2021
3-2021-02377	28/09/2021
3-2022-00927	11/05/2022
3-2022-02442	08/11/2022

Mục sửa đổi: Tên, địa chỉ chủ đơn

Nội dung mới: DAIKIN INDUSTRIES, LTD. (JP)
Osaka Umeda Twin Towers South, 1-13-1, Umeda, Kita-ku, Osaka-shi,
Osaka 530-0001, Japan

Thông báo số: 88651/TB-SHTT.IP, ngày 14/11/2023 về việc ghi nhận sửa đổi đơn

Số Yêu cầu: SĐ3-2022-02297 Ngày nộp: 02/12/2022

Liên quan đến đơn yêu cầu cấp Bằng độc quyền kiểu dáng công nghiệp:

(21) Số đơn	(22) Ngày nộp đơn
3-2019-02305	11/09/2019
3-2019-02375	18/09/2019
3-2020-00322	12/02/2020

Mục sửa đổi: Đại diện sở hữu công nghiệp

Nội dung mới: CÔNG TY TNHH KHANG LUẬT(KHANGLAW)
A426OT01, tầng 26, tòa A4, Vinhomes Golden River, số 2 Tôn Đức
Thắng, phường Bến Nghé, Quận 1, Thành phố Hồ Chí Minh

Thông báo số: 88652/TB-SHTT.IP, ngày 14/11/2023 về việc ghi nhận sửa đổi đơn

Số Yêu cầu: SĐ3-2022-01028 Ngày nộp: 15/06/2022

Liên quan đến đơn yêu cầu cấp Bằng độc quyền kiểu dáng công nghiệp:

CÔNG BÁO SỞ HỮU CÔNG NGHIỆP SỐ 429 TẬP A – QUYỀN 2 (12.2023)

(21) Số đơn	(22) Ngày nộp đơn
3-2021-00871	13/04/2021

Mục sửa đổi: Tên, địa chỉ chủ đơn

Nội dung mới: Công ty cổ phần tập đoàn đầu tư Uniland (VN)
45 Trần Cao Vân, phường Võ Thị Sáu, quận 3, thành phố Hồ Chí Minh

Thông báo số: 88653/TB-SHTT._{IP}, ngày 14/11/2023 về việc ghi nhận sửa đổi đơn

Số Yêu cầu: SĐ3-2022-01027 Ngày nộp: 15/06/2022

Liên quan đến đơn yêu cầu cấp Bằng độc quyền kiểu dáng công nghiệp:

(21) Số đơn	(22) Ngày nộp đơn
3-2021-00870	13/04/2021

Mục sửa đổi: Tên, địa chỉ chủ đơn

Nội dung mới: Công ty cổ phần tập đoàn đầu tư Uniland (VN)
45 Trần Cao Vân, phường Võ Thị Sáu, quận 3, thành phố Hồ Chí Minh

Thông báo số: 88654/TB-SHTT._{IP}, ngày 14/11/2023 về việc ghi nhận sửa đổi đơn

Số Yêu cầu: SĐ3-2022-01138 Ngày nộp: 27/06/2022

Liên quan đến đơn yêu cầu cấp Bằng độc quyền kiểu dáng công nghiệp:

(21) Số đơn	(22) Ngày nộp đơn
3-2022-00814	25/04/2022

Mục sửa đổi: Tên, địa chỉ chủ đơn

Nội dung mới: Công ty TNHH xuất nhập khẩu kỹ thuật nông nghiệp Yakara (VN)
144B đường ấp Đông 3, ấp Đông 1, xã Thới Tam Thôn, huyện Hóc Môn, thành phố Hồ Chí Minh

CÔNG BÁO SỞ HỮU CÔNG NGHIỆP SỐ 429 TẬP A – QUYỀN 2 (12.2023)

Thông báo số: 88749/TB-SHTT._{IP}, ngày 14/11/2023 về việc ghi nhận sửa đổi đơn

Số Yêu cầu: SĐ3-2022-02155 Ngày nộp: 15/11/2022

Liên quan đến đơn yêu cầu cấp Bằng độc quyền kiểu dáng công nghiệp:

(21) Số đơn	(22) Ngày nộp đơn
3-2022-01819	26/08/2022

Mục sửa đổi: Tên, địa chỉ chủ đơn

Nội dung mới: Công ty TNHH Bảo Quyên Việt Nam (VN)
611/12/8 Quốc lộ 1A, phường Bình Hưng Hòa, quận Bình Tân, thành phố Hồ Chí Minh

Thông báo số: 91079/TB-SHTT._{IP}, ngày 21/11/2023 về việc ghi nhận sửa đổi đơn

Số Yêu cầu: SĐ3-2023-00058 Ngày nộp: 13/01/2023

Liên quan đến đơn yêu cầu cấp Bằng độc quyền kiểu dáng công nghiệp:

(21) Số đơn	(22) Ngày nộp đơn
3-2022-02430	07/11/2022

Mục sửa đổi: Tên, địa chỉ chủ đơn

Nội dung mới: Công ty cổ phần chế biến gỗ Đức Thành (VN)
221/4 Phan Huy Ích, phường 14, quận Gò Vấp, thành phố Hồ Chí Minh

Thông báo số: 91080/TB-SHTT._{IP}, ngày 21/11/2023 về việc ghi nhận sửa đổi đơn

Số Yêu cầu: SĐ3-2023-00057 Ngày nộp: 13/01/2023

Liên quan đến đơn yêu cầu cấp Bằng độc quyền kiểu dáng công nghiệp:

CÔNG BÁO SỞ HỮU CÔNG NGHIỆP SỐ 429 TẬP A – QUYỀN 2 (12.2023)

(21) Số đơn	(22) Ngày nộp đơn
3-2022-02429	07/11/2022

Mục sửa đổi: Tên, địa chỉ chủ đơn

Nội dung mới: Công ty cổ phần chế biến gỗ Đức Thành (VN)
221/4 Phan Huy Ích, phường 14, quận Gò Vấp, thành phố Hồ Chí Minh

Thông báo số: 92340/TB-SHTT._{IP}, ngày 23/11/2023 về việc ghi nhận sửa đổi đơn

Số Yêu cầu: SĐ3-2021-00328 Ngày nộp: 29/01/2021

Liên quan đến đơn yêu cầu cấp Bằng độc quyền kiểu dáng công nghiệp:

(21) Số đơn	(22) Ngày nộp đơn
3-2020-02698	04/11/2020

Mục sửa đổi: Đại diện Sở hữu công nghiệp

Nội dung mới: **Công ty TNHH Khang Luật**
Địa chỉ: 441/84 Lê Văn Quới, phường Bình Trị Đông A, quận Bình Tân, thành phố Hồ Chí Minh

PHẦN III

THAY ĐỔI CHỦ ĐƠN

Thông báo số: 87360/TB-SHTT.IP, ngày 09/11/2023 về việc ghi nhận thay đổi chủ đơn
Số Yêu cầu: CD3-2023-00284 Ngày nộp: 24/04/2023

Liên quan đến đơn yêu cầu cấp bằng độc quyền kiểu dáng công nghiệp:

(21) Số đơn	(22) Ngày nộp đơn
3-2022-02886	27/12/2022
3-2022-02887	27/12/2022

Bên chuyển nhượng: CÔNG TY TNHH SẢN XUẤT NGÂN PHÁT (VN)
Thửa đất 2588, tờ bản đồ 14, tổ 4, ấp Phú Thuận, xã Phú An, thị xã Bến Cát, tỉnh Bình Dương

Bên được chuyển nhượng: Sun Hsien - Wei (VN)
Thửa đất 2588, tờ bản đồ 14, tổ 4, ấp Phú Thuận, xã Phú An, thị xã Bến Cát, tỉnh Bình Dương

CÔNG BÁO SỞ HỮU CÔNG NGHIỆP

Do Cục Sở hữu trí tuệ thuộc Bộ Khoa học và Công nghệ ấn hành theo Luật Sở hữu trí tuệ số 50/2005/QH11 được Quốc hội thông qua ngày 29 tháng 11 năm 2005 và được sửa đổi bằng Luật sửa đổi, bổ sung một số điều của Luật sở hữu trí tuệ số 50/2005/QH11 được Quốc hội thông qua ngày 19 tháng 6 năm 2009.

Địa chỉ liên hệ:

384-386 đường Nguyễn Trãi, quận Thanh Xuân,
thành phố Hà Nội, Việt Nam
ĐT: 024. 38583069
Fax: 024. 38588449