

CỘNG HÒA XÃ HỘI CHỦ NGHĨA VIỆT NAM
BỘ KHOA HỌC VÀ CÔNG NGHỆ

CỤC SỞ HỮU TRÍ TUỆ

CÔNG BÁO
SỞ HỮU CÔNG NGHIỆP

TẬP A

QUYỂN 2: KIỂU DÁNG CÔNG NGHIỆP

11 - 2023

428

CỘNG HOÀ XÃ HỘI CHỦ NGHĨA VIỆT NAM
BỘ KHOA HỌC VÀ CÔNG NGHỆ
CỤC SỞ HỮU TRÍ TUỆ

CÔNG BÁO
SỞ HỮU CÔNG NGHIỆP
TẬP A

QUYỂN 2: KIỂU DÁNG CÔNG NGHIỆP

11 - 2023

428

HÀ NỘI

MỤC LỤC

	Trang
<u>PHẦN I:</u> Đơn yêu cầu cấp Bằng độc quyền kiểu dáng công nghiệp	7
<u>PHẦN II:</u> Sửa đổi đơn	307

CONTENTS

<u>PART I:</u> Applications for Industrial Design Patents	7
<u>PART II:</u> Amendment of Applications	307

CÔNG BÁO SỞ HỮU CÔNG NGHIỆP SỐ 428 TẬP A - QUYỂN 2 (11.2023)

MÃ SỐ HAI CHỮ CÁI THỂ HIỆN TÊN NƯỚC VÀ CÁC THỰC THỂ KHÁC TRONG CÁC TƯ LIỆU SỞ HỮU CÔNG NGHIỆP THEO TIÊU CHUẨN ST3 CỦA WIPO

AE	United Arab Emirates	CN	China	HK	Hong Kong
AF	Afganistan	CO	Colombia	HN	Honduras
AG	Antihua and Barbuda	CR	Costa Rica	HR	Croatia
AI	Anguilla	CU	Cuba	HT	Haiti
AL	Albania	CV	Cape Verde	HU	Hungary
AN	Netherlands Antilles	CY	Cyprus	ID	Indonesia
AO	Angola	CZ	Czech Republic	IE	Ireland
AR	Argentina	DE	Germany	IL	Israel
AT	Austria	DJ	Djibouti	IN	India
AU	Australia	DK	Denmark	IQ	Iraq
AW	Aruba	DM	Dominica	IR	Iran (Islamic Republic of)
BB	Barbados	DO	Dominican Republic	IS	Iceland
BD	Bangladesh	DZ	Algeria	IT	Italy
BE	Belgium	EC	Ecuador	JM	Jamaica
BF	Burkina Faso	EE	Estonia	JO	Jordan
BG	Bulgaria	EG	Egypt	JP	Japan
BH	Bahrain	ES	Spain	KE	Kenya
BI	Burundi	ET	Ethiopia	KH	Cambodia
BJ	Benin	FI	Finland	KI	Kiribati
BM	Bermuda	FJ	Fiji	KM	Comoros
BN	Brunei Darussalam	FK	Falkand Islands (Malvinas)	KN	Saint Kitts and Nevis
BO	Bolivia	FR	France	KP	Democratic People's Republic of Korea
BR	Brazil	GA	Gabon	KR	Republic of Korea
BS	Bahamas	GB	United Kingdom	KW	Kuwait
BT	Bhutan	GD	Grenada	KY	Cayman Islands
BW	Botswana	GE	Georgia	KZ	Kazakhstan
BY	Belarus	GH	Ghana	LA	Laos
BZ	Belize	GI	Gibraltar	LB	Lebanon
CA	Canada	GM	Gambia	LC	Saint Lucia
CF	Central African Republic	GN	Guinea	LI	Liechtenstein
CG	Congo	GQ	Equatorial Guinea	LK	SriLanka
CH	Switzerland	GR	Greece	LR	Liberia
CI	Côte d'Ivoire	GT	Guatemala	LS	Lesotho
CL	Chile	GW	Guinea-Bissau	LT	Lithuania
CM	Cameroon	GY	Guyana	TC	Turk and Caicos Islands
LU	Luxembourg	PA	Panama	TD	Chad
LV	Latvia	PE	Peru	TG	Togo
LY	Lybya	PG	Papua New Guinea	TH	Thailand
MA	Morocco	PH	Philippines	TN	Tunisia
MC	Monaco	PK	Pakistan	TO	Tonga
MD	Republic of Moldova	PL	Poland	TR	Turkey

CÔNG BÁO SỞ HỮU CÔNG NGHIỆP SỐ 428 TẬP A - QUYỂN 2 (11.2023)

MG	Madagascar	PT	Portugal	TT	Trinidad and Tobago
ML	Mali	PY	Paraguay	TV	Tuvalu
MM	Myanmar	QA	Qatar	TW	Taiwan, Province of China
MN	Mongolia	RO	Rumania	TZ	United Republic of Tanzania
MO	Macau	RU	Russian Federation	UA	Ukraine
MR	Mauritania	RW	Rwanda	UG	Uganda
MS	Montserrat	SA	Saudi Arabia	US	United States of America
MT	Malta	SB	Solomon Islands	UY	Uruguay
MU	Mauritius	SC	Seychelles	UZ	Uzbekistan
MV	Maldives	SD	Sudan	VA	Holy see
MW	Malawi	SE	Sweden	VC	Saint Vincent and the Grenadines
MX	Mexico	SG	Singapore	VE	Venezuela
MY	Malaysia	SH	Saint Helena	VG	Virgin Islands (British)
MZ	Mozambique	SL	Slovenia	VN	Vietnam
NA	Namibia	SK	Slovakia	VU	Vanuatu
NE	Niger	SL	Sierra Leone	WS	Samoa
NG	Nigeria	SM	San Marino	YE	Yemen
NJ	Nicaragua	SN	Senegal	YU	Yugoslavia
NL	Netherlands	SO	Somalia	ZA	South Africa
NO	Norway	SR	Suriname	ZM	Zambia
NP	Nepal	ST	Sao Tome and Principe	ZR	Zaire
NR	Nauru	SV	El Sanvador	ZW	Zimbabwe
NZ	New Zealand	SY	Syria		
OM	Oman	SZ	Swaziland		

CÁC TỔ CHỨC QUỐC TẾ

AO	African Intellectual Property Organization (OAPI)
AP	African Regional Industrial Property Organization (ARIPO)
BX	Benelux Trademark Office and Benelux Designs Office
EP	European Patent Office (EPO)
IB, WO	International Bureau of the World Intellectual Property Organization (WIPO)

NHỮNG MÃ SỐ INID TRÍCH TỪ TIÊU CHUẨN ST80 CỦA TỔ CHỨC SỞ HỮU TRÍ TUỆ THẾ GIỚI (WIPO) ĐỂ NHẬN BIẾT CÁC DỮ LIỆU THƯ MỤC DÙNG CÔNG BỐ ĐƠN VÀ BẰNG ĐỘC QUYỀN KIỂU DÁNG CÔNG NGHIỆP

- (11) Số bằng độc quyền kiểu dáng công nghiệp / Số công bố đơn
- (15) Ngày cấp
- (18) Ngày hết hạn hiệu lực của bằng độc quyền kiểu dáng công nghiệp
- (21) Số đơn
- (22) Ngày nộp đơn
- (23) Tên triển lãm, ngày và nơi triển lãm
- (28) Số phương án yêu cầu bảo hộ
- (30) Số đơn ưu tiên, ngày nộp đơn ưu tiên
- (43) Ngày công bố đơn
- (45) Ngày công bố bằng độc quyền kiểu dáng công nghiệp
- (51) Phân loại quốc tế kiểu dáng công nghiệp
- (54) Tên sản phẩm mang kiểu dáng công nghiệp
- (55) Ảnh chụp / hình vẽ kiểu dáng công nghiệp
- (57) Đặc điểm khác biệt yêu cầu bảo hộ của kiểu dáng công nghiệp
- (62) Số và ngày nộp đơn, số bằng độc quyền KDCN hoặc số công bố đơn liên quan đến tách đơn
- (71) Tên và địa chỉ của người nộp đơn
- (72) Tên của tác giả KDCN
- (73) Tên, địa chỉ của chủ bằng độc quyền KDCN
- (74) Tên của người đại diện SHCN

PHẦN I

ĐƠN YÊU CẦU CẤP BẰNG ĐỘC QUYỀN KIỂU DÁNG CÔNG NGHIỆP

- (11) **48321**
(21) 3-2021-02299 (28) 1
(54) **THANH NHÔM ĐỊNH HÌNH** (51) **25-01**
(22) 20/09/2021 (43) 27/11/2023
(73) **CÔNG TY TNHH MTV ĐĂNG QUANG (VN)**
Đường Trường Chinh, khu phố 1, phường Phú Tài, thành phố Phan Thiết, tỉnh Bình Thuận
(72) Võ Trường Thọ (VN)
(74) **CÔNG TY TNHH KHANG LUẬT (KHANGLAW)**
(55)

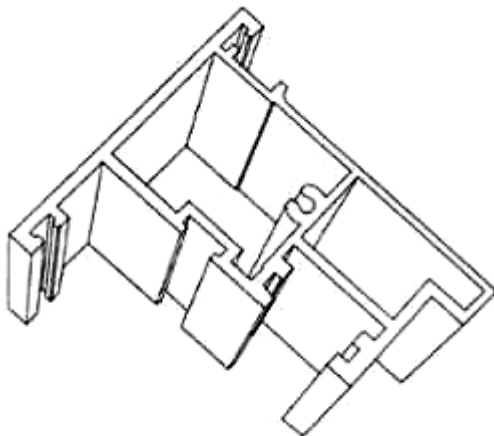

1.1

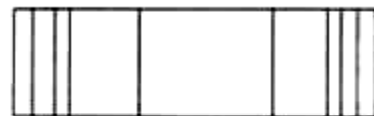

1.2



1.3



1.4



1.5

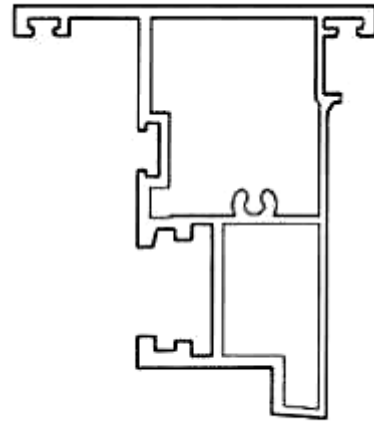

1.6

CÔNG BÁO SỞ HỮU CÔNG NGHIỆP SỐ 428 TẬP A – QUYỀN 2 (11.2023)

- (11) **48322**
(21) 3-2021-02305 (28) 1
(54) **THANH NHÔM ĐỊNH HÌNH** (51) **25-01**
(22) 21/09/2021 (43) 27/11/2023
(73) **CÔNG TY TNHH MTV ĐĂNG QUANG (VN)**
Đường Trường Chinh, khu phố 1, phường Phú Tài, thành phố Phan Thiết, tỉnh Bình Thuận
(72) Võ Trường Thọ (VN)
(74) **CÔNG TY TNHH KHANG LUẬT (KHANGLAW)**
(55)

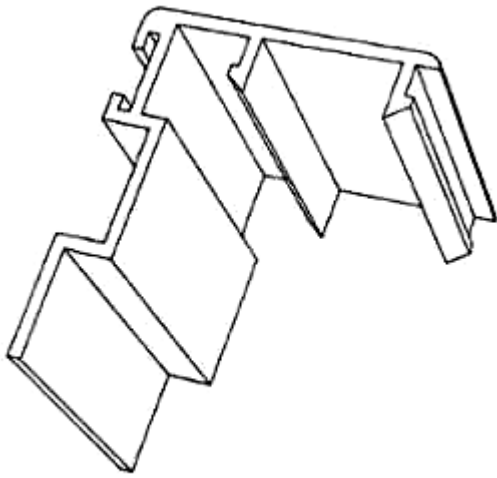

1.1

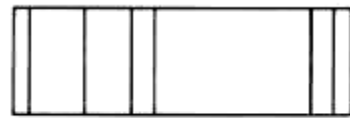

1.2



1.3

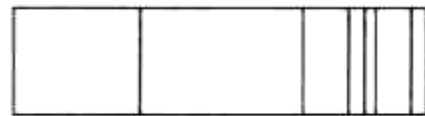

1.4



1.5

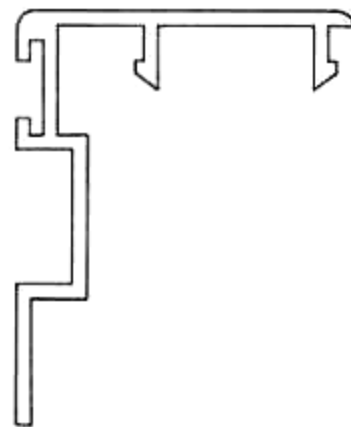

1.6

CÔNG BÁO SỞ HỮU CÔNG NGHIỆP SỐ 428 TẬP A – QUYỀN 2 (11.2023)

- (11) **48323**
(21) 3-2021-02306 (28) 1
(54) **THANH NHÔM ĐỊNH HÌNH** (51) **25-01**
(22) 21/09/2021 (43) 27/11/2023
(73) **CÔNG TY TNHH MTV ĐĂNG QUANG (VN)**
Đường Trường Chinh, khu phố 1, phường Phú Tài, thành phố Phan Thiết, tỉnh Bình Thuận
(72) Võ Trường Thọ (VN)
(74) **CÔNG TY TNHH KHANG LUẬT (KHANGLAW)**
(55)

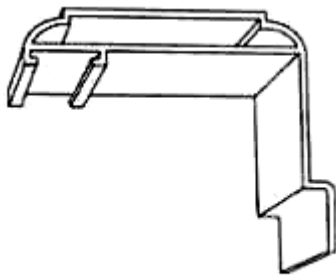

1.1



1.2



1.3

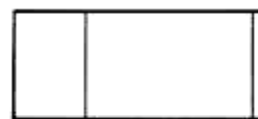

1.4



1.5

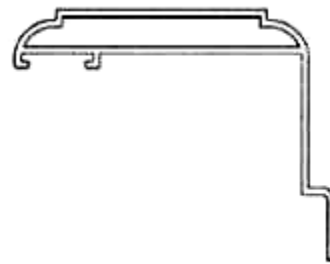

1.6

CÔNG BÁO SỞ HỮU CÔNG NGHIỆP SỐ 428 TẬP A – QUYỀN 2 (11.2023)

- (11) **48324**
(21) 3-2022-00284 (28) 1
(54) **CON LĂN VẬN CHUYỂN** (51) **23-03**
(22) 16/02/2022 (43) 27/11/2023
(73) **HITACHI ZOSEN INOVA AG (CH)**
Hardturmstrasse 127, CH-8005 Zurich, Switzerland
(72) **BRENNWALD Werner (CH)**
(74) Công ty TNHH Trần Hữu Nam và Đồng sự (TRAN H.N & ASS.)
(55)

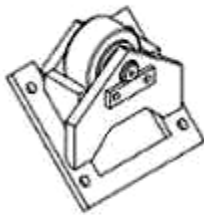

1.1

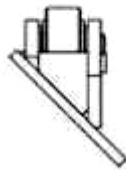

1.2



1.3

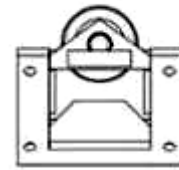

1.4

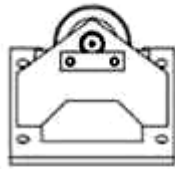

1.5

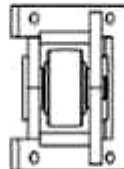

1.6

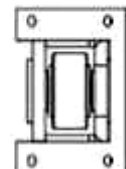

1.7

CÔNG BÁO SỞ HỮU CÔNG NGHIỆP SỐ 428 TẬP A – QUYỀN 2 (11.2023)

(11) **48325**

(21) 3-2022-00307

(54) **CHI TIẾT BỌC CÁP**

(22) 21/02/2022

(73) **CÔNG TY CỔ PHẦN ĐẦU TƯ NĂNG LƯỢNG BIỂN (VN)**

95/40 đường số 3, phường 9, quận Gò Vấp, thành phố Hồ Chí Minh

(72) 1. NGUYỄN THỊ HUYỀN TRANG (VN)

2. DƯƠNG VĂN TÂN (VN)

(74) Công ty TNHH Sở hữu trí tuệ Hải Hân (HAI HAN IP CO., LTD.)

(55)

(28) 1

(51) **13-03**

(43) 27/11/2023

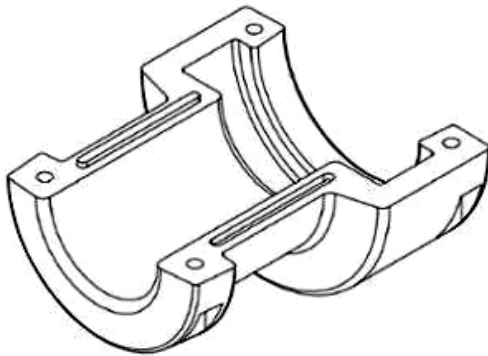

1.1

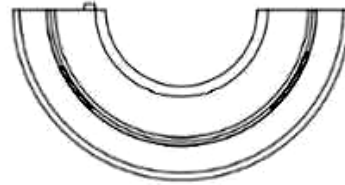

1.2

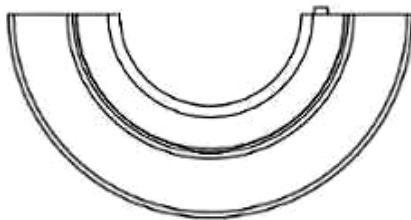

1.3

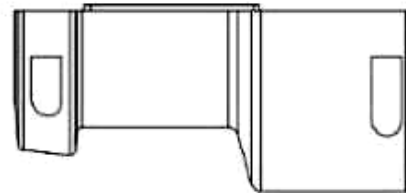

1.4

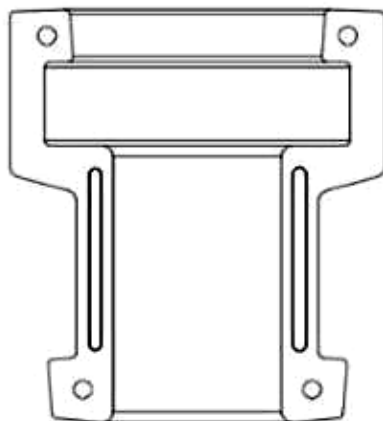

1.5

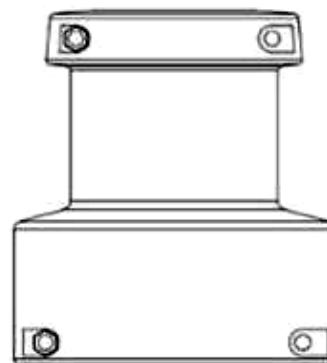

1.6

CÔNG BÁO SỞ HỮU CÔNG NGHIỆP SỐ 428 TẬP A – QUYỀN 2 (11.2023)

- (11) **48326**
(21) 3-2022-00338 (28) 1
(54) **PHẦN TỬ GHI LÒ** (51) **23-03**
(22) 25/02/2022 (43) 27/11/2023
(73) **HITACHI ZOSEN INOVA AG (CH)**
Hardturmstrasse 127, CH-8005 Zurich, Switzerland
(72) **BRENNWALD Werner (CH)**
(74) Công ty TNHH Trần Hữu Nam và Đồng sự (TRAN H.N & ASS.)
(55)

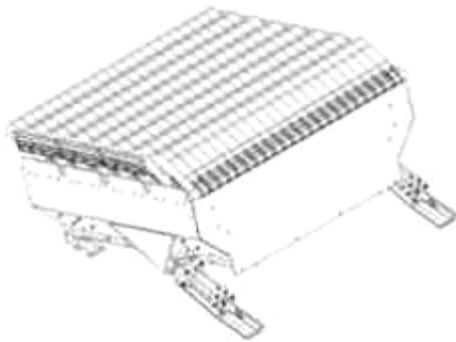

1.1

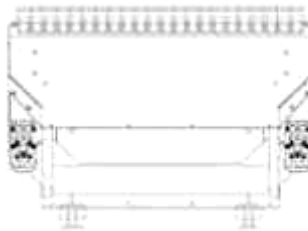

1.2

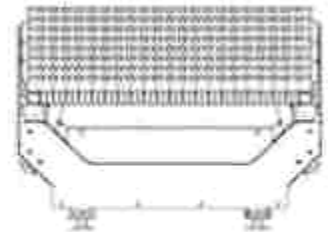

1.3

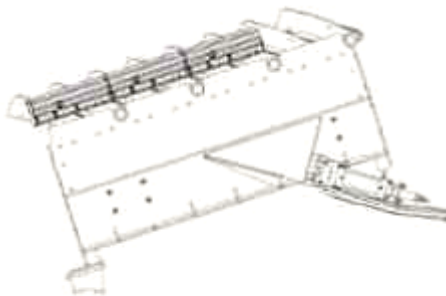

1.4

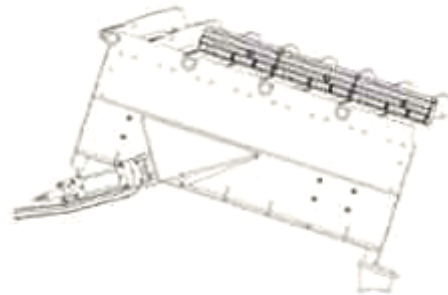

1.5

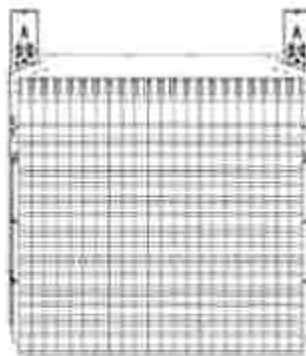

1.6

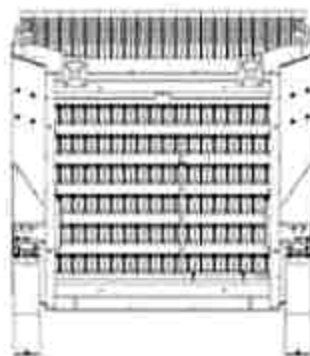

1.7

CÔNG BÁO SỞ HỮU CÔNG NGHIỆP SỐ 428 TẬP A – QUYỀN 2 (11.2023)

- (11) **48327**
(21) 3-2022-00436 (28) 1
(54) **THANH KIM LOẠI ĐỊNH HÌNH** (51) **25-01**
(22) 10/03/2022 (43) 27/11/2023
(73) **CÔNG TY TNHH MTV ĐĂNG QUANG (VN)**
Đường Trường Chinh, khu phố 1, phường Phú Tài, thành phố Phan Thiết, tỉnh Bình Thuận
(72) Võ Trường Thọ (VN)
(74) **CÔNG TY TNHH KHANG LUẬT (KHANGLAW)**
(55)

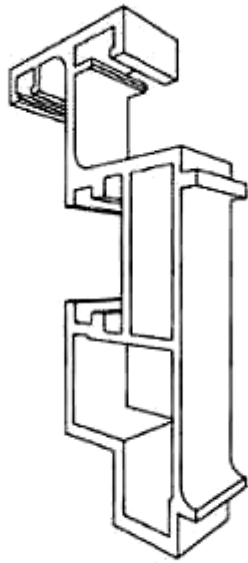

1.1

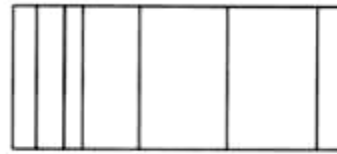

1.2



1.3



1.4

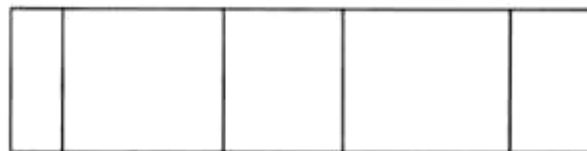

1.5

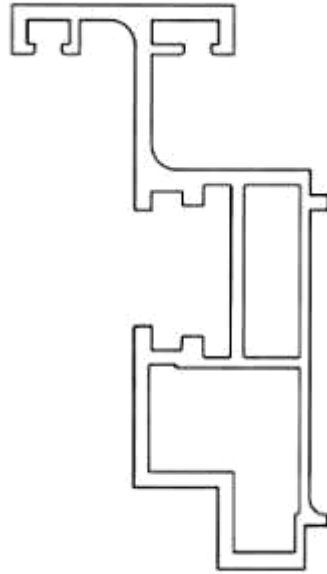

1.6

CÔNG BÁO SỞ HỮU CÔNG NGHIỆP SỐ 428 TẬP A – QUYỀN 2 (11.2023)

- (11) **48328**
(21) 3-2022-00437 (28) 1
(54) **THANH KIM LOẠI ĐỊNH HÌNH** (51) **25-01**
(22) 10/03/2022 (43) 27/11/2023
(73) **CÔNG TY TNHH MTV ĐĂNG QUANG (VN)**
Đường Trường Chinh, khu phố 1, phường Phú Tài, thành phố Phan Thiết, tỉnh Bình Thuận
(72) Võ Trường Thọ (VN)
(74) **CÔNG TY TNHH KHANG LUẬT (KHANGLAW)**
(55)

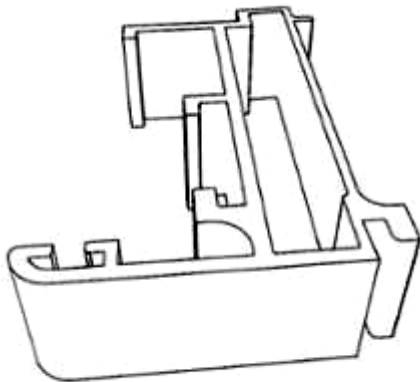

1.1

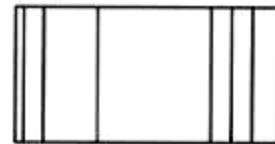

1.2



1.3



1.4

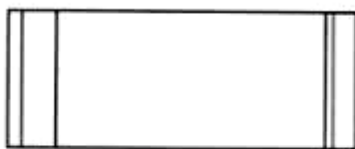

1.5

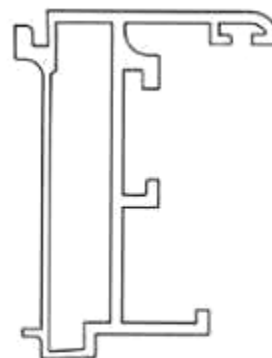

1.6

CÔNG BÁO SỞ HỮU CÔNG NGHIỆP SỐ 428 TẬP A – QUYỀN 2 (11.2023)

(11) **48329**

(21) 3-2022-00438

(28) 1

(54) **THANH KIM LOẠI ĐỊNH HÌNH**

(51) **25-01**

(22) 10/03/2022

(43) 27/11/2023

(73) **CÔNG TY TNHH MTV ĐĂNG QUANG (VN)**

Đường Trường Chinh, khu phố 1, phường Phú Tài, thành phố Phan Thiết, tỉnh Bình Thuận

(72) Võ Trường Thọ (VN)

(74) **CÔNG TY TNHH KHANG LUẬT (KHANGLAW)**

(55)

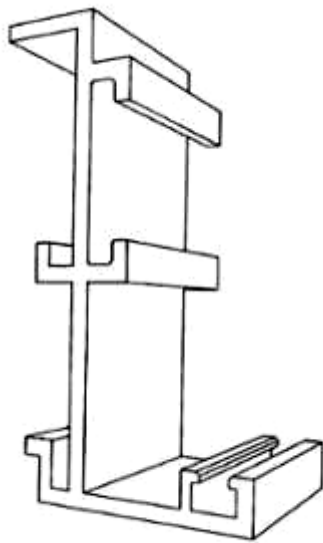

1.1



1.2



1.3

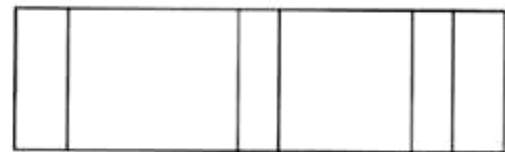

1.4

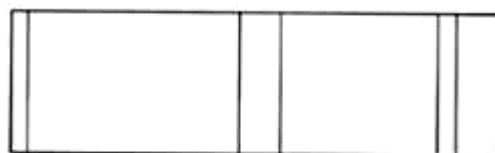

1.5

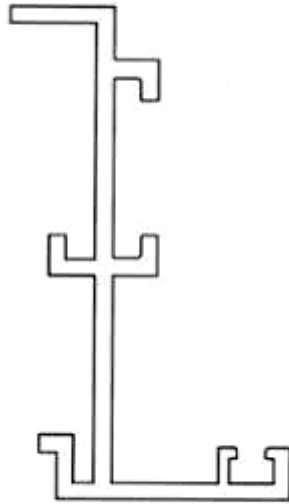

1.6

CÔNG BÁO SỞ HỮU CÔNG NGHIỆP SỐ 428 TẬP A – QUYỀN 2 (11.2023)

- (11) **48330**
(21) 3-2022-01476 (28) 1
(54) **GIÁ ĐỒ NHIỀU TẦNG** (51) **20-02**
(22) 22/07/2022 (43) 27/11/2023
(73) **CÔNG TY TNHH SẢN XUẤT VÀ THƯƠNG MẠI ONE TECH VIỆT NAM (VN)**
Số 10 ngõ 253 Nguyễn Khang, phường Yên Hòa, quận Cầu Giấy, thành phố Hà Nội
(72) Nguyễn Văn Trung (VN)
(74) Công ty TNHH Sở hữu trí tuệ Trí Việt và Cộng sự (TRI VIET & ASSOCIATES.)
(55)



1.1



1.2



1.3



1.4



1.5

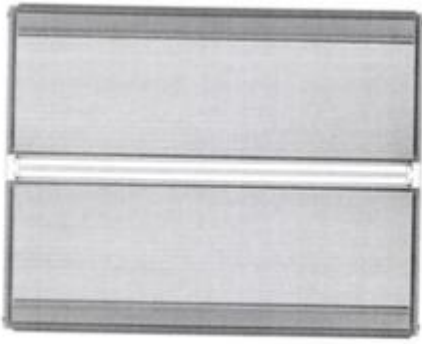

1.6

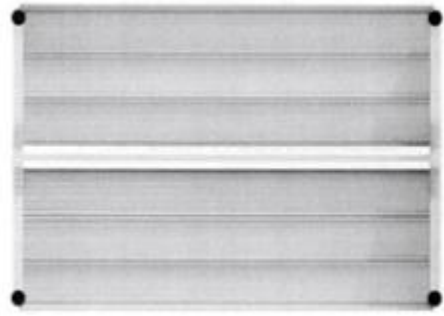

1.7

CÔNG BÁO SỞ HỮU CÔNG NGHIỆP SỐ 428 TẬP A – QUYỀN 2 (11.2023)

- (11) **48331**
(21) 3-2022-01700 (28) 1
(54) **TỦ LẠNH** (51) **15-07**
(22) 16/08/2022 (43) 27/11/2023
(30) 2022-003212 21/02/2022 JP;
(73) **MITSUBISHI ELECTRIC CORPORATION (JP)**
7-3, Marunouchi 2-chome, Chiyoda-ku, Tokyo 100-8310, Japan
(72) 1. MARIKO TOBITA (JP)
2. SHINGO KAWAKAMI (JP)
3. TAKANORI HIKIMA (JP)
4. ALESSANDRO DADONE (IT)
(74) Công ty TNHH Tâm nhìn và Liên danh (VISION & ASSOCIATES CO.LTD.)
(55)

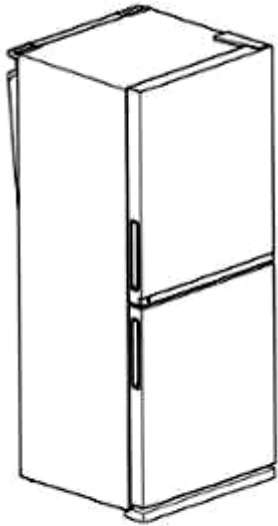

1.1

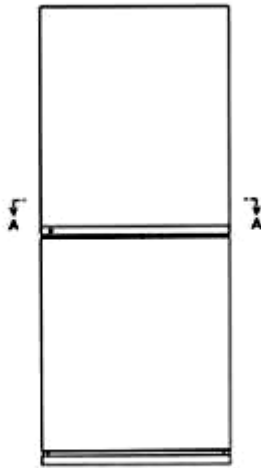

1.2

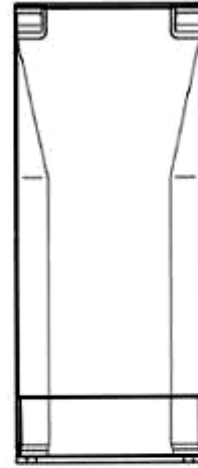

1.3



1.4

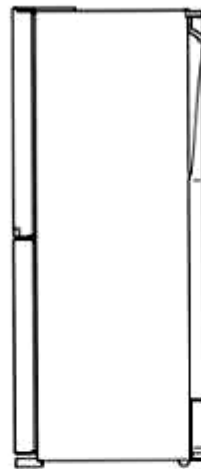

1.5

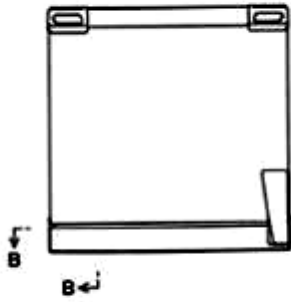

1.6

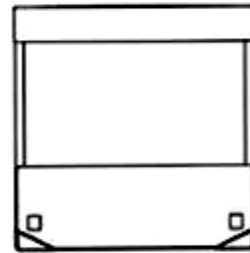

1.7

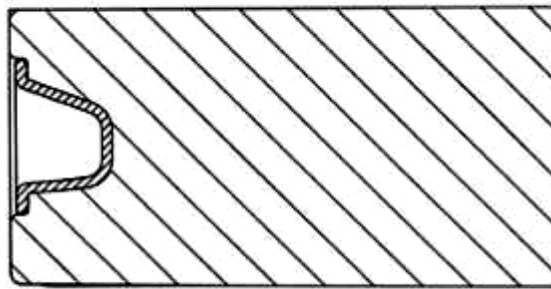

1.8

CÔNG BÁO SỞ HỮU CÔNG NGHIỆP SỐ 428 TẬP A – QUYỀN 2 (11.2023)

- (11) **48332**
(21) 3-2022-01701 (28) 1
(54) **TỦ LẠNH** (51) **15-07**
(22) 16/08/2022 (43) 27/11/2023
(30) 2022-003213 21/02/2022 JP;
(73) **MITSUBISHI ELECTRIC CORPORATION (JP)**
7-3, Marunouchi 2-chome, Chiyoda-ku, Tokyo 100-8310, Japan
(72) 1. MARIKO TOBITA (JP)
2. SHINGO KAWAKAMI (JP)
3. TAKANORI HIKIMA (JP)
4. ALESSANDRO DADONE (IT)
(74) Công ty TNHH Tâm nhìn và Liên danh (VISION & ASSOCIATES CO.LTD.)
(55)

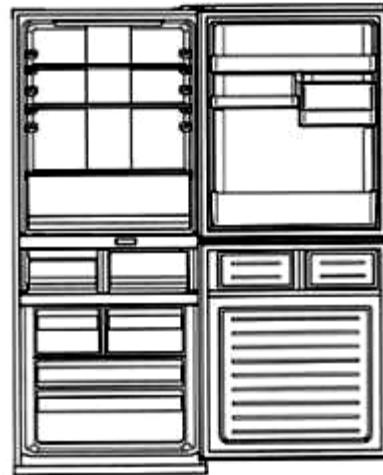
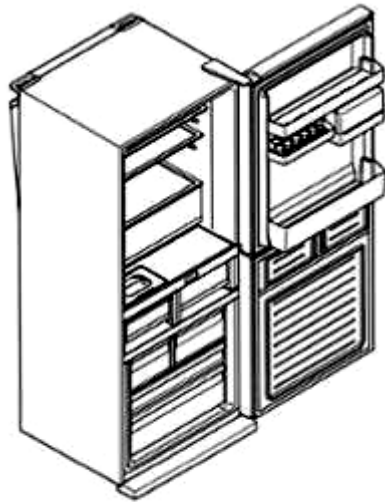

1.1

1.2

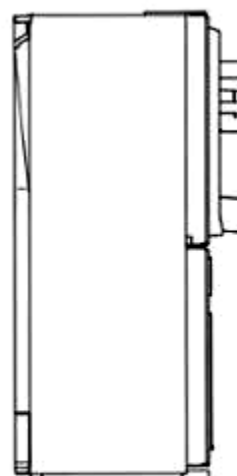
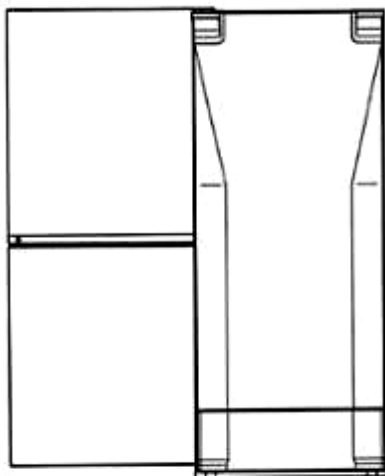

1.3

1.4

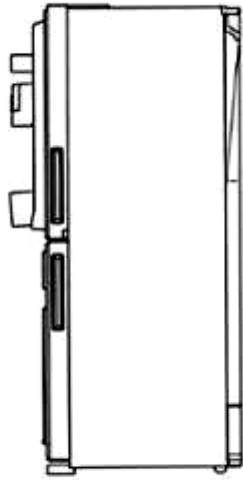

1.5

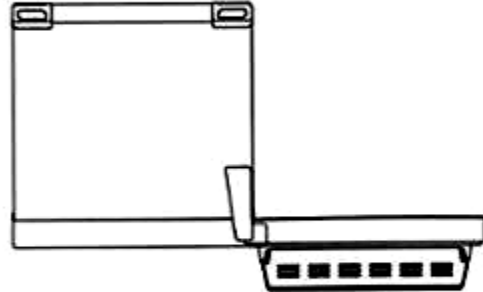

1.6

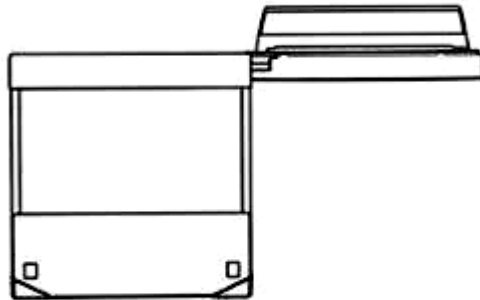

1.7

CÔNG BÁO SỞ HỮU CÔNG NGHIỆP SỐ 428 TẬP A – QUYỀN 2 (11.2023)

- (11) **48333**
(21) 3-2022-01780 (28) 1
(54) **BÀN CHẢI** (51) **04-01**
(22) 22/08/2022 (43) 27/11/2023
(73) **CÔNG TY TNHH SẢN XUẤT KINH DOANH ANH MAI (VN)**
Xóm 3 thôn Lê Tiến, xã Nguyên Xá, huyện Đông Hưng, tỉnh Thái Bình
(72) Nguyễn Tuấn Anh (VN)
(74) Công ty cổ phần Sở hữu trí tuệ BROSS và Cộng sự (BROSS & PARTNERS., JSC)
(55)



1.1



1.2

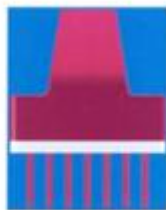

1.3

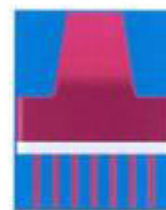

1.4



1.5



1.6



1.7

- (11) **48334**
(21) 3-2022-01925 (28) 1
(54) **DỤNG CỤ TUỐT DÂY** (51) **08-05**
(22) 12/09/2022 (43) 27/11/2023
(30) 2022-005144 14/03/2022 JP;
(73) **NAGAKI SEIKI CO., LTD.** (JP)
4-31, Tashiden 3-chome, Daito-shi, Osaka, 574-0045, JAPAN
(72) 1. TETSUROU TAKEDA (JP)
2. YASUYUKI KUWANO (JP)
(74) Công ty Luật TNHH Phạm và Liên danh (PHAM & ASSOCIATES)
(55)

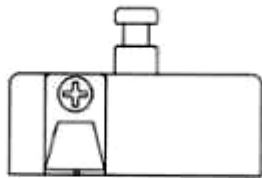

1.1

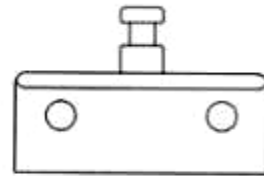

1.2

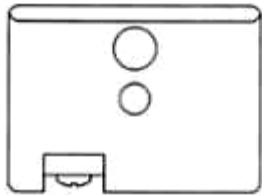

1.3

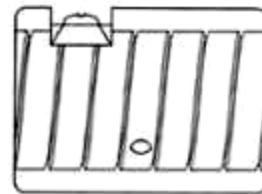

1.4

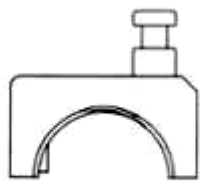

1.5

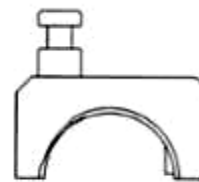

1.6

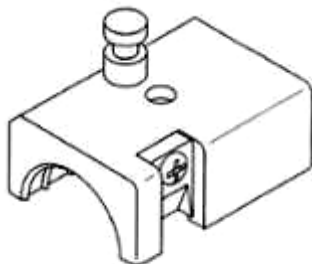

1.7

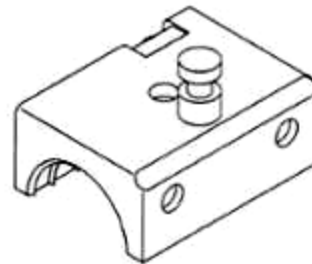

1.8



1.9



1.10

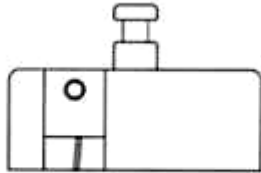

1.11

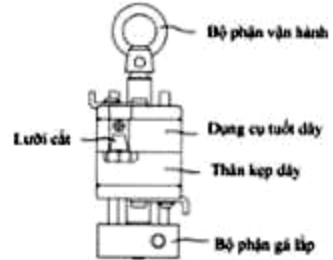

1.12

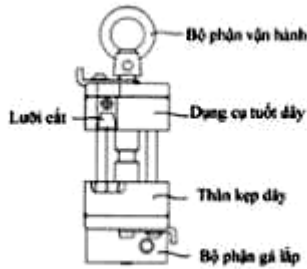

1.13

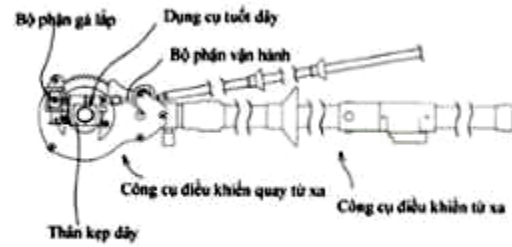

1.14

CÔNG BÁO SỞ HỮU CÔNG NGHIỆP SỐ 428 TẬP A – QUYỀN 2 (11.2023)

- (11) **48335**
(21) 3-2022-01964 (28) 1
(54) **HỘP** (51) **09-03**
(22) 16/09/2022 (43) 27/11/2023
(73) **CÔNG TY TNHH SẢN XUẤT THƯƠNG MẠI DỊCH VỤ TÂN TUỜNG KHANG (VN)**
Lô F1 & F2, đường D2 và N5, khu công nghiệp Nam Tân Uyên, phường Khánh Bình, thị xã Tân Uyên, tỉnh Bình Dương
(72) Nìm Dùng Chiếng (VN)
(74) Văn phòng Luật sư D và T (D & T LAW OFFICE)
(55)



1.1



1.2



1.3



1.4



1.5



1.6



1.7

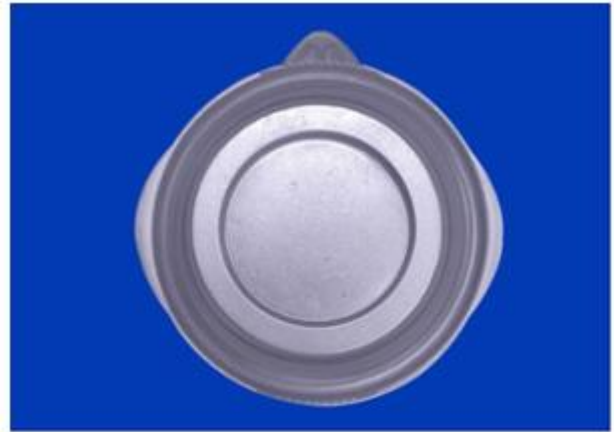

1.8

- (11) **48336**
(21) 3-2022-01975 (28) 1
(54) **QUẦN** (51) **02-02**
(22) 16/09/2022 (43) 27/11/2023
(30) 2022-006287 25/03/2022 JP;
(73) **SHINTAIKINOUKENKYUUJO CO., LTD. (JP)**
Omega Court building #102, 3-27-3, Chomeigaoka, Izumi-ku, Sendai-shi, 981-3212
Miyagi, Japan
(72) Takashi SASAKI (JP)
(74) Công ty TNHH Tầm nhìn và Liên danh (VISION & ASSOCIATES CO.LTD.)
(55)



1.1



1.2



1.3



1.4



1.5



1.6



1.7



1.8

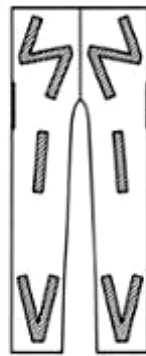

1.9

CÔNG BÁO SỞ HỮU CÔNG NGHIỆP SỐ 428 TẬP A – QUYỀN 2 (11.2023)

- (11) **48337**
(21) 3-2022-01984 (28) 1
(54) **THANH NHÔM ĐỊNH HÌNH** (51) **25-01**
(22) 19/09/2022 (43) 27/11/2023
(73) **CÔNG TY TNHH MTV CƠ KHÍ - XÂY DỰNG TRƯỜNG AN PHÁT (VN)**
Thửa đất số 354, tờ bản đồ số 24, tổ 4, thôn Vân Dương 2, xã Hòa Liên, huyện Hòa
Vang, thành phố Đà Nẵng
(72) Bùi Xuân Thương (VN)
(55)

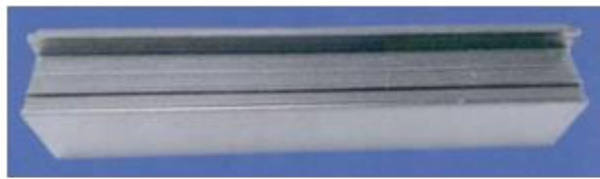

1.1



1.2



1.3

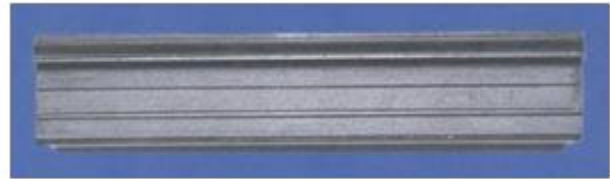

1.4



1.5



1.6

CÔNG BÁO SỞ HỮU CÔNG NGHIỆP SỐ 428 TẬP A – QUYỀN 2 (11.2023)

- (11) **48338**
(21) 3-2022-02046 (28) 1
(54) **TAY CÀM BÀN CHẢI ĐÁNH RĂNG** (51) **04-02**
(22) 23/09/2022 (43) 27/11/2023
(73) **CÔNG TY TNHH SẢN XUẤT THƯƠNG MẠI LIÊN THÀNH PHÁT (VN)**
D19/31 Hương Lộ 80, ấp 4, xã Vĩnh Lộc B, huyện Bình Chánh, thành phố Hồ Chí Minh
(72) Lâm Wai (VN)
(74) **CÔNG TY TNHH SỞ HỮU TRÍ TUỆ SETHACO (SETHACO IP CO.,LTD)**
(55)



1.1

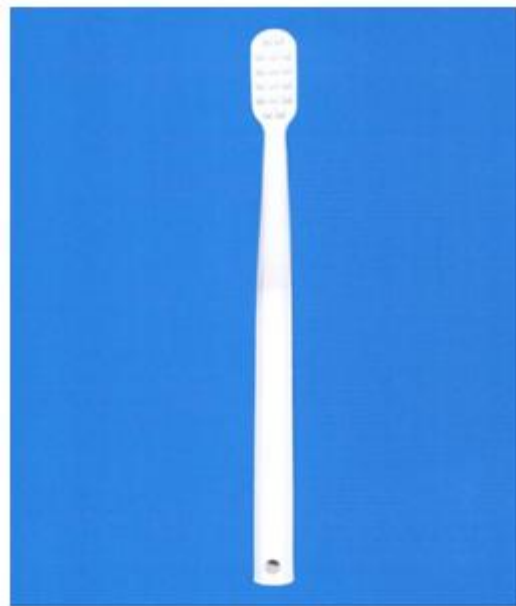

1.2

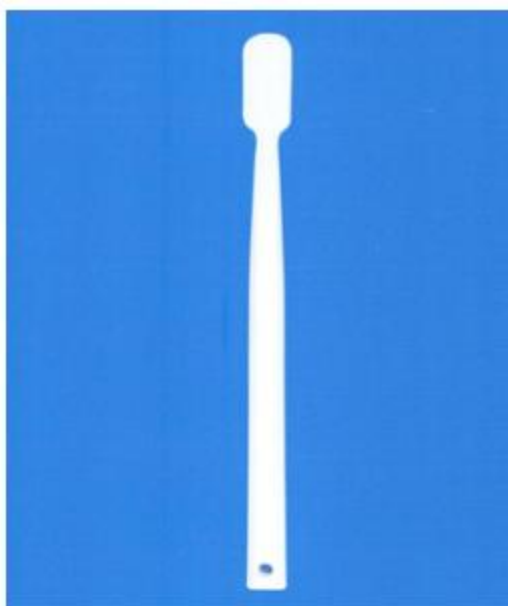

1.3

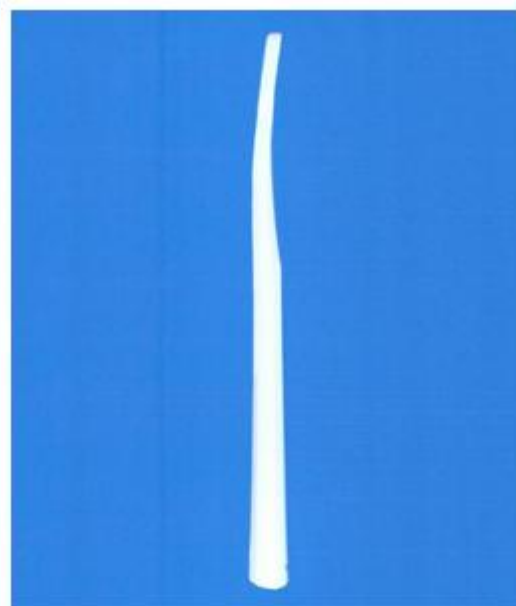

1.4

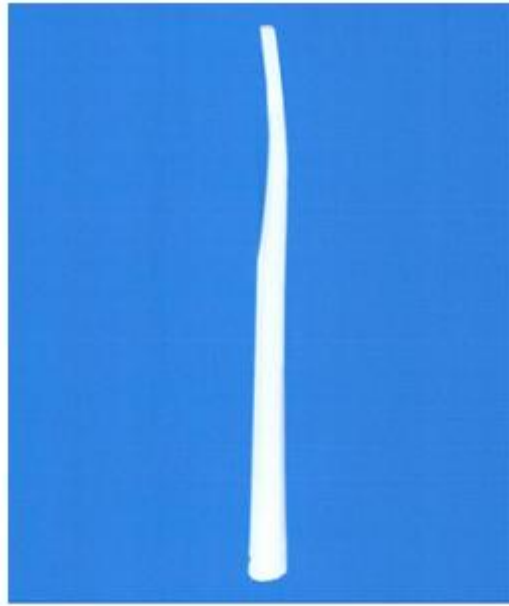

1.5



1.6



1.7

CÔNG BÁO SỞ HỮU CÔNG NGHIỆP SỐ 428 TẬP A – QUYỀN 2 (11.2023)

- (11) **48339**
(21) 3-2022-02084 (28) 1
(54) **DỤNG CỤ XÓA** (51) **19-02**
(22) 29/09/2022 (43) 27/11/2023
(30) 2022-008307 15/04/2022 JP;
(73) **PLUS CORPORATION (JP)**
1-28, Toranomom 4-chome, Minato-ku, Tokyo, JAPAN
(72) 1. SHIINA KANNO (JP)
2. SANAE ASHINO (JP)
3. CHIHIRO KAMIYAMA (JP)
4. HAYATO HORIE (JP)
(74) Công ty Luật TNHH Phạm và Liên danh (PHAM & ASSOCIATES)
(55)

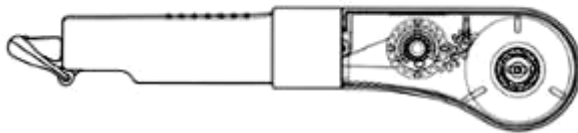

1.1

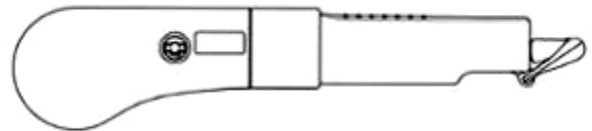

1.2



1.3



1.4



1.5



1.6

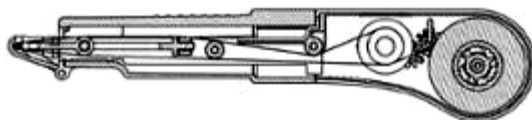

1.7

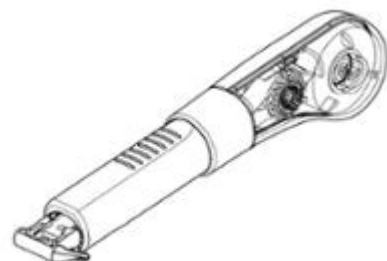

1.8

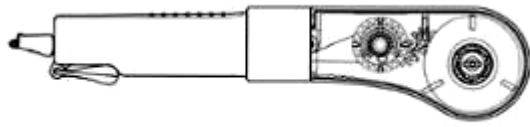

1.9



1.10

CÔNG BÁO SỞ HỮU CÔNG NGHIỆP SỐ 428 TẬP A – QUYỀN 2 (11.2023)

- (11) **48340**
(21) 3-2022-02101 (28) 1
(54) **VÒI NƯỚC** (51) **23-01**
(22) 30/09/2022 (43) 27/11/2023
(30) 2022-008891 25/04/2022 JP;
(73) **PANASONIC INTELLECTUAL PROPERTY MANAGEMENT CO., LTD.**
(JP)
1-61, Shiromi 2-chome, Chuo-ku, Osaka-shi, Osaka 540-6207 Japan
(72) Keita KONDOU (JP)
(74) Công ty TNHH một thành viên Sở hữu trí tuệ VCCI (VCCI-IP CO.,LTD)
(55)



1.1



1.2



1.3



1.4



1.5



1.6

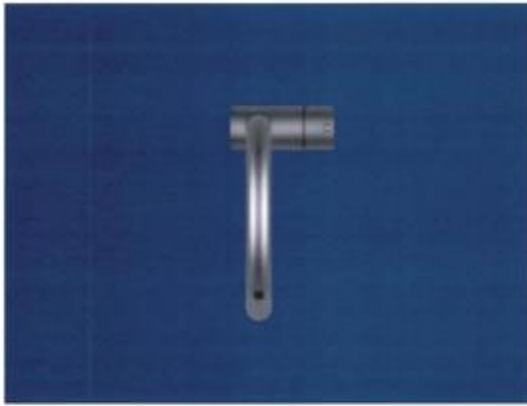

1.7



1.8

CÔNG BÁO SỞ HỮU CÔNG NGHIỆP SỐ 428 TẬP A – QUYỀN 2 (11.2023)

- (11) **48341**
(21) 3-2022-02325 (28) 1
(54) **THIẾT BỊ XẢ NƯỚC TỰ ĐỘNG DÙNG CHO NHÀ VỆ SINH** (51) **23-02**
(22) 26/10/2022 (43) 27/11/2023
(30) 2022-009278 28/04/2022 JP;
(73) **TOTO LTD. (JP)**
1-1, Nakashima 2-chome, Kokurakita-ku, Kitakyushu-shi, Fukuoka 802-8601 Japan
(72) 1. BOWEN PENG (CN)
2. ATSUSHI TOYOHARA (JP)
3. MAI YATO (JP)
(74) Công ty Cổ phần Sở hữu công nghiệp INVESTIP (INVESTIP)
(55)



1.1



1.2



1.3



1.4



1.5



1.6



1.7

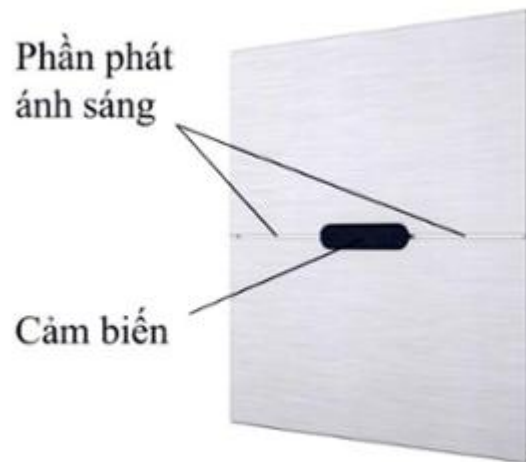

1.8

CÔNG BÁO SỞ HỮU CÔNG NGHIỆP SỐ 428 TẬP A – QUYỀN 2 (11.2023)

- (11) **48342**
(21) 3-2022-02330 (28) 1
(54) **TAY CẦM CỦA VÒI NƯỚC** (51) **23-01**
(22) 11/01/2022 (43) 27/11/2023
(30) 29/799,667 15/07/2021 US;
(73) **AS AMERICA, INC. (US)**
30 Knightsbridge Road, Piscataway, NJ 08854, United States of America
(72) 1. JEAN-JACQUES L'HENAFF (FR)
2. KI BOK SONG (US)
3. JACOB NITZ (US)
4. ALISON J. LYONS (US)
5. PAUL FLOWERS (GB)
6. GREG REINECKER (US)
(74) Công ty Luật TNHH T&G (TGVN)
(55)



1.1



1.2

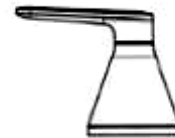

1.3



1.4



1.5



1.6



1.7

- (11) **48343**
(21) 3-2022-02378 (28) 1
(54) **MIẾNG DÁN Y TẾ** (51) **24-04**
(22) 01/11/2022 (43) 27/11/2023
(30) 2022-010449 17/05/2022 JP;
(73) **KOBAYASHI PHARMACEUTICAL CO., LTD. (JP)**
4-10, Doshomachi 4-chome, Chuo-ku, Osaka 541-0045, Japan
(72) 1. NONOMURA YUUKI (JP)
2. WATANABE HIROKAZU (JP)
(74) Công ty TNHH Sáng chế ACTIP (ACTIP PATENT LIMITED)
(55)

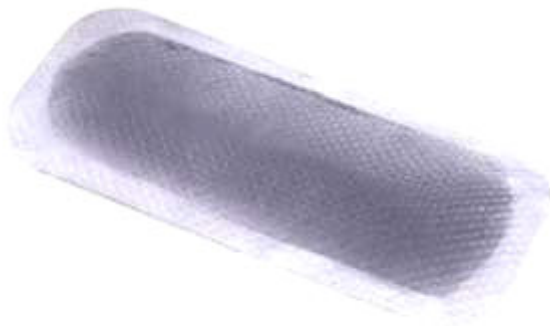

1.1



1.2



1.3

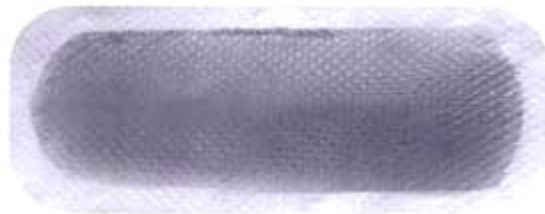

1.4



1.5

CÔNG BÁO SỞ HỮU CÔNG NGHIỆP SỐ 428 TẬP A – QUYỀN 2 (11.2023)

- (11) **48344**
(21) 3-2022-02457 (28) 1
(54) **XE MÁY** (51) **12-11**
(22) 10/11/2022 (43) 27/11/2023
(30) 2022-010149 13/05/2022 JP;
(73) **HONDA MOTOR CO., LTD. (JP)**
1-1, Minami-Aoyama 2-chome, Minato-ku, Tokyo, 107-8556 Japan
(72) 1. SATOSHI ITO (JP)
2. GIOVANNI DOVIS (IT)
(74) Công ty Luật TNHH Phạm và Liên danh (PHAM & ASSOCIATES)
(55)



1.1



1.2



1.3



1.4



1.5



1.6



1.7



1.8



1.9



1.10

CÔNG BÁO SỞ HỮU CÔNG NGHIỆP SỐ 428 TẬP A – QUYỀN 2 (11.2023)

- (11) **48345**
(21) 3-2022-02479 (28) 1
(54) **MÁY BƠM** (51) **15-02**
(22) 14/11/2022 (43) 27/11/2023
(73) **CÔNG TY CỔ PHẦN CHẾ TẠO BƠM HẢI DƯƠNG (VN)**
Số 2 đường Ngô Quyền, phường Cẩm Thượng, thành phố Hải Dương, tỉnh Hải Dương
(72) Nguyễn Trọng Nam (VN)
(74) Công ty TNHH Sở hữu trí tuệ PADEMARK (PADEMARK CO.,LTD.)
(55)

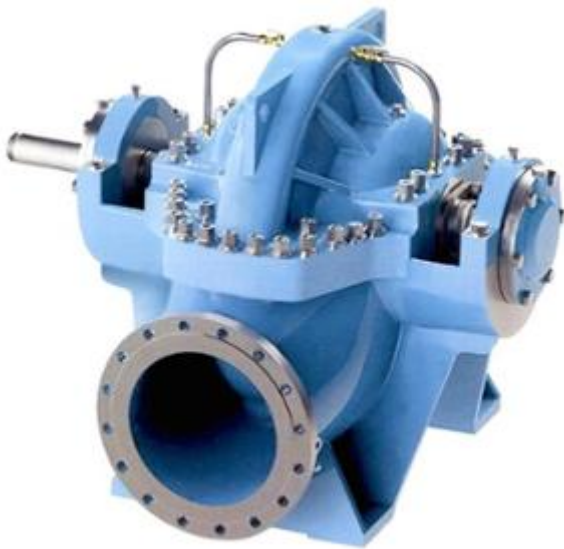

1.1

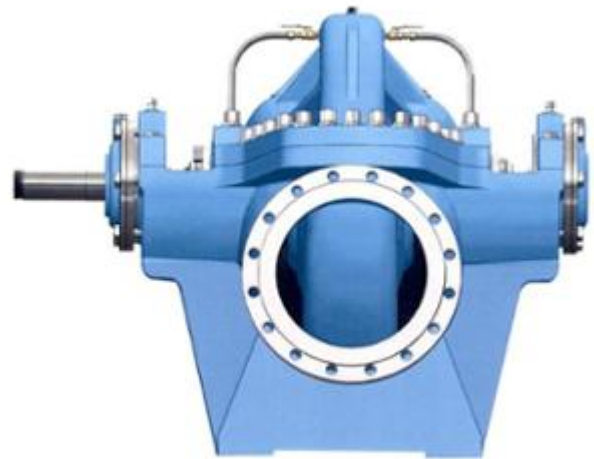

1.2

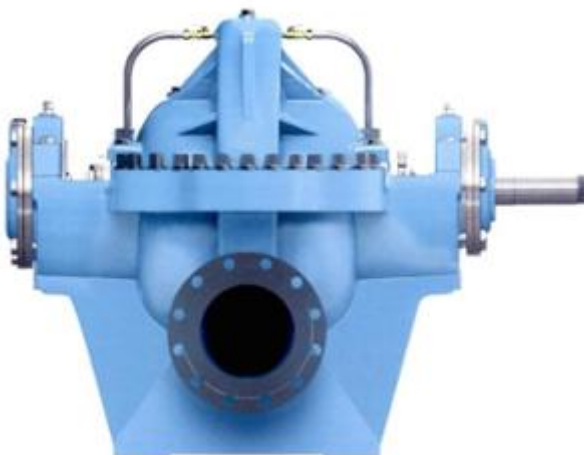

1.3



1.4



1.5

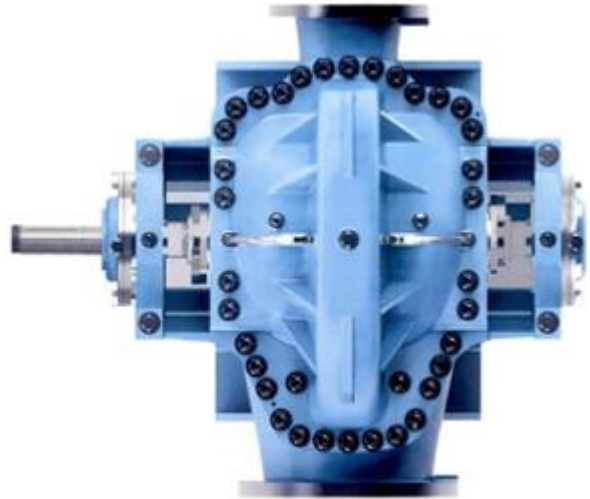

1.6

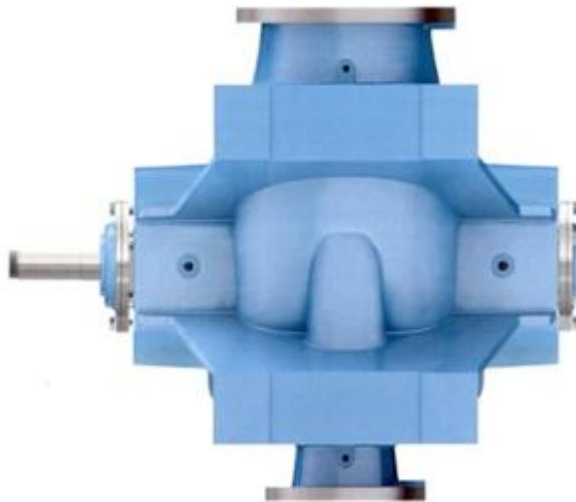

1.7

- (11) **48346**
(21) 3-2022-02480 (28) 1
(54) **MÁY BƠM BÊ TÔNG** (51) **15-04**
(22) 14/11/2022 (43) 27/11/2023
(73) **CÔNG TY CỔ PHẦN CHẾ TẠO BƠM HẢI DƯƠNG (VN)**
Số 2 đường Ngô Quyền, phường Cẩm Thượng, thành phố Hải Dương, tỉnh Hải Dương
(72) Nguyễn Trọng Nam (VN)
(74) Công ty TNHH Sở hữu trí tuệ PADEMARK (PADEMARK CO.,LTD.)
(55)

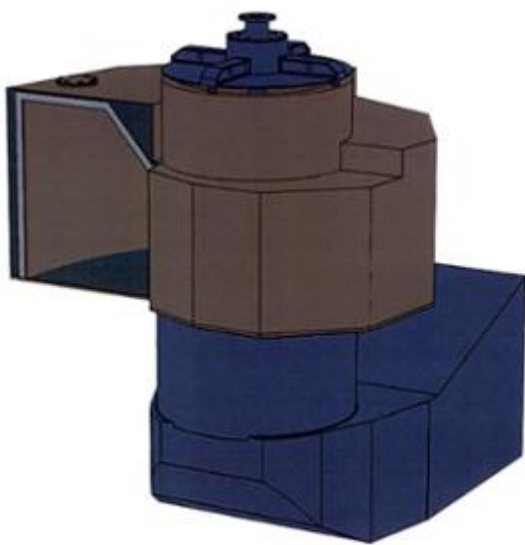

1.1

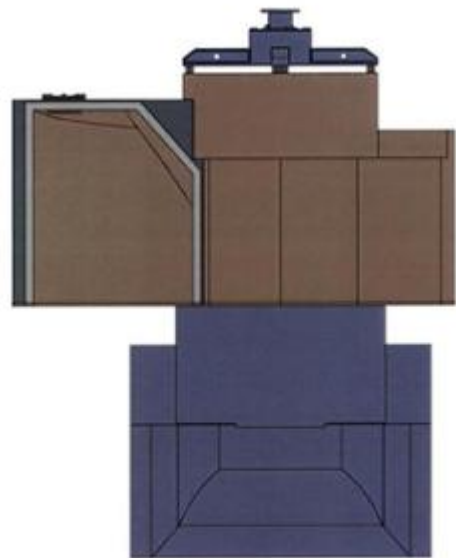

1.2



1.3

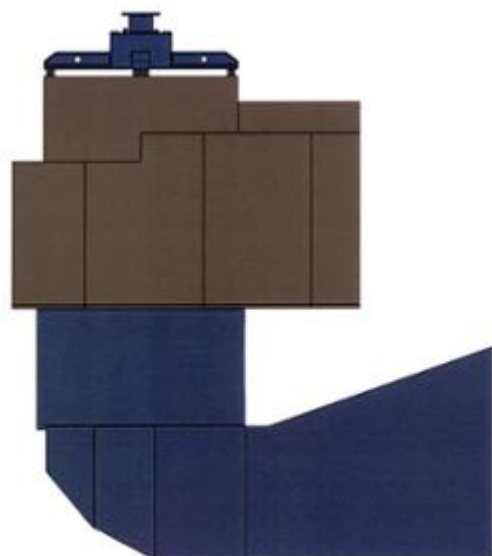

1.4



1.5

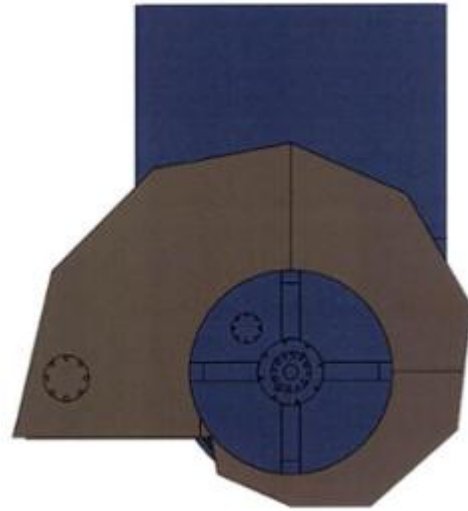

1.6



1.7

(11) **48347**

(21) 3-2022-02604

(28) 1

(54) **TƯỢNG TRANG TRÍ**

(51) **11-02**

(22) 28/11/2022

(43) 27/11/2023

(73) **CÔNG TY TNHH MINH LONG I (VN)**

Số 333 đường Hưng Định 24, khu phố Hưng Lộc, phường Hưng Định, thành phố Thuận An, tỉnh Bình Dương

(72) Lý Huy Sáng (VN)

(55)



1.1



1.2



1.3



1.4



1.5



1.6



1.7



1.8

CÔNG BÁO SỞ HỮU CÔNG NGHIỆP SỐ 428 TẬP A – QUYỀN 2 (11.2023)

- (11) **48348**
(21) 3-2022-02619 (28) 1
(54) **HỘP ĐỰNG MỰC IN** (51) **18-02**
(22) 29/11/2022 (43) 27/11/2023
(30) 2022-022994 24/10/2022 JP;
(73) **KYOCERA DOCUMENT SOLUTIONS INC. (JP)**
1-2-28, Tamatsukuri, Chuo-ku, Osaka-shi, Osaka, 540-8585, Japan
(72) Riku MINAMOTO (JP)
(74) **CÔNG TY LUẬT TRÁCH NHIỆM HỮU HẠN AMBYS HÀ NỘI (AMBYS HANOI)**
(55)

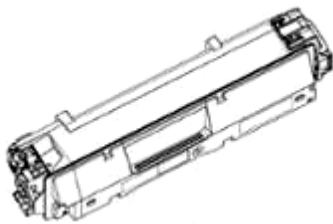

1.1

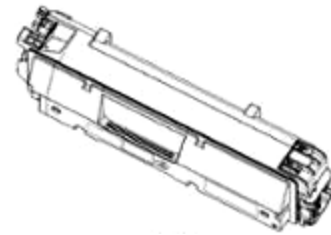

1.2

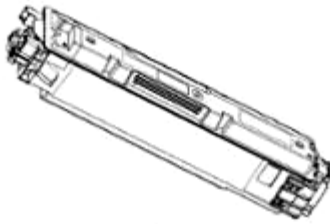

1.3

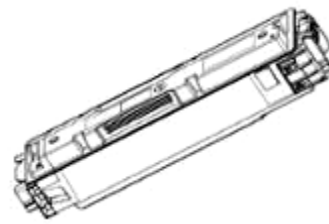

1.4

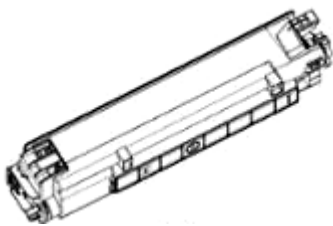

1.5

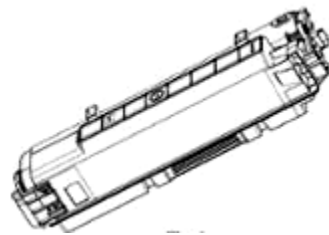

1.6

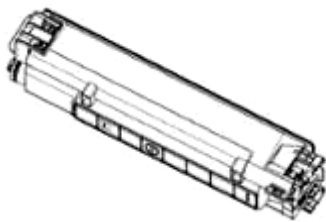

1.7



1.8



1.9



1.10



1.11



1.12

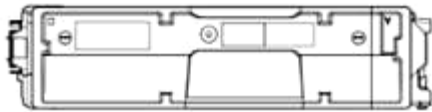

1.13



1.14

- (11) **48349**
(21) 3-2022-02620 (28) 1
(54) **HỘP ĐỰNG MỰC IN** (51) **18-02**
(22) 29/11/2022 (43) 27/11/2023
(30) 2022-011470 30/05/2022 JP;
(73) **KYOCERA DOCUMENT SOLUTIONS INC. (JP)**
1-2-28, Tamatsukuri, Chuo-ku, Osaka-shi, Osaka, 540-8585, Japan
(72) Riku MINAMOTO (JP)
(74) **CÔNG TY LUẬT TRÁCH NHIỆM HỮU HẠN AMBYS HÀ NỘI (AMBYS HANOI)**
(55)

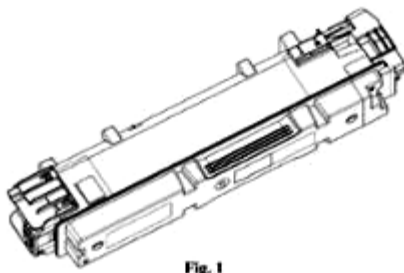

Fig. 1

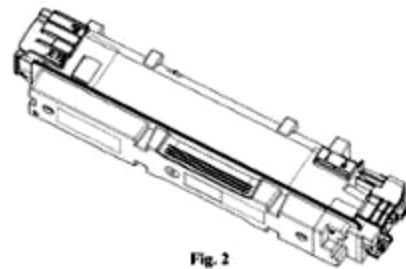

Fig. 2

1.1

1.2

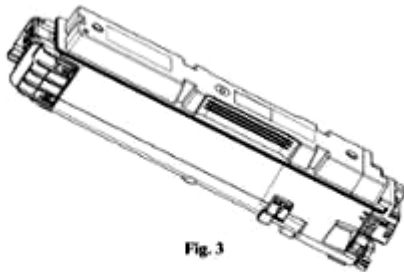

Fig. 3

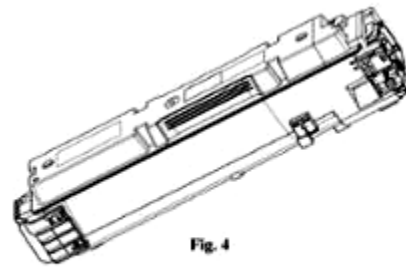

Fig. 4

1.3

1.4

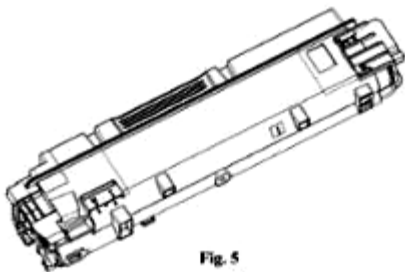

Fig. 5

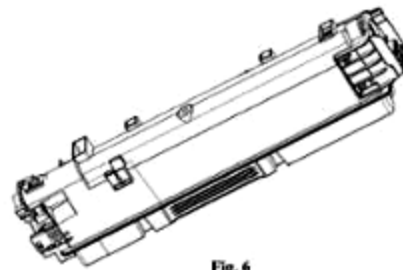

Fig. 6

1.5

1.6

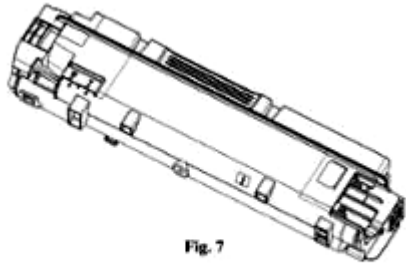

Fig. 7

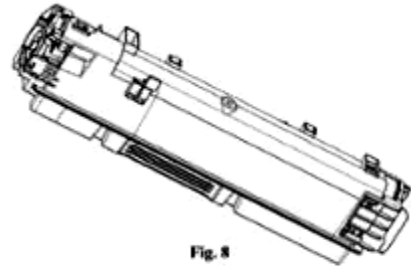

Fig. 8

1.7

1.8



1.9

1.10



1.11



1.12

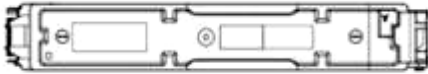

1.13

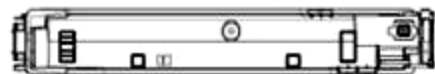

1.14

CÔNG BÁO SỞ HỮU CÔNG NGHIỆP SỐ 428 TẬP A – QUYỀN 2 (11.2023)

- (11) **48350**
(21) 3-2022-02629 (28) 1
(54) **Ô TÔ** (51) **12-08**
(22) 30/11/2022 (43) 27/11/2023
(30) 2022-014050 30/06/2022 JP;
(73) **TOYOTA SHATAI KABUSHIKI KAISHA (JP)**
100 Kanayama Ichiriyama-cho, Kariya-shi, Aichi 448-8666, Japan
(72) 1. HIROFUMI FUKUI (JP)
2. YUKIKO YANO (JP)
3. RYOSUKE TAIRADATE (JP)
4. YUKIHIRO NAGATA (JP)
(74) Công ty TNHH một thành viên Sở hữu trí tuệ VCCI (VCCI-IP CO.,LTD)
(55)



1.1



1.2



1.3



1.4



1.5



1.6



1.7

CÔNG BÁO SỞ HỮU CÔNG NGHIỆP SỐ 428 TẬP A – QUYỀN 2 (11.2023)

- (11) **48351**
(21) 3-2022-02630 (28) 1
(54) **BỘ ĐÈN PHÍA TRƯỚC CỦA Ô TÔ** (51) **26-06**
(22) 30/11/2022 (43) 27/11/2023
(30) 2022-014052 30/06/2022 JP;
(73) **TOYOTA SHATAI KABUSHIKI KAISHA (JP)**
100 Kanayama Ichiriyama-cho, Kariya-shi, Aichi 448-8666, Japan
(72) 1. YUKIHIRO NAGATA (JP)
2. SHIGETOSHI KOZAI (JP)
(74) Công ty TNHH một thành viên Sở hữu trí tuệ VCCI (VCCI-IP CO.,LTD)
(55)



1.1



1.2



1.3



1.4



1.5



1.6



1.7



1.8

CÔNG BÁO SỞ HỮU CÔNG NGHIỆP SỐ 428 TẬP A – QUYỀN 2 (11.2023)

- (11) **48352**
(21) 3-2022-02631 (28) 1
(54) **BẢNG ĐIỀU KHIỂN CỦA Ô TÔ** (51) **12-16**
(22) 30/11/2022 (43) 27/11/2023
(30) 2022-014058 30/06/2022 JP;
(73) **TOYOTA SHATAI KABUSHIKI KAISHA (JP)**
100 Kanayama Ichiriyama-cho, Kariya-shi, Aichi 448-8666, Japan
(72) Kaori SUZUKI (JP)
(74) Công ty TNHH một thành viên Sở hữu trí tuệ VCCI (VCCI-IP CO.,LTD)
(55)



1.1



1.2



1.3



1.4



1.5



1.6



1.7

CÔNG BÁO SỞ HỮU CÔNG NGHIỆP SỐ 428 TẬP A – QUYỀN 2 (11.2023)

- (11) **48353**
(21) 3-2022-02632 (28) 1
(54) **TẤM CHẴN PHÍA TRƯỚC CỦA Ô TÔ** (51) **12-16**
(22) 30/11/2022 (43) 27/11/2023
(30) 2022-014054 30/06/2022 JP;
(73) **TOYOTA SHATAI KABUSHIKI KAISHA (JP)**
100 Kanayama Ichiriyama-cho, Kariya-shi, Aichi 448-8666, Japan
(72) 1. YUKIHIRO NAGATA (JP)
2. RYOSUKE TAIRADATE (JP)
(74) Công ty TNHH một thành viên Sở hữu trí tuệ VCCI (VCCI-IP CO.,LTD)
(55)



1.1



1.2



1.3



1.4

1.5



1.6



1.7



1.8

CÔNG BÁO SỞ HỮU CÔNG NGHIỆP SỐ 428 TẬP A – QUYỀN 2 (11.2023)

- (11) **48354**
(21) 3-2022-02633 (28) 1
(54) **BỘ ĐÈN PHÍA SAU CỦA Ô TÔ** (51) **26-06**
(22) 30/11/2022 (43) 27/11/2023
(30) 2022-014056 30/06/2022 JP;
(73) **TOYOTA SHATAI KABUSHIKI KAISHA (JP)**
100 Kanayama Ichiriyama-cho, Kariya-shi, Aichi 448-8666, Japan
(72) 1. YUKIKO YANO (JP)
2. HIROYUKI KAWAGISHI (JP)
(74) Công ty TNHH một thành viên Sở hữu trí tuệ VCCI (VCCI-IP CO.,LTD)
(55)



1.1



1.2



1.3



1.4



1.5



1.6



1.7



1.8

CÔNG BÁO SỞ HỮU CÔNG NGHIỆP SỐ 428 TẬP A – QUYỀN 2 (11.2023)

- (11) **48355**
(21) 3-2022-02634 (28) 1
(54) **TẤM HÃM XUNG PHÍA SAU CỦA Ô TÔ** (51) **12-16**
(22) 30/11/2022 (43) 27/11/2023
(30) 2022-014057 30/06/2022 JP;
(73) **TOYOTA SHATAI KABUSHIKI KAISHA (JP)**
100 Kanayama Ichiriyama-cho, Kariya-shi, Aichi 448-8666, Japan
(72) Hiroyuki KAWAGISHI (JP)
(74) Công ty TNHH một thành viên Sở hữu trí tuệ VCCI (VCCI-IP CO.,LTD)
(55)



1.1



1.2



1.3



1.4

1.5



1.6



1.7



1.8

CÔNG BÁO SỞ HỮU CÔNG NGHIỆP SỐ 428 TẬP A – QUYỀN 2 (11.2023)

- (11) **48356**
(21) 3-2022-02644 (28) 1
(54) **KÉO** (51) **08-03**
(22) 02/12/2022 (43) 27/11/2023
(30) 2022-012060 06/06/2022 JP;
(73) **KOKUYO CO., LTD.** (JP)
1-1, Oimazato-minami 6-chome, Higashinari-ku, Osaka-shi, Osaka, Japan
(72) 1. TATSUYA TABATA (JP)
2. YASUHIRO NAKATSU (JP)
3. SHINGO FUJIYA (JP)
(74) Công ty TNHH Sở hữu trí tuệ HA VIP (HAVIP CO., LTD.)
(55)

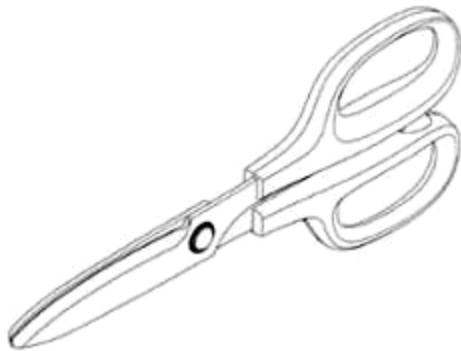

1.1

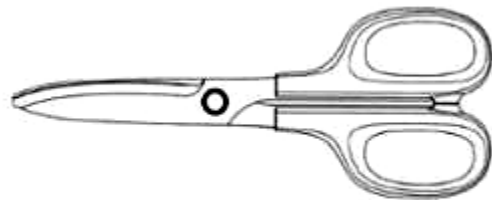

1.2



1.3



1.4



1.5



1.6



1.7

- (11) **48357**
(21) 3-2022-02645 (28) 1
(54) **KÉO** (51) **08-03**
(22) 02/12/2022 (43) 27/11/2023
(30) 2022-012061 06/06/2022 JP;
(73) **KOKUYO CO., LTD.** (JP)
1-1, Oimazato-minami 6-chome, Higashinari-ku, Osaka-shi, Osaka, Japan
(72) 1. TATSUYA TABATA (JP)
2. YASUHIRO NAKATSU (JP)
3. SHINGO FUJIYA (JP)
(74) Công ty TNHH Sở hữu trí tuệ HA VIP (HAVIP CO., LTD.)
(55)



1.1

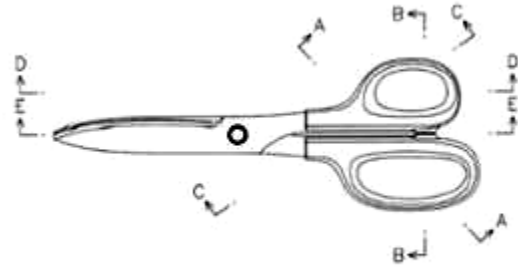

1.2

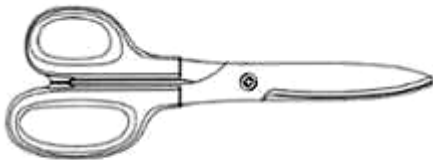

1.3



1.4



1.5



1.6



1.7

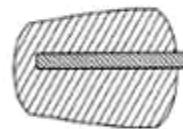

1.8



1.9

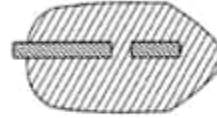

1.10



1.11

- (11) **48358**
(21) 3-2022-02646 (28) 1
(54) **KÉO** (51) **08-03**
(22) 02/12/2022 (43) 27/11/2023
(30) 2022-012062 06/06/2022 JP;
(73) **KOKUYO CO., LTD.** (JP)
1-1, Oimazato-minami 6-chome, Higashinari-ku, Osaka-shi, Osaka, Japan
(72) 1. TATSUYA TABATA (JP)
2. YASUHIRO NAKATSU (JP)
3. SHINGO FUJIYA (JP)
(74) Công ty TNHH Sở hữu trí tuệ HA VIP (HAVIP CO., LTD.)
(55)

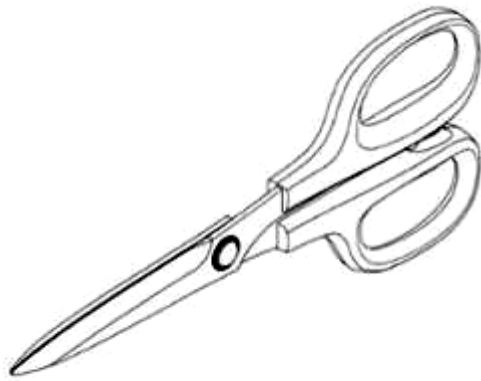

1.1

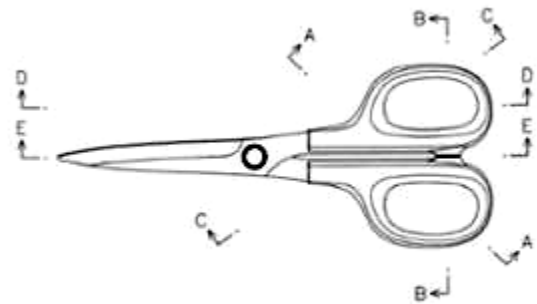

1.2



1.3



1.4



1.5



1.6



1.7

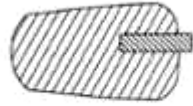

1.8



1.9



1.10



1.11



CÔNG BÁO SỞ HỮU CÔNG NGHIỆP SỐ 428 TẬP A – QUYỀN 2 (11.2023)

- (11) **48359**
(21) 3-2022-02652 (28) 1
(54) **XE MÁY** (51) **12-11**
(22) 05/12/2022 (43) 27/11/2023
(30) 2022-012453 10/06/2022 JP;
(73) **HONDA MOTOR CO., LTD. (JP)**
1-1, Minami-Aoyama 2-chome, Minato-ku, Tokyo, 107-8556 Japan
(72) 1. TOMOHIKO SASAKI (JP)
2. VALERIO AIELLO (IT)
(74) Công ty Luật TNHH Phạm và Liên danh (PHAM & ASSOCIATES)
(55)



1.1



1.2



1.3



1.4



1.5



1.6



1.7



1.8



1.9



1.10

CÔNG BÁO SỞ HỮU CÔNG NGHIỆP SỐ 428 TẬP A – QUYỀN 2 (11.2023)

- (11) **48360**
(21) 3-2022-02653 (28) 1
(54) **NẮP CHE ĐẦU XE MÁY** (51) **12-16**
(22) 05/12/2022 (43) 27/11/2023
(30) 2022-012436 10/06/2022 JP;
(73) **HONDA MOTOR CO., LTD. (JP)**
1-1, Minami-Aoyama 2-chome, Minato-ku, Tokyo, 107-8556 Japan
(72) 1. TOMOHIKO SASAKI (JP)
2. VALERIO AIELLO (IT)
(74) Công ty Luật TNHH Phạm và Liên danh (PHAM & ASSOCIATES)
(55)



1.1



1.2



1.3



1.4



1.5



1.6



1.7



1.8



1.9



1.10



1.11

CÔNG BÁO SỞ HỮU CÔNG NGHIỆP SỐ 428 TẬP A – QUYỀN 2 (11.2023)

- (11) **48361**
(21) 3-2022-02654 (28) 1
(54) **TẮM ỐP ĐẦU XE MÁY** (51) **12-16**
(22) 05/12/2022 (43) 27/11/2023
(30) 2022-012439 10/06/2022 JP;
(73) **HONDA MOTOR CO., LTD. (JP)**
1-1, Minami-Aoyama 2-chome, Minato-ku, Tokyo, 107-8556 Japan
(72) 1. TOMOHIKO SASAKI (JP)
2. VALERIO AIELLO (IT)
(74) Công ty Luật TNHH Phạm và Liên danh (PHAM & ASSOCIATES)
(55)



1.1



1.2



1.3



1.4



1.5



1.6



1.7



1.8



1.9



1.10



1.11

CÔNG BÁO SỞ HỮU CÔNG NGHIỆP SỐ 428 TẬP A – QUYỀN 2 (11.2023)

- (11) **48362**
(21) 3-2022-02679 (28) 1
(54) **BẢNG ĐIỀU KHIỂN** (51) **15-03**
(22) 06/12/2022 (43) 27/11/2023
(30) 2022-012120 07/06/2022 JP;
(73) **ISEKI & CO., LTD. (JP)**
700 Umaki-cho, Matsuyama-shi, Ehime-ken, Japan
(72) 1. TAKASHI KAWAHARADA (JP)
2. MANABU SAITO (JP)
(74) CÔNG TY LUẬT TRÁCH NHIỆM HỮU HẠN AMBYS HÀ NỘI (AMBYS
HANOI)
(55)

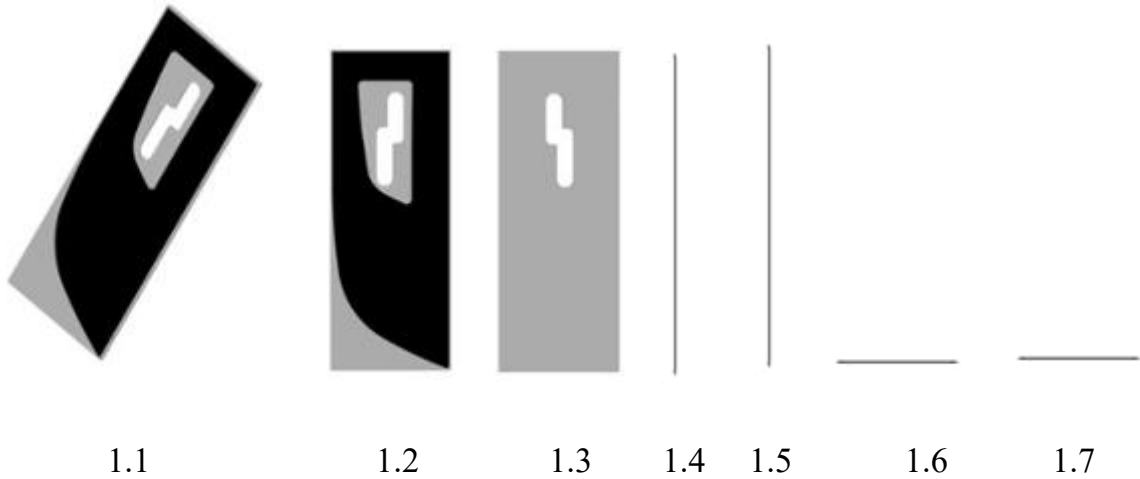

- (11) **48363**
(21) 3-2022-02680 (28) 1
(54) **ĐỒNG HỒ CHỈ THỊ** (51) **15-03**
(22) 06/12/2022 (43) 27/11/2023
(30) 2022-012119 07/06/2022 JP;
(73) **ISEKI & CO., LTD.** (JP)
700 Umaki-cho, Matsuyama-shi, Ehime-ken, JAPAN
(72) 1. TAKASHI KAWAHARADA (JP)
2. YUYA TAGUCHI (JP)
(74) CÔNG TY LUẬT TRÁCH NHIỆM HỮU HẠN AMBYS HÀ NỘI (AMBYS
HANOI)
(55)

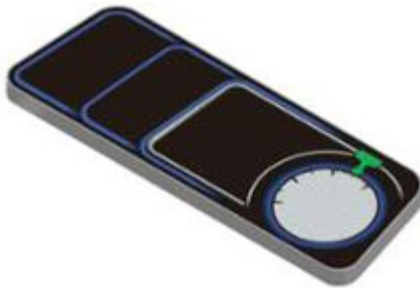

1.1



1.2



1.3

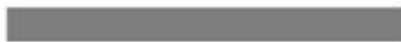

1.4

1.5

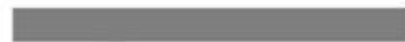

1.6

1.7

CÔNG BÁO SỞ HỮU CÔNG NGHIỆP SỐ 428 TẬP A – QUYỀN 2 (11.2023)

- (11) **48364**
(21) 3-2022-02703 (28) 3
(54) **BAO GÓI** (51) **09-05**
(22) 08/12/2022 (43) 27/11/2023
(73) **CÔNG TY TNHH XUẤT NHẬP KHẨU ĐẠI DƯƠNG XANH (VN)**
Số 52 đường số 10, khu dân cư Him Lam, phường Tân Hưng, quận 7, thành phố Hồ Chí Minh
(72) Huỳnh Văn Khỏe (VN)
(74) Công ty TNHH Tâm nhìn và Liên danh (VISION & ASSOCIATES CO.LTD.)
(55)



1.1



1.2



2.1



2.2



3.1



3.2

(11) **48365**

(21) 3-2022-02704

(54) **TUABIN GIÓ**

(22) 09/12/2022

(73) **VIỆN PHÁT TRIỂN NĂNG LƯỢNG BỀN VỮNG (VN)**

16/21 Đặng Văn Ngữ, phường 10, quận Phú Nhuận, thành phố Hồ Chí Minh

(72) Ngô Văn Minh (VN)

(55)

(28) 1

(51) **13-01**

(43) 27/11/2023



1.1



1.2



1.3

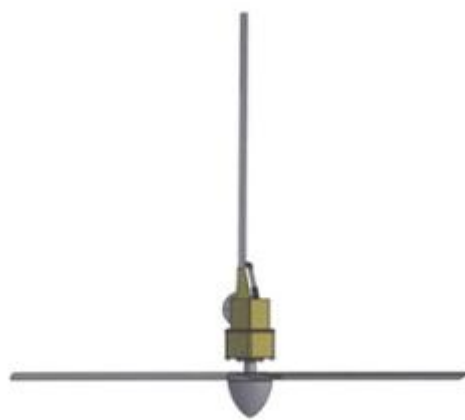

1.4



1.5

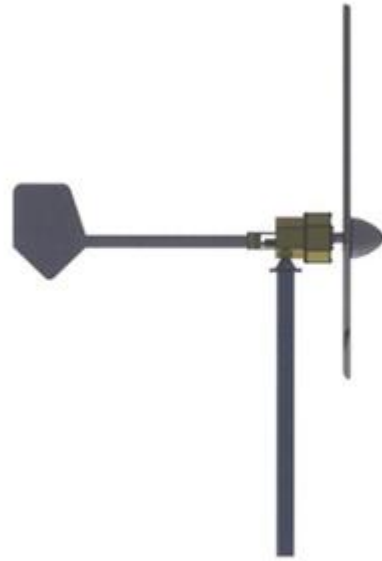

1.6

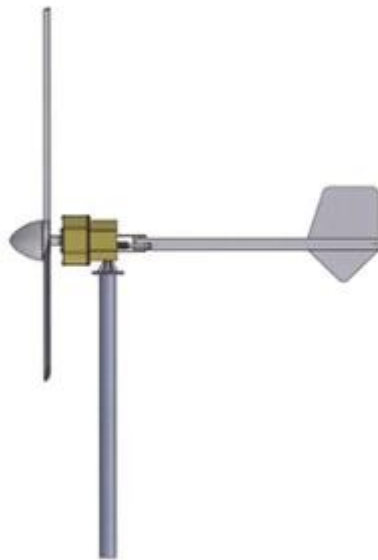

1.7

- (11) **48366**
(21) 3-2022-02718 (28) 1
(54) **GUỒN GẶT CỦA MÁY GẶT ĐẬP LIÊN HỢP** (51) **15-03**
(22) 13/12/2022 (43) 27/11/2023
(30) 2022-019513 12/09/2022 JP;
(73) **KUBOTA CORPORATION (JP)**
2-47, Shikitsuhigashi 1-chome, Naniwa-ku, Osaka-shi, Osaka 5568601, Japan
(72) 1. YOSHIAKI INOUE (JP)
2. KENTA KAMAKURA (JP)
(74) Công ty TNHH một thành viên Sở hữu trí tuệ VCCI (VCCI-IP CO.,LTD)
(55)

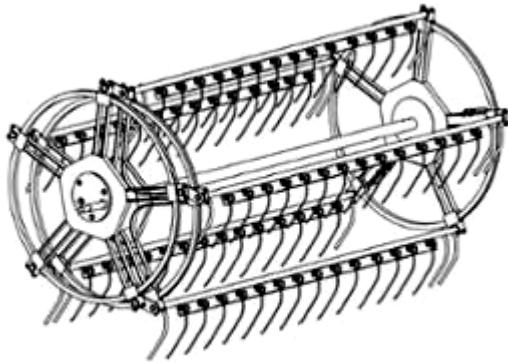

1.1



1.2

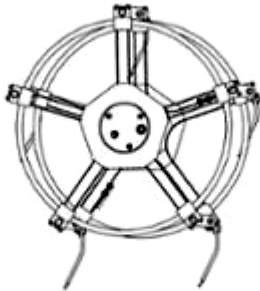

1.3

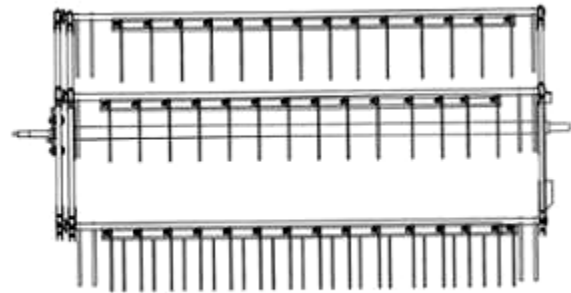

1.4

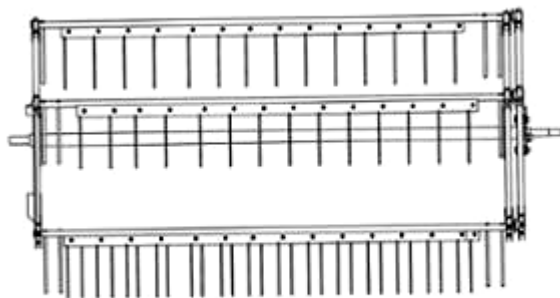

1.5

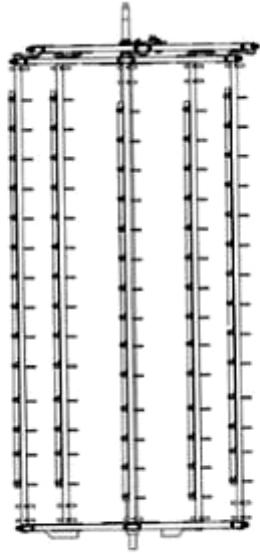

1.6

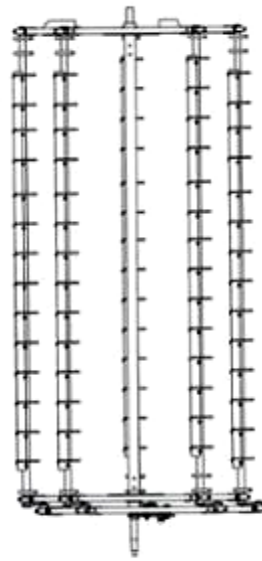

1.7

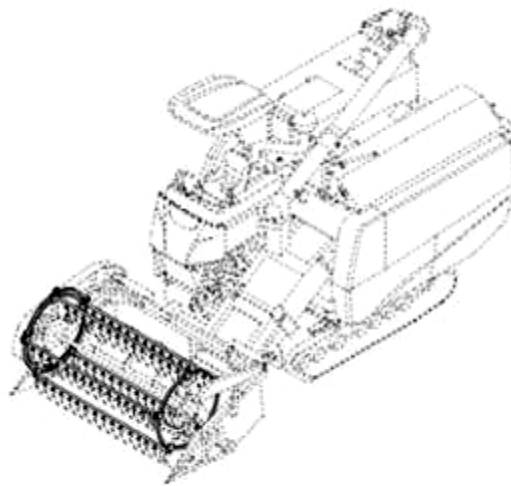

1.8

CÔNG BÁO SỞ HỮU CÔNG NGHIỆP SỐ 428 TẬP A – QUYỀN 2 (11.2023)

- (11) **48367**
(21) 3-2022-02764 (28) 1
(54) **TƯỢNG TRANG TRÍ** (51) **11-02**
(22) 16/12/2022 (43) 27/11/2023
(73) **CÔNG TY TNHH SYBSY (VN)**
18bis/22 Nguyễn Thị Minh Khai, phường Đa Kao, quận 1, thành phố Hồ Chí Minh
(72) Nguyễn Thị Thu Hòa (VN)
(55)



1.1



1.2



1.3



1.4



1.5



1.6



1.7

CÔNG BÁO SỞ HỮU CÔNG NGHIỆP SỐ 428 TẬP A – QUYỀN 2 (11.2023)

- (11) **48368**
(21) 3-2022-02774 (28) 1
(54) **THIẾT BỊ KIỂM SOÁT RA VÀO** (51) **14-02**
(22) 16/12/2022 (43) 27/11/2023
(73) **CÔNG TY CỔ PHẦN MK VISION (VN)**
Lô C-1B, khu công nghiệp Thăng Long Vĩnh Phúc, xã Thiện Kê, huyện Bình Xuyên, tỉnh Vĩnh Phúc
(72) Nguyễn Trọng Khang (VN)
(74) Công ty TNHH Sở hữu trí tuệ PADEMARK (PADEMARK CO.,LTD.)
(55)



1.1

1.2

1.3

1.4

1.5



1.6



1.7

CÔNG BÁO SỞ HỮU CÔNG NGHIỆP SỐ 428 TẬP A – QUYỀN 2 (11.2023)

- (11) **48369**
(21) 3-2022-02801 (28) 1
(54) **BỘ CHUYỂN ĐỔI** (51) **25-01**
(22) 20/12/2022 (43) 27/11/2023
(73) **CÔNG TY CỔ PHẦN CAD GROUP (VN)**
Số 8 ngõ 81, phố Trạm, phường Long Biên, quận Long Biên, thành phố Hà Nội
(72) Lâm Việt An (VN)
(74) Công ty TNHH Sở hữu trí tuệ Gia Việt (GIAVIET CO., LTD.)
(55)



1.1

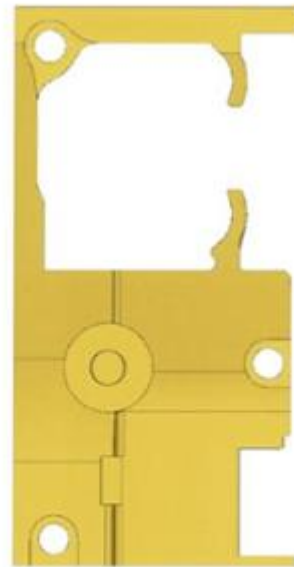

1.2

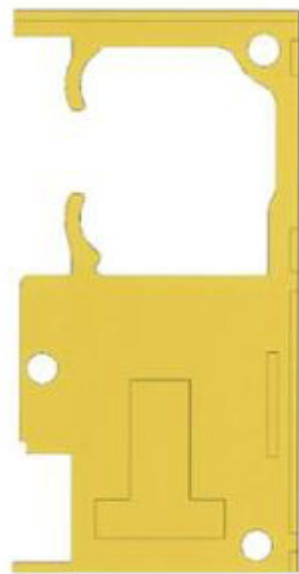

1.3



1.4



1.5



1.6



1.7

CÔNG BÁO SỞ HỮU CÔNG NGHIỆP SỐ 428 TẬP A – QUYỀN 2 (11.2023)

- (11) **48370**
(21) 3-2022-02802 (28) 1
(54) **BỘ CHUYỂN ĐỔI** (51) **25-01**
(22) 20/12/2022 (43) 27/11/2023
(73) **CÔNG TY CỔ PHẦN CAD GROUP (VN)**
Số 8 ngõ 81, phố Trạm, phường Long Biên, quận Long Biên, thành phố Hà Nội
(72) Lâm Viết An (VN)
(74) Công ty TNHH Sở hữu trí tuệ Gia Việt (GIAVIET CO., LTD.)
(55)

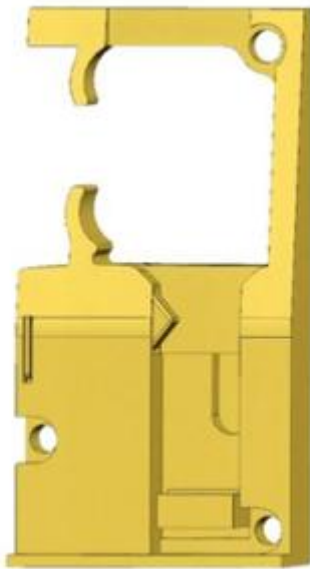

1.1

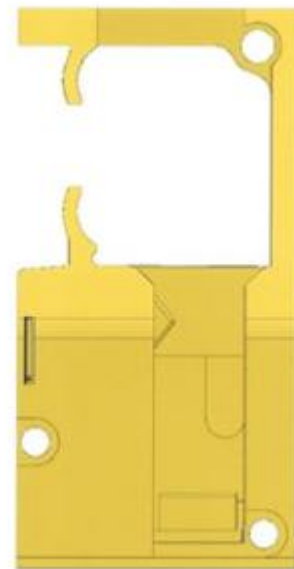

1.2

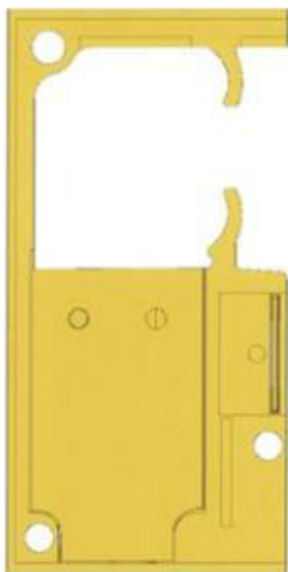

1.3

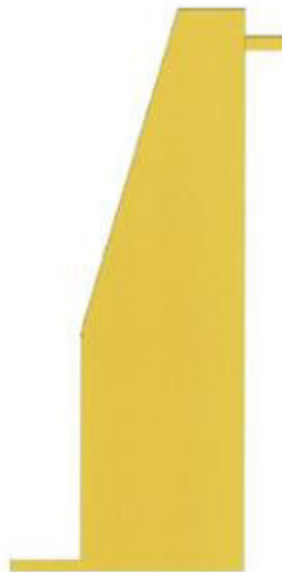

1.4



1.5

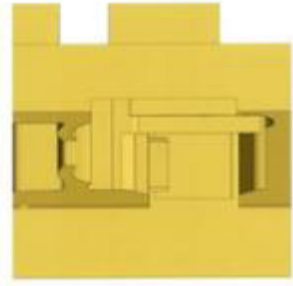

1.6



1.7

CÔNG BÁO SỞ HỮU CÔNG NGHIỆP SỐ 428 TẬP A – QUYỀN 2 (11.2023)

(11) **48371**

(21) 3-2022-02824

(28) 1

(54) **NẤP**

(51) **07-02**

(22) 21/12/2022

(43) 27/11/2023

(73) **CÔNG TY TNHH MINH LONG I (VN)**

333 Đường Hưng Định 24, khu phố Hưng Lộc, phường Hưng Định, thành phố Thuận An, tỉnh Bình Dương

(72) Lý Ngọc Minh (VN)

(55)



1.1



1.2



1.3



1.4



1.5



1.6



1.7

CÔNG BÁO SỞ HỮU CÔNG NGHIỆP SỐ 428 TẬP A – QUYỀN 2 (11.2023)

- (11) **48372**
(21) 3-2022-02835 (28) 1
(54) **TẮM ỐP PHÍA TRƯỚC XE MÁY** (51) **12-16**
(22) 23/12/2022 (43) 27/11/2023
(30) 2022-014232 01/07/2022 JP;
(73) **HONDA MOTOR CO., LTD. (JP)**
1-1, Minami-Aoyama 2-Chome, Minato-ku, Tokyo, 107-8556 Japan
(72) 1. ISANA SUZUKI (JP)
2. ASATO KATO (JP)
(74) Công ty Luật TNHH Phạm và Liên danh (PHAM & ASSOCIATES)
(55)



1.1



1.2



1.3



1.4



1.5



1.6



1.7



1.8



1.9

CÔNG BÁO SỞ HỮU CÔNG NGHIỆP SỐ 428 TẬP A – QUYỀN 2 (11.2023)

- (11) **48373**
(21) 3-2022-02884 (28) 1
(54) **LÒ ĐỐT CHẤT THẢI CÔNG NGHIỆP** (51) **23-99**
(22) 26/12/2022 (43) 27/11/2023
(30) 2022-026069 02/12/2022 JP;
(73) **SEC ELEVATOR CO., LTD. (JP)**
3-18-3 Taito, Taito-ku, Tokyo JAPAN 1100016
(72) Takao SUZUKI (JP)
(74) Công ty TNHH Trà và cộng sự (TRA & ASSOCIATES CO.,LTD)
(55)

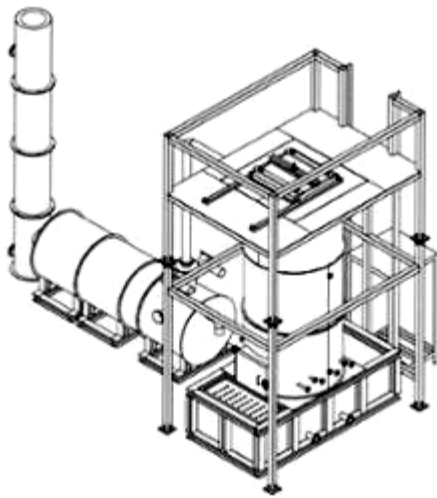

1.1

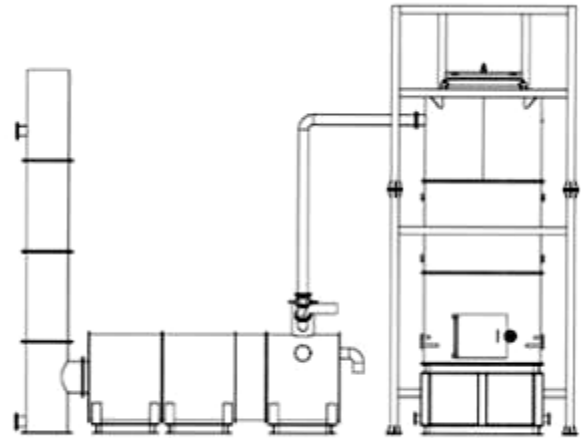

1.2

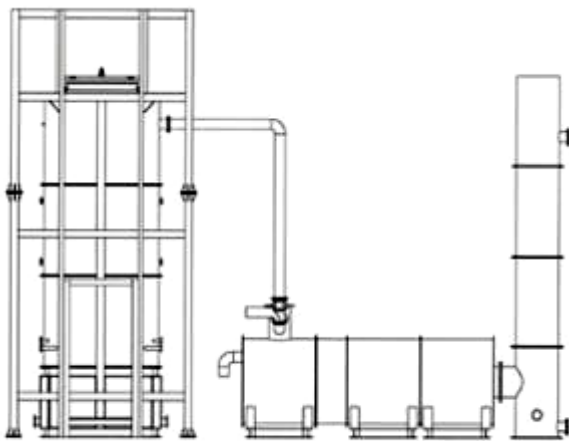

1.3

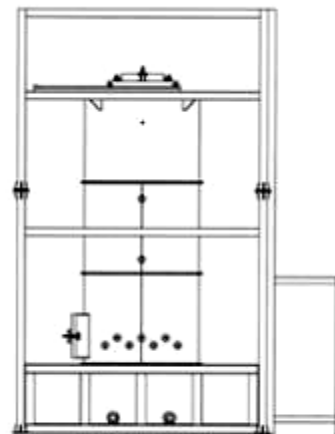

1.4

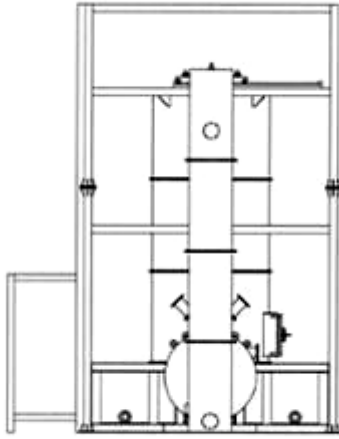

1.5

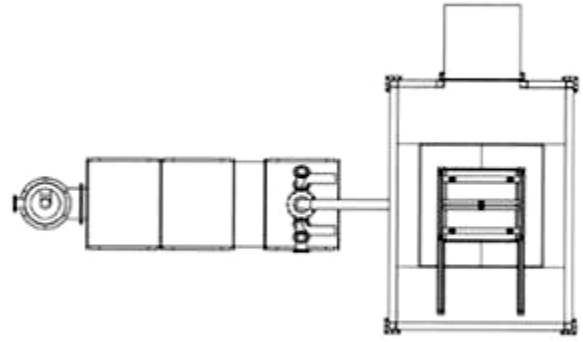

1.6

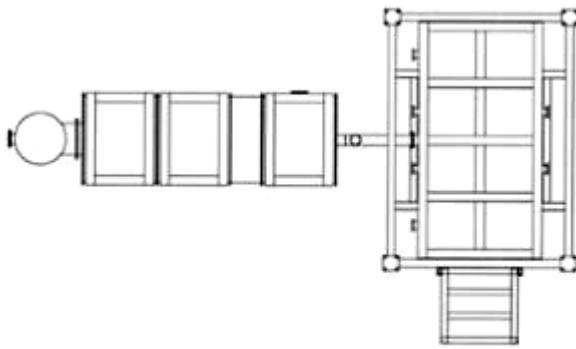

1.7

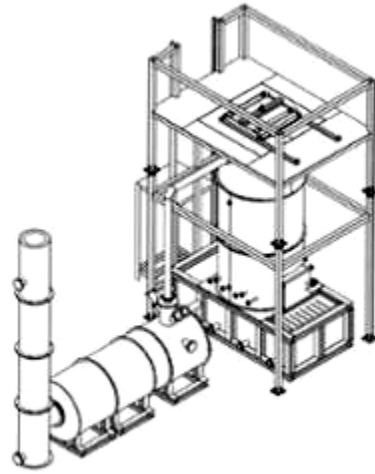

1.8

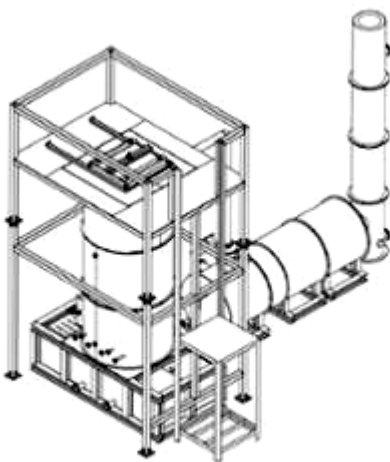

1.9

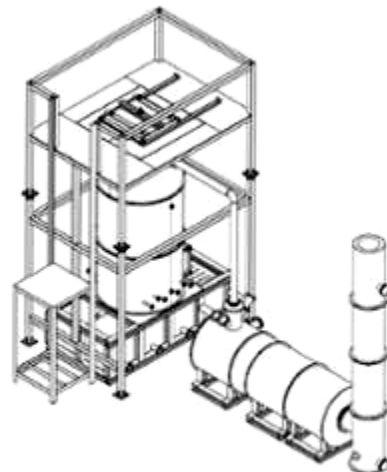

1.10

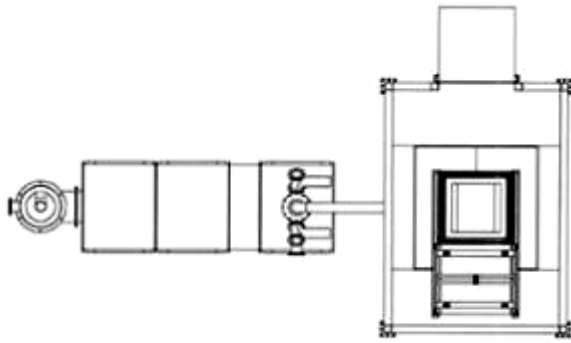

1.11

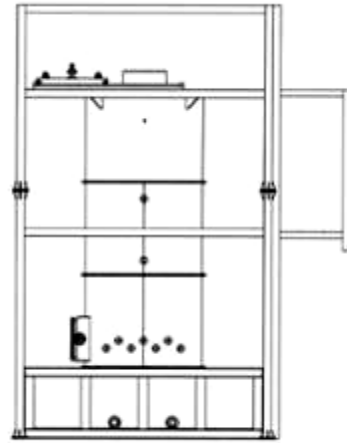

1.12

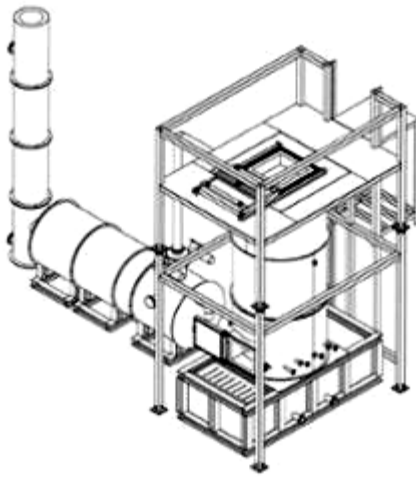

1.13

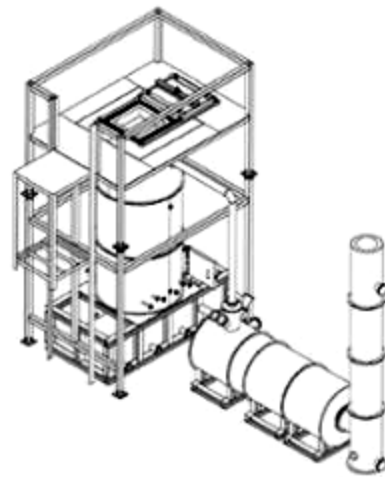

1.14

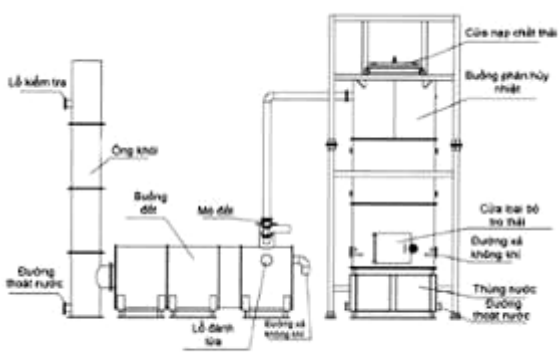

1.15

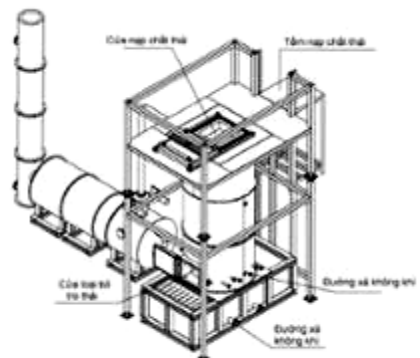

1.16

- (11) **48374**
(21) 3-2022-02917 (28) 1
(54) **VỎ THIẾT BỊ ĐIỆN TỬ DI ĐỘNG** (51) **03-01; 14-03**
(22) 28/12/2022 (43) 27/11/2023
(30) 29/844,384 28/06/2022 US;
(73) **ANNEX PRODUCTS PTY. LTD. (AU)**
299 Toorak Rd., Suite 6A Level 3, South Yarra, VIC 3141, Australia
(72) 1. PETERS, CHRISTOPHER L. (AU)
2. SEBASTIANI, MARCO (AU)
(74) Công ty TNHH một thành viên Sở hữu trí tuệ VCCI (VCCI-IP CO.,LTD)
(55)

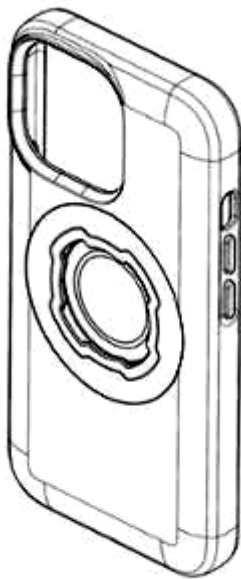

1.1

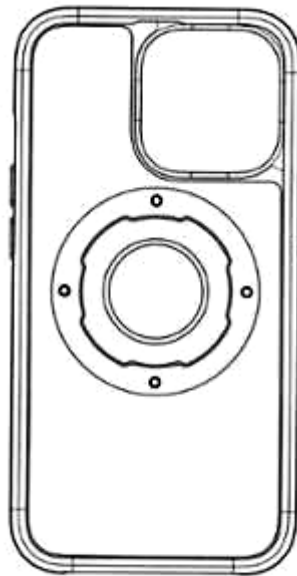

1.2

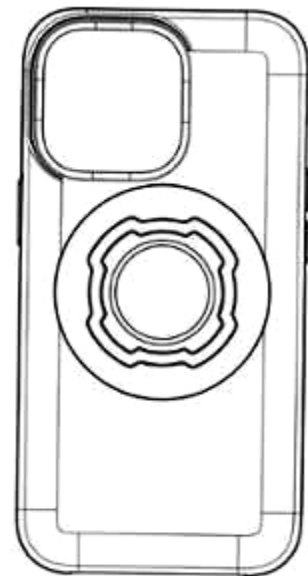

1.3



1.4



1.5



1.6



1.7

CÔNG BÁO SỞ HỮU CÔNG NGHIỆP SỐ 428 TẬP A – QUYỀN 2 (11.2023)

- (11) **48375**
(21) 3-2022-02918 (28) 1
(54) **ĐẦU GẮN ĐIỆN THOẠI** (51) **14-99**
(22) 28/12/2022 (43) 27/11/2023
(30) 29/844,388 28/06/2022 US;
(73) **ANNEX PRODUCTS PTY. LTD. (AU)**
299 Toorak Rd., Suite 6A Level 3, South Yarra, VIC 3141, Australia
(72) 1. PETERS, CHRISTOPHER L. (AU)
2. SEBASTIANI, MARCO (AU)
3. RYAN, LEIGH M. (AU)
(74) Công ty TNHH một thành viên Sở hữu trí tuệ VCCI (VCCI-IP CO.,LTD)
(55)

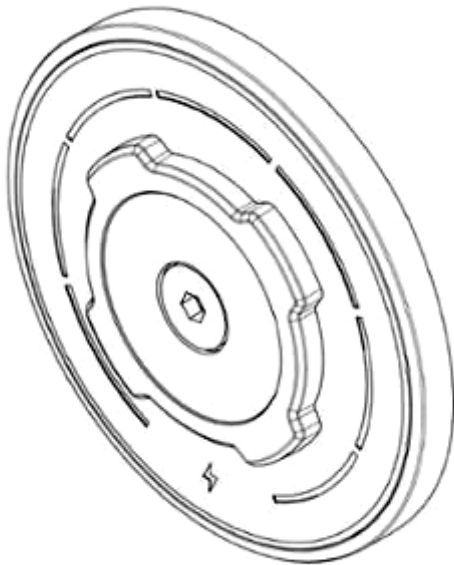

1.1

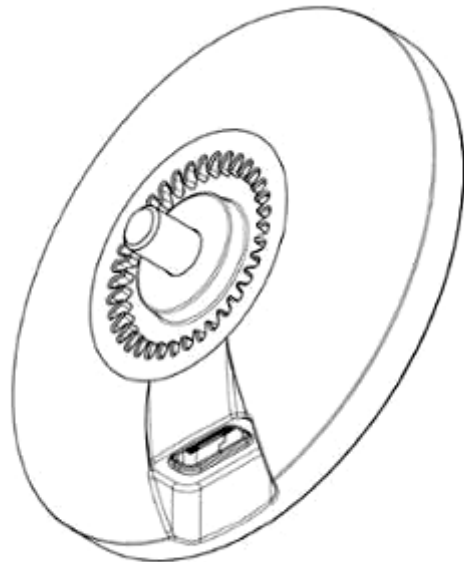

1.2



1.3

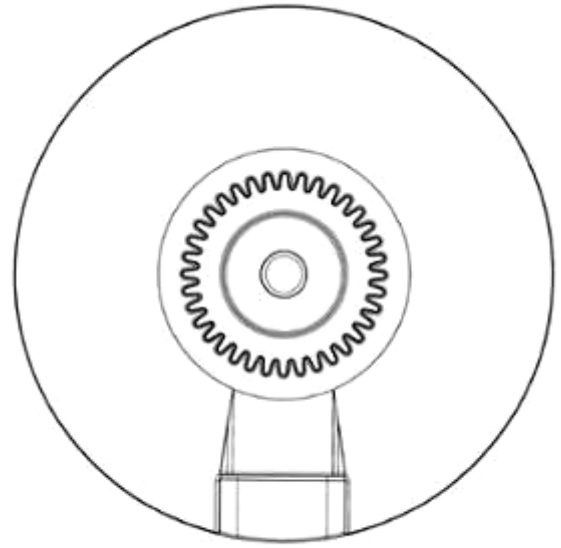

1.4

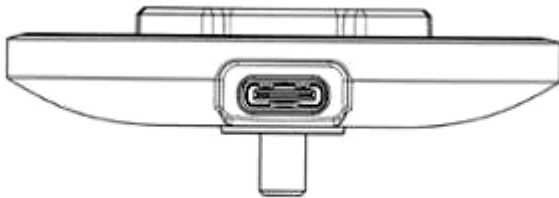

1.5

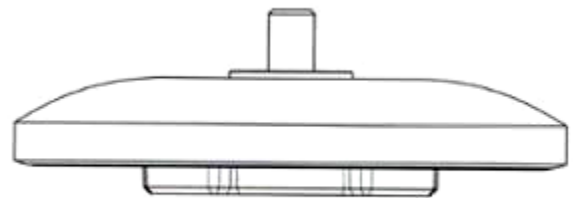

1.6

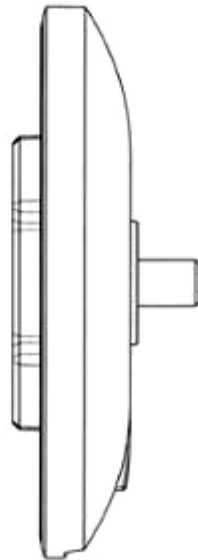

1.7

CÔNG BÁO SỞ HỮU CÔNG NGHIỆP SỐ 428 TẬP A – QUYỀN 2 (11.2023)

- (11) **48376**
(21) 3-2022-02920 (28) 1
(54) **GIÁ ĐỠ THIẾT BỊ ĐIỆN TỬ DI ĐỘNG** (51) **14-99**
(22) 28/12/2022 (43) 27/11/2023
(30) 29/844,507 29/06/2022 US;
(73) **ANNEX PRODUCTS PTY. LTD. (AU)**
299 Toorak Rd., Suite 6A Level 3, South Yarra, VIC 3141, Australia
(72) 1. RYAN, LEIGH M. (AU)
2. SEBASTIANI, MARCO (AU)
3. PETERS, CHRISTOPHER L. (AU)
(74) Công ty TNHH một thành viên Sở hữu trí tuệ VCCI (VCCI-IP CO.,LTD)
(55)

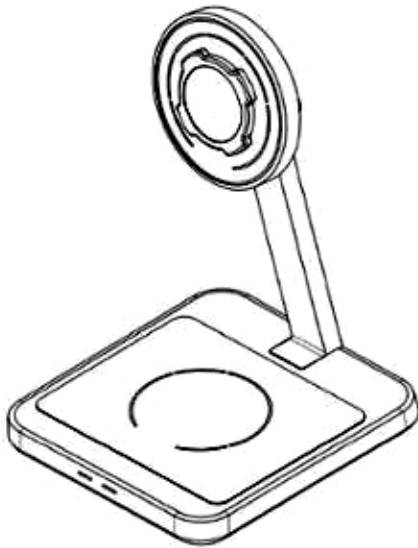

1.1

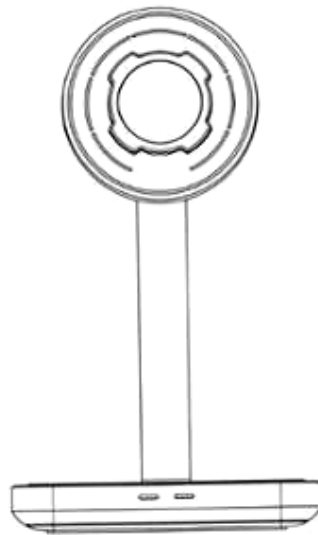

1.2

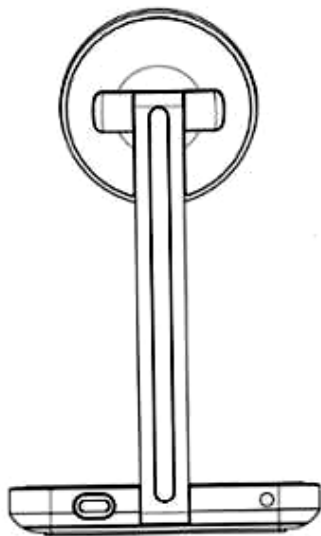

1.3

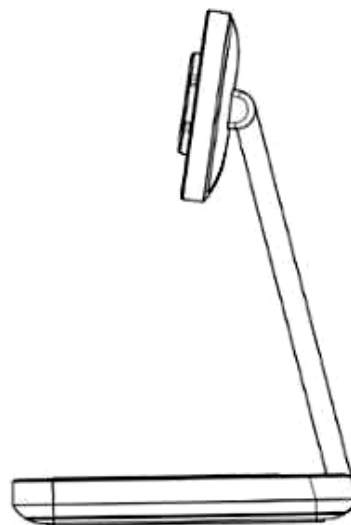

1.4

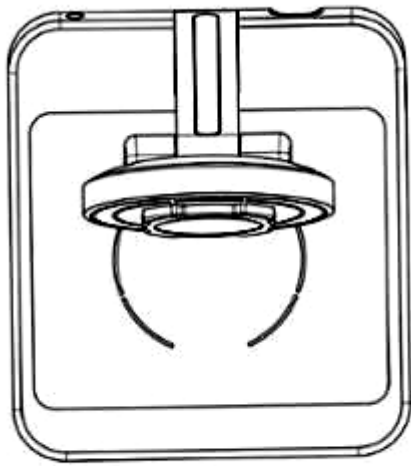

1.5

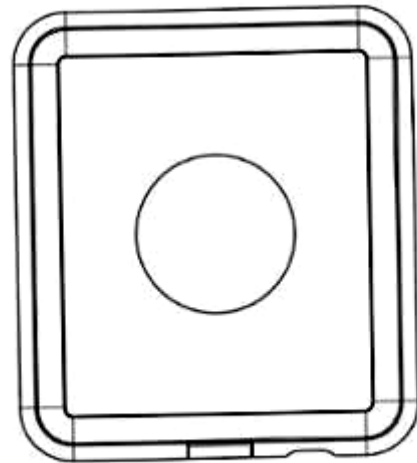

1.6

CÔNG BÁO SỞ HỮU CÔNG NGHIỆP SỐ 428 TẬP A – QUYỀN 2 (11.2023)

- (11) **48377**
(21) 3-2022-02921 (28) 1
(54) **GIÁ ĐỠ ĐIỆN THOẠI** (51) **14-99**
(22) 28/12/2022 (43) 27/11/2023
(30) 29/844,391 28/06/2022 US;
(73) **ANNEX PRODUCTS PTY. LTD. (AU)**
299 Toorak Rd., Suite 6A Level 3, South Yarra, VIC 3141, Australia
(72) 1. PARAB, NISH (AU)
2. PETERS, CHRISTOPHER L. (AU)
3. RYAN, LEIGH M. (AU)
(74) Công ty TNHH một thành viên Sở hữu trí tuệ VCCI (VCCI-IP CO.,LTD)
(55)

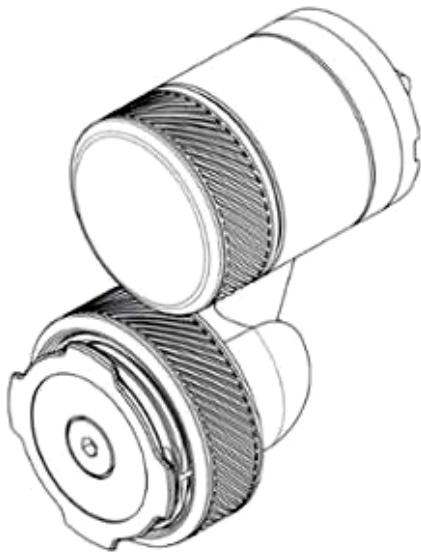

1.1

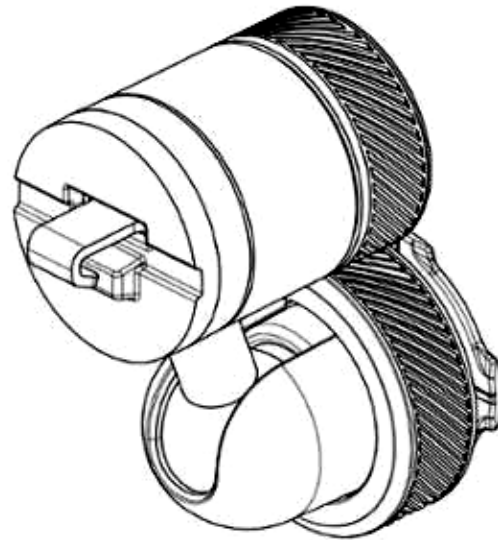

1.2

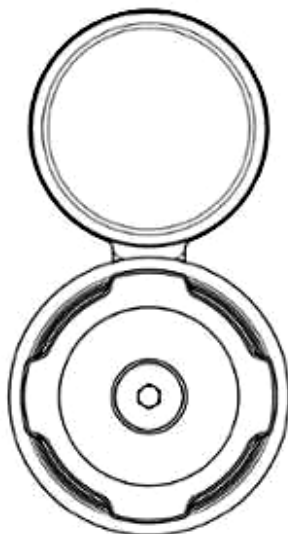

1.3

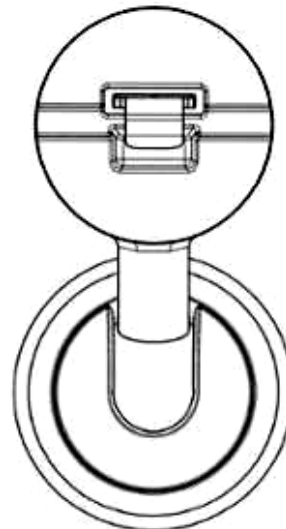

1.4

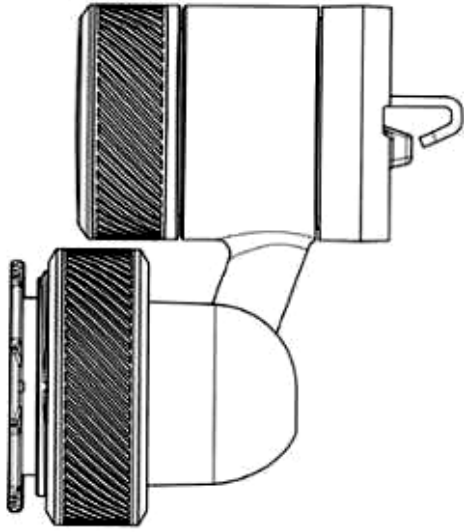

1.5

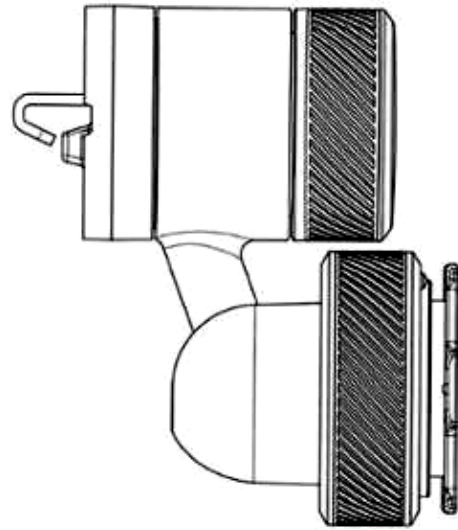

1.6

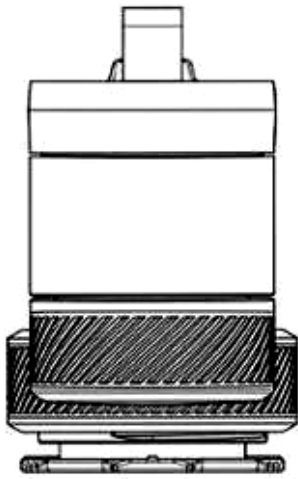

1.7

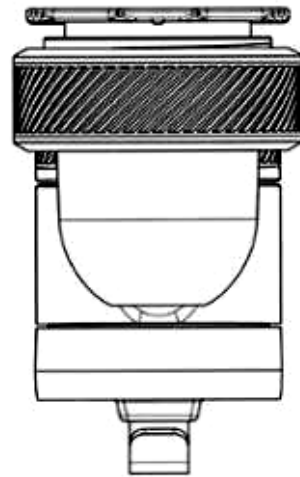

1.8

- (11) **48378**
(21) 3-2022-02922 (28) 1
(54) **GIÁ ĐỠ ĐIỆN THOẠI** (51) **14-99**
(22) 28/12/2022 (43) 27/11/2023
(30) 29/844,395 28/06/2022 US;
(73) **ANNEX PRODUCTS PTY. LTD. (AU)**
299 Toorak Rd., Suite 6A Level 3, South Yarra, VIC 3141, Australia
(72) 1. PARAB, NISH (AU)
2. PETERS, CHRISTOPHER L. (AU)
3. RYAN, LEIGH M. (AU)
(74) Công ty TNHH một thành viên Sở hữu trí tuệ VCCI (VCCI-IP CO.,LTD)
(55)

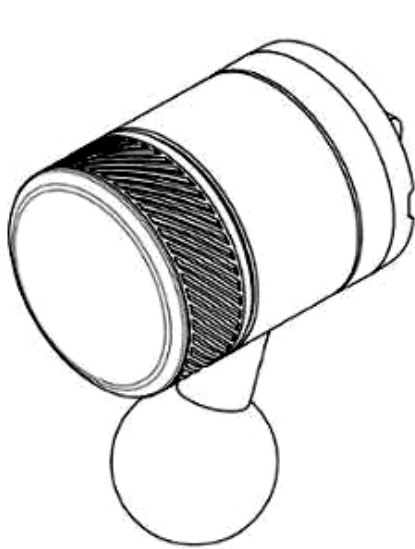

1.1

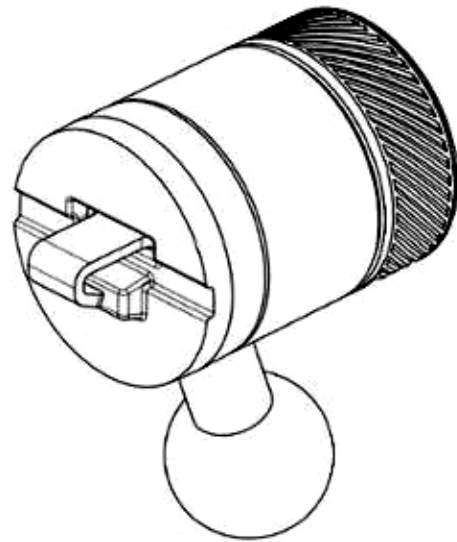

1.2

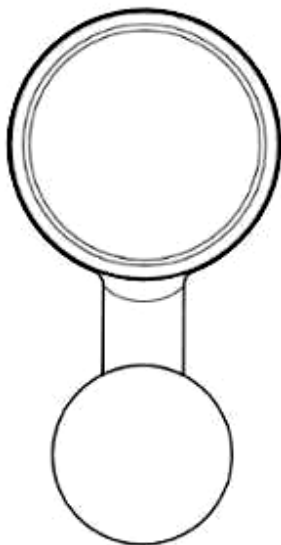

1.3

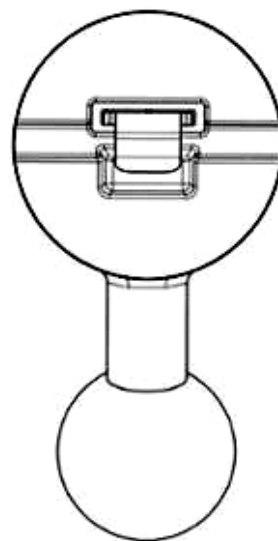

1.4

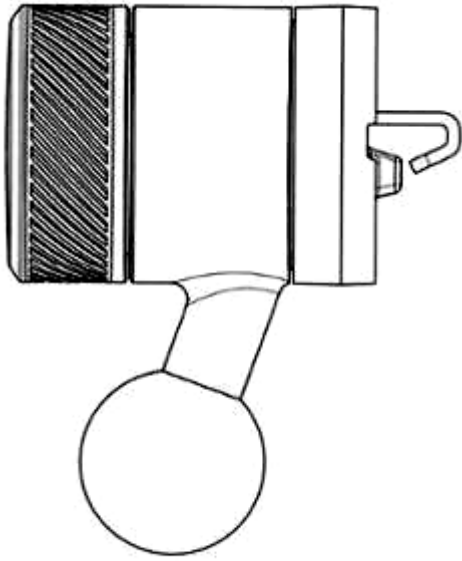

1.5

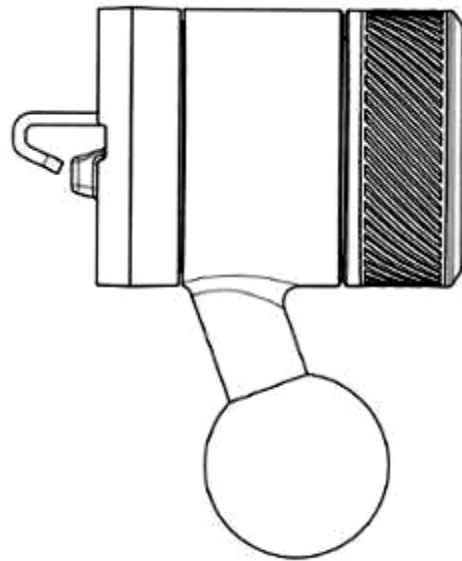

1.6

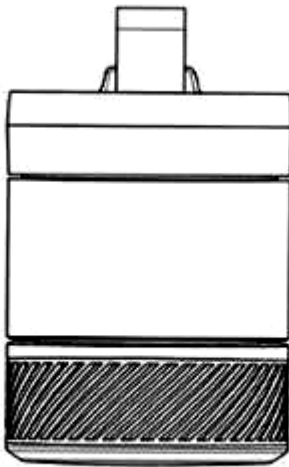

1.7



1.8

CÔNG BÁO SỞ HỮU CÔNG NGHIỆP SỐ 428 TẬP A – QUYỀN 2 (11.2023)

(11) **48379**

(21) 3-2022-02958

(28) 1

(54) **XE MÁY**

(51) **12-11**

(22) 29/12/2022

(43) 27/11/2023

(73) **AEON MOTOR CO., LTD. (TW)**

No. 41, Nan Jou, Nanjou Tsuen, Shanshang Dist., Tainan City, Taiwan

(72) CHUNG, Chieh-Lin (TW)

(74) Công ty TNHH Sáng chế ACTIP (ACTIP PATENT LIMITED)

(55)



1.1

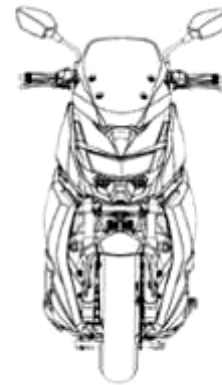

1.2

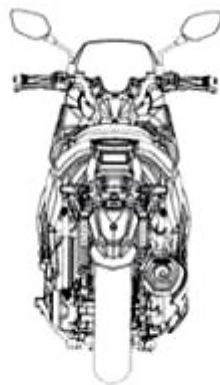

1.3

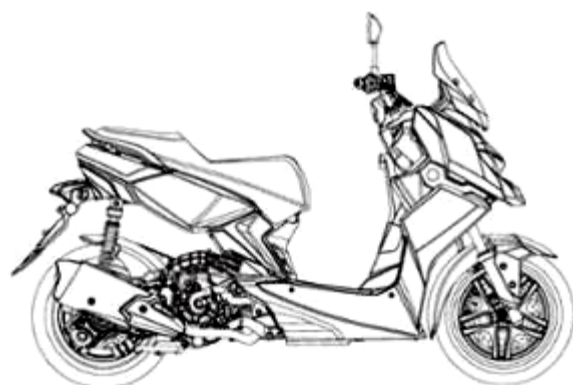

1.4

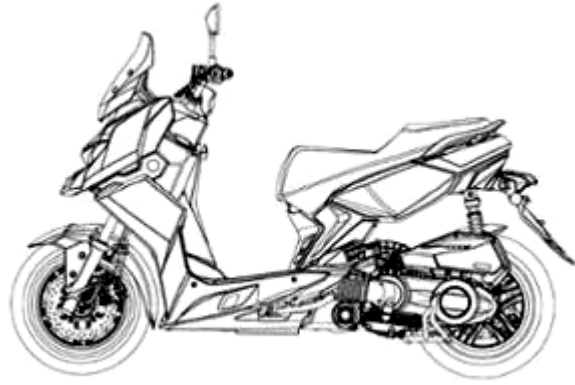

1.5

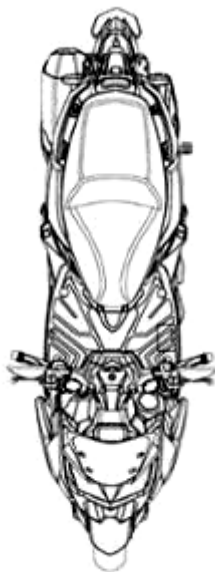

1.6

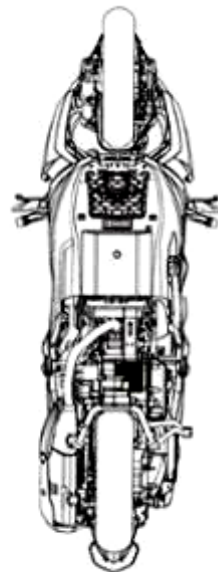

1.7

CÔNG BÁO SỞ HỮU CÔNG NGHIỆP SỐ 428 TẬP A – QUYỀN 2 (11.2023)

- (11) **48380**
- (21) 3-2022-02975 (28) 1
- (54) **VỎ THIẾT BỊ THU PHÁT VÔ TUYẾN** (51) **14-03**
- (22) 30/12/2022 (43) 27/11/2023
- (73) **TẬP ĐOÀN CÔNG NGHIỆP - VIỄN THÔNG QUÂN ĐỘI (VN)**
Lô D26 khu đô thị mới Cầu Giấy, phường Yên Hoà, quận Cầu Giấy, thành phố Hà Nội
- (72) 1. NGUYỄN CÔNG CHIÊU (VN)
2. TRẦN VĂN HƯỞNG (VN)
3. NGUYỄN QUANG MẠNH (VN)
4. NGUYỄN HUY HOÀNG (VN)
- (74) Công ty TNHH NACILAW (NACILAW)
- (55)



1.1



1.2



1.3



1.4



1.5



1.6



1.7



1.8

- (11) **48381**
(21) 3-2023-00060 (28) 2
(54) **BĂNG XÓA KÉO** (51) **19-02**
(22) 06/01/2023 (43) 27/11/2023
(30) 2022-016195 28/07/2022 JP; 2022-016194 28/07/2022 JP;
(73) **KOKUYO CO., LTD.** (JP)
1-1, Oimazato-minami 6-chome, Higashinari-ku, Osaka-shi, Osaka, Japan
(72) 1. HISASHI YAMAMOTO (JP)
2. SHU WAGATSUMA (JP)
3. HIDETO SHIMA (JP)
(74) Công ty TNHH Sở hữu trí tuệ HA VIP (HAVIP CO., LTD.)
(55)

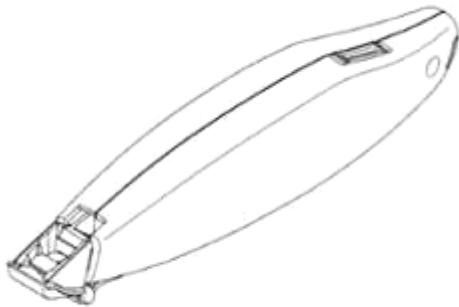

1.1



1.2

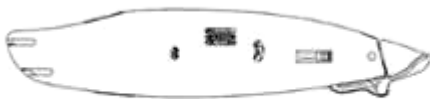

1.3

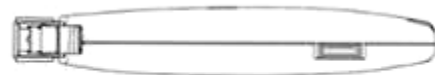

1.4



1.5



1.6



1.7

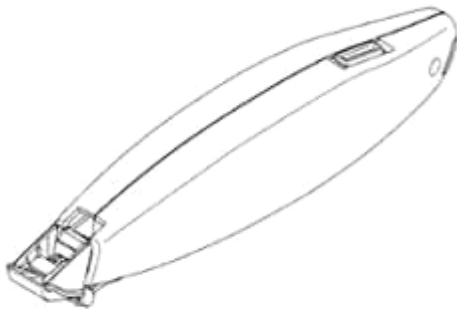

2.1



2.2



2.3

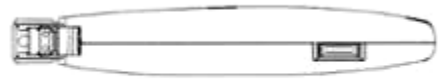

2.4

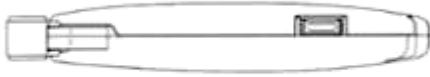

2.5



2.6



2.7

CÔNG BÁO SỞ HỮU CÔNG NGHIỆP SỐ 428 TẬP A – QUYỀN 2 (11.2023)

- (11) **48382**
(21) 3-2023-00153 (28) 1
(54) **GHẾ** (51) **06-01**
(22) 17/01/2023 (43) 27/11/2023
(73) **CÔNG TY TNHH SẢN XUẤT THƯƠNG MẠI LỢI HÀO VIỆT NAM (VN)**
Lô J3, đường N4, khu công nghiệp Nam Tân Uyên Mở Rộng, phường Hội Nghĩa,
thành phố Tân Uyên, tỉnh Bình Dương
(72) TSOI TUNG LEUNG TORO (CN)
(74) **CÔNG TY LUẬT TNHH KHÔI NGỌC (KHOI NGOC LAW COMPANY LTD)**
(55)



1.1



1.2



1.3



1.4



1.5



1.6



1.7

CÔNG BÁO SỞ HỮU CÔNG NGHIỆP SỐ 428 TẬP A – QUYỀN 2 (11.2023)

- (11) **48383**
(21) 3-2023-00154 (28) 1
(54) **GHẾ** (51) **06-01**
(22) 17/01/2023 (43) 27/11/2023
(73) **CÔNG TY TNHH SẢN XUẤT THƯƠNG MẠI LỢI HÀO VIỆT NAM (VN)**
Lô J3, đường N4, khu công nghiệp Nam Tân Uyên Mở Rộng, phường Hội Nghĩa,
thành phố Tân Uyên, tỉnh Bình Dương
(72) TSOI TUNG LEUNG TORO (CN)
(74) **CÔNG TY LUẬT TNHH KHÔI NGỌC (KHOI NGOC LAW COMPANY LTD)**
(55)



1.1

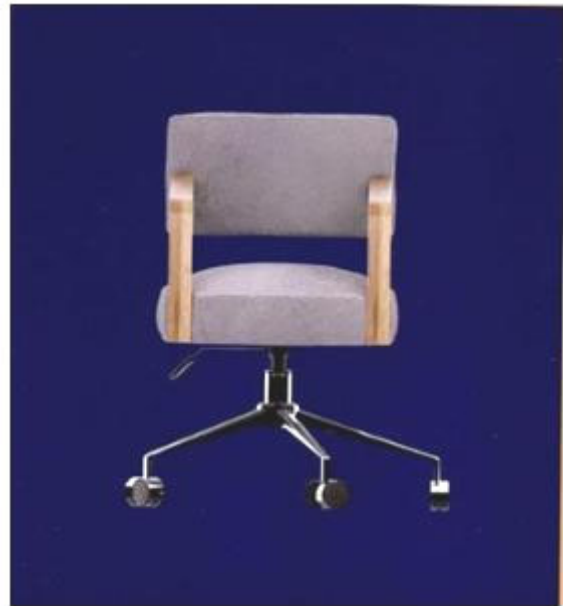

1.2



1.3



1.4



1.5



1.6

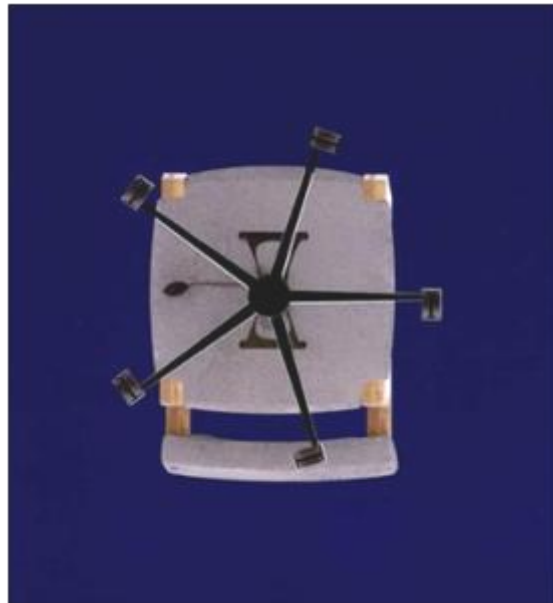

1.7

CÔNG BÁO SỞ HỮU CÔNG NGHIỆP SỐ 428 TẬP A – QUYỀN 2 (11.2023)

- (11) **48384**
(21) 3-2023-00155 (28) 1
(54) **GHẾ** (51) **06-01**
(22) 17/01/2023 (43) 27/11/2023
(73) **CÔNG TY TNHH SẢN XUẤT THƯƠNG MẠI LỢI HÀO VIỆT NAM (VN)**
Lô J3, đường N4, khu công nghiệp Nam Tân Uyên Mở Rộng, phường Hội Nghĩa,
thành phố Tân Uyên, tỉnh Bình Dương
(72) TSOI TUNG LEUNG TORO (CN)
(74) **CÔNG TY LUẬT TNHH KHÔI NGỌC (KHOI NGOC LAW COMPANY LTD)**
(55)



1.1



1.2



1.3



1.4



1.5



1.6



1.7

CÔNG BÁO SỞ HỮU CÔNG NGHIỆP SỐ 428 TẬP A – QUYỀN 2 (11.2023)

- (11) **48385**
(21) 3-2023-00156 (28) 1
(54) **GHẾ** (51) **06-01**
(22) 17/01/2023 (43) 27/11/2023
(73) **CÔNG TY TNHH SẢN XUẤT THƯƠNG MẠI LỢI HÀO VIỆT NAM (VN)**
Lô J3, đường N4, khu công nghiệp Nam Tân Uyên Mở Rộng, phường Hội Nghĩa,
thành phố Tân Uyên, tỉnh Bình Dương
(72) TSOI TUNG LEUNG TORO (CN)
(74) **CÔNG TY LUẬT TNHH KHÔI NGỌC (KHOI NGOC LAW COMPANY LTD)**
(55)



1.1



1.2



1.3



1.4



1.5



1.6

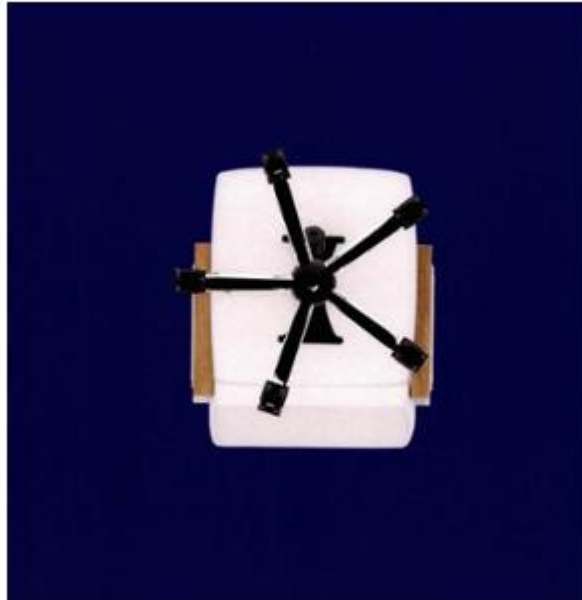

1.7

CÔNG BÁO SỞ HỮU CÔNG NGHIỆP SỐ 428 TẬP A – QUYỀN 2 (11.2023)

- (11) **48386**
(21) 3-2023-00157 (28) 1
(54) **GHẾ** (51) **06-01**
(22) 17/01/2023 (43) 27/11/2023
(73) **CÔNG TY TNHH SẢN XUẤT THƯƠNG MẠI LỢI HÀO VIỆT NAM (VN)**
Lô J3, đường N4, khu công nghiệp Nam Tân Uyên Mở Rộng, phường Hội Nghĩa,
thành phố Tân Uyên, tỉnh Bình Dương
(72) TSOI TUNG LEUNG TORO (CN)
(74) **CÔNG TY LUẬT TNHH KHÔI NGỌC (KHOI NGOC LAW COMPANY LTD)**
(55)



1.1



1.2



1.3



1.4



1.5



1.6



1.7

CÔNG BÁO SỞ HỮU CÔNG NGHIỆP SỐ 428 TẬP A – QUYỀN 2 (11.2023)

- (11) **48387**
(21) 3-2023-00158 (28) 1
(54) **GHẾ** (51) **06-01**
(22) 17/01/2023 (43) 27/11/2023
(73) **CÔNG TY TNHH SẢN XUẤT THƯƠNG MẠI LỢI HÀO VIỆT NAM (VN)**
Lô J3, đường N4, khu công nghiệp Nam Tân Uyên Mở Rộng, phường Hội Nghĩa,
thành phố Tân Uyên, tỉnh Bình Dương
(72) TSOI TUNG LEUNG TORO (CN)
(74) **CÔNG TY LUẬT TNHH KHÔI NGỌC (KHOI NGOC LAW COMPANY LTD)**
(55)



1.1

1.2

1.3



1.4

1.5



1.6



1.7

CÔNG BÁO SỞ HỮU CÔNG NGHIỆP SỐ 428 TẬP A – QUYỀN 2 (11.2023)

- (11) **48388**
(21) 3-2023-00159 (28) 1
(54) **GHẾ** (51) **06-01**
(22) 17/01/2023 (43) 27/11/2023
(73) **CÔNG TY TNHH SẢN XUẤT THƯƠNG MẠI LỢI HÀO VIỆT NAM (VN)**
Lô J3, đường N4, khu công nghiệp Nam Tân Uyên Mở Rộng, phường Hội Nghĩa,
thành phố Tân Uyên, tỉnh Bình Dương
(72) TSOI TUNG LEUNG TORO (CN)
(74) **CÔNG TY LUẬT TNHH KHÔI NGỌC (KHOI NGOC LAW COMPANY LTD)**
(55)



1.1



1.2



1.3



1.4



1.5



1.6



1.7

CÔNG BÁO SỞ HỮU CÔNG NGHIỆP SỐ 428 TẬP A – QUYỀN 2 (11.2023)

- (11) **48389**
(21) 3-2023-00160 (28) 1
(54) **GHẾ** (51) **06-01**
(22) 17/01/2023 (43) 27/11/2023
(73) **CÔNG TY TNHH SẢN XUẤT THƯƠNG MẠI LỢI HÀO VIỆT NAM (VN)**
Lô J3, đường N4, khu công nghiệp Nam Tân Uyên Mở Rộng, phường Hội Nghĩa,
thành phố Tân Uyên, tỉnh Bình Dương
(72) TSOI TUNG LEUNG TORO (CN)
(74) **CÔNG TY LUẬT TNHH KHÔI NGỌC (KHOI NGOC LAW COMPANY LTD)**
(55)



1.1

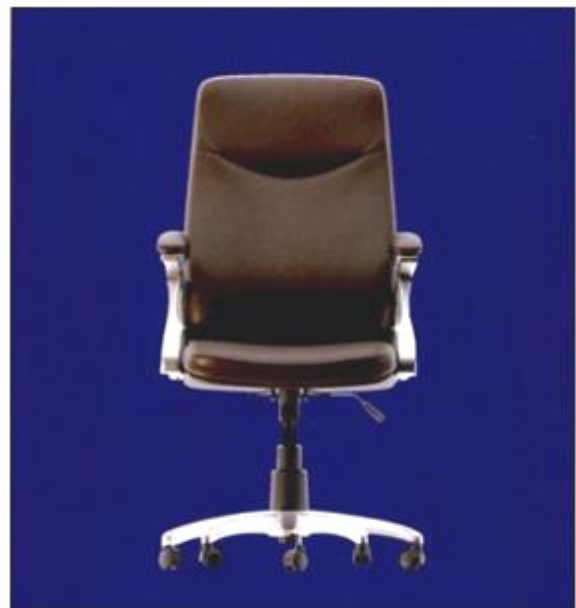

1.2



1.3



1.4



1.5



1.6



1.7

CÔNG BÁO SỞ HỮU CÔNG NGHIỆP SỐ 428 TẬP A – QUYỀN 2 (11.2023)

- (11) **48390**
(21) 3-2023-00161 (28) 1
(54) **GHẾ** (51) **06-01**
(22) 17/01/2023 (43) 27/11/2023
(73) **CÔNG TY TNHH SẢN XUẤT THƯƠNG MẠI LỢI HÀO VIỆT NAM (VN)**
Lô J3, đường N4, khu công nghiệp Nam Tân Uyên Mở Rộng, phường Hội Nghĩa,
thành phố Tân Uyên, tỉnh Bình Dương
(72) TSOI TUNG LEUNG TORO (CN)
(74) **CÔNG TY LUẬT TNHH KHÔI NGỌC (KHOI NGOC LAW COMPANY LTD)**
(55)



1.1



1.2



1.3



1.4



1.5



1.6



1.7

CÔNG BÁO SỞ HỮU CÔNG NGHIỆP SỐ 428 TẬP A – QUYỀN 2 (11.2023)

- (11) **48391**
(21) 3-2023-00233 (28) 1
(54) **TỦ LẠNH** (51) **15-07**
(22) 01/02/2023 (43) 27/11/2023
(30) 2022-020685 28/09/2022 JP;
(73) **MITSUBISHI ELECTRIC CORPORATION (JP)**
7-3, Marunouchi 2-chome, Chiyoda-ku, Tokyo 100-8310, Japan
(72) 1. MISAKO OHASHI (JP)
2. TAKANORI HIKIMA (JP)
(74) Công ty TNHH Tâm nhìn và Liên danh (VISION & ASSOCIATES CO.LTD.)
(55)



1.1



1.2

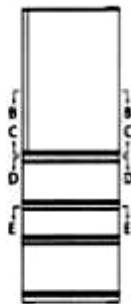

1.3



1.4



1.5

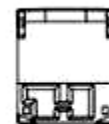

1.6



1.7

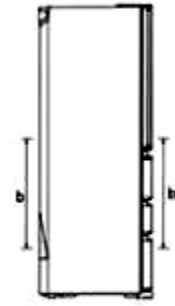

1.8



1.9



1.10



1.11

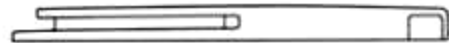

1.12



1.13



1.14

- (11) **48392**
(21) 3-2023-00251 (28) 1
(54) **ĐẦU NỐI ỐNG** (51) **23-01**
(22) 03/02/2023 (43) 27/11/2023
(30) 2022-016909 08/08/2022 JP;
(73) **TOYOX CO., LTD.** (JP)
4371, Maezawa, Kurobe-shi, Toyama-ken, Japan
(72) 1. SHUJI SUGITA (JP)
2. KAZUKI SHIMIZU (JP)
(74) Công ty Cổ phần Sở hữu công nghiệp INVESTIP (INVESTIP)
(55)

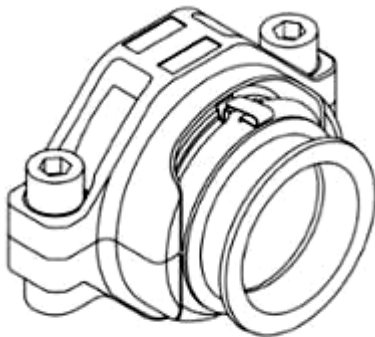

1.1

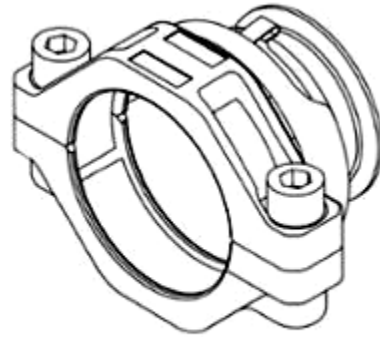

1.2

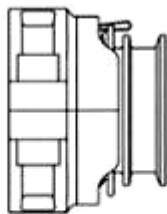

1.3

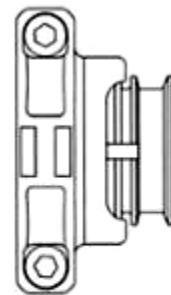

1.4

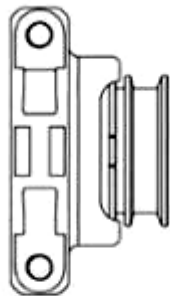

1.5

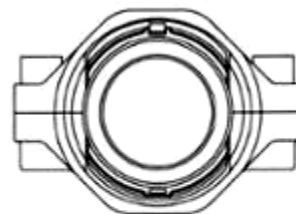

1.6

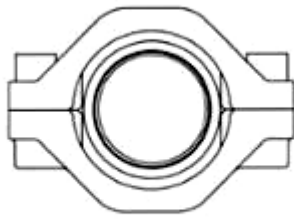

1.7



1.8

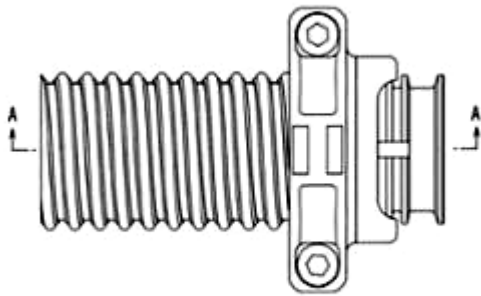

1.9

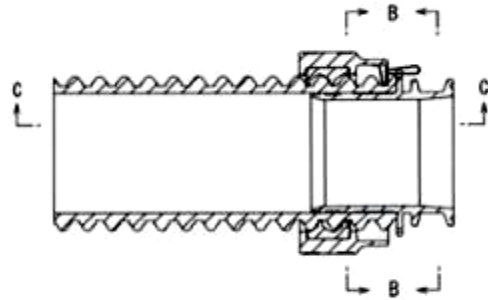

1.10

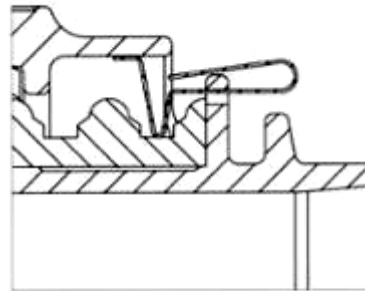

1.11

CÔNG BÁO SỞ HỮU CÔNG NGHIỆP SỐ 428 TẬP A – QUYỀN 2 (11.2023)

- (11) **48393**
(21) 3-2023-00309 (28) 1
(54) **XE MÁY** (51) **12-11**
(22) 17/02/2023 (43) 27/11/2023
(30) 2022-018021 24/08/2022 JP;
(73) **HONDA MOTOR CO., LTD. (JP)**
1-1, Minami-Aoyama 2-chome, Minato-ku, Tokyo, 107-8556 Japan
(72) 1. YUKI KANEMURA (JP)
2. YUYA TSUTSUMI (JP)
(74) Công ty Luật TNHH Phạm và Liên danh (PHAM & ASSOCIATES)
(55)



1.1



1.2



1.3



1.4



1.5



1.6



1.7



1.8



1.9



1.10

CÔNG BÁO SỞ HỮU CÔNG NGHIỆP SỐ 428 TẬP A – QUYỀN 2 (11.2023)

- (11) **48394**
(21) 3-2023-00310 (28) 1
(54) **XE MÁY** (51) **12-11**
(22) 17/02/2023 (43) 27/11/2023
(30) 2022-018024 24/08/2022 JP;
(73) **HONDA MOTOR CO., LTD. (JP)**
1-1, Minami-Aoyama 2-chome, Minato-ku, Tokyo, 107-8556 Japan
(72) Kenji WATANABE (JP)
(74) Công ty Luật TNHH Phạm và Liên danh (PHAM & ASSOCIATES)
(55)



1.1



1.2



1.3



1.4



1.5



1.6



1.7



1.8



1.9

CÔNG BÁO SỞ HỮU CÔNG NGHIỆP SỐ 428 TẬP A – QUYỀN 2 (11.2023)

- (11) **48395**
(21) 3-2023-00315 (28) 1
(54) **TÚI** (51) **03-01**
(22) 17/02/2023 (43) 27/11/2023
(73) **LÊ HOÀNG QUỐC VIỆT (VN)**
40 Lâm Hoàn, phường An Lạc, quận Bình Tân, thành phố Hồ Chí Minh
(72) Lê Hoàng Quốc Việt (VN)
(55)



1.1



1.2



1.3



1.4



1.5



1.6



1.7

CÔNG BÁO SỞ HỮU CÔNG NGHIỆP SỐ 428 TẬP A – QUYỀN 2 (11.2023)

(11) **48396**

(21) 3-2023-00316

(28) 1

(54) **TÚI**

(51) **03-01**

(22) 17/02/2023

(43) 27/11/2023

(73) **LÊ HOÀNG QUỐC VIỆT (VN)**

40 Lâm Hoàn, phường An Lạc, quận Bình Tân, thành phố Hồ Chí Minh

(72) Lê Hoàng Quốc Việt (VN)

(55)



1.1



1.2



1.3



1.4



1.5



1.6



1.7

CÔNG BÁO SỞ HỮU CÔNG NGHIỆP SỐ 428 TẬP A – QUYỀN 2 (11.2023)

- (11) **48397**
(21) 3-2023-00325 (28) 1
(54) **XE SCUTO** (51) **12-11**
(22) 21/02/2023 (43) 27/11/2023
(30) 2022-018769 01/09/2022 JP;
(73) **HONDA MOTOR CO., LTD. (JP)**
1-1, Minami-Aoyama 2-Chome, Minato-ku, Tokyo, 107-8556 Japan
(72) 1. JINGWEN KUANG (CN)
2. BIN HAN (CN)
3. KENJI WATANABE (JP)
(74) Công ty Luật TNHH Phạm và Liên danh (PHAM & ASSOCIATES)
(55)



1.1



1.2



1.3



1.4



1.5



1.6



1.7



1.8



1.9

CÔNG BÁO SỞ HỮU CÔNG NGHIỆP SỐ 428 TẬP A – QUYỀN 2 (11.2023)

- (11) **48398**
(21) 3-2023-00372 (28) 1
(54) **THIẾT BỊ ĐIỀU HÒA KHÔNG KHÍ** (51) **23-04**
(22) 27/02/2023 (43) 27/11/2023
(30) 2022-024797 16/11/2022 JP;
(73) **TOSHIBA CARRIER CORPORATION (JP)**
72-34, Horikawa-cho, Saiwai-ku, Kawasaki -shi, Kanagawa 212-8585, Japan
(72) Masao ISSHIKI (JP)
(74) Công ty Luật TNHH WINCO (WINCO LAW FIRM)
(55)



1.1



1.2

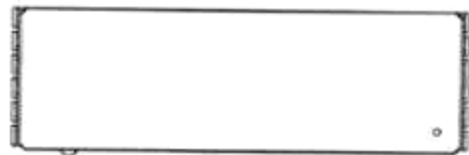

1.3



1.4



1.5

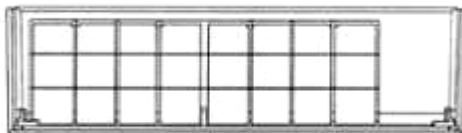

1.6



1.7

CÔNG BÁO SỞ HỮU CÔNG NGHIỆP SỐ 428 TẬP A – QUYỀN 2 (11.2023)

- (11) **48399**
(21) 3-2023-00373 (28) 1
(54) **THIẾT BỊ ĐIỀU HÒA KHÔNG KHÍ** (51) **23-04**
(22) 27/02/2023 (43) 27/11/2023
(30) 2022-024798 16/11/2022 JP;
(73) **TOSHIBA CARRIER CORPORATION (JP)**
72-34, Horikawa-cho, Saiwai-ku, Kawasaki -shi, Kanagawa 212-8585, Japan
(72) Masao ISSHIKI (JP)
(74) Công ty Luật TNHH WINCO (WINCO LAW FIRM)
(55)

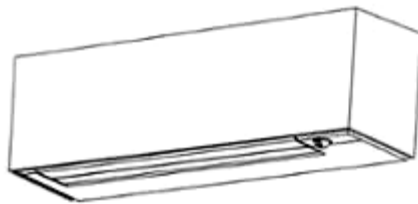

1.1



1.2



1.3



1.4



1.5

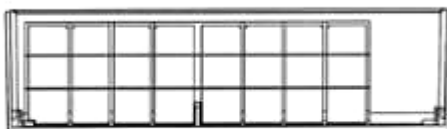

1.6



1.7

CÔNG BÁO SỞ HỮU CÔNG NGHIỆP SỐ 428 TẬP A – QUYỀN 2 (11.2023)

- (11) **48400**
(21) 3-2023-00392 (28) 1
(54) **GIÁ ĐỖ VÒI SEN** (51) **23-02**
(22) 28/02/2023 (43) 27/11/2023
(30) 202215148 31/08/2022 AU;
(73) **PHOENIX INDUSTRIES PTY LTD (AU)**
926 Mountain Hwy, Bayswater, Victoria, 3153, Australia
(72) Alexander Tomlinson (AU)
(74) Công ty TNHH Tầm nhìn và Liên danh (VISION & ASSOCIATES CO.LTD.)
(55)



1.1



1.2



1.3

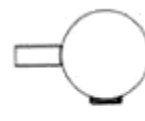

1.4

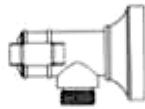

1.5

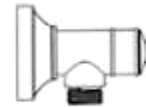

1.6



1.7



1.8



1.9

CÔNG BÁO SỞ HỮU CÔNG NGHIỆP SỐ 428 TẬP A – QUYỀN 2 (11.2023)

- (11) **48401**
(21) 3-2023-00395 (28) 1
(54) **VÒI NƯỚC GẮN TƯỜNG** (51) **23-01**
(22) 28/02/2023 (43) 27/11/2023
(30) 202215196 01/09/2022 AU;
(73) **PHOENIX INDUSTRIES PTY LTD (AU)**
926 Mountain Hwy, Bayswater, Victoria, 3153, Australia
(72) Ban Hsi Liu (AU)
(74) Công ty TNHH Tầm nhìn và Liên danh (VISION & ASSOCIATES CO.LTD.)
(55)

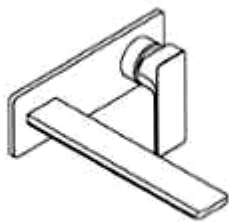

1.1

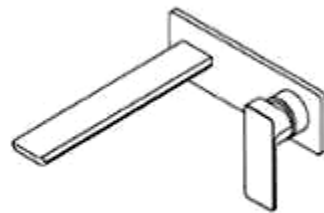

1.2

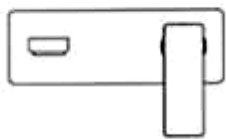

1.3

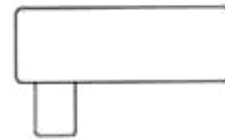

1.4

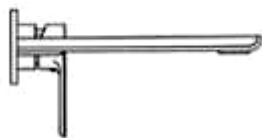

1.5



1.6

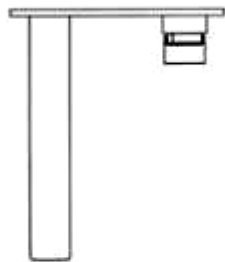

1.7

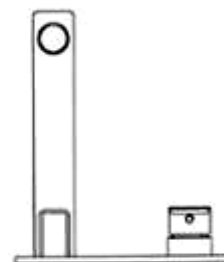

1.8

CÔNG BÁO SỞ HỮU CÔNG NGHIỆP SỐ 428 TẬP A – QUYỀN 2 (11.2023)

- (11) **48402**
(21) 3-2023-00396 (28) 1
(54) **BỘ VÒI NƯỚC GẮN NÚT ĐIỀU HƯỚNG** (51) **23-01**
(22) 28/02/2023 (43) 27/11/2023
(30) 202215197 01/09/2022 AU;
(73) **PHOENIX INDUSTRIES PTY LTD (AU)**
926 Mountain Hwy, Bayswater, Victoria, 3153, Australia
(72) Ban Hsi Liu (AU)
(74) Công ty TNHH Tầm nhìn và Liên danh (VISION & ASSOCIATES CO.LTD.)
(55)

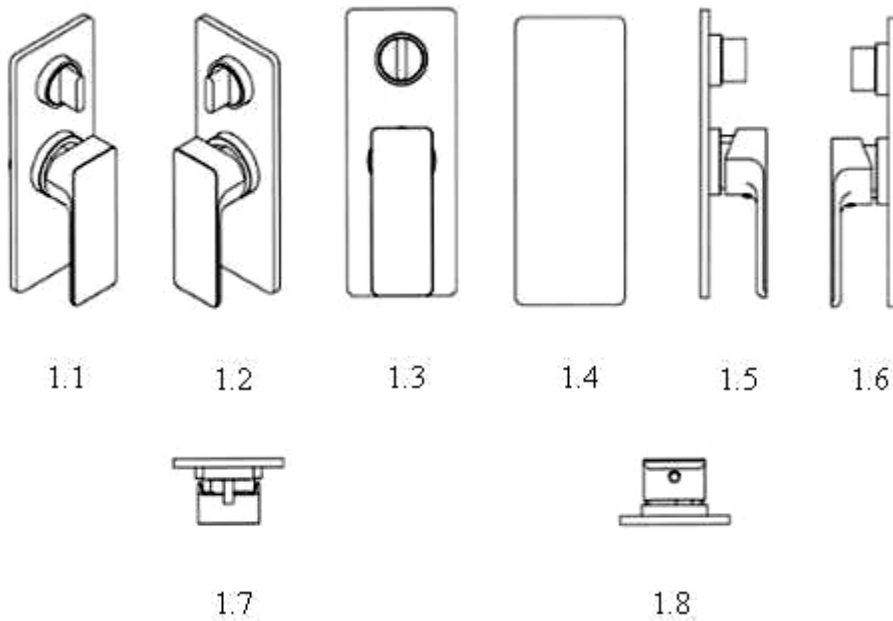

- (11) **48403**
(21) 3-2023-00599 (28) 1
(54) **LƯỢC CHẢI TÓC** (51) **28-03**
(22) 21/03/2023 (43) 27/11/2023
(30) 2022-021184 30/09/2022 JP;
(73) **MTG CO., LTD. (JP)**
2-32 Honjin-tori, Nakamura-ku, Nagoya, Aichi 4530041, Japan
(72) Kei ITO (JP)
(74) **CÔNG TY LUẬT TRÁCH NHIỆM HỮU HẠN AMBYS HÀ NỘI (AMBYS HANOI)**
(55)

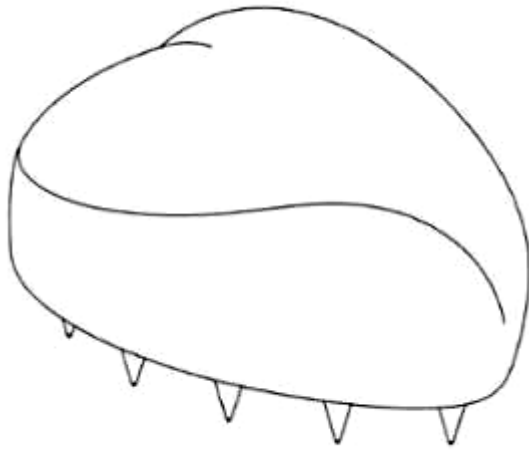

1.1

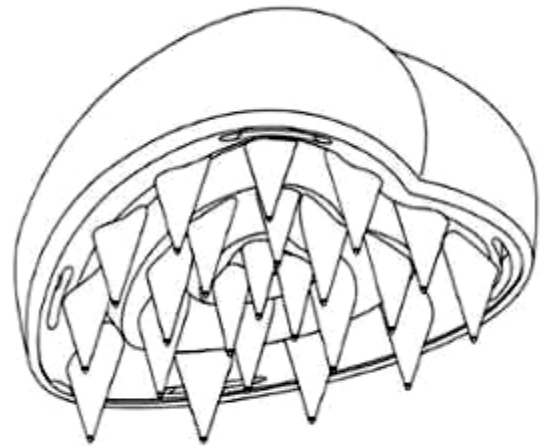

1.2

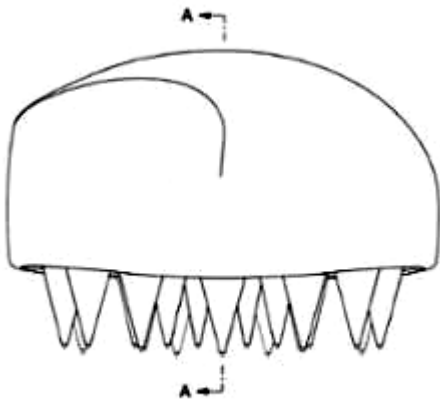

1.3

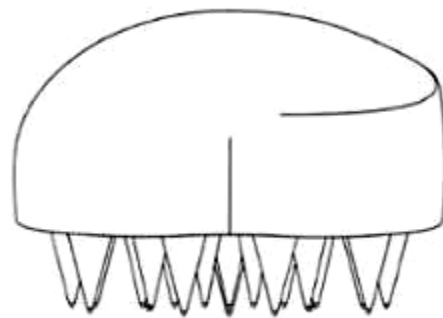

1.4

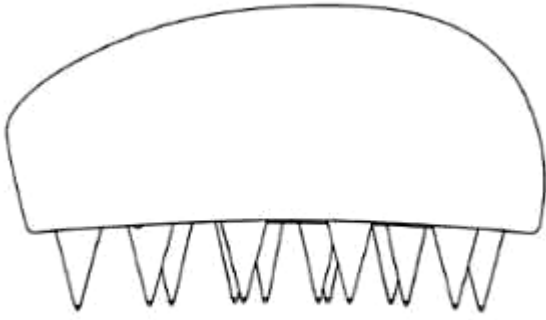

1.5

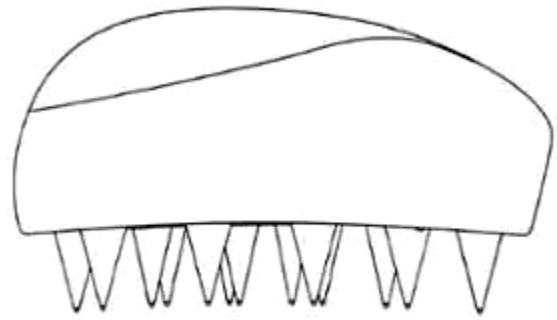

1.6

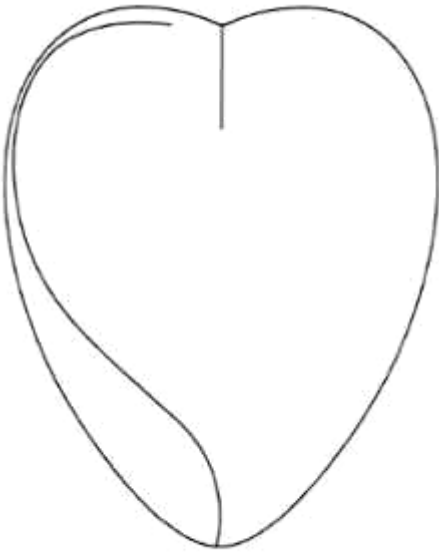

1.7

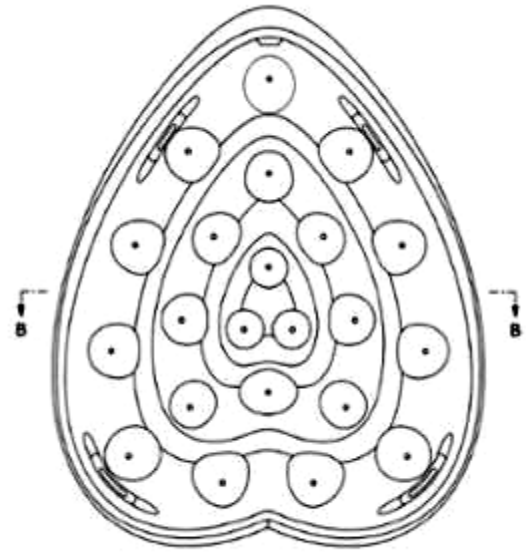

1.8

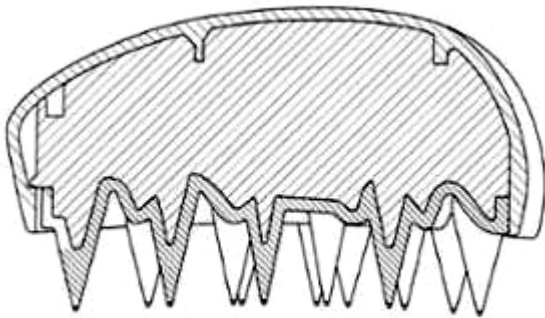

1.9

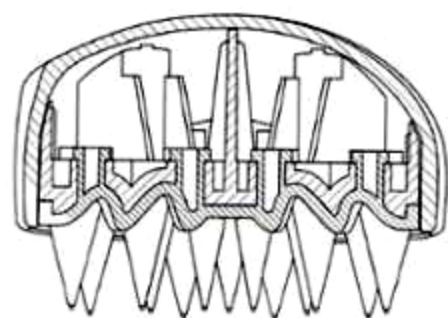

1.10

CÔNG BÁO SỞ HỮU CÔNG NGHIỆP SỐ 428 TẬP A – QUYỀN 2 (11.2023)

- (11) **48404**
(21) 3-2023-00610 (28) 1
(54) **BỘ PHẬN DẪN HƯỚNG XÍCH CHO XE ĐẠP** (51) **12-16**
(22) 22/03/2023 (43) 27/11/2023
(30) 009184237-0003 23/09/2022 EM;
(73) **DECATHLON (FR)**
4, Boulevard de Mons, F-59650 Villeneuve d'Ascq, France
(72) Charles Hermant (FR)
(74) Công ty Luật TNHH T&G (TGVN)
(55)



1.1



1.2



1.3



1.4



1.5



1.6



1.7

CÔNG BÁO SỞ HỮU CÔNG NGHIỆP SỐ 428 TẬP A – QUYỀN 2 (11.2023)

- (11) **48405**
(21) 3-2023-00611 (28) 1
(54) **BỘ PHẬN BẢO VỆ KHUNG XE ĐẠP** (51) **12-16**
(22) 22/03/2023 (43) 27/11/2023
(30) 009184237-0005 23/09/2022 EM;
(73) **DECATHLON (FR)**
4, Boulevard de Mons, F-59650 Villeneuve d’Ascq, France
(72) Charles Hermant (FR)
(74) Công ty Luật TNHH T&G (TGVN)
(55)



1.1



1.2



1.3



1.4

1.5



1.6



1.7

CÔNG BÁO SỞ HỮU CÔNG NGHIỆP SỐ 428 TẬP A – QUYỀN 2 (11.2023)

- (11) **48406**
(21) 3-2023-00793 (28) 1
(54) **BẢNG QUẢNG CÁO** (51) **20-03**
(22) 10/04/2023 (43) 27/11/2023
(73) **CÔNG TY CỔ PHẦN THƯƠNG MẠI QUẢNG CÁO NGUYỄN TRẦN (VN)**
01 Phan Chu Trinh, phường Bến Thành, quận 1, thành phố Hồ Chí Minh
(72) Trần Thị Thu Hà (VN)
(74) Công ty TNHH Dịch vụ thương mại và sở hữu công nghiệp Song Ngọc (I.P.T.S.)
(55)

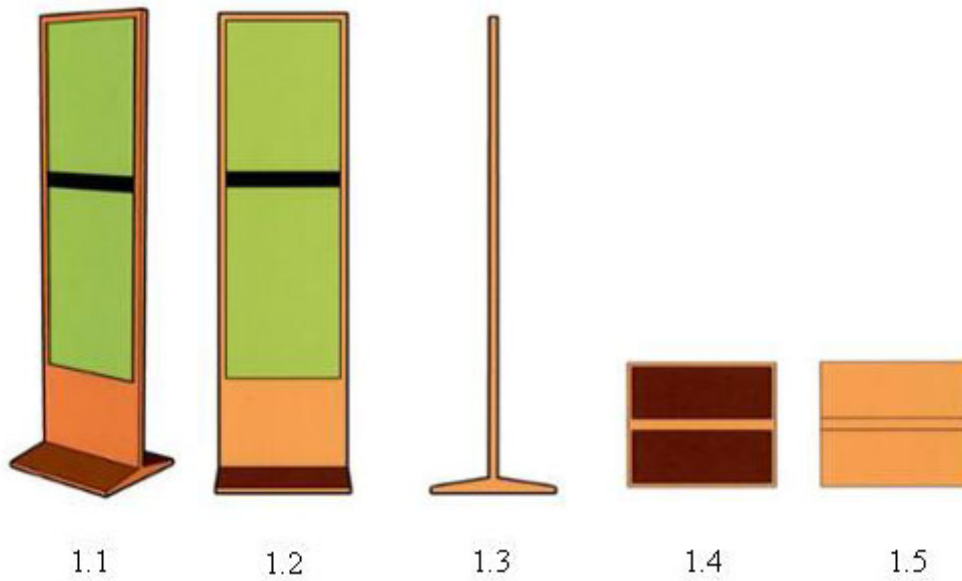

CÔNG BÁO SỞ HỮU CÔNG NGHIỆP SỐ 428 TẬP A – QUYỀN 2 (11.2023)

- (11) **48407**
(21) 3-2023-00873 (28) 1
(54) **BÀN CHẢI ĐÁNH RĂNG** (51) **04-02**
(22) 18/04/2023 (43) 27/11/2023
(73) **CÔNG TY TNHH MỘT THÀNH VIÊN MỸ NGUYỄN VIỆT NAM (VN)**
Ấp Thanh Trì A, xã Đa Lộc, huyện Châu Thành, tỉnh Trà Vinh
(72) Trần Chí Đức (VN)
(55)



1.1



1.2



1.3



1.4



1.5



1.6

CÔNG BÁO SỞ HỮU CÔNG NGHIỆP SỐ 428 TẬP A – QUYỀN 2 (11.2023)

- (11) **48408**
(21) 3-2023-00939 (28) 3
(54) **MŨ BẢO HIỂM** (51) **02-03**
(22) 27/04/2023 (43) 27/11/2023
(30) 015002516 07/11/2022 EM;
(73) **LOCATELLI S.P.A. (IT)**
Via Della Resistenza, 5/A, I-24030 Almenno San Bartolomeo (Bergamo), Italy
(72) LOCATELLI Antonio (IT)
(74) Công ty TNHH Sở hữu trí tuệ ALNGUYEN (ALNGUYEN IP CO.,LTD.)
(55)



1.1



1.2



1.3



1.4



1.5



1.6



1.7



1.8



2.1



2.2



2.3



2.4



2.5



2.6



2.7



2.8



3.1



3.2



3.3



3.4



3.5



3.6



3.7



3.8

CÔNG BÁO SỞ HỮU CÔNG NGHIỆP SỐ 428 TẬP A – QUYỀN 2 (11.2023)

- (11) **48409**
(21) 3-2023-01106 (28) 1
(54) **MŨ** (51) **02-03**
(22) 22/05/2023 (43) 27/11/2023
(30) 009186307-0004 22/11/2022 EU;
(73) **CHRISTIAN DIOR COUTURE (FR)**
30 Avenue Montaigne, 75008 Paris, France
(72) Maria Grazia Chiuri (IT)
(74) Công ty TNHH một thành viên Sở hữu trí tuệ VCCI (VCCI-IP CO.,LTD)
(55)



1.1



1.2



1.3



1.4



1.5



1.6



1.7

CÔNG BÁO SỞ HỮU CÔNG NGHIỆP SỐ 428 TẬP A – QUYỀN 2 (11.2023)

- (11) **48410**
(21) 3-2023-01159 (28) 1
(54) **XE Ô TÔ** (51) **12-08**
(22) 26/05/2023 (43) 27/11/2023
(73) **CÔNG TY CỔ PHẦN SẢN XUẤT VÀ KINH DOANH VINFAST (VN)**
Khu Kinh tế Đình Vũ - Cát Hải, đảo Cát Hải, thị trấn Cát Hải, huyện Cát Hải, thành phố Hải Phòng
(72) 1. JOAO MARCOS DE OLIVEIRA RAMOS (BR)
2. JAE HOON LEE (NZ)
3. JUSTIN JAMES THOMPSON (AU)
4. ADAM TY DEAN SMITH (AU)
(74) **CÔNG TY LUẬT TRÁCH NHIỆM HỮU HẠN AMBYS HÀ NỘI (AMBYS HANOI)**
(55)



1.1



1.2



1.3

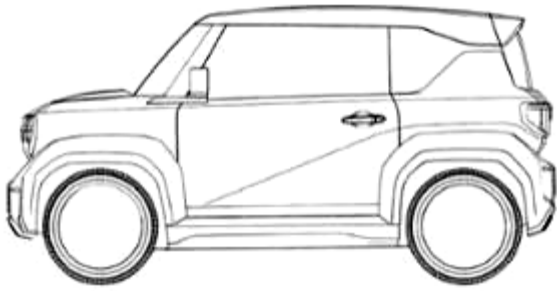

1.4

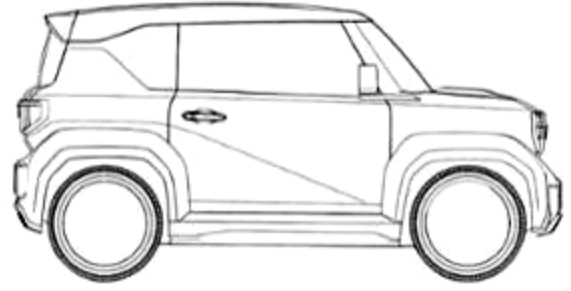

1.5



1.6

CÔNG BÁO SỞ HỮU CÔNG NGHIỆP SỐ 428 TẬP A – QUYỀN 2 (11.2023)

(11) **48411**

(21) 3-2023-01194

(54) **CẤU KIỆN KÈ LẮP GHÉP**

(22) 01/06/2023

(73) **CÔNG TY CỔ PHẦN KHOA HỌC CÔNG NGHỆ VIỆT NAM (VN)**

Số 6 đường 3 tháng 2, phường 8, thành phố Vũng Tàu, tỉnh Bà Rịa - Vũng Tàu

(72) Hoàng Đức Thảo (VN)

(55)

(28) 1

(51) **25-02**

(43) 27/11/2023

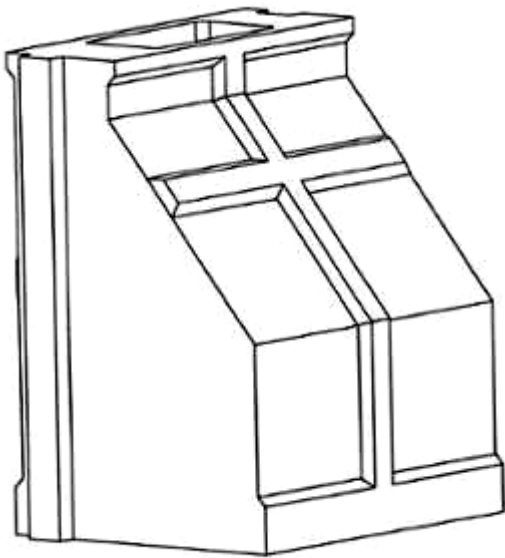

1.1

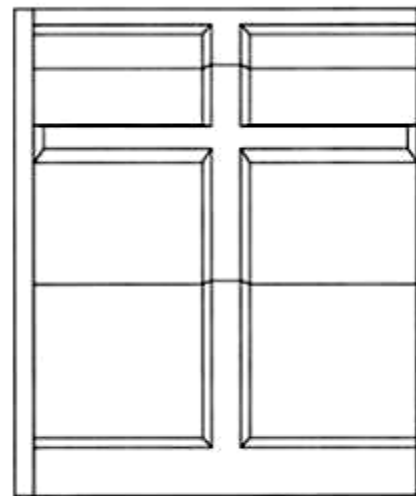

1.2

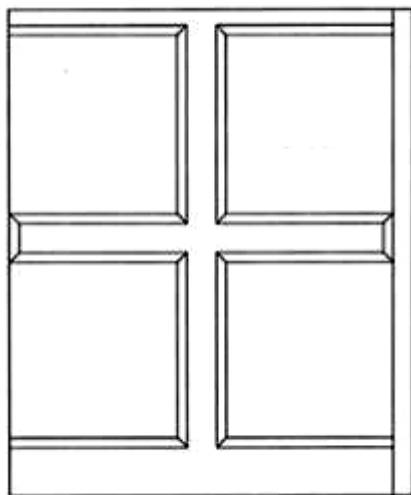

1.3

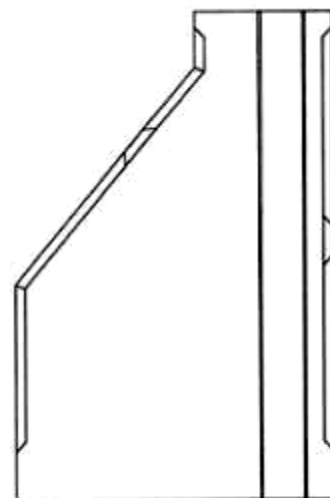

1.4

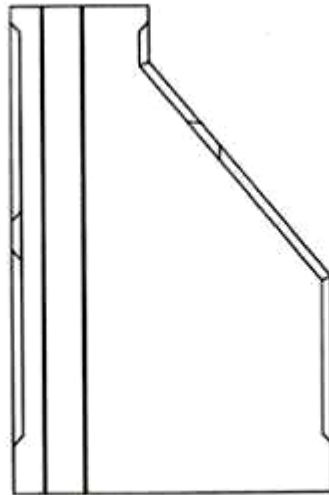

1.5

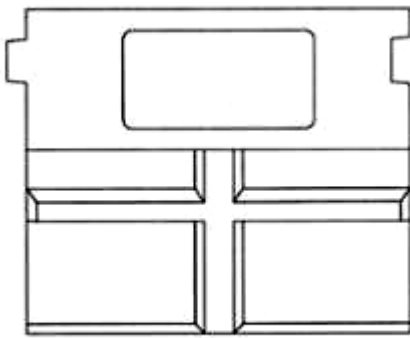

1.6

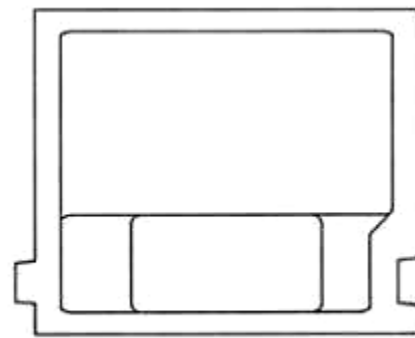

1.7

(11) **48412**

(21) 3-2023-01195

(28) 1

(54) **CẤU KIỆN KÈ LẮP GHÉP**

(51) **25-02**

(22) 01/06/2023

(43) 27/11/2023

(73) **CÔNG TY CỔ PHẦN KHOA HỌC CÔNG NGHỆ VIỆT NAM (VN)**

Số 6, đường 3 tháng 2, phường 8, thành phố Vũng Tàu, tỉnh Bà Rịa - Vũng Tàu

(72) Hoàng Đức Thảo (VN)

(55)

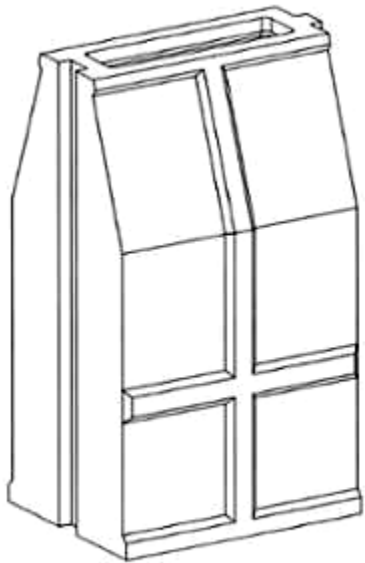

1.1

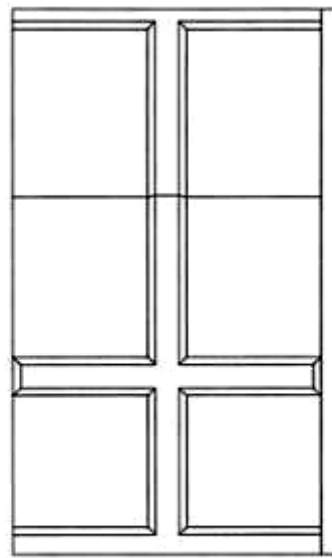

1.2

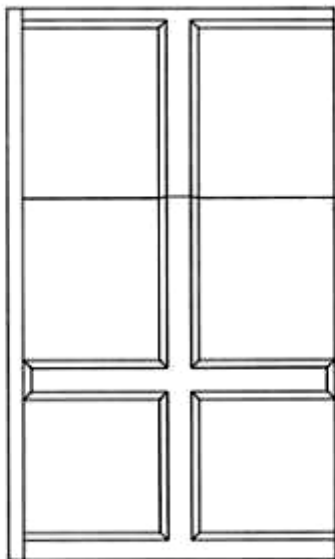

1.3

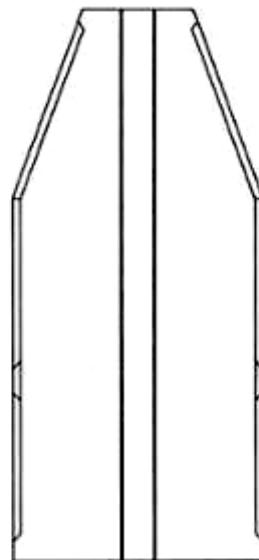

1.4

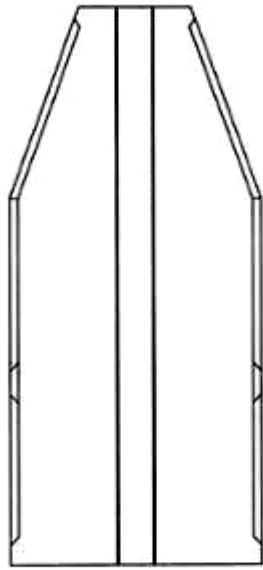

1.5

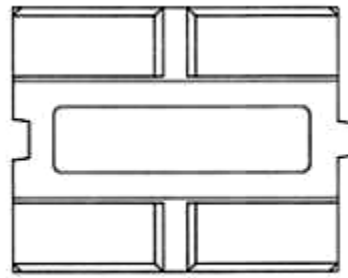

1.6

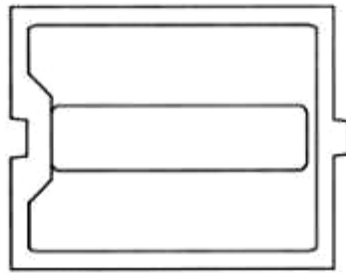

1.7

CÔNG BÁO SỞ HỮU CÔNG NGHIỆP SỐ 428 TẬP A – QUYỀN 2 (11.2023)

(11) **48413**

(21) 3-2023-01196

(28) 2

(54) **KÈ RỌ ĐÁ BÊ TÔNG ĐÚC SẴN**

(51) **25-02**

(22) 01/06/2023

(43) 27/11/2023

(73) **CÔNG TY CỔ PHẦN KHOA HỌC CÔNG NGHỆ VIỆT NAM (VN)**

Số 6, đường 3 tháng 2, phường 8, thành phố Vũng Tàu, tỉnh Bà Rịa - Vũng Tàu

(72) Hoàng Đức Thảo (VN)

(55)

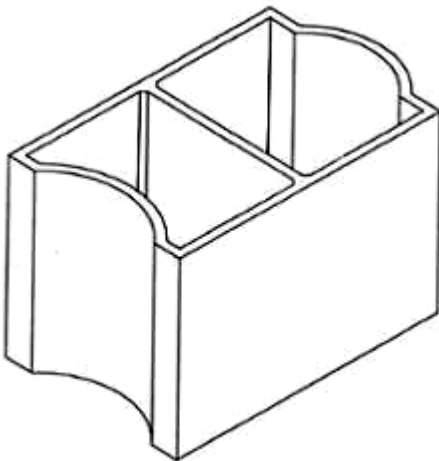

1.1

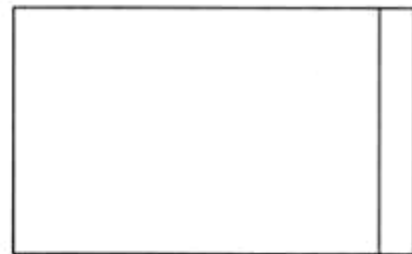

1.2

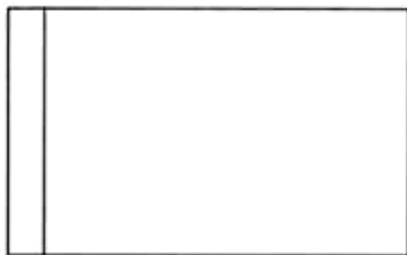

1.3

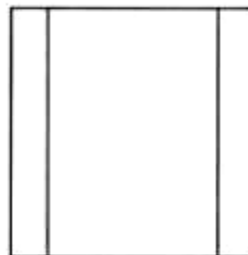

1.4

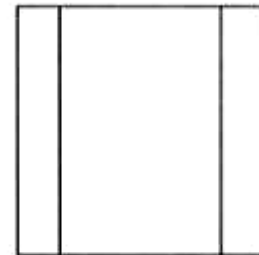

1.5

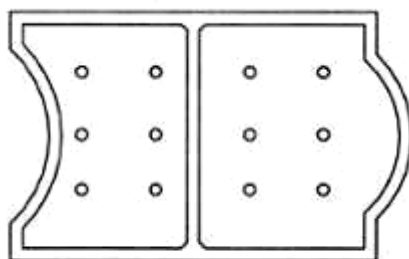

1.6

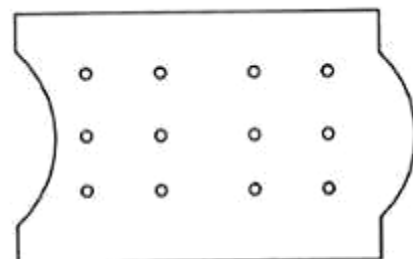

1.7

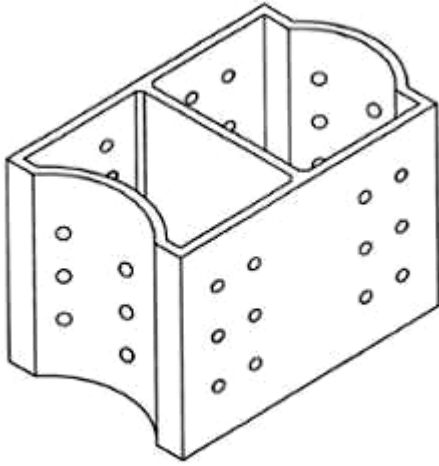

2.1

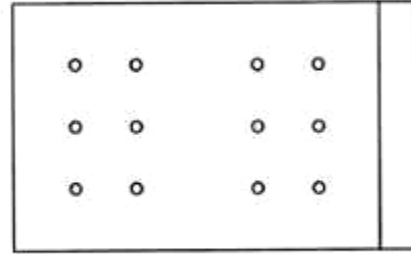

2.2

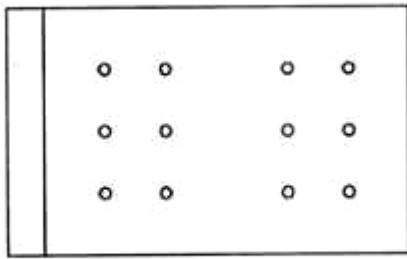

2.3

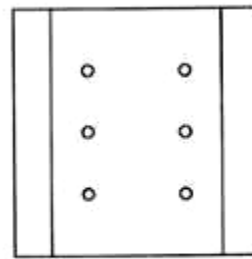

2.4

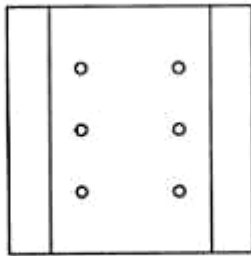

2.5

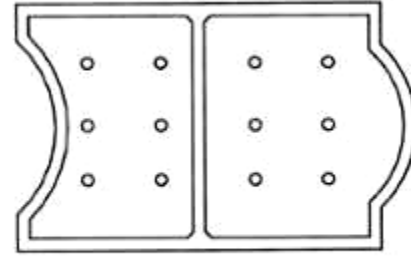

2.6

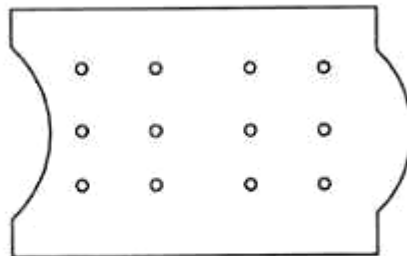

2.7

CÔNG BÁO SỞ HỮU CÔNG NGHIỆP SỐ 428 TẬP A – QUYỀN 2 (11.2023)

- (11) **48414**
(21) 3-2023-01204 (28) 1
(54) **ĐIỆN THOẠI DI ĐỘNG** (51) **14-03**
(22) 01/06/2023 (43) 27/11/2023
(30) 202230809575.3 02/12/2022 CN;
(73) **HUAWEI TECHNOLOGIES CO., LTD. (CN)**
Huawei Administration Building, Bantian, Longgang District, Shenzhen,
Guangdong 518129, P. R. China
(72) 1. LIAO, JENHUI (TW)
2. XIE, BIN (CN)
(74) Công ty Cổ phần Sở hữu công nghiệp INVESTIP (INVESTIP)
(55)



1.1

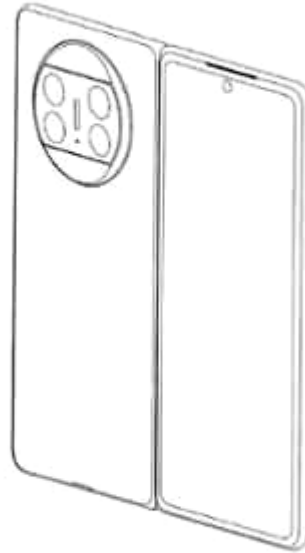

1.2



1.3

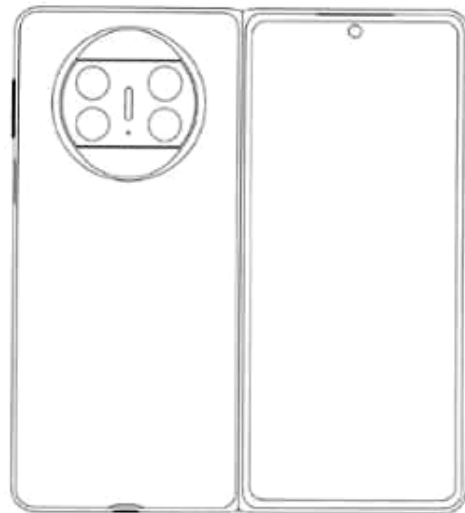

1.4



1.5



1.6



1.7



1.8

CÔNG BÁO SỞ HỮU CÔNG NGHIỆP SỐ 428 TẬP A – QUYỀN 2 (11.2023)

- (11) **48415**
(21) 3-2023-01205 (28) 1
(54) **ĐIỆN THOẠI DI ĐỘNG** (51) **14-03**
(22) 01/06/2023 (43) 27/11/2023
(30) 202230809575.3 02/12/2022 CN;
(73) **HUAWEI TECHNOLOGIES CO., LTD. (CN)**
Huawei Administration Building, Bantian, Longgang District, Shenzhen,
Guangdong 518129, P. R. China
(72) 1. LIAO, JENHUI (TW)
2. XIE, BIN (CN)
(74) Công ty Cổ phần Sở hữu công nghiệp INVESTIP (INVESTIP)
(55)



1.1



1.2



1.3



1.4



1.5



1.6



1.7



1.8

CÔNG BÁO SỞ HỮU CÔNG NGHIỆP SỐ 428 TẬP A – QUYỀN 2 (11.2023)

- (11) **48416**
(21) 3-2023-01217 (28) 2
(54) **ĐIỆN THOẠI DI ĐỘNG** (51) **14-03**
(22) 02/06/2023 (43) 27/11/2023
(30) 202230812066.6 05/12/2022 CN;
(73) **HUAWEI TECHNOLOGIES CO., LTD. (CN)**
Huawei Administration Building, Bantian, Longgang District, Shenzhen,
Guangdong 518129, P. R. China
(72) 1. LIAO, JENHUI (TW)
2. XIE, BIN (CN)
(74) Công ty Cổ phần Sở hữu công nghiệp INVESTIP (INVESTIP)
(55)

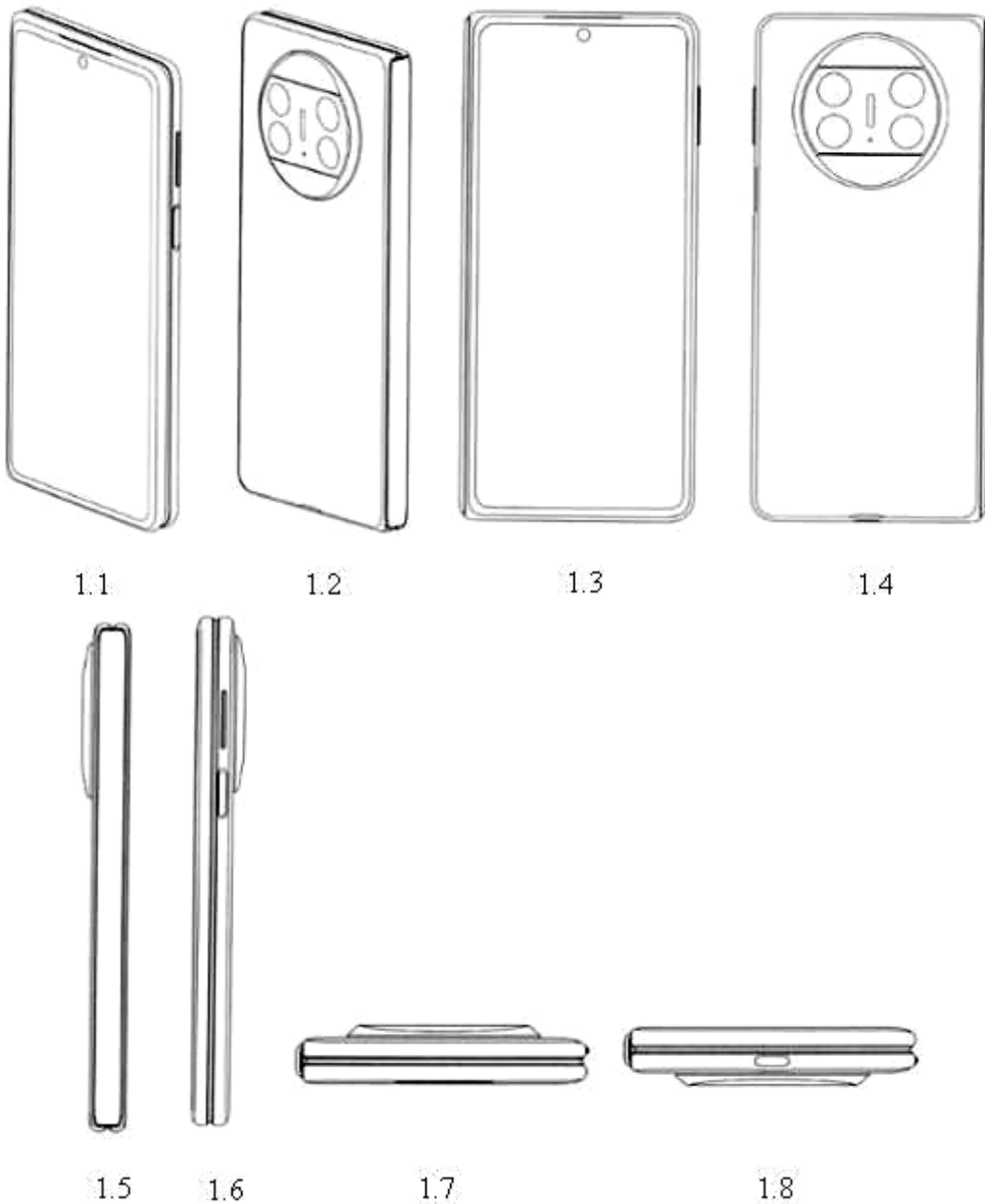



2.1



2.2



2.3



2.4



2.5



2.6



2.7



2.8

CÔNG BÁO SỞ HỮU CÔNG NGHIỆP SỐ 428 TẬP A – QUYỀN 2 (11.2023)

- (11) **48417**
(21) 3-2023-01269 (28) 1
(54) **THIẾT BỊ NÂNG XE GẮN MÁY** (51) **12-05**
(22) 08/06/2023 (43) 27/11/2023
(73) **CÔNG TY CỔ PHẦN THIẾT BỊ VÀ DỊCH VỤ LÂM PHÁT (VN)**
192 Trần Quang Khải, phường Tân Định, quận 1, thành phố Hồ Chí Minh
(72) Trần Nguyễn Thanh Lâm (VN)
(74) Công ty Cổ phần Sở hữu công nghiệp INVESTIP (INVESTIP)
(55)

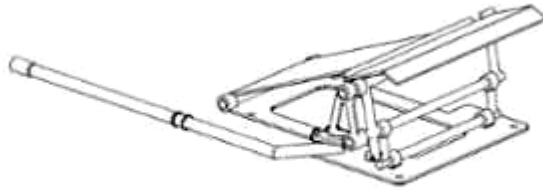

1.1

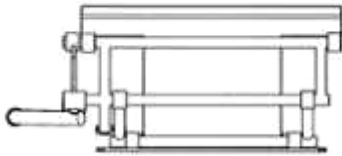

1.2

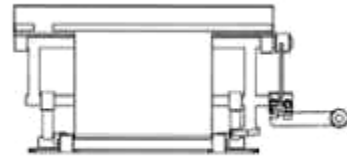

1.3

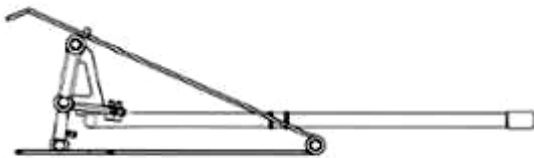

1.4

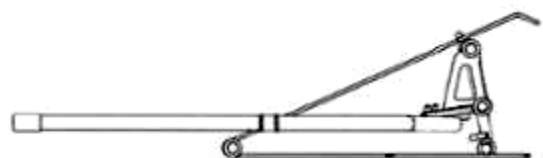

1.5

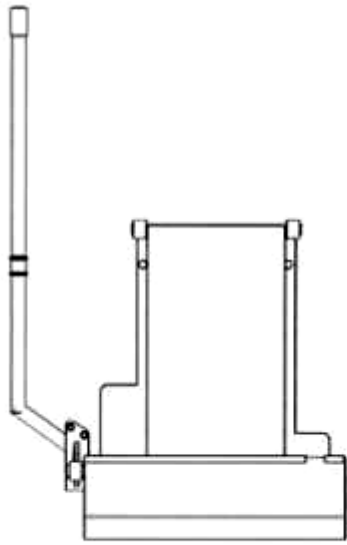

1.6

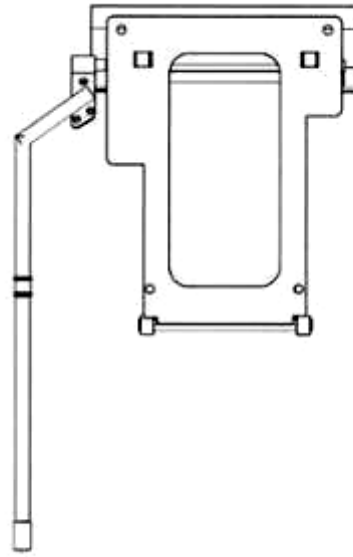

1.7

CÔNG BÁO SỞ HỮU CÔNG NGHIỆP SỐ 428 TẬP A – QUYỀN 2 (11.2023)

- (11) **48418**
(21) 3-2023-01298 (28) 3
(54) **GHẾ SÔ PHA** (51) **06-01**
(22) 13/06/2023 (43) 27/11/2023
(73) **CÔNG TY TNHH NỘI THẤT TIVANY (VIỆT NAM) (VN)**
Số 304/16, đường Đồng Khởi, khu 3, phường Hoà Phú, thành phố Thủ Dầu Một,
tỉnh Bình Dương
(72) 1. JIANG PING (CN)
2. ZHOU XIAO MING (CN)
3. KUMARAN ARUMUGAM KRISHNADAS (US)
4. ANAGHA YOGESH PADGAOKAR (ALSO KNOWN AS ANA ARUN) (US)
(74) Công ty TNHH Tư vấn đầu tư và Sở hữu trí tuệ Hoàng Phi (HOANG PHI INVEST
& I.P CO., LTD)
(55)



1.1



1.2



1.3



1.4



1.5

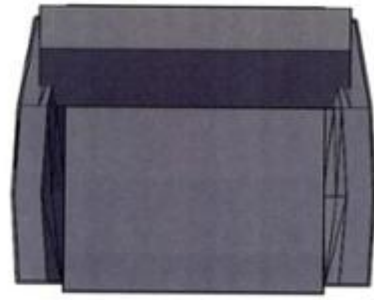

1.6

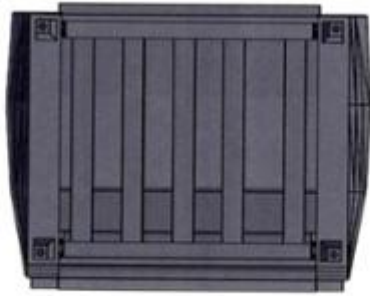

1.7



2.1

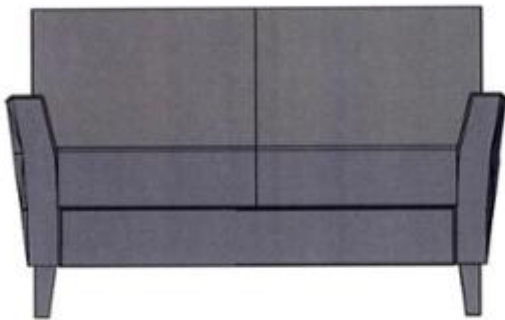

2.2



2.3



2.4



2.5



2.6

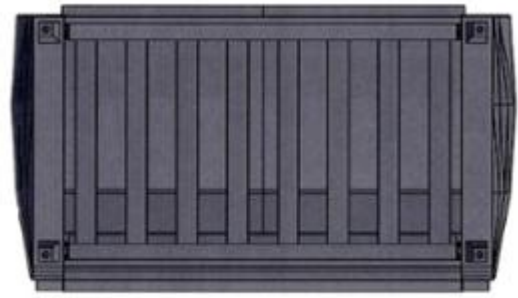

2.7



3.1

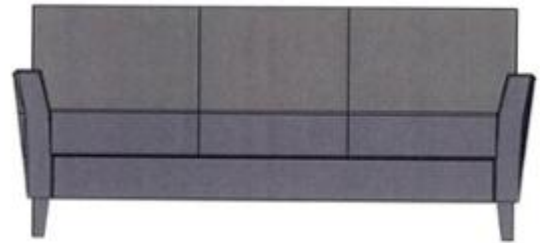

3.2



3.3

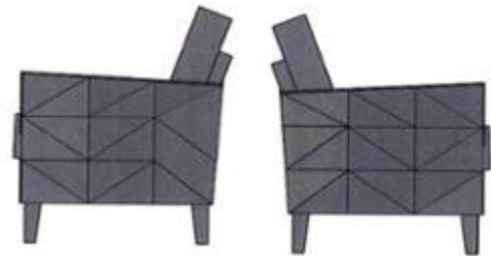

3.4

3.5



3.6



3.7

- (11) **48419**
(21) 3-2023-01300 (28) 1
(54) **THANH NHÔM ĐỊNH HÌNH** (51) **25-01**
(22) 14/06/2023 (43) 27/11/2023
(73) **CÔNG TY TNHH THANH PHÚC WINDOW (VN)**
478 Nguyễn Thị Thập, phường Tân Quy, quận 7, thành phố Hồ Chí Minh
(72) Nguyễn Thị Kim Hoàn (VN)
(55)



1.1

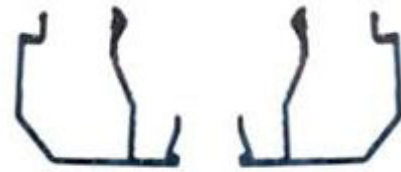

1.2

1.3



1.4



1.5



1.6



1.7

CÔNG BÁO SỞ HỮU CÔNG NGHIỆP SỐ 428 TẬP A – QUYỀN 2 (11.2023)

(11) **48420**

(21) 3-2023-01301

(28) 1

(54) **THANH NHÔM ĐỊNH HÌNH**

(51) **25-01**

(22) 14/06/2023

(43) 27/11/2023

(73) **CÔNG TY TNHH THANH PHÚC WINDOW (VN)**

478 Nguyễn Thị Thập, phường Tân Quy, quận 7, thành phố Hồ Chí Minh

(72) Nguyễn Thị Kim Hoàn (VN)

(55)



1.1



1.2

1.3



1.4



1.5



1.6



1.7

CÔNG BÁO SỞ HỮU CÔNG NGHIỆP SỐ 428 TẬP A – QUYỀN 2 (11.2023)

- (11) **48421**
(21) 3-2023-01304 (28) 1
(54) **MÁY CẮT TÁCH HẠT ĐIỀU** (51) **15-03**
(22) 14/06/2023 (43) 27/11/2023
(73) **CÔNG TY TNHH MỘT THÀNH VIÊN CƠ KHÍ ĐẠI XƯƠNG THẠNH (VN)**
A2/35 Võ Văn Vân, ấp 1A, xã Vĩnh Lộc B, huyện Bình Chánh, thành phố Hồ Chí Minh
(72) Lâm Chí Huy (VN)
(74) Công ty Luật TNHH bản quyền Quốc tế (CIS LAW FIRM)
(55)

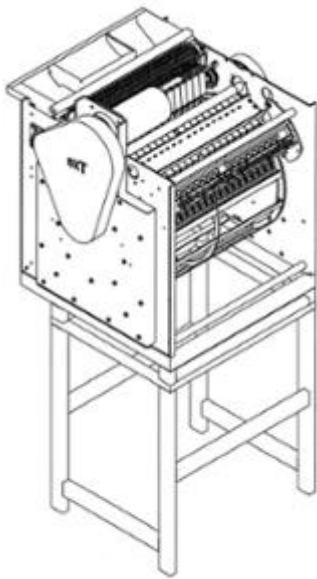

1.1

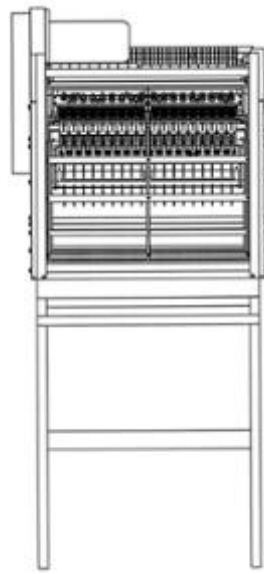

1.2

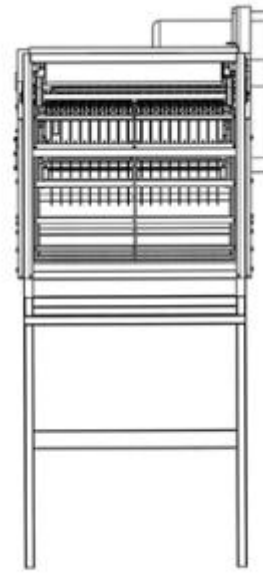

1.3

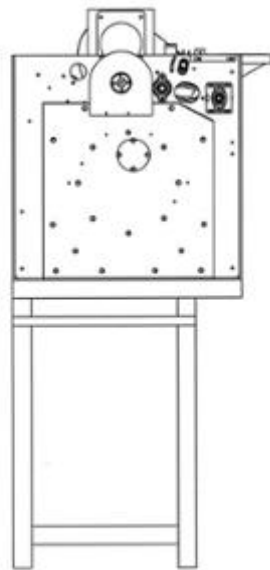

1.4

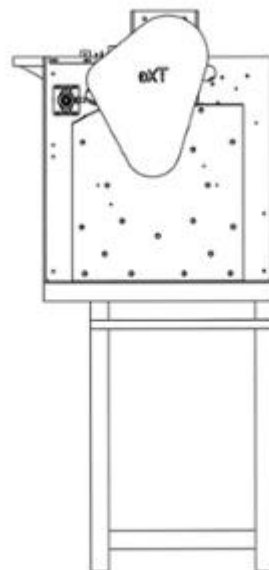

1.5

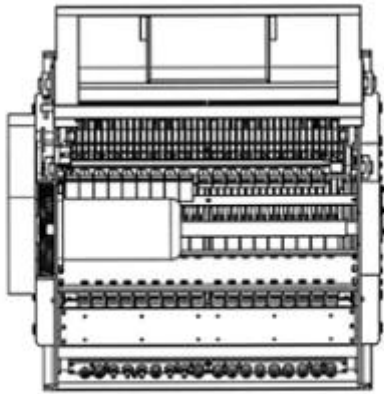

1.6

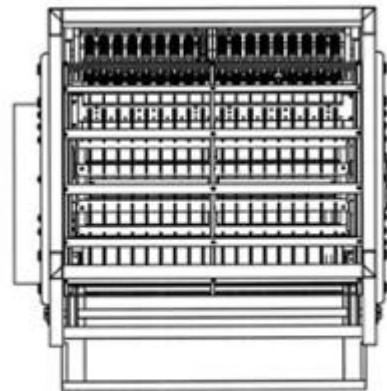

1.7

- (11) **48422**
(21) 3-2023-01310 (28) 1
(54) **THANH NHÔM ĐỊNH HÌNH** (51) **25-01**
(22) 15/06/2023 (43) 27/11/2023
(73) **CÔNG TY TNHH THANH PHÚC WINDOW (VN)**
478 Nguyễn Thị Thập, phường Tân Quy, quận 7, thành phố Hồ Chí Minh
(72) Nguyễn Thị Kim Hoàn (VN)
(55)



1.1



1.2



1.3

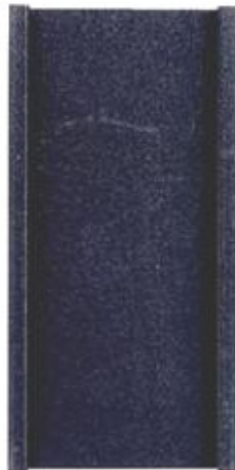

1.4



1.5

CÔNG BÁO SỞ HỮU CÔNG NGHIỆP SỐ 428 TẬP A – QUYỀN 2 (11.2023)

- (11) **48423**
(21) 3-2023-01311 (28) 1
(54) **THANH NHÔM ĐỊNH HÌNH** (51) **25-01**
(22) 15/06/2023 (43) 27/11/2023
(73) **CÔNG TY TNHH THANH PHÚC WINDOW (VN)**
478 Nguyễn Thị Thập, phường Tân Quy, quận 7, thành phố Hồ Chí Minh
(72) Nguyễn Thị Kim Hoàn (VN)
(55)



1.1

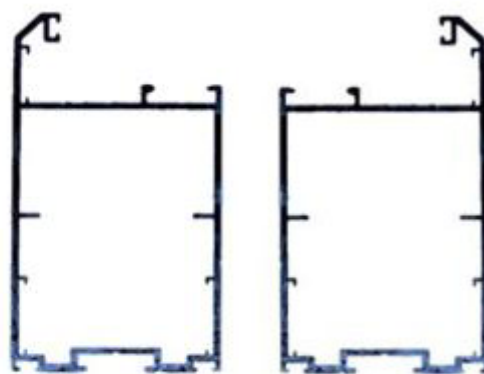

1.2

1.3



1.4



1.5



1.6



1.7

CÔNG BÁO SỞ HỮU CÔNG NGHIỆP SỐ 428 TẬP A – QUYỀN 2 (11.2023)

- (11) **48424**
(21) 3-2023-01346 (28) 1
(54) **TẤM NHÁM VÂN KIM CƯƠNG** (51) **08-05**
(22) 19/06/2023 (43) 27/11/2023
(73) **CÔNG TY TNHH THIẾT BỊ CÔNG NGHIỆP CÔNG NGHỆ CAO (VN)**
Số nhà 26, ngõ 379, đường Minh Khai, phường Vĩnh Tuy, quận Hai Bà Trưng,
thành phố Hà Nội
(72) Nguyễn Văn Định (VN)
(55)

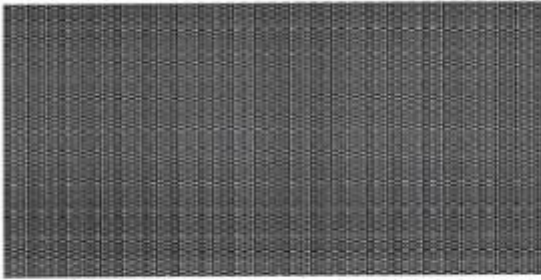

1.1



1.2

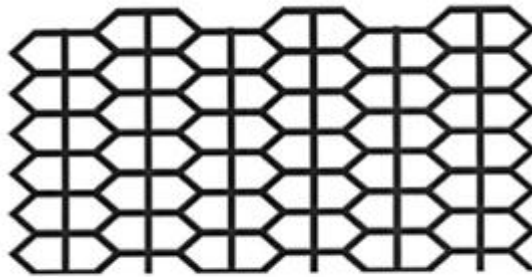

1.3

CÔNG BÁO SỞ HỮU CÔNG NGHIỆP SỐ 428 TẬP A – QUYỀN 2 (11.2023)

- (11) **48425**
(21) 3-2023-01390 (28) 1
(54) **TÚI** (51) **03-01**
(22) 22/06/2023 (43) 27/11/2023
(30) DM/225939 05/01/2023 WO;
(73) **CHRISTIAN DIOR COUTURE (FR)**
30 Avenue Montaigne, 75008 Paris, France
(72) Maria Grazia Chiuri (IT)
(74) Công ty TNHH một thành viên Sở hữu trí tuệ VCCI (VCCI-IP CO.,LTD)
(55)



1.1



1.2



1.3

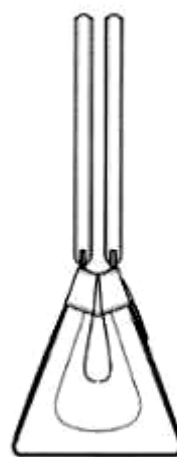

1.4

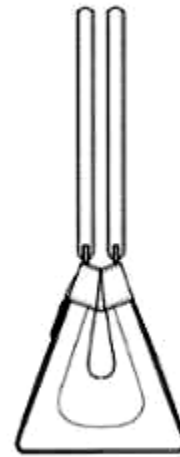

1.5

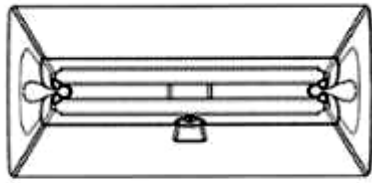

1.6

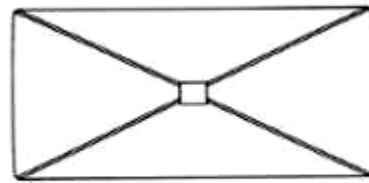

1.7

CÔNG BÁO SỞ HỮU CÔNG NGHIỆP SỐ 428 TẬP A – QUYỀN 2 (11.2023)

- (11) **48426**
(21) 3-2023-01391 (28) 1
(54) **XE ĐẠP ĐIỆN** (51) **12-11**
(22) 22/06/2023 (43) 27/11/2023
(73) **SHENZHEN ENGWE INTELLIGENT TECHNOLOGY CO., LTD (CN)**
408, Floor 4, No. 137, Xuegang South Road, Xiangjiaotang Community, Bantian
Street, Longgang District, Shenzhen, CHINA
(72) Huang Ning (CN)
(74) Công ty TNHH ADASTRA IP (VIỆT NAM) (ADASTRA IP (VIETNAM) CO.,
LTD.)
(55)



1.1



1.2



1.3



1.4



1.5



1.6



1.7

CÔNG BÁO SỞ HỮU CÔNG NGHIỆP SỐ 428 TẬP A – QUYỀN 2 (11.2023)

- (11) **48427**
(21) 3-2023-01392 (28) 1
(54) **XE ĐẠP ĐIỆN** (51) **12-11**
(22) 22/06/2023 (43) 27/11/2023
(73) **SHENZHEN ENGWE INTELLIGENT TECHNOLOGY CO., LTD (CN)**
408, Floor 4, No. 137, Xuegang South Road, Xiangjiaotang Community, Bantian
Street, Longgang District, Shenzhen, CHINA
(72) Huang Ning (CN)
(74) Công ty TNHH ADASTRA IP (VIỆT NAM) (ADASTRA IP (VIETNAM) CO.,
LTD.)
(55)



1.1



1.2



1.3



1.4



1.5



1.6



1.7

CÔNG BÁO SỞ HỮU CÔNG NGHIỆP SỐ 428 TẬP A – QUYỀN 2 (11.2023)

- (11) **48428**
(21) 3-2023-01404 (28) 1
(54) **THANH NHÔM ĐỊNH HÌNH** (51) **25-01**
(22) 23/06/2023 (43) 27/11/2023
(73) **CÔNG TY TNHH THANH PHÚC WINDOW (VN)**
478 Nguyễn Thị Thập, phường Tân Quy, quận 7, Thành phố Hồ Chí Minh
(72) Nguyễn Thị Kim Hoàn (VN)
(55)

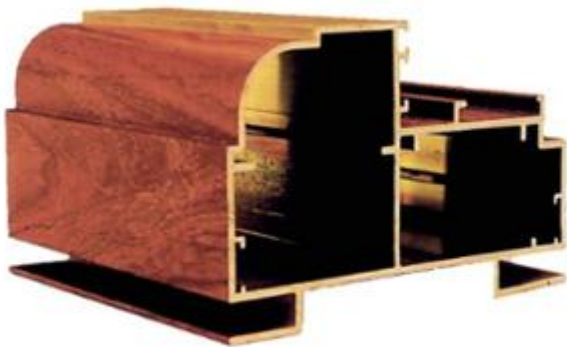

1.1

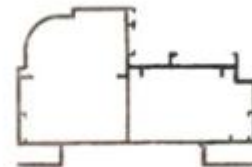

1.2

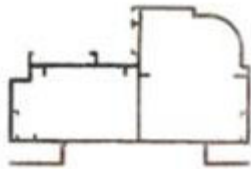

1.3



1.4



1.5



1.6



1.7

- (11) **48429**
- (21) 3-2023-01433
- (54) **THANH NHÔM ĐỊNH HÌNH**
- (22) 27/06/2023
- (73) **CÔNG TY TNHH THANH PHÚC WINDOW (VN)**
478 Nguyễn Thị Thập, phường Tân Quy, quận 7, thành phố Hồ Chí Minh
- (72) Nguyễn Thị Kim Hoàn (VN)
- (55)
- (28) 1
- (51) **25-01**
- (43) 27/11/2023



1.1

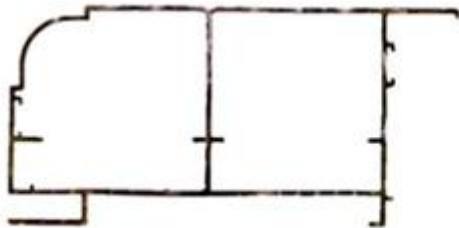

1.2



1.3



1.4



1.5



1.6



1.7

CÔNG BÁO SỞ HỮU CÔNG NGHIỆP SỐ 428 TẬP A – QUYỀN 2 (11.2023)

(11) **48430**

(21) 3-2023-01437

(28) 1

(54) **XE Ô TÔ KHÁCH**

(51) **12-08**

(22) 27/06/2023

(43) 27/11/2023

(73) **CÔNG TY CỔ PHẦN TẬP ĐOÀN THÀNH CÔNG (VN)**

CN1, khu công nghiệp Nguyên Khê, xã Nguyên Khê, huyện Đông Anh, thành phố Hà Nội

(72) 1. **LÊ VĂN HOÀI (VN)**

2. **VŨ ĐÌNH CHIẾN (VN)**

(74) Công ty Cổ phần Sở hữu công nghiệp INVESTIP (INVESTIP)

(55)



1.1



1.2



1.3



1.4

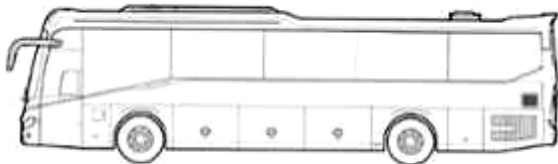

1.5

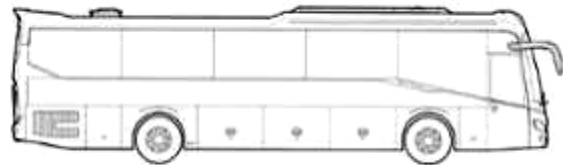

1.6



1.7

CÔNG BÁO SỞ HỮU CÔNG NGHIỆP SỐ 428 TẬP A – QUYỀN 2 (11.2023)

(11) **48431**

(21) 3-2023-01438

(28) 1

(54) **XE Ô TÔ KHÁCH**

(51) **12-08**

(22) 27/06/2023

(43) 27/11/2023

(73) **CÔNG TY CỔ PHẦN TẬP ĐOÀN THÀNH CÔNG (VN)**

CN1, khu công nghiệp Nguyên Khê, xã Nguyên Khê, huyện Đông Anh, thành phố Hà Nội

(72) 1. **LÊ VĂN HOÀI (VN)**

2. **VŨ ĐÌNH CHIẾN (VN)**

(74) Công ty Cổ phần Sở hữu công nghiệp INVESTIP (INVESTIP)

(55)



1.1



1.2



1.3



1.4

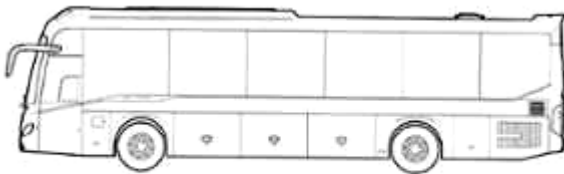

1.5

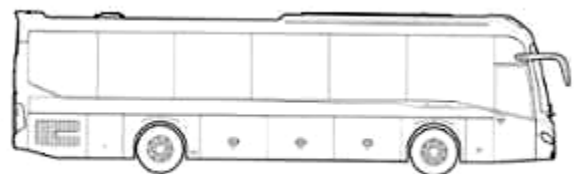

1.6

- (11) **48432**
(21) 3-2023-01443 (28) 1
(54) **KHAY GẬP GỌN ĐƯỢC** (51) **09-03**
(22) 28/06/2023 (43) 27/11/2023
(73) **CÔNG TY CỔ PHẦN BAO BÌ FUJI (VN)**
Thôn 1 (thuê của công ty TNHH Phước Hồng), xã Bắc Sơn, huyện An Dương,
thành phố Hải Phòng
(72) Fujiwara Ryohsuke (JP)
(74) **CÔNG TY LUẬT TRÁCH NHIỆM HỮU HẠN AMBYS HÀ NỘI (AMBYS
HANOI)**
(55)

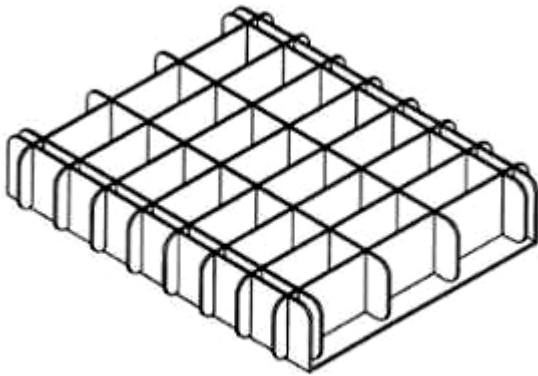

1.1



1.2

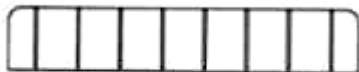

1.3



1.4

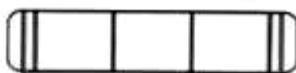

1.5



1.6



1.7

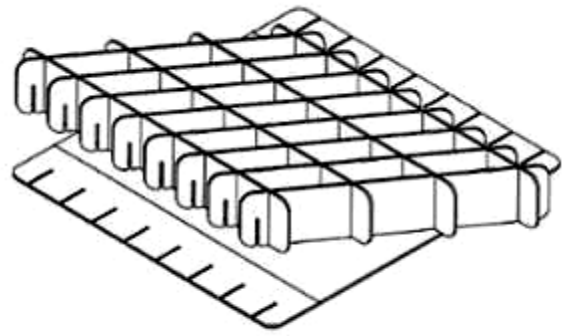

1.8



1.9

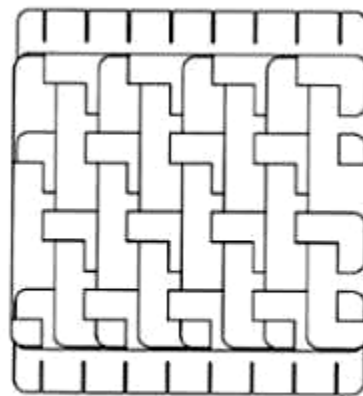

1.10

- (11) **48433**
(21) 3-2023-01444 (28) 1
(54) **KHUNG CHIA NGĂN GẤP GỌN** (51) **09-03**
(22) 28/06/2023 (43) 27/11/2023
(73) **CÔNG TY CỔ PHẦN BAO BÌ FUJI (VN)**
Thôn 1 (thuê của Công ty TNHH Phước Hồng), xã Bắc Sơn, huyện An Dương,
thành phố Hải Phòng
(72) Fujiwara Ryohsuke (JP)
(74) **CÔNG TY LUẬT TRÁCH NHIỆM HỮU HẠN AMBYS HÀ NỘI (AMBYS
HANOI)**
(55)

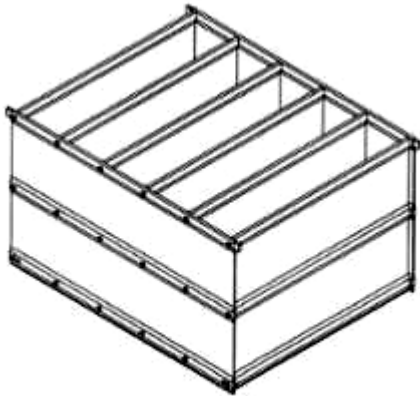

1.1



1.2



1.3



1.4

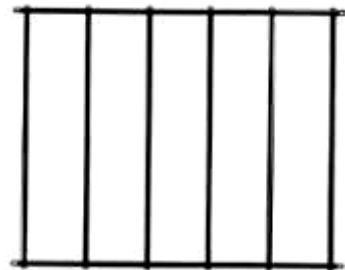

1.5

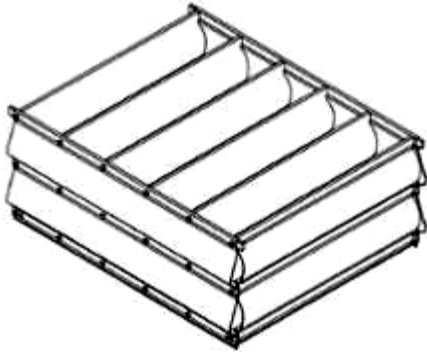

1.6

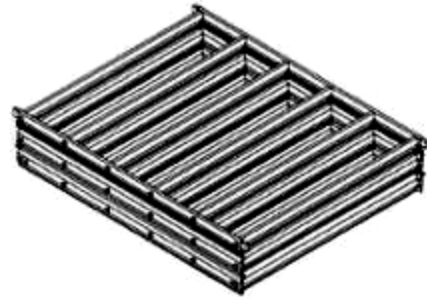

1.7

CÔNG BÁO SỞ HỮU CÔNG NGHIỆP SỐ 428 TẬP A – QUYỀN 2 (11.2023)

- (11) **48434**
(21) 3-2023-01473 (28) 1
(54) **MŨ BẢO HỘ LAO ĐỘNG** (51) **02-03**
(22) 30/06/2023 (43) 27/11/2023
(73) **CÔNG TY TRÁCH NHIỆM HỮU HẠN COV VINA (VN)**
Khu công nghiệp Sonadezi Châu Đức, xã Suối Nghệ, huyện Châu Đức, tỉnh Bà Rịa
- Vũng Tàu
(72) JUNG, YEON DONG (KR)
(74) **CÔNG TY TNHH SỞ HỮU TRÍ TUỆ SETHACO (SETHACO IP CO.,LTD)**
(55)



1.1



1.2



1.3

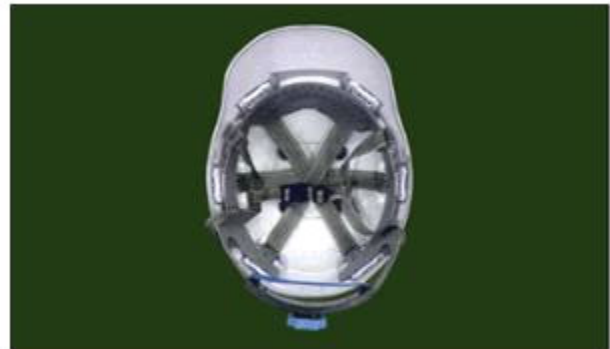

1.4



1.5



1.6



1.7

CÔNG BÁO SỞ HỮU CÔNG NGHIỆP SỐ 428 TẬP A – QUYỀN 2 (11.2023)

- (11) **48435**
(21) 3-2023-01474 (28) 1
(54) **MŨ BẢO HỘ LAO ĐỘNG** (51) **02-03**
(22) 30/06/2023 (43) 27/11/2023
(73) **CÔNG TY TRÁCH NHIỆM HỮU HẠN COV VINA (VN)**
Khu công nghiệp Sonadezi Châu Đức, xã Suối Nghệ, huyện Châu Đức, tỉnh Bà Rịa
-Vũng Tàu
(72) JUNG, YEON DONG (KR)
(74) **CÔNG TY TNHH SỞ HỮU TRÍ TUỆ SETHACO (SETHACO IP CO.,LTD)**
(55)



1.1



1.2



1.3



1.4



1.5



1.6



1.7

CÔNG BÁO SỞ HỮU CÔNG NGHIỆP SỐ 428 TẬP A – QUYỀN 2 (11.2023)

- (11) **48436**
(21) 3-2023-01499 (28) 1
(54) **KHÓA GÓC** (51) **08-08**
(22) 04/07/2023 (43) 27/11/2023
(73) **CÔNG TY CỔ PHẦN BAO BÌ FUJI (VN)**
Thôn 1 (thuê của Công ty TNHH Phước Hồng), xã Bắc Sơn, huyện An Dương,
thành phố Hải Phòng
(72) FUJIWARA RYOHSUKE (JP)
(74) **CÔNG TY LUẬT TRÁCH NHIỆM HỮU HẠN AMBYS HÀ NỘI (AMBYS HANOI)**
(55)



1.1



1.2



1.3



1.4

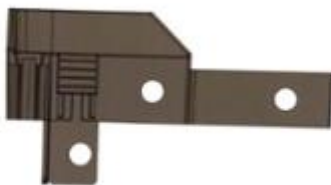

1.5



1.6



1.7

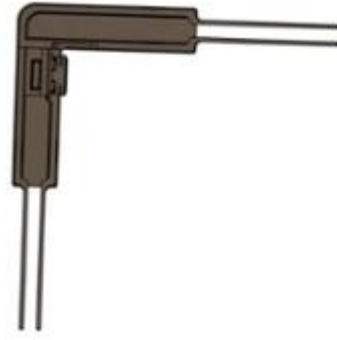

1.8

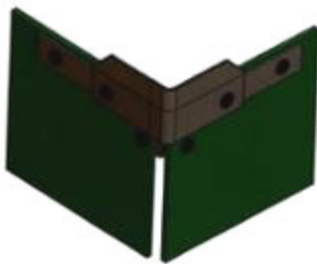

1.9

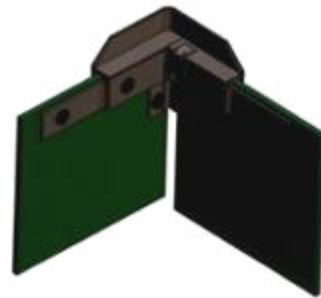

1.10



1.11

CÔNG BÁO SỞ HỮU CÔNG NGHIỆP SỐ 428 TẬP A – QUYỀN 2 (11.2023)

- (11) **48437**
(21) 3-2023-01501 (28) 2
(54) **ĐIỆN THOẠI DI ĐỘNG** (51) **14-03**
(22) 04/07/2023 (43) 27/11/2023
(30) 202330015021.0 10/01/2023 CN;
(73) **HUAWEI TECHNOLOGIES CO., LTD. (CN)**
Huawei Administration Building, Bantian, Longgang District, Shenzhen,
Guangdong 518129, P. R. China
(72) 1. HUANG, LU (CN)
2. XU, TING (CN)
3. XU, HAOSAN (CN)
(74) Công ty Cổ phần Sở hữu công nghiệp INVESTIP (INVESTIP)
(55)

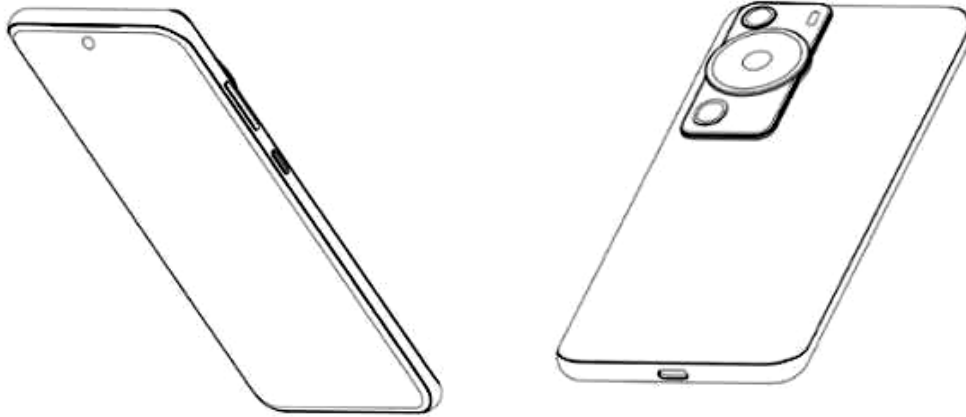

1.1

1.2

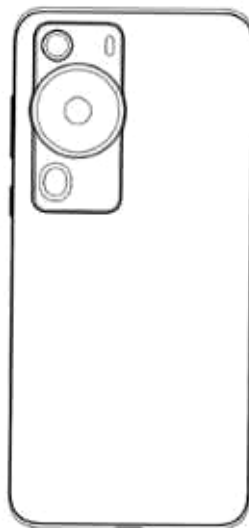

1.3

1.4

1.5

1.6



1.7



1.8



2.1



2.2



2.3



2.4



2.5

2.6



2.7



2.8

CÔNG BÁO SỞ HỮU CÔNG NGHIỆP SỐ 428 TẬP A – QUYỀN 2 (11.2023)

- (11) **48438**
(21) 3-2023-01541 (28) 1
(54) **MÁY HÚT BỤI** (51) **15-05**
(22) 07/07/2023 (43) 27/11/2023
(73) **LÊ VIỆT HÙNG (VN)**
Khu phố 8, phường 1, thành phố Đông Hà, tỉnh Quảng Trị
(72) Lê Việt Hùng (VN)
(74) **CÔNG TY TNHH KHANG LUẬT (KHANGLAW)**
(55)



1.1



1.2



1.3



1.4



1.5

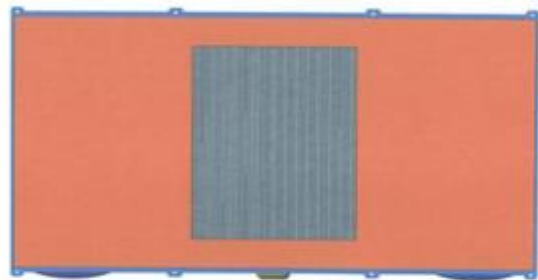

1.6



1.7

CÔNG BÁO SỞ HỮU CÔNG NGHIỆP SỐ 428 TẬP A – QUYỀN 2 (11.2023)

- (11) **48439**
(21) 3-2023-01542 (28) 1
(54) **BẢN MẪ LIÊN KẾT CHO NHÀ LẮP GHÉP** (51) **25-01; 25-02**
(22) 10/07/2023 (43) 27/11/2023
(73) **NGUYỄN XUÂN THỦY (VN)**
Tổ 3, khu 10, phường Bãi Cháy, thành phố Hạ Long, tỉnh Quảng Ninh
(72) Nguyễn Xuân Thủy (VN)
(55)

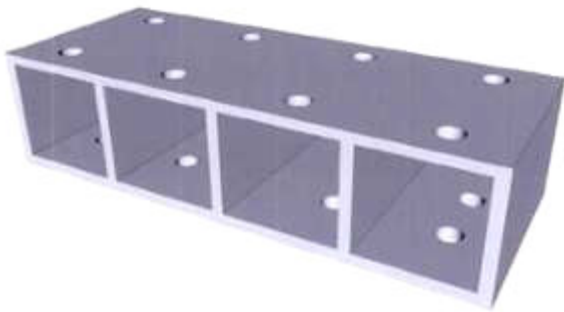

1.1



1.2



1.3

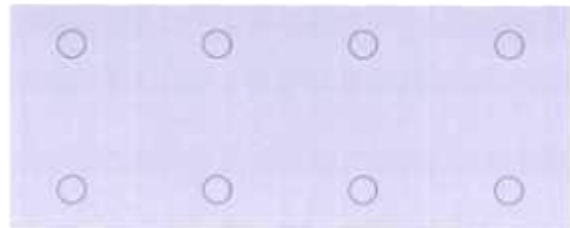

1.4

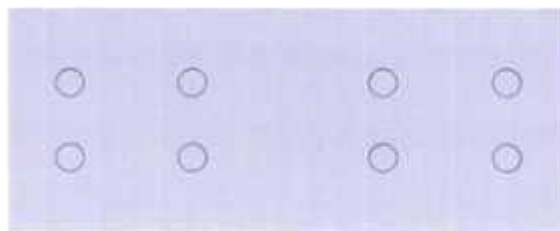

1.5

CÔNG BÁO SỞ HỮU CÔNG NGHIỆP SỐ 428 TẬP A – QUYỀN 2 (11.2023)

(11) **48440**

(21) 3-2023-01543

(28) 1

(54) **CỐT THÉP CỘT BÊ TÔNG LẮP GHEP**

(51) **25-01**

(22) 10/07/2023

(43) 27/11/2023

(73) **NGUYỄN XUÂN THỦY (VN)**

Tổ 3, khu 10, phường Bãi Cháy, thành phố Hạ Long, tỉnh Quảng Ninh

(72) Nguyễn Xuân Thủy (VN)

(55)



1.1



1.2



1.3

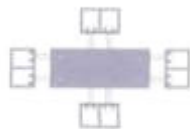

1.4

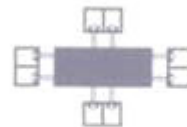

1.5

CÔNG BÁO SỞ HỮU CÔNG NGHIỆP SỐ 428 TẬP A – QUYỀN 2 (11.2023)

- (11) **48441**
(21) 3-2023-01545 (28) 1
(54) **BẢN MẪ LIÊN KẾT CHO NHÀ LẮP GHÉP** (51) **25-01; 25-02**
(22) 10/07/2023 (43) 27/11/2023
(73) **NGUYỄN XUÂN THỦY (VN)**
Tổ 3, khu 10, phường Bãi Cháy, thành phố Hạ Long, tỉnh Quảng Ninh
(72) Nguyễn Xuân Thủy (VN)
(55)



1.1



1.2

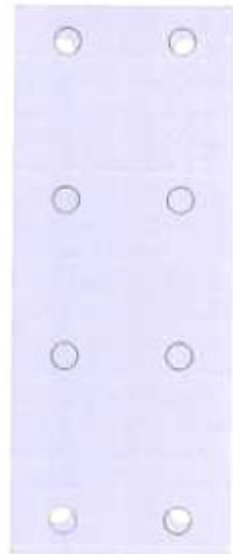

1.3

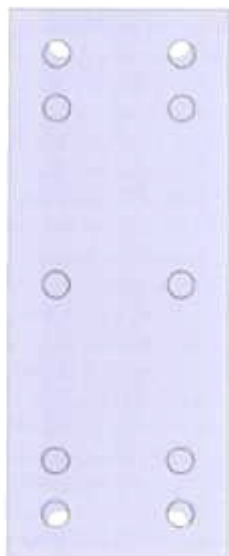

1.4

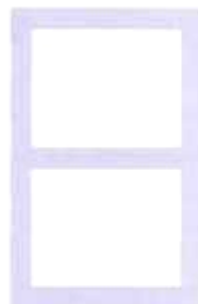

1.5

CÔNG BÁO SỞ HỮU CÔNG NGHIỆP SỐ 428 TẬP A – QUYỀN 2 (11.2023)

- (11) **48442**
(21) 3-2023-01551 (28) 2
(54) **ĐIỆN THOẠI DI ĐỘNG** (51) **14-03**
(22) 10/07/2023 (43) 27/11/2023
(30) 202330015883.3 10/01/2023 CN;
(73) **HUAWEI TECHNOLOGIES CO., LTD. (CN)**
Huawei Administration Building, Bantian, Longgang District, Shenzhen,
Guangdong 518129, P. R. China
(72) 1. GERBER, SYLVAIN (FR)
2. SUN, WENJING (CN)
3. WAN, YANG (CN)
4. WANG, JINGHAO (CN)
5. LIU, YI (CN)
(74) Công ty Cổ phần Sở hữu công nghiệp INVESTIP (INVESTIP)
(55)



1.1

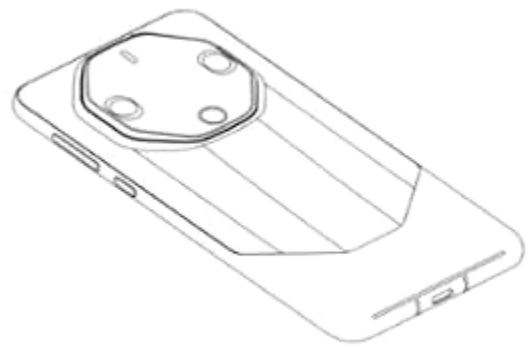

1.2



1.3

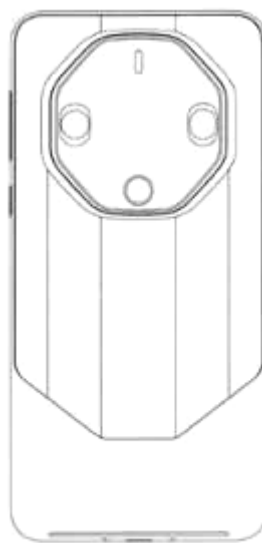

1.4



1.5



1.6



1.7



1.8



2.1



2.2



2.3



2.4



2.5

2.6



2.7



2.8

CÔNG BÁO SỞ HỮU CÔNG NGHIỆP SỐ 428 TẬP A – QUYỀN 2 (11.2023)

(11) **48443**

(21) 3-2023-01552

(28) 1

(54) **THÙNG XE MÔ TÔ**

(51) **12-16**

(22) 10/07/2023

(43) 27/11/2023

(73) **GIVI SPA (IT)**

Via G. Ungaretti, 48, 25020 Flero (BS), Italy

(72) Visenzi Giuseppe (IT)

(74) Công ty Cổ phần Sở hữu công nghiệp INVESTIP (INVESTIP)

(55)



1.1



1.2



1.3



1.4



1.5



1.6



1.7



1.8

CÔNG BÁO SỞ HỮU CÔNG NGHIỆP SỐ 428 TẬP A – QUYỀN 2 (11.2023)

- (11) **48444**
(21) 3-2023-01597 (28) 1
(54) **MẶT NẠ TRƯỚC CHO XE MÁY** (51) **12-16**
(22) 13/07/2023 (43) 27/11/2023
(30) 2023303668147 14/06/2023 CN;
(73) **TAIZHOU LINXIAO INTELLIGENT TECHNOLOGY CO., LTD. (CN)**
4th Floor, No. 176, Luoyang Road, Luoyang Street, Luqiao District, Taizhou City,
Zhejiang Province, China
(72) LIU Pengwei (CN)
(74) Công ty TNHH Đại Tín và Liên Danh (DAITIN AND ASSOCIATES CO.,LTD)
(55)



1.1



1.2



1.3



1.4



1.5



1.6

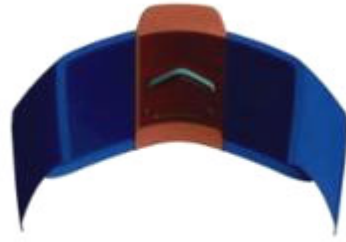

1.7

CÔNG BÁO SỞ HỮU CÔNG NGHIỆP SỐ 428 TẬP A – QUYỀN 2 (11.2023)

- (11) **48445**
(21) 3-2023-01622 (28) 1
(54) **HỘP ĐỰNG SẢN PHẨM** (51) **09-03**
(22) 14/07/2023 (43) 27/11/2023
(73) **CÔNG TY TNHH MINH DŨNG (VN)**
Tổ dân phố Kêu, thị trấn Đạo Đức, huyện Bình Xuyên, tỉnh Vĩnh Phúc
(72) Hà Hữu Tuyên (VN)
(74) Công ty TNHH Tư vấn đầu tư và Sở hữu trí tuệ Hoàng Phi (HOANG PHI INVEST & I.P CO., LTD)
(55)

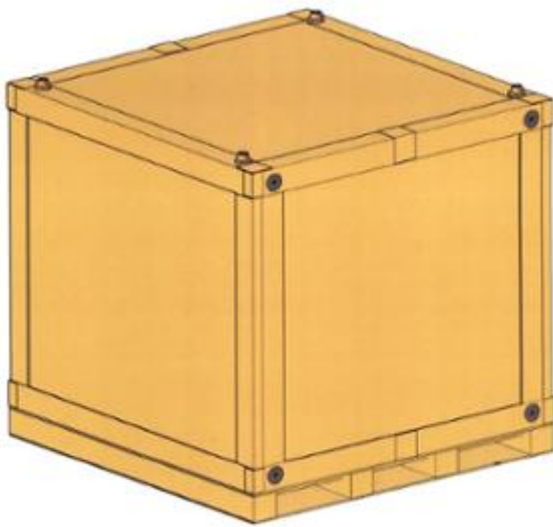

1.1

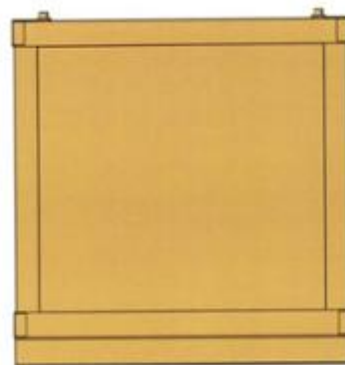

1.2



1.3

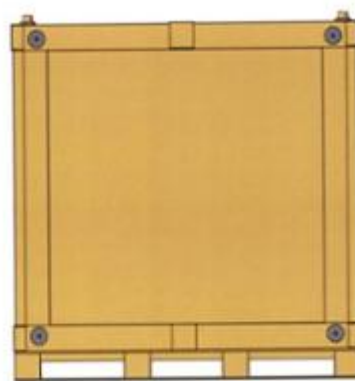

1.4



1.5

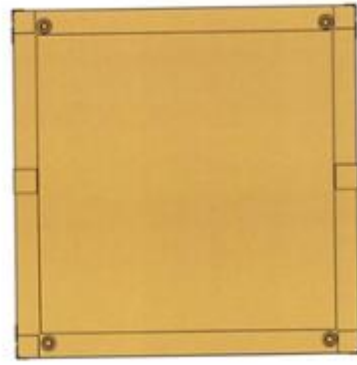

1.6

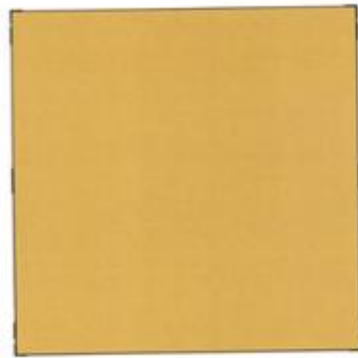

1.7

CÔNG BÁO SỞ HỮU CÔNG NGHIỆP SỐ 428 TẬP A – QUYỀN 2 (11.2023)

- (11) **48446**
(21) 3-2023-01625 (28) 1
(54) **GHẾ** (51) **06-01**
(22) 14/07/2023 (43) 27/11/2023
(73) **VEYER, LLC (US)**
6600 North Military Trail, Boca Raton, Florida 33496, U.S.A.
(72) 1. DANIELLE STELLA-FISCHER (US)
2. RAMON PINTO (VE)
(74) Công ty TNHH Sở hữu trí tuệ HA VIP (HAVIP CO., LTD.)
(55)



1.1



1.2



1.3



1.4



1.5



1.6



1.7



1.8



1.9

CÔNG BÁO SỞ HỮU CÔNG NGHIỆP SỐ 428 TẬP A – QUYỀN 2 (11.2023)

- (11) **48447**
(21) 3-2023-01626 (28) 1
(54) **GHẾ** (51) **06-01**
(22) 14/07/2023 (43) 27/11/2023
(73) **VEYER, LLC (US)**
6600 North Military Trail, Boca Raton, Florida 33496, U.S.A.
(72) 1. DANIELLE STELLA-FISCHER (US)
2. RAMON PINTO (VE)
(74) Công ty TNHH Sở hữu trí tuệ HA VIP (HAVIP CO., LTD.)
(55)



1.1



1.2



1.3



1.4



1.5



1.6



1.7



1.8



1.9

CÔNG BÁO SỞ HỮU CÔNG NGHIỆP SỐ 428 TẬP A – QUYỀN 2 (11.2023)

(11) **48448**

(21) 3-2023-01627

(54) **GHẾ**

(22) 14/07/2023

(73) **VEYER, LLC (US)**

6600 North Military Trail, Boca Raton, Florida 33496, U.S.A.

(72) 1. DANIELLE STELLA-FISCHER (US)

2. RAMON PINTO (VE)

(74) Công ty TNHH Sở hữu trí tuệ HA VIP (HAVIP CO., LTD.)

(55)

(28) 1

(51) **06-01**

(43) 27/11/2023



1.1



1.2



1.3



1.4



1.5



1.6



1.7



1.8



1.9

CÔNG BÁO SỞ HỮU CÔNG NGHIỆP SỐ 428 TẬP A – QUYỀN 2 (11.2023)

- (11) **48449**
(21) 3-2023-01635 (28) 1
(54) **CHAI** (51) **09-01**
(22) 18/07/2023 (43) 27/11/2023
(73) **CÔNG TY CỔ PHẦN SỮA VITADAIRY VIỆT NAM (VN)**
Tầng 5, Số 37 Tôn Đức Thắng, phường Bến Nghé, quận 1, thành phố Hồ Chí Minh
(72) Nguyễn Thị Hà (VN)
(55)



1.1



1.2



1.3



1.4



1.5

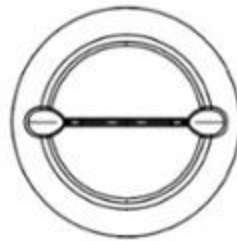

1.6

CÔNG BÁO SỞ HỮU CÔNG NGHIỆP SỐ 428 TẬP A – QUYỀN 2 (11.2023)

- (11) **48450**
(21) 3-2023-01636 (28) 1
(54) **KHÓA CỬA KỸ THUẬT SỐ** (51) **08-06; 08-07**
(22) 18/07/2023 (43) 27/11/2023
(30) 30-2023-0018048 11/05/2023 KR;
(73) **SOLITY CO., LTD. (KR)**
#103~105, #201~207, Yangcheon Venture Town, 267 Sinjeong-ro, Yangcheon-gu,
Seoul 08079, Republic of Korea
(72) Byun, Chang Hoo (KR)
(74) Công ty TNHH Luật ALIAT (ALIAT LEGAL)
(55)

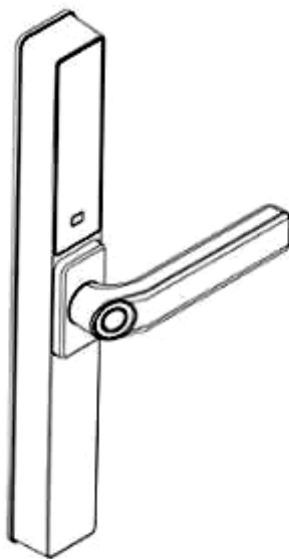

1.1

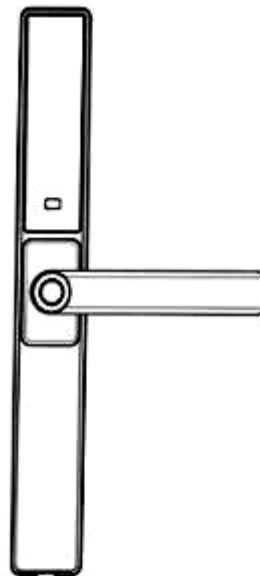

1.2

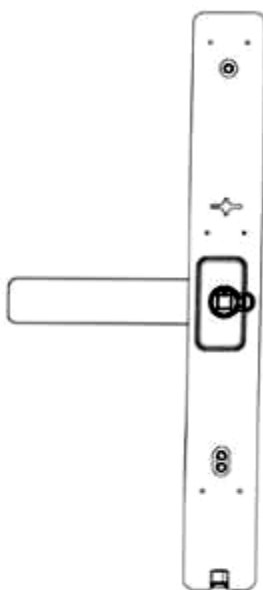

1.3

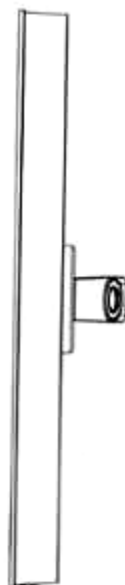

1.4

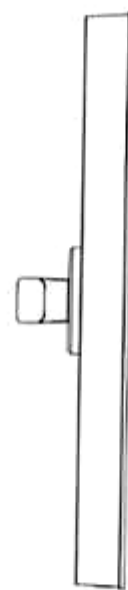

1.5

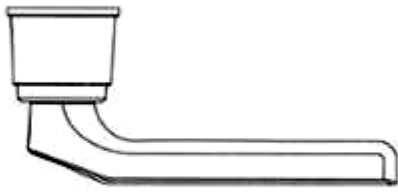

1.6

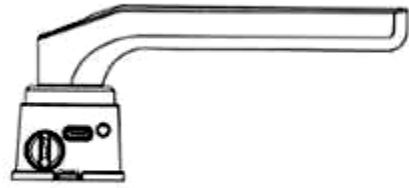

1.7

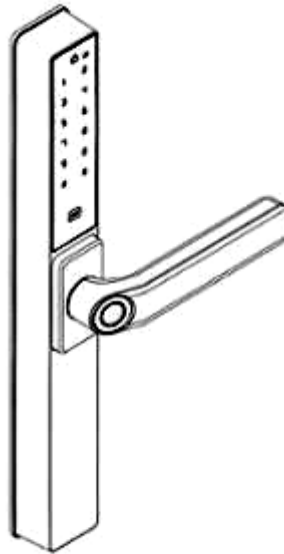

1.8

CÔNG BÁO SỞ HỮU CÔNG NGHIỆP SỐ 428 TẬP A – QUYỀN 2 (11.2023)

- (11) **48451**
(21) 3-2023-01641 (28) 1
(54) **BÌNH** (51) **09-01**
(22) 18/07/2023 (43) 27/11/2023
(73) **CÔNG TY CỔ PHẦN UNIVCLEANER (VN)**
Số 198 Võ Văn Kiệt, phường Cầu Ông Lãnh, quận 1, thành phố Hồ Chí Minh
(72) Phạm Văn Vũ (VN)
(74) Công ty TNHH Tư vấn - Dịch thuật - Sở hữu trí tuệ Á Đông (Á Đông IP
CONSULTANCY CO.,LTD.)
(55)



1.1



1.2



1.3



1.4



1.5



1.6



1.7

CÔNG BÁO SỞ HỮU CÔNG NGHIỆP SỐ 428 TẬP A – QUYỀN 2 (11.2023)

- (11) **48452**
(21) 3-2023-01645 (28) 1
(54) **MÁY LỌC NƯỚC** (51) **23-01**
(22) 19/07/2023 (43) 27/11/2023
(73) **CÔNG TY CỔ PHẦN TẬP ĐOÀN SUNHOUSE (VN)**
Số 139, phố Nguyễn Thái Học, phường Điện Biên, quận Ba Đình, thành phố Hà Nội
(72) Lại Văn Kiên (VN)
(74) Công ty TNHH Sở hữu trí tuệ Bình Minh (SUNRISE IP CO.,LTD.)
(55)

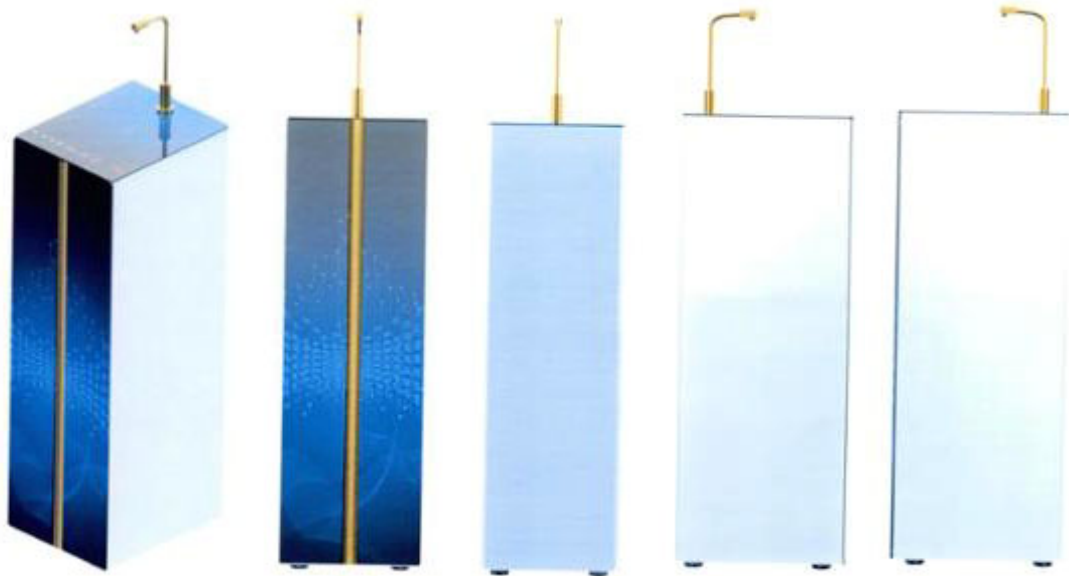

1.1

1.2

1.3

1.4

1.5



1.6



1.7

CÔNG BÁO SỞ HỮU CÔNG NGHIỆP SỐ 428 TẬP A – QUYỀN 2 (11.2023)

- (11) **48453**
(21) 3-2023-01664
(54) **SỢT ĐỤNG**
(22) 24/07/2023
(73) **CÔNG TY CỔ PHẦN THAKE (VN)**
29/17 đường liên xã thị trấn Thới Tam Thôn, xã Thới Tam Thôn, huyện Hóc Môn,
thành Phố Hồ Chí Minh
(72) Chim Văn Cang (VN)
(55)
- (28) 1
(51) **09-04**
(43) 27/11/2023



1.1



1.2



1.3

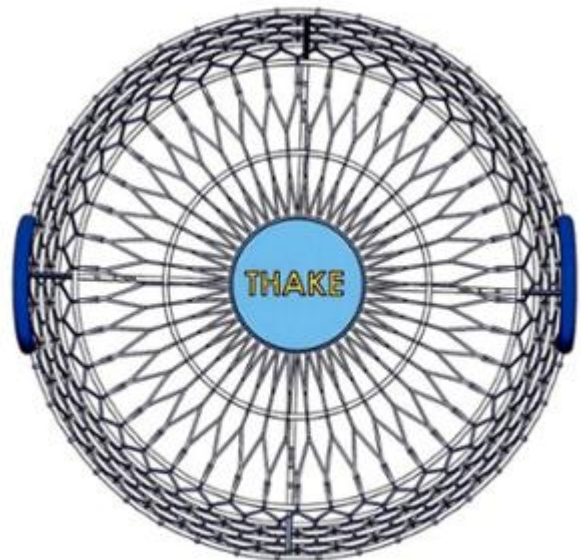

1.4

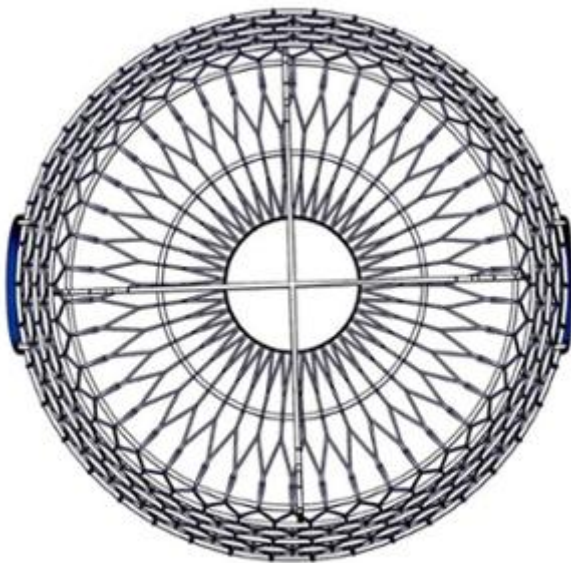

1.5



1.6

CÔNG BÁO SỞ HỮU CÔNG NGHIỆP SỐ 428 TẬP A – QUYỀN 2 (11.2023)

- (11) **48454**
(21) 3-2023-01667 (28) 1
(54) **BÚT** (51) **19-06**
(22) 24/07/2023 (43) 27/11/2023
(73) **CÔNG TY CỔ PHẦN TẬP ĐOÀN THIÊN LONG (VN)**
Tầng 10, Sofie Tower, số 10 đường Mai Chí Thọ, phường Thủ Thiêm, thành phố Thủ Đức, thành phố Hồ Chí Minh
(72) Cô Gia Thọ (VN)
(74) Công ty TNHH Tư vấn sở hữu trí tuệ Việt (VIET IP CO.,LTD.)
(55)

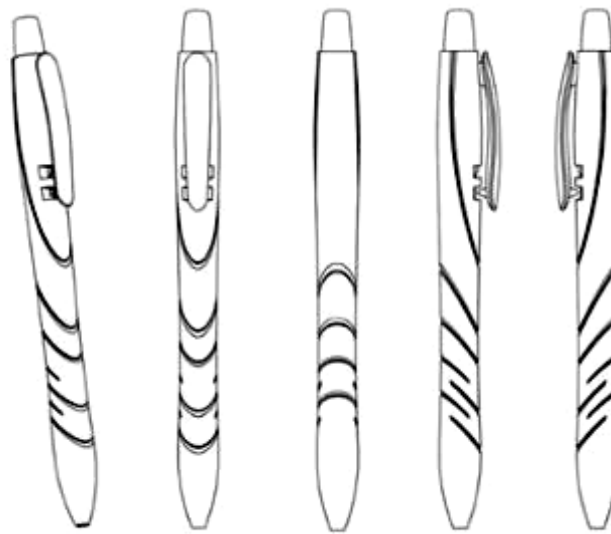

1.1

1.2

1.3

1.4

1.5



1.6



1.7

- (11) **48455**
(21) 3-2023-01672 (28) 2
(54) **TAI NGHE** (51) **14-01**
(22) 25/07/2023 (43) 27/11/2023
(30) 29/883,297 26/01/2023 US;
(73) **APPLE INC. (US)**
One Apple Park Way, Cupertino, California 95014, United States of America
(72) 1. WENJIE ZHUANG (CN)
2. ROBERT BOYD (US)
3. DUY P. LE (US)
4. JEFFREY SCOTT CROYLE (US)
5. JOSEPH F. DEMBS (US)
6. GUILLAUME RAOULT (FR)
7. JAMES SWASEY (US)
8. CHRISTOPHER KUH (DE)
9. ROBERT BRUNNER (US)
(74) Công ty TNHH Lê & Lê (LE & LE)
(55)

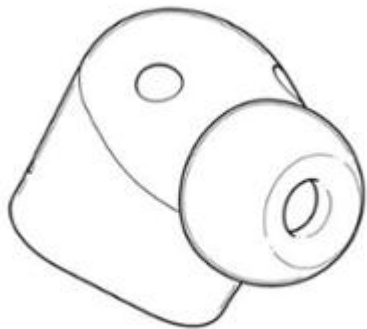

1.1



1.2



1.3



1.4

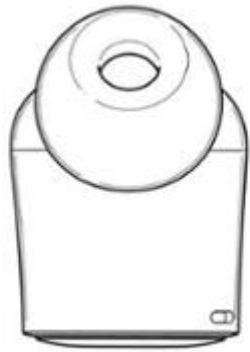

1.5



1.6

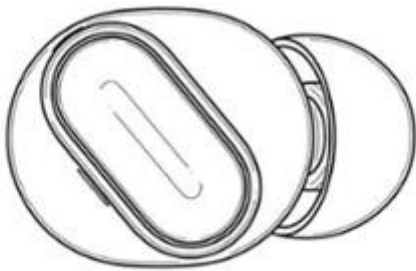

1.7

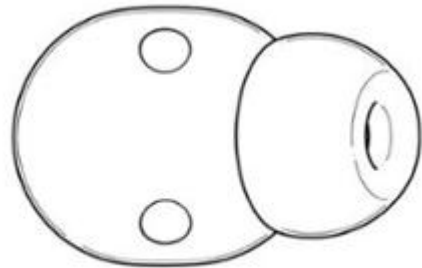

1.8

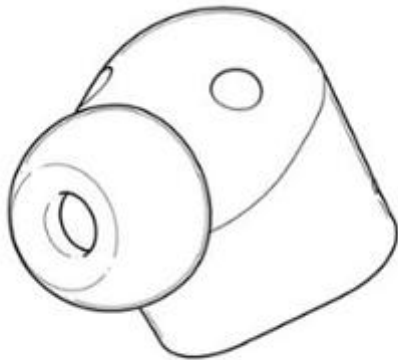

2.1

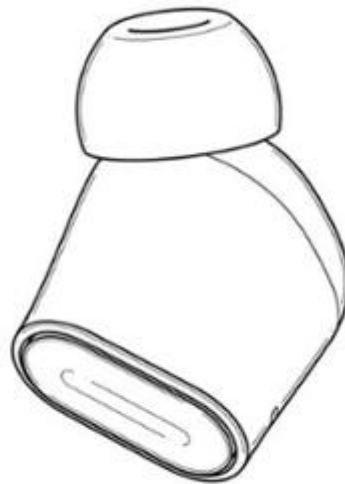

2.2



2.3



2.4

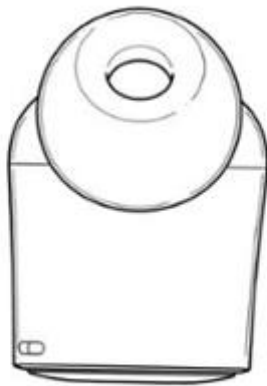

2.5



2.6

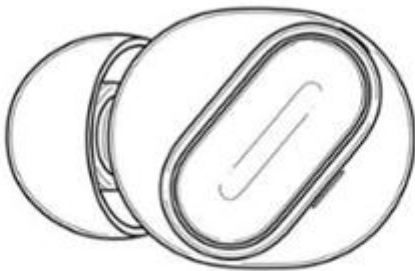

2.7

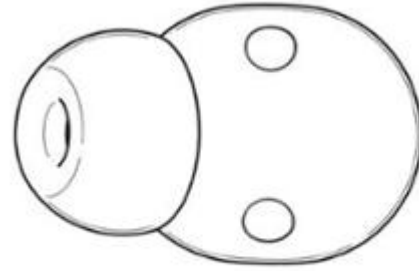

2.8

CÔNG BÁO SỞ HỮU CÔNG NGHIỆP SỐ 428 TẬP A – QUYỀN 2 (11.2023)

(11) **48456**

(21) 3-2023-01676

(28) 1

(54) **MŨ BẢO HIỂM**

(51) **02-03**

(22) 25/07/2023

(43) 27/11/2023

(73) **HENRY TEDJAKUSUMA (ID)**

Jalan Wuluh Blok II/3, RT/RW 009/006, Kota Bambu Utara, Palmerah Jakarta Barat 11420, Indonesia

(72) Henry Tedjakusuma (ID)

(74) Công ty TNHH Sở hữu trí tuệ HA VIP (HAVIP CO., LTD.)

(55)



1.1



1.2



1.3



1.4



1.5



1.6

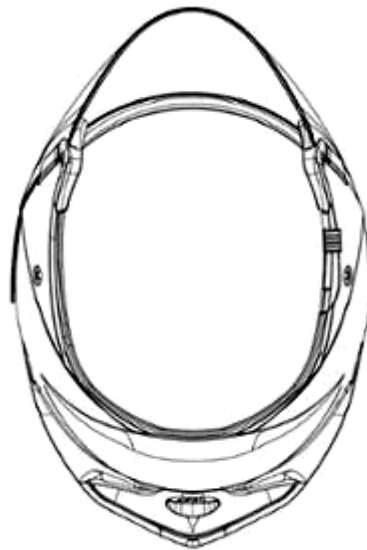

1.7

- (11) **48457**
(21) 3-2023-01684 (28) 1
(54) **CHUỖI RĂNG CỦA KHÓA KÉO** (51) **02-07**
(22) 26/07/2023 (43) 27/11/2023
(30) 202330168479X 31/03/2023 CN;
(73) **YKK CORPORATION (JP)**
1, Kanda Izumi-cho, Chiyoda-ku, Tokyo 101-8642 Japan
(72) 1. KOHEI KAWARADA (JP)
2. MIZUKI KURIKAWA (JP)
(74) Công ty Luật TNHH Phạm và Liên danh (PHAM & ASSOCIATES)
(55)

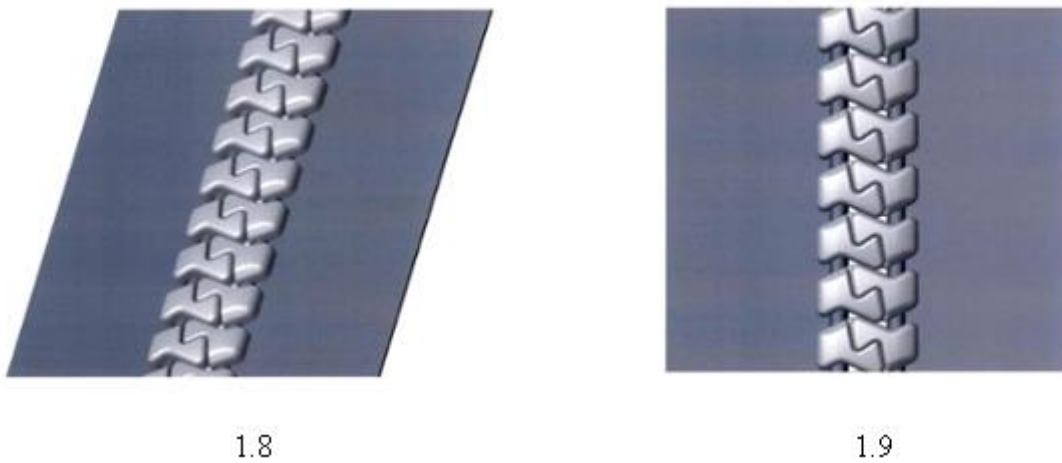
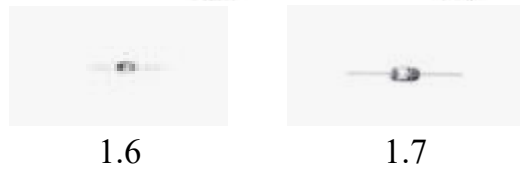
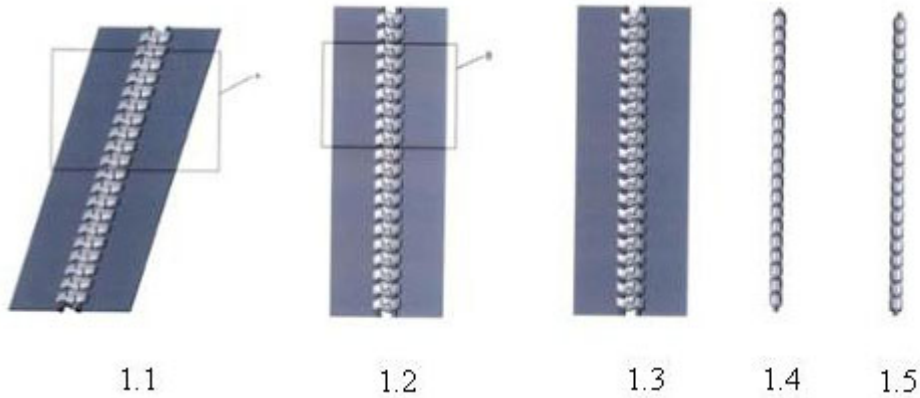

- (11) **48458**
(21) 3-2023-01685 (28) 1
(54) **CHUỖI RĂNG CỦA KHÓA KÉO** (51) **02-07**
(22) 26/07/2023 (43) 27/11/2023
(30) 202330168479X 31/03/2023 CN;
(73) **YKK CORPORATION (JP)**
1, Kanda Izumi-cho, Chiyoda-ku, Tokyo 101-8642 Japan
(72) 1. KOHEI KAWARADA (JP)
2. MIZUKI KURIKAWA (JP)
(74) Công ty Luật TNHH Phạm và Liên danh (PHAM & ASSOCIATES)
(55)

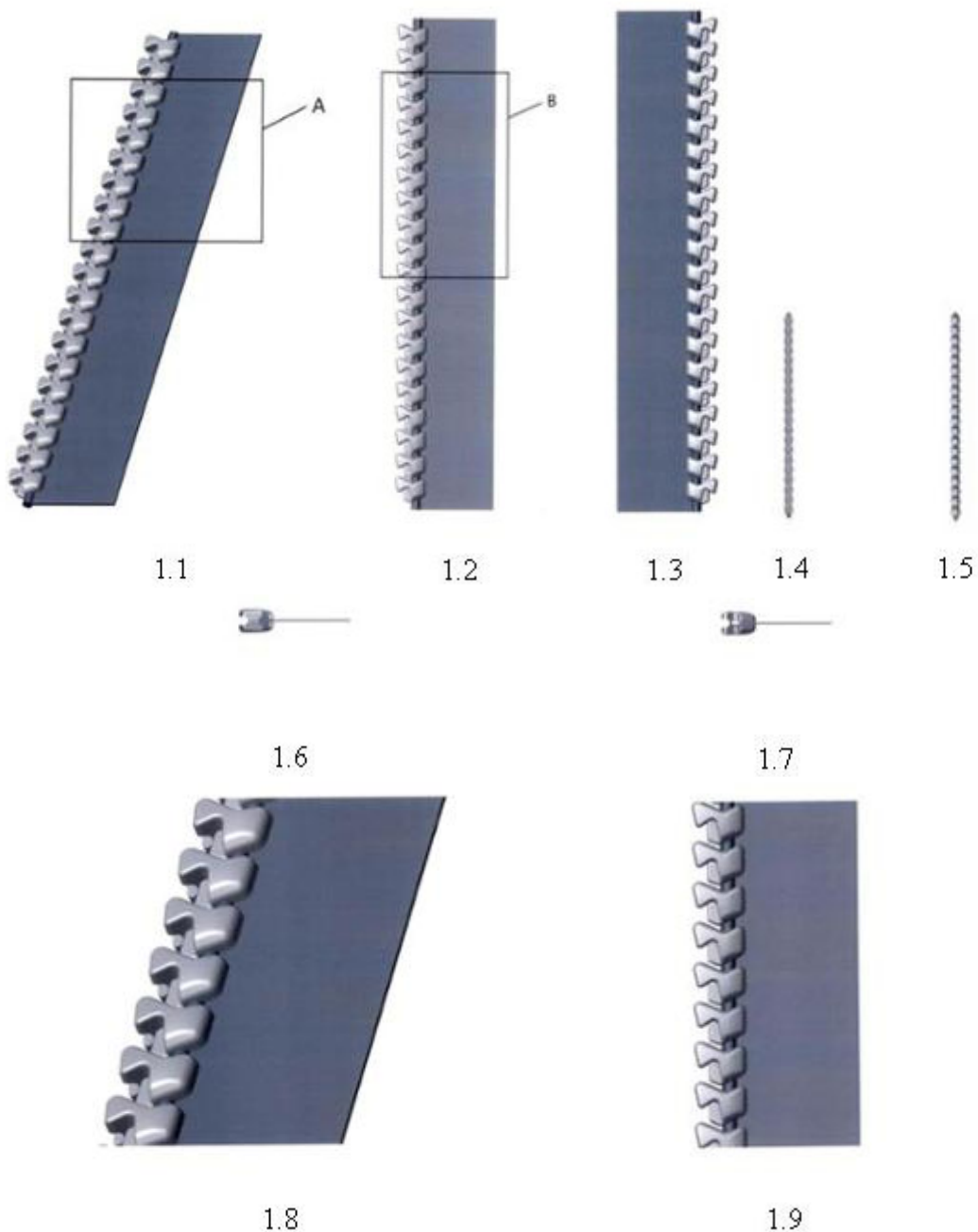

CÔNG BÁO SỞ HỮU CÔNG NGHIỆP SỐ 428 TẬP A – QUYỀN 2 (11.2023)

- (11) **48459**
(21) 3-2023-01686 (28) 2
(54) **TÚI ĐỰNG** (51) **09-05**
(22) 26/07/2023 (43) 27/11/2023
(30) 29/883,927 05/02/2023 US;
(73) **DART INDUSTRIES INC. (US)**
14901 S. Orange Blossom Trail, Orlando, Florida, 32837, United States of America
(72) 1. JUDICAËL CORNU (FR)
2. PAULINE FOSSIEZ (FR)
3. SIMON MILLECAM (BE)
4. DIMITRI M.C.J. BACKAERT (BE)
5. WIM DE VOS (BE)
(74) **CÔNG TY LUẬT TRÁCH NHIỆM HỮU HẠN AMBYS HÀ NỘI (AMBYS HANOI)**
(55)



1.1

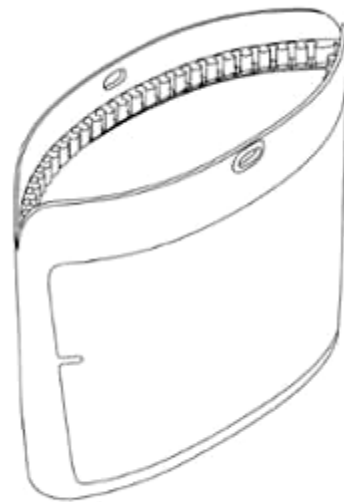

1.2

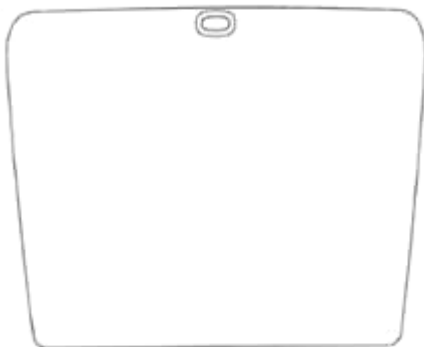

1.3

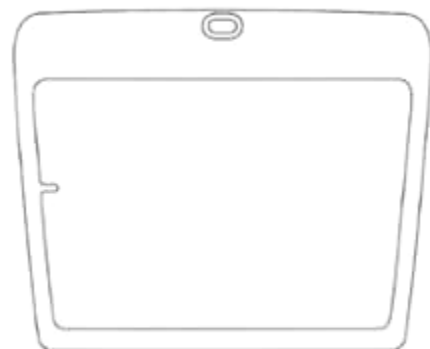

1.4



1.5



1.6

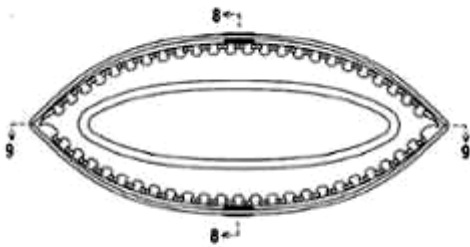

1.7



1.8

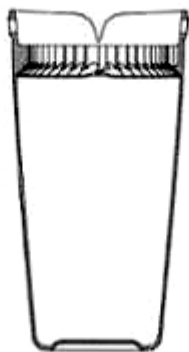

1.9

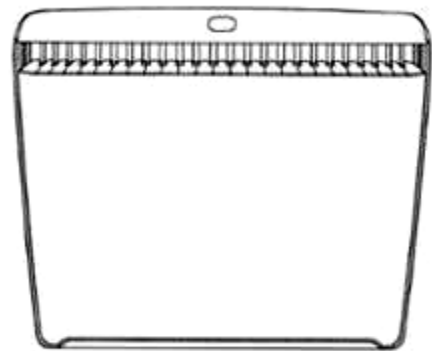

1.10

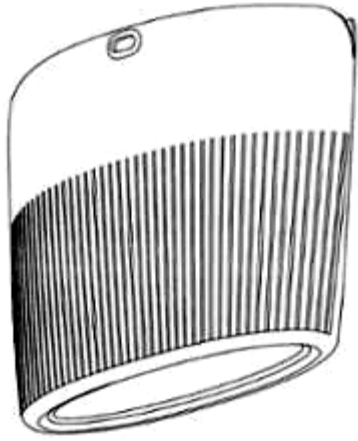

2.1

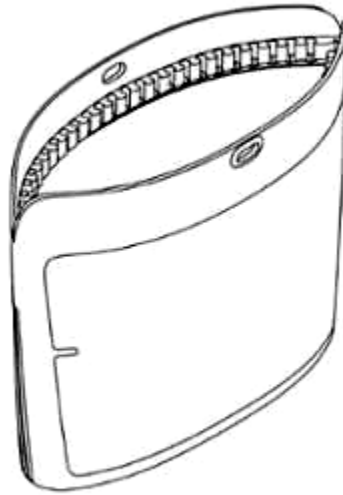

2.2

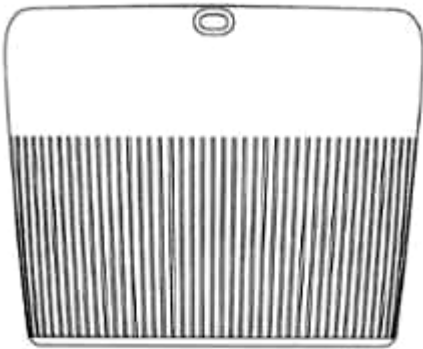

2.3

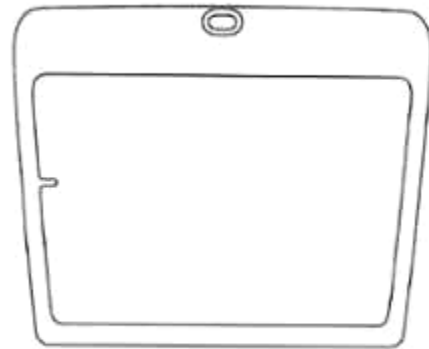

2.4

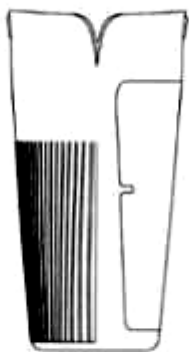

2.5

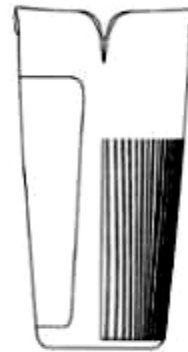

2.6

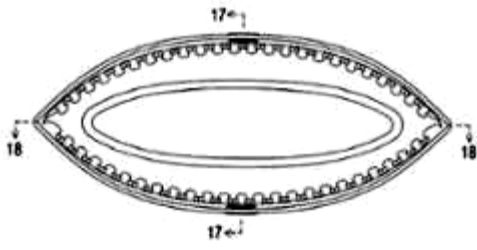

2.7



2.8

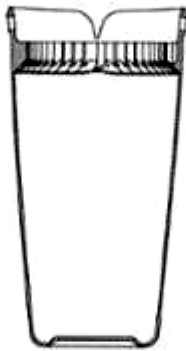

2.9

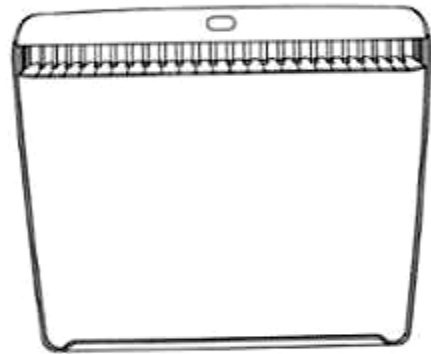

2.10

CÔNG BÁO SỞ HỮU CÔNG NGHIỆP SỐ 428 TẬP A – QUYỀN 2 (11.2023)

- (11) **48460**
(21) 3-2023-01691 (28) 1
(54) **SÚNG PHUN XỊT** (51) **23-01**
(22) 26/07/2023 (43) 27/11/2023
(73) **SHIN TAI SPURT WATER OF THE GARDEN TOOLS CO., LTD. (TW)**
No. 109-7, Liaocuo Ln., Liaocuo Vil., Lukang Township, Changhua County
505030, Taiwan
(72) Chin-Yuan CHEN (TW)
(74) Công ty TNHH Sở hữu trí tuệ HA VIP (HAVIP CO., LTD.)
(55)

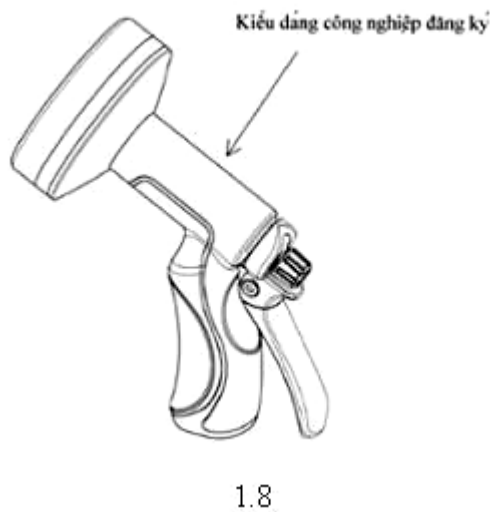
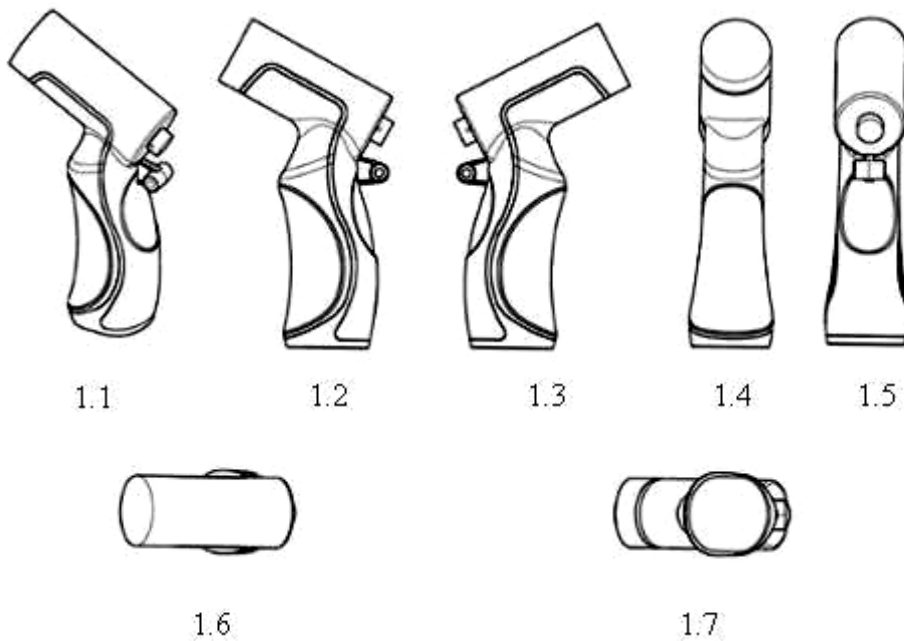

CÔNG BÁO SỞ HỮU CÔNG NGHIỆP SỐ 428 TẬP A – QUYỀN 2 (11.2023)

- (11) **48461**
(21) 3-2023-01692 (28) 1
(54) **DỤNG CỤ PHUN NƯỚC** (51) **23-01**
(22) 26/07/2023 (43) 27/11/2023
(73) **SHIN TAI SPURT WATER OF THE GARDEN TOOLS CO., LTD. (TW)**
No. 109-7, Liaocuo Ln., Liaocuo Vil, Lukang Township, Changhua County 505030,
Taiwan
(72) Chin-Yuan CHEN (TW)
(74) Công ty TNHH Sở hữu trí tuệ HA VIP (HAVIP CO., LTD.)
(55)

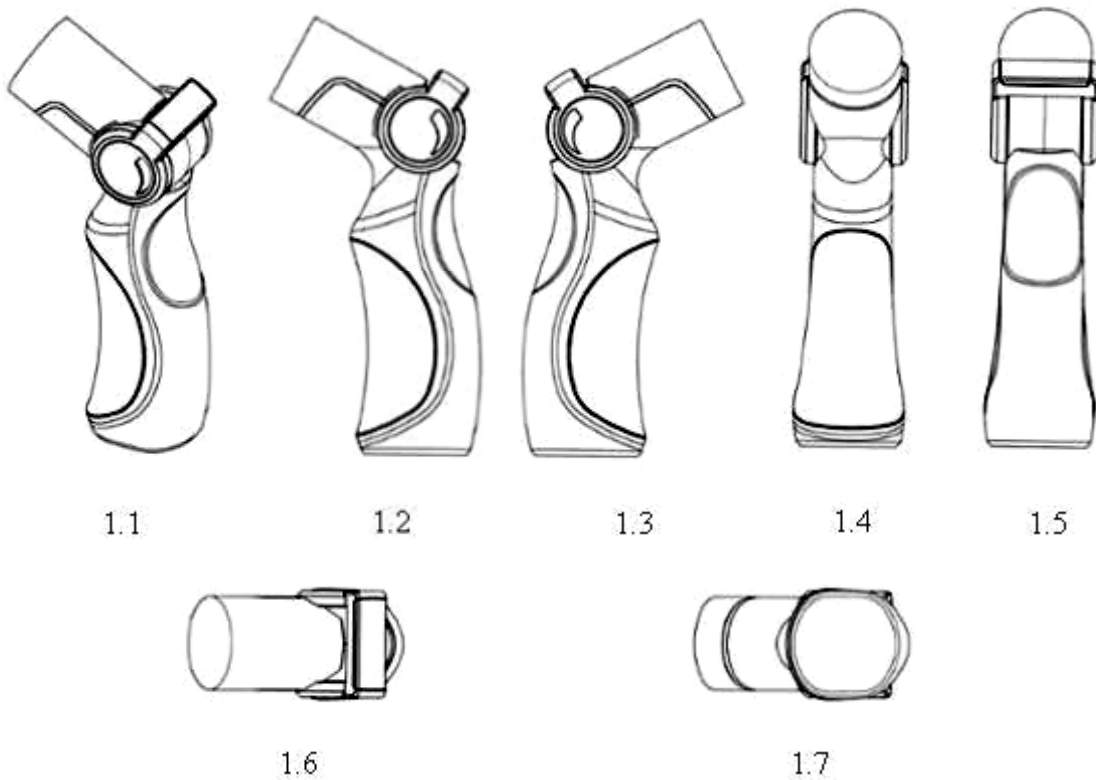

CÔNG BÁO SỞ HỮU CÔNG NGHIỆP SỐ 428 TẬP A – QUYỀN 2 (11.2023)

- (11) **48462**
(21) 3-2023-01693 (28) 1
(54) **DỤNG CỤ PHUN NƯỚC** (51) **23-01**
(22) 26/07/2023 (43) 27/11/2023
(73) **SHIN TAI SPURT WATER OF THE GARDEN TOOLS CO., LTD. (TW)**
No. 109-7, Liaocuo Ln., Liaocuo Vil., Lukang Township, Changhua County
505030, Taiwan
(72) Chin-Yuan CHEN (TW)
(74) Công ty TNHH Sở hữu trí tuệ HA VIP (HAVIP CO., LTD.)
(55)



1.1

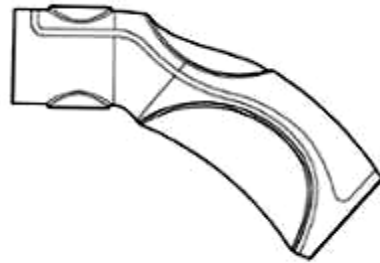

1.2

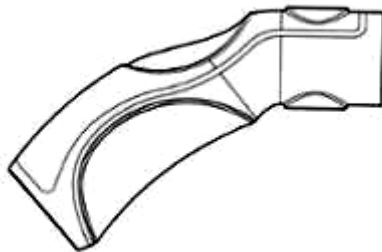

1.3



1.4



1.5



1.6



1.7

- (11) **48463**
(21) 3-2023-01717 (28) 1
(54) **MÁY LỌC KHÔNG KHÍ** (51) **23-04**
(22) 27/07/2023 (43) 27/11/2023
(30) 015010216-0001 31/01/2023 EM;
(73) **BLUEAIR AB** (SE)
Karlavägen 108, 115 26 Stockholm, Sweden
(72) 1. TONI LUUKKONEN FREDÄNG (SE)
2. SIMON ANDREAS FREDRIKSSON (SE)
3. RYAN STEPHEN HELPS (GB)
4. ANDREA MAMBRINI (IT)
5. JAKOB KARL MINGETTIG (SE)
(74) Công ty TNHH Trần Hữu Nam và Đồng sự (TRAN H.N & ASS.)
(55)

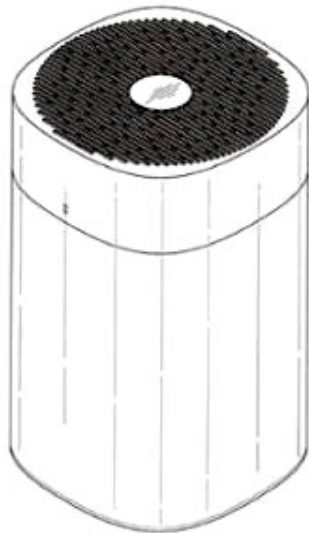

1.1

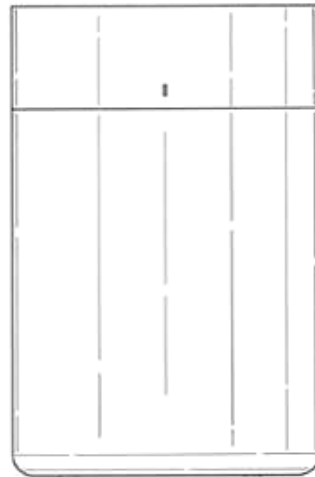

1.2

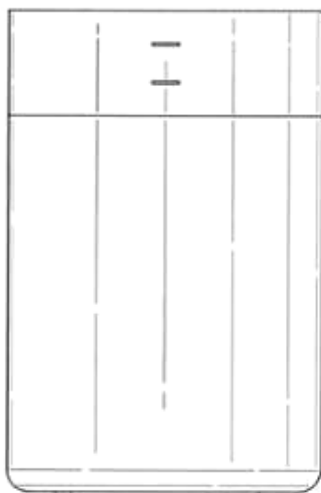

1.3

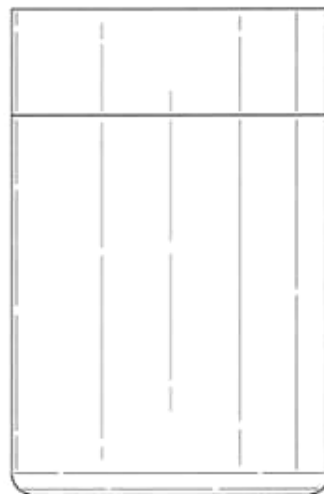

1.4

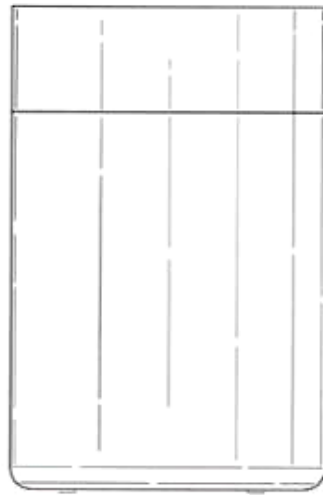

1.5

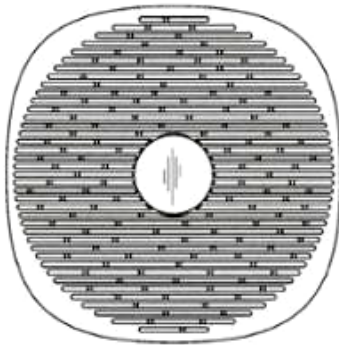

1.6

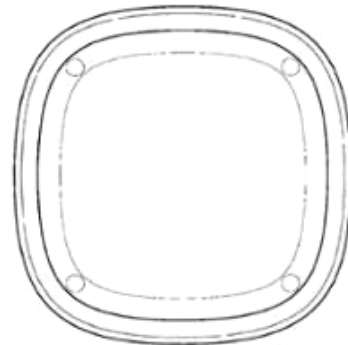

1.7

- (11) **48464**
(21) 3-2023-01718 (28) 1
(54) **MÁY LỌC KHÔNG KHÍ** (51) **23-04**
(22) 27/07/2023 (43) 27/11/2023
(30) 015010214-0001 31/01/2023 EM;
(73) **BLUEAIR AB** (SE)
Karlavägen 108, 115 26 Stockholm, Sweden
(72) 1. TONI LUUKKONEN FREDÄNG (SE)
2. SIMON ANDREAS FREDRIKSSON (SE)
3. RYAN STEPHEN HELPS (GB)
4. ANDREA MAMBRINI (IT)
5. JAKOB KARL MINGETTIG (SE)
(74) Công ty TNHH Trần Hữu Nam và Đồng sự (TRAN H.N & ASS.)
(55)

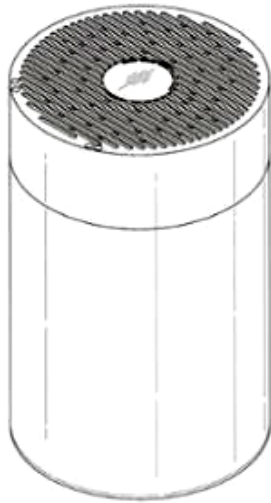

1.1

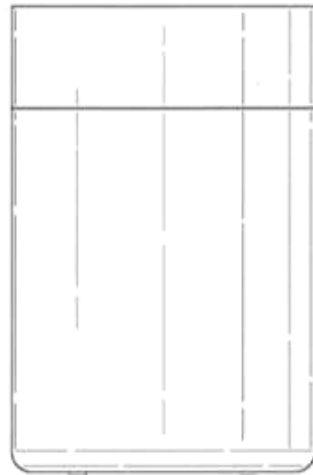

1.2

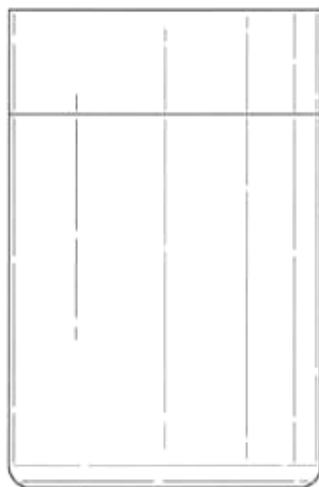

1.3

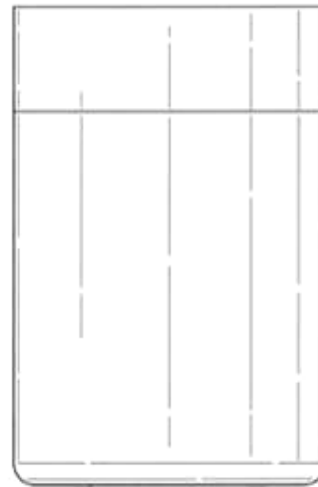

1.4

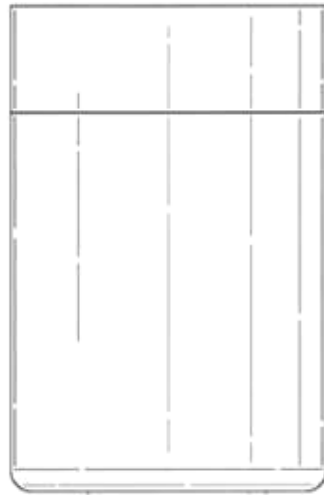

1.5

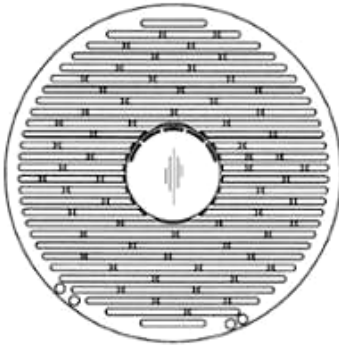

1.6

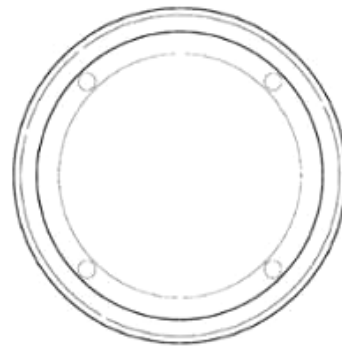

1.7

CÔNG BÁO SỞ HỮU CÔNG NGHIỆP SỐ 428 TẬP A – QUYỀN 2 (11.2023)

- (11) **48465**
(21) 3-2023-01722 (28) 1
(54) **ÁO NỮ** (51) **02-02**
(22) 27/07/2023 (43) 27/11/2023
(30) 202310640 03/02/2023 AU;
(73) **CATAPULT GROUP INTERNATIONAL LTD (AU)**
75 High Street, Prahran VIC 3181, Australia
(72) 1. ARDALAN KATEBI (IR)
2. JAMES MOHAN (US)
3. ANNA ASNIS (US)
(74) Công ty TNHH Đại Tín và Liên Danh (DAITIN AND ASSOCIATES CO.,LTD)
(55)

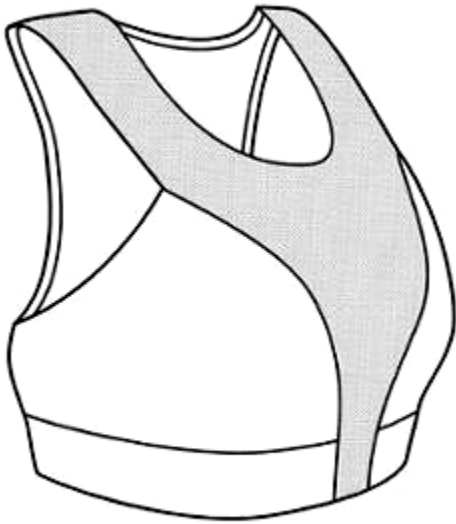

1.1

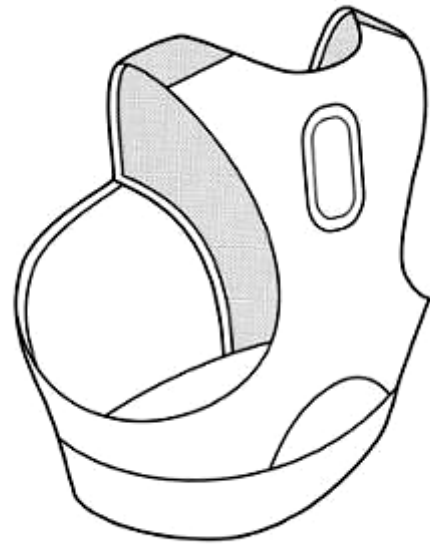

1.2

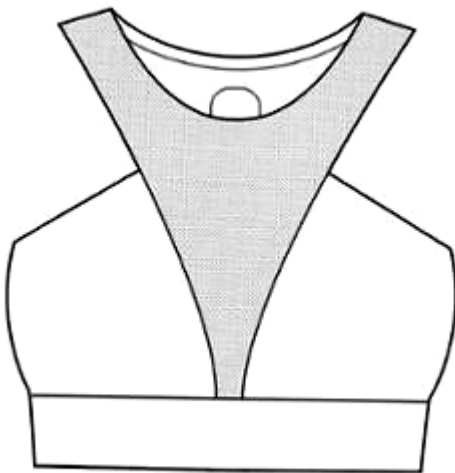

1.3

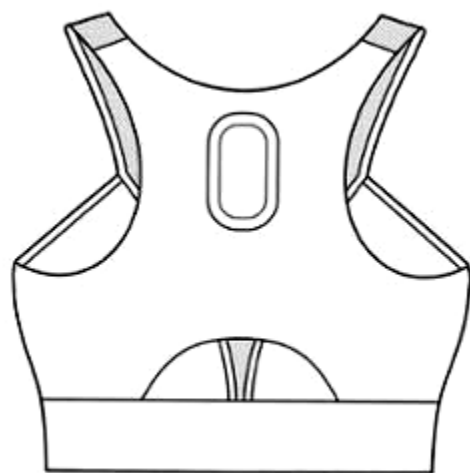

1.4

CÔNG BÁO SỞ HỮU CÔNG NGHIỆP SỐ 428 TẬP A – QUYỀN 2 (11.2023)

- (11) **48466**
(21) 3-2023-01724 (28) 1
(54) **ĐÈN CHIẾU SÁNG** (51) **26-03**
(22) 28/07/2023 (43) 27/11/2023
(73) **CÔNG TY CỔ PHẦN TẬP ĐOÀN S.LIGHTING (VN)**
Số 23/1/8 đường 27, khu phố 9, phường Hiệp Bình Chánh, thành phố Thủ Đức,
thành phố Hồ Chí Minh
(72) Lê Chí Trung (VN)
(74) Công ty TNHH Trà và cộng sự (TRA & ASSOCIATES CO.,LTD)
(55)



1.1



1.2



1.3



1.4



1.5

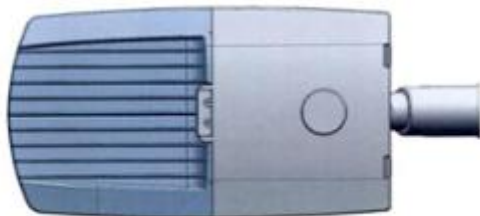

1.6



1.7

CÔNG BÁO SỞ HỮU CÔNG NGHIỆP SỐ 428 TẬP A – QUYỀN 2 (11.2023)

- (11) **48467**
(21) 3-2023-01725
(54) **BA LÔ**
(22) 28/07/2023
(73) **CÔNG TY CỔ PHẦN XUẤT NHẬP KHẨU BÌNH TÂY (VN)**
Đường tỉnh 835, ấp 3A, xã Phước Lợi, huyện Bến Lức, tỉnh Long An
(72) Nguyễn Xuân Dũng (VN)
(55)
- (28) 1
(51) **03-01**
(43) 27/11/2023



1.1



1.2



1.3



1.4



1.5



1.6



1.7

CÔNG BÁO SỞ HỮU CÔNG NGHIỆP SỐ 428 TẬP A – QUYỀN 2 (11.2023)

- (11) **48468**
(21) 3-2023-01729 (28) 1
(54) **BÌNH ĐỰNG NƯỚC** (51) **07-07**
(22) 28/07/2023 (43) 27/11/2023
(73) **CÔNG TY CỔ PHẦN BÓNG ĐÈN PHÍCH NƯỚC RẠNG ĐÔNG (VN)**
87-89 phố Hạ Đình, phường Thanh Xuân Trung, quận Thanh Xuân, thành phố Hà Nội
(72) Trần Trung Tường (VN)
(55)



1.1



1.2



1.3



1.4

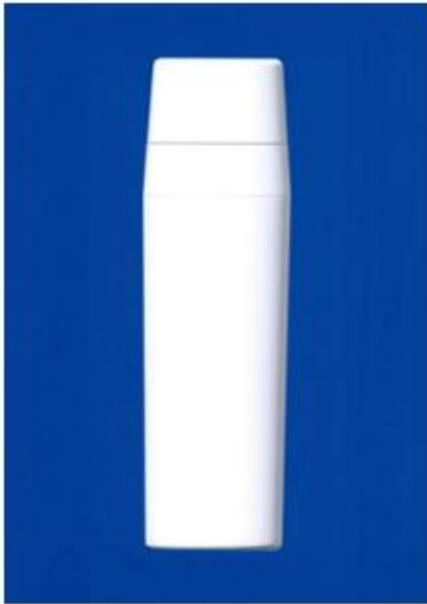

1.5



1.6



1.7

CÔNG BÁO SỞ HỮU CÔNG NGHIỆP SỐ 428 TẬP A – QUYỀN 2 (11.2023)

- (11) **48469**
(21) 3-2023-01730 (28) 1
(54) **BÌNH GIỮ NHIỆT** (51) **07-07**
(22) 28/07/2023 (43) 27/11/2023
(73) **CÔNG TY CỔ PHẦN BÓNG ĐÈN PHÍCH NƯỚC RẠNG ĐÔNG (VN)**
87-89 phố Hạ Đình, phường Thanh Xuân Trung, quận Thanh Xuân, thành phố Hà Nội
(72) Trần Trung Tường (VN)
(55)



1.1



1.2



1.3



1.4



1.5



1.6



1.7

CÔNG BÁO SỞ HỮU CÔNG NGHIỆP SỐ 428 TẬP A – QUYỀN 2 (11.2023)

- (11) **48470**
(21) 3-2023-01731 (28) 1
(54) **BÌNH GIỮ NHIỆT** (51) **07-07**
(22) 28/07/2023 (43) 27/11/2023
(73) **CÔNG TY CỔ PHẦN BÓNG ĐÈN PHÍCH NƯỚC RẠNG ĐÔNG (VN)**
87-89 phố Hạ Đình, phường Thanh Xuân Trung, quận Thanh Xuân, thành phố Hà Nội
(72) Trần Trung Tường (VN)
(55)



1.1



1.2



1.3



1.4



1.5



1.6



1.7

CÔNG BÁO SỞ HỮU CÔNG NGHIỆP SỐ 428 TẬP A – QUYỀN 2 (11.2023)

- (11) **48471**
(21) 3-2023-01732 (28) 1
(54) **BÌNH GIỮ NHIỆT** (51) **07-07**
(22) 28/07/2023 (43) 27/11/2023
(73) **CÔNG TY CỔ PHẦN BÓNG ĐÈN PHÍCH NƯỚC RẠNG ĐÔNG (VN)**
87-89 phố Hạ Đình, phường Thanh Xuân Trung, quận Thanh Xuân, thành phố Hà
Nội
(72) Trần Trung Tường (VN)
(55)



1.1



1.2



1.3



1.4



1.5



1.6



1.7

CÔNG BÁO SỞ HỮU CÔNG NGHIỆP SỐ 428 TẬP A – QUYỀN 2 (11.2023)

- (11) **48472**
(21) 3-2023-01773 (28) 1
(54) **MÁY GIẶT** (51) **15-05**
(22) 03/08/2023 (43) 27/11/2023
(30) 30-2023-0004107 03/02/2023 KR;
(73) **LG ELECTRONICS INC. (KR)**
128, Yeoui-daero, Yeongdeungpo-gu, Seoul, 07336, Republic of Korea
(72) 1. KYUJIN PARK (KR)
2. HOIL JEON (KR)
3. YOUNGSOO HA (KR)
4. KYUTAE PARK (KR)
(74) Công ty Luật TNHH T&G (TGVN)
(55)

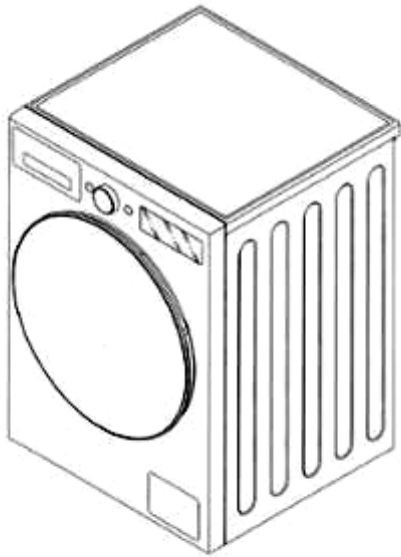

1.1

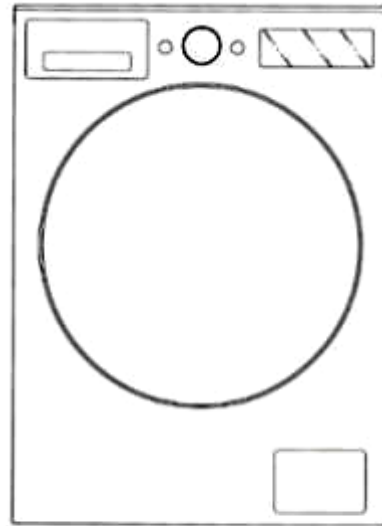

1.2

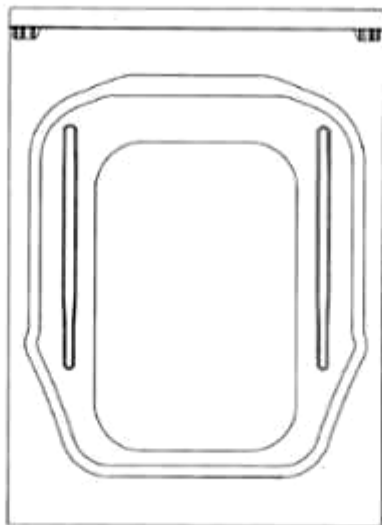

1.3

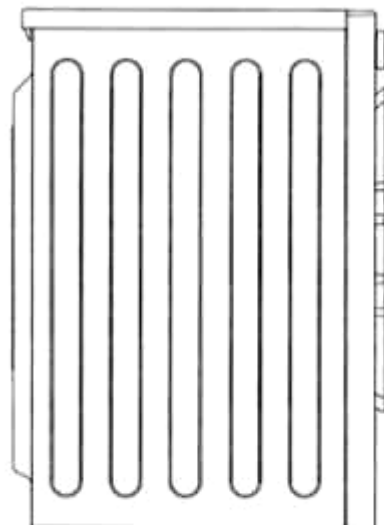

1.4

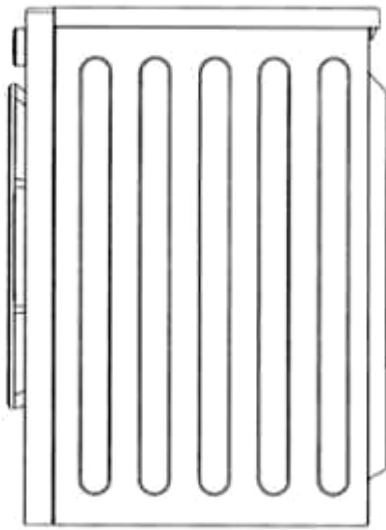

1.5



1.6

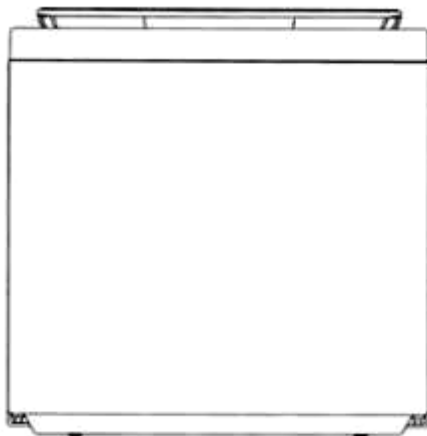

1.7

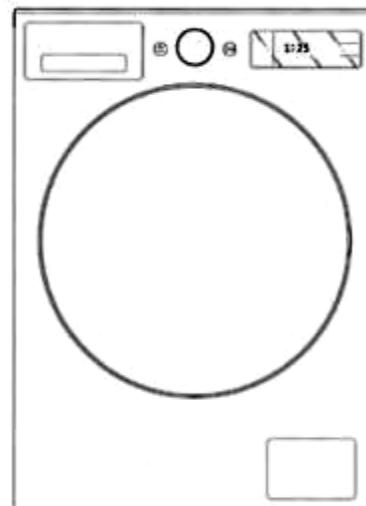

1.8

CÔNG BÁO SỞ HỮU CÔNG NGHIỆP SỐ 428 TẬP A – QUYỀN 2 (11.2023)

- (11) **48473**
(21) 3-2023-01806 (28) 1
(54) **HỮ** (51) **09-01**
(22) 07/08/2023 (43) 27/11/2023
(73) **CÔNG TY CỔ PHẦN SẢN XUẤT NHỰA DUY TÂN (VN)**
298 Hồ Học Lãm, phường An Lạc, quận Bình Tân, thành phố Hồ Chí Minh
(72) Trần Đức Xuyên (VN)
(74) Công ty TNHH Sở hữu trí tuệ INVENTIO (INVENTIO CO.,LTD)
(55)



1.1



1.2



1.3



1.4



1.5

CÔNG BÁO SỞ HỮU CÔNG NGHIỆP SỐ 428 TẬP A – QUYỀN 2 (11.2023)

(11) **48474**

(21) 3-2023-01807

(28) 1

(54) **HỮ**

(51) **09-01**

(22) 07/08/2023

(43) 27/11/2023

(73) **CÔNG TY CỔ PHẦN SẢN XUẤT NHỰA DUY TÂN (VN)**

298 Hồ Ngọc Lâm, phường An Lạc, quận Bình Tân, thành phố Hồ Chí Minh

(72) Trần Đức Xuyên (VN)

(74) Công ty TNHH Sở hữu trí tuệ INVENTIO (INVENTIO CO.,LTD)

(55)



1.1



1.2



1.3



1.4



1.5

CÔNG BÁO SỞ HỮU CÔNG NGHIỆP SỐ 428 TẬP A – QUYỀN 2 (11.2023)

- (11) **48475**
(21) 3-2023-01808 (28) 1
(54) **HỮ** (51) **09-01**
(22) 07/08/2023 (43) 27/11/2023
(73) **CÔNG TY CỔ PHẦN SẢN XUẤT NHỰA DUY TÂN (VN)**
298 Hồ Học Lãm, phường An Lạc, quận Bình Tân, thành phố Hồ Chí Minh
(72) Trần Đức Xuyên (VN)
(74) Công ty TNHH Sở hữu trí tuệ INVENTIO (INVENTIO CO.,LTD)
(55)



1.1



1.2



1.3



1.4



1.5

CÔNG BÁO SỞ HỮU CÔNG NGHIỆP SỐ 428 TẬP A – QUYỀN 2 (11.2023)

- (11) **48476**
(21) 3-2023-01819 (28) 1
(54) **QUAI BÌNH** (51) **09-07**
(22) 07/08/2023 (43) 27/11/2023
(73) **CÔNG TY CỔ PHẦN SẢN XUẤT NHỰA DUY TÂN (VN)**
298 Hồ Học Lãm, phường An Lạc, quận Bình Tân, thành phố Hồ Chí Minh
(72) Trần Đức Xuyên (VN)
(74) Công ty TNHH Sở hữu trí tuệ INVENTIO (INVENTIO CO.,LTD)
(55)



1.1



1.2



1.3



1.4



1.5



1.6

CÔNG BÁO SỞ HỮU CÔNG NGHIỆP SỐ 428 TẬP A – QUYỀN 2 (11.2023)

- (11) **48477**
(21) 3-2023-01824 (28) 1
(54) **MÁY LỌC NƯỚC** (51) **23-01**
(22) 08/08/2023 (43) 27/11/2023
(73) **CÔNG TY CỔ PHẦN TẬP ĐOÀN SUNHOUSE (VN)**
Số 139, phố Nguyễn Thái Học, phường Điện Biên, quận Ba Đình, thành phố Hà Nội
(72) Lại Văn Kiên (VN)
(74) Công ty TNHH Sở hữu trí tuệ Bình Minh (SUNRISE IP CO.,LTD.)
(55)

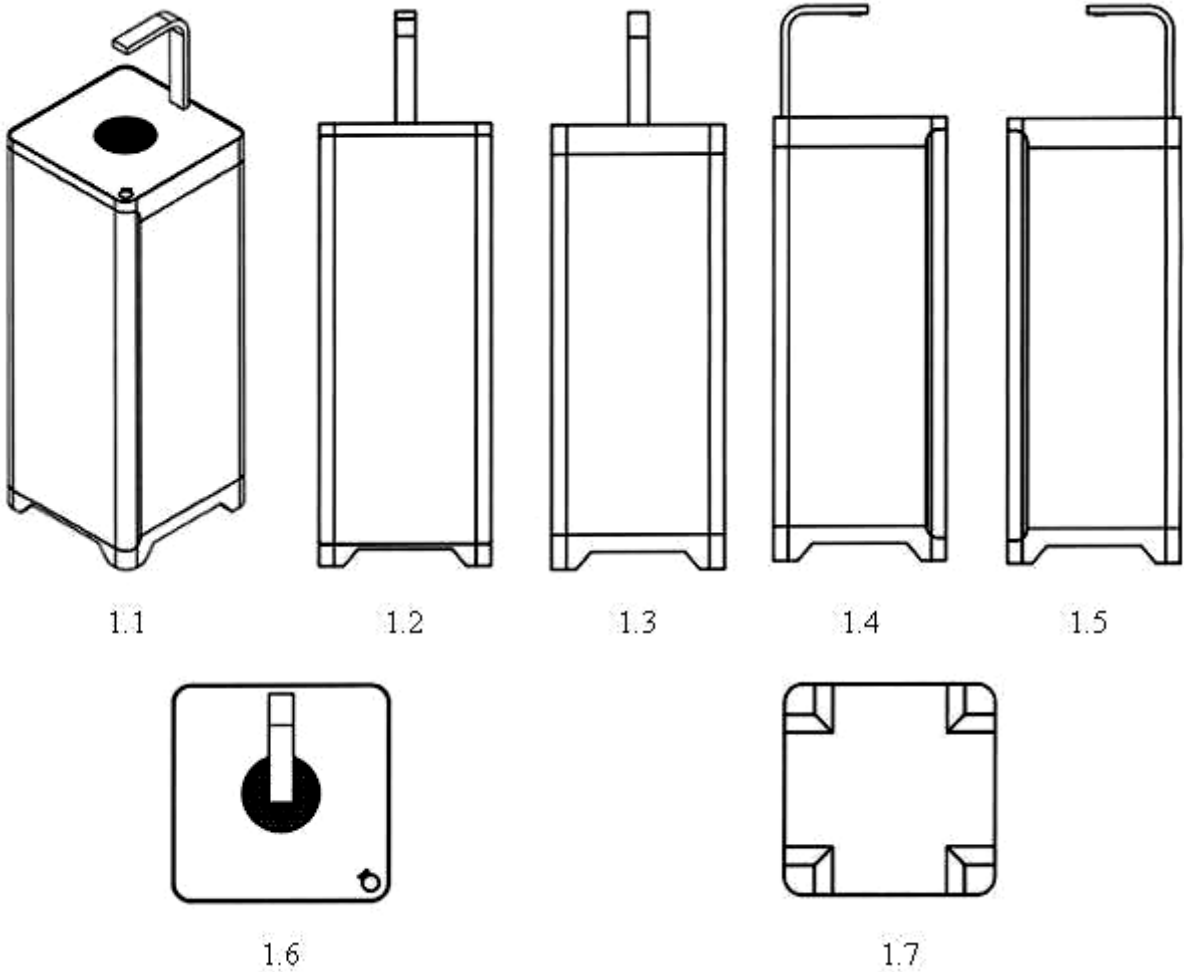

CÔNG BÁO SỞ HỮU CÔNG NGHIỆP SỐ 428 TẬP A – QUYỀN 2 (11.2023)

- (11) **48478**
(21) 3-2023-01828 (28) 1
(54) **MIẾNG DÁN DÙNG CHO TẮM THẨM HÚT NƯỚC**
TIÊU CHO THỦ NUÔI (51) **30-99**
(22) 08/08/2023 (43) 27/11/2023
(30) 2023-002859 15/02/2023 JP;
(73) **UNICHARM CORPORATION (JP)**
182, Shimobun, Kinsei-cho, Shikokuchuo-City, Ehime 799-0111, Japan
(72) 1. MAMI NASHIKI (JP)
2. HIRONAO MINATO (JP)
3. MAI IWATA (JP)
(74) Công ty Cổ phần Sở hữu công nghiệp INVESTIP (INVESTIP)
(55)

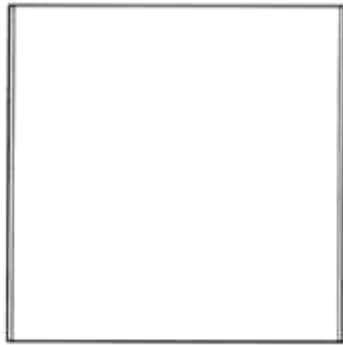

1.1

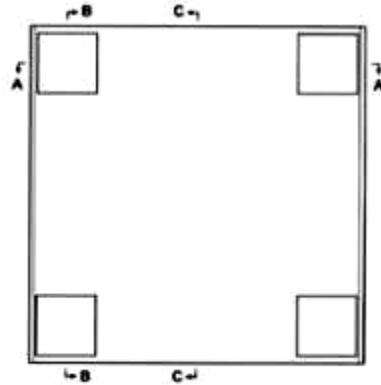

1.2



1.3



1.4



1.5



1.6

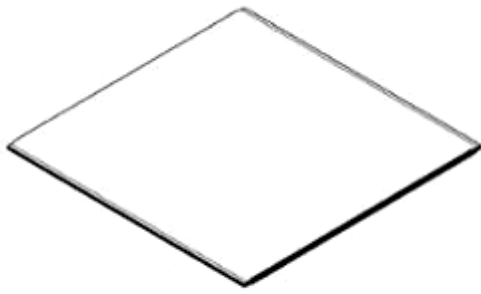

1.7

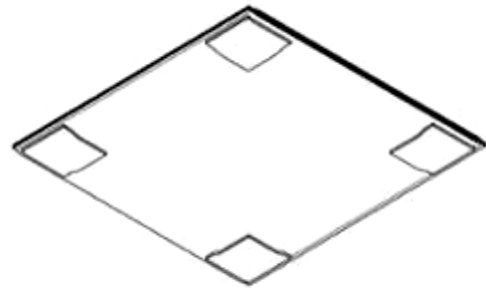

1.8



1.9

1.10

1.11



1.12

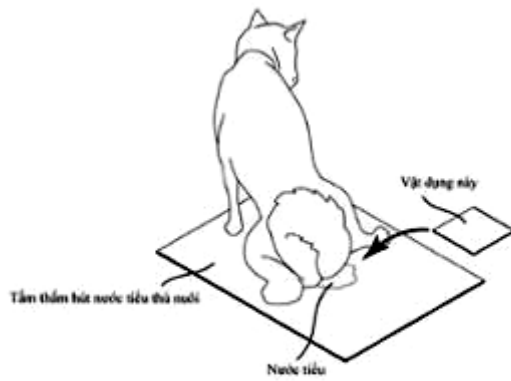

1.13

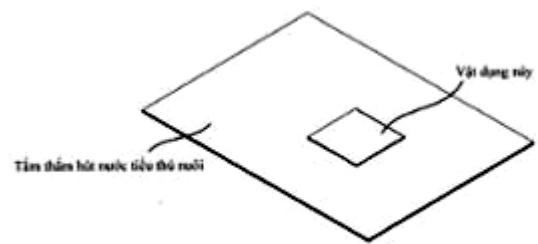

1.14

CÔNG BÁO SỞ HỮU CÔNG NGHIỆP SỐ 428 TẬP A – QUYỀN 2 (11.2023)

- (11) **48479**
(21) 3-2023-01829 (28) 1
(54) **MIẾNG DÁN DÙNG CHO TẮM THẨM HÚT NƯỚC**
TIÊU CHO THÚ NUÔI (51) **30-99**
(22) 08/08/2023 (43) 27/11/2023
(30) 2023-002863 15/02/2023 JP;
(73) **UNICHARM CORPORATION (JP)**
182, Shimobun, Kinsei-cho, Shikokuchuo-City, Ehime 799-0111, Japan
(72) 1. MAMI NASHIKI (JP)
2. HIRONAO MINATO (JP)
3. MAI IWATA (JP)
(74) Công ty Cổ phần Sở hữu công nghiệp INVESTIP (INVESTIP)
(55)

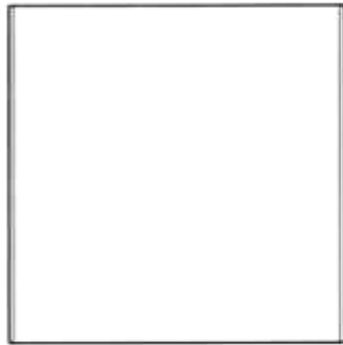

1.1

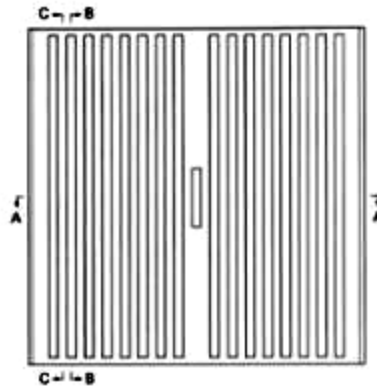

1.2



1.3



1.4



1.5



1.6

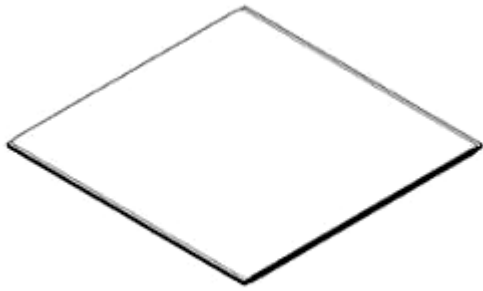

1.7

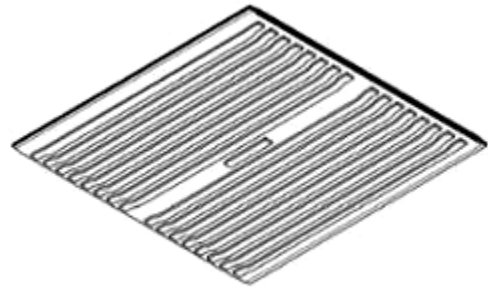

1.8



1.9



1.10



1.11



1.12

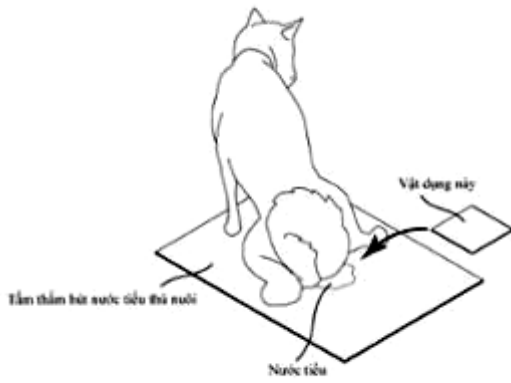

1.13

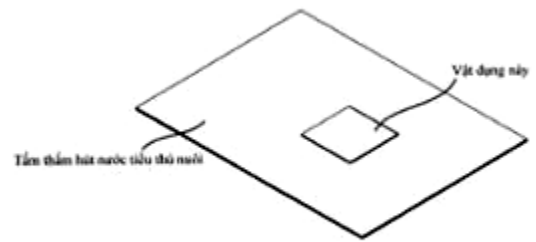

1.14

CÔNG BÁO SỞ HỮU CÔNG NGHIỆP SỐ 428 TẬP A – QUYỀN 2 (11.2023)

- (11) **48480**
(21) 3-2023-01830 (28) 1
(54) **CHAI** (51) **09-01**
(22) 08/08/2023 (43) 27/11/2023
(30) 2023-002665 13/02/2023 JP;
(73) **EARTH CORPORATION (JP)**
12-1, Kanda-Tsukasamachi 2-chome, Chiyoda-ku, Tokyo, Japan
(72) 1. NAMI IKEDA (JP)
2. KENGO TAKAHATA (JP)
(74) Công ty Cổ phần Sở hữu công nghiệp INVESTIP (INVESTIP)
(55)



CÔNG BÁO SỞ HỮU CÔNG NGHIỆP SỐ 428 TẬP A – QUYỀN 2 (11.2023)

- (11) **48481**
(21) 3-2023-01834 (28) 1
(54) **LỌ** (51) **09-01**
(22) 08/08/2023 (43) 27/11/2023
(73) **LG H&H CO., LTD. (KR)**
58, Saemunan-ro, Jongno-gu, Seoul, Republic of Korea
(72) LEE, So Yoon (KR)
(74) Công ty TNHH Tầm nhìn và Liên danh (VISION & ASSOCIATES CO.LTD.)
(55)

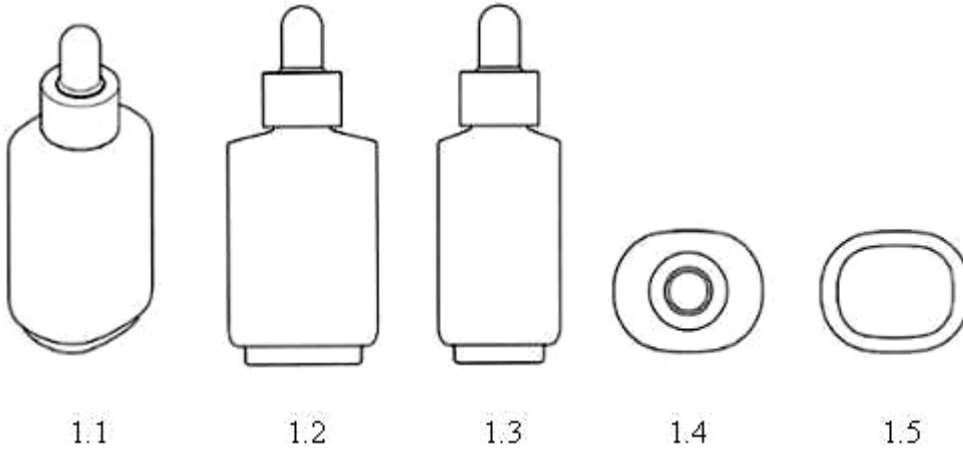

CÔNG BÁO SỞ HỮU CÔNG NGHIỆP SỐ 428 TẬP A – QUYỀN 2 (11.2023)

- (11) **48482**
(21) 3-2023-01835 (28) 1
(54) **LỌ** (51) **09-01**
(22) 08/08/2023 (43) 27/11/2023
(73) **LG H&H CO., LTD. (KR)**
58, Saemunan-ro, Jongno-gu, Seoul, Republic of Korea
(72) LEE, So Yoon (KR)
(74) Công ty TNHH Tâm nhìn và Liên danh (VISION & ASSOCIATES CO.LTD.)
(55)

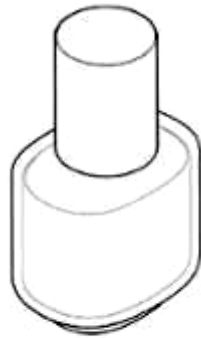

1.1

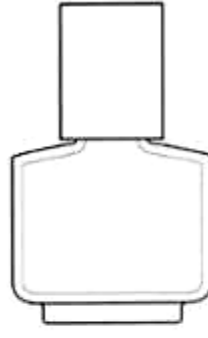

1.2

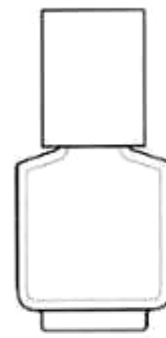

1.3

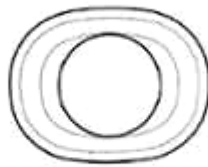

1.4

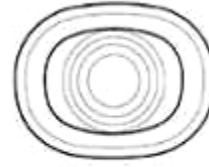

1.5

CÔNG BÁO SỞ HỮU CÔNG NGHIỆP SỐ 428 TẬP A – QUYỀN 2 (11.2023)

- (11) **48483**
(21) 3-2023-01858 (28) 1
(54) **NẮP CHAI** (51) **09-07**
(22) 09/08/2023 (43) 27/11/2023
(73) **CÔNG TY CỔ PHẦN SẢN XUẤT NHỰA DUY TÂN (VN)**
298 Hồ Học Lãm, phường An Lạc, quận Bình Tân, thành phố Hồ Chí Minh
(72) Trần Đức Xuyên (VN)
(74) Công ty TNHH Sở hữu trí tuệ INVENTIO (INVENTIO CO.,LTD)
(55)



1.1



1.2



1.3



1.4



1.5



1.6



1.7

CÔNG BÁO SỞ HỮU CÔNG NGHIỆP SỐ 428 TẬP A – QUYỀN 2 (11.2023)

- (11) **48484**
(21) 3-2023-01860 (28) 1
(54) **CHAI** (51) **09-01**
(22) 09/08/2023 (43) 27/11/2023
(73) **CÔNG TY CỔ PHẦN THỰC PHẨM VÀ NƯỚC GIẢI KHÁT NAM VIỆT (VN)**
Số 994/1C, đường Nguyễn Thị Minh Khai, khu phố Tân Thắng, phường Tân Bình, thành phố Dĩ An, tỉnh Bình Dương
(72) Bùi Thị Thu Hương (VN)
(74) **CÔNG TY TNHH SỞ HỮU TRÍ TUỆ ANLIS VIỆT NAM (ANLIS IP CO.,LTD)**
(55)



1.1



1.2



1.3



1.4



1.5

CÔNG BÁO SỞ HỮU CÔNG NGHIỆP SỐ 428 TẬP A – QUYỀN 2 (11.2023)

- (11) **48485**
(21) 3-2023-01864 (28) 1
(54) **BÌNH ĐỰNG THỰC PHẨM** (51) **07-07**
(22) 10/08/2023 (43) 27/11/2023
(73) **LOCK & LOCK CO., LTD. (KR)**
1260, Manse-ro, Wongok-myeon, Anseong-si, Gyeonggi-do, Republic of Korea
(72) NAM, Soo Jung (KR)
(74) Công ty TNHH Tâm nhìn và Liên danh (VISION & ASSOCIATES CO.LTD.)
(55)



1.1



1.2



1.3



1.4



1.5



1.6



1.7



1.8



1.9

CÔNG BÁO SỞ HỮU CÔNG NGHIỆP SỐ 428 TẬP A – QUYỀN 2 (11.2023)

- (11) **48486**
(21) 3-2023-01865 (28) 1
(54) **BÌNH** (51) **07-07**
(22) 10/08/2023 (43) 27/11/2023
(73) **LOCK & LOCK CO., LTD. (KR)**
1260, Manse-ro, Wongok-myeon, Anseong-si, Gyeonggi-do, Republic of Korea
(72) KIM, Kwang Ik (KR)
(74) Công ty TNHH Tầm nhìn và Liên danh (VISION & ASSOCIATES CO.LTD.)
(55)



1.1

1.2

1.3

1.4

1.5



1.6



1.7

CÔNG BÁO SỞ HỮU CÔNG NGHIỆP SỐ 428 TẬP A – QUYỀN 2 (11.2023)

- (11) **48487**
(21) 3-2023-01866 (28) 1
(54) **BÌNH** (51) **07-07**
(22) 10/08/2023 (43) 27/11/2023
(73) **LOCK & LOCK CO., LTD. (KR)**
1260, Manse-ro, Wongok-myeon, Anseong-si, Gyeonggi-do, Republic of Korea
(72) KIM, Kwang Ik (KR)
(74) Công ty TNHH Tầm nhìn và Liên danh (VISION & ASSOCIATES CO.LTD.)
(55)



1.1



1.2



1.3



1.4



1.5



1.6



1.7

CÔNG BÁO SỞ HỮU CÔNG NGHIỆP SỐ 428 TẬP A – QUYỀN 2 (11.2023)

- (11) **48488**
(21) 3-2023-01867 (28) 1
(54) **BÌNH** (51) **07-07**
(22) 10/08/2023 (43) 27/11/2023
(73) **LOCK & LOCK CO., LTD. (KR)**
1260, Manse-ro, Wongok-myeon, Anseong-si, Gyeonggi-do, Republic of Korea
(72) KIM, Kwang Ik (KR)
(74) Công ty TNHH Tầm nhìn và Liên danh (VISION & ASSOCIATES CO.LTD.)
(55)



1.1

1.2

1.3

1.4

1.5



1.6



1.7

CÔNG BÁO SỞ HỮU CÔNG NGHIỆP SỐ 428 TẬP A – QUYỀN 2 (11.2023)

- (11) **48489**
(21) 3-2023-01868 (28) 1
(54) **HỘP ĐỰNG THỰC PHẨM** (51) **07-07**
(22) 10/08/2023 (43) 27/11/2023
(73) **LOCK & LOCK CO., LTD. (KR)**
1260, Manse-ro, Wongok-myeon, Anseong-si, Gyeonggi-do, Republic of Korea
(72) SONG, Ga Young (KR)
(74) Công ty TNHH Tầm nhìn và Liên danh (VISION & ASSOCIATES CO.LTD.)
(55)



1.1



1.2



1.3



1.4



1.5



1.6



1.7



1.8

CÔNG BÁO SỞ HỮU CÔNG NGHIỆP SỐ 428 TẬP A – QUYỀN 2 (11.2023)

- (11) **48490**
(21) 3-2023-01869 (28) 1
(54) **CHẢO** (51) **07-02**
(22) 10/08/2023 (43) 27/11/2023
(73) **LOCK & LOCK CO., LTD. (KR)**
1260, Manse-ro, Wongok-myeon, Anseong-si, Gyeonggi-do, Republic of Korea
(72) SHIM, Dong Seop (KR)
(74) Công ty TNHH Tầm nhìn và Liên danh (VISION & ASSOCIATES CO.LTD.)
(55)



1.1



1.2

1.3



1.4



1.5



1.6



1.7

CÔNG BÁO SỞ HỮU CÔNG NGHIỆP SỐ 428 TẬP A – QUYỀN 2 (11.2023)

- (11) **48491**
(21) 3-2023-01870 (28) 1
(54) **BÌNH** (51) **07-07**
(22) 10/08/2023 (43) 27/11/2023
(73) **LOCK & LOCK CO., LTD. (KR)**
1260, Manse-ro, Wongok-myeon, Anseong-si, Gyeonggi-do, Republic of Korea
(72) KIM, Kwang Ik (KR)
(74) Công ty TNHH Tâm nhìn và Liên danh (VISION & ASSOCIATES CO.LTD.)
(55)



1.1



1.2



1.3



1.4



1.5



1.6



1.7

- (11) **48492**
(21) 3-2023-01872 (28) 1
(54) **ĐỒ TRANG TRÍ** (51) **11-02**
(22) 10/08/2023 (43) 27/11/2023
(30) 2023302599968 06/05/2023 CN;
(73) **FUJIAN NETDRAGON WEBSOFT CO., LTD. (CN)**
RM Q475, F4, Sci and Tech Dvpt. Center Building, No. 83 Junzhu Road,
Development Zone, Fuzhou City, Fujian Province, China
(72) Dejian, LIU (CN)
(74) Công ty TNHH Tầm nhìn và Liên danh (VISION & ASSOCIATES CO.LTD.)
(55)



1.1



1.2



1.3



1.4



1.5



1.6



1.7

CÔNG BÁO SỞ HỮU CÔNG NGHIỆP SỐ 428 TẬP A – QUYỀN 2 (11.2023)

- (11) **48493**
(21) 3-2023-01892 (28) 1
(54) **CA BIN XE TẢI** (51) **12-16**
(22) 14/08/2023 (43) 27/11/2023
(30) 2023-003471 22/02/2023 JP;
(73) **ISUZU MOTORS LIMITED (JP)**
2-5, Takashima 1-chome, Nishi-ku, Yokohama-shi, Kanagawa, 220-8720, JAPAN
(72) 1. TAKUYA HIRAKAWA (JP)
2. NOBUYUKI HORISAWA (JP)
3. RYOU KAWAHARA (JP)
4. EIJI NAKAJIMA (JP)
5. NOBORU KUDOU (JP)
6. KIZASHI KOBAYASHI (JP)
7. MAKOTO KIMURA (JP)
(74) Công ty Luật TNHH Phạm và Liên danh (PHAM & ASSOCIATES)
(55)



1.1



1.2



1.3



1.4



1.5



1.6

CÔNG BÁO SỞ HỮU CÔNG NGHIỆP SỐ 428 TẬP A – QUYỀN 2 (11.2023)

- (11) **48494**
(21) 3-2023-01893 (28) 1
(54) **CA BIN XE TẢI** (51) **12-16**
(22) 14/08/2023 (43) 27/11/2023
(30) 2023-003472 22/02/2023 JP;
(73) **ISUZU MOTORS LIMITED (JP)**
2-5, Takashima 1-chome, Nishi-ku, Yokohama-shi, Kanagawa, 220-8720, JAPAN
(72) 1. TAKUYA HIRAKAWA (JP)
2. NOBUYUKI HORISAWA (JP)
3. RYOU KAWAHARA (JP)
4. EIJI NAKAJIMA (JP)
5. NOBORU KUDOU (JP)
6. DAIKI WATANABE (JP)
7. MAKOTO KIMURA (JP)
(74) Công ty Luật TNHH Phạm và Liên danh (PHAM & ASSOCIATES)
(55)



1.1



1.2



1.3



1.4



1.5



1.6

CÔNG BÁO SỞ HỮU CÔNG NGHIỆP SỐ 428 TẬP A – QUYỀN 2 (11.2023)

- (11) **48495**
(21) 3-2023-01895 (28) 1
(54) **CA BIN XE TẢI** (51) **12-16**
(22) 14/08/2023 (43) 27/11/2023
(30) 2023-003478 22/02/2023 JP;
(73) **ISUZU MOTORS LIMITED (JP)**
2-5, Takashima 1-chome, Nishi-ku, Yokohama-shi, Kanagawa, 220-8720, JAPAN
(72) 1. TAKUYA HIRAKAWA (JP)
2. NOBUYUKI HORISAWA (JP)
3. RYOU KAWAHARA (JP)
4. EIJI NAKAJIMA (JP)
5. NOBORU KUDOU (JP)
6. DAIKI WATANABE (JP)
7. YOSHIKI TANAKA (JP)
(74) Công ty Luật TNHH Phạm và Liên danh (PHAM & ASSOCIATES)
(55)



1.1



1.2



1.3



1.4



1.5



1.6

CÔNG BÁO SỞ HỮU CÔNG NGHIỆP SỐ 428 TẬP A – QUYỀN 2 (11.2023)

- (11) **48496**
(21) 3-2023-01921 (28) 1
(54) **CHẢO RÁN** (51) **07-02**
(22) 14/08/2023 (43) 27/11/2023
(73) **LOCK & LOCK CO., LTD. (KR)**
1260, Manse-ro, Wongok-myeon, Anseong-si, Gyeonggi-do, Republic of Korea
(72) YOU, Sung Ik (KR)
(74) Công ty TNHH Tầm nhìn và Liên danh (VISION & ASSOCIATES CO.LTD.)
(55)



1.1



1.2



1.3



1.4



1.5



1.6



1.7



1.8

CÔNG BÁO SỞ HỮU CÔNG NGHIỆP SỐ 428 TẬP A – QUYỀN 2 (11.2023)

- (11) **48497**
(21) 3-2023-01922 (28) 1
(54) **CỐC** (51) **07-01**
(22) 14/08/2023 (43) 27/11/2023
(73) **LOCK & LOCK CO., LTD. (KR)**
1260, Manse-ro, Wongok-myeon, Anseong-si, Gyeonggi-do, Republic of Korea
(72) LEE, Youn Jung (KR)
(74) Công ty TNHH Tâm nhìn và Liên danh (VISION & ASSOCIATES CO.LTD.)
(55)



1.1



1.2



1.3



1.4



1.5



1.6



1.7

CÔNG BÁO SỞ HỮU CÔNG NGHIỆP SỐ 428 TẬP A – QUYỀN 2 (11.2023)

- (11) **48498**
(21) 3-2023-01928 (28) 1
(54) **MÁY GIẶT** (51) **15-05**
(22) 16/08/2023 (43) 27/11/2023
(73) **ARCELIK HITACHI HOME APPLIANCES (THAILAND) LIMITED (TH)**
No. 610/1, Mu 9, Nong Ki Sub-district, Kabin Buri District, Prachin Buri Province,
THAILAND
(72) Denizhan Arda (TR)
(74) Công ty Luật TNHH T&G (TGVN)
(55)



1.1



1.2



1.3



1.4



1.5



1.6



1.7



1.8



1.9

CÔNG BÁO SỞ HỮU CÔNG NGHIỆP SỐ 428 TẬP A – QUYỀN 2 (11.2023)

- (11) **48499**
(21) 3-2023-01929 (28) 1
(54) **MÂM MÁY GIẶT** (51) **15-05**
(22) 16/08/2023 (43) 27/11/2023
(73) **ARCELIK HITACHI HOME APPLIANCES (THAILAND) LIMITED (TH)**
No. 610/1, Mu 9, Nong Ki Sub-district, Kabin Buri District, Prachin Buri Province,
THAILAND
(72) Denizhan Arda (TR)
(74) Công ty Luật TNHH T&G (TGVN)
(55)



1.1



1.2



1.3



1.4



1.5



1.6

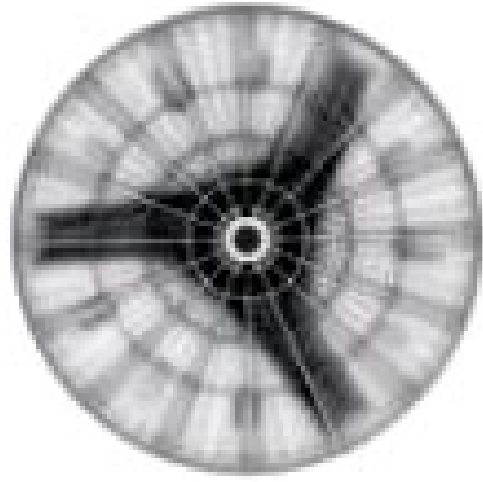

1.7

PHẦN II

SỬA ĐỔI ĐƠN

Thông báo số: 66869/TB-SHTT.IP, ngày 25/09/2023 về việc ghi nhận sửa đổi đơn

Số Yêu cầu: SĐ3-2023-01333 Ngày nộp: 14/07/2023

Liên quan đến đơn yêu cầu cấp Bằng độc quyền kiểu dáng công nghiệp:

(21) Số đơn	(22) Ngày nộp đơn
3-2022-01584	09/08/2022
3-2022-01587	09/08/2022
3-2022-02151	06/10/2022
3-2022-02152	06/10/2022
3-2022-02153	06/10/2022
3-2022-02154	06/10/2022
3-2022-02155	06/10/2022

Mục sửa đổi: Tên, địa chỉ chủ đơn, đại diện sở hữu công nghiệp

Nội dung mới: Chủ đơn mới:

Công ty TNHH LC FOODS (VN)

Lô G4-1 (khu B2), Đường D10, Khu công nghiệp Rạch Bắp, Xã An Tây, Thị xã Bến Cát, Tỉnh Bình Dương

Đại diện mới:

CÔNG TY TNHH SỞ HỮU TRÍ TUỆ ANLIS VIỆT NAM(ANLIS IP CO.,LTD)

Số 151, ngõ 254 Minh Khai, phường Mai Động, quận Hoàng Mai, Thành phố Hà Nội

CÔNG BÁO SỞ HỮU CÔNG NGHIỆP SỐ 428 TẬP A – QUYỀN 2 (11.2023)

Thông báo số: 68240/TB-SHTT.IP, ngày 27/09/2023 về việc ghi nhận sửa đổi đơn

Số Yêu cầu: SĐ3-2023-01371 Ngày nộp: 24/07/2023

Liên quan đến đơn yêu cầu cấp Bằng độc quyền kiểu dáng công nghiệp:

(21) Số đơn	(22) Ngày nộp đơn
3-2023-00153	17/01/2023
3-2023-00154	17/01/2023
3-2023-00155	17/01/2023
3-2023-00156	17/01/2023
3-2023-00157	17/01/2023
3-2023-00158	17/01/2023
3-2023-00159	17/01/2023
3-2023-00160	17/01/2023
3-2023-00161	17/01/2023

Mục sửa đổi: Tên, địa chỉ chủ đơn

Nội dung mới: Công ty TNHH sản xuất thương mại Lợi Hào Việt Nam (VN)
Lô J3, Đường N4, Khu Công Nghiệp Nam Tân Uyên Mở Rộng, Phường
Hội Nghĩa, Thành phố Tân Uyên, Tỉnh Bình Dương

CÔNG BÁO SỞ HỮU CÔNG NGHIỆP

Do Cục Sở hữu trí tuệ thuộc Bộ Khoa học và Công nghệ ấn hành theo Luật Sở hữu trí tuệ số 50/2005/QH11 được Quốc hội thông qua ngày 29 tháng 11 năm 2005 và được sửa đổi bằng Luật sửa đổi, bổ sung một số điều của Luật sở hữu trí tuệ số 50/2005/QH11 được Quốc hội thông qua ngày 19 tháng 6 năm 2009.

Địa chỉ liên hệ:

384-386 đường Nguyễn Trãi, quận Thanh Xuân,
thành phố Hà Nội, Việt Nam
ĐT: 024. 38583069
Fax: 024. 38588449