

CỘNG HÒA XÃ HỘI CHỦ NGHĨA VIỆT NAM
BỘ KHOA HỌC VÀ CÔNG NGHỆ

CỤC SỞ HỮU TRÍ TUỆ

CÔNG BÁO
SỞ HỮU CÔNG NGHIỆP

TẬP A

QUYỂN 2: KIỂU DÁNG CÔNG NGHIỆP

08 - 2023

425

CỘNG HOÀ XÃ HỘI CHỦ NGHĨA VIỆT NAM
BỘ KHOA HỌC VÀ CÔNG NGHỆ
CỤC SỞ HỮU TRÍ TUỆ

CÔNG BÁO
SỞ HỮU CÔNG NGHIỆP
TẬP A

QUYỂN 2: KIỂU DÁNG CÔNG NGHIỆP

08 - 2023

425

HÀ NỘI

MỤC LỤC

	Trang
<u>PHẦN I:</u> Đơn yêu cầu cấp Bằng độc quyền kiểu dáng công nghiệp	7-217

CONTENTS

<u>PART I:</u> Applications for Industrial Design Patents	7-217
---	-------

CÔNG BÁO SỞ HỮU CÔNG NGHIỆP SỐ 425 TẬP A - QUYỂN 2 (08.2023)

MÃ SỐ HAI CHỮ CÁI THỂ HIỆN TÊN NƯỚC VÀ CÁC THỰC THỂ KHÁC TRONG CÁC TƯ LIỆU SỞ HỮU CÔNG NGHIỆP THEO TIÊU CHUẨN ST3 CỦA WIPO

AE	United Arab Emirates	CN	China	HK	Hong Kong
AF	Afganistan	CO	Colombia	HN	Honduras
AG	Antihua and Barbuda	CR	Costa Rica	HR	Croatia
AI	Anguilla	CU	Cuba	HT	Haiti
AL	Albania	CV	Cape Verde	HU	Hungary
AN	Netherlands Antilles	CY	Cyprus	ID	Indonesia
AO	Angola	CZ	Czech Republic	IE	Ireland
AR	Argentina	DE	Germany	IL	Israel
AT	Austria	DJ	Djibouti	IN	India
AU	Australia	DK	Denmark	IQ	Iraq
AW	Aruba	DM	Dominica	IR	Iran (Islamic Republic of)
BB	Barbados	DO	Dominican Republic	IS	Iceland
BD	Bangladesh	DZ	Algeria	IT	Italy
BE	Belgium	EC	Ecuador	JM	Jamaica
BF	Burkina Faso	EE	Estonia	JO	Jordan
BG	Bulgaria	EG	Egypt	JP	Japan
BH	Bahrain	ES	Spain	KE	Kenya
BI	Burundi	ET	Ethiopia	KH	Cambodia
BJ	Benin	FI	Finland	KI	Kiribati
BM	Bermuda	FJ	Fiji	KM	Comoros
BN	Brunei Darussalam	FK	Falkand Islands (Malvinas)	KN	Saint Kitts and Nevis
BO	Bolivia	FR	France	KP	Democratic People's Republic of Korea
BR	Brazil	GA	Gabon	KR	Republic of Korea
BS	Bahamas	GB	United Kingdom	KW	Kuwait
BT	Bhutan	GD	Grenada	KY	Cayman Islands
BW	Botswana	GE	Georgia	KZ	Kazakhstan
BY	Belarus	GH	Ghana	LA	Laos
BZ	Belize	GI	Gibraltar	LB	Lebanon
CA	Canada	GM	Gambia	LC	Saint Lucia
CF	Central African Republic	GN	Guinea	LI	Liechtenstein
CG	Congo	GQ	Equatorial Guinea	LK	SriLanka
CH	Switzerland	GR	Greece	LR	Liberia
CI	Côte d'Ivoire	GT	Guatemala	LS	Lesotho
CL	Chile	GW	Guinea-Bissau	LT	Lithuania
CM	Cameroon	GY	Guyana	TC	Turk and Caicos Islands
LU	Luxembourg	PA	Panama	TD	Chad
LV	Latvia	PE	Peru	TG	Togo
LY	Lybya	PG	Papua New Guinea	TH	Thailand
MA	Morocco	PH	Philippines	TN	Tunisia
MC	Monaco	PK	Pakistan	TO	Tonga
MD	Republic of Moldova	PL	Poland	TR	Turkey

CÔNG BÁO SỞ HỮU CÔNG NGHIỆP SỐ 425 TẬP A - QUYỂN 2 (08.2023)

MG	Madagascar	PT	Portugal	TT	Trinidad and Tobago
ML	Mali	PY	Paraguay	TV	Tuvalu
MM	Myanmar	QA	Qatar	TW	Taiwan, Province of China
MN	Mongolia	RO	Rumania	TZ	United Republic of Tanzania
MO	Macau	RU	Russian Federation	UA	Ukraine
MR	Mauritania	RW	Rwanda	UG	Uganda
MS	Montserrat	SA	Saudi Arabia	US	United States of America
MT	Malta	SB	Solomon Islands	UY	Uruguay
MU	Mauritius	SC	Seychelles	UZ	Uzbekistan
MV	Maldives	SD	Sudan	VA	Holy see
MW	Malawi	SE	Sweden	VC	Saint Vincent and the Grenadines
MX	Mexico	SG	Singapore	VE	Venezuela
MY	Malaysia	SH	Saint Helena	VG	Virgin Islands (British)
MZ	Mozambique	SL	Slovenia	VN	Vietnam
NA	Namibia	SK	Slovakia	VU	Vanuatu
NE	Niger	SL	Sierra Leone	WS	Samoa
NG	Nigeria	SM	San Marino	YE	Yemen
NJ	Nicaragua	SN	Senegal	YU	Yugoslavia
NL	Netherlands	SO	Somalia	ZA	South Africa
NO	Norway	SR	Suriname	ZM	Zambia
NP	Nepal	ST	Sao Tome and Principe	ZR	Zaire
NR	Nauru	SV	El Sanvador	ZW	Zimbabwe
NZ	New Zealand	SY	Syria		
OM	Oman	SZ	Swaziland		

CÁC TỔ CHỨC QUỐC TẾ

AO	African Intellectual Property Organization (OAPI)
AP	African Regional Industrial Property Organization (ARIPO)
BX	Benelux Trademark Office and Benelux Designs Office
EP	European Patent Office (EPO)
IB, WO	International Bureau of the World Intellectual Property Organization (WIPO)

NHỮNG MÃ SỐ INID TRÍCH TỪ TIÊU CHUẨN ST80 CỦA TỔ CHỨC SỞ HỮU TRÍ TUỆ THẾ GIỚI (WIPO) ĐỂ NHẬN BIẾT CÁC DỮ LIỆU THƯ MỤC DÙNG CÔNG BỐ ĐƠN VÀ BẰNG ĐỘC QUYỀN KIỂU DÁNG CÔNG NGHIỆP

- (11) Số bằng độc quyền kiểu dáng công nghiệp / Số công bố đơn
- (15) Ngày cấp
- (18) Ngày hết hạn hiệu lực của bằng độc quyền kiểu dáng công nghiệp
- (21) Số đơn
- (22) Ngày nộp đơn
- (23) Tên triển lãm, ngày và nơi triển lãm
- (28) Số phương án yêu cầu bảo hộ
- (30) Số đơn ưu tiên, ngày nộp đơn ưu tiên
- (43) Ngày công bố đơn
- (45) Ngày công bố bằng độc quyền kiểu dáng công nghiệp
- (51) Phân loại quốc tế kiểu dáng công nghiệp
- (54) Tên sản phẩm mang kiểu dáng công nghiệp
- (55) Ảnh chụp / hình vẽ kiểu dáng công nghiệp
- (57) Đặc điểm khác biệt yêu cầu bảo hộ của kiểu dáng công nghiệp
- (62) Số và ngày nộp đơn, số bằng độc quyền KDCN hoặc số công bố đơn liên quan đến tách đơn
- (71) Tên và địa chỉ của người nộp đơn
- (72) Tên của tác giả KDCN
- (73) Tên, địa chỉ của chủ bằng độc quyền KDCN
- (74) Tên của người đại diện SHCN

PHẦN I

ĐƠN YÊU CẦU CẤP BẰNG ĐỘC QUYỀN KIỂU DÁNG CÔNG NGHIỆP

- (11) **47613**
(21) 3-2020-02809 (28) 1
(54) **HỘP ĐỰNG THUỐC** (51) **09-03**
(22) 20/11/2020 (43) 25/08/2023
(73) **VŨ THỊ PHƯƠNG (VN)**
Khu DT Dệt May, phường Năng Tĩnh, thành phố Nam Định, tỉnh Nam Định
(72) Vũ Thị Phương (VN)
(55)



1.1



1.2

CÔNG BÁO SỞ HỮU CÔNG NGHIỆP SỐ 425 TẬP A – QUYỀN 2 (08.2023)

- (11) **47614**
(21) 3-2020-02810
(54) **HỘP ĐỰNG THUỐC**
(22) 20/11/2020
(73) **VŨ THỊ PHƯƠNG (VN)**
Khu ĐT Dệt May, phường Năng Tĩnh, thành phố Nam Định, tỉnh Nam Định
(72) Vũ Thị Phương (VN)
(55)
- (28) 1
(51) **09-03**
(43) 25/08/2023



1.1



1.2

CÔNG BÁO SỞ HỮU CÔNG NGHIỆP SỐ 425 TẬP A – QUYỀN 2 (08.2023)

- (11) **47615**
(21) 3-2020-02892 (28) 1
(54) **HỮ** (51) **09-03**
(22) 01/12/2020 (43) 25/08/2023
(73) **CÔNG TY TNHH SẢN XUẤT DƯỢC MỸ PHẨM NHẬT VIỆT KHANG (VN)**
A15 Khu Little Village đường số 22, phường Hiệp Bình Chánh, quận Thủ Đức,
thành phố Hồ Chí Minh
(72) Tạ Thị Như Thủy (VN)
(74) **CÔNG TY TNHH KHANG LUẬT (KHANGLAW)**
(55)



1.1



1.2



1.3



1.4



1.5



1.6



1.7

CÔNG BÁO SỞ HỮU CÔNG NGHIỆP SỐ 425 TẬP A – QUYỀN 2 (08.2023)

(11) **47616**

(21) 3-2021-00121

(28) 1

(54) **LOA**

(51) **14-01**

(22) 19/01/2021

(43) 25/08/2023

(73) **CÔNG TY CỔ PHẦN KIDPOD TECHNOLOGY (VN)**

Tầng 16, Saigon Tower, 29 Lê Duẩn, phường Bến Nghé, quận 1, thành phố Hồ Chí Minh, Việt Nam

(72) Shinya Korninami (CA)

(74) Công ty Luật TNHH Tư vấn Quốc tế (INDOCHINE COUNSEL)

(55)



1.1



1.2



1.3



1.4



1.5



1.6

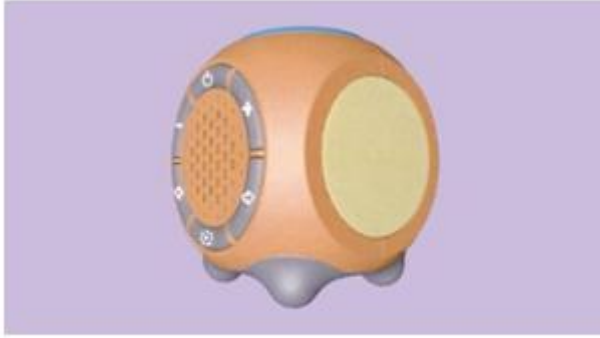

1.7

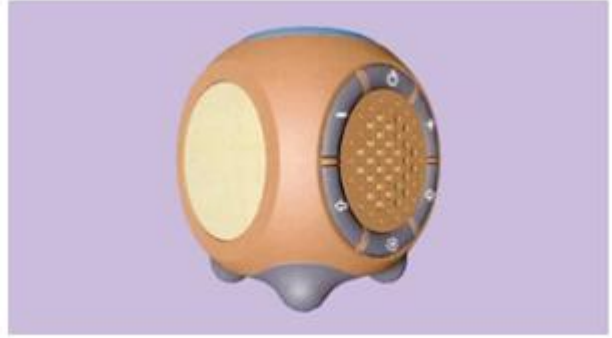

1.8

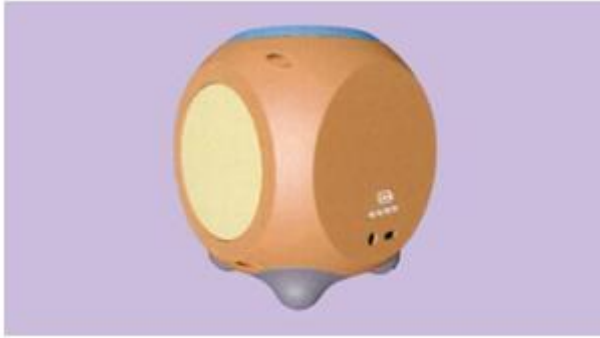

1.9



1.10

CÔNG BÁO SỞ HỮU CÔNG NGHIỆP SỐ 425 TẬP A – QUYỀN 2 (08.2023)

(11) **47617**

(21) 3-2021-00742

(28) 1

(54) **TÚI**

(51) **03-01**

(22) 30/03/2021

(43) 25/08/2023

(73) **NGUYỄN VĂN HIỆP (VN)**

805/51/13, khu phố 1, phường Tân Hiệp, thành phố Biên Hòa, tỉnh Đồng Nai

(72) Nguyễn Văn Hiệp (VN)

(55)

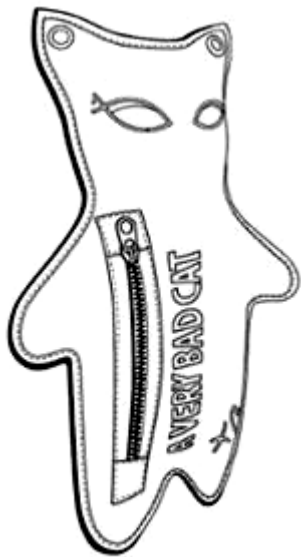

1.1

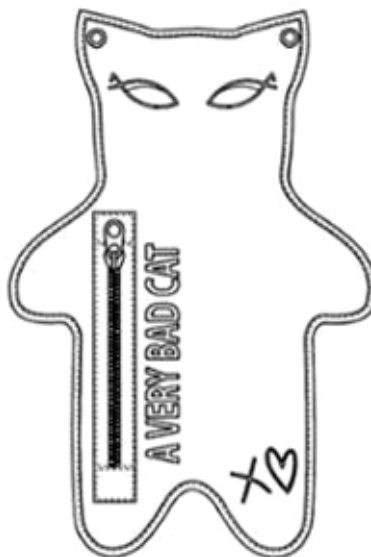

1.2

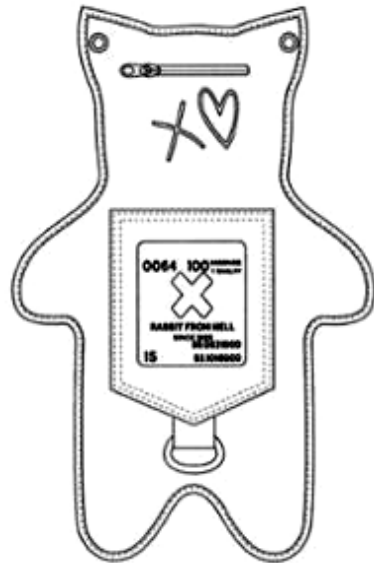

1.3

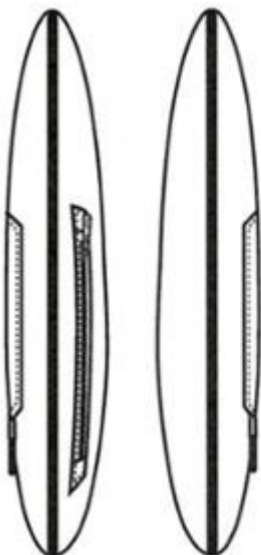

1.4

1.5



1.6



1.7

- (11) **47618**
(21) 3-2021-00743 (28) 1
(54) **TÚI** (51) **03-01**
(22) 30/03/2021 (43) 25/08/2023
(73) **NGUYỄN VĂN HIỆP (VN)**
805/51/13, khu phố 1, phường Tân Hiệp, thành phố Biên Hòa, tỉnh Đồng Nai
(72) Nguyễn Văn Hiệp (VN)
(55)

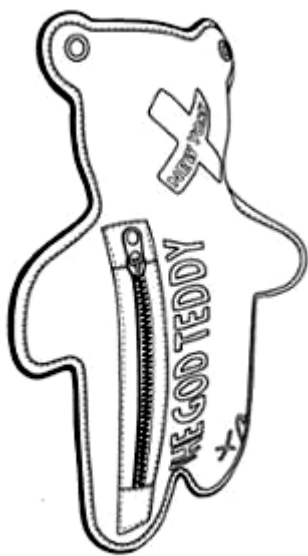

1.1

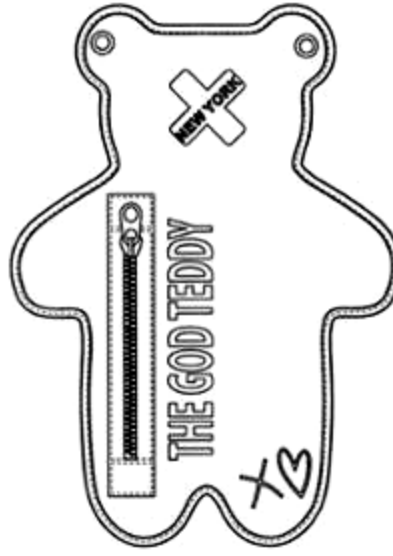

1.2



1.3

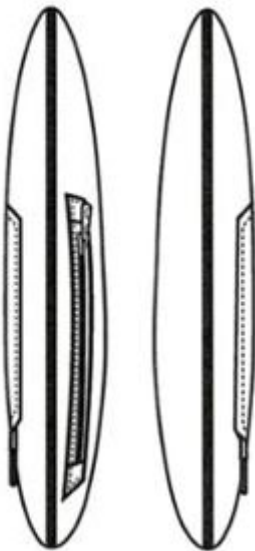

1.4

1.5



1.6



1.7

CÔNG BÁO SỞ HỮU CÔNG NGHIỆP SỐ 425 TẬP A – QUYỀN 2 (08.2023)

- (11) **47619**
(21) 3-2021-02686 (28) 1
(54) **TRẠM THỰC HÀNH KỸ NĂNG LẮP ĐẶT CÁP MẠNG** (51) **14-03**
(22) 28/10/2021 (43) 25/08/2023
(73) **CÔNG TY TNHH NHÂN SINH PHÚC (VN)**
124 Hồng Hà, phường 2, quận Tân Bình, thành phố Hồ Chí Minh
(72) Phạm Trung Hiếu (VN)
(55)

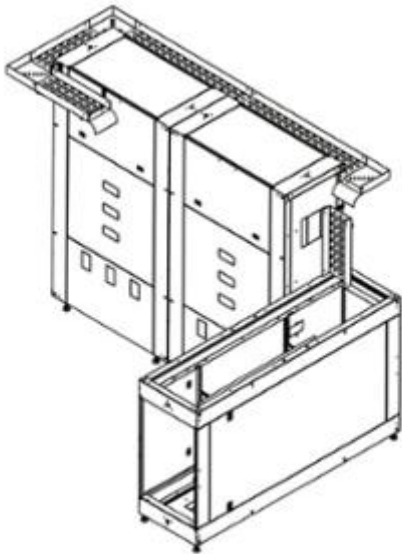

1.1

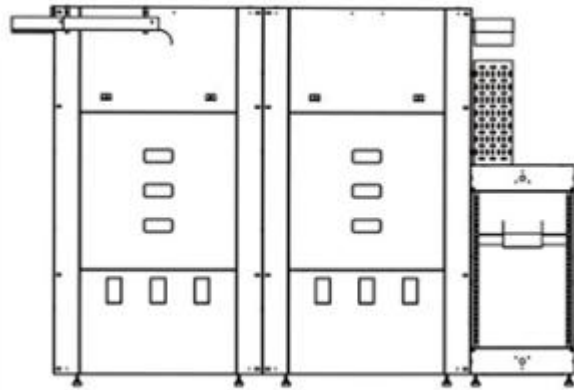

1.2

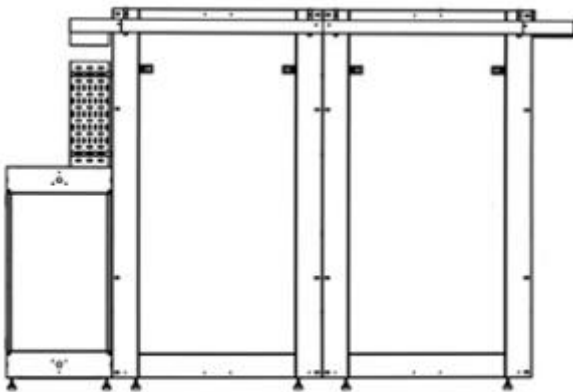

1.3

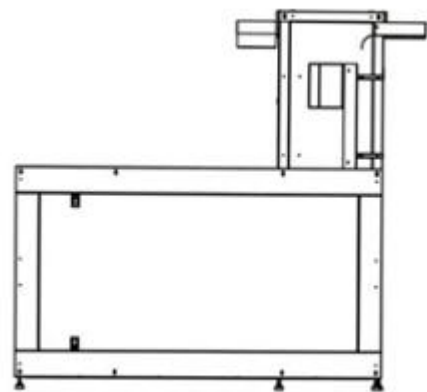

1.4

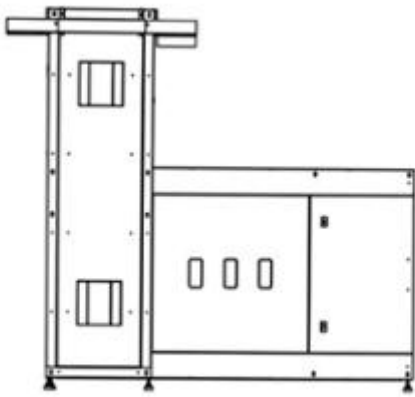

1.5

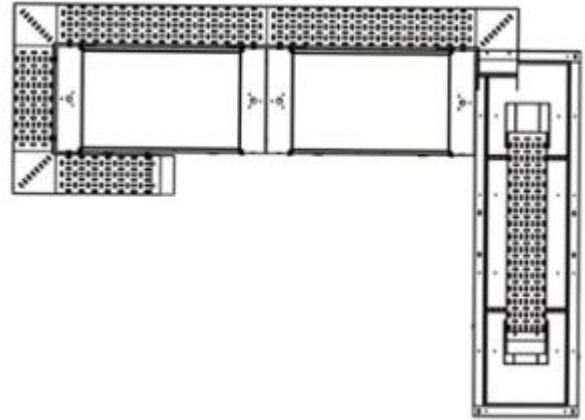

1.6

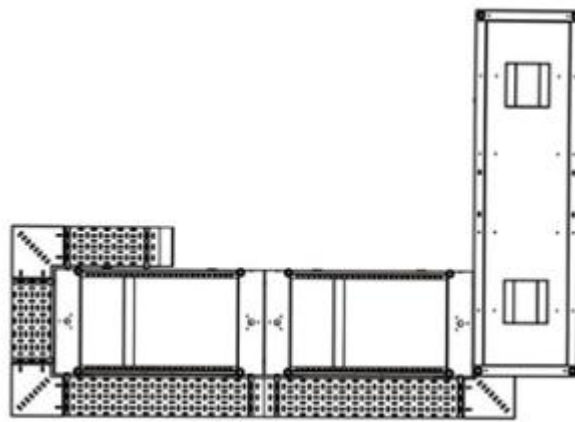

1.7

CÔNG BÁO SỞ HỮU CÔNG NGHIỆP SỐ 425 TẬP A – QUYỀN 2 (08.2023)

- (11) **47620**
(21) 3-2022-00936 (28) 2
(54) **Ô TÔ** (51) **12-08**
(22) 12/05/2022 (43) 25/08/2023
(30) DM/217524 12/11/2021 WO;
(73) **FERRARI S.P.A. (IT)**
Via Emilia Est 1163, MODENA, Italy
(72) Flavio MANZONI (IT)
(74) Công ty TNHH một thành viên Sở hữu trí tuệ VCCI (VCCI-IP CO.,LTD)
(55)

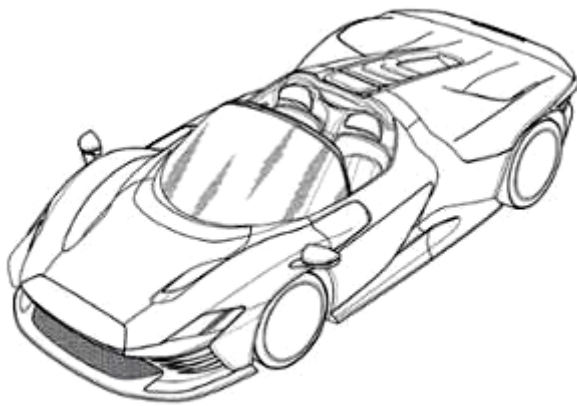

1.1

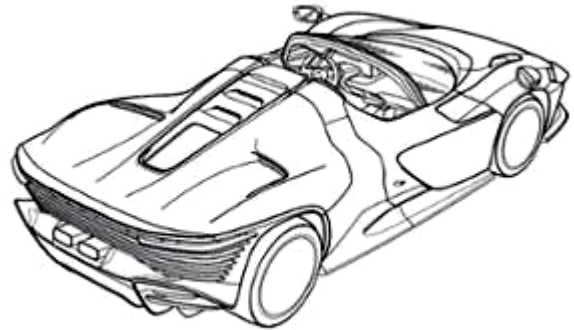

1.2



1.3

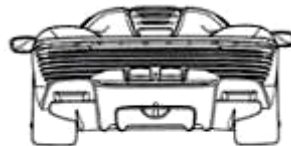

1.4



1.5

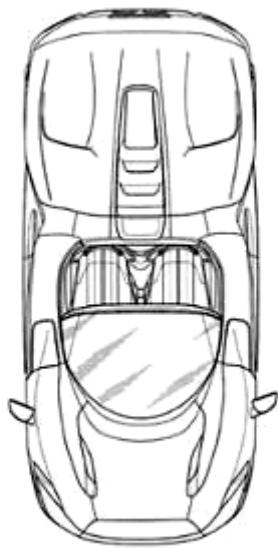

1.6

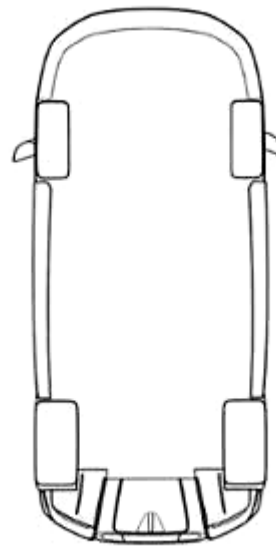

1.7

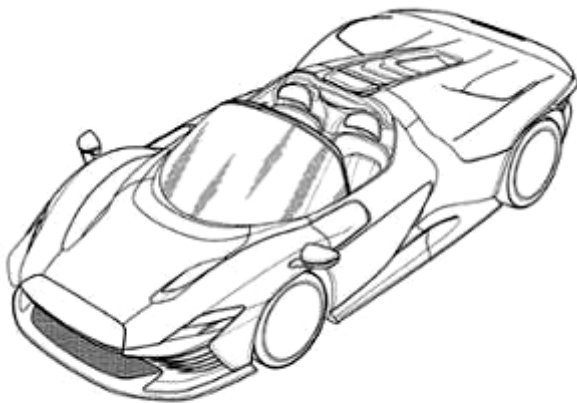

2.1

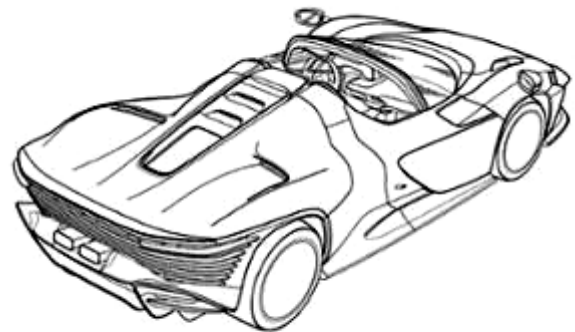

2.2



2.3

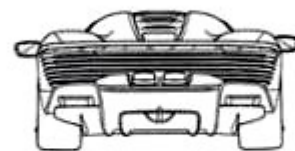

2.4



2.5



2.6

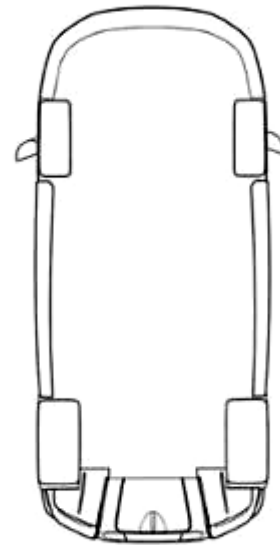

2.7

CÔNG BÁO SỞ HỮU CÔNG NGHIỆP SỐ 425 TẬP A – QUYỀN 2 (08.2023)

- (11) **47621**
(21) 3-2022-00937 (28) 2
(54) **Ô TÔ** (51) **12-08**
(22) 12/05/2022 (43) 25/08/2023
(30) DM/217524 12/11/2021 WO;
(73) **FERRARI S.P.A. (IT)**
Via Emilia Est 1163, MODENA, Italy
(72) Flavio MANZONI (IT)
(74) Công ty TNHH một thành viên Sở hữu trí tuệ VCCI (VCCI-IP CO.,LTD)
(55)

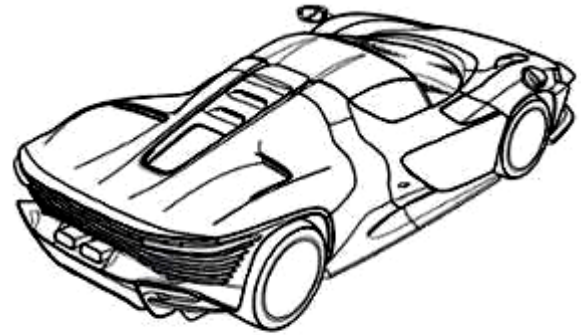
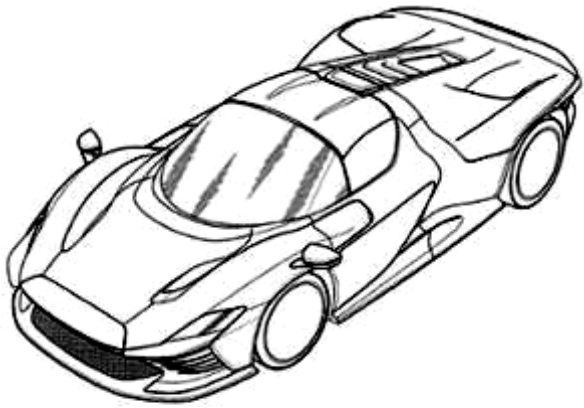

1.1



1.2



1.3

1.4

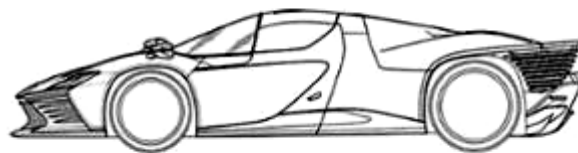

1.5

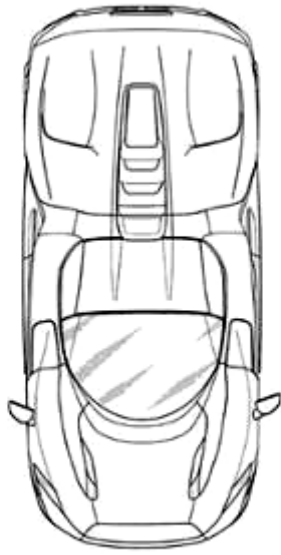

1.6

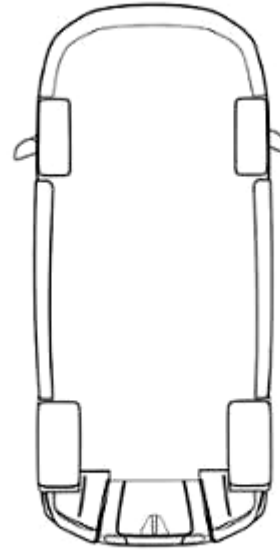

1.7

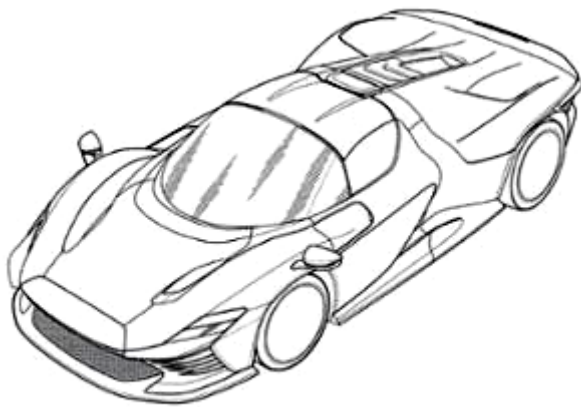

2.1

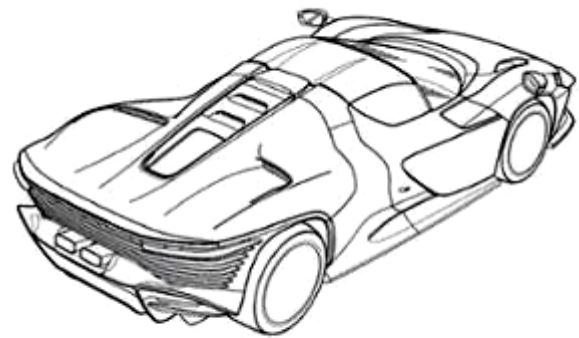

2.2



2.3

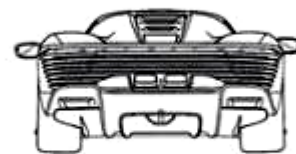

2.4



2.5

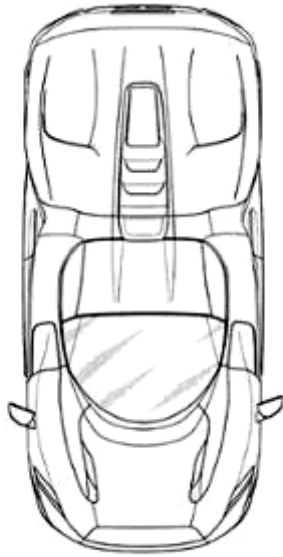

2.6

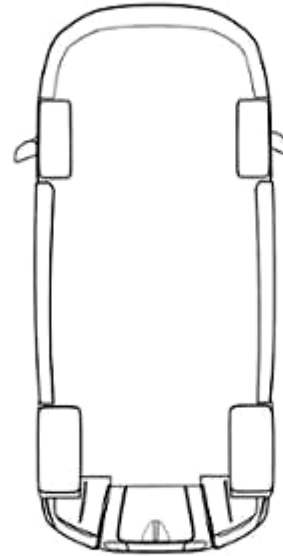

2.7

CÔNG BÁO SỞ HỮU CÔNG NGHIỆP SỐ 425 TẬP A – QUYỀN 2 (08.2023)

(11) **47622**

(21) 3-2022-01683

(28) 1

(54) **BỒN CẦU**

(51) **23-02**

(22) 16/08/2022

(43) 25/08/2023

(73) **CÔNG TY CỔ PHẦN THƯƠNG MẠI VIGLACERA (VN)**

Tầng 3, tòa nhà Viglacera, số 1 Đại lộ Thăng Long, phường Mỹ Trì, quận Nam Từ Liêm, thành phố Hà Nội

(72) Phạm Tiến Dũng (VN)

(55)



1.1



1.2



1.3



1.4



1.5



1.6

CÔNG BÁO SỞ HỮU CÔNG NGHIỆP SỐ 425 TẬP A – QUYỀN 2 (08.2023)

(11) **47623**

(21) 3-2022-01684

(28) 1

(54) **BỒN CẦU**

(51) **23-02**

(22) 16/08/2022

(43) 25/08/2023

(73) **CÔNG TY CỔ PHẦN THƯƠNG MẠI VIGLACERA (VN)**

Tầng 3, tòa nhà Viglacera, số 1 Đại lộ Thăng Long, phường Mỹ Trì, quận Nam Từ Liêm, thành phố Hà Nội

(72) Phạm Tiến Dũng (VN)

(55)



1.1



1.2



1.3



1.4



1.5



1.6

CÔNG BÁO SỞ HỮU CÔNG NGHIỆP SỐ 425 TẬP A – QUYỀN 2 (08.2023)

(11) **47624**

(21) 3-2022-01690

(54) **BỒN CẦU**

(22) 16/08/2022

(73) **CÔNG TY CỔ PHẦN THƯƠNG MẠI VIGLACERA (VN)**

Tầng 3, tòa nhà Viglacera, số 1 Đại lộ Thăng Long, phường Mễ Trì, quận Nam Từ Liêm, thành phố Hà Nội

(72) Phạm Tiến Dũng (VN)

(55)

(28) 1

(51) **23-02**

(43) 25/08/2023



1.1



1.2



1.3



1.4



1.5

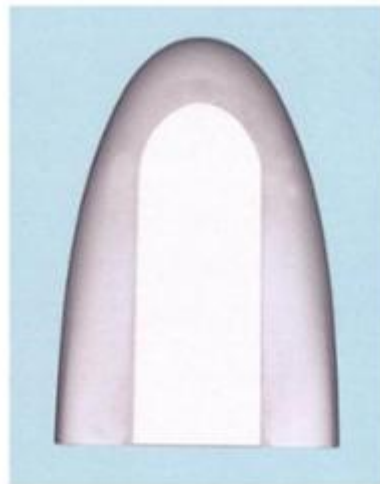

1.6

CÔNG BÁO SỞ HỮU CÔNG NGHIỆP SỐ 425 TẬP A – QUYỀN 2 (08.2023)

- (11) **47625**
(21) 3-2022-01781 (28) 1
(54) **XE CỨU HỘ LỚP VÀ THAY THẾ LỚP PHỤ Ô TÔ** (51) **12-02**
(22) 23/08/2022 (43) 25/08/2023
(73) **ĐÀO VĂN MINH (VN)**
Tổ 1 phường Phúc Diễn, quận Bắc Từ Liêm, thành phố Hà Nội
(72) Đào Văn Minh (VN)
(74) Công ty Luật TNHH OPIC & Cộng sự (OPIC & ASSOCIATES)
(55)



1.1



1.2



1.3



1.4



1.5



1.6



1.7



1.8



1.9

(11) **47626**

(21) 3-2022-01954

(54) **BÀN CHẢI ĐÁNH RĂNG**

(22) 15/09/2022

(73) **CÔNG TY TNHH TAIYO BRUSH VIỆT NAM (VN)**

Đường số 6, khu công nghiệp An Phước, xã An Phước, huyện Long Thành, tỉnh Đồng Nai

(72) Kenta Yada (JP)

(55)

(28) 1

(51) **04-02**

(43) 25/08/2023



1.1



1.2



1.3



1.4



1.5



1.6

CÔNG BÁO SỞ HỮU CÔNG NGHIỆP SỐ 425 TẬP A – QUYỀN 2 (08.2023)

- (11) **47627**
(21) 3-2022-01957 (28) 1
(54) **TUÝP ĐỰNG MỸ PHẨM** (51) **09-05**
(22) 15/09/2022 (43) 25/08/2023
(73) **LG HOUSEHOLD & HEALTH CARE LTD. (KR)**
58, Saemunan-ro, Jongno-gu, Seoul, Republic of Korea
(72) KIM, Jeong Woo (KR)
(74) Công ty TNHH Tâm nhìn và Liên danh (VISION & ASSOCIATES CO.LTD.)
(55)



1.1



1.2



1.3



1.4



1.5

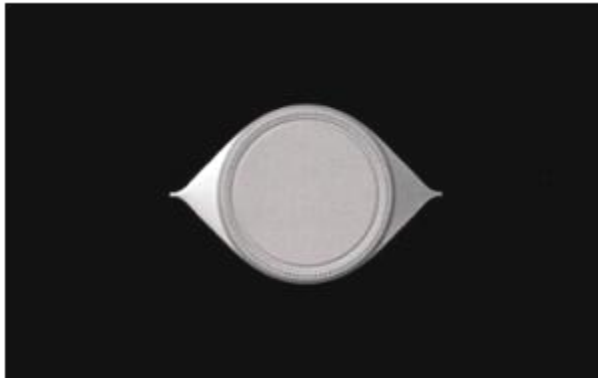

1.6

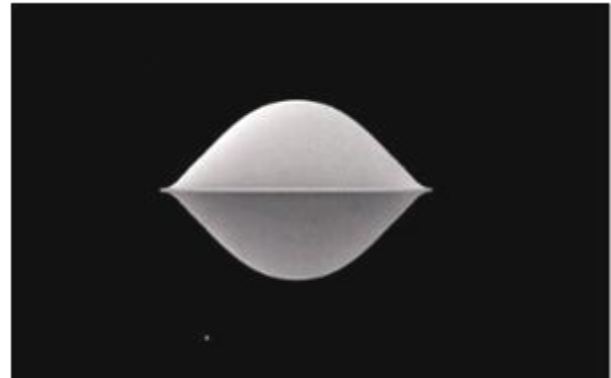

1.7

CÔNG BÁO SỞ HỮU CÔNG NGHIỆP SỐ 425 TẬP A – QUYỀN 2 (08.2023)

- (11) **47628**
(21) 3-2022-02199 (28) 1
(54) **BAO GÓI** (51) **09-05**
(22) 11/10/2022 (43) 25/08/2023
(73) **CÔNG TY CỔ PHẦN LIWAYWAY VIỆT NAM (VN)**
Số 14, đường số 05, khu công nghiệp Việt Nam - Singapore, phường Bình Hòa,
thành phố Thuận An, tỉnh Bình Dương
(72) Robert Tan Li (PH)
(74) Văn phòng Luật sư Tân Hà (VPLS TAN HA)
(55)



1.1



1.2

(11) **47629**

(21) 3-2022-02426

(28) 1

(54) **GIÁ ĐỀ HỘP THƯ**

(51) **06-04**

(22) 04/11/2022

(43) 25/08/2023

(73) **NGUYỄN THÀNH HẬU (VN)**

180/5/22 Bacu, phường 3, thành phố Vũng Tàu, tỉnh Bà Rịa - Vũng Tàu

(72) Nguyễn Thành Hậu (VN)

(55)



1.1



1.2



1.3



1.4



1.5

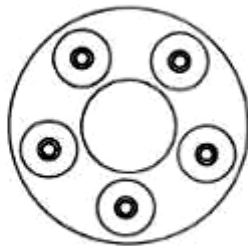

1.6

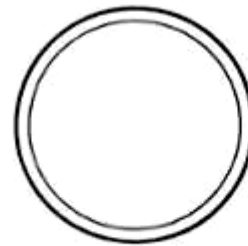

1.7

- (11) **47630**
(21) 3-2022-02459 (28) 1
(54) **ĐỒ TRANG TRÍ** (51) **11-02**
(22) 10/11/2022 (43) 25/08/2023
(73) **HỘ KINH DOANH AN VĨNH PHÁT (VN)**
R23/39/36 Cư xá Phú Lâm A, phường 12, quận 6, thành phố Hồ Chí Minh
(72) Khuu Sở Dinh (VN)
(55)



1.1



1.2



1.3



1.4



1.5

- (11) **47631**
(21) 3-2022-02503 (28) 3
(54) **NẮP ĐẬY** (51) **09-07**
(22) 16/11/2022 (43) 25/08/2023
(73) **CÔNG TY CỔ PHẦN KHUÔN CHÍNH XÁC MINH ĐẠT (VN)**
Quốc lộ 1A, ấp 1, xã Mỹ Yên, huyện Bến Lức, tỉnh Long An
(72) Trịnh Hoài Sang (VN)
(74) Công ty TNHH Sở hữu trí tuệ Thảo Thọ Quyển (INVENCO.,LTD)
(55)



1.1



1.2



1.3



1.4



1.5



1.6



1.7



2.1



2.2



2.3



2.4



2.5



2.6



2.7



3.1



3.2



3.3



3.4



3.5



3.6



3.7

CÔNG BÁO SỞ HỮU CÔNG NGHIỆP SỐ 425 TẬP A – QUYỀN 2 (08.2023)

- (11) **47632**
(21) 3-2022-02590 (28) 1
(54) **MÁY CẮT BỤNG TÔM** (51) **15-03**
(22) 24/11/2022 (43) 25/08/2023
(73) **CÔNG TY TNHH ANH PHÁT (VN)**
60 Vũ Văn Tân, phường 3, quận Bình Thạnh, thành phố Hồ Chí Minh
(72) Phạm Văn Y (VN)
(55)



1.1



1.2



1.3



1.4



1.5



1.6

CÔNG BÁO SỞ HỮU CÔNG NGHIỆP SỐ 425 TẬP A – QUYỀN 2 (08.2023)

- (11) **47633**
(21) 3-2022-02627 (28) 1
(54) **Ô TÔ** (51) **12-08**
(22) 30/11/2022 (43) 25/08/2023
(30) DM/221272 31/05/2022 WO;
(73) **FERRARI S.P.A.** (IT)
Via Emilia Est 1163, MODENA, Italy
(72) Flavio MANZONI (IT)
(74) Công ty TNHH một thành viên Sở hữu trí tuệ VCCI (VCCI-IP CO.,LTD)
(55)

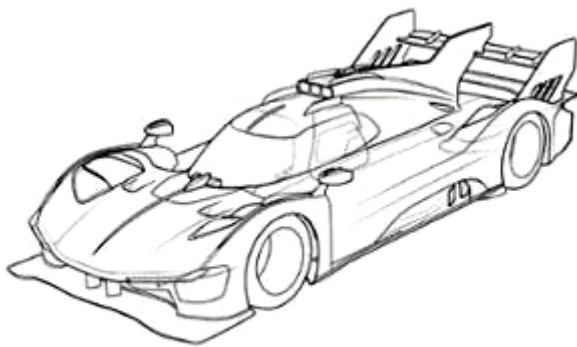

1.1

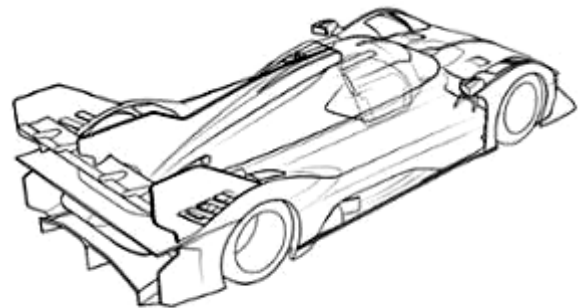

1.2

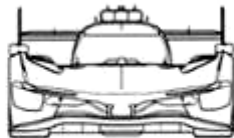

1.3



1.4



1.5

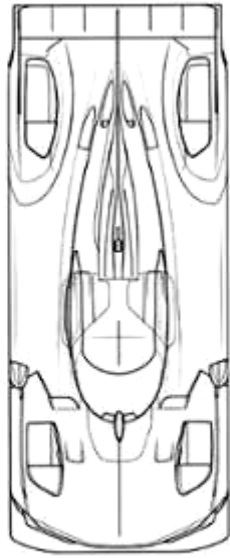

1.6

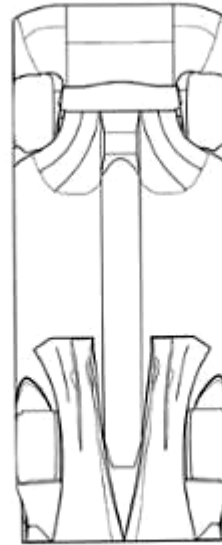

1.7

CÔNG BÁO SỞ HỮU CÔNG NGHIỆP SỐ 425 TẬP A – QUYỀN 2 (08.2023)

- (11) **47634**
(21) 3-2022-02628 (28) 1
(54) **Ô TÔ ĐỒ CHƠI** (51) **21-01**
(22) 30/11/2022 (43) 25/08/2023
(30) DM/221271 31/05/2022 WO;
(73) **FERRARI S.P.A. (IT)**
Via Emilia Est 1163, MODENA, Italy
(72) Flavio MANZONI (IT)
(74) Công ty TNHH một thành viên Sở hữu trí tuệ VCCI (VCCI-IP CO.,LTD)
(55)

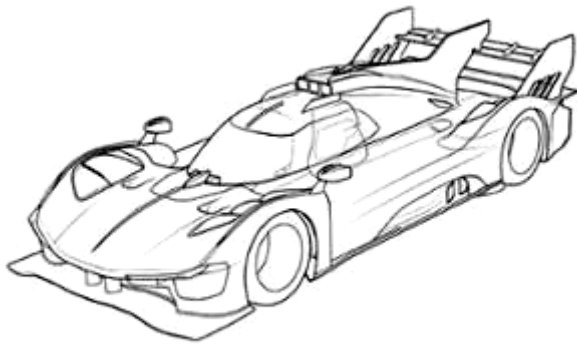

1.1

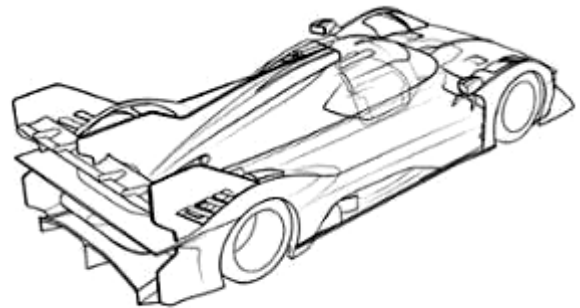

1.2

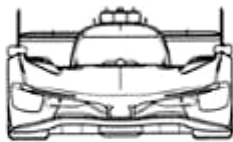

1.3

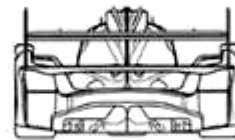

1.4

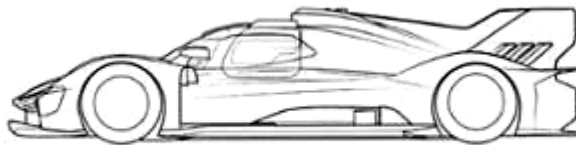

1.5

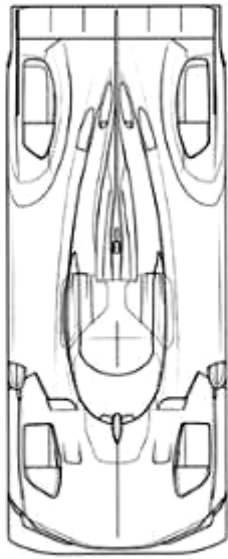

1.6

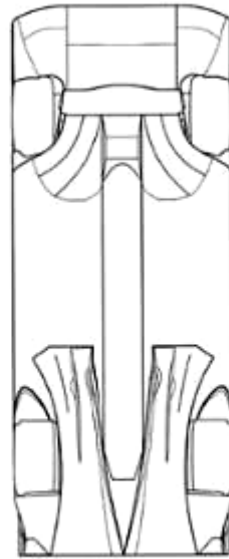

1.7

CÔNG BÁO SỞ HỮU CÔNG NGHIỆP SỐ 425 TẬP A – QUYỀN 2 (08.2023)

- (11) **47635**
(21) 3-2022-02799 (28) 1
(54) **MÁY SẤY** (51) **15-03**
(22) 19/12/2022 (43) 25/08/2023
(73) **CÔNG TY CỔ PHẦN CƠ KHÍ CHẾ TẠO MÁY LONG AN (VN)**
1128 quốc lộ 1A, phường Khánh Hậu, thành phố Tân An, tỉnh Long An
(72) 1. LÊ HỮU DUYÊN (VN)
2. NGUYỄN THANH SANG (VN)
(74) Công ty Cổ phần Sở hữu công nghiệp INVESTIP (INVESTIP)
(55)

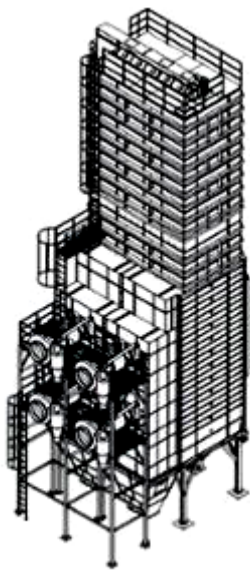

1.1

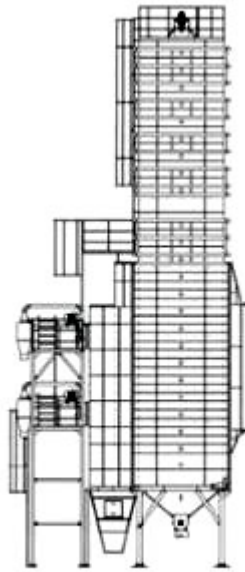

1.2

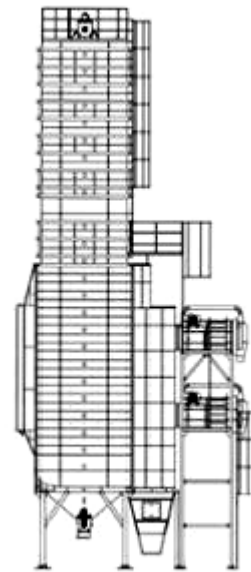

1.3

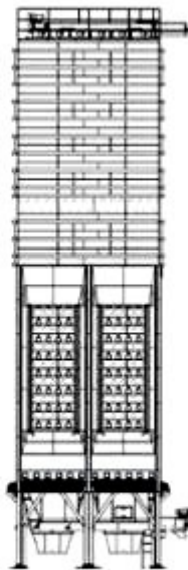

1.4

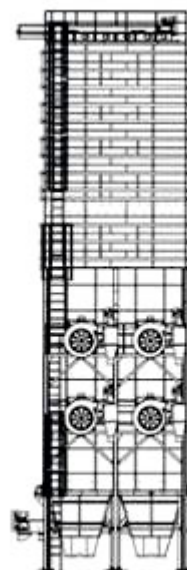

1.5

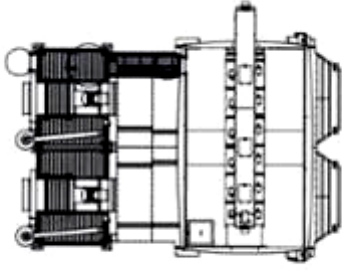

1.6

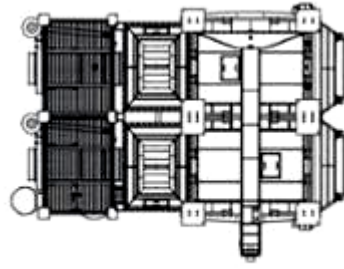

1.7

CÔNG BÁO SỞ HỮU CÔNG NGHIỆP SỐ 425 TẬP A – QUYỀN 2 (08.2023)

- (11) **47636**
(21) 3-2022-02833 (28) 2
(54) **NẮP ĐẬY** (51) **09-07**
(22) 23/12/2022 (43) 25/08/2023
(30) 29/846,340 15/07/2022 US;
(73) **DART INDUSTRIES INC. (US)**
14901 S. Orange Blossom Trail, Orlando, Florida 32837, United States of America
(72) Johan Carrette (BE)
(74) **CÔNG TY LUẬT TRÁCH NHIỆM HỮU HẠN AMBYS HÀ NỘI (AMBYS HANOI)**
(55)

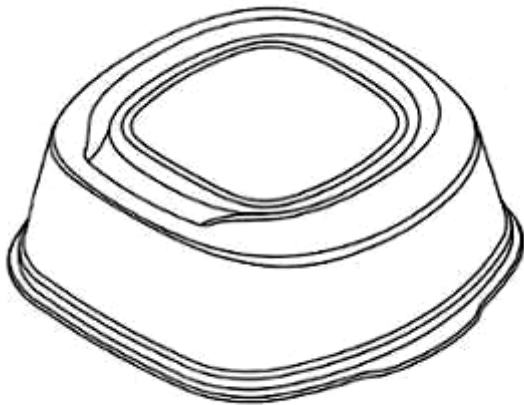

1.1

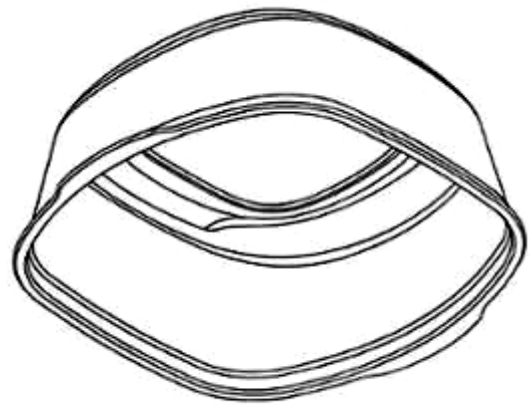

1.2

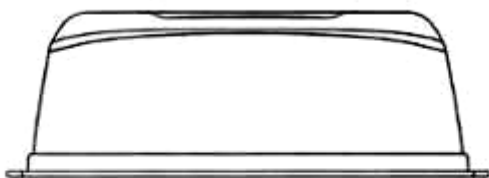

1.3



1.4



1.5

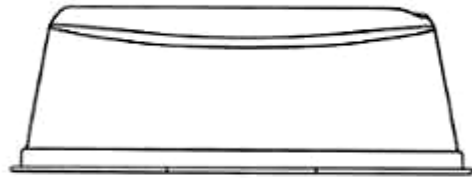

1.6

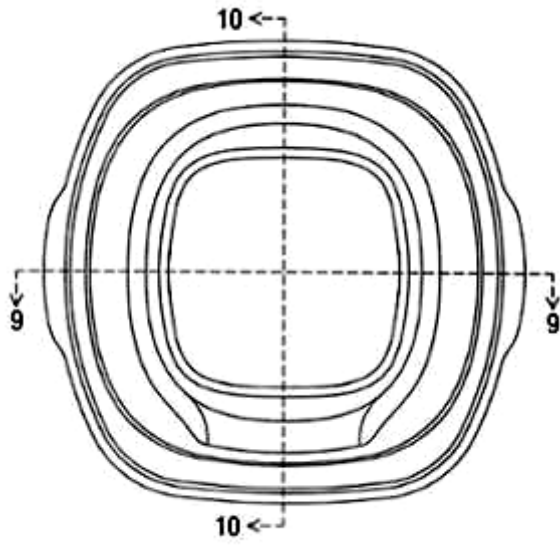

1.7

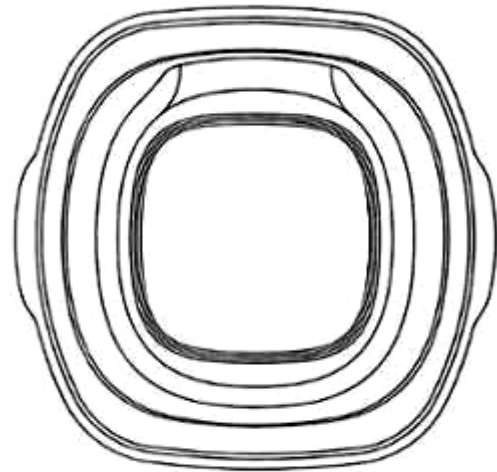

1.8

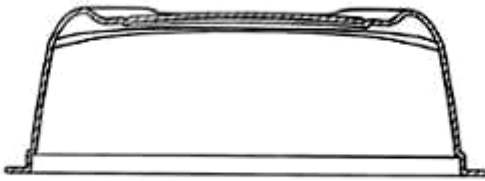

1.9

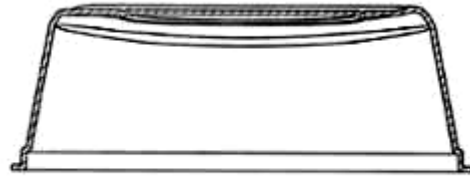

1.10

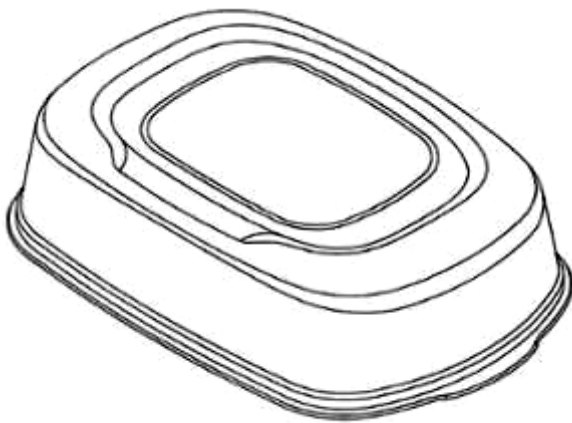

2.1

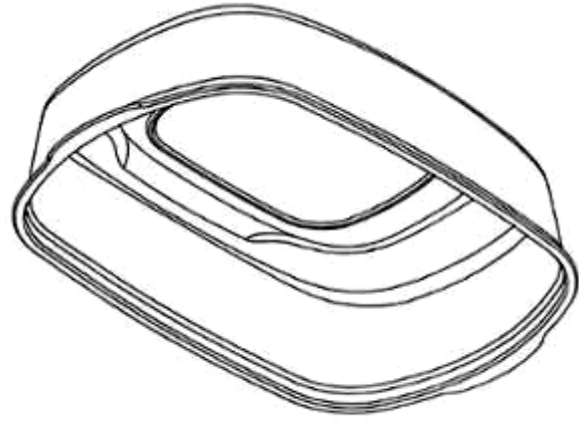

2.2



2.3



2.4

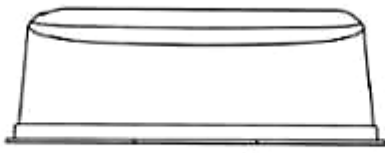

2.5



2.6

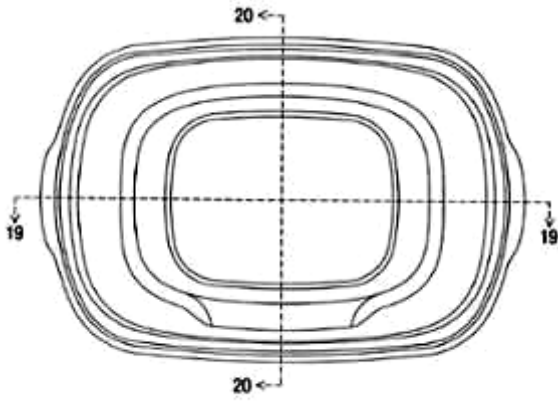

2.7

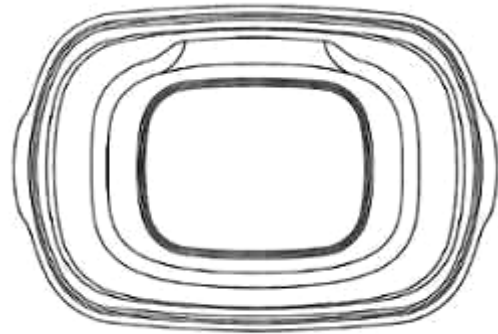

2.8



2.9



2.10

CÔNG BÁO SỞ HỮU CÔNG NGHIỆP SỐ 425 TẬP A – QUYỀN 2 (08.2023)

- (11) **47637**
- (21) 3-2022-02851 (28) 1
- (54) **HỘP THUỐC THỬ** (51) **24-01**
- (22) 23/12/2022 (43) 25/08/2023
- (30) 29/865,269 15/07/2022 US;
- (73) 1. **ILLUMINA, INC.** (US)
5200 Illumina Way, San Diego, CA 92122 USA
2. **ILLUMINA SINGAPORE PTE. LTD.** (SG)
29 Woodlands Industrial Park E1, North Tech Lobby 3 #02-13/18,
Singapore,757716 Singapore
- (72) 1. ALLEGOREN, ERIK (US)
2. POLLOCK, MAX WARREN (US)
3. DEAN, ROBERT NICHOLAS (US)
4. BREWER, EMERICO ALBERTO (US)
5. SUBRAMANIAN, BASHKARAN (SG)
- (74) Văn phòng Luật sư Ân Nam (ANNAM IP & LAW)
- (55)

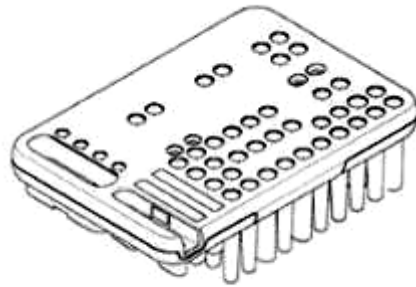

1.1

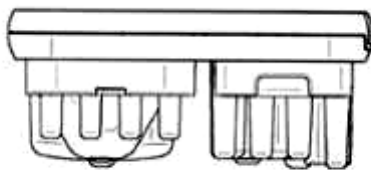

1.2

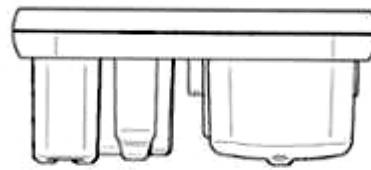

1.3

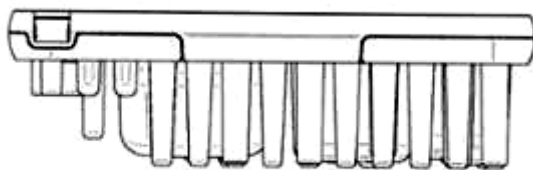

1.4

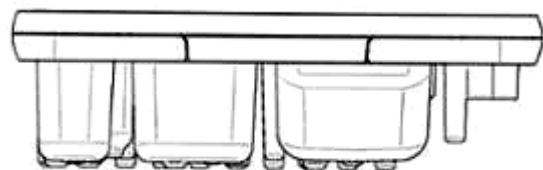

1.5

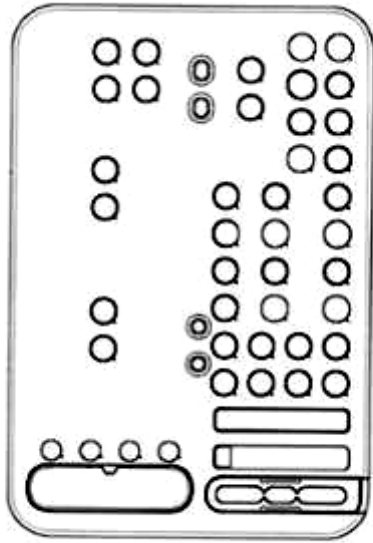

1.6

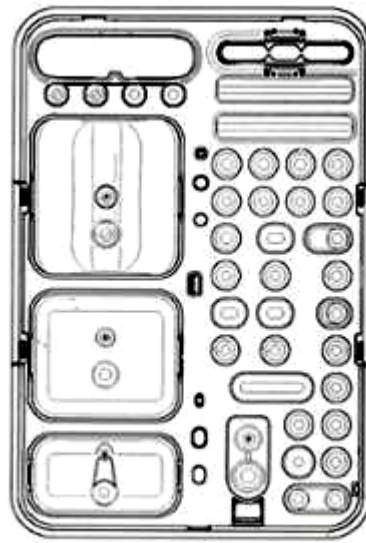

1.7

CÔNG BÁO SỞ HỮU CÔNG NGHIỆP SỐ 425 TẬP A – QUYỀN 2 (08.2023)

- (11) **47638**
(21) 3-2023-00073 (28) 1
(54) **THÂN VỎ NHỰA XE MÁY** (51) **12-16**
(22) 09/01/2023 (43) 25/08/2023
(30) 202230493710.8 30/07/2022 CN;
(73) **TAIZHOU QIMAN TECHNOLOGY CO., LTD.** (CN)
Room 101, Building 6, Zone 3, No. 555, Yongyuan Road, Lunan Subdistrict,
Luqiao District, Taizhou City, Zhejiang Province, P.R.China
(72) LIN, Ruman (CN)
(74) Công ty TNHH Sáng chế ACTIP (ACTIP PATENT LIMITED)
(55)



1.1



1.2



1.3



1.4



1.5



1.6



1.7



1.8

CÔNG BÁO SỞ HỮU CÔNG NGHIỆP SỐ 425 TẬP A – QUYỀN 2 (08.2023)

- (11) **47639**
(21) 3-2023-00083 (28) 1
(54) **TẮM ỐP PHÍA TRƯỚC XE ĐIỆN** (51) **12-16**
(22) 10/01/2023 (43) 25/08/2023
(73) **CÔNG TY TNHH TRƯỜNG PHÁT BN (VN)**
Lô 24, LK2, đường Huyền Quang 2, phường Võ Cường, thành phố Bắc Ninh, tỉnh Bắc Ninh
(72) Nguyễn Văn Đạt (VN)
(74) **CÔNG TY LUẬT TNHH KHÔI NGỌC (KHOI NGOC LAW COMPANY LTD)**
(55)

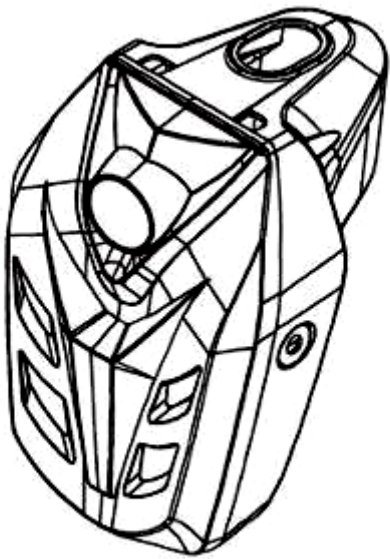

1.1

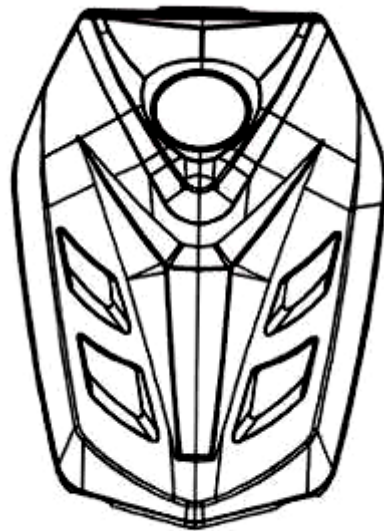

1.2

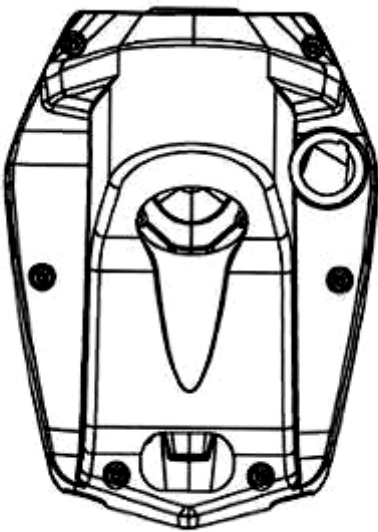

1.3

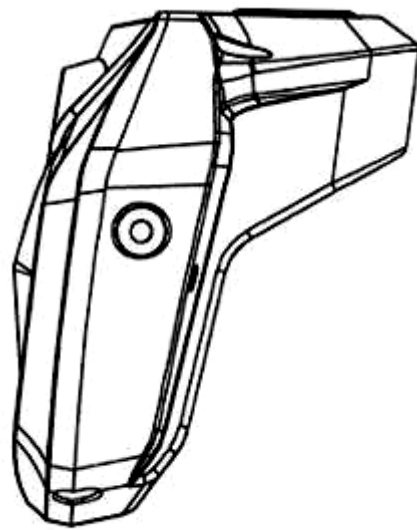

1.4

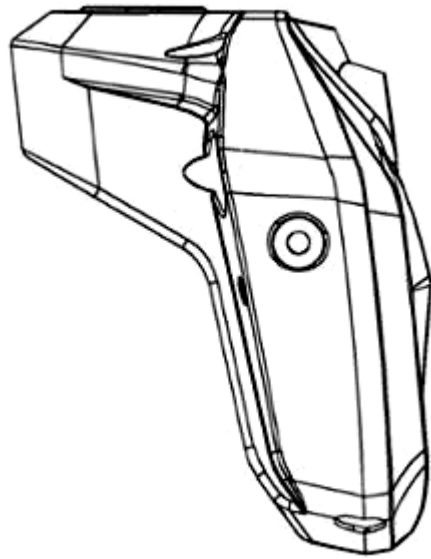

1.5

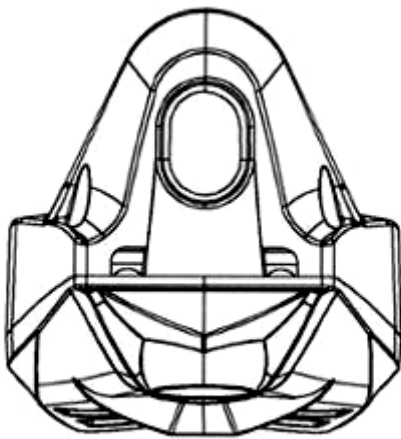

1.6

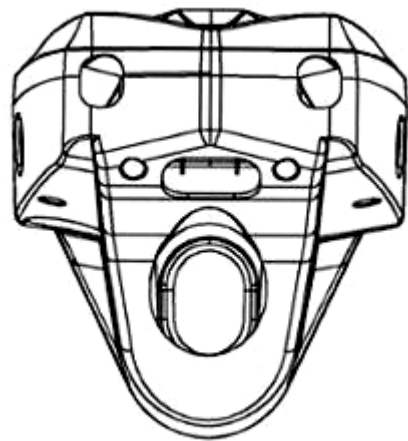

1.7

CÔNG BÁO SỞ HỮU CÔNG NGHIỆP SỐ 425 TẬP A – QUYỀN 2 (08.2023)

- (11) **47640**
(21) 3-2023-00084 (28) 1
(54) **ĐÈN XE MÁY** (51) **26-06**
(22) 10/01/2023 (43) 25/08/2023
(73) **CÔNG TY TNHH SẢN XUẤT- THƯƠNG MẠI - DỊCH VỤ ĐÀI PHONG (VN)**
Số 382 đường số 1, phường Bình Trị Đông B, quận Bình Tân, thành phố Hồ Chí Minh
(72) Hà Quảng Chánh (VN)
(74) Công ty TNHH Tư vấn sở hữu trí tuệ Việt (VIET IP CO.,LTD.)
(55)

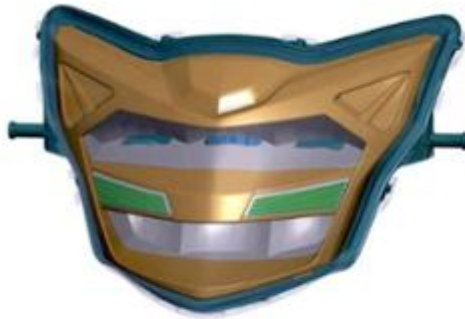

1.1

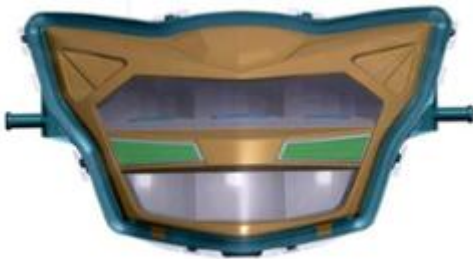

1.2



1.3

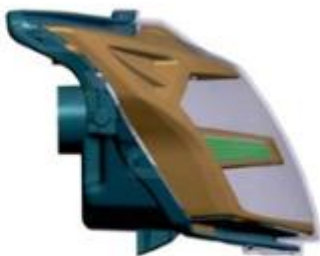

1.4

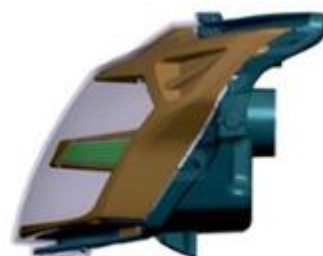

1.5

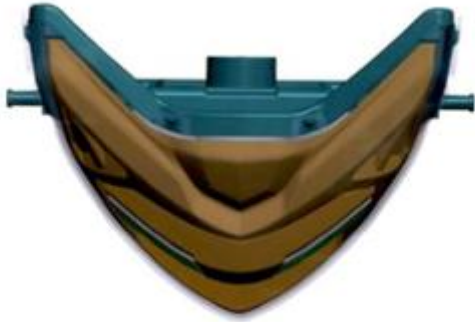

1.6

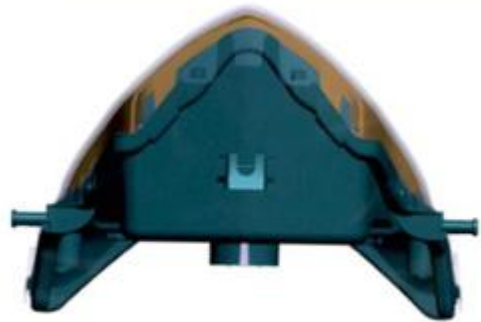

1.7

CÔNG BÁO SỞ HỮU CÔNG NGHIỆP SỐ 425 TẬP A – QUYỀN 2 (08.2023)

(11) **47641**

(21) 3-2023-00085

(28) 1

(54) **ĐÈN XE MÁY**

(51) **26-06**

(22) 10/01/2023

(43) 25/08/2023

(73) **CÔNG TY TNHH SẢN XUẤT- THƯƠNG MẠI - DỊCH VỤ ĐÀI PHONG (VN)**

Số 382 đường số 1, phường Bình Trị Đông B, quận Bình Tân, thành phố Hồ Chí Minh

(72) Hà Quảng Chánh (VN)

(74) Công ty TNHH Tư vấn sở hữu trí tuệ Việt (VIET IP CO.,LTD.)

(55)



1.1



1.2



1.3



1.4



1.5

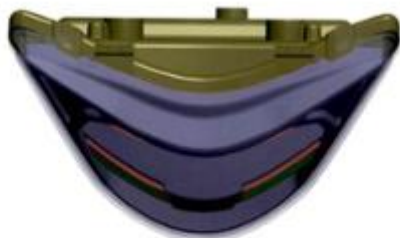

1.6



1.7

CÔNG BÁO SỞ HỮU CÔNG NGHIỆP SỐ 425 TẬP A – QUYỀN 2 (08.2023)

- (11) **47642**
(21) 3-2023-00086 (28) 1
(54) **ĐÈN XE MÁY** (51) **26-06**
(22) 10/01/2023 (43) 25/08/2023
(73) **CÔNG TY TNHH SẢN XUẤT- THƯƠNG MẠI - DỊCH VỤ ĐÀI PHONG (VN)**
Số 382 đường số 1, phường Bình Trị Đông B, quận Bình Tân, thành phố Hồ Chí Minh
(72) Hà Quảng Chánh (VN)
(74) Công ty TNHH Tư vấn sở hữu trí tuệ Việt (VIET IP CO.,LTD.)
(55)



1.1

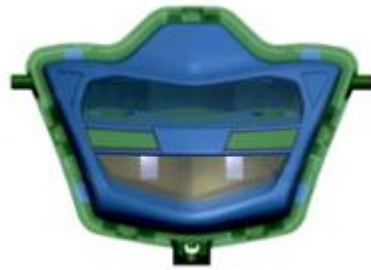

1.2



1.3

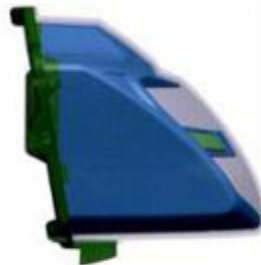

1.4

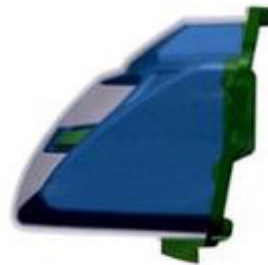

1.5

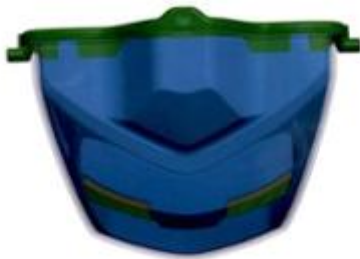

1.6

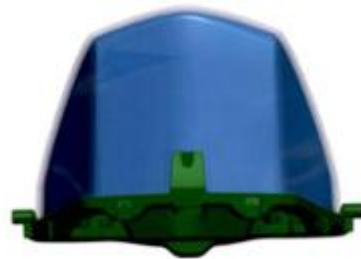

1.7

CÔNG BÁO SỞ HỮU CÔNG NGHIỆP SỐ 425 TẬP A – QUYỀN 2 (08.2023)

- (11) **47643**
(21) 3-2023-00087 (28) 1
(54) **ĐÈN XE MÁY** (51) **26-06**
(22) 10/01/2023 (43) 25/08/2023
(73) **CÔNG TY TNHH SẢN XUẤT- THƯƠNG MẠI - DỊCH VỤ ĐÀI PHONG (VN)**
Số 382 đường số 1, phường Bình Trị Đông B, quận Bình Tân, thành phố Hồ Chí Minh
(72) Hà Quảng Chánh (VN)
(74) Công ty TNHH Tư vấn sở hữu trí tuệ Việt (VIET IP CO.,LTD.)
(55)



1.1



1.2



1.3

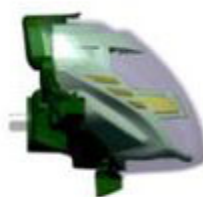

1.4



1.5

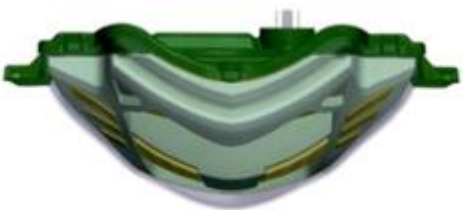

1.6



1.7

CÔNG BÁO SỞ HỮU CÔNG NGHIỆP SỐ 425 TẬP A – QUYỀN 2 (08.2023)

- (11) **47644**
(21) 3-2023-00088 (28) 1
(54) **ĐÈN XE MÁY** (51) **26-06**
(22) 10/01/2023 (43) 25/08/2023
(73) **CÔNG TY TNHH SẢN XUẤT- THƯƠNG MẠI - DỊCH VỤ ĐÀI PHONG (VN)**
Số 382 đường số 1, phường Bình Trị Đông B, quận Bình Tân, thành phố Hồ Chí Minh
(72) Hà Quảng Chánh (VN)
(74) Công ty TNHH Tư vấn sở hữu trí tuệ Việt (VIET IP CO.,LTD.)
(55)

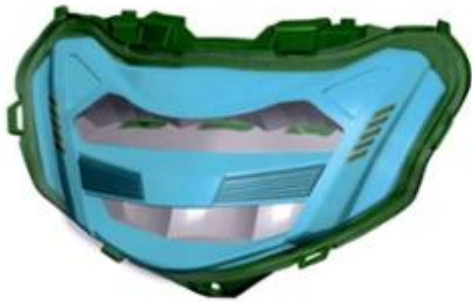

1.1

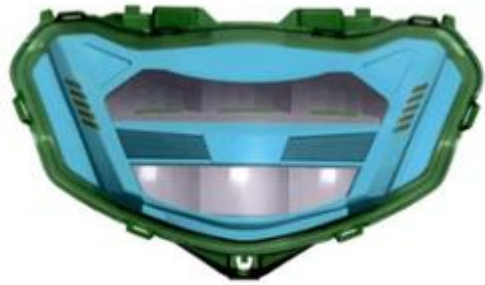

1.2



1.3



1.4



1.5

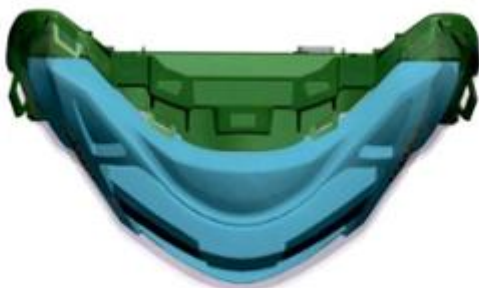

1.6

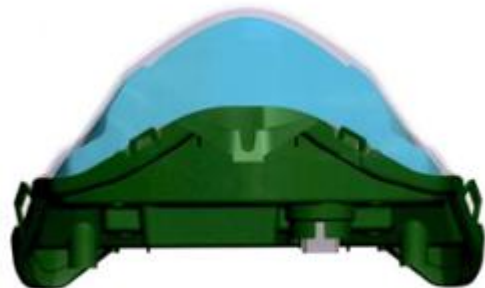

1.7

CÔNG BÁO SỞ HỮU CÔNG NGHIỆP SỐ 425 TẬP A – QUYỀN 2 (08.2023)

- (11) **47645**
(21) 3-2023-00089 (28) 1
(54) **ĐÈN XE MÁY** (51) **26-06**
(22) 10/01/2023 (43) 25/08/2023
(73) **CÔNG TY TNHH SẢN XUẤT - THƯƠNG MẠI - DỊCH VỤ ĐÀI PHONG (VN)**
Số 382 đường số 1, phường Bình Trị Đông B, quận Bình Tân, thành phố Hồ Chí Minh
(72) Hà Quảng Chánh (VN)
(74) Công ty TNHH Tư vấn sở hữu trí tuệ Việt (VIET IP CO.,LTD.)
(55)



1.1



1.2



1.3



1.4



1.5

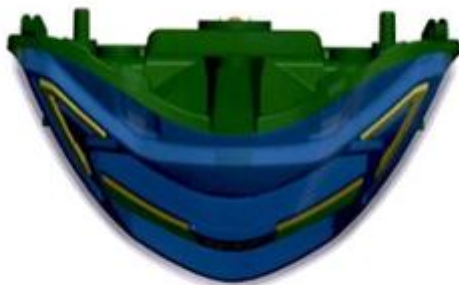

1.6



1.7

CÔNG BÁO SỞ HỮU CÔNG NGHIỆP SỐ 425 TẬP A – QUYỀN 2 (08.2023)

- (11) **47646**
(21) 3-2023-00090 (28) 1
(54) **ĐÈN XE MÁY** (51) **26-06**
(22) 10/01/2023 (43) 25/08/2023
(73) **CÔNG TY TNHH SẢN XUẤT - THƯƠNG MẠI - DỊCH VỤ ĐÀI PHONG (VN)**
Số 382 đường số 1, phường Bình Trị Đông B, quận Bình Tân, thành phố Hồ Chí Minh
(72) Hà Quảng Chánh (VN)
(74) Công ty TNHH Tư vấn sở hữu trí tuệ Việt (VIET IP CO.,LTD.)
(55)



1.1

1.2

1.3



1.4



1.5

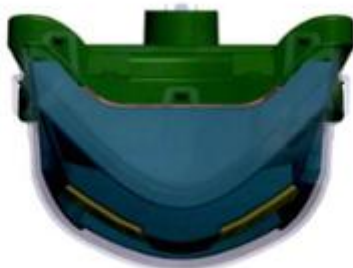

1.6

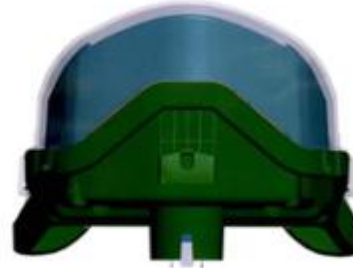

1.7

CÔNG BÁO SỞ HỮU CÔNG NGHIỆP SỐ 425 TẬP A – QUYỀN 2 (08.2023)

(11) **47647**

(21) 3-2023-00091

(28) 1

(54) **ĐÈN XE MÁY**

(51) **26-06**

(22) 10/01/2023

(43) 25/08/2023

(73) **CÔNG TY TNHH SẢN XUẤT - THƯƠNG MẠI - DỊCH VỤ ĐÀI PHONG (VN)**
Số 382 đường số 1, phường Bình Trị Đông B, quận Bình Tân, thành phố Hồ Chí Minh

(72) Hà Quảng Chánh (VN)

(74) Công ty TNHH Tư vấn sở hữu trí tuệ Việt (VIET IP CO.,LTD.)

(55)

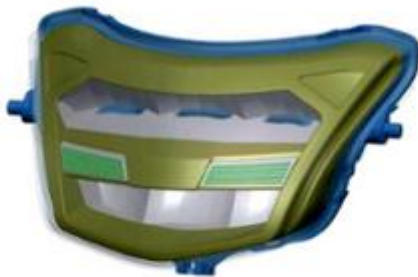

1.1



1.2



1.3



1.4

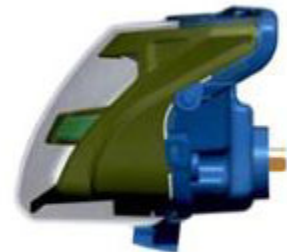

1.5

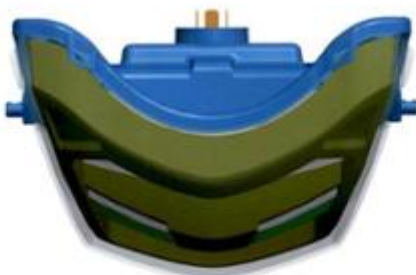

1.6



1.7

CÔNG BÁO SỞ HỮU CÔNG NGHIỆP SỐ 425 TẬP A – QUYỀN 2 (08.2023)

- (11) **47648**
(21) 3-2023-00186 (28) 1
(54) **BỒN CHỨA CHẤT THẢI** (51) **23-01; 23-99**
(22) 19/01/2023 (43) 25/08/2023
(73) **CÔNG TY CỔ PHẦN QUỐC TẾ SATA (VN)**
Số 9, ngách 43/98, TDP Đống 6, đường Cổ Nhuế, phường Cổ Nhuế 2, quận Bắc Từ Liêm, thành phố Hà Nội
(72) 1. BIỆN VĂN BẢY (VN)
2. NGUYỄN VĂN THANH (VN)
3. TRẦN VĂN THẮNG (VN)
4. TRỊNH THỊ PHƯỢNG (VN)
5. LÊ THỊ HẰNG (VN)
(74) Công ty TNHH Nghiên cứu và Tư vấn chuyên giao công nghệ và đầu tư (CONCETTI)
(55)



1.1



1.2



1.3



1.4



1.5



1.6



1.7

- (11) **47649**
(21) 3-2023-00248 (28) 2
(54) **THIẾT BỊ CHO HỒ ĐỐT LỬA** (51) **23-03**
(22) 03/02/2023 (43) 25/08/2023
(30) 29/866,181 31/08/2022 US;
(73) **SOLO BRANDS, LLC (US)**
1001 Mustang Dr., Grapevine, TX 76051, United States of America
(72) 1. JEFFREY R. WEILERT (US)
2. ALEXANDER K. MAGHSADI (US)
(74) Công ty Luật TNHH T&G (TGVN)
(55)

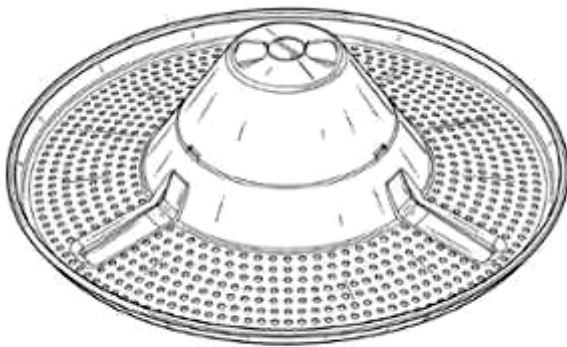

1.1

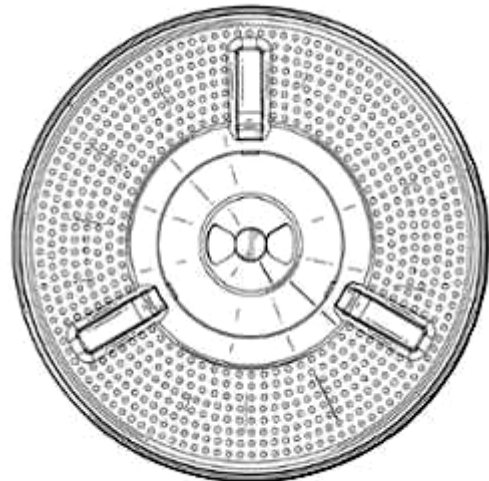

1.2

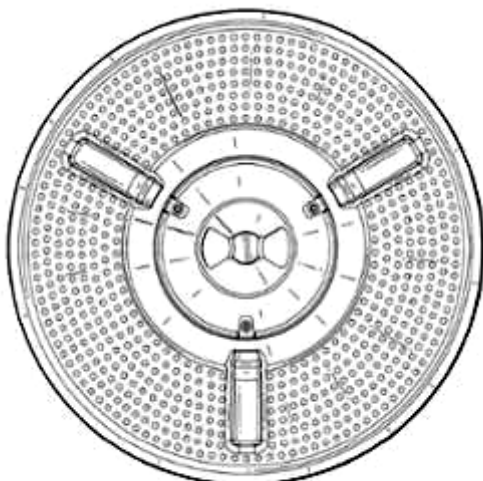

1.3

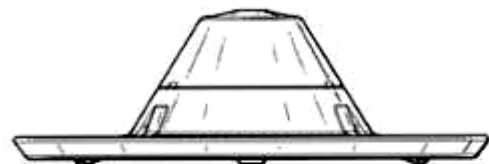

1.4

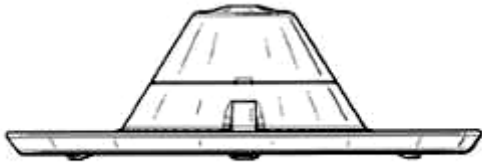

1.5

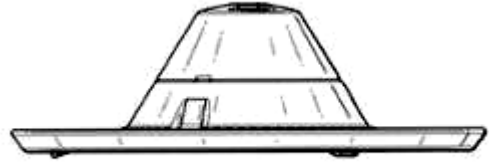

1.6



1.7

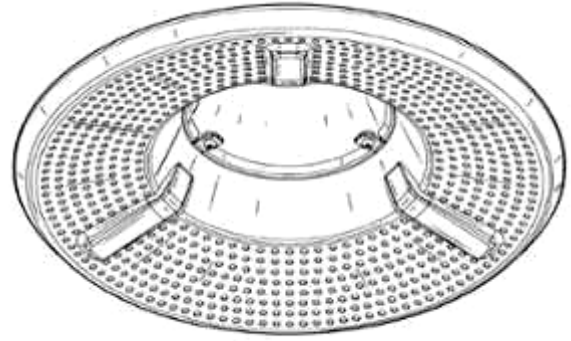

1.8



1.9

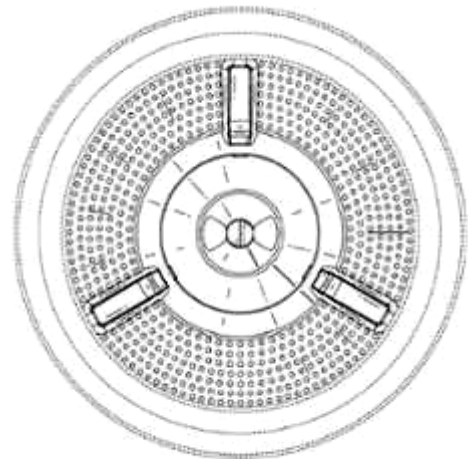

1.10

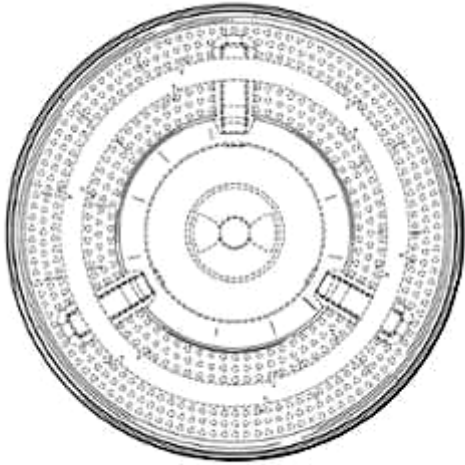

1.11

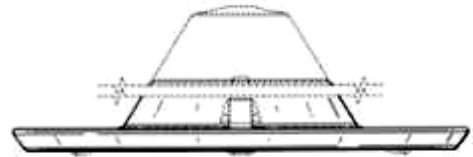

1.12

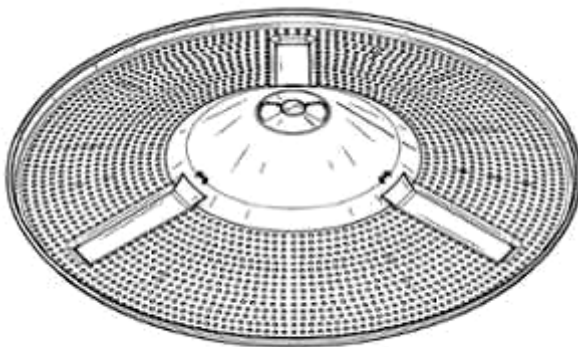

2.1

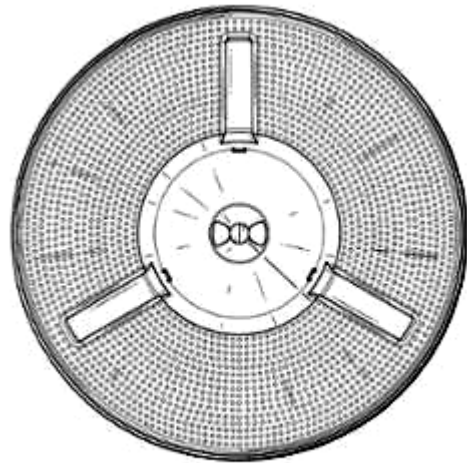

2.2

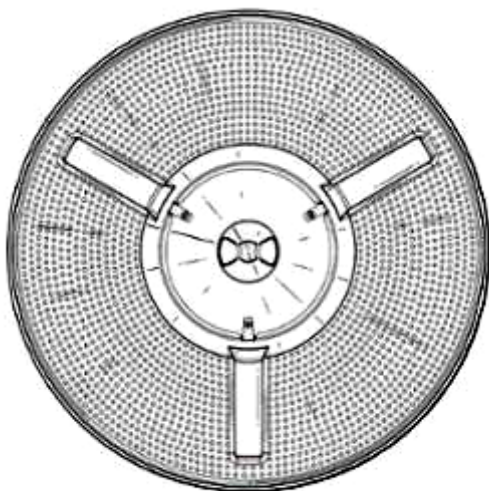

2.3



2.4



2.5



2.6



2.7

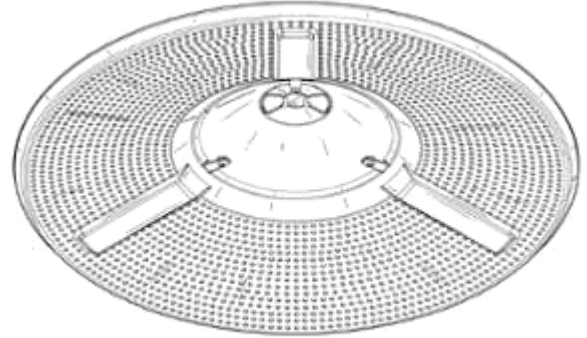

2.8

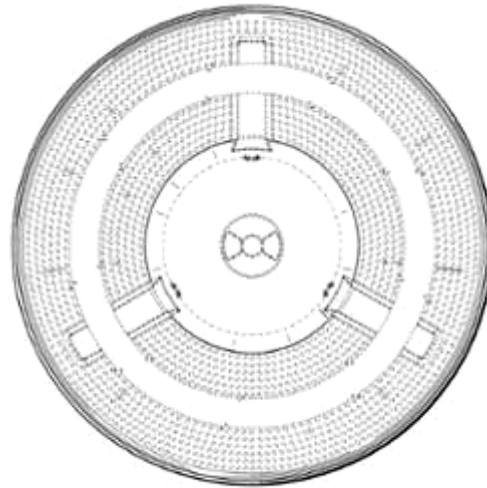

2.9

- (11) **47650**
(21) 3-2023-00480 (28) 1
(54) **NẮP BÌNH** (51) **07-01; 09-07**
(22) 06/03/2023 (43) 25/08/2023
(30) 30-2022-0036461 06/09/2022 KR;
(73) **LOCK & LOCK CO., LTD.** (KR)
104, Sapgyocheon-ro, Seonjang-myeon, Asan-si, Chungcheongnam-do, Republic of Korea
(72) LEE, Kyung Mee (KR)
(74) Công ty TNHH Tầm nhìn và Liên danh (VISION & ASSOCIATES CO.LTD.)
(55)



1.1

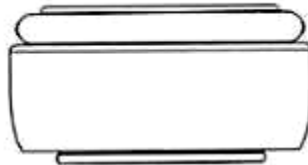

1.2

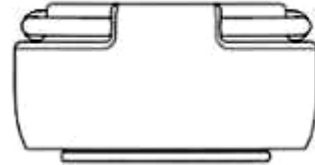

1.3

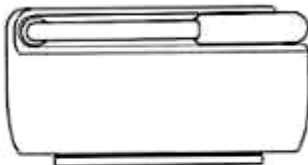

1.4



1.5



1.6



1.7



1.8

CÔNG BÁO SỞ HỮU CÔNG NGHIỆP SỐ 425 TẬP A – QUYỀN 2 (08.2023)

- (11) **47651**
(21) 3-2023-00501 (28) 1
(54) **CHẢO** (51) **07-02**
(22) 08/03/2023 (43) 25/08/2023
(30) 30-2022-0039604 27/09/2022 KR;
(73) **LOCK & LOCK CO., LTD.** (KR)
104, Sapyocheon-ro, Seonjang-myeon, Asan-si, Chungcheongnam-do, Republic of Korea
(72) YOU, Sung Ik (KR)
(74) Công ty TNHH Tầm nhìn và Liên danh (VISION & ASSOCIATES CO.LTD.)
(55)

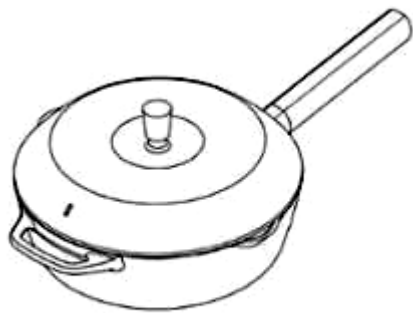

1.1

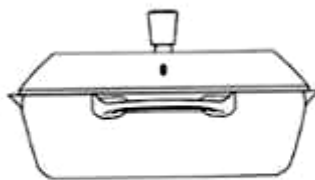

1.2

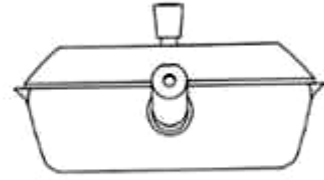

1.3

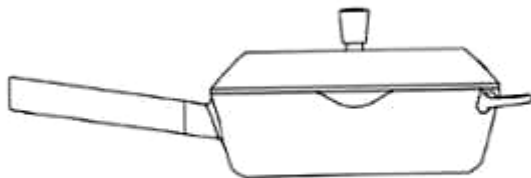

1.4

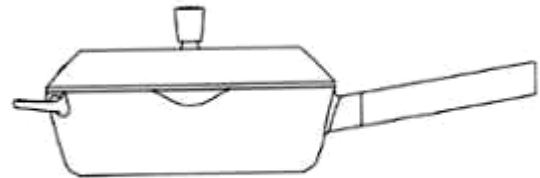

1.5



1.6

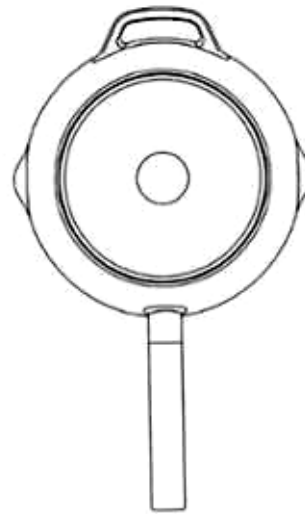

1.7

CÔNG BÁO SỞ HỮU CÔNG NGHIỆP SỐ 425 TẬP A – QUYỀN 2 (08.2023)

- (11) **47652**
(21) 3-2023-00503 (28) 1
(54) **ĐÈN XE MÁY** (51) **26-06**
(22) 08/03/2023 (43) 25/08/2023
(73) **CÔNG TY TNHH SẢN XUẤT - THƯƠNG MẠI - DỊCH VỤ ĐÀI PHONG (VN)**
Số 382 đường số 1, phường Bình Trị Đông B, quận Bình Tân, thành phố Hồ Chí Minh
(72) Hà Quảng Chánh (VN)
(74) Công ty TNHH Tư vấn sở hữu trí tuệ Việt (VIET IP CO.,LTD.)
(55)

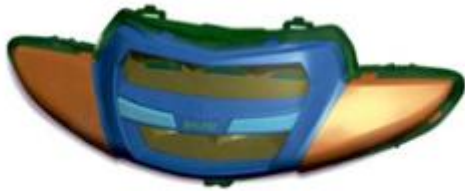

1.1



1.2



1.3



1.4



1.5

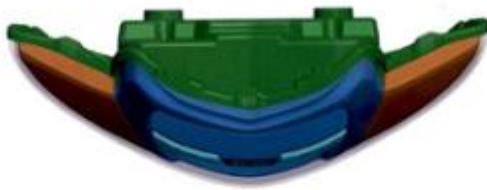

1.6



1.7

- (11) **47653**
(21) 3-2023-00515 (28) 1
(54) **THANH KIM LOẠI ĐỊNH HÌNH** (51) **25-01**
(22) 10/03/2023 (43) 25/08/2023
(73) **CÔNG TY TNHH CƠ KHÍ THƯƠNG MẠI MINH HIỀN (VN)**
62-64 đường T1, phường Tây Thạnh, quận Tân Phú, thành phố Hồ Chí Minh
(72) Trần Hiền (VN)
(55)

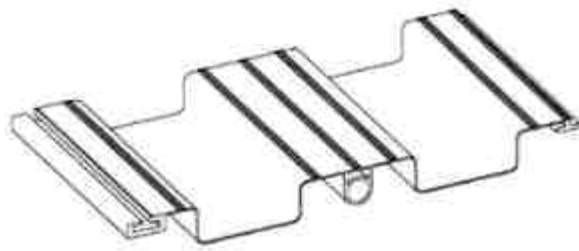

1.1



1.2



1.3

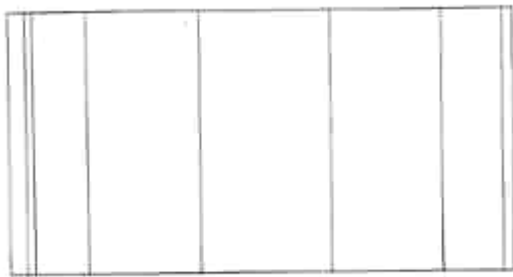

1.4

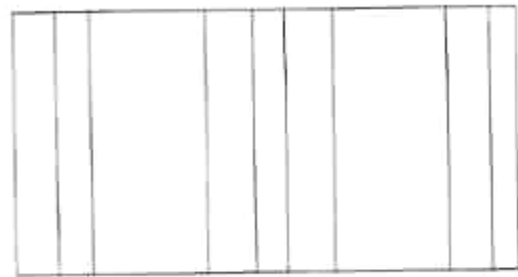

1.5



1.6



1.7

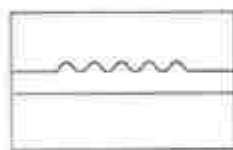

1.8

- (11) **47654**
(21) 3-2023-00516 (28) 1
(54) **THANH KIM LOẠI ĐỊNH HÌNH** (51) **25-01**
(22) 10/03/2023 (43) 25/08/2023
(73) **CÔNG TY TNHH CƠ KHÍ THƯƠNG MẠI MINH HIỀN (VN)**
62-64 đường T1, phường Tây Thạnh, quận Tân Phú, thành phố Hồ Chí Minh
(72) Trần Hiền (VN)
(55)

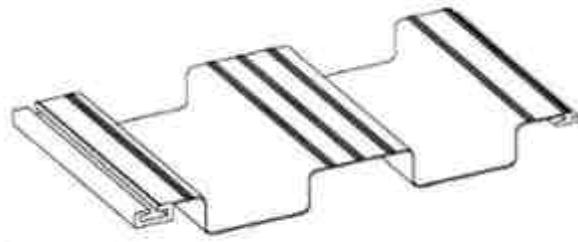

11



12



13

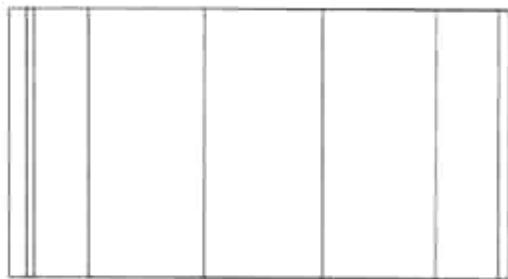

14

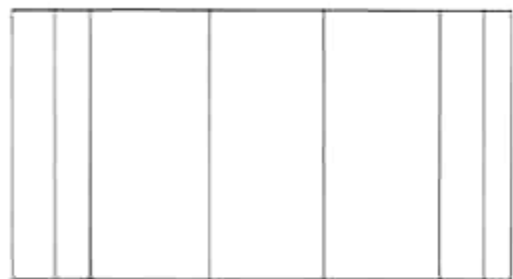

15



16



17

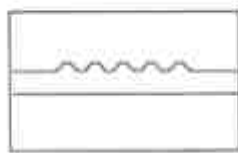

18

- (11) **47655**
(21) 3-2023-00517 (28) 1
(54) **THANH KIM LOẠI ĐỊNH HÌNH** (51) **25-01**
(22) 10/03/2023 (43) 25/08/2023
(73) **CÔNG TY TNHH CƠ KHÍ THƯƠNG MẠI MINH HIỀN (VN)**
62-64 đường T1, phường Tây Thạnh, quận Tân Phú, thành phố Hồ Chí Minh
(72) Trần Hiền (VN)
(55)

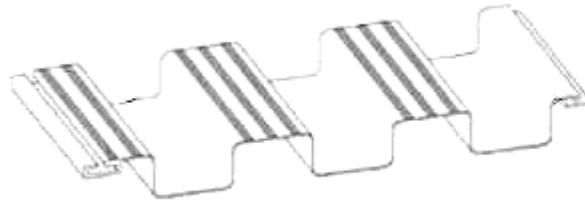

1.1



1.2



1.3

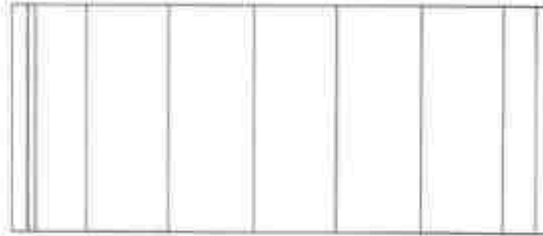

1.4

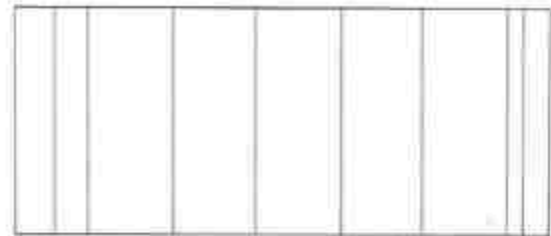

1.5

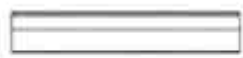

1.6



1.7



1.8

CÔNG BÁO SỞ HỮU CÔNG NGHIỆP SỐ 425 TẬP A – QUYỀN 2 (08.2023)

- (11) **47656**
(21) 3-2023-00557 (28) 1
(54) **TAI KẸP GIẢM XÓC** (51) **12-16**
(22) 15/03/2023 (43) 25/08/2023
(30) 2302000100 11/01/2023 TH;
(73) **Y.S.S. (THAILAND) COMPANY LIMITED. (TH)**
88/88 Moo.9 Soi Phikulthong Thepharak Rd., Bangpla, Bangphli, Samutprakarn
10540, Thailand
(72) Pinyo Panichgasem (TH)
(74) Công ty TNHH Sáng chế ACTIP (ACTIP PATENT LIMITED)
(55)



1.1



1.2



1.3



1.4



1.5



1.6



1.7



1.8

CÔNG BÁO SỞ HỮU CÔNG NGHIỆP SỐ 425 TẬP A – QUYỀN 2 (08.2023)

- (11) **47657**
(21) 3-2023-00563 (28) 1
(54) **XE ĐẠP** (51) **12-11**
(22) 17/03/2023 (43) 25/08/2023
(30) 009184237-0001 23/09/2022 EM;
(73) **DECATHLON (FR)**
4, Boulevard de Mons, F-59650 Villeneuve d’Ascq, France
(72) Benjamin SIMON (FR)
(74) Công ty Luật TNHH T&G (TGVN)
(55)



1.1



1.2

1.3



1.4



1.5



1.6



1.7

CÔNG BÁO SỞ HỮU CÔNG NGHIỆP SỐ 425 TẬP A – QUYỀN 2 (08.2023)

- (11) **47658**
(21) 3-2023-00564 (28) 1
(54) **XE ĐẠP** (51) **12-11**
(22) 17/03/2023 (43) 25/08/2023
(30) 009184237-0002 23/09/2022 EM;
(73) **DECATHLON (FR)**
4, Boulevard de Mons, F-59650 Villeneuve d’Ascq, France
(72) Benjamin SIMON (FR)
(74) Công ty Luật TNHH T&G (TGVN)
(55)



1.1



1.2



1.3



1.4



1.5



1.6



1.7

CÔNG BÁO SỞ HỮU CÔNG NGHIỆP SỐ 425 TẬP A – QUYỀN 2 (08.2023)

- (11) **47659**
(21) 3-2023-00583 (28) 1
(54) **XE MÁY ĐIỆN** (51) **12-11**
(22) 21/03/2023 (43) 25/08/2023
(30) 202230628020.9 22/09/2022 CN;
(73) 1. **TAILG SCIENCE AND TECHNOLOGY INC., LTD (CN)**
No.3-1 and No.3-2, Dongsheng Road, Anzhen Street, Xishan District, Wuxi City,
Jiangsu Province, China
2. **TAILG SCIENCE AND TECHNOLOGY (JIANGSU) INC., LTD. (CN)**
No.3 Dongsheng Road, Anzhen Street, Xishan District, Wuxi City, Jiangsu
Province, China
(72) 1. MUCHU SUN (CN)
2. LANMEI ZUO (CN)
(74) Công ty Luật TNHH Phạm và Liên danh (PHAM & ASSOCIATES)
(55)



1.1



1.2



1.3



1.4



1.5



1.6



1.7

CÔNG BÁO SỞ HỮU CÔNG NGHIỆP SỐ 425 TẬP A – QUYỀN 2 (08.2023)

- (11) **47660**
(21) 3-2023-00596 (28) 1
(54) **MÁY NƯỚNG ĐIỆN** (51) **07-02**
(22) 21/03/2023 (43) 25/08/2023
(30) 30-2022-0042045 14/10/2022 KR;
(73) **LOCK & LOCK CO., LTD.** (KR)
104, Sapgyocheon-ro, Seonjang-myeon, Asan-si, Chungcheongnam-do, Republic of Korea
(72) SONG, Ga Young (KR)
(74) Công ty TNHH Tầm nhìn và Liên danh (VISION & ASSOCIATES CO.LTD.)
(55)

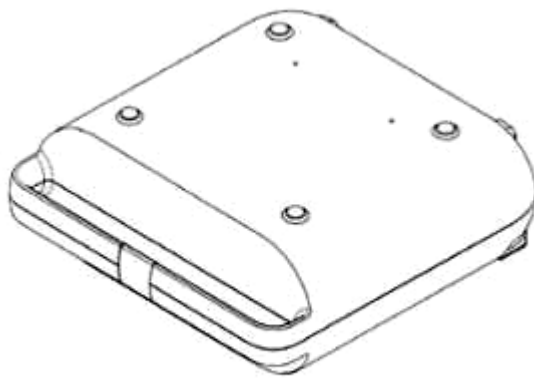

1.1

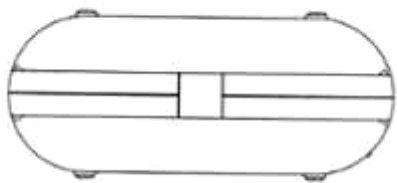

1.2

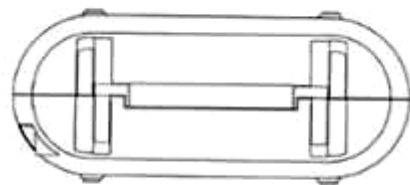

1.3

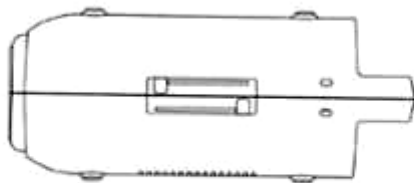

1.4



1.5

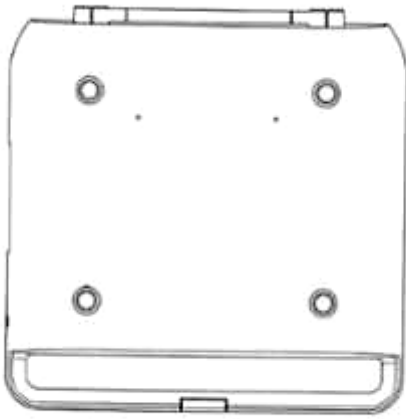

1.6

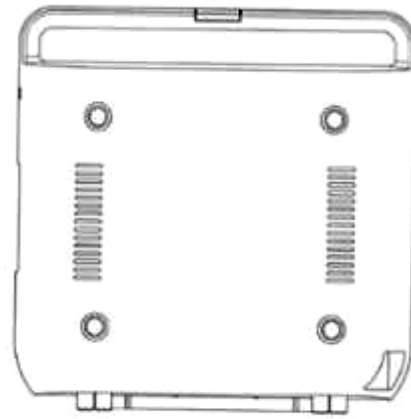

1.7

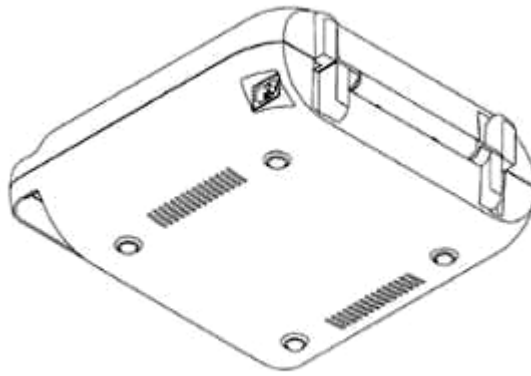

1.8

CÔNG BÁO SỞ HỮU CÔNG NGHIỆP SỐ 425 TẬP A – QUYỀN 2 (08.2023)

- (11) **47661**
(21) 3-2023-00597 (28) 1
(54) **BÌNH NƯỚC** (51) **07-01; 07-07**
(22) 21/03/2023 (43) 25/08/2023
(30) 30-2022-0045863 08/11/2022 KR;
(73) **LOCK & LOCK CO., LTD.** (KR)
104, Sapgyocheon-ro, Seonjang-myeon, Asan-si, Chungcheongnam-do, Republic of Korea
(72) LEE, Kyung Mee (KR)
(74) Công ty TNHH Tầm nhìn và Liên danh (VISION & ASSOCIATES CO.LTD.)
(55)

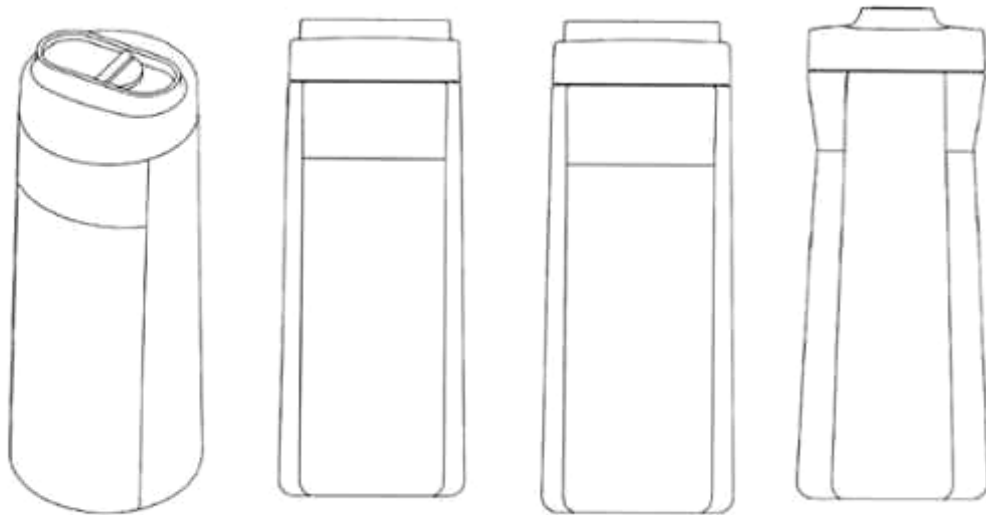

1.1

1.2

1.3

1.4

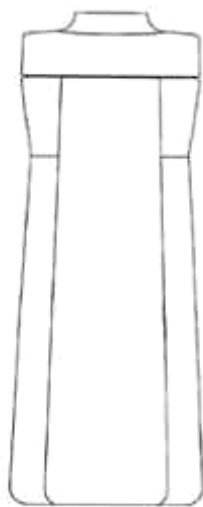

1.5

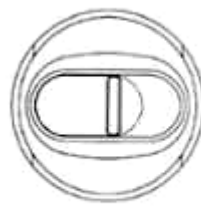

1.6



1.7

- (11) **47662**
(21) 3-2023-00598 (28) 1
(54) **HỘP ĐỰNG THỰC PHẨM** (51) **07-07; 09-03**
(22) 21/03/2023 (43) 25/08/2023
(30) 30-2022-0045864 08/11/2022 KR;
(73) **LOCK & LOCK CO., LTD.** (KR)
104, Sapgyocheon-ro, Seonjang-myeon, Asan-si, Chungcheongnam-do, Republic of Korea
(72) NAM, Soo Jung (KR)
(74) Công ty TNHH Tầm nhìn và Liên danh (VISION & ASSOCIATES CO.LTD.)
(55)

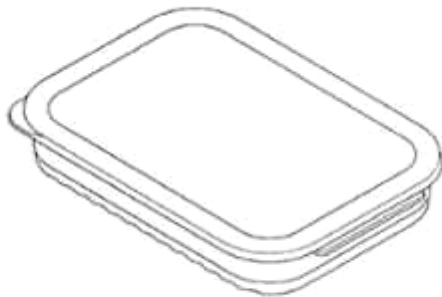

1.1



1.2



1.3



1.4

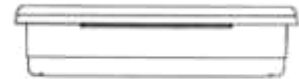

1.5



1.6



1.7



1.8



1.9

CÔNG BÁO SỞ HỮU CÔNG NGHIỆP SỐ 425 TẬP A – QUYỀN 2 (08.2023)

(11) **47663**

(21) 3-2023-00600

(54) **XE ĐIỆN**

(22) 21/03/2023

(73) **SANYANG MOTOR CO., LTD. (TW)**

No. 184, Keng Tzu Kou, Shang Keng Village, Hsin Fong Shiang, Hsinchu County
304, Taiwan

(72) Ching Chung CHIU (TW)

(74) Công ty TNHH Trường Xuân (AGELESS CO.,LTD.)

(55)

(28) 1

(51) **12-11**

(43) 25/08/2023



1.1



1.2



1.3



1.4



1.5



1.6



1.7



1.8



1.9



1.10

- (11) **47664**
(21) 3-2023-00609 (28) 1
(54) **KHUNG XE** (51) **12-16**
(22) 22/03/2023 (43) 25/08/2023
(30) 009184237-0004 23/09/2022 EM;
(73) **DECATHLON (FR)**
4, Boulevard de Mons, F-59650 Villeneuve d'Ascq, France
(72) Charles Hermant (FR)
(74) Công ty Luật TNHH T&G (TGVN)
(55)



1.1



1.2



1.3

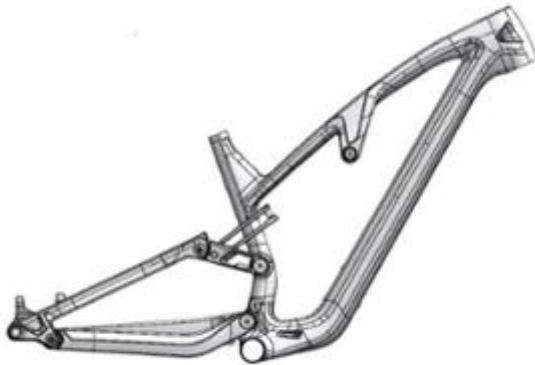

1.4

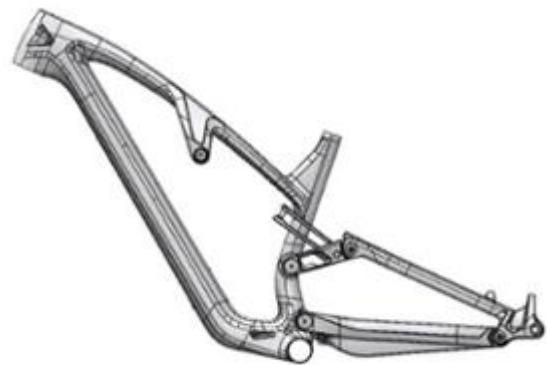

1.5



1.6



1.7

- (11) **47665**
(21) 3-2023-00662 (28) 1
(54) **CHAI** (51) **09-01**
(22) 27/03/2023 (43) 25/08/2023
(73) **CÔNG TY CỔ PHẦN SỮA VIỆT NAM (VINAMILK) (VN)**
Số 10 Tân Trào, phường Tân Phú, quận 7, thành phố Hồ Chí Minh
(72) Jürgen Rödgers (DE)
(74) **CÔNG TY LUẬT TNHH AGL (AGL LAW)**
(55)



1.1



1.2



1.3



1.4



1.5

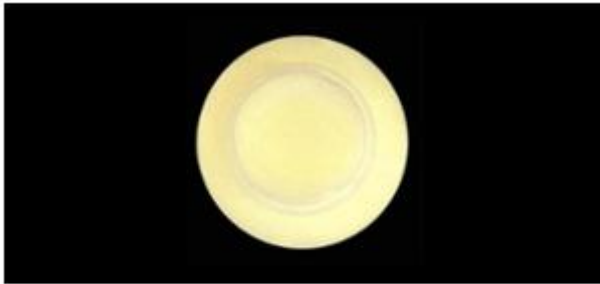

1.6



1.7

CÔNG BÁO SỞ HỮU CÔNG NGHIỆP SỐ 425 TẬP A – QUYỀN 2 (08.2023)

- (11) **47666**
(21) 3-2023-00668 (28) 1
(54) **BAO GÓI** (51) **09-05**
(22) 27/03/2023 (43) 25/08/2023
(73) **CÔNG TY TNHH SẢN XUẤT THƯƠNG MẠI VÀ DỊCH VỤ VINO (VN)**
68 Nguyễn Huệ, phường Bến Nghé, quận 1, thành phố Hồ Chí Minh
(72) Lê Công Hà (VN)
(74) Công ty TNHH một thành viên Trường Luật (Trường Luật)
(55)



1.1



1.2

CÔNG BÁO SỞ HỮU CÔNG NGHIỆP SỐ 425 TẬP A – QUYỀN 2 (08.2023)

- (11) **47667**
(21) 3-2023-00677 (28) 1
(54) **THÙNG LẠNH** (51) **07-07**
(22) 28/03/2023 (43) 25/08/2023
(30) 29/855,299 30/09/2022 US;
(73) **PEPSICO, INC. (US)**
700 Anderson Hill Road, Purchase, New York 10577, United States of America
(72) 1. MICHEL ALVAREZ (US)
2. XAVIER CORTADELLAS (US)
3. SEAN JOSEPH HULS (US)
4. WILLIAM OWEN STOCK (US)
5. MATTHEW K. LIDER (US)
6. YANG OUYANG (US)
7. DAVID ROBERT SCHLESINGER (US)
8. JOSHUA STOUGH (US)
9. SARAH WHITE (US)
(74) Văn phòng Luật sư MINERVAS (MINERVAS)
(55)



1.1



1.2

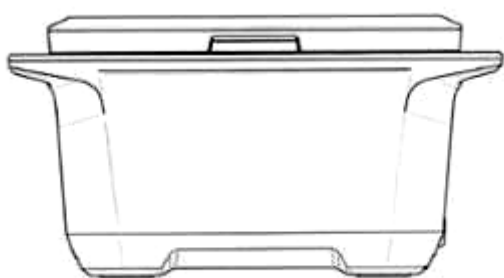

1.3

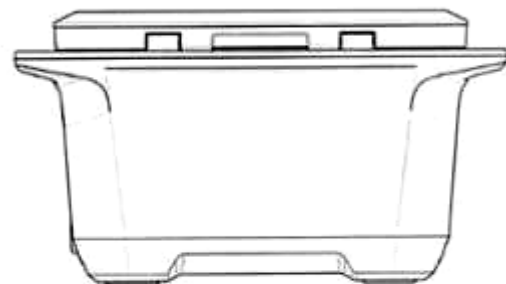

1.4



1.5



1.6



1.7



1.8

CÔNG BÁO SỞ HỮU CÔNG NGHIỆP SỐ 425 TẬP A – QUYỀN 2 (08.2023)

- (11) **47668**
- (21) 3-2023-00678 (28) 2
- (54) **THÙNG LẠNH** (51) **07-07**
- (22) 28/03/2023 (43) 25/08/2023
- (30) 29/855,301 30/09/2022 US;
- (73) **PEPSICO, INC. (US)**
700 Anderson Hill Road, Purchase, New York 10577, United State of America
- (72) 1. MICHEL ALVAREZ (US)
2. XAVIER CORTADELLAS (US)
3. SEAN JOSEPH HULS (US)
4. WILLIAM OWEN STOCK (US)
5. MATTHEW K. LIDER (US)
6. YANG OUYANG (US)
7. DAVID ROBERT SCHLESINGER (US)
8. JOSHUA STOUGH (US)
9. SARAH WHITE (US)
- (74) Văn phòng Luật sư MINERVAS (MINERVAS)
- (55)



1.1



1.2

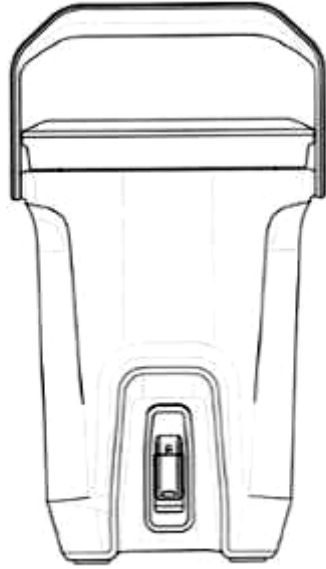

1.3



1.4

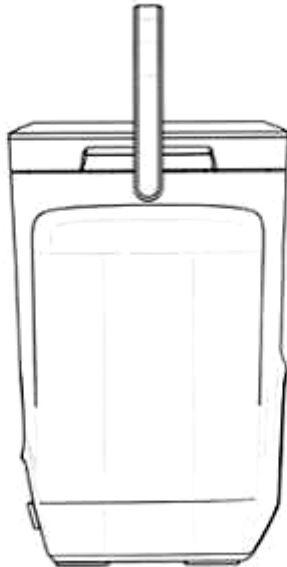

1.5



1.6

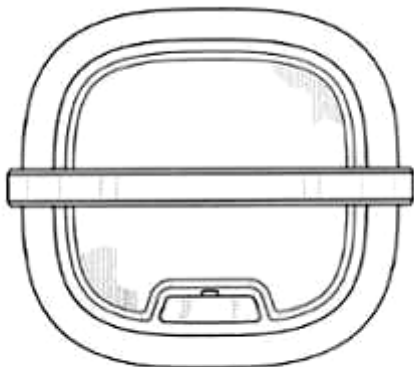

1.7

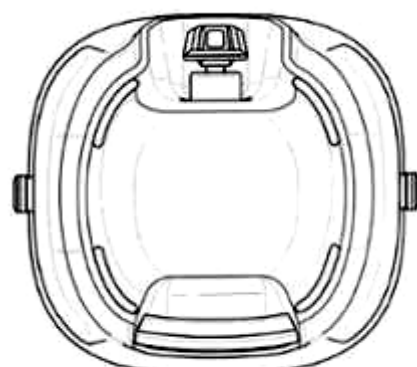

1.8



2.1



2.2

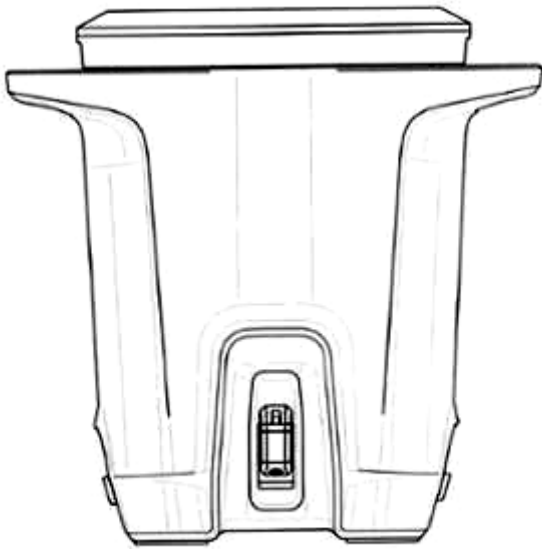

2.3

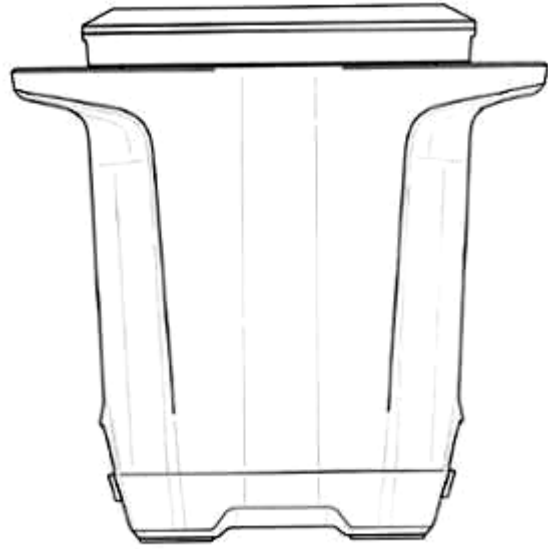

2.4

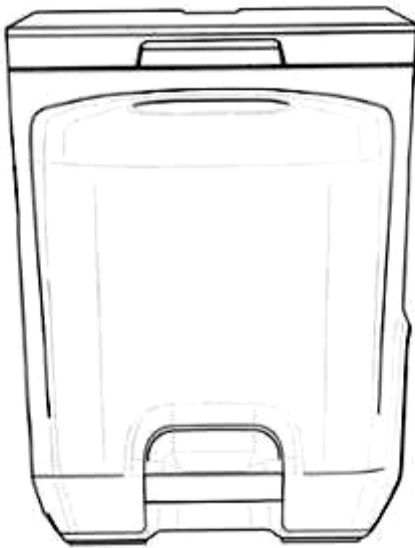

2.5

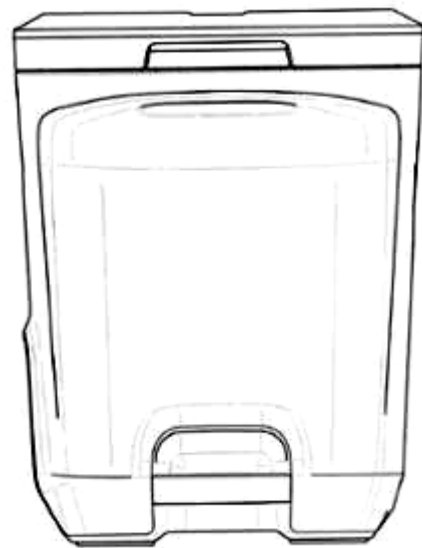

2.6

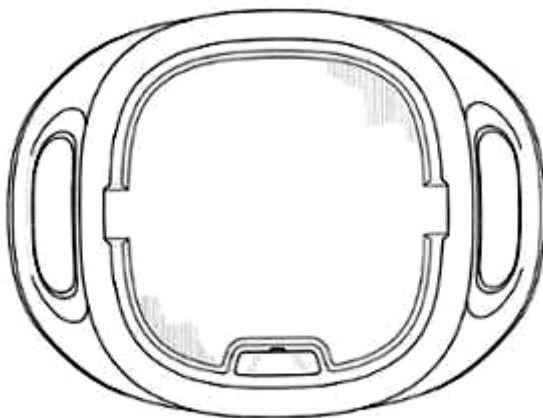

2.7

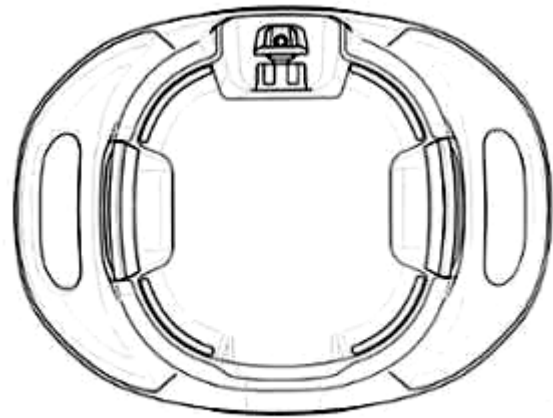

2.8

CÔNG BÁO SỞ HỮU CÔNG NGHIỆP SỐ 425 TẬP A – QUYỀN 2 (08.2023)

- (11) **47669**
(21) 3-2023-00683 (28) 1
(54) **ĐỂ NGOÀI** (51) **02-04**
(22) 29/03/2023 (43) 25/08/2023
(30) 015003686-0001 21/11/2022 EM;
(73) **DECATHLON (FR)**
4, Boulevard de Mons, F-59650 Villeneuve d'Ascq, France
(72) Gaspard MILLET (FR)
(74) Công ty Luật TNHH T&G (TGVN)
(55)



1.1



1.2

1.3



1.4



1.5



1.6



1.7

CÔNG BÁO SỞ HỮU CÔNG NGHIỆP SỐ 425 TẬP A – QUYỀN 2 (08.2023)

- (11) **47670**
(21) 3-2023-00684 (28) 1
(54) **THÙNG DỰNG CHẤT LỎNG** (51) **09-02**
(22) 29/03/2023 (43) 25/08/2023
(30) 202310280 17/01/2023 AU;
(73) **MACH IV PTY LTD (AU)**
C/- AYVA Packaging Pty Ltd 73C Elizabeth Street Wetherill Park NSW 2164
Australia
(72) Mitchell Brown (AU)
(74) Công ty TNHH ADAstra IP (VIỆT NAM) (ADAstra IP (VIETNAM) CO.,
LTD.)
(55)



1.1

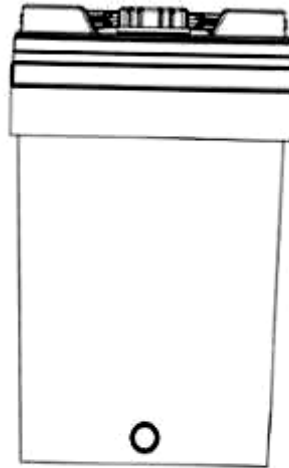

1.2

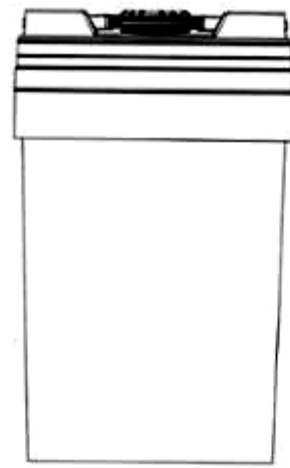

1.3

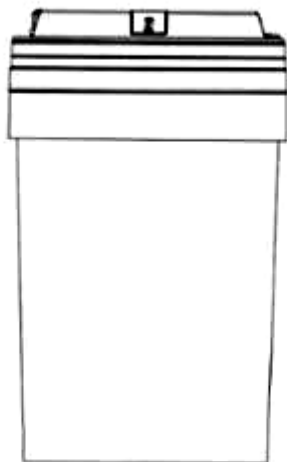

1.4

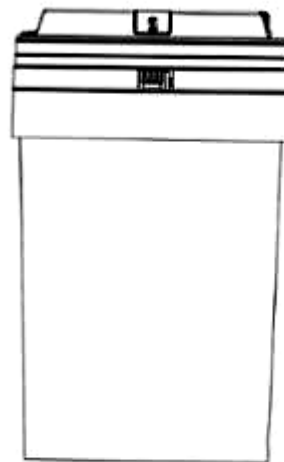

1.5

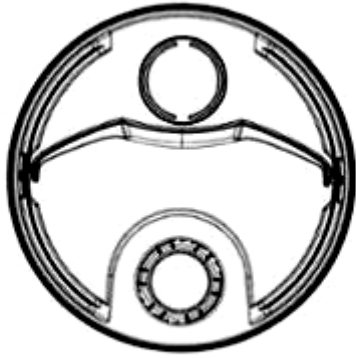

1.6

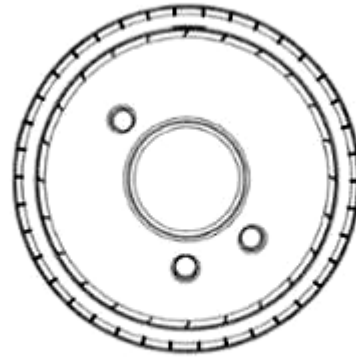

1.7

CÔNG BÁO SỞ HỮU CÔNG NGHIỆP SỐ 425 TẬP A – QUYỀN 2 (08.2023)

- (11) **47671**
(21) 3-2023-00689 (28) 1
(54) **CHAI** (51) **09-01**
(22) 29/03/2023 (43) 25/08/2023
(73) **CÔNG TY TNHH NƯỚC GIẢI KHÁT TINGCO VIỆT NAM (VN)**
47 đường Linh Đông, khu phố 7, phường Linh Đông, thành phố Thủ Đức, thành phố Hồ Chí Minh
(72) Võ Thị Nguyệt Nga (VN)
(74) Công ty Cổ phần Sở hữu công nghiệp INVESTIP (INVESTIP)
(55)



1.1



1.2



1.3



1.4

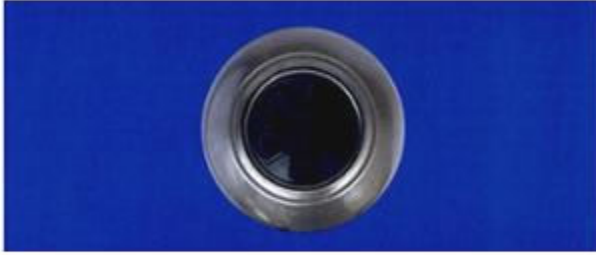

1.5



1.6

CÔNG BÁO SỞ HỮU CÔNG NGHIỆP SỐ 425 TẬP A – QUYỀN 2 (08.2023)

- (11) **47672**
(21) 3-2023-00736 (28) 1
(54) **CHAI** (51) **09-01**
(22) 31/03/2023 (43) 25/08/2023
(73) **CÔNG TY TNHH THỰC PHẨM THÁI SƠN (VN)**
90 Đỗ Tấn Phong, phường 09, quận Phú Nhuận, thành phố Hồ Chí Minh
(72) Lâm Trường Sơn (VN)
(74) Công ty Cổ phần Sở hữu công nghiệp INVESTIP (INVESTIP)
(55)



1.1



1.2



1.3



1.4



1.5



1.6



1.7

CÔNG BÁO SỞ HỮU CÔNG NGHIỆP SỐ 425 TẬP A – QUYỀN 2 (08.2023)

- (11) **47673**
(21) 3-2023-00779 (28) 2
(54) **TẮM ỐP LƯNG CÓ GIÁ ĐỠ DỪNG CHO THIẾT BỊ HIỂN THỊ** (51) **03-01; 14-02**
(22) 07/04/2023 (43) 25/08/2023
(30) 29/856,158 11/10/2022 US;
(73) **GOOGLE LLC (US)**
1600 Amphitheatre Parkway, Mountain View, California 94043, United States of America
(72) 1. BENGT GUNNAR BRÜMMER (SE)
2. MAJ ISABELLE OLSSON (SE)
3. CARL CEPRESS (US)
4. FRED SIMON (US)
5. NICK GILLETT (US)
(74) Công ty Luật TNHH ROUSE Việt Nam (ROUSE LEGAL VIETNAM LTD.)
(55)

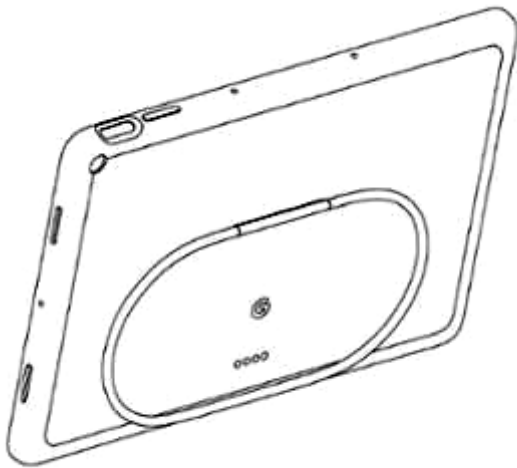

1.1



1.2



1.3

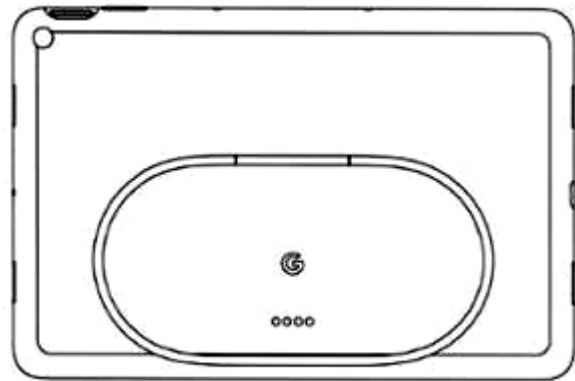

1.4



1.5



1.6



1.7

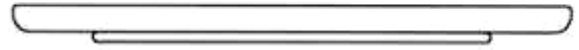

1.8

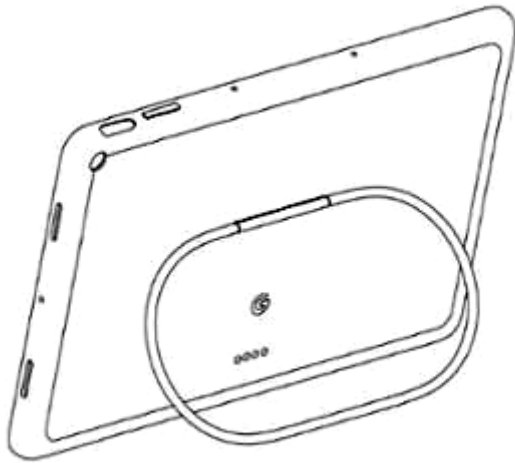

1.9



2.1



2.2



2.3



2.4



2.5

2.6



2.7



2.8



2.9

- (11) **47674**
(21) 3-2023-00820 (28) 1
(54) **TẮM HƯỚNG GIÓ CHO XE CỘ** (51) **12-16**
(22) 11/04/2023 (43) 25/08/2023
(30) 015000938-0001 20/10/2022 EM;
(73) **IGOR AKRAPOVIČ (SI)**
Rožna Dolina C.VIII/10A, SI-1000 Ljubljana, Slovenia
(72) 1. IGOR AKRAPOVIČ (SI)
2. ERMIN KOSOVEL (SI)
3. PRIMOŽ HAUPTMAN (SI)
(74) Công ty TNHH Đại Tín và Liên Danh (DAITIN AND ASSOCIATES CO.,LTD)
(55)



1.1



1.2



1.3



1.4



1.5



1.6



1.7



1.8



1.9

CÔNG BÁO SỞ HỮU CÔNG NGHIỆP SỐ 425 TẬP A – QUYỀN 2 (08.2023)

(11) **47675**

(21) 3-2023-00844

(28) 1

(54) **ĐINH VÍT**

(51) **08-08**

(22) 13/04/2023

(43) 25/08/2023

(73) **THẠCH KHÔI NGUYỄN (VN)**

405 chung cư Thanh Niên, đường Bàu Cát 2, phường 14, quận Tân Bình, thành phố Hồ Chí Minh

(72) Thạch Khôi Nguyễn (VN)

(74) Công ty Cổ phần Sở hữu công nghiệp INVESTIP (INVESTIP)

(55)

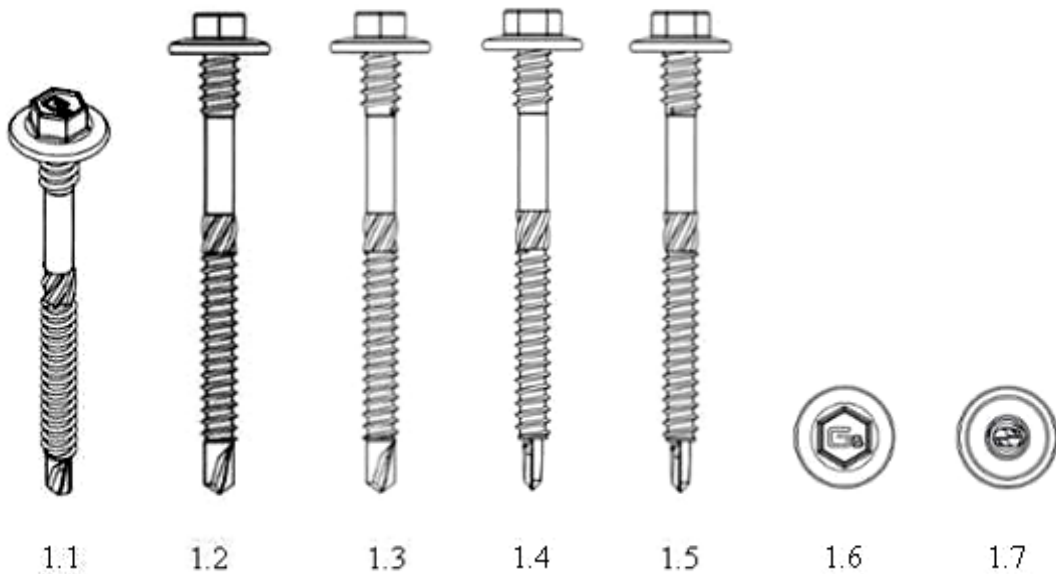

CÔNG BÁO SỞ HỮU CÔNG NGHIỆP SỐ 425 TẬP A – QUYỀN 2 (08.2023)

- (11) **47676**
(21) 3-2023-00852 (28) 1
(54) **BÌNH ĐỰNG NƯỚC** (51) **07-07**
(22) 14/04/2023 (43) 25/08/2023
(73) **CÔNG TY CỔ PHẦN BÓNG ĐÈN PHÍCH NƯỚC RẠNG ĐÔNG (VN)**
87-89 phố Hạ Đình, phường Thanh Xuân Trung, quận Thanh Xuân, thành phố Hà Nội
(72) Trần Trung Tường (VN)
(55)



1.1

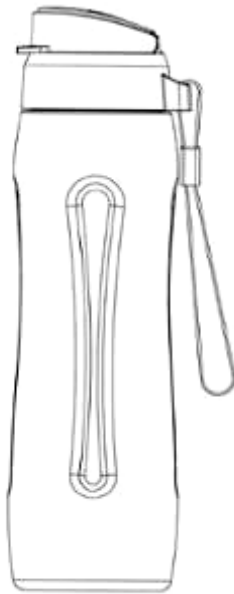

1.2



1.3



1.4

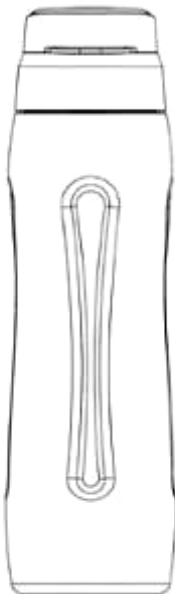

1.5

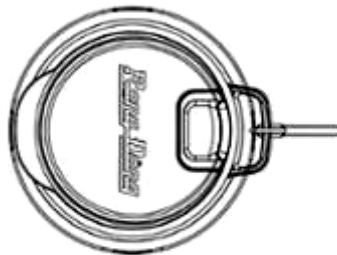

1.6



1.7

CÔNG BÁO SỞ HỮU CÔNG NGHIỆP SỐ 425 TẬP A – QUYỀN 2 (08.2023)

(11) **47677**

(21) 3-2023-00858

(28) 1

(54) **GIƯỜNG**

(51) **06-02**

(22) 14/04/2023

(43) 25/08/2023

(73) **CÔNG TY CỔ PHẦN SEMA GROUP (VN)**

Số 69, đường 23, khu đô thị thành phố Giao lưu, phường Cổ Nhuế 1, quận Bắc Từ Liêm, thành phố Hà Nội

(72) 1. NGUYỄN PHƯƠNG CHI (VN)

2. PHẠM TUẤN ANH (VN)

3. NGUYỄN ĐÌNH PHÚC (VN)

(74) Công ty TNHH NACILAW (NACILAW)

(55)



1.1



1.2



1.3



1.4

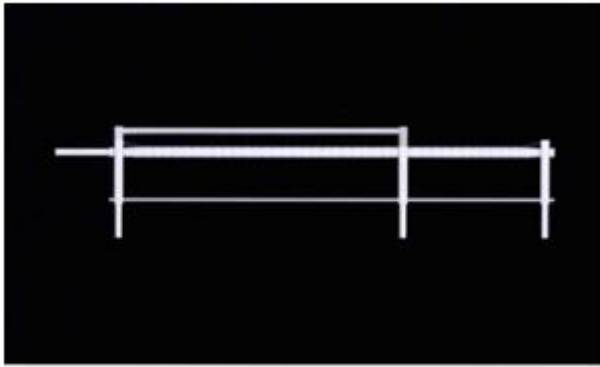

1.5

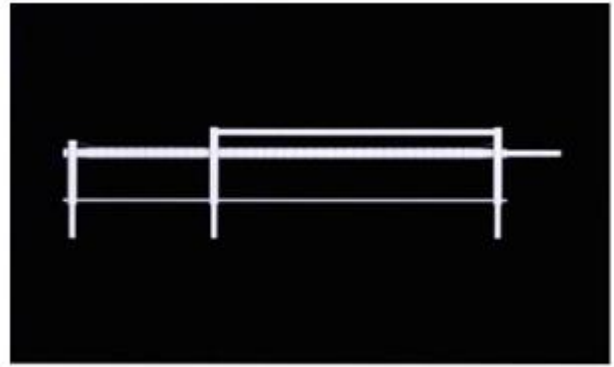

1.6

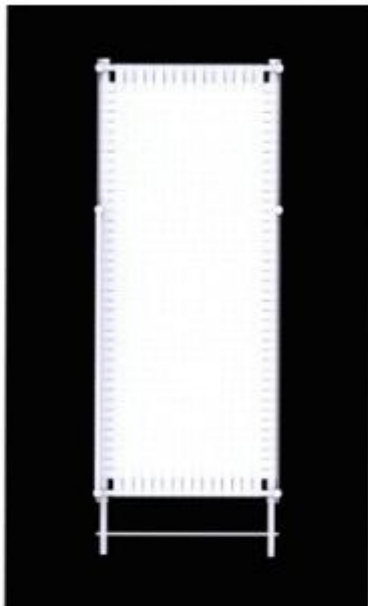

1.7

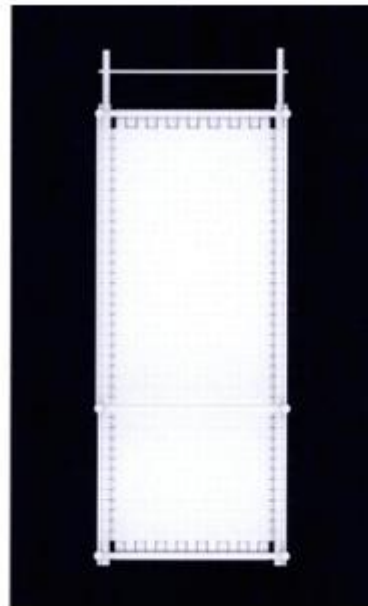

1.8

CÔNG BÁO SỞ HỮU CÔNG NGHIỆP SỐ 425 TẬP A – QUYỀN 2 (08.2023)

- (11) **47678**
(21) 3-2023-00869 (28) 1
(54) **BỘ ĐIỀU KHIỂN** (51) **13-03**
(22) 17/04/2023 (43) 25/08/2023
(30) 202330144354.3 23/03/2023 CN;
(73) **EMOMO TECH (ZHEJIANG) CO.,LTD (CN)**
7# Workshop, Kangshan Industrial Park, West Road of Jier Road, Dipu Sub-district,
Anji County, Huzhou City, Zhejiang Province, China
(72) 1. YUSHU ZHAO (CN)
2. JING SONG (CN)
3. WENJI TANG (CN)
4. WEI ZHOU (CN)
5. ZHIGANG WANG (CN)
6. GUOHAO YE (CN)
(74) Công ty TNHH Đại Tín và Liên Danh (DAITIN AND ASSOCIATES CO.,LTD)
(55)

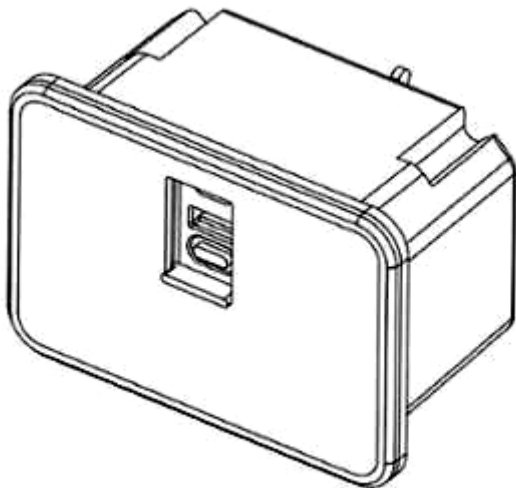

1.1

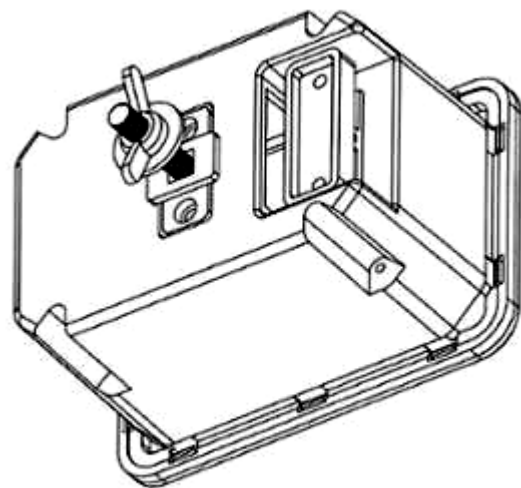

1.2

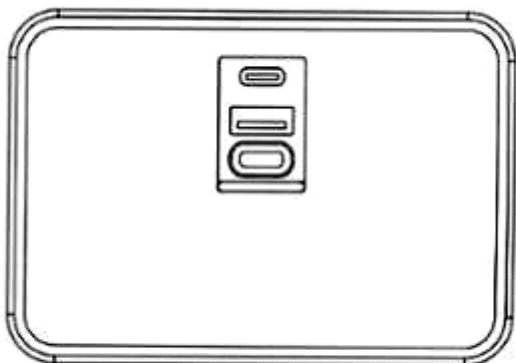

1.3

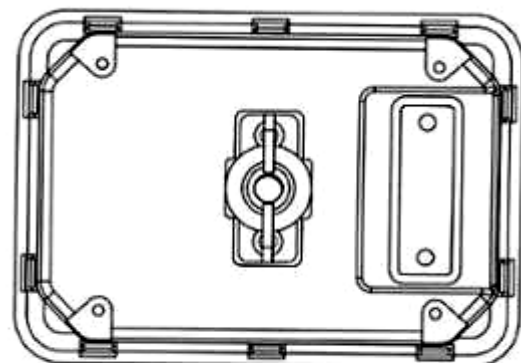

1.4

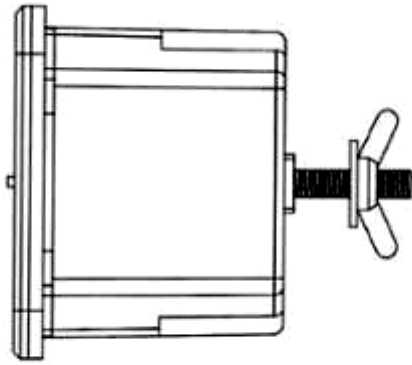

1.5

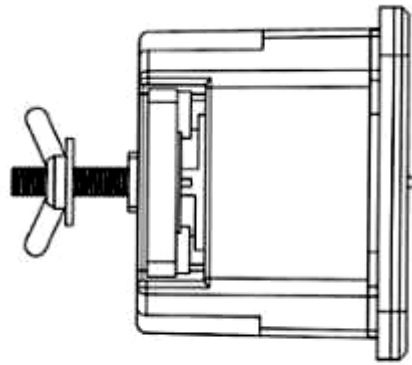

1.6

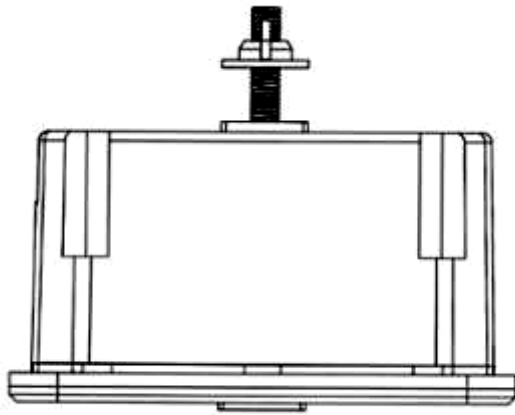

1.7

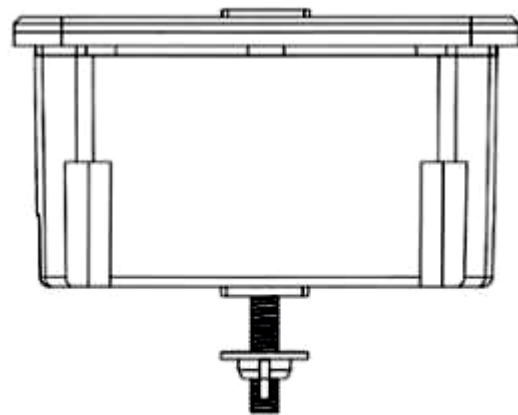

1.8

CÔNG BÁO SỞ HỮU CÔNG NGHIỆP SỐ 425 TẬP A – QUYỀN 2 (08.2023)

- (11) **47679**
(21) 3-2023-00896 (28) 1
(54) **THIẾT BỊ CẢM BIẾN** (51) **10-05**
(22) 21/04/2023 (43) 25/08/2023
(73) **CÔNG TY CỔ PHẦN BÓNG ĐÈN PHÍCH NƯỚC RẠNG ĐÔNG (VN)**
87-89 phố Hạ Đình, phường Thanh Xuân Trung, quận Thanh Xuân, thành phố Hà Nội
(72) Trần Trung Tường (VN)
(55)

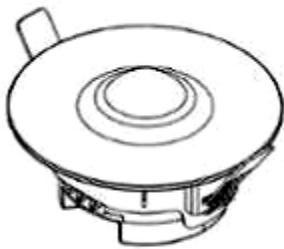

1.1

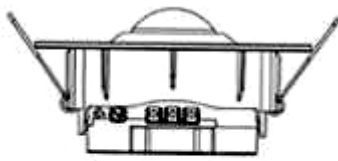

1.2

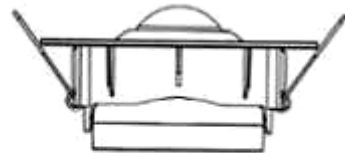

1.3

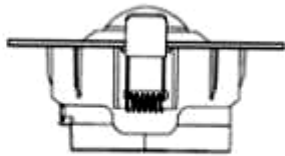

1.4

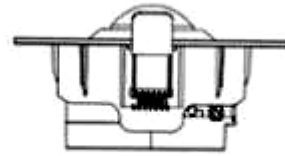

1.5

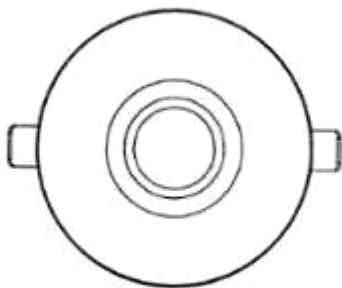

1.6

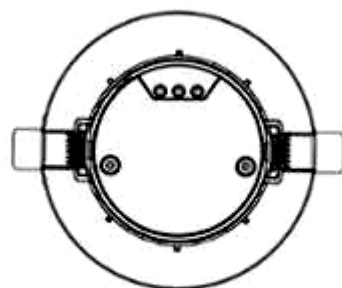

1.7

CÔNG BÁO SỞ HỮU CÔNG NGHIỆP SỐ 425 TẬP A – QUYỀN 2 (08.2023)

- (11) **47680**
(21) 3-2023-00904 (28) 1
(54) **CHAI** (51) **09-01**
(22) 24/04/2023 (43) 25/08/2023
(73) **CÔNG TY TNHH THỰC PHẨM THÁI SƠN (VN)**
90 Đỗ Tấn Phong, phường 09, quận Phú Nhuận, thành phố Hồ Chí Minh
(72) Lâm Trường Sơn (VN)
(74) Công ty Cổ phần Sở hữu công nghiệp INVESTIP (INVESTIP)
(55)



1.1



1.2



1.3



1.4



1.5



1.6



1.7

CÔNG BÁO SỞ HỮU CÔNG NGHIỆP SỐ 425 TẬP A – QUYỀN 2 (08.2023)

- (11) **47681**
(21) 3-2023-00954 (28) 1
(54) **TÚI ĐỰNG TRÀ** (51) **09-05**
(22) 28/04/2023 (43) 25/08/2023
(73) **CÔNG TY CỔ PHẦN ĐẦU TƯ THƯƠNG MẠI XÂY DỰNG DỊCH VỤ VÀ SẢN XUẤT ECOHOME (VN)**
Ấp Mỹ Thới, xã Mỹ Xương, huyện Cao Lãnh, tỉnh Đồng Tháp
(72) Nguyễn Thị Hồng Ngọc (VN)
(74) **CÔNG TY LUẬT TNHH AGL (AGL LAW)**
(55)



1.1



1.2



1.3

CÔNG BÁO SỞ HỮU CÔNG NGHIỆP SỐ 425 TẬP A – QUYỀN 2 (08.2023)

- (11) **47682**
- (21) 3-2023-00980
- (54) **KHÓA**
- (22) 04/05/2023
- (73) **KIM YU SIN (KR)**
105ho, 211dong, 5, Ogeum-ro 32-gil, Songpa-gu, Seoul 05673, Republic of Korea
- (72) KIM YU SIN (KR)
- (74) Công ty TNHH Trường Xuân (AGELESS CO.,LTD.)
- (55)



1.1



1.2



1.3



1.4



1.5



1.6



1.7

CÔNG BÁO SỞ HỮU CÔNG NGHIỆP SỐ 425 TẬP A – QUYỀN 2 (08.2023)

- (11) **47683**
(21) 3-2023-00988 (28) 1
(54) **TƯỢNG TRANG TRÍ** (51) **11-02**
(22) 08/05/2023 (43) 25/08/2023
(73) **CÔNG TY TNHH MINH LONG I (VN)**
Số 333 đường Hưng Định 24, khu phố Hưng Lộc, phường Hưng Định, thành phố Thuận An, tỉnh Bình Dương
(72) Lý Huy Sáng (VN)
(55)



1.1



1.2



1.3



1.4



1.5



1.6



1.7



1.8

CÔNG BÁO SỞ HỮU CÔNG NGHIỆP SỐ 425 TẬP A – QUYỀN 2 (08.2023)

- (11) **47684**
(21) 3-2023-00997 (28) 1
(54) **THIẾT BỊ THU MẪU KHỐI LƯỢNG BỤI MỊN** (51) **10-04**
(22) 08/05/2023 (43) 25/08/2023
(73) **DƯƠNG THÀNH NAM (VN)**
Số nhà 45 TT1 ngõ 537 Bát Khôi, quận Long Biên, thành phố Hà Nội
(72) Dương Thành Nam (VN)
(55)



1.1



1.2



1.3



1.4



1.5



1.6

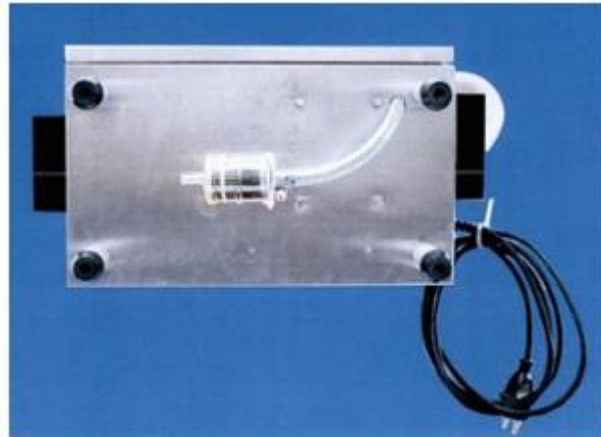

1.7

CÔNG BÁO SỞ HỮU CÔNG NGHIỆP SỐ 425 TẬP A – QUYỀN 2 (08.2023)

- (11) **47685**
(21) 3-2023-01027 (28) 1
(54) **BAO GÓI** (51) **09-05**
(22) 12/05/2023 (43) 25/08/2023
(73) **CÔNG TY TNHH IPLUS PRO VIỆT NAM (VN)**
Ấp Cái Sậy, xã Tuyên Thạnh, thị xã Kiến Tường, tỉnh Long An
(72) Trương Thành Trung (VN)
(74) Công ty Luật TNHH Phạm và Liên danh (PHAM & ASSOCIATES)
(55)



1.1



1.2

CÔNG BÁO SỞ HỮU CÔNG NGHIỆP SỐ 425 TẬP A – QUYỀN 2 (08.2023)

- (11) **47686**
(21) 3-2023-01067 (28) 1
(54) **NHÃN SẢN PHẨM** (51) **19-08**
(22) 16/05/2023 (43) 25/08/2023
(73) **CÔNG TY CỔ PHẦN TINGCO BÌNH ĐỊNH (VN)**
Lô A3.12+A3.13 khu công nghiệp Nhơn Hội (Khu A), khu kinh tế Nhơn Hội, xã
Nhơn Hội, thành phố Quy Nhơn, tỉnh Bình Định
(72) Võ Thị Nguyệt Nga (VN)
(74) Công ty Cổ phần Sở hữu công nghiệp INVESTIP (INVESTIP)
(55)



1.1



1.2

CÔNG BÁO SỞ HỮU CÔNG NGHIỆP SỐ 425 TẬP A – QUYỀN 2 (08.2023)

- (11) **47687**
(21) 3-2023-01068 (28) 1
(54) **NHÃN SẢN PHẨM** (51) **19-08**
(22) 16/05/2023 (43) 25/08/2023
(73) **CÔNG TY CỔ PHẦN TINGCO BÌNH ĐỊNH (VN)**
Lô A3.12+A3.13 khu công nghiệp Nhơn Hội (Khu A), khu kinh tế Nhơn Hội, xã
Nhơn Hội, thành phố Quy Nhơn, tỉnh Bình Định
(72) Võ Thị Nguyệt Nga (VN)
(74) Công ty Cổ phần Sở hữu công nghiệp INVESTIP (INVESTIP)
(55)



1.1



1.2

CÔNG BÁO SỞ HỮU CÔNG NGHIỆP SỐ 425 TẬP A – QUYỀN 2 (08.2023)

- (11) **47688**
(21) 3-2023-01069 (28) 1
(54) **NHÃN SẢN PHẨM** (51) **19-08**
(22) 16/05/2023 (43) 25/08/2023
(73) **CÔNG TY CỔ PHẦN TINGCO BÌNH ĐỊNH (VN)**
Lô A3.12+A3.13 khu công nghiệp Nhơn Hội (Khu A), khu kinh tế Nhơn Hội, xã
Nhơn Hội, thành phố Quy Nhơn, tỉnh Bình Định
(72) Võ Thị Nguyệt Nga (VN)
(74) Công ty Cổ phần Sở hữu công nghiệp INVESTIP (INVESTIP)
(55)



1.1



1.2

CÔNG BÁO SỞ HỮU CÔNG NGHIỆP SỐ 425 TẬP A – QUYỀN 2 (08.2023)

- (11) **47689**
(21) 3-2023-01070 (28) 1
(54) **BAO GÓI** (51) **09-05**
(22) 17/05/2023 (43) 25/08/2023
(73) **CÔNG TY CỔ PHẦN ACECOOK VIỆT NAM (VN)**
Lô số II-3, đường số 11, nhóm CN II, Khu công nghiệp Tân Bình, phường Tây
Thạnh, quận Tân Phú, thành phố Hồ Chí Minh
(72) Kajiwara Junichi (JP)
(74) Công ty Luật TNHH Phạm và Liên danh (PHAM & ASSOCIATES)
(55)



1.1



1.2

CÔNG BÁO SỞ HỮU CÔNG NGHIỆP SỐ 425 TẬP A – QUYỀN 2 (08.2023)

- (11) **47690**
(21) 3-2023-01071 (28) 1
(54) **THÙNG MÌ** (51) **09-03**
(22) 17/05/2023 (43) 25/08/2023
(73) **CÔNG TY CỔ PHẦN ACECOOK VIỆT NAM (VN)**
Lô số II-3, đường số 11, nhóm CN II, Khu công nghiệp Tân Bình, phường Tây
Thạnh, quận Tân Phú, thành phố Hồ Chí Minh
(72) Kajiwara Junich (JP)
(74) Công ty Luật TNHH Phạm và Liên danh (PHAM & ASSOCIATES)
(55)



1.1

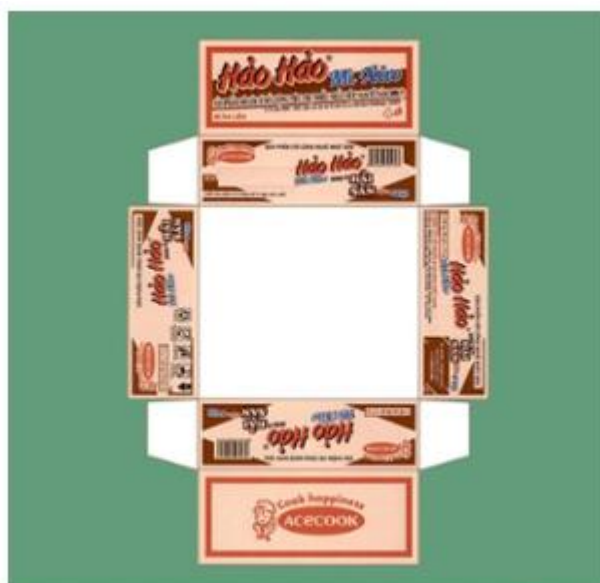

1.2

CÔNG BÁO SỞ HỮU CÔNG NGHIỆP SỐ 425 TẬP A – QUYỀN 2 (08.2023)

- (11) **47691**
(21) 3-2023-01074 (28) 1
(54) **BÉC TƯỚI** (51) **23-01**
(22) 17/05/2023 (43) 25/08/2023
(73) **CÔNG TY TNHH SẢN XUẤT THƯƠNG MẠI BONSAIMIENNAM (VN)**
34/13 Nguyễn Thị Thập, phường Bình Thuận, quận 7, thành phố Hồ Chí Minh
(72) Dương Duyên Nghệ (VN)
(74) Công ty cổ phần FAS INVEST (FAS INVEST JSC)
(55)



1.1



1.2



1.3



1.4



1.5



1.6



1.7



1.8

- (11) **47692**
(21) 3-2023-01081 (28) 1
(54) **ĐÈN** (51) **26-03; 26-05**
(22) 18/05/2023 (43) 25/08/2023
(73) **CÔNG TY CỔ PHẦN BÓNG ĐÈN PHÍCH NƯỚC RẠNG ĐÔNG (VN)**
87-89 phố Hạ Đình, phường Thanh Xuân Trung, quận Thanh Xuân, thành phố Hà Nội
(72) Trần Trung Tường (VN)
(55)

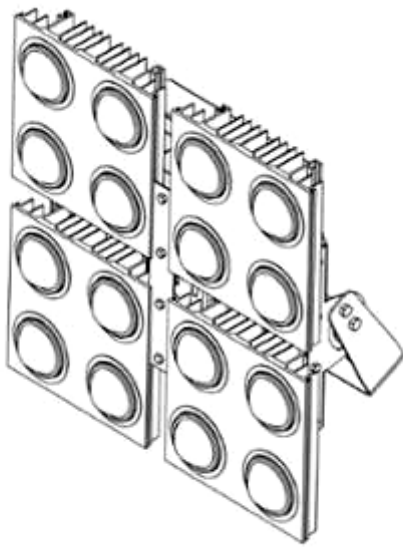

1.1

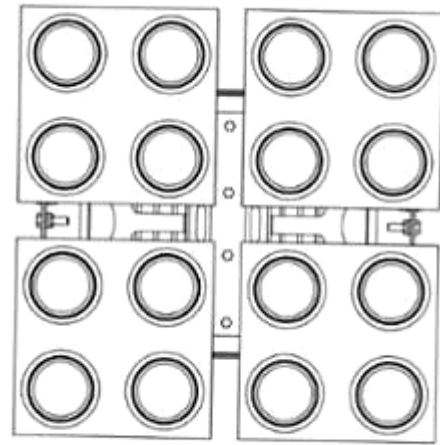

1.2

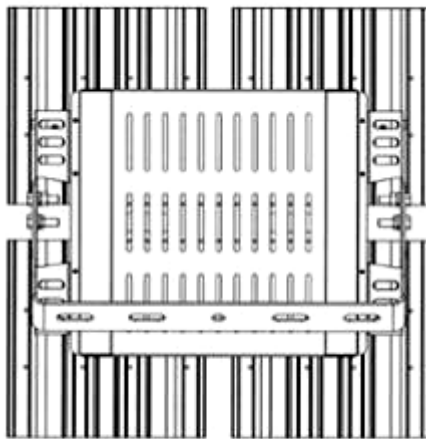

1.3

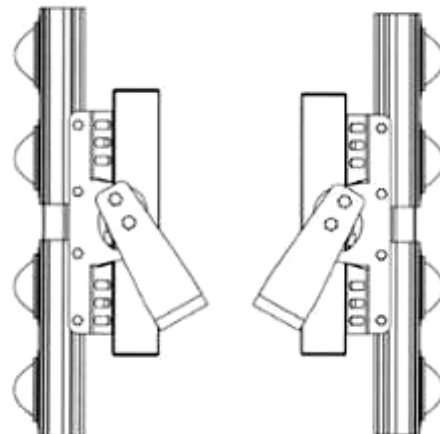

1.4

1.5

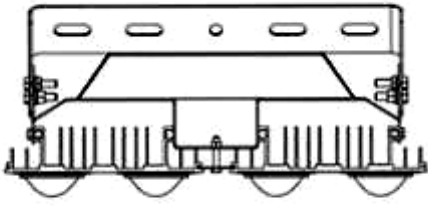

1.6

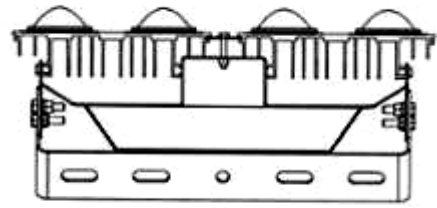

1.7

- (11) **47693**
(21) 3-2023-01083 (28) 1
(54) **TẮM MẶT CỦA Ổ CẮM** (51) **13-03**
(22) 18/05/2023 (43) 25/08/2023
(73) **CÔNG TY CỔ PHẦN BÓNG ĐÈN PHÍCH NƯỚC RẠNG ĐÔNG (VN)**
87-89 phố Hạ Đình, phường Thanh Xuân Trung, quận Thanh Xuân, thành phố Hà Nội
(72) Trần Trung Tường (VN)
(55)

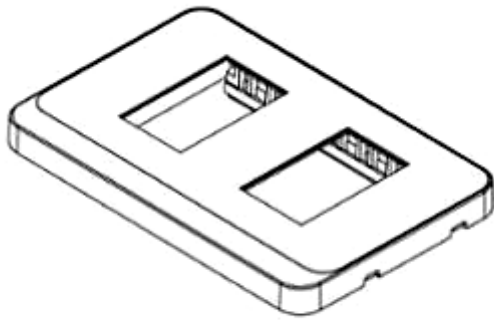

1.1

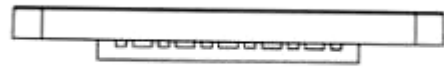

1.2



1.3

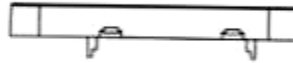

1.4



1.5

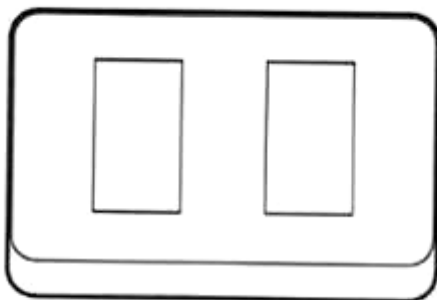

1.6

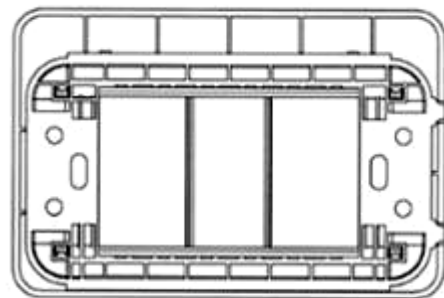

1.7

(11) **47694**

(21) 3-2023-01084

(28) 1

(54) **TẮM MẶT CỬA Ồ CẮM**

(51) **13-03**

(22) 18/05/2023

(43) 25/08/2023

(73) **CÔNG TY CỔ PHẦN BÓNG ĐÈN PHÍCH NƯỚC RẠNG ĐÔNG (VN)**

87-89 phố Hạ Đình, phường Thanh Xuân Trung, quận Thanh Xuân, thành phố Hà Nội

(72) Trần Trung Tường (VN)

(55)

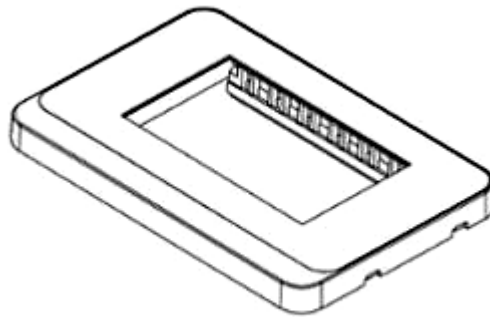

1.1

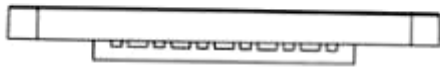

1.2



1.3



1.4



1.5

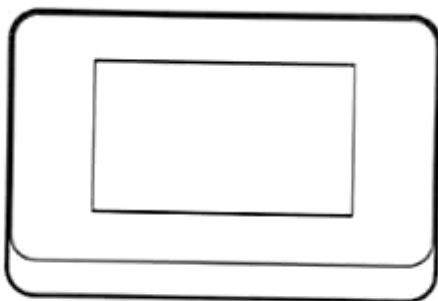

1.6

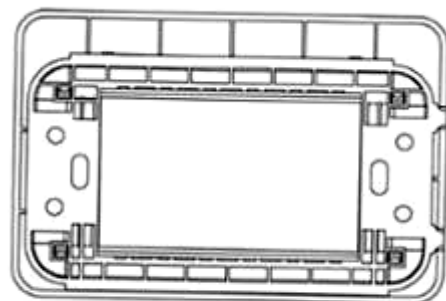

1.7

CÔNG BÁO SỞ HỮU CÔNG NGHIỆP SỐ 425 TẬP A – QUYỀN 2 (08.2023)

- (11) **47695**
(21) 3-2023-01085 (28) 1
(54) **GIƯỜNG** (51) **06-02**
(22) 18/05/2023 (43) 25/08/2023
(73) **CÔNG TY CỔ PHẦN CAO SU SÀI GÒN - KYMDAN (VN)**
28 Bình Thới, quận 11, thành phố Hồ Chí Minh
(72) Nguyễn Trí Tân (VN)
(74) Công ty TNHH Sở hữu trí tuệ Thảo Thọ Quyển (INVENCO.,LTD)
(55)



1.1



1.2



1.3



1.4



1.5



1.6



1.7

CÔNG BÁO SỞ HỮU CÔNG NGHIỆP SỐ 425 TẬP A – QUYỀN 2 (08.2023)

- (11) **47696**
(21) 3-2023-01090 (28) 1
(54) **KẾT SẮT** (51) **06-04**
(22) 19/05/2023 (43) 25/08/2023
(73) **CÔNG TY TNHH SẢN XUẤT VÀ THƯƠNG MẠI KẾT SẮT VIỆT TIỆP (VN)**
Số nhà 4, ngách 63/180/18 Lê Đức Thọ, phường Mỹ Đình 2, quận Nam Từ Liêm, thành phố Hà Nội
(72) Nguyễn Hồng Quân (VN)
(55)



1.1



1.2



1.3



1.4



1.5



1.6



1.7

CÔNG BÁO SỞ HỮU CÔNG NGHIỆP SỐ 425 TẬP A – QUYỀN 2 (08.2023)

- (11) **47697**
(21) 3-2023-01095 (28) 1
(54) **HỘP ĐỰNG THỰC PHẨM ĂN LIỀN** (51) **09-03**
(22) 19/05/2023 (43) 25/08/2023
(73) **CÔNG TY CỔ PHẦN EROSEA (VN)**
Số 10 lô 2C đường Trung Yên 6, phường Yên Hòa, quận Cầu Giấy, thành phố Hà Nội
(72) Trần Trọng Tài (VN)
(74) Công ty TNHH Sở hữu trí tuệ và Công nghệ Thủ đô (CAPITAL IP&T CO.LTD.)
(55)



1.1



1.2

CÔNG BÁO SỞ HỮU CÔNG NGHIỆP SỐ 425 TẬP A – QUYỀN 2 (08.2023)

- (11) **47698**
- (21) 3-2023-01096 (28) 1
- (54) **HỘP ĐỰNG THỰC PHẨM ĂN LIỀN** (51) **09-03**
- (22) 19/05/2023 (43) 25/08/2023
- (73) **CÔNG TY CỔ PHẦN EROSEA (VN)**
Số 10 lô 2C đường Trung Yên 6, phường Yên Hòa, quận Cầu Giấy, thành phố Hà Nội
- (72) Trần Trọng Tài (VN)
- (74) Công ty TNHH Sở hữu trí tuệ và Công nghệ Thủ đô (CAPITAL IP&T CO.LTD.)
- (55)



1.1



1.2

CÔNG BÁO SỞ HỮU CÔNG NGHIỆP SỐ 425 TẬP A – QUYỀN 2 (08.2023)

- (11) **47699**
(21) 3-2023-01107 (28) 1
(54) **HỘP ĐỰNG TRÀ** (51) **09-03**
(22) 23/05/2023 (43) 25/08/2023
(73) **CÔNG TY TNHH NHIÊN HOUSE (VN)**
37 Trần Văn Khánh, phường Tân Thuận Đông, quận 7, thành phố Hồ Chí Minh
(72) Lâm Tấn Tài (VN)
(55)



1.1



1.2

CÔNG BÁO SỞ HỮU CÔNG NGHIỆP SỐ 425 TẬP A – QUYỀN 2 (08.2023)

- (11) **47700**
(21) 3-2023-01111 (28) 1
(54) **BAO GÓI** (51) **09-05**
(22) 23/05/2023 (43) 25/08/2023
(73) **CÔNG TY TNHH BAO BÌ VÀ LƯƠNG THỰC AN THÁI (VN)**
Số nhà 5 dãy M khu đấu giá quyền sử dụng đất Ngõ Thị Nhậm, phường Hà Cầu,
quận Hà Đông, thành phố Hà Nội
(72) Trần Thị Kim Tuyền (VN)
(74) Công ty TNHH Sở hữu trí tuệ HA VIP (HAVIP CO., LTD.)
(55)



1.1



1.2

CÔNG BÁO SỞ HỮU CÔNG NGHIỆP SỐ 425 TẬP A – QUYỀN 2 (08.2023)

- (11) 47701
- (21) 3-2023-01112
- (54) **BAO GÓI SẢN PHẨM**
- (22) 23/05/2023
- (73) **CÔNG TY TNHH TM DV XNK AN HÒA HOUSE (VN)**
Số 9/1 Đặng Văn Ngữ, phường 10, quận Phú Nhuận, thành phố Hồ Chí Minh
- (72) Trần Ái Quốc (VN)
- (55)
- (28) 2
- (51) **09-05**
- (43) 25/08/2023



1.1



1.2



2.1



2.2

CÔNG BÁO SỞ HỮU CÔNG NGHIỆP SỐ 425 TẬP A – QUYỀN 2 (08.2023)

- (11) **47702**
(21) 3-2023-01118 (28) 1
(54) **TAY NẮM CỬA** (51) **08-06**
(22) 24/05/2023 (43) 25/08/2023
(73) **LƯU VĂN THƯỜNG (VN)**
Đội 6, thôn Đào Viên, xã Dân Tiến, huyện Khoái Châu, tỉnh Hưng Yên
(72) Lưu Văn Thường (VN)
(74) Công ty TNHH Sở hữu trí tuệ Đại Diện (IPACO.,LTD.)
(55)



1.1



1.2



1.3



1.4



1.5



1.6

CÔNG BÁO SỞ HỮU CÔNG NGHIỆP SỐ 425 TẬP A – QUYỀN 2 (08.2023)

- (11) **47703**
(21) 3-2023-01138 (28) 1
(54) **HỘP TRÀ TÚI LỘC** (51) **09-03**
(22) 25/05/2023 (43) 25/08/2023
(73) **CÔNG TY TRÁCH NHIỆM HỮU HẠN HATODO (VN)**
Tổ dân phố 7, thị trấn Bảo Lạc, huyện Bảo Lạc, tỉnh Cao Bằng
(72) Ninh Văn Tuyên (VN)
(74) Công ty TNHH Sở hữu trí tuệ M.I.T (M.I.T IP CO., LTD)
(55)



1.1



1.2

CÔNG BÁO SỞ HỮU CÔNG NGHIỆP SỐ 425 TẬP A – QUYỀN 2 (08.2023)

- (11) **47704**
(21) 3-2023-01140 (28) 1
(54) **BAO GÓI MIẾN** (51) **09-05**
(22) 25/05/2023 (43) 25/08/2023
(73) **HỘ KINH DOANH HOÀNG NGUYỄN (VN)**
Đội 7B, xã Dương Liễu, huyện Hoài Đức, thành phố Hà Nội
(72) Đoàn Hữu Thịnh (VN)
(74) Công ty TNHH Tư vấn đầu tư và Sở hữu trí tuệ Hoàng Phi (HOANG PHI INVEST & I.P CO., LTD)
(55)



1.1



1.2

CÔNG BÁO SỞ HỮU CÔNG NGHIỆP SỐ 425 TẬP A – QUYỀN 2 (08.2023)

- (11) **47705**
(21) 3-2023-01158 (28) 1
(54) **HỘP** (51) **09-03**
(22) 26/05/2023 (43) 25/08/2023
(73) **CÔNG TY TNHH NUTRI - PHARMA USA (VN)**
710-712 Cách Mạng Tháng Tám, phường 5, quận Tân Bình, thành phố Hồ Chí Minh
(72) Phạm Tuấn Kiệt (VN)
(74) Công ty Luật TNHH một thành viên LEADCO (LEADCO)
(55)



1.1



1.2

CÔNG BÁO SỞ HỮU CÔNG NGHIỆP SỐ 425 TẬP A – QUYỀN 2 (08.2023)

- (11) **47706**
(21) 3-2023-01163 (28) 1
(54) **THANH NGANG CỦA RÈM NÂNG** (51) **06-10**
(22) 29/05/2023 (43) 25/08/2023
(30) 112301322 22/03/2023 TW;
(73) **SHEEN WORLD TECHNOLOGY CORPORATION (TW)**
21F-7, No. 386, Shizheng Rd., Xitun Dist., Taichung City 407, Taiwan
(72) CHEN, PO-YU (TW)
(74) Công ty TNHH một thành viên Sở hữu trí tuệ VCCI (VCCI-IP CO.,LTD)
(55)

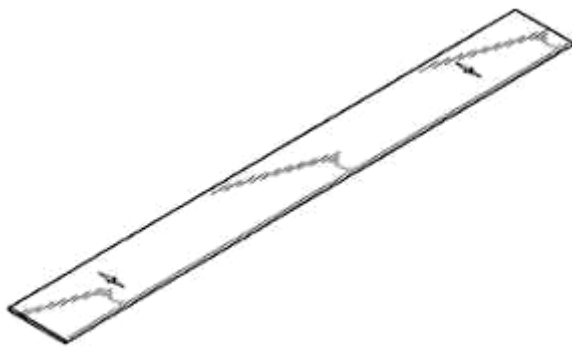

1.1



1.2



1.3



1.4

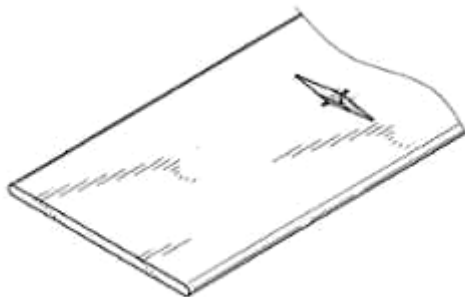

1.5

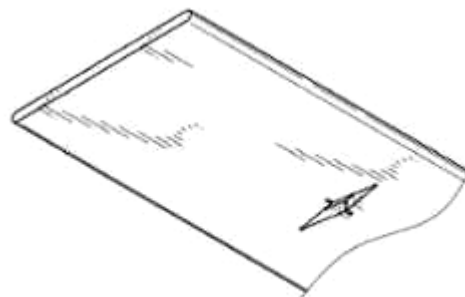

1.6

CÔNG BÁO SỞ HỮU CÔNG NGHIỆP SỐ 425 TẬP A – QUYỀN 2 (08.2023)

- (11) **47707**
(21) 3-2023-01164 (28) 1
(54) **BÀN ĐẠP XE ĐẠP** (51) **12-16**
(22) 08/09/2021 (43) 25/08/2023
(30) 29/773,172 08/03/2021 US;
(73) **WAHOO FITNESS L.L.C. (US)**
90 W. Wieuca Rd #110, Atlanta, Georgia 30342, United States of America
(72) David R. BUENGER (US)
(74) Văn phòng Luật sư Ân Nam (ANNAM IP & LAW)
(55)



1.1

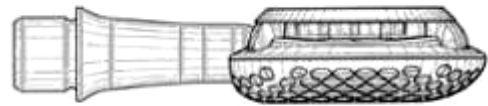

1.2

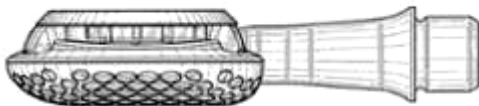

1.3

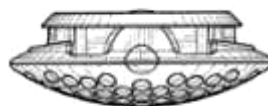

1.4

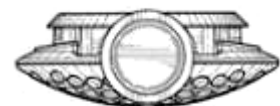

1.5



1.6

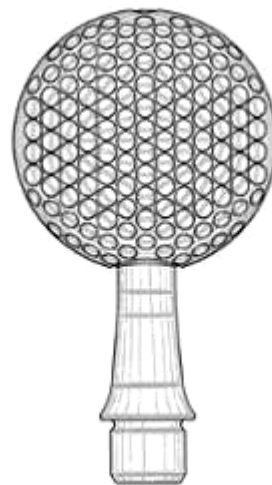

1.7

CÔNG BÁO SỞ HỮU CÔNG NGHIỆP SỐ 425 TẬP A – QUYỀN 2 (08.2023)

- (11) **47708**
(21) 3-2023-01166 (28) 1
(54) **BAO GÓI** (51) **09-05**
(22) 29/05/2023 (43) 25/08/2023
(73) **CÔNG TY TNHH BAK VN (VN)**
Số 1676/53, khu phố Long Khánh 3, phường Tam Phước, thành phố Biên Hòa, tỉnh
Đồng Nai
(72) Lê Đức Hiếu (VN)
(55)



1.1



1.2

CÔNG BÁO SỞ HỮU CÔNG NGHIỆP SỐ 425 TẬP A – QUYỀN 2 (08.2023)

- (11) **47709**
(21) 3-2023-01169 (28) 2
(54) **BAO GÓI SẢN PHẨM** (51) **09-05**
(22) 29/05/2023 (43) 25/08/2023
(73) **CÔNG TY CỔ PHẦN NƯỚC GIẢI KHÁT YẾN SÀO KHÁNH HÒA (VN)**
Quốc lộ 1A, xã Suối Hiệp, huyện Diên Khánh, tỉnh Khánh Hòa
(72) Trịnh Thị Hồng Vân (VN)
(74) Công ty TNHH Tư vấn sở hữu trí tuệ Việt (VIET IP CO.,LTD.)
(55)



1.1



1.2



2.1



2.2

CÔNG BÁO SỞ HỮU CÔNG NGHIỆP SỐ 425 TẬP A – QUYỀN 2 (08.2023)

- (11) **47710**
(21) 3-2023-01170 (28) 1
(54) **BAO GÓI SẢN PHẨM** (51) **09-05**
(22) 29/05/2023 (43) 25/08/2023
(73) **CÔNG TY CỔ PHẦN NƯỚC GIẢI KHÁT YẾN SÀO KHÁNH HÒA (VN)**
Quốc lộ 1A, xã Suối Hiệp, huyện Diên Khánh, tỉnh Khánh Hòa
(72) Trịnh Thị Hồng Vân (VN)
(74) Công ty TNHH Tư vấn sở hữu trí tuệ Việt (VIET IP CO.,LTD.)
(55)



1.1



1.2

- (11) **47711**
- (21) 3-2023-01172
- (54) **THIẾT BỊ NGẮT DÒNG**
- (22) 08/08/2019
- (30) 201930107958.4 15/03/2019 CN;
- (73) **SMC CORPORATION (JP)**
14-1, Sotokanda 4-chome, Chiyoda-ku, Tokyo 101-0021, JAPAN
- (72) 1. TAKAYOSHI OKAWARA (JP)
2. TAKAHISA MIURA (JP)
- (74) Công ty Luật TNHH Phạm và Liên danh (PHAM & ASSOCIATES)
- (55)

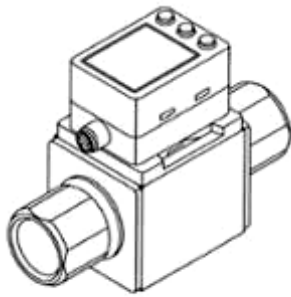

1.1

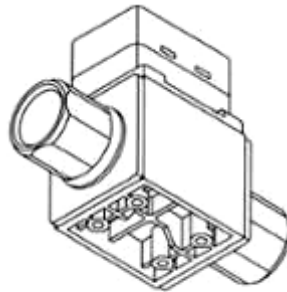

1.2

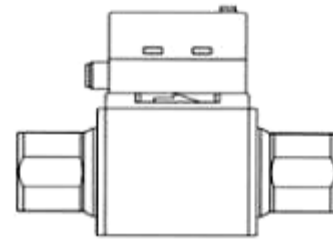

1.3

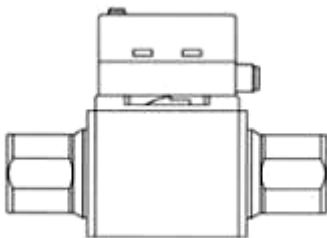

1.4

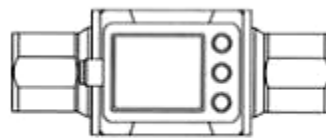

1.5

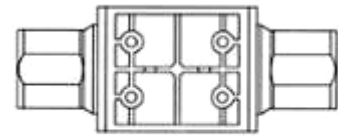

1.6

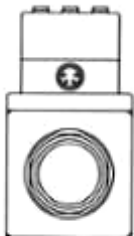

1.7

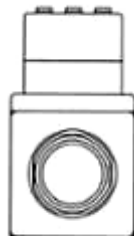

1.8

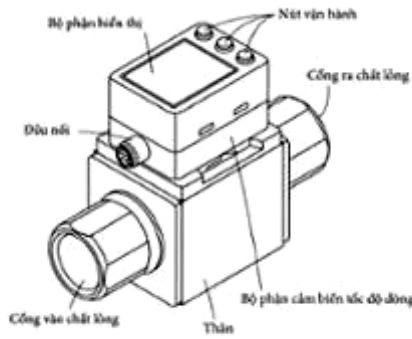

1.9



2.1

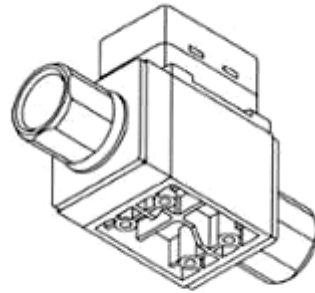

2.2

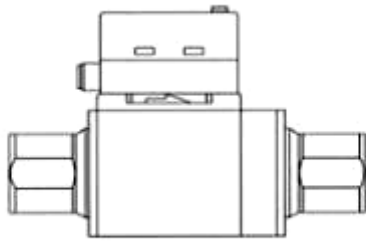

2.3

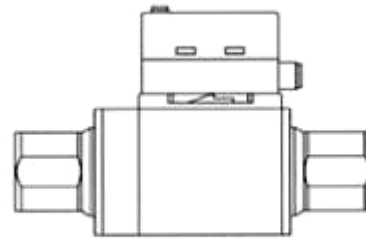

2.4

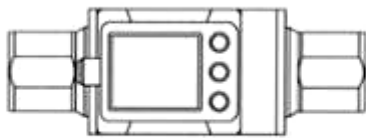

2.5

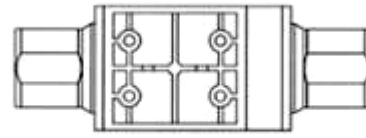

2.6



2.7

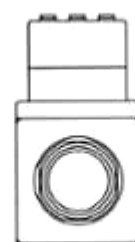

2.8

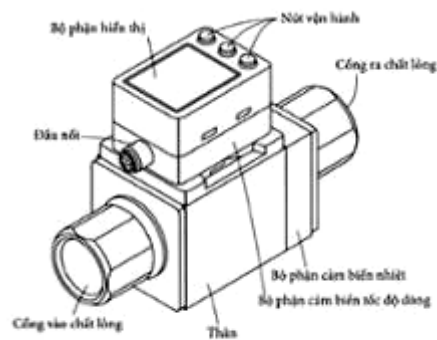

2.9

- (11) **47712**
(21) 3-2023-01173 (28) 2
(54) **THIẾT BỊ NGẮT DÒNG** (51) **10-05; 23-01**
(22) 08/08/2019 (43) 25/08/2023
(30) 201930107958.4 15/03/2019 CN;
(73) **SMC CORPORATION (JP)**
14-1, Sotokanda 4-chome, Chiyoda-ku, Tokyo 101-0021, JAPAN
(72) 1. TAKAYOSHI OKAWARA (JP)
2. TAKAHISA MIURA (JP)
(74) Công ty Luật TNHH Phạm và Liên danh (PHAM & ASSOCIATES)
(55)

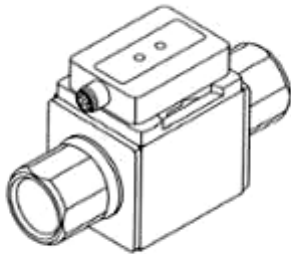

1.1

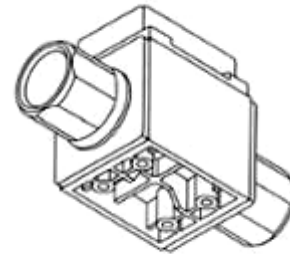

1.2

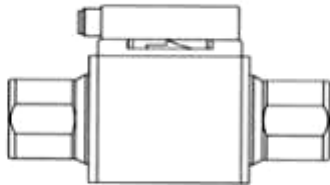

1.3

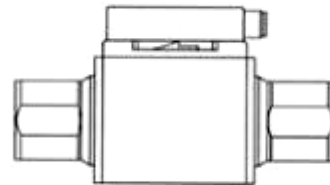

1.4



1.5

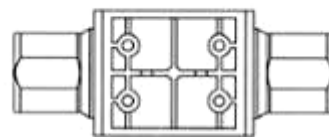

1.6



1.7



1.8

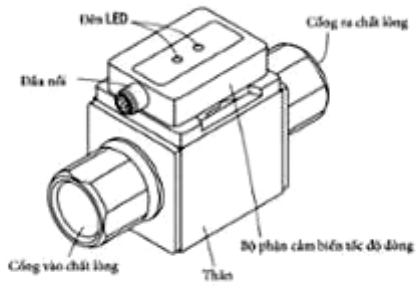

1.9

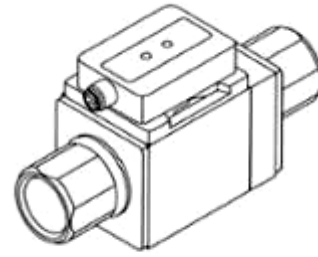

2.1

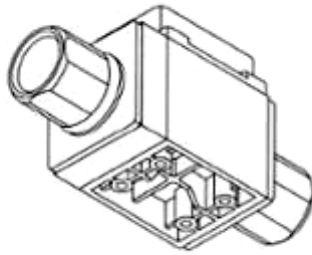

2.2

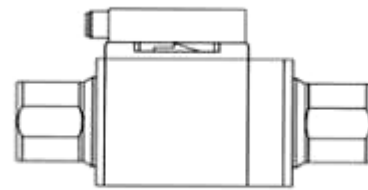

2.3

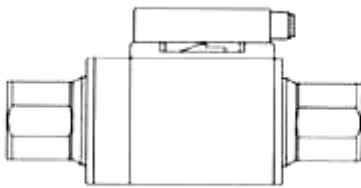

2.4

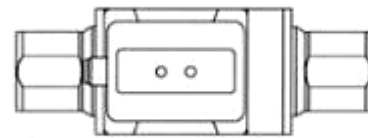

2.5

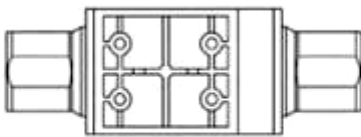

2.6



2.7



2.8

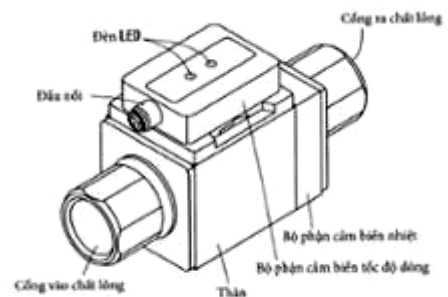

2.9

- (11) **47713**
(21) 3-2023-01174 (28) 1
(54) **THIẾT BỊ NGẮT DÒNG** (51) **10-05; 23-01**
(22) 08/08/2019 (43) 25/08/2023
(30) 201930108470.3 15/03/2019 CN;
(73) **SMC CORPORATION (JP)**
14-1, Sotokanda 4-chome, Chiyoda-ku, Tokyo 101-0021, JAPAN
(72) 1. TAKAYOSHI OKAWARA (JP)
2. TAKAHISA MIURA (JP)
(74) Công ty Luật TNHH Phạm và Liên danh (PHAM & ASSOCIATES)
(55)

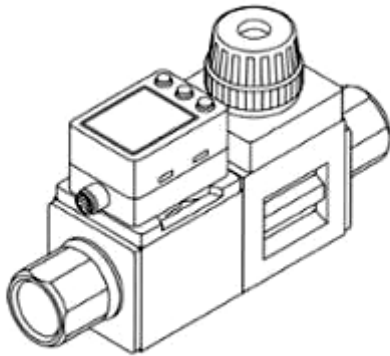

1.1

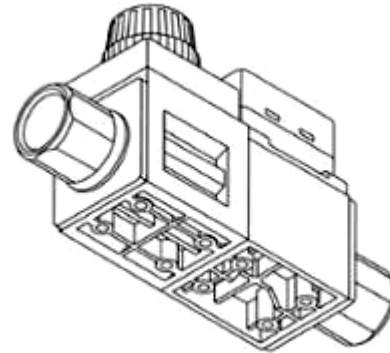

1.2

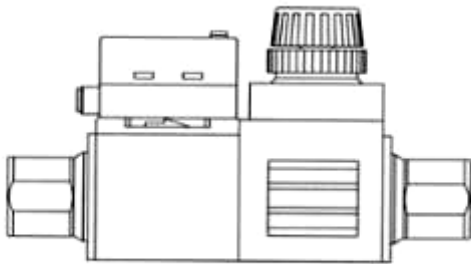

1.3

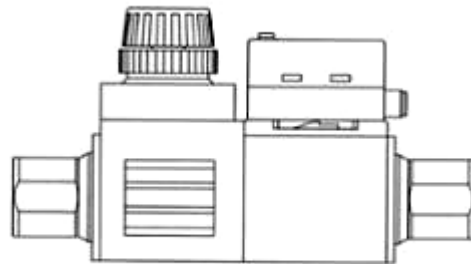

1.4

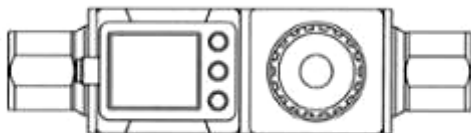

1.5

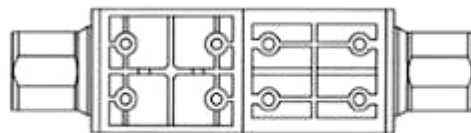

1.6

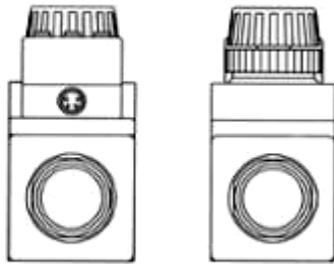

1.7

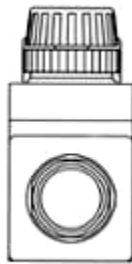

1.8

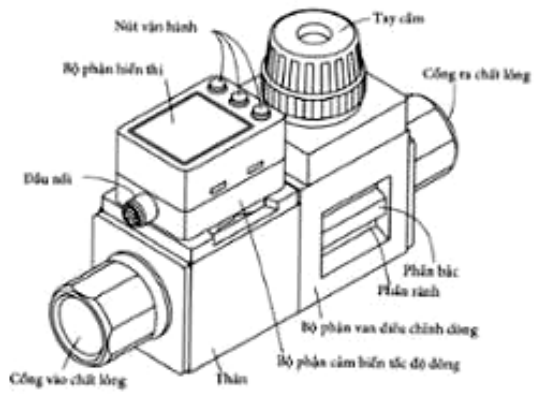

1.9

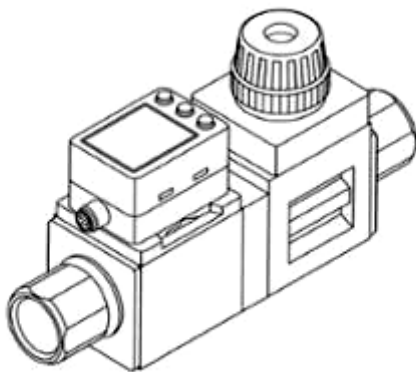

2.1

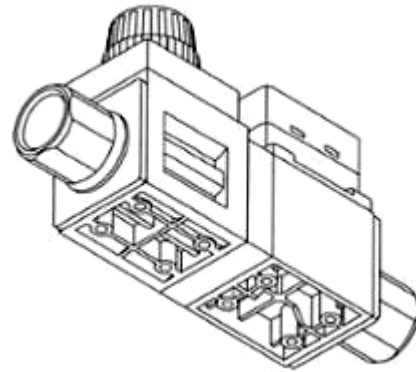

2.2

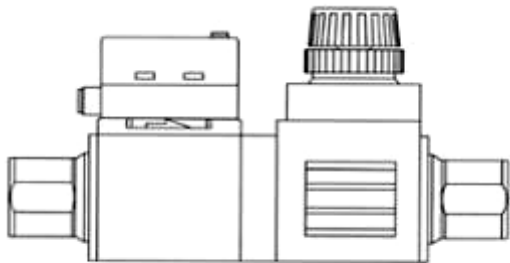

2.3

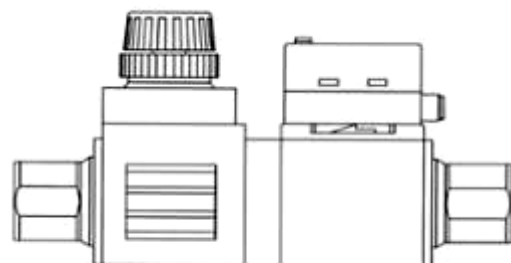

2.4



2.5

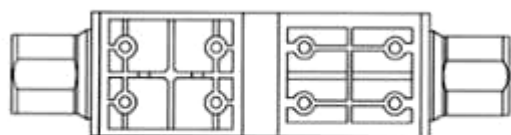

2.6

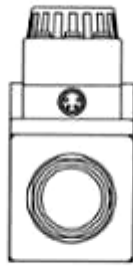

2.7

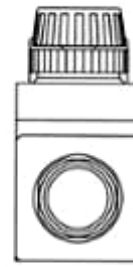

2.8

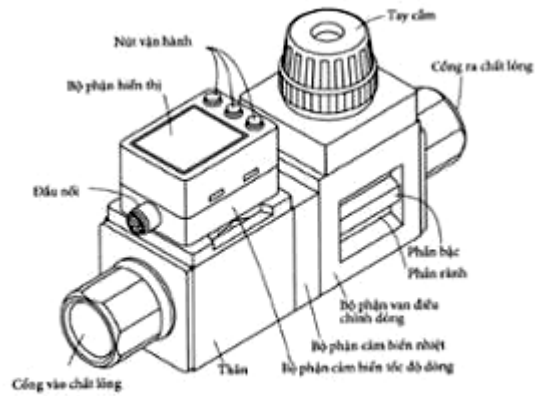

2.9

- (11) **47714**
(21) 3-2023-01175 (28) 2
(54) **THIẾT BỊ NGẮT DÒNG** (51) **10-05; 23-01**
(22) 08/08/2019 (43) 25/08/2023
(30) 201930108470.3 15/03/2019 CN;
(73) **SMC CORPORATION (JP)**
14-1, Sotokanda 4-chome, Chiyoda-ku, Tokyo 101-0021, JAPAN
(72) 1. TAKAYOSHI OKAWARA (JP)
2. TAKAHISA MIURA (JP)
(74) Công ty Luật TNHH Phạm và Liên danh (PHAM & ASSOCIATES)
(55)

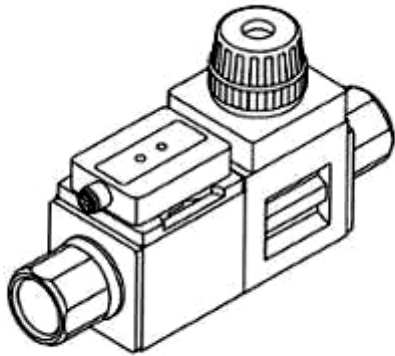

1.1

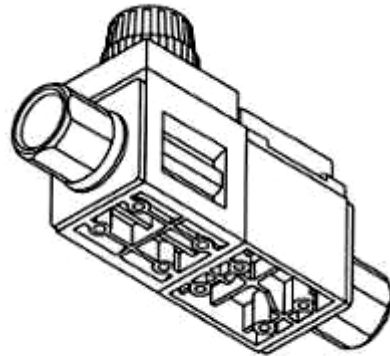

1.2

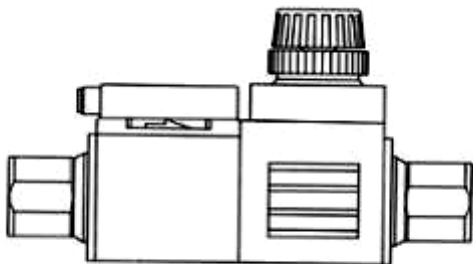

1.3

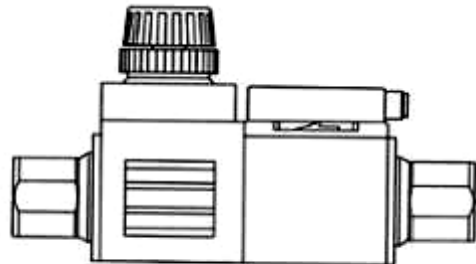

1.4

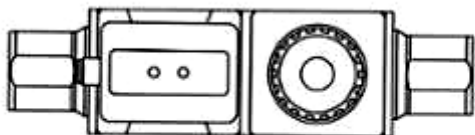

1.5

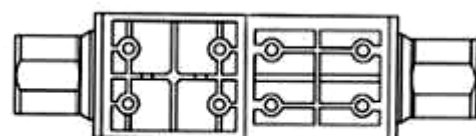

1.6



1.7

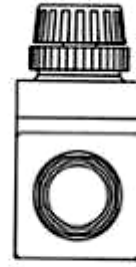

1.8

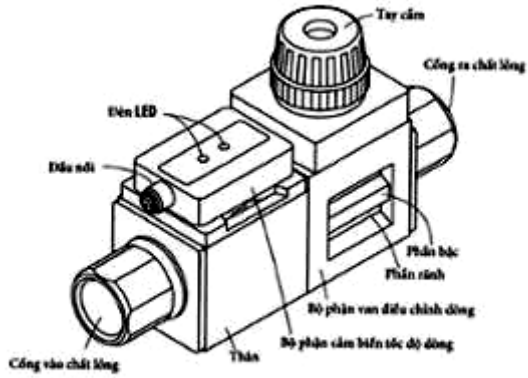

1.9

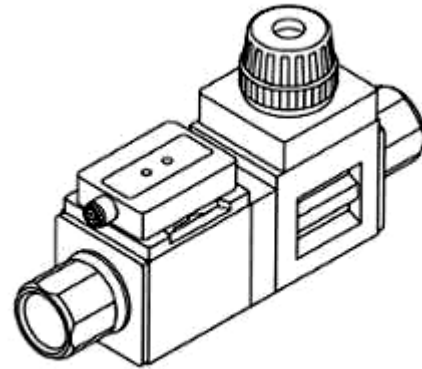

2.1

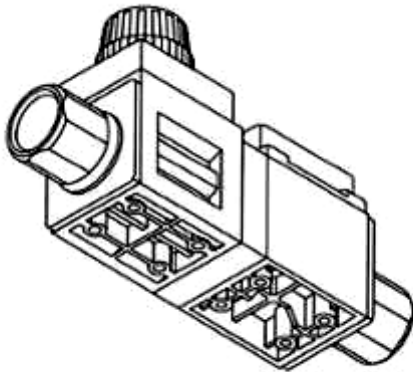

2.2

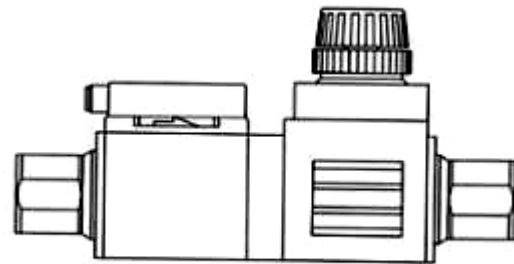

2.3

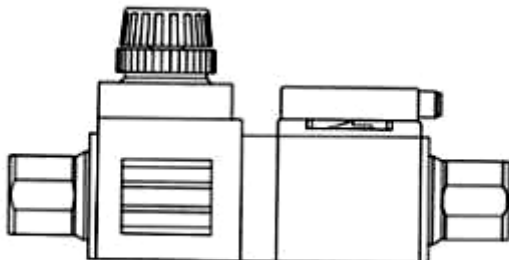

2.4



2.5

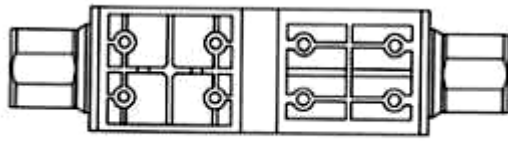

2.6



2.7



2.8

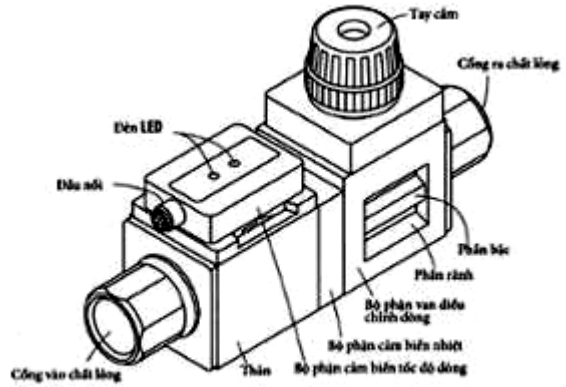

2.9

CÔNG BÁO SỞ HỮU CÔNG NGHIỆP SỐ 425 TẬP A – QUYỀN 2 (08.2023)

- (11) 47715
(21) 3-2023-01184
(54) **BIỂN BÁO CẤM LỬA**
(22) 31/05/2023
(73) **CÔNG TY TNHH THƯƠNG MẠI DỊCH VỤ TỔNG HỢP HIQ THIÊN AN (VN)**
Số 33 đường 31 tháng 03, phường Lê Lợi, thành phố Quy Nhơn, tỉnh Bình Định
(72) Nguyễn Ngọc Minh (VN)
(55)
- (28) 1
(51) **20-03**
(43) 25/08/2023

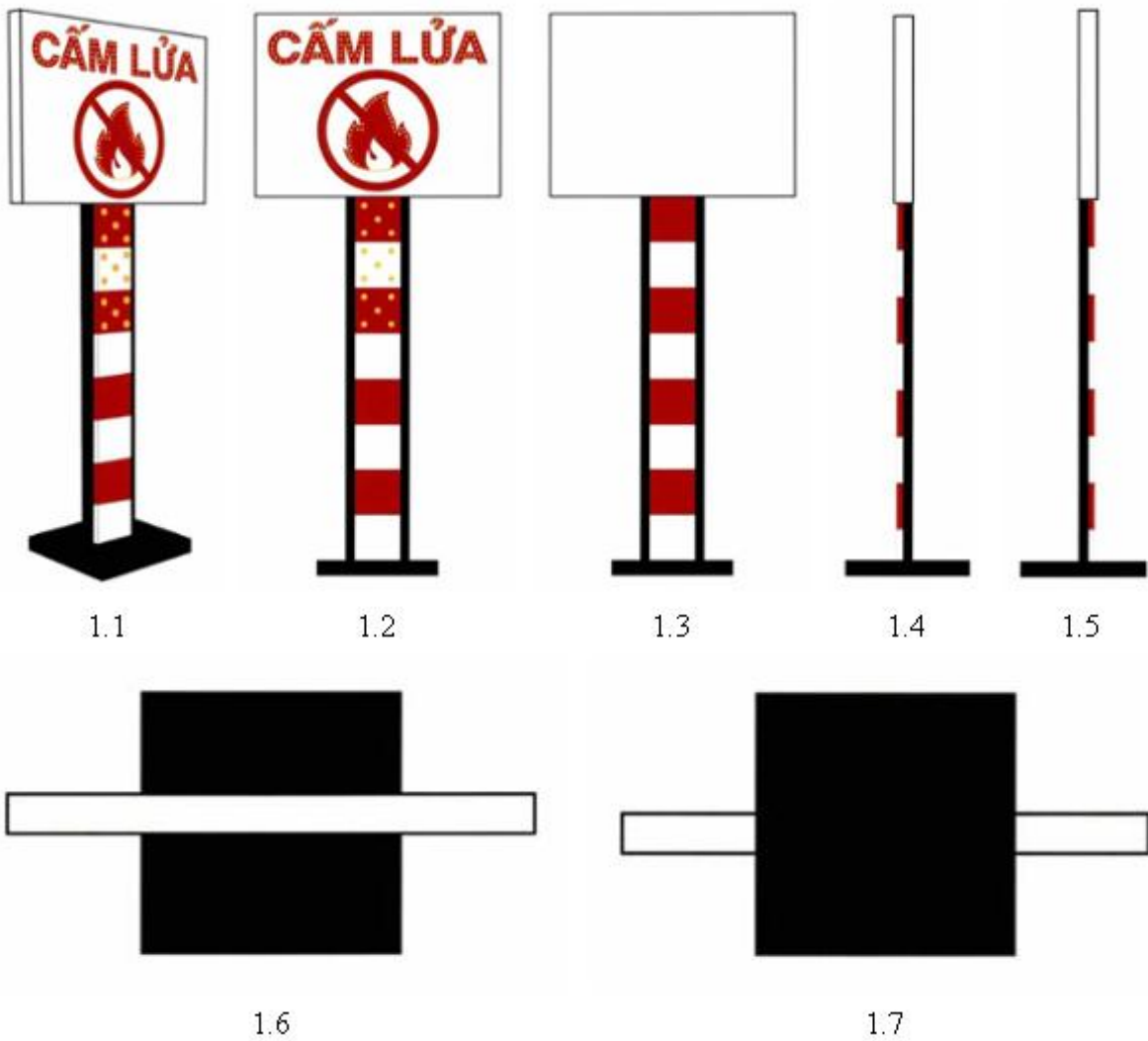

CÔNG BÁO SỞ HỮU CÔNG NGHIỆP SỐ 425 TẬP A – QUYỀN 2 (08.2023)

- (11) **47716**
(21) 3-2023-01191 (28) 1
(54) **VỎ ĐIỆN THOẠI** (51) **03-01**
(22) 31/05/2023 (43) 25/08/2023
(73) **CÔNG TY TNHH TẬP ĐOÀN THƯƠNG MẠI DỊCH VỤ Ô TÔ ĐẠI HOÀNG KIM (VN)**
494 Hồ Học Lãm, phường An Lạc, quận Bình Tân, thành phố Hồ Chí Minh
(72) 1. NGUYỄN VŨ DUY THIÊN (VN)
2. DƯƠNG TRẦN QUANG MINH (VN)
(74) **CÔNG TY TNHH KHANG LUẬT (KHANGLAW)**
(55)



1.1

1.2

1.3



1.4

1.5



1.6



1.7

CÔNG BÁO SỞ HỮU CÔNG NGHIỆP SỐ 425 TẬP A – QUYỀN 2 (08.2023)

- (11) 47717
(21) 3-2023-01192 (28) 1
(54) **HỘP** (51) **09-03**
(22) 31/05/2023 (43) 25/08/2023
(73) **CÔNG TY CỔ PHẦN DẦU THỰC VẬT TÂN BÌNH (VN)**
889 Trường Chinh, phường Tây Thạnh, quận Tân Phú, thành phố Hồ Chí Minh
(72) Huỳnh Trung Lập (VN)
(74) **CÔNG TY TNHH SỞ HỮU TRÍ TUỆ SETHACO (SETHACO IP CO.,LTD)**
(55)



1.1



1.2



1.3



1.4



1.5



1.6



1.7

CÔNG BÁO SỞ HỮU CÔNG NGHIỆP SỐ 425 TẬP A – QUYỀN 2 (08.2023)

- (11) **47718**
(21) 3-2023-01213 (28) 1
(54) **BẾP NƯỚNG** (51) **07-02**
(22) 02/06/2023 (43) 25/08/2023
(73) **CÔNG TY TNHH MỘT THÀNH VIÊN VŨ KHẢI (VN)**
95/10 Tôn Đản, phường 14, quận 4, thành phố Hồ Chí Minh
(72) Trương Thế Khải (VN)
(74) Công ty Luật TNHH WINCO (WINCO LAW FIRM)
(55)



1.1



1.2



1.3



1.4



1.5



1.6



1.7



1.8

CÔNG BÁO SỞ HỮU CÔNG NGHIỆP SỐ 425 TẬP A – QUYỀN 2 (08.2023)

- (11) 47719
(21) 3-2023-01214
(54) **HỘP**
(22) 02/06/2023
(73) **CÔNG TY CỔ PHẦN ĐÔNG TRÙNG HẠ THẢO (VN)**
Số 82, tổ 3, ấp 6, xã Long Trung, huyện Cai Lậy, tỉnh Tiền Giang
(72) Đỗ Văn Huệ (VN)
(55)
- (28) 1
(51) **09-03**
(43) 25/08/2023



1.1



1.2

CÔNG BÁO SỞ HỮU CÔNG NGHIỆP SỐ 425 TẬP A – QUYỀN 2 (08.2023)

- (11) **47720**
(21) 3-2023-01220 (28) 1
(54) **LON BIA** (51) **09-03**
(22) 02/06/2023 (43) 25/08/2023
(73) **TỔNG CÔNG TY CỔ PHẦN BIA-RƯỢU-NƯỚC GIẢI KHÁT SÀI GÒN (VN)**
187 Nguyễn Chí Thanh, phường 12, quận 5, thành phố Hồ Chí Minh
(72) Neo Gim Siong Bennett (SG)
(74) Công ty TNHH Luật ALIAT (ALIAT LEGAL)
(55)



1.1



1.2



1.3



1.4



1.5



1.6



1.7

- (11) **47721**
(21) 3-2023-01227 (28) 1
(54) **VAN ĐIỀU CHỈNH DÒNG** (51) **23-01**
(22) 28/05/2020 (43) 25/08/2023
(30) 201930697167.1 13/12/2019 CN;
(73) **SMC CORPORATION (JP)**
14-1, Sotokanda 4-chome, Chiyoda-ku, Tokyo 101-0021, JAPAN
(72) 1. HIROSUKE YAMADA (JP)
2. KENJI SHISHIDO (JP)
3. TAKAHIRO UEYAMA (JP)
(74) Công ty Luật TNHH Phạm và Liên danh (PHAM & ASSOCIATES)
(55)

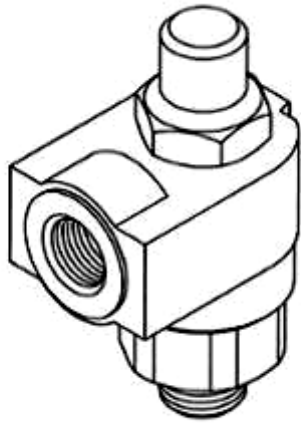

1.1

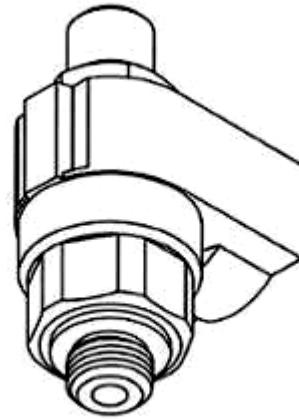

1.2

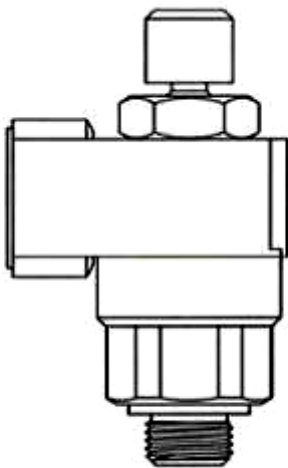

1.3

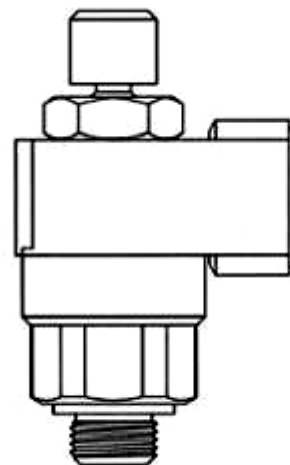

1.4

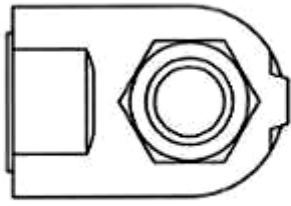

1.5

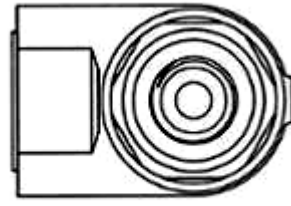

1.6

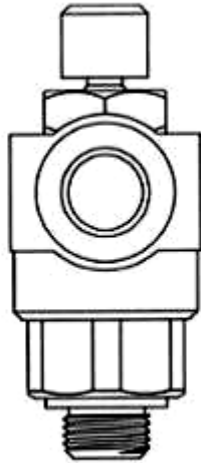

1.7

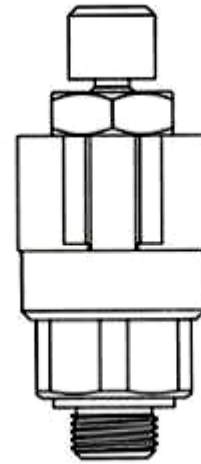

1.8

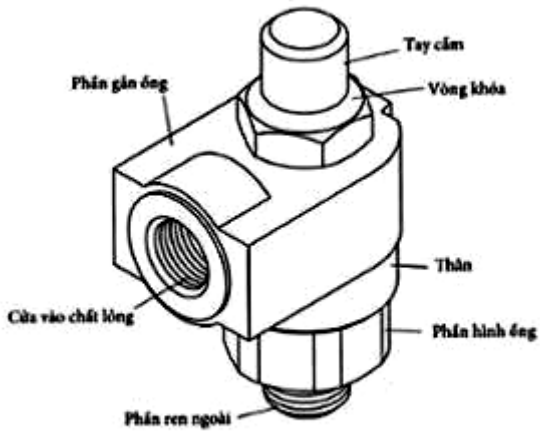

1.9

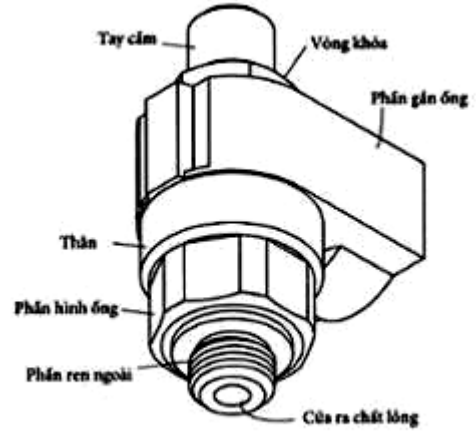

1.10

- (11) **47722**
(21) 3-2023-01228 (28) 1
(54) **VAN ĐIỀU CHỈNH DÒNG** (51) **23-01**
(22) 28/05/2020 (43) 25/08/2023
(30) 201930697167.1 13/12/2019 CN;
(73) **SMC CORPORATION (JP)**
14-1, Sotokanda 4-chome, Chiyoda-ku, Tokyo 101-0021, JAPAN
(72) 1. HIROSUKE YAMADA (JP)
2. KENJI SHISHIDO (JP)
3. TAKAHIRO UEYAMA (JP)
(74) Công ty Luật TNHH Phạm và Liên danh (PHAM & ASSOCIATES)
(55)

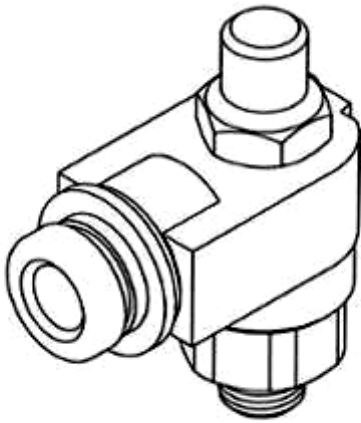

1.1

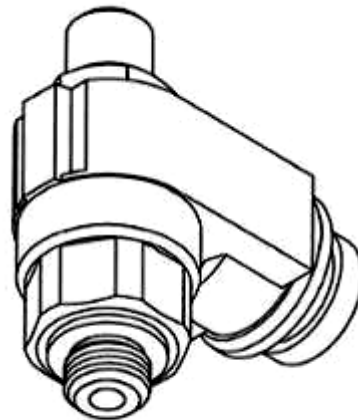

1.2

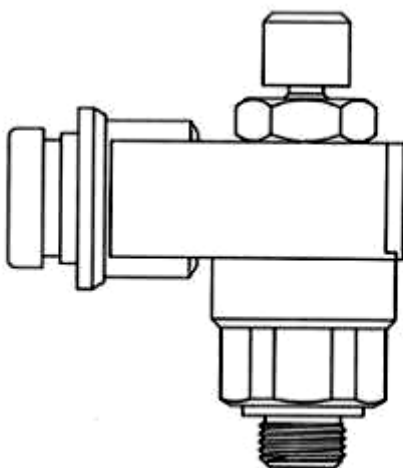

1.3

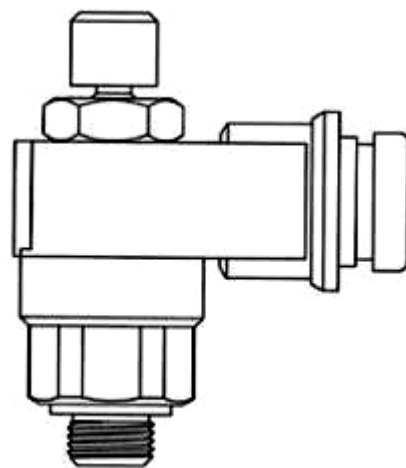

1.4

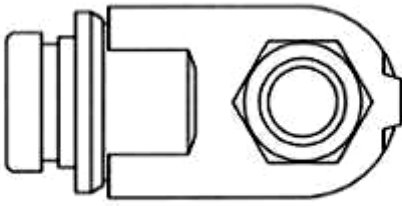

1.5

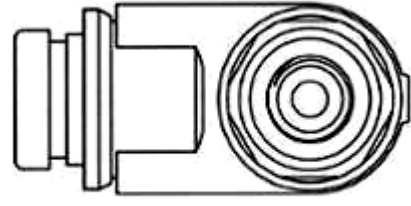

1.6

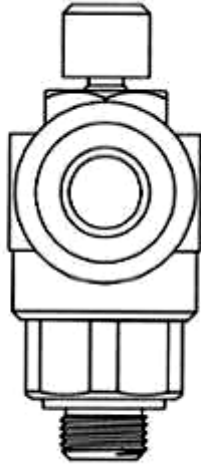

1.7

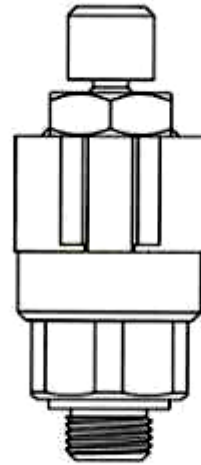

1.8

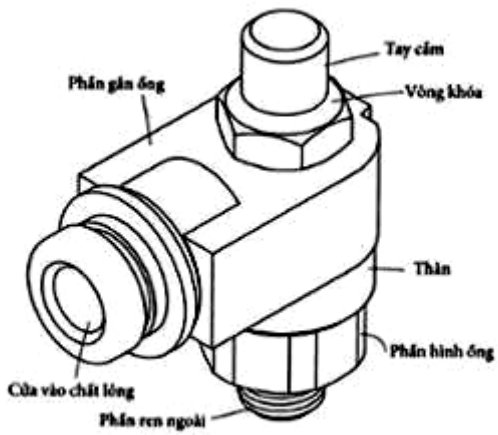

1.9

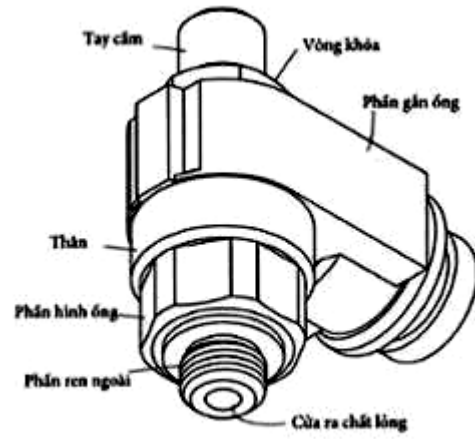

1.10

- (11) **47723**
(21) 3-2023-01229 (28) 1
(54) **VAN ĐIỀU CHỈNH DÒNG** (51) **23-01**
(22) 28/05/2020 (43) 25/08/2023
(30) 201930697167.1 13/12/2019 CN;
(73) **SMC CORPORATION (JP)**
14-1, Sotokanda 4-chome, Chiyoda-ku, Tokyo 101-0021, JAPAN
(72) 1. HIROSUKE YAMADA (JP)
2. KENJI SHISHIDO (JP)
3. TAKAHIRO UEYAMA (JP)
(74) Công ty Luật TNHH Phạm và Liên danh (PHAM & ASSOCIATES)
(55)

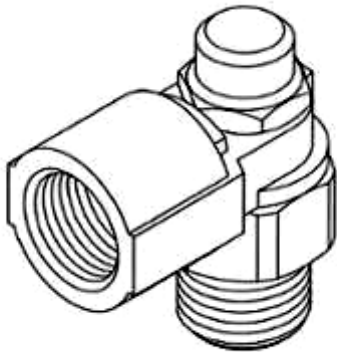

1.1



1.2

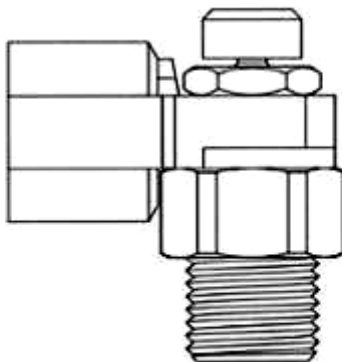

1.3

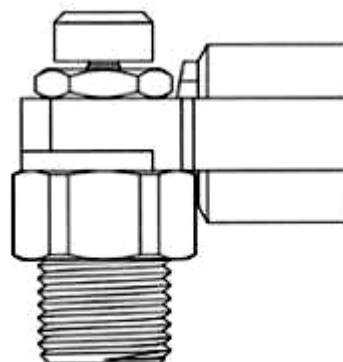

1.4



1.5



1.6

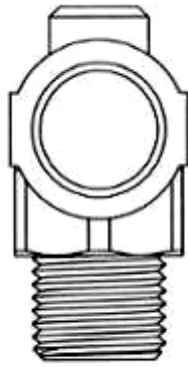

1.7

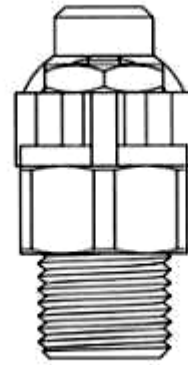

1.8

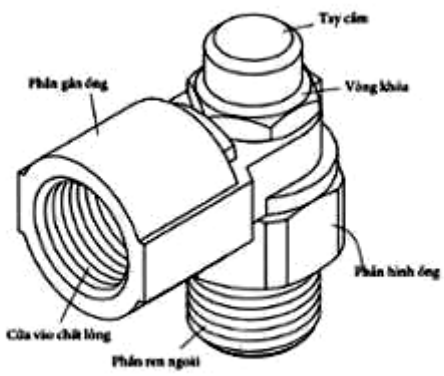

1.9

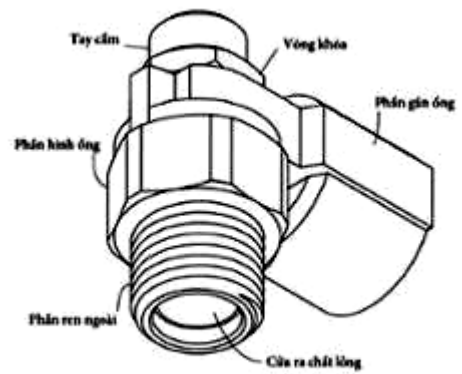

1.10

CÔNG BÁO SỞ HỮU CÔNG NGHIỆP SỐ 425 TẬP A – QUYỀN 2 (08.2023)

- (11) **47724**
(21) 3-2023-01244 (28) 1
(54) **TƯỢNG TRANG TRÍ** (51) **11-02**
(22) 07/06/2023 (43) 25/08/2023
(73) **CÔNG TY TNHH TƯ VẤN THIẾT KẾ ĐỊA LÝ LẠC VIỆT (VN)**
Số 8, đường số 14, khu phố 5, phường Hiệp Bình Chánh, quận Thủ Đức, thành phố Hồ Chí Minh
(72) Nguyễn Vũ Diệu (VN)
(55)



1.1



1.2



1.3



1.4



1.5



1.6



1.7

CÔNG BÁO SỞ HỮU CÔNG NGHIỆP SỐ 425 TẬP A – QUYỀN 2 (08.2023)

- (11) **47725**
(21) 3-2023-01245 (28) 1
(54) **NHÃN SẢN PHẨM** (51) **19-08**
(22) 07/06/2023 (43) 25/08/2023
(73) **PHẠM THANH TÙNG (VN)**
R4B-2020 Royal City, 72A Nguyễn Trãi, quận Thanh Xuân, thành phố Hà Nội
(72) Phạm Thanh Tùng (VN)
(55)



CÔNG BÁO SỞ HỮU CÔNG NGHIỆP SỐ 425 TẬP A – QUYỀN 2 (08.2023)

- (11) **47726**
(21) 3-2023-01246 (28) 1
(54) **NHÃN SẢN PHẨM** (51) **19-08**
(22) 07/06/2023 (43) 25/08/2023
(73) **PHẠM THANH TÙNG (VN)**
R4B-2020 Royal City, 72A Nguyễn Trãi, quận Thanh Xuân, thành phố Hà Nội
(72) Phạm Thanh Tùng (VN)
(55)



CÔNG BÁO SỞ HỮU CÔNG NGHIỆP SỐ 425 TẬP A – QUYỀN 2 (08.2023)

- | | | | |
|------|--|------|--------------|
| (11) | 47727 | | |
| (21) | 3-2023-01247 | (28) | 1 |
| (54) | NHÃN SẢN PHẨM | (51) | 19-08 |
| (22) | 07/06/2023 | (43) | 25/08/2023 |
| (73) | PHẠM THANH TÙNG (VN)
R4B-2020 Royal City, 72A Nguyễn Trãi, quận Thanh Xuân, thành phố Hà Nội | | |
| (72) | Phạm Thanh Tùng (VN) | | |
| (55) | | | |



CÔNG BÁO SỞ HỮU CÔNG NGHIỆP SỐ 425 TẬP A – QUYỀN 2 (08.2023)

- (11) **47728**
(21) 3-2023-01260 (28) 1
(54) **TƯỢNG TRANG TRÍ** (51) **11-02**
(22) 07/06/2023 (43) 25/08/2023
(73) **CÔNG TY TNHH ĐÈN TRANG TRÍ PHẬT QUANG (VN)**
42 đường số 21, khu dân cư ấp 5, xã Phong Phú, huyện Bình Chánh, thành phố Hồ Chí Minh
(72) Vương Quốc Cường (VN)
(74) Công ty Cổ phần Sở hữu công nghiệp INVESTIP (INVESTIP)
(55)



1.1



1.2



1.3



1.4



1.5



1.6



1.7

CÔNG BÁO SỞ HỮU CÔNG NGHIỆP SỐ 425 TẬP A – QUYỀN 2 (08.2023)

- (11) 47729
(21) 3-2023-01262 (28) 1
(54) **NHÃN SẢN PHẨM BIA** (51) **19-08**
(22) 08/06/2023 (43) 25/08/2023
(73) **CÔNG TY TNHH TOÀN CẦU BEVERAGE (VN)**
Số 8B đường Ngô Quyền, khu 4, phường Cẩm Thượng, thành phố Hải Dương, tỉnh Hải Dương
(72) Nguyễn Thế Phương (VN)
(74) Công ty TNHH Sở hữu trí tuệ M.I.T (M.I.T IP CO., LTD)
(55)



1.1



1.2

CÔNG BÁO SỞ HỮU CÔNG NGHIỆP SỐ 425 TẬP A – QUYỀN 2 (08.2023)

- (11) **47730**
(21) 3-2023-01263 (28) 2
(54) **NÚT BẮM CỬA CÔNG TẮC ĐIỆN** (51) **13-03**
(22) 08/06/2023 (43) 25/08/2023
(73) **CÔNG TY CỔ PHẦN BÓNG ĐÈN PHÍCH NƯỚC RẠNG ĐÔNG (VN)**
87-89 phố Hạ Đình, phường Thanh Xuân Trung, quận Thanh Xuân, thành phố Hà Nội
(72) Trần Trung Tường (VN)
(55)

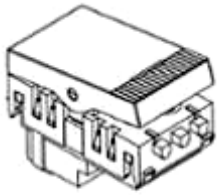

1.1

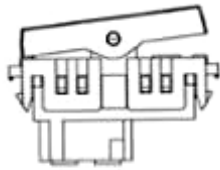

1.2

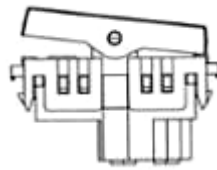

1.3

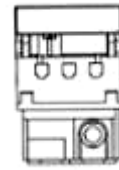

1.4

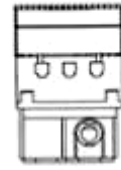

1.5



1.6

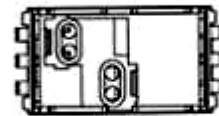

1.7

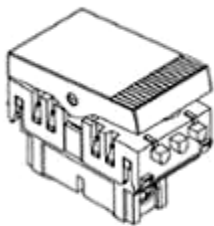

2.1



2.2

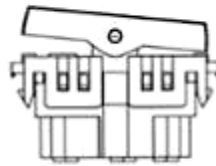

2.3

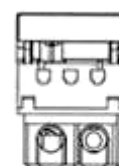

2.4

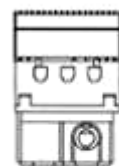

2.5



2.6

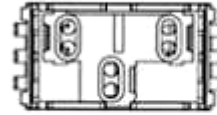

2.7

(11) **47731**

(21) 3-2023-01264

(54) **THIẾT BỊ KẾT NỐI ĐIỆN TỬ**

(22) 08/06/2023

(73) **CÔNG TY CỔ PHẦN BÓNG ĐÈN PHÍCH NƯỚC RẠNG ĐÔNG (VN)**

87-89 phố Hạ Đình, phường Thanh Xuân Trung, quận Thanh Xuân, thành phố Hà Nội

(72) Trần Trung Tường (VN)

(55)

(28) 1

(51) **14-02; 14-03**

(43) 25/08/2023

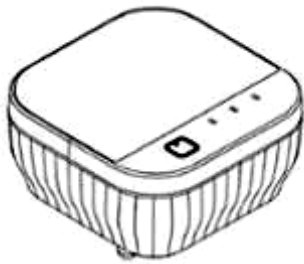

1.1



1.2

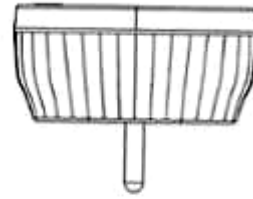

1.3



1.4



1.5



1.6

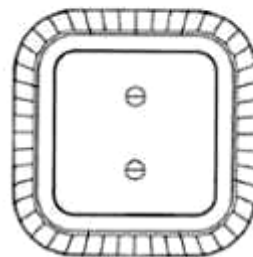

1.7

CÔNG BÁO SỞ HỮU CÔNG NGHIỆP SỐ 425 TẬP A – QUYỀN 2 (08.2023)

- (11) 47732
- (21) 3-2023-01270 (28) 1
- (54) **BAO GÓI** (51) **09-05**
- (22) 09/06/2023 (43) 25/08/2023
- (73) **HỘ KINH DOANH THANH SUNG (VN)**
 Ấp 6B, xã Trường Xuân, huyện Tháp Mười, tỉnh Đồng Tháp
- (72) Phạm Văn Sung (VN)
- (74) **CÔNG TY LUẬT TNHH AGL (AGL LAW)**
- (55)



1.1



1.2



1.3

- (11) **47733**
(21) 3-2023-01281 (28) 1
(54) **CHUỖI RĂNG CỦA KHÓA KÉO** (51) **02-07**
(22) 20/06/2016 (43) 25/08/2023
(30) 201530541676.7 18/12/2015 CN;
(73) **YKK CORPORATION (JP)**
1, Kandaizumi-cho, Chiyoda-ku, Tokyo, 101-8642 Japan
(72) 1. MASAYOSHI KOJIMA (JP)
2. HIDEKI SATO (JP)
(74) Công ty Luật TNHH Phạm và Liên danh (PHAM & ASSOCIATES)
(55)



1.1



1.2



1.3



1.4



1.5



1.6



1.7

- (11) **47734**
(21) 3-2023-01282 (28) 1
(54) **CHUỖI RĂNG CỦA KHÓA KÉO** (51) **02-07**
(22) 20/06/2016 (43) 25/08/2023
(30) 201530541676.7 18/12/2015 CN;
(73) **YKK CORPORATION (JP)**
1, Kandaizumi-cho, Chiyoda-ku, Tokyo, 101-8642 Japan
(72) 1. MASAYOSHI KOJIMA (JP)
2. HIDEKI SATO (JP)
(74) Công ty Luật TNHH Phạm và Liên danh (PHAM & ASSOCIATES)
(55)



1.1



1.2



1.3



1.4



1.5



1.6



1.7



1.8

- (11) **47735**
(21) 3-2023-01283 (28) 1
(54) **CHUỖI RĂNG CỦA KHÓA KÉO** (51) **02-07**
(22) 20/06/2016 (43) 25/08/2023
(30) 201530541676.7 18/12/2015 CN;
(73) **YKK CORPORATION (JP)**
1, Kandaizumi-cho, Chiyoda-ku, Tokyo, 101-8642 Japan
(72) 1. MASAYOSHI KOJIMA (JP)
2. HIDEKI SATO (JP)
(74) Công ty Luật TNHH Phạm và Liên danh (PHAM & ASSOCIATES)
(55)



1.1



1.2



1.3



1.4



1.5



1.6



1.7

- (11) **47736**
(21) 3-2023-01284 (28) 1
(54) **CHUỖI RĂNG CỦA KHÓA KÉO** (51) **02-07**
(22) 20/06/2016 (43) 25/08/2023
(30) 201530541676.7 18/12/2015 CN;
(73) **YKK CORPORATION (JP)**
1, Kandaizumi-cho, Chiyoda-ku, Tokyo, 101-8642 Japan
(72) 1. MASAYOSHI KOJIMA (JP)
2. HIDEKI SATO (JP)
(74) Công ty Luật TNHH Phạm và Liên danh (PHAM & ASSOCIATES)
(55)



1.1



1.2



1.3

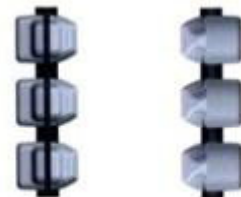

1.4

1.5



1.6



1.7

- (11) **47737**
(21) 3-2023-01285 (28) 1
(54) **CHUỖI RĂNG CỦA KHÓA KÉO** (51) **02-07**
(22) 20/06/2016 (43) 25/08/2023
(30) 201530541676.7 18/12/2015 CN;
(73) **YKK CORPORATION (JP)**
1, Kandaizumi-cho, Chiyoda-ku, Tokyo, 101-8642 Japan
(72) 1. MASAYOSHI KOJIMA (JP)
2. HIDEKI SATO (JP)
(74) Công ty Luật TNHH Phạm và Liên danh (PHAM & ASSOCIATES)
(55)



1.1



1.2



1.3



1.4



1.5



1.6



1.7

- (11) **47738**
(21) 3-2023-01286 (28) 1
(54) **CHUỖI RĂNG CỦA KHÓA KÉO** (51) **02-07**
(22) 20/06/2016 (43) 25/08/2023
(30) 201530541676.7 18/12/2015 CN;
(73) **YKK CORPORATION (JP)**
1, Kandaizumi-cho, Chiyoda-ku, Tokyo, 101-8642 Japan
(72) 1. MASAYOSHI KOJIMA (JP)
2. HIDEKI SATO (JP)
(74) Công ty Luật TNHH Phạm và Liên danh (PHAM & ASSOCIATES)
(55)

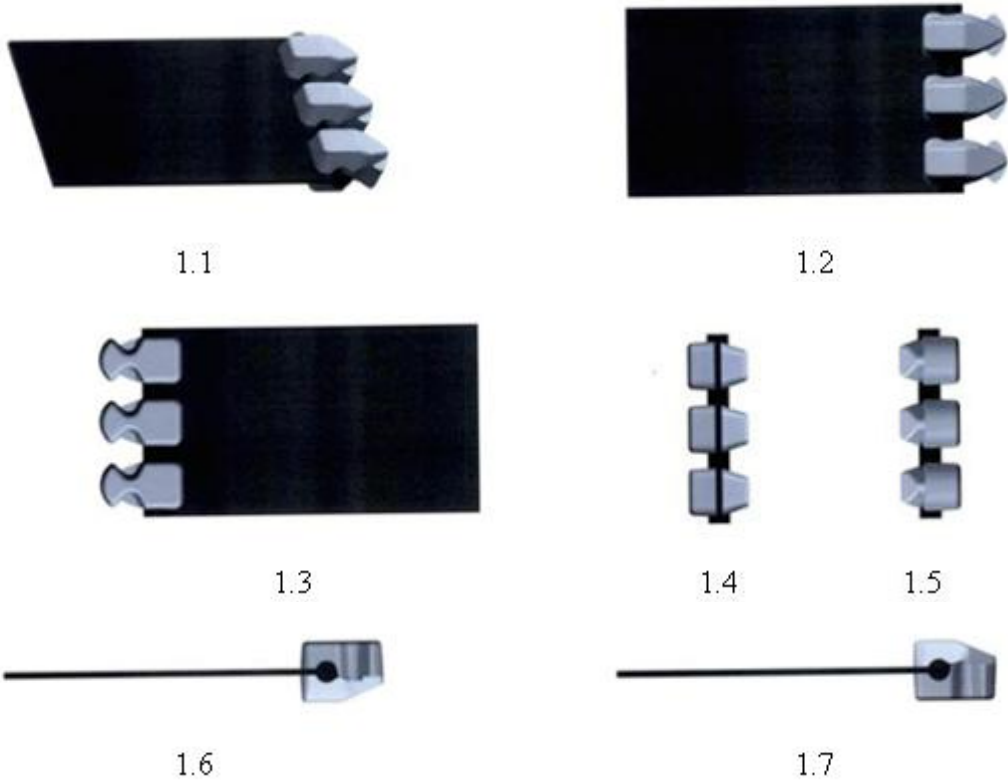

- (11) **47739**
(21) 3-2023-01287 (28) 1
(54) **CHUỖI RĂNG CỦA KHÓA KÉO** (51) **02-07**
(22) 20/06/2016 (43) 25/08/2023
(30) 201530541676.7 18/12/2015 CN;
(73) **YKK CORPORATION (JP)**
1, Kandaizumi-cho, Chiyoda-ku, Tokyo, 101-8642 Japan
(72) 1. MASAYOSHI KOJIMA (JP)
2. HIDEKI SATO (JP)
(74) Công ty Luật TNHH Phạm và Liên danh (PHAM & ASSOCIATES)
(55)

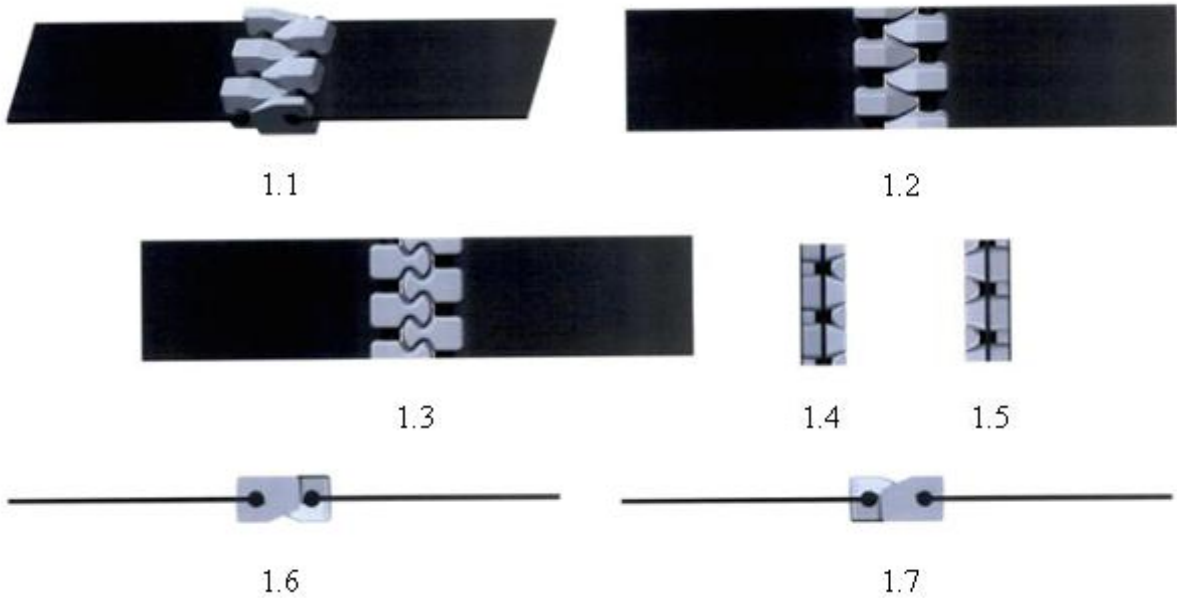

- (11) **47740**
(21) 3-2023-01288 (28) 1
(54) **CHUỖI RĂNG CỦA KHÓA KÉO** (51) **02-07**
(22) 20/06/2016 (43) 25/08/2023
(30) 201530541676.7 18/12/2015 CN;
(73) **YKK CORPORATION (JP)**
1, Kandaizumi-cho, Chiyoda-ku, Tokyo, 101-8642 Japan
(72) 1. MASAYOSHI KOJIMA (JP)
2. HIDEKI SATO (JP)
(74) Công ty Luật TNHH Phạm và Liên danh (PHAM & ASSOCIATES)
(55)



1.1



1.2



1.3



1.4



1.5



1.6



1.7

CÔNG BÁO SỞ HỮU CÔNG NGHIỆP SỐ 425 TẬP A – QUYỀN 2 (08.2023)

- (11) **47741**
(21) 3-2023-01289 (28) 1
(54) **GHẾ** (51) **06-01**
(22) 12/06/2023 (43) 25/08/2023
(73) **CÔNG TY TNHH NỘI THẤT SAO BIỂN (VN)**
1787/7 đường Nguyễn Duy Trinh, phường Trường Thạnh, thành phố Thủ Đức,
thành phố Hồ Chí Minh
(72) Lê Thanh Tâm (VN)
(74) Công ty TNHH Tư vấn - Dịch thuật - Sở hữu trí tuệ Á Đông (Á Đông IP
CONSULTANCY CO.,LTD.)
(55)



1.1

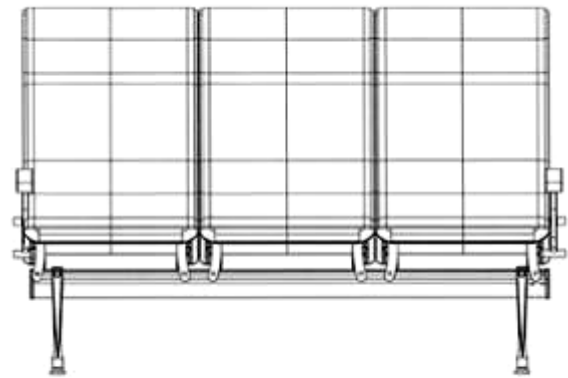

1.2

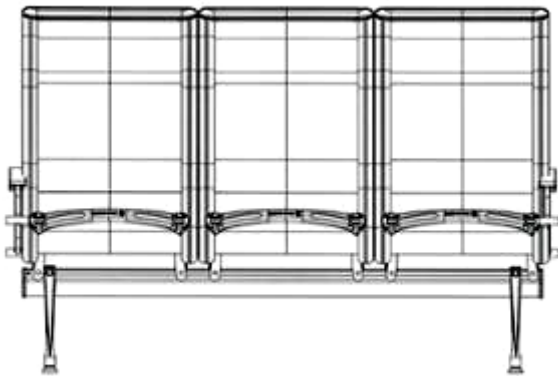

1.3

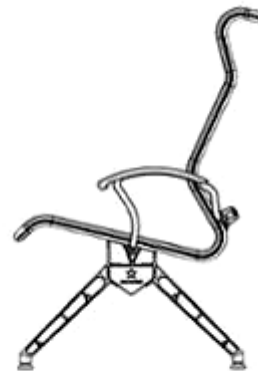

1.4



1.5

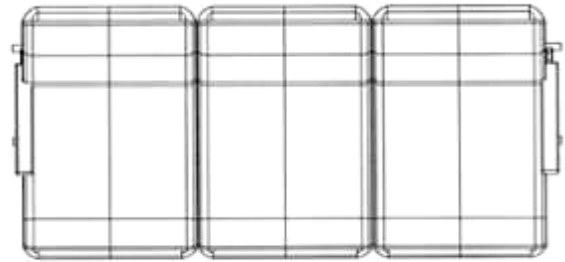

1.6

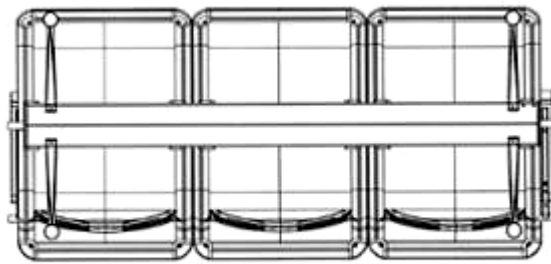

1.7

CÔNG BÁO SỞ HỮU CÔNG NGHIỆP SỐ 425 TẬP A – QUYỀN 2 (08.2023)

(11) **47742**

(21) 3-2023-01292

(28) 1

(54) **ĐẦU VÒI PHUN**

(51) **23-01**

(22) 12/06/2023

(43) 25/08/2023

(73) **CHIN-YUAN CHEN (TW)**

No. 75-6, Liaocuo Ln., Liaocuo Vil., Lukang Township, Changhua County 50565, Taiwan

(72) Chin-Yuan CHEN (TW)

(74) Công ty TNHH Sở hữu trí tuệ HA VIP (HAVIP CO., LTD.)

(55)

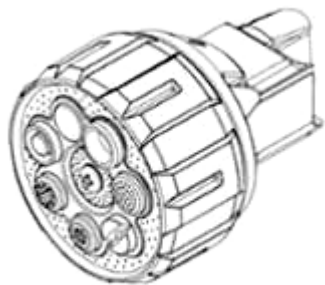

1.1



1.2



1.3

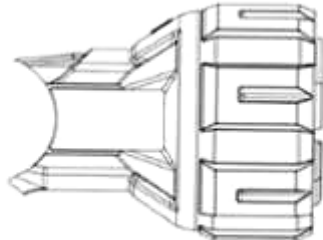

1.4

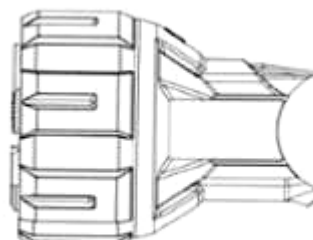

1.5

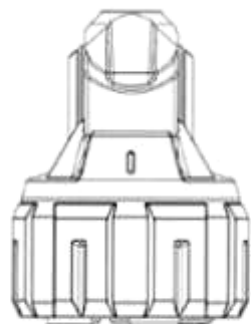

1.6

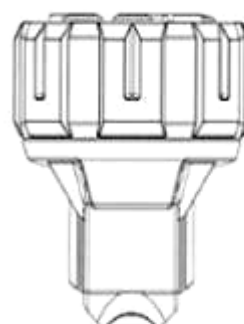

1.7

CÔNG BÁO SỞ HỮU CÔNG NGHIỆP SỐ 425 TẬP A – QUYỀN 2 (08.2023)

- (11) **47743**
(21) 3-2023-01293 (28) 1
(54) **TAY KÉO CỦA BÌNH PHUN XỊT** (51) **23-01**
(22) 12/06/2023 (43) 25/08/2023
(73) **CHIN-YUAN CHEN (TW)**
No. 75-6, Liaocuo Ln., Liaocuo Vil., Lukang Township, Changhua County 50565,
Taiwan
(72) Chin-Yuan CHEN (TW)
(74) Công ty TNHH Sở hữu trí tuệ HA VIP (HAVIP CO., LTD.)
(55)



1.1



1.2



1.3



1.4



1.5

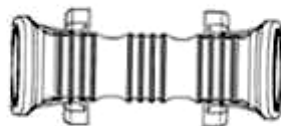

1.6

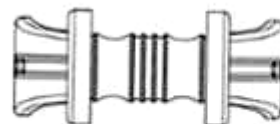

1.7

CÔNG BÁO SỞ HỮU CÔNG NGHIỆP SỐ 425 TẬP A – QUYỀN 2 (08.2023)

- (11) **47744**
(21) 3-2023-01294 (28) 1
(54) **TAY CẦM CỦA SÚNG PHUN XỊT** (51) **23-01**
(22) 12/06/2023 (43) 25/08/2023
(73) **CHIN-YUAN CHEN (TW)**
No. 75-6, Liaocuo Ln., Liaocuo Vil., Lukang Township, Changhua County 50565,
Taiwan
(72) Chin-Yuan CHEN (TW)
(74) Công ty TNHH Sở hữu trí tuệ HA VIP (HAVIP CO., LTD.)
(55)

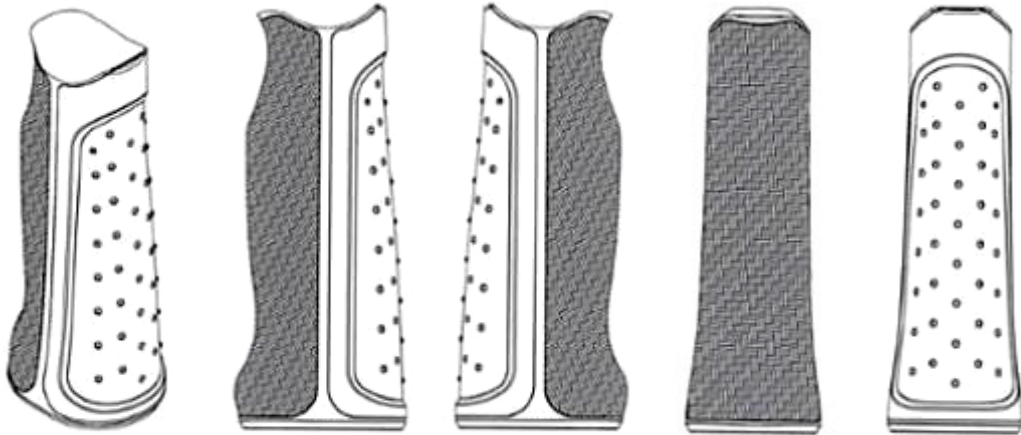

1.1

1.2

1.3

1.4

1.5



1.6



1.7

CÔNG BÁO SỞ HỮU CÔNG NGHIỆP SỐ 425 TẬP A – QUYỀN 2 (08.2023)

- (11) **47745**
(21) 3-2023-01295 (28) 1
(54) **ĐẦU VÒI PHUN** (51) **23-01**
(22) 12/06/2023 (43) 25/08/2023
(73) **CHIN-YUAN CHEN (TW)**
No. 75-6, Liaocuo Ln., Liaocuo Vil., Lukang Township, Changhua County 50565,
Taiwan
(72) Chin-Yuan CHEN (TW)
(74) Công ty TNHH Sở hữu trí tuệ HA VIP (HAVIP CO., LTD.)
(55)



1.1



1.2



1.3



1.4



1.5

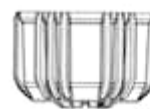

1.6

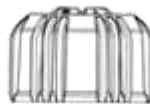

1.7

CÔNG BÁO SỞ HỮU CÔNG NGHIỆP SỐ 425 TẬP A – QUYỀN 2 (08.2023)

- (11) **47746**
(21) 3-2023-01296 (28) 1
(54) **ĐẦU VÒI PHUN** (51) **23-01**
(22) 12/06/2023 (43) 25/08/2023
(73) **Chin-Yuan CHEN (TW)**
No. 75-6, Liaocuo Ln., Liaocuo Vil., Lukang Township, Changhua County 50565,
Taiwan
(72) Chin-Yuan CHEN (TW)
(74) Công ty TNHH Sở hữu trí tuệ HA VIP (HAVIP CO., LTD.)
(55)



1.1



1.2



1.3



1.4



1.5

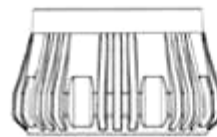

1.6



1.7

CÔNG BÁO SỞ HỮU CÔNG NGHIỆP SỐ 425 TẬP A – QUYỀN 2 (08.2023)

- (11) 47747
(21) 3-2023-01316
(54) **TÚI ĐỰNG SẢN PHẨM**
(22) 15/06/2023
(73) **DƯƠNG TUẤN ANH (VN)**
Tổ 2, phường Tây Sơn, thành phố Tam Điệp, tỉnh Ninh Bình
(72) Dương Tuấn Anh (VN)
(55)
- (28) 1
(51) **09-05**
(43) 25/08/2023



1.1



1.2

CÔNG BÁO SỞ HỮU CÔNG NGHIỆP SỐ 425 TẬP A – QUYỀN 2 (08.2023)

- (11) **47748**
(21) 3-2023-01318 (28) 1
(54) **GHẾ** (51) **06-01**
(22) 15/06/2023 (43) 25/08/2023
(73) **CÔNG TY TNHH ATRIUM DESIGN AND BUILD (VN)**
L3-19, tầng 3, khu cao ốc Văn phòng - Thương mại - Dịch vụ tổng hợp lô 5.5, số 8 -
10, đường Mai Chí Thọ, phường Thủ Thiêm, thành phố Thủ Đức, thành phố Hồ Chí
Minh
(72) Trần Viên Ngọc Trân (VN)
(74) Công ty TNHH T&T INVENMARK Sở hữu trí tuệ Quốc tế (T&T INVENMARK
CO., LTD.)
(55)

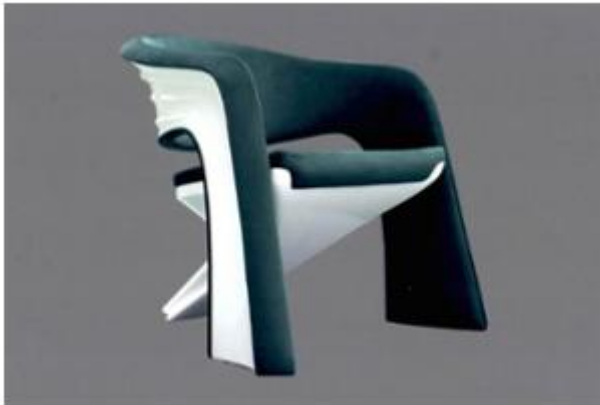

1.1



1.2



1.3



1.4



1.5

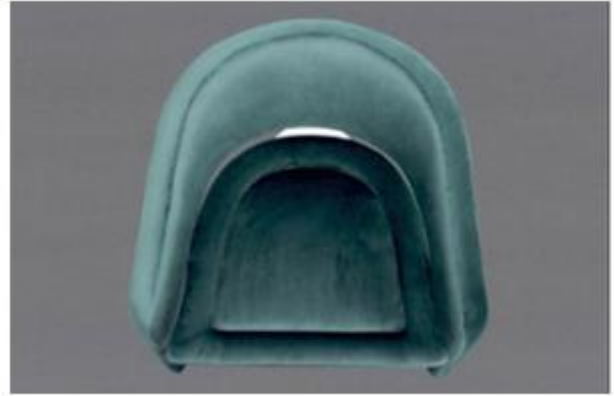

1.6



1.7

CÔNG BÁO SỞ HỮU CÔNG NGHIỆP SỐ 425 TẬP A – QUYỀN 2 (08.2023)

- (11) **47749**
(21) 3-2023-01321 (28) 1
(54) **DỤNG CỤ ĐỤC DỪA** (51) **08-01; 08-05**
(22) 28/08/2019 (43) 25/08/2023
(73) **K FRESH CO., LTD. (TH)**
No. 98/38 moo 6, Bangmuangmai sub-district, Muang samutprakarn district,
Samutprakarn 10270, Thailand
(72) 1. KEMTAS MANUSRUNGSRI (TH)
2. WARAPORN MANUSRUNGSRI (TH)
(74) Công ty TNHH Trà và cộng sự (TRA & ASSOCIATES CO.,LTD)
(55)



1.1

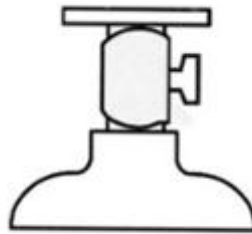

1.2

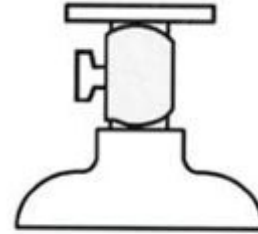

1.3



1.4

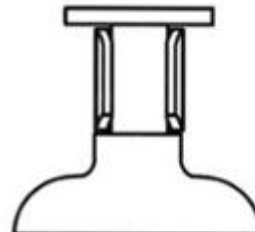

1.5

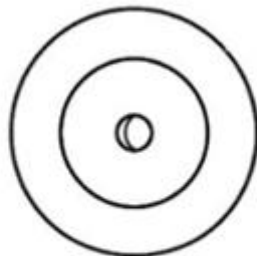

1.6

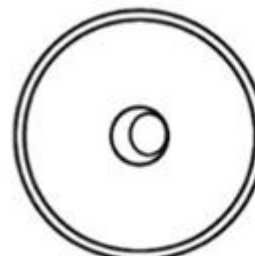

1.7

CÔNG BÁO SỞ HỮU CÔNG NGHIỆP SỐ 425 TẬP A – QUYỀN 2 (08.2023)

- (11) **47750**
(21) 3-2023-01322 (28) 1
(54) **DỤNG CỤ ĐỤC DỪA** (51) **08-01; 08-05**
(22) 28/08/2019 (43) 25/08/2023
(73) **K FRESH CO., LTD. (TH)**
No. 98/38 moo 6, Bangmuangmai sub-district, Muang samutprakarn district,
Samutprakarn 10270, Thailand
(72) 1. KEMTAS MANUSRUNGSRI (TH)
2. WARAPORN MANUSRUNGSRI (TH)
(74) Công ty TNHH Trà và cộng sự (TRA & ASSOCIATES CO.,LTD)
(55)



1.1

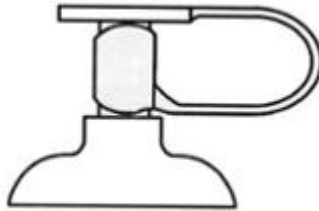

1.2

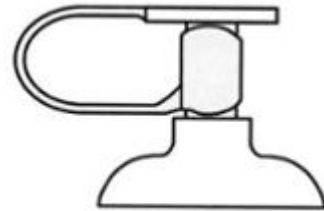

1.3

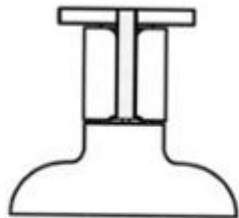

1.4



1.5

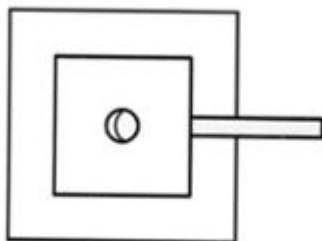

1.6

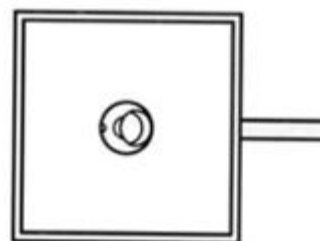

1.7

- (11) **47751**
(21) 3-2023-01323 (28) 1
(54) **DỤNG CỤ ĐỤC DỪA** (51) **08-01; 08-05**
(22) 28/08/2019 (43) 25/08/2023
(73) **K FRESH CO., LTD. (TH)**
No. 98/38 moo 6, Bangmuangmai sub-district, Muang samutprakarn district,
Samutprakarn 10270, Thailand
(72) 1. KEMTAS MANUSRUNGSRI (TH)
2. WARAPORN MANUSRUNGSRI (TH)
(74) Công ty TNHH Trà và cộng sự (TRA & ASSOCIATES CO.,LTD)
(55)



1.1

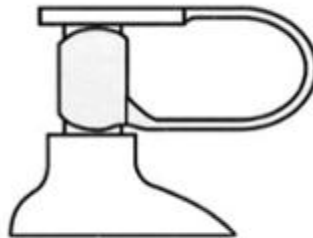

1.2

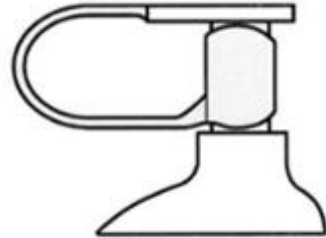

1.3



1.4

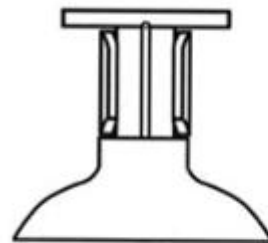

1.5

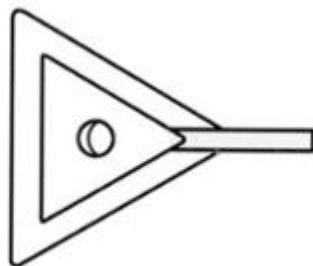

1.6

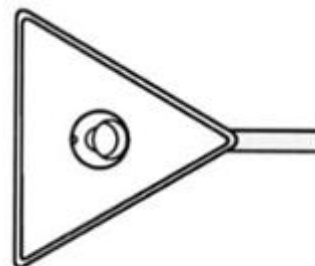

1.7

CÔNG BÁO SỞ HỮU CÔNG NGHIỆP SỐ 425 TẬP A – QUYỀN 2 (08.2023)

- (11) 47752
(21) 3-2023-01333 (28) 1
(54) **HỘP** (51) **09-03**
(22) 16/06/2023 (43) 25/08/2023
(73) **CÔNG TY CỔ PHẦN DƯỢC PHẨM FOOD TECH (VN)**
Số nhà 16, lô biệt thự 1, khu X1 Bắc Linh Đàm, phường Đại Kim, quận Hoàng Mai,
thành phố Hà Nội
(72) Đoàn Văn Đại (VN)
(74) Công ty TNHH MASTERBRAND (MASTERBRAND)
(55)



1.1



1.2

CÔNG BÁO SỞ HỮU CÔNG NGHIỆP SỐ 425 TẬP A – QUYỀN 2 (08.2023)

- (11) **47753**
(21) 3-2023-01334 (28) 1
(54) **HỘP** (51) **09-03**
(22) 16/06/2023 (43) 25/08/2023
(73) **CÔNG TY CỔ PHẦN DƯỢC PHẨM FOOD TECH (VN)**
Số nhà 16, lô biệt thự 1, khu X1 Bắc Linh Đàm, phường Đại Kim, quận Hoàng Mai,
thành phố Hà Nội
(72) Đoàn Văn Đại (VN)
(74) Công ty TNHH MASTERBRAND (MASTERBRAND)
(55)



1.1



1.2

CÔNG BÁO SỞ HỮU CÔNG NGHIỆP SỐ 425 TẬP A – QUYỀN 2 (08.2023)

(11) **47754**

(21) 3-2023-01338

(28) 1

(54) **LỌ**

(51) **09-01**

(22) 16/06/2023

(43) 25/08/2023

(73) **NGUYỄN THỊ THANH HUYỀN (VN)**

Liên kê 16-19, khu đô thị An Hưng, phường La Khê, quận Hà Đông, thành phố Hà Nội

(72) Nguyễn Thị Thanh Huyền (VN)

(55)

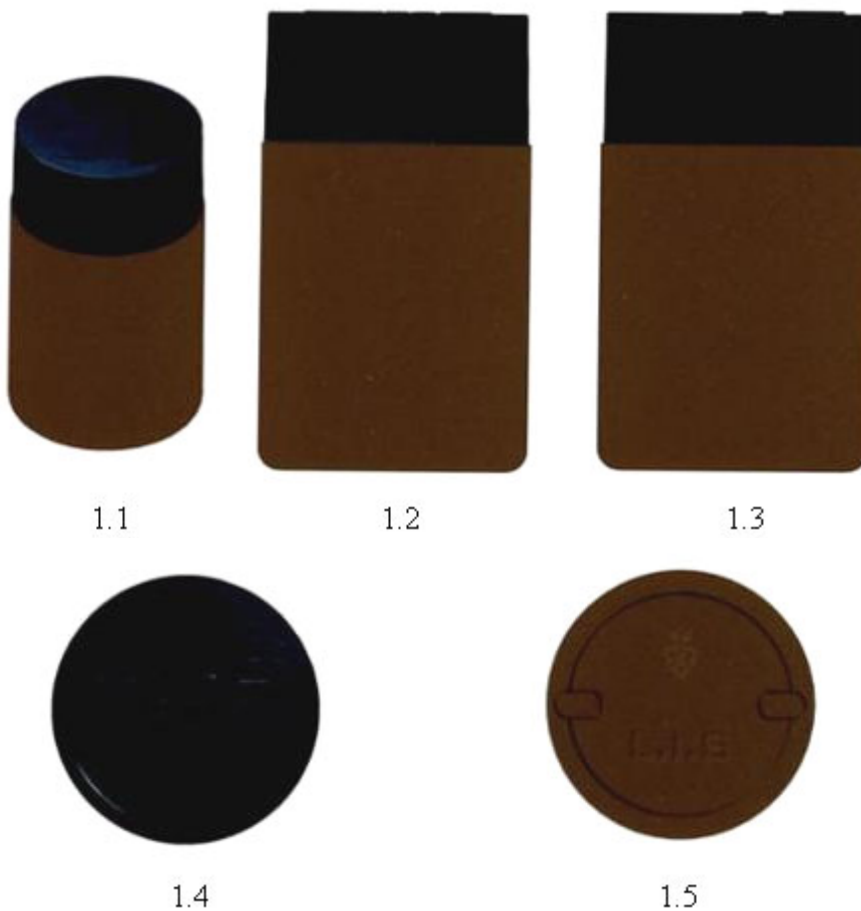

CÔNG BÁO SỞ HỮU CÔNG NGHIỆP SỐ 425 TẬP A – QUYỀN 2 (08.2023)

- (11) **47755**
(21) 3-2023-01339 (28) 1
(54) **HỘP** (51) **09-03**
(22) 16/06/2023 (43) 25/08/2023
(73) **ORION CORPORATION (KR)**
13, Baekbeom-ro 90da-gil, Yongsan-gu, Seoul 04369, Republic of Korea
(72) 1. NOH, SU BEEN (KR)
2. LEE, A REUM (KR)
(74) Công ty Luật TNHH quốc tế BMVN (BMVN INTERNATIONAL LLC)
(55)



1.1



1.2

CÔNG BÁO SỞ HỮU CÔNG NGHIỆP SỐ 425 TẬP A – QUYỀN 2 (08.2023)

- (11) **47756**
(21) 3-2023-01341 (28) 1
(54) **BAO GÓI** (51) **09-05**
(22) 16/06/2023 (43) 25/08/2023
(73) **ORION CORPORATION (KR)**
13, Baekbeom-ro 90da-gil, Yongsan-gu, Seoul 04369, Republic of Korea
(72) 1. LEE, A REUM (KR)
2. LEE, SEUNG JU (KR)
(74) Công ty Luật TNHH quốc tế BMVN (BMVN INTERNATIONAL LLC)
(55)



1.1



1.2

CÔNG BÁO SỞ HỮU CÔNG NGHIỆP

Do Cục Sở hữu trí tuệ thuộc Bộ Khoa học và Công nghệ ấn hành theo Luật Sở hữu trí tuệ số 50/2005/QH11 được Quốc hội thông qua ngày 29 tháng 11 năm 2005 và được sửa đổi bằng Luật sửa đổi, bổ sung một số điều của Luật sở hữu trí tuệ số 50/2005/QH11 được Quốc hội thông qua ngày 19 tháng 6 năm 2009.

Địa chỉ liên hệ:

384-386 đường Nguyễn Trãi, quận Thanh Xuân,
thành phố Hà Nội, Việt Nam
ĐT: 024. 38583069
Fax: 024. 38588449