

CỘNG HÒA XÃ HỘI CHỦ NGHĨA VIỆT NAM
BỘ KHOA HỌC VÀ CÔNG NGHỆ

CỤC SỞ HỮU TRÍ TUỆ

CÔNG BÁO
SỞ HỮU CÔNG NGHIỆP

TẬP A

QUYỂN 2: KIỂU DÁNG CÔNG NGHIỆP

07 - 2023

424

CỘNG HOÀ XÃ HỘI CHỦ NGHĨA VIỆT NAM
BỘ KHOA HỌC VÀ CÔNG NGHỆ
CỤC SỞ HỮU TRÍ TUỆ

CÔNG BÁO
SỞ HỮU CÔNG NGHIỆP
TẬP A

QUYỂN 2: KIỂU DÁNG CÔNG NGHIỆP

07 - 2023

424

HÀ NỘI

MỤC LỤC

	Trang
<u>PHẦN I:</u> Đơn yêu cầu cấp Bằng độc quyền kiểu dáng công nghiệp	7
<u>PHẦN II:</u> Sửa đổi đơn	566

CONTENTS

<u>PART I:</u> Applications for Industrial Design Patents	7
<u>PART II:</u> Amendment of Applications	566

CÔNG BÁO SỞ HỮU CÔNG NGHIỆP SỐ 424 TẬP A - QUYỂN 2 (07.2023)

MÃ SỐ HAI CHỮ CÁI THỂ HIỆN TÊN NƯỚC VÀ CÁC THỰC THỂ KHÁC TRONG CÁC TƯ LIỆU SỞ HỮU CÔNG NGHIỆP THEO TIÊU CHUẨN ST3 CỦA WIPO

AE	United Arab Emirates	CN	China	HK	Hong Kong
AF	Afganistan	CO	Colombia	HN	Honduras
AG	Antihua and Barbuda	CR	Costa Rica	HR	Croatia
AI	Anguilla	CU	Cuba	HT	Haiti
AL	Albania	CV	Cape Verde	HU	Hungary
AN	Netherlands Antilles	CY	Cyprus	ID	Indonesia
AO	Angola	CZ	Czech Republic	IE	Ireland
AR	Argentina	DE	Germany	IL	Israel
AT	Austria	DJ	Djibouti	IN	India
AU	Australia	DK	Denmark	IQ	Iraq
AW	Aruba	DM	Dominica	IR	Iran (Islamic Republic of)
BB	Barbados	DO	Dominican Republic	IS	Iceland
BD	Bangladesh	DZ	Algeria	IT	Italy
BE	Belgium	EC	Ecuador	JM	Jamaica
BF	Burkina Faso	EE	Estonia	JO	Jordan
BG	Bulgaria	EG	Egypt	JP	Japan
BH	Bahrain	ES	Spain	KE	Kenya
BI	Burundi	ET	Ethiopia	KH	Cambodia
BJ	Benin	FI	Finland	KI	Kiribati
BM	Bermuda	FJ	Fiji	KM	Comoros
BN	Brunei Darussalam	FK	Falkand Islands (Malvinas)	KN	Saint Kitts and Nevis
BO	Bolivia	FR	France	KP	Democratic People's Republic of Korea
BR	Brazil	GA	Gabon	KR	Republic of Korea
BS	Bahamas	GB	United Kingdom	KW	Kuwait
BT	Bhutan	GD	Grenada	KY	Cayman Islands
BW	Botswana	GE	Georgia	KZ	Kazakhstan
BY	Belarus	GH	Ghana	LA	Laos
BZ	Belize	GI	Gibraltar	LB	Lebanon
CA	Canada	GM	Gambia	LC	Saint Lucia
CF	Central African Republic	GN	Guinea	LI	Liechtenstein
CG	Congo	GQ	Equatorial Guinea	LK	SriLanka
CH	Switzerland	GR	Greece	LR	Liberia
CI	Côte d'Ivoire	GT	Guatemala	LS	Lesotho
CL	Chile	GW	Guinea-Bissau	LT	Lithuania
CM	Cameroon	GY	Guyana	TC	Turk and Caicos Islands
LU	Luxembourg	PA	Panama	TD	Chad
LV	Latvia	PE	Peru	TG	Togo
LY	Lybya	PG	Papua New Guinea	TH	Thailand
MA	Morocco	PH	Philippines	TN	Tunisia
MC	Monaco	PK	Pakistan	TO	Tonga
MD	Republic of Moldova	PL	Poland	TR	Turkey

CÔNG BÁO SỞ HỮU CÔNG NGHIỆP SỐ 424 TẬP A - QUYỂN 2 (07.2023)

MG	Madagascar	PT	Portugal	TT	Trinidad and Tobago
ML	Mali	PY	Paraguay	TV	Tuvalu
MM	Myanmar	QA	Qatar	TW	Taiwan, Province of China
MN	Mongolia	RO	Rumania	TZ	United Republic of Tanzania
MO	Macau	RU	Russian Federation	UA	Ukraine
MR	Mauritania	RW	Rwanda	UG	Uganda
MS	Montserrat	SA	Saudi Arabia	US	United States of America
MT	Malta	SB	Solomon Islands	UY	Uruguay
MU	Mauritius	SC	Seychelles	UZ	Uzbekistan
MV	Maldives	SD	Sudan	VA	Holy see
MW	Malawi	SE	Sweden	VC	Saint Vincent and the Grenadines
MX	Mexico	SG	Singapore	VE	Venezuela
MY	Malaysia	SH	Saint Helena	VG	Virgin Islands (British)
MZ	Mozambique	SL	Slovenia	VN	Vietnam
NA	Namibia	SK	Slovakia	VU	Vanuatu
NE	Niger	SL	Sierra Leone	WS	Samoa
NG	Nigeria	SM	San Marino	YE	Yemen
NJ	Nicaragua	SN	Senegal	YU	Yugoslavia
NL	Netherlands	SO	Somalia	ZA	South Africa
NO	Norway	SR	Suriname	ZM	Zambia
NP	Nepal	ST	Sao Tome and Principe	ZR	Zaire
NR	Nauru	SV	El Sanvador	ZW	Zimbabwe
NZ	New Zealand	SY	Syria		
OM	Oman	SZ	Swaziland		

CÁC TỔ CHỨC QUỐC TẾ

AO	African Intellectual Property Organization (OAPI)
AP	African Regional Industrial Property Organization (ARIPO)
BX	Benelux Trademark Office and Benelux Designs Office
EP	European Patent Office (EPO)
IB, WO	International Bureau of the World Intellectual Property Organization (WIPO)

NHỮNG MÃ SỐ INID TRÍCH TỪ TIÊU CHUẨN ST80 CỦA TỔ CHỨC SỞ HỮU TRÍ TUỆ THẾ GIỚI (WIPO) ĐỂ NHẬN BIẾT CÁC DỮ LIỆU THƯ MỤC DÙNG CÔNG BỐ ĐƠN VÀ BẰNG ĐỘC QUYỀN KIỂU DÁNG CÔNG NGHIỆP

- (11) Số bằng độc quyền kiểu dáng công nghiệp / Số công bố đơn
- (15) Ngày cấp
- (18) Ngày hết hạn hiệu lực của bằng độc quyền kiểu dáng công nghiệp
- (21) Số đơn
- (22) Ngày nộp đơn
- (23) Tên triển lãm, ngày và nơi triển lãm
- (28) Số phương án yêu cầu bảo hộ
- (30) Số đơn ưu tiên, ngày nộp đơn ưu tiên
- (43) Ngày công bố đơn
- (45) Ngày công bố bằng độc quyền kiểu dáng công nghiệp
- (51) Phân loại quốc tế kiểu dáng công nghiệp
- (54) Tên sản phẩm mang kiểu dáng công nghiệp
- (55) Ảnh chụp / hình vẽ kiểu dáng công nghiệp
- (57) Đặc điểm khác biệt yêu cầu bảo hộ của kiểu dáng công nghiệp
- (62) Số và ngày nộp đơn, số bằng độc quyền KDCN hoặc số công bố đơn liên quan đến tách đơn
- (71) Tên và địa chỉ của người nộp đơn
- (72) Tên của tác giả KDCN
- (73) Tên, địa chỉ của chủ bằng độc quyền KDCN
- (74) Tên của người đại diện SHCN

PHẦN I

ĐƠN YÊU CẦU CẤP BẰNG ĐỘC QUYỀN KIỂU DÁNG CÔNG NGHIỆP

- (11) **47224**
(21) 3-2023-00690 (28) 1
(54) **TUÝP ĐỰNG MỸ PHẨM** (51) **09-05**
(22) 30/03/2023 (43) 25/07/2023
(73) **CÔNG TY TNHH ĐẦU TƯ THƯƠNG MẠI DỊCH VỤ BẠCH VŨ (VN)**
Căn Sor 334 đường Sorrento 3, Địa Trung Hải, phường An Thới, thành phố Phú Quốc, tỉnh Kiên Giang
(72) Bạch Thanh Tùng (VN)
(55)



1.1



1.2



1.3



1.4



1.5



1.6

CÔNG BÁO SỞ HỮU CÔNG NGHIỆP SỐ 424 TẬP A – QUYỀN 2 (07.2023)

- (11) **47225**
(21) 3-2023-00691
(54) **LỌ MỸ PHẨM**
(22) 30/03/2023
(73) **CÔNG TY TNHH ĐẦU TƯ THƯƠNG MẠI DỊCH VỤ BẠCH VŨ (VN)**
Căn số 334 đường Sorrento 3, Địa Trung Hải, phường An Thới, thành phố Phú Quốc, tỉnh Kiên Giang
(72) Bạch Thanh Tùng (VN)
(55)
(28) 1
(51) **09-01**
(43) 25/07/2023



1.1



1.2



1.3

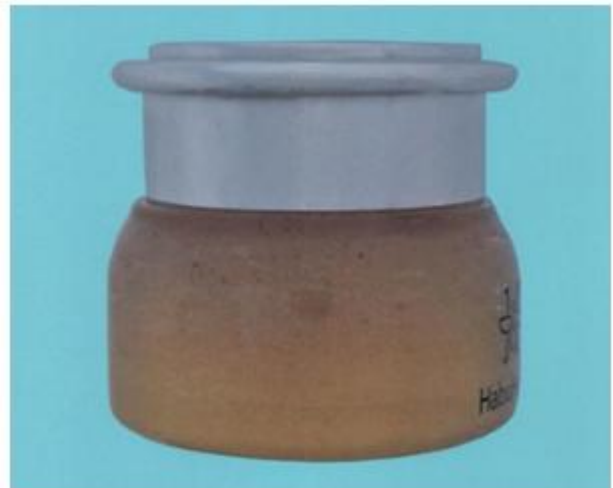

1.4



1.5

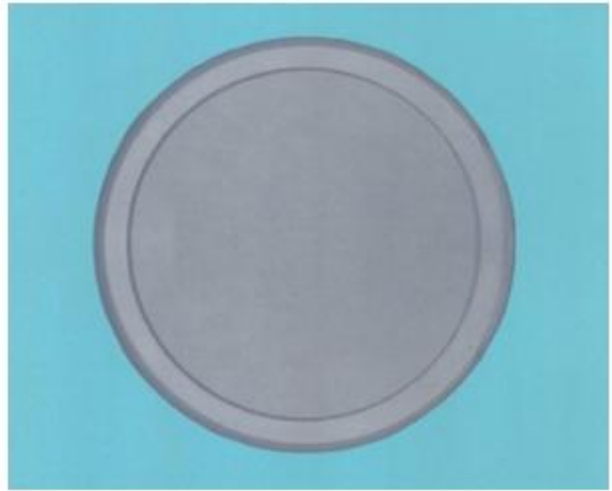

1.6

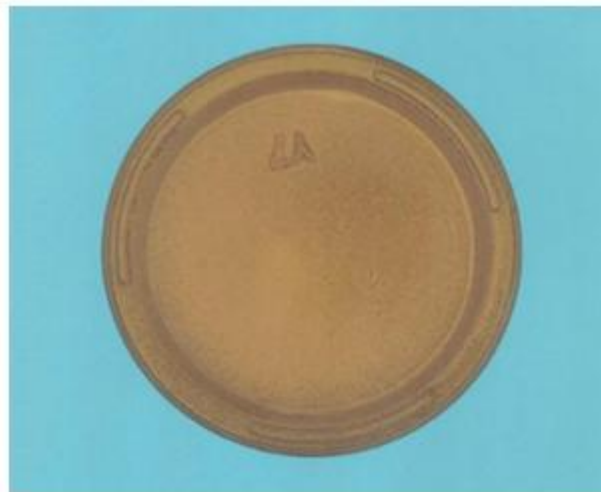

1.7

CÔNG BÁO SỞ HỮU CÔNG NGHIỆP SỐ 424 TẬP A – QUYỀN 2 (07.2023)

- (11) **47226**
(21) 3-2023-00748 (28) 1
(54) **MŨ BẢO HIỂM** (51) **02-03**
(22) 25/12/2020 (43) 25/07/2023
(30) 008035802 08/07/2020 EM;
(73) **LOCATELLI S.P.A. (IT)**
Via Della Resistenza, 5/A, 1-24030 Almenno San Bartolomeo (Bergamo), Italy
(72) LOCATELLI Antonio (IT)
(74) Công ty TNHH Sở hữu trí tuệ ALNGUYEN (ALNGUYEN IP CO.,LTD.)
(55)



1.1



1.2



1.3



1.4



1.5



1.6



1.7

CÔNG BÁO SỞ HỮU CÔNG NGHIỆP SỐ 424 TẬP A – QUYỀN 2 (07.2023)

- (11) 47227
(21) 3-2023-00757 (28) 1
(54) **LỌ MỸ PHẨM** (51) **09-01**
(22) 06/04/2023 (43) 25/07/2023
(73) **CÔNG TY TNHH ĐẦU TƯ THƯƠNG MẠI DỊCH VỤ BẠCH VŨ (VN)**
Căn Sor 334 đường Sorento 3, Địa Trung Hải, phường An Thới, thành phố Phú Quốc, tỉnh Kiên Giang
(72) Bạch Thanh Tùng (VN)
(55)



1.1



1.2



1.3



1.4



1.5



1.6

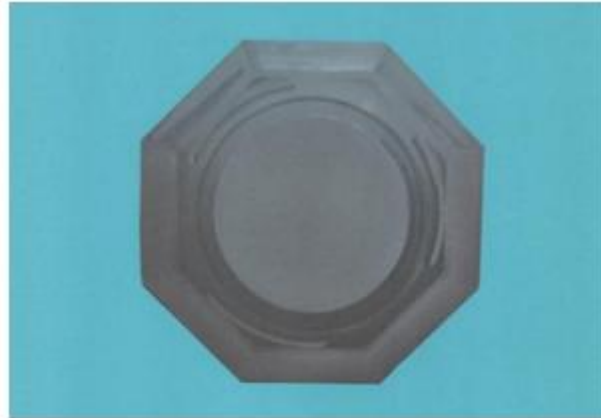

1.7

CÔNG BÁO SỞ HỮU CÔNG NGHIỆP SỐ 424 TẬP A – QUYỀN 2 (07.2023)

- (11) **47228**
(21) 3-2023-00927 (28) 2
(54) **KHAY CỬA TỦ LẠNH** (51) **15-07**
(22) 27/04/2023 (43) 25/07/2023
(73) **ARCELIK HITACHI HOME APPLIANCES (THAILAND) LIMITED (TH)**
No. 610/1, Mu 9, Nong Ki Sub-district, Kabin Buri District, Prachin Buri Province,
THAILAND
(72) Ali Ihsan Incukur (TR)
(74) Công ty Luật TNHH T&G (TGVN)
(55)



1.1



1.2



1.3



1.4



1.5



1.6



1.7



1.8



2.1



2.2



2.3

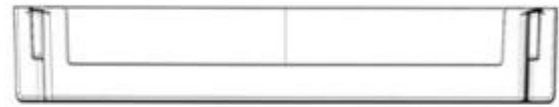

2.4



2.5



2.6



2.7

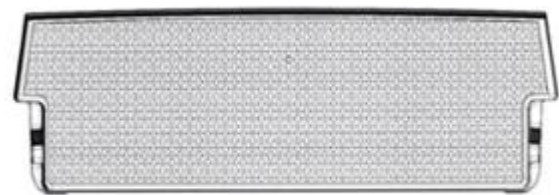

2.8

CÔNG BÁO SỞ HỮU CÔNG NGHIỆP SỐ 424 TẬP A – QUYỀN 2 (07.2023)

- (11) **47229**
(21) 3-2023-00928 (28) 1
(54) **TAY CẦM TỬ LẠNH** (51) **15-07**
(22) 27/04/2023 (43) 25/07/2023
(73) **ARCELIK HITACHI HOME APPLIANCES (THAILAND) LIMITED (TH)**
No. 610/1, Mu 9, Nong Ki Sub-district, Kabin Buri District, Prachin Buri Province,
THAILAND
(72) Ali Ihsan Incukur (TR)
(74) Công ty Luật TNHH T&G (TGVN)
(55)



1.1



1.2

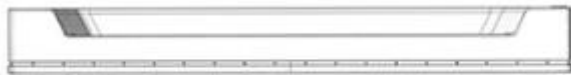

1.3



1.4



1.5



1.6



1.7



1.8

CÔNG BÁO SỞ HỮU CÔNG NGHIỆP SỐ 424 TẬP A – QUYỀN 2 (07.2023)

- (11) **47230**
(21) 3-2023-00929 (28) 1
(54) **KHAY ĐỰNG ĐÁ TỦ LẠNH** (51) **15-07**
(22) 27/04/2023 (43) 25/07/2023
(73) **ARCELIK HITACHI HOME APPLIANCES (THAILAND) LIMITED (TH)**
No. 610/1, Mu 9, Nong Ki Sub-district, Kabin Buri District, Prachin Buri Province,
THAILAND
(72) Ali Ihsan Incukur (TR)
(74) Công ty Luật TNHH T&G (TGVN)
(55)



1.1



1.2



1.3



1.4



1.5



1.6

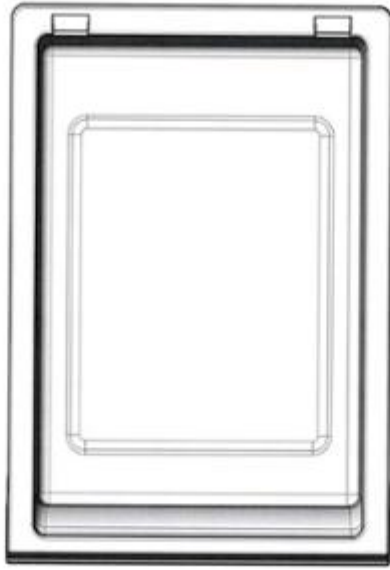

1.7



1.8

CÔNG BÁO SỞ HỮU CÔNG NGHIỆP SỐ 424 TẬP A – QUYỀN 2 (07.2023)

- (11) **47231**
(21) 3-2023-00769 (28) 1
(54) **HỘP LÀM NÓNG KHĂN** (51) **15-05**
(22) 06/04/2023 (43) 25/07/2023
(73) **SHENZHEN KEENRAY INNOVATIONS LIMITED (CN)**
901, Building 6, Phase II, Dongjiu Innovation Science Park, No. 73, Xiali South
Road, Xiali Lang Community, Nanwan Street, Longgang District, Shenzhen, China
(72) Wenfeng Peng (CN)
(74) Công ty TNHH Sáng chế ACTIP (ACTIP PATENT LIMITED)
(55)

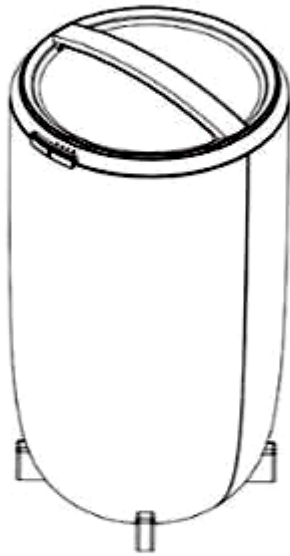

1.1

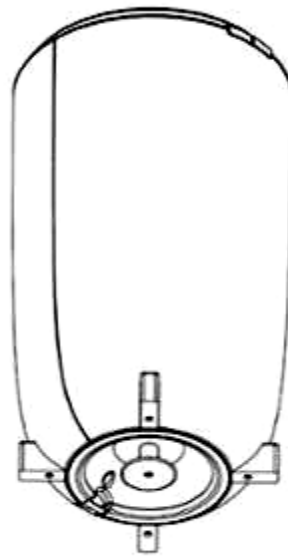

1.2

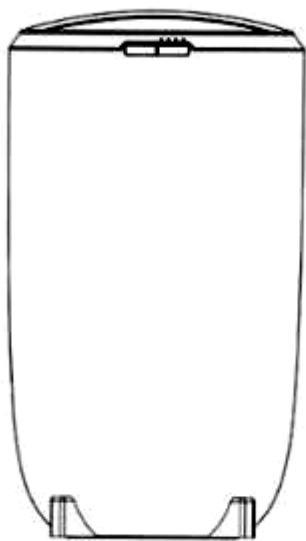

1.3



1.4

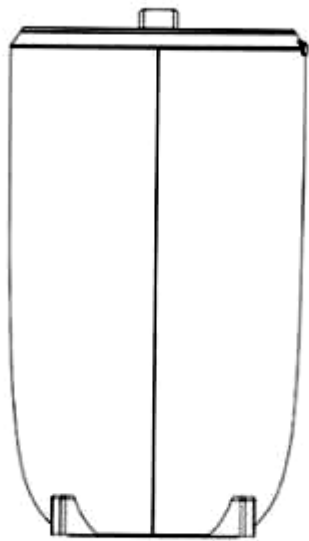

1.5

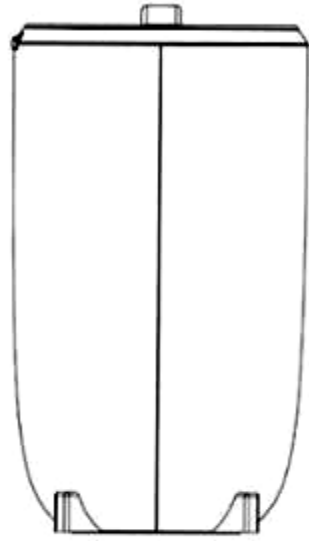

1.6



1.7

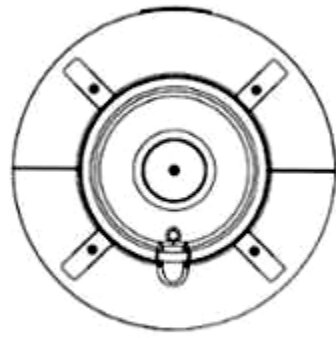

1.8

CÔNG BÁO SỞ HỮU CÔNG NGHIỆP SỐ 424 TẬP A – QUYỀN 2 (07.2023)

- (11) **47232**
(21) 3-2023-00770 (28) 1
(54) **HỘP LÀM NÓNG KHĂN** (51) **15-05**
(22) 06/04/2023 (43) 25/07/2023
(73) **SHENZHEN KEENRAY INNOVATIONS LIMITED (CN)**
901, Building 6, Phase II, Dongjiu Innovation Science Park, No. 73, Xiali South Road, Xiali Lang Community, Nanwan Street, Longgang District, Shenzhen, China
(72) Wenfeng Peng (CN)
(74) Công ty TNHH Sáng chế ACTIP (ACTIP PATENT LIMITED)
(55)



1.1



1.2

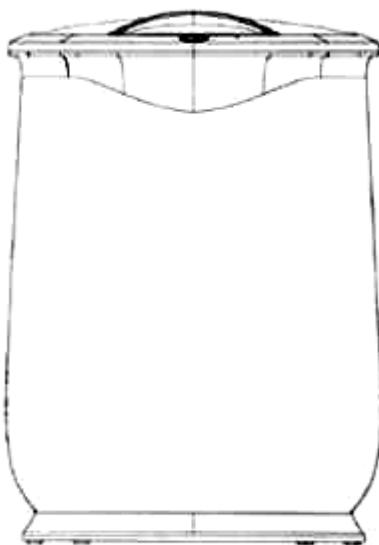

1.3



1.4

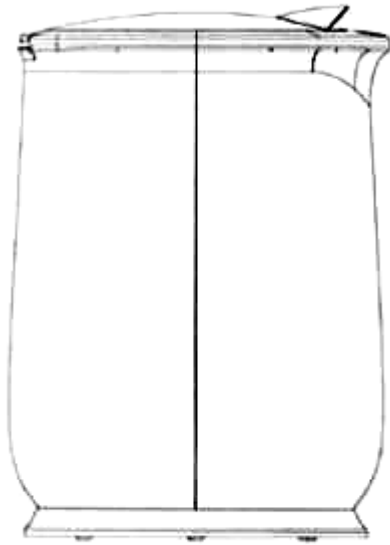

1.5

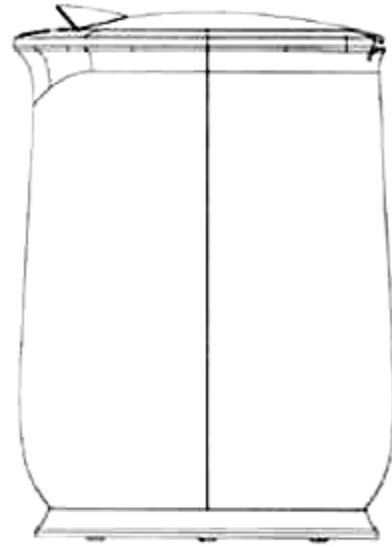

1.6

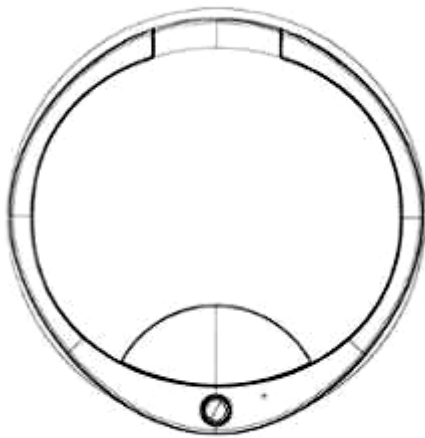

1.7

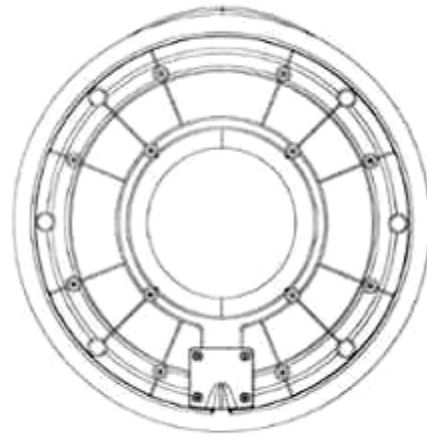

1.8

CÔNG BÁO SỞ HỮU CÔNG NGHIỆP SỐ 424 TẬP A – QUYỀN 2 (07.2023)

- (11) **47233**
(21) 3-2023-00923 (28) 1
(54) **NGĂN KÉO TỦ LẠNH** (51) **15-07**
(22) 27/04/2023 (43) 25/07/2023
(73) **ARCELIK HITACHI HOME APPLIANCES (THAILAND) LIMITED (TH)**
No. 610/1, Mu 9, Nong Ki Sub-district, Kabin Buri District, Prachin Buri Province,
THAILAND
(72) Ali Ihsan Incukur (TR)
(74) Công ty Luật TNHH T&G (TGVN)
(55)



1.1



1.2



1.3



1.4



1.5



1.6



1.7



1.8

CÔNG BÁO SỞ HỮU CÔNG NGHIỆP SỐ 424 TẬP A – QUYỀN 2 (07.2023)

- (11) **47234**
(21) 3-2023-00924 (28) 1
(54) **NGĂN LÀM MÁT CỦA TỦ LẠNH** (51) **15-07**
(22) 27/04/2023 (43) 25/07/2023
(73) **ARCELIK HITACHI HOME APPLIANCES (THAILAND) LIMITED (TH)**
No. 610/1, Mu 9, Nong Ki Sub-district, Kabin Buri District, Prachin Buri Province,
THAILAND
(72) Ali Ihsan Incukur (TR)
(74) Công ty Luật TNHH T&G (TGVN)
(55)



1.1



1.2



1.3



1.4

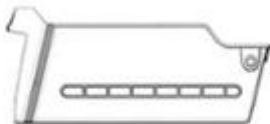

1.5

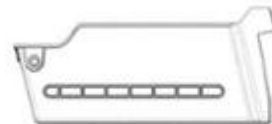

1.6



1.7



1.8

CÔNG BÁO SỞ HỮU CÔNG NGHIỆP SỐ 424 TẬP A – QUYỀN 2 (07.2023)

- (11) **47235**
(21) 3-2023-00925 (28) 1
(54) **KHAY CỬA NGĂN ĐÁ TỬ LẠNH** (51) **15-07**
(22) 27/04/2023 (43) 25/07/2023
(73) **ARCELIK HITACHI HOME APPLIANCES (THAILAND) LIMITED (TH)**
No. 610/1, Mu 9, Nong Ki Sub-district, Kabin Buri District, Prachin Buri Province,
THAILAND
(72) Ali Ihsan Incukur (TR)
(74) Công ty Luật TNHH T&G (TGVN)
(55)



1.1

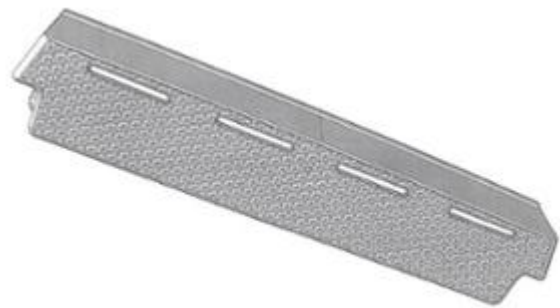

1.2

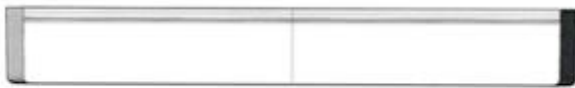

1.3



1.4



1.5



1.6



1.7



1.8

CÔNG BÁO SỞ HỮU CÔNG NGHIỆP SỐ 424 TẬP A – QUYỀN 2 (07.2023)

- (11) **47236**
(21) 3-2023-00926 (28) 1
(54) **KHAY CỬA TỦ LẠNH** (51) **15-07**
(22) 27/04/2023 (43) 25/07/2023
(73) **ARCELIK HITACHI HOME APPLIANCES (THAILAND) LIMITED (TH)**
No. 610/1, Mu 9, Nong Ki Sub-district, Kabin Buri District, Prachin Buri Province,
THAILAND
(72) Ali Ihsan Incukur (TR)
(74) Công ty Luật TNHH T&G (TGVN)
(55)



1.1



1.2



1.3



1.4



1.5



1.6



1.7



1.8

CÔNG BÁO SỞ HỮU CÔNG NGHIỆP SỐ 424 TẬP A – QUYỀN 2 (07.2023)

- (11) **47237**
(21) 3-2023-00535 (28) 3
(54) **BỘ BÁT ĐĨA** (51) **07-01**
(22) 13/03/2023 (43) 25/07/2023
(73) **CÔNG TY CỔ PHẦN GỐM SỨ TOÀN QUỐC (VN)**
KCN Gò Dầu, xã Phước Thái, huyện Long Thành, tỉnh Đồng Nai
(72) WU CHING YUAN (TW)
(55)



1.1



1.2



1.3



1.4



1.5



1.6



1.7



1.8



1.9



1.10



1.11



1.12



1.13



1.14

CÔNG BÁO SỞ HỮU CÔNG NGHIỆP SỐ 424 TẬP A – QUYỀN 2 (07.2023)

(11) **47238**

(21) 3-2023-00907

(54) **CHẢO**

(22) 25/04/2023

(73) **CÔNG TY TNHH GIA PHÁT THỊNH PHÚ (VN)**

Áp 5 đường số 8, xã Đức Hòa Đông, huyện Đức Hòa, tỉnh Long An

(72) Huỳnh Chí Dũng (VN)

(55)

(28) 1

(51) **07-02**

(43) 25/07/2023



1.1



1.2



1.3



1.4



1.5



1.6

CÔNG BÁO SỞ HỮU CÔNG NGHIỆP SỐ 424 TẬP A – QUYỀN 2 (07.2023)

- (11) **47239**
(21) 3-2023-00541 (28) 1
(54) **MÁY BÁN HÀNG TỰ ĐỘNG** (51) **20-01**
(22) 13/03/2023 (43) 25/07/2023
(73) **CÔNG TY TNHH TẬP ĐOÀN TIHM (VN)**
Lầu 19, tòa nhà Indochina Park, số 4 Nguyễn Đình Chiểu, phường Đa Kao, quận 1,
thành phố Hồ Chí Minh
(72) 1. PHẠM HOÀNG THỨC (VN)
2. PHẠM AN NHÀN (VN)
(74) Công ty Luật TNHH bản quyền Quốc tế (CIS LAW FIRM)
(55)

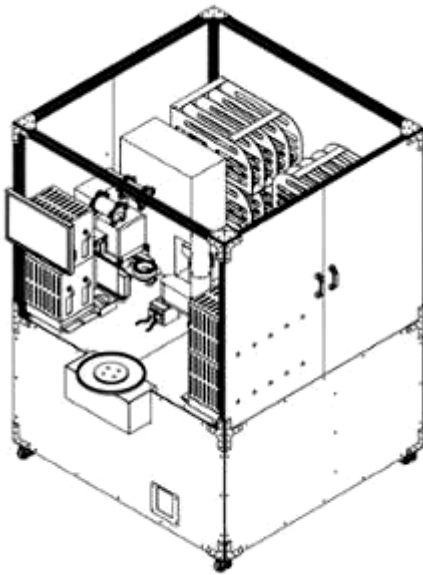

1.1

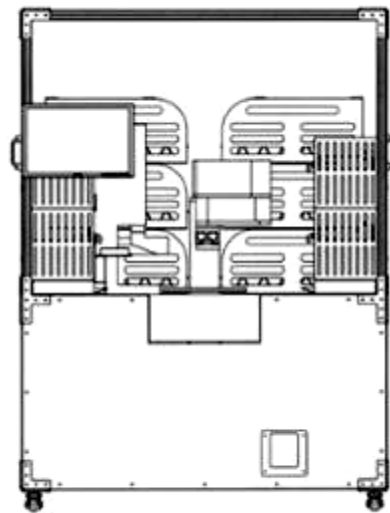

1.2

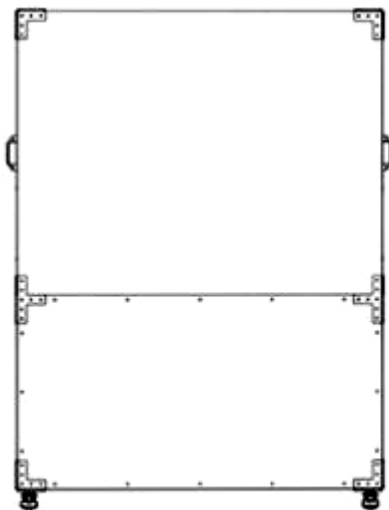

1.3

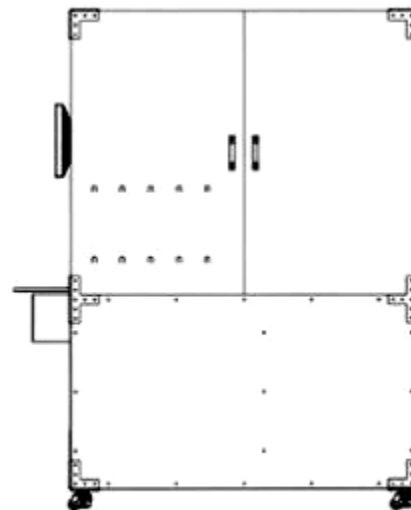

1.4

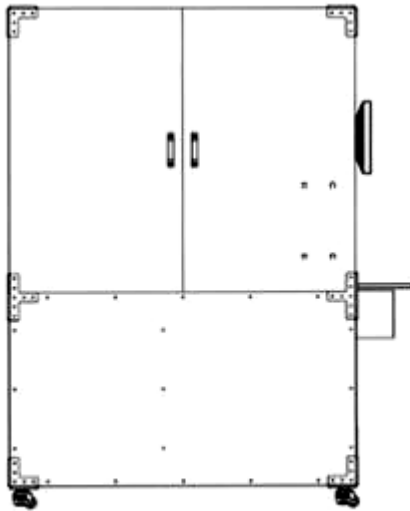

1.5

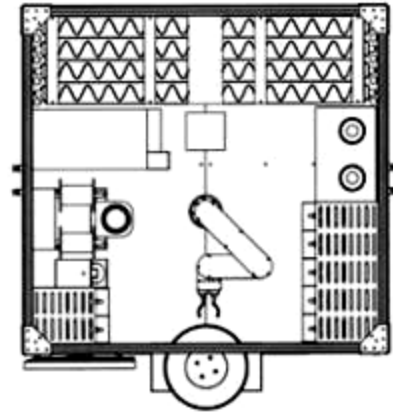

1.6

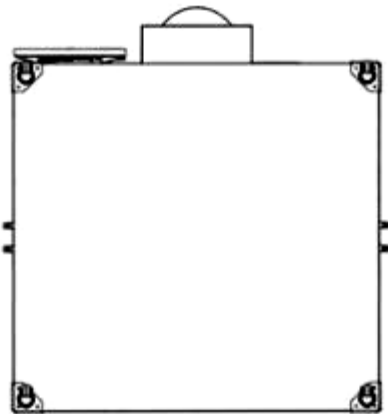

1.7

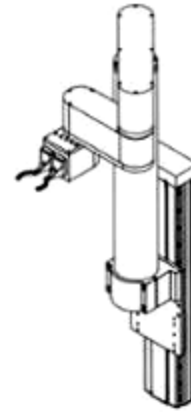

1.8

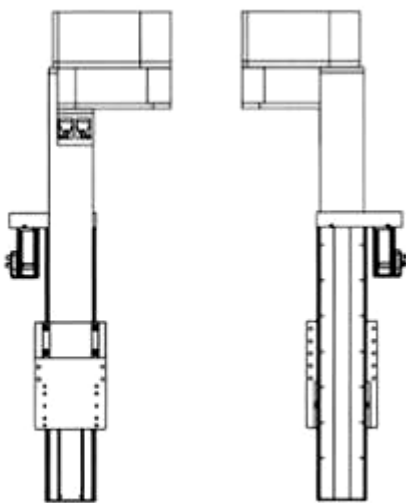

1.9

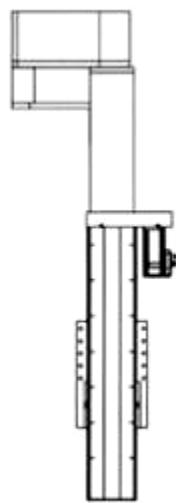

1.10

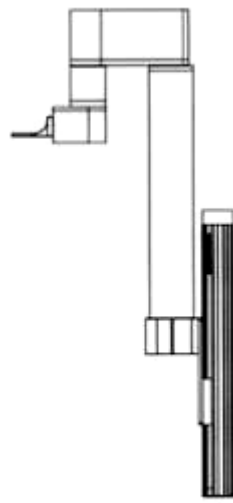

1.11

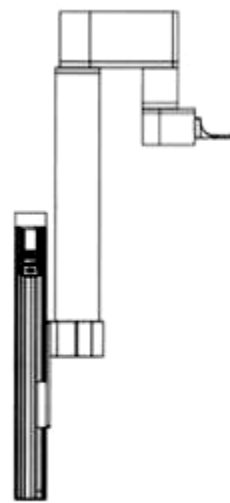

1.12

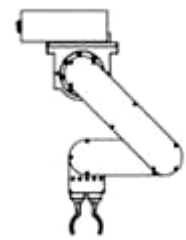

1.13



1.14

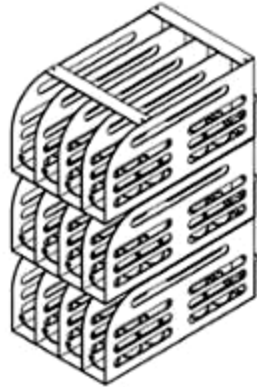

1.15

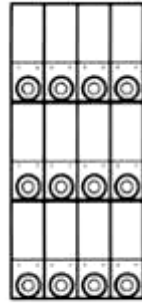

1.16



1.17

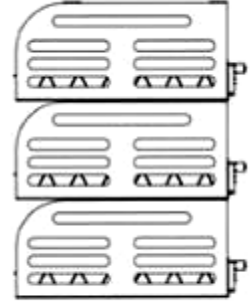

1.18

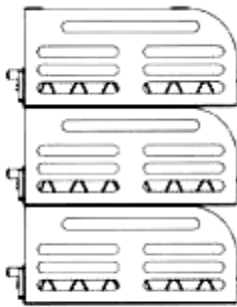

1.19

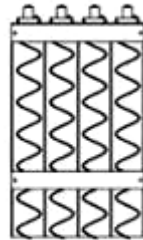

1.20



1.21

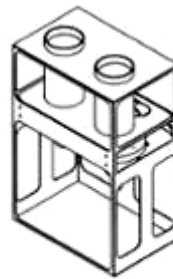

1.22

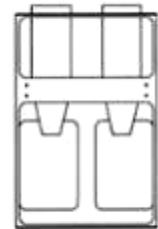

1.23

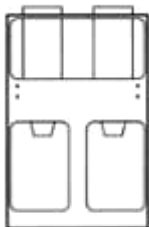

1.24

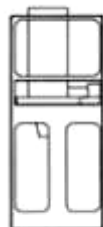

1.25

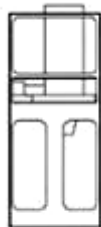

1.26



1.27



1.28

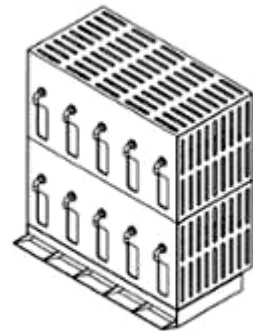

1.29

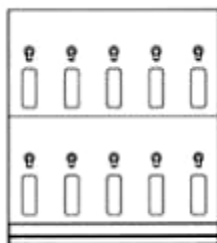

1.30

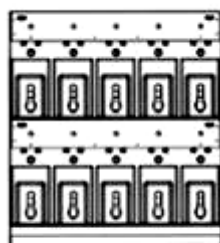

1.31

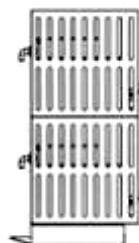

1.32



1.33

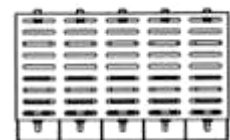

1.34

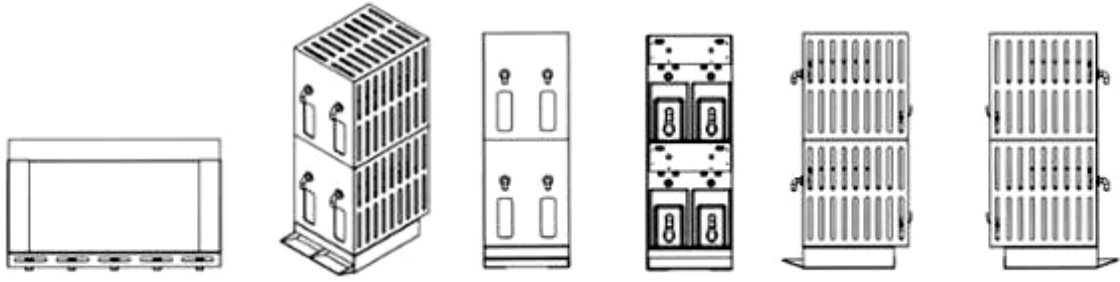

1.35

1.36

1.37

1.38

1.39

1.40

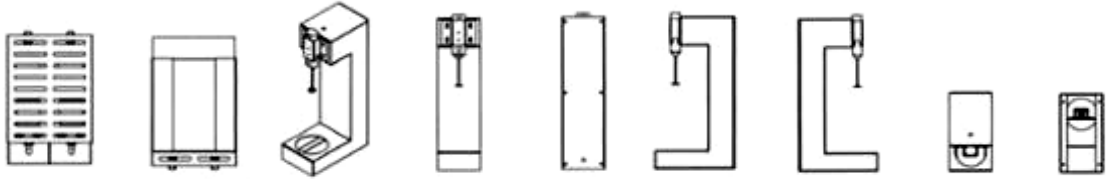

1.41

1.42

1.43

1.44

1.45

1.46

1.47

1.48

1.49

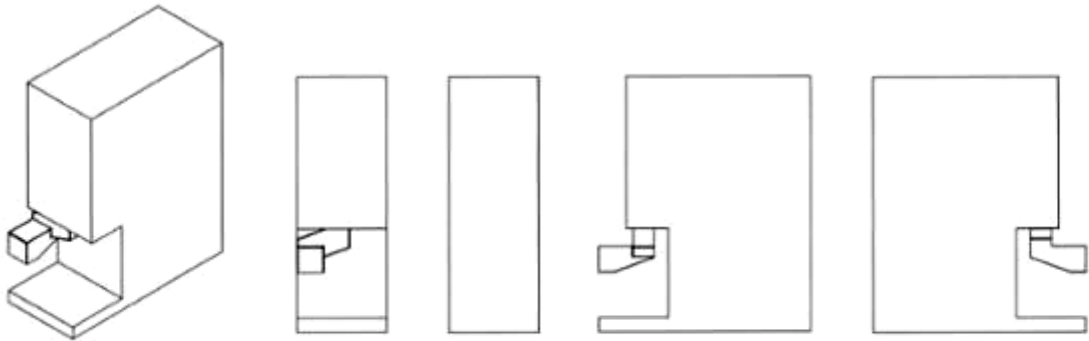

1.50

1.51

1.52

1.53

1.54

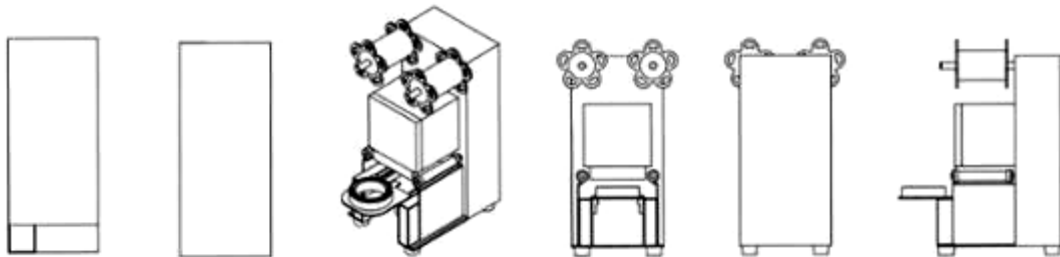

1.55

1.56

1.57

1.58

1.59

1.60

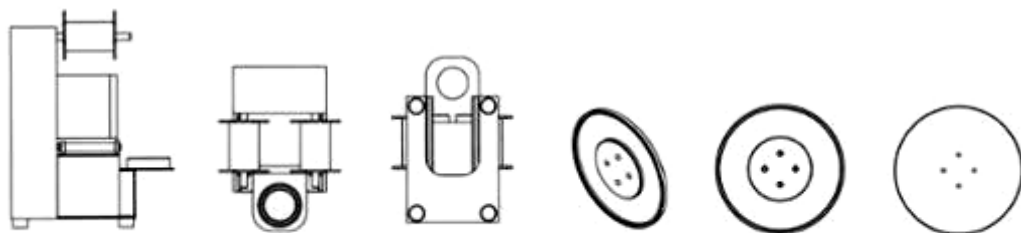

1.61

1.62

1.63

1.64

1.65

1.66



1.67



1.69



1.68



1.70

CÔNG BÁO SỞ HỮU CÔNG NGHIỆP SỐ 424 TẬP A – QUYỀN 2 (07.2023)

- (11) **47240**
(21) 3-2023-00191 (28) 1
(54) **GIƯỜNG** (51) **06-07**
(22) 19/01/2023 (43) 25/07/2023
(30) 009098064-0005 27/07/2022 EM;
(73) **HANS GROHE SE (DE)**
Austr. 5-9, 77761 Schiltach, Germany
(72) 1. ANDREAS DIEFENBACH (DE)
2. DAVID SAMUEL WEISKOPF (AT)
(74) Công ty TNHH Trường Xuân (AGELESS CO.,LTD.)
(55)

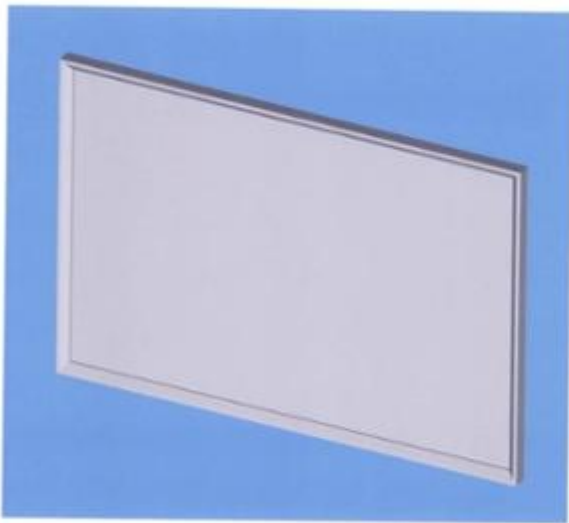

1.1

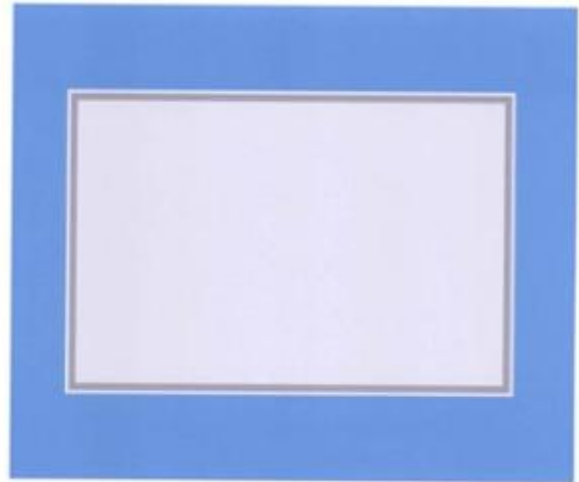

1.2

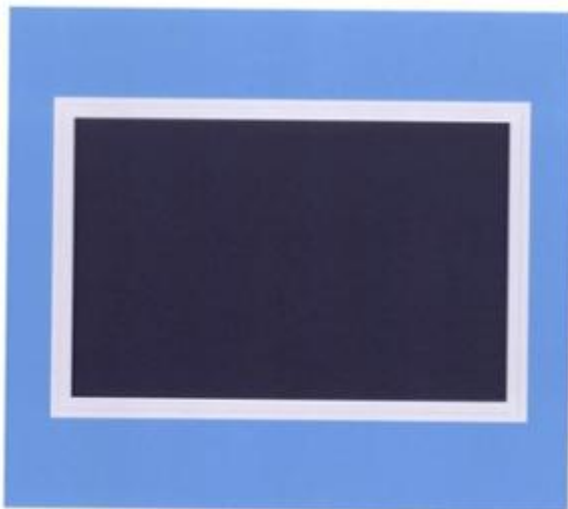

1.3



1.4



1.5



1.6



1.7

- (11) **47241**
(21) 3-2023-00192 (28) 1
(54) **GIƯỜNG** (51) **06-07**
(22) 19/01/2023 (43) 25/07/2023
(30) 009098064-0006 27/07/2022 EM;
(73) **HANS GROHE SE (DE)**
Austr. 5-9, 77761 Schiltach, Germany
(72) 1. ANDREAS DIEFENBACH (DE)
2. DAVID SAMUEL WEISKOPF (AT)
(74) Công ty TNHH Trường Xuân (AGELESS CO.,LTD.)
(55)

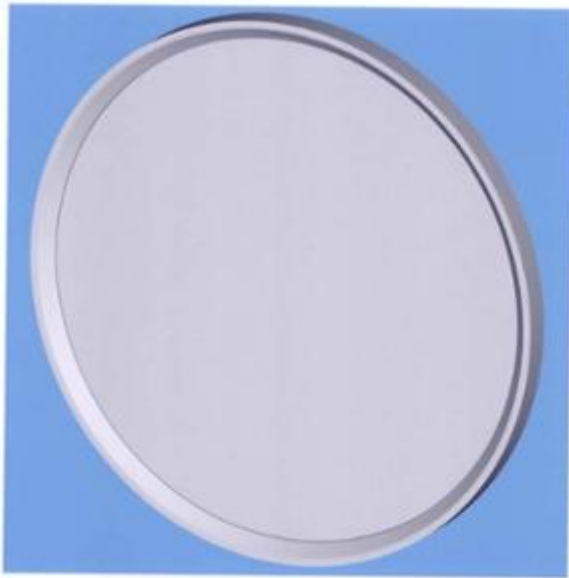

1.1

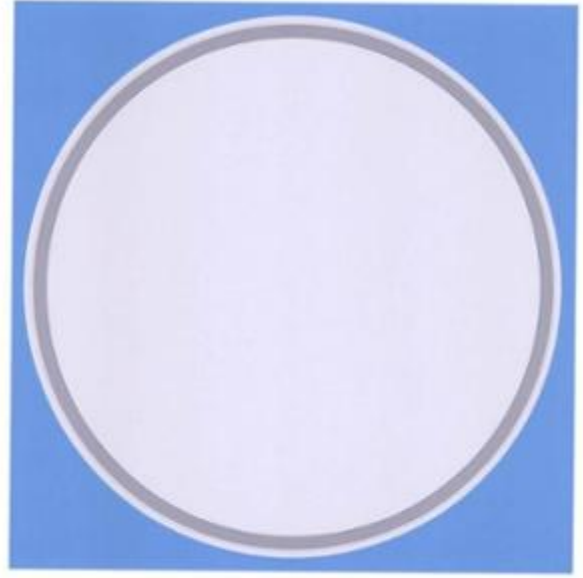

1.2



1.3



1.4



1.5



1.6



1.7

CÔNG BÁO SỞ HỮU CÔNG NGHIỆP SỐ 424 TẬP A – QUYỀN 2 (07.2023)

- (11) **47242**
(21) 3-2023-00190 (28) 1
(54) **GIƯỜNG** (51) **06-07**
(22) 19/01/2023 (43) 25/07/2023
(30) 009098064-0004 27/07/2022 EM;
(73) **HANS GROHE SE (DE)**
Austr. 5-9, 77761 Schiltach, Germany
(72) 1. ANDREAS DIEFENBACH (DE)
2. DAVID SAMUEL WEISKOPF (AT)
(74) Công ty TNHH Trường Xuân (AGELESS CO.,LTD.)
(55)

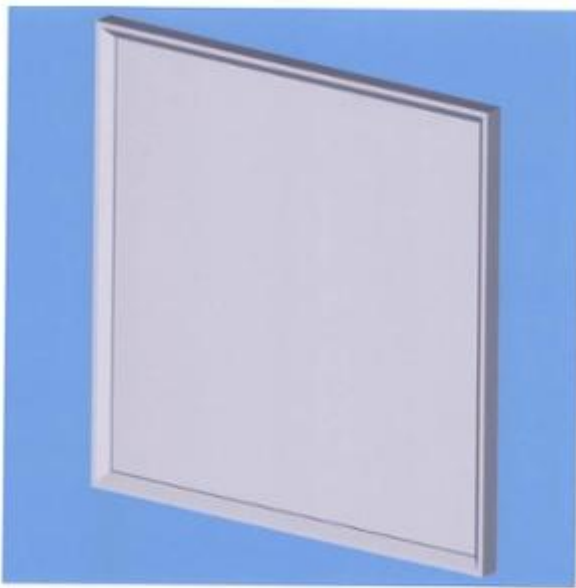

1.1



1.2

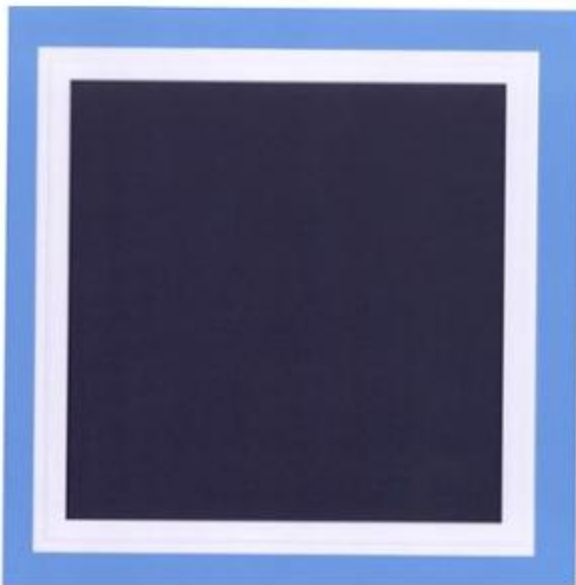

1.3



1.4



1.5



1.6



1.7

CÔNG BÁO SỞ HỮU CÔNG NGHIỆP SỐ 424 TẬP A – QUYỀN 2 (07.2023)

- (11) **47243**
(21) 3-2023-00830 (28) 1
(54) **CHAI** (51) **09-01**
(22) 12/04/2023 (43) 25/07/2023
(73) **CÔNG TY TNHH NAM PHƯƠNG V.N (VN)**
124 Lê Lai, phường 03, quận Gò Vấp, thành phố Hồ Chí Minh
(72) Hoàng Thị Minh Hiếu (VN)
(74) Công ty Luật TNHH Phạm và Liên danh (PHAM & ASSOCIATES)
(55)



1.1



1.2



1.3



1.4

CÔNG BÁO SỞ HỮU CÔNG NGHIỆP SỐ 424 TẬP A – QUYỀN 2 (07.2023)

- (11) **47244**
(21) 3-2023-00849 (28) 1
(54) **CHAI** (51) **09-01**
(22) 14/04/2023 (43) 25/07/2023
(73) **CÔNG TY CỔ PHẦN THỦY SẢN ĐẠI YÊN (VN)**
Tổ 3, khu Yên Cư, phường Đại Yên, thành phố Hạ Long, tỉnh Quảng Ninh
(72) Dương Thanh Liêm (VN)
(74) Công ty Luật TNHH VIETTHINK (VIETTHINK LAW FIRM)
(55)



1.1



1.2



1.3



1.4



1.5



1.6



1.7

CÔNG BÁO SỞ HỮU CÔNG NGHIỆP SỐ 424 TẬP A – QUYỀN 2 (07.2023)

- (11) **47245**
(21) 3-2023-00899 (28) 1
(54) **THIẾT BỊ GIÚP GIẢM TIẾNG ĐỘNG VÀ HÚT MÙI BỒN CẦU** (51) **23-02**
(22) 21/04/2023 (43) 25/07/2023
(73) **VŨ MINH VƯƠNG (VN)**
Số 28, ngõ 33, tổ 35, phố Lãng Yên, phường Thanh Lương, quận Hai Bà Trưng, thành phố Hà Nội
(72) Vũ Minh Vương (VN)
(55)



1.1



1.2

1.3



1.4



1.5

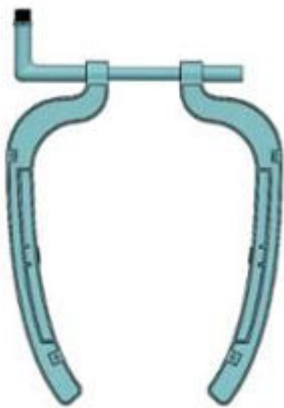

1.6

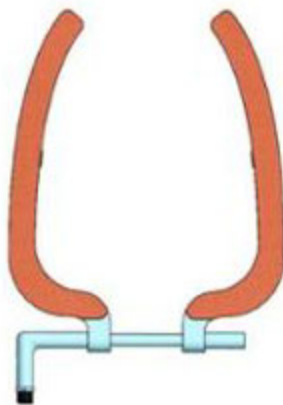

1.7

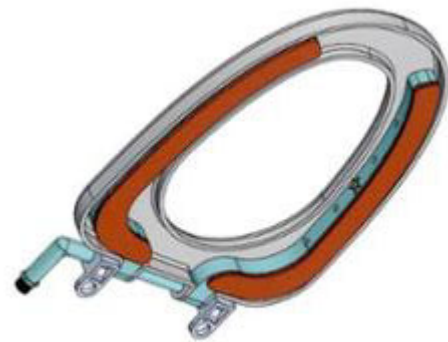

1.8

CÔNG BÁO SỞ HỮU CÔNG NGHIỆP SỐ 424 TẬP A – QUYỀN 2 (07.2023)

- (11) **47246**
(21) 3-2023-00864 (28) 1
(54) **THIẾT BỊ GIÚP GIẢM TIẾNG ĐỘNG VÀ HÚT MÙI BỒN CẦU** (51) **23-02**
(22) 17/04/2023 (43) 25/07/2023
(73) **VŨ MINH VƯƠNG (VN)**
Số 28, ngõ 33, tổ 35, phố Lãng Yên, phường Thanh Lương, quận Hai Bà Trưng, thành phố Hà Nội
(72) Vũ Minh Vương (VN)
(55)



1.1



1.2

1.3



1.4



1.5

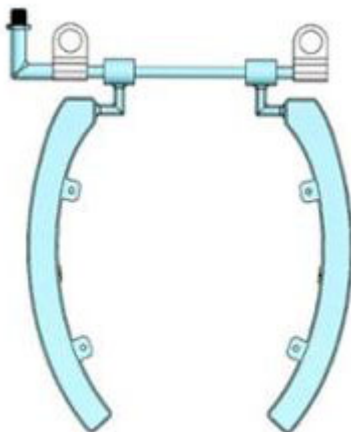

1.6

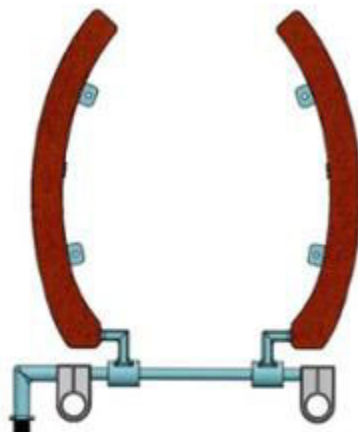

1.7



1.8

CÔNG BÁO SỞ HỮU CÔNG NGHIỆP SỐ 424 TẬP A – QUYỀN 2 (07.2023)

- (11) **47247**
(21) 3-2023-00903 (28) 1
(54) **THIẾT BỊ LỌC NƯỚC** (51) **23-01**
(22) 24/04/2023 (43) 25/07/2023
(73) **ĐÌNH VIẾT CƯỜNG (VN)**
55 Giải Phóng, quận Hai Bà Trưng, thành phố Hà Nội
(72) Đình Viết Cường (VN)
(55)

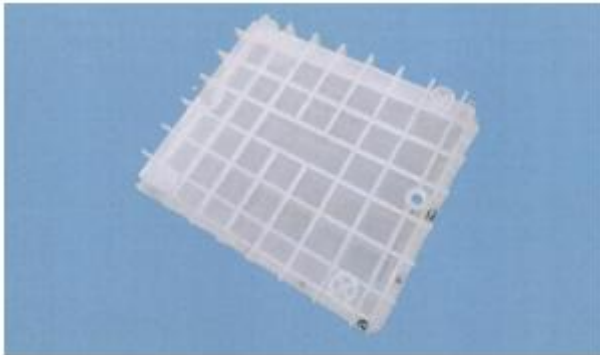

1.1



1.2



1.3



1.4

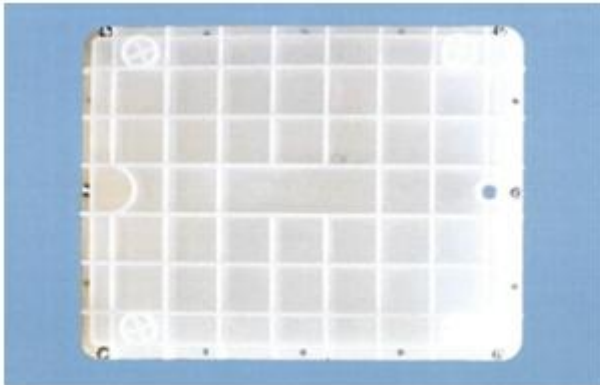

1.5

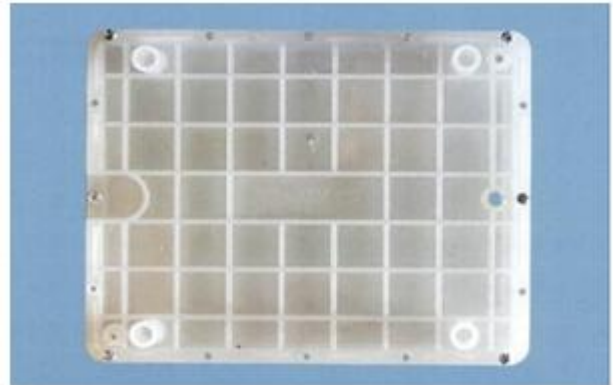

1.6

CÔNG BÁO SỞ HỮU CÔNG NGHIỆP SỐ 424 TẬP A – QUYỀN 2 (07.2023)

(11) **47248**

(21) 3-2023-00908

(28) 1

(54) **NỒI**

(51) **07-02**

(22) 25/04/2023

(43) 25/07/2023

(73) **CÔNG TY TNHH GIA PHÁT THỊNH PHÚ (VN)**

Áp 5 đường số 8, xã Đức Hòa Đông, huyện Đức Hòa, tỉnh Long An

(72) Huỳnh Chí Dũng (VN)

(55)



1.1



1.2



1.3



1.4



1.5

CÔNG BÁO SỞ HỮU CÔNG NGHIỆP SỐ 424 TẬP A – QUYỀN 2 (07.2023)

- (11) **47249**
(21) 3-2023-00900
(54) **QUẠT ĐEO CỔ**
(22) 21/04/2023
(73) **CÔNG TY TNHH BUMAS (VN)**
Số 1, ngách 247, ngõ 211 đường Khương Trung, phường Khương Đình, quận Thanh Xuân, thành phố Hà Nội
(72) Trương Tuấn Vũ (VN)
(55)
- (28) 1
(51) **23-04**
(43) 25/07/2023



1.1



1.2



1.3



1.4



1.5



1.6



1.7

CÔNG BÁO SỞ HỮU CÔNG NGHIỆP SỐ 424 TẬP A – QUYỀN 2 (07.2023)

- (11) 47250
(21) 3-2023-00947
(54) LON ĐỰNG SẢN PHẨM
(22) 28/04/2023
(73) CÔNG TY TNHH XNK NANOIL USA (VN)
Lô Q13 đường số 11, KCN Hải Sơn Mở Rộng (GD 3+4), xã Đức Hòa Hạ, huyện Đức Hòa, tỉnh Long An
(72) Mai Xuân Quang (VN)
(55)
- (28) 1
(51) 09-03
(43) 25/07/2023



1.1



1.2



1.3



1.4



1.5



1.6



1.7

- (11) **47251**
(21) 3-2023-00979 (28) 1
(54) **BẾP GA DI ĐỘNG** (51) **07-02**
(22) 04/05/2023 (43) 25/07/2023
(73) **DR. HOWS CO., LTD. (KR)**
97, Neunggil-ro, Danwon-gu, Ansan-si, Gyeonggi-do 15420 Republic of Korea
(72) 1. KIM, KYUNG BEOM (KR)
2. KIM, MIN CHEOL (KR)
3. KIM, MYEOUNG JUN (KR)
(74) CÔNG TY LUẬT TRÁCH NHIỆM HỮU HẠN AMBYS HÀ NỘI (AMBYS HANOI)
(55)

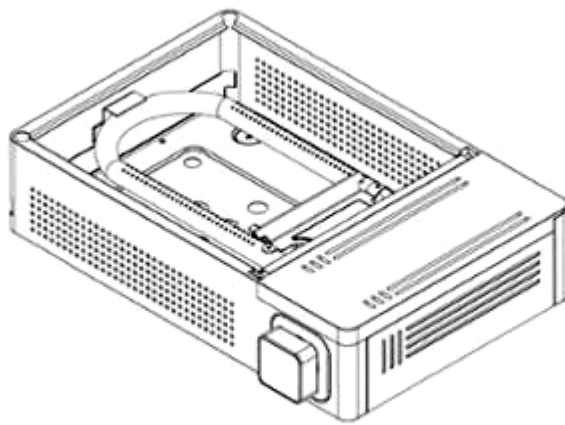

1.1

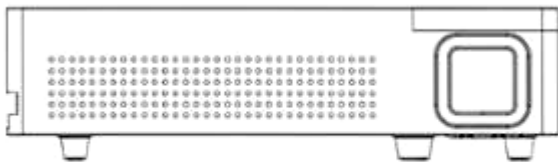

1.2

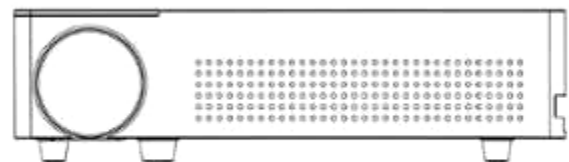

1.3

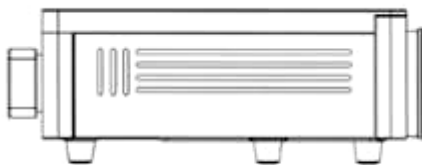

1.4

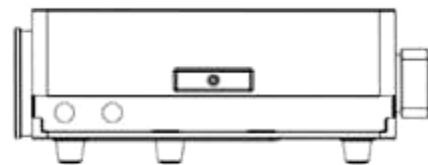

1.5

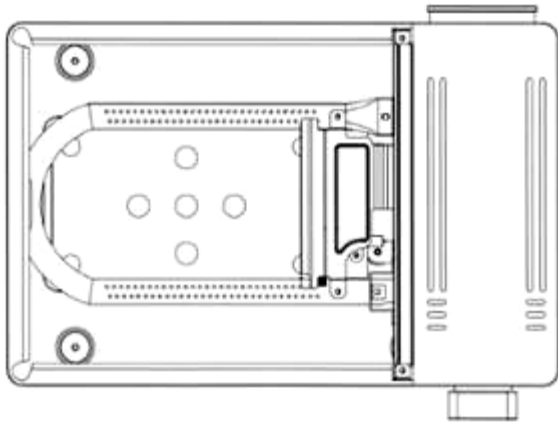

1.6

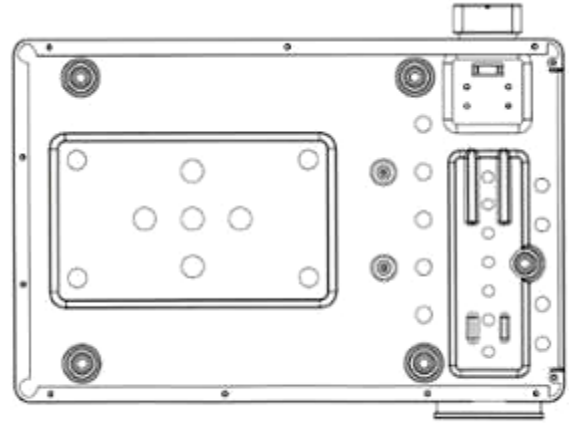

1.7

CÔNG BÁO SỞ HỮU CÔNG NGHIỆP SỐ 424 TẬP A – QUYỀN 2 (07.2023)

- (11) **47252**
(21) 3-2023-01037 (28) 1
(54) **LÈU** (51) **21-04**
(22) 15/05/2023 (43) 25/07/2023
(30) 015004084-0001 23/11/2022 EM;
(73) **DECATHLON (FR)**
4, Boulevard de Mons, F-59650 Villeneuve d'Ascq, France
(72) Céleste DERYCKE (FR)
(74) Công ty Luật TNHH T&G (TGVN)
(55)



1.1

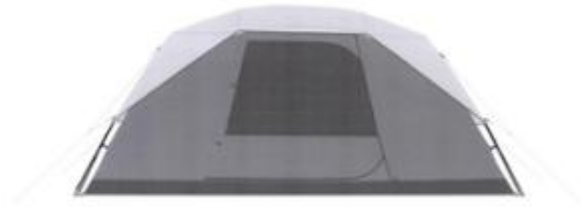

1.2



1.3



1.4



1.5



1.6



1.7

(11) **47253**

(21) 3-2023-01009

(28) 1

(54) **MŨ BẢO HIỂM**

(51) **02-03**

(22) 10/05/2023

(43) 25/07/2023

(73) **HENRY TEDJAKUSUMA (ID)**

Jalan Wuluh Blok II/3, RT/RW 009/006, Kota Bambu Utara, Palmerah Jakarta Barat 11420, Indonesia

(72) Henry Tedjakusuma (ID)

(74) Công ty TNHH Sở hữu trí tuệ HA VIP (HAVIP CO., LTD.)

(55)



1.1



1.2

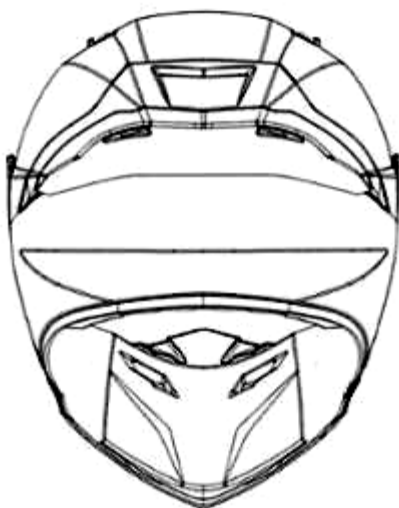

1.3

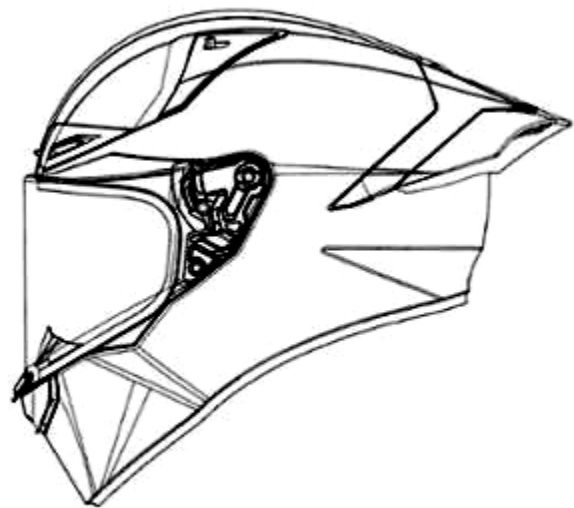

1.4

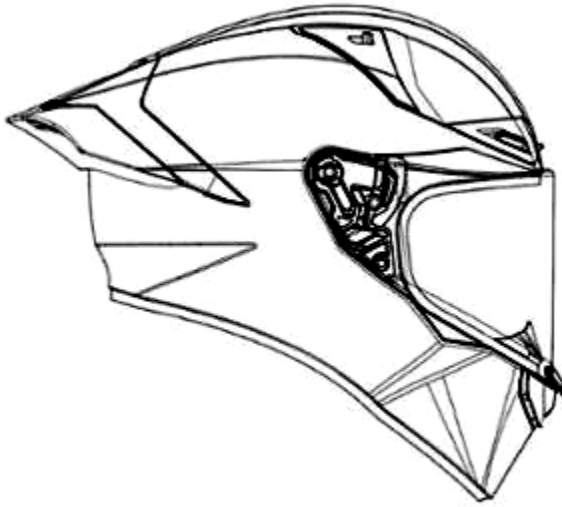

1.5

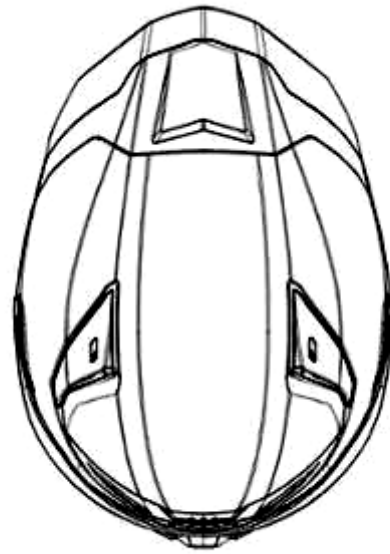

1.6

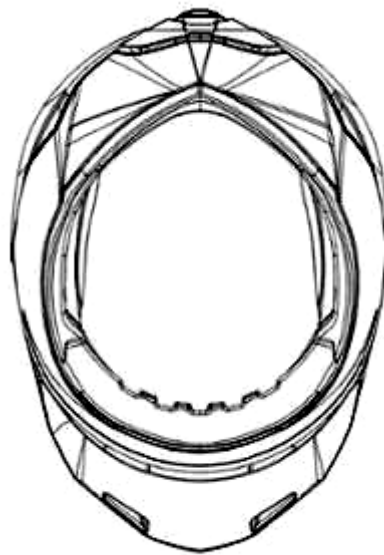

1.7

CÔNG BÁO SỞ HỮU CÔNG NGHIỆP SỐ 424 TẬP A – QUYỀN 2 (07.2023)

- (11) 47254
(21) 3-2023-01011 (28) 1
(54) **MÁY LỌC NƯỚC** (51) **23-01**
(22) 10/05/2023 (43) 25/07/2023
(73) **CÔNG TY CỔ PHẦN CÔNG NGHỆ VIETDREAM (VN)**
Số 52 đường Nam Cao, phường Tân Phú, thành phố Thủ Đức, thành phố Hồ Chí Minh
(72) Lương Văn Quyên (VN)
(74) Công ty TNHH Đại Tín và Liên Danh (DAITIN AND ASSOCIATES CO.,LTD)
(55)



1.1



1.2



1.3



1.4



1.5



1.6

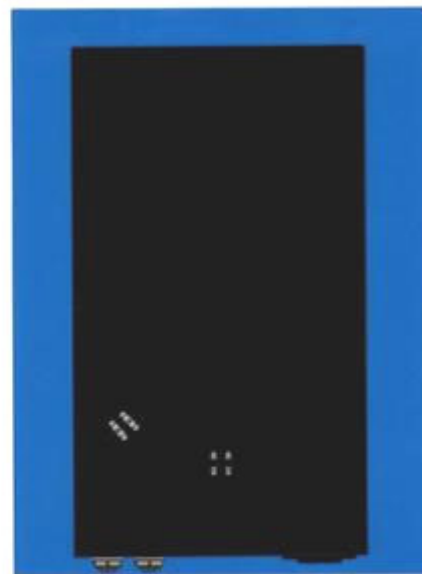

1.7

CÔNG BÁO SỞ HỮU CÔNG NGHIỆP SỐ 424 TẬP A – QUYỀN 2 (07.2023)

(11) **47255**

(21) 3-2022-00882

(28) 1

(54) **LỌ**

(51) **07-06**

(22) 05/05/2022

(43) 25/07/2023

(73) **CÔNG TY TNHH LUCAS VIỆT NAM (VN)**

88 đường 36, phường Bình Trị Đông B, quận Bình Tân, thành phố Hồ Chí Minh

(72) Nguyễn Vĩnh Long (VN)

(55)



1.1



1.2



1.3



1.4

CÔNG BÁO SỞ HỮU CÔNG NGHIỆP SỐ 424 TẬP A – QUYỀN 2 (07.2023)

- (11) **47256**
(21) 3-2022-02504 (28) 3
(54) **NẮP ĐẬY** (51) **09-07**
(22) 16/11/2022 (43) 25/07/2023
(73) **CÔNG TY CỔ PHẦN KHUÔN CHÍNH XÁC MINH ĐẠT (VN)**
Quốc lộ 1A, ấp 1, xã Mỹ Yên, huyện Bến Lức, tỉnh Long An
(72) Trịnh Hoài Sang (VN)
(74) Công ty TNHH Sở hữu trí tuệ Thảo Thọ Quyển (INVENCO.,LTD)
(55)



1.1



1.2



1.3



1.4



1.5



1.6



1.7



2.1



2.2



2.3



2.4



2.5



2.6



2.7



3.1



3.2



3.3



3.4



3.5



3.6



3.7

CÔNG BÁO SỞ HỮU CÔNG NGHIỆP SỐ 424 TẬP A – QUYỀN 2 (07.2023)

- (11) **47257**
(21) 3-2022-02733 (28) 3
(54) **CỌ TRANG ĐIỂM** (51) **28-03**
(22) 14/12/2022 (43) 25/07/2023
(30) 202230732561.6 03/11/2022 CN;
(73) **HUIZHOU JIESONG ELECTRONIC TECHNOLOGY CO., LTD. (CN)**
White Clay, Group 4, Longgang Village, Longxi Town, Boluo County, Huizhou
City, Guangdong 516100, China
(72) Chuanhui LIN (CN)
(74) Công ty TNHH Đại Tín và Liên Danh (DAITIN AND ASSOCIATES CO.,LTD)
(55)

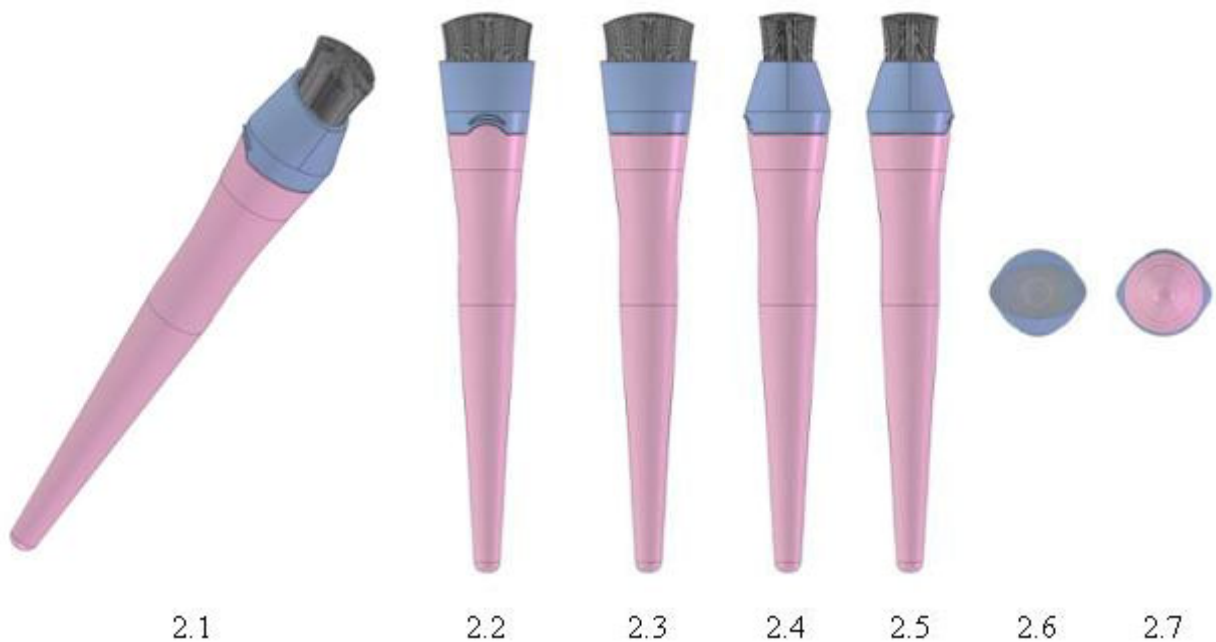



3.1

3.2

3.3

3.4

3.5



3.6



3.7

- (11) **47258**
(21) 3-2023-00028 (28) 1
(54) **NHÃN** (51) **11-01**
(22) 04/01/2023 (43) 25/07/2023
(30) DM/223919 28/09/2022 WO;
(73) **CARTIER INTERNATIONAL AG (CH)**
Hinterbergstrasse 22, 6312 Steinhausen, Switzerland
(72) Emmanuelle SALLARD (FR)
(74) Công ty TNHH Tầm nhìn và Liên danh (VISION & ASSOCIATES CO.LTD.)
(55)



1.1



1.2



1.3

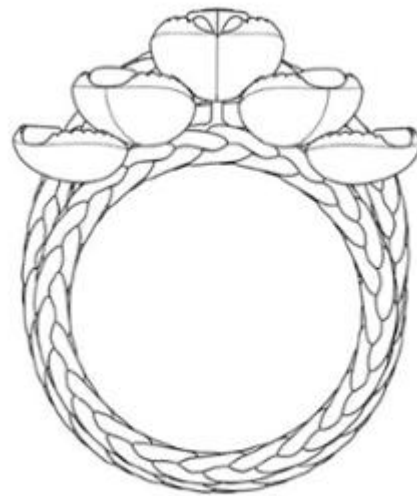

1.4



1.5

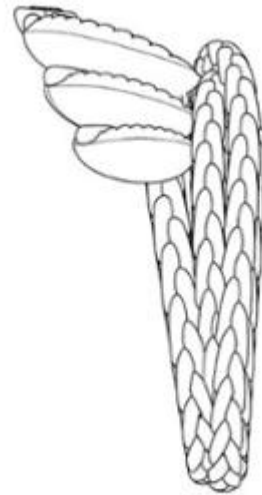

1.6



1.7

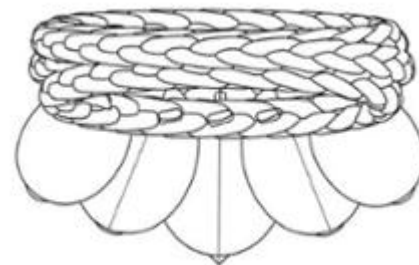

1.8

- (11) **47259**
(21) 3-2023-00027 (28) 1
(54) **NHÃN** (51) **11-01**
(22) 04/01/2023 (43) 25/07/2023
(30) DM/223919 28/09/2022 WO;
(73) **CARTIER INTERNATIONAL AG (CH)**
Hinterbergstrasse 22, 6312 Steinhausen, Switzerland
(72) Emmanuelle SALLARD (FR)
(74) Công ty TNHH Tầm nhìn và Liên danh (VISION & ASSOCIATES CO.LTD.)
(55)



1.1

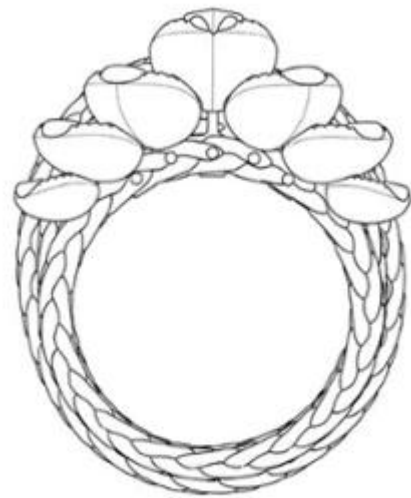

1.2

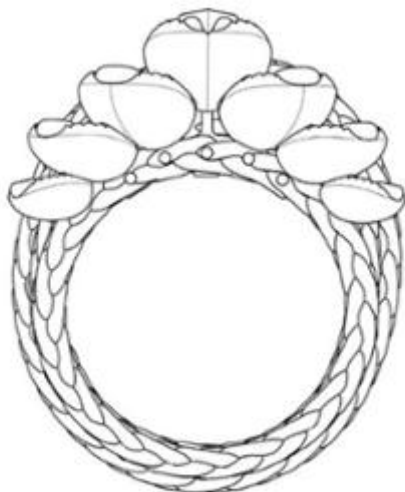

1.3



1.4

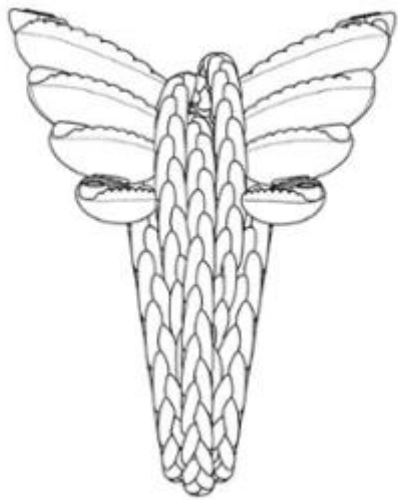

1.5



1.6

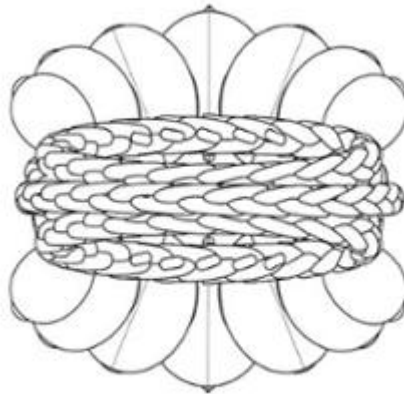

1.7

CÔNG BÁO SỞ HỮU CÔNG NGHIỆP SỐ 424 TẬP A – QUYỀN 2 (07.2023)

- (11) **47260**
(21) 3-2023-00221 (28) 1
(54) **DÉP LÊ** (51) **02-04**
(22) 30/01/2023 (43) 25/07/2023
(30) 202230621711.6 20/09/2022 CN;
(73) **WU, ZHIWEI (CN)**
No. 6, Juntinghou, Nansheng Village, Fengping Township, Songyang County,
Lishui City, Zhejiang Province, China
(72) WU, Zhiwei (CN)
(74) Công ty TNHH Sở hữu trí tuệ VIPATCO (VIPATCO CO., LTD.)
(55)



1.1



1.2



1.3



1.4



1.5



1.6



1.7

- (11) **47261**
(21) 3-2023-00029 (28) 1
(54) **NHÃN** (51) **11-01**
(22) 04/01/2023 (43) 25/07/2023
(30) DM/223919 28/09/2022 WO;
(73) **CARTIER INTERNATIONAL AG (CH)**
Hinterbergstrasse 22, 6312 Steinhausen, Switzerland
(72) Emmanuelle SALLARD (FR)
(74) Công ty TNHH Tầm nhìn và Liên danh (VISION & ASSOCIATES CO.LTD.)
(55)



1.1



1.2



1.3



1.4



1.5

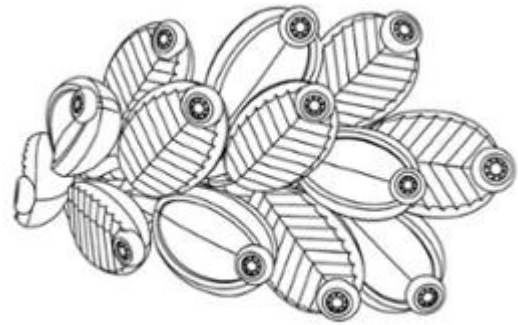

1.6

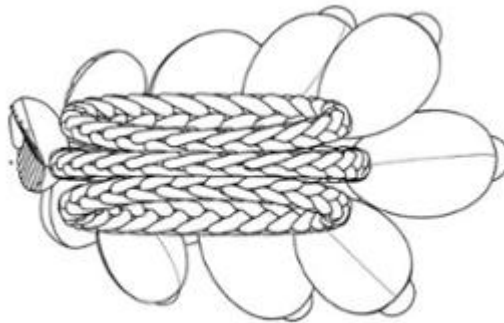

1.7

CÔNG BÁO SỞ HỮU CÔNG NGHIỆP SỐ 424 TẬP A – QUYỀN 2 (07.2023)

- (11) **47262**
(21) 3-2023-00033 (28) 1
(54) **ĐỒ TRANG SỨC** (51) **11-01**
(22) 04/01/2023 (43) 25/07/2023
(30) DM/223919 28/09/2022 WO;
(73) **CARTIER INTERNATIONAL AG (CH)**
Hinterbergstrasse 22, 6312 Steinhausen, Switzerland
(72) Emmanuelle SALLARD (FR)
(74) Công ty TNHH Tầm nhìn và Liên danh (VISION & ASSOCIATES CO.LTD.)
(55)

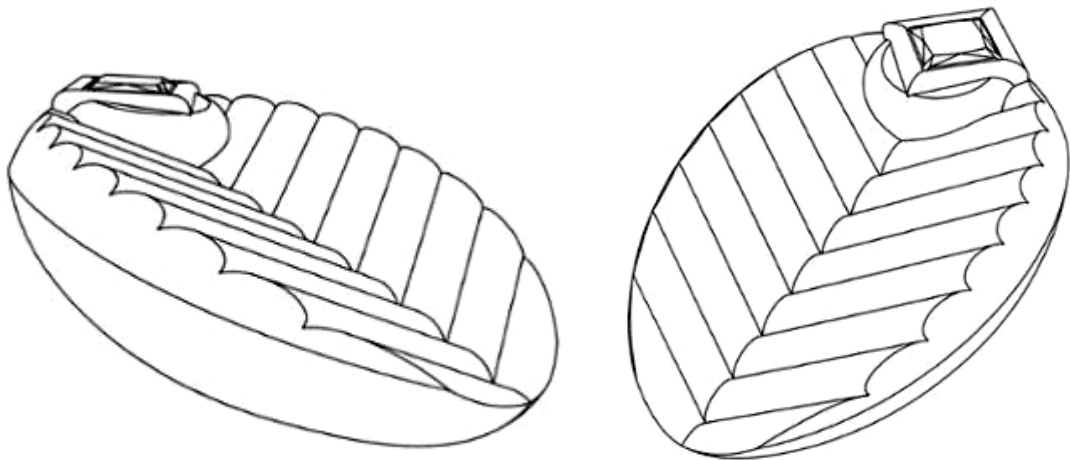

1.1

1.2

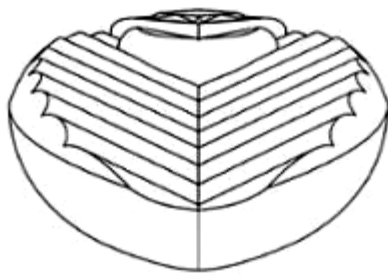

1.3

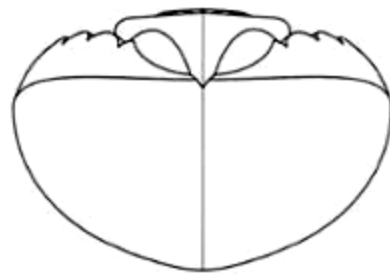

1.4



1.5

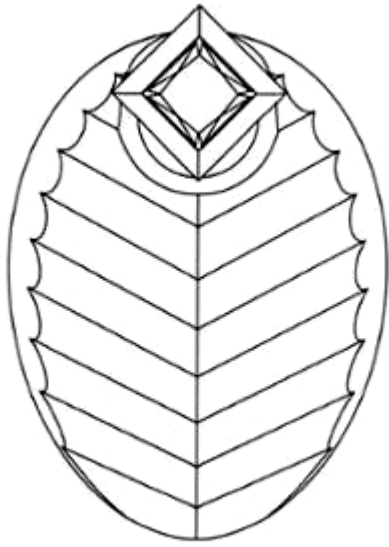

1.6

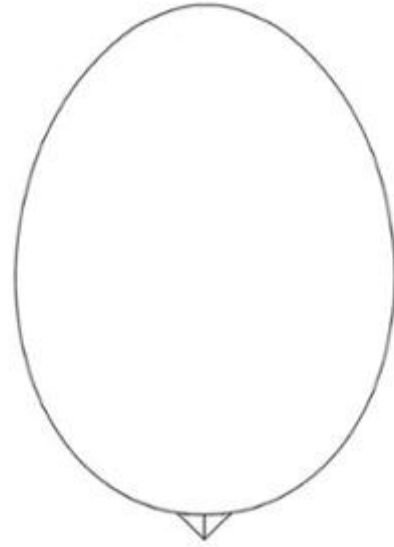

1.7

CÔNG BÁO SỞ HỮU CÔNG NGHIỆP SỐ 424 TẬP A – QUYỀN 2 (07.2023)

- (11) **47263**
(21) 3-2023-00230 (28) 1
(54) **DÉP** (51) **02-04**
(22) 31/01/2023 (43) 25/07/2023
(30) 29/865,568 01/08/2022 US;
(73) **CROCS, INC. (US)**
13601 Via Varra, Broomfield, Colorado 80020, United States of America
(72) Catherine Lam (US)
(74) Công ty Luật TNHH quốc tế BMVN (BMVN INTERNATIONAL LLC)
(55)



1.1



1.2



1.3



1.4



1.5



1.6



1.7

CÔNG BÁO SỞ HỮU CÔNG NGHIỆP SỐ 424 TẬP A – QUYỀN 2 (07.2023)

- (11) **47264**
(21) 3-2023-00229 (28) 1
(54) **DÉP** (51) **02-04**
(22) 31/01/2023 (43) 25/07/2023
(30) 29/865,566 01/08/2022 US;
(73) **CROCS, INC. (US)**
13601 Via Varra, Broomfield, Colorado 80020, United States of America
(72) Federico FONGHER (IT)
(74) Công ty Luật TNHH quốc tế BMVN (BMVN INTERNATIONAL LLC)
(55)



1.1



1.2



1.3



1.4



1.5



1.6



1.7

CÔNG BÁO SỞ HỮU CÔNG NGHIỆP SỐ 424 TẬP A – QUYỀN 2 (07.2023)

- (11) **47265**
(21) 3-2023-00875 (28) 1
(54) **CHẬU RỬA** (51) **23-02**
(22) 18/04/2023 (43) 25/07/2023
(30) 202230766201.8 17/11/2022 CN;
(73) **LIXIL INTERNATIONAL PTE. LTD.** (SG)
180 Clemenceau Avenue, #06-02 Haw Par Centre, Singapore 239922, Singapore
(72) 1. ANTOINE BESSEYRE DES HORTS (FR)
2. MINSEONG KIM (KR)
(74) Công ty Luật TNHH Phạm và Liên danh (PHAM & ASSOCIATES)
(55)



1.1



1.2



1.3



1.4



1.5



1.6



1.7

CÔNG BÁO SỞ HỮU CÔNG NGHIỆP SỐ 424 TẬP A – QUYỀN 2 (07.2023)

- (11) **47266**
(21) 3-2023-00874 (28) 2
(54) **BỆ XÍ** (51) **23-02**
(22) 18/04/2023 (43) 25/07/2023
(30) 202230778440.5 17/11/2022 CN;
(73) **LIXIL INTERNATIONAL PTE. LTD.** (SG)
180 Clemenceau Avenue, #06-02 Haw Par Centre, Singapore 239922, Singapore
(72) 1. ANTOINE BESSEYRE DES HORTS (FR)
2. TSUCHIYA RYOSUKE (JP)
3. HELDER FILIPOV (BR)
(74) Công ty Luật TNHH Phạm và Liên danh (PHAM & ASSOCIATES)
(55)



1.1



1.2



1.3



1.4



1.5



1.6



1.7



2.1



2.2



2.3



2.4



2.5



2.6



2.7

CÔNG BÁO SỞ HỮU CÔNG NGHIỆP SỐ 424 TẬP A – QUYỀN 2 (07.2023)

- (11) **47267**
(21) 3-2023-00876 (28) 1
(54) **BỒN TIỂU** (51) **23-02**
(22) 18/04/2023 (43) 25/07/2023
(30) 202330080915.8 28/02/2023 CN;
(73) **LIXIL INTERNATIONAL PTE. LTD. (SG)**
180 Clemenceau Avenue, #06-02 Haw Par Centre, Singapore 239922, Singapore
(72) 1. ANTOINE BESSEYRE DES HORTS (FR)
2. JEABYUN YEON (KR)
(74) Công ty Luật TNHH Phạm và Liên danh (PHAM & ASSOCIATES)
(55)



1.1



1.2



1.3



1.4



1.5



1.6



1.7

CÔNG BÁO SỞ HỮU CÔNG NGHIỆP SỐ 424 TẬP A – QUYỀN 2 (07.2023)

- (11) **47268**
(21) 3-2023-00878 (28) 1
(54) **CHẬU RỬA** (51) **23-02**
(22) 18/04/2023 (43) 25/07/2023
(30) 202330080980.0 28/02/2023 CN;
(73) **LIXIL INTERNATIONAL PTE. LTD.** (SG)
180 Clemenceau Avenue, #06-02 Haw Par Centre, Singapore 239922, Singapore
(72) 1. ANTOINE BESSEYRE DES HORTS (FR)
2. SINLAPACHAI PUTPAN (TH)
(74) Công ty Luật TNHH Phạm và Liên danh (PHAM & ASSOCIATES)
(55)



1.1



1.2



1.3



1.4



1.5



1.6



1.7

CÔNG BÁO SỞ HỮU CÔNG NGHIỆP SỐ 424 TẬP A – QUYỀN 2 (07.2023)

- (11) **47269**
(21) 3-2023-00877 (28) 1
(54) **BỆ XÍ** (51) **23-02**
(22) 18/04/2023 (43) 25/07/2023
(30) 202330080866.8 28/02/2023 CN;
(73) **LIXIL INTERNATIONAL PTE. LTD.** (SG)
180 Clemenceau Avenue, #06-02 Haw Par Centre, Singapore 239922, Singapore
(72) 1. ANTOINE BESSEYRE DES HORTS (FR)
2. SINLAPACHAI PUTPAN (TH)
(74) Công ty Luật TNHH Phạm và Liên danh (PHAM & ASSOCIATES)
(55)



1.1



1.2



1.3



1.4



1.5



1.6



1.7

CÔNG BÁO SỞ HỮU CÔNG NGHIỆP SỐ 424 TẬP A – QUYỀN 2 (07.2023)

- (11) **47270**
(21) 3-2023-00879 (28) 1
(54) **CHẬU RỬA** (51) **23-02**
(22) 18/04/2023 (43) 25/07/2023
(30) 202330080944.4 28/02/2023 CN;
(73) **LIXIL INTERNATIONAL PTE. LTD.** (SG)
180 Clemenceau Avenue, #06-02 Haw Par Centre, Singapore 239922, Singapore
(72) 1. ANTOINE BESSEYRE DES HORTS (FR)
2. SINLAPACHAI PUTPAN (TH)
(74) Công ty Luật TNHH Phạm và Liên danh (PHAM & ASSOCIATES)
(55)



1.1



1.2



1.3



1.4



1.5



1.6



1.7

- (11) **47271**
(21) 3-2023-00933 (28) 1
(54) **ĐỒ TRANG SỨC** (51) **11-01**
(22) 27/04/2023 (43) 25/07/2023
(30) DM/227 398 03/03/2023 WO;
(73) **CARTIER INTERNATIONAL AG (CH)**
Hinterbergstrasse 22, 6312 STEINHAUSEN, SWITZERLAND
(72) Sébastien VANDELLI (FR)
(74) Công ty TNHH Tầm nhìn và Liên danh (VISION & ASSOCIATES CO.LTD.)
(55)

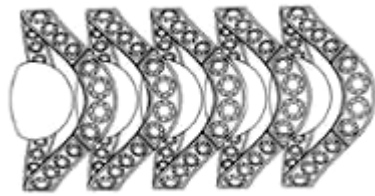

1.1

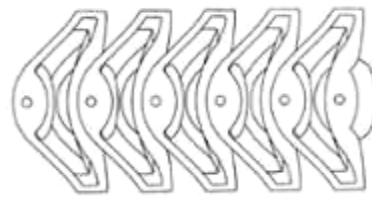

1.2



1.3



1.4



1.5



1.6



1.7

CÔNG BÁO SỞ HỮU CÔNG NGHIỆP SỐ 424 TẬP A – QUYỀN 2 (07.2023)

- (11) 47272
(21) 3-2023-00518 (28) 1
(54) **NHÃN SẢN PHẨM** (51) **19-08**
(22) 10/03/2023 (43) 25/07/2023
(73) **CÔNG TY TNHH MỘT THÀNH VIÊN KEM CHÂU ĐỐC - SÀI GÒN (VN)**
Số 622 Thủ Khoa Huân, phường Châu Phú B, thành phố Châu Đốc, tỉnh An Giang
(72) Tạ Thị Thu Thủy (VN)
(55)



CÔNG BÁO SỞ HỮU CÔNG NGHIỆP SỐ 424 TẬP A – QUYỀN 2 (07.2023)

- (11) 47273
(21) 3-2023-00519 (28) 1
(54) **NHÃN SẢN PHẨM** (51) **19-08**
(22) 10/03/2023 (43) 25/07/2023
(73) **CÔNG TY TNHH MỘT THÀNH VIÊN KEM CHÂU ĐỐC - SÀI GÒN (VN)**
Số 622 Thủ Khoa Huân, phường Châu Phú B, thành phố Châu Đốc, tỉnh An Giang
(72) Tạ Thị Thu Thủy (VN)
(55)

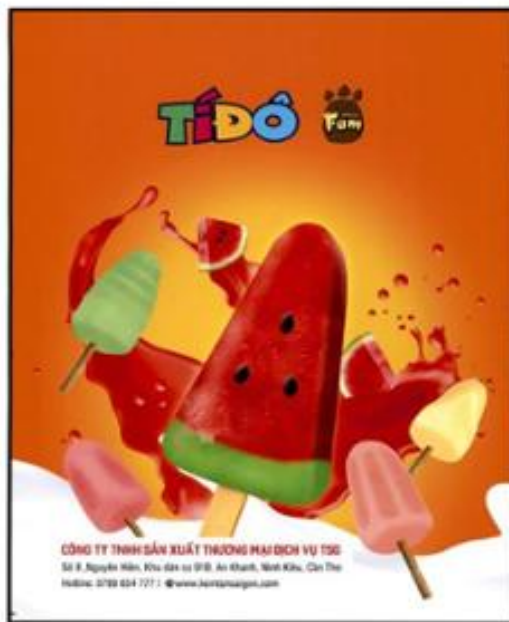

CÔNG BÁO SỞ HỮU CÔNG NGHIỆP SỐ 424 TẬP A – QUYỀN 2 (07.2023)

- (11) 47274
(21) 3-2023-00520 (28) 1
(54) **NHÃN SẢN PHẨM** (51) **19-08**
(22) 10/03/2023 (43) 25/07/2023
(73) **CÔNG TY TNHH MỘT THÀNH VIÊN KEM CHÂU ĐỐC - SÀI GÒN (VN)**
Số 622 Thủ Khoa Huân, phường Châu Phú B, thành phố Châu Đốc, tỉnh An Giang
(72) Tạ Thị Thu Thủy (VN)
(55)



CÔNG BÁO SỞ HỮU CÔNG NGHIỆP SỐ 424 TẬP A – QUYỀN 2 (07.2023)

- (11) 47275
(21) 3-2023-00521 (28) 1
(54) **NHÃN SẢN PHẨM** (51) **19-08**
(22) 10/03/2023 (43) 25/07/2023
(73) **CÔNG TY TNHH MỘT THÀNH VIÊN KEM CHÂU ĐỐC - SÀI GÒN (VN)**
Số 622 Thủ Khoa Huân, phường Châu Phú B, thành phố Châu Đốc, tỉnh An Giang
(72) Tạ Thị Thu Thủy (VN)
(55)



CÔNG BÁO SỞ HỮU CÔNG NGHIỆP SỐ 424 TẬP A – QUYỀN 2 (07.2023)

- (11) **47276**
(21) 3-2023-00621 (28) 1
(54) **HỘP** (51) **09-03**
(22) 23/03/2023 (43) 25/07/2023
(73) **CÔNG TY TNHH ĐẦU TƯ THƯƠNG MẠI DỊCH VỤ BẠCH VŨ (VN)**
Căn Sor 334 đường Sorento 3, Địa Trung Hải, phường An Thới, thành phố Phú Quốc, tỉnh Kiên Giang
(72) Bạch Thanh Tùng (VN)
(55)



1.1



1.2

CÔNG BÁO SỞ HỮU CÔNG NGHIỆP SỐ 424 TẬP A – QUYỀN 2 (07.2023)

- (11) 47277
(21) 3-2023-00761 (28) 2
(54) **HỘP** (51) **09-03**
(22) 06/04/2023 (43) 25/07/2023
(73) **CÔNG TY CỔ PHẦN THỰC PHẨM SỮA TH (VN)**
Xã Nghĩa Sơn, huyện Nghĩa Đàn, tỉnh Nghệ An
(72) Vũ Thanh Hương (VN)
(74) **CÔNG TY LUẬT TNHH IP MAX (IPMAX LAW FIRM)**
(55)



1.1



1.2



1.3



2.1



2.2



2.3

CÔNG BÁO SỞ HỮU CÔNG NGHIỆP SỐ 424 TẬP A – QUYỀN 2 (07.2023)

- (11) 47278
(21) 3-2023-00661
(54) **BAO GÓI BĂNG VỆ SINH**
(22) 27/03/2023
(73) **CÔNG TY CỔ PHẦN DIANA UNICHARM (VN)**
Khu công nghiệp Vĩnh Tuy, đường Lĩnh Nam, phường Vĩnh Hưng, quận Hoàng Mai, thành phố Hà Nội
(72) Đỗ Anh Tú (VN)
(74) Công ty TNHH Sở hữu trí tuệ và Công nghệ Thủ đô (CAPITAL IP&T CO.LTD.)
(55)
- (28) 2
(51) 09-05
(43) 25/07/2023



1.1



1.2



2.1



2.2

CÔNG BÁO SỞ HỮU CÔNG NGHIỆP SỐ 424 TẬP A – QUYỀN 2 (07.2023)

- (11) **47279**
(21) 3-2023-00622 (28) 1
(54) **HỘP** (51) **09-03**
(22) 23/03/2023 (43) 25/07/2023
(73) **CÔNG TY TNHH ĐẦU TƯ THƯƠNG MẠI DỊCH VỤ BẠCH VŨ (VN)**
Căn Sor 334 đường Sorento 3, Địa Trung Hải, phường An Thới, thành phố Phú Quốc, tỉnh Kiên Giang
(72) Bạch Thanh Tùng (VN)
(55)



1.1



1.2

CÔNG BÁO SỞ HỮU CÔNG NGHIỆP SỐ 424 TẬP A – QUYỀN 2 (07.2023)

- (11) **47280**
(21) 3-2023-00955 (28) 4
(54) **HỘP** (51) **09-03**
(22) 28/04/2023 (43) 25/07/2023
(73) **CÔNG TY CỔ PHẦN THỰC PHẨM Á LONG (VN)**
175-177 Xô Viết Nghệ Tĩnh, phường 17, quận Bình Thạnh, thành phố Hồ Chí Minh
(72) Phạm Quang Huy (VN)
(74) Công ty TNHH Sở hữu trí tuệ Tầm Nhìn Mới (FRESHVIEW CO., LTD.)
(55)



1.1



1.2



2.1



2.2



3.1



3.2



4.1



4.2

CÔNG BÁO SỞ HỮU CÔNG NGHIỆP SỐ 424 TẬP A – QUYỀN 2 (07.2023)

- (11) **47281**
(21) 3-2023-00762 (28) 2
(54) **HỘP** (51) **09-03**
(22) 06/04/2023 (43) 25/07/2023
(73) **CÔNG TY CỔ PHẦN THỰC PHẨM SỮA TH (VN)**
Xã Nghĩa Sơn, huyện Nghĩa Đàn, tỉnh Nghệ An
(72) Vũ Thanh Hương (VN)
(74) **CÔNG TY LUẬT TNHH IP MAX (IPMAX LAW FIRM)**
(55)



1.1



1.2



1.3



2.1



2.2



2.3

CÔNG BÁO SỞ HỮU CÔNG NGHIỆP SỐ 424 TẬP A – QUYỀN 2 (07.2023)

- (11) **47282**
(21) 3-2023-01028 (28) 1
(54) **BAO GÓI** (51) **09-05**
(22) 12/05/2023 (43) 25/07/2023
(73) **CÔNG TY CỔ PHẦN RICHY GROUP (VN)**
Tầng 15, tòa nhà Richy, tổ 32, phường Yên Hòa, quận Cầu Giấy, thành phố Hà Nội
(72) Trần Sỹ Trực (VN)
(74) Công ty TNHH Sở hữu trí tuệ HA VIP (HAVIP CO., LTD.)
(55)



1.1



1.2

CÔNG BÁO SỞ HỮU CÔNG NGHIỆP SỐ 424 TẬP A – QUYỀN 2 (07.2023)

- | | | | |
|------|--|------|--------------|
| (11) | 47283 | | |
| (21) | 3-2023-01023 | (28) | 1 |
| (54) | BAO BÌ THỰC PHẨM | (51) | 09-05 |
| (22) | 11/05/2023 | (43) | 25/07/2023 |
| (73) | PALDO CO., LTD. (KR)
7th Floor, 577, Gangnam-daero, Seocho-gu, Seoul, 06530, Republic of Korea | | |
| (72) | Ko Jung-wan (KR) | | |
| (74) | Công ty TNHH Dương và Trần (DUONG & TRAN CO., LTD) | | |
| (55) | | | |



1.1



1.2



1.3



1.4

1.5



1.6



1.7

CÔNG BÁO SỞ HỮU CÔNG NGHIỆP SỐ 424 TẬP A – QUYỀN 2 (07.2023)

- (11) 47284
- (21) 3-2023-00529 (28) 1
- (54) **BAO GÓI KHĂN GIẤY ƯỚT** (51) **09-05**
- (22) 10/03/2023 (43) 25/07/2023
- (73) **CÔNG TY TNHH SẢN XUẤT THƯƠNG MẠI GIẤY GIA NGUYỄN (VN)**
16/1 ấp 7, xã Xuân Thới Thượng, huyện Hóc Môn, thành phố Hồ Chí Minh
- (72) Nguyễn Thanh Phong (VN)
- (74) **CÔNG TY TNHH KHANG LUẬT (KHANGLAW)**
- (55)



1.1



1.2



1.3



1.4



1.5



1.6



1.7

CÔNG BÁO SỞ HỮU CÔNG NGHIỆP SỐ 424 TẬP A – QUYỀN 2 (07.2023)

(11) **47285**

(21) 3-2023-00754

(28) 1

(54) **NHÃN SẢN PHẨM**

(51) **19-08**

(22) 05/04/2023

(43) 25/07/2023

(73) **CÔNG TY CỔ PHẦN THỰC PHẨM VÀ NƯỚC GIẢI KHÁT NAM VIỆT (VN)**

Số 994/1C, đường Nguyễn Thị Minh Khai, khu phố Tân Thắng, phường Tân Bình, thành phố Dĩ An, tỉnh Bình Dương

(72) Bùi Thị Thu Hương (VN)

(74) **CÔNG TY TNHH SỞ HỮU TRÍ TUỆ ANLIS VIỆT NAM (ANLIS IP CO.,LTD)**

(55)



CÔNG BÁO SỞ HỮU CÔNG NGHIỆP SỐ 424 TẬP A – QUYỀN 2 (07.2023)

- (11) **47286**
- (21) 3-2023-00750 (28) 1
- (54) **NHÃN SẢN PHẨM** (51) **19-08**
- (22) 04/04/2023 (43) 25/07/2023
- (73) **DU VĂN PHƯỚC (VN)**
209 Âu Cơ, phường 5, quận 11, thành phố Hồ Chí Minh
- (72) Du Văn Phước (VN)
- (74) Công ty TNHH một thành viên Trường Luật (Trường Luật)
- (55)



CÔNG BÁO SỞ HỮU CÔNG NGHIỆP SỐ 424 TẬP A – QUYỀN 2 (07.2023)

- (11) **47287**
- (21) 3-2023-00795 (28) 1
- (54) **NHÃN SẢN PHẨM** (51) **19-08**
- (22) 10/04/2023 (43) 25/07/2023
- (73) **CÔNG TY TNHH CÔNG NGHỆ NAVA VIỆT NAM (VN)**
Số 18, ngõ 117 phố Lãng Yên, phường Thanh Lương, quận Hai Bà Trưng, thành phố Hà Nội
- (72) Nguyễn Khắc Trung (VN)
- (74) Công ty TNHH Sở hữu trí tuệ và Công nghệ Thủ đô (CAPITAL IP&T CO.LTD.)
- (55)



CÔNG BÁO SỞ HỮU CÔNG NGHIỆP SỐ 424 TẬP A – QUYỀN 2 (07.2023)

- (11) **47288**
(21) 3-2023-00837 (28) 1
(54) **NHÃN SẢN PHẨM** (51) **19-08**
(22) 12/04/2023 (43) 25/07/2023
(73) **ĐẶNG THỊ KIM MẠNH (VN)**
Tổ 3, phường Nghĩa Lộ, thành phố Quảng Ngãi, tỉnh Quảng Ngãi
(72) Đặng Thị Kim Mạnh (VN)
(74) Văn phòng Luật sư D và T (D & T LAW OFFICE)
(55)



1.1



1.2

CÔNG BÁO SỞ HỮU CÔNG NGHIỆP SỐ 424 TẬP A – QUYỀN 2 (07.2023)

- (11) **47289**
- (21) 3-2023-00865 (28) 1
- (54) **NHÃN SẢN PHẨM** (51) **19-08**
- (22) 17/04/2023 (43) 25/07/2023
- (73) **CÔNG TY TNHH DỊCH VỤ VÀ CUNG CẤP THỰC PHẨM QUỐC TẾ - IFSS**
(VN)
Số 2 Bis Nguyễn Thị Minh Khai, phường Đa Kao, quận 1, thành phố Hồ Chí Minh
- (72) Nguyễn Thị Việt Ngân (VN)
- (55)



CÔNG BÁO SỞ HỮU CÔNG NGHIỆP SỐ 424 TẬP A – QUYỀN 2 (07.2023)

- (11) **47290**
(21) 3-2023-00838 (28) 1
(54) **NHÃN SẢN PHẨM** (51) **19-08**
(22) 13/04/2023 (43) 25/07/2023
(73) **CÔNG TY CỔ PHẦN D-SHINING (VN)**
7C Nguyễn Ngọc Phương, phường 19, quận Bình Thạnh, thành phố Hồ Chí Minh
(72) Nguyễn Thái Dương (VN)
(74) Văn phòng Luật sư D và T (D & T LAW OFFICE)
(55)



1.1



1.2

CÔNG BÁO SỞ HỮU CÔNG NGHIỆP SỐ 424 TẬP A – QUYỀN 2 (07.2023)

- (11) **47291**
(21) 3-2023-00856 (28) 1
(54) **NHÃN SẢN PHẨM** (51) **19-08**
(22) 14/04/2023 (43) 25/07/2023
(73) **CÔNG TY CỔ PHẦN CHẾ BIẾN THỰC PHẨM CAO BẰNG (VN)**
Thôn Thượng Thôn, xã Đông Tiến, huyện Yên Phong, tỉnh Bắc Ninh
(72) Trần Thị Vượng (VN)
(74) Công ty TNHH Sở hữu trí tuệ và Công nghệ Thủ đô (CAPITAL IP&T CO.LTD.)
(55)



CÔNG BÁO SỞ HỮU CÔNG NGHIỆP SỐ 424 TẬP A – QUYỀN 2 (07.2023)

- (11) **47292**
(21) 3-2023-00883 (28) 1
(54) **NHÃN SẢN PHẨM** (51) **19-08**
(22) 18/04/2023 (43) 25/07/2023
(73) **LÝ QUỐC DÂN (VN)**
Khu phố Lâm Trúc 1, phường Hoài Thanh, thị xã Hoài Nhơn, tỉnh Bình Định
(72) Lý Quốc Dân (VN)
(74) **CÔNG TY TNHH SỞ HỮU TRÍ TUỆ SETHACO (SETHACO IP CO.,LTD)**
(55)



CÔNG BÁO SỞ HỮU CÔNG NGHIỆP SỐ 424 TẬP A – QUYỀN 2 (07.2023)

- (11) **47293**
(21) 3-2023-00884 (28) 1
(54) **NHÃN SẢN PHẨM** (51) **19-08**
(22) 18/04/2023 (43) 25/07/2023
(73) **CÔNG TY TNHH XUẤT NHẬP KHẨU PHÂN BÓN TRƯỜNG PHÁT - USA**
(VN)
50/3B, Quốc lộ 1A, ấp Nam Lân, xã Bà Điểm, huyện Hóc Môn, thành phố Hồ Chí Minh
(72) Phạm Văn Chính (VN)
(74) Công ty Cổ phần Sở hữu công nghiệp INVESTIP (INVESTIP)
(55)



1.1



1.2

CÔNG BÁO SỞ HỮU CÔNG NGHIỆP SỐ 424 TẬP A – QUYỀN 2 (07.2023)

- (11) **47294**
- (21) 3-2023-00866 (28) 1
- (54) **NHÃN SẢN PHẨM** (51) **19-08**
- (22) 17/04/2023 (43) 25/07/2023
- (73) **CÔNG TY TNHH DỊCH VỤ VÀ CUNG CẤP THỰC PHẨM QUỐC TẾ - IFSS**
(VN)
Số 2 Bis Nguyễn Thị Minh Khai, phường Đa Kao, quận 1, thành phố Hồ Chí Minh
- (72) Nguyễn Thị Việt Ngân (VN)
- (55)



CÔNG BÁO SỞ HỮU CÔNG NGHIỆP SỐ 424 TẬP A – QUYỀN 2 (07.2023)

- (11) **47295**
(21) 3-2023-00894 (28) 1
(54) **NHÃN SẢN PHẨM** (51) **19-08**
(22) 20/04/2023 (43) 25/07/2023
(73) **CƠ SỞ GIẤY LONG GIANG (VN)**
Khu Dương Ổ, phường Phong Khê, thành phố Bắc Ninh, tỉnh Bắc Ninh
(72) Nguyễn Xuân Vũ (VN)
(55)



CÔNG BÁO SỞ HỮU CÔNG NGHIỆP SỐ 424 TẬP A – QUYỀN 2 (07.2023)

- (11) **47296**
(21) 3-2023-00912 (28) 1
(54) **NHÃN SẢN PHẨM** (51) **19-08**
(22) 25/04/2023 (43) 25/07/2023
(73) **CÔNG TY CỔ PHẦN TINGCO BÌNH ĐỊNH (VN)**
Lô A3.12+A3.13 khu công nghiệp Nhơn Hội (Khu A), khu kinh tế Nhơn Hội, xã
Nhơn Hội, thành phố Quy Nhơn, tỉnh Bình Định
(72) Võ Thị Nguyệt Nga (VN)
(74) Công ty Cổ phần Sở hữu công nghiệp INVESTIP (INVESTIP)
(55)



1.1



1.2

CÔNG BÁO SỞ HỮU CÔNG NGHIỆP SỐ 424 TẬP A – QUYỀN 2 (07.2023)

- (11) **47297**
(21) 3-2023-00913 (28) 1
(54) **NHÃN SẢN PHẨM** (51) **19-08**
(22) 25/04/2023 (43) 25/07/2023
(73) **CÔNG TY CỔ PHẦN TINGCO BÌNH ĐỊNH (VN)**
Lô A3.12+A3.13 khu công nghiệp Nhơn Hội (Khu A), khu kinh tế Nhơn Hội, xã Nhơn Hội, thành phố Quy Nhơn, tỉnh Bình Định
(72) Võ Thị Nguyệt Nga (VN)
(74) Công ty Cổ phần Sở hữu công nghiệp INVESTIP (INVESTIP)
(55)



1.1



1.2

CÔNG BÁO SỞ HỮU CÔNG NGHIỆP SỐ 424 TẬP A – QUYỀN 2 (07.2023)

- (11) **47298**
(21) 3-2023-00922 (28) 1
(54) **NHÃN SẢN PHẨM** (51) **19-08**
(22) 26/04/2023 (43) 25/07/2023
(73) **CÔNG TY TNHH SẢN XUẤT THỰC PHẨM ĐÀ LẠT (VN)**
Tổ 4 thôn 2, xã Tà Nung, thành phố Đà Lạt, tỉnh Lâm Đồng
(72) Phùng Thị Thảo (VN)
(74) Văn phòng Luật sư A Hoà (AHOA LAW OFFICE)
(55)



CÔNG BÁO SỞ HỮU CÔNG NGHIỆP SỐ 424 TẬP A – QUYỀN 2 (07.2023)

- (11) **47299**
(21) 3-2023-00945 (28) 1
(54) **NHÃN SẢN PHẨM** (51) **19-08**
(22) 28/04/2023 (43) 25/07/2023
(73) **PHẠM THANH TÙNG (VN)**
R4B-2020 Royal City, 72A Nguyễn Trãi, quận Thanh Xuân, thành phố Hà Nội
(72) Phạm Thanh Tùng (VN)
(55)



CÔNG BÁO SỞ HỮU CÔNG NGHIỆP SỐ 424 TẬP A – QUYỀN 2 (07.2023)

- (11) **47300**
(21) 3-2023-00944 (28) 1
(54) **NHÃN SẢN PHẨM** (51) **19-08**
(22) 28/04/2023 (43) 25/07/2023
(73) **PHẠM THANH TÙNG (VN)**
R4B-2020 Royal City, 72A Nguyễn Trãi, quận Thanh Xuân, thành phố Hà Nội
(72) Phạm Thanh Tùng (VN)
(55)



- (11) **47301**
(21) 3-2023-00946 (28) 1
(54) **NHÃN SẢN PHẨM** (51) **19-08**
(22) 28/04/2023 (43) 25/07/2023
(73) **PHẠM THANH TÙNG (VN)**
R4B-2020 Royal City, 72A Nguyễn Trãi, quận Thanh Xuân, thành phố Hà Nội
(72) Phạm Thanh Tùng (VN)
(55)



CÔNG BÁO SỞ HỮU CÔNG NGHIỆP SỐ 424 TẬP A – QUYỀN 2 (07.2023)

- (11) **47302**
(21) 3-2023-00977 (28) 1
(54) **BAO GÓI** (51) **09-05**
(22) 04/05/2023 (43) 25/07/2023
(73) **ĐẶNG THỊ KIM MẠNH (VN)**
Tổ 3, phường Nghĩa Lộ, thành phố Quảng Ngãi, tỉnh Quảng Ngãi
(72) Đặng Thị Kim Mạnh (VN)
(74) Văn phòng Luật sư D và T (D & T LAW OFFICE)
(55)



1.1

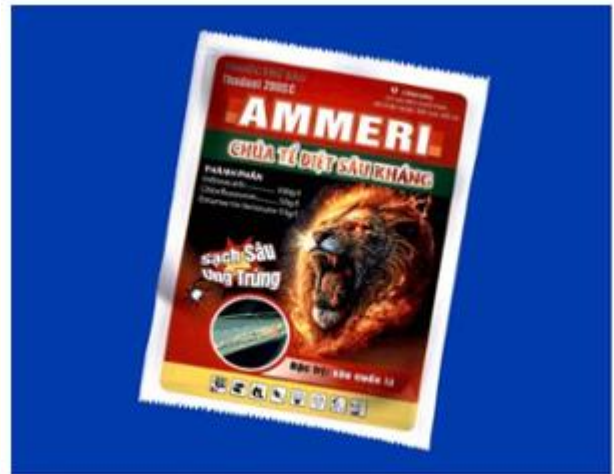

1.2

CÔNG BÁO SỞ HỮU CÔNG NGHIỆP SỐ 424 TẬP A – QUYỀN 2 (07.2023)

- (11) **47303**
- (21) 3-2023-01013
- (54) **BAO GÓI**
- (22) 11/05/2023
- (73) **CÔNG TY CỔ PHẦN PHÚ NÔNG (VN)**
Km 18, quốc lộ 10, xã Ân Hòa, huyện Kim Sơn, tỉnh Ninh Bình
- (72) Phạm Đình Khiêm (VN)
- (55)
- (28) 1
- (51) **09-05**
- (43) 25/07/2023



1.1



1.2

CÔNG BÁO SỞ HỮU CÔNG NGHIỆP SỐ 424 TẬP A – QUYỀN 2 (07.2023)

- (11) **47304**
(21) 3-2023-01014 (28) 1
(54) **BAO GÓI** (51) **09-05**
(22) 11/05/2023 (43) 25/07/2023
(73) **CÔNG TY CỔ PHẦN PHÚ NÔNG (VN)**
Km 18, quốc lộ 10, xã Ân Hòa, huyện Kim Sơn, tỉnh Ninh Bình
(72) Phạm Đình Khiêm (VN)
(55)



1.1



1.2

CÔNG BÁO SỞ HỮU CÔNG NGHIỆP SỐ 424 TẬP A – QUYỀN 2 (07.2023)

- (11) **47305**
(21) 3-2022-02742 (28) 1
(54) **HỘP ĐỰNG KẸO** (51) **09-03**
(22) 15/12/2022 (43) 25/07/2023
(73) **CÔNG TY TNHH VĨNH TIẾN (VN)**
Số 60A4, khu phố 1, phường Phú Tân, thành phố Bến Tre, tỉnh Bến Tre
(72) Đặng Thị Trúc Lan Chi (VN)
(55)



1.2



1.1

CÔNG BÁO SỞ HỮU CÔNG NGHIỆP SỐ 424 TẬP A – QUYỀN 2 (07.2023)

- (11) **47306**
(21) 3-2022-02743 (28) 1
(54) **HỘP ĐỰNG KẸO** (51) **09-03**
(22) 15/12/2022 (43) 25/07/2023
(73) **CÔNG TY TNHH VĨNH TIẾN (VN)**
Số 60A4, khu phố 1, phường Phú Tân, thành phố Bến Tre, tỉnh Bến Tre
(72) Đặng Thị Trúc Lan Chi (VN)
(55)



1.2



1.1

CÔNG BÁO SỞ HỮU CÔNG NGHIỆP SỐ 424 TẬP A – QUYỀN 2 (07.2023)

- (11) **47307**
(21) 3-2023-00636 (28) 1
(54) **THANH KIM LOẠI ĐỊNH HÌNH** (51) **25-01**
(22) 24/03/2023 (43) 25/07/2023
(73) **CÔNG TY CỔ PHẦN TẬP ĐOÀN KENWIN (VN)**
Tầng 4 tòa nhà VG Building, số 235 đường Nguyễn Trãi, phường Thanh Xuân
Trung, quận Thanh Xuân, thành phố Hà Nội
(72) Ngô Thọ Long (VN)
(74) Công ty TNHH Sở hữu trí tuệ PADEMARK (PADEMARK CO.,LTD.)
(55)



1.1



1.2



1.3

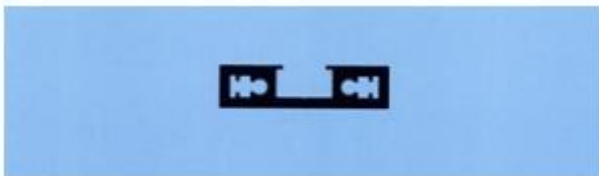

1.4

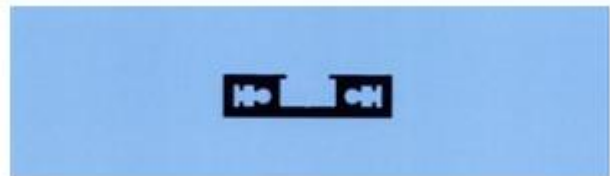

1.5



1.6



1.7

CÔNG BÁO SỞ HỮU CÔNG NGHIỆP SỐ 424 TẬP A – QUYỀN 2 (07.2023)

- (11) **47308**
(21) 3-2023-00637 (28) 1
(54) **THANH KIM LOẠI ĐỊNH HÌNH** (51) **25-01**
(22) 24/03/2023 (43) 25/07/2023
(73) **CÔNG TY CỔ PHẦN TẬP ĐOÀN KENWIN (VN)**
Tầng 4 tòa nhà VG Building, số 235 đường Nguyễn Trãi, phường Thanh Xuân
Trung, quận Thanh Xuân, thành phố Hà Nội
(72) Ngô Thọ Long (VN)
(74) Công ty TNHH Sở hữu trí tuệ PADEMARK (PADEMARK CO.,LTD.)
(55)



1.1



1.2



1.3



1.4

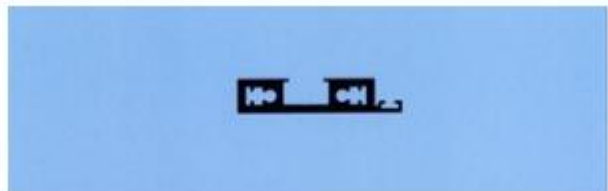

1.5



1.6



1.7

CÔNG BÁO SỞ HỮU CÔNG NGHIỆP SỐ 424 TẬP A – QUYỀN 2 (07.2023)

- (11) **47309**
(21) 3-2023-00640 (28) 1
(54) **THANH KIM LOẠI ĐỊNH HÌNH** (51) **25-01**
(22) 24/03/2023 (43) 25/07/2023
(73) **CÔNG TY CỔ PHẦN TẬP ĐOÀN KENWIN (VN)**
Tầng 4 tòa nhà VG Building, số 235 đường Nguyễn Trãi, phường Thanh Xuân
Trung, quận Thanh Xuân, thành phố Hà Nội
(72) Ngô Thọ Long (VN)
(74) Công ty TNHH Sở hữu trí tuệ PADEMARK (PADEMARK CO.,LTD.)
(55)



1.1



1.2



1.3

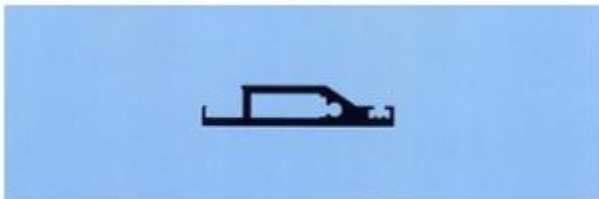

1.4



1.5



1.6



1.7

CÔNG BÁO SỞ HỮU CÔNG NGHIỆP SỐ 424 TẬP A – QUYỀN 2 (07.2023)

- (11) **47310**
(21) 3-2023-00638 (28) 1
(54) **THANH KIM LOẠI ĐỊNH HÌNH** (51) **25-01**
(22) 24/03/2023 (43) 25/07/2023
(73) **CÔNG TY CỔ PHẦN TẬP ĐOÀN KENWIN (VN)**
Tầng 4 tòa nhà VG Building, số 235 đường Nguyễn Trãi, phường Thanh Xuân
Trung, quận Thanh Xuân, thành phố Hà Nội
(72) Ngô Thọ Long (VN)
(74) Công ty TNHH Sở hữu trí tuệ PADEMARK (PADEMARK CO.,LTD.)
(55)



1.1



1.2



1.3



1.4

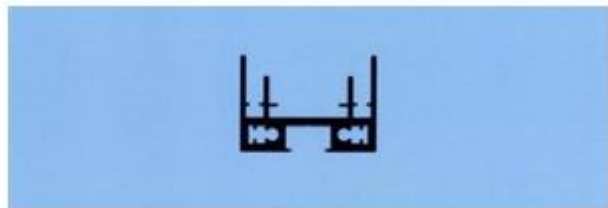

1.5



1.6



1.7

CÔNG BÁO SỞ HỮU CÔNG NGHIỆP SỐ 424 TẬP A – QUYỀN 2 (07.2023)

- (11) **47311**
(21) 3-2023-00641 (28) 1
(54) **THANH KIM LOẠI ĐỊNH HÌNH** (51) **25-01**
(22) 24/03/2023 (43) 25/07/2023
(73) **CÔNG TY CỔ PHẦN TẬP ĐOÀN KENWIN (VN)**
Tầng 4 tòa nhà VG Building, số 235 đường Nguyễn Trãi, phường Thanh Xuân
Trung, quận Thanh Xuân, thành phố Hà Nội
(72) Ngô Thọ Long (VN)
(74) Công ty TNHH Sở hữu trí tuệ PADEMARK (PADEMARK CO.,LTD.)
(55)



1.1



1.2



1.3



1.4

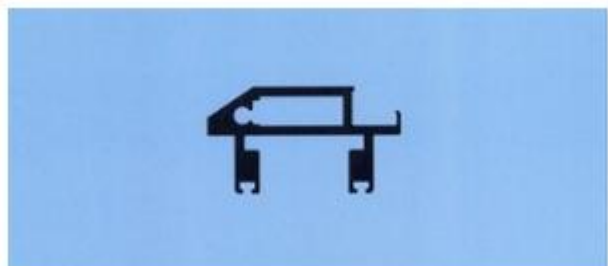

1.5



1.6



1.7

CÔNG BÁO SỞ HỮU CÔNG NGHIỆP SỐ 424 TẬP A – QUYỀN 2 (07.2023)

- (11) **47312**
(21) 3-2023-00642 (28) 1
(54) **THANH KIM LOẠI ĐỊNH HÌNH** (51) **25-01**
(22) 24/03/2023 (43) 25/07/2023
(73) **CÔNG TY CỔ PHẦN TẬP ĐOÀN KENWIN (VN)**
Tầng 4 tòa nhà VG Building, số 235 đường Nguyễn Trãi, phường Thanh Xuân
Trung, quận Thanh Xuân, thành phố Hà Nội
(72) Ngô Thọ Long (VN)
(74) Công ty TNHH Sở hữu trí tuệ PADEMARK (PADEMARK CO.,LTD.)
(55)



1.1



1.2



1.3



1.4



1.5



1.6



1.7

CÔNG BÁO SỞ HỮU CÔNG NGHIỆP SỐ 424 TẬP A – QUYỀN 2 (07.2023)

- (11) **47313**
(21) 3-2023-00645 (28) 1
(54) **THANH KIM LOẠI ĐỊNH HÌNH** (51) **25-01**
(22) 24/03/2023 (43) 25/07/2023
(73) **CÔNG TY CỔ PHẦN TẬP ĐOÀN KENWIN (VN)**
Tầng 4 tòa nhà VG Building, số 235 đường Nguyễn Trãi, phường Thanh Xuân
Trung, quận Thanh Xuân, thành phố Hà Nội
(72) Ngô Thọ Long (VN)
(74) Công ty TNHH Sở hữu trí tuệ PADEMARK (PADEMARK CO.,LTD.)
(55)



1.1



1.2



1.3



1.4

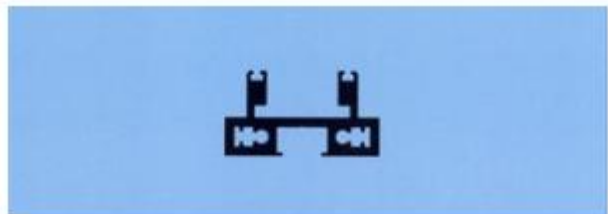

1.5



1.6



1.7

CÔNG BÁO SỞ HỮU CÔNG NGHIỆP SỐ 424 TẬP A – QUYỀN 2 (07.2023)

- (11) **47314**
(21) 3-2023-00643 (28) 1
(54) **THANH KIM LOẠI ĐỊNH HÌNH** (51) **25-01**
(22) 24/03/2023 (43) 25/07/2023
(73) **CÔNG TY CỔ PHẦN TẬP ĐOÀN KENWIN (VN)**
Tầng 4 tòa nhà VG Building, số 235 đường Nguyễn Trãi, phường Thanh Xuân
Trung, quận Thanh Xuân, thành phố Hà Nội
(72) Ngô Thọ Long (VN)
(74) Công ty TNHH Sở hữu trí tuệ PADEMARK (PADEMARK CO.,LTD.)
(55)



1.1



1.2



1.3



1.4



1.5



1.6



1.7

CÔNG BÁO SỞ HỮU CÔNG NGHIỆP SỐ 424 TẬP A – QUYỀN 2 (07.2023)

- (11) **47315**
(21) 3-2023-00644 (28) 1
(54) **THANH KIM LOẠI ĐỊNH HÌNH** (51) **25-01**
(22) 24/03/2023 (43) 25/07/2023
(73) **CÔNG TY CỔ PHẦN TẬP ĐOÀN KENWIN (VN)**
Tầng 4 tòa nhà VG Building, số 235 đường Nguyễn Trãi, phường Thanh Xuân
Trung, quận Thanh Xuân, thành phố Hà Nội
(72) Ngô Thọ Long (VN)
(74) Công ty TNHH Sở hữu trí tuệ PADEMARK (PADEMARK CO.,LTD.)
(55)



1.1



1.2



1.3

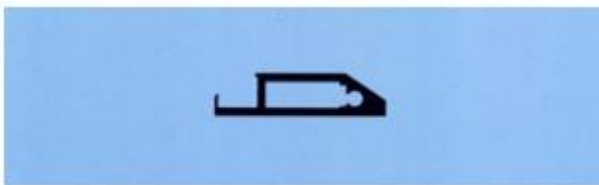

1.4

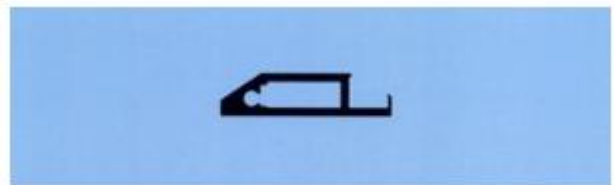

1.5



1.6



1.7

CÔNG BÁO SỞ HỮU CÔNG NGHIỆP SỐ 424 TẬP A – QUYỀN 2 (07.2023)

- (11) **47316**
(21) 3-2023-00693 (28) 1
(54) **THANH KIM LOẠI ĐỊNH HÌNH** (51) **25-01**
(22) 30/03/2023 (43) 25/07/2023
(73) **CÔNG TY CỔ PHẦN TẬP ĐOÀN KENWIN (VN)**
Tầng 4 tòa nhà VG Building, số 235 đường Nguyễn Trãi, phường Thanh Xuân
Trung, quận Thanh Xuân, thành phố Hà Nội
(72) Ngô Thọ Long (VN)
(74) Công ty TNHH Sở hữu trí tuệ PADEMARK (PADEMARK CO.,LTD.)
(55)

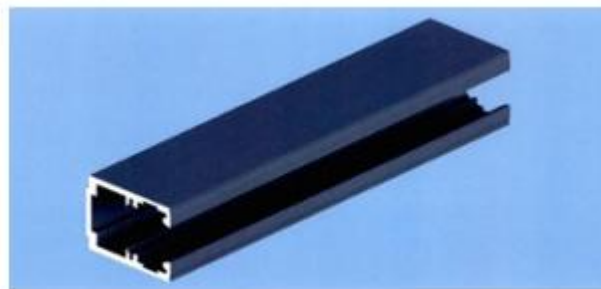

1.1



1.2



1.3



1.4

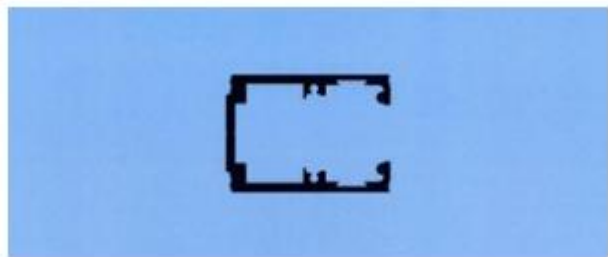

1.5



1.6



1.7

CÔNG BÁO SỞ HỮU CÔNG NGHIỆP SỐ 424 TẬP A – QUYỀN 2 (07.2023)

- (11) **47317**
(21) 3-2023-00692 (28) 1
(54) **THANH KIM LOẠI ĐỊNH HÌNH** (51) **25-01**
(22) 30/03/2023 (43) 25/07/2023
(73) **CÔNG TY CỔ PHẦN TẬP ĐOÀN KENWIN (VN)**
Tầng 4 tòa nhà VG Building, số 235 đường Nguyễn Trãi, phường Thanh Xuân
Trung, quận Thanh Xuân, thành phố Hà Nội
(72) Ngô Thọ Long (VN)
(74) Công ty TNHH Sở hữu trí tuệ PADEMARK (PADEMARK CO.,LTD.)
(55)



1.1



1.2



1.3



1.4



1.5



1.6



1.7

CÔNG BÁO SỞ HỮU CÔNG NGHIỆP SỐ 424 TẬP A – QUYỀN 2 (07.2023)

- (11) **47318**
(21) 3-2023-00694 (28) 1
(54) **THANH KIM LOẠI ĐỊNH HÌNH** (51) **25-01**
(22) 30/03/2023 (43) 25/07/2023
(73) **CÔNG TY CỔ PHẦN TẬP ĐOÀN KENWIN (VN)**
Tầng 4 tòa nhà VG Building, số 235 đường Nguyễn Trãi, phường Thanh Xuân
Trung, quận Thanh Xuân, thành phố Hà Nội
(72) Ngô Thọ Long (VN)
(74) Công ty TNHH Sở hữu trí tuệ PADEMARK (PADEMARK CO.,LTD.)
(55)



1.1



1.2



1.3



1.4



1.5



1.6



1.7

CÔNG BÁO SỞ HỮU CÔNG NGHIỆP SỐ 424 TẬP A – QUYỀN 2 (07.2023)

(11) **47319**

(21) 3-2023-00992

(28) 1

(54) **ĐẦU VÒI PHUN**

(51) **23-01**

(22) 08/05/2023

(43) 25/07/2023

(73) **CHIN-YUAN CHEN (TW)**

No. 75-6, Liaocuo Ln., Liaocuo Vil., Lukang Township, Changhua County 50565, Taiwan

(72) Chin-Yuan CHEN (TW)

(74) Công ty TNHH Sở hữu trí tuệ HA VIP (HAVIP CO., LTD.)

(55)

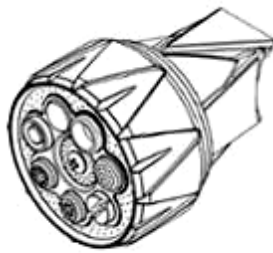

1.1



1.2



1.3

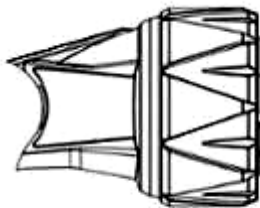

1.4

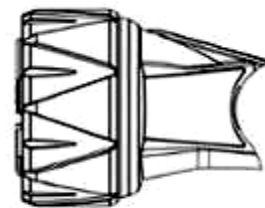

1.5



1.6



1.7

CÔNG BÁO SỞ HỮU CÔNG NGHIỆP SỐ 424 TẬP A – QUYỀN 2 (07.2023)

- (11) **47320**
(21) 3-2023-00967 (28) 1
(54) **THANH NHÔM ĐỊNH HÌNH** (51) **25-01**
(22) 28/04/2023 (43) 25/07/2023
(73) **CÔNG TY CỔ PHẦN EUROHOUSE VIỆT NAM (VN)**
Số 374 đường Nguyễn Thiện Thuật, phường Nhân Hòa, thị xã Mỹ Hào, tỉnh Hưng Yên
(72) Phạm Trường Giang (VN)
(55)

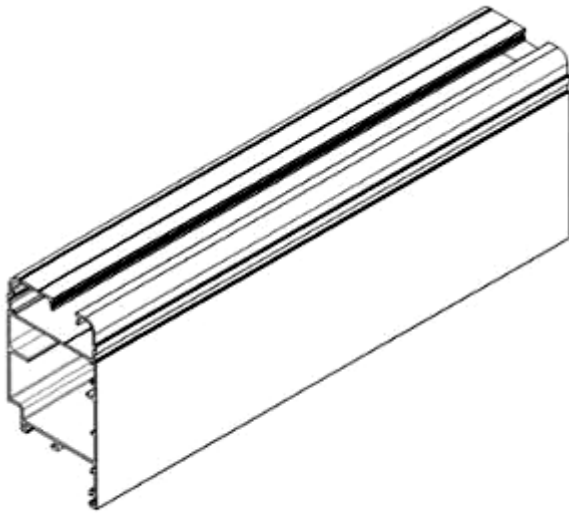

1.1

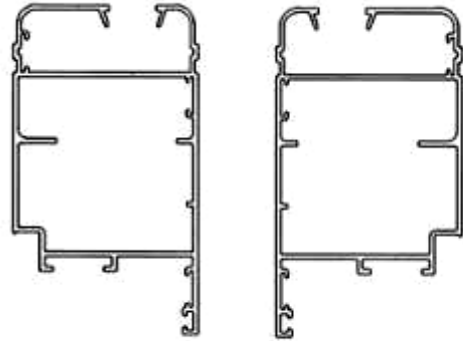

1.2

1.3

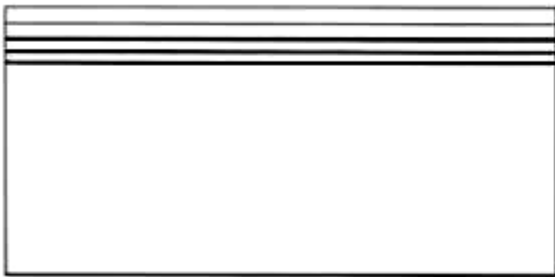

1.4

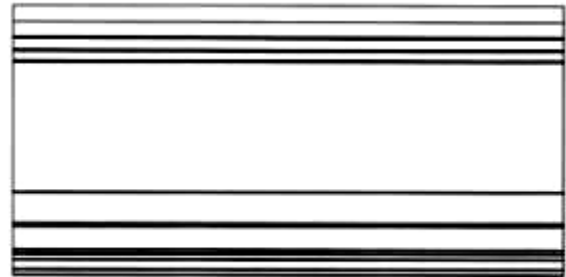

1.5

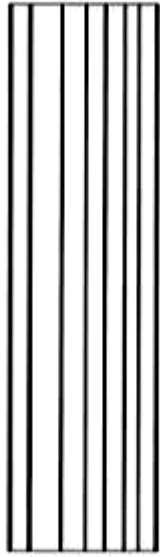

1.6



1.7

(11) **47321**

(21) 3-2023-00995

(28) 1

(54) **ĐẦU VÒI PHUN**

(51) **23-01**

(22) 08/05/2023

(43) 25/07/2023

(73) **CHIN-YUAN CHEN (TW)**

No. 75-6, Liaocuo Ln., Liaocuo Vil., Lukang Township, Changhua County 50565, Taiwan

(72) Chin-Yuan CHEN (TW)

(74) Công ty TNHH Sở hữu trí tuệ HA VIP (HAVIP CO., LTD.)

(55)



1.1



1.2



1.3



1.4

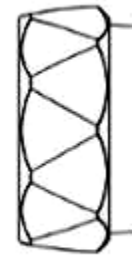

1.5

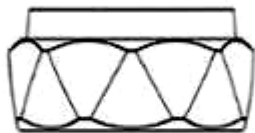

1.6

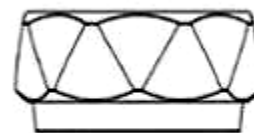

1.7

- (11) **47322**
(21) 3-2023-00994 (28) 1
(54) **TAY CÀM CỦA SÚNG PHUN XỊT** (51) **23-01**
(22) 08/05/2023 (43) 25/07/2023
(73) **CHIN-YUAN CHEN (TW)**
No. 75-6, Liaocuo Ln., Liaocuo Vil., Lukang Township, Changhua County 50565,
Taiwan
(72) Chin-Yuan CHEN (TW)
(74) Công ty TNHH Sở hữu trí tuệ HA VIP (HAVIP CO., LTD.)
(55)

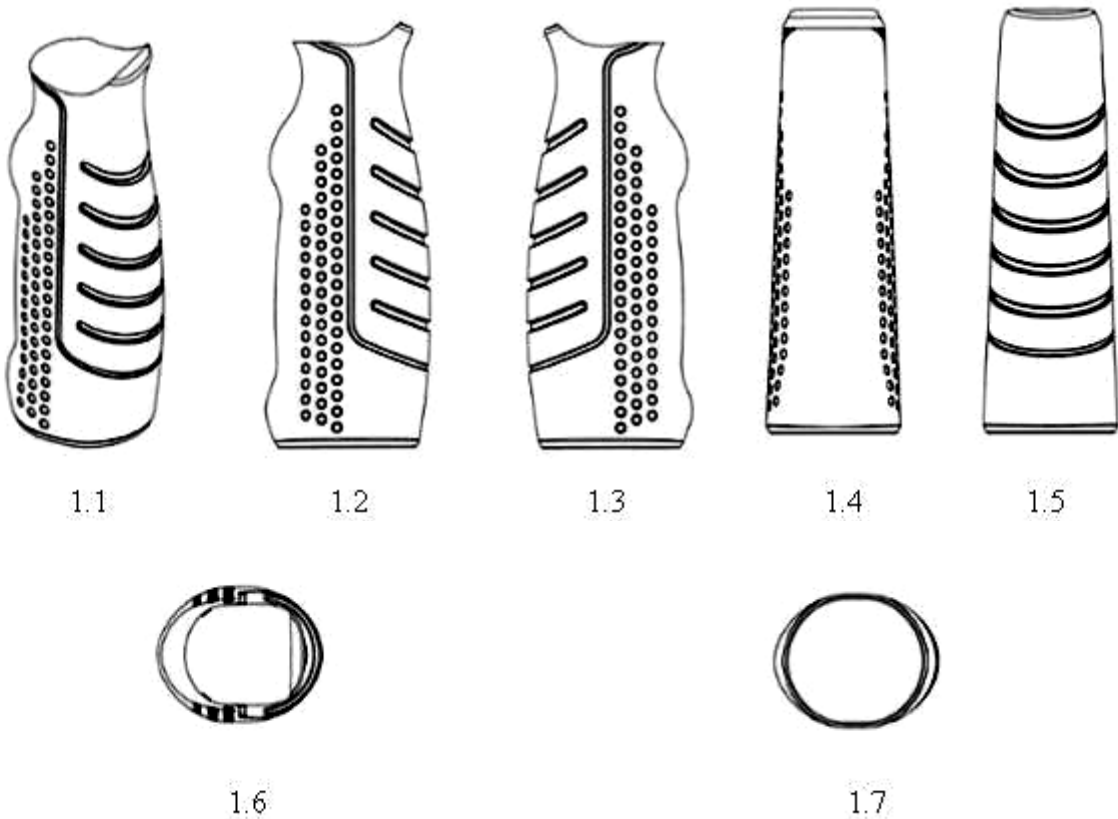

CÔNG BÁO SỞ HỮU CÔNG NGHIỆP SỐ 424 TẬP A – QUYỀN 2 (07.2023)

- (11) **47323**
(21) 3-2023-00993 (28) 1
(54) **TAY KÉO CỦA BÌNH PHUN XỊT** (51) **23-01**
(22) 08/05/2023 (43) 25/07/2023
(73) **CHIN-YUAN CHEN (TW)**
No. 75-6, Liaocuo Ln., Liaocuo Vil., Lukang Township, Changhua County 50565,
Taiwan
(72) Chin-Yuan CHEN (TW)
(74) Công ty TNHH Sở hữu trí tuệ HA VIP (HAVIP CO., LTD.)
(55)



1.1



1.2



1.3



1.4



1.5

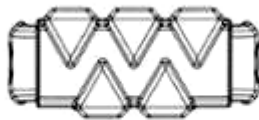

1.6



1.7

CÔNG BÁO SỞ HỮU CÔNG NGHIỆP SỐ 424 TẬP A – QUYỀN 2 (07.2023)

- (11) **47324**
(21) 3-2023-00996 (28) 1
(54) **ĐẦU VÒI PHUN** (51) **23-01**
(22) 08/05/2023 (43) 25/07/2023
(73) **CHIN-YUAN CHEN (TW)**
No. 75-6, Liaocuo Ln., Liaocuo Vil., Lukang Township, Changhua County 50565,
Taiwan
(72) Chin-Yuan CHEN (TW)
(74) Công ty TNHH Sở hữu trí tuệ HA VIP (HAVIP CO., LTD.)
(55)



1.1



1.2



1.3

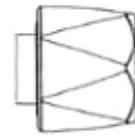

1.4



1.5



1.6



1.7

CÔNG BÁO SỞ HỮU CÔNG NGHIỆP SỐ 424 TẬP A – QUYỀN 2 (07.2023)

- (11) **47325**
(21) 3-2021-03326 (28) 1
(54) **THANH NHÔM ĐỊNH HÌNH** (51) **25-01**
(22) 24/12/2021 (43) 25/07/2023
(73) **CÔNG TY TNHH NHÔM SADONA (VN)**
B16/27 quốc lộ 1A, xã Bình Chánh, huyện Bình Chánh, thành phố Hồ Chí Minh
(72) Nguyễn Văn Điệp (VN)
(55)



1.1



1.2

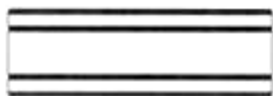

1.3

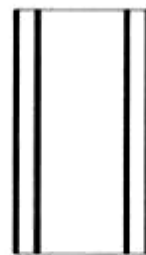

1.4

CÔNG BÁO SỞ HỮU CÔNG NGHIỆP SỐ 424 TẬP A – QUYỀN 2 (07.2023)

- (11) **47326**
(21) 3-2021-03315 (28) 1
(54) **THANH NHÔM ĐỊNH HÌNH** (51) **25-01**
(22) 23/12/2021 (43) 25/07/2023
(73) **CÔNG TY TNHH NHÔM SADONA (VN)**
B16/27 quốc lộ 1A, xã Bình Chánh, huyện Bình Chánh, thành phố Hồ Chí Minh
(72) Nguyễn Văn Điệp (VN)
(55)



1.1



1.2



1.3



1.4

CÔNG BÁO SỞ HỮU CÔNG NGHIỆP SỐ 424 TẬP A – QUYỀN 2 (07.2023)

- (11) **47327**
(21) 3-2021-03327 (28) 1
(54) **THANH NHÔM ĐỊNH HÌNH** (51) **25-01**
(22) 24/12/2021 (43) 25/07/2023
(73) **CÔNG TY TNHH NHÔM SADONA (VN)**
B16/27 quốc lộ 1A, xã Bình Chánh, huyện Bình Chánh, thành phố Hồ Chí Minh
(72) Nguyễn Văn Điệp (VN)
(55)



1.1



1.2



1.3



1.4

CÔNG BÁO SỞ HỮU CÔNG NGHIỆP SỐ 424 TẬP A – QUYỀN 2 (07.2023)

- (11) **47328**
- (21) 3-2022-01113
- (54) **PIN MẶT TRỜI**
- (22) 08/06/2022
- (30) 008790414 08/12/2021 EM;
- (73) **REC SOLAR PTE. LTD.** (SG)
20 Tuas South Avenue 14, Singapore 637312, Singapore
- (72) Kenta Nakayashiki (JP)
- (74) Công ty TNHH Tầm nhìn và Liên danh (VISION & ASSOCIATES CO.LTD.)
- (55)



1.1

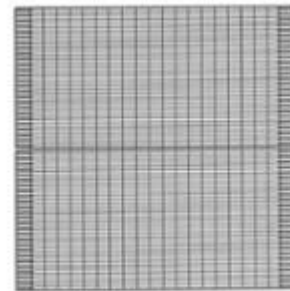

1.2

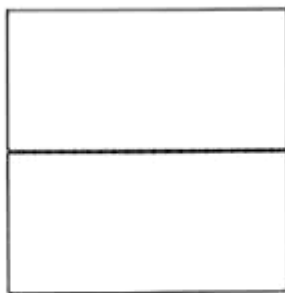

1.3



1.4



1.5



1.7



2.1

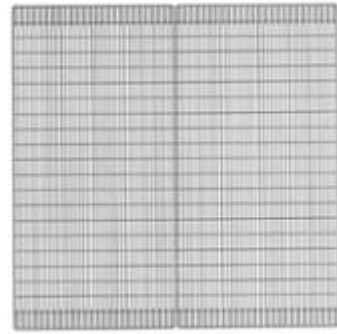

2.2

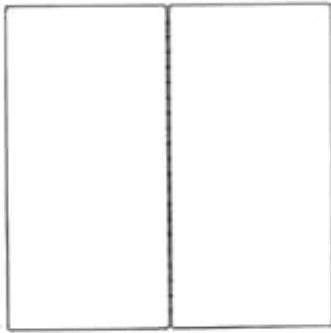

2.3



2.4



2.5



2.6



2.7



1.6

CÔNG BÁO SỞ HỮU CÔNG NGHIỆP SỐ 424 TẬP A – QUYỀN 2 (07.2023)

- (11) **47329**
(21) 3-2022-01114 (28) 2
(54) **PIN MẶT TRỜI** (51) **13-99**
(22) 08/06/2022 (43) 25/07/2023
(30) 008790414 08/12/2021 EM;
(73) **REC SOLAR PTE. LTD.** (SG)
20 Tuas South Avenue 14, Singapore 637312, Singapore
(72) Kenta Nakayashiki (JP)
(74) Công ty TNHH Tầm nhìn và Liên danh (VISION & ASSOCIATES CO.LTD.)
(55)



1.1

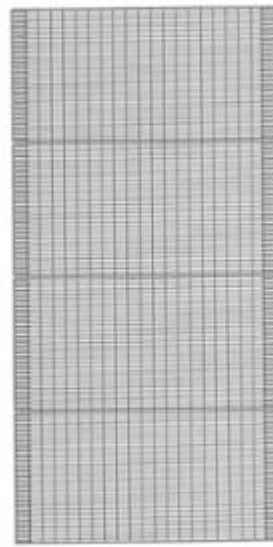

1.2

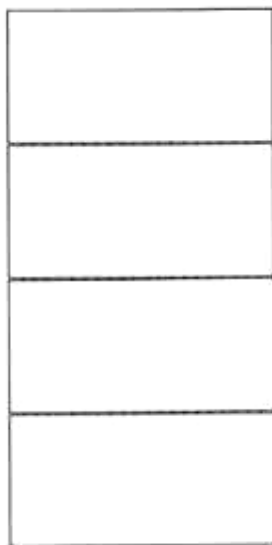

1.3



1.4



1.5



2.1



1.7

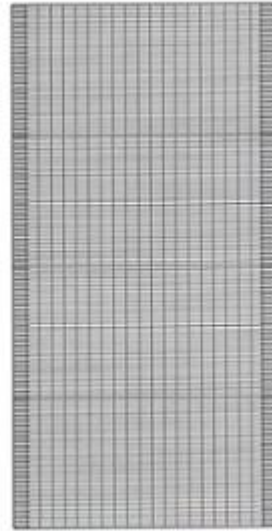

2.2

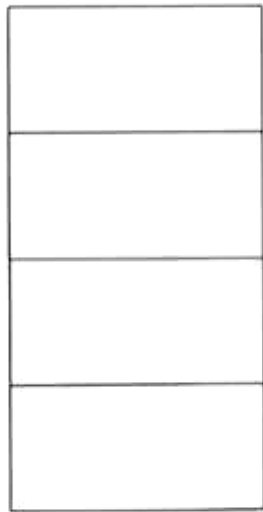

2.3



2.4



2.5



1.6



2.6



2.7

(11) **47330**

(21) 3-2022-01449

(28) 1

(54) **XE BA BÁNH**

(51) **12-11**

(22) 20/07/2022

(43) 25/07/2023

(73) **TRƯỜNG ĐẠI HỌC BÁCH KHOA - ĐẠI HỌC QUỐC GIA THÀNH PHỐ HỒ CHÍ MINH (VN)**

268 Lý Thường Kiệt, phường 14, quận 10, thành phố Hồ Chí Minh

(72) 1. HỒNG ĐỨC THÔNG (VN)

2. HỒ VĨNH KỲ (VN)

3. PHẠM QUANG MINH (VN)

(55)

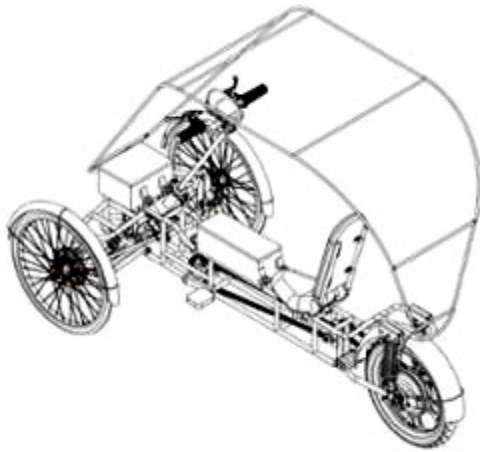

1.1

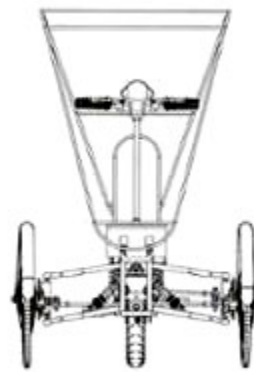

1.2

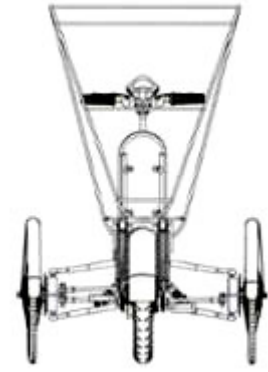

1.3

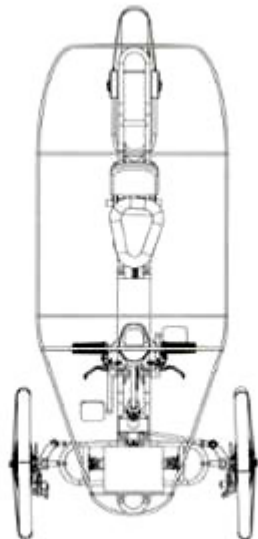

1.4

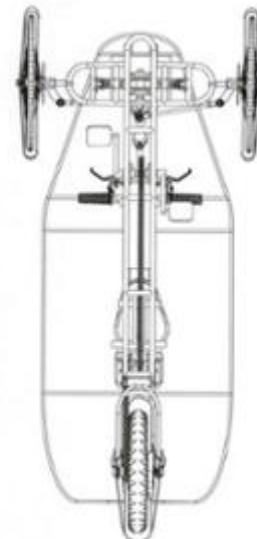

1.5

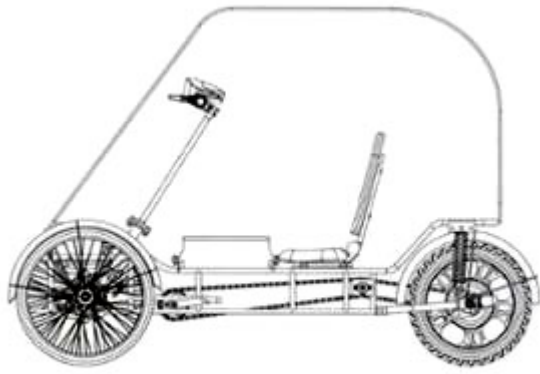

1.6

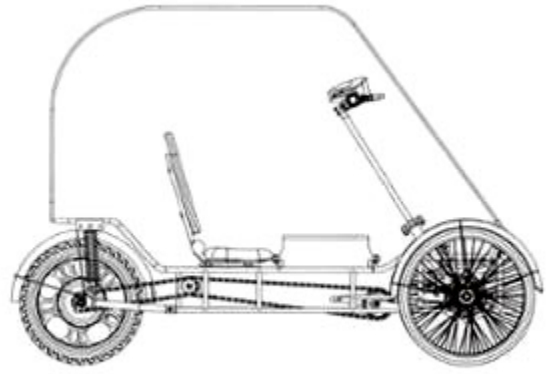

1.7

CÔNG BÁO SỞ HỮU CÔNG NGHIỆP SỐ 424 TẬP A – QUYỀN 2 (07.2023)

(11) **47331**

(21) 3-2022-02049

(28) 1

(54) **PIN**

(51) **13-02**

(22) 23/09/2022

(43) 25/07/2023

(73) **PHẠM TÙNG DƯƠNG (VN)**

Khu phố La Văn Cầu, thị trấn Nam Sách, huyện Nam Sách, tỉnh Hải Dương

(72) Phạm Tùng Dương (VN)

(74) Công ty TNHH Thương mại và dịch vụ IP Ngọc Anh (IP NGOC ANH TRADE AND SERVICE COMPANY LIMITED)

(55)



1.1



1.2



1.3



1.4



1.5

CÔNG BÁO SỞ HỮU CÔNG NGHIỆP SỐ 424 TẬP A – QUYỀN 2 (07.2023)

- (11) **47332**
(21) 3-2022-01896 (28) 1
(54) **THANH KIM LOẠI ĐỊNH HÌNH** (51) **25-01**
(22) 07/09/2022 (43) 25/07/2023
(73) **CÔNG TY CỔ PHẦN SẢN XUẤT VÀ ĐẦU TƯ HƯNG PHÁT (VN)**
Tổ dân phố Thịnh Vạn, phường Minh Đức, thị xã Mỹ Hào, tỉnh Hưng Yên
(72) Nguyễn Văn Tâm (VN)
(74) Công ty TNHH Sở hữu trí tuệ Gia Việt (GIAVIET CO., LTD.)
(55)



1.1



1.2



1.3



1.4



1.5

CÔNG BÁO SỞ HỮU CÔNG NGHIỆP SỐ 424 TẬP A – QUYỀN 2 (07.2023)

- (11) **47333**
(21) 3-2022-01612 (28) 1
(54) **THANH KIM LOẠI ĐỊNH HÌNH** (51) **25-01**
(22) 10/08/2022 (43) 25/07/2023
(73) **CÔNG TY CỔ PHẦN SẢN XUẤT VÀ ĐẦU TƯ HƯNG PHÁT (VN)**
Tổ dân phố Thịnh Vạn, phường Minh Đức, thị xã Mỹ Hào, tỉnh Hưng Yên
(72) Nguyễn Văn Tâm (VN)
(74) Công ty TNHH Sở hữu trí tuệ Gia Việt (GIAVIET CO., LTD.)
(55)



1.1

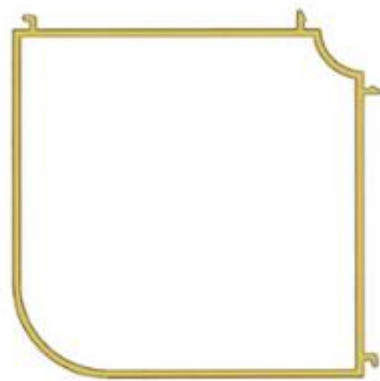

1.2



1.3



1.4



1.5

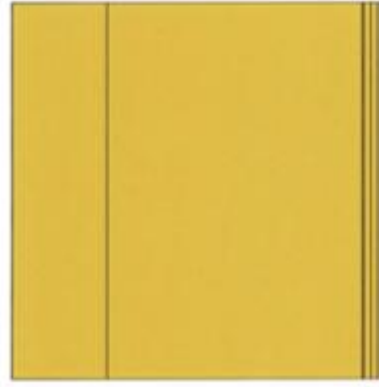

1.6

CÔNG BÁO SỞ HỮU CÔNG NGHIỆP SỐ 424 TẬP A – QUYỀN 2 (07.2023)

- (11) **47334**
(21) 3-2022-02405 (28) 1
(54) **ĐỘNG CƠ ĐIỆN** (51) **13-01**
(22) 04/11/2022 (43) 25/07/2023
(73) **CÔNG TY TNHH LEON LEGION (VN)**
269 Đường Liên Phường, phường Phước Long B, thành phố Thủ Đức, thành phố Hồ Chí Minh
(72) Hoàng Xuân Thành (VN)
(74) Công ty Luật TNHH Tư vấn Quốc tế (INDOCHINE COUNSEL)
(55)



1.1

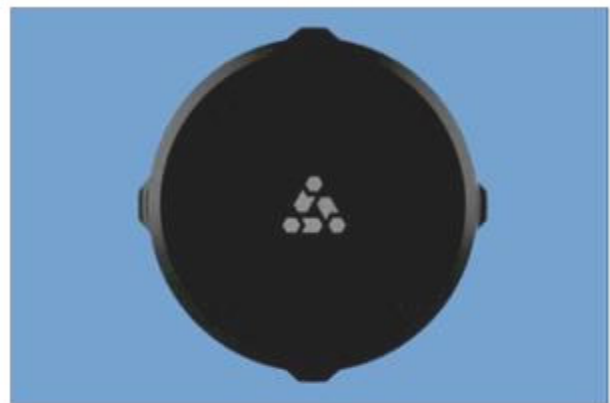

1.2



1.3

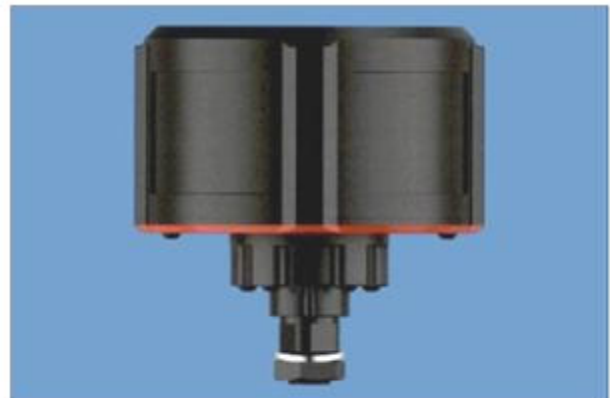

1.4



1.5



1.6



1.7

CÔNG BÁO SỞ HỮU CÔNG NGHIỆP SỐ 424 TẬP A – QUYỀN 2 (07.2023)

- (11) **47335**
(21) 3-2022-02334 (28) 1
(54) **HỘP** (51) **09-03**
(22) 27/10/2022 (43) 25/07/2023
(73) **CÔNG TY TNHH SẢN XUẤT THƯƠNG MẠI DỊCH VỤ TÂN TUỜNG KHANG (VN)**
Lô F1 & F2, đường D2 và N5, khu công nghiệp Nam Tân Uyên, phường Khánh Bình, thị xã Tân Uyên, tỉnh Bình Dương
(72) Nìm Dùng Chiếng (VN)
(74) Văn phòng Luật sư D và T (D & T LAW OFFICE)
(55)



1.1



1.2



1.3



1.4



1.5



1.6



1.7



1.8

- (11) **47336**
(21) 3-2022-02549 (28) 1
(54) **THIẾT BỊ NỔI MI CÓ THỂ ĐIỀU CHỈNH NHIỆT ĐỘ** (51) **28-03**
(22) 18/11/2022 (43) 25/07/2023
(30) 29/846,969 20/07/2022 US;
(73) **LASHIFY, INC. (US)**
11437 Chandler Boulevard, North Hollywood, California 91601, United States of America
(72) Sahara LOTTI (US)
(74) Công ty TNHH Tầm nhìn và Liên danh (VISION & ASSOCIATES CO.LTD.)
(55)



1.1



1.2



1.3



1.4



1.5



1.6



1.7

CÔNG BÁO SỞ HỮU CÔNG NGHIỆP SỐ 424 TẬP A – QUYỀN 2 (07.2023)

- (11) **47337**
- (21) 3-2022-02446 (28) 2
- (54) **TẮM ỐP LƯNG DÙNG CHO THIẾT BỊ HIỂN THỊ** (51) **03-01; 14-99**
- (22) 08/11/2022 (43) 25/07/2023
- (30) 29/838,041 10/05/2022 US;
- (73) **GOOGLE LLC (US)**
1600 Amphitheatre Parkway, Mountain View, California 94043, United States of America
- (72) 1. BENGT GUNNAR BRUMMER (SE)
2. MAJ ISABELLE OLSSON (SE)
3. CARL CEPRESS (US)
4. FRED SIMON (US)
5. NICK GILLETT (US)
- (74) Công ty Luật TNHH ROUSE Việt Nam (ROUSE LEGAL VIETNAM LTD.)
- (55)



1.1



1.2



1.3



1.4



1.5



1.6



1.7



1.8



2.1

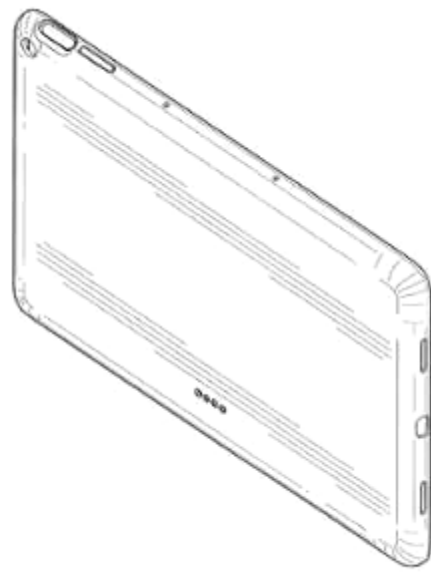

2.2

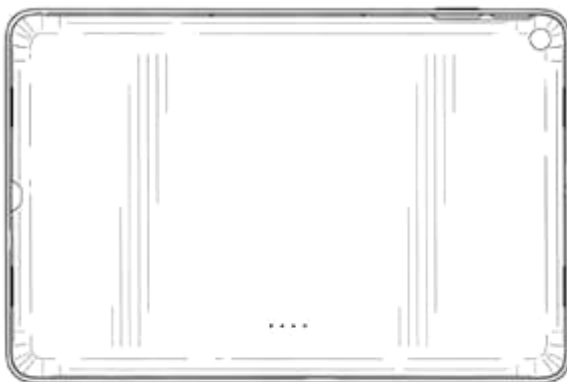

2.3

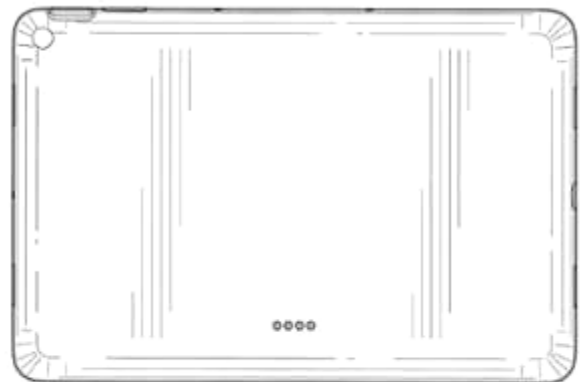

2.4



2.5



2.6



2.7



2.8

CÔNG BÁO SỞ HỮU CÔNG NGHIỆP SỐ 424 TẬP A – QUYỀN 2 (07.2023)

(11) **47338**

(21) 3-2022-02435

(54) **MỎ LẾT**

(22) 08/11/2022

(73) **CÔNG TY CỔ PHẦN AUTOMAC VIỆT NAM (VN)**

Tầng 4 tòa HUD3, số 121-123 Tô Hiệu, phường Nguyễn Trãi, quận Hà Đông, thành phố Hà Nội

(72) Vi Viết Quân (VN)

(55)

(28) 1

(51) **08-05**

(43) 25/07/2023

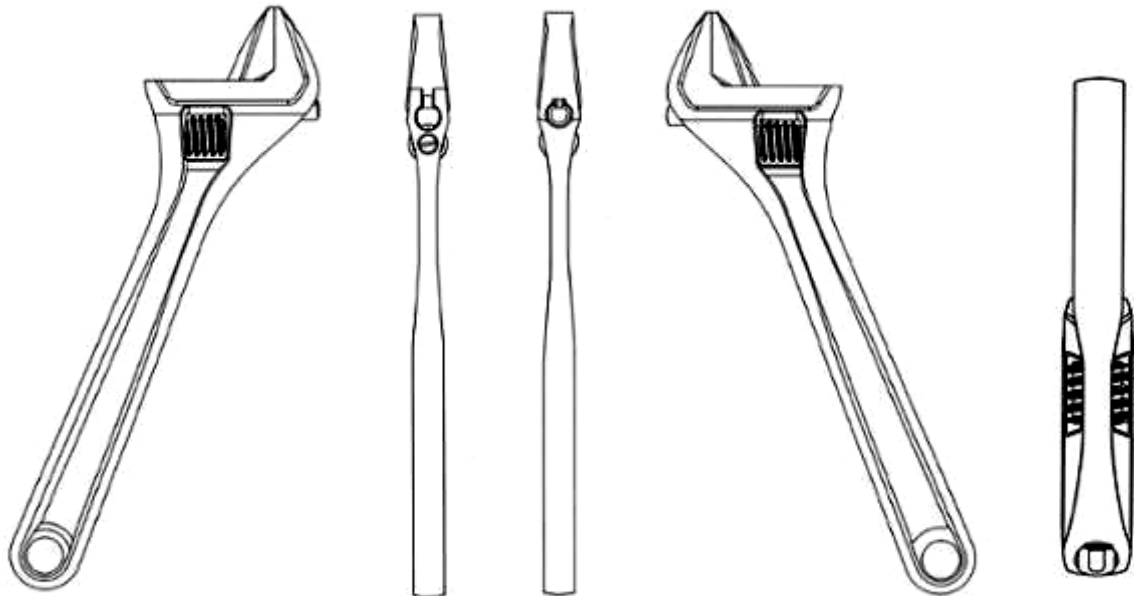

1.1

1.2

1.3

1.4

1.5

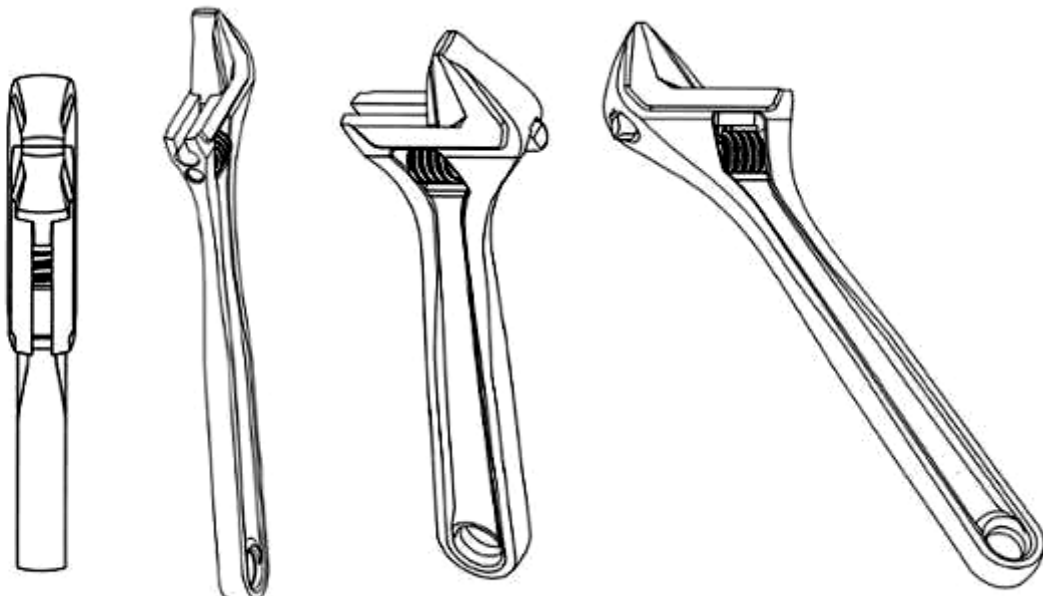

1.6

1.7

1.8

1.9

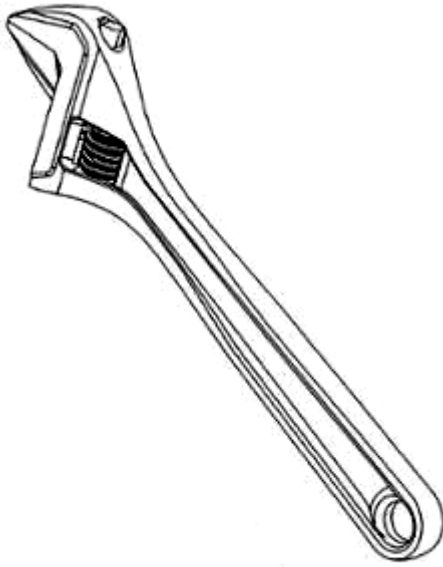

1.10

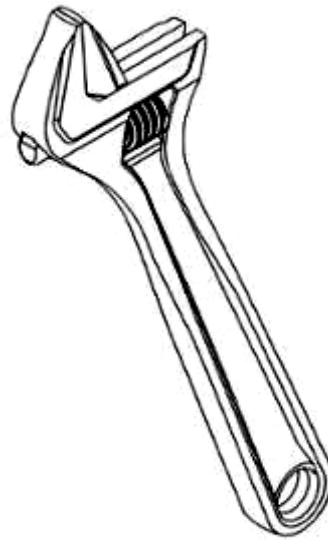

1.11



1.12

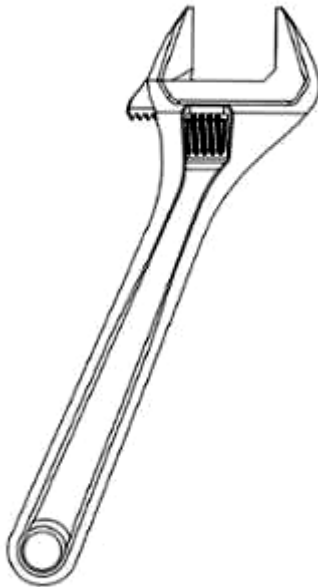

1.13



1.14



1.15



1.16



1.17

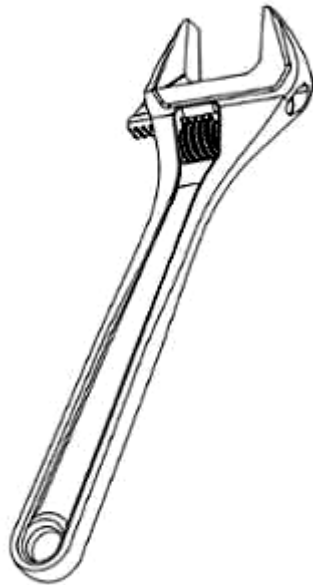

1.18



1.19

CÔNG BÁO SỞ HỮU CÔNG NGHIỆP SỐ 424 TẬP A – QUYỀN 2 (07.2023)

- (11) **47339**
(21) 3-2022-02773 (28) 1
(54) **THIẾT BỊ KIỂM SOÁT RA VÀO** (51) **10-05**
(22) 16/12/2022 (43) 25/07/2023
(73) **CÔNG TY CỔ PHẦN MK VISION (VN)**
Lô C-1B, khu công nghiệp Thăng Long Vĩnh Phúc, xã Thiện Kê, huyện Bình Xuyên, tỉnh Vĩnh Phúc
(72) Nguyễn Trọng Khang (VN)
(74) Công ty TNHH Sở hữu trí tuệ PADEMARK (PADEMARK CO.,LTD.)
(55)



CÔNG BÁO SỞ HỮU CÔNG NGHIỆP SỐ 424 TẬP A – QUYỀN 2 (07.2023)

- (11) **47340**
(21) 3-2022-02756 (28) 1
(54) **CƠ CẤU CHẤP HÀNH KIỂU ĐIỆN KHÍ** (51) **15-99**
(22) 15/12/2022 (43) 25/07/2023
(73) **TẬP ĐOÀN CÔNG NGHIỆP - VIỆN THÔNG QUÂN ĐỘI (VN)**
Lô D26 khu đô thị mới Cầu Giấy, phường Yên Hoà, quận Cầu Giấy, thành phố Hà Nội
(72) 1. PHẠM KỶ NAM (VN)
2. CAO VĂN BÌNH (VN)
(74) Công ty TNHH NACILAW (NACILAW)
(55)

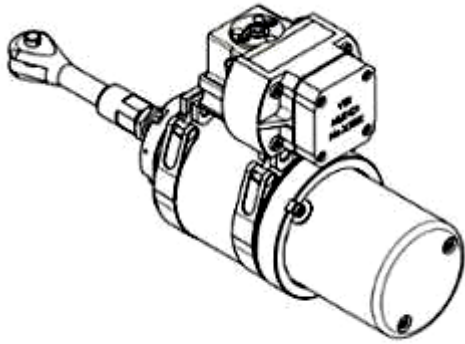

1.1

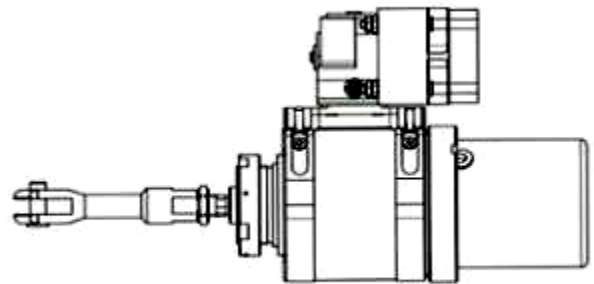

1.2

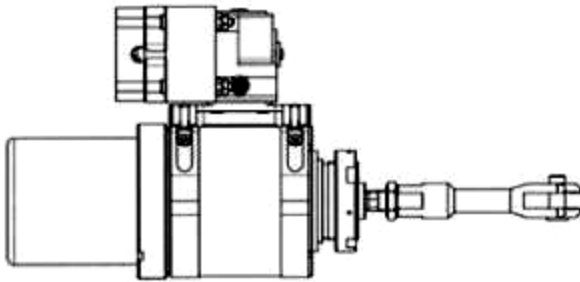

1.3



1.4



1.5

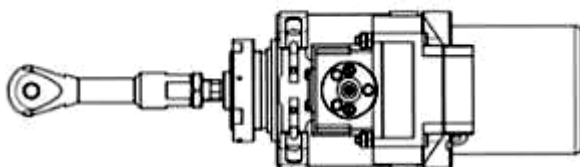

1.6

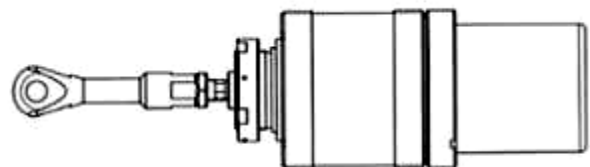

1.7

- (11) **47341**
(21) 3-2022-02855 (28) 1
(54) **BAO THUỐC LÁ** (51) **09-03**
(22) 23/12/2022 (43) 25/07/2023
(73) **CÔNG TY CỔ PHẦN THƯƠNG MẠI THUỐC LÁ LOTUS HÀ NỘI (VN)**
Số 98 đường Tô Ngọc Vân, phường Quảng An, quận Tây Hồ, thành phố Hà Nội
(72) Trần Quang Thạch (VN)
(55)



1.1



1.2

CÔNG BÁO SỞ HỮU CÔNG NGHIỆP SỐ 424 TẬP A – QUYỀN 2 (07.2023)

(11) **47342**

(21) 3-2022-02782

(28) 1

(54) **ĐỒNG HỒ ĐEO TAY**

(51) **10-02**

(22) 19/12/2022

(43) 25/07/2023

(73) **CHANEL (FR)**

135 avenue Charles de Gaulle, F-92200 Neuilly-sur-Seine, France

(72) Marianna NITSCH (AT)

(74) Công ty Luật TNHH Phạm và Liên danh (PHAM & ASSOCIATES)

(55)

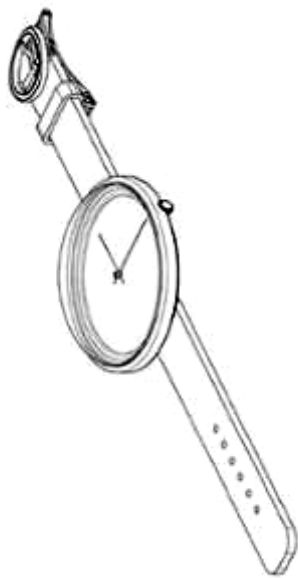

1.1



1.2



1.3

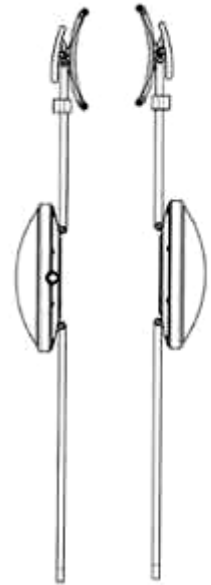

1.4

1.5



1.6



1.7

(11) **47343**

(21) 3-2022-02783

(28) 5

(54) **MẶT ĐỒNG HỒ**

(51) **10-07**

(22) 19/12/2022

(43) 25/07/2023

(73) **CHANEL (FR)**

135 avenue Charles de Gaulle, F-92200 Neuilly-sur-Seine, France

(72) Marianna NITSCH (AT)

(74) Công ty Luật TNHH Phạm và Liên danh (PHAM & ASSOCIATES)

(55)



1.1



1.2

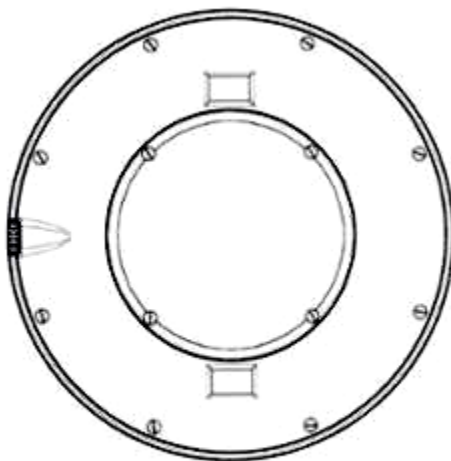

1.3

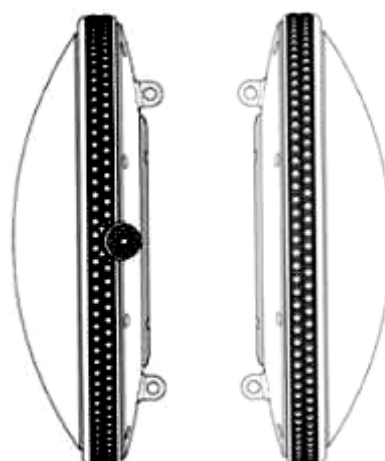

1.4

1.5



1.6

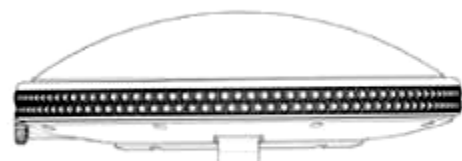

1.7



2.1

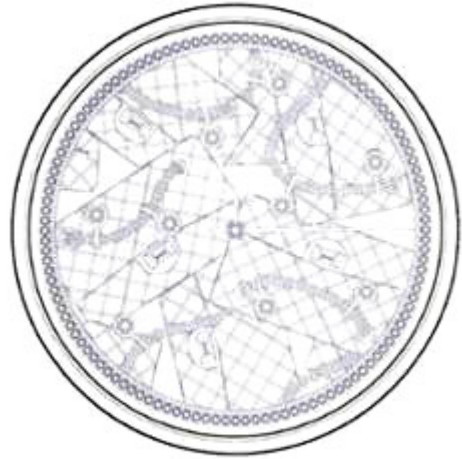

2.2

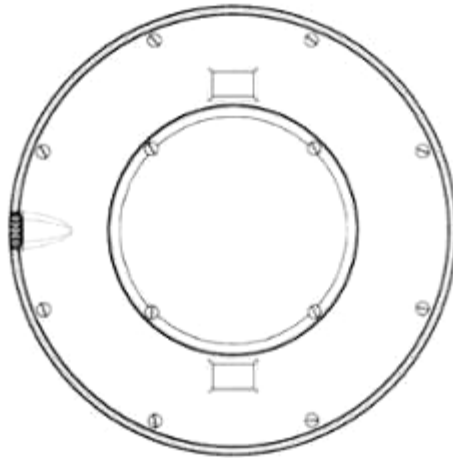

2.3

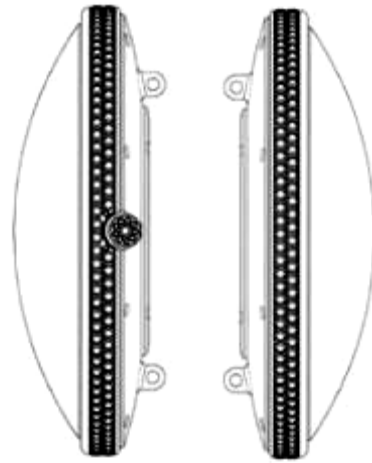

2.4

2.5

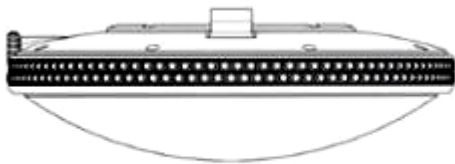

2.6

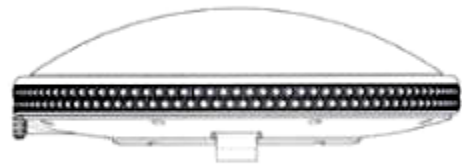

2.7



3.1

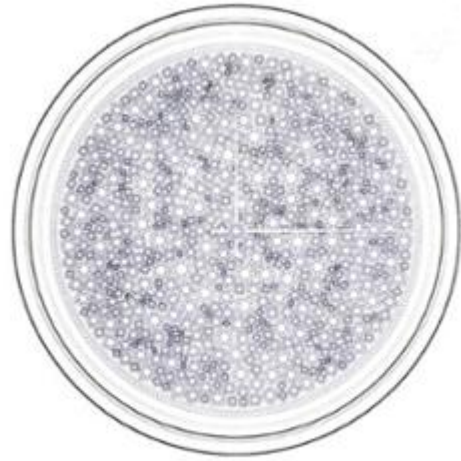

3.2

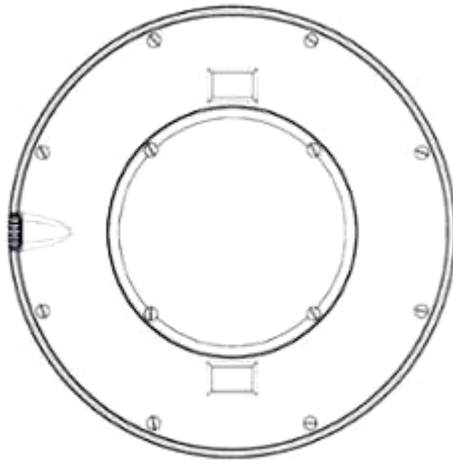

3.3



3.4



3.5

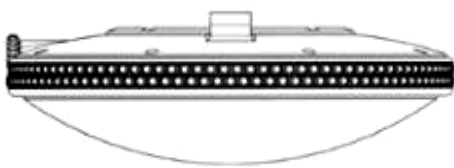

3.6

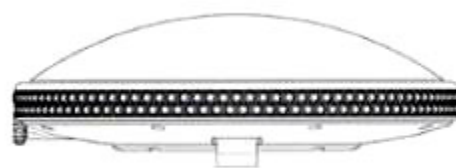

3.7



4.1



4.2

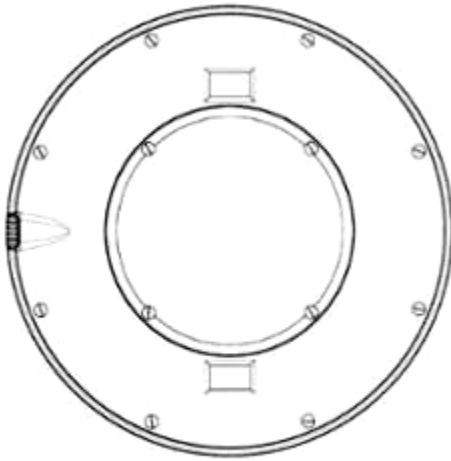

4.3



4.4



4.5

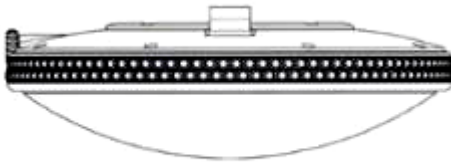

4.6

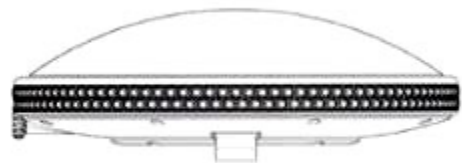

4.7



5.1

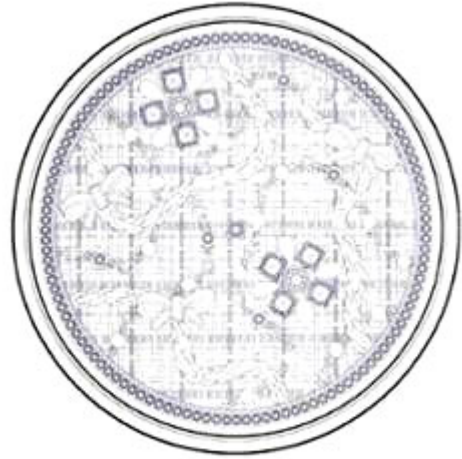

5.2

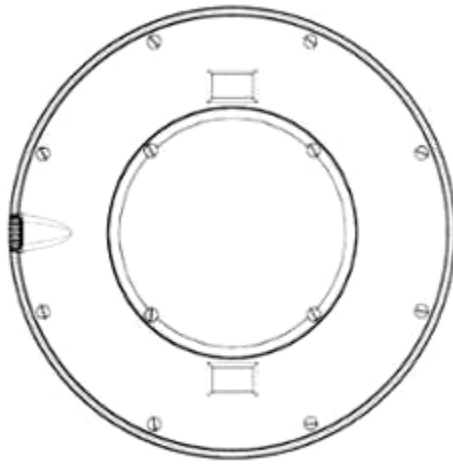

5.3

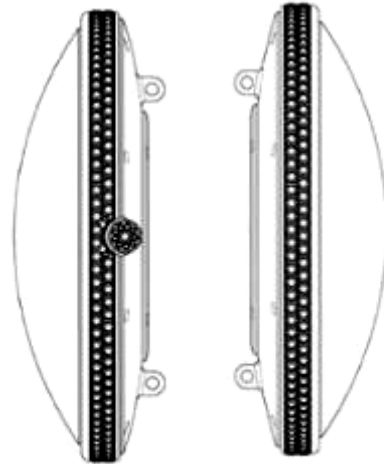

5.4

5.5

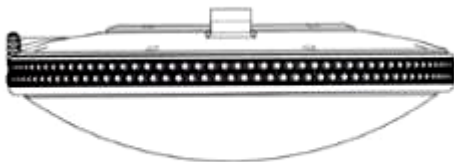

5.6

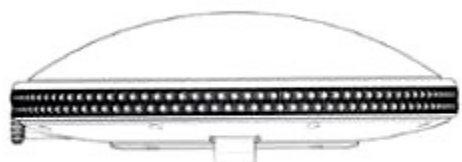

5.7

CÔNG BÁO SỞ HỮU CÔNG NGHIỆP SỐ 424 TẬP A – QUYỀN 2 (07.2023)

- (11) **47344**
(21) 3-2022-02910 (28) 1
(54) **CHAI** (51) **09-01**
(22) 27/12/2022 (43) 25/07/2023
(73) **CÔNG TY TNHH KHAI THÁC HẢI SẢN, CHẾ BIẾN NƯỚC MẮM THANH HÀ (VN)**
11/18 đường Nguyễn Huệ, khu phố 11, phường Dương Đông, thành phố Phú Quốc, tỉnh Kiên Giang
(72) Nguyễn Thị Nguyệt Hà (VN)
(55)



1.1



1.2



1.3



1.4



1.5



1.6

(11) **47345**

(21) 3-2022-02941

(54) **ĐỀ**

(22) 29/12/2022

(73) **HỘ KINH DOANH AN VĨNH PHÁT (VN)**

R23/39/36 cư xá Phú Lâm A, phường 12, quận 6, thành phố Hồ Chí Minh

(72) Khuu Sở Dinh (VN)

(55)

(28) 1

(51) **99-00**

(43) 25/07/2023



1.1



1.2



1.3



1.4



1.5



1.6

- (11) **47346**
(21) 3-2023-00700 (28) 1
(54) **THANH NHÔM ĐỊNH HÌNH** (51) **25-01**
(22) 30/03/2023 (43) 25/07/2023
(73) **CÔNG TY TNHH THANH PHÚC WINDOW (VN)**
478 Nguyễn Thị Thập, phường Tân Quy, quận 7, thành phố Hồ Chí Minh
(72) Nguyễn Thị Kim Hoàn (VN)
(55)



1.1

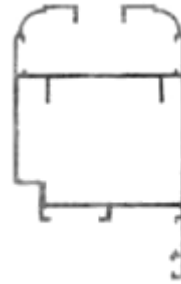

1.2

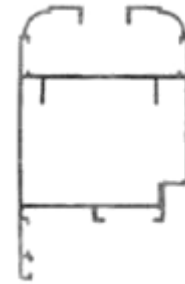

1.3



1.4



1.5



1.6



1.7

CÔNG BÁO SỞ HỮU CÔNG NGHIỆP SỐ 424 TẬP A – QUYỀN 2 (07.2023)

- (11) 47347
(21) 3-2023-00702 (28) 1
(54) **THANH NHÔM ĐỊNH HÌNH** (51) **25-01**
(22) 30/03/2023 (43) 25/07/2023
(73) **CÔNG TY TNHH THANH PHÚC WINDOW (VN)**
478 Nguyễn Thị Thập, phường Tân Quy, quận 7, thành phố Hồ Chí Minh
(72) Nguyễn Thị Kim Hoàn (VN)
(55)



1.1

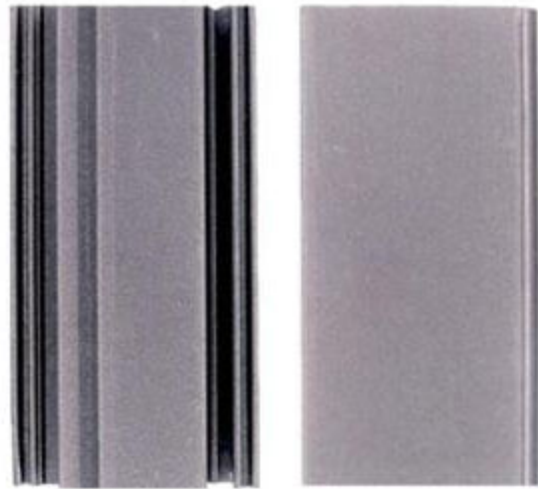

1.2

1.3

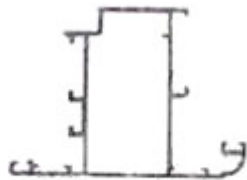

1.4



1.5



1.6



1.7

- (11) **47348**
(21) 3-2023-00707 (28) 1
(54) **THANH NHÔM ĐỊNH HÌNH** (51) **25-01**
(22) 30/03/2023 (43) 25/07/2023
(73) **CÔNG TY TNHH THANH PHÚC WINDOW (VN)**
478 Nguyễn Thị Thập, phường Tân Quy, quận 7, thành phố Hồ Chí Minh
(72) Nguyễn Thị Kim Hoàn (VN)
(55)



1.1



1.2



1.3

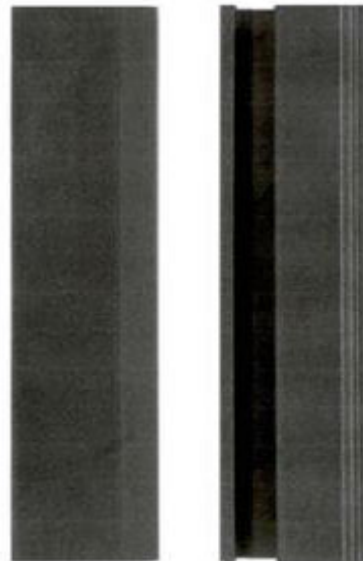

1.4

1.5



1.6



1.7

CÔNG BÁO SỞ HỮU CÔNG NGHIỆP SỐ 424 TẬP A – QUYỀN 2 (07.2023)

- (11) **47349**
(21) 3-2023-00706 (28) 1
(54) **THANH NHÔM ĐỊNH HÌNH** (51) **25-01**
(22) 30/03/2023 (43) 25/07/2023
(73) **CÔNG TY TNHH THANH PHÚC WINDOW (VN)**
478 Nguyễn Thị Thập, phường Tân Quy, quận 7, thành phố Hồ Chí Minh
(72) Nguyễn Thị Kim Hoàn (VN)
(55)



1.1



1.2

1.3



1.4



1.5



1.6



1.7

CÔNG BÁO SỞ HỮU CÔNG NGHIỆP SỐ 424 TẬP A – QUYỀN 2 (07.2023)

- (11) **47350**
(21) 3-2023-00710 (28) 1
(54) **THANH NHÔM ĐỊNH HÌNH** (51) **25-01**
(22) 30/03/2023 (43) 25/07/2023
(73) **CÔNG TY TNHH THANH PHÚC WINDOW (VN)**
478 Nguyễn Thị Thập, phường Tân Quy, quận 7, thành phố Hồ Chí Minh
(72) Nguyễn Thị Kim Hoàn (VN)
(55)

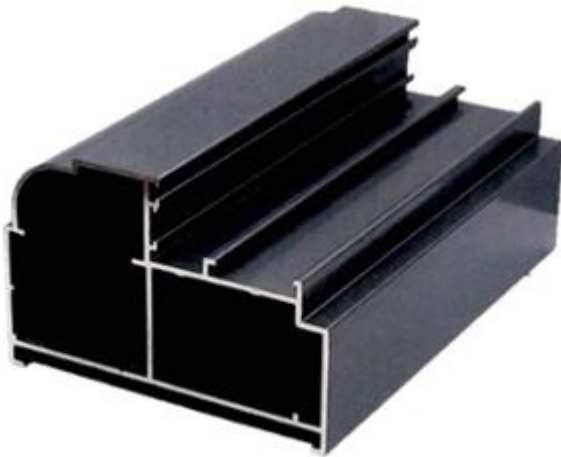

1.1

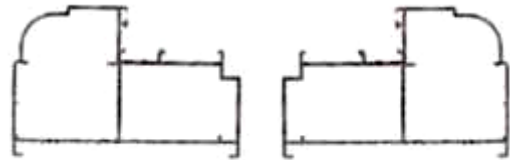

1.2

1.3



1.4



1.5



1.6



1.7

CÔNG BÁO SỞ HỮU CÔNG NGHIỆP SỐ 424 TẬP A – QUYỀN 2 (07.2023)

- (11) **47351**
(21) 3-2023-00708 (28) 1
(54) **THANH NHÔM ĐỊNH HÌNH** (51) **25-01**
(22) 30/03/2023 (43) 25/07/2023
(73) **CÔNG TY TNHH THANH PHÚC WINDOW (VN)**
478 Nguyễn Thị Thập, phường Tân Quy, quận 7, thành phố Hồ Chí Minh
(72) Nguyễn Thị Kim Hoàn (VN)
(55)



1.1



1.2



1.3

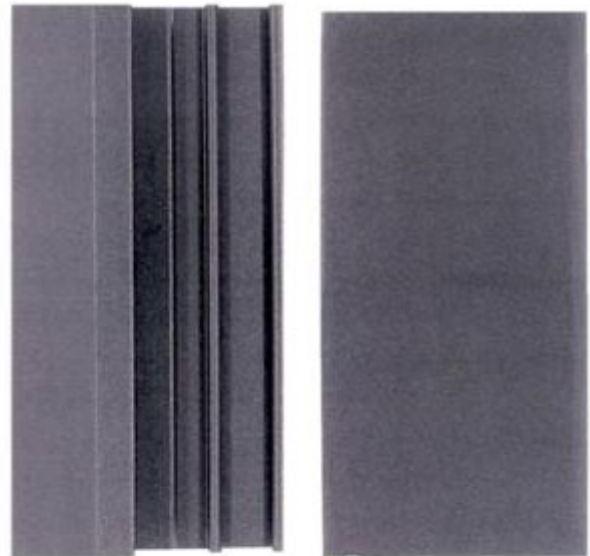

1.4

1.5



1.6

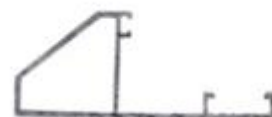

1.7

CÔNG BÁO SỞ HỮU CÔNG NGHIỆP SỐ 424 TẬP A – QUYỀN 2 (07.2023)

- (11) **47352**
(21) 3-2023-00709 (28) 1
(54) **THANH NHÔM ĐỊNH HÌNH** (51) **25-01**
(22) 30/03/2023 (43) 25/07/2023
(73) **CÔNG TY TNHH THANH PHÚC WINDOW (VN)**
478 Nguyễn Thị Thập, phường Tân Quy, quận 7, thành phố Hồ Chí Minh
(72) Nguyễn Thị Kim Thoán (VN)
(55)



1.1



1.2

1.3



1.4

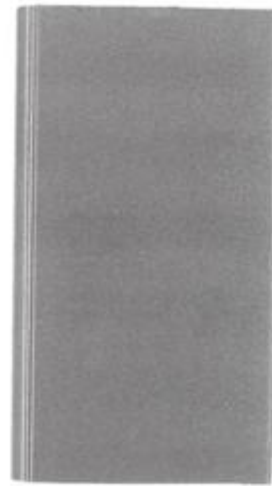

1.5



1.6



1.7

- (11) **47353**
(21) 3-2023-00712 (28) 1
(54) **THANH NHÔM ĐỊNH HÌNH** (51) **25-01**
(22) 30/03/2023 (43) 25/07/2023
(73) **CÔNG TY TNHH THANH PHÚC WINDOW (VN)**
478 Nguyễn Thị Thập, phường Tân Quy, quận 7, thành phố Hồ Chí Minh
(72) Nguyễn Thị Kim Hoàn (VN)
(55)

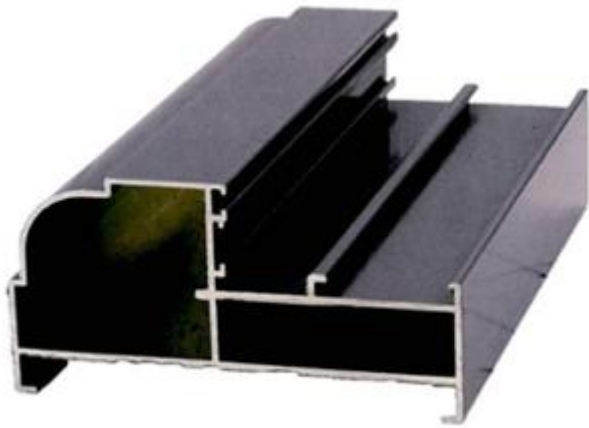

1.1

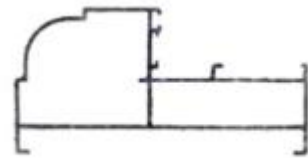

1.2

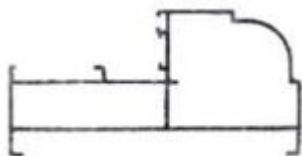

1.3



1.4



1.5



1.6



1.7

- (11) **47354**
(21) 3-2023-00711 (28) 1
(54) **THANH NHÔM ĐỊNH HÌNH** (51) **25-01**
(22) 30/03/2023 (43) 25/07/2023
(73) **CÔNG TY TNHH THANH PHÚC WINDOW (VN)**
478 Nguyễn Thị Thập, phường Tân Quy, quận 7, thành phố Hồ Chí Minh
(72) Nguyễn Thị Kim Hoàn (VN)
(55)



1.1

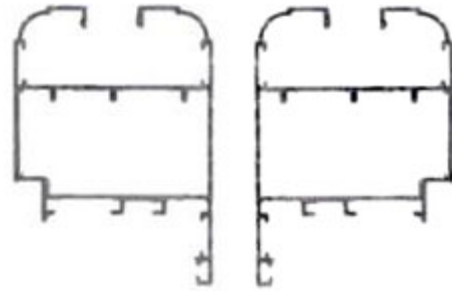

1.2

1.3



1.4



1.5



1.6



1.7

- (11) **47355**
(21) 3-2023-00713 (28) 1
(54) **THANH NHÔM ĐỊNH HÌNH** (51) **25-01**
(22) 30/03/2023 (43) 25/07/2023
(73) **CÔNG TY TNHH THANH PHÚC WINDOW (VN)**
478 Nguyễn Thị Thập, phường Tân Quy, quận 7, thành phố Hồ Chí Minh
(72) Nguyễn Thị Kim Hoàn (VN)
(55)



1.1



1.2

1.3



1.4

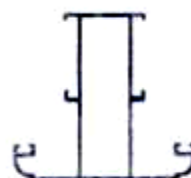

1.5

CÔNG BÁO SỞ HỮU CÔNG NGHIỆP SỐ 424 TẬP A – QUYỀN 2 (07.2023)

- (11) **47356**
(21) 3-2023-00714 (28) 1
(54) **THANH NHÔM ĐỊNH HÌNH** (51) **25-01**
(22) 30/03/2023 (43) 25/07/2023
(73) **CÔNG TY TNHH THANH PHÚC WINDOW (VN)**
478 Nguyễn Thị Thập, phường Tân Quy, quận 7, thành phố Hồ Chí Minh
(72) Nguyễn Thị Kim Hoàn (VN)
(55)



1.1



1.2



1.3



1.4



1.5

CÔNG BÁO SỞ HỮU CÔNG NGHIỆP SỐ 424 TẬP A – QUYỀN 2 (07.2023)

- (11) **47357**
(21) 3-2023-00723 (28) 1
(54) **THANH NHÔM ĐỊNH HÌNH** (51) **25-01**
(22) 31/03/2023 (43) 25/07/2023
(73) **CÔNG TY TNHH THANH PHÚC WINDOW (VN)**
478 Nguyễn Thị Thập, phường Tân Quy, quận 7, thành phố Hồ Chí Minh
(72) Nguyễn Thị Kim Hoàn (VN)
(55)



1.1



1.2

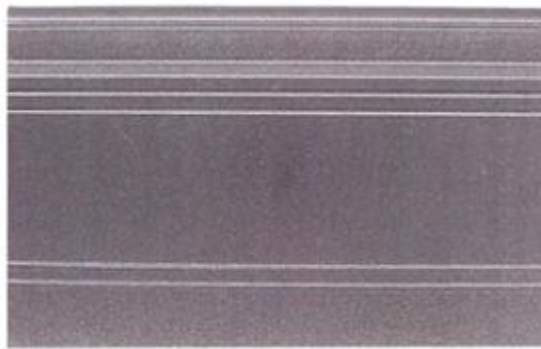

1.3

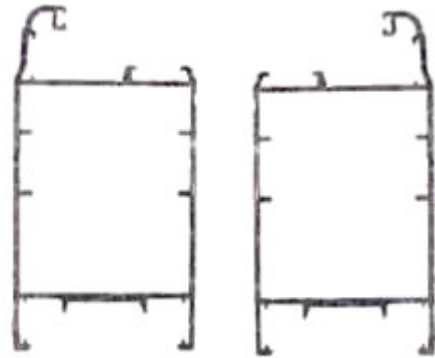

1.4

1.5



1.6



1.7

CÔNG BÁO SỞ HỮU CÔNG NGHIỆP SỐ 424 TẬP A – QUYỀN 2 (07.2023)

- (11) **47358**
(21) 3-2023-00724 (28) 1
(54) **THANH NHÔM ĐỊNH HÌNH** (51) **25-01**
(22) 31/03/2023 (43) 25/07/2023
(73) **CÔNG TY TNHH THANH PHÚC WINDOW (VN)**
478 Nguyễn Thị Thập, phường Tân Quy, quận 7, thành phố Hồ Chí Minh
(72) Nguyễn Thị Kim Hoàn (VN)
(55)

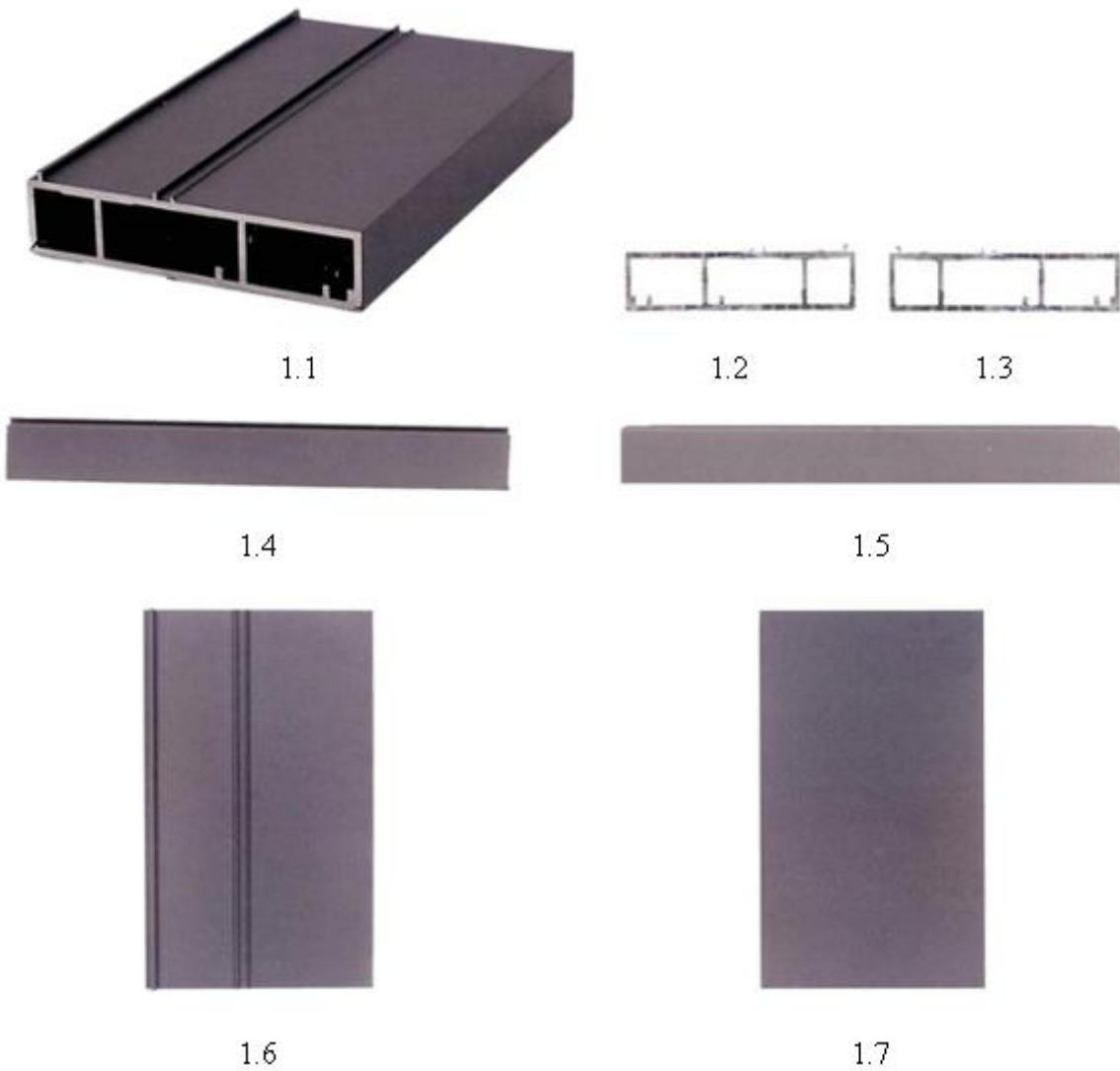

CÔNG BÁO SỞ HỮU CÔNG NGHIỆP SỐ 424 TẬP A – QUYỀN 2 (07.2023)

- (11) **47359**
(21) 3-2023-00726 (28) 1
(54) **THANH NHÔM ĐỊNH HÌNH** (51) **25-01**
(22) 31/03/2023 (43) 25/07/2023
(73) **CÔNG TY TNHH THANH PHÚC WINDOW (VN)**
478 Nguyễn Thị Thập, phường Tân Quy, quận 7, thành phố Hồ Chí Minh
(72) Nguyễn Thị Kim Hoàn (VN)
(55)



1.1



1.2



1.3

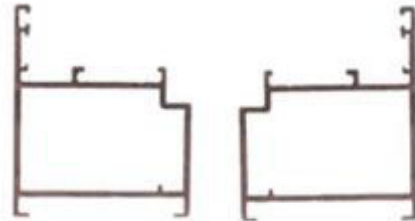

1.4

1.5



1.6



1.7

CÔNG BÁO SỞ HỮU CÔNG NGHIỆP SỐ 424 TẬP A – QUYỀN 2 (07.2023)

- (11) **47360**
(21) 3-2023-00727 (28) 1
(54) **THANH NHÔM ĐỊNH HÌNH** (51) **25-01**
(22) 31/03/2023 (43) 25/07/2023
(73) **CÔNG TY TNHH THANH PHÚC WINDOW (VN)**
478 Nguyễn Thị Thập, phường Tân Quy, quận 7, thành phố Hồ Chí Minh
(72) Nguyễn Thị Kim Hoàn (VN)
(55)



1.1



1.2



1.3

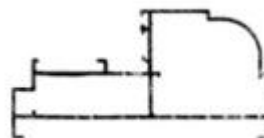

1.4

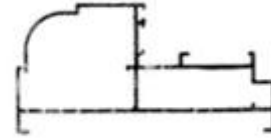

1.5



1.6



1.7

CÔNG BÁO SỞ HỮU CÔNG NGHIỆP SỐ 424 TẬP A – QUYỀN 2 (07.2023)

- (11) **47361**
(21) 3-2023-00730 (28) 1
(54) **THANH NHÔM ĐỊNH HÌNH** (51) **25-01**
(22) 31/03/2023 (43) 25/07/2023
(73) **CÔNG TY TNHH THANH PHÚC WINDOW (VN)**
478 Nguyễn Thị Thập, phường Tân Quy, quận 7, thành phố Hồ Chí Minh
(72) Nguyễn Thị Kim Hoàn (VN)
(55)



1.1



1.2

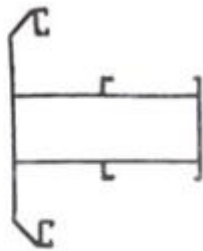

1.3

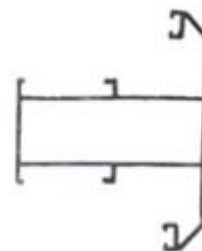

1.4



1.5



1.6

- (11) **47362**
(21) 3-2023-00731 (28) 1
(54) **THANH NHÔM ĐỊNH HÌNH** (51) **25-01**
(22) 31/03/2023 (43) 25/07/2023
(73) **CÔNG TY TNHH THANH PHÚC WINDOW (VN)**
478 Nguyễn Thị Thập, phường Tân Quy, quận 7, thành phố Hồ Chí Minh
(72) Nguyễn Thị Kim Hoàn (VN)
(55)



1.1



1.2

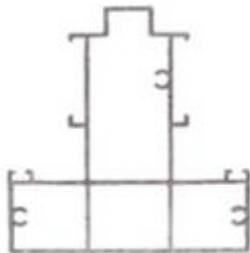

1.3

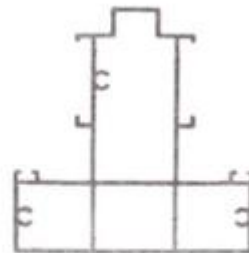

1.4



1.5



1.6

CÔNG BÁO SỞ HỮU CÔNG NGHIỆP SỐ 424 TẬP A – QUYỀN 2 (07.2023)

- (11) **47363**
(21) 3-2023-00733 (28) 1
(54) **THANH NHÔM ĐỊNH HÌNH** (51) **25-01**
(22) 31/03/2023 (43) 25/07/2023
(73) **CÔNG TY TNHH THANH PHÚC WINDOW (VN)**
478 Nguyễn Thị Thập, phường Tân Quy, quận 7, thành phố Hồ Chí Minh
(72) Nguyễn Thị Kim Hoàn (VN)
(55)



1.1



1.2

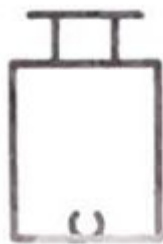

1.3



1.4



1.5

CÔNG BÁO SỞ HỮU CÔNG NGHIỆP SỐ 424 TẬP A – QUYỀN 2 (07.2023)

- (11) **47364**
(21) 3-2023-00734 (28) 1
(54) **THANH NHÔM ĐỊNH HÌNH** (51) **25-01**
(22) 31/03/2023 (43) 25/07/2023
(73) **CÔNG TY TNHH THANH PHÚC WINDOW (VN)**
478 Nguyễn Thị Thập, phường Tân Quy, quận 7, thành phố Hồ Chí Minh
(72) Nguyễn Thị Kim Hoàn (VN)
(55)



1.1



1.2

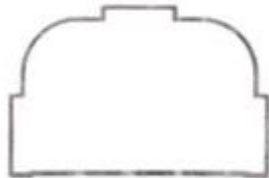

1.3



1.4



1.5

CÔNG BÁO SỞ HỮU CÔNG NGHIỆP SỐ 424 TẬP A – QUYỀN 2 (07.2023)

- (11) **47365**
(21) 3-2022-02486 (28) 1
(54) **CHAI** (51) **09-01**
(22) 14/11/2022 (43) 25/07/2023
(73) **CÔNG TY CỔ PHẦN D-SHINING (VN)**
7C Nguyễn Ngọc Phương, phường 19, quận Bình Thạnh, thành phố Hồ Chí Minh
(72) Nguyễn Thái Dương (VN)
(74) Văn phòng Luật sư D và T (D & T LAW OFFICE)
(55)



1.1

1.2

1.3

1.4

1.5



1.6



1.7

CÔNG BÁO SỞ HỮU CÔNG NGHIỆP SỐ 424 TẬP A – QUYỀN 2 (07.2023)

(11) **47366**

(21) 3-2023-00863

(54) **GIÁ ĐỒ TẮM BẢN MÃ**

(22) 14/04/2023

(73) **CÔNG TY CỔ PHẦN AN TOÀN SSTC (VN)**

372/6 Dương Thị Mười, khu phố 3, phường Tân Thới Hiệp, quận 12, thành phố Hồ Chí Minh

(72) Dương Đình Luân (VN)

(74) Công ty Cổ phần Sở hữu công nghiệp INVESTIP (INVESTIP)

(55)

(28) 1

(51) **25-01**

(43) 25/07/2023

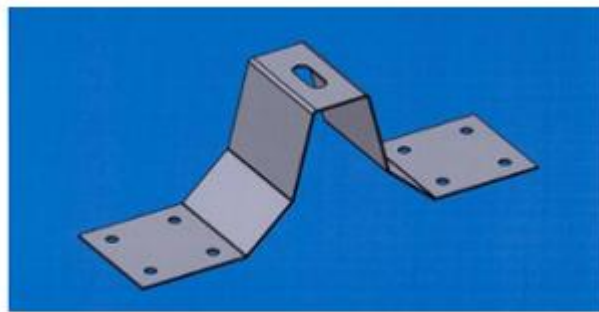

1.1

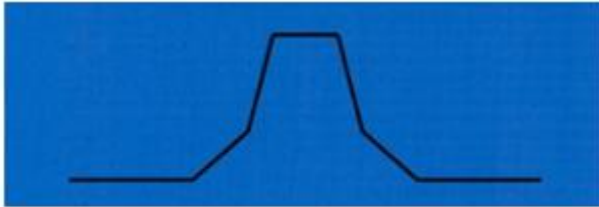

1.2

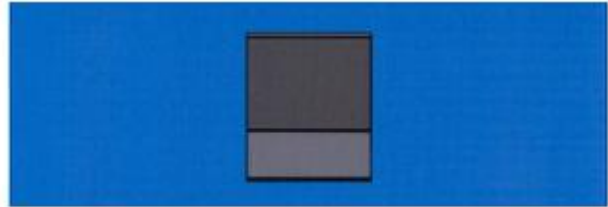

1.3

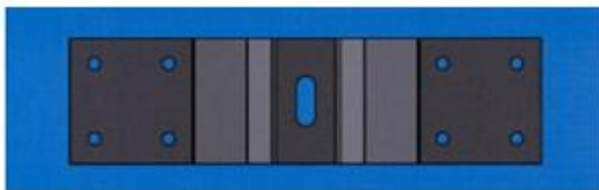

1.4

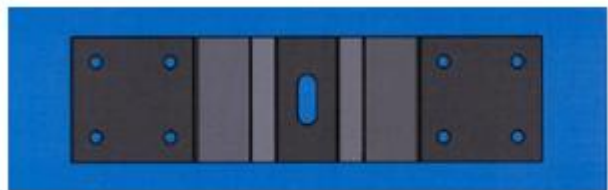

1.5

CÔNG BÁO SỞ HỮU CÔNG NGHIỆP SỐ 424 TẬP A – QUYỀN 2 (07.2023)

- (11) **47367**
(21) 3-2023-01010 (28) 1
(54) **NHÃN SẢN PHẨM** (51) **19-08**
(22) 10/05/2023 (43) 25/07/2023
(73) **TRẦN THỊ ÁI THU (VN)**
17 Phan Bội Châu, khu phố 2, phường 1, thành phố Đông Hà, tỉnh Quảng Trị
(72) Trần Thị Ái Thu (VN)
(74) Công ty TNHH Sở hữu trí tuệ VIPATCO (VIPATCO CO., LTD.)
(55)



CÔNG BÁO SỞ HỮU CÔNG NGHIỆP SỐ 424 TẬP A – QUYỀN 2 (07.2023)

- (11) **47368**
(21) 3-2023-01018 (28) 1
(54) **NHÃN SẢN PHẨM** (51) **19-08**
(22) 11/05/2023 (43) 25/07/2023
(73) **CÔNG TY TNHH THƯƠNG MẠI LOVEWINE (VN)**
41/28 Nguyễn Oanh, phường 10, quận Gò Vấp, thành phố Hồ Chí Minh
(72) Huỳnh Thu Vân (VN)
(55)

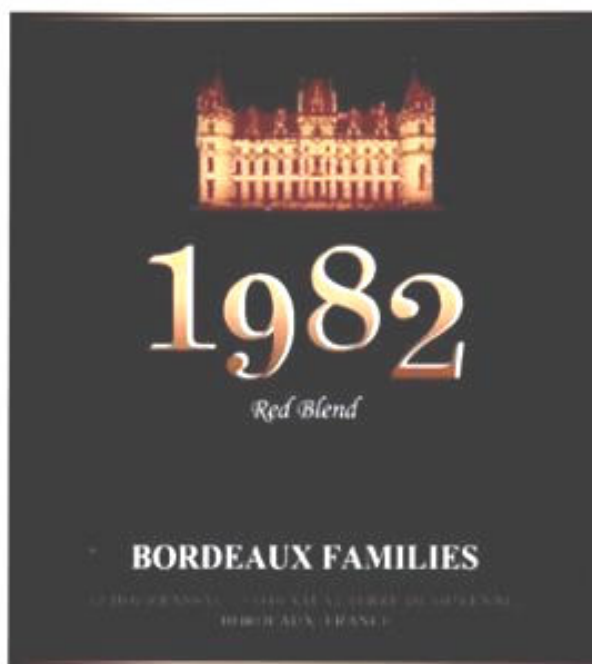

CÔNG BÁO SỞ HỮU CÔNG NGHIỆP SỐ 424 TẬP A – QUYỀN 2 (07.2023)

- (11) **47369**
(21) 3-2023-01052 (28) 1
(54) **CHAI** (51) **09-01**
(22) 15/05/2023 (43) 25/07/2023
(73) **CÔNG TY CỔ PHẦN THỰC PHẨM VÀ NƯỚC GIẢI KHÁT NAM VIỆT (VN)**
Số 994/1C, đường Nguyễn Thị Minh Khai, khu phố Tân Thắng, phường Tân Bình, thành phố Dĩ An, tỉnh Bình Dương
(72) Bùi Thị Thu Hương (VN)
(74) **CÔNG TY TNHH SỞ HỮU TRÍ TUỆ ANLIS VIỆT NAM (ANLIS IP CO.,LTD)**
(55)



1.1



1.2



1.3



1.4



1.5

CÔNG BÁO SỞ HỮU CÔNG NGHIỆP SỐ 424 TẬP A – QUYỀN 2 (07.2023)

- (11) **47370**
(21) 3-2023-00738 (28) 1
(54) **LỌ** (51) **09-01**
(22) 03/04/2023 (43) 25/07/2023
(73) **LG HOUSEHOLD & HEALTH CARE LTD. (KR)**
58, Saemunan-ro, Jongno-gu, Seoul, Republic of Korea
(72) JUNG, Min Jeong (KR)
(74) Công ty TNHH Tâm nhìn và Liên danh (VISION & ASSOCIATES CO.LTD.)
(55)



1.1



1.2



1.3



1.4



1.5



1.6



1.7

CÔNG BÁO SỞ HỮU CÔNG NGHIỆP SỐ 424 TẬP A – QUYỀN 2 (07.2023)

- (11) **47371**
(21) 3-2023-00788 (28) 1
(54) **CHAI** (51) **09-01**
(22) 07/04/2023 (43) 25/07/2023
(73) **CÔNG TY CỔ PHẦN HÀNG TIÊU DÙNG MASAN (VN)**
Tầng 12, tòa nhà MPlaza Saigon, số 39 Lê Duẩn, phường Bến Nghé, quận 1, thành phố Hồ Chí Minh
(72) Nguyễn Hoàng Yên (VN)
(74) Công ty cổ phần Sở hữu trí tuệ BROSS và Cộng sự (BROSS & PARTNERS., JSC)
(55)



1.1



1.2



1.3



1.4

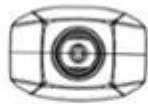

1.5

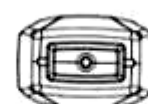

1.6



1.7

CÔNG BÁO SỞ HỮU CÔNG NGHIỆP SỐ 424 TẬP A – QUYỀN 2 (07.2023)

- (11) **47372**
(21) 3-2023-00767 (28) 1
(54) **CHAI** (51) **09-01**
(22) 06/04/2023 (43) 25/07/2023
(73) **CÔNG TY CỔ PHẦN THỰC PHẨM VÀ NƯỚC GIẢI KHÁT NAM VIỆT (VN)**
Số 994/1C, đường Nguyễn Thị Minh Khai, khu phố Tân Thắng, phường Tân Bình, thành phố Dĩ An, tỉnh Bình Dương
(72) Bùi Thị Thu Hương (VN)
(74) **CÔNG TY TNHH SỞ HỮU TRÍ TUỆ ANLIS VIỆT NAM (ANLIS IP CO.,LTD)**
(55)



1.1



1.2



1.3



1.4



1.5

CÔNG BÁO SỞ HỮU CÔNG NGHIỆP SỐ 424 TẬP A – QUYỀN 2 (07.2023)

- (11) **47373**
(21) 3-2023-00854 (28) 1
(54) **LỌ** (51) **09-01**
(22) 14/04/2023 (43) 25/07/2023
(73) **LG HOUSEHOLD & HEALTH CARE LTD. (KR)**
58, Saemunan-ro, Jongno-gu, Seoul, Republic of Korea
(72) LEE, Seul Ki (KR)
(74) Công ty TNHH Tâm nhìn và Liên danh (VISION & ASSOCIATES CO.LTD.)
(55)



1.1



1.2



1.3



1.4



1.5



1.6



1.7

CÔNG BÁO SỞ HỮU CÔNG NGHIỆP SỐ 424 TẬP A – QUYỀN 2 (07.2023)

- (11) **47374**
(21) 3-2023-00880 (28) 1
(54) **CHAI** (51) **09-01**
(22) 18/04/2023 (43) 25/07/2023
(73) **CÔNG TY TNHH 8 SANG BDS (VN)**
166 đường số 5, phường Bình Trị Đông B, quận Bình Tân, thành phố Hồ Chí Minh
(72) Trần Huy Đăng (VN)
(74) Công ty TNHH Dịch vụ thương mại và sở hữu công nghiệp Song Ngọc (I.P.T.S.)
(55)



1.1



1.2



1.3



1.4



1.5



1.6

CÔNG BÁO SỞ HỮU CÔNG NGHIỆP SỐ 424 TẬP A – QUYỀN 2 (07.2023)

- (11) **47375**
(21) 3-2023-00943 (28) 1
(54) **NHÃN SẢN PHẨM** (51) **19-08**
(22) 28/04/2023 (43) 25/07/2023
(73) **PHẠM THANH TÙNG (VN)**
R4B-2020 Royal City, 72A Nguyễn Trãi, quận Thanh Xuân, thành phố Hà Nội
(72) Phạm Thanh Tùng (VN)
(55)



CÔNG BÁO SỞ HỮU CÔNG NGHIỆP SỐ 424 TẬP A – QUYỀN 2 (07.2023)

- (11) **47376**
(21) 3-2023-01001 (28) 1
(54) **CHAI** (51) **09-01**
(22) 09/05/2023 (43) 25/07/2023
(73) **CÔNG TY CỔ PHẦN TẬP ĐOÀN VIHAMARK (VN)**
Lô N3-6, KCN Đồng Văn II, phường Duy Minh, thị xã Duy Tiên, tỉnh Hà Nam
(72) Nguyễn Thiên Thắng (VN)
(74) Công ty TNHH Thương mại và dịch vụ IP Ngọc Anh (IP NGOC ANH TRADE AND SERVICE COMPANY LIMITED)
(55)

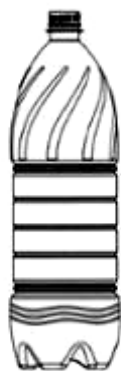

1.1



1.2

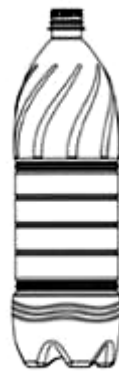

1.3



1.4



1.5



1.6



1.7



1.8

CÔNG BÁO SỞ HỮU CÔNG NGHIỆP SỐ 424 TẬP A – QUYỀN 2 (07.2023)

- (11) **47377**
(21) 3-2023-01002 (28) 1
(54) **CHAI** (51) **09-01**
(22) 09/05/2023 (43) 25/07/2023
(73) **CÔNG TY CỔ PHẦN TẬP ĐOÀN VIHAMARK (VN)**
Lô N3-6, KCN Đồng Văn II, phường Duy Minh, thị xã Duy Tiên, tỉnh Hà Nam
(72) Nguyễn Thiên Thắng (VN)
(74) Công ty TNHH Thương mại và dịch vụ IP Ngọc Anh (IP NGOC ANH TRADE AND SERVICE COMPANY LIMITED)
(55)



1.1



1.2



1.3



1.4



1.5



1.6



1.7



1.8

CÔNG BÁO SỞ HỮU CÔNG NGHIỆP SỐ 424 TẬP A – QUYỀN 2 (07.2023)

- (11) **47378**
(21) 3-2023-01008 (28) 1
(54) **NHÃN SẢN PHẨM** (51) **19-08**
(22) 10/05/2023 (43) 25/07/2023
(73) **CÔNG TY TNHH XUẤT NHẬP KHẨU THỰC PHẨM ĐÀ LẠT (VN)**
Ấp Phú Hòa, xã Phú Hội, huyện Đức Trọng, tỉnh Lâm Đồng
(72) Lê Trọng Hưng (VN)
(55)

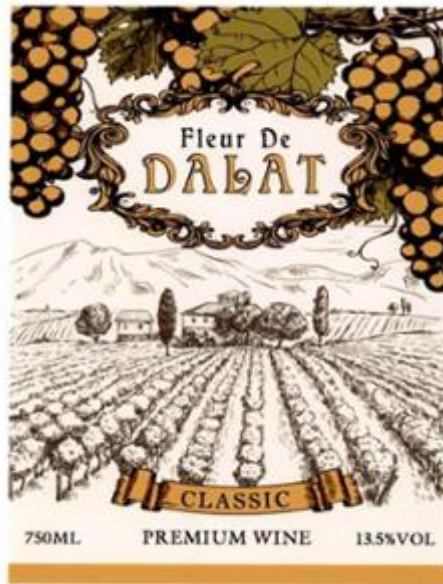

(11) **47379**

(21) 3-2022-01442

(28) 1

(54) **CỐT THÉP CỦA CỘT XÂY DỰNG**

(51) **25-02**

(22) 19/07/2022

(43) 25/07/2023

(73) **NGUYỄN XUÂN THỦY (VN)**

Tổ 3, khu 10, phường Bãi Cháy, thành phố Hạ Long, tỉnh Quảng Ninh

(72) Nguyễn Xuân Thủy (VN)

(55)

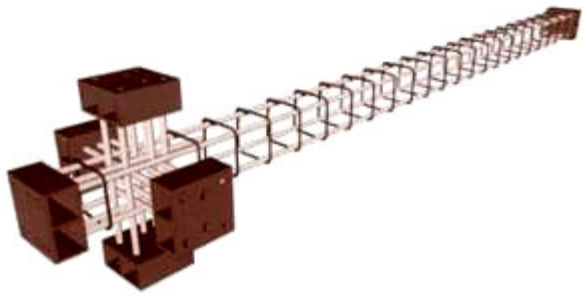

1.1

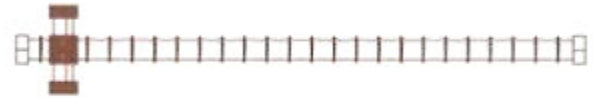

1.2

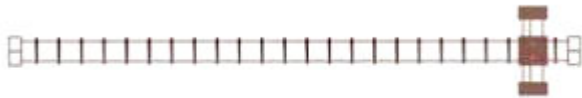

1.3

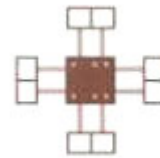

1.4

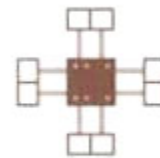

1.5

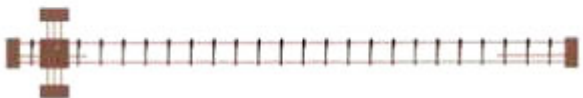

1.6



1.7

CÔNG BÁO SỞ HỮU CÔNG NGHIỆP SỐ 424 TẬP A – QUYỀN 2 (07.2023)

- (11) **47380**
(21) 3-2022-01574 (28) 1
(54) **TẮM CHẤN BÙN XE MÁY** (51) **12-16**
(22) 08/08/2022 (43) 25/07/2023
(73) **CÔNG TY CỔ PHẦN SẢN XUẤT VÀ THƯƠNG MẠI ĐỨC MINH (VN)**
Thôn Nhuận Tháp, xã Phụng Công, huyện Văn Giang, tỉnh Hưng Yên
(72) Nghiêm Xuân Minh (VN)
(55)



1.1



1.2



1.3



1.4



1.5



1.6

CÔNG BÁO SỞ HỮU CÔNG NGHIỆP SỐ 424 TẬP A – QUYỀN 2 (07.2023)

- (11) **47381**
(21) 3-2022-01926 (28) 1
(54) **BẾP ĐIỆN** (51) **07-02**
(22) 12/09/2022 (43) 25/07/2023
(30) 30-2022-0015246 18/04/2022 KR;
(73) **DR. HOWS CO., LTD. (KR)**
97, Neunggil-ro, Danwon-gu, Ansan-si, Gyeonggi-do 15420 Republic of Korea
(72) KIM, Kyung Beom (KR)
(74) CÔNG TY LUẬT TRÁCH NHIỆM HỮU HẠN AMBYS HÀ NỘI (AMBYS HANOI)
(55)

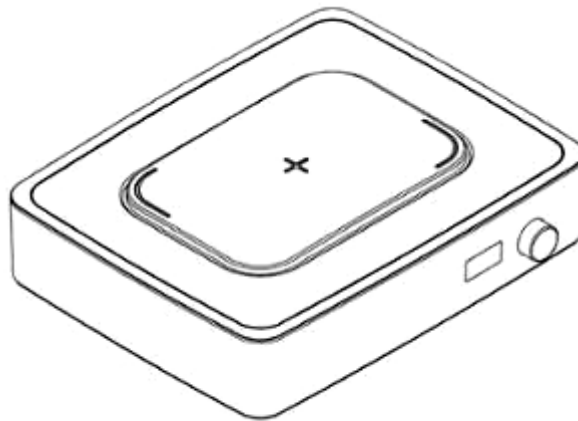

1.1

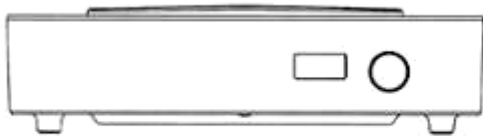

1.2



1.3



1.4



1.5

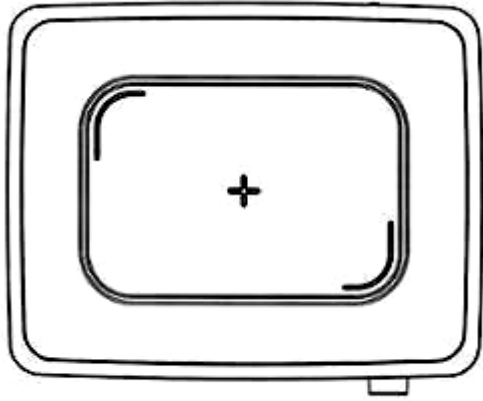

1.6

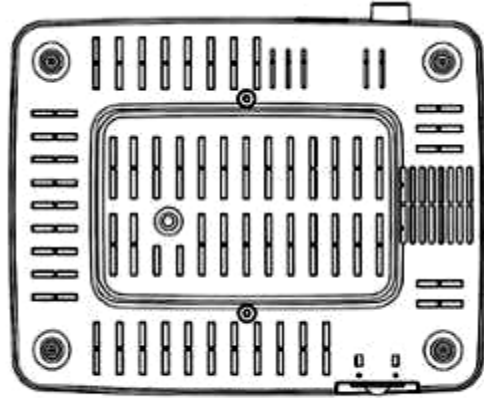

1.7

CÔNG BÁO SỞ HỮU CÔNG NGHIỆP SỐ 424 TẬP A – QUYỀN 2 (07.2023)

(11) **47382**

(21) 3-2022-01935

(28) 1

(54) **THIẾT BỊ XỬ LÝ NƯỚC THẢI**

(51) **23-01**

(22) 14/09/2022

(43) 25/07/2023

(73) **CÔNG TY CỔ PHẦN JOKASO VIỆT NAM (VN)**

Ô 11 - LK2 - Tiểu khu đô thị Vạn Phúc, phường Vạn Phúc, quận Hà Đông, thành phố Hà Nội

(72) Trương Văn Đàn (VN)

(55)

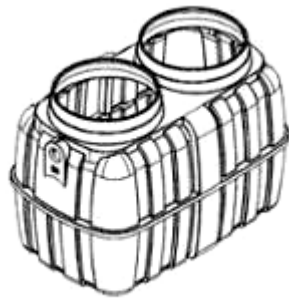

1.1



1.2



1.3



1.4

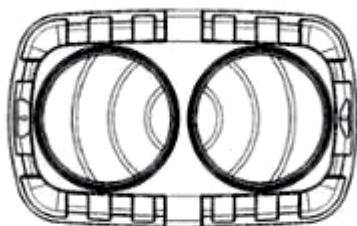

1.5

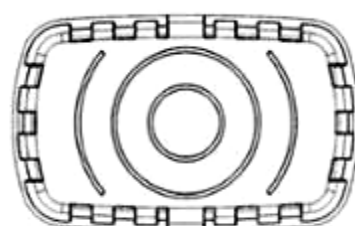

1.6

- (11) **47383**
(21) 3-2022-02354 (28) 1
(54) **TẤM ỐP LÓT SÀN XE TAY GA** (51) **12-16**
(22) 31/10/2022 (43) 25/07/2023
(73) **HỘ KINH DOANH HÙNG CƯỜNG (VN)**
Số 71/33 Lãn Bình Thăng, phường 12, quận 11, thành phố Hồ Chí Minh
(72) Lưu Chí Hùng (VN)
(74) Công ty Cổ phần Sở hữu công nghiệp INVESTIP (INVESTIP)
(55)



1.1



1.2

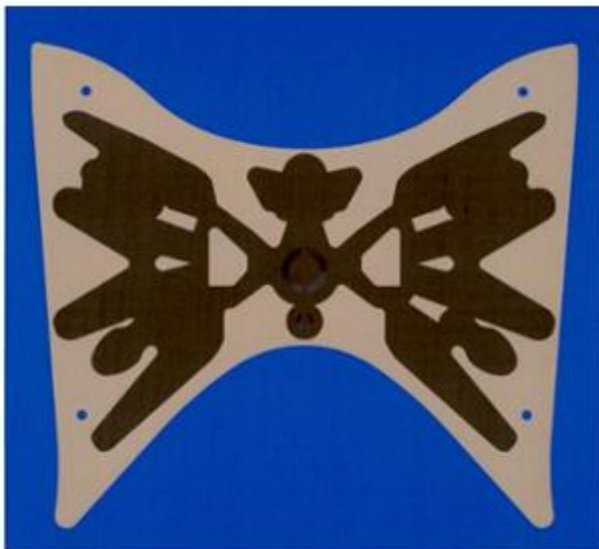

1.3



1.4



1.5



1.6

CÔNG BÁO SỞ HỮU CÔNG NGHIỆP SỐ 424 TẬP A – QUYỀN 2 (07.2023)

(11) **47384**

(21) 3-2022-02739

(28) 1

(54) **CÁNH QUẠT GIÓ**

(51) **23-04; 23-99**

(22) 15/12/2022

(43) 25/07/2023

(73) **VIỆN CƠ KHÍ NĂNG LƯỢNG VÀ MỎ- VINACOMIN (VN)**

Số 565 đường Nguyễn Trãi, phường Thanh Xuân Nam, quận Thanh Xuân, thành phố Hà Nội

(72) Lê Thùy Dương (VN)

(55)



1.1

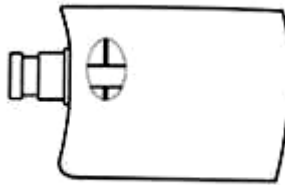

1.2

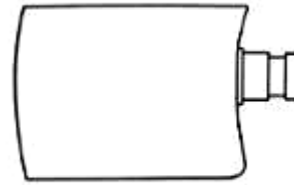

1.3



1.4



1.5



1.6



1.7

CÔNG BÁO SỞ HỮU CÔNG NGHIỆP SỐ 424 TẬP A – QUYỀN 2 (07.2023)

(11) **47385**

(21) 3-2023-00239

(28) 1

(54) **Ô TÔ ĐỒ CHƠI**

(51) **21-01**

(22) 02/02/2023

(43) 25/07/2023

(73) **CÔNG TY CỔ PHẦN TẬP ĐOÀN THIÊN LONG (VN)**

Tầng 10, Sofic Tower, số 10 đường Mai Chí Thọ, phường Thủ Thiêm, thành phố Thủ Đức, thành phố Hồ Chí Minh

(72) Cô Gia Thọ (VN)

(74) Công ty TNHH Tư vấn sở hữu trí tuệ Việt (VIET IP CO.,LTD.)

(55)

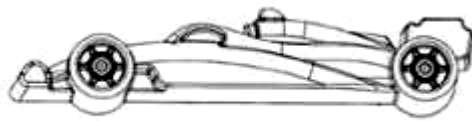

1.1



1.2



1.3



1.4

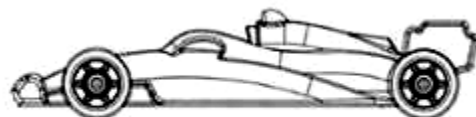

1.5



1.6



1.7

CÔNG BÁO SỞ HỮU CÔNG NGHIỆP SỐ 424 TẬP A – QUYỀN 2 (07.2023)

(11) **47386**

(21) 3-2023-00240

(28) 1

(54) **Ô TÔ ĐỒ CHƠI**

(51) **21-01**

(22) 02/02/2023

(43) 25/07/2023

(73) **CÔNG TY CỔ PHẦN TẬP ĐOÀN THIÊN LONG (VN)**

Tầng 10, Sofic Tower, số 10 đường Mai Chí Thọ, phường Thủ Thiêm, thành phố Thủ Đức, thành phố Hồ Chí Minh

(72) Cô Gia Thọ (VN)

(74) Công ty TNHH Tư vấn sở hữu trí tuệ Việt (VIET IP CO.,LTD.)

(55)

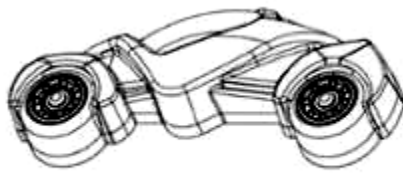

1.1



1.2



1.3



1.4

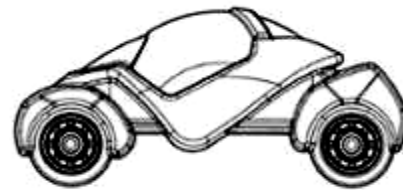

1.5



1.6

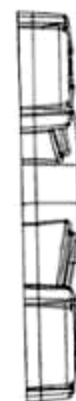

1.7

CÔNG BÁO SỞ HỮU CÔNG NGHIỆP SỐ 424 TẬP A – QUYỀN 2 (07.2023)

(11) **47387**

(21) 3-2023-00241

(28) 1

(54) **Ô TÔ ĐỒ CHƠI**

(51) **21-01**

(22) 02/02/2023

(43) 25/07/2023

(73) **CÔNG TY CỔ PHẦN TẬP ĐOÀN THIÊN LONG (VN)**

Tầng 10, Sofic Tower, số 10 đường Mai Chí Thọ, phường Thủ Thiêm, thành phố Thủ Đức, thành phố Hồ Chí Minh

(72) Cô Gia Thọ (VN)

(74) Công ty TNHH Tư vấn sở hữu trí tuệ Việt (VIET IP CO.,LTD.)

(55)



1.1



1.2



1.3



1.4



1.5



1.6



1.7

CÔNG BÁO SỞ HỮU CÔNG NGHIỆP SỐ 424 TẬP A – QUYỀN 2 (07.2023)

- (11) **47388**
(21) 3-2023-00260 (28) 1
(54) **NẮP CHAI** (51) **09-07**
(22) 07/02/2023 (43) 25/07/2023
(73) **CÔNG TY TNHH KHOA HỌC CÔNG NGHỆ LIÊN HIỆP PHÁT (VN)**
18B đường số 2, Cư xá Lữ Gia, phường 15, quận 11, thành phố Hồ Chí Minh
(72) Huỳnh Trí Nhon (VN)
(55)



1.1



1.2



1.3



1.4



1.5

CÔNG BÁO SỞ HỮU CÔNG NGHIỆP SỐ 424 TẬP A – QUYỀN 2 (07.2023)

- (11) **47389**
(21) 3-2023-00290 (28) 1
(54) **VAN TƯỚI NƯỚC** (51) **23-01**
(22) 14/02/2023 (43) 25/07/2023
(73) **CÔNG TY TNHH SẢN XUẤT THƯƠNG MẠI BONSAI MIỀN NAM (VN)**
34/13 Nguyễn Thị Thập, phường Bình Thuận, quận 7, thành phố Hồ Chí Minh
(72) Dương Duyên Nghệ (VN)
(74) Công ty cổ phần FAS INVEST (FAS INVEST JSC)
(55)



1.1



1.2



1.3

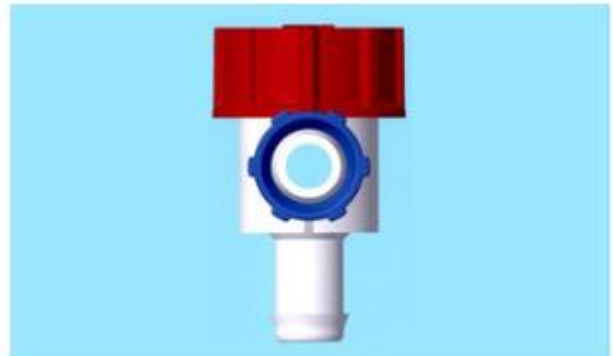

1.4

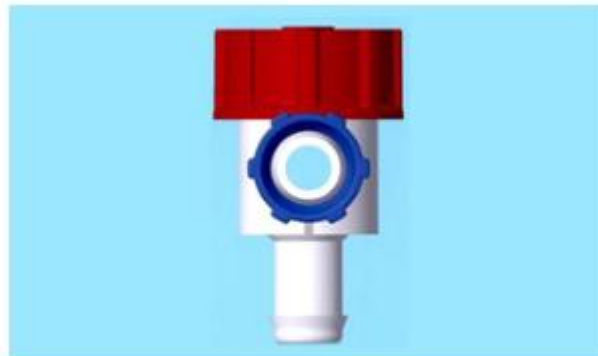

1.5

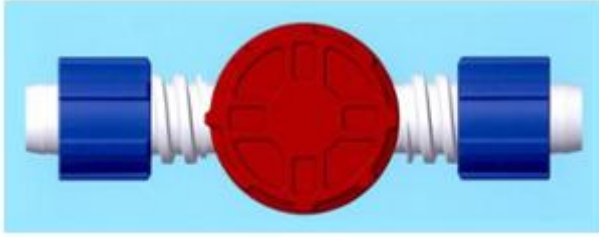

1.6



1.7

CÔNG BÁO SỞ HỮU CÔNG NGHIỆP SỐ 424 TẬP A – QUYỀN 2 (07.2023)

(11) **47390**

(21) 3-2023-00580

(28) 1

(54) **CAMERA**

(51) **16-01**

(22) 20/03/2023

(43) 25/07/2023

(73) **CÔNG TY CỔ PHẦN VIỄN THÔNG FPT (VN)**

Tầng 2, tòa nhà FPT Cầu Giấy, số 17 phố Duy Tân, phường Dịch Vọng Hậu, quận Cầu Giấy, thành phố Hà Nội

(72) 1. ĐOÀN HUỖNH THỦY TIÊN (VN)

2. TRƯƠNG THỊ THỦY (VN)

3. NGUYỄN TẤN PHONG (VN)

4. NGUYỄN TUẤN SƠN (VN)

5. ĐINH CAO SƠN (VN)

6. NGUYỄN VIỆT HIẾU (VN)

7. NGUYỄN ANH ĐỨC (VN)

(74) Công ty TNHH NACILAW (NACILAW)

(55)

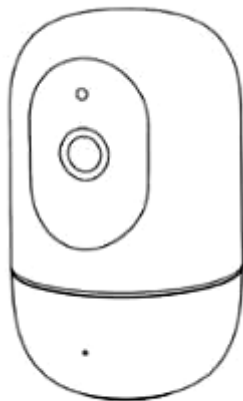

1.1

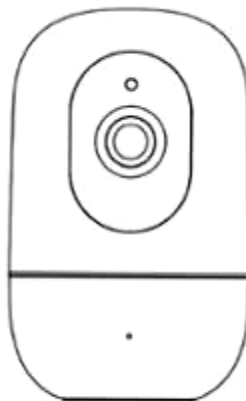

1.2

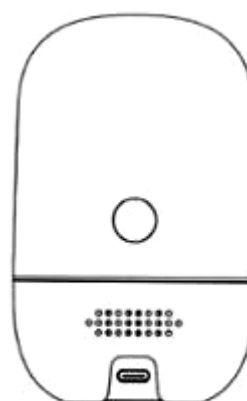

1.3

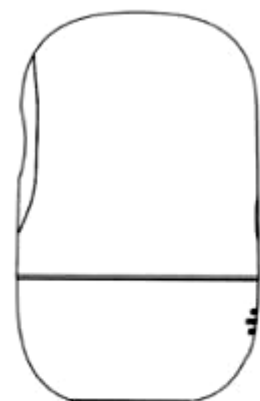

1.4

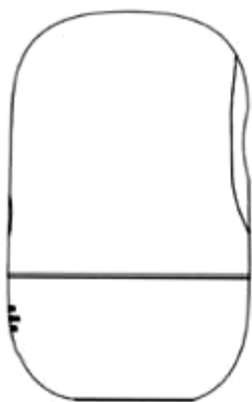

1.5



1.6

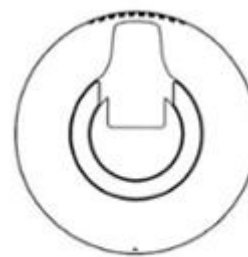

1.7

CÔNG BÁO SỞ HỮU CÔNG NGHIỆP SỐ 424 TẬP A – QUYỀN 2 (07.2023)

- (11) **47391**
(21) 3-2023-00589 (28) 1
(54) **ỐNG NỐI CHO MÁY HÚT BỤI** (51) **15-05**
(22) 21/03/2023 (43) 25/07/2023
(73) **CÔNG TY TNHH EUNSUNG ELECTRONICS VINA (VN)**
Lô K01-KCN Quê Võ (Khu vực mở rộng), xã Nam Sơn, thành phố Bắc Ninh, tỉnh Bắc Ninh
(72) Ha chong Mok (KR)
(74) Công ty TNHH Sở hữu trí tuệ Vàng (GINTASSET CO., LTD.)
(55)

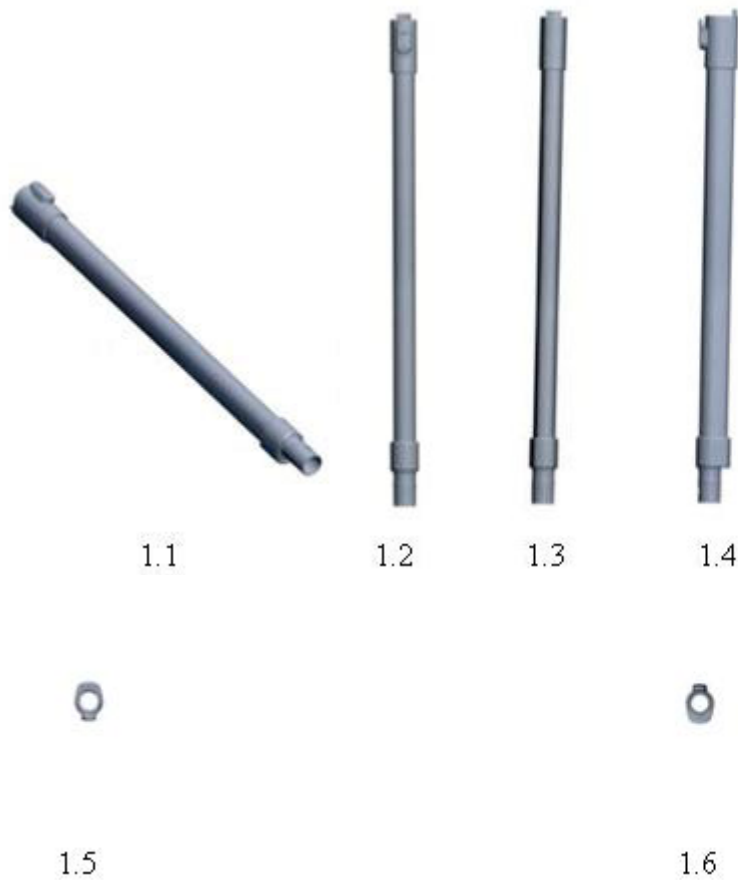

CÔNG BÁO SỞ HỮU CÔNG NGHIỆP SỐ 424 TẬP A – QUYỀN 2 (07.2023)

- (11) **47392**
(21) 3-2023-00625 (28) 1
(54) **CHAI** (51) **09-01**
(22) 23/03/2023 (43) 25/07/2023
(73) **LG HOUSEHOLD & HEALTH CARE LTD. (KR)**
58, Saemunan-ro, Jongno-gu, Seoul, Republic of Korea
(72) HONG, Ji Min (KR)
(74) Công ty TNHH Tầm nhìn và Liên danh (VISION & ASSOCIATES CO.LTD.)
(55)



1.1



1.2



1.3



1.4



1.5



1.6



1.7

CÔNG BÁO SỞ HỮU CÔNG NGHIỆP SỐ 424 TẬP A – QUYỀN 2 (07.2023)

(11) **47393**

(21) 3-2023-00043

(28) 1

(54) **TỦ**

(51) **06-04**

(22) 06/01/2023

(43) 25/07/2023

(73) **ĐÀO TRIỆU NGUYỄN (VN)**

259 Võ Văn Tần, phường 5, quận 3, thành phố Hồ Chí Minh

(72) **ĐÀO TRIỆU NGUYỄN (VN)**

(74) Văn phòng Luật sư A Hoà (AHOA LAW OFFICE)

(55)



1.1



1.2



1.3



1.4

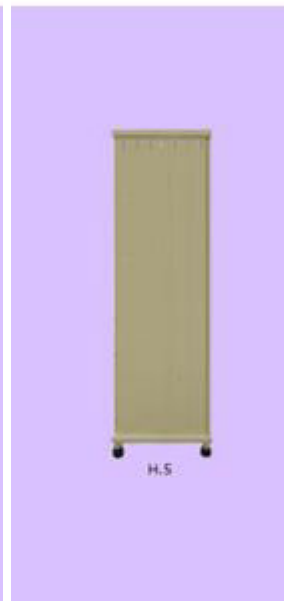

1.5

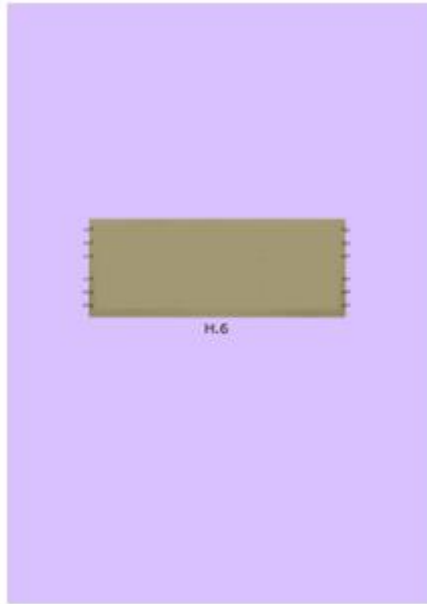

1.6



1.7



1.8



1.9

CÔNG BÁO SỞ HỮU CÔNG NGHIỆP SỐ 424 TẬP A – QUYỀN 2 (07.2023)

- (11) **47394**
(21) 3-2023-00044 (28) 2
(54) **TỦ** (51) **06-04**
(22) 06/01/2023 (43) 25/07/2023
(73) **ĐÀO TRIỆU NGUYỄN (VN)**
259 Võ Văn Tần, phường 5, quận 3, thành phố Hồ Chí Minh
(72) **ĐÀO TRIỆU NGUYỄN (VN)**
(74) Văn phòng Luật sư A Hoà (AHOA LAW OFFICE)
(55)



1.1



1.2



1.3



1.4



1.5



1.6



1.7



1.8



1.9



H.2.1

2.1



H.2.2

2.2



H.2.3

2.3



H.2.4

2.4



H.2.5

2.5



2.6



2.7



2.8



2.9

CÔNG BÁO SỞ HỮU CÔNG NGHIỆP SỐ 424 TẬP A – QUYỀN 2 (07.2023)

- (11) **47395**
(21) 3-2023-00145 (28) 1
(54) **TỦ** (51) **06-04**
(22) 13/01/2023 (43) 25/07/2023
(73) **ĐÀO TRIỆU NGUYỄN (VN)**
259 Võ Văn Tần, phường 5, quận 3, thành phố Hồ Chí Minh
(72) Đào Triệu Nguyên (VN)
(74) Văn phòng Luật sư A Hoà (AHOA LAW OFFICE)
(55)



1.1



1.2



1.3

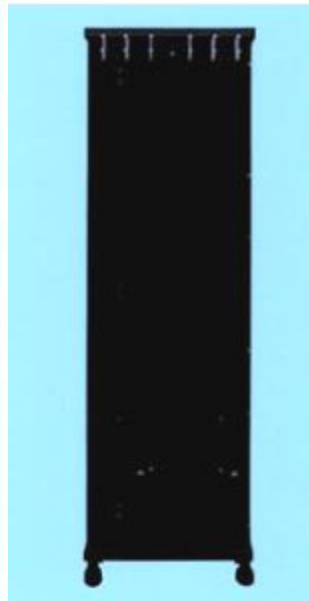

1.4

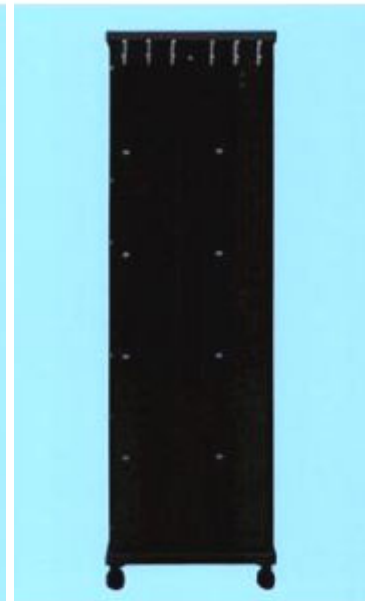

1.5

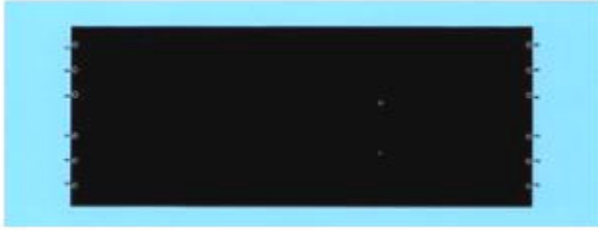

1.6

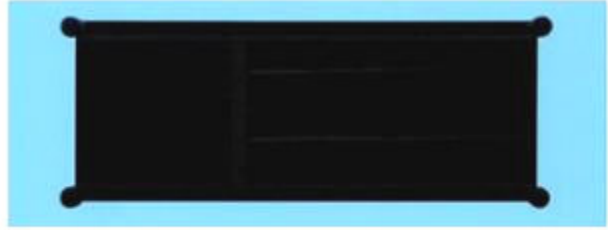

1.7



1.8



1.9

CÔNG BÁO SỞ HỮU CÔNG NGHIỆP SỐ 424 TẬP A – QUYỀN 2 (07.2023)

- (11) **47396**
(21) 3-2023-00330 (28) 1
(54) **LỢ** (51) **09-01**
(22) 21/02/2023 (43) 25/07/2023
(73) **CÔNG TY CỔ PHẦN DƯỢC PHẨM NUTIFINE (VN)**
Số 08, đường Phạm Thế Hiển, phường Mỹ Phú, thành phố Cao Lãnh, tỉnh Đồng Tháp
(72) Lê Anh Huy (VN)
(74) Công ty TNHH Tư vấn sở hữu trí tuệ Việt (VIET IP CO.,LTD.)
(55)



1.1



1.2



1.3



1.4



1.5



1.6

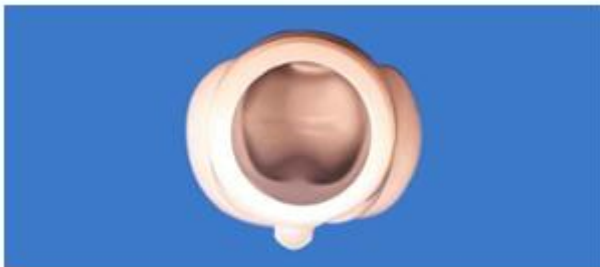

1.7



1.8

CÔNG BÁO SỞ HỮU CÔNG NGHIỆP SỐ 424 TẬP A – QUYỀN 2 (07.2023)

- (11) **47397**
(21) 3-2023-00555 (28) 2
(54) **KHAY** (51) **07-01**
(22) 15/03/2023 (43) 25/07/2023
(30) 29/855,759 06/10/2022 US;
(73) **DART INDUSTRIES INC. (US)**
14901 S. Orange Blossom Trail, Orlando, Florida, 32837, United States of America
(72) 1. TEO SOK YEE (MY)
2. ALEC VERCRUYSSSEN (BE)
3. ARTHUR LORRÉ (BE)
(74) **CÔNG TY LUẬT TRÁCH NHIỆM HỮU HẠN AMBYS HÀ NỘI (AMBYS HANOI)**
(55)

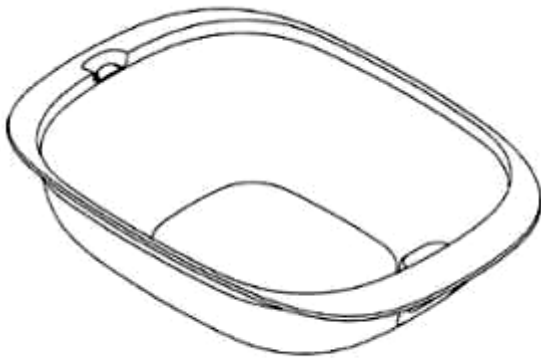

1.1



1.2

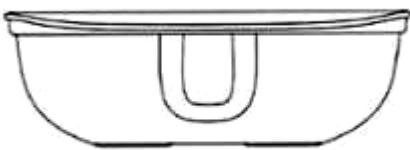

1.3



1.4



1.5

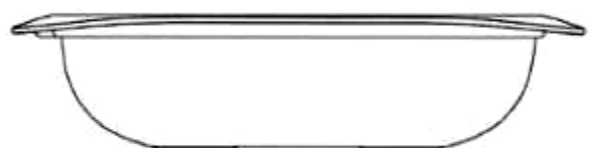

1.6

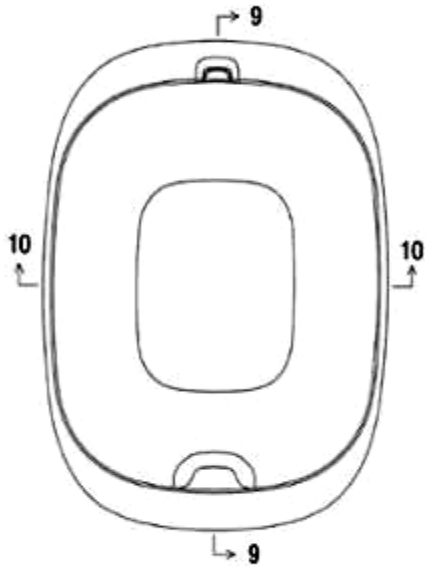

1.7

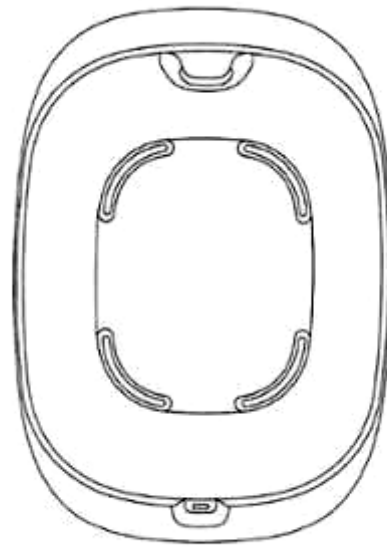

1.8

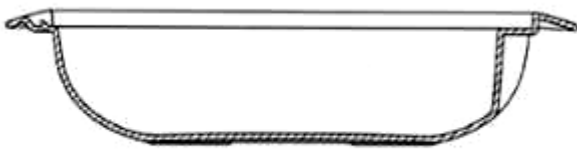

1.9

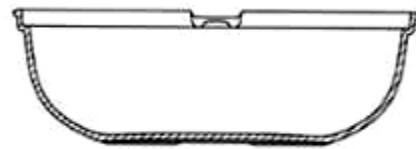

1.10

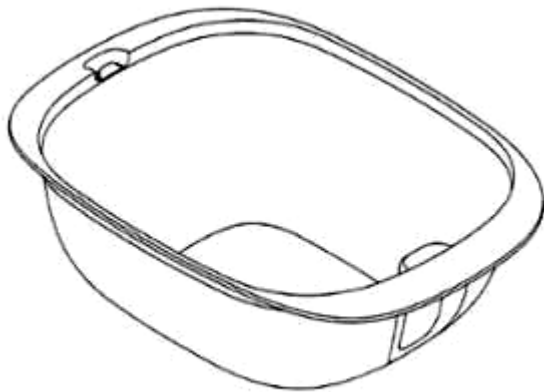

2.1

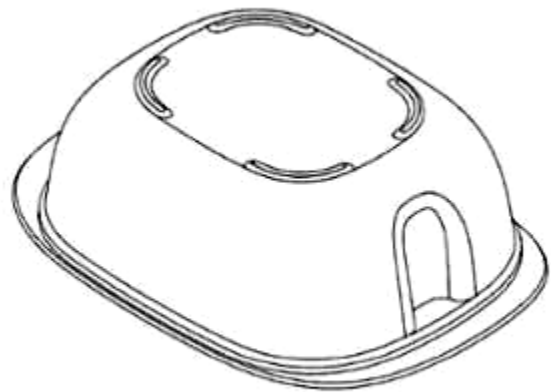

2.2

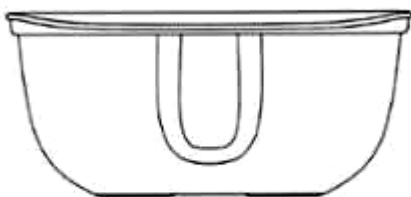

2.3



2.4



2.5

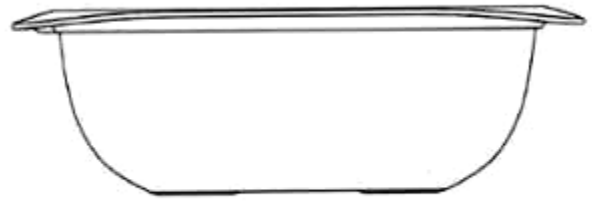

2.6

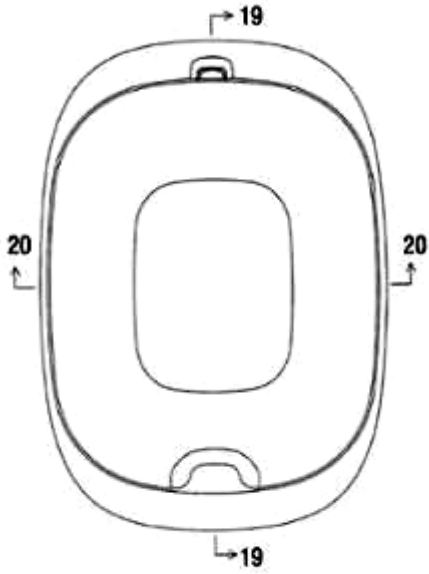

2.7

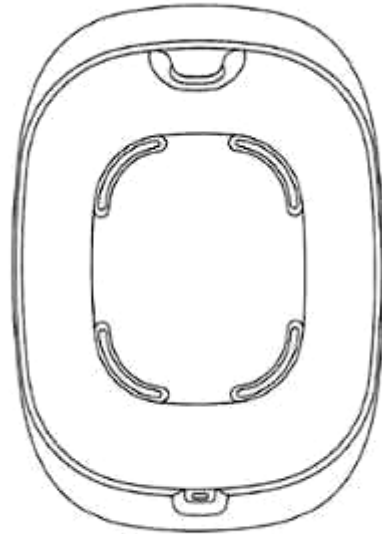

2.8

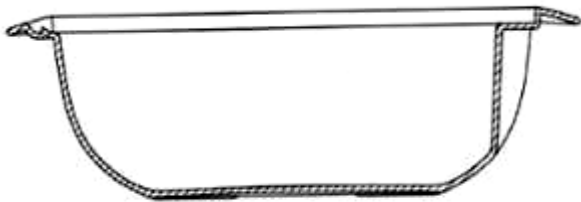

2.9

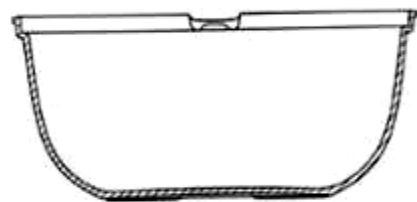

2.10

CÔNG BÁO SỞ HỮU CÔNG NGHIỆP SỐ 424 TẬP A – QUYỀN 2 (07.2023)

(11) **47398**

(21) 3-2023-00149

(28) 1

(54) **GHẾ**

(51) **06-01**

(22) 16/01/2023

(43) 25/07/2023

(73) **CÔNG TY CỔ PHẦN SẢN XUẤT NHỰA DUY TÂN (VN)**

298 Hồ Học Lãm, phường An Lạc, quận Bình Tân, thành phố Hồ Chí Minh

(72) Trần Đức Xuyên (VN)

(74) Công ty TNHH Sở hữu trí tuệ INVENTIO (INVENTIO CO.,LTD)

(55)



1.1



1.2



1.3



1.4



1.5



1.6

CÔNG BÁO SỞ HỮU CÔNG NGHIỆP SỐ 424 TẬP A – QUYỀN 2 (07.2023)

(11) **47399**

(21) 3-2023-00042

(28) 1

(54) **TỦ**

(51) **06-04**

(22) 06/01/2023

(43) 25/07/2023

(73) **ĐÀO TRIỆU NGUYỄN (VN)**

259 Võ Văn Tần, phường 5, quận 3, thành phố Hồ Chí Minh

(72) **ĐÀO TRIỆU NGUYỄN (VN)**

(74) Văn phòng Luật sư A Hoà (AHOA LAW OFFICE)

(55)



1.1



1.2



1.3

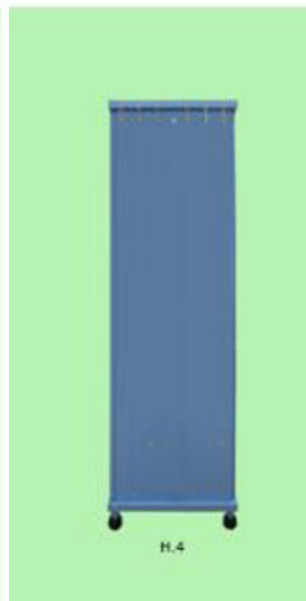

1.4

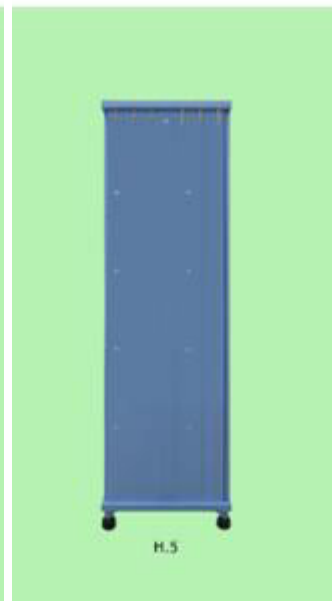

1.5

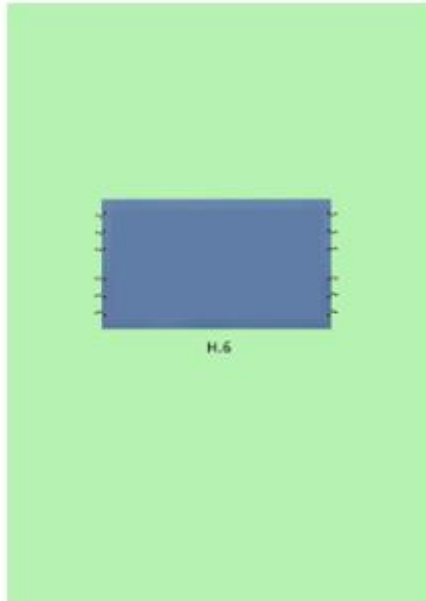

H.6

1.6



H.7

1.7



H.8

1.8



H.9

1.9

CÔNG BÁO SỞ HỮU CÔNG NGHIỆP SỐ 424 TẬP A – QUYỀN 2 (07.2023)

- (11) **47400**
(21) 3-2023-00208 (28) 1
(54) **HỘP ĐỰNG THỰC PHẨM** (51) **09-03**
(22) 27/01/2023 (43) 25/07/2023
(30) 30-2022-0030775 29/07/2022 KR;
(73) **LOCK & LOCK CO., LTD** (KR)
104, Sapgyocheon-ro, Seonjang-myeon, Asan-si, Chungcheongnam-do, Republic of
Korea
(72) LEE, Hye Ri (KR)
(74) Công ty TNHH Tầm nhìn và Liên danh (VISION & ASSOCIATES CO.LTD.)
(55)

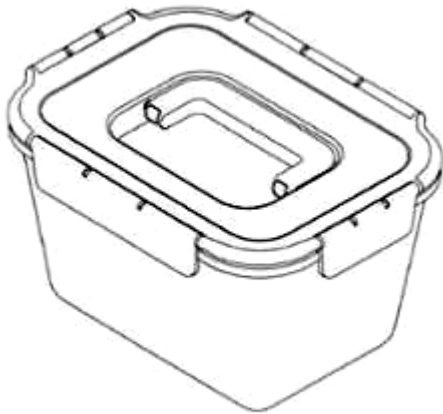

1.1

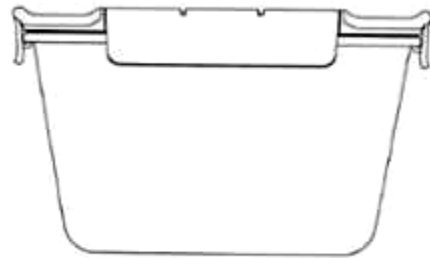

1.2

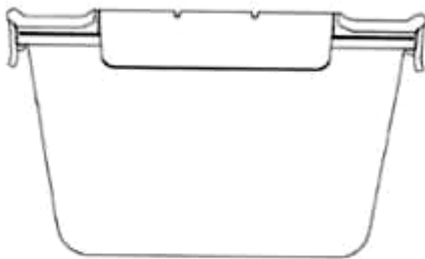

1.3



1.4



1.5

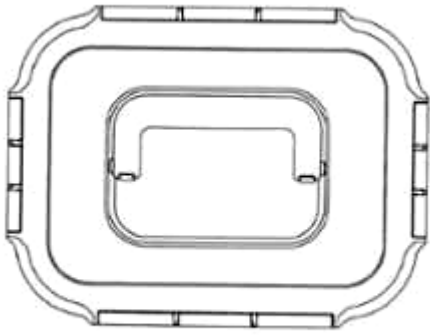

1.6



1.7

CÔNG BÁO SỞ HỮU CÔNG NGHIỆP SỐ 424 TẬP A – QUYỀN 2 (07.2023)

- (11) **47401**
(21) 3-2023-00209 (28) 1
(54) **HỘP ĐỰNG THỰC PHẨM** (51) **09-03**
(22) 27/01/2023 (43) 25/07/2023
(30) 30-2022-0030774 29/07/2022 KR;
(73) **LOCK & LOCK CO., LTD** (KR)
104, Sapgyocheon-ro, Seonjang-myeon, Asan-si, Chungcheongnam-do, Republic of Korea
(72) 1. NAM, SOO JUNG (KR)
2. SHIM, DONG SEOP (KR)
(74) Công ty TNHH Tầm nhìn và Liên danh (VISION & ASSOCIATES CO.LTD.)
(55)



1.1

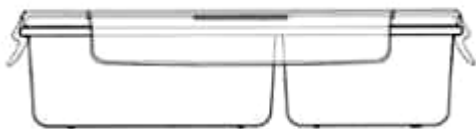

1.2

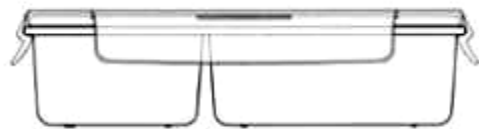

1.3



1.4



1.5

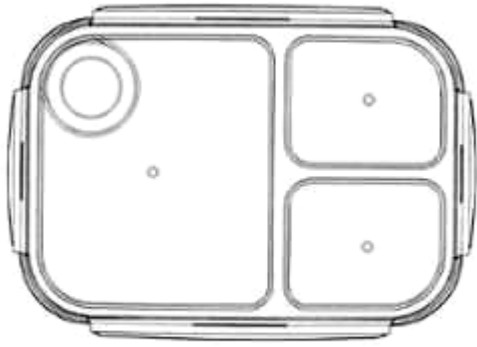

1.6

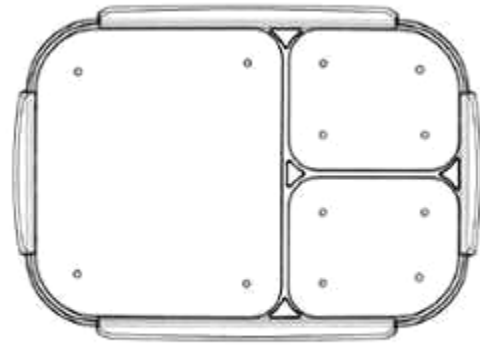

1.7

CÔNG BÁO SỞ HỮU CÔNG NGHIỆP SỐ 424 TẬP A – QUYỀN 2 (07.2023)

- (11) **47402**
(21) 3-2023-00456 (28) 1
(54) **LỌ** (51) **09-01**
(22) 03/03/2023 (43) 25/07/2023
(73) **LG HOUSEHOLD & HEALTH CARE LTD. (KR)**
58, Saemunan-ro, Jongno-gu, Seoul, Republic of Korea
(72) KIM, Eul Ran (KR)
(74) Công ty TNHH Tâm nhìn và Liên danh (VISION & ASSOCIATES CO.LTD.)
(55)



1.1



1.2



1.3



1.4



1.5



1.6



CÔNG BÁO SỞ HỮU CÔNG NGHIỆP SỐ 424 TẬP A – QUYỀN 2 (07.2023)

- (11) **47403**
(21) 3-2023-00470 (28) 1
(54) **KHÓA VÒI MÁY LỌC NƯỚC** (51) **23-01**
(22) 06/03/2023 (43) 25/07/2023
(73) **CÔNG TY TNHH KAROFI R&D (VN)**
Số 5C, ngách 184/85 Trần Khát Chân, phường Thanh Lương, quận Hai Bà Trưng,
thành phố Hà Nội
(72) Ngô Thị Thanh Hải (VN)
(55)



1.1



1.2



1.3



1.4

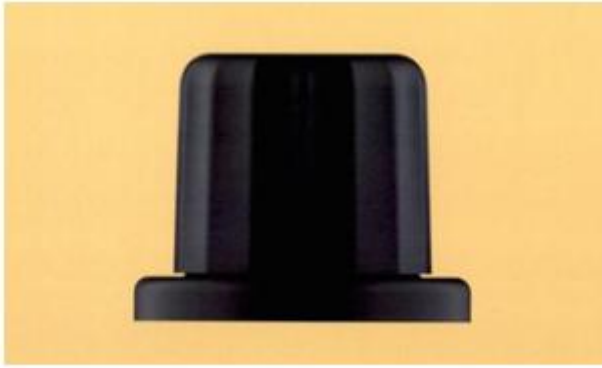

1.5

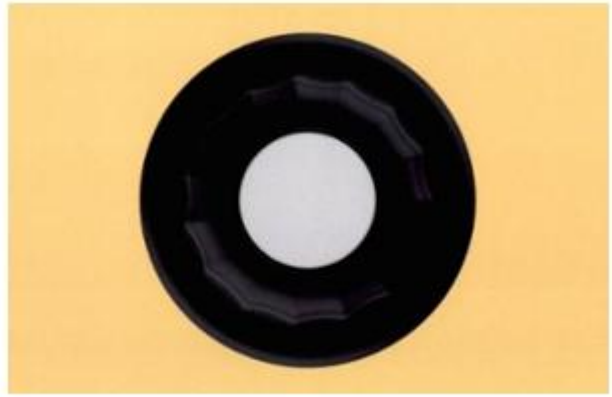

1.6

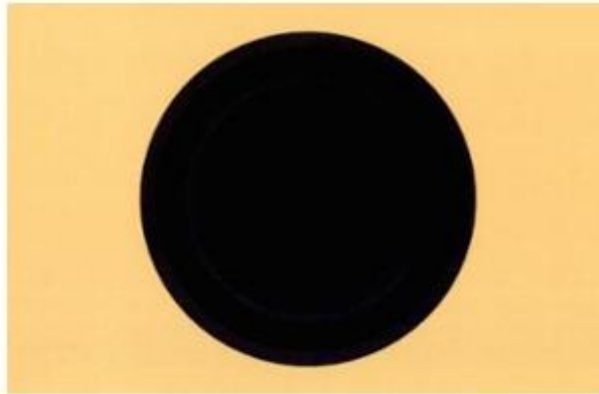

1.7

CÔNG BÁO SỞ HỮU CÔNG NGHIỆP SỐ 424 TẬP A – QUYỀN 2 (07.2023)

(11) **47404**

(21) 3-2023-00471

(54) **VÒI MÁY LỌC NƯỚC**

(22) 06/03/2023

(73) **CÔNG TY TNHH KAROFI R&D (VN)**

Số 5C, ngách 184/85 Trần Khát Chân, phường Thanh Lương, quận Hai Bà Trưng, thành phố Hà Nội

(72) Ngô Thị Thanh Hải (VN)

(55)

(28) 1

(51) **23-01**

(43) 25/07/2023



1.1



1.2



1.3



1.4



1.5



1.6



1.7

CÔNG BÁO SỞ HỮU CÔNG NGHIỆP SỐ 424 TẬP A – QUYỀN 2 (07.2023)

- (11) **47405**
(21) 3-2023-00552 (28) 1
(54) **NẮP KHAY** (51) **07-01**
(22) 14/03/2023 (43) 25/07/2023
(30) 29/855,760 06/10/2022 US;
(73) **DART INDUSTRIES INC. (US)**
14901 S. Orange Blossom Trail, Orlando, Florida, 32837, United States of America
(72) 1. TEO SOK YEE (MY)
2. ALEC VERCRUYSSSEN (BE)
3. ARTHUR LORRÉ (BE)
(74) **CÔNG TY LUẬT TRÁCH NHIỆM HỮU HẠN AMBYS HÀ NỘI (AMBYS HANOI)**
(55)

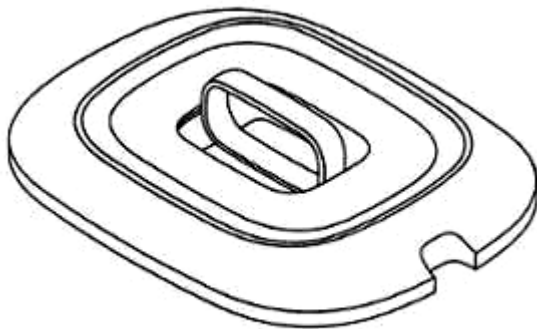

1.1

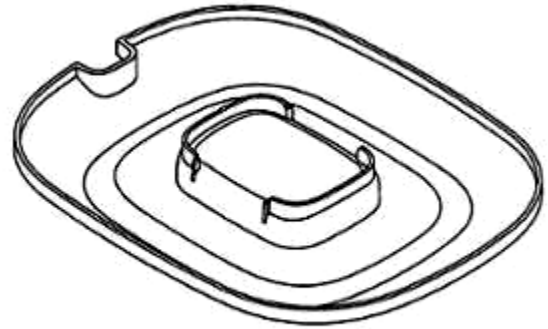

1.2

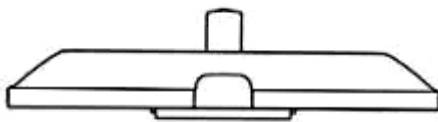

1.3

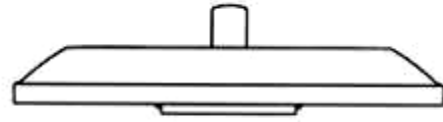

1.4



1.5

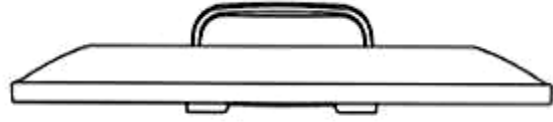

1.6

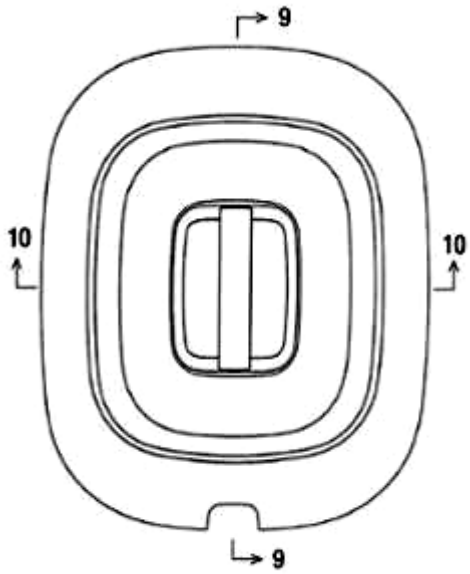

1.7

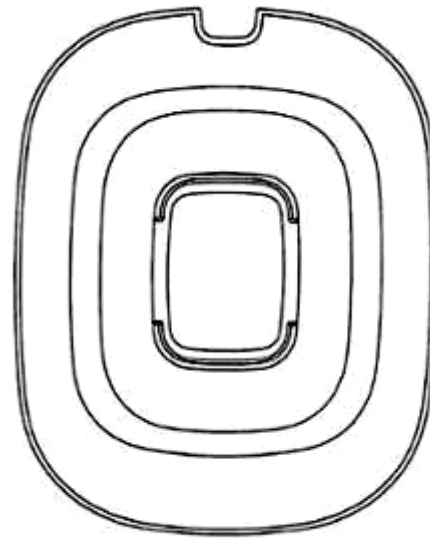

1.8

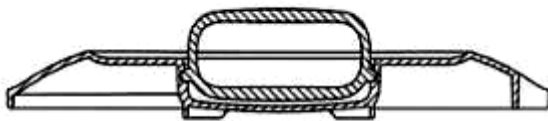

1.9

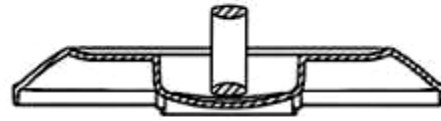

1.10

CÔNG BÁO SỞ HỮU CÔNG NGHIỆP SỐ 424 TẬP A – QUYỀN 2 (07.2023)

- (11) **47406**
(21) 3-2023-00101 (28) 1
(54) **THANH NHÔM ĐỊNH HÌNH** (51) **25-01**
(22) 11/01/2023 (43) 25/07/2023
(73) **CÔNG TY TNHH THANH PHÚC WINDOW (VN)**
478 Nguyễn Thị Thập, phường Tân Quy, quận 7, thành phố Hồ Chí Minh
(72) Nguyễn Thị Kim Hoàn (VN)
(55)



1.1

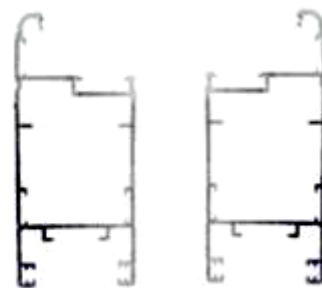

1.2

1.3



1.4



1.5



1.6



1.7

CÔNG BÁO SỞ HỮU CÔNG NGHIỆP SỐ 424 TẬP A – QUYỀN 2 (07.2023)

- (11) **47407**
(21) 3-2023-00100 (28) 1
(54) **THANH NHÔM ĐỊNH HÌNH** (51) **25-01**
(22) 11/01/2023 (43) 25/07/2023
(73) **CÔNG TY TNHH THANH PHÚC WINDOW (VN)**
478 Nguyễn Thị Thập, phường Tân Quy, quận 7, thành phố Hồ Chí Minh
(72) Nguyễn Thị Kim Thoán (VN)
(55)



1.1



1.2



1.3



1.4



1.5



1.6



1.7

CÔNG BÁO SỞ HỮU CÔNG NGHIỆP SỐ 424 TẬP A – QUYỀN 2 (07.2023)

- (11) **47408**
(21) 3-2023-00106 (28) 1
(54) **THANH NHÔM ĐỊNH HÌNH** (51) **25-01**
(22) 11/01/2023 (43) 25/07/2023
(73) **CÔNG TY TNHH THANH PHÚC WINDOW (VN)**
478 Nguyễn Thị Thập, phường Tân Quy, quận 7, thành phố Hồ Chí Minh
(72) Nguyễn Thị Kim Hoàn (VN)
(55)



1.1



1.2



1.3



1.4

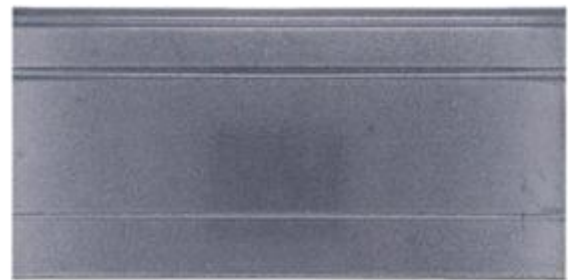

1.5



1.6



1.7

CÔNG BÁO SỞ HỮU CÔNG NGHIỆP SỐ 424 TẬP A – QUYỀN 2 (07.2023)

- (11) **47409**
(21) 3-2023-00103 (28) 1
(54) **THANH NHÔM ĐỊNH HÌNH** (51) **25-01**
(22) 11/01/2023 (43) 25/07/2023
(73) **CÔNG TY TNHH THANH PHÚC WINDOW (VN)**
478 Nguyễn Thị Thập, phường Tân Quy, quận 7, thành phố Hồ Chí Minh
(72) Nguyễn Thị Kim Hoàn (VN)
(55)



1.1



1.2



1.3



1.4



1.5



1.6



1.7

CÔNG BÁO SỞ HỮU CÔNG NGHIỆP SỐ 424 TẬP A – QUYỀN 2 (07.2023)

- (11) **47410**
(21) 3-2023-00109 (28) 1
(54) **THANH NHÔM ĐỊNH HÌNH** (51) **25-01**
(22) 11/01/2023 (43) 25/07/2023
(73) **CÔNG TY TNHH THANH PHÚC WINDOW (VN)**
478 Nguyễn Thị Thập, phường Tân Quy, quận 7, thành phố Hồ Chí Minh
(72) Nguyễn Thị Kim Hoàn (VN)
(55)



1.1



1.2



1.3

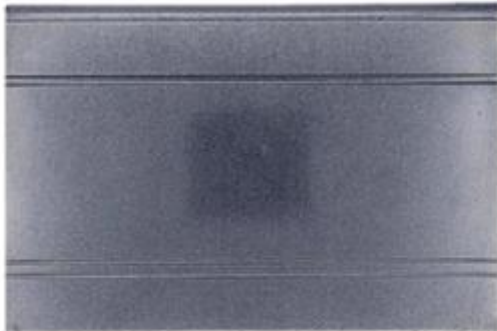

1.4



1.5



1.6



1.7

CÔNG BÁO SỞ HỮU CÔNG NGHIỆP SỐ 424 TẬP A – QUYỀN 2 (07.2023)

- (11) **47411**
(21) 3-2023-00107 (28) 1
(54) **THANH NHÔM ĐỊNH HÌNH** (51) **25-01**
(22) 11/01/2023 (43) 25/07/2023
(73) **CÔNG TY TNHH THANH PHÚC WINDOW (VN)**
478 Nguyễn Thị Thập, phường Tân Quy, quận 7, thành phố Hồ Chí Minh
(72) Nguyễn Thị Kim Hoàn (VN)
(55)



1.1



1.2



1.3

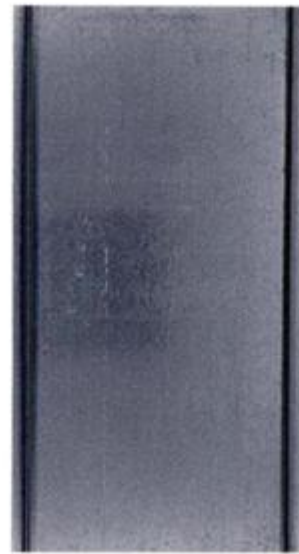

1.4

CÔNG BÁO SỞ HỮU CÔNG NGHIỆP SỐ 424 TẬP A – QUYỀN 2 (07.2023)

- (11) **47412**
(21) 3-2023-00112 (28) 1
(54) **THANH NHÔM ĐỊNH HÌNH** (51) **25-01**
(22) 11/01/2023 (43) 25/07/2023
(73) **CÔNG TY TNHH THANH PHÚC WINDOW (VN)**
478 Nguyễn Thị Thập, phường Tân Quy, quận 7, thành phố Hồ Chí Minh
(72) Nguyễn Thị Kim Hoàn (VN)
(55)



1.1

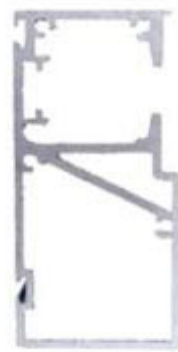

1.2



1.3



1.4



1.5



1.6



1.7

CÔNG BÁO SỞ HỮU CÔNG NGHIỆP SỐ 424 TẬP A – QUYỀN 2 (07.2023)

- (11) **47413**
(21) 3-2023-00111 (28) 1
(54) **THANH NHÔM ĐỊNH HÌNH** (51) **25-01**
(22) 11/01/2023 (43) 25/07/2023
(73) **CÔNG TY TNHH THANH PHÚC WINDOW (VN)**
478 Nguyễn Thị Thập, phường Tân Quy, quận 7, thành phố Hồ Chí Minh
(72) Nguyễn Thị Kim Hoàn (VN)
(55)



1.1

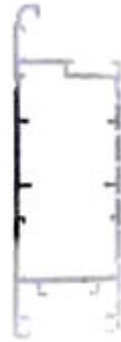

1.2



1.3



1.4



1.5



1.6



1.7

CÔNG BÁO SỞ HỮU CÔNG NGHIỆP SỐ 424 TẬP A – QUYỀN 2 (07.2023)

- (11) **47414**
(21) 3-2023-00113 (28) 1
(54) **THANH NHÔM ĐỊNH HÌNH** (51) **25-01**
(22) 11/01/2023 (43) 25/07/2023
(73) **CÔNG TY TNHH THANH PHÚC WINDOW (VN)**
478 Nguyễn Thị Thập, phường Tân Quy, quận 7, thành phố Hồ Chí Minh
(72) Nguyễn Thị Kim Hoàn (VN)
(55)



1.1



1.2

1.3



1.4



1.5



1.6



1.7

CÔNG BÁO SỞ HỮU CÔNG NGHIỆP SỐ 424 TẬP A – QUYỀN 2 (07.2023)

- (11) **47415**
(21) 3-2023-00115 (28) 1
(54) **THANH NHÔM ĐỊNH HÌNH** (51) **25-01**
(22) 11/01/2023 (43) 25/07/2023
(73) **CÔNG TY TNHH THANH PHÚC WINDOW (VN)**
478 Nguyễn Thị Thập, phường Tân Quy, quận 7, thành phố Hồ Chí Minh
(72) Nguyễn Thị Kim Hoàn (VN)
(55)



1.1



1.2



1.3



1.4



1.5



1.6



1.7

CÔNG BÁO SỞ HỮU CÔNG NGHIỆP SỐ 424 TẬP A – QUYỀN 2 (07.2023)

- (11) **47416**
(21) 3-2023-00114 (28) 1
(54) **THANH NHÔM ĐỊNH HÌNH** (51) **25-01**
(22) 11/01/2023 (43) 25/07/2023
(73) **CÔNG TY TNHH THANH PHÚC WINDOW (VN)**
478 Nguyễn Thị Thập, phường Tân Quy, quận 7, thành phố Hồ Chí Minh
(72) Nguyễn Thị Kim Hoàn (VN)
(55)



1.1



1.2



1.3

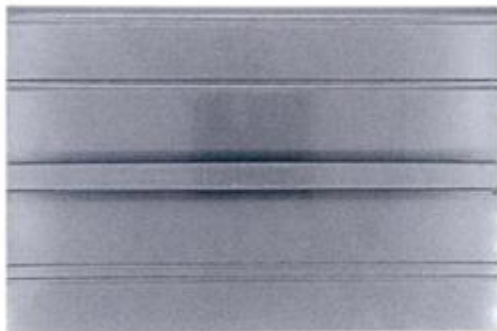

1.4



1.5



1.6



1.7

CÔNG BÁO SỞ HỮU CÔNG NGHIỆP SỐ 424 TẬP A – QUYỀN 2 (07.2023)

(11) 47417

(21) 3-2023-00232

(28) 1

(54) **THIẾT BỊ NGHỊCH LƯU ĐIỆN ÁP**

(51) **13-02**

(22) 01/02/2023

(43) 25/07/2023

(73) **VIỆN KỸ THUẬT ĐIỀU KHIỂN VÀ TỰ ĐỘNG HÓA, TRƯỜNG ĐẠI HỌC BÁCH KHOA HÀ NỘI (VN)**

Phòng 201, tòa nhà Công nghệ cao, Đại học Bách khoa, số 1 Đại Cồ Việt, phường Bách Khoa, quận Hai Bà Trưng, thành phố Hà Nội

(72) Nguyễn Kiên Trung (VN)

(55)



1.1



1.2



1.3



1.4



1.5



1.6

CÔNG BÁO SỞ HỮU CÔNG NGHIỆP SỐ 424 TẬP A – QUYỀN 2 (07.2023)

- (11) **47418**
(21) 3-2023-00259 (28) 1
(54) **THANH KIM LOẠI ĐỊNH HÌNH** (51) **25-01**
(22) 07/02/2023 (43) 25/07/2023
(73) **CÔNG TY CỔ PHẦN TẬP ĐOÀN KENWIN (VN)**
Tầng 4 tòa nhà VG Building, số 235 đường Nguyễn Trãi, phường Thanh Xuân
Trung, quận Thanh Xuân, thành phố Hà Nội
(72) Ngô Thọ Long (VN)
(74) Công ty TNHH Sở hữu trí tuệ PADEMARK (PADEMARK CO.,LTD.)
(55)



1.1



1.2



1.3



1.4

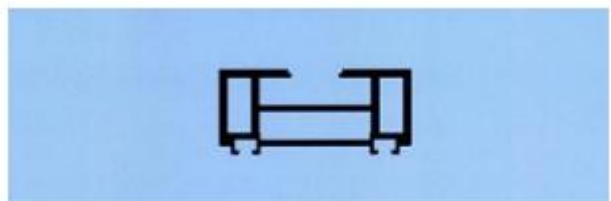

1.5



1.6



1.7

- (11) **47419**
(21) 3-2023-00116 (28) 1
(54) **THANH NHÔM ĐỊNH HÌNH** (51) **25-01**
(22) 11/01/2023 (43) 25/07/2023
(73) **CÔNG TY TNHH THANH PHÚC WINDOW (VN)**
478 Nguyễn Thị Thập, phường Tân Quy, quận 7, thành phố Hồ Chí Minh
(72) Nguyễn Thị Kim Hoàn (VN)
(55)



1.1



1.2



1.3

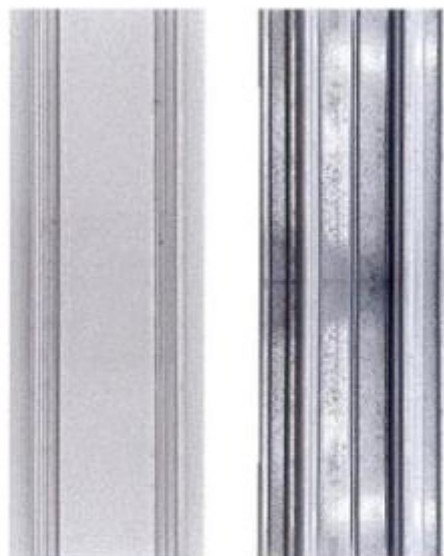

1.4

1.5

CÔNG BÁO SỞ HỮU CÔNG NGHIỆP SỐ 424 TẬP A – QUYỀN 2 (07.2023)

- (11) **47420**
(21) 3-2023-00294 (28) 1
(54) **THANH KIM LOẠI ĐỊNH HÌNH** (51) **25-01**
(22) 15/02/2023 (43) 25/07/2023
(73) **CÔNG TY CỔ PHẦN TẬP ĐOÀN EUROVIEW (VN)**
Số 150 đường Cổ Bi, xã Cổ Bi, huyện Gia Lâm, thành phố Hà Nội
(72) Nguyễn Thị Trung Thủy (VN)
(74) Công ty TNHH Sở hữu trí tuệ Gia Việt (GIAVIET CO., LTD.)
(55)

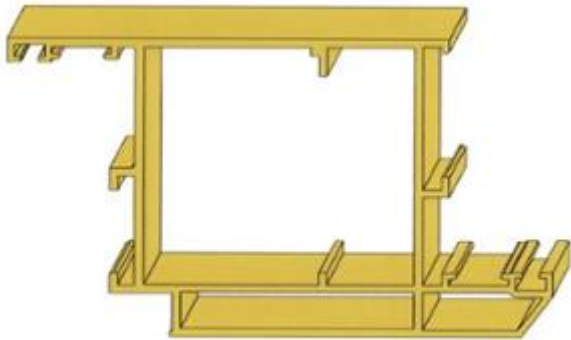

1.1

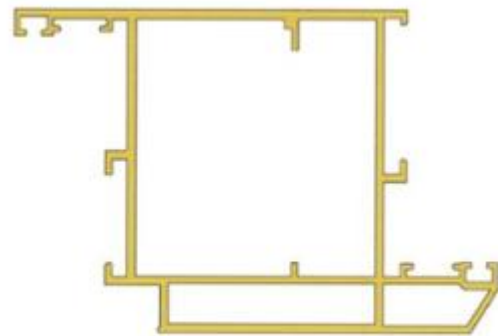

1.2



1.3

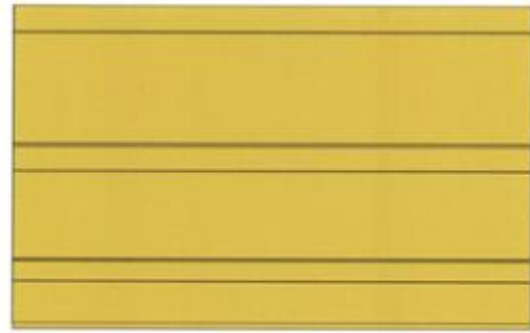

1.4



1.5



1.6

CÔNG BÁO SỞ HỮU CÔNG NGHIỆP SỐ 424 TẬP A – QUYỀN 2 (07.2023)

- (11) **47421**
(21) 3-2023-00295 (28) 1
(54) **THANH KIM LOẠI ĐỊNH HÌNH** (51) **25-01**
(22) 15/02/2023 (43) 25/07/2023
(73) **CÔNG TY CỔ PHẦN TẬP ĐOÀN EUROVIEW (VN)**
Số 150 đường Cổ Bi, xã Cổ Bi, huyện Gia Lâm, thành phố Hà Nội
(72) Nguyễn Thị Trung Thủy (VN)
(74) Công ty TNHH Sở hữu trí tuệ Gia Việt (GIAVIET CO., LTD.)
(55)

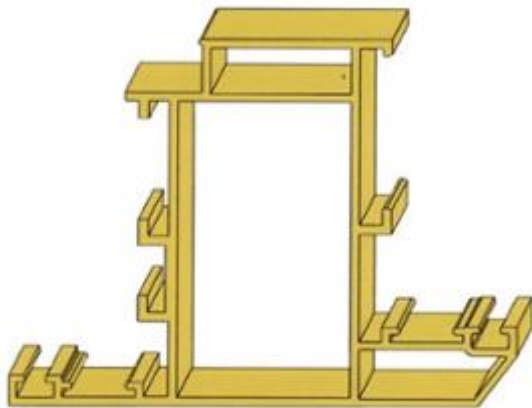

1.1

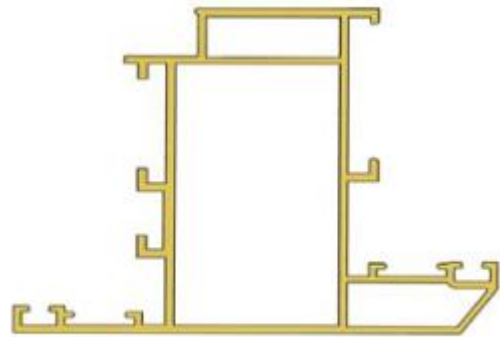

1.2



1.3



1.4

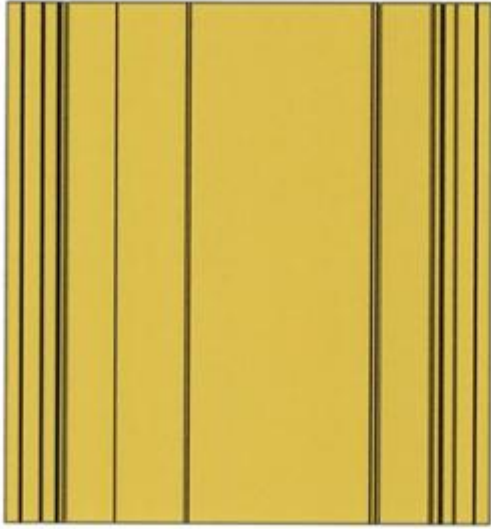

1.5

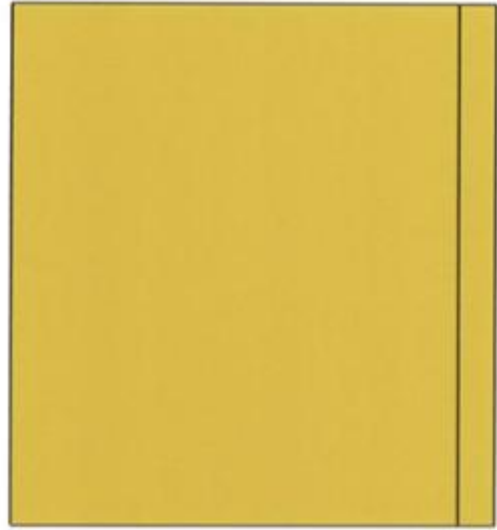

1.6

CÔNG BÁO SỞ HỮU CÔNG NGHIỆP SỐ 424 TẬP A – QUYỀN 2 (07.2023)

- (11) **47422**
(21) 3-2023-00326 (28) 1
(54) **THANH KIM LOẠI ĐỊNH HÌNH** (51) **25-01**
(22) 21/02/2023 (43) 25/07/2023
(73) **CÔNG TY TNHH SẢN XUẤT VÀ THƯƠNG MẠI BÁCH VIỆT (VN)**
Số 101, đường Đại Cồ Việt, phường Lê Đại Hành, quận Hai Bà Trưng, thành phố Hà Nội
(72) Vũ Xuân Hòa (VN)
(74) Công ty TNHH Sở hữu trí tuệ Bình Minh (SUNRISE IP CO.,LTD.)
(55)



1.1



1.2

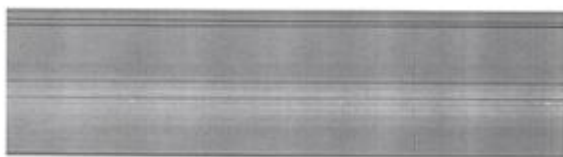

1.3



1.4



1.5



1.6



1.7

CÔNG BÁO SỞ HỮU CÔNG NGHIỆP SỐ 424 TẬP A – QUYỀN 2 (07.2023)

- (11) **47423**
(21) 3-2023-00296 (28) 1
(54) **THANH KIM LOẠI ĐỊNH HÌNH** (51) **25-01**
(22) 15/02/2023 (43) 25/07/2023
(73) **CÔNG TY TNHH SẢN XUẤT VÀ THƯƠNG MẠI BÁCH VIỆT (VN)**
Số 101, đường Đại Cồ Việt, phường Lê Đại Hành, quận Hai Bà Trưng, thành phố Hà Nội
(72) Vũ Xuân Hòa (VN)
(74) Công ty TNHH Sở hữu trí tuệ Bình Minh (SUNRISE IP CO.,LTD.)
(55)

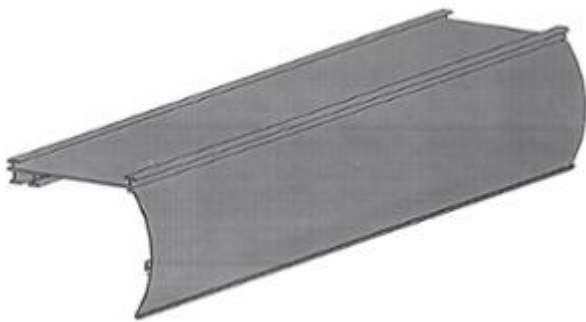

1.1

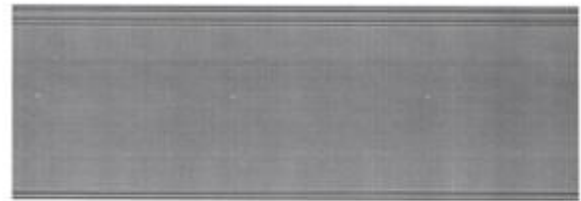

1.2



1.3

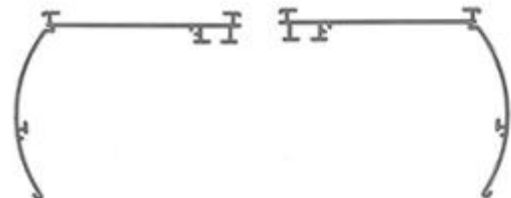

1.4

1.5

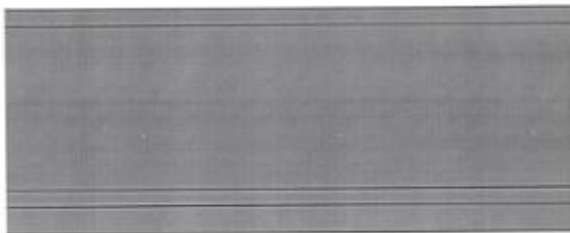

1.6

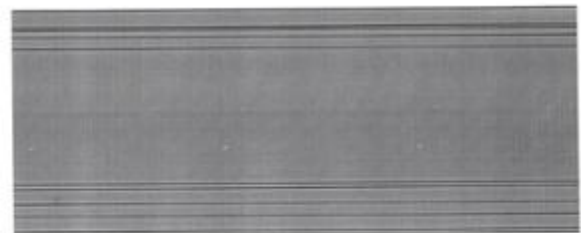

1.7

CÔNG BÁO SỞ HỮU CÔNG NGHIỆP SỐ 424 TẬP A – QUYỀN 2 (07.2023)

- (11) **47424**
(21) 3-2023-00357 (28) 1
(54) **ẮC QUY** (51) **13-02**
(22) 24/02/2023 (43) 25/07/2023
(73) **TRẦN VĂN CẢNG (VN)**
Tầng 4, số nhà 63, đường Tây Cao Tốc, thôn Bàu, xã Kim Chung, huyện Đông Anh, thành phố Hà Nội
(72) Trần Văn Cảng (VN)
(74) Công ty TNHH Tâm nhìn và Liên danh (VISION & ASSOCIATES CO.LTD.)
(55)



1.1



1.2



1.3



1.4



1.5



1.6



1.7

CÔNG BÁO SỞ HỮU CÔNG NGHIỆP SỐ 424 TẬP A – QUYỀN 2 (07.2023)

- (11) **47425**
(21) 3-2023-00358 (28) 1
(54) **ẮC QUY** (51) **13-02**
(22) 24/02/2023 (43) 25/07/2023
(73) **TRẦN VĂN CẢNG (VN)**
Tầng 4, số nhà 63, đường Tây Cao Tốc, thôn Bàu, xã Kim Chung, huyện Đông Anh, thành phố Hà Nội
(72) Trần Văn Cảng (VN)
(74) Công ty TNHH Tâm nhìn và Liên danh (VISION & ASSOCIATES CO.LTD.)
(55)



1.1



1.2



1.3



1.4



1.5



1.6



1.7



1.8

CÔNG BÁO SỞ HỮU CÔNG NGHIỆP SỐ 424 TẬP A – QUYỀN 2 (07.2023)

- (11) **47426**
(21) 3-2023-00359 (28) 1
(54) **ẮC QUY** (51) **13-02**
(22) 24/02/2023 (43) 25/07/2023
(73) **TRẦN VĂN CẢNG (VN)**
Tầng 4, số nhà 63, đường Tây Cao Tốc, thôn Bàu, xã Kim Chung, huyện Đông Anh,
thành phố Hà Nội
(72) Trần Văn Cảng (VN)
(74) Công ty TNHH Tâm nhìn và Liên danh (VISION & ASSOCIATES CO.LTD.)
(55)



1.1



1.2



1.3



1.4



1.5



1.6



1.7



1.8

CÔNG BÁO SỞ HỮU CÔNG NGHIỆP SỐ 424 TẬP A – QUYỀN 2 (07.2023)

(11) **47427**

(21) 3-2023-00368

(28) 1

(54) **THANH NHÔM ĐỊNH HÌNH**

(51) **25-01**

(22) 27/02/2023

(43) 25/07/2023

(73) **CÔNG TY TNHH THƯƠNG MẠI HÙNG UYÊN (VN)**

Thôn 2, xã Chàng Sơn, huyện Thạch Thất, thành phố Hà Nội

(72) Chu Văn Hưng (VN)

(55)

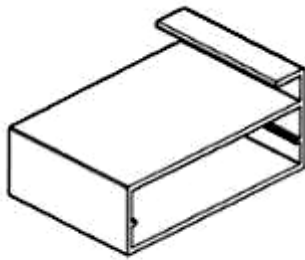

1.1

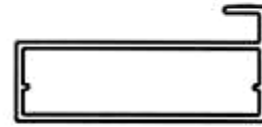

1.2

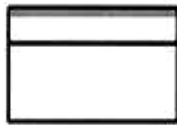

1.3

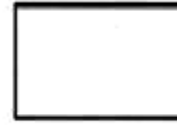

1.4



1.5



1.6

CÔNG BÁO SỞ HỮU CÔNG NGHIỆP SỐ 424 TẬP A – QUYỀN 2 (07.2023)

- (11) **47428**
(21) 3-2023-00400 (28) 1
(54) **THUYỀN PHAO** (51) **12-06**
(22) 28/02/2023 (43) 25/07/2023
(73) **CÔNG TY CỔ PHẦN TẬP ĐOÀN NHỰA SUPER TRƯỜNG PHÁT (VN)**
Số T151, lô đất H4, khu đấu giá 31ha, thị trấn Trâu Quỳ, huyện Gia Lâm, thành phố Hà Nội
(72) Phạm Quốc Chính (VN)
(74) Công ty TNHH Sở hữu trí tuệ VIPATCO (VIPATCO CO., LTD.)
(55)

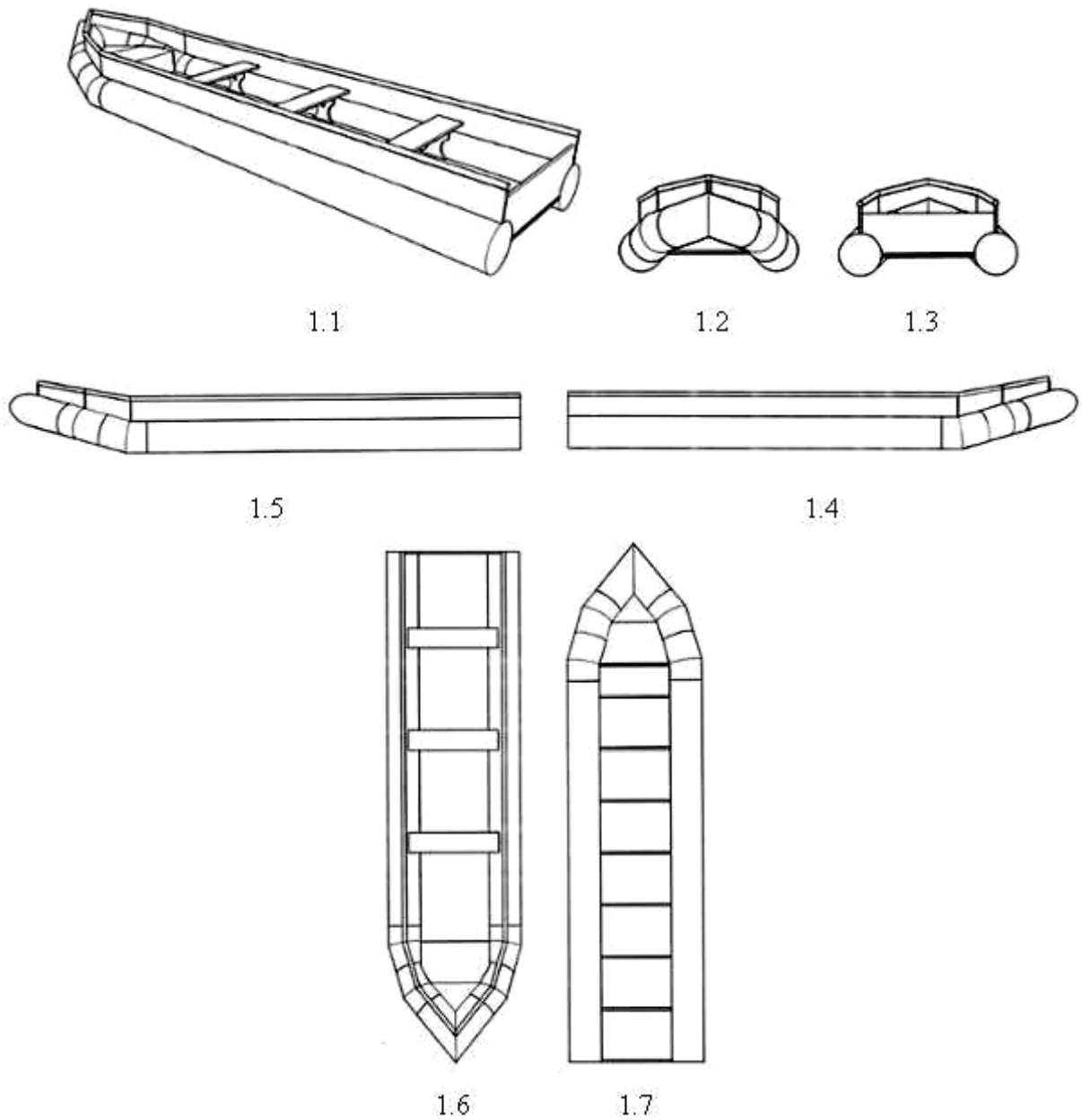

CÔNG BÁO SỞ HỮU CÔNG NGHIỆP SỐ 424 TẬP A – QUYỀN 2 (07.2023)

- (11) **47429**
(21) 3-2023-00451 (28) 1
(54) **THANH KIM LOẠI ĐỊNH HÌNH** (51) **25-01**
(22) 03/03/2023 (43) 25/07/2023
(73) **CÔNG TY CỔ PHẦN TẬP ĐOÀN KENWIN (VN)**
Tầng 4 tòa nhà VG Building, số 235 đường Nguyễn Trãi, phường Thanh Xuân
Trung, quận Thanh Xuân, thành phố Hà Nội
(72) Ngô Thọ Long (VN)
(74) Công ty TNHH Sở hữu trí tuệ PADEMARK (PADEMARK CO.,LTD.)
(55)



1.1



1.2



1.3



1.4



1.5

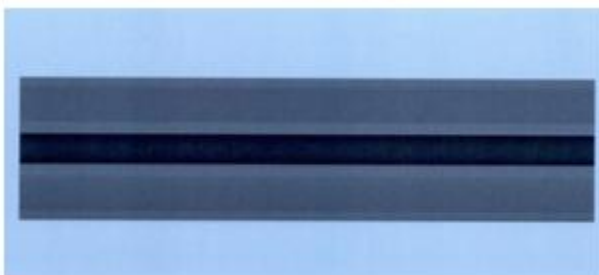

1.6



1.7

CÔNG BÁO SỞ HỮU CÔNG NGHIỆP SỐ 424 TẬP A – QUYỀN 2 (07.2023)

- (11) **47430**
(21) 3-2023-00595 (28) 1
(54) **THANH KIM LOẠI ĐỊNH HÌNH** (51) **25-01**
(22) 21/03/2023 (43) 25/07/2023
(73) **CÔNG TY CỔ PHẦN TẬP ĐOÀN KENWIN (VN)**
Tầng 4 tòa nhà VG Building, số 235 đường Nguyễn Trãi, phường Thanh Xuân
Trung, quận Thanh Xuân, thành phố Hà Nội
(72) Ngô Thọ Long (VN)
(74) Công ty TNHH Sở hữu trí tuệ PADEMARK (PADEMARK CO.,LTD.)
(55)



1.1



1.2



1.3



1.4

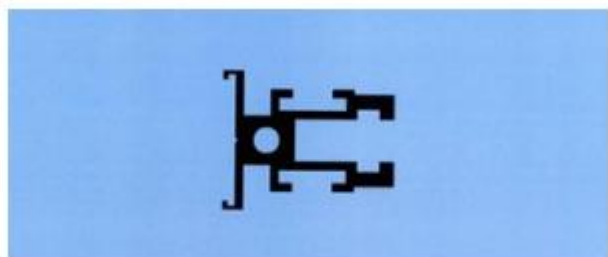

1.5



1.6



1.7

CÔNG BÁO SỞ HỮU CÔNG NGHIỆP SỐ 424 TẬP A – QUYỀN 2 (07.2023)

- (11) **47431**
(21) 3-2023-00514 (28) 1
(54) **TẮM LỢP** (51) **25-01**
(22) 10/03/2023 (43) 25/07/2023
(73) **CÔNG TY TNHH CƠ KHÍ CÔNG NGHIỆP SÀI GÒN (VN)**
Lô 12A, đường số 9, khu công nghiệp Tân Tạo, phường Tân Tạo A, quận Bình Tân,
thành phố Hồ Chí Minh
(72) Nguyễn Phú Quốc (VN)
(55)



1.1



1.2



1.3



1.4



1.5

CÔNG BÁO SỞ HỮU CÔNG NGHIỆP SỐ 424 TẬP A – QUYỀN 2 (07.2023)

- (11) **47432**
(21) 3-2023-00620 (28) 1
(54) **THANH NHÔM ĐỊNH HÌNH** (51) **25-01**
(22) 23/03/2023 (43) 25/07/2023
(73) **CÔNG TY TNHH THƯƠNG MẠI HÙNG UYÊN (VN)**
Thôn 2, xã Chàng Sơn, huyện Thạch Thất, thành phố Hà Nội
(72) Chu Văn Hưng (VN)
(55)

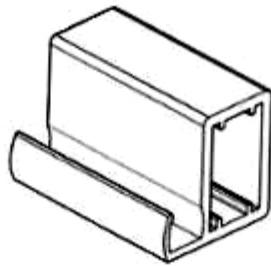

1.1

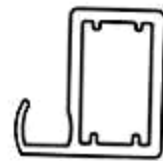

1.2



1.3



1.4



1.5



1.6

CÔNG BÁO SỞ HỮU CÔNG NGHIỆP SỐ 424 TẬP A – QUYỀN 2 (07.2023)

- (11) **47433**
(21) 3-2023-00619 (28) 1
(54) **THANH NHÔM ĐỊNH HÌNH** (51) **25-01**
(22) 23/03/2023 (43) 25/07/2023
(73) **CÔNG TY TNHH THƯƠNG MẠI HÙNG UYÊN (VN)**
Thôn 2, xã Chàng Sơn, huyện Thạch Thất, thành phố Hà Nội
(72) Chu Văn Hưng (VN)
(55)

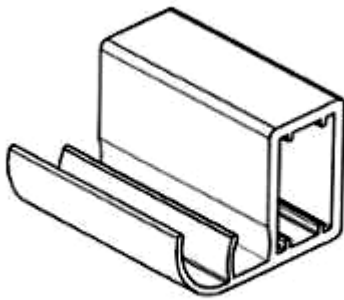

1.1



1.2



1.3

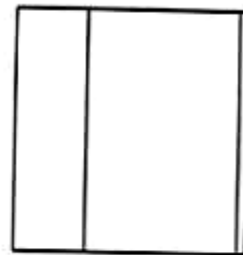

1.4



1.5



1.6

CÔNG BÁO SỞ HỮU CÔNG NGHIỆP SỐ 424 TẬP A – QUYỀN 2 (07.2023)

(11) **47434**

(21) 3-2023-00071

(28) 1

(54) **DÉP**

(51) **02-04**

(22) 09/01/2023

(43) 25/07/2023

(73) **CÔNG TY TNHH SẢN XUẤT THƯƠNG MẠI HÙ KIỆT (VN)**

Tỉnh Lộ 830, ấp 8, xã Lương Hòa, huyện Bến Lức, tỉnh Long An

(72) Gíp Cao Thanh (VN)

(55)



1.1



1.2



1.3



1.4



1.5



1.6



1.7

CÔNG BÁO SỞ HỮU CÔNG NGHIỆP SỐ 424 TẬP A – QUYỀN 2 (07.2023)

(11) **47435**

(21) 3-2023-00144

(28) 1

(54) **DÉP**

(51) **02-04**

(22) 13/01/2023

(43) 25/07/2023

(73) **CÔNG TY TNHH GIÀY Á CHÂU (VN)**

451/29/8 Tô Hiến Thành, phường 14, quận 10, thành phố Hồ Chí Minh

(72) Nguyễn Đình Kim (VN)

(74) Văn phòng Luật sư A Hoà (AHOA LAW OFFICE)

(55)



1.1



1.2



1.3



1.4



1.5



1.6



1.7

CÔNG BÁO SỞ HỮU CÔNG NGHIỆP SỐ 424 TẬP A – QUYỀN 2 (07.2023)

- (11) **47436**
(21) 3-2023-00164 (28) 1
(54) **GIÀY** (51) **02-04**
(22) 17/01/2023 (43) 25/07/2023
(30) 009095136-0001 22/07/2022 EM;
(73) **DECATHLON (FR)**
4, Boulevard de Mons, F-59650 Villeneuve d’Ascq, France
(72) Pierrick BUSTIN (FR)
(74) Công ty Luật TNHH T&G (TGVN)
(55)



1.1



1.2



1.3



1.4



1.5



1.6



1.7

CÔNG BÁO SỞ HỮU CÔNG NGHIỆP SỐ 424 TẬP A – QUYỀN 2 (07.2023)

- (11) **47437**
(21) 3-2023-00165 (28) 2
(54) **GIÀY** (51) **02-04**
(22) 17/01/2023 (43) 25/07/2023
(30) 009095136-0003 22/07/2022 EM; 009095136-0002 22/07/2022 EM;
(73) **DECATHLON (FR)**
4, Boulevard de Mons, F-59650 Villeneuve d'Ascq, France
(72) Pierrick BUSTIN (FR)
(74) Công ty Luật TNHH T&G (TGVN)
(55)



1.1



1.2



1.3



1.4



1.5



1.6



1.7



2.1



2.2



2.3



2.4



2.5



2.6



2.7

CÔNG BÁO SỞ HỮU CÔNG NGHIỆP SỐ 424 TẬP A – QUYỀN 2 (07.2023)

- (11) 47438
(21) 3-2023-00181
(54) BA LÔ
(22) 18/01/2023
(73) CÔNG TY CỔ PHẦN XUẤT NHẬP KHẨU BÌNH TÂY (VN)
Đường tỉnh 835, ấp 3A, xã Phước Lợi, huyện Bến Lức, tỉnh Long An
(72) Nguyễn Xuân Dũng (VN)
(55)
- (28) 1
(51) 03-01
(43) 25/07/2023



1.1



1.2



1.3



1.4



1.5



1.6



1.7

CÔNG BÁO SỞ HỮU CÔNG NGHIỆP SỐ 424 TẬP A – QUYỀN 2 (07.2023)

- (11) 47439
(21) 3-2023-00182
(54) BA LÔ
(22) 18/01/2023
(73) CÔNG TY CỔ PHẦN XUẤT NHẬP KHẨU BÌNH TÂY (VN)
Đường tỉnh 835, ấp 3A, xã Phước Lợi, huyện Bến Lức, tỉnh Long An
(72) Nguyễn Xuân Dũng (VN)
(55)
- (28) 1
(51) 03-01
(43) 25/07/2023



1.1



1.2



1.3



1.4



1.5



1.6



1.7

CÔNG BÁO SỞ HỮU CÔNG NGHIỆP SỐ 424 TẬP A – QUYỀN 2 (07.2023)

- (11) 47440
(21) 3-2023-00183
(54) BA LÔ
(22) 18/01/2023
(73) CÔNG TY CỔ PHẦN XUẤT NHẬP KHẨU BÌNH TÂY (VN)
Đường tỉnh 835, ấp 3A, xã Phước Lợi, huyện Bến Lức, tỉnh Long An
(72) Nguyễn Xuân Dũng (VN)
(55)
- (28) 1
(51) 03-01
(43) 25/07/2023



1.1



1.2



1.3



1.4



1.5



1.6



1.7

CÔNG BÁO SỞ HỮU CÔNG NGHIỆP SỐ 424 TẬP A – QUYỀN 2 (07.2023)

- (11) **47441**
(21) 3-2023-00231 (28) 2
(54) **GIÀY** (51) **02-04**
(22) 01/02/2023 (43) 25/07/2023
(30) 009145584-0002 10/08/2022 EM; 009145584-0001 10/08/2022 EM;
(73) **DECATHLON (FR)**
4, Boulevard de Mons, F-59650 Villeneuve d’Ascq, France
(72) Pierrick BUSTIN (FR)
(74) Công ty Luật TNHH T&G (TGVN)
(55)



1.1



1.2



1.3



1.4



1.5



1.6



1.7



2.1



2.2



2.3



2.4



2.5



2.6



2.7

(11) **47442**

(21) 3-2023-00279

(54) **MẶT DÂY CHUYỀN**

(22) 10/02/2023

(73) **NGUYỄN THỊ HỒNG ĐÀO (VN)**

Tổ 20, Tín Nghĩa, Xuân Thiện, Thống Nhất, Đồng Nai

(72) Nguyễn Thị Hồng Đào (VN)

(55)

(28) 1

(51) **11-01**

(43) 25/07/2023



1.1



1.2



1.3



1.4



1.5

CÔNG BÁO SỞ HỮU CÔNG NGHIỆP SỐ 424 TẬP A – QUYỀN 2 (07.2023)

(11) **47443**

(21) 3-2023-00377

(28) 1

(54) **DÉP**

(51) **02-04**

(22) 28/02/2023

(43) 25/07/2023

(73) **CÔNG TY TNHH GIÀY Á CHÂU (VN)**

451/29/8 Tô Hiến Thành, phường 14, quận 10, thành phố Hồ Chí Minh

(72) Nguyễn Đình Kim (VN)

(74) Văn phòng Luật sư A Hoà (AHOA LAW OFFICE)

(55)



1.1



1.2



1.3



1.4



1.5



1.6



1.7

CÔNG BÁO SỞ HỮU CÔNG NGHIỆP SỐ 424 TẬP A – QUYỀN 2 (07.2023)

- (11) **47444**
(21) 3-2023-00417 (28) 1
(54) **ĐỆM KHUYỬ TAY** (51) **02-99**
(22) 02/03/2023 (43) 25/07/2023
(30) 009182686-0002 23/09/2022 EM;
(73) **DECATHLON (FR)**
4, Boulevard de Mons, F-59650 Villeneuve d'Ascq, France
(72) Ruben MONTERO (FR)
(74) Công ty Luật TNHH T&G (TGVN)
(55)

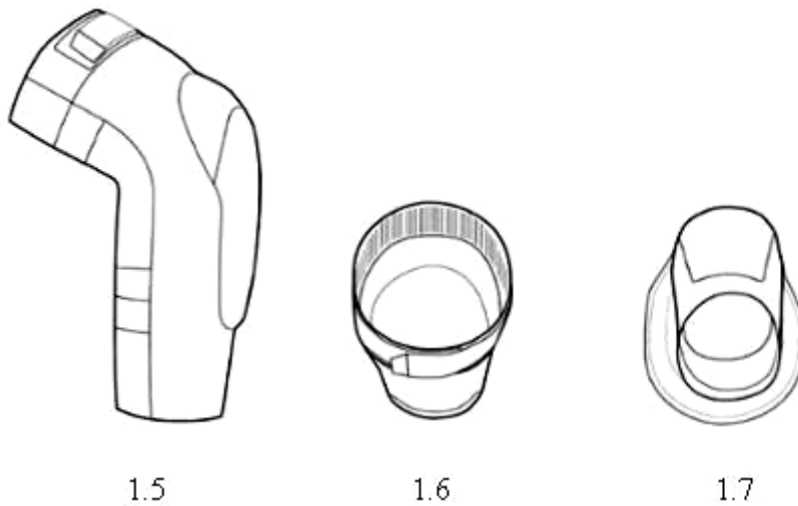
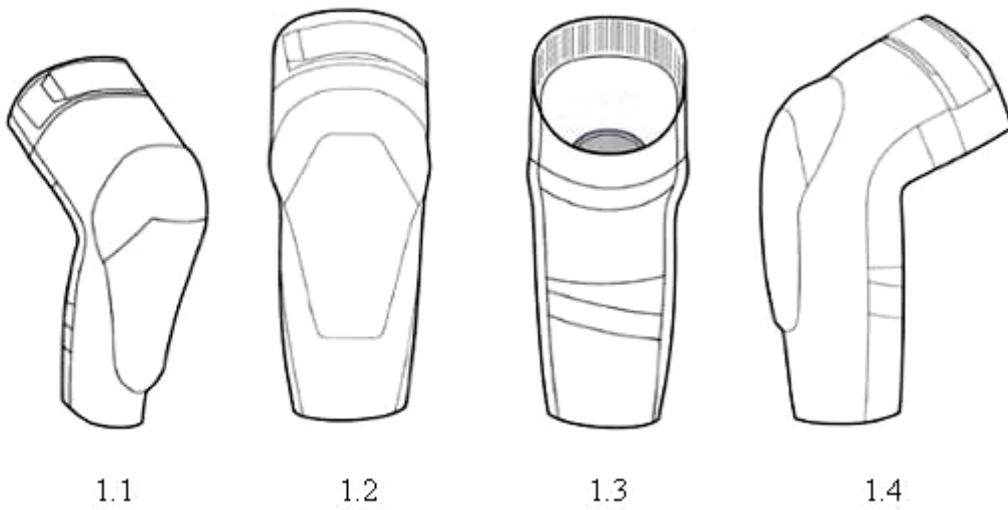

CÔNG BÁO SỞ HỮU CÔNG NGHIỆP SỐ 424 TẬP A – QUYỀN 2 (07.2023)

- (11) **47445**
(21) 3-2023-00423
(54) **BA LÔ**
(22) 02/03/2023
(73) **CÔNG TY CỔ PHẦN XUẤT NHẬP KHẨU BÌNH TÂY (VN)**
Đường tỉnh 835, ấp 3A, xã Phước Lợi, huyện Bến Lức, tỉnh Long An
(72) Nguyễn Xuân Dũng (VN)
(55)
- (28) 1
(51) **03-01**
(43) 25/07/2023



1.1



1.2



1.3



1.4



1.5



1.6



1.7

CÔNG BÁO SỞ HỮU CÔNG NGHIỆP SỐ 424 TẬP A – QUYỀN 2 (07.2023)

- (11) 47446
(21) 3-2023-00425
(54) BA LÔ
(22) 02/03/2023
(73) CÔNG TY CỔ PHẦN XUẤT NHẬP KHẨU BÌNH TÂY (VN)
Đường tỉnh 835, ấp 3A, xã Phước Lợi, huyện Bến Lức, tỉnh Long An
(72) Nguyễn Xuân Dũng (VN)
(55)
- (28) 1
(51) 03-01
(43) 25/07/2023



1.1



1.2



1.3



1.4



1.5



1.6



1.7

CÔNG BÁO SỞ HỮU CÔNG NGHIỆP SỐ 424 TẬP A – QUYỀN 2 (07.2023)

- (11) 47447
(21) 3-2023-00426
(54) BA LÔ
(22) 02/03/2023
(73) **CÔNG TY CỔ PHẦN XUẤT NHẬP KHẨU BÌNH TÂY (VN)**
Đường tỉnh 835, ấp 3A, xã Phước Lợi, huyện Bến Lức, tỉnh Long An
(72) Nguyễn Xuân Dũng (VN)
(55)
- (28) 1
(51) 03-01
(43) 25/07/2023



1.1



1.2



1.3



1.4



1.5



1.6



1.7

CÔNG BÁO SỞ HỮU CÔNG NGHIỆP SỐ 424 TẬP A – QUYỀN 2 (07.2023)

- (11) 47448
(21) 3-2023-00428
(54) BA LÔ
(22) 02/03/2023
(73) **CÔNG TY CỔ PHẦN XUẤT NHẬP KHẨU BÌNH TÂY (VN)**
Đường tỉnh 835, ấp 3A, xã Phước Lợi, huyện Bến Lức, tỉnh Long An
(72) Nguyễn Xuân Dũng (VN)
(55)
- (28) 1
(51) 03-01
(43) 25/07/2023



1.1



1.2



1.3



1.4



1.5



1.6



1.7

CÔNG BÁO SỞ HỮU CÔNG NGHIỆP SỐ 424 TẬP A – QUYỀN 2 (07.2023)

- (11) 47449
(21) 3-2023-00429
(54) BA LÔ
(22) 02/03/2023
(73) **CÔNG TY CỔ PHẦN XUẤT NHẬP KHẨU BÌNH TÂY (VN)**
Đường tỉnh 835, ấp 3A, xã Phước Lợi, huyện Bến Lức, tỉnh Long An
(72) Nguyễn Xuân Dũng (VN)
(55)
- (28) 1
(51) 03-01
(43) 25/07/2023



1.1



1.2



1.3



1.4



1.5



1.6



1.7

CÔNG BÁO SỞ HỮU CÔNG NGHIỆP SỐ 424 TẬP A – QUYỀN 2 (07.2023)

- (11) **47450**
(21) 3-2023-00432 (28) 1
(54) **BA LÔ** (51) **03-01**
(22) 02/03/2023 (43) 25/07/2023
(73) **CÔNG TY CỔ PHẦN XUẤT NHẬP KHẨU BÌNH TÂY (VN)**
Đường tỉnh 835, ấp 3A, xã Phước Lợi, huyện Bến Lức, tỉnh Long An
(72) Nguyễn Xuân Dũng (VN)
(55)



1.1



1.2



1.3



1.4



1.5



1.6



1.7

CÔNG BÁO SỞ HỮU CÔNG NGHIỆP SỐ 424 TẬP A – QUYỀN 2 (07.2023)

- (11) 47451
(21) 3-2023-00433
(54) BA LÔ
(22) 02/03/2023
(73) CÔNG TY CỔ PHẦN XUẤT NHẬP KHẨU BÌNH TÂY (VN)
Đường tỉnh 835, ấp 3A, xã Phước Lợi, huyện Bến Lức, tỉnh Long An
(72) Nguyễn Xuân Dũng (VN)
(55)
- (28) 1
(51) 03-01
(43) 25/07/2023



1.1



1.2



1.3



1.4



1.5



1.6



1.7

CÔNG BÁO SỞ HỮU CÔNG NGHIỆP SỐ 424 TẬP A – QUYỀN 2 (07.2023)

- (11) 47452
(21) 3-2023-00434
(54) BA LÔ
(22) 02/03/2023
(73) CÔNG TY CỔ PHẦN XUẤT NHẬP KHẨU BÌNH TÂY (VN)
Đường tỉnh 835, ấp 3A, xã Phước Lợi, huyện Bến Lức, tỉnh Long An
(72) Nguyễn Xuân Dũng (VN)
(55)
- (28) 1
(51) 03-01
(43) 25/07/2023



1.1



1.2



1.3



1.4



1.5



1.6



1.7

CÔNG BÁO SỞ HỮU CÔNG NGHIỆP SỐ 424 TẬP A – QUYỀN 2 (07.2023)

- (11) **47453**
(21) 3-2023-00435 (28) 1
(54) **BA LÔ** (51) **03-01**
(22) 02/03/2023 (43) 25/07/2023
(73) **CÔNG TY CỔ PHẦN XUẤT NHẬP KHẨU BÌNH TÂY (VN)**
Đường tỉnh 835, ấp 3A, xã Phước Lợi, huyện Bến Lức, tỉnh Long An
(72) Nguyễn Xuân Dũng (VN)
(55)



1.1



1.2



1.3



1.4



1.5



1.6



1.7

CÔNG BÁO SỞ HỮU CÔNG NGHIỆP SỐ 424 TẬP A – QUYỀN 2 (07.2023)

- (11) **47454**
(21) 3-2023-00458
(54) **BA LÔ**
(22) 03/03/2023
(73) **CÔNG TY CỔ PHẦN XUẤT NHẬP KHẨU BÌNH TÂY (VN)**
Đường tỉnh 835, ấp 3A, xã Phước Lợi, huyện Bến Lức, tỉnh Long An
(72) Nguyễn Xuân Dũng (VN)
(55)
- (28) 1
(51) **03-01**
(43) 25/07/2023



1.1



1.2



1.3



1.4



1.5



1.6



1.7

CÔNG BÁO SỞ HỮU CÔNG NGHIỆP SỐ 424 TẬP A – QUYỀN 2 (07.2023)

(11) **47455**

(21) 3-2023-00460

(28) 1

(54) **ĐÉ GIẦY**

(51) **02-04**

(22) 03/03/2023

(43) 25/07/2023

(73) **CÔNG TY TNHH BÌNH TIÊN BIÊN HÒA (VN)**

Lô 101/2 khu công nghiệp Amata, phường Long Bình, thành phố Biên Hòa, tỉnh Đồng Nai

(72) Lai Khiêm (VN)

(74) Công ty TNHH Tư vấn sở hữu trí tuệ Việt (VIET IP CO.,LTD.)

(55)



1.1



1.2



1.3



1.4



1.5



1.6



1.7

CÔNG BÁO SỞ HỮU CÔNG NGHIỆP SỐ 424 TẬP A – QUYỀN 2 (07.2023)

(11) **47456**

(21) 3-2023-00461

(28) 1

(54) **ĐÉ GIẦY**

(51) **02-04**

(22) 03/03/2023

(43) 25/07/2023

(73) **CÔNG TY TNHH BÌNH TIÊN BIÊN HÒA (VN)**

Lô 101/2 khu công nghiệp Amata, phường Long Bình, thành phố Biên Hòa, tỉnh Đồng Nai

(72) Lai Khiêm (VN)

(74) Công ty TNHH Tư vấn sở hữu trí tuệ Việt (VIET IP CO.,LTD.)

(55)



1.1



1.2



1.3



1.4



1.5



1.6



1.7

CÔNG BÁO SỞ HỮU CÔNG NGHIỆP SỐ 424 TẬP A – QUYỀN 2 (07.2023)

(11) **47457**

(21) 3-2023-00462

(28) 1

(54) **DÉP**

(51) **02-04**

(22) 03/03/2023

(43) 25/07/2023

(73) **CÔNG TY TNHH BÌNH TIÊN BIÊN HÒA (VN)**

Lô 101/2 khu công nghiệp Amata, phường Long Bình, thành phố Biên Hòa, tỉnh Đồng Nai

(72) Lai Khiêm (VN)

(74) Công ty TNHH Tư vấn sở hữu trí tuệ Việt (VIET IP CO.,LTD.)

(55)



1.1



1.2



1.3



1.4



1.5



1.6



1.7

CÔNG BÁO SỞ HỮU CÔNG NGHIỆP SỐ 424 TẬP A – QUYỀN 2 (07.2023)

- (11) **47458**
(21) 3-2023-00695 (28) 1
(54) **THIẾT BỊ CHĂM SÓC DA** (51) **28-03**
(22) 30/03/2023 (43) 25/07/2023
(73) **LG HOUSEHOLD & HEALTH CARE LTD. (KR)**
58, Saemunan-ro, Jongno-gu, Seoul, Republic of Korea
(72) KIM, Sung Hwan (KR)
(74) Công ty TNHH Tâm nhìn và Liên danh (VISION & ASSOCIATES CO.LTD.)
(55)

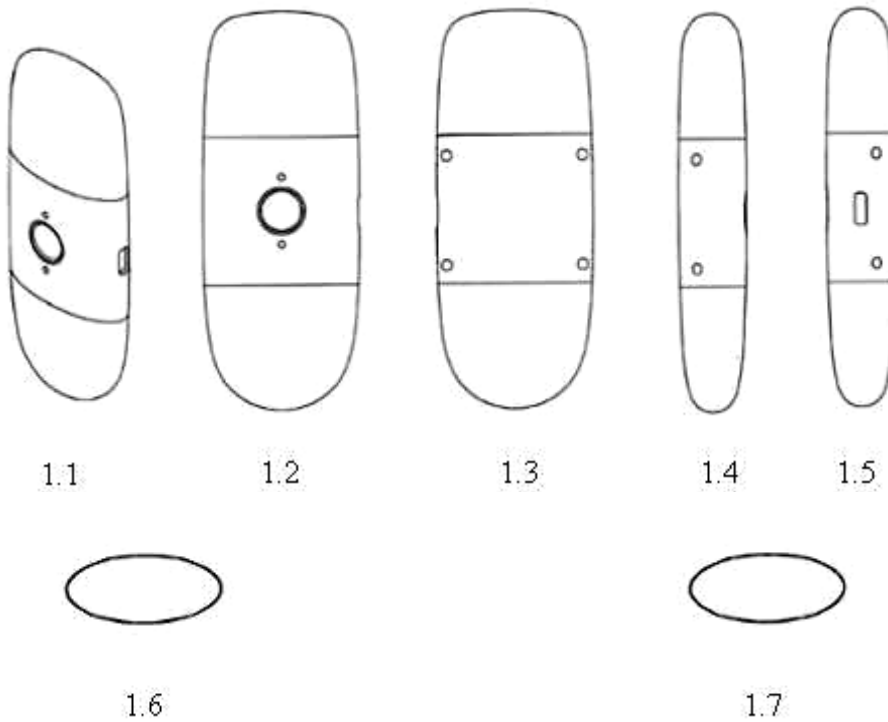

CÔNG BÁO SỞ HỮU CÔNG NGHIỆP SỐ 424 TẬP A – QUYỀN 2 (07.2023)

- (11) **47459**
(21) 3-2023-00696 (28) 1
(54) **THIẾT BỊ CHĂM SÓC DA** (51) **28-03**
(22) 30/03/2023 (43) 25/07/2023
(73) **LG HOUSEHOLD & HEALTH CARE LTD. (KR)**
58, Saemunan-ro, Jongno-gu, Seoul, Republic of Korea
(72) KIM, Sung Hwan (KR)
(74) Công ty TNHH Tâm nhìn và Liên danh (VISION & ASSOCIATES CO.LTD.)
(55)

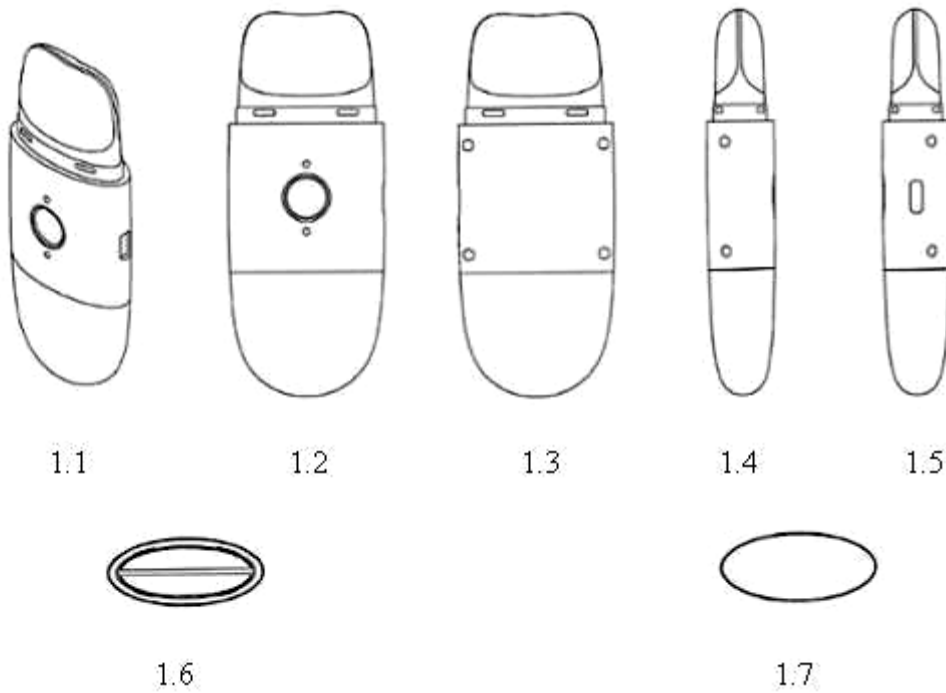

CÔNG BÁO SỞ HỮU CÔNG NGHIỆP SỐ 424 TẬP A – QUYỀN 2 (07.2023)

(11) **47460**

(21) 3-2023-00859

(28) 1

(54) **BA LÔ**

(51) **03-01**

(22) 14/04/2023

(43) 25/07/2023

(73) **CÔNG TY CỔ PHẦN TẬP ĐOÀN THIÊN LONG (VN)**

Tầng 10, Sofic Tower, số 10 đường Mai Chí Thọ, phường Thủ Thiêm, thành phố Thủ Đức, thành phố Hồ Chí Minh

(72) Cô Gia Thọ (VN)

(74) Công ty TNHH Tư vấn sở hữu trí tuệ Việt (VIET IP CO.,LTD.)

(55)



1.1



1.2



1.3



1.4



1.5



1.6



1.7

CÔNG BÁO SỞ HỮU CÔNG NGHIỆP SỐ 424 TẬP A – QUYỀN 2 (07.2023)

- (11) **47461**
(21) 3-2023-00860 (28) 1
(54) **BA LÔ** (51) **03-01**
(22) 14/04/2023 (43) 25/07/2023
(73) **CÔNG TY CỔ PHẦN TẬP ĐOÀN THIÊN LONG (VN)**
Tầng 10, Sofic Tower, số 10 đường Mai Chí Thọ, phường Thủ Thiêm, thành phố Thủ Đức, thành phố Hồ Chí Minh
(72) Cô Gia Thọ (VN)
(74) Công ty TNHH Tư vấn sở hữu trí tuệ Việt (VIET IP CO.,LTD.)
(55)



1.1



1.2



1.3



1.4



1.5



1.6



1.7

CÔNG BÁO SỞ HỮU CÔNG NGHIỆP SỐ 424 TẬP A – QUYỀN 2 (07.2023)

- (11) **47462**
(21) 3-2023-00861 (28) 1
(54) **BA LÔ** (51) **03-01**
(22) 14/04/2023 (43) 25/07/2023
(73) **CÔNG TY CỔ PHẦN TẬP ĐOÀN THIÊN LONG (VN)**
Tầng 10, Sofic Tower, số 10 đường Mai Chí Thọ, phường Thủ Thiêm, thành phố Thủ Đức, thành phố Hồ Chí Minh
(72) Cô Gia Thọ (VN)
(74) Công ty TNHH Tư vấn sở hữu trí tuệ Việt (VIET IP CO.,LTD.)
(55)



1.1



1.2



1.3



1.4



1.5



1.6



1.7

- (11) **47463**
(21) 3-2023-00697 (28) 1
(54) **THIẾT BỊ CHĂM SÓC DA** (51) **28-03**
(22) 30/03/2023 (43) 25/07/2023
(73) **LG HOUSEHOLD & HEALTH CARE LTD. (KR)**
58, Saemunan-ro, Jongno-gu, Seoul, Republic of Korea
(72) KIM, Sung Hwan (KR)
(74) Công ty TNHH Tâm nhìn và Liên danh (VISION & ASSOCIATES CO.LTD.)
(55)

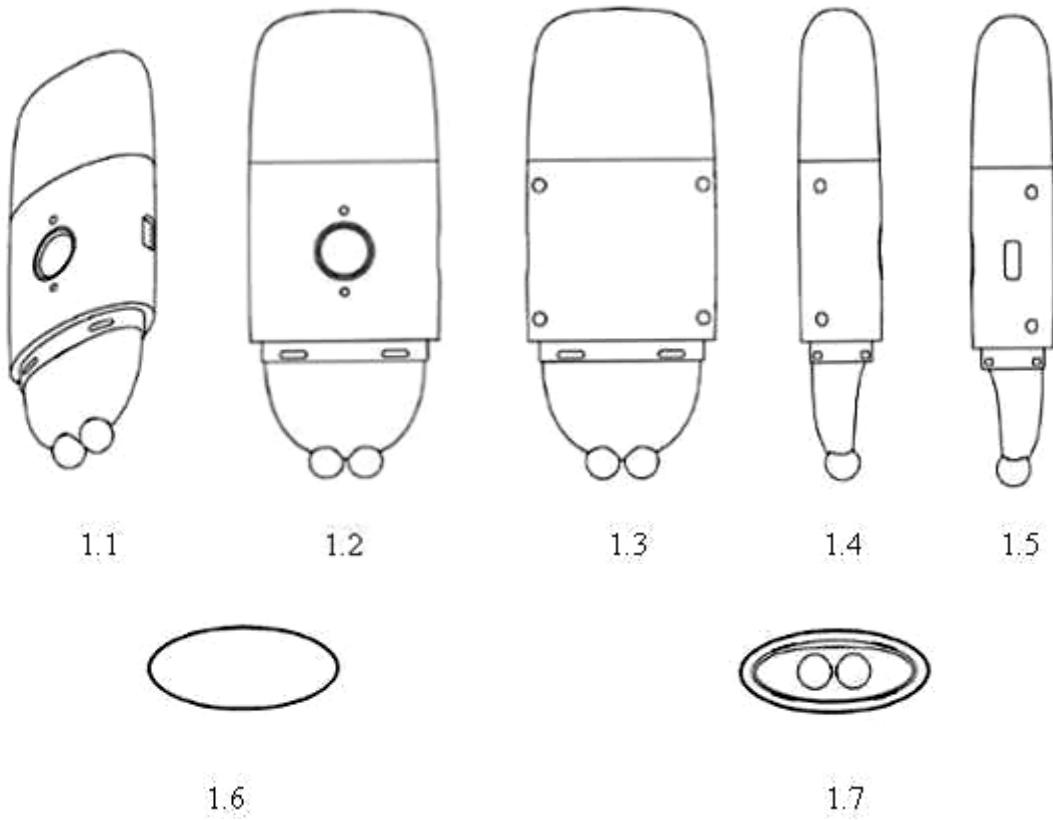

CÔNG BÁO SỞ HỮU CÔNG NGHIỆP SỐ 424 TẬP A – QUYỀN 2 (07.2023)

- (11) **47464**
(21) 3-2023-00452 (28) 1
(54) **THANH KIM LOẠI ĐỊNH HÌNH** (51) **25-01**
(22) 03/03/2023 (43) 25/07/2023
(73) **CÔNG TY CỔ PHẦN TẬP ĐOÀN KENWIN (VN)**
Tầng 4 tòa nhà VG Building, số 235 đường Nguyễn Trãi, phường Thanh Xuân
Trung, quận Thanh Xuân, thành phố Hà Nội
(72) Ngô Thọ Long (VN)
(74) Công ty TNHH Sở hữu trí tuệ PADEMARK (PADEMARK CO.,LTD.)
(55)



1.1



1.2



1.3

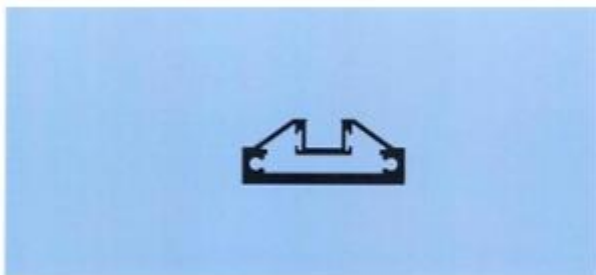

1.4

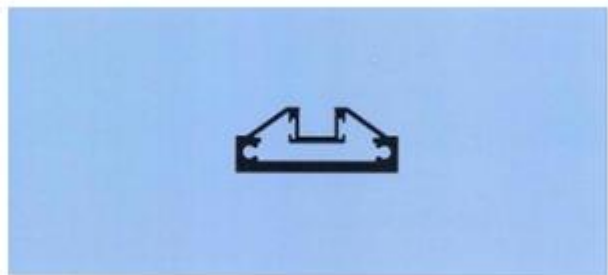

1.5



1.6



1.7

CÔNG BÁO SỞ HỮU CÔNG NGHIỆP SỐ 424 TẬP A – QUYỀN 2 (07.2023)

- (11) **47465**
(21) 3-2023-00497 (28) 1
(54) **ĐÈN BÀN** (51) **26-05**
(22) 08/03/2023 (43) 25/07/2023
(73) **CÔNG TY CỔ PHẦN BÓNG ĐÈN PHÍCH NƯỚC RẠNG ĐÔNG (VN)**
87-89 phố Hạ Đình, phường Thanh Xuân Trung, quận Thanh Xuân, thành phố Hà Nội
(72) Trần Trung Tường (VN)
(55)

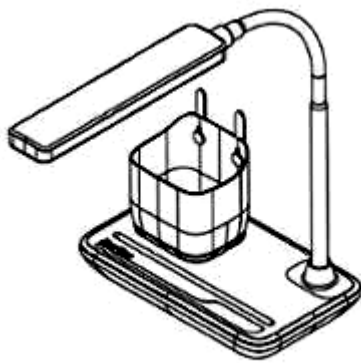

1.1

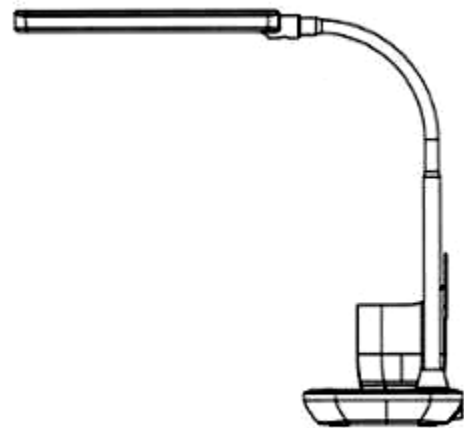

1.2

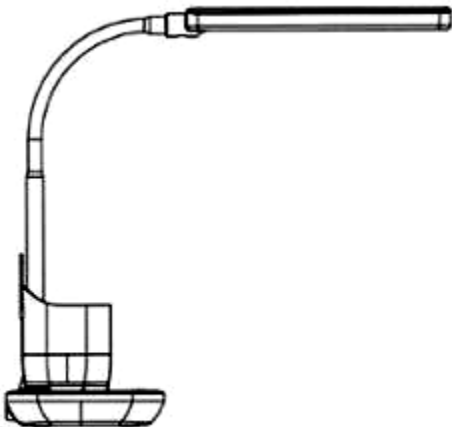

1.3

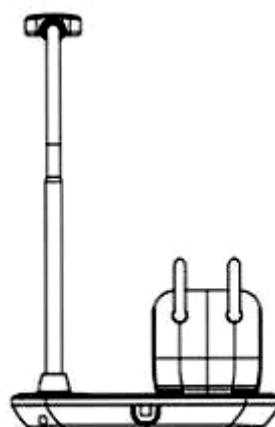

1.4

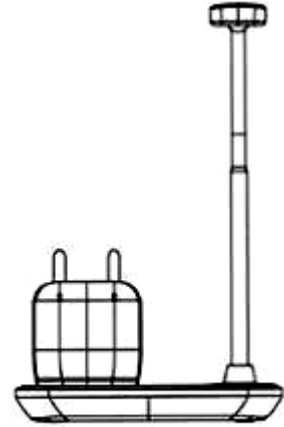

1.5

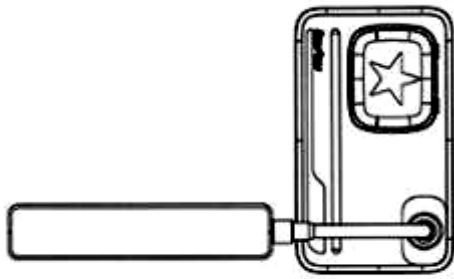

1.6

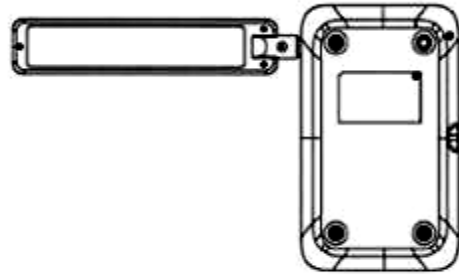

1.7

CÔNG BÁO SỞ HỮU CÔNG NGHIỆP SỐ 424 TẬP A – QUYỀN 2 (07.2023)

(11) **47466**

(21) 3-2023-00498

(28) 1

(54) **ĐÈN BÀN**

(51) **26-05**

(22) 08/03/2023

(43) 25/07/2023

(73) **CÔNG TY CỔ PHẦN BÓNG ĐÈN PHÍCH NƯỚC RẠNG ĐÔNG (VN)**

87-89 phố Hạ Đình, phường Thanh Xuân Trung, quận Thanh Xuân, thành phố Hà Nội

(72) Trần Trung Tường (VN)

(55)

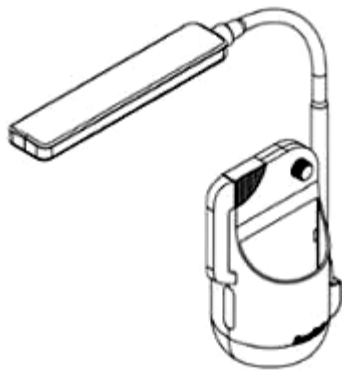

1.1

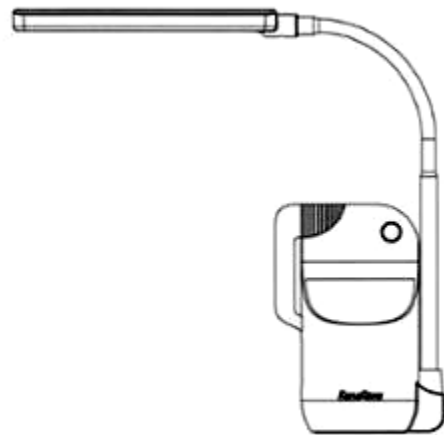

1.2

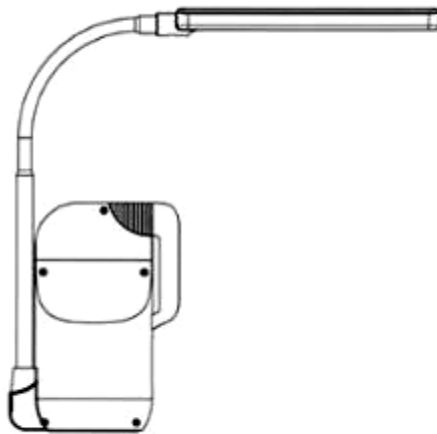

1.3



1.4



1.5

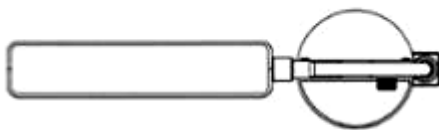

1.6



1.7

- (11) **47467**
(21) 3-2023-00499 (28) 1
(54) **ĐÈN** (51) **26-05**
(22) 08/03/2023 (43) 25/07/2023
(73) **CÔNG TY CỔ PHẦN BÓNG ĐÈN PHÍCH NƯỚC RẠNG ĐÔNG (VN)**
87-89 phố Hạ Đình, phường Thanh Xuân Trung, quận Thanh Xuân, thành phố Hà Nội
(72) Trần Trung Tường (VN)
(55)

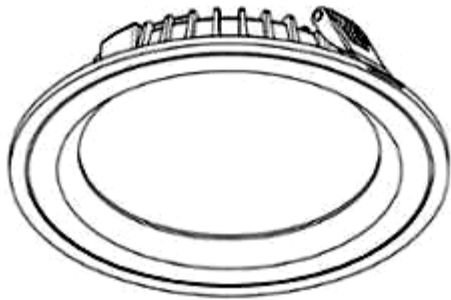

1.1

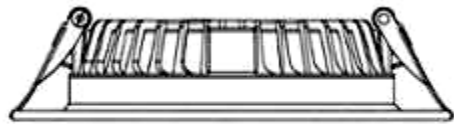

1.2



1.3



1.4



1.5



1.6

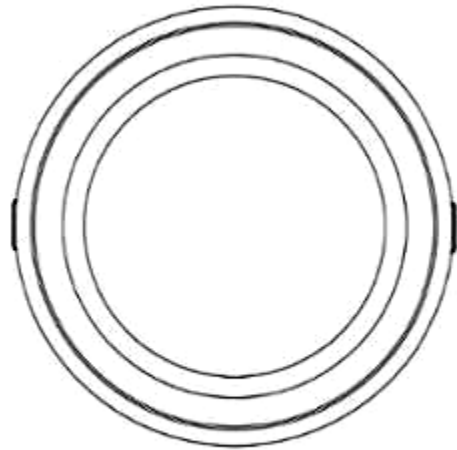

1.7

(11) **47468**

(21) 3-2023-00500

(28) 1

(54) **ĐÈN**

(51) **26-05**

(22) 08/03/2023

(43) 25/07/2023

(73) **CÔNG TY CỔ PHẦN BÓNG ĐÈN PHÍCH NƯỚC RẠNG ĐÔNG (VN)**

87-89 phố Hạ Đình, phường Thanh Xuân Trung, quận Thanh Xuân, thành phố Hà Nội

(72) Trần Trung Tường (VN)

(55)

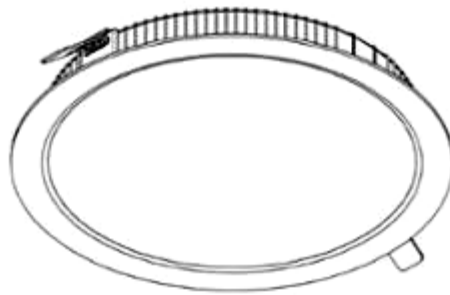

1.1



1.2



1.3



1.4

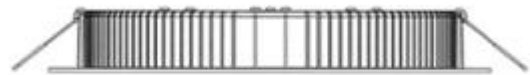

1.5

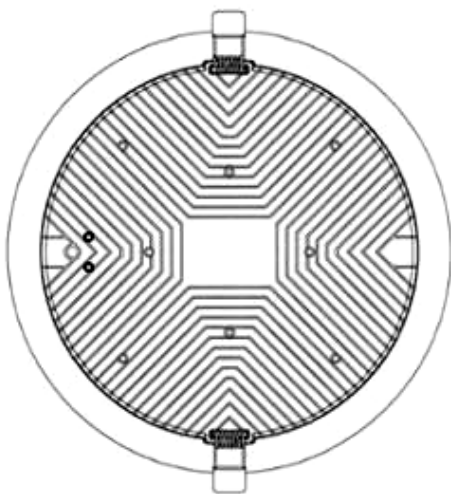

1.6

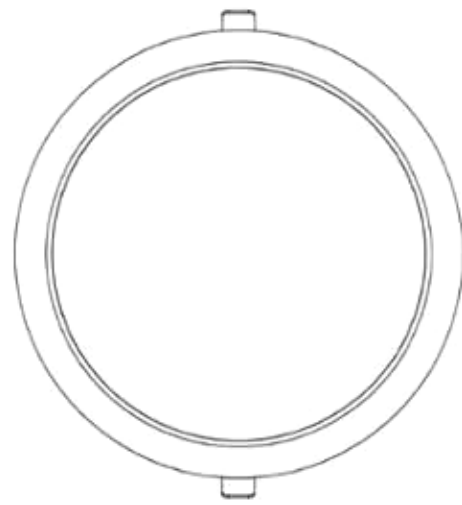

1.7

CÔNG BÁO SỞ HỮU CÔNG NGHIỆP SỐ 424 TẬP A – QUYỀN 2 (07.2023)

- (11) **47469**
(21) 3-2023-00504 (28) 1
(54) **HỆ THỐNG GIÁM SÁT SÂU RẦY THÔNG MINH** (51) **10-05**
(22) 08/03/2023 (43) 25/07/2023
(73) **CÔNG TY CỔ PHẦN RYNAN TECHNOLOGIES VIETNAM (VN)**
Ấp Long Trị, xã Long Đức, thành phố Trà Vinh, tỉnh Trà Vinh
(72) 1. NGUYỄN THANH MỸ (VN)
2. TRẦN QUỐC TOẢN (VN)
3. HỒNG QUỐC CƯỜNG (VN)
4. SƠN HOÀNG PHƯƠNG (VN)
5. ĐOÀN QUỐC NAM (VN)
6. NGUYỄN VĂN TIỀN (VN)
7. THÁI NGUYỄN HOÀI THIÊN (VN)
8. ĐOÀN MINH TRƯỜNG (VN)
9. ĐỒNG NGỌC TRANG (VN)
10. TRẦN TRUNG TÍN (VN)
(74) Công ty TNHH Đại Tín và Liên Danh (DAITIN AND ASSOCIATES CO.,LTD)
(55)



1.1

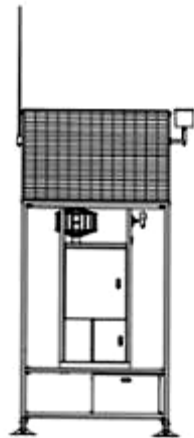

1.2

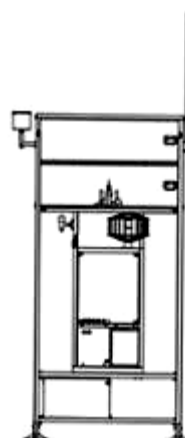

1.3



1.4



1.5

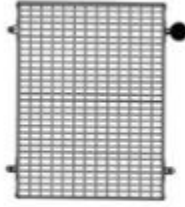

1.6

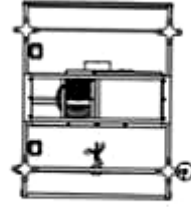

1.7

CÔNG BÁO SỞ HỮU CÔNG NGHIỆP SỐ 424 TẬP A – QUYỀN 2 (07.2023)

- (11) **47470**
(21) 3-2023-00523 (28) 1
(54) **THANH KIM LOẠI ĐỊNH HÌNH** (51) **25-01**
(22) 10/03/2023 (43) 25/07/2023
(73) **CÔNG TY CỔ PHẦN TẬP ĐOÀN KENWIN (VN)**
Tầng 4 tòa nhà VG Building, số 235 đường Nguyễn Trãi, phường Thanh Xuân
Trung, quận Thanh Xuân, thành phố Hà Nội
(72) Ngô Thọ Long (VN)
(74) Công ty TNHH Sở hữu trí tuệ PADEMARK (PADEMARK CO.,LTD.)
(55)



1.1



1.2



1.3

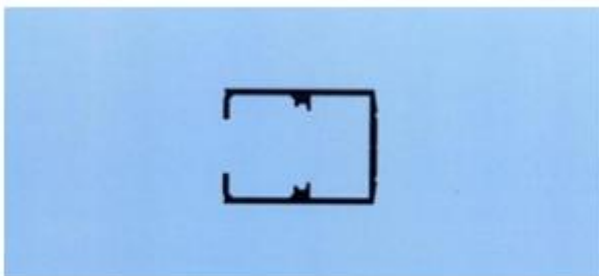

1.4

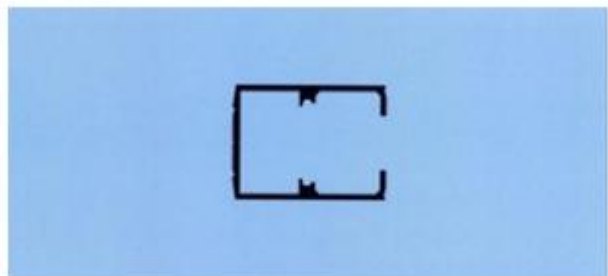

1.5



1.6



1.7

CÔNG BÁO SỞ HỮU CÔNG NGHIỆP SỐ 424 TẬP A – QUYỀN 2 (07.2023)

- (11) **47471**
(21) 3-2023-00524 (28) 1
(54) **THANH KIM LOẠI ĐỊNH HÌNH** (51) **25-01**
(22) 10/03/2023 (43) 25/07/2023
(73) **CÔNG TY CỔ PHẦN TẬP ĐOÀN KENWIN (VN)**
Tầng 4 tòa nhà VG Building, số 235 đường Nguyễn Trãi, phường Thanh Xuân
Trung, quận Thanh Xuân, thành phố Hà Nội
(72) Ngô Thọ Long (VN)
(74) Công ty TNHH Sở hữu trí tuệ PADEMARK (PADEMARK CO.,LTD.)
(55)



1.1

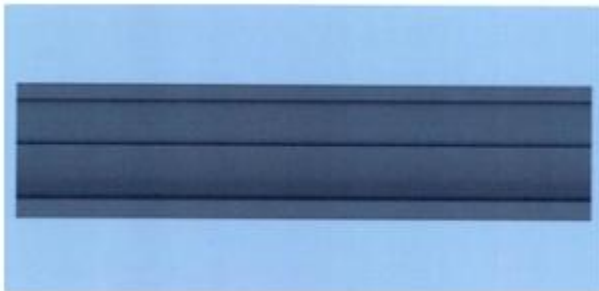

1.2

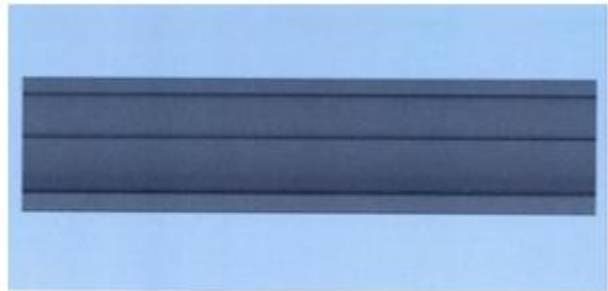

1.3



1.4



1.5



1.6



1.7

CÔNG BÁO SỞ HỮU CÔNG NGHIỆP SỐ 424 TẬP A – QUYỀN 2 (07.2023)

- (11) **47472**
(21) 3-2023-00525 (28) 1
(54) **THANH KIM LOẠI ĐỊNH HÌNH** (51) **25-01**
(22) 10/03/2023 (43) 25/07/2023
(73) **CÔNG TY CỔ PHẦN TẬP ĐOÀN KENWIN (VN)**
Tầng 4 tòa nhà VG Building, số 235 đường Nguyễn Trãi, phường Thanh Xuân
Trung, quận Thanh Xuân, thành phố Hà Nội
(72) Ngô Thọ Long (VN)
(74) Công ty TNHH Sở hữu trí tuệ PADEMARK (PADEMARK CO.,LTD.)
(55)



1.1



1.2



1.3

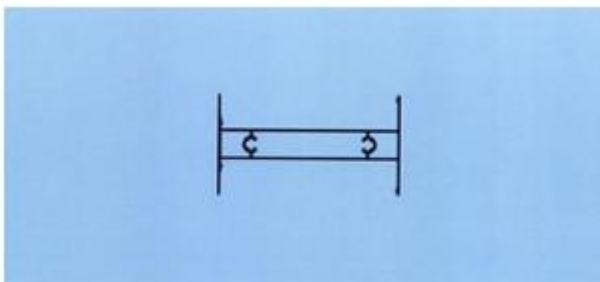

1.4

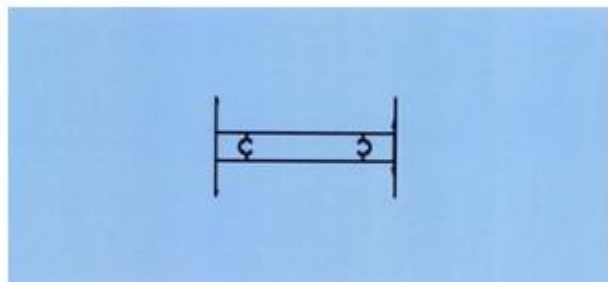

1.5



1.6



1.7

CÔNG BÁO SỞ HỮU CÔNG NGHIỆP SỐ 424 TẬP A – QUYỀN 2 (07.2023)

- (11) **47473**
(21) 3-2023-00851 (28) 2
(54) **BÌNH ĐỰNG NƯỚC** (51) **07-07**
(22) 14/04/2023 (43) 25/07/2023
(73) **CÔNG TY CỔ PHẦN BÓNG ĐÈN PHÍCH NƯỚC RẠNG ĐÔNG (VN)**
87-89 phố Hạ Đình, phường Thanh Xuân Trung, quận Thanh Xuân, thành phố Hà Nội
(72) Trần Trung Tường (VN)
(55)

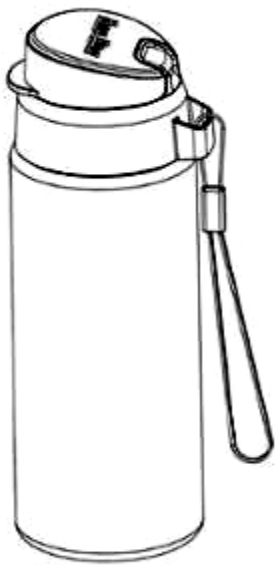

1.1

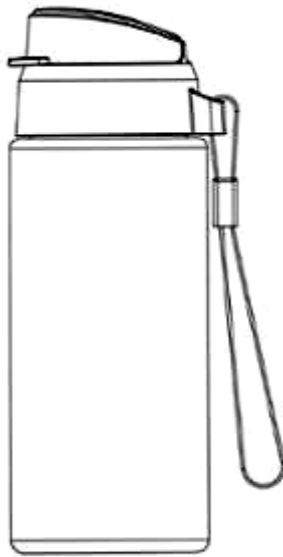

1.2

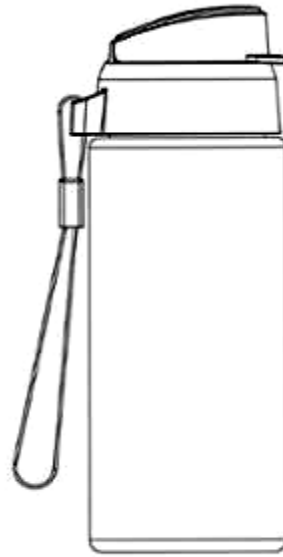

1.3



1.4



1.5



1.6

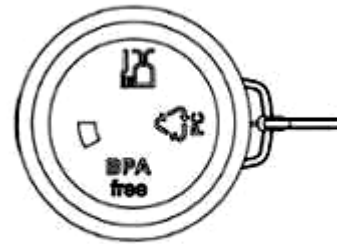

1.7



2.1

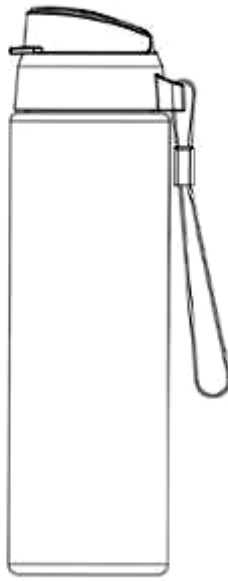

2.2



2.3



2.4



2.5



2.6

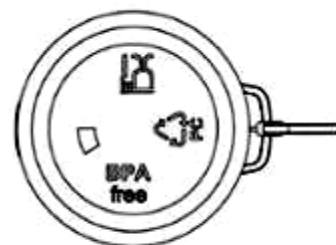

2.7

CÔNG BÁO SỞ HỮU CÔNG NGHIỆP SỐ 424 TẬP A – QUYỀN 2 (07.2023)

- (11) **47474**
(21) 3-2023-00853 (28) 1
(54) **BÌNH ĐỰNG NƯỚC** (51) **07-07**
(22) 14/04/2023 (43) 25/07/2023
(73) **CÔNG TY CỔ PHẦN BÓNG ĐÈN PHÍCH NƯỚC RẠNG ĐÔNG (VN)**
87-89 phố Hạ Đình, phường Thanh Xuân Trung, quận Thanh Xuân, thành phố Hà Nội
(72) Trần Trung Tường (VN)
(55)

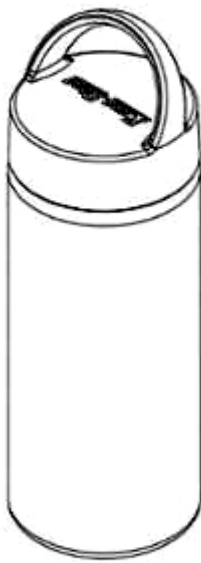

1.1



1.2



1.3



1.4



1.5



1.6

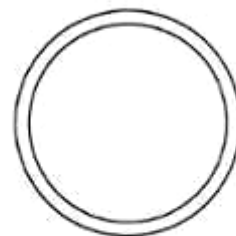

1.7

(11) **47475**

(21) 3-2023-00897

(28) 1

(54) **ĐÈN**

(51) **26-05**

(22) 21/04/2023

(43) 25/07/2023

(73) **CÔNG TY CỔ PHẦN BÓNG ĐÈN PHÍCH NƯỚC RẠNG ĐÔNG (VN)**

87-89 phố Hạ Đình, phường Thanh Xuân Trung, quận Thanh Xuân, thành phố Hà Nội

(72) Trần Trung Tường (VN)

(55)



1.1



1.2



1.3

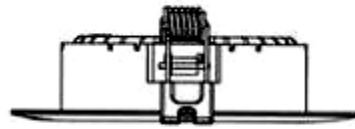

1.4

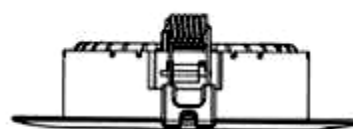

1.5

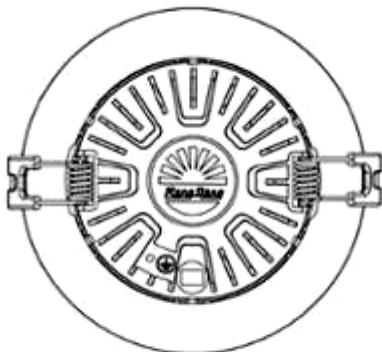

1.6

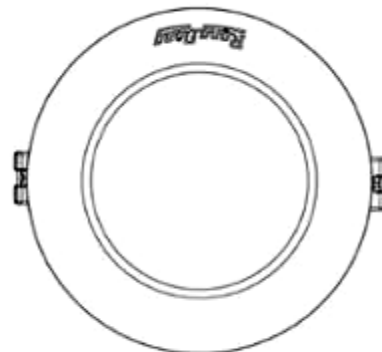

1.7

CÔNG BÁO SỞ HỮU CÔNG NGHIỆP SỐ 424 TẬP A – QUYỀN 2 (07.2023)

(11) 47476

(21) 3-2023-00968

(54) **MÁY SẢN XUẤT NGÓI BÊ TÔNG**

(22) 28/04/2023

(73) **CÔNG TY TNHH HỒ HOÀN CẦU (VN)**

Xóm 6, xã Quỳnh Văn, huyện Quỳnh Lưu, tỉnh Nghệ An

(72) Hồ Xuân Vinh (VN)

(55)

(28) 1

(51) **15-04**

(43) 25/07/2023



1.1



1.2

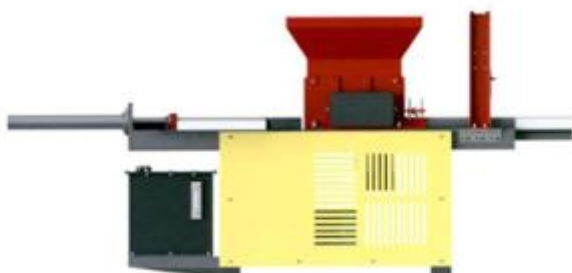

1.3

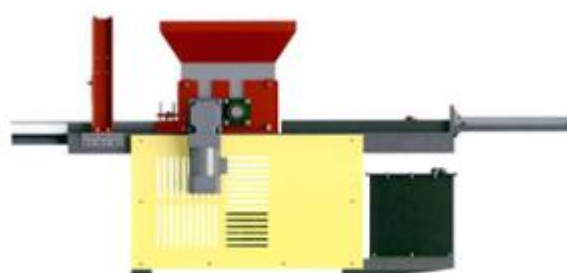

1.4



1.5



1.6



1.7



1.8

CÔNG BÁO SỞ HỮU CÔNG NGHIỆP SỐ 424 TẬP A – QUYỀN 2 (07.2023)

- (11) **47477**
(21) 3-2023-01024 (28) 1
(54) **ĐẦU NỐI DÙNG CHO THIẾT BỊ ĐIỆN TỬ** (51) **13-03**
(22) 16/07/2021 (43) 25/07/2023
(73) **GOOGLE LLC (US)**
1600 Amphitheatre Parkway, Mountain View, California 94043, United States of America
(72) 1. KIM, MOONCHUL (KR)
2. BAI, SUNG (KR)
3. OLSSON, MAJ ISABELLE (SE)
(74) Công ty Luật TNHH ROUSE Việt Nam (ROUSE LEGAL VIETNAM LTD.)
(55)

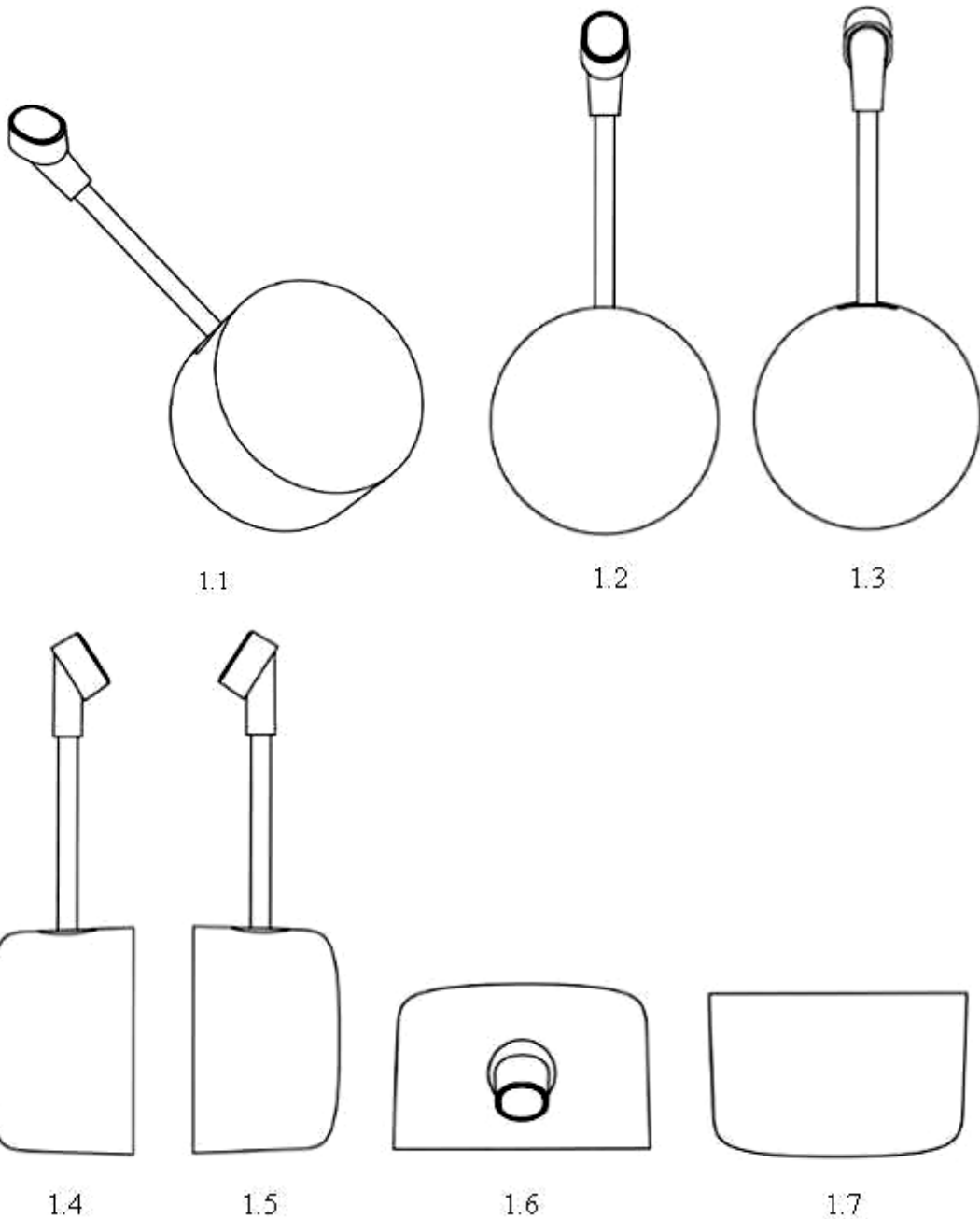

CÔNG BÁO SỞ HỮU CÔNG NGHIỆP SỐ 424 TẬP A – QUYỀN 2 (07.2023)

- (11) **47478**
(21) 3-2023-01025 (28) 1
(54) **ĐẦU NỔI DÙNG CHO THIẾT BỊ ĐIỆN TỬ** (51) **13-03**
(22) 16/07/2021 (43) 25/07/2023
(73) **GOOGLE LLC (US)**
1600 Amphitheatre Parkway, Mountain View, California 94043, United States of America
(72) 1. KIM, MOONCHUL (KR)
2. BAI, SUNG (KR)
3. OLSSON, MAJ ISABELLE (SE)
(74) Công ty Luật TNHH ROUSE Việt Nam (ROUSE LEGAL VIETNAM LTD.)
(55)



1.1



1.2



1.3



1.4

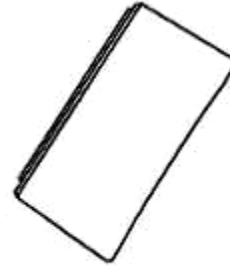

1.5



1.6

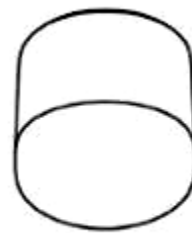

1.7

CÔNG BÁO SỞ HỮU CÔNG NGHIỆP SỐ 424 TẬP A – QUYỀN 2 (07.2023)

- (11) **47479**
(21) 3-2023-01030 (28) 1
(54) **THIỆT BỊ GHI HÌNH** (51) **16-01**
(22) 16/07/2021 (43) 25/07/2023
(73) **GOOGLE LLC (US)**
1600 Amphitheatre Parkway, Mountain View, California 94043, United States of America
(72) 1. HUANG, MARK WOOLHISER (US)
2. BAI, SUNG (KR)
3. OLSSON, MAJ ISABELLE (SE)
4. LEE, ALBERT (US)
(74) Công ty Luật TNHH ROUSE Việt Nam (ROUSE LEGAL VIETNAM LTD.)
(55)

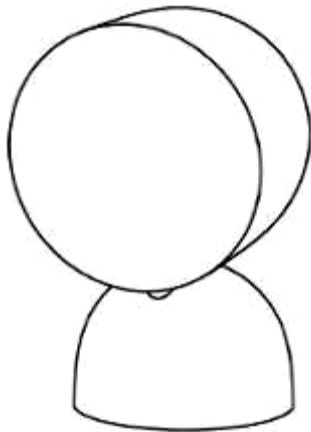

1.1

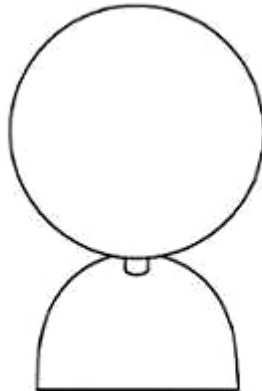

1.2

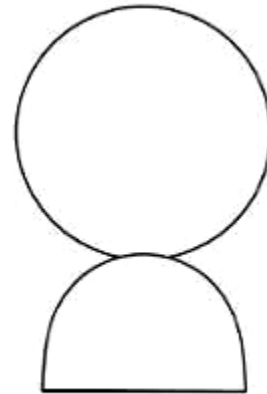

1.3

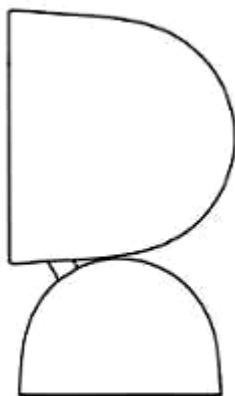

1.4

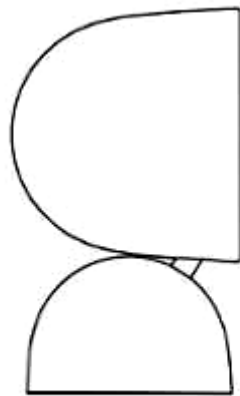

1.5

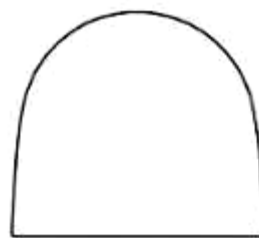

1.6

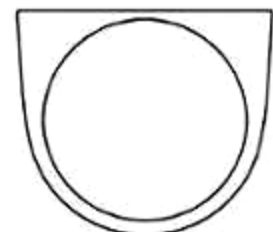

1.7

- (11) **47480**
(21) 3-2023-01031 (28) 1
(54) **ĐÈ CỬA THIẾT BỊ GHI HÌNH** (51) **16-01**
(22) 16/07/2021 (43) 25/07/2023
(73) **GOOGLE LLC (US)**
1600 Amphitheatre Parkway, Mountain View, California 94043, United States of America
(72) 1. HUANG, MARK WOOLHISER (US)
2. BAI, SUNG (KR)
3. OLSSON, MAJ ISABELLE (SE)
4. LEE, ALBERT (US)
(74) Công ty Luật TNHH ROUSE Việt Nam (ROUSE LEGAL VIETNAM LTD.)
(55)



1.1



1.2



1.3



1.4



1.5



1.6

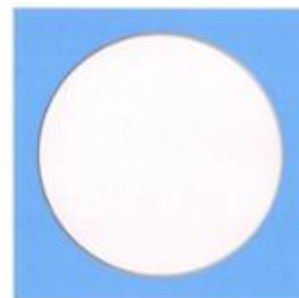

1.7

- (11) **47481**
(21) 3-2023-01033 (28) 1
(54) **THIẾT BỊ GHI HÌNH** (51) **16-01**
(22) 16/07/2021 (43) 25/07/2023
(73) **GOOGLE LLC (US)**
1600 Amphitheatre Parkway, Mountain View, California 94043, United States of America
(72) 1. HUANG, MARK WOOLHISER (US)
2. BAI, SUNG (KR)
3. OLSSON, MAJ ISABELLE (SE)
4. LEE, ALBERT (US)
(74) Công ty Luật TNHH ROUSE Việt Nam (ROUSE LEGAL VIETNAM LTD.)
(55)

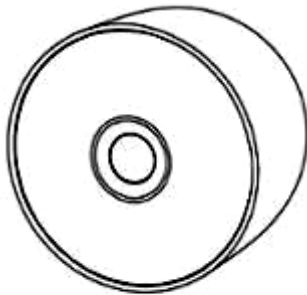

1.1

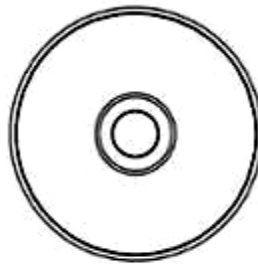

1.2

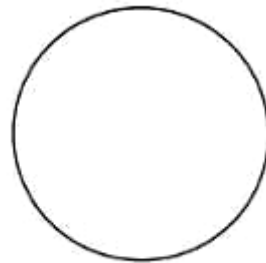

1.3

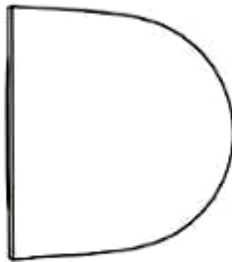

1.4

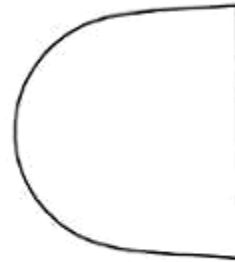

1.5

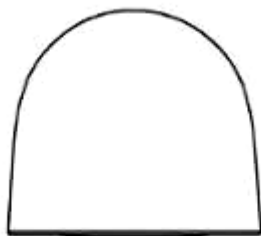

1.6

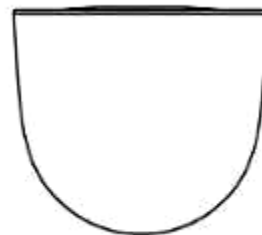

1.7

CÔNG BÁO SỞ HỮU CÔNG NGHIỆP SỐ 424 TẬP A – QUYỀN 2 (07.2023)

- (11) **47482**
(21) 3-2023-01034 (28) 1
(54) **ĐÈ CỬA THIẾT BỊ GHI HÌNH** (51) **16-01**
(22) 16/07/2021 (43) 25/07/2023
(73) **GOOGLE LLC (US)**
1600 Amphitheatre Parkway, Mountain View, California 94043, United States of America
(72) 1. HUANG, MARK WOOLHISER (US)
2. BAI, SUNG (KR)
3. OLSSON, MAJ ISABELLE (SE)
4. LEE, ALBERT (US)
(74) Công ty Luật TNHH ROUSE Việt Nam (ROUSE LEGAL VIETNAM LTD.)
(55)



1.1

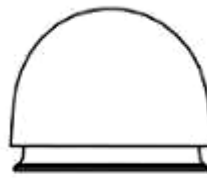

1.2

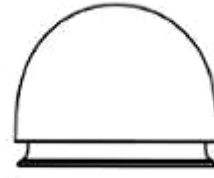

1.3

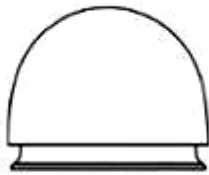

1.4

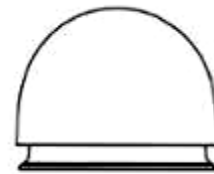

1.5

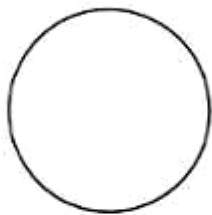

1.6

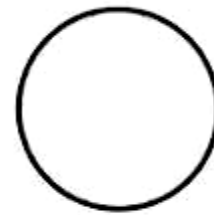

1.7



1.8

CÔNG BÁO SỞ HỮU CÔNG NGHIỆP SỐ 424 TẬP A – QUYỀN 2 (07.2023)

- (11) **47483**
(21) 3-2023-01058 (28) 1
(54) **CHUÔNG CỬA** (51) **10-06**
(22) 16/07/2021 (43) 25/07/2023
(73) **GOOGLE LLC (US)**
1600 Amphitheatre Parkway, Mountain View, California 94043, United States of America
(72) 1. JEONG, HAE RIM (KR)
2. BAI, SUNG (KR)
3. OLSSON, MAJ ISABELLE (SE)
4. BÉRUBÉ, ÉTIENNE (CA)
(74) Công ty Luật TNHH ROUSE Việt Nam (ROUSE LEGAL VIETNAM LTD.)
(55)

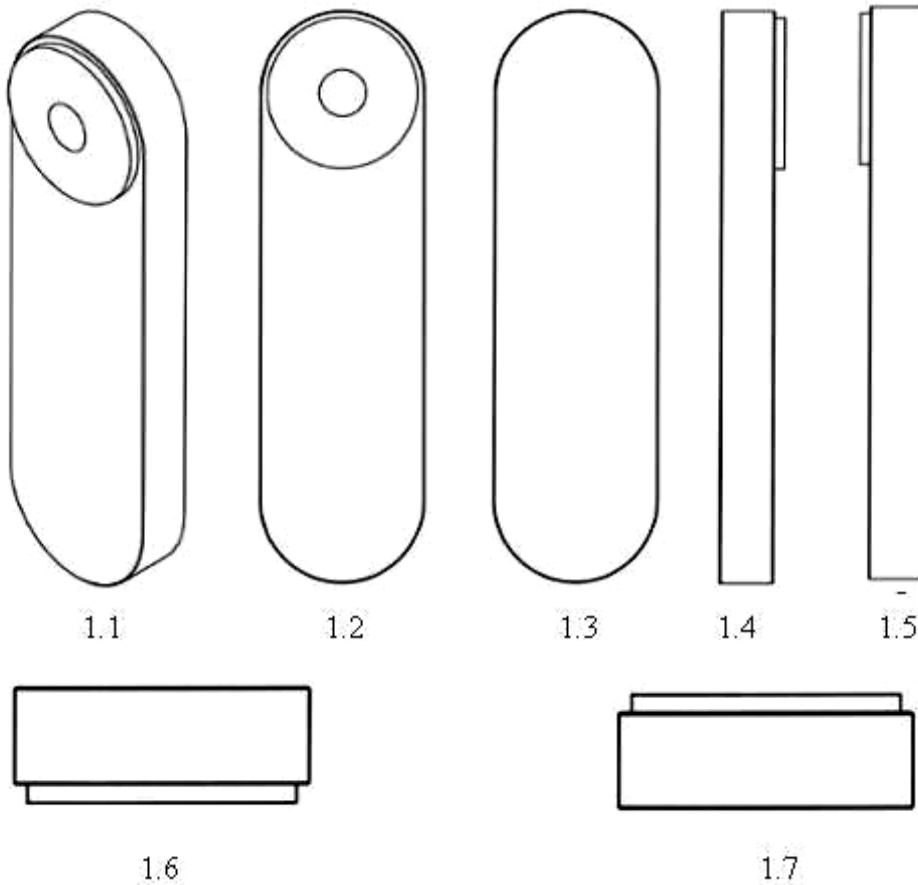

CÔNG BÁO SỞ HỮU CÔNG NGHIỆP SỐ 424 TẬP A – QUYỀN 2 (07.2023)

- (11) **47484**
(21) 3-2023-01035 (28) 1
(54) **ĐỂ GẮN TƯỜNG DÙNG CHO THIẾT BỊ GHI HÌNH** (51) **16-01**
(22) 16/07/2021 (43) 25/07/2023
(73) **GOOGLE LLC (US)**
1600 Amphitheatre Parkway, Mountain View, California 94043, United States of America
(72) 1. KIM, MOONCHUL (KR)
2. BAI, SUNG (KR)
3. OLSSON, MAJ ISABELLE (SE)
(74) Công ty Luật TNHH ROUSE Việt Nam (ROUSE LEGAL VIETNAM LTD.)
(55)

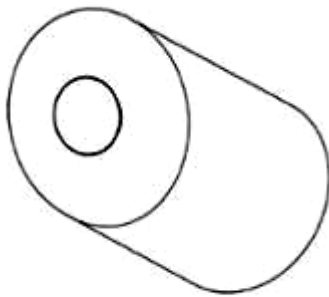

1.1



1.2

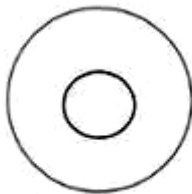

1.3



1.4

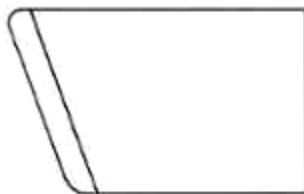

1.5



1.6



1.7



1.8

CÔNG BÁO SỞ HỮU CÔNG NGHIỆP SỐ 424 TẬP A – QUYỀN 2 (07.2023)

- (11) **47485**
(21) 3-2023-00667 (28) 1
(54) **BAO GÓI** (51) **09-05**
(22) 27/03/2023 (43) 25/07/2023
(73) **CÔNG TY TNHH NÔNG HẢI (VN)**
Số 29 đường số 6, khu dân cư Hai Thành, phường Tân Tạo A, quận Bình Tân, thành
Phố Hồ Chí Minh
(72) Đặng Thị Thúy Quỳnh (VN)
(74) Công ty TNHH một thành viên Trường Luật (Trường Luật)
(55)



1.1

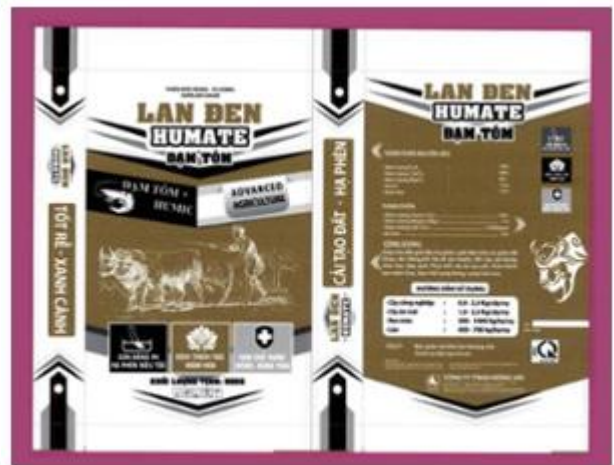

1.2

CÔNG BÁO SỞ HỮU CÔNG NGHIỆP SỐ 424 TẬP A – QUYỀN 2 (07.2023)

- (11) **47486**
(21) 3-2023-00718 (28) 1
(54) **BAO BÌ SẢN PHẨM** (51) **09-05**
(22) 31/03/2023 (43) 25/07/2023
(73) **CÔNG TY TNHH EUROCHEF PETFOOD VIỆT NAM (VN)**
Số 15 ngõ 9 đường Nguyễn Hoàng, phường Mỹ Đình 2, quận Nam Từ Liêm, thành phố Hà Nội
(72) Nguyễn Tùng Lâm (VN)
(55)



1.1



1.2

CÔNG BÁO SỞ HỮU CÔNG NGHIỆP SỐ 424 TẬP A – QUYỀN 2 (07.2023)

- (11) **47487**
- (21) 3-2023-00719 (28) 1
- (54) **HỘP ĐỰNG THIẾT BỊ CHỐNG CẠN** (51) **09-03**
- (22) 31/03/2023 (43) 25/07/2023
- (73) **CÔNG TY CỔ PHẦN HỌC VIỆN SÁNG TẠO (VN)**
Số 26 TT26 khu đô thị Văn Phú, phường Phú La, quận Hà Đông, thành phố Hà Nội
- (72) Đặng Văn Sơn (VN)
- (55)



1.1



1.2

CÔNG BÁO SỞ HỮU CÔNG NGHIỆP SỐ 424 TẬP A – QUYỀN 2 (07.2023)

- (11) **47488**
(21) 3-2023-00720 (28) 1
(54) **HỘP ĐỰNG ĐÈN NGỦ TỰ SÁNG** (51) **09-03**
(22) 31/03/2023 (43) 25/07/2023
(73) **CÔNG TY CỔ PHẦN HỌC VIỆN SÁNG TẠO (VN)**
Số 26 TT26 khu đô thị Văn Phú, phường Phú La, quận Hà Đông, thành phố Hà Nội
(72) Đặng Văn Sơn (VN)
(55)



1.1



1.2

CÔNG BÁO SỞ HỮU CÔNG NGHIỆP SỐ 424 TẬP A – QUYỀN 2 (07.2023)

- (11) **47489**
(21) 3-2023-00721 (28) 1
(54) **BAO GÓI** (51) **09-05**
(22) 31/03/2023 (43) 25/07/2023
(73) **CÔNG TY TNHH NGÂN ANH (VN)**
378/4 Điện Biên Phủ, phường 11, quận 10, thành phố Hồ Chí Minh
(72) Võ Thanh Đăng (VN)
(74) Công ty TNHH Sở hữu trí tuệ INNETCO-Hoàng Phúc (INNETCO CO., LTD)
(55)



1.1



1.2

CÔNG BÁO SỞ HỮU CÔNG NGHIỆP SỐ 424 TẬP A – QUYỀN 2 (07.2023)

(11) **47490**

(21) 3-2023-00836

(28) 1

(54) **BAO BÌ**

(51) **09-05**

(22) 12/04/2023

(43) 25/07/2023

(73) **THÁI VĂN DŨNG (VN)**

322 Lô I, C/c Tây Thạnh, đường C8, phường Tây Thạnh, quận Tân Phú, thành phố Hồ Chí Minh

(72) Thái Văn Dũng (VN)

(74) Công ty TNHH Sở hữu trí tuệ Đông Dương (DONG DUONG IP CO.,LTD)

(55)



1.1



1.2

CÔNG BÁO SỞ HỮU CÔNG NGHIỆP SỐ 424 TẬP A – QUYỀN 2 (07.2023)

- (11) **47491**
(21) 3-2023-00885 (28) 7
(54) **BAO GÓI SẢN PHẨM** (51) **09-05**
(22) 19/04/2023 (43) 25/07/2023
(73) **CÔNG TY TNHH VÂN NGUYỄN NGUYỄN (VN)**
Số 01 Hùng Vương, phường Lộc Thọ, thành phố Nha Trang, tỉnh Khánh Hòa
(72) Ngô Thị Thanh Huyền (VN)
(74) Công ty TNHH ADASTRA IP (VIỆT NAM) (ADASTRA IP (VIETNAM) CO., LTD.)
(55)

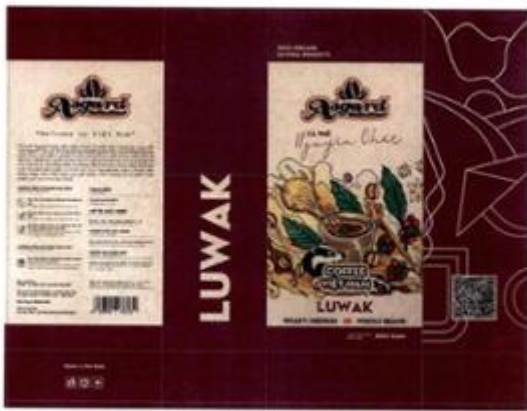

1.1



1.2

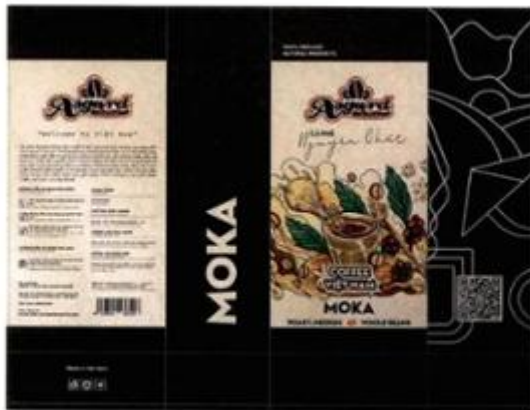

2.1



2.2

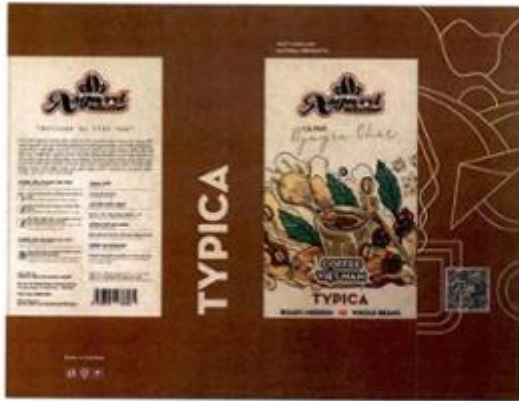

3.1



3.2

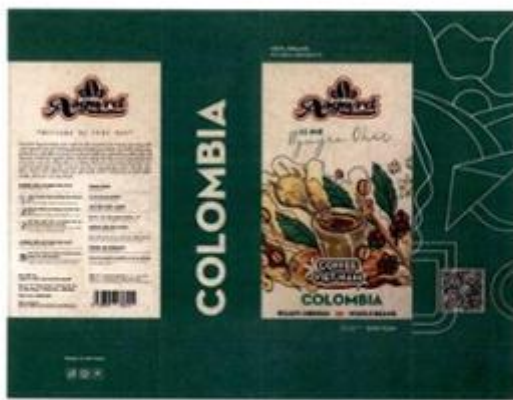

4.1



4.2

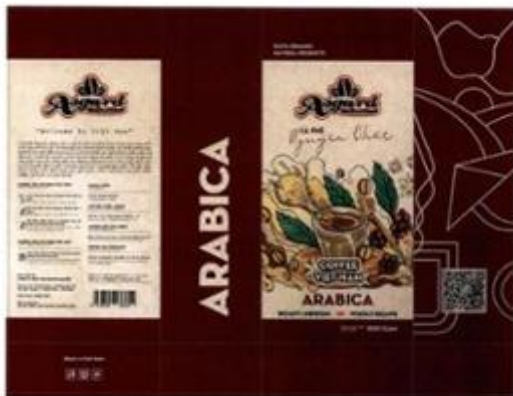

5.1



5.2



6.1



6.2

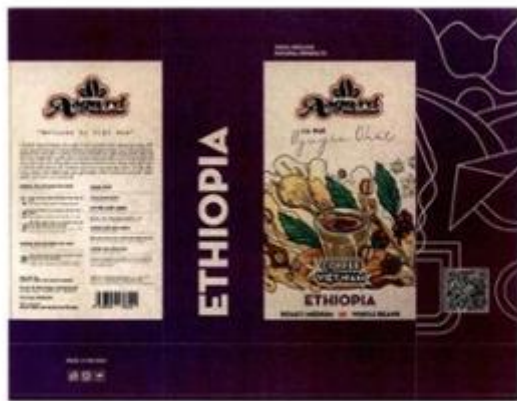

7.1



7.2

CÔNG BÁO SỞ HỮU CÔNG NGHIỆP SỐ 424 TẬP A – QUYỀN 2 (07.2023)

- (11) **47492**
(21) 3-2023-00942 (28) 1
(54) **BAO GÓI PHÂN BÓN** (51) **09-05**
(22) 27/04/2023 (43) 25/07/2023
(73) **CÔNG TY TNHH SẢN XUẤT DỊCH VỤ THƯƠNG MẠI TRUNG HIỆP LỢI (VN)**
40 Trần Ngọc Diện, khu phố 1, phường Thảo Điền, thành phố Thủ Đức, thành phố Hồ Chí Minh
(72) Trần Văn Hiệp (VN)
(74) Công ty TNHH Luật ALIAT (ALIAT LEGAL)
(55)



1.1



1.2



1.3

CÔNG BÁO SỞ HỮU CÔNG NGHIỆP SỐ 424 TẬP A – QUYỀN 2 (07.2023)

- (11) **47493**
(21) 3-2023-00628 (28) 1
(54) **BAO GÓI** (51) **09-05**
(22) 23/03/2023 (43) 25/07/2023
(73) **HỘ KINH DOANH TRÀ CÀ PHÊ LONG HOA (VN)**
Thửa đất số 2971, tờ bản đồ số 15 (cạnh nhà số 15A) đường Võ Văn Kiệt, khu vực
Bình Nhựt, phường Long Hòa, quận Bình Thủy, thành phố Cần Thơ
(72) Nguyễn Văn Vinh (VN)
(55)



1.1



1.2

CÔNG BÁO SỞ HỮU CÔNG NGHIỆP SỐ 424 TẬP A – QUYỀN 2 (07.2023)

- (11) **47494**
(21) 3-2023-00646 (28) 1
(54) **BAO GÓI** (51) **09-05**
(22) 24/03/2023 (43) 25/07/2023
(73) **CÔNG TY TNHH CON CÒ VÀNG (VN)**
23 lô B đường số 1, phường Phú Thuận, quận 7, thành phố Hồ Chí Minh
(72) Hoàng Mai Dẫn (VN)
(74) Công ty TNHH một thành viên Trường Luật (Trường Luật)
(55)



1.1

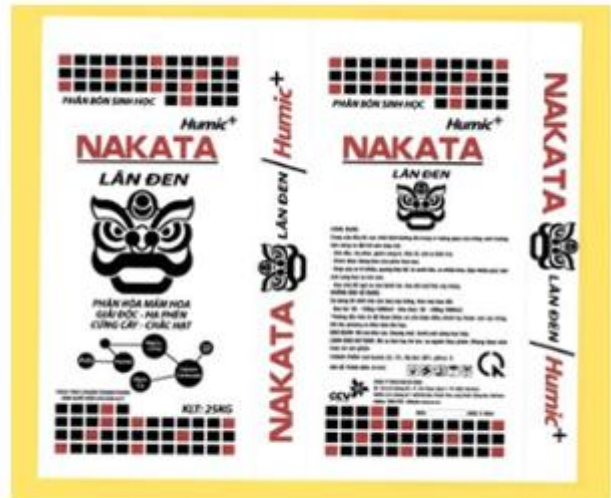

1.2

CÔNG BÁO SỞ HỮU CÔNG NGHIỆP SỐ 424 TẬP A – QUYỀN 2 (07.2023)

- (11) **47495**
(21) 3-2023-00756 (28) 1
(54) **BAO GÓI** (51) **09-05**
(22) 05/04/2023 (43) 25/07/2023
(73) **CÔNG TY TNHH MTK (VN)**
Lô 5.05.OT.05 Landmark 5, Vinhomes Central Park, 720A Điện Biên Phủ, phường
22, quận Bình Thạnh, thành phố Hồ Chí Minh
(72) Trương Thành Trung (VN)
(74) Công ty Luật TNHH Phạm và Liên danh (PHAM & ASSOCIATES)
(55)



1.1



1.2

CÔNG BÁO SỞ HỮU CÔNG NGHIỆP SỐ 424 TẬP A – QUYỀN 2 (07.2023)

- (11) **47496**
(21) 3-2023-00783 (28) 1
(54) **BAO GÓI** (51) **09-05**
(22) 07/04/2023 (43) 25/07/2023
(73) **CÔNG TY TNHH XUẤT NHẬP KHẨU GERMANY DRAGON (VN)**
68 Nguyễn Huệ, phường Bến Nghé, quận 1, thành phố Hồ Chí Minh
(72) Trần Tuấn Bảo (VN)
(74) Công ty TNHH một thành viên Trường Luật (Trường Luật)
(55)



1.1



1.2

CÔNG BÁO SỞ HỮU CÔNG NGHIỆP SỐ 424 TẬP A – QUYỀN 2 (07.2023)

- (11) 47497
(21) 3-2023-00784 (28) 1
(54) **BAO GÓI** (51) **09-05**
(22) 07/04/2023 (43) 25/07/2023
(73) **CÔNG TY TNHH XUẤT NHẬP KHẨU GERMANY DRAGON (VN)**
68 Nguyễn Huệ, phường Bến Nghé, quận 1, thành phố Hồ Chí Minh
(72) Trần Tuấn Bảo (VN)
(74) Công ty TNHH một thành viên Trường Luật (Trường Luật)
(55)



1.1



1.2

CÔNG BÁO SỞ HỮU CÔNG NGHIỆP SỐ 424 TẬP A – QUYỀN 2 (07.2023)

- (11) **47498**
(21) 3-2023-00170 (28) 1
(54) **THANH KIM LOẠI ĐỊNH HÌNH** (51) **25-01**
(22) 17/01/2023 (43) 25/07/2023
(73) **CÔNG TY CỔ PHẦN TẬP ĐOÀN KENWIN (VN)**
Tầng 4 tòa nhà VG Building, số 235 đường Nguyễn Trãi, phường Thanh Xuân
Trung, quận Thanh Xuân, thành phố Hà Nội
(72) Ngô Thọ Long (VN)
(74) Công ty TNHH Sở hữu trí tuệ PADEMARK (PADEMARK CO.,LTD.)
(55)

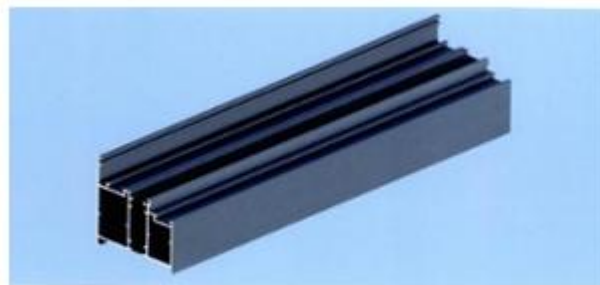

1.1



1.2



1.3

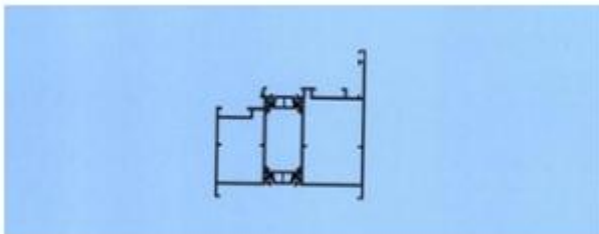

1.4

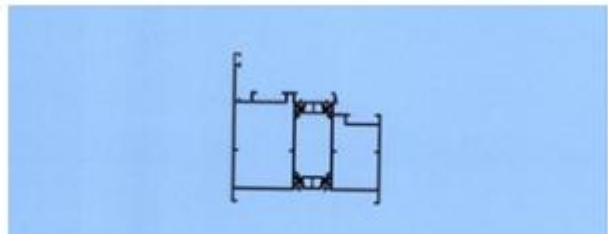

1.5



1.6



1.7

CÔNG BÁO SỞ HỮU CÔNG NGHIỆP SỐ 424 TẬP A – QUYỀN 2 (07.2023)

(11) **47499**

(21) 3-2023-00459

(28) 1

(54) **ĐÈN XE MÁY**

(51) **26-06**

(22) 03/03/2023

(43) 25/07/2023

(73) **CÔNG TY TNHH SẢN XUẤT - THƯƠNG MẠI - DỊCH VỤ ĐÀI PHONG (VN)**

Số 382, đường số 1, phường Bình Trị Đông B, quận Bình Tân, thành phố Hồ Chí Minh

(72) Hà Quảng Chánh (VN)

(74) Công ty TNHH Tư vấn sở hữu trí tuệ Việt (VIET IP CO.,LTD.)

(55)

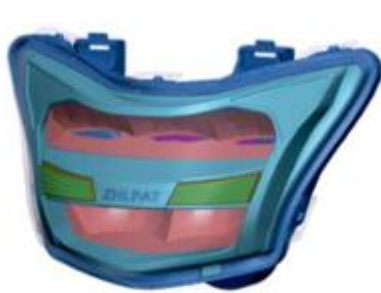

1.1



1.2



1.3



1.4



1.5

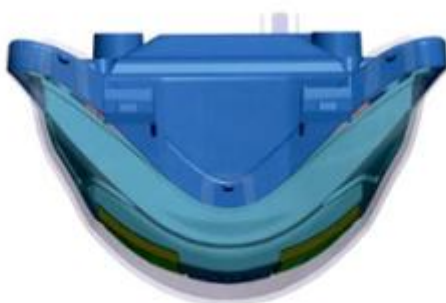

1.6

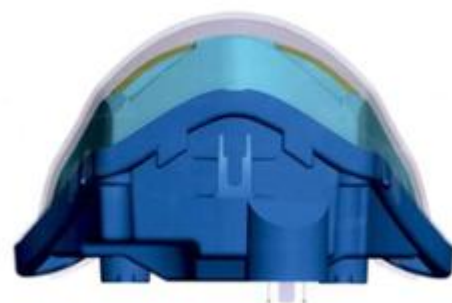

1.7

CÔNG BÁO SỞ HỮU CÔNG NGHIỆP SỐ 424 TẬP A – QUYỀN 2 (07.2023)

(11) **47500**

(21) 3-2023-00502

(28) 1

(54) **ĐÈN XE MÁY**

(51) **26-06**

(22) 08/03/2023

(43) 25/07/2023

(73) **CÔNG TY TNHH SẢN XUẤT - THƯƠNG MẠI - DỊCH VỤ ĐÀI PHONG (VN)**
Số 382 đường số 1, phường Bình Trị Đông B, quận Bình Tân, thành phố Hồ Chí Minh

(72) Hà Quảng Chánh (VN)

(74) Công ty TNHH Tư vấn sở hữu trí tuệ Việt (VIET IP CO.,LTD.)

(55)



1.1



1.2



1.3



1.4

1.5



1.6



1.7

CÔNG BÁO SỞ HỮU CÔNG NGHIỆP SỐ 424 TẬP A – QUYỀN 2 (07.2023)

- (11) **47501**
(21) 3-2022-01653 (28) 1
(54) **TAY CẦM DỤNG CỤ LÀM VƯỜN** (51) **08-03**
(22) 12/08/2022 (43) 25/07/2023
(73) **CÔNG TY TNHH UNITED JUMBO (VN)**
Đường số 10, KCN Suối Tre, phường Suối Tre, thành phố Long Khánh, tỉnh Đồng Nai
(72) Wang, Jui-Fu (TW)
(74) **CÔNG TY TNHH SỞ HỮU TRÍ TUỆ SETHACO (SETHACO IP CO.,LTD)**
(55)



1.1



1.2



1.3



1.4



1.5



1.6



1.7

CÔNG BÁO SỞ HỮU CÔNG NGHIỆP SỐ 424 TẬP A – QUYỀN 2 (07.2023)

- (11) **47502**
(21) 3-2022-01719 (28) 1
(54) **ỐNG NỐI** (51) **23-01; 25-01**
(22) 17/08/2022 (43) 25/07/2023
(30) 202211405 14/03/2022 AU;
(73) **C S TRADERS PTY LTD (AU)**
1 Maryland Avenue, CARRARA QLD 4211, AUSTRALIA
(72) Steven Croft (AU)
(74) Công ty TNHH Trường Xuân (AGELESS CO.,LTD.)
(55)

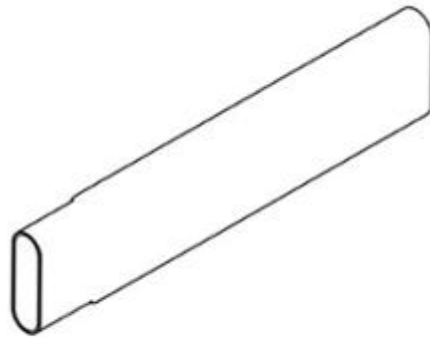

1.1



1.2



1.3



1.4



1.5



1.6



1.7

CÔNG BÁO SỞ HỮU CÔNG NGHIỆP SỐ 424 TẬP A – QUYỀN 2 (07.2023)

(11) **47503**

(21) 3-2022-01880

(28) 1

(54) **TỦ ĐIỆN**

(51) **13-03**

(22) 05/09/2022

(43) 25/07/2023

(73) **1. CÔNG TY CỔ PHẦN CÔNG NGHỆ OTANICS (VN)**

Khu công nghiệp phường 8, phường 8, thành phố Cà Mau, tỉnh Cà Mau

2. VŨ VĂN VÂN (VN)

Căn hộ Cảnh Viên 3, Đường C, phường Tân Phú, quận 7, thành phố Hồ Chí Minh

3. NGUYỄN NHẤT TUẤN (VN)

89 Song Hành, phường 10, quận 6, thành phố Hồ Chí Minh

(72) **1. VŨ VĂN VÂN (VN)**

2. NGUYỄN NHẤT TUẤN (VN)

3. ĐẶNG HỮU NAM (VN)

4. TRẦN PHÚC TRƯỜNG (VN)

5. PHẠM VĨNH HÒA (VN)

(74) Công ty TNHH Sáng chế ACTIP (ACTIP PATENT LIMITED)

(55)

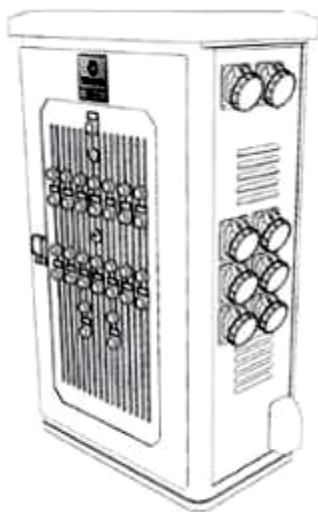

1.1

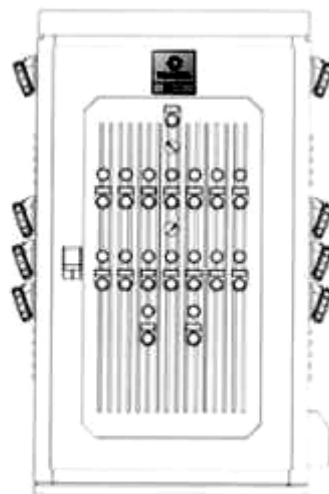

1.2

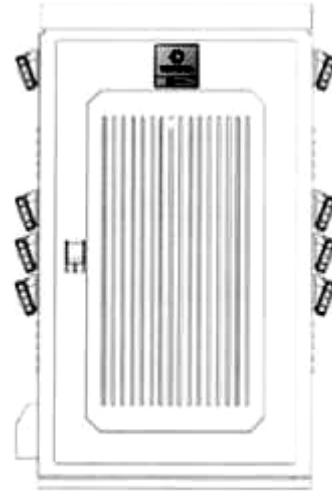

1.3

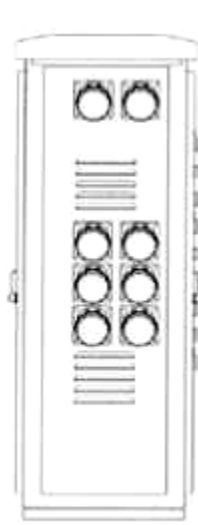

1.4

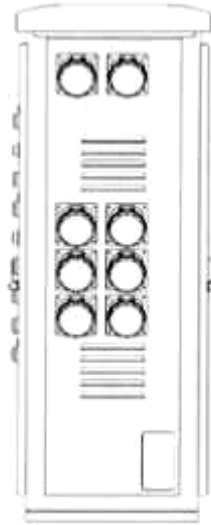

1.5



1.6

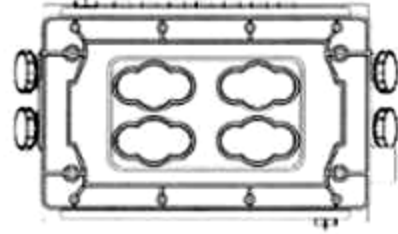

1.7

CÔNG BÁO SỞ HỮU CÔNG NGHIỆP SỐ 424 TẬP A – QUYỀN 2 (07.2023)

- (11) **47504**
(21) 3-2022-02448 (28) 1
(54) **ĐỒ CHƠI CHO ĐỘNG VẬT** (51) **30-99**
(22) 09/11/2022 (43) 25/07/2023
(73) **CÔNG TY TNHH THƯƠNG MẠI VÀ DỊCH VỤ PUPDY (VN)**
Số 98/3, khu phố 3, phường An Bình, thành phố Biên Hoà, tỉnh Đồng Nai
(72) Võ Thùy Trang (VN)
(74) Công ty Luật TNHH Gia Phạm (GIA PHAM LAW CO.,LTD)
(55)



1.1



1.2



1.3



1.4



1.5



1.6



1.7

CÔNG BÁO SỞ HỮU CÔNG NGHIỆP SỐ 424 TẬP A – QUYỀN 2 (07.2023)

- (11) **47505**
- (21) 3-2022-02463 (28) 1
- (54) **THÙNG CHỤP ẢNH TÔM** (51) **16-99**
- (22) 10/11/2022 (43) 25/07/2023
- (73) **1. CÔNG TY CỔ PHẦN CÔNG NGHỆ OTANICS (VN)**
Khu công nghiệp phường 8, phường 8, thành phố Cà Mau, tỉnh Cà Mau
- 2. VŨ VĂN VÂN (VN)**
Căn hộ Cảnh Viên 3, đường C, phường Tân Phú, quận 7, thành phố Hồ Chí Minh
- 3. NGUYỄN NHẤT TUẤN (VN)**
89 Song Hành, phường 10, quận 6, thành phố Hồ Chí Minh
- (72) **1. VŨ VĂN VÂN (VN)**
2. NGUYỄN NHẤT TUẤN (VN)
3. LƯU VẠN TÍN (VN)
4. PHẠM VĨNH HÒA (VN)
5. PHẠM MỸ THUẬN (VN)
- (74) Công ty TNHH Sáng chế ACTIP (ACTIP PATENT LIMITED)
- (55)

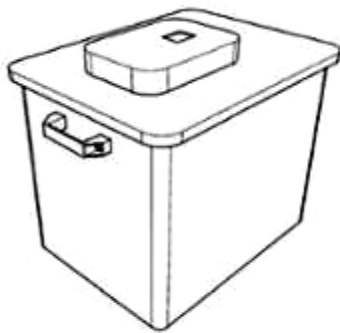

1.1

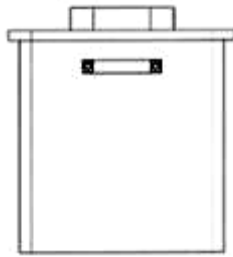

1.2

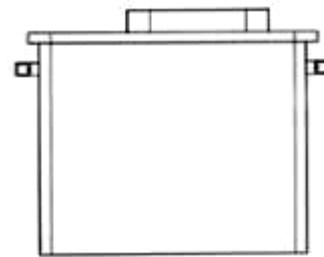

1.3

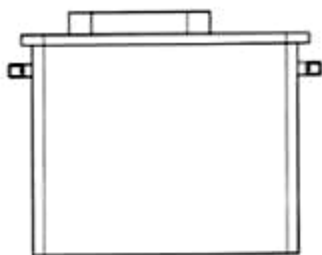

1.4

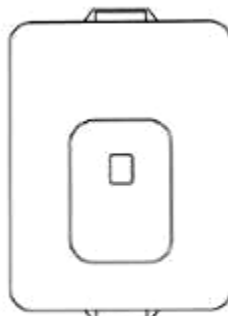

1.5

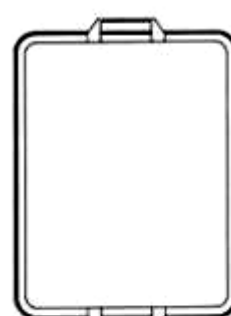

1.6

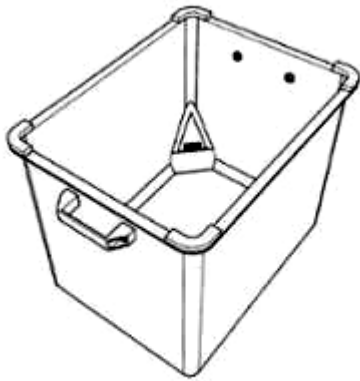

1.7

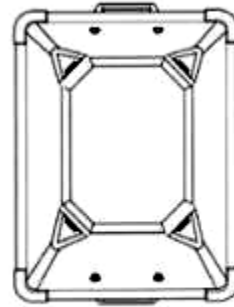

1.8

CÔNG BÁO SỞ HỮU CÔNG NGHIỆP SỐ 424 TẬP A – QUYỀN 2 (07.2023)

(11) **47506**

(21) 3-2022-02497

(28) 1

(54) **GIOẪNG CAO SU**

(51) **25-01**

(22) 16/11/2022

(43) 25/07/2023

(73) **CÔNG TY TNHH GROBER VIỆT NAM (VN)**

266 Nguyễn Thị Minh Khai, khu phố Đông Chiêu, phường Tân Đông Hiệp, thành phố Dĩ An, tỉnh Bình Dương

(72) Đinh Văn Thắng (VN)

(55)



1.1



1.2



1.3



1.4

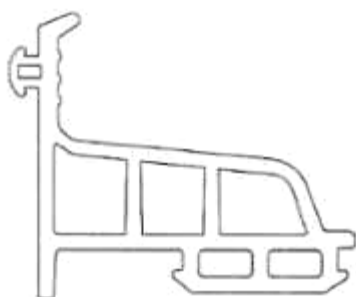

1.5

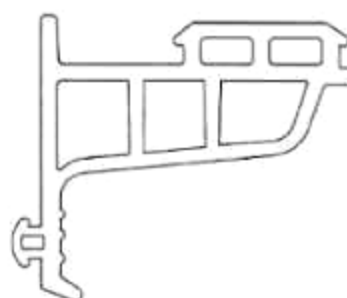

1.6

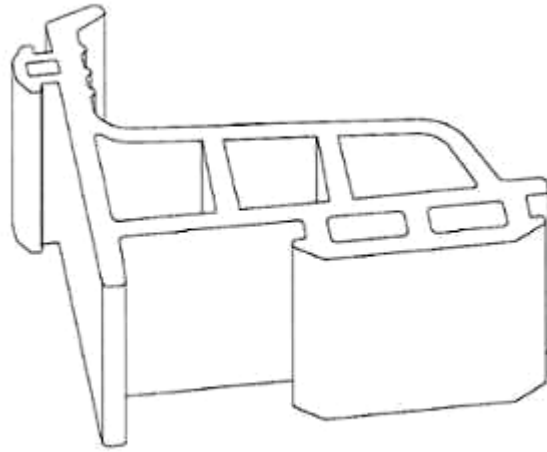

1.7

CÔNG BÁO SỞ HỮU CÔNG NGHIỆP SỐ 424 TẬP A – QUYỀN 2 (07.2023)

- (11) **47507**
(21) 3-2022-02895 (28) 2
(54) **MÔ-ĐUN MÁY QUAY PHIM** (51) **16-01**
(22) 27/12/2022 (43) 25/07/2023
(30) 29/844,547 29/06/2022 US;
(73) **UBIQUITI INC. (US)**
685 Third Avenue, 27th Floor, New York NY 10017, United States of America
(72) 1. ROBERT J. PERA (US)
2. TSUNG HWA YANG (TW)
3. HONG WEI LIN (TW)
4. CHUNG-MING LO (TW)
5. YUE-LIN HAN (TW)
(74) Công ty Luật TNHH T&G (TGVN)
(55)

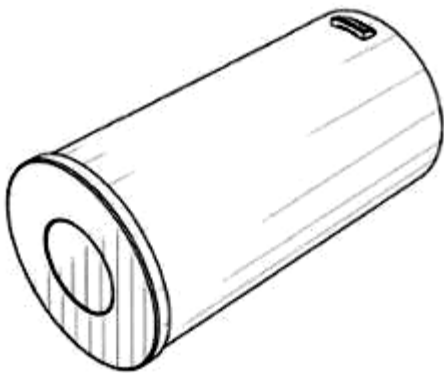

1.1

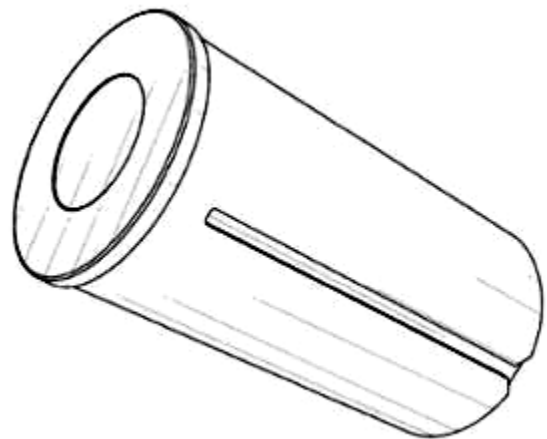

1.2

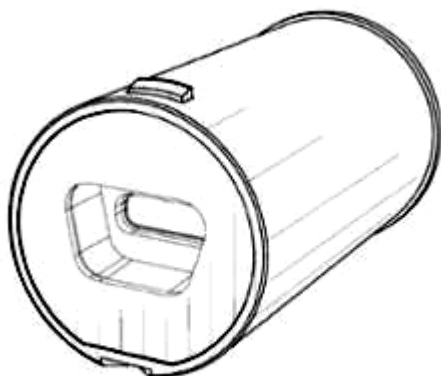

1.3



1.4

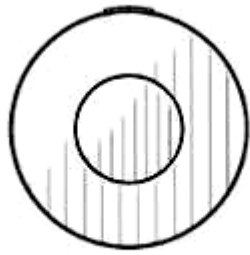

1.5



1.6



1.7



1.8



1.9



1.10

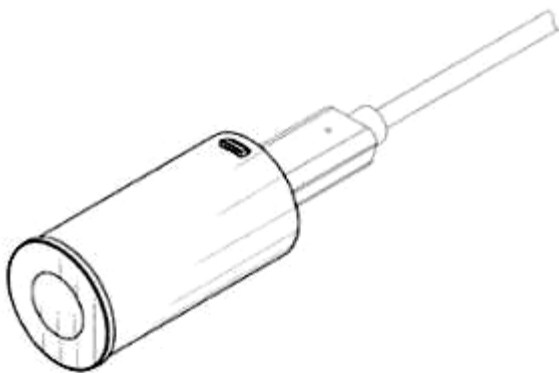

1.11

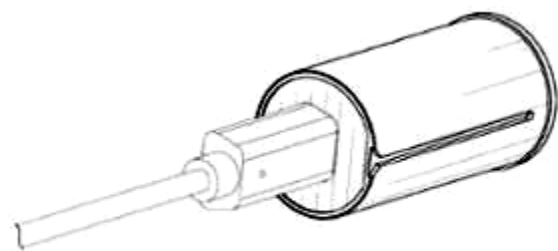

1.12

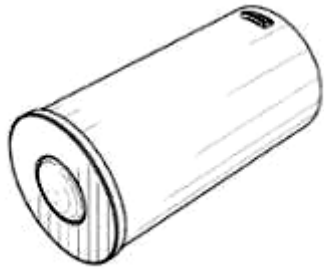

2.1



2.2



2.3



2.4



2.5

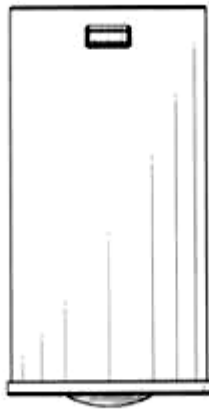

2.6

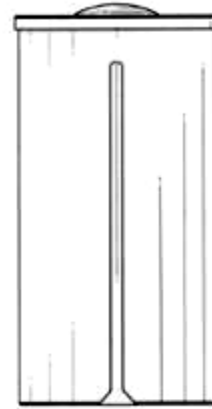

2.7

CÔNG BÁO SỞ HỮU CÔNG NGHIỆP SỐ 424 TẬP A – QUYỀN 2 (07.2023)

- (11) **47508**
(21) 3-2022-02896 (28) 1
(54) **BỘ GẮN MÁY QUAY PHIM** (51) **16-01**
(22) 27/12/2022 (43) 25/07/2023
(30) 29/844,549 29/06/2022 US;
(73) **UBIQUITI INC. (US)**
685 Third Avenue, 27th Floor, New York NY 10017, United States of America
(72) 1. ROBERT J. PERA (US)
2. TSUNG HWA YANG (TW)
3. HONG WEI LIN (TW)
4. PAI-CHEN SUN (TW)
(74) Công ty Luật TNHH T&G (TGVN)
(55)



1.1

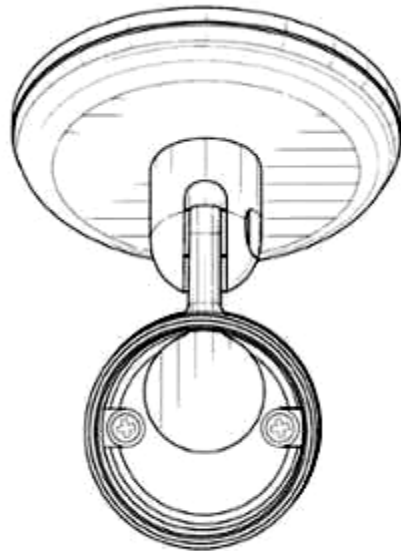

1.2

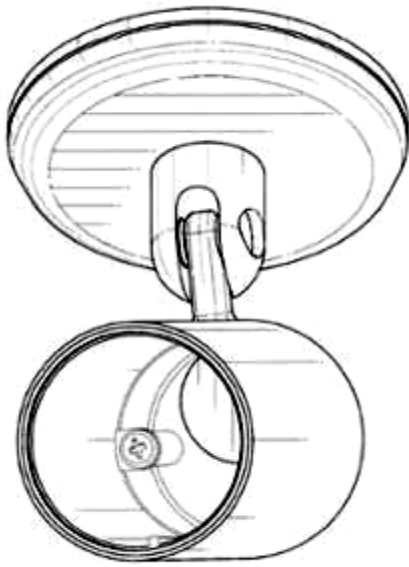

1.3

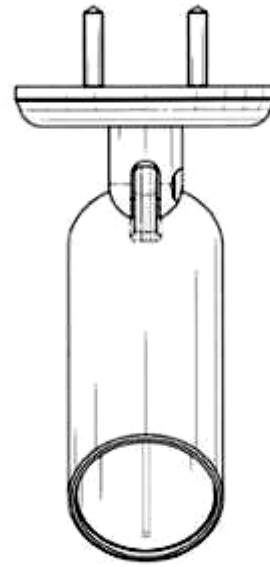

1.4

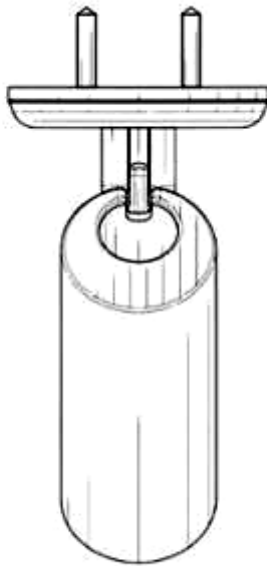

1.5

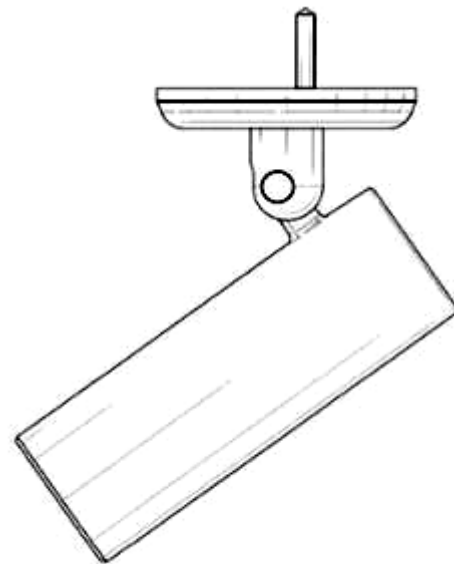

1.6

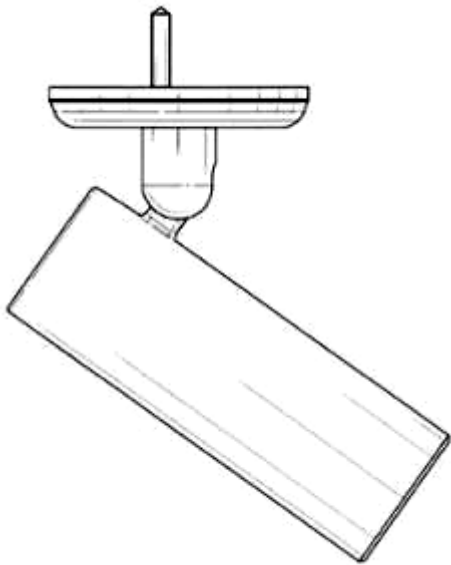

1.7



1.8

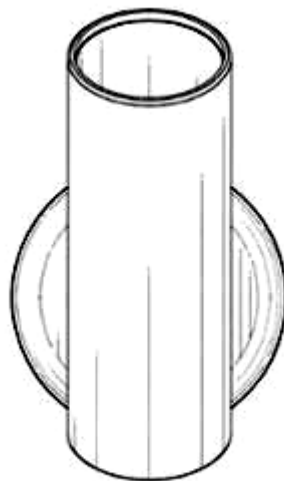

1.9

CÔNG BÁO SỞ HỮU CÔNG NGHIỆP SỐ 424 TẬP A – QUYỀN 2 (07.2023)

- (11) **47509**
(21) 3-2023-00054 (28) 1
(54) **THANH KIM LOẠI ĐỊNH HÌNH** (51) **25-01**
(22) 06/01/2023 (43) 25/07/2023
(73) **CÔNG TY CỔ PHẦN TẬP ĐOÀN KENWIN (VN)**
Tầng 4 tòa nhà VG Building, số 235 đường Nguyễn Trãi, phường Thanh Xuân
Trung, quận Thanh Xuân, thành phố Hà Nội
(72) Ngô Thọ Long (VN)
(74) Công ty TNHH Sở hữu trí tuệ PADEMARK (PADEMARK CO.,LTD.)
(55)



1.1



1.2

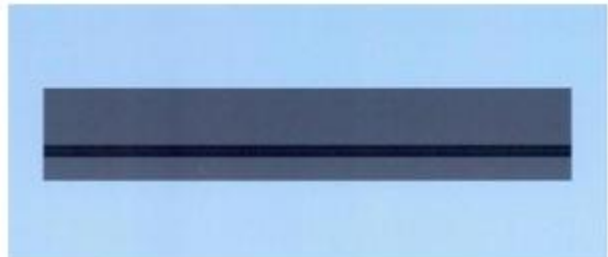

1.3



1.4



1.5



1.6



1.7

CÔNG BÁO SỞ HỮU CÔNG NGHIỆP SỐ 424 TẬP A – QUYỀN 2 (07.2023)

- (11) **47510**
(21) 3-2023-00055 (28) 1
(54) **THANH KIM LOẠI ĐỊNH HÌNH** (51) **25-01**
(22) 06/01/2023 (43) 25/07/2023
(73) **CÔNG TY CỔ PHẦN TẬP ĐOÀN KENWIN (VN)**
Tầng 4 tòa nhà VG Building, số 235 đường Nguyễn Trãi, phường Thanh Xuân
Trung, quận Thanh Xuân, thành phố Hà Nội
(72) Ngô Thọ Long (VN)
(74) Công ty TNHH Sở hữu trí tuệ PADEMARK (PADEMARK CO.,LTD.)
(55)



1.1



1.2



1.3

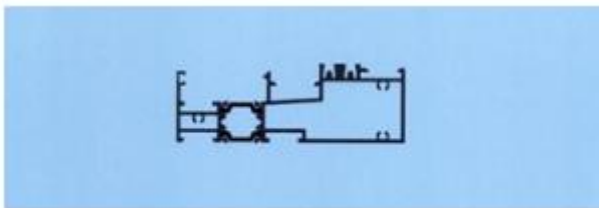

1.4

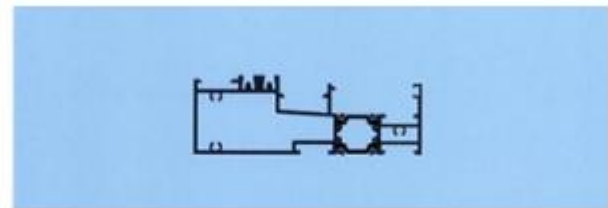

1.5



1.6



1.7

CÔNG BÁO SỞ HỮU CÔNG NGHIỆP SỐ 424 TẬP A – QUYỀN 2 (07.2023)

- (11) **47511**
(21) 3-2023-00058 (28) 1
(54) **THANH KIM LOẠI ĐỊNH HÌNH** (51) **25-01**
(22) 06/01/2023 (43) 25/07/2023
(73) **CÔNG TY CỔ PHẦN TẬP ĐOÀN KENWIN (VN)**
Tầng 4 tòa nhà VG Building, số 235 đường Nguyễn Trãi, phường Thanh Xuân
Trung, quận Thanh Xuân, thành phố Hà Nội
(72) Ngô Thọ Long (VN)
(74) Công ty TNHH Sở hữu trí tuệ PADEMARK (PADEMARK CO.,LTD.)
(55)



1.1



1.2



1.3



1.4



1.5



1.6



1.7

CÔNG BÁO SỞ HỮU CÔNG NGHIỆP SỐ 424 TẬP A – QUYỀN 2 (07.2023)

- (11) **47512**
(21) 3-2023-00059 (28) 1
(54) **THANH KIM LOẠI ĐỊNH HÌNH** (51) **25-01**
(22) 06/01/2023 (43) 25/07/2023
(73) **CÔNG TY CỔ PHẦN TẬP ĐOÀN KENWIN (VN)**
Tầng 4 tòa nhà VG Building, số 235 đường Nguyễn Trãi, phường Thanh Xuân
Trung, quận Thanh Xuân, thành phố Hà Nội
(72) Ngô Thọ Long (VN)
(74) Công ty TNHH Sở hữu trí tuệ PADEMARK (PADEMARK CO.,LTD.)
(55)



1.1



1.2



1.3



1.4

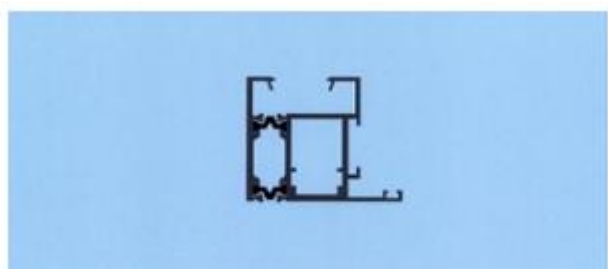

1.5



1.6



1.7

CÔNG BÁO SỞ HỮU CÔNG NGHIỆP SỐ 424 TẬP A – QUYỀN 2 (07.2023)

- (11) **47513**
(21) 3-2023-00139 (28) 1
(54) **THANH KIM LOẠI ĐỊNH HÌNH** (51) **25-01**
(22) 13/01/2023 (43) 25/07/2023
(73) **CÔNG TY CỔ PHẦN TẬP ĐOÀN KENWIN (VN)**
Tầng 4 tòa nhà VG Building, số 235 đường Nguyễn Trãi, phường Thanh Xuân
Trung, quận Thanh Xuân, thành phố Hà Nội
(72) Ngô Thọ Long (VN)
(74) Công ty TNHH Sở hữu trí tuệ PADEMARK (PADEMARK CO.,LTD.)
(55)



1.1



1.2



1.3

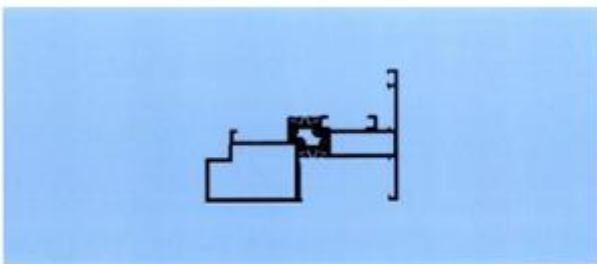

1.4

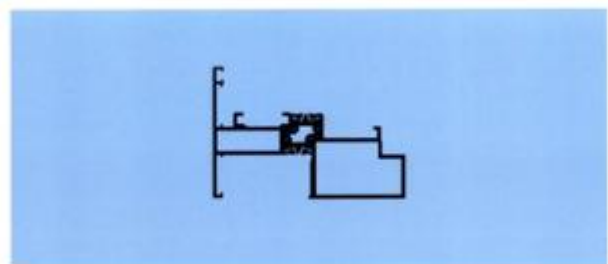

1.5



1.6



1.7

CÔNG BÁO SỞ HỮU CÔNG NGHIỆP SỐ 424 TẬP A – QUYỀN 2 (07.2023)

- (11) **47514**
(21) 3-2023-00140 (28) 1
(54) **THANH KIM LOẠI ĐỊNH HÌNH** (51) **25-01**
(22) 13/01/2023 (43) 25/07/2023
(73) **CÔNG TY CỔ PHẦN TẬP ĐOÀN KENWIN (VN)**
Tầng 4 tòa nhà VG Building, số 235 đường Nguyễn Trãi, phường Thanh Xuân
Trung, quận Thanh Xuân, thành phố Hà Nội
(72) Ngô Thọ Long (VN)
(74) Công ty TNHH Sở hữu trí tuệ PADEMARK (PADEMARK CO.,LTD.)
(55)

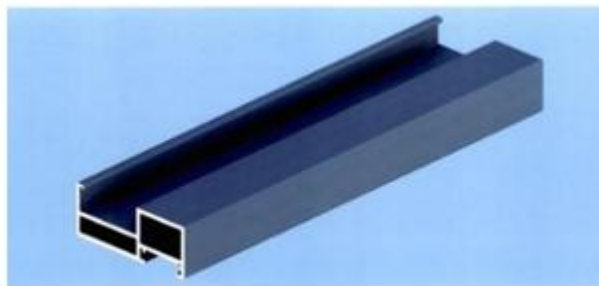

1.1



1.2



1.3

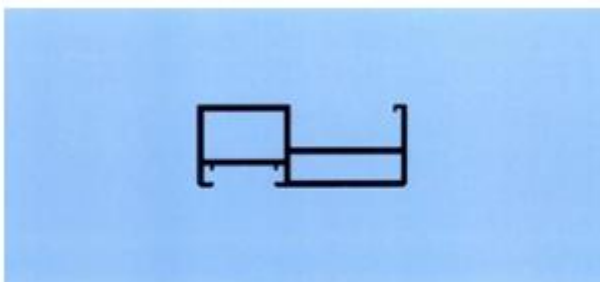

1.4

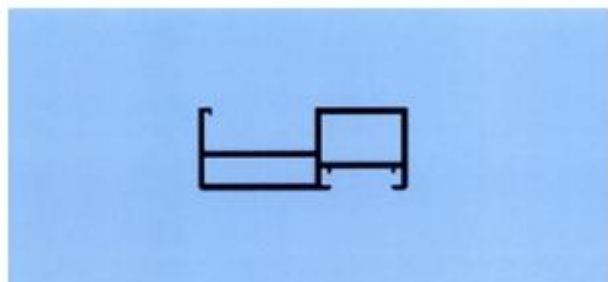

1.5



1.6



1.7

CÔNG BÁO SỞ HỮU CÔNG NGHIỆP SỐ 424 TẬP A – QUYỀN 2 (07.2023)

- (11) **47515**
(21) 3-2023-00167 (28) 1
(54) **THANH KIM LOẠI ĐỊNH HÌNH** (51) **25-01**
(22) 17/01/2023 (43) 25/07/2023
(73) **CÔNG TY CỔ PHẦN TẬP ĐOÀN KENWIN (VN)**
Tầng 4 tòa nhà VG Building, số 235 đường Nguyễn Trãi, phường Thanh Xuân
Trung, quận Thanh Xuân, thành phố Hà Nội
(72) Ngô Thọ Long (VN)
(74) Công ty TNHH Sở hữu trí tuệ PADEMARK (PADEMARK CO.,LTD.)
(55)



1.1



1.2



1.3

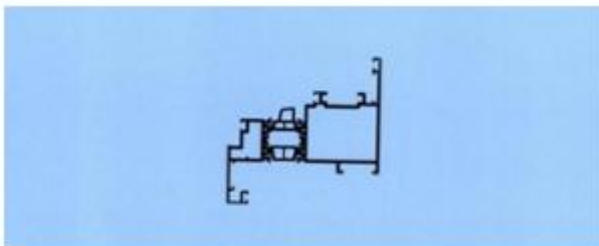

1.4

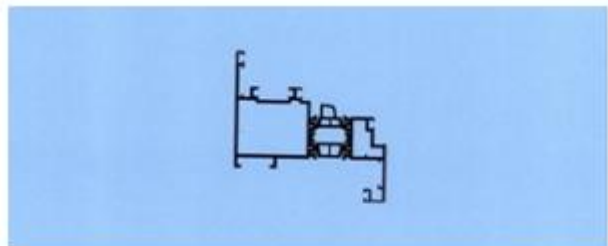

1.5



1.6



1.7

CÔNG BÁO SỞ HỮU CÔNG NGHIỆP SỐ 424 TẬP A – QUYỀN 2 (07.2023)

- (11) **47516**
(21) 3-2023-00168 (28) 1
(54) **THANH KIM LOẠI ĐỊNH HÌNH** (51) **25-01**
(22) 17/01/2023 (43) 25/07/2023
(73) **CÔNG TY CỔ PHẦN TẬP ĐOÀN KENWIN (VN)**
Tầng 4 tòa nhà VG Building, số 235 đường Nguyễn Trãi, phường Thanh Xuân
Trung, quận Thanh Xuân, thành phố Hà Nội
(72) Ngô Thọ Long (VN)
(74) Công ty TNHH Sở hữu trí tuệ PADEMARK (PADEMARK CO.,LTD.)
(55)



1.1



1.2



1.3

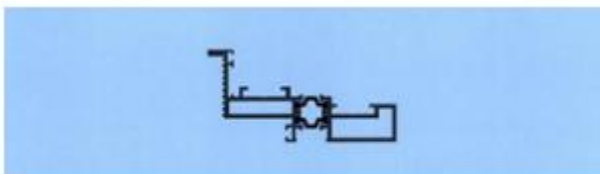

1.4

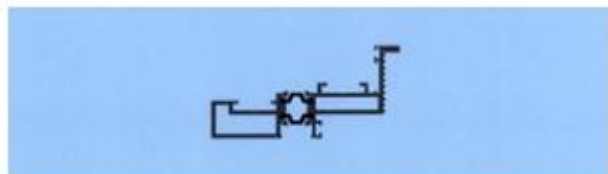

1.5



1.6



1.7

CÔNG BÁO SỞ HỮU CÔNG NGHIỆP SỐ 424 TẬP A – QUYỀN 2 (07.2023)

- (11) **47517**
(21) 3-2023-00169 (28) 1
(54) **THANH KIM LOẠI ĐỊNH HÌNH** (51) **25-01**
(22) 17/01/2023 (43) 25/07/2023
(73) **CÔNG TY CỔ PHẦN TẬP ĐOÀN KENWIN (VN)**
Tầng 4 tòa nhà VG Building, số 235 đường Nguyễn Trãi, phường Thanh Xuân
Trung, quận Thanh Xuân, thành phố Hà Nội
(72) Ngô Thọ Long (VN)
(74) Công ty TNHH Sở hữu trí tuệ PADEMARK (PADEMARK CO.,LTD.)
(55)



1.1



1.2



1.3

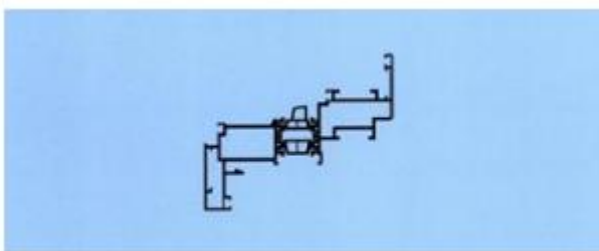

1.4

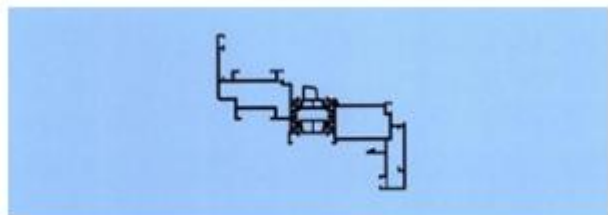

1.5



1.6



1.7

CÔNG BÁO SỞ HỮU CÔNG NGHIỆP SỐ 424 TẬP A – QUYỀN 2 (07.2023)

- (11) **47518**
(21) 3-2021-00296 (28) 2
(54) **BAO BÌ SẢN PHẨM** (51) **09-05**
(22) 05/02/2021 (43) 25/07/2023
(73) **CÔNG TY TNHH CÀ PHÊ KAVA (VN)**
218 Phạm Văn Đồng, phường 1, quận Gò Vấp, thành phố Hồ Chí Minh
(72) Trần Văn Kha (VN)
(55)



1.1



2.2



2.1



1.2

CÔNG BÁO SỞ HỮU CÔNG NGHIỆP SỐ 424 TẬP A – QUYỀN 2 (07.2023)

- (11) **47519**
(21) 3-2021-00297 (28) 3
(54) **BAO BÌ SẢN PHẨM** (51) **09-05**
(22) 05/02/2021 (43) 25/07/2023
(73) **CÔNG TY TNHH SẢN XUẤT - THƯƠNG MẠI CÀ PHÊ TUẤN KIỆT (VN)**
381 Trần Văn Giàu, phường Bình Trị Đông B, quận Bình Tân, thành phố Hồ Chí Minh
(72) Trần Văn Kha (VN)
(55)



1.1



1.2



2.1



2.2



3.1



3.2

CÔNG BÁO SỞ HỮU CÔNG NGHIỆP SỐ 424 TẬP A – QUYỀN 2 (07.2023)

- (11) **47520**
(21) 3-2023-00553 (28) 1
(54) **NHÃN SẢN PHẨM** (51) **19-08**
(22) 14/03/2023 (43) 25/07/2023
(73) **CÔNG TY CỔ PHẦN TINGCO BÌNH ĐỊNH (VN)**
Lô A3.12+A3.13 khu công nghiệp Nhơn Hội (Khu A), khu kinh tế Nhơn Hội, xã
Nhơn Hội, thành phố Quy Nhơn, tỉnh Bình Định
(72) Võ Thị Nguyệt Nga (VN)
(74) Công ty Cổ phần Sở hữu công nghiệp INVESTIP (INVESTIP)
(55)



1.1



1.2

CÔNG BÁO SỞ HỮU CÔNG NGHIỆP SỐ 424 TẬP A – QUYỀN 2 (07.2023)

- (11) **47521**
(21) 3-2023-00666 (28) 1
(54) **BAO GÓI** (51) **09-05**
(22) 27/03/2023 (43) 25/07/2023
(73) **CÔNG TY TNHH HÓA NÔNG NASAKI (VN)**
Tầng 1, tòa nhà Packsimex, 52 Đông Du, phường Bến Nghé, quận 1, thành phố Hồ Chí Minh
(72) Trương Minh Mẫn (VN)
(74) Công ty TNHH một thành viên Trường Luật (Trường Luật)
(55)



1.1



1.2

CÔNG BÁO SỞ HỮU CÔNG NGHIỆP SỐ 424 TẬP A – QUYỀN 2 (07.2023)

- (11) **47522**
(21) 3-2023-00674 (28) 1
(54) **TÚI ĐỰNG TRÀ** (51) **09-05**
(22) 28/03/2023 (43) 25/07/2023
(73) **HỢP TÁC XÃ HƯƠNG THÀNH PHÚ (VN)**
Tổ 11, phường Túc Duyên, thành phố Thái Nguyên, tỉnh Thái Nguyên
(72) Phạm Thị Thu Hương (VN)
(74) Công ty TNHH Sở hữu trí tuệ INNETCO-Hoàng Phúc (INNETCO CO., LTD)
(55)



1.1



1.2

CÔNG BÁO SỞ HỮU CÔNG NGHIỆP SỐ 424 TẬP A – QUYỀN 2 (07.2023)

- (11) **47523**
(21) 3-2023-00679 (28) 1
(54) **BAO GÓI** (51) **09-05**
(22) 28/03/2023 (43) 25/07/2023
(73) **CÔNG TY TNHH HÓA NÔNG NASAKI (VN)**
Tầng 1, tòa nhà Packsimex, 52 Đông Du, phường Bến Nghé, quận 1, thành phố Hồ Chí Minh
(72) Trương Minh Mẫn (VN)
(74) Công ty TNHH một thành viên Trường Luật (Trường Luật)
(55)



1.1



1.2

CÔNG BÁO SỞ HỮU CÔNG NGHIỆP SỐ 424 TẬP A – QUYỀN 2 (07.2023)

- (11) 47524
- (21) 3-2023-00680
- (54) **BAO GÓI**
- (22) 28/03/2023
- (73) **CÔNG TY TNHH SẢN XUẤT THƯƠNG MẠI DỊCH VỤ VINO (VN)**
68 Nguyễn Huệ, phường Bến Nghé, quận 1, thành Phố Hồ Chí Minh
- (72) Lê Công Hà (VN)
- (74) Công ty TNHH một thành viên Trường Luật (Trường Luật)
- (55)

- (28) 1
- (51) **09-05**
- (43) 25/07/2023



1.1



1.2

CÔNG BÁO SỞ HỮU CÔNG NGHIỆP SỐ 424 TẬP A – QUYỀN 2 (07.2023)

- (11) **47525**
(21) 3-2023-00681 (28) 1
(54) **BAO GÓI** (51) **09-05**
(22) 28/03/2023 (43) 25/07/2023
(73) **CÔNG TY TNHH NÔNG HẢI (VN)**
Số 29 đường số 6, khu dân cư Hai Thành, phường Tân Tạo A, quận Bình Tân, thành phố Hồ Chí Minh
(72) Đặng Thị Thúy Quỳnh (VN)
(74) Công ty TNHH một thành viên Trường Luật (Trường Luật)
(55)



1.1



1.2

CÔNG BÁO SỞ HỮU CÔNG NGHIỆP SỐ 424 TẬP A – QUYỀN 2 (07.2023)

- (11) **47526**
(21) 3-2023-00755 (28) 1
(54) **BAO GÓI** (51) **09-05**
(22) 05/04/2023 (43) 25/07/2023
(73) **CÔNG TY TNHH NTPM (VIỆT NAM) (VN)**
Số 22 VSIP II-A, đường số 23, khu công nghiệp Việt Nam - Singapore II-A,
phường Vĩnh Tân, thị xã Tân Uyên, tỉnh Bình Dương
(72) LEE KUAN PHENG (MY)
(74) Công ty TNHH Sở hữu trí tuệ HA VIP (HAVIP CO., LTD.)
(55)



1.1



1.2

CÔNG BÁO SỞ HỮU CÔNG NGHIỆP SỐ 424 TẬP A – QUYỀN 2 (07.2023)

- (11) 47527
(21) 3-2023-00760 (28) 2
(54) **HỘP** (51) **09-05**
(22) 06/04/2023 (43) 25/07/2023
(73) **CÔNG TY CỔ PHẦN THỰC PHẨM SỮA TH (VN)**
Xã Nghĩa Sơn, huyện Nghĩa Đàn, tỉnh Nghệ An
(72) Vũ Thanh Hương (VN)
(74) **CÔNG TY LUẬT TNHH IP MAX (IPMAX LAW FIRM)**
(55)



1.1



1.2



1.3



2.1



2.2



2.3

- (11) **47528**
(21) 3-2022-00909 (28) 1
(54) **TÚI CHỨA CHẤT GIẶT TÂY** (51) **28-02**
(22) 09/05/2022 (43) 25/07/2023
(30) 202130737033.5 10/11/2021 CN;
(73) **UNILEVER GLOBAL IP LIMITED (GB)**
Port Sunlight Wirral, Merseyside CH62 4ZD, United Kingdom
(72) TOH Meng Lee (SG)
(74) Công ty TNHH Trần Hữu Nam và Đồng sự (TRAN H.N & ASS.)
(55)

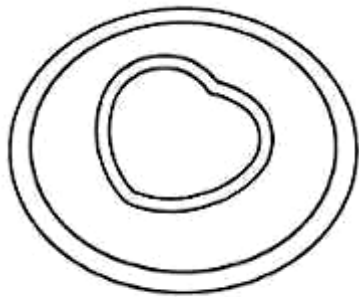

1.1

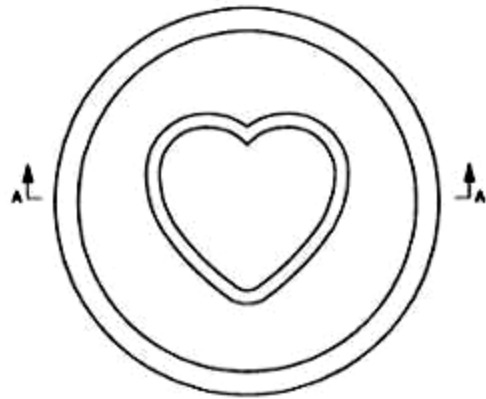

1.2

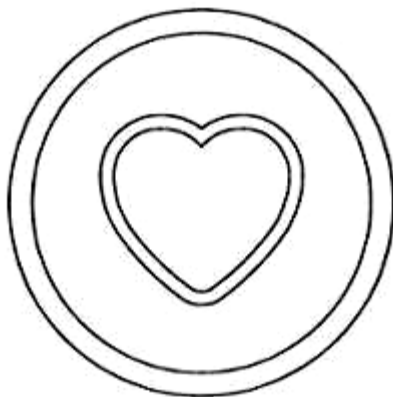

1.3



1.4



1.5

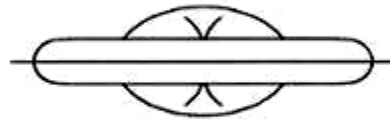

1.6



1.7



1.8

- (11) **47529**
(21) 3-2022-00910 (28) 1
(54) **TÚI CHỨA CHẤT GIẶT TẮY** (51) **28-02**
(22) 09/05/2022 (43) 25/07/2023
(30) 202130737033.5 10/11/2021 CN;
(73) **UNILEVER GLOBAL IP LIMITED (GB)**
Port Sunlight Wirral, Merseyside CH62 4ZD, United Kingdom
(72) TOH Meng Lee (SG)
(74) Công ty TNHH Trần Hữu Nam và Đồng sự (TRAN H.N & ASS.)
(55)

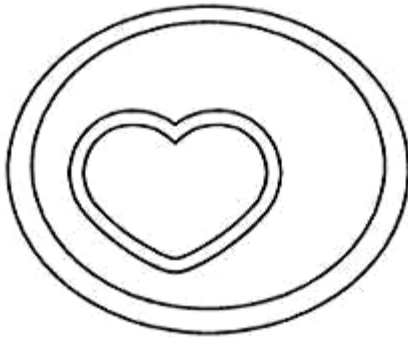

1.1

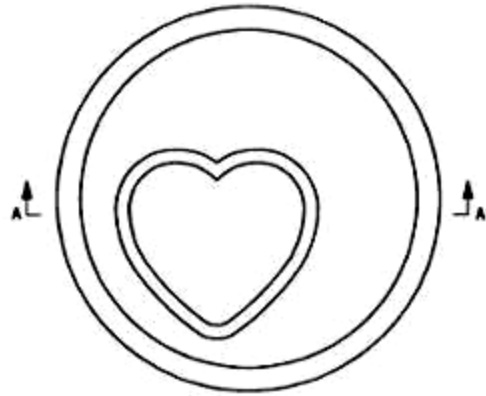

1.2

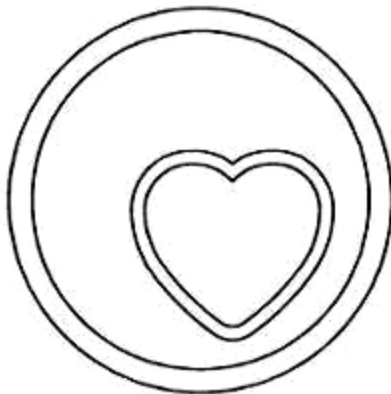

1.3

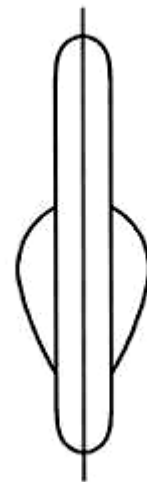

1.4

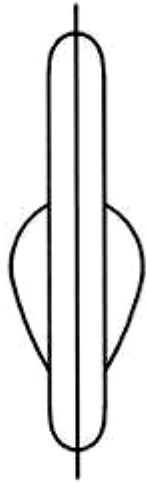

1.5

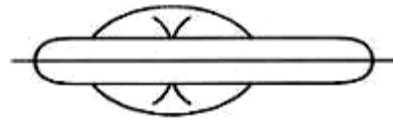

1.6

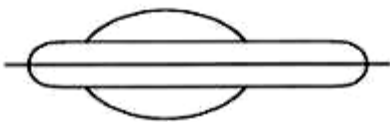

1.7



1.8

CÔNG BÁO SỞ HỮU CÔNG NGHIỆP SỐ 424 TẬP A – QUYỀN 2 (07.2023)

- (11) **47530**
(21) 3-2023-00466 (28) 2
(54) **MÁY ĐIỀU HÒA NHIỆT ĐỘ** (51) **23-04**
(22) 06/03/2023 (43) 25/07/2023
(73) **PANASONIC APPLIANCES AIR-CONDITIONING MALAYSIA SDN. BHD.**
(MY)
Lot 2, Persiaran Tengku Ampuan, Section 21, Shah Alam Industrial Site, 40300
Shah Alam, Selangor Darul Ehsan, Malaysia
(72) 1. RAY TAN CHIEN SHIUNG (MY)
2. YAP KAI WEN (MY)
(74) Công ty cổ phần tư vấn Trung Thực (TRUNG THUC.,JSC)
(55)

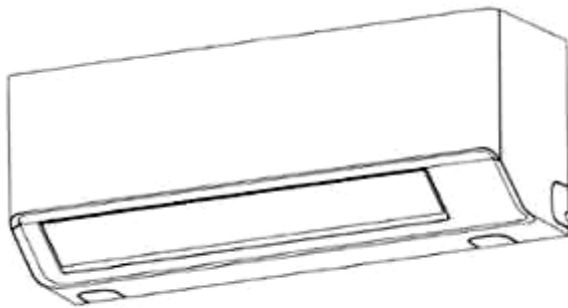

1.1

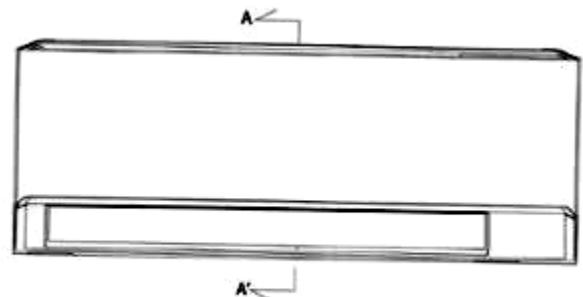

1.2

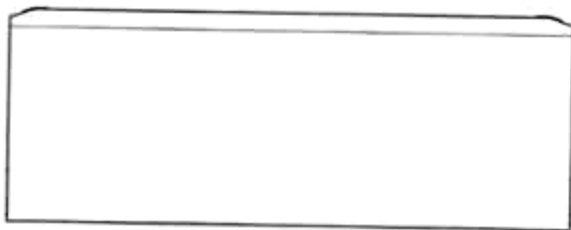

1.3



1.4



1.5

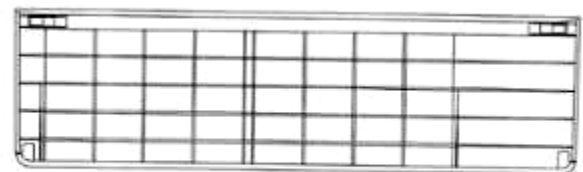

1.6



1.7

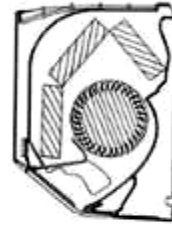

1.8

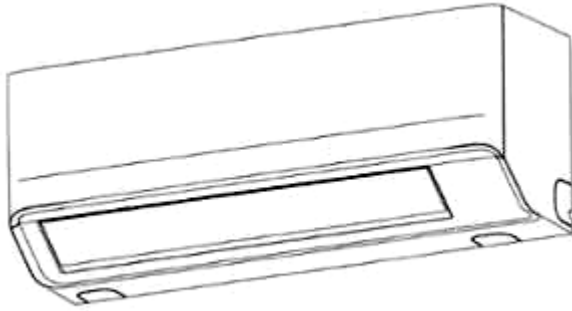

2.1

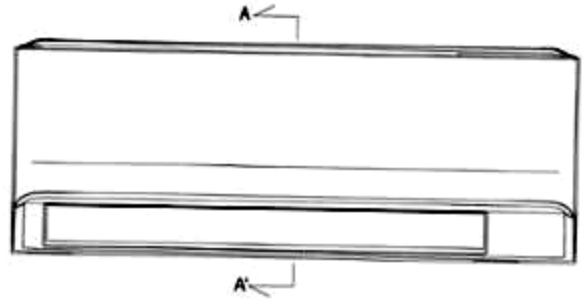

2.2



2.3



2.4



2.5

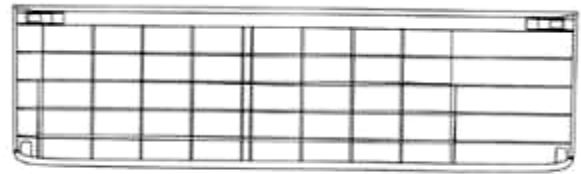

2.6



2.7



2.8

CÔNG BÁO SỞ HỮU CÔNG NGHIỆP SỐ 424 TẬP A – QUYỀN 2 (07.2023)

- (11) **47531**
(21) 3-2023-00549 (28) 1
(54) **MÁY IN XĂM HÌNH** (51) **28-03**
(22) 14/03/2023 (43) 25/07/2023
(30) 30-2023-0007162 24/02/2023 KR;
(73) **LG H&H CO., LTD. (KR)**
58, Saemunan-ro, Jongno-gu, Seoul, Republic of Korea
(72) 1. LEE, JI HEE (KR)
2. K.WEON, HYEON JIN (KR)
3. JANG, SUNG HYOUN (KR)
(74) Công ty TNHH Tầm nhìn và Liên danh (VISION & ASSOCIATES CO.LTD.)
(55)



1.1



1.2



1.3



1.4



1.5



1.6



1.7

CÔNG BÁO SỞ HỮU CÔNG NGHIỆP SỐ 424 TẬP A – QUYỀN 2 (07.2023)

- (11) **47532**
(21) 3-2023-00550 (28) 1
(54) **MÁY IN XĂM HÌNH** (51) **28-03**
(22) 14/03/2023 (43) 25/07/2023
(30) 30-2023-0006567 21/02/2023 KR;
(73) **LG H&H CO., LTD. (KR)**
58, Saemunan-ro, Jongno-gu, Seoul, Republic of Korea
(72) 1. LEE, JI HEE (KR)
2. KWEON, HYEON JIN (KR)
3. JANG, SUNG HYOUN (KR)
(74) Công ty TNHH Tầm nhìn và Liên danh (VISION & ASSOCIATES CO.LTD.)
(55)



1.1



1.2



1.3



1.4



1.5



1.6



1.7



1.8



1.9

- (11) **47533**
(21) 3-2023-01004 (28) 1
(54) **VỎ ĐỒNG HỒ** (51) **10-02**
(22) 09/05/2023 (43) 25/07/2023
(30) DM/224981 15/11/2022 WO;
(73) **RADO UHREN AG (RADO WATCH CO. LTD.) (MONTRES RADO SA)**
(CH)
Bielstrasse 45, 2543 Lengnau (Switzerland)
(72) 1. SOVYRA SROU (CH)
2. MÉLANIE ARMENTI (CH)
(74) Công ty TNHH Trường Xuân (AGELESS CO.,LTD.)
(55)



1.1

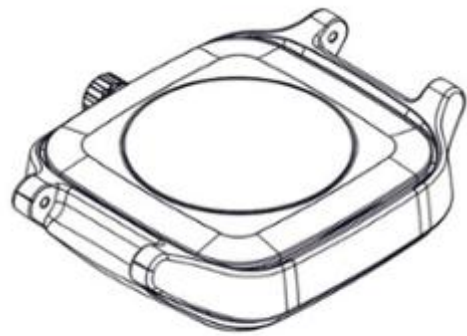

1.2



1.3



1.4



1.5



1.6



1.7



1.8

- (11) **47534**
(21) 3-2023-01019 (28) 1
(54) **LỚP XE** (51) **12-15**
(22) 11/05/2023 (43) 25/07/2023
(30) 015005242 06/12/2022 EM;
(73) **COMPAGNIE GENERALE DES ETABLISSEMENTS MICHELIN (FR)**
23, Place des Carmes-Déchaux - 63000 CLERMONT-FERRAND - France
(72) DJABOUR Walid (FR)
(74) Công ty Luật TNHH quốc tế BMVN (BMVN INTERNATIONAL LLC)
(55)



1.1



1.2



1.3



1.4



1.5

- (11) **47535**
(21) 3-2023-01020 (28) 1
(54) **LỚP XE** (51) **12-15**
(22) 11/05/2023 (43) 25/07/2023
(30) 015005241 06/12/2022 EM;
(73) **COMPAGNIE GENERALE DES ETABLISSEMENTS MICHELIN (FR)**
23, Place des Carmes-Déchaux - 63000 CLERMONT-FERRAND - France
(72) DJABOUR Walid (FR)
(74) Công ty Luật TNHH quốc tế BMVN (BMVN INTERNATIONAL LLC)
(55)



1.1



1.2



1.3



1.4



1.5

CÔNG BÁO SỞ HỮU CÔNG NGHIỆP SỐ 424 TẬP A – QUYỀN 2 (07.2023)

- (11) **47536**
(21) 3-2023-00134 (28) 1
(54) **CAN ĐỰNG DẦU NHỚT** (51) **09-02**
(22) 13/01/2023 (43) 25/07/2023
(73) **CÔNG TY TNHH NAK VIỆT NAM (VN)**
45 Đường D4A, Khu dân cư Hưng Phú, Phường Phước Long B, Thành phố Thủ Đức, Thành phố Hồ Chí Minh
(72) Nguyễn Lê Khoa Thy (VN)
(55)



1.1



1.2



1.3



1.4



1.5



1.6

CÔNG BÁO SỞ HỮU CÔNG NGHIỆP SỐ 424 TẬP A – QUYỀN 2 (07.2023)

- (11) **47537**
(21) 3-2023-00135 (28) 1
(54) **CAN ĐỰNG DẦU NHỚT** (51) **09-02**
(22) 13/01/2023 (43) 25/07/2023
(73) **CÔNG TY TNHH NAK VIỆT NAM (VN)**
45 Đường D4A, Khu dân cư Hưng Phú, Phường Phước Long B, Thành phố Thủ Đức, Thành phố Hồ Chí Minh
(72) Nguyễn Lê Khoa Thy (VN)
(55)



1.1



1.2



1.3



1.4



1.5



1.6

CÔNG BÁO SỞ HỮU CÔNG NGHIỆP SỐ 424 TẬP A – QUYỀN 2 (07.2023)

- (11) **47538**
(21) 3-2023-00098 (28) 1
(54) **SỨ CÁCH ĐIỆN** (51) **13-03**
(22) 11/01/2023 (43) 25/07/2023
(73) **CÔNG TY TNHH SỬ KỸ THUẬT MINH LONG 2 (VN)**
Số 328, Đại lộ Bình Dương, Khu phố Hưng Lộc, Phường Hưng Định, Thành phố
Thuận An, Tỉnh Bình Dương
(72) Dương Tuấn Vũ (VN)
(74) Công ty TNHH Tư vấn - Dịch thuật - Sở hữu trí tuệ Á Đông (Á Đông IP
CONSULTANCY CO.,LTD.)
(55)



1.1



1.2



1.3



1.4



1.5

CÔNG BÁO SỞ HỮU CÔNG NGHIỆP SỐ 424 TẬP A – QUYỀN 2 (07.2023)

(11) **47539**

(21) 3-2023-00177

(28) 1

(54) **MÁY ĐO HUYẾT ÁP**

(51) **24-01**

(22) 17/01/2023

(43) 25/07/2023

(73) **CÔNG TY CỔ PHẦN MEIKO AUTOMATION (VN)**

Tầng 1, nhà EMS 2, lô CN9, khu công nghiệp Thạch Thất - Quốc Oai, xã Phùng Xá, huyện Thạch Thất, thành phố Hà Nội

(72) Nguyễn Huy Biên (VN)

(55)

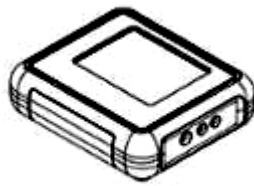

1.1



1.2



1.3



1.4



1.5



1.6

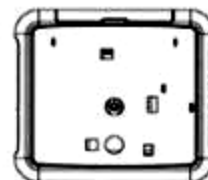

1.7

- (11) **47540**
(21) 3-2023-00235 (28) 1
(54) **THIẾT BỊ SẠC CHO MÁY KHỬ TRÙNG BÀN CHẢI** (51) **13-02**
(22) 02/02/2023 (43) 25/07/2023
(30) 30-2022-0034304 23/08/2022 KR;
(73) **LOCK & LOCK CO., LTD.** (KR)
104, Sapgyocheon-ro, Seonjang-myeon, Asan-si, Chungcheongnam-do, Republic of Korea
(72) SONG, Ga Young (KR)
(74) Công ty TNHH Tầm nhìn và Liên danh (VISION & ASSOCIATES CO.LTD.)
(55)

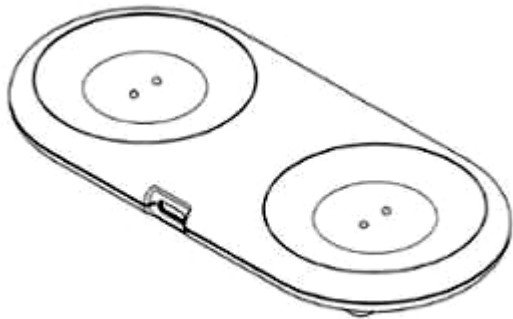

1.1



1.2



1.3



1.4

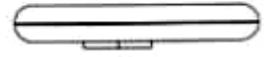

1.5

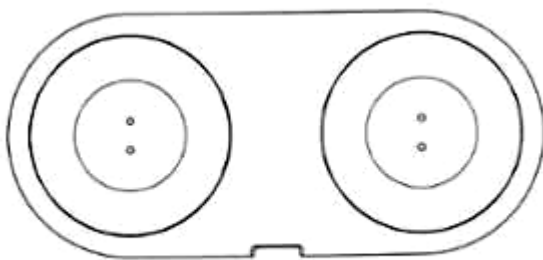

1.6

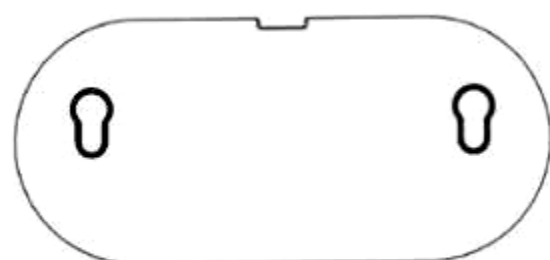

1.7

- (11) **47541**
(21) 3-2023-00236 (28) 1
(54) **MÁY KHỬ TRÙNG BÀN CHẢI** (51) **15-05**
(22) 02/02/2023 (43) 25/07/2023
(30) 30-2022-0034303 23/08/2022 KR;
(73) **LOCK & LOCK CO., LTD.** (KR)
104, Sapgyocheon-ro, Seonjang-myeon, Asan-si, Chungcheongnam-do, Republic of Korea
(72) SONG, Ga Young (KR)
(74) Công ty TNHH Tầm nhìn và Liên danh (VISION & ASSOCIATES CO.LTD.)
(55)

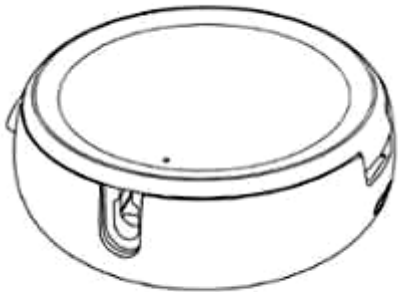

1.1

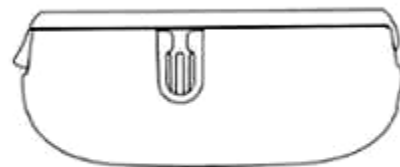

1.2

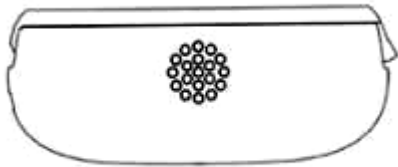

1.3

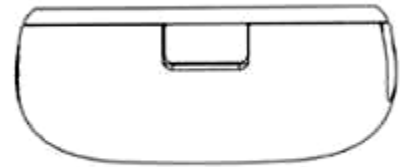

1.4

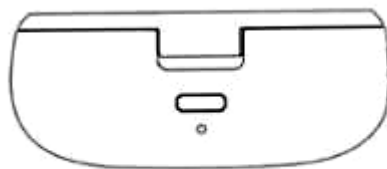

1.5

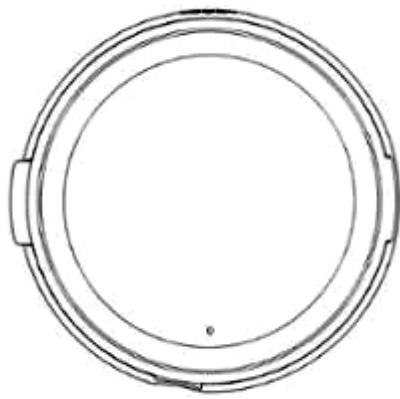

1.6

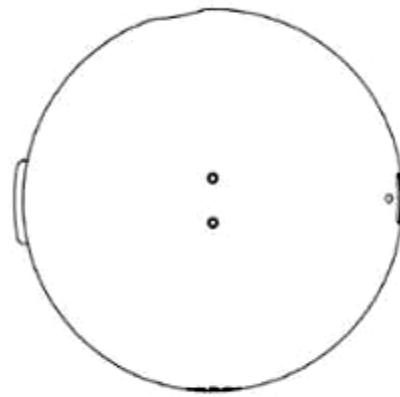

1.7

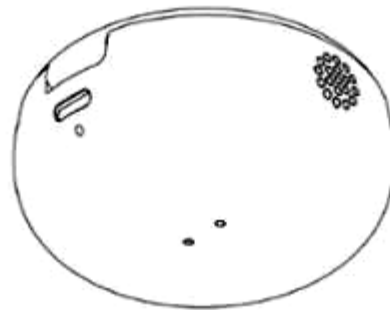

1.8

CÔNG BÁO SỞ HỮU CÔNG NGHIỆP SỐ 424 TẬP A – QUYỀN 2 (07.2023)

- (11) **47542**
(21) 3-2023-00237 (28) 2
(54) **MẮC TREO** (51) **06-08**
(22) 02/02/2023 (43) 25/07/2023
(30) 6246512 25/11/2022 GB; 6250941 20/12/2022 GB;
(73) **TAM PLASTIK VE KALIP SANAYI TICARET LIMITED SIRKETI (TR)**
Kavakli Mh. Deniz Aktas Cd. No: 32, 34520 Beylikduzu, Istanbul, Turkey
(72) TEZSEZER, Gokhan (TR)
(74) Công ty TNHH Trường Xuân (AGELESS CO.,LTD.)
(55)

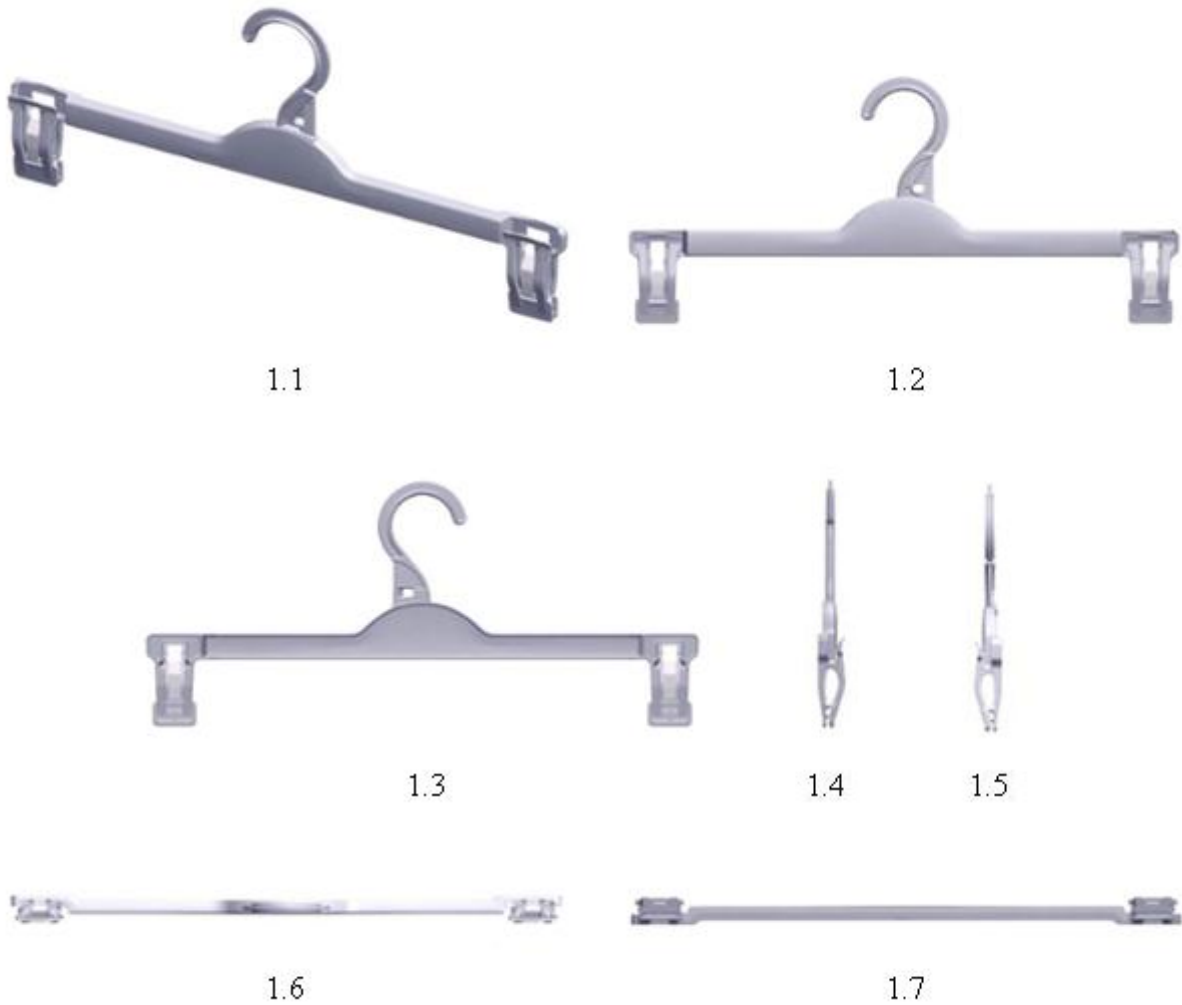



2.1



2.2



2.3



2.4



2.5



2.6



2.7

CÔNG BÁO SỞ HỮU CÔNG NGHIỆP SỐ 424 TẬP A – QUYỀN 2 (07.2023)

- (11) **47543**
(21) 3-2023-00238 (28) 2
(54) **MẮC TREO** (51) **06-08**
(22) 02/02/2023 (43) 25/07/2023
(30) 6246518 25/11/2022 GB; 6250942 20/12/2022 GB;
(73) **TAM PLASTIK VE KALIP SANAYI TICARET LIMITED SIRKETI (TR)**
Kavakli Mh. Deniz Aktas Cd. No: 32, 34520 Beylikduzu, Istanbul, Turkey
(72) TEZSEZER, Gokhan (TR)
(74) Công ty TNHH Trường Xuân (AGELESS CO.,LTD.)
(55)



1.1



1.2



1.3



1.4



1.5



1.6



1.7



2.1



2.2



2.3



2.4



2.5



2.6



2.7

CÔNG BÁO SỞ HỮU CÔNG NGHIỆP SỐ 424 TẬP A – QUYỀN 2 (07.2023)

- (11) **47544**
(21) 3-2023-00846 (28) 1
(54) **HỘP ĐỰNG QUÀ TẶNG** (51) **09-03**
(22) 14/04/2023 (43) 25/07/2023
(73) **HIỆP HỘI DOANH NGHIỆP TỈNH TUYÊN QUANG (VN)**
Số 6 Chiến Thắng Sông Lô, tổ 7, phường Tân Quang, thành phố Tuyên Quang, tỉnh
Tuyên Quang
(72) Nguyễn Thế Hoà (VN)
(74) Công ty TNHH Tư vấn Nhiệt tâm và Cộng sự (NT & PARTNERS CO.,LTD.)
(55)



1.1



1.2



1.3



1.4



1.5



1.6



1.7



1.8

CÔNG BÁO SỞ HỮU CÔNG NGHIỆP SỐ 424 TẬP A – QUYỀN 2 (07.2023)

- (11) **47545**
(21) 3-2023-00688 (28) 5
(54) **HỘP ĐỰNG SẢN PHẨM** (51) **09-03**
(22) 29/03/2023 (43) 25/07/2023
(73) **CÔNG TY CỔ PHẦN SỮA VIỆT NAM (VINAMILK) (VN)**
Số 10 đường Tân Trào, phường Tân Phú, quận 7, thành phố Hồ Chí Minh
(72) Đào Đức Duy (VN)
(74) Công ty Luật TNHH WINCO (WINCO LAW FIRM)
(55)



1.1



1.2



2.1



2.2



3.1



3.2



4.1



4.2



5.1



5.2

CÔNG BÁO SỞ HỮU CÔNG NGHIỆP SỐ 424 TẬP A – QUYỀN 2 (07.2023)

- (11) **47546**
(21) 3-2021-01855 (28) 1
(54) **ĐẦU NỐI DÙNG CHO THIẾT BỊ ĐIỆN TỬ** (51) **13-03; 14-02**
(22) 16/07/2021 (43) 25/07/2023
(73) **GOOGLE LLC (US)**
1600 Amphitheatre Parkway, Mountain View, California 94043, United States of America
(72) 1. KIM, MOONCHUL (KR)
2. BAI, SUNG (KR)
3. OLSSON, MAJ ISABELLE (SE)
(74) Công ty Luật TNHH ROUSE Việt Nam (ROUSE LEGAL VIETNAM LTD.)
(55)



1.1



1.2



1.3



1.4



1.5



1.6



1.7

CÔNG BÁO SỞ HỮU CÔNG NGHIỆP SỐ 424 TẬP A – QUYỀN 2 (07.2023)

- (11) **47547**
(21) 3-2021-00723 (28) 3
(54) **CỐC** (51) **07-01**
(22) 29/03/2021 (43) 25/07/2023
(30) 29/771,364 22/02/2021 US;
(73) **BALL CORPORATION (US)**
9200 West 108th Circle, Westminster, Colorado 80021, UNITED STATES
(72) 1. SEAN K. FITZSIMONS (US)
2. JONATHAN A. WHITMORE (US)
3. LINDA HINES (US)
(74) Công ty TNHH Trường Xuân (AGELESS CO.,LTD.)
(55)

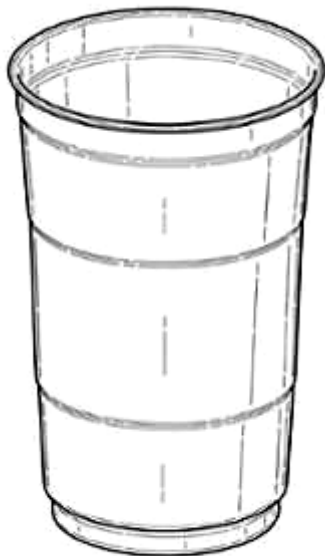

1.1

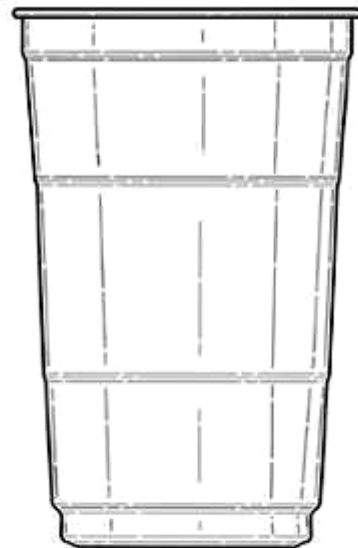

1.2

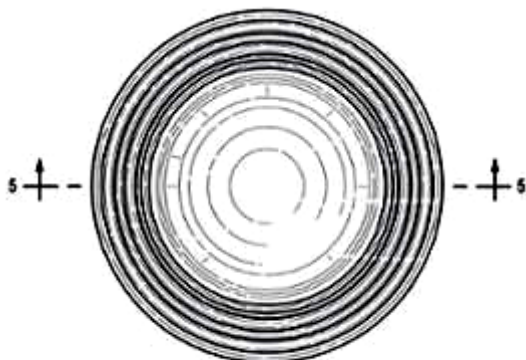

1.3

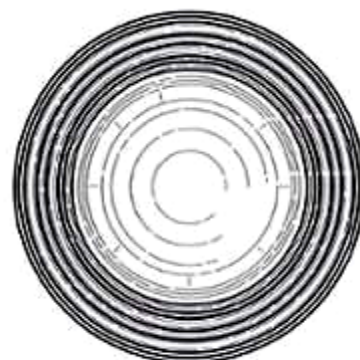

1.4

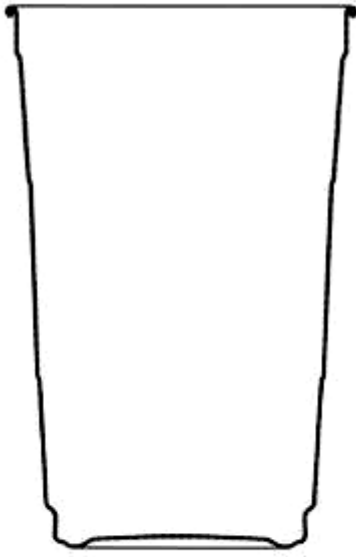

1.5

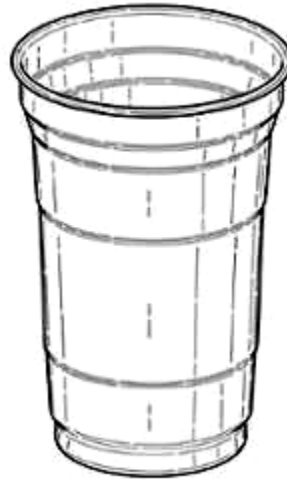

2.1



2.2

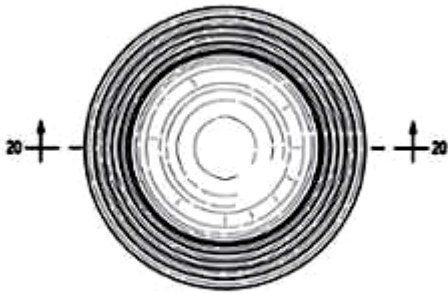

2.3



2.4

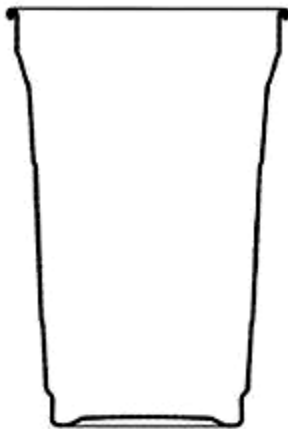

2.5

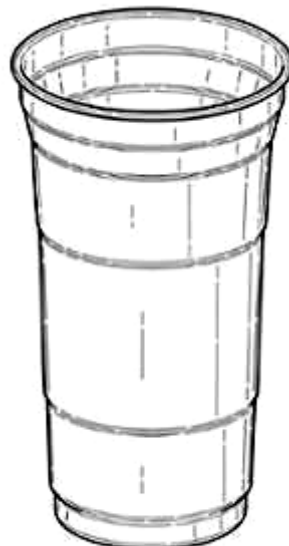

3.1

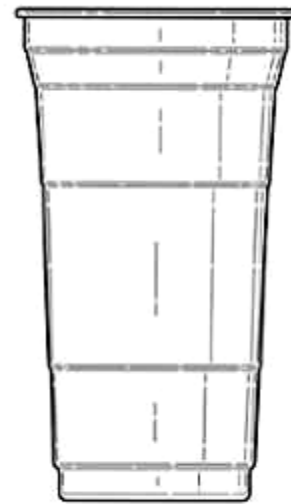

3.2



3.3



3.4

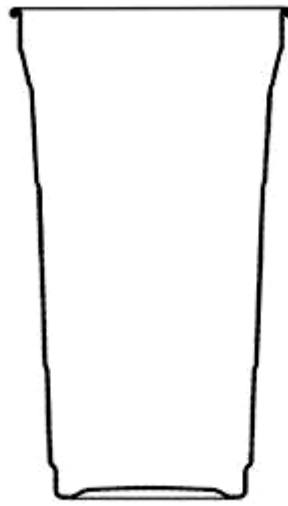

3.5

CÔNG BÁO SỞ HỮU CÔNG NGHIỆP SỐ 424 TẬP A – QUYỀN 2 (07.2023)

- (11) **47548**
(21) 3-2022-02564 (28) 1
(54) **HỆ THỐNG GIÁM SÁT MỤC TIÊU DI ĐỘNG** (51) **14-03**
(22) 21/11/2022 (43) 25/07/2023
(73) **CÔNG TY CỔ PHẦN ĐẦU TƯ VÀ CÔNG NGHỆ HTI (VN)**
Tầng 15-VP2, tòa nhà Sun Square, số 21 Lê Đức Thọ, phường Mỹ Đình 2, quận
Nam Từ Liêm, thành phố Hà Nội
(72) Tạ Ngọc Thanh (VN)
(74) Công ty TNHH Dịch thuật sáng chế PROINVEN (PROINVEN CO.,LTD.)
(55)



1.1



1.2



1.3



1.4



1.5



1.6



1.7

CÔNG BÁO SỞ HỮU CÔNG NGHIỆP SỐ 424 TẬP A – QUYỀN 2 (07.2023)

- (11) **47549**
(21) 3-2021-02745 (28) 2
(54) **ĐỒ ĐỰNG ĐĨA TẠ** (51) **03-01; 09-05**
(22) 05/11/2021 (43) 25/07/2023
(30) 29/782,474 06/05/2021 US;
(73) **GORUCK HOLDINGS, LLC (US)**
415 Pablo Avenue, Suite 140, Jacksonville Beach, Florida 32250, United States of America
(72) 1. MCCARTHY, JASON JEROME (US)
2. SBAILO, CHRISTIAN (US)
3. METZLER, SPENCER (US)
(74) Công ty TNHH Dịch vụ Sở hữu trí tuệ KENFOX (KENFOX IP SERVICE CO.,LTD.)
(55)

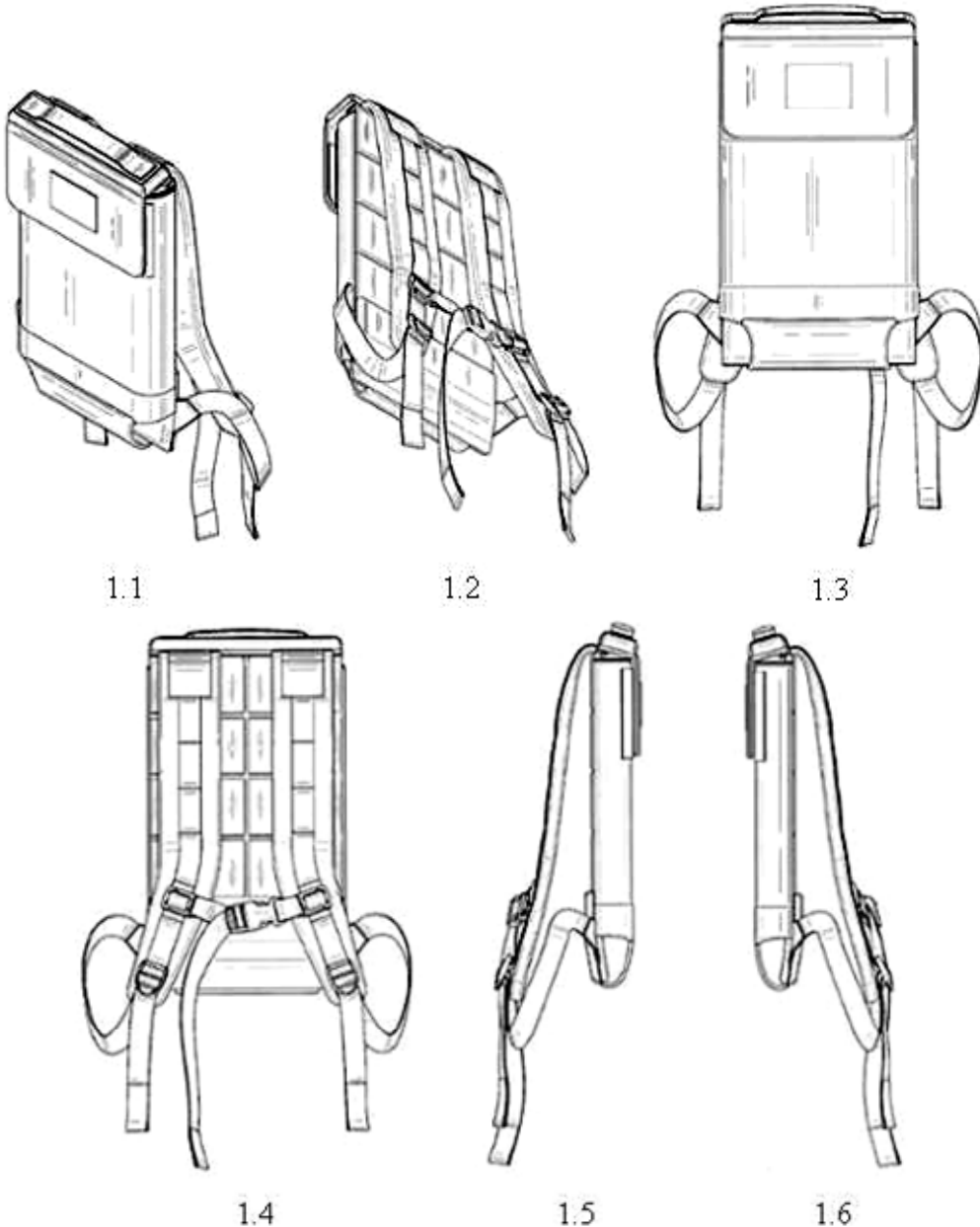

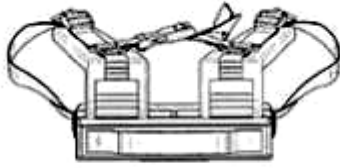

1.7



1.8

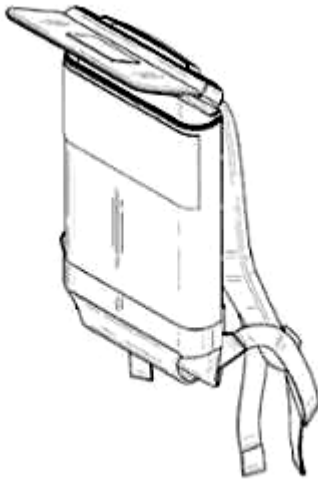

1.9

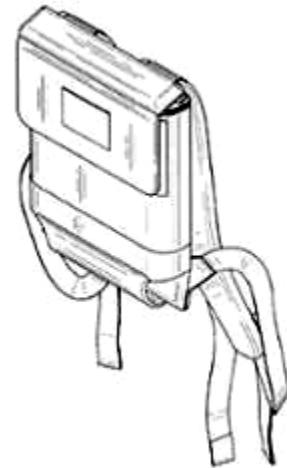

2.1



2.2

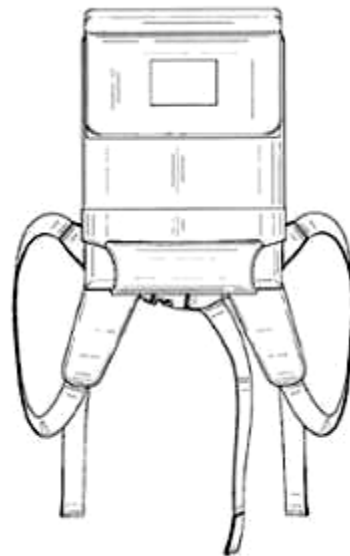

2.3

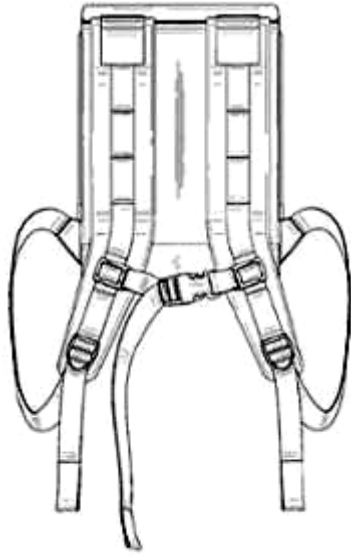

2.4



2.5



2.6

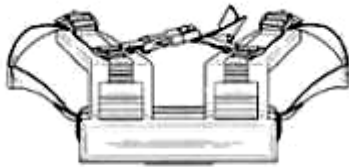

2.7



2.8

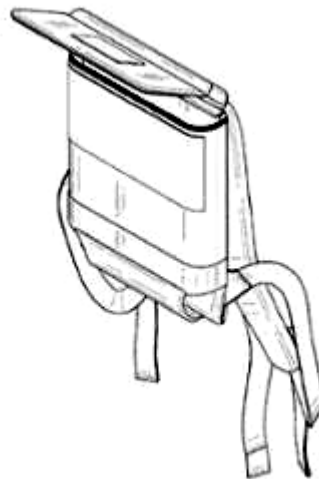

2.9

CÔNG BÁO SỞ HỮU CÔNG NGHIỆP SỐ 424 TẬP A – QUYỀN 2 (07.2023)

- (11) **47550**
(21) 3-2022-02610 (28) 1
(54) **DÂY CÁP TREO RÈM** (51) **08-99**
(22) 28/11/2022 (43) 25/07/2023
(73) 1. **KIM, HONG GYU (KR)**
102dong 2904ho, 16, Jeonpo-daero, Nam-gu, Busan, Republic of Korea (post code: 48415)
2. **JUNG, MI HEE (KR)**
102dong 2904ho, 16, Jeonpo-daero, Nam-gu, Busan, Republic of Korea (post code: 48415)
(72) 1. KIM, HONG GYU (KR)
2. JUNG, MI HEE (KR)
(74) Công ty TNHH Dương và Trần (DUONG & TRAN CO., LTD)
(55)

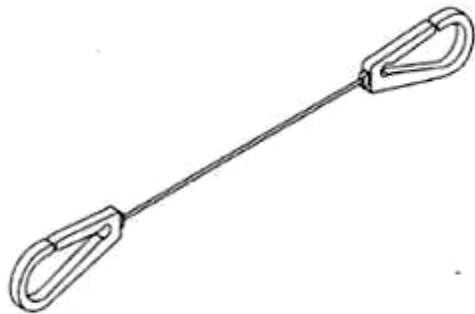

1.1



1.2



1.3



1.4



1.5



1.6

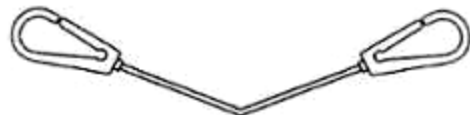

1.7

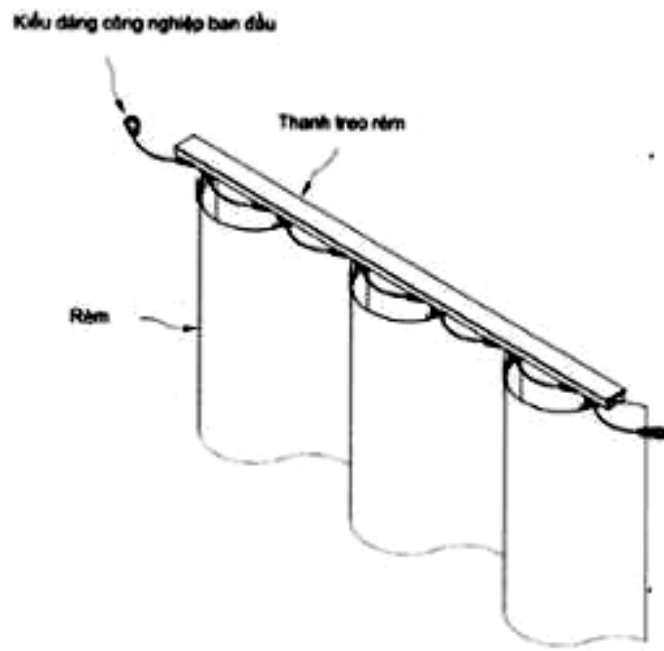

1.8

- (11) **47551**
- (21) 3-2022-02846 (28) 1
- (54) **XE Ô TÔ** (51) **12-08**
- (22) 23/12/2022 (43) 25/07/2023
- (30) 202230394363.3 24/06/2022 CN;
- (73) 1. **ZHEJIANG GEELY HOLDING GROUP CO., LTD.** (CN)
No. 1760 Jiangling Road, Binjiang District, Hangzhou, Zhejiang, 310000 China
2. **GEELY AUTOMOBILE RESEARCH INSTITUTE (NINGBO) CO., LTD**
(CN)
No. 818, Binhai 2nd Road, Hangzhou Bay New District, Ningbo, Zhejiang, China
315336
- (72) 1. LIU, GUISONG (CN)
2. ZHOU, XINNUO (CN)
3. MA, BOYUN (CN)
4. SUN, WEI (CN)
5. LIU, YUZHOU (CN)
6. WU, ZHENZHEN (CN)
7. RUI, CHAO (CN)
8. CHEN, JIANDU (CN)
- (74) Công ty TNHH Sáng chế ACTIP (ACTIP PATENT LIMITED)
- (55)



1.1



1.2



1.3



1.4



1.5



1.6



1.7

CÔNG BÁO SỞ HỮU CÔNG NGHIỆP SỐ 424 TẬP A – QUYỀN 2 (07.2023)

- (11) **47552**
(21) 3-2022-02850 (28) 1
(54) **XE Ô TÔ** (51) **12-08**
(22) 23/12/2022 (43) 25/07/2023
(30) 202230394859.0 24/06/2022 CN;
(73) 1. **ZHEJIANG GEELY HOLDING GROUP CO., LTD.** (CN)
No. 1760 Jiangling Road, Binjiang District, Hangzhou, Zhejiang, 310000 China
2. **GEELY AUTOMOBILE RESEARCH INSTITUTE (NINGBO) CO., LTD**
(CN)
No. 818, Binhai 2nd Road, Hangzhou Bay New District, Ningbo, Zhejiang, China
315336
(72) LIU, Guisong (CN)
(74) Công ty TNHH Sáng chế ACTIP (ACTIP PATENT LIMITED)
(55)



1.1



1.2



1.3



1.4



1.5



1.6



1.7

CÔNG BÁO SỞ HỮU CÔNG NGHIỆP SỐ 424 TẬP A – QUYỀN 2 (07.2023)

- (11) **47553**
(21) 3-2021-01853 (28) 2
(54) **THIẾT BỊ GHI HÌNH** (51) **16-01**
(22) 16/07/2021 (43) 25/07/2023
(73) **GOOGLE LLC (US)**
1600 Amphitheatre Parkway, Mountain View, California 94043, United States of America
(72) 1. HUANG, MARK WOOLHISER (US)
2. BAI, SUNG (KR)
3. OLSSON, MAJ ISABELLE (SE)
4. LEE, ALBERT (US)
(74) Công ty Luật TNHH ROUSE Việt Nam (ROUSE LEGAL VIETNAM LTD.)
(55)

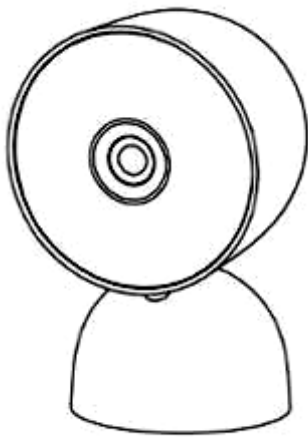

1.1

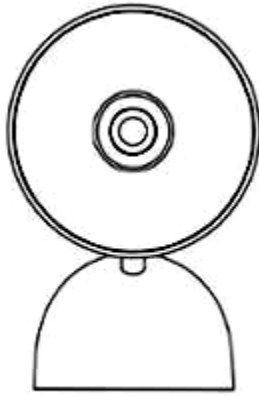

1.2

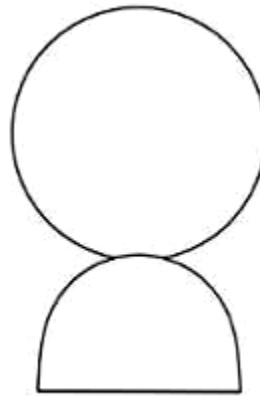

1.3

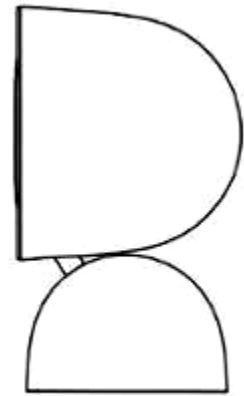

1.4

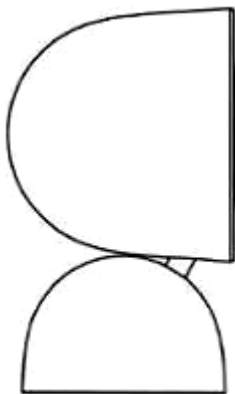

1.5

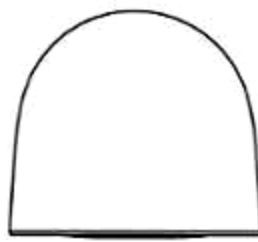

1.6

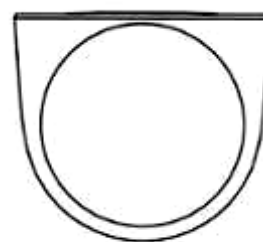

1.7



2.1



2.2

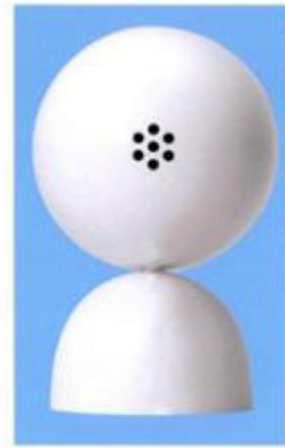

2.3

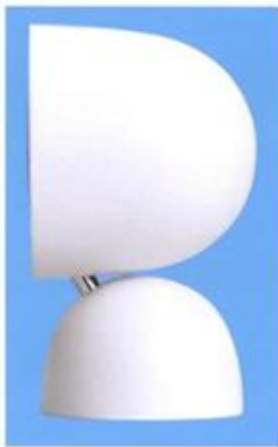

2.4



2.5



2.6



2.7

- (11) **47554**
(21) 3-2021-00919 (28) 1
(54) **MÁNG KÉO HÀM DƯỚI** (51) **24-02**
(22) 20/04/2021 (43) 25/07/2023
(73) **NGUYỄN HOÀNG HẢI (VN)**
Số 08, ngách 167, ngõ 245, phố Định Công, quận Hoàng Mai, thành phố Hà Nội
(72) Nguyễn Hoàng Hải (VN)
(55)



1.1



1.2



1.3



1.4



1.5



1.6



1.7

CÔNG BÁO SỞ HỮU CÔNG NGHIỆP SỐ 424 TẬP A – QUYỀN 2 (07.2023)

- (11) **47555**
(21) 3-2021-01854 (28) 2
(54) **ĐỂ GẮN TƯỜNG DÙNG CHO THIẾT BỊ GHI HÌNH** (51) **16-01**
(22) 16/07/2021 (43) 25/07/2023
(73) **GOOGLE LLC (US)**
1600 Amphitheatre Parkway, Mountain View, California 94043, United States of America
(72) 1. KIM, MOONCHUL (KR)
2. BAI, SUNG (KR)
3. OLSSON, MAJ ISABELLE (SE)
(74) Công ty Luật TNHH ROUSE Việt Nam (ROUSE LEGAL VIETNAM LTD.)
(55)

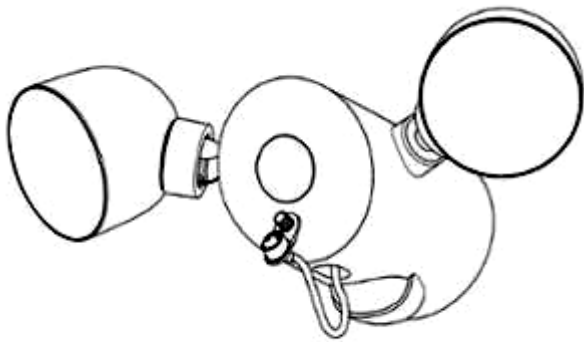

1.1

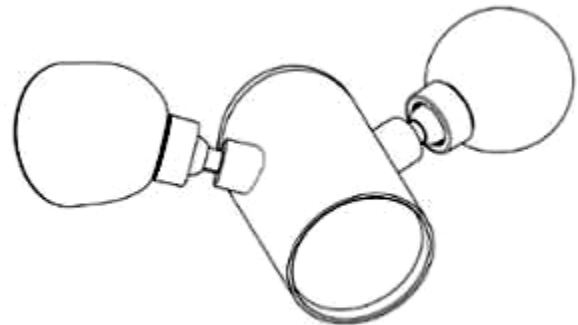

1.2

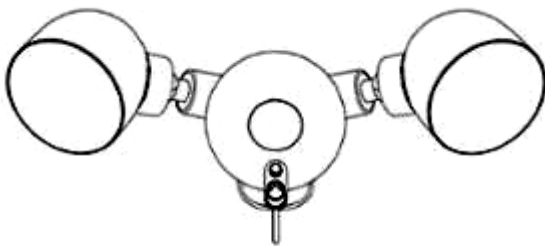

1.3

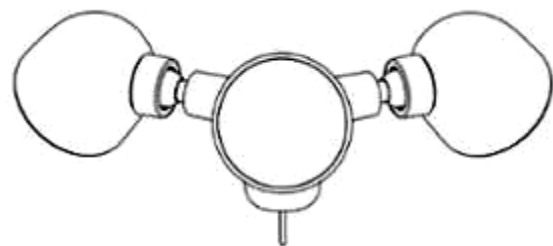

1.4

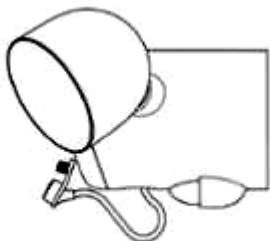

1.5



1.6

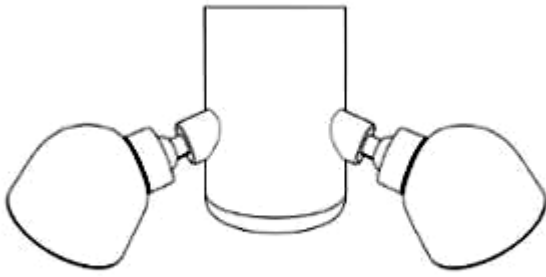

1.7

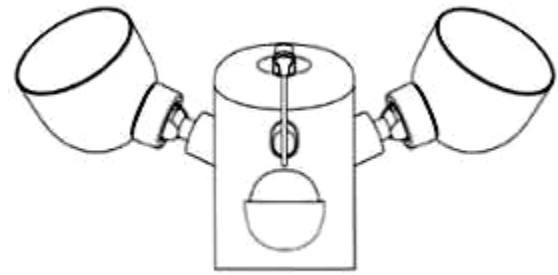

1.8

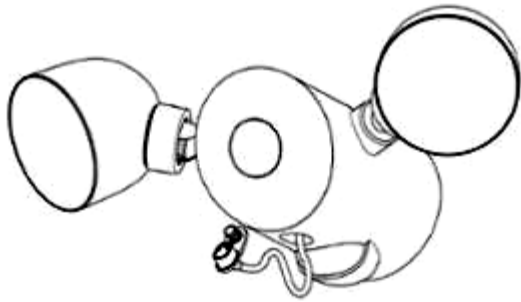

1.9



2.1



2.2



2.3



2.4



2.5



2.6



2.7

- (11) **47556**
(21) 3-2021-01856 (28) 3
(54) **THIẾT BỊ GHI HÌNH** (51) **16-01**
(22) 16/07/2021 (43) 25/07/2023
(73) **GOOGLE LLC (US)**
1600 Amphitheatre Parkway, Mountain View, California 94043, United States of America
(72) 1. KIM, MOONCHUL (KR)
2. BAI, SUNG (KR)
3. OLSSON, MAJ ISABELLE (SE)
4. BÉRUBÉ, ÉTIENNE (CA)
(74) Công ty Luật TNHH ROUSE Việt Nam (ROUSE LEGAL VIETNAM LTD.)
(55)

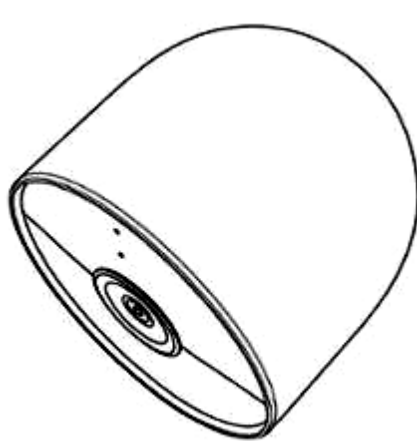

1.1

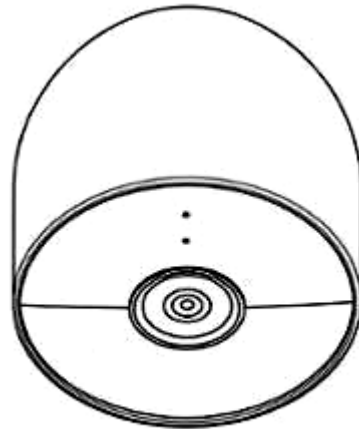

1.2

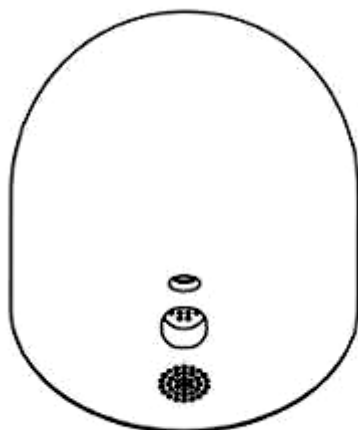

1.3

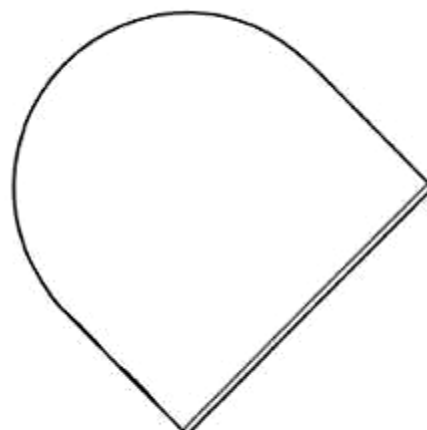

1.4

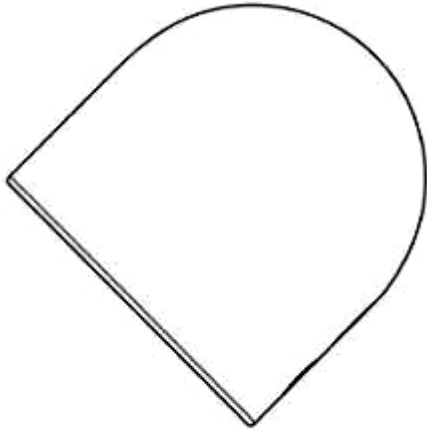

1.5

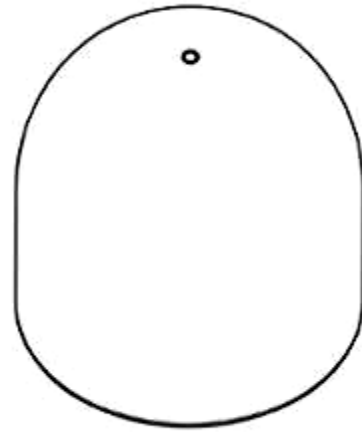

1.6

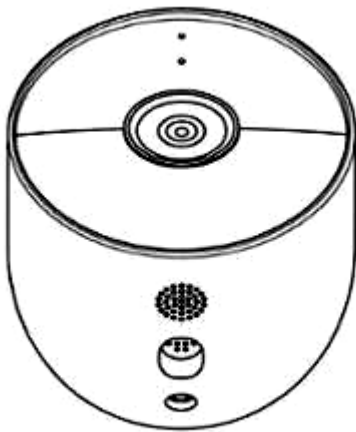

1.7

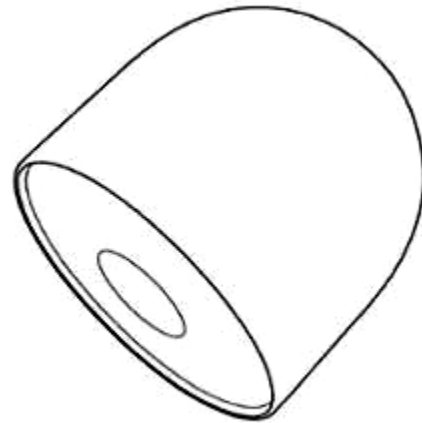

2.1

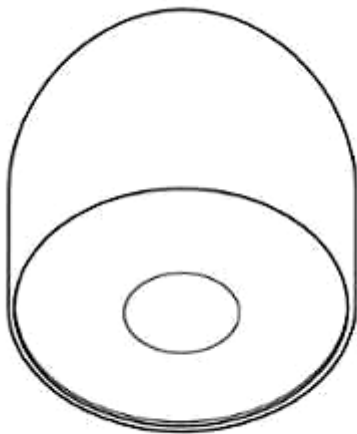

2.2

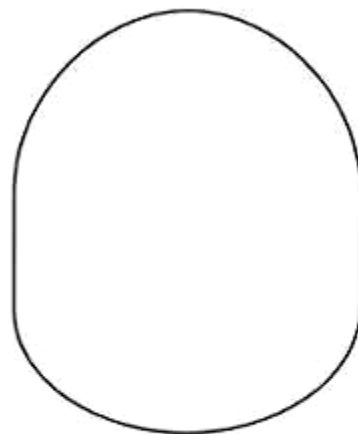

2.3

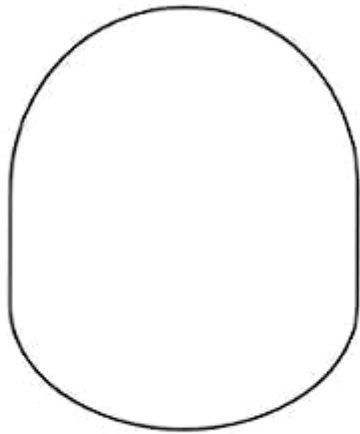

2.4

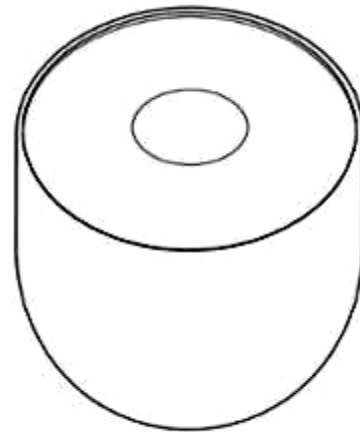

2.5

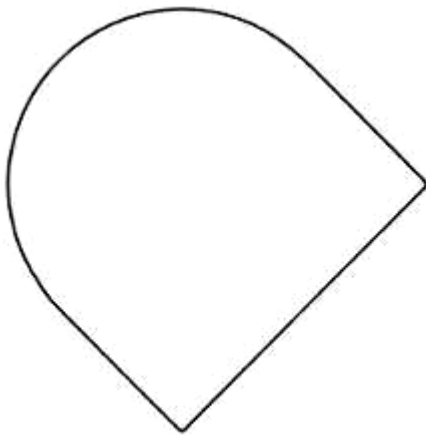

2.6

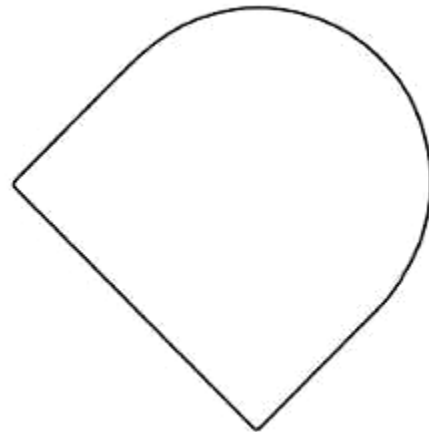

2.7



3.1

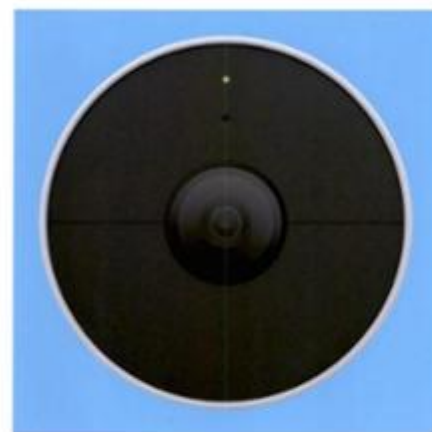

3.2



3.3

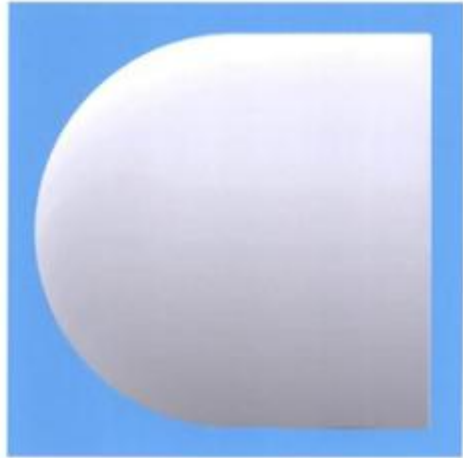

3.4

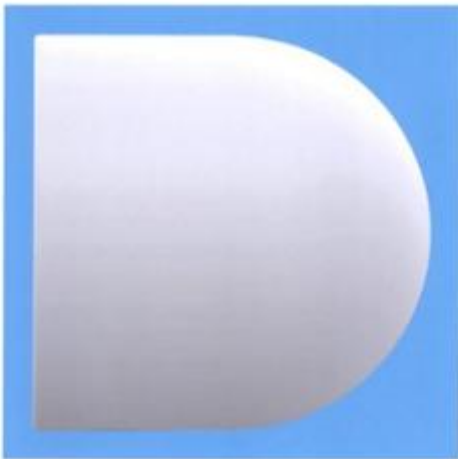

3.5

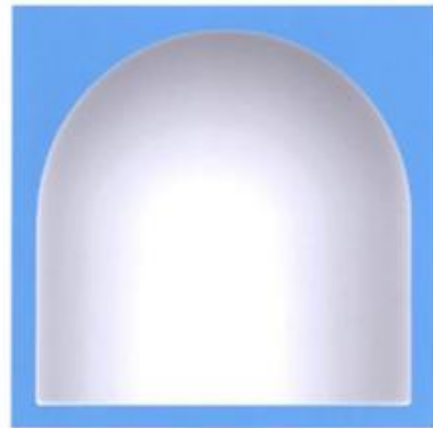

3.6



3.7

CÔNG BÁO SỞ HỮU CÔNG NGHIỆP SỐ 424 TẬP A – QUYỀN 2 (07.2023)

- (11) **47557**
(21) 3-2021-01857 (28) 2
(54) **CHUÔNG CỬA** (51) **10-06**
(22) 16/07/2021 (43) 25/07/2023
(73) **GOOGLE LLC (US)**
1600 Amphitheatre Parkway, Mountain View, California 94043, United States of America
(72) 1. JEONG, HAE RIM (KR)
2. BAI, SUNG (KR)
3. OLSSON, MAJ ISABELLE (SE)
4. BÉRUBÉ, ÉTIENNE (CA)
(74) Công ty Luật TNHH ROUSE Việt Nam (ROUSE LEGAL VIETNAM LTD.)
(55)

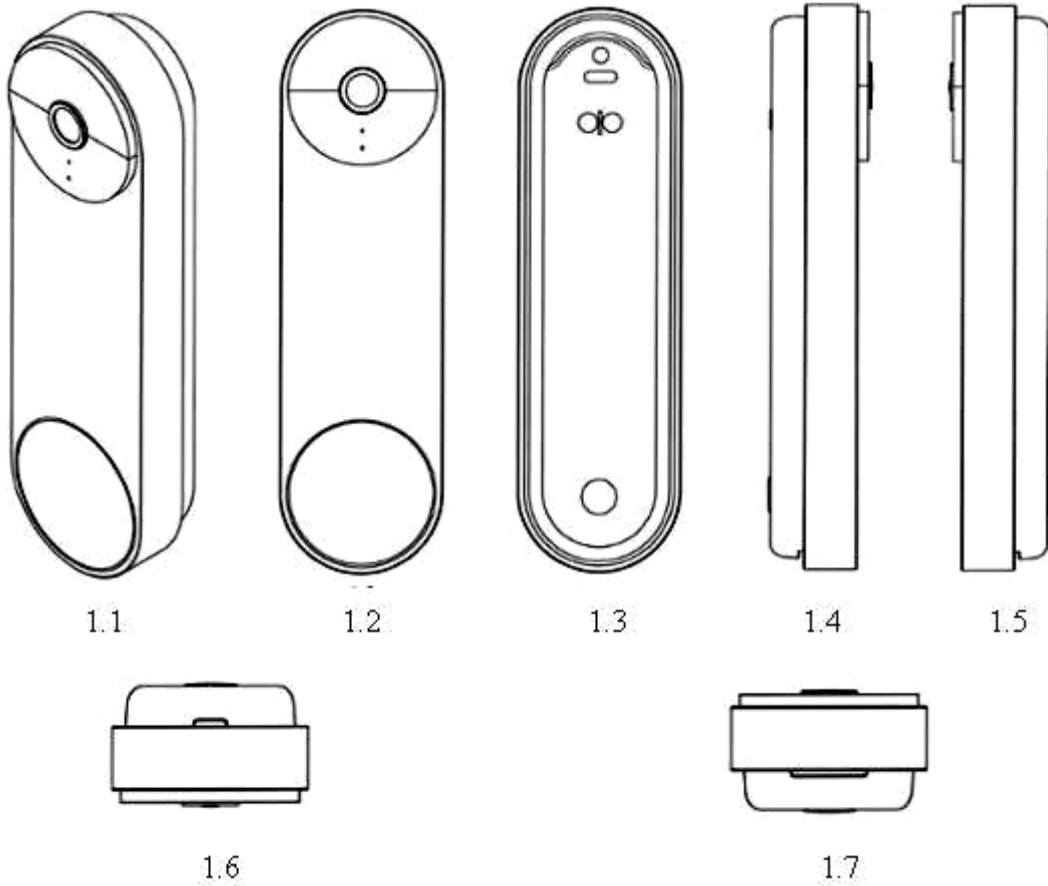



2.1



2.2



2.3



2.4



2.5



2.6



2.7

CÔNG BÁO SỞ HỮU CÔNG NGHIỆP SỐ 424 TẬP A – QUYỀN 2 (07.2023)

- (11) **47558**
(21) 3-2022-00935 (28) 1
(54) **BÁNH XE ĐÁNH LUỐNG** (51) **15-03**
(22) 12/05/2022 (43) 25/07/2023
(73) **CÔNG TY TNHH MỘT THÀNH VIÊN LẬP TƯỜNG (VN)**
20A Nguyễn Văn Bứa, xã Xuân Thới Sơn, huyện Hóc Môn, thành phố Hồ Chí Minh
(72) Trần Lê Hằng (VN)
(74) Công ty TNHH Dịch vụ thương mại và sở hữu công nghiệp Song Ngọc (I.P.T.S.)
(55)



1.1



1.2



1.3



1.4

CÔNG BÁO SỞ HỮU CÔNG NGHIỆP SỐ 424 TẬP A – QUYỀN 2 (07.2023)

- (11) **47559**
(21) 3-2023-00081 (28) 1
(54) **THIẾT BỊ LÀM SẠCH KHÔNG KHÍ** (51) **23-04**
(22) 09/01/2023 (43) 25/07/2023
(30) 202213981 12/07/2022 AU;
(73) **VBREATHE PTY LTD (AU)**
NEXIA AUSTRALIA, Level 16, 1 Market Street, SYDNEY NSW 2000, Australia
(72) 1. ANGUS MABIN (AU)
2. ANTHONY LEO (AU)
3. CHRISTER ENGSTROM (AU)
4. JAKE LI (CN)
5. LACHLAN CHOW (AU)
6. NOAH KELLY (AU)
7. SIMON BARNACOAT (AU)
(74) Công ty TNHH Đại Tín và Liên Danh (DAITIN AND ASSOCIATES CO.,LTD)
(55)

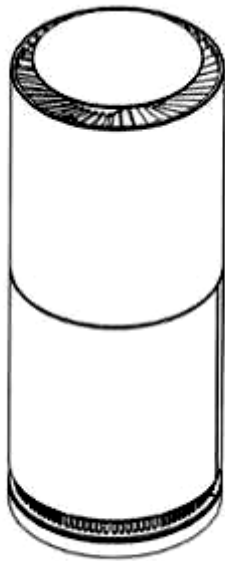

1.1



1.2

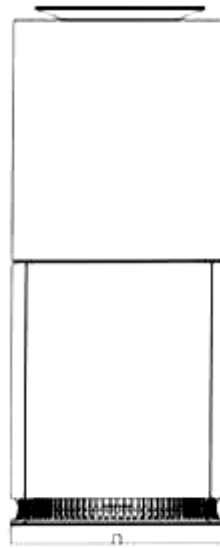

1.3

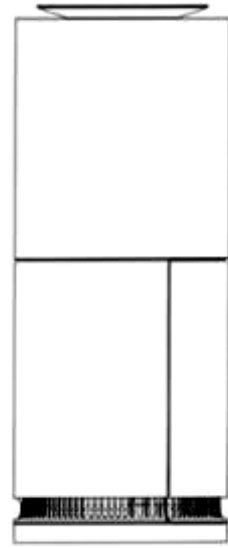

1.4

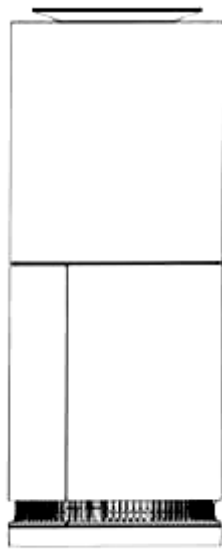

1.5

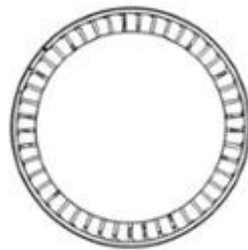

1.6



1.7

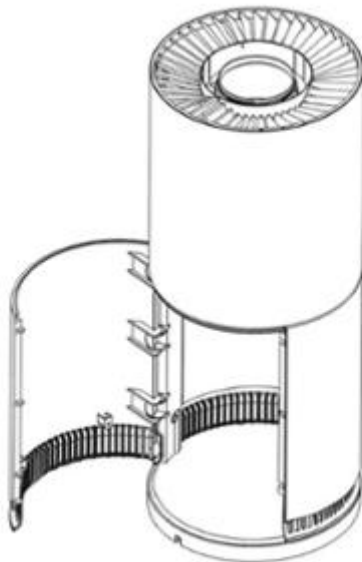

1.8



1.9

CÔNG BÁO SỞ HỮU CÔNG NGHIỆP SỐ 424 TẬP A – QUYỀN 2 (07.2023)

- (11) **47560**
(21) 3-2023-00092 (28) 2
(54) **NỒI CƠM ĐIỆN** (51) **07-02**
(22) 10/01/2023 (43) 25/07/2023
(30) 202230445147.7 13/07/2022 CN;
(73) **FOSHAN SHUNDE MIDEA ELECTRICAL HEATING APPLIANCES
MANUFACTURING CO.,LTD. (CN)**
San Le Road #19, Beijiao, Shunde, Foshan, Guangdong Province 528311, China
(72) 1. DENG, ZHIPENG (CN)
2. CAO, YUXIN (CN)
3. HUANG, YINGWEN (CN)
(74) Công ty TNHH Tâm nhìn và Liên danh (VISION & ASSOCIATES CO.LTD.)
(55)



1.1



1.2



1.3



1.4



1.5



1.6



1.7



2.1



2.2



2.3



2.4



2.5



2.6



2.7

CÔNG BÁO SỞ HỮU CÔNG NGHIỆP SỐ 424 TẬP A – QUYỀN 2 (07.2023)

- (11) **47561**
(21) 3-2023-00095 (28) 2
(54) **MÁY NƯỚC NÓNG** (51) **23-03**
(22) 11/01/2023 (43) 25/07/2023
(30) 009109937-0002 03/08/2022 EM; 009109937-0001 03/08/2022 EM;
(73) **ATLANTIC SOCIETE FRANCAISE DE DEVELOPPEMENT THERMIQUE (FR)**
44 Boulevard des Etats-Unis, 85000 LA ROCHE-SUR-YON, France
(72) Manon MALATRAY (FR)
(74) Công ty Luật TNHH Phạm và Liên danh (PHAM & ASSOCIATES)
(55)

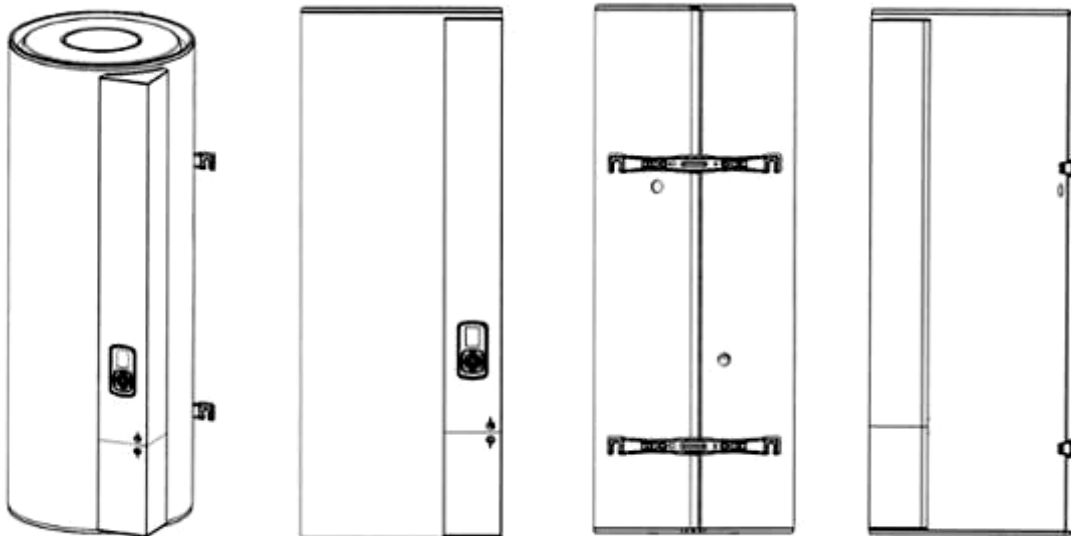

1.1

1.2

1.3

1.4

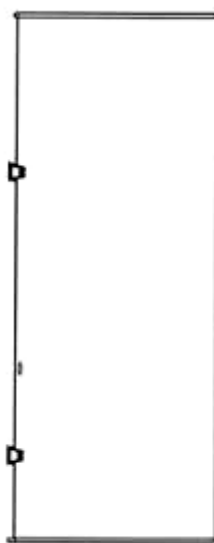

1.5



1.6

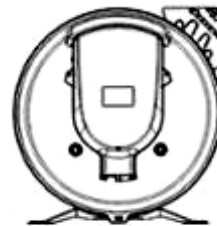

1.7

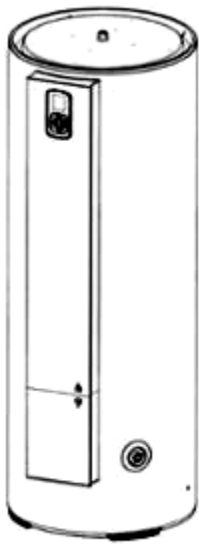

2.1

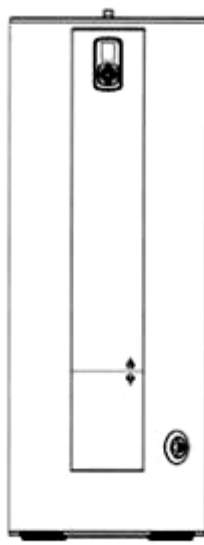

2.2

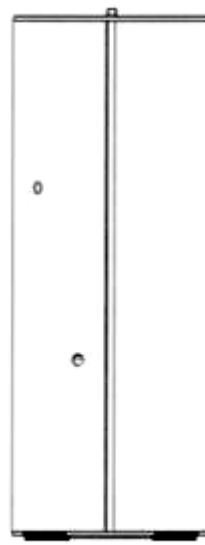

2.3

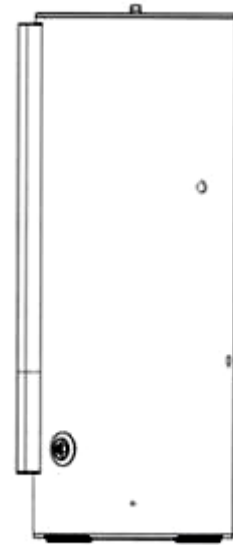

2.4

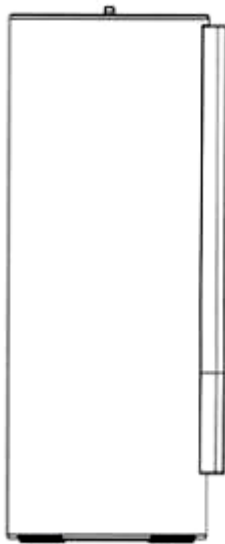

2.5

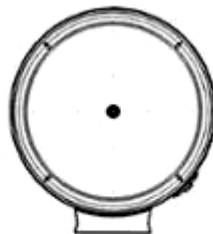

2.6



2.7

- (11) **47562**
(21) 3-2023-00096 (28) 1
(54) **LÒ SỬỞI** (51) **23-03**
(22) 11/01/2023 (43) 25/07/2023
(30) 29/865,797 12/08/2022 US;
(73) **SOLO BRANDS, LLC (US)**
1001 Mustang Dr., Grapevine, TX 76051, United States of America
(72) 1. JEFFREY R. WEILERT (US)
2. ALEXANDER K. MAGHSADI (US)
(74) Công ty Luật TNHH T&G (TGVN)
(55)

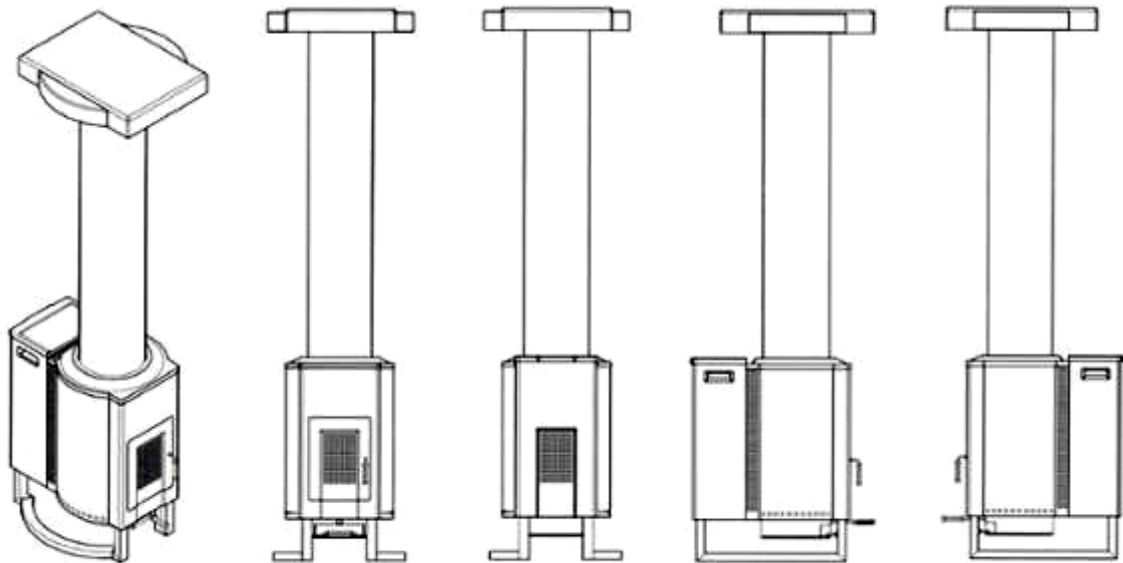

1.1

1.2

1.3

1.4

1.5

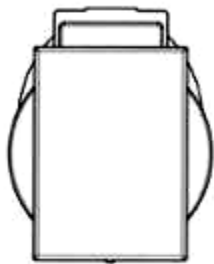

1.6



1.7

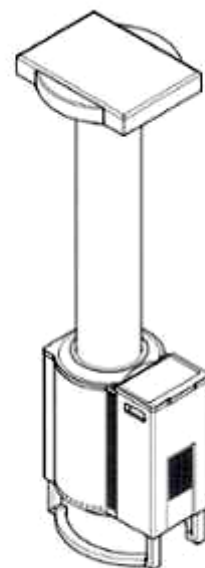

1.8

CÔNG BÁO SỞ HỮU CÔNG NGHIỆP SỐ 424 TẬP A – QUYỀN 2 (07.2023)

- (11) **47563**
(21) 3-2023-00097 (28) 1
(54) **MÁY HÚT BỤI DẠNG CÁN** (51) **15-05**
(22) 11/01/2023 (43) 25/07/2023
(73) **ARCELIK HITACHI HOME APPLIANCES (THAILAND) LIMITED (TH)**
No. 610/1, Mu 9, Nong Ki Sub-district, Kabin Buri District, Prachin Buri Province,
Thailand
(72) 1. HANS HAN (CN)
2. SYLVIA XIE (CN)
3. ERIC TAN (CN)
(74) Công ty Luật TNHH T&G (TGVN)
(55)



1.1

1.2

1.3

1.4

1.5



1.6



1.7

- (11) **47564**
(21) 3-2023-00201 (28) 1
(54) **VỎ BỘ ĐIỀU KHIỂN THIẾT BỊ ĐIỆN TỬ** (51) **21-01**
(22) 27/01/2023 (43) 25/07/2023
(30) 202230508377.3 05/08/2022 CN;
(73) **SONY INTERACTIVE ENTERTAINMENT INC. (JP)**
1-7-1 Konan, Minato-ku, Tokyo, Japan
(72) Daisuke KURIHARA (JP)
(74) Công ty Luật TNHH Phạm và Liên danh (PHAM & ASSOCIATES)
(55)

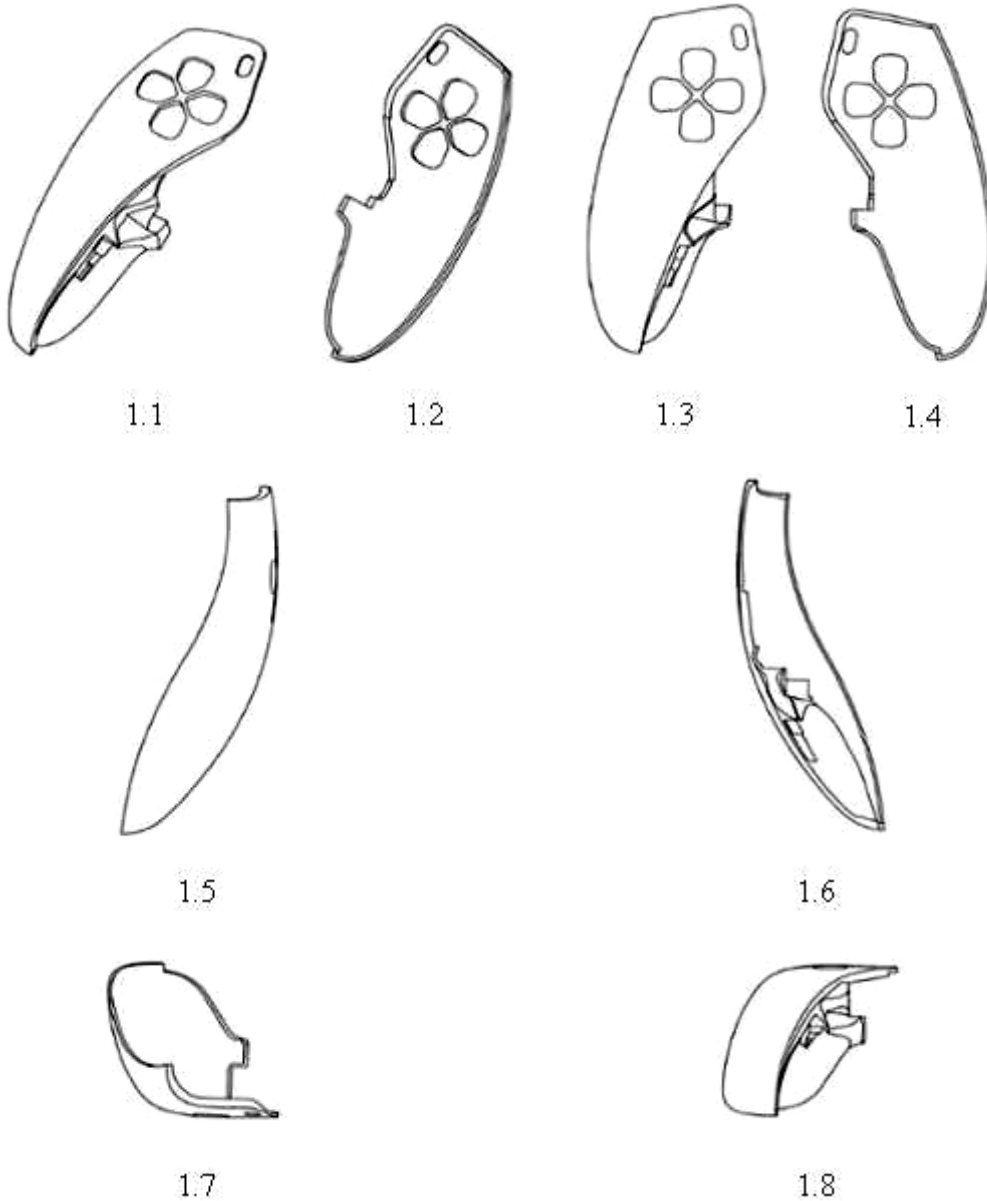

CÔNG BÁO SỞ HỮU CÔNG NGHIỆP SỐ 424 TẬP A – QUYỀN 2 (07.2023)

- (11) **47565**
(21) 3-2023-00202 (28) 1
(54) **VỎ BỘ ĐIỀU KHIỂN THIẾT BỊ ĐIỆN TỬ** (51) **21-01**
(22) 27/01/2023 (43) 25/07/2023
(30) 202230508377.3 05/08/2022 CN;
(73) **SONY INTERACTIVE ENTERTAINMENT INC. (JP)**
1-7-1 Konan, Minato-ku, Tokyo, Japan
(72) Daisuke KURIHARA (JP)
(74) Công ty Luật TNHH Phạm và Liên danh (PHAM & ASSOCIATES)
(55)

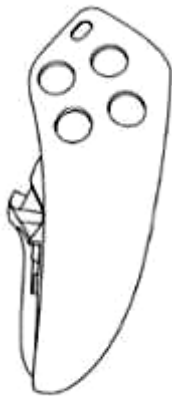

1.1



1.2



1.3

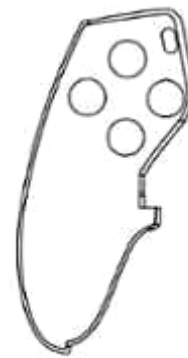

1.4



1.5



1.6



1.7



1.8

- (11) **47566**
- (21) 3-2023-00246
- (54) **HỒ ĐỐT LỬA**
- (22) 03/02/2023
- (30) 29/865,766 11/08/2022 US;
- (73) **SOLO BRANDS, LLC (US)**
1001 Mustang Dr., Grapevine, TX 76051, United States of America
- (72) 1. JEFFREY R. WEILERT (US)
2. ALEXANDER K. MAGHSADI (US)
- (74) Công ty Luật TNHH T&G (TGVN)
- (55)

- (28) 1
- (51) **23-03**
- (43) 25/07/2023

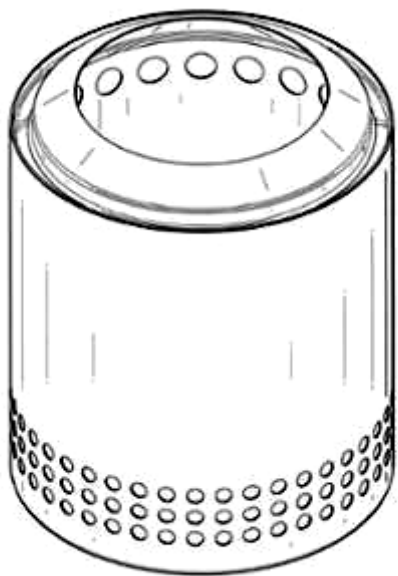

1.1

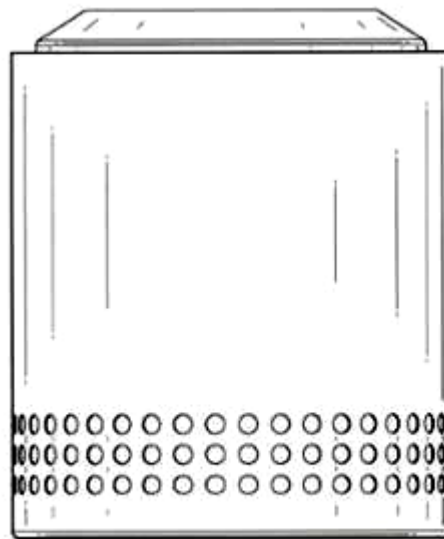

1.2

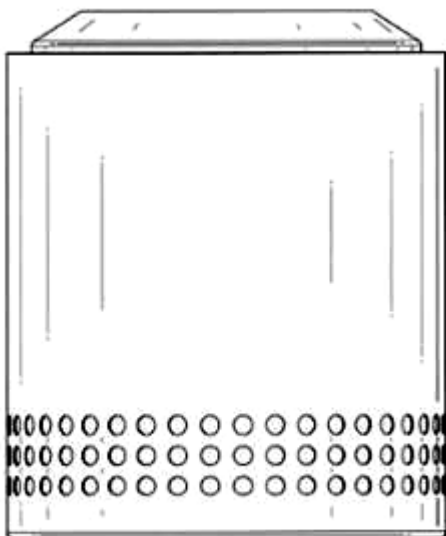

1.3

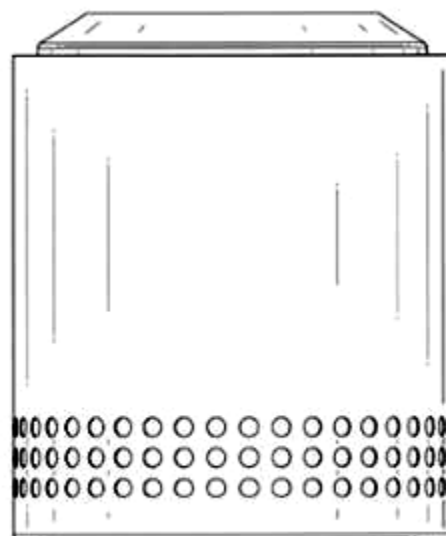

1.4

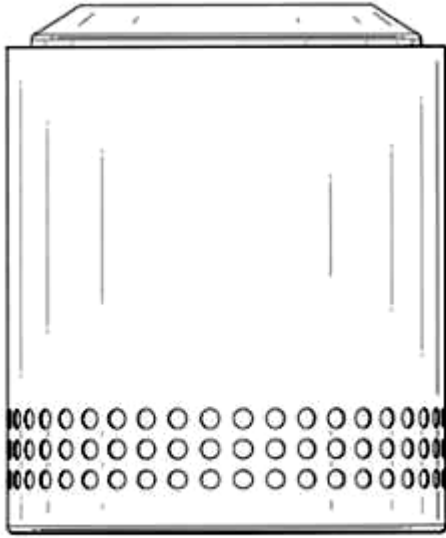

1.5

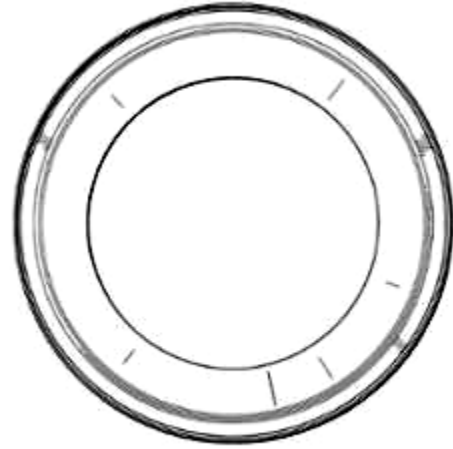

1.6

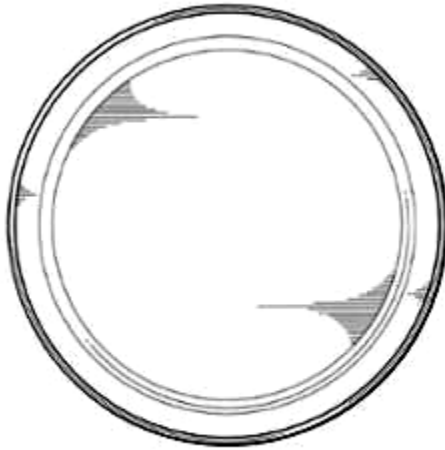

1.7

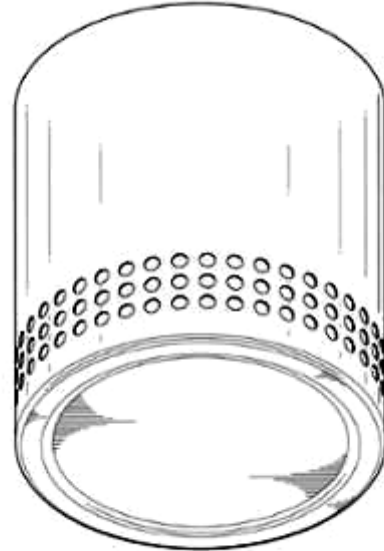

1.8

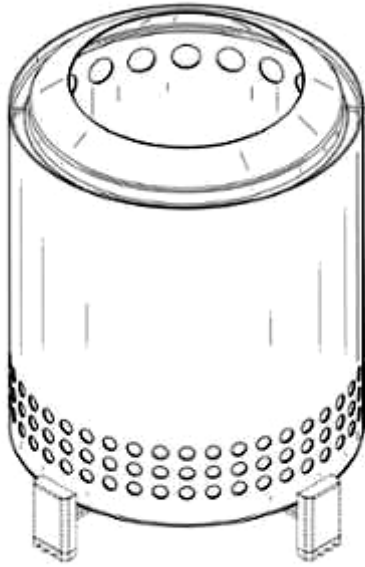

1.9

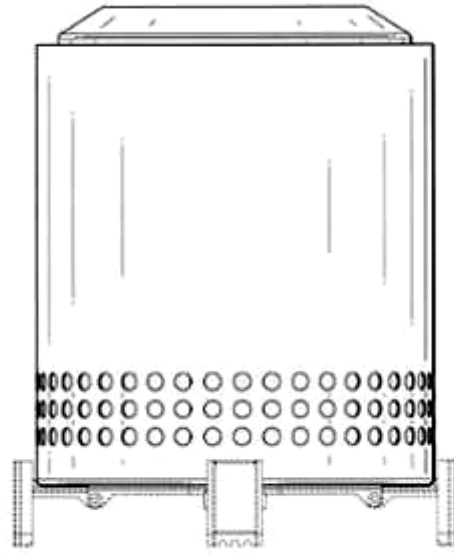

1.10

CÔNG BÁO SỞ HỮU CÔNG NGHIỆP SỐ 424 TẬP A – QUYỀN 2 (07.2023)

- (11) **47567**
(21) 3-2023-00324 (28) 1
(54) **NẮP CHAI NƯỚC XÁCH TAY** (51) **09-07**
(22) 20/02/2023 (43) 25/07/2023
(73) **ENVIONEER CO., LTD (KR)**
85-1, 85, Hanbang expo-ro, Jecheon-si, Chungcheongbuk-do 27116 Republic of Korea
(72) HAN, Jeong Cheol (KR)
(74) Công ty Luật TNHH Phạm và Liên danh (PHAM & ASSOCIATES)
(55)

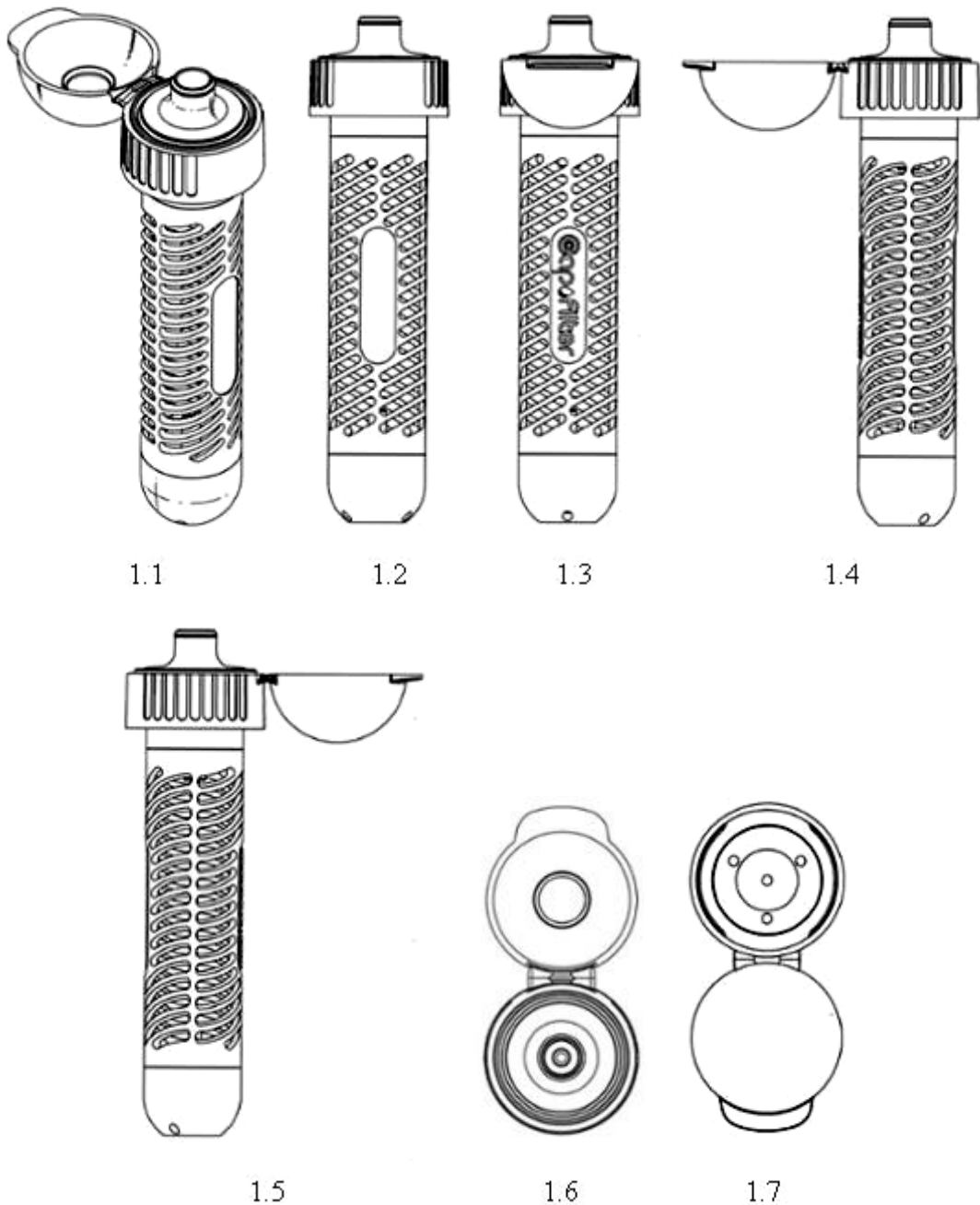

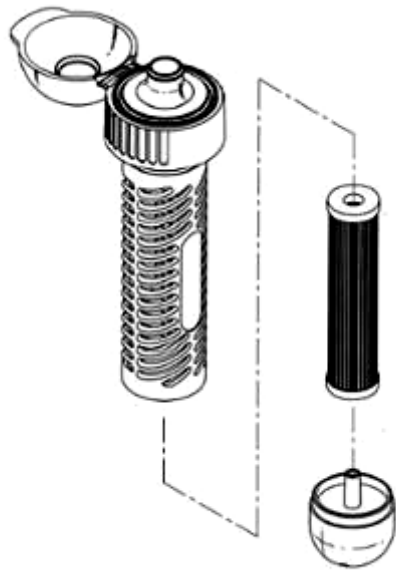

1.8



1.9

CÔNG BÁO SỞ HỮU CÔNG NGHIỆP SỐ 424 TẬP A – QUYỀN 2 (07.2023)

- (11) **47568**
(21) 3-2023-00336 (28) 2
(54) **TAY CẦM CỦA DỤNG CỤ CHĂM SÓC RĂNG MIỆNG** (51) **04-02**
(22) 22/02/2023 (43) 25/07/2023
(30) 29/851,429 29/08/2022 US;
(73) **COLGATE-PALMOLIVE COMPANY (US)**
300 Park Avenue, New York, New York 10022, United States of America
(72) 1. JIANG ZHOU (CN)
2. JINHONG YUAN (CN)
3. JOHN YAO (CN)
4. JINGBO WU (CN)
5. MIN TENG (CN)
(74) Văn phòng Luật sư Ân Nam (ANNAM IP & LAW)
(55)

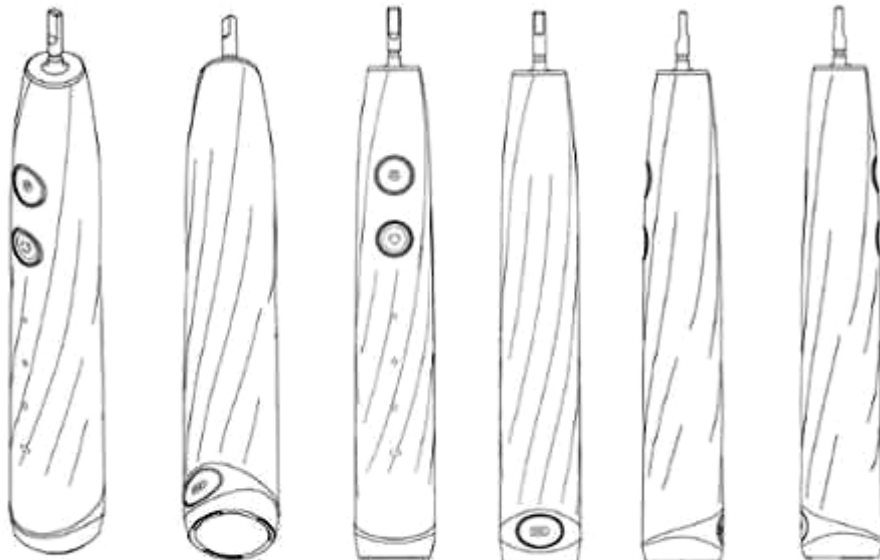

1.1

1.2

1.3

1.4

1.5

1.6



1.7



1.8



2.1

2.2

2.3

2.4

2.5

2.6



2.7



2.8

CÔNG BÁO SỞ HỮU CÔNG NGHIỆP SỐ 424 TẬP A – QUYỀN 2 (07.2023)

(11) **47569**

(21) 3-2023-00562

(28) 1

(54) **MÁY NGHIỀN**

(51) **15-99**

(22) 17/03/2023

(43) 25/07/2023

(73) **NGÔ QUỐC VINH (VN)**

630/17/5 Quốc lộ 13, phường Hiệp Bình Phước, thành phố Thủ Đức, thành phố Hồ Chí Minh

(72) Ngô Quốc Vinh (VN)

(55)

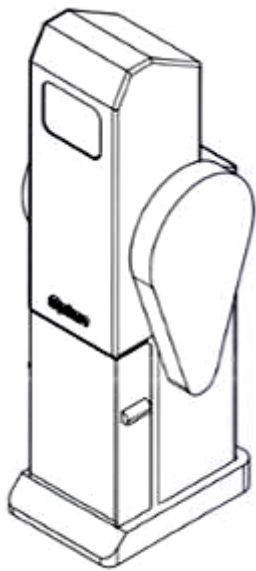

1.1



1.2

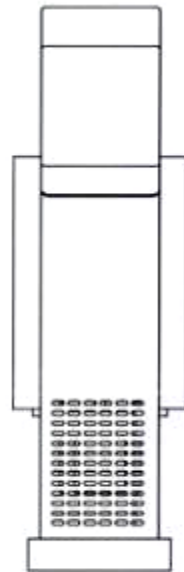

1.3

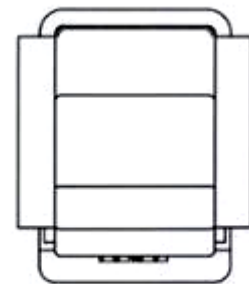

1.4

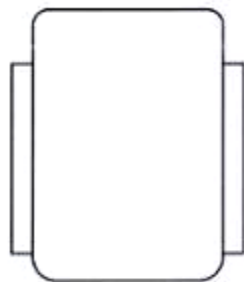

1.5

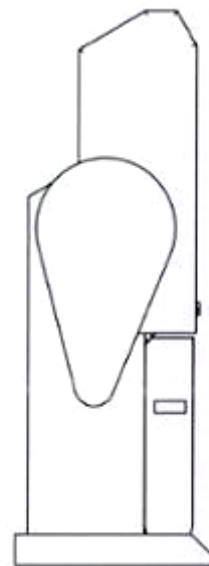

1.6

CÔNG BÁO SỞ HỮU CÔNG NGHIỆP SỐ 424 TẬP A – QUYỀN 2 (07.2023)

- (11) **47570**
(21) 3-2023-00673 (28) 1
(54) **THIẾT BỊ GIÚP GIẢM TIẾNG ĐỘNG VÀ HÚT MÙI BỒN CẦU** (51) **23-02**
(22) 28/03/2023 (43) 25/07/2023
(73) **VŨ MINH VƯƠNG (VN)**
Số 28, ngõ 33, tổ 35, phố Lãng Yên, phường Thanh Lương, quận Hai Bà Trưng, thành phố Hà Nội
(72) Vũ Minh Vương (VN)
(55)



1.1



1.2



1.3



1.4



1.5

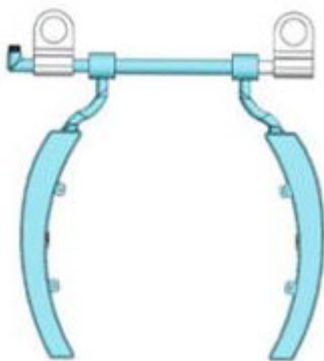

1.6

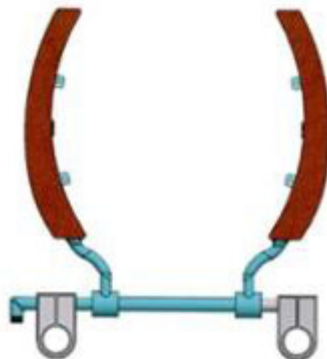

1.7



1.8

CÔNG BÁO SỞ HỮU CÔNG NGHIỆP SỐ 424 TẬP A – QUYỀN 2 (07.2023)

- (11) **47571**
(21) 3-2023-00812 (28) 1
(54) **GẠCH LÁT NỀN** (51) **25-01**
(22) 11/04/2023 (43) 25/07/2023
(73) **VÕ NHƯ THẮNG (VN)**
K294/40 Nguyễn Lương Bằng, phường Hòa Khánh Bắc, quận Liên Chiểu, thành phố Đà Nẵng
(72) Võ Như Thắng (VN)
(55)



1.1



1.2



1.3



1.4



1.5



1.6



1.7

CÔNG BÁO SỞ HỮU CÔNG NGHIỆP SỐ 424 TẬP A – QUYỀN 2 (07.2023)

- (11) 47572
(21) 3-2023-00982
(54) **CAN ĐỰNG SẢN PHẨM**
(22) 05/05/2023
(73) **CÔNG TY TNHH XNK NANOIL USA (VN)**
Lô Q13 đường số 11, KCN Hải Sơn mở rộng (GD 3+4), xã Đức Hòa Hạ, huyện Đức Hoà, tỉnh Long An
(72) Mai Xuân Quang (VN)
(55)
- (28) 1
(51) **09-02**
(43) 25/07/2023



1.1



1.2



1.3



1.4



1.5



1.6



1.7

(11) **47573**

(21) 3-2023-00984

(28) 1

(54) **CHÓT NỐI GẠCH**

(51) **25-01**

(22) 05/05/2023

(43) 25/07/2023

(73) **ASURO CO.,LTD. (JP)**

2-16-1, Nishi, Shiraoka-shi, Saitama 3490205 Japan

(72) SUGA, Masaaki (JP)

(74) Công ty TNHH Ban Ca (BANCA)

(55)

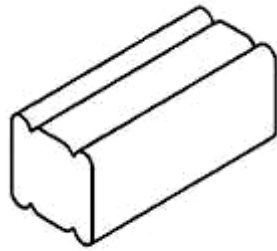

1.1



1.2



1.3



1.4



1.5



1.6



1.7



1.8

(11) **47574**

(21) 3-2023-00985

(28) 1

(54) **GẠCH BÊ TÔNG**

(51) **25-01**

(22) 05/05/2023

(43) 25/07/2023

(73) **ASURO CO.,LTD. (JP)**

2-16-1, Nishi, Shiraoka-shi, Saitama 3490205 Japan

(72) SUGA, Masaaki (JP)

(74) Công ty TNHH Ban Ca (BANCA)

(55)

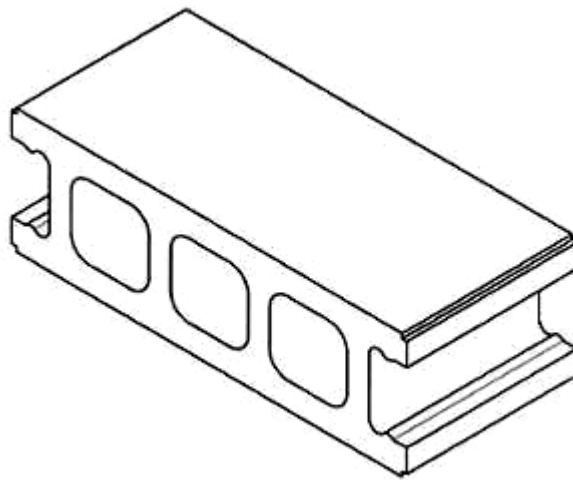

1.1

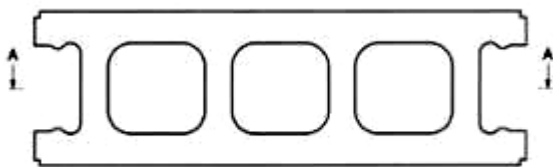

1.2

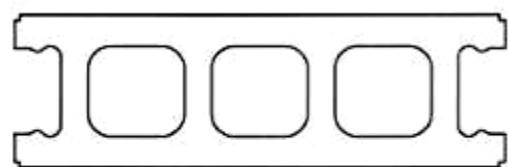

1.3

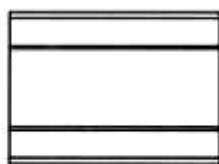

1.4

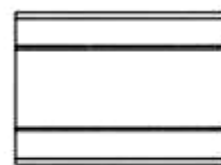

1.5



1.6



1.7

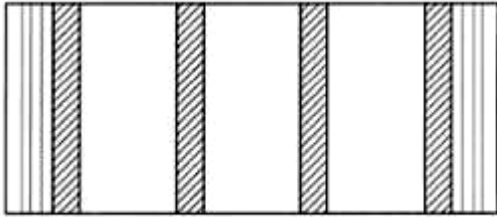

1.8

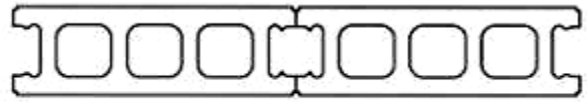

1.9

CÔNG BÁO SỞ HỮU CÔNG NGHIỆP SỐ 424 TẬP A – QUYỀN 2 (07.2023)

- (11) **47575**
(21) 3-2022-02936 (28) 1
(54) **XE ĐẠP ĐIỆN** (51) **12-11**
(22) 29/12/2022 (43) 25/07/2023
(73) **CÔNG TY CỔ PHẦN SẢN XUẤT VÀ KINH DOANH VINFAST (VN)**
Khu Kinh tế Đình Vũ-Cát Hải, đảo Cát Hải, thị trấn Cát Hải, huyện Cát Hải, thành phố Hải Phòng
(72) 1. ESKILD HANSEN (DK)
2. ANDERS LASSEN (DK)
(74) **CÔNG TY LUẬT TRÁCH NHIỆM HỮU HẠN AMBYS HÀ NỘI (AMBYS HANOI)**
(55)



1.1



1.2



1.3



1.4



1.5



1.6



1.7



1.8

CÔNG BÁO SỞ HỮU CÔNG NGHIỆP SỐ 424 TẬP A – QUYỀN 2 (07.2023)

- (11) **47576**
(21) 3-2022-02937 (28) 1
(54) **XE ĐẠP ĐIỆN** (51) **12-11**
(22) 29/12/2022 (43) 25/07/2023
(73) **CÔNG TY CỔ PHẦN SẢN XUẤT VÀ KINH DOANH VINFAST (VN)**
Khu Kinh tế Đình Vũ-Cát Hải, đảo Cát Hải, thị trấn Cát Hải, huyện Cát Hải, thành phố Hải Phòng
(72) 1. ESKILD HANSEN (DK)
2. ANDERS LASSEN (DK)
(74) **CÔNG TY LUẬT TRÁCH NHIỆM HỮU HẠN AMBYS HÀ NỘI (AMBYS HANOI)**
(55)



1.1



1.2



1.3



1.4



1.5



1.6

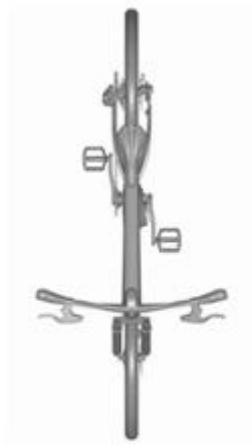

17



18

CÔNG BÁO SỞ HỮU CÔNG NGHIỆP SỐ 424 TẬP A – QUYỀN 2 (07.2023)

(11) **47577**

(21) 3-2022-02938

(28) 1

(54) **XE ĐẠP ĐIỆN**

(51) **12-11**

(22) 29/12/2022

(43) 25/07/2023

(73) **CÔNG TY CỔ PHẦN SẢN XUẤT VÀ KINH DOANH VINFAST (VN)**

Khu Kinh tế Đình Vũ-Cát Hải, đảo Cát Hải, thị trấn Cát Hải, huyện Cát Hải, thành phố Hải Phòng

(72) 1. ESKILD HANSEN (DK)

2. ANDERS LASSEN (DK)

(74) **CÔNG TY LUẬT TRÁCH NHIỆM HỮU HẠN AMBYS HÀ NỘI (AMBYS HANOI)**

(55)



1.1



1.2



1.3



1.4



1.5



1.6

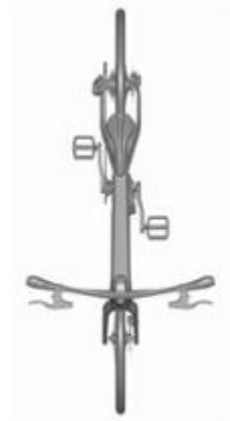

17

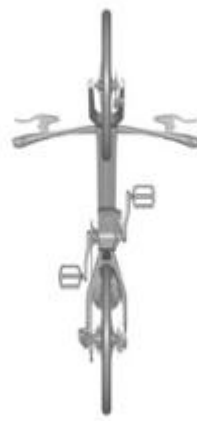

18

CÔNG BÁO SỞ HỮU CÔNG NGHIỆP SỐ 424 TẬP A – QUYỀN 2 (07.2023)

- (11) **47578**
(21) 3-2022-02939 (28) 1
(54) **XE ĐẠP ĐIỆN** (51) **12-11**
(22) 29/12/2022 (43) 25/07/2023
(73) **CÔNG TY CỔ PHẦN SẢN XUẤT VÀ KINH DOANH VINFAST (VN)**
Khu Kinh tế Đình Vũ-Cát Hải, đảo Cát Hải, thị trấn Cát Hải, huyện Cát Hải, thành phố Hải Phòng
(72) 1. ESKILD HANSEN (DK)
2. ANDERS LASSEN (DK)
(74) **CÔNG TY LUẬT TRÁCH NHIỆM HỮU HẠN AMBYS HÀ NỘI (AMBYS HANOI)**
(55)



1.1

1.2

1.3

1.4



1.5

1.6

1.7

1.8

- (11) **47579**
(21) 3-2021-02713 (28) 1
(54) **LỢ** (51) **09-01**
(22) 03/11/2021 (43) 25/07/2023
(30) 30-2021-0026299 02/06/2021 KR;
(73) **AMOREPACIFIC CORPORATION (KR)**
100, Hangang-daero, Yongsan-gu, Seoul, Republic of Korea
(72) SHIN, Min Kyung (KR)
(74) Công ty Luật TNHH T&G (TGVN)
(55)



1.1



1.2



1.3



1.4



1.5



1.6



1.7

- (11) **47580**
- (21) 3-2022-01081
- (54) **BĂNG VỆ SINH**
- (22) 29/07/2021
- (30) 202130179655.0 31/03/2021 CN;
- (73) **UNICHARM CORPORATION (JP)**
182, Shimobun, Kinsei-cho, Shikokuchuo-City, Ehime 7990111, Japan
- (72) 1. AKIRA HASHINO (JP)
2. RANIDA KONTHIENG (TH)
3. MANTHANA WANASBODEE (TH)
- (74) Công ty Cổ phần Sở hữu công nghiệp INVESTIP (INVESTIP)
- (55)



1.1



1.2



1.3



1.4



1.5



1.6



1.7

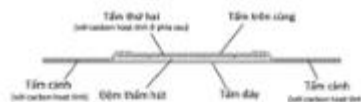

1.8

CÔNG BÁO SỞ HỮU CÔNG NGHIỆP SỐ 424 TẬP A – QUYỀN 2 (07.2023)

- (11) **47581**
- (21) 3-2022-02523 (28) 1
- (54) **VẢI** (51) **05-05**
- (22) 18/11/2022 (43) 25/07/2023
- (30) 30-2022-0019827 18/05/2022 KR;
- (73) **HOTEL LOTTE CO., LTD.** (KR)
30, Eulji-Ro, Jung-Gu, Seoul, Republic Of Korea (Sogong-dong)
- (72) Lee, Sangjean (KR)
- (74) Công ty TNHH Trường Xuân (AGELESS CO.,LTD.)
- (55)

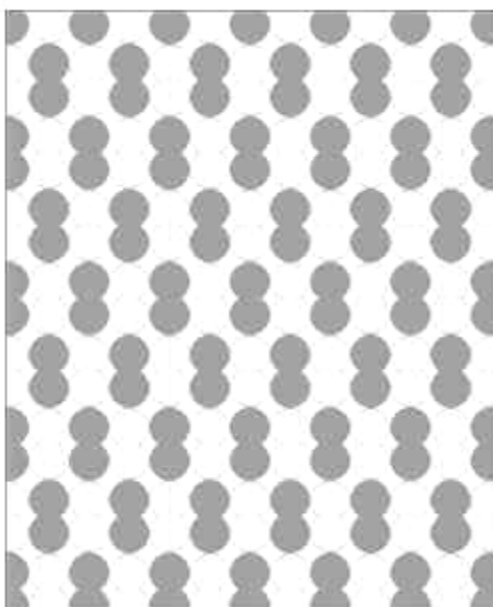

CÔNG BÁO SỞ HỮU CÔNG NGHIỆP SỐ 424 TẬP A – QUYỀN 2 (07.2023)

- (11) **47582**
- (21) 3-2022-02530 (28) 1
- (54) **GIẤY** (51) **05-06**
- (22) 18/11/2022 (43) 25/07/2023
- (30) 30-2022-0019820 18/05/2022 KR; 30-2022-0019819 18/05/2022 KR;
- (73) **HOTEL LOTTE CO., LTD.** (KR)
30, Eulji-Ro, Jung-Gu, Seoul, Republic Of Korea (Sogong-dong)
- (72) Lee, Sangjean (KR)
- (74) Công ty TNHH Trường Xuân (AGELESS CO.,LTD.)
- (55)



CÔNG BÁO SỞ HỮU CÔNG NGHIỆP SỐ 424 TẬP A – QUYỀN 2 (07.2023)

- (11) **47583**
- (21) 3-2022-02531 (28) 1
- (54) **GIẤY** (51) **05-06**
- (22) 18/11/2022 (43) 25/07/2023
- (30) 30-2022-0019823 18/05/2022 KR; 30-2022-0019822 18/05/2022 KR;
- (73) **HOTEL LOTTE CO., LTD.** (KR)
30, Eulji-Ro, Jung-Gu, Seoul, Republic Of Korea (Sogong-dong)
- (72) Lee, Sangjean (KR)
- (74) Công ty TNHH Trường Xuân (AGELESS CO.,LTD.)
- (55)



CÔNG BÁO SỞ HỮU CÔNG NGHIỆP SỐ 424 TẬP A – QUYỀN 2 (07.2023)

- (11) **47584**
(21) 3-2022-02532 (28) 1
(54) **GIẤY** (51) **05-06**
(22) 18/11/2022 (43) 25/07/2023
(30) 30-2022-0019832 18/05/2022 KR; 30-2022-0019831 18/05/2022 KR;
(73) **HOTEL LOTTE CO., LTD.** (KR)
30, Eulji-Ro, Jung-Gu, Seoul, Republic Of Korea (Sogong-dong)
(72) Lee, Sangjean (KR)
(74) Công ty TNHH Trường Xuân (AGELESS CO.,LTD.)
(55)



CÔNG BÁO SỞ HỮU CÔNG NGHIỆP SỐ 424 TẬP A – QUYỀN 2 (07.2023)

- (11) **47585**
- (21) 3-2022-02537 (28) 1
- (54) **VẢI** (51) **05-05**
- (22) 18/11/2022 (43) 25/07/2023
- (30) 30-2022-0019818 18/05/2022 KR;
- (73) **HOTEL LOTTE CO., LTD.** (KR)
30, Eulji-Ro, Jung-Gu, Seoul, Republic Of Korea (Sogong-dong)
- (72) Lee, Sangjean (KR)
- (74) Công ty TNHH Trường Xuân (AGELESS CO.,LTD.)
- (55)



CÔNG BÁO SỞ HỮU CÔNG NGHIỆP SỐ 424 TẬP A – QUYỀN 2 (07.2023)

- (11) **47586**
- (21) 3-2022-02538 (28) 1
- (54) **VẢI** (51) **05-05**
- (22) 18/11/2022 (43) 25/07/2023
- (30) 30-2022-0019830 18/05/2022 KR;
- (73) **HOTEL LOTTE CO., LTD.** (KR)
30, Eulji-Ro, Jung-Gu, Seoul, Republic Of Korea (Sogong-dong)
- (72) Lee, Sangjean (KR)
- (74) Công ty TNHH Trường Xuân (AGELESS CO.,LTD.)
- (55)



CÔNG BÁO SỞ HỮU CÔNG NGHIỆP SỐ 424 TẬP A – QUYỀN 2 (07.2023)

- (11) **47587**
- (21) 3-2022-02541 (28) 1
- (54) **VẢI** (51) **05-05**
- (22) 18/11/2022 (43) 25/07/2023
- (30) 30-2022-0019824 18/05/2022 KR;
- (73) **HOTEL LOTTE CO., LTD.** (KR)
30, Eulji-Ro, Jung-Gu, Seoul, Republic Of Korea (Sogong-dong)
- (72) Lee, Sangjean (KR)
- (74) Công ty TNHH Trường Xuân (AGELESS CO.,LTD.)
- (55)

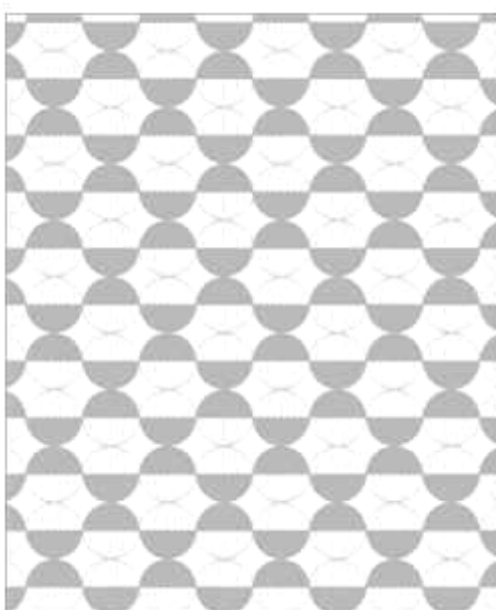

CÔNG BÁO SỞ HỮU CÔNG NGHIỆP SỐ 424 TẬP A – QUYỀN 2 (07.2023)

- (11) **47588**
(21) 3-2022-02542 (28) 1
(54) **GIẤY** (51) **05-06**
(22) 18/11/2022 (43) 25/07/2023
(30) 30-2022-0019826 18/05/2022 KR; 30-2022-0019825 18/05/2022 KR;
(73) **HOTEL LOTTE CO., LTD.** (KR)
30, Eulji-Ro, Jung-Gu, Seoul, Republic Of Korea (Sogong-dong)
(72) Lee, Sangjean (KR)
(74) Công ty TNHH Trường Xuân (AGELESS CO.,LTD.)
(55)

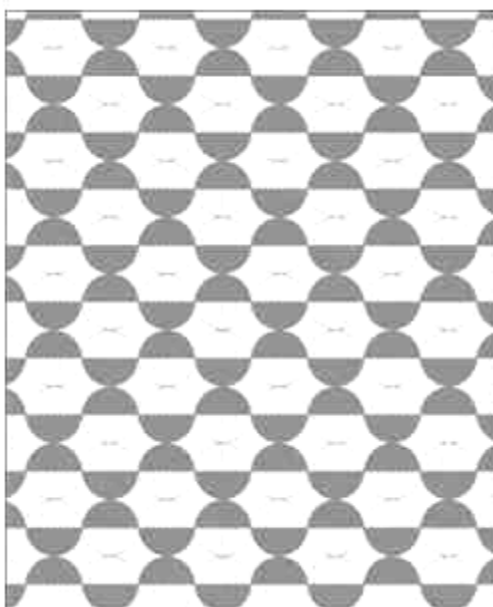

CÔNG BÁO SỞ HỮU CÔNG NGHIỆP SỐ 424 TẬP A – QUYỀN 2 (07.2023)

- (11) **47589**
- (21) 3-2022-02543 (28) 1
- (54) **GIẤY** (51) **05-06**
- (22) 18/11/2022 (43) 25/07/2023
- (30) 30-2022-0019829 18/05/2022 KR; 30-2022-0019828 18/05/2022 KR;
- (73) **HOTEL LOTTE CO., LTD.** (KR)
30, Eulji-Ro, Jung-Gu, Seoul, Republic Of Korea (Sogong-dong)
- (72) Lee, Sangjean (KR)
- (74) Công ty TNHH Trường Xuân (AGELESS CO.,LTD.)
- (55)

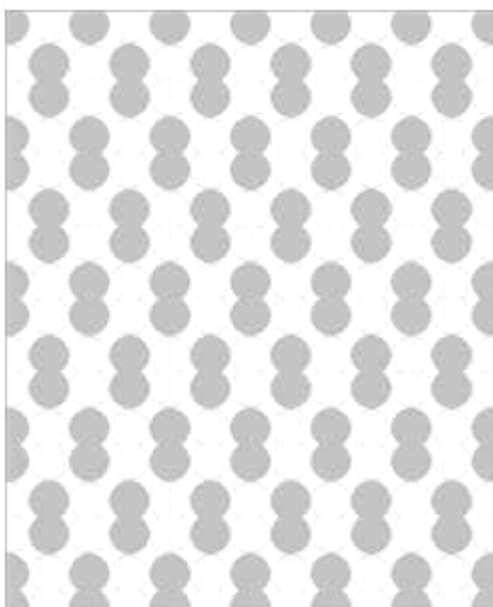

CÔNG BÁO SỞ HỮU CÔNG NGHIỆP SỐ 424 TẬP A – QUYỀN 2 (07.2023)

- (11) **47590**
- (21) 3-2022-02546 (28) 1
- (54) **VẢI** (51) **05-05**
- (22) 18/11/2022 (43) 25/07/2023
- (30) 30-2022-0019821 18/05/2022 KR;
- (73) **HOTEL LOTTE CO., LTD.** (KR)
30, Eulji-Ro, Jung-Gu, Seoul, Republic Of Korea (Sogong-dong)
- (72) Lee, Sangjean (KR)
- (74) Công ty TNHH Trường Xuân (AGELESS CO.,LTD.)
- (55)



CÔNG BÁO SỞ HỮU CÔNG NGHIỆP SỐ 424 TẬP A – QUYỀN 2 (07.2023)

- (11) **47591**
(21) 3-2023-00540 (28) 1
(54) **CHAI** (51) **09-01**
(22) 13/03/2023 (43) 25/07/2023
(73) **CÔNG TY TNHH HÓA MỸ PHẨM NGỌC THỦY (VN)**
101/31 Phạm Đình Hồ, phường 06, quận 6, thành phố Hồ Chí Minh
(72) Trịnh Gia Phú (VN)
(74) **CÔNG TY TNHH SỞ HỮU TRÍ TUỆ SETHACO (SETHACO IP CO.,LTD)**
(55)



1.1



1.2



1.3



1.4



1.5

CÔNG BÁO SỞ HỮU CÔNG NGHIỆP SỐ 424 TẬP A – QUYỀN 2 (07.2023)

- (11) **47592**
(21) 3-2023-00545 (28) 1
(54) **CAN ĐỰNG DẦU NHỚT** (51) **09-02**
(22) 14/03/2023 (43) 25/07/2023
(73) **CÔNG TY TNHH NAK VIỆT NAM (VN)**
45 đường D4A, khu dân cư Hưng Phú, phường Phước Long B, thành phố Thủ Đức,
thành phố Hồ Chí Minh
(72) Nguyễn Lê Khoa Thy (VN)
(55)



1.1



1.2



1.3



1.4



1.5



1.6

CÔNG BÁO SỞ HỮU CÔNG NGHIỆP SỐ 424 TẬP A – QUYỀN 2 (07.2023)

- (11) **47593**
(21) 3-2023-00582 (28) 1
(54) **KHAY** (51) **09-04**
(22) 20/03/2023 (43) 25/07/2023
(73) **CÔNG TY CỔ PHẦN TẬP ĐOÀN THIÊN LONG (VN)**
Tầng 10, Sofic Tower, số 10 đường Mai Chí Thọ, phường Thủ Thiêm, thành phố
Thủ Đức, thành phố Hồ Chí Minh
(72) Cô Gia Thọ (VN)
(74) Công ty TNHH Tư vấn sở hữu trí tuệ Việt (VIET IP CO.,LTD.)
(55)

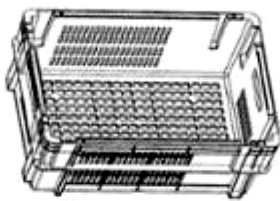

1.1

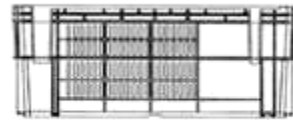

1.2



1.3

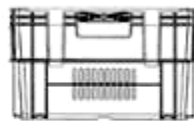

1.4

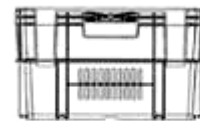

1.5

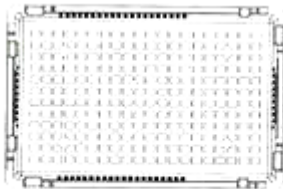

1.6

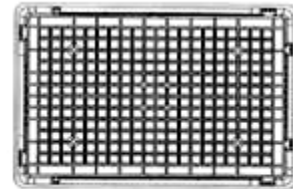

1.7

CÔNG BÁO SỞ HỮU CÔNG NGHIỆP SỐ 424 TẬP A – QUYỀN 2 (07.2023)

- (11) **47594**
(21) 3-2023-00613 (28) 1
(54) **HỘP GIẤY** (51) **09-03**
(22) 22/03/2023 (43) 25/07/2023
(73) **CÔNG TY CỔ PHẦN GIẢI PHÁP ĐÓNG GÓI MAGIX (VN)**
Số 02-04 Alexandre de Rhodes, phường Bến Nghé, quận 1, thành phố Hồ Chí Minh
(72) Đỗ Hữu Tân (VN)
(74) Công ty TNHH MASTERBRAND (MASTERBRAND)
(55)



1.1



1.2



1.3



1.4



1.5



1.6



1.7



1.8

CÔNG BÁO SỞ HỮU CÔNG NGHIỆP SỐ 424 TẬP A – QUYỀN 2 (07.2023)

- (11) **47595**
(21) 3-2023-00664 (28) 1
(54) **HỘP GIẤY** (51) **09-03**
(22) 27/03/2023 (43) 25/07/2023
(73) **CÔNG TY CỔ PHẦN GIẢI PHÁP ĐÓNG GÓI MAGIX (VN)**
Số 02-04 Alexandre de Rhodes, phường Bến Nghé, quận 1, thành phố Hồ Chí Minh
(72) Đỗ Hữu Tân (VN)
(74) Công ty TNHH MASTERBRAND (MASTERBRAND)
(55)



1.1



1.2



1.3



1.4



1.5



1.6



1.7

- (11) **47596**
(21) 3-2023-00328 (28) 1
(54) **LỌ** (51) **09-01**
(22) 21/02/2023 (43) 25/07/2023
(73) **LG HOUSEHOLD & HEALTH CARE LTD. (KR)**
58, Saemunan-ro, Jongno-gu, Seoul, Republic of Korea
(72) 1. JUNG, MIN JEONG (KR)
2. LEE, HYE JIN (KR)
(74) Công ty TNHH Tâm nhìn và Liên danh (VISION & ASSOCIATES CO.LTD.)
(55)



1.1



1.2



1.3



1.4



1.5



1.6



1.7



1.8

CÔNG BÁO SỞ HỮU CÔNG NGHIỆP SỐ 424 TẬP A – QUYỀN 2 (07.2023)

(11) **47597**

(21) 3-2023-00332

(28) 1

(54) **CHÉN**

(51) **07-01**

(22) 22/02/2023

(43) 25/07/2023

(73) **CÔNG TY TNHH MINH LONG I (VN)**

333 đường Hưng Định 24, khu phố Hưng Lộc, phường Hưng Định, thành phố Thuận An, tỉnh Bình Dương

(72) Lý Huy Sáng (VN)

(55)



1.1



1.2



1.3



1.4

CÔNG BÁO SỞ HỮU CÔNG NGHIỆP SỐ 424 TẬP A – QUYỀN 2 (07.2023)

- (11) **47598**
(21) 3-2023-00333 (28) 1
(54) **SỨ CÁCH ĐIỆN** (51) **13-03**
(22) 22/02/2023 (43) 25/07/2023
(73) **CÔNG TY TNHH SỬ KỸ THUẬT MINH LONG 2 (VN)**
Số 328, đại lộ Bình Dương, khu phố Hưng Lộc, phường Hưng Định, thành phố
Thuận An, tỉnh Bình Dương
(72) Dương Tuấn Vũ (VN)
(74) Công ty TNHH Tư vấn - Dịch thuật - Sở hữu trí tuệ Á Đông (Á Đông IP
CONSULTANCY CO.,LTD.)
(55)



1.1



1.2



1.3



1.4



1.5

- (11) **47599**
(21) 3-2023-00334 (28) 1
(54) **SỨ CÁCH ĐIỆN** (51) **13-03**
(22) 22/02/2023 (43) 25/07/2023
(73) **CÔNG TY TNHH SỨ KỸ THUẬT MINH LONG 2 (VN)**
Số 328, đại lộ Bình Dương, khu phố Hưng Lộc, phường Hưng Định, thành phố Thuận An, tỉnh Bình Dương
(72) Dương Tuấn Vũ (VN)
(74) Công ty TNHH Tư vấn - Dịch thuật - Sở hữu trí tuệ Á Đông (Á Đông IP CONSULTANCY CO.,LTD.)
(55)



1.1



1.2



1.3



1.4



1.5

CÔNG BÁO SỞ HỮU CÔNG NGHIỆP SỐ 424 TẬP A – QUYỀN 2 (07.2023)

- (11) **47600**
(21) 3-2023-00494 (28) 1
(54) **ROBOT TỰ HÀNH** (51) **12-14**
(22) 08/03/2023 (43) 25/07/2023
(73) **CÔNG TY TNHH LEON LEGION (VN)**
269 Đường Liên Phường, Phường Phước Long B, Thành phố Thủ Đức, Thành phố Hồ Chí Minh
(72) Hoàng Xuân Thành (VN)
(74) Công ty Luật TNHH Tư vấn Quốc tế (INDOCHINE COUNSEL)
(55)



1.1



1.2



1.3



1.4



1.5



1.6



1.7



1.8



1.9

CÔNG BÁO SỞ HỮU CÔNG NGHIỆP SỐ 424 TẬP A – QUYỀN 2 (07.2023)

- (11) **47601**
(21) 3-2023-00495 (28) 1
(54) **ROBOT TỰ HÀNH** (51) **12-14**
(22) 08/03/2023 (43) 25/07/2023
(73) **CÔNG TY TNHH LEON LEGION (VN)**
269 Đường Liên Phường, Phường Phước Long B, Thành phố Thủ Đức, Thành phố Hồ Chí Minh
(72) Hoàng Xuân Thành (VN)
(74) Công ty Luật TNHH Tư vấn Quốc tế (INDOCHINE COUNSEL)
(55)



1.1



1.2



1.3



1.4



1.5

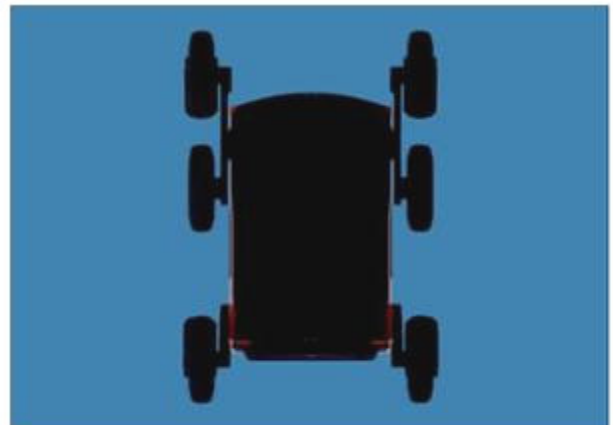

1.6



1.7



1.8



1.9

CÔNG BÁO SỞ HỮU CÔNG NGHIỆP SỐ 424 TẬP A – QUYỀN 2 (07.2023)

- (11) **47602**
(21) 3-2023-00766 (28) 1
(54) **HỘP** (51) **09-03**
(22) 06/04/2023 (43) 25/07/2023
(73) **LG HOUSEHOLD & HEALTH CARE LTD. (KR)**
58, Saemunan-ro, Jongno-gu, Seoul, Republic of Korea
(72) LEE, Seul Ki (KR)
(74) Công ty TNHH Tâm nhìn và Liên danh (VISION & ASSOCIATES CO.LTD.)
(55)



1.1



1.2



1.3



1.4



1.5



1.6



1.7

CÔNG BÁO SỞ HỮU CÔNG NGHIỆP SỐ 424 TẬP A – QUYỀN 2 (07.2023)

- (11) **47603**
(21) 3-2023-00839 (28) 1
(54) **BÌNH CÁCH NHIỆT** (51) **07-07**
(22) 13/04/2023 (43) 25/07/2023
(73) **CÔNG TY CỔ PHẦN ELMICH (VN)**
Cụm công nghiệp An Mỹ - Đồn Xá, thị trấn Bình Mỹ, huyện Bình Lục, tỉnh Hà Nam
(72) Đỗ Thành Trung (VN)
(74) Công ty Luật TNHH LEADCONSULT (LEADCONSULT)
(55)

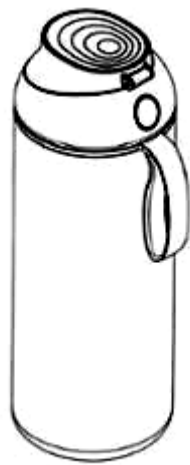

1.1



1.2



1.3



1.4



1.5

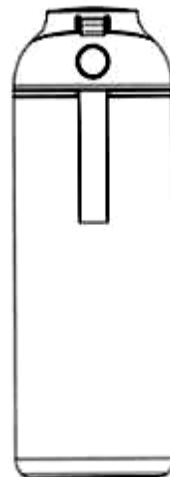

1.6

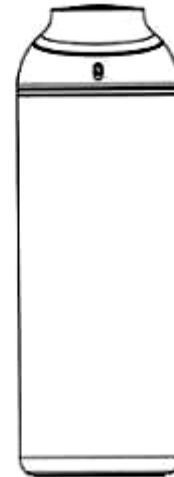

1.7

CÔNG BÁO SỞ HỮU CÔNG NGHIỆP SỐ 424 TẬP A – QUYỀN 2 (07.2023)

- (11) **47604**
(21) 3-2023-00840 (28) 1
(54) **BÌNH CÁCH NHIỆT** (51) **07-07**
(22) 13/04/2023 (43) 25/07/2023
(73) **CÔNG TY CỔ PHẦN ELMICH (VN)**
Cụm công nghiệp An Mỹ - Đồn Xá, thị trấn Bình Mỹ, huyện Bình Lục, tỉnh Hà Nam
(72) Đỗ Thành Trung (VN)
(74) Công ty Luật TNHH LEADCONSULT (LEADCONSULT)
(55)

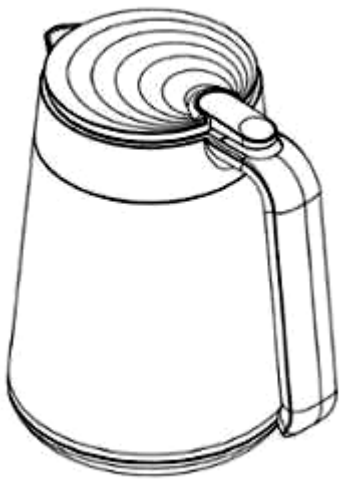

1.1



1.2



1.3

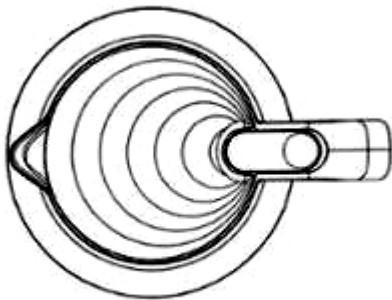

1.4

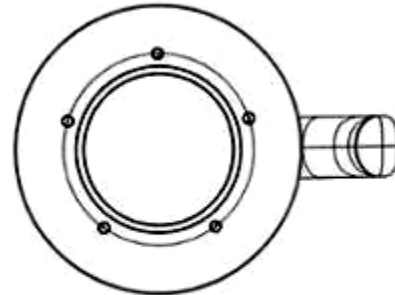

1.5

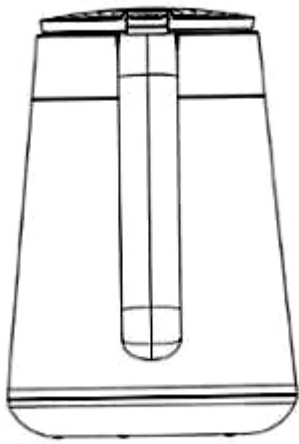

1.6

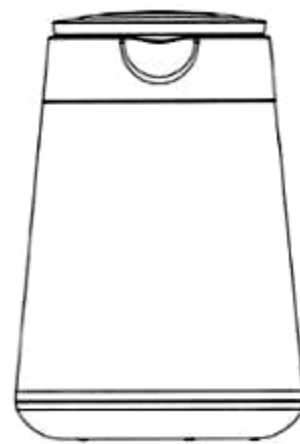

1.7

CÔNG BÁO SỞ HỮU CÔNG NGHIỆP SỐ 424 TẬP A – QUYỀN 2 (07.2023)

- (11) **47605**
(21) 3-2023-00841 (28) 1
(54) **BÌNH CÁCH NHIỆT** (51) **07-07**
(22) 13/04/2023 (43) 25/07/2023
(73) **CÔNG TY CỔ PHẦN ELMICH (VN)**
Cụm công nghiệp An Mỹ - Đôn Xá, thị trấn Bình Mỹ, huyện Bình Lục, tỉnh Hà Nam
(72) Đỗ Thành Trung (VN)
(74) Công ty Luật TNHH LEADCONSULT (LEADCONSULT)
(55)



1.1

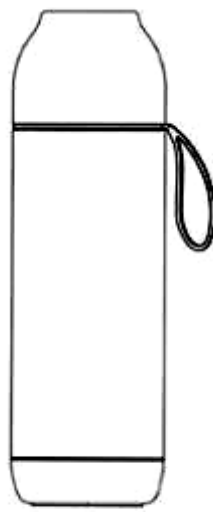

1.2



1.3

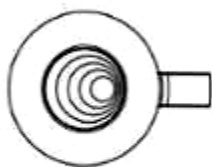

1.4

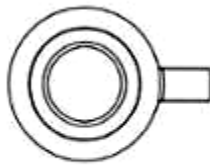

1.5

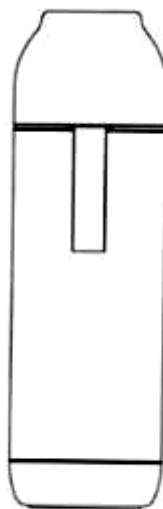

1.6



1.7

CÔNG BÁO SỞ HỮU CÔNG NGHIỆP SỐ 424 TẬP A – QUYỀN 2 (07.2023)

- (11) **47606**
(21) 3-2023-00842 (28) 1
(54) **BÌNH CÁCH NHIỆT** (51) **07-07**
(22) 13/04/2023 (43) 25/07/2023
(73) **CÔNG TY CỔ PHẦN ELMICH (VN)**
Cụm công nghiệp An Mỹ - Đồn Xá, thị trấn Bình Mỹ, huyện Bình Lục, tỉnh Hà Nam
(72) Đỗ Thành Trung (VN)
(74) Công ty Luật TNHH LEADCONSULT (LEADCONSULT)
(55)



1.1



1.2

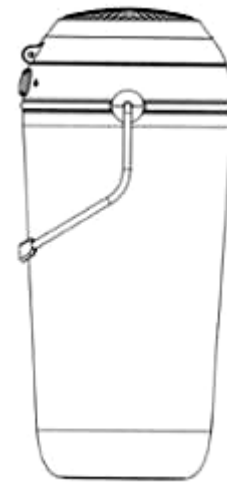

1.3



1.4



1.5



1.6

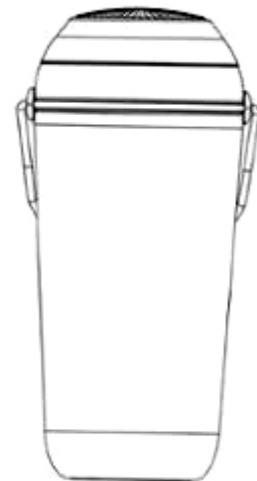

1.7

CÔNG BÁO SỞ HỮU CÔNG NGHIỆP SỐ 424 TẬP A – QUYỀN 2 (07.2023)

- (11) **47607**
(21) 3-2023-00843 (28) 1
(54) **BÌNH CÁCH NHIỆT** (51) **07-07**
(22) 13/04/2023 (43) 25/07/2023
(73) **CÔNG TY CỔ PHẦN ELMICH (VN)**
Cụm công nghiệp An Mỹ - Đồn Xá, thị trấn Bình Mỹ, huyện Bình Lục, tỉnh Hà Nam
(72) Đỗ Thành Trung (VN)
(74) Công ty Luật TNHH LEADCONSULT (LEADCONSULT)
(55)



1.1



1.2



1.3

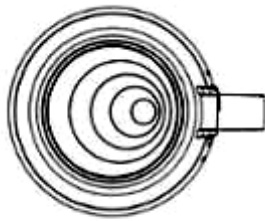

1.4

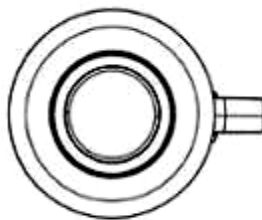

1.5



1.6

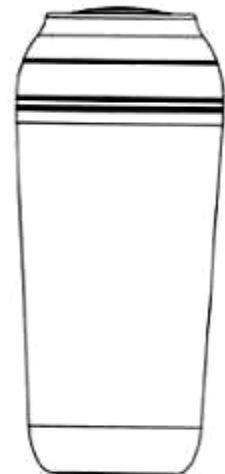

1.7

CÔNG BÁO SỞ HỮU CÔNG NGHIỆP SỐ 424 TẬP A – QUYỀN 2 (07.2023)

- (11) **47608**
(21) 3-2023-00855 (28) 1
(54) **HỘP** (51) **09-03**
(22) 14/04/2023 (43) 25/07/2023
(73) **LG HOUSEHOLD & HEALTH CARE LTD. (KR)**
58, Saemunan-ro, Jongno-gu, Seoul, Republic of Korea
(72) YUN, Tae Ung (KR)
(74) Công ty TNHH Tâm nhìn và Liên danh (VISION & ASSOCIATES CO.LTD.)
(55)



1.1



1.2



1.3



1.4



1.5



1.6



1.7

CÔNG BÁO SỞ HỮU CÔNG NGHIỆP SỐ 424 TẬP A – QUYỀN 2 (07.2023)

- (11) **47609**
(21) 3-2022-01409 (28) 1
(54) **TUÝP ĐỰNG** (51) **09-05**
(22) 14/07/2022 (43) 25/07/2023
(30) 2202000193 18/01/2022 TH;
(73) **KIM PACK CO., LTD. (TH)**
1741 Chan Rd., Thungmahamek, Sathorn, Bangkok, 10120 Thailand
(72) Sumet Limatibul (TH)
(74) Văn phòng Luật sư Ân Nam (ANNAM IP & LAW)
(55)

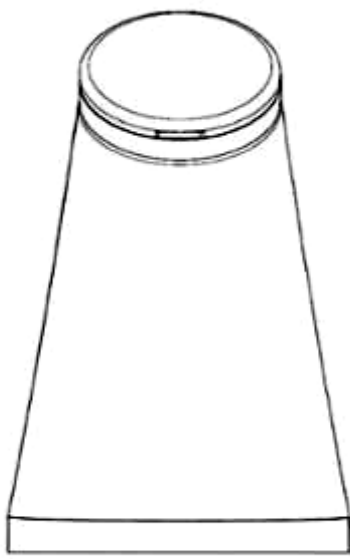

1.1

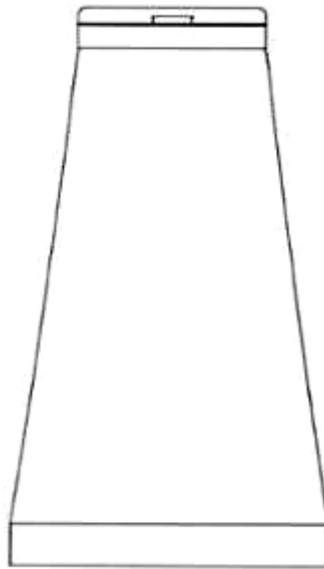

1.2

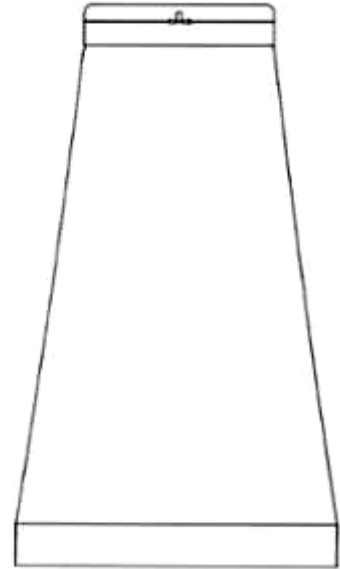

1.3



1.4



1.5

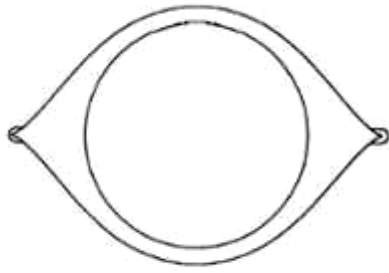

1.6

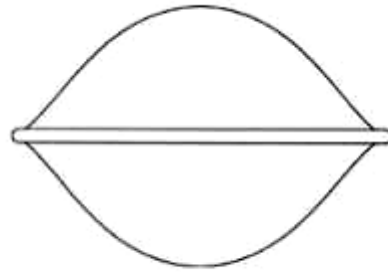

1.7

(11) **47610**

(21) 3-2022-01618

(54) **XE TẢI CHUYÊN CHỖ HÀNG HÓA**

(22) 10/08/2022

(73) **LÊ MINH ĐỨC (VN)**

Khoa Cơ khí giao thông - Trường Đại học Bách Khoa - Đại học Đà Nẵng, 54 Nguyễn Lương Bằng, Hòa Khánh Bắc, quận Liên Chiểu, thành phố Đà Nẵng

(72) Dương Đình Nghĩa (VN)

(55)

(28) 1

(51) **12-14**

(43) 25/07/2023

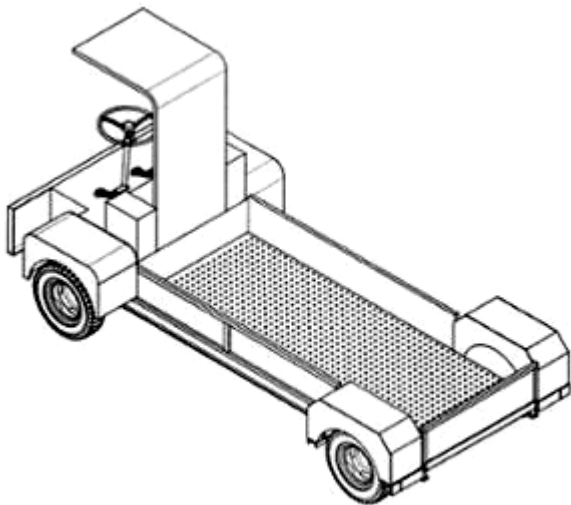

1.1

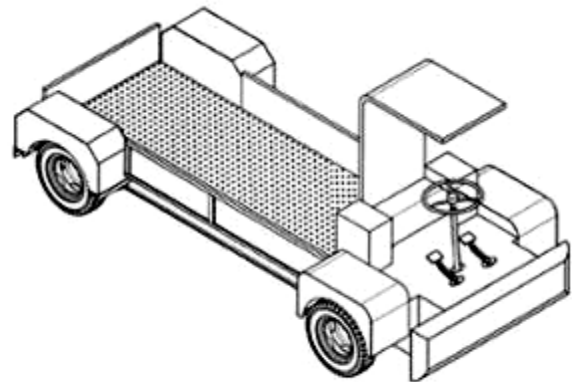

1.2

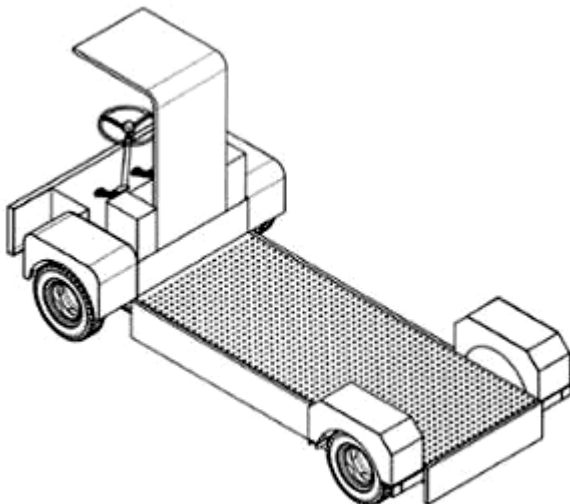

1.3

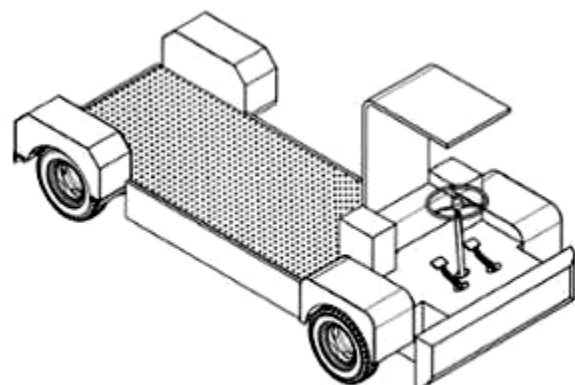

1.4

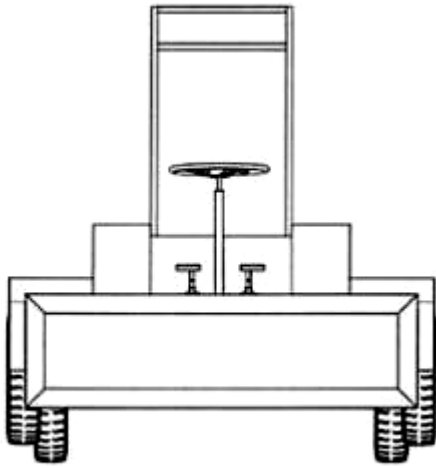

1.5

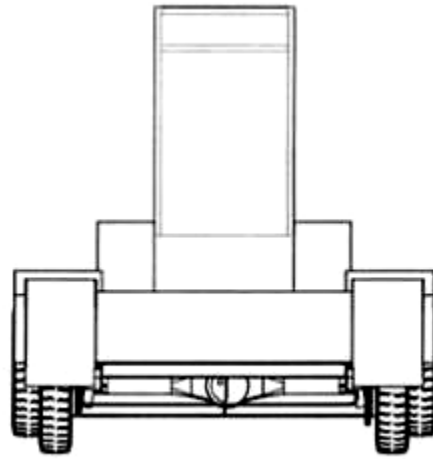

1.6

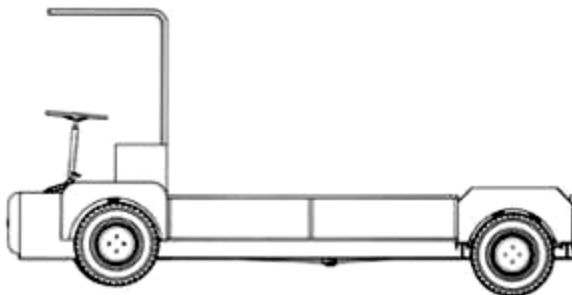

1.7

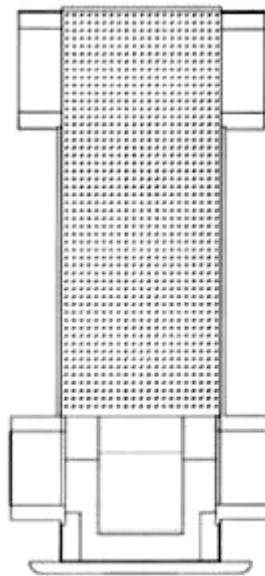

1.8

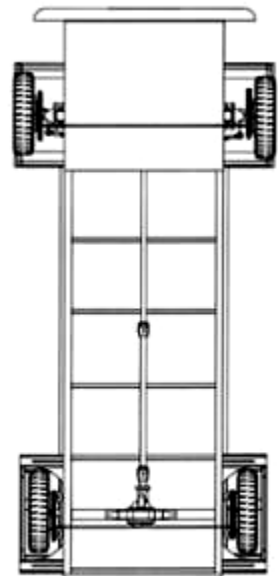

1.9

CÔNG BÁO SỞ HỮU CÔNG NGHIỆP SỐ 424 TẬP A – QUYỀN 2 (07.2023)

- (11) **47611**
(21) 3-2023-00447 (28) 1
(54) **KÍNH MŨ BẢO HIỂM** (51) **02-03**
(22) 02/03/2023 (43) 25/07/2023
(73) **HENRY TEDJAKUSUMA (ID)**
Jalan Wuluh Blok II/3, RT/RW 009/006, Kota Bambu Utara, Palmerah Jakarta Barat 11420, Indonesia
(72) Henry Tedjakusuma (ID)
(74) Công ty TNHH Sở hữu trí tuệ HA VIP (HAVIP CO., LTD.)
(55)

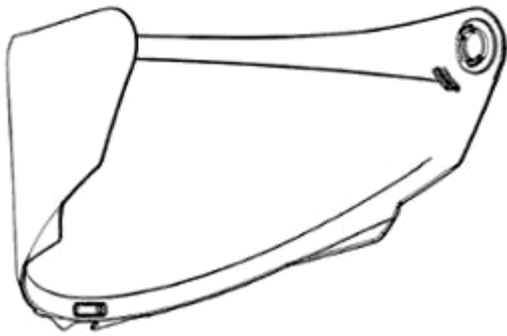

1.1

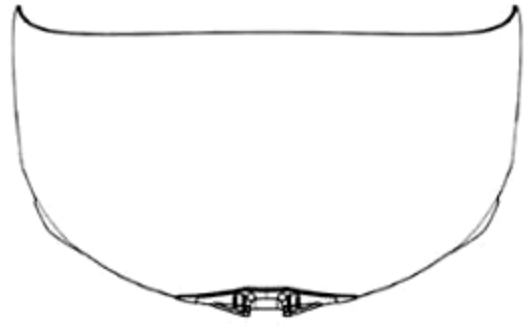

1.2

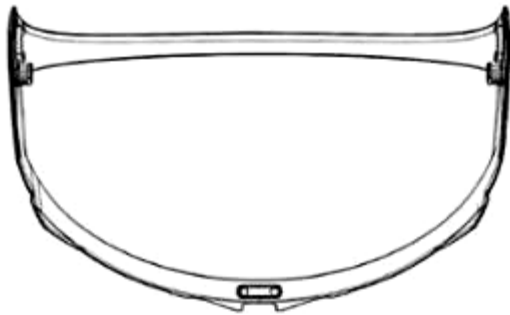

1.3

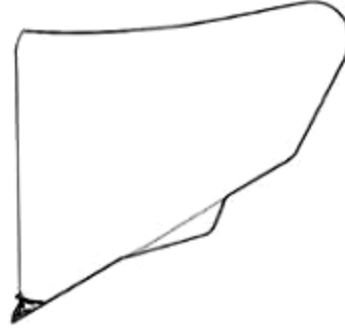

1.4

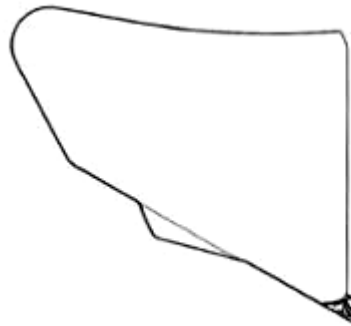

1.5



1.6



1.7

- (11) **47612**
(21) 3-2023-00448 (28) 1
(54) **KHÓA KÍNH MŨ BẢO HIỂM** (51) **02-03**
(22) 02/03/2023 (43) 25/07/2023
(73) **HENRY TEDJAKUSUMA (ID)**
Jalan Wuluh Blok II/3, RT/RW 009/006, Kota Bambu Utara, Palmerah Jakarta Barat 11420, Indonesia
(72) Henry Tedjakusuma (ID)
(74) Công ty TNHH Sở hữu trí tuệ HA VIP (HAVIP CO., LTD.)
(55)

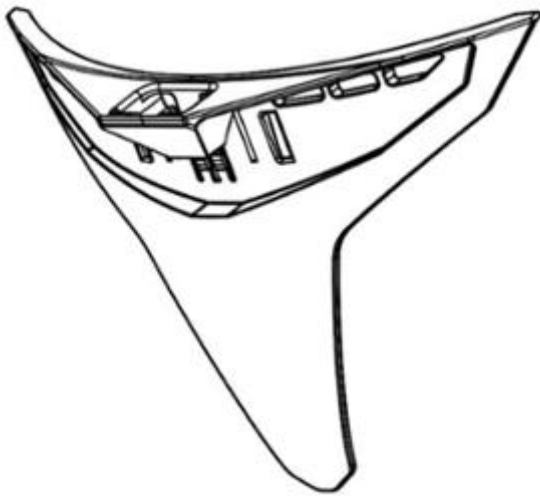

1.1

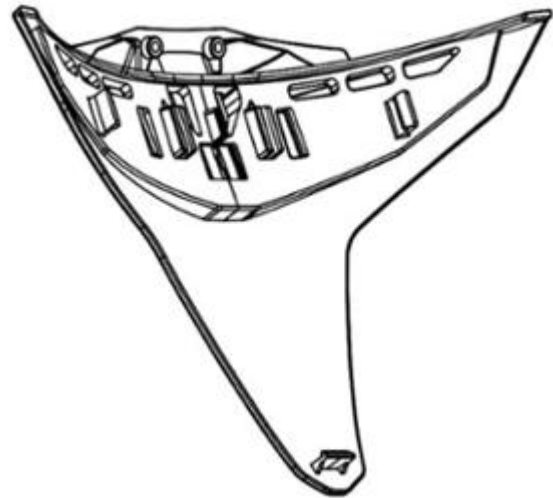

1.2

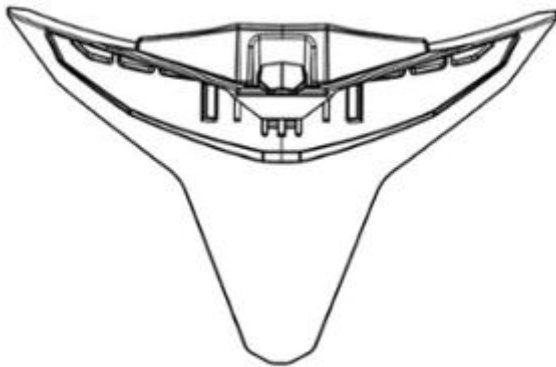

1.3

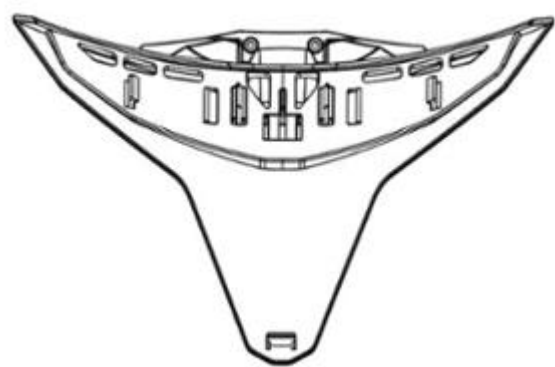

1.4



1.5



1.6

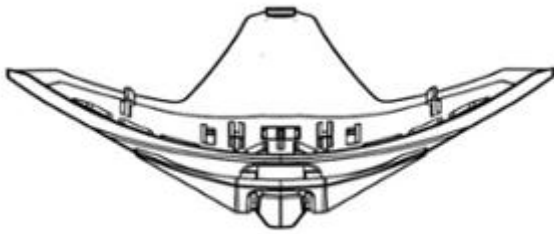

1.7

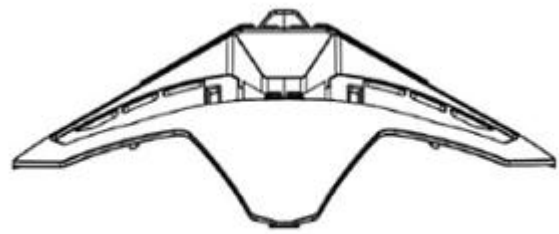

1.8

PHẦN II

SỬA ĐỔI ĐƠN

Thông báo số: 25065/TB-SHTT.IP, ngày 16/06/2023 về việc ghi nhận sửa đổi đơn

Số Yêu cầu: SĐ3-2021-00405 Ngày nộp: 17/02/2021

Liên quan đến đơn yêu cầu cấp Bằng độc quyền kiểu dáng công nghiệp:

(21) Số đơn	(22) Ngày nộp đơn
3-2018-01941	13/09/2018

Mục sửa đổi: Đại diện sở hữu công nghiệp

Nội dung mới: Công ty TNHH Tư vấn đầu tư và Sở hữu trí tuệ Hoàng Phi(HOANG PHI INVEST & I.P CO., LTD)
Số 15, dãy số 2, Thôn Ải, xã Di Trạch, Huyện Hoài Đức, TP. Hà Nội.

CÔNG BÁO SỞ HỮU CÔNG NGHIỆP

Do Cục Sở hữu trí tuệ thuộc Bộ Khoa học và Công nghệ ấn hành theo Luật Sở hữu trí tuệ số 50/2005/QH11 được Quốc hội thông qua ngày 29 tháng 11 năm 2005 và được sửa đổi bằng Luật sửa đổi, bổ sung một số điều của Luật sở hữu trí tuệ số 50/2005/QH11 được Quốc hội thông qua ngày 19 tháng 6 năm 2009.

Địa chỉ liên hệ:

384-386 đường Nguyễn Trãi, quận Thanh Xuân,
thành phố Hà Nội, Việt Nam
ĐT: 024. 38583069
Fax: 024. 38588449