

CỘNG HÒA XÃ HỘI CHỦ NGHĨA VIỆT NAM
BỘ KHOA HỌC VÀ CÔNG NGHỆ

CỤC SỞ HỮU TRÍ TUỆ

CÔNG BÁO
SỞ HỮU CÔNG NGHIỆP

TẬP A

QUYỂN 2: KIỂU DÁNG CÔNG NGHIỆP

06 - 2023

423

CỘNG HOÀ XÃ HỘI CHỦ NGHĨA VIỆT NAM
BỘ KHOA HỌC VÀ CÔNG NGHỆ
CỤC SỞ HỮU TRÍ TUỆ

CÔNG BÁO
SỞ HỮU CÔNG NGHIỆP
TẬP A

QUYỂN 2: KIỂU DÁNG CÔNG NGHIỆP

06 - 2023

423

HÀ NỘI

MỤC LỤC

	Trang
<u>PHẦN I:</u> Đơn yêu cầu cấp Bằng độc quyền kiểu dáng công nghiệp	7
<u>PHẦN II:</u> Sửa đổi đơn	369
<u>PHẦN III:</u> Thay đổi chủ đơn	370

CONTENTS

<u>PART I:</u> Applications for Industrial Design Patents	7
<u>PART II:</u> Amendment of Applications	369
<u>PART III:</u> Change of Applicants	370

CÔNG BÁO SỞ HỮU CÔNG NGHIỆP SỐ 423 TẬP A - QUYỂN 2 (06.2023)

MÃ SỐ HAI CHỮ CÁI THỂ HIỆN TÊN NƯỚC VÀ CÁC THỰC THỂ KHÁC TRONG CÁC TƯ LIỆU SỞ HỮU CÔNG NGHIỆP THEO TIÊU CHUẨN ST3 CỦA WIPO

AE	United Arab Emirates	CN	China	HK	Hong Kong
AF	Afganistan	CO	Colombia	HN	Honduras
AG	Antihua and Barbuda	CR	Costa Rica	HR	Croatia
AI	Anguilla	CU	Cuba	HT	Haiti
AL	Albania	CV	Cape Verde	HU	Hungary
AN	Netherlands Antilles	CY	Cyprus	ID	Indonesia
AO	Angola	CZ	Czech Republic	IE	Ireland
AR	Argentina	DE	Germany	IL	Israel
AT	Austria	DJ	Djibouti	IN	India
AU	Australia	DK	Denmark	IQ	Iraq
AW	Aruba	DM	Dominica	IR	Iran (Islamic Republic of)
BB	Barbados	DO	Dominican Republic	IS	Iceland
BD	Bangladesh	DZ	Algeria	IT	Italy
BE	Belgium	EC	Ecuador	JM	Jamaica
BF	Burkina Faso	EE	Estonia	JO	Jordan
BG	Bulgaria	EG	Egypt	JP	Japan
BH	Bahrain	ES	Spain	KE	Kenya
BI	Burundi	ET	Ethiopia	KH	Cambodia
BJ	Benin	FI	Finland	KI	Kiribati
BM	Bermuda	FJ	Fiji	KM	Comoros
BN	Brunei Darussalam	FK	Falkand Islands (Malvinas)	KN	Saint Kitts and Nevis
BO	Bolivia	FR	France	KP	Democratic People's Republic of Korea
BR	Brazil	GA	Gabon	KR	Republic of Korea
BS	Bahamas	GB	United Kingdom	KW	Kuwait
BT	Bhutan	GD	Grenada	KY	Cayman Islands
BW	Botswana	GE	Georgia	KZ	Kazakhstan
BY	Belarus	GH	Ghana	LA	Laos
BZ	Belize	GI	Gibraltar	LB	Lebanon
CA	Canada	GM	Gambia	LC	Saint Lucia
CF	Central African Republic	GN	Guinea	LI	Liechtenstein
CG	Congo	GQ	Equatorial Guinea	LK	SriLanka
CH	Switzerland	GR	Greece	LR	Liberia
CI	Côte d'Ivoire	GT	Guatemala	LS	Lesotho
CL	Chile	GW	Guinea-Bissau	LT	Lithuania
CM	Cameroon	GY	Guyana	TC	Turk and Caicos Islands
LU	Luxembourg	PA	Panama	TD	Chad
LV	Latvia	PE	Peru	TG	Togo
LY	Lybya	PG	Papua New Guinea	TH	Thailand
MA	Morocco	PH	Philippines	TN	Tunisia
MC	Monaco	PK	Pakistan	TO	Tonga
MD	Republic of Moldova	PL	Poland	TR	Turkey

CÔNG BÁO SỞ HỮU CÔNG NGHIỆP SỐ 423 TẬP A - QUYỂN 2 (06.2023)

MG	Madagascar	PT	Portugal	TT	Trinidad and Tobago
ML	Mali	PY	Paraguay	TV	Tuvalu
MM	Myanmar	QA	Qatar	TW	Taiwan, Province of China
MN	Mongolia	RO	Rumania	TZ	United Republic of Tanzania
MO	Macau	RU	Russian Federation	UA	Ukraine
MR	Mauritania	RW	Rwanda	UG	Uganda
MS	Montserrat	SA	Saudi Arabia	US	United States of America
MT	Malta	SB	Solomon Islands	UY	Uruguay
MU	Mauritius	SC	Seychelles	UZ	Uzbekistan
MV	Maldives	SD	Sudan	VA	Holy see
MW	Malawi	SE	Sweden	VC	Saint Vincent and the Grenadines
MX	Mexico	SG	Singapore	VE	Venezuela
MY	Malaysia	SH	Saint Helena	VG	Virgin Islands (British)
MZ	Mozambique	SL	Slovenia	VN	Vietnam
NA	Namibia	SK	Slovakia	VU	Vanuatu
NE	Niger	SL	Sierra Leone	WS	Samoa
NG	Nigeria	SM	San Marino	YE	Yemen
NJ	Nicaragua	SN	Senegal	YU	Yugoslavia
NL	Netherlands	SO	Somalia	ZA	South Africa
NO	Norway	SR	Suriname	ZM	Zambia
NP	Nepal	ST	Sao Tome and Principe	ZR	Zaire
NR	Nauru	SV	El Sanvador	ZW	Zimbabwe
NZ	New Zealand	SY	Syria		
OM	Oman	SZ	Swaziland		

CÁC TỔ CHỨC QUỐC TẾ

AO	African Intellectual Property Organization (OAPI)
AP	African Regional Industrial Property Organization (ARIPO)
BX	Benelux Trademark Office and Benelux Designs Office
EP	European Patent Office (EPO)
IB, WO	International Bureau of the World Intellectual Property Organization (WIPO)

NHỮNG MÃ SỐ INID TRÍCH TỪ TIÊU CHUẨN ST80 CỦA TỔ CHỨC SỞ HỮU TRÍ TUỆ THẾ GIỚI (WIPO) ĐỂ NHẬN BIẾT CÁC DỮ LIỆU THƯ MỤC DÙNG CÔNG BỐ ĐƠN VÀ BẰNG ĐỘC QUYỀN KIỂU DÁNG CÔNG NGHIỆP

- (11) Số bằng độc quyền kiểu dáng công nghiệp / Số công bố đơn
- (15) Ngày cấp
- (18) Ngày hết hạn hiệu lực của bằng độc quyền kiểu dáng công nghiệp
- (21) Số đơn
- (22) Ngày nộp đơn
- (23) Tên triển lãm, ngày và nơi triển lãm
- (28) Số phương án yêu cầu bảo hộ
- (30) Số đơn ưu tiên, ngày nộp đơn ưu tiên
- (43) Ngày công bố đơn
- (45) Ngày công bố bằng độc quyền kiểu dáng công nghiệp
- (51) Phân loại quốc tế kiểu dáng công nghiệp
- (54) Tên sản phẩm mang kiểu dáng công nghiệp
- (55) Ảnh chụp / hình vẽ kiểu dáng công nghiệp
- (57) Đặc điểm khác biệt yêu cầu bảo hộ của kiểu dáng công nghiệp
- (62) Số và ngày nộp đơn, số bằng độc quyền KDCN hoặc số công bố đơn liên quan đến tách đơn
- (71) Tên và địa chỉ của người nộp đơn
- (72) Tên của tác giả KDCN
- (73) Tên, địa chỉ của chủ bằng độc quyền KDCN
- (74) Tên của người đại diện SHCN

PHẦN I

ĐƠN YÊU CẦU CẤP BẰNG ĐỘC QUYỀN KIỂU DÁNG CÔNG NGHIỆP

- (11) **46972**
(21) 3-2021-00718 (28) 1
(54) **CHI TIẾT NÓI DỪNG CHO GIÁ VÀ KỆ** (51) **06-05**
(22) 29/03/2021 (43) 26/06/2023
(73) **CÔNG TY TNHH ĐẦU TƯ SẢN XUẤT VÀ THƯƠNG MẠI MINH KHUÊ**
(VN)
Xóm 10 thôn Đồng Mít, xã Đồng Tâm, huyện Mỹ Đức, thành phố Hà Nội
(72) Lã Viết Nhật (VN)
(74) Công ty TNHH Sở hữu trí tuệ VIPATCO (VIPATCO CO., LTD.)
(55)

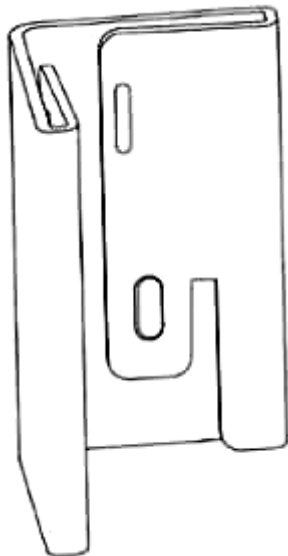

1.1

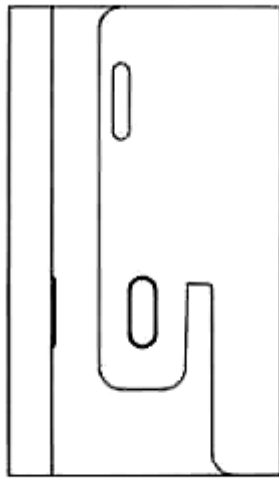

1.2



1.3

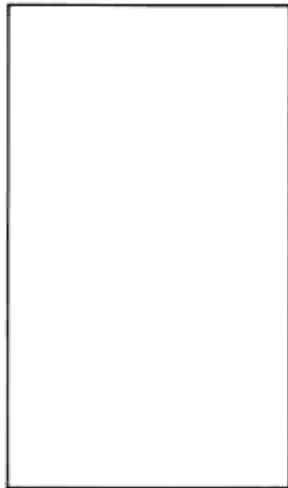

1.4

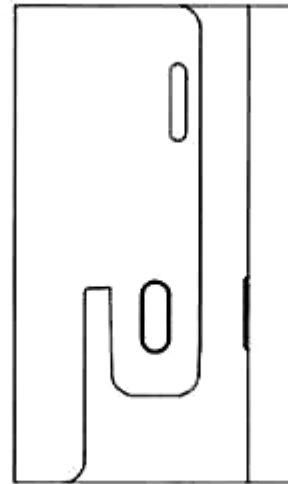

1.5



1.6

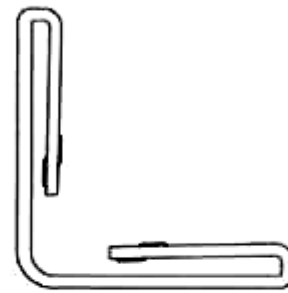

1.7

CÔNG BÁO SỞ HỮU CÔNG NGHIỆP SỐ 423 TẬP A – QUYỀN 2 (06.2023)

- (11) **46973**
(21) 3-2021-02886 (28) 1
(54) **NHÃN SẢN PHẨM** (51) **19-08**
(22) 19/11/2021 (43) 26/06/2023
(73) **CÔNG TY CỔ PHẦN D-SHINING (VN)**
7C Nguyễn Ngọc Phương, phường 19, quận Bình Thạnh, thành phố Hồ Chí Minh
(72) Nguyễn Thái Dương (VN)
(74) Văn phòng Luật sư D và T (D & T LAW OFFICE)
(55)



1.1



1.2

CÔNG BÁO SỞ HỮU CÔNG NGHIỆP SỐ 423 TẬP A – QUYỀN 2 (06.2023)

- (11) **46974**
(21) 3-2021-02887 (28) 1
(54) **NHÃN SẢN PHẨM** (51) **19-08**
(22) 19/11/2021 (43) 26/06/2023
(73) **CÔNG TY CỔ PHẦN D-SHINING (VN)**
7C Nguyễn Ngọc Phương, phường 19, quận Bình Thạnh, thành phố Hồ Chí Minh
(72) Nguyễn Thái Dương (VN)
(74) Văn phòng Luật sư D và T (D & T LAW OFFICE)
(55)



1.1



1.2

CÔNG BÁO SỞ HỮU CÔNG NGHIỆP SỐ 423 TẬP A – QUYỀN 2 (06.2023)

- (11) **46975**
(21) 3-2021-03251 (28) 1
(54) **TẤM NÂNG HÀNG** (51) **09-08**
(22) 17/12/2021 (43) 26/06/2023
(30) 21-E1685-0101 19/11/2021 MY;
(73) **SEE HAU GLOBAL SDN BHD (MY)**
NO.80, JALAN PAHANG, 53000 W.P. KUALA LUMPUR MALAYSIA
(72) CHEAH CHEE CHON (MY)
(74) Công ty TNHH Đại Tín và Liên Danh (DAITIN AND ASSOCIATES CO.,LTD)
(55)

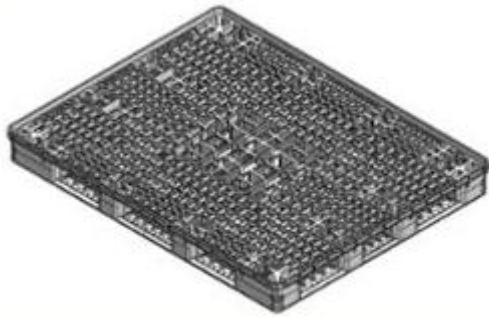

1.1



1.2



1.3

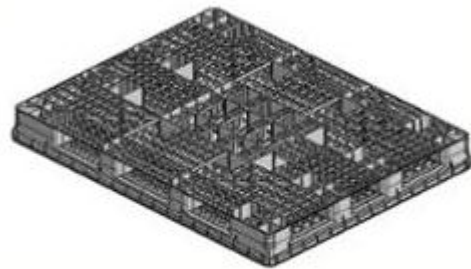

1.4

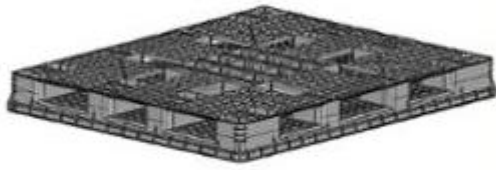

1.5

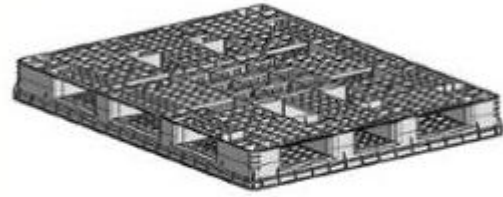

1.6



1.7



1.8

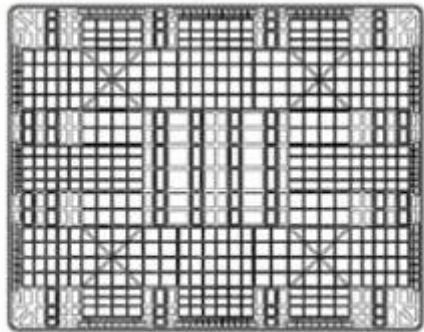

1.9

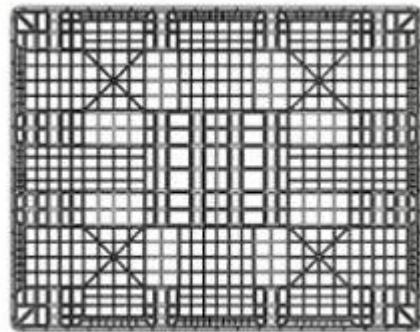

1.10

CÔNG BÁO SỞ HỮU CÔNG NGHIỆP SỐ 423 TẬP A – QUYỀN 2 (06.2023)

- (11) **46976**
(21) 3-2021-03271 (28) 1
(54) **QUẦN NGẮN** (51) **02-02**
(22) 20/12/2021 (43) 26/06/2023
(73) **CÔNG TY TNHH MAY THỜI TRANG B.N (VN)**
101/62/6 Lê Văn Lương, tổ 17, ấp 3, xã Phước Kiển, huyện Nhà Bè, thành phố Hồ Chí Minh
(72) Lê Thị Thanh Thúy (VN)
(74) **CÔNG TY TNHH SỞ HỮU TRÍ TUỆ SETHACO (SETHACO IP CO.,LTD)**
(55)



1.1



1.2



1.3



1.4



1.5



1.6



1.7

CÔNG BÁO SỞ HỮU CÔNG NGHIỆP SỐ 423 TẬP A – QUYỀN 2 (06.2023)

- (11) **46977**
- (21) 3-2022-00702 (28) 1
- (54) **BỘ PHẬN DẬP DÙNG CHO THIẾT BỊ GẮN VÀ SỬA CHỮA CHÍP** (51) **15-99**
- (22) 14/04/2022 (43) 26/06/2023
- (30) 2021-022437 15/10/2021 JP;
- (73) **SHIN-ETSU CHEMICAL CO., LTD. (JP)**
4-1, Marunouchi 1-chome, Chiyoda-ku, Tokyo 100-0005, Japan
- (72) 1. YOSHINORI OGAWA (JP)
2. KAZUNORI KONDO (JP)
3. NOBUAKI TOMURA (JP)
4. NOBUAKI MATSUMOTO (JP)
5. AKIRA SAKAMOTO (JP)
6. TAICHI KITAGAWA (JP)
- (74) Công ty TNHH Tư vấn - Dịch thuật - Sở hữu trí tuệ Á Đông (Á Đông IP CONSULTANCY CO.,LTD.)
- (55)

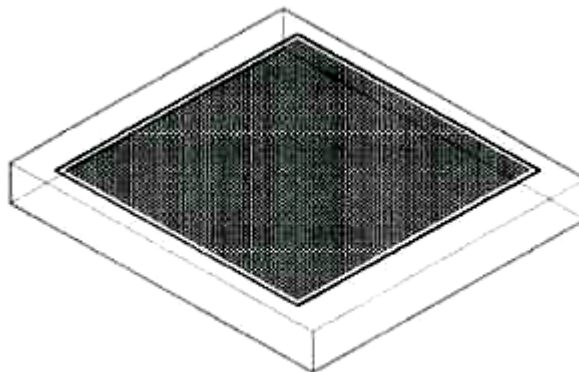

1.1



1.2

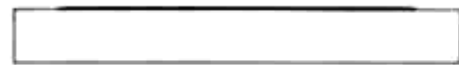

1.3



1.4



1.5

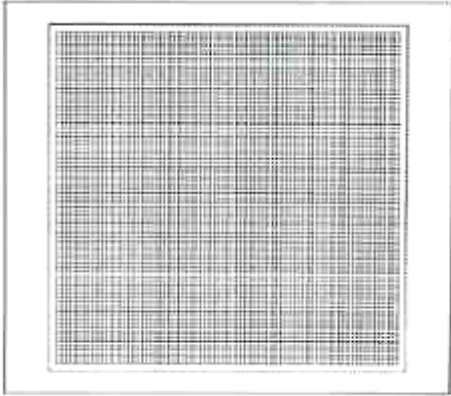

1.6

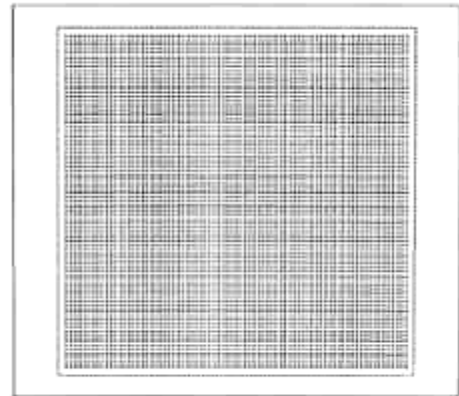

1.7

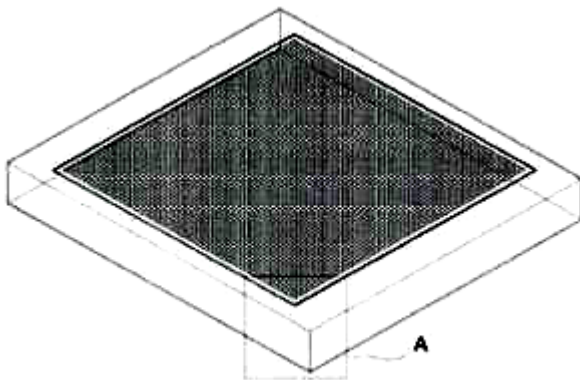

1.8



1.9

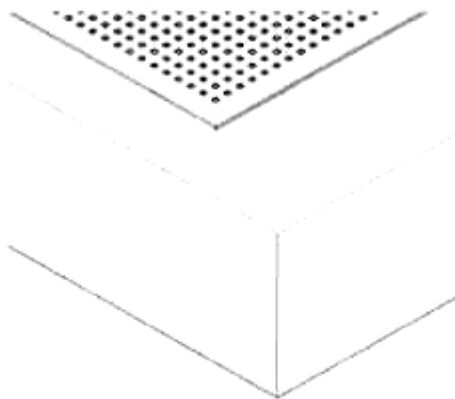

1.10

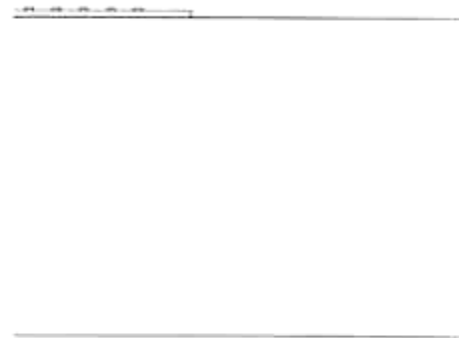

1.11

CÔNG BÁO SỞ HỮU CÔNG NGHIỆP SỐ 423 TẬP A – QUYỀN 2 (06.2023)

- (11) **46978**
- (21) 3-2022-00704 (28) 1
- (54) **BỘ PHẬN DẬP DỪNG CHO THIẾT BỊ GẮN VÀ SỬA CHỮA CHÍP** (51) **15-99**
- (22) 14/04/2022 (43) 26/06/2023
- (30) 2021-022439 15/10/2021 JP;
- (73) **SHIN-ETSU CHEMICAL CO., LTD. (JP)**
4-1, Marunouchi 1-chome, Chiyoda-ku, Tokyo 100-0005, Japan
- (72) 1. YOSHINORI OGAWA (JP)
2. KAZUNORI KONDO (JP)
3. NOBUAKI TOMURA (JP)
4. NOBUAKI MATSUMOTO (JP)
5. AKIRA SAKAMOTO (JP)
6. TAICHI KITAGAWA (JP)
- (74) Công ty TNHH Tư vấn - Dịch thuật - Sở hữu trí tuệ Á Đông (Á Đông IP CONSULTANCY CO.,LTD.)
- (55)



1.1



1.2



1.3



1.4



1.5

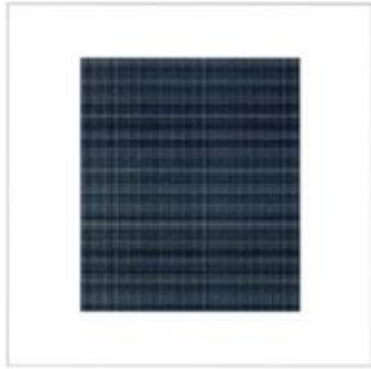

1.6



1.7

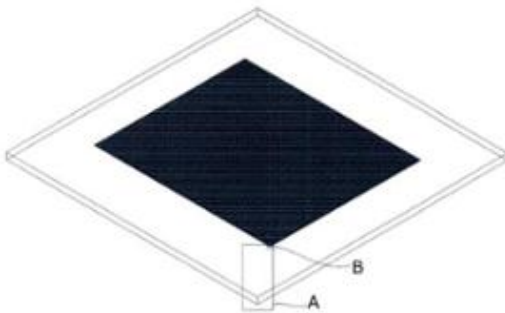

1.8

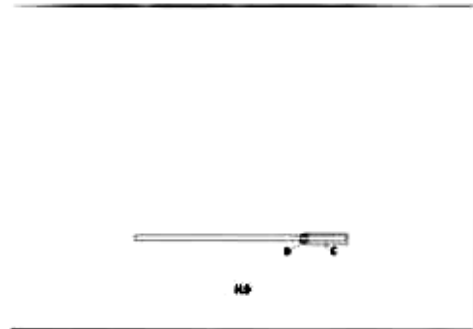

1.9

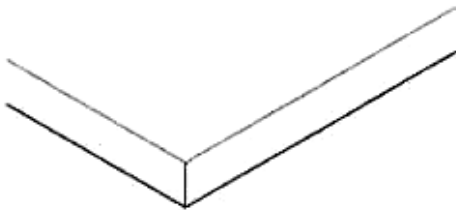

1.10

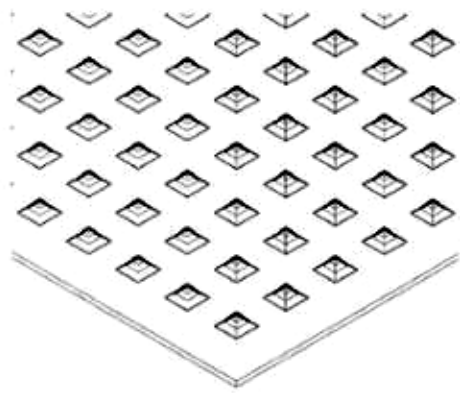

1.11



1.12



1.13

CÔNG BÁO SỞ HỮU CÔNG NGHIỆP SỐ 423 TẬP A – QUYỀN 2 (06.2023)

- (11) **46979**
- (21) 3-2022-00705 (28) 1
- (54) **BỘ PHẬN DẬP DÙNG CHO THIẾT BỊ GẮN VÀ SỬA CHỮA CHÍP** (51) **15-99**
- (22) 14/04/2022 (43) 26/06/2023
- (30) 2021-022443 15/10/2021 JP;
- (73) **SHIN-ETSU CHEMICAL CO., LTD. (JP)**
4-1, Marunouchi 1-chome, Chiyoda-ku, Tokyo 100-0005, Japan
- (72) 1. YOSHINORI OGAWA (JP)
2. KAZUNORI KONDO (JP)
3. NOBUAKI TOMURA (JP)
4. NOBUAKI MATSUMOTO (JP)
5. AKIRA SAKAMOTO (JP)
6. TAICHI KITAGAWA (JP)
- (74) Công ty TNHH Tư vấn - Dịch thuật - Sở hữu trí tuệ Á Đông (Á Đông IP CONSULTANCY CO.,LTD.)
- (55)

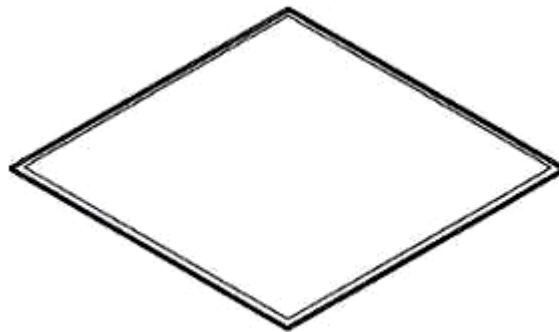

1.1



1.2



1.3



1.4



1.5

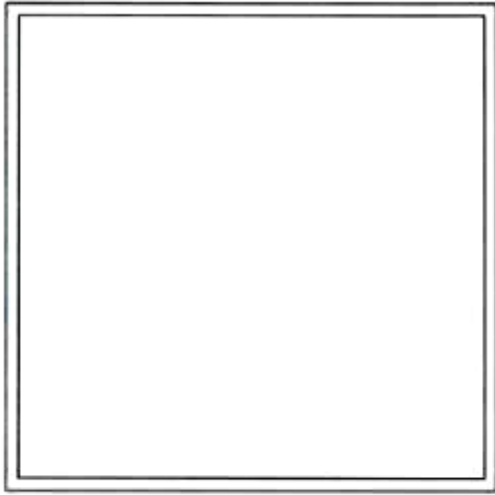

1.6

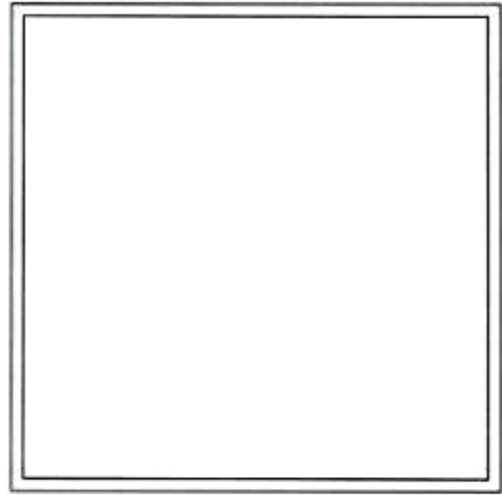

1.7

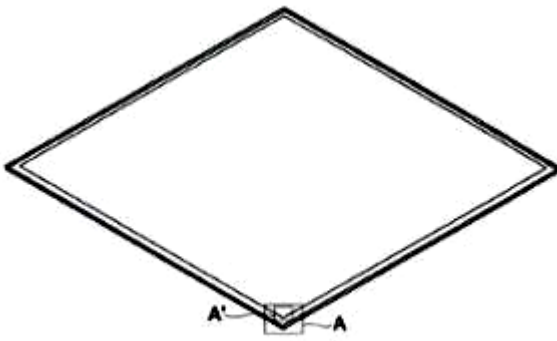

1.8



1.9

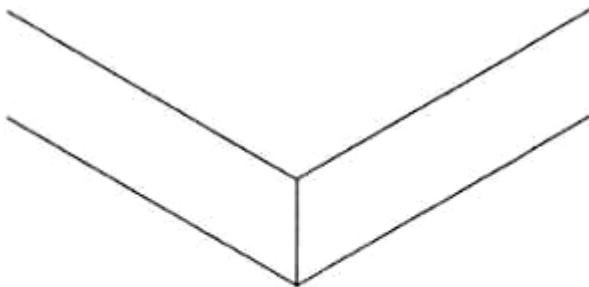

1.10

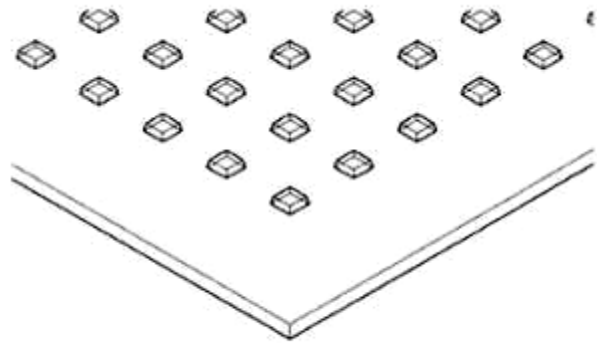

1.11



1.12

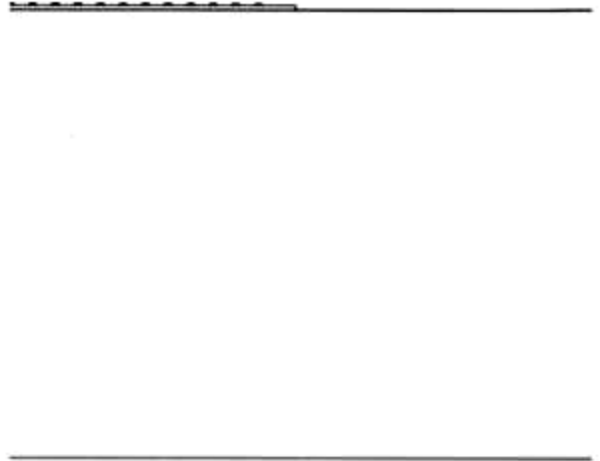

1.13

CÔNG BÁO SỞ HỮU CÔNG NGHIỆP SỐ 423 TẬP A – QUYỀN 2 (06.2023)

- (11) **46980**
- (21) 3-2022-00706 (28) 1
- (54) **BỘ PHẬN DẬP DỪNG CHO THIẾT BỊ GẮN VÀ SỬA CHỮA CHÍP** (51) **15-99**
- (22) 14/04/2022 (43) 26/06/2023
- (30) 2021-022445 15/10/2021 JP;
- (73) **SHIN-ETSU CHEMICAL CO., LTD. (JP)**
4-1, Marunouchi 1-chome, Chiyoda-ku, Tokyo 100-0005, Japan
- (72) 1. YOSHINORI OGAWA (JP)
2. KAZUNORI KONDO (JP)
3. NOBUAKI TOMURA (JP)
4. NOBUAKI MATSUMOTO (JP)
5. AKIRA SAKAMOTO (JP)
6. TAICHI KITAGAWA (JP)
- (74) Công ty TNHH Tư vấn - Dịch thuật - Sở hữu trí tuệ Á Đông (Á Đông IP CONSULTANCY CO.,LTD.)
- (55)

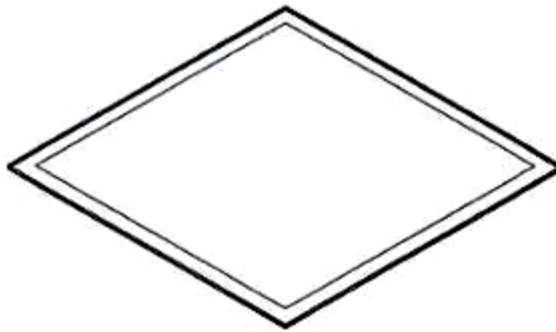

1.1



1.2



1.3



1.4



1.5

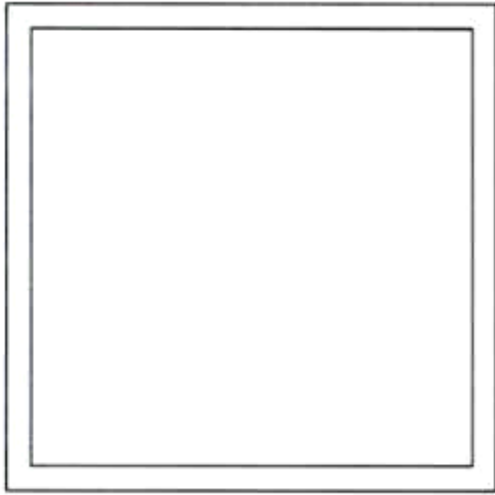

1.6

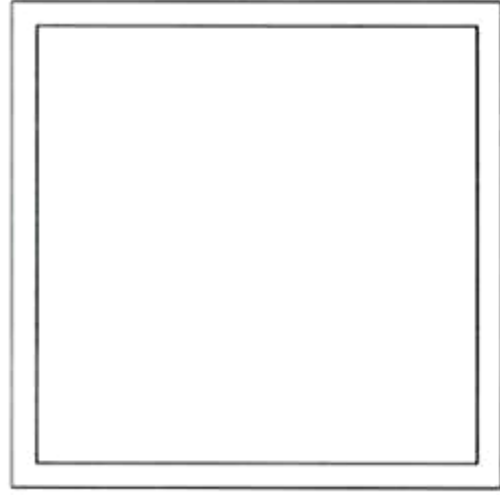

1.7

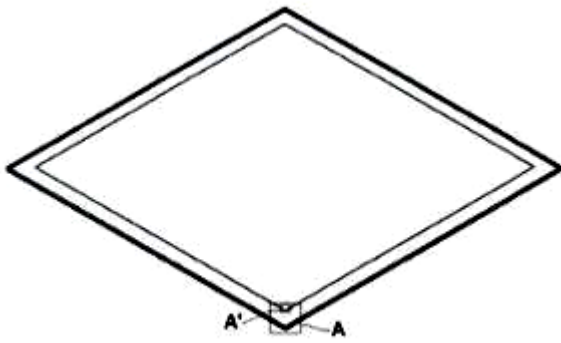

1.8



1.9

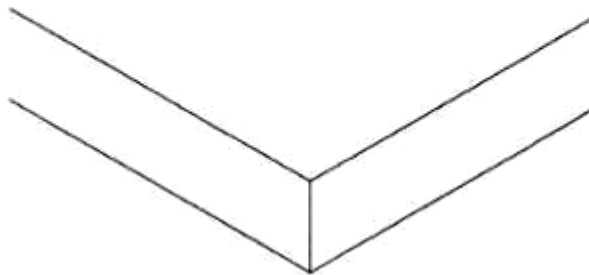

1.10

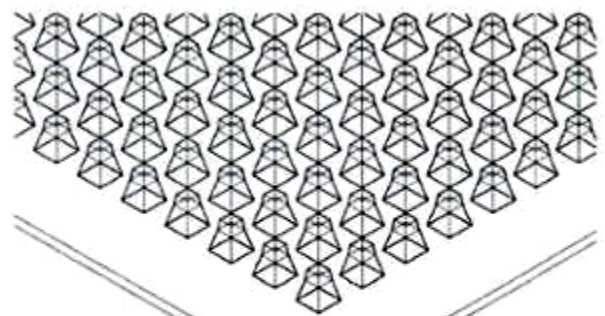

1.11

AAAAAAAAAA



1.12



1.13

CÔNG BÁO SỞ HỮU CÔNG NGHIỆP SỐ 423 TẬP A – QUYỀN 2 (06.2023)

- (11) **46981**
- (21) 3-2022-00707 (28) 1
- (54) **BỘ PHẬN DẬP DÙNG CHO THIẾT BỊ GẮN VÀ SỬA CHỮA CHÍP** (51) **15-99**
- (22) 14/04/2022 (43) 26/06/2023
- (30) 2021-022455 15/10/2021 JP;
- (73) **SHIN-ETSU CHEMICAL CO., LTD.** (JP)
4-1, Marunouchi 1-chome, Chiyoda-ku, Tokyo 100-0005, Japan
- (72) 1. YOSHINORI OGAWA (JP)
2. KAZUNORI KONDO (JP)
3. NOBUAKI TOMURA (JP)
4. NOBUAKI MATSUMOTO (JP)
5. AKIRA SAKAMOTO (JP)
6. TAICHI KITAGAWA (JP)
- (74) Công ty TNHH Tư vấn - Dịch thuật - Sở hữu trí tuệ Á Đông (Á Đông IP CONSULTANCY CO.,LTD.)
- (55)

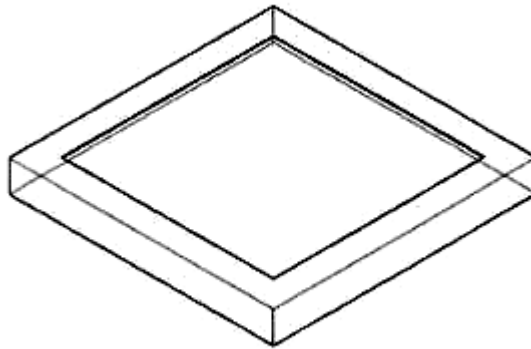

1.1



1.2



1.3



1.4



1.5

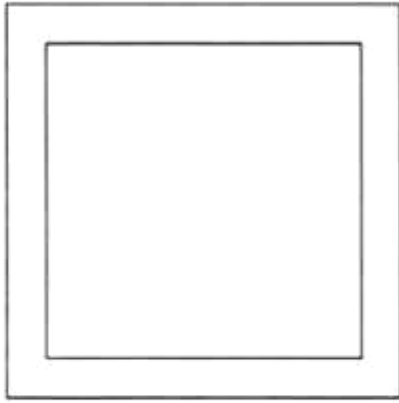

1.6

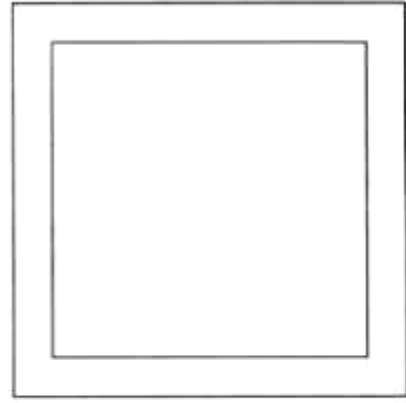

1.7

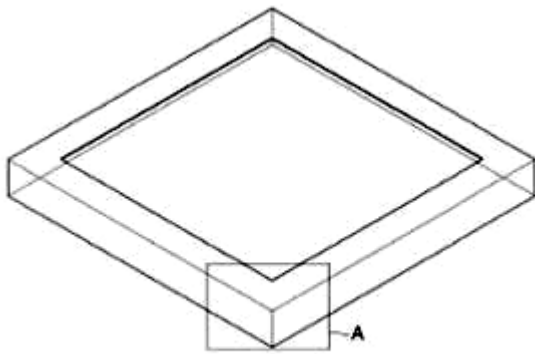

1.8

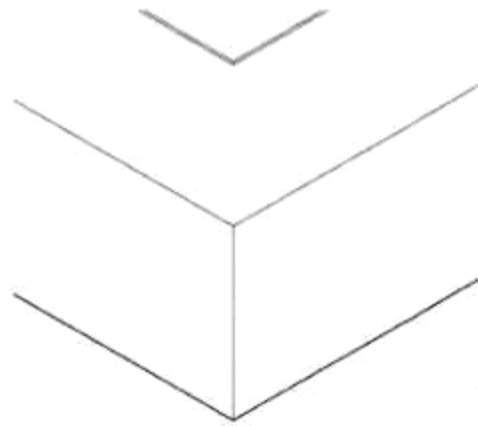

1.9

CÔNG BÁO SỞ HỮU CÔNG NGHIỆP SỐ 423 TẬP A – QUYỀN 2 (06.2023)

- (11) **46982**
- (21) 3-2022-00708 (28) 1
- (54) **BỘ PHẬN DẬP DÙNG CHO THIẾT BỊ GẮN VÀ SỬA CHỮA CHÍP** (51) **15-99**
- (22) 14/04/2022 (43) 26/06/2023
- (30) 2021-22457 15/10/2021 JP;
- (73) **SHIN-ETSU CHEMICAL CO., LTD (JP)**
4-1, Marunouchi 1-chome, Chiyoda-ku, Tokyo 100-0005, Japan
- (72) 1. YOSHINORI OGAWA (JP)
2. KAZUNORI KONDO (JP)
3. NOBUAKI TOMURA (JP)
4. NOBUAKI MATSUMOTO (JP)
5. AKIRA SAKAMOTO (JP)
6. TAICHI KITAGAWA (JP)
- (74) Công ty TNHH Tư vấn - Dịch thuật - Sở hữu trí tuệ Á Đông (Á Đông IP CONSULTANCY CO.,LTD.)
- (55)

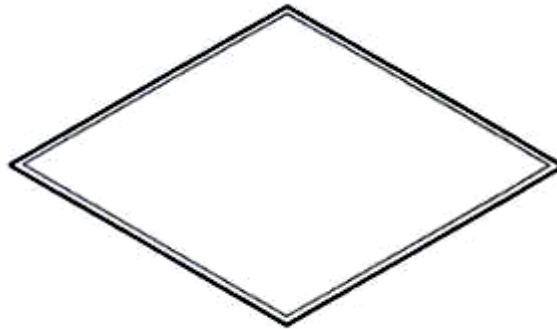

1.1



1.2



1.3



1.4



1.5

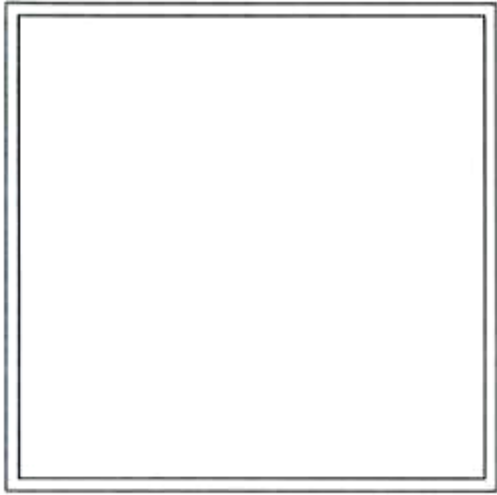

1.6

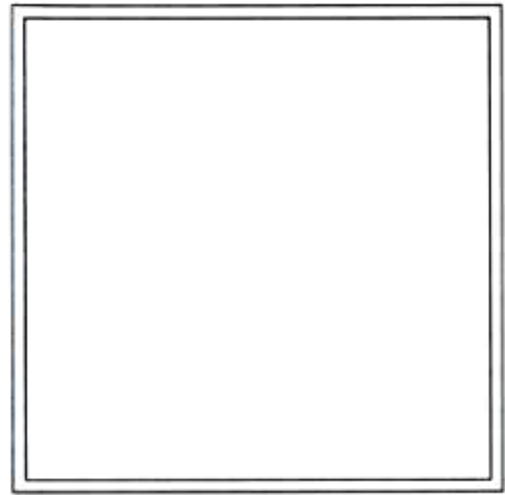

1.7

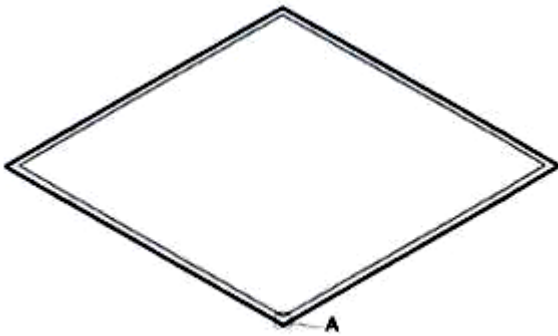

1.8



1.9

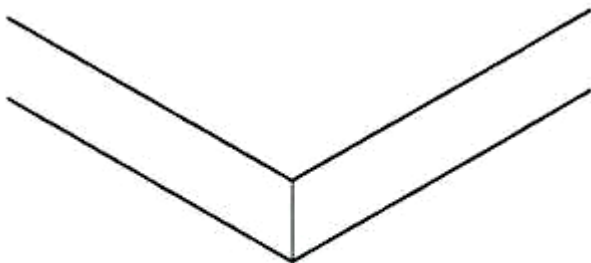

1.10



1.11

1.12

CÔNG BÁO SỞ HỮU CÔNG NGHIỆP SỐ 423 TẬP A – QUYỀN 2 (06.2023)

- (11) **46983**
- (21) 3-2022-00709 (28) 1
- (54) **BỘ PHẬN DẬP DỪNG CHO THIẾT BỊ GẮN VÀ SỬA CHỮA CHÍP** (51) **15-99**
- (22) 14/04/2022 (43) 26/06/2023
- (30) 2021-22458 15/10/2021 JP;
- (73) **SHIN-ETSU CHEMICAL CO., LTD (JP)**
4-1, Marunouchi 1-chome, Chiyoda-ku, Tokyo 100-0005, Japan
- (72) 1. YOSHINORI OGAWA (JP)
2. KAZUNORI KONDO (JP)
3. NOBUAKI TOMURA (JP)
4. AKIRA SAKAMOTO (JP)
5. NOBUAKI MATSUMOTO (JP)
6. TAICHI KITAGAWA (JP)
- (74) Công ty TNHH Tư vấn - Dịch thuật - Sở hữu trí tuệ Á Đông (Á Đông IP CONSULTANCY CO.,LTD.)
- (55)

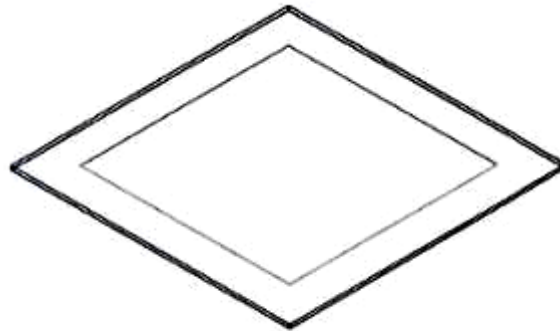

1.1



1.2



1.3



1.4



1.5

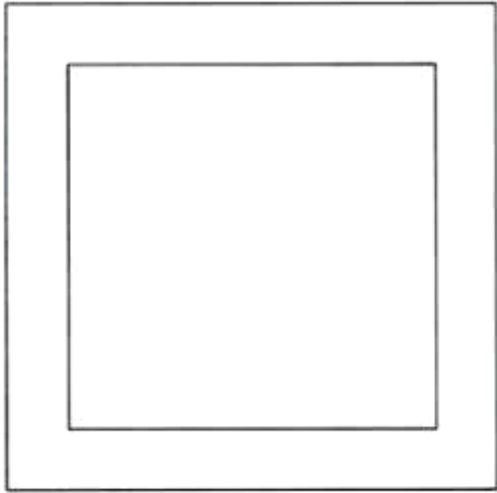

1.6

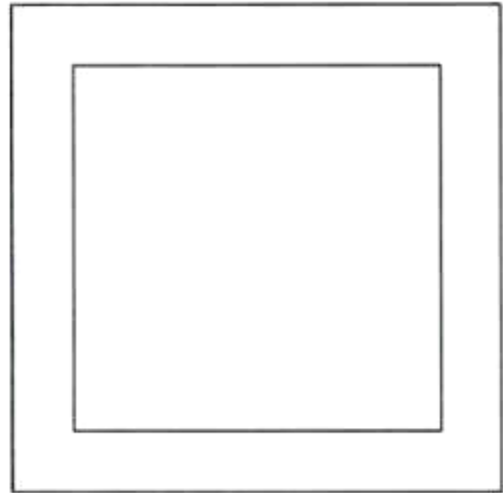

1.7

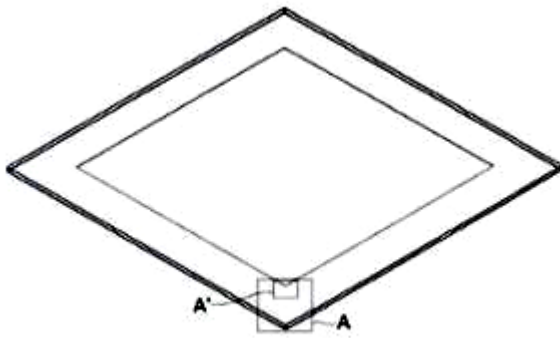

1.8



1.9

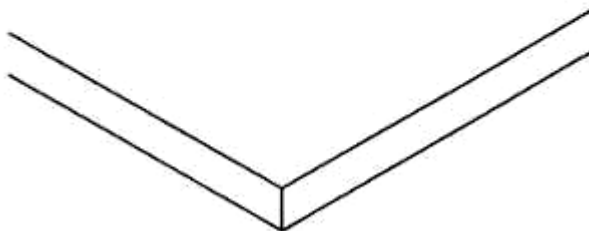

1.10



1.11



1.12



1.13

CÔNG BÁO SỞ HỮU CÔNG NGHIỆP SỐ 423 TẬP A – QUYỀN 2 (06.2023)

- (11) **46984**
- (21) 3-2022-00710 (28) 1
- (54) **BỘ PHẬN DẬP DÙNG CHO THIẾT BỊ GẮN VÀ SỬA CHỮA CHÍP** (51) **15-99**
- (22) 14/04/2022 (43) 26/06/2023
- (30) 2021-022461 15/10/2021 JP;
- (73) **SHIN-ETSU CHEMICAL CO., LTD. (JP)**
4-1, Marunouchi 1-chome, Chiyoda-ku, Tokyo 100-0005, Japan
- (72) 1. YOSHINORI OGAWA (JP)
2. KAZUNORI KONDO (JP)
3. NOBUAKI TOMURA (JP)
4. NOBUAKI MATSUMOTO (JP)
5. AKIRA SAKAMOTO (JP)
6. TAICHI KITAGAWA (JP)
- (74) Công ty TNHH Tư vấn - Dịch thuật - Sở hữu trí tuệ Á Đông (Á Đông IP CONSULTANCY CO.,LTD.)
- (55)

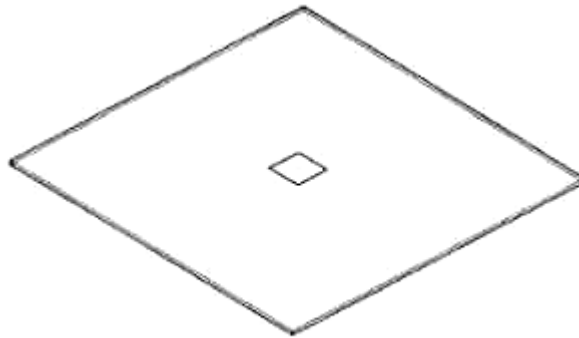

1.1



1.2



1.3



1.4



1.5

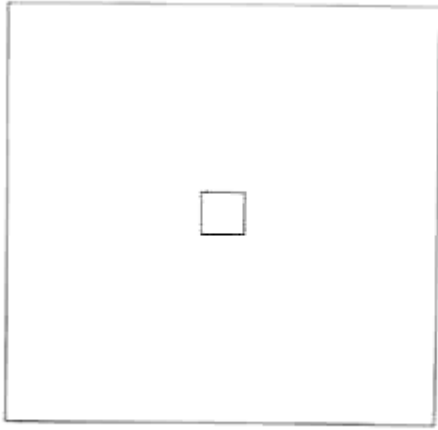

1.6

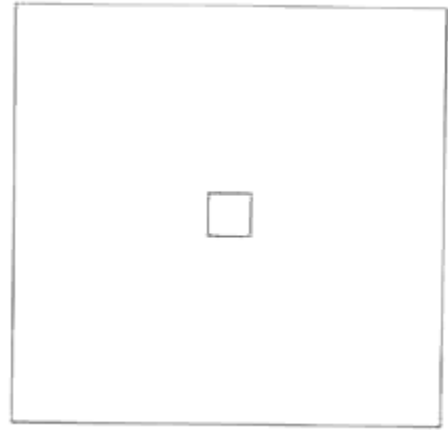

1.7

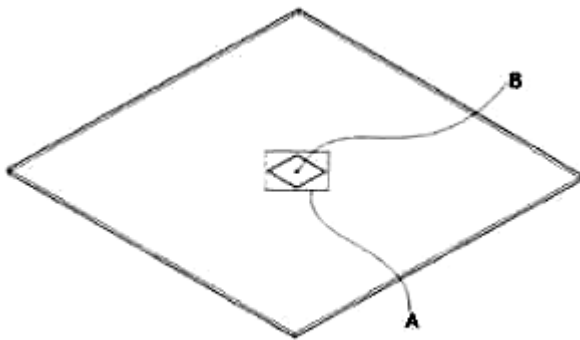

1.8

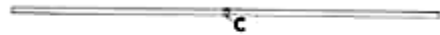

1.9

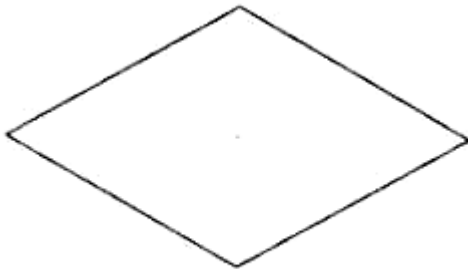

1.10

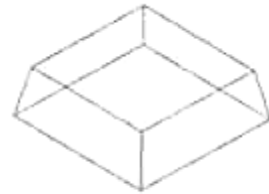

1.11



1.12

CÔNG BÁO SỞ HỮU CÔNG NGHIỆP SỐ 423 TẬP A – QUYỀN 2 (06.2023)

- (11) **46985**
- (21) 3-2022-00711 (28) 1
- (54) **BỘ PHẬN DẬP DÙNG CHO THIẾT BỊ GẮN VÀ SỬA CHỮA CHÍP** (51) **15-99**
- (22) 14/04/2022 (43) 26/06/2023
- (30) 2021-022462 15/10/2021 JP;
- (73) **SHIN-ETSU CHEMICAL CO., LTD. (JP)**
4-1, Marunouchi 1-chome, Chiyoda-ku, Tokyo 100-0005, Japan
- (72) 1. YOSHINORI OGAWA (JP)
2. KAZUNORI KONDO (JP)
3. NOBUAKI TOMURA (JP)
4. NOBUAKI MATSUMOTO (JP)
5. AKIRA SAKAMOTO (JP)
6. TAICHI KITAGAWA (JP)
- (74) Công ty TNHH Tư vấn - Dịch thuật - Sở hữu trí tuệ Á Đông (Á Đông IP CONSULTANCY CO.,LTD.)
- (55)

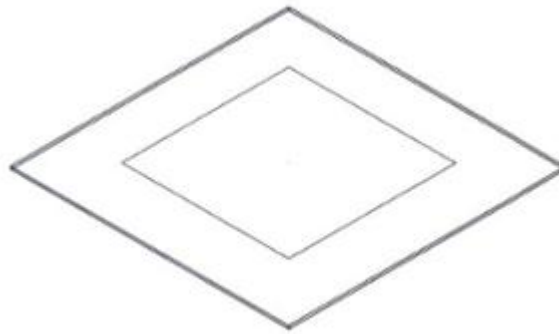

1.1



1.2



1.3



1.4



1.5

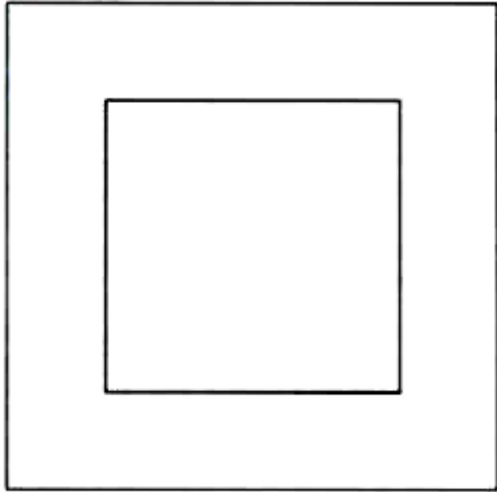

1.6

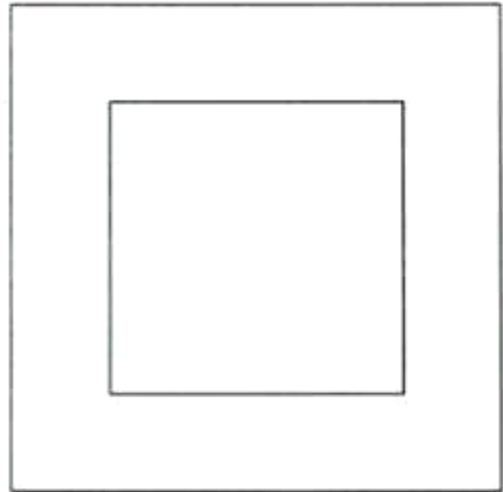

1.7

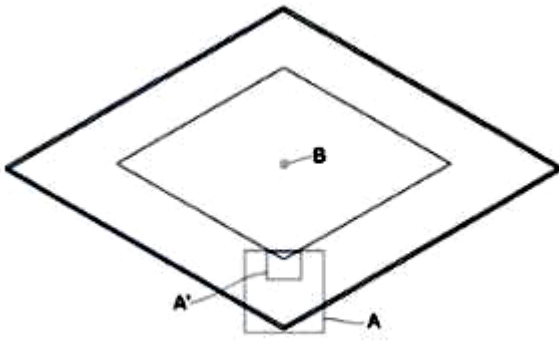

1.8



1.9

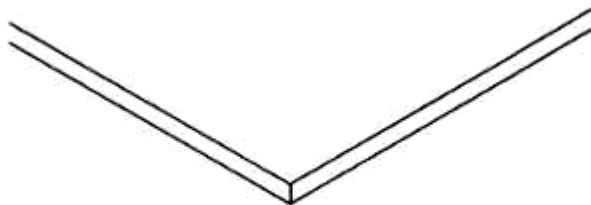
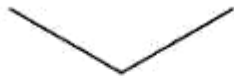

1.10



1.11

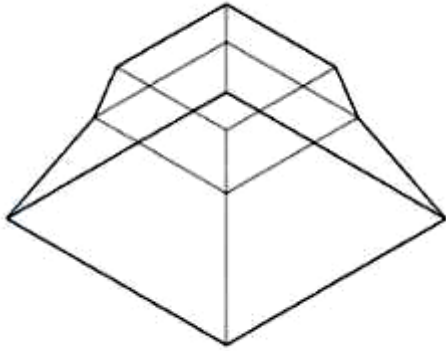

1.12



1.13



1.14

CÔNG BÁO SỞ HỮU CÔNG NGHIỆP SỐ 423 TẬP A – QUYỀN 2 (06.2023)

- (11) **46986**
- (21) 3-2022-00712 (28) 1
- (54) **BỘ PHẬN DẬP DÙNG CHO THIẾT BỊ GẮN VÀ SỬA CHỮA CHÍP** (51) **15-99**
- (22) 14/04/2022 (43) 26/06/2023
- (30) 2021-022463 15/10/2021 JP;
- (73) **SHIN-ETSU CHEMICAL CO., LTD. (JP)**
4-1, Marunouchi 1-chome, Chiyoda-ku, Tokyo 100-0005, Japan
- (72) 1. YOSHINORI OGAWA (JP)
2. KAZUNORI KONDO (JP)
3. NOBUAKI TOMURA (JP)
4. NOBUAKI MATSUMOTO (JP)
5. AKIRA SAKAMOTO (JP)
6. TAICHI KITAGAWA (JP)
- (74) Công ty TNHH Tư vấn - Dịch thuật - Sở hữu trí tuệ Á Đông (Á Đông IP CONSULTANCY CO.,LTD.)
- (55)

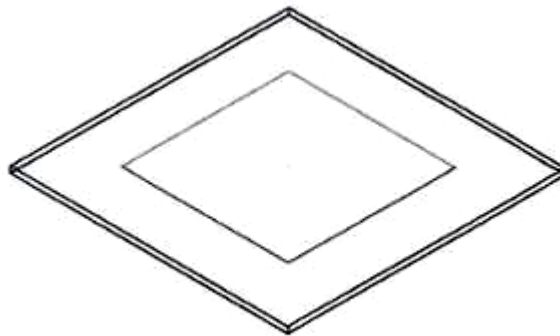

1.1



1.2



1.3



1.4



1.5

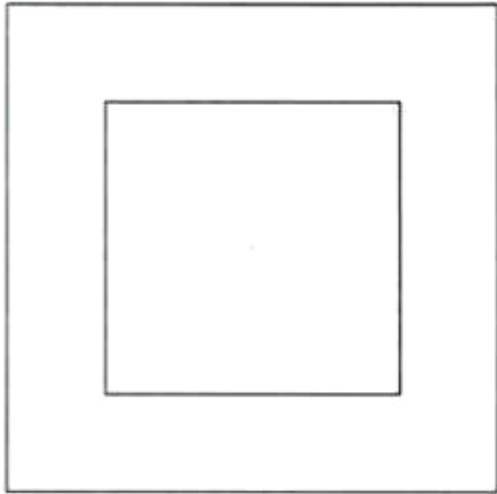

1.6

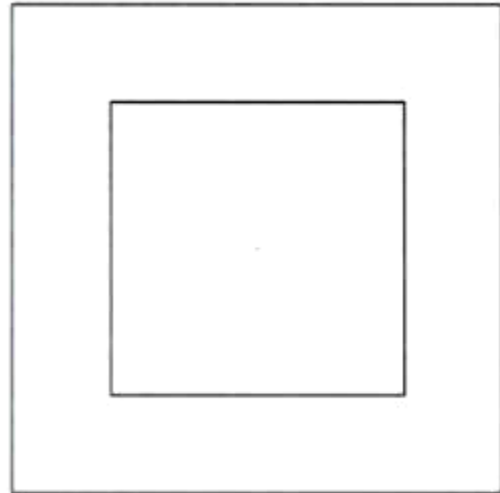

1.7

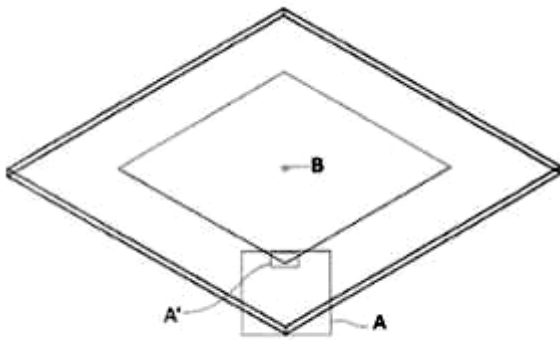

1.8



1.9

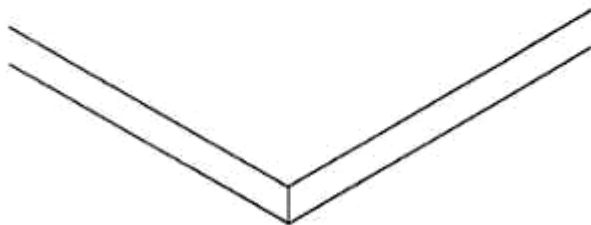

1.10

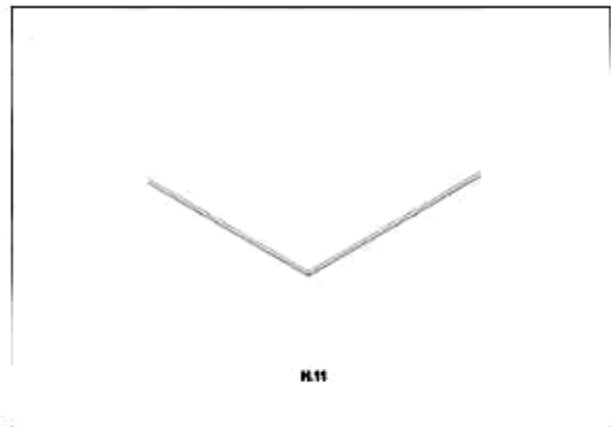

1.11

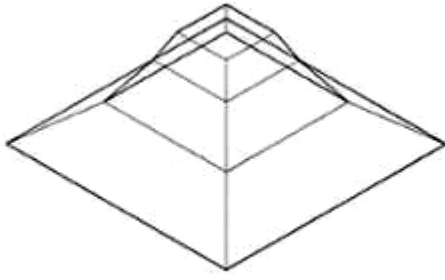

1.12



1.13



1.14

CÔNG BÁO SỞ HỮU CÔNG NGHIỆP SỐ 423 TẬP A – QUYỀN 2 (06.2023)

- (11) **46987**
- (21) 3-2022-00713 (28) 1
- (54) **BỘ PHẬN DẬP DÙNG CHO THIẾT BỊ GẮN VÀ SỬA CHỮA CHÍP** (51) **15-99**
- (22) 14/04/2022 (43) 26/06/2023
- (30) 2021-22464 15/10/2021 JP;
- (73) **SHIN-ETSU CHEMICAL CO., LTD (JP)**
4-1, Marunouchi 1-chome, Chiyoda-ku, Tokyo 100-0005, Japan
- (72) 1. YOSHINORI OGAWA (JP)
2. KAZUNORI KONDO (JP)
3. NOBUAKI TOMURA (JP)
4. NOBUAKI MATSUMOTO (JP)
5. AKIRA SAKAMOTO (JP)
6. TAICHI KITAGAWA (JP)
- (74) Công ty TNHH Tư vấn - Dịch thuật - Sở hữu trí tuệ Á Đông (Á Đông IP CONSULTANCY CO.,LTD.)
- (55)

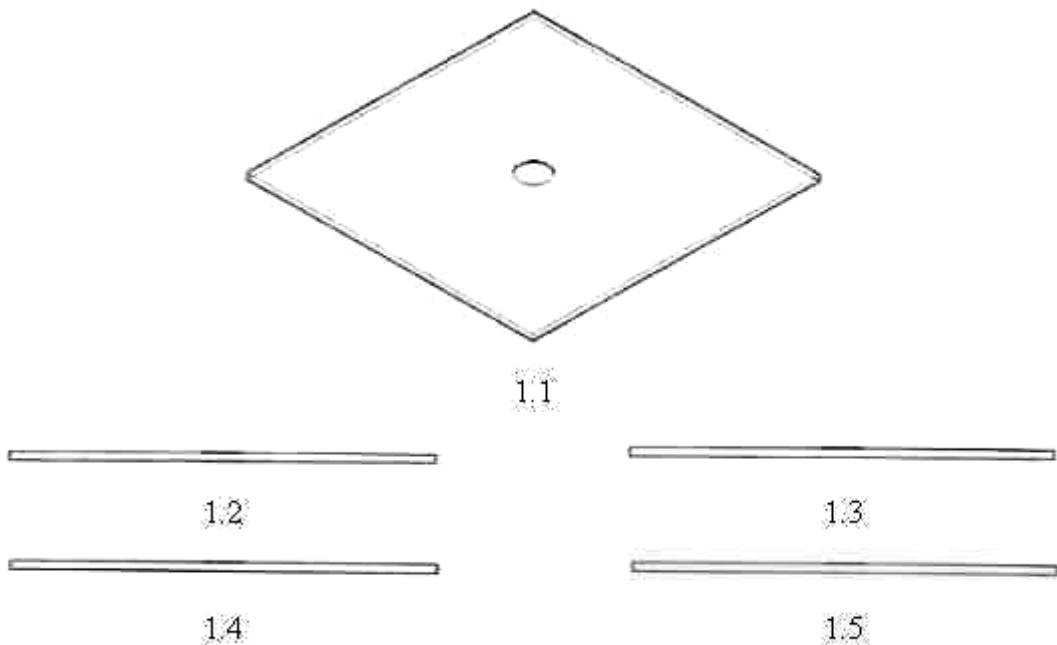

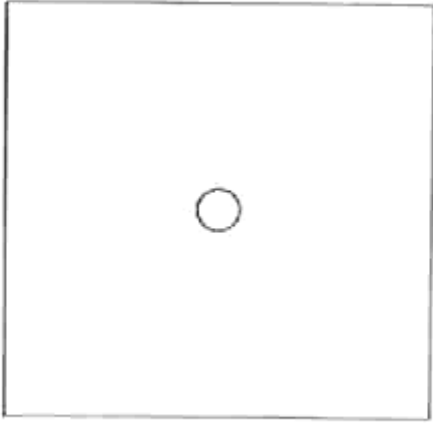

1.6

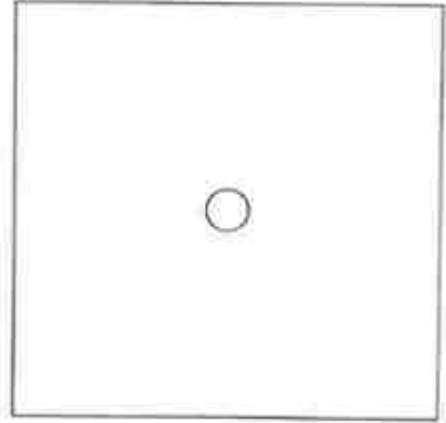

1.7

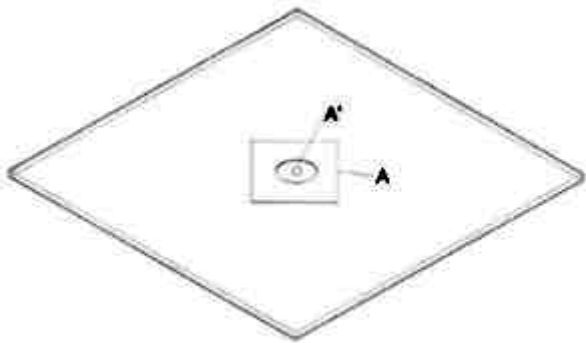

1.8



1.9



1.10

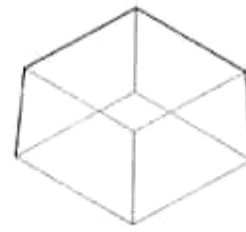

1.11



1.12



CÔNG BÁO SỞ HỮU CÔNG NGHIỆP SỐ 423 TẬP A – QUYỀN 2 (06.2023)

- (11) **46988**
- (21) 3-2022-00714 (28) 1
- (54) **BỘ PHẬN DẬP DỪNG CHO THIẾT BỊ GẮN VÀ SỬA CHỮA CHÍP** (51) **15-99**
- (22) 14/04/2022 (43) 26/06/2023
- (30) 2021-22465 15/10/2021 JP;
- (73) **SHIN-ETSU CHEMICAL CO., LTD (JP)**
4-1, Marunouchi 1-chome, Chiyoda-ku, Tokyo 100-0005, Japan
- (72) 1. YOSHINORI OGAWA (JP)
2. KAZUNORI KONDO (JP)
3. NOBUAKI TOMURA (JP)
4. NOBUAKI MATSUMOTO (JP)
5. AKIRA SAKAMOTO (JP)
6. TAICHI KITAGAWA (JP)
- (74) Công ty TNHH Tư vấn - Dịch thuật - Sở hữu trí tuệ Á Đông (Á Đông IP CONSULTANCY CO.,LTD.)
- (55)

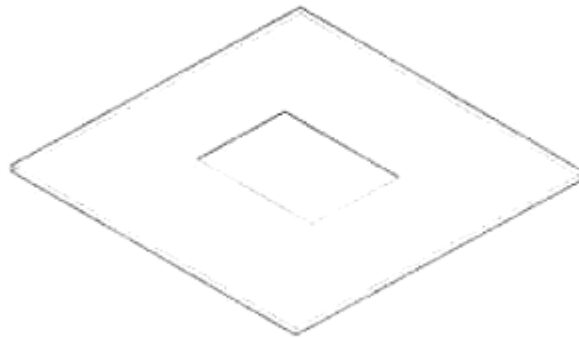

1.1



1.2



1.3



1.4



1.5

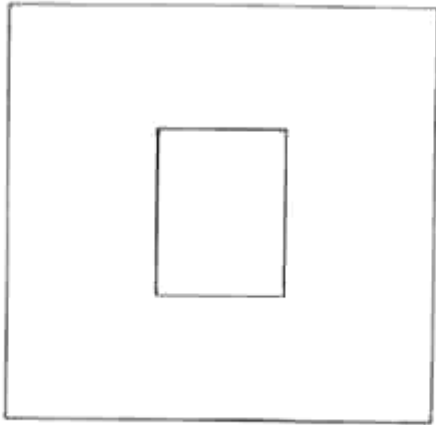

1.6

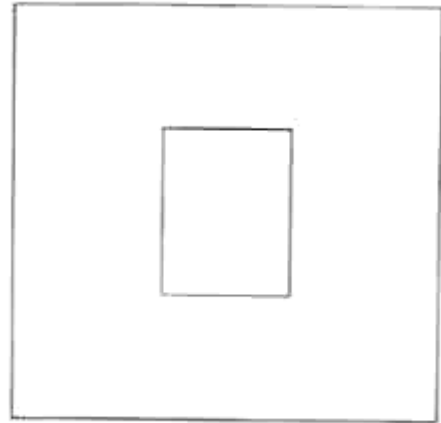

1.7

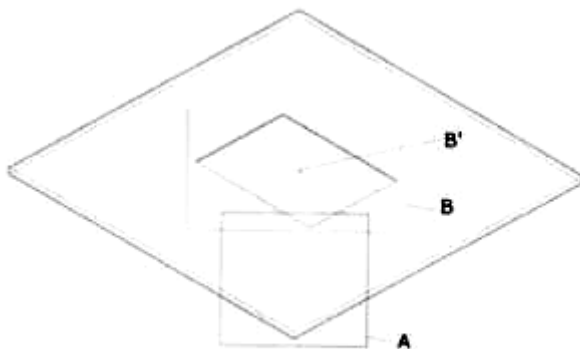

1.8



1.9



1.10

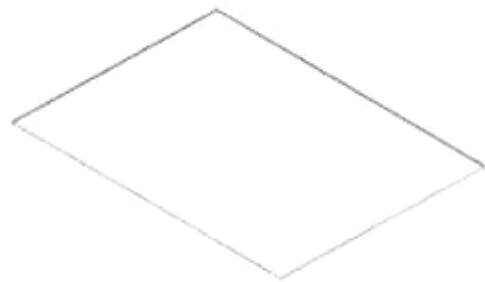

1.11

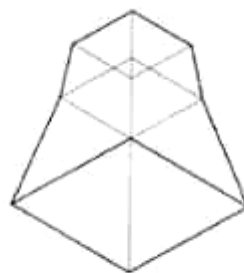

1.12



1.13



1.14

CÔNG BÁO SỞ HỮU CÔNG NGHIỆP SỐ 423 TẬP A – QUYỀN 2 (06.2023)

- (11) **46989**
- (21) 3-2022-00715 (28) 1
- (54) **TẤM NỀN TIẾP NHẬN VI CẤU TRÚC** (51) **15-99**
- (22) 14/04/2022 (43) 26/06/2023
- (30) 2021-22469 15/10/2021 JP;
- (73) **SHIN-ETSU CHEMICAL CO., LTD (JP)**
4-1, Marunouchi 1-chome, Chiyoda-ku, Tokyo 100-0005, Japan
- (72) 1. YOSHINORI OGAWA (JP)
2. KAZUNORI KONDO (JP)
3. NOBUAKI TOMURA (JP)
4. NOBUAKI MATSUMOTO (JP)
5. AKIRA SAKAMOTO (JP)
6. TAICHI KITAGAWA (JP)
- (74) Công ty TNHH Tư vấn - Dịch thuật - Sở hữu trí tuệ Á Đông (Á Đông IP CONSULTANCY CO.,LTD.)
- (55)

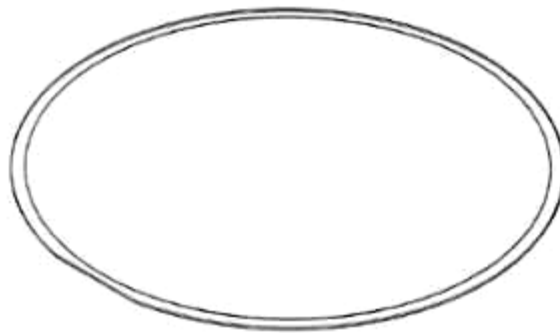

1.1



1.2



1.3



1.4



1.5

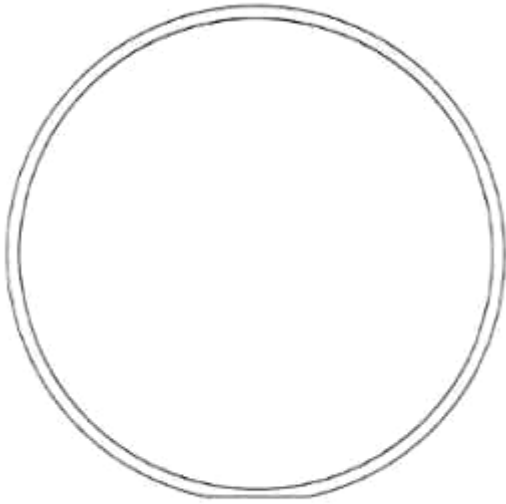

1.6

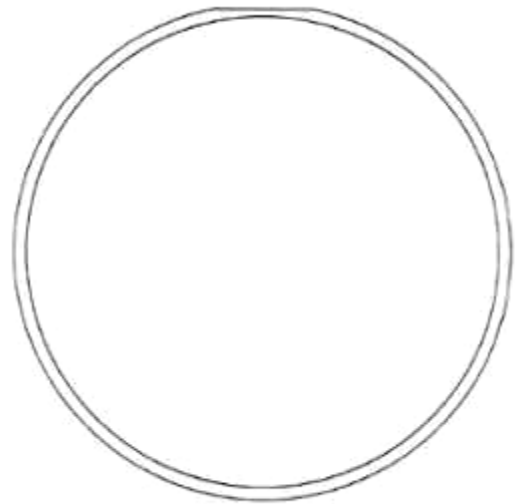

1.7

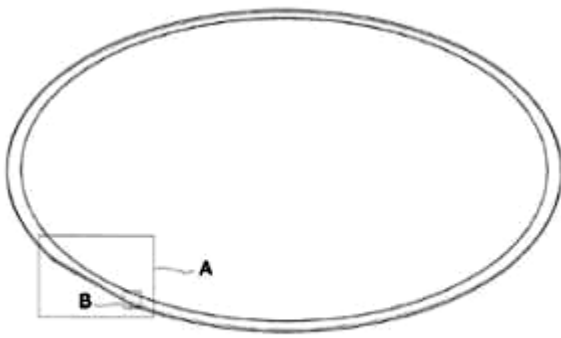

1.8

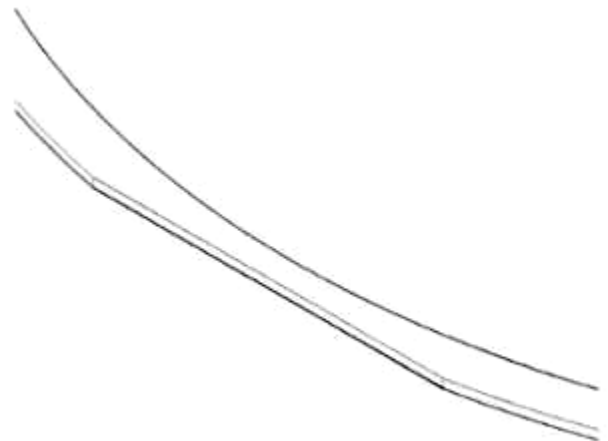

1.9

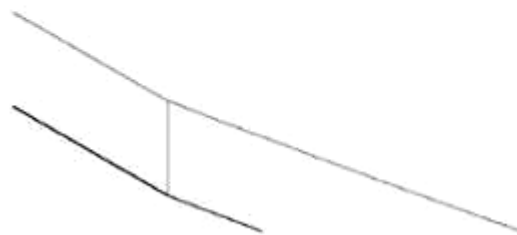

1.10

CÔNG BÁO SỞ HỮU CÔNG NGHIỆP SỐ 423 TẬP A – QUYỀN 2 (06.2023)

- (11) **46990**
- (21) 3-2022-00716 (28) 1
- (54) **TẤM NỀN TIẾP NHẬN VI CẤU TRÚC** (51) **15-99**
- (22) 14/04/2022 (43) 26/06/2023
- (30) 2021-22470 15/10/2021 JP;
- (73) **SHIN-ETSU CHEMICAL CO., LTD (JP)**
4-1, Marunouchi 1-chome, Chiyoda-ku, Tokyo 100-0005, Japan
- (72) 1. YOSHINORI OGAWA (JP)
2. KAZUNORI KONDO (JP)
3. NOBUAKI TOMURA (JP)
4. NOBUAKI MATSUMOTO (JP)
5. AKIRA SAKAMOTO (JP)
6. TAICHI KITAGAWA (JP)
- (74) Công ty TNHH Tư vấn - Dịch thuật - Sở hữu trí tuệ Á Đông (Á Đông IP CONSULTANCY CO.,LTD.)
- (55)

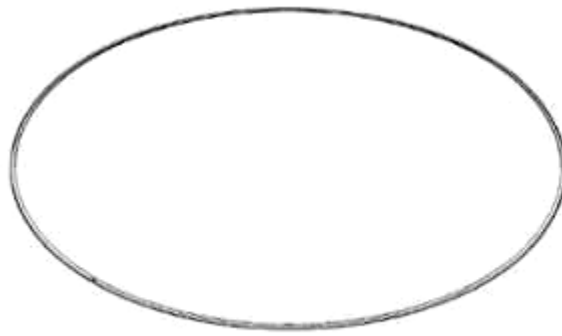

1.1

1.2

1.3

1.4

1.5

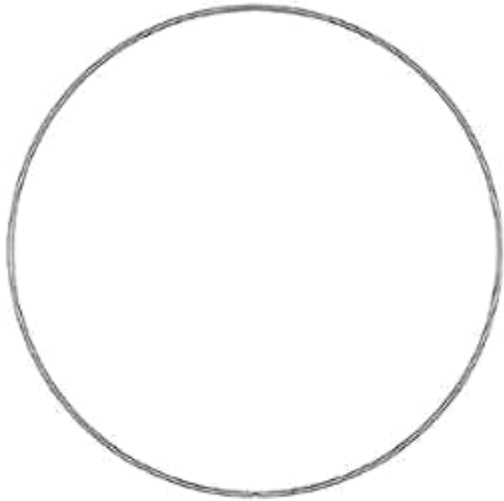

1.6

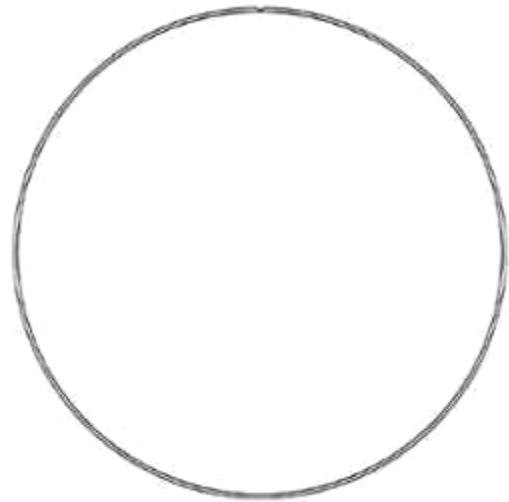

1.7

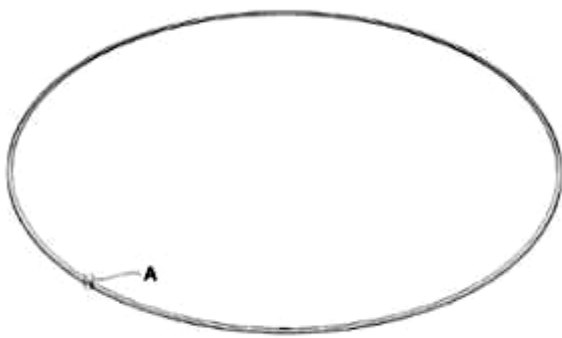

1.8

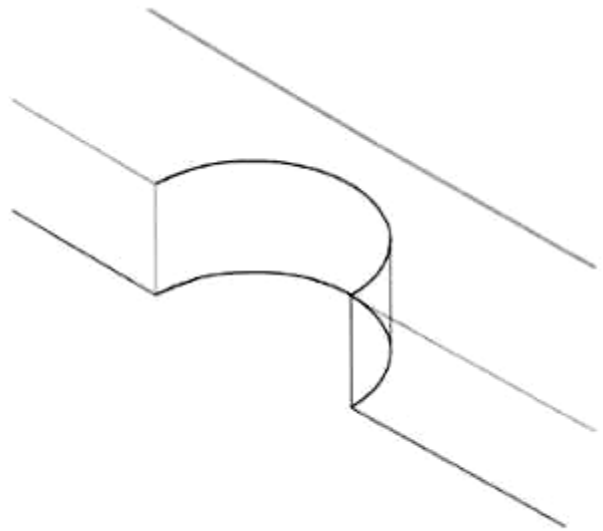

1.9

- (11) **46991**
- (21) 3-2022-00717 (28) 1
- (54) **TẦM NỀN GIẢI PHÓNG VI CẤU TRÚC** (51) **15-99**
- (22) 14/04/2022 (43) 26/06/2023
- (30) 2021-022471 15/10/2021 JP;
- (73) **SHIN-ETSU CHEMICAL CO., LTD.** (JP)
4-1, Marunouchi 1-chome, Chiyoda-ku, Tokyo 100-0005, Japan
- (72) 1. YOSHINORI OGAWA (JP)
2. KAZUNORI KONDO (JP)
3. NOBUAKI TOMURA (JP)
4. NOBUAKI MATSUMOTO (JP)
5. AKIRA SAKAMOTO (JP)
6. TAICHI KITAGAWA (JP)
- (74) Công ty TNHH Tư vấn - Dịch thuật - Sở hữu trí tuệ Á Đông (Á Đông IP CONSULTANCY CO.,LTD.)
- (55)

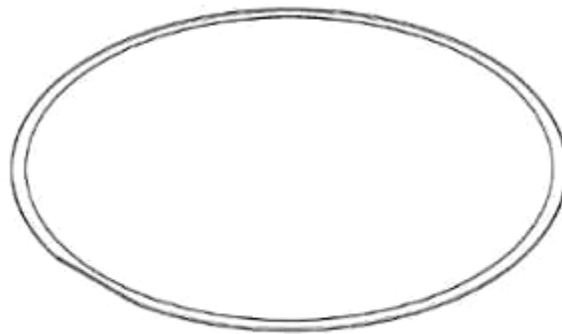

1.1

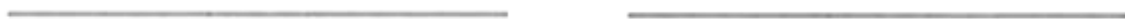

1.2

1.3



1.4

1.5

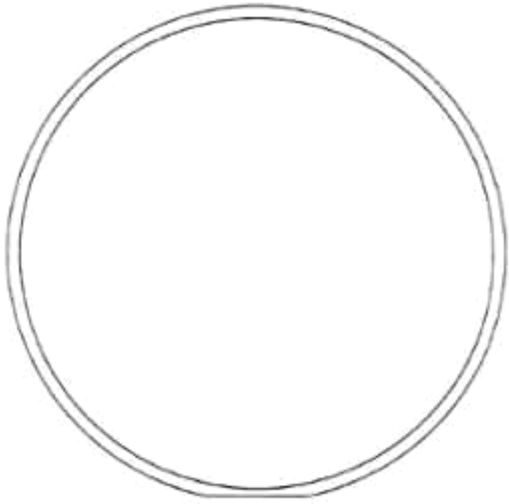

1.6

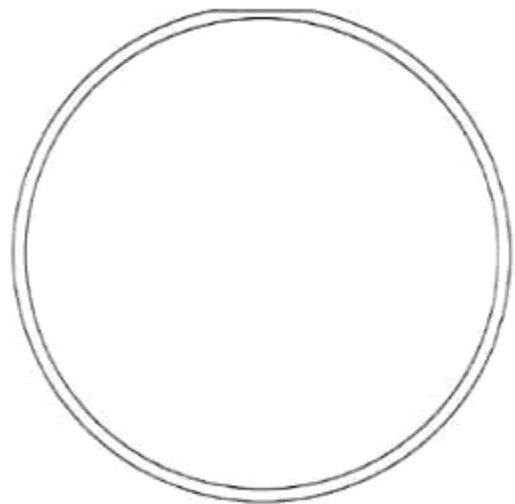

1.7

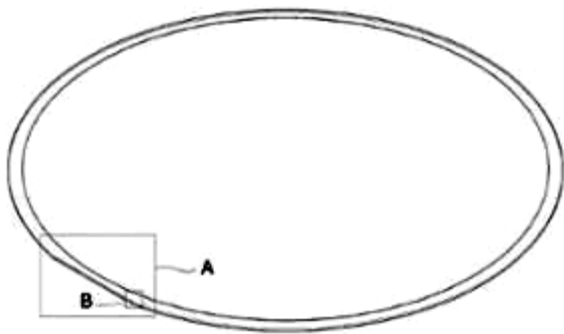

1.8

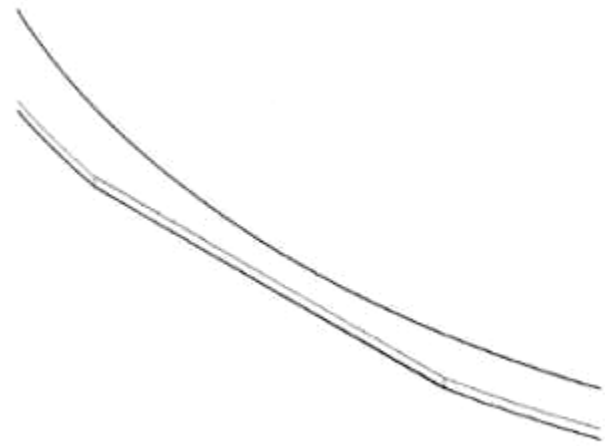

1.9

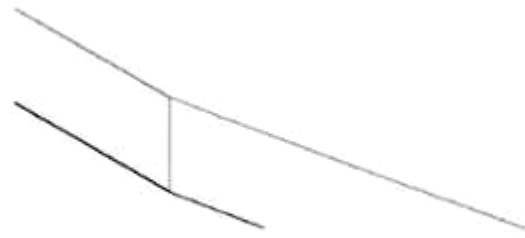

1.10

- (11) **46992**
- (21) 3-2022-00718 (28) 1
- (54) **TẦM NỀN GIẢI PHÓNG VI CẤU TRÚC** (51) **15-99**
- (22) 14/04/2022 (43) 26/06/2023
- (30) 2021-22472 15/10/2021 JP;
- (73) **SHIN-ETSU CHEMICAL CO., LTD (JP)**
4-1, Marunouchi 1-chome, Chiyoda-ku, Tokyo 100-0005, Japan
- (72) 1. YOSHINORI OGAWA (JP)
2. KAZUNORI KONDO (JP)
3. NOBUAKI TOMURA (JP)
4. NOBUAKI MATSUMOTO (JP)
5. AKIRA SAKAMOTO (JP)
6. TAICHI KITAGAWA (JP)
- (74) Công ty TNHH Tư vấn - Dịch thuật - Sở hữu trí tuệ Á Đông (Á Đông IP CONSULTANCY CO.,LTD.)
- (55)

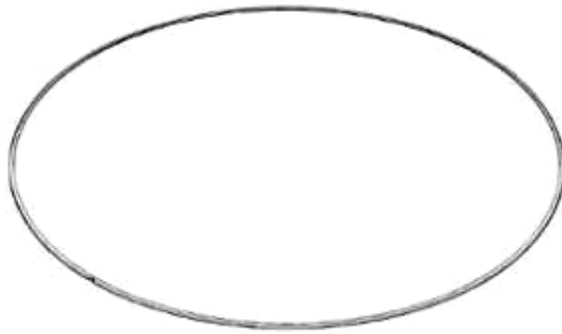

1.1

1.2

1.3

1.4

1.5

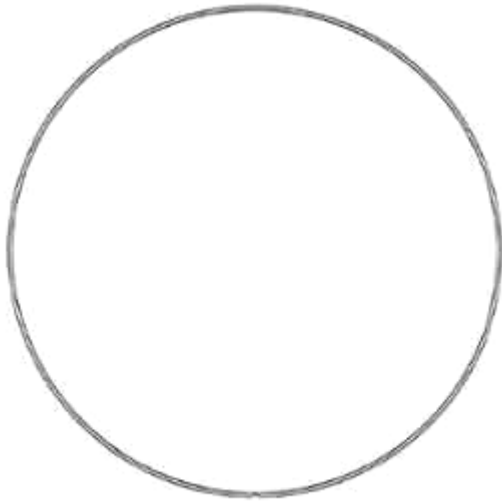

1.6

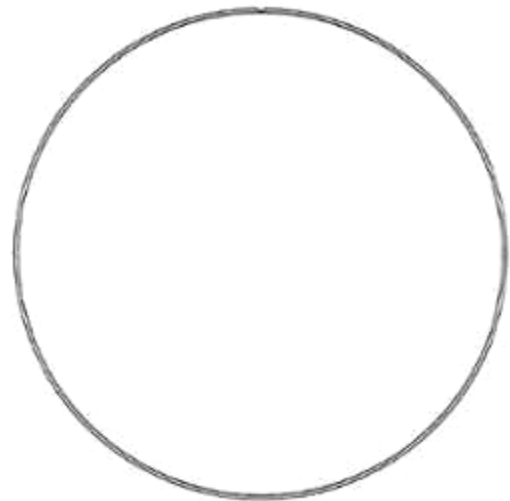

1.7

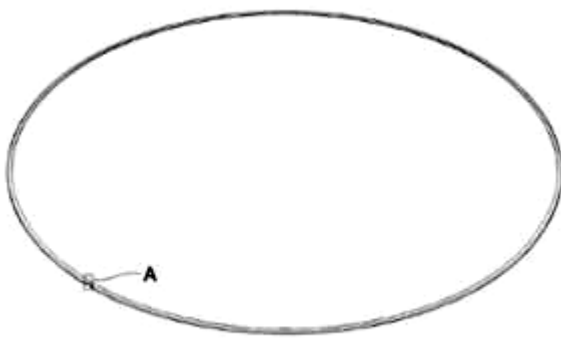

1.8

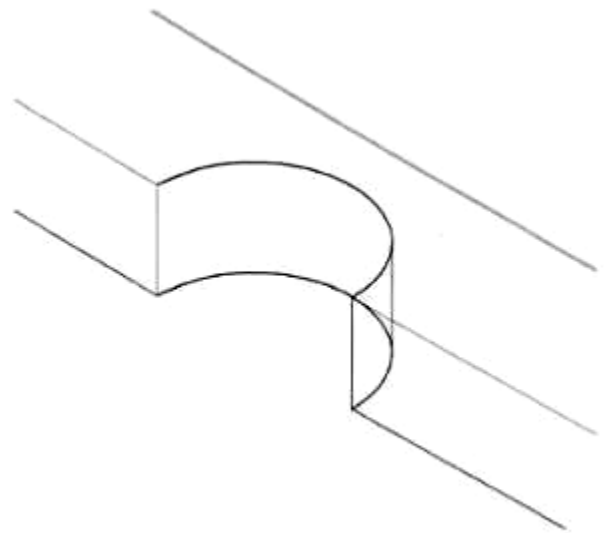

1.9

CÔNG BÁO SỞ HỮU CÔNG NGHIỆP SỐ 423 TẬP A – QUYỀN 2 (06.2023)

- (11) **46993**
- (21) 3-2022-00719 (28) 1
- (54) **TẤM NỀN TIẾP NHẬN VI CẤU TRÚC** (51) **15-99**
- (22) 14/04/2022 (43) 26/06/2023
- (30) 2021-22473 15/10/2021 JP;
- (73) **SHIN-ETSU CHEMICAU CO., LTD (JP)**
4-1, Marunouchi 1-chome, Chiyoda-ku, Tokyo 100-0005, Japan
- (72) 1. YOSHINORI OGAWA (JP)
2. KAZUNORI KONDO (JP)
3. NOBUAKI TOMURA (JP)
4. NOBUAKI MATSUMOTO (JP)
5. AKIRA SAKAMOTO (JP)
6. TAICHI KITAGAWA (JP)
- (74) Công ty TNHH Tư vấn - Dịch thuật - Sở hữu trí tuệ Á Đông (Á Đông IP CONSULTANCY CO.,LTD.)
- (55)

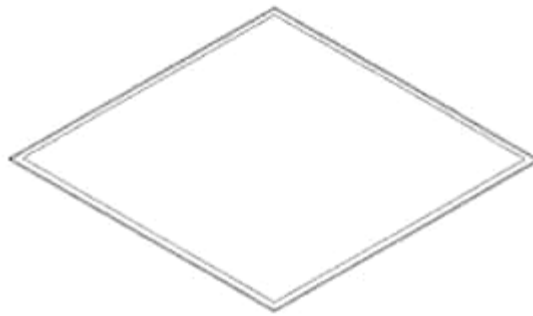

1.1



1.2

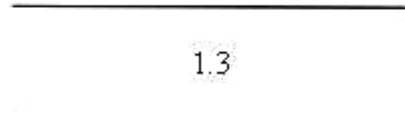

1.3

1.4

1.5

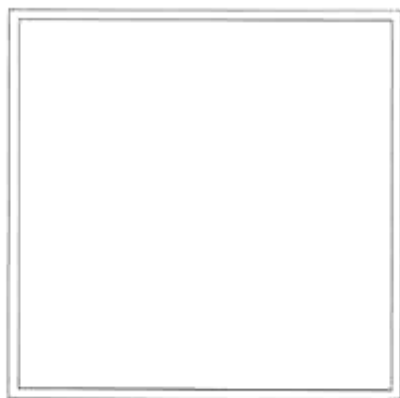

1.6

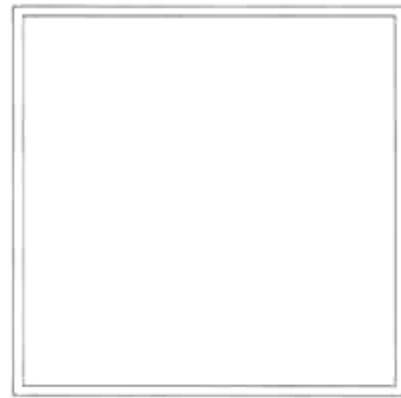

1.7

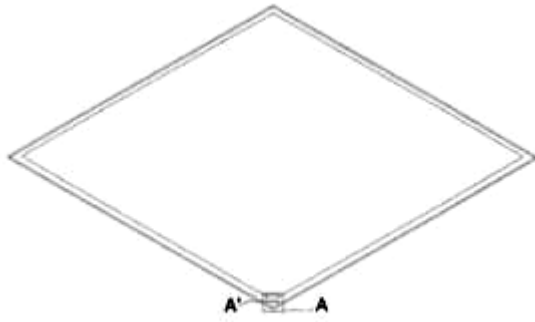

1.8



1.9

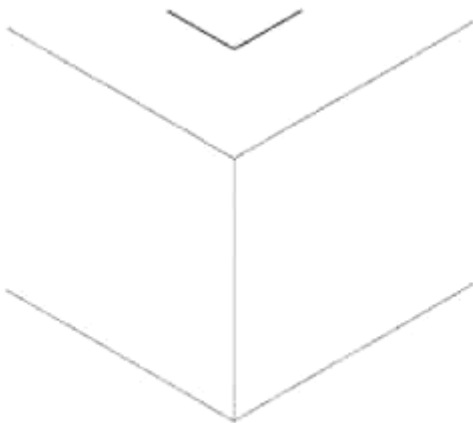

1.10



1.11



1.12



1.13

- (11) **46994**
- (21) 3-2022-00720 (28) 1
- (54) **TẤM NỀN TIẾP NHẬN VI CẤU TRÚC** (51) **15-99**
- (22) 14/04/2022 (43) 26/06/2023
- (30) 2021-22474 15/10/2021 JP;
- (73) **SHIN-ETSU CHEMICAL CO., LTD (JP)**
4-1, Marunouchi 1-chome, Chiyoda-ku, Tokyo 100-0005, Japan
- (72) 1. YOSHINORI OGAWA (JP)
2. KAZUNORI KONDO (JP)
3. NOBUAKI TOMURA (JP)
4. NOBUAKI MATSUMOTO (JP)
5. AKIRA SAKAMOTO (JP)
6. TAICHI KITAGAWA (JP)
- (74) Công ty TNHH Tư vấn - Dịch thuật - Sở hữu trí tuệ Á Đông (Á Đông IP CONSULTANCY CO.,LTD.)
- (55)

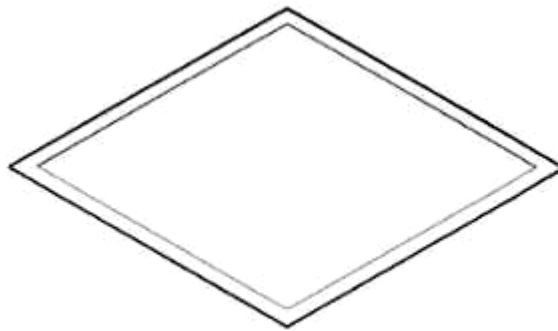

1.1

1.2

1.3

1.4

1.5

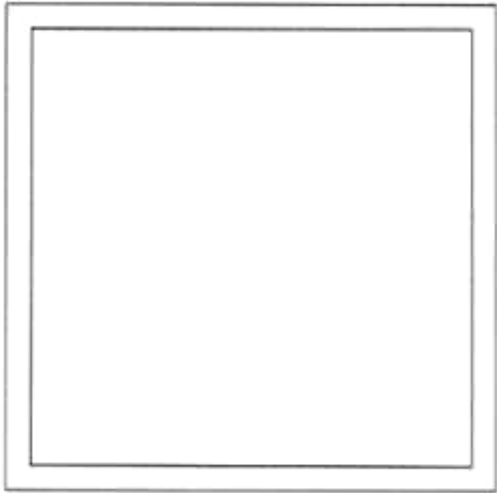

1.6

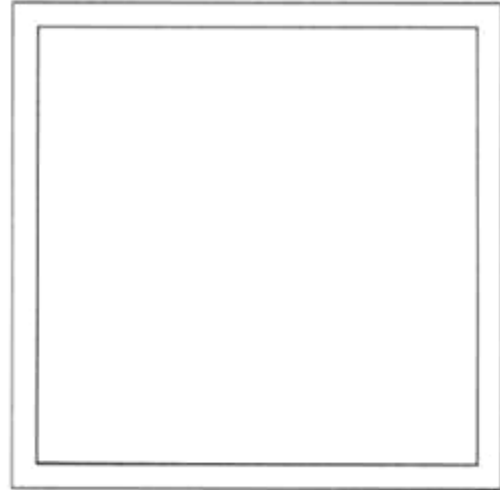

1.7

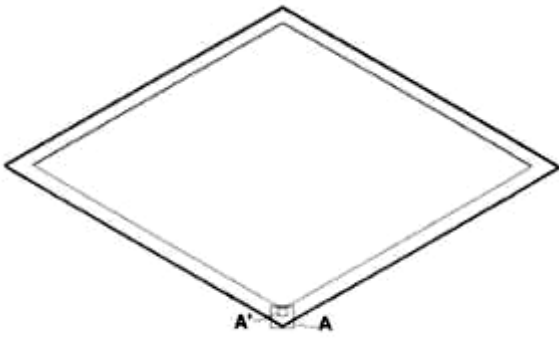

1.8



1.9



1.10



1.11



1.12



1.13

CÔNG BÁO SỞ HỮU CÔNG NGHIỆP SỐ 423 TẬP A – QUYỀN 2 (06.2023)

- (11) **46995**
- (21) 3-2022-00721 (28) 1
- (54) **TẤM NỀN TIẾP NHẬN VI CẤU TRÚC** (51) **15-99**
- (22) 14/04/2022 (43) 26/06/2023
- (30) 2021-22475 15/10/2021 JP;
- (73) **SHIN-ETSU CHEMICAL CO., LTD (JP)**
4-1, Marunouchi 1-chome, Chiyoda-ku, Tokyo 100-0005, Japan
- (72) 1. YOSHINORI OGAWA (JP)
2. KAZUNORI KONDO (JP)
3. NOBUAKI TOMURA (JP)
4. NOBUAKI MATSUMOTO (JP)
5. AKIRA SAKAMOTO (JP)
6. TAICHI KITAGAWA (JP)
- (74) Công ty TNHH Tư vấn - Dịch thuật - Sở hữu trí tuệ Á Đông (Á Đông IP CONSULTANCY CO.,LTD.)
- (55)

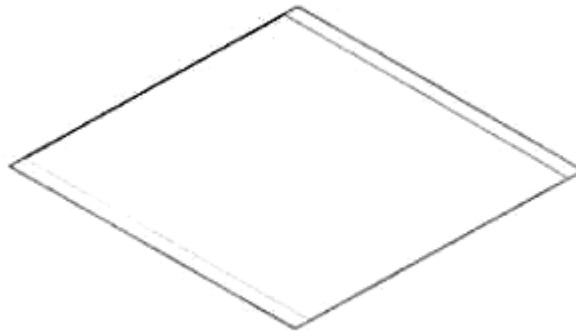

1.1



1.2

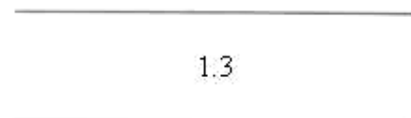

1.3



1.4

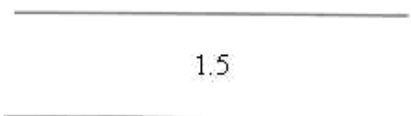

1.5

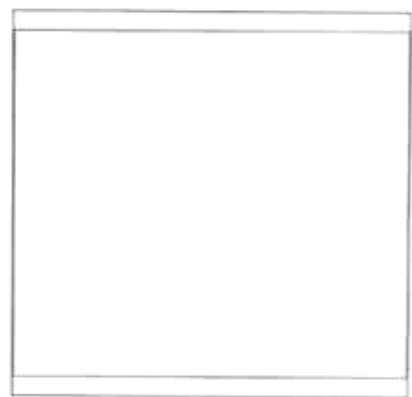

1.6



1.7

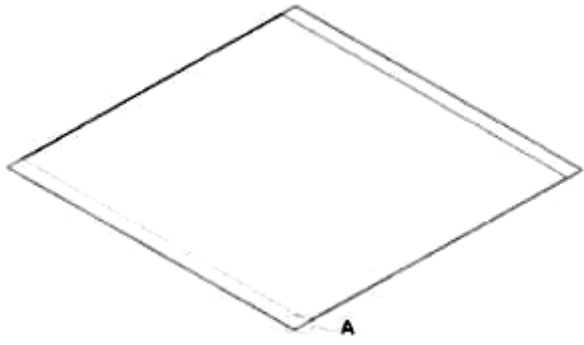

1.8



1.9



1.10

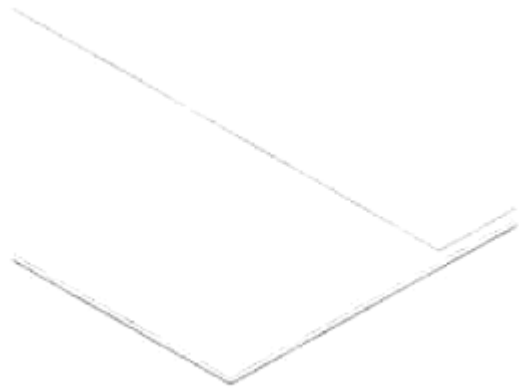

1.11



1.12



1.13

CÔNG BÁO SỞ HỮU CÔNG NGHIỆP SỐ 423 TẬP A – QUYỀN 2 (06.2023)

- (11) **46996**
(21) 3-2022-00722 (28) 1
(54) **TẤM NỀN TIẾP NHẬN VI CẤU TRÚC** (51) **15-99**
(22) 14/04/2022 (43) 26/06/2023
(30) 2021-22478 15/10/2021 JP;
(73) **SHIN-ETSU CHEMICAL CO., LTD (JP)**
4-1, Marunouchi 1-chome, Chiyoda-ku, Tokyo 100-0005, Japan
(72) 1. YOSHINORI OGAWA (JP)
2. KAZUNORI KONDO (JP)
3. NOBUAKI TOMURA (JP)
4. NOBUAKI MATSUMOTO (JP)
5. AKIRA SAKAMOTO (JP)
6. TAICHI KITAGAWA (JP)
(74) Công ty TNHH Tư vấn - Dịch thuật - Sở hữu trí tuệ Á Đông (Á Đông IP
CONSULTANCY CO.,LTD.)
(55)

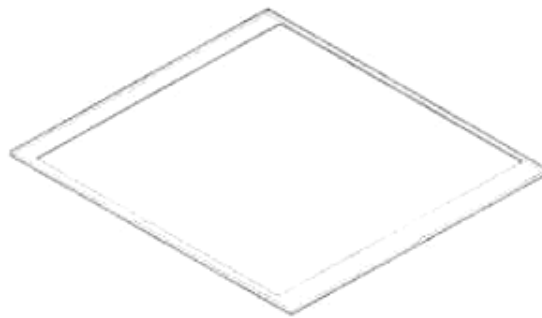

1.1



1.2



1.3



1.4



1.5

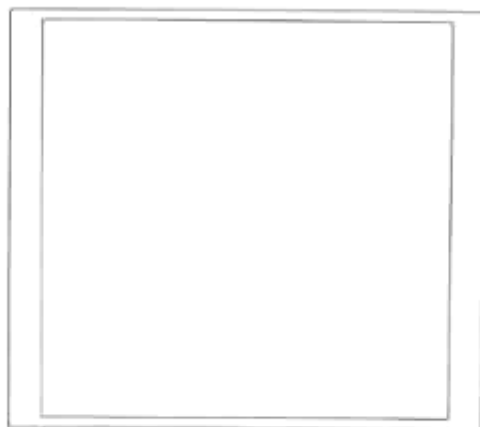

1.6

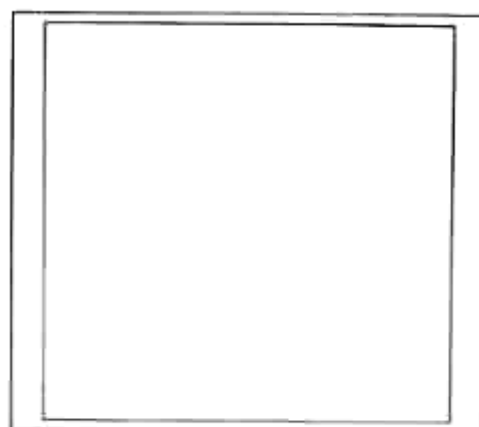

1.7

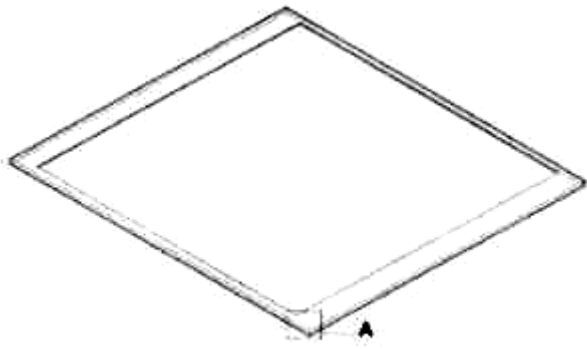

1.8



1.9

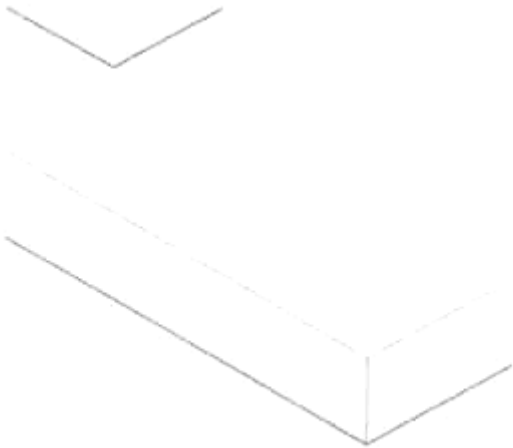

1.10



1.11



1.12

CÔNG BÁO SỞ HỮU CÔNG NGHIỆP SỐ 423 TẬP A – QUYỀN 2 (06.2023)

- (11) **46997**
- (21) 3-2022-00723 (28) 1
- (54) **BỘ PHẬN DẬP DÙNG CHO THIẾT BỊ GẮN VÀ SỬA CHỮA CHÍP** (51) **15-99**
- (22) 14/04/2022 (43) 26/06/2023
- (30) 2021-22480 15/10/2021 JP;
- (73) **SHIN-ETSU CHEMICAL CO., LTD. (JP)**
4-1, Marunouchi 1-chome, Chiyoda-ku, Tokyo 100-0005, Japan
- (72) 1. YOSHINORI OGAWA (JP)
2. KAZUNORI KONDO (JP)
3. NOBUAKI TOMURA (JP)
4. NOBUAKI MATSUMOTO (JP)
5. AKIRA SAKAMOTO (JP)
6. TAICHI KITAGAWA (JP)
- (74) Công ty TNHH Tư vấn - Dịch thuật - Sở hữu trí tuệ Á Đông (Á Đông IP CONSULTANCY CO.,LTD.)
- (55)

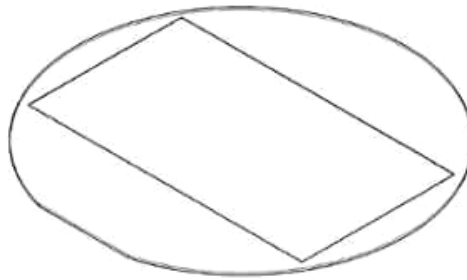

1.1



1.2



1.3



1.4



1.5

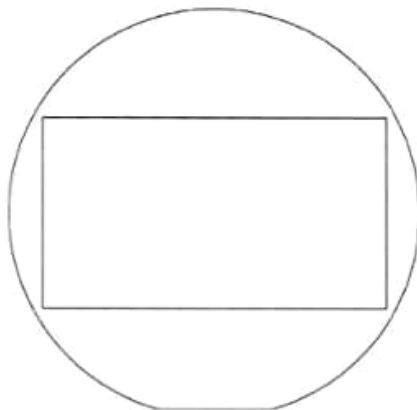

1.6

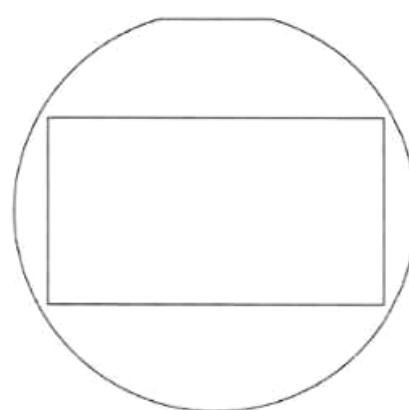

1.7

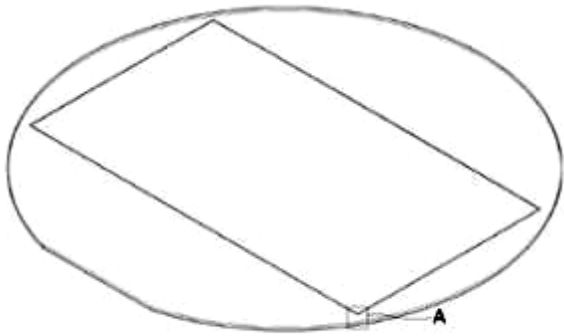

1.8



1.9



1.10



1.11



1.12



CÔNG BÁO SỞ HỮU CÔNG NGHIỆP SỐ 423 TẬP A – QUYỀN 2 (06.2023)

- (11) **46998**
- (21) 3-2022-00724 (28) 1
- (54) **BỘ PHẬN DẬP DÙNG CHO THIẾT BỊ GẮN VÀ SỮA CHỮA CHÍP** (51) **15-99**
- (22) 14/04/2022 (43) 26/06/2023
- (30) 2021-22482 15/10/2021 JP;
- (73) **SHIN-ETSU CHEMICAL CO., LTD. (JP)**
4-1, Marunouchi 1-chome, Chiyoda-ku, Tokyo 100-0005, Japan
- (72) 1. YOSHINORI OGAWA (JP)
2. KAZUNORI KONDO (JP)
3. NOBUAKI TOMURA (JP)
4. NOBUAKI MATSUMOTO (JP)
5. AKIRA SAKAMOTO (JP)
6. TAICHI KITAGAWA (JP)
- (74) Công ty TNHH Tư vấn - Dịch thuật - Sở hữu trí tuệ Á Đông (Á Đông IP CONSULTANCY CO.,LTD.)
- (55)

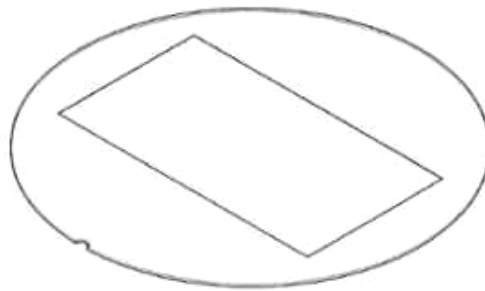

1.1

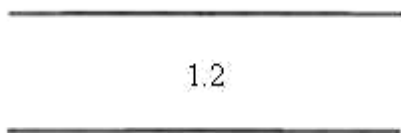

1.2

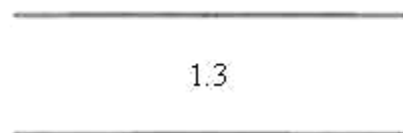

1.3

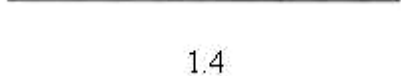

1.4



1.5

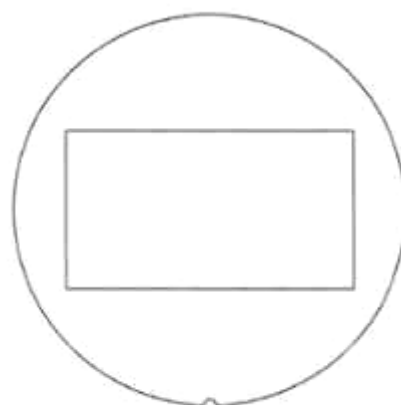

1.6

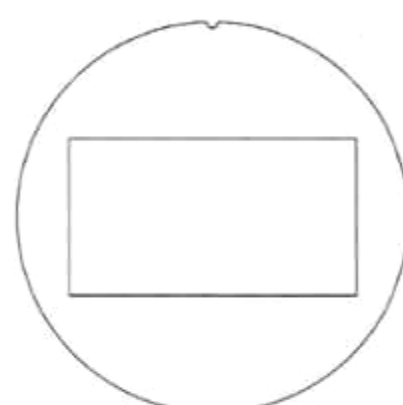

1.7

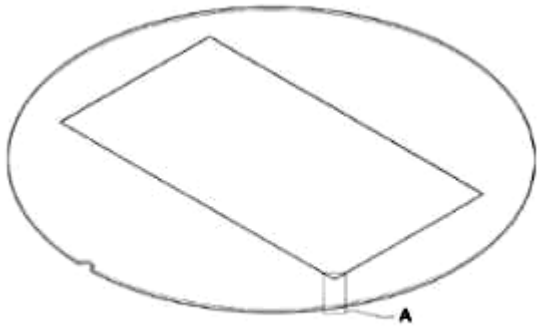

1.8



1.9



1.10



1.11



1.12

CÔNG BÁO SỞ HỮU CÔNG NGHIỆP SỐ 423 TẬP A – QUYỀN 2 (06.2023)

- (11) **46999**
- (21) 3-2022-00725 (28) 1
- (54) **BỘ PHẬN DẬP DÙNG CHO THIẾT BỊ GẮN VÀ SỬA CHỮA CHÍP** (51) **15-99**
- (22) 14/04/2022 (43) 26/06/2023
- (30) 2021-22484 15/10/2021 JP;
- (73) **SHIN-ETSU CHEMICAL CO., LTD. (JP)**
4-1, Marunouchi 1-chome, Chiyoda-ku, Tokyo 100-0005, Japan
- (72) 1. YOSHINORI OGAWA (JP)
2. KAZUNORI KONDO (JP)
3. NOBUAKI TOMURA (JP)
4. NOBUAKI MATSUMOTO (JP)
5. AKIRA SAKAMOTO (JP)
6. TAICHI KITAGAWA (JP)
- (74) Công ty TNHH Tư vấn - Dịch thuật - Sở hữu trí tuệ Á Đông (Á Đông IP CONSULTANCY CO.,LTD.)
- (55)

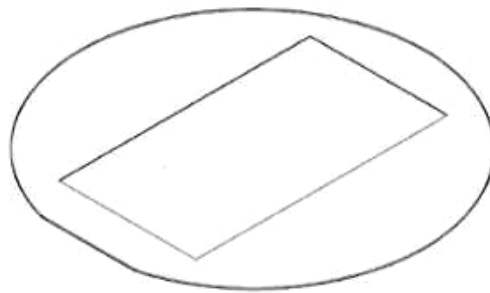

1.1



1.2

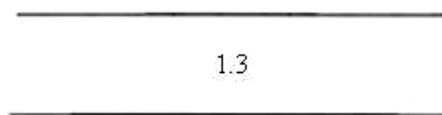

1.3

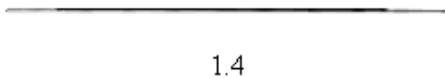

1.4

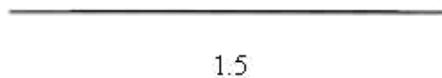

1.5

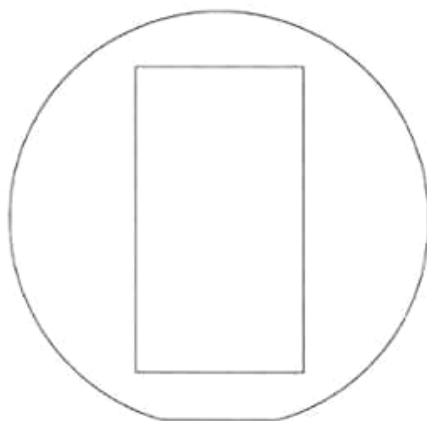

1.6

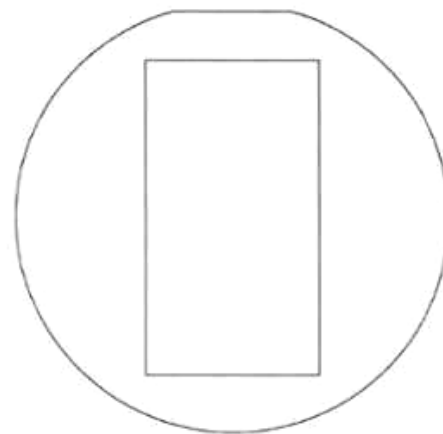

1.7

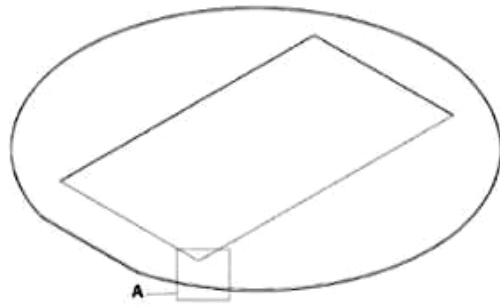

1.8



1.9



1.10



1.11



1.12

CÔNG BÁO SỞ HỮU CÔNG NGHIỆP SỐ 423 TẬP A – QUYỀN 2 (06.2023)

- (11) **47000**
- (21) 3-2022-00726 (28) 1
- (54) **BỘ PHẬN DẬP DÙNG CHO THIẾT BỊ GẮN VÀ SỮA CHỮA CHÍP** (51) **15-99**
- (22) 14/04/2022 (43) 26/06/2023
- (30) 2021-22485 15/10/2021 JP;
- (73) **SHIN-ETSU CHEMICAL CO., LTD. (JP)**
4-1, Marunouchi 1-chome, Chiyoda-ku, Tokyo 100-0005, Japan
- (72) 1. YOSHINORI OGAWA (JP)
2. KAZUNORI KONDO (JP)
3. NOBUAKI TOMURA (JP)
4. NOBUAKI MATSUMOTO (JP)
5. AKIRA SAKAMOTO (JP)
6. TAICHI KITAGAWA (JP)
- (74) Công ty TNHH Tư vấn - Dịch thuật - Sở hữu trí tuệ Á Đông (Á Đông IP CONSULTANCY CO.,LTD.)
- (55)

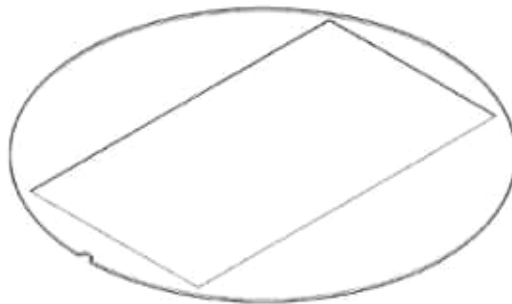

1.1



1.2



1.4



1.3



1.5

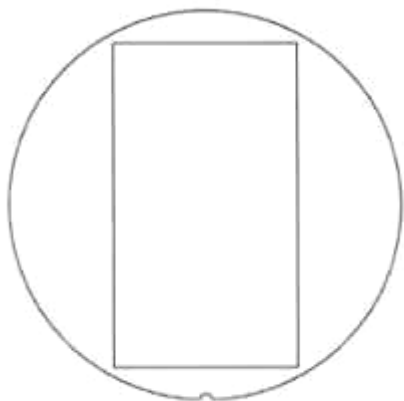

1.6

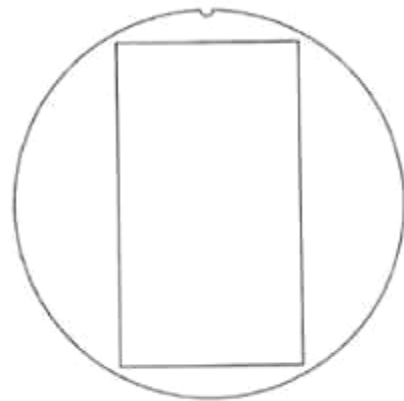

1.7

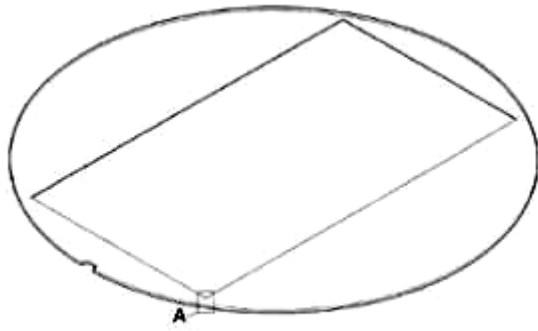

1.8



1.9



1.10



1.11



1.12



CÔNG BÁO SỞ HỮU CÔNG NGHIỆP SỐ 423 TẬP A – QUYỀN 2 (06.2023)

- (11) **47001**
- (21) 3-2022-00727 (28) 1
- (54) **BỘ PHẬN DẬP DÙNG CHO THIẾT BỊ GẮN VÀ SỮA CHỮA CHÍP** (51) **15-99**
- (22) 14/04/2022 (43) 26/06/2023
- (30) 2021-22486 15/10/2021 JP;
- (73) **SHIN-ETSU CHEMICAL CO., LTD. (JP)**
4-1, Marunouchi 1-chome, Chiyoda-ku, Tokyo 100-0005, Japan
- (72) 1. YOSHINORI OGAWA (JP)
2. KAZUNORI KONDO (JP)
3. NOBUAKI TOMURA (JP)
4. NOBUAKI MATSUMOTO (JP)
5. AKIRA SAKAMOTO (JP)
6. TAICHI KITAGAWA (JP)
- (74) Công ty TNHH Tư vấn - Dịch thuật - Sở hữu trí tuệ Á Đông (Á Đông IP CONSULTANCY CO.,LTD.)
- (55)

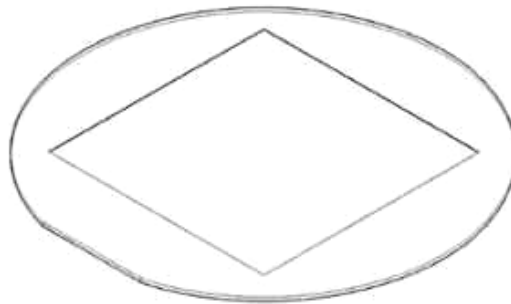

1.1



1.2



1.3



1.4



1.5

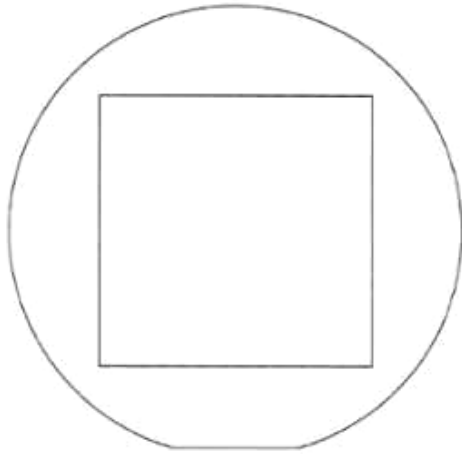

1.6

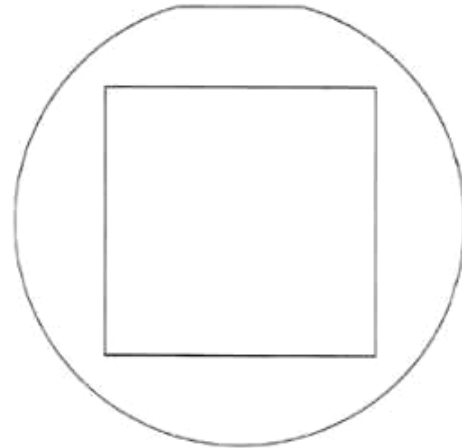

1.7

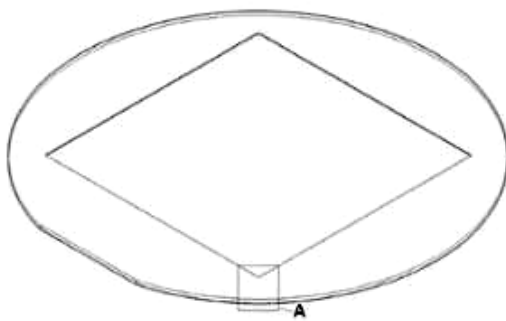

1.8



1.9



1.10

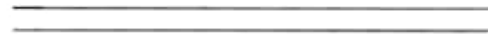

1.11



1.12

CÔNG BÁO SỞ HỮU CÔNG NGHIỆP SỐ 423 TẬP A – QUYỀN 2 (06.2023)

- (11) **47002**
- (21) 3-2022-00728 (28) 1
- (54) **BỘ PHẬN DẬP DÙNG CHO THIẾT BỊ GẮN VÀ SỬA CHỮA CHÍP** (51) **15-99**
- (22) 14/04/2022 (43) 26/06/2023
- (30) 2021-22487 15/10/2021 JP;
- (73) **SHIN-ETSU CHEMICAL CO., LTD. (JP)**
4-1, Marunouchi 1-chome, Chiyoda-ku, Tokyo 100-0005, Japan
- (72) 1. YOSHINORI OGAWA (JP)
2. KAZUNORI KONDO (JP)
3. NOBUAKI TOMURA (JP)
4. NOBUAKI MATSUMOTO (JP)
5. AKIRA SAKAMOTO (JP)
6. TAICHI KITAGAWA (JP)
- (74) Công ty TNHH Tư vấn - Dịch thuật - Sở hữu trí tuệ Á Đông (Á Đông IP CONSULTANCY CO.,LTD.)
- (55)

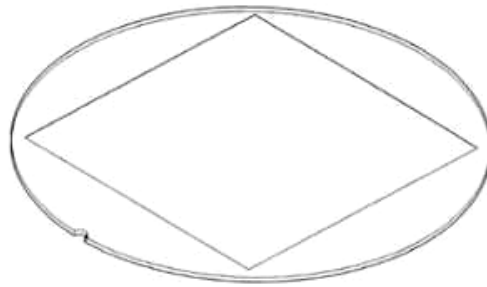

1.1



1.2



1.3



1.4



1.5

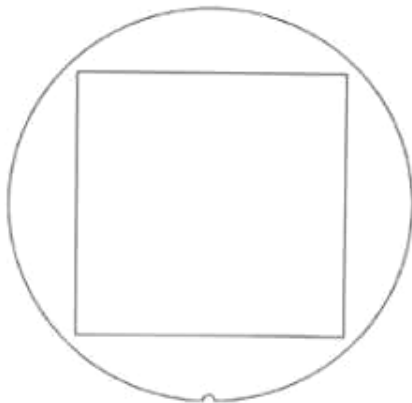

1.6

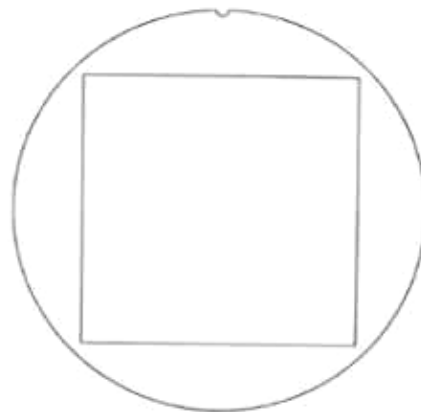

1.7

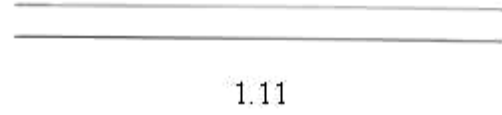
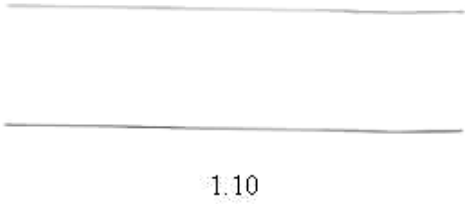
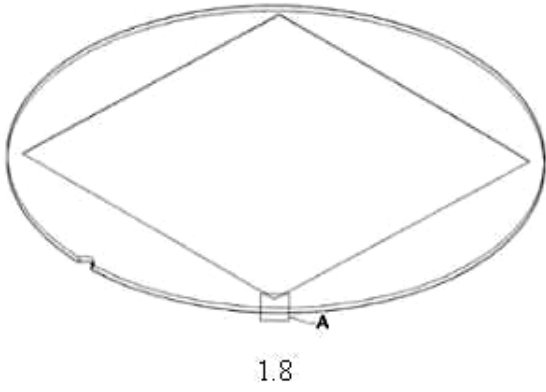

1.12

CÔNG BÁO SỞ HỮU CÔNG NGHIỆP SỐ 423 TẬP A – QUYỀN 2 (06.2023)

- (11) **47003**
- (21) 3-2022-00729 (28) 1
- (54) **TẤM NỀN GẮN TẠM VI CẤU TRÚC VÀ MẢNH MỎNG VẬT LIỆU BẮN DẪN** (51) **15-99**
- (22) 14/04/2022 (43) 26/06/2023
- (30) 2021-22497 15/10/2021 JP;
- (73) **SHIN-ETSU CHEMICAL CO., LTD. (JP)**
4-1, Marunouchi 1-chome, Chiyoda-ku, Tokyo 100-0005, Japan
- (72) 1. YOSHINORI OGAWA (JP)
2. KAZUNORI KONDO (JP)
3. NOBUAKI TOMURA (JP)
4. NOBUAKI MATSUMOTO (JP)
5. AKIRA SAKAMOTO (JP)
6. TAICHI KITAGAWA (JP)
- (74) Công ty TNHH Tư vấn - Dịch thuật - Sở hữu trí tuệ Á Đông (Á Đông IP CONSULTANCY CO.,LTD.)
- (55)

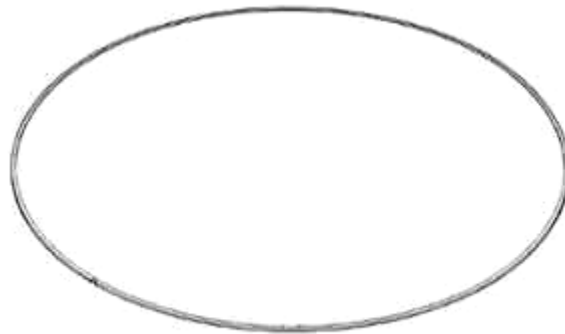

1.1



1.2



1.3



1.4



1.5

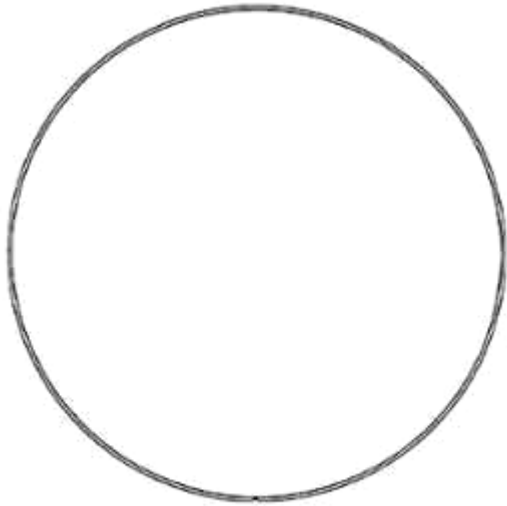

1.6

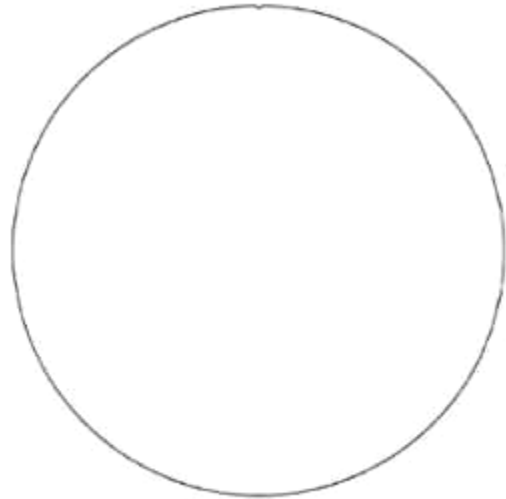

1.7

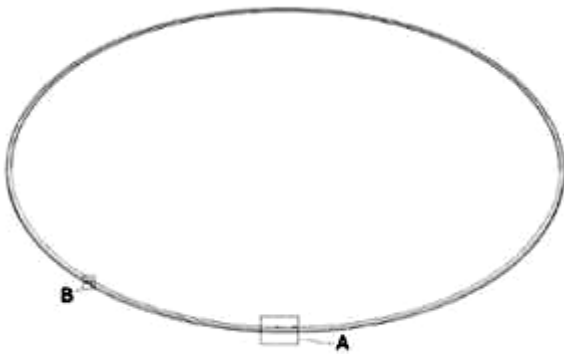

1.8



1.9

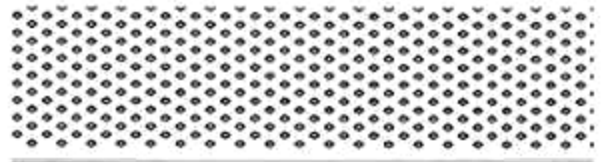

1.10



1.11

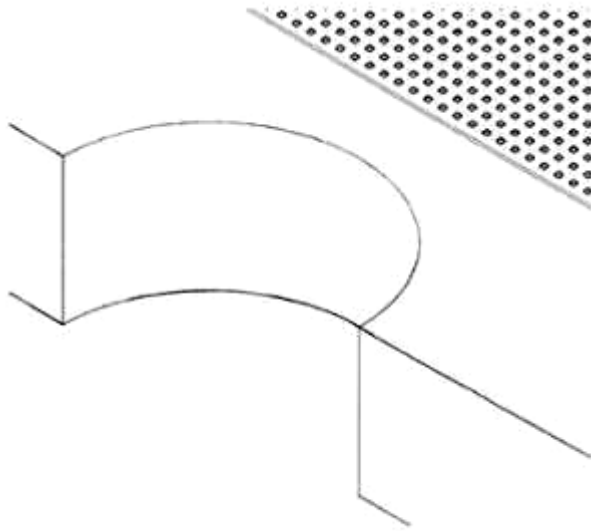

1.12



1.13



1.14

CÔNG BÁO SỞ HỮU CÔNG NGHIỆP SỐ 423 TẬP A – QUYỀN 2 (06.2023)

- (11) **47004**
- (21) 3-2022-00730 (28) 1
- (54) **TẤM NỀN GẮN TẠM VI CẤU TRÚC VÀ MẢNH MỎNG VẬT LIỆU BÁN DẪN** (51) **15-99**
- (22) 14/04/2022 (43) 26/06/2023
- (30) 2021-22498 15/10/2021 JP;
- (73) **SHIN-ETSU CHEMICAL CO., LTD (JP)**
4-1, Marunouchi 1-chome, Chiyoda-ku, Tokyo 100-0005, Japan
- (72) 1. YOSHINORI OGAWA (JP)
2. KAZUNORI KONDO (JP)
3. NOBUAKI TOMURA (JP)
4. NOBUAKI MATSUMOTO (JP)
5. AKIRA SAKAMOTO (JP)
6. TAICHI KITAGAWA (JP)
- (74) Công ty TNHH Tư vấn - Dịch thuật - Sở hữu trí tuệ Á Đông (Á Đông IP CONSULTANCY CO.,LTD.)
- (55)

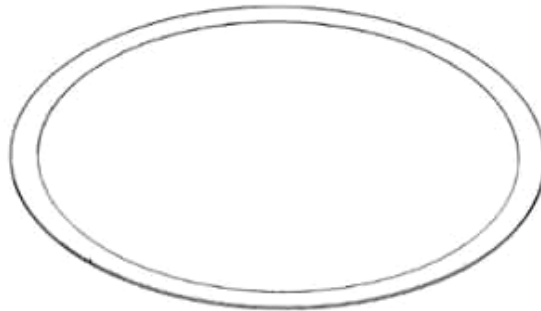

1.1



1.2



1.3



1.4



1.5

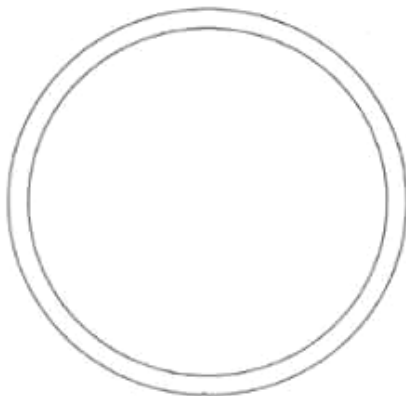

1.6

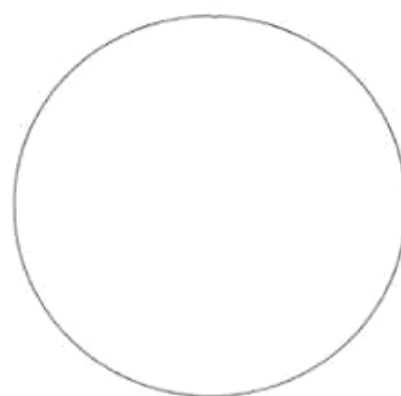

1.7

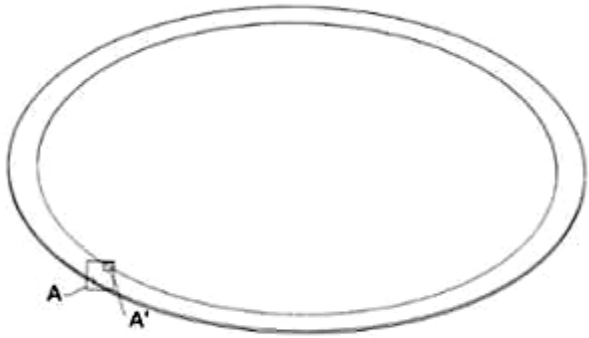

1.8



1.9

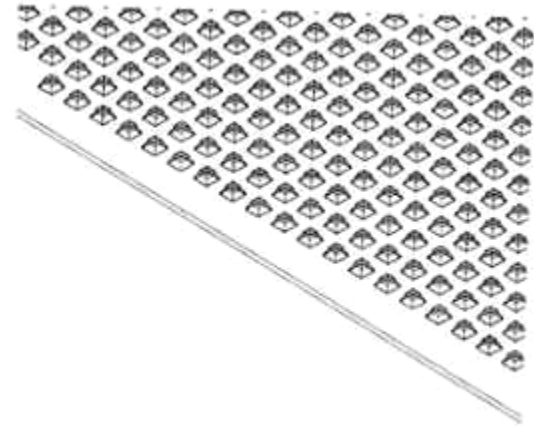

1.11



1.10



1.13



1.12

CÔNG BÁO SỞ HỮU CÔNG NGHIỆP SỐ 423 TẬP A – QUYỀN 2 (06.2023)

- (11) **47005**
- (21) 3-2022-00731 (28) 1
- (54) **TẤM NỀN GẮN TẠM VI CẤU TRÚC VÀ MẢNH MỎNG VẬT LIỆU BÁN DẪN** (51) **15-99**
- (22) 14/04/2022 (43) 26/06/2023
- (30) 2021-22499 15/10/2021 JP;
- (73) **SHIN-ETSU CHEMICAL CO., LTD (JP)**
4-1, Marunouchi 1-chome, Chiyoda-ku, Tokyo 100-0005, Japan
- (72) 1. YOSHINORI OGAWA (JP)
2. KAZUNORI KONDO (JP)
3. NOBUAKI TOMURA (JP)
4. NOBUAKI MATSUMOTO (JP)
5. AKIRA SAKAMOTO (JP)
6. TAICHI KITAGAWA (JP)
- (74) Công ty TNHH Tư vấn - Dịch thuật - Sở hữu trí tuệ Á Đông (Á Đông IP CONSULTANCY CO.,LTD.)
- (55)

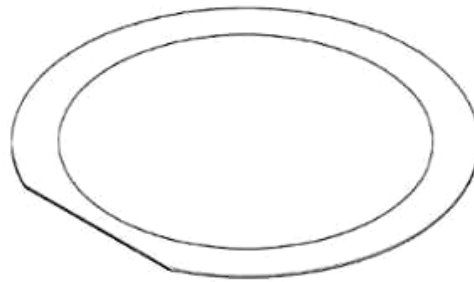

1.1



1.2



1.3



1.4



1.5

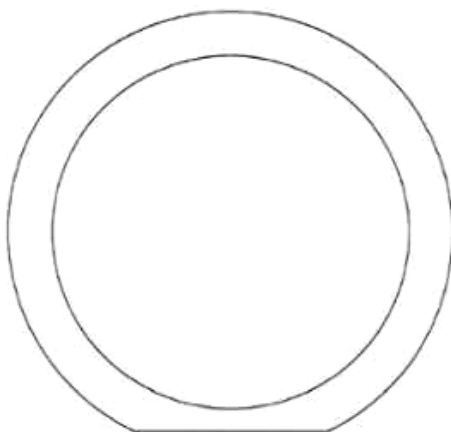

1.6

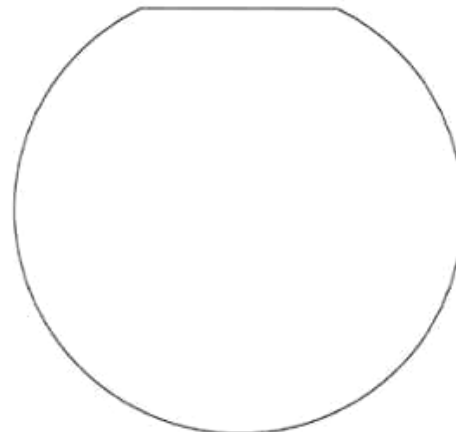

1.7

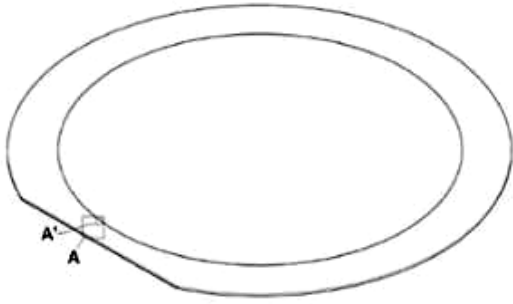

1.8



1.9

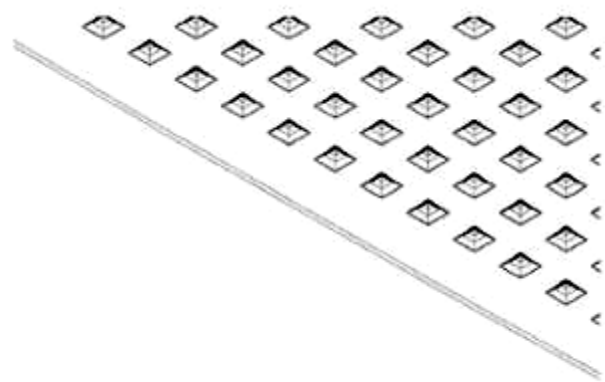
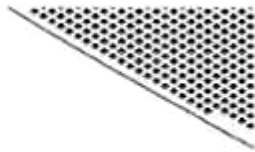

1.10

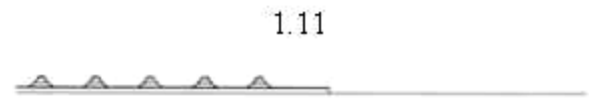

1.11



1.12



1.13

CÔNG BÁO SỞ HỮU CÔNG NGHIỆP SỐ 423 TẬP A – QUYỀN 2 (06.2023)

- (11) **47006**
- (21) 3-2022-00732 (28) 1
- (54) **TẤM NỀN GẮN TẠM VI CẤU TRÚC VÀ MẢNH MỎNG VẬT LIỆU BẮN DẪN** (51) **15-99**
- (22) 14/04/2022 (43) 26/06/2023
- (30) 2021-22501 15/10/2021 JP;
- (73) **SHIN-ETSU CHEMICAL CO., LTD (JP)**
4-1, Marunouchi 1-chome, Chiyoda-ku, Tokyo 100-0005, Japan
- (72) 1. YOSHINORI OGAWA (JP)
2. KAZUNORI KONDO (JP)
3. NOBUAKI TOMURA (JP)
4. NOBUAKI MATSUMOTO (JP)
5. AKIRA SAKAMOTO (JP)
6. TAICHI KITAGAWA (JP)
- (74) Công ty TNHH Tư vấn - Dịch thuật - Sở hữu trí tuệ Á Đông (Á Đông IP CONSULTANCY CO.,LTD.)
- (55)

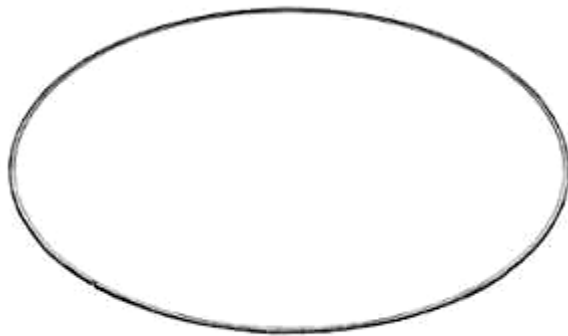

1.1

1.2

1.3

1.4

1.5

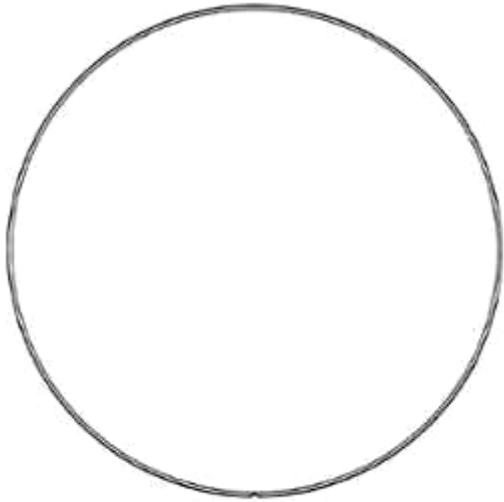

1.6

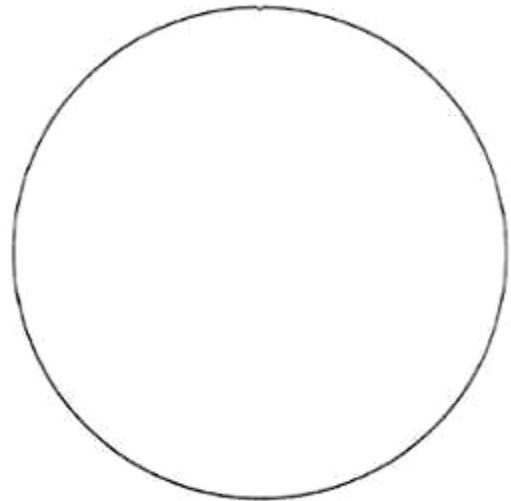

1.7

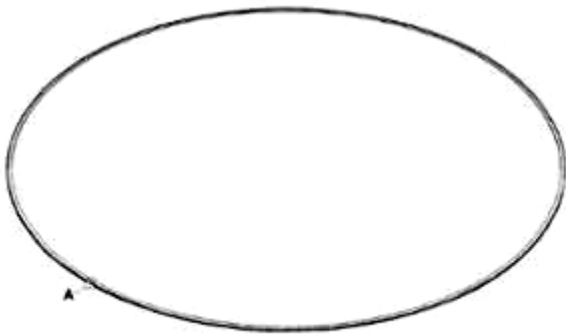

1.8



1.9

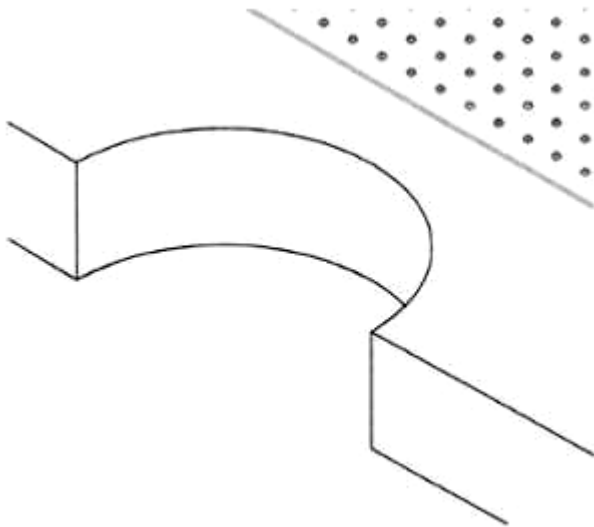

1.10

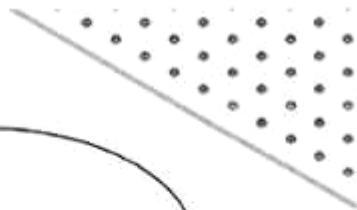

1.11

CÔNG BÁO SỞ HỮU CÔNG NGHIỆP SỐ 423 TẬP A – QUYỀN 2 (06.2023)

- (11) **47007**
- (21) 3-2022-00733 (28) 1
- (54) **TẤM NỀN GẮN TẠM VI CẤU TRÚC VÀ MẢNH MỎNG VẬT LIỆU BÁN DẪN** (51) **15-99**
- (22) 14/04/2022 (43) 26/06/2023
- (30) 2021-22502 15/10/2021 JP;
- (73) **SHIN-ETSU CHEMICAL CO., LTD (JP)**
4-1, Marunouchi 1-chome, Chiyoda-ku, Tokyo 100-0005, Japan
- (72) 1. YOSHINORI OGAWA (JP)
2. KAZUNORI KONDO (JP)
3. NOBUAKI TOMURA (JP)
4. NOBUAKI MATSUMOTO (JP)
5. AKIRA SAKAMOTO (JP)
6. TAICHI KITAGAWA (JP)
- (74) Công ty TNHH Tư vấn - Dịch thuật - Sở hữu trí tuệ Á Đông (Á Đông IP CONSULTANCY CO.,LTD.)
- (55)

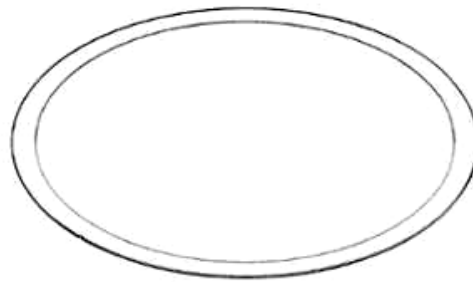

1.1



1.2



1.3



1.4



1.5

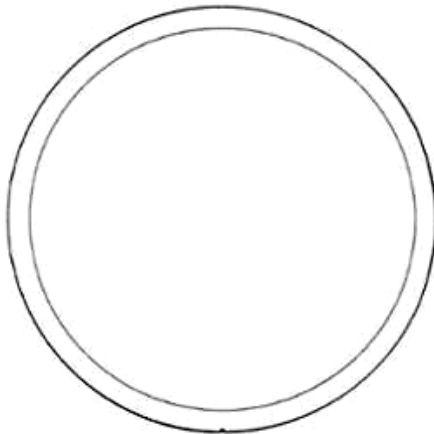

1.6

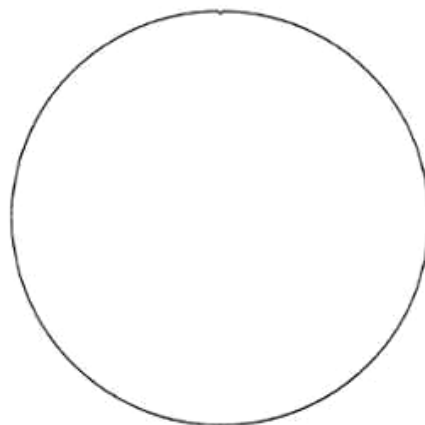

1.7

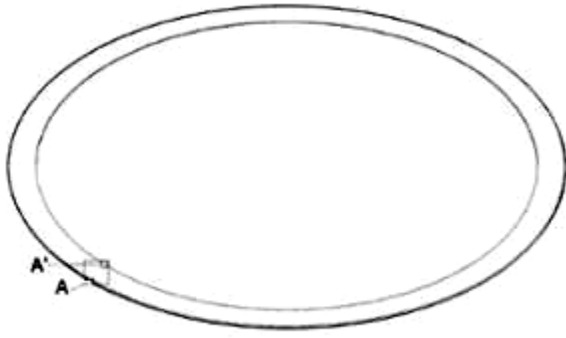

1.8



1.9

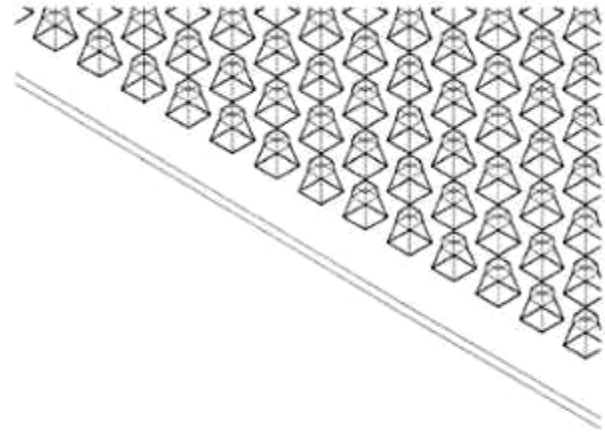

1.11

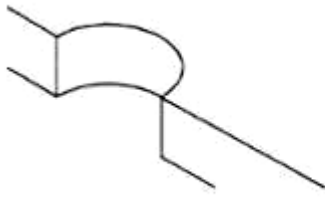

1.10



1.13



1.12

CÔNG BÁO SỞ HỮU CÔNG NGHIỆP SỐ 423 TẬP A – QUYỀN 2 (06.2023)

- (11) **47008**
(21) 3-2022-00757 (28) 3
(54) **ĐẦU GẬY ĐÁNH GÔN** (51) **21-02**
(22) 19/04/2022 (43) 26/06/2023
(73) **HWA JA GU (KR)**
402ho, 15, Samseongyo-ro 18-gil, Seongbuk-gu, Seoul 02863, Republic of Korea
(72) Hwa Ja GU (KR)
(74) Công ty Luật TNHH WINCO (WINCO LAW FIRM)
(55)



1.1



1.2



1.3



1.4



1.5



1.6



1.7



2.1



2.2



2.3



2.4



2.5

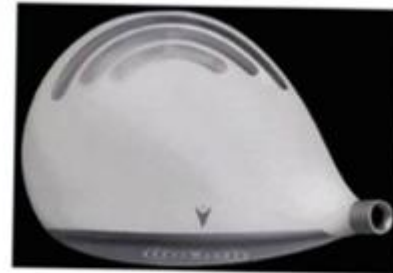

2.6



2.7



3.1



3.2

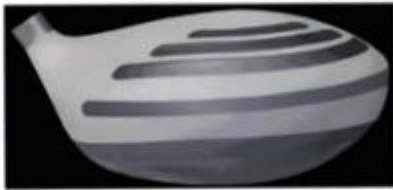

3.3

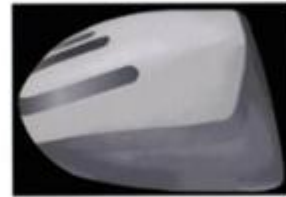

3.4



3.5



3.6



3.7

CÔNG BÁO SỞ HỮU CÔNG NGHIỆP SỐ 423 TẬP A – QUYỀN 2 (06.2023)

(11) **47009**

(21) 3-2022-00962

(28) 1

(54) **LỘ**

(51) **09-01**

(22) 17/05/2022

(43) 26/06/2023

(73) **TAI GUK PHARM. CO., LTD (KR)**

821 Geumbaek-ro, Chochon-myeon, Buyeo-gun, Chungcheongnam-do, Republic of Korea

(72) SHIN, Ho Jun (KR)

(74) Công ty TNHH Tâm nhìn và Liên danh (VISION & ASSOCIATES CO.LTD.)

(55)

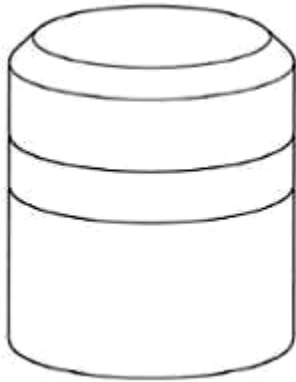

1.1

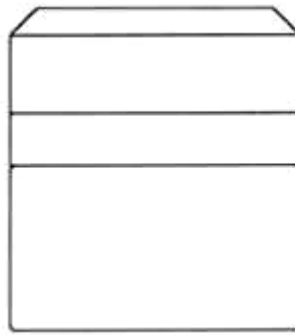

1.2

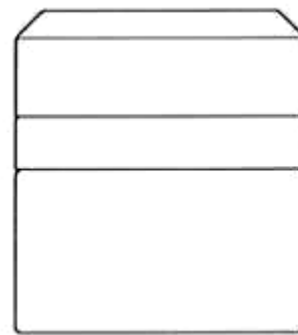

1.3

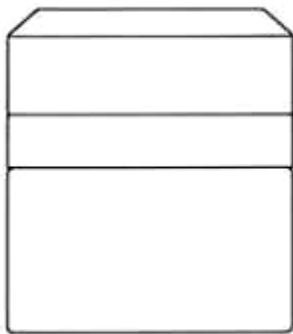

1.4

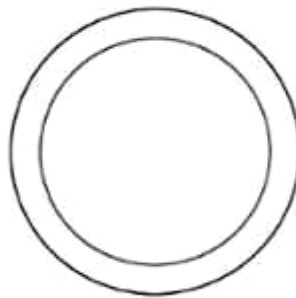

1.5

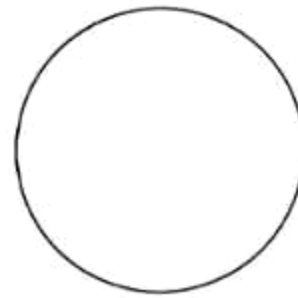

1.6

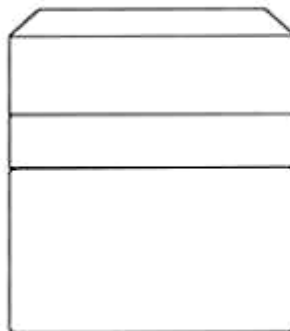

1.7

CÔNG BÁO SỞ HỮU CÔNG NGHIỆP SỐ 423 TẬP A – QUYỀN 2 (06.2023)

- (11) **47010**
- (21) 3-2022-01387 (28) 2
- (54) **ĐỒ CHỨA DÙNG ĐỂ ĐỰNG THỰC PHẨM** (51) **09-03**
- (22) 12/07/2022 (43) 26/06/2023
- (30) 30-2022-0025746 28/06/2022 KR; 30-2022-0025745 28/06/2022 KR;
- (73) **CJ CHEILJEDANG CORPORATION (KR)**
(Ssangnim-dong) 330, Dongho-ro, Jung-gu, Seoul 04560 Republic of Korea
- (72) JO, Young Sin (KR)
- (74) Công ty Luật TNHH ROUSE Việt Nam (ROUSE LEGAL VIETNAM LTD.)
- (55)



1.1



1.2



1.3



1.4



1.5



1.6



1.7



2.1



2.2



2.3



2.4



2.5



2.6



2.7

CÔNG BÁO SỞ HỮU CÔNG NGHIỆP SỐ 423 TẬP A – QUYỀN 2 (06.2023)

(11) **47011**

(21) 3-2022-01403

(28) 1

(54) **MÁY IN NHÃN**

(51) **14-02; 18-02**

(22) 13/07/2022

(43) 26/06/2023

(30) 202230251558.2 29/04/2022 CN;

(73) **WUHAN JINGCHEN INTELLIGENT IDENTIFICATION TECHNOLOGY CO.,LTD (CN)**

1st Floor, No. 5, Creative Workshop, Phase III, Wuhan Creative World, Hongshan District, Wuhan City, Hubei Province 430070, China

(72) Xiong LIU (CN)

(74) Công ty TNHH Sáng chế ACTIP (ACTIP PATENT LIMITED)

(55)

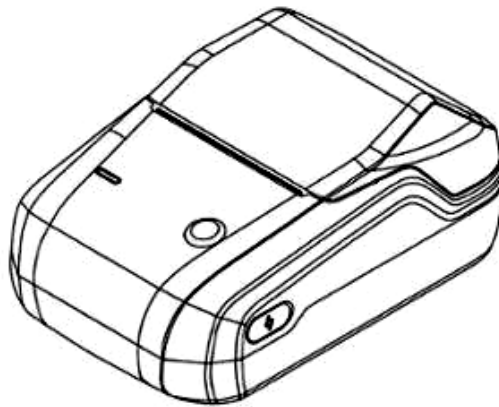

1.1

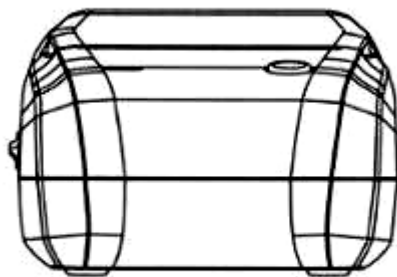

1.2

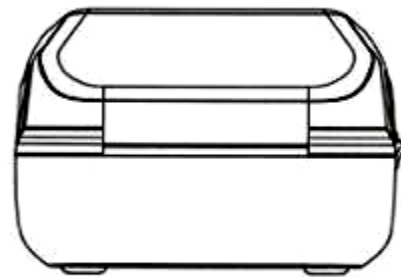

1.3

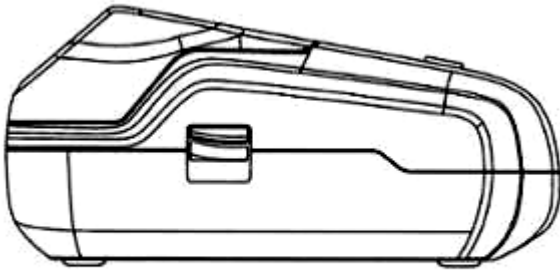

1.4

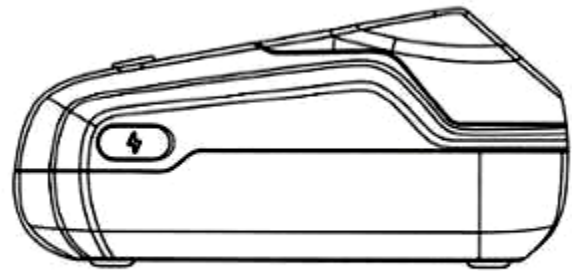

1.5

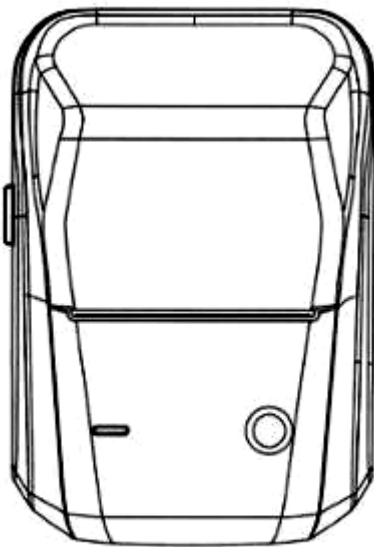

1.6

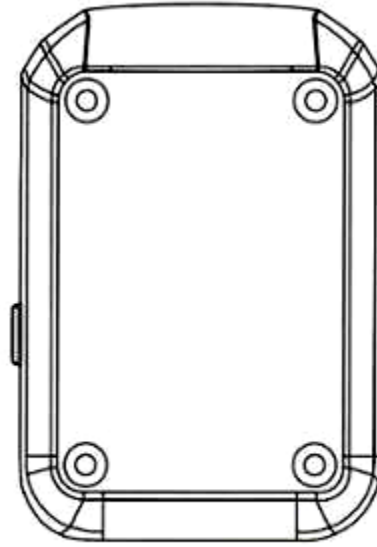

1.7

- (11) **47012**
(21) 3-2022-01424 (28) 1
(54) **THIẾT BỊ SẢN XUẤT KHÍ HYDRO** (51) **23-01**
(22) 15/07/2022 (43) 26/06/2023
(30) 202230038563.5 20/01/2022 CN;
(73) **LIN, HSIN-YUNG (CN)**
No.758, Jiaxin Highway, Jiading District, Shanghai, China
(72) LIN, Hsin-Yung (TW)
(74) Công ty TNHH Tầm nhìn và Liên danh (VISION & ASSOCIATES CO.LTD.)
(55)

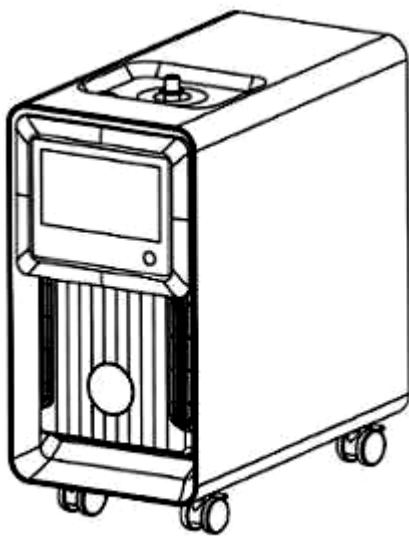

1.1

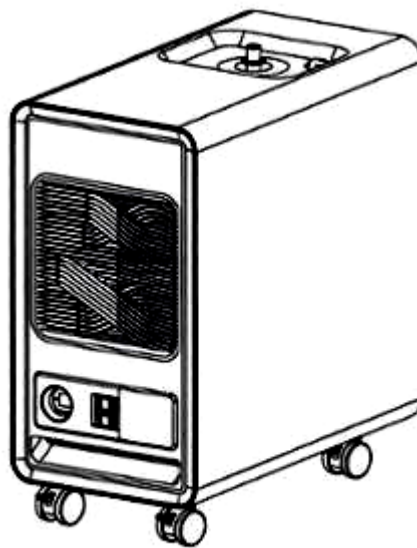

1.2

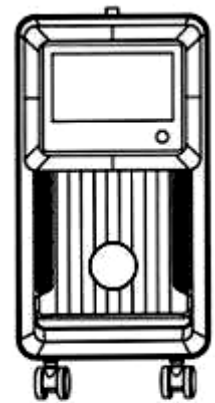

1.3



1.4

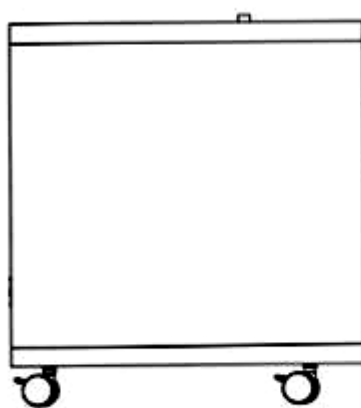

1.5

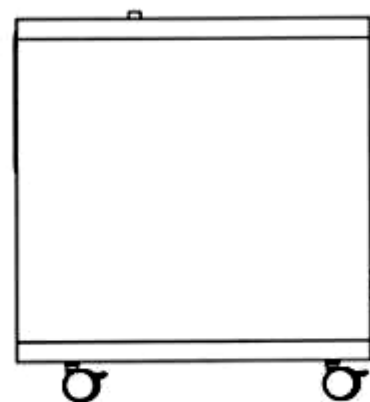

1.6

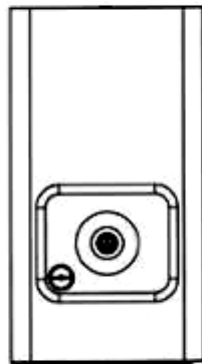

1.7

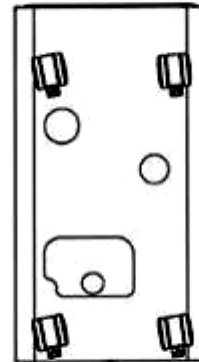

1.8

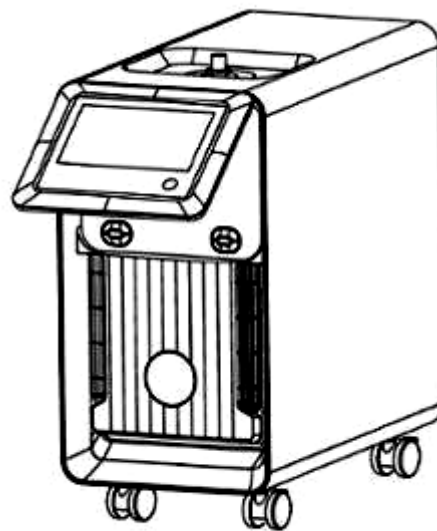

1.9

CÔNG BÁO SỞ HỮU CÔNG NGHIỆP SỐ 423 TẬP A – QUYỀN 2 (06.2023)

- (11) **47013**
(21) 3-2022-01425 (28) 1
(54) **THIẾT BỊ SẢN XUẤT KHÍ HYDRO** (51) **23-01**
(22) 15/07/2022 (43) 26/06/2023
(30) 202230038608.9 20/01/2022 CN;
(73) **LIN, HSIN-YUNG (CN)**
No.758, Jiaxin Highway, Jiading District, Shanghai, China
(72) LIN, Hsin-Yung (TW)
(74) Công ty TNHH Tầm nhìn và Liên danh (VISION & ASSOCIATES CO.LTD.)
(55)

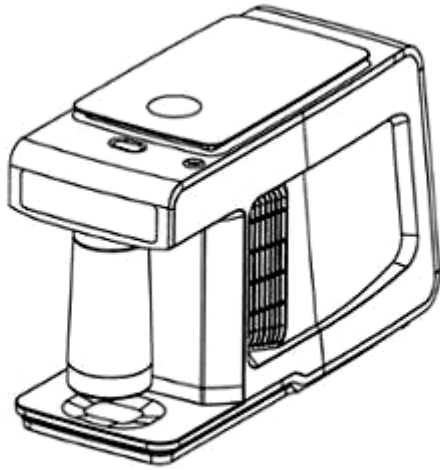

1.1

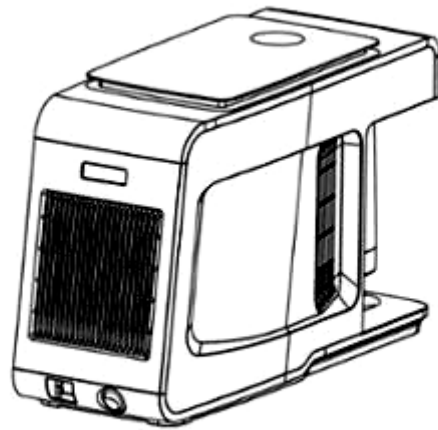

1.2

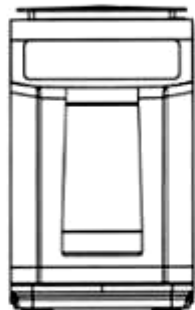

1.3



1.4

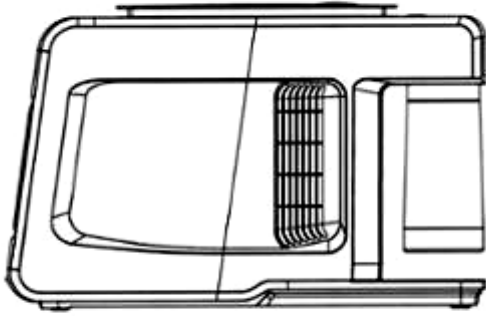

1.5

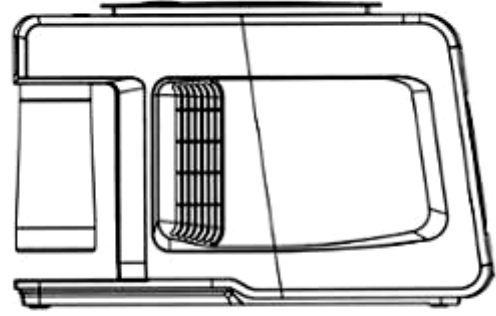

1.6



1.7

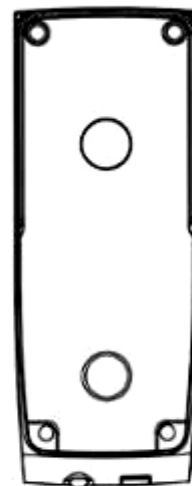

1.8

CÔNG BÁO SỞ HỮU CÔNG NGHIỆP SỐ 423 TẬP A – QUYỀN 2 (06.2023)

- (11) **47014**
(21) 3-2022-01461 (28) 1
(54) **VỎ BỌC ĐIỆN THOẠI DI ĐỘNG** (51) **03-01**
(22) 21/07/2022 (43) 26/06/2023
(30) 2219326.8 21/01/2022 HK;
(73) **CASETAGRAM LIMITED (CN)**
11/F, Fun Tower, 35 Hung To Road, Kwun Tong, Kowloon, Hong Kong
(72) NG Pui Sun Wesley (HK)
(74) Công ty TNHH Sáng chế ACTIP (ACTIP PATENT LIMITED)
(55)

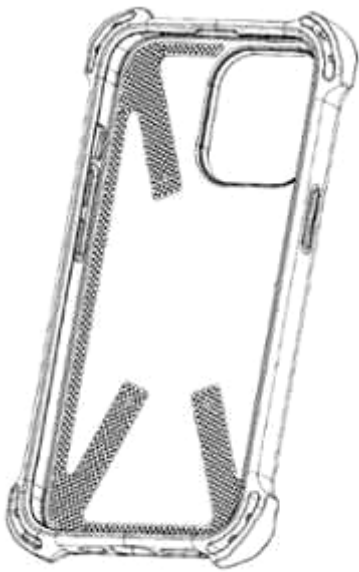

1.1



1.2



1.3



1.4

1.5

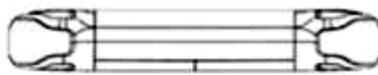

1.6

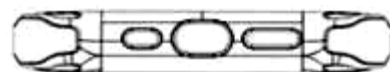

1.7

- (11) **47015**
(21) 3-2022-01462 (28) 1
(54) **DỤNG CỤ TRÙM ĐẦU** (51) **02-03**
(22) 21/07/2022 (43) 26/06/2023
(30) 008842355-0001 25/01/2022 EM;
(73) **NIKOLAOS MITSOPOULOS (GR)**
Elianou 8-10, Athens 11254, Greece
(72) Nikolaos Mitsopoulos (GR)
(74) Công ty TNHH Trường Xuân (AGELESS CO.,LTD.)
(55)

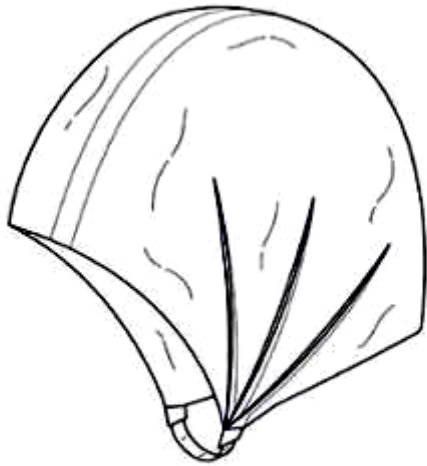

1.1

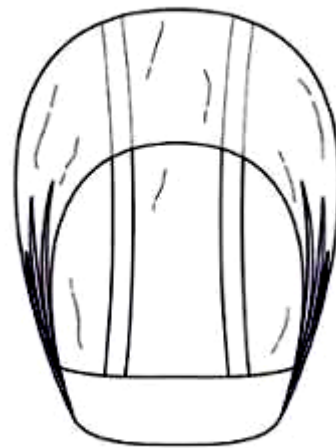

1.2

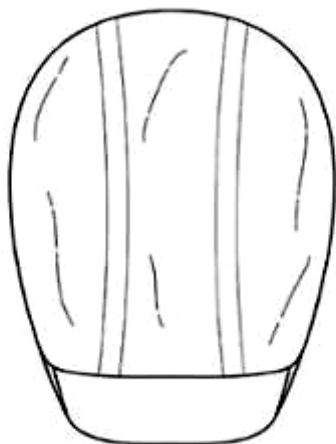

1.3

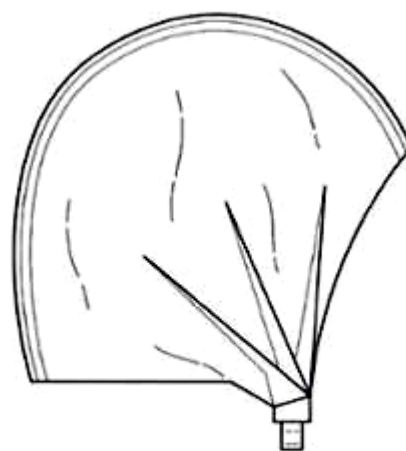

1.4

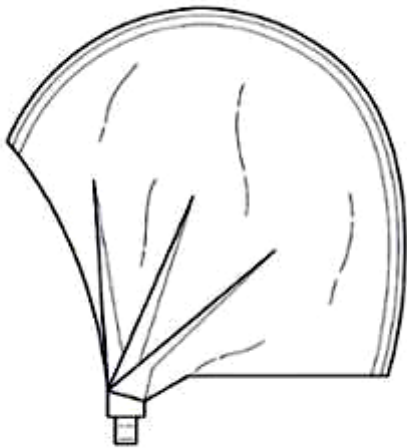

1.5

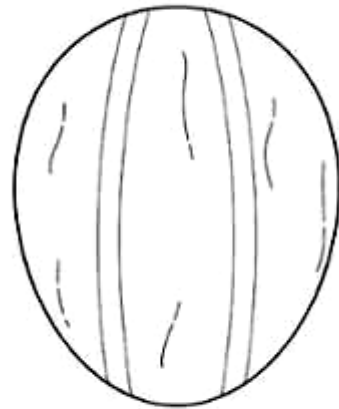

1.6

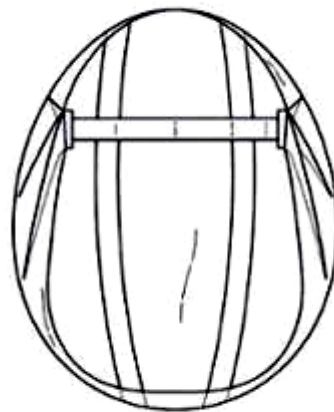

1.7

CÔNG BÁO SỞ HỮU CÔNG NGHIỆP SỐ 423 TẬP A – QUYỀN 2 (06.2023)

- (11) **47016**
(21) 3-2022-01477 (28) 1
(54) **DỤNG CỤ XỊT VỆ SINH CẢM TAY** (51) **23-02**
(22) 22/07/2022 (43) 26/06/2023
(30) 30-2022-0003637 26/01/2022 KR;
(73) 1. **WSBTS CO., LTD.** (KR)
Rm. 417, 418, Fourth floor 583 Neungheodaero-ro, Namdong-gu, Incheon 21699
Republic of Korea
2. **LEE, DONG JIN** (KR)
915-506, 349 Jungsim-sangga-ro, Siheung-si, Gyeonggi-do 15062 Republic of Korea
(72) 1. LEE, DONG JIN (KR)
2. LEE WOONG JUN (KR)
3. HEO HYE SUK (KR)
4. HEO HEA RAN (KR)
(74) Công ty TNHH Đại Tín và Liên Danh (DAITIN AND ASSOCIATES CO.,LTD)
(55)

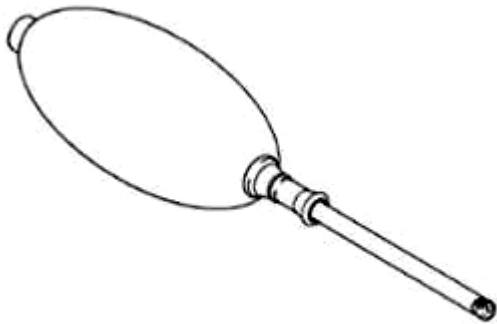

1.1



1.2

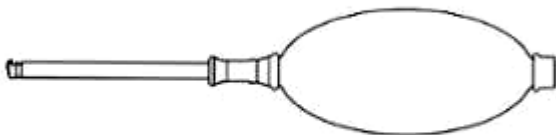

1.3

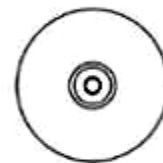

1.4

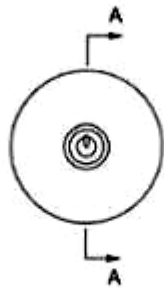

1.5



1.6

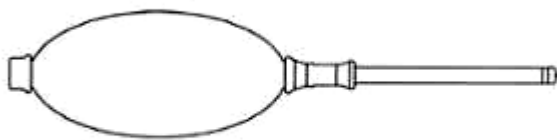

1.7

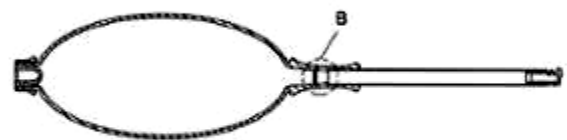

1.8

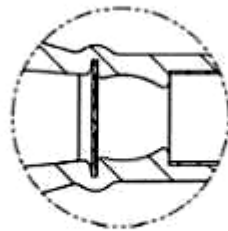

1.9

CÔNG BÁO SỞ HỮU CÔNG NGHIỆP SỐ 423 TẬP A – QUYỀN 2 (06.2023)

- (11) **47017**
(21) 3-2022-01535 (28) 1
(54) **NẮP BÌNH** (51) **09-07**
(22) 28/07/2022 (43) 26/06/2023
(73) **WUYI TAICHISO DRINKWARE CORPORATION (CN)**
No. 20, Mudan South Road, Shenzhai Village, Baiyang Industrial Functional Zone,
Baiyang Street, Wuyi County, Jinhua City, Zhejiang Province, 321200, CHINA
(72) Chen, Yuxiao (CN)
(74) Công ty TNHH ADASTRA IP (VIỆT NAM) (ADASTRA IP (VIETNAM) CO.,
LTD.)
(55)



1.1



1.2



1.3



1.4



1.5



1.6



1.7



1.8



1.9

CÔNG BÁO SỞ HỮU CÔNG NGHIỆP SỐ 423 TẬP A – QUYỀN 2 (06.2023)

- (11) **47018**
(21) 3-2022-01549 (28) 1
(54) **ĐẦU CHÂN LÒ XO** (51) **10-05**
(22) 01/08/2022 (43) 26/06/2023
(30) 29/791,709 01/02/2022 US;
(73) **JOHNSTECH INTERNATIONAL CORPORATION (US)**
1210 New Brighton Boulevard, Minneapolis, Minnesota 55413, United States of
America
(72) Valts Treibergs (US)
(74) Công ty TNHH Lê & Lê (LE & LE)
(55)

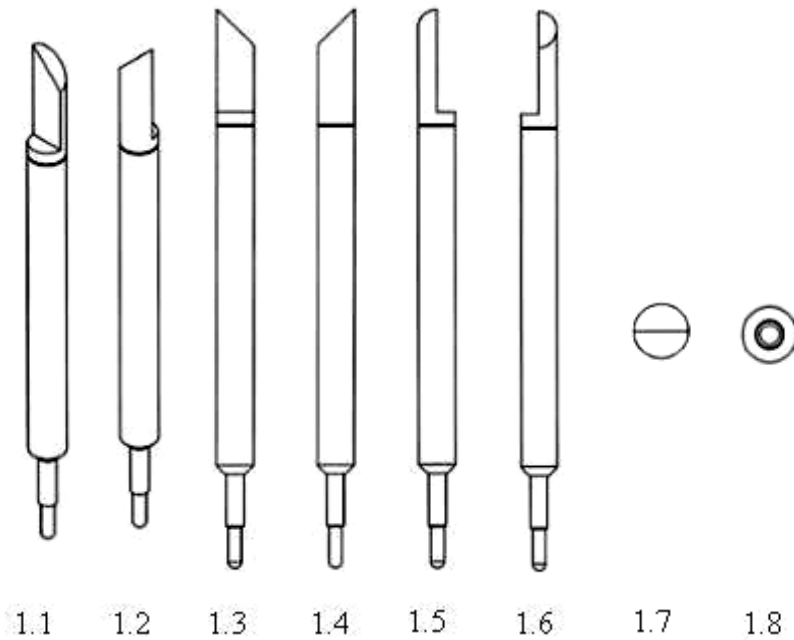

CÔNG BÁO SỞ HỮU CÔNG NGHIỆP SỐ 423 TẬP A – QUYỀN 2 (06.2023)

- (11) **47019**
(21) 3-2022-01804 (28) 1
(54) **THANH NHÔM ĐỊNH HÌNH** (51) **25-01**
(22) 25/08/2022 (43) 26/06/2023
(73) **CÔNG TY TNHH XUẤT NHẬP KHẨU THANH PHÚC (VN)**
317 Nguyễn Thị Thập, phường Tân Phú, quận 7, thành phố Hồ Chí Minh
(72) Nguyễn Văn Phúc (VN)
(55)



(11) **47020**

(21) 3-2022-01879

(28) 1

(54) **VỎ HỘ TỬ ĐIỀU KHIỂN NUÔI TÔM**

(51) **13-03**

(22) 05/09/2022

(43) 26/06/2023

(73) **1. TRƯỜNG ĐẠI HỌC CÔNG NGHIỆP THÀNH PHỐ HỒ CHÍ MINH (VN)**

Số 12 Nguyễn Văn Bảo, phường 4, quận Gò Vấp, thành phố Hồ Chí Minh

2. BÙI THƯ CAO (VN)

Số 70, đường số 9, khu phố 6, p. Hiệp Bình Chánh, thành phố Thủ Đức, thành phố Hồ Chí Minh

(72) Bùi Thư Cao (VN)

(55)

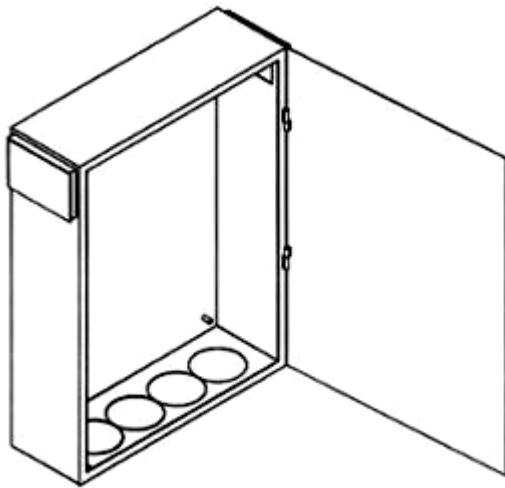

1.1

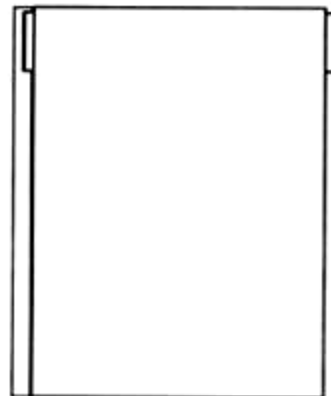

1.2

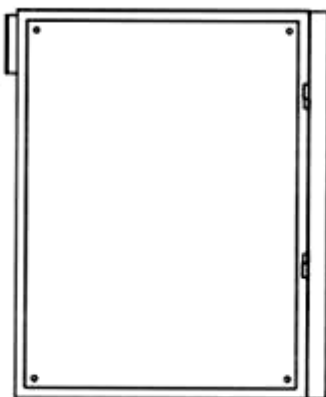

1.3

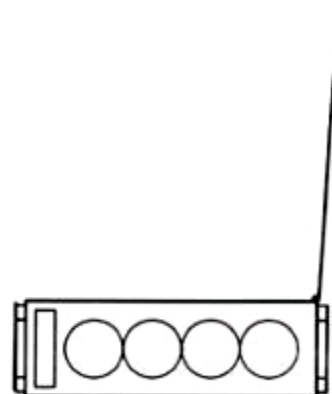

1.4

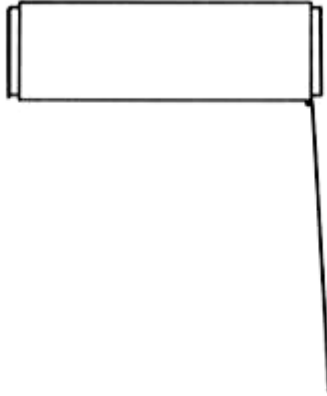

1.5

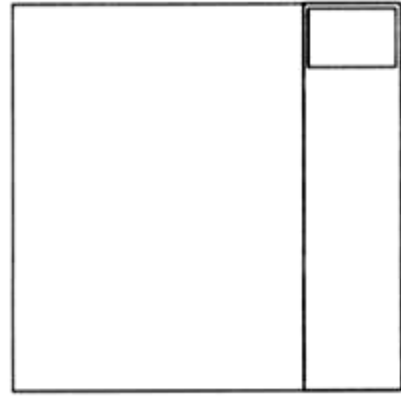

1.6

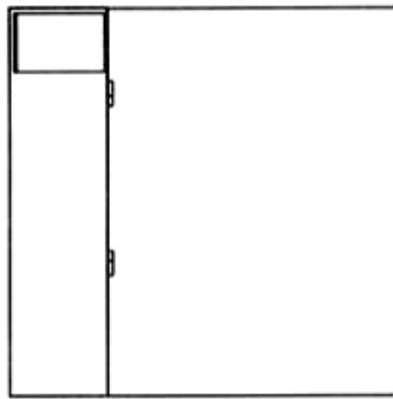

1.7

CÔNG BÁO SỞ HỮU CÔNG NGHIỆP SỐ 423 TẬP A – QUYỀN 2 (06.2023)

- (11) **47021**
(21) 3-2022-02009 (28) 1
(54) **CẦN CẦU DI ĐỘNG** (51) **12-05**
(22) 20/09/2022 (43) 26/06/2023
(73) **CÔNG TY CỔ PHẦN AN TOÀN SSTC (VN)**
372/6 Dương Thị Mười, khu phố 3, phường Tân Thới Hiệp, quận 12, thành phố Hồ Chí Minh
(72) Dương Đình Luân (VN)
(74) Công ty Cổ phần Sở hữu công nghiệp INVESTIP (INVESTIP)
(55)



1.1

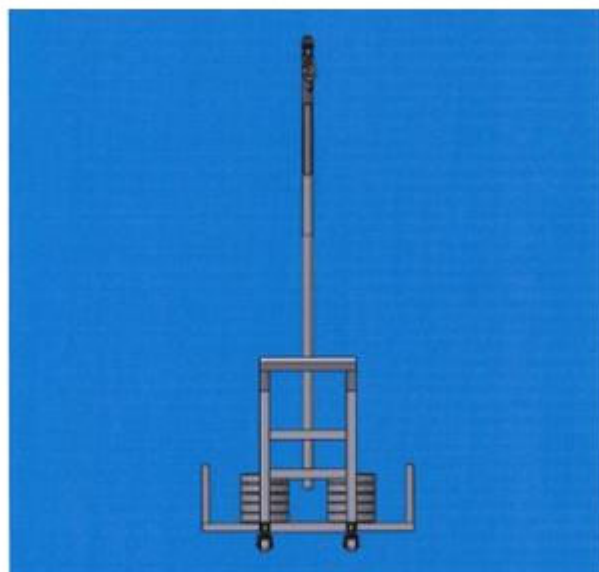

1.2

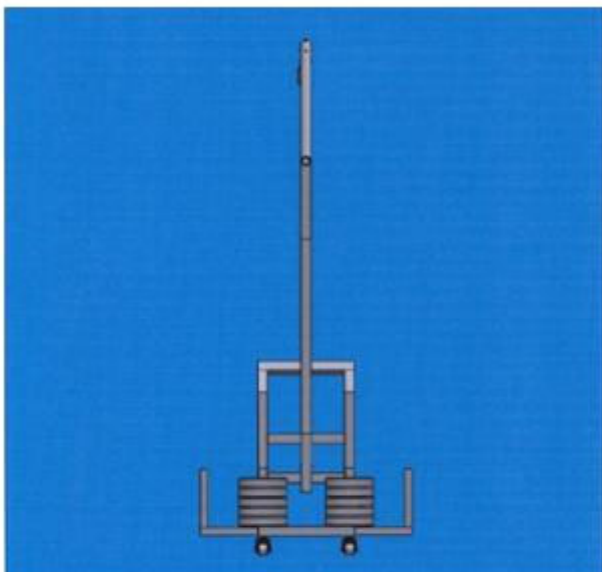

1.3



1.4



1.5

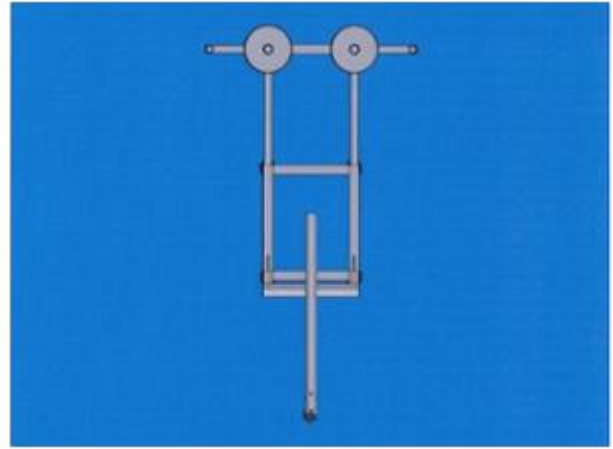

1.6

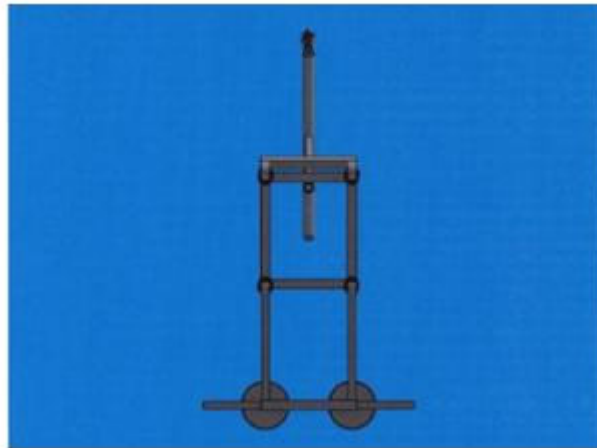

1.7

CÔNG BÁO SỞ HỮU CÔNG NGHIỆP SỐ 423 TẬP A – QUYỀN 2 (06.2023)

(11) **47022**

(21) 3-2022-02125

(54) **BÌNH TƯỚI**

(22) 04/10/2022

(73) **CÔNG TY TNHH SUVINA (VN)**

Số 50, ngõ 215, Định Công Thượng, phường Định Công, quận Hoàng Mai, thành phố Hà Nội

(72) Vũ Hoàng Dương (VN)

(55)

(28) 1

(51) **08-05**

(43) 26/06/2023



1.1



1.2



1.3



1.4



1.5



1.6



1.7

CÔNG BÁO SỞ HỮU CÔNG NGHIỆP SỐ 423 TẬP A – QUYỀN 2 (06.2023)

- (11) **47023**
(21) 3-2022-02195 (28) 1
(54) **BỒN CẦU** (51) **23-02**
(22) 11/10/2022 (43) 26/06/2023
(30) 009028517-0001 16/05/2022 EM;
(73) **HANSGROHE SE (DE)**
Austr. 5-9, 77761 Schiltach, Germany
(72) Laura Somaglino (DE)
(74) Công ty TNHH Trường Xuân (AGELESS CO.,LTD.)
(55)



1.1



1.2



1.3



1.4



1.5



1.6



1.7

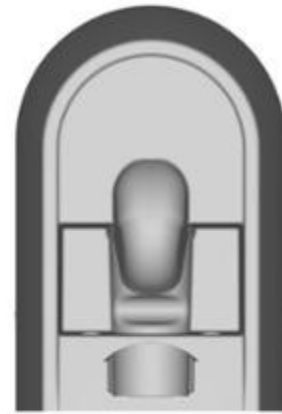

1.8



1.9

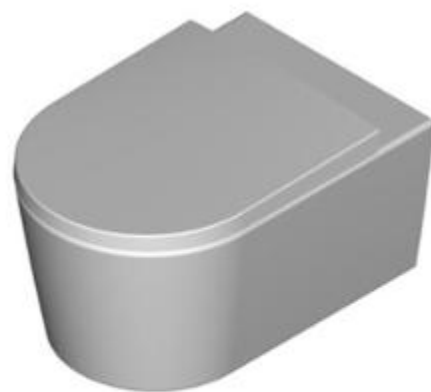

1.10

CÔNG BÁO SỞ HỮU CÔNG NGHIỆP SỐ 423 TẬP A – QUYỀN 2 (06.2023)

- (11) **47024**
(21) 3-2022-02196 (28) 1
(54) **BỒN CẦU** (51) **23-02**
(22) 11/10/2022 (43) 26/06/2023
(30) 009028517-0003 16/05/2022 EM;
(73) **HANSGROHE SE (DE)**
Austr. 5-9, 77761 Schiltach, Germany
(72) Laura Somaglino (DE)
(74) Công ty TNHH Trường Xuân (AGELESS CO.,LTD.)
(55)



1.1



1.2



1.3



1.4

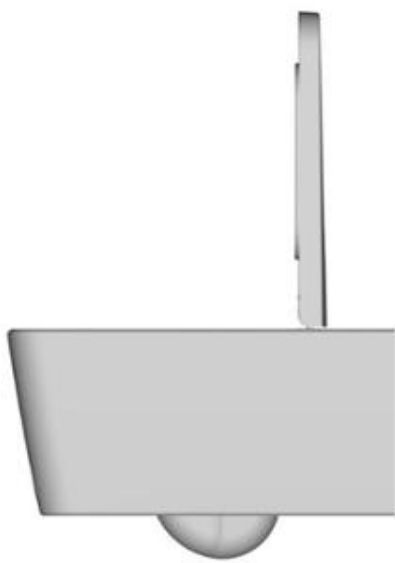

1.5

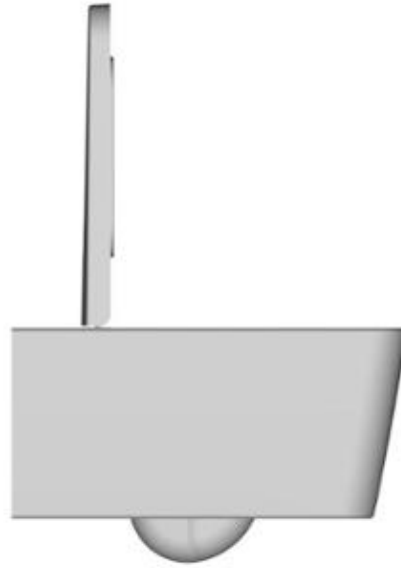

1.6



1.7

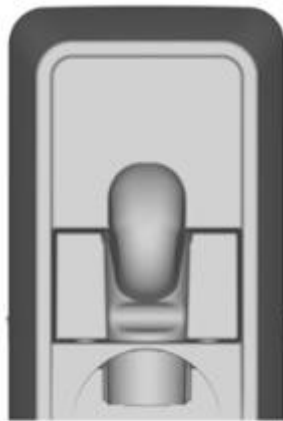

1.8



1.9

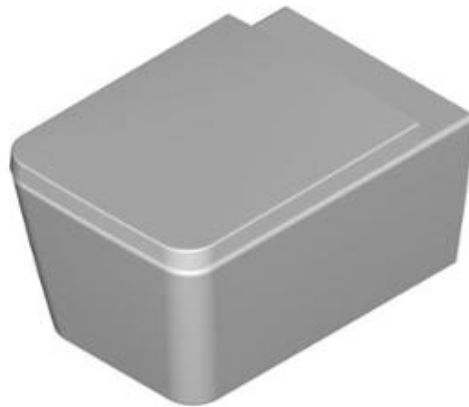

1.10

CÔNG BÁO SỞ HỮU CÔNG NGHIỆP SỐ 423 TẬP A – QUYỀN 2 (06.2023)

- (11) **47025**
(21) 3-2022-02197 (28) 1
(54) **BỒN CẦU** (51) **23-02**
(22) 11/10/2022 (43) 26/06/2023
(30) 009028517-0005 16/05/2022 EM;
(73) **HANSGROHE SE (DE)**
Austr. 5-9, 77761 Schiltach, Germany
(72) Laura Somaglino (DE)
(74) Công ty TNHH Trường Xuân (AGELESS CO.,LTD.)
(55)



1.1



1.2



1.3



1.4



1.5



1.6



1.7

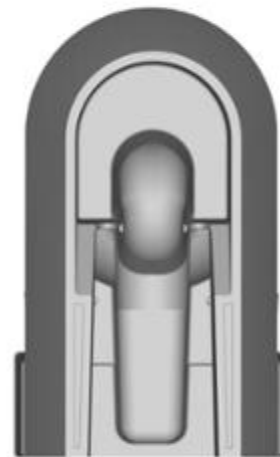

1.8



1.9



1.10

CÔNG BÁO SỞ HỮU CÔNG NGHIỆP SỐ 423 TẬP A – QUYỀN 2 (06.2023)

- (11) **47026**
(21) 3-2022-02356 (28) 1
(54) **RÔ BỐT TỰ HÀNH** (51) **15-99**
(22) 01/11/2022 (43) 26/06/2023
(73) **CÔNG TY CỔ PHẦN TẬP ĐOÀN KỸ THUẬT VÀ CÔNG NGHIỆP VIỆT NAM (VN)**
Lô A2 CN5 cụm công nghiệp Từ Liêm, phường Minh Khai, quận Bắc Từ Liêm, thành phố Hà Nội
(72) Hoàng Hữu Thắng (VN)
(55)

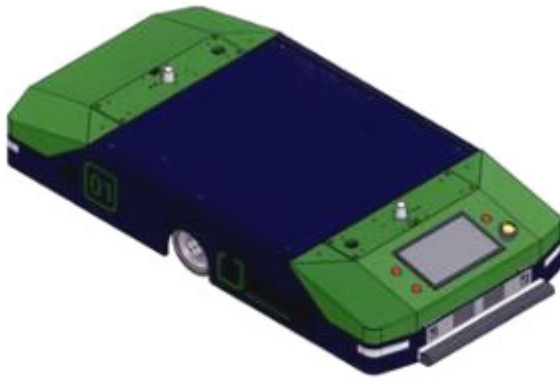

1.1



1.2

1.3



1.4

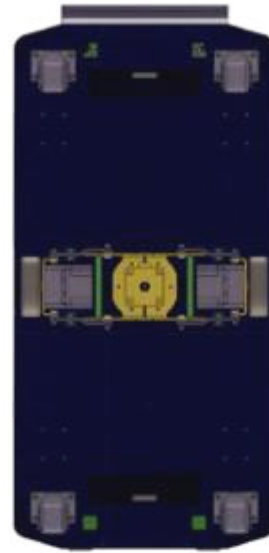

1.5



1.6



1.7

CÔNG BÁO SỞ HỮU CÔNG NGHIỆP SỐ 423 TẬP A – QUYỀN 2 (06.2023)

- (11) **47027**
(21) 3-2022-02357 (28) 1
(54) **RÔ BỐT TỰ HÀNH** (51) **15-99**
(22) 01/11/2022 (43) 26/06/2023
(73) **CÔNG TY CỔ PHẦN TẬP ĐOÀN KỸ THUẬT VÀ CÔNG NGHIỆP VIỆT NAM (VN)**
Lô A2 CN5 cụm công nghiệp Từ Liêm, phường Minh Khai, quận Bắc Từ Liêm, thành phố Hà Nội
(72) Hoàng Hữu Thắng (VN)
(55)

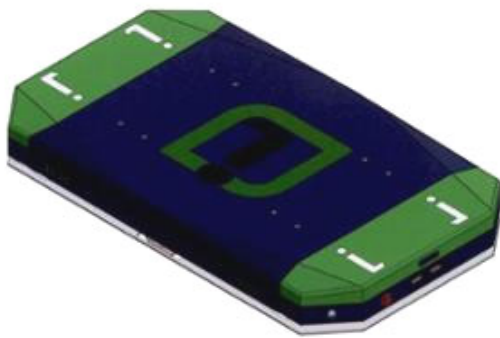

1.1



1.2

1.3



1.4

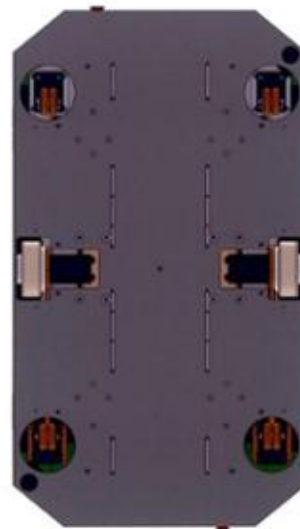

1.5



1.6



1.7

CÔNG BÁO SỞ HỮU CÔNG NGHIỆP SỐ 423 TẬP A – QUYỀN 2 (06.2023)

- (11) **47028**
(21) 3-2022-02382 (28) 1
(54) **THANH NHÔM ĐỊNH HÌNH** (51) **25-01**
(22) 01/11/2022 (43) 26/06/2023
(73) **CÔNG TY TNHH HOPO QUỐC TẾ (VN)**
Số nhà 177, tổ 5, đường Nguyễn Ngọc Vũ, phường Trung Hoà, quận Cầu Giấy,
thành phố Hà Nội
(72) Châu Đình An (VN)
(74) Công ty cổ phần Sở hữu trí tuệ BROSS và Cộng sự (BROSS & PARTNERS., JSC)
(55)

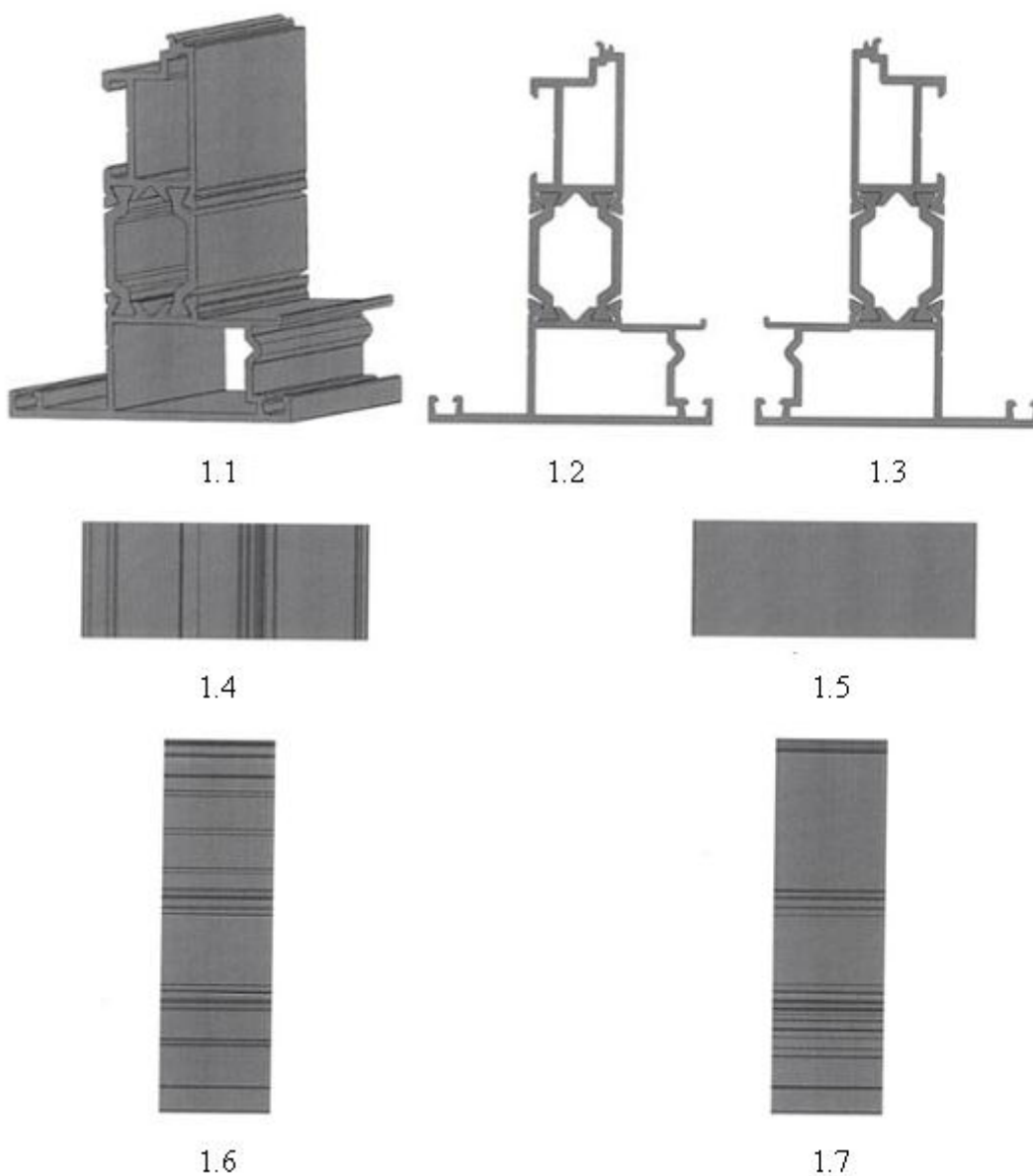

CÔNG BÁO SỞ HỮU CÔNG NGHIỆP SỐ 423 TẬP A – QUYỀN 2 (06.2023)

- (11) **47029**
(21) 3-2022-02383 (28) 1
(54) **THANH NHÔM ĐỊNH HÌNH** (51) **25-01**
(22) 01/11/2022 (43) 26/06/2023
(73) **CÔNG TY TNHH HOPO QUỐC TẾ (VN)**
Số nhà 177, tổ 5, đường Nguyễn Ngọc Vũ, phường Trung Hoà, quận Cầu Giấy,
thành phố Hà Nội
(72) Châu Đình An (VN)
(74) Công ty cổ phần Sở hữu trí tuệ BROSS và Cộng sự (BROSS & PARTNERS., JSC)
(55)

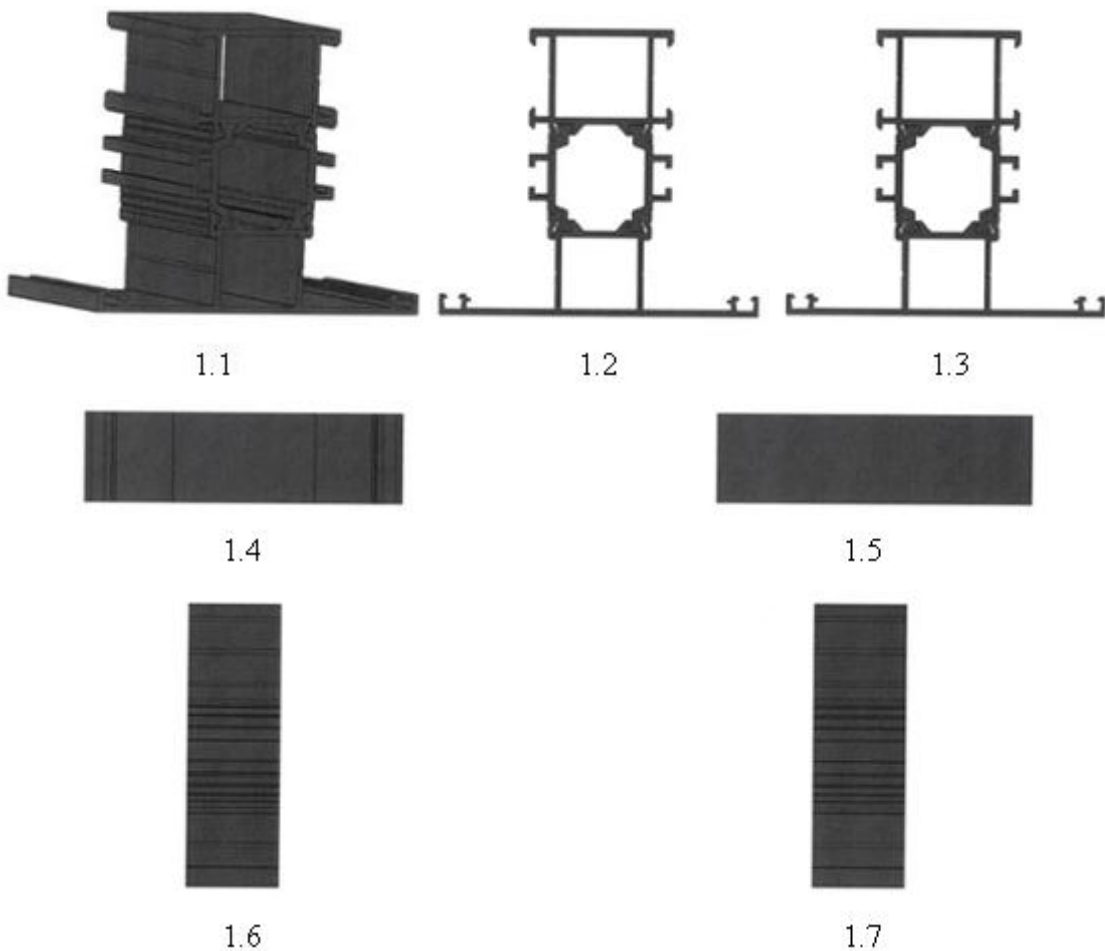

CÔNG BÁO SỞ HỮU CÔNG NGHIỆP SỐ 423 TẬP A – QUYỀN 2 (06.2023)

- (11) **47030**
(21) 3-2022-02384 (28) 1
(54) **THANH NHÔM ĐỊNH HÌNH** (51) **25-01**
(22) 01/11/2022 (43) 26/06/2023
(73) **CÔNG TY TNHH HOPO QUỐC TẾ (VN)**
Số nhà 177, tổ 5, đường Nguyễn Ngọc Vũ, phường Trung Hoà, quận Cầu Giấy,
thành phố Hà Nội
(72) Châu Đình An (VN)
(74) Công ty cổ phần Sở hữu trí tuệ BROSS và Cộng sự (BROSS & PARTNERS., JSC)
(55)

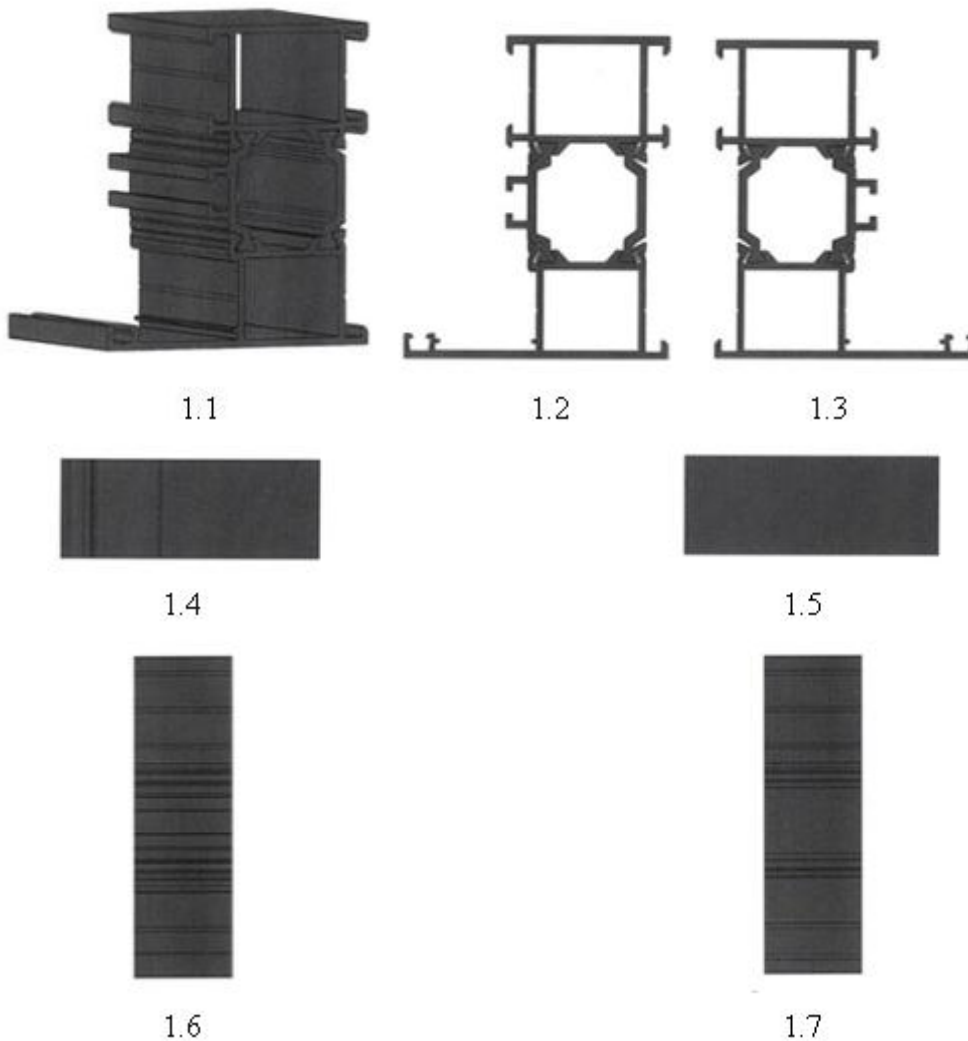

CÔNG BÁO SỞ HỮU CÔNG NGHIỆP SỐ 423 TẬP A – QUYỀN 2 (06.2023)

- (11) **47031**
(21) 3-2022-02392 (28) 1
(54) **HỘP SẠC TAI NGHE** (51) **13-02**
(22) 03/11/2022 (43) 26/06/2023
(30) 202230263180.8 07/05/2022 CN;
(73) **HUAWEI TECHNOLOGIES CO., LTD. (CN)**
Huawei Administration Building, Bantian, Longgang District, Shenzhen,
Guangdong 518129, P. R. China
(72) 1. DIAO, GUOFEI (CN)
2. HUANG, JIE (CN)
(74) Công ty Cổ phần Sở hữu công nghiệp INVESTIP (INVESTIP)
(55)

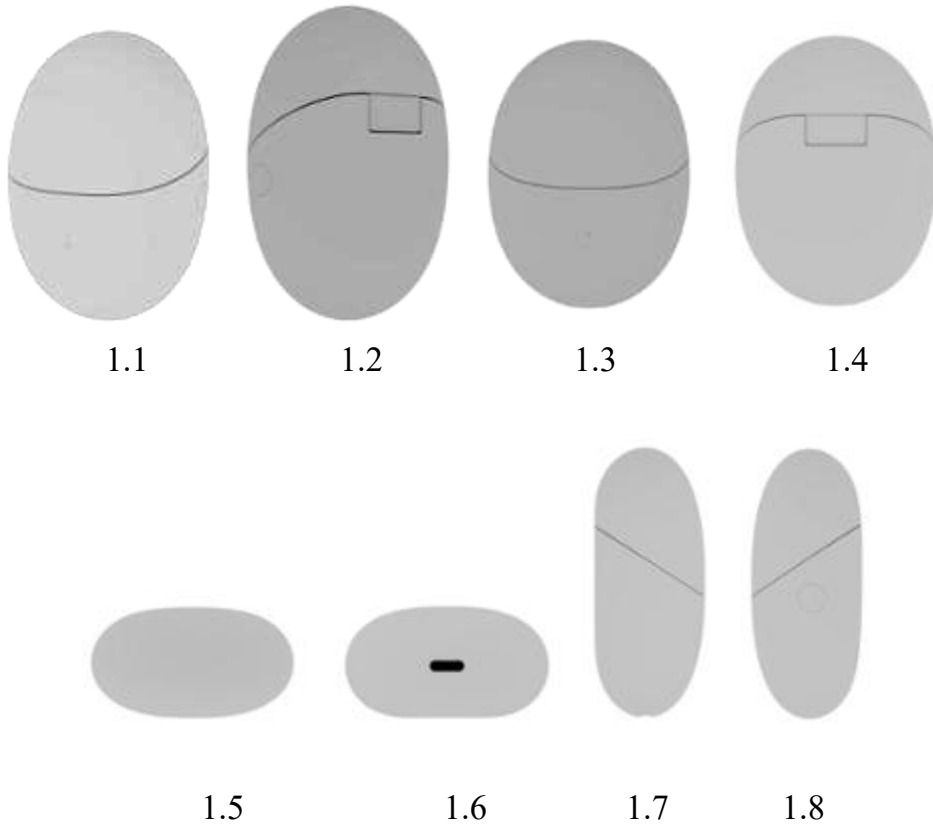

CÔNG BÁO SỞ HỮU CÔNG NGHIỆP SỐ 423 TẬP A – QUYỀN 2 (06.2023)

(11) **47032**

(21) 3-2022-02393

(28) 1

(54) **HỘP SẠC TAI NGHE**

(51) **13-02**

(22) 03/11/2022

(43) 26/06/2023

(30) 202230263158.3 07/05/2022 CN;

(73) **HUAWEI TECHNOLOGIES CO., LTD. (CN)**

Huawei Administration Building, Bantian, Longgang District, Shenzhen,
Guangdong 518129, P. R. China

(72) 1. DIAO, GUOFEI (CN)

2. HUANG, JIE (CN)

(74) Công ty Cổ phần Sở hữu công nghiệp INVESTIP (INVESTIP)

(55)



1.1



1.2



1.3



1.4

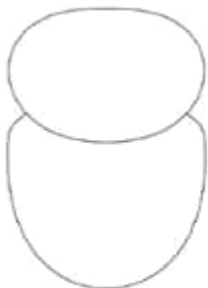

1.5



1.6



1.7



1.8



1.9

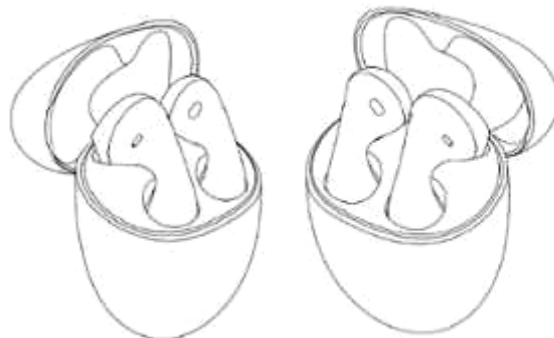

1.10

1.11

- (11) **47033**
(21) 3-2022-02394 (28) 1
(54) **TAI NGHE KHÔNG DÂY** (51) **14-01**
(22) 03/11/2022 (43) 26/06/2023
(30) 202230263362.5 07/05/2022 CN;
(73) **HUAWEI TECHNOLOGIES CO., LTD. (CN)**
Huawei Administration Building, Bantian, Longgang District, Shenzhen,
Guangdong 518129, P. R. China
(72) 1. DIAO, GUOFEI (CN)
2. HUANG, JIE (CN)
(74) Công ty Cổ phần Sở hữu công nghiệp INVESTIP (INVESTIP)
(55)

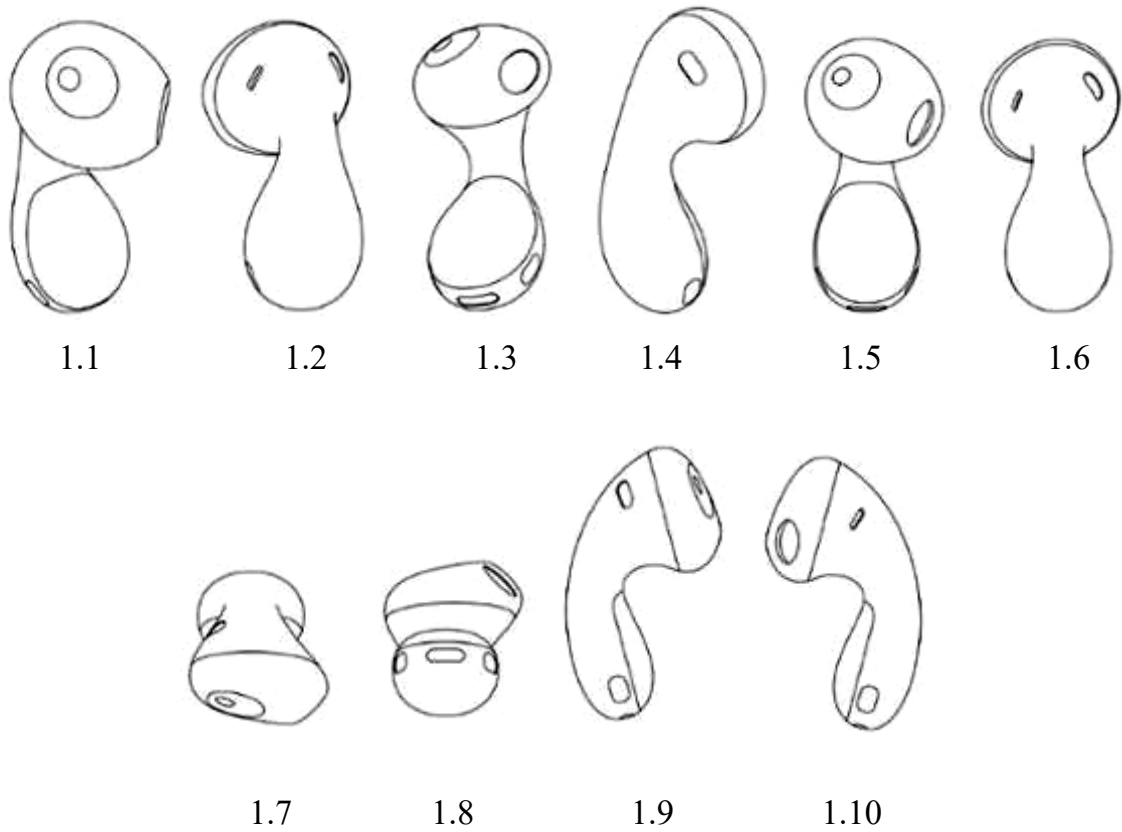

CÔNG BÁO SỞ HỮU CÔNG NGHIỆP SỐ 423 TẬP A – QUYỀN 2 (06.2023)

- (11) **47034**
(21) 3-2022-02403 (28) 1
(54) **MÁY XAY CẦM TAY** (51) **31-00**
(22) 04/11/2022 (43) 26/06/2023
(30) 29/838,673 13/05/2022 US;
(73) **DART INDUSTRIES INC. (US)**
14901 S. Orange Blossom Trail, Orlando, Florida 32837, U.S.A.
(72) Hsiao Fong Lee (SG)
(74) **CÔNG TY LUẬT TRÁCH NHIỆM HỮU HẠN AMBYS HÀ NỘI (AMBYS HANOI)**
(55)

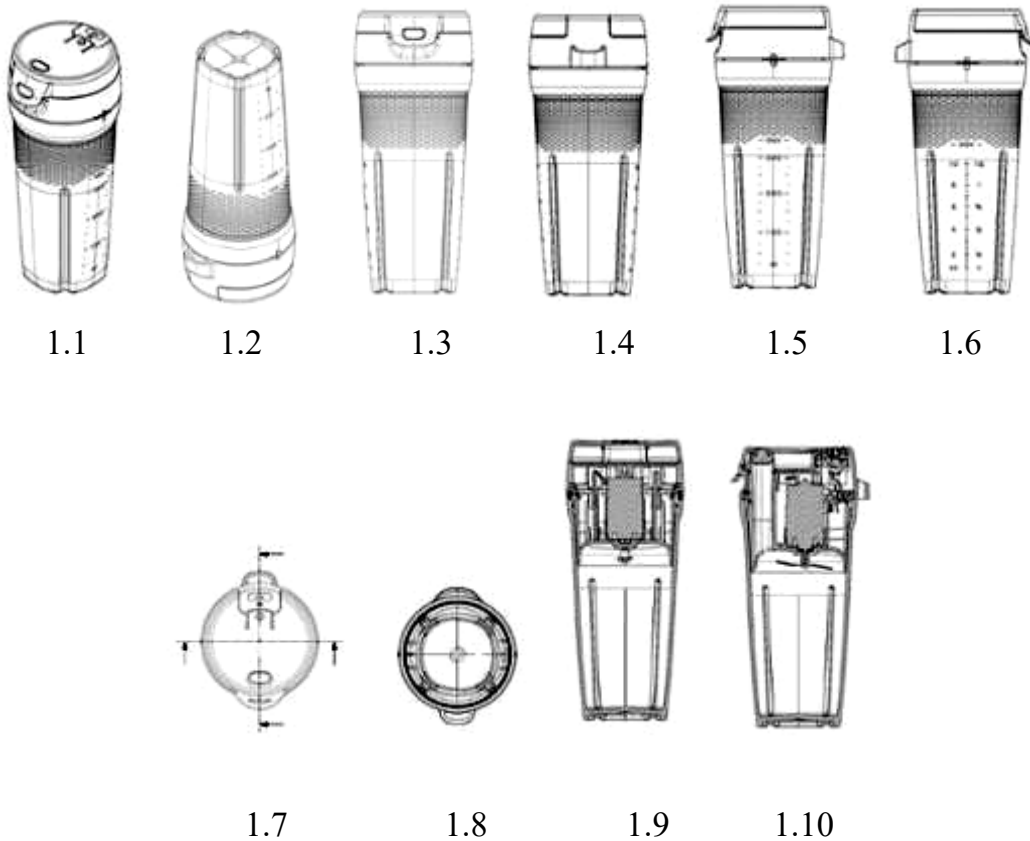

CÔNG BÁO SỞ HỮU CÔNG NGHIỆP SỐ 423 TẬP A – QUYỀN 2 (06.2023)

- (11) **47035**
(21) 3-2022-02453 (28) 1
(54) **THIẾT BỊ LOA CÓ GẮN MICRO** (51) **14-01**
(22) 09/11/2022 (43) 26/06/2023
(73) **NGUYỄN ĐÌNH ĐỆ (VN)**
20/D75 cư xá Nguyễn Trung Trực, đường 3/2, phường 12, quận 10, thành phố Hồ Chí Minh
(72) Nguyễn Đình Đệ (VN)
(74) Công ty TNHH Tư vấn - Dịch thuật - Sở hữu trí tuệ Á Đông (Á Đông IP CONSULTANCY CO.,LTD.)
(55)



1.1



1.2



1.3



1.4



1.5



1.6



1.7

CÔNG BÁO SỞ HỮU CÔNG NGHIỆP SỐ 423 TẬP A – QUYỀN 2 (06.2023)

- (11) **47036**
(21) 3-2022-02464 (28) 1
(54) **BÌNH** (51) **07-07**
(22) 10/11/2022 (43) 26/06/2023
(73) **CÔNG TY CỔ PHẦN SẢN XUẤT NHỰA DUY TÂN (VN)**
298 Hồ Học Lãm, phường An Lạc, quận Bình Tân, thành phố Hồ Chí Minh
(72) Trần Đức Xuyên (VN)
(74) Công ty TNHH Sở hữu trí tuệ INVENTIO (INVENTIO CO.,LTD)
(55)



1.1



1.2



1.3



1.4



1.5

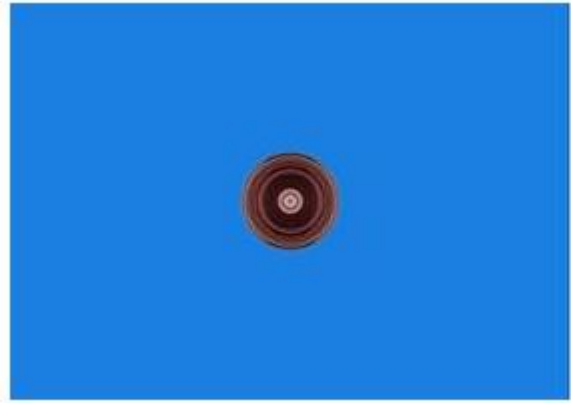

1.6



1.7

CÔNG BÁO SỞ HỮU CÔNG NGHIỆP SỐ 423 TẬP A – QUYỀN 2 (06.2023)

- (11) **47037**
(21) 3-2022-02467 (28) 1
(54) **KHAY NHỰA ĐA NĂNG** (51) **09-04**
(22) 11/11/2022 (43) 26/06/2023
(73) **CÔNG TY TNHH MỘT THÀNH VIÊN SẢN XUẤT THƯƠNG MẠI XUẤT NHẬP KHẨU THẮNG LỢI (VN)**
Số 334D đường Mã Lò, khu phố 6, phường Bình Trị Đông A, quận Bình Tân, thành phố Hồ Chí Minh
(72) Tô Lợi Thành (VN)
(74) Công ty Cổ phần PHANLAW VIETNAM (PHANLAW VIETNAM JSC)
(55)

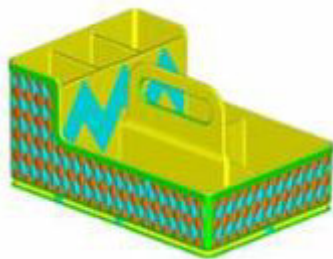

1.1

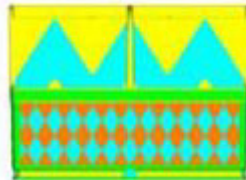

1.2

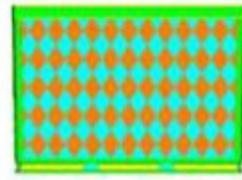

1.3



1.4



1.5

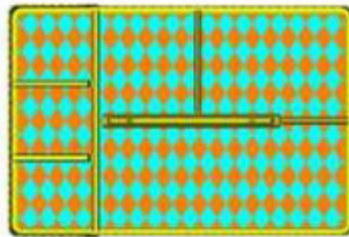

1.6

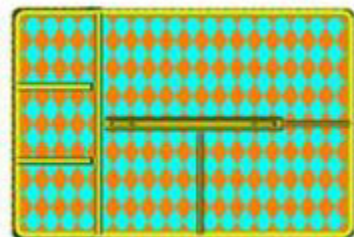

1.7

CÔNG BÁO SỞ HỮU CÔNG NGHIỆP SỐ 423 TẬP A – QUYỀN 2 (06.2023)

- (11) **47038**
(21) 3-2022-02492 (28) 1
(54) **BÚT** (51) **19-06**
(22) 15/11/2022 (43) 26/06/2023
(73) **CÔNG TY CỔ PHẦN TẬP ĐOÀN THIÊN LONG (VN)**
Tầng 10, Sofic Tower, số 10 đường Mai Chí Thọ, phường Thủ Thiêm, thành phố
Thủ Đức, thành phố Hồ Chí Minh
(72) Cô Gia Thọ (VN)
(74) Công ty TNHH Tư vấn sở hữu trí tuệ Việt (VIET IP CO.,LTD.)
(55)

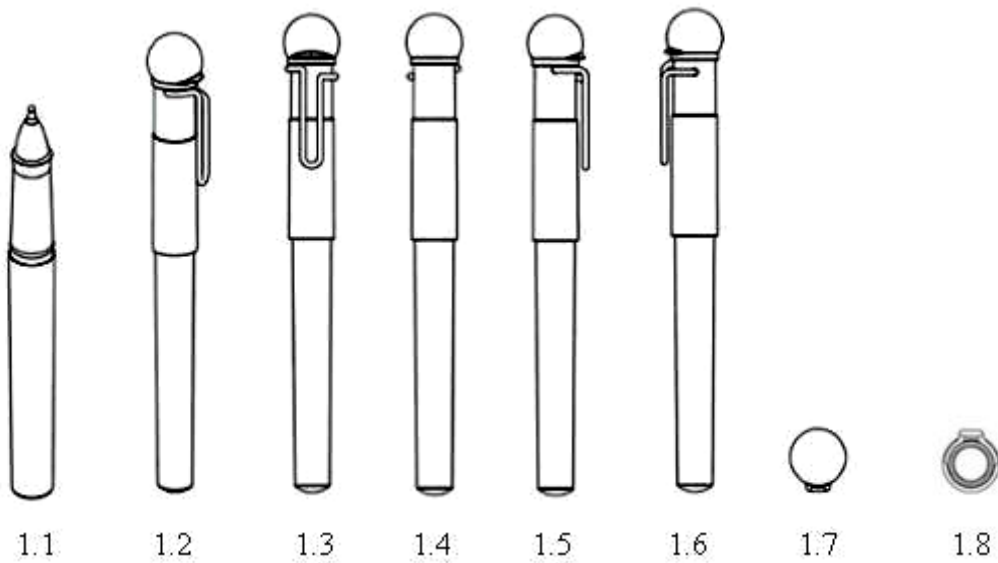

CÔNG BÁO SỞ HỮU CÔNG NGHIỆP SỐ 423 TẬP A – QUYỀN 2 (06.2023)

(11) **47039**

(21) 3-2022-02508

(28) 1

(54) **BẾP GA**

(51) **07-02**

(22) 17/11/2022

(43) 26/06/2023

(73) **CÔNG TY CỔ PHẦN TẬP ĐOÀN SUNHOUSE (VN)**

139 Nguyễn Thái Học, phường Điện Biên, quận Ba Đình, thành phố Hà Nội

(72) Lại Văn Kiên (VN)

(74) Công ty TNHH Sở hữu trí tuệ Bình Minh (SUNRISE IP CO.,LTD.)

(55)



1.1



1.2



1.3

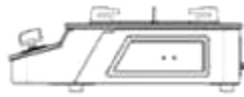

1.4

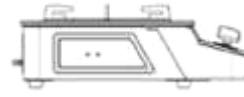

1.5

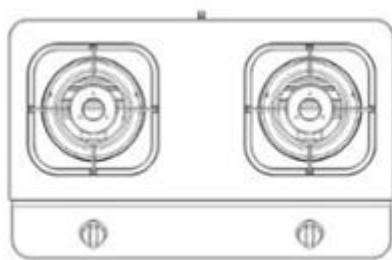

1.6

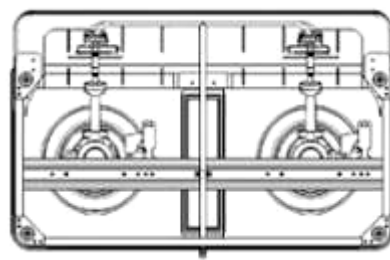

1.7

CÔNG BÁO SỞ HỮU CÔNG NGHIỆP SỐ 423 TẬP A – QUYỀN 2 (06.2023)

- (11) **47040**
(21) 3-2022-02603 (28) 1
(54) **NẮP** (51) **07-02**
(22) 28/11/2022 (43) 26/06/2023
(73) **CÔNG TY TNHH MINH LONG I (VN)**
Số 333 đường Hưng Định 24, khu phố Hưng Lộc, phường Hưng Định, thành phố
Thuận An, tỉnh Bình Dương
(72) Lý Huy Sáng (VN)
(55)



1.1



1.2



1.3



1.4

CÔNG BÁO SỞ HỮU CÔNG NGHIỆP SỐ 423 TẬP A – QUYỀN 2 (06.2023)

(11) **47041**

(21) 3-2022-02605

(28) 1

(54) **NẤP**

(51) **07-01**

(22) 28/11/2022

(43) 26/06/2023

(73) **CÔNG TY TNHH MINH LONG I (VN)**

Số 333 đường Hưng Định 24, khu phố Hưng Lộc, phường Hưng Định, thành phố Thuận An, tỉnh Bình Dương

(72) Lý Ngọc Minh (VN)

(55)



1.1



1.2



1.3



1.4



1.5

CÔNG BÁO SỞ HỮU CÔNG NGHIỆP SỐ 423 TẬP A – QUYỀN 2 (06.2023)

- (11) **47042**
(21) 3-2022-02607 (28) 2
(54) **VA LI** (51) **03-01**
(22) 28/11/2022 (43) 26/06/2023
(73) **CÔNG TY TNHH SẢN XUẤT VÀ THƯƠNG MẠI HOÀNG KIM (VN)**
60B1 Nguyễn Văn Bứa, ấp 4, xã Xuân Thới Sơn, huyện Hóc Môn, thành phố Hồ Chí Minh
(72) Lưu Văn Thành (VN)
(74) Công ty Luật TNHH WINCO (WINCO LAW FIRM)
(55)



1.1



1.2



1.3



1.4



1.5



1.6

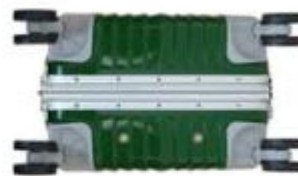

1.7



1.8



1.9



2.1



2.2



2.3



2.4



2.5



2.6



2.7



2.8



2.9

- (11) **47043**
(21) 3-2022-02621 (28) 1
(54) **VÒI RỬA** (51) **23-01**
(22) 29/11/2022 (43) 26/06/2023
(30) 402022000001277 30/05/2022 IT;
(73) **GESSI S.P.A. (IT)**
PARCO GESSI - FRAZIONE VINTEBBIO -13037 SERRAVALLE SESIA (VC) -
Italy
(72) GESSI, Gian Luca (IT)
(74) Công ty TNHH T&T INVENMARK Sở hữu trí tuệ Quốc tế (T&T INVENMARK
CO., LTD.)
(55)

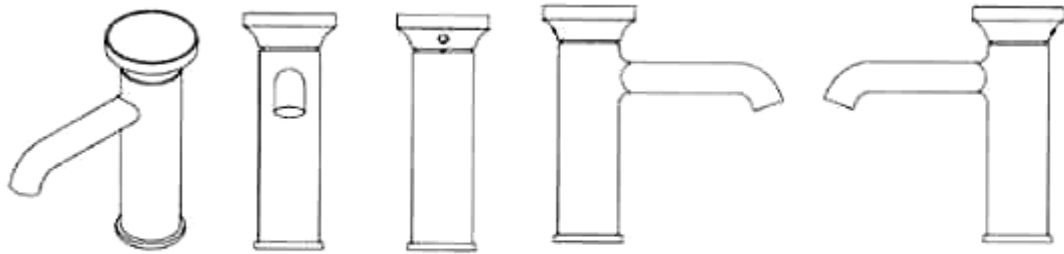

1.1

1.2

1.3

1.4

1.5

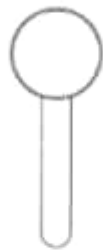

1.6



1.7

CÔNG BÁO SỞ HỮU CÔNG NGHIỆP SỐ 423 TẬP A – QUYỀN 2 (06.2023)

- (11) **47044**
(21) 3-2022-02639 (28) 2
(54) **MŨ BẢO HIỂM** (51) **02-03**
(22) 30/11/2022 (43) 26/06/2023
(30) 009054703 07/06/2022 EM;
(73) **LOCATELLI S.P.A. (IT)**
Via Della Resistenza, 5/A, I-24030 Almenno San Bartolomeo (Bergamo), Italy
(72) LOCATELLI Antonio (IT)
(74) Công ty TNHH Sở hữu trí tuệ ALNGUYEN (ALNGUYEN IP CO.,LTD.)
(55)



1.1



1.2



1.3



1.4



1.5



1.6



1.7



2.1



2.2



2.3



2.4



2.5



2.6



2.7

- (11) **47045**
(21) 3-2022-02643
(54) **THIẾT BỊ LỌC NƯỚC**
(22) 02/12/2022
(73) **NGUYỄN CHÍ THU (VN)**
Khu phố Vạn Hạnh, phường Phú Mỹ, thị xã Phú Mỹ, tỉnh Bà Rịa - Vũng Tàu
(72) Nguyễn Chí Thu (VN)
(74) Công ty TNHH Tư vấn công nghệ và Sở hữu trí tuệ IP GROUP (IP GROUP CO.,LTD.)
(55)

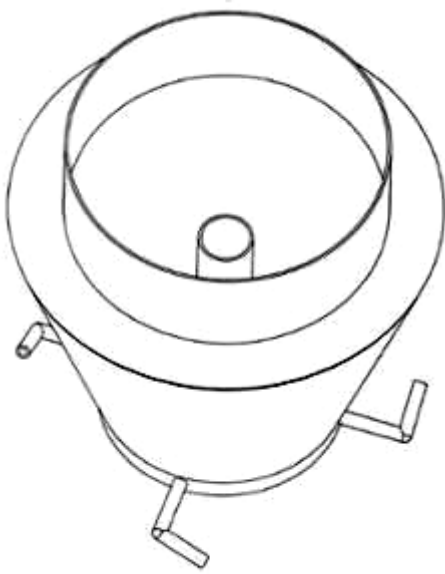

1.1

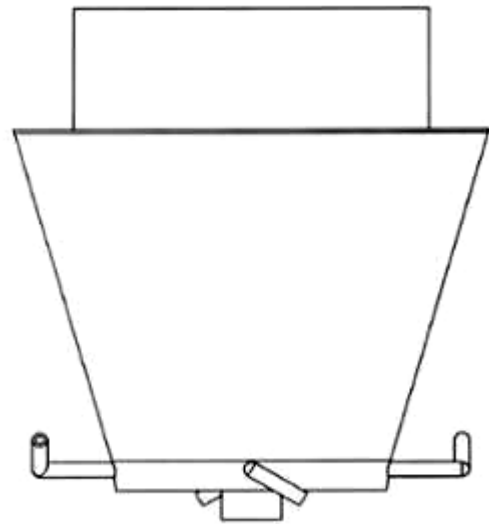

1.2

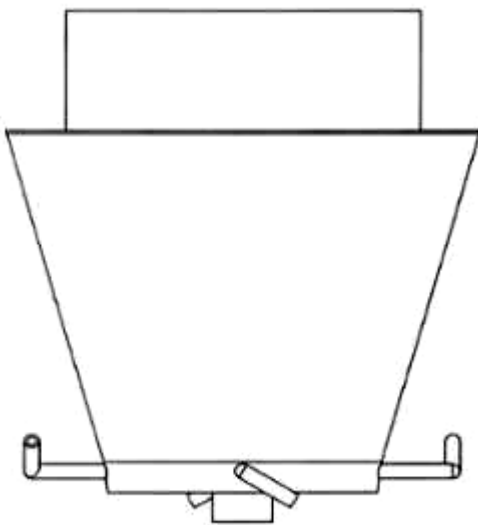

1.3

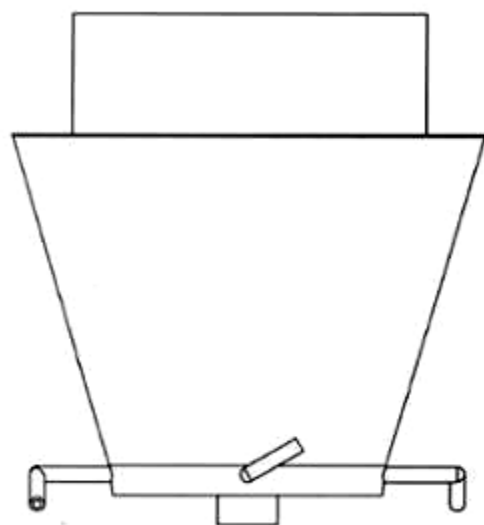

1.4

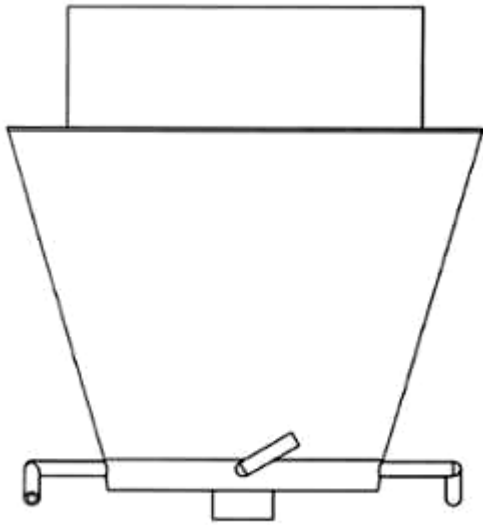

1.5

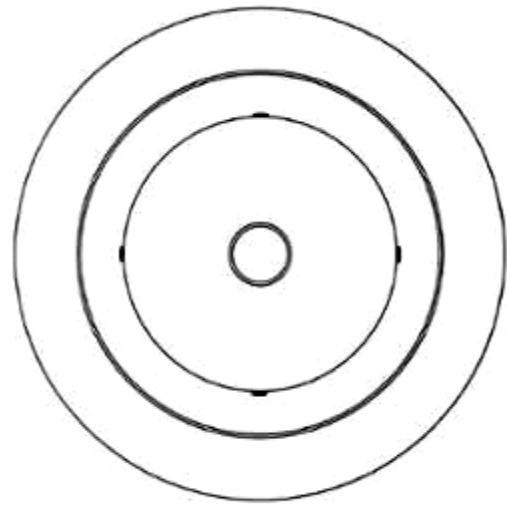

1.6

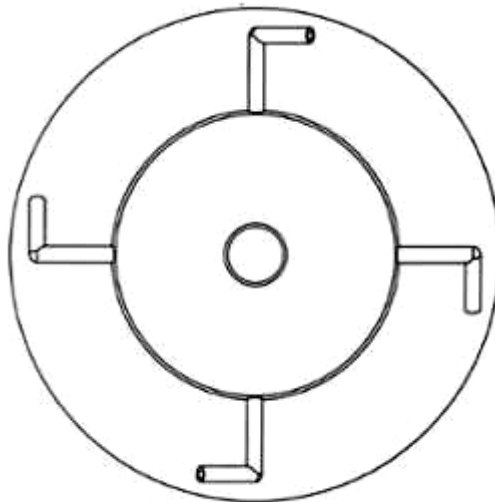

1.7

CÔNG BÁO SỞ HỮU CÔNG NGHIỆP SỐ 423 TẬP A – QUYỀN 2 (06.2023)

- (11) **47046**
(21) 3-2022-02647 (28) 1
(54) **BA LÔ** (51) **03-01**
(22) 02/12/2022 (43) 26/06/2023
(30) 009081904-0001 12/07/2022 EM;
(73) **DECATHLON (FR)**
4, Boulevard de Mons, F-59650 Villeneuve d’Ascq, France
(72) Malo SAHORES (FR)
(74) Công ty Luật TNHH T&G (TGVN)
(55)



1.1



1.2



1.3



1.4



1.5



1.6



1.7

CÔNG BÁO SỞ HỮU CÔNG NGHIỆP SỐ 423 TẬP A – QUYỀN 2 (06.2023)

(11) **47047**

(21) 3-2022-02708

(54) **BÀN CHẢI ĐÁNH RĂNG**

(22) 12/12/2022

(73) **NGUYỄN BÁ HIỀN (VN)**

Số 24, đường 232 Cao Lỗ, phường 4, quận 8, thành phố Hồ Chí Minh

(72) Nguyễn Bá Hiền (VN)

(55)

(28) 1

(51) **04-02**

(43) 26/06/2023



1.1



1.2



1.3



1.4



1.5

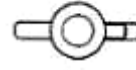

1.6



1.7

(11) **47048**

(21) 3-2022-02716

(28) 1

(54) **NẮP**

(51) **07-02**

(22) 13/12/2022

(43) 26/06/2023

(73) **CÔNG TY TNHH MINH LONG I (VN)**

333 đường Hưng Định 24, khu phố Hưng Lộc, phường Hưng Định, thành phố Thuận An, tỉnh Bình Dương

(72) Lý Ngọc Minh (VN)

(55)

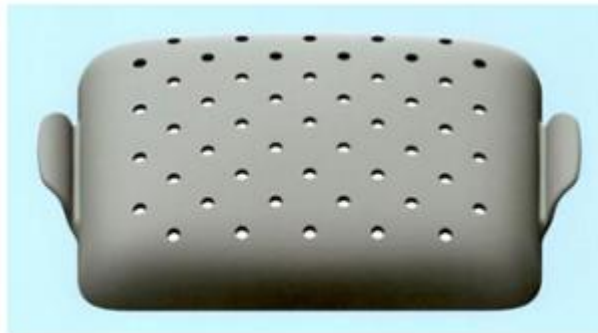

1.1



1.2



1.3



1.4



1.5

CÔNG BÁO SỞ HỮU CÔNG NGHIỆP SỐ 423 TẬP A – QUYỀN 2 (06.2023)

- (11) **47049**
(21) 3-2022-02719 (28) 1
(54) **BÉC TƯỚI** (51) **23-01**
(22) 13/12/2022 (43) 26/06/2023
(73) **CÔNG TY TNHH ĐẦU TƯ THƯƠNG MẠI THAFACO (VN)**
203-205 Điện Biên Phủ, phường Thành Công, thành phố Buôn Ma Thuột, tỉnh Đắk Lắk
(72) Lê Công Đà (VN)
(55)



1.1



1.2

1.3



1.4



1.5



1.6



1.7

CÔNG BÁO SỞ HỮU CÔNG NGHIỆP SỐ 423 TẬP A – QUYỀN 2 (06.2023)

- (11) **47050**
(21) 3-2022-02828 (28) 1
(54) **THANH KIM LOẠI ĐỊNH HÌNH** (51) **25-01**
(22) 22/12/2022 (43) 26/06/2023
(73) **CÔNG TY CỔ PHẦN TẬP ĐOÀN EUROVIEW (VN)**
Số 150 đường Cổ Bi, xã Cổ Bi, huyện Gia Lâm, thành phố Hà Nội
(72) Nguyễn Thị Trung Thủy (VN)
(74) Công ty TNHH Sở hữu trí tuệ Gia Việt (GIAVIET CO., LTD.)
(55)

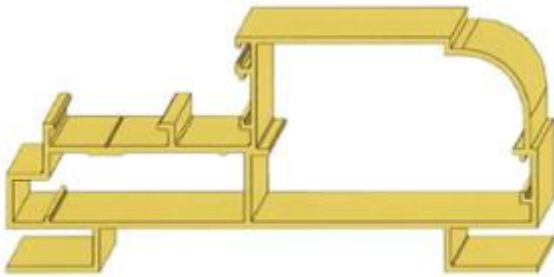

1.1

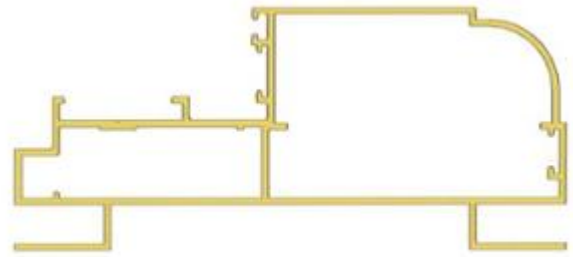

1.2



1.3

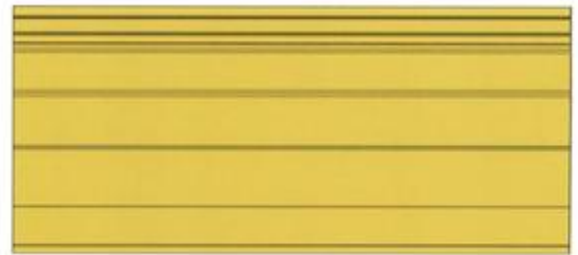

1.4

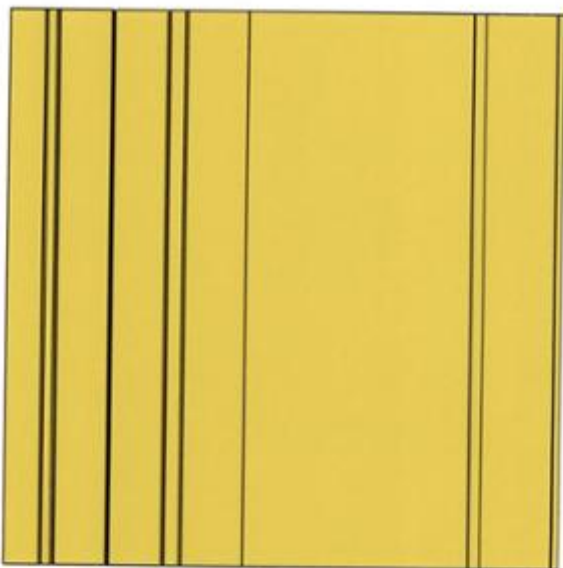

1.5

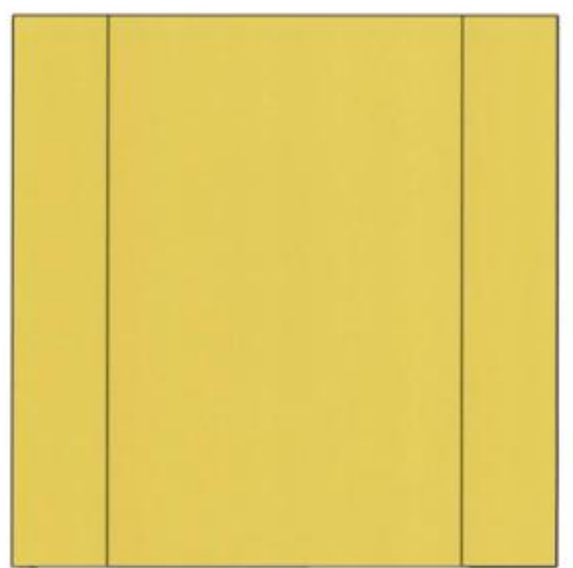

1.6

CÔNG BÁO SỞ HỮU CÔNG NGHIỆP SỐ 423 TẬP A – QUYỀN 2 (06.2023)

- (11) **47051**
(21) 3-2022-02830 (28) 1
(54) **THANH KIM LOẠI ĐỊNH HÌNH** (51) **25-01**
(22) 22/12/2022 (43) 26/06/2023
(73) **CÔNG TY CỔ PHẦN TẬP ĐOÀN EUROVIEW (VN)**
Số 150 đường Cổ Bi, xã Cổ Bi, huyện Gia Lâm, thành phố Hà Nội
(72) Nguyễn Thị Trung Thủy (VN)
(74) Công ty TNHH Sở hữu trí tuệ Gia Việt (GIAVIET CO., LTD.)
(55)



1.1



1.2



1.3



1.4

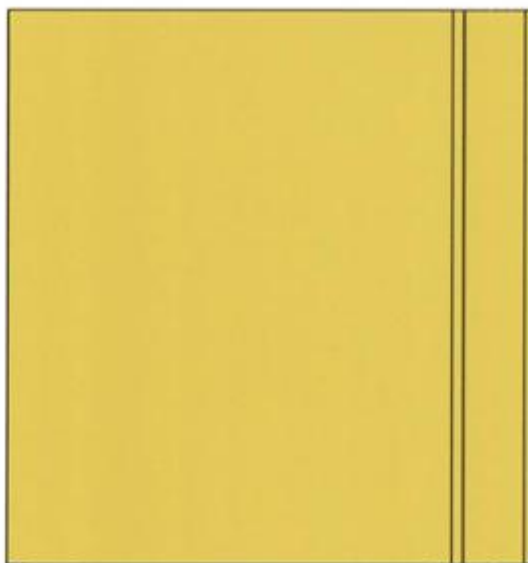

1.5

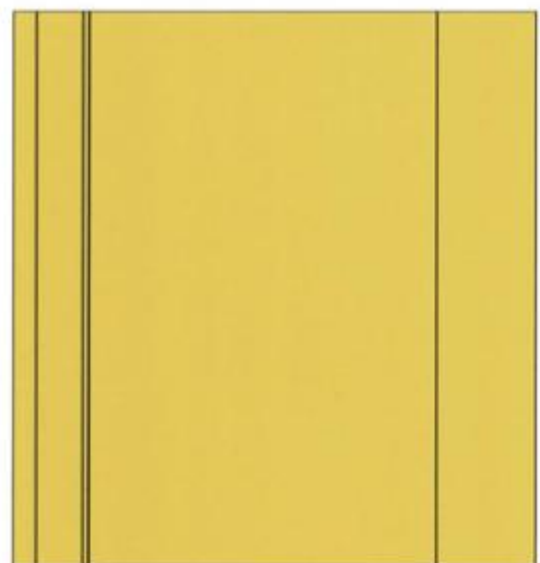

1.6

CÔNG BÁO SỞ HỮU CÔNG NGHIỆP SỐ 423 TẬP A – QUYỀN 2 (06.2023)

- (11) **47052**
(21) 3-2022-02854 (28) 1
(54) **HỘP** (51) **09-03**
(22) 20/10/2021 (43) 26/06/2023
(73) **NGUYỄN THỊ THU HOA (VN)**
Tân Thành, thị trấn Thanh Sơn, huyện Thanh Sơn, tỉnh Phú Thọ
(72) Nguyễn Thị Thu Hoa (VN)
(74) Công ty TNHH Sở hữu trí tuệ WITIP Việt Nam (WITIP CO., LTD.)
(55)



1.1



1.2

CÔNG BÁO SỞ HỮU CÔNG NGHIỆP SỐ 423 TẬP A – QUYỀN 2 (06.2023)

- (11) **47053**
(21) 3-2022-02894 (28) 1
(54) **MÁY DIỆT MUỖI** (51) **22-06**
(22) 27/12/2022 (43) 26/06/2023
(73) **CÔNG TY TNHH DƯỢC PHẨM TUỆ ĐĂNG (VN)**
Số 23 BT5 KĐT Pháp Vân, phường Hoàng Liệt, quận Hoàng Mai, thành phố Hà Nội
(72) Quách Văn Thuận (VN)
(55)



1.1



1.2



1.3



1.4



1.5



1.6



1.7

- (11) **47054**
(21) 3-2022-02970 (28) 1
(54) **THANH KIM LOẠI ĐỊNH HÌNH** (51) **25-01**
(22) 30/12/2022 (43) 26/06/2023
(73) **TRẦN ĐÌNH THI (VN)**
3X8-03 Sky Garden 3, Tân Phong, quận 7, thành phố Hồ Chí Minh
(72) Trần Đình Thi (VN)
(74) Công ty Luật TNHH MINH KHUÊ (MK LAW FIRM)
(55)



1.1



1.2



1.3



1.4



1.5



1.6



1.7

CÔNG BÁO SỞ HỮU CÔNG NGHIỆP SỐ 423 TẬP A – QUYỀN 2 (06.2023)

- (11) **47055**
(21) 3-2022-02979 (28) 1
(54) **THANH KIM LOẠI ĐỊNH HÌNH** (51) **25-01**
(22) 30/12/2022 (43) 26/06/2023
(73) **CÔNG TY TNHH FRAVI VIỆT NAM (VN)**
Tổ dân phố Tứ Mỹ, phường Phùng Chí Kiên, thị xã Mỹ Hòa, tỉnh Hưng Yên
(72) Đặng Thị Thanh Tân (VN)
(74) Công ty TNHH Sở hữu trí tuệ Gia Việt (GIAVIET CO., LTD.)
(55)



1.1

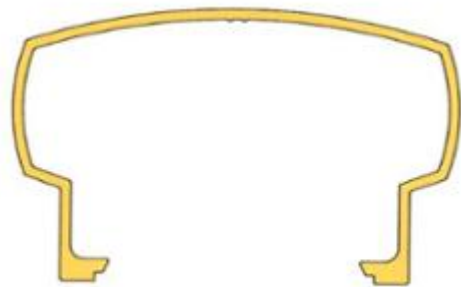

1.2



1.3



1.4

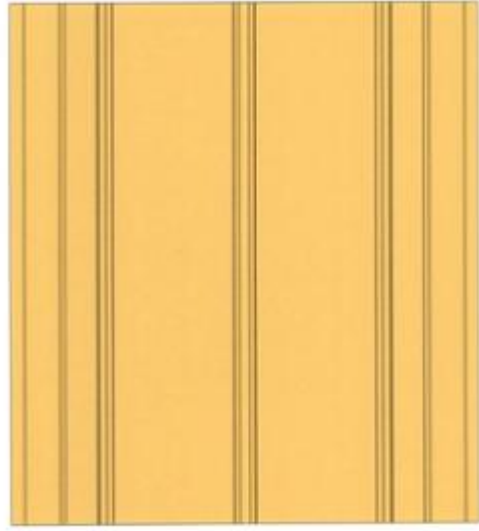

1.5

CÔNG BÁO SỞ HỮU CÔNG NGHIỆP SỐ 423 TẬP A – QUYỀN 2 (06.2023)

- (11) **47056**
(21) 3-2022-02988 (28) 1
(54) **THANH KIM LOẠI ĐỊNH HÌNH** (51) **25-01**
(22) 30/12/2022 (43) 26/06/2023
(73) **CÔNG TY CỔ PHẦN TẬP ĐOÀN KENWIN (VN)**
Tầng 4 tòa nhà VG Building, số 235 đường Nguyễn Trãi, phường Thanh Xuân
Trung, quận Thanh Xuân, thành phố Hà Nội
(72) Ngô Thọ Long (VN)
(74) Công ty TNHH Sở hữu trí tuệ PADEMARK (PADEMARK CO.,LTD.)
(55)

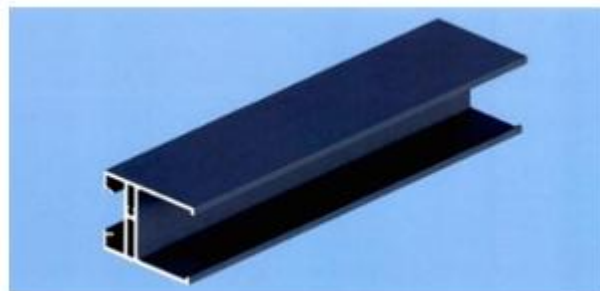

1.1



1.2



1.3

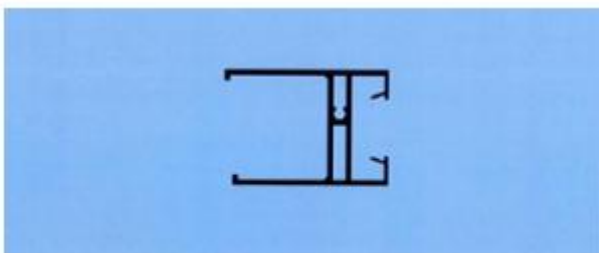

1.4

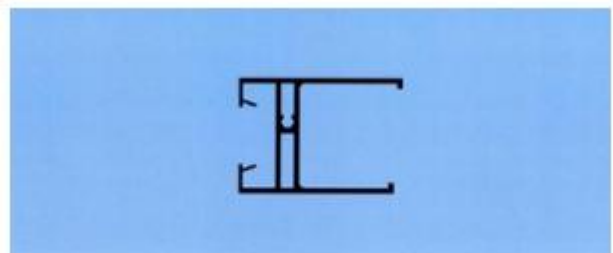

1.5



1.6



1.7

CÔNG BÁO SỞ HỮU CÔNG NGHIỆP SỐ 423 TẬP A – QUYỀN 2 (06.2023)

- (11) **47057**
(21) 3-2023-00004 (28) 1
(54) **BAO GÓI QUẦN TẮ** (51) **09-05**
(22) 03/01/2023 (43) 26/06/2023
(73) **CÔNG TY CỔ PHẦN DIANA UNICHARM (VN)**
Khu công nghiệp Vĩnh Tuy, đường Lĩnh Nam, phường Vĩnh Hưng, quận Hoàng
Mai, thành phố Hà Nội
(72) Đỗ Anh Tú (VN)
(74) Công ty TNHH Sở hữu trí tuệ và Công nghệ Thủ đô (CAPITAL IP&T CO.LTD.)
(55)



1.1



1.2

CÔNG BÁO SỞ HỮU CÔNG NGHIỆP SỐ 423 TẬP A – QUYỀN 2 (06.2023)

- (11) **47058**
(21) 3-2023-00005 (28) 1
(54) **BAO GÓI QUẦN TÃ** (51) **09-05**
(22) 03/01/2023 (43) 26/06/2023
(73) **CÔNG TY CỔ PHẦN DIANA UNICHARM (VN)**
Khu công nghiệp Vĩnh Tuy, đường Lĩnh Nam, phường Vĩnh Hưng, quận Hoàng
Mai, thành phố Hà Nội
(72) Đỗ Anh Tú (VN)
(74) Công ty TNHH Sở hữu trí tuệ và Công nghệ Thủ đô (CAPITAL IP&T CO.LTD.)
(55)



1.1



1.2

CÔNG BÁO SỞ HỮU CÔNG NGHIỆP SỐ 423 TẬP A – QUYỀN 2 (06.2023)

- (11) **47059**
(21) 3-2023-00006 (28) 1
(54) **BAO GÓI QUẦN TÃ** (51) **09-05**
(22) 03/01/2023 (43) 26/06/2023
(73) **CÔNG TY CỔ PHẦN DIANA UNICHARM (VN)**
Khu công nghiệp Vĩnh Tuy, đường Lĩnh Nam, phường Vĩnh Hưng, quận Hoàng
Mai, thành phố Hà Nội
(72) Đỗ Anh Tú (VN)
(74) Công ty TNHH Sở hữu trí tuệ và Công nghệ Thủ đô (CAPITAL IP&T CO.LTD.)
(55)



1.1



1.2

CÔNG BÁO SỞ HỮU CÔNG NGHIỆP SỐ 423 TẬP A – QUYỀN 2 (06.2023)

- (11) **47060**
(21) 3-2023-00007 (28) 1
(54) **BAO GÓI QUẦN TÃ** (51) **09-05**
(22) 03/01/2023 (43) 26/06/2023
(73) **CÔNG TY CỔ PHẦN DIANA UNICHARM (VN)**
Khu công nghiệp Vĩnh Tuy, đường Lĩnh Nam, phường Vĩnh Hưng, quận Hoàng
Mai, thành phố Hà Nội
(72) Đỗ Anh Tú (VN)
(74) Công ty TNHH Sở hữu trí tuệ và Công nghệ Thủ đô (CAPITAL IP&T CO.LTD.)
(55)



1.1



1.2

CÔNG BÁO SỞ HỮU CÔNG NGHIỆP SỐ 423 TẬP A – QUYỀN 2 (06.2023)

- (11) **47061**
(21) 3-2023-00008 (28) 1
(54) **BAO GÓI QUẦN TÃ** (51) **09-05**
(22) 03/01/2023 (43) 26/06/2023
(73) **CÔNG TY CỔ PHẦN DIANA UNICHARM (VN)**
Khu công nghiệp Vĩnh Tuy, đường Lĩnh Nam, phường Vĩnh Hưng, quận Hoàng
Mai, thành phố Hà Nội
(72) Đỗ Anh Tú (VN)
(74) Công ty TNHH Sở hữu trí tuệ và Công nghệ Thủ đô (CAPITAL IP&T CO.LTD.)
(55)



1.1



1.2

CÔNG BÁO SỞ HỮU CÔNG NGHIỆP SỐ 423 TẬP A – QUYỀN 2 (06.2023)

- (11) **47062**
(21) 3-2023-00009 (28) 1
(54) **BAO GÓI QUẦN TẮ** (51) **09-05**
(22) 03/01/2023 (43) 26/06/2023
(73) **CÔNG TY CỔ PHẦN DIANA UNICHARM (VN)**
Khu công nghiệp Vĩnh Tuy, đường Lĩnh Nam, phường Vĩnh Hưng, quận Hoàng
Mai, thành phố Hà Nội
(72) Đỗ Anh Tú (VN)
(74) Công ty TNHH Sở hữu trí tuệ và Công nghệ Thủ đô (CAPITAL IP&T CO.LTD.)
(55)



1.1



1.2

CÔNG BÁO SỞ HỮU CÔNG NGHIỆP SỐ 423 TẬP A – QUYỀN 2 (06.2023)

- (11) **47063**
(21) 3-2023-00010 (28) 1
(54) **BAO GÓI QUẦN TẮ** (51) **09-05**
(22) 03/01/2023 (43) 26/06/2023
(73) **CÔNG TY CỔ PHẦN DIANA UNICHARM (VN)**
Khu công nghiệp Vĩnh Tuy, đường Lĩnh Nam, phường Vĩnh Hưng, quận Hoàng
Mai, thành phố Hà Nội
(72) Đỗ Anh Tú (VN)
(74) Công ty TNHH Sở hữu trí tuệ và Công nghệ Thủ đô (CAPITAL IP&T CO.LTD.)
(55)



1.1



1.2

CÔNG BÁO SỞ HỮU CÔNG NGHIỆP SỐ 423 TẬP A – QUYỀN 2 (06.2023)

(11) **47064**

(21) 3-2023-00012

(28) 1

(54) **BỒN CẦU**

(51) **23-02**

(22) 03/01/2023

(43) 26/06/2023

(73) **DAELIM B&CO CO., LTD. (KR)**

52, Gongdan-ro, Seongsan-gu, Changwon-si, Gyeongsangnam-do, 51565 Republic of Korea

(72) TAE SIK, KANG (KR)

(74) Công ty TNHH Đại Tín và Liên Danh (DAITIN AND ASSOCIATES CO.,LTD)

(55)

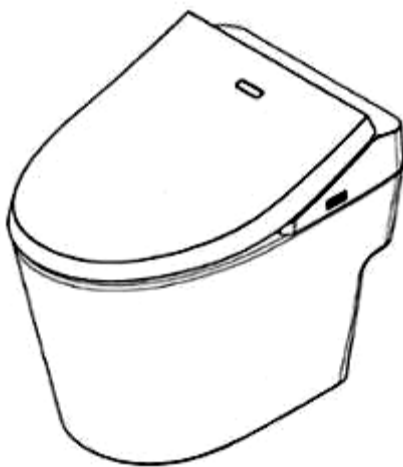

1.1



1.2

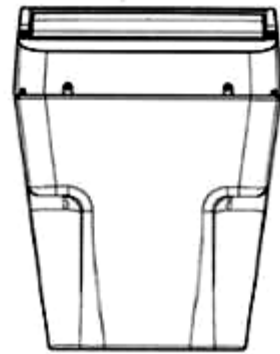

1.3



1.4

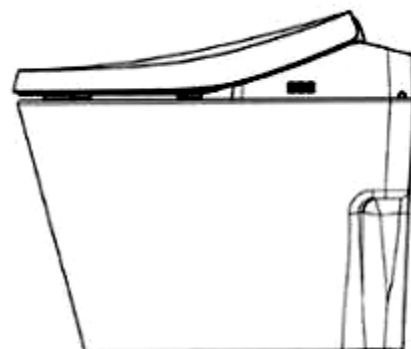

1.5

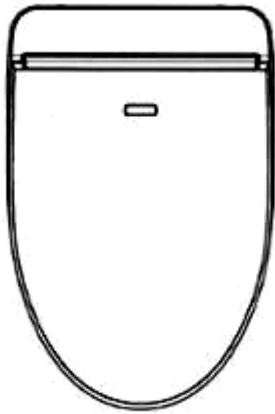

1.6

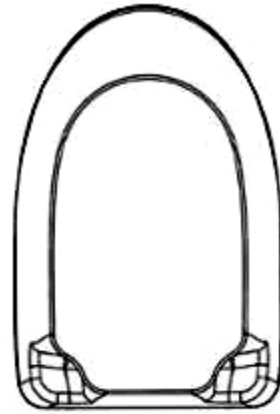

1.7

CÔNG BÁO SỞ HỮU CÔNG NGHIỆP SỐ 423 TẬP A – QUYỀN 2 (06.2023)

- (11) **47065**
(21) 3-2023-00014 (28) 3
(54) **BỆ XÍ** (51) **23-02**
(22) 04/01/2023 (43) 26/06/2023
(30) 2022304352999 11/07/2022 CN;
(73) **LIXIL INTERNATIONAL PTE. LTD. (SG)**
180 Clemenceau Avenue, #06-02 Haw Par Centre, Singapore 239922 Singapore
(72) 1. ANTOINE BESSEYRE DES HORTS (FR)
2. JIALU CHENG (CN)
3. HELDER FILIPOV (BR)
(74) Công ty Luật TNHH Phạm và Liên danh (PHAM & ASSOCIATES)
(55)



1.1



1.2



1.3



1.4



1.5



1.6



1.7



2.1



2.2



2.3



2.4



2.5



2.6



2.7



3.1



3.2



3.3



3.4



3.5



3.6



3.7

CÔNG BÁO SỞ HỮU CÔNG NGHIỆP SỐ 423 TẬP A – QUYỀN 2 (06.2023)

- (11) **47066**
(21) 3-2023-00015 (28) 1
(54) **CHÂN VÒI SEN** (51) **23-01**
(22) 04/01/2023 (43) 26/06/2023
(30) 2022304596141 19/07/2022 CN;
(73) **LIXIL INTERNATIONAL PTE. LTD.** (SG)
180 Clemenceau Avenue, #06-02 Haw Par Centre, Singapore 239922 Singapore
(72) 1. ANTOINE BESSEYRE DES HORTS (FR)
2. MINSEONG KIM (KR)
3. HELDER FILIPOV (BR)
(74) Công ty Luật TNHH Phạm và Liên danh (PHAM & ASSOCIATES)
(55)



CÔNG BÁO SỞ HỮU CÔNG NGHIỆP SỐ 423 TẬP A – QUYỀN 2 (06.2023)

- (11) **47067**
(21) 3-2023-00016 (28) 1
(54) **CHÂN VÒI TẮM** (51) **23-01**
(22) 04/01/2023 (43) 26/06/2023
(30) 202230459625X 19/07/2022 CN;
(73) **LIXIL INTERNATIONAL PTE. LTD.** (SG)
180 Clemenceau Avenue, #06-02 Haw Par Centre, Singapore 239922 Singapore
(72) 1. ANTOINE BESSEYRE DES HORTS (FR)
2. MINSEONG KIM (KR)
3. HELDER FILIPOV (BR)
(74) Công ty Luật TNHH Phạm và Liên danh (PHAM & ASSOCIATES)
(55)



CÔNG BÁO SỞ HỮU CÔNG NGHIỆP SỐ 423 TẬP A – QUYỀN 2 (06.2023)

- (11) **47068**
(21) 3-2023-00017 (28) 1
(54) **BỆ XÍ** (51) **23-02**
(22) 04/01/2023 (43) 26/06/2023
(30) 202230472077.4 22/07/2022 CN;
(73) **LIXIL INTERNATIONAL PTE. LTD. (SG)**
180 Clemenceau Avenue, #06-02 Haw Par Centre, Singapore 239922 Singapore
(72) 1. ANTOINE BESSEYRE DES HORTS (FR)
2. SINLAPACHAI PUTPAN (TH)
(74) Công ty Luật TNHH Phạm và Liên danh (PHAM & ASSOCIATES)
(55)



1.1



1.2



1.3



1.4



1.5



1.6



1.7

CÔNG BÁO SỞ HỮU CÔNG NGHIỆP SỐ 423 TẬP A – QUYỀN 2 (06.2023)

- (11) **47069**
(21) 3-2023-00018 (28) 1
(54) **BAO GÓI TẤ DÁN** (51) **09-05**
(22) 04/01/2023 (43) 26/06/2023
(73) **CÔNG TY CỔ PHẦN DIANA UNICHARM (VN)**
Khu công nghiệp Vĩnh Tuy, đường Lĩnh Nam, phường Vĩnh Hưng, quận Hoàng
Mai, thành phố Hà Nội
(72) Đỗ Anh Tú (VN)
(74) Công ty TNHH Sở hữu trí tuệ và Công nghệ Thủ đô (CAPITAL IP&T CO.LTD.)
(55)



1.1



1.2

CÔNG BÁO SỞ HỮU CÔNG NGHIỆP SỐ 423 TẬP A – QUYỀN 2 (06.2023)

- (11) **47070**
(21) 3-2023-00019 (28) 1
(54) **BAO GÓI TẤ DÁN** (51) **09-05**
(22) 04/01/2023 (43) 26/06/2023
(73) **CÔNG TY CỔ PHẦN DIANA UNICHARM (VN)**
Khu công nghiệp Vĩnh Tuy, đường Lĩnh Nam, phường Vĩnh Hưng, quận Hoàng
Mai, thành phố Hà Nội
(72) Đỗ Anh Tú (VN)
(74) Công ty TNHH Sở hữu trí tuệ và Công nghệ Thủ đô (CAPITAL IP&T CO.LTD.)
(55)



1.1



1.2

CÔNG BÁO SỞ HỮU CÔNG NGHIỆP SỐ 423 TẬP A – QUYỀN 2 (06.2023)

- (11) **47071**
(21) 3-2023-00020 (28) 1
(54) **BAO GÓI TẤ DÁN** (51) **09-05**
(22) 04/01/2023 (43) 26/06/2023
(73) **CÔNG TY CỔ PHẦN DIANA UNICHARM (VN)**
Khu công nghiệp Vĩnh Tuy, đường Lĩnh Nam, phường Vĩnh Hưng, quận Hoàng
Mai, thành phố Hà Nội
(72) Đỗ Anh Tú (VN)
(74) Công ty TNHH Sở hữu trí tuệ và Công nghệ Thủ đô (CAPITAL IP&T CO.LTD.)
(55)



1.1



1.2

CÔNG BÁO SỞ HỮU CÔNG NGHIỆP SỐ 423 TẬP A – QUYỀN 2 (06.2023)

- (11) **47072**
(21) 3-2023-00021 (28) 1
(54) **BAO GÓI TẤ DÁN** (51) **09-05**
(22) 04/01/2023 (43) 26/06/2023
(73) **CÔNG TY CỔ PHẦN DIANA UNICHARM (VN)**
Khu công nghiệp Vĩnh Tuy, đường Lĩnh Nam, phường Vĩnh Hưng, quận Hoàng
Mai, thành phố Hà Nội
(72) Đỗ Anh Tú (VN)
(74) Công ty TNHH Sở hữu trí tuệ và Công nghệ Thủ đô (CAPITAL IP&T CO.LTD.)
(55)



1.1



1.2

CÔNG BÁO SỞ HỮU CÔNG NGHIỆP SỐ 423 TẬP A – QUYỀN 2 (06.2023)

- (11) **47073**
(21) 3-2023-00022 (28) 1
(54) **BAO GÓI TẤ DÁN** (51) **09-05**
(22) 04/01/2023 (43) 26/06/2023
(73) **CÔNG TY CỔ PHẦN DIANA UNICHARM (VN)**
Khu công nghiệp Vĩnh Tuy, đường Lĩnh Nam, phường Vĩnh Hưng, quận Hoàng
Mai, thành phố Hà Nội
(72) Đỗ Anh Tú (VN)
(74) Công ty TNHH Sở hữu trí tuệ và Công nghệ Thủ đô (CAPITAL IP&T CO.LTD.)
(55)



1.1



1.2

CÔNG BÁO SỞ HỮU CÔNG NGHIỆP SỐ 423 TẬP A – QUYỀN 2 (06.2023)

- (11) **47074**
(21) 3-2023-00023 (28) 1
(54) **BAO GÓI TẤ DÁN** (51) **09-05**
(22) 04/01/2023 (43) 26/06/2023
(73) **CÔNG TY CỔ PHẦN DIANA UNICHARM (VN)**
Khu công nghiệp Vĩnh Tuy, đường Lĩnh Nam, phường Vĩnh Hưng, quận Hoàng
Mai, thành phố Hà Nội
(72) Đỗ Anh Tú (VN)
(74) Công ty TNHH Sở hữu trí tuệ và Công nghệ Thủ đô (CAPITAL IP&T CO.LTD.)
(55)



1.1



1.2

CÔNG BÁO SỞ HỮU CÔNG NGHIỆP SỐ 423 TẬP A – QUYỀN 2 (06.2023)

- (11) **47075**
(21) 3-2023-00024 (28) 1
(54) **BAO GÓI TẤ DÁN** (51) **09-05**
(22) 04/01/2023 (43) 26/06/2023
(73) **CÔNG TY CỔ PHẦN DIANA UNICHARM (VN)**
Khu công nghiệp Vĩnh Tuy, đường Lĩnh Nam, phường Vĩnh Hưng, quận Hoàng
Mai, thành phố Hà Nội
(72) Đỗ Anh Tú (VN)
(74) Công ty TNHH Sở hữu trí tuệ và Công nghệ Thủ đô (CAPITAL IP&T CO.LTD.)
(55)



1.1



1.2

- (11) **47076**
(21) 3-2023-00030 (28) 1
(54) **VÒNG ĐEO TAY** (51) **11-01**
(22) 04/01/2023 (43) 26/06/2023
(30) DM/223919 28/09/2022 WO;
(73) **CARTIER INTERNATIONAL AG (CH)**
Hinterbergstrasse 22, 6312 STEINHAUSEN, SWITZERLAND
(72) Emmanuelle SALLARD (FR)
(74) Công ty TNHH Tầm nhìn và Liên danh (VISION & ASSOCIATES CO.LTD.)
(55)



1.1



1.2



1.3



1.4

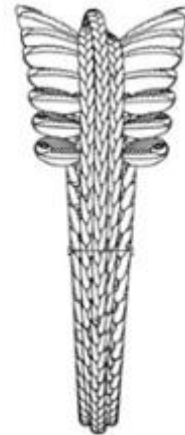

1.5

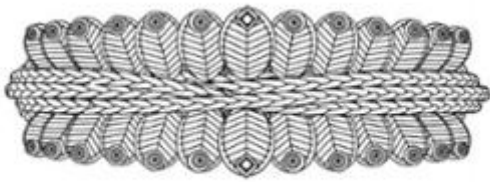

1.6

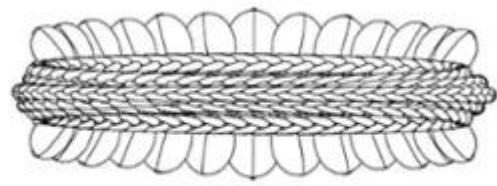

1.7

- (11) **47077**
(21) 3-2023-00031 (28) 1
(54) **VÒNG ĐEO CỔ** (51) **11-01**
(22) 04/01/2023 (43) 26/06/2023
(30) DM/223919 28/09/2022 WO;
(73) **CARTIER INTERNATIONAL AG (CH)**
Hinterbergstrasse 22, 6312 STEINHAUSEN, SWITZERLAND
(72) Emmanuelle SALLARD (FR)
(74) Công ty TNHH Tầm nhìn và Liên danh (VISION & ASSOCIATES CO.LTD.)
(55)



1.1



1.2



1.3



1.4



1.5



1.6



1.7

- (11) **47078**
(21) 3-2023-00032 (28) 1
(54) **VÒNG ĐEO CỔ** (51) **11-01**
(22) 04/01/2023 (43) 26/06/2023
(30) DM/223919 28/09/2022 WO;
(73) **CARTIER INTERNATIONAL AG (CH)**
Hinterbergstrasse 22, 6312 STEINHAUSEN, SWITZERLAND
(72) Emmanuelle SALLARD (FR)
(74) Công ty TNHH Tầm nhìn và Liên danh (VISION & ASSOCIATES CO.LTD.)
(55)



1.1



1.2



1.3



1.4



1.5



1.6



1.7

- (11) **47079**
(21) 3-2023-00034 (28) 1
(54) **ĐỒ TRANG SỨC** (51) **11-01**
(22) 04/01/2023 (43) 26/06/2023
(30) DM/223919 28/09/2022 WO;
(73) **CARTIER INTERNATIONAL AG (CH)**
Hinterbergstrasse 22, 6312 STEINHAUSEN, SWITZERLAND
(72) Emmanuelle SALLARD (FR)
(74) Công ty TNHH Tầm nhìn và Liên danh (VISION & ASSOCIATES CO.LTD.)
(55)

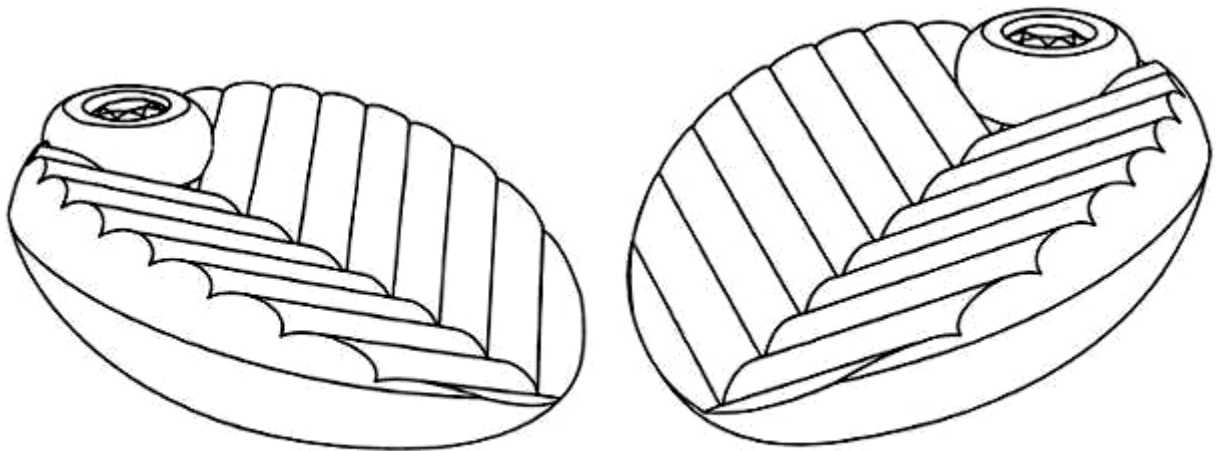

1.1

1.2

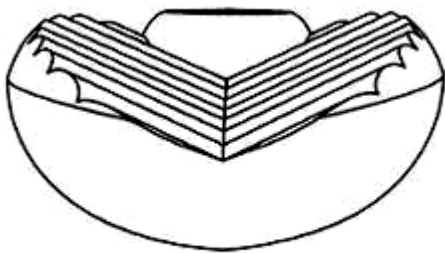

1.3

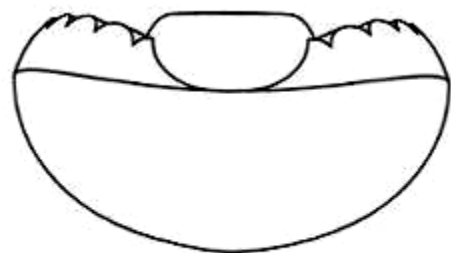

1.4

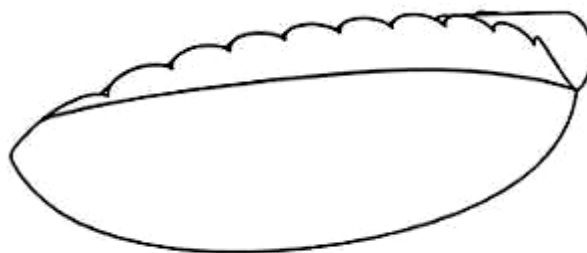

1.5

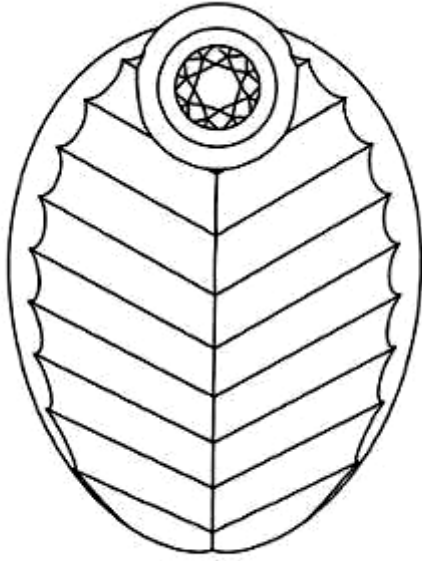

1.6

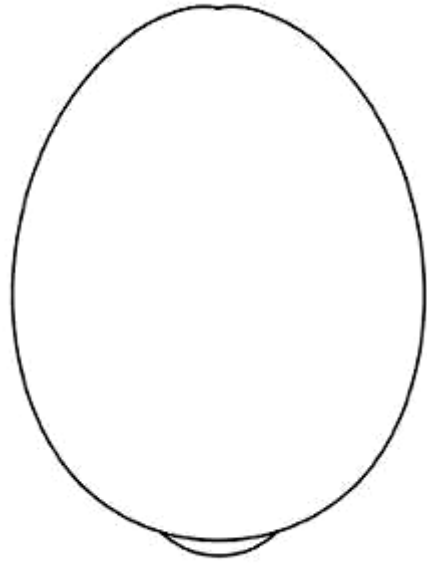

1.7

CÔNG BÁO SỞ HỮU CÔNG NGHIỆP SỐ 423 TẬP A – QUYỀN 2 (06.2023)

- (11) **47080**
(21) 3-2023-00036 (28) 1
(54) **CHAI** (51) **09-01**
(22) 05/01/2023 (43) 26/06/2023
(73) **CÔNG TY CỔ PHẦN BỘT GIẶT LIX (VN)**
Số 3, đường số 2, khu phố 4, phường Linh Trung, thành phố Thủ Đức, thành phố Hồ Chí Minh.
(72) Cao Thành Tín (VN)
(74) Văn phòng Luật sư A Hoà (AHOA LAW OFFICE)
(55)

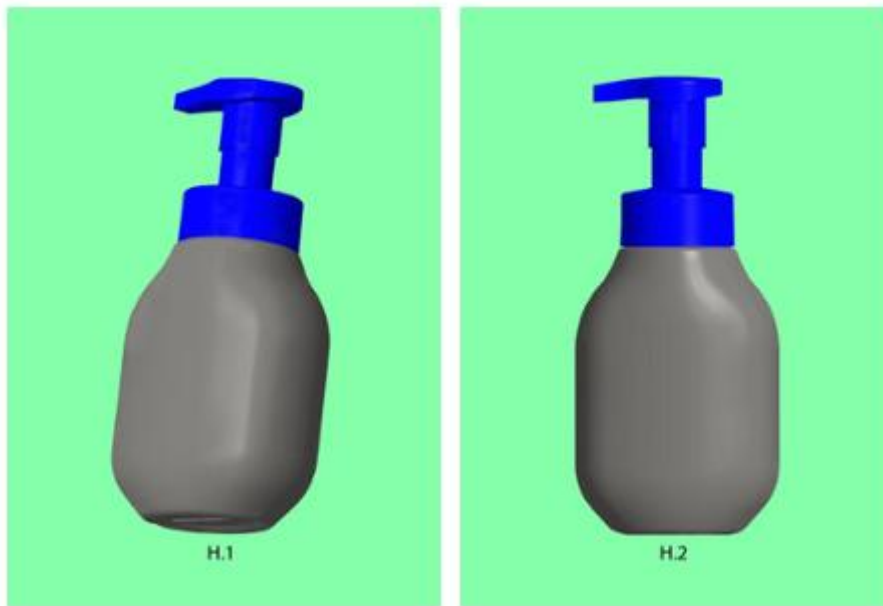

1.1

1.2

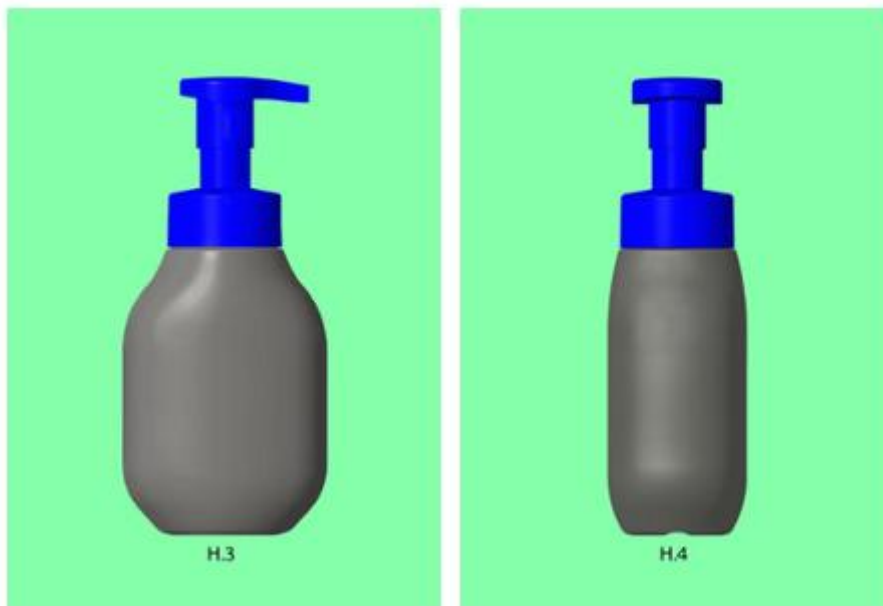

1.3

1.4



1.5

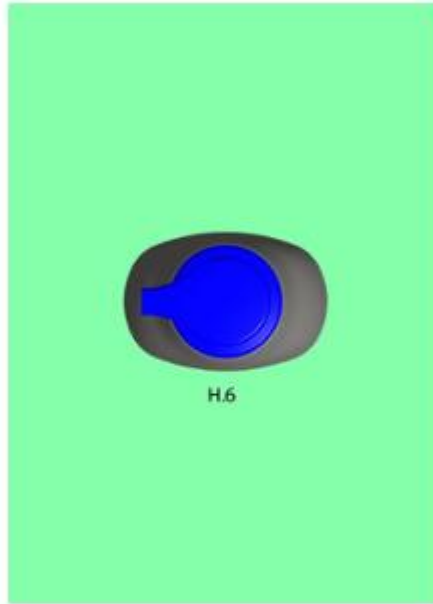

1.6



1.7



1.8

CÔNG BÁO SỞ HỮU CÔNG NGHIỆP SỐ 423 TẬP A – QUYỀN 2 (06.2023)

- (11) **47081**
(21) 3-2023-00038 (28) 1
(54) **BAO GÓI TẤ DÁN** (51) **09-05**
(22) 05/01/2023 (43) 26/06/2023
(73) **CÔNG TY CỔ PHẦN DIANA UNICHARM (VN)**
Khu công nghiệp Vĩnh Tuy, đường Lĩnh Nam, phường Vĩnh Hưng, quận Hoàng
Mai, thành phố Hà Nội
(72) Đỗ Anh Tú (VN)
(74) Công ty TNHH Sở hữu trí tuệ và Công nghệ Thủ đô (CAPITAL IP&T CO.LTD.)
(55)



1.1



1.2

CÔNG BÁO SỞ HỮU CÔNG NGHIỆP SỐ 423 TẬP A – QUYỀN 2 (06.2023)

- (11) **47082**
(21) 3-2023-00039 (28) 1
(54) **BAO GÓI TẤ DÁN** (51) **09-05**
(22) 05/01/2023 (43) 26/06/2023
(73) **CÔNG TY CỔ PHẦN DIANA UNICHARM (VN)**
Khu công nghiệp Vĩnh Tuy, đường Lĩnh Nam, phường Vĩnh Hưng, quận Hoàng
Mai, thành phố Hà Nội
(72) Đỗ Anh Tú (VN)
(74) Công ty TNHH Sở hữu trí tuệ và Công nghệ Thủ đô (CAPITAL IP&T CO.LTD.)
(55)



1.1



1.2

CÔNG BÁO SỞ HỮU CÔNG NGHIỆP SỐ 423 TẬP A – QUYỀN 2 (06.2023)

- (11) **47083**
(21) 3-2023-00046 (28) 1
(54) **BAO GÓI** (51) **09-05**
(22) 06/01/2023 (43) 26/06/2023
(73) **CÔNG TY CỔ PHẦN NÔNG NGHIỆP SAO VÀNG (VN)**
P2-15, đường số 4, phường An Hòa, thành phố Rạch Giá, tỉnh Kiên Giang
(72) Hà Hoàng Khanh (VN)
(74) **CÔNG TY TNHH SỞ HỮU TRÍ TUỆ SETHACO (SETHACO IP CO.,LTD)**
(55)



Hình 1: hình phối cảnh

1.1



Hình 2: hình triển khai

1.2

- (11) **47084**
(21) 3-2023-00049 (28) 1
(54) **BÀN CHẢI TÂY TẾ BÀO CHẾT TRÊN CƠ THỂ** (51) **28-03**
(22) 06/01/2023 (43) 26/06/2023
(30) 29/850,778 23/08/2022 US;
(73) **MANSCAPED, LLC (US)**
10054 Old Grove Road, San Diego, CA 92131, United States of America
(72) 1. ANH HAO TRAN (US)
2. EDILBERT NERI ABILLAR (US)
3. JOSHUA GIBERSON (US)
4. DANIEL VEIGA (US)
(74) Công ty cổ phần tư vấn Trung Thực (TRUNG THUC.,JSC)
(55)

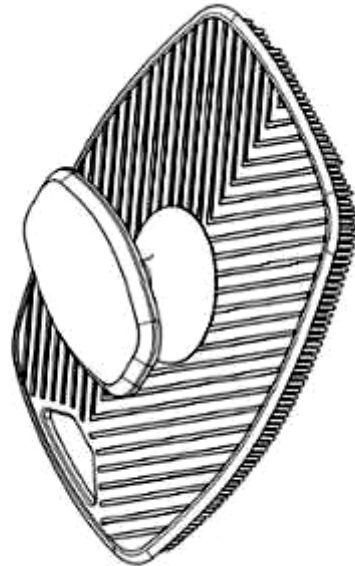

1.1

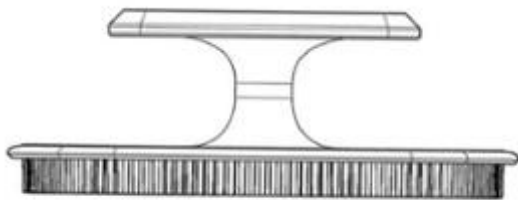

1.2

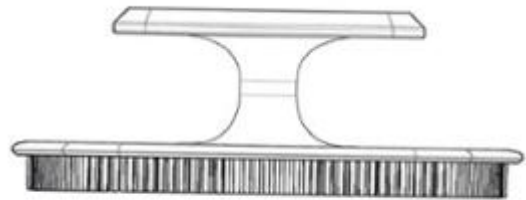

1.3



1.4



1.5



1.6

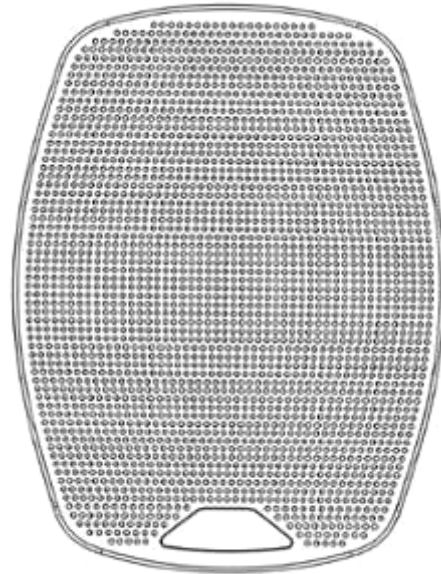

1.7

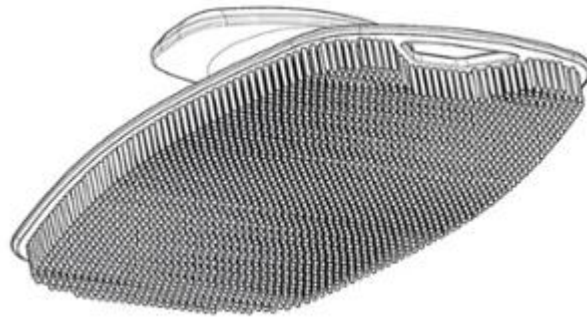

1.8

- (11) **47085**
(21) 3-2023-00050 (28) 1
(54) **BÀN CHẢI TÂY TẾ BÀO CHẾT TRÊN CƠ THỂ** (51) **28-03**
(22) 06/01/2023 (43) 26/06/2023
(30) 29/850,778 23/08/2022 US;
(73) **MANSCAPED, LLC (US)**
10054 Old Grove Road, San Diego, CA 92131, United States of America
(72) 1. ANH HAO TRAN (US)
2. EDILBERT NERI ABILLAR (US)
3. JOSHUA GIBERSON (US)
4. DANIEL VEIGA (US)
(74) Công ty cổ phần tư vấn Trung Thực (TRUNG THUC.,JSC)
(55)



1.1

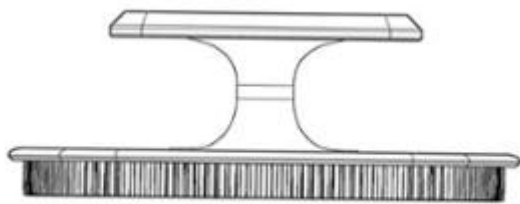

1.2

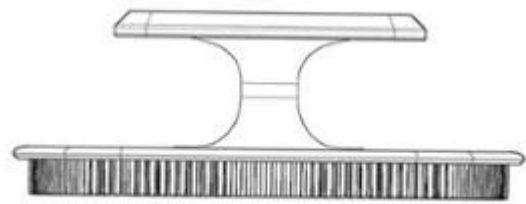

1.3



1.4



1.5



1.6

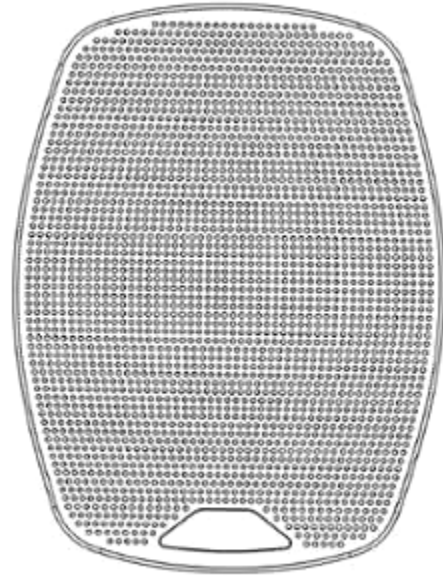

1.7

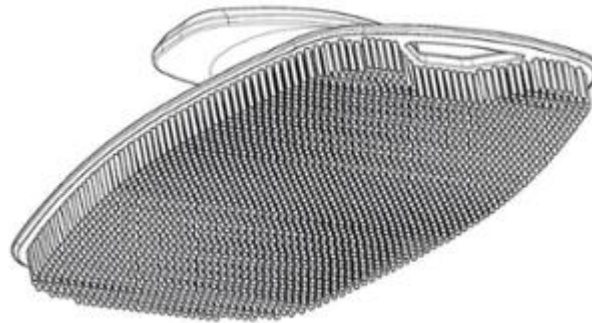

1.8

- (11) **47086**
(21) 3-2023-00051 (28) 1
(54) **VỎ CỦA THIẾT BỊ CẢM BIẾN BÁO CHÁY** (51) **10-05**
(22) 06/01/2023 (43) 26/06/2023
(73) **VIỆN KỸ THUẬT ĐIỀU KHIỂN VÀ TỰ ĐỘNG HÓA (VN)**
Phòng 201, tòa nhà Công nghệ cao, Đại học Bách khoa, số 1 Đại Cồ Việt, phường
Bách Khoa, quận Hai Bà Trưng, thành phố Hà Nội
(72) Hoàng Đức Chính (VN)
(55)



1.1



1.2



1.3



1.4



1.5



1.6



1.7

CÔNG BÁO SỞ HỮU CÔNG NGHIỆP SỐ 423 TẬP A – QUYỀN 2 (06.2023)

- (11) **47087**
(21) 3-2023-00062 (28) 1
(54) **HỘP** (51) **09-03**
(22) 06/01/2023 (43) 26/06/2023
(73) **CÔNG TY TNHH NHÀ NƯỚC MỘT THÀNH VIÊN YẾN SÀO KHÁNH HÒA (VN)**
248 Thống Nhất, phường Phương Sơn, thành phố Nha Trang, tỉnh Khánh Hòa
(72) Nguyễn Anh Hùng (VN)
(74) Công ty TNHH Tư vấn sở hữu trí tuệ Việt (VIET IP CO.,LTD.)
(55)



1.1



1.2



1.3



1.4



1.5



1.6



1.7



1.8

CÔNG BÁO SỞ HỮU CÔNG NGHIỆP SỐ 423 TẬP A – QUYỀN 2 (06.2023)

- (11) **47088**
(21) 3-2023-00063 (28) 1
(54) **HỘP** (51) **09-03**
(22) 06/01/2023 (43) 26/06/2023
(73) **CÔNG TY TNHH NHÀ NƯỚC MỘT THÀNH VIÊN YÊN SÀO KHÁNH HÒA (VN)**
248 Thống Nhất, phường Phương Sơn, thành phố Nha Trang, tỉnh Khánh Hòa
(72) Nguyễn Anh Hùng (VN)
(74) Công ty TNHH Tư vấn sở hữu trí tuệ Việt (VIET IP CO.,LTD.)
(55)



1.1



1.2



1.3



1.4



1.5



1.6



1.7



1.8

CÔNG BÁO SỞ HỮU CÔNG NGHIỆP SỐ 423 TẬP A – QUYỀN 2 (06.2023)

- (11) **47089**
(21) 3-2023-00064 (28) 1
(54) **BAO GÓI** (51) **09-05**
(22) 09/01/2023 (43) 26/06/2023
(73) **CÔNG TY CỔ PHẦN NÔNG NGHIỆP SAO VÀNG (VN)**
P2-15, đường số 4, phường An Hòa, thành phố Rạch Giá, tỉnh Kiên Giang
(72) Hà Hoàng Khanh (VN)
(74) **CÔNG TY TNHH SỞ HỮU TRÍ TUỆ SETHACO (SETHACO IP CO.,LTD)**
(55)



Hình 1: hình phối cảnh

1.1



Hình 2: hình triển khai

1.2

CÔNG BÁO SỞ HỮU CÔNG NGHIỆP SỐ 423 TẬP A – QUYỀN 2 (06.2023)

- (11) **47090**
(21) 3-2023-00065 (28) 1
(54) **BAO GÓI** (51) **09-05**
(22) 09/01/2023 (43) 26/06/2023
(73) **CÔNG TY CỔ PHẦN NÔNG NGHIỆP SAO VÀNG (VN)**
P2-15, đường số 4, phường An Hòa, thành phố Rạch Giá, tỉnh Kiên Giang
(72) Hà Hoàng Khanh (VN)
(74) **CÔNG TY TNHH SỞ HỮU TRÍ TUỆ SETHACO (SETHACO IP CO.,LTD)**
(55)



Hình 1: hình phối cảnh

1.1



Hình 2: hình triển khai

1.2

CÔNG BÁO SỞ HỮU CÔNG NGHIỆP SỐ 423 TẬP A – QUYỀN 2 (06.2023)

- (11) **47091**
(21) 3-2023-00068 (28) 1
(54) **HỘP ĐỰNG GÓI BỘT ĐẬU XANH** (51) **09-03**
(22) 09/01/2023 (43) 26/06/2023
(73) **CÔNG TY CỔ PHẦN THƯƠNG MẠI RỒNG VÀNG MINH NGỌC (VN)**
Khu 6 phường Cẩm Thượng, thành phố Hải Dương, tỉnh Hải Dương
(72) Thái Thị Vân Anh (VN)
(74) Công ty TNHH Sở hữu trí tuệ M.I.T (M.I.T IP CO., LTD)
(55)



1.1



1.2

CÔNG BÁO SỞ HỮU CÔNG NGHIỆP SỐ 423 TẬP A – QUYỀN 2 (06.2023)

- (11) **47092**
(21) 3-2023-00069
(54) **BAO GÓI SẢN PHẨM**
(22) 09/01/2023
(73) **HỘ KINH DOANH SƠN TÙNG (VN)**
Số 24 An Dương Vương, phường 16, quận 8, thành phố Hồ Chí Minh
(72) Trần Thị Thu Sơn (VN)
(55)
- (28) 2
(51) **09-05**
(43) 26/06/2023



1.1



1.2



2.1



2.2

CÔNG BÁO SỞ HỮU CÔNG NGHIỆP SỐ 423 TẬP A – QUYỀN 2 (06.2023)

- (11) **47093**
(21) 3-2023-00072 (28) 1
(54) **HỘP ĐỰNG** (51) **09-03**
(22) 09/01/2023 (43) 26/06/2023
(73) **CÔNG TY TNHH MỘT THÀNH VIÊN DƯỢC PHẨM PV HEALTHCARE (VN)**
4/5 Khu Dân Cư Vạn Xuân Đất Việt, đường số 5, phường Bình Hưng Hòa, quận Bình Tân, thành phố Hồ Chí Minh
(72) Nguyễn Thị Ngọc Phương (VN)
(74) Công ty TNHH Đại Tín và Liên Danh (DAITIN AND ASSOCIATES CO.,LTD)
(55)



1.1



1.2

CÔNG BÁO SỞ HỮU CÔNG NGHIỆP SỐ 423 TẬP A – QUYỀN 2 (06.2023)

- (11) **47094**
- (21) 3-2023-00074 (28) 1
- (54) **NHÃN SẢN PHẨM** (51) **19-08**
- (22) 30/12/2021 (43) 26/06/2023
- (73) **CERIOTI HOLDING S.A. (LU)**
23, Rue Aldringen L-1118 Luxembourg
- (72) Lê Thị Ánh Phương (VN)
- (74) Công ty TNHH Tầm nhìn và Liên danh (VISION & ASSOCIATES CO.LTD.)
- (55)



CÔNG BÁO SỞ HỮU CÔNG NGHIỆP SỐ 423 TẬP A – QUYỀN 2 (06.2023)

- (11) **47095**
(21) 3-2023-00075 (28) 1
(54) **NHÃN SẢN PHẨM** (51) **19-08**
(22) 30/12/2021 (43) 26/06/2023
(73) **CERIOTI HOLDING S.A. (LU)**
23, Rue Aldringen L-1118 Luxembourg
(72) Lê Thị Ánh Phương (VN)
(74) Công ty TNHH Tâm nhìn và Liên danh (VISION & ASSOCIATES CO.LTD.)
(55)



CÔNG BÁO SỞ HỮU CÔNG NGHIỆP SỐ 423 TẬP A – QUYỀN 2 (06.2023)

- (11) **47096**
(21) 3-2023-00076 (28) 1
(54) **NHÃN SẢN PHẨM** (51) **19-08**
(22) 30/12/2021 (43) 26/06/2023
(73) **CERIOTI HOLDING S.A. (LU)**
23, Rue Aldringen L-1118 Luxembourg
(72) Lê Thị Ánh Phương (VN)
(74) Công ty TNHH Tầm nhìn và Liên danh (VISION & ASSOCIATES CO.LTD.)
(55)



CÔNG BÁO SỞ HỮU CÔNG NGHIỆP SỐ 423 TẬP A – QUYỀN 2 (06.2023)

- (11) **47097**
(21) 3-2023-00077 (28) 1
(54) **NHÃN SẢN PHẨM** (51) **19-08**
(22) 30/12/2021 (43) 26/06/2023
(73) **CERIOTI HOLDING S.A. (LU)**
23, Rue Aldringen L-1118 Luxembourg
(72) Lê Thị Ánh Phương (VN)
(74) Công ty TNHH Tầm nhìn và Liên danh (VISION & ASSOCIATES CO.LTD.)
(55)



CÔNG BÁO SỞ HỮU CÔNG NGHIỆP SỐ 423 TẬP A – QUYỀN 2 (06.2023)

- (11) **47098**
- (21) 3-2023-00078 (28) 1
- (54) **NHÃN SẢN PHẨM** (51) **19-08**
- (22) 30/12/2021 (43) 26/06/2023
- (73) **CERIOTI HOLDING S.A. (LU)**
23, Rue Aldringen L-1118 Luxembourg
- (72) Lê Thị Ánh Phương (VN)
- (74) Công ty TNHH Tầm nhìn và Liên danh (VISION & ASSOCIATES CO.LTD.)
- (55)



CÔNG BÁO SỞ HỮU CÔNG NGHIỆP SỐ 423 TẬP A – QUYỀN 2 (06.2023)

- (11) **47099**
(21) 3-2023-00079 (28) 1
(54) **NHÃN SẢN PHẨM** (51) **19-08**
(22) 30/12/2021 (43) 26/06/2023
(73) **CERIOTI HOLDING S.A. (LU)**
23, Rue Aldringen L-1118 Luxembourg
(72) Lê Thị Ánh Phương (VN)
(74) Công ty TNHH Tầm nhìn và Liên danh (VISION & ASSOCIATES CO.LTD.)
(55)



CÔNG BÁO SỞ HỮU CÔNG NGHIỆP SỐ 423 TẬP A – QUYỀN 2 (06.2023)

- (11) **47100**
- (21) 3-2023-00080 (28) 1
- (54) **NHÃN SẢN PHẨM** (51) **19-08**
- (22) 30/12/2021 (43) 26/06/2023
- (73) **CERIOTI HOLDING S.A. (LU)**
23, Rue Aldringen L-1118 Luxembourg
- (72) Lê Thị Ánh Phương (VN)
- (74) Công ty TNHH Tầm nhìn và Liên danh (VISION & ASSOCIATES CO.LTD.)
- (55)



CÔNG BÁO SỞ HỮU CÔNG NGHIỆP SỐ 423 TẬP A – QUYỀN 2 (06.2023)

- (11) **47101**
(21) 3-2023-00094 (28) 1
(54) **BAO BÌ** (51) **09-05**
(22) 11/01/2023 (43) 26/06/2023
(73) **CÔNG TY CỔ PHẦN LƯƠNG THỰC A AN (VN)**
Tầng 14 tòa nhà Diamond Flower, số 48 đường Lê Văn Lương, khu đô thị mới N1,
phường Nhân Chính, quận Thanh Xuân, thành phố Hà Nội
(72) Võ Quang Hải (VN)
(74) Công ty Cổ phần Sở hữu công nghiệp INVESTIP (INVESTIP)
(55)



1.1



1.2

- (11) **47102**
(21) 3-2023-00119 (28) 2
(54) **TẤM TRANG TRÍ KIỂU KHÂU** (51) **02-04; 02-99**
(22) 12/01/2023 (43) 26/06/2023
(30) 29/865,178 12/07/2022 US;
(73) **AURIC ENTERPRISES, LLC (US)**
2230 Douglass Blvd., Louisville, KY 40205, United States of America
(72) James Payden Sewell (US)
(74) Công ty cổ phần tư vấn Trung Thực (TRUNG THUC.,JSC)
(55)

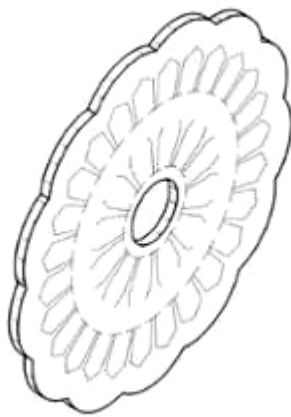

1.1

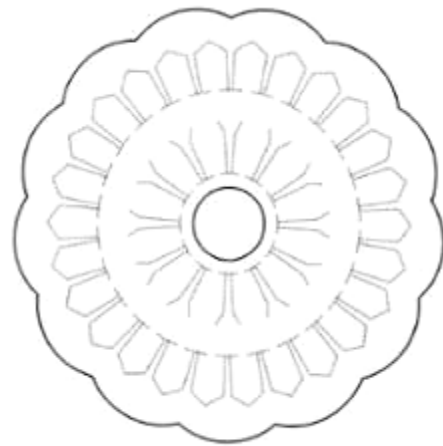

1.2

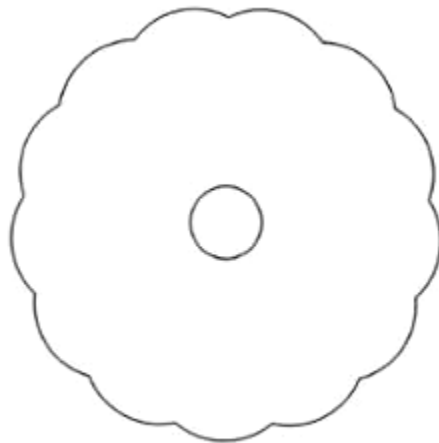

1.3

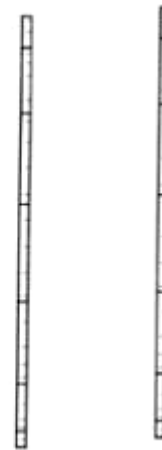

1.4

1.5



1.6



1.7



2.1

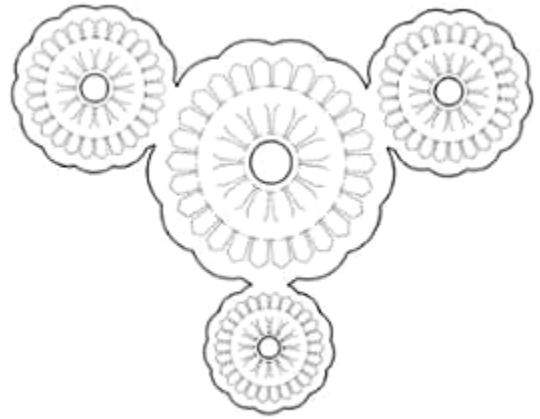

2.2

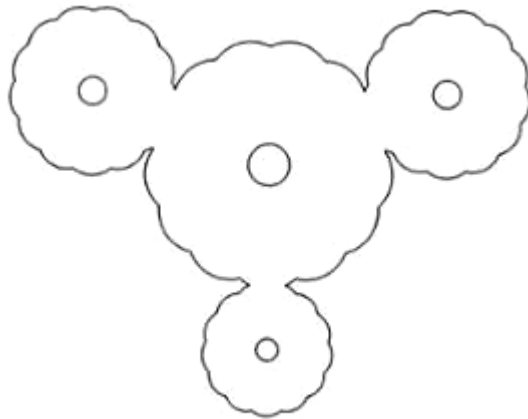

2.3



2.4



2.5



2.6



2.7



2.8

(11) **47103**

(21) 3-2023-00123

(28) 1

(54) **MŨ BẢO HIỂM**

(51) **02-03**

(22) 12/01/2023

(43) 26/06/2023

(73) **HENRY TEDJAKUSUMA (IN)**

Jalan Wuluh Blok II/3, RT/RW 009/006, Kota Bambu Utara, Palmerah Jakarta Barat 11420, Indonesia

(72) Henry Tedjakusuma (ID)

(74) Công ty TNHH Sở hữu trí tuệ HA VIP (HAVIP CO., LTD.)

(55)



1.1



1.2



1.3



1.4



1.5

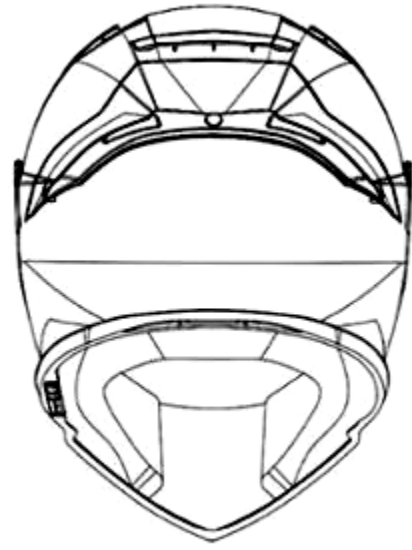

1.6



1.7



1.8

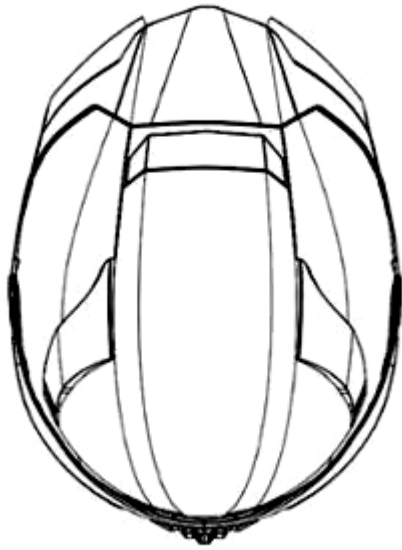

1.9

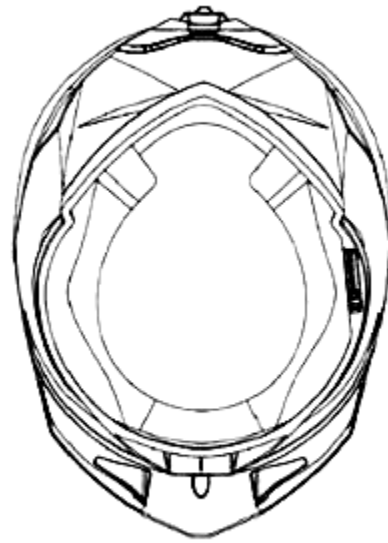

1.10

CÔNG BÁO SỞ HỮU CÔNG NGHIỆP SỐ 423 TẬP A – QUYỀN 2 (06.2023)

(11) **47104**

(21) 3-2023-00124

(28) 1

(54) **MÁY ĐÚC CẦU KIẾN BÊ TÔNG**

(51) **15-04; 15-09**

(22) 12/01/2023

(43) 26/06/2023

(73) **CÔNG TY TNHH HỒ HOÀN CẦU (VN)**

Xóm 6, xã Quỳnh Văn, huyện Quỳnh Lưu, tỉnh Nghệ An

(72) Hồ Xuân Vinh (VN)

(55)

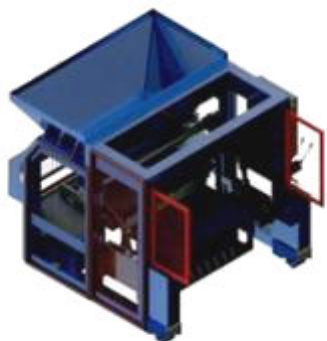

1.1



1.2



1.3

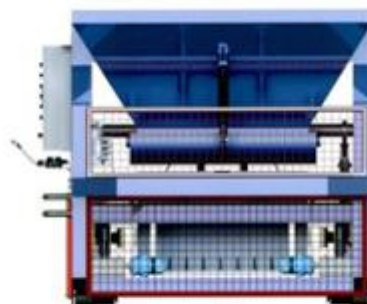

1.4



1.5



1.6



1.7

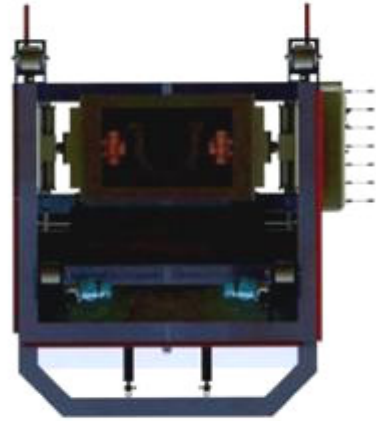

1.8

CÔNG BÁO SỞ HỮU CÔNG NGHIỆP SỐ 423 TẬP A – QUYỀN 2 (06.2023)

- (11) **47105**
(21) 3-2023-00150 (28) 1
(54) **CHẬU RỬA** (51) **23-02**
(22) 16/01/2023 (43) 26/06/2023
(30) 009096209-0001 25/07/2022 EM;
(73) **HANSGROHE SE (DE)**
Austr. 5-9, 77761 Schiltach, Germany
(72) Laura Somaglino (IT)
(74) Công ty TNHH Trường Xuân (AGELESS CO.,LTD.)
(55)



1.1



1.2



1.3



1.4



1.5



1.6



1.7

CÔNG BÁO SỞ HỮU CÔNG NGHIỆP SỐ 423 TẬP A – QUYỀN 2 (06.2023)

- (11) **47106**
(21) 3-2023-00151 (28) 1
(54) **CHẬU RỬA** (51) **23-02**
(22) 16/01/2023 (43) 26/06/2023
(30) 009096209-0003 25/07/2022 EM;
(73) **HANSGROHE SE (DE)**
Austr. 5-9, 77761 Schiltach, Germany
(72) Laura Somaglino (IT)
(74) Công ty TNHH Trường Xuân (AGELESS CO.,LTD.)
(55)



1.1



1.2



1.3



1.4



1.5



1.6



1.7

CÔNG BÁO SỞ HỮU CÔNG NGHIỆP SỐ 423 TẬP A – QUYỀN 2 (06.2023)

- (11) **47107**
(21) 3-2023-00152 (28) 1
(54) **CHẬU RỬA** (51) **23-02**
(22) 16/01/2023 (43) 26/06/2023
(30) 009096209-0004 25/07/2022 EM;
(73) **HANSGROHE SE (DE)**
Austr. 5-9, 77761 Schiltach, Germany
(72) Laura Somaglino (IT)
(74) Công ty TNHH Trường Xuân (AGELESS CO.,LTD.)
(55)



1.1



1.2



1.3



1.4



1.5



1.6



1.7

CÔNG BÁO SỞ HỮU CÔNG NGHIỆP SỐ 423 TẬP A – QUYỀN 2 (06.2023)

- (11) **47108**
(21) 3-2023-00163 (28) 1
(54) **LÒN ĐỰNG SẢN PHẨM** (51) **09-03**
(22) 17/01/2023 (43) 26/06/2023
(73) **CÔNG TY TNHH XNK NANOIL USA (VN)**
Lô Q13 đường số 11, KCN Hải Sơn mở rộng (GD 3+4), xã Đức Hòa Hạ, huyện Đức
Hoà, tỉnh Long An
(72) Mai Xuân Quang (VN)
(55)



1.1



1.2



1.3



1.4



1.5



1.6



1.7

CÔNG BÁO SỞ HỮU CÔNG NGHIỆP SỐ 423 TẬP A – QUYỀN 2 (06.2023)

- (11) **47109**
- (21) 3-2023-00179 (28) 1
- (54) **NHÃN SẢN PHẨM** (51) **19-08**
- (22) 18/01/2023 (43) 26/06/2023
- (73) **CÔNG TY TNHH NÔNG SẢN HAI TÙNG (VN)**
101 Trần Văn Xã, khu phố 3, phường Trảng Dài, thành phố Biên Hoà, tỉnh Đồng Nai
- (72) Phạm Viết Tùng (VN)
- (74) Công ty TNHH IPVC (IP.VC CO.,LTD)
- (55)



CÔNG BÁO SỞ HỮU CÔNG NGHIỆP SỐ 423 TẬP A – QUYỀN 2 (06.2023)

- (11) **47110**
(21) 3-2023-00184 (28) 1
(54) **BAO GÓI** (51) **09-05**
(22) 18/01/2023 (43) 26/06/2023
(73) **CÔNG TY TNHH BC VŨ LONG (VN)**
Khóm 4, phường 6, thành phố Cao Lãnh, tỉnh Đồng Tháp
(72) Phạm Thị Thùy Linh (VN)
(55)



1.1



1.2

CÔNG BÁO SỞ HỮU CÔNG NGHIỆP SỐ 423 TẬP A – QUYỀN 2 (06.2023)

- (11) **47111**
(21) 3-2023-00185 (28) 1
(54) **BAO GÓI** (51) **09-05**
(22) 18/01/2023 (43) 26/06/2023
(73) **CÔNG TY TNHH BC VŨ LONG (VN)**
Khóm 4, phường 6, thành phố Cao Lãnh, tỉnh Đồng Tháp
(72) Phạm Thị Thùy Linh (VN)
(55)



1.1



1.2

CÔNG BÁO SỞ HỮU CÔNG NGHIỆP SỐ 423 TẬP A – QUYỀN 2 (06.2023)

- (11) **47112**
(21) 3-2023-00193 (28) 1
(54) **BAO GÓI** (51) **09-05**
(22) 19/01/2023 (43) 26/06/2023
(73) **CÔNG TY TNHH MTK (VN)**
L5.05.OT.05 Landmark 5, Vinhomes Central Park, 720A Điện Biên Phủ, phường
22, quận Bình Thạnh, thành phố Hồ Chí Minh
(72) Trương Thành Trung (VN)
(74) Công ty Luật TNHH Phạm và Liên danh (PHAM & ASSOCIATES)
(55)



1.1



1.2

CÔNG BÁO SỞ HỮU CÔNG NGHIỆP SỐ 423 TẬP A – QUYỀN 2 (06.2023)

- (11) **47113**
(21) 3-2023-00194 (28) 1
(54) **BAO GÓI** (51) **09-05**
(22) 19/01/2023 (43) 26/06/2023
(73) **CÔNG TY TNHH MTK (VN)**
L5.05.OT.05 Landmark 5, Vinhomes Central Park, 720A Điện Biên Phủ, phường
22, quận Bình Thạnh, thành phố Hồ Chí Minh
(72) Trương Thành Trung (VN)
(74) Công ty Luật TNHH Phạm và Liên danh (PHAM & ASSOCIATES)
(55)



1.1



1.2

CÔNG BÁO SỞ HỮU CÔNG NGHIỆP SỐ 423 TẬP A – QUYỀN 2 (06.2023)

(11) **47114**

(21) 3-2023-00211

(28) 1

(54) **ĐUÔI GIÓ MŨ BẢO HIỂM**

(51) **02-03**

(22) 27/01/2023

(43) 26/06/2023

(73) **HENRY TEDJAKUSUMA (ID)**

Jalan Wuluh Blok II/3, RT/RW 009/006, Kota Bambu Utara, Palmerah Jakarta Barat 11420, Indonesia

(72) Henry Tedjakusuma (ID)

(74) Công ty TNHH Sở hữu trí tuệ HA VIP (HAVIP CO., LTD.)

(55)

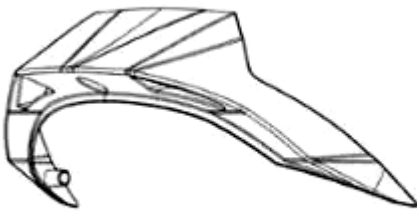

1.1

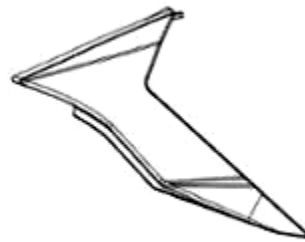

1.2

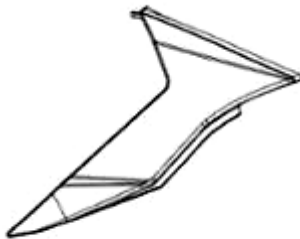

1.3

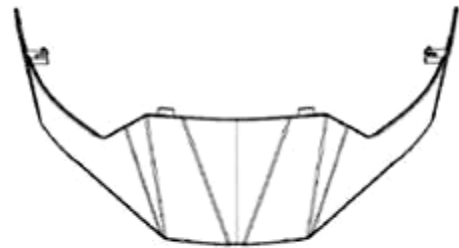

1.4

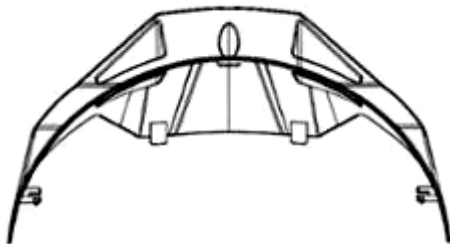

1.5



1.6

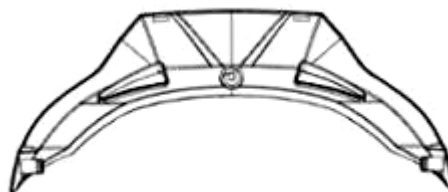

1.7

(11) **47115**

(21) 3-2023-00212

(54) **ĐUÔI GIÓ MŨ BẢO HIỂM**

(22) 27/01/2023

(73) **HENRY TEDJAKUSUMA (ID)**

Jalan Wuluh Blok II/3, RT/RW 009/006, Kota Bambu Utara, Palmerah Jakarta Barat 11420, Indonesia

(72) Henry Tedjakusuma (ID)

(74) Công ty TNHH Sở hữu trí tuệ HA VIP (HAVIP CO., LTD.)

(55)

(28) 1

(51) **02-03**

(43) 26/06/2023

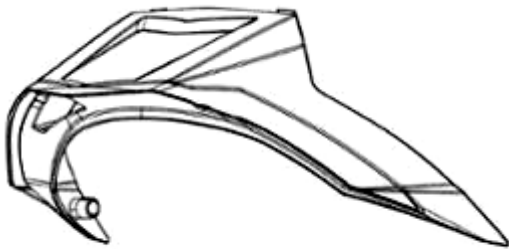

1.1

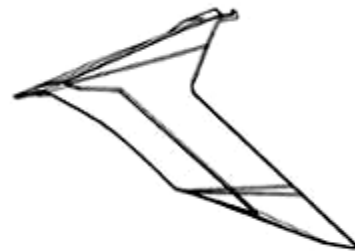

1.2



1.3

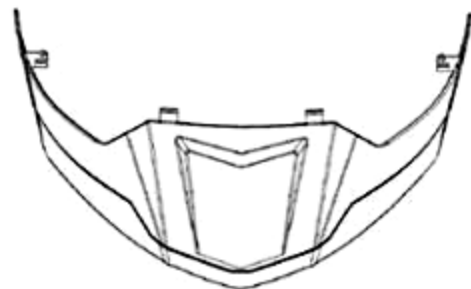

1.4

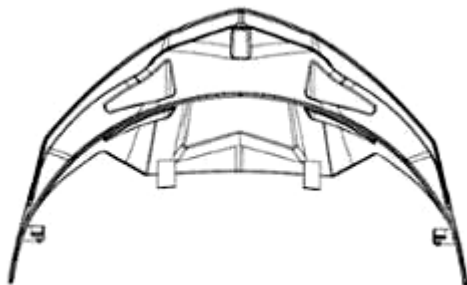

1.5

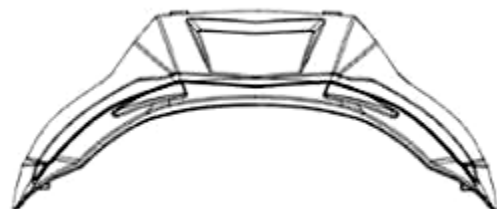

1.6

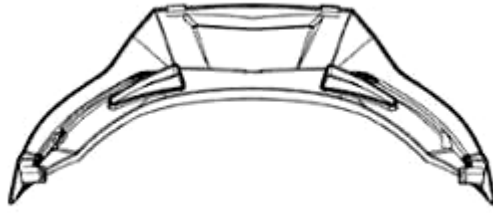

1.7

(11) **47116**

(21) 3-2023-00213

(28) 1

(54) **ĐUÔI GIÓ MŨ BẢO HIỂM**

(51) **02-03**

(22) 27/01/2023

(43) 26/06/2023

(73) **HENRY TEDJAKUSUMA (ID)**

Jalan Wuluh Blok II/3, RT/RW 009/006, Kota Bambu Utara, Palmerah Jakarta Barat 11420, Indonesia

(72) Henry Tedjakusuma (ID)

(74) Công ty TNHH Sở hữu trí tuệ HA VIP (HAVIP CO., LTD.)

(55)

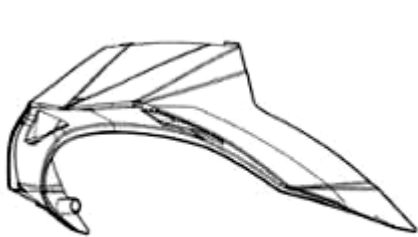

1.1

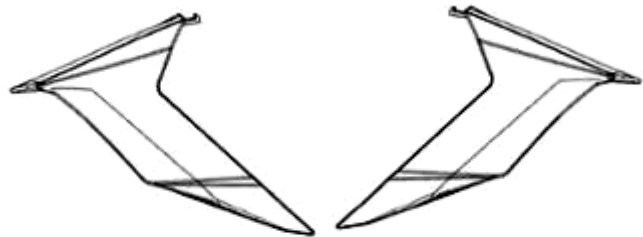

1.2

1.3

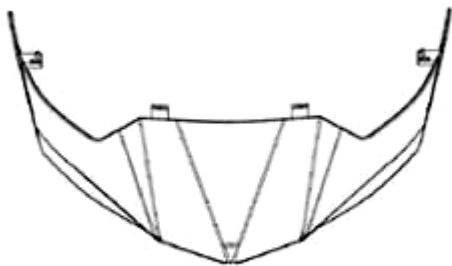

1.4

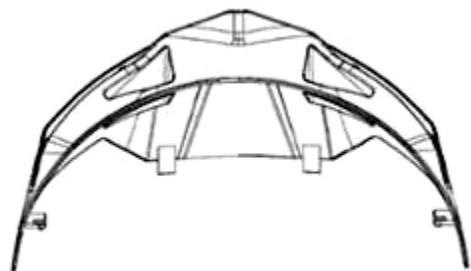

1.5



1.6

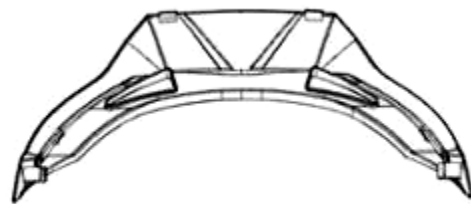

1.7

CÔNG BÁO SỞ HỮU CÔNG NGHIỆP SỐ 423 TẬP A – QUYỀN 2 (06.2023)

- (11) **47117**
(21) 3-2023-00219 (28) 1
(54) **BÌNH CHỨA DUNG DỊCH CHỮA CHÁY** (51) **29-01**
(22) 30/01/2023 (43) 26/06/2023
(30) 30-2022-0030752 29/07/2022 KR;
(73) **SCHAFFENGOTT CO. LTD (KR)**
1203ho, 102dong, 28, Centum 1-ro, Haeundae-gu, Busan 48060, Republic of Korea
(72) KWON, Ik Hwan (KR)
(74) Công ty TNHH Trà và cộng sự (TRA & ASSOCIATES CO.,LTD)
(55)

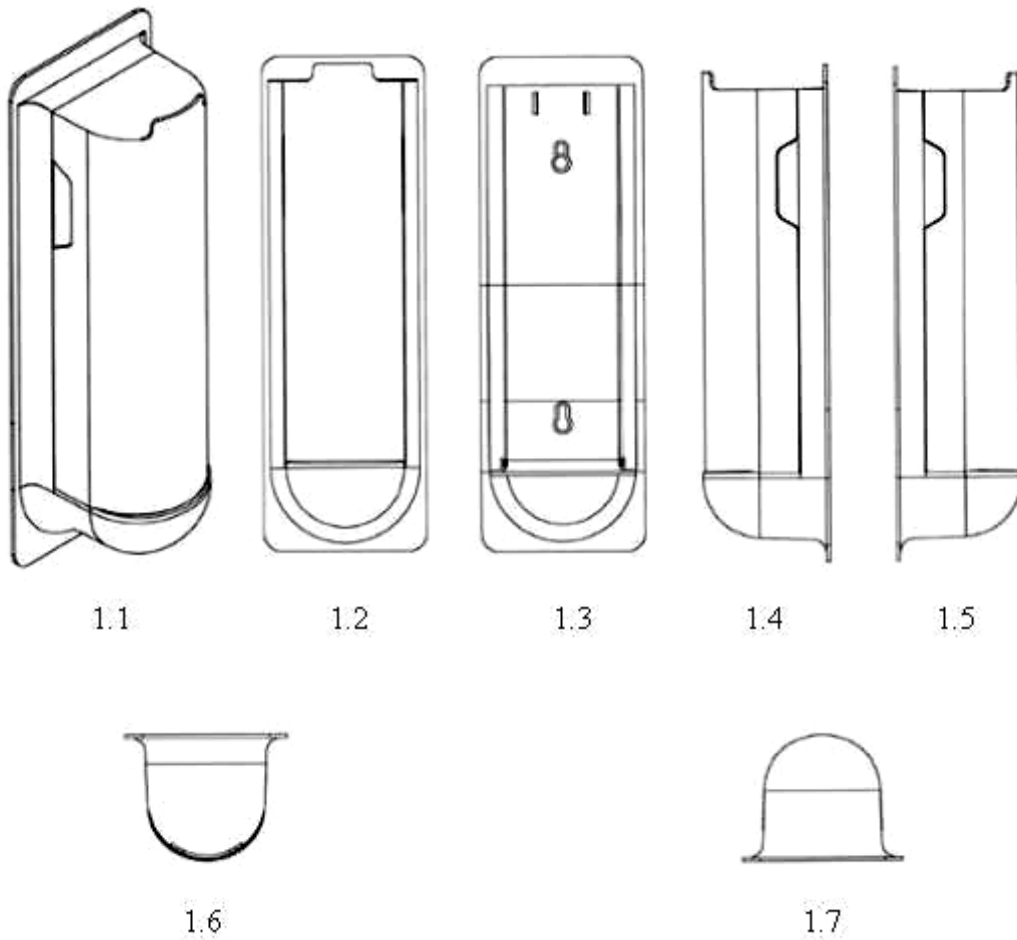

CÔNG BÁO SỞ HỮU CÔNG NGHIỆP SỐ 423 TẬP A – QUYỀN 2 (06.2023)

- (11) **47118**
(21) 3-2023-00220 (28) 1
(54) **BÌNH CHỮA CHÁY DẠNG NÉM** (51) **29-01**
(22) 30/01/2023 (43) 26/06/2023
(30) 30-2022-0030969 01/08/2022 KR;
(73) **SCHAFFENGOTT CO. LTD (KR)**
1203ho,102dong, 28, Centum 1-ro, Haeundae-gu, Busan 48060, Republic of Korea
(72) KWON, Ik Hwan (KR)
(74) Công ty TNHH Trà và cộng sự (TRA & ASSOCIATES CO.,LTD)
(55)

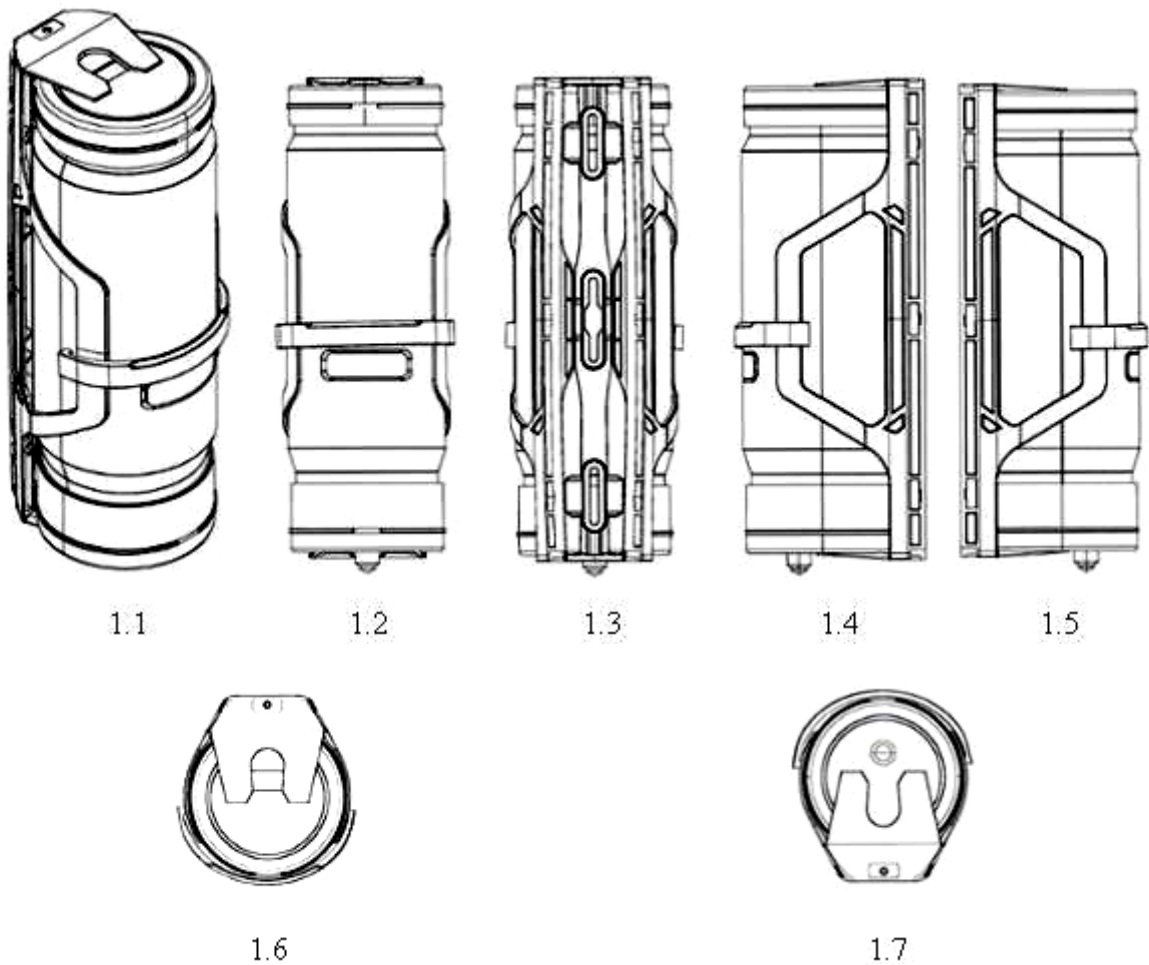

CÔNG BÁO SỞ HỮU CÔNG NGHIỆP SỐ 423 TẬP A – QUYỀN 2 (06.2023)

- (11) **47119**
(21) 3-2023-00228 (28) 1
(54) **BAO GÓI MIỀN** (51) **09-05**
(22) 31/01/2023 (43) 26/06/2023
(73) **HỘ KINH DOANH HOÀNG NGUYỄN (VN)**
Đội 7B, xã Dương Liễu, huyện Hoài Đức, thành phố Hà Nội
(72) Đoàn Hữu Thịnh (VN)
(74) Công ty TNHH Tư vấn đầu tư và Sở hữu trí tuệ Hoàng Phi (HOANG PHI INVEST & I.P CO., LTD)
(55)



1.1



1.2

CÔNG BÁO SỞ HỮU CÔNG NGHIỆP SỐ 423 TẬP A – QUYỀN 2 (06.2023)

- (11) **47120**
- (21) 3-2023-00244 (28) 1
- (54) **NHÃN SẢN PHẨM** (51) **19-08**
- (22) 03/02/2023 (43) 26/06/2023
- (73) **CÔNG TY TNHH THƯƠNG MẠI XUẤT NHẬP KHẨU AN HƯNG PHƯỚC**
(VN)
Thửa đất số 643, tờ Bản đồ số 89, ấp Tân An, xã Bình Thạnh Trung, huyện Lấp Vò,
tỉnh Đồng Tháp
- (72) Đỗ Thị Ngọc Mai (VN)
- (55)



CÔNG BÁO SỞ HỮU CÔNG NGHIỆP SỐ 423 TẬP A – QUYỀN 2 (06.2023)

- (11) **47121**
(21) 3-2023-00245 (28) 1
(54) **NHÃN SẢN PHẨM** (51) **19-08**
(22) 03/02/2023 (43) 26/06/2023
(73) **CÔNG TY TNHH THƯƠNG MẠI DỊCH VỤ ĐẦU TƯ TOÀN PHÁT (VN)**
C3/84D ấp 3, xã Bình Lợi, huyện Bình Chánh, thành phố Hồ Chí Minh
(72) Nguyễn Bảo Toàn (VN)
(55)



CÔNG BÁO SỞ HỮU CÔNG NGHIỆP SỐ 423 TẬP A – QUYỀN 2 (06.2023)

- (11) **47122**
(21) 3-2023-00252 (28) 1
(54) **BÉC TƯỚI** (51) **23-01**
(22) 03/02/2023 (43) 26/06/2023
(73) **CÔNG TY TNHH SẢN XUẤT THƯƠNG MẠI BONSAI MIỀN NAM (VN)**
34/13 Nguyễn Thị Thập, phường Bình Thuận, quận 7, thành phố Hồ Chí Minh
(72) Dương Duyên Nghệ (VN)
(74) Công ty cổ phần FAS INVEST (FAS INVEST JSC)
(55)



1.1



1.2



1.3



1.4

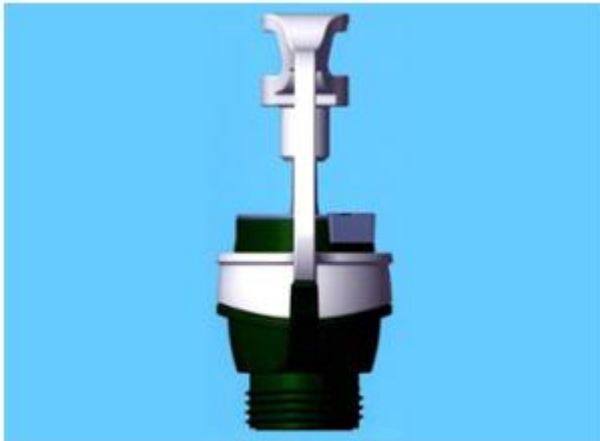

1.5

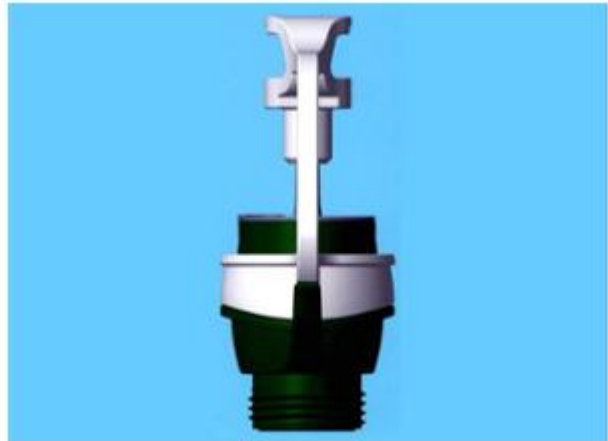

1.6



1.7



1.8

CÔNG BÁO SỞ HỮU CÔNG NGHIỆP SỐ 423 TẬP A – QUYỀN 2 (06.2023)

- (11) **47123**
(21) 3-2023-00254 (28) 1
(54) **THÂN CỦA THIẾT BỊ THEO DÕI SỨC KHỎE** (51) **10-04**
(22) 03/02/2023 (43) 26/06/2023
(30) 29/865,633 04/08/2022 US;
(73) **GOOGLE LLC (US)**
1600 Amphitheatre Parkway, Mountain View, California 94043, United States of America
(72) 1. VALENTIN SOLLIER (US)
2. DAVID MIN (US)
3. YIDAN ZHANG (BR)
4. IRINA IGOREVNA KOZLOVSKAYA (US)
5. JONAH BECKER (US)
(74) Công ty Luật TNHH ROUSE Việt Nam (ROUSE LEGAL VIETNAM LTD.)
(55)

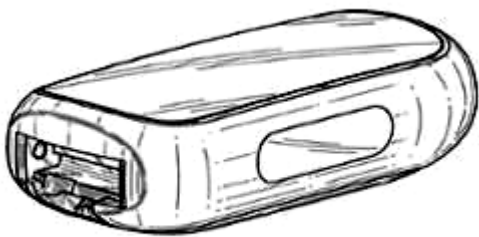

1.1

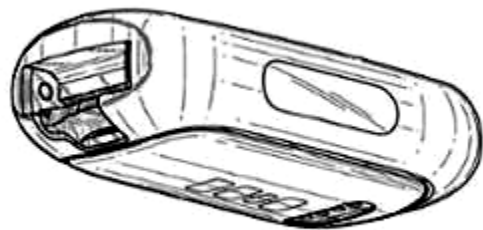

1.2



1.3

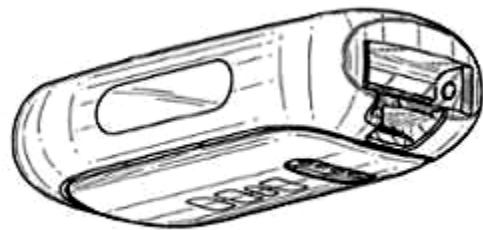

1.4

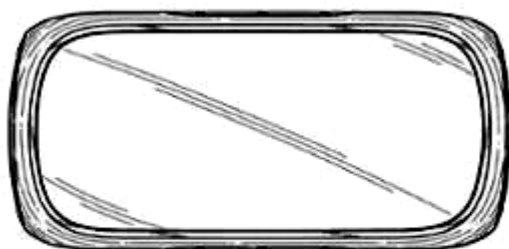

1.5

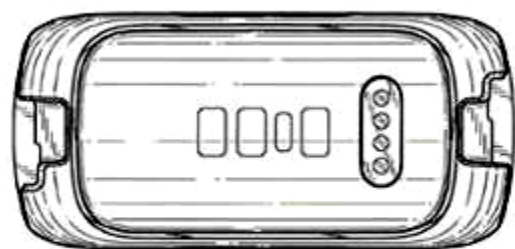

1.6



1.7



1.8

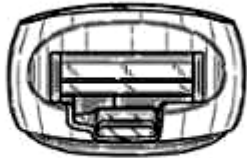

1.9

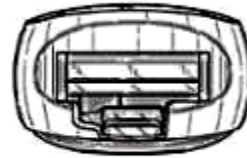

1.10



1.11



1.12

- (11) **47124**
(21) 3-2023-00256 (28) 1
(54) **TẤM ỐP LÓT SÀN XE TAY GA** (51) **12-16**
(22) 03/02/2023 (43) 26/06/2023
(73) **HỘ KINH DOANH HÙNG CƯỜNG (VN)**
Số 71/33 Lãn Bình Thăng, phường 12, quận 11, thành phố Hồ Chí Minh
(72) Lưu Chí Hùng (VN)
(74) Công ty Cổ phần Sở hữu công nghiệp INVESTIP (INVESTIP)
(55)



1.1



1.2

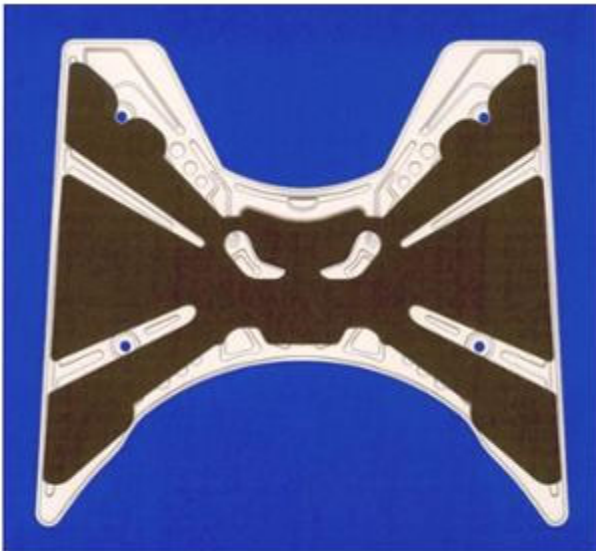

1.3



1.4



1.5



1.6

CÔNG BÁO SỞ HỮU CÔNG NGHIỆP SỐ 423 TẬP A – QUYỀN 2 (06.2023)

- (11) **47125**
(21) 3-2023-00261 (28) 1
(54) **HỘP ĐỰNG SỮA** (51) **09-03**
(22) 07/02/2023 (43) 26/06/2023
(73) **CÔNG TY TRÁCH NHIỆM HỮU HẠN THANH AN (VN)**
P809 tầng 8, tòa nhà Plaschem, số 562 đường Nguyễn Văn Cừ, phường Gia Thụy,
quận Long Biên, thành phố Hà Nội
(72) Tạ Bá Thuyết (VN)
(74) Công ty TNHH Sở hữu trí tuệ và Công nghệ Thủ đô (CAPITAL IP&T CO.LTD.)
(55)



1.1



1.2

CÔNG BÁO SỞ HỮU CÔNG NGHIỆP SỐ 423 TẬP A – QUYỀN 2 (06.2023)

- (11) **47126**
(21) 3-2023-00262 (28) 1
(54) **HỘP ĐỰNG SỮA** (51) **09-03**
(22) 07/02/2023 (43) 26/06/2023
(73) **CÔNG TY TRÁCH NHIỆM HỮU HẠN THANH AN (VN)**
P809 tầng 8, tòa nhà Plaschem, số 562 đường Nguyễn Văn Cừ, phường Gia Thụy,
quận Long Biên, thành phố Hà Nội
(72) Tạ Bá Thuyết (VN)
(74) Công ty TNHH Sở hữu trí tuệ và Công nghệ Thủ đô (CAPITAL IP&T CO.LTD.)
(55)



1.1



1.2

CÔNG BÁO SỞ HỮU CÔNG NGHIỆP SỐ 423 TẬP A – QUYỀN 2 (06.2023)

- (11) 47127
(21) 3-2023-00263 (28) 1
(54) **HỘP ĐỰNG SỮA** (51) **09-03**
(22) 07/02/2023 (43) 26/06/2023
(73) **CÔNG TY TRÁCH NHIỆM HỮU HẠN THANH AN (VN)**
P809 tầng 8, tòa nhà Plaschem, số 562 đường Nguyễn Văn Cừ, phường Gia Thụy,
quận Long Biên, thành phố Hà Nội
(72) Tạ Bá Thuyết (VN)
(74) Công ty TNHH Sở hữu trí tuệ và Công nghệ Thủ đô (CAPITAL IP&T CO.LTD.)
(55)



1.1



1.2

- (11) **47128**
(21) 3-2023-00265 (28) 1
(54) **ĐUÔI GIÓ MŨ BẢO HIỂM** (51) **02-03**
(22) 07/02/2023 (43) 26/06/2023
(73) **HENRY TEDJAKUSUMA (IN)**
Jalan Wuluh Blok II/3, RT/RW 009/006, Kota Bambu Utara, Palmerah Jakarta Barat 11420, Indonesia
(72) Henry Tedjakusuma (ID)
(74) Công ty TNHH Sở hữu trí tuệ HA VIP (HAVIP CO., LTD.)
(55)



1.1

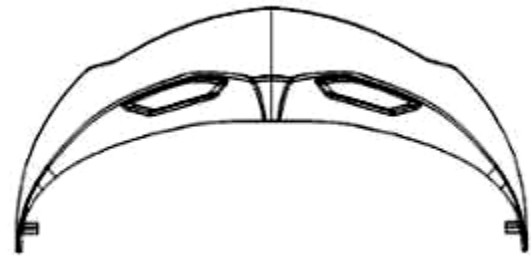

1.2

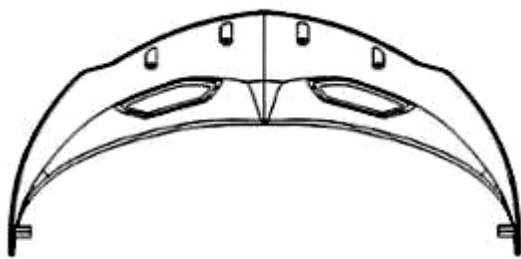

1.3



1.4



1.5

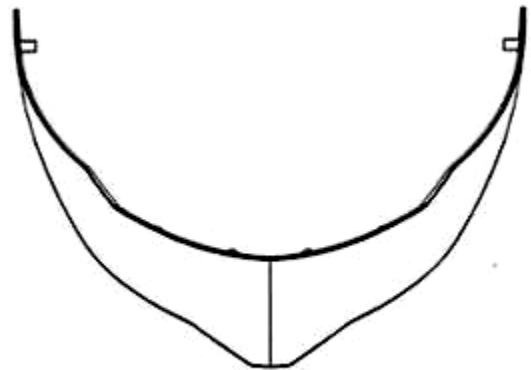

1.6

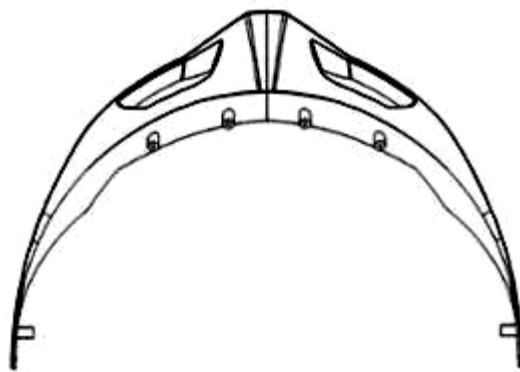

1.7

(11) **47129**

(21) 3-2023-00267

(28) 1

(54) **MŨ BẢO HIỂM**

(51) **02-03**

(22) 07/02/2023

(43) 26/06/2023

(73) **HENRY TEDJAKUSUMA (IN)**

Jalan Wuluh Blok II/3, RT/RW 009/006, Kota Bambu Utara, Palmerah Jakarta Barat 11420, Indonesia

(72) Henry Tedjakusuma (ID)

(74) Công ty TNHH Sở hữu trí tuệ HA VIP (HAVIP CO., LTD.)

(55)

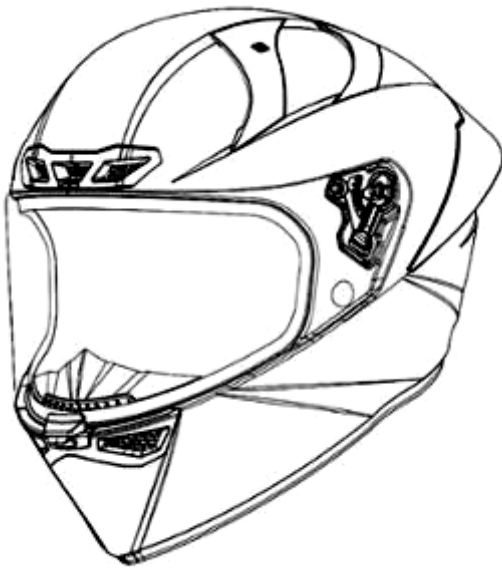

1.1



1.2

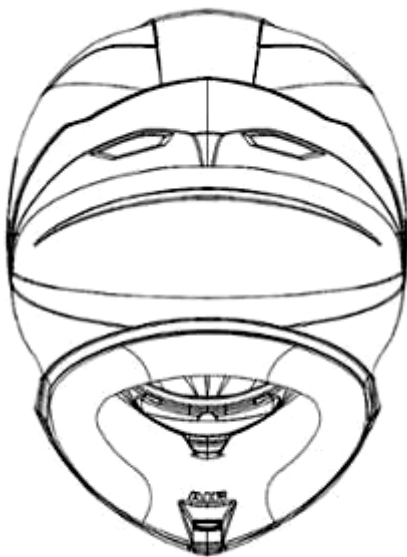

1.3



1.4

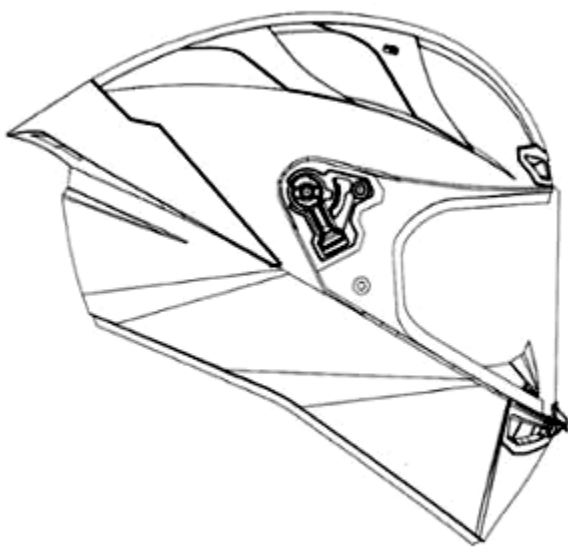

1.5

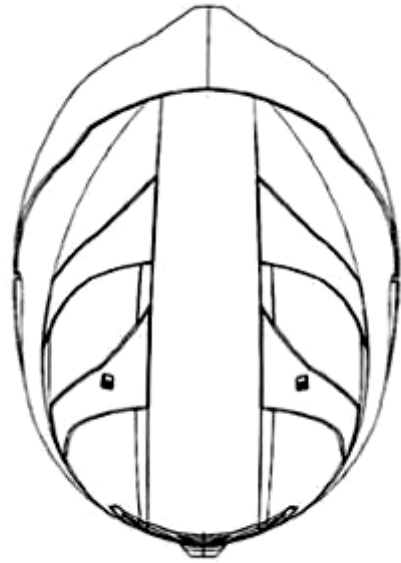

1.6

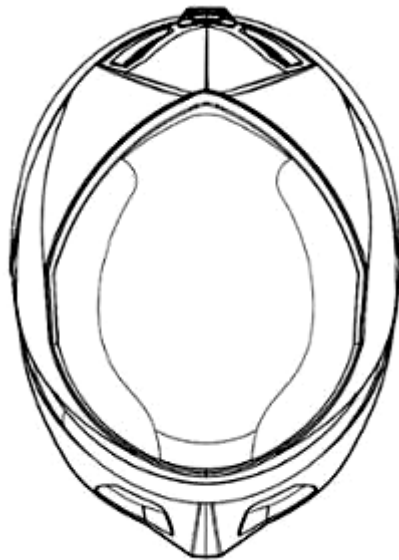

1.7

CÔNG BÁO SỞ HỮU CÔNG NGHIỆP SỐ 423 TẬP A – QUYỀN 2 (06.2023)

- (11) **47130**
- (21) 3-2023-00268 (28) 1
- (54) **NHÃN SẢN PHẨM** (51) **19-08**
- (22) 07/02/2023 (43) 26/06/2023
- (73) **CÔNG TY TNHH XUẤT NHẬP KHẨU THƯƠNG MẠI PHÂN PHỐI THỰC PHẨM MET (VN)**
C2/24A1 đường Phạm Hùng, xã Bình Hưng, huyện Bình Chánh, thành phố Hồ Chí Minh
- (72) Nguyễn Văn Mết (VN)
- (74) Công ty TNHH một thành viên Trường Luật (Trường Luật)
- (55)



- (11) **47131**
(21) 3-2023-00271 (28) 1
(54) **THIẾT BỊ CHO HỒ ĐỐT LỬA** (51) **23-03**
(22) 08/02/2023 (43) 26/06/2023
(30) 29/866,179 31/08/2022 US;
(73) **SOLO BRANDS, LLC (US)**
1001 Mustang Dr., Grapevine, TX 76051, United States of America
(72) 1. JEFFREY R. WEILERT (US)
2. ALEXANDER K. MAGHSADI (US)
(74) Công ty Luật TNHH T&G (TGVN)
(55)



1.1



1.2



1.3



1.4

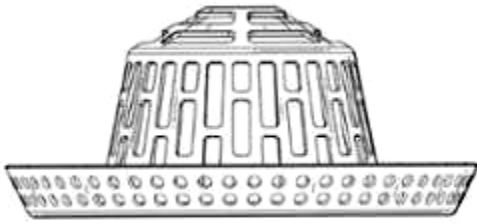

1.5

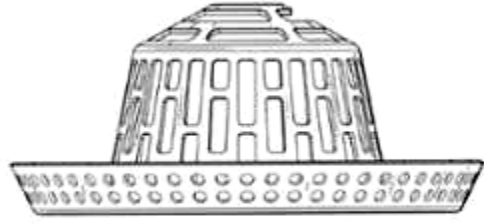

1.6



1.7



1.8

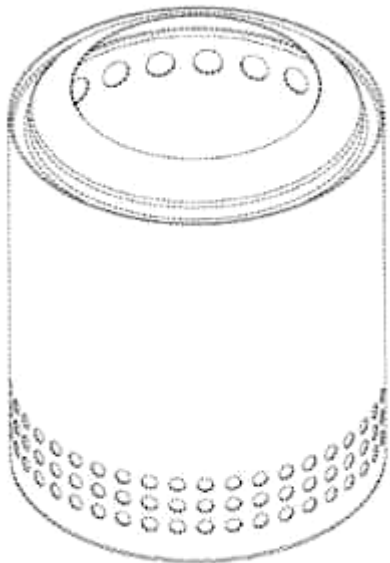

1.9



1.10

CÔNG BÁO SỞ HỮU CÔNG NGHIỆP SỐ 423 TẬP A – QUYỀN 2 (06.2023)

- (11) **47132**
(21) 3-2023-00277 (28) 1
(54) **MŨ BẢO HIỂM** (51) **02-03**
(22) 10/02/2023 (43) 26/06/2023
(30) 29/865,796 12/08/2022 US;
(73) **DEFENDER SAFETY, INC. (US)**
30 SKYLINE DRIVE, PLAINVIEW, NEW YORK 11803, UNITED STATES
(72) 1. ISLAM, NAHAL (US)
2. COOPER, DYLAN MAYNARD (ZA)
3. HUGO, GEORGE ALEXIS (ZA)
4. LE ROUX, STEPHAN (ZA)
(74) Công ty TNHH Sở hữu trí tuệ Toàn Cầu (GLOBAL IP CO., LTD.)
(55)

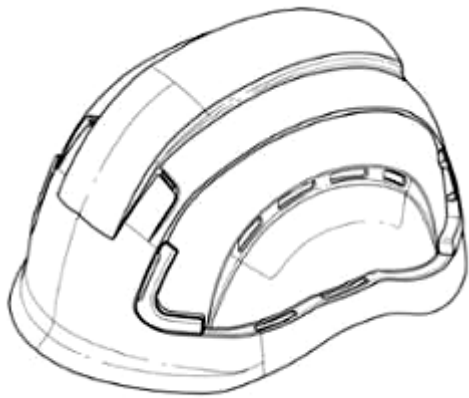

1.1

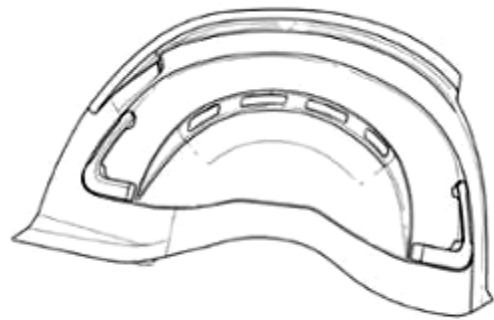

1.2

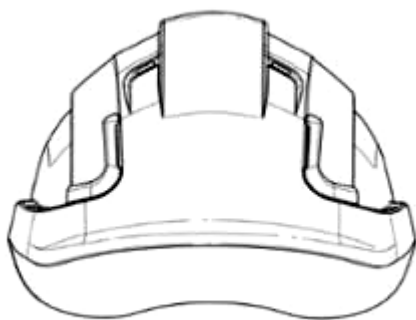

1.3

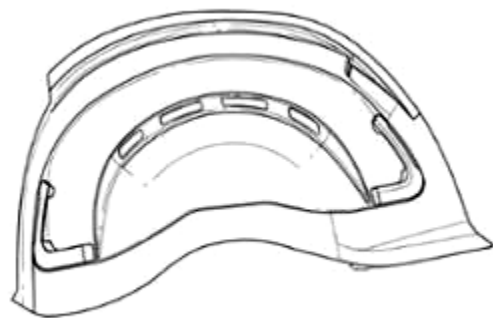

1.4

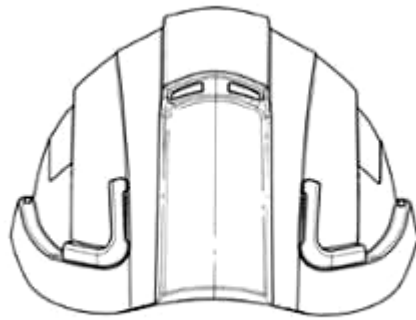

1.5

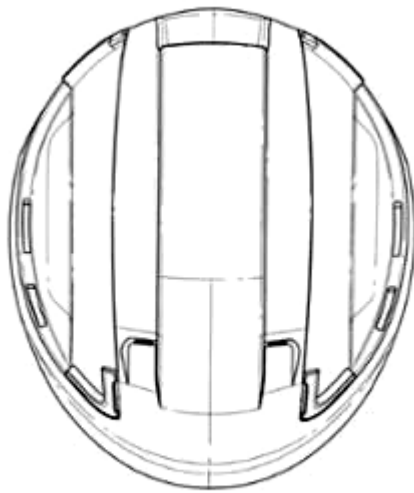

1.6



1.7

CÔNG BÁO SỞ HỮU CÔNG NGHIỆP SỐ 423 TẬP A – QUYỀN 2 (06.2023)

- (11) **47133**
(21) 3-2023-00278 (28) 1
(54) **MŨ BẢO HIỂM** (51) **02-03**
(22) 10/02/2023 (43) 26/06/2023
(30) 29/849,827 15/08/2022 US;
(73) **DEFENDER SAFETY, INC. (US)**
30 SKYLINE DRIVE, PLAINVIEW, NEW YORK 11803, UNITED STATES
(72) 1. ISLAM, NAHAL (US)
2. COOPER, DYLAN MAYNARD (ZA)
3. HUGO, GEORGE ALEXIS (ZA)
4. LE ROUX, STEPHAN (ZA)
(74) Công ty TNHH Sở hữu trí tuệ Toàn Cầu (GLOBAL IP CO., LTD.)
(55)



1.1

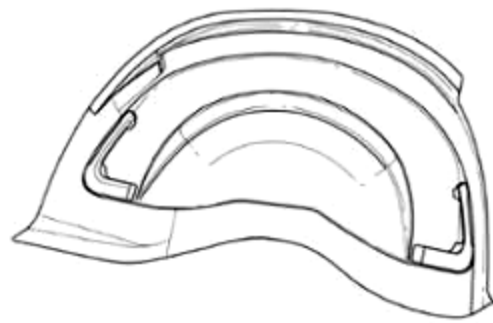

1.2

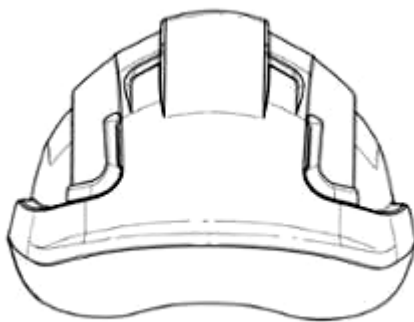

1.3

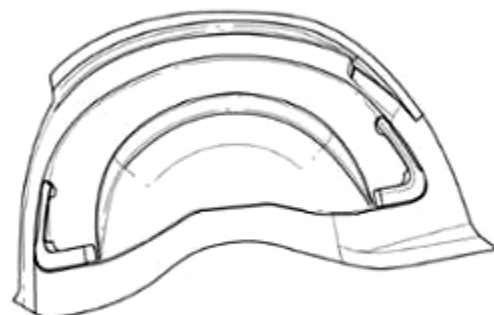

1.4

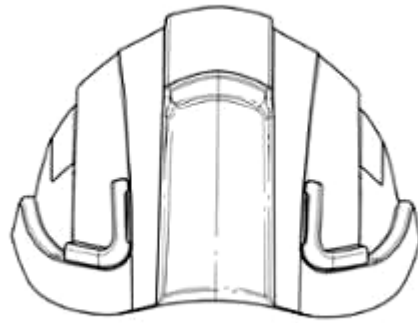

1.5

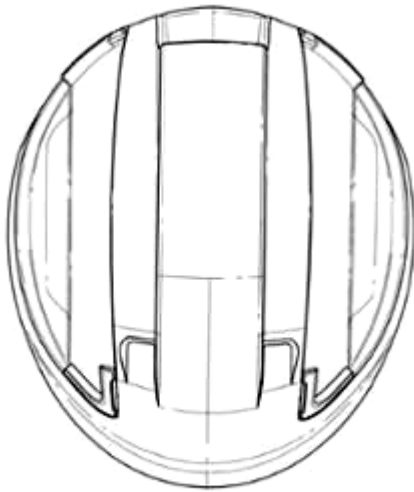

1.6



1.7

CÔNG BÁO SỞ HỮU CÔNG NGHIỆP SỐ 423 TẬP A – QUYỀN 2 (06.2023)

- (11) **47134**
(21) 3-2023-00283 (28) 1
(54) **ĐỒ CHỨA** (51) **09-05**
(22) 23/10/2020 (43) 26/06/2023
(30) 145322 23/04/2020 CH;
(73) **ALPLA WERKE ALWIN LEHNER GMBH & CO. KG (AT)**
Allmendstrasse, A-6971 Hard, Austria
(72) 1. OLIVER UNTERLECHNER (AT)
2. DANIEL SCHNETZER (AT)
3. MICHAEL ZORN, BSC (AT)
4. THOMAS BOHLE (AT)
(74) Công ty TNHH Sở hữu trí tuệ ALNGUYEN (ALNGUYEN IP CO.,LTD.)
(55)

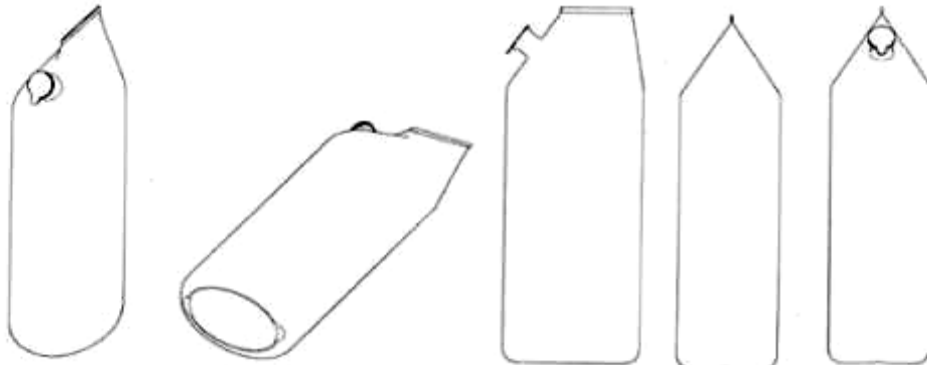

1.1

1.2

1.3

1.4

1.5

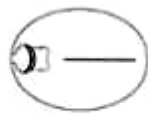

1.6

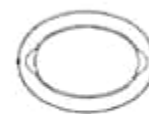

1.7

CÔNG BÁO SỞ HỮU CÔNG NGHIỆP SỐ 423 TẬP A – QUYỀN 2 (06.2023)

- (11) **47135**
(21) 3-2023-00284 (28) 1
(54) **ĐỒ CHỨA** (51) **09-05**
(22) 23/10/2020 (43) 26/06/2023
(30) 145322 23/04/2020 CH;
(73) **ALPLA WERKE ALWIN LEHNER GMBH & CO. KG (AT)**
Allmendstrasse, A-6971 Hard, Austria
(72) 1. OLIVER UNTERLECHNER (AT)
2. DANIEL SCHNETZER (AT)
3. MICHAEL ZORN, BSC (AT)
4. THOMAS BOHLE (AT)
(74) Công ty TNHH Sở hữu trí tuệ ALNGUYEN (ALNGUYEN IP CO.,LTD.)
(55)

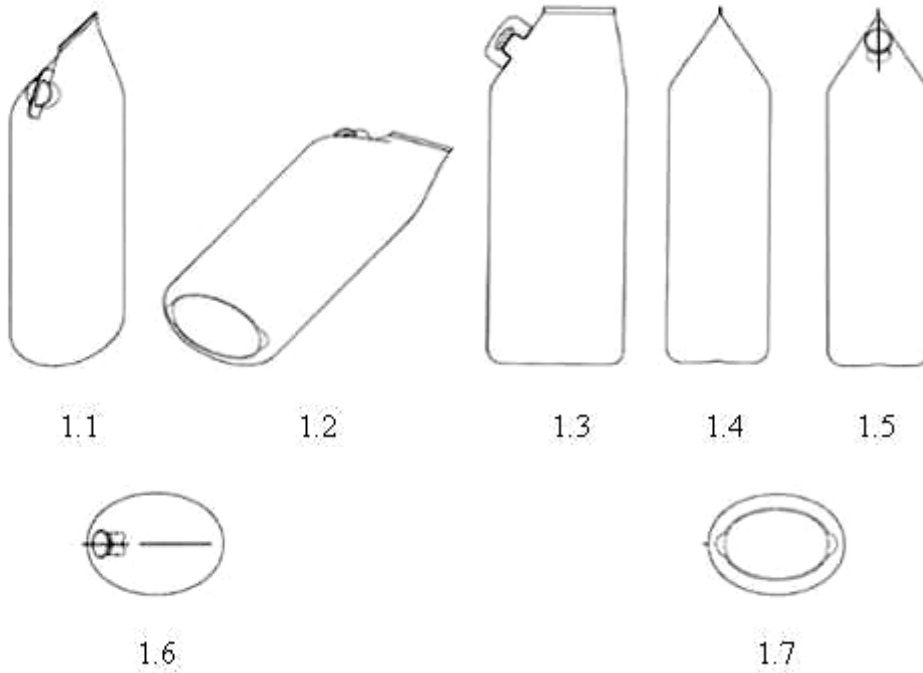

CÔNG BÁO SỞ HỮU CÔNG NGHIỆP SỐ 423 TẬP A – QUYỀN 2 (06.2023)

- (11) **47136**
(21) 3-2023-00298 (28) 1
(54) **KÍNH MŨ BẢO HIỂM** (51) **02-03**
(22) 15/02/2023 (43) 26/06/2023
(73) **HENRY TEDJAKUSUMA (ID)**
Jalan Wuluh Blok II/3, RT/RW 009/006, Kota Bambu Utara, Palmerah Jakarta Barat 11420, Indonesia
(72) Henry Tedjakusuma (ID)
(74) Công ty TNHH Sở hữu trí tuệ HA VIP (HAVIP CO., LTD.)
(55)

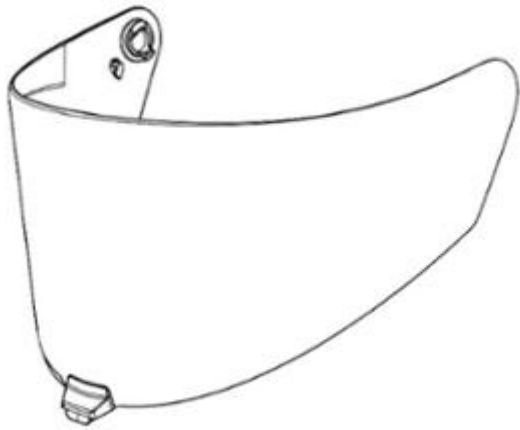

1.1

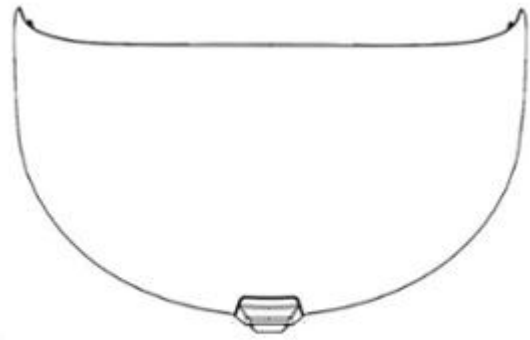

1.2



1.3

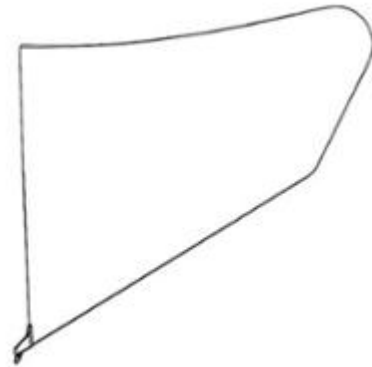

1.4



1.5



1.6



1.7

CÔNG BÁO SỞ HỮU CÔNG NGHIỆP SỐ 423 TẬP A – QUYỀN 2 (06.2023)

- (11) **47137**
(21) 3-2023-00299 (28) 1
(54) **DÉP** (51) **02-04**
(22) 15/02/2023 (43) 26/06/2023
(30) 29/850,033 16/08/2022 US;
(73) **CROCS, INC. (US)**
13601 Via Varra, Broomfield, Colorado 80020, United States of America
(72) Jie LIU (US)
(74) Công ty Luật TNHH quốc tế BMVN (BMVN INTERNATIONAL LLC)
(55)



1.1



1.2



1.3



1.4



1.5



1.6



1.7

CÔNG BÁO SỞ HỮU CÔNG NGHIỆP SỐ 423 TẬP A – QUYỀN 2 (06.2023)

- (11) **47138**
- (21) 3-2023-00317 (28) 1
- (54) **BAO GÓI SẢN PHẨM** (51) **09-05**
- (22) 17/02/2023 (43) 26/06/2023
- (73) **CÔNG TY TNHH SẢN XUẤT PHÁT TRIỂN TỰ CƯỜNG (VN)**
Số nhà 13, ngõ 91/109 đường Quán Trữ, phường Lãm Hà, quận Kiến An, thành phố Hải Phòng
- (72) Nguyễn Văn Phương (VN)
- (74) Công ty TNHH Nghiên cứu và Tư vấn chuyên giao công nghệ và đầu tư (CONCETTI)
- (55)



1.1



1.2

CÔNG BÁO SỞ HỮU CÔNG NGHIỆP SỐ 423 TẬP A – QUYỀN 2 (06.2023)

- (11) **47139**
- (21) 3-2023-00318 (28) 1
- (54) **BAO GÓI SẢN PHẨM** (51) **09-05**
- (22) 17/02/2023 (43) 26/06/2023
- (73) **CÔNG TY TNHH SẢN XUẤT PHÁT TRIỂN TỰ CƯỜNG (VN)**
Số nhà 13, ngõ 91/109 đường Quán Trữ, phường Lãm Hà, quận Kiến An, thành phố Hải Phòng
- (72) Nguyễn Văn Phương (VN)
- (74) Công ty TNHH Nghiên cứu và Tư vấn chuyên giao công nghệ và đầu tư (CONCETTI)
- (55)



1.1



1.2

CÔNG BÁO SỞ HỮU CÔNG NGHIỆP SỐ 423 TẬP A – QUYỀN 2 (06.2023)

- (11) **47140**
(21) 3-2023-00319 (28) 1
(54) **BAO GÓI SẢN PHẨM** (51) **09-05**
(22) 17/02/2023 (43) 26/06/2023
(73) **CÔNG TY TNHH SẢN XUẤT PHÁT TRIỂN TỰ CƯỜNG (VN)**
Số nhà 13, ngõ 91/109 đường Quán Trữ, phường Lãm Hà, quận Kiến An, thành phố Hải Phòng
(72) Nguyễn Văn Phương (VN)
(74) Công ty TNHH Nghiên cứu và Tư vấn chuyên giao công nghệ và đầu tư (CONCETTI)
(55)



1.1



1.2

- (11) **47141**
(21) 3-2023-00321 (28) 1
(54) **KHAY TRỒNG CÂY** (51) **11-02**
(22) 17/02/2023 (43) 26/06/2023
(73) **CÔNG TY TNHH PHÁT TRIỂN NÔNG NGHIỆP TOKAI (VN)**
Phòng 802, tầng 8, tòa nhà VCCI số 171 Võ Thị Sáu, phường Võ Thị Sáu, quận 3,
thành phố Hồ Chí Minh
(72) DOI MAMI (JP)
(74) Công ty TNHH một thành viên Trường Luật (Trường Luật)
(55)



1.1



1.2



1.3



1.4

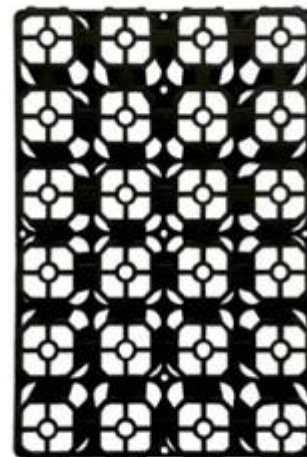

1.5

- (11) **47142**
(21) 3-2023-00322 (28) 1
(54) **KHAY TRỒNG CÂY** (51) **11-02**
(22) 17/02/2023 (43) 26/06/2023
(73) **CÔNG TY TNHH PHÁT TRIỂN NÔNG NGHIỆP TOKAI (VN)**
Phòng 802, tầng 8, Tòa nhà VCCI số 171 Võ Thị Sáu, phường Võ Thị Sáu, quận 3,
thành phố Hồ Chí Minh
(72) DOI MAMI (JP)
(74) Công ty TNHH một thành viên Trường Luật (Trường Luật)
(55)



1.1



1.2



1.3

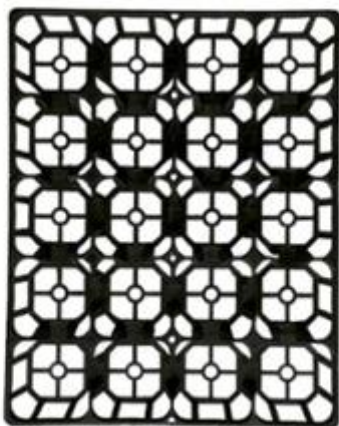

1.4



1.5

(11) **47143**

(21) 3-2023-00323

(28) 1

(54) **KHAY TRỒNG CÂY**

(51) **11-02**

(22) 17/02/2023

(43) 26/06/2023

(73) **CÔNG TY TNHH PHÁT TRIỂN NÔNG NGHIỆP TOKAI (VN)**

Phòng 802, tầng 8, tòa nhà VCCI số 171 Võ Thị Sáu, phường Võ Thị Sáu, quận 3, thành phố Hồ Chí Minh

(72) DOI MAMI (JP)

(74) Công ty TNHH một thành viên Trường Luật (Trường Luật)

(55)



1.1



1.2



1.3

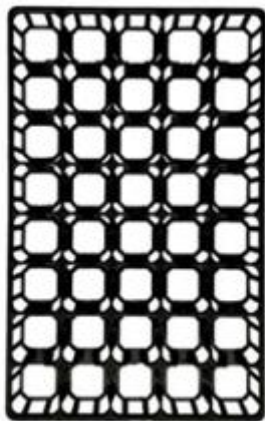

1.4

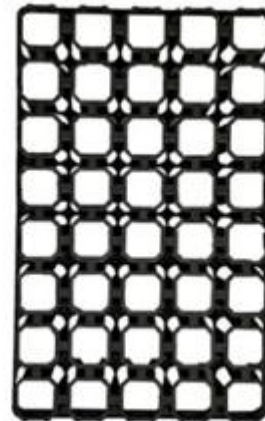

1.5

CÔNG BÁO SỞ HỮU CÔNG NGHIỆP SỐ 423 TẬP A – QUYỀN 2 (06.2023)

- (11) **47144**
(21) 3-2023-00329 (28) 1
(54) **BAO GÓI** (51) **09-05**
(22) 21/02/2023 (43) 26/06/2023
(73) **ORION CORPORATION (KR)**
13, Baekbeom-ro 90da-gil, Yongsan-gu, Seoul 04369, Republic of Korea
(72) 1. LEE, HYUN A (KR)
2. LEE, A REUM (KR)
(74) Công ty Luật TNHH quốc tế BMVN (BMVN INTERNATIONAL LLC)
(55)



1.1



1.2

- (11) **47145**
(21) 3-2023-00335 (28) 1
(54) **BẦY CHUỘT** (51) **22-06**
(22) 22/02/2023 (43) 26/06/2023
(30) 30-2022-0047724 17/11/2022 KR;
(73) **CESCO CO., LTD.** (KR)
(Sangil-dong) 46, Sangil-ro 10-gil, Gangdong-gu, Seoul 05288, Republic of Korea
(72) CHYUN, Chan Hyuk (KR)
(74) Công ty TNHH Tầm nhìn và Liên danh (VISION & ASSOCIATES CO.LTD.)
(55)

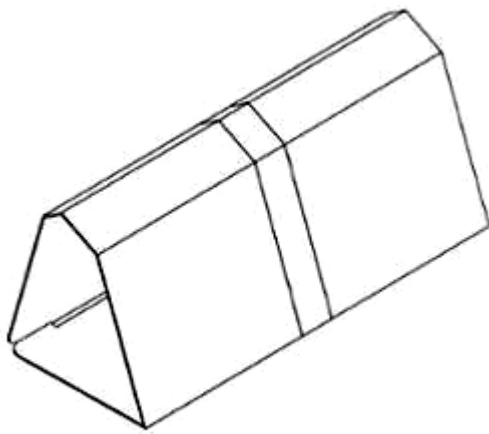

1.1

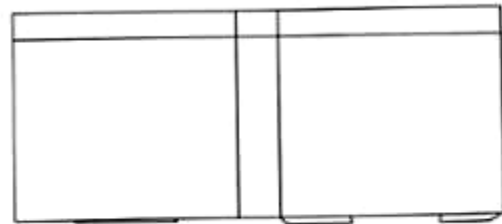

1.2

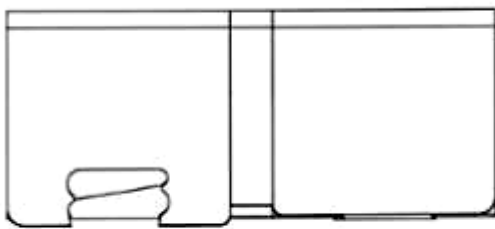

1.3



1.4



1.5

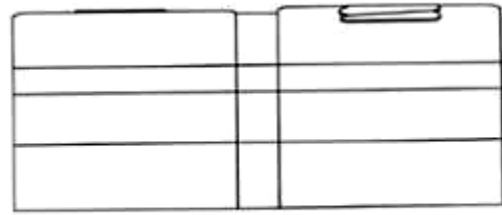

1.6

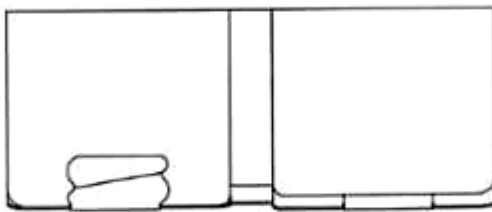

1.7

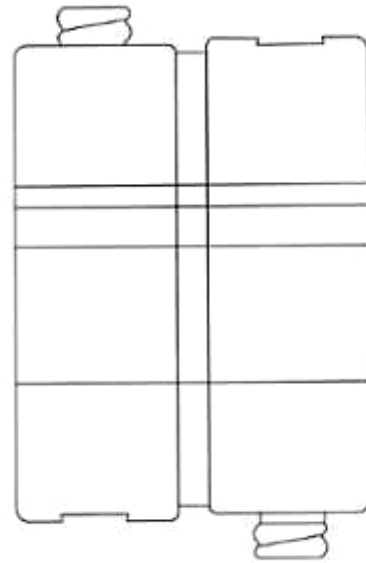

1.8

CÔNG BÁO SỞ HỮU CÔNG NGHIỆP SỐ 423 TẬP A – QUYỀN 2 (06.2023)

- (11) **47146**
(21) 3-2023-00337 (28) 1
(54) **MŨI KHOAN** (51)
(22) 22/02/2023 (43) 26/06/2023
(73) **SHANGHAI DRAGON-STAR TOOLS CO., LTD. (CN)**
No. 888, XingRong Road, Jiading Industrial Zone, Shanghai, China
(72) Hong Wu (CN)
(74) Công ty TNHH Sở hữu trí tuệ Hải Hân (HAI HAN IP CO., LTD.)
(55)

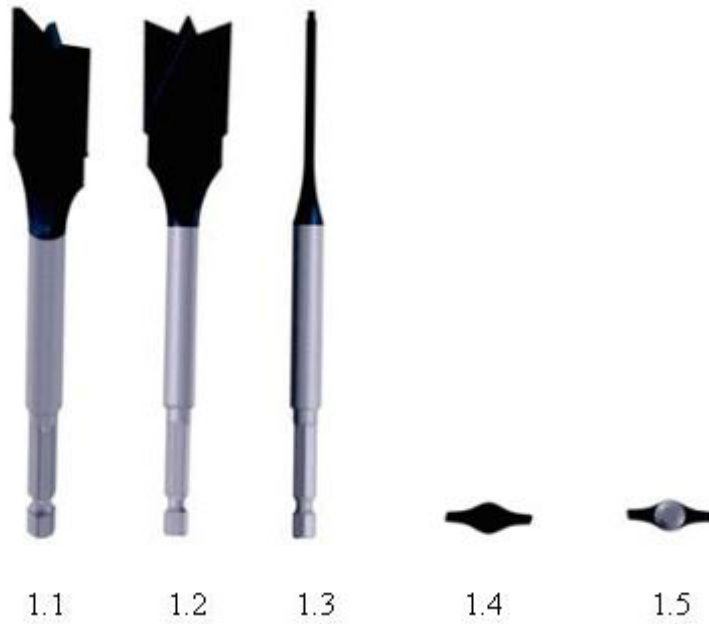

CÔNG BÁO SỞ HỮU CÔNG NGHIỆP SỐ 423 TẬP A – QUYỀN 2 (06.2023)

- (11) **47147**
(21) 3-2023-00344 (28) 1
(54) **HỘP ĐỰNG DUNG DỊCH RỬA MŨI** (51) **09-03**
(22) 23/02/2023 (43) 26/06/2023
(73) **CÔNG TY TNHH DƯỢC PHẨM INNOCARE (VN)**
Số 558 đường Quang Trung, phường La Khê, quận Hà Đông, thành phố Hà Nội
(72) Nguyễn Bá Nghĩa (VN)
(74) Công ty TNHH Sở hữu trí tuệ và Công nghệ Thủ đô (CAPITAL IP&T CO.LTD.)
(55)



1.1



1.2

CÔNG BÁO SỞ HỮU CÔNG NGHIỆP SỐ 423 TẬP A – QUYỀN 2 (06.2023)

- (11) **47148**
(21) 3-2023-00347 (28) 1
(54) **BAO GÓI** (51) **09-05**
(22) 23/02/2023 (43) 26/06/2023
(73) **CÔNG TY TNHH THƯƠNG MẠI DỊCH VỤ BIHACO (VN)**
Đường Nguyễn Hữu Tiến, tổ 6, phường Lê Hồng Phong, thành phố Phủ Lý, tỉnh Hà Nam
(72) Nguyễn Văn Bình (VN)
(74) Công ty TNHH một thành viên Trường Luật (Trường Luật)
(55)



1.1



1.2



1.3



1.4



1.5



1.6



1.7

CÔNG BÁO SỞ HỮU CÔNG NGHIỆP SỐ 423 TẬP A – QUYỀN 2 (06.2023)

- (11) **47149**
- (21) 3-2023-00352 (28) 1
- (54) **NHÃN SẢN PHẨM** (51) **19-08**
- (22) 24/02/2023 (43) 26/06/2023
- (73) **CÔNG TY CỔ PHẦN METRO SÀI GÒN (VN)**
35/21 đường TL30, phường Thạnh Lộc, quận 12, thành phố Hồ Chí Minh
- (72) Lý Thị Quy (VN)
- (74) **CÔNG TY LUẬT TNHH QUỐC TẾ ICT (ICT LAW INTERNATIONAL CO., LTD)**
- (55)



CÔNG BÁO SỞ HỮU CÔNG NGHIỆP SỐ 423 TẬP A – QUYỀN 2 (06.2023)

- (11) **47150**
- (21) 3-2023-00353 (28) 1
- (54) **NHÃN SẢN PHẨM** (51) **19-08**
- (22) 24/02/2023 (43) 26/06/2023
- (73) **CÔNG TY CỔ PHẦN METRO SÀI GÒN (VN)**
35/21 đường TL30, phường Thạnh Lộc, quận 12, thành phố Hồ Chí Minh
- (72) Lý Thị Quy (VN)
- (74) **CÔNG TY LUẬT TNHH QUỐC TẾ ICT (ICT LAW INTERNATIONAL CO., LTD)**
- (55)



CÔNG BÁO SỞ HỮU CÔNG NGHIỆP SỐ 423 TẬP A – QUYỀN 2 (06.2023)

- (11) **47151**
- (21) 3-2023-00354 (28) 1
- (54) **NHÃN SẢN PHẨM** (51) **19-08**
- (22) 24/02/2023 (43) 26/06/2023
- (73) **CÔNG TY CỔ PHẦN METRO SÀI GÒN (VN)**
35/21 đường TL30, phường Thạnh Lộc, quận 12, thành phố Hồ Chí Minh
- (72) Lý Thị Quy (VN)
- (74) **CÔNG TY LUẬT TNHH QUỐC TẾ ICT (ICT LAW INTERNATIONAL CO., LTD)**
- (55)



(11) **47152**

(21) 3-2023-00362

(54) **MÁY TẬP THỂ DỤC**

(22) 24/02/2023

(73) **TRẦN QUỐC DANH (VN)**

Tổ 1, khóm 2, phường An Bình B, thành phố Hồng Ngự, tỉnh Đồng Tháp

(72) Trần Quốc Danh (VN)

(74) Công ty TNHH NACILAW (NACILAW)

(55)

(28) 1

(51) **21-02**

(43) 26/06/2023

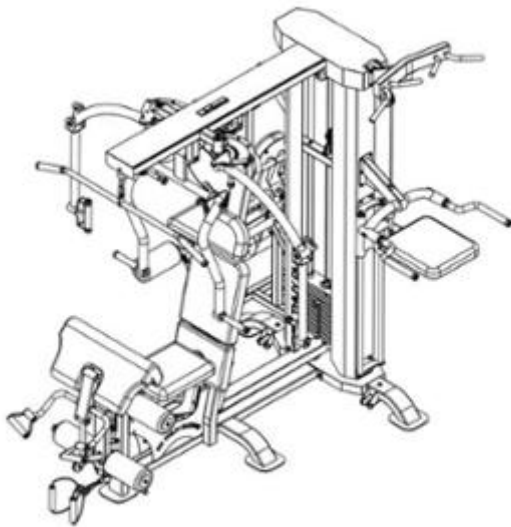

1.1

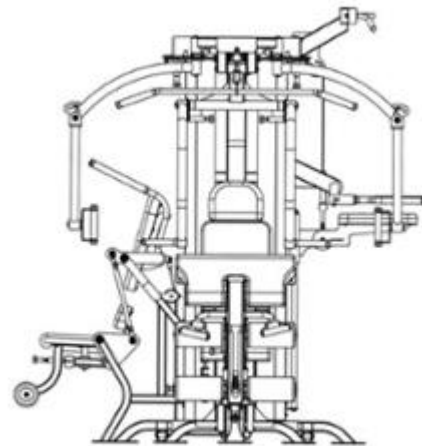

1.2

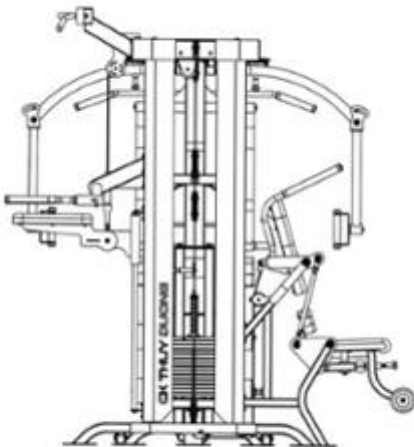

1.3

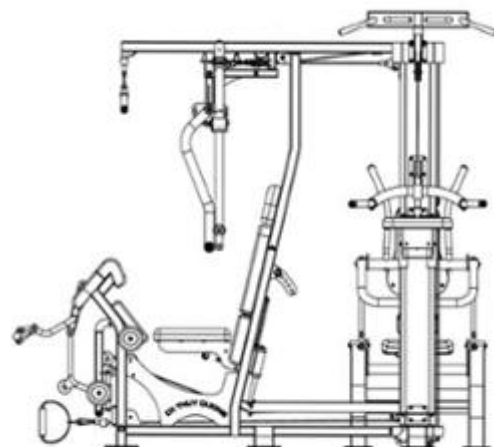

1.4

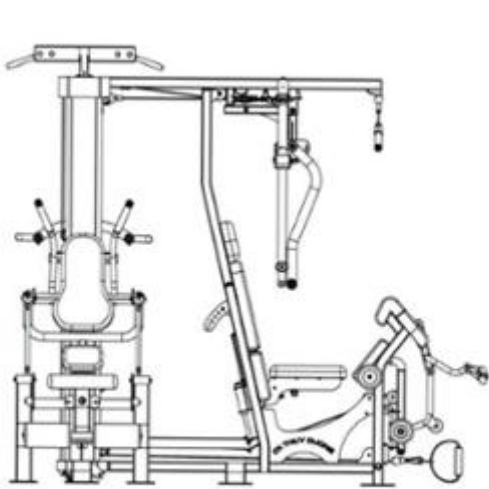

1.5

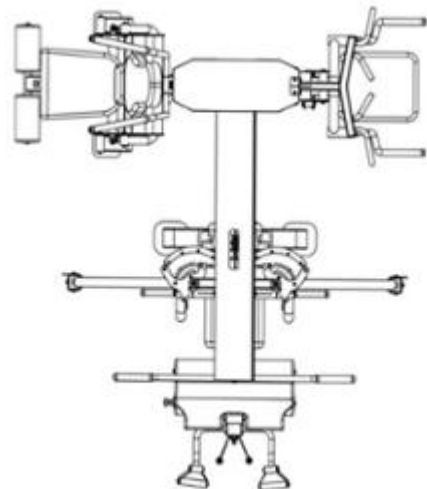

1.6

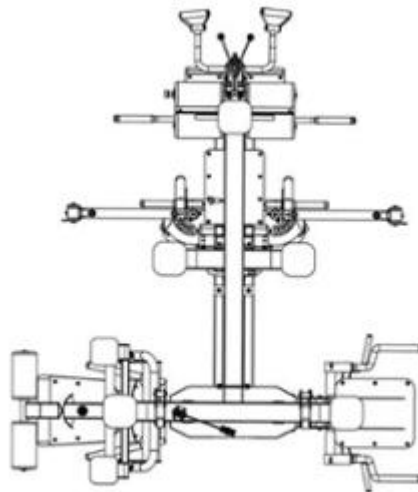

1.7

CÔNG BÁO SỞ HỮU CÔNG NGHIỆP SỐ 423 TẬP A – QUYỀN 2 (06.2023)

- (11) **47153**
- (21) 3-2023-00363 (28) 1
- (54) **NHÃN SẢN PHẨM** (51) **19-08**
- (22) 24/02/2023 (43) 26/06/2023
- (73) **CÔNG TY TNHH SACHI NGUYỄN (VN)**
Khu phố 8, phường Tam Quan, thị xã Hoài Nhơn, tỉnh Bình Định
- (72) Nguyễn Hữu Vinh (VN)
- (74) **CÔNG TY TNHH SỞ HỮU TRÍ TUỆ SETHACO (SETHACO IP CO.,LTD)**
- (55)



CÔNG BÁO SỞ HỮU CÔNG NGHIỆP SỐ 423 TẬP A – QUYỀN 2 (06.2023)

- (11) **47154**
(21) 3-2023-00366 (28) 1
(54) **HỘP** (51) **09-03**
(22) 24/02/2023 (43) 26/06/2023
(73) **CÔNG TY CỔ PHẦN YẾN VIỆT (VN)**
Cụm công nghiệp Thành Hải, xã Thành Hải, thành phố Phan Rang-Tháp Chàm, tỉnh Ninh Thuận
(72) Đặng Phạm Minh Loan (VN)
(74) **CÔNG TY TNHH KHANG LUẬT (KHANGLAW)**
(55)



1.1



1.2

CÔNG BÁO SỞ HỮU CÔNG NGHIỆP SỐ 423 TẬP A – QUYỀN 2 (06.2023)

- (11) **47155**
(21) 3-2023-00369 (28) 1
(54) **THANH NHÔM ĐỊNH HÌNH** (51) **25-01**
(22) 27/02/2023 (43) 26/06/2023
(73) **CÔNG TY TNHH THƯƠNG MẠI HÙNG UYÊN (VN)**
Thôn 2, xã Chàng Sơn, huyện Thạch Thất, thành phố Hà Nội
(72) Chu Văn Hưng (VN)
(55)

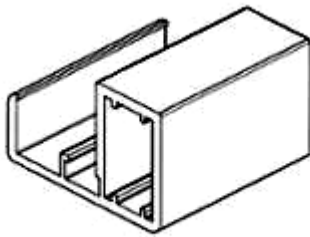

1.1

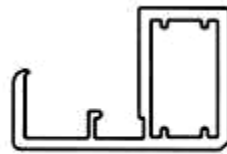

1.2



1.3

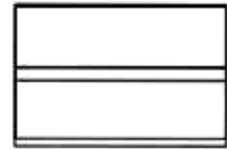

1.4



1.5



1.6

CÔNG BÁO SỞ HỮU CÔNG NGHIỆP SỐ 423 TẬP A – QUYỀN 2 (06.2023)

- (11) **47156**
(21) 3-2023-00370 (28) 1
(54) **THANH NHÔM ĐỊNH HÌNH** (51) **25-01**
(22) 27/02/2023 (43) 26/06/2023
(73) **CÔNG TY TNHH THƯƠNG MẠI HÙNG UYÊN (VN)**
Thôn 2, xã Chàng Sơn, huyện Thạch Thất, thành phố Hà Nội
(72) Chu Văn Hưng (VN)
(55)

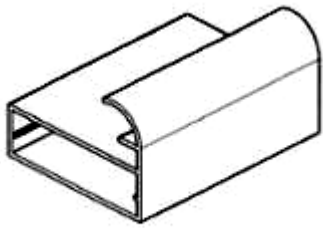

1.1

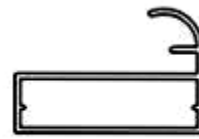

1.2



1.3



1.4

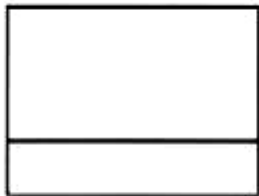

1.5

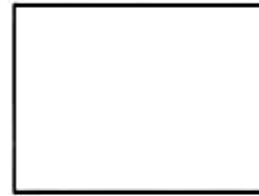

1.6

CÔNG BÁO SỞ HỮU CÔNG NGHIỆP SỐ 423 TẬP A – QUYỀN 2 (06.2023)

- (11) **47157**
(21) 3-2023-00371 (28) 1
(54) **THANH NHÔM ĐỊNH HÌNH** (51) **25-01**
(22) 27/02/2023 (43) 26/06/2023
(73) **CÔNG TY TNHH THƯƠNG MẠI HÙNG UYÊN (VN)**
Thôn 2, xã Chàng Sơn, huyện Thạch Thất, thành phố Hà Nội
(72) Chu Văn Hưng (VN)
(55)

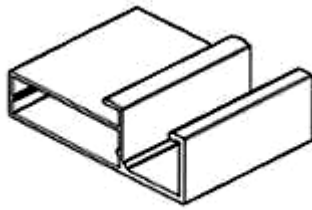

1.1



1.2

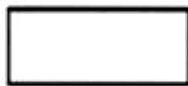

1.3

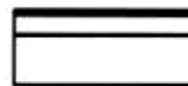

1.4



1.5

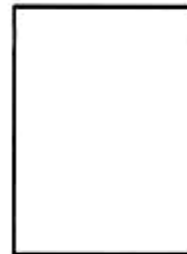

1.6

CÔNG BÁO SỞ HỮU CÔNG NGHIỆP SỐ 423 TẬP A – QUYỀN 2 (06.2023)

- (11) **47158**
(21) 3-2023-00374 (28) 1
(54) **BAO GÓI** (51) **09-05**
(22) 28/02/2023 (43) 26/06/2023
(73) **CÔNG TY TNHH SẢN XUẤT VÀ THƯƠNG MẠI QUỐC TẾ VIỆT SING**
(VN)
Cụm CN Xuân Lâm, xã Xuân Lâm, huyện Thuận Thành, tỉnh Bắc Ninh
(72) Nguyễn Đăng Dũng (VN)
(55)



1.1



1.2

CÔNG BÁO SỞ HỮU CÔNG NGHIỆP SỐ 423 TẬP A – QUYỀN 2 (06.2023)

- (11) **47159**
(21) 3-2023-00375 (28) 1
(54) **BAO GÓI** (51) **09-05**
(22) 28/02/2023 (43) 26/06/2023
(73) **CÔNG TY TNHH SẢN XUẤT VÀ THƯƠNG MẠI QUỐC TẾ VIỆT SING (VN)**
Cụm CN Xuân Lâm, xã Xuân Lâm, huyện Thuận Thành, tỉnh Bắc Ninh
(72) Nguyễn Đăng Dũng (VN)
(55)



1.1



1.2

CÔNG BÁO SỞ HỮU CÔNG NGHIỆP SỐ 423 TẬP A – QUYỀN 2 (06.2023)

- (11) **47160**
(21) 3-2023-00376 (28) 1
(54) **BAO GÓI** (51) **09-05**
(22) 28/02/2023 (43) 26/06/2023
(73) **CÔNG TY TNHH SẢN XUẤT VÀ THƯƠNG MẠI QUỐC TẾ VIỆT SING (VN)**
Cụm CN Xuân Lâm, xã Xuân Lâm, huyện Thuận Thành, tỉnh Bắc Ninh
(72) Nguyễn Đăng Dũng (VN)
(55)



1.1



1.2

CÔNG BÁO SỞ HỮU CÔNG NGHIỆP SỐ 423 TẬP A – QUYỀN 2 (06.2023)

- (11) **47161**
(21) 3-2023-00378 (28) 1
(54) **CHẬU RỬA BÁT** (51) **23-02**
(22) 28/02/2023 (43) 26/06/2023
(30) 202215130 31/08/2022 AU;
(73) **PHOENIX INDUSTRIES PTY LTD (AU)**
926 Mountain Hwy, Bayswater, Victoria, 3153, Australia
(72) Alexander Tomlinson (AU)
(74) Công ty TNHH Tầm nhìn và Liên danh (VISION & ASSOCIATES CO.LTD.)
(55)



1.1

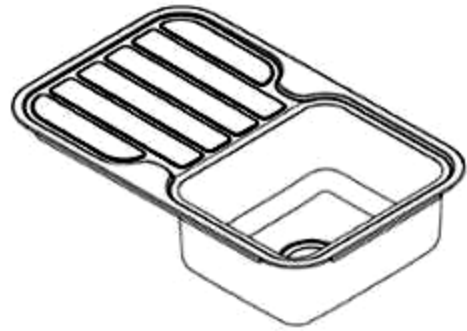

1.2



1.3

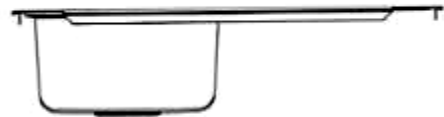

1.4



1.5



1.6

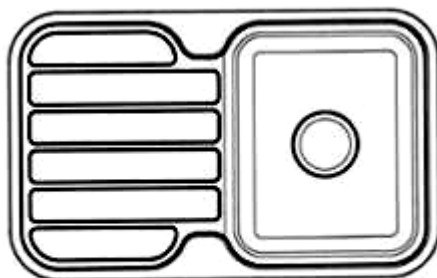

1.7

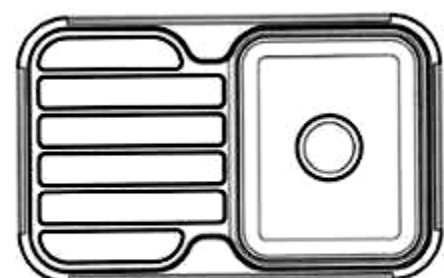

1.8

CÔNG BÁO SỞ HỮU CÔNG NGHIỆP SỐ 423 TẬP A – QUYỀN 2 (06.2023)

- (11) **47162**
(21) 3-2023-00379 (28) 1
(54) **CHẬU RỬA BÁT** (51) **23-02**
(22) 28/02/2023 (43) 26/06/2023
(30) 202215131 31/08/2022 AU;
(73) **PHOENIX INDUSTRIES PTY LTD (AU)**
926 Mountain Hwy, Bayswater, Victoria, 3153, Australia
(72) Alexander Tomlinson (AU)
(74) Công ty TNHH Tầm nhìn và Liên danh (VISION & ASSOCIATES CO.LTD.)
(55)



1.1



1.2



1.3

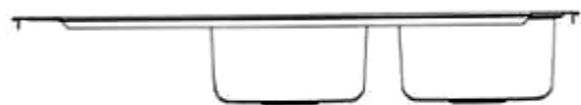

1.4

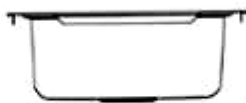

1.5



1.6

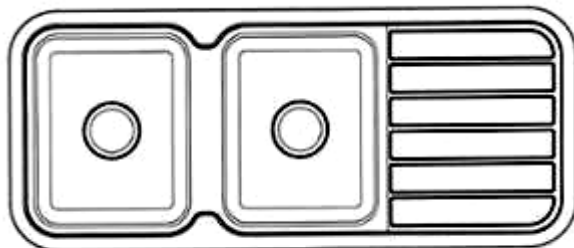

1.7

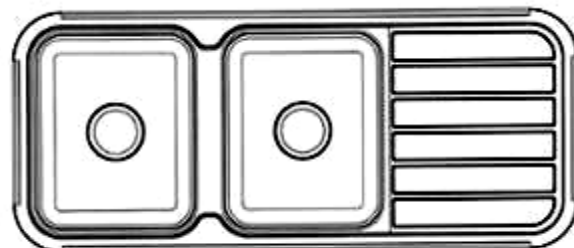

1.8

CÔNG BÁO SỞ HỮU CÔNG NGHIỆP SỐ 423 TẬP A – QUYỀN 2 (06.2023)

- (11) **47163**
(21) 3-2023-00380 (28) 2
(54) **CHẬU RỬA BÁT** (51) **23-02**
(22) 28/02/2023 (43) 26/06/2023
(30) 202215133 31/08/2022 AU; 202215132 31/08/2022 AU;
(73) **PHOENIX INDUSTRIES PTY LTD (AU)**
926 Mountain Hwy, Bayswater, Victoria, 3153, Australia
(72) Alexander Tomlinson (AU)
(74) Công ty TNHH Tầm nhìn và Liên danh (VISION & ASSOCIATES CO.LTD.)
(55)

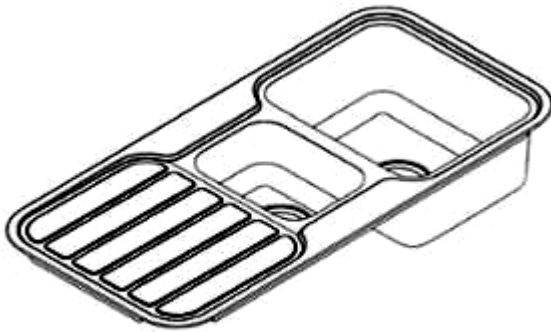

1.1

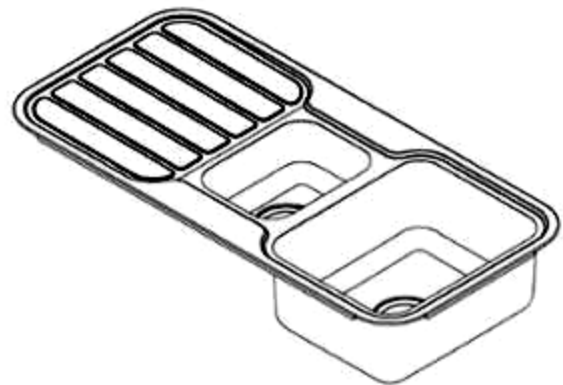

1.2



1.3



1.4

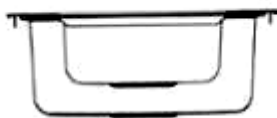

1.5



1.6

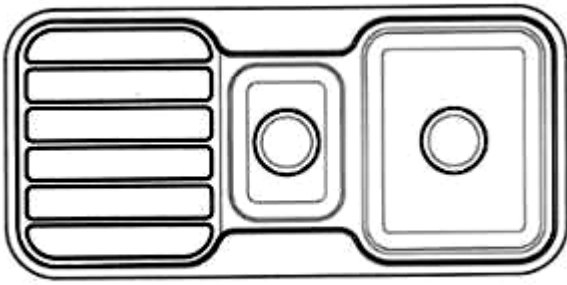

1.7

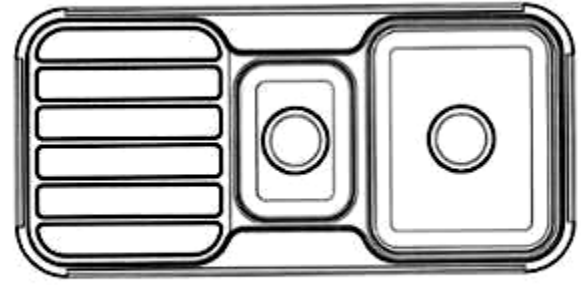

1.8

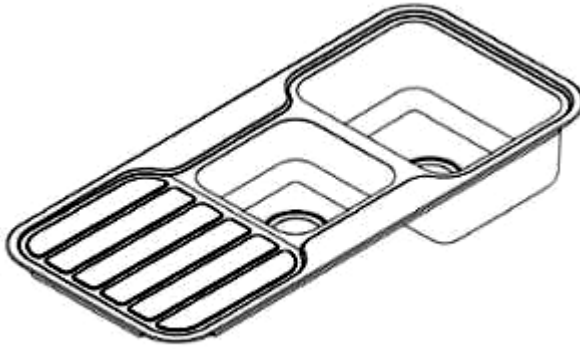

2.1

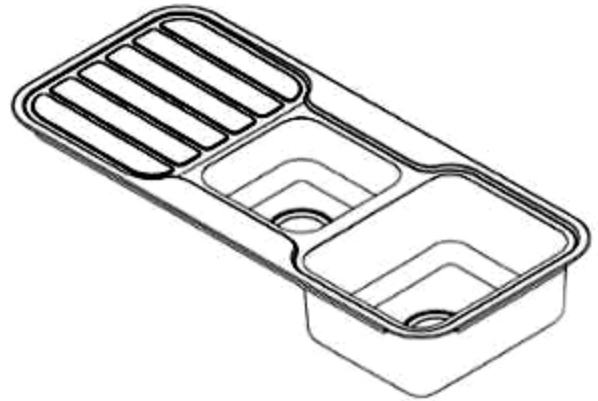

2.2



2.3



2.4



2.5



2.6

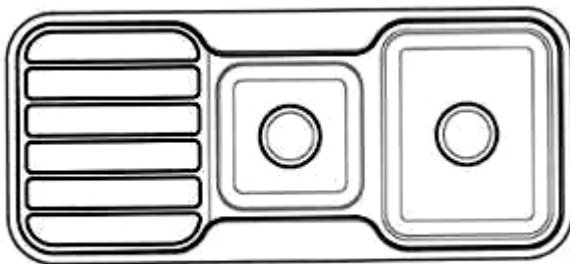

2.7

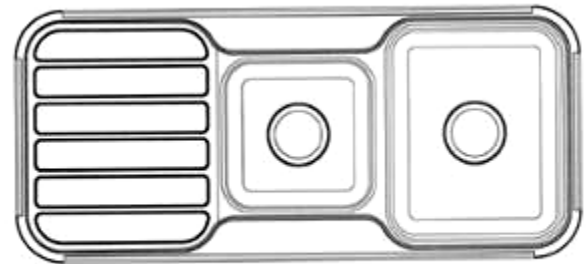

2.8

CÔNG BÁO SỞ HỮU CÔNG NGHIỆP SỐ 423 TẬP A – QUYỀN 2 (06.2023)

- (11) **47164**
 - (21) 3-2023-00381
 - (54) **THANH TREO KHĂN**
 - (22) 28/02/2023
 - (30) 202215135 31/08/2022 AU;
 - (73) **PHOENIX INDUSTRIES PTY LTD (AU)**
926 Mountain Hwy, Bayswater, Victoria, 3153, Australia
 - (72) Alexander Tomlinson (AU)
 - (74) Công ty TNHH Tầm nhìn và Liên danh (VISION & ASSOCIATES CO.LTD.)
 - (55)
- (28) 1
 - (51) **23-02**
 - (43) 26/06/2023

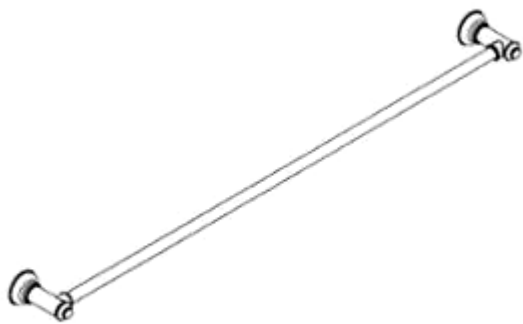

1.1

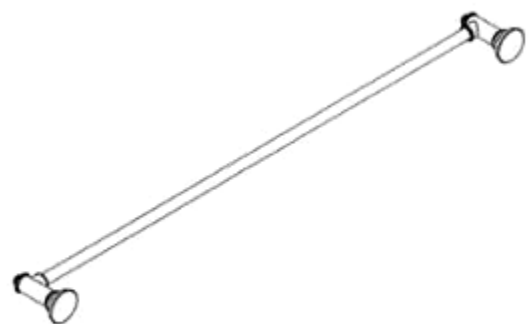

1.2



1.3



1.4



1.5



1.6



1.7



1.8

CÔNG BÁO SỞ HỮU CÔNG NGHIỆP SỐ 423 TẬP A – QUYỀN 2 (06.2023)

- (11) **47165**
(21) 3-2023-00382 (28) 1
(54) **THANH TREO KHĂN** (51) **23-02**
(22) 28/02/2023 (43) 26/06/2023
(30) 202215136 31/08/2022 AU;
(73) **PHOENIX INDUSTRIES PTY LTD (AU)**
926 Mountain Hwy, Bayswater, Victoria, 3153, Australia
(72) Alexander Tomlinson (AU)
(74) Công ty TNHH Tầm nhìn và Liên danh (VISION & ASSOCIATES CO.LTD.)
(55)

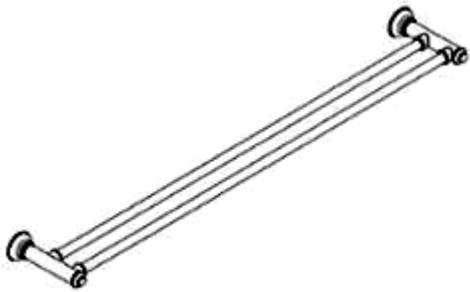

1.1

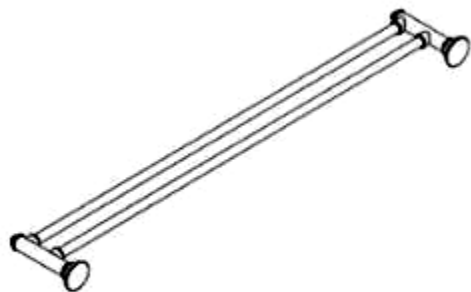

1.2



1.3



1.4



1.5



1.6



1.7



1.8

CÔNG BÁO SỞ HỮU CÔNG NGHIỆP SỐ 423 TẬP A – QUYỀN 2 (06.2023)

- (11) **47166**
(21) 3-2023-00383 (28) 1
(54) **GIÁ ĐỖ GIẤY VỆ SINH** (51) **23-02**
(22) 28/02/2023 (43) 26/06/2023
(30) 202215137 31/08/2022 AU;
(73) **PHOENIX INDUSTRIES PTY LTD (AU)**
926 Mountain Hwy, Bayswater, Victoria, 3153, Australia
(72) Alexander Tomlinson (AU)
(74) Công ty TNHH Tầm nhìn và Liên danh (VISION & ASSOCIATES CO.LTD.)
(55)



1.1



1.2

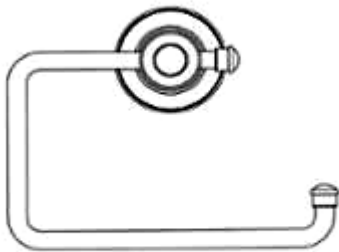

1.3

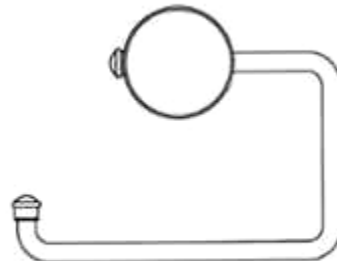

1.4

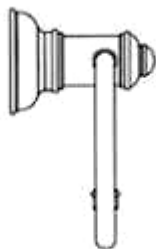

1.5

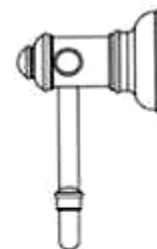

1.6

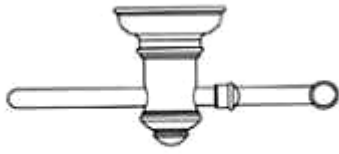

1.7

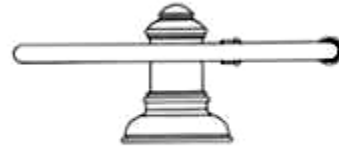

1.8

CÔNG BÁO SỞ HỮU CÔNG NGHIỆP SỐ 423 TẬP A – QUYỀN 2 (06.2023)

- (11) **47167**
(21) 3-2023-00384 (28) 1
(54) **MÓC TREO** (51) **08-08**
(22) 28/02/2023 (43) 26/06/2023
(30) 202215138 31/08/2022 AU;
(73) **PHOENIX INDUSTRIES PTY LTD (AU)**
926 Mountain Hwy, Bayswater, Victoria, 3153, Australia
(72) Alexander Tomlinson (AU)
(74) Công ty TNHH Tầm nhìn và Liên danh (VISION & ASSOCIATES CO.LTD.)
(55)



1.1



1.2



1.3



1.4

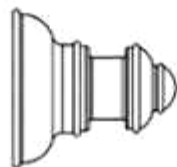

1.5

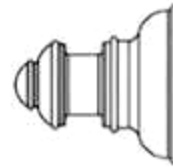

1.6



1.7



1.8

CÔNG BÁO SỞ HỮU CÔNG NGHIỆP SỐ 423 TẬP A – QUYỀN 2 (06.2023)

- (11) **47168**
(21) 3-2023-00385 (28) 1
(54) **GIÁ TREO KHĂN TAY** (51) **23-02**
(22) 28/02/2023 (43) 26/06/2023
(30) 202215139 31/08/2022 AU;
(73) **PHOENIX INDUSTRIES PTY LTD (AU)**
926 Mountain Hwy, Bayswater, Victoria, 3153, Australia
(72) Alexander Tomlinson (AU)
(74) Công ty TNHH Tầm nhìn và Liên danh (VISION & ASSOCIATES CO.LTD.)
(55)



1.1



1.2



1.3

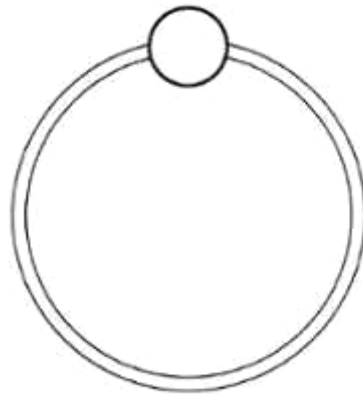

1.4



1.5



1.6

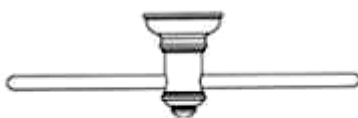

1.7



1.8

CÔNG BÁO SỞ HỮU CÔNG NGHIỆP SỐ 423 TẬP A – QUYỀN 2 (06.2023)

- (11) **47169**
- (21) 3-2023-00386
- (54) **GIÁ ĐỖ**
- (22) 28/02/2023
- (30) 202215140 31/08/2022 AU;
- (73) **PHOENIX INDUSTRIES PTY LTD (AU)**
926 Mountain Hwy, Bayswater, Victoria, 3153, Australia
- (72) Alexander Tomlinson (AU)
- (74) Công ty TNHH Tầm nhìn và Liên danh (VISION & ASSOCIATES CO.LTD.)
- (55)

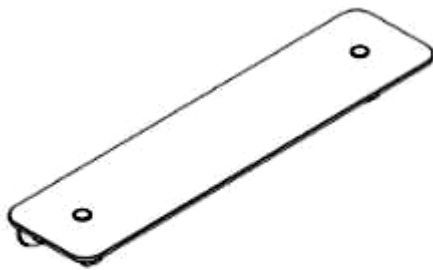

1.1

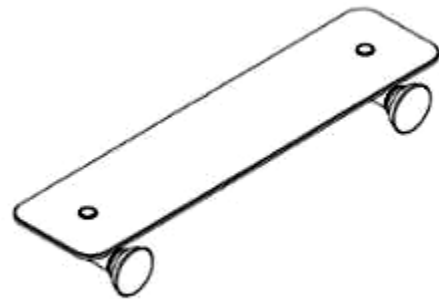

1.2



1.3



1.4



1.5



1.6



1.7

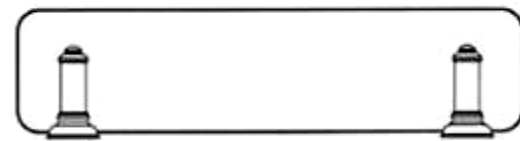

1.8

CÔNG BÁO SỞ HỮU CÔNG NGHIỆP SỐ 423 TẬP A – QUYỀN 2 (06.2023)

- (11) **47170**
(21) 3-2023-00387 (28) 1
(54) **THANG SẤY KHĂN TẮM** (51) **23-02**
(22) 28/02/2023 (43) 26/06/2023
(30) 202215141 31/08/2022 AU;
(73) **PHOENIX INDUSTRIES PTY LTD (AU)**
926 Mountain Hwy, Bayswater, Victoria, 3153, Australia
(72) Alexander Tomlinson (AU)
(74) Công ty TNHH Tầm nhìn và Liên danh (VISION & ASSOCIATES CO.LTD.)
(55)



1.1



1.2



1.3

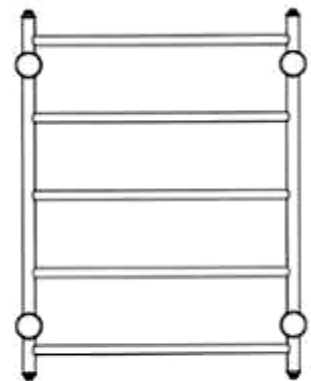

1.4



1.5



1.6



1.7



1.8

CÔNG BÁO SỞ HỮU CÔNG NGHIỆP SỐ 423 TẬP A – QUYỀN 2 (06.2023)

- (11) **47171**
(21) 3-2023-00388 (28) 1
(54) **BÁT SEN** (51) **23-02**
(22) 28/02/2023 (43) 26/06/2023
(30) 202215143 31/08/2022 AU;
(73) **PHOENIX INDUSTRIES PTY LTD (AU)**
926 Mountain Hwy, Bayswater, Victoria, 3153, Australia
(72) Alexander Tomlinson (AU)
(74) Công ty TNHH Tầm nhìn và Liên danh (VISION & ASSOCIATES CO.LTD.)
(55)



1.1



1.2

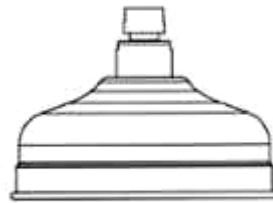

1.3

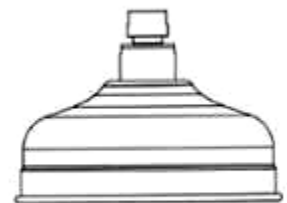

1.4

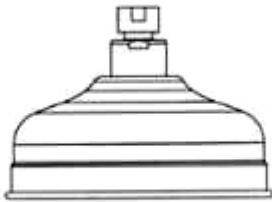

1.5

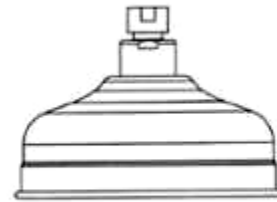

1.6

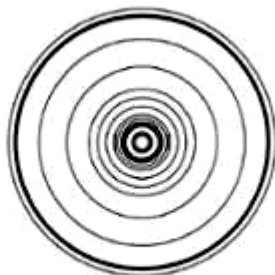

1.7

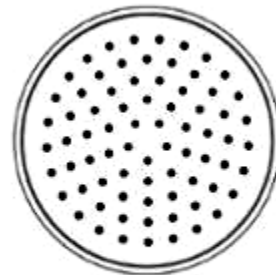

1.8

CÔNG BÁO SỞ HỮU CÔNG NGHIỆP SỐ 423 TẬP A – QUYỀN 2 (06.2023)

- (11) **47172**
(21) 3-2023-00389 (28) 1
(54) **VÒI SEN** (51) **23-02**
(22) 28/02/2023 (43) 26/06/2023
(30) 202215145 31/08/2022 AU;
(73) **PHOENIX INDUSTRIES PTY LTD (AU)**
926 Mountain Hwy, Bayswater, Victoria, 3153, Australia
(72) Alexander Tomlinson (AU)
(74) Công ty TNHH Tầm nhìn và Liên danh (VISION & ASSOCIATES CO.LTD.)
(55)



1.1

1.2

1.3

1.4

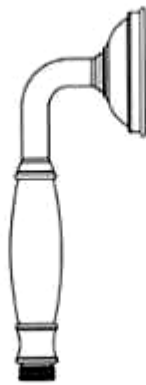

1.5

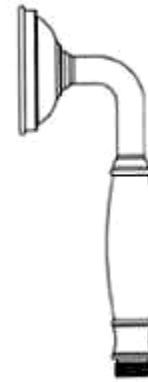

1.6



1.7



1.8

CÔNG BÁO SỞ HỮU CÔNG NGHIỆP SỐ 423 TẬP A – QUYỀN 2 (06.2023)

- (11) **47173**
(21) 3-2023-00390 (28) 1
(54) **VÒI SEN** (51) **23-02**
(22) 28/02/2023 (43) 26/06/2023
(30) 202215146 31/08/2022 AU;
(73) **PHOENIX INDUSTRIES PTY LTD (AU)**
926 Mountain Hwy, Bayswater, Victoria, 3153, Australia
(72) Alexander Tomlinson (AU)
(74) Công ty TNHH Tầm nhìn và Liên danh (VISION & ASSOCIATES CO.LTD.)
(55)



1.1



1.2



1.3



1.4



1.5



1.6



1.7



1.8

CÔNG BÁO SỞ HỮU CÔNG NGHIỆP SỐ 423 TẬP A – QUYỀN 2 (06.2023)

- (11) **47174**
(21) 3-2023-00394 (28) 1
(54) **BỘ TRỘN VÒI SEN** (51) **23-01**
(22) 28/02/2023 (43) 26/06/2023
(30) 202215195 01/09/2022 AU;
(73) **PHOENIX INDUSTRIES PTY LTD (AU)**
926 Mountain Hwy, Bayswater, Victoria, 3153, Australia
(72) Ban Hsi Liu (AU)
(74) Công ty TNHH Tâm nhìn và Liên danh (VISION & ASSOCIATES CO.LTD.)
(55)



1.1



1.2

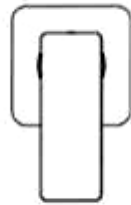

1.3



1.4



1.5



1.6



1.7



1.8

CÔNG BÁO SỞ HỮU CÔNG NGHIỆP SỐ 423 TẬP A – QUYỀN 2 (06.2023)

- (11) **47175**
(21) 3-2023-00397 (28) 1
(54) **VÒI TRỘN BỒN RỬA** (51) **23-01**
(22) 28/02/2023 (43) 26/06/2023
(30) 202215198 01/09/2022 AU;
(73) **PHOENIX INDUSTRIES PTY LTD (AU)**
926 Mountain Hwy, Bayswater, Victoria, 3153, Australia
(72) Ban Hsi Liu (AU)
(74) Công ty TNHH Tầm nhìn và Liên danh (VISION & ASSOCIATES CO.LTD.)
(55)



1.1



1.2



1.3



1.4

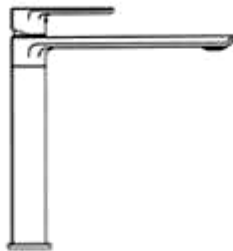

1.5

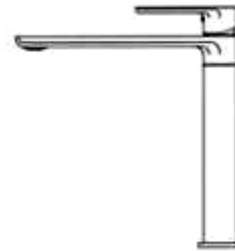

1.6



1.7



1.8

CÔNG BÁO SỞ HỮU CÔNG NGHIỆP SỐ 423 TẬP A – QUYỀN 2 (06.2023)

- (11) **47176**
(21) 3-2023-00398 (28) 1
(54) **VÒI NƯỚC GẮN TƯỜNG** (51) **23-01**
(22) 28/02/2023 (43) 26/06/2023
(30) 202215199 01/09/2022 AU;
(73) **PHOENIX INDUSTRIES PTY LTD (AU)**
926 Mountain Hwy, Bayswater, Victoria, 3153, Australia
(72) Ban Hsi Liu (AU)
(74) Công ty TNHH Tầm nhìn và Liên danh (VISION & ASSOCIATES CO.LTD.)
(55)

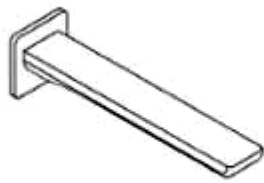

1.1



1.2



1.3



1.4



1.5



1.6



1.7



1.8

CÔNG BÁO SỞ HỮU CÔNG NGHIỆP SỐ 423 TẬP A – QUYỀN 2 (06.2023)

- (11) **47177**
(21) 3-2023-00399 (28) 2
(54) **VÒI TRỘN NƯỚC BỒN TẮM** (51) **23-01**
(22) 28/02/2023 (43) 26/06/2023
(30) 202215201 01/09/2022 AU; 202215200 01/09/2022 AU;
(73) **PHOENIX INDUSTRIES PTY LTD (AU)**
926 Mountain Hwy, Bayswater, Victoria, 3153, Australia
(72) Ban Hsi Liu (AU)
(74) Công ty TNHH Tầm nhìn và Liên danh (VISION & ASSOCIATES CO.LTD.)
(55)

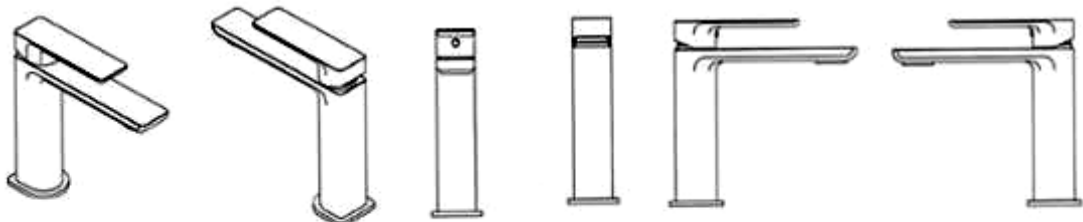

1.1

1.2

1.3

1.4

1.5

1.6



1.7



1.8

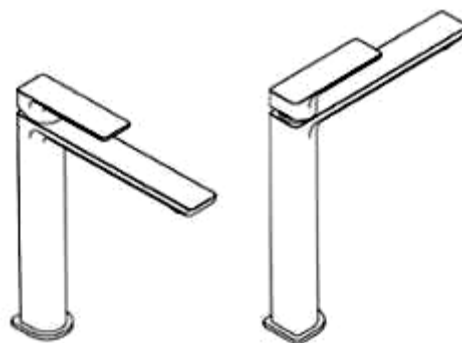

2.1

2.2

2.3

2.4

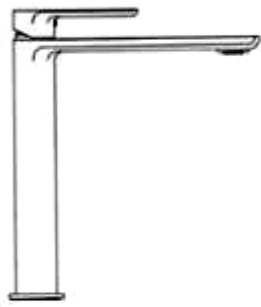

2.5

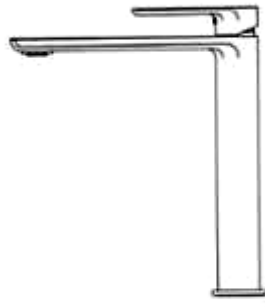

2.6



2.7



2.8

CÔNG BÁO SỞ HỮU CÔNG NGHIỆP SỐ 423 TẬP A – QUYỀN 2 (06.2023)

- (11) **47178**
(21) 3-2023-00404 (28) 1
(54) **CHAI ĐỰNG NƯỚC** (51) **09-01**
(22) 01/03/2023 (43) 26/06/2023
(73) **CÔNG TY TNHH DATAFA (VN)**
Số 474/6/4 khu phố Bình Đường 1, phường An Bình, thành phố Dĩ An, tỉnh Bình
Dương
(72) Phạm Thành Danh (VN)
(55)



1.1



1.2



1.3

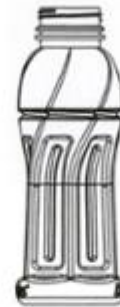

1.4



1.5



1.6



1.7

CÔNG BÁO SỞ HỮU CÔNG NGHIỆP SỐ 423 TẬP A – QUYỀN 2 (06.2023)

- (11) **47179**
(21) 3-2023-00408 (28) 1
(54) **HỘP** (51) **09-03**
(22) 01/03/2023 (43) 26/06/2023
(73) **CÔNG TY CỔ PHẦN THỰC PHẨM Á LONG (VN)**
175-177 Xô Viết Nghệ Tĩnh, phường 17, quận Bình Thạnh, thành phố Hồ Chí Minh
(72) Phạm Quang Huy (VN)
(74) Công ty TNHH Sở hữu trí tuệ Tầm Nhìn Mới (FRESHVIEW CO., LTD.)
(55)



1.1



1.2

CÔNG BÁO SỞ HỮU CÔNG NGHIỆP SỐ 423 TẬP A – QUYỀN 2 (06.2023)

- (11) **47180**
(21) 3-2023-00409 (28) 1
(54) **HỘP** (51) **09-03**
(22) 01/03/2023 (43) 26/06/2023
(73) **CÔNG TY CỔ PHẦN THỰC PHẨM Á LONG (VN)**
175-177 Xô Viết Nghệ Tĩnh, phường 17, quận Bình Thạnh, thành phố Hồ Chí Minh
(72) Phạm Quang Huy (VN)
(74) Công ty TNHH Sở hữu trí tuệ Tầm Nhìn Mới (FRESHVIEW CO., LTD.)
(55)



1.1



1.2

CÔNG BÁO SỞ HỮU CÔNG NGHIỆP SỐ 423 TẬP A – QUYỀN 2 (06.2023)

- (11) **47181**
(21) 3-2023-00410 (28) 1
(54) **HỘP** (51) **09-03**
(22) 01/03/2023 (43) 26/06/2023
(73) **CÔNG TY CỔ PHẦN THỰC PHẨM Á LONG (VN)**
175-177 Xô Viết Nghệ Tĩnh, phường 17, quận Bình Thạnh, thành phố Hồ Chí Minh
(72) Phạm Quang Huy (VN)
(74) Công ty TNHH Sở hữu trí tuệ Tầm Nhìn Mới (FRESHVIEW CO., LTD.)
(55)



1.1



1.2

CÔNG BÁO SỞ HỮU CÔNG NGHIỆP SỐ 423 TẬP A – QUYỀN 2 (06.2023)

- (11) **47182**
(21) 3-2023-00419 (28) 2
(54) **NHÃN SẢN PHẨM** (51) **19-08**
(22) 02/03/2023 (43) 26/06/2023
(73) **TỔNG CÔNG TY CỔ PHẦN BIA - RƯỢU - NƯỚC GIẢI KHÁT HÀ NỘI**
(VN)
Số 183, phố Hoàng Hoa Thám, phường Ngọc Hà, quận Ba Đình, thành phố Hà Nội
(72) Lê Minh Đức (VN)
(74) Công ty TNHH tư vấn Sở hữu trí tuệ IPFLAME (IPFLAME CO.,LTD)
(55)



1



2

(11) **47183**

(21) 3-2023-00436

(54) **THANH NHÔM ĐỊNH HÌNH**

(22) 02/03/2023

(73) **TRẦN VĂN PHI (VN)**

Lô A- A6, cụm công nghiệp Phùng, thị trấn Phùng, huyện Đan Phượng, thành phố Hà Nội

(72) Trần Văn Phi (VN)

(55)

(28) 1

(51) **25-01**

(43) 26/06/2023

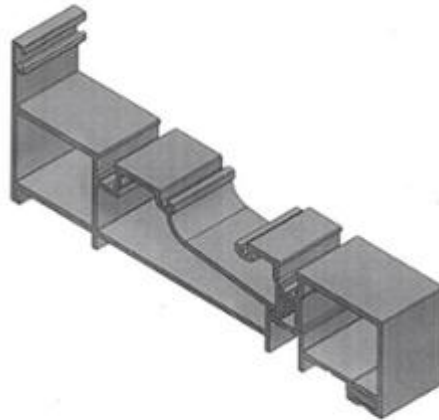

1.1



1.2

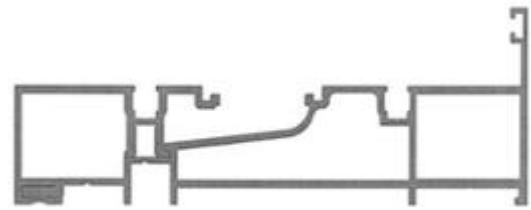

1.3



1.4



1.5



1.6



1.7

(11) **47184**

(21) 3-2023-00437

(54) **THANH NHÔM ĐỊNH HÌNH**

(22) 02/03/2023

(73) **TRẦN VĂN PHI (VN)**

Lô A- A6, cụm công nghiệp Phùng, thị trấn Phùng, huyện Đan Phượng, thành phố Hà Nội

(72) Trần Văn Phi (VN)

(55)

(28) 1

(51) **25-01**

(43) 26/06/2023



1.1

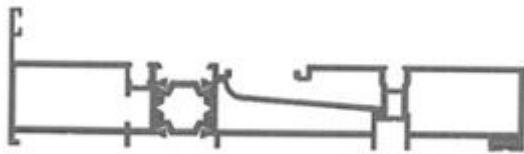

1.2

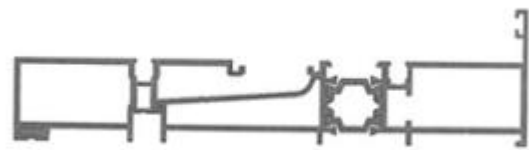

1.3



1.4



1.5



1.6



1.7

(11) **47185**

(21) 3-2023-00438

(54) **THANH NHÔM ĐỊNH HÌNH**

(22) 02/03/2023

(73) **TRẦN VĂN PHI (VN)**

Lô A- A6, cụm công nghiệp Phùng, thị trấn Phùng, huyện Đan Phượng, thành phố Hà Nội

(72) Trần Văn Phi (VN)

(55)

(28) 1

(51) **25-01**

(43) 26/06/2023



1.1

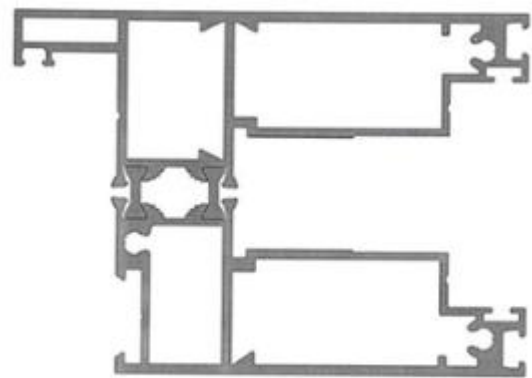

1.2

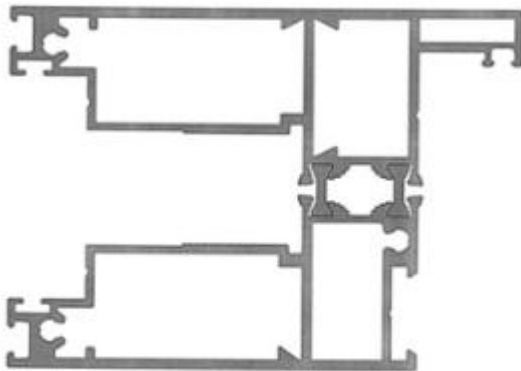

1.3



1.4



1.5



1.6



1.7

CÔNG BÁO SỞ HỮU CÔNG NGHIỆP SỐ 423 TẬP A – QUYỀN 2 (06.2023)

- (11) **47186**
(21) 3-2023-00442 (28) 1
(54) **HỘP ĐỰNG** (51) **09-03**
(22) 02/03/2023 (43) 26/06/2023
(73) **CÔNG TY TNHH NTPM (VIỆT NAM) (VN)**
Số 22 VSIP II-A, đường số 23, khu công nghiệp Việt Nam - Singapore II-A,
phường Vĩnh Tân, thị xã Tân Uyên, tỉnh Bình Dương
(72) LEE KUAN PHENG (MY)
(74) Công ty TNHH Sở hữu trí tuệ HA VIP (HAVIP CO., LTD.)
(55)



1.1



1.2

CÔNG BÁO SỞ HỮU CÔNG NGHIỆP SỐ 423 TẬP A – QUYỀN 2 (06.2023)

- (11) **47187**
(21) 3-2023-00443 (28) 1
(54) **HỘP ĐỰNG** (51) **09-03**
(22) 02/03/2023 (43) 26/06/2023
(73) **CÔNG TY TNHH NTPM (VIỆT NAM) (VN)**
Số 22 VSIP II-A, đường số 23, khu công nghiệp Việt Nam - Singapore II-A,
phường Vĩnh Tân, thị xã Tân Uyên, tỉnh Bình Dương
(72) LEE KUAN PHENG (MY)
(74) Công ty TNHH Sở hữu trí tuệ HA VIP (HAVIP CO., LTD.)
(55)



1.1



1.2

CÔNG BÁO SỞ HỮU CÔNG NGHIỆP SỐ 423 TẬP A – QUYỀN 2 (06.2023)

- (11) **47188**
(21) 3-2023-00444 (28) 1
(54) **HỘP ĐỰNG** (51) **09-03**
(22) 02/03/2023 (43) 26/06/2023
(73) **CÔNG TY TNHH NTPM (VIỆT NAM) (VN)**
Số 22 VSIP II-A, đường số 23, khu công nghiệp Việt Nam - Singapore II-A,
phường Vĩnh Tân, thị xã Tân Uyên, tỉnh Bình Dương
(72) LEE KUAN PHENG (MY)
(74) Công ty TNHH Sở hữu trí tuệ HA VIP (HAVIP CO., LTD.)
(55)



1.1



1.2

CÔNG BÁO SỞ HỮU CÔNG NGHIỆP SỐ 423 TẬP A – QUYỀN 2 (06.2023)

- (11) **47189**
(21) 3-2023-00445 (28) 1
(54) **HỘP ĐỰNG** (51) **09-03**
(22) 02/03/2023 (43) 26/06/2023
(73) **CÔNG TY TNHH NTPM (VIỆT NAM) (VN)**
Số 22 VSIP II-A, đường số 23, khu công nghiệp Việt Nam - Singapore II-A,
phường Vĩnh Tân, thị xã Tân Uyên, tỉnh Bình Dương
(72) LEE KUAN PHENG (MY)
(74) Công ty TNHH Sở hữu trí tuệ HA VIP (HAVIP CO., LTD.)
(55)



1.1

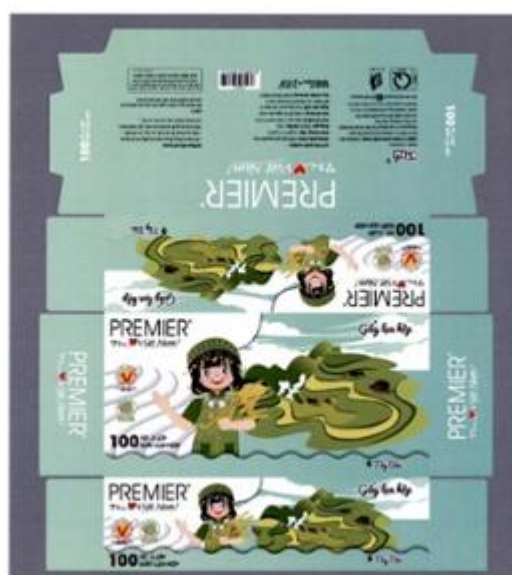

1.2

CÔNG BÁO SỞ HỮU CÔNG NGHIỆP SỐ 423 TẬP A – QUYỀN 2 (06.2023)

- (11) **47190**
(21) 3-2023-00446 (28) 1
(54) **HỘP ĐỰNG** (51) **09-03**
(22) 02/03/2023 (43) 26/06/2023
(73) **CÔNG TY TNHH NTPM (VIỆT NAM) (VN)**
Số 22 VSIP II-A, đường số 23, khu công nghiệp Việt Nam - Singapore II-A,
phường Vĩnh Tân, thị xã Tân Uyên, tỉnh Bình Dương
(72) LEE KUAN PHENG (MY)
(74) Công ty TNHH Sở hữu trí tuệ HA VIP (HAVIP CO., LTD.)
(55)



1.1



1.2

CÔNG BÁO SỞ HỮU CÔNG NGHIỆP SỐ 423 TẬP A – QUYỀN 2 (06.2023)

- (11) **47191**
(21) 3-2023-00464 (28) 3
(54) **NHÃN SẢN PHẨM** (51) **19-08**
(22) 06/03/2023 (43) 26/06/2023
(73) **CÔNG TY CỔ PHẦN SỮA VIỆT NAM (VINAMILK) (VN)**
Số 10 đường Tân Trào, phường Tân Phú, quận 7, thành phố Hồ Chí Minh
(72) Schaberg Lennart Cornelius (DE)
(74) Công ty Luật TNHH WINCO (WINCO LAW FIRM)
(55)



1



2



3

CÔNG BÁO SỞ HỮU CÔNG NGHIỆP SỐ 423 TẬP A – QUYỀN 2 (06.2023)

- (11) **47192**
(21) 3-2023-00467 (28) 1
(54) **BAO BÌ SẢN PHẨM** (51) **09-05**
(22) 06/03/2023 (43) 26/06/2023
(73) **CÔNG TY TNHH FUSION GROUP (VN)**
Lô L1-06B, lô L1-07B, lô L1-08B khu du lịch sinh thái cao cấp An Khánh, xã An Khánh, huyện Hoài Đức, thành phố Hà Nội
(72) CHO YOUNGJUN (KR)
(55)



1.1



1.2



1.3



1.4



1.5



1.6



1.7

CÔNG BÁO SỞ HỮU CÔNG NGHIỆP SỐ 423 TẬP A – QUYỀN 2 (06.2023)

- (11) **47193**
- (21) 3-2023-00468 (28) 1
- (54) **NHÃN SẢN PHẨM** (51) **19-08**
- (22) 06/03/2023 (43) 26/06/2023
- (73) **CÔNG TY TNHH LAN VIỆT ORCHIDS (VN)**
50 Lê Thánh Tôn, phường Bến Nghé, quận 1, thành phố Hồ Chí Minh
- (72) Đào Minh Hạnh (VN)
- (74) **CÔNG TY TNHH SỞ HỮU TRÍ TUỆ SETHACO (SETHACO IP CO.,LTD)**
- (55)



CÔNG BÁO SỞ HỮU CÔNG NGHIỆP SỐ 423 TẬP A – QUYỀN 2 (06.2023)

- (11) **47194**
(21) 3-2023-00492 (28) 2
(54) **BAO GÓI** (51) **09-05**
(22) 08/03/2023 (43) 26/06/2023
(73) **CÔNG TY CỔ PHẦN ACECOOK VIỆT NAM (VN)**
Lô số II-3, đường số 11, nhóm CN II, khu công nghiệp Tân Bình, phường Tây
Thạnh, quận Tân Phú, Thành phố Hồ Chí Minh
(72) Kajiwara Junichi (JP)
(74) Công ty Luật TNHH Phạm và Liên danh (PHAM & ASSOCIATES)
(55)



1.1



1.2



2.1



2.2

CÔNG BÁO SỞ HỮU CÔNG NGHIỆP SỐ 423 TẬP A – QUYỀN 2 (06.2023)

- (11) **47195**
- (21) 3-2023-00493
- (54) **THÙNG MÌ**
- (22) 08/03/2023
- (73) **CÔNG TY CỔ PHẦN ACECOOK VIỆT NAM (VN)**
Lô số II-3, đường số 11, nhóm CN II, khu công nghiệp Tân Bình, phường Tây Thạnh, quận Tân Phú, thành phố Hồ Chí Minh
- (72) Kajiwara Junichi (JP)
- (74) Công ty Luật TNHH Phạm và Liên danh (PHAM & ASSOCIATES)
- (55)



1.1



1.2



2.1



2.2

CÔNG BÁO SỞ HỮU CÔNG NGHIỆP SỐ 423 TẬP A – QUYỀN 2 (06.2023)

- (11) **47196**
(21) 3-2023-00509 (28) 1
(54) **HỘP** (51) **09-03**
(22) 09/03/2023 (43) 26/06/2023
(73) **DAMTUH F&B CO., LTD (KR)**
12, Bangbae-ro 35-gil, Seocho-gu, Seoul, Republic of Korea
(72) JANG, Se Kun (KR)
(74) Công ty TNHH Tầm nhìn và Liên danh (VISION & ASSOCIATES CO.LTD.)
(55)



1.1

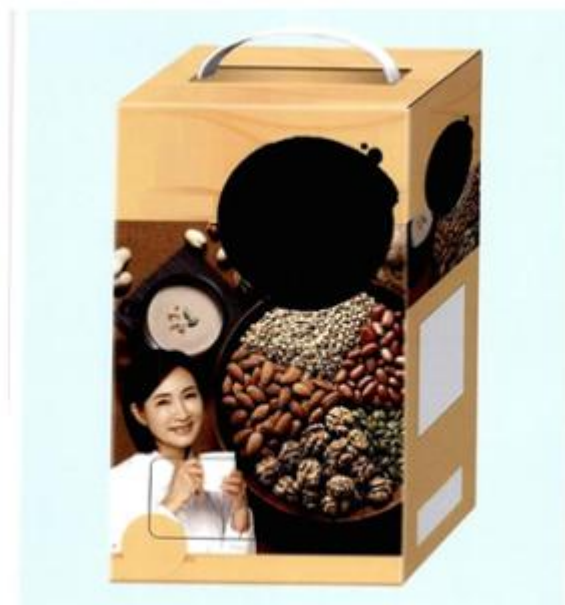

1.2

CÔNG BÁO SỞ HỮU CÔNG NGHIỆP SỐ 423 TẬP A – QUYỀN 2 (06.2023)

- (11) **47197**
(21) 3-2023-00526 (28) 1
(54) **THIẾT BỊ ỔN ĐỊNH NHIỆT ĐỘ VÀ ĐỘ ẨM** (51) **10-05**
(22) 10/03/2023 (43) 26/06/2023
(73) **U-CAN DYNATEX INC. (TW)**
NO.26, Houkou S. Rd., Houli Township, Central Taiwan Science Park, Taichung
City 42152 Taiwan
(72) Huang-Feng Tsun (TW)
(74) Công ty Cổ phần Sở hữu công nghiệp INVESTIP (INVESTIP)
(55)

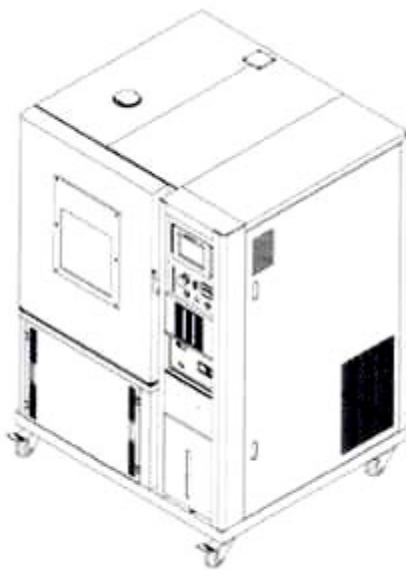

1.1

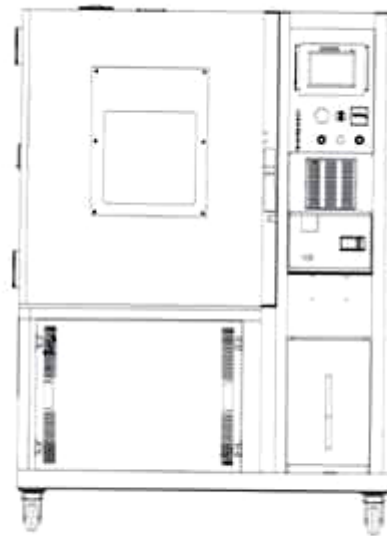

1.2

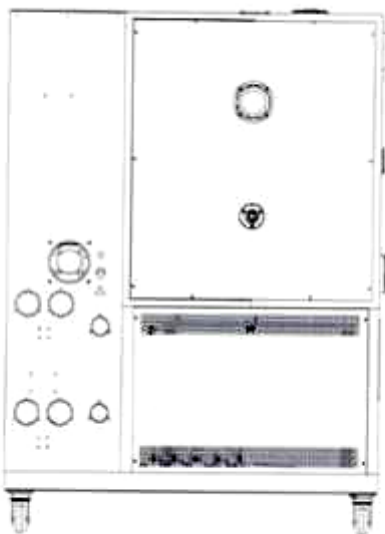

1.3

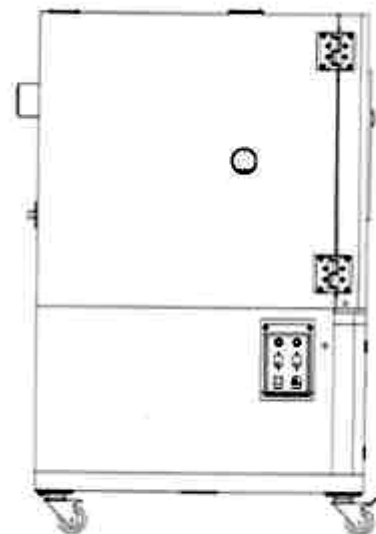

1.4

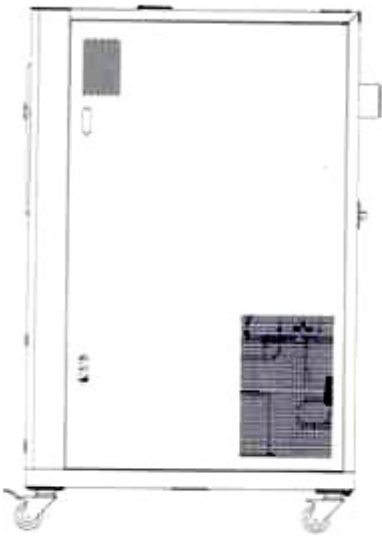

1.5

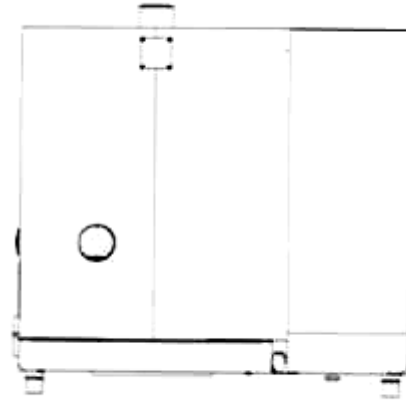

1.6

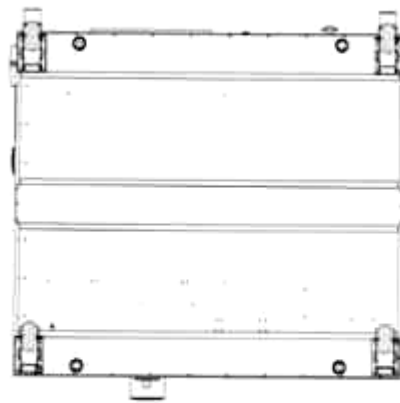

1.7

CÔNG BÁO SỞ HỮU CÔNG NGHIỆP SỐ 423 TẬP A – QUYỀN 2 (06.2023)

- (11) **47198**
(21) 3-2023-00527 (28) 1
(54) **THIẾT BỊ THỬ NGHIỆM KHẢ NĂNG CHỐNG OZON** (51) **10-05**
(22) 10/03/2023 (43) 26/06/2023
(73) **U-CAN DYNATEX INC. (TW)**
NO.26, Houkou S. Rd., Houli Township, Central Taiwan Science Park, Taichung
City 42152 Taiwan
(72) Huang-Feng Tsun (TW)
(74) Công ty Cổ phần Sở hữu công nghiệp INVESTIP (INVESTIP)
(55)

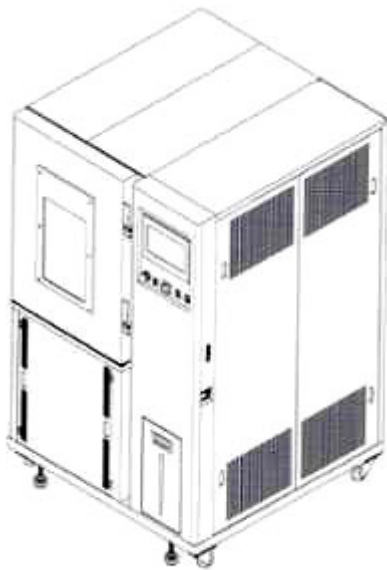

1.1



1.2

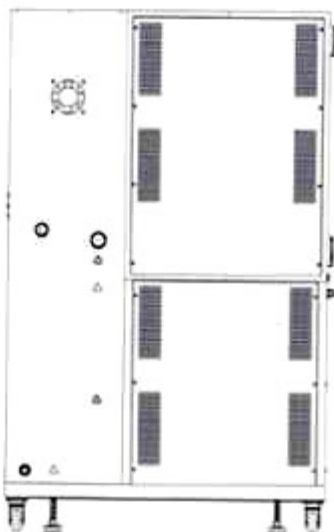

1.3

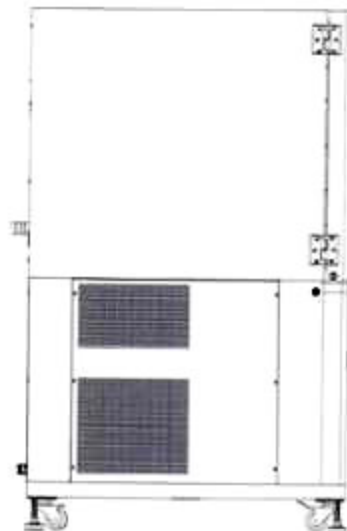

1.4

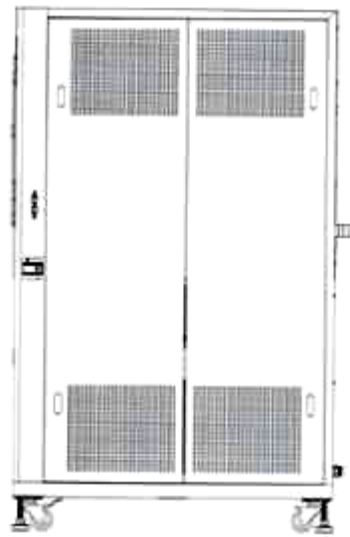

1.5

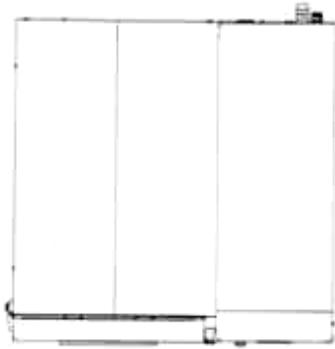

1.6

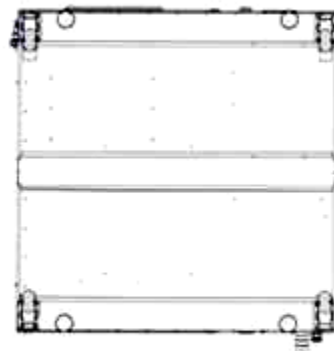

1.7

CÔNG BÁO SỞ HỮU CÔNG NGHIỆP SỐ 423 TẬP A – QUYỀN 2 (06.2023)

- (11) **47199**
(21) 3-2023-00528 (28) 1
(54) **BAO GÓI** (51) **09-05**
(22) 10/03/2023 (43) 26/06/2023
(73) **CÔNG TY TNHH BẢO VỆ THỰC VẬT SOVIFARM (VN)**
Số nhà 1A, ngõ 138 phố Hạ Đình, phường Thanh Xuân Trung, quận Thanh Xuân,
thành phố Hà Nội
(72) Hoàng Văn Thường (VN)
(74) Công ty TNHH Sở hữu trí tuệ INNETCO-Hoàng Phúc (INNETCO CO., LTD)
(55)



1.1

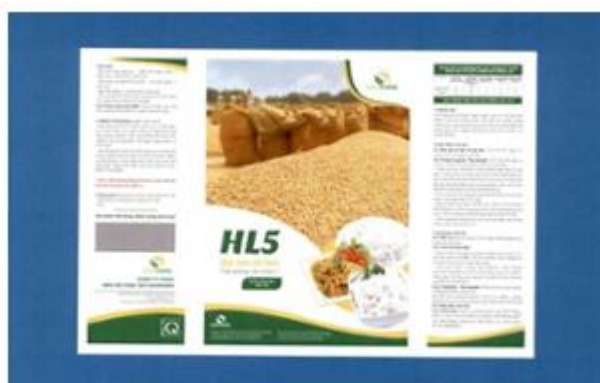

1.2

CÔNG BÁO SỞ HỮU CÔNG NGHIỆP SỐ 423 TẬP A – QUYỀN 2 (06.2023)

- (11) **47200**
(21) 3-2023-00530 (28) 1
(54) **MÔ ĐUN PHUN** (51) **22-06**
(22) 10/03/2023 (43) 26/06/2023
(73) **CÔNG TY TNHH LEON LEGION (VN)**
269 đường Liên Phường, phường Phước Long B, thành phố Thủ Đức, thành phố Hồ Chí Minh
(72) Hoàng Xuân Thành (VN)
(74) Công ty TNHH Tư vấn đầu tư và Sở hữu trí tuệ Hoàng Phi (HOANG PHI INVEST & I.P CO., LTD)
(55)



1.1



1.2



1.3



1.4



1.5



1.6



1.7

- (11) **47201**
(21) 3-2023-00532 (28) 1
(54) **THIẾT BỊ TÁCH KHÍ OXY THÔNG MINH** (51) **15-99; 23-01**
(22) 10/03/2023 (43) 26/06/2023
(73) **CÔNG TY CỔ PHẦN RYNAN TECHNOLOGIES VIETNAM (VN)**
Ấp Long Trị, xã Long Đức, thành phố Trà Vinh, tỉnh Trà Vinh
(72) 1. NGUYỄN THANH MỸ (VN)
2. TRẦN QUỐC TOẢN (VN)
3. VÕ VŨ KHANH (VN)
4. VÕ QUỐC VIỆT (VN)
(74) Công ty TNHH Đại Tín và Liên Danh (DAITIN AND ASSOCIATES CO.,LTD)
(55)

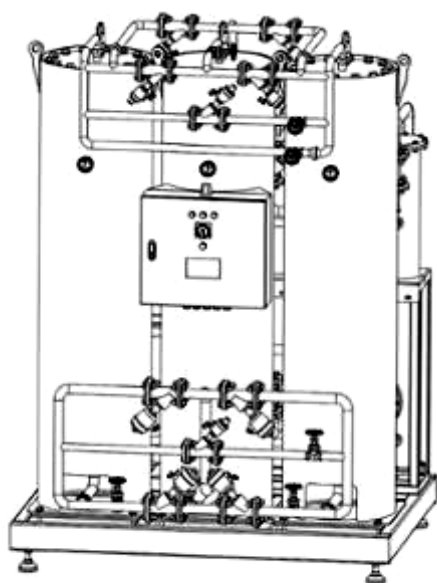

1.1

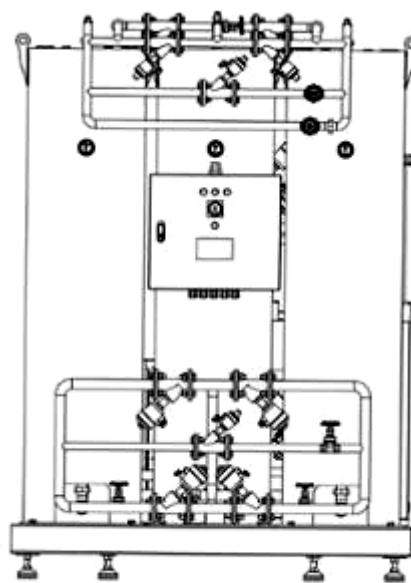

1.2

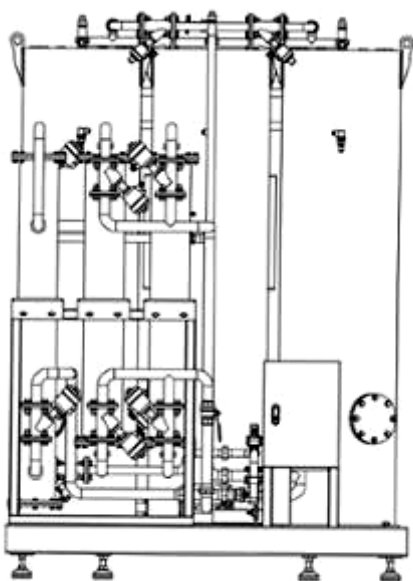

1.3

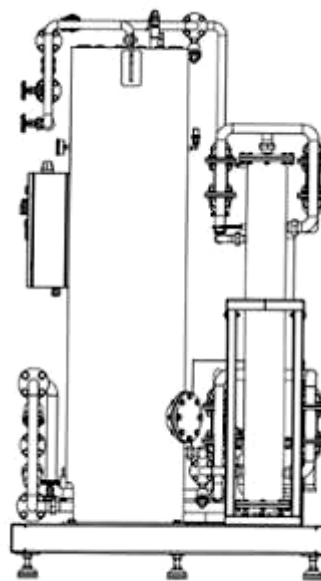

1.4

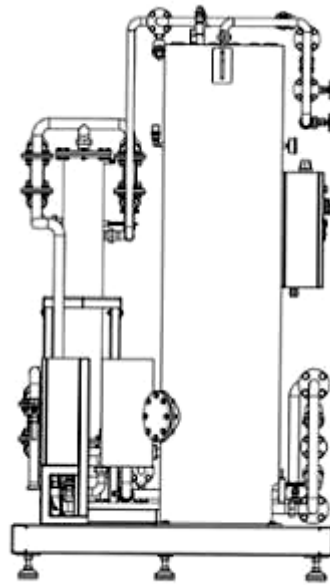

1.5

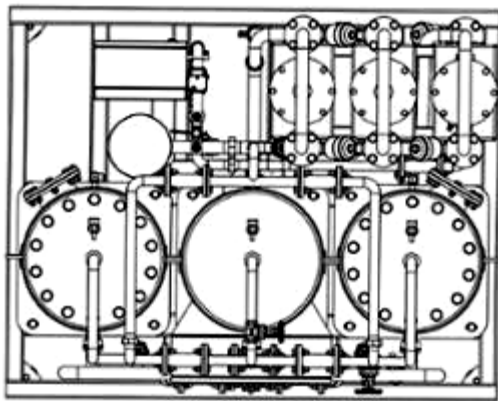

1.6

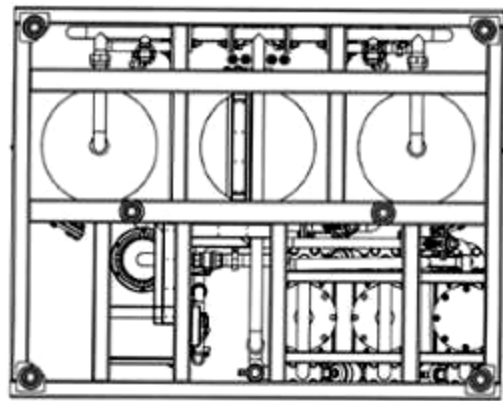

1.7

CÔNG BÁO SỞ HỮU CÔNG NGHIỆP SỐ 423 TẬP A – QUYỀN 2 (06.2023)

- (11) **47202**
- (21) 3-2023-00533 (28) 1
- (54) **NHÃN SẢN PHẨM** (51) **19-08**
- (22) 13/03/2023 (43) 26/06/2023
- (73) **ĐÀO VIỆT HUY (VN)**
Số 12 ngách 175 ngõ Thịnh Quang, phường Thịnh Quang, quận Đống Đa, thành phố Hà Nội
- (72) Đào Việt Huy (VN)
- (55)



CÔNG BÁO SỞ HỮU CÔNG NGHIỆP SỐ 423 TẬP A – QUYỀN 2 (06.2023)

- (11) **47203**
- (21) 3-2023-00534 (28) 1
- (54) **THIẾT BỊ TRUYỀN THANH THÔNG MINH** (51) **14-03**
- (22) 13/03/2023 (43) 26/06/2023
- (73) **CÔNG TY CỔ PHẦN SMATEC (VN)**
TT17 - B24, khu đô thị Văn Quán - Yên Phúc, phường Phúc La, quận Hà Đông,
thành phố Hà Nội
- (72) 1. NGUYỄN HỒNG SƠN (VN)
2. LÊ BÌNH DẪN (VN)
- (55)

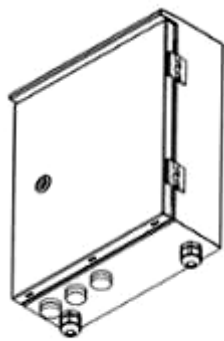

1.1



1.2

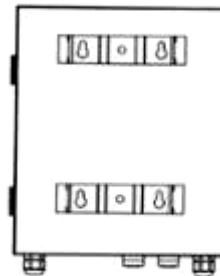

1.3



1.4



1.5



1.6



1.7

CÔNG BÁO SỞ HỮU CÔNG NGHIỆP SỐ 423 TẬP A – QUYỀN 2 (06.2023)

- (11) **47204**
(21) 3-2023-00546 (28) 1
(54) **HỘP** (51) **09-03**
(22) 14/03/2023 (43) 26/06/2023
(73) **HỢP TÁC XÃ SẢN XUẤT VÀ THƯƠNG MẠI XỨ TUYỀN (VN)**
Tổ 2, phường Mỹ Lâm, thành phố Tuyên Quang, tỉnh Tuyên Quang
(72) Nguyễn Thị Thủy (VN)
(74) Công ty TNHH Sở hữu trí tuệ INVENTIO (INVENTIO CO.,LTD)
(55)



1.1



1.2

CÔNG BÁO SỞ HỮU CÔNG NGHIỆP SỐ 423 TẬP A – QUYỀN 2 (06.2023)

- (11) **47205**
(21) 3-2023-00547 (28) 2
(54) **BỘ NHÃN SẢN PHẨM** (51) **19-08**
(22) 14/03/2023 (43) 26/06/2023
(73) **HỢP TÁC XÃ SẢN XUẤT VÀ THƯƠNG MẠI XỨ TUYÊN (VN)**
Tổ 2, phường Mỹ Lâm, thành phố Tuyên Quang, tỉnh Tuyên Quang
(72) Nguyễn Thị Thủy (VN)
(74) Công ty TNHH Sở hữu trí tuệ INVENTIO (INVENTIO CO.,LTD)
(55)



1.1



2.1



3.1

CÔNG BÁO SỞ HỮU CÔNG NGHIỆP SỐ 423 TẬP A – QUYỀN 2 (06.2023)

- (11) **47206**
(21) 3-2023-00556 (28) 1
(54) **THIẾT BỊ TÁCH KHÍ OXY THÔNG MINH** (51) **15-99; 23-01**
(22) 15/03/2023 (43) 26/06/2023
(73) **CÔNG TY CỔ PHẦN RYNAN TECHNOLOGIES VIETNAM (VN)**
Áp Long Trị, xã Long Đức, thành phố Trà Vinh, tỉnh Trà Vinh
(72) 1. NGUYỄN THANH MỸ (VN)
2. HUỖNH LÊ NHỰT HÀO (VN)
3. TRẦN QUỐC TOẢN (VN)
4. VÕ VŨ KHANH (VN)
5. VÕ QUỐC VIỆT (VN)
(74) Công ty TNHH Đại Tín và Liên Danh (DAITIN AND ASSOCIATES CO.,LTD)
(55)

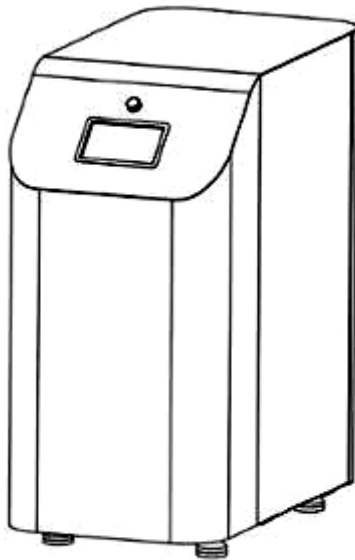

1.1

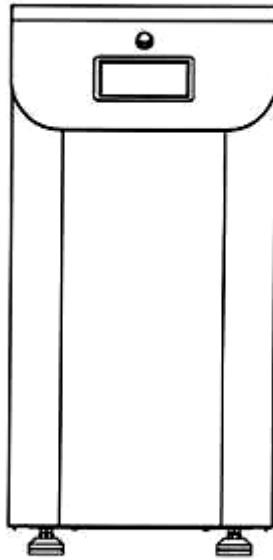

1.2

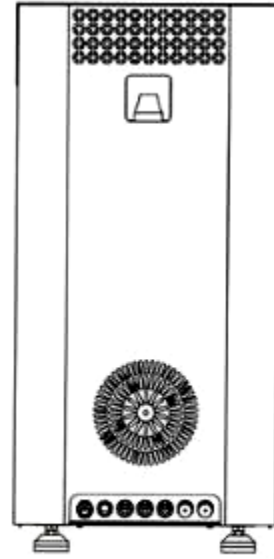

1.3

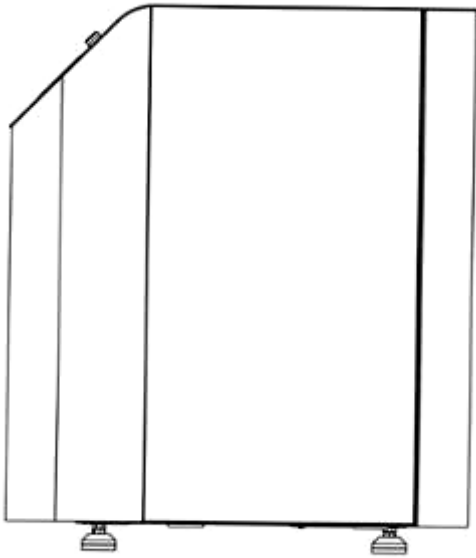

1.4

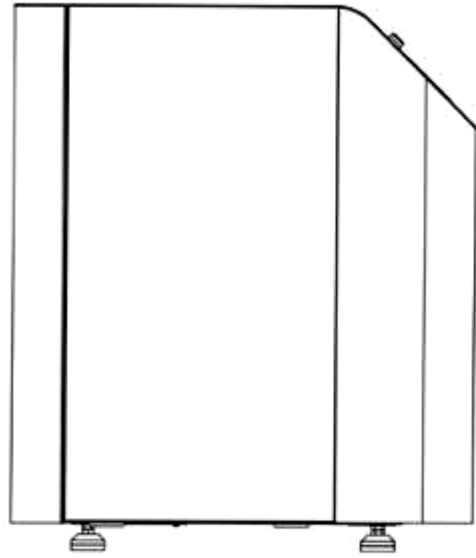

1.5

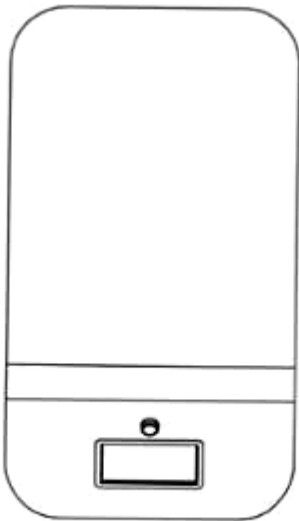

1.6

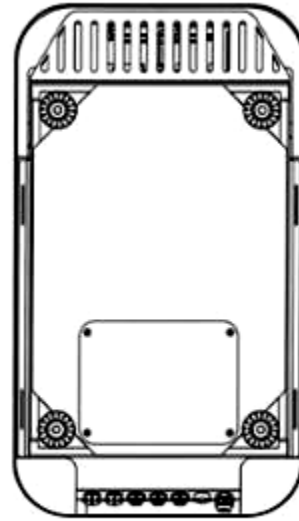

1.7

CÔNG BÁO SỞ HỮU CÔNG NGHIỆP SỐ 423 TẬP A – QUYỀN 2 (06.2023)

- (11) **47207**
(21) 3-2023-00566 (28) 1
(54) **MICRÔ HỘI THẢO** (51) **14-01**
(22) 17/03/2023 (43) 26/06/2023
(73) **CÔNG TY TNHH CÔNG NGHỆ HAN (VN)**
Số 5, ngõ 444 Thụy Khuê, phường Bưởi, quận Tây Hồ, thành phố Hà Nội
(72) 1. HOÀNG ANH (VN)
2. ĐẶNG THỊ HIỀN (VN)
(74) **CÔNG TY LUẬT TRÁCH NHIỆM HỮU HẠN AMBYS HÀ NỘI (AMBYS HANOI)**
(55)



1.1



1.2



1.3



1.4



1.5



1.6



1.7



1.8



1.9



1.10

- (11) **47208**
(21) 3-2023-00568 (28) 1
(54) **TẮM CHE ĐUÔI GIÓ MŨ BẢO HIỂM** (51) **02-03**
(22) 17/03/2023 (43) 26/06/2023
(73) **HENRY TEDJAKUSUMA (ID)**
Jalan Wuluh Blok II/3, RT/RW 009/006, Kota Bambu Utara, Palmerah Jakarta Barat 11420, Indonesia
(72) Henry Tedjakusuma (ID)
(74) Công ty TNHH Sở hữu trí tuệ HA VIP (HAVIP CO., LTD.)
(55)



1.1

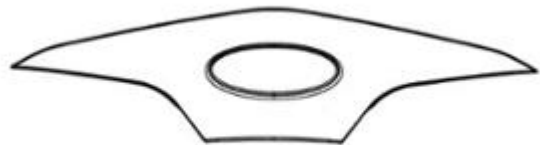

1.2



1.3



1.4

1.5



1.6



1.7

- (11) **47209**
(21) 3-2023-00569 (28) 1
(54) **PHẦN MỞ RỘNG CỦA ĐUÔI GIÓ MŨ BẢO HIỂM** (51) **02-03**
(22) 17/03/2023 (43) 26/06/2023
(73) **HENRY TEDJAKUSUMA (ID)**
Jalan Wuluh Blok II/3, RT/RW 009/006, Kota Bambu Utara, Palmerah Jakarta Barat 11420, Indonesia
(72) Henry Tedjakusuma (ID)
(74) Công ty TNHH Sở hữu trí tuệ HA VIP (HAVIP CO., LTD.)
(55)



1.1

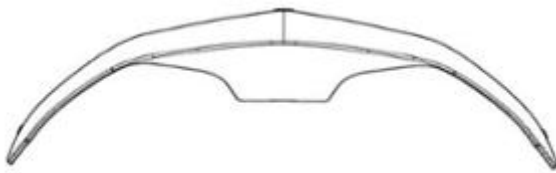

1.2



1.3



1.4



1.5

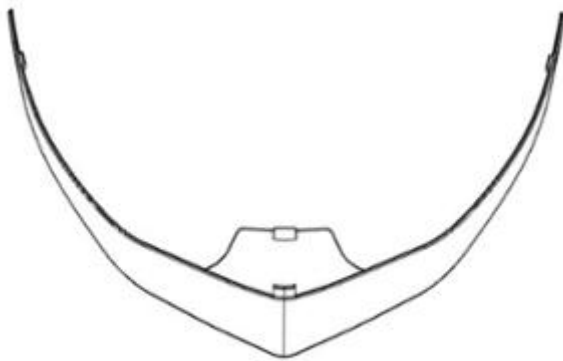

1.6



1.7

(11) **47210**

(21) 3-2023-00570

(28) 1

(54) **ĐUÔI GIÓ MŨ BẢO HIỂM**

(51) **02-03**

(22) 17/03/2023

(43) 26/06/2023

(73) **HENRY TEDJAKUSUMA (ID)**

Jalan Wuluh Blok II/3, RT/RW 009/006, Kota Bambu Utara, Palmerah Jakarta Barat 11420, Indonesia

(72) Henry Tedjakusuma (ID)

(74) Công ty TNHH Sở hữu trí tuệ HA VIP (HAVIP CO., LTD.)

(55)

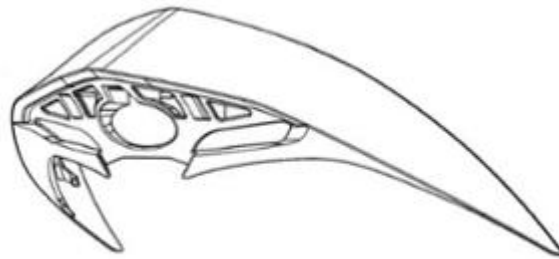

1.1

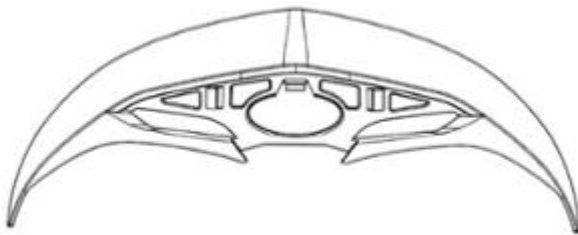

1.2

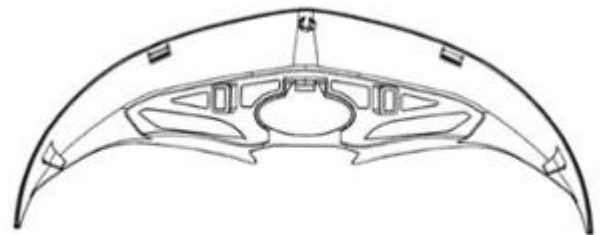

1.3

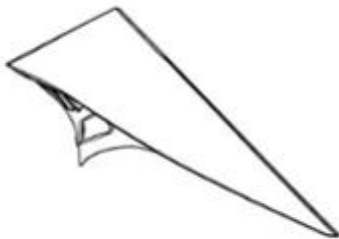

1.4

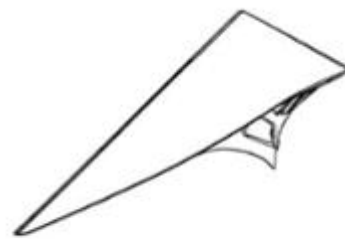

1.5



1.6

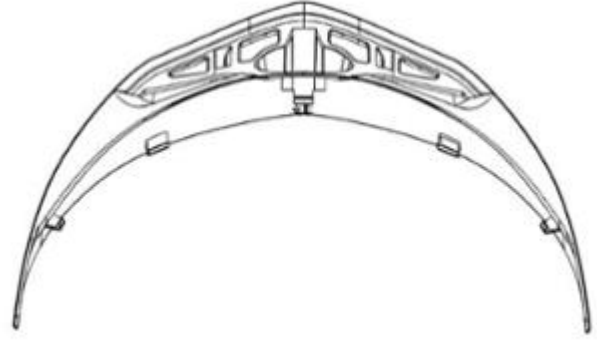

1.7

CÔNG BÁO SỞ HỮU CÔNG NGHIỆP SỐ 423 TẬP A – QUYỀN 2 (06.2023)

- (11) 47211
(21) 3-2023-00572 (28) 1
(54) **NHÃN SẢN PHẨM** (51) 19-08
(22) 20/03/2023 (43) 26/06/2023
(73) **HỢP TÁC XÃ SẢN XUẤT VÀ TIÊU THỤ MỠ CHỮ SỐ 1 (VN)**
Thôn Thủ Dương, xã Nam Dương, huyện Lục Ngạn, tỉnh Bắc Giang
(72) Nguyễn Văn Tuyền (VN)
(55)

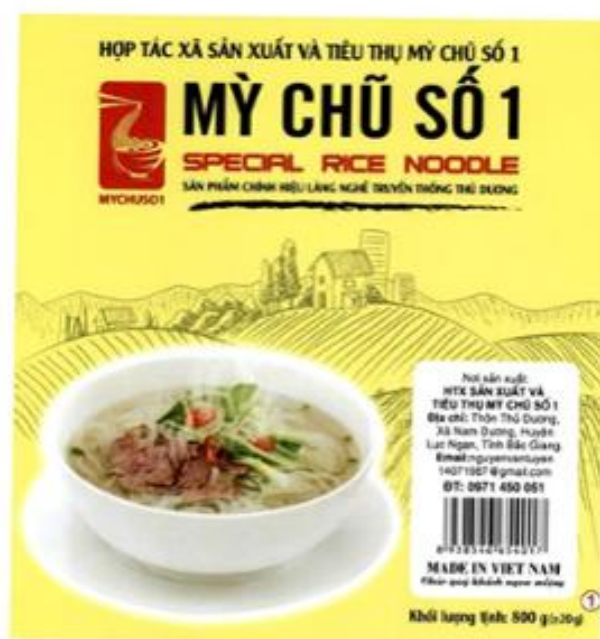

CÔNG BÁO SỞ HỮU CÔNG NGHIỆP SỐ 423 TẬP A – QUYỀN 2 (06.2023)

- (11) **47212**
(21) 3-2023-00574 (28) 1
(54) **NHÃN SẢN PHẨM** (51) **19-08**
(22) 20/03/2023 (43) 26/06/2023
(73) **HỢP TÁC XÃ NÔNG LÂM NGHIỆP 369 (VN)**
Thôn 1, xã Kim Phú, thành phố Tuyên Quang, tỉnh Tuyên Quang
(72) Nguyễn Thị Thu Dung (VN)
(74) Công ty TNHH Sở hữu trí tuệ INVENTIO (INVENTIO CO.,LTD)
(55)



1.1



1.2

CÔNG BÁO SỞ HỮU CÔNG NGHIỆP SỐ 423 TẬP A – QUYỀN 2 (06.2023)

- (11) **47213**
(21) 3-2023-00575 (28) 1
(54) **NHÃN SẢN PHẨM** (51) **19-08**
(22) 20/03/2023 (43) 26/06/2023
(73) **HỢP TÁC XÃ NÔNG LÂM NGHIỆP 369 (VN)**
Thôn 1, xã Kim Phú, thành phố Tuyên Quang, tỉnh Tuyên Quang
(72) Nguyễn Thị Thu Dung (VN)
(74) Công ty TNHH Sở hữu trí tuệ INVENTIO (INVENTIO CO.,LTD)
(55)



1.1



1.2

CÔNG BÁO SỞ HỮU CÔNG NGHIỆP SỐ 423 TẬP A – QUYỀN 2 (06.2023)

- (11) **47214**
(21) 3-2023-00577 (28) 1
(54) **TÚI ĐỰNG TRÀ** (51) **09-05**
(22) 20/03/2023 (43) 26/06/2023
(73) **HỢP TÁC XÃ HƯƠNG THÀNH PHÚ (VN)**
Tổ 11, phường Túc Duyên, thành phố Thái Nguyên, tỉnh Thái Nguyên
(72) Phạm Thị Thu Hương (VN)
(74) Công ty TNHH Sở hữu trí tuệ INNETCO-Hoàng Phúc (INNETCO CO., LTD)
(55)



1.1



1.2

CÔNG BÁO SỞ HỮU CÔNG NGHIỆP SỐ 423 TẬP A – QUYỀN 2 (06.2023)

- (11) **47215**
(21) 3-2023-00601 (28) 1
(54) **NHÃN SẢN PHẨM** (51) **19-08**
(22) 21/03/2023 (43) 26/06/2023
(73) **CÔNG TY CỔ PHẦN XUẤT NHẬP KHẨU LDR (VN)**
Số 273 đường Phan Đình Giót, đội 4, tổ dân phố 4, phường La Khê, quận Hà Đông,
thành phố Hà Nội
(72) Lê Anh Tuấn (VN)
(74) Công ty TNHH IPCOM Việt Nam (IPCOM CO., LTD.)
(55)

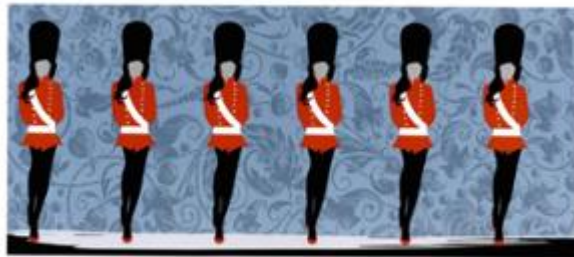

1.1



1.2

CÔNG BÁO SỞ HỮU CÔNG NGHIỆP SỐ 423 TẬP A – QUYỀN 2 (06.2023)

- (11) **47216**
(21) 3-2023-00603 (28) 1
(54) **BÓNG ĐÈN** (51) **26-04**
(22) 22/03/2023 (43) 26/06/2023
(73) **CÔNG TY CỔ PHẦN BÓNG ĐÈN PHÍCH NƯỚC RẠNG ĐÔNG (VN)**
87-89 phố Hạ Đình, phường Thanh Xuân Trung, quận Thanh Xuân, thành phố Hà Nội
(72) Trần Trung Tường (VN)
(55)

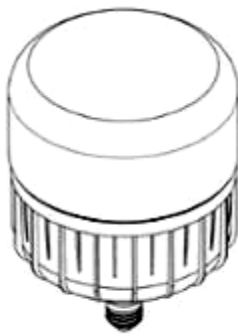

1.1

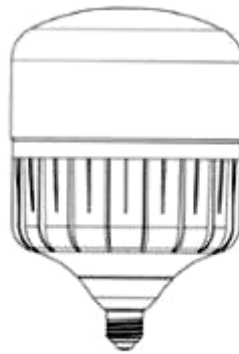

1.2

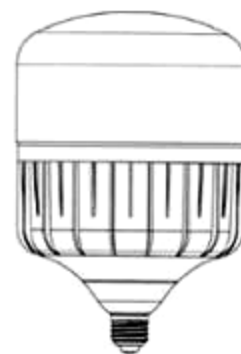

1.3

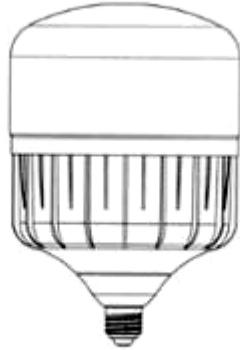

1.4

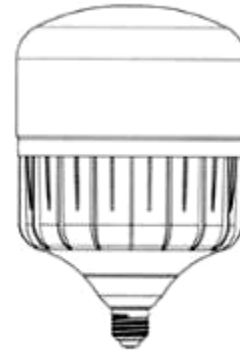

1.5

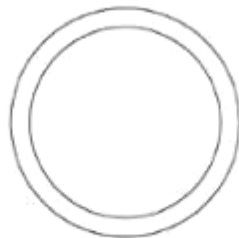

1.6

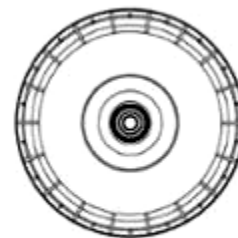

1.7

CÔNG BÁO SỞ HỮU CÔNG NGHIỆP SỐ 423 TẬP A – QUYỀN 2 (06.2023)

- (11) **47217**
(21) 3-2023-00604 (28) 1
(54) **ĐÈN** (51) **26-05**
(22) 22/03/2023 (43) 26/06/2023
(73) **CÔNG TY CỔ PHẦN BÓNG ĐÈN PHÍCH NƯỚC RẠNG ĐÔNG (VN)**
87-89 phố Hạ Đình, phường Thanh Xuân Trung, quận Thanh Xuân, thành phố Hà Nội
(72) Trần Trung Tường (VN)
(55)

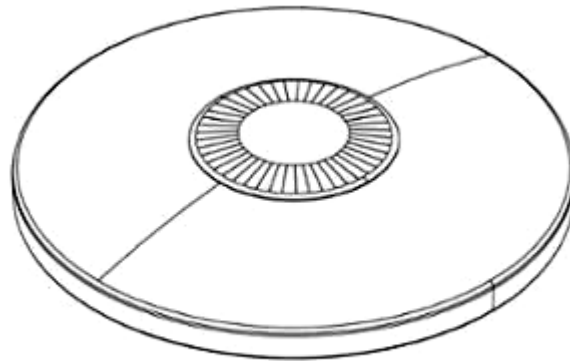

1.1

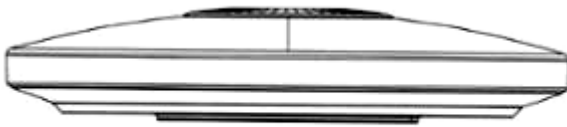

1.2

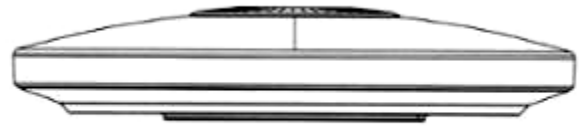

1.3



1.4



1.5

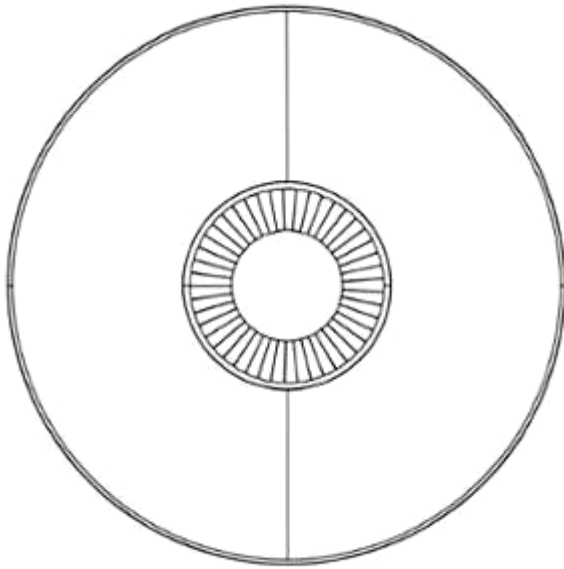

1.6

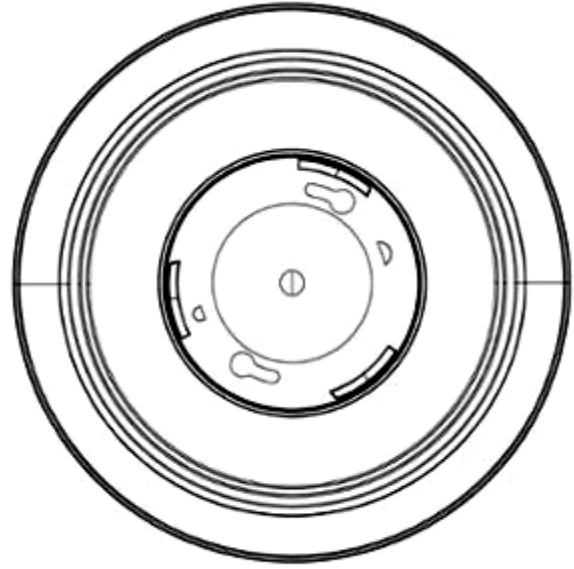

1.7

CÔNG BÁO SỞ HỮU CÔNG NGHIỆP SỐ 423 TẬP A – QUYỀN 2 (06.2023)

- (11) **47218**
(21) 3-2023-00605 (28) 2
(54) **ĐÈN** (51) **26-05**
(22) 22/03/2023 (43) 26/06/2023
(73) **CÔNG TY CỔ PHẦN BÓNG ĐÈN PHÍCH NƯỚC RẠNG ĐÔNG (VN)**
87-89 phố Hạ Đình, phường Thanh Xuân Trung, quận Thanh Xuân, thành phố Hà Nội
(72) Trần Trung Tường (VN)
(55)



1.1

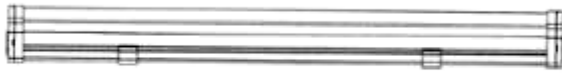

1.2

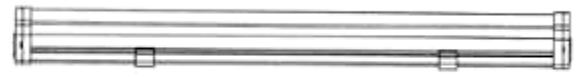

1.3



1.4



1.5



1.6



1.7

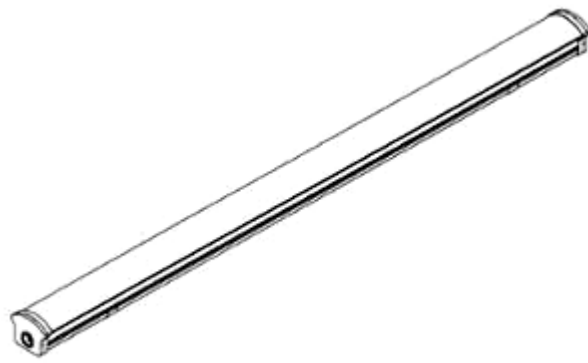

2.1



2.2



2.3



2.4



2.5



2.6



2.7

CÔNG BÁO SỞ HỮU CÔNG NGHIỆP SỐ 423 TẬP A – QUYỀN 2 (06.2023)

(11) **47219**

(21) 3-2023-00606

(28) 1

(54) **ĐÈN ÓP TRẦN**

(51) **26-05**

(22) 22/03/2023

(43) 26/06/2023

(73) **CÔNG TY CỔ PHẦN BÓNG ĐÈN PHÍCH NƯỚC RẠNG ĐÔNG (VN)**

87-89 phố Hạ Đình, phường Thanh Xuân Trung, quận Thanh Xuân, thành phố Hà Nội

(72) Trần Trung Tường (VN)

(55)

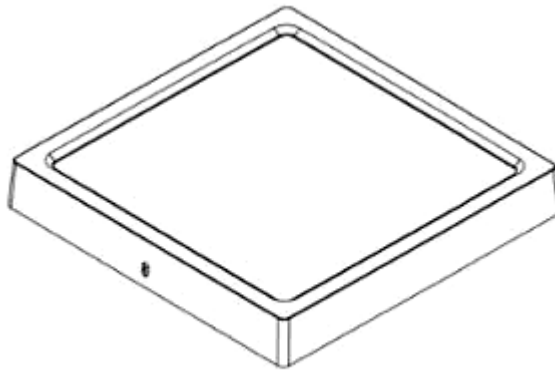

1.1



1.2

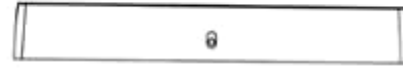

1.3



1.4



1.5



1.6

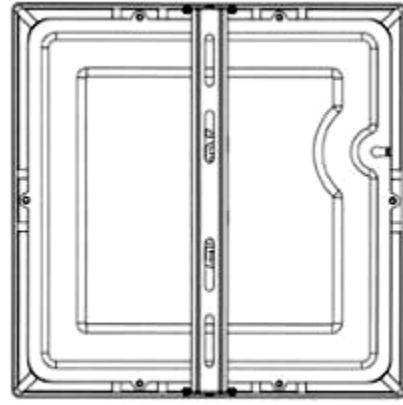

1.7

(11) **47220**

(21) 3-2023-00607

(28) 1

(54) **ĐÈN ÓP TRẦN**

(51) **26-05**

(22) 22/03/2023

(43) 26/06/2023

(73) **CÔNG TY CỔ PHẦN BÓNG ĐÈN PHÍCH NƯỚC RẠNG ĐÔNG (VN)**

87-89 phố Hạ Đình, phường Thanh Xuân Trung, quận Thanh Xuân, thành phố Hà Nội

(72) Trần Trung Tường (VN)

(55)

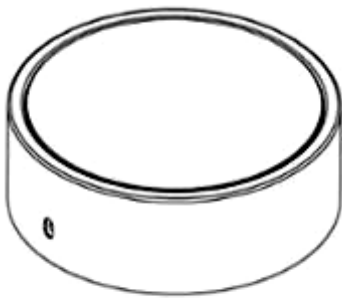

1.1

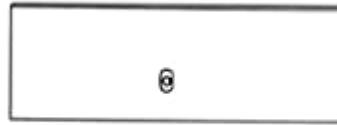

1.2

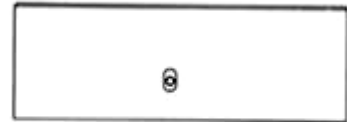

1.3



1.4



1.5

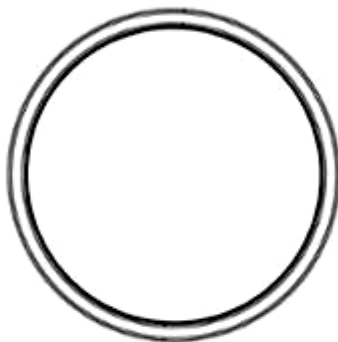

1.6

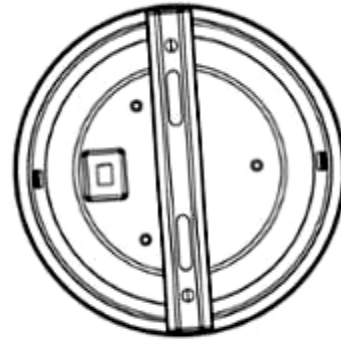

1.7

CÔNG BÁO SỞ HỮU CÔNG NGHIỆP SỐ 423 TẬP A – QUYỀN 2 (06.2023)

- (11) **47221**
(21) 3-2023-00608 (28) 1
(54) **ĐÈN ÓP TRẦN** (51) **26-05**
(22) 22/03/2023 (43) 26/06/2023
(73) **CÔNG TY CỔ PHẦN BÓNG ĐÈN PHÍCH NƯỚC RẠNG ĐÔNG (VN)**
87-89 phố Hạ Đình, phường Thanh Xuân Trung, quận Thanh Xuân, thành phố Hà Nội
(72) Trần Trung Tường (VN)
(55)

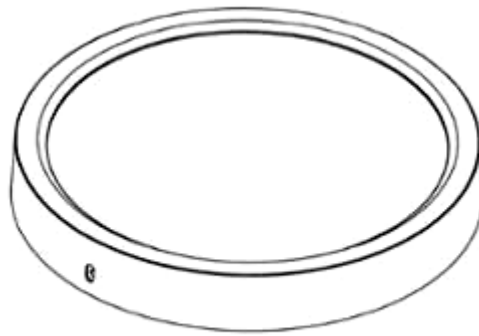

1.1



1.2

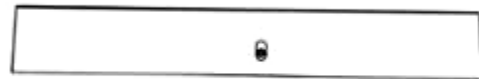

1.3



1.4



1.5

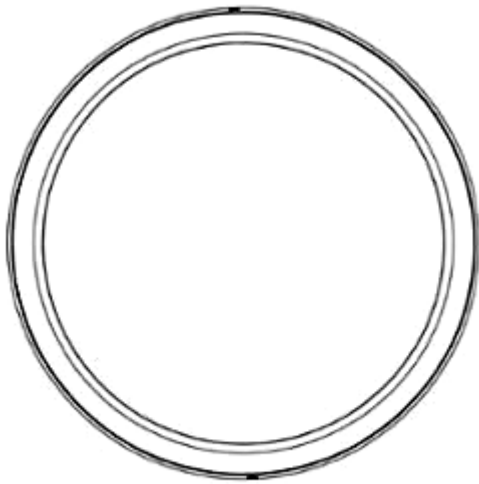

1.6

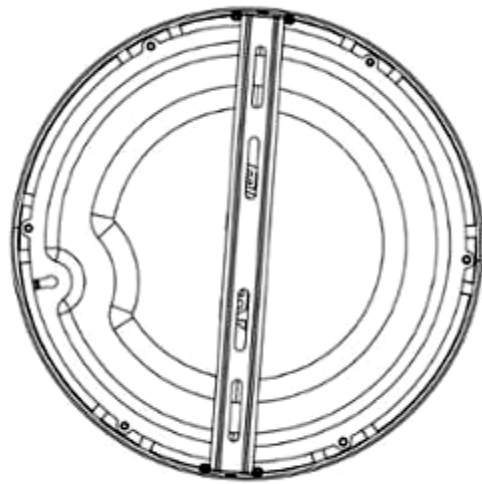

1.7

CÔNG BÁO SỞ HỮU CÔNG NGHIỆP SỐ 423 TẬP A – QUYỀN 2 (06.2023)

(11) **47222**

(21) 3-2023-00617

(28) 2

(54) **KẸP ÓNG NGHIỆM**

(51) **24-02**

(22) 23/03/2023

(43) 26/06/2023

(73) **NGUYỄN THỊ HUYỀN (VN)**

Căn hộ chung cư số 512 tòa S2.02 - U35.1 (F1-CH03-2) Dự án khu đô thị mới Tây Mỗ, Đại Mỗ - Vinhomes Park - Vinhomes Smart City, phường Tây Mỗ, quận Nam Từ Liêm, thành phố Hà Nội

(72) Nguyễn Thị Huyền (VN)

(74) Công ty Luật TNHH Phạm và Liên danh (PHAM & ASSOCIATES)

(55)



1.1



1.2



1.3



1.4



1.5



1.6



2.1



2.2



2.3



2.4



2.5



2.6

CÔNG BÁO SỞ HỮU CÔNG NGHIỆP SỐ 423 TẬP A – QUYỀN 2 (06.2023)

(11) **47223**

(21) 3-2023-00618

(28) 1

(54) **KẸP ỚNG NGHIỆM**

(51) **24-02**

(22) 23/03/2023

(43) 26/06/2023

(73) **NGUYỄN THỊ HUYỀN (VN)**

Căn hộ chung cư số 512 tòa S2.02 - U35.1 (F1-CH03-2) dự án khu đô thị mới Tây Mỗ, Đại Mỗ - Vinhomes Park - Vinhomes Smart City, phường Tây Mỗ, quận Nam Từ Liêm, thành phố Hà Nội

(72) Nguyễn Thị Huyền (VN)

(74) Công ty Luật TNHH Phạm và Liên danh (PHAM & ASSOCIATES)

(55)



1.1



1.2



1.3



1.4



1.5



1.6

PHẦN II

SỬA ĐỔI ĐƠN

Thông báo số: 14486w/TB-SHTT, ngày 09/05/2023 về việc ghi nhận sửa đổi đơn

Số Yêu cầu: SĐ3-2023-00134 Ngày nộp: 31/01/2023

Liên quan đến đơn yêu cầu cấp Bằng độc quyền kiểu dáng công nghiệp:

(21) Số đơn	(22) Ngày nộp đơn
3-2023-00012	03/01/2023

Mục sửa đổi: Tên, địa chỉ chủ đơn

Nội dung mới: DAELIM B&CO CO., LTD. (KR)
52, Gongdan-ro, Seongsan-gu, Changwon-si, Gyeongsangnam-do,
51565 Republic of Korea

PHẦN III

THAY ĐỔI CHỦ ĐƠN

Thông báo số: 11087w/TB-SHTT, ngày 25/04/2023 về việc ghi nhận thay đổi chủ đơn

Số Yêu cầu: CD3-2021-00897 Ngày nộp: 20/08/2021

Liên quan đến đơn yêu cầu cấp bằng độc quyền kiểu dáng công nghiệp:

(21) Số đơn	(22) Ngày nộp đơn
3-2021-01642	23/06/2021

Bên chuyển nhượng: CÔNG TY CỔ PHẦN SẢN XUẤT VÀ THƯƠNG MẠI
MAMABE (VN)
Số 1, phố Hòa Mã, phường Phạm Đình Hổ, quận Hai Bà
Trung, thành phố Hà Nội

Bên được chuyển nhượng: Hoàng Thị Ngọc Hân (VN)
Số 1, phố Hòa Mã, phường Phạm Đình Hổ, quận Hai Bà
Trung, thành phố Hà Nội

CÔNG BÁO SỞ HỮU CÔNG NGHIỆP

Do Cục Sở hữu trí tuệ thuộc Bộ Khoa học và Công nghệ ấn hành theo Luật Sở hữu trí tuệ số 50/2005/QH11 được Quốc hội thông qua ngày 29 tháng 11 năm 2005 và được sửa đổi bằng Luật sửa đổi, bổ sung một số điều của Luật sở hữu trí tuệ số 50/2005/QH11 được Quốc hội thông qua ngày 19 tháng 6 năm 2009.

Địa chỉ liên hệ:

384-386 đường Nguyễn Trãi, quận Thanh Xuân,
thành phố Hà Nội, Việt Nam
ĐT: 024. 38583069
Fax: 024. 38588449