

ISSN 0868 - 2534

CỘNG HÒA XÃ HỘI CHỦ NGHĨA VIỆT NAM
BỘ KHOA HỌC VÀ CÔNG NGHỆ

CỤC SỞ HỮU TRÍ TUỆ

CÔNG BÁO
SỞ HỮU CÔNG NGHIỆP

TẬP A

QUYỂN 2: KIỂU DÁNG CÔNG NGHIỆP

04 - 2023

421

HÀ NỘI

CỘNG HOÀ XÃ HỘI CHỦ NGHĨA VIỆT NAM
BỘ KHOA HỌC VÀ CÔNG NGHỆ
CỤC SỞ HỮU TRÍ TUỆ

CÔNG BÁO
SỞ HỮU CÔNG NGHIỆP
TẬP A

QUYỂN 2: KIỂU DÁNG CÔNG NGHIỆP

04 - 2023

421

HÀ NỘI

MỤC LỤC

	Trang
<u>PHẦN I:</u> Đơn yêu cầu cấp Bằng độc quyền kiểu dáng công nghiệp	7
<u>PHẦN II:</u> Sửa đổi đơn	284
<u>PHẦN III:</u> Thay đổi chủ đơn	293

CONTENTS

<u>PART I:</u> Applications for Industrial Design Patents	7
<u>PART II:</u> Amendment of Applications	284
<u>PART III:</u> Change of Applicants	293

CÔNG BÁO SỞ HỮU CÔNG NGHIỆP SỐ 421 TẬP A - QUYỂN 2 (04.2023)

MÃ SỐ HAI CHỮ CÁI THỂ HIỆN TÊN NƯỚC VÀ CÁC THỰC THỂ KHÁC TRONG CÁC TƯ LIỆU SỞ HỮU CÔNG NGHIỆP THEO TIÊU CHUẨN ST3 CỦA WIPO

AE	United Arab Emirates	CN	China	HK	Hong Kong
AF	Afganistan	CO	Colombia	HN	Honduras
AG	Antihua and Barbuda	CR	Costa Rica	HR	Croatia
AI	Anguilla	CU	Cuba	HT	Haiti
AL	Albania	CV	Cape Verde	HU	Hungary
AN	Netherlands Antilles	CY	Cyprus	ID	Indonesia
AO	Angola	CZ	Czech Republic	IE	Ireland
AR	Argentina	DE	Germany	IL	Israel
AT	Austria	DJ	Djibouti	IN	India
AU	Australia	DK	Denmark	IQ	Iraq
AW	Aruba	DM	Dominica	IR	Iran (Islamic Republic of)
BB	Barbados	DO	Dominican Republic	IS	Iceland
BD	Bangladesh	DZ	Algeria	IT	Italy
BE	Belgium	EC	Ecuador	JM	Jamaica
BF	Burkina Faso	EE	Estonia	JO	Jordan
BG	Bulgaria	EG	Egypt	JP	Japan
BH	Bahrain	ES	Spain	KE	Kenya
BI	Burundi	ET	Ethiopia	KH	Cambodia
BJ	Benin	FI	Finland	KI	Kiribati
BM	Bermuda	FJ	Fiji	KM	Comoros
BN	Brunei Darussalam	FK	Falkand Islands (Malvinas)	KN	Saint Kitts and Nevis
BO	Bolivia	FR	France	KP	Democratic People's Republic of Korea
BR	Brazil	GA	Gabon	KR	Republic of Korea
BS	Bahamas	GB	United Kingdom	KW	Kuwait
BT	Bhutan	GD	Grenada	KY	Cayman Islands
BW	Botswana	GE	Georgia	KZ	Kazakhstan
BY	Belarus	GH	Ghana	LA	Laos
BZ	Belize	GI	Gibraltar	LB	Lebanon
CA	Canada	GM	Gambia	LC	Saint Lucia
CF	Central African Republic	GN	Guinea	LI	Liechtenstein
CG	Congo	GQ	Equatorial Guinea	LK	SriLanka
CH	Switzerland	GR	Greece	LR	Liberia
CI	Côte d'Ivoire	GT	Guatemala	LS	Lesotho
CL	Chile	GW	Guinea-Bissau	LT	Lithuania
CM	Cameroon	GY	Guyana	TC	Turk and Caicos Islands
LU	Luxembourg	PA	Panama	TD	Chad
LV	Latvia	PE	Peru	TG	Togo
LY	Lybya	PG	Papua New Guinea	TH	Thailand
MA	Morocco	PH	Philippines	TN	Tunisia
MC	Monaco	PK	Pakistan	TO	Tonga
MD	Republic of Moldova	PL	Poland	TR	Turkey

CÔNG BÁO SỞ HỮU CÔNG NGHIỆP SỐ 421 TẬP A - QUYỂN 2 (04.2023)

MG	Madagascar	PT	Portugal	TT	Trinidad and Tobago
ML	Mali	PY	Paraguay	TV	Tuvalu
MM	Myanmar	QA	Qatar	TW	Taiwan, Province of China
MN	Mongolia	RO	Rumania	TZ	United Republic of Tanzania
MO	Macau	RU	Russian Federation	UA	Ukraine
MR	Mauritania	RW	Rwanda	UG	Uganda
MS	Montserrat	SA	Saudi Arabia	US	United States of America
MT	Malta	SB	Solomon Islands	UY	Uruguay
MU	Mauritius	SC	Seychelles	UZ	Uzbekistan
MV	Maldives	SD	Sudan	VA	Holy see
MW	Malawi	SE	Sweden	VC	Saint Vincent and the Grenadines
MX	Mexico	SG	Singapore	VE	Venezuela
MY	Malaysia	SH	Saint Helena	VG	Virgin Islands (British)
MZ	Mozambique	SL	Slovenia	VN	Vietnam
NA	Namibia	SK	Slovakia	VU	Vanuatu
NE	Niger	SL	Sierra Leone	WS	Samoa
NG	Nigeria	SM	San Marino	YE	Yemen
NJ	Nicaragua	SN	Senegal	YU	Yugoslavia
NL	Netherlands	SO	Somalia	ZA	South Africa
NO	Norway	SR	Suriname	ZM	Zambia
NP	Nepal	ST	Sao Tome and Principe	ZR	Zaire
NR	Nauru	SV	El Sanvador	ZW	Zimbabwe
NZ	New Zealand	SY	Syria		
OM	Oman	SZ	Swaziland		

CÁC TỔ CHỨC QUỐC TẾ

AO	African Intellectual Property Organization (OAPI)
AP	African Regional Industrial Property Organization (ARIPO)
BX	Benelux Trademark Office and Benelux Designs Office
EP	European Patent Office (EPO)
IB, WO	International Bureau of the World Intellectual Property Organization (WIPO)

NHỮNG MÃ SỐ INID TRÍCH TỪ TIÊU CHUẨN ST80 CỦA TỔ CHỨC SỞ HỮU TRÍ TUỆ THẾ GIỚI (WIPO) ĐỂ NHẬN BIẾT CÁC DỮ LIỆU THƯ MỤC DÙNG CÔNG BỐ ĐƠN VÀ BẰNG ĐỘC QUYỀN KIỂU DÁNG CÔNG NGHIỆP

- (11) Số bằng độc quyền kiểu dáng công nghiệp / Số công bố đơn
- (15) Ngày cấp
- (18) Ngày hết hạn hiệu lực của bằng độc quyền kiểu dáng công nghiệp
- (21) Số đơn
- (22) Ngày nộp đơn
- (23) Tên triển lãm, ngày và nơi triển lãm
- (28) Số phương án yêu cầu bảo hộ
- (30) Số đơn ưu tiên, ngày nộp đơn ưu tiên
- (43) Ngày công bố đơn
- (45) Ngày công bố bằng độc quyền kiểu dáng công nghiệp
- (51) Phân loại quốc tế kiểu dáng công nghiệp
- (54) Tên sản phẩm mang kiểu dáng công nghiệp
- (55) Ảnh chụp / hình vẽ kiểu dáng công nghiệp
- (57) Đặc điểm khác biệt yêu cầu bảo hộ của kiểu dáng công nghiệp
- (62) Số và ngày nộp đơn, số bằng độc quyền KDCN hoặc số công bố đơn liên quan đến tách đơn
- (71) Tên và địa chỉ của người nộp đơn
- (72) Tên của tác giả KDCN
- (73) Tên, địa chỉ của chủ bằng độc quyền KDCN
- (74) Tên của người đại diện SHCN

PHẦN I

ĐƠN YÊU CẦU CẤP BẰNG ĐỘC QUYỀN KIỂU DÁNG CÔNG NGHIỆP

(11) **46617**

(21) 3-2022-02661

(28) 1

(54) **VÒI NƯỚC**

(51) **23-01**

(22) 05/12/2022

(43) 25/04/2023

(73) **CÔNG TY CỔ PHẦN THƯƠNG MẠI VIGLACERA (VN)**

Tầng 1, tòa nhà Viglacera, số 1 Đại lộ Thăng Long, phường Mỹ Trì, quận Nam Từ Liêm, thành phố Hà Nội

(72) Phạm Ngọc Đường (VN)

(55)



1.1



1.2

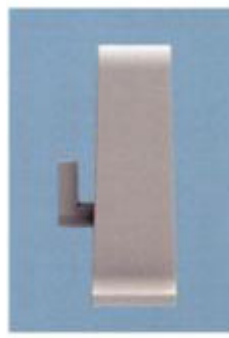

1.3



1.4



1.5



1.6



1.7

CÔNG BÁO SỞ HỮU CÔNG NGHIỆP SỐ 421 TẬP A – QUYỀN 2 (04.2023)

(11) **46618**

(21) 3-2022-02659

(28) 1

(54) **BỒN CẦU**

(51) **23-02**

(22) 05/12/2022

(43) 25/04/2023

(73) **CÔNG TY CỔ PHẦN THƯƠNG MẠI VIGLACERA (VN)**

Tầng 1, tòa nhà Viglacera, số 1 Đại lộ Thăng Long, phường Mỹ Trì, quận Nam Từ Liêm, thành phố Hà Nội

(72) Phạm Ngọc Đường (VN)

(55)



1.1



1.2



1.3



1.4



1.5



1.6



1.7

CÔNG BÁO SỞ HỮU CÔNG NGHIỆP SỐ 421 TẬP A – QUYỀN 2 (04.2023)

(11) **46619**

(21) 3-2022-02660

(28) 1

(54) **BỒN CẦU**

(51) **23-02**

(22) 05/12/2022

(43) 25/04/2023

(73) **CÔNG TY CỔ PHẦN THƯƠNG MẠI VIGLACERA (VN)**

Tầng 1, tòa nhà Viglacera, số 1 Đại lộ Thăng Long, phường Mỹ Trì, quận Nam Từ Liêm, thành phố Hà Nội

(72) Phạm Ngọc Đường (VN)

(55)



1.1



1.2



1.3



1.4



1.5



1.6

CÔNG BÁO SỞ HỮU CÔNG NGHIỆP SỐ 421 TẬP A – QUYỀN 2 (04.2023)

(11) **46620**

(21) 3-2022-02676

(28) 1

(54) **BỒN CẦU**

(51) **23-02**

(22) 05/12/2022

(43) 25/04/2023

(73) **CÔNG TY CỔ PHẦN THƯƠNG MẠI VIGLACERA (VN)**

Tầng 1, tòa nhà Viglacera, số 1 Đại lộ Thăng Long, phường Mỹ Trì, quận Nam Từ Liêm, thành phố Hà Nội

(72) Phạm Ngọc Đường (VN)

(55)



1.1



1.2



1.3



1.4



1.5



1.6

CÔNG BÁO SỞ HỮU CÔNG NGHIỆP SỐ 421 TẬP A – QUYỀN 2 (04.2023)

(11) **46621**

(21) 3-2022-02670

(28) 1

(54) **MÓC TREO**

(51) **23-02**

(22) 05/12/2022

(43) 25/04/2023

(73) **CÔNG TY CỔ PHẦN THƯƠNG MẠI VIGLACERA (VN)**

Tầng 1, tòa nhà Viglacera, số 1 Đại lộ Thăng Long, phường Mỹ Trì, quận Nam Từ Liêm, thành phố Hà Nội

(72) Phạm Ngọc Đường (VN)

(55)



1.1



1.2



1.3



1.4



1.5



1.6

CÔNG BÁO SỞ HỮU CÔNG NGHIỆP SỐ 421 TẬP A – QUYỀN 2 (04.2023)

- (11) **46622**
(21) 3-2022-02671 (28) 1
(54) **THANH VẮT KHĂN** (51) **23-02**
(22) 05/12/2022 (43) 25/04/2023
(73) **CÔNG TY CỔ PHẦN THƯƠNG MẠI VIGLACERA (VN)**
Tầng 1, tòa nhà Viglacera, số 1 Đại lộ Thăng Long, phường Mỹ Trì, quận Nam Từ
Liêm, thành phố Hà Nội
(72) Phạm Ngọc Đường (VN)
(55)

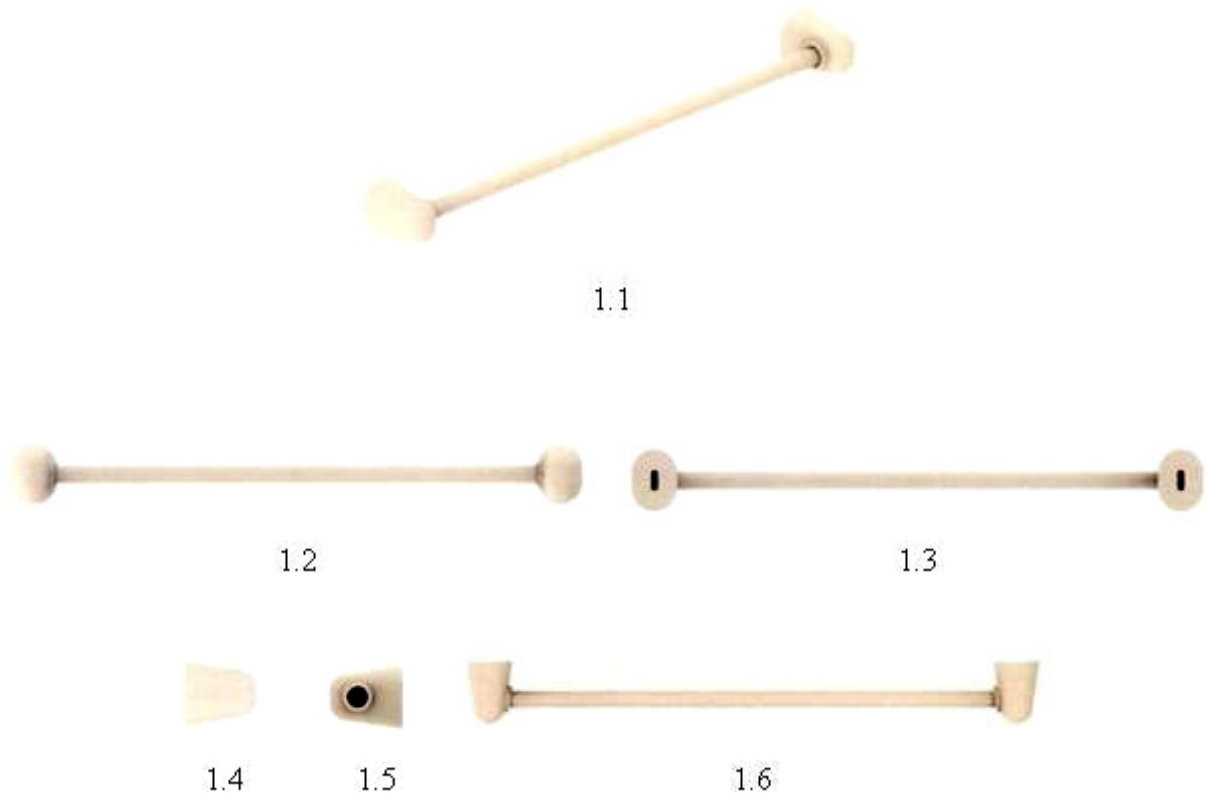

CÔNG BÁO SỞ HỮU CÔNG NGHIỆP SỐ 421 TẬP A – QUYỀN 2 (04.2023)

(11) **46623**

(21) 3-2022-02658

(28) 1

(54) **BỒN CẦU**

(51) **23-02**

(22) 05/12/2022

(43) 25/04/2023

(73) **CÔNG TY CỔ PHẦN THƯƠNG MẠI VIGLACERA (VN)**

Tầng 1, tòa nhà Viglacera, số 1 Đại lộ Thăng Long, phường Mỹ Trì, quận Nam Từ Liêm, thành phố Hà Nội

(72) Phạm Ngọc Đường (VN)

(55)



1.1



1.2



1.3



1.4



1.5



1.6

CÔNG BÁO SỞ HỮU CÔNG NGHIỆP SỐ 421 TẬP A – QUYỀN 2 (04.2023)

(11) **46624**

(21) 3-2022-02662

(28) 1

(54) **VÒI NƯỚC**

(51) **23-01**

(22) 05/12/2022

(43) 25/04/2023

(73) **CÔNG TY CỔ PHẦN THƯƠNG MẠI VIGLACERA (VN)**

Tầng 1, tòa nhà Viglacera, số 1 Đại lộ Thăng Long, phường Mễ Trì, quận Nam Từ Liêm, thành phố Hà Nội

(72) Phạm Ngọc Đường (VN)

(55)



1.1



1.2



1.3



1.4



1.5



1.6

CÔNG BÁO SỞ HỮU CÔNG NGHIỆP SỐ 421 TẬP A – QUYỀN 2 (04.2023)

(11) **46625**

(21) 3-2022-02664

(28) 1

(54) **KỆ ĐẶT ĐỒ**

(51) **23-02**

(22) 05/12/2022

(43) 25/04/2023

(73) **CÔNG TY CỔ PHẦN THƯƠNG MẠI VIGLACERA (VN)**

Tầng 1, tòa nhà Viglacera, số 1 Đại lộ Thăng Long, phường Mễ Trì, quận Nam Từ Liêm, thành phố Hà Nội

(72) Phạm Ngọc Đường (VN)

(55)



1.1



1.2



1.3



1.4



1.5



1.6

CÔNG BÁO SỞ HỮU CÔNG NGHIỆP SỐ 421 TẬP A – QUYỀN 2 (04.2023)

- (11) **46626**
(21) 3-2022-02672 (28) 1
(54) **HỘP ĐỰNG GIẤY VỆ SINH** (51) **23-02**
(22) 05/12/2022 (43) 25/04/2023
(73) **CÔNG TY CỔ PHẦN THƯƠNG MẠI VIGLACERA (VN)**
Tầng 1, tòa nhà Viglacera, số 1 Đại lộ Thăng Long, phường Mễ Trì, quận Nam Từ
Liêm, thành phố Hà Nội
(72) Phạm Ngọc Đường (VN)
(55)



CÔNG BÁO SỞ HỮU CÔNG NGHIỆP SỐ 421 TẬP A – QUYỀN 2 (04.2023)

(11) **46627**

(21) 3-2022-02663

(28) 1

(54) **KỆ ĐẶT ĐỒ**

(51) **23-02**

(22) 05/12/2022

(43) 25/04/2023

(73) **CÔNG TY CỔ PHẦN THƯƠNG MẠI VIGLACERA (VN)**

Tầng 1, tòa nhà Viglacera, số 1 Đại lộ Thăng Long, phường Mỹ Trì, quận Nam Từ Liêm, thành phố Hà Nội

(72) Phạm Ngọc Đường (VN)

(55)



1.1



1.2



1.3



1.4



1.5



1.6

CÔNG BÁO SỞ HỮU CÔNG NGHIỆP SỐ 421 TẬP A – QUYỀN 2 (04.2023)

- (11) **46628**
(21) 3-2022-02669 (28) 1
(54) **CHẬU RỬA** (51) **23-02**
(22) 05/12/2022 (43) 25/04/2023
(73) **CÔNG TY CỔ PHẦN THƯƠNG MẠI VIGLACERA (VN)**
Tầng 1, tòa nhà Viglacera, số 1 Đại lộ Thăng Long, phường Mễ Trì, quận Nam Từ
Liêm, thành phố Hà Nội
(72) Phạm Ngọc Đường (VN)
(55)



1.1



1.2



1.3



1.4

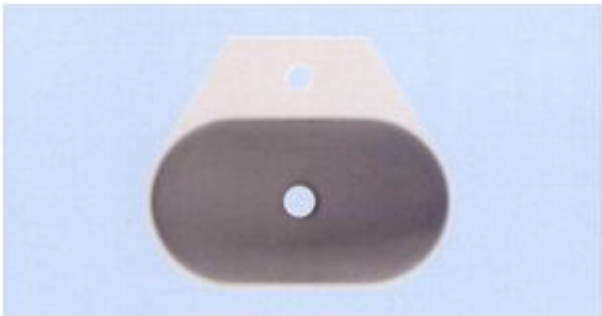

1.5



1.6

CÔNG BÁO SỞ HỮU CÔNG NGHIỆP SỐ 421 TẬP A – QUYỀN 2 (04.2023)

(11) **46629**

(21) 3-2022-02667

(28) 1

(54) **CHẬU RỬA**

(51) **23-02**

(22) 05/12/2022

(43) 25/04/2023

(73) **CÔNG TY CỔ PHẦN THƯƠNG MẠI VIGLACERA (VN)**

Tầng 1, tòa nhà Viglacera, số 1 Đại lộ Thăng Long, phường Mỹ Trì, quận Nam Từ Liêm, thành phố Hà Nội

(72) Phạm Ngọc Đường (VN)

(55)



1.1



1.2



1.3



1.4



1.5

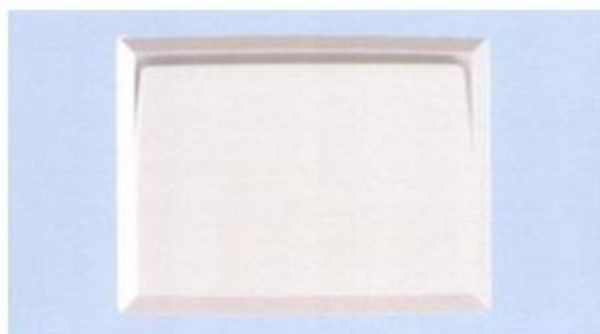

1.6

CÔNG BÁO SỞ HỮU CÔNG NGHIỆP SỐ 421 TẬP A – QUYỀN 2 (04.2023)

- (11) **46630**
(21) 3-2022-02668 (28) 1
(54) **CHẬU RỬA** (51) **23-02**
(22) 05/12/2022 (43) 25/04/2023
(73) **CÔNG TY CỔ PHẦN THƯƠNG MẠI VIGLACERA (VN)**
Tầng 1, tòa nhà Viglacera, số 1 Đại lộ Thăng Long, phường Mỹ Trì, quận Nam Từ Liêm, thành phố Hà Nội
(72) Phạm Ngọc Đường (VN)
(55)



1.1



1.2



1.3



1.4



1.5



1.6

CÔNG BÁO SỞ HỮU CÔNG NGHIỆP SỐ 421 TẬP A – QUYỀN 2 (04.2023)

(11) **46631**

(21) 3-2022-02666

(28) 1

(54) **BỒN CẦU**

(51) **23-02**

(22) 05/12/2022

(43) 25/04/2023

(73) **CÔNG TY CỔ PHẦN THƯƠNG MẠI VIGLACERA (VN)**

Tầng 1, tòa nhà Viglacera, số 1 Đại lộ Thăng Long, phường Mỹ Trì, quận Nam Từ Liêm, thành phố Hà Nội

(72) Phạm Ngọc Đường (VN)

(55)



1.1



1.2



1.3



1.4



1.5



1.6

CÔNG BÁO SỞ HỮU CÔNG NGHIỆP SỐ 421 TẬP A – QUYỀN 2 (04.2023)

(11) **46632**

(21) 3-2022-02673

(28) 1

(54) **BỒN CẦU**

(51) **23-02**

(22) 05/12/2022

(43) 25/04/2023

(73) **CÔNG TY CỔ PHẦN THƯƠNG MẠI VIGLACERA (VN)**

Tầng 1, tòa nhà Viglacera, số 1 Đại lộ Thăng Long, phường Mỹ Trì, quận Nam Từ Liêm, thành phố Hà Nội

(72) Phạm Ngọc Đường (VN)

(55)



1.1



1.2



1.3



1.4



1.5



1.6

CÔNG BÁO SỞ HỮU CÔNG NGHIỆP SỐ 421 TẬP A – QUYỀN 2 (04.2023)

(11) **46633**

(21) 3-2022-02813

(28) 1

(54) **GIƯỜNG**

(51) **06-02**

(22) 20/12/2022

(43) 25/04/2023

(73) **CÔNG TY CỔ PHẦN CAO SU SÀI GÒN - KYMDAN (VN)**

28 Bình Thới, quận 11, thành phố Hồ Chí Minh

(72) Nguyễn Trí Tân (VN)

(74) Công ty TNHH Sở hữu trí tuệ Thảo Thọ Quyển (INVENCO.,LTD)

(55)



1.1



1.2

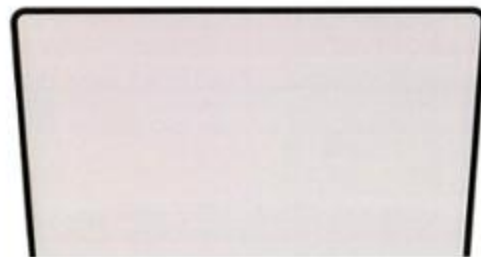

1.3



1.4



1.5



1.6



1.7

CÔNG BÁO SỞ HỮU CÔNG NGHIỆP SỐ 421 TẬP A – QUYỀN 2 (04.2023)

(11) **46634**

(21) 3-2022-02665

(28) 1

(54) **KỆ ĐẶT ĐỒ**

(51) **23-02**

(22) 05/12/2022

(43) 25/04/2023

(73) **CÔNG TY CỔ PHẦN THƯƠNG MẠI VIGLACERA (VN)**

Tầng 1, tòa nhà Viglacera, số 1 Đại lộ Thăng Long, phường Mễ Trì, quận Nam Từ Liêm, thành phố Hà Nội

(72) Phạm Ngọc Đường (VN)

(55)



CÔNG BÁO SỞ HỮU CÔNG NGHIỆP SỐ 421 TẬP A – QUYỀN 2 (04.2023)

- (11) **46635**
(21) 3-2022-02927 (28) 1
(54) **BA LÔ** (51) **03-01**
(22) 28/12/2022 (43) 25/04/2023
(73) **CÔNG TY CỔ PHẦN XUẤT NHẬP KHẨU BÌNH TÂY (VN)**
Đường tỉnh 835, ấp 3A, xã Phước Lợi, huyện Bến Lức, tỉnh Long An
(72) Nguyễn Xuân Dũng (VN)
(55)



1.1



1.2



1.3



1.4



1.5



1.6



1.7

CÔNG BÁO SỞ HỮU CÔNG NGHIỆP SỐ 421 TẬP A – QUYỀN 2 (04.2023)

- (11) **46636**
(21) 3-2022-02926 (28) 1
(54) **BA LÔ** (51) **03-01**
(22) 28/12/2022 (43) 25/04/2023
(73) **CÔNG TY CỔ PHẦN XUẤT NHẬP KHẨU BÌNH TÂY (VN)**
Đường tỉnh 835, ấp 3A, xã Phước Lợi, huyện Bến Lức, tỉnh Long An
(72) Nguyễn Xuân Dũng (VN)
(55)



1.1



1.2



1.3



1.4



1.5

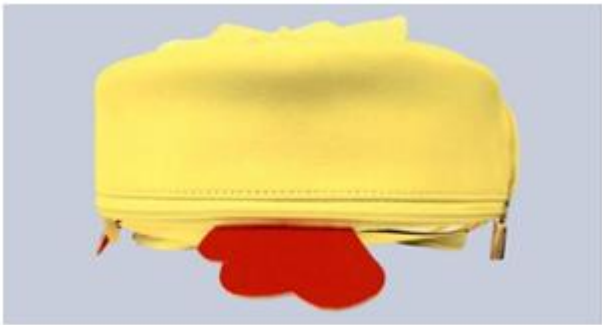

1.6



1.7

CÔNG BÁO SỞ HỮU CÔNG NGHIỆP SỐ 421 TẬP A – QUYỀN 2 (04.2023)

- (11) **46637**
(21) 3-2022-02928 (28) 1
(54) **BA LÔ** (51) **03-01**
(22) 28/12/2022 (43) 25/04/2023
(73) **CÔNG TY CỔ PHẦN XUẤT NHẬP KHẨU BÌNH TÂY (VN)**
Đường tỉnh 835, ấp 3A, xã Phước Lợi, huyện Bến Lức, tỉnh Long An
(72) Nguyễn Xuân Dũng (VN)
(55)



1.1



1.2



1.3



1.4



1.5



1.6



1.7

CÔNG BÁO SỞ HỮU CÔNG NGHIỆP SỐ 421 TẬP A – QUYỀN 2 (04.2023)

- (11) **46638**
(21) 3-2022-02924 (28) 1
(54) **BA LÔ** (51) **03-01**
(22) 28/12/2022 (43) 25/04/2023
(73) **CÔNG TY CỔ PHẦN XUẤT NHẬP KHẨU BÌNH TÂY (VN)**
Đường tỉnh 835, ấp 3A, xã Phước Lợi, huyện Bến Lức, tỉnh Long An
(72) Nguyễn Xuân Dũng (VN)
(55)



1.1



1.2



1.3



1.4



1.5



1.6



1.7

CÔNG BÁO SỞ HỮU CÔNG NGHIỆP SỐ 421 TẬP A – QUYỀN 2 (04.2023)

- (11) **46639**
(21) 3-2022-02923 (28) 1
(54) **BA LỒ** (51) **03-01**
(22) 28/12/2022 (43) 25/04/2023
(73) **CÔNG TY CỔ PHẦN XUẤT NHẬP KHẨU BÌNH TÂY (VN)**
Đường tỉnh 835, ấp 3A, xã Phước Lợi, huyện Bến Lức, tỉnh Long An
(72) Nguyễn Xuân Dũng (VN)
(55)



1.1



1.2



1.3



1.4



1.5



1.6



1.7

CÔNG BÁO SỞ HỮU CÔNG NGHIỆP SỐ 421 TẬP A – QUYỀN 2 (04.2023)

- (11) **46640**
(21) 3-2022-02911 (28) 1
(54) **BA LÔ** (51) **03-01**
(22) 27/12/2022 (43) 25/04/2023
(73) **CÔNG TY CỔ PHẦN XUẤT NHẬP KHẨU BÌNH TÂY (VN)**
Đường tỉnh 835, ấp 3A, xã Phước Lợi, huyện Bến Lức, tỉnh Long An
(72) Nguyễn Xuân Dũng (VN)
(55)



1.1



1.2



1.3



1.4



1.5



1.6



1.7

CÔNG BÁO SỞ HỮU CÔNG NGHIỆP SỐ 421 TẬP A – QUYỀN 2 (04.2023)

- (11) **46641**
(21) 3-2022-02925 (28) 1
(54) **BA LÔ** (51) **03-01**
(22) 28/12/2022 (43) 25/04/2023
(73) **CÔNG TY CỔ PHẦN XUẤT NHẬP KHẨU BÌNH TÂY (VN)**
Đường tỉnh 835, ấp 3A, xã Phước Lợi, huyện Bến Lức, tỉnh Long An
(72) Nguyễn Xuân Dũng (VN)
(55)



1.1



1.2



1.3



1.4



1.5



1.6



1.7

CÔNG BÁO SỞ HỮU CÔNG NGHIỆP SỐ 421 TẬP A – QUYỀN 2 (04.2023)

- (11) **46642**
(21) 3-2022-01904 (28) 1
(54) **NẤP HỒ GA** (51) **25-02**
(22) 07/09/2022 (43) 25/04/2023
(73) 1. **HỒ VIỆT VẼ (VN)**
106 Huyện Trần Công Chứa, phường 8, thành phố Vũng Tàu, tỉnh Bà Rịa - Vũng Tàu
2. **HỒ THÁI BÌNH (VN)**
106 Huyện Trần Công Chứa, phường 8, thành phố Vũng Tàu, tỉnh Bà Rịa - Vũng Tàu
(72) 1. **HỒ VIỆT VẼ (VN)**
2. **HỒ THÁI BÌNH (VN)**
(74) Công ty TNHH Luật ALIAT (ALIAT LEGAL)
(55)

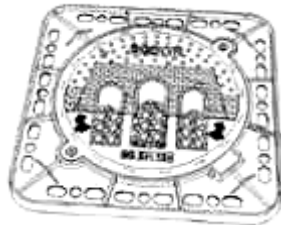

1.1



1.2



1.3



1.4



1.5



1.6

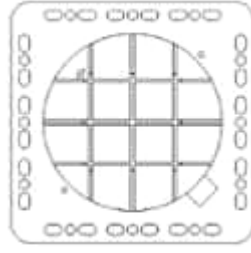

1.7

- (11) **46643**
- (21) 3-2022-02071 (28) 1
- (54) **TRẠM TRỘN NGUYÊN VẬT LIỆU** (51) **15-04**
- (22) 27/09/2022 (43) 25/04/2023
- (73) 1. **HỒ VIỆT VẼ (VN)**
106 Huyện Trần Công Chứa, phường 8, thành phố Vũng Tàu, tỉnh Bà Rịa - Vũng Tàu
2. **HỒ THÁI BÌNH (VN)**
106 Huyện Trần Công Chứa, phường 8, thành phố Vũng Tàu, tỉnh Bà Rịa - Vũng Tàu
- (72) 1. **HỒ VIỆT VẼ (VN)**
2. **HỒ THÁI BÌNH (VN)**
- (55)

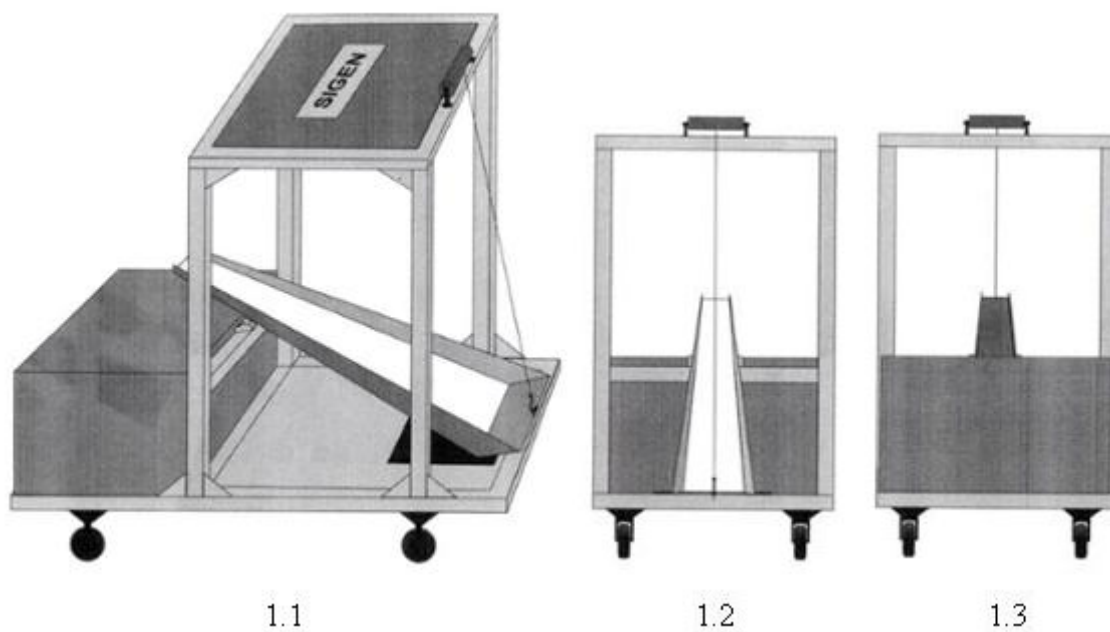

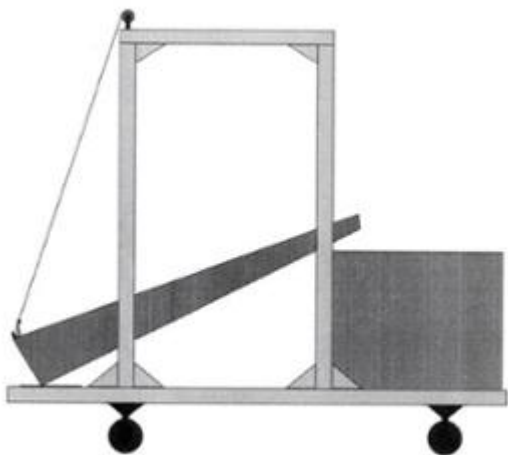

1.4

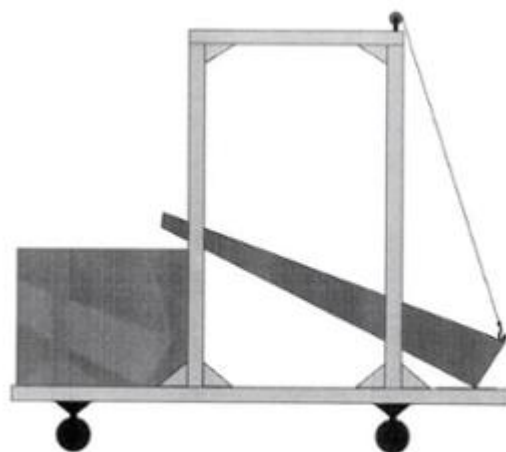

1.5



1.6

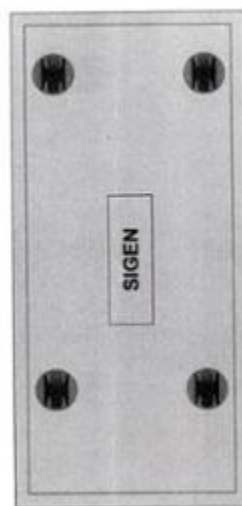

1.7

CÔNG BÁO SỞ HỮU CÔNG NGHIỆP SỐ 421 TẬP A – QUYỀN 2 (04.2023)

- (11) **46644**
(21) 3-2022-02377 (28) 1
(54) **DÉP** (51) **02-04**
(22) 01/11/2022 (43) 25/04/2023
(30) 29/837,148 02/05/2022 US;
(73) **CROCS, INC. (US)**
13601 Via Varra, Broomfield, Colorado 80020, United States of America
(72) 1. JIE LIU (US)
2. MAYHEW, ALEXANDER JACOB (US)
(74) Công ty Luật TNHH quốc tế BMVN (BMVN INTERNATIONAL LLC)
(55)



1.1



1.2

1.3



1.4



1.5



1.6



1.7

- (11) **46645**
(21) 3-2022-02510 (28) 1
(54) **DÉP** (51) **02-04**
(22) 17/11/2022 (43) 25/04/2023
(30) 29/839,102 18/05/2022 US;
(73) **CROCS, INC. (US)**
13601 Via Varra, Broomfield, Colorado 80020, United States of America
(72) 1. FEDERICO FONGHER (IT)
2. MICHAEL SARANTAKOS (US)
(74) Công ty Luật TNHH quốc tế BMVN (BMVN INTERNATIONAL LLC)
(55)



1.1



1.2



1.3



1.4



1.5



1.6



1.7

CÔNG BÁO SỞ HỮU CÔNG NGHIỆP SỐ 421 TẬP A – QUYỀN 2 (04.2023)

- (11) **46646**
(21) 3-2022-02571 (28) 1
(54) **DÉP** (51) **02-04**
(22) 21/11/2022 (43) 25/04/2023
(30) 29/840,137 26/05/2022 US;
(73) **CROCS, INC. (US)**
13601 Via Varra, Broomfield, Colorado 80020, United States of America
(72) 1. FEDERICO FONGHER (IT)
2. MICHAEL SARANTAKOS (US)
(74) Công ty Luật TNHH quốc tế BMVN (BMVN INTERNATIONAL LLC)
(55)



1.1



1.2

1.3



1.4



1.5



1.6



1.7

- (11) **46647**
(21) 3-2022-02045 (28) 1
(54) **KHẨU TRANG Y TẾ** (51) **24-02**
(22) 23/09/2022 (43) 25/04/2023
(30) 111301405 24/03/2022 TW;
(73) **TAI GUARD ENTERPRISE CO., LTD. (TW)**
4F., No. 6-1, Ln. 151, Dadun 18th St., Hecheng Vil., Xitun Dist., Taichung City,
Taiwan
(72) 1. FU-WANG HSIAO (TW)
2. HSIU-LUAN CHEN (TW)
(74) Công ty Luật TNHH Phạm và Liên danh (PHAM & ASSOCIATES)
(55)

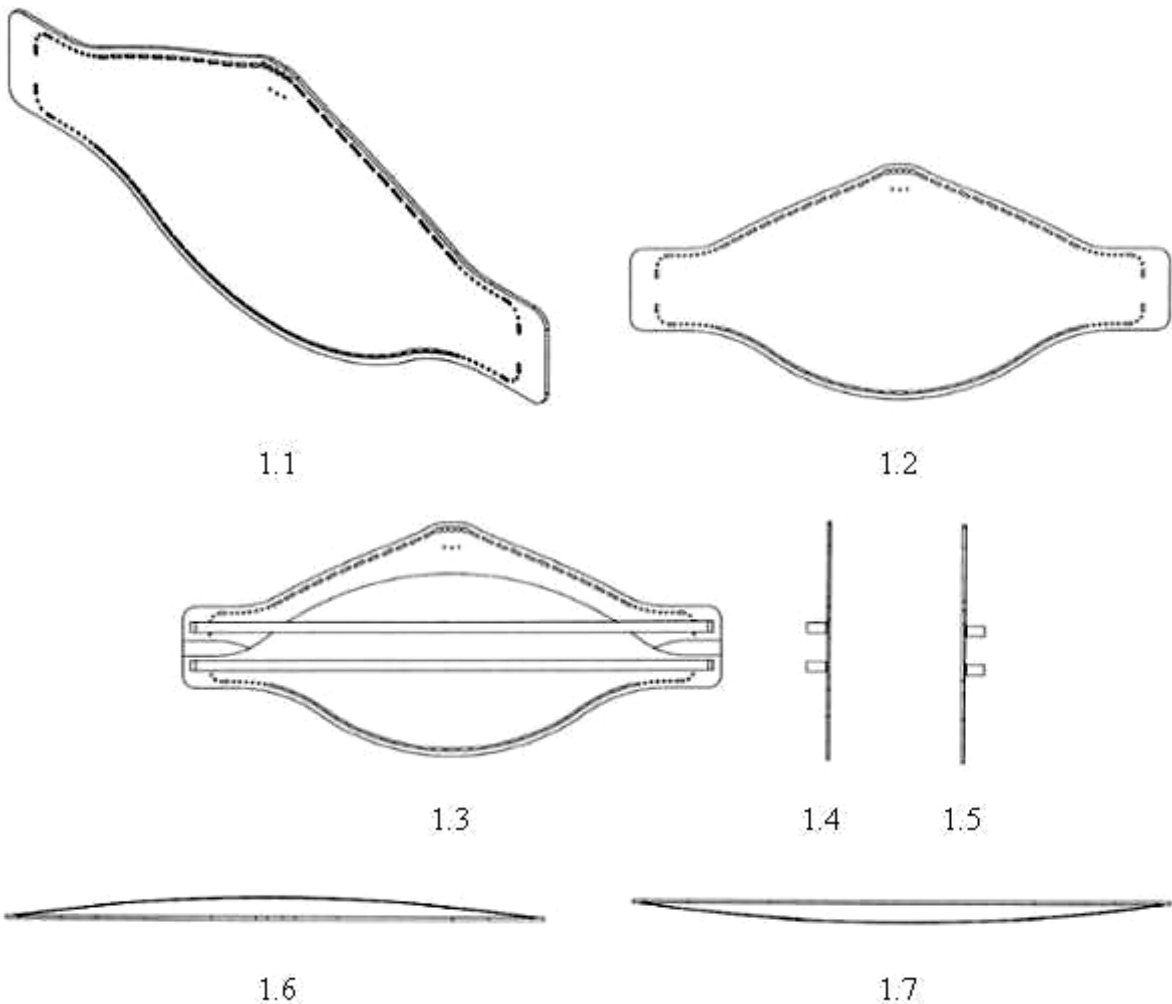



1.8

CÔNG BÁO SỞ HỮU CÔNG NGHIỆP SỐ 421 TẬP A – QUYỀN 2 (04.2023)

- (11) **46648**
(21) 3-2022-02572 (28) 1
(54) **DÉP** (51) **02-04**
(22) 21/11/2022 (43) 25/04/2023
(30) 29/840,200 26/05/2022 US;
(73) **CROCS, INC. (US)**
13601 Via Varra, Broomfield, Colorado 80020, United States of America
(72) 1. FEDERICO FONGHER (IT)
2. MICHAEL SARANTAKOS (US)
(74) Công ty Luật TNHH quốc tế BMVN (BMVN INTERNATIONAL LLC)
(55)



1.1



1.2



1.3



1.4



1.5



1.6



1.7

- (11) **46649**
(21) 3-2022-02399 (28) 1
(54) **DÉP** (51) **02-04**
(22) 03/11/2022 (43) 25/04/2023
(30) 29/837,609 06/05/2022 US;
(73) **CROCS, INC. (US)**
13601 Via Varra, Broomfield, Colorado 80020, United States of America
(72) MAYHEW, Alexander Jacob (US)
(74) Công ty Luật TNHH quốc tế BMVN (BMVN INTERNATIONAL LLC)
(55)



1.1



1.2

1.3



1.4



1.5



1.6



1.7

CÔNG BÁO SỞ HỮU CÔNG NGHIỆP SỐ 421 TẬP A – QUYỀN 2 (04.2023)

- (11) **46650**
(21) 3-2022-02487 (28) 1
(54) **KHUNG BỘ LỘC** (51) **23-04**
(22) 14/11/2022 (43) 25/04/2023
(30) 29/839,307 19/05/2022 US;
(73) **AIRDOCTOR, LLC (US)**
14724 Ventura Blvd., Suite 200, Sherman Oaks, CALIFORNIA 91403, United States of America
(72) 1. PETER G. SPIEGEL (US)
2. MICHAEL PEDERSEN (US)
(74) Công ty TNHH Tầm nhìn và Liên danh (VISION & ASSOCIATES CO.LTD.)
(55)

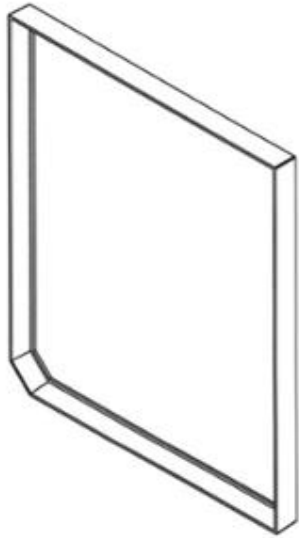

1.1

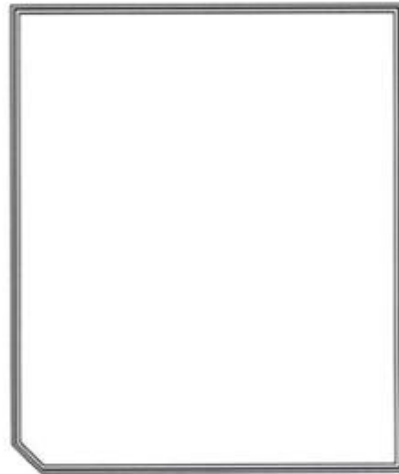

1.2

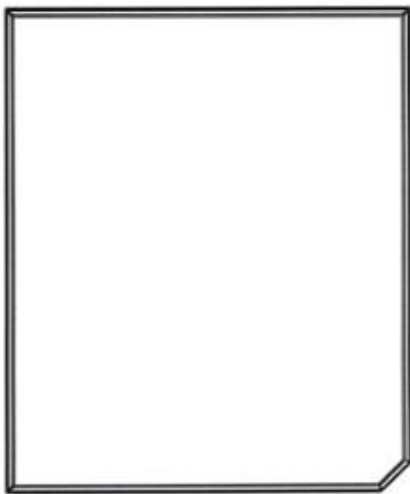

1.3



1.4

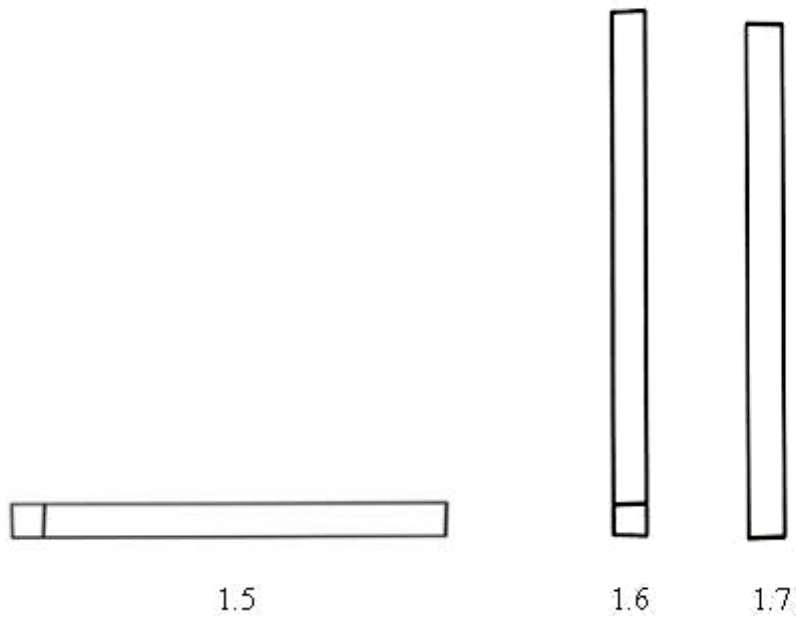

CÔNG BÁO SỞ HỮU CÔNG NGHIỆP SỐ 421 TẬP A – QUYỀN 2 (04.2023)

- (11) **46651**
(21) 3-2022-02608 (28) 1
(54) **ĐỒ CHỨA THỰC PHẨM** (51) **09-01**
(22) 28/11/2022 (43) 25/04/2023
(30) 30-2022-0034687 25/08/2022 KR;
(73) **CJ CHEILJEDANG CORPORATION (KR)**
(Ssangnim-dong) 330, Dongho-ro, Jung-gu, Seoul 04560 Republic of Korea
(72) 1. SONG, CHAE WON (KR)
2. LEE, SEUNG PYO (KR)
3. KIM, YUL JOONG (KR)
4. PARK, JI YEON (KR)
(74) Công ty Luật TNHH ROUSE Việt Nam (ROUSE LEGAL VIETNAM LTD.)
(55)



1.1



1.2



1.3



1.4



1.5



1.6



1.7

CÔNG BÁO SỞ HỮU CÔNG NGHIỆP SỐ 421 TẬP A – QUYỀN 2 (04.2023)

- (11) **46652**
(21) 3-2021-02853 (28) 1
(54) **THANG GẤP** (51) **25-04**
(22) 16/11/2021 (43) 25/04/2023
(73) **CÔNG TY TNHH CHẾ TẠO CHÍNH XÁC BÀU BÀNG VIỆT NAM (VN)**
Nhà xưởng A-18-6-B, A-18-6-C, Lô A-18-6-CN, khu công nghiệp Bàu Bàng, thị trấn Lai Uyên, huyện Bàu Bàng, tỉnh Bình Dương.
(72) Jianyuan Zhang (CN)
(74) **CÔNG TY TRÁCH NHIỆM HỮU HẠN TƯ VẤN ĐẦU TƯ VÀ SỞ HỮU TRÍ TUỆ INTERFIVE (INTERFIVE CO., LTD)**
(55)



1.1



1.2



1.3



1.4



1.5



1.6



1.7



1.8

CÔNG BÁO SỞ HỮU CÔNG NGHIỆP SỐ 421 TẬP A – QUYỀN 2 (04.2023)

(11) **46653**

(21) 3-2021-02852

(28) 1

(54) **THANG GẤP**

(51) **25-04**

(22) 16/11/2021

(43) 25/04/2023

(73) **CÔNG TY TNHH CHẾ TẠO CHÍNH XÁC BÀU BÀNG VIỆT NAM (VN)**

Nhà xưởng A-18-6-B, A-18-6-C, Lô A-18-6-CN, khu công nghiệp Bàu Bàng, thị trấn Lai Uyên, huyện Bàu Bàng, tỉnh Bình Dương.

(72) Jianyuan Zhang (CN)

(74) **CÔNG TY TRÁCH NHIỆM HỮU HẠN TƯ VẤN ĐẦU TƯ VÀ SỞ HỮU TRÍ TUỆ INTERFIVE (INTERFIVE CO., LTD)**

(55)



1.1



1.2



1.3



1.4



1.5



1.6



1.7



1.8

CÔNG BÁO SỞ HỮU CÔNG NGHIỆP SỐ 421 TẬP A – QUYỀN 2 (04.2023)

- (11) **46654**
 - (21) 3-2022-02961
 - (54) **CHẬU RỬA**
 - (22) 29/12/2022
 - (30) 009099617-0005 27/07/2022 EM;
 - (73) **HANSGROHE SE (DE)**
Austr. 5-9, 77761 Schiltach, Germany
 - (72) Laura Somaglino (IT)
 - (74) Công ty TNHH Trường Xuân (AGELESS CO.,LTD.)
 - (55)
- (28) 1
 - (51) **23-02**
 - (43) 25/04/2023



1.1



1.2



1.3



1.4



1.5



1.6



1.7

- (11) **46655**
(21) 3-2022-02885 (28) 1
(54) **GIÁ ĐỀ BÔNG TẮM VÀ PHÂN PHÁT XÀ PHÒNG** (51) **23-02**
(22) 26/12/2022 (43) 25/04/2023
(30) US29/844,133 27/06/2022 US;
(73) **SCRUB DADDY, INC. (US)**
1700 Suckle Highway, Pennsauken, NJ 08110, United States of America
(72) 1. AARON C. KRAUSE (US)
2. JOHN O'BRIEN (US)
3. ALEKSANDRS TITOV (US)
(74) Công ty TNHH Tầm nhìn và Liên danh (VISION & ASSOCIATES CO.LTD.)
(55)

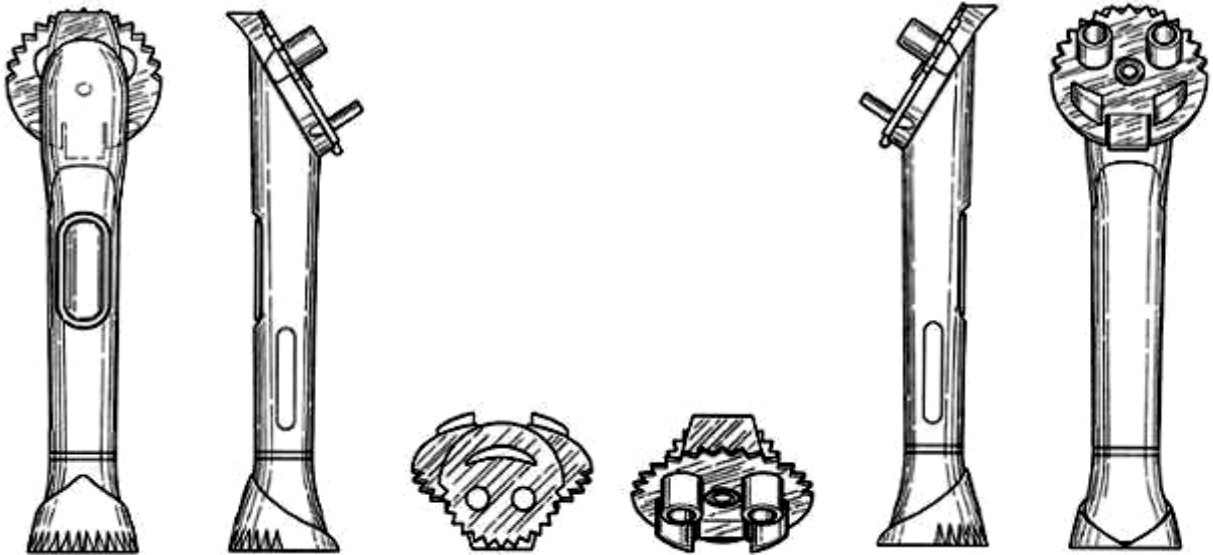

1.1

1.2

1.3

1.4

1.5

1.6



1.7

CÔNG BÁO SỞ HỮU CÔNG NGHIỆP SỐ 421 TẬP A – QUYỀN 2 (04.2023)

- (11) **46656**
(21) 3-2022-02883 (28) 1
(54) **CHẬU RỬA** (51) **23-02**
(22) 26/12/2022 (43) 25/04/2023
(30) 009094048-0007 21/07/2022 EM;
(73) **HANSGROHE SE (DE)**
Austr. 5-9, 77761 Schiltach, Germany
(72) Laura Somaglino (IT)
(74) Công ty TNHH Trường Xuân (AGELESS CO.,LTD.)
(55)



1.1



1.2



1.3



1.4

1.5



1.6



1.7

CÔNG BÁO SỞ HỮU CÔNG NGHIỆP SỐ 421 TẬP A – QUYỀN 2 (04.2023)

- (11) **46657**
 - (21) 3-2022-02960
 - (54) **CHẬU RỬA**
 - (22) 29/12/2022
 - (30) 009099617-0004 27/07/2022 EM;
 - (73) **HANSGROHE SE (DE)**
Austr. 5-9, 77761 Schiltach, Germany
 - (72) Laura Somaglino (IT)
 - (74) Công ty TNHH Trường Xuân (AGELESS CO.,LTD.)
 - (55)
- (28) 1
 - (51) **23-02**
 - (43) 25/04/2023



1.1



1.2



1.3



1.4



1.5

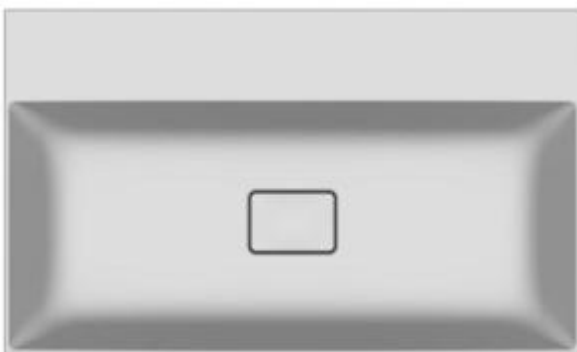

1.6



1.7

CÔNG BÁO SỞ HỮU CÔNG NGHIỆP SỐ 421 TẬP A – QUYỀN 2 (04.2023)

- (11) **46658**
 - (21) 3-2022-02881
 - (54) **CHẬU RỬA**
 - (22) 26/12/2022
 - (30) 009094048-0003 21/07/2022 EM;
 - (73) **HANSGROHE SE (DE)**
Austr. 5-9, 77761 Schiltach, Germany
 - (72) Laura Somaglino (IT)
 - (74) Công ty TNHH Trường Xuân (AGELESS CO.,LTD.)
 - (55)
- (28) 1
 - (51) **23-02**
 - (43) 25/04/2023



1.1

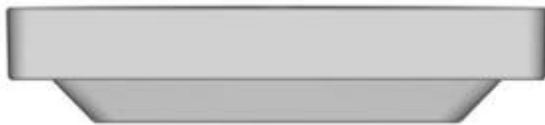

1.2



1.3



1.4



1.5

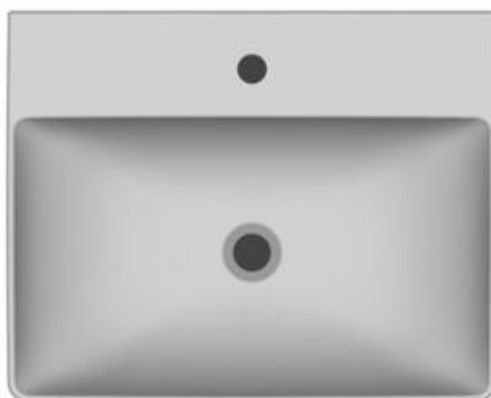

1.6



1.7

CÔNG BÁO SỞ HỮU CÔNG NGHIỆP SỐ 421 TẬP A – QUYỀN 2 (04.2023)

- (11) **46659**
(21) 3-2022-02882 (28) 1
(54) **CHẬU RỬA** (51) **23-02**
(22) 26/12/2022 (43) 25/04/2023
(30) 009094048-0005 21/07/2022 EM;
(73) **HANSGROHE SE (DE)**
Austr. 5-9, 77761 Schiltach, Germany
(72) Laura Somaglino (IT)
(74) Công ty TNHH Trường Xuân (AGELESS CO.,LTD.)
(55)



1.1



1.2



1.3

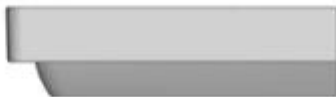

1.4



1.5

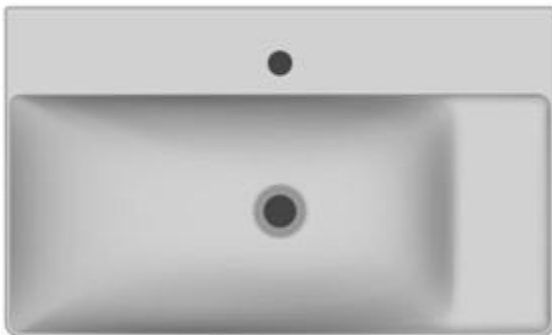

1.6

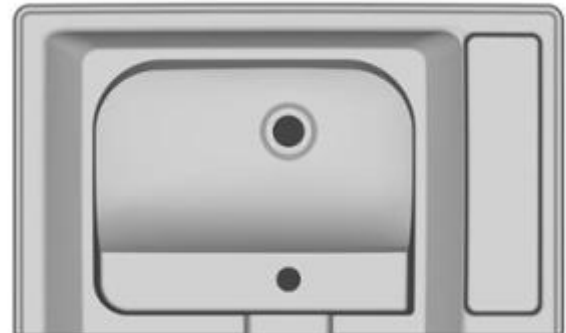

1.7

CÔNG BÁO SỞ HỮU CÔNG NGHIỆP SỐ 421 TẬP A – QUYỀN 2 (04.2023)

- (11) **46660**
 - (21) 3-2022-02959
 - (54) **CHẬU RỬA**
 - (22) 29/12/2022
 - (30) 009099617-0003 27/07/2022 EM;
 - (73) **HANSGROHE SE (DE)**
Austr. 5-9, 77761 Schiltach, Germany
 - (72) Laura Somaglino (IT)
 - (74) Công ty TNHH Trường Xuân (AGELESS CO.,LTD.)
 - (55)
- (28) 1
 - (51) **23-02**
 - (43) 25/04/2023



1.1



1.2



1.3

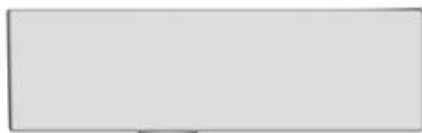

1.4



1.5

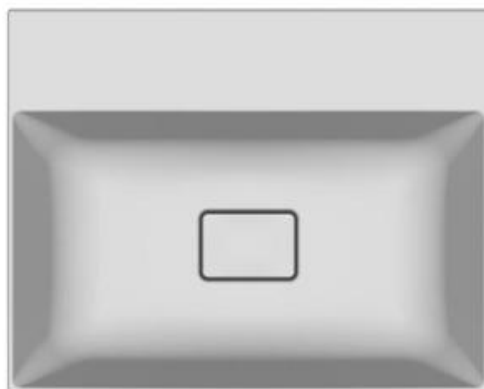

1.6

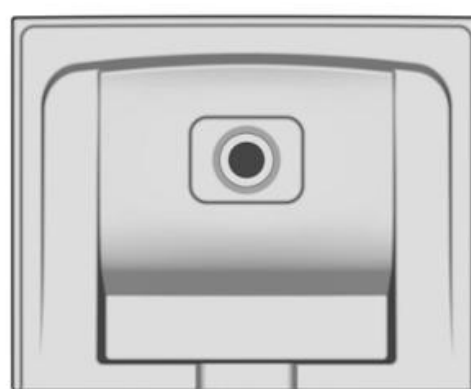

1.7

CÔNG BÁO SỞ HỮU CÔNG NGHIỆP SỐ 421 TẬP A – QUYỀN 2 (04.2023)

- (11) **46661**
(21) 3-2022-01469 (28) 1
(54) **MẶT BẠC CẦU THANG** (51) **25-04**
(22) 22/07/2022 (43) 25/04/2023
(73) **ANJI HUAXIN BAMBOO AND WOOD PRODUCTS CO., LTD. (CN)**
Tiangai Village, Shangshu Township, Anji County, Huzhou City, Zhejiang
Province, China
(72) Lichang Yang (CN)
(74) Công ty TNHH Đại Tín và Liên Danh (DAITIN AND ASSOCIATES CO.,LTD)
(55)

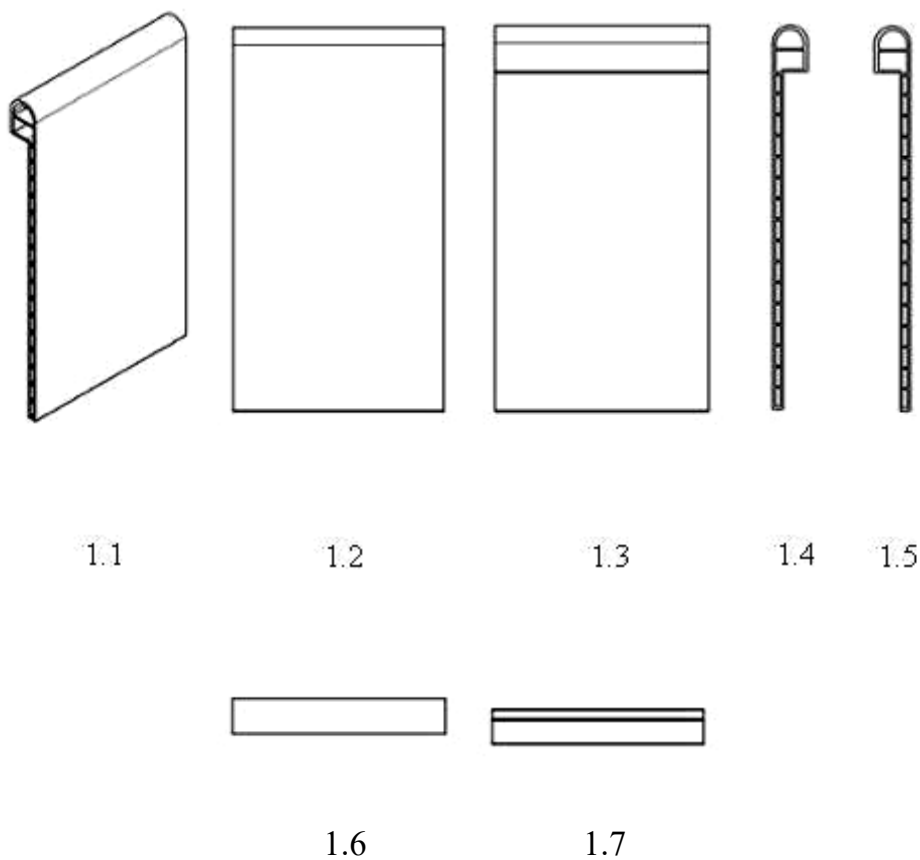

CÔNG BÁO SỞ HỮU CÔNG NGHIỆP SỐ 421 TẬP A – QUYỀN 2 (04.2023)

- (11) **46662**
(21) 3-2022-01536 (28) 1
(54) **BỘ PHẬN TRƯỢT ĐỠ NAN DỪ** (51) **03-03**
(22) 28/07/2022 (43) 25/04/2023
(73) **CÔNG TY TNHH THE WISDOM SPACE (VN)**
316/7 quốc lộ 1A, khu phố 5, phường Thạnh Xuân, quận 12, thành phố Hồ Chí Minh
(72) Đặng Ngọc Hải Thuyền (VN)
(74) Công ty TNHH Hùng Sơn và cộng sự (HUNG SON & PARTNERS)
(55)



1.1



1.2



1.3



1.4

CÔNG BÁO SỞ HỮU CÔNG NGHIỆP SỐ 421 TẬP A – QUYỀN 2 (04.2023)

- (11) **46663**
(21) 3-2022-01471 (28) 1
(54) **MŨI BẠC CẦU THANG** (51) **25-04**
(22) 22/07/2022 (43) 25/04/2023
(73) **ANJI HUAXIN BAMBOO AND WOOD PRODUCTS CO., LTD. (CN)**
Tiangai Village, Shangshu Township, Anji County, Huzhou City, Zhejiang
Province, China
(72) Lichang Yang (CN)
(74) Công ty TNHH Đại Tín và Liên Danh (DAITIN AND ASSOCIATES CO.,LTD)
(55)

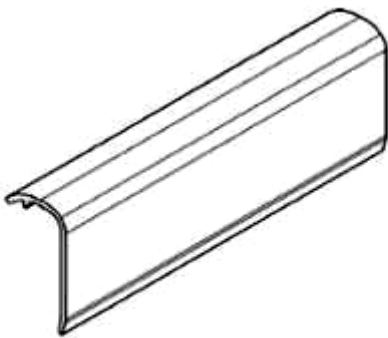

1.1

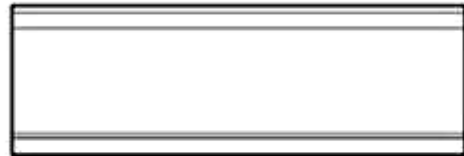

1.2



1.3



1.4

1.5



1.6



1.7

CÔNG BÁO SỞ HỮU CÔNG NGHIỆP SỐ 421 TẬP A – QUYỀN 2 (04.2023)

- (11) **46664**
(21) 3-2022-01470 (28) 1
(54) **MŨI BẠC CẦU THANG** (51) **25-04**
(22) 22/07/2022 (43) 25/04/2023
(73) **ANJI HUAXIN BAMBOO AND WOOD PRODUCTS CO., LTD. (CN)**
Tiangai Village, Shangshu Township, Anji County, Huzhou City, Zhejiang
Province, China
(72) Lichang Yang (CN)
(74) Công ty TNHH Đại Tín và Liên Danh (DAITIN AND ASSOCIATES CO.,LTD)
(55)

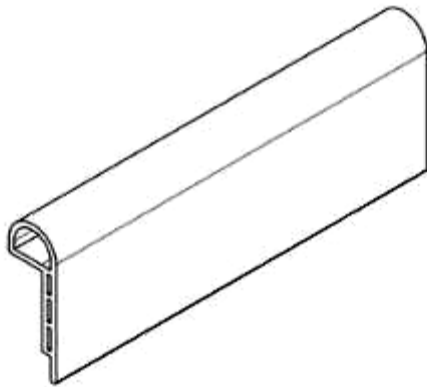

1.1

1.2

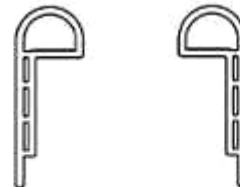
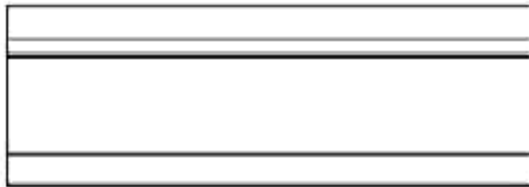

1.3

1.4

1.5



1.6

1.7

CÔNG BÁO SỞ HỮU CÔNG NGHIỆP SỐ 421 TẬP A – QUYỀN 2 (04.2023)

- (11) **46665**
(21) 3-2022-01475 (28) 1
(54) **NEP** (51) **25-01**
(22) 22/07/2022 (43) 25/04/2023
(73) **ANJI HUAXIN BAMBOO AND WOOD PRODUCTS CO., LTD. (CN)**
Tiangai Village, Shangshu Township, Anji County, Huzhou City, Zhejiang
Province, China
(72) Lichang Yang (CN)
(74) Công ty TNHH Đại Tín và Liên Danh (DAITIN AND ASSOCIATES CO.,LTD)
(55)

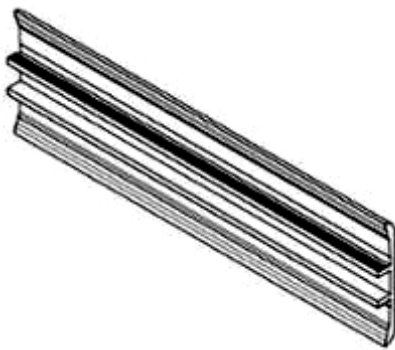

1.1

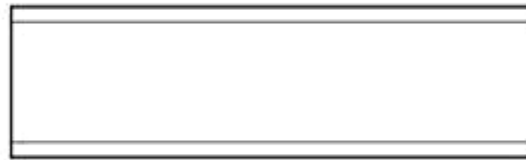

1.2

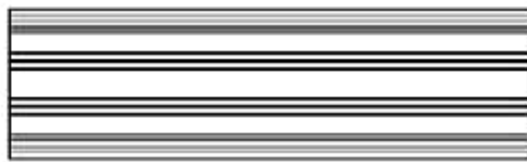

1.3



1.4



1.5



1.6



1.7

CÔNG BÁO SỞ HỮU CÔNG NGHIỆP SỐ 421 TẬP A – QUYỀN 2 (04.2023)

- (11) **46666**
(21) 3-2022-01474 (28) 1
(54) **NỆP NỔI** (51) **25-01**
(22) 22/07/2022 (43) 25/04/2023
(73) **ANJI HUAXIN BAMBOO AND WOOD PRODUCTS CO., LTD. (CN)**
Tiangai Village, Shangshu Township, Anji County, Huzhou City, Zhejiang
Province, China
(72) Lichang Yang (CN)
(74) Công ty TNHH Đại Tín và Liên Danh (DAITIN AND ASSOCIATES CO.,LTD)
(55)

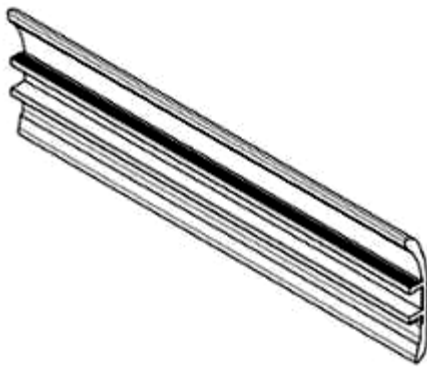

1.1

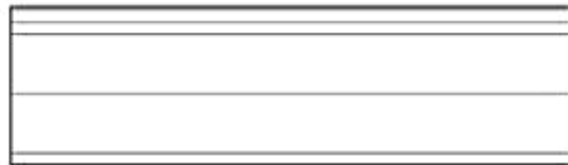

1.2



1.3



1.4



1.5



1.6



1.7

CÔNG BÁO SỞ HỮU CÔNG NGHIỆP SỐ 421 TẬP A – QUYỀN 2 (04.2023)

- (11) **46667**
(21) 3-2022-01473 (28) 1
(54) **NỆP KẾT THỨC** (51) **25-01**
(22) 22/07/2022 (43) 25/04/2023
(73) **ANJI HUAXIN BAMBOO AND WOOD PRODUCTS CO., LTD. (CN)**
Tiangai Village, Shangshu Township, Anji County, Huzhou City, Zhejiang
Province, China
(72) Lichang Yang (CN)
(74) Công ty TNHH Đại Tín và Liên Danh (DAITIN AND ASSOCIATES CO.,LTD)
(55)



1.1



1.2

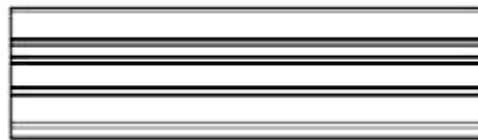

1.3



1.4 1.5



1.6



1.7

CÔNG BÁO SỞ HỮU CÔNG NGHIỆP SỐ 421 TẬP A – QUYỀN 2 (04.2023)

- (11) **46668**
(21) 3-2022-02450 (28) 1
(54) **HỘP CƠM GIỮ NHIỆT** (51) **07-07**
(22) 09/11/2022 (43) 25/04/2023
(30) 202230630607.3 23/09/2022 CN;
(73) **SHANGHAI LOCK&LOCK TRADE CO., LTD. (CN)**
Room B 1/F, Room H,J 2/F, Room B,C,D,H,M 3/F, Hechuan Building, No.2016,
Yishan Road, Minhang District, Shanghai, CHINA
(72) Zaitao LIU (CN)
(74) Công ty Luật TNHH ELITE (ELITE LAW FIRM)
(55)



1.1



1.2



1.3



1.4



1.5



1.6

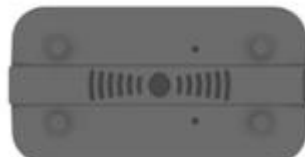

1.7

CÔNG BÁO SỞ HỮU CÔNG NGHIỆP SỐ 421 TẬP A – QUYỀN 2 (04.2023)

- (11) **46669**
(21) 3-2022-02609 (28) 1
(54) **ĐỒ CHỨA THỰC PHẨM** (51) **09-01**
(22) 28/11/2022 (43) 25/04/2023
(30) 30-2022-0035559 31/08/2022 KR;
(73) **CJ CHEILJEDANG CORPORATION (KR)**
(Ssangnim-dong) 330, Dongho-ro, Jung-gu, Seoul 04560 Republic of Korea
(72) 1. SONG, CHAE WON (KR)
2. LEE, SEUNG PYO (KR)
3. KIM, YUL JOONG (KR)
4. PARK, JI YEON (KR)
(74) Công ty Luật TNHH ROUSE Việt Nam (ROUSE LEGAL VIETNAM LTD.)
(55)



1.1



1.2



1.3



1.4



1.5



1.6



1.7

CÔNG BÁO SỞ HỮU CÔNG NGHIỆP SỐ 421 TẬP A – QUYỀN 2 (04.2023)

- (11) **46670**
(21) 3-2022-02860 (28) 1
(54) **BA LÔ** (51) **03-01**
(22) 26/12/2022 (43) 25/04/2023
(30) 009091424-0001 20/07/2022 EM;
(73) **DECATHLON (FR)**
4, Boulevard de Mons, F-59650 Villeneuve d’Ascq, France
(72) Malo SAHORES (FR)
(74) Công ty Luật TNHH T&G (TGVN)
(55)



1.1



1.2



1.3



1.4



1.5



1.6



1.7

CÔNG BÁO SỞ HỮU CÔNG NGHIỆP SỐ 421 TẬP A – QUYỀN 2 (04.2023)

(11) **46671**

(21) 3-2022-01763

(28) 1

(54) **CHAI**

(51) **09-01**

(22) 19/08/2022

(43) 25/04/2023

(73) **CÔNG TY TNHH THỰC PHẨM VÀ NƯỚC GIẢI KHÁT GREEN FOOD (VN)**

Số 11, quốc lộ 22, ấp Trạm Bom, xã Tân Phú Trung, huyện Củ Chi, thành phố Hồ Chí Minh

(72) Đặng Thị Yến (VN)

(55)



1.1



1.2



1.3



1.4



1.5



1.6



1.7

CÔNG BÁO SỞ HỮU CÔNG NGHIỆP SỐ 421 TẬP A – QUYỀN 2 (04.2023)

- (11) **46672**
(21) 3-2022-02913 (28) 1
(54) **BA LÔ** (51) **03-01**
(22) 28/12/2022 (43) 25/04/2023
(73) **CÔNG TY CỔ PHẦN XUẤT NHẬP KHẨU BÌNH TÂY (VN)**
Đường tỉnh 835, ấp 3A, xã Phước Lợi, huyện Bến Lức, tỉnh Long An
(72) Nguyễn Xuân Dũng (VN)
(55)



1.1



1.2



1.3



1.4



1.5



1.6



1.7

CÔNG BÁO SỞ HỮU CÔNG NGHIỆP SỐ 421 TẬP A – QUYỀN 2 (04.2023)

- (11) **46673**
(21) 3-2022-01803 (28) 1
(54) **CHAI** (51) **09-01**
(22) 25/08/2022 (43) 25/04/2023
(73) **CÔNG TY TNHH MTV SẢN XUẤT THƯƠNG MẠI THỰC PHẨM ĐÔNG NAM Á (VN)**
105C Phan Đăng Lưu, phường 7, quận Phú Nhuận, thành phố Hồ Chí Minh
(72) Hà Thanh Tài (VN)
(55)



1.1

1.2

1.3

1.4

1.5



1.6



1.7

CÔNG BÁO SỞ HỮU CÔNG NGHIỆP SỐ 421 TẬP A – QUYỀN 2 (04.2023)

- (11) **46674**
(21) 3-2022-02990 (28) 1
(54) **THANH KIM LOẠI ĐỊNH HÌNH** (51) **25-01**
(22) 30/12/2022 (43) 25/04/2023
(73) **CÔNG TY CỔ PHẦN TẬP ĐOÀN KENWIN (VN)**
Tầng 4 tòa nhà VG Building, số 235 đường Nguyễn Trãi, phường Thanh Xuân
Trung, quận Thanh Xuân, thành phố Hà Nội
(72) Ngô Thọ Long (VN)
(74) Công ty TNHH Sở hữu trí tuệ PADEMARK (PADEMARK CO.,LTD.)
(55)



1.1



1.2



1.3

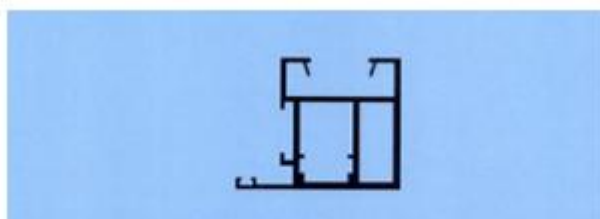

1.4

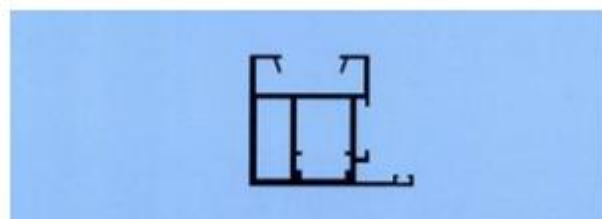

1.5



1.6



1.7

CÔNG BÁO SỞ HỮU CÔNG NGHIỆP SỐ 421 TẬP A – QUYỀN 2 (04.2023)

- (11) **46675**
(21) 3-2022-02989 (28) 1
(54) **THANH KIM LOẠI ĐỊNH HÌNH** (51) **25-01**
(22) 30/12/2022 (43) 25/04/2023
(73) **CÔNG TY CỔ PHẦN TẬP ĐOÀN KENWIN (VN)**
Tầng 4 tòa nhà VG Building, số 235 đường Nguyễn Trãi, phường Thanh Xuân
Trung, quận Thanh Xuân, thành phố Hà Nội
(72) Ngô Thọ Long (VN)
(74) Công ty TNHH Sở hữu trí tuệ PADEMARK (PADEMARK CO.,LTD.)
(55)



1.1



1.2



1.3

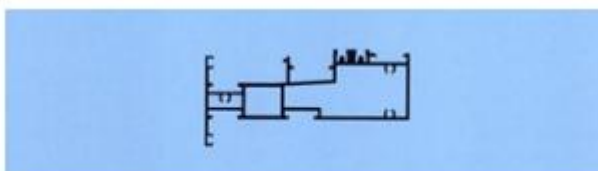

1.4

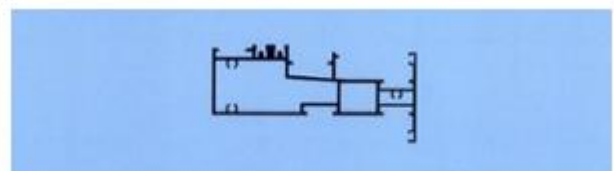

1.5



1.6

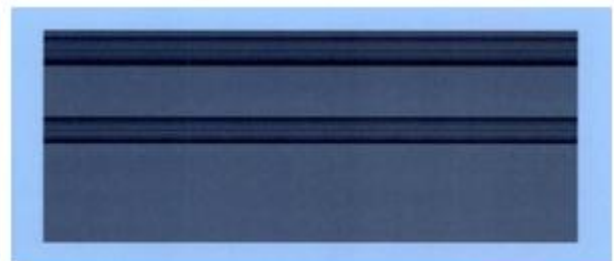

1.7

CÔNG BÁO SỞ HỮU CÔNG NGHIỆP SỐ 421 TẬP A – QUYỀN 2 (04.2023)

- (11) **46676**
(21) 3-2022-02986 (28) 1
(54) **THANH KIM LOẠI ĐỊNH HÌNH** (51) **25-01**
(22) 30/12/2022 (43) 25/04/2023
(73) **CÔNG TY CỔ PHẦN TẬP ĐOÀN KENWIN (VN)**
Tầng 4 tòa nhà VG Building, số 235 đường Nguyễn Trãi, phường Thanh Xuân
Trung, quận Thanh Xuân, thành phố Hà Nội
(72) Ngô Thọ Long (VN)
(74) Công ty TNHH Sở hữu trí tuệ PADEMARK (PADEMARK CO.,LTD.)
(55)



1.1



1.2



1.3

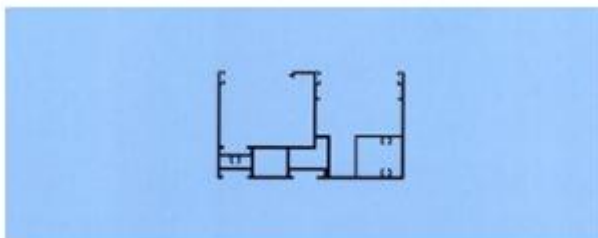

1.4

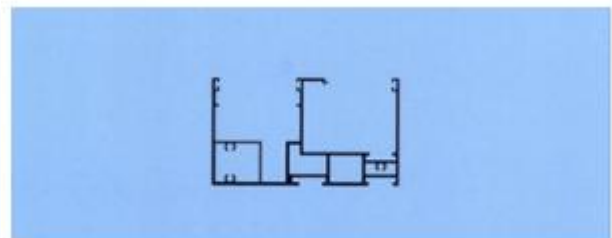

1.5



1.6



1.7

CÔNG BÁO SỞ HỮU CÔNG NGHIỆP SỐ 421 TẬP A – QUYỀN 2 (04.2023)

- (11) **46677**
(21) 3-2022-02987 (28) 1
(54) **THANH KIM LOẠI ĐỊNH HÌNH** (51) **25-01**
(22) 30/12/2022 (43) 25/04/2023
(73) **CÔNG TY CỔ PHẦN TẬP ĐOÀN KENWIN (VN)**
Tầng 4 tòa nhà VG Building, số 235 đường Nguyễn Trãi, phường Thanh Xuân
Trung, quận Thanh Xuân, thành phố Hà Nội
(72) Ngô Thọ Long (VN)
(74) Công ty TNHH Sở hữu trí tuệ PADEMARK (PADEMARK CO.,LTD.)
(55)



1.1



1.2



1.3



1.4



1.5



1.6



1.7

CÔNG BÁO SỞ HỮU CÔNG NGHIỆP SỐ 421 TẬP A – QUYỀN 2 (04.2023)

- (11) **46678**
(21) 3-2022-02985 (28) 1
(54) **THANH KIM LOẠI ĐỊNH HÌNH** (51) **25-01**
(22) 30/12/2022 (43) 25/04/2023
(73) **CÔNG TY CỔ PHẦN TẬP ĐOÀN KENWIN (VN)**
Tầng 4 tòa nhà VG Building, số 235 đường Nguyễn Trãi, phường Thanh Xuân
Trung, quận Thanh Xuân, thành phố Hà Nội
(72) Ngô Thọ Long (VN)
(74) Công ty TNHH Sở hữu trí tuệ PADEMARK (PADEMARK CO.,LTD.)
(55)



1.1



1.2



1.3

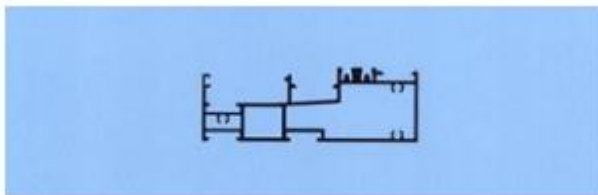

1.4

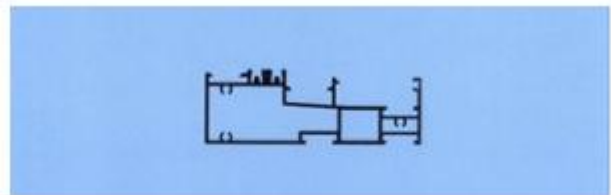

1.5



1.6



1.7

CÔNG BÁO SỞ HỮU CÔNG NGHIỆP SỐ 421 TẬP A – QUYỀN 2 (04.2023)

- (11) **46679**
(21) 3-2022-02983 (28) 1
(54) **THANH KIM LOẠI ĐỊNH HÌNH** (51) **25-01**
(22) 30/12/2022 (43) 25/04/2023
(73) **CÔNG TY TNHH FRAVI VIỆT NAM (VN)**
Tổ dân phố Tứ Mỹ, phường Phùng Chí Kiên, thị xã Mỹ Hòa, tỉnh Hưng Yên
(72) Đặng Thị Thanh Tân (VN)
(74) Công ty TNHH Sở hữu trí tuệ Gia Việt (GIAVIET CO., LTD.)
(55)

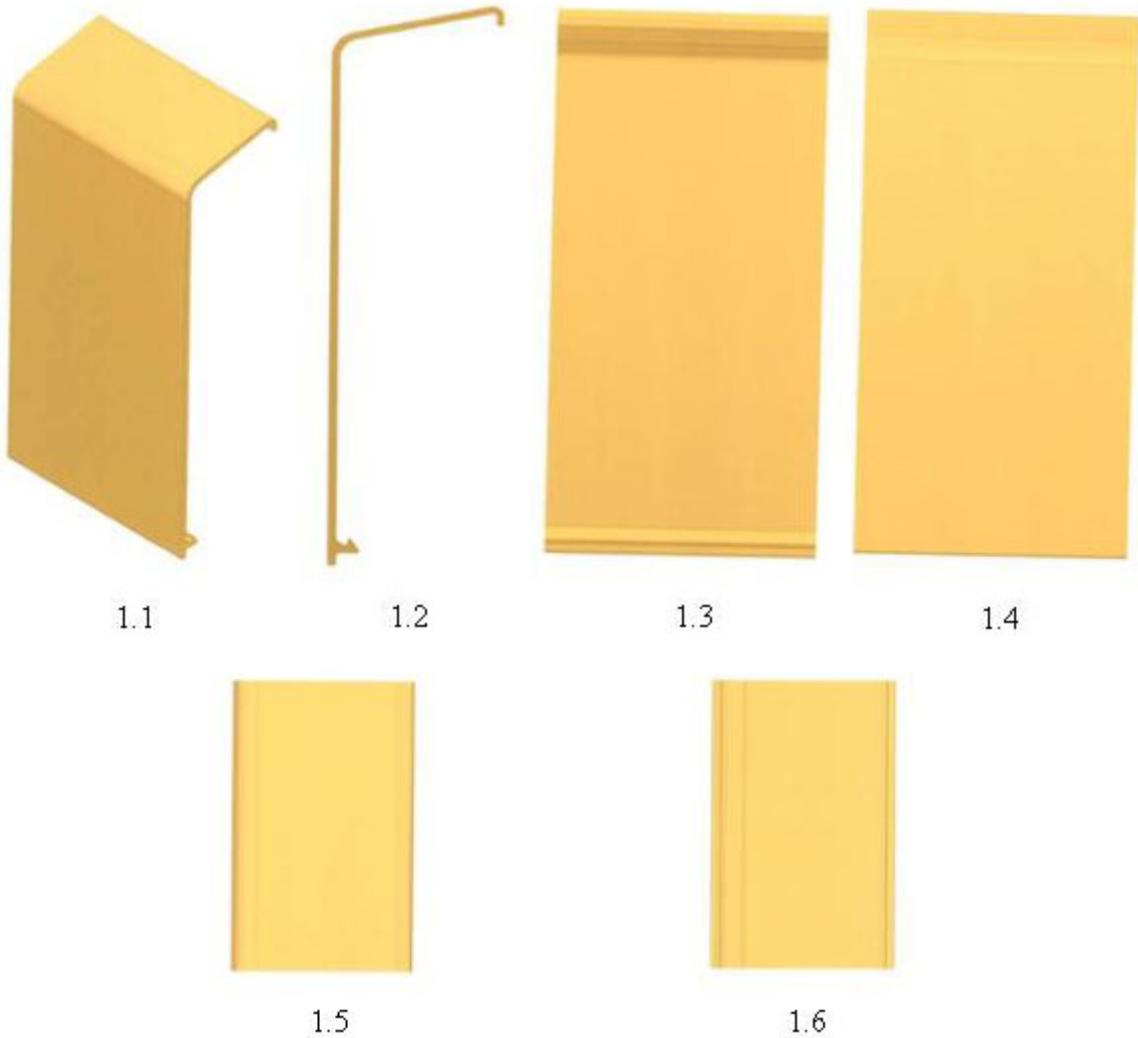

CÔNG BÁO SỞ HỮU CÔNG NGHIỆP SỐ 421 TẬP A – QUYỀN 2 (04.2023)

- (11) **46680**
(21) 3-2022-02984 (28) 1
(54) **THANH KIM LOẠI ĐỊNH HÌNH** (51) **25-01**
(22) 30/12/2022 (43) 25/04/2023
(73) **CÔNG TY CỔ PHẦN TẬP ĐOÀN KENWIN (VN)**
Tầng 4 tòa nhà VG Building, số 235 đường Nguyễn Trãi, phường Thanh Xuân
Trung, quận Thanh Xuân, thành phố Hà Nội
(72) Ngô Thọ Long (VN)
(74) Công ty TNHH Sở hữu trí tuệ PADEMARK (PADEMARK CO.,LTD.)
(55)



1.1



1.2



1.3

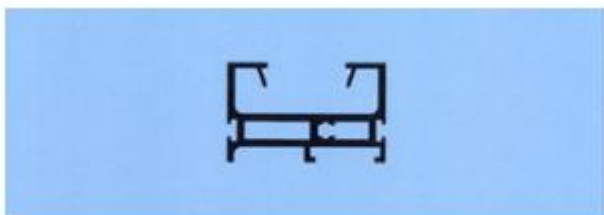

1.4



1.5



1.6



1.7

CÔNG BÁO SỞ HỮU CÔNG NGHIỆP SỐ 421 TẬP A – QUYỀN 2 (04.2023)

- (11) **46681**
(21) 3-2022-02980 (28) 1
(54) **THANH KIM LOẠI ĐỊNH HÌNH** (51) **25-01**
(22) 30/12/2022 (43) 25/04/2023
(73) **CÔNG TY TNHH FRAVI VIỆT NAM (VN)**
Tổ dân phố Tứ Mỹ, phường Phùng Chí Kiên, thị xã Mỹ Hòa, tỉnh Hưng Yên
(72) Đặng Thị Thanh Tân (VN)
(74) Công ty TNHH Sở hữu trí tuệ Gia Việt (GIAVIET CO., LTD.)
(55)



1.1

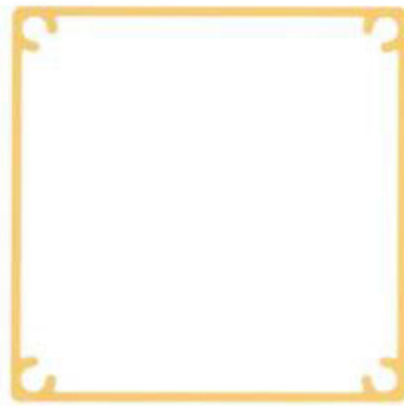

1.2



1.3



1.4

CÔNG BÁO SỞ HỮU CÔNG NGHIỆP SỐ 421 TẬP A – QUYỀN 2 (04.2023)

- (11) **46682**
(21) 3-2022-02982 (28) 1
(54) **THANH KIM LOẠI ĐỊNH HÌNH** (51) **25-01**
(22) 30/12/2022 (43) 25/04/2023
(73) **CÔNG TY TNHH FRAVI VIỆT NAM (VN)**
Tổ dân phố Tứ Mỹ, phường Phùng Chí Kiên, thị xã Mỹ Hòa, tỉnh Hưng Yên
(72) Đặng Thị Thanh Tân (VN)
(74) Công ty TNHH Sở hữu trí tuệ Gia Việt (GIAVIET CO., LTD.)
(55)



1.1



1.2



1.3



1.4



1.5

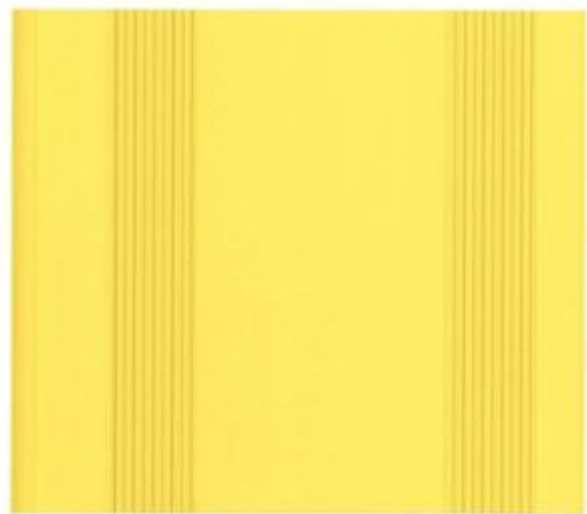

1.6

CÔNG BÁO SỞ HỮU CÔNG NGHIỆP SỐ 421 TẬP A – QUYỀN 2 (04.2023)

- (11) **46683**
(21) 3-2022-02981 (28) 1
(54) **THANH KIM LOẠI ĐỊNH HÌNH** (51) **25-01**
(22) 30/12/2022 (43) 25/04/2023
(73) **CÔNG TY TNHH FRAVI VIỆT NAM (VN)**
Tổ dân phố Tứ Mỹ, phường Phùng Chí Kiên, thị xã Mỹ Hòa, tỉnh Hưng Yên
(72) Đặng Thị Thanh Tân (VN)
(74) Công ty TNHH Sở hữu trí tuệ Gia Việt (GIAVIET CO., LTD.)
(55)



1.1



1.2



1.3



1.4



1.5



1.6

CÔNG BÁO SỞ HỮU CÔNG NGHIỆP SỐ 421 TẬP A – QUYỀN 2 (04.2023)

- (11) **46684**
(21) 3-2022-02829 (28) 1
(54) **THANH KIM LOẠI ĐỊNH HÌNH** (51) **25-01**
(22) 22/12/2022 (43) 25/04/2023
(73) **CÔNG TY CỔ PHẦN TẬP ĐOÀN EUROVIEW (VN)**
Số 150 đường Cổ Bi, xã Cổ Bi, huyện Gia Lâm, thành phố Hà Nội
(72) Nguyễn Thị Trung Thủy (VN)
(74) Công ty TNHH Sở hữu trí tuệ Gia Việt (GIAVIET CO., LTD.)
(55)

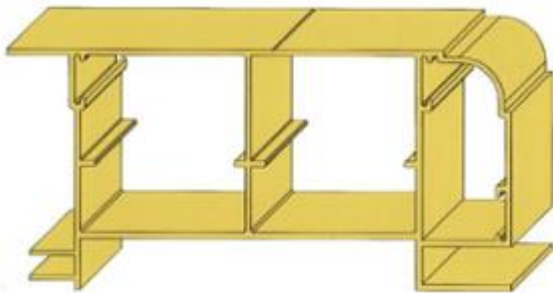

1.1

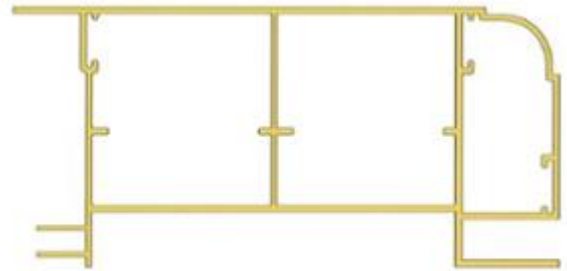

1.2



1.3



1.4

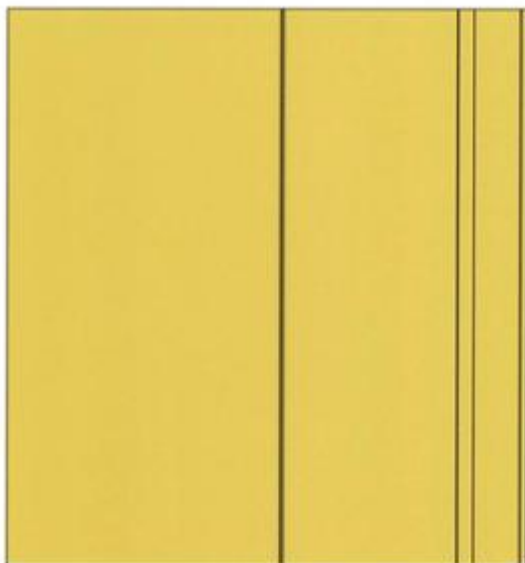

1.5

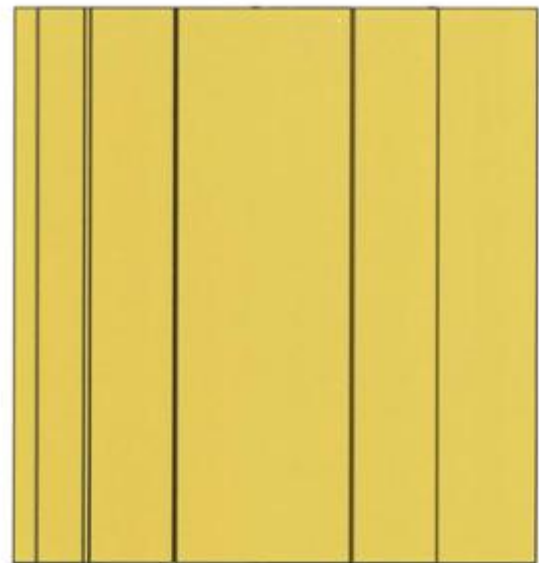

1.6

CÔNG BÁO SỞ HỮU CÔNG NGHIỆP SỐ 421 TẬP A – QUYỀN 2 (04.2023)

- (11) **46685**
(21) 3-2022-02978 (28) 1
(54) **THANH KIM LOẠI ĐỊNH HÌNH** (51) **25-01**
(22) 30/12/2022 (43) 25/04/2023
(73) **CÔNG TY TNHH FRAVI VIỆT NAM (VN)**
Tổ dân phố Tứ Mỹ, phường Phùng Chí Kiên, thị xã Mỹ Hòa, tỉnh Hưng Yên
(72) Đặng Thị Thanh Tân (VN)
(74) Công ty TNHH Sở hữu trí tuệ Gia Việt (GIAVIET CO., LTD.)
(55)



1.1



1.2



1.3



1.4



1.5

CÔNG BÁO SỞ HỮU CÔNG NGHIỆP SỐ 421 TẬP A – QUYỀN 2 (04.2023)

- (11) **46686**
(21) 3-2022-02933 (28) 1
(54) **GIÀN ÓNG PHÓNG PHÁO HOA** (51) **22-03**
(22) 29/12/2022 (43) 25/04/2023
(73) **LÊ VĂN LUÂN (VN)**
Số 114K1, phố Nghĩa Tân, phường Nghĩa Tân, quận Cầu Giấy, thành phố Hà Nội
(72) Lê Văn Luân (VN)
(55)



1.1



1.2



1.3



1.4

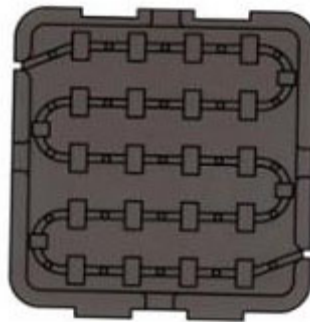

1.5



1.6



1.7



1.8

CÔNG BÁO SỞ HỮU CÔNG NGHIỆP SỐ 421 TẬP A – QUYỀN 2 (04.2023)

(11) **46687**

(21) 3-2023-00122

(28) 1

(54) **ĐÈN XE MÁY**

(51) **26-06**

(22) 30/11/2021

(43) 25/04/2023

(73) **GIVI SPA (IT)**

Via G. Ungaretti, 48. 25020 Flero (BS), Italy

(72) Visenzi Giuseppe (IT)

(74) Công ty Cổ phần Sở hữu công nghiệp INVESTIP (INVESTIP)

(55)



1.1



1.2



1.3



1.4



1.5



1.6



1.7



1.8

CÔNG BÁO SỞ HỮU CÔNG NGHIỆP SỐ 421 TẬP A – QUYỀN 2 (04.2023)

- (11) **46688**
(21) 3-2022-02499 (28) 1
(54) **CHAI** (51) **09-01**
(22) 16/11/2022 (43) 25/04/2023
(73) **CÔNG TY CỔ PHẦN HÀNG TIÊU DÙNG MASAN (VN)**
Tầng 12, tòa nhà MPlaza Saigon, số 39 Lê Duẩn, phường Bến Nghé, quận 1, thành phố Hồ Chí Minh
(72) Nguyễn Hoàng Yên (VN)
(74) Công ty cổ phần Sở hữu trí tuệ BROSS và Cộng sự (BROSS & PARTNERS., JSC)
(55)

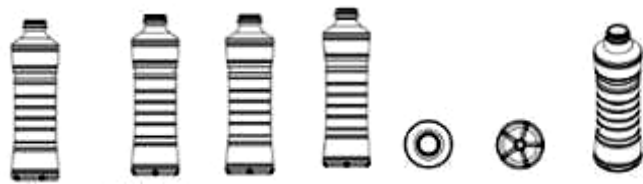

1.1 1.2 1.3 1.4 1.5 1.6 1.7

CÔNG BÁO SỞ HỮU CÔNG NGHIỆP SỐ 421 TẬP A – QUYỀN 2 (04.2023)

- (11) **46689**
(21) 3-2022-02438 (28) 1
(54) **CHAI** (51) **09-01**
(22) 08/11/2022 (43) 25/04/2023
(73) **CÔNG TY CỔ PHẦN DẦU THỰC VẬT TÂN BÌNH (VN)**
889 Trường Chinh, phường Tây Thạnh, quận Tân Phú, thành phố Hồ Chí Minh
(72) Huỳnh Trung Lập (VN)
(74) **CÔNG TY TNHH SỞ HỮU TRÍ TUỆ SETHACO (SETHACO IP CO.,LTD)**
(55)



1.1



1.2



1.3



1.4



1.5



1.6



1.7

CÔNG BÁO SỞ HỮU CÔNG NGHIỆP SỐ 421 TẬP A – QUYỀN 2 (04.2023)

- (11) **46690**
(21) 3-2022-02439 (28) 1
(54) **CHAI** (51) **09-01**
(22) 08/11/2022 (43) 25/04/2023
(73) **CÔNG TY CỔ PHẦN DẦU THỰC VẬT TÂN BÌNH (VN)**
889 Trường Chinh, phường Tây Thạnh, quận Tân Phú, thành phố Hồ Chí Minh
(72) Huỳnh Trung Lập (VN)
(74) **CÔNG TY TNHH SỞ HỮU TRÍ TUỆ SETHACO (SETHACO IP CO.,LTD)**
(55)



Hình 1: hình phối cảnh

1.1



Hình 2: hình chiếu phía trước

1.2



Hình 3: hình chiếu phía sau

1.3



Hình 4: hình chiếu bên trái

1.4



1.5



1.6



1.7

CÔNG BÁO SỞ HỮU CÔNG NGHIỆP SỐ 421 TẬP A – QUYỀN 2 (04.2023)

- (11) **46691**
(21) 3-2022-02468 (28) 1
(54) **CHAI** (51) **09-01**
(22) 11/11/2022 (43) 25/04/2023
(73) **CÔNG TY CỔ PHẦN DẦU THỰC VẬT TÂN BÌNH (VN)**
889 Trường Chinh, phường Tây Thạnh, quận Tân Phú, thành phố Hồ Chí Minh
(72) Huỳnh Trung Lập (VN)
(74) **CÔNG TY TNHH SỞ HỮU TRÍ TUỆ SETHACO (SETHACO IP CO.,LTD)**
(55)



Hình 1: hình phối cảnh

1.1



Hình 2: hình chiếu phía trước

1.2



Hình 3: hình chiếu phía sau

1.3



Hình 4: hình chiếu bên trái

1.4



1.5



1.6



1.7

CÔNG BÁO SỞ HỮU CÔNG NGHIỆP SỐ 421 TẬP A – QUYỀN 2 (04.2023)

- (11) **46692**
(21) 3-2022-02624 (28) 1
(54) **CHAI** (51) **09-01**
(22) 29/11/2022 (43) 25/04/2023
(73) **HỘ KINH DOANH CƠ SỞ SẢN XUẤT RƯỢU THỦ CÔNG TRUYỀN THỐNG ÚT TÂY (VN)**
Ấp Tân Long A, xã Tân Bình, huyện Phụng Hiệp, tỉnh Hậu Giang
(72) Lê Quang Anh (VN)
(74) Công ty Cổ phần Sở hữu công nghiệp INVESTIP (INVESTIP)
(55)



1.1

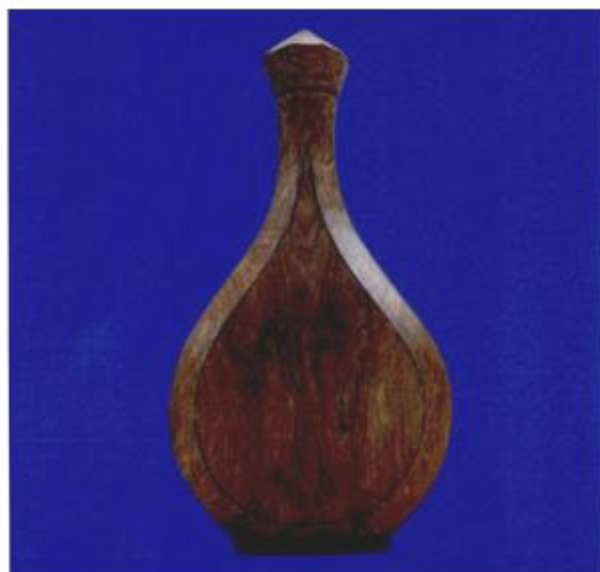

1.2

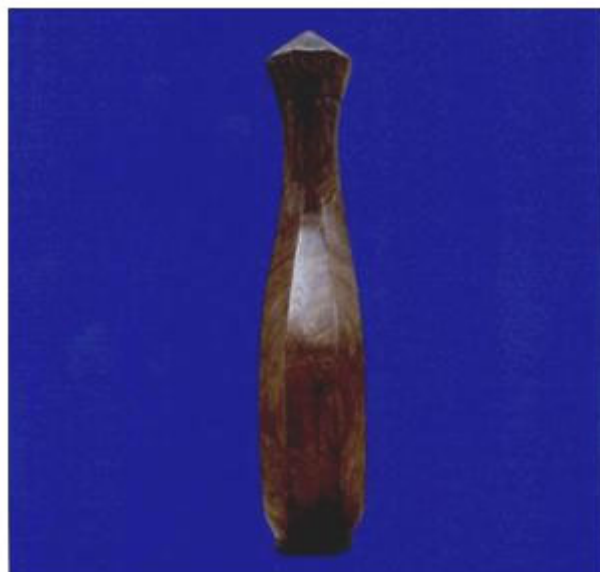

1.3



1.4



1.5

CÔNG BÁO SỞ HỮU CÔNG NGHIỆP SỐ 421 TẬP A – QUYỀN 2 (04.2023)

(11) **46693**

(21) 3-2022-02640

(28) 1

(54) **LỌ**

(51) **09-01**

(22) 30/11/2022

(43) 25/04/2023

(73) **LG HOUSEHOLD & HEALTH CARE LTD. (KR)**

58, Saemunan-ro, Jongno-gu, Seoul, Republic of Korea

(72) LEE, Da Lin (KR)

(74) Công ty TNHH Tâm nhìn và Liên danh (VISION & ASSOCIATES CO.LTD.)

(55)

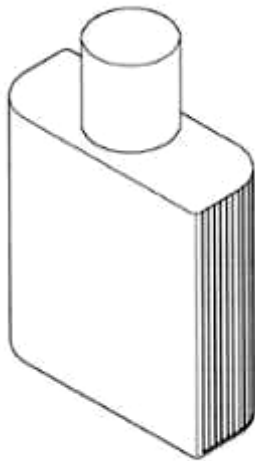

1.1

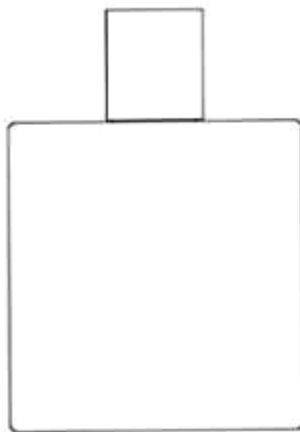

1.2

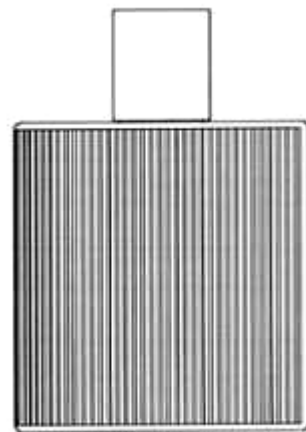

1.3



1.4

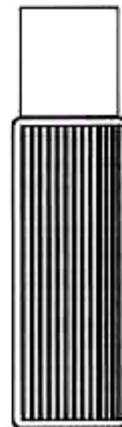

1.5

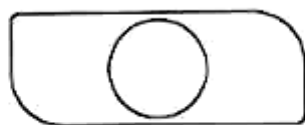

1.6



1.7

CÔNG BÁO SỞ HỮU CÔNG NGHIỆP SỐ 421 TẬP A – QUYỀN 2 (04.2023)

- (11) **46694**
(21) 3-2022-01478 (28) 1
(54) **CHAI** (51) **09-01**
(22) 22/07/2022 (43) 25/04/2023
(73) **CÔNG TY TNHH CHẾ BIẾN NƯỚC CHẤM MEKONG (VN)**
Áp Bình Tiên 2, xã Đức Hòa Hạ, huyện Đức Hoà, tỉnh Long An
(72) Phan Bảo Duy (VN)
(74) Công ty TNHH NACILAW (NACILAW)
(55)

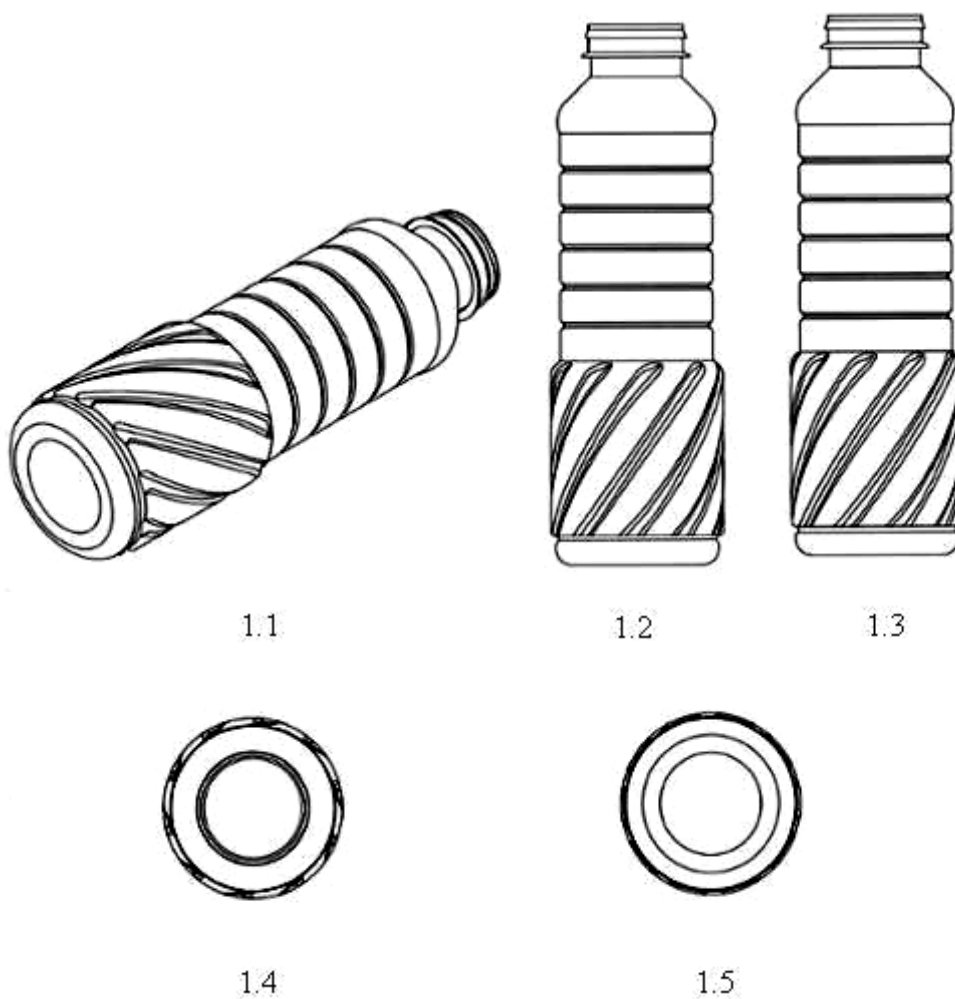

CÔNG BÁO SỞ HỮU CÔNG NGHIỆP SỐ 421 TẬP A – QUYỀN 2 (04.2023)

- (11) **46695**
(21) 3-2022-02554 (28) 1
(54) **THIẾT BỊ PHÁT SÓNG DI ĐỘNG** (51) **14-03**
(22) 21/11/2022 (43) 25/04/2023
(30) 6209629 20/05/2022 UK;
(73) **VODAFONE GROUP SERVICES LIMITED (UK)**
Vodafone House, The Connection, Newbury, Berkshire RG14 2FN, United Kingdom
(72) 1. JAMES BLYTH (UK)
2. MATTHEW PLESTED (UK)
3. TOM GUY (UK)
(74) Công ty Luật TNHH Phạm và Liên danh (PHAM & ASSOCIATES)
(55)



1.1



1.2



1.3



1.4



1.5



1.6



1.7



1.8



1.9

CÔNG BÁO SỞ HỮU CÔNG NGHIỆP SỐ 421 TẬP A – QUYỀN 2 (04.2023)

- (11) **46696**
(21) 3-2022-02642 (28) 1
(54) **CAN NƯỚC GIẶT** (51) **09-02**
(22) 02/12/2022 (43) 25/04/2023
(73) **CÔNG TY TNHH NGHỆ SĨ QUYỀN LINH (VN)**
142B, đường số 1, KDC Sông Giồng, khu phố 2, phường An Phú, thành phố Thủ Đức, thành phố Hồ Chí Minh
(72) Nguyễn Thị Vân Anh (VN)
(55)



1.1



1.2



1.3



1.4



1.5

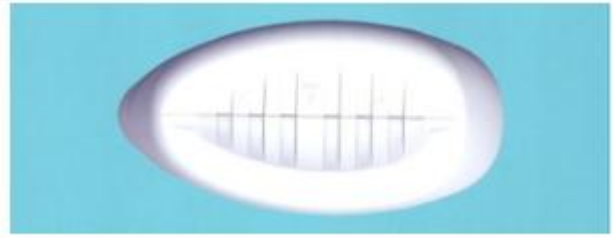

1.6

- (11) **46697**
(21) 3-2022-02555 (28) 1
(54) **THIẾT BỊ PHÁT SÓNG DI ĐỘNG** (51) **14-03**
(22) 21/11/2022 (43) 25/04/2023
(30) 6209628 20/05/2022 UK;
(73) **VODAFONE GROUP SERVICES LIMITED (UK)**
Vodafone House, The Connection, Newbury, Berkshire RG14 2FN, United Kingdom
(72) 1. JAMES BLYTH (UK)
2. MATTHEW PLESTED (UK)
3. TOM GUY (UK)
(74) Công ty Luật TNHH Phạm và Liên danh (PHAM & ASSOCIATES)
(55)



1.1

1.2

1.3

1.4



1.5



1.6



1.7



1.8

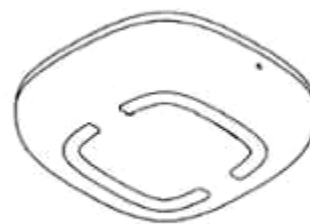

1.9

CÔNG BÁO SỞ HỮU CÔNG NGHIỆP SỐ 421 TẬP A – QUYỀN 2 (04.2023)

- (11) **46698**
(21) 3-2022-02556 (28) 1
(54) **THIẾT BỊ KÍCH SÓNG WIFI** (51) **14-03**
(22) 21/11/2022 (43) 25/04/2023
(30) 6209627 20/05/2022 UK;
(73) **VODAFONE GROUP SERVICES LIMITED (UK)**
Vodafone House, The Connection, Newbury, Berkshire RG14 2FN, United Kingdom
(72) 1. JAMES BLYTH (UK)
2. MATTHEW PLESTED (UK)
3. TOM GUY (UK)
(74) Công ty Luật TNHH Phạm và Liên danh (PHAM & ASSOCIATES)
(55)



1.1

1.2

1.3

1.4

1.5

1.6



1.7



1.8



1.9

- (11) **46699**
(21) 3-2022-02557 (28) 1
(54) **THIẾT BỊ KÍCH SÓNG WIFI** (51) **14-03**
(22) 21/11/2022 (43) 25/04/2023
(30) 6209626 20/05/2022 UK;
(73) **VODAFONE GROUP SERVICES LIMITED (UK)**
Vodafone House, The Connection, Newbury, Berkshire RG14 2FN, United Kingdom
(72) 1. JAMES BLYTH (UK)
2. MATTHEW PLESTED (UK)
3. TOM GUY (UK)
(74) Công ty Luật TNHH Phạm và Liên danh (PHAM & ASSOCIATES)
(55)

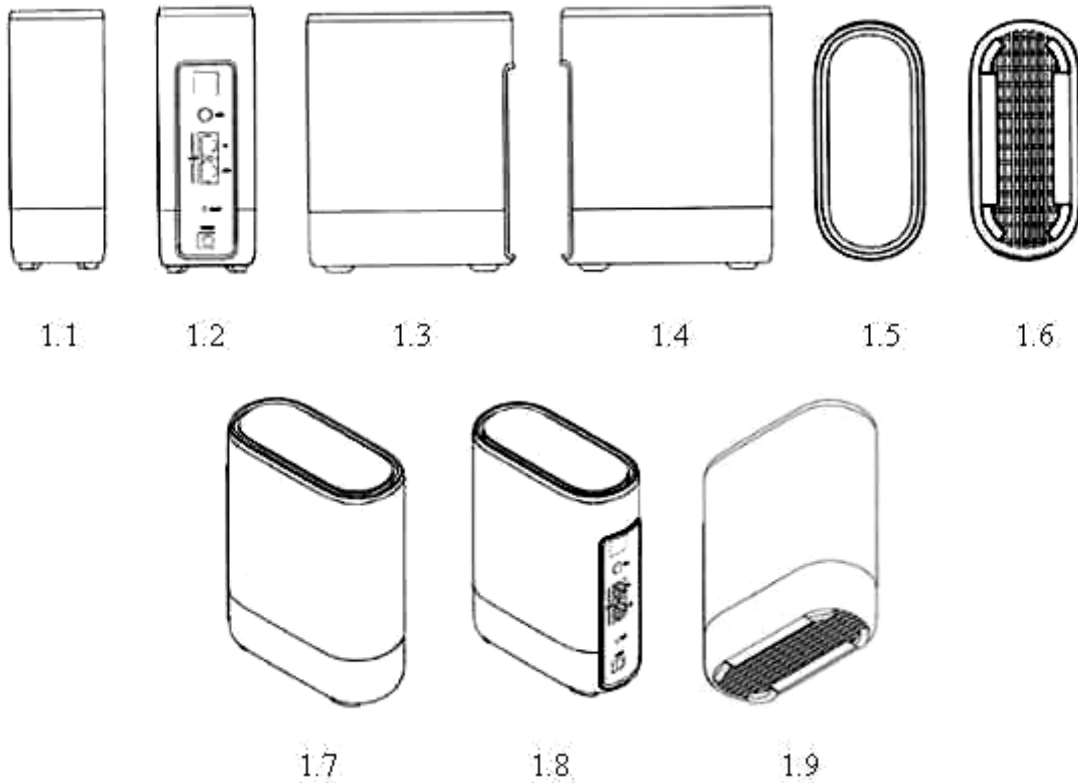

CÔNG BÁO SỞ HỮU CÔNG NGHIỆP SỐ 421 TẬP A – QUYỀN 2 (04.2023)

- (11) **46700**
(21) 3-2022-02558 (28) 1
(54) **THIẾT BỊ KẾT NỐI MẠNG** (51) **14-03**
(22) 21/11/2022 (43) 25/04/2023
(30) 6209625 20/05/2022 UK;
(73) **VODAFONE GROUP SERVICES LIMITED (UK)**
Vodafone House, The Connection, Newbury, Berkshire RG14 2FN, United Kingdom
(72) 1. JAMES BLYTH (UK)
2. MATTHEW PLESTED (UK)
3. TOM GUY (UK)
(74) Công ty Luật TNHH Phạm và Liên danh (PHAM & ASSOCIATES)
(55)



1.1



1.2



1.3



1.4



1.5



1.6

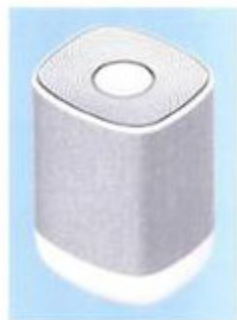

1.7



1.8



1.9

- (11) **46701**
(21) 3-2022-02559 (28) 1
(54) **THIẾT BỊ KẾT NỐI MẠNG** (51) **14-03**
(22) 21/11/2022 (43) 25/04/2023
(30) 6209624 20/05/2022 UK;
(73) **VODAFONE GROUP SERVICES LIMITED (UK)**
Vodafone House, The Connection, Newbury, Berkshire RG14 2FN, United Kingdom
(72) 1. JAMES BLYTH (UK)
2. MATTHEW PLESTED (UK)
3. TOM GUY (UK)
(74) Công ty Luật TNHH Phạm và Liên danh (PHAM & ASSOCIATES)
(55)

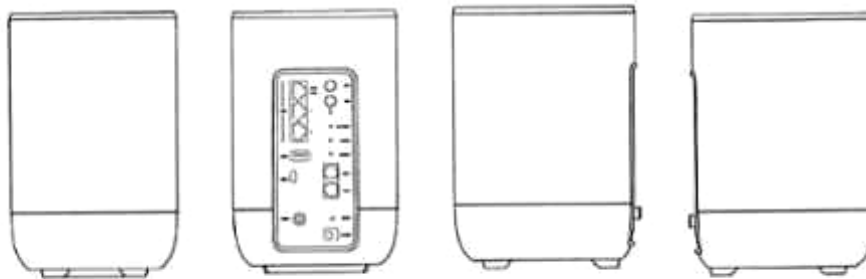

1.1

1.2

1.3

1.4



1.5

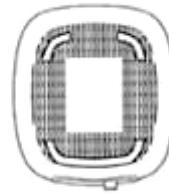

1.6



1.7



1.8



1.9

CÔNG BÁO SỞ HỮU CÔNG NGHIỆP SỐ 421 TẬP A – QUYỀN 2 (04.2023)

- (11) **46702**
(21) 3-2022-02560 (28) 1
(54) **THIẾT BỊ KẾT NỐI MẠNG** (51) **14-03**
(22) 21/11/2022 (43) 25/04/2023
(30) 6209623 20/05/2022 UK;
(73) **VODAFONE GROUP SERVICES LIMITED (UK)**
Vodafone House, The Connection, Newbury, Berkshire RG14 2FN, United Kingdom
(72) 1. JAMES BLYTH (UK)
2. MATTHEW PLESTED (UK)
3. TOM GUY (UK)
(74) Công ty Luật TNHH Phạm và Liên danh (PHAM & ASSOCIATES)
(55)



1.1

1.2

1.3

1.4



1.5



1.6



1.7



1.8



1.9

CÔNG BÁO SỞ HỮU CÔNG NGHIỆP SỐ 421 TẬP A – QUYỀN 2 (04.2023)

- (11) **46703**
(21) 3-2022-02561 (28) 1
(54) **THIẾT BỊ KẾT NỐI MẠNG** (51) **14-03**
(22) 21/11/2022 (43) 25/04/2023
(30) 6209622 20/05/2022 UK;
(73) **VODAFONE GROUP SERVICES LIMITED (UK)**
Vodafone House, The Connection, Newbury, Berkshire RG14 2FN, United Kingdom
(72) 1. JAMES BLYTH (UK)
2. MATTHEW PLESTED (UK)
3. TOM GUY (UK)
(74) Công ty Luật TNHH Phạm và Liên danh (PHAM & ASSOCIATES)
(55)

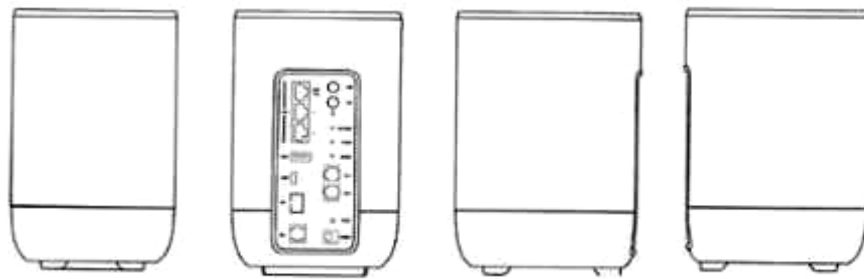

1.1

1.2

1.3

1.4



1.5

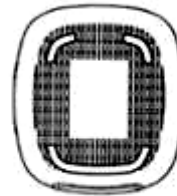

1.6



1.7



1.8



1.9

CÔNG BÁO SỞ HỮU CÔNG NGHIỆP SỐ 421 TẬP A – QUYỀN 2 (04.2023)

- (11) **46704**
- (21) 3-2022-02601 (28) 1
- (54) **TUÝP KEM ĐÁNH RĂNG** (51) **09-05**
- (22) 25/11/2022 (43) 25/04/2023
- (73) **LG HOUSEHOLD & HEALTH CARE LTD. (KR)**
58, Saemunan-ro, Jongno-gu, Seoul, Republic of Korea
- (72) **CHOI, Song (KR)**
- (74) **Công ty TNHH Tâm nhìn và Liên danh (VISION & ASSOCIATES CO.LTD.)**
- (55)

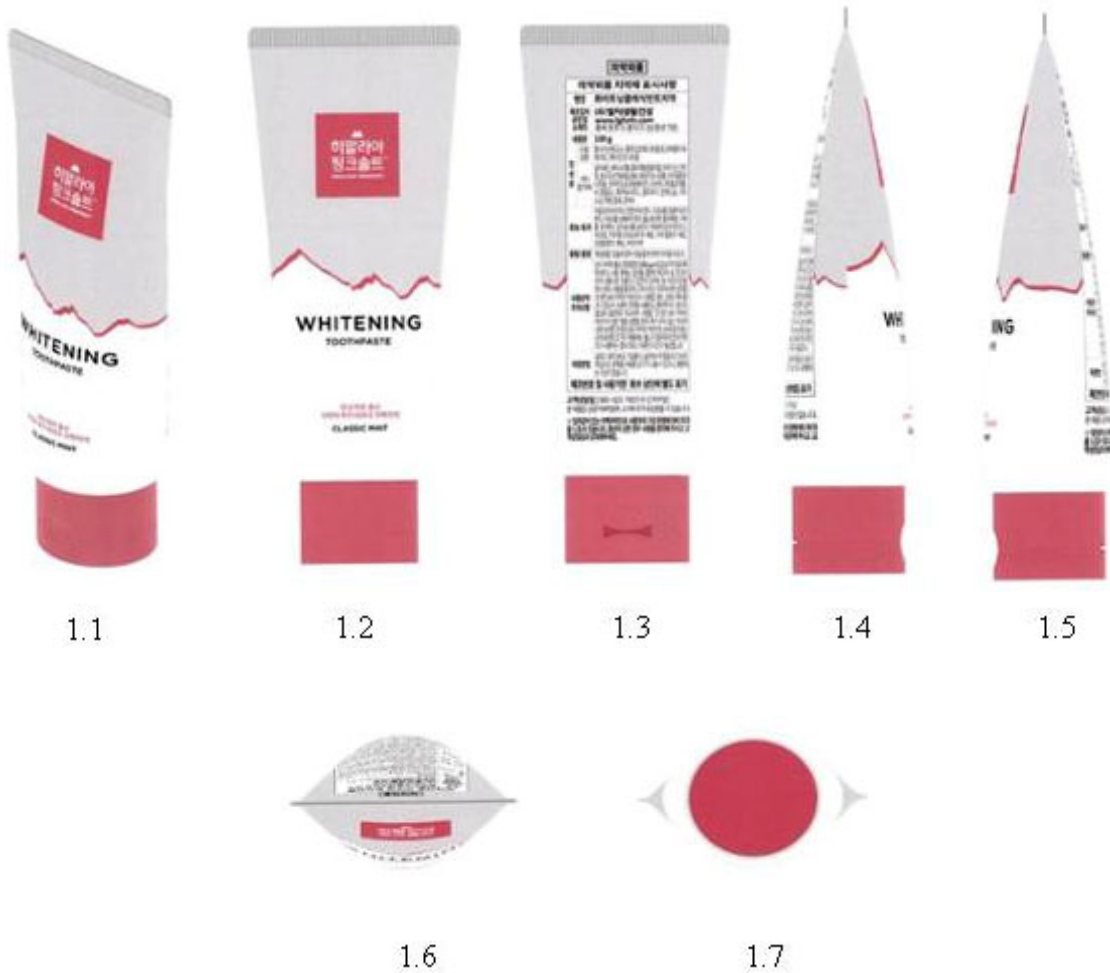

CÔNG BÁO SỞ HỮU CÔNG NGHIỆP SỐ 421 TẬP A – QUYỀN 2 (04.2023)

- (11) **46705**
(21) 3-2022-02814 (28) 1
(54) **Ô TÔ ĐỒ CHƠI** (51) **21-01**
(22) 20/12/2022 (43) 25/04/2023
(30) DM/221708 21/06/2022 WO;
(73) **FERRARI S.P.A. (IT)**
Via Emilia Est 1163, MODENA, Italy
(72) Flavio MANZONI (IT)
(74) Công ty TNHH một thành viên Sở hữu trí tuệ VCCI (VCCI-IP CO.,LTD)
(55)

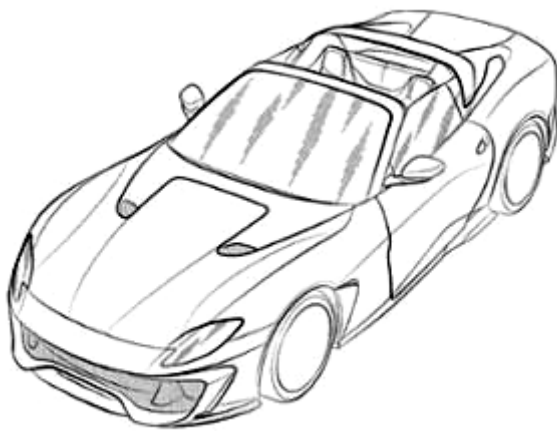

1.1



1.2



1.3



1.4



1.5

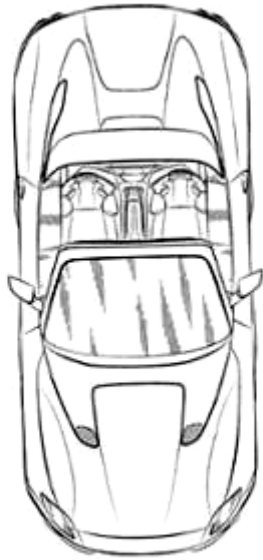

1.6

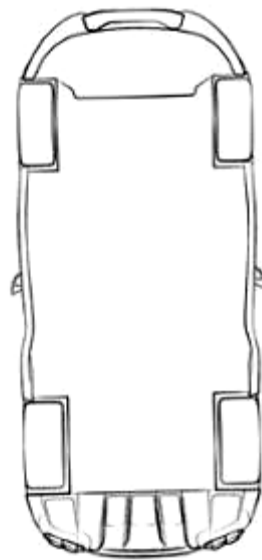

1.7

CÔNG BÁO SỞ HỮU CÔNG NGHIỆP SỐ 421 TẬP A – QUYỀN 2 (04.2023)

- (11) **46706**
(21) 3-2022-02815 (28) 1
(54) **Ô TÔ** (51) **12-08**
(22) 20/12/2022 (43) 25/04/2023
(30) DM/221724 21/06/2022 WO;
(73) **FERRARI S.P.A. (IT)**
Via Emilia Est 1163, MODENA, Italy
(72) Flavio MANZONI (IT)
(74) Công ty TNHH một thành viên Sở hữu trí tuệ VCCI (VCCI-IP CO.,LTD)
(55)

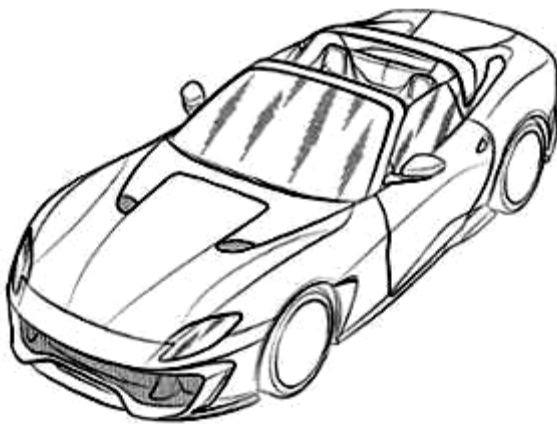

1.1



1.2



1.3



1.4

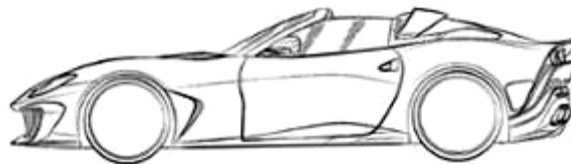

1.5

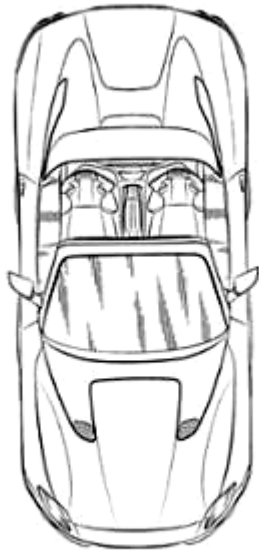

1.6

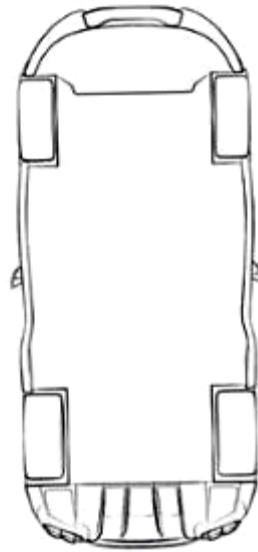

1.7

CÔNG BÁO SỞ HỮU CÔNG NGHIỆP SỐ 421 TẬP A – QUYỀN 2 (04.2023)

- (11) **46707**
- (21) 3-2022-02976 (28) 1
- (54) **XE MÁY ĐIỆN** (51) **12-11**
- (22) 30/12/2022 (43) 25/04/2023
- (73) **CÔNG TY CỔ PHẦN PHƯƠNG TIỆN ĐIỆN THÔNG MINH SELEX (VN)**
Nhà B26, BT6, khu đô thị Văn Quán, phường Văn Quán, quận Hà Đông, thành phố Hà Nội
- (72) 1. ĐẶNG HUY HOÀNG (VN)
2. NGUYỄN HỮU PHƯỚC NGUYỄN (VN)
3. NGUYỄN ĐÌNH QUẢNG (VN)
4. TRẦN QUỐC ĐĂNG (VN)
5. PHẠM THANH QUÂN (VN)
6. NGUYỄN HOÀNG LONG (VN)
- (55)



1.1



1.2



1.3



1.4



1.5



1.6



1.7



1.8



1.9



1.10

CÔNG BÁO SỞ HỮU CÔNG NGHIỆP SỐ 421 TẬP A – QUYỀN 2 (04.2023)

- (11) **46708**
(21) 3-2022-02808 (28) 1
(54) **CHAI** (51) **09-01**
(22) 20/12/2022 (43) 25/04/2023
(73) **CÔNG TY CỔ PHẦN TITAFÁ (VN)**
160 Hiền Vương, phường Phú Thạnh, quận Tân Phú, thành phố Hồ Chí Minh
(72) Ngô Văn Hùng (VN)
(55)



1.1



1.2



1.3



1.4



1.5



1.6



1.7

- (11) **46709**
(21) 3-2022-02767 (28) 1
(54) **THANH KIM LOẠI ĐỊNH HÌNH** (51) **25-01**
(22) 16/12/2022 (43) 25/04/2023
(73) **CÔNG TY CỔ PHẦN NHÔM ZHONGKAI VIỆT NAM (VN)**
Thôn Đình Dù, xã Đình Dù, huyện Văn Lâm, tỉnh Hưng Yên
(72) Đỗ Đức Thuận (VN)
(74) Công ty TNHH Sở hữu trí tuệ Gia Việt (GIAVIET CO., LTD.)
(55)

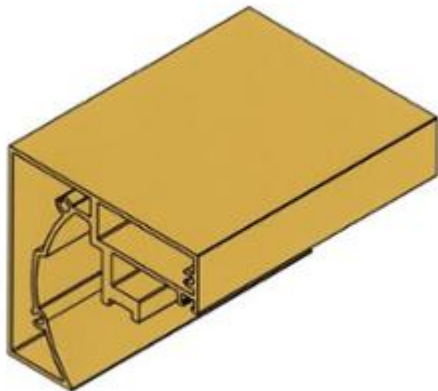

1.1

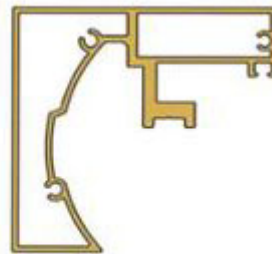

1.2



1.3



1.4



1.5



1.6

CÔNG BÁO SỞ HỮU CÔNG NGHIỆP SỐ 421 TẬP A – QUYỀN 2 (04.2023)

- (11) **46710**
(21) 3-2022-02769 (28) 1
(54) **THANH KIM LOẠI ĐỊNH HÌNH** (51) **25-01**
(22) 16/12/2022 (43) 25/04/2023
(73) **CÔNG TY CỔ PHẦN NHÔM ZHONGKAI VIỆT NAM (VN)**
Thôn Đình Dù, xã Đình Dù, huyện Văn Lâm, tỉnh Hưng Yên
(72) Đỗ Đức Thuận (VN)
(74) Công ty TNHH Sở hữu trí tuệ Gia Việt (GIAVIET CO., LTD.)
(55)

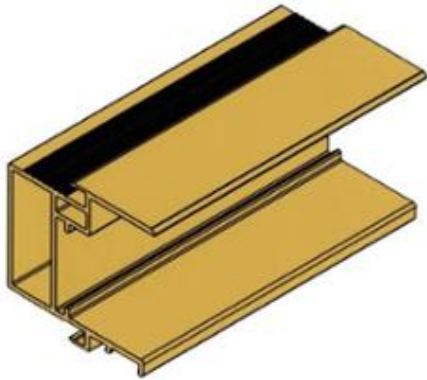

1.1



1.2



1.3



1.4

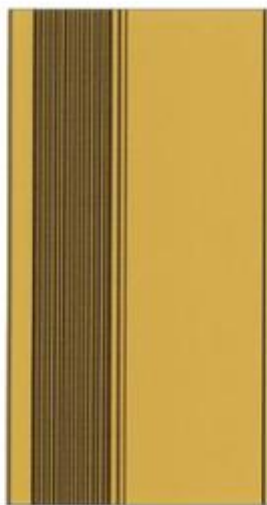

1.5

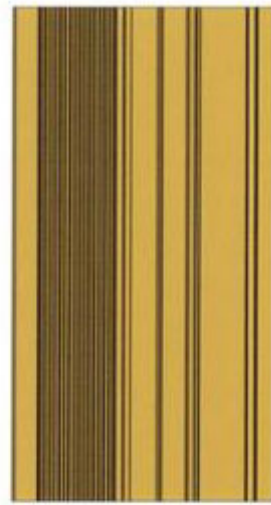

1.6

CÔNG BÁO SỞ HỮU CÔNG NGHIỆP SỐ 421 TẬP A – QUYỀN 2 (04.2023)

- (11) **46711**
(21) 3-2022-02768 (28) 1
(54) **THANH KIM LOẠI ĐỊNH HÌNH** (51) **25-01**
(22) 16/12/2022 (43) 25/04/2023
(73) **CÔNG TY CỔ PHẦN NHÔM ZHONGKAI VIỆT NAM (VN)**
Thôn Đình Dù, xã Đình Dù, huyện Văn Lâm, tỉnh Hưng Yên
(72) Đỗ Đức Thuận (VN)
(74) Công ty TNHH Sở hữu trí tuệ Gia Việt (GIAVIET CO., LTD.)
(55)

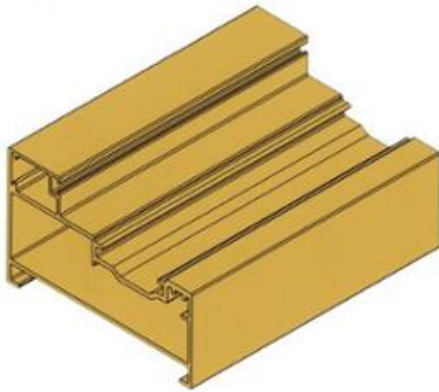

1.1

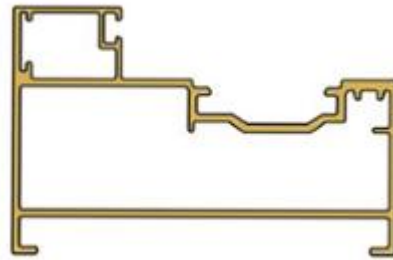

1.2



1.3



1.4

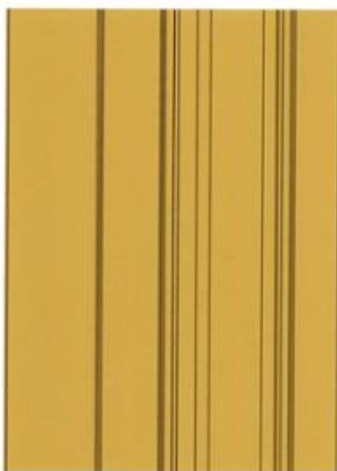

1.5



1.6

- (11) **46712**
(21) 3-2022-02771 (28) 1
(54) **THANH KIM LOẠI ĐỊNH HÌNH** (51) **25-01**
(22) 16/12/2022 (43) 25/04/2023
(73) **CÔNG TY CỔ PHẦN NHÔM ZHONGKAI VIỆT NAM (VN)**
Thôn Đình Dù, xã Đình Dù, huyện Văn Lâm, tỉnh Hưng Yên
(72) Đỗ Đức Thuận (VN)
(74) Công ty TNHH Sở hữu trí tuệ Gia Việt (GIAVIET CO., LTD.)
(55)



1.1

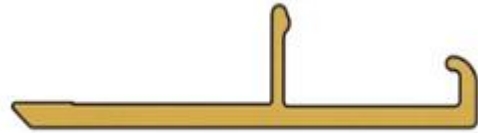

1.2

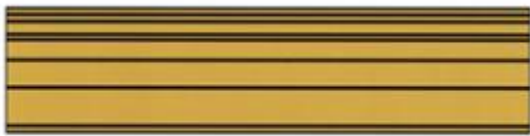

1.3



1.4

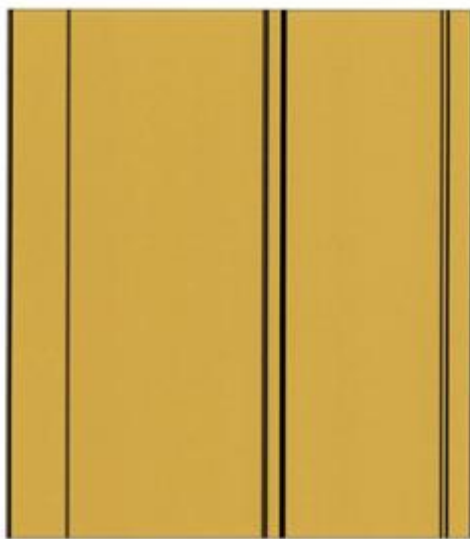

1.5



1.6

CÔNG BÁO SỞ HỮU CÔNG NGHIỆP SỐ 421 TẬP A – QUYỀN 2 (04.2023)

- (11) **46713**
(21) 3-2022-02770 (28) 1
(54) **THANH KIM LOẠI ĐỊNH HÌNH** (51) **25-01**
(22) 16/12/2022 (43) 25/04/2023
(73) **CÔNG TY CỔ PHẦN NHÔM ZHONGKAI VIỆT NAM (VN)**
Thôn Đình Dù, xã Đình Dù, huyện Văn Lâm, tỉnh Hưng Yên
(72) Đỗ Đức Thuận (VN)
(74) Công ty TNHH Sở hữu trí tuệ Gia Việt (GIAVIET CO., LTD.)
(55)

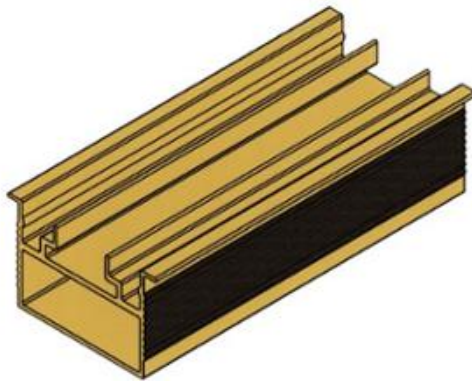

1.1

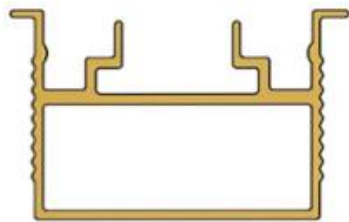

1.2

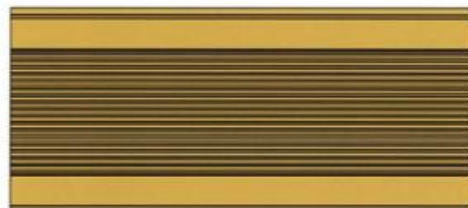

1.3

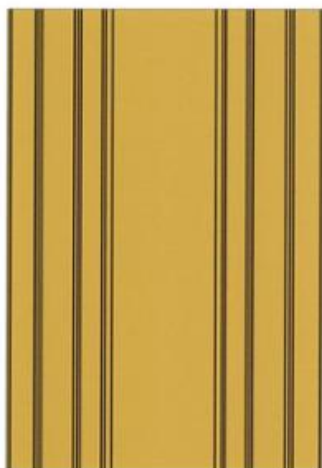

1.4



1.5

CÔNG BÁO SỞ HỮU CÔNG NGHIỆP SỐ 421 TẬP A – QUYỀN 2 (04.2023)

- (11) **46714**
(21) 3-2022-02772 (28) 1
(54) **THANH KIM LOẠI ĐỊNH HÌNH** (51) **25-01**
(22) 16/12/2022 (43) 25/04/2023
(73) **CÔNG TY CỔ PHẦN NHÔM ZHONGKAI VIỆT NAM (VN)**
Thôn Đình Dù, xã Đình Dù, huyện Văn Lâm, tỉnh Hưng Yên
(72) Đỗ Đức Thuận (VN)
(74) Công ty TNHH Sở hữu trí tuệ Gia Việt (GIAVIET CO., LTD.)
(55)

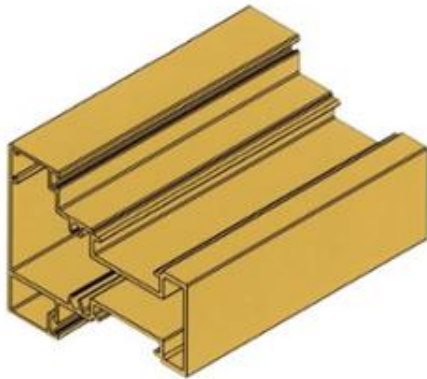

1.1

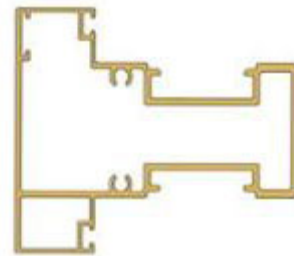

1.2



1.3



1.4

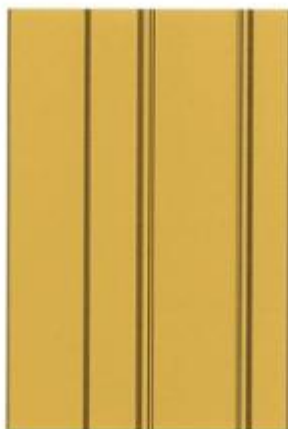

1.5

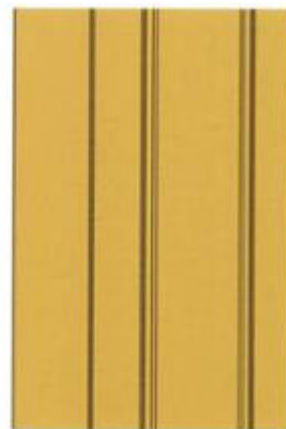

1.6

CÔNG BÁO SỞ HỮU CÔNG NGHIỆP SỐ 421 TẬP A – QUYỀN 2 (04.2023)

- (11) **46715**
(21) 3-2022-01611 (28) 2
(54) **NỆP KHUNG CỬA** (51) **25-01**
(22) 10/08/2022 (43) 25/04/2023
(73) **CÔNG TY CỔ PHẦN SẢN XUẤT VÀ ĐẦU TƯ HÙNG PHÁT (VN)**
Tổ dân phố Thịnh Vạn, phường Minh Đức, thị xã Mỹ Hào, tỉnh Hưng Yên
(72) Nguyễn Văn Tâm (VN)
(74) Công ty TNHH Sở hữu trí tuệ Gia Việt (GIAVIET CO., LTD.)
(55)

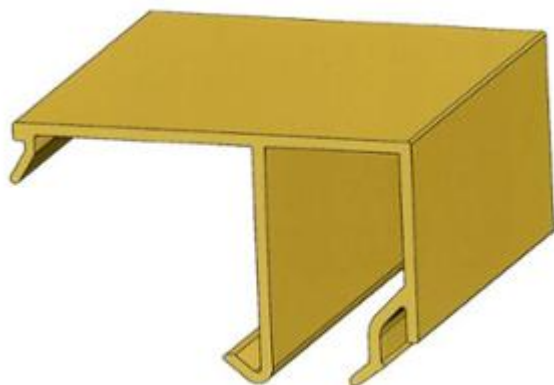

1.1

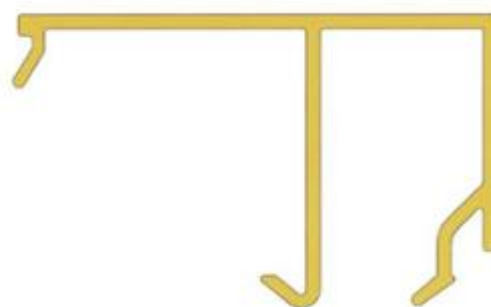

1.2



1.3



1.4



1.5

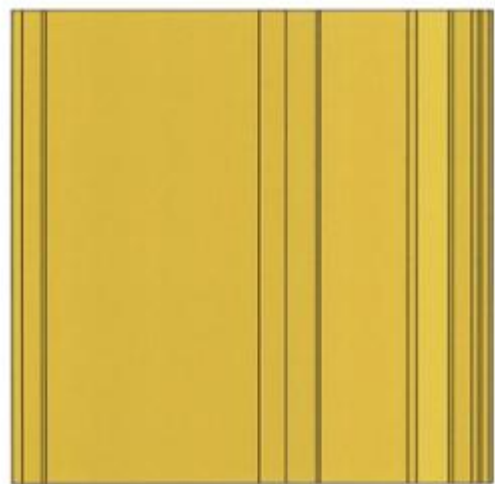

1.6



2.1



2.2



2.3



2.4



2.5

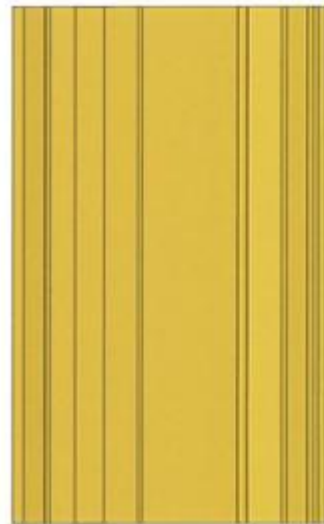

2.6

CÔNG BÁO SỞ HỮU CÔNG NGHIỆP SỐ 421 TẬP A – QUYỀN 2 (04.2023)

- (11) **46716**
(21) 3-2022-02795 (28) 1
(54) **THANH KIM LOẠI ĐỊNH HÌNH** (51) **25-01**
(22) 19/12/2022 (43) 25/04/2023
(73) **CÔNG TY CỔ PHẦN TẬP ĐOÀN KENWIN (VN)**
Tầng 4 tòa nhà VG Building, số 235 đường Nguyễn Trãi, phường Thanh Xuân
Trung, quận Thanh Xuân, thành phố Hà Nội
(72) Ngô Thọ Long (VN)
(74) Công ty TNHH Sở hữu trí tuệ PADEMARK (PADEMARK CO.,LTD.)
(55)



1.1



1.2



1.3

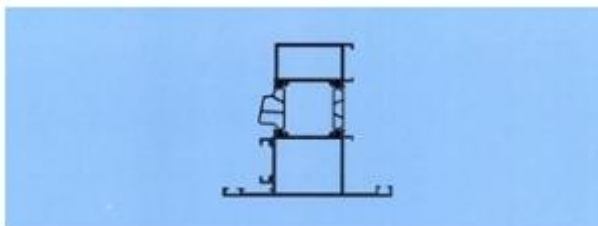

1.4

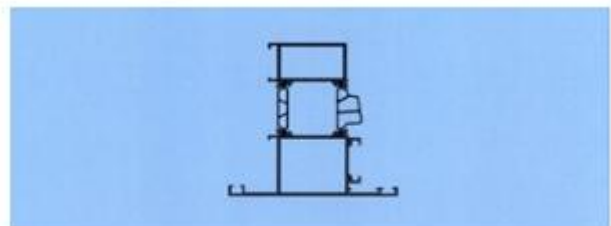

1.5



1.6



1.7

CÔNG BÁO SỞ HỮU CÔNG NGHIỆP SỐ 421 TẬP A – QUYỀN 2 (04.2023)

- (11) **46717**
(21) 3-2022-01615 (28) 2
(54) **THANH KIM LOẠI ĐỊNH HÌNH** (51) **25-01**
(22) 10/08/2022 (43) 25/04/2023
(73) **CÔNG TY CỔ PHẦN SẢN XUẤT VÀ ĐẦU TƯ HÙNG PHÁT (VN)**
Tổ dân phố Thịnh Vạn, phường Minh Đức, thị xã Mỹ Hào, tỉnh Hưng Yên
(72) Nguyễn Văn Tâm (VN)
(74) Công ty TNHH Sở hữu trí tuệ Gia Việt (GIAVIET CO., LTD.)
(55)

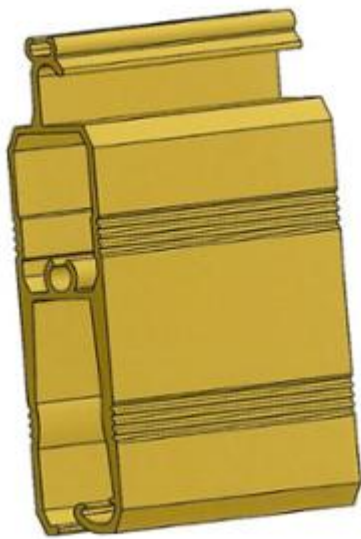

1.1



1.2

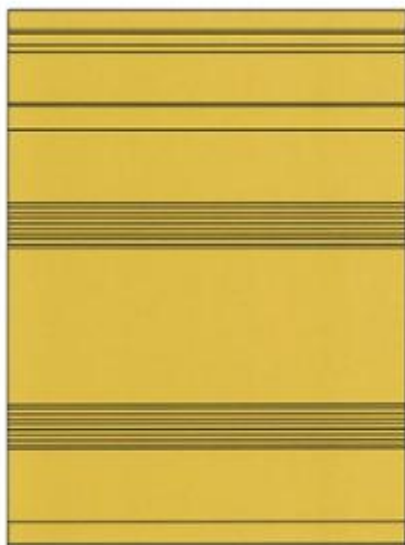

1.3

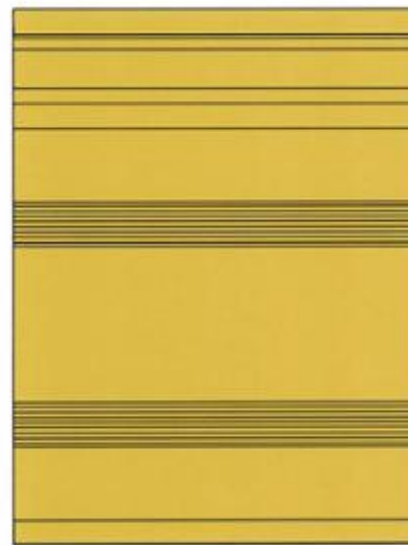

1.4

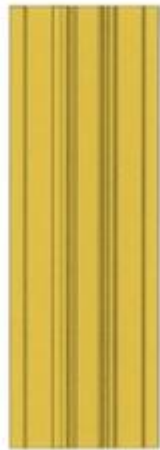

1.5

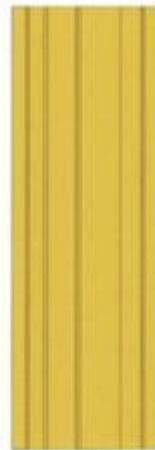

1.6

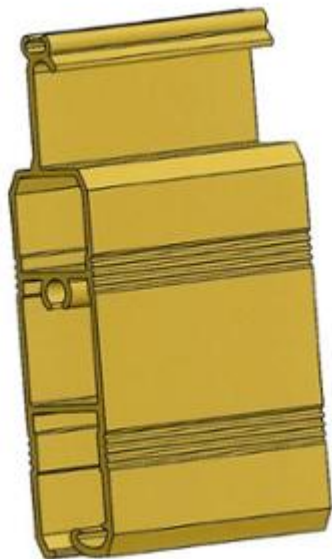

2.1



2.2

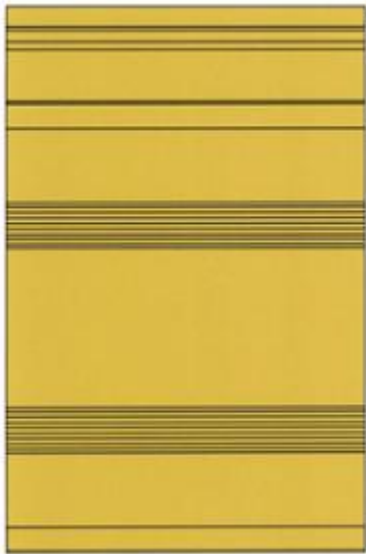

2.3



2.4

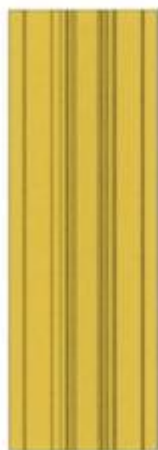

2.5



2.6

CÔNG BÁO SỞ HỮU CÔNG NGHIỆP SỐ 421 TẬP A – QUYỀN 2 (04.2023)

- (11) **46718**
(21) 3-2022-02040 (28) 1
(54) **TÚI SƠ CỨ CÁ NHÂN** (51) **03-01**
(22) 22/09/2022 (43) 25/04/2023
(73) **CÔNG TY CỔ PHẦN DỊCH VỤ SAFI (VN)**
Số 40 ngõ 11 Tô Ngọc Vân, Quảng An, quận Tây Hồ, thành phố Hà Nội
(72) Đặng Hà Trang (VN)
(55)



1.1



1.2



1.3



1.4



1.5



1.6



1.7



1.8



1.9



1.10

- (11) **46719**
(21) 3-2022-02765 (28) 1
(54) **THANH KIM LOẠI ĐỊNH HÌNH** (51) **25-01**
(22) 16/12/2022 (43) 25/04/2023
(73) **CÔNG TY TNHH SẢN XUẤT VÀ THƯƠNG MẠI HÙNG LONG (VN)**
Thôn Tráng Vũ, xã Đồng Than, huyện Yên Mỹ, tỉnh Hưng Yên
(72) Vũ Xuân Quân (VN)
(74) Công ty TNHH Sở hữu trí tuệ Gia Việt (GIAVIET CO., LTD.)
(55)

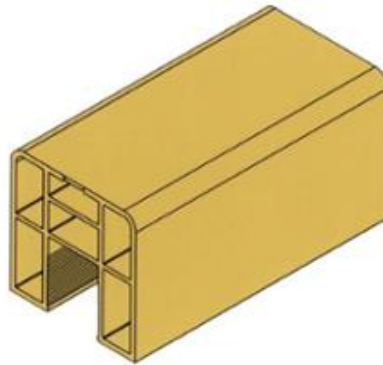

1.1



1.2



1.3



1.4

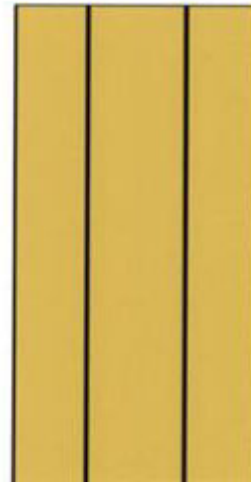

1.5

CÔNG BÁO SỞ HỮU CÔNG NGHIỆP SỐ 421 TẬP A – QUYỀN 2 (04.2023)

(11) **46720**

(21) 3-2022-02935

(28) 1

(54) **CAN**

(51) **09-02**

(22) 29/12/2022

(43) 25/04/2023

(73) **CÔNG TY CỔ PHẦN STRONGBODY VN (VN)**

Số 68 đường Nguyễn Huệ, phường Bến Nghé, quận 1, thành phố Hồ Chí Minh

(72) Lê Khắc Tiếp (VN)

(55)



1.1

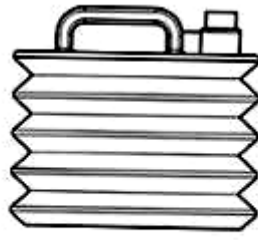

1.2

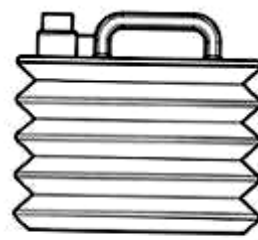

1.3

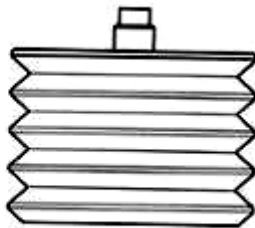

1.4

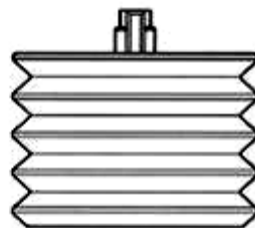

1.5

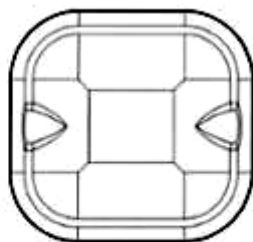

1.6



1.7



1.8

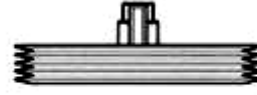

1.9

- (11) **46721**
(21) 3-2022-02766 (28) 1
(54) **THANH KIM LOẠI ĐỊNH HÌNH** (51) **25-01**
(22) 16/12/2022 (43) 25/04/2023
(73) **CÔNG TY TNHH SẢN XUẤT VÀ THƯƠNG MẠI HÙNG LONG (VN)**
Thôn Tráng Vũ, xã Đồng Than, huyện Yên Mỹ, tỉnh Hưng Yên
(72) Vũ Xuân Quân (VN)
(74) Công ty TNHH Sở hữu trí tuệ Gia Việt (GIAVIET CO., LTD.)
(55)

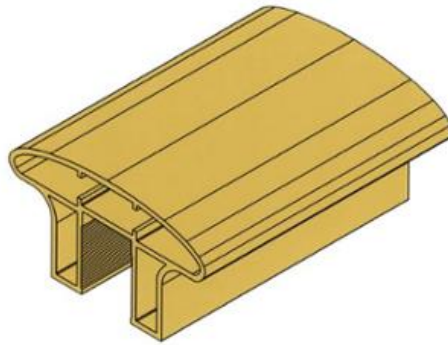

1.1

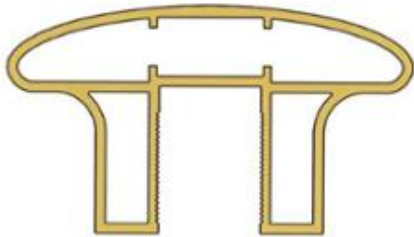

1.2



1.3

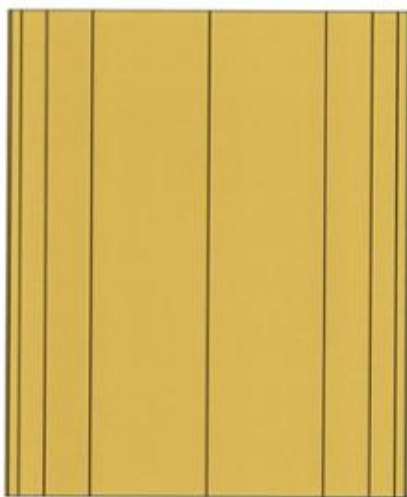

1.4

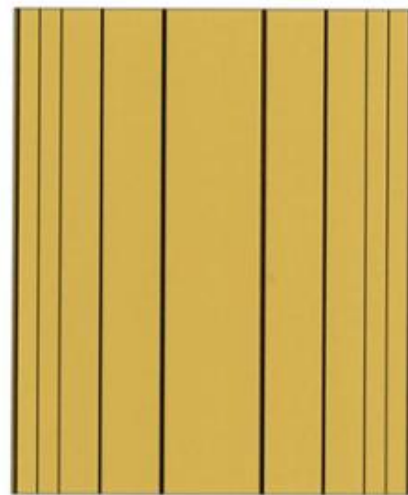

1.5

(11) **46722**

(21) 3-2022-02934

(28) 1

(54) **CAN**

(51) **09-02**

(22) 29/12/2022

(43) 25/04/2023

(73) **CÔNG TY CỔ PHẦN STRONGBODY VN (VN)**

Số 68 đường Nguyễn Huệ, phường Bến Nghé, quận 1, thành phố Hồ Chí Minh

(72) Lê Khắc Tiệp (VN)

(55)

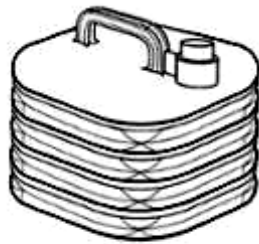

1.1

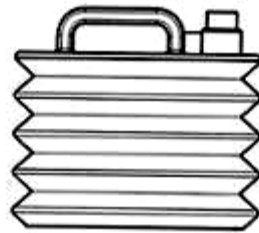

1.2

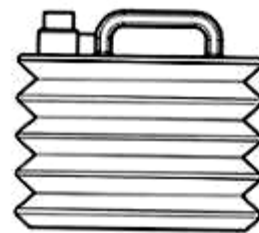

1.3

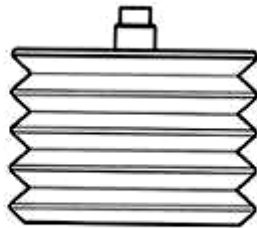

1.4

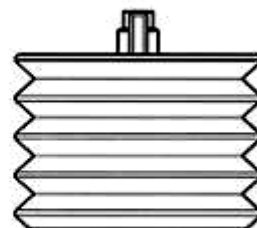

1.5

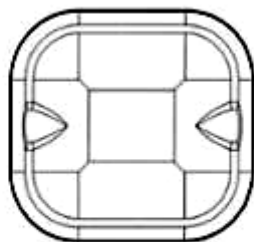

1.6

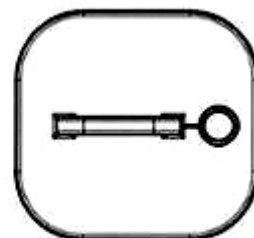

1.7



1.8



1.9

CÔNG BÁO SỞ HỮU CÔNG NGHIỆP SỐ 421 TẬP A – QUYỀN 2 (04.2023)

- (11) **46723**
(21) 3-2022-02547 (28) 1
(54) **VẢI** (51) **05-05**
(22) 18/11/2022 (43) 25/04/2023
(30) 30-2022-0019850 18/05/2022 KR;
(73) **HOTEL LOTTE CO., LTD.** (KR)
30, Eulji-Ro, Jung-Gu, Seoul, Republic Of Korea (Sogong-dong)
(72) Lee, Sangjean (KR)
(74) Công ty TNHH Trường Xuân (AGELESS CO.,LTD.)
(55)

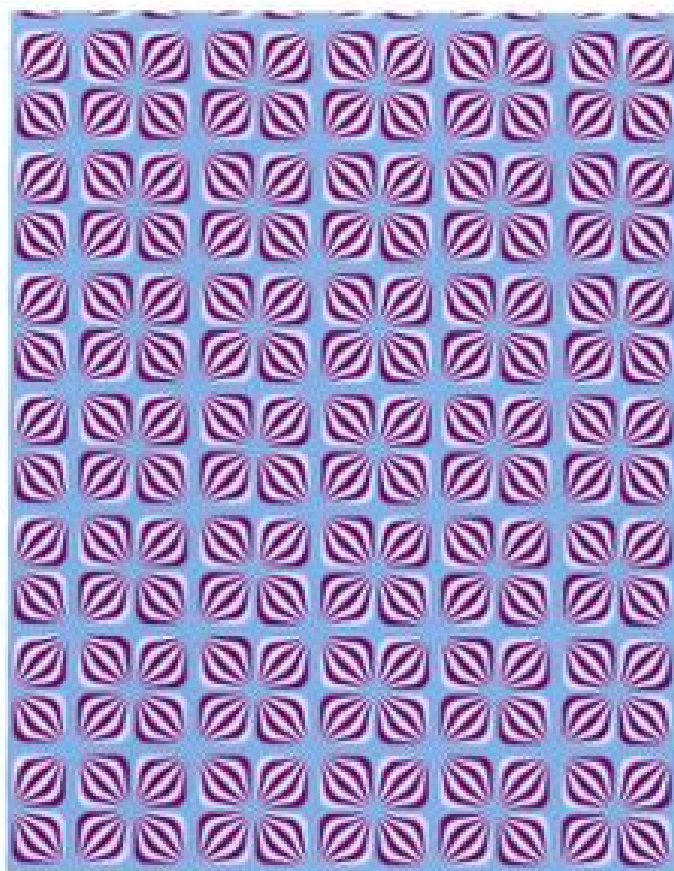

- (11) **46724**
(21) 3-2022-02539 (28) 1
(54) **GIẤY** (51) **05-06**
(22) 18/11/2022 (43) 25/04/2023
(30) 30-2022-0019838 18/05/2022 KR; 30-2022-0019837 18/05/2022 KR;
(73) **HOTEL LOTTE CO., LTD.** (KR)
30, Eulji-Ro, Jung-Gu, Seoul, Republic Of Korea (Sogong-dong)
(72) Lee, Sangjean (KR)
(74) Công ty TNHH Trường Xuân (AGELESS CO.,LTD.)
(55)

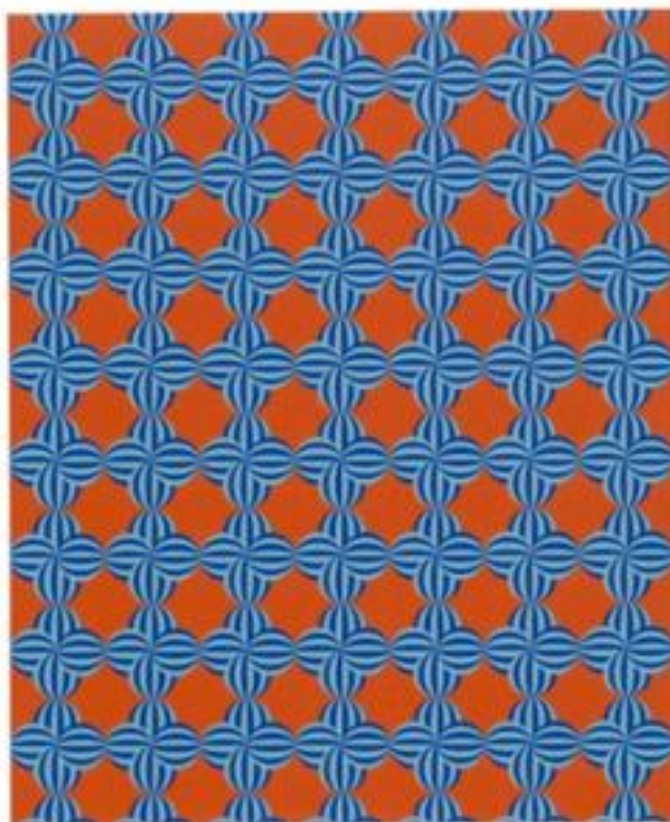

CÔNG BÁO SỞ HỮU CÔNG NGHIỆP SỐ 421 TẬP A – QUYỀN 2 (04.2023)

- (11) **46725**
(21) 3-2022-02544 (28) 1
(54) **GIẤY** (51) **05-06**
(22) 18/11/2022 (43) 25/04/2023
(30) 30-2022-0019843 18/05/2022 KR; 30-2022-0019842 18/05/2022 KR;
(73) **HOTEL LOTTE CO., LTD.** (KR)
30, Eulji-Ro, Jung-Gu, Seoul, Republic Of Korea (Sogong-dong)
(72) Lee, Sangjean (KR)
(74) Công ty TNHH Trường Xuân (AGELESS CO.,LTD.)
(55)

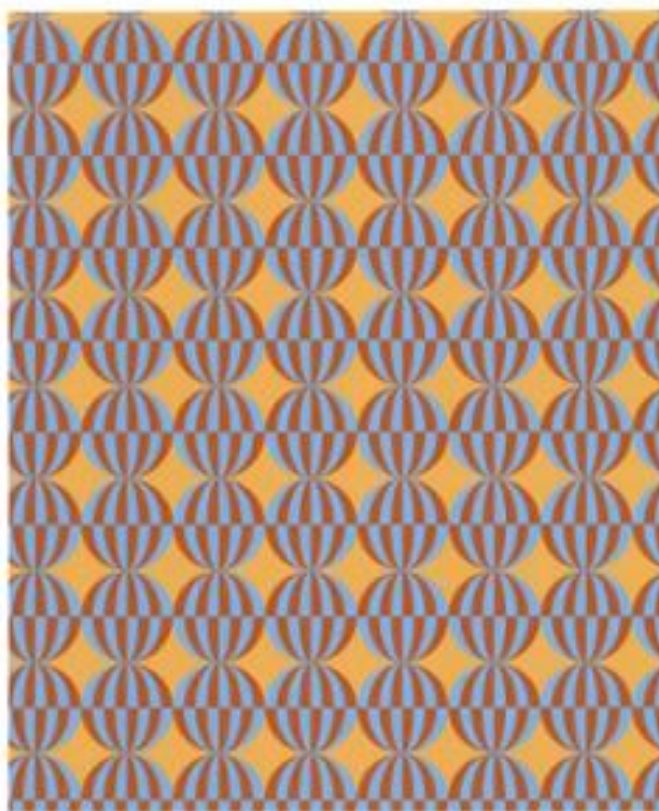

CÔNG BÁO SỞ HỮU CÔNG NGHIỆP SỐ 421 TẬP A – QUYỀN 2 (04.2023)

- (11) **46726**
(21) 3-2022-02540 (28) 1
(54) **VẢI** (51) **05-05**
(22) 18/11/2022 (43) 25/04/2023
(30) 30-2022-0019841 18/05/2022 KR;
(73) **HOTEL LOTTE CO., LTD.** (KR)
30, Eulji-Ro, Jung-Gu, Seoul, Republic Of Korea (Sogong-dong)
(72) Lee, Sangjean (KR)
(74) Công ty TNHH Trường Xuân (AGELESS CO.,LTD.)
(55)



- (11) **46727**
(21) 3-2022-02536 (28) 1
(54) **GIẤY** (51) **05-06**
(22) 18/11/2022 (43) 25/04/2023
(30) 30-2022-0019852 18/05/2022 KR; 30-2022-0019851 18/05/2022 KR;
(73) **HOTEL LOTTE CO., LTD.** (KR)
30, Eulji-Ro, Jung-Gu, Seoul, Republic Of Korea (Sogong-dong)
(72) Lee, Sangjean (KR)
(74) Công ty TNHH Trường Xuân (AGELESS CO.,LTD.)
(55)

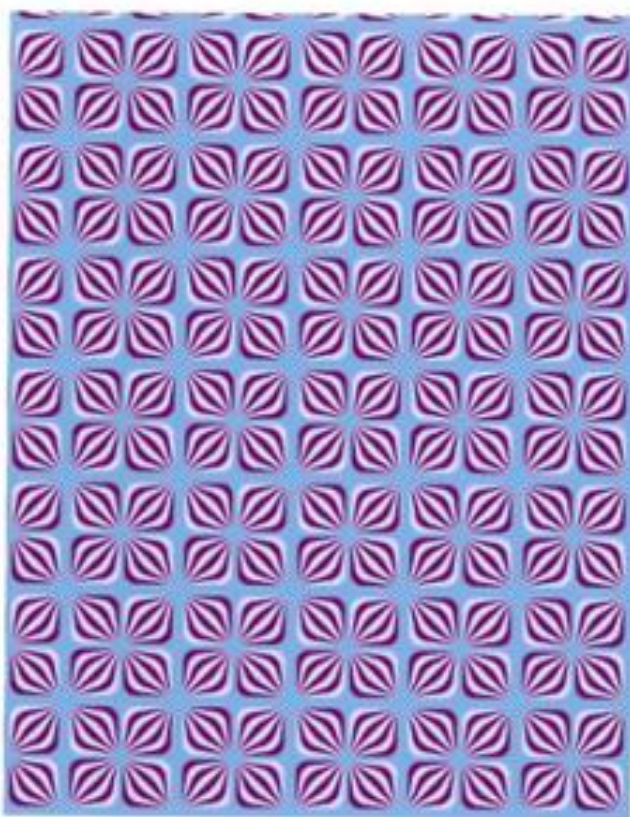

CÔNG BÁO SỞ HỮU CÔNG NGHIỆP SỐ 421 TẬP A – QUYỀN 2 (04.2023)

- (11) **46728**
(21) 3-2022-02534 (28) 1
(54) **GIẤY** (51) **05-06**
(22) 18/11/2022 (43) 25/04/2023
(30) 30-2022-0019857 18/05/2022 KR; 30-2022-0019840 18/05/2022 KR;
(73) **HOTEL LOTTE CO., LTD.** (KR)
30, Eulji-Ro, Jung-Gu, Seoul, Republic Of Korea (Sogong-dong)
(72) Lee, Sangjean (KR)
(74) Công ty TNHH Trường Xuân (AGELESS CO.,LTD.)
(55)

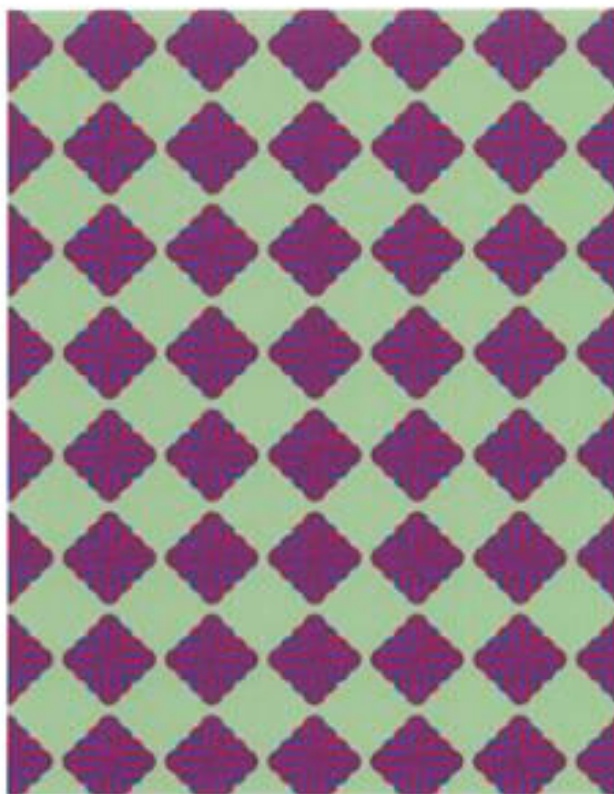

CÔNG BÁO SỞ HỮU CÔNG NGHIỆP SỐ 421 TẬP A – QUYỀN 2 (04.2023)

- (11) **46729**
(21) 3-2022-02535 (28) 1
(54) **GIẤY** (51) **05-06**
(22) 18/11/2022 (43) 25/04/2023
(30) 30-2022-0019849 18/05/2022 KR; 30-2022-0019848 18/05/2022 KR;
(73) **HOTEL LOTTE CO., LTD.** (KR)
30, Eulji-Ro, Jung-Gu, Seoul, Republic Of Korea (Sogong-dong)
(72) Lee, Sangjean (KR)
(74) Công ty TNHH Trường Xuân (AGELESS CO.,LTD.)
(55)



CÔNG BÁO SỞ HỮU CÔNG NGHIỆP SỐ 421 TẬP A – QUYỀN 2 (04.2023)

- (11) **46730**
(21) 3-2022-02528 (28) 1
(54) **VẢI** (51) **05-05**
(22) 18/11/2022 (43) 25/04/2023
(30) 30-2022-0019844 18/05/2022 KR;
(73) **HOTEL LOTTE CO., LTD.** (KR)
30, Eulji-Ro, Jung-Gu, Seoul, Republic Of Korea (Sogong-dong)
(72) Lee, Sangjean (KR)
(74) Công ty TNHH Trường Xuân (AGELESS CO.,LTD.)
(55)



CÔNG BÁO SỞ HỮU CÔNG NGHIỆP SỐ 421 TẬP A – QUYỀN 2 (04.2023)

- (11) **46731**
(21) 3-2022-02526 (28) 1
(54) **VẢI** (51) **05-05**
(22) 18/11/2022 (43) 25/04/2023
(30) 30-2022-0019839 18/05/2022 KR;
(73) **HOTEL LOTTE CO., LTD.** (KR)
30, Eulji-Ro, Jung-Gu, Seoul, Republic Of Korea (Sogong-dong)
(72) Lee, Sangjean (KR)
(74) Công ty TNHH Trường Xuân (AGELESS CO.,LTD.)
(55)



CÔNG BÁO SỞ HỮU CÔNG NGHIỆP SỐ 421 TẬP A – QUYỀN 2 (04.2023)

- (11) **46732**
- (21) 3-2022-02529 (28) 1
- (54) **VẢI** (51) **05-05**
- (22) 18/11/2022 (43) 25/04/2023
- (30) 30-2022-0019847 18/05/2022 KR;
- (73) **HOTEL LOTTE CO., LTD.** (KR)
30, Eulji-Ro, Jung-Gu, Seoul, Republic Of Korea (Sogong-dong)
- (72) Lee, Sangjean (KR)
- (74) Công ty TNHH Trường Xuân (AGELESS CO.,LTD.)
- (55)



CÔNG BÁO SỞ HỮU CÔNG NGHIỆP SỐ 421 TẬP A – QUYỀN 2 (04.2023)

- (11) **46733**
- (21) 3-2022-02522 (28) 1
- (54) **GIẤY** (51) **05-06**
- (22) 18/11/2022 (43) 25/04/2023
- (30) 30-2022-0019846 18/05/2022 KR; 30-2022-0019845 18/05/2022 KR;
- (73) **HOTEL LOTTE CO., LTD.** (KR)
30, Eulji-Ro, Jung-Gu, Seoul, Republic Of Korea (Sogong-dong)
- (72) Lee, Sangjean (KR)
- (74) Công ty TNHH Trường Xuân (AGELESS CO.,LTD.)
- (55)

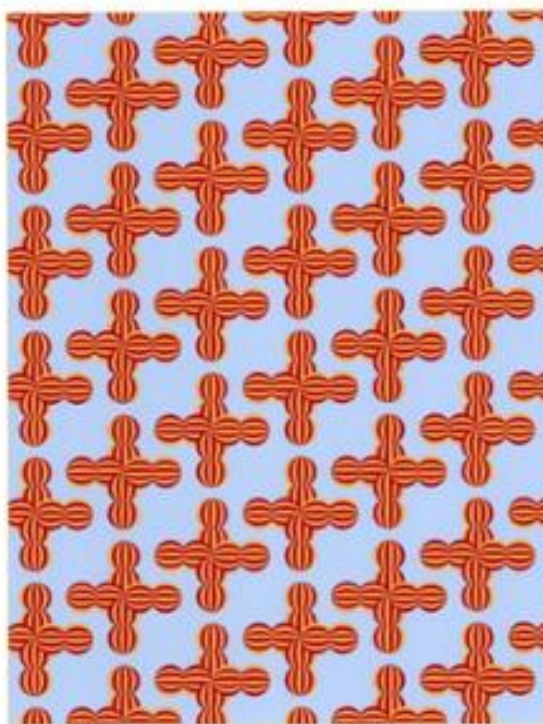

- (11) **46734**
(21) 3-2022-02525 (28)
(54) **VẢI** (51) **05-05**
(22) 18/11/2022 (43) 25/04/2023
(30) 30-2022-0019836 18/05/2022 KR;
(73) **HOTEL LOTTE CO., LTD.** (KR)
30, Eulji-Ro, Jung-Gu, Seoul, Republic Of Korea (Sogong-dong)
(72) Lee, Sangjean (KR)
(74) Công ty TNHH Trường Xuân (AGELESS CO.,LTD.)
(55)

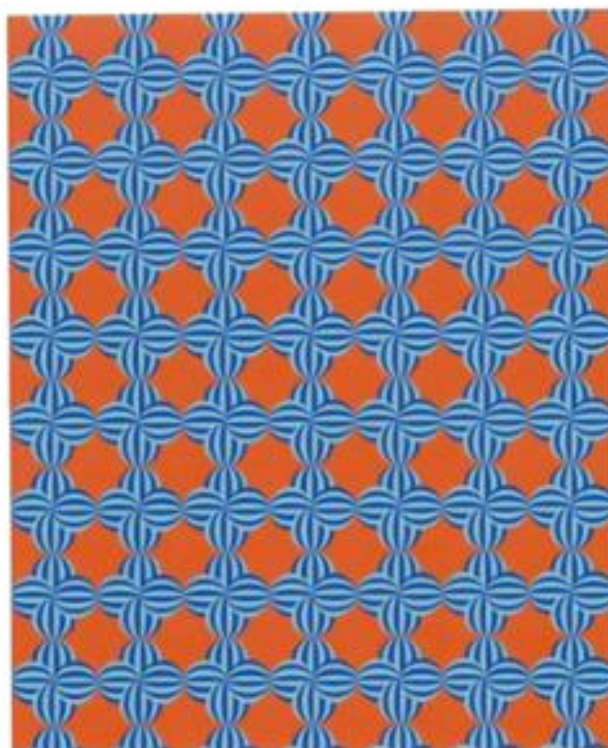

CÔNG BÁO SỞ HỮU CÔNG NGHIỆP SỐ 421 TẬP A – QUYỀN 2 (04.2023)

- (11) **46735**
(21) 3-2022-02245 (28) 1
(54) **NỒI** (51) **07-02**
(22) 14/10/2022 (43) 25/04/2023
(73) **YONGKANG NUANCHU INDUSTRY AND TRADE CO., LTD. (CN)**
No. 12, Fengxiang Road, Industrial Function Zone, Gushan Town, Yongkang City,
Jinhua City, Zhejiang Province, China, 321307
(72) Wang Xingbang (CN)
(74) Công ty TNHH Dịch vụ Sở hữu trí tuệ BIG5 (BIG5 IP CO.,LTD)
(55)



1.1



1.2



1.3



1.4



1.5



1.6



1.7

CÔNG BÁO SỞ HỮU CÔNG NGHIỆP SỐ 421 TẬP A – QUYỀN 2 (04.2023)

- (11) **46736**
(21) 3-2022-02244 (28) 1
(54) **NỒI** (51) **07-02**
(22) 14/10/2022 (43) 25/04/2023
(73) **YONGKANG NUANCHU INDUSTRY AND TRADE CO., LTD. (CN)**
No. 12, Fengxiang Road, Industrial Function Zone, Gushan Town, Yongkang City,
Jinhua City, Zhejiang Province, China, 321307
(72) Wang Xingbang (CN)
(74) Công ty TNHH Dịch vụ Sở hữu trí tuệ BIG5 (BIG5 IP CO.,LTD)
(55)



1.1



1.2



1.3



1.4



1.5



1.6



1.7

- (11) **46737**
(21) 3-2022-02035 (28) 1
(54) **HỘP ĐỰNG CÀ PHÊ HẠT** (51) **07-06**
(22) 21/09/2022 (43) 25/04/2023
(30) 30-2022-0013587 07/04/2022 KR;
(73) **LOCK & LOCK CO., LTD (KR)**
104, Sapgyocheon-ro, Seonjang-myeon, Asan-si, Chungcheongnam-do, Republic of Korea
(72) SHIM, Dong Seop (KR)
(74) Công ty TNHH Tầm nhìn và Liên danh (VISION & ASSOCIATES CO.LTD.)
(55)



1.1



1.2



1.3



1.4



1.5

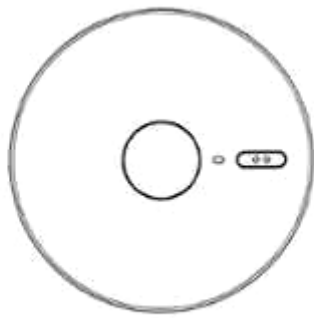

1.6



1.7



1.8

CÔNG BÁO SỞ HỮU CÔNG NGHIỆP SỐ 421 TẬP A – QUYỀN 2 (04.2023)

- (11) **46738**
(21) 3-2022-01826 (28) 1
(54) **THIẾT BỊ Y TẾ** (51) **24-04**
(22) 29/08/2022 (43) 25/04/2023
(30) 008876213-0004 04/03/2022 EM;
(73) **BTL INDUSTRIES (BG)**
8 Tzar Kaloyan str, 1000 Sofia, Bulgaria
(72) Mahaan Ghose (CZ)
(74) Công ty TNHH Đại Tín và Liên Danh (DAITIN AND ASSOCIATES CO.,LTD)
(55)

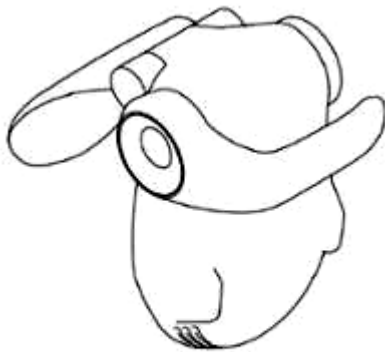

1.1



1.2



1.3

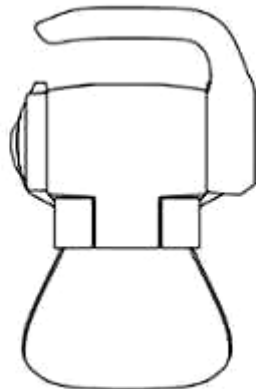

1.4

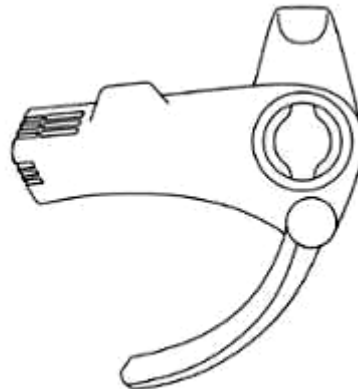

1.5



1.6

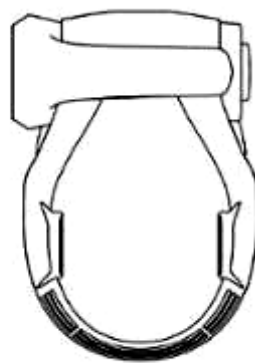

1.7



1.8

- (11) **46739**
(21) 3-2022-01820 (28) 1
(54) **GHÉ BẠP BÈNH** (51) **06-01**
(22) 26/08/2022 (43) 25/04/2023
(73) **CÔNG TY TNHH THƯƠNG MẠI SẢN XUẤT TRANG SI (VN)**
D6/643, ấp 3, xã Bình Lợi, huyện Bình Chánh, thành phố Hồ Chí Minh
(72) Nguyễn Kỳ Trung (VN)
(74) Công ty TNHH Sở hữu trí tuệ Đông Dương (DONG DUONG IP CO.,LTD)
(55)



1.1



1.2



1.3



1.4



1.5

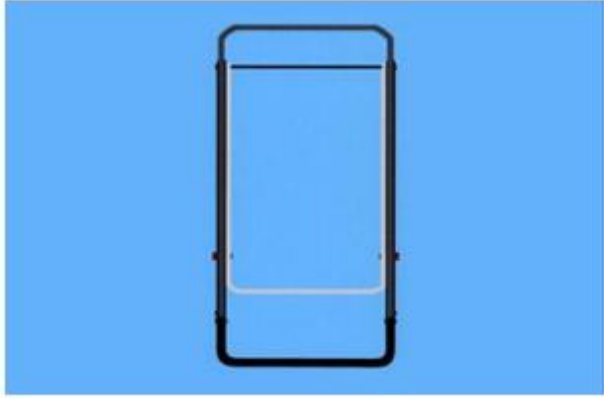

1.6

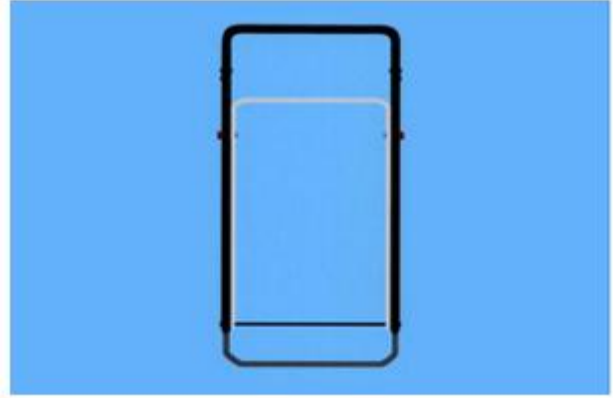

1.7

CÔNG BÁO SỞ HỮU CÔNG NGHIỆP SỐ 421 TẬP A – QUYỀN 2 (04.2023)

- (11) **46740**
(21) 3-2022-01827 (28) 1
(54) **THIẾT BỊ Y TẾ** (51) **24-04**
(22) 29/08/2022 (43) 25/04/2023
(30) 009031669-0005 19/05/2022 EM;
(73) **BTL INDUSTRIES (BG)**
8 Tzar Kaloyan str, 1000 Sofia, Bulgaria
(72) Vojtech Kubik (CZ)
(74) Công ty TNHH Đại Tín và Liên Danh (DAITIN AND ASSOCIATES CO.,LTD)
(55)



1.1

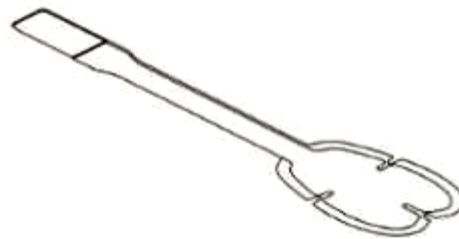

1.2



1.3



1.4



1.5



1.6



1.7



1.8

CÔNG BÁO SỞ HỮU CÔNG NGHIỆP SỐ 421 TẬP A – QUYỀN 2 (04.2023)

- (11) **46741**
(21) 3-2022-01668 (28) 1
(54) **BÌNH ĐỰNG NƯỚC MUỐI** (51) **09-01**
(22) 12/08/2022 (43) 25/04/2023
(73) **CÔNG TY CỔ PHẦN TỔNG HỢP LÂM KHANG (VN)**
Số 42, đường Gamuda Gardens 3-5, khu đô thị Gamuda Gardens, phường Trần Phú, quận Hoàng Mai, thành phố Hà Nội
(72) Đào Hồng Thẩm (VN)
(55)



1.1



1.2



1.3



1.4



1.5



1.6

CÔNG BÁO SỞ HỮU CÔNG NGHIỆP SỐ 421 TẬP A – QUYỀN 2 (04.2023)

- (11) **46742**
(21) 3-2022-01431 (28) 1
(54) **KHUNG TỦ MÁY LỌC NƯỚC** (51) **23-01**
(22) 18/07/2022 (43) 25/04/2023
(73) **CÔNG TY TNHH KAROFI R&D (VN)**
Số 5C, ngách 184/85 Trần Khát Chân, phường Thanh Lương, quận Hai Bà Trưng,
thành phố Hà Nội
(72) Bùi Hữu Kiên (VN)
(55)



1.1

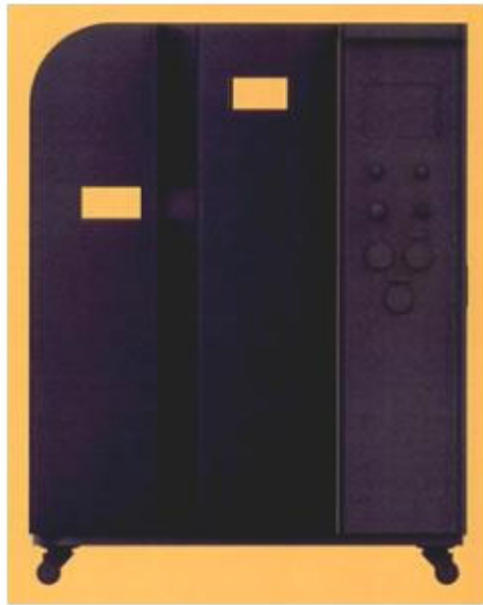

1.2

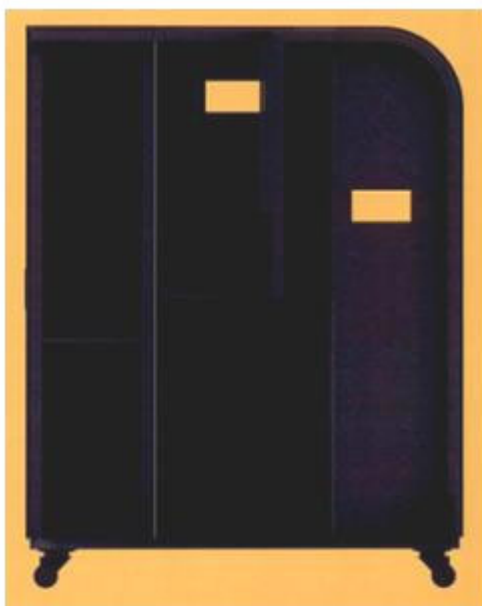

1.3



1.4

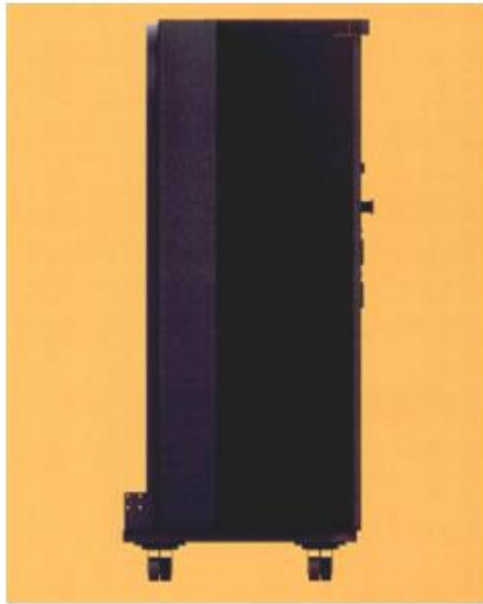

1.5



1.6



1.7

CÔNG BÁO SỞ HỮU CÔNG NGHIỆP SỐ 421 TẬP A – QUYỀN 2 (04.2023)

- (11) **46743**
(21) 3-2022-01669 (28) 1
(54) **VÒNG TRÁNH THAI** (51) **24-02**
(22) 12/08/2022 (43) 25/04/2023
(73) **CÔNG TY CỔ PHẦN TỔNG HỢP LÂM KHANG (VN)**
Số 42, đường Gamuda Gardens 3-5, khu đô thị Gamuda Gardens, phường Trần
Phú, quận Hoàng Mai, thành phố Hà Nội
(72) Đào Hồng Thẩm (VN)
(55)

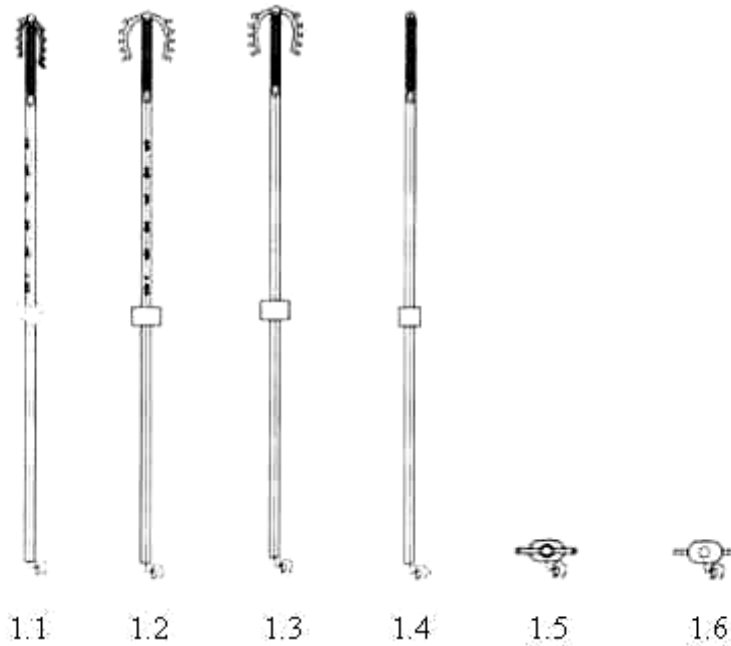

CÔNG BÁO SỞ HỮU CÔNG NGHIỆP SỐ 421 TẬP A – QUYỀN 2 (04.2023)

- (11) **46744**
(21) 3-2022-00977 (28) 1
(54) **VỈ ĐỰNG** (51) **09-05**
(22) 19/05/2022 (43) 25/04/2023
(73) **CÔNG TY CỔ PHẦN TẬP ĐOÀN VÀNG BẠC ĐÁ QUÝ MYOR (VN)**
Số 104-106 Tân Mai, phường Tân Mai, quận Hoàng Mai, thành phố Hà Nội
(72) Phùng Thị Thuyết (VN)
(55)



1.1



1.2



1.3

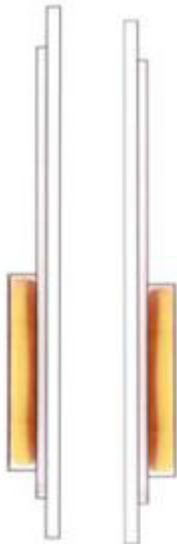

1.4

1.5



1.6



1.7

CÔNG BÁO SỞ HỮU CÔNG NGHIỆP SỐ 421 TẬP A – QUYỀN 2 (04.2023)

- (11) **46745**
(21) 3-2022-01561 (28) 1
(54) **AO NUÔI TÔM THỂ SIÊU THÂM CANH GIÀU OXY CÔNG NGHỆ SỐ** (51) **30-02**
(22) 03/08/2022 (43) 25/04/2023
(73) **CÔNG TY CỔ PHẦN RYNAN TECHNOLOGIES VIETNAM (VN)**
Ấp Long Trị, xã Long Đức, thành phố Trà Vinh, tỉnh Trà Vinh
(72) 1. NGUYỄN THANH MỸ (VN)
2. PHẠM HOÀNG LƯỢNG (VN)
3. HUỖNH THUẬN (VN)
4. VÕ VŨ KHANH (VN)
(74) Công ty TNHH Đại Tín và Liên Danh (DAITIN AND ASSOCIATES CO.,LTD)
(55)

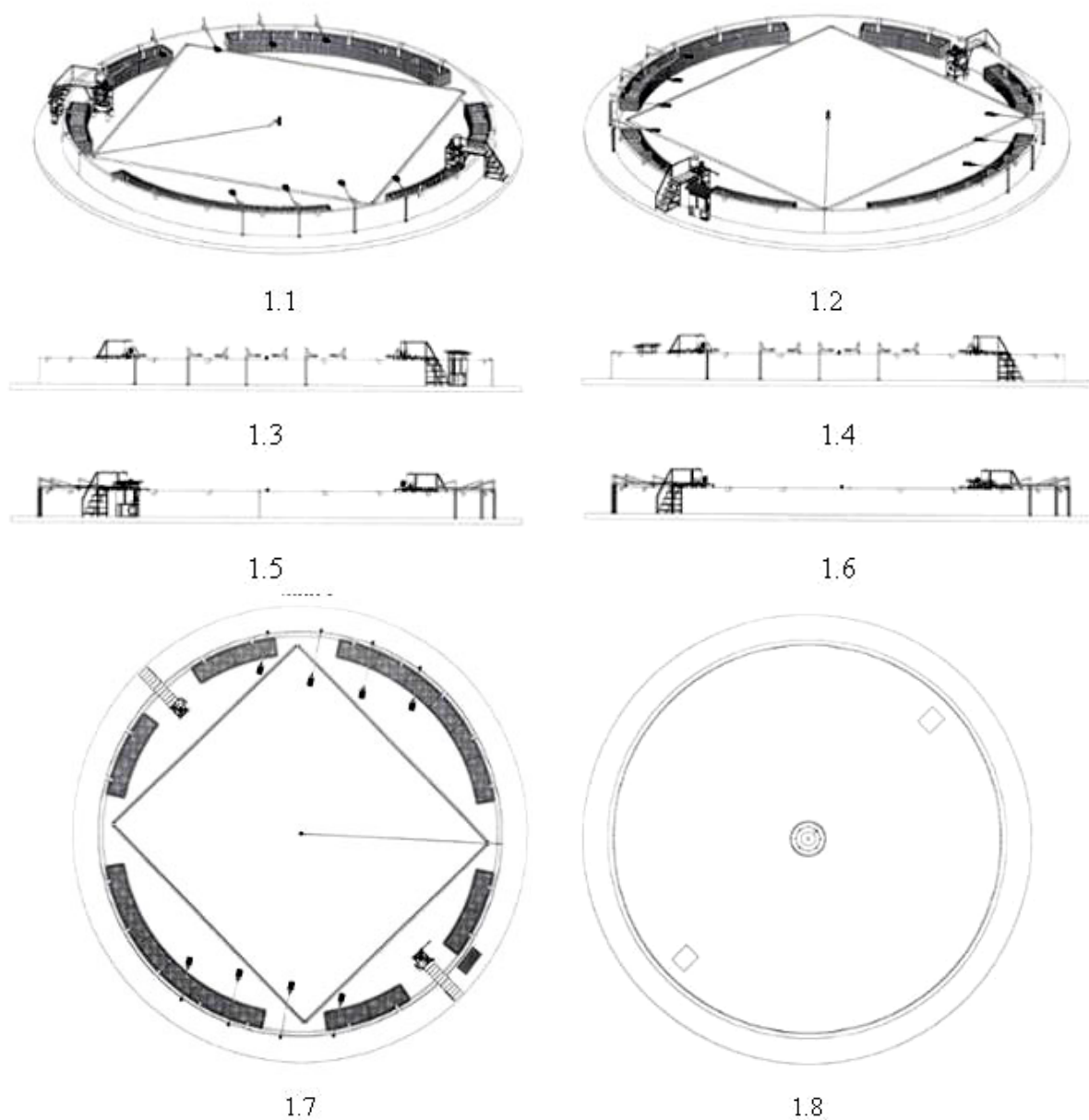



1.9

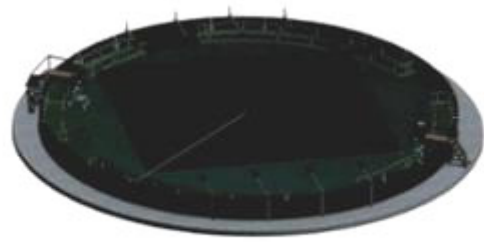

1.10

- (11) **46746**
- (21) 3-2022-02657 (28) 1
- (54) **BỘ CHUYỂN ĐỔI NGUỒN ĐIỆN** (51) **13-02; 13-03**
- (22) 05/12/2022 (43) 25/04/2023
- (30) 29/841,467 06/06/2022 US;
- (73) **APPLE INC. (US)**
One Apple Park Way, Cupertino, California 95014, United States of America
- (72) 1. JODY AKANA (US)
2. MOLLY ANDERSON (GB)
3. BARTLEY K. ANDRE (US)
4. SHOTA AOYAGI (JP)
5. ANTHONY MICHAEL ASHCROFT (FR)
6. MARINE C. BATAILLE (FR)
7. JEREMY BATAILLOU (FR)
8. ABIDUR RAHMAN CHOWDHURY (GB)
9. CLARA GENEVIEVE MARINE COURTAIGNE (FR)
10. MARKUS DIEBEL (DE)
11. JONATHAN GOMEZ GARCIA (UK)
12. M. EVANS HANKEY (US)
13. ANNE-MARIE HECK (CH)
14. MOISES HERNANDEZ HERNANDEZ (MX)
15. RICHARD P. HOWARTH (GB)
16. JULIAN JAEDE (DE)
17. DUNCAN ROBERT KERR (GB)
18. KAINOA KWON-PEREZ (US)
19. NICOLAS PEDRO LYLYK (AR)
20. PETER RUSSELL-CLARKE (AU)
21. BENJAMIN ANDREW SHAFFER (US)
22. JOE SUNG-HO TAN (US)
23. CLEMENT TISSANDIER (FR)
24. EUGENE ANTONY WHANG (CA)
- (74) Công ty TNHH Lê & Lê (LE & LE)
- (55)

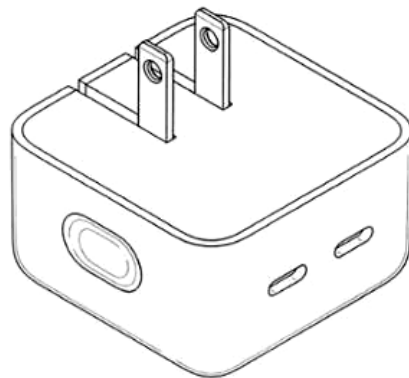

1.1

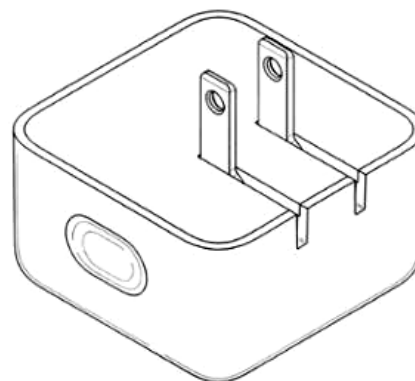

1.2

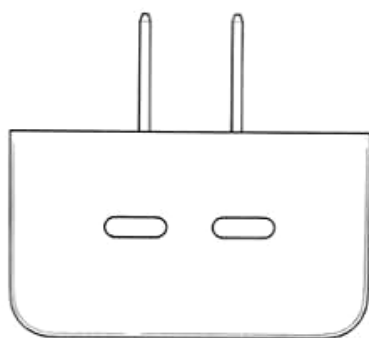

1.3

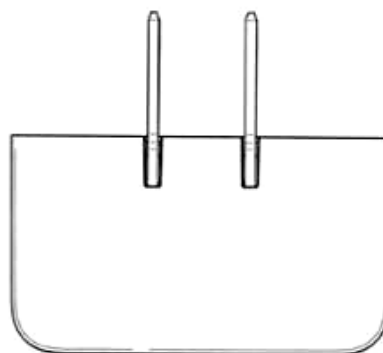

1.4

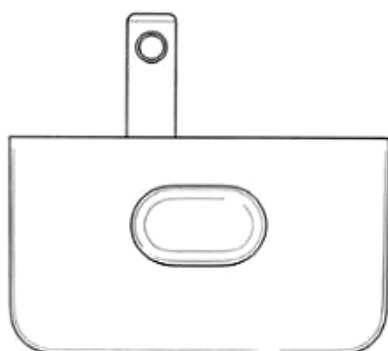

1.5

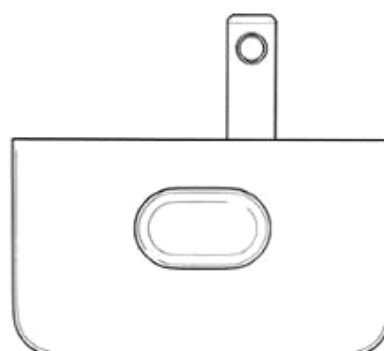

1.6

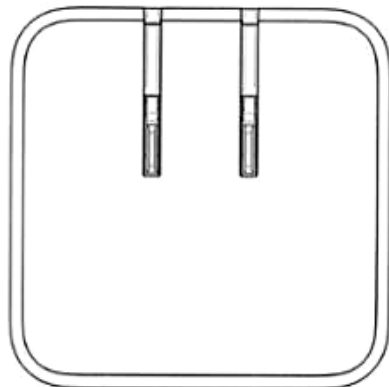

1.7



1.8

CÔNG BÁO SỞ HỮU CÔNG NGHIỆP SỐ 421 TẬP A – QUYỀN 2 (04.2023)

- (11) **46747**
- (21) 3-2022-02573 (28) 1
- (54) **ĐIỆN THOẠI DI ĐỘNG** (51) **14-03**
- (22) 22/11/2022 (43) 25/04/2023
- (30) 202230696379.X 21/10/2022 CN;
- (73) **HONOR DEVICE CO., LTD. (CN)**
Suite 3401, Unit A, Building 6, Shum Yip Sky Park, No. 8089, Hongli West Road,
Xiangmihu Street, Futian District, Shenzhen, Guangdong 518040, People's
Republic of China
- (72) 1. YANG, LIANG (CN)
2. JIANG, ZHIQIANG (CN)
3. WANG, QIAN (CN)
4. ZHANG, YANG (CN)
5. WANG, XIAOYUAN (CN)
6. DING, LIN (CN)
7. XIANG, JUN (CN)
- (74) Công ty Luật TNHH T&G (TGVN)
- (55)

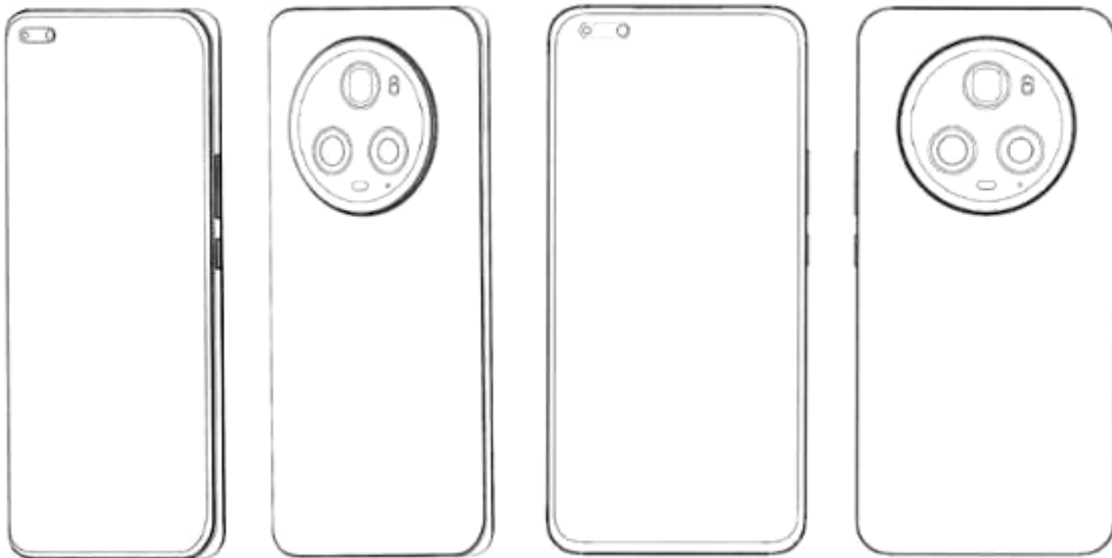

1.1

1.2

1.3

1.4

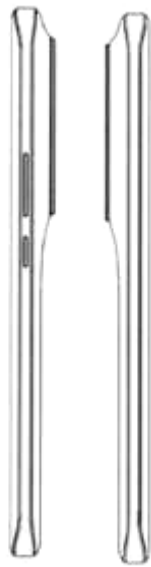

1.5

1.6



1.7



1.8

CÔNG BÁO SỞ HỮU CÔNG NGHIỆP SỐ 421 TẬP A – QUYỀN 2 (04.2023)

- (11) **46748**
- (21) 3-2022-01865 (28) 1
- (54) **THANH TREO KHĂN** (51) **23-02**
- (22) 31/08/2022 (43) 25/04/2023
- (30) 202211211 02/03/2022 AU;
- (73) **PHOENIX INDUSTRIES PTY LTD (AU)**
926 Mountain Hwy, Bayswater, Victoria, 3153, Australia
- (72) Ban Hsi Liu (AU)
- (74) Công ty TNHH Tầm nhìn và Liên danh (VISION & ASSOCIATES CO.LTD.)
- (55)



1.1



1.2



1.3



1.4



1.5



1.6



1.7

CÔNG BÁO SỞ HỮU CÔNG NGHIỆP SỐ 421 TẬP A – QUYỀN 2 (04.2023)

- (11) **46749**
(21) 3-2022-01872 (28) 1
(54) **THANH TREO KHĂN** (51) **23-02**
(22) 31/08/2022 (43) 25/04/2023
(30) 202211213 02/03/2022 AU;
(73) **PHOENIX INDUSTRIES PTY LTD (AU)**
926 Mountain Hwy, Bayswater, Victoria, 3153, Australia
(72) Ban Hsi Liu (AU)
(74) Công ty TNHH Tầm nhìn và Liên danh (VISION & ASSOCIATES CO.LTD.)
(55)

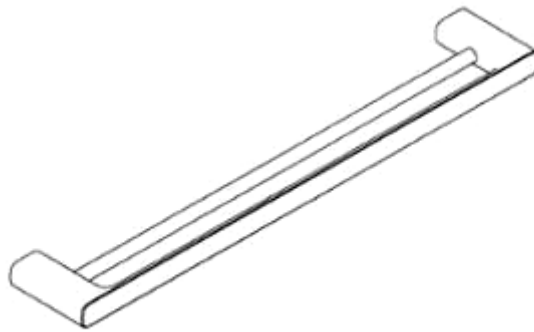

1.1



1.2



1.3



1.4



1.5

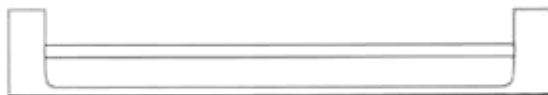

1.6

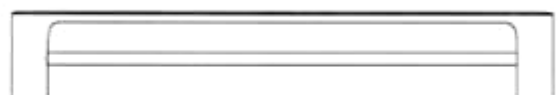

1.7

CÔNG BÁO SỞ HỮU CÔNG NGHIỆP SỐ 421 TẬP A – QUYỀN 2 (04.2023)

- (11) **46750**
(21) 3-2022-01559 (28) 1
(54) **RẮC CO REN NGOÀI** (51) **23-01**
(22) 03/08/2022 (43) 25/04/2023
(73) **NGUYỄN TIẾN THẮNG (VN)**
Xã Liên Phương, thành phố Hưng Yên, tỉnh Hưng Yên
(72) Nguyễn Tiến Thắng (VN)
(74) Công ty TNHH Trường Xuân (AGELESS CO.,LTD.)
(55)



1.1



1.2



1.3



1.4



1.5



1.6



1.7

- (11) **46751**
(21) 3-2021-01779 (28) 1
(54) **LỚP XE** (51) **12-15**
(22) 06/07/2021 (43) 25/04/2023
(30) 6112112 06/01/2021 GB;
(73) **DAVANTI TYRES LIMITED (GB)**
Oak House, Woodlands Park, Ashton Road, Newton-le-Willows, Merseyside,
WA12 0HF, United Kingdom
(72) Qiong Zhou (CN)
(74) Công ty TNHH Đại Tín và Liên Danh (DAITIN AND ASSOCIATES CO.,LTD)
(55)



1.1

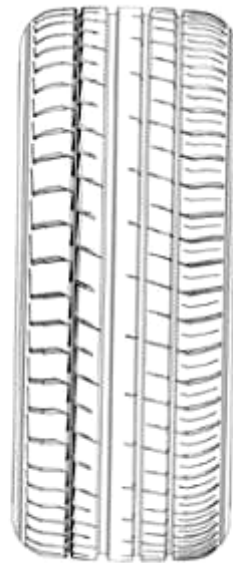

1.2



1.3



1.4

- (11) **46752**
(21) 3-2021-00761 (28) 3
(54) **MÁY PLASMA Y TẾ VÀ THẨM MỸ** (51) **24-01**
(22) 31/03/2021 (43) 25/04/2023
(73) **NGUYỄN QUỐC SỸ (VN)**
44A Tràng Thi, quận Hoàn Kiếm, thành phố Hà Nội
(72) Nguyễn Quốc Sỹ (VN)
(55)



1.1

1.2

1.3

1.4



1.5

1.6

1.7



2.1



2.2

2.3



2.4



2.5



2.6



2.7



3.1



3.2



3.3



3.4



3.5



3.6



3.7

CÔNG BÁO SỞ HỮU CÔNG NGHIỆP SỐ 421 TẬP A – QUYỀN 2 (04.2023)

- (11) **46753**
(21) 3-2022-02418 (28) 1
(54) **ĐÁ ỐP LÁT** (51) **25-01**
(22) 04/11/2022 (43) 25/04/2023
(73) **CÔNG TY CỔ PHẦN TẬP ĐOÀN PHƯỢNG HOÀNG XANH A&A (VN)**
Số 167, phố Hoàng Ngân, phường Trung Hòa, quận Cầu Giấy, thành phố Hà Nội
(72) Hồ Xuân Năng (VN)
(55)



1.1



1.2



1.3



1.4



1.5

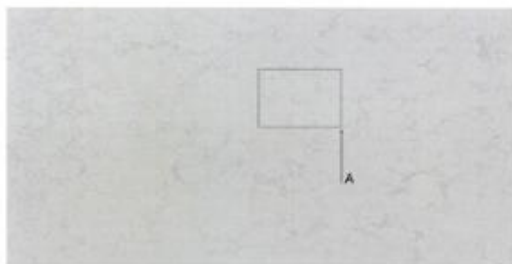

1.6



1.7

CÔNG BÁO SỞ HỮU CÔNG NGHIỆP SỐ 421 TẬP A – QUYỀN 2 (04.2023)

- (11) **46754**
(21) 3-2022-02434 (28) 1
(54) **MÁY LỌC NƯỚC** (51) **23-01**
(22) 07/11/2022 (43) 25/04/2023
(73) **CÔNG TY CỔ PHẦN ĐIỆN MÁY GIA DỤNG HÒA PHÁT HÀ NAM (VN)**
Khu công nghiệp Hòa Mạc, phường Hòa Mạc, thị xã Duy Tiên, tỉnh Hà Nam
(72) Trương Quốc Bình (VN)
(74) Công ty cổ phần Sở hữu trí tuệ BROSS và Cộng sự (BROSS & PARTNERS., JSC)
(55)



1.1



1.2



1.3



1.4



1.5

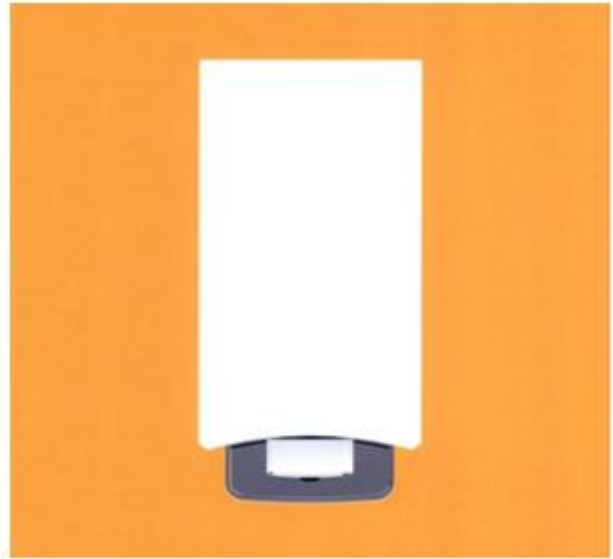

1.6



1.7

CÔNG BÁO SỞ HỮU CÔNG NGHIỆP SỐ 421 TẬP A – QUYỀN 2 (04.2023)

- (11) **46755**
(21) 3-2022-02433 (28) 1
(54) **MÁY LỌC NƯỚC** (51) **23-01**
(22) 07/11/2022 (43) 25/04/2023
(73) **CÔNG TY CỔ PHẦN ĐIỆN MÁY GIA DỤNG HÒA PHÁT HÀ NAM (VN)**
Khu công nghiệp Hòa Mạc, phường Hòa Mạc, thị xã Duy Tiên, tỉnh Hà Nam
(72) Trương Quốc Bình (VN)
(74) Công ty cổ phần Sở hữu trí tuệ BROSS và Cộng sự (BROSS & PARTNERS., JSC)
(55)



1.1



1.2

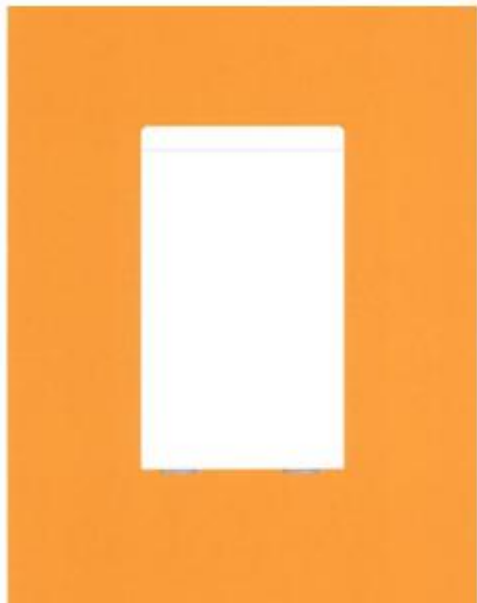

1.3



1.4



1.5



1.6



1.7

CÔNG BÁO SỞ HỮU CÔNG NGHIỆP SỐ 421 TẬP A – QUYỀN 2 (04.2023)

- (11) **46756**
(21) 3-2022-02313 (28) 1
(54) **THIẾT BỊ LỌC NƯỚC** (51) **23-01**
(22) 24/10/2022 (43) 25/04/2023
(73) **CÔNG TY CỔ PHẦN ĐIỆN MÁY GIA DỤNG HÒA PHÁT HÀ NAM (VN)**
Khu công nghiệp Hòa Mạc, phường Hòa Mạc, thị xã Duy Tiên, tỉnh Hà Nam
(72) Trương Quốc Bình (VN)
(74) Công ty cổ phần Sở hữu trí tuệ BROSS và Cộng sự (BROSS & PARTNERS., JSC)
(55)



1.1

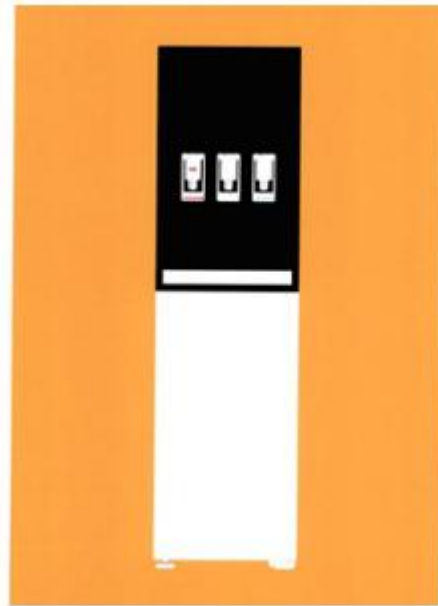

1.2

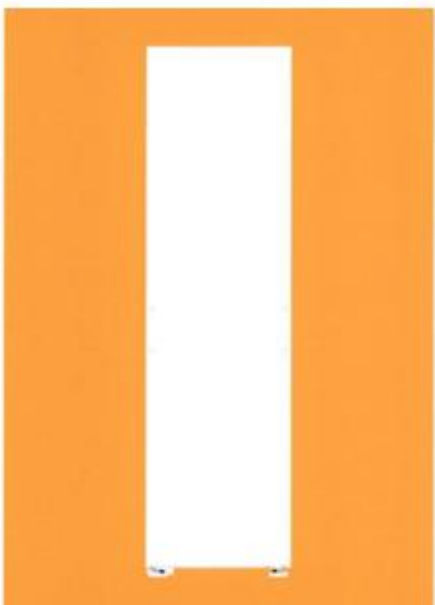

1.3

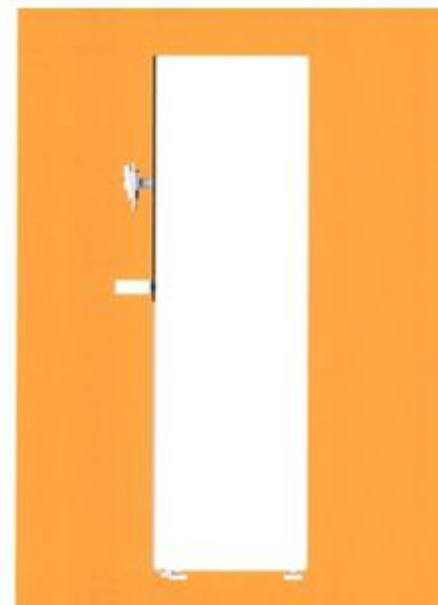

1.4

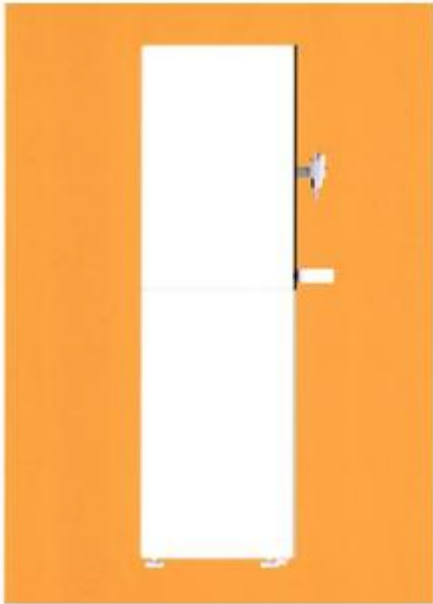

1.5



1.6



1.7

CÔNG BÁO SỞ HỮU CÔNG NGHIỆP SỐ 421 TẬP A – QUYỀN 2 (04.2023)

- (11) **46757**
(21) 3-2022-02578 (28) 1
(54) **KÊNH, MƯƠNG ĐÚC SẴN** (51) **25-02**
(22) 23/11/2022 (43) 25/04/2023
(73) **CÔNG TY CỔ PHẦN KHOA HỌC CÔNG NGHỆ VIỆT NAM (VN)**
Số 6 đường 3 tháng 2, phường 8, thành phố Vũng Tàu, tỉnh Bà Rịa - Vũng Tàu
(72) Hoàng Đức Thảo (VN)
(55)

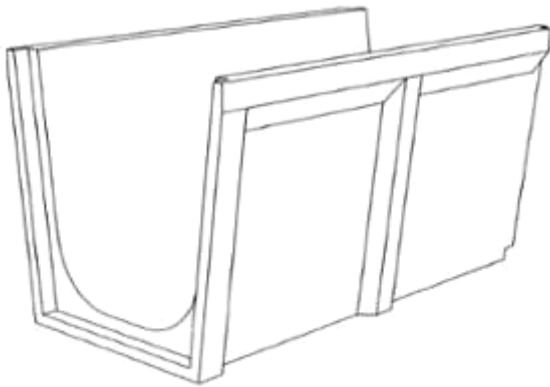

1.1

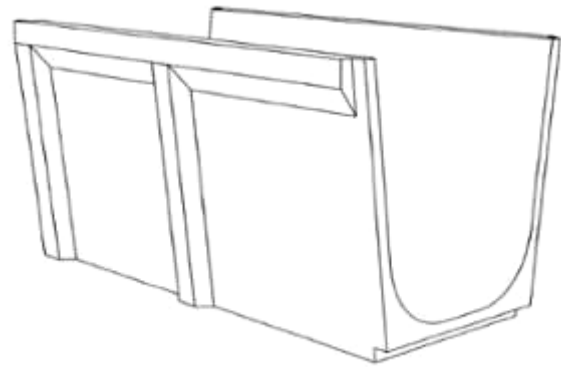

1.2

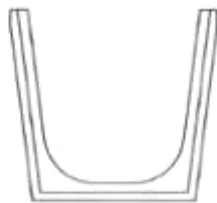

1.3



1.4

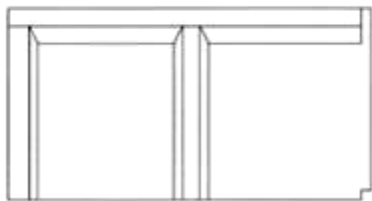

1.5

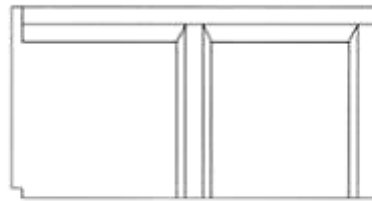

1.6



1.7

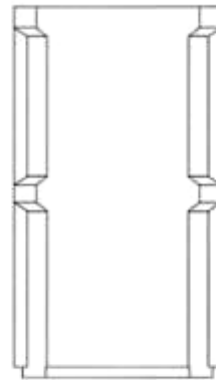

1.8

(11) **46758**

(21) 3-2022-02577

(54) **KÊNH, MƯƠNG ĐÚC SẴN**

(22) 23/11/2022

(73) **CÔNG TY CỔ PHẦN KHOA HỌC CÔNG NGHỆ VIỆT NAM (VN)**

Số 6 đường 3 tháng 2, phường 8, thành phố Vũng Tàu, tỉnh Bà Rịa-Vũng Tàu

(72) Hoàng Đức Thảo (VN)

(55)

(28) 1

(51) **25-02**

(43) 25/04/2023

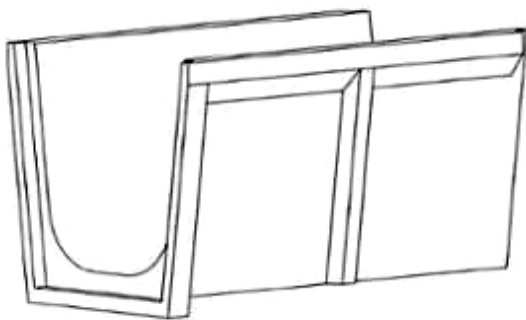

1.1

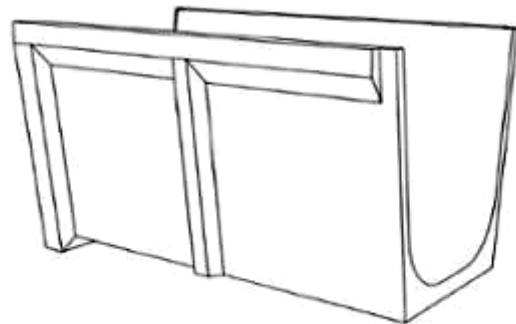

1.2

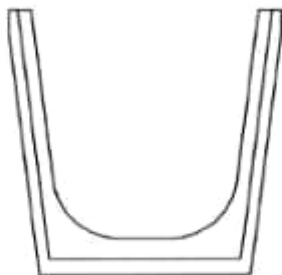

1.3

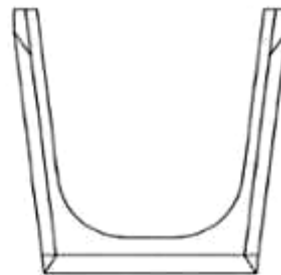

1.4

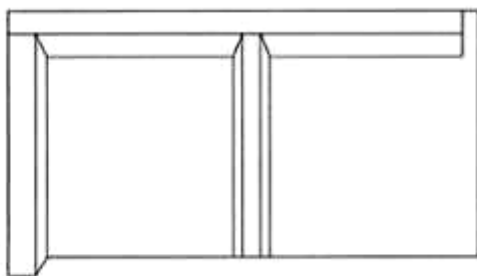

1.5

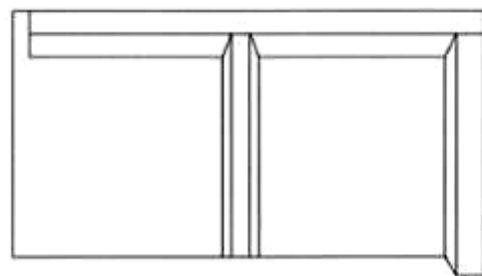

1.6

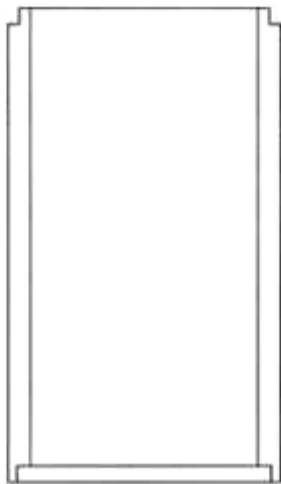

1.7

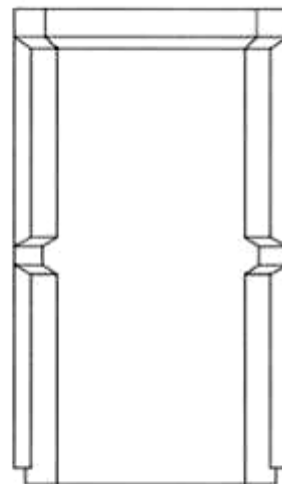

1.8

(11) **46759**

(21) 3-2022-02576

(28) 1

(54) **CÁU KIỆN KÈ LẮP GHÉP**

(51) **25-02**

(22) 23/11/2022

(43) 25/04/2023

(73) **CÔNG TY CỔ PHẦN KHOA HỌC CÔNG NGHỆ VIỆT NAM (VN)**

Số 6 đường 3 tháng 2, phường 8, thành phố Vũng Tàu, tỉnh Bà Rịa - Vũng Tàu

(72) Hoàng Đức Thảo (VN)

(55)

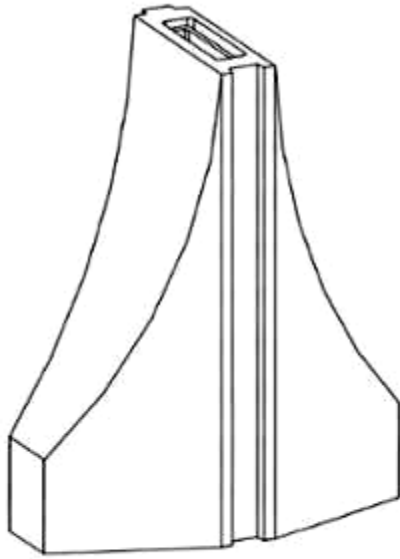

1.1

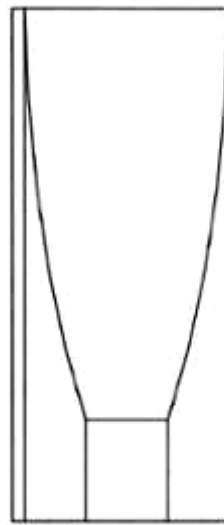

1.2

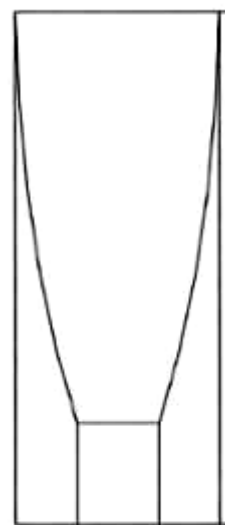

1.3

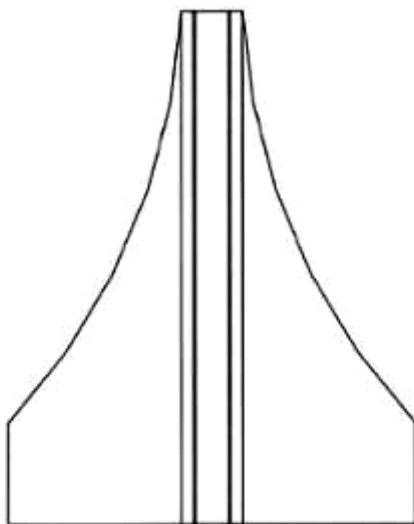

1.4

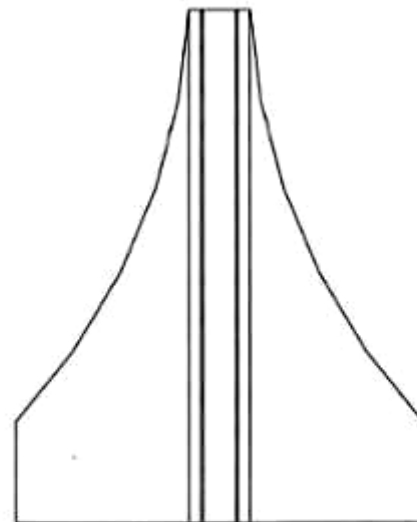

1.5

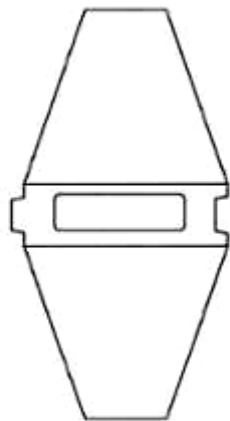

1.6

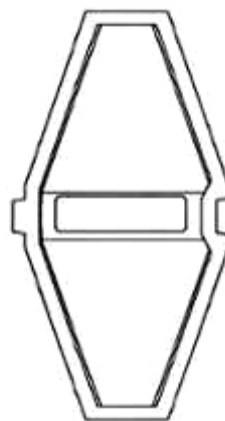

1.7

(11) **46760**

(21) 3-2022-02574

(28) 1

(54) **CẤU KIỆN KÈ LẮP GHÉP**

(51) **25-02**

(22) 23/11/2022

(43) 25/04/2023

(73) **CÔNG TY CỔ PHẦN KHOA HỌC CÔNG NGHỆ VIỆT NAM (VN)**

Số 6 đường 3 tháng 2, phường 8, thành phố Vũng Tàu, tỉnh Bà Rịa - Vũng Tàu

(72) Hoàng Đức Thảo (VN)

(55)

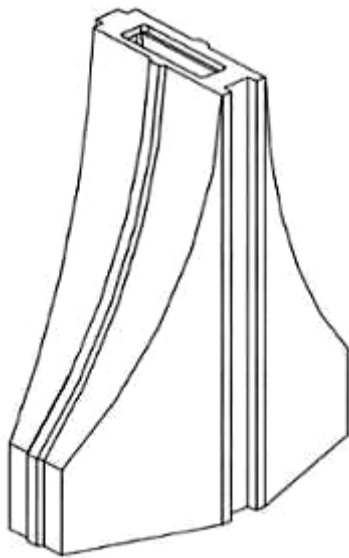

1.1

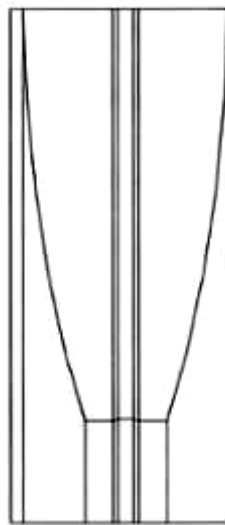

1.2

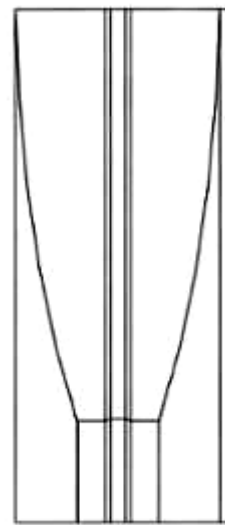

1.3

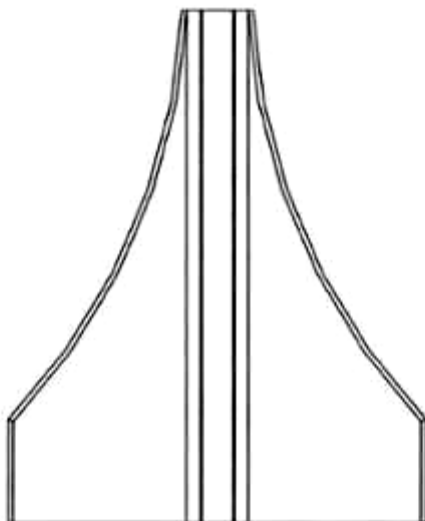

1.4

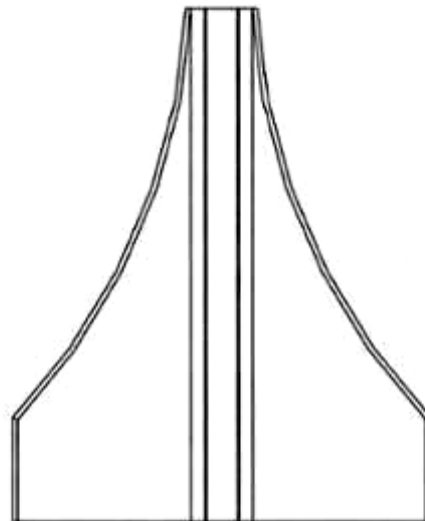

1.5

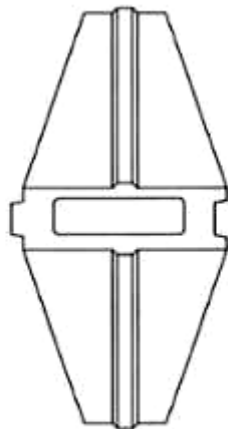

1.6

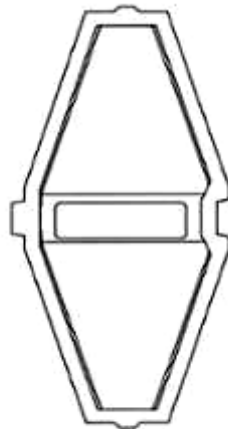

1.7

- (11) **46761**
(21) 3-2022-02836 (28) 1
(54) **HỘP ĐỂ HÀNH LÝ DÙNG CHO XE MÁY** (51) **12-16**
(22) 23/12/2022 (43) 25/04/2023
(30) 2022-014233 01/07/2022 JP;
(73) **HONDA MOTOR CO., LTD. (JP)**
1-1, Minami-Aoyama 2-Chome, Minato-ku, Tokyo, 107-8556 Japan
(72) 1. ISANA SUZUKI (JP)
2. ASATO KATO (JP)
(74) Công ty Luật TNHH Phạm và Liên danh (PHAM & ASSOCIATES)
(55)



1.1



1.2



1.3



1.4



1.5



1.6



1.7



1.8



1.9

(11) **46762**

(21) 3-2022-02575

(28) 1

(54) **CẤU KIỆN KÈ LẮP GHÉP**

(51) **25-02**

(22) 23/11/2022

(43) 25/04/2023

(73) **CÔNG TY CỔ PHẦN KHOA HỌC CÔNG NGHỆ VIỆT NAM (VN)**

Số 6 đường 3 tháng 2, phường 8, thành phố Vũng Tàu, tỉnh Bà Rịa - Vũng Tàu

(72) Hoàng Đức Thảo (VN)

(55)

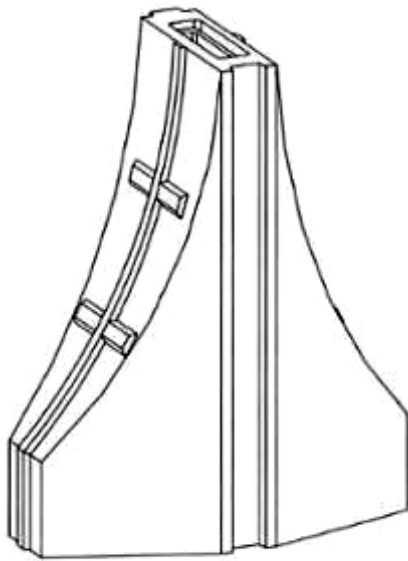

1.1

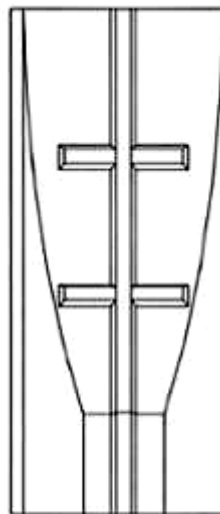

1.2

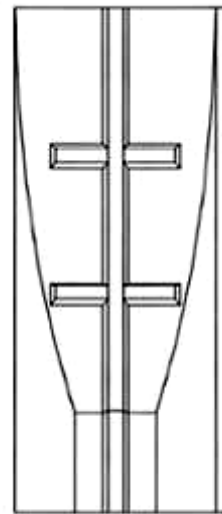

1.3

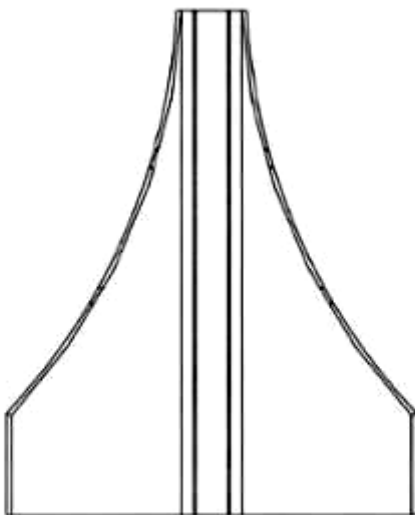

1.4

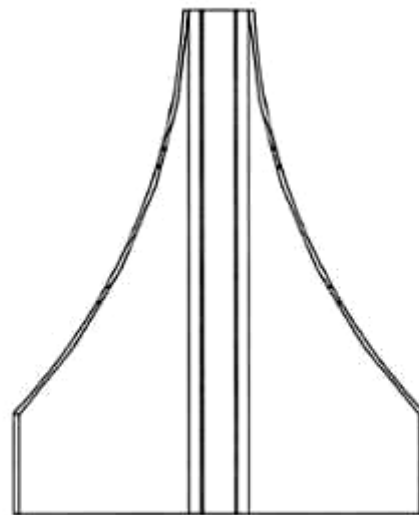

1.5

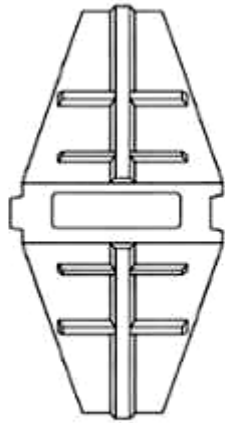

1.6



1.7

CÔNG BÁO SỞ HỮU CÔNG NGHIỆP SỐ 421 TẬP A – QUYỀN 2 (04.2023)

- (11) **46763**
(21) 3-2022-02867 (28) 1
(54) **TẮM RÀO CHẮN BẢO VỆ** (51) **25-02**
(22) 26/12/2022 (43) 25/04/2023
(73) **DONGGUAN CITY YUZHIXIN HARDWARE PLASTIC PRODUCT CO., LTD (CN)**
No.4, Jinhe Xinguang Road, Zhangmutou Town, Dongguan City, Guangdong Province, 523000, China
(72) SHENG DING (CN)
(74) Công ty TNHH Dịch vụ Sở hữu trí tuệ GREENIP (GREENIP CO., LTD)
(55)



1.1



1.2

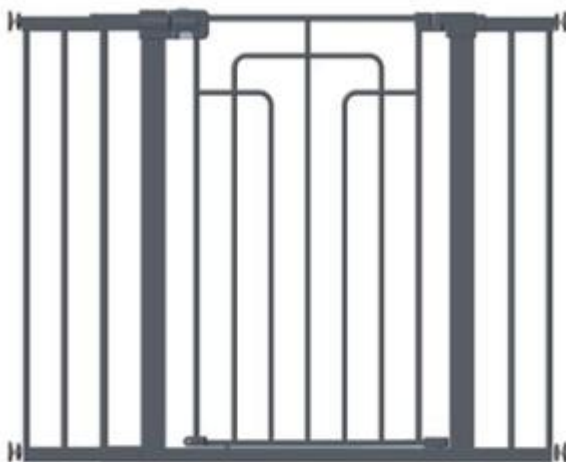

1.3



1.4



1.5



1.6



1.7



1.8

CÔNG BÁO SỞ HỮU CÔNG NGHIỆP SỐ 421 TẬP A – QUYỀN 2 (04.2023)

- (11) **46764**
(21) 3-2022-02966 (28) 1
(54) **HỘP ĐIỀU KHIỂN** (51) **13-03; 13-99**
(22) 30/12/2022 (43) 25/04/2023
(73) **CÔNG TY TNHH CÔNG NGHIỆP KINGTEC VIỆT NAM (VN)**
Lô C-4 A-CN, khu công nghiệp Mỹ Phước 3, phường Thới Hòa, thị xã Bến Cát,
tỉnh Bình Dương
(72) HUANG, WEI-HAN (TW)
(74) Công ty TNHH Tư vấn - Dịch thuật - Sở hữu trí tuệ Á Đông (Á Đông IP
CONSULTANCY CO.,LTD.)
(55)

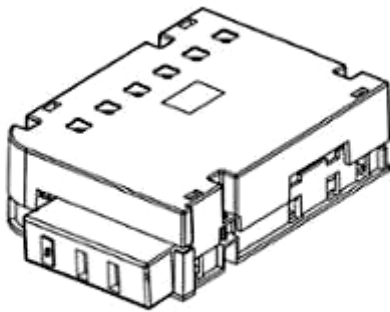

1.1



1.2

1.3



1.4

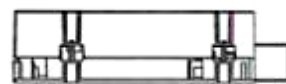

1.5

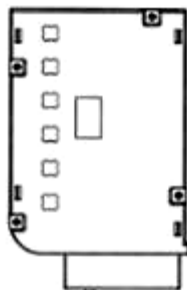

1.6

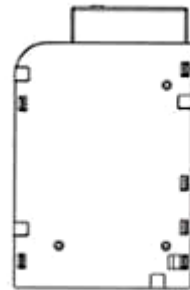

1.7

CÔNG BÁO SỞ HỮU CÔNG NGHIỆP SỐ 421 TẬP A – QUYỀN 2 (04.2023)

- (11) **46765**
(21) 3-2022-02967 (28) 1
(54) **HỘP ĐỰNG ĐỘNG CƠ** (51) **15-01**
(22) 30/12/2022 (43) 25/04/2023
(73) **CÔNG TY TNHH CÔNG NGHIỆP KINGTEC VIỆT NAM (VN)**
Lô C-4 A-CN, khu công nghiệp Mỹ Phước 3, phường Thới Hòa, thị xã Bến Cát,
tỉnh Bình Dương
(72) HUANG, WEI-HAN (TW)
(74) Công ty TNHH Tư vấn - Dịch thuật - Sở hữu trí tuệ Á Đông (Á Đông IP
CONSULTANCY CO.,LTD.)
(55)



1.1



1.2

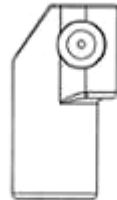

1.3

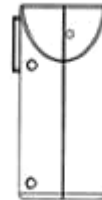

1.4

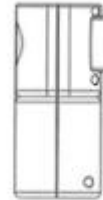

1.5

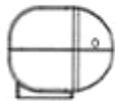

1.6



1.7

CÔNG BÁO SỞ HỮU CÔNG NGHIỆP SỐ 421 TẬP A – QUYỀN 2 (04.2023)

- (11) **46766**
(21) 3-2022-02969 (28) 1
(54) **HỘP ĐỰNG ĐỘNG CƠ** (51) **13-01**
(22) 30/12/2022 (43) 25/04/2023
(73) **CÔNG TY TNHH CÔNG NGHIỆP KINGTEC VIỆT NAM (VN)**
Lô C-4 A-CN, khu công nghiệp Mỹ Phước 3, phường Thới Hòa, thị xã Bến Cát,
tỉnh Bình Dương
(72) HUANG, WEI-HAN (TW)
(74) Công ty TNHH Tư vấn - Dịch thuật - Sở hữu trí tuệ Á Đông (Á Đông IP
CONSULTANCY CO.,LTD.)
(55)



1.1



1.2



1.3



1.4



1.5

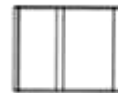

1.6



1.7

CÔNG BÁO SỞ HỮU CÔNG NGHIỆP SỐ 421 TẬP A – QUYỀN 2 (04.2023)

- (11) **46767**
(21) 3-2022-02865 (28) 1
(54) **TẮM RÀO CHẶN BẢO VỆ** (51) **25-02**
(22) 26/12/2022 (43) 25/04/2023
(73) **DONGGUAN CITY YUZHIXIN HARDWARE PLASTIC PRODUCT CO., LTD (CN)**
No.4, Jinhe Xinguang Road, Zhangmutou Town, Dongguan City, Guangdong Province, 523000, China
(72) SHENG DING (CN)
(74) Công ty TNHH Dịch vụ Sở hữu trí tuệ GREENIP (GREENIP CO., LTD)
(55)



1.1



1.2



1.3



1.4



1.5



1.6



1.7



1.8

CÔNG BÁO SỞ HỮU CÔNG NGHIỆP SỐ 421 TẬP A – QUYỀN 2 (04.2023)

- (11) **46768**
(21) 3-2022-02863 (28) 1
(54) **TẮM RÀO CHẮN BẢO VỆ** (51) **25-02**
(22) 26/12/2022 (43) 25/04/2023
(73) **DONGGUAN CITY YUZHIXIN HARDWARE PLASTIC PRODUCT CO., LTD (CN)**
No.4, Jinhe Xinguang Road, Zhangmutou Town, Dongguan City, Guangdong Province, 523000, China
(72) SHENG DING (CN)
(74) Công ty TNHH Dịch vụ Sở hữu trí tuệ GREENIP (GREENIP CO., LTD)
(55)



1.1



1.2



1.3



1.4



1.5



1.6



1.7



1.8

CÔNG BÁO SỞ HỮU CÔNG NGHIỆP SỐ 421 TẬP A – QUYỀN 2 (04.2023)

- (11) **46769**
(21) 3-2022-02866 (28) 1
(54) **TẮM RÀO CHẶN BẢO VỆ** (51) **25-02**
(22) 26/12/2022 (43) 25/04/2023
(73) **DONGGUAN CITY YUZHIXIN HARDWARE PLASTIC PRODUCT CO., LTD (CN)**
No.4, Jinhe Xinguang Road, Zhangmutou Town, Dongguan City, Guangdong Province, 523000, China
(72) SHENG DING (CN)
(74) Công ty TNHH Dịch vụ Sở hữu trí tuệ GREENIP (GREENIP CO., LTD)
(55)



1.1



1.2

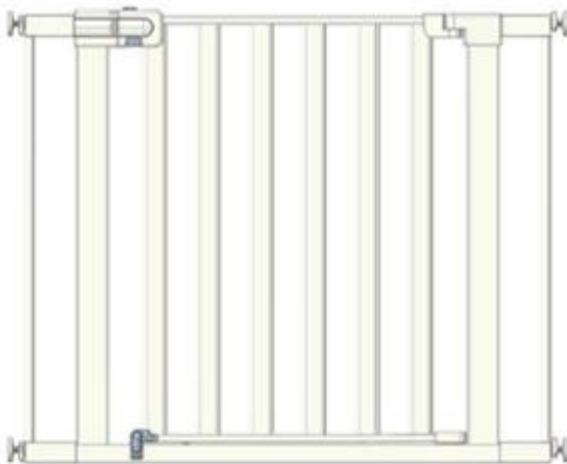

1.3



1.4



1.5



1.6



1.7



1.8

CÔNG BÁO SỞ HỮU CÔNG NGHIỆP SỐ 421 TẬP A – QUYỀN 2 (04.2023)

- (11) **46770**
(21) 3-2022-02839 (28) 1
(54) **CỬA CHẶN** (51) **25-02**
(22) 23/12/2022 (43) 25/04/2023
(30) 202230390362.1 23/06/2022 CN;
(73) **DONGGUAN CITY YUZHIXIN HARDWARE PLASTIC PRODUCT CO., LTD. (CN)**
No.4, Xinguang Road, Jinhe, Zhangmutou Town, Dongguan city 523000,
Guangdong Province, China
(72) Ning DING (CN)
(74) **CÔNG TY TRÁCH NHIỆM HỮU HẠN TƯ VẤN ĐẦU TƯ VÀ SỞ HỮU TRÍ TUỆ INTERFIVE (INTERFIVE CO., LTD)**
(55)



1.1

1.2

1.3

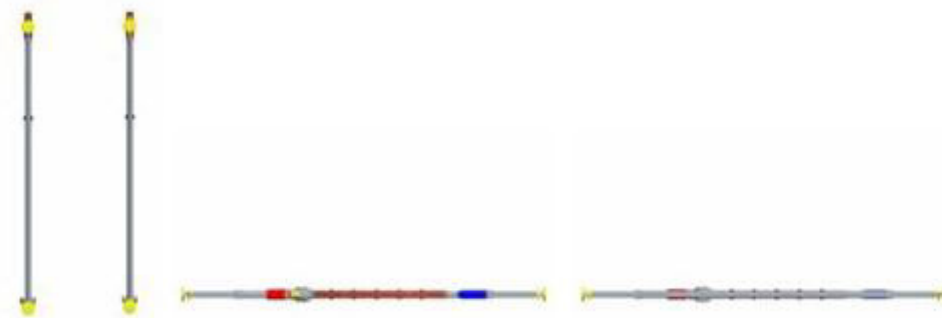

1.4

1.5

1.6

1.7

- (11) **46771**
(21) 3-2022-02838 (28) 1
(54) **CỬA CHẶN** (51) **25-02**
(22) 23/12/2022 (43) 25/04/2023
(30) 202230389812.5 23/06/2022 CN;
(73) **DONGGUAN CITY YUZHIXIN HARDWARE PLASTIC PRODUCT CO., LTD. (CN)**
No.4, Xinguang Road, Jinhe, Zhangmutou Town, Dongguan city 523000,
Guangdong Province, China
(72) Ning DING (CN)
(74) **CÔNG TY TRÁCH NHIỆM HỮU HẠN TƯ VẤN ĐẦU TƯ VÀ SỞ HỮU TRÍ TUỆ INTERFIVE (INTERFIVE CO., LTD)**
(55)

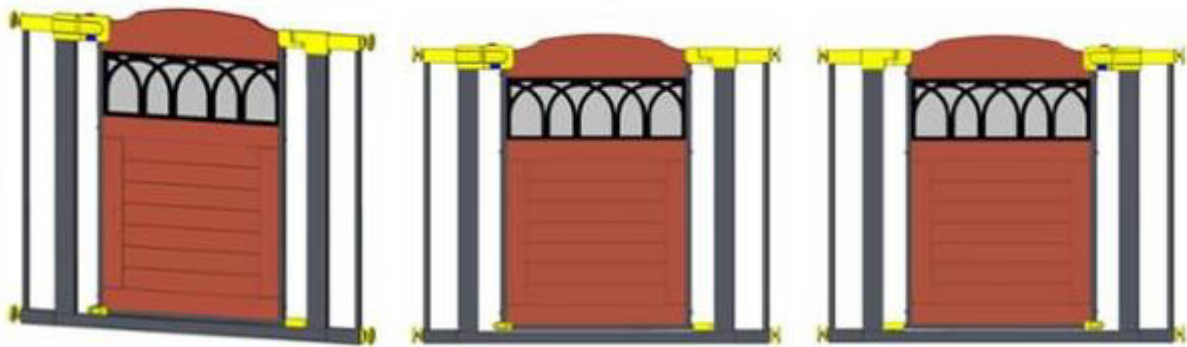

1.1

1.2

1.3



1.4 1.5

1.6

1.7

- (11) **46772**
(21) 3-2022-02861 (28) 1
(54) **TẮM RÀO CHẶN BẢO VỆ** (51) **25-02**
(22) 26/12/2022 (43) 25/04/2023
(73) **DONGGUAN CITY YUZHIXIN HARDWARE PLASTIC PRODUCT CO., LTD (CN)**
No.4, Jinhe Xinguang Road, Zhangmutou Town, Dongguan City, Guangdong Province, 523000, China
(72) SHENG DING (CN)
(74) Công ty TNHH Dịch vụ Sở hữu trí tuệ GREENIP (GREENIP CO., LTD)
(55)



1.1



1.2

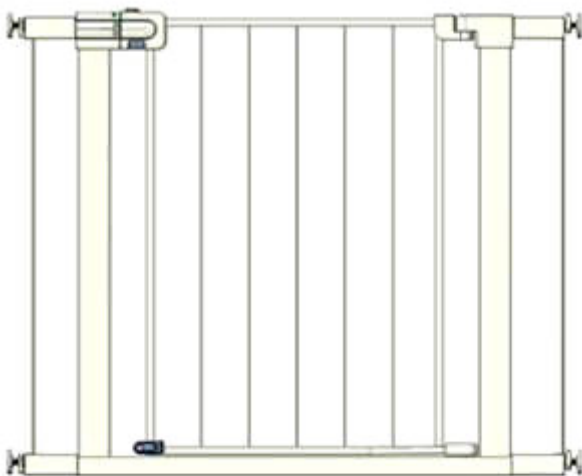

1.3

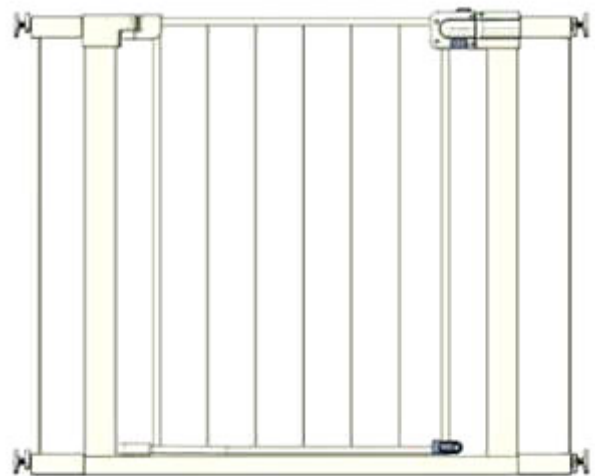

1.4



1.5



1.6



1.7



1.8

- (11) **46773**
(21) 3-2022-02840 (28) 1
(54) **CỬA CHẶN** (51) **25-02**
(22) 23/12/2022 (43) 25/04/2023
(30) 202230390350.9 23/06/2022 CN;
(73) **DONGGUAN CITY YUZHIXIN HARDWARE PLASTIC PRODUCT CO., LTD. (CN)**
No.4, Xinguang Road, Jinhe, Zhangmutou Town, Dongguan city 523000,
Guangdong Province, China
(72) Ning DING (CN)
(74) **CÔNG TY TRÁCH NHIỆM HỮU HẠN TƯ VẤN ĐẦU TƯ VÀ SỞ HỮU TRÍ TUỆ INTERFIVE (INTERFIVE CO., LTD)**
(55)



1.1

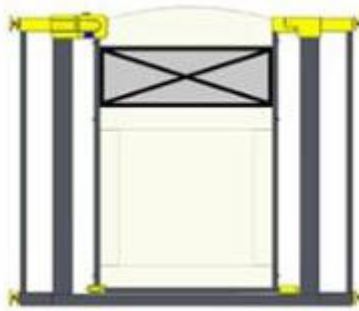

1.2



1.3



1.4



1.5



1.6



1.7

- (11) **46774**
- (21) 3-2022-02849 (28) 1
- (54) **CẢN TRƯỚC CỦA XE Ô TÔ** (51) **12-16**
- (22) 23/12/2022 (43) 25/04/2023
- (30) 202230394858.6 24/06/2022 CN;
- (73) 1. **ZHEJIANG GEELY HOLDING GROUP CO., LTD. (CN)**
No. 1760 Jiangling Road, Binjiang District, Hangzhou, Zhejiang, 310000 China
2. **GEELY AUTOMOBILE RESEARCH INSTITUTE (NINGBO) CO., LTD (CN)**
No. 818, Binhai 2nd Road, Hangzhou Bay New District, Ningbo, Zhejiang, China 315336
- (72) 1. ZHOU, XINNUO (CN)
2. CHEN, CHEN (CN)
3. WU, ZHENZHEN (CN)
4. RUI, CHAO (CN)
5. MA, BOYUN (CN)
6. SUN, WEI (CN)
7. LIU, YUZHOU (CN)
8. LIU, ZICHENG (CN)
9. CHEN, JIANDU (CN)
- (74) Công ty TNHH Sáng chế ACTIP (ACTIP PATENT LIMITED)
- (55)



1.1



1.2



1.3



1.4



1.5



1.6



1.7



1.8

- (11) **46775**
(21) 3-2022-02823 (28) 1
(54) **VỎ CHỨA ẮNG-TEN ĐIỀM TRUY CẬP** (51) **14-03**
(22) 21/12/2022 (43) 25/04/2023
(30) 29/843,473 21/06/2022 US;
(73) **UBIQUITI INC. (US)**
685 Third Avenue, 27th Floor, New York, NY 10017, United States of America
(72) 1. ROBERT J. PERA (US)
2. KONSTANTINOS TSIOPANOS (US)
3. YUWEI TU (TW)
(74) Công ty Luật TNHH T&G (TGVN)
(55)

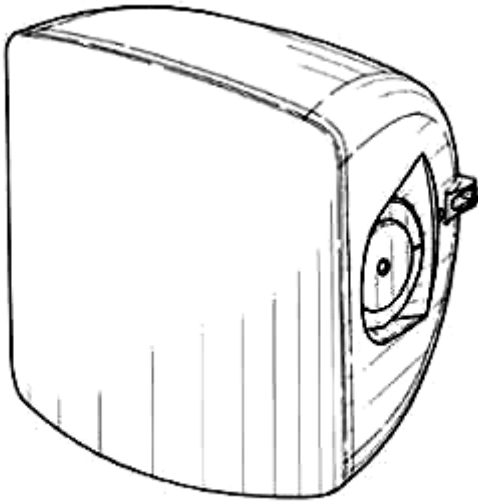

1.1

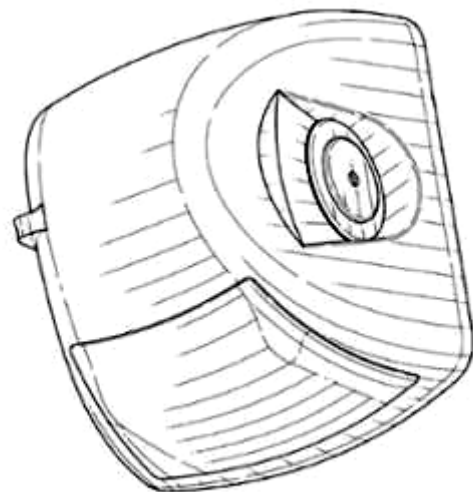

1.2

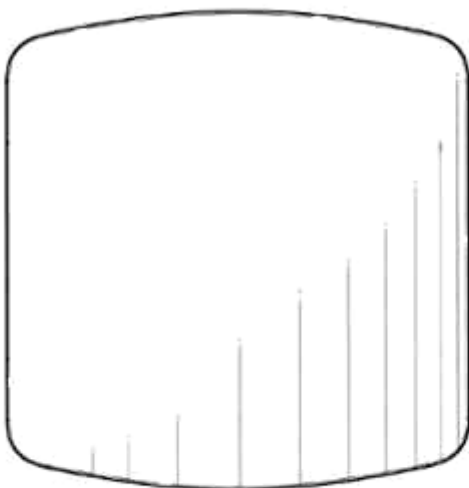

1.3

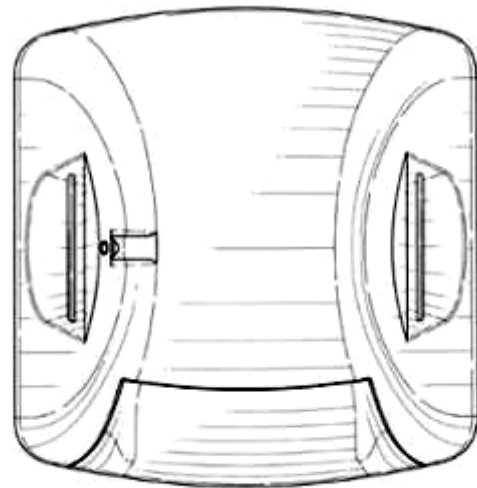

1.4

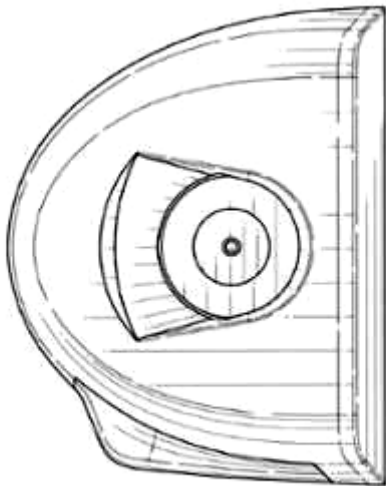

1.5

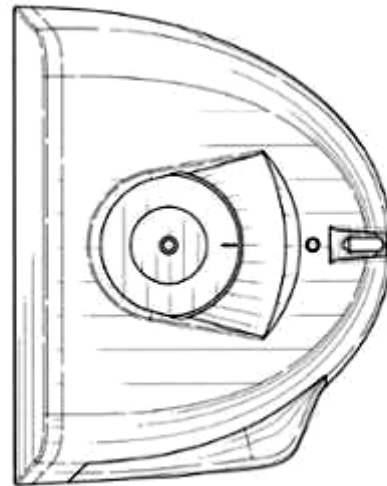

1.6

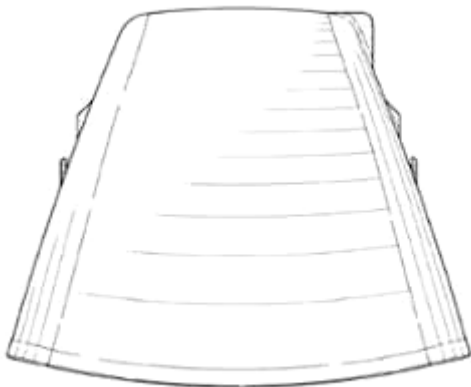

1.7



1.8

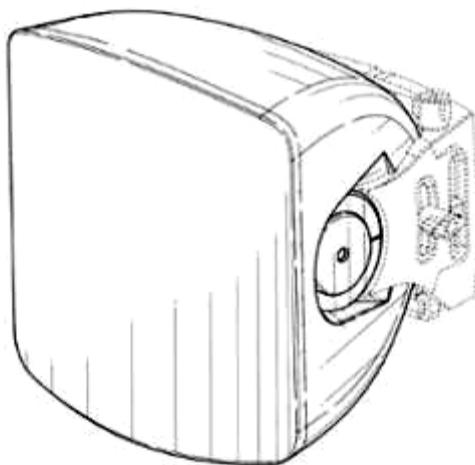

1.9

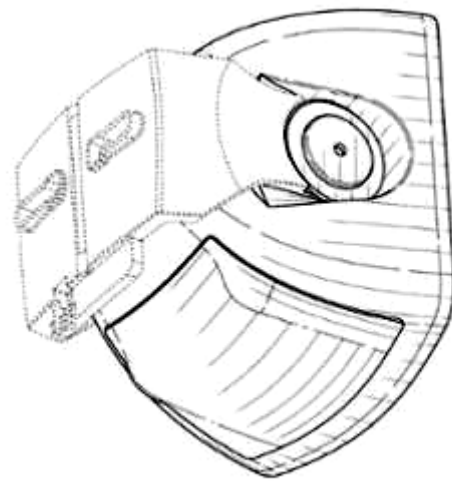

1.10

- (11) **46776**
(21) 3-2022-02837 (28) 1
(54) **CỬA CHẶN** (51) **25-02**
(22) 23/12/2022 (43) 25/04/2023
(30) 202230389814.4 23/06/2022 CN;
(73) **DONGGUAN CITY YUZHIXIN HARDWARE PLASTIC PRODUCT CO., LTD. (CN)**
No.4, Xinguang Road, Jinhe, Zhangmutou Town, Dongguan city 523000,
Guangdong Province, China
(72) Ning DING (CN)
(74) **CÔNG TY TRÁCH NHIỆM HỮU HẠN TƯ VẤN ĐẦU TƯ VÀ SỞ HỮU TRÍ TUỆ INTERFIVE (INTERFIVE CO., LTD)**
(55)



1.1

1.2

1.3

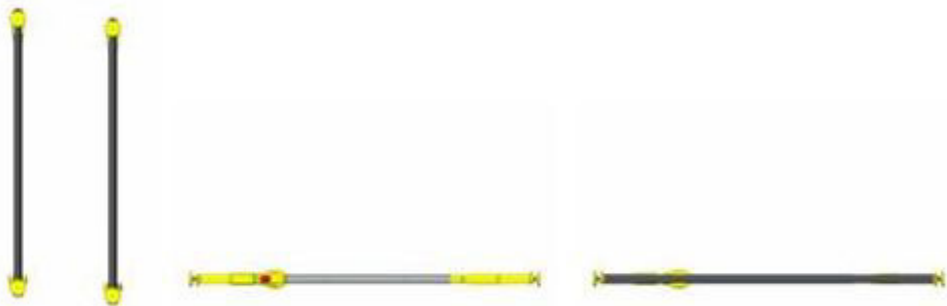

1.4

1.5

1.6

1.7

- (11) **46777**
- (21) 3-2022-02847 (28) 1
- (54) **LƯỚI TẢN NHIỆT CỦA XE Ô TÔ** (51) **12-16**
- (22) 23/12/2022 (43) 25/04/2023
- (30) 202230394861.8 24/06/2022 CN;
- (73) 1. **ZHEJIANG GEELY HOLDING GROUP CO., LTD.** (CN)
No. 1760 Jiangling Road, Binjiang District, Hangzhou, Zhejiang, 310000 China
2. **GEELY AUTOMOBILE RESEARCH INSTITUTE (NINGBO) CO., LTD**
(CN)
No. 818, Binhai 2nd Road, Hangzhou Bay New District, Ningbo, Zhejiang, China
315336
- (72) 1. ZHOU, XINNUO (CN)
2. CHEN, CHEN (CN)
3. MA, BOYUN (CN)
4. SUN, WEI (CN)
5. LIU, YUZHOU (CN)
6. WU, ZHENZHEN (CN)
7. RUI, CHAO (CN)
8. LIU, ZICHENG (CN)
9. CHEN, JIANDU (CN)
- (74) Công ty TNHH Sáng chế ACTIP (ACTIP PATENT LIMITED)
- (55)

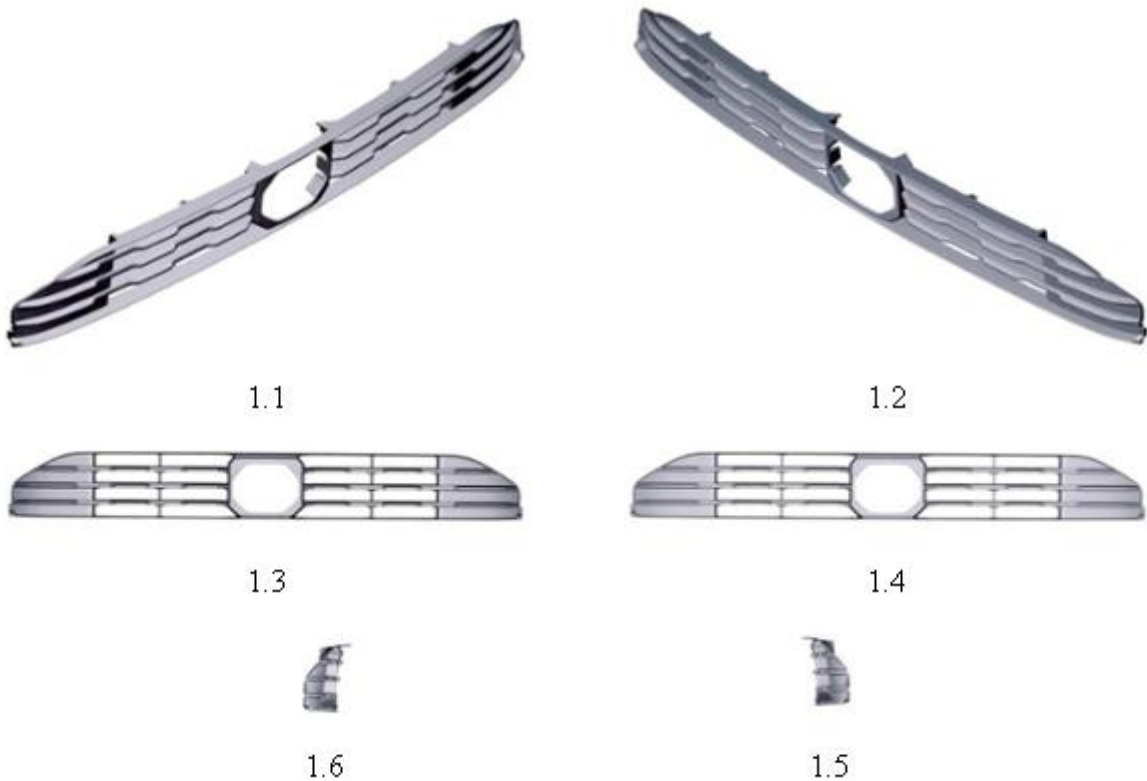



1.7



1.8

- (11) **46778**
- (21) 3-2022-02848 (28) 1
- (54) **ĐÈN TRANG TRÍ XE Ô TÔ** (51) **26-06**
- (22) 23/12/2022 (43) 25/04/2023
- (30) 202230394862.2 24/06/2022 CN;
- (73) 1. **ZHEJIANG GEELY HOLDING GROUP CO., LTD.** (CN)
No. 1760 Jiangling Road, Binjiang District, Hangzhou, Zhejiang, 310000 China
2. **GEELY AUTOMOBILE RESEARCH INSTITUTE (NINGBO) CO., LTD**
(CN)
No. 818, Binhai 2nd Road, Hangzhou Bay New District, Ningbo, Zhejiang, China
315336
- (72) 1. CHEN, CHEN (CN)
2. WU, ZHENZHEN (CN)
3. RUI, CHAO (CN)
4. MA, BOYUN (CN)
5. SUN, WEI (CN)
6. LIU, YUZHOU (CN)
7. ZHOU, XINNUO (CN)
8. LIU, ZICHENG (CN)
9. CHEN, JIANDU (CN)
- (74) Công ty TNHH Sáng chế ACTIP (ACTIP PATENT LIMITED)
- (55)

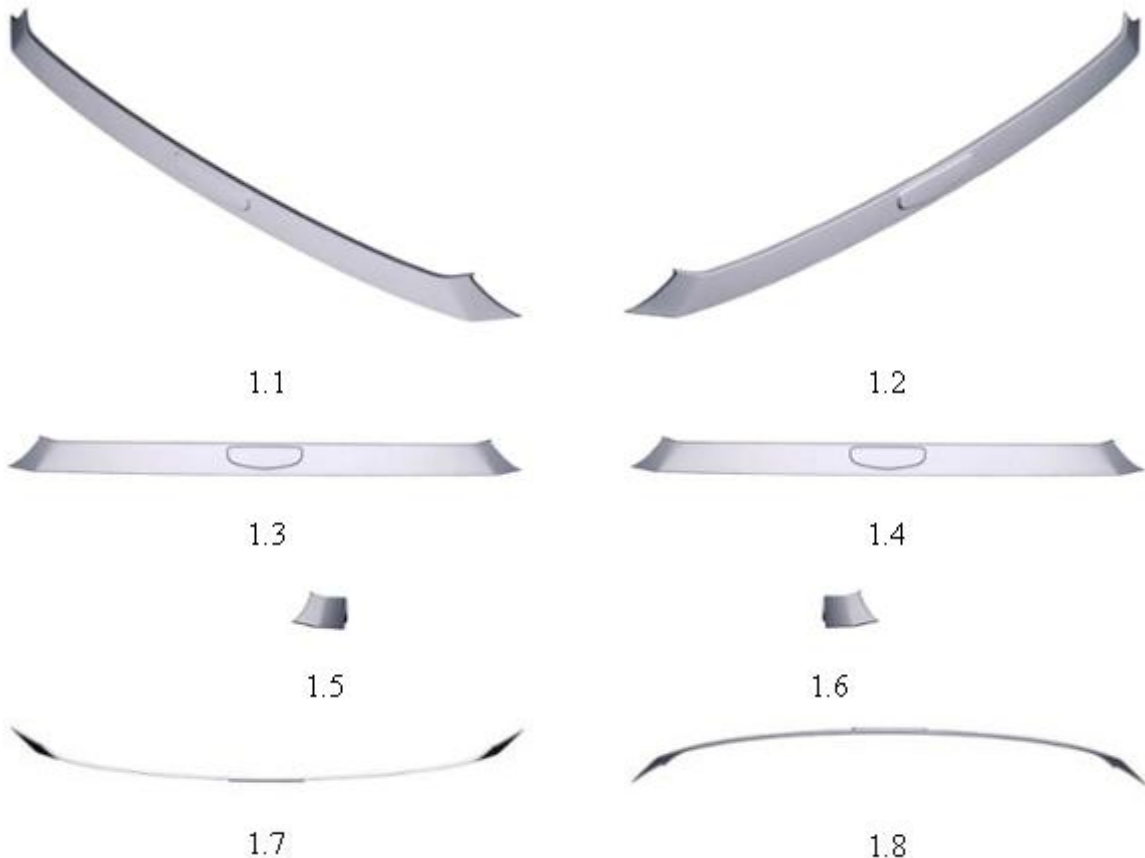

- (11) **46779**
- (21) 3-2022-02844 (28) 1
- (54) **CẢN TRƯỚC CỦA XE Ô TÔ** (51) **12-16**
- (22) 23/12/2022 (43) 25/04/2023
- (30) 202230394871.1 24/06/2022 CN;
- (73) 1. **ZHEJIANG GEELY HOLDING GROUP CO., LTD.** (CN)
No. 1760 Jiangling Road, Binjiang District, Hangzhou, Zhejiang, 310000 China
2. **GEELY AUTOMOBILE RESEARCH INSTITUTE (NINGBO) CO., LTD**
(CN)
No. 818, Binhai 2nd Road, Hangzhou Bay New District, Ningbo, Zhejiang, China
315336
- (72) 1. MA, BOYUN (CN)
2. ZHOU, XINNUO (CN)
3. SUN, WEI (CN)
4. LIU, YUZHOU (CN)
5. WU, ZHENZHEN (CN)
6. RUI, CHAO (CN)
7. CHEN, JIANDU (CN)
- (74) Công ty TNHH Sáng chế ACTIP (ACTIP PATENT LIMITED)
- (55)



1.1



1.2



1.3



1.4



1.5



1.6



1.7



1.8

- (11) **46780**
(21) 3-2022-02845 (28) 1
(54) **VÀNH BÁNH XE Ô TÔ** (51) **12-16**
(22) 23/12/2022 (43) 25/04/2023
(30) 202230394361.4 24/06/2022 CN;
(73) 1. **ZHEJIANG GEELY HOLDING GROUP CO., LTD.** (CN)
No. 1760 Jiangling Road, Binjiang District, Hangzhou, Zhejiang, 310000 China
2. **GEELY AUTOMOBILE RESEARCH INSTITUTE (NINGBO) CO., LTD**
(CN)
No. 818, Binhai 2nd Road, Hangzhou Bay New District, Ningbo, Zhejiang, China
315336
(72) LIU, Guisong (CN)
(74) Công ty TNHH Sáng chế ACTIP (ACTIP PATENT LIMITED)
(55)



- (11) **46781**
(21) 3-2022-02842 (28) 1
(54) **VÀNH BÁNH XE Ô TÔ** (51) **12-16**
(22) 23/12/2022 (43) 25/04/2023
(30) 202230394362.9 24/06/2022 CN;
(73) 1. **ZHEJIANG GEELY HOLDING GROUP CO., LTD. (CN)**
No. 1760 Jiangling Road, Binjiang District, Hangzhou, Zhejiang, 310000 China
2. **GEELY AUTOMOBILE RESEARCH INSTITUTE (NINGBO) CO., LTD (CN)**
No. 818, Binhai 2nd Road, Hangzhou Bay New District, Ningbo, Zhejiang, China 315336
(72) 1. SUN, WEI (CN)
2. ZHOU, XINNUO (CN)
3. MA, BOYUN (CN)
4. LIU, YUZHOU (CN)
5. WU, ZHENZHEN (CN)
6. RUI, CHAO (CN)
7. CHEN, JIANDU (CN)
(74) Công ty TNHH Sáng chế ACTIP (ACTIP PATENT LIMITED)
(55)



1.1

1.2

1.3



1.4



1.5



1.6



1.7



1.8

- (11) **46782**
- (21) 3-2022-02843 (28) 1
- (54) **CẢN SAU CỦA XE Ô TÔ** (51) **12-16**
- (22) 23/12/2022 (43) 25/04/2023
- (30) 202230394863.7 24/06/2022 CN;
- (73) 1. **ZHEJIANG GEELY HOLDING GROUP CO., LTD.** (CN)
No. 1760 Jiangling Road, Binjiang District, Hangzhou, Zhejiang, 310000 China
2. **GEELY AUTOMOBILE RESEARCH INSTITUTE (NINGBO) CO., LTD**
(CN)
No. 818, Binhai 2nd Road, Hangzhou Bay New District, Ningbo, Zhejiang, China
315336
- (72) 1. SUN, WEI (CN)
2. ZHOU, XINNUO (CN)
3. MA, BOYUN (CN)
4. LIU, YUZHOU (CN)
5. WU, ZHENZHEN (CN)
6. RUI, CHAO (CN)
7. CHEN, JIANDU (CN)
- (74) Công ty TNHH Sáng chế ACTIP (ACTIP PATENT LIMITED)
- (55)



1.1



1.2



1.3



1.4



1.5



1.6



1.7



1.8

- (11) **46783**
- (21) 3-2022-02841 (28) 1
- (54) **LƯỚI TẢN NHIỆT CỦA XE Ô TÔ** (51) **12-16**
- (22) 23/12/2022 (43) 25/04/2023
- (30) 202230394860.3 24/06/2022 CN;
- (73) 1. **ZHEJIANG GEELY HOLDING GROUP CO., LTD. (CN)**
No. 1760 Jiangling Road, Binjiang District, Hangzhou, Zhejiang, 310000 China
2. **GEELY AUTOMOBILE RESEARCH INSTITUTE (NINGBO) CO., LTD (CN)**
No. 818, Binhai 2nd Road, Hangzhou Bay New District, Ningbo, Zhejiang, China 315336
- (72) 1. SUN, WEI (CN)
2. ZHOU, XINNUO (CN)
3. MA, BOYUN (CN)
4. LIU, YUZHOU (CN)
5. WU, ZHENZHEN (CN)
6. RUI, CHAO (CN)
7. CHEN, JIANDU (CN)
- (74) Công ty TNHH Sáng chế ACTIP (ACTIP PATENT LIMITED)
- (55)



1.1

1.2

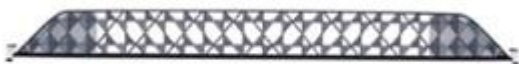

1.3

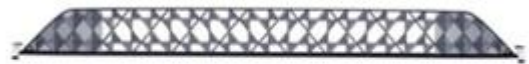

1.4



1.5



1.6



1.7



1.8

CÔNG BÁO SỞ HỮU CÔNG NGHIỆP SỐ 421 TẬP A – QUYỀN 2 (04.2023)

(11) **46784**

(21) 3-2022-01279

(28) 1

(54) **TỦ**

(51) **06-04**

(22) 27/06/2022

(43) 25/04/2023

(73) **MIN-HSUN LU (TW)**

5F-1, NO. 37, CHONGDE 11th ROAD, BEITUN DISTRICT, TAICHUNG CITY
406034, TAIWAN

(72) MIN-HSUN LU (TW)

(74) Công ty TNHH Trường Xuân (AGELESS CO.,LTD.)

(55)

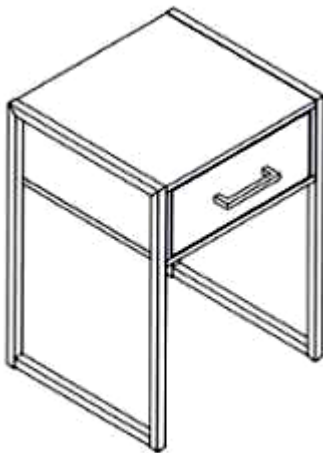

1.1

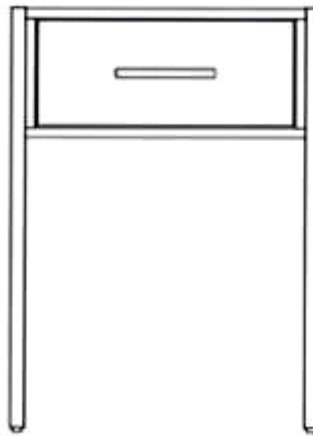

1.2

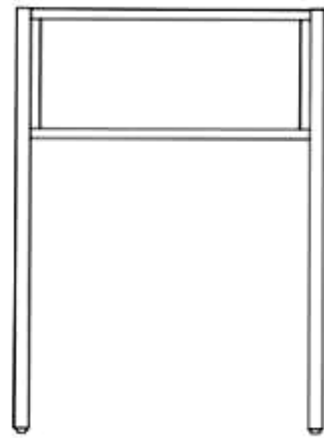

1.3

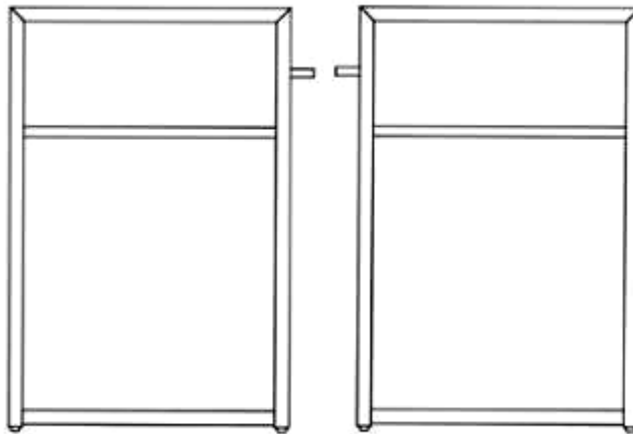

1.4

1.5

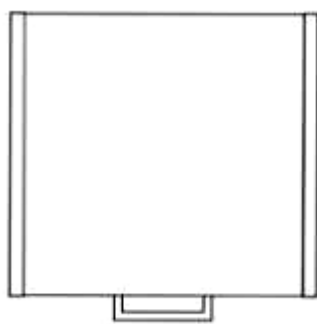

1.6

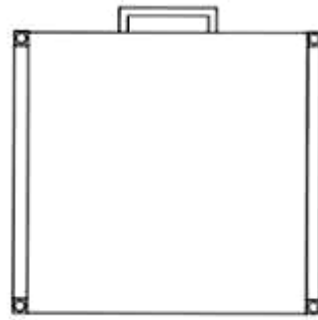

1.7

- (11) **46785**
(21) 3-2022-02345 (28) 6
(54) **THỨC ĂN CHO VẬT NUÔI** (51) **01-06**
(22) 31/10/2022 (43) 25/04/2023
(30) 29/837,036 01/05/2022 US;
(73) **SPECTRUM BRANDS, INC. (US)**
3001 Deming Way, Middleton, Wisconsin 53562, United States of America
(72) 1. MCCANN, ALLYSE (US)
2. POTTER, TIFFANY (US)
3. VAN EYK, GREGORY (US)
4. HULLVERSON, STEPHANIE (US)
(74) Công ty TNHH Sở hữu trí tuệ Thảo Thọ Quyên (INVENCO.,LTD)
(55)

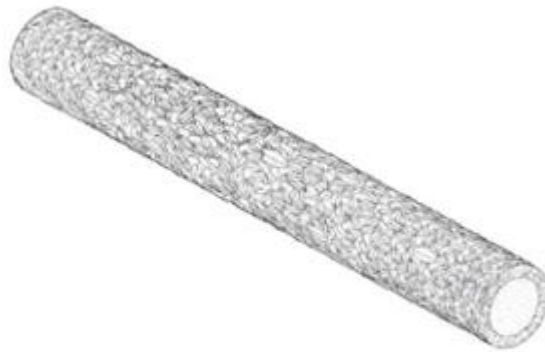

1.1



1.2



1.3



1.4



1.5



1.6



1.7

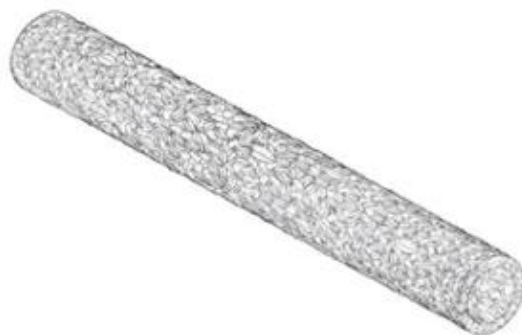

2.1



2.2



2.3



2.4



2.5



2.6



2.7

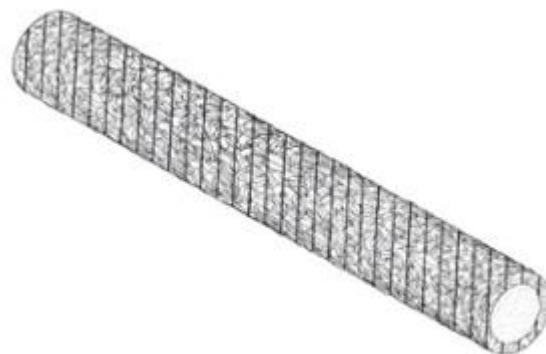

3.1



3.2



3.3



3.4



3.5



3.6



3.7

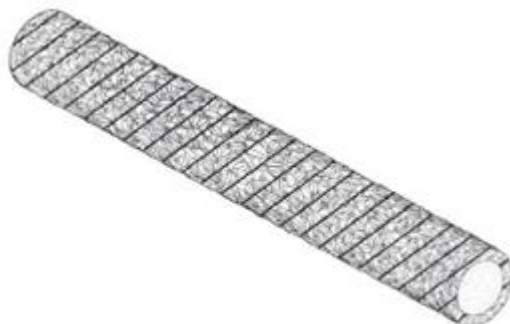

4.1



4.2



4.3



4.4



4.5



4.6



4.7

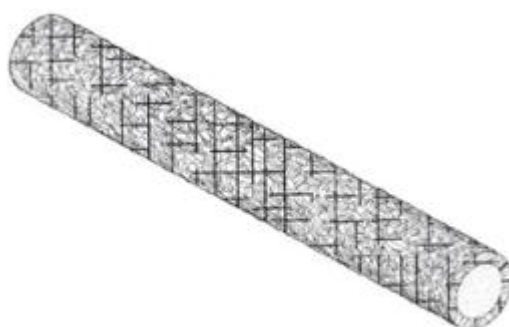

5.1



5.2



5.3



5.4



5.5

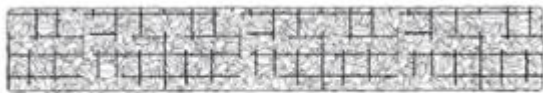

5.6



5.7



6.1



6.2



6.3



6.4

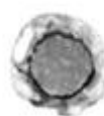

6.5



6.6



6.7

CÔNG BÁO SỞ HỮU CÔNG NGHIỆP SỐ 421 TẬP A – QUYỀN 2 (04.2023)

- (11) **46786**
- (21) 3-2022-02832 (28) 1
- (54) **NỒI CƠM ĐIỆN** (51) **07-02**
- (22) 22/12/2022 (43) 25/04/2023
- (73) **ARCELIK HITACHI HOME APPLIANCES (THAILAND) LIMITED (TH)**
No. 610/1, Mu 9, Nong Ki Sub-district, Kabin Buri District, Prachin Buri Province,
Thailand
- (72) 1. SINAN ANAYURT (TR)
2. ELIF BULUT (TR)
3. GIZEM EMRE DURAKOGLU (TR)
4. NIHAT DURAN (TR)
5. OZLEM KOK GULTEKIN (TR)
6. ASLI OKMEN (TR)
7. DOGAC CAN SAGIROSMANOGLU (TR)
8. CAN ONUR VANCI (TR)
9. TAMER YUKSEK (TR)
- (74) Công ty Luật TNHH T&G (TGVN)
- (55)



1.1



1.2



1.3



1.4



1.5



1.6



1.7

CÔNG BÁO SỞ HỮU CÔNG NGHIỆP SỐ 421 TẬP A – QUYỀN 2 (04.2023)

- (11) **46787**
(21) 3-2022-01278 (28) 1
(54) **TỦ** (51) **06-04**
(22) 27/06/2022 (43) 25/04/2023
(73) **MIN-HSUN LU (TW)**
5F-1, NO. 37, CHONGDE 11th ROAD, BEITUN DISTRICT, TAICHUNG CITY
406034, TAIWAN
(72) MIN-HSUN LU (TW)
(74) Công ty TNHH Trường Xuân (AGELESS CO.,LTD.)
(55)



1.1

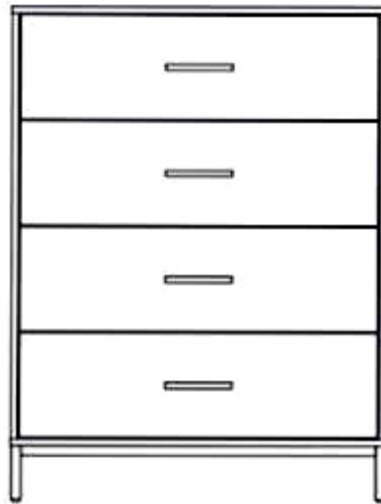

1.2

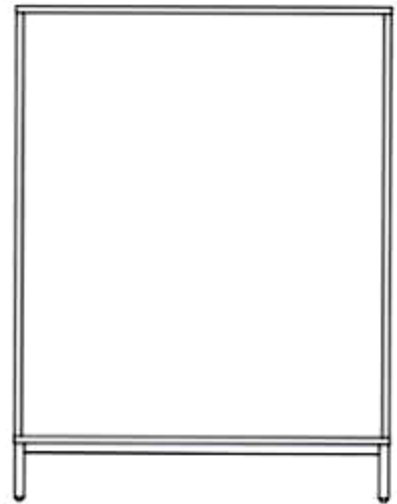

1.3

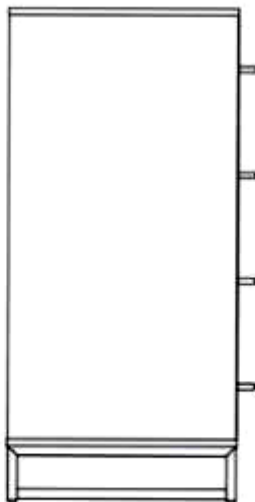

1.4

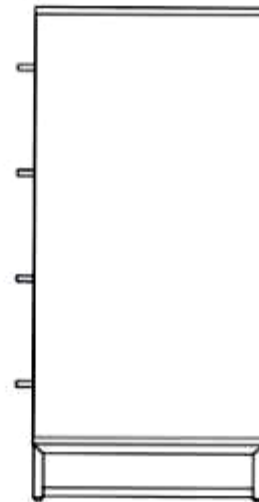

1.5

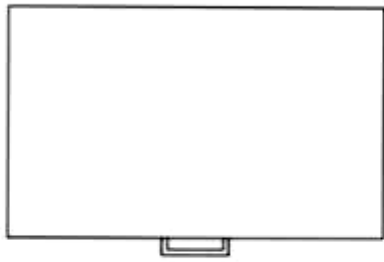

1.6

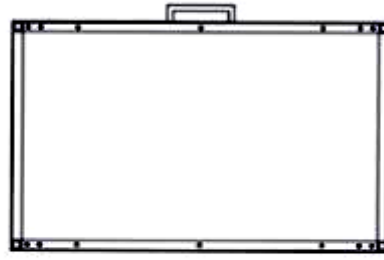

1.7

CÔNG BÁO SỞ HỮU CÔNG NGHIỆP SỐ 421 TẬP A – QUYỀN 2 (04.2023)

- (11) **46788**
(21) 3-2022-02869 (28) 1
(54) **HỘP ĐỰNG THUỐC LÁ NGẬM** (51) **27-06**
(22) 26/12/2022 (43) 25/04/2023
(30) 009071939 27/06/2022 EM;
(73) **PHILIP MORRIS PRODUCTS S.A. (CH)**
Quai Jeanrenaud 3, CH-2000 Neuchâtel, Switzerland
(72) Steven SHAINWALD (US)
(74) Công ty Luật TNHH T&G (TGVN)
(55)



1.1



1.2



1.3



1.4



1.5



1.6



1.7



1.8



1.9



1.10



1.11

CÔNG BÁO SỞ HỮU CÔNG NGHIỆP SỐ 421 TẬP A – QUYỀN 2 (04.2023)

- (11) **46789**
(21) 3-2022-02930 (28) 1
(54) **PHIN GIẤY** (51) **07-02**
(22) 28/12/2022 (43) 25/04/2023
(73) **CÔNG TY TNHH CÀ PHÊ TRÀ PHƯƠNG VY (VN)**
432a Xô Viết Nghệ Tĩnh, phường 25, quận Bình Thạnh, thành phố Hồ Chí Minh
(72) Trương Anh Dũng (VN)
(74) Công ty TNHH NACILAW (NACILAW)
(55)



1.1



1.2



1.3



1.4



1.5



1.6



1.7



1.8



1.9

CÔNG BÁO SỞ HỮU CÔNG NGHIỆP SỐ 421 TẬP A – QUYỀN 2 (04.2023)

- (11) **46790**
(21) 3-2022-02870 (28) 1
(54) **HỘP ĐỰNG THUỐC LÁ NGẬM** (51) **27-06**
(22) 26/12/2022 (43) 25/04/2023
(30) 009071939-0021 27/06/2022 EM;
(73) **PHILIP MORRIS PRODUCTS S.A. (CH)**
Quai Jeanrenaud 3, CH-2000 Neuchâtel, Switzerland
(72) Steven SHAINWALD (US)
(74) Công ty Luật TNHH T&G (TGVN)
(55)



1.1



1.2



1.3



1.4



1.5

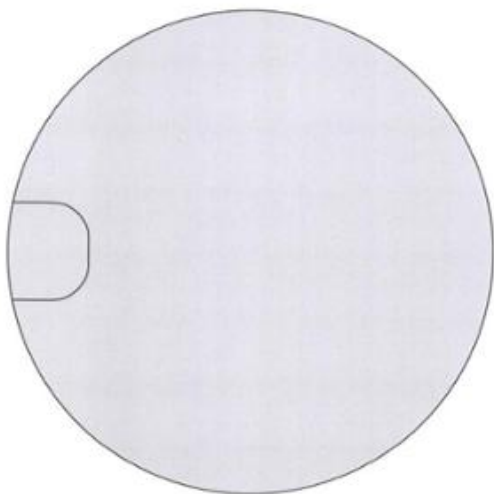

1.6



1.7

- (11) **46791**
(21) 3-2022-01854 (28) 1
(54) **BẢNG TRỒNG CÂY** (51) **11-02**
(22) 31/08/2022 (43) 25/04/2023
(73) **HỒ QUANG ĐẬU (VN)**
Xóm 3, xã Quỳnh Hồng, huyện Quỳnh Lưu, tỉnh Nghệ An
(72) Hồ Quang Đậu (VN)
(74) Công ty TNHH Tư vấn đầu tư và Sở hữu trí tuệ Hoàng Phi (HOANG PHI INVEST & I.P CO., LTD)
(55)

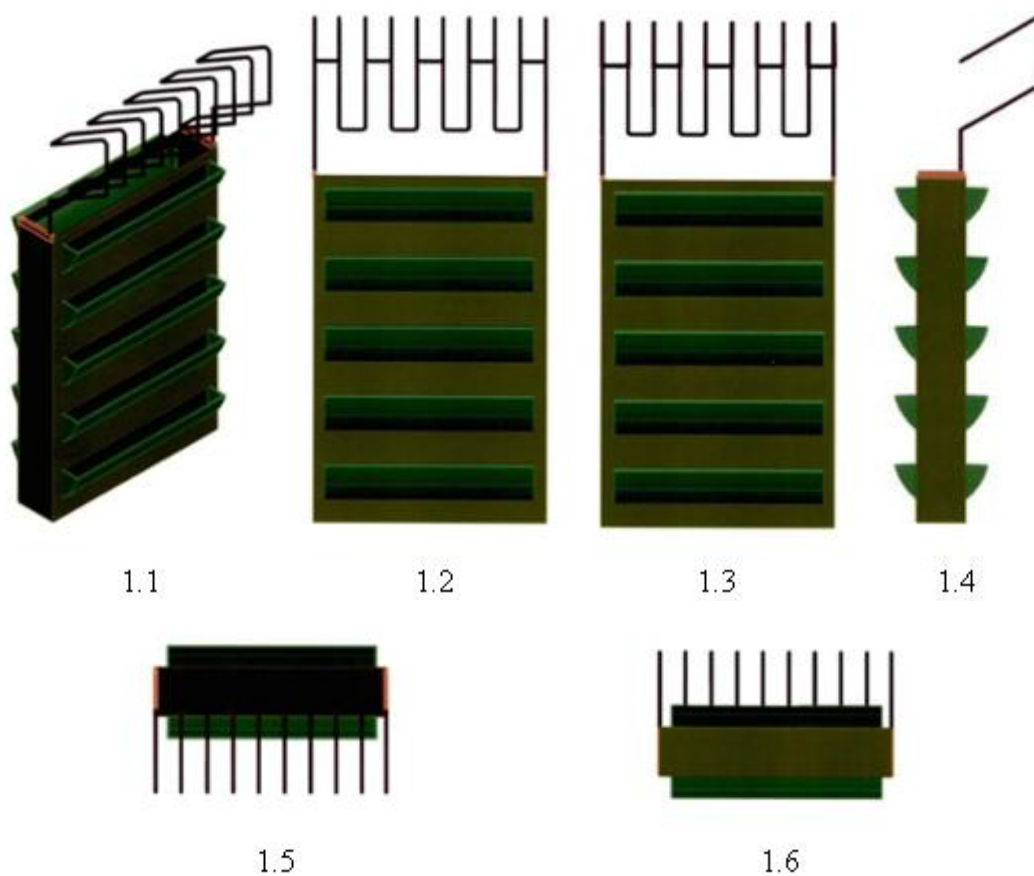

CÔNG BÁO SỞ HỮU CÔNG NGHIỆP SỐ 421 TẬP A – QUYỀN 2 (04.2023)

- (11) **46792**
(21) 3-2022-02502 (28) 1
(54) **GIƯỜNG KIM LOẠI** (51) **06-02**
(22) 16/11/2022 (43) 25/04/2023
(73) **XIA MEN MINT FURNITURE CO., LTD. (CN)**
No. 200, Zhuangshangli, Silin Village, Wuxian Town, TongAn District, Xiamen,
Fujian, China
(72) Aihua HOU (CN)
(74) Công ty cổ phần Sở hữu trí tuệ BROSS và Cộng sự (BROSS & PARTNERS., JSC)
(55)



1.1



1.2

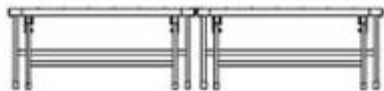

1.3

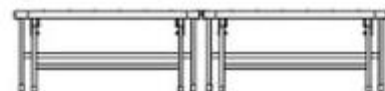

1.4

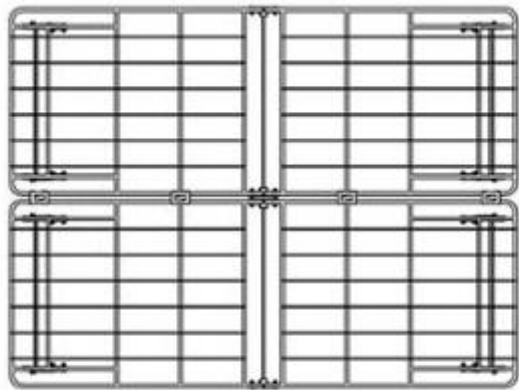

1.5

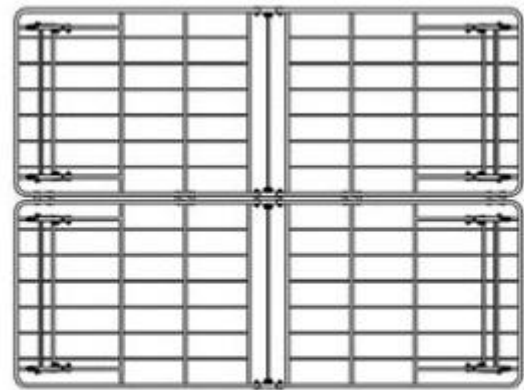

1.6



1.7

CÔNG BÁO SỞ HỮU CÔNG NGHIỆP SỐ 421 TẬP A – QUYỀN 2 (04.2023)

- (11) **46793**
(21) 3-2022-01705 (28) 1
(54) **QUÀ TẶNG TRANG TRÍ** (51) **11-02**
(22) 17/08/2022 (43) 25/04/2023
(73) **CÔNG TY CỔ PHẦN MAI VÀNG RỒNG VIỆT (VN)**
Số 45 đường Nguyễn Hữu Cảnh, phường 22, quận Bình Thạnh, thành phố Hồ Chí Minh
(72) Nguyễn Farin (VN)
(55)



1.1



1.2



1.3



1.4



1.5

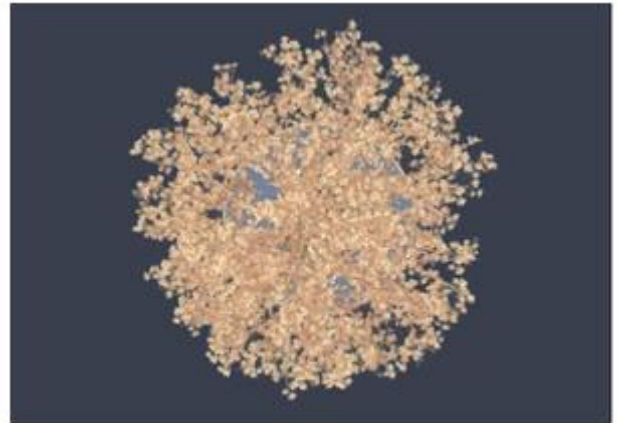

1.6

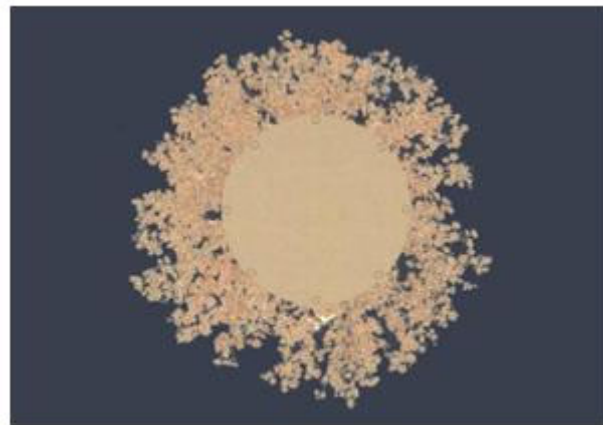

1.7

- (11) **46794**
(21) 3-2022-02963 (28) 6
(54) **NẤP HỘP** (51) **09-07**
(22) 30/12/2022 (43) 25/04/2023
(30) 29/847,026 21/07/2022 US;
(73) **DART INDUSTRIES INC. (US)**
14901 S. Orange Blossom Trail, Orlando, Florida, 32837, United States of America
(72) 1. DONGJIN BYEON (KR)
2. ALEC VERCRUYSSSEN (BE)
3. ARTHUR LORRÉ (BE)
4. DIMITRI M.C.J. BACKAERT (BE)
(74) **CÔNG TY LUẬT TRÁCH NHIỆM HỮU HẠN AMBYS HÀ NỘI (AMBYS HANOI)**
(55)

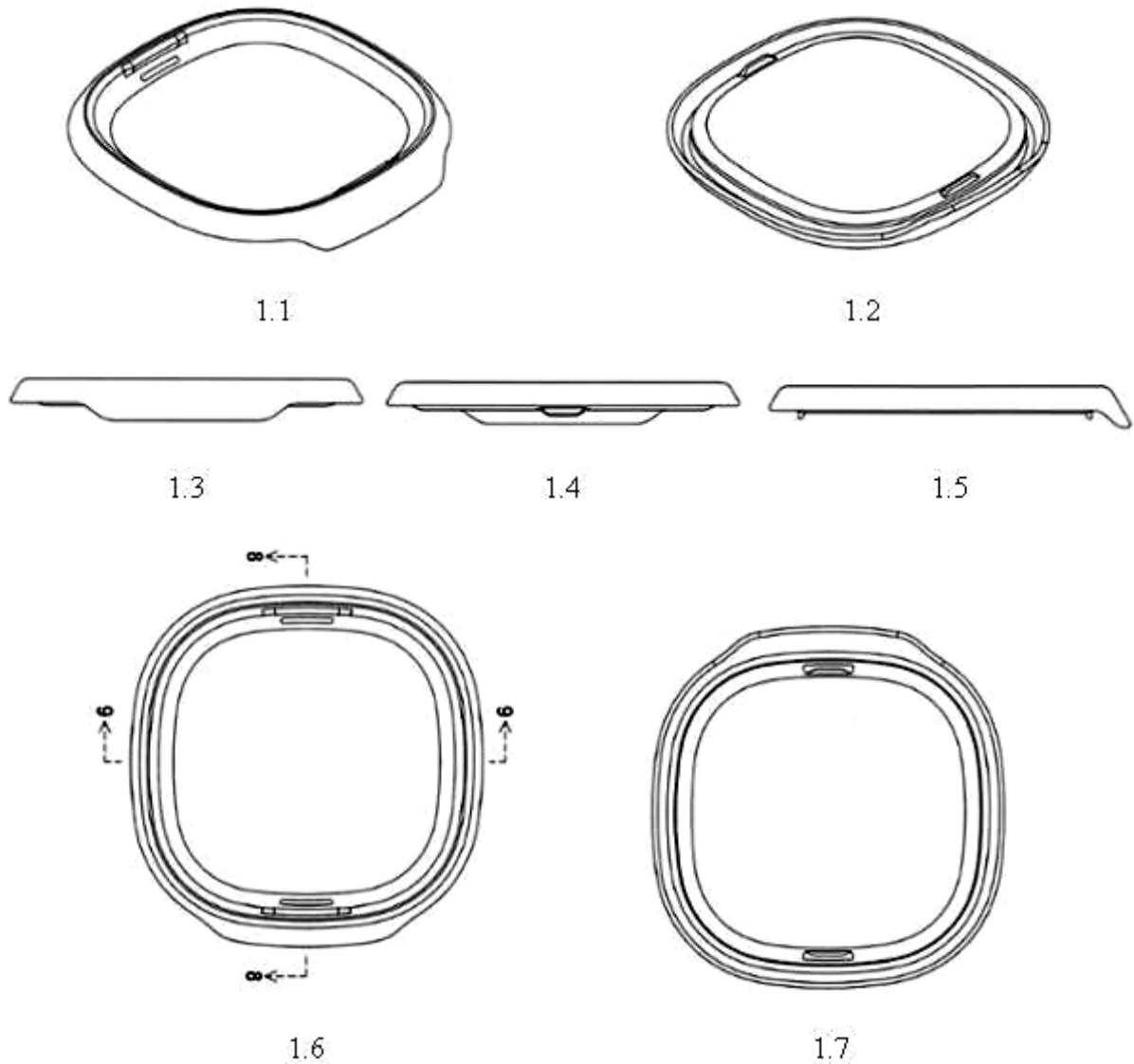



1.8



1.9



2.1



2.2



2.3

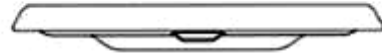

2.4



2.5

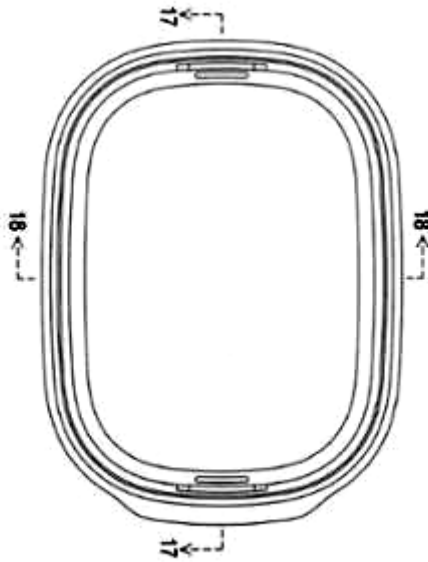

2.6

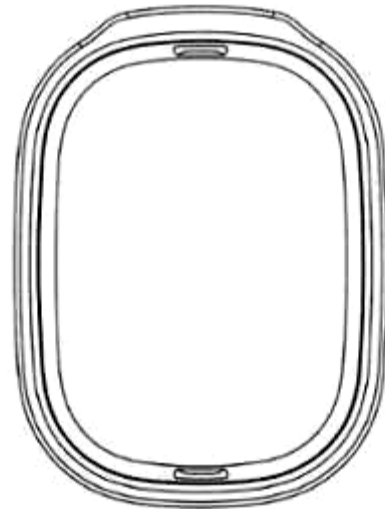

2.7



2.8



2.9

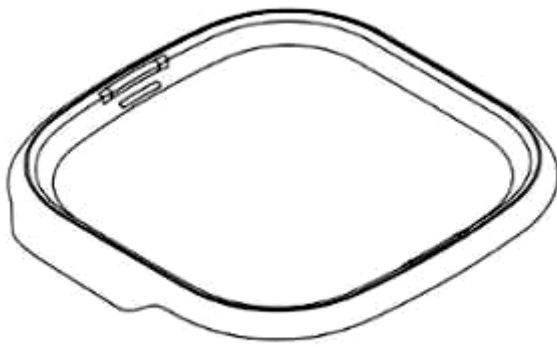

3.1



3.2



3.3



3.4



3.5



3.6

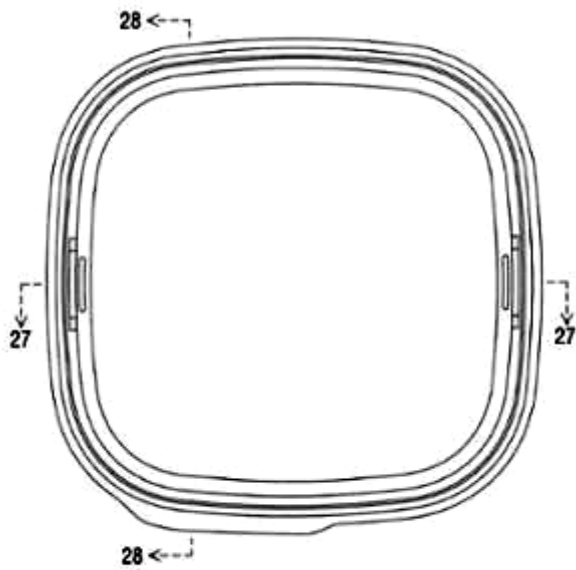

3.7



3.8



3.9



3.10

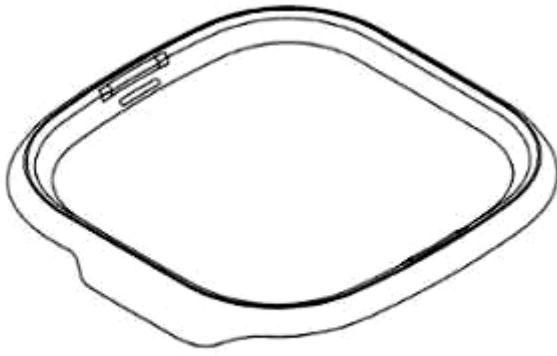

4.1



4.2



4.3



4.4



4.5



4.6

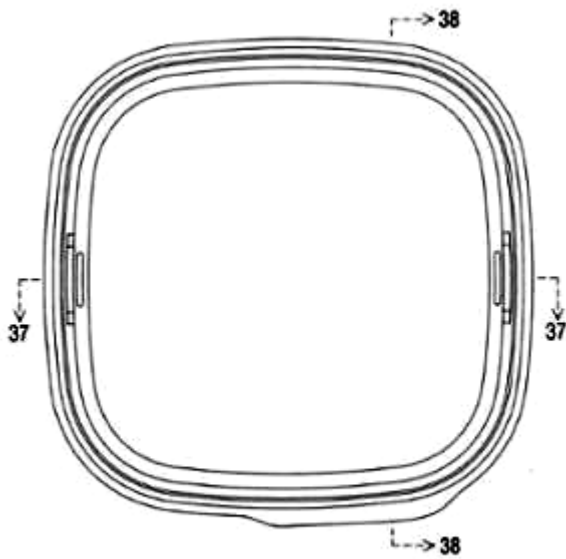

4.7



4.8



4.9



4.10



5.1



5.2



5.3



5.4



5.5



5.6

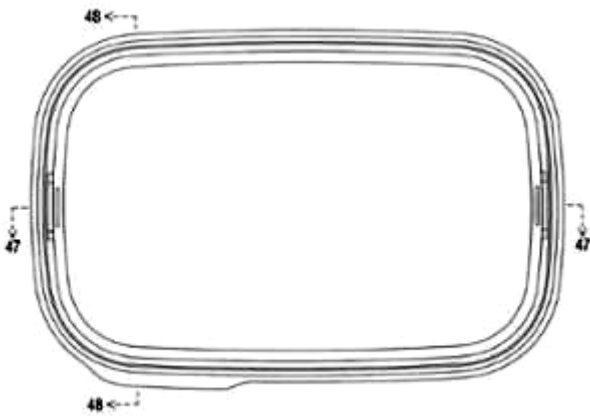

5.7

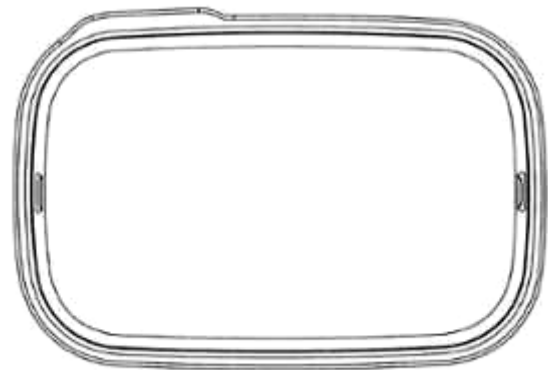

5.8



5.9



5.10



6.1



6.2



6.3



6.4



6.5



6.6

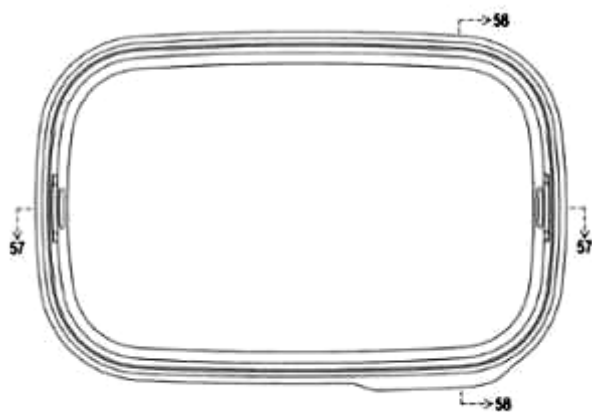

6.7

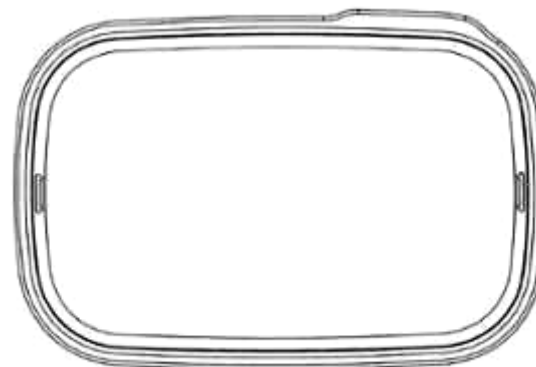

6.8



6.9



6.10

- (11) **46795**
(21) 3-2022-01408 (28) 1
(54) **TUÝP ĐỰNG** (51) **09-05**
(22) 14/07/2022 (43) 25/04/2023
(30) 2202000192 18/01/2022 TH;
(73) **KIM PACK CO., LTD. (TH)**
1741 Chan Rd., Thungmahamek, Sathorn, Bangkok, 10120 Thailand
(72) Sumet Limatibul (TH)
(74) Văn phòng Luật sư Ân Nam (ANNAM IP & LAW)
(55)

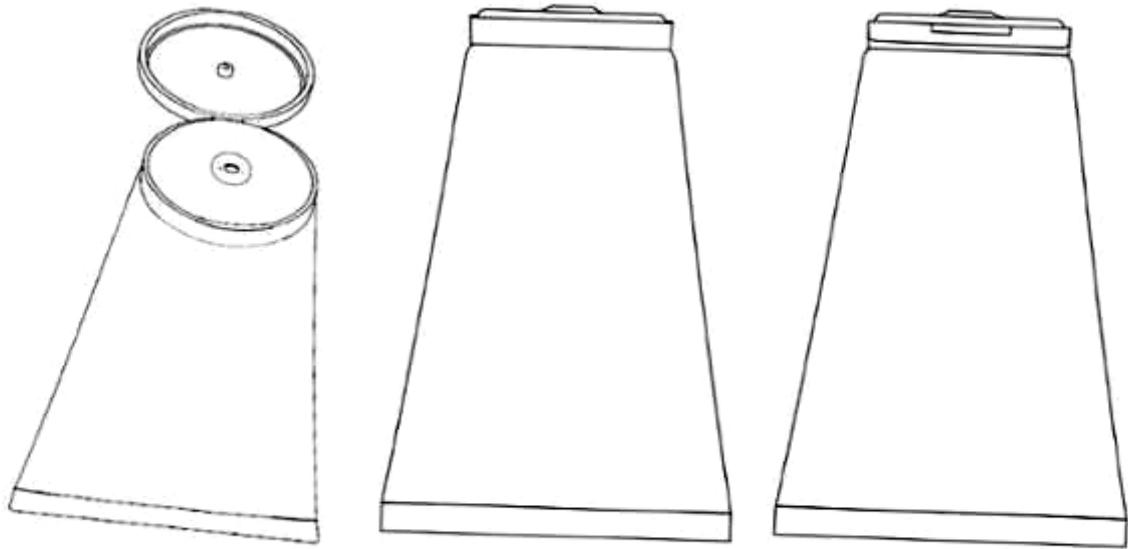

1.1

1.2

1.3

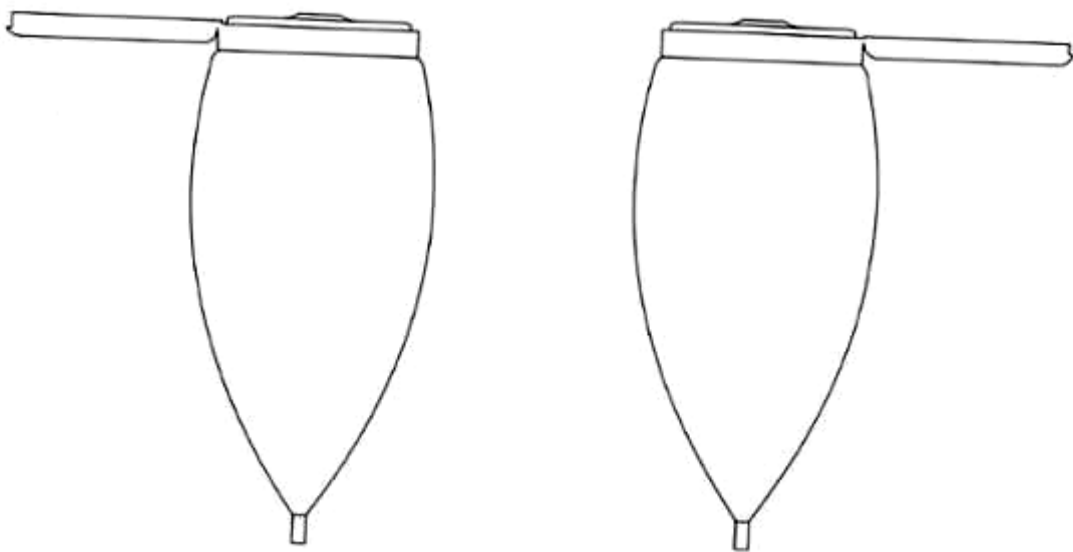

1.4

1.5

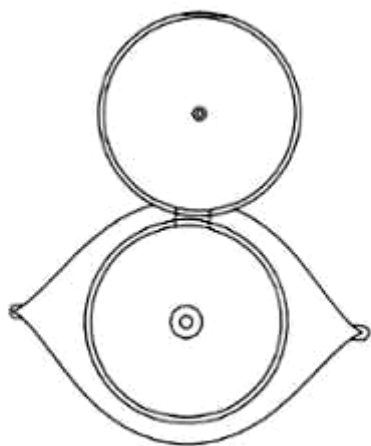

1.7

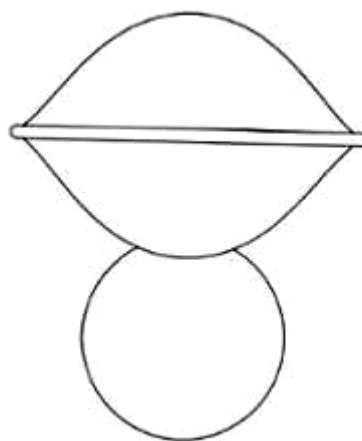

1.6

CÔNG BÁO SỞ HỮU CÔNG NGHIỆP SỐ 421 TẬP A – QUYỀN 2 (04.2023)

- (11) **46796**
(21) 3-2022-01484 (28) 1
(54) **TỦ MÁT** (51) **15-07**
(22) 25/07/2022 (43) 25/04/2023
(73) **CÔNG TY TNHH ĐẦU TƯ SẢN XUẤT XUẤT NHẬP KHẨU PHÚ HƯNG**
(VN)
144 Võ Văn Tần, phường Võ Thị Sáu, quận 3, thành phố Hồ Chí Minh
(72) Đại Vạn Quốc (VN)
(55)



1.1



1.2



1.3



1.4



1.5



1.6



1.7

CÔNG BÁO SỞ HỮU CÔNG NGHIỆP SỐ 421 TẬP A – QUYỀN 2 (04.2023)

- (11) **46797**
(21) 3-2022-01485 (28) 1
(54) **BÌNH GIỮ NHIỆT** (51) **07-07**
(22) 25/07/2022 (43) 25/04/2023
(73) **CÔNG TY TNHH ĐẦU TƯ SẢN XUẤT XUẤT NHẬP KHẨU PHÚ HƯNG**
(VN)
144 Võ Văn Tần, phường Võ Thị Sáu, quận 3, thành phố Hồ Chí Minh
(72) Đại Vạn Quốc (VN)
(55)



1.1



1.2



1.3



1.4



1.5



1.6



1.7



1.8

CÔNG BÁO SỞ HỮU CÔNG NGHIỆP SỐ 421 TẬP A – QUYỀN 2 (04.2023)

- (11) **46798**
(21) 3-2022-01575 (28) 1
(54) **MÁY LỌC NƯỚC** (51) **23-01**
(22) 08/08/2022 (43) 25/04/2023
(73) **CÔNG TY CỔ PHẦN ĐIỆN MÁY GIA DỤNG HÒA PHÁT HÀ NAM (VN)**
Khu công nghiệp Hòa Mạc, thị xã Duy Tiên, tỉnh Hà Nam
(72) Nguyễn Tuấn Anh (VN)
(74) Công ty cổ phần Sở hữu trí tuệ BROSS và Cộng sự (BROSS & PARTNERS., JSC)
(55)

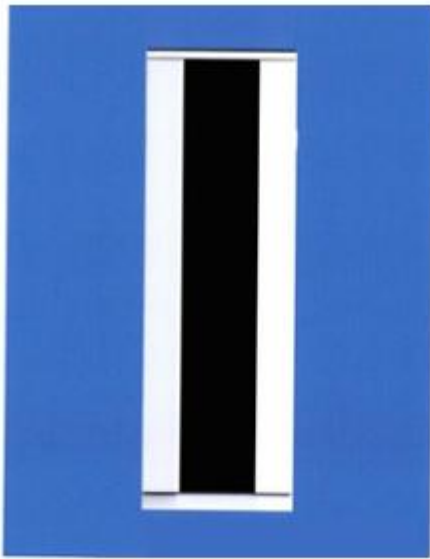

1.1



1.2



1.3



1.4

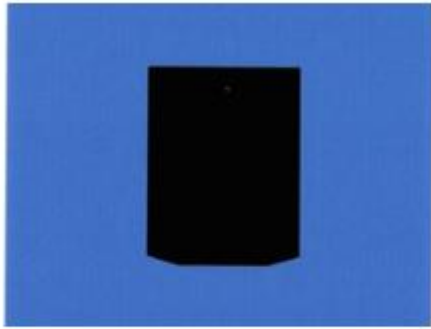

1.5

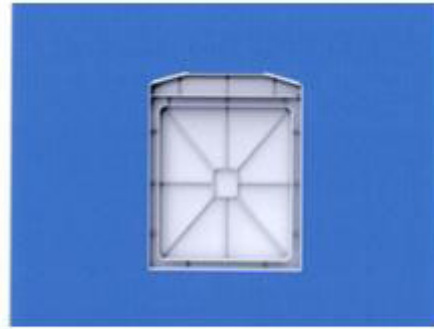

1.6



1.7

CÔNG BÁO SỞ HỮU CÔNG NGHIỆP SỐ 421 TẬP A – QUYỀN 2 (04.2023)

- (11) **46799**
(21) 3-2022-02147 (28) 2
(54) **HỘP ĐỰNG KHĂN HẠ SỐT** (51) **09-03**
(22) 06/10/2022 (43) 25/04/2023
(73) **CÔNG TY CỔ PHẦN TẬP ĐOÀN DƯỢC PHẨM VÀ THƯƠNG MẠI SOHACO (VN)**
Số 5 Láng Hạ, phường Thành Công, quận Ba Đình, thành phố Hà Nội
(72) Nguyễn Tiến Nam (VN)
(74) Công ty TNHH Dịch vụ Sở hữu trí tuệ KENFOX (KENFOX IP SERVICE CO.,LTD.)
(55)



1.1



1.2



2.1



2.2

CÔNG BÁO SỞ HỮU CÔNG NGHIỆP SỐ 421 TẬP A – QUYỀN 2 (04.2023)

- (11) **46800**
(21) 3-2022-01703 (28) 1
(54) **QUÀ TẶNG TRANG TRÍ** (51) **11-02**
(22) 17/08/2022 (43) 25/04/2023
(73) **CÔNG TY CỔ PHẦN MAI VÀNG RỒNG VIỆT (VN)**
Số 45 đường Nguyễn Hữu Cảnh, phường 22, quận Bình Thạnh, thành phố Hồ Chí Minh
(72) Nguyễn Farin (VN)
(55)



1.1



1.2



1.3

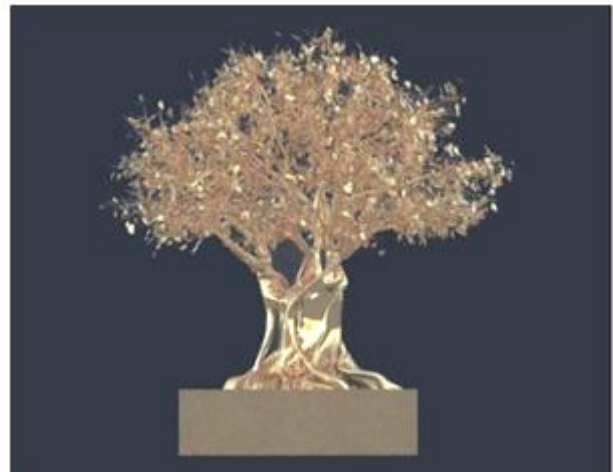

1.4



1.5

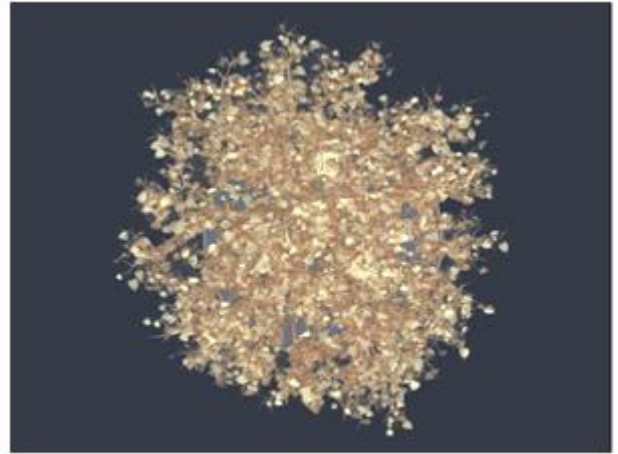

1.6

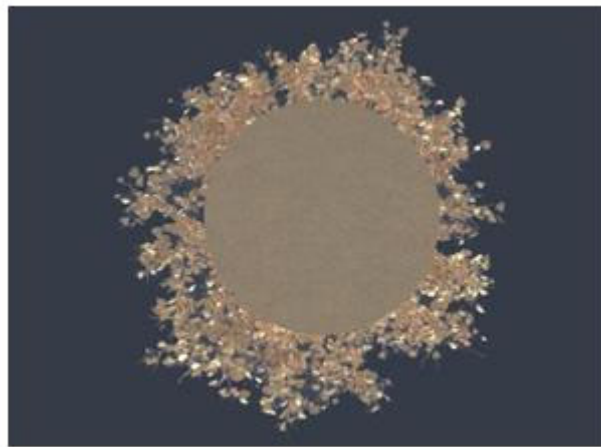

1.7

CÔNG BÁO SỞ HỮU CÔNG NGHIỆP SỐ 421 TẬP A – QUYỀN 2 (04.2023)

- (11) **46801**
(21) 3-2022-01704 (28) 1
(54) **QUÀ TẶNG TRANG TRÍ** (51) **11-02**
(22) 17/08/2022 (43) 25/04/2023
(73) **CÔNG TY CỔ PHẦN MAI VÀNG RỒNG VIỆT (VN)**
Số 45 đường Nguyễn Hữu Cảnh, phường 22, quận Bình Thạnh, thành phố Hồ Chí Minh
(72) Nguyễn Farin (VN)
(55)



1.1



1.2



1.3



1.4



1.5

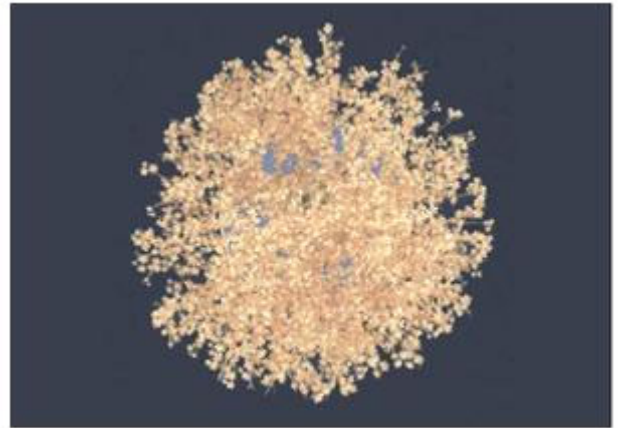

1.6

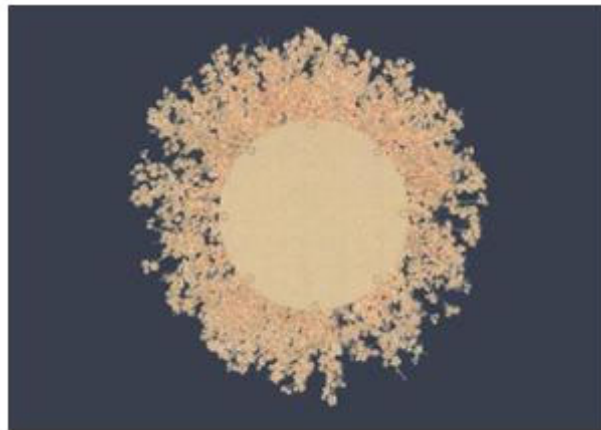

1.7

CÔNG BÁO SỞ HỮU CÔNG NGHIỆP SỐ 421 TẬP A – QUYỀN 2 (04.2023)

- (11) **46802**
(21) 3-2022-02317 (28) 1
(54) **NỒI** (51) **07-02**
(22) 24/10/2022 (43) 25/04/2023
(30) 30-2022-0026314 30/06/2022 KR;
(73) **LOCK & LOCK CO., LTD (KR)**
104, Sapgyocheon-ro, Seonjang-myeon, Asan-si, Chungcheongnam-do, Republic of Korea
(72) 1. NAM, SOO JUNG (KR)
2. KIM, SEON JEONG (KR)
(74) Công ty TNHH Tầm nhìn và Liên danh (VISION & ASSOCIATES CO.LTD.)
(55)

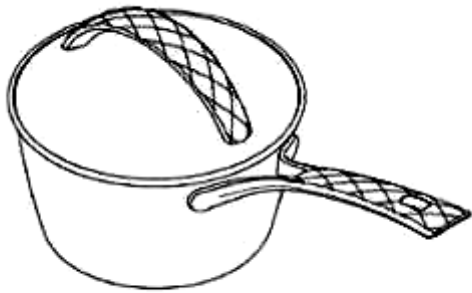

1.1



1.2



1.3

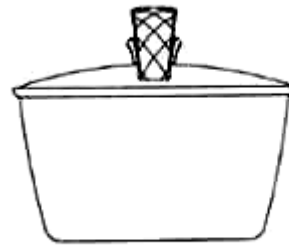

1.4

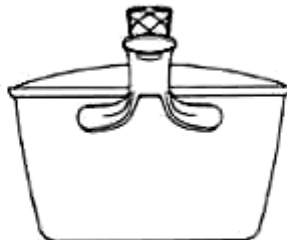

1.5

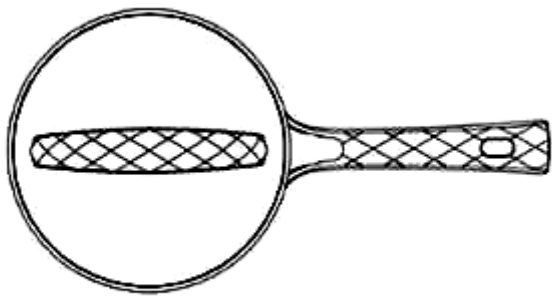

1.6

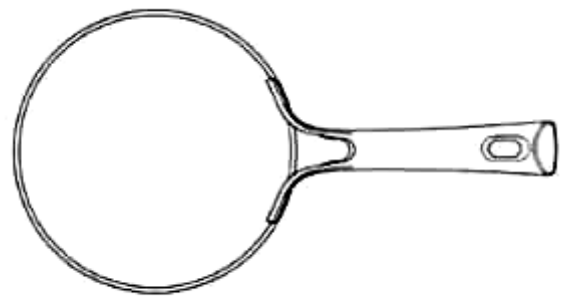

1.7

CÔNG BÁO SỞ HỮU CÔNG NGHIỆP SỐ 421 TẬP A – QUYỀN 2 (04.2023)

- (11) **46803**
(21) 3-2022-01576 (28) 1
(54) **MÁY LỌC NƯỚC** (51) **23-01**
(22) 08/08/2022 (43) 25/04/2023
(73) **CÔNG TY CỔ PHẦN ĐIỆN MÁY GIA DỤNG HÒA PHÁT HÀ NAM (VN)**
Khu công nghiệp Hòa Mạc, thị xã Duy Tiên, tỉnh Hà Nam
(72) Nguyễn Tuấn Anh (VN)
(74) Công ty cổ phần Sở hữu trí tuệ BROSS và Cộng sự (BROSS & PARTNERS., JSC)
(55)



1.1



1.2



1.3



1.4

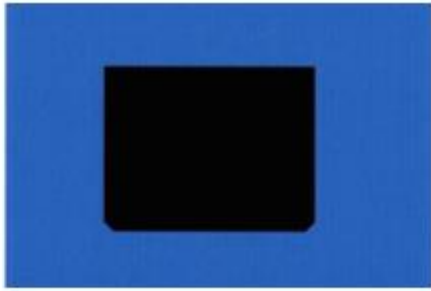

1.5

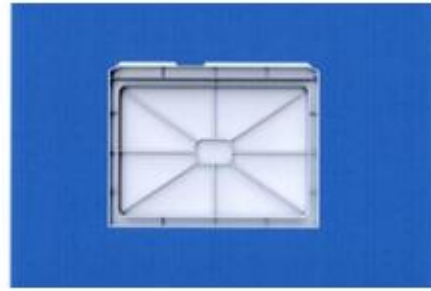

1.6



1.7

CÔNG BÁO SỞ HỮU CÔNG NGHIỆP SỐ 421 TẬP A – QUYỀN 2 (04.2023)

- (11) **46804**
(21) 3-2022-01570 (28) 1
(54) **MÁY LỌC NƯỚC** (51) **23-01**
(22) 05/08/2022 (43) 25/04/2023
(73) **CÔNG TY CỔ PHẦN ĐIỆN MÁY GIA DỤNG HÒA PHÁT HÀ NAM (VN)**
Khu công nghiệp Hòa Mạc, thị xã Duy Tiên, tỉnh Hà Nam
(72) Nguyễn Tuấn Anh (VN)
(74) Công ty cổ phần Sở hữu trí tuệ BROSS và Cộng sự (BROSS & PARTNERS., JSC)
(55)



1.1

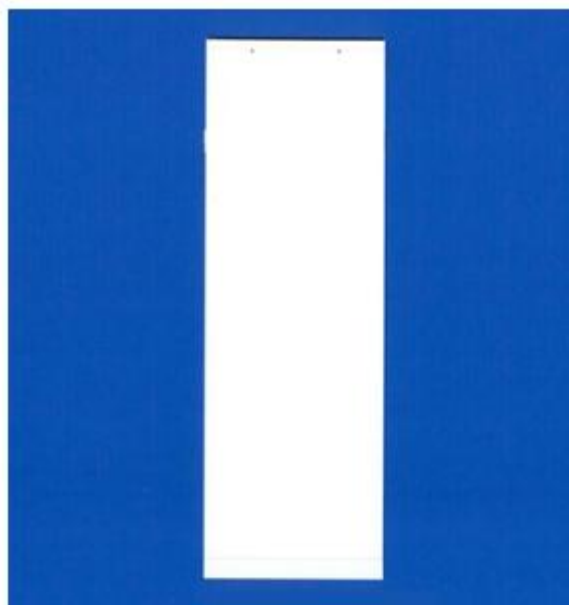

1.2



1.3



1.4

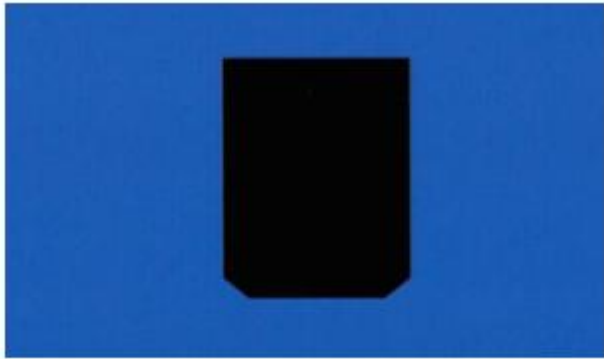

1.5

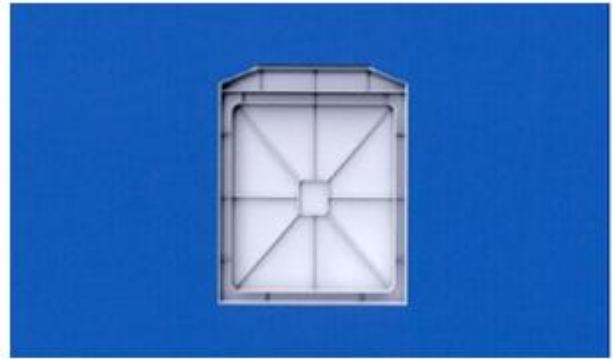

1.6



1.7

CÔNG BÁO SỞ HỮU CÔNG NGHIỆP SỐ 421 TẬP A – QUYỀN 2 (04.2023)

(11) **46805**

(21) 3-2020-01410

(28) 1

(54) **BỘ BÁT ĐĨA**

(51) **07-01**

(22) 16/06/2020

(43) 25/04/2023

(73) **CÔNG TY TNHH MINH LONG I (VN)**

333 Khu phố Hưng Lộc, phường Hưng Định, thành phố Thuận An, tỉnh Bình Dương

(72) Lý Ngọc Minh (VN)

(55)



1.1



1.2



1.3



1.4



1.5



1.6



1.7



1.8



1.9

1.10



1.11

1.12



1.13



1.14

1.15



1.16

1.17



1.18

1.19



1.20



1.21

1.22



1.23



1.24



1.25



1.26



1.27



1.28



1.29



1.30



1.31



1.32



1.33



1.34

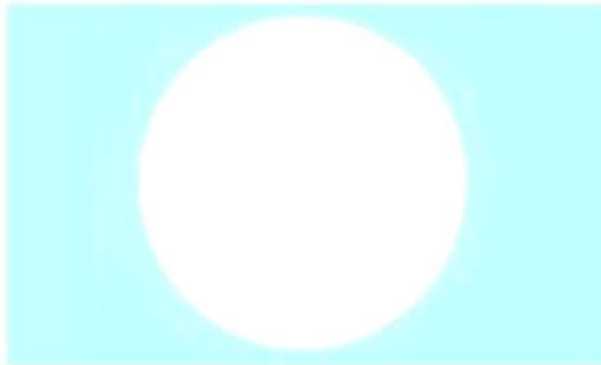

1.35



1.36



1.37



1.38



1.39



1.40



1.41



1.42



1.43

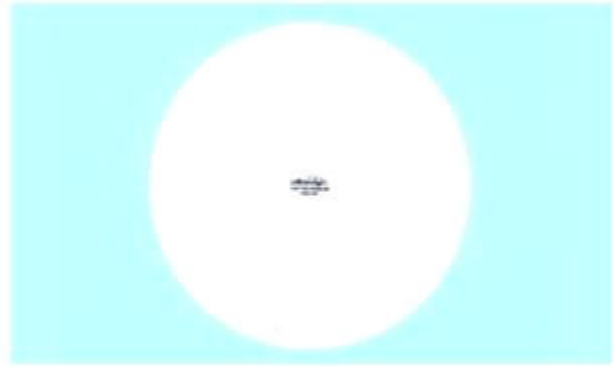

1.44



1.45



1.46



1.47



1.48

PHẦN II

SỬA ĐỔI ĐƠN

Thông báo số: 4452w/TB-SHTT, ngày 15/03/2023 về việc ghi nhận sửa đổi đơn

Số Yêu cầu: SĐ3-2022-00952 Ngày nộp: 03/06/2022

Liên quan đến đơn yêu cầu cấp Bằng độc quyền kiểu dáng công nghiệp:

(21) Số đơn	(22) Ngày nộp đơn
3-2020-03163	30/12/2020

Mục sửa đổi: Bổ sung thêm phương án

Nội dung mới: Bổ sung phương án thứ hai (từ hình 2.1 đến hình 2.7)

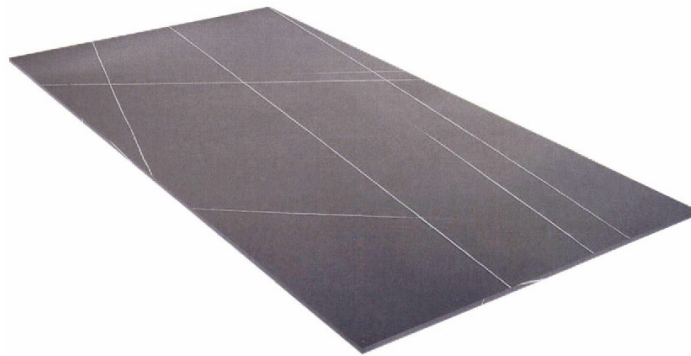

2.1



2.2

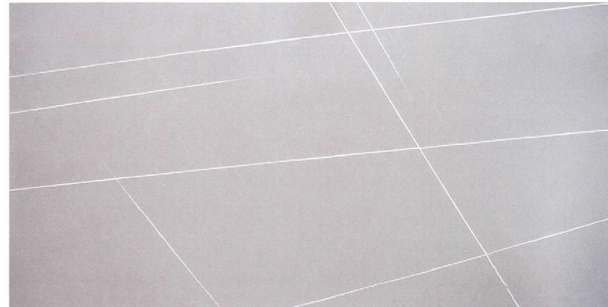

2.3



2.4



2.5

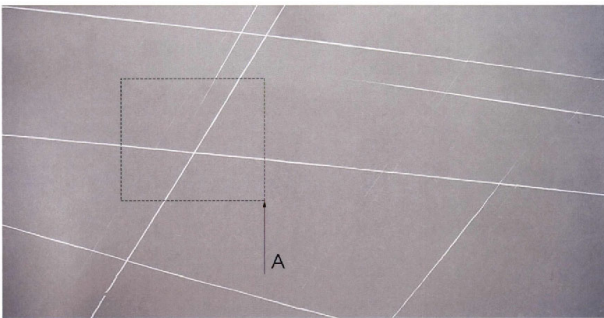

2.6



2.7

Thông báo số: 4453w/TB-SHTT, ngày 15/03/2023 về việc ghi nhận sửa đổi đơn

Số Yêu cầu: SĐ3-2022-01204 Ngày nộp: 06/07/2022

Liên quan đến đơn yêu cầu cấp Bằng độc quyền kiểu dáng công nghiệp:

(21) Số đơn	(22) Ngày nộp đơn
3-2020-01894	13/08/2020

CÔNG BÁO SỞ HỮU CÔNG NGHIỆP SỐ 421 TẬP A – QUYỀN 2 (04.2023)

Mục sửa đổi: Tên, địa chỉ chủ đơn

Nội dung mới: SHENZHEN SHOKZ CO., LTD. (CN)
Floors 1-4, Factory Building 26, Shancheng Industrial Park, Shiyan Street, Bao'an District, Shenzhen, Guangdong, China

Thông báo số: 5542w/TB-SHTT, ngày 22/03/2023 về việc ghi nhận sửa đổi đơn

Số Yêu cầu: SĐ3-2022-00698 Ngày nộp: 22/04/2022

Liên quan đến đơn yêu cầu cấp Bằng độc quyền kiểu dáng công nghiệp:

(21) Số đơn	(22) Ngày nộp đơn
3-2019-02980	20/11/2019

Mục sửa đổi: Đại diện sở hữu công nghiệp

Nội dung mới: CÔNG TY LUẬT TNHH ZILHN (VIỆT NAM)(ZILHN)
Phòng B21A, tầng 4, tòa nhà Times Tower, số 35 Lê Văn Lương, phường Nhân Chính, quận Thanh Xuân, Thành phố Hà Nội

Thông báo số: 4228w/TB-SHTT, ngày 13/03/2023 về việc ghi nhận sửa đổi đơn

Số Yêu cầu: SĐ3-2022-00639 Ngày nộp: 15/04/2022

Liên quan đến đơn yêu cầu cấp Bằng độc quyền kiểu dáng công nghiệp:

(21) Số đơn	(22) Ngày nộp đơn
3-2019-00774	27/03/2019
3-2019-00777	27/03/2019
3-2019-00778	27/03/2019
3-2019-00779	27/03/2019
3-2019-00780	27/03/2019

CÔNG BÁO SỞ HỮU CÔNG NGHIỆP SỐ 421 TẬP A – QUYỀN 2 (04.2023)

3-2019-00781	27/03/2019
3-2019-00782	27/03/2019

Mục sửa đổi: Đại diện sở hữu công nghiệp

Nội dung mới: Công ty Luật TNHH ROUSE Việt Nam (ROUSE LEGAL VIETNAM LTD.)
Phòng 1003, lầu 10, toà nhà Ruby, 81-85 Hàm Nghi, phường Nguyễn Thái Bình, Quận 1, thành phố Hồ Chí Minh

Thông báo số: 4227w/TB-SHTT, ngày 13/03/2023 về việc ghi nhận sửa đổi đơn

Số Yêu cầu: SĐ3-2022-00786 Ngày nộp: 09/05/2022

Liên quan đến đơn yêu cầu cấp Bằng độc quyền kiểu dáng công nghiệp:

(21) Số đơn	(22) Ngày nộp đơn
3-2018-01436	12/07/2018

Mục sửa đổi: Đại diện sở hữu công nghiệp

Nội dung mới: Công ty TNHH dịch vụ đại diện sở hữu công nghiệp Châu Á (ASIA SERVICE IP CO.,LTD)
86/20 Thích Quảng Đức, phường 05, quận Phú Nhuận, thành Phố Hồ Chí Minh

Thông báo số: 4274w/TB-SHTT, ngày 13/03/2023 về việc ghi nhận sửa đổi đơn

Số Yêu cầu: SĐ3-2022-00760 Ngày nộp: 05/05/2022

Liên quan đến đơn yêu cầu cấp Bằng độc quyền kiểu dáng công nghiệp:

(21) Số đơn	(22) Ngày nộp đơn
3-2021-02002	06/08/2021

CÔNG BÁO SỞ HỮU CÔNG NGHIỆP SỐ 421 TẬP A – QUYỀN 2 (04.2023)

Mục sửa đổi: Đại diện sở hữu công nghiệp

Nội dung mới: BionLifeScience, Inc. (KR)
#1001 #1002 #1005 #1006 #1007 #1008 #1009 #1012 #1013 #1014,
282, Sunhwagung-ro, Namyangju-si, Gyeonggi-do 12106, Republic of
Korea

Thông báo số: 4275w/TB-SHTT, ngày 13/03/2023 về việc ghi nhận sửa đổi đơn

Số Yêu cầu: SĐ3-2022-00761 Ngày nộp: 05/05/2022

Liên quan đến đơn yêu cầu cấp Bằng độc quyền kiểu dáng công nghiệp:

(21) Số đơn	(22) Ngày nộp đơn
3-2021-02003	06/08/2021

Mục sửa đổi: Tên, địa chỉ chủ đơn

Nội dung mới: BionLifeScience, Inc. (KR)
#1001 #1002 #1005 #1006 #1007 #1008 #1009 #1012 #1013 #1014,
282, Sunhwagung-ro, Namyangju-si, Gyeonggi-do 12106, Republic of
Korea

Thông báo số: 4390w/TB-SHTT, ngày 15/03/2023 về việc ghi nhận sửa đổi đơn

Số Yêu cầu: SĐ3-2022-00765 Ngày nộp: 05/05/2022

Liên quan đến đơn yêu cầu cấp Bằng độc quyền kiểu dáng công nghiệp:

(21) Số đơn	(22) Ngày nộp đơn
3-2022-00418	07/03/2022

Mục sửa đổi: Tên, địa chỉ chủ đơn

Nội dung mới: BionLifeScience, Inc. (KR)
#1001 #1002 #1005 #1006 #1007 #1008 #1009 #1012 #1013 #1014,
282, Sunhwagung-ro, Namyangju-si, Gyeonggi-do 12106, Republic of
Korea

CÔNG BÁO SỞ HỮU CÔNG NGHIỆP SỐ 421 TẬP A – QUYỀN 2 (04.2023)

Thông báo số: 4273w/TB-SHTT, ngày 13/03/2023 về việc ghi nhận sửa đổi đơn

Số Yêu cầu: SĐ3-2022-00766 Ngày nộp: 05/05/2022

Liên quan đến đơn yêu cầu cấp Bằng độc quyền kiểu dáng công nghiệp:

(21) Số đơn	(22) Ngày nộp đơn
3-2021-02004	06/08/2021

Mục sửa đổi: Tên, địa chỉ chủ đơn

Nội dung mới: BionLifeScience, Inc. (KR)
#1001 #1002 #1005 #1006 #1007 #1008 #1009 #1012 #1013 #1014,
282, Sunhwagung-ro, Namyangju-si, Gyeonggi-do 12106, Republic of
Korea

Thông báo số: 4272w/TB-SHTT, ngày 13/03/2023 về việc ghi nhận sửa đổi đơn

Số Yêu cầu: SĐ3-2021-02293 Ngày nộp: 06/12/2021

Liên quan đến đơn yêu cầu cấp Bằng độc quyền kiểu dáng công nghiệp:

(21) Số đơn	(22) Ngày nộp đơn
3-2021-00161	25/01/2021

Mục sửa đổi: Đại diện sở hữu công nghiệp

Nội dung mới: Công ty Cổ phần Sở hữu công nghiệp INVESTIP(INVESTIP)
Tầng 5, tòa nhà Charmvit Tower, 117 Trần Duy Hưng, phường Trung
Hòa, quận Cầu Giấy, thành phố Hà Nội

Thông báo số: 4391w/TB-SHTT, ngày 15/03/2023 về việc ghi nhận sửa đổi đơn

Số Yêu cầu: SĐ3-2022-00820 Ngày nộp: 13/05/2022

Liên quan đến đơn yêu cầu cấp Bằng độc quyền kiểu dáng công nghiệp:

CÔNG BÁO SỞ HỮU CÔNG NGHIỆP SỐ 421 TẬP A – QUYỀN 2 (04.2023)

(21) Số đơn	(22) Ngày nộp đơn
3-2020-01741	28/07/2020
3-2020-01742	28/07/2020
3-2020-01743	28/07/2020
3-2020-01744	28/07/2020
3-2020-01745	28/07/2020

Mục sửa đổi: Đại diện sở hữu công nghiệp

Nội dung mới: Công ty Luật TNHH ROUSE Việt Nam (ROUSE LEGAL VIETNAM LTD.)
Phòng 1003, lầu 10, toà nhà Ruby, 81-85 Hàm Nghi, phường Nguyễn Thái Bình, Quận 1, thành phố Hồ Chí Minh

Thông báo số: 4385w/TB-SHTT, ngày 15/03/2023 về việc ghi nhận sửa đổi đơn

Số Yêu cầu: SĐ3-2022-01525 Ngày nộp: 18/08/2022

Liên quan đến đơn yêu cầu cấp Bằng độc quyền kiểu dáng công nghiệp:

(21) Số đơn	(22) Ngày nộp đơn
3-2021-02118	20/08/2021

Mục sửa đổi: Tên, địa chỉ chủ đơn

Nội dung mới: Solo Brands, LLC (US)
1001 Mustang Dr. Grapevine, TX 76051, United States of America

Thông báo số: 4387w/TB-SHTT, ngày 15/03/2023 về việc ghi nhận sửa đổi đơn

Số Yêu cầu: SĐ3-2022-01524 Ngày nộp: 18/08/2022

Liên quan đến đơn yêu cầu cấp Bằng độc quyền kiểu dáng công nghiệp:

CÔNG BÁO SỞ HỮU CÔNG NGHIỆP SỐ 421 TẬP A – QUYỀN 2 (04.2023)

(21) Số đơn	(22) Ngày nộp đơn
3-2021-02117	20/08/2021

Mục sửa đổi: Tên, địa chỉ chủ đơn

Nội dung mới: Solo Brands, LLC (US)
1001 Mustang Dr. Grapevine, TX 76051, United States of America

Thông báo số: 4388w/TB-SHTT, ngày 15/03/2023 về việc ghi nhận sửa đổi đơn

Số Yêu cầu: SĐ3-2022-01526 Ngày nộp: 18/08/2022

Liên quan đến đơn yêu cầu cấp Bằng độc quyền kiểu dáng công nghiệp:

(21) Số đơn	(22) Ngày nộp đơn
3-2021-02119	20/08/2021

Mục sửa đổi: Tên, địa chỉ chủ đơn

Nội dung mới: Solo Brands, LLC (US)
1001 Mustang Dr. Grapevine, TX 76051, United States of America

Thông báo số: 4386w/TB-SHTT, ngày 15/03/2023 về việc ghi nhận sửa đổi đơn

Số Yêu cầu: SĐ3-2022-01523 Ngày nộp: 18/08/2022

Liên quan đến đơn yêu cầu cấp Bằng độc quyền kiểu dáng công nghiệp:

(21) Số đơn	(22) Ngày nộp đơn
3-2021-02116	20/08/2021

Mục sửa đổi: Tên, địa chỉ chủ đơn

Nội dung mới: Solo Brands, LLC (US)
1001 Mustang Dr. Grapevine, TX 76051, United States of America

CÔNG BÁO SỞ HỮU CÔNG NGHIỆP SỐ 421 TẬP A – QUYỀN 2 (04.2023)

Thông báo số: 5541w/TB-SHTT, ngày 22/03/2023 về việc ghi nhận sửa đổi đơn

Số Yêu cầu: SĐ3-2022-01933 Ngày nộp: 14/10/2022

Liên quan đến đơn yêu cầu cấp Bằng độc quyền kiểu dáng công nghiệp:

(21) Số đơn	(22) Ngày nộp đơn
3-2021-01996	05/08/2021

Mục sửa đổi: Tách đơn

Nội dung mới: Giữ lại phương án thứ nhất, tách các phương án còn lại ra khỏi đơn và nộp thành các đơn riêng biệt.

PHẦN III

THAY ĐỔI CHỦ ĐƠN

Thông báo số: 4450w/TB-SHTT, ngày 15/03/2023 về việc ghi nhận thay đổi chủ đơn

Số Yêu cầu: CD3-2021-00384 Ngày nộp: 03/02/2021

Liên quan đến đơn yêu cầu cấp bằng độc quyền kiểu dáng công nghiệp:

(21) Số đơn	(22) Ngày nộp đơn
3-2019-00954	16/04/2019
3-2019-00955	16/04/2019
3-2019-01543	18/06/2019
3-2019-02871	12/11/2019
3-2019-02874	12/11/2019
3-2019-03060	27/11/2019

Bên chuyển nhượng: ALIBABA GROUP HOLDING LIMITED (KY)
Fourth Floor, One Capital Place, P.O. Box 847, George
Town, Grand Cayman, Cayman Islands

Bên được chuyển nhượng: ADVANTAGEOUS NEW TECHNOLOGIES CO., LTD.
(KY)
Cayman Corporate Centre, 27 Hospital Road, George
Town, Grand Cayman KY1-9008, Cayman Islands

Thông báo số: 4451w/TB-SHTT, ngày 15/03/2023 về việc ghi nhận thay đổi chủ đơn

Số Yêu cầu: CD3-2021-00385 Ngày nộp: 03/02/2021

Liên quan đến đơn yêu cầu cấp bằng độc quyền kiểu dáng công nghiệp:

(21) Số đơn	(22) Ngày nộp đơn
3-2019-00954	16/04/2019
3-2019-00955	16/04/2019
3-2019-01543	18/06/2019
3-2019-02871	12/11/2019
3-2019-02874	12/11/2019
3-2019-03060	27/11/2019

CÔNG BÁO SỞ HỮU CÔNG NGHIỆP SỐ 421 TẬP A – QUYỀN 2 (04.2023)

Bên chuyển nhượng: ADVANTAGEOUS NEW TECHNOLOGIES CO., LTD. (KY)
Cayman Corporate Centre, 27 Hospital Road, George
Town, Grand Cayman KY1-9008, Cayman Islands

Bên được chuyển nhượng: ADVANCED NEW TECHNOLOGIES CO., LTD. (KY)
Cayman Corporate Centre, 27 Hospital Road, George
Town, Grand Cayman KY1-9008, Cayman Islands

Thông báo số: 5487w/TB-SHTT, ngày 22/03/2023 về việc ghi nhận thay đổi chủ đơn
Số Yêu cầu: CD3-2022-00959 Ngày nộp: 03/11/2022

Liên quan đến đơn yêu cầu cấp bằng độc quyền kiểu dáng công nghiệp:

(21) Số đơn	(22) Ngày nộp đơn
3-2022-00148	18/01/2022

Bên chuyển nhượng: NGUYỄN THỊ BÍCH PHƯƠNG (VN)
Tổ 8, ấp 6, Thạnh Phú, Vĩnh Cửu, tỉnh Đồng Nai

Bên được chuyển nhượng: Công ty TNHH đầu tư sản xuất thương mại Kim Huy
Hoàng (Việt Nam) (VN)
Số 211 Trần Nãi, khu phố 3, phường An Khánh, thành phố
Thủ Đức, thành phố Hồ Chí Minh

Thông báo số: 4178w/TB-SHTT, ngày 10/03/2023 về việc ghi nhận thay đổi chủ đơn
Số Yêu cầu: CD3-2021-01208 Ngày nộp: 06/12/2021

Liên quan đến đơn yêu cầu cấp bằng độc quyền kiểu dáng công nghiệp:

(21) Số đơn	(22) Ngày nộp đơn
3-2021-00161	25/01/2021

Bên chuyển nhượng: CÔNG TY CỔ PHẦN THÀNH CÔNG MOTOR VIỆT
NAM (VN)
Khu công nghiệp Gián Khẩu, xã Gia Trán, huyện Gia Viễn,
tỉnh Ninh Bình

Bên được chuyển nhượng: Công ty cổ phần tập đoàn Thành Công (VN)
CN1, Khu công nghiệp Nguyên Khê, xã Nguyên Khê,
huyện Đông Anh, thành phố Hà Nội

CÔNG BÁO SỞ HỮU CÔNG NGHIỆP

Do Cục Sở hữu trí tuệ thuộc Bộ Khoa học và Công nghệ ấn hành theo Luật Sở hữu trí tuệ số 50/2005/QH11 được Quốc hội thông qua ngày 29 tháng 11 năm 2005 và được sửa đổi bằng Luật sửa đổi, bổ sung một số điều của Luật sở hữu trí tuệ số 50/2005/QH11 được Quốc hội thông qua ngày 19 tháng 6 năm 2009.

Địa chỉ liên hệ:

384-386 đường Nguyễn Trãi, quận Thanh Xuân,
thành phố Hà Nội, Việt Nam
ĐT: 024. 38583069
Fax: 024. 38588449