

CỘNG HÒA XÃ HỘI CHỦ NGHĨA VIỆT NAM  
BỘ KHOA HỌC VÀ CÔNG NGHỆ

CỤC SỞ HỮU TRÍ TUỆ

CÔNG BÁO  
SỞ HỮU CÔNG NGHIỆP

TẬP A

QUYỂN 2: KIỂU DÁNG CÔNG NGHIỆP

01 - 2023

418

CỘNG HOÀ XÃ HỘI CHỦ NGHĨA VIỆT NAM  
BỘ KHOA HỌC VÀ CÔNG NGHỆ  
CỤC SỞ HỮU TRÍ TUỆ

---

CÔNG BÁO  
SỞ HỮU CÔNG NGHIỆP  
TẬP A

QUYỂN 2: KIỂU DÁNG CÔNG NGHIỆP

01 - 2023

418

---

HÀ NỘI

## MỤC LỤC

	Trang
<u>PHẦN I:</u> Đơn yêu cầu cấp Bằng độc quyền kiểu dáng công nghiệp	7-371

## CONTENTS

<u>PART I:</u> Applications for Industrial Design Patents	7-371
---	-------

---

**CÔNG BÁO SỞ HỮU CÔNG NGHIỆP SỐ 418 TẬP A - QUYỂN 2 (01.2023)**

**MÃ SỐ HAI CHỮ CÁI THỂ HIỆN TÊN NƯỚC VÀ CÁC THỰC THỂ KHÁC TRONG CÁC TƯ LIỆU SỞ HỮU CÔNG NGHIỆP THEO TIÊU CHUẨN ST3 CỦA WIPO**

AE	United Arab Emirates	CN	China	HK	Hong Kong
AF	Afganistan	CO	Colombia	HN	Honduras
AG	Antihua and Barbuda	CR	Costa Rica	HR	Croatia
AI	Anguilla	CU	Cuba	HT	Haiti
AL	Albania	CV	Cape Verde	HU	Hungary
AN	Netherlands Antilles	CY	Cyprus	ID	Indonesia
AO	Angola	CZ	Czech Republic	IE	Ireland
AR	Argentina	DE	Germany	IL	Israel
AT	Austria	DJ	Djibouti	IN	India
AU	Australia	DK	Denmark	IQ	Iraq
AW	Aruba	DM	Dominica	IR	Iran (Islamic Republic of)
BB	Barbados	DO	Dominican Republic	IS	Iceland
BD	Bangladesh	DZ	Algeria	IT	Italy
BE	Belgium	EC	Ecuador	JM	Jamaica
BF	Burkina Faso	EE	Estonia	JO	Jordan
BG	Bulgaria	EG	Egypt	JP	Japan
BH	Bahrain	ES	Spain	KE	Kenya
BI	Burundi	ET	Ethiopia	KH	Cambodia
BJ	Benin	FI	Finland	KI	Kiribati
BM	Bermuda	FJ	Fiji	KM	Comoros
BN	Brunei Darussalam	FK	Falkand Islands (Malvinas)	KN	Saint Kitts and Nevis
BO	Bolivia	FR	France	KP	Democratic People's Republic of Korea
BR	Brazil	GA	Gabon	KR	Republic of Korea
BS	Bahamas	GB	United Kingdom	KW	Kuwait
BT	Bhutan	GD	Grenada	KY	Cayman Islands
BW	Botswana	GE	Georgia	KZ	Kazakhstan
BY	Belarus	GH	Ghana	LA	Laos
BZ	Belize	GI	Gibraltar	LB	Lebanon
CA	Canada	GM	Gambia	LC	Saint Lucia
CF	Central African Republic	GN	Guinea	LI	Liechtenstein
CG	Congo	GQ	Equatorial Guinea	LK	SriLanka
CH	Switzerland	GR	Greece	LR	Liberia
CI	Côte d'Ivoire	GT	Guatemala	LS	Lesotho
CL	Chile	GW	Guinea-Bissau	LT	Lithuania
CM	Cameroon	GY	Guyana	TC	Turk and Caicos Islands
LU	Luxembourg	PA	Panama	TD	Chad
LV	Latvia	PE	Peru	TG	Togo
LY	Lybya	PG	Papua New Guinea	TH	Thailand
MA	Morocco	PH	Philippines	TN	Tunisia
MC	Monaco	PK	Pakistan	TO	Tonga
MD	Republic of Moldova	PL	Poland	TR	Turkey

**CÔNG BÁO SỞ HỮU CÔNG NGHIỆP SỐ 418 TẬP A - QUYỂN 2 (01.2023)**

MG	Madagascar	PT	Portugal	TT	Trinidad and Tobago
ML	Mali	PY	Paraguay	TV	Tuvalu
MM	Myanmar	QA	Qatar	TW	Taiwan, Province of China
MN	Mongolia	RO	Rumania	TZ	United Republic of Tanzania
MO	Macau	RU	Russian Federation	UA	Ukraine
MR	Mauritania	RW	Rwanda	UG	Uganda
MS	Montserrat	SA	Saudi Arabia	US	United States of America
MT	Malta	SB	Solomon Islands	UY	Uruguay
MU	Mauritius	SC	Seychelles	UZ	Uzbekistan
MV	Maldives	SD	Sudan	VA	Holy see
MW	Malawi	SE	Sweden	VC	Saint Vincent and the Grenadines
MX	Mexico	SG	Singapore	VE	Venezuela
MY	Malaysia	SH	Saint Helena	VG	Virgin Islands (British)
MZ	Mozambique	SL	Slovenia	VN	Vietnam
NA	Namibia	SK	Slovakia	VU	Vanuatu
NE	Niger	SL	Sierra Leone	WS	Samoa
NG	Nigeria	SM	San Marino	YE	Yemen
NJ	Nicaragua	SN	Senegal	YU	Yugoslavia
NL	Netherlands	SO	Somalia	ZA	South Africa
NO	Norway	SR	Suriname	ZM	Zambia
NP	Nepal	ST	Sao Tome and Principe	ZR	Zaire
NR	Nauru	SV	El Sanvador	ZW	Zimbabwe
NZ	New Zealand	SY	Syria		
OM	Oman	SZ	Swaziland		

**CÁC TỔ CHỨC QUỐC TẾ**

AO	African Intellectual Property Organization (OAPI)
AP	African Regional Industrial Property Organization (ARIPO)
BX	Benelux Trademark Office and Benelux Designs Office
EP	European Patent Office (EPO)
IB, WO	International Bureau of the World Intellectual Property Organization (WIPO)

**NHỮNG MÃ SỐ INID TRÍCH TỪ TIÊU CHUẨN ST80 CỦA TỔ CHỨC SỞ HỮU TRÍ TUỆ THẾ GIỚI (WIPO) ĐỂ NHẬN BIẾT CÁC DỮ LIỆU THƯ MỤC DÙNG CÔNG BỐ ĐƠN VÀ BẰNG ĐỘC QUYỀN KIỂU DÁNG CÔNG NGHIỆP**

- (11) Số bằng độc quyền kiểu dáng công nghiệp / Số công bố đơn
- (15) Ngày cấp
- (18) Ngày hết hạn hiệu lực của bằng độc quyền kiểu dáng công nghiệp
- (21) Số đơn
- (22) Ngày nộp đơn
- (23) Tên triển lãm, ngày và nơi triển lãm
- (28) Số phương án yêu cầu bảo hộ
- (30) Số đơn ưu tiên, ngày nộp đơn ưu tiên
- (43) Ngày công bố đơn
- (45) Ngày công bố bằng độc quyền kiểu dáng công nghiệp
- (51) Phân loại quốc tế kiểu dáng công nghiệp
- (54) Tên sản phẩm mang kiểu dáng công nghiệp
- (55) Ảnh chụp / hình vẽ kiểu dáng công nghiệp
- (57) Đặc điểm khác biệt yêu cầu bảo hộ của kiểu dáng công nghiệp
- (62) Số và ngày nộp đơn, số bằng độc quyền KDCN hoặc số công bố đơn liên quan đến tách đơn
- (71) Tên và địa chỉ của người nộp đơn
- (72) Tên của tác giả KDCN
- (73) Tên, địa chỉ của chủ bằng độc quyền KDCN
- (74) Tên của người đại diện SHCN

**PHẦN I**

**ĐƠN YÊU CẦU CẤP BẰNG ĐỘC QUYỀN KIỂU DÁNG CÔNG NGHIỆP**

- (11) **46202**
- (21) 3-2020-02721 (28) 1
- (54) **HỘP ĐỰNG SẢN PHẨM** (51) **09-03**
- (22) 06/11/2020 (43) 27/01/2023
- (73) **GIẢM QUỐC THÀNH (VN)**  
2.04 Lô L chung cư Bàu Cát 2, đường Hồng Lạc, phường 10, quận Tân Bình, thành phố Hồ Chí Minh
- (72) Phạm Trung Thành (VN)
- (74) Công ty TNHH Sở hữu trí tuệ ALNGUYEN (ALNGUYEN IP CO.,LTD.)
- (55)



1.1



1.2

**CÔNG BÁO SỞ HỮU CÔNG NGHIỆP SỐ 418 TẬP A – QUYỀN 2 (01.2023)**

- (11) **46203**  
(21) 3-2020-03161 (28) 1  
(54) **ĐẦU NỐI ĐIỆN** (51) **13-03**  
(22) 29/12/2020 (43) 27/01/2023  
(73) **TA TSAI LEE (CN)**  
Guangdong Province dongguan Qingxi town Tiesong Village youtai, China  
(72) **TA TSAI LEE (TW)**  
(74) Công ty TNHH Sáng chế ACTIP (ACTIP PATENT LIMITED)  
(55)

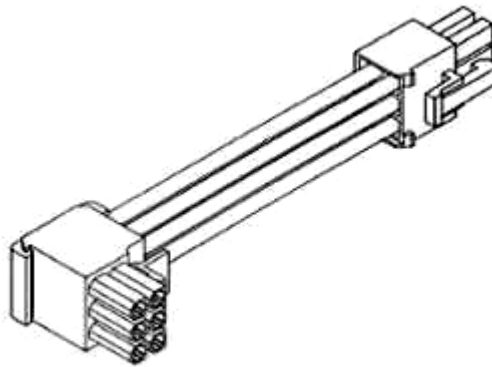

1.1



1.2



1.3

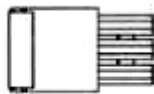

1.4

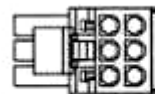

1.5



1.6



1.7



**CÔNG BÁO SỞ HỮU CÔNG NGHIỆP SỐ 418 TẬP A – QUYỀN 2 (01.2023)**

- (11) **46204**  
(21) 3-2021-00847 (28) 1  
(54) **ĐIỆN THOẠI DI ĐỘNG** (51) **14-03**  
(22) 08/04/2021 (43) 27/01/2023  
(30) 202030617220.5 16/10/2020 CN;  
(73) **VIVO MOBILE COMMUNICATION CO., LTD.** (CN)  
No.168 Jinghai East Rd., Chang'an, Dongguan, Guangdong 523863, China  
(72) 1. JING LI (CN)  
2. SHUIQIN CHEN (CN)  
(74) Công ty cổ phần Tư vấn S&B (S&B CONSULTANT., CORP.)  
(55)



1.1



1.2



1.3



1.4



1.5



1.6



1.7



1.8



1.9



1.10



1.11



1.12



1.13



1.14



1.15



1.16

**CÔNG BÁO SỞ HỮU CÔNG NGHIỆP SỐ 418 TẬP A – QUYỀN 2 (01.2023)**

- (11) **46205**
- (21) 3-2021-01449 (28) 1
- (54) **THIẾT BỊ THEO DÕI SỨC KHỎE** (51) **10-05**
- (22) 04/06/2021 (43) 27/01/2023
- (30) 29/760,763 03/12/2020 US;
- (73) **FITBIT, INC. (US)**  
1600 Amphitheatre Parkway, Mountain View, California 94043, United States of America
- (72) 1. BERNARD, CÉDRIC ERIC JEAN-EDOUARD (FR)  
2. PARK, JUNYONG (KR)  
3. FAIRBANKS, ERIC JOHN (US)  
4. RIOT, BENJAMIN PATRICK ROBERT JEAN (FR)  
5. KOZLOVSKAYA, IRINA IGOREVNA (US)  
6. PASCHKE, BRIAN DENNIS (CA)  
7. HARBER, CHADWICK JOHN (CA)  
8. BECKER, JONAH AVRAM (US)
- (74) Công ty Luật TNHH ROUSE Việt Nam (ROUSE LAW CO.,LTD)
- (55)

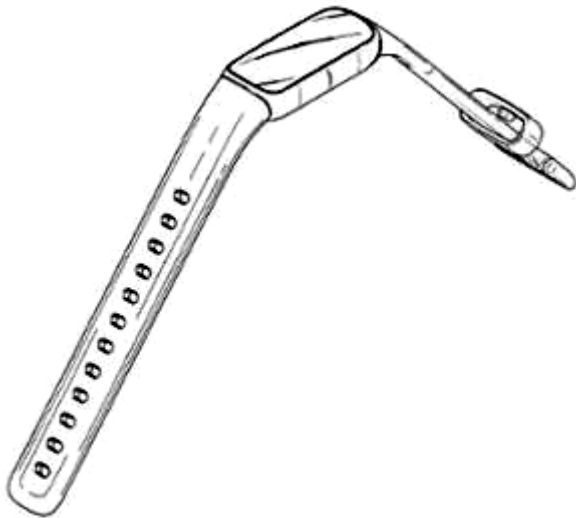

1.1

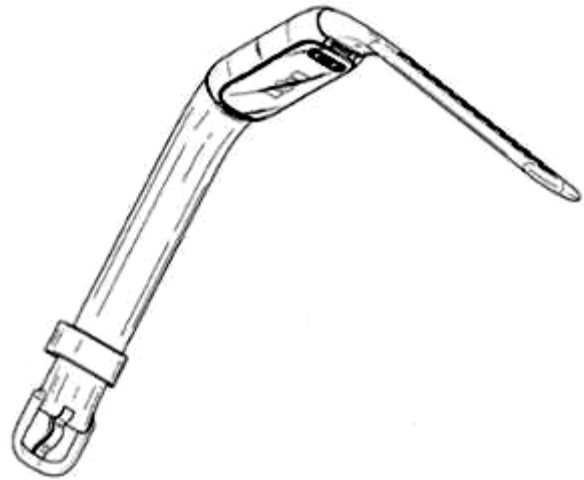

1.2



1.3



1.4



1.5



1.6



1.7



1.8

**CÔNG BÁO SỞ HỮU CÔNG NGHIỆP SỐ 418 TẬP A – QUYỀN 2 (01.2023)**

- (11) **46206**  
(21) 3-2021-02125 (28) 1  
(54) **NHÃN SẢN PHẨM** (51) **19-08**  
(22) 20/08/2021 (43) 27/01/2023  
(73) **CÔNG TY CỔ PHẦN LIFE TECH GROUP (VN)**  
Số 10/22, ngõ 230 Lạc Trung, phường Thanh Lương, quận Hai Bà Trưng, thành phố Hà Nội  
(72) Trịnh Bá Hải (VN)  
(55)



1.1



1.2

**CÔNG BÁO SỞ HỮU CÔNG NGHIỆP SỐ 418 TẬP A – QUYỀN 2 (01.2023)**

- (11) **46207**  
(21) 3-2021-02341 (28) 1  
(54) **HỘP BÁNH** (51) **09-03**  
(22) 23/09/2021 (43) 27/01/2023  
(73) **CÔNG TY CỔ PHẦN BÁNH KẸO TRÀNG AN 2- VIỆT NAM (VN)**  
Số 233, đường Sào Nam, phường Nghi Thu, thị xã Cửa Lò, tỉnh Nghệ An  
(72) Trịnh Sỹ (VN)  
(74) Công ty TNHH T&T INVENMARK Sở hữu trí tuệ Quốc tế (T&T INVENMARK CO., LTD.)  
(55)

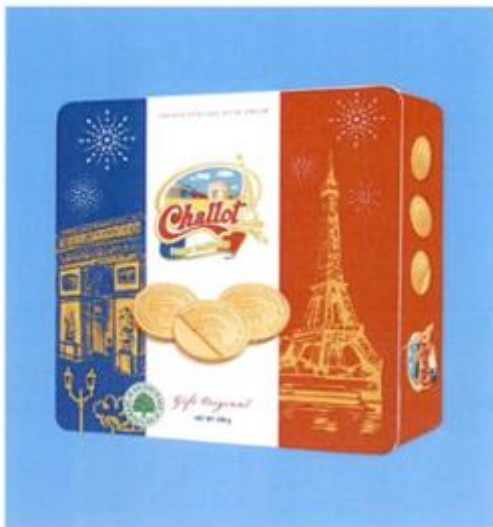

1.1



1.2



1.3



1.4



1.5



1.6



1.7

**CÔNG BÁO SỞ HỮU CÔNG NGHIỆP SỐ 418 TẬP A – QUYỀN 2 (01.2023)**

- (11) **46208**
- (21) 3-2021-02383 (28) 1
- (54) **BAO GÓI** (51) **09-05**
- (22) 29/09/2021 (43) 27/01/2023
- (73) **CERIOTI HOLDING S.A. (LU)**  
23, Rue Aldringen L-1118 Luxembourg
- (72) Lê Thị Ánh Phương (VN)
- (74) Công ty TNHH Tầm nhìn và Liên danh (VISION & ASSOCIATES CO.LTD.)
- (55)



1.1



1.2



**CÔNG BÁO SỞ HỮU CÔNG NGHIỆP SỐ 418 TẬP A – QUYỀN 2 (01.2023)**

- (11) **46209**  
(21) 3-2021-02384 (28) 1  
(54) **BAO GÓI** (51) **09-05**  
(22) 29/09/2021 (43) 27/01/2023  
(73) **CERIOTI HOLDING S.A. (LU)**  
23, Rue Aldringen L-1118 Luxembourg  
(72) Lê Thị Ánh Phương (VN)  
(74) Công ty TNHH Tầm nhìn và Liên danh (VISION & ASSOCIATES CO.LTD.)  
(55)



1.1



1.2

**CÔNG BÁO SỞ HỮU CÔNG NGHIỆP SỐ 418 TẬP A – QUYỀN 2 (01.2023)**

- (11) **46210**  
(21) 3-2021-02794 (28) 1  
(54) **HỘP ĐỰNG SẢN PHẨM** (51) **09-03**  
(22) 10/11/2021 (43) 27/01/2023  
(73) **CÔNG TY TNHH THƯƠNG MẠI & XUẤT NHẬP KHẨU NHẤT LÂM (VN)**  
Số 376, phố Xã Đàn, phường Nam Đồng, quận Đống Đa, thành phố Hà Nội  
(72) An Văn Tùng (VN)  
(74) Công ty Luật TNHH Phương Hoàng (PHOENIX LAW)  
(55)



1.1



1.2

**CÔNG BÁO SỞ HỮU CÔNG NGHIỆP SỐ 418 TẬP A – QUYỀN 2 (01.2023)**

- (11) **46211**  
(21) 3-2021-03069 (28) 1  
(54) **TÚI ĐỰNG HỘP THỰC PHẨM** (51) **09-05**  
(22) 07/12/2021 (43) 27/01/2023  
(73) **CÔNG TY TNHH QP AUTHENTIC FRESH FINE FAST FOOD VIET NAM (VN)**  
Số 121, phố 8/3, C23, phường Quỳnh Mai, quận Hai Bà Trưng, thành phố Hà Nội  
(72) Mai Thành Trung (VN)  
(74) Công ty cổ phần tư vấn Sở hữu trí tuệ IPAC (IPAC IP.,JSC.)  
(55)



1.1



1.2



1.3

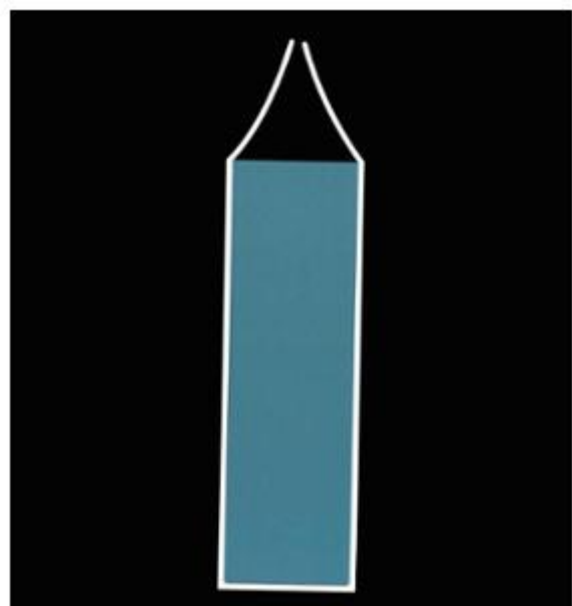

1.4

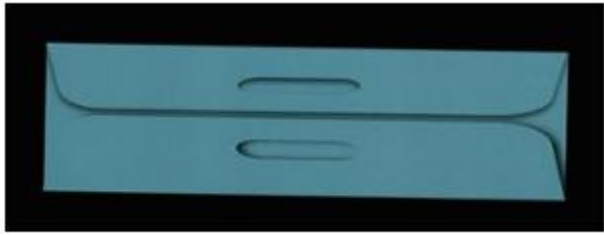

1.5



1.6

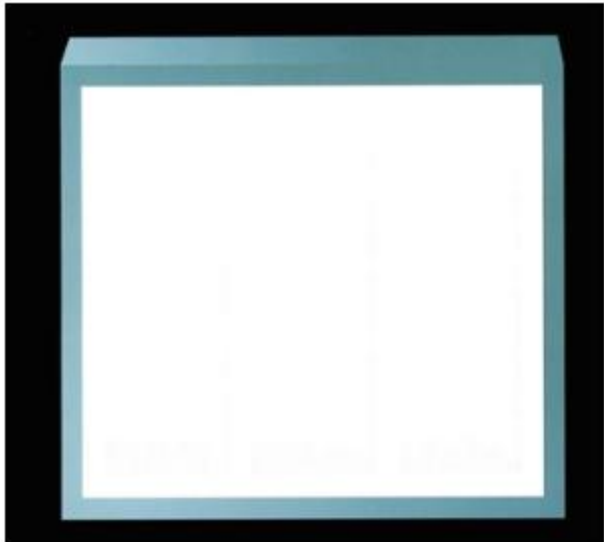

1.7



1.8

**CÔNG BÁO SỞ HỮU CÔNG NGHIỆP SỐ 418 TẬP A – QUYỀN 2 (01.2023)**

- (11) **46212**  
(21) 3-2021-03070 (28) 1  
(54) **HỘP ĐỰNG THỰC PHẨM** (51) **09-03**  
(22) 07/12/2021 (43) 27/01/2023  
(73) **CÔNG TY TNHH QP AUTHENTIC FRESH FINE FAST FOOD VIET NAM**  
(VN)  
Số 121, phố 8/3, C23, phường Quỳnh Mai, quận Hai Bà Trưng, thành phố Hà Nội  
(72) Mai Thành Trung (VN)  
(74) Công ty cổ phần tư vấn Sở hữu trí tuệ IPAC (IPAC IP.,JSC.)  
(55)



1.1

1.2

1.3

1.4

1.5



1.6

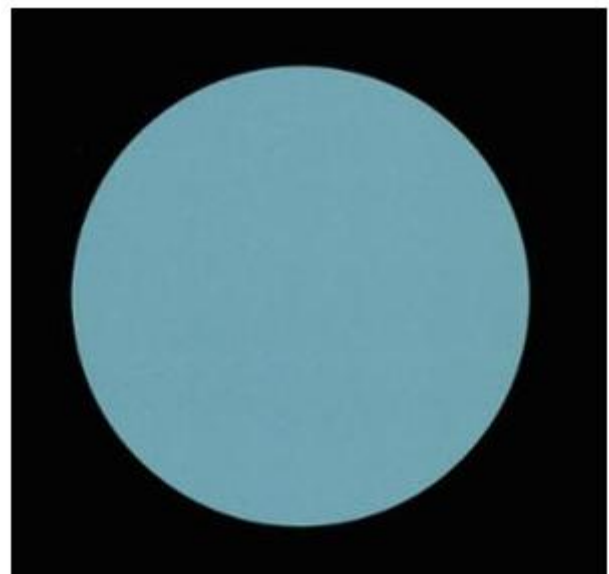

1.7

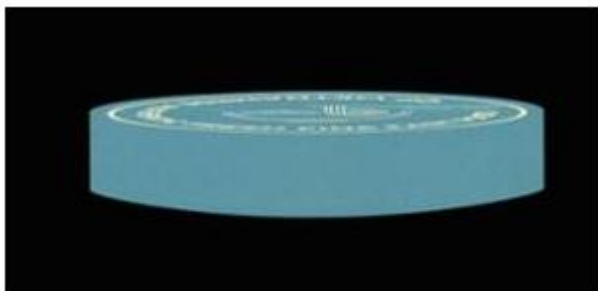

1.8



1.9

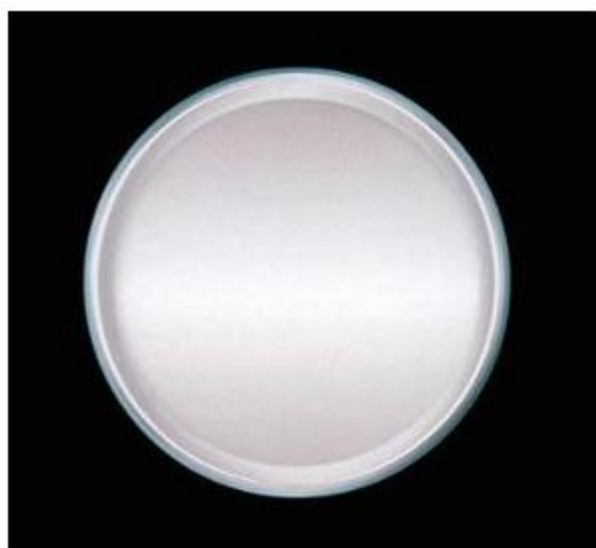

1.10



1.11



1.12



1.13

**CÔNG BÁO SỞ HỮU CÔNG NGHIỆP SỐ 418 TẬP A – QUYỀN 2 (01.2023)**

(11) **46213**

(21) 3-2022-00081

(28) 1

(54) **GHẾ NÀM**

(51) **06-01**

(22) 11/01/2022

(43) 27/01/2023

(73) **CÔNG TY TNHH KIẾN TRÚC & XÂY DỰNG SMA STUDIO (VN)**  
Số 44A19, tổ 3, phường Nghĩa Tân, quận Cầu Giấy, thành phố Hà Nội

(72) Nguyễn Phương Chi (VN)

(74) Công ty TNHH NACILAW (NACILAW)

(55)



1.1



1.2



1.3



1.4



1.5



1.6



1.7



1.8



1.9

**CÔNG BÁO SỞ HỮU CÔNG NGHIỆP SỐ 418 TẬP A – QUYỀN 2 (01.2023)**

- (11) **46214**  
(21) 3-2022-00107 (28) 1  
(54) **TẮM TẢN NHIỆT PHÍA TRƯỚC DÙNG CHO Ô TÔ** (51) **12-16**  
(22) 14/01/2022 (43) 27/01/2023  
(30) 2021-016032 21/07/2021 JP;  
(73) **HONDA MOTOR CO., LTD. (JP)**  
1-1, Minami-Aoyama 2-chome, Minato-ku, Tokyo, 107-8556 Japan  
(72) Junnosuke SATO (JP)  
(74) Công ty Luật TNHH Phạm và Liên danh (PHAM & ASSOCIATES)  
(55)



1.1



1.2



1.3



1.4



1.5



1.6



1.7



1.8



**CÔNG BÁO SỞ HỮU CÔNG NGHIỆP SỐ 418 TẬP A – QUYỀN 2 (01.2023)**

- (11) **46215**  
(21) 3-2022-00134 (28) 1  
(54) **TẮM TẢN NHIỆT PHÍA TRƯỚC DÙNG CHO Ô TÔ** (51) **12-16**  
(22) 17/01/2022 (43) 27/01/2023  
(30) 2021-016033 21/07/2021 JP;  
(73) **HONDA MOTOR CO., LTD. (JP)**  
1-1, Minami-Aoyama 2-chome, Minato-ku, Tokyo, 107-8556 Japan  
(72) Junnosuke SATO (JP)  
(74) Công ty Luật TNHH Phạm và Liên danh (PHAM & ASSOCIATES)  
(55)



1.1



1.2



1.3



1.4



1.5



1.6



1.7



1.8

**CÔNG BÁO SỞ HỮU CÔNG NGHIỆP SỐ 418 TẬP A – QUYỀN 2 (01.2023)**

- (11) **46216**  
(21) 3-2022-00169 (28) 1  
(54) **TẮM CẢN VA PHÍA SAU Ô TÔ** (51) **12-16**  
(22) 20/01/2022 (43) 27/01/2023  
(30) 2021-016035 21/07/2021 JP;  
(73) **HONDA MOTOR CO., LTD. (JP)**  
1-1, Minami-Aoyama 2-chome, Minato-ku, Tokyo, 107-8556 Japan  
(72) Mitsuhiro ABE (JP)  
(74) Công ty Luật TNHH Phạm và Liên danh (PHAM & ASSOCIATES)  
(55)



1.1



1.2



1.3



1.4



1.5



1.6



1.7



1.8

**CÔNG BÁO SỞ HỮU CÔNG NGHIỆP SỐ 418 TẬP A – QUYỀN 2 (01.2023)**

- (11) **46217**  
(21) 3-2022-00186 (28) 1  
(54) **TẮM CẢN VA PHÍA TRƯỚC Ô TÔ** (51) **12-16**  
(22) 21/01/2022 (43) 27/01/2023  
(30) 2021-016039 21/07/2021 JP;  
(73) **HONDA MOTOR CO., LTD. (JP)**  
1-1, Minami-Aoyama 2-chome, Minato-ku, Tokyo, 107-8556 Japan  
(72) Mitsuhiro ABE (JP)  
(74) Công ty Luật TNHH Phạm và Liên danh (PHAM & ASSOCIATES)  
(55)



1.1



1.2



1.3



1.4



1.5



1.6



1.7



1.8

**CÔNG BÁO SỞ HỮU CÔNG NGHIỆP SỐ 418 TẬP A – QUYỀN 2 (01.2023)**

- (11) **46218**  
(21) 3-2022-00245 (28) 1  
(54) **GẠCH** (51) **25-01**  
(22) 28/01/2022 (43) 27/01/2023  
(73) **HÀ NGỌC TUÂN (VN)**  
Tổ 1, thị trấn Chi Đông, huyện Mê Linh, thành phố Hà Nội  
(72) Hà Ngọc Tuân (VN)  
(74) Công ty Luật TNHH ELITE (ELITE LAW FIRM)  
(55)



1.1

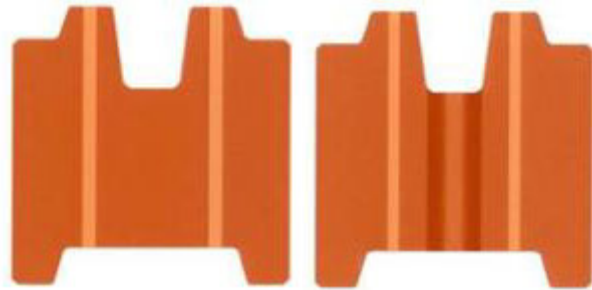

1.2

1.3



1.4



1.5

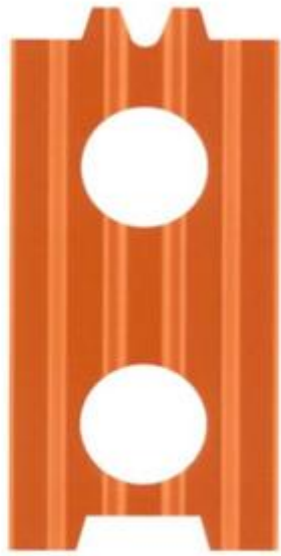

1.6

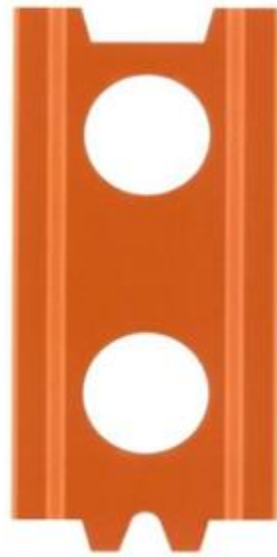

1.7

**CÔNG BÁO SỞ HỮU CÔNG NGHIỆP SỐ 418 TẬP A – QUYỀN 2 (01.2023)**

- (11) **46219**  
(21) 3-2022-00246 (28) 1  
(54) **GẠCH** (51) **25-01**  
(22) 28/01/2022 (43) 27/01/2023  
(73) **HÀ NGỌC TUÂN (VN)**  
Tổ 1, thị trấn Chi Đông, huyện Mê Linh, thành phố Hà Nội  
(72) Hà Ngọc Tuấn (VN)  
(74) Công ty Luật TNHH ELITE (ELITE LAW FIRM)  
(55)



1.1



1.2

1.3



1.4



1.5



1.6



1.7

**CÔNG BÁO SỞ HỮU CÔNG NGHIỆP SỐ 418 TẬP A – QUYỀN 2 (01.2023)**

- (11) **46220**  
(21) 3-2022-00272 (28) 1  
(54) **BẢNG GẮN CHI TIẾT ĐIỀU KHIỂN DÙNG CHO Ô TÔ** (51) **12-16**  
(22) 14/02/2022 (43) 27/01/2023  
(30) 2021-017546 16/08/2021 JP;  
(73) **HONDA MOTOR CO., LTD. (JP)**  
1-1, Minami-Aoyama 2-chome, Minato-ku, Tokyo, 107-8556 Japan  
(72) 1. HIROSHI SUDO (JP)  
2. TOMOYA SATO (JP)  
(74) Công ty Luật TNHH Phạm và Liên danh (PHAM & ASSOCIATES)  
(55)



1.1



1.2



1.3



1.4



1.5



1.6





1.7



1.8

**CÔNG BÁO SỞ HỮU CÔNG NGHIỆP SỐ 418 TẬP A – QUYỀN 2 (01.2023)**

- (11) **46221**  
(21) 3-2022-00274 (28) 1  
(54) **TẤM ỐP PHÍA SAU XE SCUTO** (51) **12-16**  
(22) 14/02/2022 (43) 27/01/2023  
(30) 2021-017652 17/08/2021 JP;  
(73) **HONDA MOTOR CO., LTD. (JP)**  
1-1, Minami-Aoyama 2-Chome, Minato-ku, Tokyo, 107-8556 Japan  
(72) 1. FUMIYA ISONO (JP)  
2. KEISUKE ARAI (JP)  
3. DAIKI GOTO (JP)  
4. HIROKI YOSHITOMI (JP)  
(74) Công ty Luật TNHH Phạm và Liên danh (PHAM & ASSOCIATES)  
(55)



1.1



1.2



1.3



1.4



1.5



1.6



1.7



1.8



1.9

- (11) **46222**  
(21) 3-2022-00510 (28) 1  
(54) **LỚP XE** (51) **12-15**  
(22) 23/03/2022 (43) 27/01/2023  
(73) **CHENG SHIN RUBBER IND. CO., LTD. (TW)**  
No. 215, Meei-Kong Road, Ta-suen, Chang-Hwa, Taiwan  
(72) Wang Sheng Chiun (TW)  
(74) Công ty TNHH một thành viên Sở hữu trí tuệ VCCI (VCCI-IP CO.,LTD)  
(55)

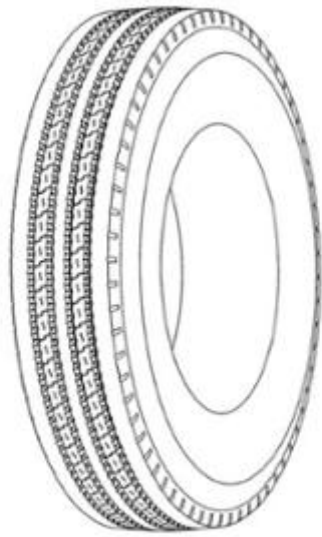

1.1

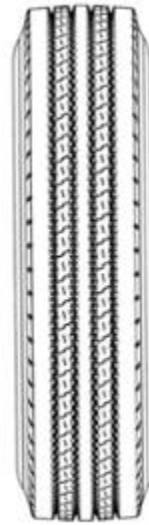

1.2

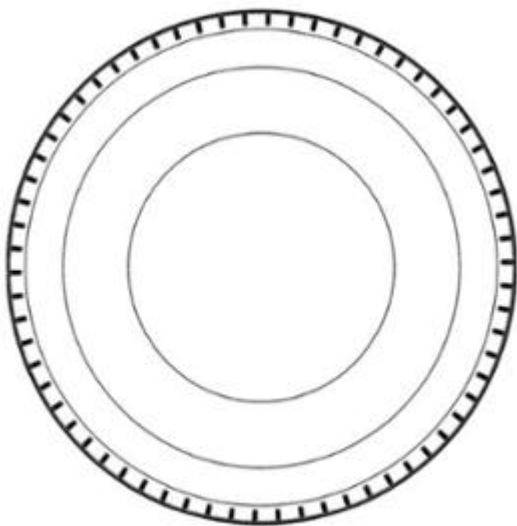

1.3

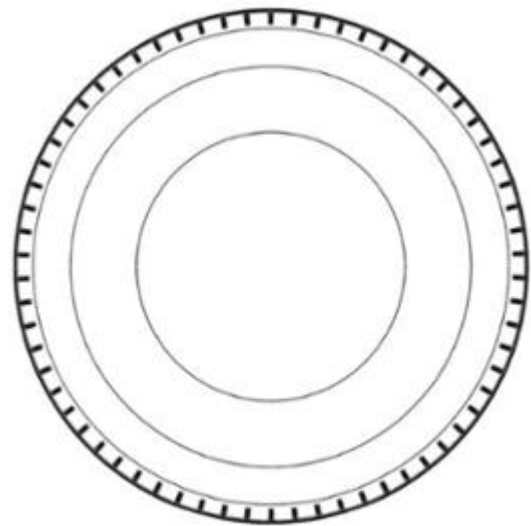

1.4

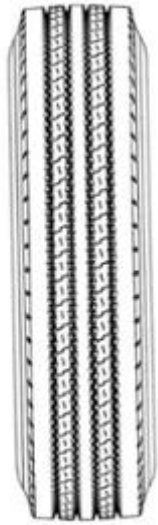

1.5

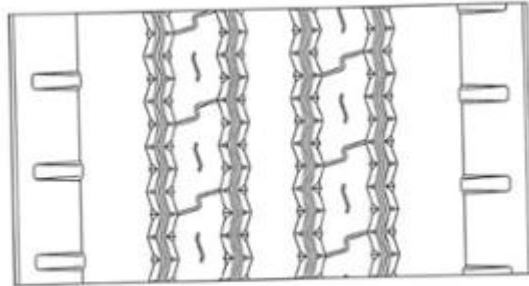

1.6

**CÔNG BÁO SỞ HỮU CÔNG NGHIỆP SỐ 418 TẬP A – QUYỀN 2 (01.2023)**

- (11) **46223**  
(21) 3-2022-00511 (28) 1  
(54) **LỚP XE** (51) **12-15**  
(22) 23/03/2022 (43) 27/01/2023  
(73) **CHENG SHIN RUBBER IND. CO., LTD. (TW)**  
No. 215, Meei-Kong Road, Ta-suen, Chang-Hwa, Taiwan  
(72) Hung Kuo Chuan (TW)  
(74) Công ty TNHH một thành viên Sở hữu trí tuệ VCCI (VCCI-IP CO.,LTD)  
(55)



1.1



1.2

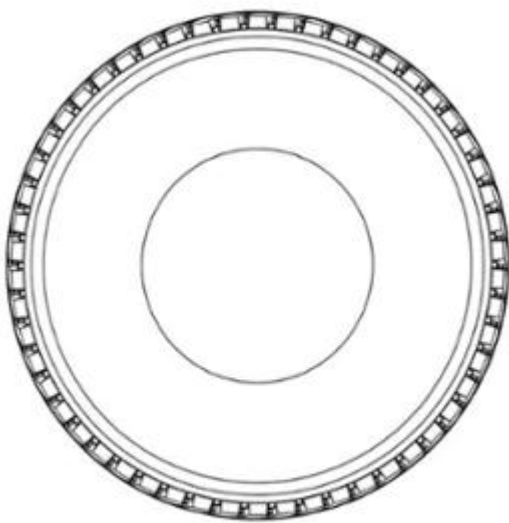

1.3

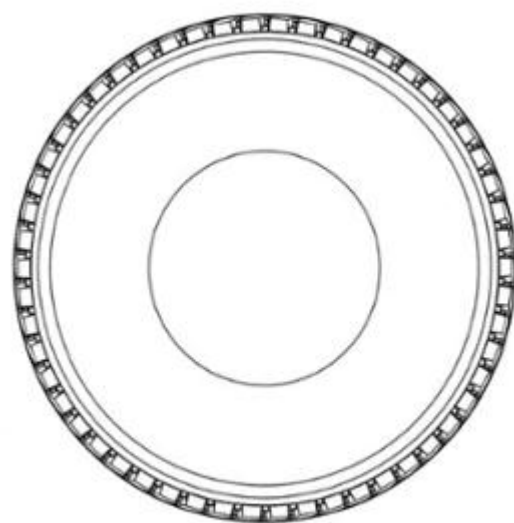

1.4



1.5

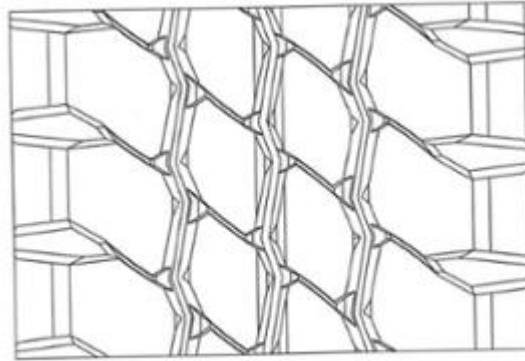

1.6

**CÔNG BÁO SỞ HỮU CÔNG NGHIỆP SỐ 418 TẬP A – QUYỀN 2 (01.2023)**

- (11) **46224**  
(21) 3-2022-00561 (28) 1  
(54) **CHAI** (51) **09-01**  
(22) 29/03/2022 (43) 27/01/2023  
(30) 29/809,617 29/09/2021 US;  
(73) **OWENS-BROCKWAY GLASS CONTAINER INC. (US)**  
One Michael Owens Way, Perrysburg, Ohio, 43551, United States of America  
(72) 1. PAUL M. HARRIS (US)  
2. KARL REISIG (US)  
(74) Công ty TNHH Tầm nhìn và Liên danh (VISION & ASSOCIATES CO.LTD.)  
(55)



1.1



1.2



1.3



1.4



**CÔNG BÁO SỞ HỮU CÔNG NGHIỆP SỐ 418 TẬP A – QUYỀN 2 (01.2023)**

- (11) **46225**  
(21) 3-2022-00911 (28) 1  
(54) **CHAI** (51) **09-01**  
(22) 09/05/2022 (43) 27/01/2023  
(73) **CÔNG TY CỔ PHẦN TẬP ĐOÀN VIHAMARK (VN)**  
Lô N3-6, KCN Đồng Văn II, phường Duy Minh, thị xã Duy Tiên, tỉnh Hà Nam  
(72) Nguyễn Thiên Thắng (VN)  
(55)



1.1



1.2



1.3



1.4



1.5



1.6

**CÔNG BÁO SỞ HỮU CÔNG NGHIỆP SỐ 418 TẬP A – QUYỀN 2 (01.2023)**

- (11) **46226**  
(21) 3-2022-00973 (28) 1  
(54) **CHAI** (51) **09-01**  
(22) 18/05/2022 (43) 27/01/2023  
(73) **CÔNG TY CỔ PHẦN TẬP ĐOÀN VIHAMARK (VN)**  
Lô N3-6, KCN Đồng Văn II, phường Duy Minh, thị xã Duy Tiên, tỉnh Hà Nam  
(72) Nguyễn Thiên Thắng (VN)  
(55)



1.1



1.2



1.3



1.4



1.5



1.7



1.6

- (11) **46227**  
(21) 3-2022-01029 (28) 1  
(54) **BÀN** (51) **06-03**  
(22) 30/05/2022 (43) 27/01/2023  
(30) 29/836,741 28/04/2022 US;  
(73) **WORKLIFE BRANDS LLC (US)**  
500 Staples Drive, Framingham, Massachusetts 01702, United States  
(72) 1. BRIAN P. CUSACK (US)  
2. JESSICA N. MONSALVE (US)  
(74) Công ty TNHH Trường Xuân (AGELESS CO.,LTD.)  
(55)

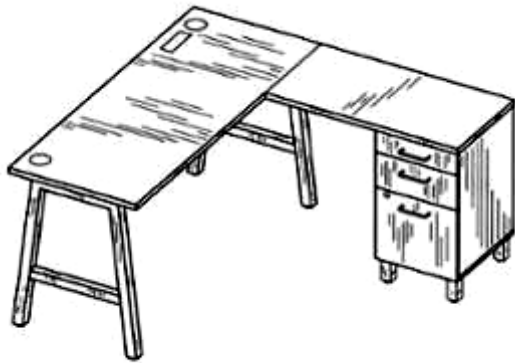

1.1



1.2

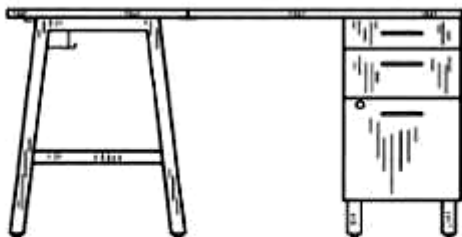

1.3

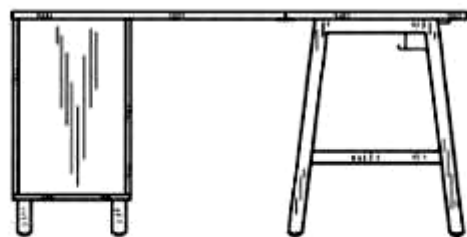

1.4

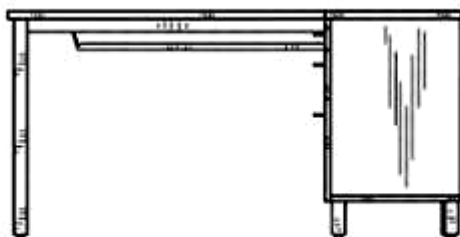

1.5

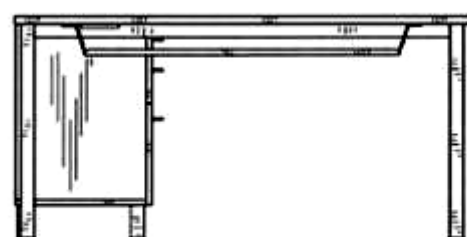

1.6

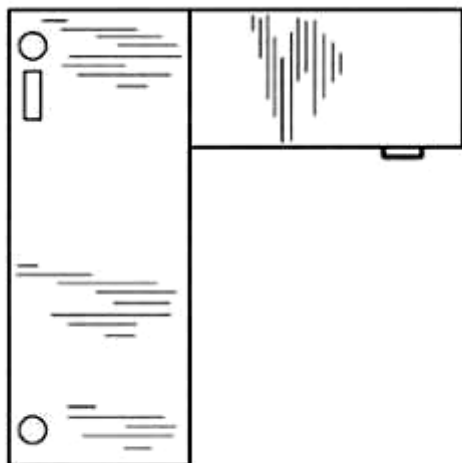

1.7

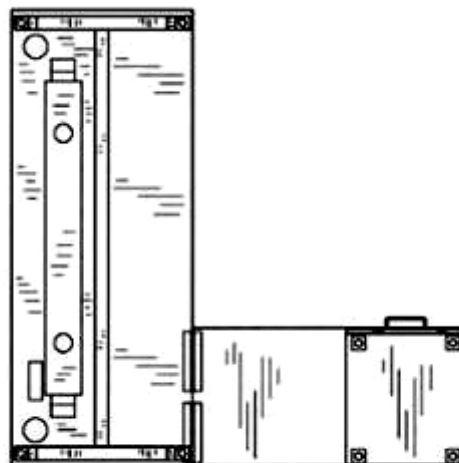

1.8

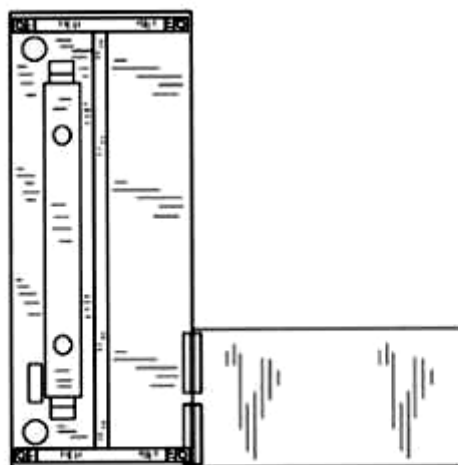

1.9

**CÔNG BÁO SỞ HỮU CÔNG NGHIỆP SỐ 418 TẬP A – QUYỀN 2 (01.2023)**

- (11) **46228**  
(21) 3-2022-01031 (28) 1  
(54) **GHẾ** (51) **06-01**  
(22) 30/05/2022 (43) 27/01/2023  
(30) 29/836,884 29/04/2022 US;  
(73) **WORKLIFE BRANDS LLC (US)**  
500 Staples Drive, Framingham, Massachusetts 01702, United States  
(72) 1. LOGAN P. STEINFELD (US)  
2. KRIS M. LONERGAN (US)  
3. COLIN L. NOURIE (US)  
4. CHIEN-MING JUAN (TW)  
5. BRIAN P. CUSACK (US)  
6. JESSICA N. MONSALVE (US)  
(74) Công ty TNHH Trường Xuân (AGELESS CO.,LTD.)  
(55)



1.1

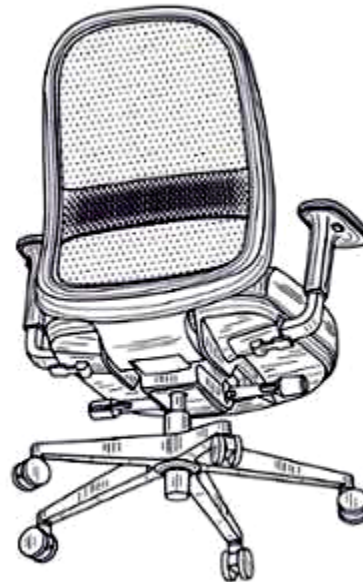

1.2

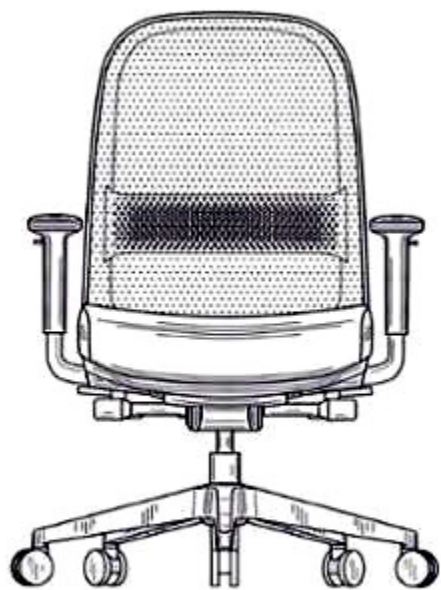

1.3

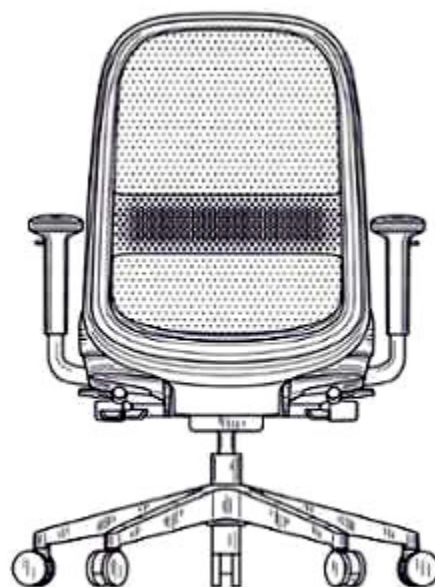

1.4



1.5



1.6



1.7

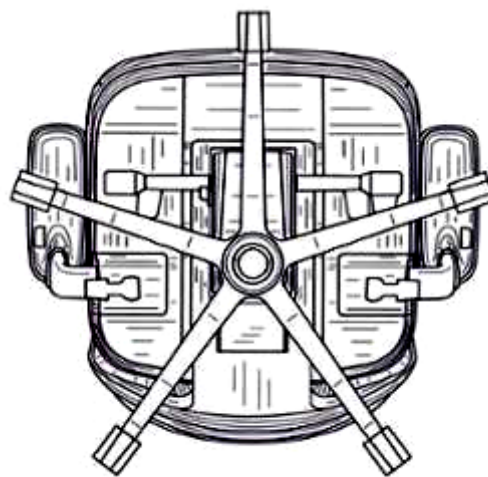

1.8

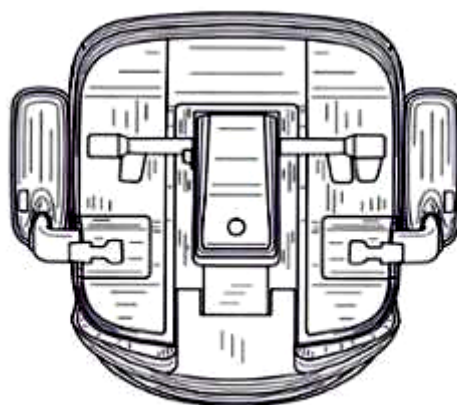

1.9

**CÔNG BÁO SỞ HỮU CÔNG NGHIỆP SỐ 418 TẬP A – QUYỀN 2 (01.2023)**

- (11) **46229**  
(21) 3-2022-01032 (28) 1  
(54) **BÀN** (51) **06-03**  
(22) 30/05/2022 (43) 27/01/2023  
(30) 29/836,731 28/04/2022 US;  
(73) **WORKLIFE BRANDS LLC (US)**  
500 Staples Drive, Framingham, Massachusetts 01702, United States  
(72) 1. BRIAN P. CUSACK (US)  
2. JESSICA N. MONSALVE (US)  
(74) Công ty TNHH Trường Xuân (AGELESS CO.,LTD.)  
(55)



1.1

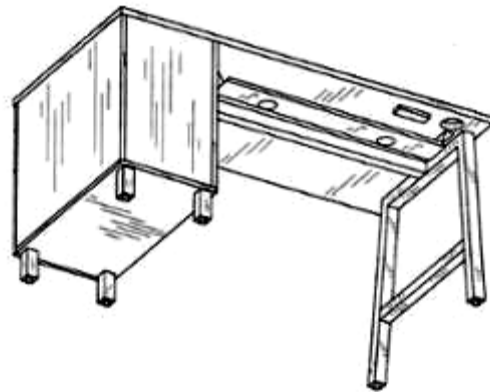

1.2

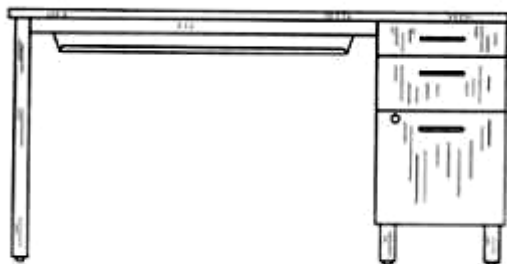

1.3

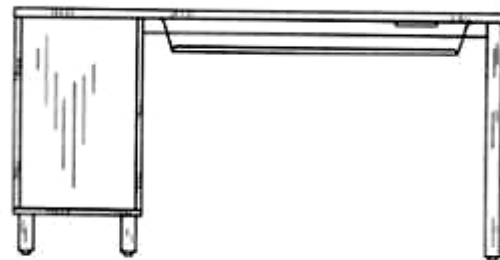

1.4

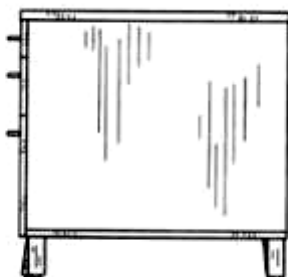

1.5

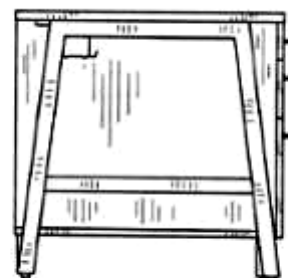

1.6





1.7

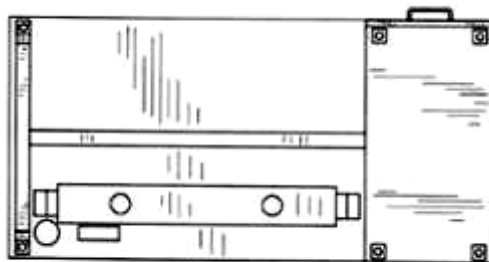

1.8

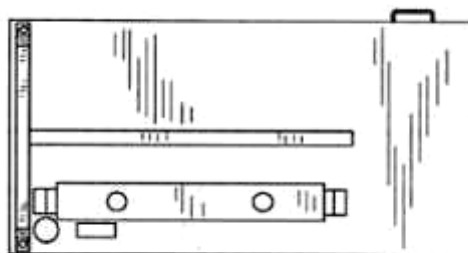

1.9

**CÔNG BÁO SỞ HỮU CÔNG NGHIỆP SỐ 418 TẬP A – QUYỀN 2 (01.2023)**

- (11) **46230**  
(21) 3-2022-01053 (28) 1  
(54) **ĐỀ SẠC** (51) **13-02**  
(22) 24/09/2021 (43) 27/01/2023  
(30) 29/775,758 25/03/2021 US;  
(73) **EISAI R&D MANAGEMENT CO., LTD. (JP)**  
6-10, Koishikawa 4-Chome, Bunkyo-ku, Tokyo 112-8088, Japan  
(72) 1. RAJEEV NARAYANAN (IN)  
2. ALEXANDER SCOTT (US)  
3. DAVID LEVIN (US)  
(74) Công ty TNHH một thành viên Sở hữu trí tuệ VCCI (VCCI-IP CO.,LTD)  
(55)

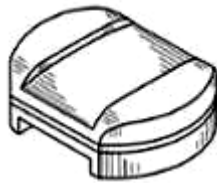

1.1

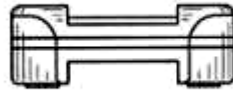

1.2



1.3

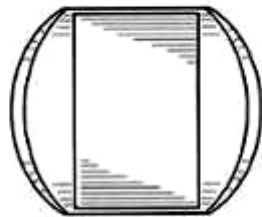

1.4

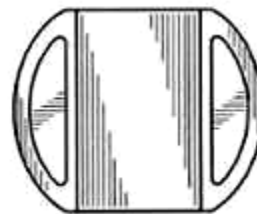

1.5

**CÔNG BÁO SỞ HỮU CÔNG NGHIỆP SỐ 418 TẬP A – QUYỀN 2 (01.2023)**

- (11) **46231**  
(21) 3-2022-01068 (28) 1  
(54) **CHAI BIA** (51) **09-01**  
(22) 01/06/2022 (43) 27/01/2023  
(73) **CÔNG TY CỔ PHẦN TẬP ĐOÀN IBB (VN)**  
Đường Nguyễn Văn Trỗi, phường Hữu Nghị, thành phố Hòa Bình, tỉnh Hòa Bình  
(72) Lê Thanh Tú (VN)  
(55)



1.1



1.2



1.3



1.4

**CÔNG BÁO SỞ HỮU CÔNG NGHIỆP SỐ 418 TẬP A – QUYỀN 2 (01.2023)**

(11) **46232**

(21) 3-2022-01083

(28) 1

(54) **BÌNH**

(51) **11-02**

(22) 03/06/2022

(43) 27/01/2023

(73) **CÔNG TY TNHH MINH LONG I (VN)**

333 khu phố Hưng Lộc, phường Hưng Định, thành phố Thuận An, tỉnh Bình Dương

(72) Lý Ngọc Minh (VN)

(55)



1.1



1.2



1.3

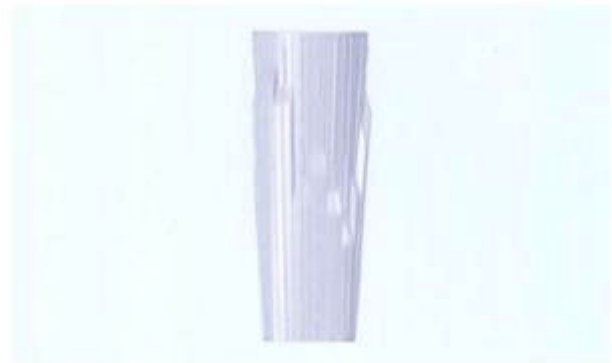

1.4



1.5



1.6



1.7

**CÔNG BÁO SỞ HỮU CÔNG NGHIỆP SỐ 418 TẬP A – QUYỀN 2 (01.2023)**

- (11) **46233**  
(21) 3-2022-01092 (28) 1  
(54) **TRỤ NƯỚC CHỮA CHÁY** (51) **23-01**  
(22) 06/06/2022 (43) 27/01/2023  
(73) **CÔNG TY TNHH THẢO TÍN VŨ (VN)**  
131/1 Lê Lợi, phường 3, quận Gò Vấp, thành phố Hồ Chí Minh  
(72) Nguyễn Hồng Cẩm Yên (VN)  
(74) Công ty Cổ phần Sở hữu công nghiệp INVESTIP (INVESTIP)  
(55)



1.1

1.2

1.3

1.4

1.5

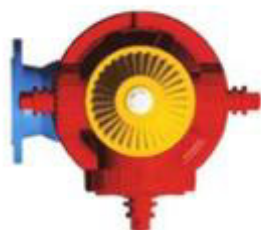

1.6



1.7

**CÔNG BÁO SỞ HỮU CÔNG NGHIỆP SỐ 418 TẬP A – QUYỀN 2 (01.2023)**

- (11) **46234**
- (21) 3-2022-01109 (28) 6
- (54) **PIN MẶT TRỜI** (51) **13-99**
- (22) 08/06/2022 (43) 27/01/2023
- (30) 008790414 08/12/2021 EM;
- (73) **REC SOLAR PTE. LTD.** (SG)  
20 Tuas South Avenue 14, Singapore 637312, Singapore
- (72) Kenta Nakayashiki (JP)
- (74) Công ty TNHH Tầm nhìn và Liên danh (VISION & ASSOCIATES CO.LTD.)
- (55)



1.1

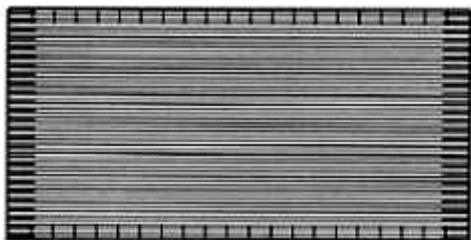

1.2



1.3



1.4



1.5



1.6



1.7



2.1

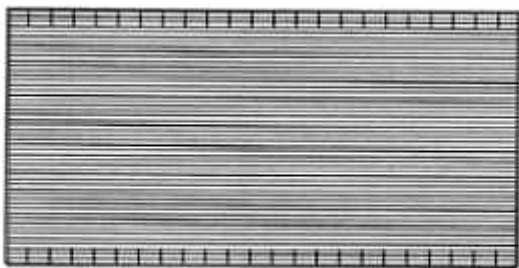

2.2



2.3



2.4



2.5



2.6



2.7





3.1

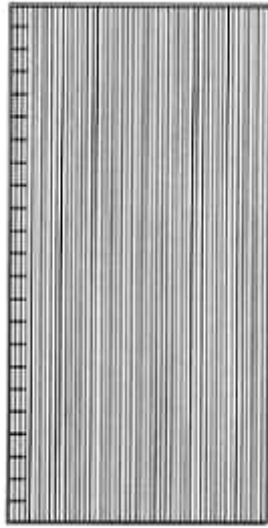

3.2



3.3



3.4



3.5



3.6



3.7

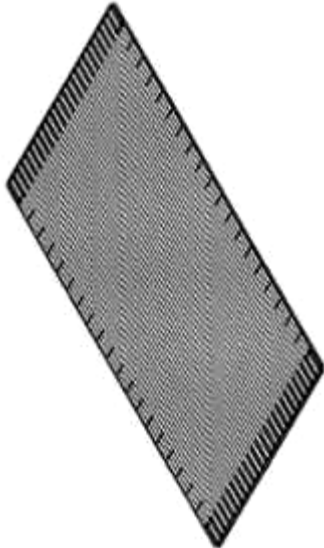

4.1

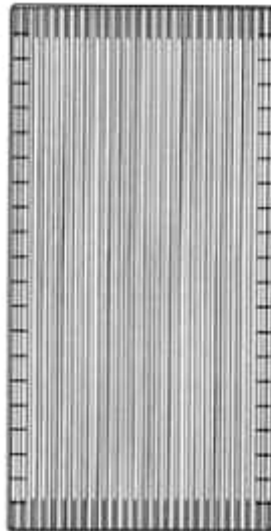

4.2



4.3



4.4



4.5

---

4.6



5.1

4.7

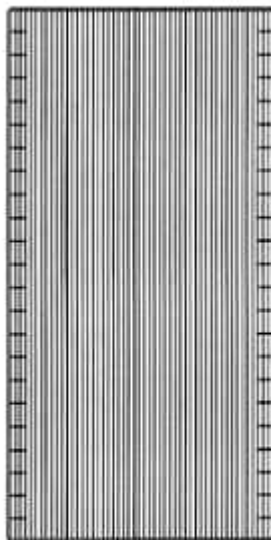

5.2



5.3

---

5.4

---

5.5

---

5.6



6.1

5.7

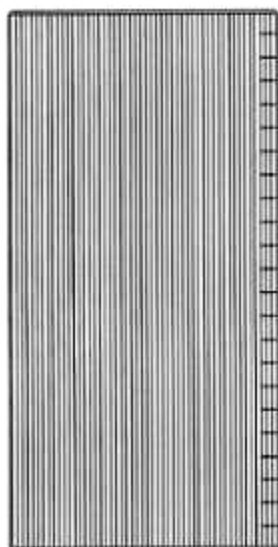

6.2



6.3

---

6.4

---

6.5

---

6.6

---

6.7

**CÔNG BÁO SỞ HỮU CÔNG NGHIỆP SỐ 418 TẬP A – QUYỀN 2 (01.2023)**

- (11) **46235**
- (21) 3-2022-01110 (28) 3
- (54) **PIN MẶT TRỜI** (51) **13-99**
- (22) 08/06/2022 (43) 27/01/2023
- (30) 008790414 08/12/2021 EM;
- (73) **REC SOLAR PTE. LTD.** (SG)  
20 Tuas South Avenue 14, Singapore 637312, Singapore
- (72) Kenta Nakayashiki (JP)
- (74) Công ty TNHH Tầm nhìn và Liên danh (VISION & ASSOCIATES CO.LTD.)
- (55)



1.1

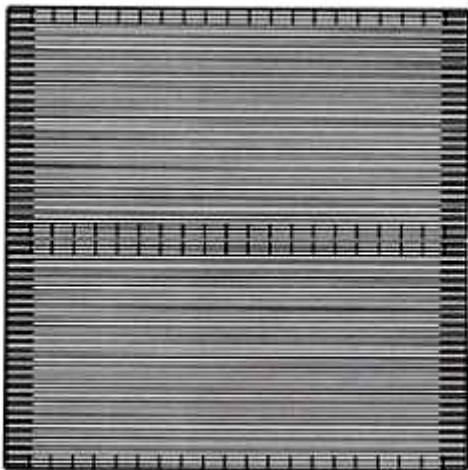

1.2

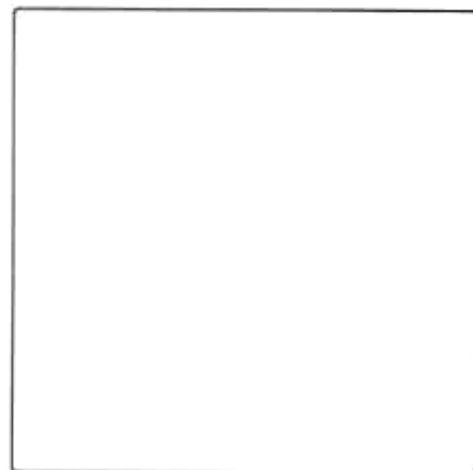

1.3



1.4



1.5



1.6



1.7



2.1

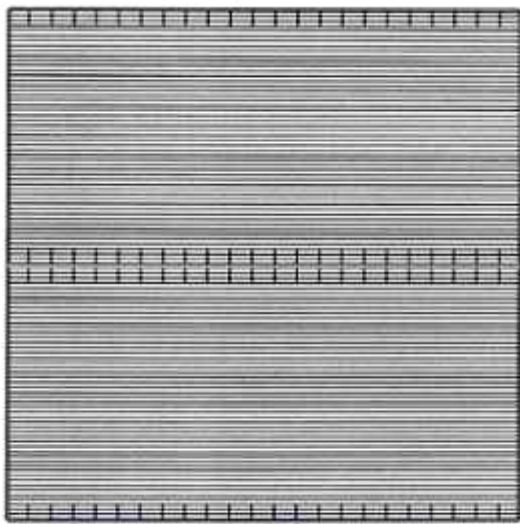

2.2

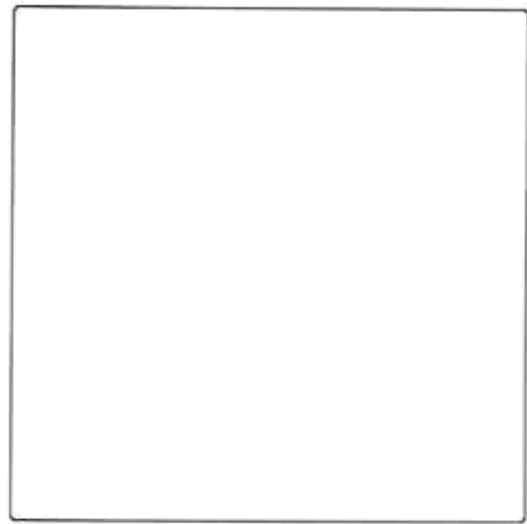

2.3



2.4



2.5



2.6



2.7



3.1

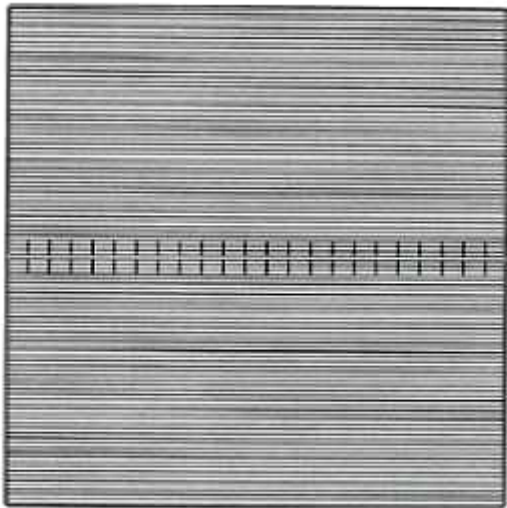

3.2

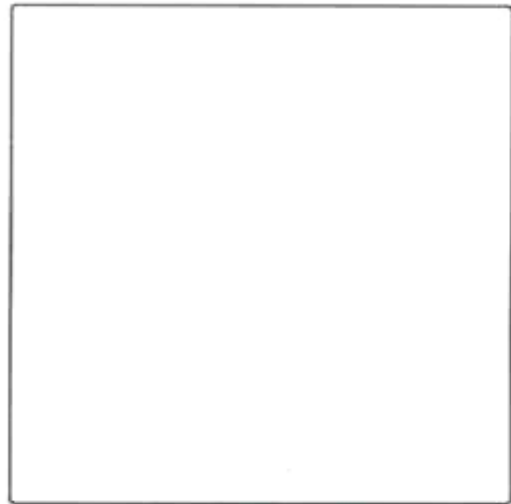

3.3



3.4



3.5



3.6



3.7

**CÔNG BÁO SỞ HỮU CÔNG NGHIỆP SỐ 418 TẬP A – QUYỀN 2 (01.2023)**

- (11) **46236**
- (21) 3-2022-01111 (28) 4
- (54) **PIN MẶT TRỜI** (51) **13-99**
- (22) 08/06/2022 (43) 27/01/2023
- (30) 008790414 08/12/2021 EM;
- (73) **REC SOLAR PTE. LTD.** (SG)  
20 Tuas South Avenue 14, Singapore 637312, Singapore
- (72) Kenta Nakayashiki (JP)
- (74) Công ty TNHH Tầm nhìn và Liên danh (VISION & ASSOCIATES CO.LTD.)
- (55)



1.1



1.2

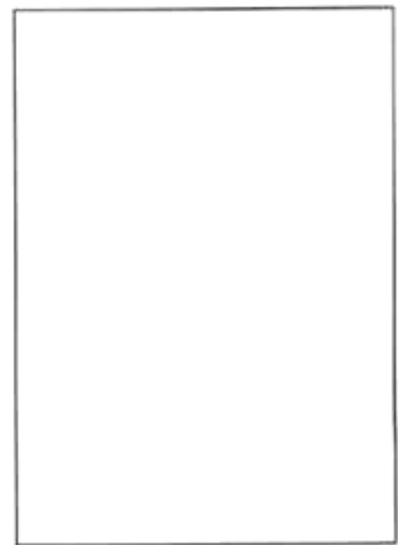

1.3



1.4



1.5



1.6



1.7



2.1

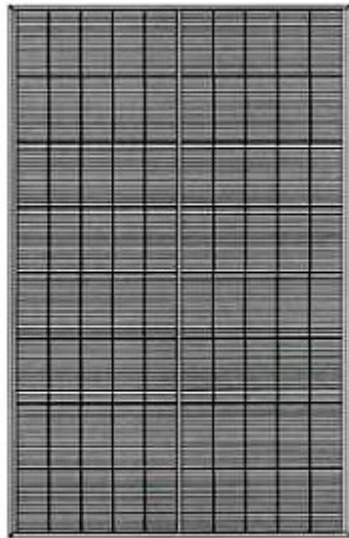

2.2



2.3



2.4



2.5



2.6



2.7



3.1

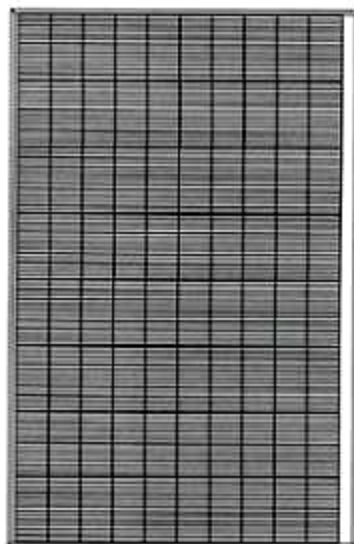

3.2



3.3



---

3.4

---

3.5

---

3.6

---

3.7



4.1

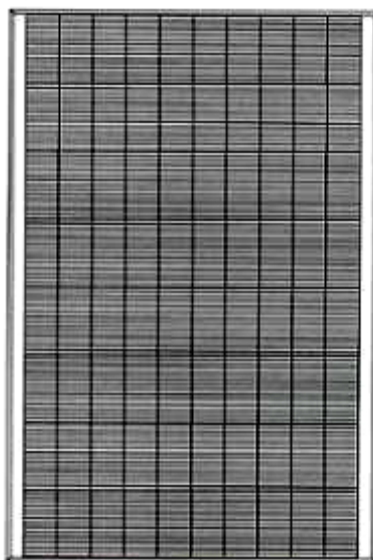

4.2

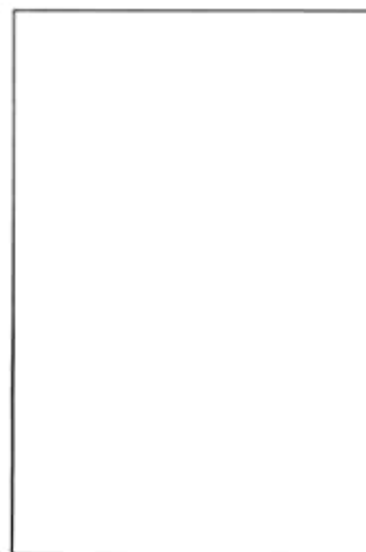

4.3

---

4.4

---

4.5

---

4.6

---

4.7

**CÔNG BÁO SỞ HỮU CÔNG NGHIỆP SỐ 418 TẬP A – QUYỀN 2 (01.2023)**

- (11) **46237**  
(21) 3-2022-01112 (28) 4  
(54) **PIN MẶT TRỜI** (51) **13-99**  
(22) 08/06/2022 (43) 27/01/2023  
(30) 008790414 08/12/2021 EM;  
(73) **REC SOLAR PTE. LTD.** (SG)  
20 Tuas South Avenue 14, Singapore 637312, Singapore  
(72) Kenta Nakayashiki (JP)  
(74) Công ty TNHH Tầm nhìn và Liên danh (VISION & ASSOCIATES CO.LTD.)  
(55)

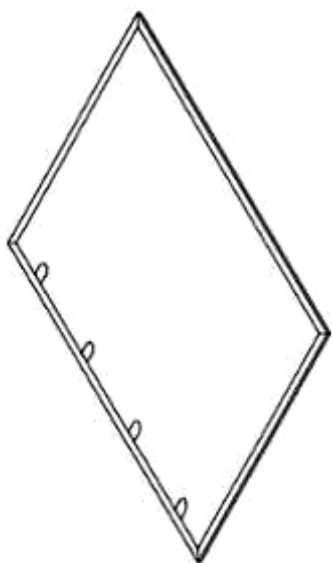

1.1

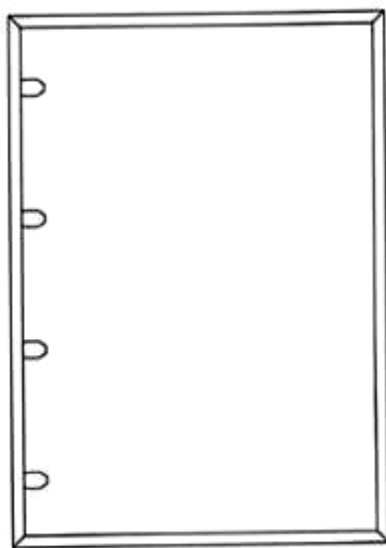

1.2



1.3



1.4



1.5



1.6



1.7

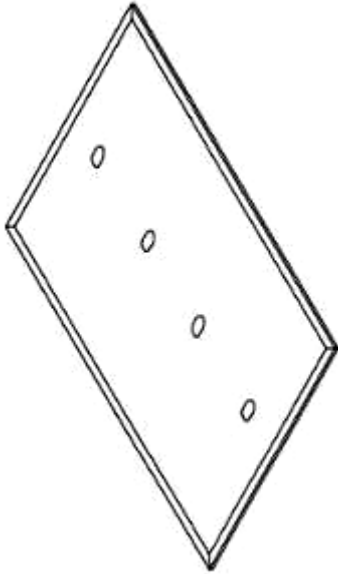

2.1

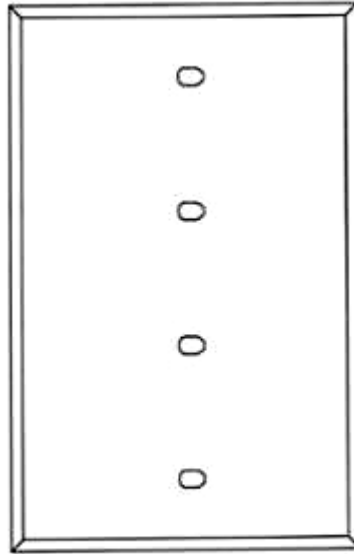

2.2

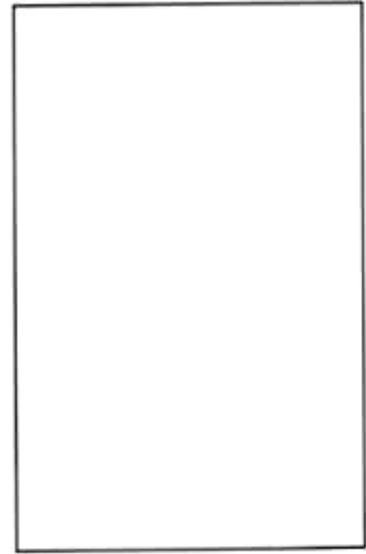

2.3



2.4



2.5



2.6

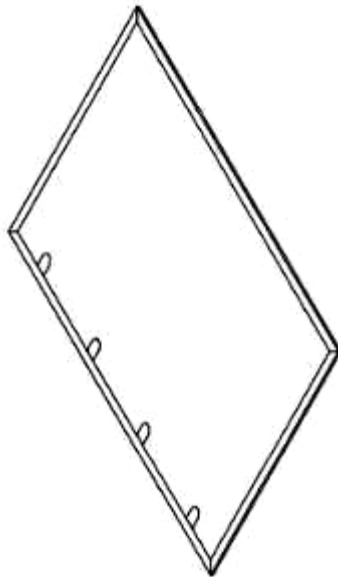

3.1

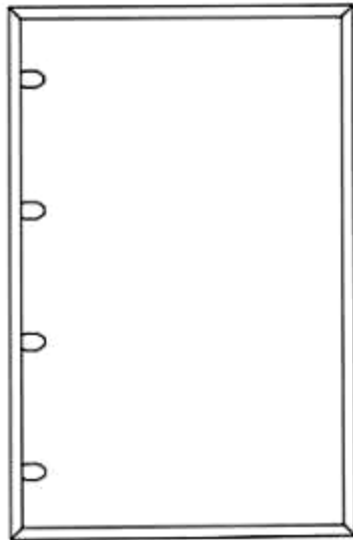

3.2

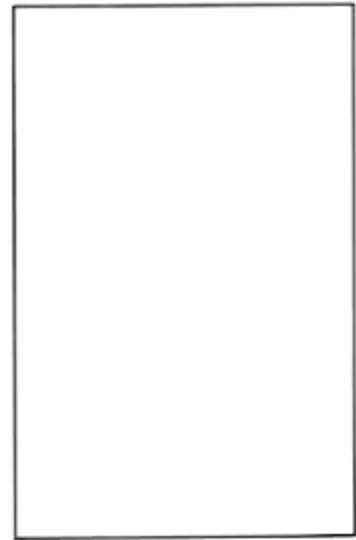

3.3



3.4



3.5

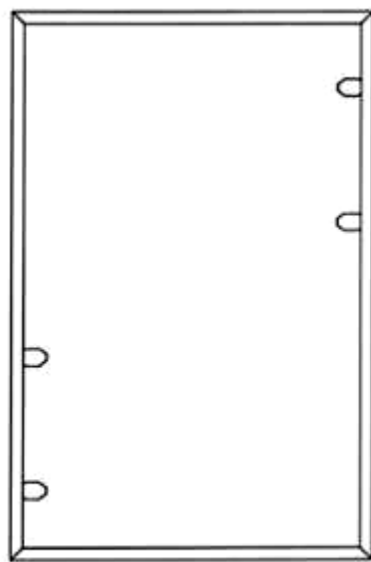
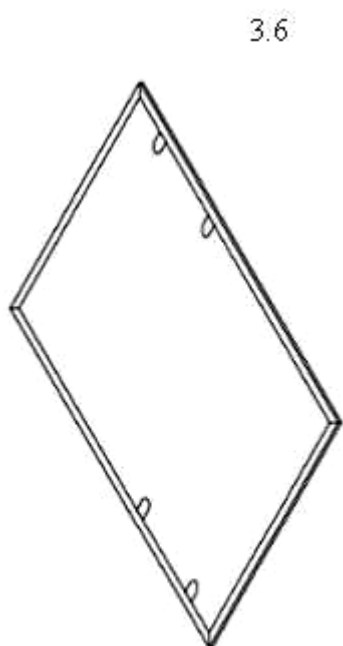

4.4



4.5



4.6

4.7

- (11) **46238**  
(21) 3-2022-01131 (28) 1  
(54) **ĐỒ CHƠI NHỒI BÔNG** (51) **21-01**  
(22) 09/06/2022 (43) 27/01/2023  
(73) **CÔNG TY TNHH SYBSY (VN)**  
18bis/22 Nguyễn Thị Minh Khai, phường Đa Kao, quận 1, thành phố Hồ Chí Minh  
(72) Nguyễn Thị Thu Hòa (VN)  
(55)



1.1

1.2

1.3

1.4

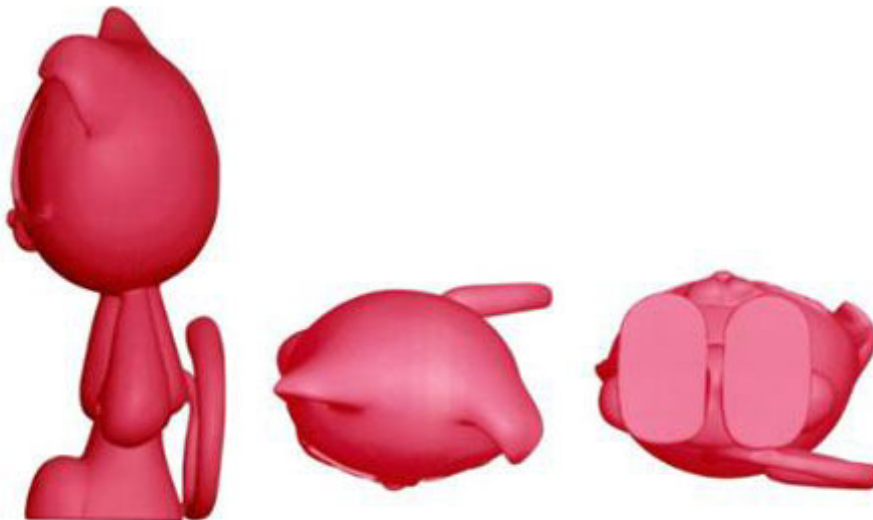

1.5

1.6

1.7

**CÔNG BÁO SỞ HỮU CÔNG NGHIỆP SỐ 418 TẬP A – QUYỀN 2 (01.2023)**

- (11) **46239**  
(21) 3-2022-01195 (28) 1  
(54) **TỦ LẠNH** (51) **15-07**  
(22) 17/06/2022 (43) 27/01/2023  
(30) 2021-028480 24/12/2021 JP;  
(73) **MITSUBISHI ELECTRIC CORPORATION (JP)**  
7-3, Marunouchi 2-chome, Chiyoda-ku, Tokyo 100-8310, Japan  
(72) 1. MARIKO TOBITA (JP)  
2. ALESSANDRO DADONE (IT)  
3. TAKANORI HIKIMA (JP)  
(74) Công ty TNHH Tầm nhìn và Liên danh (VISION & ASSOCIATES CO.LTD.)  
(55)

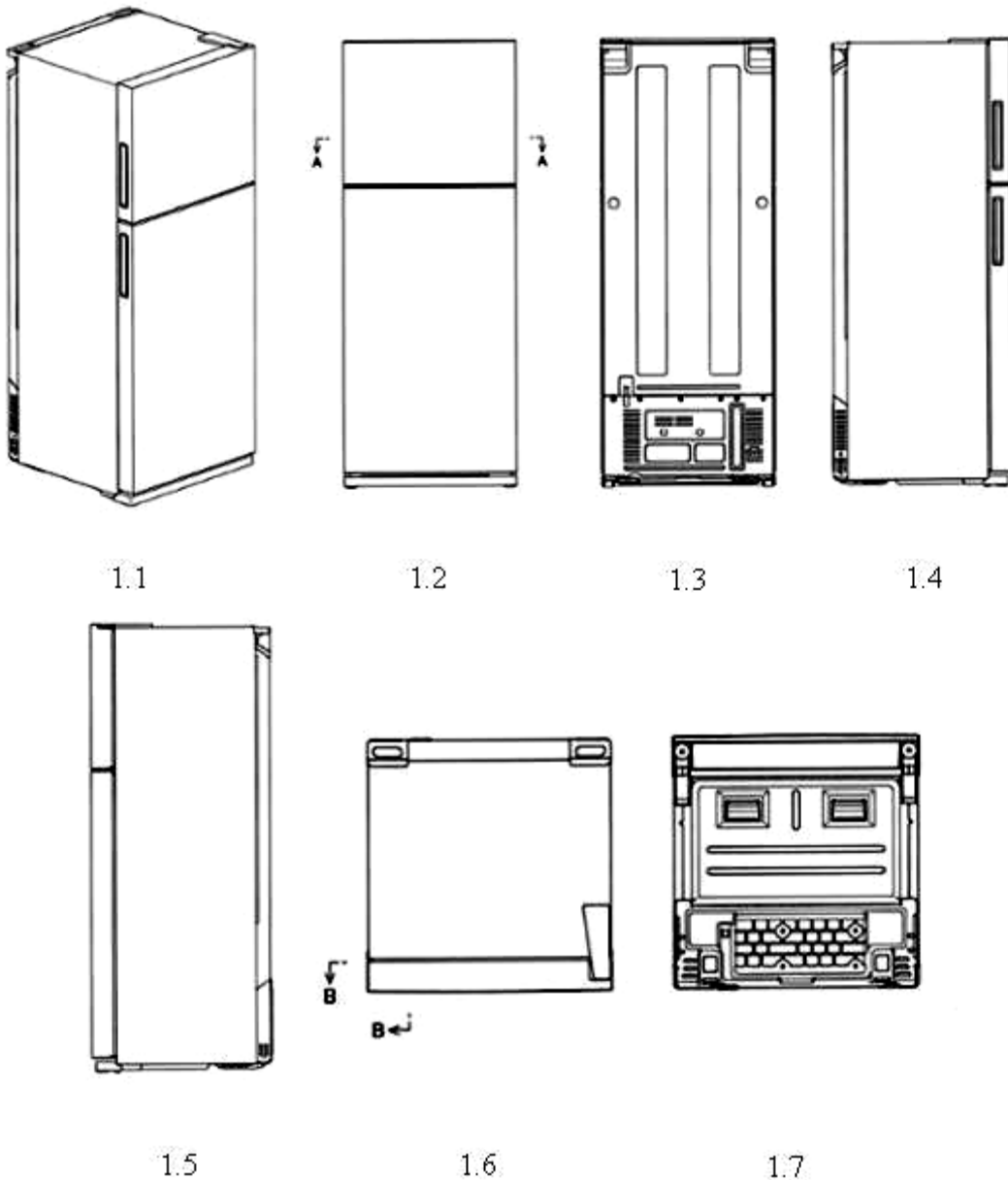

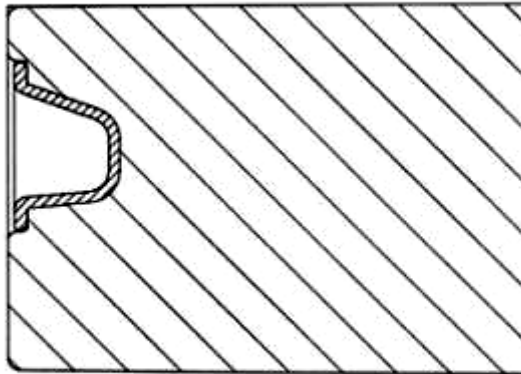

1.8

- (11) **46240**  
(21) 3-2022-01269 (28) 1  
(54) **MÁY NGHIÊN THỦY TINH** (51) **15-99**  
(22) 27/06/2022 (43) 27/01/2023  
(30) 30-2022-0001232 11/01/2022 KR;  
(73) **SCHAFFENGOTT CO. LTD (KR)**  
1203ho, 102dong, 28, Centum 1-ro, Haeundae-gu, Busan 48060, Republic of Korea  
(72) KWON, Ik Hwan (KR)  
(74) Công ty TNHH Trà và cộng sự (TRA & ASSOCIATES CO.,LTD)  
(55)

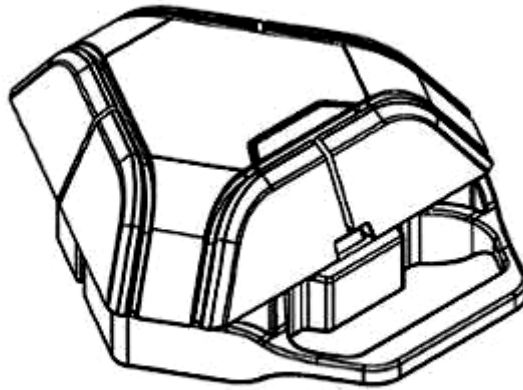

1.1

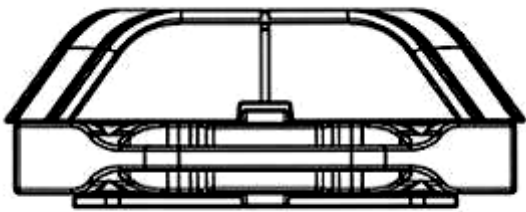

1.2

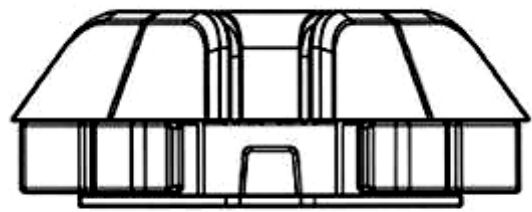

1.3

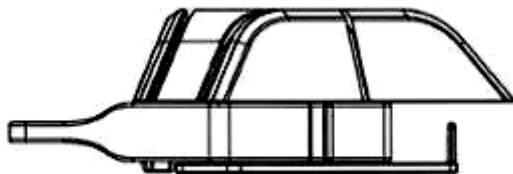

1.4



1.5



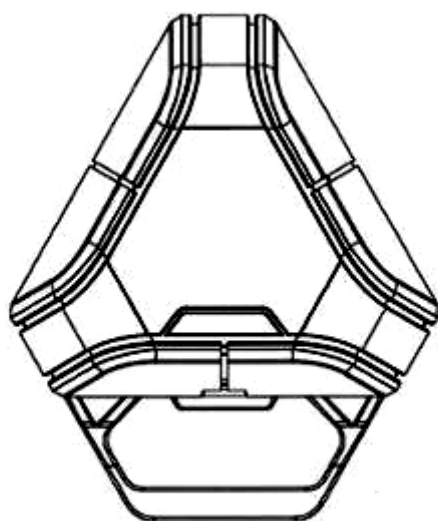

1.6

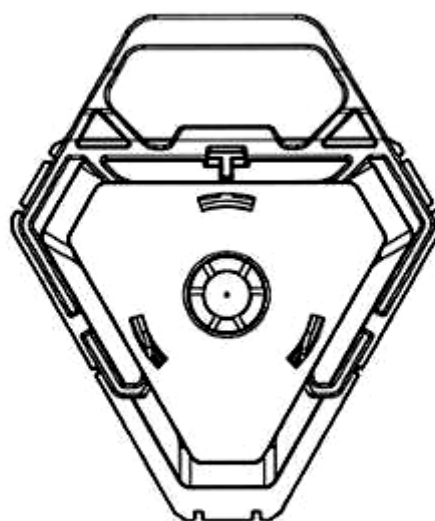

1.7

**CÔNG BÁO SỞ HỮU CÔNG NGHIỆP SỐ 418 TẬP A – QUYỂN 2 (01.2023)**

(11) **46241**

(21) 3-2022-01385

(28) 1

(54) **HỆ THỐNG XỬ LÝ NƯỚC UỐNG**

(51) **23-01**

(22) 12/07/2022

(43) 27/01/2023

(73) **CÔNG TY TNHH MÁY LỌC NƯỚC TRƯỜNG TIỀN (VN)**

31 đường Lâm Văn Bền, phường Tân Thuận Tây, quận 7, thành phố Hồ Chí Minh

(72) Nguyễn Hoàng Minh (VN)

(55)



1.1



1.2



1.3



1.4



1.5



1.6



1.7

**CÔNG BÁO SỞ HỮU CÔNG NGHIỆP SỐ 418 TẬP A – QUYỀN 2 (01.2023)**

- (11) **46242**
- (21) 3-2022-01464 (28) 2
- (54) **BỘ ĐỊNH TUYẾN KHÔNG DÂY** (51) **14-02; 14-03**
- (22) 22/07/2022 (43) 27/01/2023
- (73) **GOOGLE LLC (US)**  
1600 Amphitheatre Parkway, Mountain View, California 94043, United States of America
- (72) 1. PHAN THAO BENNO DANG (DE)  
2. HAE RIM JEONG (KR)  
3. VICKI HUICHI CHUANG (US)  
4. SHAO WEI HUANG (TW)  
5. MAJ ISABELLE OLSSON (SE)  
6. KATHERINE MORGENROTH (US)
- (74) Công ty Luật TNHH ROUSE Việt Nam (ROUSE LAW CO.,LTD)
- (55)



1.1



1.2

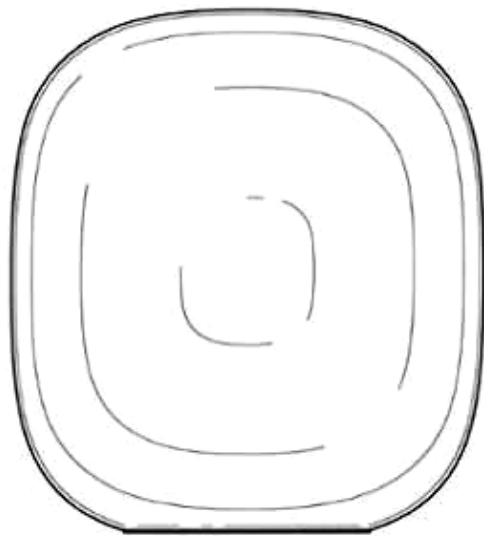

1.3

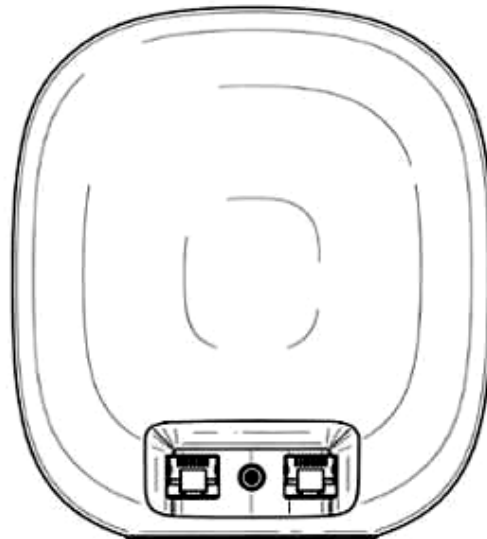

1.4

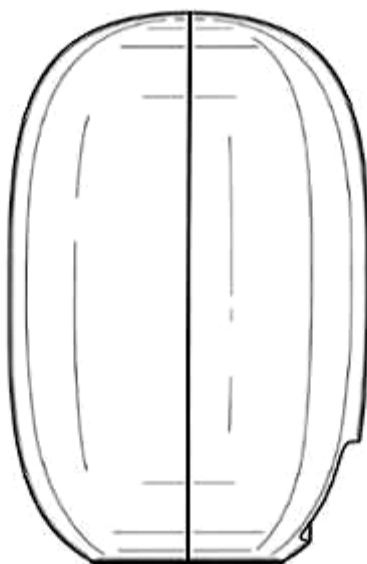

1.5

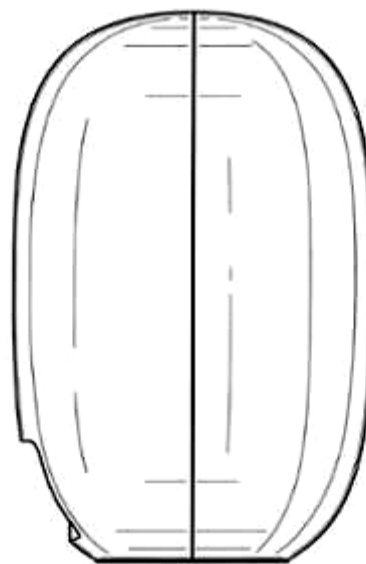

1.6

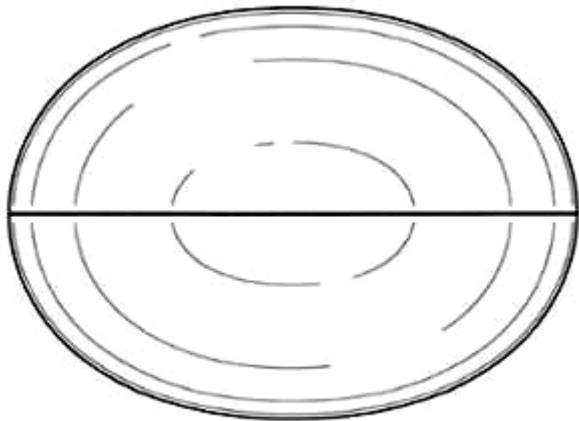

1.7

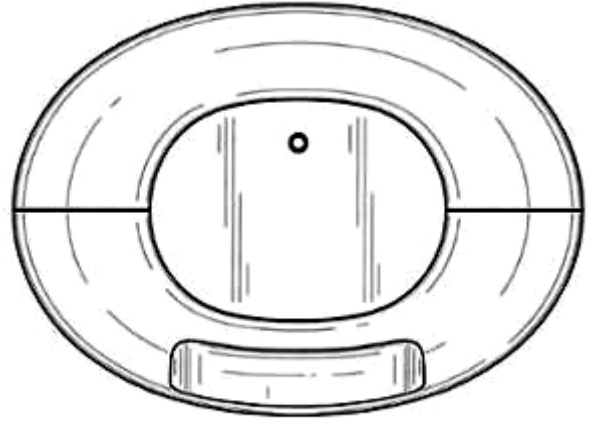

1.8



2.1



2.2



2.3



2.4



2.5

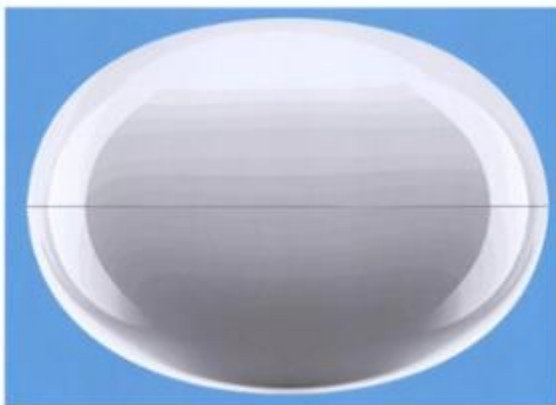

2.6



2.7

**CÔNG BÁO SỞ HỮU CÔNG NGHIỆP SỐ 418 TẬP A – QUYỀN 2 (01.2023)**

- (11) **46243**  
(21) 3-2022-01480 (28) 1  
(54) **XE MÁY** (51) **12-11**  
(22) 25/07/2022 (43) 27/01/2023  
(30) 2022-001267 25/01/2022 JP;  
(73) **YAMAHA HATSUDOKI KABUSHIKI KAISHA (JP)**  
2500 Shingai, Iwata-shi, Shizuoka-ken 438-8501, Japan  
(72) Zong-You Tsai (TW)  
(74) Công ty TNHH Tư vấn - Đầu tư N.T.K. (N.T.K. CO., LTD.)  
(55)



1.1



1.2



1.3



1.4



1.5



1.6



1.7



1.8



1.9



**CÔNG BÁO SỞ HỮU CÔNG NGHIỆP SỐ 418 TẬP A – QUYỀN 2 (01.2023)**

(11) **46244**

(21) 3-2022-01497

(28) 1

(54) **MÁY RỬA QUẶNG**

(51) **15-99**

(22) 26/07/2022

(43) 27/01/2023

(73) **VIỆN KHOA HỌC CÔNG NGHỆ MỎ - VINACOMIN (VN)**

Số 3, phố Phan Đình Giót, phường Phương Liệt, quận Thanh Xuân, thành phố Hà Nội

(72) 1. TRẦN NGÔ HUẤN (VN)

2. ĐOÀN NGỌC CẢNH (VN)

3. ĐÀO VĂN OAI (VN)

(55)

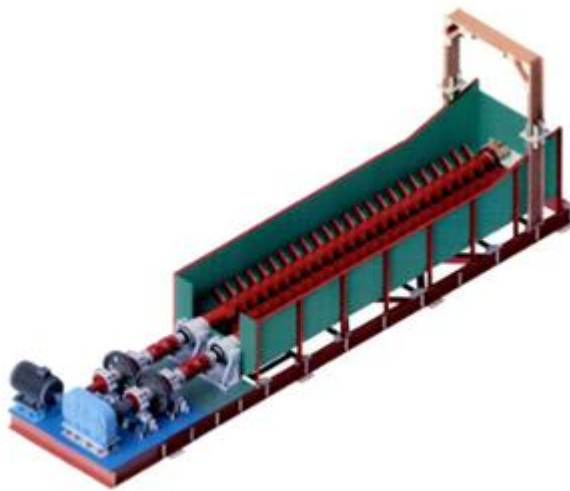

1.1



1.2

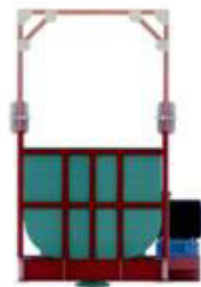

1.3



1.4



1.5

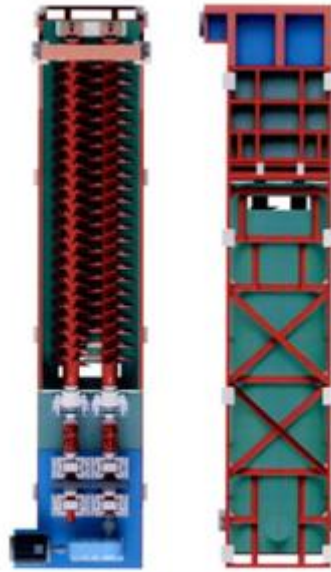

1.6

1.7

**CÔNG BÁO SỞ HỮU CÔNG NGHIỆP SỐ 418 TẬP A – QUYỀN 2 (01.2023)**

- (11) **46245**  
(21) 3-2022-01500 (28) 1  
(54) **THANH NHÔM ĐỊNH HÌNH** (51) **25-01**  
(22) 26/07/2022 (43) 27/01/2023  
(73) **CÔNG TY CỔ PHẦN ALU VIỆT (VN)**  
Số nhà 20, ngách 131/20, ngõ 131, thôn 4, xã Cát Quế, huyện Hoài Đức, thành phố Hà Nội  
(72) Lê Đức Chung (VN)  
(74) **CÔNG TY TNHH SỞ HỮU TRÍ TUỆ ANLIS VIỆT NAM (ANLIS IP CO.,LTD)**  
(55)



1.1

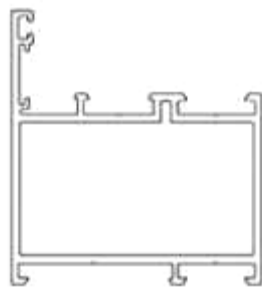

1.2



1.3



1.4

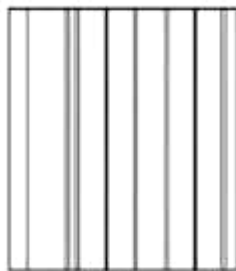

1.5

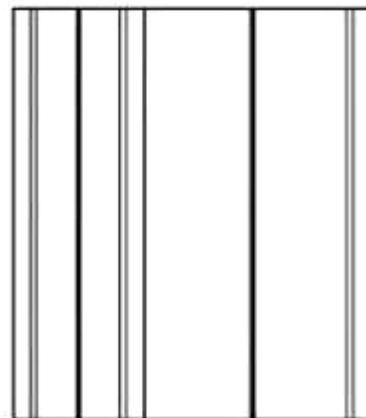

1.6

**CÔNG BÁO SỞ HỮU CÔNG NGHIỆP SỐ 418 TẬP A – QUYỀN 2 (01.2023)**

- (11) **46246**  
(21) 3-2022-01501 (28) 1  
(54) **THANH NHÔM ĐỊNH HÌNH** (51) **25-01**  
(22) 26/07/2022 (43) 27/01/2023  
(73) **CÔNG TY CỔ PHẦN ALU VIỆT (VN)**  
Số nhà 20, ngách 131/20, ngõ 131, thôn 4, xã Cát Quế, huyện Hoài Đức, thành phố Hà Nội  
(72) Lê Đức Chung (VN)  
(74) **CÔNG TY TNHH SỞ HỮU TRÍ TUỆ ANLIS VIỆT NAM (ANLIS IP CO.,LTD)**  
(55)

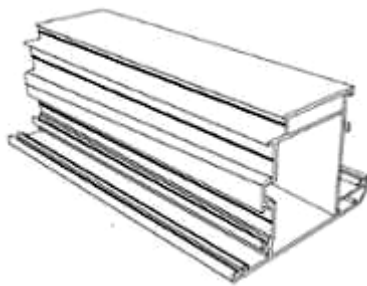

1.1

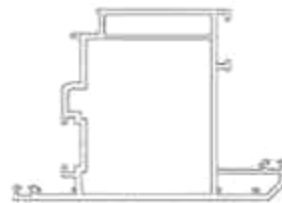

1.2



1.3

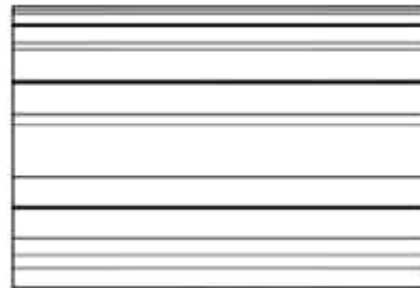

1.4

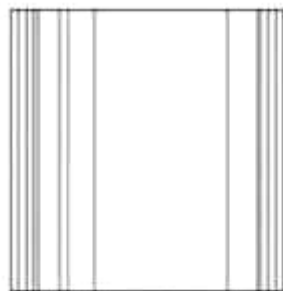

1.5



1.6

**CÔNG BÁO SỞ HỮU CÔNG NGHIỆP SỐ 418 TẬP A – QUYỀN 2 (01.2023)**

- (11) **46247**  
(21) 3-2022-01596 (28) 1  
(54) **THANH NHÔM ĐỊNH HÌNH** (51) **25-01**  
(22) 09/08/2022 (43) 27/01/2023  
(73) **CÔNG TY TNHH HOPO QUỐC TẾ (VN)**  
Số nhà 177, tổ 5, đường Nguyễn Ngọc Vũ, phường Trung Hoà, quận Cầu Giấy,  
thành phố Hà Nội  
(72) Châu Đình An (VN)  
(74) Công ty cổ phần Sở hữu trí tuệ BROSS và Cộng sự (BROSS & PARTNERS., JSC)  
(55)



1.1



1.2



1.3



1.4



1.5



1.6



1.7

**CÔNG BÁO SỞ HỮU CÔNG NGHIỆP SỐ 418 TẬP A – QUYỀN 2 (01.2023)**

- (11) **46248**  
(21) 3-2022-01597 (28) 1  
(54) **THANH NHÔM ĐỊNH HÌNH** (51) **25-01**  
(22) 09/08/2022 (43) 27/01/2023  
(73) **CÔNG TY TNHH HOPO QUỐC TẾ (VN)**  
Số nhà 177, tổ 5, đường Nguyễn Ngọc Vũ, phường Trung Hoà, quận Cầu Giấy,  
thành phố Hà Nội  
(72) Châu Đình An (VN)  
(74) Công ty cổ phần Sở hữu trí tuệ BROSS và Cộng sự (BROSS & PARTNERS., JSC)  
(55)

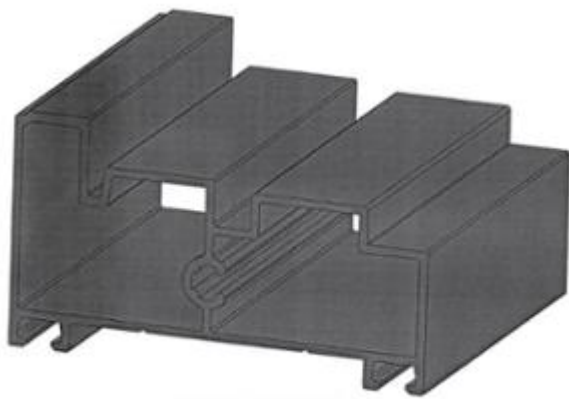

1.1

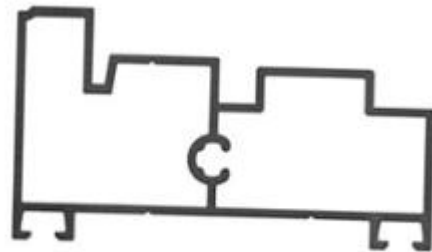

1.2

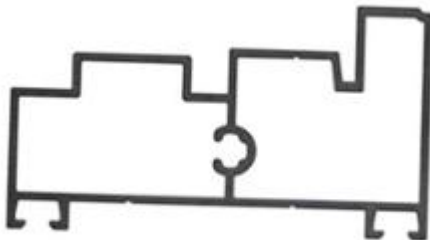

1.3



1.4



1.5



1.6



1.7

- (11) **46249**  
(21) 3-2022-01605 (28) 1  
(54) **ĐỒ KHUNG CỬA** (51) **25-01**  
(22) 10/08/2022 (43) 27/01/2023  
(73) **CÔNG TY CỔ PHẦN SẢN XUẤT VÀ ĐẦU TƯ HÙNG PHÁT (VN)**  
Tổ dân phố Thịnh Vạn, phường Minh Đức, thị xã Mỹ Hào, tỉnh Hưng Yên  
(72) Nguyễn Văn Tâm (VN)  
(74) Công ty TNHH Sở hữu trí tuệ Gia Việt (GIAVIET CO., LTD.)  
(55)

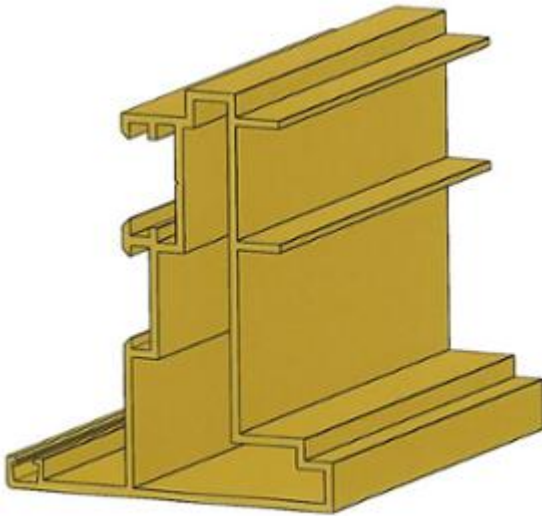

1.1

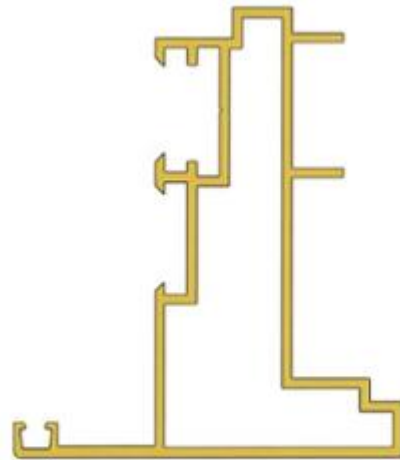

1.2



1.3



1.4



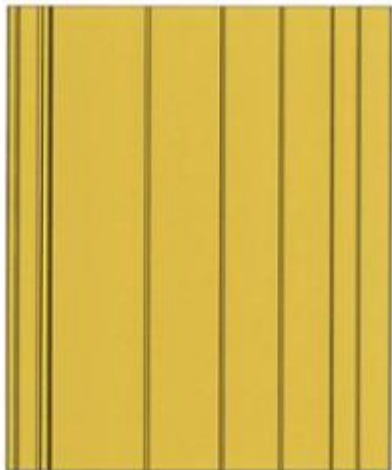

1.5



1.6

**CÔNG BÁO SỞ HỮU CÔNG NGHIỆP SỐ 418 TẬP A – QUYỀN 2 (01.2023)**

- (11) **46250**  
(21) 3-2022-01606 (28) 1  
(54) **ĐỒ KHUNG CỬA** (51) **25-01**  
(22) 10/08/2022 (43) 27/01/2023  
(73) **CÔNG TY CỔ PHẦN SẢN XUẤT VÀ ĐẦU TƯ HÙNG PHÁT (VN)**  
Tổ dân phố Thịnh Vạn, phường Minh Đức, thị xã Mỹ Hào, tỉnh Hưng Yên  
(72) Nguyễn Văn Tâm (VN)  
(74) Công ty TNHH Sở hữu trí tuệ Gia Việt (GIAVIET CO., LTD.)  
(55)

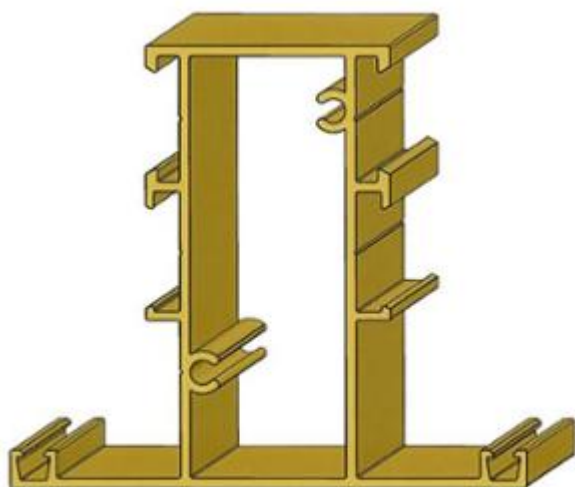

1.1

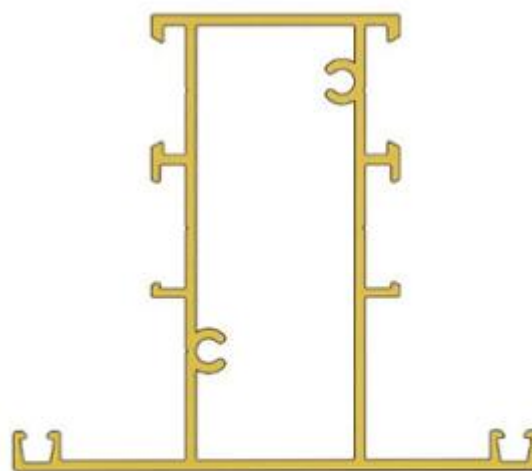

1.2



1.3

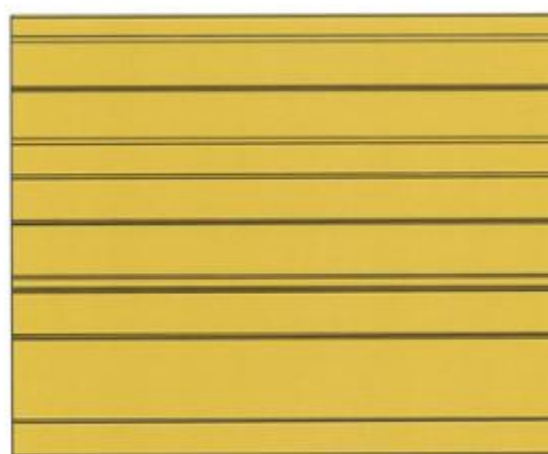

1.4

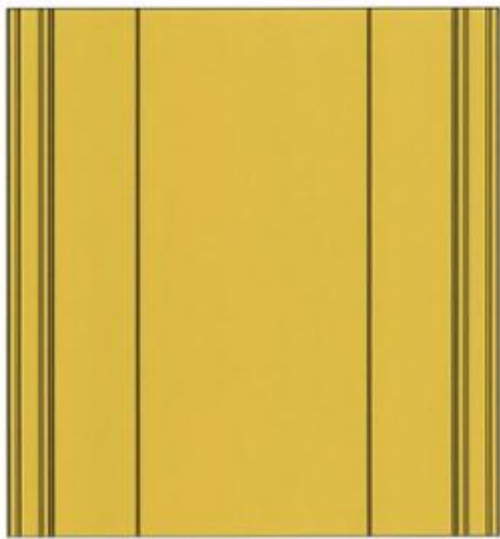

1.5



1.6

**CÔNG BÁO SỞ HỮU CÔNG NGHIỆP SỐ 418 TẬP A – QUYỀN 2 (01.2023)**

- (11) **46251**  
(21) 3-2022-01607 (28) 1  
(54) **ĐỒ KHUNG CỬA** (51) **25-01**  
(22) 10/08/2022 (43) 27/01/2023  
(73) **CÔNG TY CỔ PHẦN SẢN XUẤT VÀ ĐẦU TƯ HÙNG PHÁT (VN)**  
Tổ dân phố Thịnh Vạn, phường Minh Đức, thị xã Mỹ Hào, tỉnh Hưng Yên  
(72) Nguyễn Văn Tâm (VN)  
(74) Công ty TNHH Sở hữu trí tuệ Gia Việt (GIAVIET CO., LTD.)  
(55)

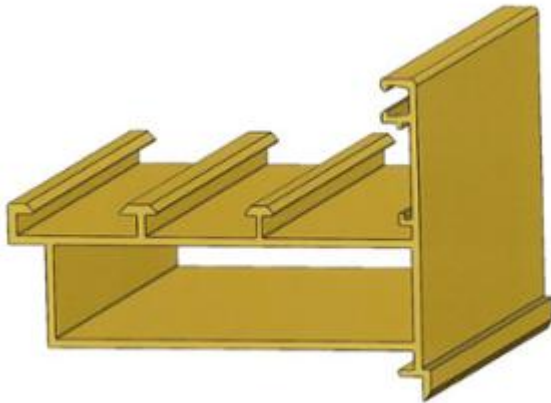

1.1

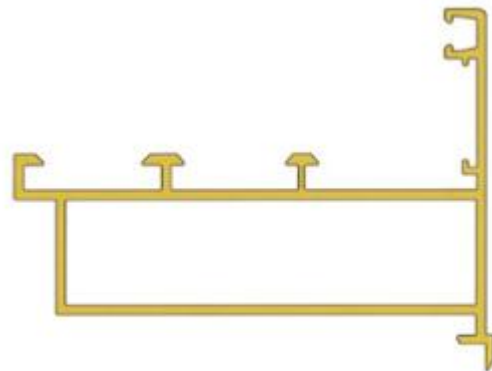

1.2



1.3



1.4

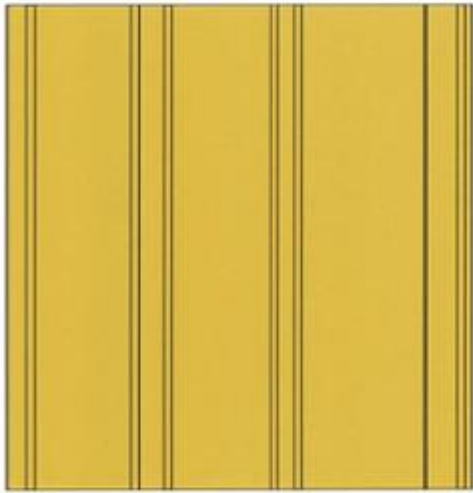

1.5



1.6

**CÔNG BÁO SỞ HỮU CÔNG NGHIỆP SỐ 418 TẬP A – QUYỀN 2 (01.2023)**

- (11) **46252**  
(21) 3-2022-01608 (28) 1  
(54) **NGŨƠNG KHUNG CỬA** (51) **25-01**  
(22) 10/08/2022 (43) 27/01/2023  
(73) **CÔNG TY CỔ PHẦN SẢN XUẤT VÀ ĐẦU TƯ HÙNG PHÁT (VN)**  
Tổ dân phố Thịnh Vạn, phường Minh Đức, thị xã Mỹ Hào, tỉnh Hưng Yên  
(72) Nguyễn Văn Tâm (VN)  
(74) Công ty TNHH Sở hữu trí tuệ Gia Việt (GIAVIET CO., LTD.)  
(55)



1.1

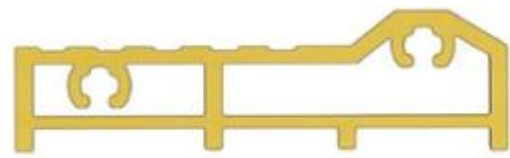

1.2



1.3



1.4

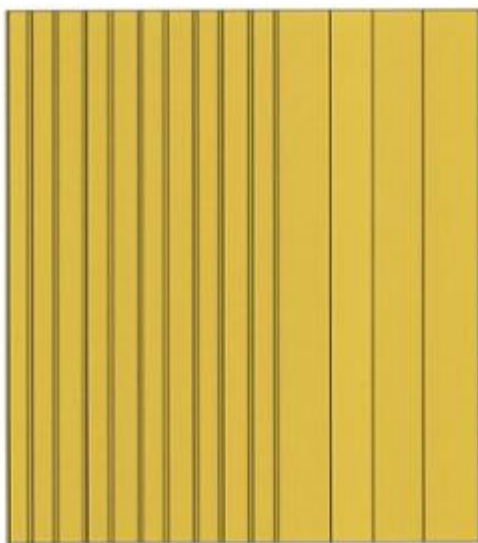

1.5

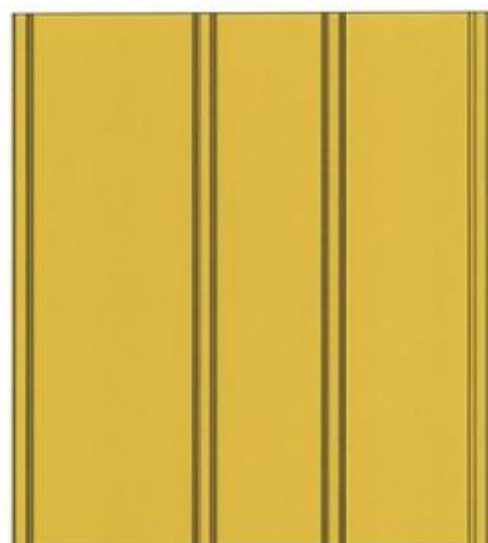

1.6

**CÔNG BÁO SỞ HỮU CÔNG NGHIỆP SỐ 418 TẬP A – QUYỀN 2 (01.2023)**

- (11) **46253**  
(21) 3-2022-01626 (28) 2  
(54) **Ô TÔ** (51) **12-08**  
(22) 10/08/2022 (43) 27/01/2023  
(30) 2022-002757 15/02/2022 JP; 2022-002756 15/02/2022 JP;  
(73) **TOYOTA JIDOSHA KABUSHIKI KAISHA (JP)**  
1, Toyota-cho, Toyota-shi, Aichi-ken, 471-8571 JAPAN  
(72) 1. NOZOMI HIRAI (JP)  
2. KAZUHIRO SATO (JP)  
3. YUKI ISOGAI (JP)  
4. STEPHAN JUBT RASMUSSEN (DE)  
5. SATOSHI KIMURA (JP)  
6. YO MATSUHASHI (JP)  
(74) Công ty TNHH một thành viên Sở hữu trí tuệ VCCI (VCCI-IP CO.,LTD)  
(55)



1.1



1.2



1.3



1.4



1.5



1.6



1.7



1.8



1.9



2.1



2.2



2.3



2.4



2.5



2.6



2.7



**CÔNG BÁO SỞ HỮU CÔNG NGHIỆP SỐ 418 TẬP A – QUYỀN 2 (01.2023)**

- (11) **46254**  
(21) 3-2022-01651 (28) 1  
(54) **TAI NGHE** (51) **14-01**  
(22) 12/08/2022 (43) 27/01/2023  
(30) 29/827,361 18/02/2022 US;  
(73) **BOSE CORPORATION (US)**  
The Mountain, Framingham, Massachusetts 01701-9168, United States of America  
(72) 1. JOSHUA KEVIN DRYDEN (US)  
2. NATHAN DAVID SCHAAL (US)  
3. PAUL C. WILLIAMSON (US)  
4. DAVID J. FUSTINO (US)  
5. ADAM A. CARR (US)  
(74) Công ty Luật TNHH Phạm và Liên danh (PHAM & ASSOCIATES)  
(55)



1.1



1.2



1.3

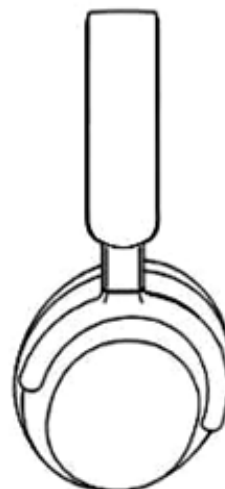

1.4

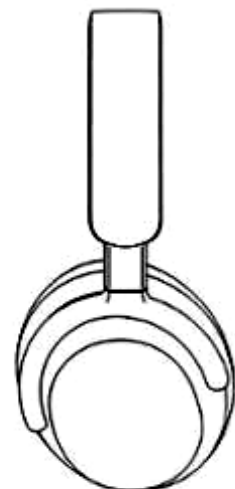

1.5

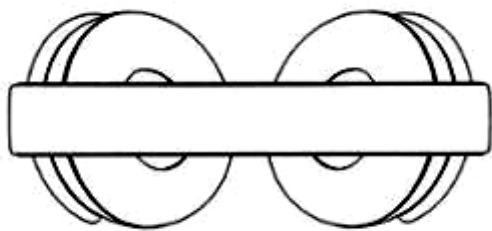

1.6

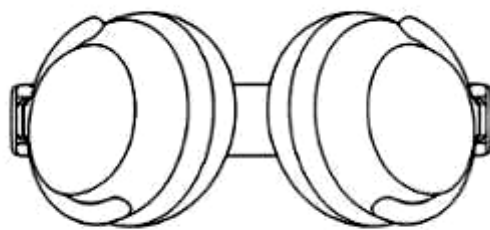

1.7

**CÔNG BÁO SỞ HỮU CÔNG NGHIỆP SỐ 418 TẬP A – QUYỀN 2 (01.2023)**

(11) **46255**

(21) 3-2022-01678

(28) 1

(54) **NỒI CƠM ĐIỆN**

(51) **07-02**

(22) 15/08/2022

(43) 27/01/2023

(73) **CÔNG TY CỔ PHẦN QUỐC TẾ SƠN HÀ (VN)**

Số 2 phố Thanh Lâm, phường Minh Khai, quận Bắc Từ Liêm, thành phố Hà Nội

(72) Lê Vĩnh Sơn (VN)

(74) Công ty TNHH Tư vấn IPNG (IPNG CO.,LTD)

(55)



Hình 1

1.1



Hình 2

1.2



Hình 3

1.3



Hình 4

1.4



Hình 5

1.5



Hình 6

1.6



Hình 7

1.7



Hình 8

1.8

**CÔNG BÁO SỞ HỮU CÔNG NGHIỆP SỐ 418 TẬP A – QUYỀN 2 (01.2023)**

(11) **46256**

(21) 3-2022-01691

(28) 1

(54) **BỒN CẦU**

(51) **23-02**

(22) 16/08/2022

(43) 27/01/2023

(73) **CÔNG TY CỔ PHẦN THƯƠNG MẠI VIGLACERA (VN)**

Tầng 3, tòa nhà Viglacera, số 1 Đại lộ Thăng Long, phường Mỹ Trì, quận Nam Từ Liêm, thành phố Hà Nội

(72) Mai Văn Thiêm (VN)

(55)



1.1



1.2



1.3



1.4



1.5



1.6

- (11) **46257**  
(21) 3-2022-01698 (28) 1  
(54) **Ô TÔ** (51) **12-08**  
(22) 16/08/2022 (43) 27/01/2023  
(30) DM/219174 16/02/2022 WO;  
(73) **FERRARI S.P.A. (IT)**  
Via Emilia Est 1163, MODENA, ITALY  
(72) Enrico CARDILE (IT)  
(74) Công ty TNHH một thành viên Sở hữu trí tuệ VCCI (VCCI-IP CO.,LTD)  
(55)

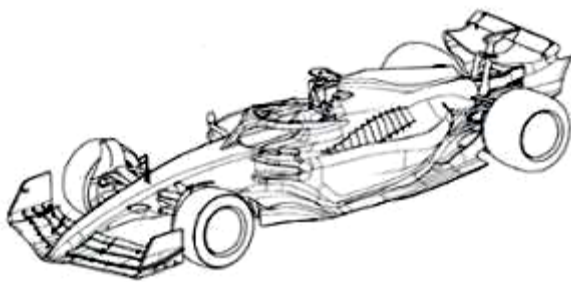

1.1

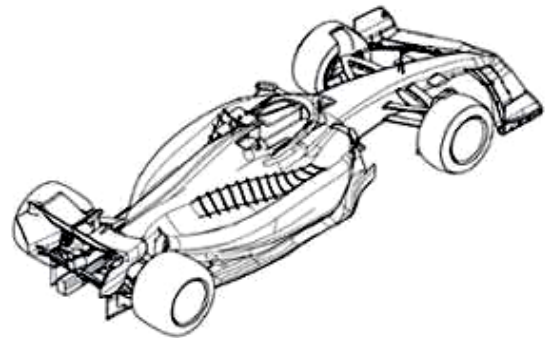

1.2

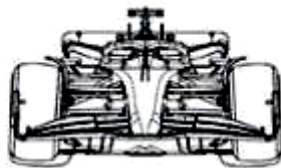

1.3

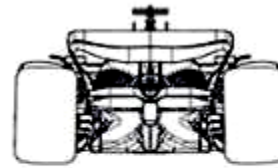

1.4

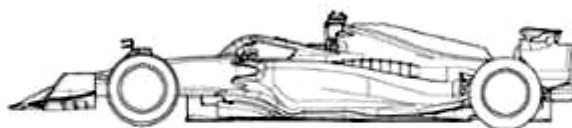

1.5

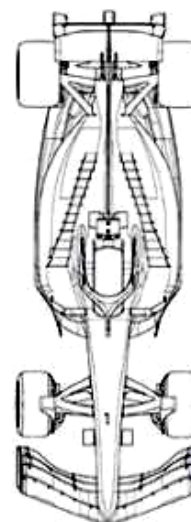

1.6

**CÔNG BÁO SỞ HỮU CÔNG NGHIỆP SỐ 418 TẬP A – QUYỀN 2 (01.2023)**

- (11) **46258**  
(21) 3-2022-01699 (28) 1  
(54) **Ô TÔ ĐỒ CHƠI** (51) **21-01**  
(22) 16/08/2022 (43) 27/01/2023  
(30) DM/219183 16/02/2022 WO;  
(73) **FERRARI S.P.A. (IT)**  
Via Emilia Est 1163, MODENA, ITALY  
(72) Enrico CARDILE (IT)  
(74) Công ty TNHH một thành viên Sở hữu trí tuệ VCCI (VCCI-IP CO.,LTD)  
(55)



1.1

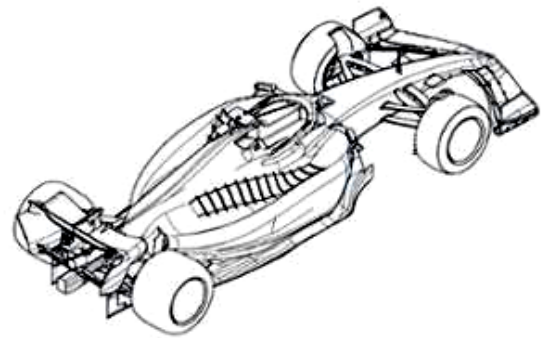

1.2

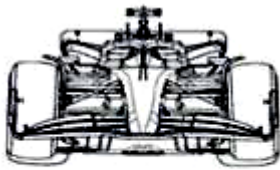

1.3

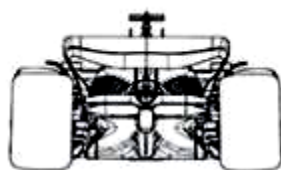

1.4



1.5

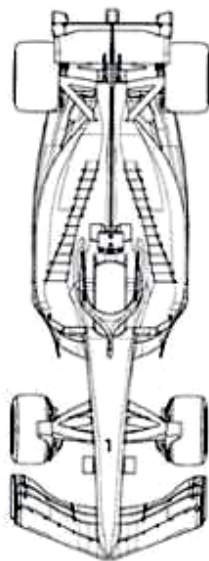

1.6



1.7

**CÔNG BÁO SỞ HỮU CÔNG NGHIỆP SỐ 418 TẬP A – QUYỀN 2 (01.2023)**

- (11) **46259**  
(21) 3-2022-01709 (28) 1  
(54) **Ô TÔ ĐỒ CHƠI** (51) **21-01**  
(22) 17/08/2022 (43) 27/01/2023  
(30) DM/219616 18/02/2022 WO;  
(73) **FERRARI S.P.A. (IT)**  
Via Emilia Est 1163, MODENA, ITALY  
(72) Flavio MANZONI (IT)  
(74) Công ty TNHH một thành viên Sở hữu trí tuệ VCCI (VCCI-IP CO.,LTD)  
(55)



1.1



1.2



1.3



1.4



1.5

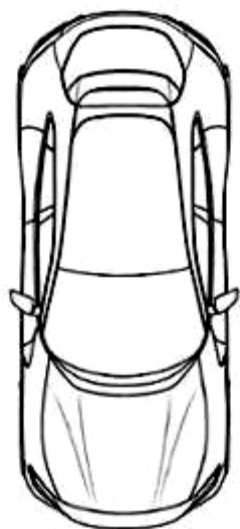

1.6

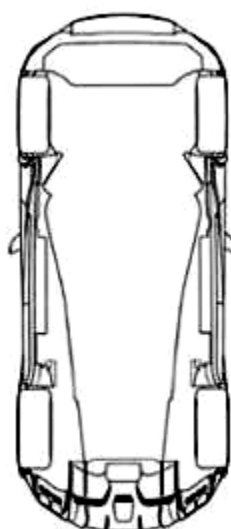

1.7



- (11) **46260**  
(21) 3-2022-01738 (28) 1  
(54) **DÉP** (51) **02-04**  
(22) 18/08/2022 (43) 27/01/2023  
(30) 29/827,338 18/02/2022 US;  
(73) **CROCS, INC. (US)**  
13601 Via Varra, Broomfield, Colorado 80020, United States of America  
(72) 1. ALEXANDER JACOB MAYHEW (US)  
2. JIE LIU (US)  
(74) Công ty Luật TNHH quốc tế BMVN (BMVN INTERNATIONAL LLC)  
(55)



1.1



1.2



1.3



1.4



1.5



1.6



1.7

- (11) **46261**  
(21) 3-2022-01739 (28) 1  
(54) **DÉP** (51) **02-04**  
(22) 18/08/2022 (43) 27/01/2023  
(30) 29/827,339 18/02/2022 US;  
(73) **CROCS, INC. (US)**  
13601 Via Varra, Broomfield, Colorado 80020, United States of America  
(72) 1. CATHERINE LAM (US)  
2. JIE LIU (US)  
(74) Công ty Luật TNHH quốc tế BMVN (BMVN INTERNATIONAL LLC)  
(55)



1.1



1.2



1.3



1.4



1.5



1.6



1.7

- (11) **46262**  
(21) 3-2022-01740 (28) 1  
(54) **DÉP** (51) **02-04**  
(22) 18/08/2022 (43) 27/01/2023  
(30) 29/827,344 18/02/2022 US;  
(73) **CROCS, INC. (US)**  
13601 Via Varra, Broomfield, Colorado 80020, United States of America  
(72) 1. CATHERINE LAM (US)  
2. FEDERICO FONGHER (IT)  
(74) Công ty Luật TNHH quốc tế BMVN (BMVN INTERNATIONAL LLC)  
(55)



1.1



1.2

1.3



1.4



1.5



1.6



1.7

**CÔNG BÁO SỞ HỮU CÔNG NGHIỆP SỐ 418 TẬP A – QUYỀN 2 (01.2023)**

- (11) **46263**
- (21) 3-2022-01741 (28) 1
- (54) **XE Ô TÔ** (51) **12-08**
- (22) 18/08/2022 (43) 27/01/2023
- (73) **GREAT WALL MOTOR COMPANY LIMITED (CN)**  
2266 Chaoyang South Street, Lianchi District, Baoding, Hebei, 071000, CHINA
- (72) 1. LI DONGLIANG (CN)  
2. WANG JIANWEI (CN)  
3. DI HAO (CN)  
4. SHI HANG (CN)  
5. WANG TIAN (CN)  
6. WU XINLI (CN)  
7. ZHANG HAN (CN)  
8. CHEN NAIHONG (CN)  
9. CHU QIANYUN (CN)
- (74) **CÔNG TY TRÁCH NHIỆM HỮU HẠN TƯ VẤN ĐẦU TƯ VÀ SỞ HỮU TRÍ TUỆ INTERFIVE (INTERFIVE CO., LTD)**
- (55)



1.1



1.2



1.3



1.4



1.5



1.6



H7

1.7

- (11) **46264**  
(21) 3-2022-01762 (28) 1  
(54) **DÉP** (51) **02-04**  
(22) 19/08/2022 (43) 27/01/2023  
(30) 29/827,734 22/02/2022 US;  
(73) **CROCS, INC. (US)**  
13601 Via Varra, Broomfield, Colorado 80020, United States of America  
(72) 1. FEDERICO FONGHER (IT)  
2. CATHERINE LAM (US)  
3. MICHAEL SARANTAKOS (US)  
(74) Công ty Luật TNHH quốc tế BMVN (BMVN INTERNATIONAL LLC)  
(55)



1.1



1.2

1.3



1.4



1.5



1.6



1.7

**CÔNG BÁO SỞ HỮU CÔNG NGHIỆP SỐ 418 TẬP A – QUYỀN 2 (01.2023)**

- (11) **46265**  
(21) 3-2022-01764 (28) 1  
(54) **BÌNH NƯỚC NÓNG** (51) **23-03**  
(22) 22/08/2022 (43) 27/01/2023  
(73) **CÔNG TY CỔ PHẦN QUỐC TẾ SƠN HÀ (VN)**  
Số 2 phố Thanh Lâm, phường Minh Khai, quận Bắc Từ Liêm, thành phố Hà Nội  
(72) Lê Vĩnh Sơn (VN)  
(74) Công ty TNHH Tư vấn IPNG (IPNG CO.,LTD)  
(55)



1.1



1.2



1.3



1.4



1.5



1.6



1.7



**CÔNG BÁO SỞ HỮU CÔNG NGHIỆP SỐ 418 TẬP A – QUYỀN 2 (01.2023)**

- (11) **46266**  
(21) 3-2022-01765 (28) 1  
(54) **BÌNH NƯỚC NÓNG** (51) **23-03**  
(22) 22/08/2022 (43) 27/01/2023  
(73) **CÔNG TY CỔ PHẦN QUỐC TẾ SƠN HÀ (VN)**  
Số 2 phố Thanh Lâm, phường Minh Khai, quận Bắc Từ Liêm, thành phố Hà Nội  
(72) Lê Vĩnh Sơn (VN)  
(74) Công ty TNHH Tư vấn IPNG (IPNG CO.,LTD)  
(55)



Hình 1

1.1



Hình 2

1.2



Hình 3

1.3



Hình 4

1.4



Hình 5

1.5



Hình 6

1.6



Hình 7

1.7

- (11) **46267**  
(21) 3-2022-01771 (28) 1  
(54) **VÀNH BÁNH XE** (51) **12-16**  
(22) 22/08/2022 (43) 27/01/2023  
(30) DM/220503 22/02/2022 WO;  
(73) **FERRARI S.P.A (IT)**  
Via Emilia Est 1163, MODENA, ITALY  
(72) Flavio MANZONI (IT)  
(74) Công ty TNHH một thành viên Sở hữu trí tuệ VCCI (VCCI-IP CO.,LTD)  
(55)

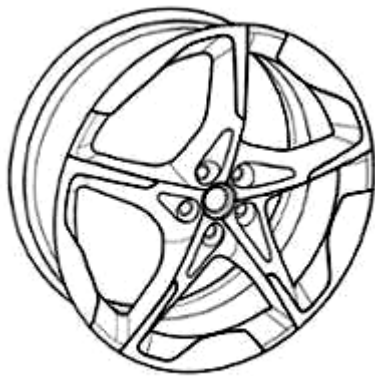

1.1

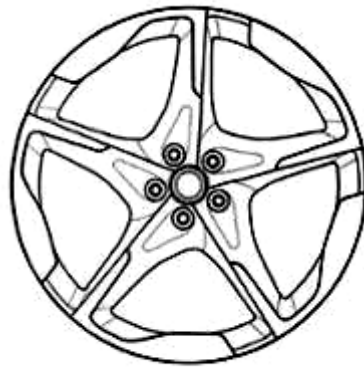

1.2



1.3



1.4



1.5

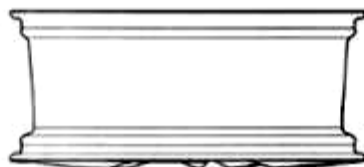

1.6

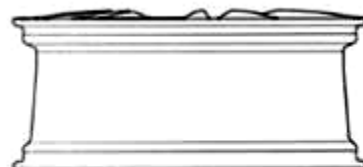

1.7

- (11) **46268**  
(21) 3-2022-01772 (28) 1  
(54) **VÀNH BÁNH XE** (51) **12-16**  
(22) 22/08/2022 (43) 27/01/2023  
(30) DM/220503 22/02/2022 WO;  
(73) **FERRARI S.P.A. (IT)**  
Via Emilia Est 1163, MODENA, ITALY  
(72) Flavio MANZONI (IT)  
(74) Công ty TNHH một thành viên Sở hữu trí tuệ VCCI (VCCI-IP CO.,LTD)  
(55)



1.1



1.2



1.3



1.4



1.5



1.6



1.7

**CÔNG BÁO SỞ HỮU CÔNG NGHIỆP SỐ 418 TẬP A – QUYỀN 2 (01.2023)**

- (11) **46269**  
(21) 3-2022-01776 (28) 1  
(54) **DÉP** (51) **02-04**  
(22) 22/08/2022 (43) 27/01/2023  
(30) 29/827,810 22/02/2022 US;  
(73) **CROCS, INC. (US)**  
13601 Via Varra, Broomfield, Colorado 80020, United States of America  
(72) Catherine LAM (US)  
(74) Công ty Luật TNHH quốc tế BMVN (BMVN INTERNATIONAL LLC)  
(55)



1.1



1.2



1.3



1.4



1.5



1.6



1.7

**CÔNG BÁO SỞ HỮU CÔNG NGHIỆP SỐ 418 TẬP A – QUYỀN 2 (01.2023)**

- (11) **46270**  
(21) 3-2022-01777 (28) 1  
(54) **DÉP** (51) **02-04**  
(22) 22/08/2022 (43) 27/01/2023  
(30) 29/827,812 22/02/2022 US;  
(73) **CROCS, INC. (US)**  
13601 Via Varra, Broomfield, Colorado 80020, United States of America  
(72) Catherine LAM (US)  
(74) Công ty Luật TNHH quốc tế BMVN (BMVN INTERNATIONAL LLC)  
(55)



1.1



1.2

1.3



1.4



1.5



1.6



1.7

**CÔNG BÁO SỞ HỮU CÔNG NGHIỆP SỐ 418 TẬP A – QUYỀN 2 (01.2023)**

- (11) **46271**  
(21) 3-2022-01811 (28) 1  
(54) **THANH KIM LOẠI ĐỊNH HÌNH** (51) **25-01**  
(22) 25/08/2022 (43) 27/01/2023  
(73) **CÔNG TY CỔ PHẦN TẬP ĐOÀN KENWIN (VN)**  
Tầng 4 tòa nhà VG Building, số 235 đường Nguyễn Trãi, phường Thanh Xuân  
Trung, quận Thanh Xuân, thành phố Hà Nội  
(72) Ngô Thọ Long (VN)  
(74) Công ty TNHH Sở hữu trí tuệ PADEMARK (PADEMARK CO.,LTD.)  
(55)



1.1



1.2



1.3



1.4

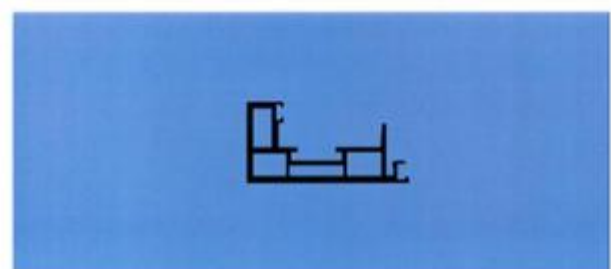

1.5



1.6



1.7

- (11) **46272**  
(21) 3-2022-01817 (28) 1  
(54) **THIẾT BỊ ĐÚC MÓNG BÊ TÔNG** (51) **15-04**  
(22) 25/08/2022 (43) 27/01/2023  
(73) **CÔNG TY TNHH FIVE STAR KIM GIANG (VN)**  
Số 2 Kim Giang, phường Kim Giang, quận Thanh Xuân, thành phố Hà Nội  
(72) 1. PHẠM THÀNH CÔNG (VN)  
2. ĐỖ ĐỨC THẮNG (VN)  
3. HỒ SỸ QUẾ (VN)  
4. LÊ QUANG HÙNG (VN)  
5. PHẠM TRƯỜNG GIANG (VN)  
(74) Công ty TNHH Sáng chế ACTIP (ACTIP PATENT LIMITED)  
(55)

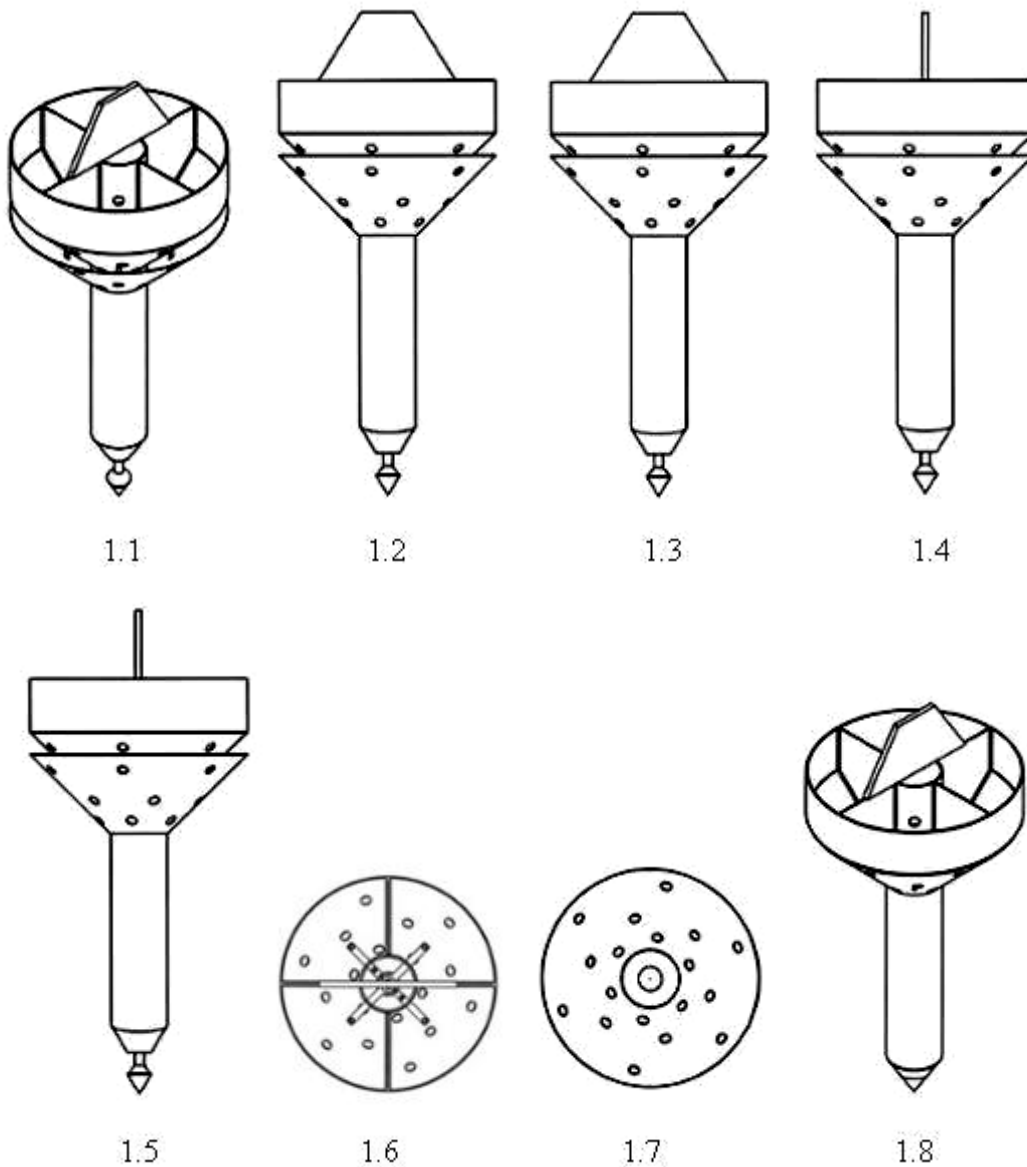

- (11) **46273**  
(21) 3-2022-01829 (28) 1  
(54) **MÁY XỬ LÝ BUNG NHÂN HẠT ĐIỀU VÀ LỌC TÁCH NHÂN HẠT ĐIỀU SAU KHI CẮT TÁCH VỎ** (51) **15-03**  
(22) 29/08/2022 (43) 27/01/2023  
(73) **CÔNG TY TNHH SẢN XUẤT THƯƠNG MẠI DỊCH VỤ KHUÔN MÁY VIỆT (VN)**  
138A Đinh Bộ Lĩnh, phường 26, quận Bình Thạnh, thành phố Hồ Chí Minh  
(72) Nguyễn Văn Lâm (VN)  
(74) Công ty cổ phần Tư vấn S&B (S&B CONSULTANT., CORP.)  
(55)

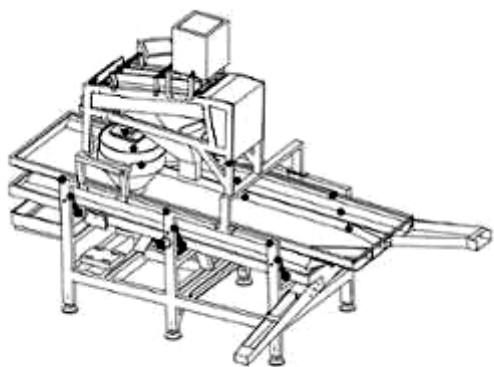

1.1

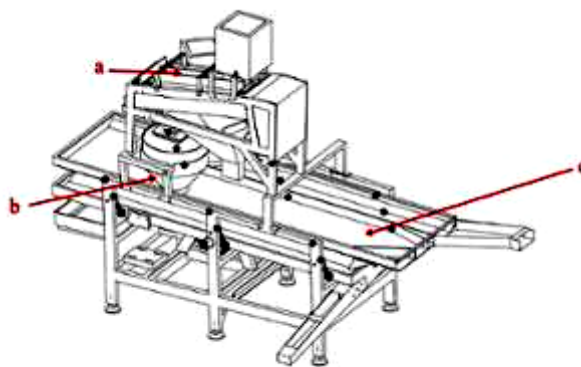

1.2

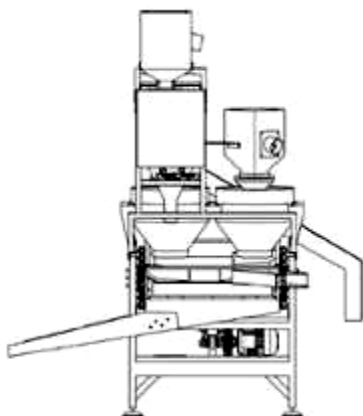

1.3

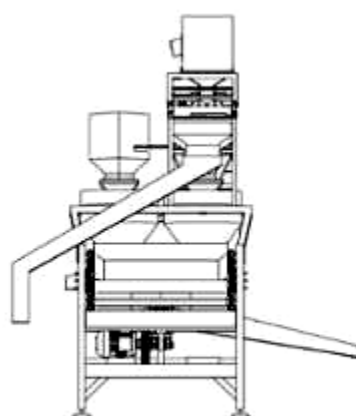

1.4



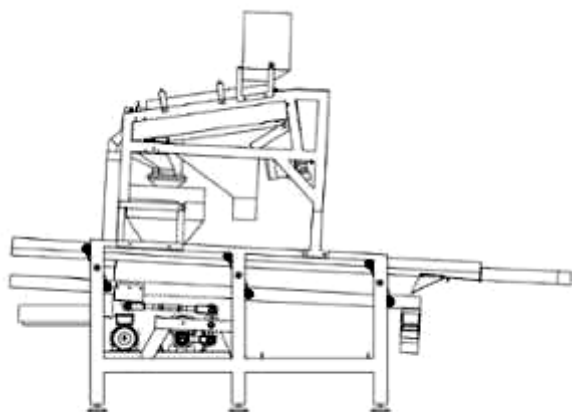

1.5

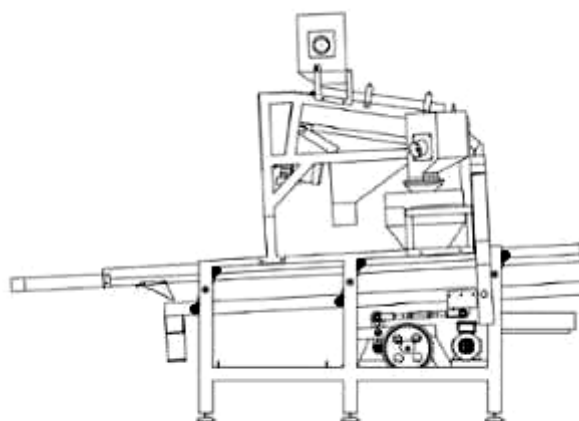

1.6

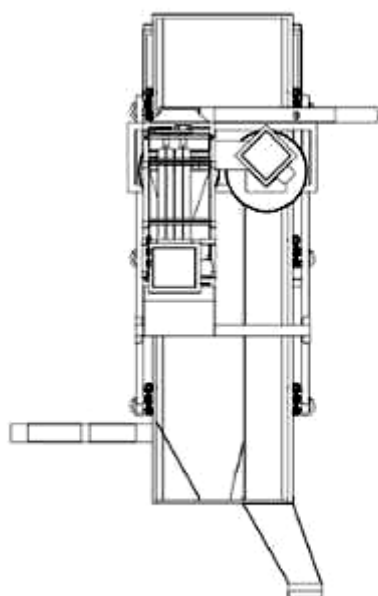

1.7

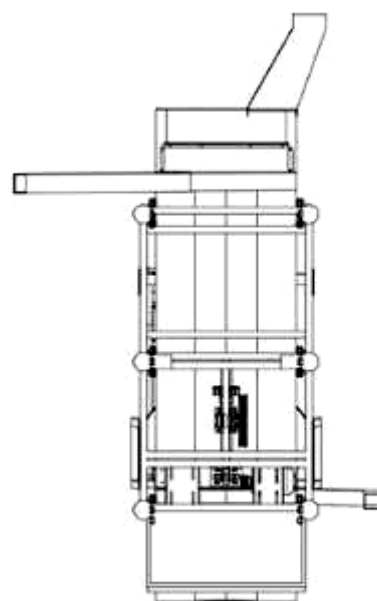

1.8

**CÔNG BÁO SỞ HỮU CÔNG NGHIỆP SỐ 418 TẬP A – QUYỀN 2 (01.2023)**

- (11) **46274**  
(21) 3-2022-01842 (28) 1  
(54) **THANH NHÔM ĐỊNH HÌNH** (51) **25-01**  
(22) 31/08/2022 (43) 27/01/2023  
(73) **CÔNG TY CỔ PHẦN XÂY DỰNG VÀ THƯƠNG MẠI GLASSHOUSE (VN)**  
Số 37, tổ 26, phường Thanh Lương, quận Hai Bà Trưng, thành phố Hà Nội  
(72) Nguyễn Đức Hiếu (VN)  
(74) **CÔNG TY TNHH SỞ HỮU TRÍ TUỆ ANLIS VIỆT NAM (ANLIS IP CO.,LTD)**  
(55)

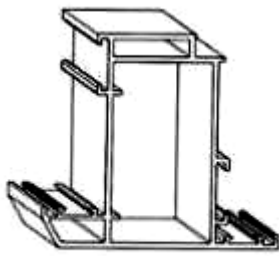

1.1

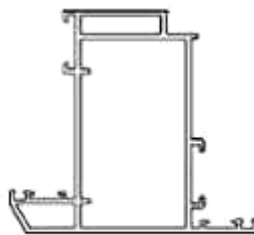

1.2

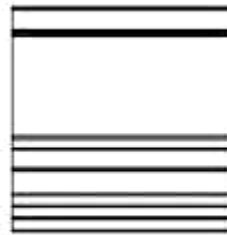

1.3



1.4

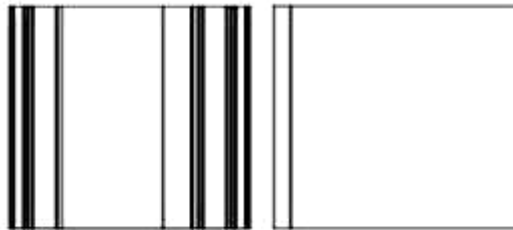

1.5



1.6

**CÔNG BÁO SỞ HỮU CÔNG NGHIỆP SỐ 418 TẬP A – QUYỀN 2 (01.2023)**

- (11) **46275**  
(21) 3-2022-01843 (28) 1  
(54) **THANH NHÔM ĐỊNH HÌNH** (51) **25-01**  
(22) 31/08/2022 (43) 27/01/2023  
(73) **CÔNG TY CỔ PHẦN XÂY DỰNG VÀ THƯƠNG MẠI GLASSHOUSE (VN)**  
Số 37, tổ 26, phường Thanh Lương, quận Hai Bà Trưng, thành phố Hà Nội  
(72) Nguyễn Đức Hiếu (VN)  
(74) **CÔNG TY TNHH SỞ HỮU TRÍ TUỆ ANLIS VIỆT NAM (ANLIS IP CO.,LTD)**  
(55)

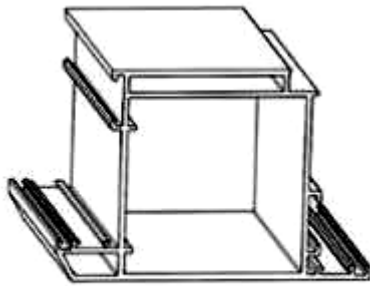

1.1

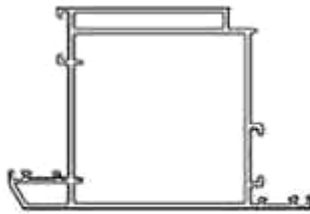

1.2



1.3

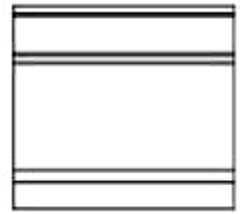

1.4



1.5

1.6

**CÔNG BÁO SỞ HỮU CÔNG NGHIỆP SỐ 418 TẬP A – QUYỀN 2 (01.2023)**

- (11) **46276**  
(21) 3-2022-01844 (28) 1  
(54) **THANH NHÔM ĐỊNH HÌNH** (51) **25-01**  
(22) 31/08/2022 (43) 27/01/2023  
(73) **CÔNG TY CỔ PHẦN XÂY DỰNG VÀ THƯƠNG MẠI GLASSHOUSE (VN)**  
Số 37, tổ 26, phường Thanh Lương, quận Hai Bà Trưng, thành phố Hà Nội  
(72) Nguyễn Đức Hiếu (VN)  
(74) **CÔNG TY TNHH SỞ HỮU TRÍ TUỆ ANLIS VIỆT NAM (ANLIS IP CO.,LTD)**  
(55)

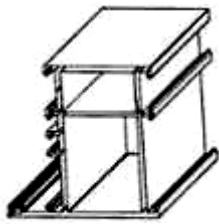

1.1

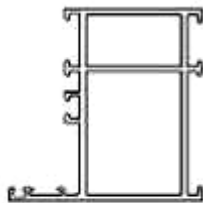

1.2

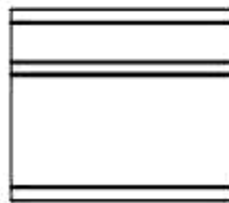

1.3

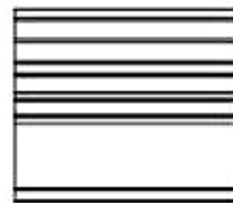

1.4

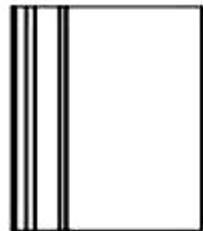

1.5



1.6

**CÔNG BÁO SỞ HỮU CÔNG NGHIỆP SỐ 418 TẬP A – QUYỀN 2 (01.2023)**

- (11) **46277**  
(21) 3-2022-01845 (28) 1  
(54) **THANH NHÔM ĐỊNH HÌNH** (51) **25-01**  
(22) 31/08/2022 (43) 27/01/2023  
(73) **CÔNG TY CỔ PHẦN XÂY DỰNG VÀ THƯƠNG MẠI GLASSHOUSE (VN)**  
Số 37, tổ 26, phường Thanh Lương, quận Hai Bà Trưng, thành phố Hà Nội  
(72) Nguyễn Đức Hiếu (VN)  
(74) **CÔNG TY TNHH SỞ HỮU TRÍ TUỆ ANLIS VIỆT NAM (ANLIS IP CO.,LTD)**  
(55)

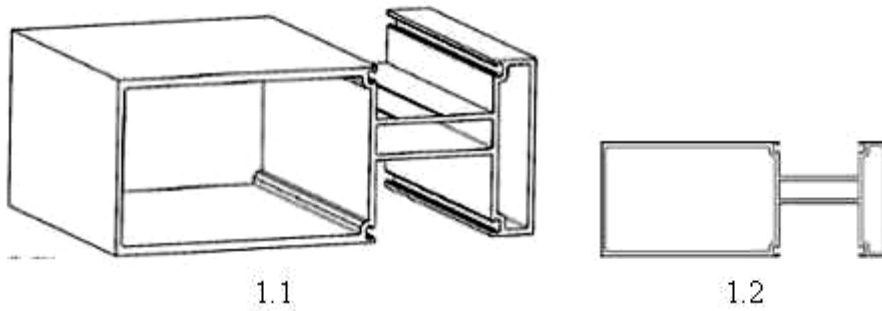

**CÔNG BÁO SỞ HỮU CÔNG NGHIỆP SỐ 418 TẬP A – QUYỀN 2 (01.2023)**

- (11) **46278**  
(21) 3-2022-01846 (28) 1  
(54) **THANH NHÔM ĐỊNH HÌNH** (51) **25-01**  
(22) 31/08/2022 (43) 27/01/2023  
(73) **CÔNG TY CỔ PHẦN XÂY DỰNG VÀ THƯƠNG MẠI GLASSHOUSE (VN)**  
Số 37, tổ 26, phường Thanh Lương, quận Hai Bà Trưng, thành phố Hà Nội  
(72) Nguyễn Đức Hiếu (VN)  
(74) **CÔNG TY TNHH SỞ HỮU TRÍ TUỆ ANLIS VIỆT NAM (ANLIS IP CO.,LTD)**  
(55)

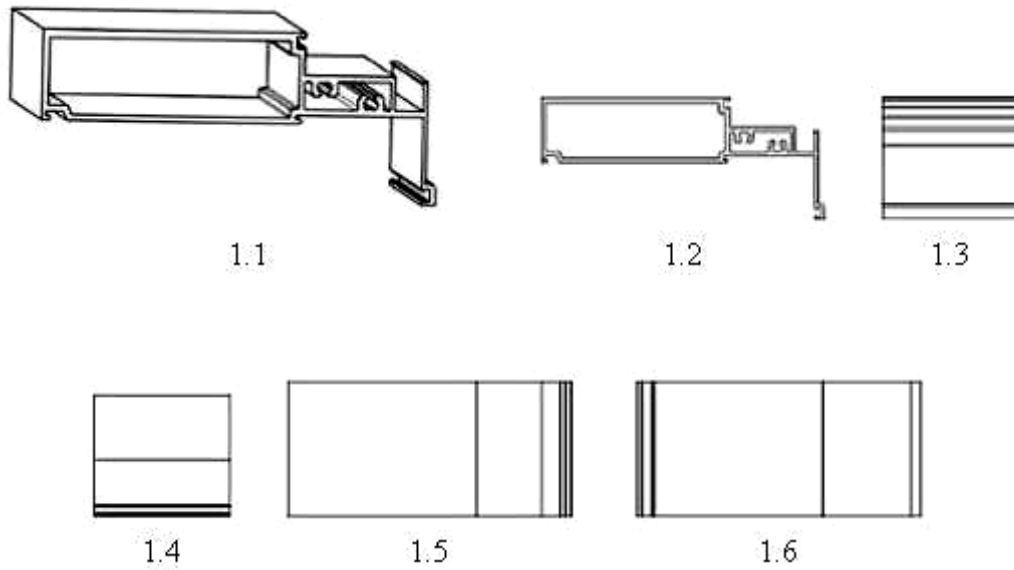

**CÔNG BÁO SỞ HỮU CÔNG NGHIỆP SỐ 418 TẬP A – QUYỀN 2 (01.2023)**

- (11) **46279**  
(21) 3-2022-01847 (28) 1  
(54) **THANH NHÔM ĐỊNH HÌNH** (51) **25-01**  
(22) 31/08/2022 (43) 27/01/2023  
(73) **CÔNG TY CỔ PHẦN XÂY DỰNG VÀ THƯƠNG MẠI GLASSHOUSE (VN)**  
Số 37, tổ 26, phường Thanh Lương, quận Hai Bà Trưng, thành phố Hà Nội  
(72) Nguyễn Đức Hiếu (VN)  
(74) **CÔNG TY TNHH SỞ HỮU TRÍ TUỆ ANLIS VIỆT NAM (ANLIS IP CO.,LTD)**  
(55)

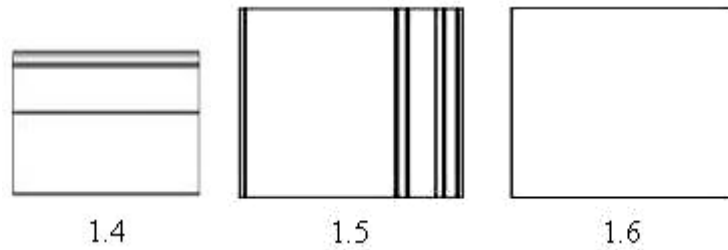
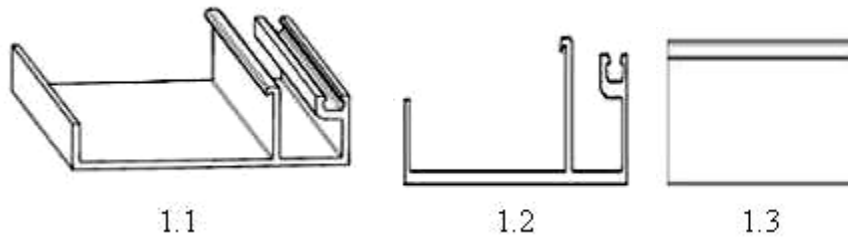

**CÔNG BÁO SỞ HỮU CÔNG NGHIỆP SỐ 418 TẬP A – QUYỀN 2 (01.2023)**

- (11) **46280**  
(21) 3-2022-01848 (28) 1  
(54) **THANH NHÔM ĐỊNH HÌNH** (51) **25-01**  
(22) 31/08/2022 (43) 27/01/2023  
(73) **CÔNG TY CỔ PHẦN XÂY DỰNG VÀ THƯƠNG MẠI GLASSHOUSE (VN)**  
Số 37, tổ 26, phường Thanh Lương, quận Hai Bà Trưng, thành phố Hà Nội  
(72) Nguyễn Đức Hiếu (VN)  
(74) **CÔNG TY TNHH SỞ HỮU TRÍ TUỆ ANLIS VIỆT NAM (ANLIS IP CO.,LTD)**  
(55)

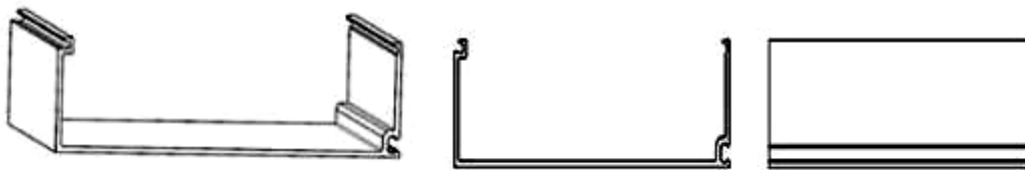

1.1

1.2

1.3



1.4

1.5

1.6



- (11) **46281**  
(21) 3-2022-01860 (28) 1  
(54) **DÉP** (51) **02-04**  
(22) 31/08/2022 (43) 27/01/2023  
(30) 29/829,020 02/03/2022 US;  
(73) **CROCS, INC. (US)**  
13601 Via Varra, Broomfield, Colorado 80020, United States of America  
(72) 1. MICHAEL SARANTAKOS (US)  
2. FEDERICO FONGHER (IT)  
3. KITTY SHUKMAN (GB)  
(74) Công ty Luật TNHH quốc tế BMVN (BMVN INTERNATIONAL LLC)  
(55)



1.1



1.2



1.3



1.4



1.5



1.6



1.7

**CÔNG BÁO SỞ HỮU CÔNG NGHIỆP SỐ 418 TẬP A – QUYỀN 2 (01.2023)**

- (11) **46282**  
(21) 3-2022-01866 (28) 1  
(54) **THANH TREO KHĂN** (51) **23-02**  
(22) 31/08/2022 (43) 27/01/2023  
(30) 202211212 02/03/2022 AU;  
(73) **PHOENIX INDUSTRIES PTY LTD (AU)**  
926 Mountain Hwy, Bayswater, Victoria, 3153, Australia  
(72) Ban Hsi Liu (AU)  
(74) Công ty TNHH Tầm nhìn và Liên danh (VISION & ASSOCIATES CO.LTD.)  
(55)

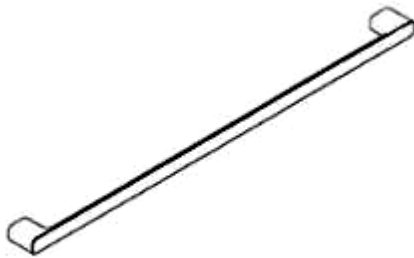

1.1



1.2



1.3



1.4



1.5



1.6



1.7

**CÔNG BÁO SỞ HỮU CÔNG NGHIỆP SỐ 418 TẬP A – QUYỀN 2 (01.2023)**

- (11) **46283**  
(21) 3-2022-01867 (28) 1  
(54) **MÓC TREO GIẤY VỆ SINH** (51) **23-02**  
(22) 31/08/2022 (43) 27/01/2023  
(30) 202211215 05/05/2022 AU;  
(73) **PHOENIX INDUSTRIES PTY LTD (AU)**  
926 Mountain Hwy, Bayswater, Victoria, 3153, Australia  
(72) Ban Hsi Liu (AU)  
(74) Công ty TNHH Tầm nhìn và Liên danh (VISION & ASSOCIATES CO.LTD.)  
(55)



1.1

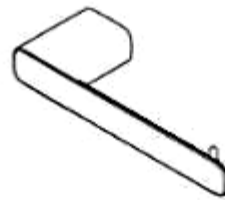

1.2



1.3

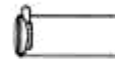

1.4

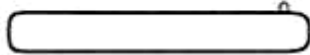

1.5



1.6



1.7



1.8

**CÔNG BÁO SỞ HỮU CÔNG NGHIỆP SỐ 418 TẬP A – QUYỀN 2 (01.2023)**

- (11) **46284**  
(21) 3-2022-01868 (28) 1  
(54) **KHAY ĐỰNG XÀ PHÒNG** (51) **23-02**  
(22) 31/08/2022 (43) 27/01/2023  
(30) 202211216 05/05/2022 AU;  
(73) **PHOENIX INDUSTRIES PTY LTD (AU)**  
926 Mountain Hwy, Bayswater, Victoria, 3153, Australia  
(72) Ban Hsi Liu (AU)  
(74) Công ty TNHH Tầm nhìn và Liên danh (VISION & ASSOCIATES CO.LTD.)  
(55)



1.1



1.2



1.3



1.4



1.5

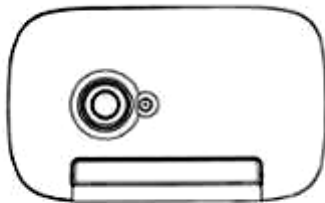

1.6

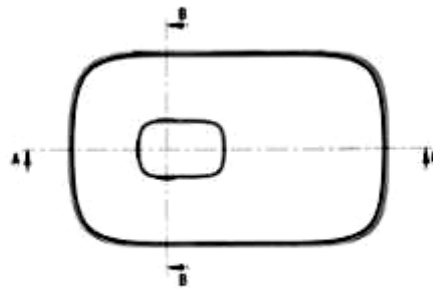

1.7

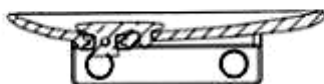

1.8



1.9

**CÔNG BÁO SỞ HỮU CÔNG NGHIỆP SỐ 418 TẬP A – QUYỀN 2 (01.2023)**

- (11) **46285**  
(21) 3-2022-01869 (28) 2  
(54) **KHAY ĐỰNG ĐỒ DÙNG TRONG PHÒNG TẮM** (51) **23-02**  
(22) 31/08/2022 (43) 27/01/2023  
(30) 202211219 05/05/2022 AU;  
(73) **PHOENIX INDUSTRIES PTY LTD (AU)**  
926 Mountain Hwy, Bayswater, Victoria, 3153, Australia  
(72) Ban Hsi Liu (AU)  
(74) Công ty TNHH Tầm nhìn và Liên danh (VISION & ASSOCIATES CO.LTD.)  
(55)

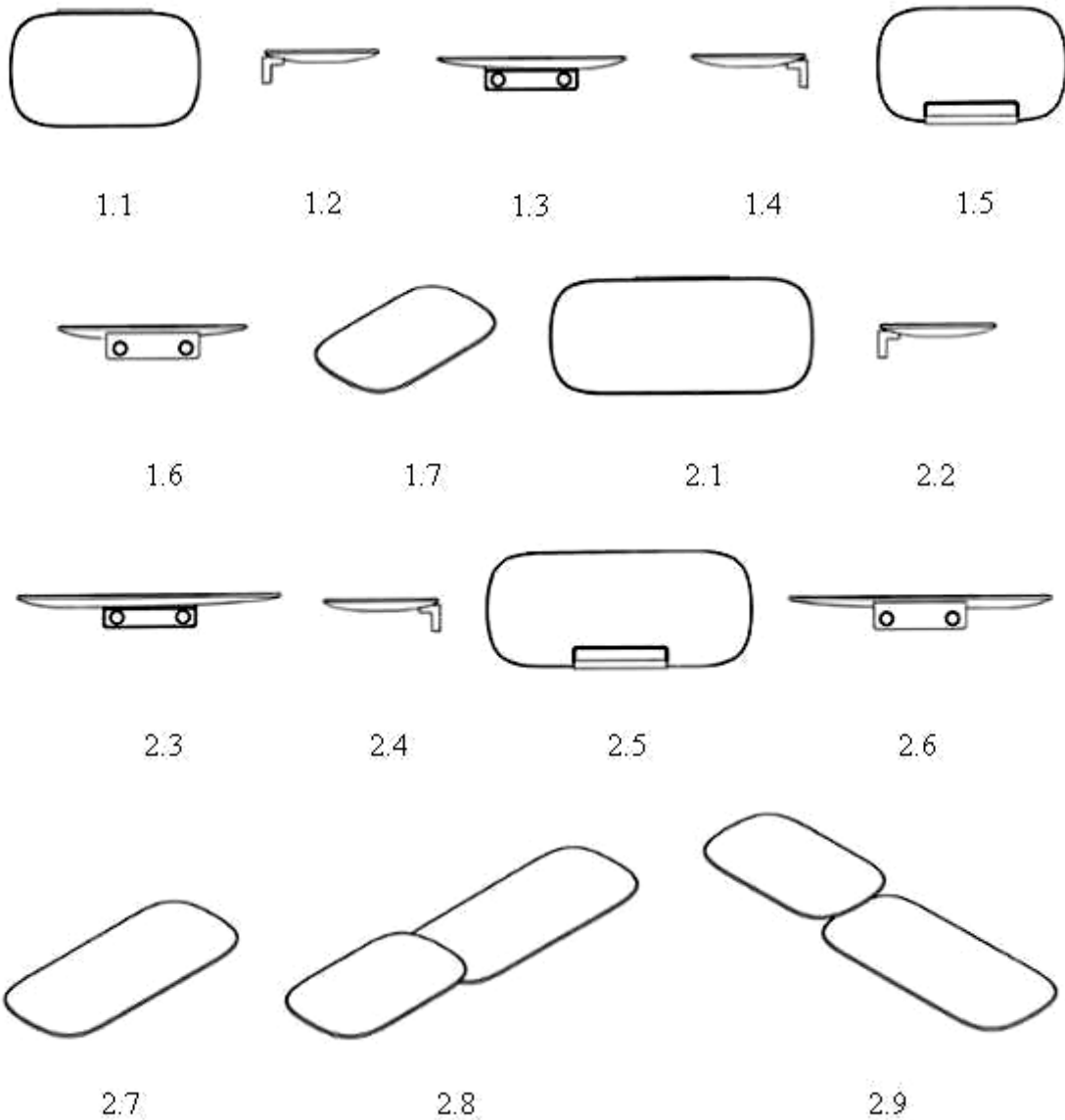

**CÔNG BÁO SỞ HỮU CÔNG NGHIỆP SỐ 418 TẬP A – QUYỀN 2 (01.2023)**

- (11) **46286**  
(21) 3-2022-01873 (28) 1  
(54) **MÓC TREO** (51) **23-02**  
(22) 31/08/2022 (43) 27/01/2023  
(30) 202211217 05/05/2022 AU;  
(73) **PHOENIX INDUSTRIES PTY LTD (AU)**  
926 Mountain Hwy, Bayswater, Victoria, 3153, Australia  
(72) Ban Hsi Liu (AU)  
(74) Công ty TNHH Tầm nhìn và Liên danh (VISION & ASSOCIATES CO.LTD.)  
(55)



1.1



1.2



1.3



1.4



1.5



1.6

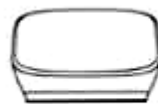

1.7

**CÔNG BÁO SỞ HỮU CÔNG NGHIỆP SỐ 418 TẬP A – QUYỀN 2 (01.2023)**

- (11) **46287**  
(21) 3-2022-01881 (28) 1  
(54) **XE MÁY** (51) **12-11**  
(22) 05/09/2022 (43) 27/01/2023  
(30) 202230224825.7 20/04/2022 CN;  
(73) **TAIZHOU QIMAN TECHNOLOGY CO., LTD. (CN)**  
Room 101, Building 6, Zone 3, No. 555, Yongyuan Road, Lunan Subdistrict,  
Luqiao District, Taizhou City, Zhejiang Province, P.R.China  
(72) LIN, Ruman (CN)  
(74) Công ty TNHH Sáng chế ACTIP (ACTIP PATENT LIMITED)  
(55)



1.1



1.2



1.3



1.4



1.5



1.6





1.7



1.8

**CÔNG BÁO SỞ HỮU CÔNG NGHIỆP SỐ 418 TẬP A – QUYỀN 2 (01.2023)**

- (11) **46288**  
(21) 3-2022-01892 (28) 1  
(54) **KẸP ĐA NĂNG** (51) **07-06**  
(22) 07/09/2022 (43) 27/01/2023  
(73) **CÔNG TY TNHH SẢN XUẤT THƯƠNG MẠI DỊCH VỤ XUẤT NHẬP  
KHẨU CẨM THÀNH (VN)**  
8 Trần Trung Lập, phường 02, quận 6, thành phố Hồ Chí Minh  
(72) Tăng Cẩm Thành (VN)  
(74) Công ty TNHH Dịch vụ thương mại và sở hữu công nghiệp Song Ngọc (I.P.T.S.)  
(55)



1.1



1.2



1.3



1.4



1.5

**CÔNG BÁO SỞ HỮU CÔNG NGHIỆP SỐ 418 TẬP A – QUYỀN 2 (01.2023)**

- (11) **46289**  
(21) 3-2022-01893 (28) 1  
(54) **THANH KIM LOẠI ĐỊNH HÌNH** (51) **25-01**  
(22) 07/09/2022 (43) 27/01/2023  
(73) **CÔNG TY CỔ PHẦN SẢN XUẤT VÀ ĐẦU TƯ HÙNG PHÁT (VN)**  
Tổ dân phố Thịnh Vạn, phường Minh Đức, thị xã Mỹ Hào, tỉnh Hưng Yên  
(72) Nguyễn Văn Tâm (VN)  
(74) Công ty TNHH Sở hữu trí tuệ Gia Việt (GIAVIET CO., LTD.)  
(55)

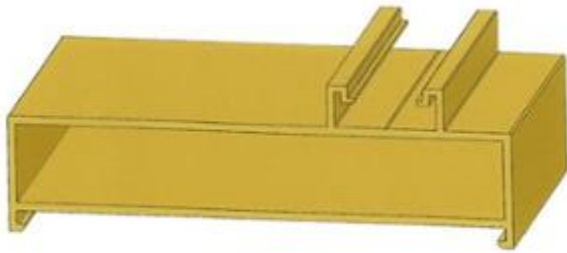

1.1

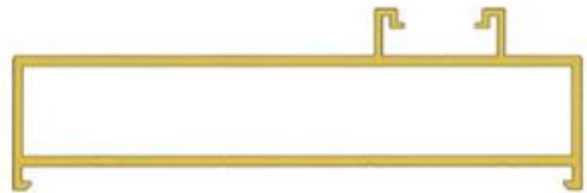

1.2



1.3

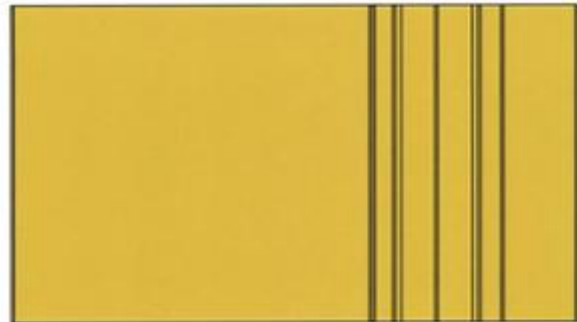

1.4



1.5

**CÔNG BÁO SỞ HỮU CÔNG NGHIỆP SỐ 418 TẬP A – QUYỀN 2 (01.2023)**

- (11) **46290**  
(21) 3-2022-01894 (28) 1  
(54) **THANH KIM LOẠI ĐỊNH HÌNH** (51) **25-01**  
(22) 07/09/2022 (43) 27/01/2023  
(73) **CÔNG TY CỔ PHẦN SẢN XUẤT VÀ ĐẦU TƯ HÙNG PHÁT (VN)**  
Tổ dân phố Thịnh Vạn, phường Minh Đức, thị xã Mỹ Hào, tỉnh Hưng Yên  
(72) Nguyễn Văn Tâm (VN)  
(74) Công ty TNHH Sở hữu trí tuệ Gia Việt (GIAVIET CO., LTD.)  
(55)

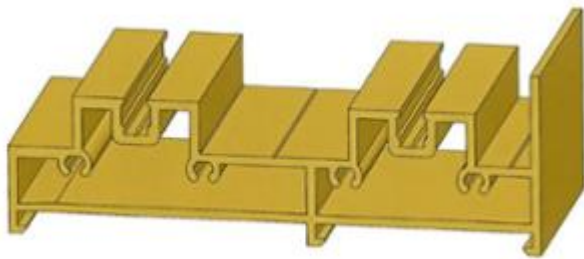

1.1

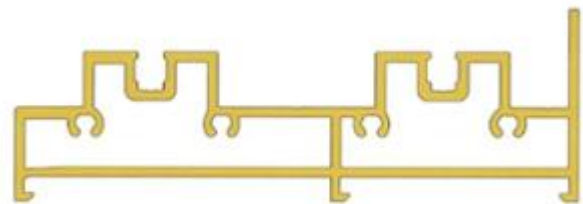

1.2



1.3



1.4

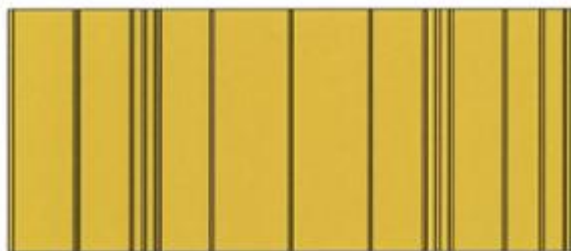

1.5



1.6

- (11) **46291**  
(21) 3-2022-01895 (28) 1  
(54) **THANH KIM LOẠI ĐỊNH HÌNH** (51) **25-01**  
(22) 07/09/2022 (43) 27/01/2023  
(73) **CÔNG TY CỔ PHẦN SẢN XUẤT VÀ ĐẦU TƯ HƯNG PHÁT (VN)**  
Tổ dân phố Thịnh Vạn, phường Minh Đức, thị xã Mỹ Hào, tỉnh Hưng Yên  
(72) Nguyễn Văn Tâm (VN)  
(74) Công ty TNHH Sở hữu trí tuệ Gia Việt (GIAVIET CO., LTD.)  
(55)

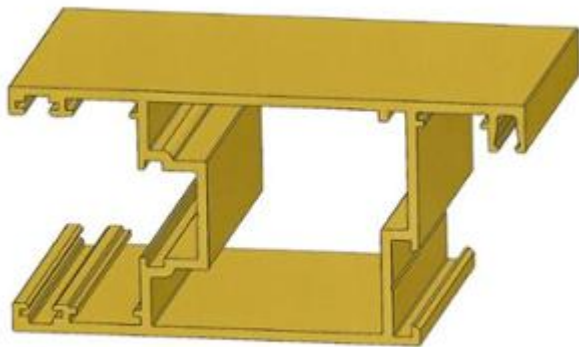

1.1

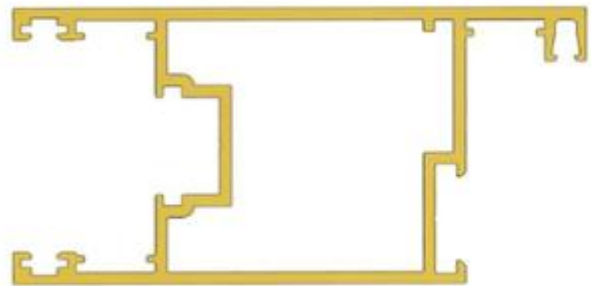

1.2



1.3



1.4



1.5



1.6

**CÔNG BÁO SỞ HỮU CÔNG NGHIỆP SỐ 418 TẬP A – QUYỀN 2 (01.2023)**

- (11) **46292**  
(21) 3-2022-01909 (28) 1  
(54) **THIẾT BỊ NẠP ẮC QUY** (51) **13-02**  
(22) 08/09/2022 (43) 27/01/2023  
(30) 2022-005158 14/03/2022 JP;  
(73) **HONDA MOTOR CO., LTD. (JP)**  
1-1, Minami-Aoyama 2-chome, Minato-ku, Tokyo, 107-8556 Japan  
(72) Satoshi HAYASHI (JP)  
(74) Công ty Luật TNHH Phạm và Liên danh (PHAM & ASSOCIATES)  
(55)



1.1



1.2



1.3



1.4



1.5



1.6



1.7



1.8



1.9



1.10



1.11



**CÔNG BÁO SỞ HỮU CÔNG NGHIỆP SỐ 418 TẬP A – QUYỀN 2 (01.2023)**

- (11) **46293**  
(21) 3-2022-01915 (28) 1  
(54) **THIẾT BỊ XỬ LÝ TÍN HIỆU ÂM THANH SỐ** (51) **14-02**  
(22) 08/09/2022 (43) 27/01/2023  
(73) **CÔNG TY TNHH NHẠC CỤ VÀ CƠ ĐIỆN TỬ MITUMI (VN)**  
7B/117/5 Thành Thái, phường 14, quận 10, thành phố Hồ Chí Minh  
(72) Bùi Minh Tuấn (VN)  
(74) Công ty Cổ phần PHANLAW VIETNAM (PHANLAW VIETNAM JSC)  
(55)



1.1



1.2

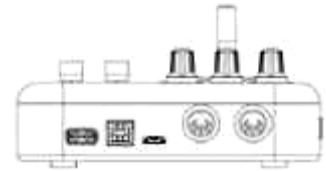

1.3

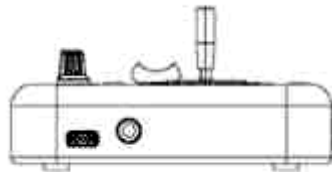

1.4

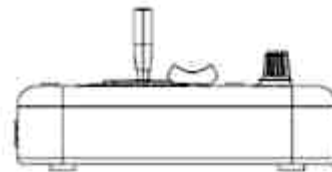

1.5

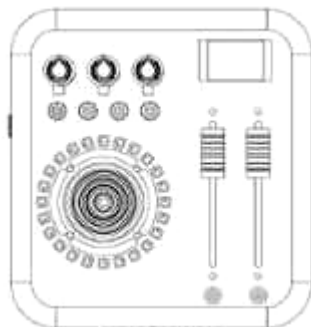

1.6



1.7

**CÔNG BÁO SỞ HỮU CÔNG NGHIỆP SỐ 418 TẬP A – QUYỀN 2 (01.2023)**

- (11) **46294**  
(21) 3-2022-01932 (28) 1  
(54) **THANH NHÔM ĐỊNH HÌNH** (51) **25-01**  
(22) 13/09/2022 (43) 27/01/2023  
(73) **CÔNG TY CỔ PHẦN EUROHOUSE VIỆT NAM (VN)**  
Số 374 đường Nguyễn Thiện Thuật, phường Nhân Hòa, thị xã Mỹ Hào, tỉnh Hưng Yên  
(72) Phạm Trường Giang (VN)  
(55)

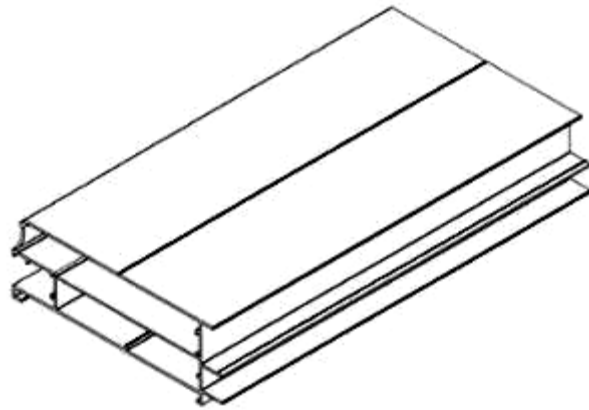

1.1

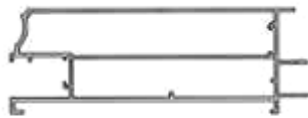

1.2

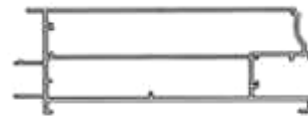

1.3

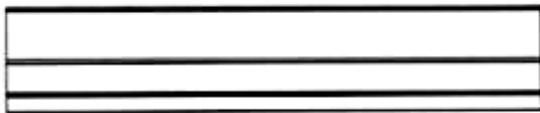

1.4



1.5

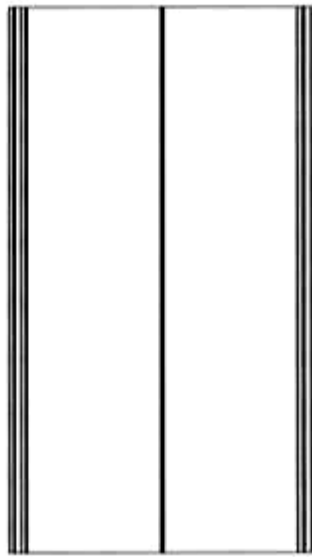

1.6

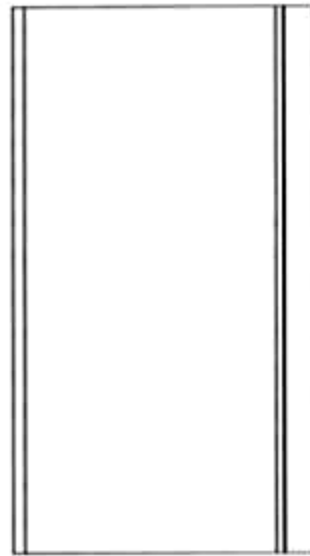

1.7

**CÔNG BÁO SỞ HỮU CÔNG NGHIỆP SỐ 418 TẬP A – QUYỀN 2 (01.2023)**

- (11) **46295**  
(21) 3-2022-01933 (28) 1  
(54) **THANH NHÔM ĐỊNH HÌNH** (51) **25-01**  
(22) 13/09/2022 (43) 27/01/2023  
(73) **CÔNG TY CỔ PHẦN EUROHOUSE VIỆT NAM (VN)**  
Số 374 đường Nguyễn Thiện Thuật, phường Nhân Hòa, thị xã Mỹ Hào, tỉnh Hưng Yên  
(72) Phạm Trường Giang (VN)  
(55)

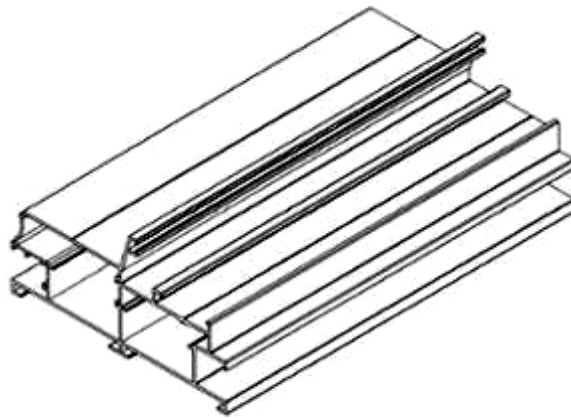

1.1

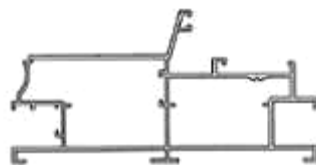

1.2

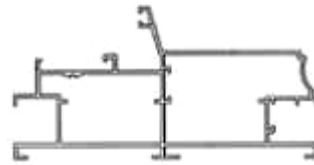

1.3



1.4

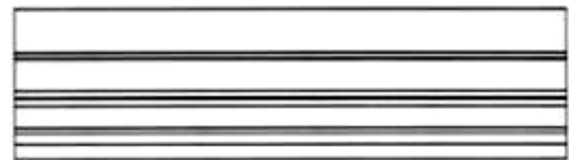

1.5

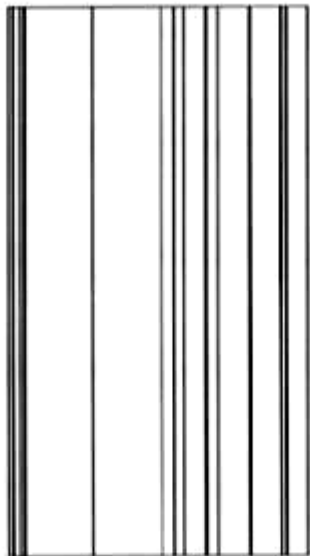

1.6

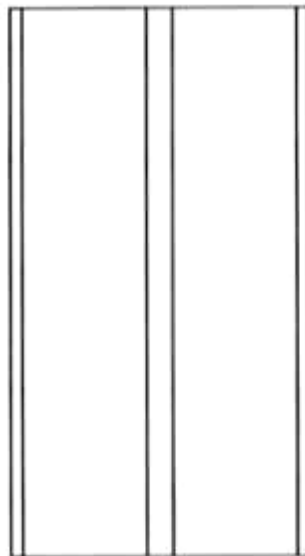

1.7

- (11) **46296**
- (21) 3-2022-01969 (28) 1
- (54) **THIẾT BỊ ĐIỆN TỬ** (51) **10-02; 10-03; 10-04; 14-01; 14-02; 14-03; 24-02**
- (22) 16/09/2022 (43) 27/01/2023
- (30) 29/831,163 17/03/2022 US;
- (73) **APPLE INC. (US)**  
One Apple Park Way, Cupertino, California 95014, United States of America
- (72) 1. JODY AKANA (US)  
2. MOLLY ANDERSON (GB)  
3. BARTLEY K. ANDRE (US)  
4. SHOTA AOYAGI (JP)  
5. ANTHONY MICHAEL ASHCROFT (FR)  
6. MARINE C. BATAILLE (FR)  
7. JEREMY BATAILLOU (FR)  
8. ABIDUR RAHMAN CHOWDHURY (GB)  
9. CLARA GENEVIÈVE MARINE COURTAIGNE (FR)  
10. MARKUS DIEBEL (DE)  
11. JONATHAN GOMEZ GARCIA (GB)  
12. M. EVANS HANKEY (US)  
13. ANNE-MARIE HECK (CH)  
14. MOISES HERNANDEZ HERNANDEZ (MX)  
15. RICHARD P. HOWARTH (GB)  
16. JONATHAN P. IVE (GB)  
17. JULIAN JAEDE (DE)  
18. DUNCAN ROBERT KERR (GB)  
19. KAINOA KWON-PEREZ (US)  
20. NICOLAS PEDRO LYLYK (AR)  
21. PETER RUSSELL-CLARKE (AU)  
22. BENJAMIN ANDREW SHAFFER (US)  
23. CLEMENT TISSANDIER (FR)  
24. EUGENE ANTONY WHANG (CA)
- (74) Công ty TNHH Lê & Lê (LE & LE)
- (55)



1.1



1.2

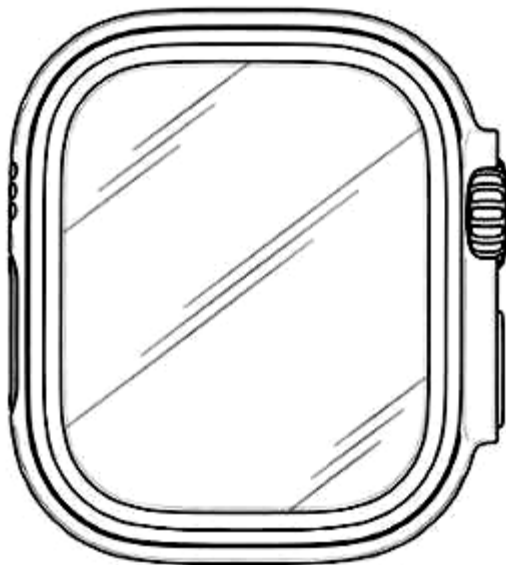

1.3

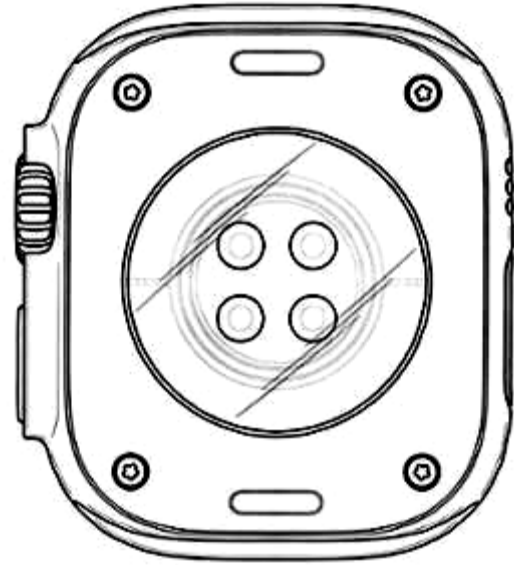

1.4

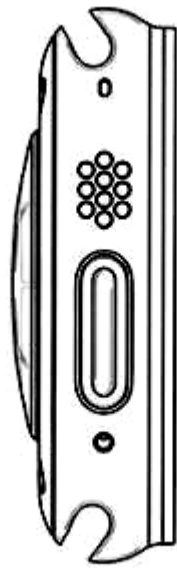

1.5



1.6



1.7



1.8



1.9



- (11) **46297**
- (21) 3-2022-01970 (28) 1
- (54) **THIẾT BỊ ĐIỆN TỬ** (51) **10-02; 10-03; 10-04; 14-01; 14-02; 14-03; 24-02**
- (22) 16/09/2022 (43) 27/01/2023
- (30) 29/852,194 04/09/2022 US;
- (73) **APPLE INC. (US)**  
One Apple Park Way, Cupertino, California 95014, United States of America
- (72) 1. JODY AKANA (US)  
2. MOLLY ANDERSON (GB)  
3. BARTLEY K. ANDRE (US)  
4. SHOTA AOYAGI (JP)  
5. ANTHONY MICHAEL ASHCROFT (FR)  
6. MARINE C. BATAILLE (FR)  
7. JEREMY BATAILLOU (FR)  
8. ABIDUR RAHMAN CHOWDHURY (GB)  
9. CLARA GENEVIÈVE MARINE COURTAIGNE (FR)  
10. MARKUS DIEBEL (DE)  
11. JONATHAN GOMEZ GARCIA (GB)  
12. M. EVANS HANKEY (US)  
13. ANNE-MARIE HECK (CH)  
14. MOISES HERNANDEZ HERNANDEZ (MX)  
15. RICHARD P. HOWARTH (GB)  
16. JONATHAN P. IVE (GB)  
17. JULIAN JAEDE (DE)  
18. DUNCAN ROBERT KERR (GB)  
19. KAINOA KWON-PEREZ (US)  
20. NICOLAS PEDRO LYLYK (AR)  
21. PETER RUSSELL-CLARKE (AU)  
22. BENJAMIN ANDREW SHAFFER (US)  
23. CLEMENT TISSANDIER (FR)  
24. EUGENE ANTONY WHANG (CA)
- (74) Công ty TNHH Lê & Lê (LE & LE)
- (55)



1.1



1.2



1.3



1.4



1.5



1.6



1.7



1.9



1.8



1.10

- (11) **46298**
- (21) 3-2022-01971 (28) 1
- (54) **THIẾT BỊ ĐIỆN TỬ** (51) **10-02; 10-03; 10-04; 14-01; 14-02; 14-03; 24-02**
- (22) 16/09/2022 (43) 27/01/2023
- (30) 29/852,530 07/09/2022 US;
- (73) **APPLE INC. (US)**  
One Apple Park Way, Cupertino, California 95014, United States of America
- (72) 1. JODY AKANA (US)  
2. MOLLY ANDERSON (GB)  
3. BARTLEY K. ANDRE (US)  
4. SHOTA AOYAGI (JP)  
5. ANTHONY MICHAEL ASHCROFT (FR)  
6. MARINE C. BATAILLE (FR)  
7. JEREMY BATAILLOU (FR)  
8. ABIDUR RAHMAN CHOWDHURY (GB)  
9. CLARA GENEVIÈVE MARINE COURTAIGNE (FR)  
10. MARKUS DIEBEL (DE)  
11. JONATHAN GOMEZ GARCIA (GB)  
12. M. EVANS HANKEY (US)  
13. ANNE-MARIE HECK (CH)  
14. MOISES HERNANDEZ HERNANDEZ (MX)  
15. RICHARD P. HOWARTH (GB)  
16. JONATHAN P. IVE (GB)  
17. JULIAN JAEDE (DE)  
18. DUNCAN ROBERT KERR (GB)  
19. KAINOA KWON-PEREZ (US)  
20. NICOLAS PEDRO LYLYK (AR)  
21. PETER RUSSELL-CLARKE (AU)  
22. BENJAMIN ANDREW SHAFFER (US)  
23. CLEMENT TISSANDIER (FR)  
24. EUGENE ANTONY WHANG (CA)
- (74) Công ty TNHH Lê & Lê (LE & LE)
- (55)



1.1



1.2

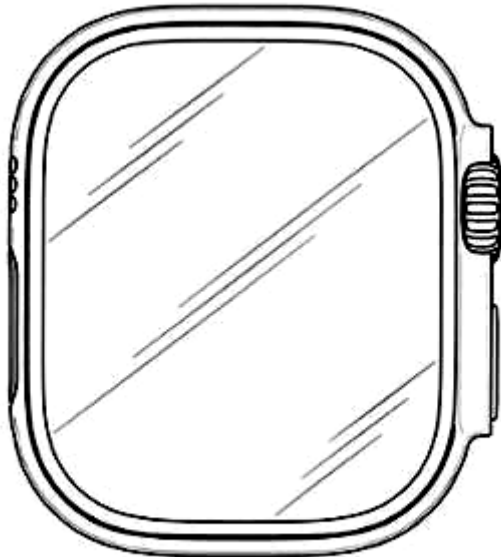

1.3



1.4

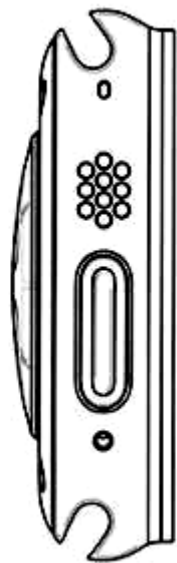

1.5



1.6



1.7



1.8

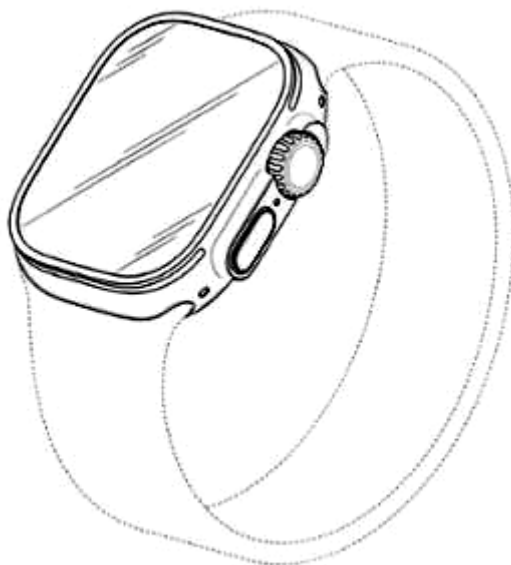

1.9

**CÔNG BÁO SỞ HỮU CÔNG NGHIỆP SỐ 418 TẬP A – QUYỀN 2 (01.2023)**

- (11) **46299**  
(21) 3-2022-01994 (28) 1  
(54) **TẤM SÀN** (51) **25-01; 25-02**  
(22) 20/09/2022 (43) 27/01/2023  
(73) **CÔNG TY CỔ PHẦN TẬP ĐOÀN NHỰA SUPER TRƯỜNG PHÁT (VN)**  
Số T151, lô đất H4, khu đấu giá 31ha, thị trấn Trâu Quỳ, huyện Gia Lâm, thành phố Hà Nội  
(72) Phạm Quốc Chính (VN)  
(74) Công ty TNHH Sở hữu trí tuệ VIPATCO (VIPATCO CO., LTD.)  
(55)

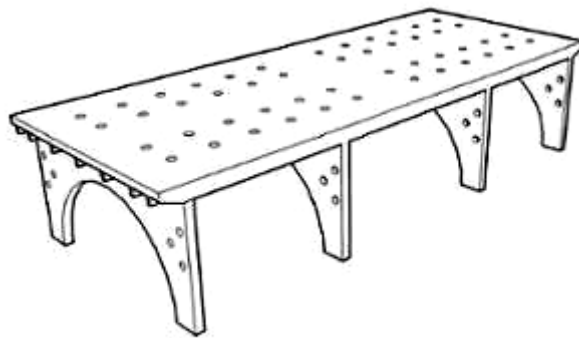

1.1



1.2

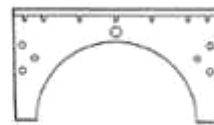

1.3

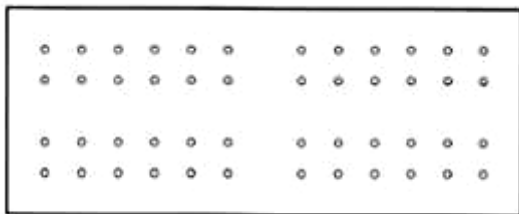

1.4

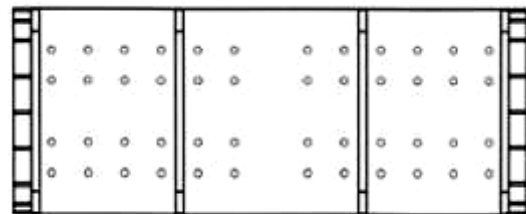

1.5

**CÔNG BÁO SỞ HỮU CÔNG NGHIỆP SỐ 418 TẬP A – QUYỀN 2 (01.2023)**

- (11) **46300**  
(21) 3-2022-01995 (28) 1  
(54) **BỂ XỬ LÝ NƯỚC THẢI** (51) **23-01**  
(22) 20/09/2022 (43) 27/01/2023  
(73) **CÔNG TY CỔ PHẦN TẬP ĐOÀN NHỰA SUPER TRƯỜNG PHÁT (VN)**  
Số T151, lô đất H4, khu đấu giá 31ha, thị trấn Trâu Quỳ, huyện Gia Lâm, thành phố Hà Nội  
(72) Phạm Quốc Chính (VN)  
(74) Công ty TNHH Sở hữu trí tuệ VIPATCO (VIPATCO CO., LTD.)  
(55)

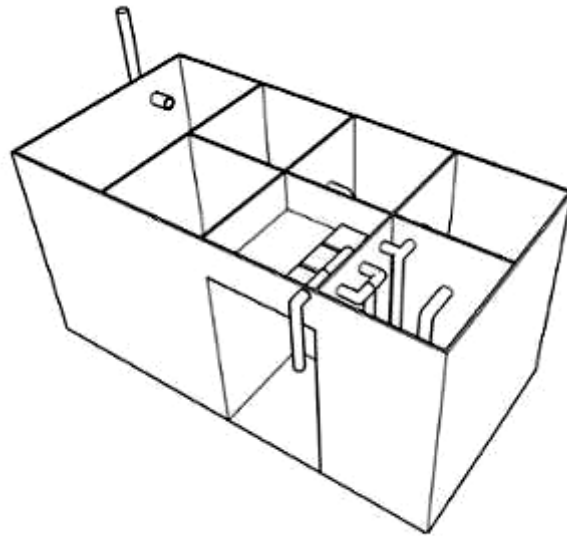

1.1

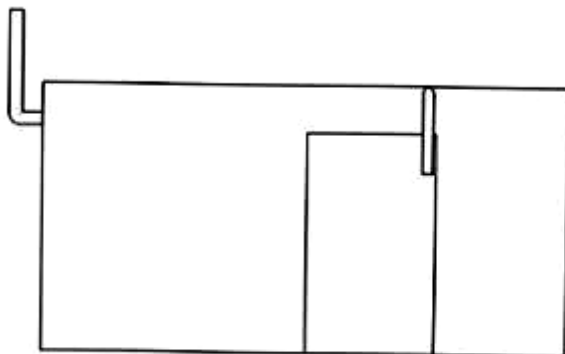

1.2

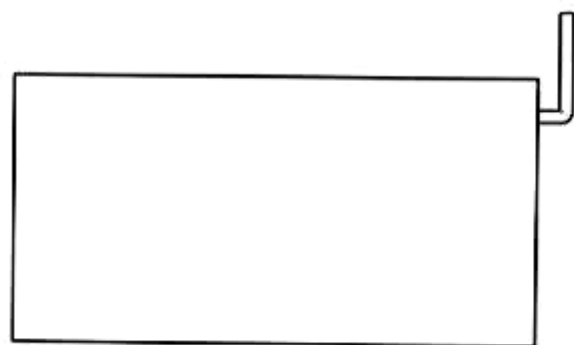

1.3



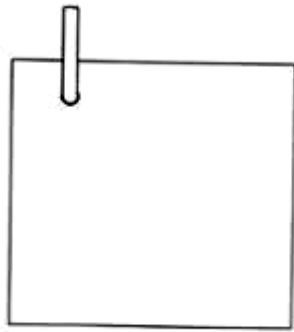

1.4

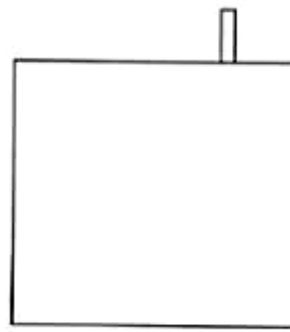

1.5

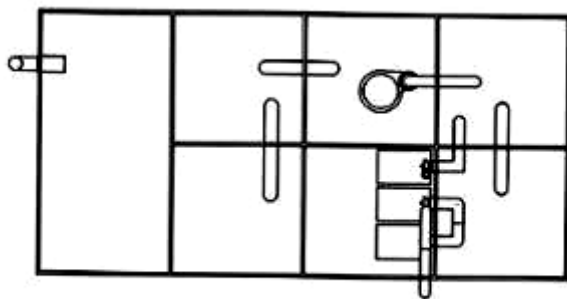

1.6

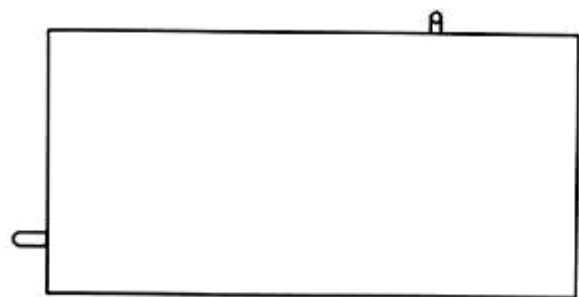

1.7

(11) **46301**

(21) 3-2022-01996

(28) 1

(54) **THÙNG RÁC**

(51) **09-09**

(22) 20/09/2022

(43) 27/01/2023

(73) **CÔNG TY CỔ PHẦN TẬP ĐOÀN NHỰA SUPER TRƯỜNG PHÁT (VN)**  
Số T151, lô đất H4, khu đấu giá 31ha, thị trấn Trâu Quỳ, huyện Gia Lâm, thành phố Hà Nội

(72) Phạm Quốc Chính (VN)

(74) Công ty TNHH Sở hữu trí tuệ VIPATCO (VIPATCO CO., LTD.)

(55)

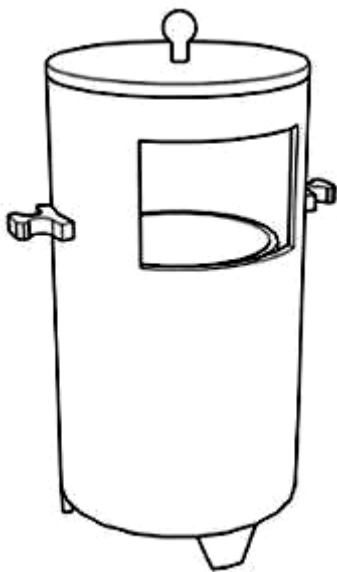

1.1

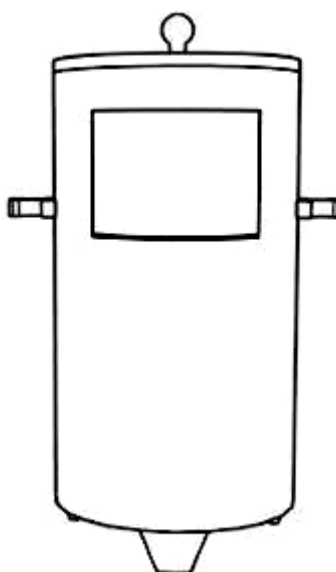

1.2

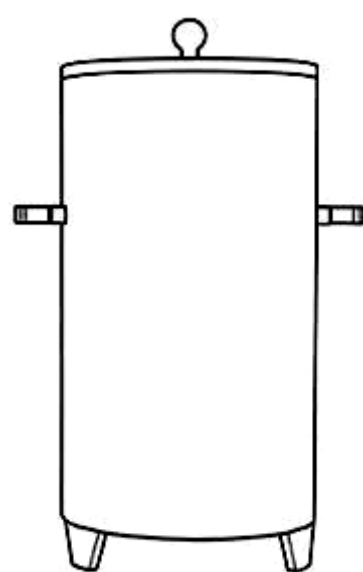

1.3

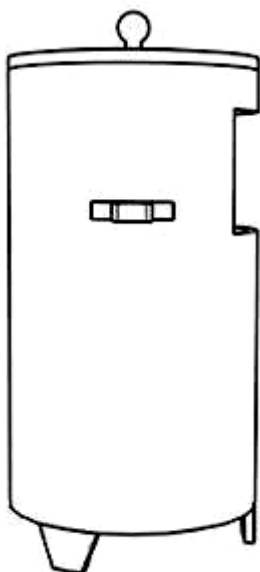

1.4

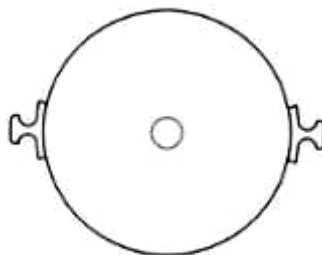

1.5



1.6

- (11) **46302**  
(21) 3-2022-01997 (28) 1  
(54) **LỒNG NUÔI TÔM** (51) **30-02**  
(22) 20/09/2022 (43) 27/01/2023  
(73) **CÔNG TY CỔ PHẦN TẬP ĐOÀN NHỰA SUPER TRƯỜNG PHÁT (VN)**  
Số T151, lô đất H4, khu đấu giá 31ha, thị trấn Trâu Quỳ, huyện Gia Lâm, thành phố Hà Nội  
(72) Phạm Quốc Chính (VN)  
(74) Công ty TNHH Sở hữu trí tuệ VIPATCO (VIPATCO CO., LTD.)  
(55)

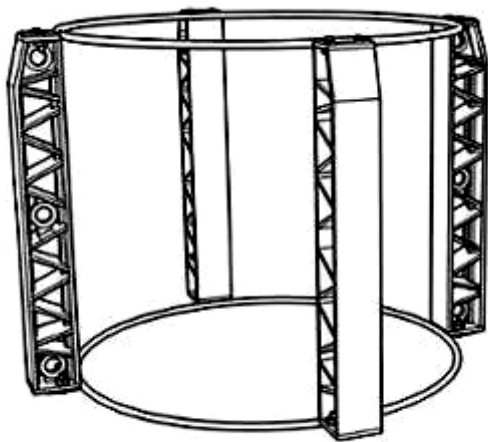

1.1

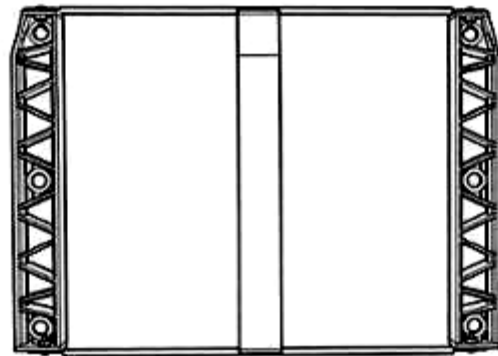

1.2

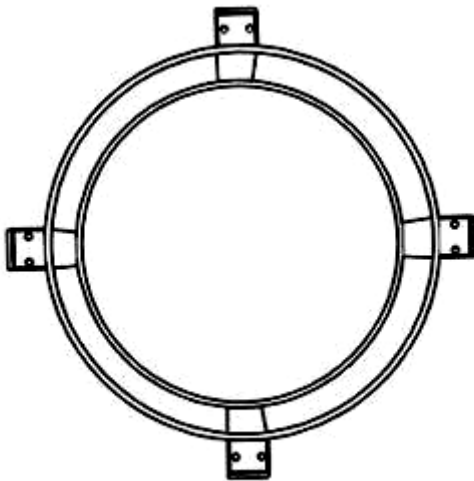

1.3

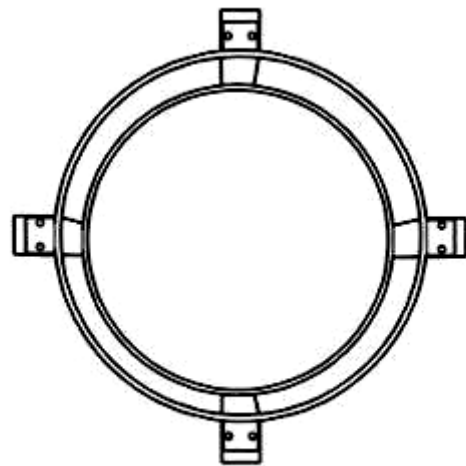

1.4

**CÔNG BÁO SỞ HỮU CÔNG NGHIỆP SỐ 418 TẬP A – QUYỀN 2 (01.2023)**

(11) **46303**

(21) 3-2022-01998

(28) 1

(54) **GIÁ ĐỖ**

(51) **25-01**

(22) 20/09/2022

(43) 27/01/2023

(73) **CÔNG TY CỔ PHẦN TẬP ĐOÀN NHỰA SUPER TRƯỜNG PHÁT (VN)**  
Số T151, lô đất H4, khu đấu giá 31ha, thị trấn Trâu Quỳ, huyện Gia Lâm, thành phố Hà Nội

(72) Phạm Quốc Chính (VN)

(74) Công ty TNHH Sở hữu trí tuệ VIPATCO (VIPATCO CO., LTD.)

(55)

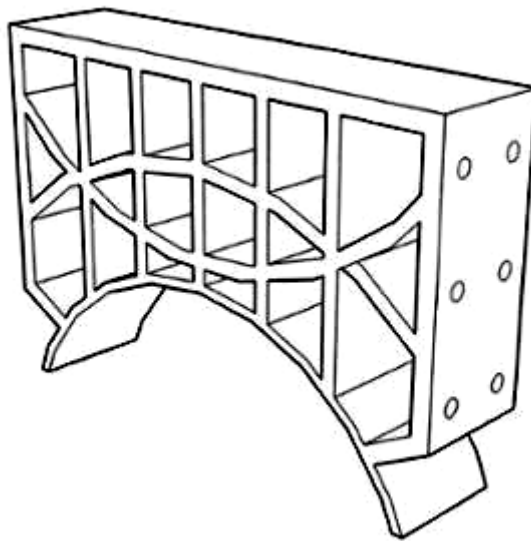

1.1

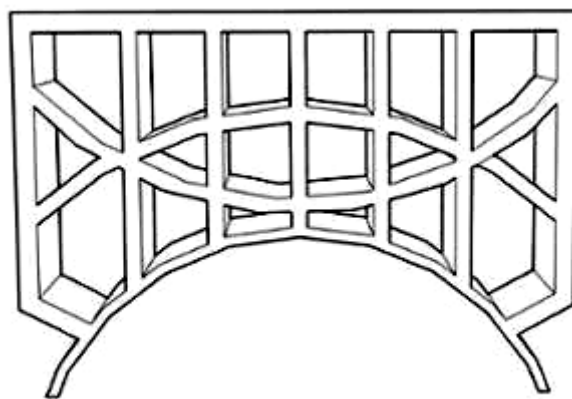

1.2

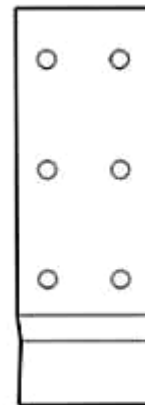

1.3



1.4

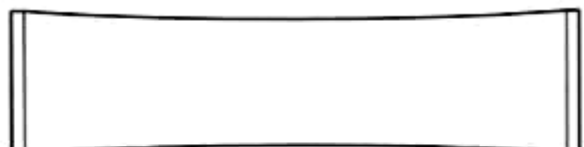

1.5

**CÔNG BÁO SỞ HỮU CÔNG NGHIỆP SỐ 418 TẬP A – QUYỀN 2 (01.2023)**

- (11) **46304**  
(21) 3-2022-01999 (28) 1  
(54) **THIẾT BỊ Y SINH ÁNH SÁNG** (51) **24-01**  
(22) 20/09/2022 (43) 27/01/2023  
(73) **CÔNG TY TNHH KỸ THUẬT THIẾT BỊ Y TẾ AMED (VN)**  
28 Phạm Phú Thứ, phường 11, quận Tân Bình, thành phố Hồ Chí Minh  
(72) Lương Vũ Đăng Quang (VN)  
(55)



1.1



1.2



1.3



1.4



1.5



1.6

**CÔNG BÁO SỞ HỮU CÔNG NGHIỆP SỐ 418 TẬP A – QUYỀN 2 (01.2023)**

- (11) **46305**  
(21) 3-2022-02010 (28) 1  
(54) **DỤNG CỤ HẤP THỤ NĂNG LƯỢNG CỦA DÂY CỨU SINH** (51) **08-08**  
(22) 20/09/2022 (43) 27/01/2023  
(73) **CÔNG TY CỔ PHẦN AN TOÀN SSTC (VN)**  
372/6 Dương Thị Mười, khu phố 3, phường Tân Thới Hiệp, quận 12, thành phố Hồ Chí Minh  
(72) Dương Đình Luân (VN)  
(74) Công ty Cổ phần Sở hữu công nghiệp INVESTIP (INVESTIP)  
(55)



1.1

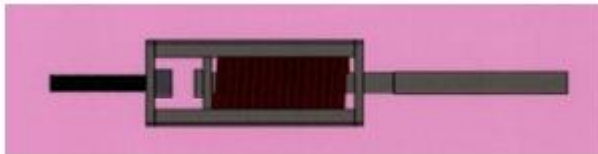

1.2



1.3



1.4



1.5



1.6

**CÔNG BÁO SỞ HỮU CÔNG NGHIỆP SỐ 418 TẬP A – QUYỀN 2 (01.2023)**

- (11) **46306**  
(21) 3-2022-02033 (28) 1  
(54) **MÁY ĐIỀU KHIỂN PHUN CHÍNH XÁC CHẤT LỎNG** (51) **15-99**  
(22) 21/09/2022 (43) 27/01/2023  
(30) 2022-006145 24/03/2022 JP;  
(73) **MUSASHI ENGINEERING, INC. (JP)**  
1-11-6, Iguchi, Mitaka-shi, Tokyo, Japan  
(72) Kazumasa Ikushima (JP)  
(74) Công ty Luật TNHH ROUSE Việt Nam (ROUSE LAW CO.,LTD)  
(55)

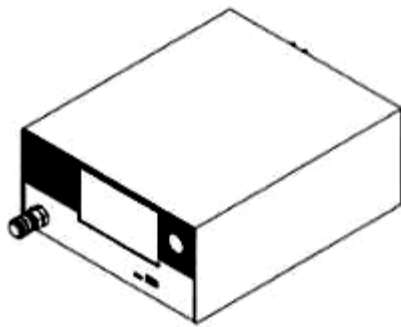

1.1



1.2

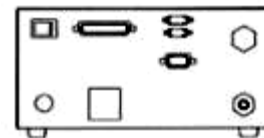

1.3



1.4



1.5



1.6

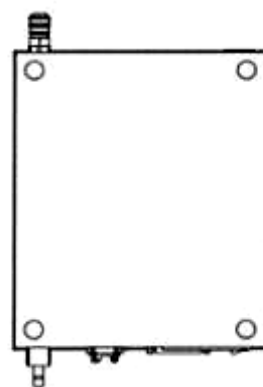

1.7

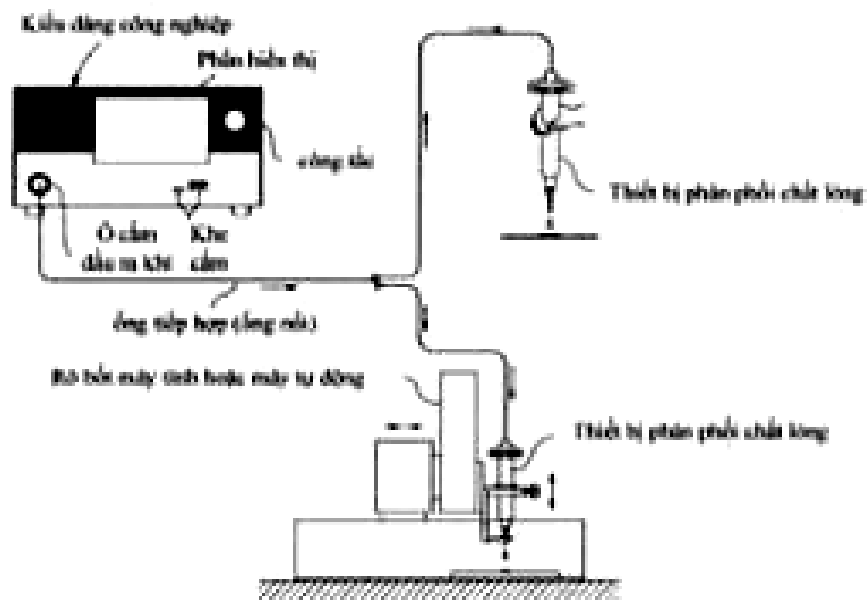

1.8



- (11) **46307**  
(21) 3-2022-02036 (28) 1  
(54) **THÙNG ĐỰNG GẠO** (51) **07-07**  
(22) 21/09/2022 (43) 27/01/2023  
(30) 30-2022-0013588 07/04/2022 KR;  
(73) **LOCK & LOCK CO., LTD (KR)**  
104, Sapgyocheon-ro, Seonjang-myeon, Asan-si, Chungcheongnam-do, Republic of Korea  
(72) SHIM, Dong Seop (KR)  
(74) Công ty TNHH Tầm nhìn và Liên danh (VISION & ASSOCIATES CO.LTD.)  
(55)

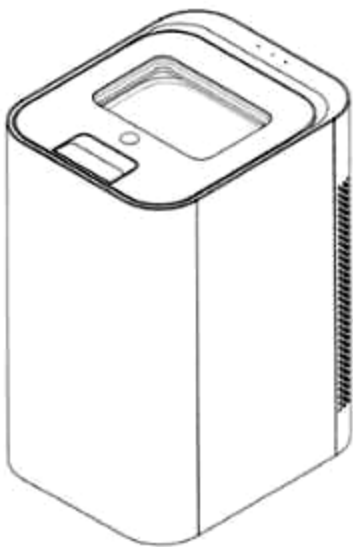

1.1



1.2

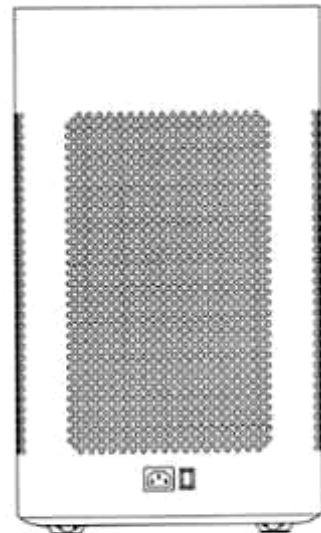

1.3

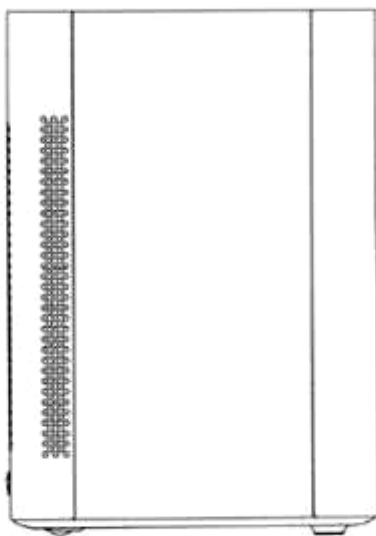

1.4

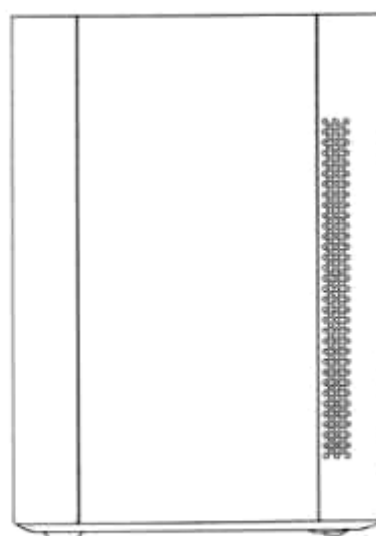

1.5



1.6

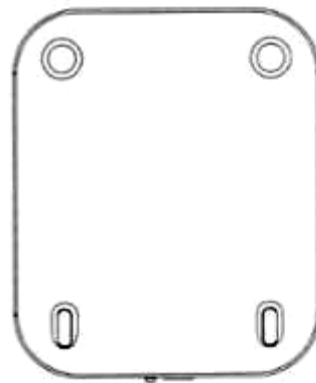

1.7

**CÔNG BÁO SỞ HỮU CÔNG NGHIỆP SỐ 418 TẬP A – QUYỀN 2 (01.2023)**

- (11) **46308**  
(21) 3-2022-02041 (28) 1  
(54) **ĐIỆN THOẠI DI ĐỘNG** (51) **14-03**  
(22) 22/09/2022 (43) 27/01/2023  
(30) 202230163517.8 26/03/2022 CN;  
(73) **HUAWEI TECHNOLOGIES CO., LTD. (CN)**  
Huawei Administration Building, Bantian, Longgang District, Shenzhen,  
Guangdong 518129, P. R. China  
(72) 1. XU, TING (CN)  
2. WANG, FEI (CN)  
3. ZENG, ZEDONG (CN)  
4. CAO, GUANG (CN)  
(74) Công ty Cổ phần Sở hữu công nghiệp INVESTIP (INVESTIP)  
(55)

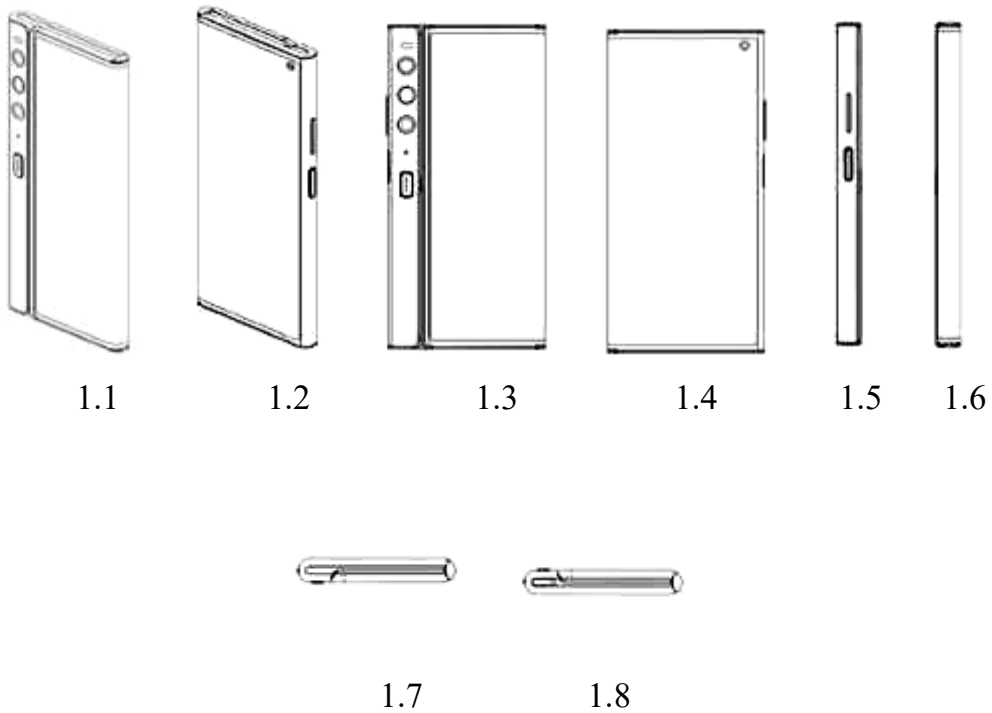

**CÔNG BÁO SỞ HỮU CÔNG NGHIỆP SỐ 418 TẬP A – QUYỀN 2 (01.2023)**

- (11) **46309**  
(21) 3-2022-02042 (28) 1  
(54) **ĐIỆN THOẠI DI ĐỘNG** (51) **14-03**  
(22) 22/09/2022 (43) 27/01/2023  
(30) 202230163530.3 26/03/2022 CN;  
(73) **HUAWEI TECHNOLOGIES CO., LTD. (CN)**  
Huawei Administration Building, Bantian, Longgang District, Shenzhen,  
Guangdong 518129, P. R. China  
(72) 1. XU, TING (CN)  
2. WANG, FEI (CN)  
3. ZENG, ZEDONG (CN)  
4. CAO, GUANG (CN)  
(74) Công ty Cổ phần Sở hữu công nghiệp INVESTIP (INVESTIP)  
(55)

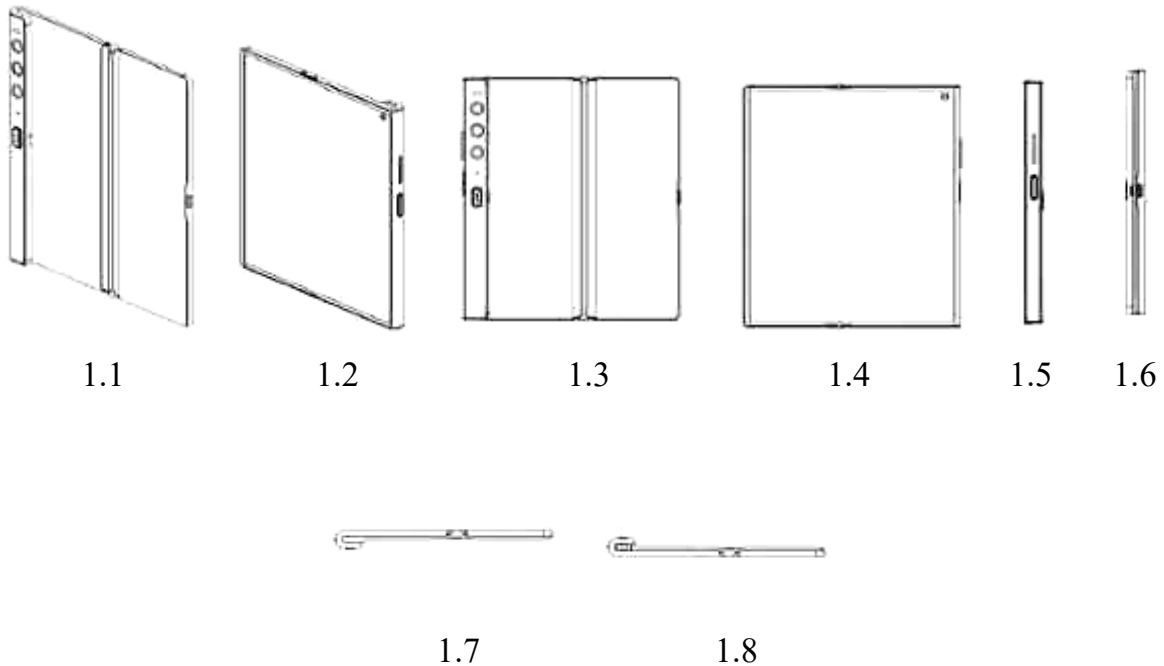

- (11) **46310**  
(21) 3-2022-02054 (28) 1  
(54) **TẤM ỐP PHÍA SAU XE SCUTO** (51) **12-16**  
(22) 26/09/2022 (43) 27/01/2023  
(30) 2022-006914 31/03/2022 JP;  
(73) **HONDA MOTOR CO., LTD. (JP)**  
1-1, Minami-Aoyama 2-chome, Minato-ku, Tokyo, 107-8556 Japan  
(72) 1. NUTTAPON SANGRAWEE (TH)  
2. TANAWUT KAEWTHONG (TH)  
(74) Công ty Luật TNHH Phạm và Liên danh (PHAM & ASSOCIATES)  
(55)



1.1



1.2



1.3



1.4



1.5



1.6



1.7



1.8



1.9



1.10



1.11

**CÔNG BÁO SỞ HỮU CÔNG NGHIỆP SỐ 418 TẬP A – QUYỀN 2 (01.2023)**

- (11) **46311**  
(21) 3-2022-02055 (28) 1  
(54) **XE MÁY** (51) **12-11**  
(22) 26/09/2022 (43) 27/01/2023  
(30) 2022-006921 31/03/2022 JP;  
(73) **HONDA MOTOR CO., LTD. (JP)**  
1-1, Minami-Aoyama 2-chome, Minato-ku, Tokyo, 107-8556 Japan  
(72) 1. PARITAS SAKAWPRYPU (TH)  
2. JATURONG APIROMBOONSOM (TH)  
3. SUPAWADEE THAINGAMSIN (TH)  
(74) Công ty Luật TNHH Phạm và Liên danh (PHAM & ASSOCIATES)  
(55)



1.1



1.2



1.3



1.4



1.5



1.6



1.7



1.8



1.9



1.10



- (11) **46312**  
(21) 3-2022-02056 (28) 1  
(54) **CỤM ĐÈN PHÍA SAU XE MÁY** (51) **26-06**  
(22) 26/09/2022 (43) 27/01/2023  
(30) 2022-006924 31/03/2022 JP;  
(73) **HONDA MOTOR CO., LTD. (JP)**  
1-1, Minami-Aoyama 2-chome, Minato-ku, Tokyo, 107-8556 Japan  
(72) 1. PARITAS SAKAWPRYPU (TH)  
2. JATURONG APIROMBOONSOM (TH)  
3. SUPAWADEE THAINGAMSIN (TH)  
(74) Công ty Luật TNHH Phạm và Liên danh (PHAM & ASSOCIATES)  
(55)



1.1



1.2



1.3



1.4



1.5



1.6



1.7



1.8



1.9



1.10

**CÔNG BÁO SỞ HỮU CÔNG NGHIỆP SỐ 418 TẬP A – QUYỀN 2 (01.2023)**

- (11) **46313**  
(21) 3-2022-02062 (28) 1  
(54) **HỘP ĐỰNG** (51) **09-03**  
(22) 26/09/2022 (43) 27/01/2023  
(73) **CÔNG TY CỔ PHẦN THƯƠNG MẠI VÀ SẢN XUẤT THỰC PHẨM KICO (VN)**  
Số 52 Hàng Bún, phường Quán Thánh, quận Ba Đình, thành phố Hà Nội  
(72) Nguyễn Văn Long (VN)  
(74) Công ty TNHH Sở hữu trí tuệ HA VIP (HAVIP CO., LTD.)  
(55)



1.1



1.2

**CÔNG BÁO SỞ HỮU CÔNG NGHIỆP SỐ 418 TẬP A – QUYỀN 2 (01.2023)**

- (11) **46314**
- (21) 3-2022-02066 (28) 1
- (54) **HỘP ĐỰNG** (51) **09-03**
- (22) 26/09/2022 (43) 27/01/2023
- (73) **HAOREN TECH CO., LTD. (KR)**  
(Dohwa-dong, teuin techno 6) # 103 B dong, 103, Yeomjeon-ro, Michuhol-gu, Incheon, Republic of Korea (Postal code : 22107)
- (72) KIM, Jong Bae (KR)
- (74) Công ty TNHH Đại Tín và Liên Danh (DAITIN AND ASSOCIATES CO.,LTD)
- (55)



1.1



1.2



1.3



1.4



1.5



1.6



1.7

**CÔNG BÁO SỞ HỮU CÔNG NGHIỆP SỐ 418 TẬP A – QUYỀN 2 (01.2023)**

- (11) **46315**
- (21) 3-2022-02070 (28) 1
- (54) **HỘP** (51) **09-03**
- (22) 26/09/2022 (43) 27/01/2023
- (73) **TRƯỜNG ĐẠI HỌC YERSIN ĐÀ LẠT (VN)**  
27 Tôn Thất Tùng, phường 8, thành phố Đà Lạt, tỉnh Lâm Đồng
- (72) 1. PHẠM ĐÌNH TRUNG (VN)  
2. THI ĐÌNH NGUYỄN (VN)  
3. TRỊNH THANH KIỀU (VN)  
4. TẠ ĐÌNH VƯƠNG (VN)  
5. TRẦN THỊ BẢO TRÂM (VN)  
6. VŨ THỊ TU (VN)  
7. NGUYỄN CAO CƯỜNG (VN)  
8. PHẠM THẾ ANH (VN)  
9. NGUYỄN HỢP TẤN (VN)
- (74) Công ty Cổ phần Sở hữu công nghiệp INVESTIP (INVESTIP)
- (55)



1.1



1.2

**CÔNG BÁO SỞ HỮU CÔNG NGHIỆP SỐ 418 TẬP A – QUYỀN 2 (01.2023)**

- (11) **46316**  
(21) 3-2022-02081 (28) 1  
(54) **BÌNH** (51) **07-07**  
(22) 28/09/2022 (43) 27/01/2023  
(30) 30-2022-0018729 11/05/2022 KR;  
(73) **LOCK & LOCK CO., LTD** (KR)  
104, Sapgyocheon-ro, Seonjang-myeon, Asan-si, Chungcheongnam-do, Republic  
of Korea  
(72) KIM, Kwang Ik (KR)  
(74) Công ty TNHH Tầm nhìn và Liên danh (VISION & ASSOCIATES CO.LTD.)  
(55)

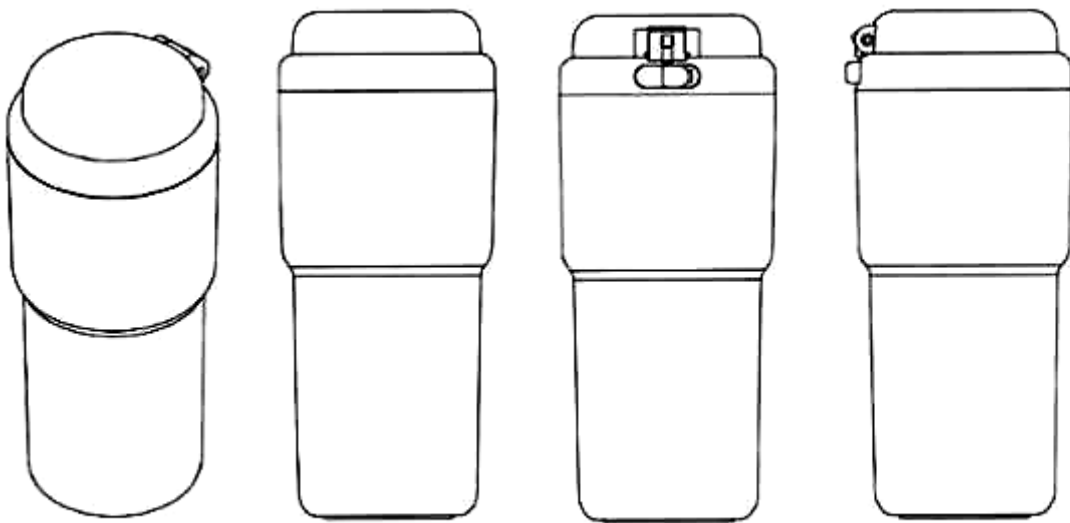

1.1

1.2

1.3

1.4

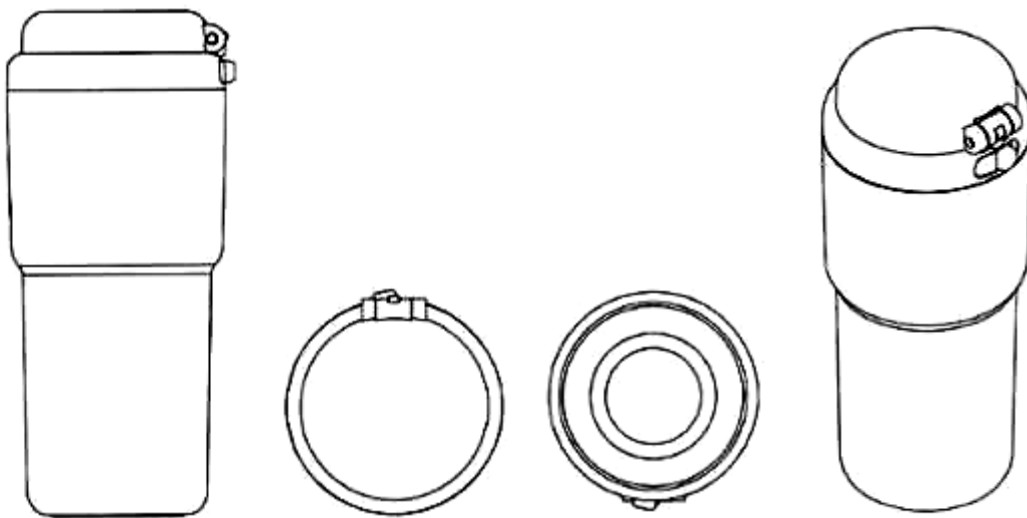

1.5

1.6

1.7

1.8

**CÔNG BÁO SỞ HỮU CÔNG NGHIỆP SỐ 418 TẬP A – QUYỀN 2 (01.2023)**

- (11) **46317**  
(21) 3-2022-02082 (28) 1  
(54) **BÌNH** (51) **07-07**  
(22) 28/09/2022 (43) 27/01/2023  
(30) 30-2022-0018730 11/05/2022 KR;  
(73) **LOCK & LOCK CO., LTD** (KR)  
104, Sapgyocheon-ro, Seonjang-myeon, Asan-si, Chungcheongnam-do, Republic  
of Korea  
(72) KIM, Kwang Ik (KR)  
(74) Công ty TNHH Tầm nhìn và Liên danh (VISION & ASSOCIATES CO.LTD.)  
(55)

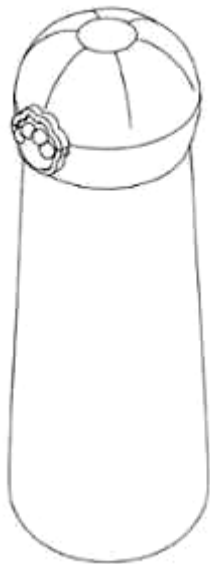

1.1



1.2

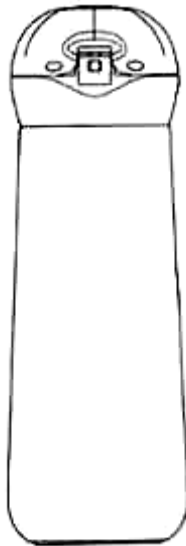

1.3



1.4



1.5



1.6



1.7

**CÔNG BÁO SỞ HỮU CÔNG NGHIỆP SỐ 418 TẬP A – QUYỀN 2 (01.2023)**

- (11) **46318**  
(21) 3-2022-02085 (28) 1  
(54) **DU THUYỀN** (51) **12-06**  
(22) 29/09/2022 (43) 27/01/2023  
(73) **CÔNG TY CỔ PHẦN CÔNG NGHIỆP HÀNG HẢI NOVA TVĐ (VN)**  
Số 65 Nguyễn Du, phường Bến Nghé, quận 1, thành phố Hồ Chí Minh  
(72) Trần Đình Quyết (VN)  
(74) Công ty Luật TNHH AGL (AGL LAW)  
(55)

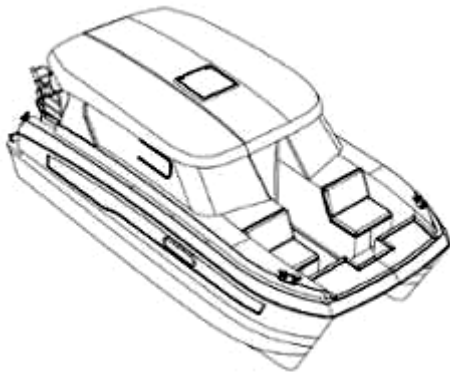

1.1



1.2

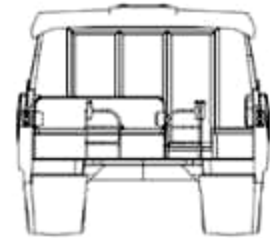

1.3

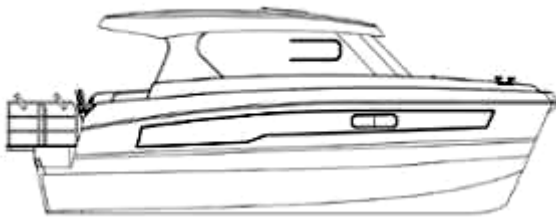

1.4

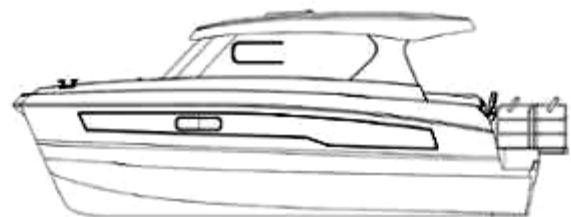

1.5

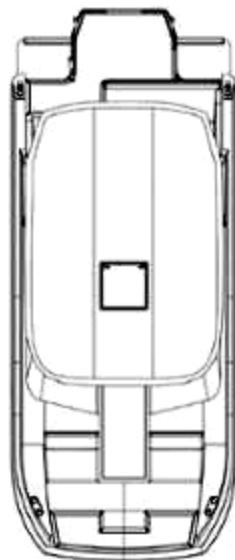

1.6

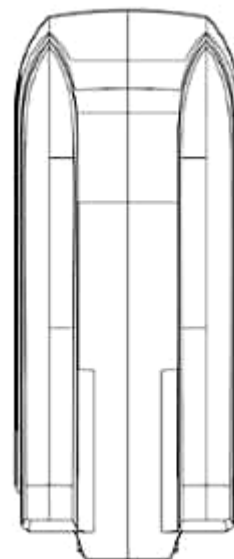

1.7



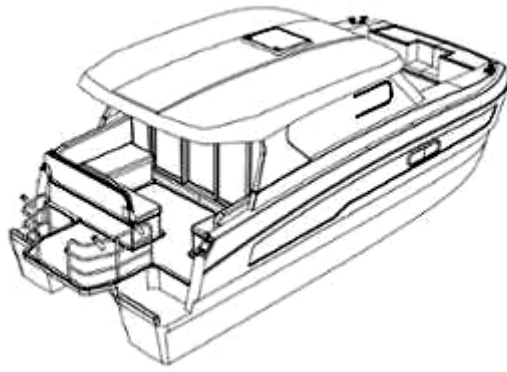

1.8

- (11) **46319**  
(21) 3-2022-02103  
(54) **GIÁ ĐỒ BẢO VỆ CÂY XANH**  
(22) 30/09/2022  
(73) **NGUYỄN VĂN ĐẮC (VN)**  
Khu 5, Nam Hải, Hải An, thành phố Hải Phòng  
(72) Nguyễn Văn Đắc (VN)  
(74) **CÔNG TY TRÁCH NHIỆM HỮU HẠN TƯ VẤN ĐẦU TƯ VÀ SỞ HỮU TRÍ TUỆ INTERFIVE (INTERFIVE CO., LTD)**  
(55)
- (28) 1  
(51) **11-02**  
(43) 27/01/2023

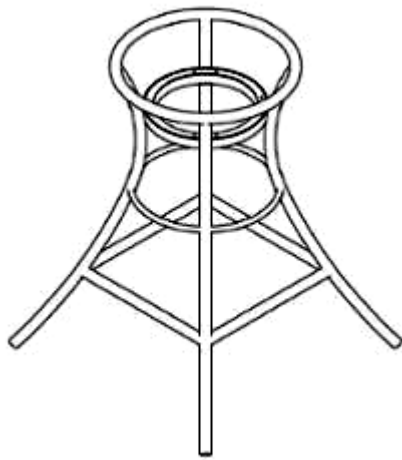

1.1

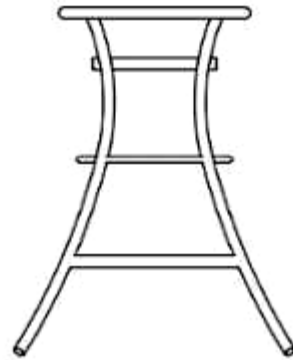

1.2

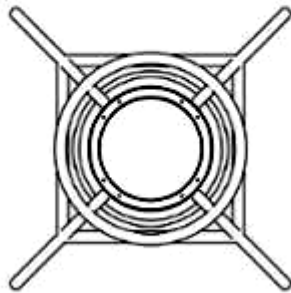

1.3

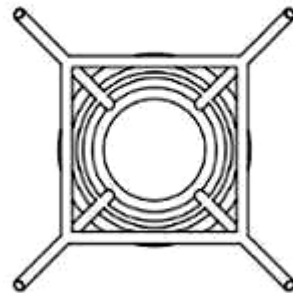

1.4

- (11) **46320**  
(21) 3-2022-02104 (28) 1  
(54) **GIÁ ĐỠ BẢO VỆ CÂY XANH** (51) **11-02**  
(22) 30/09/2022 (43) 27/01/2023  
(73) **NGUYỄN VĂN ĐẮC (VN)**  
Khu 5, Nam Hải, Hải An, thành phố Hải Phòng  
(72) Nguyễn Văn Đắc (VN)  
(74) **CÔNG TY TRÁCH NHIỆM HỮU HẠN TƯ VẤN ĐẦU TƯ VÀ SỞ HỮU TRÍ TUỆ INTERFIVE (INTERFIVE CO., LTD)**  
(55)

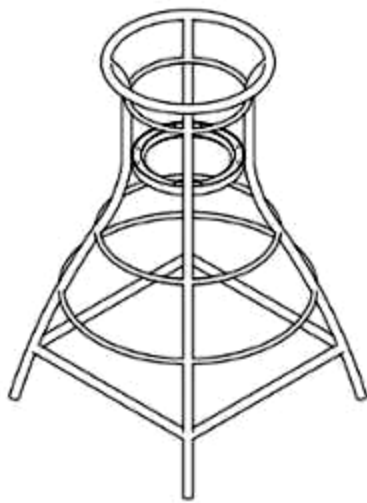

1.1



1.2

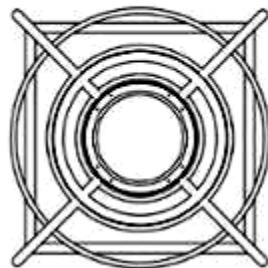

1.3

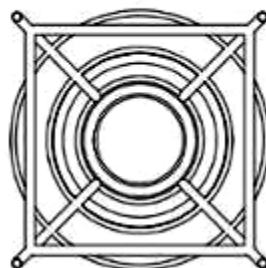

1.4

- (11) **46321**  
(21) 3-2022-02106 (28) 1  
(54) **BỘ LỌC CAO TẦN** (51) **14-03**  
(22) 30/09/2022 (43) 27/01/2023  
(73) **TẬP ĐOÀN CÔNG NGHIỆP - VIỆN THÔNG QUÂN ĐỘI (VN)**  
Lô D26 khu đô thị mới Cầu Giấy, phường Yên Hoà, quận Cầu Giấy, thành phố Hà Nội  
(72) 1. NGUYỄN QUỐC HÙNG (VN)  
2. LÊ TRƯỜNG GIANG (VN)  
3. HOÀNG ĐÌNH HẢI TRUYỀN (VN)  
4. KHÔNG VĂN MẠNH (VN)  
5. ĐÌNH VĂN HẢI (VN)  
6. BÙI THỊ VÂN (VN)  
7. NGUYỄN VĂN HƯỚNG (VN)  
(74) Công ty TNHH NACILAW (NACILAW)  
(55)

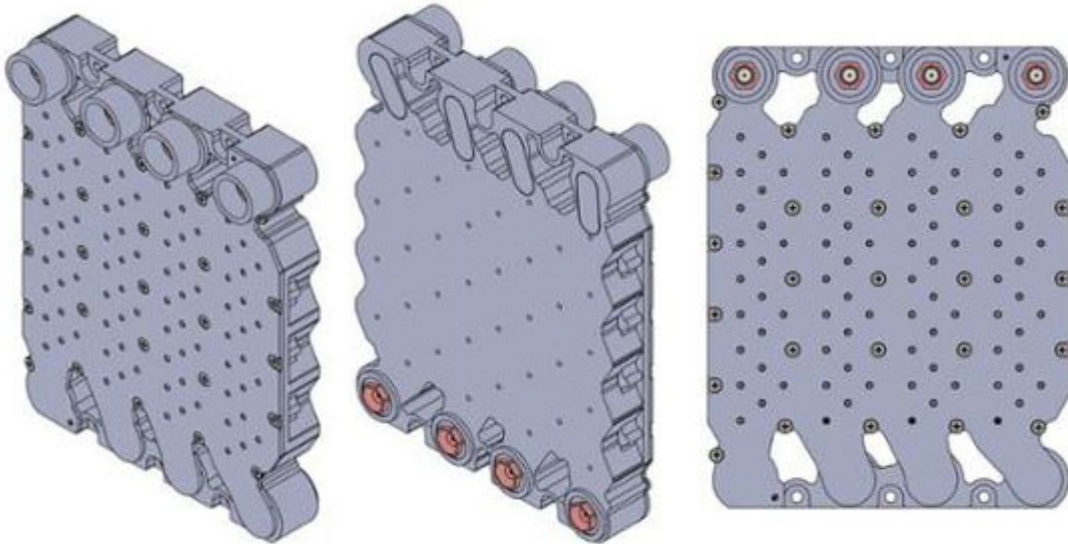

1.1

1.2

1.3

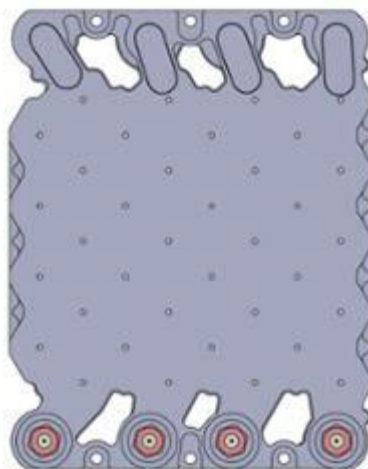

1.4

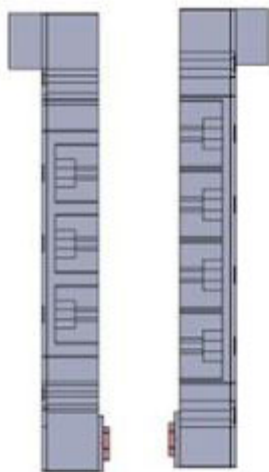

1.5

1.6



1.7



1.8

- (11) **46322**
- (21) 3-2022-02107 (28) 1
- (54) **ĂNG TEN MĂNG PHA** (51) **14-03**
- (22) 30/09/2022 (43) 27/01/2023
- (73) **TẬP ĐOÀN CÔNG NGHIỆP - VIỆN THÔNG QUÂN ĐỘI (VN)**  
Lô D26 Khu đô thị mới Cầu Giấy, phường Yên Hoà, quận Cầu Giấy, thành phố Hà Nội
- (72) 1. NGUYỄN ĐÌNH DƯƠNG (VN)  
2. NGUYỄN CHÍ LINH (VN)  
3. HOÀNG ĐÌNH HẢI TRUYỀN (VN)  
4. KHÔNG VĂN MẠNH (VN)  
5. NGUYỄN VĂN HƯỚNG (VN)  
6. TRẦN QUANG NHƯỜNG (VN)
- (74) Công ty TNHH NACILAW (NACILAW)
- (55)

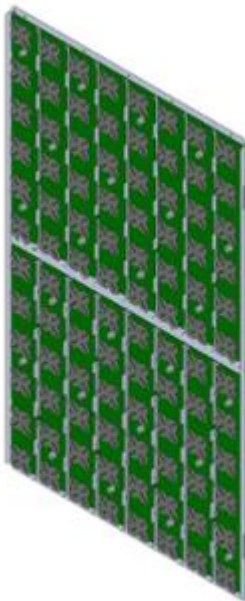

1.1

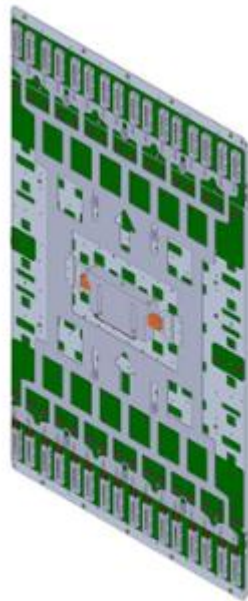

1.2

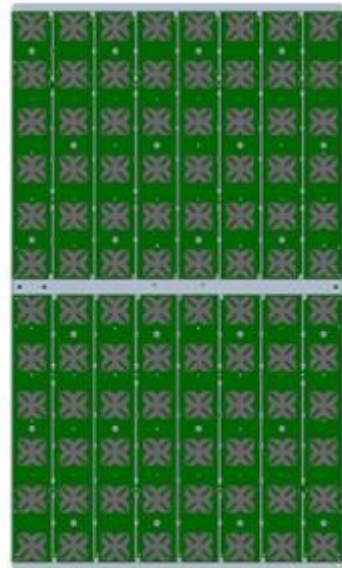

1.3

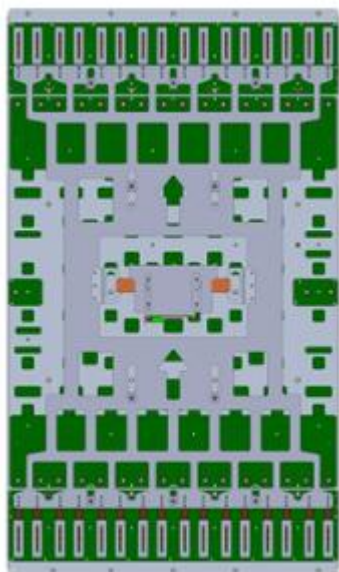

1.4



1.5



1.6



1.7



1.8

**CÔNG BÁO SỞ HỮU CÔNG NGHIỆP SỐ 418 TẬP A – QUYỀN 2 (01.2023)**

- (11) **46323**  
(21) 3-2022-02109 (28) 1  
(54) **XE SCUTO** (51) **12-11**  
(22) 03/10/2022 (43) 27/01/2023  
(30) 2022-007475 06/04/2022 JP;  
(73) **HONDA MOTOR CO., LTD. (JP)**  
1-1, Minami-Aoyama 2-Chome, Minato-ku, Tokyo, 107-8556 Japan  
(72) 1. YIBIN QI (CN)  
2. YAN HUANG (CN)  
(74) Công ty Luật TNHH Phạm và Liên danh (PHAM & ASSOCIATES)  
(55)



1.1



1.2



1.3



1.4



1.5



1.6





1.7



1.8



1.9

**CÔNG BÁO SỞ HỮU CÔNG NGHIỆP SỐ 418 TẬP A – QUYỀN 2 (01.2023)**

- (11) **46324**  
(21) 3-2022-02117 (28) 1  
(54) **BỘ CHUYỂN ĐỔI** (51) **25-01**  
(22) 04/10/2022 (43) 27/01/2023  
(73) **CÔNG TY CỔ PHẦN CAD GROUP (VN)**  
Số 8 ngõ 81, phố Trạm, phường Long Biên, quận Long Biên, thành phố Hà Nội  
(72) Lâm Viết An (VN)  
(74) Công ty TNHH Sở hữu trí tuệ Gia Việt (GIAVIET CO., LTD.)  
(55)

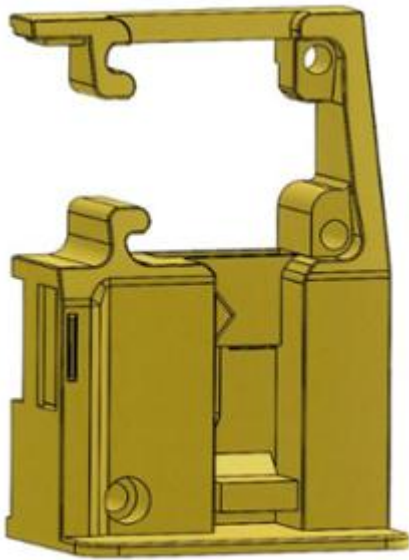

1.1

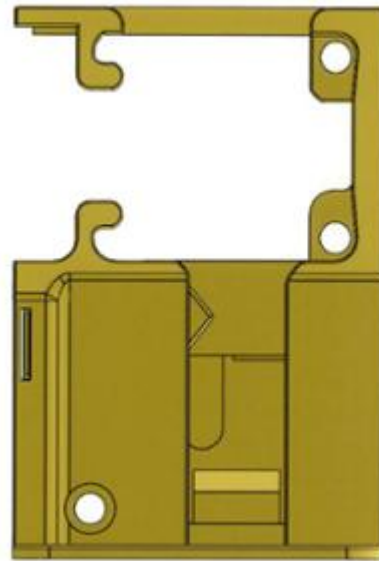

1.2

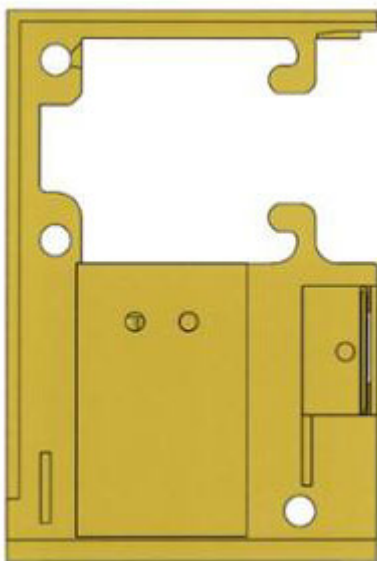

1.3

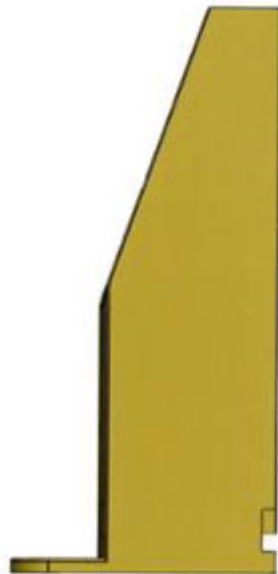

1.4



1.5

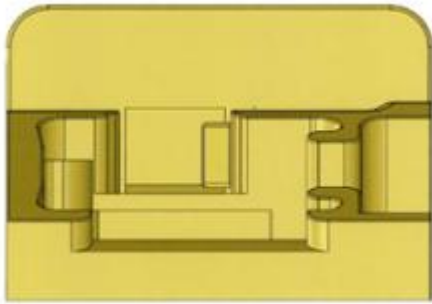

1.6



1.7

**CÔNG BÁO SỞ HỮU CÔNG NGHIỆP SỐ 418 TẬP A – QUYỀN 2 (01.2023)**

- (11) **46325**  
(21) 3-2022-02118 (28) 1  
(54) **BỘ CHUYỂN ĐỔI** (51) **25-01**  
(22) 04/10/2022 (43) 27/01/2023  
(73) **CÔNG TY CỔ PHẦN CAD GROUP (VN)**  
Số 8 ngõ 81, phố Trạm, phường Long Biên, quận Long Biên, thành phố Hà Nội  
(72) Lâm Viết An (VN)  
(74) Công ty TNHH Sở hữu trí tuệ Gia Việt (GIAVIET CO., LTD.)  
(55)

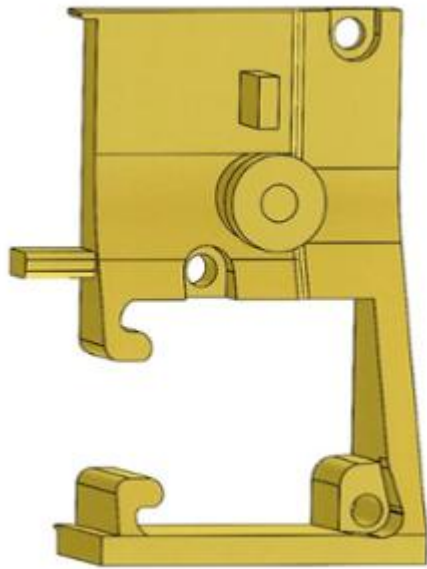

1.1

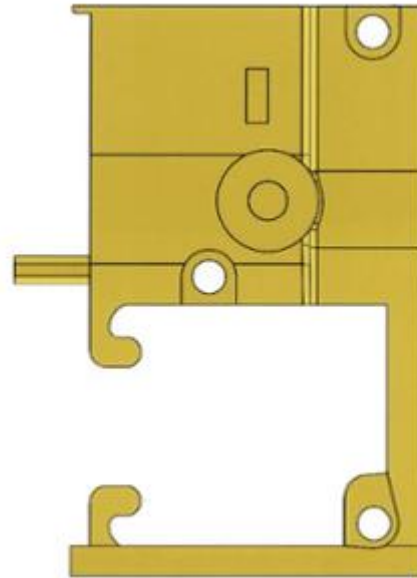

1.2

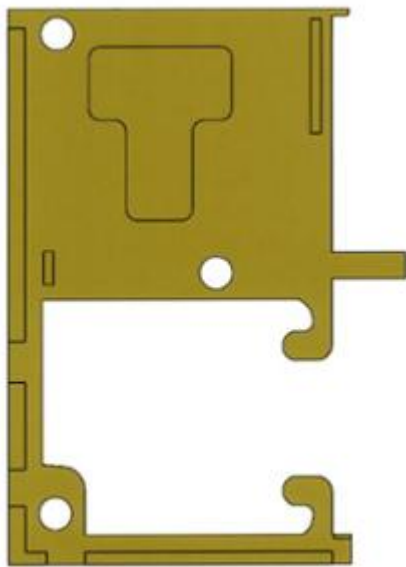

1.3



1.4



1.5

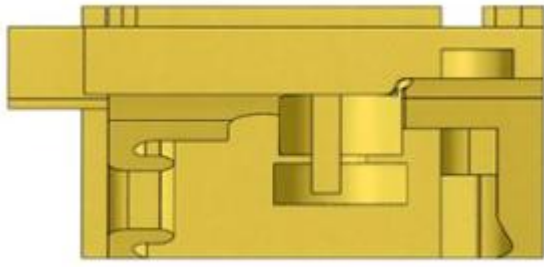

1.6



1.7

- (11) **46326**  
(21) 3-2022-02119 (28) 1  
(54) **BỘ CHUYỂN ĐỔI** (51) **25-01**  
(22) 04/10/2022 (43) 27/01/2023  
(73) **CÔNG TY CỔ PHẦN CAD GROUP (VN)**  
Số 8 ngõ 81, phố Trạm, phường Long Biên, quận Long Biên, thành phố Hà Nội  
(72) Lâm Viết An (VN)  
(74) Công ty TNHH Sở hữu trí tuệ Gia Việt (GIAVIET CO., LTD.)  
(55)

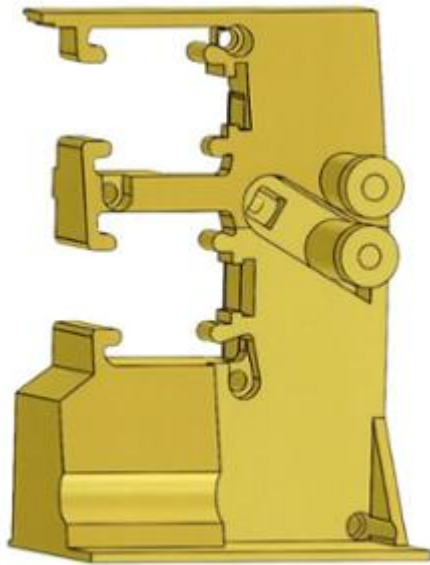

1.1

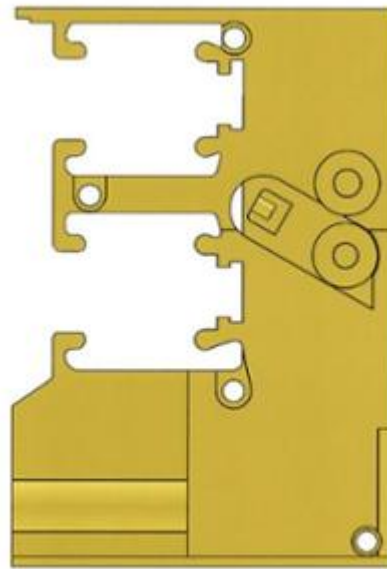

1.2

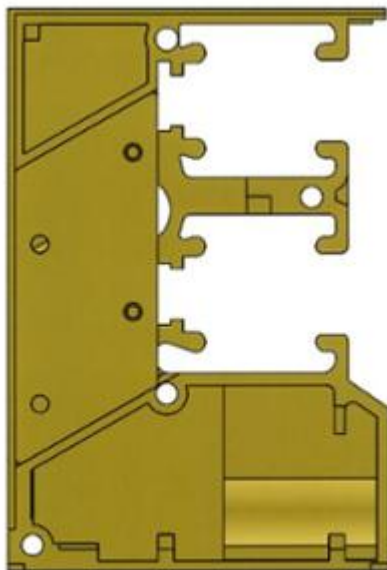

1.3

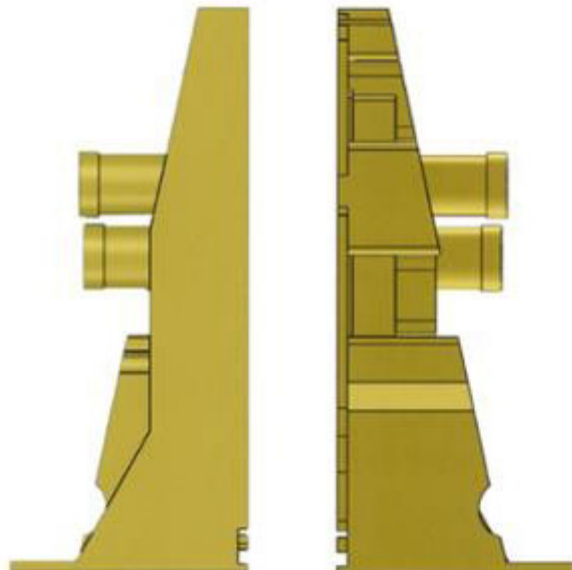

1.4

1.5

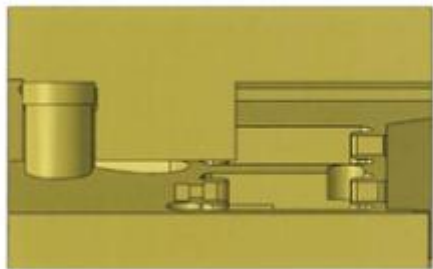

1.6



1.7

- (11) **46327**  
(21) 3-2022-02120 (28) 1  
(54) **BỘ CHUYỂN ĐỔI** (51) **25-01**  
(22) 04/10/2022 (43) 27/01/2023  
(73) **CÔNG TY CỔ PHẦN CAD GROUP (VN)**  
Số 8 ngõ 81, phố Trạm, phường Long Biên, quận Long Biên, thành phố Hà Nội  
(72) Lâm Viết An (VN)  
(74) Công ty TNHH Sở hữu trí tuệ Gia Việt (GIAVIET CO., LTD.)  
(55)

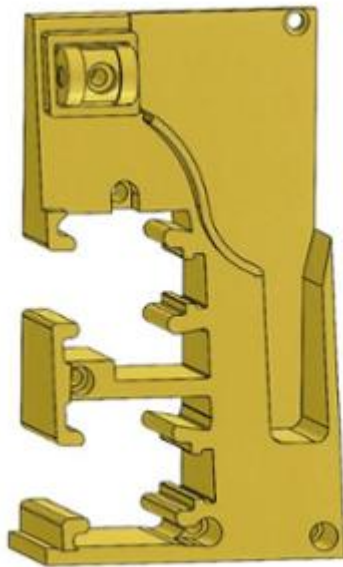

1.1

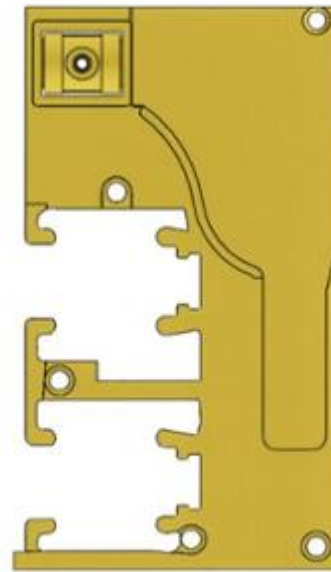

1.2

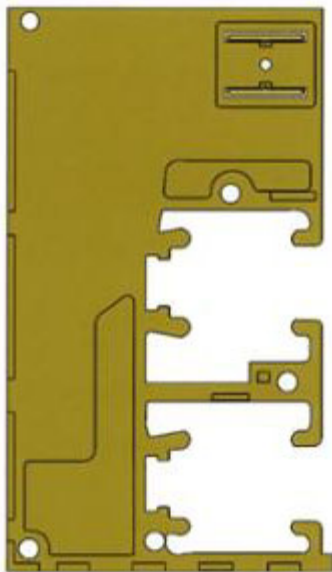

1.3

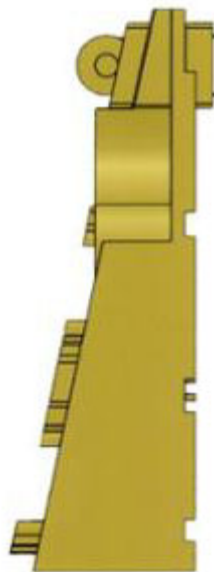

1.4

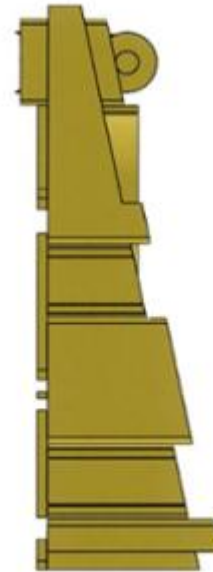

1.5



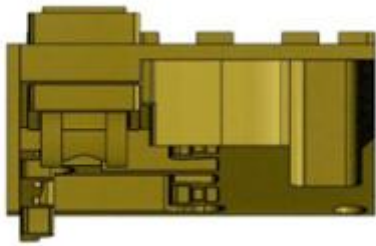

1.6

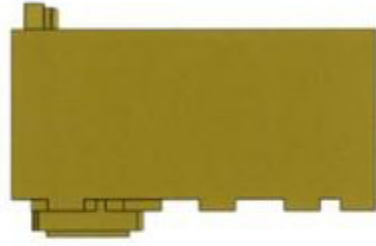

1.7

- (11) **46328**  
(21) 3-2022-02121 (28) 1  
(54) **THANH KIM LOẠI ĐỊNH HÌNH** (51) **25-01**  
(22) 04/10/2022 (43) 27/01/2023  
(73) **CÔNG TY CỔ PHẦN CAD GROUP (VN)**  
Số 8 ngõ 81, phố Trạm, phường Long Biên, quận Long Biên, thành phố Hà Nội  
(72) Lâm Viết An (VN)  
(74) Công ty TNHH Sở hữu trí tuệ Gia Việt (GIAVIET CO., LTD.)  
(55)

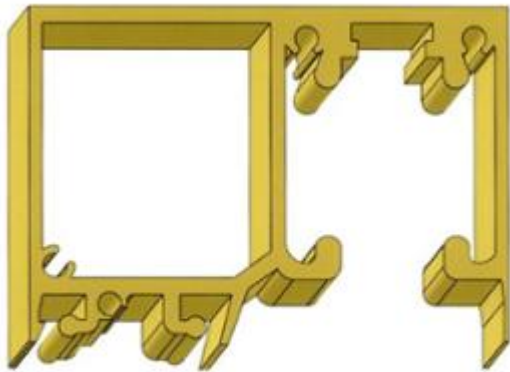

1.1

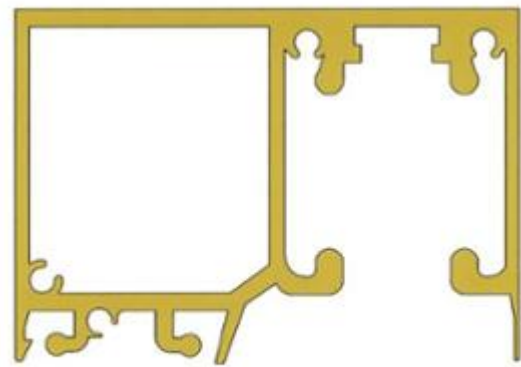

1.2



1.3



1.4



1.5

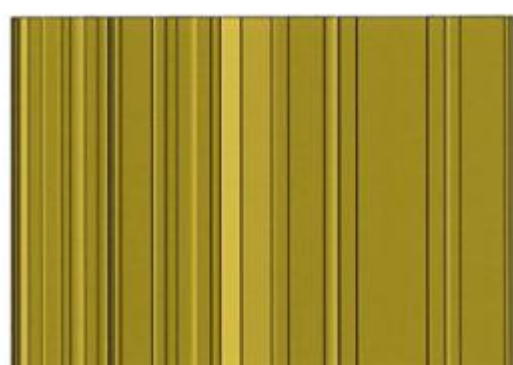

1.6

- (11) **46329**  
(21) 3-2022-02122 (28) 1  
(54) **THANH KIM LOẠI ĐỊNH HÌNH** (51) **25-01**  
(22) 04/10/2022 (43) 27/01/2023  
(73) **CÔNG TY CỔ PHẦN CAD GROUP (VN)**  
Số 8 ngõ 81, phố Trạm, phường Long Biên, quận Long Biên, thành phố Hà Nội  
(72) Lâm Viết An (VN)  
(74) Công ty TNHH Sở hữu trí tuệ Gia Việt (GIAVIET CO., LTD.)  
(55)

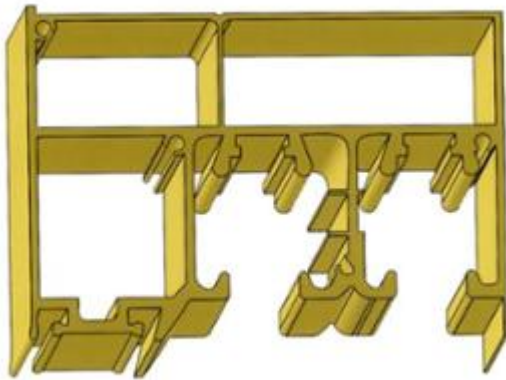

1.1

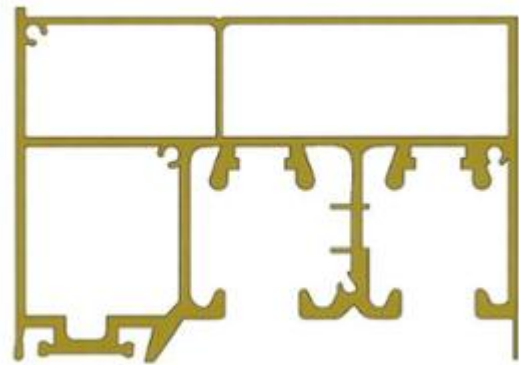

1.2



1.3



1.4



1.5

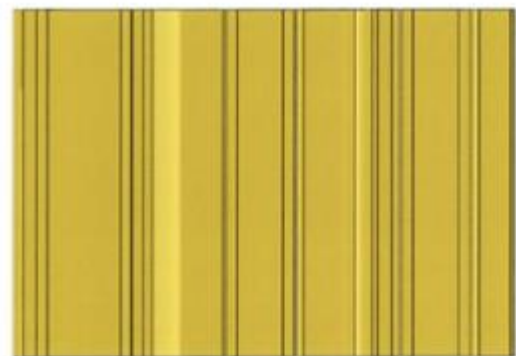

1.6

**CÔNG BÁO SỞ HỮU CÔNG NGHIỆP SỐ 418 TẬP A – QUYỀN 2 (01.2023)**

- (11) **46330**  
(21) 3-2022-02123 (28) 1  
(54) **THANH KIM LOẠI ĐỊNH HÌNH** (51) **25-01**  
(22) 04/10/2022 (43) 27/01/2023  
(73) **CÔNG TY CỔ PHẦN CAD GROUP (VN)**  
Số 8 ngõ 81, phố Trạm, phường Long Biên, quận Long Biên, thành phố Hà Nội  
(72) Lâm Viết An (VN)  
(74) Công ty TNHH Sở hữu trí tuệ Gia Việt (GIAVIET CO., LTD.)  
(55)

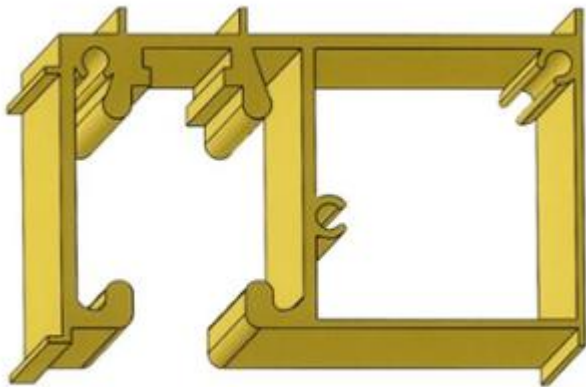

1.1

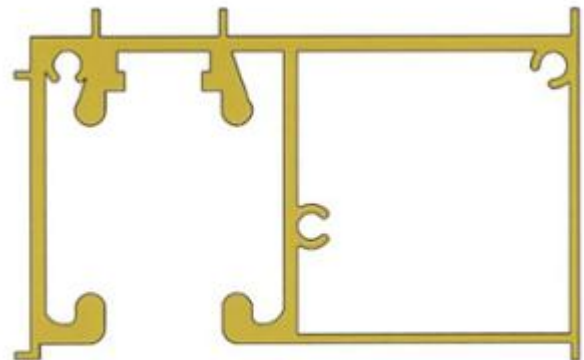

1.2



1.3



1.4



1.5



1.6

**CÔNG BÁO SỞ HỮU CÔNG NGHIỆP SỐ 418 TẬP A – QUYỀN 2 (01.2023)**

- (11) **46331**  
(21) 3-2022-02124 (28) 1  
(54) **THANH KIM LOẠI ĐỊNH HÌNH** (51) **25-01**  
(22) 04/10/2022 (43) 27/01/2023  
(73) **CÔNG TY CỔ PHẦN CAD GROUP (VN)**  
Số 8 ngõ 81, phố Trạm, phường Long Biên, quận Long Biên, thành phố Hà Nội  
(72) Lâm Viết An (VN)  
(74) Công ty TNHH Sở hữu trí tuệ Gia Việt (GIAVIET CO., LTD.)  
(55)

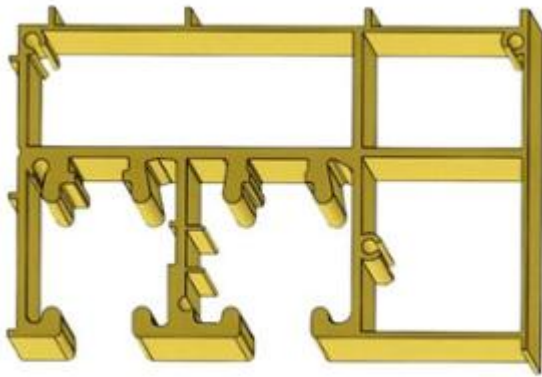

1.1

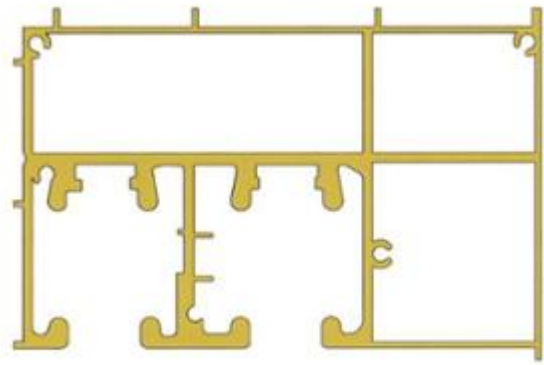

1.2



1.3



1.4



1.5

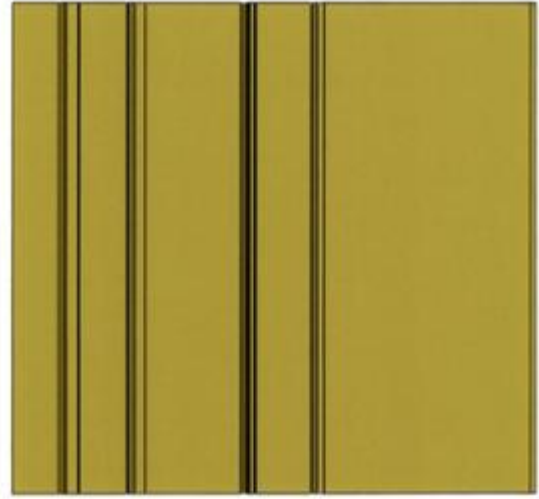

1.6

**CÔNG BÁO SỞ HỮU CÔNG NGHIỆP SỐ 418 TẬP A – QUYỀN 2 (01.2023)**

- (11) **46332**  
(21) 3-2022-02129 (28) 1  
(54) **THANH ĐỊNH HÌNH** (51) **25-01**  
(22) 04/10/2022 (43) 27/01/2023  
(73) **CÔNG TY TNHH CƠ KIM KHÍ QUANG MINH (VN)**  
275-NO-07-LK07-12 khu đất dịch vụ 1, phường Đồng Mai, quận Hà Đông, thành phố Hà Nội  
(72) Đinh Đức Anh (VN)  
(74) Công ty TNHH Trường Xuân (AGELESS CO.,LTD.)  
(55)

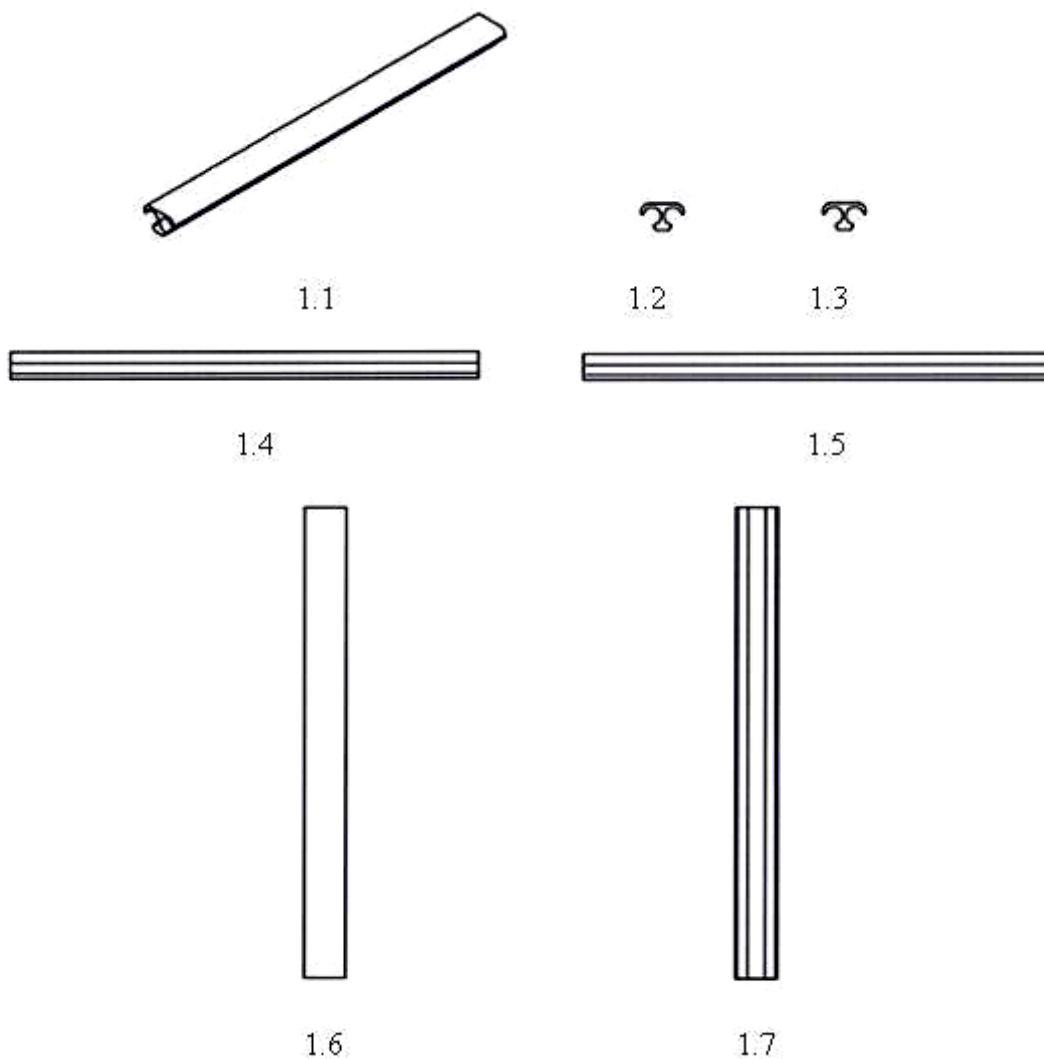

**CÔNG BÁO SỞ HỮU CÔNG NGHIỆP SỐ 418 TẬP A – QUYỀN 2 (01.2023)**

- (11) **46333**  
(21) 3-2022-02130 (28) 1  
(54) **THANH ĐỊNH HÌNH** (51) **25-01**  
(22) 04/10/2022 (43) 27/01/2023  
(73) **CÔNG TY TNHH CƠ KIM KHÍ QUANG MINH (VN)**  
275-NO-07-LK07-12 khu đất dịch vụ 1, phường Đồng Mai, quận Hà Đông, thành phố Hà Nội  
(72) Đinh Đức Anh (VN)  
(74) Công ty TNHH Trường Xuân (AGELESS CO.,LTD.)  
(55)

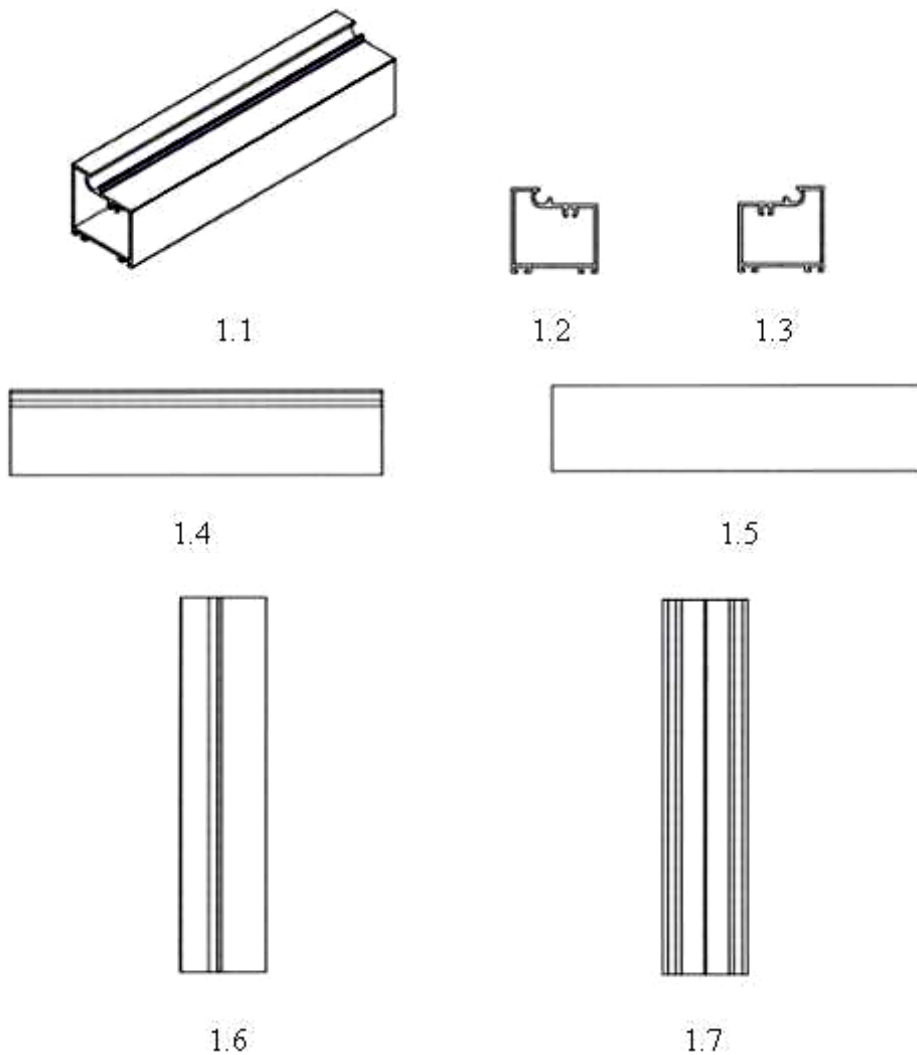



**CÔNG BÁO SỞ HỮU CÔNG NGHIỆP SỐ 418 TẬP A – QUYỀN 2 (01.2023)**

- (11) **46334**  
(21) 3-2022-02131 (28) 1  
(54) **THANH ĐỊNH HÌNH** (51) **25-01**  
(22) 04/10/2022 (43) 27/01/2023  
(73) **CÔNG TY TNHH CƠ KIM KHÍ QUANG MINH (VN)**  
275-NO-07-LK07-12 khu đất dịch vụ 1, phường Đồng Mai, quận Hà Đông, thành phố Hà Nội  
(72) Đinh Đức Anh (VN)  
(74) Công ty TNHH Trường Xuân (AGELESS CO.,LTD.)  
(55)

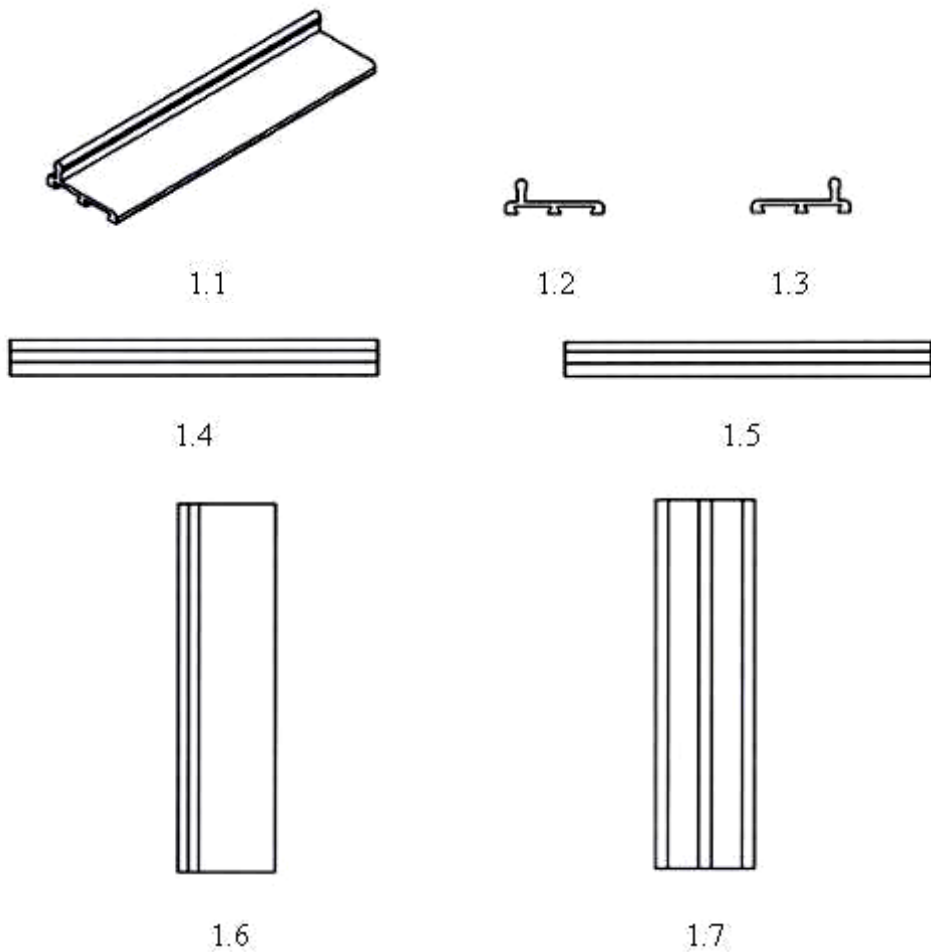

**CÔNG BÁO SỞ HỮU CÔNG NGHIỆP SỐ 418 TẬP A – QUYỀN 2 (01.2023)**

- (11) **46335**  
(21) 3-2022-02132 (28) 1  
(54) **THANH ĐỊNH HÌNH** (51) **25-01**  
(22) 04/10/2022 (43) 27/01/2023  
(73) **CÔNG TY TNHH CƠ KIM KHÍ QUANG MINH (VN)**  
275-NO-07-LK07-12 khu đất dịch vụ 1, phường Đồng Mai, quận Hà Đông, thành phố Hà Nội  
(72) Đinh Đức Anh (VN)  
(74) Công ty TNHH Trường Xuân (AGELESS CO.,LTD.)  
(55)



1.1



1.2



1.3



1.4



1.5



1.6



1.7

**CÔNG BÁO SỞ HỮU CÔNG NGHIỆP SỐ 418 TẬP A – QUYỀN 2 (01.2023)**

- (11) **46336**  
(21) 3-2022-02133 (28) 1  
(54) **THANH ĐỊNH HÌNH** (51) **25-01**  
(22) 04/10/2022 (43) 27/01/2023  
(73) **CÔNG TY TNHH CƠ KIM KHÍ QUANG MINH (VN)**  
275-NO-07-LK07-12 khu đất dịch vụ 1, phường Đồng Mai, quận Hà Đông, thành phố Hà Nội  
(72) Đinh Đức Anh (VN)  
(74) Công ty TNHH Trường Xuân (AGELESS CO.,LTD.)  
(55)

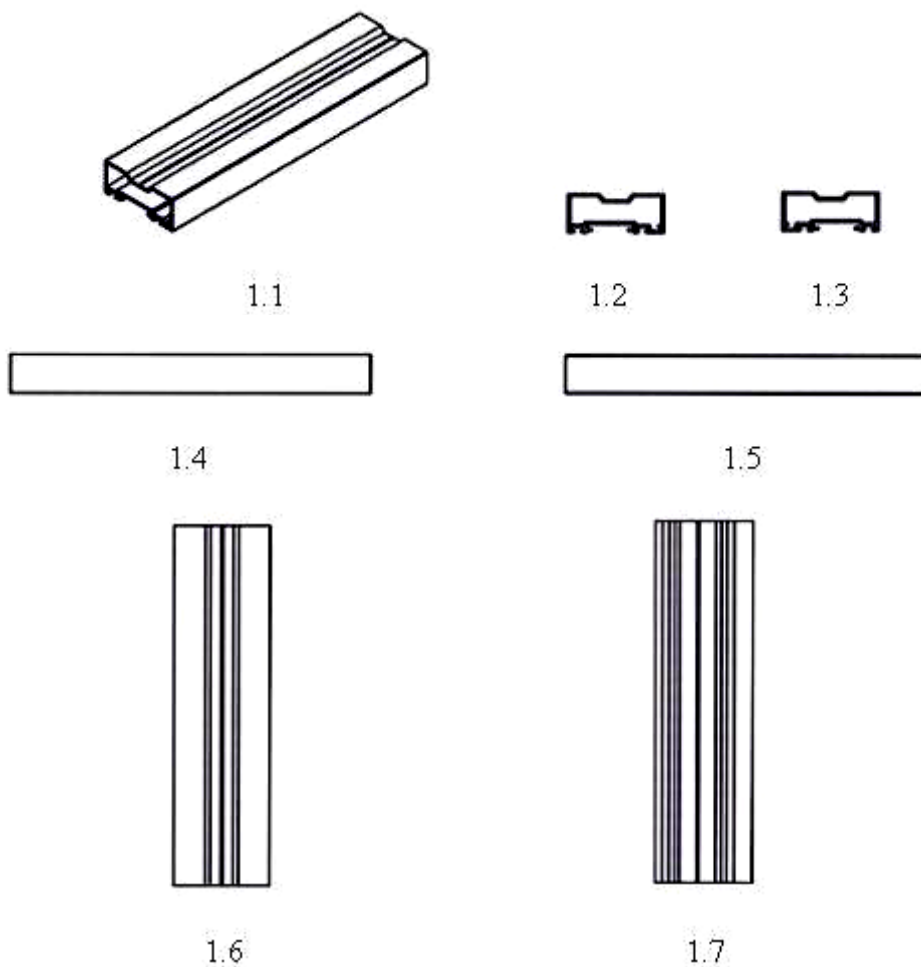

**CÔNG BÁO SỞ HỮU CÔNG NGHIỆP SỐ 418 TẬP A – QUYỀN 2 (01.2023)**

- (11) **46337**  
(21) 3-2022-02134 (28) 1  
(54) **THANH ĐỊNH HÌNH** (51) **25-01**  
(22) 04/10/2022 (43) 27/01/2023  
(73) **CÔNG TY TNHH CƠ KIM KHÍ QUANG MINH (VN)**  
275-NO-07-LK07-12 khu đất dịch vụ 1, phường Đồng Mai, quận Hà Đông, thành phố Hà Nội  
(72) Đinh Đức Anh (VN)  
(74) Công ty TNHH Trường Xuân (AGELESS CO.,LTD.)  
(55)

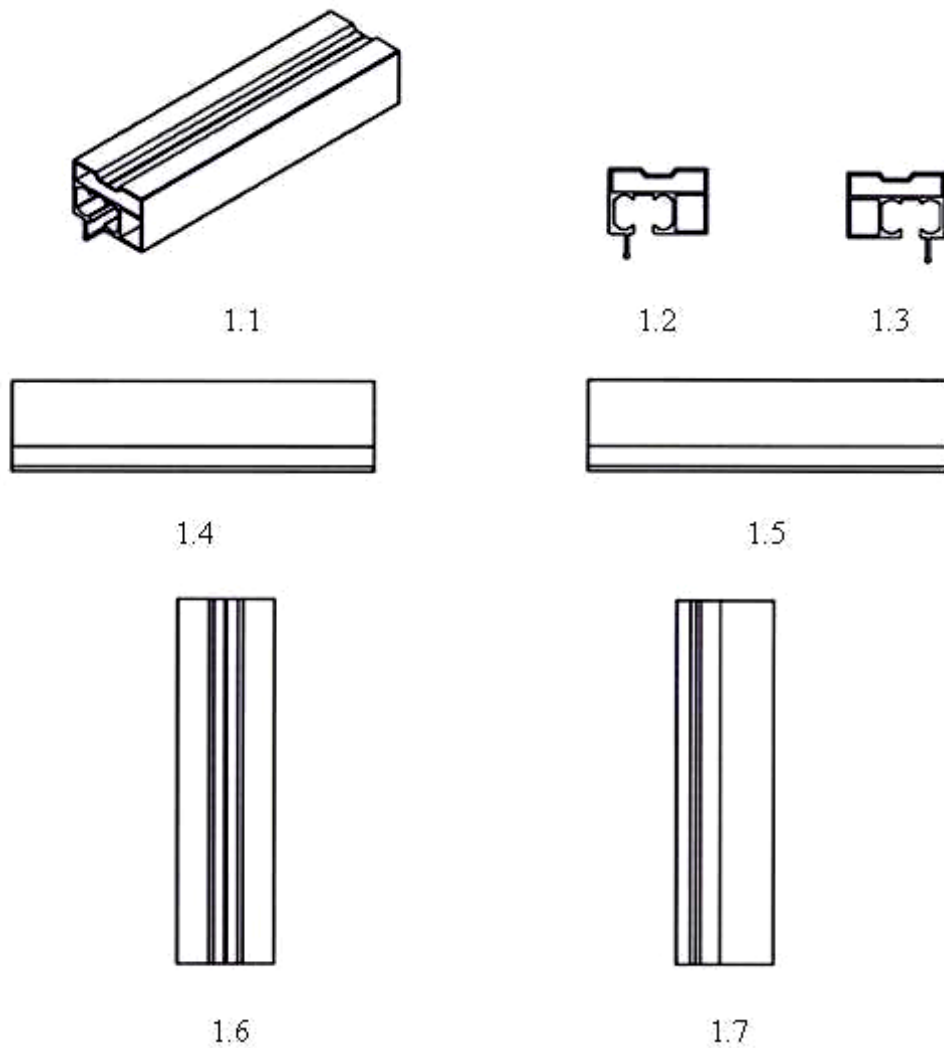

**CÔNG BÁO SỞ HỮU CÔNG NGHIỆP SỐ 418 TẬP A – QUYỀN 2 (01.2023)**

- (11) **46338**  
(21) 3-2022-02135 (28) 1  
(54) **CHAI** (51) **09-01**  
(22) 04/10/2022 (43) 27/01/2023  
(73) **CÔNG TY TRÁCH NHIỆM HỮU HẠN TRUNG PHONG (VN)**  
Tổ dân phố số 2, thị trấn Na Hang, huyện Na Hang, tỉnh Tuyên Quang  
(72) Hà Văn Phong (VN)  
(74) Công ty TNHH Sở hữu trí tuệ INVENTIO (INVENTIO CO.,LTD)  
(55)



1.1



1.2



1.3



1.4



1.5



1.6

**CÔNG BÁO SỞ HỮU CÔNG NGHIỆP SỐ 418 TẬP A – QUYỀN 2 (01.2023)**

- (11) **46339**  
(21) 3-2022-02161 (28) 1  
(54) **THANH KIM LOẠI ĐỊNH HÌNH** (51) **25-01**  
(22) 07/10/2022 (43) 27/01/2023  
(73) **CÔNG TY CỔ PHẦN TẬP ĐOÀN KENWIN (VN)**  
Tầng 4 tòa nhà VG Building, số 235 đường Nguyễn Trãi, phường Thanh Xuân  
Trung, quận Thanh Xuân, thành phố Hà Nội  
(72) Ngô Thọ Long (VN)  
(74) Công ty TNHH Sở hữu trí tuệ PADEMARK (PADEMARK CO.,LTD.)  
(55)



1.1



1.2



1.3

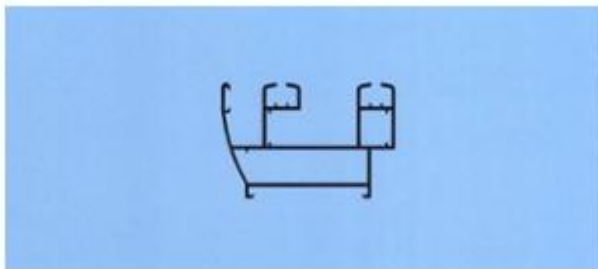

1.4

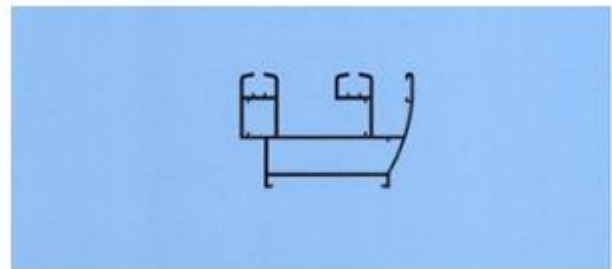

1.5



1.6



1.7

**CÔNG BÁO SỞ HỮU CÔNG NGHIỆP SỐ 418 TẬP A – QUYỀN 2 (01.2023)**

- (11) **46340**  
(21) 3-2022-02162 (28) 1  
(54) **THANH KIM LOẠI ĐỊNH HÌNH** (51) **25-01**  
(22) 07/10/2022 (43) 27/01/2023  
(73) **CÔNG TY CỔ PHẦN TẬP ĐOÀN KENWIN (VN)**  
Tầng 4 tòa nhà VG Building, số 235 đường Nguyễn Trãi, phường Thanh Xuân  
Trung, quận Thanh Xuân, thành phố Hà Nội  
(72) Ngô Thọ Long (VN)  
(74) Công ty TNHH Sở hữu trí tuệ PADEMARK (PADEMARK CO.,LTD.)  
(55)

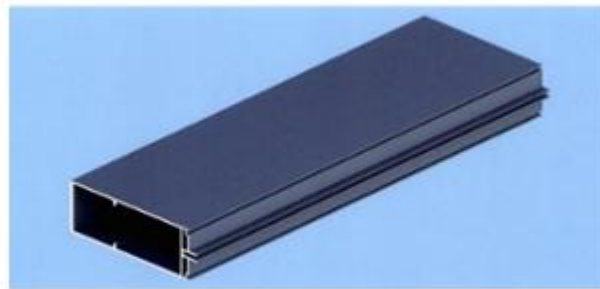

1.1



1.2



1.3

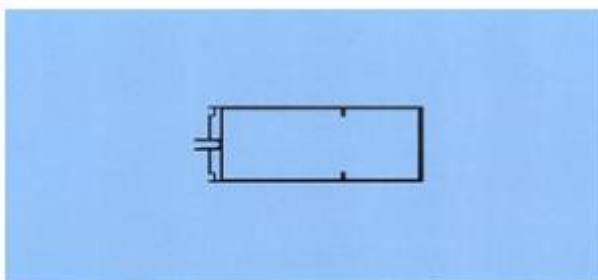

1.4

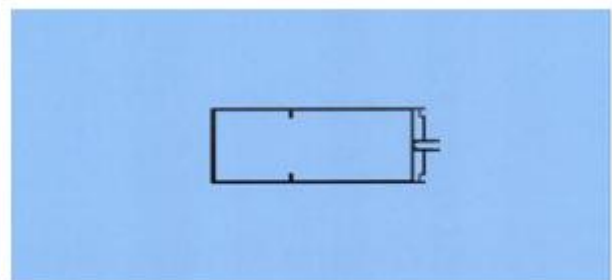

1.5



1.6



1.7

**CÔNG BÁO SỞ HỮU CÔNG NGHIỆP SỐ 418 TẬP A – QUYỀN 2 (01.2023)**

- (11) **46341**  
(21) 3-2022-02163 (28) 1  
(54) **THANH KIM LOẠI ĐỊNH HÌNH** (51) **25-01**  
(22) 07/10/2022 (43) 27/01/2023  
(73) **CÔNG TY CỔ PHẦN TẬP ĐOÀN KENWIN (VN)**  
Tầng 4 tòa nhà VG Building, số 235 đường Nguyễn Trãi, phường Thanh Xuân  
Trung, quận Thanh Xuân, thành phố Hà Nội  
(72) Ngô Thọ Long (VN)  
(74) Công ty TNHH Sở hữu trí tuệ PADEMARK (PADEMARK CO.,LTD.)  
(55)



1.1



1.2



1.3



1.4



1.5



1.6



1.7



**CÔNG BÁO SỞ HỮU CÔNG NGHIỆP SỐ 418 TẬP A – QUYỀN 2 (01.2023)**

- (11) **46342**  
(21) 3-2022-02164 (28) 1  
(54) **THANH KIM LOẠI ĐỊNH HÌNH** (51) **25-01**  
(22) 07/10/2022 (43) 27/01/2023  
(73) **CÔNG TY CỔ PHẦN TẬP ĐOÀN KENWIN (VN)**  
Tầng 4 tòa nhà VG Building, số 235 đường Nguyễn Trãi, phường Thanh Xuân  
Trung, quận Thanh Xuân, thành phố Hà Nội  
(72) Ngô Thọ Long (VN)  
(74) Công ty TNHH Sở hữu trí tuệ PADEMARK (PADEMARK CO.,LTD.)  
(55)



1.1



1.2

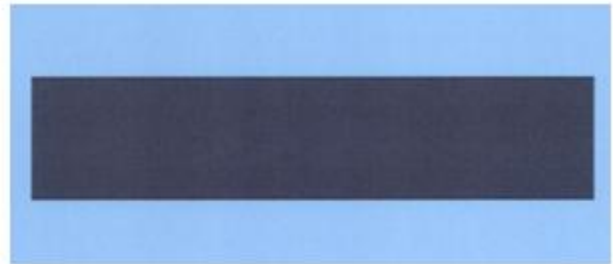

1.3



1.4



1.5



1.6



1.7

**CÔNG BÁO SỞ HỮU CÔNG NGHIỆP SỐ 418 TẬP A – QUYỀN 2 (01.2023)**

- (11) **46343**  
(21) 3-2022-02165 (28) 1  
(54) **THANH KIM LOẠI ĐỊNH HÌNH** (51) **25-01**  
(22) 07/10/2022 (43) 27/01/2023  
(73) **CÔNG TY CỔ PHẦN TẬP ĐOÀN KENWIN (VN)**  
Tầng 4 tòa nhà VG Building, số 235 đường Nguyễn Trãi, phường Thanh Xuân  
Trung, quận Thanh Xuân, thành phố Hà Nội  
(72) Ngô Thọ Long (VN)  
(74) Công ty TNHH Sở hữu trí tuệ PADEMARK (PADEMARK CO.,LTD.)  
(55)



1.1



1.2



1.3

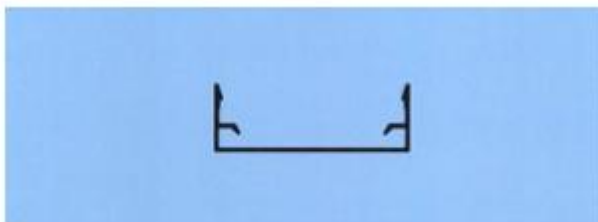

1.4

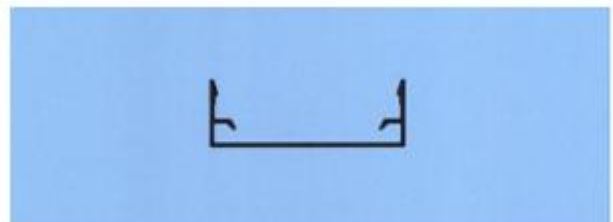

1.5



1.6



1.7

**CÔNG BÁO SỞ HỮU CÔNG NGHIỆP SỐ 418 TẬP A – QUYỀN 2 (01.2023)**

- (11) **46344**  
(21) 3-2022-02166 (28) 1  
(54) **THANH KIM LOẠI ĐỊNH HÌNH** (51) **25-01**  
(22) 07/10/2022 (43) 27/01/2023  
(73) **CÔNG TY CỔ PHẦN TẬP ĐOÀN KENWIN (VN)**  
Tầng 4 tòa nhà VG Building, số 235 đường Nguyễn Trãi, phường Thanh Xuân  
Trung, quận Thanh Xuân, thành phố Hà Nội  
(72) Ngô Thọ Long (VN)  
(74) Công ty TNHH Sở hữu trí tuệ PADEMARK (PADEMARK CO.,LTD.)  
(55)



1.1



1.2



1.3

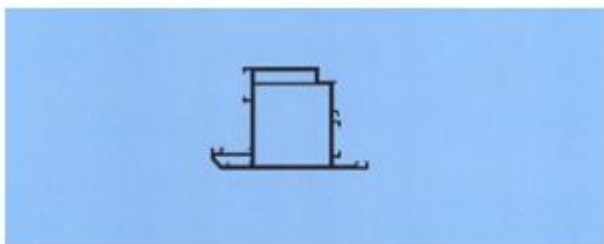

1.4

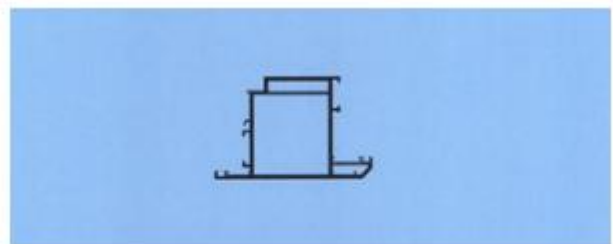

1.5



1.6



1.7

**CÔNG BÁO SỞ HỮU CÔNG NGHIỆP SỐ 418 TẬP A – QUYỀN 2 (01.2023)**

- (11) **46345**  
(21) 3-2022-02168 (28) 1  
(54) **TẤM ĐỖ SÀN** (51) **25-01; 25-02**  
(22) 07/10/2022 (43) 27/01/2023  
(73) **CÔNG TY CỔ PHẦN TẬP ĐOÀN NHỰA SUPER TRƯỜNG PHÁT (VN)**  
Số T151, lô đất H4, khu đấu giá 31ha, thị trấn Trâu Quỳ, huyện Gia Lâm, thành phố Hà Nội  
(72) Phạm Quốc Chính (VN)  
(74) Công ty TNHH Sở hữu trí tuệ VIPATCO (VIPATCO CO., LTD.)  
(55)

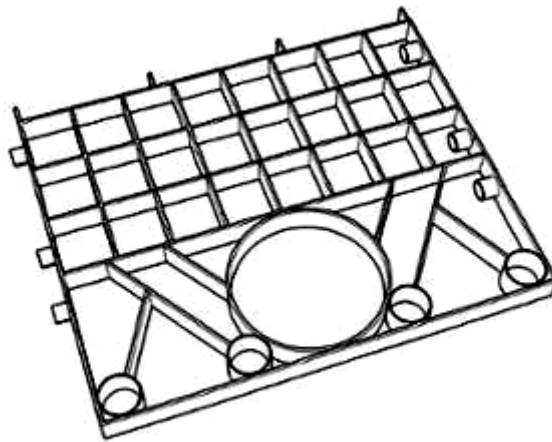

1.1



1.2

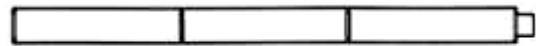

1.3

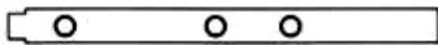

1.4



1.5

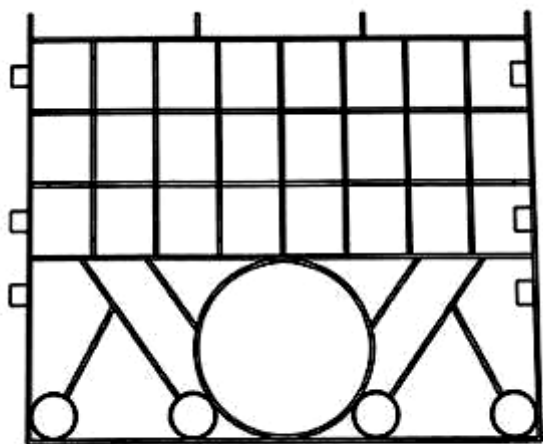

1.6

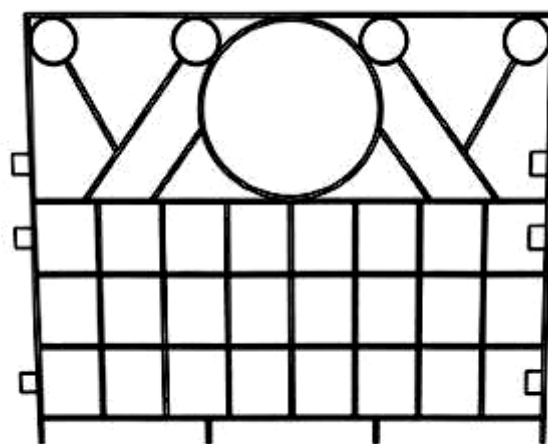

1.7

**CÔNG BÁO SỞ HỮU CÔNG NGHIỆP SỐ 418 TẬP A – QUYỀN 2 (01.2023)**

- (11) **46346**  
(21) 3-2022-02169 (28) 1  
(54) **LỒNG NUÔI THỦY SẢN** (51) **30-02**  
(22) 07/10/2022 (43) 27/01/2023  
(73) **CÔNG TY CỔ PHẦN TẬP ĐOÀN NHỰA SUPER TRƯỜNG PHÁT (VN)**  
Số T151, lô đất H4, khu đấu giá 31ha, thị trấn Trâu Quỳ, huyện Gia Lâm, thành phố Hà Nội  
(72) Phạm Quốc Chính (VN)  
(74) Công ty TNHH Sở hữu trí tuệ VIPATCO (VIPATCO CO., LTD.)  
(55)

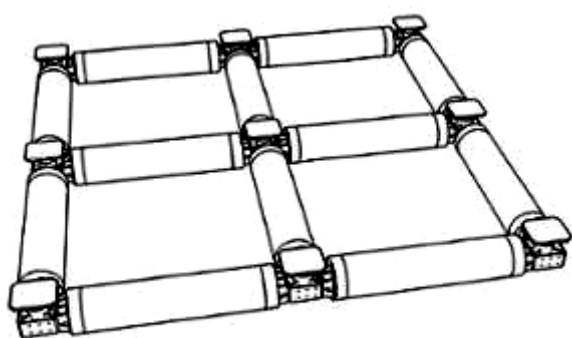

1.1



1.2

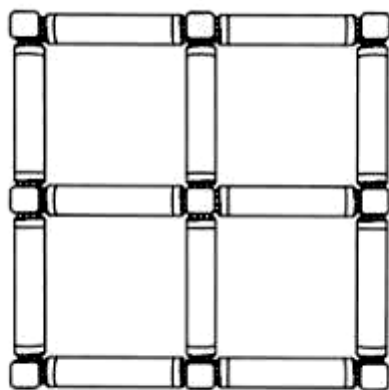

1.3

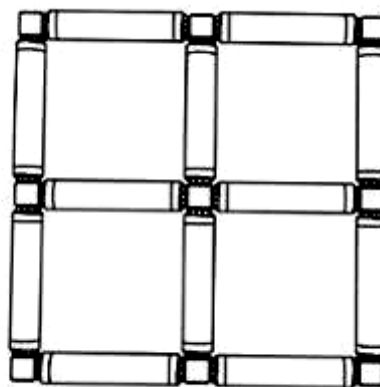

1.4

**CÔNG BÁO SỞ HỮU CÔNG NGHIỆP SỐ 418 TẬP A – QUYỀN 2 (01.2023)**

- (11) **46347**  
(21) 3-2022-02170 (28) 1  
(54) **LỒNG NUÔI TÔM** (51) **30-02**  
(22) 07/10/2022 (43) 27/01/2023  
(73) **CÔNG TY CỔ PHẦN TẬP ĐOÀN NHỰA SUPER TRƯỜNG PHÁT (VN)**  
Số T151, lô đất H4, khu đầu giá 31ha, thị trấn Trâu Quỳ, huyện Gia Lâm, thành phố Hà Nội  
(72) Phạm Quốc Chính (VN)  
(74) Công ty TNHH Sở hữu trí tuệ VIPATCO (VIPATCO CO., LTD.)  
(55)

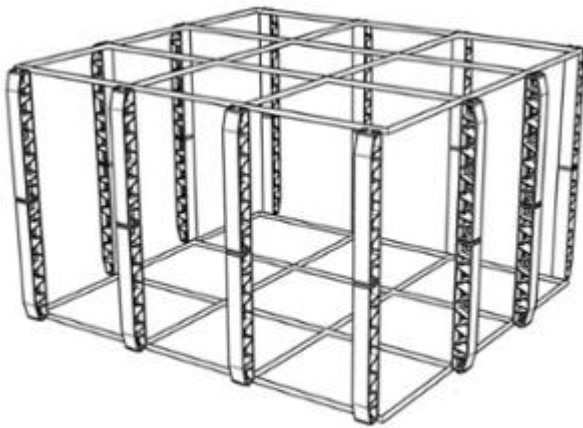

1.1

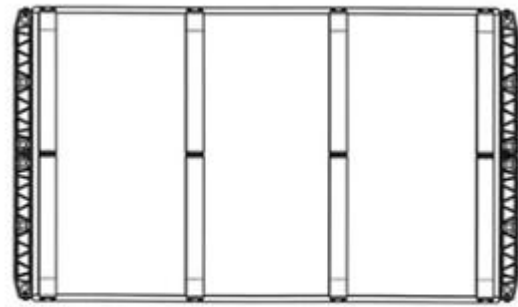

1.2

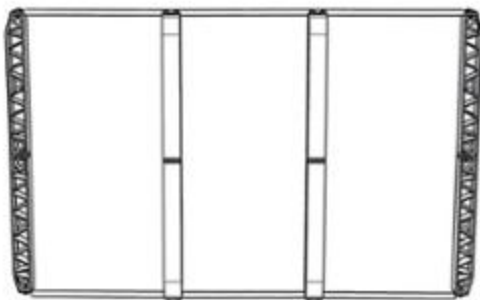

1.3

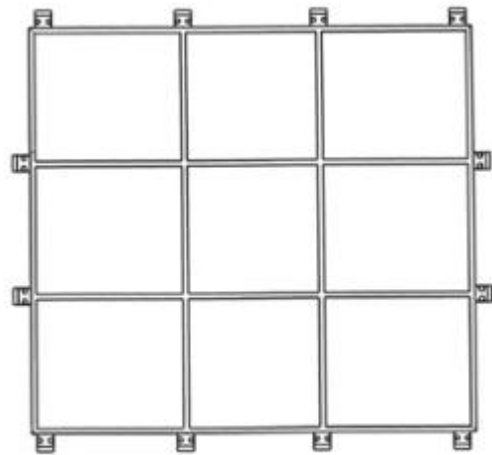

1.4

**CÔNG BÁO SỞ HỮU CÔNG NGHIỆP SỐ 418 TẬP A – QUYỀN 2 (01.2023)**

- (11) **46348**  
(21) 3-2022-02171 (28) 1  
(54) **HỘP ĐỰNG** (51) **09-03**  
(22) 07/10/2022 (43) 27/01/2023  
(73) **CÔNG TY TNHH XUẤT NHẬP KHẨU MAYCHY (VN)**  
Số 33, ngõ 260 đường Cầu Giấy, phường Quan Hoa, quận Cầu Giấy, thành phố Hà Nội  
(72) Nguyễn Văn Long (VN)  
(74) Công ty TNHH Sở hữu trí tuệ HA VIP (HAVIP CO., LTD.)  
(55)



1.1



1.2



**CÔNG BÁO SỞ HỮU CÔNG NGHIỆP SỐ 418 TẬP A – QUYỀN 2 (01.2023)**

- (11) **46349**  
(21) 3-2022-02172 (28) 1  
(54) **HỘP ĐỰNG** (51) **09-03**  
(22) 07/10/2022 (43) 27/01/2023  
(73) **CÔNG TY CỔ PHẦN THƯƠNG MẠI VÀ SẢN XUẤT THỰC PHẨM KICO (VN)**  
Số 52 Hàng Bún, phường Quán Thánh, quận Ba Đình, thành phố Hà Nội  
(72) Nguyễn Văn Long (VN)  
(74) Công ty TNHH Sở hữu trí tuệ HA VIP (HAVIP CO., LTD.)  
(55)



1.1



1.2

- (11) **46350**  
(21) 3-2022-02173 (28) 1  
(54) **HỘP** (51) **09-03**  
(22) 07/10/2022 (43) 27/01/2023  
(73) **ĐỖ THỊ KIM YẾN (VN)**  
Cụm 8, xã Ngọc Tảo, huyện Phúc Thọ, thành phố Hà Nội  
(72) Đỗ Thị Kim Yến (VN)  
(74) Công ty TNHH NACILAW (NACILAW)  
(55)



1.1



1.2



1.3



1.4



1.5



1.6

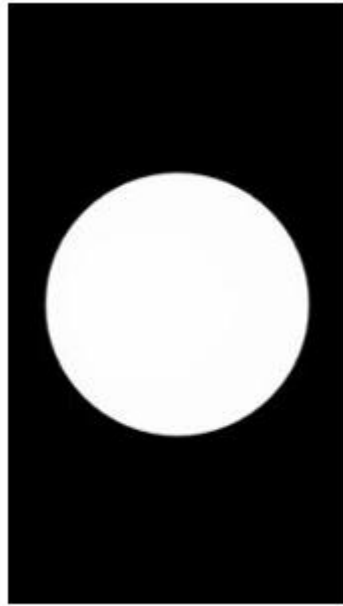

1.7

**CÔNG BÁO SỞ HỮU CÔNG NGHIỆP SỐ 418 TẬP A – QUYỀN 2 (01.2023)**

- (11) **46351**  
(21) 3-2022-02174 (28) 1  
(54) **BÉC TƯỚI** (51) **23-01**  
(22) 07/10/2022 (43) 27/01/2023  
(73) **CÔNG TY TNHH ĐẦU TƯ THƯƠNG MẠI THAFACO (VN)**  
203-205 Điện Biên Phủ, phường Thành Công, thành phố Buôn Ma Thuột, tỉnh Đắk Lắk  
(72) Lê Công Đà (VN)  
(55)

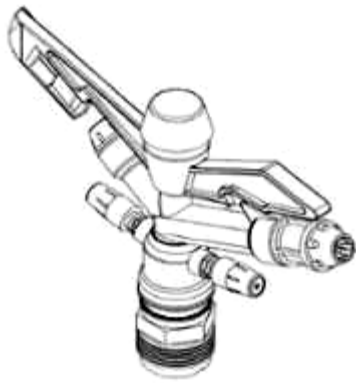

1.1



1.2



1.3

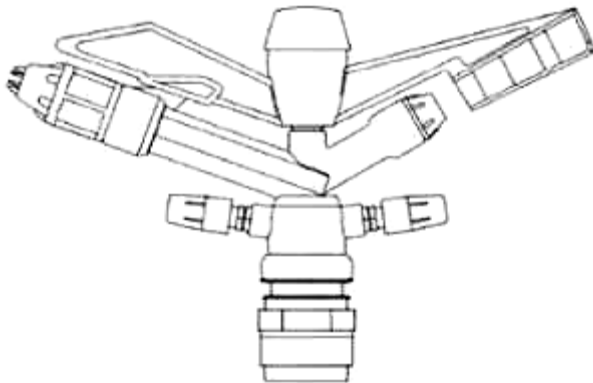

1.4

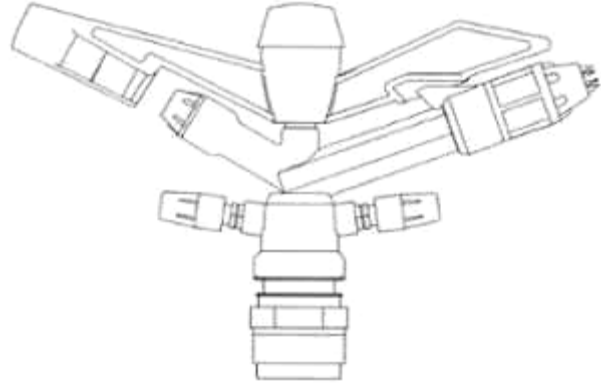

1.5



1.6



1.7

**CÔNG BÁO SỞ HỮU CÔNG NGHIỆP SỐ 418 TẬP A – QUYỀN 2 (01.2023)**

- (11) **46352**  
(21) 3-2022-02177 (28) 1  
(54) **HỘP** (51) **09-03**  
(22) 10/10/2022 (43) 27/01/2023  
(73) **CÔNG TY TNHH THƯƠNG MẠI & VẬT LIỆU XÂY DỰNG THÀNH PHÁT (VN)**  
1152-1154 đường 3/2, phường 12, quận 11, thành phố Hồ Chí Minh  
(72) Lai Diệu Hạnh (VN)  
(74) Công ty Luật TNHH Phạm và Liên danh (PHAM & ASSOCIATES)  
(55)



1.1



1.2

- (11) **46353**  
(21) 3-2022-02188 (28) 1  
(54) **RÈM CỬA** (51) **06-10**  
(22) 10/10/2022 (43) 27/01/2023  
(30) 29/838,636 13/05/2022 US;  
(73) **TEH YOR CO., LTD. (TW)**  
No. 1 & 36, Lane 338, Sidong Road, Sansia District, New Taipei City 23743,  
Taiwan  
(72) HUANG, Chien-Fong (US)  
(74) Công ty Luật TNHH quốc tế BMVN (BMVN INTERNATIONAL LLC)  
(55)

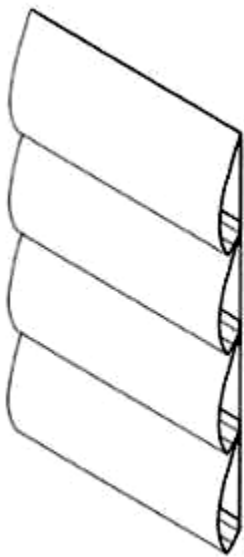

1.1



1.2



1.3



1.4 1.5



1.6

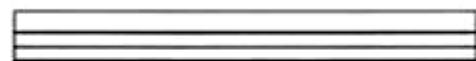

1.7

**CÔNG BÁO SỞ HỮU CÔNG NGHIỆP SỐ 418 TẬP A – QUYỀN 2 (01.2023)**

- (11) **46354**  
(21) 3-2022-02191 (28) 1  
(54) **MIẾNG ĐỘN QUẦN LÓT** (51) **02-07**  
(22) 10/10/2022 (43) 27/01/2023  
(73) **CÔNG TY TNHH TRITITANS VIỆT NAM (VN)**  
P7-18.OT07 tòa Park 7 Vinhomes Central Park, 720A Điện Biên Phủ, phường 22,  
quận Bình Thạnh, thành phố Hồ Chí Minh  
(72) Lê Nguyễn Minh Tuấn (VN)  
(74) Công ty TNHH Sở hữu trí tuệ Tâm Luật & Cộng sự (Tâm Luật)  
(55)



1.1



1.2



1.3



1.4



1.5



1.6



**CÔNG BÁO SỞ HỮU CÔNG NGHIỆP SỐ 418 TẬP A – QUYỀN 2 (01.2023)**

- (11) **46355**  
(21) 3-2022-02192 (28) 1  
(54) **VỎ BAO BÌ** (51) **09-05**  
(22) 11/10/2022 (43) 27/01/2023  
(73) **CÔNG TY TNHH THƯƠNG MẠI HÒA NHÂN (VN)**  
Tổ 48, khu A, ấp Phước Lý, xã Đại Phước, huyện Nhơn Trạch, tỉnh Đồng Nai  
(72) Nguyễn Nô Ben (VN)  
(55)



1.1



1.2

**CÔNG BÁO SỞ HỮU CÔNG NGHIỆP SỐ 418 TẬP A – QUYỀN 2 (01.2023)**

- (11) **46356**  
(21) 3-2022-02193 (28) 1  
(54) **VỎ BAO BÌ** (51) **09-05**  
(22) 11/10/2022 (43) 27/01/2023  
(73) **CÔNG TY TNHH THƯƠNG MẠI HÒA NHÂN (VN)**  
Tổ 48, khu A, ấp Phước Lý, xã Đại Phước, huyện Nhơn Trạch, tỉnh Đồng Nai  
(72) Nguyễn Nô Ben (VN)  
(55)



1.1



1.2

**CÔNG BÁO SỞ HỮU CÔNG NGHIỆP SỐ 418 TẬP A – QUYỀN 2 (01.2023)**

- (11) **46357**  
(21) 3-2022-02194 (28) 1  
(54) **VỎ BAO BÌ** (51) **09-05**  
(22) 11/10/2022 (43) 27/01/2023  
(73) **CÔNG TY TNHH THƯƠNG MẠI HÒA NHÂN (VN)**  
Tổ 48, khu A, ấp Phước Lý, xã Đại Phước, huyện Nhơn Trạch, tỉnh Đồng Nai  
(72) Nguyễn Ngô Ben (VN)  
(55)



1.1



1.2

**CÔNG BÁO SỞ HỮU CÔNG NGHIỆP SỐ 418 TẬP A – QUYỀN 2 (01.2023)**

- (11) **46358**  
(21) 3-2022-02200 (28) 1  
(54) **BAO GÓI** (51) **09-05**  
(22) 11/10/2022 (43) 27/01/2023  
(73) **CÔNG TY CỔ PHẦN LIWAYWAY VIỆT NAM (VN)**  
Số 14, đường số 05, khu công nghiệp Việt Nam - Singapore, phường Bình Hòa,  
thành phố Thuận An, tỉnh Bình Dương  
(72) Robert Tan Li (PH)  
(74) Văn phòng Luật sư Tân Hà (VPLS TAN HA)  
(55)



1.1



1.2

**CÔNG BÁO SỞ HỮU CÔNG NGHIỆP SỐ 418 TẬP A – QUYỀN 2 (01.2023)**

- (11) **46359**  
(21) 3-2022-02201 (28) 2  
(54) **BAO GÓI** (51) **09-05**  
(22) 11/10/2022 (43) 27/01/2023  
(73) **CÔNG TY CỔ PHẦN LIWAYWAY VIỆT NAM (VN)**  
Số 14, đường số 05, khu công nghiệp Việt Nam - Singapore, phường Bình Hòa,  
thành phố Thuận An, tỉnh Bình Dương  
(72) Robert Tan Li (PH)  
(74) Văn phòng Luật sư Tân Hà (VPLS TAN HA)  
(55)



1.1



1.2



2.1



2.2

- (11) **46360**  
(21) 3-2022-02208 (28) 1  
(54) **CHẢO NƯỚNG** (51) **07-02**  
(22) 12/10/2022 (43) 27/01/2023  
(73) **DR. HOWS CO., LTD. (KR)**  
97, Neunggil-ro, Danwon-gu, Ansan-si, Gyeonggi-do 15420 Republic of Korea  
(72) KIM, Kyung Beom (KR)  
(74) **CÔNG TY LUẬT TRÁCH NHIỆM HỮU HẠN AMBYS HÀ NỘI (AMBYS HANOI)**  
(55)

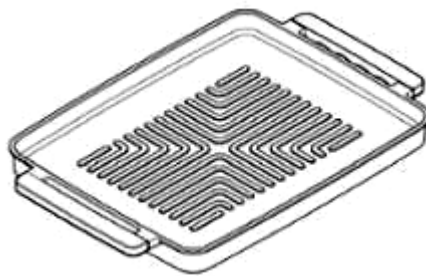

1.1



1.2



1.3



1.4

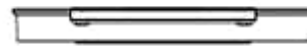

1.5

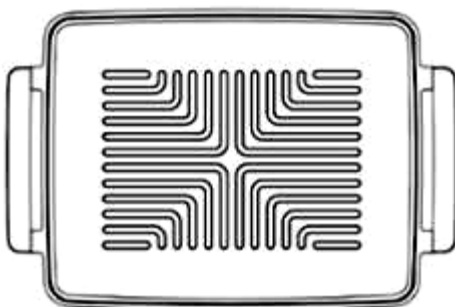

1.6



1.7

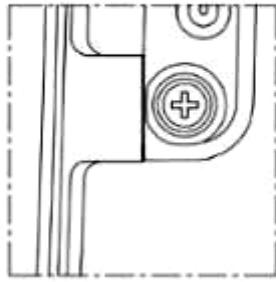

1.8

**CÔNG BÁO SỞ HỮU CÔNG NGHIỆP SỐ 418 TẬP A – QUYỀN 2 (01.2023)**

- (11) **46361**  
(21) 3-2022-02209 (28) 1  
(54) **ĐÈN** (51) **26-03**  
(22) 12/10/2022 (43) 27/01/2023  
(73) **CÔNG TY CỔ PHẦN BÓNG ĐÈN PHÍCH NƯỚC RẠNG ĐÔNG (VN)**  
87-89 phố Hạ Đình, phường Thanh Xuân Trung, quận Thanh Xuân, thành phố Hà Nội  
(72) Trần Trung Tường (VN)  
(55)

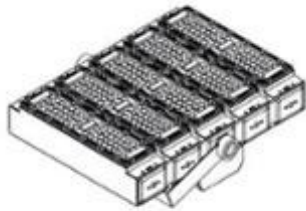

1.1



1.2

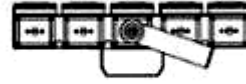

1.3

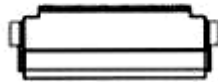

1.4

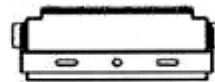

1.5

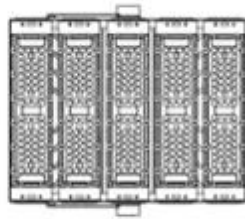

1.6

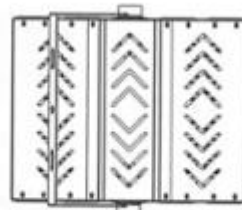

1.7



**CÔNG BÁO SỞ HỮU CÔNG NGHIỆP SỐ 418 TẬP A – QUYỀN 2 (01.2023)**

- (11) **46362**  
(21) 3-2022-02210 (28) 1  
(54) **ĐÈN** (51) **26-03**  
(22) 12/10/2022 (43) 27/01/2023  
(73) **CÔNG TY CỔ PHẦN BÓNG ĐÈN PHÍCH NƯỚC RẠNG ĐÔNG (VN)**  
87-89 phố Hạ Đình, phường Thanh Xuân Trung, quận Thanh Xuân, thành phố Hà Nội  
(72) Trần Trung Tường (VN)  
(55)

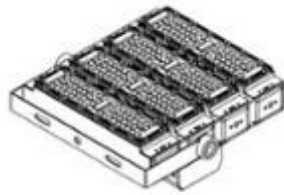

1.1



1.2

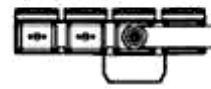

1.3



1.4



1.5

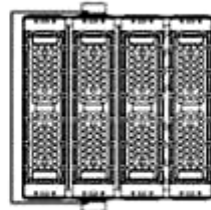

1.6

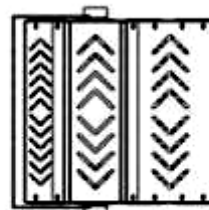

1.7

**CÔNG BÁO SỞ HỮU CÔNG NGHIỆP SỐ 418 TẬP A – QUYỀN 2 (01.2023)**

- (11) **46363**  
(21) 3-2022-02211 (28) 1  
(54) **ĐÈN** (51) **26-03**  
(22) 12/10/2022 (43) 27/01/2023  
(73) **CÔNG TY CỔ PHẦN BÓNG ĐÈN PHÍCH NƯỚC RẠNG ĐÔNG (VN)**  
87-89 phố Hạ Đình, phường Thanh Xuân Trung, quận Thanh Xuân, thành phố Hà Nội  
(72) Trần Trung Tường (VN)  
(55)

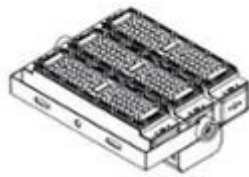

1.1



1.2

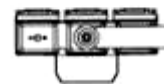

1.3



1.4

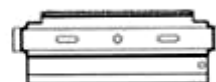

1.5



1.6



1.7

- (11) **46364**  
(21) 3-2022-02212 (28) 1  
(54) **BẾP GA DI ĐỘNG** (51) **07-02**  
(22) 12/10/2022 (43) 27/01/2023  
(30) 30-2022-0039076 23/09/2022 KR;  
(73) **DR. HOWS CO., LTD.** (KR)  
97, Neunggil-ro, Danwon-gu, Ansan-si, Gyeonggi-do 15420 Republic of Korea  
(72) 1. WON, SE KYUNG (KR)  
2. SEONG, SO YEON (KR)  
3. KIM, YONG SIK (KR)  
(74) **CÔNG TY LUẬT TRÁCH NHIỆM HỮU HẠN AMBYS HÀ NỘI (AMBYS HANOI)**  
(55)

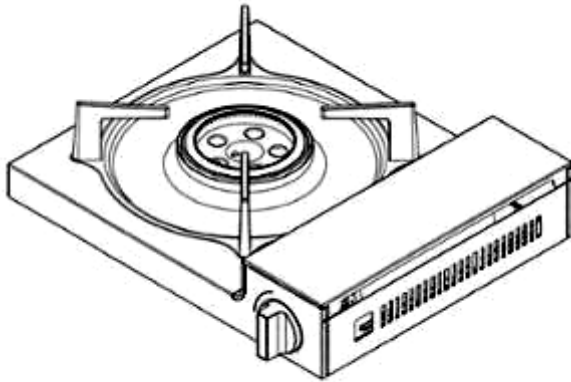

1.1

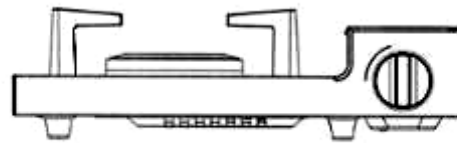

1.2

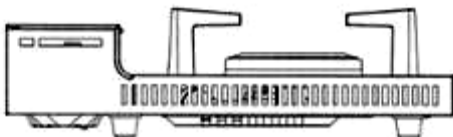

1.3

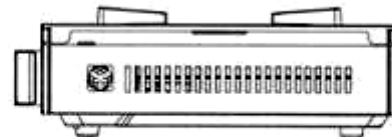

1.4

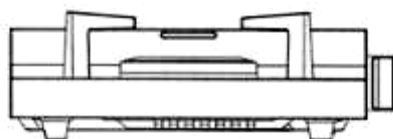

1.5

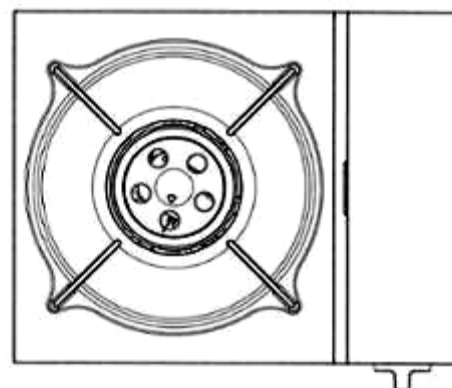

1.6

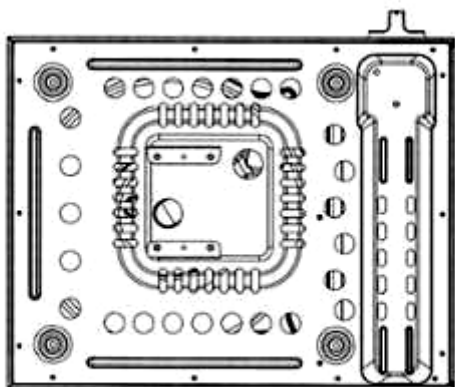

1.7



1.8

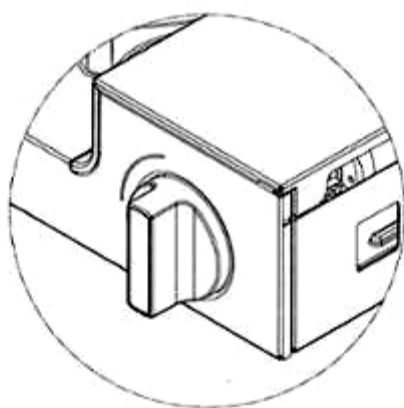

1.9

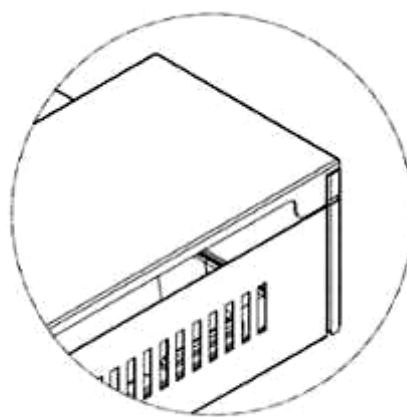

1.10

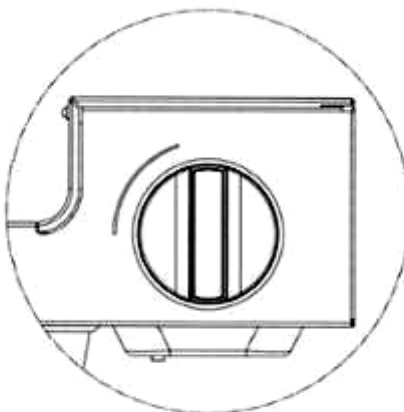

1.11

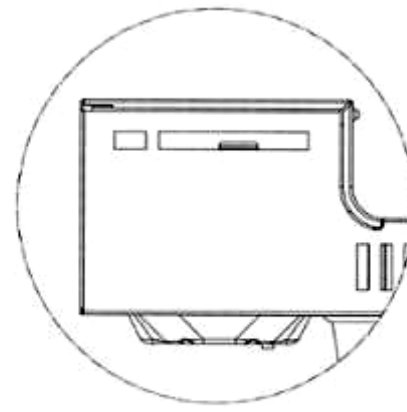

1.12

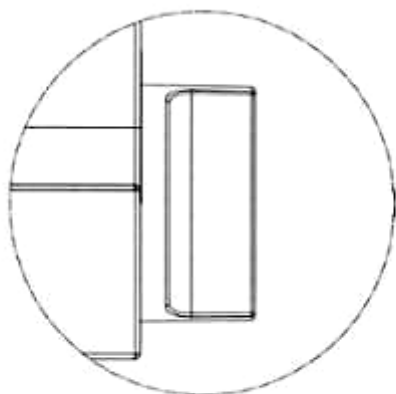

1.13

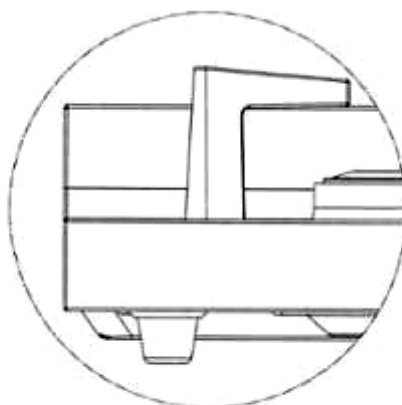

1.14

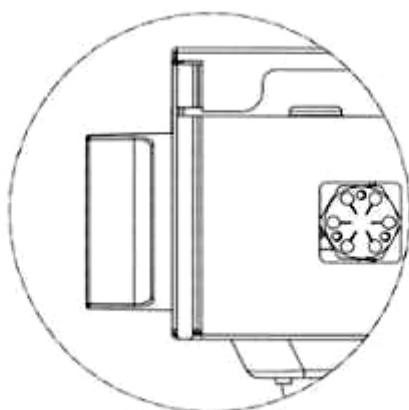

1.15

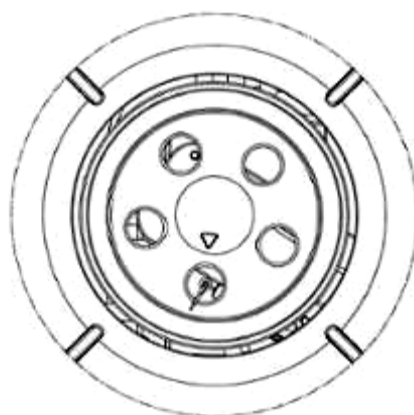

1.16

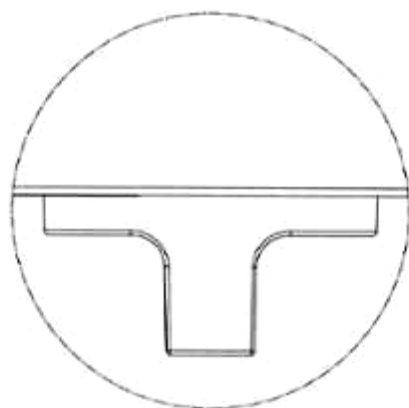

1.17

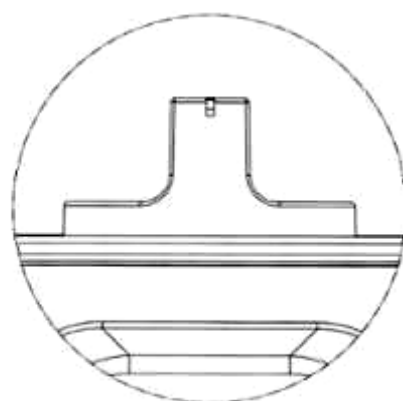

1.18

**CÔNG BÁO SỞ HỮU CÔNG NGHIỆP SỐ 418 TẬP A – QUYỀN 2 (01.2023)**

- (11) **46365**  
(21) 3-2022-02213 (28) 1  
(54) **NHÃN SẢN PHẨM** (51) **19-08**  
(22) 12/10/2022 (43) 27/01/2023  
(73) **CÔNG TY TNHH NÔNG SẢN ĐA NHIM (VN)**  
Tổ dân phố Quảng Lạc, thị trấn D’Ran, huyện Đơn Dương, tỉnh Lâm Đồng  
(72) Lê Quốc Thanh (VN)  
(74) Công ty Cổ phần Sở hữu công nghiệp INVESTIP (INVESTIP)  
(55)



1.1



1.2

**CÔNG BÁO SỞ HỮU CÔNG NGHIỆP SỐ 418 TẬP A – QUYỀN 2 (01.2023)**

- (11) **46366**  
(21) 3-2022-02214 (28) 2  
(54) **BỘ NHÃN SẢN PHẨM** (51) **19-08**  
(22) 12/10/2022 (43) 27/01/2023  
(73) **CÔNG TY TNHH NÔNG SẢN ĐA NHIM (VN)**  
Tổ dân phố Quảng Lạc, thị trấn D’Ran, huyện Đơn Dương, tỉnh Lâm Đồng  
(72) Lê Quốc Thanh (VN)  
(74) Công ty Cổ phần Sở hữu công nghiệp INVESTIP (INVESTIP)  
(55)

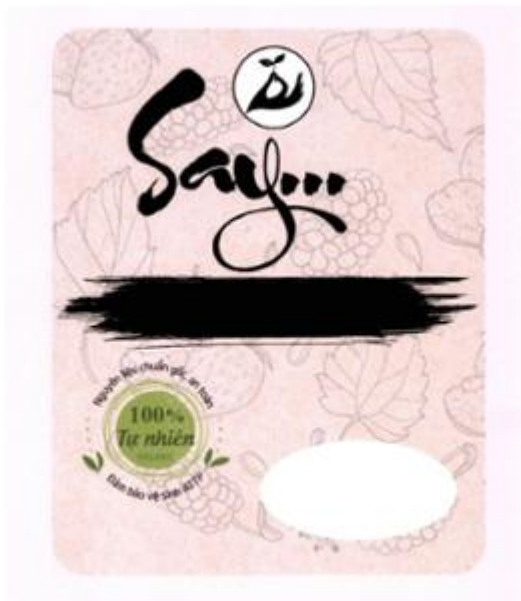

1.1



2.1

**CÔNG BÁO SỞ HỮU CÔNG NGHIỆP SỐ 418 TẬP A – QUYỀN 2 (01.2023)**

- (11) **46367**  
(21) 3-2022-02215 (28) 2  
(54) **ĐỒ CHỨA THỰC PHẨM** (51) **09-03**  
(22) 12/10/2022 (43) 27/01/2023  
(30) 30-2022-0035943 02/09/2022 KR; 30-2022-0035942 02/09/2022 KR;  
(73) **CJ CHEILJEDANG CORPORATION (KR)**  
(Ssangnim-dong) 330, Dongho-ro, Jung-gu, Seoul 04560 Republic of Korea  
(72) 1. SONG, CHAE WON (KR)  
2. LEE, SEUNG PYO (KR)  
3. KIM, YUL JOONG (KR)  
4. PARK JI YEON (KR)  
(74) Công ty Luật TNHH ROUSE Việt Nam (ROUSE LAW CO.,LTD)  
(55)



1.1



1.2





1.3



1.4



1.5



1.6



1.7



2.1



2.2



2.3



2.4



2.5



2.6



2.7

**CÔNG BÁO SỞ HỮU CÔNG NGHIỆP SỐ 418 TẬP A – QUYỀN 2 (01.2023)**

- (11) **46368**  
(21) 3-2022-02227 (28) 1  
(54) **BAO BÌ SẢN PHẨM** (51) **09-05**  
(22) 13/10/2022 (43) 27/01/2023  
(73) **CÔNG TY TNHH THƯƠNG MẠI - DỊCH VỤ MADAME HOÀNG VĨNH HY (VN)**  
Thôn Vĩnh Hy, xã Vĩnh Hải, huyện Ninh Hải, tỉnh Ninh Thuận  
(72) Hoàng Thị Hương (VN)  
(74) Công ty TNHH Tư vấn đầu tư và Sở hữu trí tuệ Hoàng Phi (HOANG PHI INVEST & I.P CO., LTD)  
(55)



1.1



1.2

**CÔNG BÁO SỞ HỮU CÔNG NGHIỆP SỐ 418 TẬP A – QUYỀN 2 (01.2023)**

- (11) **46369**  
(21) 3-2022-02228 (28) 2  
(54) **BAO GÓI** (51) **09-05**  
(22) 13/10/2022 (43) 27/01/2023  
(73) **CÔNG TY TNHH SẢN XUẤT THƯƠNG MẠI DR HIẾU (VN)**  
896A/59 Hậu Giang, phường 12, quận 6, thành phố Hồ Chí Minh  
(72) Nguyễn Chánh Trung (VN)  
(74) Công ty TNHH một thành viên Trường Luật (Trường Luật)  
(55)



1.1



1.2



2.1



2.2

**CÔNG BÁO SỞ HỮU CÔNG NGHIỆP SỐ 418 TẬP A – QUYỀN 2 (01.2023)**

- (11) **46370**  
(21) 3-2022-02229 (28) 1  
(54) **BAO GÓI** (51) **09-05**  
(22) 13/10/2022 (43) 27/01/2023  
(73) **CÔNG TY TNHH SẢN XUẤT THƯƠNG MẠI DR HIẾU (VN)**  
896A/59 Hậu Giang, phường 12, quận 6, thành phố Hồ Chí Minh  
(72) Nguyễn Chánh Trung (VN)  
(74) Công ty TNHH một thành viên Trường Luật (Trường Luật)  
(55)



1.1



1.2

**CÔNG BÁO SỞ HỮU CÔNG NGHIỆP SỐ 418 TẬP A – QUYỀN 2 (01.2023)**

- (11) **46371**  
(21) 3-2022-02240 (28) 1  
(54) **HỘP ĐỰNG** (51) **09-03**  
(22) 14/10/2022 (43) 27/01/2023  
(73) **CÔNG TY TNHH THƯƠNG MẠI VÀ DỊCH VỤ ASP VIỆT NAM (VN)**  
Số nhà 51, ngách 64/161 phố Hoa Lâm, phường Việt Hưng, quận Long Biên, thành phố Hà Nội  
(72) Hoàng Thị Hường (VN)  
(74) Công ty TNHH tư vấn Sở hữu trí tuệ IPFLAME (IPFLAME CO.,LTD)  
(55)



1.1



1.2

**CÔNG BÁO SỞ HỮU CÔNG NGHIỆP SỐ 418 TẬP A – QUYỀN 2 (01.2023)**

- (11) **46372**  
(21) 3-2022-02243 (28) 1  
(54) **BAO BÌ PHÂN BÓN** (51) **09-05**  
(22) 14/10/2022 (43) 27/01/2023  
(73) **CÔNG TY CỔ PHẦN PHÂN BÓN NA UY (VN)**  
Lô A2, KCN Tân Kim mở rộng, thị trấn Cần Giuộc, huyện Cần Giuộc, tỉnh Long An  
(72) Nguyễn Chí Cao (VN)  
(55)



1.1



1.2



**CÔNG BÁO SỞ HỮU CÔNG NGHIỆP SỐ 418 TẬP A – QUYỀN 2 (01.2023)**

- (11) **46373**  
(21) 3-2022-02248 (28) 5  
(54) **TÚI ĐỰNG GẠO** (51) **09-05**  
(22) 17/10/2022 (43) 27/01/2023  
(73) **HỘ KINH DOANH BA ĐẸP (VN)**  
Số 187, đường Mậu Thân, khóm 2, phường 1, thị xã Ngã Năm, tỉnh Sóc Trăng  
(72) Trần Ngọc Hiếu (VN)  
(74) Văn phòng Luật sư D và T (D & T LAW OFFICE)  
(55)



H.1.1

1.1



H.1.2

1.2



H.2.1

2.1



H.2.2

2.2



H.3.1

3.1



H.3.2

3.2



H.4.1

4.1



H.4.2

4.2



H.5.1

5.1



H.5.2

5.2

**CÔNG BÁO SỞ HỮU CÔNG NGHIỆP SỐ 418 TẬP A – QUYỀN 2 (01.2023)**

- (11) **46374**  
(21) 3-2022-02252 (28) 4  
(54) **BỘ NHÃN SẢN PHẨM** (51) **19-08**  
(22) 17/10/2022 (43) 27/01/2023  
(73) **CÔNG TY CỔ PHẦN ACECOOK VIỆT NAM (VN)**  
Lô số II-3, đường số 11, nhóm CN II, khu công nghiệp Tân Bình, phường Tây  
Thạnh, quận Tân Phú, thành phố Hồ Chí Minh  
(72) Kajiwara Junichi (JP)  
(74) Công ty Luật TNHH Phạm và Liên danh (PHAM & ASSOCIATES)  
(55)



1.1



1.2



1.3



2.1



2.2



2.3

**CÔNG BÁO SỞ HỮU CÔNG NGHIỆP SỐ 418 TẬP A – QUYỀN 2 (01.2023)**

- (11) **46375**  
(21) 3-2022-02253 (28) 2  
(54) **THÙNG MÌ** (51) **09-03**  
(22) 17/10/2022 (43) 27/01/2023  
(73) **CÔNG TY CỔ PHẦN ACECOOK VIỆT NAM (VN)**  
Lô số II-3, đường số 11, nhóm CN II, khu công nghiệp Tân Bình, phường Tây  
Thạnh, quận Tân Phú, thành phố Hồ Chí Minh  
(72) Kajiwara Junichi (JP)  
(74) Công ty Luật TNHH Phạm và Liên danh (PHAM & ASSOCIATES)  
(55)



1.1



1.2



2.1



2.2

**CÔNG BÁO SỞ HỮU CÔNG NGHIỆP SỐ 418 TẬP A – QUYỀN 2 (01.2023)**

- (11) **46376**
- (21) 3-2022-02257 (28) 1
- (54) **NHÃN SẢN PHẨM** (51) **19-08**
- (22) 18/10/2022 (43) 27/01/2023
- (73) **CÔNG TY TNHH INTRIXAPPLE (VN)**  
14 đường 711, khu phố 2, phường Phú Hữu, thành phố Thủ Đức, thành phố Hồ Chí Minh
- (72) AZAIS STÉPHANE ALEXANDRE (FR)
- (74) Công ty TNHH Tư vấn - Dịch thuật - Sở hữu trí tuệ Á Đông (Á Đông IP CONSULTANCY CO.,LTD.)
- (55)



1.1



1.2

**CÔNG BÁO SỞ HỮU CÔNG NGHIỆP SỐ 418 TẬP A – QUYỀN 2 (01.2023)**

- (11) **46377**  
(21) 3-2022-02258 (28) 1  
(54) **THANH KIM LOẠI ĐỊNH HÌNH** (51) **25-01**  
(22) 18/10/2022 (43) 27/01/2023  
(73) **CÔNG TY CỔ PHẦN SẢN XUẤT & THƯƠNG MẠI AG VIỆT NAM (VN)**  
Số 46/165 đường Cầu Giấy, phường Dịch Vọng, quận Cầu Giấy, thành phố Hà Nội  
(72) Nguyễn Khắc Sơn (VN)  
(74) Công ty TNHH Sở hữu trí tuệ Gia Việt (GIAVIET CO., LTD.)  
(55)

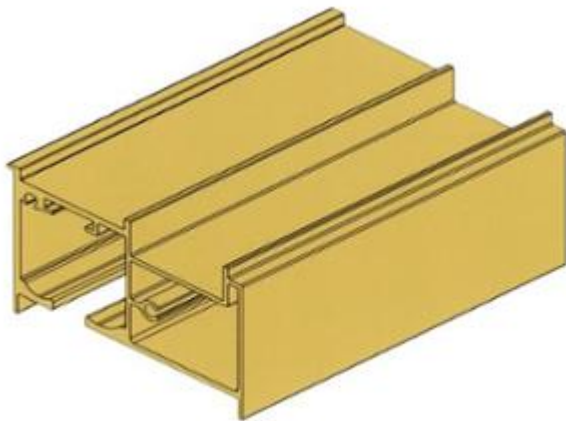

1.1

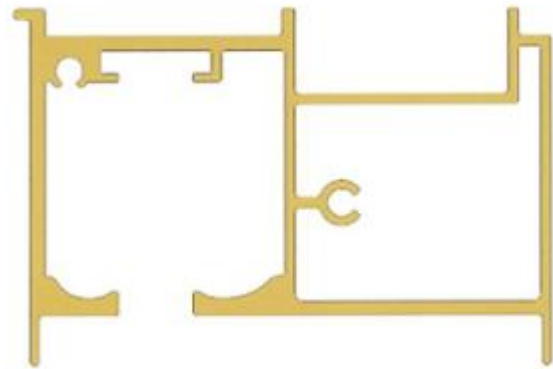

1.2



1.3



1.4



1.5



1.6

**CÔNG BÁO SỞ HỮU CÔNG NGHIỆP SỐ 418 TẬP A – QUYỀN 2 (01.2023)**

- (11) **46378**  
(21) 3-2022-02259 (28) 1  
(54) **THANH KIM LOẠI ĐỊNH HÌNH** (51) **25-01**  
(22) 18/10/2022 (43) 27/01/2023  
(73) **CÔNG TY CỔ PHẦN SẢN XUẤT & THƯƠNG MẠI AG VIỆT NAM (VN)**  
Số 46/165 đường Cầu Giấy, phường Dịch Vọng, quận Cầu Giấy, thành phố Hà Nội  
(72) Nguyễn Khắc Sơn (VN)  
(74) Công ty TNHH Sở hữu trí tuệ Gia Việt (GIAVIET CO., LTD.)  
(55)

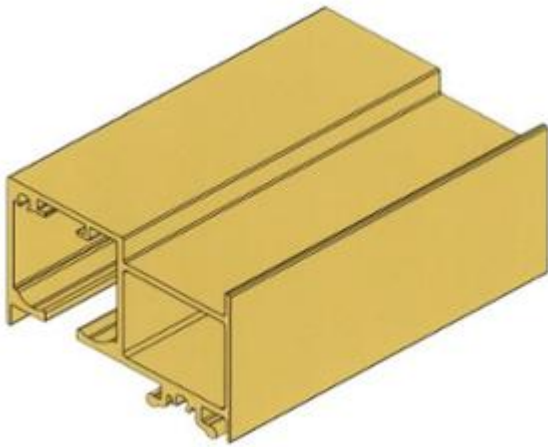

1.1

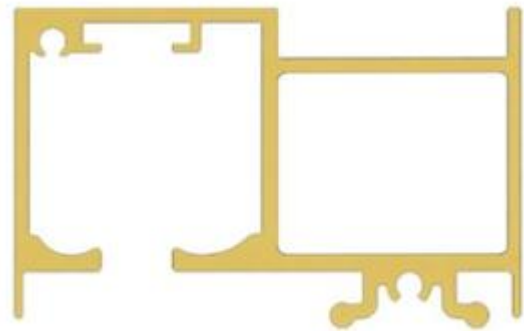

1.2



1.3



1.4



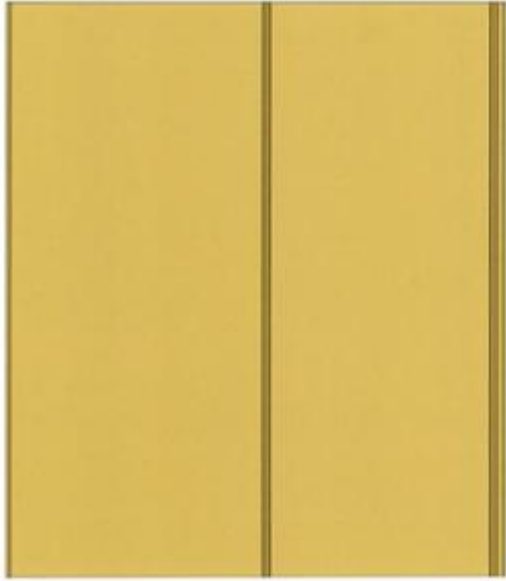

1.5

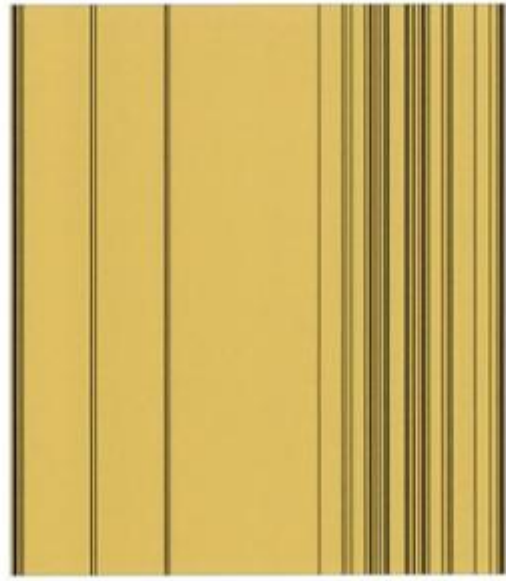

1.6

**CÔNG BÁO SỞ HỮU CÔNG NGHIỆP SỐ 418 TẬP A – QUYỀN 2 (01.2023)**

- (11) **46379**  
(21) 3-2022-02264 (28) 1  
(54) **GẠCH** (51) **25-01**  
(22) 19/10/2022 (43) 27/01/2023  
(73) **HÀ NGỌC TUÂN (VN)**  
Tổ 1, thị trấn Chi Đông, huyện Mê Linh, thành phố Hà Nội  
(72) Hà Ngọc Tuấn (VN)  
(74) Công ty Luật TNHH ELITE (ELITE LAW FIRM)  
(55)



1.1



1.2



1.3



1.4



1.5



1.6



1.7

**CÔNG BÁO SỞ HỮU CÔNG NGHIỆP SỐ 418 TẬP A – QUYỀN 2 (01.2023)**

- (11) **46380**  
(21) 3-2022-02265 (28) 1  
(54) **BỒN NƯỚC KHÁNG KHUẨN** (51) **23-01**  
(22) 19/10/2022 (43) 27/01/2023  
(73) **CÔNG TY TNHH CÔNG NGHỆ WAVE VIỆT NAM (VN)**  
Ngõ Chính, thôn Chợ, xã Bình Minh, huyện Thanh Oai, thành phố Hà Nội  
(72) Đào Thị Vân Hà (VN)  
(74) Công ty TNHH Sở hữu trí tuệ Hải Hân (HAI HAN IP CO., LTD.)  
(55)



1.1

1.2

1.3

1.4



1.5



1.6



1.7

**CÔNG BÁO SỞ HỮU CÔNG NGHIỆP SỐ 418 TẬP A – QUYỀN 2 (01.2023)**

- (11) **46381**  
(21) 3-2022-02271 (28) 1  
(54) **NHÃN SẢN PHẨM** (51) **19-08**  
(22) 21/10/2022 (43) 27/01/2023  
(73) **CÔNG TY CP GIẤY HÙNG CƯỜNG (VN)**  
Số nhà 56, đường Lý Quốc Sư, khu Hòa Đình, phường Võ Cường, thành phố Bắc Ninh, tỉnh Bắc Ninh  
(72) Bùi Trọng Cường (VN)  
(55)



**CÔNG BÁO SỞ HỮU CÔNG NGHIỆP SỐ 418 TẬP A – QUYỀN 2 (01.2023)**

- (11) **46382**  
(21) 3-2022-02273 (28) 1  
(54) **THANH KIM LOẠI ĐỊNH HÌNH** (51) **25-01**  
(22) 21/10/2022 (43) 27/01/2023  
(73) **CÔNG TY TNHH SẢN XUẤT VÀ THƯƠNG MẠI BÁCH VIỆT (VN)**  
Số 101, đường Đại Cồ Việt, phường Lê Đại Hành, quận Hai Bà Trưng, thành phố Hà Nội  
(72) Vũ Xuân Hòa (VN)  
(74) Công ty TNHH Sở hữu trí tuệ Bình Minh (SUNRISE IP CO.,LTD.)  
(55)

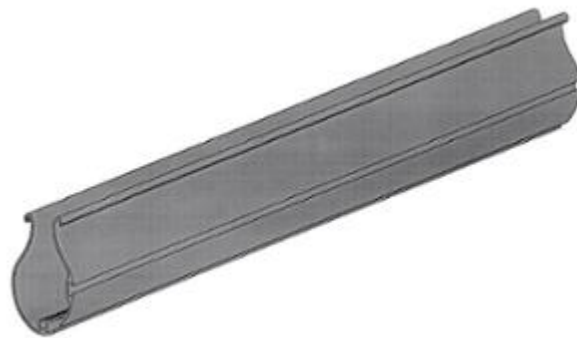

1.1



1.2



1.3



1.4



1.5



1.6



1.7

**CÔNG BÁO SỞ HỮU CÔNG NGHIỆP SỐ 418 TẬP A – QUYỀN 2 (01.2023)**

- (11) **46383**
  - (21) 3-2022-02274
  - (54) **CHẬU RỬA**
  - (22) 21/10/2022
  - (30) 009024987-0001 12/05/2022 EM;
  - (73) **HANS GROHE SE (DE)**  
Austr. 5-9, 77761 Schiltach, Germany
  - (72) Laura Somaglino (IT)
  - (74) Công ty TNHH Trường Xuân (AGELESS CO.,LTD.)
  - (55)
- (28) 1
  - (51) **23-02**
  - (43) 27/01/2023



1.1



1.2



1.3



1.4



1.5

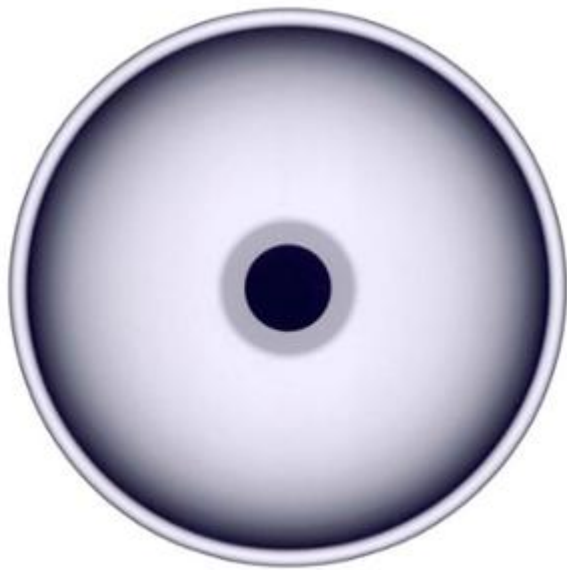

1.6

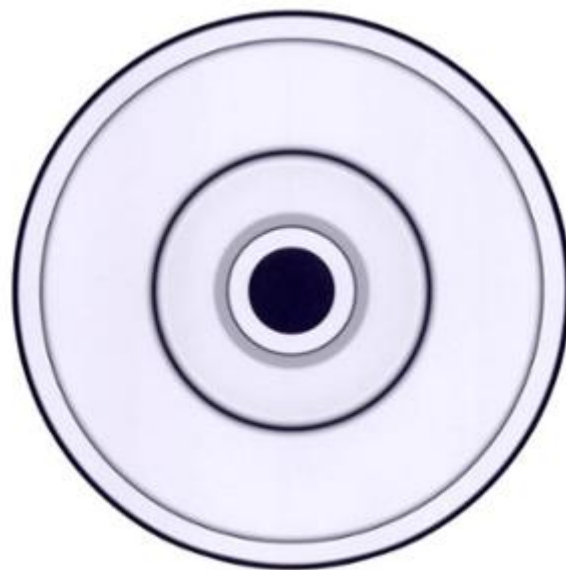

1.7

**CÔNG BÁO SỞ HỮU CÔNG NGHIỆP SỐ 418 TẬP A – QUYỀN 2 (01.2023)**

- (11) **46384**
  - (21) 3-2022-02275
  - (54) **CHẬU RỬA**
  - (22) 21/10/2022
  - (30) 009024987-0002 12/05/2022 EM;
  - (73) **HANSGROHE SE (DE)**  
Austr. 5-9, 77761 Schiltach, Germany
  - (72) Laura Somaglino (IT)
  - (74) Công ty TNHH Trường Xuân (AGELESS CO.,LTD.)
  - (55)
- (28) 1
  - (51) **23-02**
  - (43) 27/01/2023



1.1



1.2



1.3



1.4



1.5





1.6



1.7

**CÔNG BÁO SỞ HỮU CÔNG NGHIỆP SỐ 418 TẬP A – QUYỀN 2 (01.2023)**

- (11) **46385**  
(21) 3-2022-02276 (28) 1  
(54) **TÚI ĐỰNG GẠO** (51) **09-05**  
(22) 21/10/2022 (43) 27/01/2023  
(73) **HỢP TÁC XÃ NÔNG NGHIỆP VINH LỢI (VN)**  
Ấp 15, xã Vĩnh Lợi, huyện Thạnh Trị, tỉnh Sóc Trăng  
(72) Nguyễn Văn Út (VN)  
(74) Văn phòng Luật sư D và T (D & T LAW OFFICE)  
(55)



H.1

1.1



H.2

1.2

**CÔNG BÁO SỞ HỮU CÔNG NGHIỆP SỐ 418 TẬP A – QUYỀN 2 (01.2023)**

- (11) **46386**  
(21) 3-2022-02277 (28) 1  
(54) **CHẬU RỬA** (51) **23-02**  
(22) 21/10/2022 (43) 27/01/2023  
(30) 009024987-0003 12/05/2022 EM;  
(73) **HANS GROHE SE (DE)**  
Austr. 5-9, 77761 Schiltach, Germany  
(72) Laura Somaglino (IT)  
(74) Công ty TNHH Trường Xuân (AGELESS CO.,LTD.)  
(55)



1.1



1.2



1.3



1.4



1.5

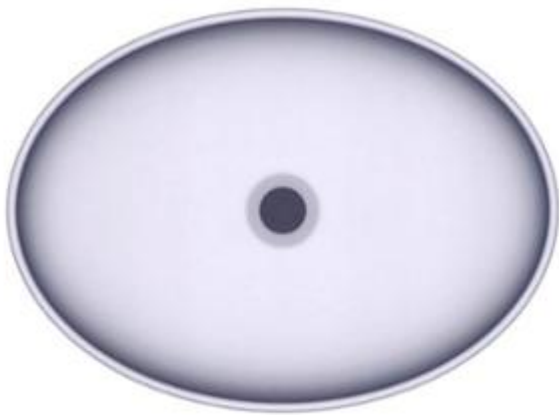

1.6



1.7

**CÔNG BÁO SỞ HỮU CÔNG NGHIỆP SỐ 418 TẬP A – QUYỀN 2 (01.2023)**

- (11) **46387**  
(21) 3-2022-02278 (28) 1  
(54) **CHẬU RỬA** (51) **23-02**  
(22) 21/10/2022 (43) 27/01/2023  
(30) 009024987-0004 12/05/2022 EM;  
(73) **HANSGROHE SE (DE)**  
Austr. 5-9, 77761 Schiltach, Germany  
(72) Laura Somaglino (IT)  
(74) Công ty TNHH Trường Xuân (AGELESS CO.,LTD.)  
(55)



1.1



1.2



1.3



1.4



1.5



1.6

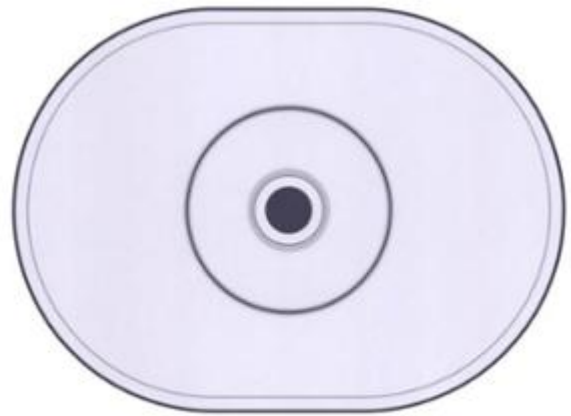

1.7

**CÔNG BÁO SỞ HỮU CÔNG NGHIỆP SỐ 418 TẬP A – QUYỀN 2 (01.2023)**

- (11) **46388**  
(21) 3-2022-02279 (28) 1  
(54) **THANH KIM LOẠI ĐỊNH HÌNH** (51) **25-01**  
(22) 21/10/2022 (43) 27/01/2023  
(73) **CÔNG TY CỔ PHẦN TẬP ĐOÀN KENWIN (VN)**  
Tầng 4 tòa nhà VG Building, số 235 đường Nguyễn Trãi, phường Thanh Xuân  
Trung, quận Thanh Xuân, thành phố Hà Nội  
(72) Ngô Thọ Long (VN)  
(74) Công ty TNHH Sở hữu trí tuệ PADEMARK (PADEMARK CO.,LTD.)  
(55)



1.1



1.2



1.3

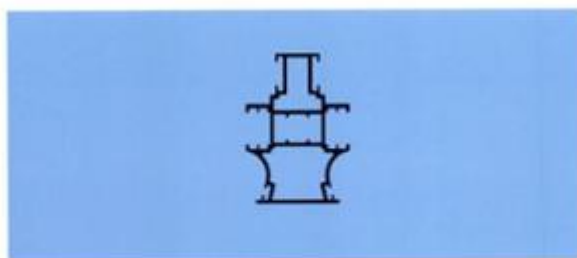

1.4

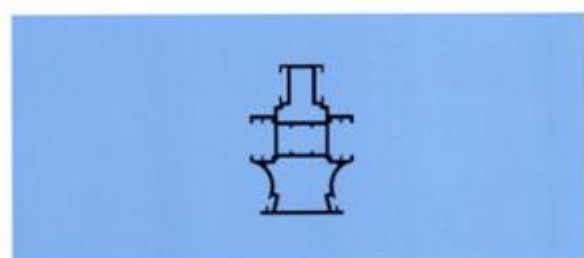

1.5



1.6



1.7

**CÔNG BÁO SỞ HỮU CÔNG NGHIỆP SỐ 418 TẬP A – QUYỀN 2 (01.2023)**

- (11) **46389**  
(21) 3-2022-02280 (28) 1  
(54) **THANH KIM LOẠI ĐỊNH HÌNH** (51) **25-01**  
(22) 21/10/2022 (43) 27/01/2023  
(73) **CÔNG TY CỔ PHẦN TẬP ĐOÀN KENWIN (VN)**  
Tầng 4 tòa nhà VG Building, số 235 đường Nguyễn Trãi, phường Thanh Xuân  
Trung, quận Thanh Xuân, thành phố Hà Nội  
(72) Ngô Thọ Long (VN)  
(74) Công ty TNHH Sở hữu trí tuệ PADEMARK (PADEMARK CO.,LTD.)  
(55)



1.1



1.2



1.3

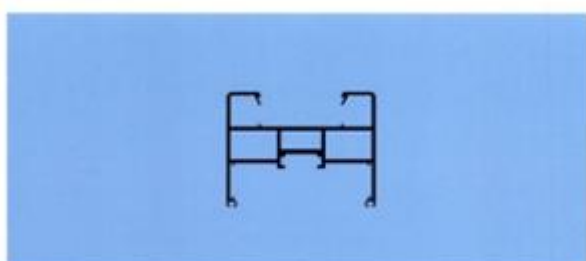

1.4

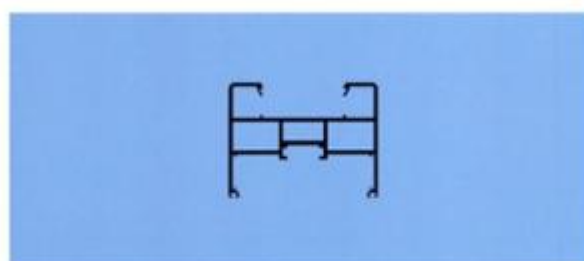

1.5



1.6



1.7



**CÔNG BÁO SỞ HỮU CÔNG NGHIỆP SỐ 418 TẬP A – QUYỀN 2 (01.2023)**

- (11) **46390**  
(21) 3-2022-02281 (28) 1  
(54) **THANH KIM LOẠI ĐỊNH HÌNH** (51) **25-01**  
(22) 21/10/2022 (43) 27/01/2023  
(73) **CÔNG TY CỔ PHẦN TẬP ĐOÀN KENWIN (VN)**  
Tầng 4 tòa nhà VG Building, số 235 đường Nguyễn Trãi, phường Thanh Xuân  
Trung, quận Thanh Xuân, thành phố Hà Nội  
(72) Ngô Thọ Long (VN)  
(74) Công ty TNHH Sở hữu trí tuệ PADEMARK (PADEMARK CO.,LTD.)  
(55)



1.1



1.2



1.3

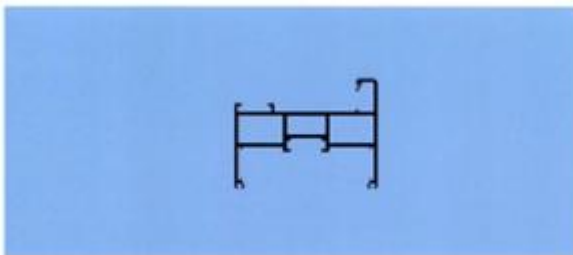

1.4

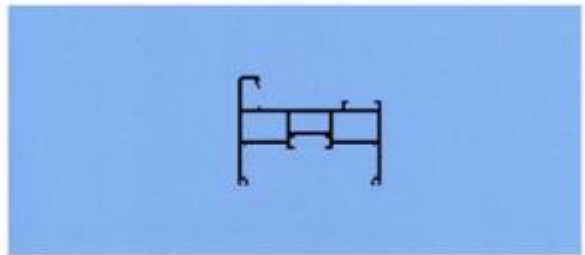

1.5



1.6



1.7

**CÔNG BÁO SỞ HỮU CÔNG NGHIỆP SỐ 418 TẬP A – QUYỀN 2 (01.2023)**

- (11) **46391**  
(21) 3-2022-02282 (28) 1  
(54) **THANH KIM LOẠI ĐỊNH HÌNH** (51) **25-01**  
(22) 21/10/2022 (43) 27/01/2023  
(73) **CÔNG TY CỔ PHẦN TẬP ĐOÀN KENWIN (VN)**  
Tầng 4 tòa nhà VG Building, số 235 đường Nguyễn Trãi, phường Thanh Xuân  
Trung, quận Thanh Xuân, thành phố Hà Nội  
(72) Ngô Thọ Long (VN)  
(74) Công ty TNHH Sở hữu trí tuệ PADEMARK (PADEMARK CO.,LTD.)  
(55)



1.1



1.2



1.3

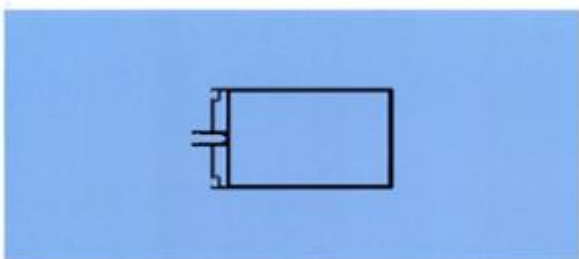

1.4

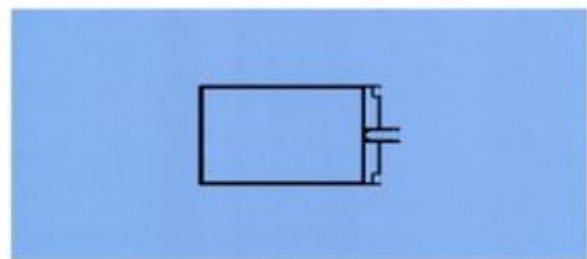

1.5

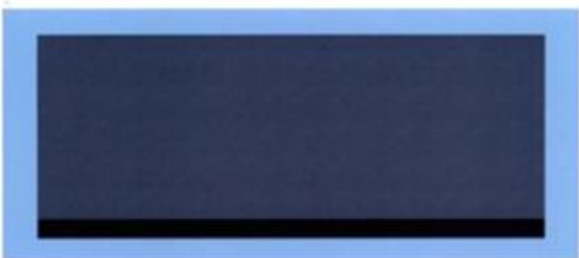

1.6



1.7

**CÔNG BÁO SỞ HỮU CÔNG NGHIỆP SỐ 418 TẬP A – QUYỀN 2 (01.2023)**

- (11) **46392**  
(21) 3-2022-02283 (28) 1  
(54) **THANH KIM LOẠI ĐỊNH HÌNH** (51) **25-01**  
(22) 21/10/2022 (43) 27/01/2023  
(73) **CÔNG TY CỔ PHẦN TẬP ĐOÀN KENWIN (VN)**  
Tầng 4 tòa nhà VG Building, số 235 đường Nguyễn Trãi, phường Thanh Xuân  
Trung, quận Thanh Xuân, thành phố Hà Nội  
(72) Ngô Thọ Long (VN)  
(74) Công ty TNHH Sở hữu trí tuệ PADEMARK (PADEMARK CO.,LTD.)  
(55)



1.1



1.2



1.3

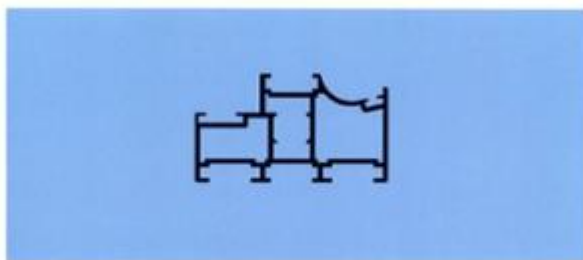

1.4

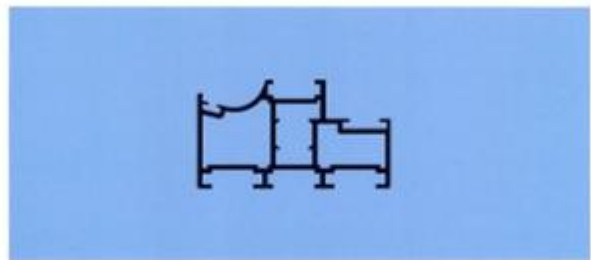

1.5



1.6



1.7

**CÔNG BÁO SỞ HỮU CÔNG NGHIỆP SỐ 418 TẬP A – QUYỀN 2 (01.2023)**

- (11) **46393**  
(21) 3-2022-02284 (28) 1  
(54) **THANH KIM LOẠI ĐỊNH HÌNH** (51) **25-01**  
(22) 21/10/2022 (43) 27/01/2023  
(73) **CÔNG TY CỔ PHẦN TẬP ĐOÀN KENWIN (VN)**  
Tầng 4 tòa nhà VG Building, số 235 đường Nguyễn Trãi, phường Thanh Xuân  
Trung, quận Thanh Xuân, thành phố Hà Nội  
(72) Ngô Thọ Long (VN)  
(74) Công ty TNHH Sở hữu trí tuệ PADEMARK (PADEMARK CO.,LTD.)  
(55)



1.1



1.2



1.3

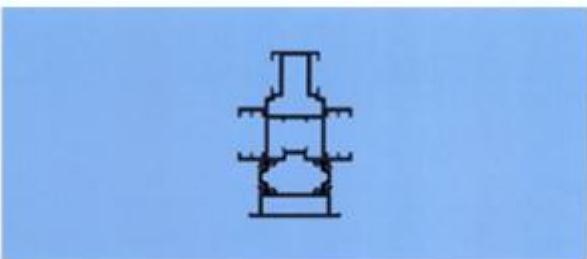

1.4

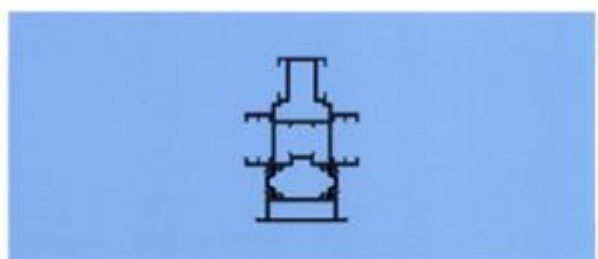

1.5



1.6



1.7

**CÔNG BÁO SỞ HỮU CÔNG NGHIỆP SỐ 418 TẬP A – QUYỀN 2 (01.2023)**

- (11) **46394**  
(21) 3-2022-02286 (28) 1  
(54) **THANH KIM LOẠI ĐỊNH HÌNH** (51) **25-01**  
(22) 21/10/2022 (43) 27/01/2023  
(73) **CÔNG TY CỔ PHẦN TẬP ĐOÀN KENWIN (VN)**  
Tầng 4 tòa nhà VG Building, số 235 đường Nguyễn Trãi, phường Thanh Xuân  
Trung, quận Thanh Xuân, thành phố Hà Nội  
(72) Ngô Thọ Long (VN)  
(74) Công ty TNHH Sở hữu trí tuệ PADEMARK (PADEMARK CO.,LTD.)  
(55)



1.1



1.2



1.3

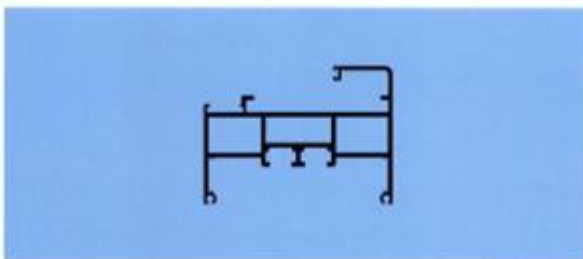

1.4

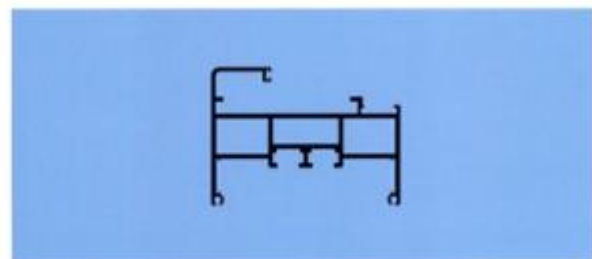

1.5



1.6



1.7

**CÔNG BÁO SỞ HỮU CÔNG NGHIỆP SỐ 418 TẬP A – QUYỀN 2 (01.2023)**

- (11) **46395**  
(21) 3-2022-02287 (28) 1  
(54) **THANH KIM LOẠI ĐỊNH HÌNH** (51) **25-01**  
(22) 21/10/2022 (43) 27/01/2023  
(73) **CÔNG TY CỔ PHẦN TẬP ĐOÀN KENWIN (VN)**  
Tầng 4 tòa nhà VG Building, số 235 đường Nguyễn Trãi, phường Thanh Xuân  
Trung, quận Thanh Xuân, thành phố Hà Nội  
(72) Ngô Thọ Long (VN)  
(74) Công ty TNHH Sở hữu trí tuệ PADEMARK (PADEMARK CO.,LTD.)  
(55)



1.1



1.2



1.3



1.4

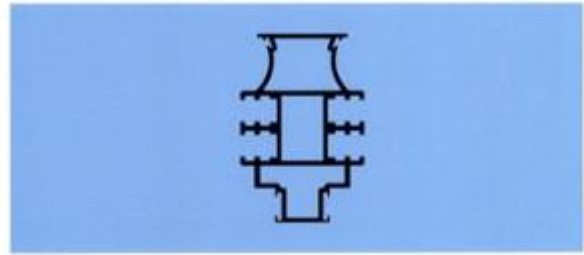

1.5



1.6



1.7

**CÔNG BÁO SỞ HỮU CÔNG NGHIỆP SỐ 418 TẬP A – QUYỀN 2 (01.2023)**

- (11) **46396**
  - (21) 3-2022-02288
  - (54) **CHẬU RỬA**
  - (22) 21/10/2022
  - (30) 009024987-0005 12/05/2022 EM;
  - (73) **HANSGROHE SE (DE)**  
Austr. 5-9, 77761 Schiltach, Germany
  - (72) Laura Somaglino (IT)
  - (74) Công ty TNHH Trường Xuân (AGELESS CO.,LTD.)
  - (55)
- (28) 1
  - (51) **23-02**
  - (43) 27/01/2023



1.1



1.2



1.3



1.4



1.5



1.6



1.7



**CÔNG BÁO SỞ HỮU CÔNG NGHIỆP SỐ 418 TẬP A – QUYỀN 2 (01.2023)**

- (11) **46397**  
(21) 3-2022-02289 (28) 1  
(54) **CHẬU RỬA** (51) **23-02**  
(22) 21/10/2022 (43) 27/01/2023  
(30) 009024987-0006 12/05/2022 EM;  
(73) **HANSGROHE SE (DE)**  
Austr. 5-9, 77761 Schiltach, Germany  
(72) Laura Somaglino (IT)  
(74) Công ty TNHH Trường Xuân (AGELESS CO.,LTD.)  
(55)



1.1



1.2



1.3



1.4



1.5



1.6

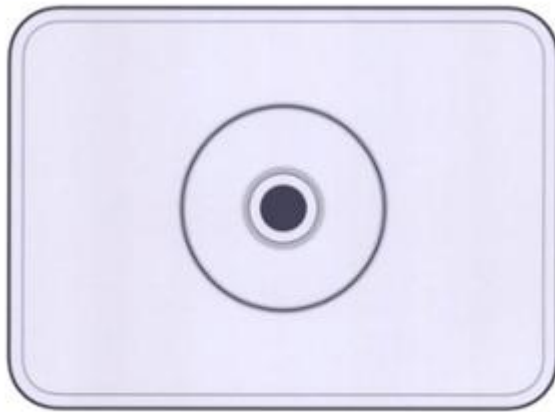

1.7

**CÔNG BÁO SỞ HỮU CÔNG NGHIỆP SỐ 418 TẬP A – QUYỀN 2 (01.2023)**

- (11) **46398**  
(21) 3-2022-02290 (28) 1  
(54) **CHẬU RỬA** (51) **23-02**  
(22) 21/10/2022 (43) 27/01/2023  
(30) 009024987-0007 12/05/2022 EM;  
(73) **HANSGROHE SE (DE)**  
Austr. 5-9, 77761 Schiltach, Germany  
(72) Laura Somaglino (IT)  
(74) Công ty TNHH Trường Xuân (AGELESS CO.,LTD.)  
(55)



1.1



1.2



1.3



1.4



1.5



1.6



1.7

**CÔNG BÁO SỞ HỮU CÔNG NGHIỆP SỐ 418 TẬP A – QUYỀN 2 (01.2023)**

- (11) **46399**
  - (21) 3-2022-02291
  - (54) **CHẬU RỬA**
  - (22) 21/10/2022
  - (30) 009024987-0008 12/05/2022 EM;
  - (73) **HANSGROHE SE (DE)**  
Austr. 5-9, 77761 Schiltach, Germany
  - (72) Laura Somaglino (IT)
  - (74) Công ty TNHH Trường Xuân (AGELESS CO.,LTD.)
  - (55)
- (28) 1
  - (51) **23-02**
  - (43) 27/01/2023



1.1



1.2



1.3



1.4



1.5



1.6



1.7

**CÔNG BÁO SỞ HỮU CÔNG NGHIỆP SỐ 418 TẬP A – QUYỀN 2 (01.2023)**

- (11) **46400**  
(21) 3-2022-02292 (28) 1  
(54) **CHẬU RỬA** (51) **23-02**  
(22) 21/10/2022 (43) 27/01/2023  
(30) 009024987-0009 12/05/2022 EM;  
(73) **HANSGROHE SE (DE)**  
Austr. 5-9, 77761 Schiltach, Germany  
(72) Laura Somaglino (IT)  
(74) Công ty TNHH Trường Xuân (AGELESS CO.,LTD.)  
(55)



1.1



1.2



1.3



1.4



1.5



1.6



1.7



**CÔNG BÁO SỞ HỮU CÔNG NGHIỆP SỐ 418 TẬP A – QUYỀN 2 (01.2023)**

- (11) **46401**  
(21) 3-2022-02293 (28) 1  
(54) **CHẬU RỬA** (51) **23-02**  
(22) 21/10/2022 (43) 27/01/2023  
(30) 009024987-0010 12/05/2022 EM;  
(73) **HANSGROHE SE (DE)**  
Austr. 5-9, 77761 Schiltach, Germany  
(72) Laura Somaglino (IT)  
(74) Công ty TNHH Trường Xuân (AGELESS CO.,LTD.)  
(55)



1.1



1.2



1.3



1.4



1.5



1.6



1.7

**CÔNG BÁO SỞ HỮU CÔNG NGHIỆP SỐ 418 TẬP A – QUYỀN 2 (01.2023)**

- (11) **46402**
- (21) 3-2022-02296 (28) 2
- (54) **BAO GÓI** (51) **09-05**
- (22) 21/10/2022 (43) 27/01/2023
- (73) **CÔNG TY CỔ PHẦN LIWAYWAY VIỆT NAM (VN)**  
Số 14, đường số 05, khu công nghiệp Việt Nam - Singapore, phường Bình Hòa, thành phố Thuận An, tỉnh Bình Dương
- (72) Robert Tan Li (PH)
- (74) Văn phòng Luật sư Tân Hà (VPLS TAN HA)
- (55)



1.1



1.2



2.1



2.2

**CÔNG BÁO SỞ HỮU CÔNG NGHIỆP SỐ 418 TẬP A – QUYỀN 2 (01.2023)**

(11) **46403**

(21) 3-2022-02300

(28) 1

(54) **ĐỒ CHƠI**

(51) **21-01**

(22) 24/10/2022

(43) 27/01/2023

(73) **ĐỒ ĐÌNH CHÍNH (VN)**

Thôn Quang Trung, xã Tiên Lữ, huyện Lập Thạch, tỉnh Vĩnh Phúc

(72) **Đồ Đình Chính (VN)**

(55)



1.1



1.2



1.3



1.4



1.5



1.6



1.7

**CÔNG BÁO SỞ HỮU CÔNG NGHIỆP SỐ 418 TẬP A – QUYỀN 2 (01.2023)**

(11) **46404**

(21) 3-2022-02301

(28) 1

(54) **BAO BÌ**

(51) **09-05**

(22) 24/10/2022

(43) 27/01/2023

(73) **CÔNG TY TNHH SUMI&SUKI (VN)**

Lô 90-92 đường Trần Nam Trung, phường Hòa Xuân, quận Cẩm Lệ, thành phố Đà Nẵng

(72) Lê Văn Đông (VN)

(55)



1.1



1.2

**CÔNG BÁO SỞ HỮU CÔNG NGHIỆP SỐ 418 TẬP A – QUYỀN 2 (01.2023)**

(11) **46405**

(21) 3-2022-02302

(28) 1

(54) **BAO BÌ**

(51) **09-05**

(22) 24/10/2022

(43) 27/01/2023

(73) **CÔNG TY TNHH SUMI&SUKI (VN)**

Lô 90-92 đường Trần Nam Trung, phường Hòa Xuân, quận Cẩm Lệ, thành phố Đà Nẵng

(72) Lê Văn Đông (VN)

(55)



1.1



1.2

**CÔNG BÁO SỞ HỮU CÔNG NGHIỆP SỐ 418 TẬP A – QUYỀN 2 (01.2023)**

- (11) **46406**  
(21) 3-2022-02305 (28) 1  
(54) **BAO GÓI** (51) **09-05**  
(22) 24/10/2022 (43) 27/01/2023  
(73) **CÔNG TY TNHH TẬP ĐOÀN DINH DƯỠNG BEONE (VN)**  
Số 52 Bà Triệu, phường Hàng Bài, quận Hoàn Kiếm, thành phố Hà Nội  
(72) Phạm Nhật Linh (VN)  
(74) **CÔNG TY TNHH KHANG LUẬT (KHANGLAW)**  
(55)



1.1



1.2

**CÔNG BÁO SỞ HỮU CÔNG NGHIỆP SỐ 418 TẬP A – QUYỀN 2 (01.2023)**

- (11) **46407**  
(21) 3-2022-02306 (28) 1  
(54) **HỘP** (51) **09-03**  
(22) 24/10/2022 (43) 27/01/2023  
(73) **CÔNG TY TNHH TẬP ĐOÀN DINH DƯỠNG BEONE (VN)**  
Số 52 Bà Triệu, phường Hàng Bài, quận Hoàn Kiếm, thành phố Hà Nội  
(72) Phạm Nhật Linh (VN)  
(74) **CÔNG TY TNHH KHANG LUẬT (KHANGLAW)**  
(55)



1.1



1.2



**CÔNG BÁO SỞ HỮU CÔNG NGHIỆP SỐ 418 TẬP A – QUYỀN 2 (01.2023)**

- (11) **46408**  
(21) 3-2022-02307 (28) 1  
(54) **RÈM CỬA** (51) **06-10**  
(22) 24/10/2022 (43) 27/01/2023  
(30) 29/838,652 13/05/2022 US;  
(73) **TEH YOR CO., LTD.** (TW)  
No. 1 & 36, Lane 338, Sidong Road, Sansia District, New Taipei City 23743,  
Taiwan  
(72) HUANG, Chien-Fong (US)  
(74) Công ty Luật TNHH quốc tế BMVN (BMVN INTERNATIONAL LLC)  
(55)

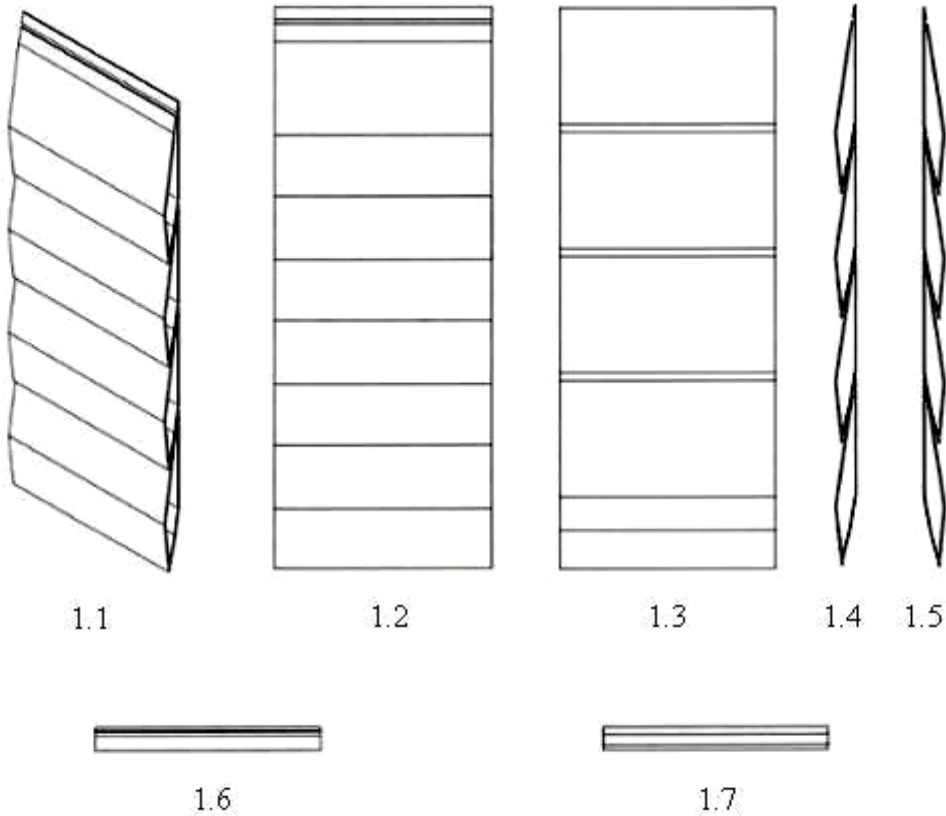

**CÔNG BÁO SỞ HỮU CÔNG NGHIỆP SỐ 418 TẬP A – QUYỀN 2 (01.2023)**

- (11) **46409**  
(21) 3-2022-02308 (28) 1  
(54) **RÈM CỬA** (51) **06-10**  
(22) 24/10/2022 (43) 27/01/2023  
(30) 29/838,656 13/05/2022 US;  
(73) **TEH YOR CO., LTD.** (TW)  
No. 1 & 36, Lane 338, Sidong Road, Sansia District, New Taipei City 23743,  
Taiwan  
(72) HUANG, Chien-Fong (US)  
(74) Công ty Luật TNHH quốc tế BMVN (BMVN INTERNATIONAL LLC)  
(55)

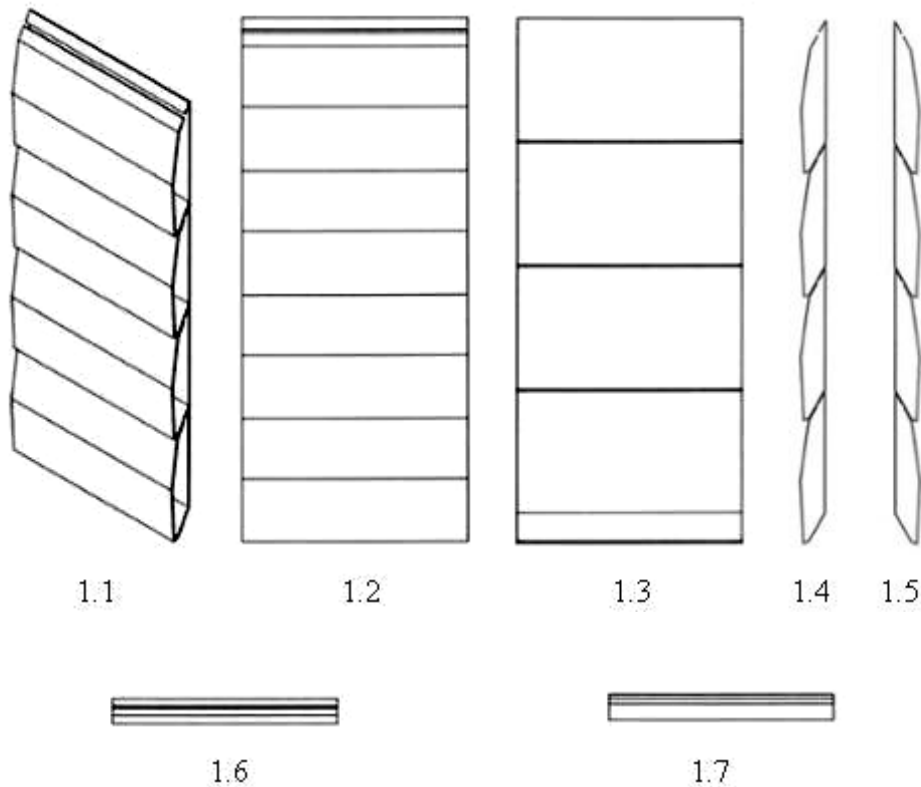

**CÔNG BÁO SỞ HỮU CÔNG NGHIỆP SỐ 418 TẬP A – QUYỀN 2 (01.2023)**

- (11) **46410**
- (21) 3-2022-02309 (28) 1
- (54) **LỢ** (51) **09-01**
- (22) 24/10/2022 (43) 27/01/2023
- (30) 30-2022-0024535 20/06/2022 KR;
- (73) **AE KYUNG INDUSTRIAL CO., LTD (KR)**  
188, Yanghwa-ro, Mapo-gu, Seoul, Republic of Korea
- (72) Shin Aera (KR)
- (74) Công ty TNHH Sở hữu trí tuệ Thảo Thọ Quyển (INVENCO.,LTD)
- (55)

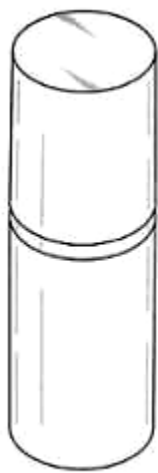

1.1



1.2



1.3

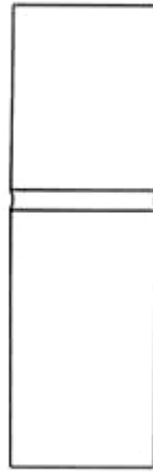

1.4

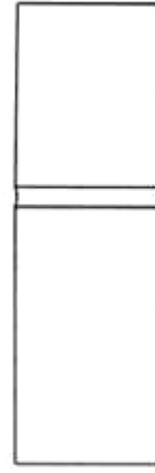

1.5

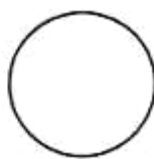

1.6

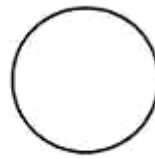

1.7

**CÔNG BÁO SỞ HỮU CÔNG NGHIỆP SỐ 418 TẬP A – QUYỀN 2 (01.2023)**

- (11) **46411**
- (21) 3-2022-02310 (28) 1
- (54) **LỢ** (51) **09-03**
- (22) 24/10/2022 (43) 27/01/2023
- (30) 30-2022-0024536 20/06/2022 KR;
- (73) **AE KYUNG INDUSTRIAL CO., LTD (KR)**  
188, Yanghwa-ro, Mapo-gu, Seoul, Republic of Korea
- (72) Shin Aera (KR)
- (74) Công ty TNHH Sở hữu trí tuệ Thảo Thọ Quyển (INVENCO.,LTD)
- (55)



1.1

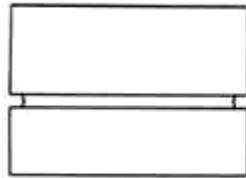

1.2

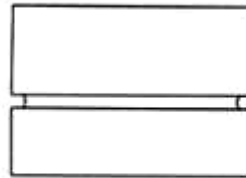

1.3

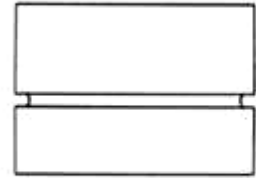

1.4

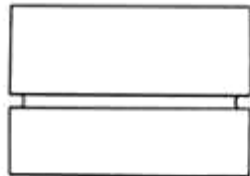

1.5

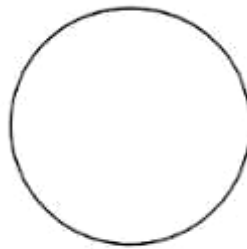

1.6

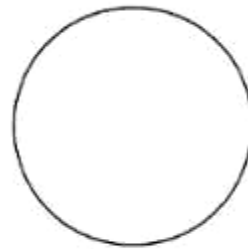

1.7

**CÔNG BÁO SỞ HỮU CÔNG NGHIỆP SỐ 418 TẬP A – QUYỀN 2 (01.2023)**

- (11) **46412**
- (21) 3-2022-02311 (28) 1
- (54) **LỢ** (51) **09-01**
- (22) 24/10/2022 (43) 27/01/2023
- (30) 30-2022-0024537 20/06/2022 KR;
- (73) **AE KYUNG INDUSTRIAL CO., LTD (KR)**  
188, Yanghwa-ro, Mapo-gu, Seoul, Republic of Korea
- (72) Shin Aera (KR)
- (74) Công ty TNHH Sở hữu trí tuệ Thảo Thọ Quyển (INVENCO.,LTD)
- (55)

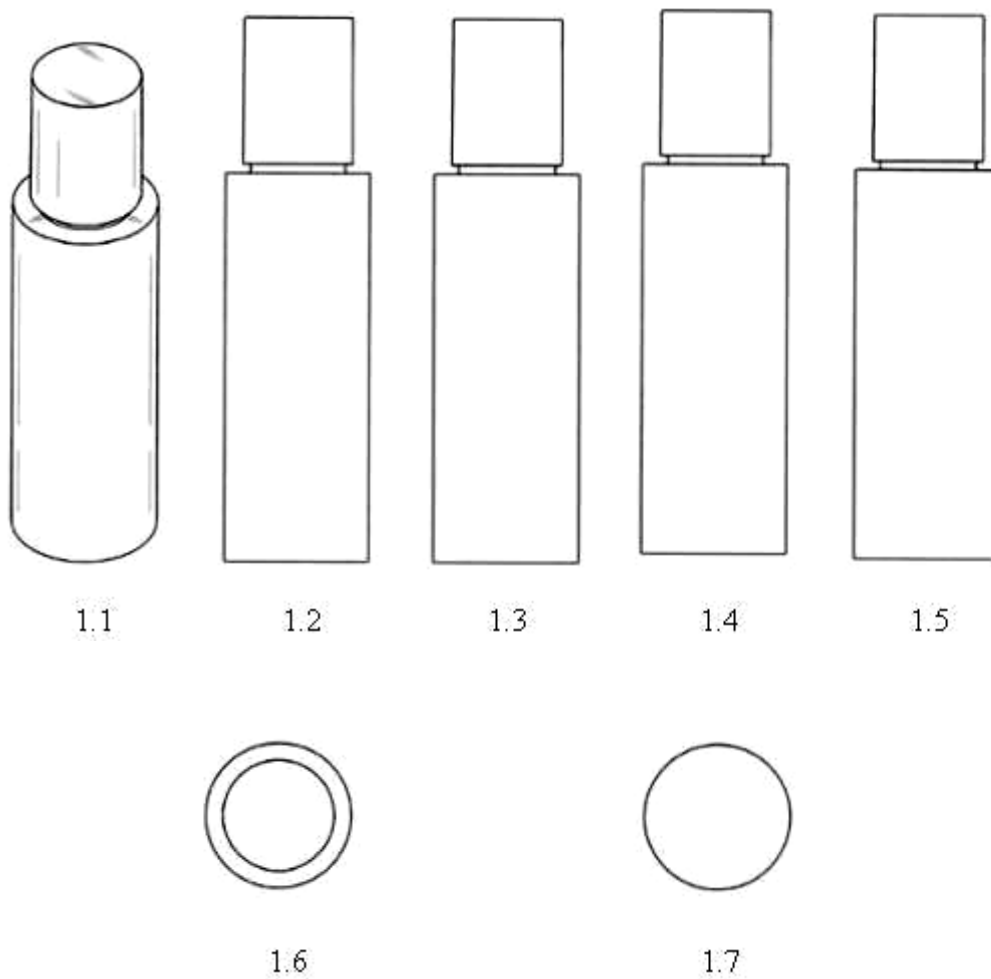

**CÔNG BÁO SỞ HỮU CÔNG NGHIỆP SỐ 418 TẬP A – QUYỀN 2 (01.2023)**

- (11) **46413**  
(21) 3-2022-02312 (28) 1  
(54) **LỌ** (51) **09-01**  
(22) 24/10/2022 (43) 27/01/2023  
(30) 30-2022-0024538 20/06/2022 KR;  
(73) **AE KYUNG INDUSTRIAL CO., LTD (KR)**  
188, Yanghwa-ro, Mapo-gu, Seoul, Republic of Korea  
(72) Shin Aera (KR)  
(74) Công ty TNHH Sở hữu trí tuệ Thảo Thọ Quyển (INVENCO.,LTD)  
(55)

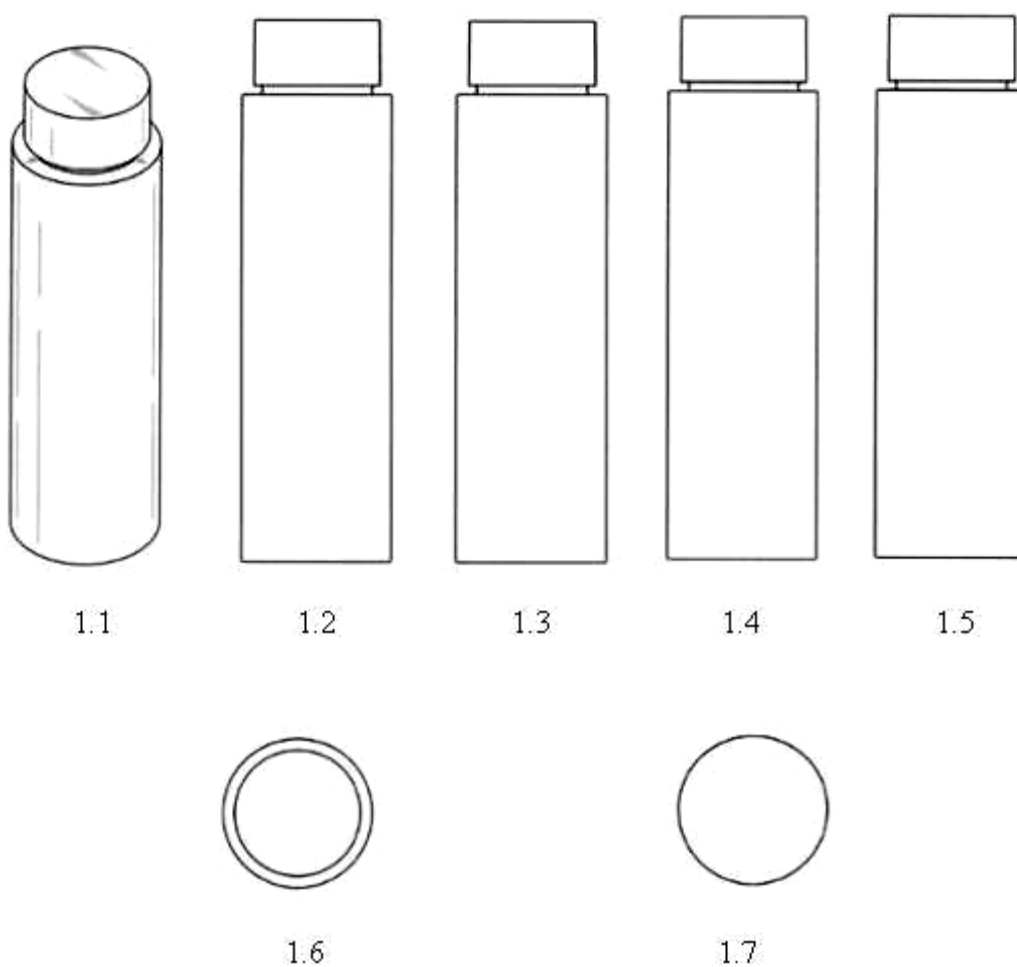

- (11) **46414**  
(21) 3-2022-02314 (28) 1  
(54) **NẤP HỘP ĐỰNG THỰC PHẨM** (51) **07-07; 09-07**  
(22) 24/10/2022 (43) 27/01/2023  
(30) 30-2022-0024326 17/06/2022 KR;  
(73) **LOCK & LOCK CO., LTD (KR)**  
104, Sapyocheon-ro, Seonjang-myeon, Asan-si, Chungcheongnam-do, Republic of Korea  
(72) LEE, Kyung Mee (KR)  
(74) Công ty TNHH Tầm nhìn và Liên danh (VISION & ASSOCIATES CO.LTD.)  
(55)



1.1



1.2



1.3



1.4



1.5



1.6



1.7

**CÔNG BÁO SỞ HỮU CÔNG NGHIỆP SỐ 418 TẬP A – QUYỀN 2 (01.2023)**

- (11) **46415**  
(21) 3-2022-02315 (28) 1  
(54) **BÌNH NƯỚC** (51) **07-07**  
(22) 24/10/2022 (43) 27/01/2023  
(30) 30-2022-0026312 30/06/2022 KR;  
(73) **LOCK & LOCK CO., LTD (KR)**  
104, Sapgyocheon-ro, Seonjang-myeon, Asan-si, Chungcheongnam-do, Republic  
of Korea  
(72) LEE, Hye Ri (KR)  
(74) Công ty TNHH Tầm nhìn và Liên danh (VISION & ASSOCIATES CO.LTD.)  
(55)



1.1



1.2

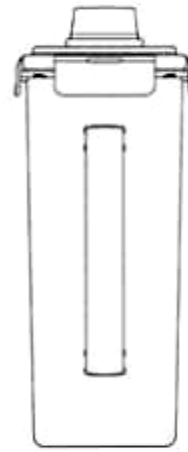

1.3

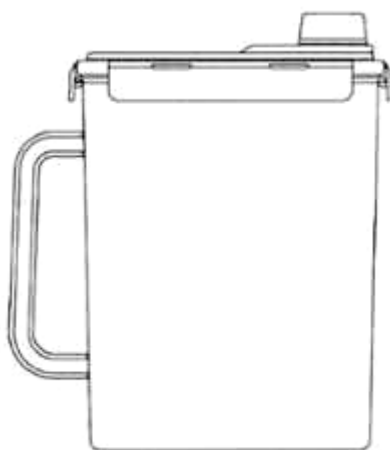

1.4



1.5



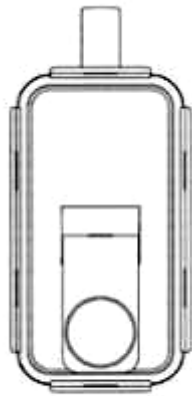

1.6



1.7

- (11) **46416**  
(21) 3-2022-02316 (28) 1  
(54) **NỒI** (51) **07-02**  
(22) 24/10/2022 (43) 27/01/2023  
(30) 30-2022-0026313 30/06/2022 KR;  
(73) **LOCK & LOCK CO., LTD (KR)**  
104, Sapgyocheon-ro, Seonjang-myeon, Asan-si, Chungcheongnam-do, Republic of Korea  
(72) 1. YOU, SUNG IK (KR)  
2. LIM, JI HUN (KR)  
(74) Công ty TNHH Tầm nhìn và Liên danh (VISION & ASSOCIATES CO.LTD.)  
(55)

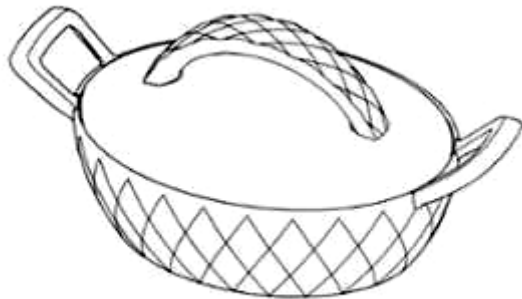

1.1



1.2



1.3



1.4



1.5

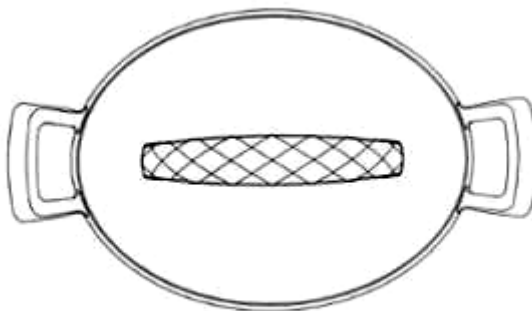

1.6

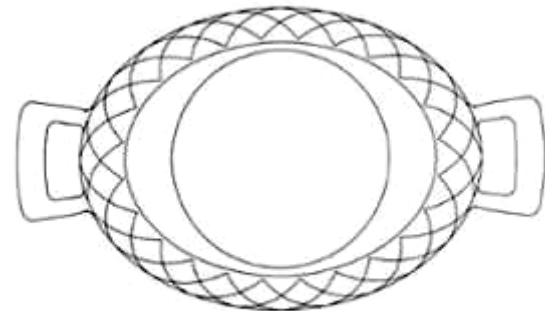

1.7

**CÔNG BÁO SỞ HỮU CÔNG NGHIỆP SỐ 418 TẬP A – QUYỀN 2 (01.2023)**

- (11) **46417**  
(21) 3-2022-02318 (28) 1  
(54) **CHẢO RÁN** (51) **07-02**  
(22) 24/10/2022 (43) 27/01/2023  
(30) 30-2022-0026315 30/06/2022 KR;  
(73) **LOCK & LOCK CO., LTD (KR)**  
104, Sapgyocheon-ro, Seonjang-myeon, Asan-si, Chungcheongnam-do, Republic of Korea  
(72) 1. NAM, SOO JUNG (KR)  
2. KIM, SEON JEONG (KR)  
(74) Công ty TNHH Tầm nhìn và Liên danh (VISION & ASSOCIATES CO.LTD.)  
(55)



1.1



1.2

1.3



1.4



1.5

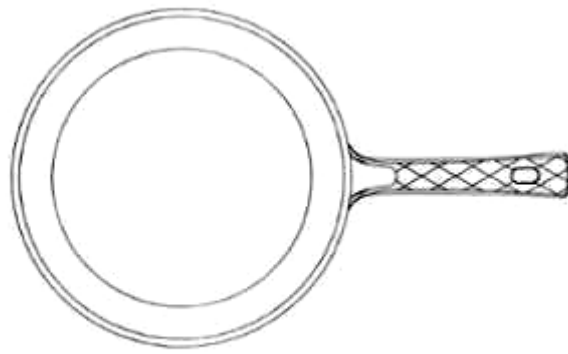

1.6

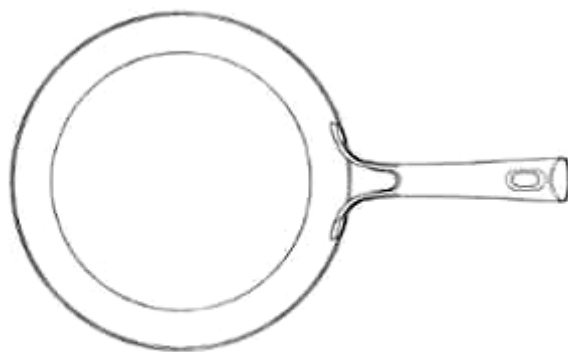

1.7

**CÔNG BÁO SỞ HỮU CÔNG NGHIỆP SỐ 418 TẬP A – QUYỀN 2 (01.2023)**

- (11) **46418**  
(21) 3-2022-02319 (28) 1  
(54) **NỒI** (51) **07-02**  
(22) 24/10/2022 (43) 27/01/2023  
(30) 30-2022-0026316 30/06/2022 KR;  
(73) **LOCK & LOCK CO., LTD (KR)**  
104, Sapgyocheon-ro, Seonjang-myeon, Asan-si, Chungcheongnam-do, Republic of Korea  
(72) 1. NAM, SOO JUNG (KR)  
2. KIM, SEON JEONG (KR)  
(74) Công ty TNHH Tầm nhìn và Liên danh (VISION & ASSOCIATES CO.LTD.)  
(55)



1.1



1.2



1.3

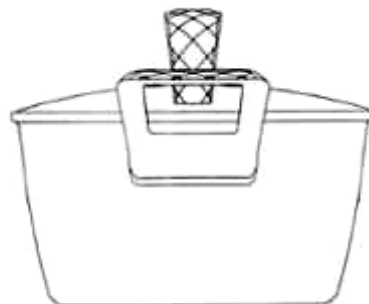

1.4

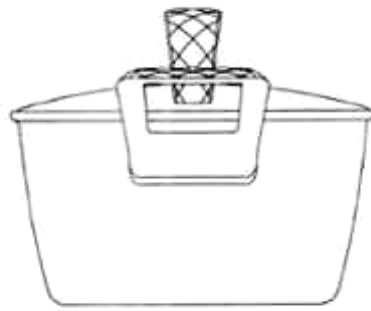

1.5

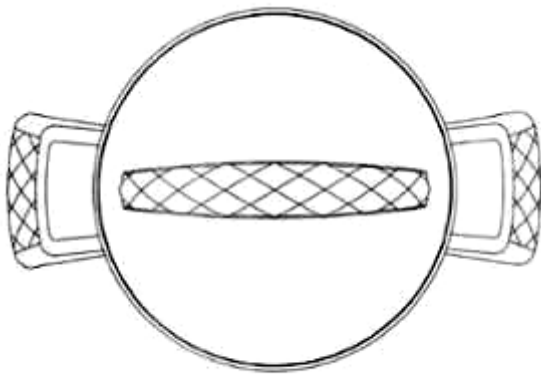

1.6

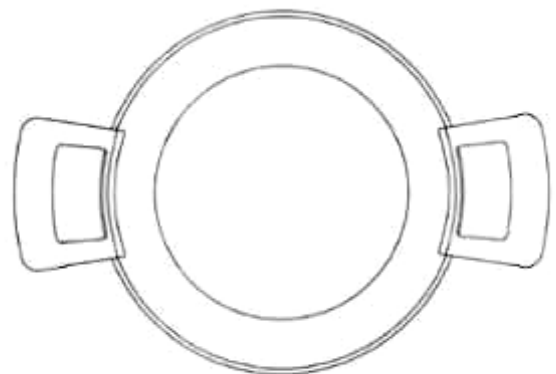

1.7

**CÔNG BÁO SỞ HỮU CÔNG NGHIỆP SỐ 418 TẬP A – QUYỀN 2 (01.2023)**

- (11) **46419**  
(21) 3-2022-02323 (28) 1  
(54) **CHAI** (51) **09-01**  
(22) 25/10/2022 (43) 27/01/2023  
(73) **CÔNG TY CỔ PHẦN DẦU THỰC VẬT TÂN BÌNH (VN)**  
889 Trường Chinh, phường Tây Thạnh, quận Tân Phú, thành phố Hồ Chí Minh  
(72) Huỳnh Trung Lập (VN)  
(74) **CÔNG TY TNHH SỞ HỮU TRÍ TUỆ SETHACO (SETHACO IP CO.,LTD)**  
(55)



1.1



1.2



1.3



1.4

**CÔNG BÁO SỞ HỮU CÔNG NGHIỆP SỐ 418 TẬP A – QUYỀN 2 (01.2023)**

(11) **46420**

(21) 3-2022-02326

(28) 1

(54) **HỘP ĐỰNG**

(51) **28-02**

(22) 26/10/2022

(43) 27/01/2023

(73) **CLIO COSMETICS (KR)**

66, Wangsimni-ro, Seongdong-gu, Seoul, Republic of Korea

(72) Han, Hyun-ok (KR)

(74) Công ty TNHH Trường Xuân (AGELESS CO.,LTD.)

(55)



1.1



1.2



1.3



1.4



1.5



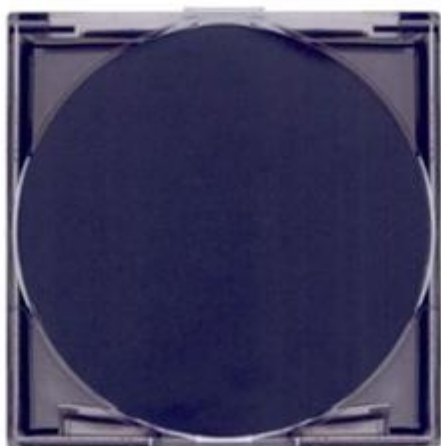

1.6



1.7



1.8

**CÔNG BÁO SỞ HỮU CÔNG NGHIỆP SỐ 418 TẬP A – QUYỀN 2 (01.2023)**

- (11) **46421**  
(21) 3-2022-02327 (28) 1  
(54) **BAO GÓI** (51) **09-05**  
(22) 27/10/2022 (43) 27/01/2023  
(73) **CÔNG TY TNHH SẢN XUẤT VÀ THƯƠNG MẠI QUỐC TẾ VIỆT SING**  
(VN)  
Cụm CN Xuân Lâm, xã Xuân Lâm, huyện Thuận Thành, tỉnh Bắc Ninh  
(72) Nguyễn Đăng Dũng (VN)  
(55)



1.1



1.2

**CÔNG BÁO SỞ HỮU CÔNG NGHIỆP SỐ 418 TẬP A – QUYỀN 2 (01.2023)**

- (11) **46422**  
(21) 3-2022-02328 (28) 1  
(54) **BAO GÓI** (51) **09-05**  
(22) 27/10/2022 (43) 27/01/2023  
(73) **CÔNG TY TNHH SẢN XUẤT VÀ THƯƠNG MẠI QUỐC TẾ VIỆT SING**  
(VN)  
Cụm CN Xuân Lâm, xã Xuân Lâm, huyện Thuận Thành, tỉnh Bắc Ninh  
(72) Nguyễn Đăng Dũng (VN)  
(55)



1.1



1.2

**CÔNG BÁO SỞ HỮU CÔNG NGHIỆP SỐ 418 TẬP A – QUYỀN 2 (01.2023)**

- (11) **46423**  
(21) 3-2022-02329 (28) 1  
(54) **BAO GÓI** (51) **09-05**  
(22) 27/10/2022 (43) 27/01/2023  
(73) **CÔNG TY TNHH SẢN XUẤT VÀ THƯƠNG MẠI QUỐC TẾ VIỆT SING**  
(VN)  
Cụm CN Xuân Lâm, xã Xuân Lâm, huyện Thuận Thành, tỉnh Bắc Ninh  
(72) Nguyễn Đăng Dũng (VN)  
(55)



1.1



1.2

**CÔNG BÁO SỞ HỮU CÔNG NGHIỆP SỐ 418 TẬP A – QUYỀN 2 (01.2023)**

- (11) **46424**  
(21) 3-2022-02333 (28) 1  
(54) **BAO GÓI** (51) **09-05**  
(22) 27/10/2022 (43) 27/01/2023  
(73) **CÔNG TY TNHH NTPM (VIỆT NAM) (VN)**  
Số 22 VSIP II-A, đường số 23, khu công nghiệp Việt Nam - Singapore II-A,  
phường Vĩnh Tân, thị xã Tân Uyên, tỉnh Bình Dương  
(72) LEE KUAN PHENG (MY)  
(74) Công ty TNHH Sở hữu trí tuệ HA VIP (HAVIP CO., LTD.)  
(55)



1.1



1.2

**CÔNG BÁO SỞ HỮU CÔNG NGHIỆP SỐ 418 TẬP A – QUYỀN 2 (01.2023)**

- (11) **46425**  
(21) 3-2022-02337 (28) 1  
(54) **CHAI** (51) **09-01**  
(22) 28/10/2022 (43) 27/01/2023  
(73) **CÔNG TY CỔ PHẦN DẦU THỰC VẬT TÂN BÌNH (VN)**  
889 Trường Chinh, phường Tây Thạnh, quận Tân Phú, thành phố Hồ Chí Minh  
(72) Huỳnh Trung Lập (VN)  
(74) **CÔNG TY TNHH SỞ HỮU TRÍ TUỆ SETHACO (SETHACO IP CO.,LTD)**  
(55)



1.1



1.2



1.3



1.4

**CÔNG BÁO SỞ HỮU CÔNG NGHIỆP SỐ 418 TẬP A – QUYỀN 2 (01.2023)**

- (11) **46426**  
(21) 3-2022-02338 (28) 1  
(54) **CHAI** (51) **09-01**  
(22) 28/10/2022 (43) 27/01/2023  
(73) **CÔNG TY CỔ PHẦN DẦU THỰC VẬT TÂN BÌNH (VN)**  
889 Trường Chinh, phường Tây Thạnh, quận Tân Phú, thành phố Hồ Chí Minh  
(72) Huỳnh Trung Lập (VN)  
(74) **CÔNG TY TNHH SỞ HỮU TRÍ TUỆ SETHACO (SETHACO IP CO.,LTD)**  
(55)



1.1



1.2



1.3



1.4



1.5



1.6



**CÔNG BÁO SỞ HỮU CÔNG NGHIỆP SỐ 418 TẬP A – QUYỀN 2 (01.2023)**

- (11) **46427**
- (21) 3-2022-02346 (28) 1
- (54) **NHÃN SẢN PHẨM** (51) **19-08**
- (22) 31/10/2022 (43) 27/01/2023
- (73) **CÔNG TY CỔ PHẦN TẬP ĐOÀN THỰC PHẨM AUVI (VN)**  
Số 3 Vũ Đức Thận, phường Việt Hưng, quận Long Biên, thành phố Hà Nội
- (72) Nguyễn An Toàn (VN)
- (74) Công ty TNHH Sở hữu trí tuệ và Công nghệ Thủ đô (CAPITAL IP&T CO.LTD.)
- (55)



**CÔNG BÁO SỞ HỮU CÔNG NGHIỆP SỐ 418 TẬP A – QUYỀN 2 (01.2023)**

- (11) **46428**  
(21) 3-2022-02347 (28) 1  
(54) **NHÃN SẢN PHẨM** (51) **19-08**  
(22) 31/10/2022 (43) 27/01/2023  
(73) **CÔNG TY CỔ PHẦN TẬP ĐOÀN THỰC PHẨM AUVI (VN)**  
Số 3 Vũ Đức Thận, phường Việt Hưng, quận Long Biên, thành phố Hà Nội  
(72) Nguyễn An Toàn (VN)  
(74) Công ty TNHH Sở hữu trí tuệ và Công nghệ Thủ đô (CAPITAL IP&T CO.LTD.)  
(55)

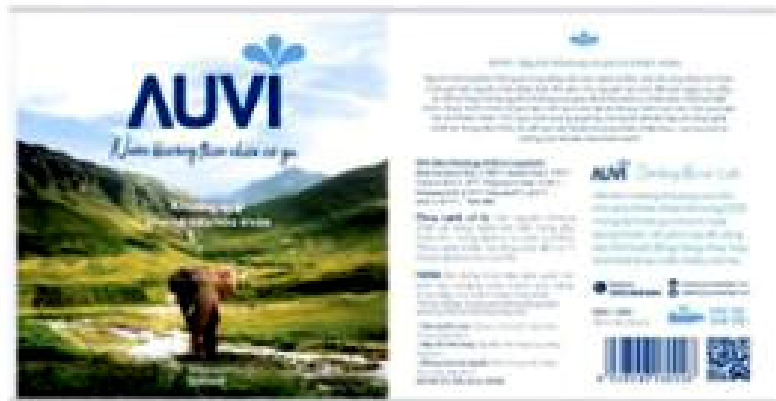

**CÔNG BÁO SỞ HỮU CÔNG NGHIỆP SỐ 418 TẬP A – QUYỀN 2 (01.2023)**

- (11) **46429**  
(21) 3-2022-02348 (28) 1  
(54) **THANH KIM LOẠI ĐỊNH HÌNH** (51) **25-01**  
(22) 31/10/2022 (43) 27/01/2023  
(73) **BÙI MINH TUẤN (VN)**  
P.706 NƠ 5, KĐT Pháp Vân - Tứ Hiệp, phường Hoàng Liệt, quận Hoàng Mai,  
thành phố Hà Nội  
(72) Bùi Minh Tuấn (VN)  
(74) Công ty TNHH Sở hữu trí tuệ PADEMARK (PADEMARK CO.,LTD.)  
(55)



1.1

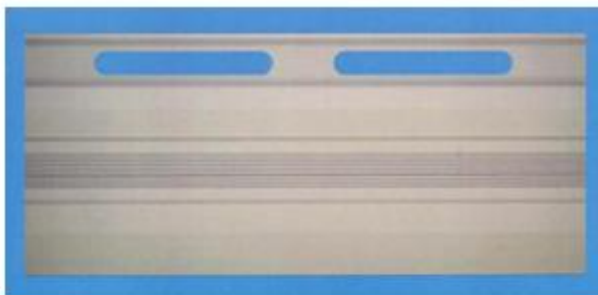

1.2

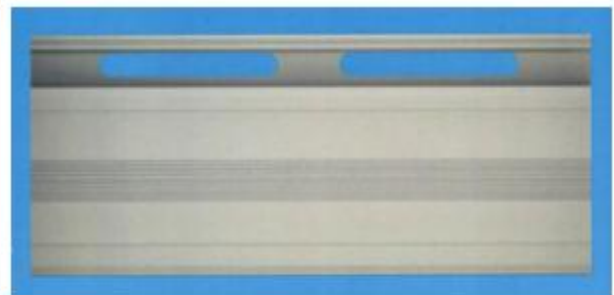

1.3



1.4

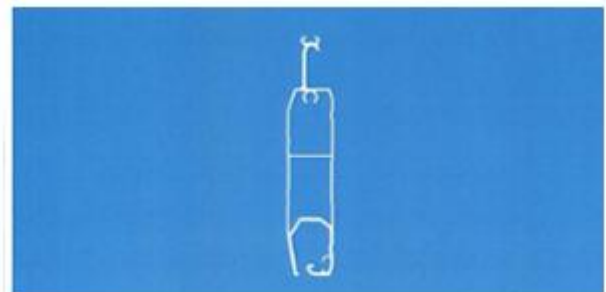

1.5



1.6



1.7

**CÔNG BÁO SỞ HỮU CÔNG NGHIỆP SỐ 418 TẬP A – QUYỀN 2 (01.2023)**

- (11) **46430**  
(21) 3-2022-02349 (28) 1  
(54) **BAO GÓI SẢN PHẨM** (51) **09-05**  
(22) 31/10/2022 (43) 27/01/2023  
(73) **HỢP TÁC XÃ NÔNG SẢN AN TOÀN AN HÒA (VN)**  
Ấp Tân Thạnh, xã An Nhơn, huyện Châu Thành, tỉnh Đồng Tháp  
(72) Lê Văn Hùng (VN)  
(74) Công ty TNHH Sở hữu trí tuệ PADEMARK (PADEMARK CO.,LTD.)  
(55)



1.1



1.2



1.3



1.4



1.5



1.6



1.7

**CÔNG BÁO SỞ HỮU CÔNG NGHIỆP SỐ 418 TẬP A – QUYỀN 2 (01.2023)**

- (11) **46431**
- (21) 3-2022-02362 (28) 1
- (54) **NHÃN SẢN PHẨM** (51) **19-08**
- (22) 01/11/2022 (43) 27/01/2023
- (73) **CÔNG TY CỔ PHẦN TẬP ĐOÀN THỰC PHẨM AUVI (VN)**  
Số 3 Vũ Đức Thận, phường Việt Hưng, quận Long Biên, thành phố Hà Nội
- (72) Nguyễn An Toàn (VN)
- (74) Công ty TNHH Sở hữu trí tuệ và Công nghệ Thủ đô (CAPITAL IP&T CO.LTD.)
- (55)



**CÔNG BÁO SỞ HỮU CÔNG NGHIỆP SỐ 418 TẬP A – QUYỀN 2 (01.2023)**

- (11) **46432**
- (21) 3-2022-02363 (28) 1
- (54) **NHÃN SẢN PHẨM** (51) **19-08**
- (22) 01/11/2022 (43) 27/01/2023
- (73) **CÔNG TY CỔ PHẦN TẬP ĐOÀN THỰC PHẨM AUVI (VN)**  
Số 3 Vũ Đức Thận, phường Việt Hưng, quận Long Biên, thành phố Hà Nội
- (72) Nguyễn An Toàn (VN)
- (74) Công ty TNHH Sở hữu trí tuệ và Công nghệ Thủ đô (CAPITAL IP&T CO.LTD.)
- (55)



**CÔNG BÁO SỞ HỮU CÔNG NGHIỆP SỐ 418 TẬP A – QUYỀN 2 (01.2023)**

- (11) **46433**
- (21) 3-2022-02364 (28) 1
- (54) **NHÃN SẢN PHẨM** (51) **19-08**
- (22) 01/11/2022 (43) 27/01/2023
- (73) **CÔNG TY CỔ PHẦN TẬP ĐOÀN THỰC PHẨM AUVI (VN)**  
Số 3 Vũ Đức Thận, phường Việt Hưng, quận Long Biên, thành phố Hà Nội
- (72) Nguyễn An Toàn (VN)
- (74) Công ty TNHH Sở hữu trí tuệ và Công nghệ Thủ đô (CAPITAL IP&T CO.LTD.)
- (55)





**CÔNG BÁO SỞ HỮU CÔNG NGHIỆP SỐ 418 TẬP A – QUYỀN 2 (01.2023)**

- (11) **46434**
- (21) 3-2022-02365 (28) 1
- (54) **NHÃN SẢN PHẨM** (51) **19-08**
- (22) 01/11/2022 (43) 27/01/2023
- (73) **CÔNG TY CỔ PHẦN TẬP ĐOÀN THỰC PHẨM AUVI (VN)**  
Số 3 Vũ Đức Thận, phường Việt Hưng, quận Long Biên, thành phố Hà Nội
- (72) Nguyễn An Toàn (VN)
- (74) Công ty TNHH Sở hữu trí tuệ và Công nghệ Thủ đô (CAPITAL IP&T CO.LTD.)
- (55)



**CÔNG BÁO SỞ HỮU CÔNG NGHIỆP SỐ 418 TẬP A – QUYỀN 2 (01.2023)**

- (11) **46435**
- (21) 3-2022-02366 (28) 1
- (54) **NHÃN SẢN PHẨM** (51) **19-08**
- (22) 01/11/2022 (43) 27/01/2023
- (73) **CÔNG TY CỔ PHẦN TẬP ĐOÀN THỰC PHẨM AUVI (VN)**  
Số 3 Vũ Đức Thận, phường Việt Hưng, quận Long Biên, thành phố Hà Nội
- (72) Nguyễn An Toàn (VN)
- (74) Công ty TNHH Sở hữu trí tuệ và Công nghệ Thủ đô (CAPITAL IP&T CO.LTD.)
- (55)



**CÔNG BÁO SỞ HỮU CÔNG NGHIỆP SỐ 418 TẬP A – QUYỀN 2 (01.2023)**

- (11) **46436**  
(21) 3-2022-02367 (28) 1  
(54) **CHAI** (51) **09-01**  
(22) 01/11/2022 (43) 27/01/2023  
(73) **CÔNG TY CỔ PHẦN DẦU THỰC VẬT TÂN BÌNH (VN)**  
889 Trường Chinh, phường Tây Thạnh, quận Tân Phú, thành phố Hồ Chí Minh  
(72) Huỳnh Trung Lập (VN)  
(74) **CÔNG TY TNHH SỞ HỮU TRÍ TUỆ SETHACO (SETHACO IP CO.,LTD)**  
(55)



Hình 1: hình phối cảnh

1.1



Hình 2: hình chiếu phía trước

1.2



Hình 3: hình chiếu phía sau

1.3



Hình 4: hình chiếu bên trái, bên phải

1.4



Hình 5: hình chiếu phía trên

1.5



Hình 6: hình chiếu phía dưới

1.6

**CÔNG BÁO SỞ HỮU CÔNG NGHIỆP SỐ 418 TẬP A – QUYỀN 2 (01.2023)**

- (11) **46437**
- (21) 3-2022-02386 (28) 1
- (54) **NHÃN SẢN PHẨM** (51) **19-08**
- (22) 02/11/2022 (43) 27/01/2023
- (73) **VŨ TIỀN TIẾN (VN)**  
Số nhà 16, ngõ 177/56, phố Thanh Đàm, phường Thanh Trì, quận Hoàng Mai,  
thành phố Hà Nội
- (72) Triệu Văn Sơn (VN)
- (74) Công ty TNHH Sở hữu trí tuệ HA VIP (HAVIP CO., LTD.)
- (55)



**CÔNG BÁO SỞ HỮU CÔNG NGHIỆP SỐ 418 TẬP A – QUYỀN 2 (01.2023)**

- (11) **46438**
- (21) 3-2022-02387 (28) 1
- (54) **BAO GÓI** (51) **09-05**
- (22) 02/11/2022 (43) 27/01/2023
- (73) **CÔNG TY TNHH NTPM (VIỆT NAM) (VN)**  
Số 22 VSIP II-A, đường số 23, khu công nghiệp Việt Nam - Singapore II-A,  
phường Vĩnh Tân, thị xã Tân Uyên, tỉnh Bình Dương
- (72) LEE KUAN PHENG (MY)
- (74) Công ty TNHH Sở hữu trí tuệ HA VIP (HAVIP CO., LTD.)
- (55)



1.1



1.2

- (11) **46439**  
(21) 3-2022-02389 (28) 1  
(54) **HỘP ĐỰNG ĐỒ UỐNG** (51) **07-07**  
(22) 03/11/2022 (43) 27/01/2023  
(30) 2022-009821 10/05/2022 JP;  
(73) **RICHELL CORPORATION (JP)**  
136 Mizuhashi sakuragi, Toyama-shi, Toyama, Japan  
(72) Nobuharu NAMIKAWA (JP)  
(74) Công ty Luật TNHH Phạm và Liên danh (PHAM & ASSOCIATES)  
(55)



1.1

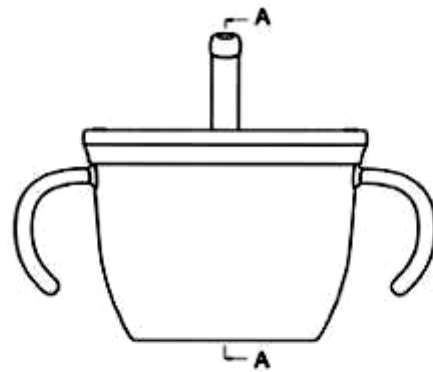

1.2

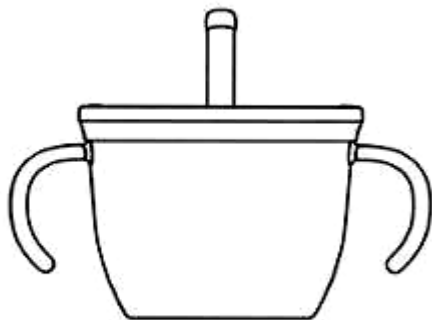

1.3

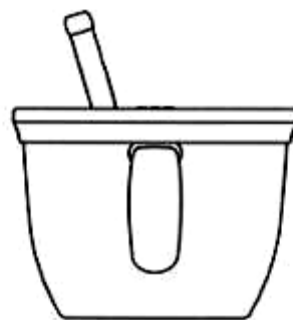

1.4

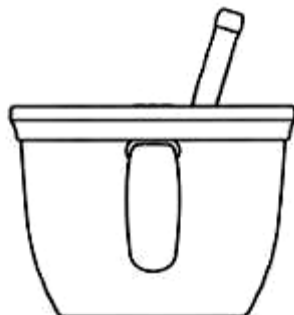

1.5

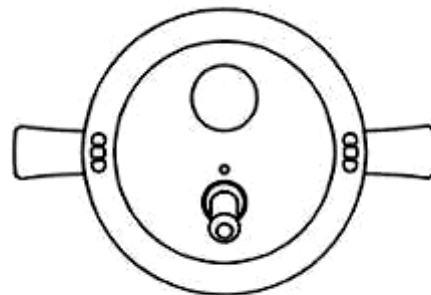

1.6

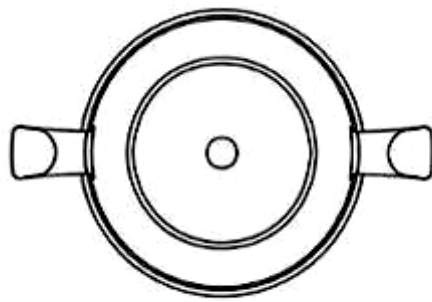

1.7

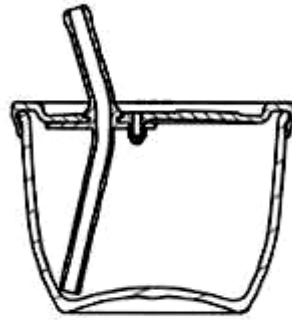

1.8



**CÔNG BÁO SỞ HỮU CÔNG NGHIỆP SỐ 418 TẬP A – QUYỀN 2 (01.2023)**

- (11) **46440**  
(21) 3-2022-02390 (28) 1  
(54) **CHAI** (51) **09-01**  
(22) 03/11/2022 (43) 27/01/2023  
(73) **CÔNG TY CỔ PHẦN DẦU THỰC VẬT TÂN BÌNH (VN)**  
889 Trường Chinh, phường Tây Thạnh, quận Tân Phú, thành phố Hồ Chí Minh  
(72) Huỳnh Trung Lập (VN)  
(74) **CÔNG TY TNHH SỞ HỮU TRÍ TUỆ SETHACO (SETHACO IP CO.,LTD)**  
(55)



Hình 1: hình phối cảnh

1.1



Hình 2: hình chiếu phía trước

1.2



Hình 3: hình chiếu phía sau

1.3



Hình 4: hình chiếu bên trái

1.4



1.5



1.6



1.7

**CÔNG BÁO SỞ HỮU CÔNG NGHIỆP SỐ 418 TẬP A – QUYỀN 2 (01.2023)**

- (11) **46441**  
(21) 3-2022-02396 (28) 1  
(54) **DU THUYỀN ĐIỆN MẶT TRỜI** (51) **12-06**  
(22) 03/11/2022 (43) 27/01/2023  
(73) **LÊ HUY THẢO (VN)**  
Lô B.34 Cư xá Nguyễn Đình Chiểu, phường 4, quận Phú Nhuận, thành phố Hồ Chí Minh  
(72) Lê Huy Thảo (VN)  
(74) Công ty TNHH Tư vấn đầu tư và Sở hữu trí tuệ Hoàng Phi (HOANG PHI INVEST & I.P CO., LTD)  
(55)

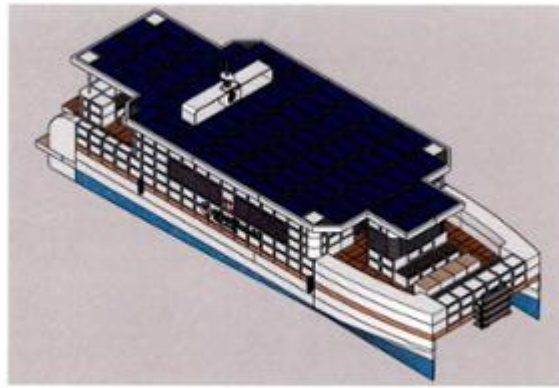

1.1

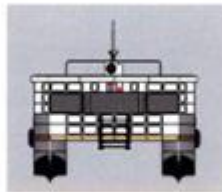

1.2

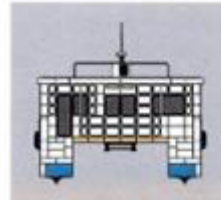

1.3

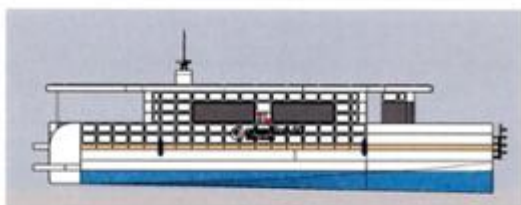

1.4

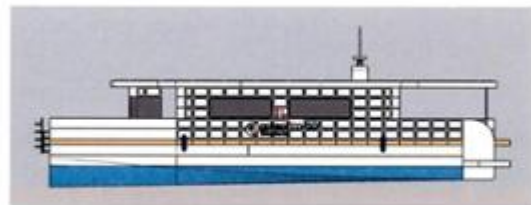

1.5



1.6

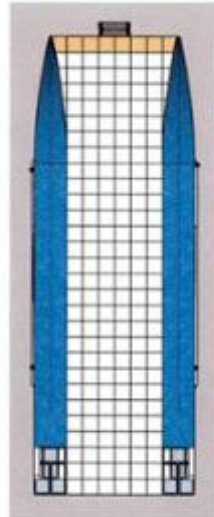

1.7

**CÔNG BÁO SỞ HỮU CÔNG NGHIỆP SỐ 418 TẬP A – QUYỀN 2 (01.2023)**

- (11) **46442**  
(21) 3-2022-02397 (28) 1  
(54) **DU THUYỀN ĐIỆN MẶT TRỜI** (51) **12-06**  
(22) 03/11/2022 (43) 27/01/2023  
(73) **LÊ HUY THẢO (VN)**  
Lô B.34 Cư xá Nguyễn Đình Chiểu, phường 4, quận Phú Nhuận, thành phố Hồ Chí Minh  
(72) Lê Huy Thảo (VN)  
(74) Công ty TNHH Tư vấn đầu tư và Sở hữu trí tuệ Hoàng Phi (HOANG PHI INVEST & I.P CO., LTD)  
(55)

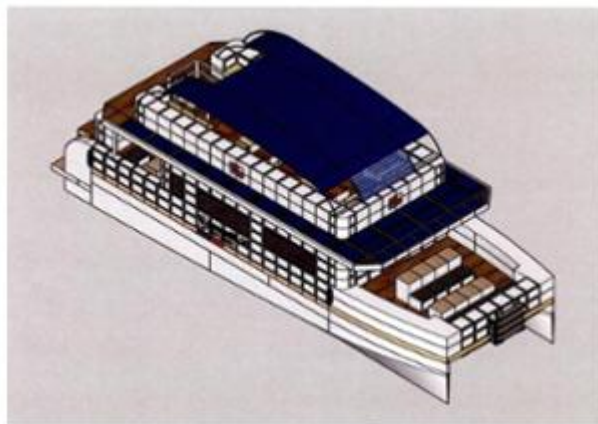

1.1



1.2



1.3

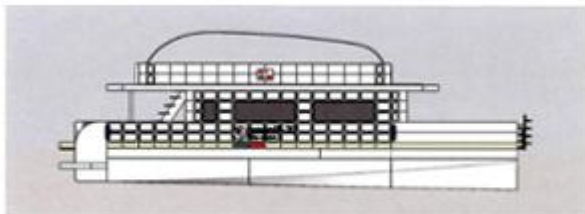

1.4

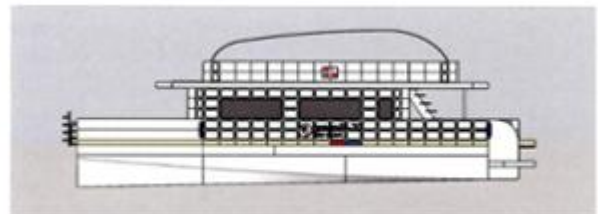

1.5

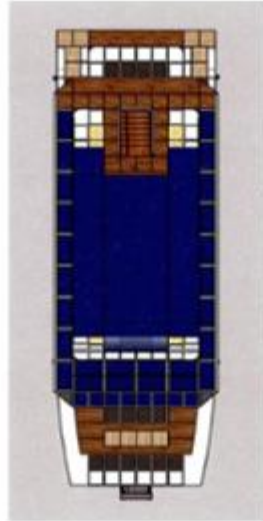

1.6

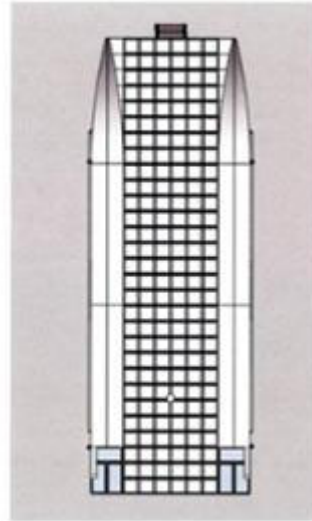

1.7

- (11) **46443**  
(21) 3-2022-02401 (28) 1  
(54) **THIẾT BỊ ĐO KHÍ MÔI TRƯỜNG THÔNG MINH** (51) **10-04**  
(22) 03/11/2022 (43) 27/01/2023  
(73) **CÔNG TY CỔ PHẦN RYNAN TECHNOLOGIES VIETNAM (VN)**  
Áp Long Trị, xã Long Đức, thành phố Trà Vinh, tỉnh Trà Vinh  
(72) 1. NGUYỄN THANH MỸ (VN)  
2. VÕ VŨ KHANH (VN)  
3. PHẠM THÁI BÌNH (VN)  
4. LÊ THANH TRIỀU (VN)  
5. VÕ QUỐC VIỆT (VN)  
(74) Công ty TNHH Đại Tín và Liên Danh (DAITIN AND ASSOCIATES CO.,LTD)  
(55)

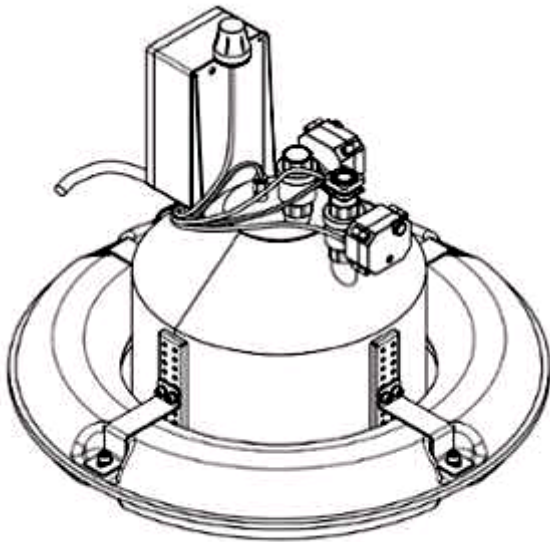

1.1

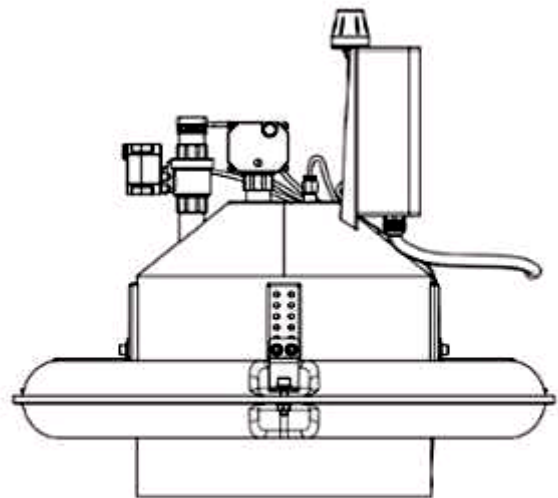

1.2

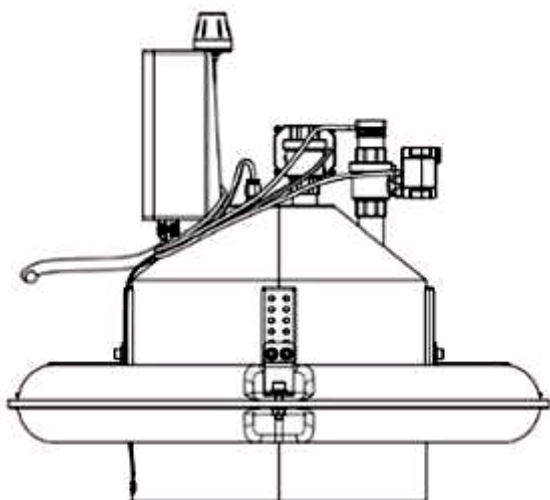

1.3

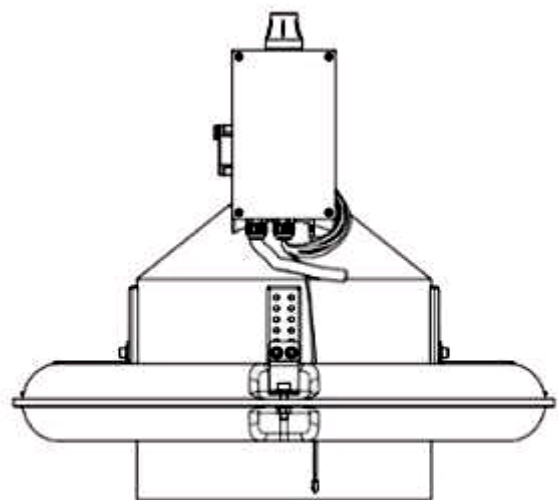

1.4

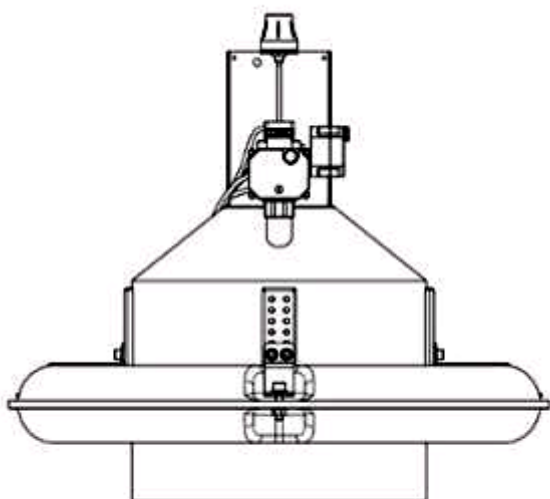

1.5

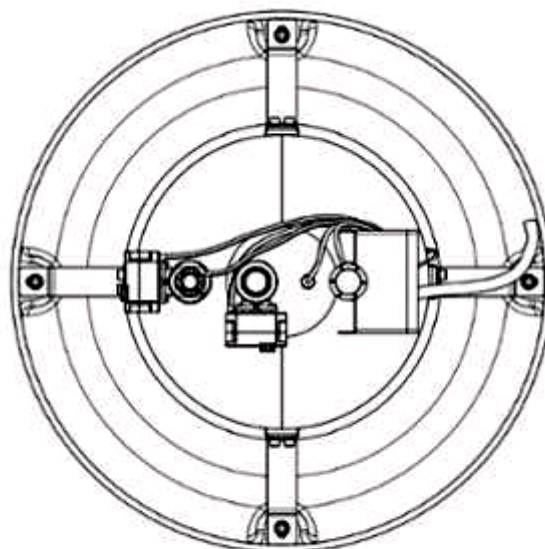

1.6

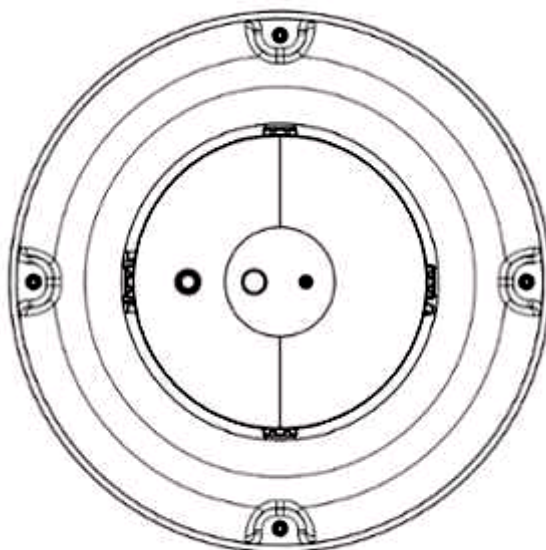

1.7



**CÔNG BÁO SỞ HỮU CÔNG NGHIỆP SỐ 418 TẬP A – QUYỀN 2 (01.2023)**

- (11) **46444**  
(21) 3-2022-02402 (28) 1  
(54) **THIẾT BỊ ĐO KHÍ MÔI TRƯỜNG THÔNG MINH** (51) **10-04**  
(22) 03/11/2022 (43) 27/01/2023  
(73) **CÔNG TY CỔ PHẦN RYNAN TECHNOLOGIES VIETNAM (VN)**  
Ấp Long Trị, xã Long Đức, thành phố Trà Vinh, tỉnh Trà Vinh  
(72) 1. NGUYỄN THANH MỸ (VN)  
2. VÕ VŨ KHANH (VN)  
3. PHẠM THÁI BÌNH (VN)  
4. LÊ THANH TRIỀU (VN)  
5. VÕ QUỐC VIỆT (VN)  
(74) Công ty TNHH Đại Tín và Liên Danh (DAITIN AND ASSOCIATES CO.,LTD)  
(55)

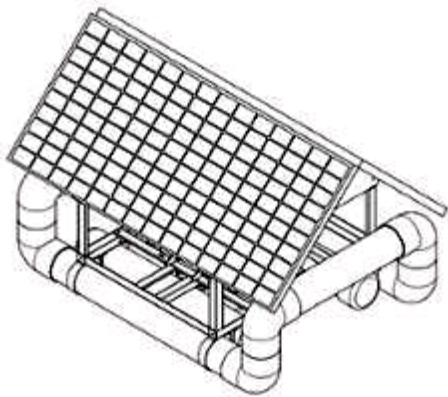

1.1

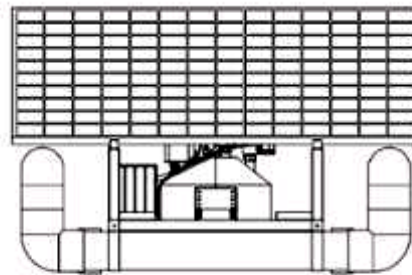

1.2

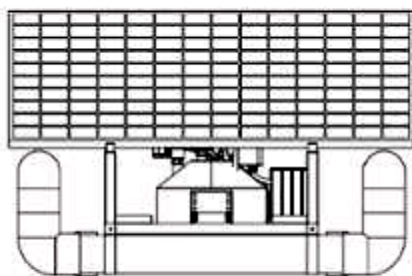

1.3

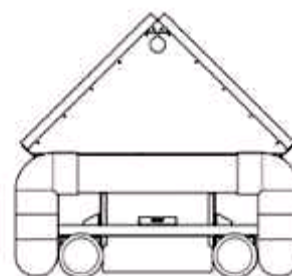

1.4

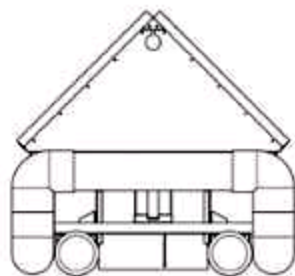

1.5



1.6

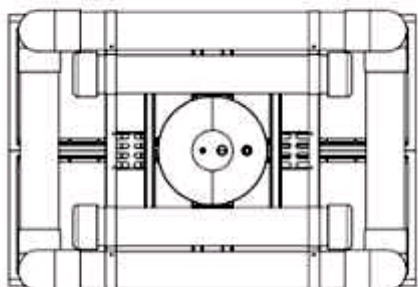

1.7

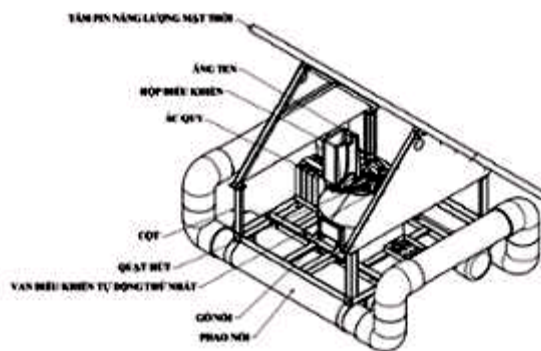

1.8

**CÔNG BÁO SỞ HỮU CÔNG NGHIỆP SỐ 418 TẬP A – QUYỀN 2 (01.2023)**

- (11) **46445**  
(21) 3-2022-02406 (28) 1  
(54) **CHAI** (51) **09-01**  
(22) 04/11/2022 (43) 27/01/2023  
(73) **CÔNG TY CỔ PHẦN DẦU THỰC VẬT TÂN BÌNH (VN)**  
889 Trường Chinh, phường Tây Thạnh, quận Tân Phú, thành phố Hồ Chí Minh  
(72) Huỳnh Trung Lập (VN)  
(74) **CÔNG TY TNHH SỞ HỮU TRÍ TUỆ SETHACO (SETHACO IP CO.,LTD)**  
(55)



Hình 1: hình phối cảnh

1.1



Hình 2: hình chiếu phía trước

1.2



Hình 3: hình chiếu phía sau

1.3



Hình 4: hình chiếu bên trái

1.4



Hình 5: hình chiếu bên phải

1.5



Hình 6: hình chiếu phía trên

1.6



Hình 7: hình chiếu phía dưới

1.7

- (11) **46446**  
(21) 3-2022-02411 (28) 1  
(54) **ĐÁ ỐP LÁT** (51) **25-01**  
(22) 04/11/2022 (43) 27/01/2023  
(73) **CÔNG TY CỔ PHẦN TẬP ĐOÀN PHƯỢNG HOÀNG XANH A&A (VN)**  
Số 167, phố Hoàng Ngân, phường Trung Hòa, quận Cầu Giấy, thành phố Hà Nội  
(72) Hồ Xuân Năng (VN)  
(55)



1.1



1.2



1.3



1.4



1.5



1.6



1.7

- (11) **46447**  
(21) 3-2022-02412 (28) 1  
(54) **ĐÁ ỐP LÁT** (51) **25-01**  
(22) 04/11/2022 (43) 27/01/2023  
(73) **CÔNG TY CỔ PHẦN TẬP ĐOÀN PHƯỢNG HOÀNG XANH A&A (VN)**  
Số 167, phố Hoàng Ngân, phường Trung Hòa, quận Cầu Giấy, thành phố Hà Nội  
(72) Hồ Xuân Năng (VN)  
(55)



1.1



1.2



1.3



1.4



1.5



1.6



1.7

**CÔNG BÁO SỞ HỮU CÔNG NGHIỆP SỐ 418 TẬP A – QUYỀN 2 (01.2023)**

- (11) **46448**  
(21) 3-2022-02413 (28) 1  
(54) **ĐÁ ỐP LÁT** (51) **25-01**  
(22) 04/11/2022 (43) 27/01/2023  
(73) **CÔNG TY CỔ PHẦN TẬP ĐOÀN PHƯỢNG HOÀNG XANH A&A (VN)**  
Số 167, phố Hoàng Ngân, phường Trung Hòa, quận Cầu Giấy, thành phố Hà Nội  
(72) Hồ Xuân Năng (VN)  
(55)



1.1



1.2



1.3



1.4



1.5

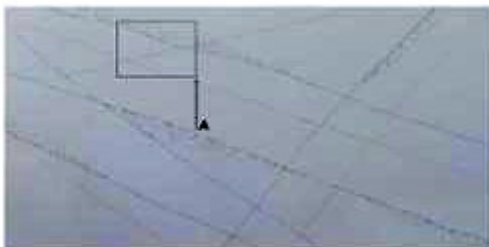

1.6



1.7

**CÔNG BÁO SỞ HỮU CÔNG NGHIỆP SỐ 418 TẬP A – QUYỀN 2 (01.2023)**

- (11) **46449**  
(21) 3-2022-02414 (28) 1  
(54) **ĐÁ ỐP LÁT** (51) **25-01**  
(22) 04/11/2022 (43) 27/01/2023  
(73) **CÔNG TY CỔ PHẦN TẬP ĐOÀN PHƯỢNG HOÀNG XANH A&A (VN)**  
Số 167, phố Hoàng Ngân, phường Trung Hòa, quận Cầu Giấy, thành phố Hà Nội  
(72) Hồ Xuân Năng (VN)  
(55)



1.1



1.2



1.3



1.4



1.5



1.6



1.7



- (11) **46450**  
(21) 3-2022-02415 (28) 1  
(54) **ĐÁ ỐP LÁT** (51) **25-01**  
(22) 04/11/2022 (43) 27/01/2023  
(73) **CÔNG TY CỔ PHẦN TẬP ĐOÀN PHƯỢNG HOÀNG XANH A&A (VN)**  
Số 167, phố Hoàng Ngân, phường Trung Hòa, quận Cầu Giấy, thành phố Hà Nội  
(72) Hồ Xuân Năng (VN)  
(55)

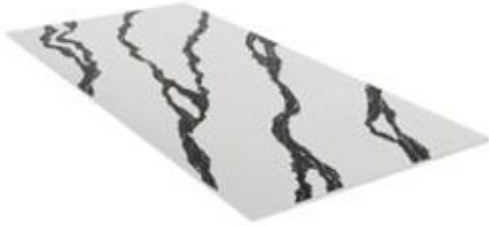

1.1

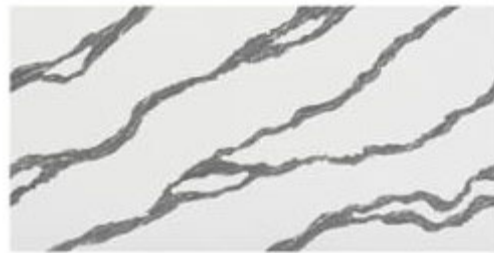

1.2



1.3



1.4

1.5

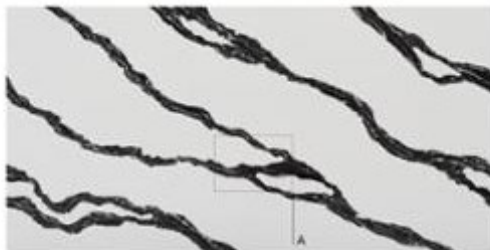

1.6

1.7

- (11) **46451**  
(21) 3-2022-02416 (28) 1  
(54) **ĐÁ ỐP LÁT** (51) **25-01**  
(22) 04/11/2022 (43) 27/01/2023  
(73) **CÔNG TY CỔ PHẦN TẬP ĐOÀN PHƯỢNG HOÀNG XANH A&A (VN)**  
Số 167, phố Hoàng Ngân, phường Trung Hòa, quận Cầu Giấy, thành phố Hà Nội  
(72) Hồ Xuân Năng (VN)  
(55)

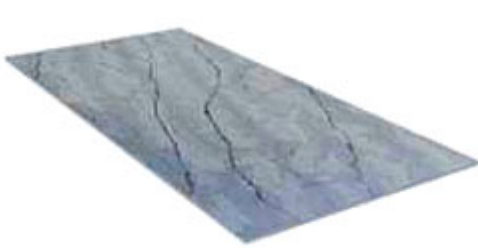

1.1

1.2



1.3

1.4



1.5



1.6

1.7

**CÔNG BÁO SỞ HỮU CÔNG NGHIỆP SỐ 418 TẬP A – QUYỂN 2 (01.2023)**

- (11) **46452**
- (21) 3-2022-02417
- (54) **ĐÁ ỐP LÁT**
- (22) 04/11/2022
- (73) **CÔNG TY CỔ PHẦN TẬP ĐOÀN PHƯỢNG HOÀNG XANH A&A (VN)**  
Số 167, phố Hoàng Ngân, phường Trung Hòa, quận Cầu Giấy, thành phố Hà Nội
- (72) Hồ Xuân Nãng (VN)
- (55)



1.1

1.2

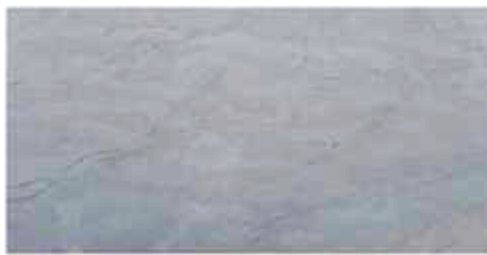

1.3

1.4



1.5



1.6

1.7

- (11) **46453**  
(21) 3-2022-02420 (28) 1  
(54) **TẮM ĐỒ LƯNG GHẾ** (51) **06-01**  
(22) 30/05/2022 (43) 27/01/2023  
(30) 29/836,884 29/04/2022 US;  
(73) **WORKLIFE BRANDS LLC (US)**  
500 Staples Drive, Framingham, Massachusetts 01702, United States  
(72) 1. LOGAN P. STEINFELD (US)  
2. KRIS M. LONERGAN (US)  
3. COLIN L. NOURIE (US)  
4. CHIEN-MING JUAN (TW)  
5. BRIAN P. CUSACK (US)  
6. JESSICA N. MONSALVE (US)  
(74) Công ty TNHH Trường Xuân (AGELESS CO.,LTD.)  
(55)

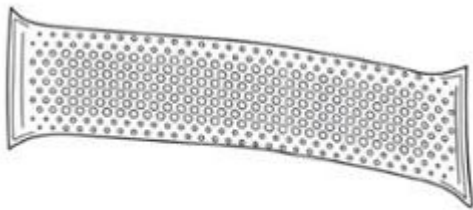

1.1

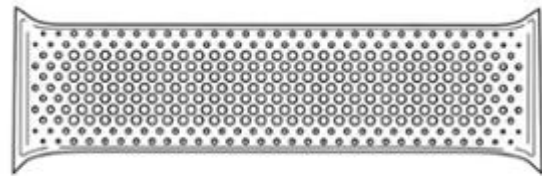

1.2

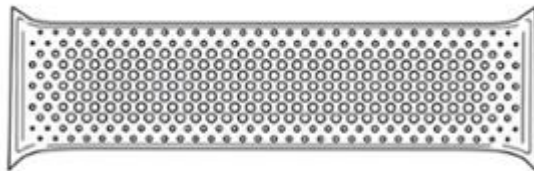

1.3

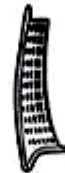

1.4



1.5



1.6



1.7

**CÔNG BÁO SỞ HỮU CÔNG NGHIỆP SỐ 418 TẬP A – QUYỀN 2 (01.2023)**

- (11) **46454**  
(21) 3-2022-02429 (28) 1  
(54) **THỚT ĐÔI** (51) **07-04**  
(22) 07/11/2022 (43) 27/01/2023  
(73) **CÔNG TY CỔ PHẦN CHẾ BIẾN GỖ ĐỨC THÀNH (VN)**  
21/6D Phan Huy Ích, phường 14, quận Gò Vấp, thành phố Hồ Chí Minh  
(72) Lê Hải Liễu (VN)  
(74) Công ty TNHH Sở hữu trí tuệ Thảo Thọ Quyển (INVENCO.,LTD)  
(55)



1.1



1.2



1.3



1.4



1.5

1.6



1.7



1.8

- (11) **46455**  
(21) 3-2022-02430 (28) 1  
(54) **THỚT ĐÔI** (51) **07-04**  
(22) 07/11/2022 (43) 27/01/2023  
(73) **CÔNG TY CỔ PHẦN CHẾ BIẾN GỖ ĐỨC THÀNH (VN)**  
21/6D Phan Huy Ích, phường 14, quận Gò Vấp, thành phố Hồ Chí Minh  
(72) Lê Hải Liễu (VN)  
(74) Công ty TNHH Sở hữu trí tuệ Thảo Thọ Quyên (INVENCO.,LTD)  
(55)



1.1



1.2



1.3



1.4



1.5



1.6



1.7



1.8

- (11) **46456**  
(21) 3-2022-02431 (28) 1  
(54) **GÁC TAY TRÊN GHẾ** (51) **06-01**  
(22) 07/11/2022 (43) 27/01/2023  
(30) 202230642958.6 28/09/2022 CN;  
(73) **UE FURNITURE CO., LTD** (CN)  
NO.1, West Yongyi Road, Dipu Town, Anji County, Huzhou City, Zhejiang  
Province, China  
(72) Zonglei, Zuo (CN)  
(74) Công ty TNHH Sở hữu trí tuệ NTT (NTT IP CO.,LTD)  
(55)

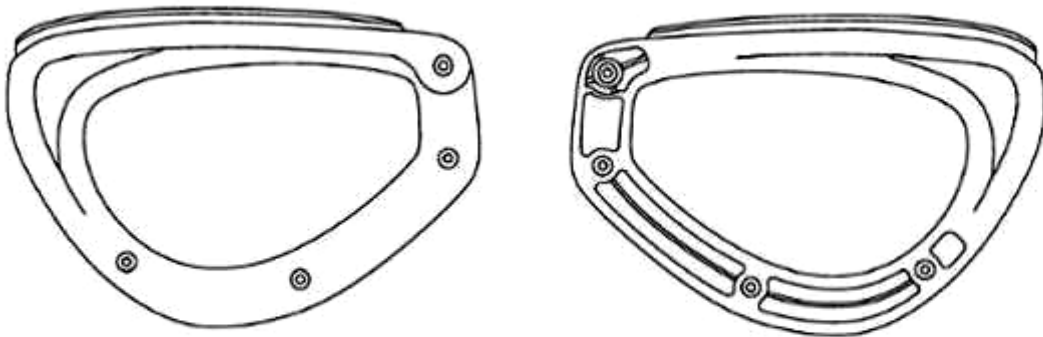

1.1



1.2



1.3



1.4



1.5

1.6



1.7



- (11) **46457**  
(21) 3-2022-02436 (28) 1  
(54) **KÉO LÀM BÉP** (51) **08-03**  
(22) 08/11/2022 (43) 27/01/2023  
(30) 2022-011406 30/05/2022 JP;  
(73) **PLUS CORPORATION (JP)**  
1-28, Toranomon 4-chome, Minato-ku, Tokyo, JAPAN  
1. RYO YASUI (JP)  
(72) 2. SO KUBOTA (JP)  
3. HAYATO HORIE (JP)  
(74) Công ty Luật TNHH Phạm và Liên danh (PHAM & ASSOCIATES)  
(55)

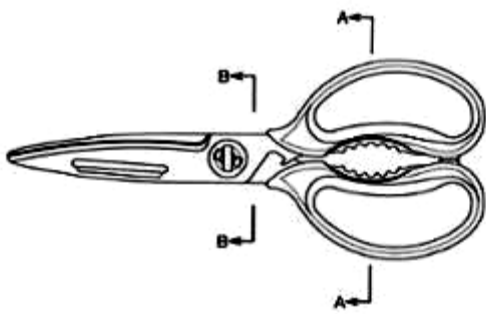

1.1

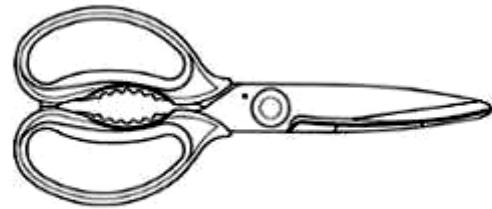

1.2



1.3



1.4



1.5



1.6



1.7



1.8



1.9



1.10



1.11



1.12



1.13



1.14



1.15

**CÔNG BÁO SỞ HỮU CÔNG NGHIỆP SỐ 418 TẬP A – QUYỀN 2 (01.2023)**

- (11) **46458**  
(21) 3-2022-02447 (28) 1  
(54) **THÙNG** (51) **07-07**  
(22) 08/11/2022 (43) 27/01/2023  
(73) **CÔNG TY CỔ PHẦN SẢN XUẤT NHỰA DUY TÂN (VN)**  
298 Hồ Học Lãm, phường An Lạc, quận Bình Tân, thành phố Hồ Chí Minh  
(72) Trần Đức Xuyên (VN)  
(74) Công ty TNHH Sở hữu trí tuệ INVENTIO (INVENTIO CO.,LTD)  
(55)



1.1



1.2



1.3



1.4



1.5



1.6

## **CÔNG BÁO SỞ HỮU CÔNG NGHIỆP**

*Do Cục Sở hữu trí tuệ thuộc Bộ Khoa học và Công nghệ ấn hành theo Luật Sở hữu trí tuệ số 50/2005/QH11 được Quốc hội thông qua ngày 29 tháng 11 năm 2005 và được sửa đổi bằng Luật sửa đổi, bổ sung một số điều của Luật sở hữu trí tuệ số 50/2005/QH11 được Quốc hội thông qua ngày 19 tháng 6 năm 2009.*

### ***Địa chỉ liên hệ:***

384-386 đường Nguyễn Trãi, quận Thanh Xuân,  
thành phố Hà Nội, Việt Nam  
ĐT: 024. 38583069  
Fax: 024. 38588449