

CỘNG HÒA XÃ HỘI CHỦ NGHĨA VIỆT NAM  
BỘ KHOA HỌC VÀ CÔNG NGHỆ

CỤC SỞ HỮU TRÍ TUỆ

CÔNG BÁO  
SỞ HỮU CÔNG NGHIỆP

TẬP A

QUYỂN 2: KIỂU DÁNG CÔNG NGHIỆP

07 - 2022

412

CỘNG HOÀ XÃ HỘI CHỦ NGHĨA VIỆT NAM  
BỘ KHOA HỌC VÀ CÔNG NGHỆ  
CỤC SỞ HỮU TRÍ TUỆ

---

CÔNG BÁO  
SỞ HỮU CÔNG NGHIỆP  
TẬP A

QUYỂN 2: KIỂU DÁNG CÔNG NGHIỆP

07-2022

---

412

---

HÀ NỘI

## MỤC LỤC

	Trang
<u>PHẦN I:</u> Đơn yêu cầu cấp Bằng độc quyền kiểu dáng công nghiệp	7
<u>PHẦN II:</u> Sửa đổi đơn	307
<u>PHẦN III:</u> Thay đổi chủ đơn	311

## CONTENTS

<u>PART I:</u> Applications for Industrial Design Patents	7
<u>PART II:</u> Amendment of Applications	307
<u>PART III:</u> Change of Applicants	311

---

**CÔNG BÁO SỞ HỮU CÔNG NGHIỆP SỐ 412 TẬP A - QUYỂN 2 (07.2022)**

**MÃ SỐ HAI CHỮ CÁI THỂ HIỆN TÊN NƯỚC VÀ CÁC THỰC THỂ KHÁC TRONG CÁC TƯ LIỆU SỞ HỮU CÔNG NGHIỆP THEO TIÊU CHUẨN ST3 CỦA WIPO**

AE	United Arab Emirates	CN	China	HK	Hong Kong
AF	Afganistan	CO	Colombia	HN	Honduras
AG	Antihua and Barbuda	CR	Costa Rica	HR	Croatia
AI	Anguilla	CU	Cuba	HT	Haiti
AL	Albania	CV	Cape Verde	HU	Hungary
AN	Netherlands Antilles	CY	Cyprus	ID	Indonesia
AO	Angola	CZ	Czech Republic	IE	Ireland
AR	Argentina	DE	Germany	IL	Israel
AT	Austria	DJ	Djibouti	IN	India
AU	Australia	DK	Denmark	IQ	Iraq
AW	Aruba	DM	Dominica	IR	Iran (Islamic Republic of)
BB	Barbados	DO	Dominican Republic	IS	Iceland
BD	Bangladesh	DZ	Algeria	IT	Italy
BE	Belgium	EC	Ecuador	JM	Jamaica
BF	Burkina Faso	EE	Estonia	JO	Jordan
BG	Bulgaria	EG	Egypt	JP	Japan
BH	Bahrain	ES	Spain	KE	Kenya
BI	Burundi	ET	Ethiopia	KH	Cambodia
BJ	Benin	FI	Finland	KI	Kiribati
BM	Bermuda	FJ	Fiji	KM	Comoros
BN	Brunei Darussalam	FK	Falkand Islands (Malvinas)	KN	Saint Kitts and Nevis
BO	Bolivia	FR	France	KP	Democratic People's Republic of Korea
BR	Brazil	GA	Gabon	KR	Republic of Korea
BS	Bahamas	GB	United Kingdom	KW	Kuwait
BT	Bhutan	GD	Grenada	KY	Cayman Islands
BW	Botswana	GE	Georgia	KZ	Kazakhstan
BY	Belarus	GH	Ghana	LA	Laos
BZ	Belize	GI	Gibraltar	LB	Lebanon
CA	Canada	GM	Gambia	LC	Saint Lucia
CF	Central African Republic	GN	Guinea	LI	Liechtenstein
CG	Congo	GQ	Equatorial Guinea	LK	SriLanka
CH	Switzerland	GR	Greece	LR	Liberia
CI	Côte d'Ivoire	GT	Guatemala	LS	Lesotho
CL	Chile	GW	Guinea-Bissau	LT	Lithuania
CM	Cameroon	GY	Guyana	TC	Turk and Caicos Islands
LU	Luxembourg	PA	Panama	TD	Chad
LV	Latvia	PE	Peru	TG	Togo
LY	Lybya	PG	Papua New Guinea	TH	Thailand
MA	Morocco	PH	Philippines	TN	Tunisia
MC	Monaco	PK	Pakistan	TO	Tonga
MD	Republic of Moldova	PL	Poland	TR	Turkey



**CÔNG BÁO SỞ HỮU CÔNG NGHIỆP SỐ 412 TẬP A - QUYỂN 2 (07.2022)**

MG	Madagascar	PT	Portugal	TT	Trinidad and Tobago
ML	Mali	PY	Paraguay	TV	Tuvalu
MM	Myanmar	QA	Qatar	TW	Taiwan, Province of China
MN	Mongolia	RO	Rumania	TZ	United Republic of Tanzania
MO	Macau	RU	Russian Federation	UA	Ukraine
MR	Mauritania	RW	Rwanda	UG	Uganda
MS	Montserrat	SA	Saudi Arabia	US	United States of America
MT	Malta	SB	Solomon Islands	UY	Uruguay
MU	Mauritius	SC	Seychelles	UZ	Uzbekistan
MV	Maldives	SD	Sudan	VA	Holy see
MW	Malawi	SE	Sweden	VC	Saint Vincent and the Grenadines
MX	Mexico	SG	Singapore	VE	Venezuela
MY	Malaysia	SH	Saint Helena	VG	Virgin Islands (British)
MZ	Mozambique	SL	Slovenia	VN	Vietnam
NA	Namibia	SK	Slovakia	VU	Vanuatu
NE	Niger	SL	Sierra Leone	WS	Samoa
NG	Nigeria	SM	San Marino	YE	Yemen
NJ	Nicaragua	SN	Senegal	YU	Yugoslavia
NL	Netherlands	SO	Somalia	ZA	South Africa
NO	Norway	SR	Suriname	ZM	Zambia
NP	Nepal	ST	Sao Tome and Principe	ZR	Zaire
NR	Nauru	SV	El Sanvador	ZW	Zimbabwe
NZ	New Zealand	SY	Syria		
OM	Oman	SZ	Swaziland		

**CÁC TỔ CHỨC QUỐC TẾ**

AO	African Intellectual Property Organization (OAPI)
AP	African Regional Industrial Property Organization (ARIPO)
BX	Benelux Trademark Office and Benelux Designs Office
EP	European Patent Office (EPO)
IB, WO	International Bureau of the World Intellectual Property Organization (WIPO)

**NHỮNG MÃ SỐ INID TRÍCH TỪ TIÊU CHUẨN ST80 CỦA TỔ CHỨC SỞ HỮU TRÍ TUỆ THẾ GIỚI (WIPO) ĐỂ NHẬN BIẾT CÁC DỮ LIỆU THƯ MỤC DÙNG CÔNG BỐ ĐƠN VÀ BẰNG ĐỘC QUYỀN KIỂU DÁNG CÔNG NGHIỆP**

- (11) Số bằng độc quyền kiểu dáng công nghiệp / Số công bố đơn
- (15) Ngày cấp
- (18) Ngày hết hạn hiệu lực của bằng độc quyền kiểu dáng công nghiệp
- (21) Số đơn
- (22) Ngày nộp đơn
- (23) Tên triển lãm, ngày và nơi triển lãm
- (28) Số phương án yêu cầu bảo hộ
- (30) Số đơn ưu tiên, ngày nộp đơn ưu tiên
- (43) Ngày công bố đơn
- (45) Ngày công bố bằng độc quyền kiểu dáng công nghiệp
- (51) Phân loại quốc tế kiểu dáng công nghiệp
- (54) Tên sản phẩm mang kiểu dáng công nghiệp
- (55) Ảnh chụp / hình vẽ kiểu dáng công nghiệp
- (57) Đặc điểm khác biệt yêu cầu bảo hộ của kiểu dáng công nghiệp
- (62) Số và ngày nộp đơn, số bằng độc quyền KDCN hoặc số công bố đơn liên quan đến tách đơn
- (71) Tên và địa chỉ của người nộp đơn
- (72) Tên của tác giả KDCN
- (73) Tên, địa chỉ của chủ bằng độc quyền KDCN
- (74) Tên của người đại diện SHCN

PHẦN I

**ĐƠN YÊU CẦU CẤP BẰNG ĐỘC QUYỀN KIỂU DÁNG CÔNG NGHIỆP**

(11) **44851**

(21) 3-2018-01445

(28) 1

(54) **CAN**

(51) **09-02**

(22) 12/07/2018

(43) 25/07/2022

(73) **CÔNG TY TNHH SX TM QUỐC TẾ HOÀNG PHÁT (VN)**

Phòng 702A, tòa nhà Centerpoint, 106 Nguyễn Văn Trỗi, phường 8, quận Phú Nhuận, thành phố Hồ Chí Minh

(72) Trần Hoàng Việt (VN)

(55)



1.1



1.2



1.3



1.4



1.5



1.6



1.7

- (11) **44852**  
(21) 3-2019-03178 (28) 1  
(54) **BỘ PHẬN CỦA MÁY DỆT** (51) **15-06**  
(22) 06/12/2019 (43) 25/07/2022  
(30) 006576351-0002 12/06/2019 EM;  
(73) **SANTONI S.P.A. (IT)**  
Via Carlo Fenzi, 14 - 25135 Brescia - Italy  
(72) 1. LONATI ETTORE (IT)  
2. LONATI FAUSTO (IT)  
3. LONATI ANDREA (IT)  
(74) Công ty TNHH T&T INVENMARK Sở hữu trí tuệ Quốc tế (T&T INVENMARK CO., LTD.)  
(55)

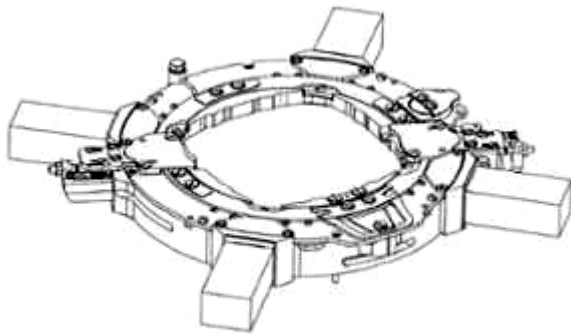

1.1

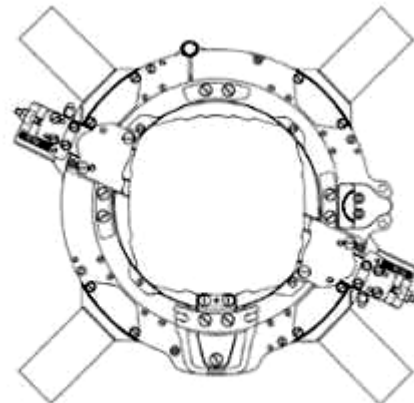

1.2

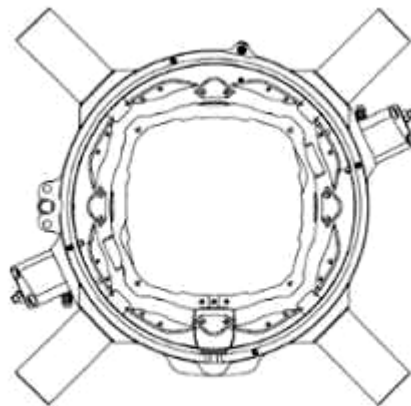

1.3



1.4



1.5

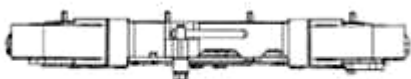

1.6



1.7

**CÔNG BÁO SỞ HỮU CÔNG NGHIỆP SỐ 412 TẬP A – QUYỀN 2 (07.2022)**

- (11) **44853**  
(21) 3-2019-03179  
(54) **BỘ PHẬN CỦA MÁY DỆT**  
(22) 06/12/2019  
(30) 006576351-0001 12/06/2019 EM;  
(73) **SANTONI S.P.A. (IT)**  
Via Carlo Fenzi, 14 - 25135 Brescia - Italy  
(72) 1. LONATI ETTORE (IT)  
2. LONATI FAUSTO (IT)  
3. LONATI ANDREA (IT)  
(74) Công ty TNHH T&T INVENMARK Sở hữu trí tuệ Quốc tế (T&T INVENMARK CO., LTD.)  
(55)

(28) 1

(51) **15-06**

(43) 25/07/2022

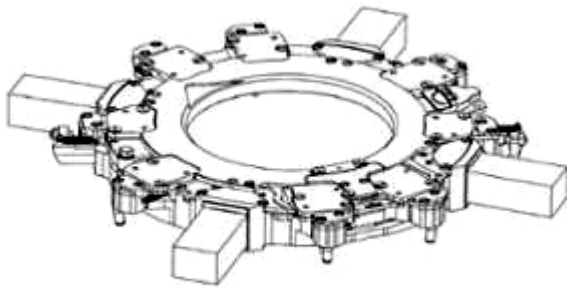

1.1

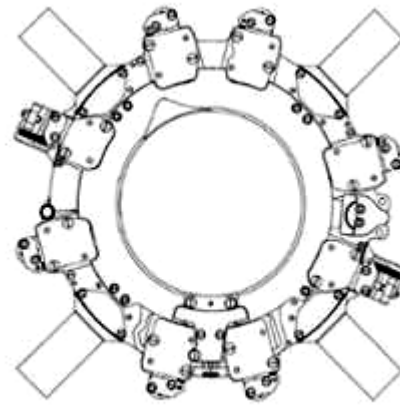

1.2

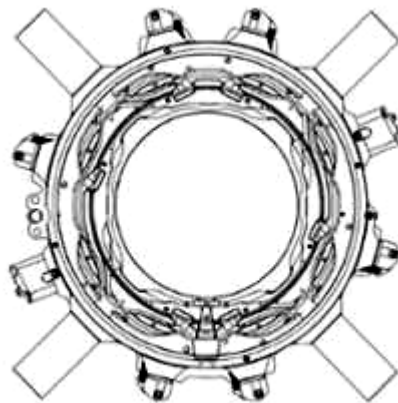

1.3



1.4

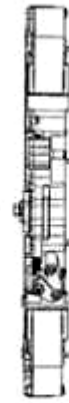

1.5



1.6



1.7

- (11) **44854**  
(21) 3-2019-03306 (28) 1  
(54) **BỘ PHẬN CỦA MÁY DỆT** (51) **15-06**  
(22) 16/12/2019 (43) 25/07/2022  
(30) 006583290-0004 18/06/2019 EM;  
(73) **SANTONI S.P.A. (IT)**  
Via Carlo Fenzi, 14 - 25135 Brescia - Italy  
(72) 1. LONATI ETTORE (IT)  
2. LONATI FAUSTO (IT)  
3. LONATI ANDREA (IT)  
(74) Công ty TNHH T&T INVENMARK Sở hữu trí tuệ Quốc tế (T&T INVENMARK CO., LTD.)  
(55)

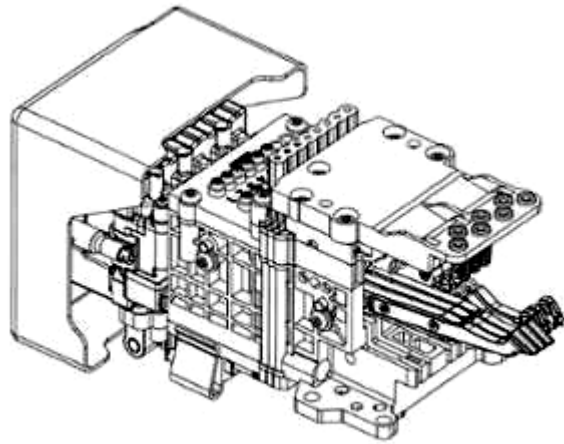

1.1

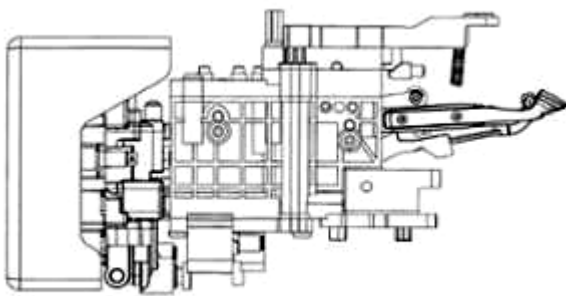

1.2

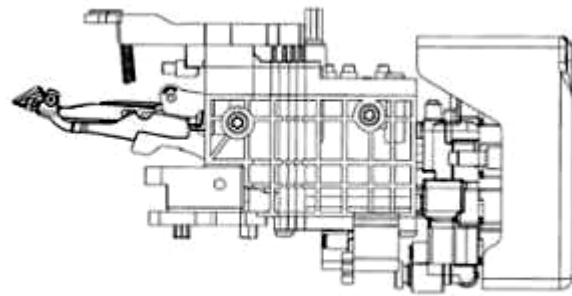

1.3

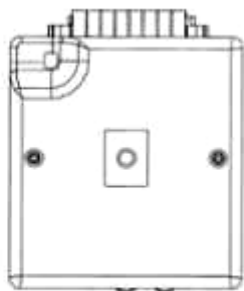

1.4

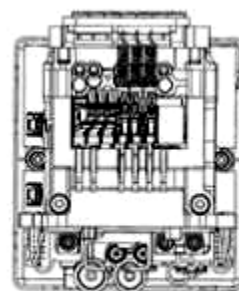

1.5

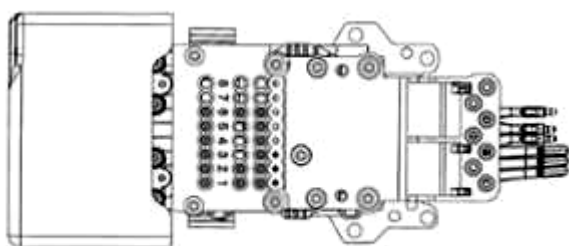

1.6

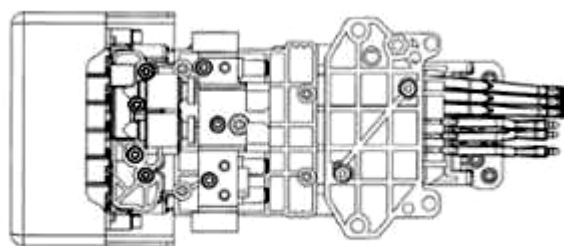

1.7

- (11) **44855**  
(21) 3-2020-00250  
(54) **BỘ PHẬN CỦA MÁY DỆT**  
(22) 11/10/2019  
(30) 006376950 12/04/2019 EM;  
(73) **SANTONI S.P.A. (IT)**  
Via Carlo Fenzi, 14 - 25135 Brescia, Italy  
(72) 1. STEFANO RIZZI (IT)  
2. MARCO ANDREOLI (IT)  
(74) Công ty TNHH T&T INVENMARK Sở hữu trí tuệ Quốc tế (T&T INVENMARK CO., LTD.)  
(55)
- (28) 1  
(51) **15-06**  
(43) 25/07/2022



1.1

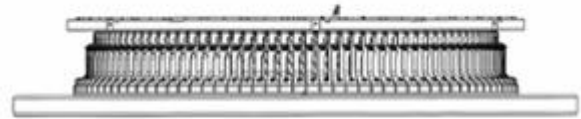

1.2

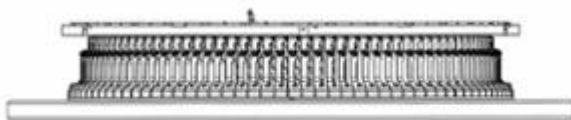

1.3

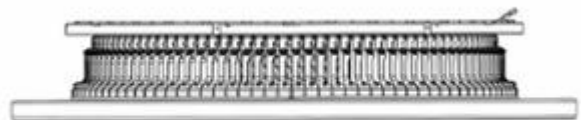

1.4

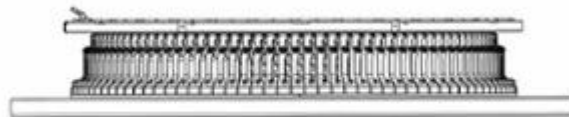

1.5



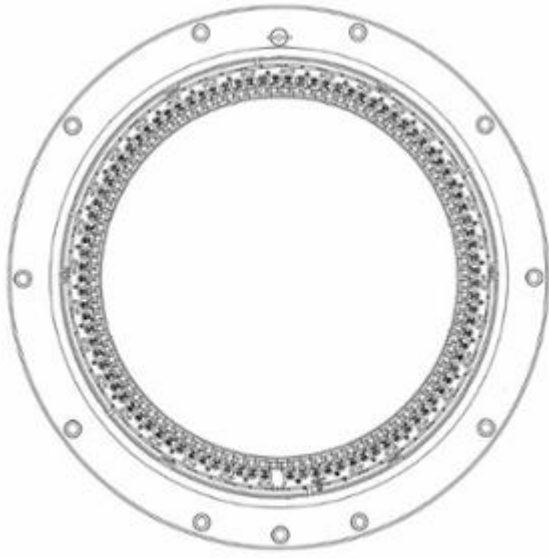

1.6

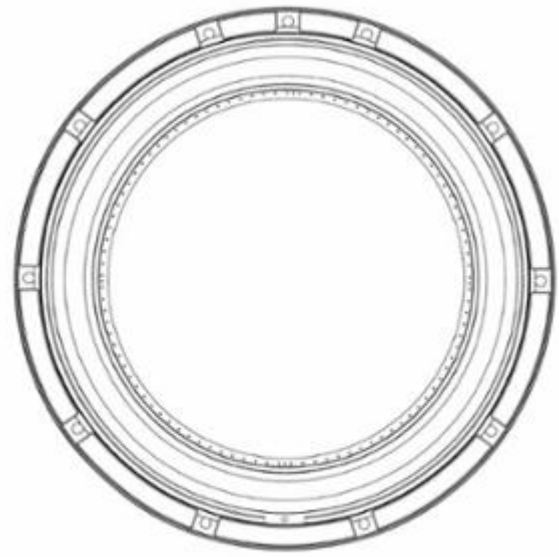

1.7

**CÔNG BÁO SỞ HỮU CÔNG NGHIỆP SỐ 412 TẬP A – QUYỀN 2 (07.2022)**

- (11) **44856**  
(21) 3-2020-00829 (28) 4  
(54) **THIẾT BỊ NẠP ĐIỆN DÙNG CHO THIẾT BỊ TẠO KHÍ DUNG** (51) **13-02**  
(22) 15/04/2020 (43) 25/07/2022  
(30) 007039631 17/10/2019 EM;  
(73) **PHILIP MORRIS PRODUCTS S.A. (CH)**  
Quai Jeanrenaud 3, CH-2000 Neuchatel, Switzerland  
(72) Alexander Farrow (CA)  
(74) Công ty Luật TNHH T&G (TGVN)  
(55)

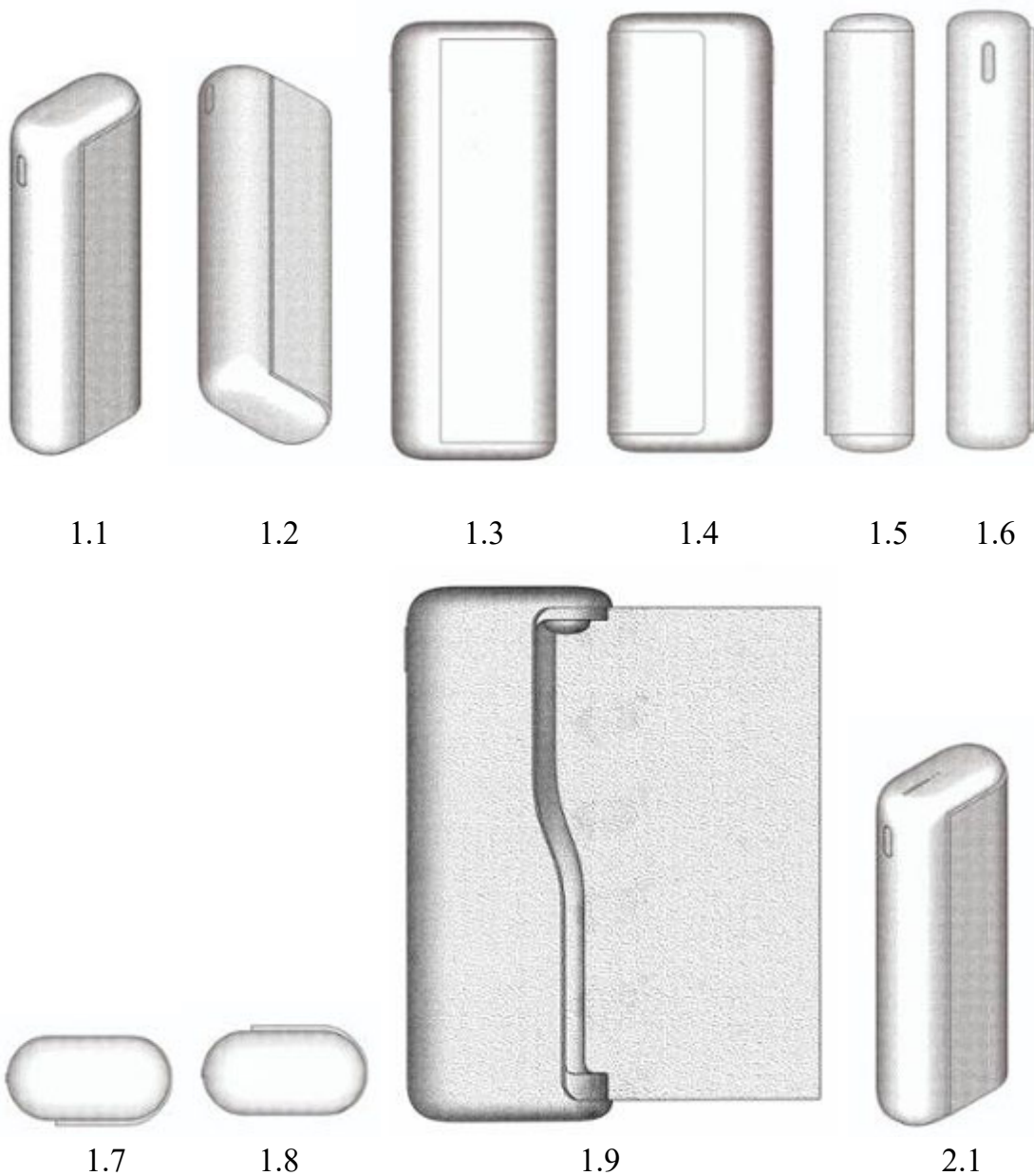

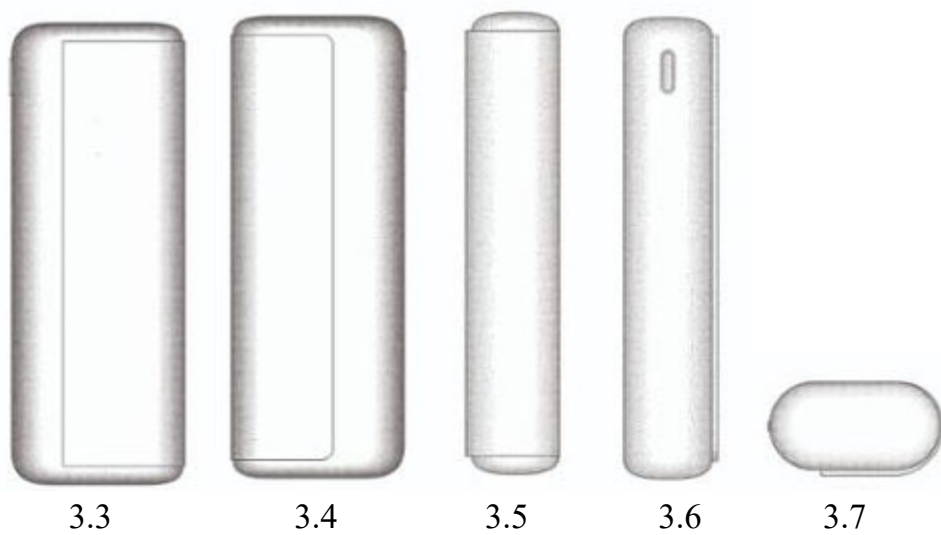
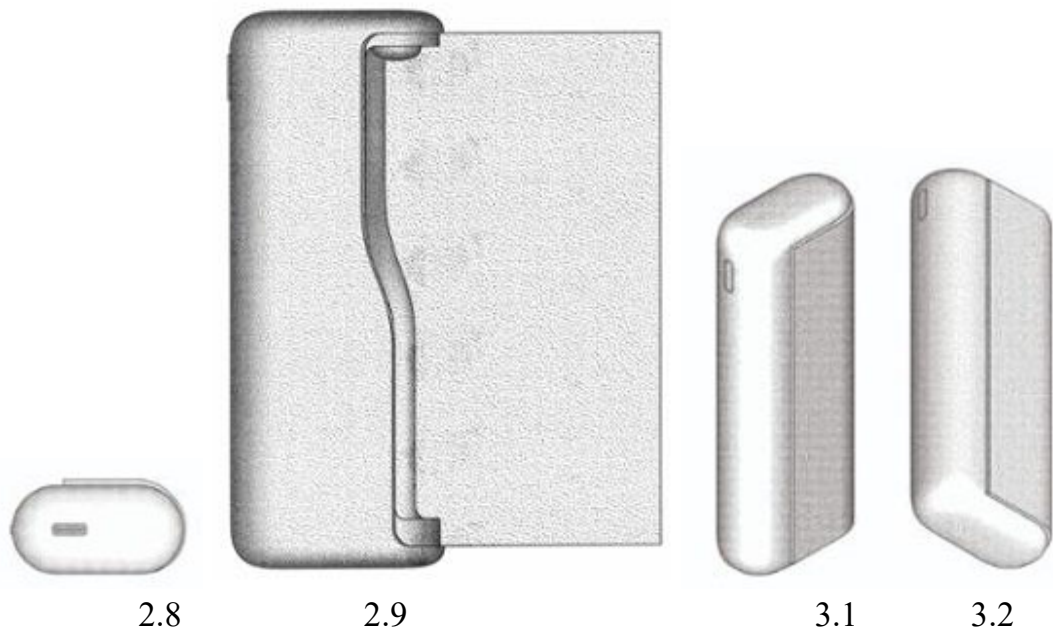
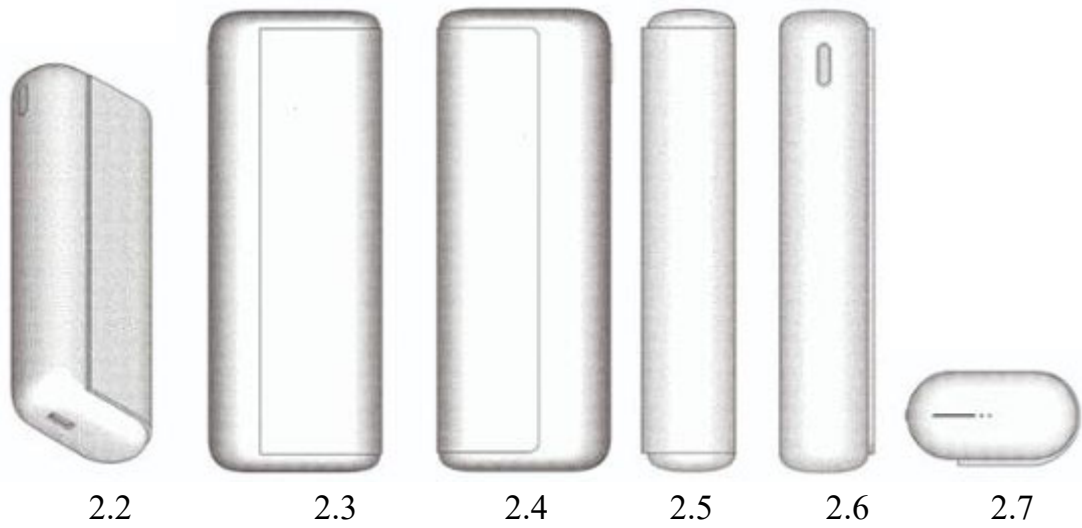

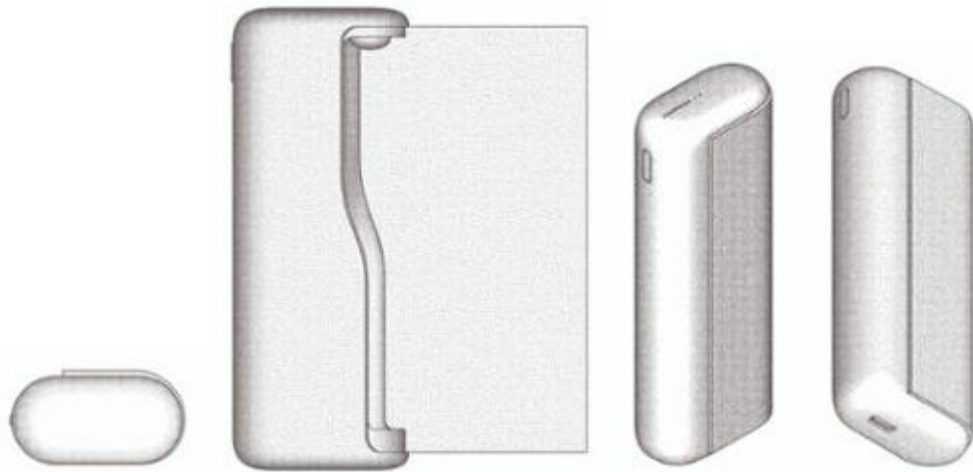

3.8

3.9

4.1

4.2

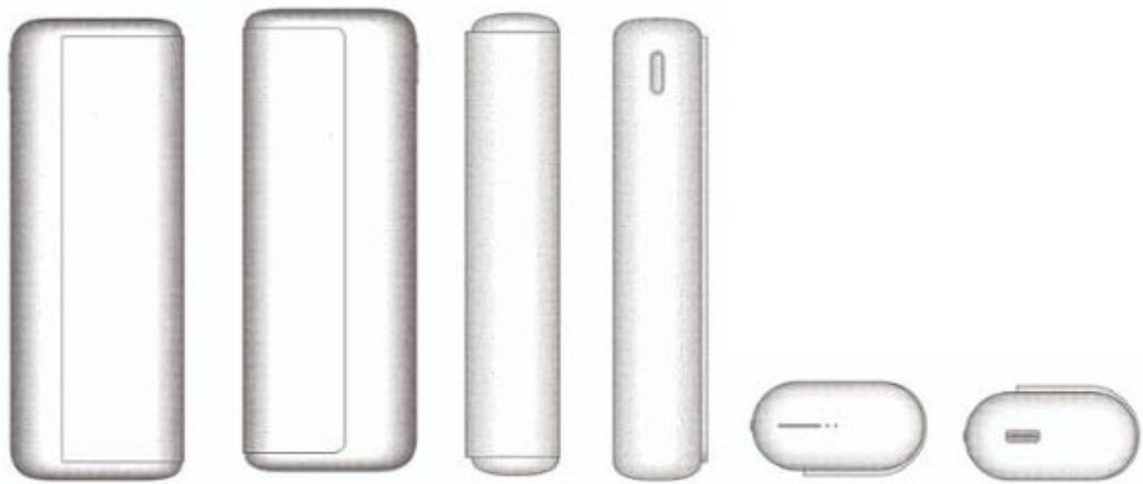

4.3

4.4

4.5

4.6

4.7

4.8

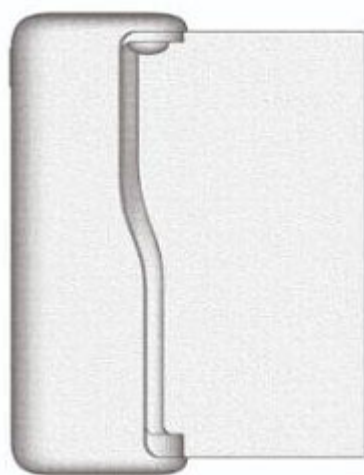

4.9

**CÔNG BÁO SỞ HỮU CÔNG NGHIỆP SỐ 412 TẬP A – QUYỀN 2 (07.2022)**

- (11) **44857**  
(21) 3-2020-01538 (28) 1  
(54) **NHÃN SẢN PHẨM** (51) **19-08**  
(22) 02/07/2020 (43) 25/07/2022  
(73) **TRẦN THỊ KIM NHẬT (VN)**  
378/11 Xô Viết Nghệ Tĩnh, phường 25, quận Bình Thạnh, thành phố Hồ Chí Minh  
(72) Trần Thị Kim Nhật (VN)  
(55)



(11) **44858**

(21) 3-2020-02249

(54) **ÁO MƯA**

(22) 11/09/2020

(73) **NGUYỄN MINH HOÀNG (VN)**

241/16/7 Tân Hòa Đông, phường 14, quận 6, thành phố Hồ Chí Minh

(72) Nguyễn Minh Hoàng (VN)

(55)

(28) 1

(51) **02-02**

(43) 25/07/2022



1.1



1.2



1.3

1.4



1.5



1.6



1.7



1.8



1.9

**CÔNG BÁO SỞ HỮU CÔNG NGHIỆP SỐ 412 TẬP A – QUYỀN 2 (07.2022)**

- (11) **44859**  
(21) 3-2020-02767 (28) 1  
(54) **BAO GÓI SẢN PHẨM** (51) **09-05**  
(22) 13/11/2020 (43) 25/07/2022  
(73) **NGUYỄN DANH BÌNH (VN)**  
Đội 8, xã Dương Liễu, huyện Hoài Đức, thành phố Hà Nội  
(72) Nguyễn Danh Bình (VN)  
(74) Công ty Luật TNHH WINCO (WINCO LAW FIRM)  
(55)



1.1



1.2



**CÔNG BÁO SỞ HỮU CÔNG NGHIỆP SỐ 412 TẬP A – QUYỀN 2 (07.2022)**

- (11) **44860**  
(21) 3-2020-02768 (28) 1  
(54) **BAO GÓI SẢN PHẨM** (51) **09-05**  
(22) 13/11/2020 (43) 25/07/2022  
(73) **NGUYỄN DANH BÌNH (VN)**  
Đội 8, xã Dương Liễu, huyện Hoài Đức, thành phố Hà Nội  
(72) Nguyễn Danh Bình (VN)  
(74) Công ty Luật TNHH WINCO (WINCO LAW FIRM)  
(55)



1.1



1.2



**CÔNG BÁO SỞ HỮU CÔNG NGHIỆP SỐ 412 TẬP A – QUYỀN 2 (07.2022)**

- (11) **44861**  
(21) 3-2020-02769 (28) 1  
(54) **BAO GÓI SẢN PHẨM** (51) **09-05**  
(22) 13/11/2020 (43) 25/07/2022  
(73) **NGUYỄN DANH BÌNH (VN)**  
Đội 8, xã Dương Liễu, huyện Hoài Đức, thành phố Hà Nội  
(72) Nguyễn Danh Bình (VN)  
(74) Công ty Luật TNHH WINCO (WINCO LAW FIRM)  
(55)



1.1



1.2

**CÔNG BÁO SỞ HỮU CÔNG NGHIỆP SỐ 412 TẬP A – QUYỀN 2 (07.2022)**

- (11) **44862**
- (21) 3-2020-03178 (28) 1
- (54) **HỘ ĐỰNG SẢN PHẨM** (51) **09-03**
- (22) 31/12/2020 (43) 25/07/2022
- (73) **HỘ KINH DOANH THÁI NGUYÊN Á ĐÔNG (VN)**  
Số 74 đường Võ Văn Truyen, khu phố 1, phường 2, thành phố Tây Ninh, tỉnh Tây Ninh
- (72) Đặng Vũ Minh Bằng (VN)
- (74) Công ty Luật TNHH WINCO (WINCO LAW FIRM)
- (55)



1.1



1.2

**CÔNG BÁO SỞ HỮU CÔNG NGHIỆP SỐ 412 TẬP A – QUYỀN 2 (07.2022)**

- (11) **44863**  
(21) 3-2020-03215 (28) 1  
(54) **HỘP** (51) **09-03**  
(22) 31/12/2020 (43) 25/07/2022  
(73) **CÔNG TY CỔ PHẦN TẬP ĐOÀN THIÊN LONG (VN)**  
Lô 6-8-10-12 đường số 3, khu công nghiệp Tân Tạo, quận Bình Tân, thành phố Hồ Chí Minh  
(72) Cô Gia Thọ (VN)  
(74) Công ty TNHH Tư vấn sở hữu trí tuệ Việt (VIET IP CO.,LTD.)  
(55)



1.1



1.2

**CÔNG BÁO SỞ HỮU CÔNG NGHIỆP SỐ 412 TẬP A – QUYỀN 2 (07.2022)**

(11) **44864**

(21) 3-2021-00618

(28) 1

(54) **GHẾ SÔ-PHA**

(51) **06-01**

(22) 18/03/2021

(43) 25/07/2022

(73) **HTL FURNITURE (CHINA) CO., LTD. (CN)**

Wusong Jiangnan Road, Kunshan Development Zone, Jiangsu Province, China

(72) PHUA YONG TAT (SG)

(74) Công ty Luật TNHH quốc tế BMVN (BMVN INTERNATIONAL LLC)

(55)



1.1



1.2



1.3



1.4



1.5



1.6

**CÔNG BÁO SỞ HỮU CÔNG NGHIỆP SỐ 412 TẬP A – QUYỀN 2 (07.2022)**

- (11) **44865**
- (21) 3-2021-00720 (28) 1
- (54) **THIẾT BỊ LƯU TRỮ SẢN PHẨM Y TẾ** (51) **24-01**
- (22) 29/03/2021 (43) 25/07/2022
- (30) 29/753,856 02/10/2020 US;
- (73) **ETHICON, INC. (US)**  
U.S. Route 22, P.O. Box 151, Somerville, NJ 08876, United States of America
- (72) 1. JONATHAN SYBY (US)  
2. MATTHEW CHILA (US)  
3. DAVID WADE (US)  
4. KEVIN MCHALE (US)  
5. ALEX WEBER (US)
- (74) Công ty Cổ phần Sở hữu công nghiệp INVESTIP (INVESTIP)
- (55)

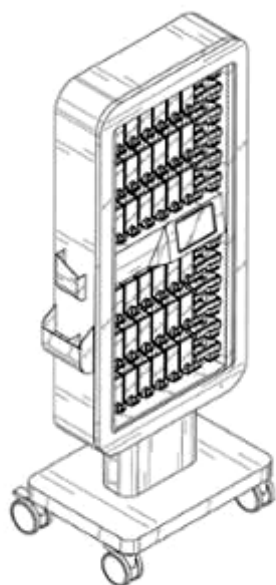

1.1

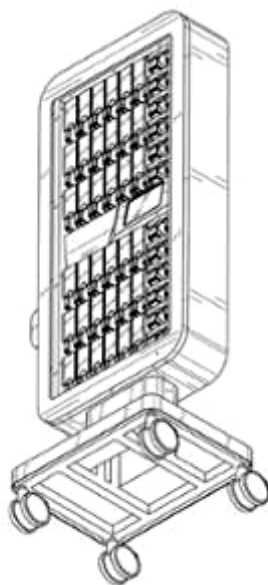

1.2

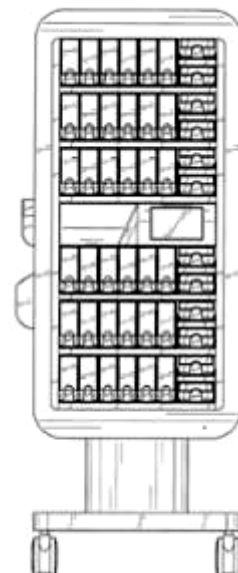

1.3

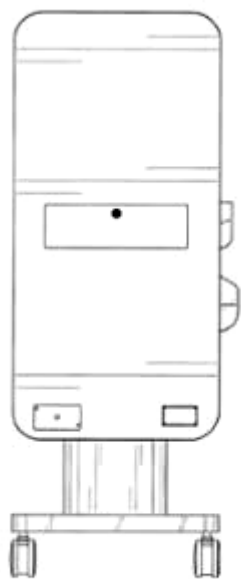

1.4

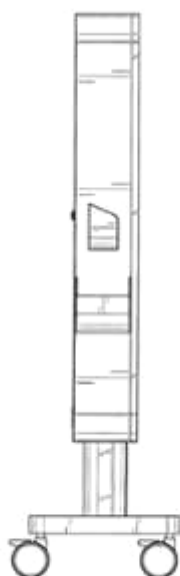

1.5



1.6

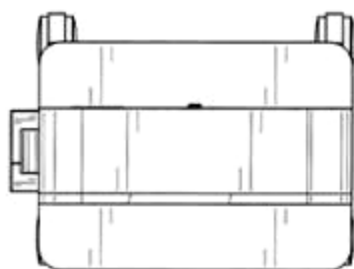

1.7

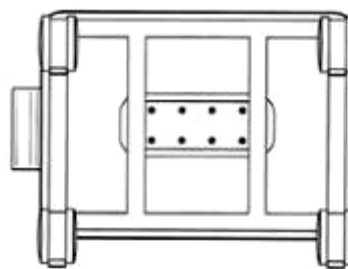

1.8

**CÔNG BÁO SỞ HỮU CÔNG NGHIỆP SỐ 412 TẬP A – QUYỀN 2 (07.2022)**

- (11) **44866**  
(21) 3-2021-00721 (28) 3  
(54) **THIẾT BỊ PHÂN PHỐI VÀ LƯU TRỮ SẢN PHẨM Y TẾ** (51) **24-01**  
(22) 29/03/2021 (43) 25/07/2022  
(30) 29/753,879 02/10/2020 US;  
(73) **ETHICON, INC. (US)**  
U.S. Route 22, P.O. Box 151, Somerville, NJ 08876, United States of America  
(72) 1. JONATHAN SYBY (US)  
2. MATTHEW CHILA (US)  
3. DAVID WADE (US)  
4. KEVIN MCHALE (US)  
5. ALEX WEBER (US)  
6. KYUNGMIN ANDY LEE (US)  
(74) Công ty Cổ phần Sở hữu công nghiệp INVESTIP (INVESTIP)  
(55)

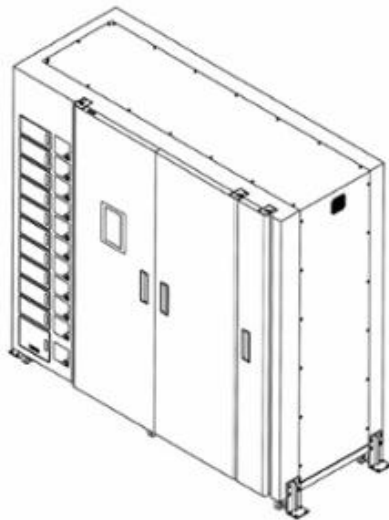

1.1

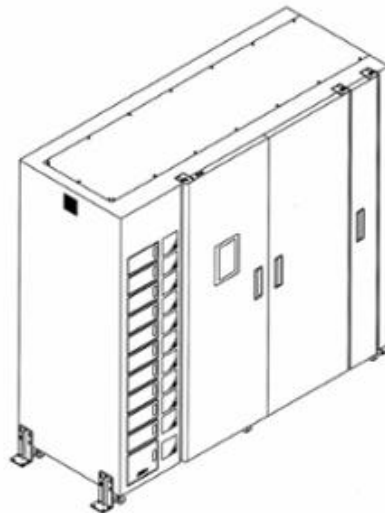

1.2

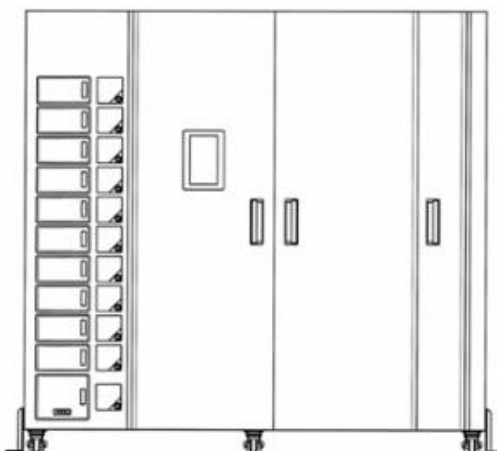

1.3

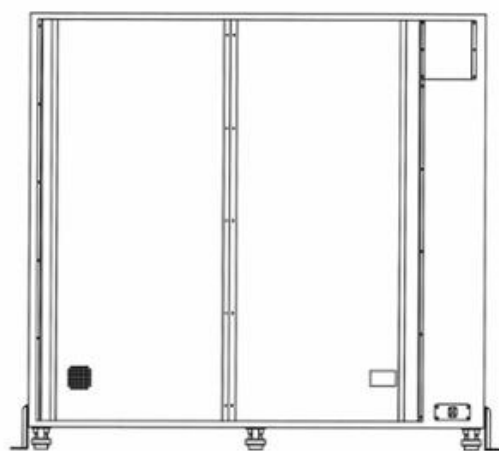

1.4



1.5

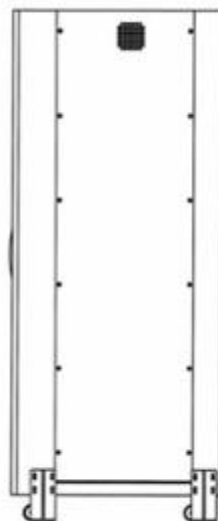

1.6



1.7

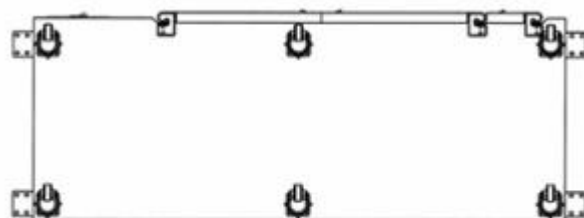

1.8

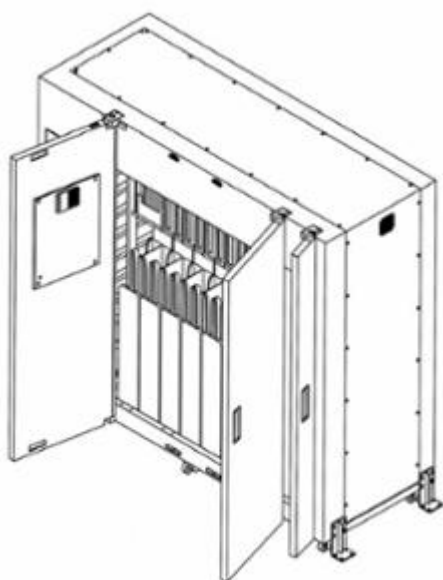

2.1

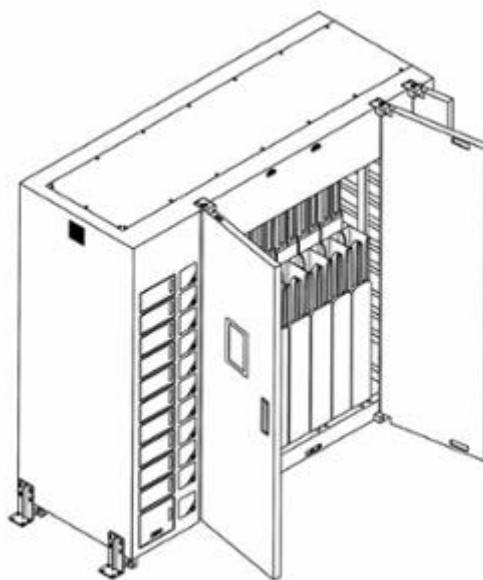

2.2



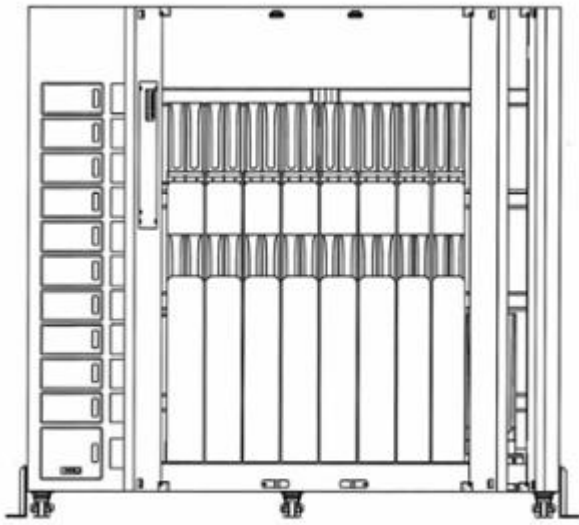

2.3

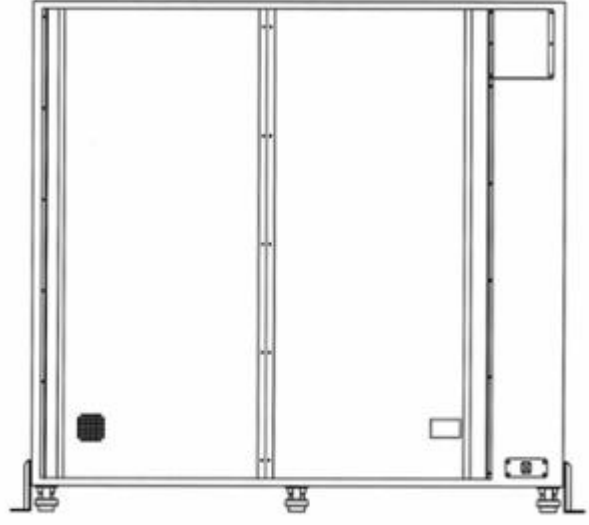

2.4

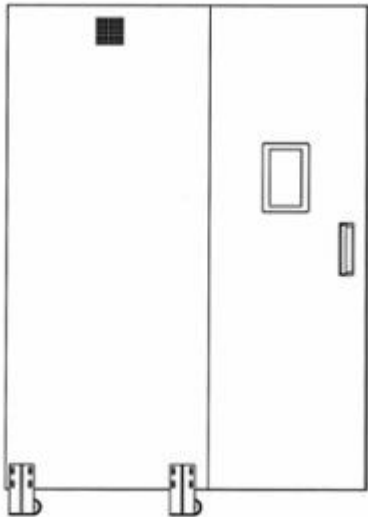

2.5

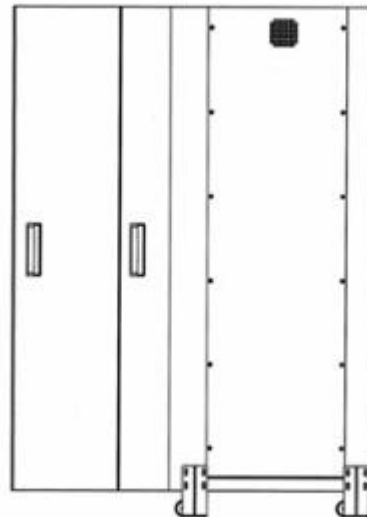

2.6

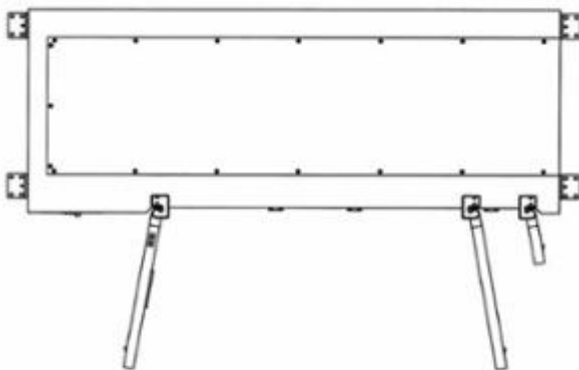

2.7

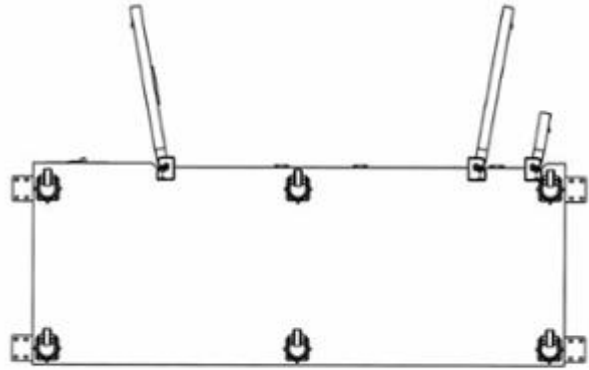

2.8

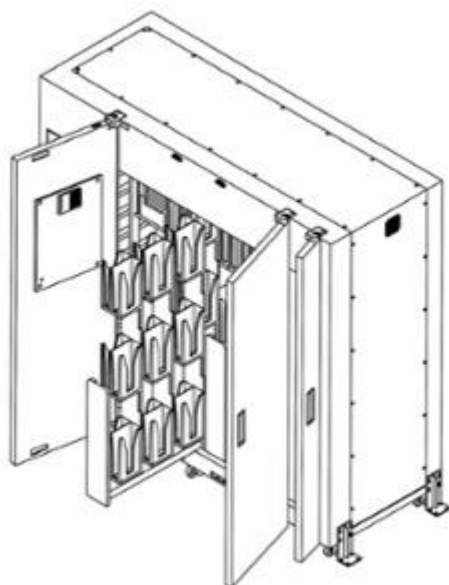

3.1

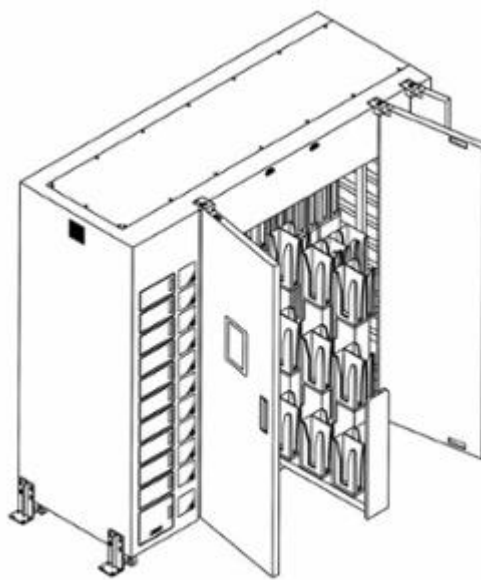

3.2

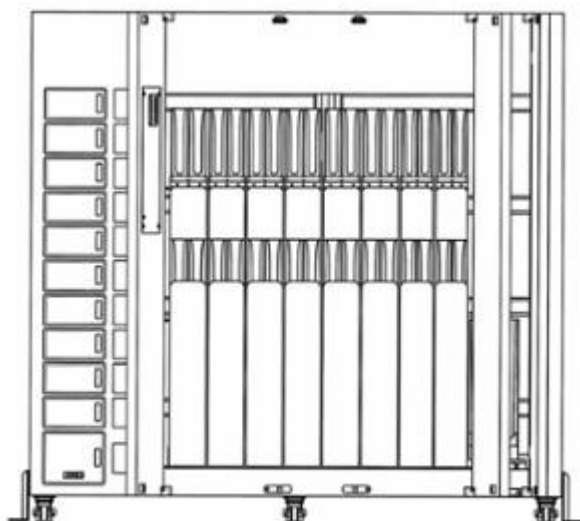

3.3

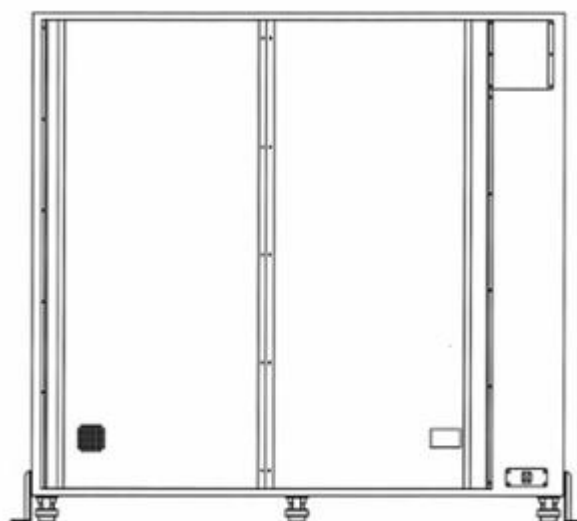

3.4

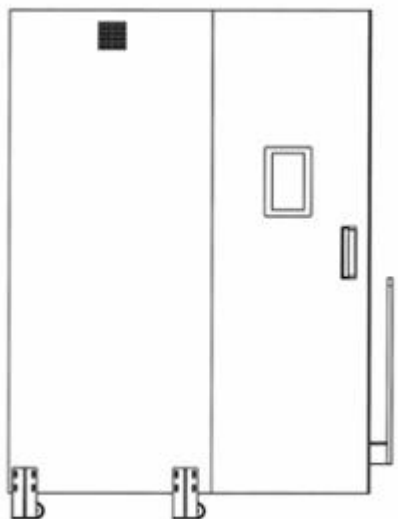

3.5

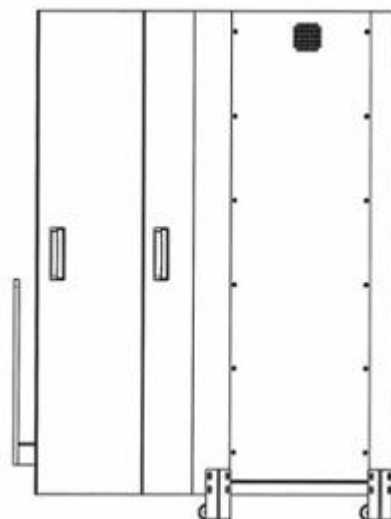

3.6

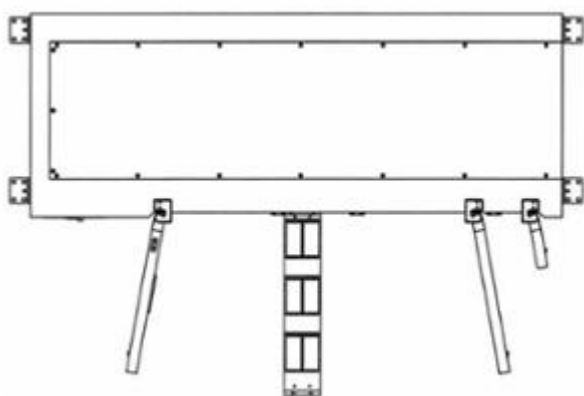

3.7

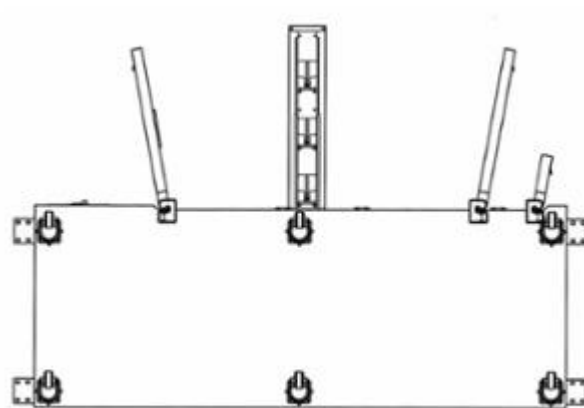

3.8

**CÔNG BÁO SỞ HỮU CÔNG NGHIỆP SỐ 412 TẬP A – QUYỀN 2 (07.2022)**

- (11) **44867**  
(21) 3-2021-00910 (28) 1  
(54) **HỘP NỐI ĐIỆN** (51) **13-03**  
(22) 19/04/2021 (43) 25/07/2022  
(73) **CÔNG TY TNHH KỸ THUẬT ĐIỆN SẢN XUẤT VÀ THƯƠNG MẠI TÂN ĐỨC HÀN (VN)**  
8 đường số 5 cư xá Chu Văn An, phường 26, quận Bình Thạnh, thành phố Hồ Chí Minh  
(72) Nguyễn Chí Sỹ (VN)  
(55)

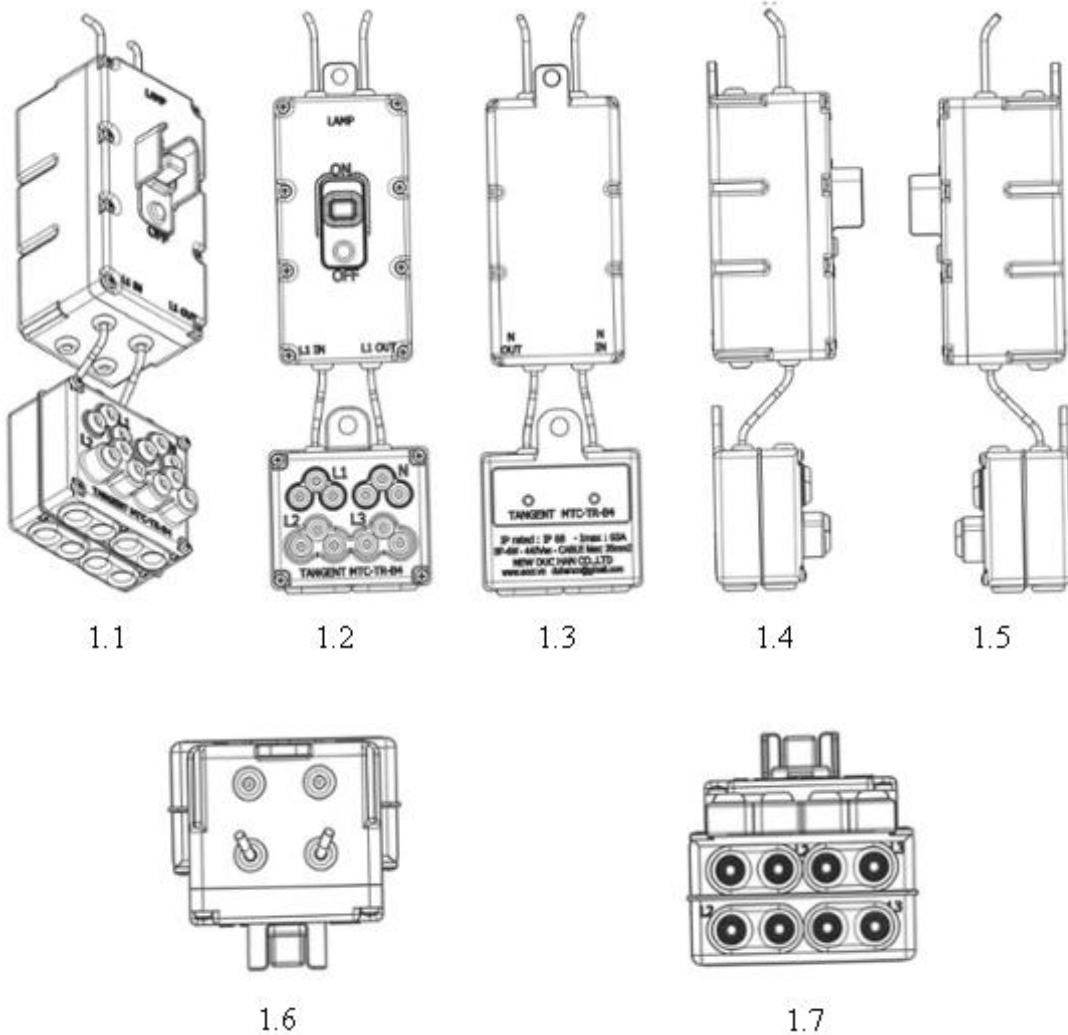

- (11) **44868**
- (21) 3-2021-01487 (28) 1
- (54) **DỤNG CỤ BẮM MÓNG TAY ĐA NĂNG** (51) **28-03**
- (22) 08/06/2021 (43) 25/07/2022
- (73) **1. CÔNG TY CỔ PHẦN CÔNG NGHIỆP NGŨ KIM FORTRESS VIỆT NAM (VN)**  
 Lô B8+B9+B10, Khu công nghiệp Phúc Khánh, phường Phú Khánh, thành phố Thái Bình, tỉnh Thái Bình  
**2. TSAI, CHUI-TIEN (TW)**  
 No 32, Wenchang St., Qingshui Dist., Taichung City 436, Taiwan
- (72) Tsai, Chui-Tien (TW)
- (74) Công ty TNHH Sở hữu trí tuệ Mặt trời mới (NEWSUN IPCO.,LTD.)
- (55)

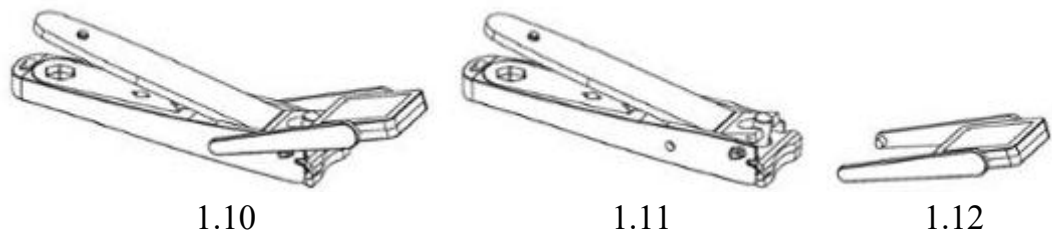
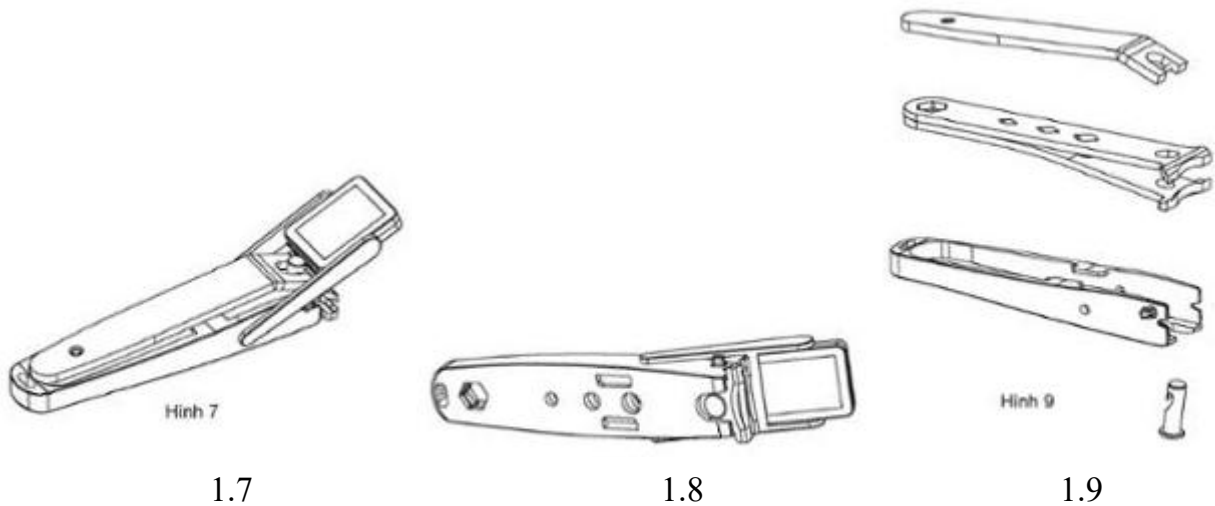
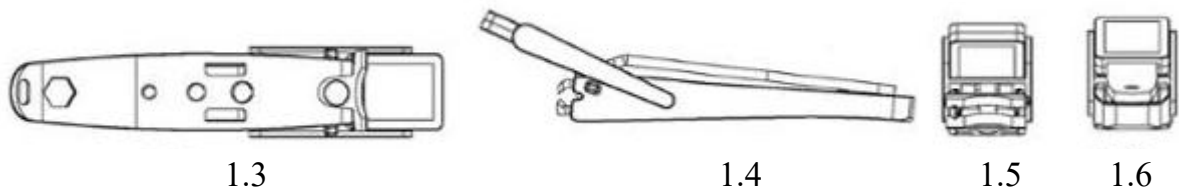
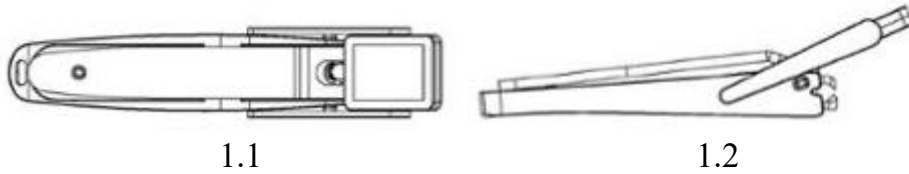

**CÔNG BÁO SỞ HỮU CÔNG NGHIỆP SỐ 412 TẬP A – QUYỀN 2 (07.2022)**

- (11) **44869**  
(21) 3-2021-01572 (28) 1  
(54) **VAN AN TOÀN CỦA Lò NUNG RÁC** (51) **23-99**  
(22) 17/06/2021 (43) 25/07/2022  
(73) **ĐOÀN QUYẾT TIẾN (VN)**  
Tổ 4, khu phố Bình Tây, phường Hưng Chiến, thị xã Bình Long, tỉnh Bình Phước  
(72) **ĐOÀN QUYẾT TIẾN (VN)**  
(74) Công ty TNHH Tư vấn - Dịch thuật - Sở hữu trí tuệ Á Đông (Á Đông IP CONSULTANCY CO.,LTD.)  
(55)

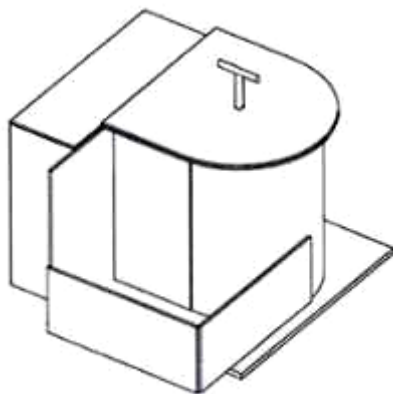

1.1

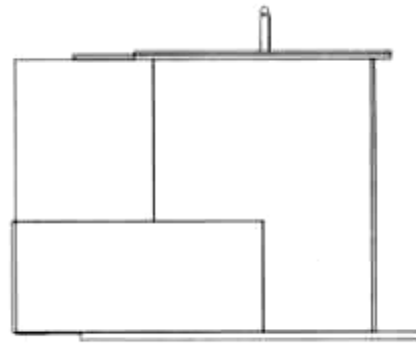

1.2

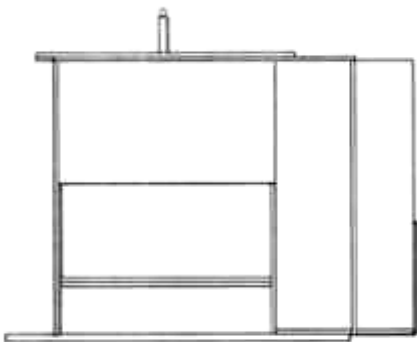

1.3

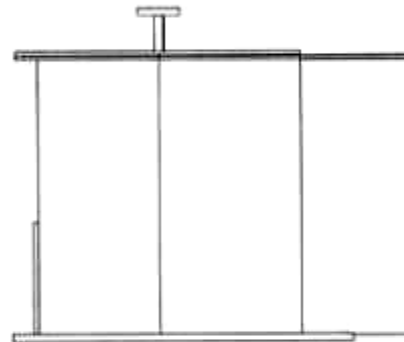

1.4

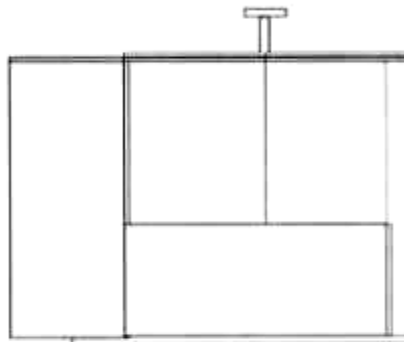

1.5

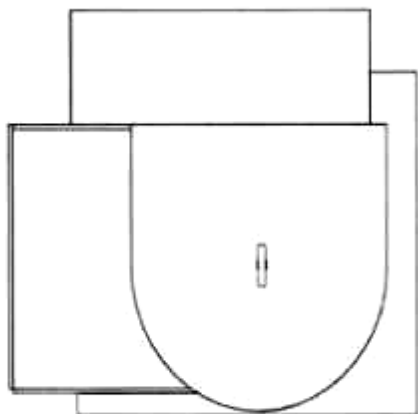

1.6

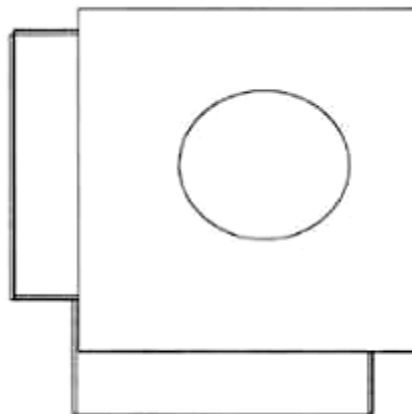

1.7

- (11) **44870**  
(21) 3-2021-01614 (28) 1  
(54) **GIƯỜNG SOI** (51) **06-07**  
(22) 21/06/2021 (43) 25/07/2022  
(73) **CÔNG TY CỔ PHẦN SẢN XUẤT THƯƠNG MẠI NAM ĐÔ (VN)**  
2C đường số 10, phường Bình Hưng Hòa A, quận Bình Tân, thành phố Hồ Chí Minh  
(72) Nguyễn Tấn Tài (VN)  
(55)



1.1



1.2



1.3



1.4



1.5



1.6



1.7



**CÔNG BÁO SỞ HỮU CÔNG NGHIỆP SỐ 412 TẬP A – QUYỀN 2 (07.2022)**

- (11) **44871**  
(21) 3-2021-01775 (28) 1  
(54) **NHÀ HÀNG LẶN NỔI** (51) **25-03**  
(22) 05/07/2021 (43) 25/07/2022  
(73) **CÔNG TY TNHH MỘT THÀNH VIÊN NGỌC TRAI NGỌC HIỀN PHÚ QUỐC (VN)**  
Tổ 1, ấp Dương Tơ, xã Dương Tơ, thành phố Phú Quốc, tỉnh Kiên Giang  
(72) Hồ Phi Thủy (VN)  
(74) Công ty TNHH Tư vấn đầu tư và Sở hữu trí tuệ Hoàng Phi (HOANG PHI INVEST & I.P CO., LTD)  
(55)

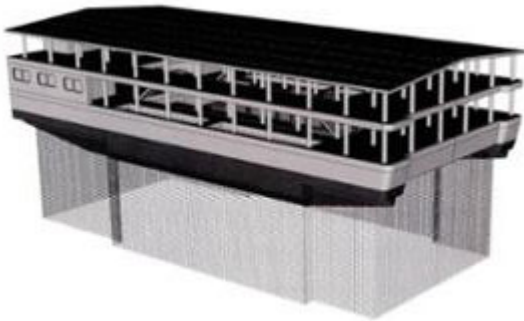

1.1

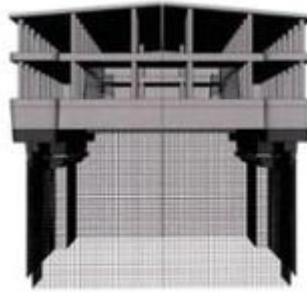

1.2



1.3



1.4



1.5

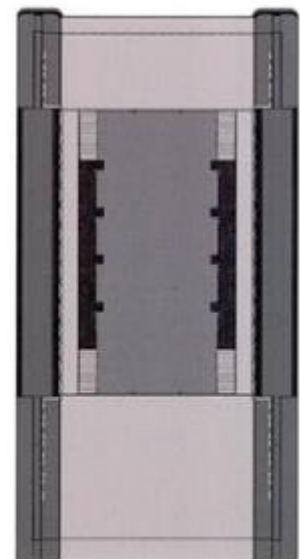

1.6

**CÔNG BÁO SỞ HỮU CÔNG NGHIỆP SỐ 412 TẬP A – QUYỀN 2 (07.2022)**

- (11) **44872**
- (21) 3-2021-01800
- (54) **THÙNG BIA**
- (22) 09/07/2021
- (73) **CÔNG TY TNHH TOÀN CẦU BEVERAGE (VN)**  
Số 8B đường Ngô Quyền, khu 4, phường Cẩm Thượng, thành phố Hải Dương, tỉnh Hải Dương
- (72) Nguyễn Thế Phương (VN)
- (74) Công ty TNHH Sở hữu trí tuệ M.I.T (M.I.T IP CO., LTD)
- (55)



1.1



1.2



2.1



2.2

- (11) **44873**  
(21) 3-2021-01822 (28) 1  
(54) **THÂN KHẨU TRANG** (51) **02-99**  
(22) 13/07/2021 (43) 25/07/2022  
(30) 2021-000847 18/01/2021 JP;  
(73) **IRIS OHYAMA INC. (JP)**  
2-12-1, Itsutsubashi, Aoba-ku, Sendai-shi, Miyagi, 980-8510 Japan  
(72) Rie MAEDA (JP)  
(74) Công ty Cổ phần Sở hữu công nghiệp INVESTIP (INVESTIP)  
(55)



1.1

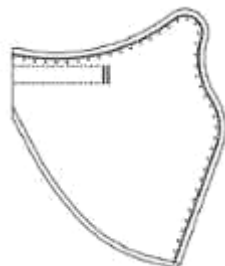

1.2



1.3



1.4



1.5



1.6

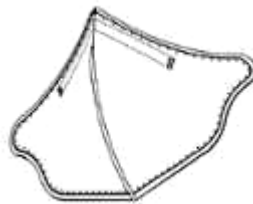

1.7

**CÔNG BÁO SỞ HỮU CÔNG NGHIỆP SỐ 412 TẬP A – QUYỀN 2 (07.2022)**

- (11) **44874**  
(21) 3-2021-01913 (28) 1  
(54) **GHẾ SOFA ĐIỆN** (51) **06-01**  
(22) 23/07/2021 (43) 25/07/2022  
(73) **1. CÔNG TY TNHH MOTOMOTION VIỆT NAM (VN)**  
Xưởng C-1B-D1 đến C-1B-D4A và C-1B-B5 đến C-1B-B8, Lô C-1B-CN, đường DE4, KCN Mỹ Phước 3, phường Thới Hòa, thị xã Bến Cát, tỉnh Bình Dương  
**2. HHC CHANGZHOU CORP. (CN)**  
No. 61 Xinggang Road, Zhonglou Economic Development Zone, Changzhou, Jiangsu, P.R. China  
(72) 1. CHIH-HSIUNG LIU (ZA)  
2. MEI JUN XU (CN)  
(74) Công ty TNHH Tư vấn đầu tư và Sở hữu trí tuệ Hoàng Phi (HOANG PHI INVEST & I.P CO., LTD)  
(55)



1.1



1.2



1.3



1.4



1.5



1.6



1.7



1.8

- (11) **44875**  
(21) 3-2021-01931  
(54) **MÁY ÉP NHỰA ĐỨNG**  
(22) 27/07/2021  
(73) **CÔNG TY TNHH THƯƠNG MẠI DỊCH VỤ KỸ THUẬT TỰ ĐỘNG HÓA MINH TÂM (VN)**  
38A/8 khu phố 1, phường Tam Hòa, thành phố Biên Hòa, tỉnh Đồng Nai  
(72) Nguyễn Quốc Minh (VN)  
(74) Công ty TNHH Tư vấn đầu tư và Sở hữu trí tuệ Hoàng Phi (HOANG PHI INVEST & I.P CO., LTD)  
(55)

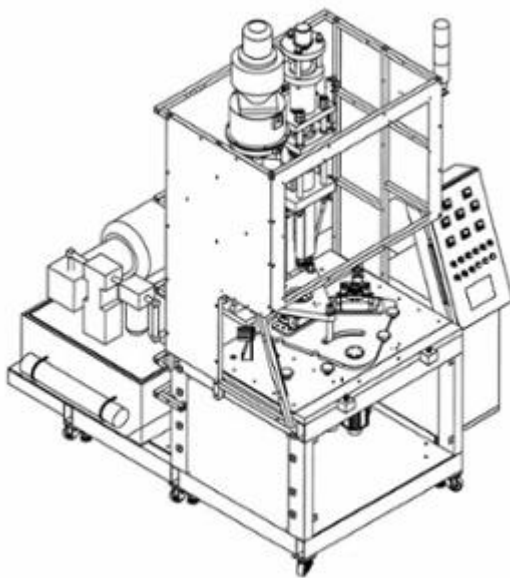

1.1

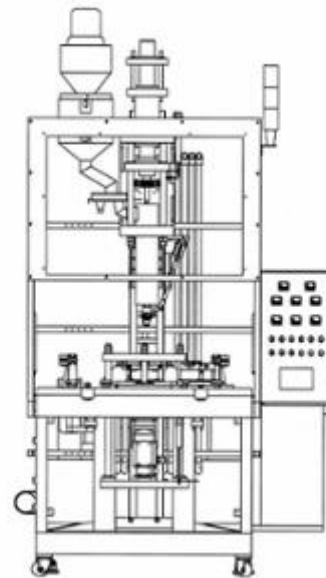

1.2

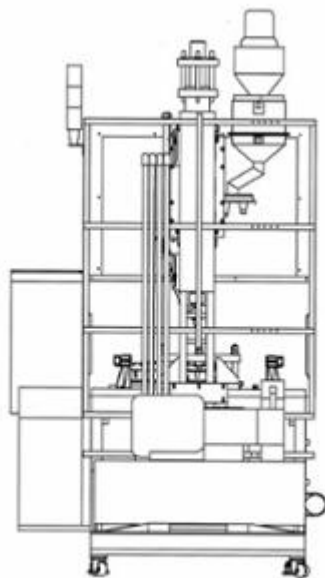

1.3

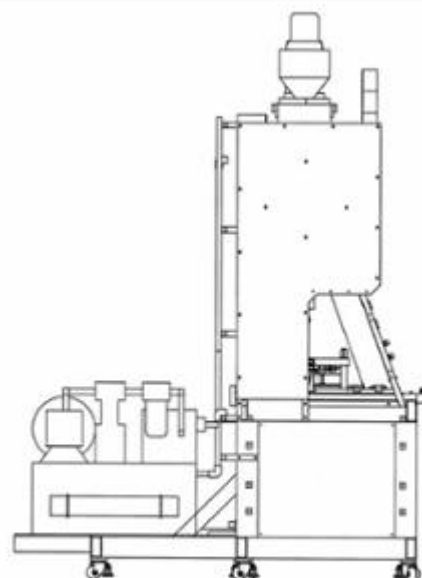

1.4

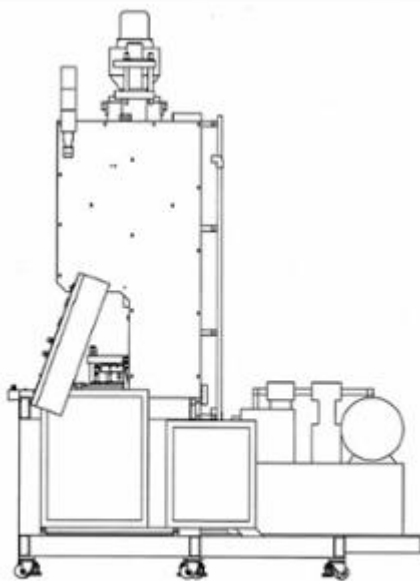

1.5

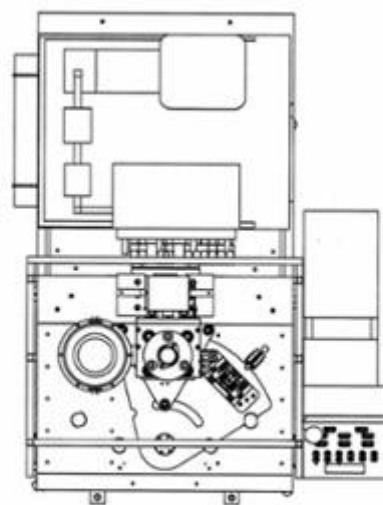

1.6

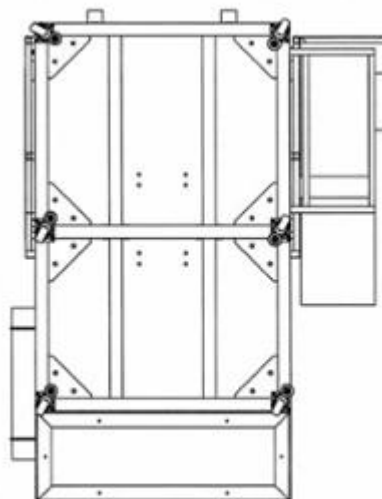

1.7

- (11) **44876**  
(21) 3-2021-01964 (28) 1  
(54) **THIẾT BỊ SẠC DÙNG CHO XE ĐIỆN** (51) **13-02**  
(22) 30/07/2021 (43) 25/07/2022  
(30) 30-2021-0017545 12/04/2021 KR;  
(73) **DAEYOUNG CHAEVI CO., LTD.** (KR)  
25, Techno sunhwan-ro 7-gil, Yuga-eup, Dalseong-gun, Daegu, Republic of Korea  
43023  
(72) Min Kyo JUNG (KR)  
(74) Công ty TNHH Tầm nhìn và Liên danh (VISION & ASSOCIATES CO.LTD.)  
(55)

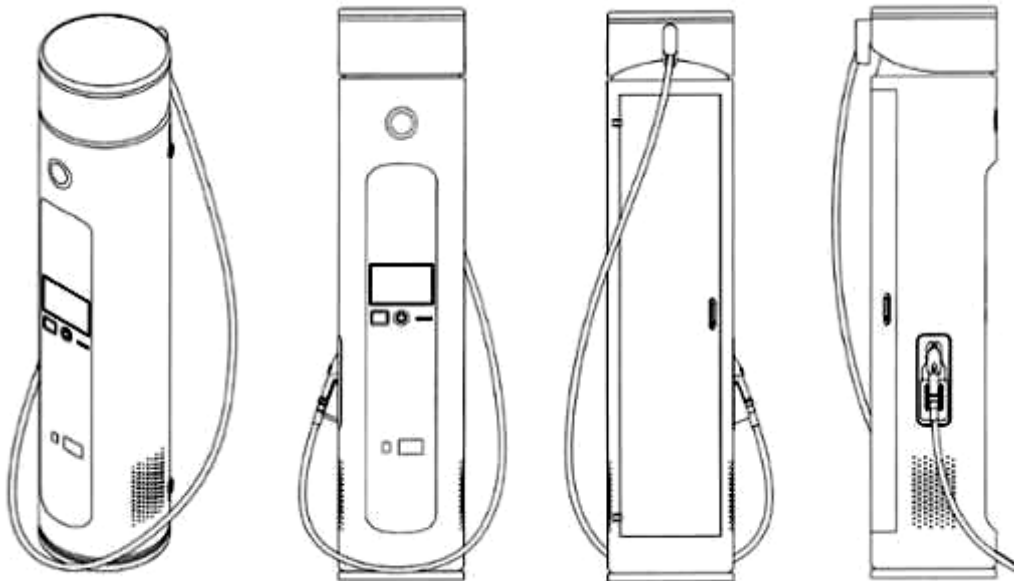

1.1

1.2

1.3

1.4



1.5



1.6

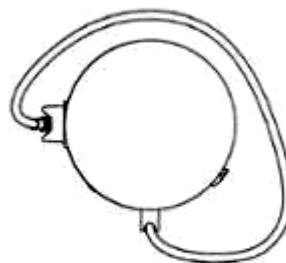

1.7



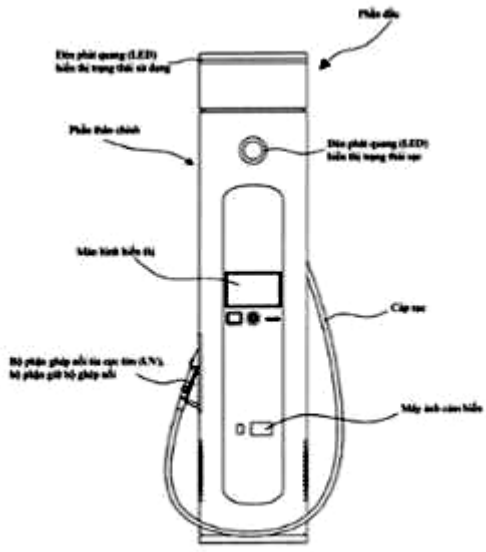

1.8

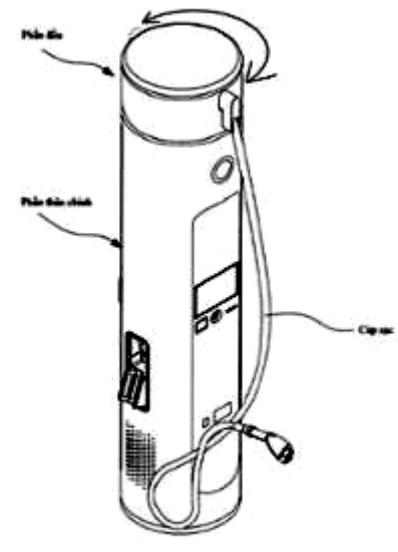

1.9

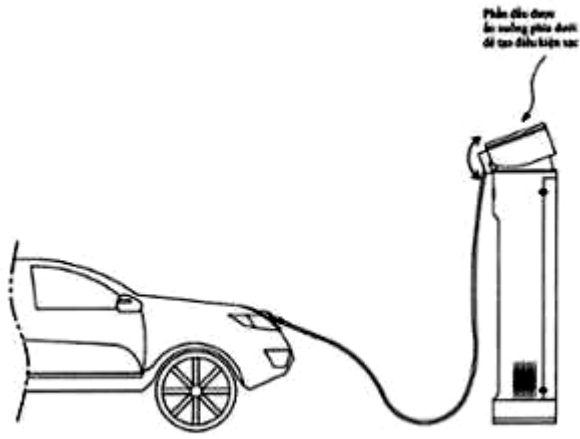

1.10

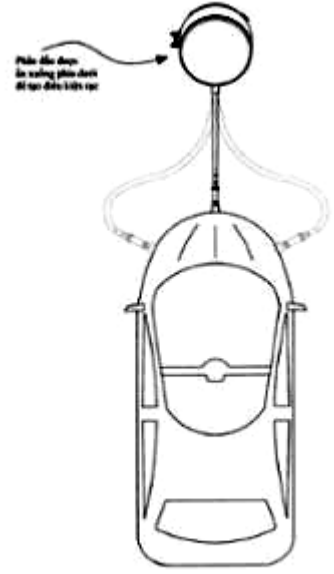

1.11

- (11) **44877**  
(21) 3-2021-02128 (28) 1  
(54) **ĐÉ DÉP** (51) **02-04**  
(22) 20/08/2021 (43) 25/07/2022  
(30) 29/771,660 24/02/2021 US;  
(73) **CROCS, INC. (US)**  
13601 Via Varra, Broomfield, Colorado 80020, United States of America  
(72) Alexander Jacob MAYHEW (US)  
(74) Công ty Luật TNHH quốc tế BMVN (BMVN INTERNATIONAL LLC)  
(55)



1.1

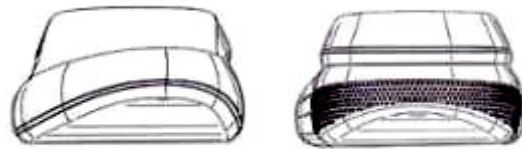

1.2



1.3



1.4



1.5



1.6

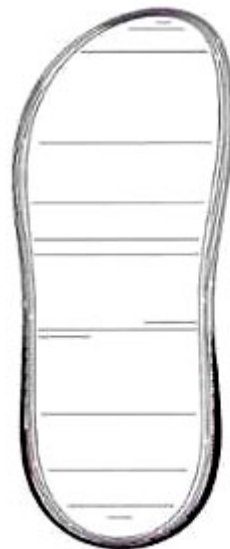

1.7

**CÔNG BÁO SỞ HỮU CÔNG NGHIỆP SỐ 412 TẬP A – QUYỀN 2 (07.2022)**

- (11) **44878**  
(21) 3-2021-02550 (28) 4  
(54) **TAI NGHE** (51) **14-01**  
(22) 18/10/2021 (43) 25/07/2022  
(30) 29/779,369 19/04/2021 US;  
(73) **GOOGLE LLC (US)**  
1600 Amphitheatre Parkway, Mountain View, California 94043, United States of America  
(72) 1. REIMANN, GINA (US)  
2. SU, JUNG CHENG (TW)  
3. OLSSON, MAJ ISABELLE (SE)  
4. LEE, DUSTIN (CA)  
5. BAKER, JEREMY DAVID (US)  
(74) Công ty Luật TNHH ROUSE Việt Nam (ROUSE LAW CO.,LTD)  
(55)



1.1

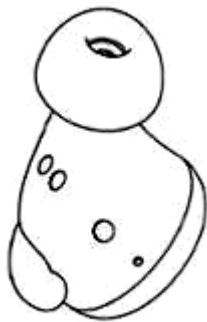

1.2



1.3

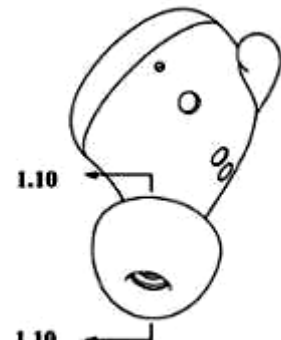

1.4



1.5



1.6



1.7



1.8

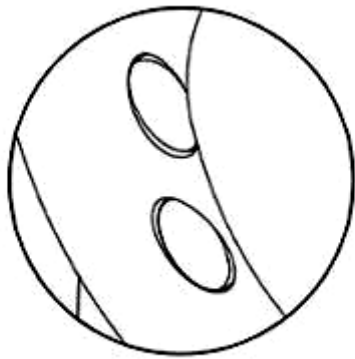

1.9



1.10



2.1

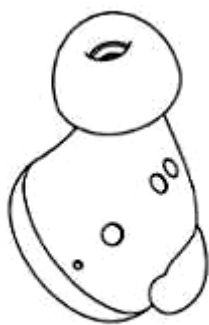

2.2



2.3

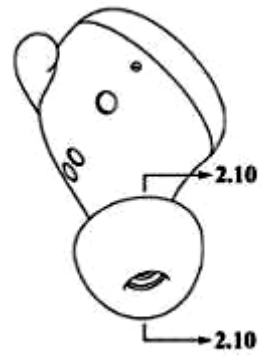

2.4



2.5



2.6



2.7



2.8

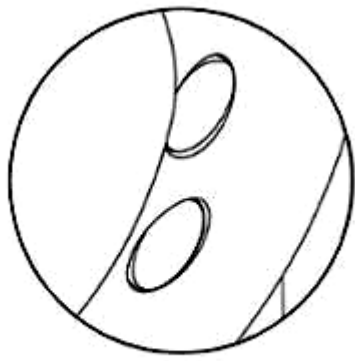

2.9



2.10

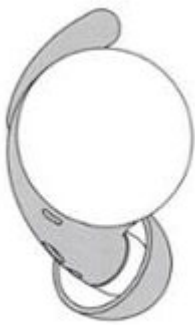

3.1

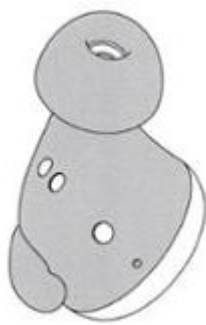

3.2



3.3

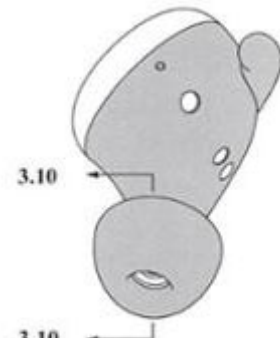

3.4



3.5



3.6



3.7

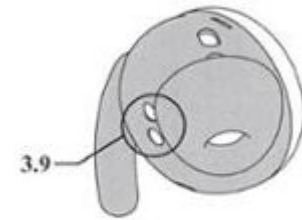

3.8

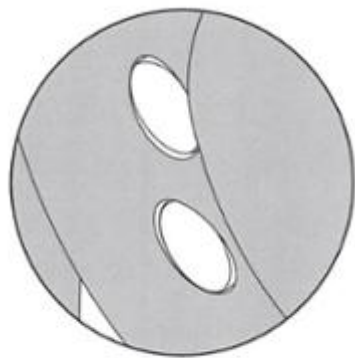

3.9



3.10



4.1

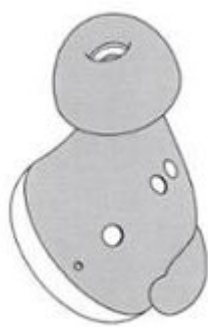

4.2



4.3

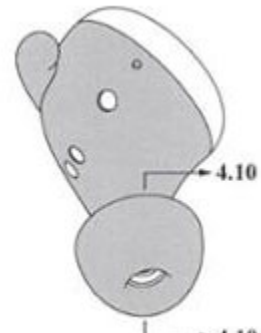

4.4



4.5



4.6



4.7

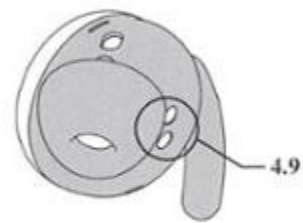

4.8



4.9



4.10

**CÔNG BÁO SỞ HỮU CÔNG NGHIỆP SỐ 412 TẬP A – QUYỀN 2 (07.2022)**

- (11) **44879**  
(21) 3-2021-02661 (28) 1  
(54) **THANH KIM LOẠI ĐỊNH HÌNH** (51) **25-01**  
(22) 25/10/2021 (43) 25/07/2022  
(73) **CÔNG TY TNHH SẢN XUẤT THƯƠNG MẠI DỊCH VỤ HAI THI (VN)**  
14/13/39 Thân Nhân Trung, phường 13, quận Tân Bình, thành phố Hồ Chí Minh  
(72) Trần Đình Thi (VN)  
(74) Công ty Luật TNHH LEADCONSULT (LEADCONSULT)  
(55)

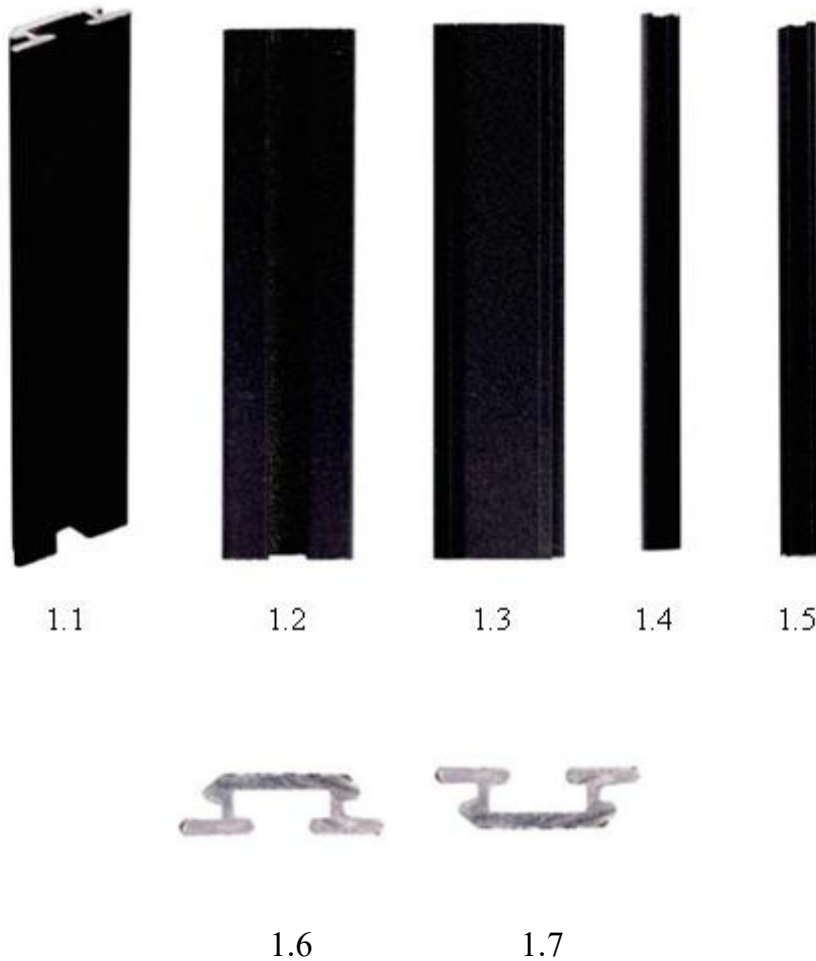

**CÔNG BÁO SỞ HỮU CÔNG NGHIỆP SỐ 412 TẬP A – QUYỀN 2 (07.2022)**

- (11) **44880**  
(21) 3-2021-02662 (28) 1  
(54) **THANH KIM LOẠI ĐỊNH HÌNH** (51) **25-01**  
(22) 25/10/2021 (43) 25/07/2022  
(73) **CÔNG TY TNHH SẢN XUẤT THƯƠNG MẠI DỊCH VỤ HAI THI (VN)**  
14/13/39 Thân Nhân Trung, phường 13, quận Tân Bình, thành phố Hồ Chí Minh  
(72) Trần Đình Thi (VN)  
(74) Công ty Luật TNHH LEADCONSULT (LEADCONSULT)  
(55)



1.1

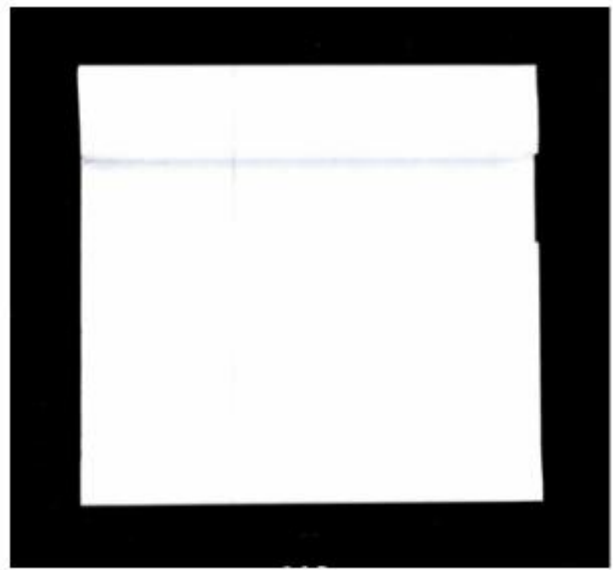

1.2

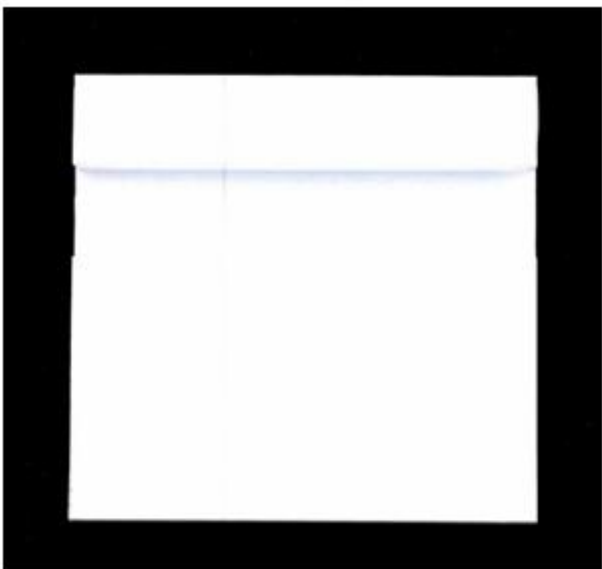

1.3

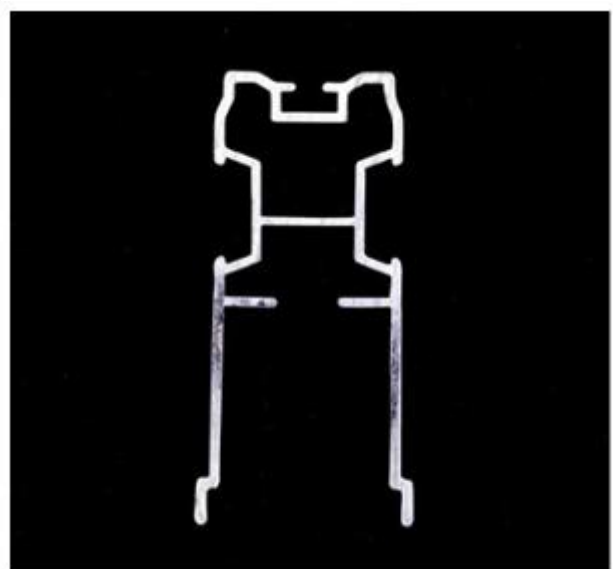

1.4



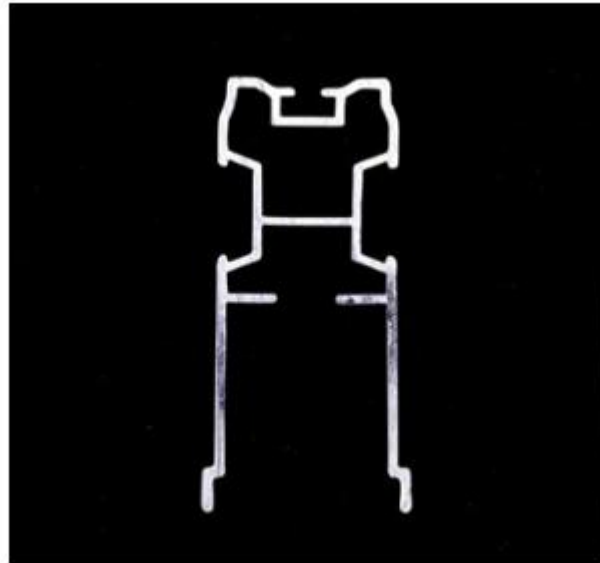

1.5

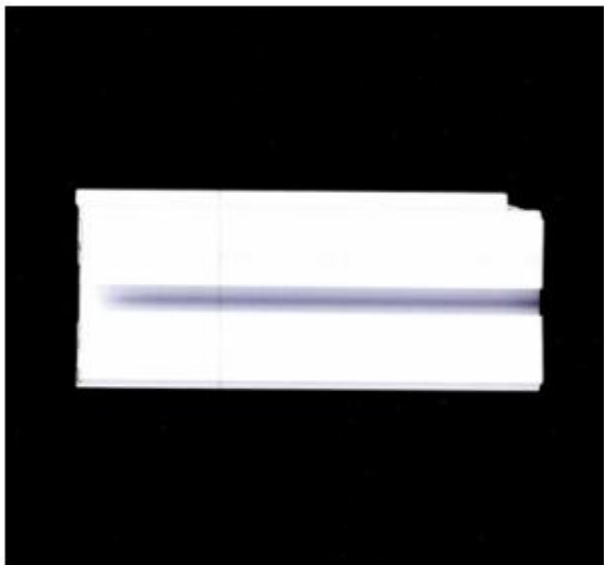

1.6

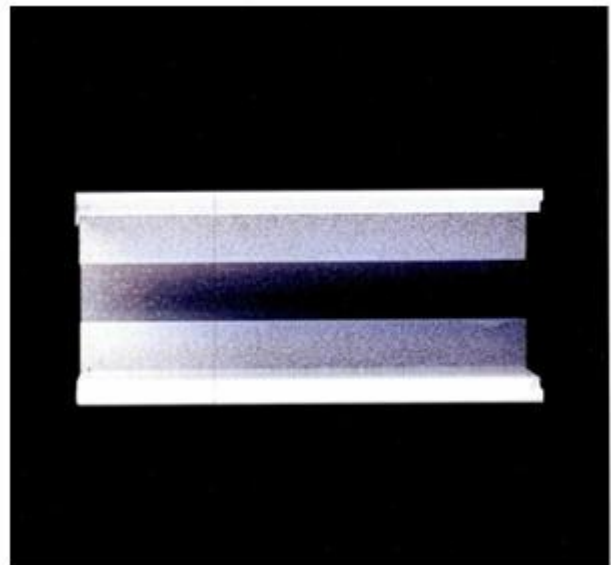

1.7

- (11) **44881**  
(21) 3-2021-02664 (28) 1  
(54) **NÚT NHỰA** (51) **08-08**  
(22) 25/10/2021 (43) 25/07/2022  
(73) **CÔNG TY TNHH SẢN XUẤT THƯƠNG MẠI DỊCH VỤ HAI THI (VN)**  
14/13/39 Thân Nhân Trung, phường 13, quận Tân Bình, thành phố Hồ Chí Minh  
(72) Trần Đình Thi (VN)  
(74) Công ty Luật TNHH LEADCONSULT (LEADCONSULT)  
(55)



1.1

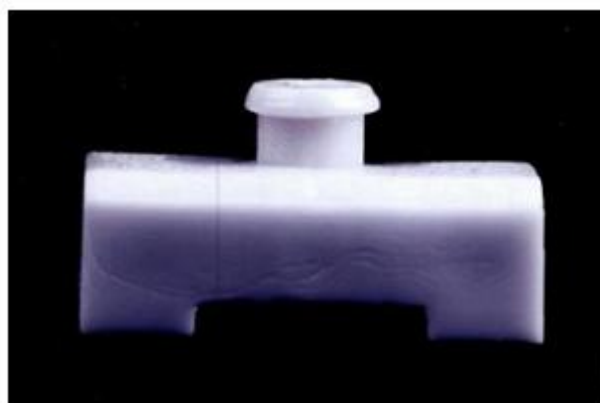

1.2

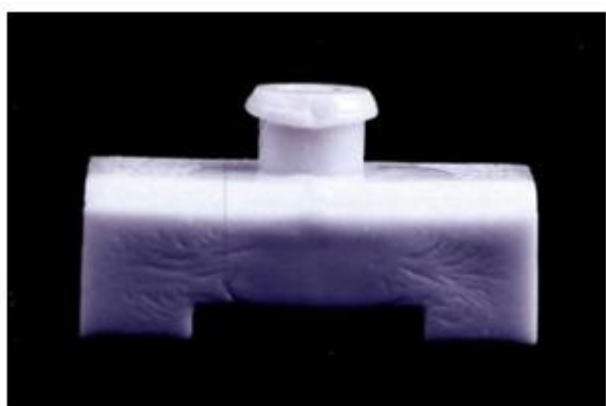

1.3



1.4



1.5

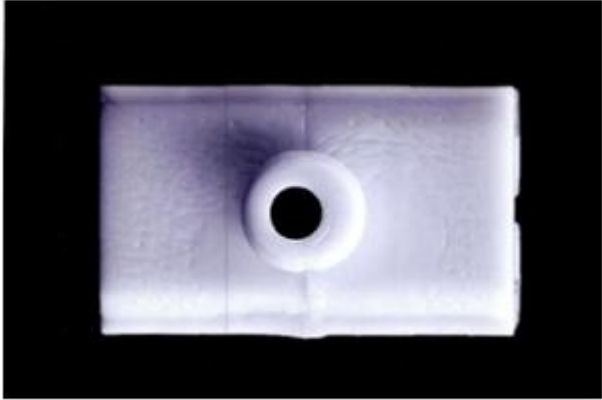

1.6

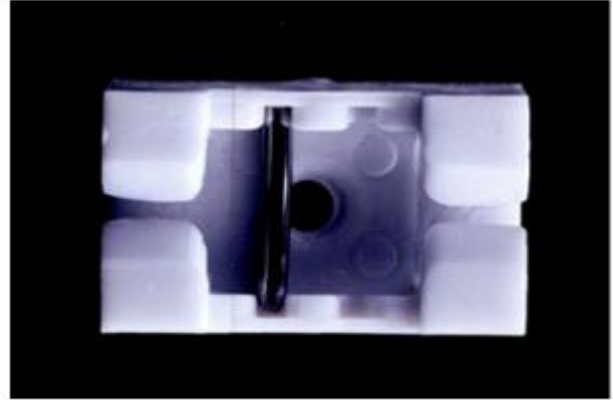

1.7

**CÔNG BÁO SỞ HỮU CÔNG NGHIỆP SỐ 412 TẬP A – QUYỀN 2 (07.2022)**

- (11) **44882**  
(21) 3-2021-02665 (28) 1  
(54) **THANH KIM LOẠI ĐỊNH HÌNH** (51) **25-01**  
(22) 25/10/2021 (43) 25/07/2022  
(73) **CÔNG TY TNHH SẢN XUẤT THƯƠNG MẠI DỊCH VỤ HAI THI (VN)**  
14/13/39 Thân Nhân Trung, phường 13, quận Tân Bình, thành phố Hồ Chí Minh  
(72) Trần Đình Thi (VN)  
(74) Công ty Luật TNHH LEADCONSULT (LEADCONSULT)  
(55)

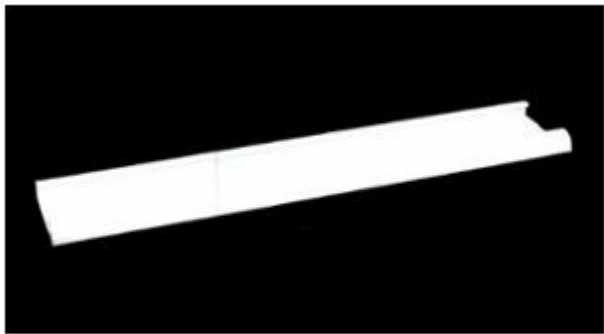

1.1



1.2



1.3

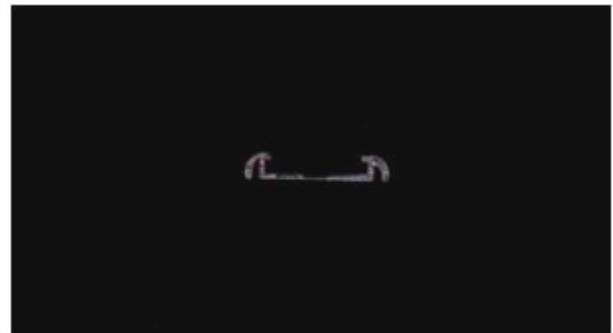

1.4



1.5

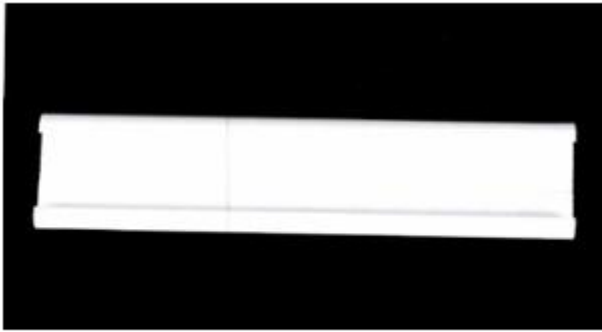

1.6



1.7

**CÔNG BÁO SỞ HỮU CÔNG NGHIỆP SỐ 412 TẬP A – QUYỀN 2 (07.2022)**

- (11) **44883**  
(21) 3-2021-02666 (28) 1  
(54) **THANH KIM LOẠI ĐỊNH HÌNH** (51) **25-01**  
(22) 25/10/2021 (43) 25/07/2022  
(73) **CÔNG TY TNHH SẢN XUẤT THƯƠNG MẠI DỊCH VỤ HAI THI (VN)**  
14/13/39 Thân Nhân Trung, phường 13, quận Tân Bình, thành phố Hồ Chí Minh  
(72) Trần Đình Thi (VN)  
(74) Công ty Luật TNHH LEADCONSULT (LEADCONSULT)  
(55)

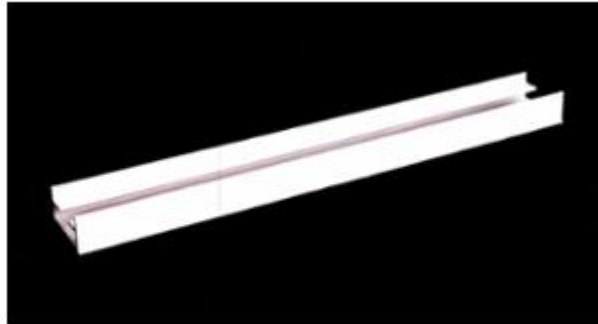

1.1



1.2



1.3

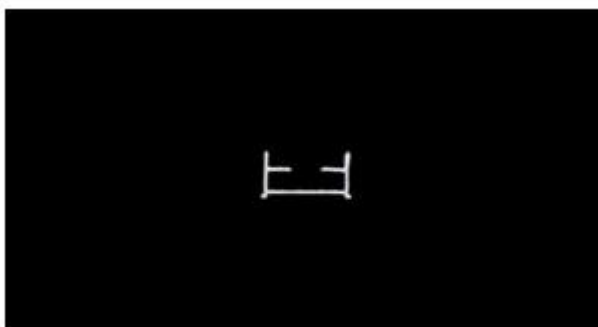

1.4



1.5



1.6



1.7

**CÔNG BÁO SỞ HỮU CÔNG NGHIỆP SỐ 412 TẬP A – QUYỀN 2 (07.2022)**

- (11) **44884**  
(21) 3-2021-02668 (28) 1  
(54) **THANH KIM LOẠI ĐỊNH HÌNH** (51) **25-01**  
(22) 25/10/2021 (43) 25/07/2022  
(73) **CÔNG TY TNHH SẢN XUẤT THƯƠNG MẠI DỊCH VỤ HAI THI (VN)**  
14/13/39 Thân Nhân Trung, phường 13, quận Tân Bình, thành phố Hồ Chí Minh  
(72) Trần Đình Thi (VN)  
(74) Công ty Luật TNHH LEADCONSULT (LEADCONSULT)  
(55)



1.1



1.2



1.3

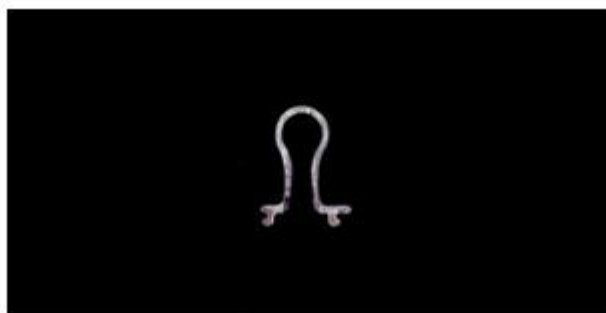

1.4

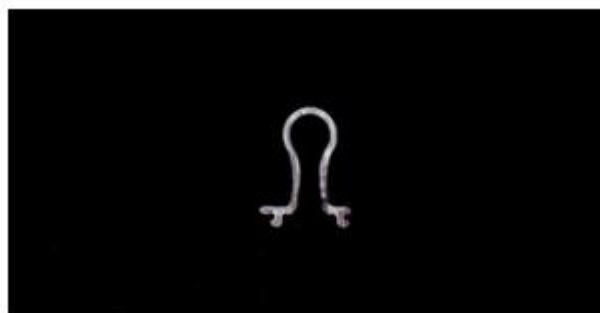

1.5



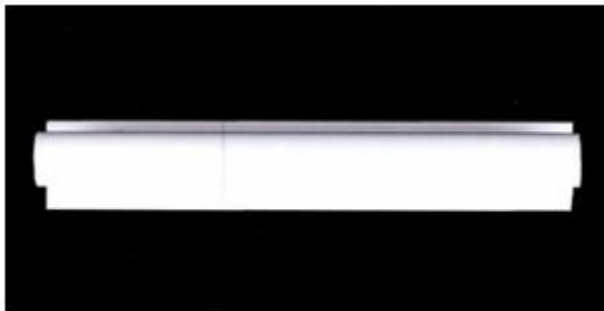

1.6

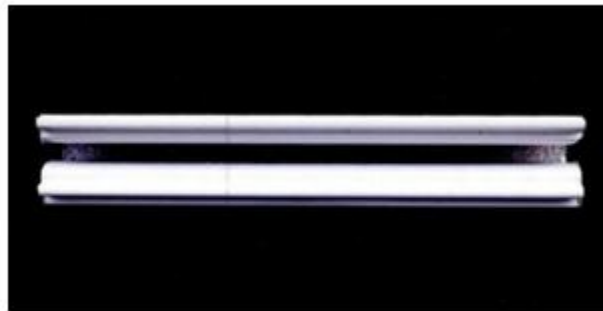

1.7

**CÔNG BÁO SỞ HỮU CÔNG NGHIỆP SỐ 412 TẬP A – QUYỀN 2 (07.2022)**

- (11) **44885**
- (21) 3-2021-02676 (28) 1
- (54) **NHÃN SẢN PHẨM** (51) **19-08**
- (22) 26/10/2021 (43) 25/07/2022
- (73) **CÔNG TY CỔ PHẦN SẢN XUẤT KINH DOANH GIẤY HỒNG PHÁT (VN)**  
Nhà số 8, ngách 46, ngõ 389 Trương Định, phường Tân Mai, quận Hoàng Mai,  
thành phố Hà Nội
- (72) Nguyễn Hòa Hiệp (VN)
- (74) Công ty Luật TNHH LEADCONSULT (LEADCONSULT)
- (55)



**CÔNG BÁO SỞ HỮU CÔNG NGHIỆP SỐ 412 TẬP A – QUYỀN 2 (07.2022)**

- (11) **44886**
- (21) 3-2021-02677 (28) 1
- (54) **NHÃN SẢN PHẨM** (51) **19-08**
- (22) 26/10/2021 (43) 25/07/2022
- (73) **CÔNG TY CỔ PHẦN SẢN XUẤT KINH DOANH GIẤY HỒNG PHÁT (VN)**  
Nhà số 8, ngách 46, ngõ 389 Trương Định, phường Tân Mai, quận Hoàng Mai,  
thành phố Hà Nội
- (72) Nguyễn Hòa Hiệp (VN)
- (74) Công ty Luật TNHH LEADCONSULT (LEADCONSULT)
- (55)



(11) **44887**

(21) 3-2021-02709

(28) 1

(54) **BA LÔ**

(51) **03-01**

(22) 02/11/2021

(43) 25/07/2022

(73) **NGUYỄN KÍNH QUỐC (VN)**

22 quốc lộ 80, khóm Hòa An, phường 2, thành phố Sa Đéc, tỉnh Đồng Tháp

(72) **NGUYỄN KÍNH QUỐC (VN)**

(55)



1.1

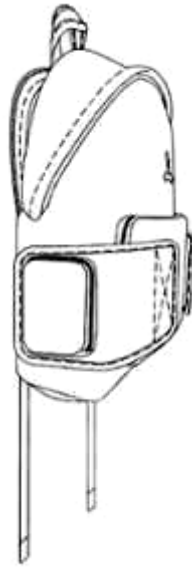

1.2



1.3

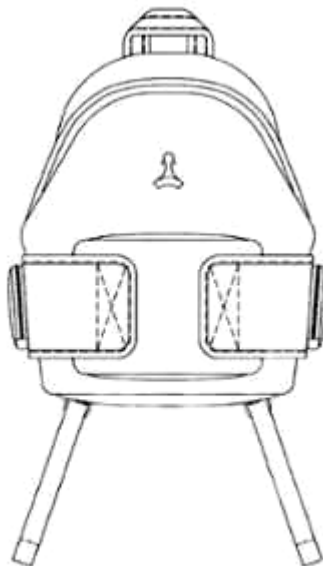

1.4

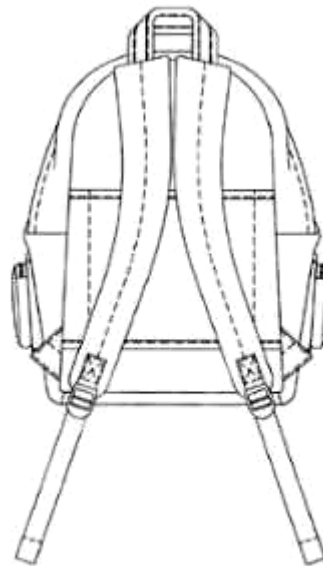

1.5

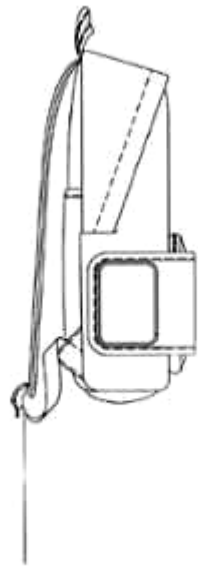

1.6

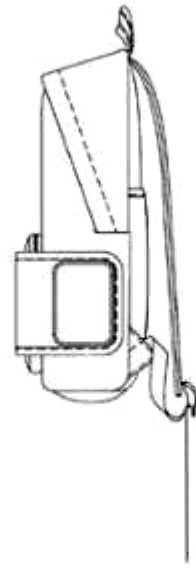

1.7

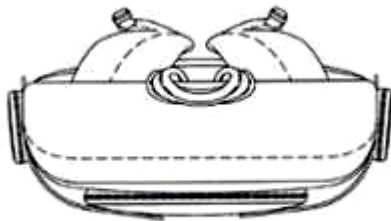

1.8

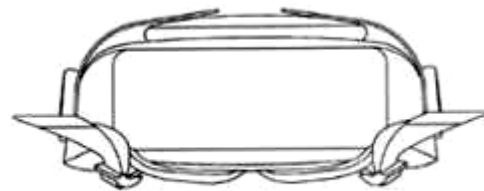

1.9

**CÔNG BÁO SỞ HỮU CÔNG NGHIỆP SỐ 412 TẬP A – QUYỀN 2 (07.2022)**

- (11) **44888**  
(21) 3-2021-02743 (28) 1  
(54) **HỘP ĐỰNG SẢN PHẨM** (51) **09-03**  
(22) 05/11/2021 (43) 25/07/2022  
(73) **CÔNG TY TNHH THƯƠNG MẠI & XUẤT NHẬP KHẨU NHẤT LÂM (VN)**  
Số 376, phố Xã Đàn, phường Nam Đồng, quận Đống Đa, thành phố Hà Nội  
(72) An Văn Tùng (VN)  
(74) Công ty Luật TNHH Phương Hoàng (PHOENIX LAW)  
(55)



1.1



1.2

**CÔNG BÁO SỞ HỮU CÔNG NGHIỆP SỐ 412 TẬP A – QUYỀN 2 (07.2022)**

- (11) **44889**  
(21) 3-2021-02744 (28) 1  
(54) **HỘP ĐỰNG SẢN PHẨM** (51) **09-03**  
(22) 05/11/2021 (43) 25/07/2022  
(73) **CÔNG TY TNHH THƯƠNG MẠI & XUẤT NHẬP KHẨU NHẤT LÂM (VN)**  
Số 376, phố Xã Đàn, phường Nam Đồng, quận Đống Đa, thành phố Hà Nội  
(72) An Văn Tùng (VN)  
(74) Công ty Luật TNHH Phương Hoàng (PHOENIX LAW)  
(55)



1.1



1.2

**CÔNG BÁO SỞ HỮU CÔNG NGHIỆP SỐ 412 TẬP A – QUYỀN 2 (07.2022)**

- (11) **44890**  
(21) 3-2021-02746 (28) 1  
(54) **TRẠM ĐỔI PIN TỰ ĐỘNG CHO XE ĐIỆN** (51) **13-02**  
(22) 05/11/2021 (43) 25/07/2022  
(73) **CÔNG TY CỔ PHẦN PHƯƠNG TIỆN ĐIỆN THÔNG MINH SELEX (VN)**  
B26, BT6, khu đô thị Văn Quán, quận Hà Đông, thành phố Hà Nội  
(72) 1. ĐẶNG HUY HOÀNG (VN)  
2. NGUYỄN HỮU PHƯỚC NGUYỄN (VN)  
3. NGUYỄN HOÀNG LONG (VN)  
(55)

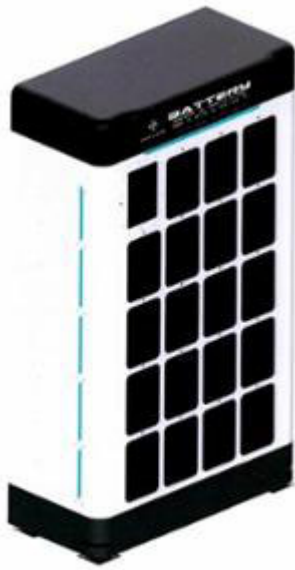

1.1



1.2



1.3



1.4

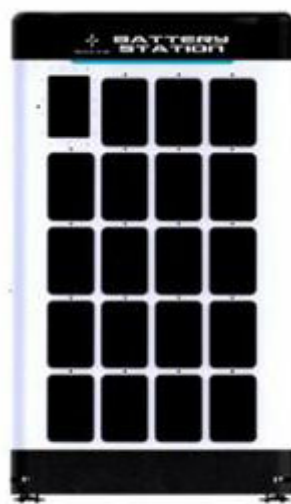

1.5

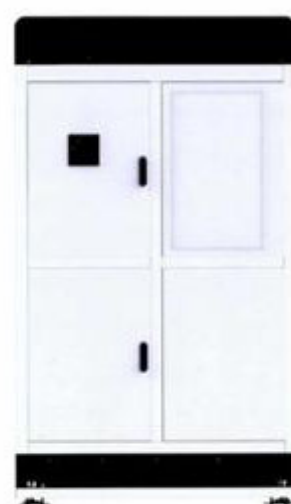

1.6





1.7



1.8



1.9

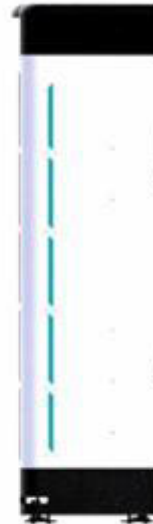

1.10

**CÔNG BÁO SỞ HỮU CÔNG NGHIỆP SỐ 412 TẬP A – QUYỀN 2 (07.2022)**

- (11) **44891**  
(21) 3-2021-02747 (28) 1  
(54) **XE MÁY ĐIỆN** (51) **12-11**  
(22) 05/11/2021 (43) 25/07/2022  
(73) **CÔNG TY CỔ PHẦN PHƯƠNG TIỆN ĐIỆN THÔNG MINH SELEX (VN)**  
B26, BT6, khu đô thị Văn Quán, quận Hà Đông, thành phố Hà Nội  
(72) 1. ĐẶNG HUY HOÀNG (VN)  
2. NGUYỄN HỮU PHƯỚC NGUYỄN (VN)  
3. NGUYỄN ĐÌNH QUẢNG (VN)  
(55)



1.1



1.2



1.3



1.4



1.5



1.6



1.7



1.8



1.9



1.10



1.11



1.12



1.13



1.14



1.15



1.16



1.17



1.18



1.19



1.20

**CÔNG BÁO SỞ HỮU CÔNG NGHIỆP SỐ 412 TẬP A – QUYỀN 2 (07.2022)**

- (11) **44892**  
(21) 3-2021-02783 (28) 1  
(54) **LỐC BIA** (51) **09-03; 09-05**  
(22) 09/11/2021 (43) 25/07/2022  
(73) **TỔNG CÔNG TY CỔ PHẦN BIA – RƯỢU – NƯỚC GIẢI KHÁT SÀI GÒN (VN)**  
187 Nguyễn Chí Thanh, phường 12, quận 5, thành phố Hồ Chí Minh  
(72) Neo Gim Siong Bennett (SG)  
(74) Công ty TNHH Tư vấn ALIATLEGAL (ALIAT LEGAL)  
(55)



1.1



1.2

**CÔNG BÁO SỞ HỮU CÔNG NGHIỆP SỐ 412 TẬP A – QUYỀN 2 (07.2022)**

- (11) **44893**  
(21) 3-2021-02808 (28) 1  
(54) **BAO GÓI SẢN PHẨM** (51) **09-05**  
(22) 10/11/2021 (43) 25/07/2022  
(73) **CÔNG TY TNHH THƯƠNG MẠI & XUẤT NHẬP KHẨU NHẤT LÂM (VN)**  
Số 376, phố Xã Đàn, phường Nam Đồng, quận Đống Đa, thành phố Hà Nội  
(72) An Văn Tùng (VN)  
(74) Công ty Luật TNHH Phương Hoàng (PHOENIX LAW)  
(55)



1.1



1.2

**CÔNG BÁO SỞ HỮU CÔNG NGHIỆP SỐ 412 TẬP A – QUYỀN 2 (07.2022)**

- (11) **44894**  
(21) 3-2021-02812 (28) 1  
(54) **NHÃN SẢN PHẨM** (51) **19-08**  
(22) 10/11/2021 (43) 25/07/2022  
(73) **CÔNG TY TNHH THƯƠNG MẠI & XUẤT NHẬP KHẨU NHẤT LÂM (VN)**  
Số 376, phố Xã Đàn, phường Nam Đồng, quận Đống Đa, thành phố Hà Nội  
(72) An Văn Tùng (VN)  
(74) Công ty Luật TNHH Phượng Hoàng (PHOENIX LAW)  
(55)





**CÔNG BÁO SỞ HỮU CÔNG NGHIỆP SỐ 412 TẬP A – QUYỀN 2 (07.2022)**

- (11) **44895**  
(21) 3-2021-02814 (28) 1  
(54) **BAO GÓI SẢN PHẨM** (51) **09-05**  
(22) 10/11/2021 (43) 25/07/2022  
(73) **CÔNG TY TNHH THƯƠNG MẠI & XUẤT NHẬP KHẨU NHẤT LÂM (VN)**  
Số 376, phố Xã Đàn, phường Nam Đồng, quận Đống Đa, thành phố Hà Nội  
(72) An Văn Tùng (VN)  
(74) Công ty Luật TNHH Phương Hoàng (PHOENIX LAW)  
(55)



1.1



1.2

**CÔNG BÁO SỞ HỮU CÔNG NGHIỆP SỐ 412 TẬP A – QUYỀN 2 (07.2022)**

- (11) **44896**  
(21) 3-2021-02822 (28) 1  
(54) **HỘP ĐỰNG SẢN PHẨM** (51) **09-03**  
(22) 12/11/2021 (43) 25/07/2022  
(73) **DƯƠNG TUẤN ANH (VN)**  
Tổ 2, phường Tây Sơn, thành phố Tam Điệp, tỉnh Ninh Bình  
(72) Dương Tuấn Anh (VN)  
(55)



1.1



1.2

**CÔNG BÁO SỞ HỮU CÔNG NGHIỆP SỐ 412 TẬP A – QUYỀN 2 (07.2022)**

(11) **44897**

(21) 3-2021-02874

(28) 1

(54) **QUẠT TRẦN**

(51) **23-04**

(22) 18/11/2021

(43) 25/07/2022

(73) **CÔNG TY CỔ PHẦN CƠ ĐIỆN THỐNG NHẤT (VN)**

Số 164, phố Nguyễn Đức Cảnh, phường Tương Mai, quận Hoàng Mai, thành phố Hà Nội

(72) Lê Tuấn Sơn (VN)

(74) Công ty TNHH IPVC (IP.VC CO.,LTD)

(55)



1.1



1.2



1.3



1.4



1.5



1.6



1.7



1.8

(11) **44898**

(21) 3-2021-02945

(28) 1

(54) **ĐÈN CHIẾU SÁNG ĐƯỜNG PHỐ**

(51) **26-03**

(22) 25/11/2021

(43) 25/07/2022

(73) **CÔNG TY CỔ PHẦN ĐIỆN VÀ CHIẾU SÁNG PHÚ THẮNG (VN)**

Lô số CN1, KCN Thạch Thất, Quốc Oai, huyện Thạch Thất, thành phố Hà Nội

(72) He Jun Zhen (CN)

(55)



1.1



1.2



1.3



1.4



1.5



1.6



1.7

- (11) **44899**  
(21) 3-2021-02968 (28) 1  
(54) **KHỚP NỐI ỐNG** (51) **23-01**  
(22) 29/11/2021 (43) 25/07/2022  
(30) 30-20210025842 31/05/2021 KR;  
(73) 1. **LEE, JONG HO** (KR)  
1187-1, Daewangpangyo-ro, Sujeong-gu, Seongnam-si, Gyeonggi-do, Republic of Korea  
2. **LEE, HYE JUNG** (KR)  
1187-1, Daewangpangyo-ro, Sujeong-gu, Seongnam-si, Gyeonggi-do, Republic of Korea  
(72) 1. LEE, JONG HO (KR)  
2. LEE, HYE JUNG (KR)  
(74) Công ty TNHH Sở hữu trí tuệ PADEMARK (PADEMARK CO.,LTD.)  
(55)



1.1



1.2



1.3

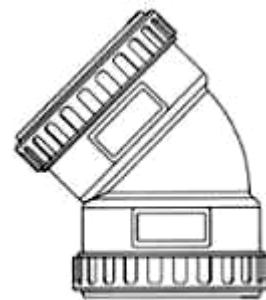

1.4

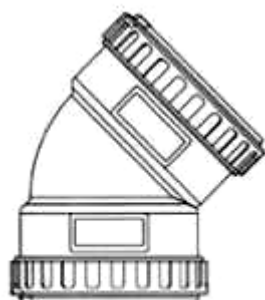

1.5



1.6



1.7



1.8

- (11) **44900**  
(21) 3-2021-02969 (28) 1  
(54) **KHỚP NỐI ỐNG** (51) **23-01**  
(22) 29/11/2021 (43) 25/07/2022  
(30) 30-20210025843 31/05/2021 KR;  
(73) 1. **LEE, JONG HO** (KR)  
1187-1, Daewangpangyo-ro, Sujeong-gu, Seongnam-si, Gyeonggi-do, Republic of Korea  
2. **LEE, HYE JUNG** (KR)  
1187-1, Daewangpangyo-ro, Sujeong-gu, Seongnam-si, Gyeonggi-do, Republic of Korea  
(72) 1. LEE, JONG HO (KR)  
2. LEE, HYE JUNG (KR)  
(74) Công ty TNHH Sở hữu trí tuệ PADEMARK (PADEMARK CO.,LTD.)  
(55)



1.1

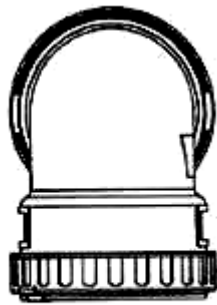

1.2



1.3

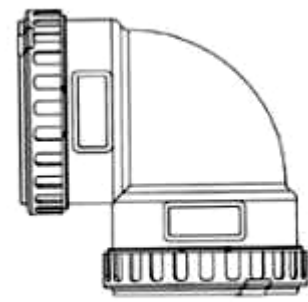

1.4

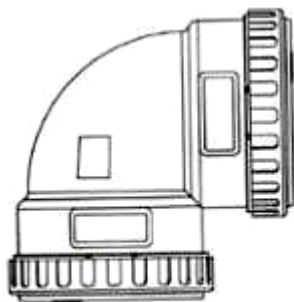

1.5

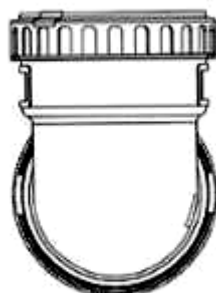

1.6

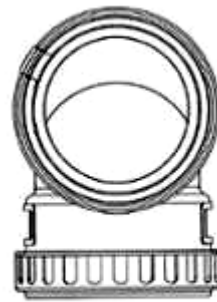

1.7



1.8

(11) **44901**

(21) 3-2021-02970

(28) 1

(54) **KHỚP NỐI ỐNG**

(51) **23-01**

(22) 29/11/2021

(43) 25/07/2022

(30) 30-20210025845 31/05/2021 KR;

(73) 1. **LEE, JONG HO** (KR)

1187-1, Daewangpangyo-ro, Sujeong-gu, Seongnam-si, Gyeonggi-do, Republic of Korea

2. **LEE, HYE JUNG** (KR)

1187-1, Daewangpangyo-ro, Sujeong-gu, Seongnam-si, Gyeonggi-do, Republic of Korea

(72) 1. **LEE, JONG HO** (KR)

2. **LEE, HYE JUNG** (KR)

(74) Công ty TNHH Sở hữu trí tuệ PADEMARK (PADEMARK CO.,LTD.)

(55)



1.1



1.2



1.3

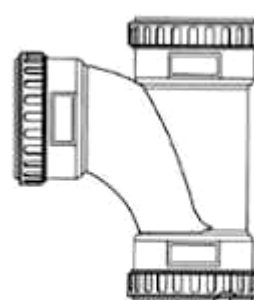

1.4

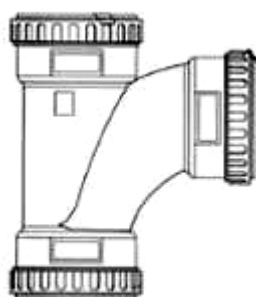

1.5



1.6



1.7



1.8



- (11) **44902**  
(21) 3-2021-03015 (28) 1  
(54) **NẤP HỘP** (51) **09-03**  
(22) 30/11/2021 (43) 25/07/2022  
(73) **E2COLLECTION CO.,LTD. (KR)**  
192, Daemyeongnam-ro, Nam-gu, Daegu, Republic of Korea  
(72) Jun-hee, Kwak (KR)  
(74) Công ty TNHH Sở hữu trí tuệ Trần & Trần (TRAN & TRAN CO., LTD.)  
(55)



1.1



1.2



1.3

(11) **44903**

(21) 3-2021-03024

(28) 1

(54) **ĐÈN CHIẾU SÁNG ĐƯỜNG PHỐ**

(51) **26-03**

(22) 01/12/2021

(43) 25/07/2022

(73) **CÔNG TY CỔ PHẦN ĐIỆN VÀ CHIẾU SÁNG PHÚ THẮNG (VN)**

Lô số CN1, KCN Thạch Thất, Quốc Oai, huyện Thạch Thất, thành phố Hà Nội

(72) Ye Fei (CN)

(55)



1.1



1.2



1.3



1.4



1.5



1.6



1.7

**CÔNG BÁO SỞ HỮU CÔNG NGHIỆP SỐ 412 TẬP A – QUYỀN 2 (07.2022)**

- (11) **44904**  
(21) 3-2021-03064 (28) 1  
(54) **SQT** (51) **09-04**  
(22) 11/11/2020 (43) 25/07/2022  
(73) **CÔNG TY CỔ PHẦN ĐẠI ĐỒNG TIẾN (VN)**  
216 Tân Thành, phường 15, quận 5, thành phố Hồ Chí Minh  
(72) Trịnh Chí Cường (VN)  
(74) Công ty TNHH Dịch vụ thương mại và sở hữu công nghiệp Song Ngọc (I.P.T.S.)  
(55)



1.1



1.2



1.3



1.4



1.5



1.6

**CÔNG BÁO SỞ HỮU CÔNG NGHIỆP SỐ 412 TẬP A – QUYỀN 2 (07.2022)**

- (11) **44905**  
(21) 3-2021-03227 (28) 1  
(54) **QUẦN NGẮN** (51) **02-02**  
(22) 16/12/2021 (43) 25/07/2022  
(73) **CÔNG TY TNHH MAY THỜI TRANG B.N (VN)**  
101/62/6 Lê Văn Lương, tổ 17, ấp 3, xã Phước Kiển, huyện Nhà Bè, thành phố Hồ Chí Minh  
(72) Lê Thị Thanh Thúy (VN)  
(74) **CÔNG TY TNHH SỞ HỮU TRÍ TUỆ SETHACO (SETHACO IP CO.,LTD)**  
(55)



1.1



1.2



1.3



1.4



1.5



1.6



1.7

**CÔNG BÁO SỞ HỮU CÔNG NGHIỆP SỐ 412 TẬP A – QUYỀN 2 (07.2022)**

- (11) **44906**  
(21) 3-2021-03252 (28) 1  
(54) **THANH NHÔM ĐỊNH HÌNH** (51) **25-01**  
(22) 17/12/2021 (43) 25/07/2022  
(73) **CÔNG TY TNHH HOPO QUỐC TẾ (VN)**  
Số nhà 177, tổ 5, đường Nguyễn Ngọc Vũ, phường Trung Hoà, quận Cầu Giấy,  
thành phố Hà Nội  
(72) Châu Đình An (VN)  
(74) Công ty cổ phần Sở hữu trí tuệ BROSS và Cộng sự (BROSS & PARTNERS., JSC)  
(55)

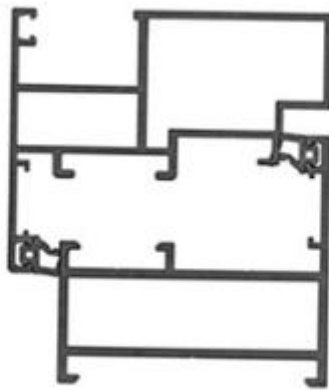

1.1

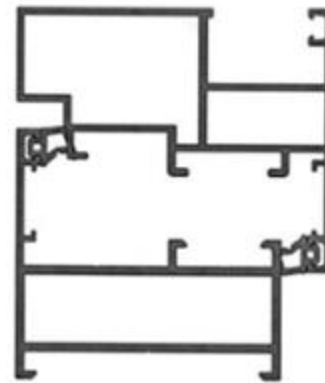

1.2



1.3



1.4



1.5



1.6

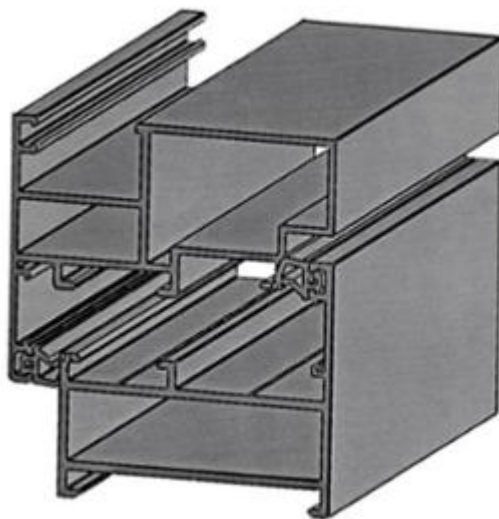

1.7

**CÔNG BÁO SỞ HỮU CÔNG NGHIỆP SỐ 412 TẬP A – QUYỀN 2 (07.2022)**

- (11) **44907**  
(21) 3-2021-03259 (28) 5  
(54) **NHÃN SẢN PHẨM** (51) **19-08**  
(22) 20/12/2021 (43) 25/07/2022  
(73) **CÔNG TY CỔ PHẦN D-SHINING (VN)**  
7C Nguyễn Ngọc Phương, phường 19, quận Bình Thạnh, thành phố Hồ Chí Minh  
(72) Nguyễn Thái Dương (VN)  
(74) Văn phòng Luật sư D và T (D & T LAW OFFICE)  
(55)



1.1



1.2



2.1



2.2





3.1



3.2



4.1



4.2



5.1



5.2



**CÔNG BÁO SỞ HỮU CÔNG NGHIỆP SỐ 412 TẬP A – QUYỀN 2 (07.2022)**

(11) **44908**

(21) 3-2021-03270

(28) 1

(54) **CHAI**

(51) **09-01**

(22) 20/12/2021

(43) 25/07/2022

(73) **CÔNG TY TNHH CÁNH ĐỒNG VÀNG (VN)**

57-59 đường số 3, khu phố 8, phường Trường Thọ, thành phố Thủ Đức, thành phố Hồ Chí Minh

(72) Lê Kim Khánh (VN)

(74) Công ty TNHH Sở hữu trí tuệ INVENTIO (INVENTIO CO.,LTD)

(55)



1.1

1.2

1.3

1.4

1.5

**CÔNG BÁO SỞ HỮU CÔNG NGHIỆP SỐ 412 TẬP A – QUYỀN 2 (07.2022)**

- (11) **44909**  
(21) 3-2021-03285 (28) 1  
(54) **NHÃN SẢN PHẨM** (51) **19-08**  
(22) 22/12/2021 (43) 25/07/2022  
(73) **CÔNG TY CỔ PHẦN D-SHINING (VN)**  
7C Nguyễn Ngọc Phương, phường 19, quận Bình Thạnh, thành phố Hồ Chí Minh  
(72) Nguyễn Thái Dương (VN)  
(74) Văn phòng Luật sư D và T (D & T LAW OFFICE)  
(55)



1.1



1.2

**CÔNG BÁO SỞ HỮU CÔNG NGHIỆP SỐ 412 TẬP A – QUYỀN 2 (07.2022)**

- (11) **44910**  
(21) 3-2021-03286 (28) 1  
(54) **NHÃN SẢN PHẨM** (51) **19-08**  
(22) 22/12/2021 (43) 25/07/2022  
(73) **CÔNG TY CỔ PHẦN D-SHINING (VN)**  
7C Nguyễn Ngọc Phương, phường 19, quận Bình Thạnh, thành phố Hồ Chí Minh  
(72) Nguyễn Thái Dương (VN)  
(74) Văn phòng Luật sư D và T (D & T LAW OFFICE)  
(55)



1.1



1.2

**CÔNG BÁO SỞ HỮU CÔNG NGHIỆP SỐ 412 TẬP A – QUYỀN 2 (07.2022)**

- (11) **44911**  
(21) 3-2021-03287 (28) 1  
(54) **NHÃN SẢN PHẨM** (51) **19-08**  
(22) 22/12/2021 (43) 25/07/2022  
(73) **CÔNG TY CỔ PHẦN D-SHINING (VN)**  
7C Nguyễn Ngọc Phương, phường 19, quận Bình Thạnh, thành phố Hồ Chí Minh  
(72) Nguyễn Thái Dương (VN)  
(74) Văn phòng Luật sư D và T (D & T LAW OFFICE)  
(55)



1.1



1.2

**CÔNG BÁO SỞ HỮU CÔNG NGHIỆP SỐ 412 TẬP A – QUYỀN 2 (07.2022)**

- (11) **44912**  
(21) 3-2022-00084 (28) 1  
(54) **TRẠM SẠC ĐIỆN CHO PHƯƠNG TIỆN GIAO THÔNG ĐIỆN** (51) **13-02**  
(22) 12/01/2022 (43) 25/07/2022  
(30) 30-2021-0061029 17/12/2021 KR;  
(73) **DAEYOUNG CHAEVI CO., LTD.** (KR)  
25, Techno sunhwan-ro 7-gil, Yuga-eup, Dalseong-gun, 43023 Daegu, Republic of Korea  
(72) Min Kyo JUNG (KR)  
(74) Văn phòng Luật sư Ân Nam (ANNAM IP & LAW)  
(55)



1.1

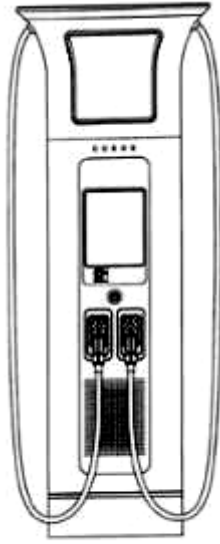

1.2

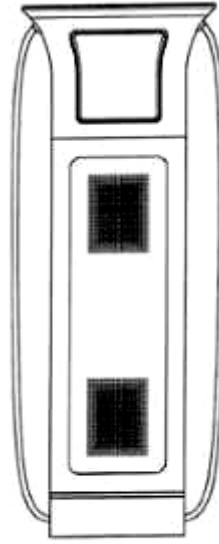

1.3

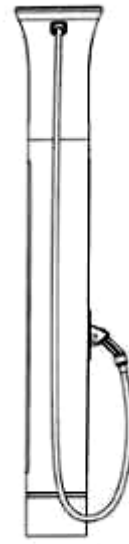

1.4



1.5

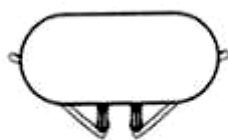

1.6



1.7

**CÔNG BÁO SỞ HỮU CÔNG NGHIỆP SỐ 412 TẬP A – QUYỀN 2 (07.2022)**

- (11) **44913**  
(21) 3-2022-00085 (28) 1  
(54) **TRẠM SẠC ĐIỆN** (51) **13-02**  
(22) 12/01/2022 (43) 25/07/2022  
(30) 30-2021-0061028 17/12/2021 KR;  
(73) **DAEYOUNG CHAEVI CO., LTD.** (KR)  
25, Techno sunhwan-ro 7-gil, Yuga-eup, Dalseong-gun, 43023 Daegu, Republic of Korea  
(72) Min Kyo JUNG (KR)  
(74) Văn phòng Luật sư Ân Nam (ANNAM IP & LAW)  
(55)

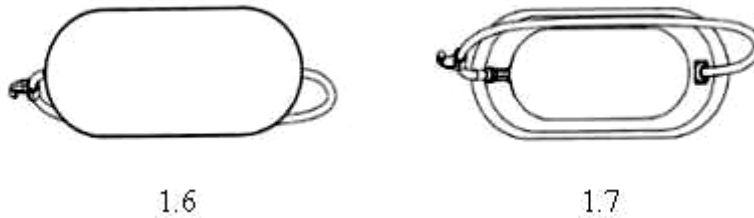
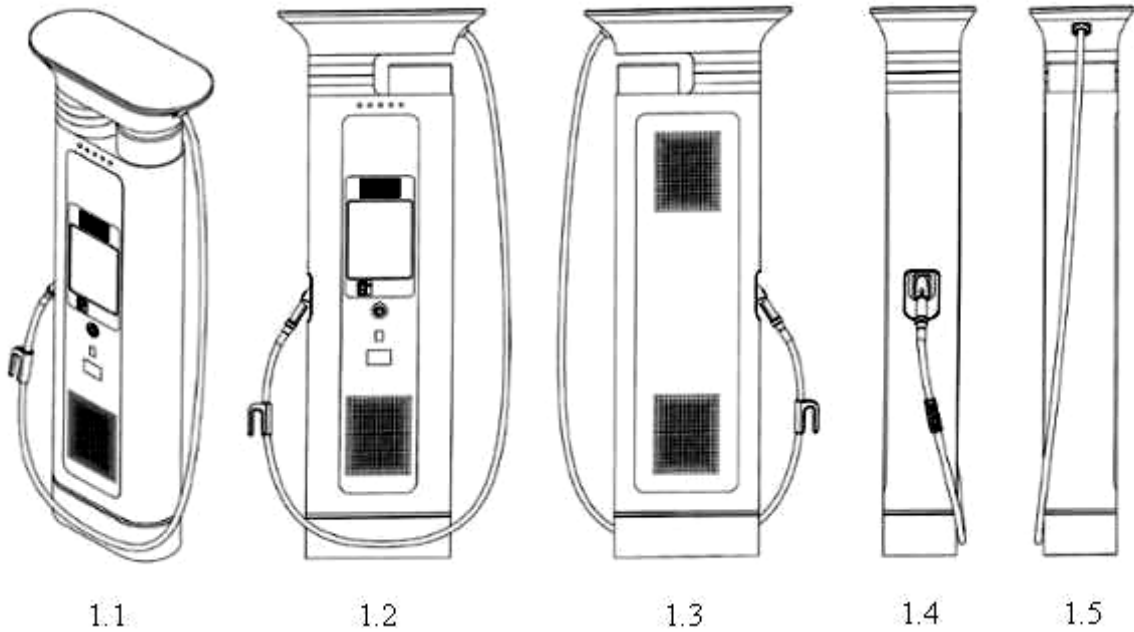

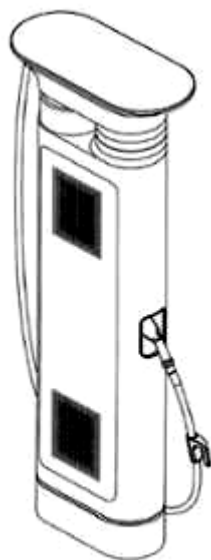

1.8

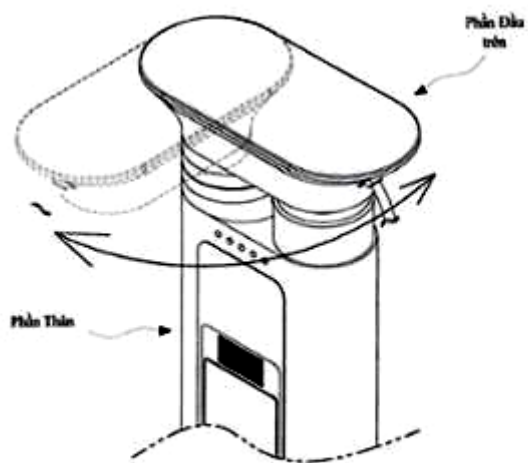

1.9

(11) **44914**

(21) 3-2022-00149

(54) **KHỐI ĐỒ CHƠI GIẢI ĐỒ**

(22) 18/01/2022

(73) **CÔNG TY CỔ PHẦN HANOIMINX (VN)**

41-C7, Tập thể Viện Địa Kỹ thuật, ngõ 106 Hoàng Quốc Việt, phường Cổ Nhuế 1, quận Bắc Từ Liêm, thành phố Hà Nội

(72) Mai Phú Sơn (VN)

(55)

(28) 1

(51) **21-01**

(43) 25/07/2022



1.1



1.2



1.3



1.4



1.5



1.6



**CÔNG BÁO SỞ HỮU CÔNG NGHIỆP SỐ 412 TẬP A – QUYỀN 2 (07.2022)**

- (11) **44915**  
(21) 3-2022-00205 (28) 1  
(54) **BAO BÌ** (51) **09-05**  
(22) 25/01/2022 (43) 25/07/2022  
(73) **CÔNG TY TNHH SUMI&SUKI (VN)**  
Lô 90-92 đường Trần Nam Trung, phường Hòa Xuân, quận Cẩm Lệ, thành phố Đà Nẵng  
(72) Lê Văn Đông (VN)  
(55)



1.1



1.2

**CÔNG BÁO SỞ HỮU CÔNG NGHIỆP SỐ 412 TẬP A – QUYỀN 2 (07.2022)**

- (11) **44916**  
(21) 3-2022-00206 (28) 1  
(54) **BAO BÌ** (51) **09-05**  
(22) 25/01/2022 (43) 25/07/2022  
(73) **CÔNG TY TNHH SUMI&SUKI (VN)**  
Lô 90-92 đường Trần Nam Trung, phường Hòa Xuân, quận Cẩm Lệ, thành phố Đà Nẵng  
(72) Lê Văn Đông (VN)  
(55)



1.1



1.2

**CÔNG BÁO SỞ HỮU CÔNG NGHIỆP SỐ 412 TẬP A – QUYỀN 2 (07.2022)**

- (11) **44917**  
(21) 3-2022-00273 (28) 1  
(54) **XE SCUTO** (51) **12-11**  
(22) 14/02/2022 (43) 25/07/2022  
(30) 2021-017651 17/08/2021 JP;  
(73) **HONDA MOTOR CO., LTD. (JP)**  
1-1, Minami-Aoyama 2-Chome, Minato-ku, Tokyo, 107-8556 Japan  
(72) 1. FUMIYA ISONO (JP)  
2. KEISUKE ARAI (JP)  
3. DAIKI GOTO (JP)  
4. HIROKI YOSHITOMI (JP)  
(74) Công ty Luật TNHH Phạm và Liên danh (PHAM & ASSOCIATES)  
(55)



1.1



1.2



1.3



1.4



1.5



1.6



1.7



1.8



1.9

- (11) **44918**  
(21) 3-2022-00288 (28) 1  
(54) **TẮM ỐP PHÍA TRƯỚC XE SCUTO** (51) **12-16**  
(22) 17/02/2022 (43) 25/07/2022  
(30) 2021-017966 20/08/2021 JP;  
(73) **HONDA MOTOR CO., LTD. (JP)**  
1-1, Minami-Aoyama 2-chome, Minato-ku, Tokyo, 107-8556 Japan  
(72) 1. TAKASHI WATANABE (JP)  
2. WORAWIT CHAWALITNIMITKUL (TH)  
(74) Công ty Luật TNHH Phạm và Liên danh (PHAM & ASSOCIATES)  
(55)



1.1



1.2



1.3



1.4



1.5



1.6



1.7



1.8



1.9



1.10



1.11



**CÔNG BÁO SỞ HỮU CÔNG NGHIỆP SỐ 412 TẬP A – QUYỀN 2 (07.2022)**

- (11) **44919**  
(21) 3-2022-00289 (28) 1  
(54) **CỤM ĐÈN ĐẦU XE SCUTO** (51) **26-06**  
(22) 17/02/2022 (43) 25/07/2022  
(30) 2021-017967 20/08/2021 JP;  
(73) **HONDA MOTOR CO., LTD. (JP)**  
1-1, Minami-Aoyama 2-chome, Minato-ku, Tokyo, 107-8556 Japan  
(72) 1. AYUMU TSUJI (JP)  
2. TAKASHI WATANABE (JP)  
3. WORAWIT CHAWALITNIMITKUL (TH)  
(74) Công ty Luật TNHH Phạm và Liên danh (PHAM & ASSOCIATES)  
(55)



1.1



1.2



1.3



1.4



1.5



1.6



1.7



1.8



1.9



1.10



1.11



- (11) **44920**  
(21) 3-2022-00290 (28) 1  
(54) **TẮM ỐP PHÍA SAU XE SCUTO** (51) **12-16**  
(22) 17/02/2022 (43) 25/07/2022  
(30) 2021-017968 20/08/2021 JP;  
(73) **HONDA MOTOR CO., LTD. (JP)**  
1-1, Minami-Aoyama 2-chome, Minato-ku, Tokyo, 107-8556 Japan  
(72) 1. KAZUYUKI TACHIBANA (JP)  
2. WORAWIT CHAWALITNIMITKUL (TH)  
(74) Công ty Luật TNHH Phạm và Liên danh (PHAM & ASSOCIATES)  
(55)



1.1



1.2



1.3



1.4



1.5



1.6



1.7



1.8



1.9



1.10



1.11

**CÔNG BÁO SỞ HỮU CÔNG NGHIỆP SỐ 412 TẬP A – QUYỀN 2 (07.2022)**

- (11) **44921**  
(21) 3-2022-00297 (28) 1  
(54) **XE Ô TÔ ĐỒ CHƠI** (51) **21-01**  
(22) 17/02/2022 (43) 25/07/2022  
(73) **NGUYỄN XUÂN HÙNG (VN)**  
T2804 Tổ hợp nhà đa năng 28 tầng Làng Quốc tế Thăng Long, phường Dịch Vọng,  
quận Cầu Giấy, thành phố Hà Nội  
(72) Nguyễn Xuân Hùng (VN)  
(74) Công ty Luật TNHH MINH KHUÊ (MK LAW FIRM)  
(55)



1.1



1.2



1.3



1.4



1.5

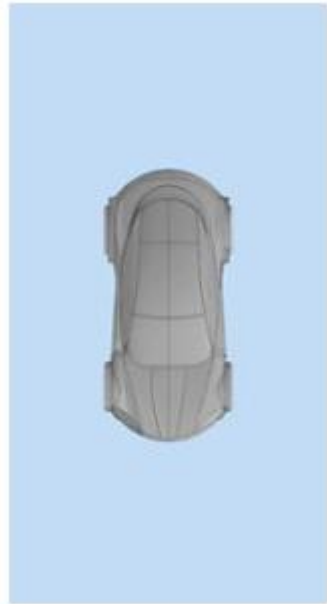

1.6



1.7

- (11) **44922**  
(21) 3-2022-00312 (28) 1  
(54) **KÍNH MẮT** (51) **16-06**  
(22) 22/02/2022 (43) 25/07/2022  
(30) 202230031240.3 18/01/2022 CN;  
(73) **SHENZHEN SHOKZ CO., LTD.** (CN)  
Floors 1-4, Factory Building 26, Shancheng Industrial Park, Shiyan Street, Bao'an District, Shenzhen, Guangdong, China  
(72) 1. ZETENG YAN (CN)  
2. LEI ZHONG (CN)  
3. ZHI CAI (CN)  
4. SUNJIE HUANG (CN)  
5. HAOFENG ZHANG (CN)  
6. XIN FU (CN)  
7. ZHIQING LIU (CN)  
(74) Công ty TNHH Trường Xuân (AGELESS CO.,LTD.)  
(55)

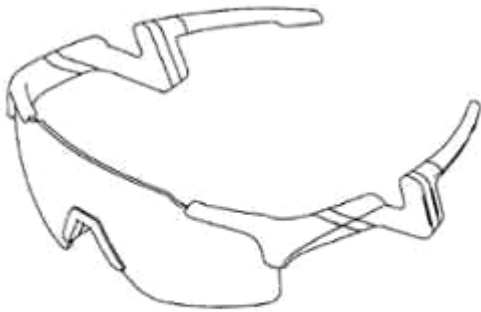

1.1



1.2



1.3



1.4



1.5



1.6



1.7

**CÔNG BÁO SỞ HỮU CÔNG NGHIỆP SỐ 412 TẬP A – QUYỀN 2 (07.2022)**

- (11) **44923**  
(21) 3-2022-00321 (28) 1  
(54) **THÙNG ĐỰNG** (51) **09-03**  
(22) 23/02/2022 (43) 25/07/2022  
(73) **CÔNG TY CỔ PHẦN THỦY SẢN VIỆT ÚC (VN)**  
KM 1595, QL1A, xã Vĩnh Tân, huyện Tuy Phong, tỉnh Bình Thuận  
(72) NGUYỄN DUY NHÂN (VN)  
(74) Công ty TNHH Tư vấn ALIATLEGAL (ALIAT LEGAL)  
(55)



1.1



1.2

**CÔNG BÁO SỞ HỮU CÔNG NGHIỆP SỐ 412 TẬP A – QUYỀN 2 (07.2022)**

- (11) **44924**  
(21) 3-2022-00390 (28) 2  
(54) **ĐỒ CHỨA** (51) **09-01**  
(22) 28/02/2022 (43) 25/07/2022  
(30) 29/806,332 02/09/2021 US;  
(73) **MERRILEE KICK (US)**  
2114 McDaniel Drive, Carrollton, Texas 75006, United States of America  
(72) Merrilee Kick (US)  
(74) Công ty Luật TNHH ROUSE Việt Nam (ROUSE LAW CO.,LTD)  
(55)



1.1

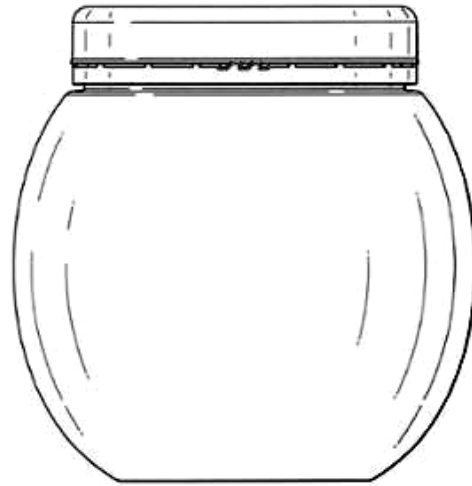

1.2

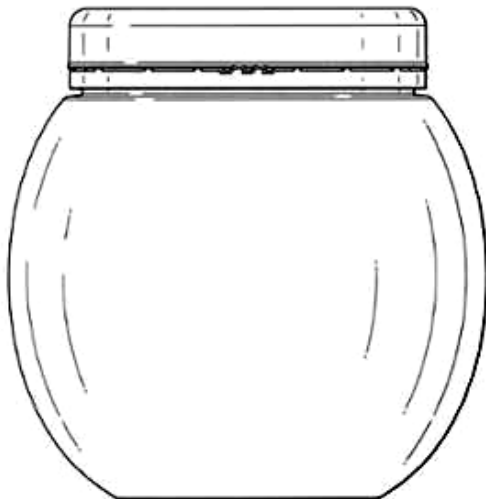

1.3

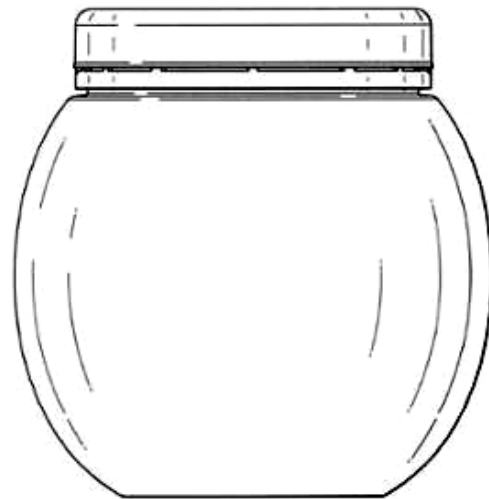

1.4



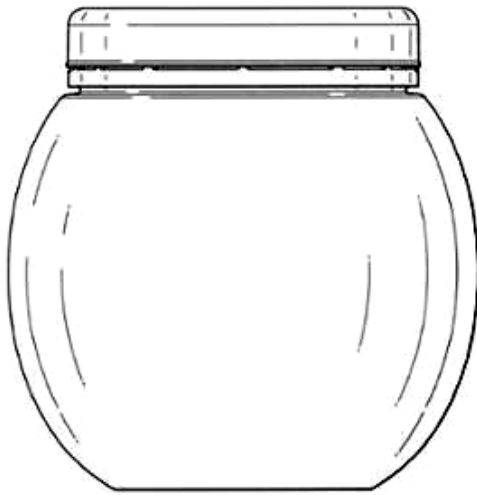

1.5

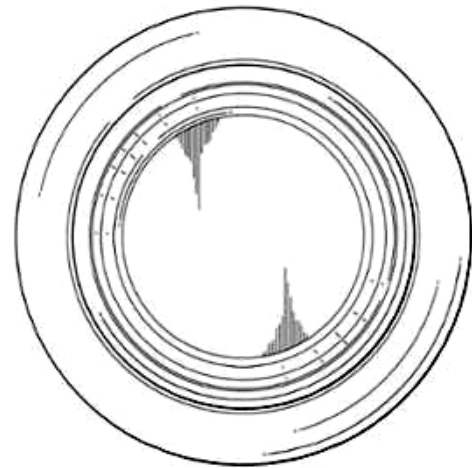

1.6

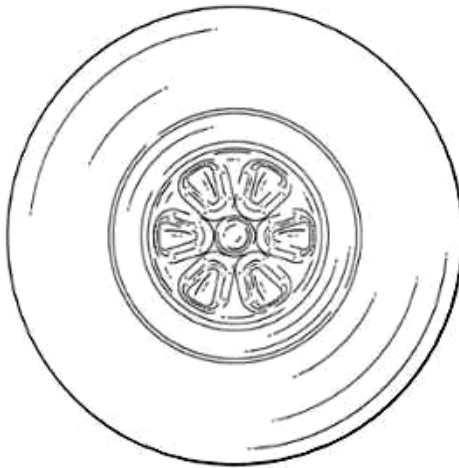

1.7



1.8



2.1



2.2



2.3



2.4



2.5

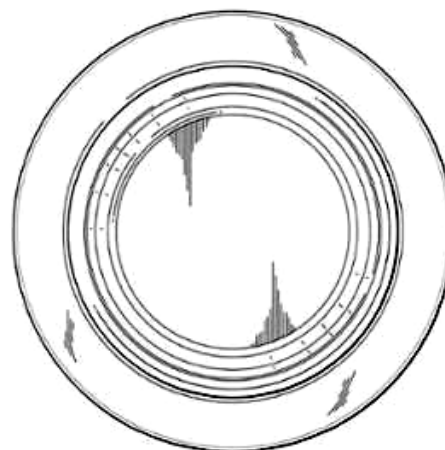

2.6

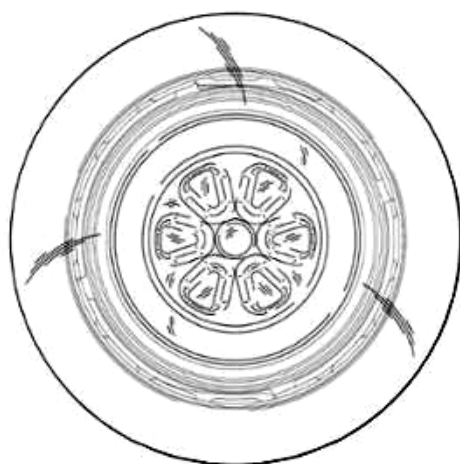

2.7



2.8

**CÔNG BÁO SỞ HỮU CÔNG NGHIỆP SỐ 412 TẬP A – QUYỀN 2 (07.2022)**

- (11) **44925**  
(21) 3-2022-00393 (28) 1  
(54) **XE MÔ TÔ ĐIỆN** (51) **12-11**  
(22) 01/03/2022 (43) 25/07/2022  
(73) **CÔNG TY CỔ PHẦN XE ĐIỆN PEGA LTT (VN)**  
Tầng 8, số 1 Thái Hà, phường Trung Liệt, quận Đống Đa, thành phố Hà Nội  
(72) Đoàn Ngọc Linh (VN)  
(55)



1.1



1.2



1.3



1.4



1.5



1.6



1.7



1.8



1.9

**CÔNG BÁO SỞ HỮU CÔNG NGHIỆP SỐ 412 TẬP A – QUYỀN 2 (07.2022)**

- (11) **44926**  
(21) 3-2022-00441 (28) 1  
(54) **ĐÈN XE MÁY** (51) **26-06**  
(22) 11/03/2022 (43) 25/07/2022  
(73) **CÔNG TY TNHH SẢN XUẤT THƯƠNG MẠI DỊCH VỤ ĐÀI PHONG (VN)**  
Số 382, đường số 1, phường Bình Trị Đông B, quận Bình Tân, thành phố Hồ Chí Minh  
(72) Hà Quảng Chánh (VN)  
(74) Công ty Cổ phần PHANLAW VIETNAM (PHANLAW VIETNAM JSC)  
(55)



1.1



1.2

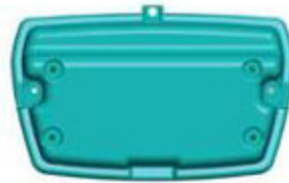

1.3



1.4



1.5



1.6



1.7

**CÔNG BÁO SỞ HỮU CÔNG NGHIỆP SỐ 412 TẬP A – QUYỀN 2 (07.2022)**

- (11) **44927**  
(21) 3-2022-00442 (28) 4  
(54) **CÔNG TẮC** (51) **13-03**  
(22) 11/03/2022 (43) 25/07/2022  
(30) 202130693570.4 22/10/2021 CN;  
(73) **SCHNEIDER ELECTRIC (AUSTRALIA) PTY LTD (AU)**  
78 Waterloo Road, Macquarie Park, Nsw 2113, Australia  
(72) 1. MA, ZHEN (CN)  
2. MENG, HUANBIN (CN)  
3. ZHANG, DAHAI (CN)  
(74) Công ty TNHH Trường Xuân (AGELESS CO.,LTD.)  
(55)

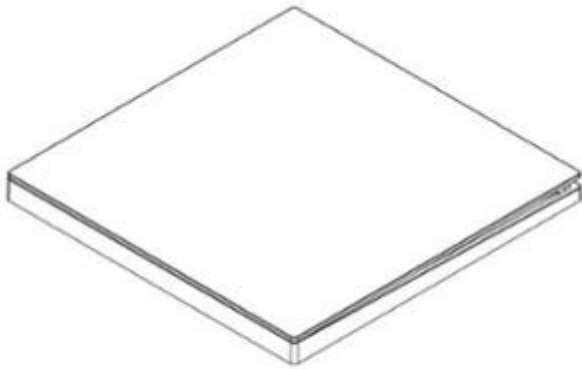

1.1



1.2



1.3

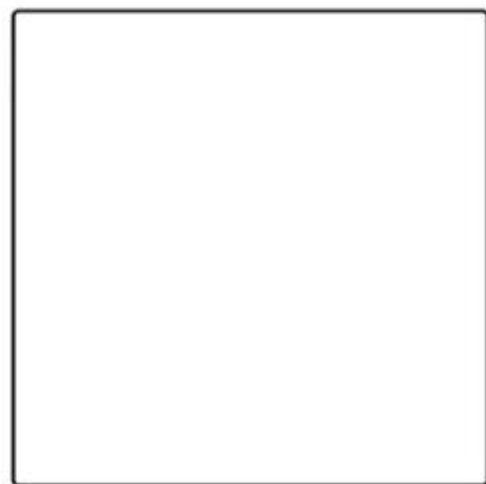

1.4

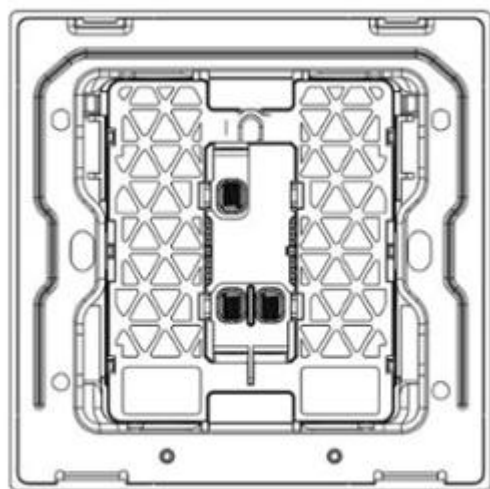

1.5

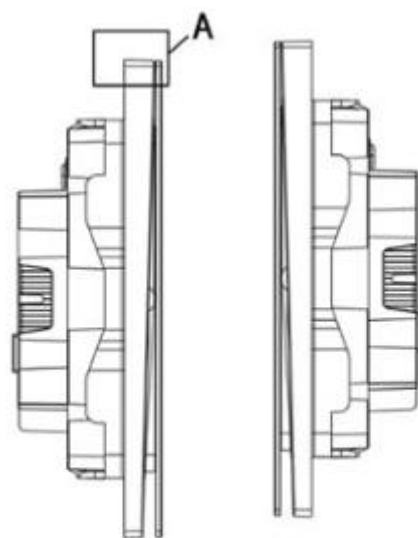

1.6

1.7

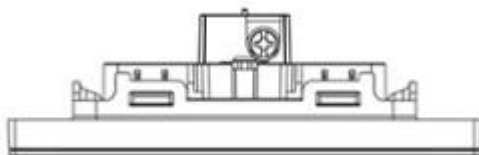

1.8

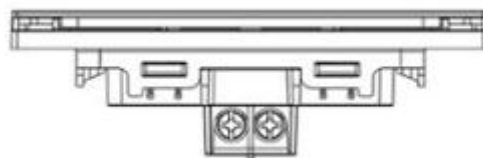

1.9

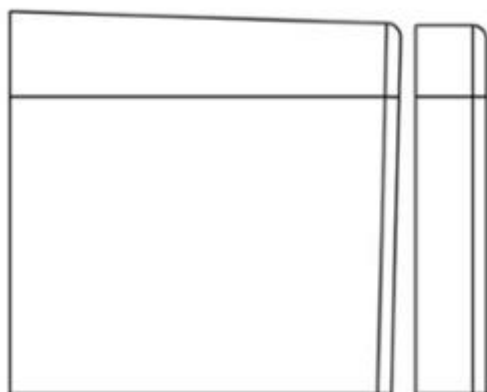

1.10

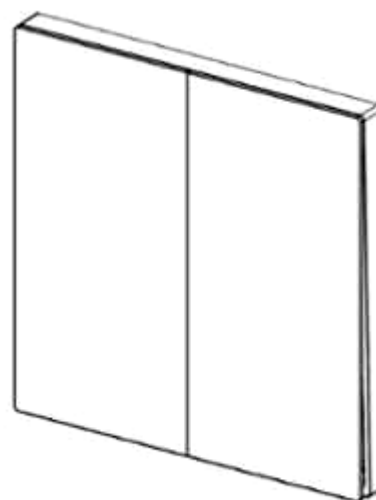

2.1

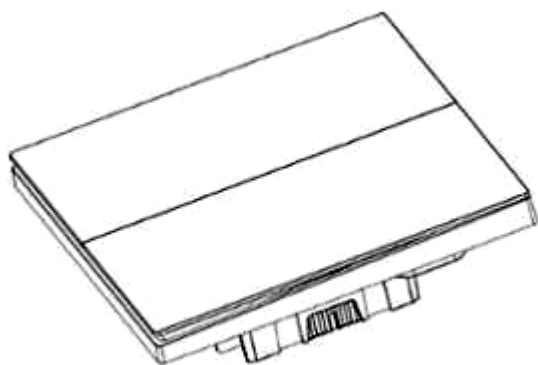

2.2

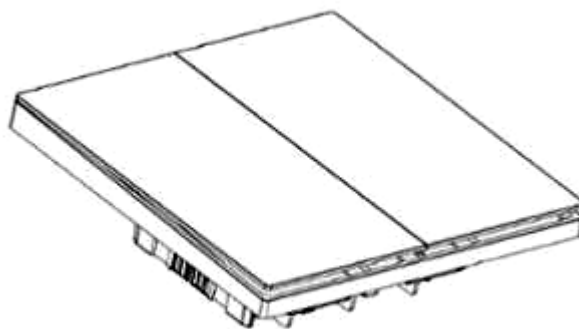

2.3

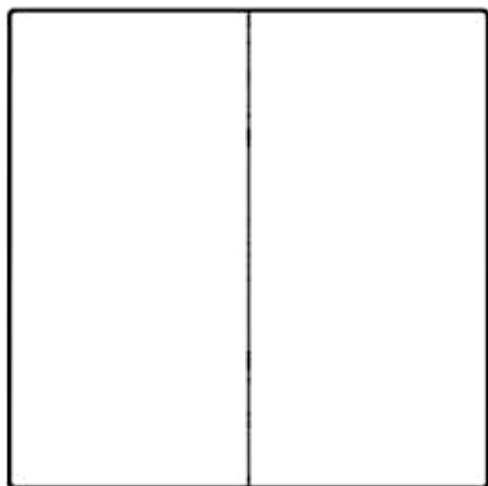

2.4

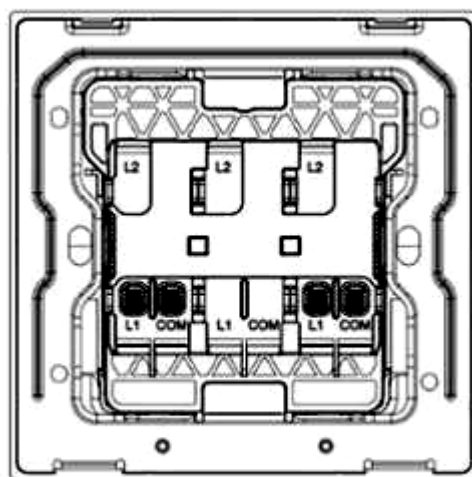

2.5

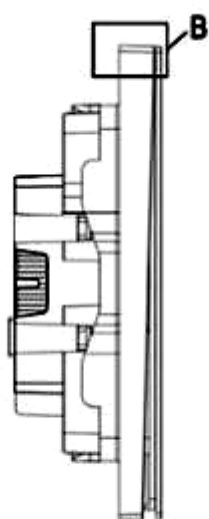

2.6

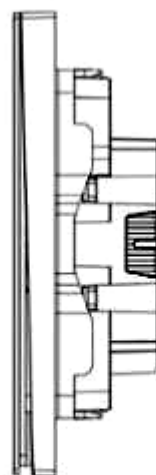

2.7



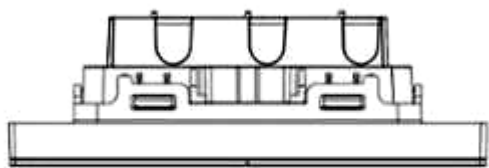

2.8

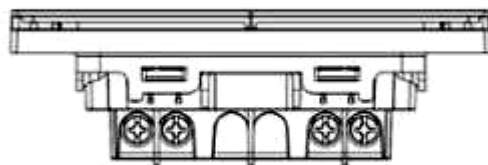

2.9

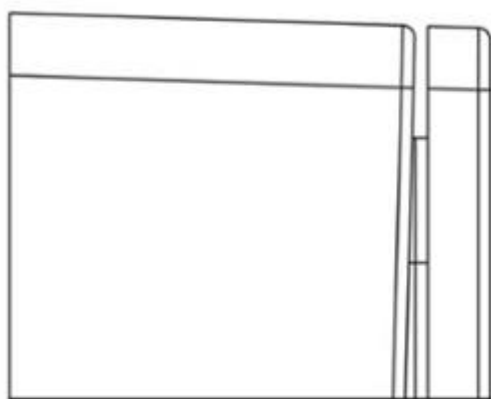

2.10

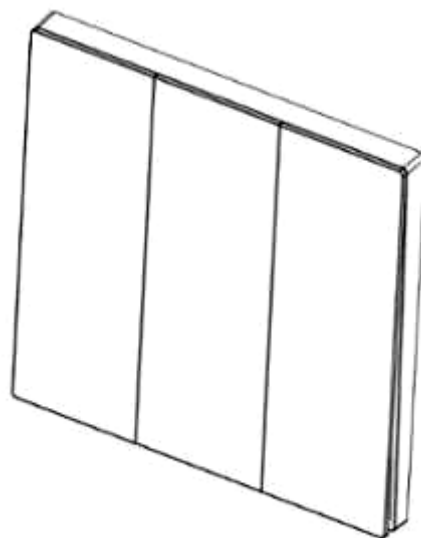

3.1

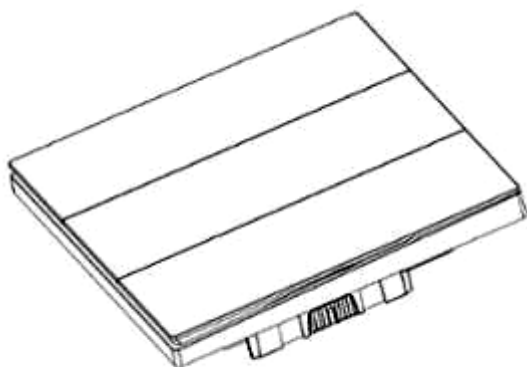

3.2

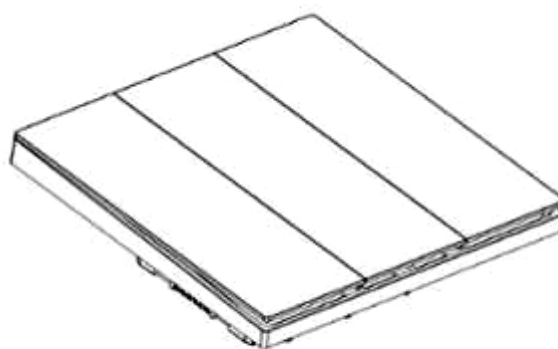

3.3

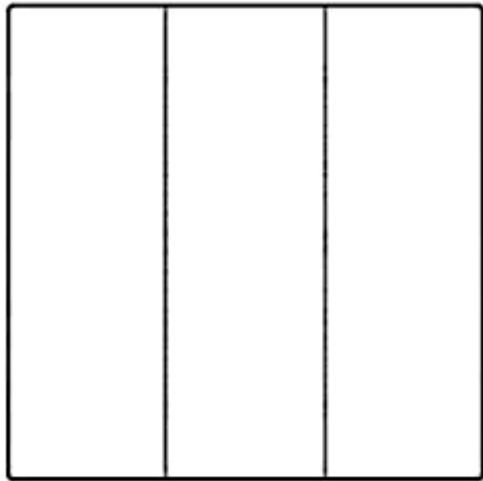

3.4

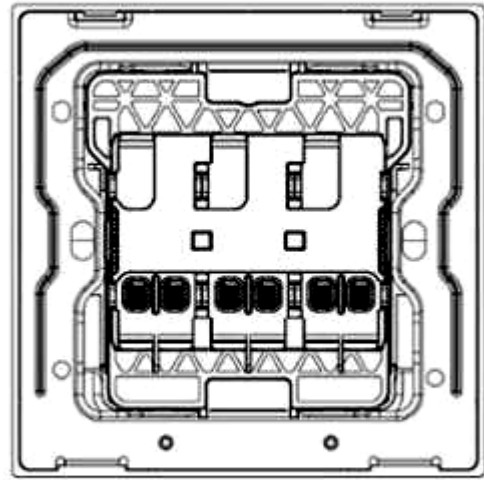

3.5

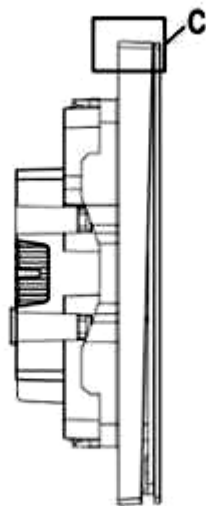

3.6

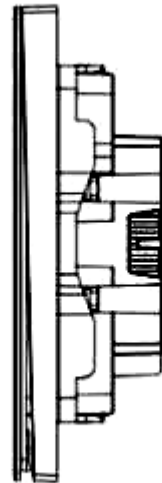

3.7

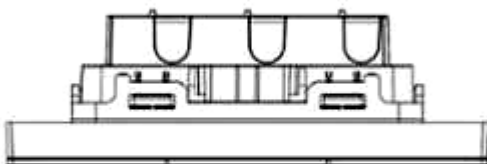

3.8

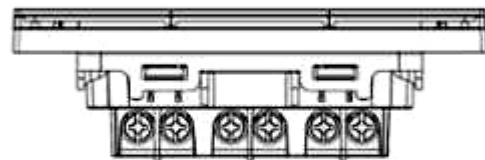

3.9

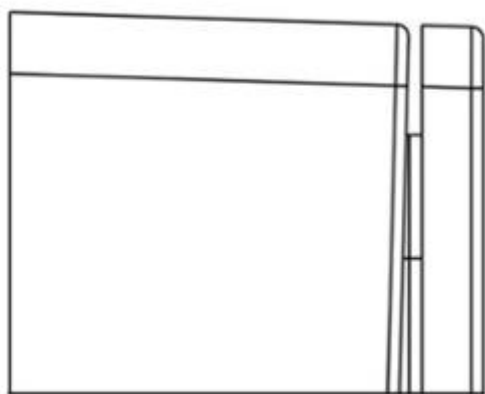

3.10

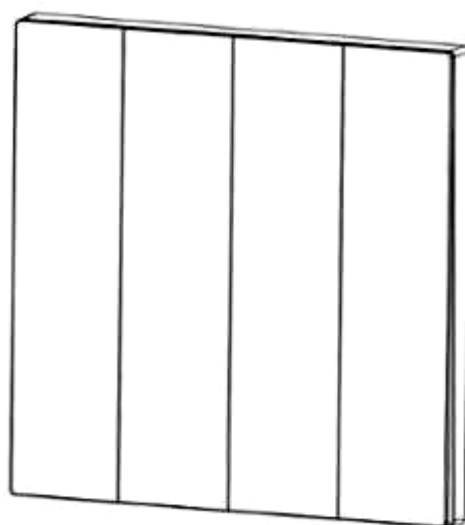

4.1

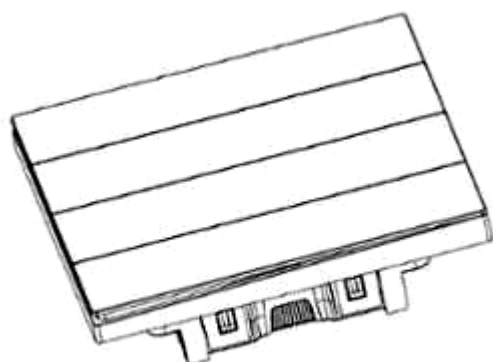

4.2

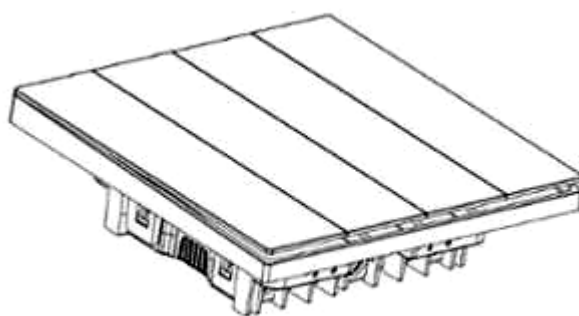

4.3

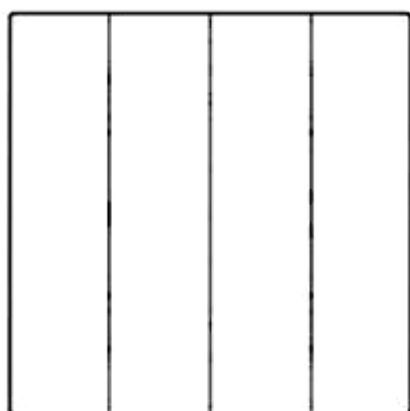

4.4

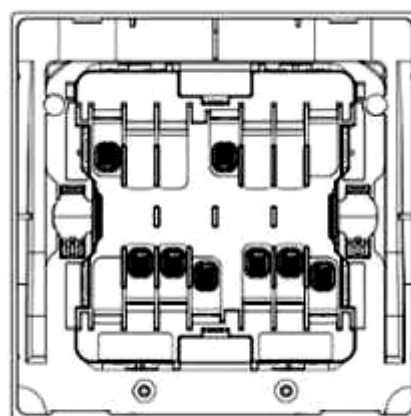

4.5

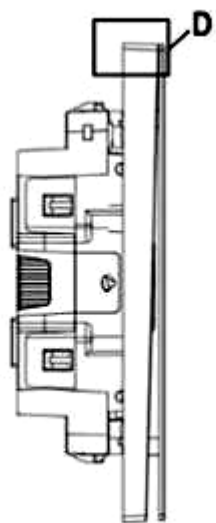

4.6

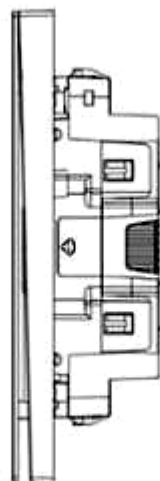

4.7

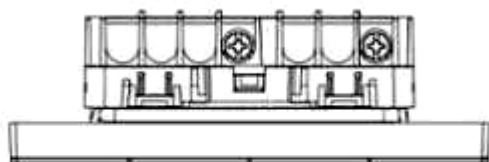

4.8

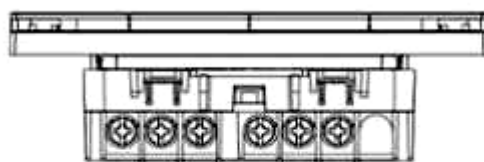

4.9

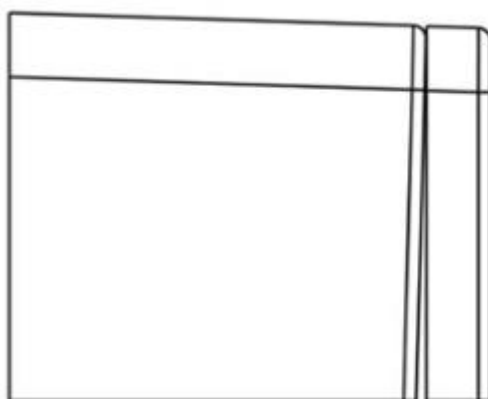

4.10

- (11) **44928**  
(21) 3-2022-00443 (28) 2  
(54) **CÔNG TẮC** (51) **13-03**  
(22) 11/03/2022 (43) 25/07/2022  
(30) 202130745681.5 12/11/2021 CN;  
(73) **SCHNEIDER ELECTRIC (AUSTRALIA) PTY LTD (AU)**  
78 Waterloo Road, Macquarie Park, Nsw 2113, Australia  
(72) 1. LI, YUN (CN)  
2. MA, ZHEN (CN)  
(74) Công ty TNHH Trường Xuân (AGELESS CO.,LTD.)  
(55)

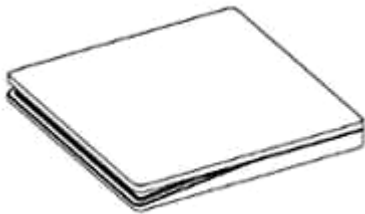

1.1

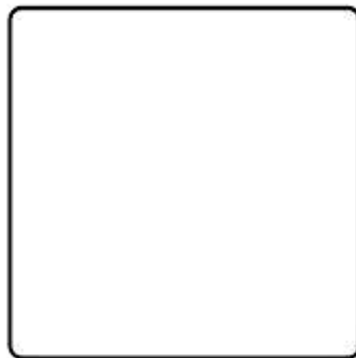

1.2

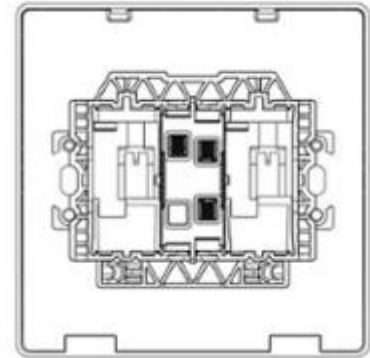

1.3

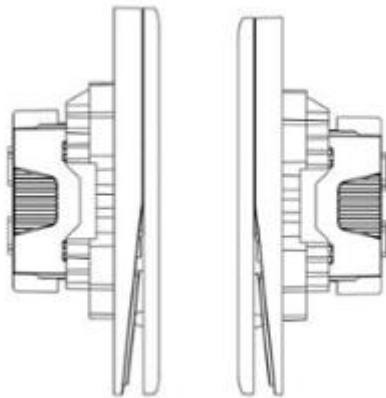

1.4

1.5

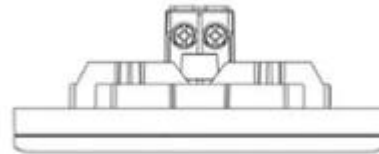

1.6

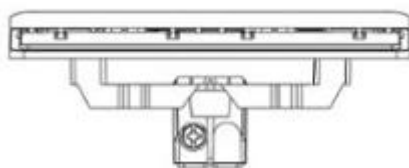

1.7



1.8

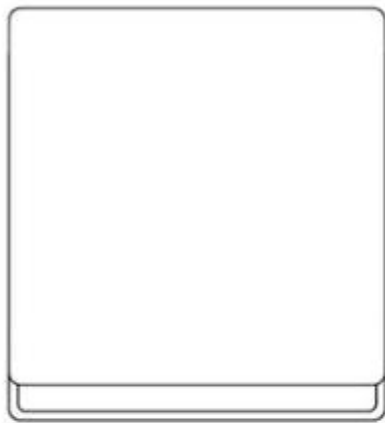

1.9

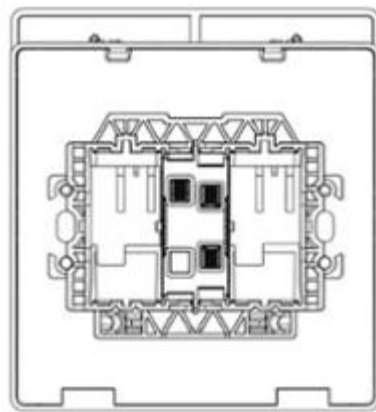

1.10

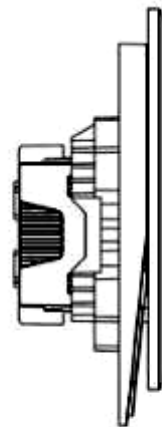

1.11



1.12

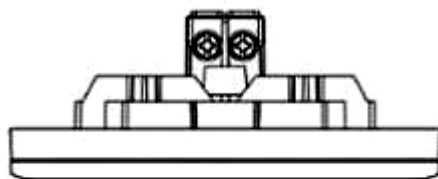

1.13

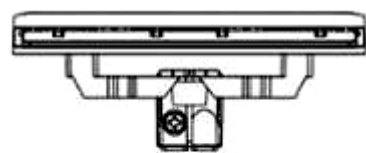

1.14

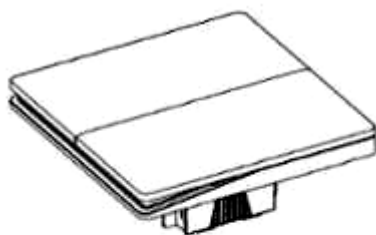

2.1

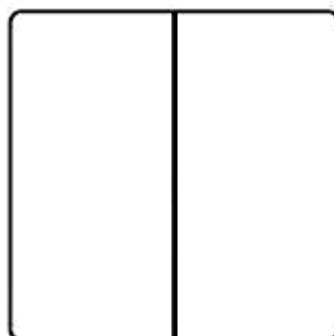

2.2

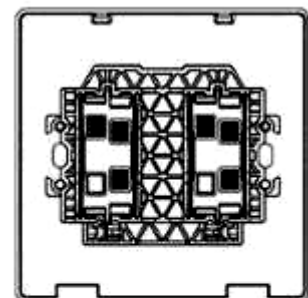

2.3

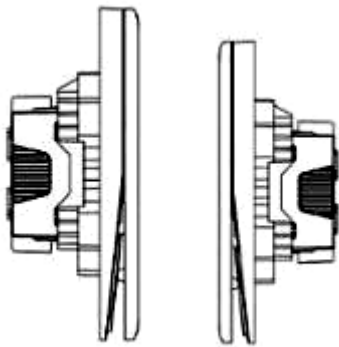

2.4

2.5

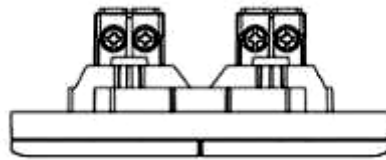

2.6

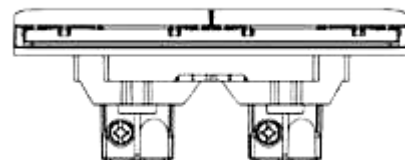

2.7

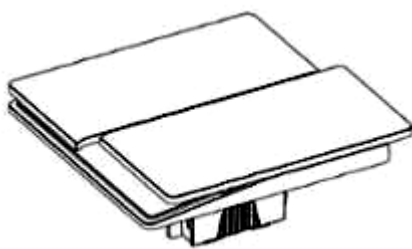

2.8

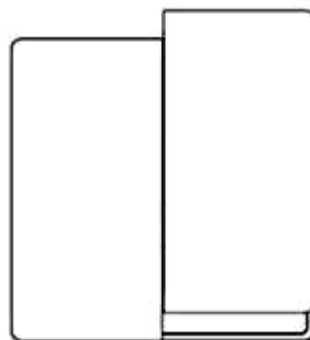

2.9

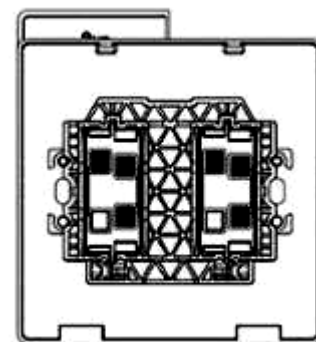

2.10

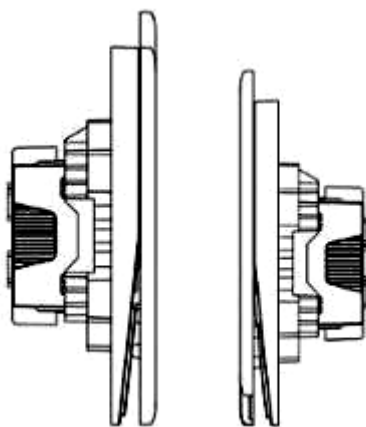

2.11

2.12

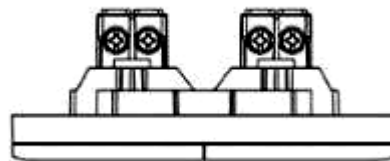

2.13

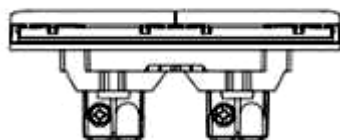

2.14



2.15

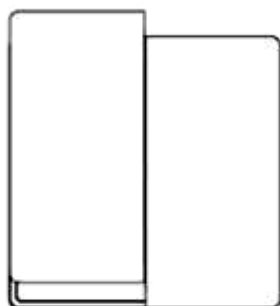

2.16

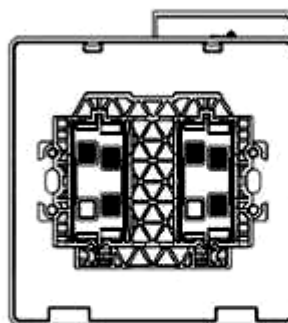

2.17

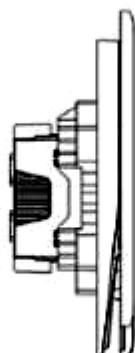

2.18

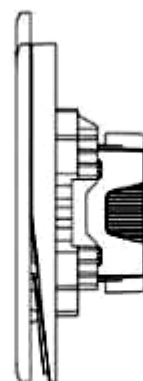

2.19

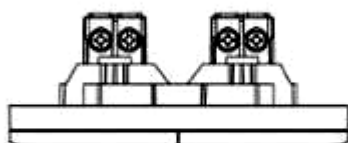

2.20

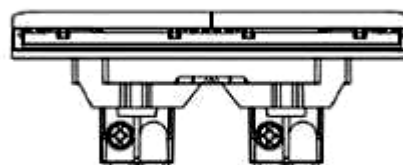

2.21



**CÔNG BÁO SỞ HỮU CÔNG NGHIỆP SỐ 412 TẬP A – QUYỀN 2 (07.2022)**

- (11) **44929**  
(21) 3-2022-00481 (28) 1  
(54) **KHÓA** (51) **02-07**  
(22) 18/03/2022 (43) 25/07/2022  
(73) **WOJIN PLASTIC CO., LTD (KR)**  
45, Paryasandan-ro, Jinjeop-eup, Namyangju-si, Gyeonggi-do 12017 Republic of Korea  
(72) 1. JISOOK PAIK (KR)  
2. NAN HEE PAIK (KR)  
3. JI HYE PAIK (KR)  
4. JI WON SON (KR)  
(74) Công ty TNHH Trường Xuân (AGELESS CO.,LTD.)  
(55)

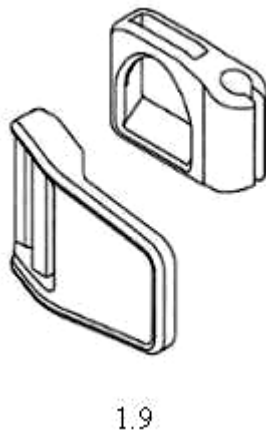
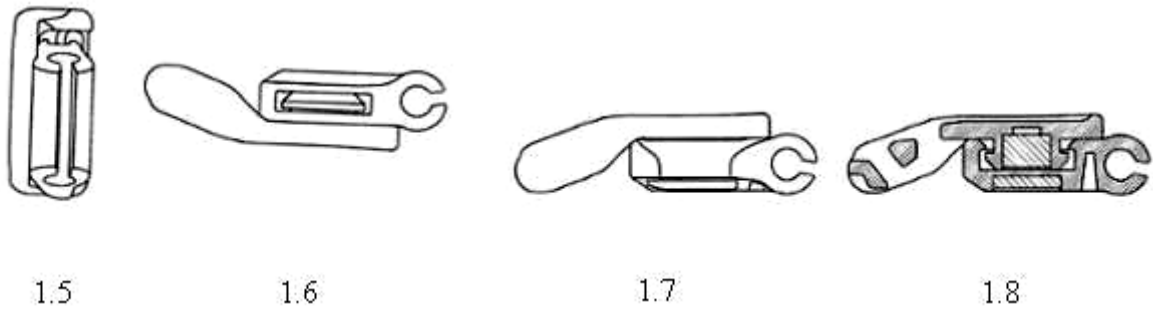
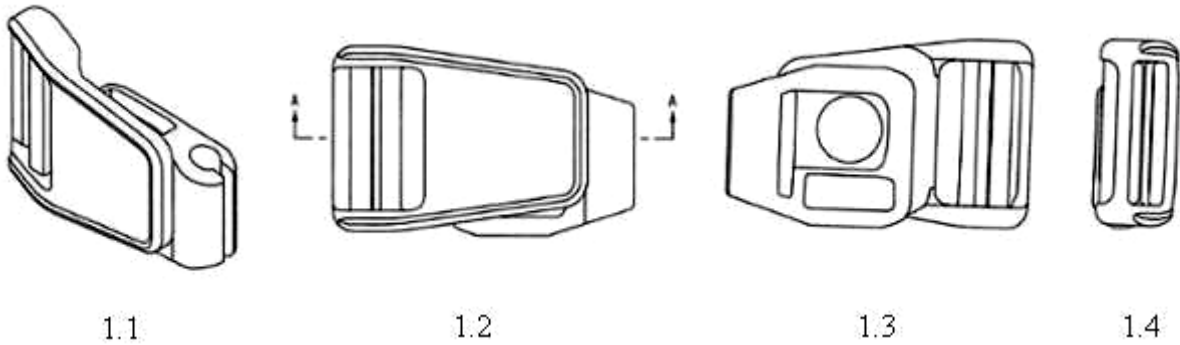

**CÔNG BÁO SỞ HỮU CÔNG NGHIỆP SỐ 412 TẬP A – QUYỀN 2 (07.2022)**

- (11) **44930**  
(21) 3-2022-00491 (28) 1  
(54) **BÃY CHUỘT** (51) **22-06**  
(22) 21/03/2022 (43) 25/07/2022  
(73) **CESCO CO., LTD. (KR)**  
#4, (Sangil-dong) 46, Sangil-ro 10-gil, Gangdong-gu, Seoul, Republic of Korea  
(72) CHYUN, Chan Hyuk (KR)  
(74) Công ty Luật TNHH quốc tế BMVN (BMVN INTERNATIONAL LLC)  
(55)

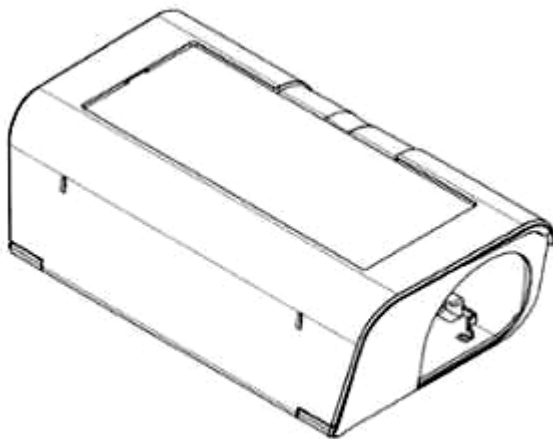

1.1



1.2

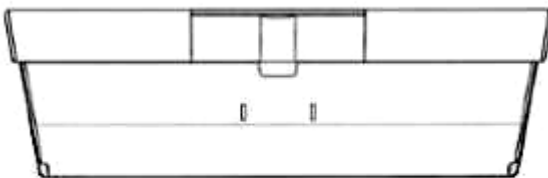

1.3



1.4

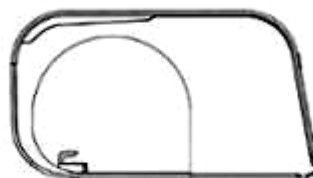

1.5

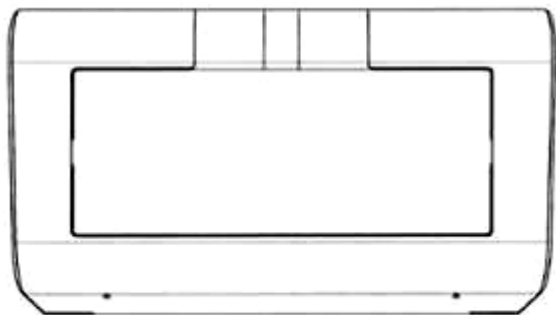

1.6



1.7

**CÔNG BÁO SỞ HỮU CÔNG NGHIỆP SỐ 412 TẬP A – QUYỀN 2 (07.2022)**

- (11) **44931**  
(21) 3-2022-00499 (28) 1  
(54) **MẶT ĐỒNG HỒ** (51) **10-07**  
(22) 22/03/2022 (43) 25/07/2022  
(30) 202130632287.0 24/09/2021 CN;  
(73) **HUAWEI TECHNOLOGIES CO., LTD. (CN)**  
Huawei Administration Building, Bantian, Longgang District, Shenzhen,  
Guangdong 518129, P. R. China  
(72) ZHANG, Letian (CN)  
(74) Công ty Cổ phần Sở hữu công nghiệp INVESTIP (INVESTIP)  
(55)

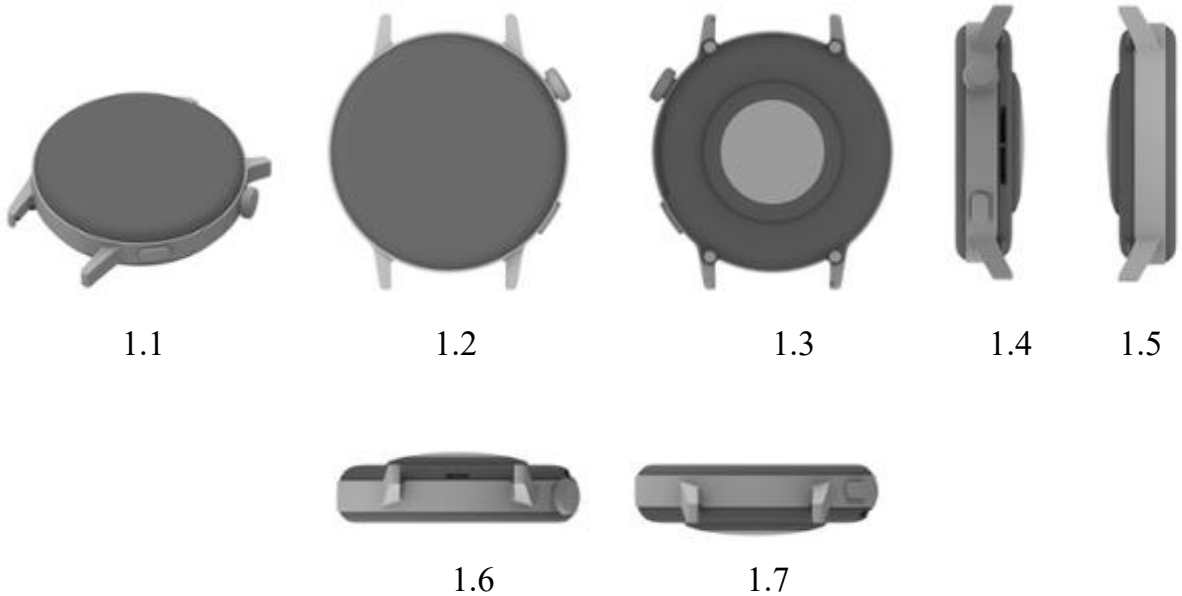

**CÔNG BÁO SỞ HỮU CÔNG NGHIỆP SỐ 412 TẬP A – QUYỀN 2 (07.2022)**

- (11) **44932**
- (21) 3-2022-00503 (28) 1
- (54) **HỘP ĐỰNG** (51) **09-03**
- (22) 22/03/2022 (43) 25/07/2022
- (30) 30-2021-0049148 18/10/2021 KR;
- (73) **BINGGRAE CO., LTD. (KR)**  
45, Dasansunhwan-ro, Namyangju-si, Gyeonggi-do, Republic of Korea
- (72) **CHOI GIJUN (KR)**
- (74) Công ty TNHH Trường Xuân (AGELESS CO.,LTD.)
- (55)



1.1

1.2

1.3

1.4



1.5

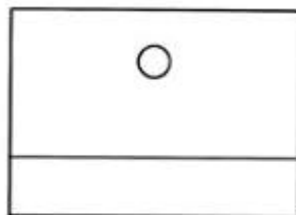

1.6

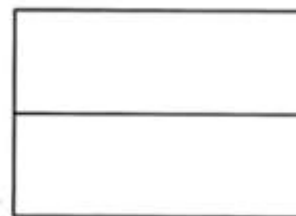

1.7

**CÔNG BÁO SỞ HỮU CÔNG NGHIỆP SỐ 412 TẬP A – QUYỀN 2 (07.2022)**

- (11) **44933**  
(21) 3-2022-00520 (28) 1  
(54) **BÌNH** (51) **07-07**  
(22) 23/03/2022 (43) 25/07/2022  
(30) 30-2021-0054433 15/11/2021 KR;  
(73) **LOCK & LOCK CO., LTD** (KR)  
104, Sapgyocheon-ro, Seonjang-myeon, Asan-si, Chungcheongnam-do, Republic  
of Korea  
(72) YOU, Sung Ik (KR)  
(74) Công ty TNHH Tầm nhìn và Liên danh (VISION & ASSOCIATES CO.LTD.)  
(55)

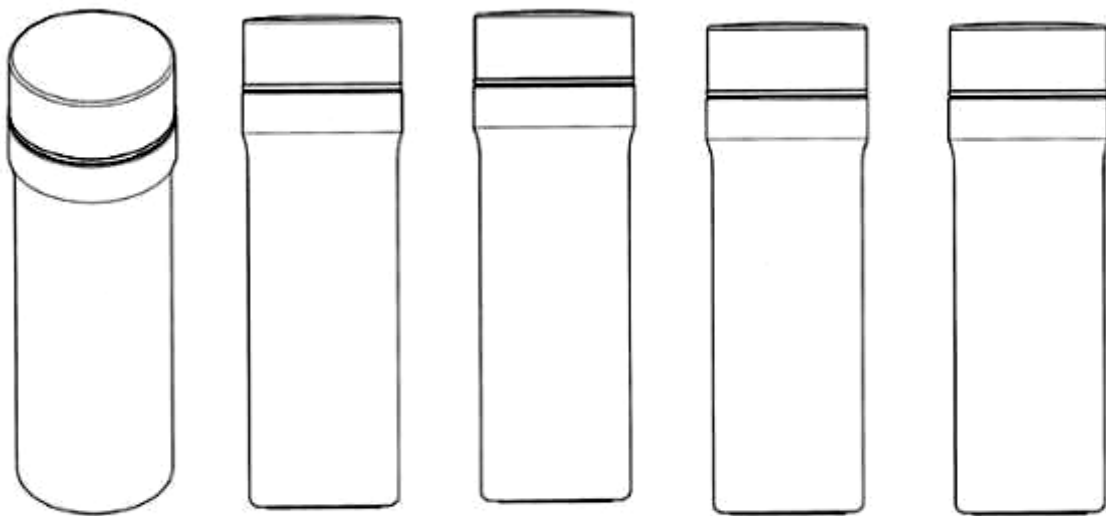

1.1

1.2

1.3

1.4

1.5

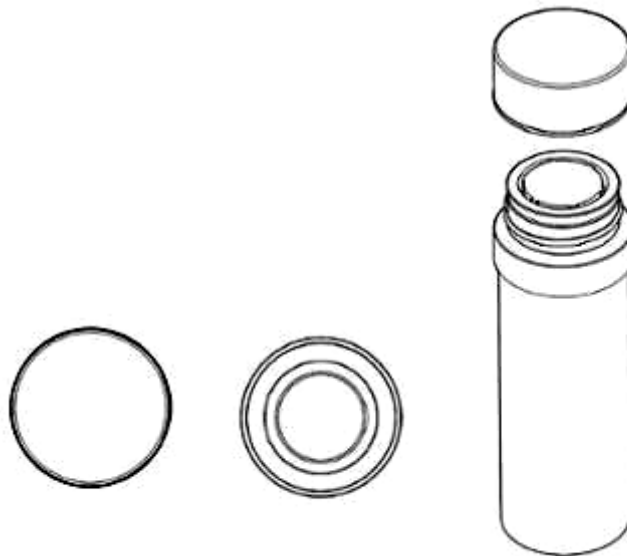

1.6

1.7

1.8

- (11) **44934**  
(21) 3-2022-00521 (28) 1  
(54) **BÌNH** (51) **07-07**  
(22) 23/03/2022 (43) 25/07/2022  
(30) 30-2021-0056853 26/11/2021 KR;  
(73) **LOCK & LOCK CO., LTD** (KR)  
104, Sapgyocheon-ro, Seonjang-myeon, Asan-si, Chungcheongnam-do, Republic  
of Korea  
(72) KIM, Kwang Ik (KR)  
(74) Công ty TNHH Tầm nhìn và Liên danh (VISION & ASSOCIATES CO.LTD.)  
(55)

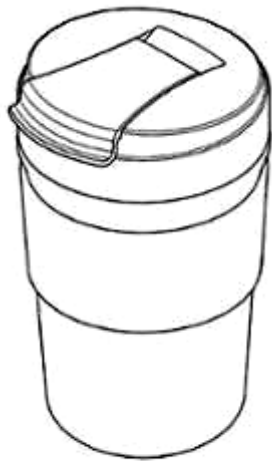

1.1

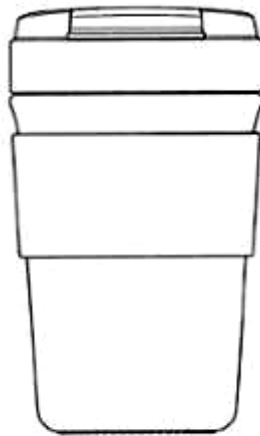

1.2

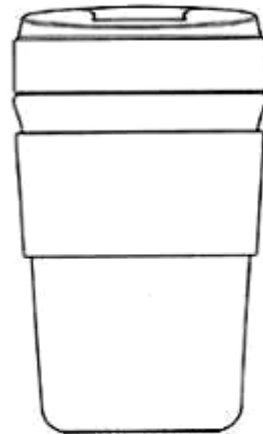

1.3

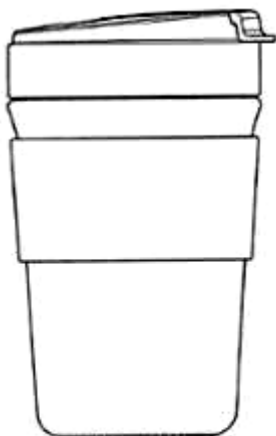

1.4

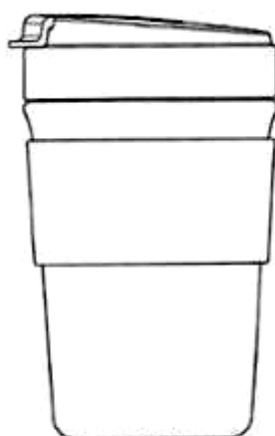

1.5



1.6



1.7

**CÔNG BÁO SỞ HỮU CÔNG NGHIỆP SỐ 412 TẬP A – QUYỀN 2 (07.2022)**

- (11) **44935**  
(21) 3-2022-00523 (28) 1  
(54) **BÌNH** (51) **07-07**  
(22) 23/03/2022 (43) 25/07/2022  
(30) 30-2021-0046684 01/10/2021 KR;  
(73) **LOCK & LOCK CO., LTD** (KR)  
104, Sapgyocheon-ro, Seonjang-myeon, Asan-si, Chungcheongnam-do, Republic  
of Korea  
(72) HONG, Wookie (KR)  
(74) Công ty TNHH Tầm nhìn và Liên danh (VISION & ASSOCIATES CO.LTD.)  
(55)



1.1



1.2



1.3



1.4



1.5



1.6



1.7



- (11) **44936**  
(21) 3-2022-00524 (28) 1  
(54) **NẮP BÌNH** (51) **07-01; 09-07**  
(22) 23/03/2022 (43) 25/07/2022  
(30) 30-2021-0050464 25/10/2021 KR;  
(73) **LOCK & LOCK CO., LTD (KR)**  
104, Sapgyocheon-ro, Seonjang-myeon, Asan-si, Chungcheongnam-do, Republic of Korea  
(72) LEE, Kyung Mee (KR)  
(74) Công ty TNHH Tầm nhìn và Liên danh (VISION & ASSOCIATES CO.LTD.)  
(55)



1.1

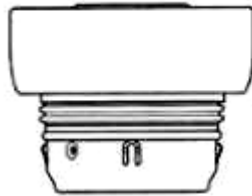

1.2

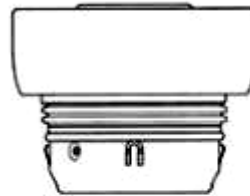

1.3

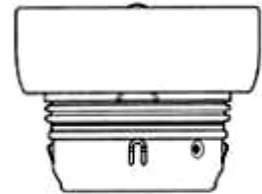

1.4

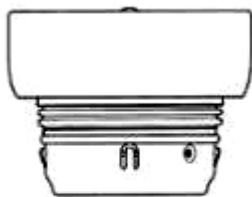

1.5

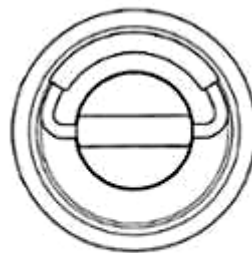

1.6



1.7



1.8

**CÔNG BÁO SỞ HỮU CÔNG NGHIỆP SỐ 412 TẬP A – QUYỀN 2 (07.2022)**

- (11) **44937**  
(21) 3-2022-00542 (28) 2  
(54) **VÒI NƯỚC** (51) **23-01**  
(22) 28/03/2022 (43) 25/07/2022  
(30) 202230005064.6 06/01/2022 CN;  
(73) **LIXIL INTERNATIONAL PTE. LTD (SG)**  
180 Clemenceau Avenue, Haw Par Centre, #06-02 Singapore 239922 Singapore  
(72) 1. ANTOINE BESSEYRE DES HORTS (FR)  
2. MATSUMOTO DAISUKE (JP)  
3. TSUCHIYA RYOSUKE (JP)  
(74) Công ty Luật TNHH Phạm và Liên danh (PHAM & ASSOCIATES)  
(55)





1.7



1.8



2.1



2.2



2.3



2.4



2.5



2.6



2.7



2.8

**CÔNG BÁO SỞ HỮU CÔNG NGHIỆP SỐ 412 TẬP A – QUYỀN 2 (07.2022)**

(11) **44938**

(21) 3-2022-00549

(28) 1

(54) **NỒI**

(51) **07-02**

(22) 28/03/2022

(43) 25/07/2022

(73) **CÔNG TY CỔ PHẦN ELMICH (VN)**

Cụm công nghiệp An Mỹ - Đôn Xá, thị trấn Bình Mỹ, huyện Bình Lục, tỉnh Hà Nam

(72) Đỗ Thành Trung (VN)

(74) Công ty Luật TNHH LEADCONSULT (LEADCONSULT)

(55)

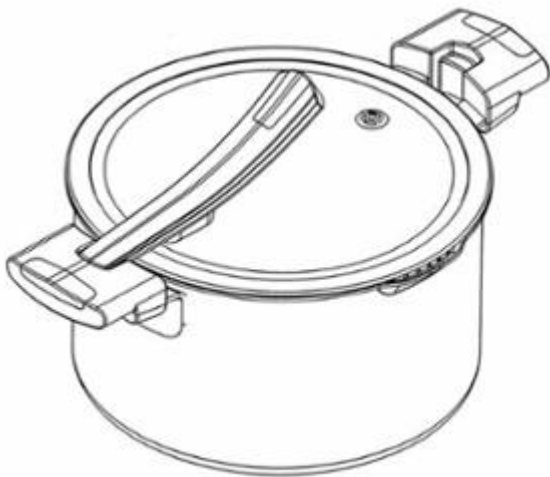

1.1

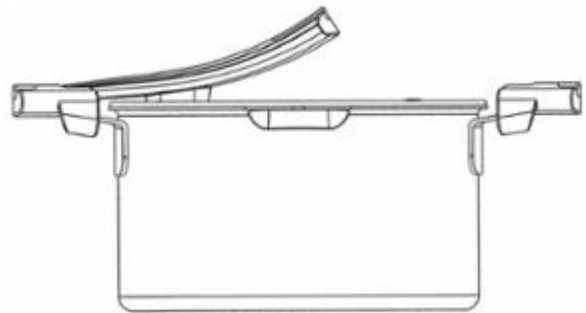

1.2

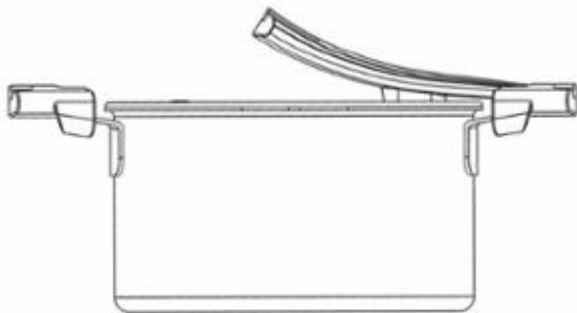

1.3

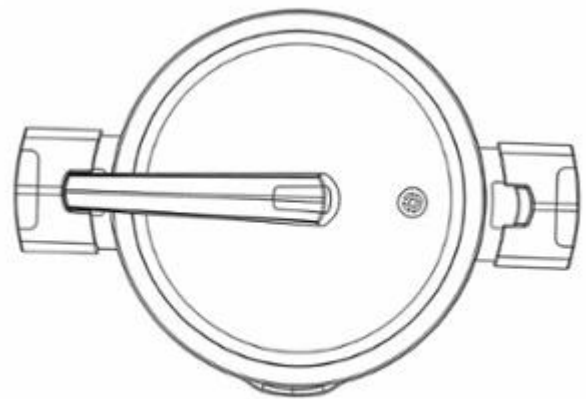

1.4

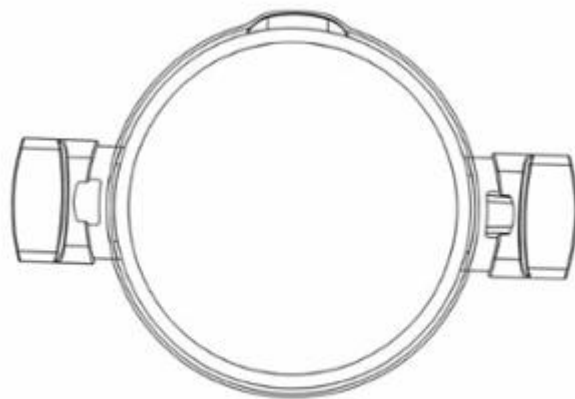

1.5

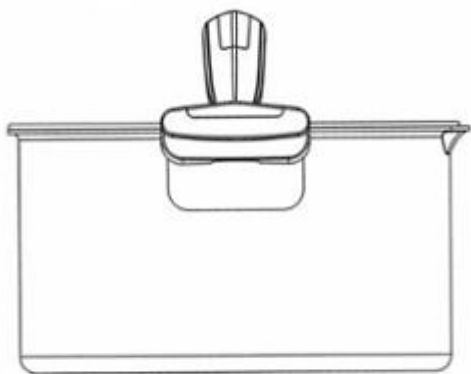

1.6

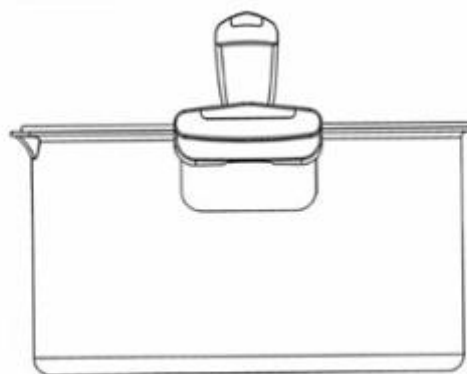

1.7

**CÔNG BÁO SỞ HỮU CÔNG NGHIỆP SỐ 412 TẬP A – QUYỀN 2 (07.2022)**

(11) **44939**

(21) 3-2022-00550

(28) 1

(54) **CHẢO**

(51) **07-02**

(22) 28/03/2022

(43) 25/07/2022

(73) **CÔNG TY CỔ PHẦN ELMICH (VN)**

Cụm công nghiệp An Mỹ - Đôn Xá, thị trấn Bình Mỹ, huyện Bình Lục, tỉnh Hà Nam

(72) Đỗ Thành Trung (VN)

(74) Công ty Luật TNHH LEADCONSULT (LEADCONSULT)

(55)

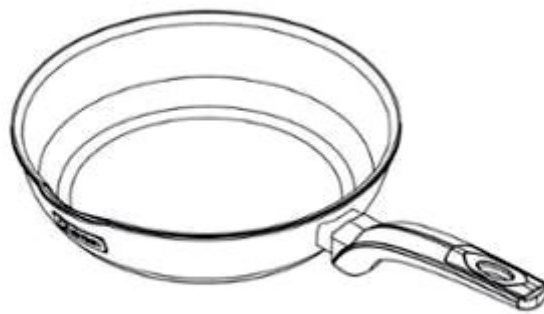

1.1



1.2

1.3

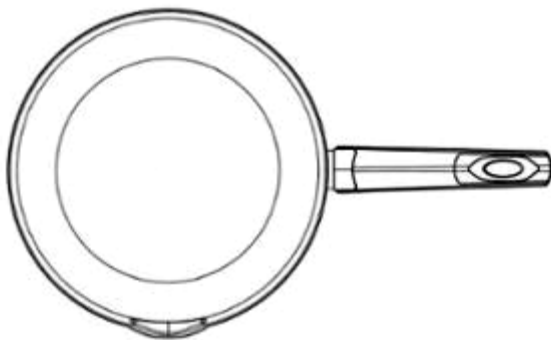

1.4

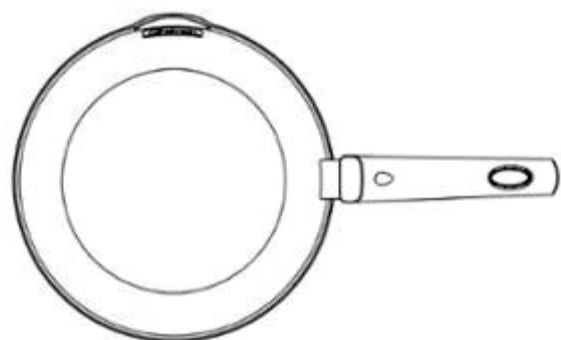

1.5



1.6



1.7



**CÔNG BÁO SỞ HỮU CÔNG NGHIỆP SỐ 412 TẬP A – QUYỀN 2 (07.2022)**

- (11) **44940**  
(21) 3-2022-00551 (28) 1  
(54) **BA LÔ** (51) **03-01**  
(22) 29/03/2022 (43) 25/07/2022  
(30) 008741532-0001 29/10/2021 EM;  
(73) **DECATHLON (FR)**  
4, Boulevard de Mons, F-59650 Villeneuve d'Ascq, France  
(72) Malo Sahores (FR)  
(74) Công ty Luật TNHH T&G (TGVN)  
(55)



1.1



1.2



1.3



1.4



1.5



1.6



1.7

**CÔNG BÁO SỞ HỮU CÔNG NGHIỆP SỐ 412 TẬP A – QUYỀN 2 (07.2022)**

- (11) **44941**  
(21) 3-2022-00597 (28) 2  
(54) **BỘ NHÃN SẢN PHẨM** (51) **19-08**  
(22) 31/03/2022 (43) 25/07/2022  
(73) **CÔNG TY CỔ PHẦN SAO VIỆT NAM (VN)**  
Tầng 6, tòa CT4, ECO Green, khu đô thị Tây Nam Kim Giang, xã Tân Triều,  
huyện Thanh Trì, thành phố Hà Nội  
(72) Nguyễn Thị Nhung (VN)  
(74) Công ty Luật TNHH LEADCONSULT (LEADCONSULT)  
(55)



1



2

**CÔNG BÁO SỞ HỮU CÔNG NGHIỆP SỐ 412 TẬP A – QUYỀN 2 (07.2022)**

- (11) **44942**
- (21) 3-2022-00598 (28) 2
- (54) **BỘ NHÃN SẢN PHẨM** (51) **19-08**
- (22) 31/03/2022 (43) 25/07/2022
- (73) **CÔNG TY CỔ PHẦN SAO VIỆT NAM (VN)**  
Tầng 6, tòa CT4, ECO Green, khu đô thị Tây Nam Kim Giang, xã Tân Triều,  
huyện Thanh Trì, thành phố Hà Nội
- (72) Nguyễn Thị Nhung (VN)
- (74) Công ty Luật TNHH LEADCONSULT (LEADCONSULT)
- (55)



1



2

**CÔNG BÁO SỞ HỮU CÔNG NGHIỆP SỐ 412 TẬP A – QUYỀN 2 (07.2022)**

(11) **44943**

(21) 3-2022-00613

(28) 1

(54) **GHẾ**

(51) **06-01**

(22) 01/04/2022

(43) 25/07/2022

(73) **CÔNG TY CỔ PHẦN PHONG CÁCH ÂU CHÂU (VN)**

Số nhà 12, phố Cao Bá Quát, phường Điện Biên, quận Ba Đình, thành phố Hà Nội

(72) Lê Gia Huy (VN)

(74) Công ty TNHH IPVC (IP.VC CO.,LTD)

(55)



1.1

1.2

1.3



1.4

1.5



1.6



1.7

**CÔNG BÁO SỞ HỮU CÔNG NGHIỆP SỐ 412 TẬP A – QUYỀN 2 (07.2022)**

- (11) **44944**  
(21) 3-2022-00619 (28) 1  
(54) **NẮP BÌNH** (51) **07-07; 09-07**  
(22) 04/04/2022 (43) 25/07/2022  
(30) 30-2022-0001708 13/01/2022 KR;  
(73) **LOCK & LOCK CO., LTD** (KR)  
104, Sapgyocheon-ro, Seonjang-myeon, Asan-si, Chungcheongnam-do, Republic  
of Korea  
(72) KIM, Kwang Ik (KR)  
(74) Công ty TNHH Tầm nhìn và Liên danh (VISION & ASSOCIATES CO.LTD.)  
(55)



1.1

1.2

1.3

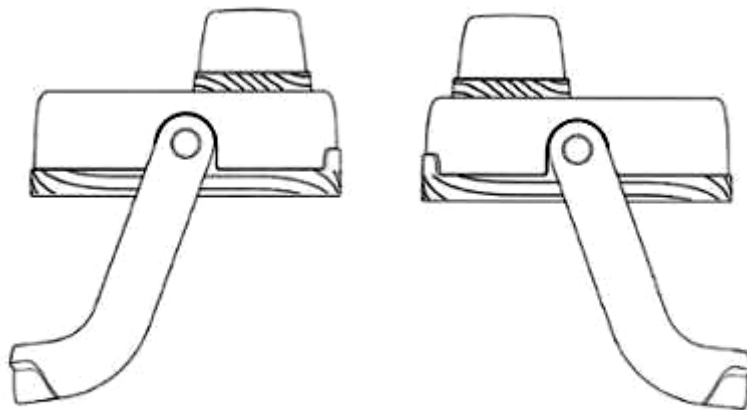

1.4

1.5



1.6

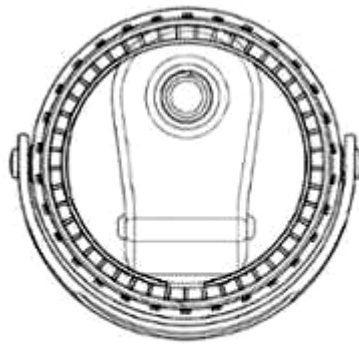

1.7

- (11) **44945**  
(21) 3-2022-00620 (28) 1  
(54) **NẮP BÌNH** (51) **07-07; 09-07**  
(22) 04/04/2022 (43) 25/07/2022  
(30) 30-2022-0002685 19/01/2022 KR;  
(73) **LOCK & LOCK CO., LTD (KR)**  
104, Sapgyocheon-ro, Seonjang-myeon, Asan-si, Chungcheongnam-do, Republic of Korea  
(72) KIM, Kwang Ik (KR)  
(74) Công ty TNHH Tầm nhìn và Liên danh (VISION & ASSOCIATES CO.LTD.)  
(55)

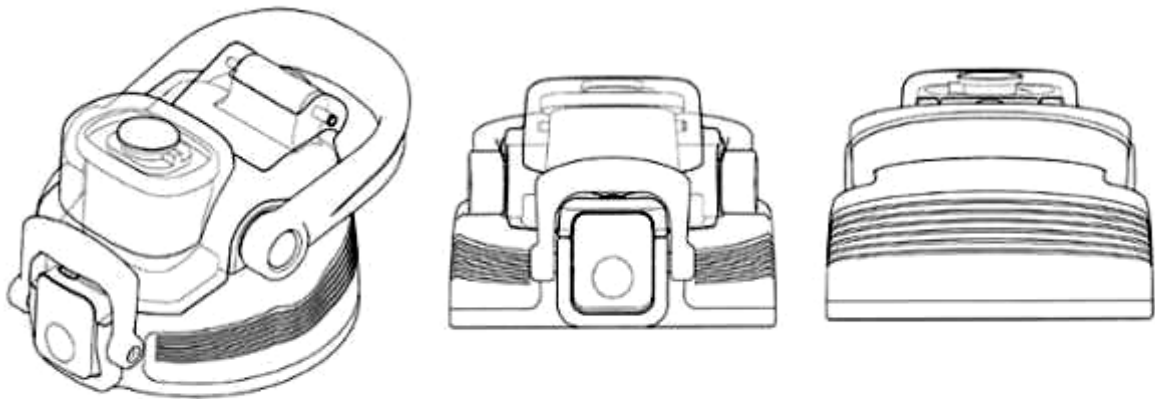

1.1

1.2

1.3

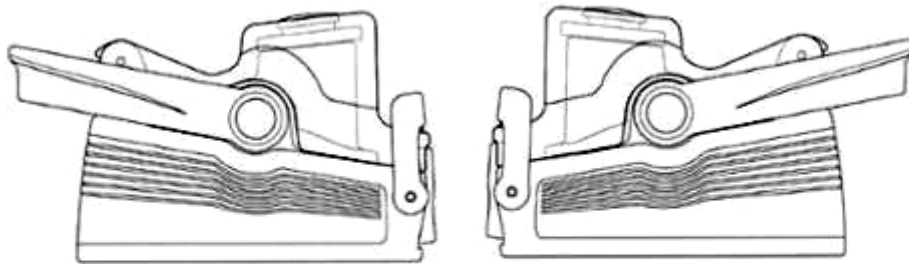

1.4

1.5



1.6

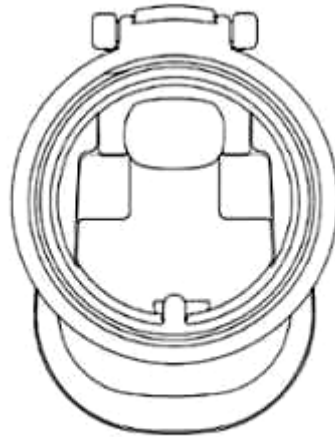

1.7



- (11) **44946**  
(21) 3-2022-00621 (28) 1  
(54) **NẮP BÌNH** (51) **07-07; 09-07**  
(22) 04/04/2022 (43) 25/07/2022  
(30) 30-2022-0003634 26/01/2022 KR;  
(73) **LOCK & LOCK CO., LTD** (KR)  
104, Sapgyocheon-ro, Seonjang-myeon, Asan-si, Chungcheongnam-do, Republic of Korea  
(72) KIM, Kwang Ik (KR)  
(74) Công ty TNHH Tầm nhìn và Liên danh (VISION & ASSOCIATES CO.LTD.)  
(55)



1.1

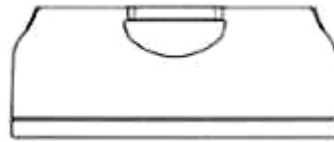

1.2

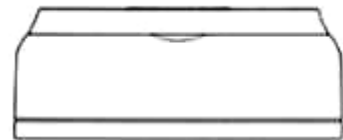

1.3



1.4



1.5



1.6

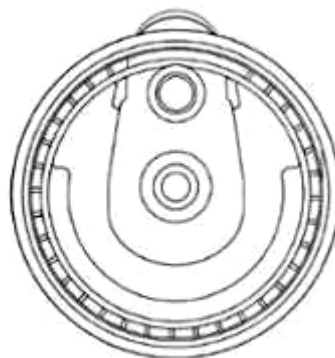

1.7

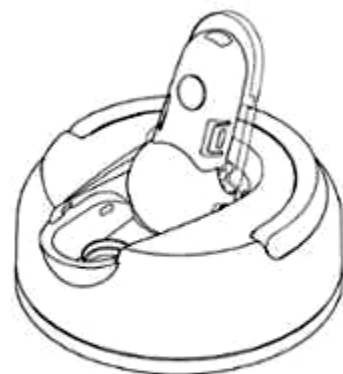

1.8

- (11) **44947**  
(21) 3-2022-00625 (28) 1  
(54) **QUẠT ĐIỆN** (51) **23-04**  
(22) 04/04/2022 (43) 25/07/2022  
(73) **CÔNG TY CP CƠ ĐIỆN VÀ XUẤT NHẬP KHẨU TOÀN CẦU (VN)**  
Km 26, Khê Than, Phú Nghĩa, huyện Chương Mỹ, thành phố Hà Nội  
(72) 1. LÊ QUÝ VINH (VN)  
2. LÊ QUÝ GIANG (VN)  
3. NGUYỄN ĐÌNH KHANG (VN)  
(55)



1.1



1.2



1.3



1.4



1.5



1.6



1.7

- (11) **44948**  
(21) 3-2022-00630 (28) 1  
(54) **DỤNG CỤ CHỨA MẪU** (51) **24-02**  
(22) 05/04/2022 (43) 25/07/2022  
(30) 30-2021-0050988 28/10/2021 KR;  
(73) **BIONLIFESCIENCE, INC. (KR)**  
#1001 #1002 #1005 #1006 #1007 #1008 #1009 #1012 #1013 #1014, 282,  
Sunhwagung-ro, Namyangju-si, Gyeonggi-do 12106, Republic of Korea  
(72) GOH, Chang Wook (KR)  
(74) Công ty TNHH Trường Xuân (AGELESS CO.,LTD.)  
(55)

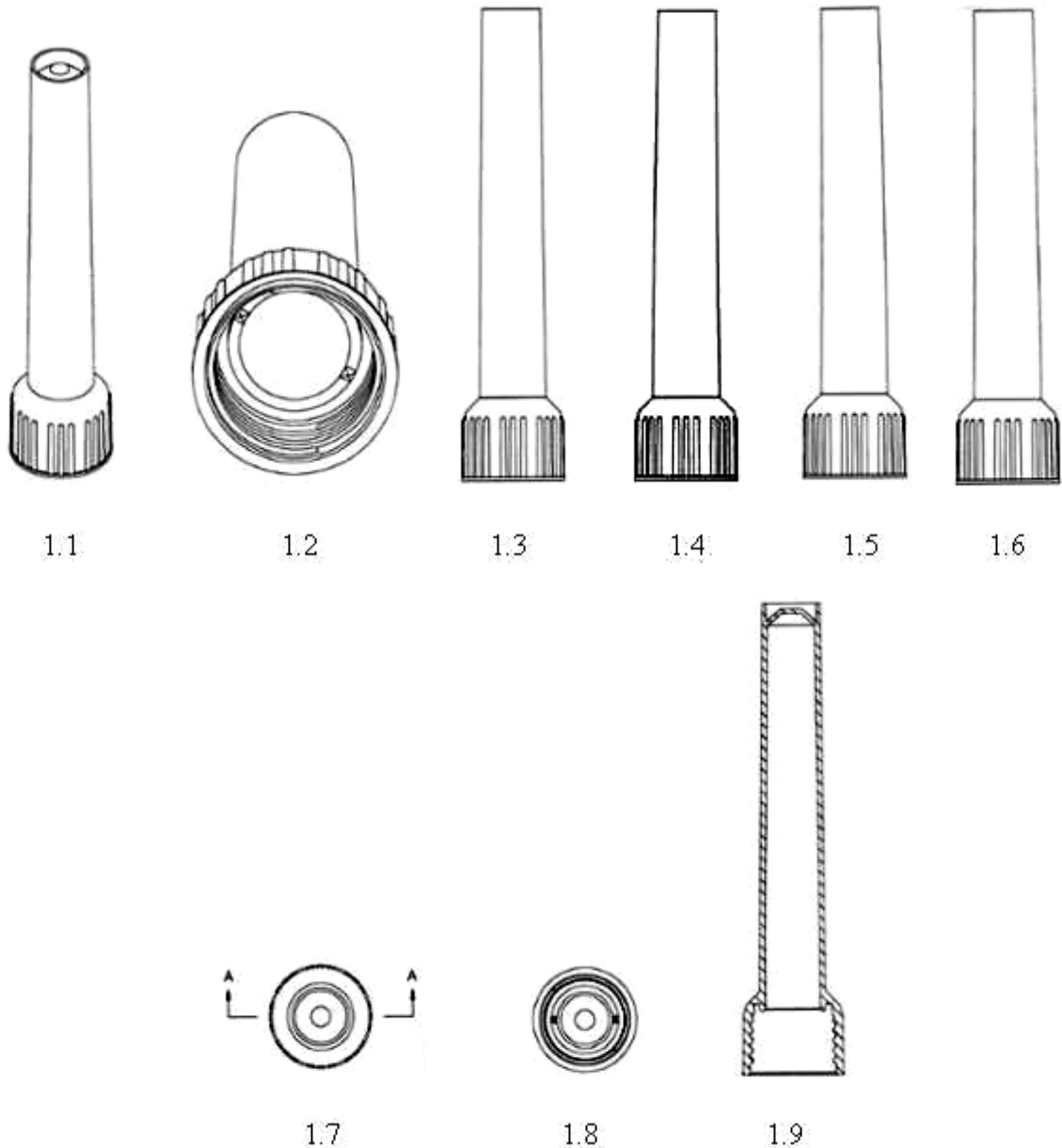

- (11) **44949**
- (21) 3-2022-00632
- (54) **DỤNG CỤ LẤY MẪU**
- (22) 05/04/2022
- (30) 30-2021-0048449 14/10/2021 KR;
- (73) **BIONLIFESCIENCE, INC. (KR)**  
 #1001 #1002 #1005 #1006 #1007 #1008 #1009 #1012 #1013 #1014, 282,  
 Sunhwagung-ro, Namyangju-si, Gyeonggi-do 12106, Republic of Korea
- (72) 1. GOH, CHANG WOOK (KR)  
 2. JEONG, JOONG HWAN (KR)
- (74) Công ty TNHH Trường Xuân (AGELESS CO.,LTD.)
- (55)

- (28) 1
- (51) **24-02**
- (43) 25/07/2022

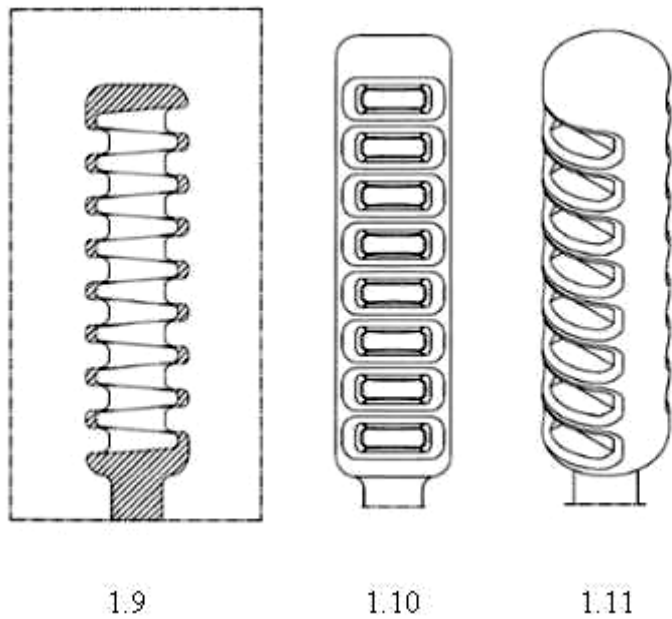
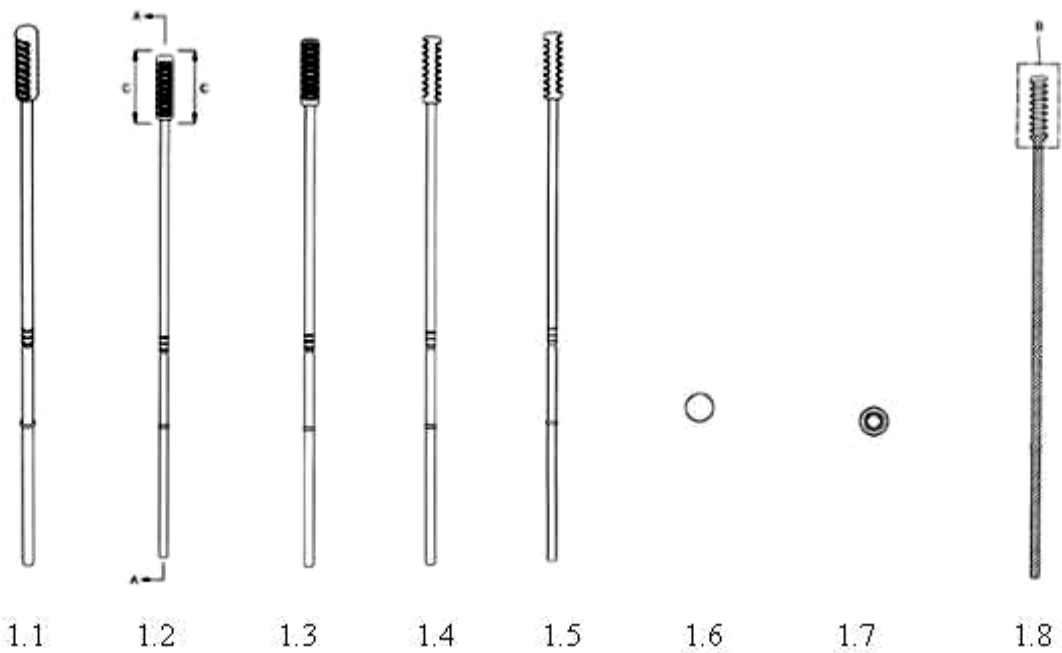

**CÔNG BÁO SỞ HỮU CÔNG NGHIỆP SỐ 412 TẬP A – QUYỀN 2 (07.2022)**

- (11) **44950**  
(21) 3-2022-00656 (28) 1  
(54) **THANH KIM LOẠI ĐỊNH HÌNH** (51) **25-01**  
(22) 08/04/2022 (43) 25/07/2022  
(73) **CÔNG TY CỔ PHẦN CAD GROUP (VN)**  
Số 8 ngõ 81, phố Trạm, phường Long Biên, quận Long Biên, thành phố Hà Nội  
(72) Lâm Viết An (VN)  
(74) Công ty TNHH Sở hữu trí tuệ Gia Việt (GIAVIET CO., LTD.)  
(55)

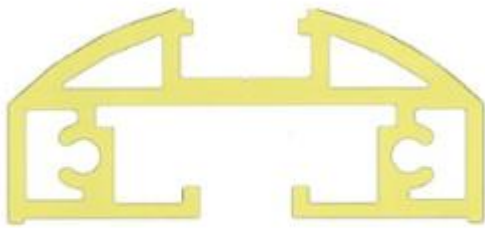

1.1



1.2



1.3

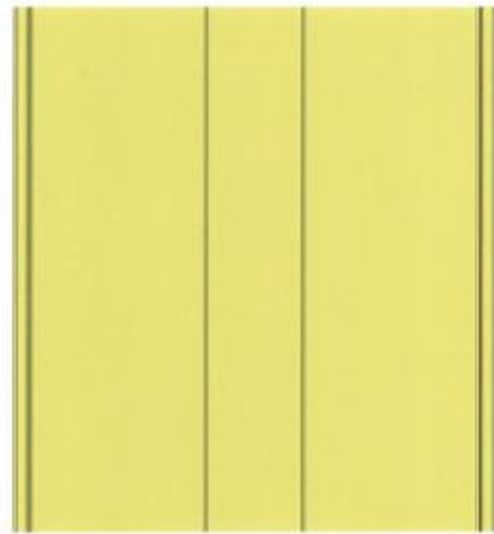

1.4



1.5

**CÔNG BÁO SỞ HỮU CÔNG NGHIỆP SỐ 412 TẬP A – QUYỀN 2 (07.2022)**

- (11) **44951**  
(21) 3-2022-00657 (28) 1  
(54) **THANH KIM LOẠI ĐỊNH HÌNH** (51) **25-01**  
(22) 08/04/2022 (43) 25/07/2022  
(73) **CÔNG TY CỔ PHẦN CAD GROUP (VN)**  
Số 8 ngõ 81, phố Trạm, phường Long Biên, quận Long Biên, thành phố Hà Nội  
(72) Lâm Viết An (VN)  
(74) Công ty TNHH Sở hữu trí tuệ Gia Việt (GIAVIET CO., LTD.)  
(55)

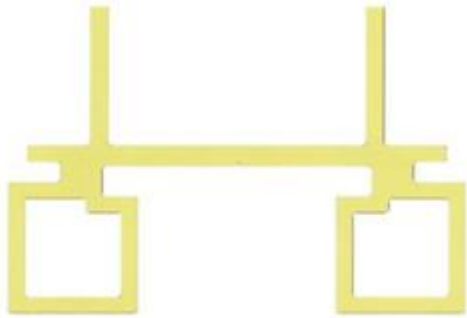

1.1



1.2

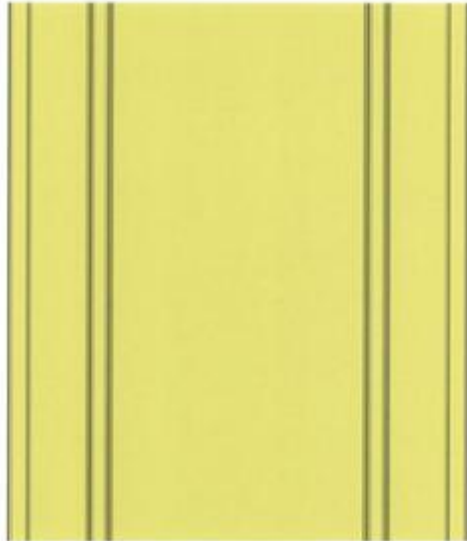

1.3

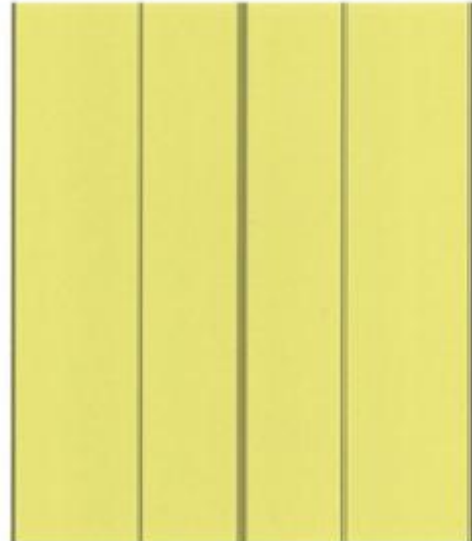

1.4

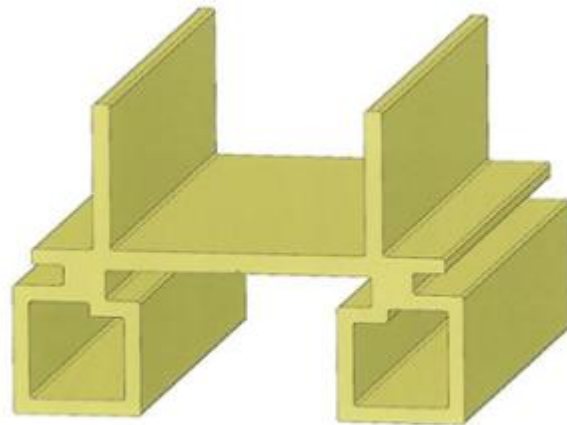

1.5

**CÔNG BÁO SỞ HỮU CÔNG NGHIỆP SỐ 412 TẬP A – QUYỀN 2 (07.2022)**

- (11) **44952**  
(21) 3-2022-00658 (28) 1  
(54) **THANH KIM LOẠI ĐỊNH HÌNH** (51) **25-01**  
(22) 08/04/2022 (43) 25/07/2022  
(73) **CÔNG TY CỔ PHẦN CAD GROUP (VN)**  
Số 8 ngõ 81, phố Trạm, phường Long Biên, quận Long Biên, thành phố Hà Nội  
(72) Lâm Viết An (VN)  
(74) Công ty TNHH Sở hữu trí tuệ Gia Việt (GIAVIET CO., LTD.)  
(55)

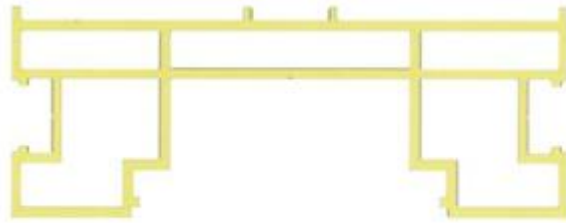

1.1



1.2



1.3



1.4

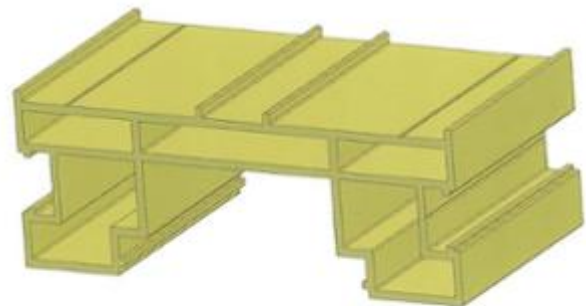

1.5



**CÔNG BÁO SỞ HỮU CÔNG NGHIỆP SỐ 412 TẬP A – QUYỀN 2 (07.2022)**

- (11) **44953**  
(21) 3-2022-00659 (28) 1  
(54) **THANH KIM LOẠI ĐỊNH HÌNH** (51) **25-01**  
(22) 08/04/2022 (43) 25/07/2022  
(73) **CÔNG TY CỔ PHẦN CAD GROUP (VN)**  
Số 8 ngõ 81, phố Trạm, phường Long Biên, quận Long Biên, thành phố Hà Nội  
(72) Lâm Viết An (VN)  
(74) Công ty TNHH Sở hữu trí tuệ Gia Việt (GIAVIET CO., LTD.)  
(55)



1.1



1.2



1.3

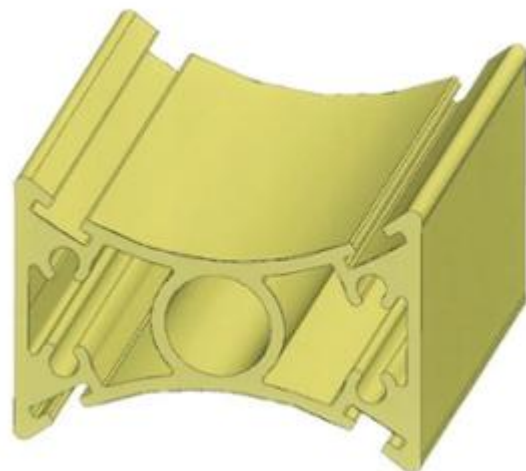

1.4

**CÔNG BÁO SỞ HỮU CÔNG NGHIỆP SỐ 412 TẬP A – QUYỀN 2 (07.2022)**

- (11) **44954**  
(21) 3-2022-00660 (28) 1  
(54) **THANH KIM LOẠI ĐỊNH HÌNH** (51) **25-01**  
(22) 08/04/2022 (43) 25/07/2022  
(73) **CÔNG TY CỔ PHẦN CAD GROUP (VN)**  
Số 8 ngõ 81, phố Trạm, phường Long Biên, quận Long Biên, thành phố Hà Nội  
(72) Lâm Viết An (VN)  
(74) Công ty TNHH Sở hữu trí tuệ Gia Việt (GIAVIET CO., LTD.)  
(55)



1.1



1.2



1.3



1.4



1.5

- (11) **44955**  
(21) 3-2022-00661 (28) 1  
(54) **THANH KIM LOẠI ĐỊNH HÌNH** (51) **25-01**  
(22) 08/04/2022 (43) 25/07/2022  
(73) **CÔNG TY CỔ PHẦN CAD GROUP (VN)**  
Số 8 ngõ 81, phố Trạm, phường Long Biên, quận Long Biên, thành phố Hà Nội  
(72) Lâm Viết An (VN)  
(74) Công ty TNHH Sở hữu trí tuệ Gia Việt (GIAVIET CO., LTD.)  
(55)



1.1



1.2



1.3



1.4

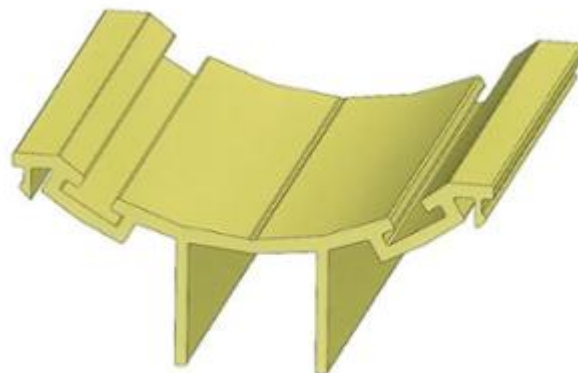

1.5

**CÔNG BÁO SỞ HỮU CÔNG NGHIỆP SỐ 412 TẬP A – QUYỀN 2 (07.2022)**

- (11) **44956**  
(21) 3-2022-00662 (28) 1  
(54) **THANH KIM LOẠI ĐỊNH HÌNH** (51) **25-01**  
(22) 08/04/2022 (43) 25/07/2022  
(73) **CÔNG TY CỔ PHẦN CAD GROUP (VN)**  
Số 8 ngõ 81, phố Trạm, phường Long Biên, quận Long Biên, thành phố Hà Nội  
(72) Lâm Viết An (VN)  
(74) Công ty TNHH Sở hữu trí tuệ Gia Việt (GIAVIET CO., LTD.)  
(55)

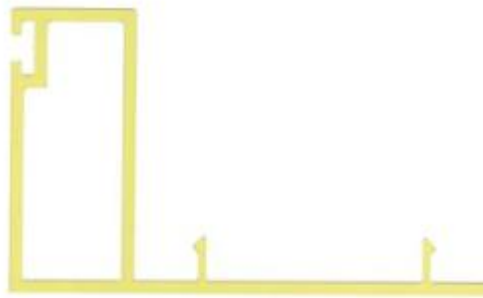

1.1



1.2



1.3



1.4



1.5

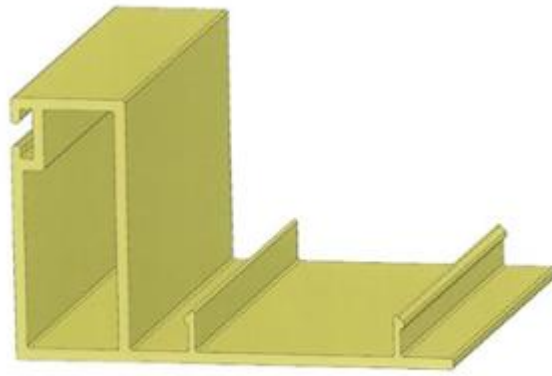

1.6

**CÔNG BÁO SỞ HỮU CÔNG NGHIỆP SỐ 412 TẬP A – QUYỀN 2 (07.2022)**

- (11) **44957**  
(21) 3-2022-00664 (28) 1  
(54) **THANH KIM LOẠI ĐỊNH HÌNH** (51) **25-01**  
(22) 08/04/2022 (43) 25/07/2022  
(73) **CÔNG TY CỔ PHẦN CAD GROUP (VN)**  
Số 8 ngõ 81, phố Trạm, phường Long Biên, quận Long Biên, thành phố Hà Nội  
(72) Lâm Viết An (VN)  
(74) Công ty TNHH Sở hữu trí tuệ Gia Việt (GIAVIET CO., LTD.)  
(55)



1.1

1.2

1.3

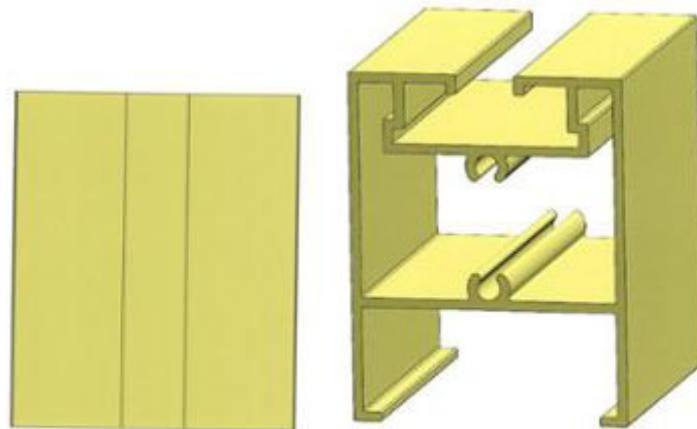

1.4

1.5

**CÔNG BÁO SỞ HỮU CÔNG NGHIỆP SỐ 412 TẬP A – QUYỀN 2 (07.2022)**

- (11) **44958**  
(21) 3-2022-00665 (28) 1  
(54) **GIÀY** (51) **02-04**  
(22) 08/04/2022 (43) 25/07/2022  
(30) 29/827,348 18/02/2022 US;  
(73) **NIKE INNOVATE C.V. (US)**  
One Bowerman Drive, Beaverton, Oregon, 97005-6453, United States of America  
(72) Remy BATISTE (FR)  
(74) Văn phòng Luật sư Ân Nam (ANNAM IP & LAW)  
(55)



1.1



1.2



1.3



1.4



1.5



1.6



1.7

**CÔNG BÁO SỞ HỮU CÔNG NGHIỆP SỐ 412 TẬP A – QUYỀN 2 (07.2022)**

- (11) **44959**  
(21) 3-2022-00686 (28) 1  
(54) **BAO GÓI SẢN PHẨM** (51) **09-05**  
(22) 13/04/2022 (43) 25/07/2022  
(73) **CÔNG TY CỔ PHẦN KEM HÙNG LINH (VN)**  
Thôn Mạch Kỳ, xã Hồng Dương, huyện Thanh Oai, thành phố Hà Nội  
(72) Nguyễn Xuân Biểu (VN)  
(74) Công ty Luật TNHH WINCO (WINCO LAW FIRM)  
(55)



1.1



1.2



**CÔNG BÁO SỞ HỮU CÔNG NGHIỆP SỐ 412 TẬP A – QUYỀN 2 (07.2022)**

- (11) **44960**  
(21) 3-2022-00700 (28) 1  
(54) **DỤNG CỤ KHUẾCH TÁN HƯƠNG THƠM** (51) **23-04**  
(22) 13/04/2022 (43) 25/07/2022  
(73) **YIHITEH ELECTRIC PRODUCTS CO., LTD. (TW)**  
7F.-1, No. 15, Sec. 2, Tiding Blvd., Neihu Dist., Taipei City 114737, Taiwan  
(72) Hsiao, Ming-Jen (TW)  
(74) Công ty Luật TNHH WINCO (WINCO LAW FIRM)  
(55)



1.1



1.2



1.3



1.4



1.5

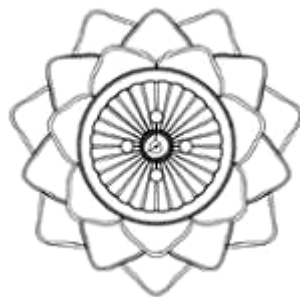

1.6



1.7

**CÔNG BÁO SỞ HỮU CÔNG NGHIỆP SỐ 412 TẬP A – QUYỀN 2 (07.2022)**

- (11) **44961**
- (21) 3-2022-00701 (28) 1
- (54) **BAO GÓI SẢN PHẨM** (51) **09-05**
- (22) 13/04/2022 (43) 25/07/2022
- (73) **CÔNG TY TNHH THƯƠNG MẠI VÀ DỊCH VỤ HƯƠNG HƯƠNG PHÚ (VN)**  
Thôn Liên Trì 1, xã Bình Kiến, thành phố Tuy Hòa, tỉnh Phú Yên
- (72) Nguyễn Thị Thu Hương (VN)
- (74) Công ty Luật TNHH WINCO (WINCO LAW FIRM)
- (55)



1.1



1.2

**CÔNG BÁO SỞ HỮU CÔNG NGHIỆP SỐ 412 TẬP A – QUYỀN 2 (07.2022)**

- (11) **44962**  
(21) 3-2022-00745 (28) 1  
(54) **GIÀY** (51) **02-04**  
(22) 15/04/2022 (43) 25/07/2022  
(30) 29/825,697 04/02/2022 US;  
(73) **NIKE INNOVATE C.V. (US)**  
One Bowerman Drive, Beaverton, Oregon, 97005-6453, United States of America  
(72) Can ELDEM (TR)  
(74) Văn phòng Luật sư Ân Nam (ANNAM IP & LAW)  
(55)



1.1



1.2



1.3



1.4



1.5



1.6



1.7

**CÔNG BÁO SỞ HỮU CÔNG NGHIỆP SỐ 412 TẬP A – QUYỀN 2 (07.2022)**

- (11) **44963**  
(21) 3-2022-00749 (28) 1  
(54) **BAO GÓI** (51) **09-05**  
(22) 15/04/2022 (43) 25/07/2022  
(73) **CÔNG TY CP THỰC PHẨM DINH DƯỠNG NUTIFOOD (VN)**  
281-283 Hoàng Diệu, phường 6, quận 4, thành phố Hồ Chí Minh  
(72) Trần Thị Lệ (VN)  
(74) Công ty TNHH Tâm nhìn và Liên danh (VISION & ASSOCIATES CO.LTD.)  
(55)

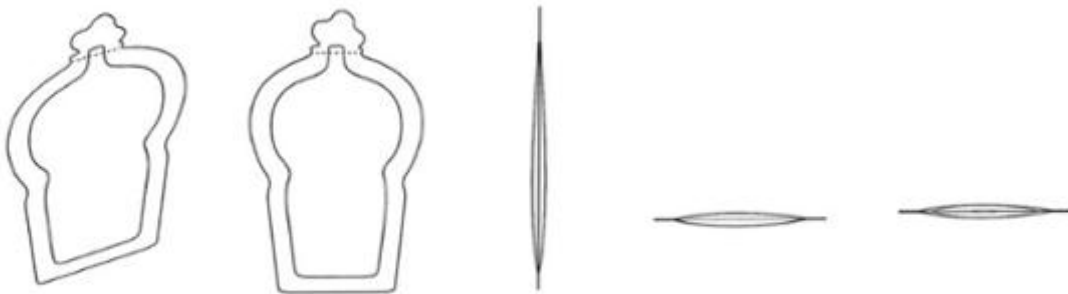

1.1

1.2

1.3

1.4

1.5

**CÔNG BÁO SỞ HỮU CÔNG NGHIỆP SỐ 412 TẬP A – QUYỀN 2 (07.2022)**

- (11) **44964**  
(21) 3-2022-00751 (28) 2  
(54) **NHÃN SẢN PHẨM** (51) **19-08**  
(22) 15/04/2022 (43) 25/07/2022  
(73) **CÔNG TY CỔ PHẦN THUỐC THÚ Y TRUNG ƯƠNG NAVETCO (VN)**  
29A Nguyễn Đình Chiểu, phường Đakao, quận 1, thành phố Hồ Chí Minh  
(72) Trần Xuân Hạnh (VN)  
(55)

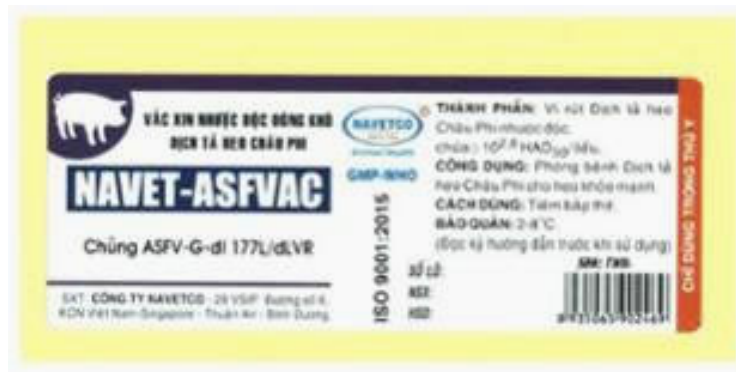

1



2

- (11) **44965**  
(21) 3-2022-00752 (28) 1  
(54) **GHÉ XÍCH ĐU** (51) **21-03**  
(22) 18/04/2022 (43) 25/07/2022  
(73) **PHẠM VĂN QUÝ (VN)**  
117/29/6 Hồ Văn Long, phường Tân Tạo, quận Bình Tân, thành phố Hồ Chí Minh  
(72) Phạm Văn Quý (VN)  
(74) Công ty TNHH Dịch vụ thương mại và sở hữu công nghiệp Song Ngọc (I.P.T.S.)  
(55)



1.1

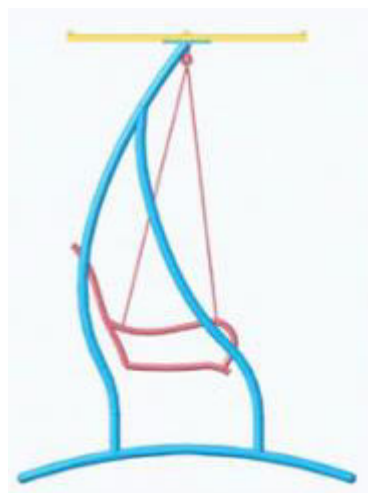

1.2

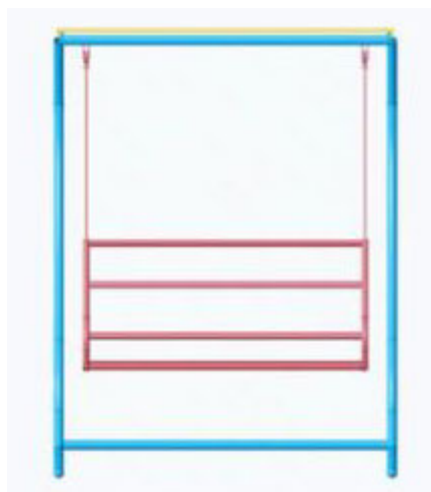

1.3

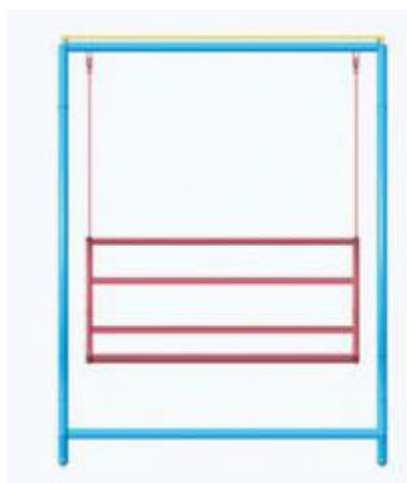

1.4



1.5

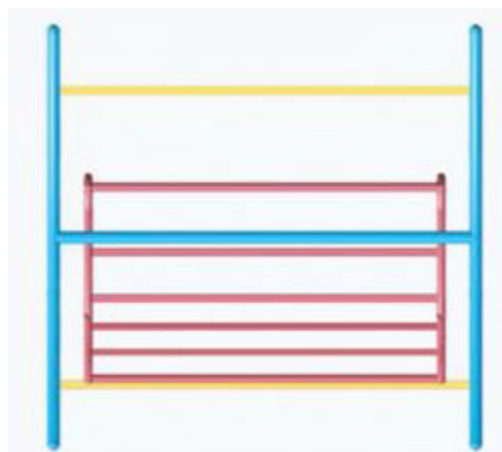

1.6

**CÔNG BÁO SỞ HỮU CÔNG NGHIỆP SỐ 412 TẬP A – QUYỀN 2 (07.2022)**

- (11) **44966**  
(21) 3-2022-00758 (28) 1  
(54) **ĐẦU GẬY ĐÁNH GÔN** (51) **21-02**  
(22) 19/04/2022 (43) 25/07/2022  
(73) **HWA JA GU (KR)**  
402ho, 15, Samseongyo-ro 18-gil, Seongbuk-gu, Seoul 02863, Republic of Korea  
(72) Hwa Ja GU (KR)  
(74) Công ty Luật TNHH WINCO (WINCO LAW FIRM)  
(55)



1.1



1.2



1.3



1.4



1.5



1.6



1.7



**CÔNG BÁO SỞ HỮU CÔNG NGHIỆP SỐ 412 TẬP A – QUYỀN 2 (07.2022)**

- (11) **44967**  
(21) 3-2022-00778 (28) 1  
(54) **LỌ** (51) **09-01**  
(22) 21/04/2022 (43) 25/07/2022  
(30) 30-2022-0009587 11/03/2022 KR;  
(73) **AE KYUNG INDUSTRIAL CO., LTD (KR)**  
188, Yanghwa-ro, Mapo-gu, Seoul, Republic of Korea  
(72) Young Hyun Park (KR)  
(74) Công ty TNHH Sở hữu trí tuệ Thảo Thọ Quyển (INVENCO.,LTD)  
(55)

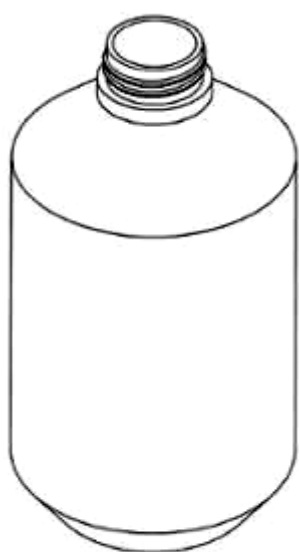

1.1

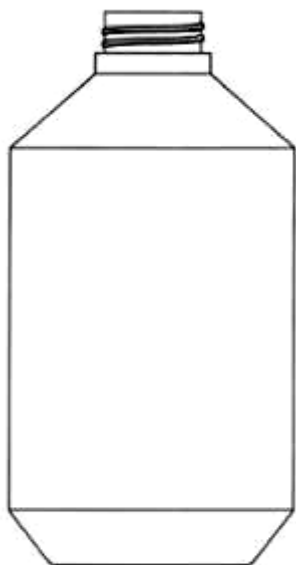

1.2

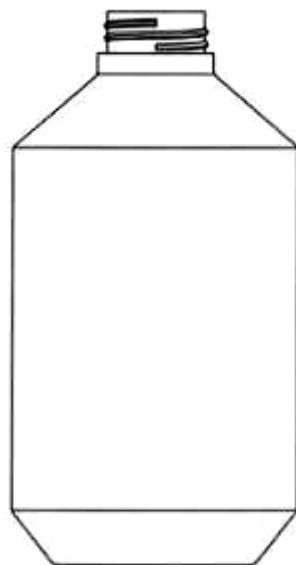

1.3

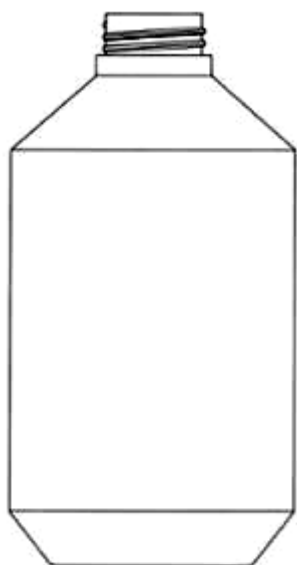

1.4

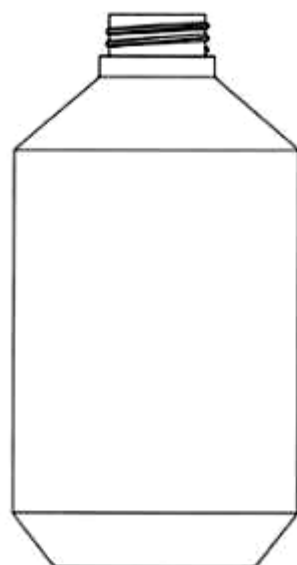

1.5



1.6

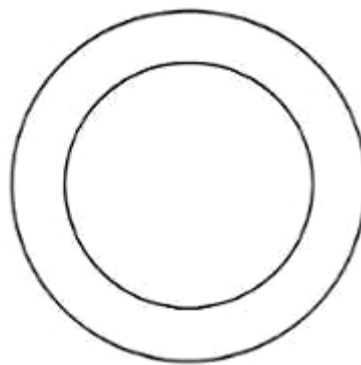

1.7

**CÔNG BÁO SỞ HỮU CÔNG NGHIỆP SỐ 412 TẬP A – QUYỀN 2 (07.2022)**

- (11) **44968**  
(21) 3-2022-00781 (28) 1  
(54) **XE MÁY ĐIỆN** (51) **12-11**  
(22) 22/04/2022 (43) 25/07/2022  
(73) **CÔNG TY TNHH MTV DAT BIKE VIETNAM (VN)**  
85 Cao Bá Quát, phường An Hải Tây, quận Sơn Trà, thành phố Đà Nẵng  
(72) Trương Mạnh Hà (VN)  
(74) Công ty Luật TNHH VIETTHINK (VIETTHINK LAW FIRM)  
(55)



1.1



1.2



1.3



1.4



1.5



1.6



1.7



1.8

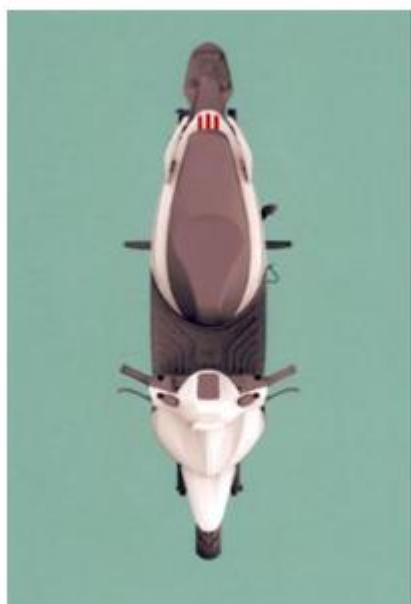

1.9



1.10

**CÔNG BÁO SỞ HỮU CÔNG NGHIỆP SỐ 412 TẬP A – QUYỀN 2 (07.2022)**

(11) **44969**

(21) 3-2022-00782

(28) 1

(54) **CHẬU RỬA**

(51) **23-02**

(22) 22/04/2022

(43) 25/07/2022

(73) **CÔNG TY CỔ PHẦN THƯƠNG MẠI VIGLACERA (VN)**

Tầng 1, tòa nhà Viglacera, số 1 đại lộ Thăng Long, phường Mỹ Trì, quận Nam Từ Liêm, thành phố Hà Nội

(72) Phạm Ngọc Đường (VN)

(55)



1.1



1.2



1.3



1.4



1.5



1.6

**CÔNG BÁO SỞ HỮU CÔNG NGHIỆP SỐ 412 TẬP A – QUYỀN 2 (07.2022)**

(11) **44970**

(21) 3-2022-00784

(28) 1

(54) **CHẬU RỬA**

(51) **23-02**

(22) 22/04/2022

(43) 25/07/2022

(73) **CÔNG TY CỔ PHẦN THƯƠNG MẠI VIGLACERA (VN)**

Tầng 1, tòa nhà Viglacera, số 1 đại lộ Thăng Long, phường Mỹ Trì, quận Nam Từ Liêm, thành phố Hà Nội

(72) Phạm Ngọc Đường (VN)

(55)

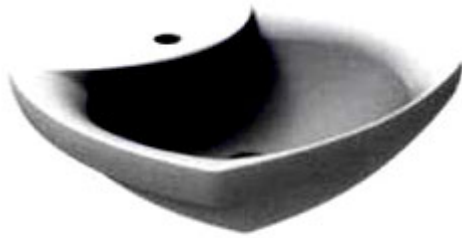

1.1



1.2



1.3



1.4



1.5



1.6

**CÔNG BÁO SỞ HỮU CÔNG NGHIỆP SỐ 412 TẬP A – QUYỀN 2 (07.2022)**

(11) **44971**

(21) 3-2022-00785

(28) 1

(54) **CHẬU RỬA**

(51) **23-02**

(22) 22/04/2022

(43) 25/07/2022

(73) **CÔNG TY CỔ PHẦN THƯƠNG MẠI VIGLACERA (VN)**

Tầng 1, tòa nhà Viglacera, số 1 đại lộ Thăng Long, phường Mỹ Trì, quận Nam Từ Liêm, thành phố Hà Nội

(72) Phạm Ngọc Đường (VN)

(55)



1.1



1.2



1.3



1.4



1.5



1.6

**CÔNG BÁO SỞ HỮU CÔNG NGHIỆP SỐ 412 TẬP A – QUYỀN 2 (07.2022)**

(11) **44972**

(21) 3-2022-00786

(28) 1

(54) **CHẬU RỬA**

(51) **23-02**

(22) 22/04/2022

(43) 25/07/2022

(73) **CÔNG TY CỔ PHẦN THƯƠNG MẠI VIGLACERA (VN)**

Tầng 1, tòa nhà Viglacera, số 1 đại lộ Thăng Long, phường Mỹ Trì, quận Nam Từ Liêm, thành phố Hà Nội

(72) Phạm Ngọc Đường (VN)

(55)



1.1



1.2



1.3



1.4



1.5



1.6



**CÔNG BÁO SỞ HỮU CÔNG NGHIỆP SỐ 412 TẬP A – QUYỀN 2 (07.2022)**

(11) **44973**

(21) 3-2022-00787

(28) 1

(54) **CHẬU RỬA**

(51) **23-02**

(22) 22/04/2022

(43) 25/07/2022

(73) **CÔNG TY CỔ PHẦN THƯƠNG MẠI VIGLACERA (VN)**

Tầng 1, tòa nhà Viglacera, số 1 đại lộ Thăng Long, phường Mỹ Trì, quận Nam Từ Liêm, thành phố Hà Nội

(72) Phạm Ngọc Đường (VN)

(55)



1.1



1.2



1.3



1.4



1.5



1.6

**CÔNG BÁO SỞ HỮU CÔNG NGHIỆP SỐ 412 TẬP A – QUYỀN 2 (07.2022)**

(11) **44974**

(21) 3-2022-00788

(28) 1

(54) **CHẬU RỬA**

(51) **23-02**

(22) 22/04/2022

(43) 25/07/2022

(73) **CÔNG TY CỔ PHẦN THƯƠNG MẠI VIGLACERA (VN)**

Tầng 1, tòa nhà Viglacera, số 1 đại lộ Thăng Long, phường Mỹ Trì, quận Nam Từ Liêm, thành phố Hà Nội

(72) Phạm Ngọc Đường (VN)

(55)



1.1



1.2



1.3



1.4



1.5

**CÔNG BÁO SỞ HỮU CÔNG NGHIỆP SỐ 412 TẬP A – QUYỀN 2 (07.2022)**

(11) **44975**

(21) 3-2022-00789

(28) 1

(54) **BỒN TIỂU**

(51) **23-02**

(22) 22/04/2022

(43) 25/07/2022

(73) **CÔNG TY CỔ PHẦN THƯƠNG MẠI VIGLACERA (VN)**

Tầng 1, tòa nhà Viglacera, số 1 đại lộ Thăng Long, phường Mỹ Trì, quận Nam Từ Liêm, thành phố Hà Nội

(72) Phạm Ngọc Đường (VN)

(55)



1.1



1.2



1.3



1.4



1.5



1.6

**CÔNG BÁO SỞ HỮU CÔNG NGHIỆP SỐ 412 TẬP A – QUYỀN 2 (07.2022)**

(11) **44976**

(21) 3-2022-00790

(28) 1

(54) **CHẬU RỬA**

(51) **23-02**

(22) 22/04/2022

(43) 25/07/2022

(73) **CÔNG TY CỔ PHẦN THƯƠNG MẠI VIGLACERA (VN)**

Tầng 1, tòa nhà Viglacera, số 1 đại lộ Thăng Long, phường Mỹ Trì, quận Nam Từ Liêm, thành phố Hà Nội

(72) Phạm Ngọc Đường (VN)

(55)



1.1



1.2



1.3



1.4



1.5



1.6

**CÔNG BÁO SỞ HỮU CÔNG NGHIỆP SỐ 412 TẬP A – QUYỀN 2 (07.2022)**

(11) **44977**

(21) 3-2022-00791

(28) 1

(54) **CHẬU RỬA**

(51) **23-02**

(22) 22/04/2022

(43) 25/07/2022

(73) **CÔNG TY CỔ PHẦN THƯƠNG MẠI VIGLACERA (VN)**

Tầng 1, tòa nhà Viglacera, số 1 đại lộ Thăng Long, phường Mỹ Trì, quận Nam Từ Liêm, thành phố Hà Nội

(72) Phạm Ngọc Đường (VN)

(55)



1.1



1.2



1.3



1.4



1.5



1.6

**CÔNG BÁO SỞ HỮU CÔNG NGHIỆP SỐ 412 TẬP A – QUYỀN 2 (07.2022)**

(11) **44978**

(21) 3-2022-00792

(28) 1

(54) **CHẬU RỬA**

(51) **23-02**

(22) 22/04/2022

(43) 25/07/2022

(73) **CÔNG TY CỔ PHẦN THƯƠNG MẠI VIGLACERA (VN)**

Tầng 1, tòa nhà Viglacera, số 1 đại lộ Thăng Long, phường Mễ Trì, quận Nam Từ Liêm, thành phố Hà Nội

(72) Phạm Ngọc Đường (VN)

(55)



1.1



1.2



1.3



1.4



1.5



1.6

**CÔNG BÁO SỞ HỮU CÔNG NGHIỆP SỐ 412 TẬP A – QUYỀN 2 (07.2022)**

(11) **44979**

(21) 3-2022-00793

(28) 1

(54) **CHẬU RỬA**

(51) **23-02**

(22) 22/04/2022

(43) 25/07/2022

(73) **CÔNG TY CỔ PHẦN THƯƠNG MẠI VIGLACERA (VN)**

Tầng 1, tòa nhà Viglacera, số 1 đại lộ Thăng Long, phường Mễ Trì, quận Nam Từ Liêm, thành phố Hà Nội

(72) Phạm Ngọc Đường (VN)

(55)



1.1



1.2



1.3



1.4



1.5



1.6

**CÔNG BÁO SỞ HỮU CÔNG NGHIỆP SỐ 412 TẬP A – QUYỀN 2 (07.2022)**

(11) **44980**

(21) 3-2022-00794

(28) 1

(54) **CHẬU RỬA**

(51) **23-02**

(22) 22/04/2022

(43) 25/07/2022

(73) **CÔNG TY CỔ PHẦN THƯƠNG MẠI VIGLACERA (VN)**

Tầng 1, tòa nhà Viglacera, số 1 đại lộ Thăng Long, phường Mỹ Trì, quận Nam Từ Liêm, thành phố Hà Nội

(72) Phạm Ngọc Đường (VN)

(55)



1.1



1.2



1.3



1.4



1.5



1.6



**CÔNG BÁO SỞ HỮU CÔNG NGHIỆP SỐ 412 TẬP A – QUYỀN 2 (07.2022)**

(11) **44981**

(21) 3-2022-00795

(28) 1

(54) **CHẬU RỬA**

(51) **23-02**

(22) 22/04/2022

(43) 25/07/2022

(73) **CÔNG TY CỔ PHẦN THƯƠNG MẠI VIGLACERA (VN)**

Tầng 1, tòa nhà Viglacera, số 1 đại lộ Thăng Long, phường Mễ Trì, quận Nam Từ Liêm, thành phố Hà Nội

(72) Phạm Ngọc Đường (VN)

(55)



1.1



1.2



1.3



1.4



1.5



1.6



1.7

**CÔNG BÁO SỞ HỮU CÔNG NGHIỆP SỐ 412 TẬP A – QUYỀN 2 (07.2022)**

(11) **44982**

(21) 3-2022-00796

(28) 1

(54) **CHẬU RỬA**

(51) **23-02**

(22) 22/04/2022

(43) 25/07/2022

(73) **CÔNG TY CỔ PHẦN THƯƠNG MẠI VIGLACERA (VN)**

Tầng 1, tòa nhà Viglacera, số 1 đại lộ Thăng Long, phường Mễ Trì, quận Nam Từ Liêm, thành phố Hà Nội

(72) Phạm Ngọc Đường (VN)

(55)



1.1



1.2



1.3



1.4



1.5



1.6

**CÔNG BÁO SỞ HỮU CÔNG NGHIỆP SỐ 412 TẬP A – QUYỀN 2 (07.2022)**

(11) **44983**

(21) 3-2022-00797

(28) 1

(54) **CHẬU RỬA**

(51) **23-02**

(22) 22/04/2022

(43) 25/07/2022

(73) **CÔNG TY CỔ PHẦN THƯƠNG MẠI VIGLACERA (VN)**

Tầng 1, tòa nhà Viglacera, số 1 đại lộ Thăng Long, phường Mỹ Trì, quận Nam Từ Liêm, thành phố Hà Nội

(72) Phạm Ngọc Đường (VN)

(55)



1.1



1.2



1.3



1.4



1.5



1.6

**CÔNG BÁO SỞ HỮU CÔNG NGHIỆP SỐ 412 TẬP A – QUYỀN 2 (07.2022)**

- (11) **44984**
- (21) 3-2022-00798 (28) 1
- (54) **NHÃN SẢN PHẨM** (51) **19-08**
- (22) 22/04/2022 (43) 25/07/2022
- (73) **TRẦN THỊ ÁI THU (VN)**  
17 Phan Bội Châu, khu phố 2, phường 1, thành phố Đông Hà, tỉnh Quảng Trị
- (72) Trần Thị Ái Thu (VN)
- (74) Công ty TNHH Sở hữu trí tuệ VIPATCO (VIPATCO CO., LTD.)
- (55)



- (11) **44985**  
(21) 3-2022-00801 (28) 1  
(54) **MÁY IN NHÃN** (51) **18-02**  
(22) 22/04/2022 (43) 25/07/2022  
(30) 008761654-0001 16/11/2021 EM;  
(73) **WUHAN JINGCHEN WISDOM SIGN TECHNOLOGY CO., LTD. (CN)**  
1st Floor, No. 5, Creative Workshop, Phase III, Wuhan Creative World, Hongshan  
District, Wuhan City, Hubei Province 430070, China  
(72) Xiong LIU (CN)  
(74) Công ty TNHH Sáng chế ACTIP (ACTIP PATENT LIMITED)  
(55)



1.1



1.2



1.3



1.4



1.5



1.6



1.7

**CÔNG BÁO SỞ HỮU CÔNG NGHIỆP SỐ 412 TẬP A – QUYỀN 2 (07.2022)**

- (11) **44986**  
(21) 3-2022-00802 (28) 1  
(54) **NẮP CHAI** (51) **09-07**  
(22) 25/04/2022 (43) 25/07/2022  
(73) **VƯƠNG TRẦN SĨ HIỆP (VN)**  
D46 đường số 4, KDC Nông Thổ Sản, phường Phú Thứ, quận Cái Răng, thành phố  
Cần Thơ  
(72) Vương Trần Sĩ Hiệp (VN)  
(55)



1.1



1.2



1.3



1.4



1.5



1.6



1.7

**CÔNG BÁO SỞ HỮU CÔNG NGHIỆP SỐ 412 TẬP A – QUYỀN 2 (07.2022)**

(11) **44987**

(21) 3-2022-00803

(28) 1

(54) **NẤP HỘP ĐỰNG KHĂN ƯỚT**

(51) **09-07**

(22) 25/04/2022

(43) 25/07/2022

(73) **NGUYỄN THỊ MAI DUNG (VN)**

985/11 Hương lộ 2, khu phố 8, phường Bình Trị Đông A, quận Bình Tân, thành phố Hồ Chí Minh

(72) Nguyễn Thị Mai Dung (VN)

(55)



1.1



1.2



1.3



1.4



1.5



1.6



1.7



**CÔNG BÁO SỞ HỮU CÔNG NGHIỆP SỐ 412 TẬP A – QUYỀN 2 (07.2022)**

- (11) **44988**  
(21) 3-2022-00809 (28) 1  
(54) **CHÂN ĐỂ MÁY THU HÌNH** (51) **14-03**  
(22) 25/04/2022 (43) 25/07/2022  
(30) 2021-024112 05/11/2021 JP;  
(73) **SHARP KABUSHIKI KAISHA (JP)**  
1 Takumi-cho, Sakai-ku, Sakai City, Osaka 590-8522, Japan  
(72) 1. YUSUKE KONISHI (JP)  
2. AKIHIKO HOTTA (JP)  
3. TING JUI CHANG (JP)  
(74) Công ty TNHH một thành viên Sở hữu trí tuệ VCCI (VCCI-IP CO.,LTD)  
(55)



- (11) **44989**  
(21) 3-2022-00810 (28) 3  
(54) **BAO GÓI** (51) **09-05**  
(22) 25/04/2022 (43) 25/07/2022  
(73) **CÔNG TY CỔ PHẦN LIWAYWAY VIỆT NAM (VN)**  
Số 14, đường số 05, khu công nghiệp Việt Nam - Singapore, phường Bình Hòa,  
thành phố Thuận An, tỉnh Bình Dương  
(72) Robert Tan Li (PH)  
(74) Văn phòng Luật sư Tân Hà (VPLS TAN HA)  
(55)



1.1



1.2



2.1



2.2



3.1



3.2

**CÔNG BÁO SỞ HỮU CÔNG NGHIỆP SỐ 412 TẬP A – QUYỀN 2 (07.2022)**

- (11) **44990**  
(21) 3-2022-00813 (28) 1  
(54) **AO NUÔI TÔM SIÊU THÂM CANH VỚI HỆ THỐNG CẤP KHÍ NANO OXY** (51) **30-02**  
(22) 11/01/2021 (43) 25/07/2022  
(73) **CÔNG TY CỔ PHẦN RYNAN TECHNOLOGIES VIETNAM (VN)**  
Ấp Long Trị, xã Long Đức, thành phố Trà Vinh, tỉnh Trà Vinh  
(72) 1. NGUYỄN THANH MỸ (VN)  
2. TRẦN QUỐC TOẢN (VN)  
3. VÕ VŨ KHANH (VN)  
4. VÕ QUỐC VIỆT (VN)  
5. NGUYỄN KHẮC NHỰT (VN)  
6. BÙI MINH CHÂU (VN)  
7. HỒNG QUỐC CƯỜNG (VN)  
8. TÔ HUỖNH NGỌC DUY (VN)  
(74) Công ty TNHH Đại Tín và Liên Danh (DAITIN AND ASSOCIATES CO.,LTD)  
(55)

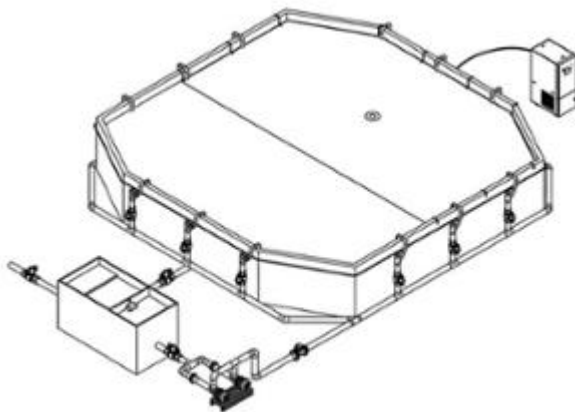

1.1

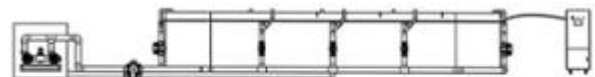

1.2



1.3

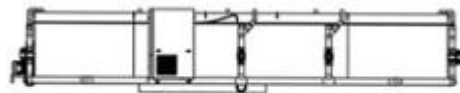

1.4



1.5

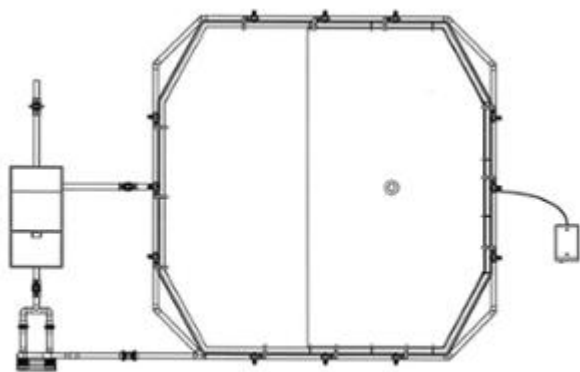

1.6

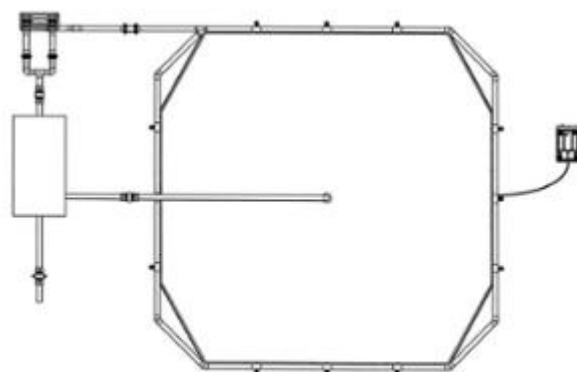

1.7

**CÔNG BÁO SỞ HỮU CÔNG NGHIỆP SỐ 412 TẬP A – QUYỀN 2 (07.2022)**

- (11) **44991**  
(21) 3-2022-00814 (28) 1  
(54) **NHÃN SẢN PHẨM** (51) **19-08**  
(22) 25/04/2022 (43) 25/07/2022  
(73) **CÔNG TY TNHH XUẤT NHẬP KHẨU KỸ THUẬT NÔNG NGHIỆP  
YAKARA (VN)**  
57/8B ấp Thới Tây 2, xã Tân Hiệp, huyện Hóc Môn, thành phố Hồ Chí Minh  
(72) Nguyễn Trung Khương (VN)  
(74) Công ty Cổ phần Sở hữu công nghiệp INVESTIP (INVESTIP)  
(55)



1.1



1.2

**CÔNG BÁO SỞ HỮU CÔNG NGHIỆP SỐ 412 TẬP A – QUYỀN 2 (07.2022)**

- (11) **44992**  
(21) 3-2022-00815 (28) 1  
(54) **BAO GÓI** (51) **09-05**  
(22) 25/04/2022 (43) 25/07/2022  
(73) **CÔNG TY TNHH KHÁNH NGUYỄN (VN)**  
Số 522 đường Nguyễn Đình Chiểu, phường 3, thành phố Tân An, tỉnh Long An  
(72) Tạ Quốc Tuấn (VN)  
(74) Công ty Cổ phần Sở hữu công nghiệp INVESTIP (INVESTIP)  
(55)



1.1



1.2



**CÔNG BÁO SỞ HỮU CÔNG NGHIỆP SỐ 412 TẬP A – QUYỀN 2 (07.2022)**

- (11) **44993**  
(21) 3-2022-00816 (28) 1  
(54) **BAO GÓI** (51) **09-05**  
(22) 25/04/2022 (43) 25/07/2022  
(73) **CÔNG TY TNHH KHÁNH NGUYỄN (VN)**  
Số 522 đường Nguyễn Đình Chiểu, phường 3, thành phố Tân An, tỉnh Long An  
(72) Tạ Quốc Tuấn (VN)  
(74) Công ty Cổ phần Sở hữu công nghiệp INVESTIP (INVESTIP)  
(55)



1.1



1.2



- (11) **44994**  
(21) 3-2022-00817 (28) 1  
(54) **THIẾT BỊ LỌC NƯỚC** (51) **23-01**  
(22) 26/04/2022 (43) 25/07/2022  
(30) 29/816,158 19/11/2021 US;  
(73) **DART INDUSTRIES INC. (US)**  
14901 S. Orange Blossom Trail, Orlando, Florida, 32837, United States of America  
(72) 1. IWAN SOETOMO SALIM (ID)  
2. RALPH F. E. EIKELBERG (NL)  
(74) **CÔNG TY LUẬT TRÁCH NHIỆM HỮU HẠN AMBYS HÀ NỘI (AMBYS HANOI)**  
(55)

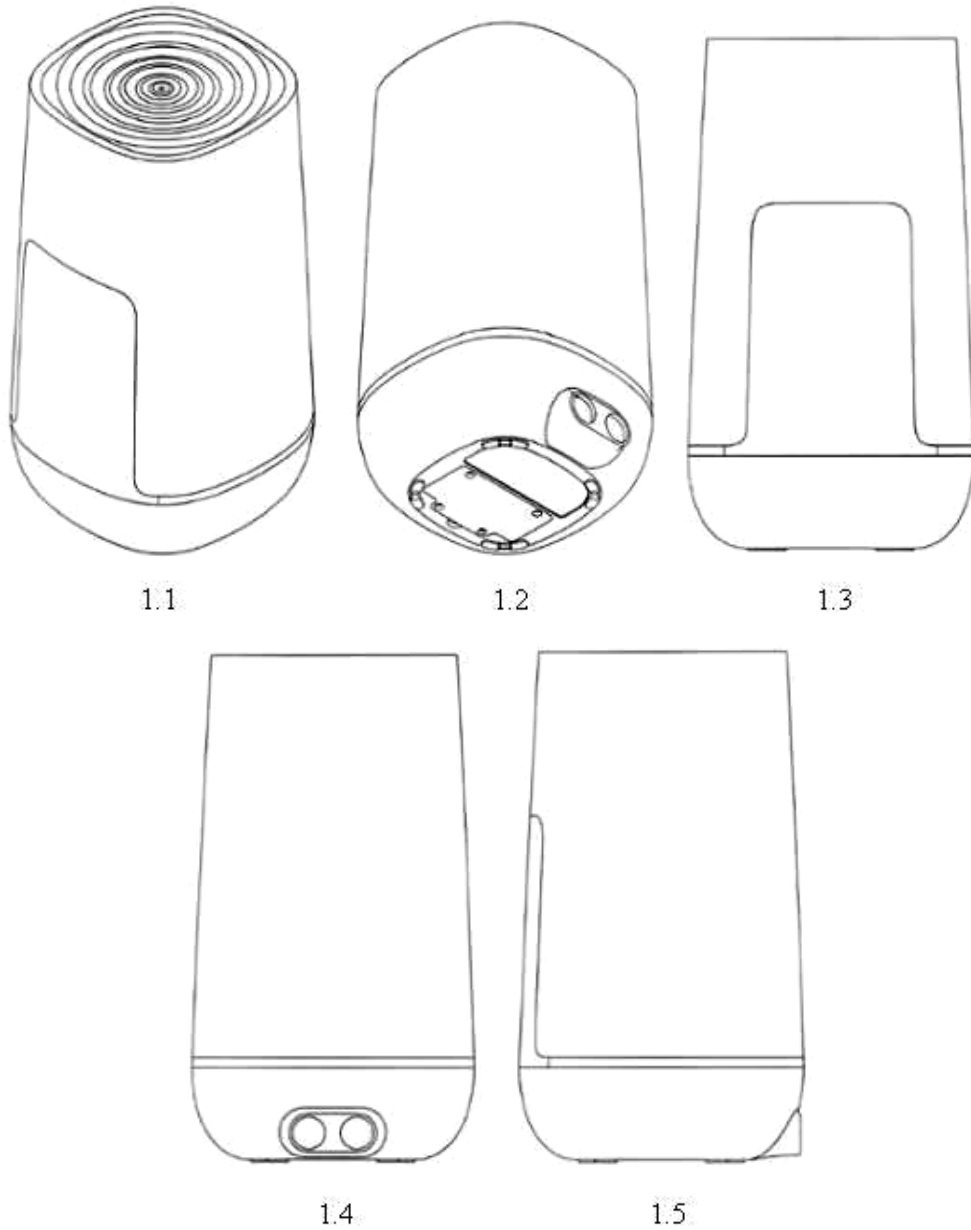

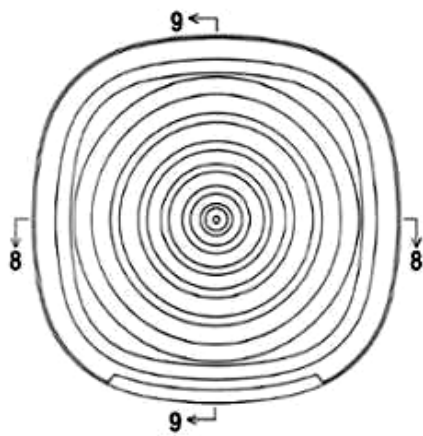

1.6

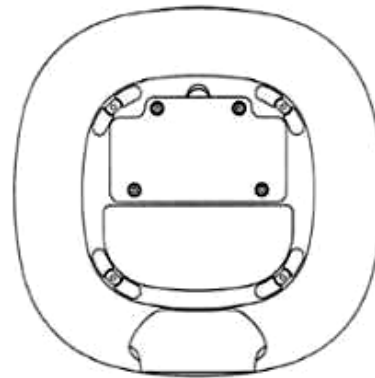

1.7

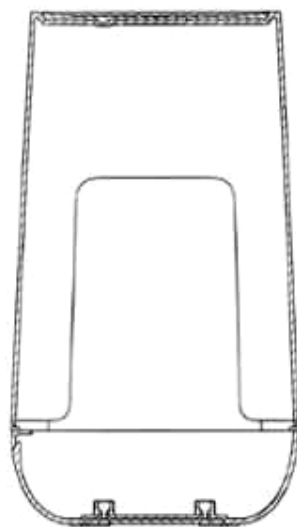

1.8



1.9

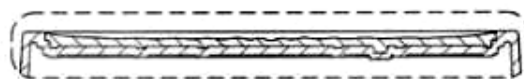

1.10

- (11) **44995**  
(21) 3-2022-00818 (28) 4  
(54) **HỘP ĐỰNG** (51) **09-03**  
(22) 26/04/2022 (43) 25/07/2022  
(30) 29/814,610 08/11/2021 US;  
(73) **DART INDUSTRIES INC. (US)**  
14901 S. Orange Blossom Trail, Orlando, Florida, 32837, United States of America  
(72) Dongjin Byeon (KR)  
(74) **CÔNG TY LUẬT TRÁCH NHIỆM HỮU HẠN AMBYS HÀ NỘI (AMBYS HANOI)**  
(55)

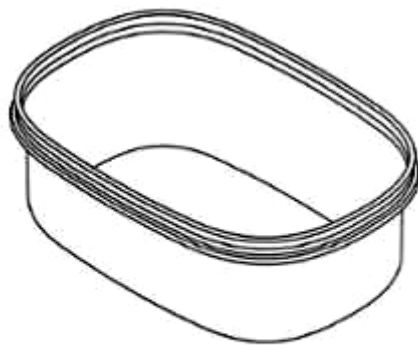

1.1

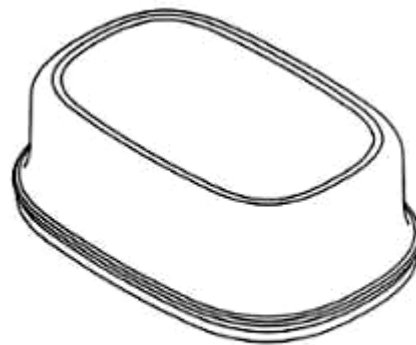

1.2



1.3



1.4

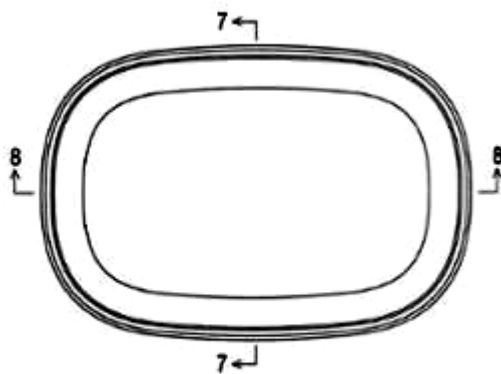

1.5

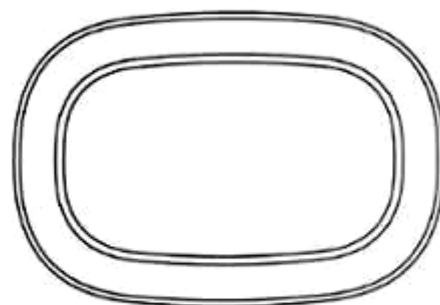

1.6



1.7

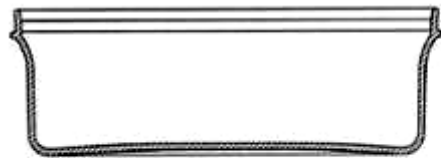

1.8

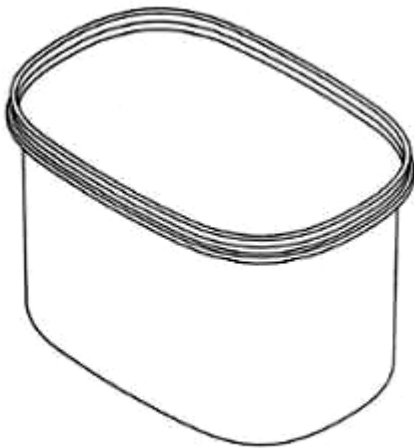

2.1

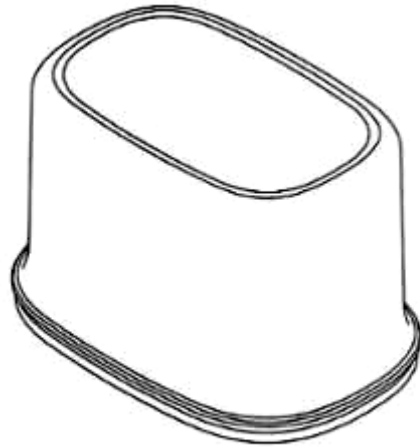

2.2

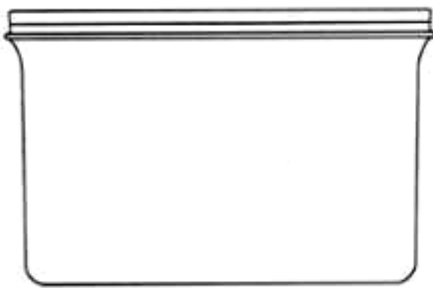

2.3

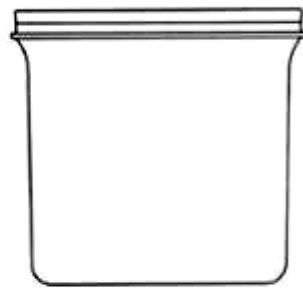

2.4

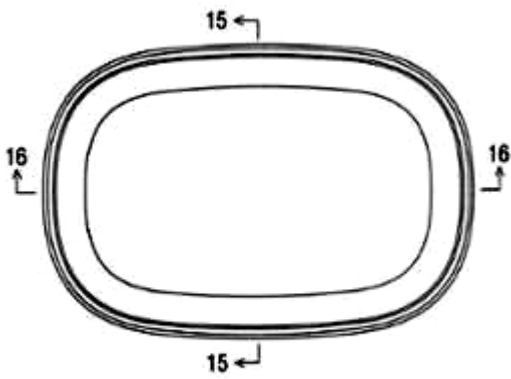

2.5

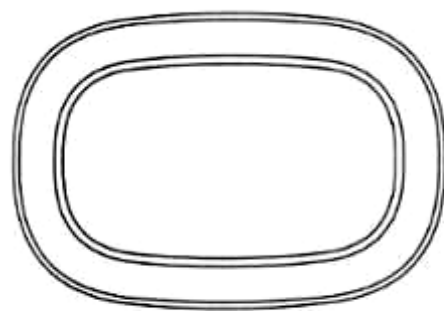

2.6

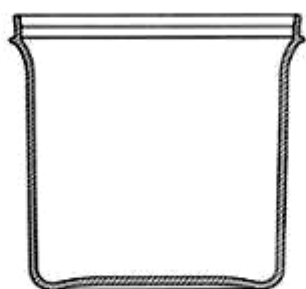

2.7



2.8



3.1

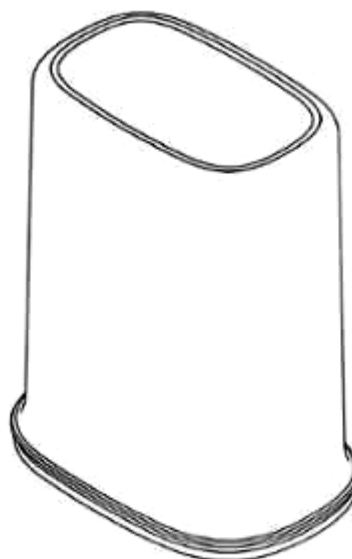

3.2

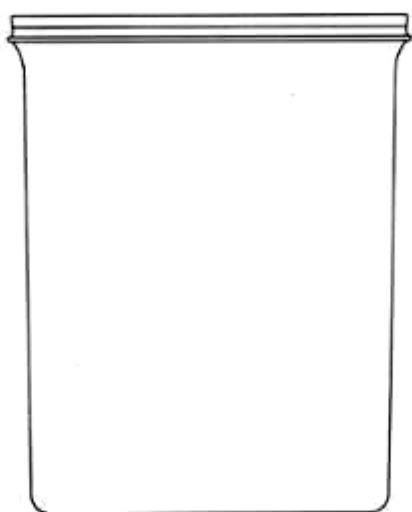

3.3

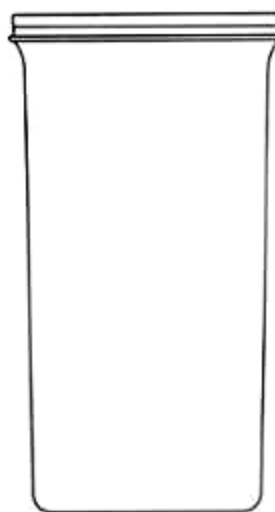

3.4

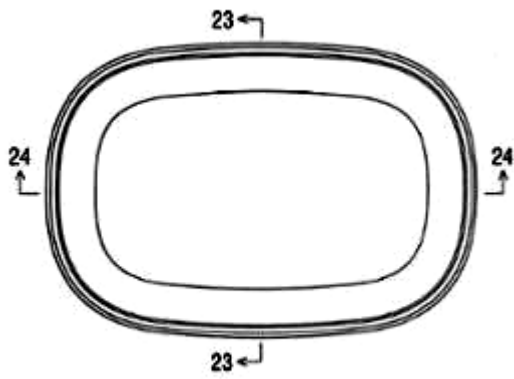

3.5

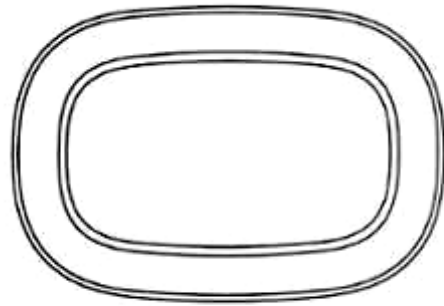

3.6



3.7

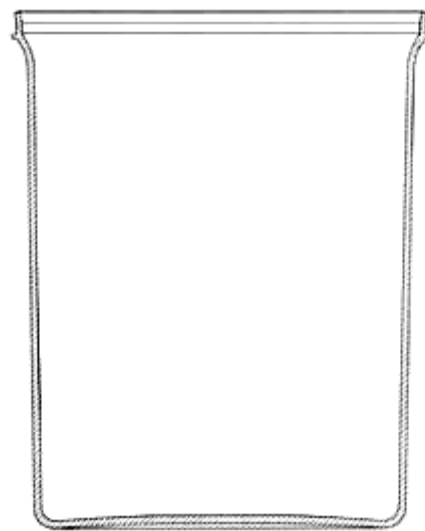

3.8



4.1

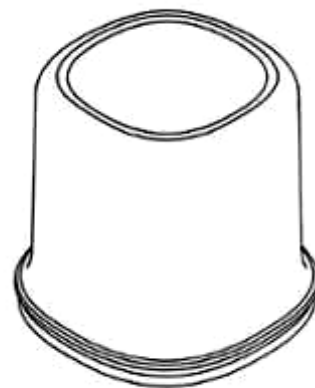

4.2

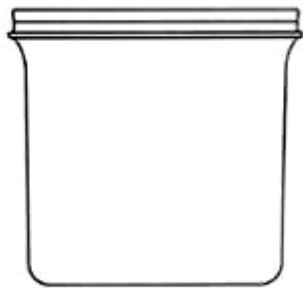

4.3

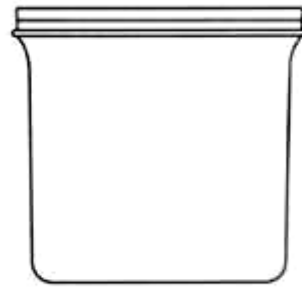

4.4

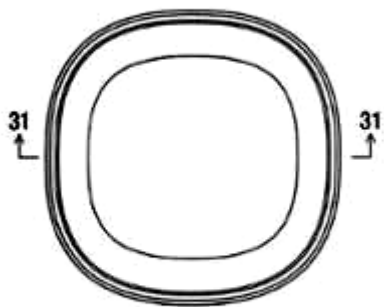

4.5

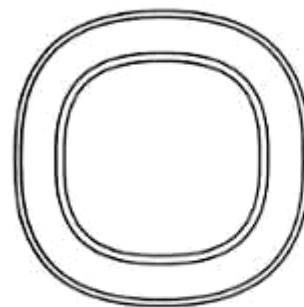

4.6



4.7

- (11) **44996**  
(21) 3-2022-00819 (28) 1  
(54) **XE ĐIỆN** (51) **12-11**  
(22) 26/04/2022 (43) 25/07/2022  
(73) **CÔNG TY CỔ PHẦN SẢN XUẤT VÀ KINH DOANH VINFAST (VN)**  
Khu kinh tế Đình Vũ-Cát Hải, đảo Cát Hải, thị trấn Cát Hải, huyện Cát Hải, thành phố Hải Phòng  
(72) 1. BÙI ĐỨC CÔNG (VN)  
2. TRẦN VĂN LONG (VN)  
(74) **CÔNG TY LUẬT TRÁCH NHIỆM HỮU HẠN AMBYS HÀ NỘI (AMBYS HANOI)**  
(55)



1.1



1.2



1.3



1.4



1.5



1.6



1.7



**CÔNG BÁO SỞ HỮU CÔNG NGHIỆP SỐ 412 TẬP A – QUYỀN 2 (07.2022)**

- (11) **44997**  
(21) 3-2022-00823 (28) 2  
(54) **Ô TÔ** (51) **12-08**  
(22) 26/04/2022 (43) 25/07/2022  
(30) 2021-023421 27/10/2021 JP; 2021-023420 27/10/2021 JP;  
(73) **DAIHATSU MOTOR CO., LTD. (JP)**  
1-1, Daihatsu-Cho, Ikeda-Shi, Osaka 563-8651 Japan  
(72) 1. KOICHI MIZUTA (JP)  
2. MANABU FUKUDA (JP)  
3. JIRO MATSUEDA (JP)  
4. KATSUTARO KIMURA (JP)  
5. ANTONIUS DIMAS TRI WIBOWO (ID)  
6. ZAKI MUBAROK (ID)  
7. HIDEYU HONDA (JP)  
(74) Công ty TNHH một thành viên Sở hữu trí tuệ VCCI (VCCI-IP CO.,LTD)  
(55)



1.1



1.2



1.3



1.4



1.5



1.6



1.7



2.1



2.2



2.3



2.4



2.5



2.6



2.7

**CÔNG BÁO SỞ HỮU CÔNG NGHIỆP SỐ 412 TẬP A – QUYỀN 2 (07.2022)**

- (11) **44998**  
(21) 3-2022-00824 (28) 1  
(54) **TẮM CHẮN PHÍA TRƯỚC CỦA Ô TÔ** (51) **12-16**  
(22) 26/04/2022 (43) 25/07/2022  
(30) 2021-023423 27/10/2021 JP;  
(73) **DAIHATSU MOTOR CO., LTD. (JP)**  
1-1, Daihatsu-Cho, Ikeda-Shi, Osaka 563-8651 Japan  
(72) 1. HIDEYU HONDA (JP)  
2. JUNYA HACHISU (JP)  
3. REO KATSUNO (JP)  
(74) Công ty TNHH một thành viên Sở hữu trí tuệ VCCI (VCCI-IP CO.,LTD)  
(55)



1.1



1.2

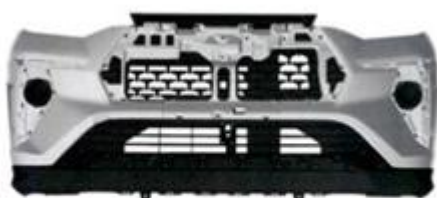

1.3



1.4

1.5



1.6



1.7



1.8

**CÔNG BÁO SỞ HỮU CÔNG NGHIỆP SỐ 412 TẬP A – QUYỀN 2 (07.2022)**

- (11) **44999**  
(21) 3-2022-00825 (28) 1  
(54) **BỘ ĐÈN PHÍA TRƯỚC CỦA Ô TÔ** (51) **26-06**  
(22) 26/04/2022 (43) 25/07/2022  
(30) 2021-023425 27/10/2021 JP;  
(73) **DAIHATSU MOTOR CO., LTD. (JP)**  
1-1, Daihatsu-Cho, Ikeda-Shi, Osaka 563-8651 Japan  
(72) Hideyu HONDA (JP)  
(74) Công ty TNHH một thành viên Sở hữu trí tuệ VCCI (VCCI-IP CO.,LTD)  
(55)



1.1



1.2



1.3



1.4



1.5



1.6



1.7



1.8

**CÔNG BÁO SỞ HỮU CÔNG NGHIỆP SỐ 412 TẬP A – QUYỀN 2 (07.2022)**

- (11) **45000**  
(21) 3-2022-00826 (28) 1  
(54) **BỘ ĐÈN PHÍA SAU CỦA Ô TÔ** (51) **26-06**  
(22) 26/04/2022 (43) 25/07/2022  
(30) 2021-023427 27/10/2021 JP;  
(73) **DAIHATSU MOTOR CO., LTD. (JP)**  
1-1, Daihatsu-Cho, Ikeda-Shi, Osaka 563-8651 Japan  
(72) Shinji TAMURA (JP)  
(74) Công ty TNHH một thành viên Sở hữu trí tuệ VCCI (VCCI-IP CO.,LTD)  
(55)



1.1



1.2



1.3



1.4



1.5



1.6



1.7



1.8

**CÔNG BÁO SỞ HỮU CÔNG NGHIỆP SỐ 412 TẬP A – QUYỀN 2 (07.2022)**

- (11) **45001**  
(21) 3-2022-00827 (28) 1  
(54) **TẮM HÃM XUNG PHÍA SAU CỦA Ô TÔ** (51) **12-16**  
(22) 26/04/2022 (43) 25/07/2022  
(30) 2021-023429 27/10/2021 JP;  
(73) **DAIHATSU MOTOR CO., LTD. (JP)**  
1-1, Daihatsu-Cho, Ikeda-Shi, Osaka 563-8651 Japan  
(72) Shinji TAMURA (JP)  
(74) Công ty TNHH một thành viên Sở hữu trí tuệ VCCI (VCCI-IP CO.,LTD)  
(55)



1.1



1.2



1.3



1.4

1.5



1.6



1.7



1.8



**CÔNG BÁO SỞ HỮU CÔNG NGHIỆP SỐ 412 TẬP A – QUYỀN 2 (07.2022)**

- (11) **45002**  
(21) 3-2022-00828 (28) 1  
(54) **BẢNG ĐIỀU KHIỂN CỦA Ô TÔ** (51) **12-16**  
(22) 26/04/2022 (43) 25/07/2022  
(30) 2021-023431 27/10/2021 JP;  
(73) **DAIHATSU MOTOR CO., LTD. (JP)**  
1-1, Daihatsu-Cho, Ikeda-Shi, Osaka 563-8651 Japan  
(72) 1. KOJI NAGAI (JP)  
2. AYUMI KADOTA (JP)  
(74) Công ty TNHH một thành viên Sở hữu trí tuệ VCCI (VCCI-IP CO.,LTD)  
(55)



1.1



1.2



1.3



1.4



1.5



1.6



1.7

- (11) **45003**  
(21) 3-2022-00830 (28) 1  
(54) **TẮM LỌC MÁY ĐIỀU HÒA KHÔNG KHÍ** (51) **23-04**  
(22) 26/04/2022 (43) 25/07/2022  
(30) 2021-024295 08/11/2021 JP;  
(73) **MITSUBISHI ELECTRIC CORPORATION (JP)**  
7-3, Marunouchi 2-chome, Chiyoda-ku, Tokyo 100-8310, Japan  
(72) 1. IZURU HAMASAKI (JP)  
2. JANGRYUL RIM (KR)  
3. SATOSHI ARAI (JP)  
(74) Công ty TNHH Tầm nhìn và Liên danh (VISION & ASSOCIATES CO.LTD.)  
(55)

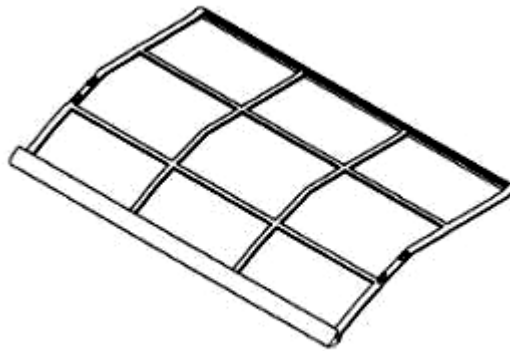

1.1

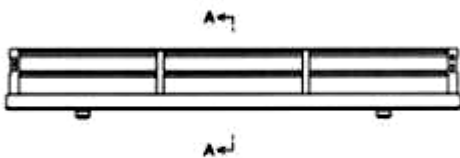

1.2



1.3



1.4



1.5

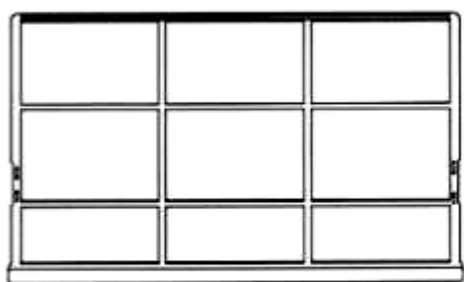

1.6

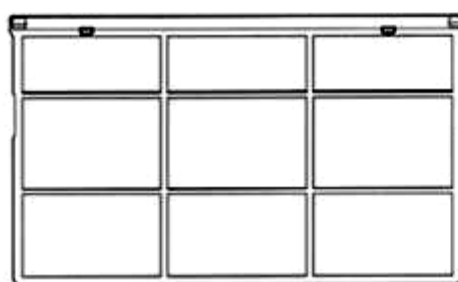

1.7



1.8

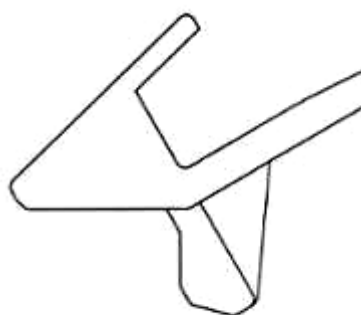

1.9

**CÔNG BÁO SỞ HỮU CÔNG NGHIỆP SỐ 412 TẬP A – QUYỀN 2 (07.2022)**

(11) **45004**

(21) 3-2022-00834

(28) 1

(54) **NỒI**

(51) **07-02**

(22) 26/04/2022

(43) 25/07/2022

(73) **CÔNG TY CỔ PHẦN ELMICH (VN)**

Cụm công nghiệp An Mỹ - Đồn Xá, thị trấn Bình Mỹ, huyện Bình Lục, tỉnh Hà Nam

(72) Đỗ Thành Trung (VN)

(74) Công ty Luật TNHH LEADCONSULT (LEADCONSULT)

(55)



1.1

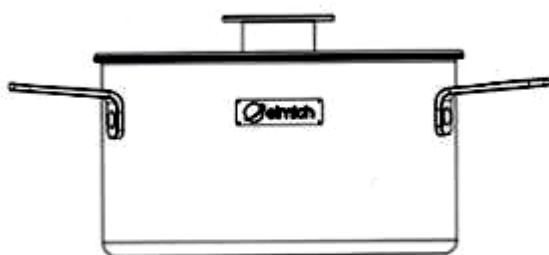

1.2

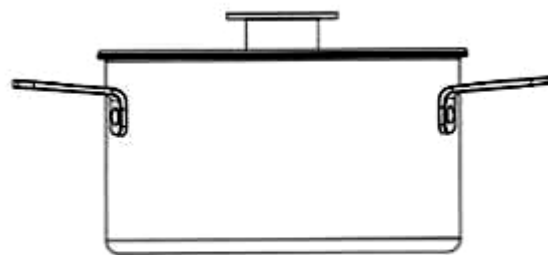

1.3



1.4

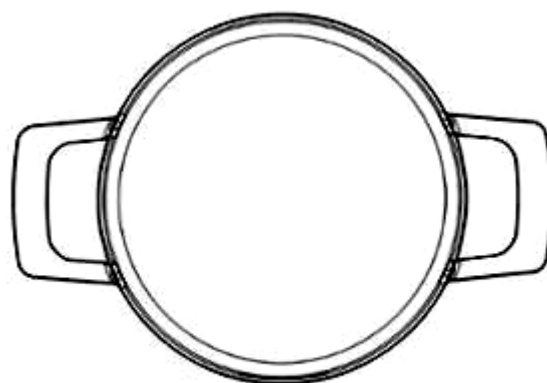

1.5

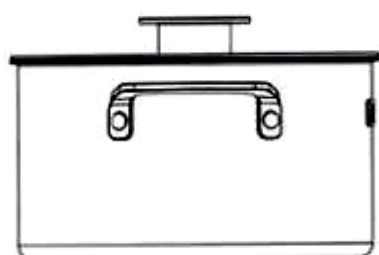

1.6

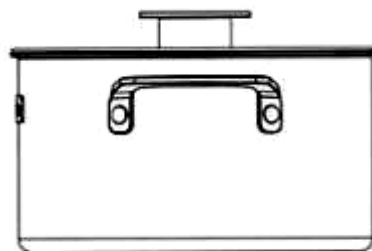

1.7

**CÔNG BÁO SỞ HỮU CÔNG NGHIỆP SỐ 412 TẬP A – QUYỀN 2 (07.2022)**

(11) **45005**

(21) 3-2022-00837

(28) 1

(54) **GHẾ**

(51) **06-01**

(22) 27/04/2022

(43) 25/07/2022

(73) **CÔNG TY CỔ PHẦN SOFIA NỘI THẤT (VN)**

Số 946 đường La Thành, phường Ngọc Khánh, quận Ba Đình, thành phố Hà Nội

(72) Nguyễn Minh Phương (VN)

(55)



1.1



1.2



1.3



1.4



1.5



1.6



(11) **45006**

(21) 3-2022-00839

(54) **GHẾ**

(22) 27/04/2022

(73) **CÔNG TY CỔ PHẦN SOFIA NỘI THẤT (VN)**

Số 946 đường La Thành, phường Ngọc Khánh, quận Ba Đình, thành phố Hà Nội

(72) Nguyễn Minh Phương (VN)

(55)

(28) 1

(51) **06-01**

(43) 25/07/2022



1.1



1.2



1.3



1.4



1.5



1.6

**CÔNG BÁO SỞ HỮU CÔNG NGHIỆP SỐ 412 TẬP A – QUYỀN 2 (07.2022)**

(11) **45007**

(21) 3-2022-00840

(28) 1

(54) **TỦ BẾP**

(51) **06-04**

(22) 27/04/2022

(43) 25/07/2022

(73) **CÔNG TY CỔ PHẦN SOFIA NỘI THẤT (VN)**

Số 946 đường La Thành, phường Ngọc Khánh, quận Ba Đình, thành phố Hà Nội

(72) Nguyễn Minh Phương (VN)

(55)

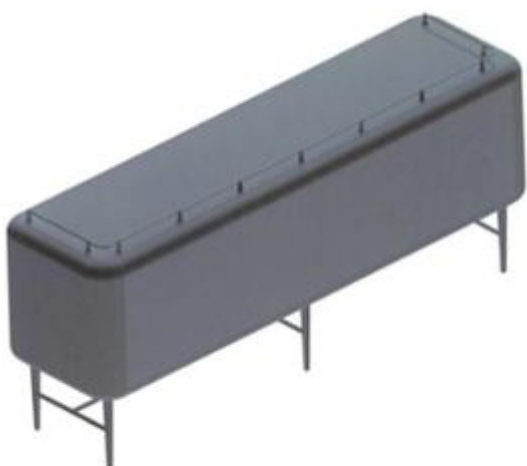

1.1

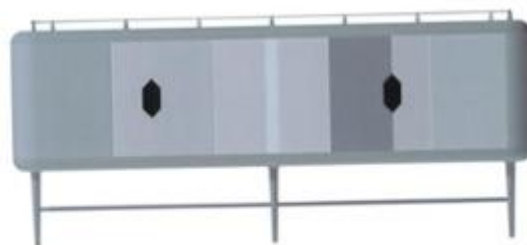

1.2



1.3



1.4



1.5



1.6

- (11) **45008**  
(21) 3-2022-00842 (28) 1  
(54) **QUẠT SẠC TÍCH ĐIỆN** (51) **23-04**  
(22) 27/04/2022 (43) 25/07/2022  
(73) **LEADER BRIGHT INDUSTRIES LIMITED (CN)**  
E2, 1/F., Tuen Mun Industrial Centre, Pui To Road, TMTL 76, Tuen Mun, New Territories, Hong Kong  
(72) 1. WON KWONG MING, ARTHUR (CN)  
2. LEUNG WING HONG (CN)  
(74) Công ty Cổ phần Sở hữu công nghiệp INVESTIP (INVESTIP)  
(55)

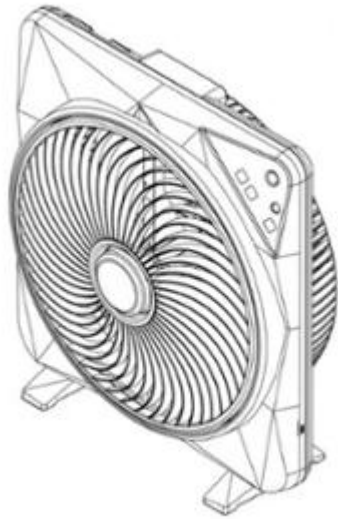

1.1

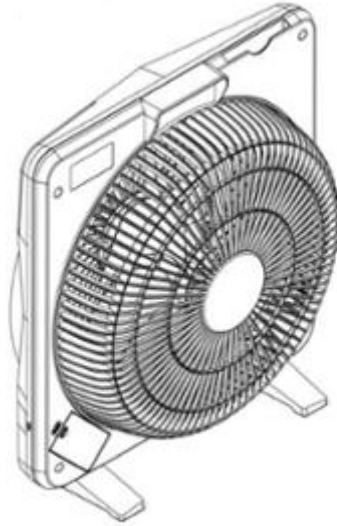

1.2

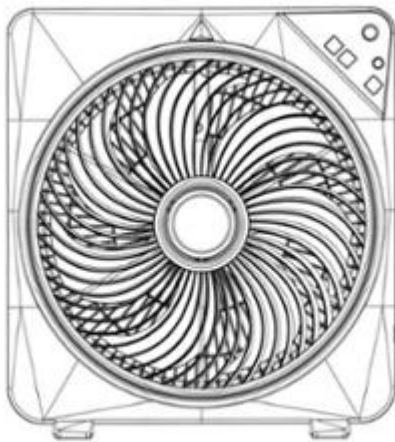

1.3

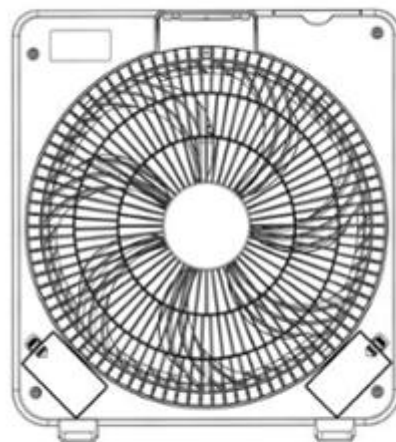

1.4

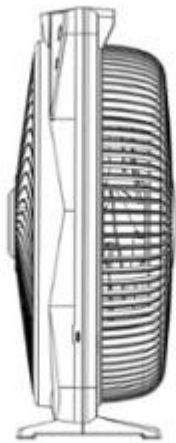

1.5

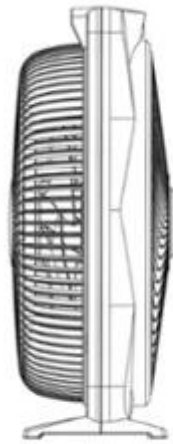

1.6

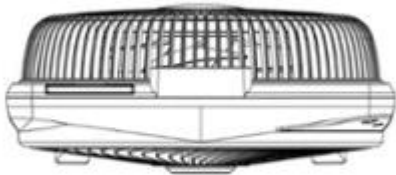

1.7

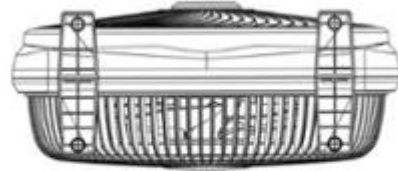

1.8

**CÔNG BÁO SỞ HỮU CÔNG NGHIỆP SỐ 412 TẬP A – QUYỀN 2 (07.2022)**

(11) **45009**

(21) 3-2022-00848

(28) 1

(54) **GHẾ**

(51) **06-01**

(22) 28/04/2022

(43) 25/07/2022

(73) **CÔNG TY CỔ PHẦN SEMA GROUP (VN)**

Số 69, đường 23, khu đô thị thành phố Giao lưu, phường Cổ Nhuế 1, quận Bắc Từ Liêm, thành phố Hà Nội

(72) Nguyễn Phương Chi (VN)

(74) Công ty TNHH NACILAW (NACILAW)

(55)



1.1



1.2



1.3



1.4



1.5



1.6



1.7

**CÔNG BÁO SỞ HỮU CÔNG NGHIỆP SỐ 412 TẬP A – QUYỀN 2 (07.2022)**

(11) **45010**

(21) 3-2022-00849

(28) 1

(54) **GHẾ**

(51) **06-01**

(22) 28/04/2022

(43) 25/07/2022

(73) **CÔNG TY CỔ PHẦN SEMA GROUP (VN)**

Số 69, đường 23, khu đô thị thành phố Giao lưu, phường Cổ Nhuế 1, quận Bắc Từ Liêm, thành phố Hà Nội

(72) Nguyễn Phương Chi (VN)

(74) Công ty TNHH NACILAW (NACILAW)

(55)



1.1



1.2



1.3



1.4





1.5



1.6



1.7

**CÔNG BÁO SỞ HỮU CÔNG NGHIỆP SỐ 412 TẬP A – QUYỀN 2 (07.2022)**

- (11) **45011**  
(21) 3-2022-00854 (28) 1  
(54) **BAO GÓI** (51) **09-05**  
(22) 29/04/2022 (43) 25/07/2022  
(73) **CÔNG TY CỔ PHẦN ACECOOK VIỆT NAM (VN)**  
Lô số II-3, đường số 11, nhóm CN II, khu công nghiệp Tân Bình, phường Tây  
Thạnh, quận Tân Phú, thành phố Hồ Chí Minh  
(72) Kajiwara Junichi (JP)  
(74) Công ty Luật TNHH Phạm và Liên danh (PHAM & ASSOCIATES)  
(55)



1.1



1.2

- (11) **45012**  
(21) 3-2022-00855 (28) 1  
(54) **GIÀY** (51) **02-04**  
(22) 29/04/2022 (43) 25/07/2022  
(30) 008786818-0003 03/12/2021 EM;  
(73) **DECATHLON (FR)**  
4, Boulevard de Mons, F-59650 Villeneuve d'Ascq, France  
(72) Pierre DUQUENOY (FR)  
(74) Công ty Luật TNHH T&G (TGVN)  
(55)



1.1



1.2



1.3



1.4



1.5



1.6



1.7

**CÔNG BÁO SỞ HỮU CÔNG NGHIỆP SỐ 412 TẬP A – QUYỀN 2 (07.2022)**

- (11) **45013**  
(21) 3-2022-00856 (28) 1  
(54) **GIÀY** (51) **02-04**  
(22) 29/04/2022 (43) 25/07/2022  
(30) 008786818-0002 03/12/2021 EM;  
(73) **DECATHLON (FR)**  
4, Boulevard de Mons, F-59650 Villeneuve d'Ascq, France  
(72) Pierre DUQUENOY (FR)  
(74) Công ty Luật TNHH T&G (TGVN)  
(55)



1.1



1.2



1.3



1.4



1.5



1.6



1.7

**CÔNG BÁO SỞ HỮU CÔNG NGHIỆP SỐ 412 TẬP A – QUYỀN 2 (07.2022)**

- (11) **45014**  
(21) 3-2022-00857 (28) 1  
(54) **GIÀY** (51) **02-04**  
(22) 29/04/2022 (43) 25/07/2022  
(30) 008786818-0001 03/12/2021 EM;  
(73) **DECATHLON (FR)**  
4, Boulevard de Mons, F-59650 Villeneuve d'Ascq, France  
(72) Pierre DUQUENOY (FR)  
(74) Công ty Luật TNHH T&G (TGVN)  
(55)



1.1



1.2



1.3



1.4



1.5



1.6



1.7



**CÔNG BÁO SỞ HỮU CÔNG NGHIỆP SỐ 412 TẬP A – QUYỀN 2 (07.2022)**

(11) **45015**

(21) 3-2022-00858

(28) 1

(54) **NỒI NẤU**

(51) **07-02**

(22) 29/04/2022

(43) 25/07/2022

(73) **CÔNG TY CỔ PHẦN TẬP ĐOÀN SUNHOUSE (VN)**

139 Nguyễn Thái Học, phường Điện Biên, quận Ba Đình, thành phố Hà Nội

(72) Lại Văn Kiên (VN)

(74) Công ty TNHH Sở hữu trí tuệ Bình Minh (SUNRISE IP CO.,LTD.)

(55)



1.1

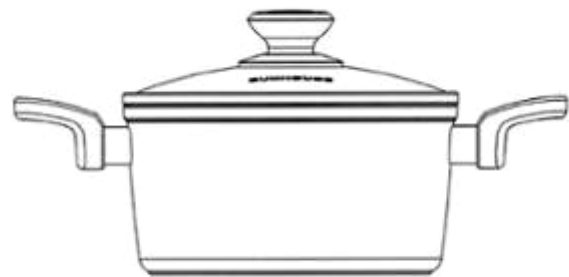

1.2

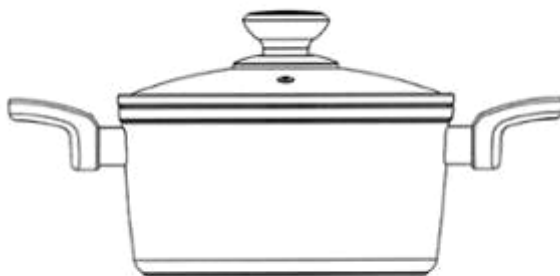

1.3



1.4

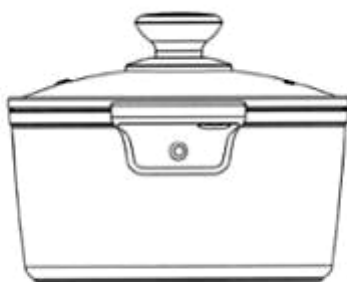

1.5



1.6

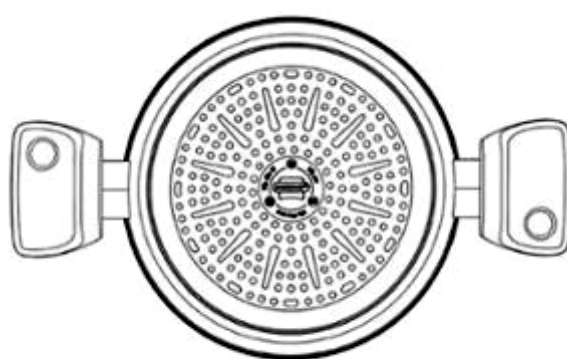

1.7

**CÔNG BÁO SỞ HỮU CÔNG NGHIỆP SỐ 412 TẬP A – QUYỀN 2 (07.2022)**

(11) **45016**

(21) 3-2022-00861

(28) 1

(54) **LƯỚI TẢN DÒNG**

(51) **07-01**

(22) 29/04/2022

(43) 25/07/2022

(73) **CÔNG TY TNHH MINH LONG I (VN)**

333 khu phố Hưng Lộc, phường Hưng Định, thành phố Thuận An, tỉnh Bình Dương

(72) Lý Ngọc Minh (VN)

(55)



1.1



1.2



1.3



1.4



1.5



1.6



1.7

**CÔNG BÁO SỞ HỮU CÔNG NGHIỆP SỐ 412 TẬP A – QUYỀN 2 (07.2022)**

- (11) **45017**  
(21) 3-2022-00862 (28) 2  
(54) **HỮ** (51) **09-01**  
(22) 29/04/2022 (43) 25/07/2022  
(30) 202230060685.4 28/01/2022 CN;  
(73) **YANG YUGE (CN)**  
Xiahe Village, Erlong Township, Zhenping County, Nanyang, Henan, China  
(72) Yang Yuge (CN)  
(74) Công ty TNHH Sở hữu trí tuệ Trần & Trần (TRAN & TRAN CO., LTD.)  
(55)



1.1

1.2

1.3

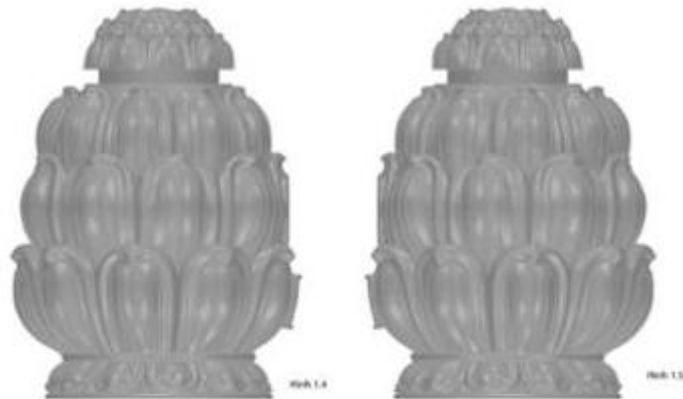

1.4

1.5

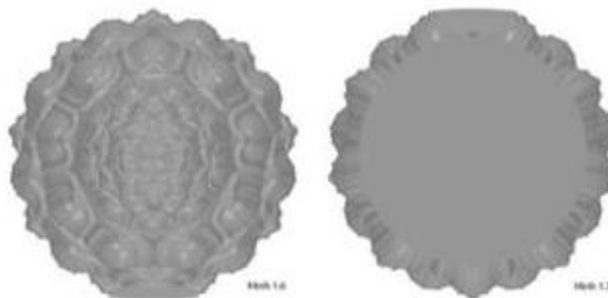

1.6

1.7



Hình 2.1

2.1



Hình 2.2

2.2



Hình 2.3

2.3



Hình 2.4

2.4



Hình 2.5

2.5



Hình 2.6

2.6



Hình 2.7

2.7

**CÔNG BÁO SỞ HỮU CÔNG NGHIỆP SỐ 412 TẬP A – QUYỀN 2 (07.2022)**

(11) **45018**

(21) 3-2022-00863

(28) 1

(54) **XE MÔ TÔ**

(51) **12-11**

(22) 29/04/2022

(43) 25/07/2022

(73) **SANYANG MOTOR CO., LTD. (CN)**

No. 184, Keng Tzu Kou, Shang Keng Village, Hsin Fong Shiang, Hsinchu County  
304, TAIWAN

(72) Uei-Tyng CHEN (TW)

(74) Công ty TNHH Trường Xuân (AGELESS CO.,LTD.)

(55)



1.1



1.2



1.3



1.4



1.5



1.6



1.7



1.8



1.9



1.10

**CÔNG BÁO SỞ HỮU CÔNG NGHIỆP SỐ 412 TẬP A – QUYỀN 2 (07.2022)**

- (11) **45019**  
(21) 3-2022-00878 (28) 1  
(54) **NHÃN SẢN PHẨM** (51) **19-08**  
(22) 05/05/2022 (43) 25/07/2022  
(73) **CÔNG TY TNHH XNK NANOIL USA (VN)**  
Lô Q13 đường số 11, KCN Hải Sơn mở rộng (GD 3+4), xã Đức Hòa Hạ, huyện Đức Hòa, tỉnh Long An  
(72) Mai Xuân Quang (VN)  
(55)





(11) **45020**

(21) 3-2022-00879

(28) 1

(54) **MŨ BẢO HIỂM**

(51) **02-03**

(22) 05/05/2022

(43) 25/07/2022

(73) **GIVI SPA (IT)**

Via G. Ungaretti, 48, 25020 Flero (BS), Italy

(72) Visenzi Giuseppe (IT)

(74) Công ty Cổ phần Sở hữu công nghiệp INVESTIP (INVESTIP)

(55)



1.1



1.2



1.3



1.4



1.5



1.6



1.7



1.8

- (11) **45021**  
(21) 3-2022-00881 (28) 1  
(54) **HỆ THỐNG CẤP THỨC ĂN, OXY PHÂN TỬ VÀ TẠO DÒNG NƯỚC DỪNG TRONG NUÔI TRỒNG THỦY SẢN** (51) **15-03; 15-99; 30-03**  
(22) 05/05/2022 (43) 25/07/2022  
(73) **CÔNG TY CỔ PHẦN RYNAN TECHNOLOGIES VIETNAM (VN)**  
Ấp Long Trị, xã Long Đức, thành phố Trà Vinh, tỉnh Trà Vinh  
(72) 1. NGUYỄN THANH MỸ (VN)  
2. VÕ VŨ KHANH (VN)  
3. TRẦN QUỐC TOÀN (VN)  
4. VÕ QUỐC VIỆT (VN)  
5. HUỖNH LÊ NHỰT HÀO (VN)  
(74) Công ty TNHH Đại Tín và Liên Danh (DAITIN AND ASSOCIATES CO.,LTD)  
(55)

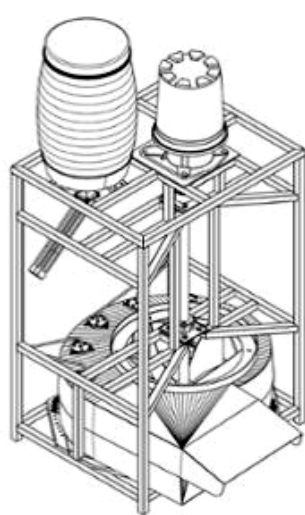

1.1

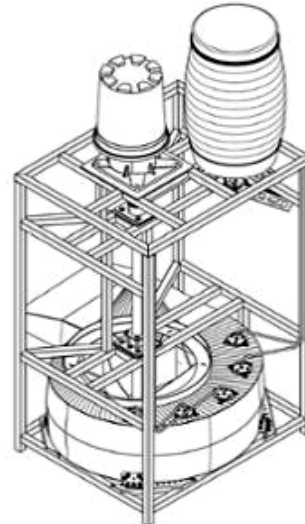

1.2

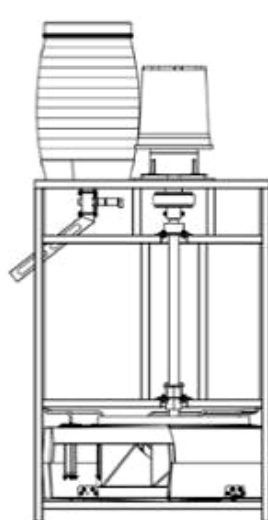

1.3

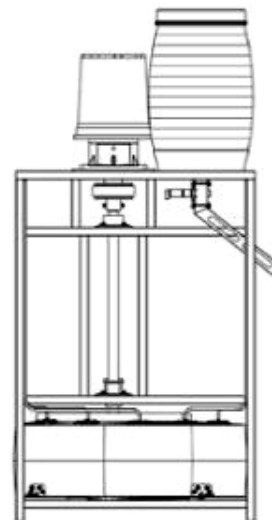

1.4

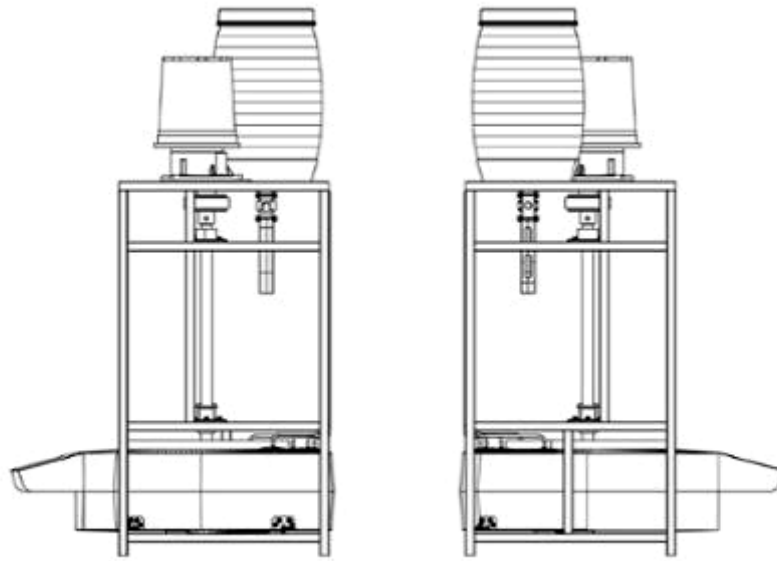

1.5

1.6

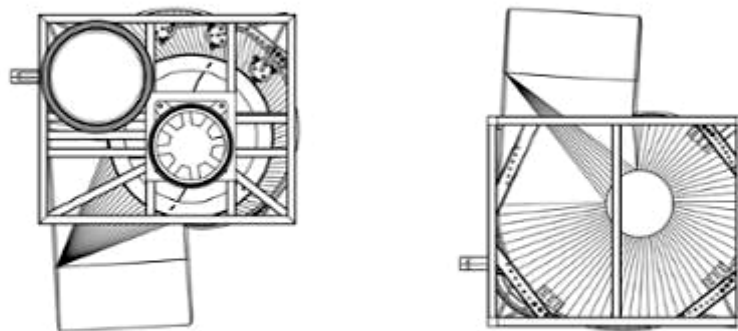

1.7

1.8

- (11) **45022**  
(21) 3-2022-00883 (28) 1  
(54) **GẬY ĐÁNH GÔN** (51) **21-02**  
(22) 06/05/2022 (43) 25/07/2022  
(73) **LÊ HỒNG SƠN (VN)**  
22/1, tổ 6, KP1, phường Tân Thuận Tây, quận 7, thành phố Hồ Chí Minh  
(72) Lê Hồng Sơn (VN)  
(55)



**CÔNG BÁO SỞ HỮU CÔNG NGHIỆP SỐ 412 TẬP A – QUYỀN 2 (07.2022)**

(11) **45023**

(21) 3-2022-00885

(28) 1

(54) **BAO GÓI NGŨ CỐC**

(51) **09-05**

(22) 06/05/2022

(43) 25/07/2022

(73) **CÔNG TY TNHH MIL STAR VIỆT NAM (VN)**

Phố 295 phố Thanh Am, phường Thượng Thanh, quận Long Biên, thành phố Hà Nội

(72) Cao Thị Hằng (VN)

(55)



1.1



1.2

**CÔNG BÁO SỞ HỮU CÔNG NGHIỆP SỐ 412 TẬP A – QUYỀN 2 (07.2022)**

(11) **45024**

(21) 3-2022-00886

(28) 1

(54) **BÀN**

(51) **06-03**

(22) 06/05/2022

(43) 25/07/2022

(73) **CÔNG TY CỔ PHẦN SOFIA NỘI THẤT (VN)**

Số 946 đường La Thành, phường Ngọc Khánh, quận Ba Đình, thành phố Hà Nội

(72) Nguyễn Minh Phương (VN)

(55)



1.1



1.2



1.3



1.4



1.5

- (11) **45025**  
(21) 3-2022-00891 (28) 1  
(54) **ĐÈN CHIẾU SÁNG ĐƯỜNG PHỐ** (51) **26-03**  
(22) 06/05/2022 (43) 25/07/2022  
(73) **CÔNG TY CỔ PHẦN ĐIỆN VÀ CHIẾU SÁNG PHÚ THẮNG (VN)**  
Lô số CN1, KCN Thạch Thất, Quốc Oai, huyện Thạch Thất, thành phố Hà Nội  
(72) Phùng Hữu Thắng (VN)  
(55)



1.1

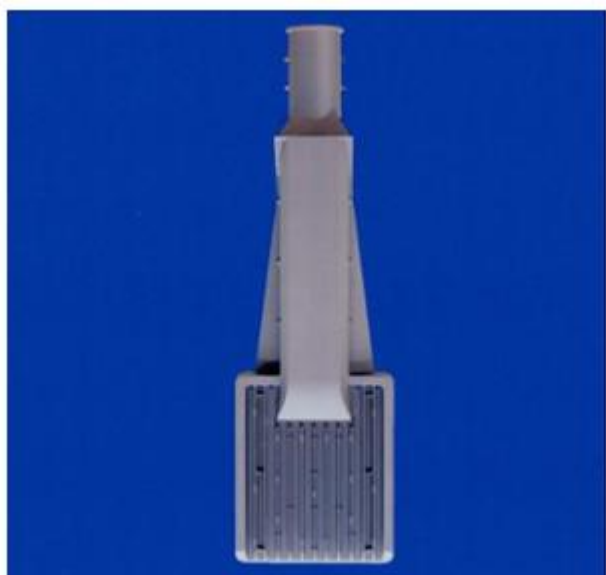

1.2



1.3



1.4



1.5



1.6



1.7



(11) **45026**

(21) 3-2022-00893

(28) 1

(54) **ĐÉ GIẦY**

(51) **02-04**

(22) 06/05/2022

(43) 25/07/2022

(73) **CÔNG TY TNHH BÌNH TIÊN BIÊN HÒA (VN)**

Lô 101/2 khu công nghiệp Amata, phường Long Bình, thành phố Biên Hòa, tỉnh Đồng Nai

(72) Lai Khiêm (VN)

(74) Công ty TNHH Tư vấn sở hữu trí tuệ Việt (VIET IP CO.,LTD.)

(55)



1.1

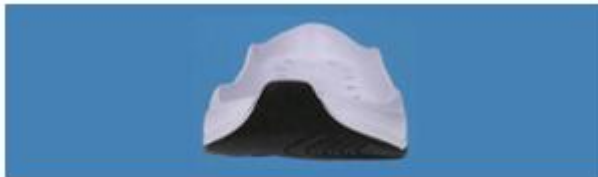

1.2



1.3



1.4



1.5



1.6



1.7

(11) **45027**

(21) 3-2022-00894

(28) 1

(54) **ĐÈN**

(51) **26-05**

(22) 09/05/2022

(43) 25/07/2022

(73) **CÔNG TY CỔ PHẦN BÓNG ĐÈN PHÍCH NƯỚC RẠNG ĐÔNG (VN)**  
87-89 phố Hạ Đình, phường Thanh Xuân Trung, quận Thanh Xuân, thành phố Hà Nội

(72) Trần Trung Tường (VN)

(55)

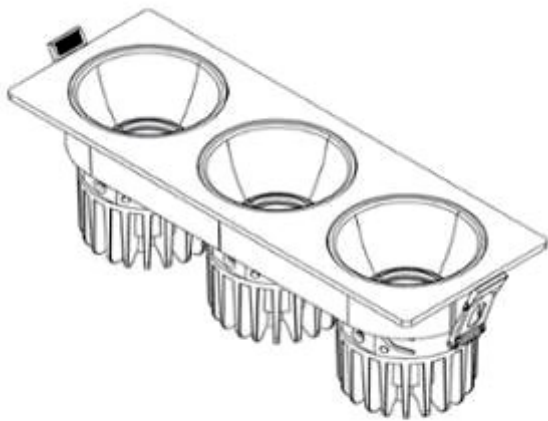

1.1

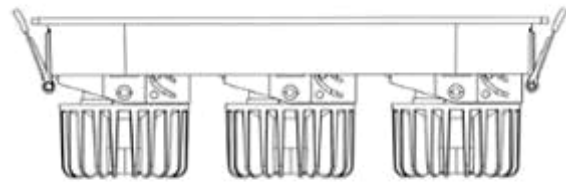

1.2

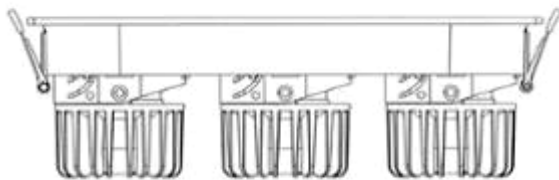

1.3

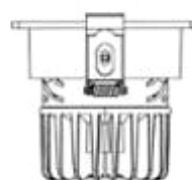

1.4

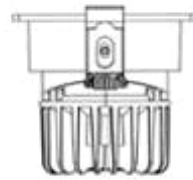

1.5

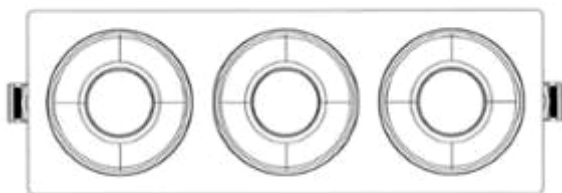

1.6

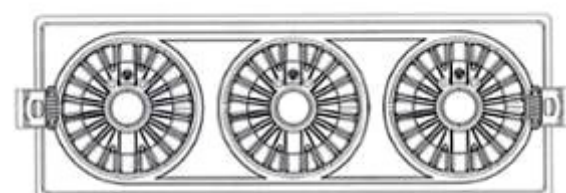

1.7

(11) **45028**

(21) 3-2022-00895

(28) 1

(54) **ĐÈN**

(51) **26-05**

(22) 09/05/2022

(43) 25/07/2022

(73) **CÔNG TY CỔ PHẦN BÓNG ĐÈN PHÍCH NƯỚC RẠNG ĐÔNG (VN)**

87-89 phố Hạ Đình, phường Thanh Xuân Trung, quận Thanh Xuân, thành phố Hà Nội

(72) Trần Trung Tường (VN)

(55)

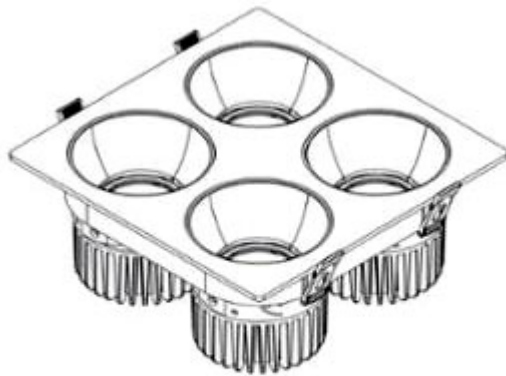

1.1

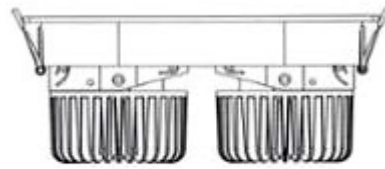

1.2

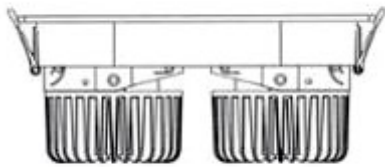

1.3

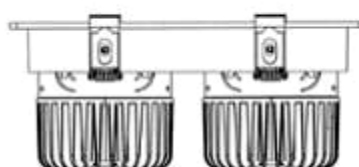

1.4

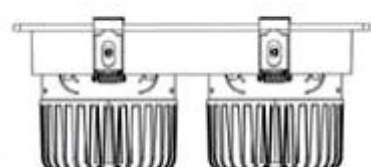

1.5

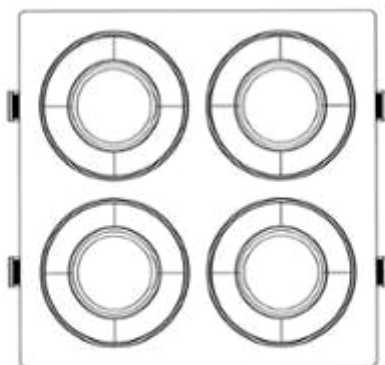

1.6

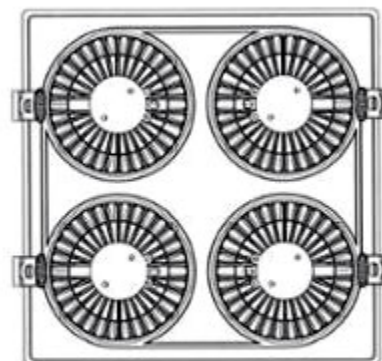

1.7

(11) **45029**

(21) 3-2022-00896

(28) 1

(54) **ĐÈN**

(51) **26-05**

(22) 09/05/2022

(43) 25/07/2022

(73) **CÔNG TY CỔ PHẦN BÓNG ĐÈN PHÍCH NƯỚC RẠNG ĐÔNG (VN)**  
87-89 phố Hạ Đình, phường Thanh Xuân Trung, quận Thanh Xuân, thành phố Hà Nội

(72) Trần Trung Tường (VN)

(55)



1.1

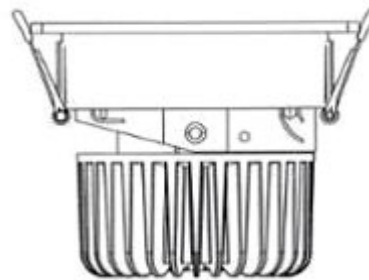

1.2

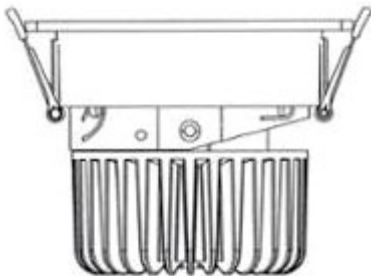

1.3

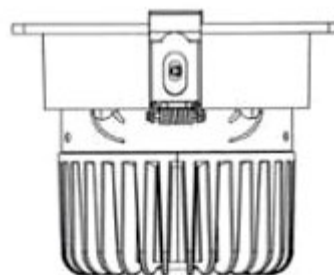

1.4

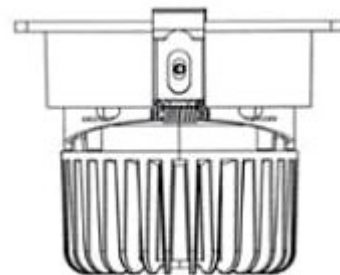

1.5

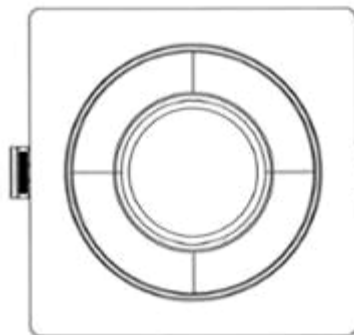

1.6

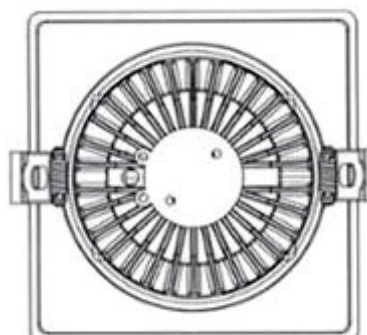

1.7

(11) **45030**

(21) 3-2022-00897

(28) 1

(54) **ĐÈN**

(51) **26-03**

(22) 09/05/2022

(43) 25/07/2022

(73) **CÔNG TY CỔ PHẦN BÓNG ĐÈN PHÍCH NƯỚC RẠNG ĐÔNG (VN)**

87-89 phố Hạ Đình, phường Thanh Xuân Trung, quận Thanh Xuân, thành phố Hà Nội

(72) Trần Trung Tường (VN)

(55)

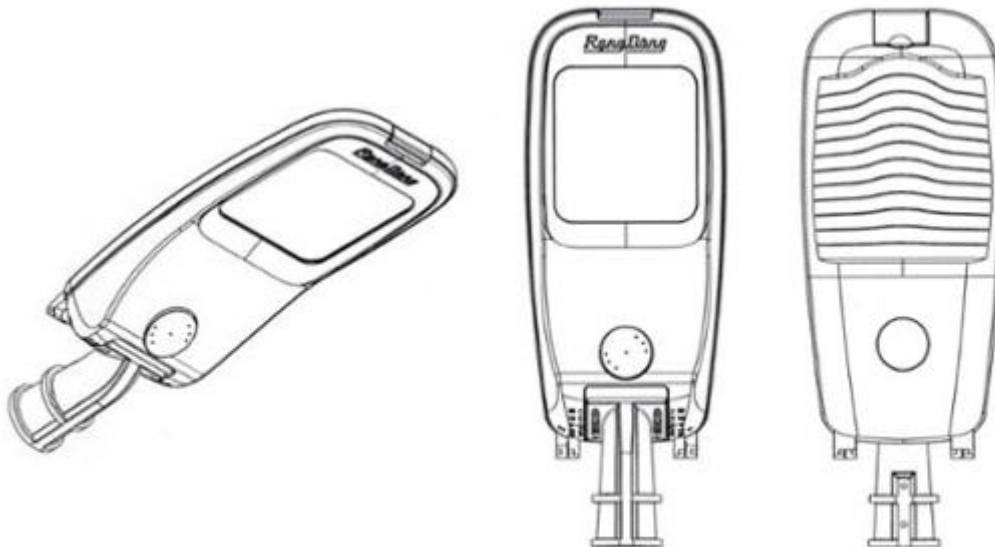

1.1

1.2

1.3

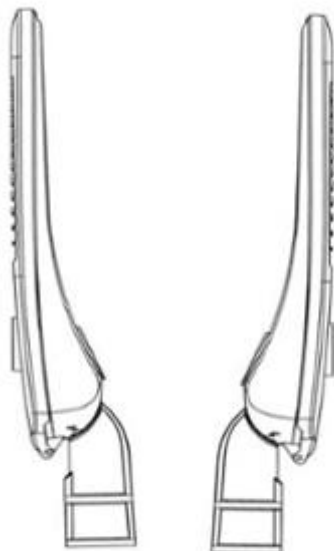

1.4

1.5



1.6

1.7

- (11) **45031**  
(21) 3-2022-00898 (28) 1  
(54) **TÚI XÁCH** (51) **03-01**  
(22) 09/05/2022 (43) 25/07/2022  
(73) **CÔNG TY TNHH SHONAN VIỆT NAM (VN)**  
Thôn 3, xã Vạn Phúc, huyện Thanh Trì, thành phố Hà Nội  
(72) Nguyễn Thị Thanh Hương (VN)  
(74) Công ty TNHH Sở hữu trí tuệ Gia Việt (GIAVIET CO., LTD.)  
(55)



1.1

1.2

1.3



1.4

1.5



**CÔNG BÁO SỞ HỮU CÔNG NGHIỆP SỐ 412 TẬP A – QUYỀN 2 (07.2022)**

- (11) **45032**  
(21) 3-2022-00901 (28) 1  
(54) **XE MÁY** (51) **12-11**  
(22) 09/05/2022 (43) 25/07/2022  
(30) 2021-024665 11/11/2021 JP;  
(73) **HONDA MOTOR CO., LTD. (JP)**  
1-1, Minami-Aoyama 2-Chome, Minato-ku, Tokyo, 107-8556 Japan  
(72) 1. WORAWIT CHAWALITNIMITKUL (TH)  
2. CHALERMPOL THEPPRAPAN (TH)  
3. MANIT PHRAMMANO (TH)  
(74) Công ty Luật TNHH Phạm và Liên danh (PHAM & ASSOCIATES)  
(55)



1.1



1.2



1.3



1.4



1.5



1.6



1.7



1.8



1.9



- (11) **45033**  
(21) 3-2022-00902 (28) 1  
(54) **TẮM ỐP PHÍA TRƯỚC XE MÁY** (51) **12-16**  
(22) 09/05/2022 (43) 25/07/2022  
(30) 2021-024666 11/11/2021 JP;  
(73) **HONDA MOTOR CO., LTD. (JP)**  
1-1, Minami-Aoyama 2-Chome, Minato-ku, Tokyo, 107-8556 Japan  
(72) 1. WORAWIT CHAWALITNIMITKUL (TH)  
2. CHALERMPOL THEPPRAPAN (TH)  
3. MANIT PHRAMMANO (TH)  
(74) Công ty Luật TNHH Phạm và Liên danh (PHAM & ASSOCIATES)  
(55)



1.1

1.2



1.3

1.4



1.5

1.6



1.7



1.8



1.9

- (11) **45034**  
(21) 3-2022-00903 (28) 1  
(54) **TẮM ỐP BÊN PHÍA TRƯỚC XE MÁY** (51) **12-16**  
(22) 09/05/2022 (43) 25/07/2022  
(30) 2021-024667 11/11/2021 JP;  
(73) **HONDA MOTOR CO., LTD. (JP)**  
1-1, Minami-Aoyama 2-Chome, Minato-ku, Tokyo, 107-8556 Japan  
(72) 1. WORAWIT CHAWALITNIMITKUL (TH)  
2. CHALERMPOL THEPPRAPAN (TH)  
3. MANIT PHRAMMANO (TH)  
(74) Công ty Luật TNHH Phạm và Liên danh (PHAM & ASSOCIATES)  
(55)



1.1



1.2



1.3



1.4



1.5



1.6



1.7



1.8



1.9

- (11) **45035**  
(21) 3-2022-00904 (28) 1  
(54) **TẮM ỐP PHÍA TRƯỚC XE SCUTO** (51) **12-16**  
(22) 09/05/2022 (43) 25/07/2022  
(30) 2021-024668 11/11/2021 JP;  
(73) **HONDA MOTOR CO., LTD. (JP)**  
1-1, Minami-Aoyama 2-Chome, Minato-ku, Tokyo, 107-8556 Japan  
(72) 1. PANITHI AREESNGARKUL (TH)  
2. PHERMYOT SODSRI (TH)  
(74) Công ty Luật TNHH Phạm và Liên danh (PHAM & ASSOCIATES)  
(55)



1.1



1.2



1.3



1.4



1.5



1.6



1.7



1.8



1.9

**CÔNG BÁO SỞ HỮU CÔNG NGHIỆP SỐ 412 TẬP A – QUYỀN 2 (07.2022)**

(11) **45036**

(21) 3-2022-00905

(28) 1

(54) **BÀN**

(51) **06-03**

(22) 09/05/2022

(43) 25/07/2022

(73) **CÔNG TY CỔ PHẦN SEMA GROUP (VN)**

Số 69, đường 23, khu đô thị thành phố giao lưu, phường Cổ Nhuế 1, quận Bắc Từ Liêm, thành phố Hà Nội

(72) Nguyễn Phương Chi (VN)

(74) Công ty TNHH NACILAW (NACILAW)

(55)



1.1



1.2

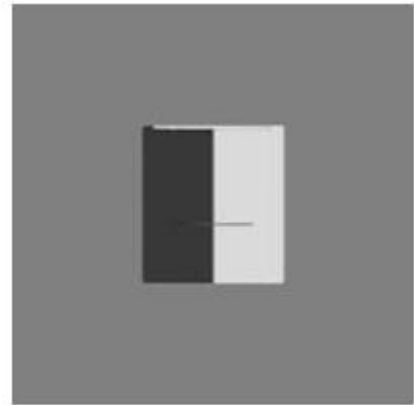

1.3



1.4

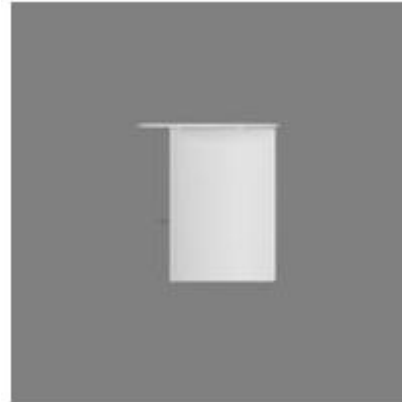

1.5



1.6

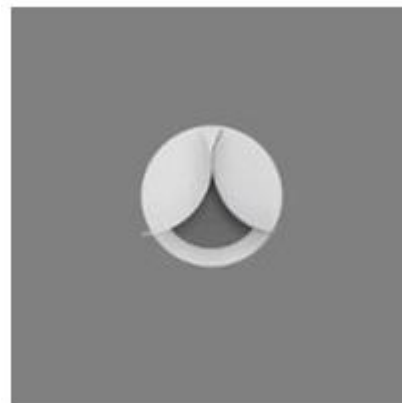

1.7

**CÔNG BÁO SỞ HỮU CÔNG NGHIỆP SỐ 412 TẬP A – QUYỀN 2 (07.2022)**

(11) **45037**

(21) 3-2022-00906

(28) 1

(54) **BÀN**

(51) **06-03**

(22) 09/05/2022

(43) 25/07/2022

(73) **CÔNG TY CỔ PHẦN SEMA GROUP (VN)**

Số 69, đường 23, khu đô thị thành phố giao lưu, phường Cổ Nhuế 1, quận Bắc Từ Liêm, thành phố Hà Nội

(72) Nguyễn Phương Chi (VN)

(74) Công ty TNHH NACILAW (NACILAW)

(55)



1.1



1.2

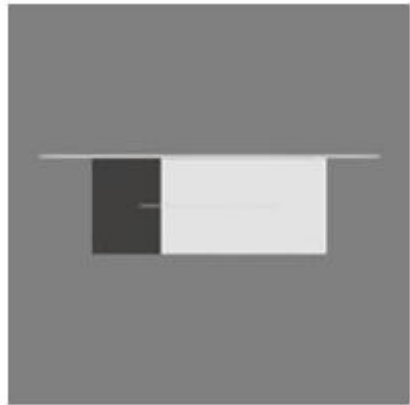

1.3



1.4

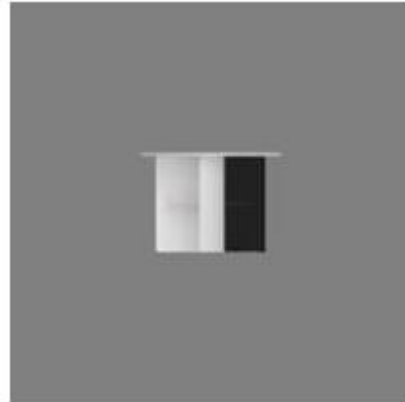

1.5



1.6

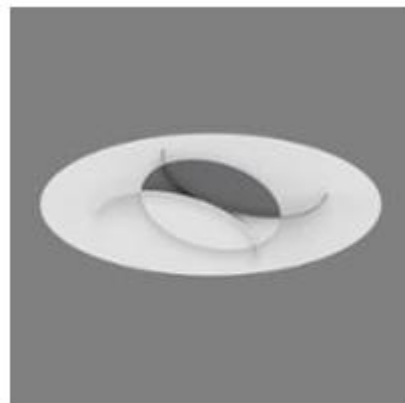

1.7



**CÔNG BÁO SỞ HỮU CÔNG NGHIỆP SỐ 412 TẬP A – QUYỀN 2 (07.2022)**

(11) **45038**

(21) 3-2022-00907

(28) 1

(54) **GIƯỜNG**

(51) **06-02**

(22) 09/05/2022

(43) 25/07/2022

(73) **CÔNG TY CỔ PHẦN SEMA GROUP (VN)**

Số 69, đường 23, khu đô thị thành phố Giao lưu, phường Cổ Nhuế 1, quận Bắc Từ Liêm, thành phố Hà Nội

(72) Nguyễn Phương Chi (VN)

(74) Công ty TNHH NACILAW (NACILAW)

(55)



1.1

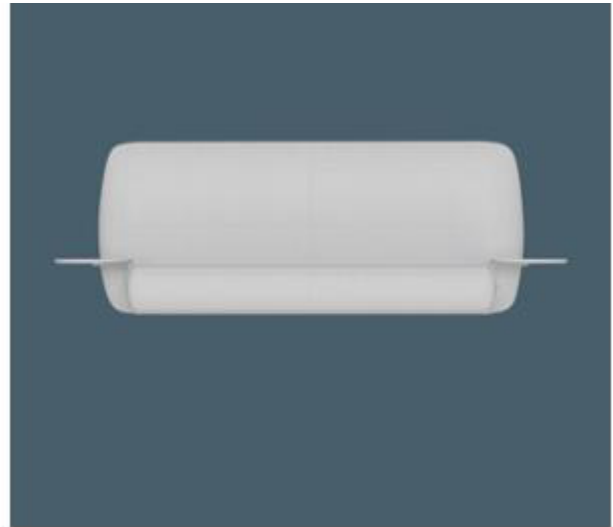

1.2



1.3



1.4



1.5



1.6

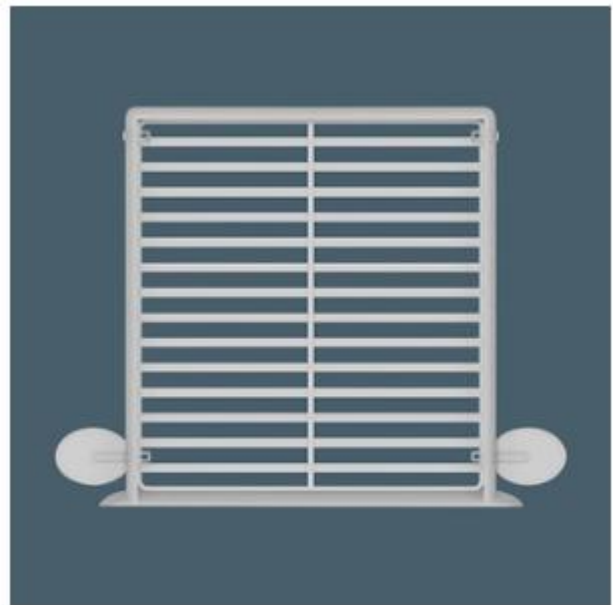

1.7

**CÔNG BÁO SỞ HỮU CÔNG NGHIỆP SỐ 412 TẬP A – QUYỀN 2 (07.2022)**

- (11) **45039**  
(21) 3-2022-00908 (28) 2  
(54) **BAO GÓI** (51) **09-05**  
(22) 09/05/2022 (43) 25/07/2022  
(73) **ORION CORPORATION (KR)**  
13, Baekbeom-ro 90da-gil Yongsan-gu, Seoul 04369, Republic of Korea  
(72) 1. LEE, HYUN A (KR)  
2. CHOE, EUN JE (KR)  
(74) Công ty Luật TNHH quốc tế BMVN (BMVN INTERNATIONAL LLC)  
(55)



1.1



1.2



2.1



2.2

- (11) **45040**  
(21) 3-2022-00912 (28) 1  
(54) **THÁP NÓN** (51) **25-03**  
(22) 10/05/2022 (43) 25/07/2022  
(73) **CÔNG TY CỔ PHẦN THIẾT KẾ SÁNG TẠO NGHỆ THUẬT MIW (VN)**  
Số 220-222 quốc lộ 13, phường 26, quận Bình Thạnh, thành phố Hồ Chí Minh  
(72) Hoàng Bích Nhung (VN)  
(74) Công ty cổ phần Tư vấn S&B (S&B CONSULTANT., CORP.)  
(55)

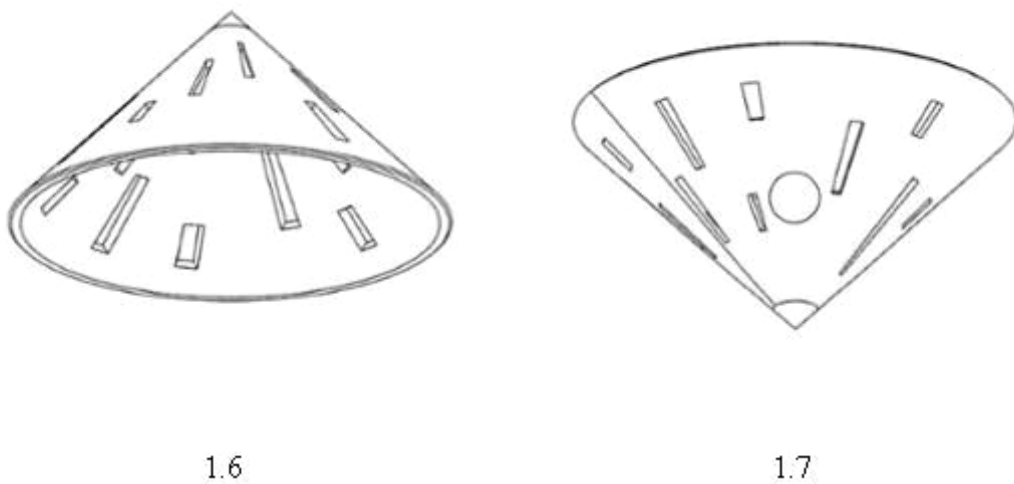
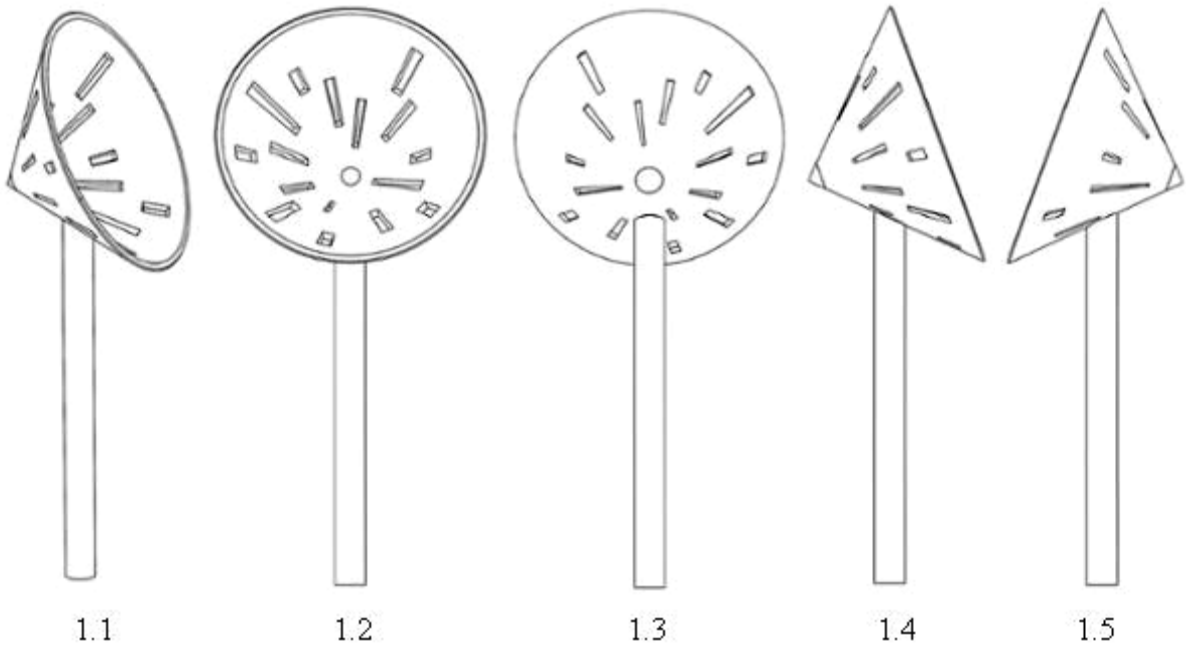

**CÔNG BÁO SỞ HỮU CÔNG NGHIỆP SỐ 412 TẬP A – QUYỀN 2 (07.2022)**

- (11) **45041**
- (21) 3-2022-00914 (28) 1
- (54) **NHÃN SẢN PHẨM** (51) **19-08**
- (22) 10/05/2022 (43) 25/07/2022
- (73) **TRẦN ĐĂNG HẠNH (VN)**  
Thôn Tênh Pò, xã Phong Dụ, huyện Tiên Yên, tỉnh Quảng Ninh
- (72) 1. **TRẦN ĐĂNG HẠNH (VN)**  
2. **TRẦN VĂN ĐA (VN)**
- (55)



**CÔNG BÁO SỞ HỮU CÔNG NGHIỆP SỐ 412 TẬP A – QUYỀN 2 (07.2022)**

- (11) **45042**  
(21) 3-2022-00915 (28) 1  
(54) **HỘP ĐỰNG SẢN PHẨM** (51) **09-03**  
(22) 10/05/2022 (43) 25/07/2022  
(73) **DƯƠNG TUẤN ANH (VN)**  
Tổ 2, phường Tây Sơn, thành phố Tam Điệp, tỉnh Ninh Bình  
(72) Dương Tuấn Anh (VN)  
(55)



1.1



1.2

**CÔNG BÁO SỞ HỮU CÔNG NGHIỆP SỐ 412 TẬP A – QUYỀN 2 (07.2022)**

- (11) **45043**  
(21) 3-2022-00916 (28) 1  
(54) **HỘP ĐỰNG SẢN PHẨM** (51) **09-03**  
(22) 10/05/2022 (43) 25/07/2022  
(73) **DƯƠNG TUẤN ANH (VN)**  
Tổ 2, phường Tây Sơn, thành phố Tam Điệp, tỉnh Ninh Bình  
(72) Dương Tuấn Anh (VN)  
(55)



1.1



1.2

**CÔNG BÁO SỞ HỮU CÔNG NGHIỆP SỐ 412 TẬP A – QUYỀN 2 (07.2022)**

- (11) **45044**  
(21) 3-2022-00921 (28) 1  
(54) **BAO GÓI** (51) **09-05**  
(22) 10/05/2022 (43) 25/07/2022  
(73) **CÔNG TY TNHH CON CỎ VÀNG (VN)**  
23 Lô B đường số 1, phường Phú Thuận, quận 7, thành phố Hồ Chí Minh  
(72) Hoàng Mai Dẫn (VN)  
(74) Công ty TNHH một thành viên Trường Luật (Trường Luật)  
(55)



1.1



1.2



**CÔNG BÁO SỞ HỮU CÔNG NGHIỆP SỐ 412 TẬP A – QUYỀN 2 (07.2022)**

- (11) **45045**  
(21) 3-2022-00922 (28) 1  
(54) **BAO GÓI** (51) **09-05**  
(22) 10/05/2022 (43) 25/07/2022  
(73) **CÔNG TY TNHH CON CỎ VÀNG (VN)**  
23 Lô B đường số 1, phường Phú Thuận, quận 7, thành phố Hồ Chí Minh  
(72) Hoàng Mai Dẫn (VN)  
(74) Công ty TNHH một thành viên Trường Luật (Trường Luật)  
(55)



1.1



1.2

**CÔNG BÁO SỞ HỮU CÔNG NGHIỆP SỐ 412 TẬP A – QUYỀN 2 (07.2022)**

- (11) **45046**  
(21) 3-2022-00923 (28) 1  
(54) **BAO GÓI** (51) **09-05**  
(22) 10/05/2022 (43) 25/07/2022  
(73) **CÔNG TY TNHH CON CỎ VÀNG (VN)**  
23 Lô B đường số 1, phường Phú Thuận, quận 7, thành phố Hồ Chí Minh  
(72) Hoàng Mai Dẫn (VN)  
(74) Công ty TNHH một thành viên Trường Luật (Trường Luật)  
(55)



1.1



1.2

**CÔNG BÁO SỞ HỮU CÔNG NGHIỆP SỐ 412 TẬP A – QUYỀN 2 (07.2022)**

- (11) **45047**  
(21) 3-2022-00945 (28) 1  
(54) **BÌNH NƯỚC NÓNG** (51) **23-03**  
(22) 13/05/2022 (43) 25/07/2022  
(73) **CÔNG TY CỔ PHẦN PHÁT TRIỂN CÔNG NGHỆ NHÀ MÁY THÔNG MINH S-FD (VN)**  
Xóm 4, thôn Hải Bối, xã Hải Bối, huyện Đông Anh, thành phố Hà Nội  
(72) Nguyễn Duy Dương (VN)  
(74) Công ty TNHH Tư vấn IPNG (IPNG CO.,LTD)  
(55)



1.1

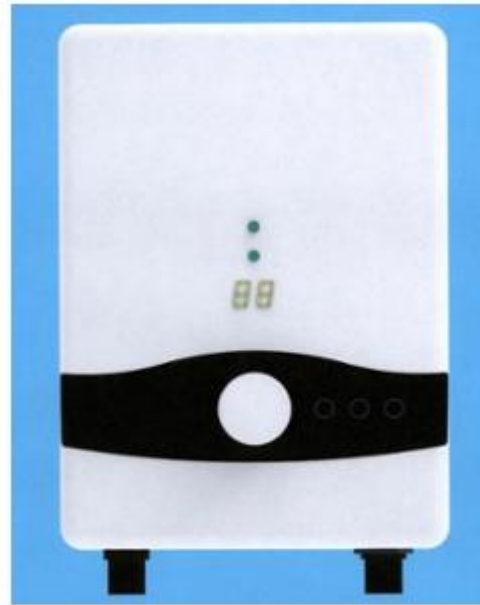

1.2



1.3

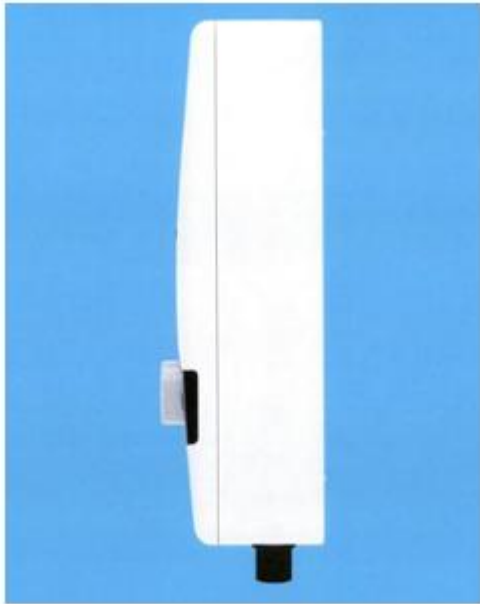

1.4



1.5

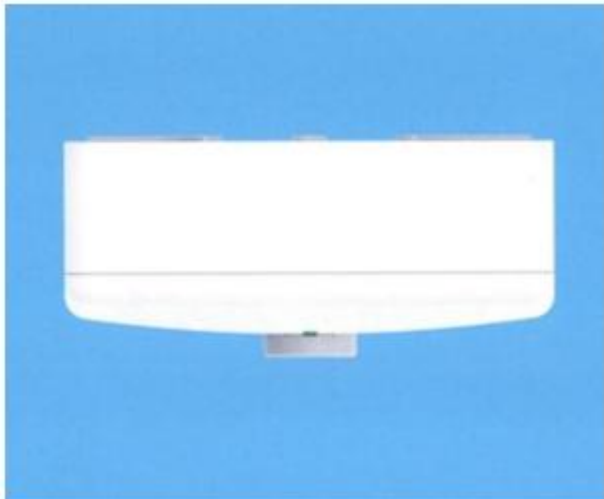

1.6



1.7

**CÔNG BÁO SỞ HỮU CÔNG NGHIỆP SỐ 412 TẬP A – QUYỀN 2 (07.2022)**

- (11) **45048**  
(21) 3-2022-00948 (28) 1  
(54) **MÁY TẠO ION KIỀM** (51) **23-01**  
(22) 16/05/2022 (43) 25/07/2022  
(73) **CÔNG TY CỔ PHẦN PHÁT TRIỂN CÔNG NGHỆ NHÀ MÁY THÔNG MINH S-FD (VN)**  
Xóm 4, thôn Hải Bối, xã Hải Bối, huyện Đông Anh, thành phố Hà Nội  
(72) Nguyễn Duy Dương (VN)  
(74) Công ty TNHH Tư vấn IPNG (IPNG CO.,LTD)  
(55)



1.1

1.2

1.3



1.4



1.5

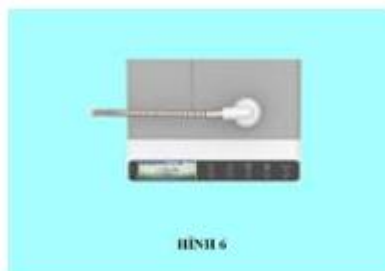

1.6

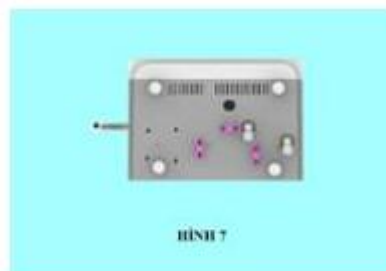

1.7

**CÔNG BÁO SỞ HỮU CÔNG NGHIỆP SỐ 412 TẬP A – QUYỀN 2 (07.2022)**

- (11) **45049**  
(21) 3-2022-00959 (28) 1  
(54) **SỨ CÁCH ĐIỆN** (51) **13-03**  
(22) 17/05/2022 (43) 25/07/2022  
(73) **CÔNG TY CỔ PHẦN SỬ KỸ THUẬT HOÀNG LIÊN SƠN (VN)**  
93 đường Lê Lợi, phường Yên Ninh, thành phố Yên Bái, tỉnh Yên Bái  
(72) Lê Anh Đức (VN)  
(74) Công ty Luật TNHH ELITE (ELITE LAW FIRM)  
(55)



1.1

1.2

1.3

1.4

1.5



1.6

1.7

**CÔNG BÁO SỞ HỮU CÔNG NGHIỆP SỐ 412 TẬP A – QUYỀN 2 (07.2022)**

(11) **45050**

(21) 3-2022-00971

(28) 1

(54) **GIƯỜNG NGỦ**

(51) **06-02**

(22) 18/05/2022

(43) 25/07/2022

(73) **CÔNG TY CỔ PHẦN CAO SU SÀI GÒN - KYMDAN (VN)**

Số 28 Bình Thới, phường 14, quận 11, thành phố Hồ Chí Minh

(72) Nguyễn Trí Tân (VN)

(55)



1.1



1.2



1.3



1.4



1.5



1.6



1.7

**CÔNG BÁO SỞ HỮU CÔNG NGHIỆP SỐ 412 TẬP A – QUYỀN 2 (07.2022)**

(11) **45051**

(21) 3-2022-00972

(28) 1

(54) **TỦ ĐÀU GIƯỜNG**

(51) **06-04**

(22) 18/05/2022

(43) 25/07/2022

(73) **CÔNG TY CỔ PHẦN CAO SU SÀI GÒN - KYMDAN (VN)**

Số 28 Bình Thới, phường 14, quận 11, thành phố Hồ Chí Minh

(72) Nguyễn Trí Tân (VN)

(55)

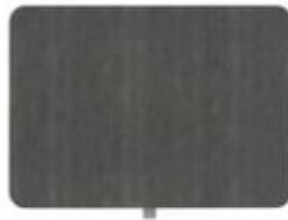

1.1

1.2

1.3



1.4

1.5



1.6

1.7



**CÔNG BÁO SỞ HỮU CÔNG NGHIỆP SỐ 412 TẬP A – QUYỀN 2 (07.2022)**

- (11) **45052**  
(21) 3-2022-01020 (28) 1  
(54) **DÉP** (51) **02-04**  
(22) 27/05/2022 (43) 25/07/2022  
(73) **CÔNG TY TNHH SẢN XUẤT THƯƠNG MẠI XUẤT NHẬP KHẨU ĐỨC HOA (VN)**  
Tỉnh lộ 830, ấp 3, xã An Thạnh, huyện Bến Lức, tỉnh Long An  
(72) Trần Đức (VN)  
(74) Công ty TNHH Sở hữu trí tuệ Đại Diện (IPACO.,LTD.)  
(55)



1.1



1.2



1.3



1.4



1.5



1.6



1.7

**CÔNG BÁO SỞ HỮU CÔNG NGHIỆP SỐ 412 TẬP A – QUYỀN 2 (07.2022)**

- (11) **45053**  
(21) 3-2022-01074 (28) 1  
(54) **MÁY ĐỊNH VỊ** (51) **10-04**  
(22) 02/06/2022 (43) 25/07/2022  
(73) **CÔNG TY CỔ PHẦN CÔNG NGHỆ HẠ TẦNG CƠ SỞ AITOGY (VN)**  
Số 16B, ngõ 187 phố Mai Dịch, phường Mai Dịch, quận Cầu Giấy, thành phố Hà Nội  
(72) Dương Thành Trung (VN)  
(55)



1.1



1.2



1.3

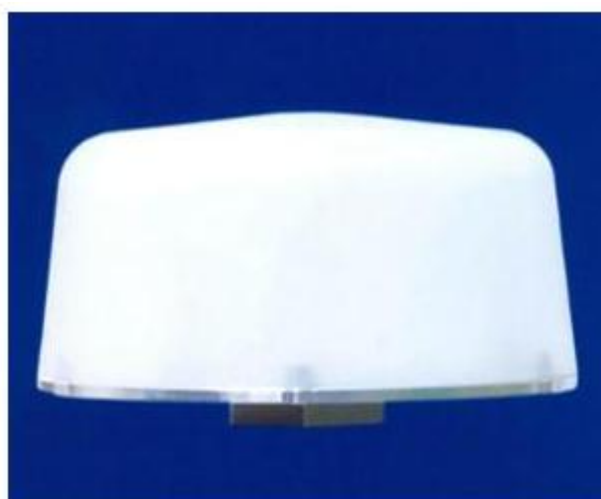

1.4



1.5

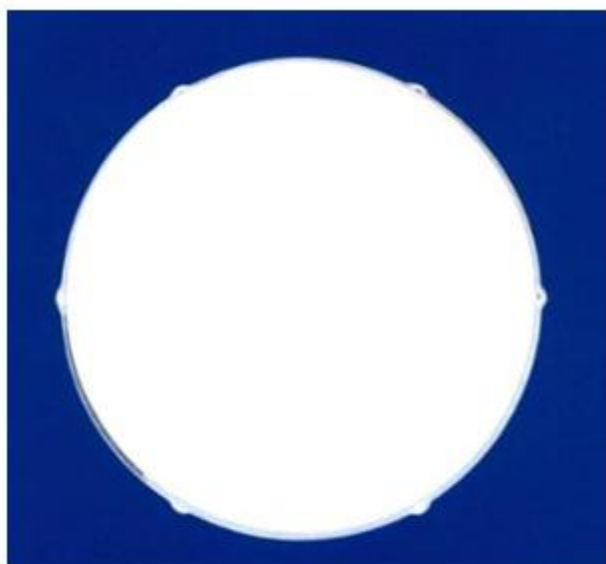

1.6



1.7

**CÔNG BÁO SỞ HỮU CÔNG NGHIỆP SỐ 412 TẬP A – QUYỀN 2 (07.2022)**

- (11) **45054**
- (21) 3-2022-01085 (28) 1
- (54) **NHÃN SẢN PHẨM** (51) **19-08**
- (22) 03/06/2022 (43) 25/07/2022
- (73) **HỘ KINH DOANH NGỌC GIÀU (VN)**  
Ấp Tân Thành, xã Tân Tiên, huyện Đầm Dơi, tỉnh Cà Mau
- (72) Trương Ngọc Giàu (VN)
- (74) Công ty Luật TNHH AGL (AGL LAW)
- (55)



Hình 1

- (11) **45055**  
(21) 3-2022-01086 (28) 1  
(54) **HỘP** (51) **09-03**  
(22) 03/06/2022 (43) 25/07/2022  
(73) **HỘ KINH DOANH NGỌC GIÀU (VN)**  
Áp Tân Thành, xã Tân Tiên, huyện Đầm Dơi, tỉnh Cà Mau  
(72) Trương Ngọc Giàu (VN)  
(74) Công ty Luật TNHH AGL (AGL LAW)  
(55)



Hình 1

1.1



Hình 2

1.2

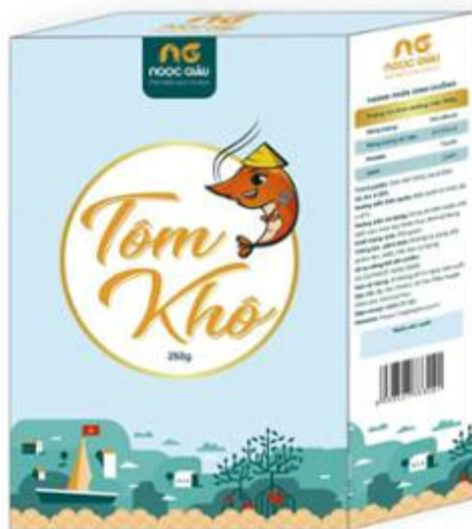

Hình 3

1.3

**PHẦN II**

**SỬA ĐỔI ĐƠN**

***Ghi nhận sửa đổi đơn yêu cầu cấp Bằng độc quyền kiểu dáng công nghiệp***

Thông báo số: 13482w/TB-SHTT, ngày 08/06/2022 về việc ghi nhận sửa đổi đơn

Số Yêu cầu: SĐ3-2021-01487 Ngày nộp: 15/07/2021

Liên quan đến đơn yêu cầu cấp Bằng độc quyền kiểu dáng công nghiệp:

(21) Số đơn	(22) Ngày nộp đơn
3-2019-02849	11/11/2019

Mục sửa đổi: Bổ sung phương án

Nội dung mới: Bổ sung phương án 2 (từ 2.1 đến 2.8)

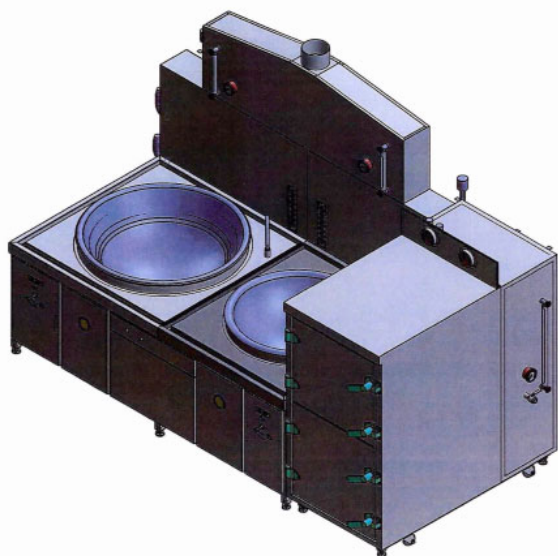

2.1

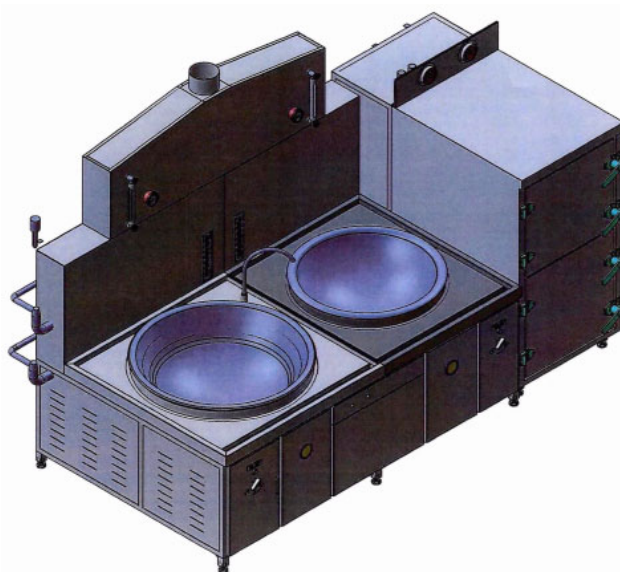

2.2



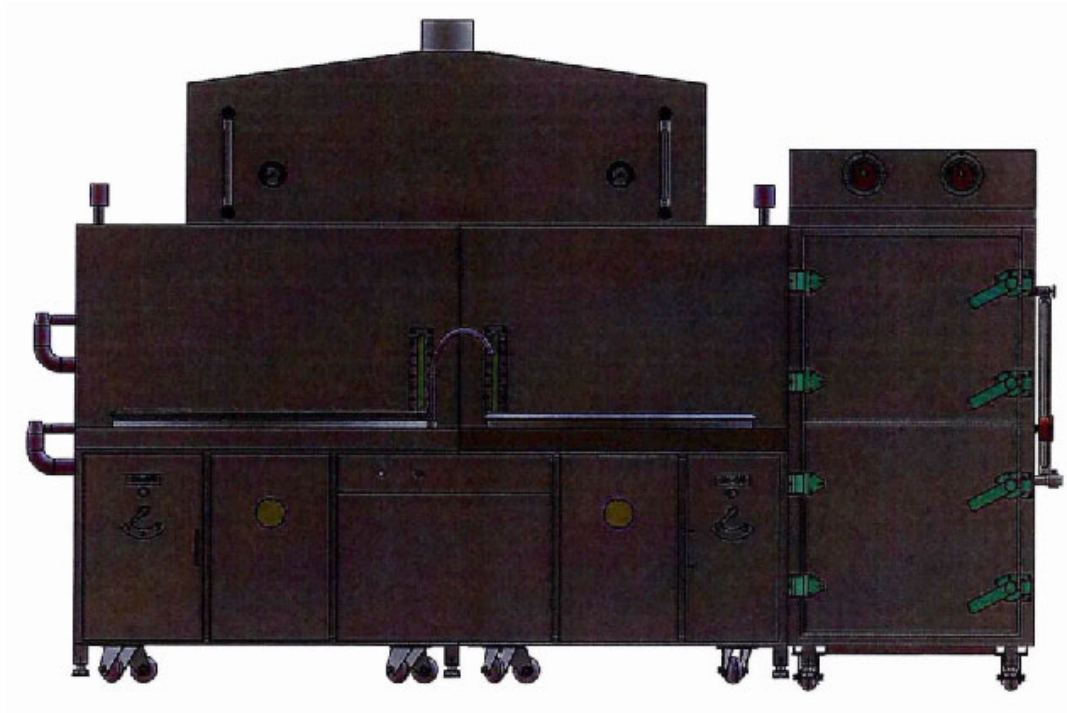

2.3

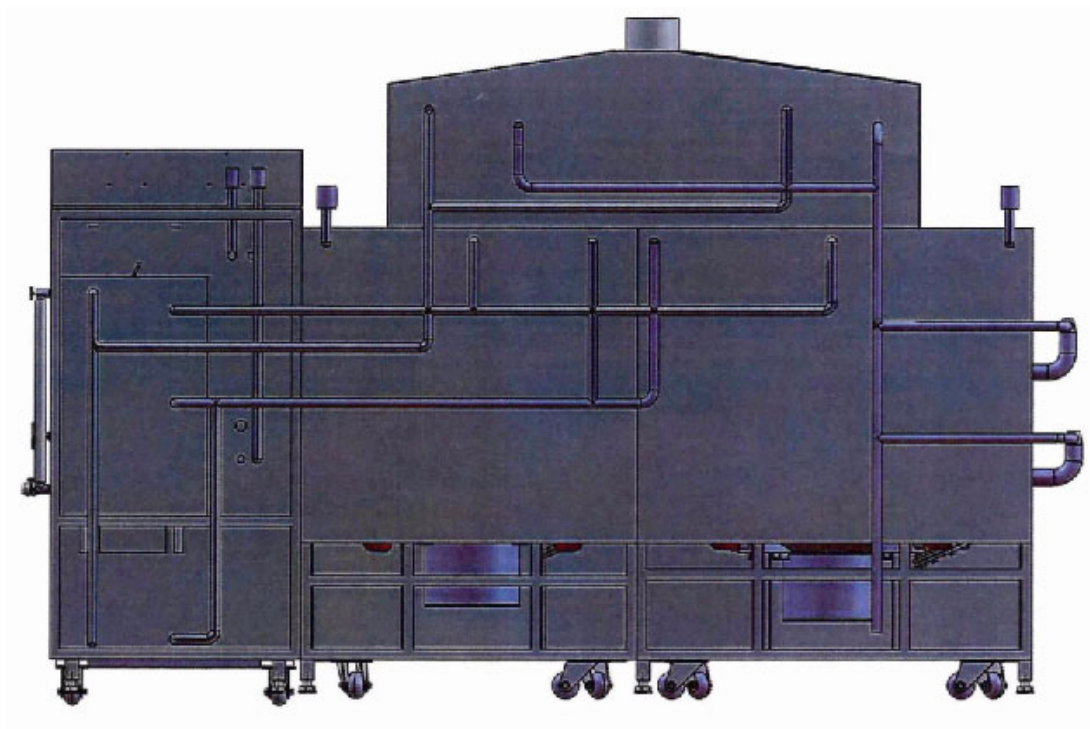

2.4



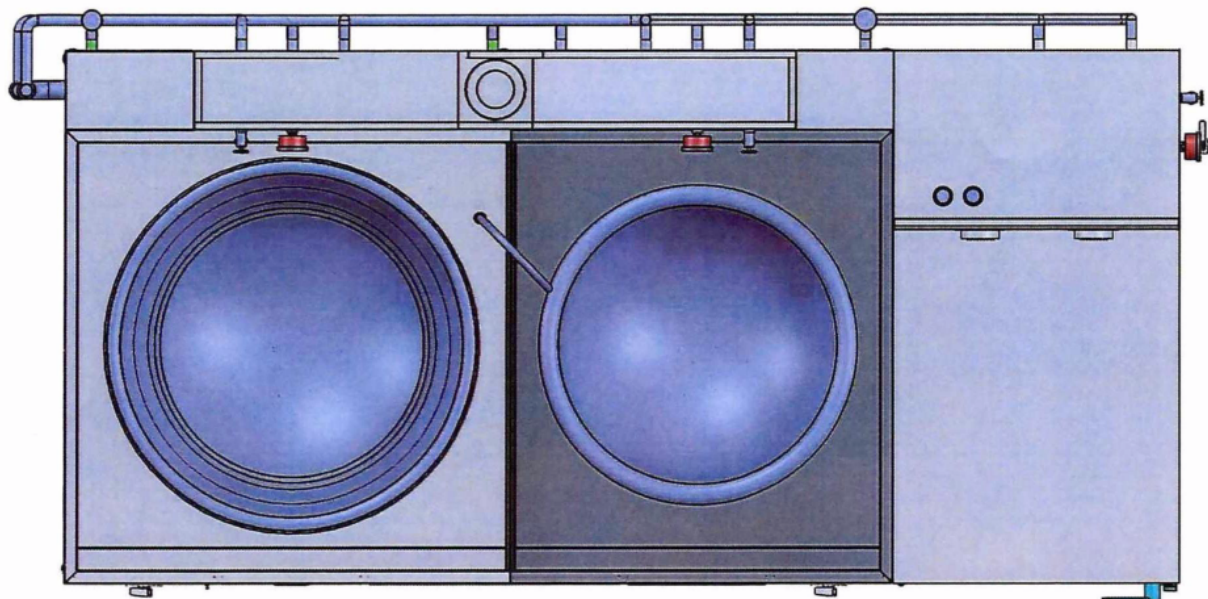

2.5

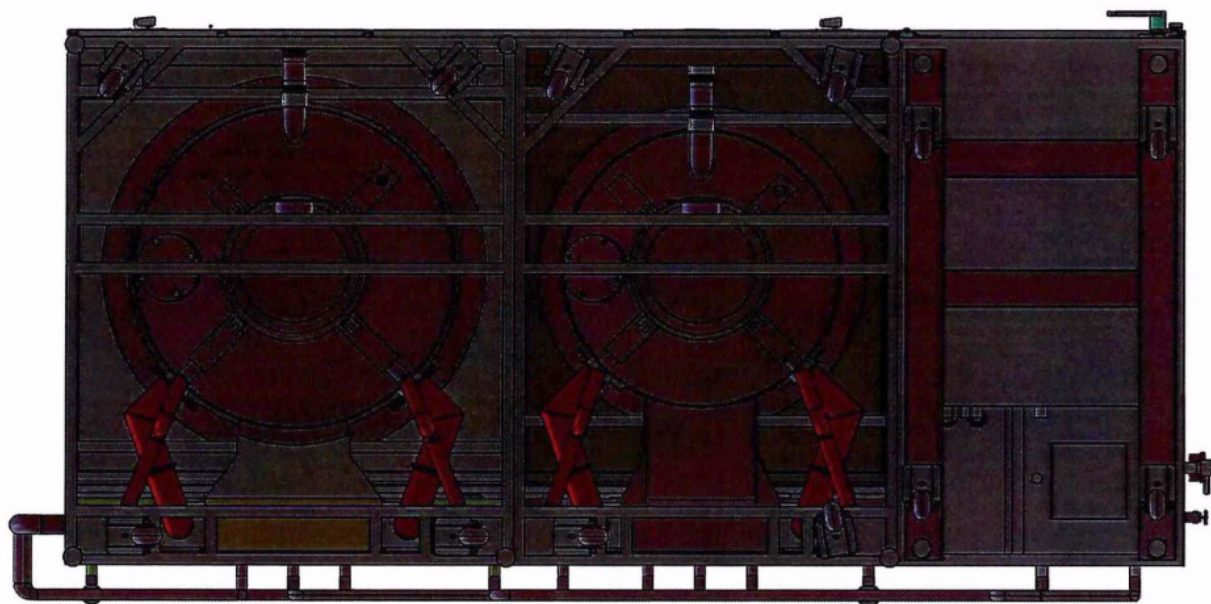

2.6

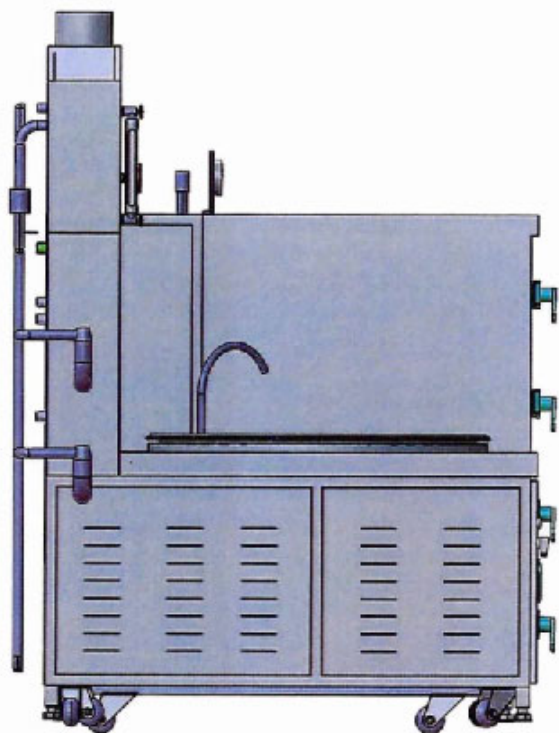

2.7

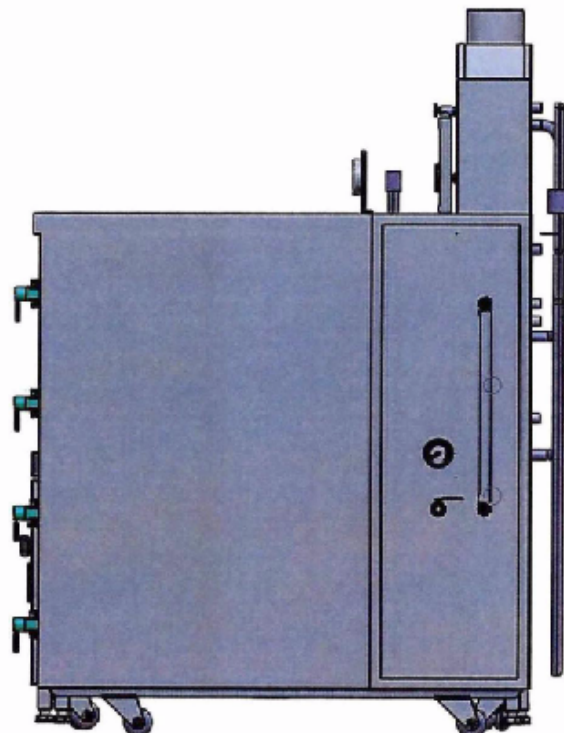

2.8

**PHẦN III**

**THAY ĐỔI CHỦ ĐƠN**

*Ghi nhận thay đổi chủ đơn yêu cầu cấp Bằng độc quyền Kiểu dáng công nghiệp*

Thông báo số: 13011w/TB-SHTT, ngày 07/06/2022 về việc ghi nhận thay đổi chủ đơn

Số Yêu cầu: CD3-2021-00691 Ngày nộp: 31/05/2021

Liên quan đến đơn yêu cầu cấp bằng độc quyền kiểu dáng công nghiệp:

(21) Số đơn	(22) Ngày nộp đơn
3-2020-00957	29/04/2020

Bên chuyển nhượng: HUAWEI TECHNOLOGIES CO., LTD. (CN)  
Huawei Administration Building, Bantian, Longgang  
District, Shenzhen, Guangdong 518129, P.R. China

Bên được chuyển nhượng: Honor Device Co., Ltd. (CN)  
Suite 3401, Unit A, Building 6, Shum Yip Sky Park, No.  
8089, Hongli West Road, Xiangmihu Street, Futian District,  
Shenzhen, Guangdong 518040, People's Republic of China

---

Thông báo số: 13012w/TB-SHTT, ngày 07/06/2022 về việc ghi nhận thay đổi chủ đơn

Số Yêu cầu: CD3-2021-00850 Ngày nộp: 15/07/2021

Liên quan đến đơn yêu cầu cấp bằng độc quyền kiểu dáng công nghiệp:

(21) Số đơn	(22) Ngày nộp đơn
3-2021-01800	09/07/2021

Bên chuyển nhượng: CÔNG TY CỔ PHẦN BIA - RƯỢU HẢI ĐÀ (VN)  
Đường Ngô Quyền, khu 4, phường Cẩm Thượng, thành phố  
Hải Dương, tỉnh Hải Dương

Bên được chuyển nhượng: Công ty TNHH Toàn cầu Beverage (VN)  
Số 8B đường Ngô Quyền, khu 4, phường Cẩm Thượng,  
thành phố Hải Dương, tỉnh Hải Dương

---

**CÔNG BÁO SỞ HỮU CÔNG NGHIỆP SỐ 412 TẬP A – QUYỀN 2 (07.2022)**

---

Thông báo số: 13670w/TB-SHTT, ngày 13/06/2022 về việc ghi nhận thay đổi chủ đơn  
Số Yêu cầu: CD3-2022-00242 Ngày nộp: 30/03/2022

Liên quan đến đơn yêu cầu cấp bằng độc quyền kiểu dáng công nghiệp:

(21) Số đơn	(22) Ngày nộp đơn
3-2021-00525	17/03/2021
3-2021-00830	07/04/2021
3-2021-01652	23/06/2021
3-2021-02511	14/10/2021

Bên chuyển nhượng: CÔNG TY CỔ PHẦN KAROFI HOLDING (VN)  
Số 12, lô TT1A, khu đô thị mới Tây Nam Hồ Linh Đàm,  
phường Hoàng Liệt, quận Hoàng Mai, thành phố Hà Nội

Bên được chuyển nhượng: Công Ty TNHH công nghệ Tecomen (VN)  
Thôn Từ Hồ, xã Yên Phú, huyện Yên Mỹ, tỉnh Hưng Yên

---

## **CÔNG BÁO SỞ HỮU CÔNG NGHIỆP**

*Do Cục Sở hữu trí tuệ thuộc Bộ Khoa học và Công nghệ ấn hành theo Luật Sở hữu trí tuệ số 50/2005/QH11 được Quốc hội thông qua ngày 29 tháng 11 năm 2005 và được sửa đổi bằng Luật sửa đổi, bổ sung một số điều của Luật sở hữu trí tuệ số 50/2005/QH11 được Quốc hội thông qua ngày 19 tháng 6 năm 2009.*

### ***Địa chỉ liên hệ:***

384-386 đường Nguyễn Trãi, quận Thanh Xuân,  
thành phố Hà Nội, Việt Nam  
ĐT: 024. 38583069  
Fax: 024. 38588449