

CỘNG HÒA XÃ HỘI CHỦ NGHĨA VIỆT NAM  
BỘ KHOA HỌC VÀ CÔNG NGHỆ

CỤC SỞ HỮU TRÍ TUỆ

CÔNG BÁO  
SỞ HỮU CÔNG NGHIỆP

TẬP A

QUYỂN 2: KIỂU DÁNG CÔNG NGHIỆP

08 - 2022

413

CỘNG HOÀ XÃ HỘI CHỦ NGHĨA VIỆT NAM  
BỘ KHOA HỌC VÀ CÔNG NGHỆ  
CỤC SỞ HỮU TRÍ TUỆ

---

CÔNG BÁO  
SỞ HỮU CÔNG NGHIỆP  
TẬP A

QUYỂN 2: KIỂU DÁNG CÔNG NGHIỆP

08 - 2022

413

---

HÀ NỘI

## MỤC LỤC

	Trang
<u>PHẦN I:</u> Đơn yêu cầu cấp Bằng độc quyền kiểu dáng công nghiệp	7
<u>PHẦN II:</u> Sửa đổi đơn	380
<u>PHẦN III:</u> Thay đổi chủ đơn	381

## CONTENTS

<u>PART I:</u> Applications for Industrial Design Patents	7
<u>PART II:</u> Amendment of Applications	380
<u>PART III:</u> Change of Applicants	381

---

**CÔNG BÁO SỞ HỮU CÔNG NGHIỆP SỐ 413 TẬP A - QUYỂN 2 (08.2022)**

**MÃ SỐ HAI CHỮ CÁI THỂ HIỆN TÊN NƯỚC VÀ CÁC THỰC THỂ KHÁC TRONG CÁC TƯ LIỆU SỞ HỮU CÔNG NGHIỆP THEO TIÊU CHUẨN ST3 CỦA WIPO**

AE	United Arab Emirates	CN	China	HK	Hong Kong
AF	Afganistan	CO	Colombia	HN	Honduras
AG	Antihua and Barbuda	CR	Costa Rica	HR	Croatia
AI	Anguilla	CU	Cuba	HT	Haiti
AL	Albania	CV	Cape Verde	HU	Hungary
AN	Netherlands Antilles	CY	Cyprus	ID	Indonesia
AO	Angola	CZ	Czech Republic	IE	Ireland
AR	Argentina	DE	Germany	IL	Israel
AT	Austria	DJ	Djibouti	IN	India
AU	Australia	DK	Denmark	IQ	Iraq
AW	Aruba	DM	Dominica	IR	Iran (Islamic Republic of)
BB	Barbados	DO	Dominican Republic	IS	Iceland
BD	Bangladesh	DZ	Algeria	IT	Italy
BE	Belgium	EC	Ecuador	JM	Jamaica
BF	Burkina Faso	EE	Estonia	JO	Jordan
BG	Bulgaria	EG	Egypt	JP	Japan
BH	Bahrain	ES	Spain	KE	Kenya
BI	Burundi	ET	Ethiopia	KH	Cambodia
BJ	Benin	FI	Finland	KI	Kiribati
BM	Bermuda	FJ	Fiji	KM	Comoros
BN	Brunei Darussalam	FK	Falkand Islands (Malvinas)	KN	Saint Kitts and Nevis
BO	Bolivia	FR	France	KP	Democratic People's Republic of Korea
BR	Brazil	GA	Gabon	KR	Republic of Korea
BS	Bahamas	GB	United Kingdom	KW	Kuwait
BT	Bhutan	GD	Grenada	KY	Cayman Islands
BW	Botswana	GE	Georgia	KZ	Kazakhstan
BY	Belarus	GH	Ghana	LA	Laos
BZ	Belize	GI	Gibraltar	LB	Lebanon
CA	Canada	GM	Gambia	LC	Saint Lucia
CF	Central African Republic	GN	Guinea	LI	Liechtenstein
CG	Congo	GQ	Equatorial Guinea	LK	SriLanka
CH	Switzerland	GR	Greece	LR	Liberia
CI	Côte d'Ivoire	GT	Guatemala	LS	Lesotho
CL	Chile	GW	Guinea-Bissau	LT	Lithuania
CM	Cameroon	GY	Guyana	TC	Turk and Caicos Islands
LU	Luxembourg	PA	Panama	TD	Chad
LV	Latvia	PE	Peru	TG	Togo
LY	Lybya	PG	Papua New Guinea	TH	Thailand
MA	Morocco	PH	Philippines	TN	Tunisia
MC	Monaco	PK	Pakistan	TO	Tonga
MD	Republic of Moldova	PL	Poland	TR	Turkey



**CÔNG BÁO SỞ HỮU CÔNG NGHIỆP SỐ 413 TẬP A - QUYỂN 2 (08.2022)**

MG	Madagascar	PT	Portugal	TT	Trinidad and Tobago
ML	Mali	PY	Paraguay	TV	Tuvalu
MM	Myanmar	QA	Qatar	TW	Taiwan, Province of China
MN	Mongolia	RO	Rumania	TZ	United Republic of Tanzania
MO	Macau	RU	Russian Federation	UA	Ukraine
MR	Mauritania	RW	Rwanda	UG	Uganda
MS	Montserrat	SA	Saudi Arabia	US	United States of America
MT	Malta	SB	Solomon Islands	UY	Uruguay
MU	Mauritius	SC	Seychelles	UZ	Uzbekistan
MV	Maldives	SD	Sudan	VA	Holy see
MW	Malawi	SE	Sweden	VC	Saint Vincent and the Grenadines
MX	Mexico	SG	Singapore	VE	Venezuela
MY	Malaysia	SH	Saint Helena	VG	Virgin Islands (British)
MZ	Mozambique	SL	Slovenia	VN	Vietnam
NA	Namibia	SK	Slovakia	VU	Vanuatu
NE	Niger	SL	Sierra Leone	WS	Samoa
NG	Nigeria	SM	San Marino	YE	Yemen
NJ	Nicaragua	SN	Senegal	YU	Yugoslavia
NL	Netherlands	SO	Somalia	ZA	South Africa
NO	Norway	SR	Suriname	ZM	Zambia
NP	Nepal	ST	Sao Tome and Principe	ZR	Zaire
NR	Nauru	SV	El Sanvador	ZW	Zimbabwe
NZ	New Zealand	SY	Syria		
OM	Oman	SZ	Swaziland		

**CÁC TỔ CHỨC QUỐC TẾ**

AO	African Intellectual Property Organization (OAPI)
AP	African Regional Industrial Property Organization (ARIPO)
BX	Benelux Trademark Office and Benelux Designs Office
EP	European Patent Office (EPO)
IB, WO	International Bureau of the World Intellectual Property Organization (WIPO)

**NHỮNG MÃ SỐ INID TRÍCH TỪ TIÊU CHUẨN ST80 CỦA TỔ CHỨC SỞ HỮU TRÍ TUỆ THẾ GIỚI (WIPO) ĐỂ NHẬN BIẾT CÁC DỮ LIỆU THƯ MỤC DÙNG CÔNG BỐ ĐƠN VÀ BẰNG ĐỘC QUYỀN KIỂU DÁNG CÔNG NGHIỆP**

- (11) Số bằng độc quyền kiểu dáng công nghiệp / Số công bố đơn
- (15) Ngày cấp
- (18) Ngày hết hạn hiệu lực của bằng độc quyền kiểu dáng công nghiệp
- (21) Số đơn
- (22) Ngày nộp đơn
- (23) Tên triển lãm, ngày và nơi triển lãm
- (28) Số phương án yêu cầu bảo hộ
- (30) Số đơn ưu tiên, ngày nộp đơn ưu tiên
- (43) Ngày công bố đơn
- (45) Ngày công bố bằng độc quyền kiểu dáng công nghiệp
- (51) Phân loại quốc tế kiểu dáng công nghiệp
- (54) Tên sản phẩm mang kiểu dáng công nghiệp
- (55) Ảnh chụp / hình vẽ kiểu dáng công nghiệp
- (57) Đặc điểm khác biệt yêu cầu bảo hộ của kiểu dáng công nghiệp
- (62) Số và ngày nộp đơn, số bằng độc quyền KDCN hoặc số công bố đơn liên quan đến tách đơn
- (71) Tên và địa chỉ của người nộp đơn
- (72) Tên của tác giả KDCN
- (73) Tên, địa chỉ của chủ bằng độc quyền KDCN
- (74) Tên của người đại diện SHCN

PHẦN I

**ĐƠN YÊU CẦU CẤP BẰNG ĐỘC QUYỀN KIỂU DÁNG CÔNG NGHIỆP**

- (11) **45056**  
(21) 3-2019-00421 (28) 1  
(54) **MÁY HÚT ẨM** (51) **15-99**  
(22) 14/02/2019 (43) 25/08/2022  
(73) **CÔNG TY TNHH CÔNG NGHIỆP BELLINTURF VIỆT NAM (VN)**  
Lô 111A, 112A, 113A, 115A, 116A, 117A, 118B-C, 119A-B, 120A-B, 121A-B,  
122A-B, 123A-B, khu công nghiệp Long Giang, xã Tân Lập 1, huyện Tân Phước,  
tỉnh Tiền Giang  
(72) WANG FENG LING (CN)  
(74) Công ty cổ phần Tư vấn S&B (S&B CONSULTANT., CORP.)  
(55)

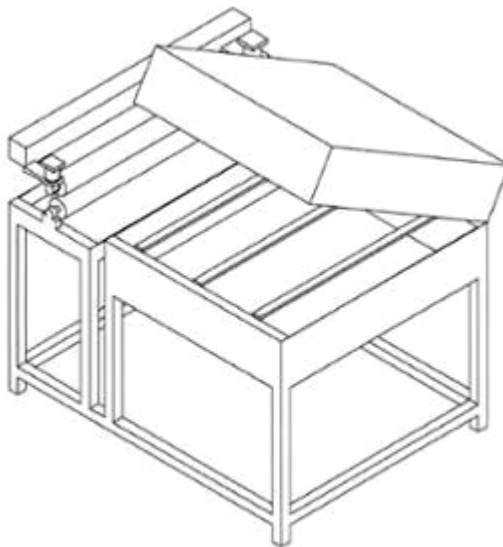

1.1

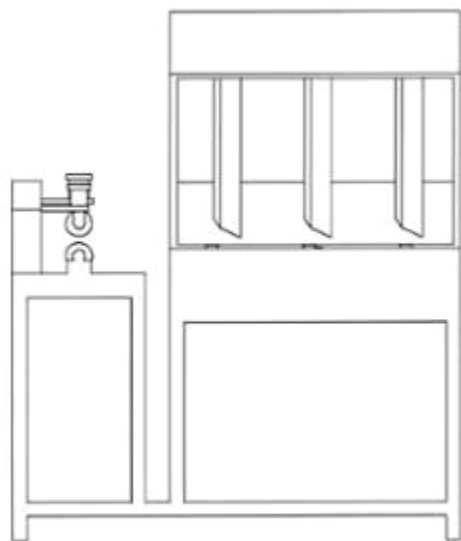

1.2

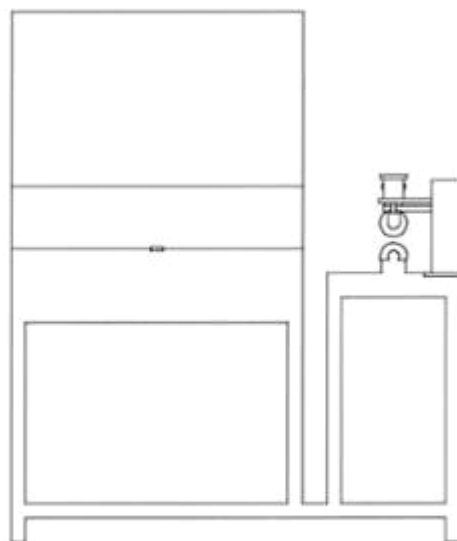

1.3

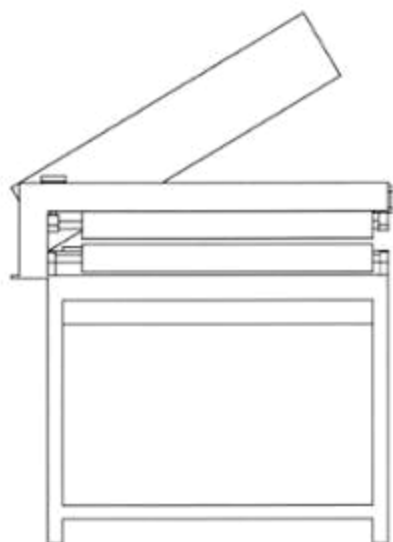

1.4

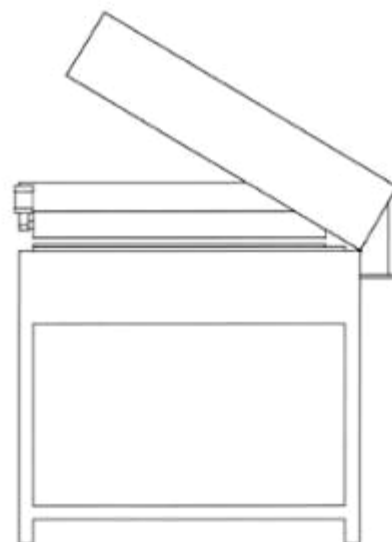

1.5

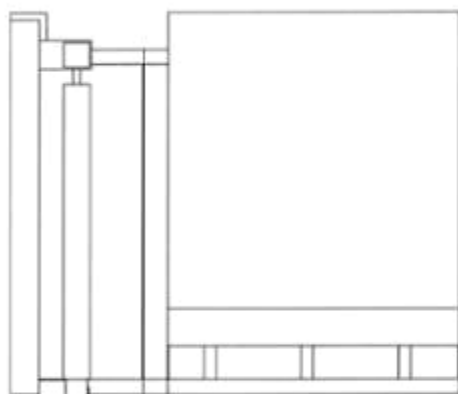

1.6

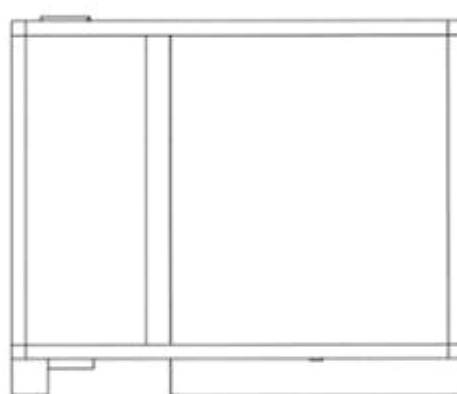

1.7

**CÔNG BÁO SỞ HỮU CÔNG NGHIỆP SỐ 413 TẬP A – QUYỀN 2 (08.2022)**

(11) **45057**

(21) 3-2019-00465

(28) 1

(54) **MÓC DỆT**

(51) **15-99**

(22) 20/02/2019

(43) 25/08/2022

(73) **CÔNG TY TNHH CÔNG NGHIỆP BELLINTURF VIỆT NAM (VN)**

Lô 111A, 112A, 113A, 115A, 116A, 117A, 118B-C, 119A-B, 120A-B, 121A-B, 122A-B, 123A-B, Khu công nghiệp Long Giang, xã Tân Lập 1, huyện Tân Phước, tỉnh Tiền Giang

(72) WANG FENG LING (CN)

(74) Công ty TNHH Tầm nhìn và Liên danh (VISION & ASSOCIATES CO.LTD.)

(55)

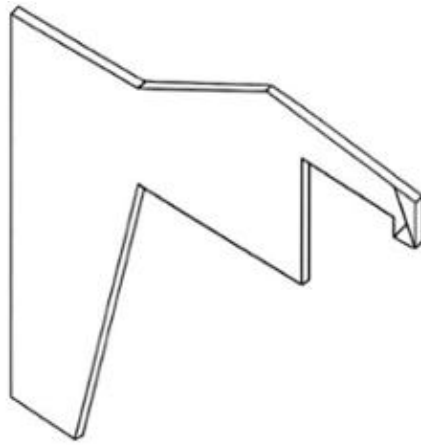

1.1



1.2



1.3

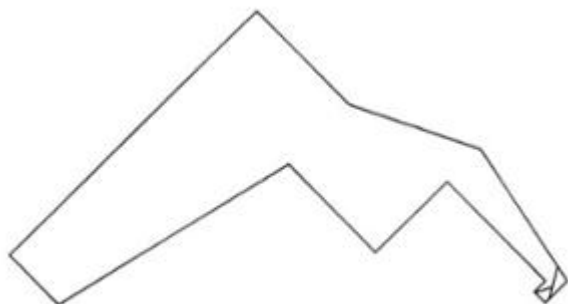

1.4

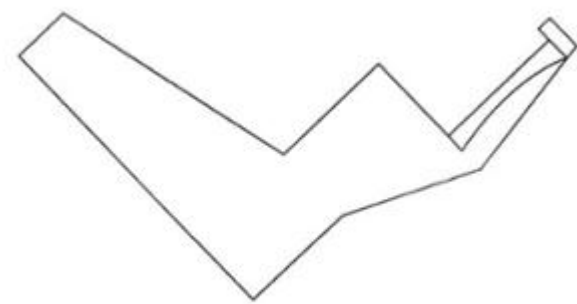

1.5



1.6



1.7

**CÔNG BÁO SỞ HỮU CÔNG NGHIỆP SỐ 413 TẬP A – QUYỀN 2 (08.2022)**

(11) **45058**

(21) 3-2019-02059

(28) 1

(54) **THANH NHÔM ĐỊNH HÌNH**

(51) **25-01**

(22) 15/08/2019

(43) 25/08/2022

(73) **CÔNG TY TNHH THƯƠNG MẠI DỊCH VỤ NAM LỘC (VN)**

299/10 Lý Thường Kiệt, phường 15, quận 11, thành phố Hồ Chí Minh

(72) Võ Thị Ngọc Ánh (VN)

(55)



1.1

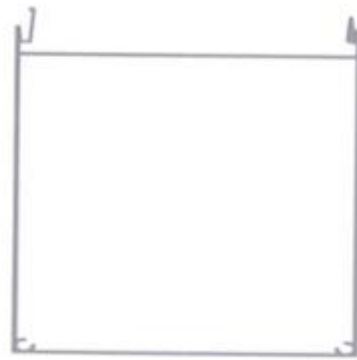

1.2



1.3



1.4



1.5



1.6

**CÔNG BÁO SỞ HỮU CÔNG NGHIỆP SỐ 413 TẬP A – QUYỀN 2 (08.2022)**

(11) **45059**

(21) 3-2019-02060

(28) 1

(54) **THANH NHÔM ĐỊNH HÌNH**

(51) **25-01**

(22) 15/08/2019

(43) 25/08/2022

(73) **CÔNG TY TNHH THƯƠNG MẠI DỊCH VỤ NAM LỘC (VN)**

299/10 Lý Thường Kiệt, phường 15, quận 11, thành phố Hồ Chí Minh

(72) Võ Thị Ngọc Ánh (VN)

(55)



1.1

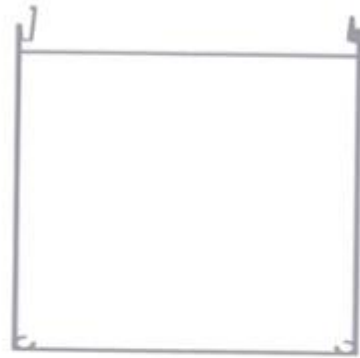

1.2



1.3



1.4



1.5



1.6

(11) **45060**

(21) 3-2019-02903

(28) 1

(54) **THANH NHÔM ĐỊNH HÌNH**

(51) **25-01**

(22) 15/11/2019

(43) 25/08/2022

(73) **CÔNG TY TNHH THƯƠNG MẠI DỊCH VỤ NAM LỘC (VN)**

299/10 Lý Thường Kiệt, phường 15, quận 11, thành phố Hồ Chí Minh

(72) Võ Thị Ngọc Ánh (VN)

(55)



1.1



1.2



1.3



1.4



1.5



1.6



**CÔNG BÁO SỞ HỮU CÔNG NGHIỆP SỐ 413 TẬP A – QUYỀN 2 (08.2022)**

(11) **45061**

(21) 3-2020-00151

(28) 1

(54) **GIƯỜNG**

(51) **06-02**

(22) 17/01/2020

(43) 25/08/2022

(73) **CÔNG TY TNHH NỘI THẤT ZIP (VN)**

Số 5, lô A, tập thể trường Trung học Nông Nghiệp, phố Vũ Hữu, phường Thanh Xuân Bắc, quận Thanh Xuân, thành phố Hà Nội

(72) Nguyễn Mai Linh (VN)

(74) Công ty TNHH Tư vấn IPNG (IPNG CO.,LTD)

(55)



1.1



1.2

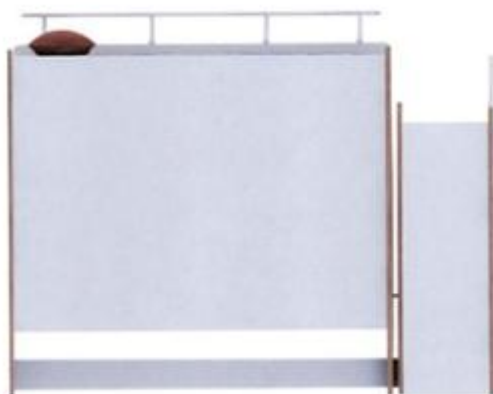

1.3



1.4



1.5



1.6



1.7



1.8

**CÔNG BÁO SỞ HỮU CÔNG NGHIỆP SỐ 413 TẬP A – QUYỀN 2 (08.2022)**

- (11) **45062**  
(21) 3-2020-01122 (28) 1  
(54) **BAO BÌ** (51) **09-05**  
(22) 15/05/2020 (43) 25/08/2022  
(73) **CÔNG TY TNHH SUMI&SUKI (VN)**  
Lô 90-92 đường Trần Nam Trung, phường Hòa Xuân, quận Cẩm Lệ, thành phố Đà Nẵng  
(72) Lê Văn Đông (VN)  
(55)



1.1



1.2

- (11) **45063**  
(21) 3-2020-02287 (28) 2  
(54) **HỒ GA** (51) **23-99**  
(22) 16/09/2020 (43) 25/08/2022  
(73) **CÔNG TY CỔ PHẦN GIẢI PHÁP CÔNG NGHỆ THUẬN THIÊN (VN)**  
136 Nguyễn Văn Công, phường 3, quận Gò Vấp, thành phố Hồ Chí Minh  
(72) Thân Thế Hào (VN)  
(74) Công ty TNHH Sở hữu trí tuệ Thảo Thọ Quyển (INVENCO.,LTD)  
(55)



1.1

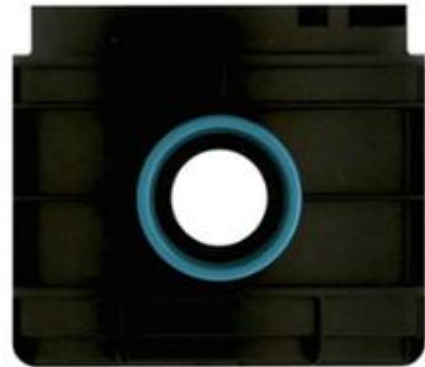

1.2



1.3



1.4



1.5



1.6



1.7



2.1



2.2



2.3



2.4



2.5



2.6



2.7

**CÔNG BÁO SỞ HỮU CÔNG NGHIỆP SỐ 413 TẬP A – QUYỀN 2 (08.2022)**

- (11) **45064**  
(21) 3-2020-02928 (28) 1  
(54) **THANH DÀM ĐỒ** (51) **25-01**  
(22) 03/12/2020 (43) 25/08/2022  
(30) 29/652,181 04/06/2020 US;  
(73) **JS PRODUCTS, INC. (US)**  
6445 Montessouri Street, Las Vegas, NV 89113, United States of America  
(72) 1. JARED HANLON (US)  
2. DYLAN WILLIAMS (US)  
(74) Công ty TNHH Quốc tế D&N (D&N INTERNATIONAL CO.,LTD.)  
(55)



1.1



1.2



1.3



1.4



1.5



1.6



1.7



1.8



1.9



**CÔNG BÁO SỞ HỮU CÔNG NGHIỆP SỐ 413 TẬP A – QUYỀN 2 (08.2022)**

- (11) **45065**  
(21) 3-2021-00162 (28) 1  
(54) **MÁY NÂNG HẠ VẢI** (51) **12-05**  
(22) 25/01/2021 (43) 25/08/2022  
(73) **CÔNG TY TNHH SẢN XUẤT THƯƠNG MẠI DỊCH VỤ MẠNH ĐẠT (VN)**  
551/212/62 đường Lê Văn Khương, khu phố 7, phường Hiệp Thành, quận 12,  
thành phố Hồ Chí Minh  
(72) BEA CHON SUK (KR)  
(74) Công ty TNHH Tư vấn A & S (A&S CO.,LTD)  
(55)



1.1

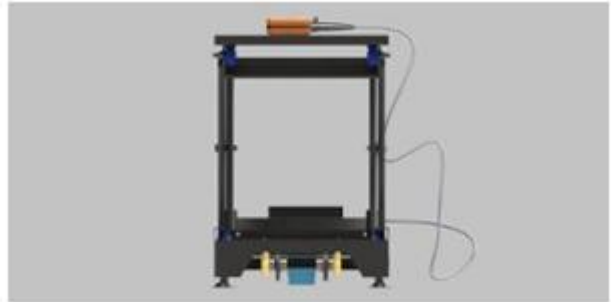

1.2



1.3

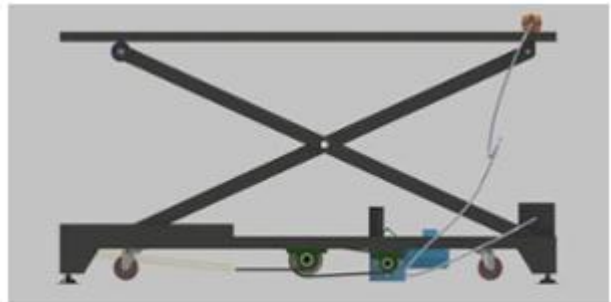

1.4

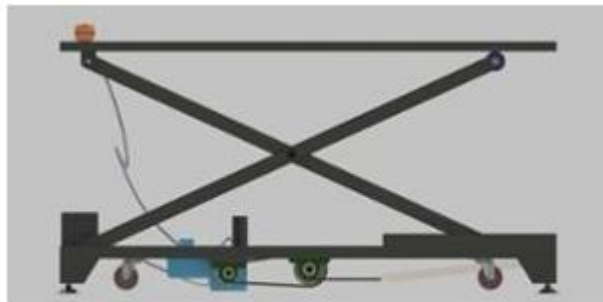

1.5



1.6

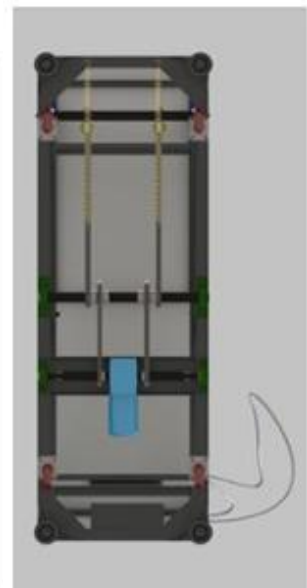

1.7

**CÔNG BÁO SỞ HỮU CÔNG NGHIỆP SỐ 413 TẬP A – QUYỀN 2 (08.2022)**

- (11) **45066**  
(21) 3-2021-00261 (28) 1  
(54) **THIẾT BỊ XỬ LÝ NHIỆT** (51) **24-01**  
(22) 03/02/2021 (43) 25/08/2022  
(30) 008070239-0001 03/08/2020 EM;  
(73) **DERMAPHARM AG (DE)**  
Lil-Dagover-Ring 7, D-82031 Grünwald, ALEMANIA (DE)  
(72) 1. DANIEL BÜNGER VON WURMB (DE)  
2. CAMILL MAIER (DE)  
(74) Công ty cổ phần Tư vấn S&B (S&B CONSULTANT., CORP.)  
(55)



1.1

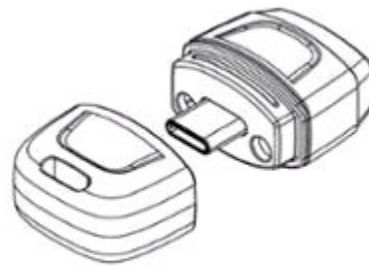

1.2

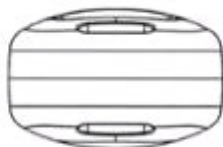

1.3

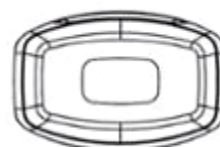

1.4



1.5

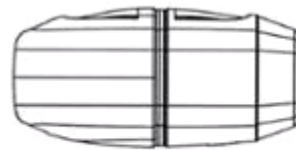

1.6

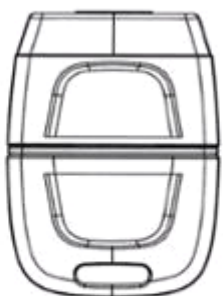

1.7



1.8

**CÔNG BÁO SỞ HỮU CÔNG NGHIỆP SỐ 413 TẬP A – QUYỀN 2 (08.2022)**

- (11) **45067**  
(21) 3-2021-00262 (28) 1  
(54) **THIẾT BỊ XỬ LÝ NHIỆT** (51) **24-01**  
(22) 03/02/2021 (43) 25/08/2022  
(30) 008070239-0003 03/08/2020 EM;  
(73) **DERMAPHARM AG (DE)**  
Lil-Dagover-Ring 7, D-82031 Grünwald, ALEMANIA (DE)  
(72) 1. DANIEL BÜNGER VON WURMB (DE)  
2. CAMILL MAIER (DE)  
(74) Công ty cổ phần Tư vấn S&B (S&B CONSULTANT., CORP.)  
(55)

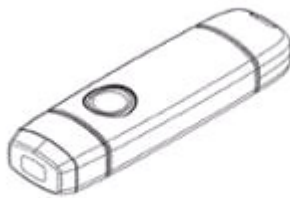

1.1

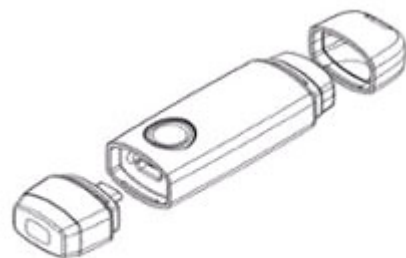

1.2



1.3



1.4

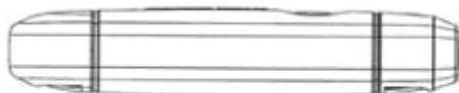

1.5

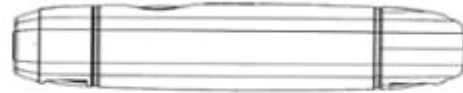

1.6



1.7



1.8

**CÔNG BÁO SỞ HỮU CÔNG NGHIỆP SỐ 413 TẬP A – QUYỀN 2 (08.2022)**

- (11) **45068**  
(21) 3-2021-00293 (28) 1  
(54) **TRẠM QUAN TRẮC CHÁY RỪNG BẰNG CAMERA QUANG HỌC** (51) **10-05**  
(22) 05/02/2021 (43) 25/08/2022  
(73) **TRUNG TÂM NGHIÊN CỨU QUẢN LÝ THIÊN TAI VÀ CHÁY RỪNG (VN)**  
Số 10, tổ 3, khu Xuân Hà, thị trấn Xuân Mai, huyện Chương Mỹ, thành phố Hà Nội  
(72) Vương Văn Quỳnh (VN)  
(74) Công ty TNHH Sở hữu trí tuệ ALNGUYEN (ALNGUYEN IP CO.,LTD.)  
(55)

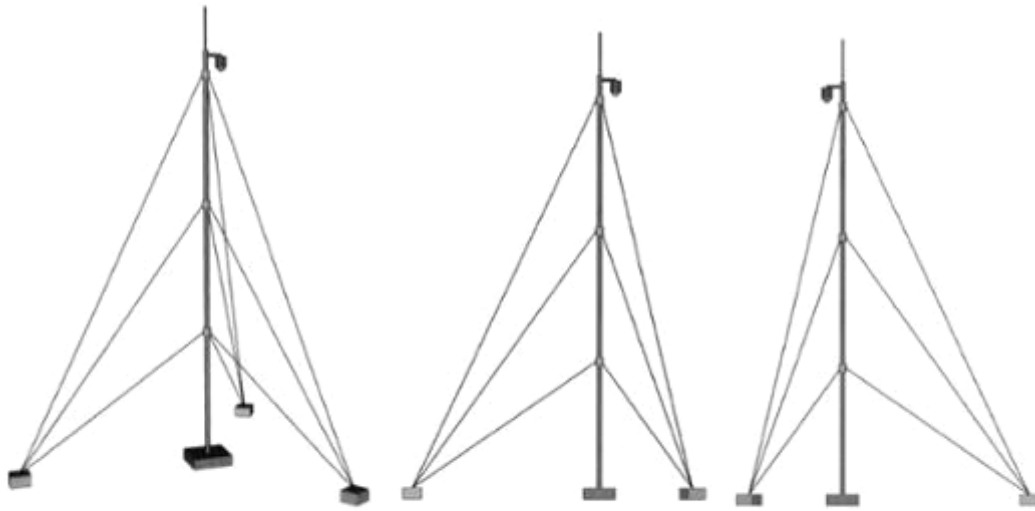

1.1

1.2

1.3

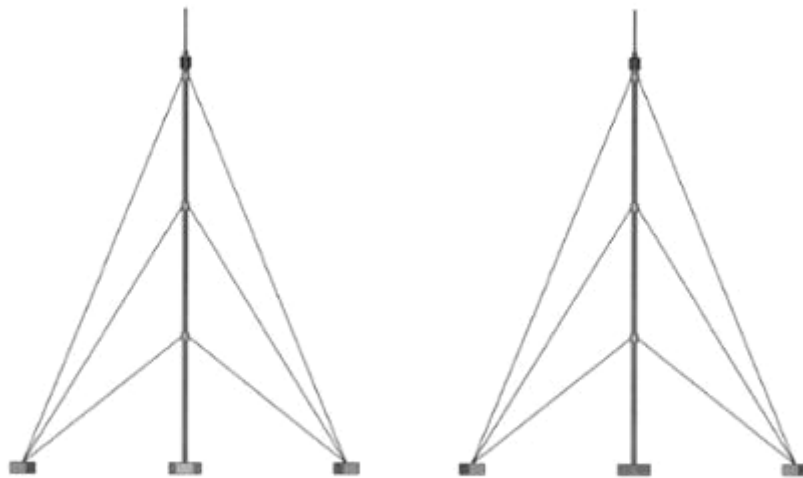

1.4

1.5

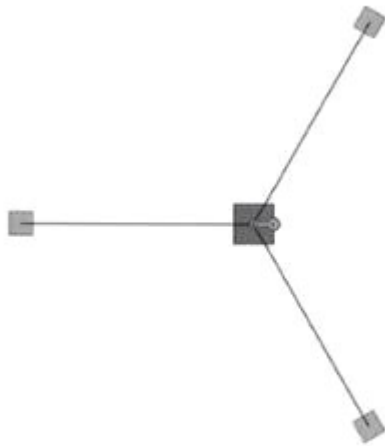

1.6

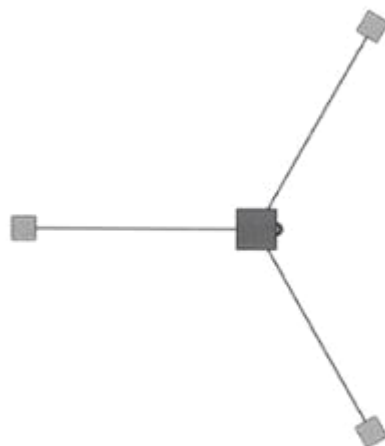

1.7

**CÔNG BÁO SỞ HỮU CÔNG NGHIỆP SỐ 413 TẬP A – QUYỀN 2 (08.2022)**

(11) **45069**

(21) 3-2021-00708

(28) 1

(54) **CHAI**

(51) **09-01**

(22) 26/03/2021

(43) 25/08/2022

(73) **NGUYỄN HOÀNG TRUNG (VN)**

Phòng 2505, nhà CT7C, chung cư Sparks Dương Nội, quận Hà Đông, thành phố Hà Nội

(72) Nguyễn Hoàng Trung (VN)

(55)



1.1

1.2

1.3

1.4

1.5



1.6



1.7

**CÔNG BÁO SỞ HỮU CÔNG NGHIỆP SỐ 413 TẬP A – QUYỀN 2 (08.2022)**

- (11) **45070**  
(21) 3-2021-00716 (28) 1  
(54) **THANH LẮP GHÉP DÙNG CHO GIÁ VÀ KỆ** (51) **06-05**  
(22) 29/03/2021 (43) 25/08/2022  
(73) **CÔNG TY TNHH ĐẦU TƯ SẢN XUẤT VÀ THƯƠNG MẠI MINH KHUÊ (VN)**  
Xóm 10 thôn Đồng Mít, xã Đồng Tâm, huyện Mỹ Đức, thành phố Hà Nội  
(72) Lã Viết Nhật (VN)  
(74) Công ty TNHH Sở hữu trí tuệ VIPATCO (VIPATCO CO., LTD.)  
(55)



1.1



1.2



1.3



1.4

1.5



1.6



1.7

- (11) **45071**  
(21) 3-2021-01647 (28) 2  
(54) **THỨC ĂN CHO VẬT NUÔI** (51) **01-06**  
(22) 23/06/2021 (43) 25/08/2022  
(30) 29/763,605 23/12/2020 US;  
(73) **SPECTRUM BRANDS, INC. (US)**  
3001 Deming Way, Middleton, Wisconsin 53562, United States of America  
(72) 1. VAN EYK, GREGORY (US)  
2. POTTER, TIFFANY DAWN (US)  
3. KENDRICK, VICTORIA GRAY (US)  
(74) Công ty TNHH Sở hữu trí tuệ Thảo Thọ Quyển (INVENCO.,LTD)  
(55)

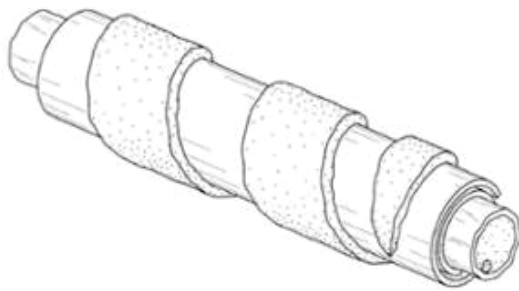

1.1

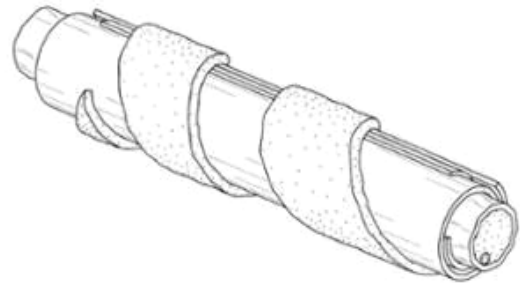

1.2



1.3

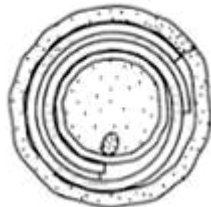

1.4

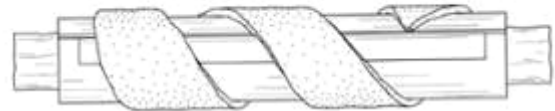

1.5

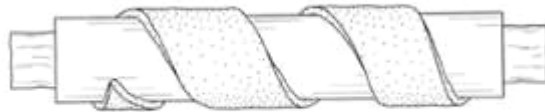

1.6



1.7



1.8





2.1



2.2



2.3



2.4



2.5



2.6



2.7



2.8

- (11) **45072**  
(21) 3-2021-01711 (28) 1  
(54) **CABIN MÔ PHỎNG LÁI XE Ô TÔ** (51) **19-07**  
(22) 29/06/2021 (43) 25/08/2022  
(73) **TẬP ĐOÀN CÔNG NGHIỆP - VIỆN THÔNG QUÂN ĐỘI (VN)**  
Lô D26 khu đô thị mới Cầu Giấy, phường Yên Hoà, quận Cầu Giấy, thành phố Hà Nội  
(72) 1. **ĐỖ MINH THẮNG (VN)**  
2. **CAO XUÂN SÁNG (VN)**  
(74) Công ty TNHH Tư vấn Quốc Dân (NACILAW)  
(55)

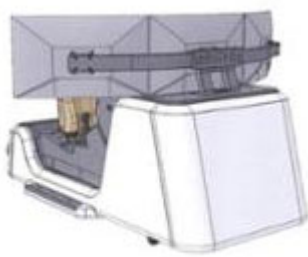

1.1



1.2

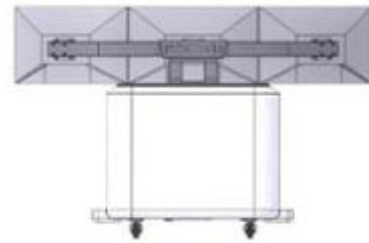

1.3

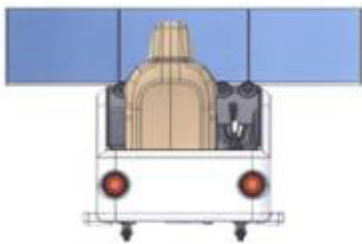

1.4

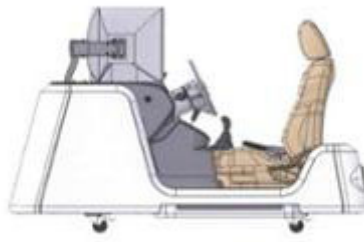

1.5



1.6

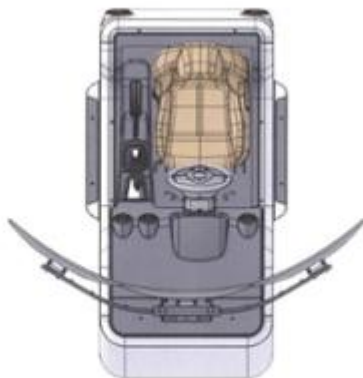

1.7

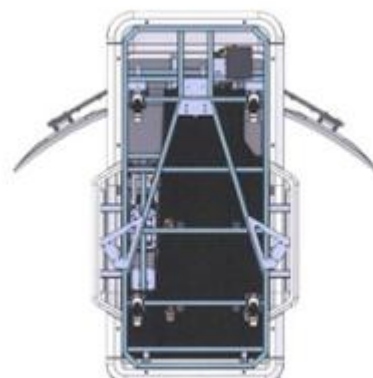

1.8

**CÔNG BÁO SỞ HỮU CÔNG NGHIỆP SỐ 413 TẬP A – QUYỀN 2 (08.2022)**

- (11) **45073**  
(21) 3-2021-01723 (28) 1  
(54) **THANH ĐỊNH HÌNH** (51) **25-01**  
(22) 30/06/2021 (43) 25/08/2022  
(73) **LÝ PHÚC HẬU (VN)**  
Số 2/33 đường Diệp Minh Châu, phường Tân Sơn Nhì, quận Tân Phú, thành phố Hồ Chí Minh  
(72) **LÝ PHÚC HẬU (VN)**  
(55)



1.1



1.2



1.3



1.4



1.5



1.6



1.7

**CÔNG BÁO SỞ HỮU CÔNG NGHIỆP SỐ 413 TẬP A – QUYỀN 2 (08.2022)**

- (11) **45074**  
(21) 3-2021-01724 (28) 1  
(54) **THANH ĐỊNH HÌNH** (51) **25-01**  
(22) 30/06/2021 (43) 25/08/2022  
(73) **LÝ PHÚC HẬU (VN)**  
Số 2/33 đường Diệp Minh Châu, phường Tân Sơn Nhì, quận Tân Phú, thành phố Hồ Chí Minh  
(72) **LÝ PHÚC HẬU (VN)**  
(55)

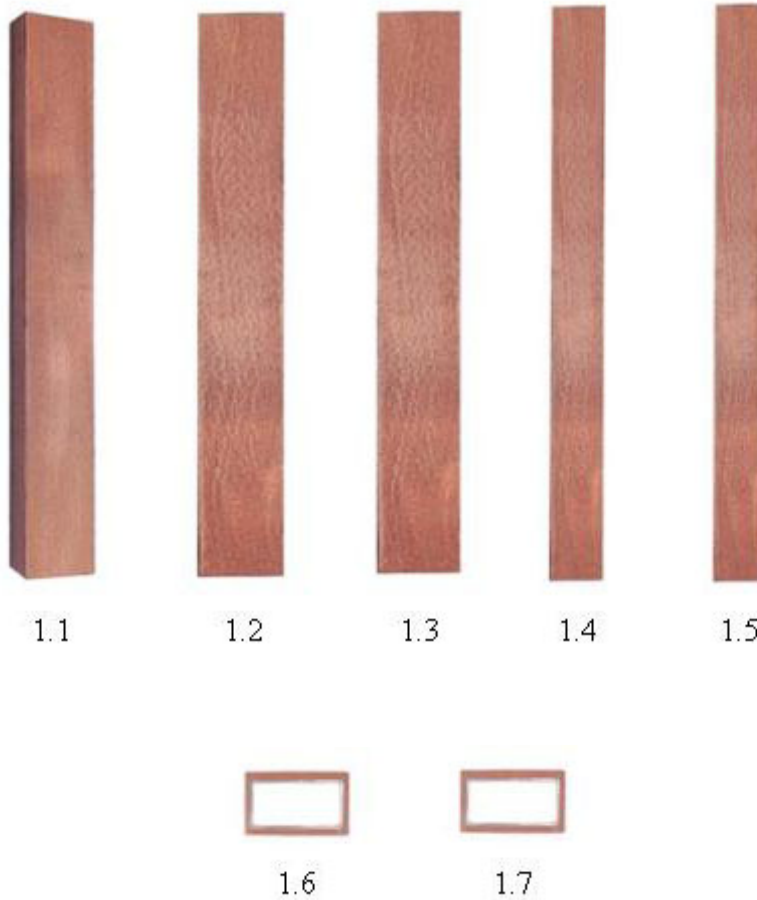

**CÔNG BÁO SỞ HỮU CÔNG NGHIỆP SỐ 413 TẬP A – QUYỀN 2 (08.2022)**

(11) **45075**

(21) 3-2021-01817

(54) **NHÀ TẮM DI ĐỘNG**

(22) 13/07/2021

(73) **TRẦN ĐÌNH LỢI (US)**

289 Beechwood Rd, West Hartford, CT 06107 (US)

(72) Trần Đình Lợi (VN)

(74) Công ty cổ phần Tư vấn S&B (S&B CONSULTANT., CORP.)

(55)

(28) 1

(51) **23-02**

(43) 25/08/2022

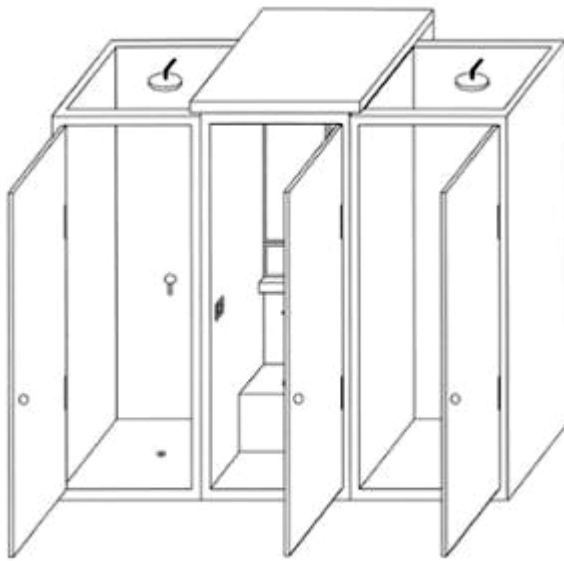

1.1

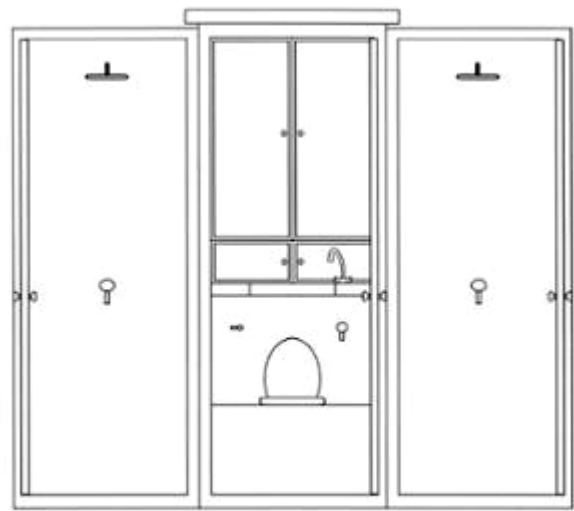

1.2

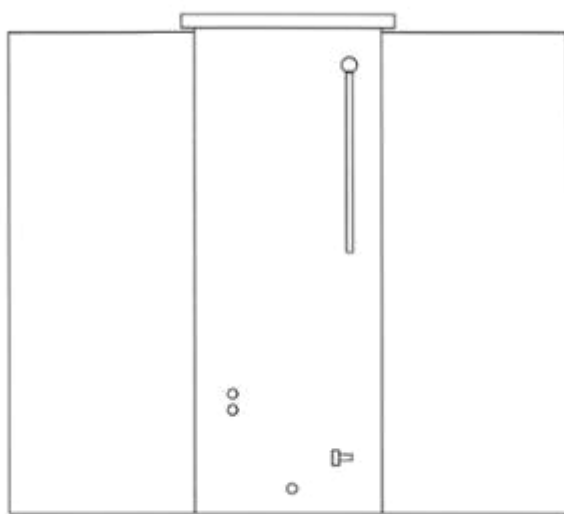

1.3

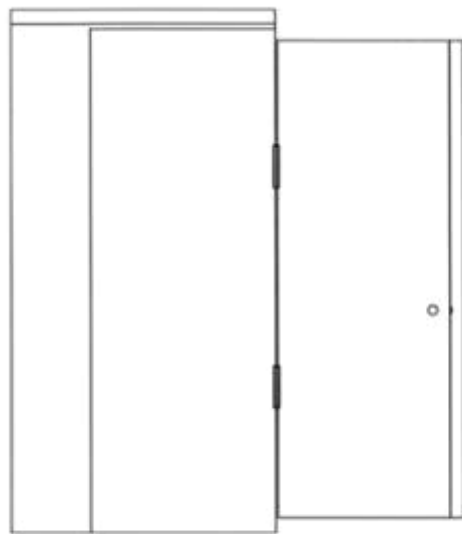

1.4

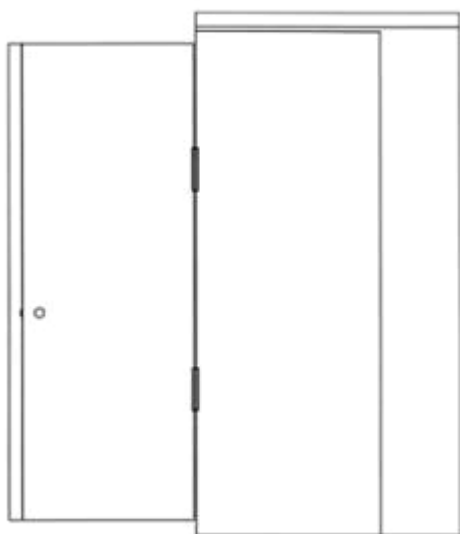

1.5

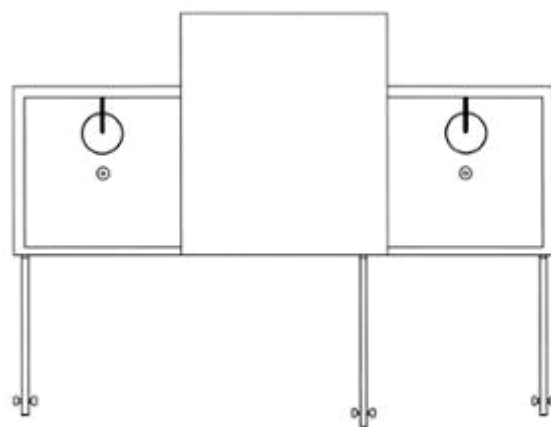

1.6

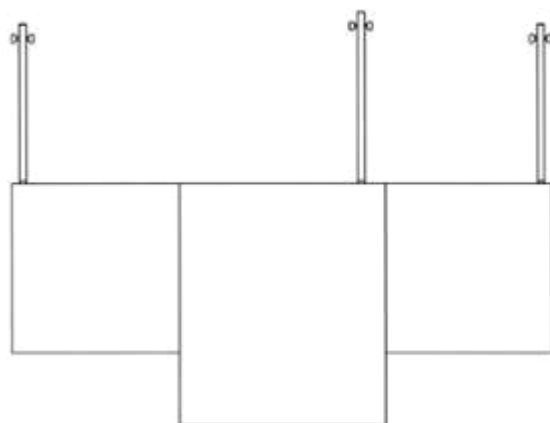

1.7

**CÔNG BÁO SỞ HỮU CÔNG NGHIỆP SỐ 413 TẬP A – QUYỀN 2 (08.2022)**

- (11) **45076**  
(21) 3-2021-01818 (28) 1  
(54) **BUỒNG TẮM DI ĐỘNG** (51) **23-02**  
(22) 13/07/2021 (43) 25/08/2022  
(73) **TRẦN ĐÌNH LỢI (US)**  
289 Beechwood Rd, West Hartford, CT 06107 (US)  
(72) Trần Đình Lợi (VN)  
(74) Công ty cổ phần Tư vấn S&B (S&B CONSULTANT., CORP.)  
(55)

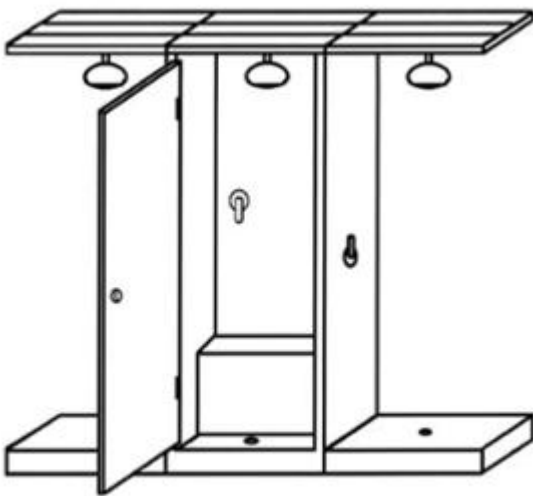

1.1

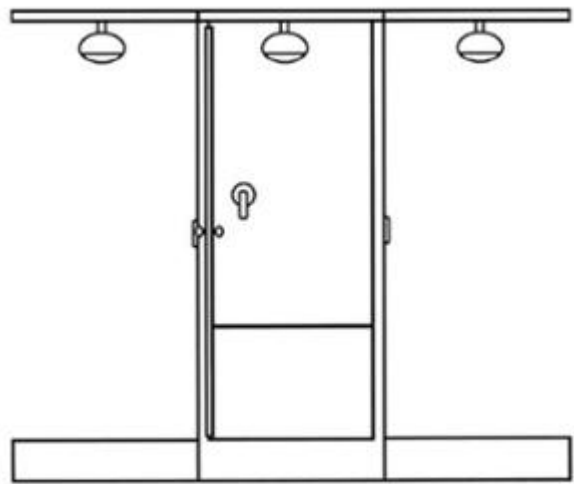

1.2

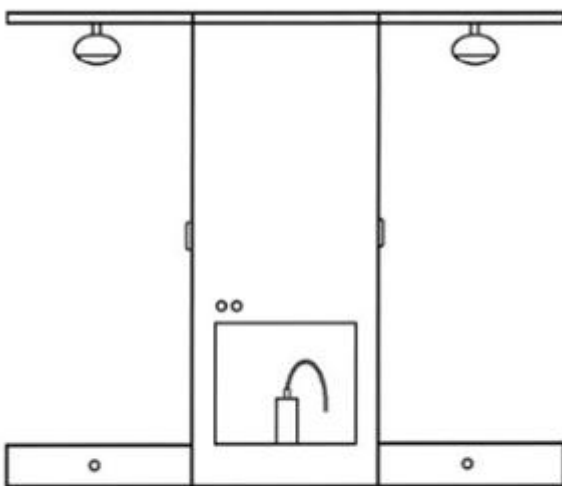

1.3

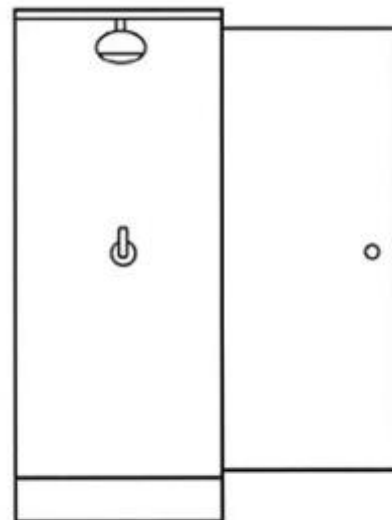

1.4

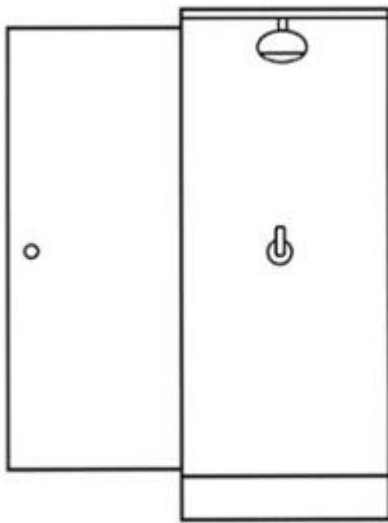

1.5

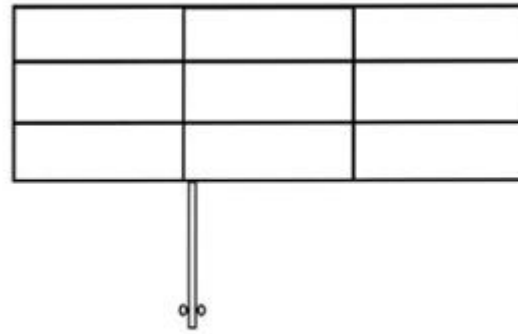

1.6

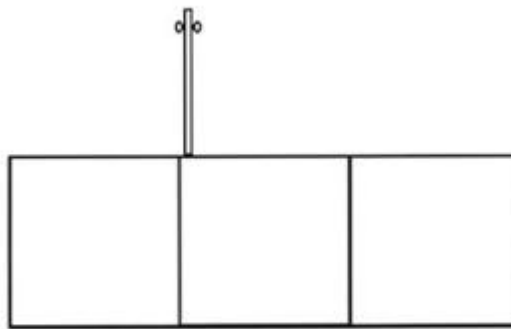

1.7



- (11) **45077**  
(21) 3-2021-01904 (28) 6  
(54) **THỨC ĂN CHO VẬT NUÔI** (51) **01-06**  
(22) 22/07/2021 (43) 25/08/2022  
(30) 29/767,497 22/01/2021 US;  
(73) **SPECTRUM BRANDS, INC. (US)**  
3001 Deming Way, Middleton, Wisconsin 53562, United States of America  
(72) 1. TIFFANY DAWN POTTER (US)  
2. ALLYSE MCCANN (US)  
3. STEPHANIE HULLVERSON (US)  
(74) Công ty TNHH Sở hữu trí tuệ Thảo Thọ Quyển (INVENCO.,LTD)  
(55)

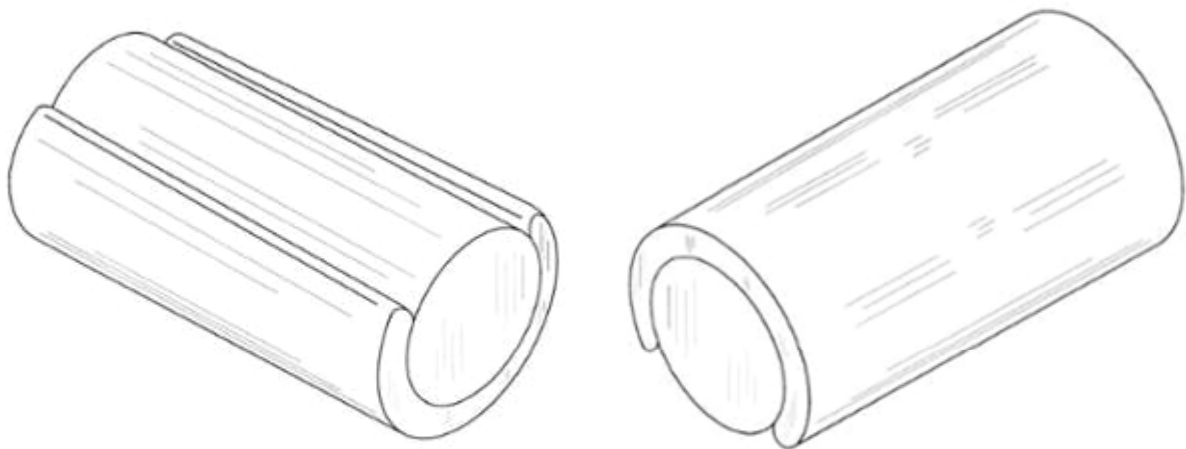

1.1

1.2



1.3

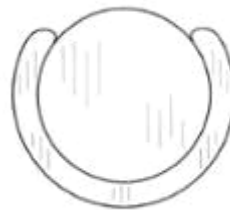

1.4



1.5



1.6

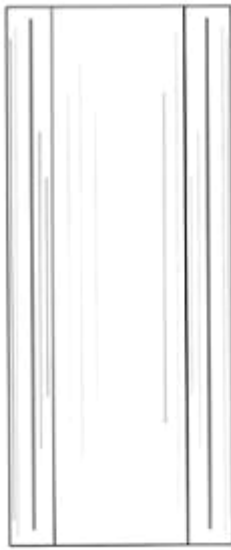

1.7

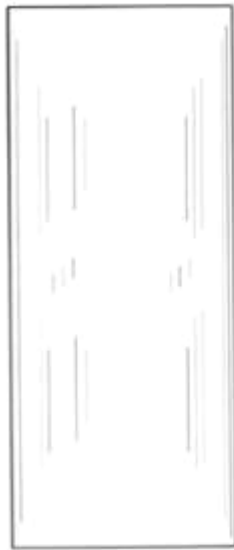

1.8

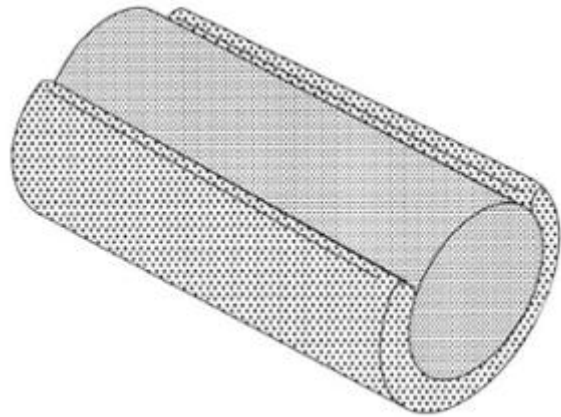

2.1

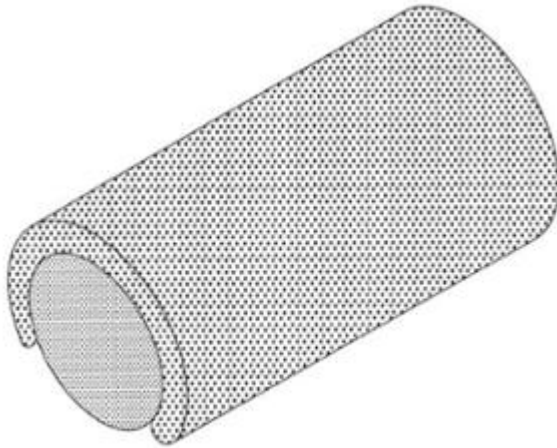

2.2

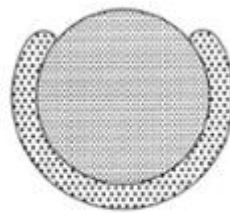

2.3

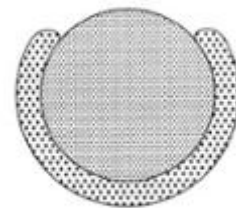

2.4

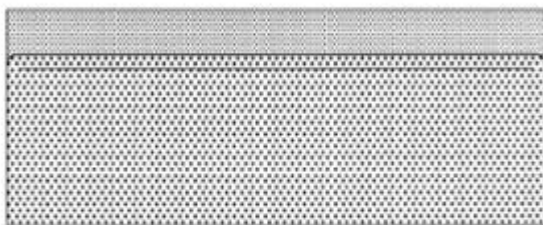

2.5



2.6

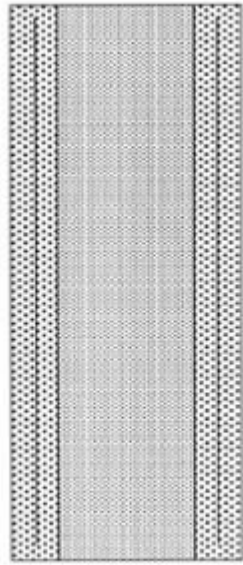

2.7

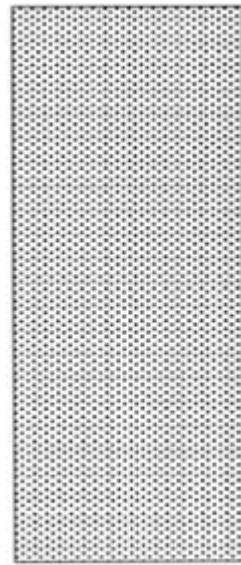

2.8



3.1



3.2



3.3



3.4



3.5



4.1



4.2



4.3

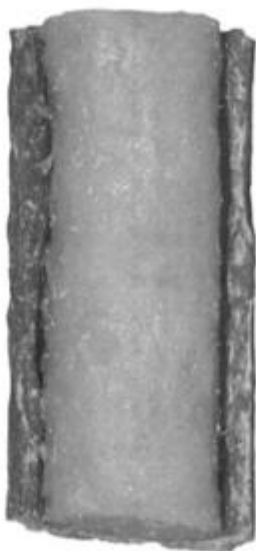

4.4



4.5



5.1



5.2

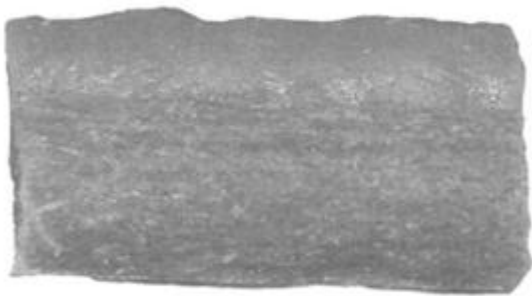

5.3

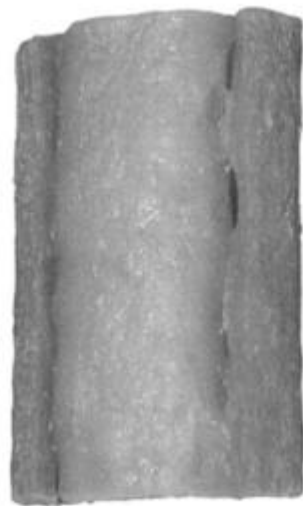

5.4



5.5



6.1

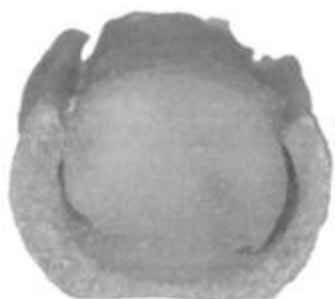

6.2



6.3

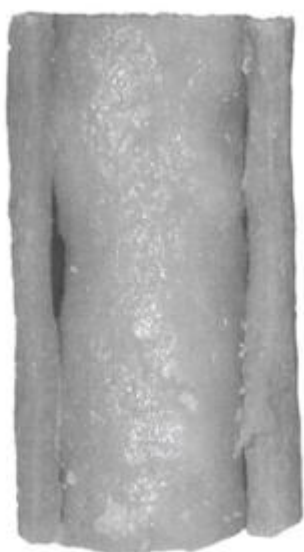

6.4



6.5

**CÔNG BÁO SỞ HỮU CÔNG NGHIỆP SỐ 413 TẬP A – QUYỀN 2 (08.2022)**

- (11) **45078**  
(21) 3-2021-02049 (28) 2  
(54) **THỨC ĂN CHO VẬT NUÔI** (51) **01-06**  
(22) 12/08/2021 (43) 25/08/2022  
(30) 29/770,019 09/02/2021 US;  
(73) **SPECTRUM BRANDS, INC. (US)**  
3001 Deming Way, Middleton, Wisconsin 53562, United States of America  
(72) 1. ALLYSE MCCANN (US)  
2. TIFFANY DAWN POTTER (US)  
3. GREGORY VAN EYK (US)  
(74) Công ty TNHH Sở hữu trí tuệ Thảo Thọ Quyển (INVENCO.,LTD)  
(55)

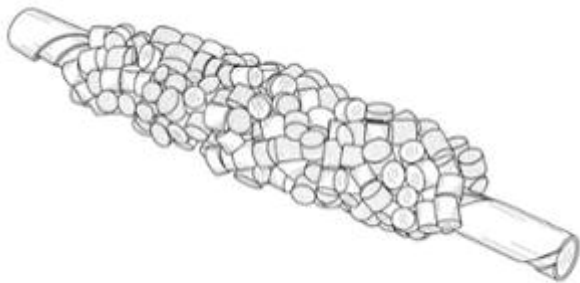

1.1



1.2



1.3

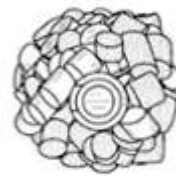

1.4



1.5



1.6

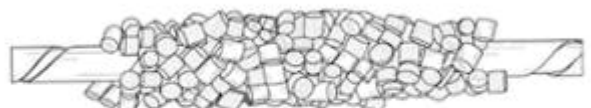

1.7



2.1



2.2



2.3



2.4



2.5



2.6



2.7



- (11) **45079**  
(21) 3-2021-02050 (28) 2  
(54) **THỨC ĂN CHO VẬT NUÔI** (51) **01-06**  
(22) 12/08/2021 (43) 25/08/2022  
(30) 29/769,808 08/02/2021 US;  
(73) **SPECTRUM BRANDS, INC. (US)**  
3001 Deming Way, Middleton, Wisconsin 53562, United States of America  
(72) 1. ALLYSE MCCANN (US)  
2. TIFFANY DAWN POTTER (US)  
3. ERIN VANTREASE (US)  
4. STEPHANIE HULLVERSON (US)  
(74) Công ty TNHH Sở hữu trí tuệ Thảo Thọ Quyên (INVENCO.,LTD)  
(55)

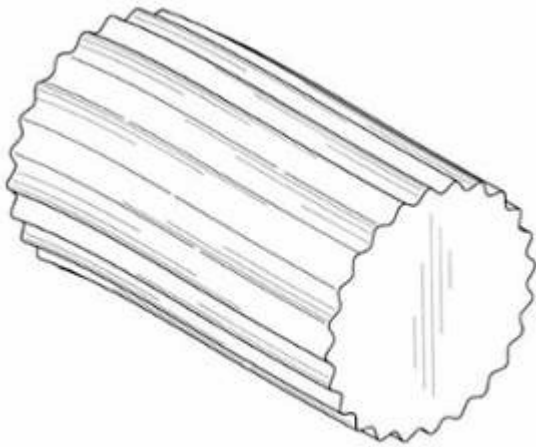

1.1



1.2



1.3



1.4



1.5



1.6



1.7

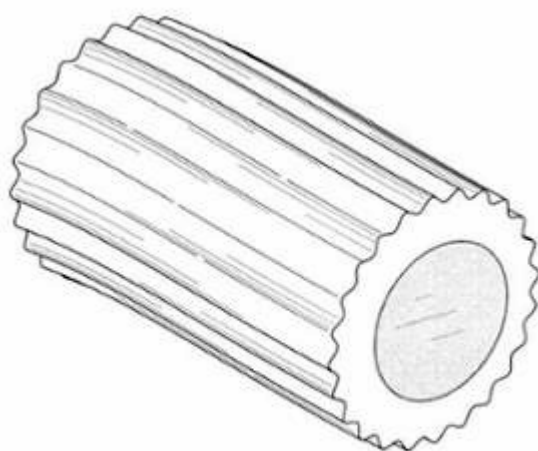

2.1



2.2



2.3



2.4



2.5



2.6



2.7

- (11) **45080**  
(21) 3-2021-02051 (28) 2  
(54) **THỨC ĂN CHO VẬT NUÔI** (51) **01-06**  
(22) 12/08/2021 (43) 25/08/2022  
(30) 29/769,809 08/02/2021 US;  
(73) **SPECTRUM BRANDS, INC. (US)**  
3001 Deming Way, Middleton, Wisconsin 53562, United States of America  
(72) 1. ALLYSE MCCANN (US)  
2. TIFFANY DAWN POTTER (US)  
3. ERIN VANTREASE (US)  
4. STEPHANIE HULLVERSON (US)  
(74) Công ty TNHH Sở hữu trí tuệ Thảo Thọ Quyên (INVENCO.,LTD)  
(55)

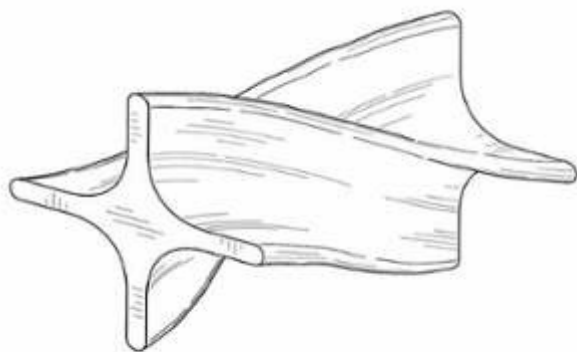

1.1



1.2



1.3

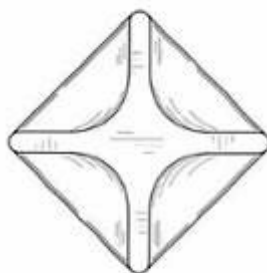

1.4

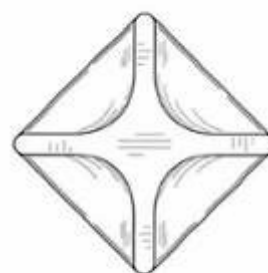

1.5

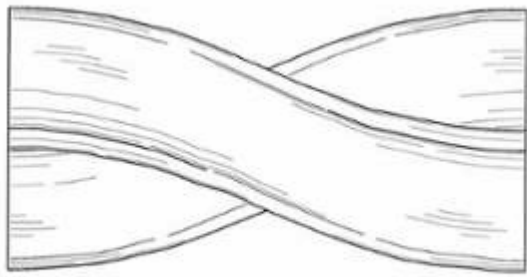

1.6

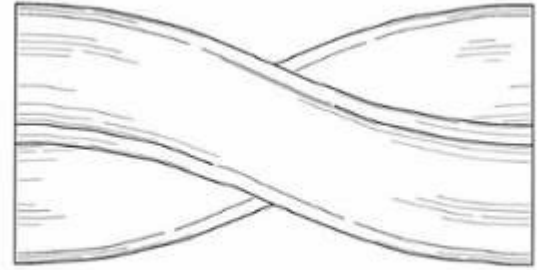

1.7

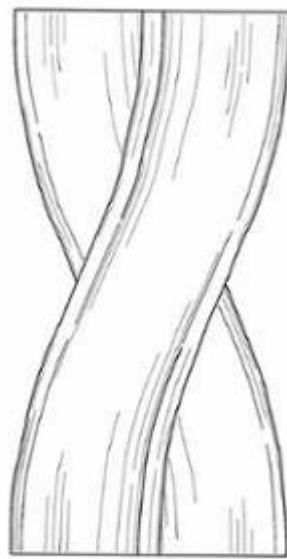

1.8



1.9

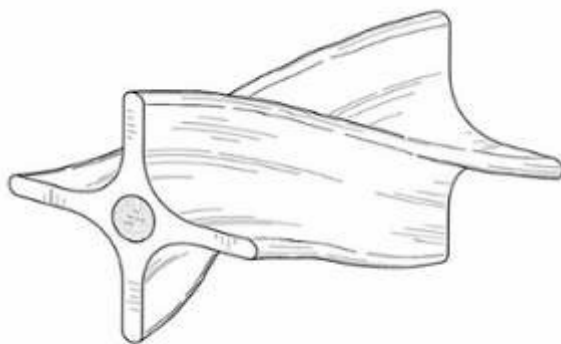

2.1

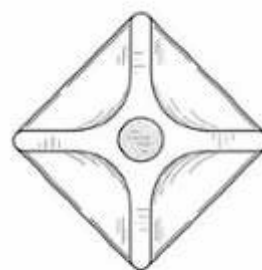

2.2

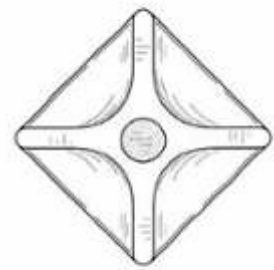

2.3

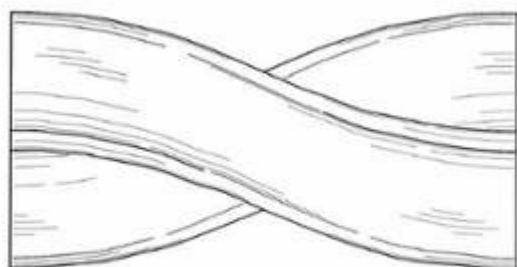

2.4

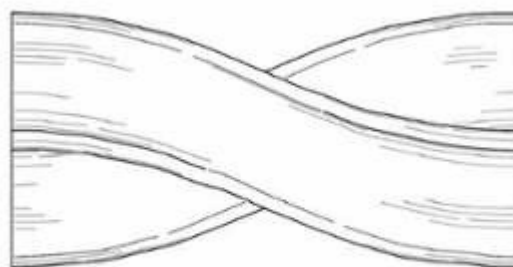

2.5



2.6



2.7

- (11) **45081**  
(21) 3-2021-02052 (28) 2  
(54) **THỨC ĂN CHO VẬT NUÔI** (51) **01-06**  
(22) 12/08/2021 (43) 25/08/2022  
(30) 29/769,810 08/02/2021 US;  
(73) **SPECTRUM BRANDS, INC. (US)**  
3001 Deming Way, Middleton, Wisconsin 53562, United States of America  
(72) 1. ALLYSE MCCANN (US)  
2. TIFFANY DAWN POTTER (US)  
3. ERIN VANTREASE (US)  
4. STEPHANIE HULLVERSON (US)  
(74) Công ty TNHH Sở hữu trí tuệ Thảo Thọ Quyên (INVENCO.,LTD)  
(55)



1.1



1.2



1.3



1.4



1.5



1.6

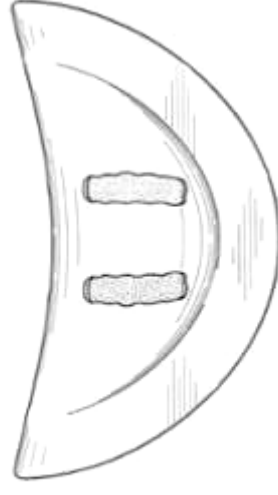

1.7



1.8



1.9



1.10



2.1



2.2



2.3



2.4



2.5



2.6



2.7



- (11) **45082**  
(21) 3-2021-02053 (28) 1  
(54) **THỨC ĂN CHO VẬT NUÔI** (51) **01-06**  
(22) 12/08/2021 (43) 25/08/2022  
(30) 29/770,012 09/02/2021 US;  
(73) **SPECTRUM BRANDS, INC. (US)**  
3001 Deming Way, Middleton, Wisconsin 53562, United States of America  
(72) 1. VICTORIA GRAY KENDRICK (US)  
2. TIFFANY DAWN POTTER (US)  
(74) Công ty TNHH Sở hữu trí tuệ Thảo Thọ Quyên (INVENCO.,LTD)  
(55)



1.1



1.2



1.4

1.5



1.3



1.6



1.7

**CÔNG BÁO SỞ HỮU CÔNG NGHIỆP SỐ 413 TẬP A – QUYỀN 2 (08.2022)**

- (11) **45083**  
(21) 3-2021-02124 (28) 2  
(54) **BỘ NHÃN SẢN PHẨM** (51) **19-08**  
(22) 20/08/2021 (43) 25/08/2022  
(73) **CÔNG TY CỔ PHẦN LIFE TECH GROUP (VN)**  
Số 10/22, ngõ 230 Lạc Trung, phường Thanh Lương, quận Hai Bà Trưng, thành phố Hà Nội  
(72) Trịnh Bá Hải (VN)  
(55)



1.1



1.2



1.3



1.4

(11) **45084**

(21) 3-2021-02231

(28) 1

(54) **THẢM BÊ TÔNG BẢO VỆ CHÂN KÈ**

(51) **25-02**

(22) 08/09/2021

(43) 25/08/2022

(73) **CÔNG TY CỔ PHẦN KHOA HỌC CÔNG NGHỆ VIỆT NAM (VN)**

Số 6 đường 3 tháng 2, phường 8, thành phố Vũng Tàu, tỉnh Bà Rịa - Vũng Tàu

(72) Hoàng Đức Thảo (VN)

(55)

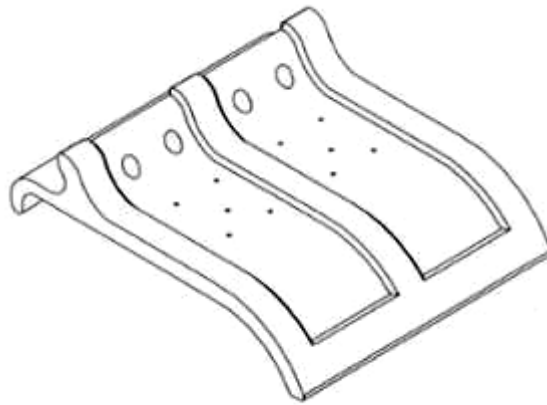

1.1

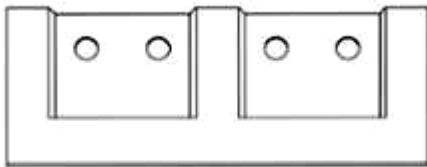

1.2

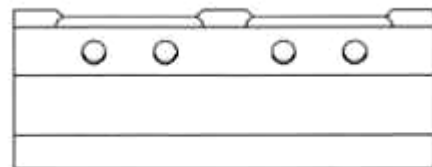

1.3



1.4



1.5

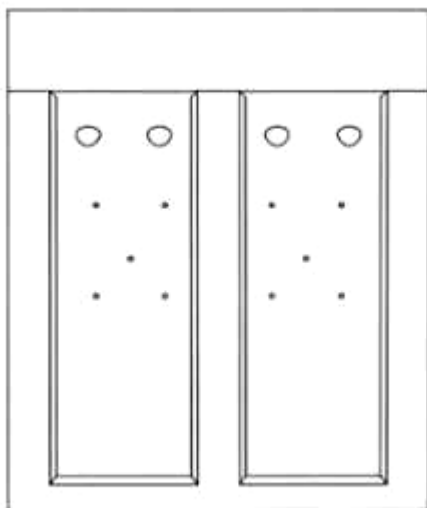

1.6

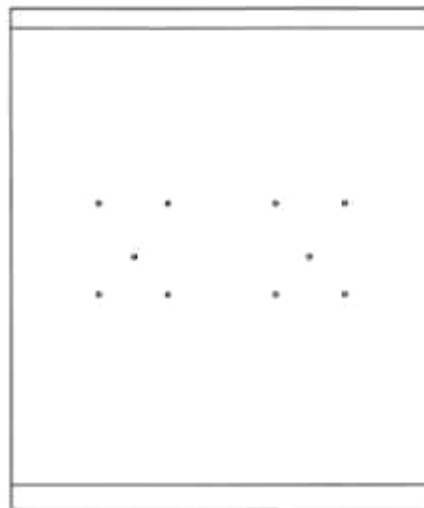

1.7

- (11) **45085**  
(21) 3-2021-02232 (28) 1  
(54) **THẨM BÊ TÔNG BẢO VỆ CHÂN KÈ** (51) **25-02**  
(22) 08/09/2021 (43) 25/08/2022  
(73) **CÔNG TY CỔ PHẦN KHOA HỌC CÔNG NGHỆ VIỆT NAM (VN)**  
Số 6 đường 3 tháng 2, phường 8, thành phố Vũng Tàu, tỉnh Bà Rịa - Vũng Tàu  
(72) Hoàng Đức Thảo (VN)  
(55)

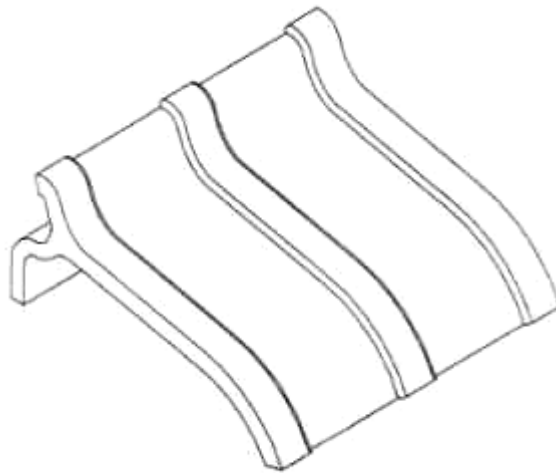

1.1

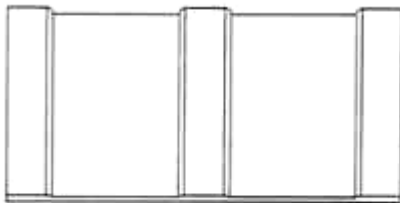

1.2



1.3



1.4



1.5

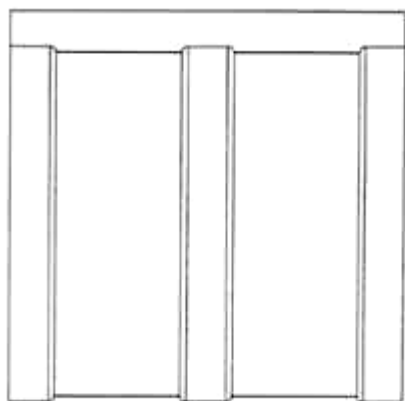

1.6



1.7

(11) **45086**

(21) 3-2021-02233

(28) 1

(54) **THẢM BÊ TÔNG BẢO VỆ CHÂN KÈ**

(51) **25-02**

(22) 08/09/2021

(43) 25/08/2022

(73) **CÔNG TY CỔ PHẦN KHOA HỌC CÔNG NGHỆ VIỆT NAM (VN)**

Số 6 đường 3 tháng 2, phường 8, thành phố Vũng Tàu, tỉnh Bà Rịa - Vũng Tàu

(72) Hoàng Đức Thảo (VN)

(55)

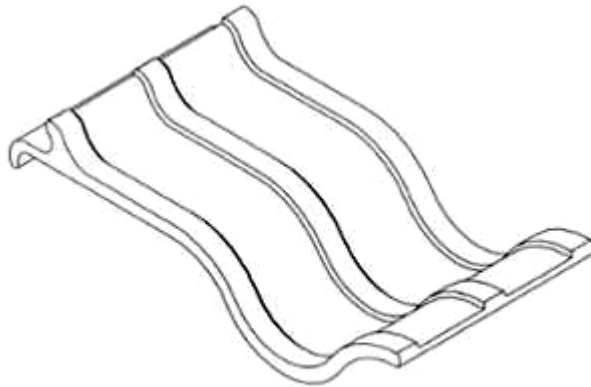

1.1

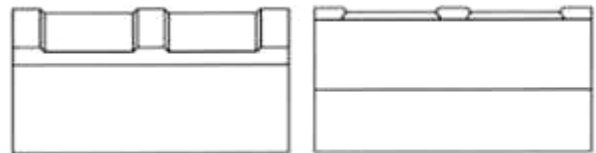

1.2

1.3



1.4



1.5

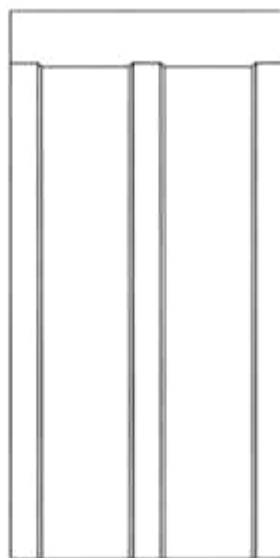

1.6



1.7

(11) **45087**

(21) 3-2021-02234

(28) 1

(54) **THẨM BÊ TÔNG BẢO VỆ CHÂN KÈ**

(51) **25-02**

(22) 08/09/2021

(43) 25/08/2022

(73) **CÔNG TY CỔ PHẦN KHOA HỌC CÔNG NGHỆ VIỆT NAM (VN)**

Số 6 đường 3 tháng 2, phường 8, thành phố Vũng Tàu, tỉnh Bà Rịa - Vũng Tàu

(72) Hoàng Đức Thảo (VN)

(55)

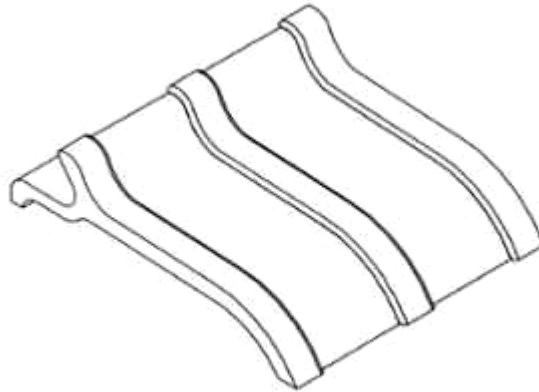

1.1

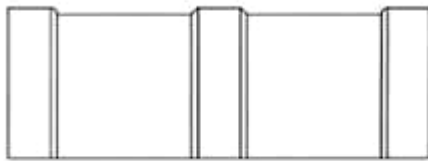

1.2



1.3



1.4

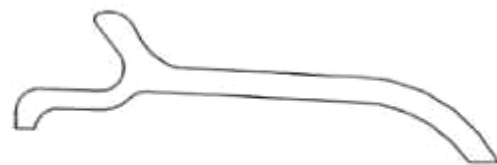

1.5



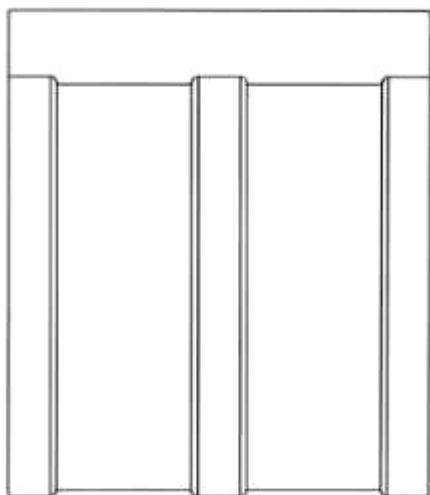

1.6



1.7

(11) **45088**

(21) 3-2021-02237

(28) 1

(54) **THẨM BÊ TÔNG BẢO VỆ CHÂN KÈ**

(51) **25-02**

(22) 08/09/2021

(43) 25/08/2022

(73) **CÔNG TY CỔ PHẦN KHOA HỌC CÔNG NGHỆ VIỆT NAM (VN)**

Số 6 đường 3 tháng 2, phường 8, thành phố Vũng Tàu, tỉnh Bà Rịa - Vũng Tàu

(72) Hoàng Đức Thảo (VN)

(55)

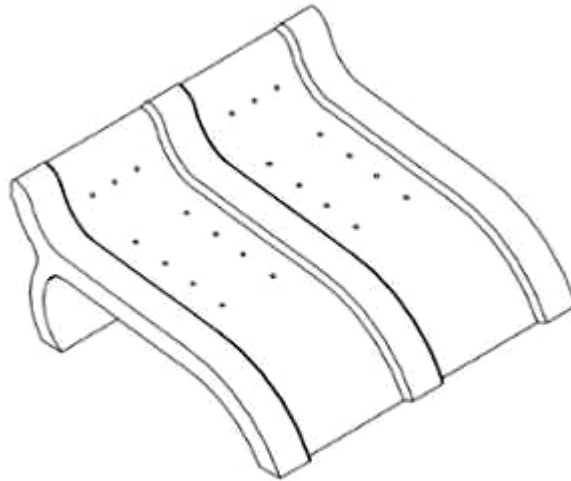

1.1

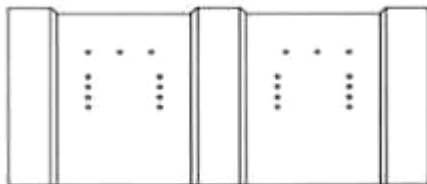

1.2

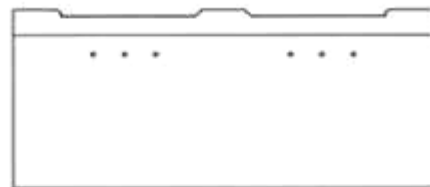

1.3



1.4



1.5

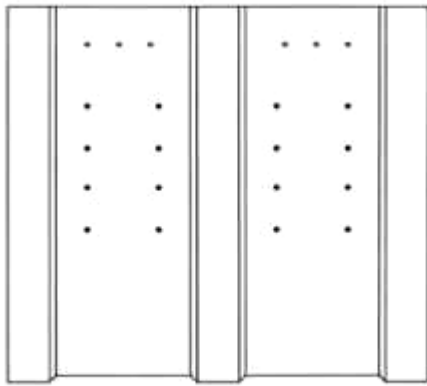

1.6

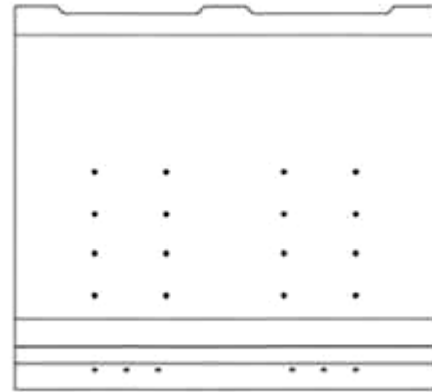

1.7

(11) **45089**

(21) 3-2021-02238

(28) 1

(54) **THẨM BÊ TÔNG BẢO VỆ CHÂN KÈ**

(51) **25-02**

(22) 08/09/2021

(43) 25/08/2022

(73) **CÔNG TY CỔ PHẦN KHOA HỌC CÔNG NGHỆ VIỆT NAM (VN)**

Số 6 đường 3 tháng 2, phường 8, thành phố Vũng Tàu, tỉnh Bà Rịa - Vũng Tàu

(72) Hoàng Đức Thảo (VN)

(55)

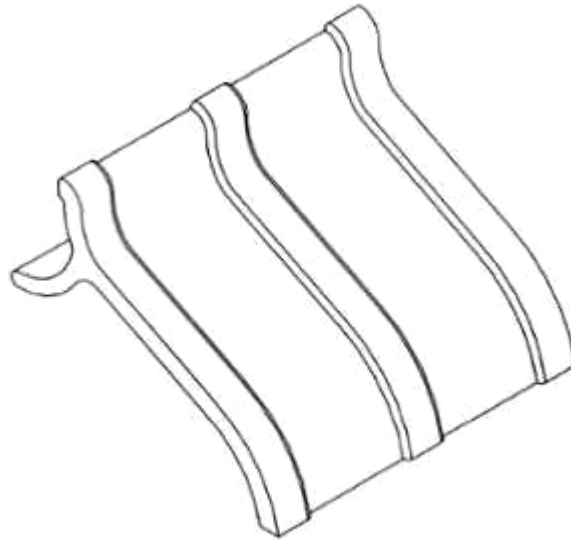

1.1

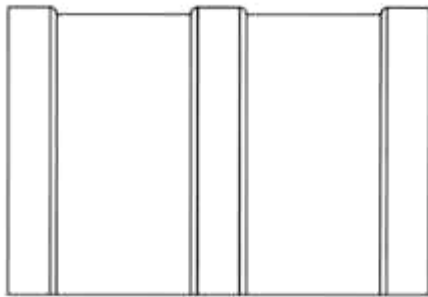

1.2

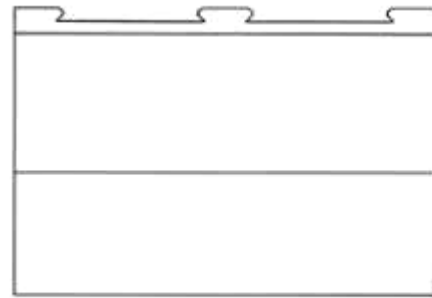

1.3

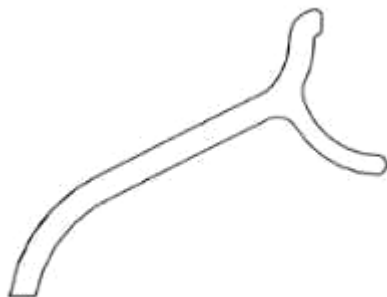

1.4

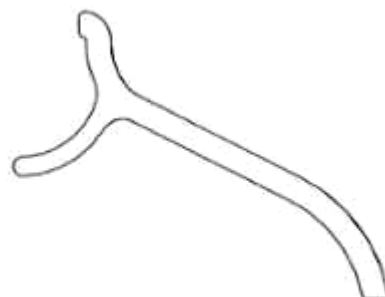

1.5

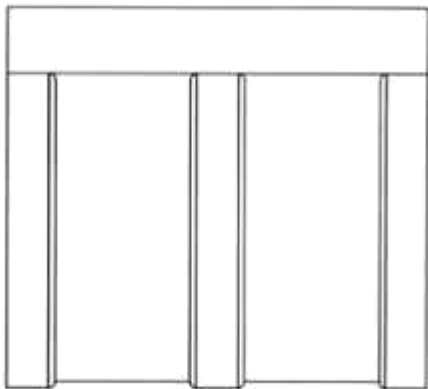

1.6



1.7

(11) **45090**

(21) 3-2021-02239

(28) 1

(54) **THẨM BÊ TÔNG BẢO VỆ CHÂN KÈ**

(51) **25-02**

(22) 08/09/2021

(43) 25/08/2022

(73) **CÔNG TY CỔ PHẦN KHOA HỌC CÔNG NGHỆ VIỆT NAM (VN)**

Số 6 đường 3 tháng 2, phường 8, thành phố Vũng Tàu, tỉnh Bà Rịa - Vũng Tàu

(72) Hoàng Đức Thảo (VN)

(55)

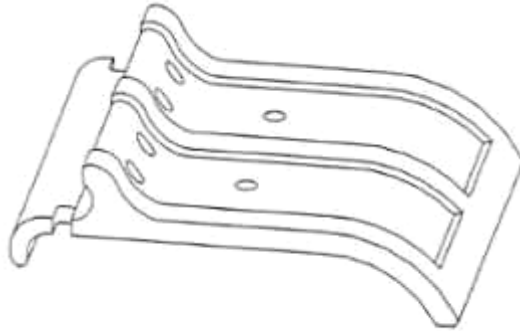

1.1

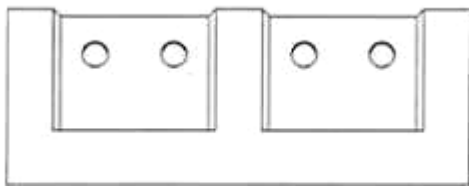

1.2

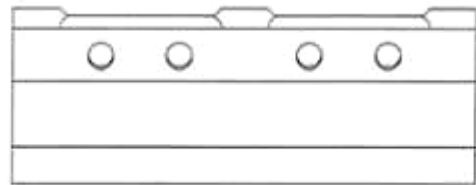

1.3



1.4

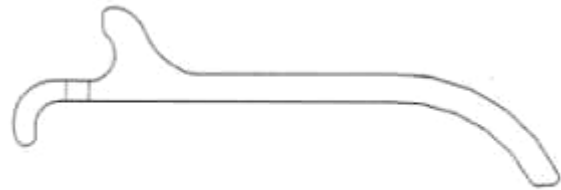

1.5

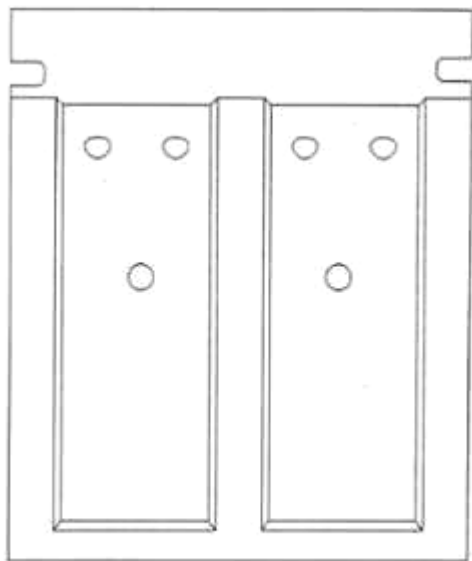

1.6

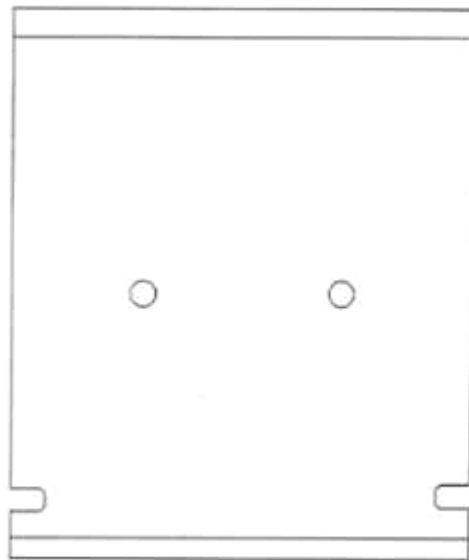

1.7

**CÔNG BÁO SỞ HỮU CÔNG NGHIỆP SỐ 413 TẬP A – QUYỀN 2 (08.2022)**

- (11) **45091**  
(21) 3-2021-02240 (28) 3  
(54) **BÀN ĐẠP XE ĐẠP** (51) **12-16**  
(22) 08/09/2021 (43) 25/08/2022  
(30) 29/773,175 08/03/2021 US; 29/773,172 08/03/2021 US;  
(73) **WAHOO FITNESS L.L.C. (US)**  
90 W. Wieuca Rd #110, Atlanta, Georgia 30342, United States of America  
(72) David R. BUENGER (US)  
(74) Văn phòng Luật sư Ân Nam (ANNAM IP & LAW)  
(55)

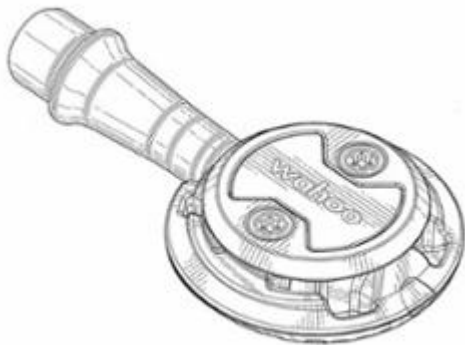

1.1

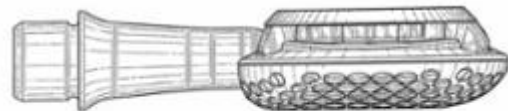

1.2

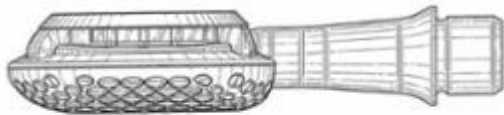

1.3

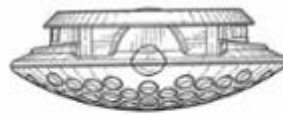

1.4



1.5



1.6

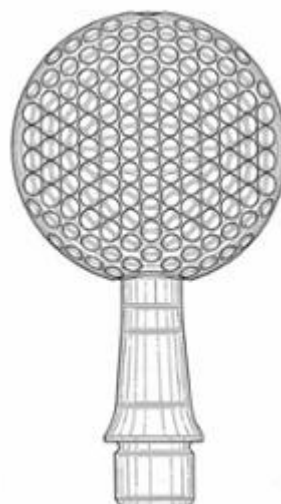

1.7





2.1

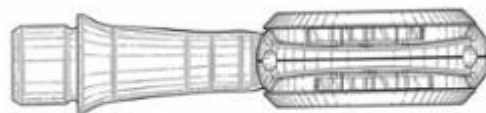

2.2

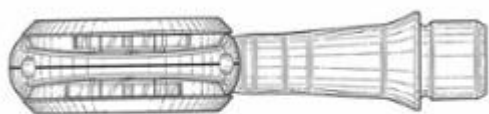

2.3

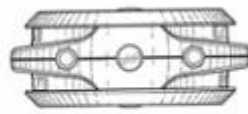

2.4

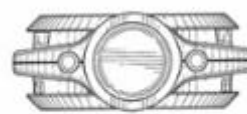

2.5



2.6



2.7

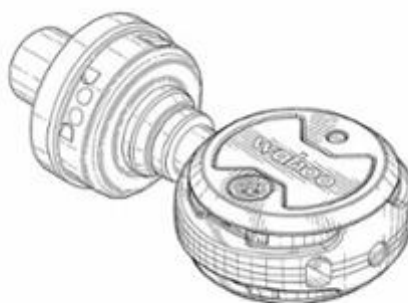

3.1

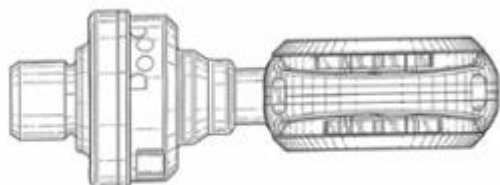

3.2

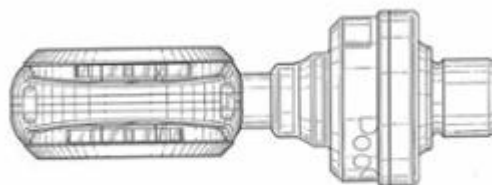

3.3

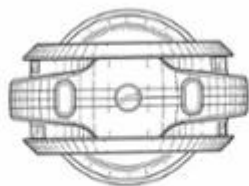

3.4

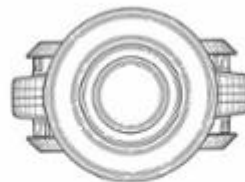

3.5

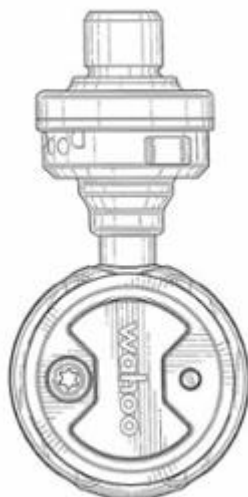

3.6



3.7

**CÔNG BÁO SỞ HỮU CÔNG NGHIỆP SỐ 413 TẬP A – QUYỀN 2 (08.2022)**

- (11) **45092**
- (21) 3-2021-02330 (28) 1
- (54) **NHÃN SẢN PHẨM** (51) **19-08**
- (22) 23/09/2021 (43) 25/08/2022
- (73) **CÔNG TY TNHH ĐẦU TƯ PHÁT TRIỂN THƯƠNG MẠI VÀ DỊCH VỤ ĐẠT LINH HƯƠNG (VN)**  
Số 345 đường Nguyễn Văn Cừ, phường Võ Cường, thành phố Bắc Ninh, tỉnh Bắc Ninh
- (72) Nguyễn Việt Hùng (VN)
- (74) Công ty Luật TNHH LEADCONSULT (LEADCONSULT)
- (55)



**CÔNG BÁO SỞ HỮU CÔNG NGHIỆP SỐ 413 TẬP A – QUYỀN 2 (08.2022)**

- (11) **45093**
- (21) 3-2021-02331 (28) 1
- (54) **NHÃN SẢN PHẨM** (51) **19-08**
- (22) 23/09/2021 (43) 25/08/2022
- (73) **CÔNG TY TNHH ĐẦU TƯ PHÁT TRIỂN THƯƠNG MẠI VÀ DỊCH VỤ ĐẠT LINH HƯƠNG (VN)**  
Số 345 đường Nguyễn Văn Cừ, phường Võ Cường, thành phố Bắc Ninh, tỉnh Bắc Ninh
- (72) Nguyễn Việt Hùng (VN)
- (74) Công ty Luật TNHH LEADCONSULT (LEADCONSULT)
- (55)



- (11) **45094**  
(21) 3-2021-02352 (28) 1  
(54) **THIẾT BỊ THEO DÕI SỨC KHỎE** (51) **10-04**  
(22) 24/09/2021 (43) 25/08/2022  
(30) 29/775,758 25/03/2021 US;  
(73) **EISAI R&D MANAGEMENT CO., LTD. (JP)**  
6-10, Koishikawa 4-Chome, Bunkyo-ku, Tokyo 112-8088, Japan  
(72) 1. RAJEEV NARAYANAN (IN)  
2. ALEXANDER SCOTT (US)  
3. DAVID LEVIN (US)  
(74) Công ty TNHH một thành viên Sở hữu trí tuệ VCCI (VCCI-IP CO.,LTD)  
(55)

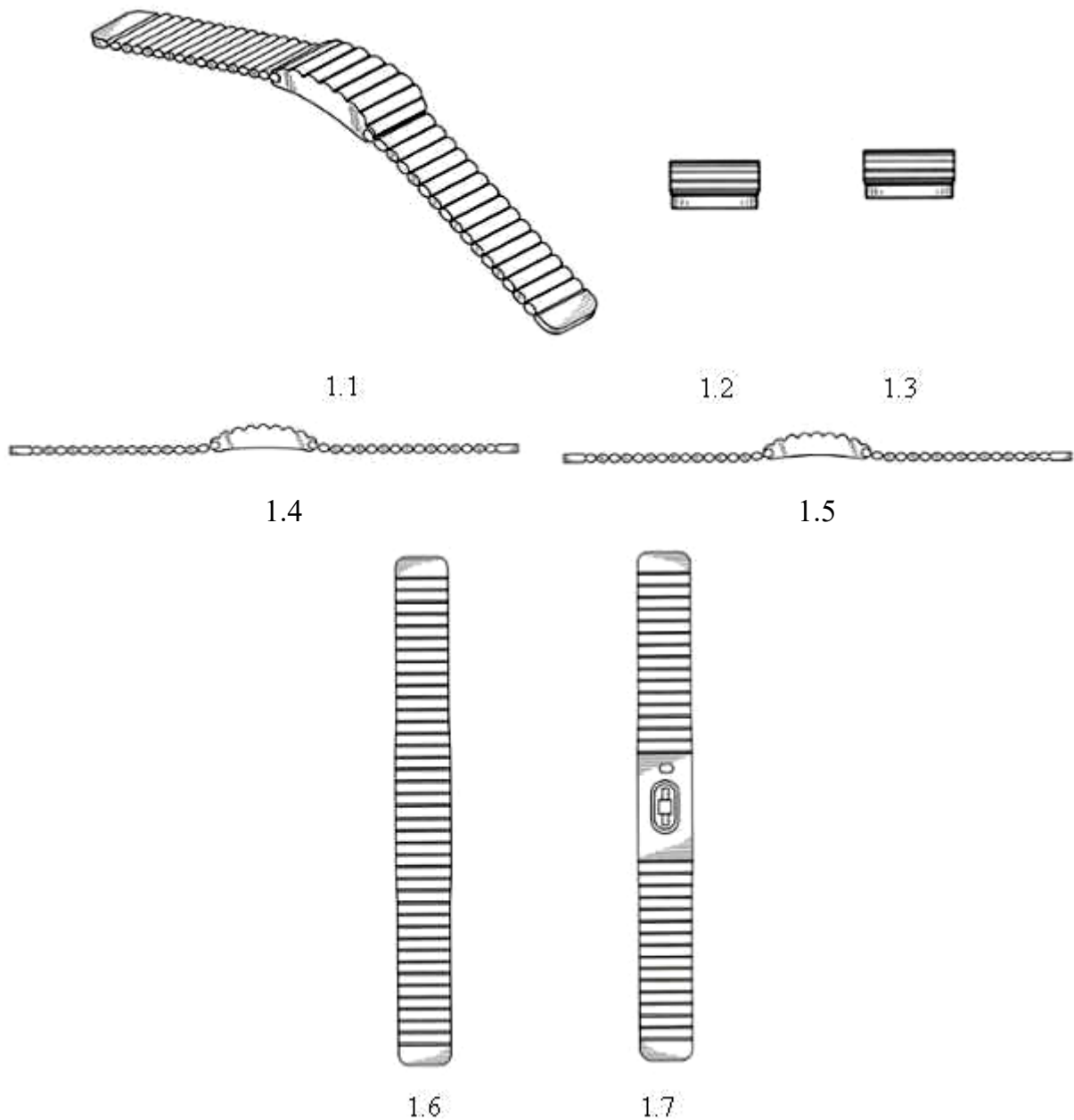

**CÔNG BÁO SỞ HỮU CÔNG NGHIỆP SỐ 413 TẬP A – QUYỀN 2 (08.2022)**

- (11) **45095**  
(21) 3-2021-02357 (28) 3  
(54) **NHÃN SẢN PHẨM** (51) **19-08**  
(22) 24/09/2021 (43) 25/08/2022  
(73) **CÔNG TY CỔ PHẦN NOVA NUTRITION & WELLNESS (VN)**  
Số 3.01, TM-DV18, Lầu 3, Khối tháp V5-V6, Khu chung cư kết hợp thương mại,  
văn phòng lô V (Sunrise City, Khu South Towers), 23 Nguyễn Hữu Thọ, phường  
Tân Hưng, quận 7, thành phố Hồ Chí Minh  
(72) Trần Thị Thu (VN)  
(74) Công ty cổ phần Sở hữu trí tuệ BROSS và Cộng sự (BROSS & PARTNERS., JSC)  
(55)



1



2



3

**CÔNG BÁO SỞ HỮU CÔNG NGHIỆP SỐ 413 TẬP A – QUYỀN 2 (08.2022)**

- (11) **45096**  
(21) 3-2021-02439 (28) 6  
(54) **NHÃN SẢN PHẨM** (51) **19-08**  
(22) 08/10/2021 (43) 25/08/2022  
(73) **CÔNG TY TNHH KING ATTORNEY APP 5.0 (VN)**  
28D Lý Chiêu Hoàng, phường 10, quận 6, thành phố Hồ Chí Minh  
(72) Đỗ Hữu Chiến (VN)  
(55)



1



2



3



4



5



6



**CÔNG BÁO SỞ HỮU CÔNG NGHIỆP SỐ 413 TẬP A – QUYỀN 2 (08.2022)**

- (11) **45097**  
(21) 3-2021-02516 (28) 1  
(54) **THANH KIM LOẠI ĐỊNH HÌNH** (51) **25-01**  
(22) 14/10/2021 (43) 25/08/2022  
(73) **CÔNG TY CỔ PHẦN CAD GROUP (VN)**  
Số 8 ngõ 81, phố Trạm, phường Long Biên, quận Long Biên, thành phố Hà Nội  
(72) Lâm Viết An (VN)  
(74) Công ty TNHH Sở hữu trí tuệ Gia Việt (GIAVIET CO., LTD.)  
(55)

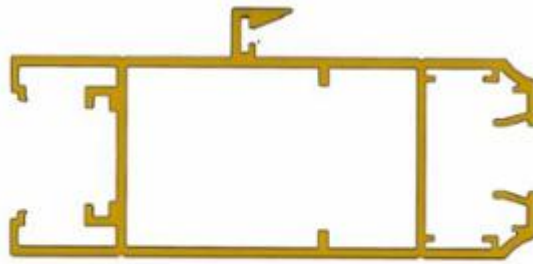

1.1



1.2



1.3



1.4

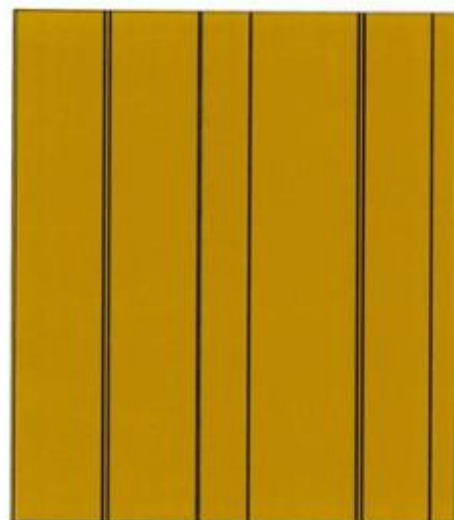

1.5



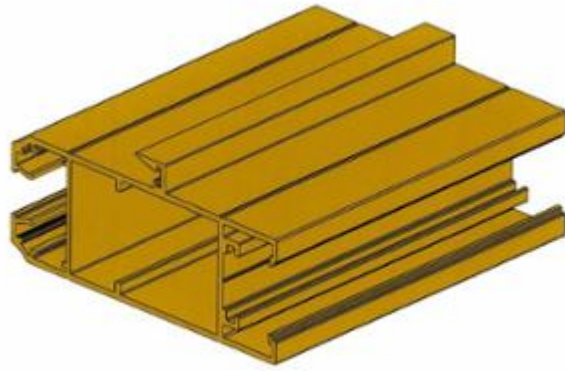

1.6

**CÔNG BÁO SỞ HỮU CÔNG NGHIỆP SỐ 413 TẬP A – QUYỀN 2 (08.2022)**

- (11) **45098**  
(21) 3-2021-02660 (28) 1  
(54) **THANH KIM LOẠI ĐỊNH HÌNH** (51) **25-01**  
(22) 25/10/2021 (43) 25/08/2022  
(73) **CÔNG TY TNHH SẢN XUẤT THƯƠNG MẠI DỊCH VỤ HAI THI (VN)**  
14/13/39 Thân Nhân Trung, phường 13, quận Tân Bình, thành phố Hồ Chí Minh  
(72) Trần Đình Thi (VN)  
(74) Công ty Luật TNHH LEADCONSULT (LEADCONSULT)  
(55)



1.1



1.2



1.3

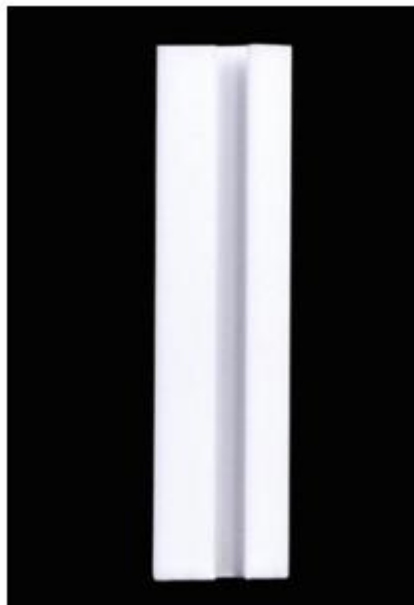

1.4



1.5

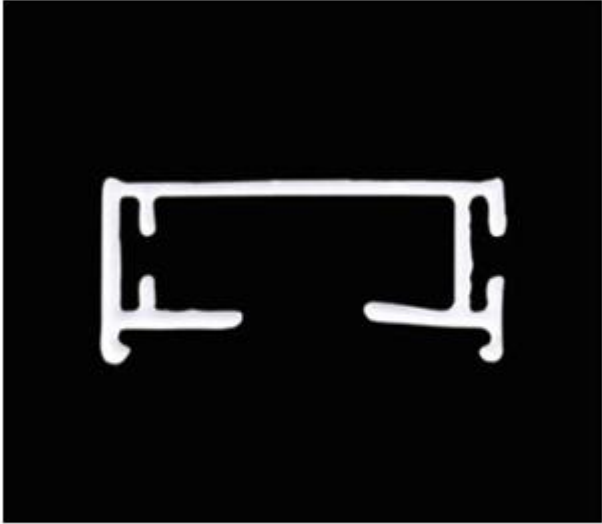

1.6

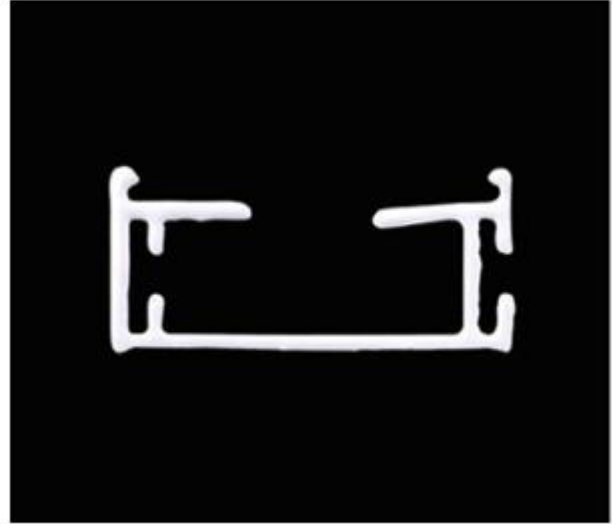

1.7

**CÔNG BÁO SỞ HỮU CÔNG NGHIỆP SỐ 413 TẬP A – QUYỀN 2 (08.2022)**

- (11) **45099**  
(21) 3-2021-02663 (28) 1  
(54) **NÚT CÀI RAY CỬA LÒA XẾP** (51) **08-08; 08-09**  
(22) 25/10/2021 (43) 25/08/2022  
(73) **CÔNG TY TNHH SẢN XUẤT THƯƠNG MẠI DỊCH VỤ HAI THI (VN)**  
14/13/39 Thân Nhân Trung, phường 13, quận Tân Bình, thành phố Hồ Chí Minh  
(72) Trần Đình Thi (VN)  
(74) Công ty Luật TNHH LEADCONSULT (LEADCONSULT)  
(55)

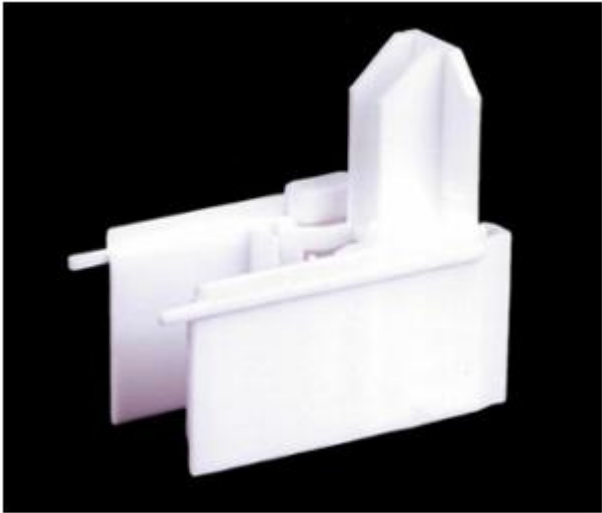

1.1



1.2



1.3



1.4



1.5



1.6

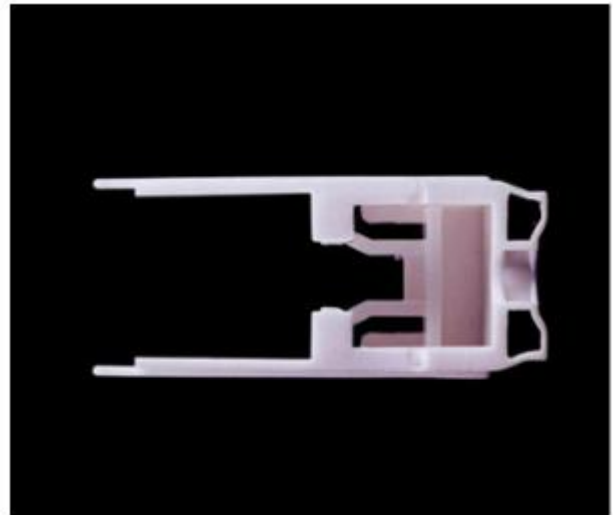

1.7

**CÔNG BÁO SỞ HỮU CÔNG NGHIỆP SỐ 413 TẬP A – QUYỀN 2 (08.2022)**

- (11) **45100**  
(21) 3-2021-02751 (28) 1  
(54) **HỘP TỖ TAY DỪNG CHO XE Ô TÔ CÓ BỘ PHẬN SẠC KHÔNG DÂY** (51) **12-16**  
(22) 05/11/2021 (43) 25/08/2022  
(30) 30-2021-0045618 27/09/2021 KR;  
(73) **KCLP CO., LTD. (KR)**  
302 ho, 333, Cheomdangwagi-ro, Buk-gu, Gwangju 61008, Republic of Korea  
(72) CHOI, Gi Ho (KR)  
(74) Công ty TNHH Sở hữu trí tuệ Hải Hân (HAI HAN IP CO., LTD.)  
(55)

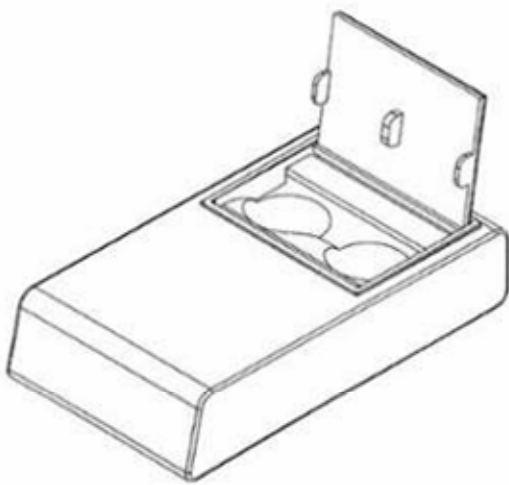

1.1

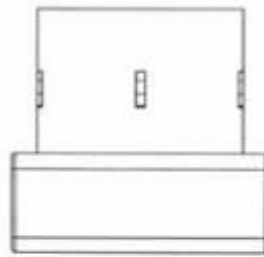

1.2

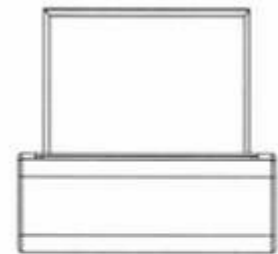

1.3



1.4

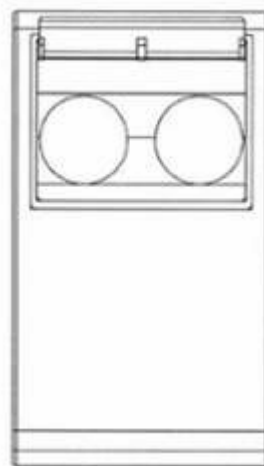

1.5



1.6

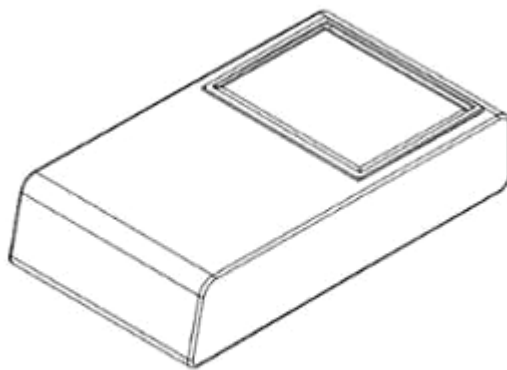

1.7

**CÔNG BÁO SỞ HỮU CÔNG NGHIỆP SỐ 413 TẬP A – QUYỂN 2 (08.2022)**

- (11) **45101**  
(21) 3-2021-02754 (28) 1  
(54) **THIẾT BỊ XỬ LÝ NƯỚC THẢI** (51) **23-01**  
(22) 08/11/2021 (43) 25/08/2022  
(73) **CÔNG TY TNHH GIẢI PHÁP MÔI TRƯỜNG ĐẠI NAM (VN)**  
144 đường Chu Văn An, phường 26, quận Bình Thạnh, thành phố Hồ Chí Minh  
(72) Ngô Quang Hiếu (VN)  
(55)

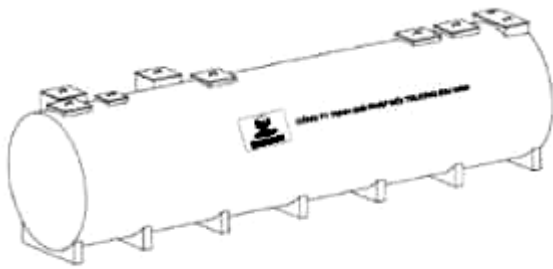

1.1



1.2



1.3

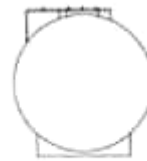

1.4

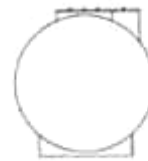

1.5



1.6



1.7



- (11) **45102**  
(21) 3-2021-02777 (28) 5  
(54) **BAO GÓI SẢN PHẨM** (51) **09-05**  
(22) 09/11/2021 (43) 25/08/2022  
(73) **CÔNG TY CỔ PHẦN THỰC PHẨM GIA ĐÌNH AN CO (VN)**  
Lô M, đường số 10, cụm công nghiệp Lợi Bình Nhơn, xã Lợi Bình Nhơn, thành phố Tân An, tỉnh Long An  
(72) Phan Thị Thanh Vân (VN)  
(74) Công ty cổ phần Sở hữu trí tuệ BROSS và Cộng sự (BROSS & PARTNERS., JSC)  
(55)



1.1



1.2



2.1



2.2



3.1



3.2



4.1



4.2



5.1



5.2

**CÔNG BÁO SỞ HỮU CÔNG NGHIỆP SỐ 413 TẬP A – QUYỀN 2 (08.2022)**

(11) **45103**

(21) 3-2021-02825

(28) 1

(54) **GẠCH**

(51) **25-01**

(22) 12/11/2021

(43) 25/08/2022

(73) **NGUYỄN HỮU THỌ (VN)**

Số 23 Đỗ Công Tường, phường Tân Quý, quận Tân Phú, thành phố Hồ Chí Minh

(72) Nguyễn Hữu Thọ (VN)

(74) Công ty TNHH NACILAW (NACILAW)

(55)

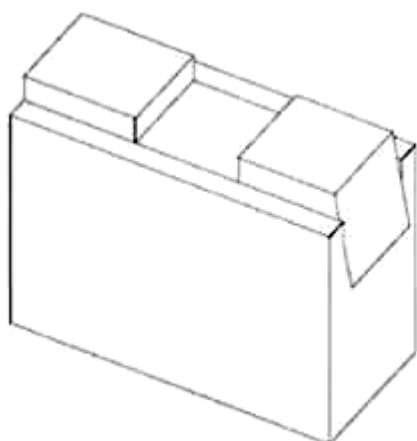

1.1

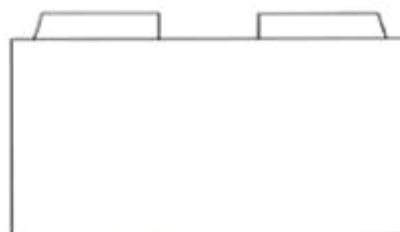

1.2

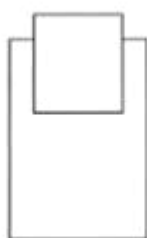

1.3



1.4

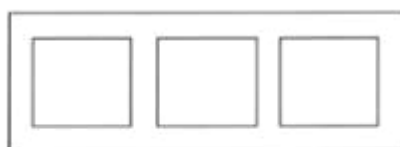

1.5

**CÔNG BÁO SỞ HỮU CÔNG NGHIỆP SỐ 413 TẬP A – QUYỀN 2 (08.2022)**

(11) **45104**

(21) 3-2021-02884

(54) **THANH NHÔM ĐỊNH HÌNH**

(22) 19/11/2021

(73) **CÔNG TY TNHH XUẤT NHẬP KHẨU QUỐC TẾ ALHACO (VN)**

93 đường Kênh 19/5, phường Sơn Kỳ, quận Tân Phú, thành phố Hồ Chí Minh

(72) Nguyễn Phi Khánh (VN)

(55)

(28) 1

(51) **25-01**

(43) 25/08/2022



1.1

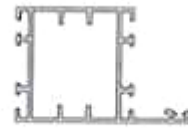

1.2

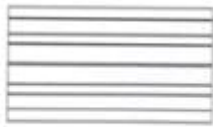

1.3



1.4



1.5



1.6

- (11) **45105**  
(21) 3-2021-02890 (28) 2  
(54) **TAI NGHE** (51) **14-01**  
(22) 19/11/2021 (43) 25/08/2022  
(30) 29/784,431 19/05/2021 US;  
(73) **APPLE INC. (US)**  
One Apple Park Way, Cupertino, California 95014, United States of America  
(72) 1. VIJAY KARTHIK KONERU (IN)  
2. ROBERT BOYD (US)  
3. DUY P. LE (US)  
4. JOSEPH F. DEMBS (US)  
5. JEFFREY SCOTT CROYLE (US)  
6. MATTHEW PHILLIP CASEBOLT (US)  
7. MATTHEW VINCENT COSTELLO (US)  
8. ELVIN CHU (US)  
9. GUILLAUME RAOULT (FR)  
10. ZU-NING CHEN (AU)  
11. CHRISTOPHER KUH (DE)  
12. ROBERT BRUNNER (US)  
(74) Công ty TNHH Lê & Lê (LE & LE)  
(55)

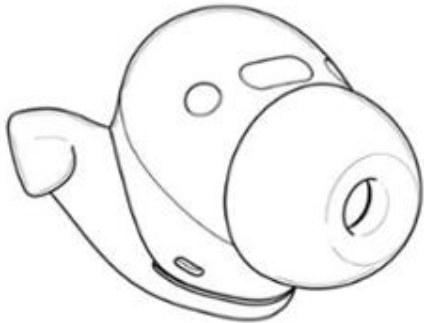

1.1

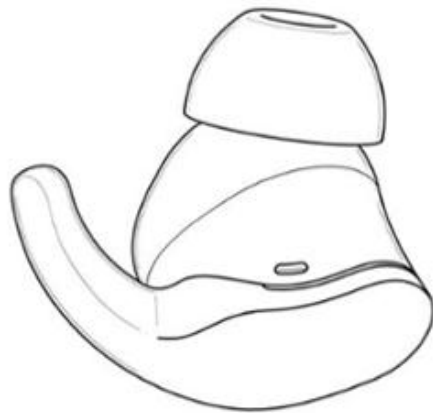

1.2



1.3

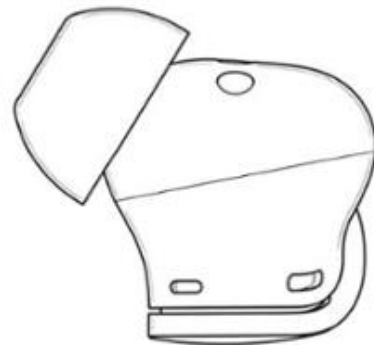

1.4

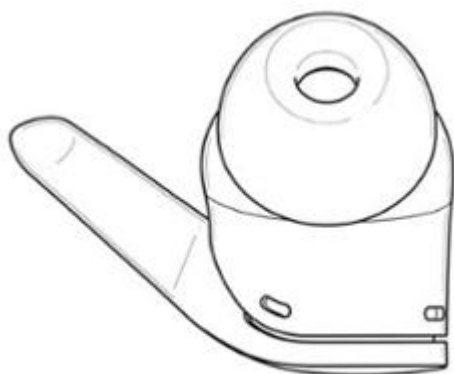

1.5

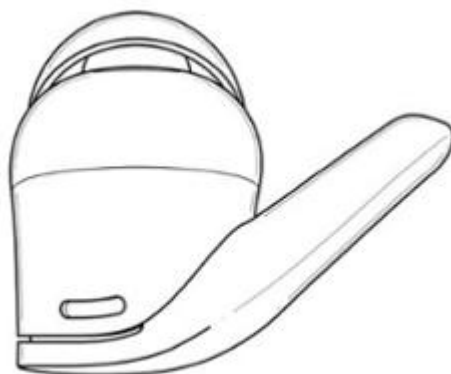

1.6



1.7



1.8

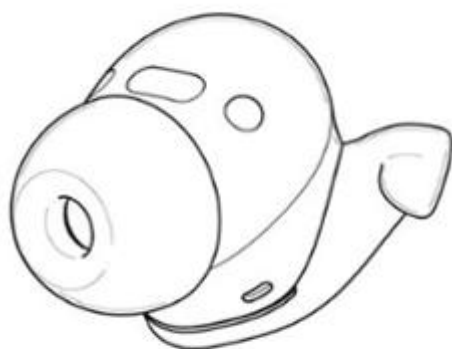

2.1



2.2



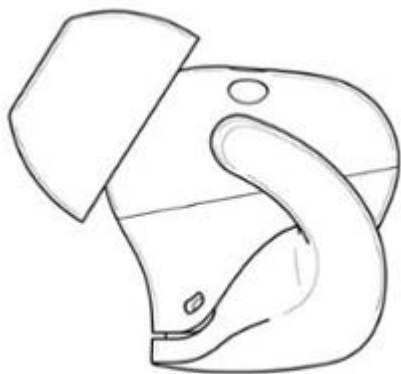

2.3

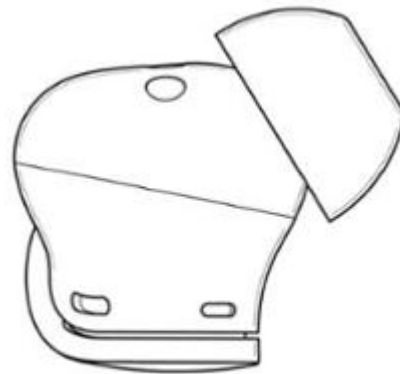

2.4

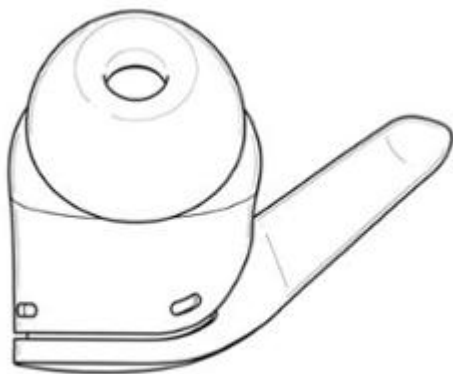

2.5

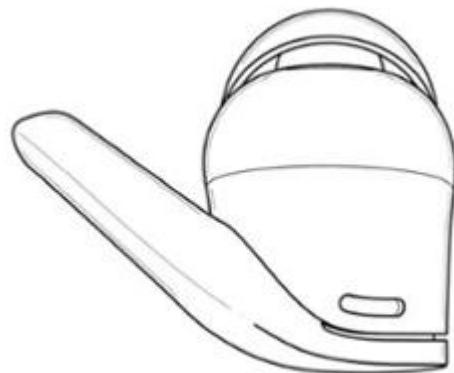

2.6

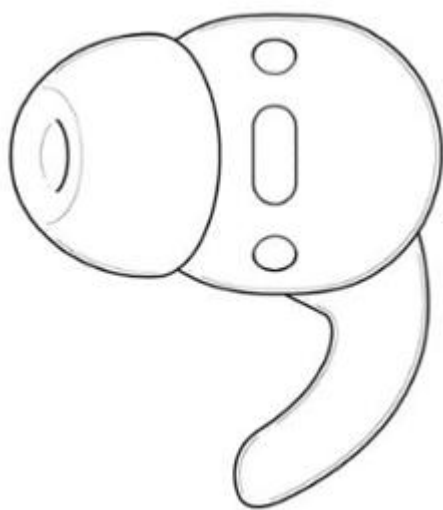

2.7



2.8



**CÔNG BÁO SỞ HỮU CÔNG NGHIỆP SỐ 413 TẬP A – QUYỀN 2 (08.2022)**

- (11) **45106**  
(21) 3-2021-02899 (28) 1  
(54) **BAO BÌ** (51) **09-05**  
(22) 22/11/2021 (43) 25/08/2022  
(73) **CÔNG TY TNHH SUMI&SUKI (VN)**  
Lô 90-92 đường Trần Nam Trung, phường Hòa Xuân, quận Cẩm Lệ, thành phố Đà Nẵng  
(72) Lê Văn Đông (VN)  
(55)



1.1



1.2

**CÔNG BÁO SỞ HỮU CÔNG NGHIỆP SỐ 413 TẬP A – QUYỀN 2 (08.2022)**

- (11) **45107**  
(21) 3-2021-02900 (28) 1  
(54) **BAO BÌ** (51) **09-05**  
(22) 22/11/2021 (43) 25/08/2022  
(73) **CÔNG TY TNHH SUMI&SUKI (VN)**  
Lô 90-92 đường Trần Nam Trung, phường Hòa Xuân, quận Cẩm Lệ, thành phố Đà Nẵng  
(72) Lê Văn Đông (VN)  
(55)



1.1



1.2

**CÔNG BÁO SỞ HỮU CÔNG NGHIỆP SỐ 413 TẬP A – QUYỀN 2 (08.2022)**

- (11) **45108**  
(21) 3-2021-02901 (28) 1  
(54) **BAO BÌ** (51) **09-05**  
(22) 22/11/2021 (43) 25/08/2022  
(73) **CÔNG TY TNHH SUMI&SUKI (VN)**  
Lô 90-92 đường Trần Nam Trung, phường Hòa Xuân, quận Cẩm Lệ, thành phố Đà Nẵng  
(72) Lê Văn Đông (VN)  
(55)



1.1



1.2

**CÔNG BÁO SỞ HỮU CÔNG NGHIỆP SỐ 413 TẬP A – QUYỀN 2 (08.2022)**

- (11) **45109**  
(21) 3-2021-02902 (28) 1  
(54) **BAO BÌ** (51) **09-05**  
(22) 22/11/2021 (43) 25/08/2022  
(73) **CÔNG TY TNHH SUMI&SUKI (VN)**  
Lô 90-92 đường Trần Nam Trung, phường Hòa Xuân, quận Cẩm Lệ, thành phố Đà Nẵng  
(72) Lê Văn Đông (VN)  
(55)



1.1



1.2

**CÔNG BÁO SỞ HỮU CÔNG NGHIỆP SỐ 413 TẬP A – QUYỀN 2 (08.2022)**

- (11) **45110**  
(21) 3-2021-02925 (28) 1  
(54) **ĐẦU NỐI DẪN CHẤT LƯU** (51) **23-01**  
(22) 24/11/2021 (43) 25/08/2022  
(30) 29/785,162 24/05/2021 US;  
(73) **KPR U.S., LLC (US)**  
777 West Street, Mansfield, Massachusetts 02048 United States of America  
(72) 1. BRADLEY CHIGA (US)  
2. VINIT PATEL (US)  
3. PHILLIP SHALTIS (US)  
4. JUSTIN GILLUM (US)  
5. MIKE LORENZ (US)  
6. RYAN BERGER (US)  
(74) Công ty TNHH Tâm nhìn và Liên danh (VISION & ASSOCIATES CO.LTD.)  
(55)

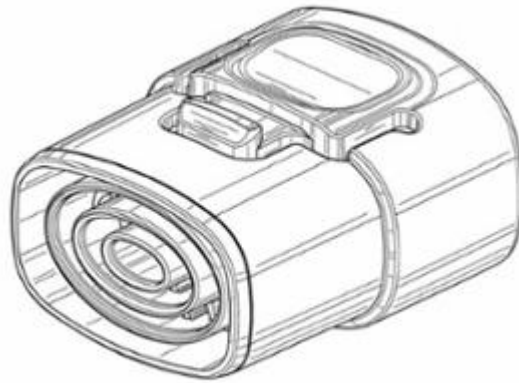

1.1

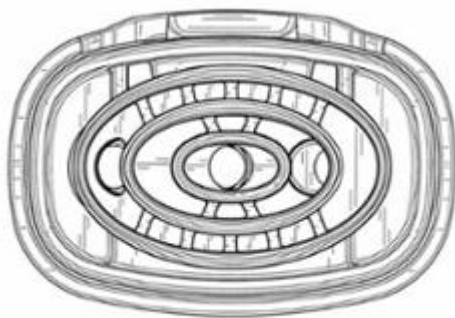

1.2

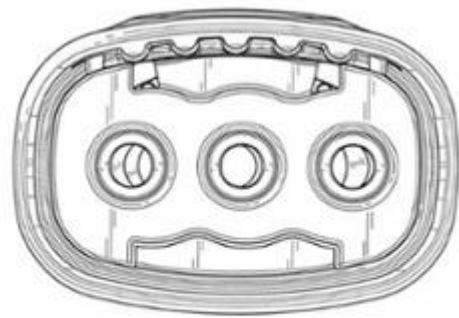

1.3

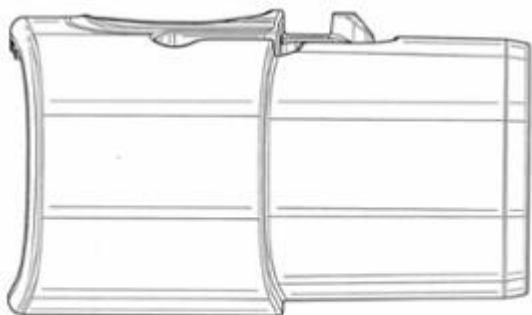

1.4

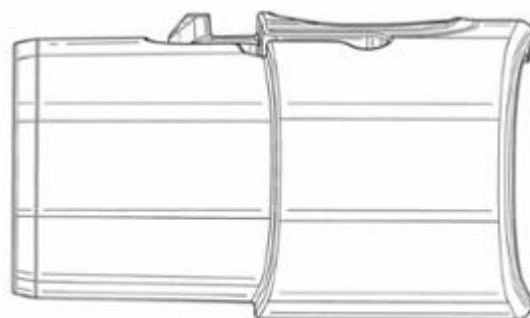

1.5

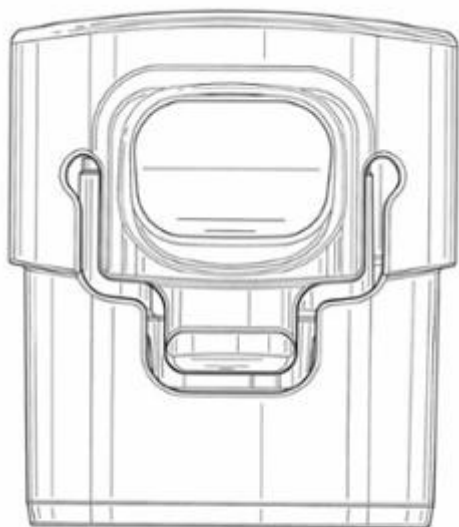

1.6

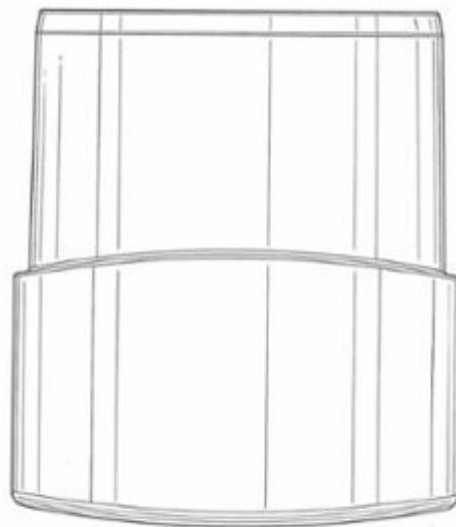

1.7

- (11) **45111**  
(21) 3-2021-02927 (28) 1  
(54) **ĐẦU NỐI DẪN CHẤT LƯU** (51) **23-01**  
(22) 24/11/2021 (43) 25/08/2022  
(30) 29/785,163 24/05/2021 US;  
(73) **KPR U.S., LLC (US)**  
777 West Street, Mansfield, Massachusetts 02048 United States of America  
(72) 1. BRADLEY CHIGA (US)  
2. VINIT PATEL (US)  
3. PHILLIP SHALTIS (US)  
4. JUSTIN GILLUM (US)  
5. MIKE LORENZ (US)  
6. RYAN BERGER (US)  
(74) Công ty TNHH Tâm nhìn và Liên danh (VISION & ASSOCIATES CO.LTD.)  
(55)

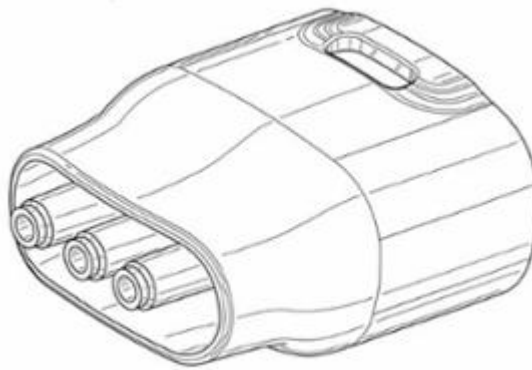

1.1

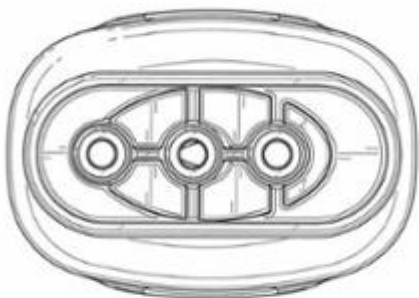

1.2

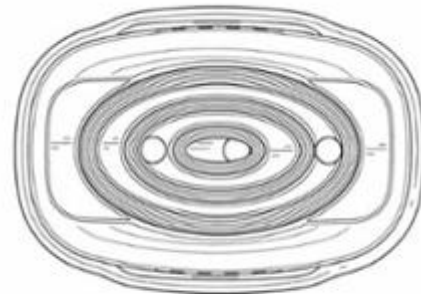

1.3

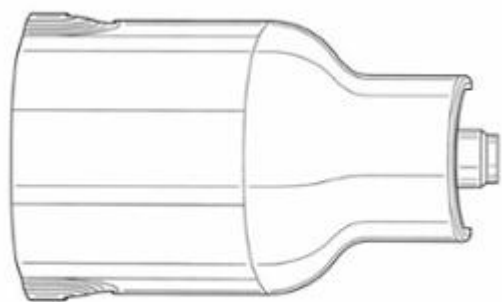

1.4

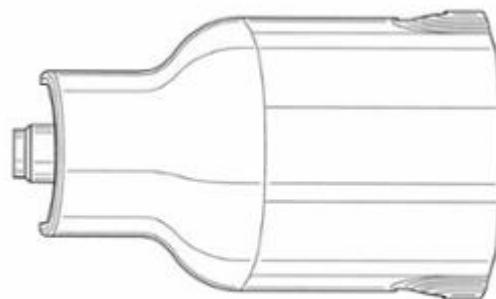

1.5

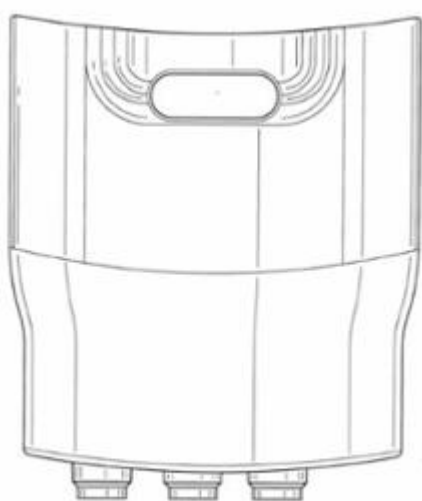

1.6

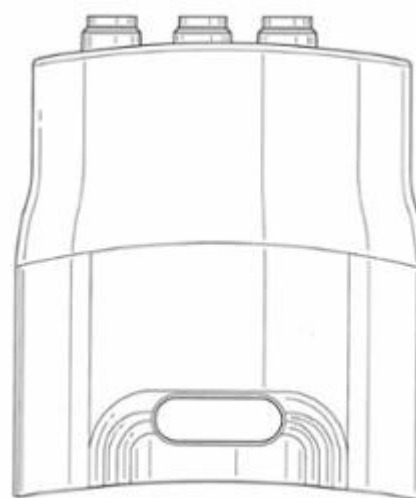

1.7



**CÔNG BÁO SỞ HỮU CÔNG NGHIỆP SỐ 413 TẬP A – QUYỀN 2 (08.2022)**

- (11) **45112**  
(21) 3-2021-02928 (28) 1  
(54) **ĐẦU NỐI DẪN CHẤT LƯU** (51) **23-01**  
(22) 24/11/2021 (43) 25/08/2022  
(30) 29/785,164 24/05/2021 US;  
(73) **KPR U.S., LLC (US)**  
777 West Street, Mansfield, Massachusetts 02048 United States of America  
(72) 1. BRADLEY CHIGA (US)  
2. VINIT PATEL (US)  
3. PHILLIP SHALTIS (US)  
4. JUSTIN GILLUM (US)  
5. MIKE LORENZ (US)  
6. RYAN BERGER (US)  
(74) Công ty TNHH Tâm nhìn và Liên danh (VISION & ASSOCIATES CO.LTD.)  
(55)

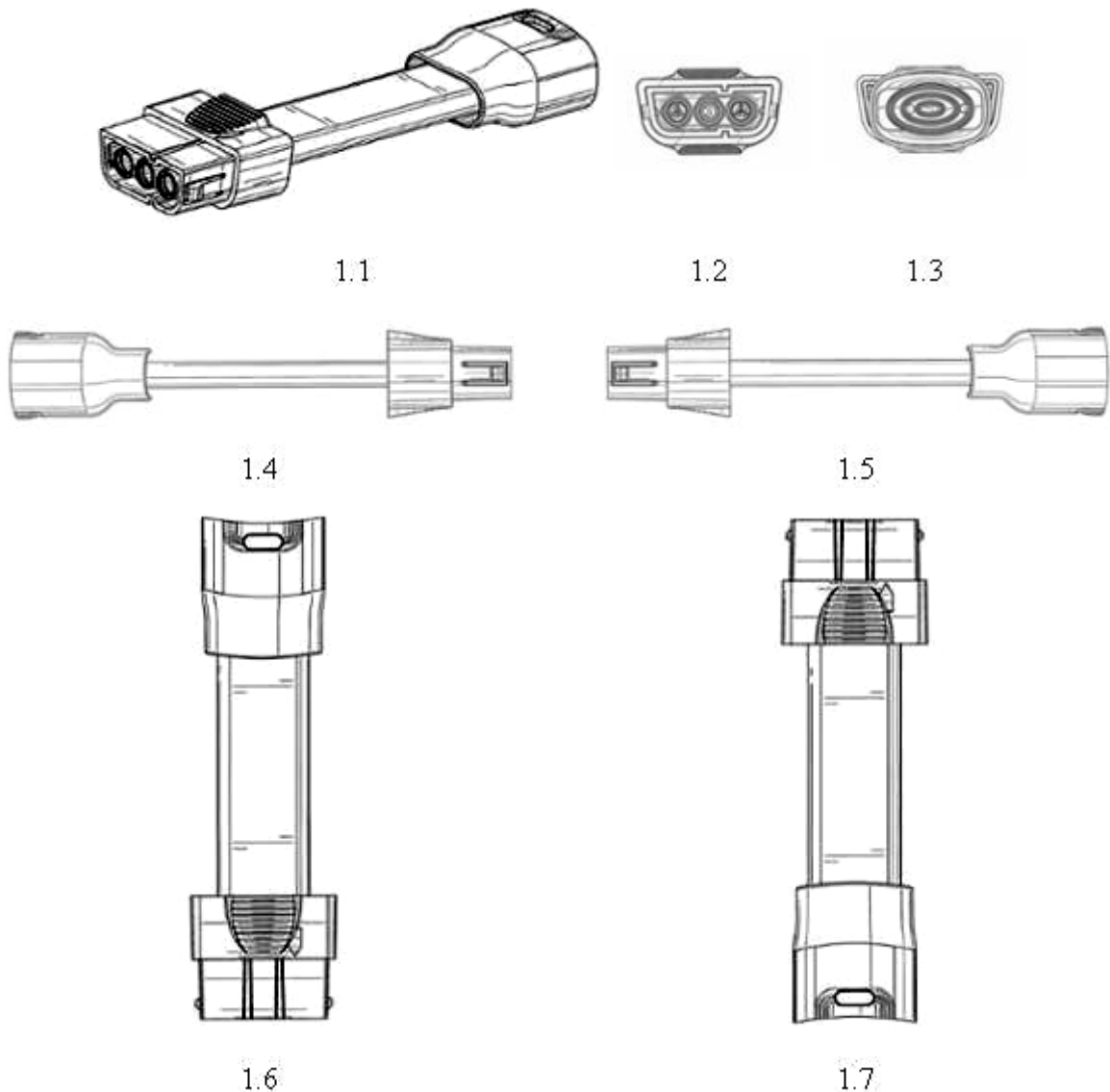

**CÔNG BÁO SỞ HỮU CÔNG NGHIỆP SỐ 413 TẬP A – QUYỀN 2 (08.2022)**

- (11) **45113**  
(21) 3-2021-02930 (28) 1  
(54) **ĐẦU NỐI DẪN CHẤT LƯU** (51) **23-01**  
(22) 24/11/2021 (43) 25/08/2022  
(30) 29/785,136 24/05/2021 US;  
(73) **KPR U.S., LLC (US)**  
777 West Street, Mansfield, Massachusetts 02048 United States of America  
(72) 1. BRADLEY CHIGA (US)  
2. VINIT PATEL (US)  
3. PHILLIP SHALTIS (US)  
4. JUSTIN GILLUM (US)  
5. MIKE LORENZ (US)  
6. RYAN BERGER (US)  
(74) Công ty TNHH Tâm nhìn và Liên danh (VISION & ASSOCIATES CO.LTD.)  
(55)

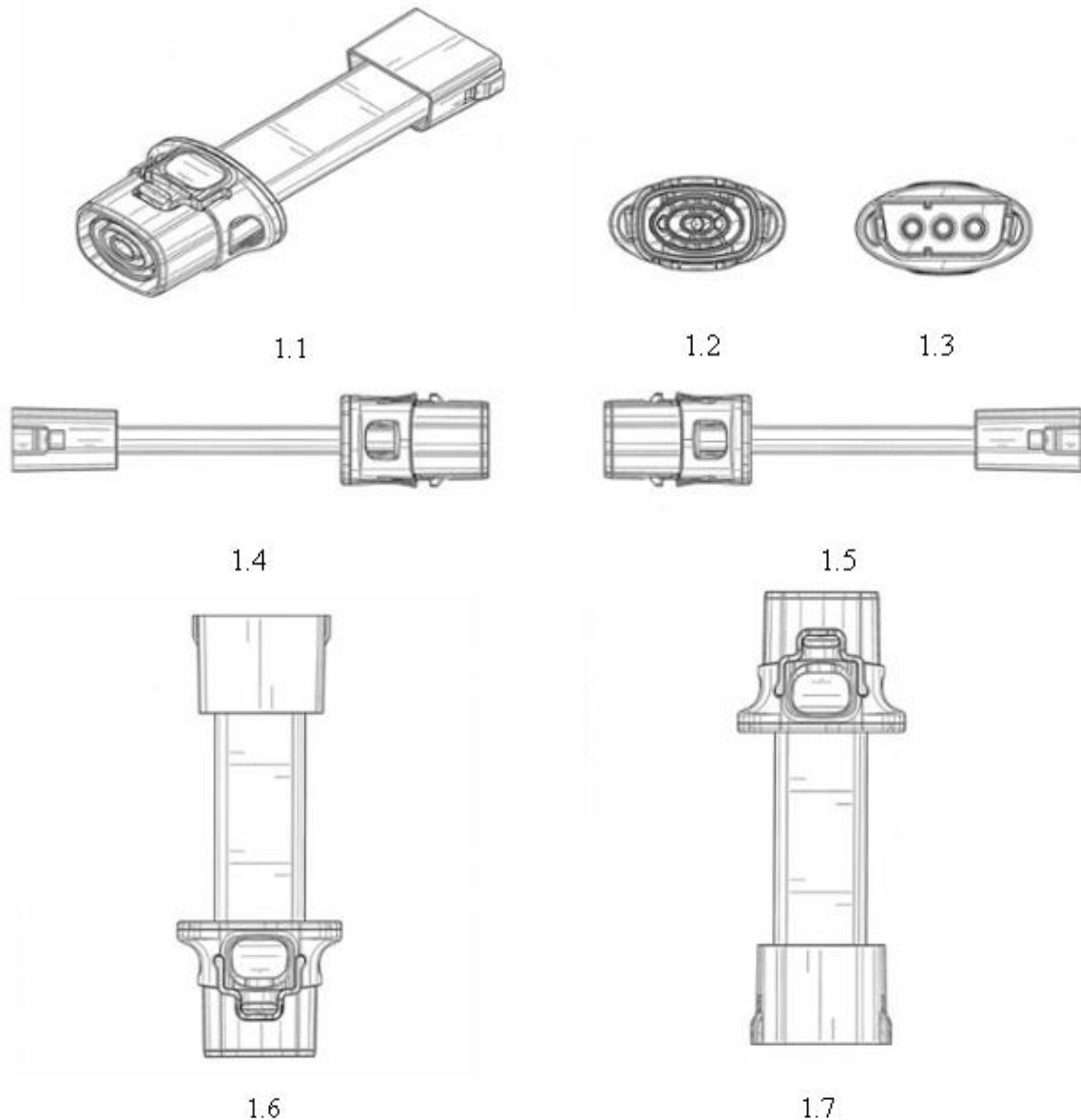

(11) **45114**

(21) 3-2021-02976

(28) 1

(54) **TẮM ỐP ĐUÔI XE MÁY**

(51) **12-16**

(22) 29/11/2021

(43) 25/08/2022

(73) **CÔNG TY CỔ PHẦN HYOSUNG VIỆT NAM (VN)**

Kho thiết bị, tổ 37, đường Đào Cam Mộc, TT Đông Anh, thành phố Hà Nội

(72) Tô Xuân Hiếu (VN)

(55)



1.1



1.2



1.3



1.4



1.5



1.6



1.7

**CÔNG BÁO SỞ HỮU CÔNG NGHIỆP SỐ 413 TẬP A – QUYỀN 2 (08.2022)**

(11) **45115**

(21) 3-2021-03006

(28) 1

(54) **THANH NHÔM ĐỊNH HÌNH**

(51) **25-01**

(22) 30/11/2021

(43) 25/08/2022

(73) **CÔNG TY TNHH XUẤT NHẬP KHẨU QUỐC TẾ ALHACO (VN)**

93 đường Kênh 19/5, phường Sơn Kỳ, quận Tân Phú, thành phố Hồ Chí Minh

(72) Nguyễn Phi Khánh (VN)

(55)



1.1



1.2



1.3



1.4



1.5



1.6

- (11) **45116**  
(21) 3-2021-03007 (28) 1  
(54) **THANH NHÔM ĐỊNH HÌNH** (51) **25-01**  
(22) 30/11/2021 (43) 25/08/2022  
(73) **CÔNG TY TNHH XUẤT NHẬP KHẨU QUỐC TẾ ALHACO (VN)**  
93 đường Kênh 19/5, phường Sơn Kỳ, quận Tân Phú, thành phố Hồ Chí Minh  
(72) Nguyễn Phi Khánh (VN)  
(55)



1.1

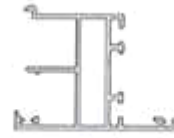

1.2



1.3



1.4



1.5

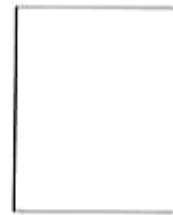

1.6

**CÔNG BÁO SỞ HỮU CÔNG NGHIỆP SỐ 413 TẬP A – QUYỀN 2 (08.2022)**

- (11) **45117**  
(21) 3-2021-03008 (28) 1  
(54) **THANH NHÔM ĐỊNH HÌNH** (51) **25-01**  
(22) 30/11/2021 (43) 25/08/2022  
(73) **CÔNG TY TNHH XUẤT NHẬP KHẨU QUỐC TẾ ALHACO (VN)**  
93 đường Kênh 19/5, phường Sơn Kỳ, quận Tân Phú, thành phố Hồ Chí Minh  
(72) Nguyễn Phi Khánh (VN)  
(55)



1.1

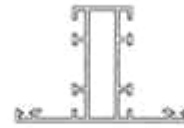

1.2



1.3



1.4

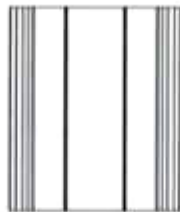

1.5



1.6

**CÔNG BÁO SỞ HỮU CÔNG NGHIỆP SỐ 413 TẬP A – QUYỀN 2 (08.2022)**

- (11) **45118**  
(21) 3-2021-03009 (28) 1  
(54) **THANH NHÔM ĐỊNH HÌNH** (51) **25-01**  
(22) 30/11/2021 (43) 25/08/2022  
(73) **CÔNG TY TNHH XUẤT NHẬP KHẨU QUỐC TẾ ALHACO (VN)**  
93 đường Kênh 19/5, phường Sơn Kỳ, quận Tân Phú, thành phố Hồ Chí Minh  
(72) Nguyễn Phi Khánh (VN)  
(55)



1.1

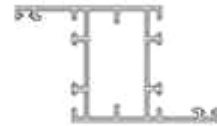

1.2

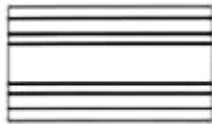

1.3

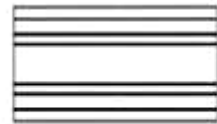

1.4



1.5

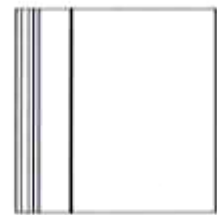

1.6

**CÔNG BÁO SỞ HỮU CÔNG NGHIỆP SỐ 413 TẬP A – QUYỀN 2 (08.2022)**

- (11) **45119**  
(21) 3-2021-03010 (28) 1  
(54) **THANH NHÔM ĐỊNH HÌNH** (51) **25-01**  
(22) 30/11/2021 (43) 25/08/2022  
(73) **CÔNG TY TNHH XUẤT NHẬP KHẨU QUỐC TẾ ALHACO (VN)**  
93 đường Kênh 19/5, phường Sơn Kỳ, quận Tân Phú, thành phố Hồ Chí Minh  
(72) Nguyễn Phi Khánh (VN)  
(55)



1.1



1.2



1.3



1.4



1.5



1.6



**CÔNG BÁO SỞ HỮU CÔNG NGHIỆP SỐ 413 TẬP A – QUYỀN 2 (08.2022)**

- (11) **45120**  
(21) 3-2021-03011 (28) 1  
(54) **THANH NHÔM ĐỊNH HÌNH** (51) **25-01**  
(22) 30/11/2021 (43) 25/08/2022  
(73) **CÔNG TY TNHH XUẤT NHẬP KHẨU QUỐC TẾ ALHACO (VN)**  
93 đường Kênh 19/5, phường Sơn Kỳ, quận Tân Phú, thành phố Hồ Chí Minh  
(72) Nguyễn Phi Khánh (VN)  
(55)



1.1

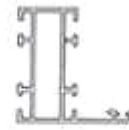

1.2



1.3



1.4



1.5



1.6

**CÔNG BÁO SỞ HỮU CÔNG NGHIỆP SỐ 413 TẬP A – QUYỀN 2 (08.2022)**

(11) **45121**

(21) 3-2021-03012

(28) 1

(54) **THANH NHÔM ĐỊNH HÌNH**

(51) **25-01**

(22) 30/11/2021

(43) 25/08/2022

(73) **CÔNG TY TNHH XUẤT NHẬP KHẨU QUỐC TẾ ALHACO (VN)**

93 đường Kênh 19/5, phường Sơn Kỳ, quận Tân Phú, thành phố Hồ Chí Minh

(72) Nguyễn Phi Khánh (VN)

(55)



1.1



1.2

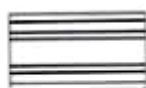

1.3



1.4



1.5



1.6

- (11) **45122**  
(21) 3-2021-03013 (28) 1  
(54) **THANH NHÔM ĐỊNH HÌNH** (51) **25-01**  
(22) 30/11/2021 (43) 25/08/2022  
(73) **CÔNG TY TNHH XUẤT NHẬP KHẨU QUỐC TẾ ALHACO (VN)**  
93 đường Kênh 19/5, phường Sơn Kỳ, quận Tân Phú, thành phố Hồ Chí Minh  
(72) Nguyễn Phi Khánh (VN)  
(55)



1.1

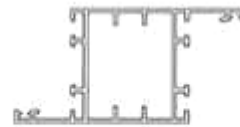

1.2

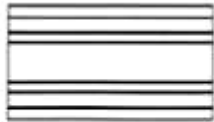

1.3

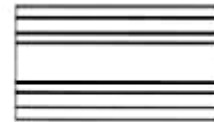

1.4



1.5



1.6

**CÔNG BÁO SỞ HỮU CÔNG NGHIỆP SỐ 413 TẬP A – QUYỀN 2 (08.2022)**

- (11) **45123**  
(21) 3-2021-03014  
(54) **THANH NHÔM ĐỊNH HÌNH**  
(22) 30/11/2021  
(73) **CÔNG TY TNHH XUẤT NHẬP KHẨU QUỐC TẾ ALHACO (VN)**  
93 đường Kênh 19/5, phường Sơn Kỳ, quận Tân Phú, thành phố Hồ Chí Minh  
(72) Nguyễn Phi Khánh (VN)  
(55)
- (28) 1  
(51) **25-01**  
(43) 25/08/2022



1.1

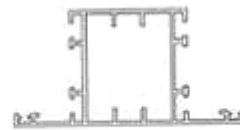

1.2



1.3



1.4

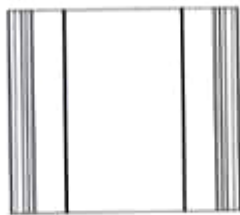

1.5



1.6

(11) **45124**

(21) 3-2021-03053

(54) **TẮM ỐP ĐUÔI XE MÁY**

(22) 06/12/2021

(73) **CÔNG TY CỔ PHẦN HYOSUNG VIỆT NAM (VN)**

Kho thiết bị, Tổ 37, đường Đào Cam Mộc, TT Đông Anh, thành phố Hà Nội

(72) Tô Xuân Hiếu (VN)

(55)

(28) 1

(51) **12-16**

(43) 25/08/2022



1.1



1.2



1.3



1.4



1.5



1.6



1.7

- (11) **45125**  
(21) 3-2021-03156 (28) 1  
(54) **BỘ ĐÈN PHÍA SAU CỦA Ô TÔ** (51) **26-06**  
(22) 09/12/2021 (43) 25/08/2022  
(30) DM/214831 10/06/2021 WO;  
(73) **FERRARI S.P.A. (IT)**  
Via Emilia Est 1163, MODENA, Italy  
(72) Flavio MANZONI (IT)  
(74) Công ty TNHH một thành viên Sở hữu trí tuệ VCCI (VCCI-IP CO.,LTD)  
(55)



1.1



1.2



1.3



1.4



1.5



1.6



1.7

**CÔNG BÁO SỞ HỮU CÔNG NGHIỆP SỐ 413 TẬP A – QUYỀN 2 (08.2022)**

- (11) **45126**  
(21) 3-2021-03157  
(54) **Ô TÔ**  
(22) 09/12/2021  
(30) DM/214850 10/06/2021 WO;  
(73) **FERRARI S.P.A. (IT)**  
Via Emilia Est 1163, MODENA, Italy  
(72) Flavio MANZONI (IT)  
(74) Công ty TNHH một thành viên Sở hữu trí tuệ VCCI (VCCI-IP CO.,LTD)  
(55)

- (28) 1  
(51) **12-08**  
(43) 25/08/2022

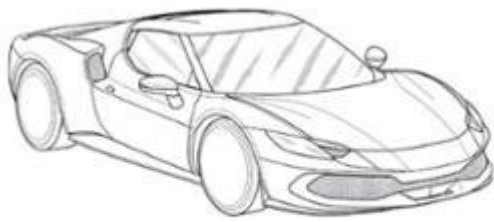

1.1



1.2



1.3

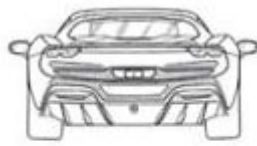

1.4

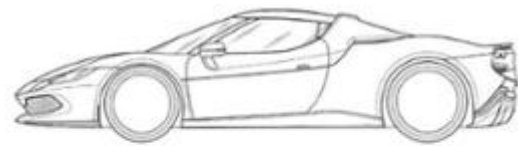

1.5

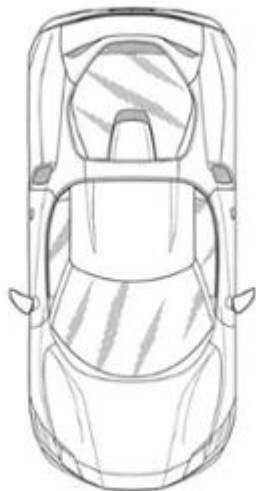

1.6

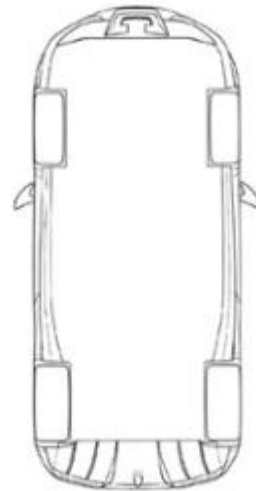

1.7

**CÔNG BÁO SỞ HỮU CÔNG NGHIỆP SỐ 413 TẬP A – QUYỀN 2 (08.2022)**

- (11) **45127**  
(21) 3-2021-03159 (28) 1  
(54) **Ô TÔ ĐỒ CHƠI** (51) **21-01**  
(22) 09/12/2021 (43) 25/08/2022  
(30) DM/216002 10/06/2021 WO;  
(73) **FERRARI S.P.A. (IT)**  
Via Emilia Est 1163, MODENA, Italy  
(72) Flavio MANZONI (IT)  
(74) Công ty TNHH một thành viên Sở hữu trí tuệ VCCI (VCCI-IP CO.,LTD)  
(55)

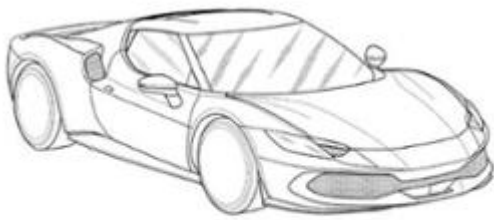

1.1



1.2



1.3

1.4

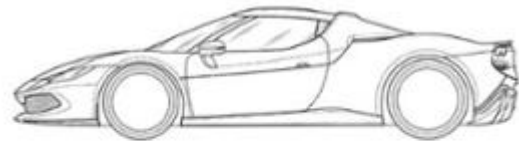

1.5

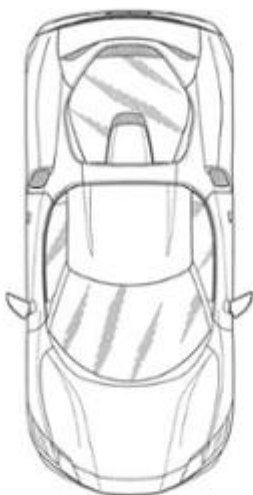

1.6

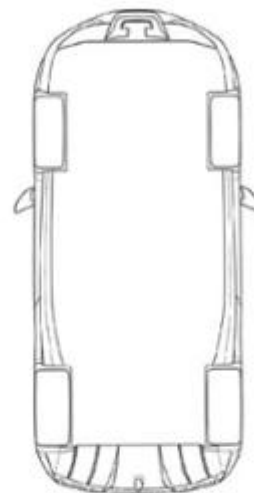

1.7



**CÔNG BÁO SỞ HỮU CÔNG NGHIỆP SỐ 413 TẬP A – QUYỀN 2 (08.2022)**

- (11) **45128**  
(21) 3-2021-03173 (28) 1  
(54) **THANH KIM LOẠI ĐỊNH HÌNH** (51) **25-01**  
(22) 10/12/2021 (43) 25/08/2022  
(73) **CÔNG TY CỔ PHẦN TẬP ĐOÀN AUSTDOOR (VN)**  
Số 37, đường Lê Văn Thiêm, phường Nhân Chính, quận Thanh Xuân, thành phố Hà Nội  
(72) Dương Thạch Nguyên (VN)  
(55)

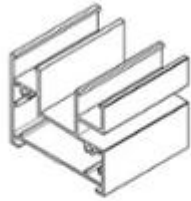

1.1

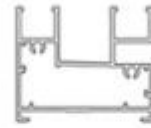

1.2

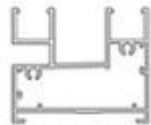

1.3

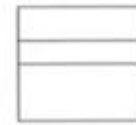

1.4



1.5

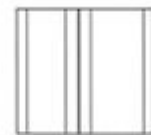

1.6

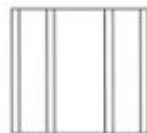

1.7

**CÔNG BÁO SỞ HỮU CÔNG NGHIỆP SỐ 413 TẬP A – QUYỀN 2 (08.2022)**

- (11) **45129**  
(21) 3-2021-03195 (28) 1  
(54) **TUÝP** (51) **09-05**  
(22) 14/12/2021 (43) 25/08/2022  
(73) **KIM PACK CO., LTD. (TH)**  
1741 Chan Rd., Thungmahamek, Sathorn, Bangkok, 10120, Thailand  
(72) LIMATIBUL, Sumet (TH)  
(74) Văn phòng Luật sư Ân Nam (ANNAM IP & LAW)  
(55)



1.1



1.2



1.3

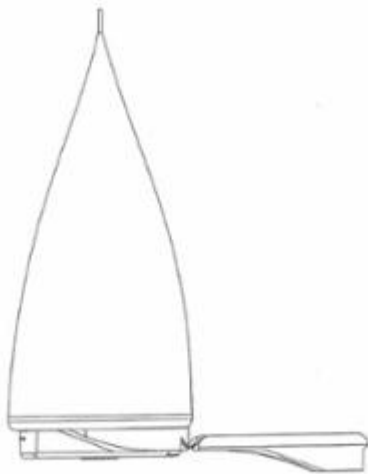

1.4



1.5

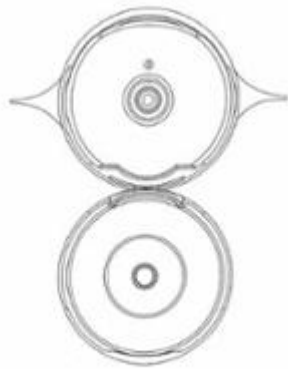

1.6

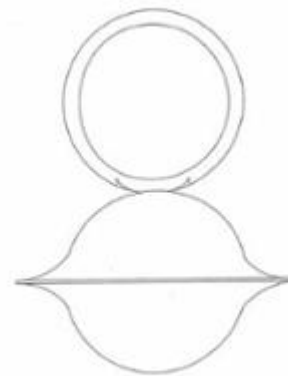

1.7

**CÔNG BÁO SỞ HỮU CÔNG NGHIỆP SỐ 413 TẬP A – QUYỀN 2 (08.2022)**

- (11) **45130**  
(21) 3-2021-03196 (28) 1  
(54) **TUÝP** (51) **09-05**  
(22) 14/12/2021 (43) 25/08/2022  
(73) **KIM PACK CO., LTD. (TH)**  
1741 Chan Rd., Thungmahamek, Sathorn, Bangkok, 10120, Thailand  
(72) LIMATIBUL, Sumet (TH)  
(74) Văn phòng Luật sư Ân Nam (ANNAM IP & LAW)  
(55)

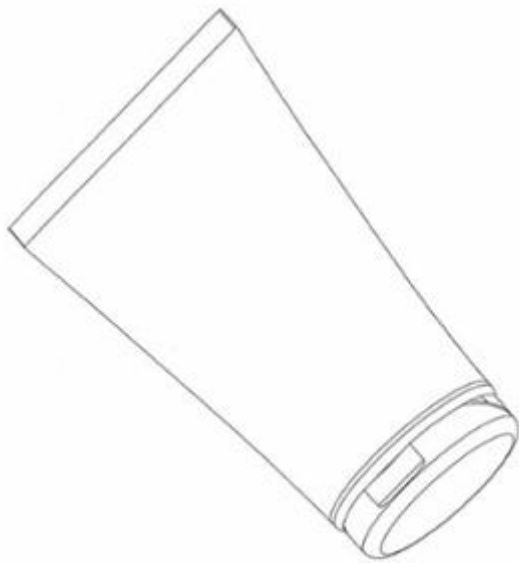

1.1

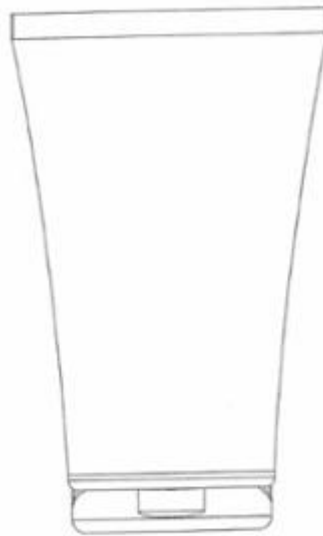

1.2



1.3



1.4



1.5



1.6



1.7

(11) **45131**

(21) 3-2021-03203

(28) 1

(54) **CỤM THAY DAO TRONG MÁY PHAY CNC**

(51) **15-09**

(22) 15/12/2021

(43) 25/08/2022

(73) **1. SỞ KHOA HỌC VÀ CÔNG NGHỆ THÀNH PHỐ HỒ CHÍ MINH (VN)**

244 Điện Biên Phủ, phường Võ Thị Sáu, quận 3, thành phố Hồ Chí Minh

**2. PHÒNG THÍ NGHIỆM TRỌNG ĐIỂM ĐIỀU KHIỂN SỐ VÀ KỸ THUẬT HỆ THỐNG (VN)**

Nhà C6, Trường Đại học Bách Khoa - 268 Lý Thường Kiệt, phường 14, quận 10, thành phố Hồ Chí Minh

(72) Bùi Trọng Hiếu (VN)

(55)



1.1

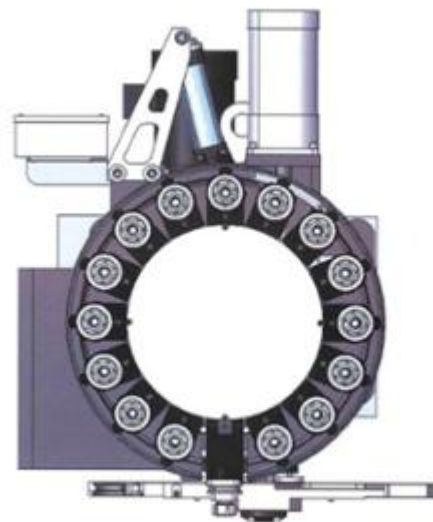

1.2

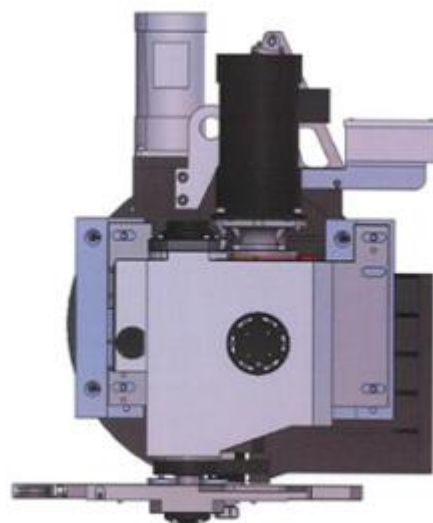

1.3

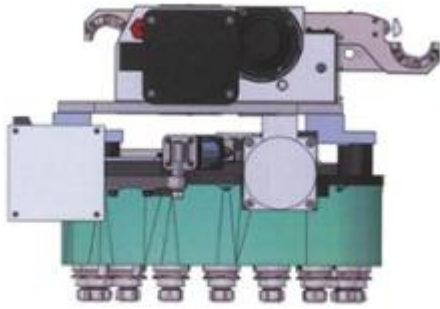

1.4

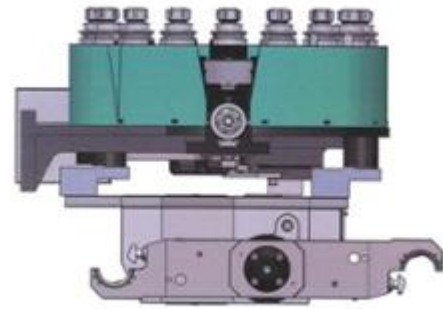

1.5

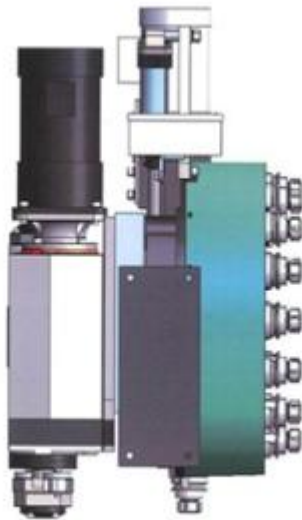

1.6

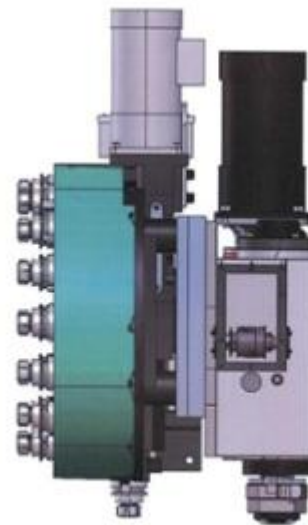

1.7

**CÔNG BÁO SỞ HỮU CÔNG NGHIỆP SỐ 413 TẬP A – QUYỀN 2 (08.2022)**

- (11) **45132**  
(21) 3-2021-03254 (28) 2  
(54) **BAO GÓI** (51) **09-05**  
(22) 17/12/2021 (43) 25/08/2022  
(73) **CÔNG TY CỔ PHẦN ACECOOK VIỆT NAM (VN)**  
Lô II-3, đường số 11, nhóm CN II, khu công nghiệp Tân Bình, phường Tây Thạnh, quận Tân Phú, thành phố Hồ Chí Minh  
(72) Kajiwara Junichi (JP)  
(74) Công ty Luật TNHH Phạm và Liên danh (PHAM & ASSOCIATES)  
(55)



1.1



1.2



2.1



2.2

**CÔNG BÁO SỞ HỮU CÔNG NGHIỆP SỐ 413 TẬP A – QUYỀN 2 (08.2022)**

- (11) **45133**
- (21) 3-2021-03255 (28) 2
- (54) **BAO GÓI** (51) **09-05**
- (22) 17/12/2021 (43) 25/08/2022
- (73) **CÔNG TY CỔ PHẦN ACECOOK VIỆT NAM (VN)**  
 Lô II-3, đường số 11, nhóm CN II, khu công nghiệp Tân Bình, phường Tây Thạnh, quận Tân Phú, thành phố Hồ Chí Minh
- (72) Kajiwara Junichi (JP)
- (74) Công ty Luật TNHH Phạm và Liên danh (PHAM & ASSOCIATES)
- (55)



1.1



1.2



2.1



2.2



- (11) **45134**  
(21) 3-2021-03268 (28) 1  
(54) **ÁO** (51) **02-02**  
(22) 20/12/2021 (43) 25/08/2022  
(30) 29/795,830 21/06/2021 US;  
(73) **ALLEGIANCE CORPORATION (US)**  
7000 Cardinal Place, Dublin, OH 43017, United States of America  
(72) 1. JOEL COLYER (US)  
2. DOUGLAS WOLFE (US)  
3. NICOLE DOUGLAS (US)  
(74) Công ty TNHH Tầm nhìn và Liên danh (VISION & ASSOCIATES CO.LTD.)  
(55)

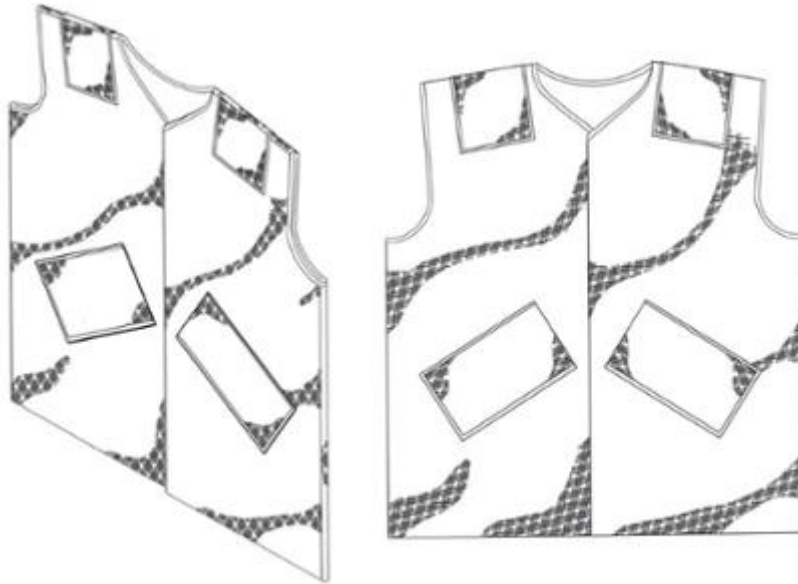

1.1

1.2

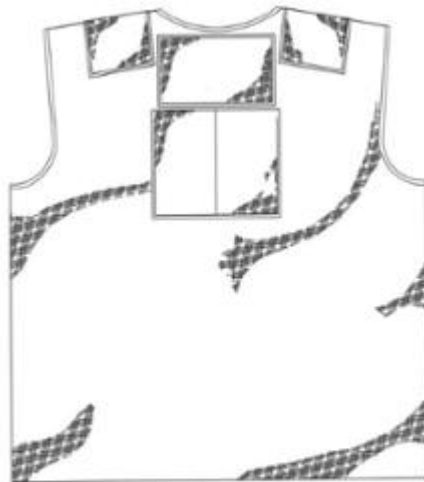

1.3



1.4

1.5



1.6



1.7

**CÔNG BÁO SỞ HỮU CÔNG NGHIỆP SỐ 413 TẬP A – QUYỀN 2 (08.2022)**

- (11) **45135**  
(21) 3-2021-03292 (28) 3  
(54) **NHÃN SẢN PHẨM** (51) **19-08**  
(22) 22/12/2021 (43) 25/08/2022  
(73) **LÊ TIẾN CÔNG (VN)**  
Phường Đông Ngàn, thị xã Từ Sơn, tỉnh Bắc Ninh  
(72) Lê Tiến Công (VN)  
(74) Công ty Luật TNHH Gia Phạm (GIA PHAM LAW CO.,LTD)  
(55)



1



2



3

**CÔNG BÁO SỞ HỮU CÔNG NGHIỆP SỐ 413 TẬP A – QUYỀN 2 (08.2022)**

- (11) **45136**  
(21) 3-2021-03325 (28) 1  
(54) **BAO GÓI** (51) **09-05**  
(22) 24/12/2021 (43) 25/08/2022  
(73) **CÔNG TY TNHH NAM PHƯƠNG V.N (VN)**  
124 Lê Lai, phường 03, quận Gò Vấp, thành phố Hồ Chí Minh  
(72) Hoàng Thị Minh Hiếu (VN)  
(74) Công ty Luật TNHH Phạm và Liên danh (PHAM & ASSOCIATES)  
(55)



1.1



1.2

(11) **45137**

(21) 3-2022-00004

(28) 1

(54) **BÌNH ĐỰNG SỮA**

(51) **07-01**

(22) 04/01/2022

(43) 25/08/2022

(73) **CÔNG TY TNHH MINH LONG I (VN)**

333 Khu phố Hưng Lộc, phường Hưng Định, thành phố Thuận An, tỉnh Bình Dương

(72) Lý Ngọc Minh (VN)

(55)



1.1



1.2



1.3



1.4



1.5



1.6



1.7

(11) **45138**

(21) 3-2022-00005

(28) 1

(54) **BÌNH ĐỰNG SỮA**

(51) **07-01**

(22) 04/01/2022

(43) 25/08/2022

(73) **CÔNG TY TNHH MINH LONG I (VN)**

333 Khu phố Hưng Lộc, phường Hưng Định, thành phố Thuận An, tỉnh Bình Dương

(72) Lý Ngọc Minh (VN)

(55)



1.1



1.2



1.3



1.4



1.5



1.6



1.7

- (11) **45139**  
(21) 3-2022-00038 (28) 7  
(54) **BÀN CHẢI** (51) **04-02**  
(22) 07/01/2022 (43) 25/08/2022  
(30) 008606644-0004 08/07/2021 EM; 008606644-0001 08/07/2021 EM;  
(73) **UNILEVER GLOBAL IP LIMITED (GB)**  
Port Sunlight Wirral, Merseyside CH62 4ZD, United Kingdom  
(72) 1. DAI XIAO GUO (CN)  
2. BARON NEIL MARTIN (GB)  
3. CAROEN ADRIAN BARCLAY (GB)  
4. BILLINGTON CHARLES PETER (GB)  
(74) Công ty TNHH Trần Hữu Nam và Đồng sự (TRAN H.N & ASS.)  
(55)

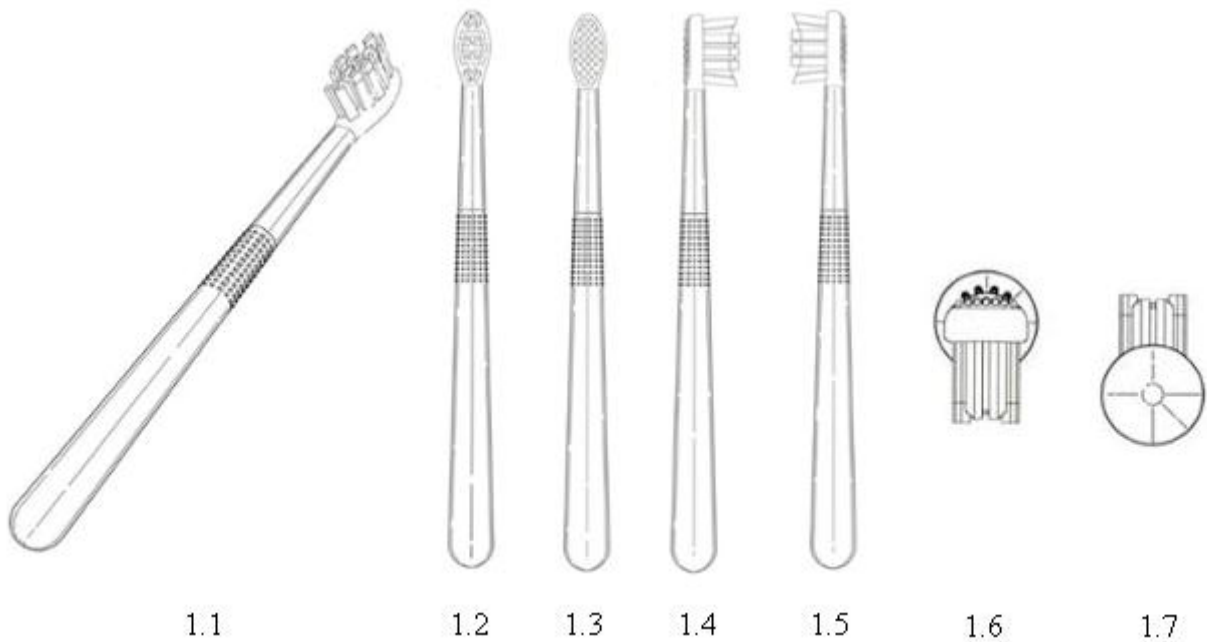





**CÔNG BÁO SỞ HỮU CÔNG NGHIỆP SỐ 413 TẬP A – QUYỀN 2 (08.2022)**

- (11) **45140**  
(21) 3-2022-00102 (28) 1  
(54) **MICRÔ CỒNG USB** (51) **14-01**  
(22) 13/01/2022 (43) 25/08/2022  
(30) 29/799,423 14/07/2021 US;  
(73) **PRESONUS AUDIO ELECTRONICS, INC. (US)**  
18011 Grand Bay Court, Baton Rouge, Louisiana 70809, United States of America  
(72) 1. CALVIN BOND (US)  
2. BRIAN SMITH (US)  
(74) Công ty Luật TNHH ROUSE Việt Nam (ROUSE LAW CO.,LTD)  
(55)

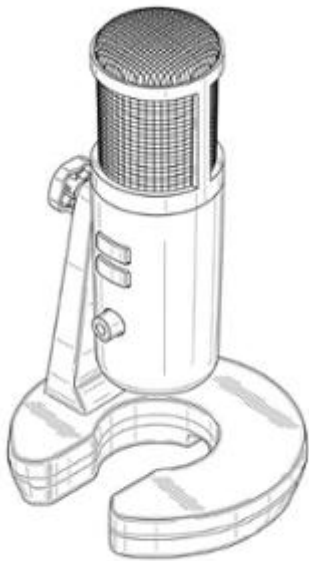

1.1

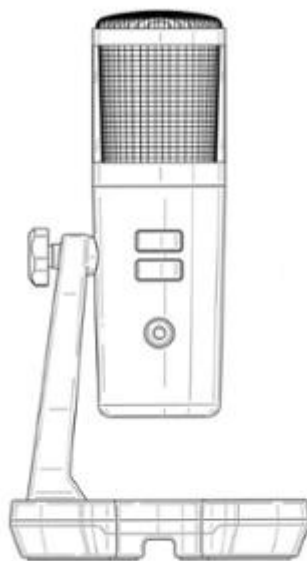

1.2

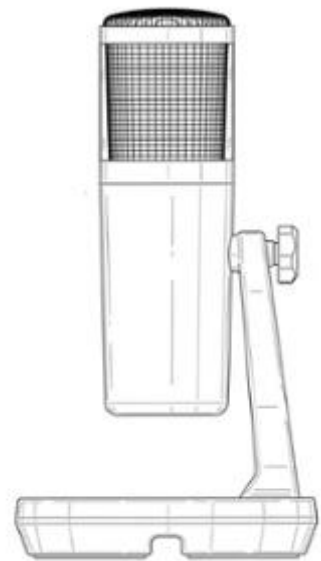

1.3

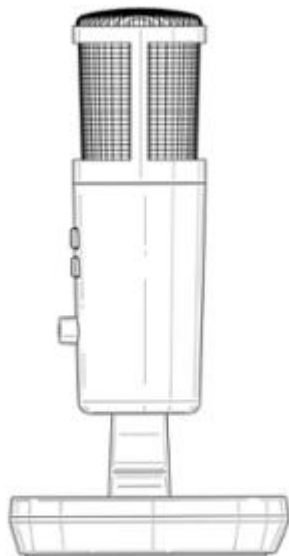

1.4



1.5



1.6



1.7

- (11) **45141**  
(21) 3-2022-00119 (28) 1  
(54) **TẤM ĐỆM LÒ XO CHO GÓT GIÀY** (51) **02-04**  
(22) 14/01/2022 (43) 25/08/2022  
(30) 29/799,912 16/07/2021 US;  
(73) **WALMART APOLLO, LLC (US)**  
702 Southwest 8th Street, Bentonville, AR 72716, United States of America  
(72) Salvo Farina (US)  
(74) Công ty TNHH ADASTRA IP (VIỆT NAM) (ADASTRA IP (VIETNAM) CO., LTD.)  
(55)

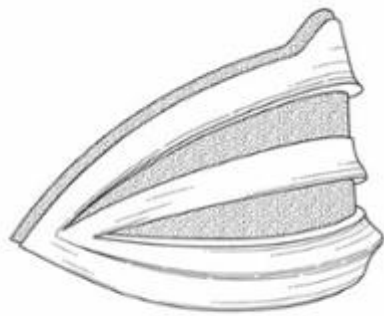

1.1

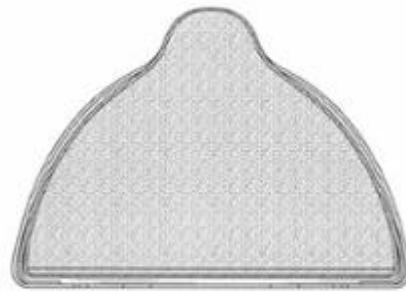

1.2

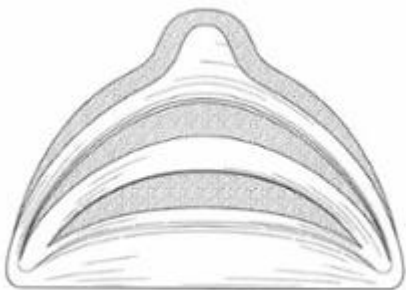

1.3



1.4



1.5



1.6

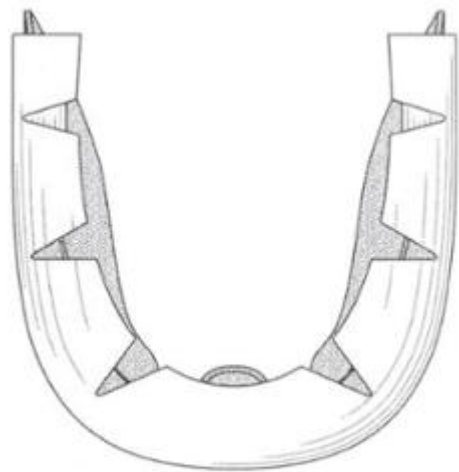

1.7

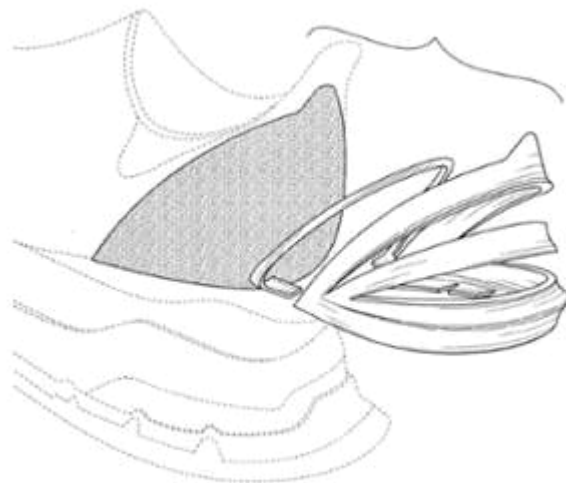

1.8

(11) **45142**

(21) 3-2022-00148

(28) 1

(54) **VAN MỘT CHIỀU KHÓA LIỆU TỰ ĐỘNG**

(51) **15-99**

(22) 18/01/2022

(43) 25/08/2022

(73) **NGUYỄN THỊ BÍCH PHƯƠNG (VN)**

Áp 6 Thanh Phú - Vĩnh Cửu - Đồng Nai

(72) Nguyễn Thị Bích Phương (VN)

(55)

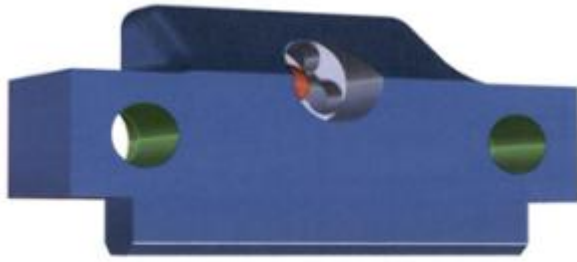

1.1



1.2



1.3



1.4



1.5



1.6



1.7

- (11) **45143**  
(21) 3-2022-00161 (28) 1  
(54) **ĐÈN** (51) **26-05**  
(22) 19/01/2022 (43) 25/08/2022  
(73) **CÔNG TY CỔ PHẦN BÓNG ĐÈN PHÍCH NƯỚC RẠNG ĐÔNG (VN)**  
87-89 phố Hạ Đình, phường Thanh Xuân Trung, quận Thanh Xuân, thành phố Hà Nội  
(72) Trần Trung Tường (VN)  
(55)

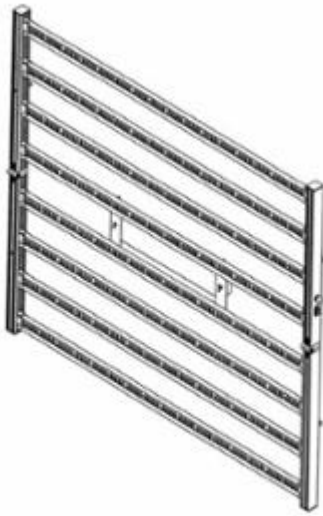

1.1

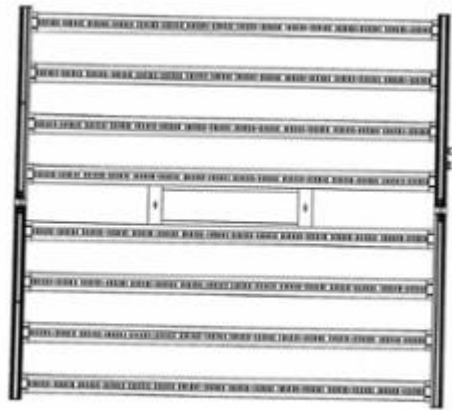

1.2

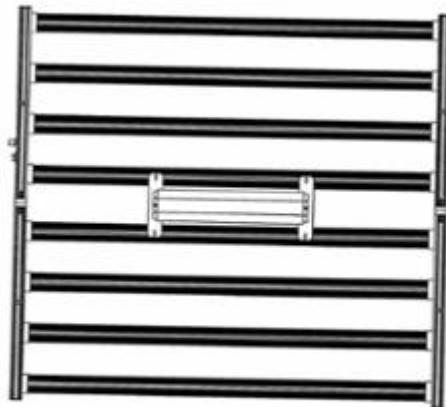

1.3

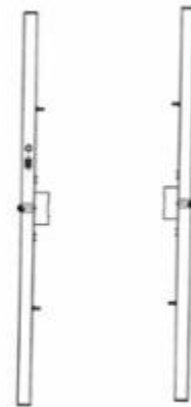

1.4

1.5



1.6



1.7

- (11) **45144**  
(21) 3-2022-00167 (28) 2  
(54) **TRỤ ĐÈN CHIẾU SÁNG** (51) **26-03**  
(22) 19/01/2022 (43) 25/08/2022  
(73) **CÔNG TY TNHH CÔNG NGHỆ LONG KHANG (VN)**  
Số 24 đường 68, khu phố 1, phường Thạnh Mỹ Lợi, thành phố Thủ Đức, thành phố Hồ Chí Minh  
(72) Nguyễn Thị Lan Hương (VN)  
(74) Văn phòng Luật sư D và T (D & T LAW OFFICE)  
(55)

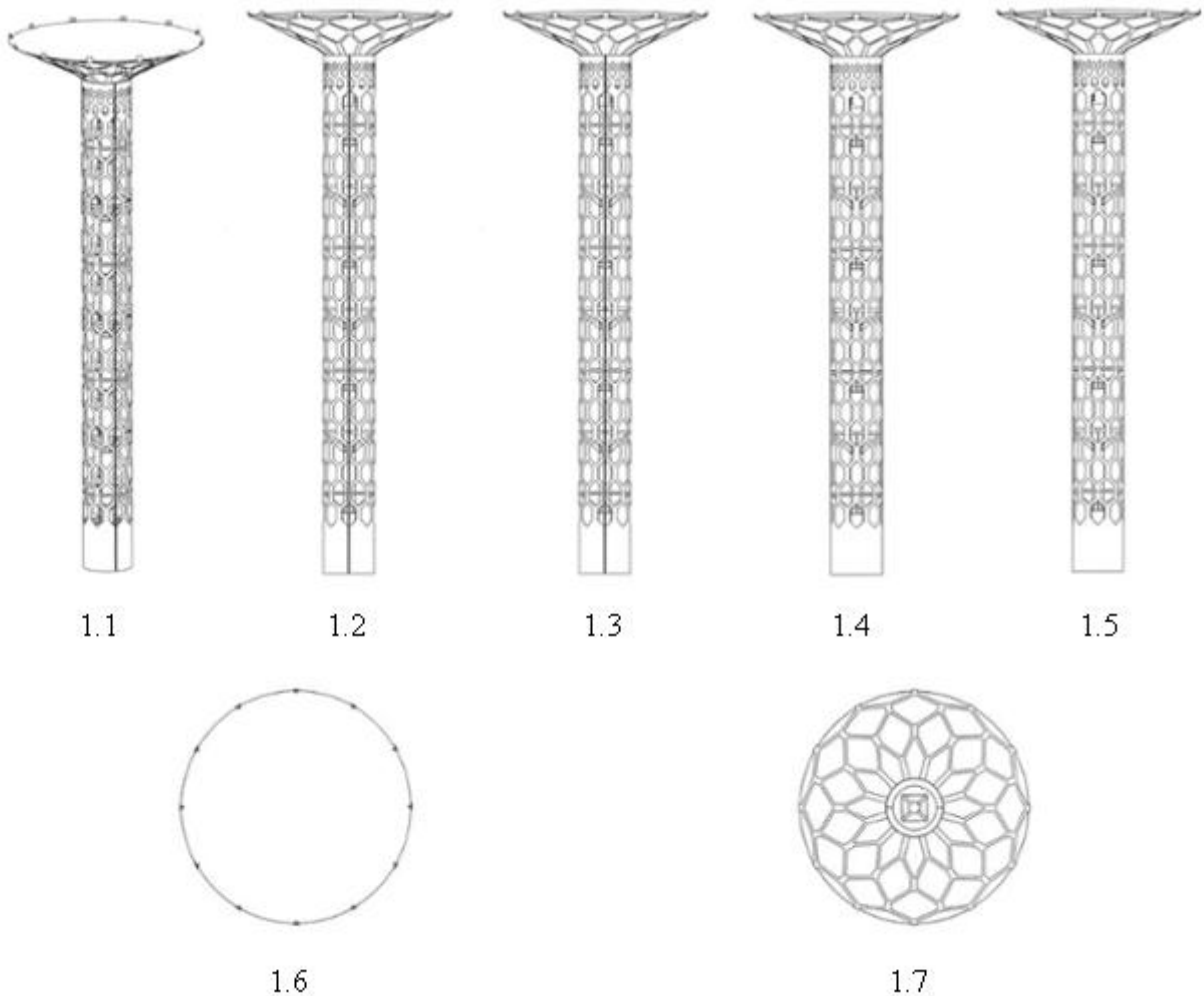

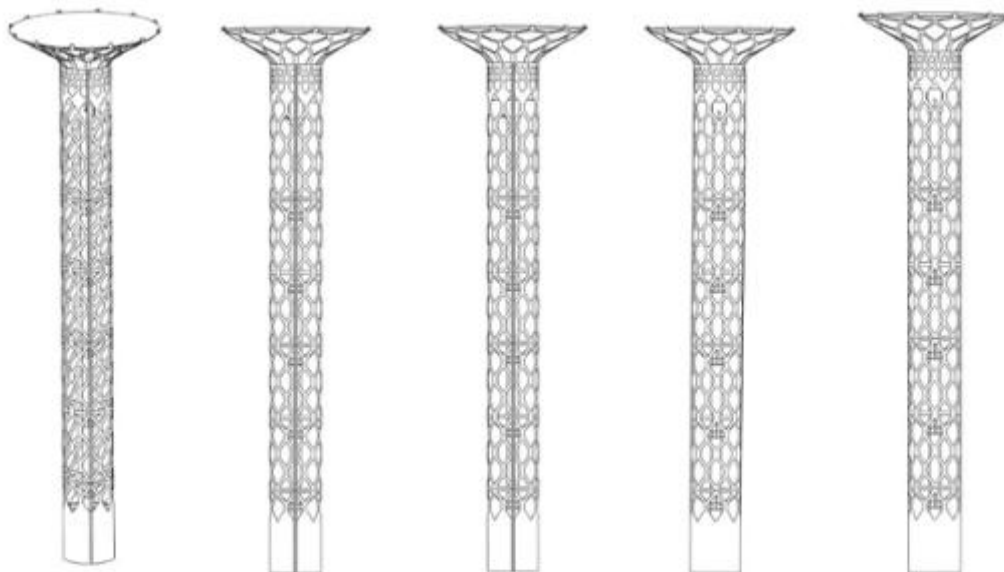

2.1

2.2

2.3

2.4

2.5

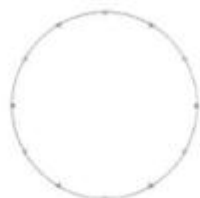

2.6

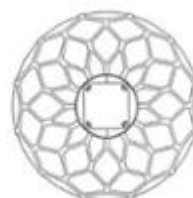

2.7



- (11) **45145**  
(21) 3-2022-00168 (28) 1  
(54) **TRỤ ĐÈN CHIẾU SÁNG** (51) **26-03**  
(22) 19/01/2022 (43) 25/08/2022  
(73) **CÔNG TY TNHH CÔNG NGHỆ LONG KHANG (VN)**  
Số 24 đường 68, khu phố 1, phường Thạnh Mỹ Lợi, thành phố Thủ Đức, thành phố Hồ Chí Minh  
(72) Nguyễn Thị Lan Hương (VN)  
(74) Văn phòng Luật sư D và T (D & T LAW OFFICE)  
(55)

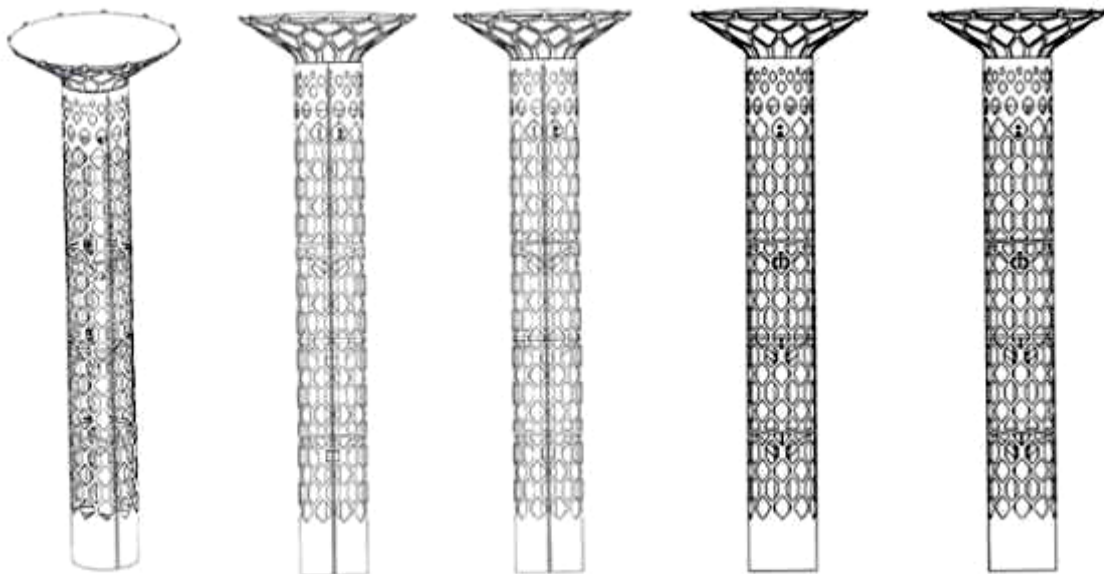

1.1

1.2

1.3

1.4

1.5



1.6

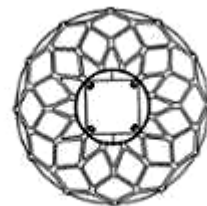

1.7

**CÔNG BÁO SỞ HỮU CÔNG NGHIỆP SỐ 413 TẬP A – QUYỀN 2 (08.2022)**

- (11) **45146**  
(21) 3-2022-00180 (28) 1  
(54) **NHÃN SẢN PHẨM** (51) **19-08**  
(22) 21/01/2022 (43) 25/08/2022  
(73) **CÔNG TY CỔ PHẦN DẦU CÁ CHÂU Á (VN)**  
Quốc lộ 80, ấp An Thạnh, xã Bình Thành, huyện Lấp Vò, tỉnh Đồng Tháp  
(72) Lê Văn Chính (VN)  
(55)



**CÔNG BÁO SỞ HỮU CÔNG NGHIỆP SỐ 413 TẬP A – QUYỀN 2 (08.2022)**

- (11) **45147**  
(21) 3-2022-00182 (28) 1  
(54) **HỘP ĐỰNG SẢN PHẨM** (51) **09-03**  
(22) 21/01/2022 (43) 25/08/2022  
(73) **DƯƠNG TUẤN ANH (VN)**  
Tổ 2, phường Tây Sơn, thành phố Tam Điệp, tỉnh Ninh Bình  
(72) Dương Tuấn Anh (VN)  
(55)



1.2



1.1

**CÔNG BÁO SỞ HỮU CÔNG NGHIỆP SỐ 413 TẬP A – QUYỀN 2 (08.2022)**

- (11) **45148**  
(21) 3-2022-00183 (28) 1  
(54) **HỘP ĐỰNG SẢN PHẨM** (51) **09-03**  
(22) 21/01/2022 (43) 25/08/2022  
(73) **DƯƠNG TUẤN ANH (VN)**  
Tổ 2, phường Tây Sơn, thành phố Tam Điệp, tỉnh Ninh Bình  
(72) Dương Tuấn Anh (VN)  
(55)



1.1



1.2

- (11) **45149**  
(21) 3-2022-00248 (28) 1  
(54) **PHỤ KIỆN NHÀ TẮM** (51) **23-02**  
(22) 28/01/2022 (43) 25/08/2022  
(73) **CÔNG TY CỔ PHẦN SẢN XUẤT THƯƠNG MẠI NAM ĐÔ (VN)**  
2C đường số 10, phường Bình Hưng Hòa A, quận Bình Tân, thành phố Hồ Chí Minh  
(72) Nguyễn Tấn Tài (VN)  
(55)



1.1



1.2



1.3



1.4



1.5



1.6



1.7

(11) **45150**

(21) 3-2022-00251

(54) **NHÀ LẮP GHÉP**

(22) 28/01/2022

(73) **HIỆP HỘI Ô TÔ, XE MÁY, XE ĐẠP VIỆT NAM (VN)**

Số 21 phố Lâm Hạ, phường Bồ Đề, quận Long Biên, thành phố Hà Nội

(72) Lưu Hồng Phong (VN)

(55)

(28) 1

(51) **25-03**

(43) 25/08/2022



1.1



1.2

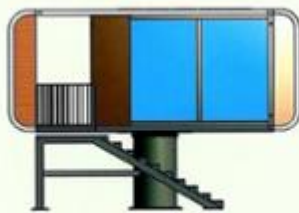

1.3



1.4



1.5

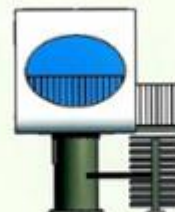

1.6



1.7

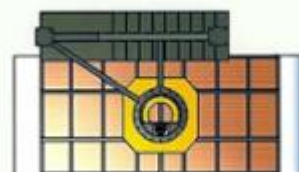

1.8

- (11) **45151**  
(21) 3-2022-00280 (28) 1  
(54) **THANH NHÔM ĐỊNH HÌNH** (51) **25-01**  
(22) 15/02/2022 (43) 25/08/2022  
(73) **CÔNG TY CỔ PHẦN SẢN XUẤT & THƯƠNG MẠI NAM HÙNG (VN)**  
Số 5/67 ngõ 5, phố Đức Minh, phường Thanh Bình, thành phố Hải Dương, tỉnh Hải Dương  
(72) Lê Duy Tú (VN)  
(74) Công ty TNHH tư vấn THB (THB CONSULTING CO.,LTD)  
(55)



1.1

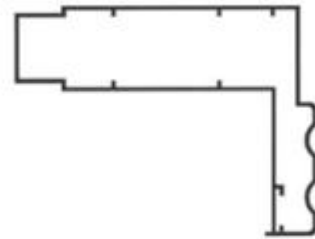

1.2



1.3



1.4



1.5



1.6



1.7

**CÔNG BÁO SỞ HỮU CÔNG NGHIỆP SỐ 413 TẬP A – QUYỀN 2 (08.2022)**

- (11) **45152**  
(21) 3-2022-00281 (28) 1  
(54) **THANH NHÔM ĐỊNH HÌNH** (51) **25-01**  
(22) 15/02/2022 (43) 25/08/2022  
(73) **CÔNG TY CỔ PHẦN SẢN XUẤT & THƯƠNG MẠI NAM HÙNG (VN)**  
Số 5/67 ngõ 5, phố Đức Minh, phường Thanh Bình, thành phố Hải Dương, tỉnh Hải Dương  
(72) Lê Duy Tú (VN)  
(74) Công ty TNHH tư vấn THB (THB CONSULTING CO.,LTD)  
(55)

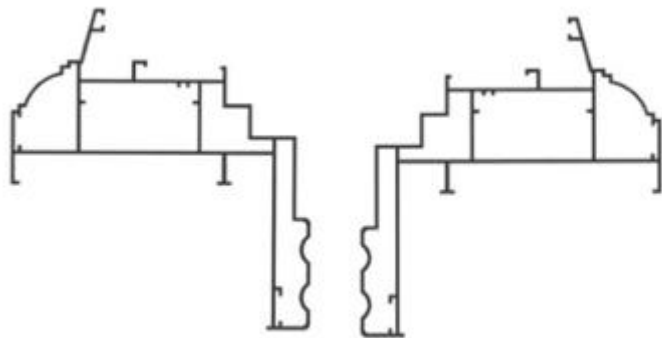
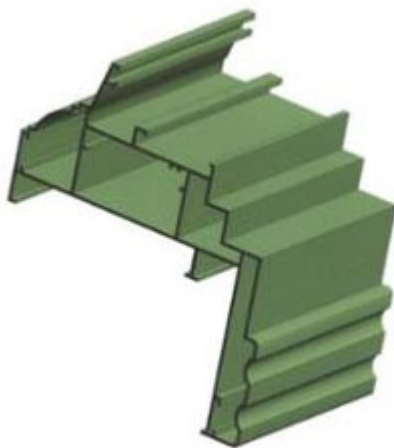

1.1



1.2

1.3



1.4



1.5



1.6

1.7



**CÔNG BÁO SỞ HỮU CÔNG NGHIỆP SỐ 413 TẬP A – QUYỀN 2 (08.2022)**

- (11) **45153**  
(21) 3-2022-00296 (28) 1  
(54) **CHAI** (51) **09-01**  
(22) 17/02/2022 (43) 25/08/2022  
(73) **CÔNG TY CỔ PHẦN NOSAFOOD (VN)**  
E4/20 Nguyễn Hữu Trí, thị trấn Tân Túc, huyện Bình Chánh, thành phố Hồ Chí Minh  
(72) Ho Joong (KR)  
(74) Công ty TNHH Tầm nhìn và Liên danh (VISION & ASSOCIATES CO.LTD.)  
(55)

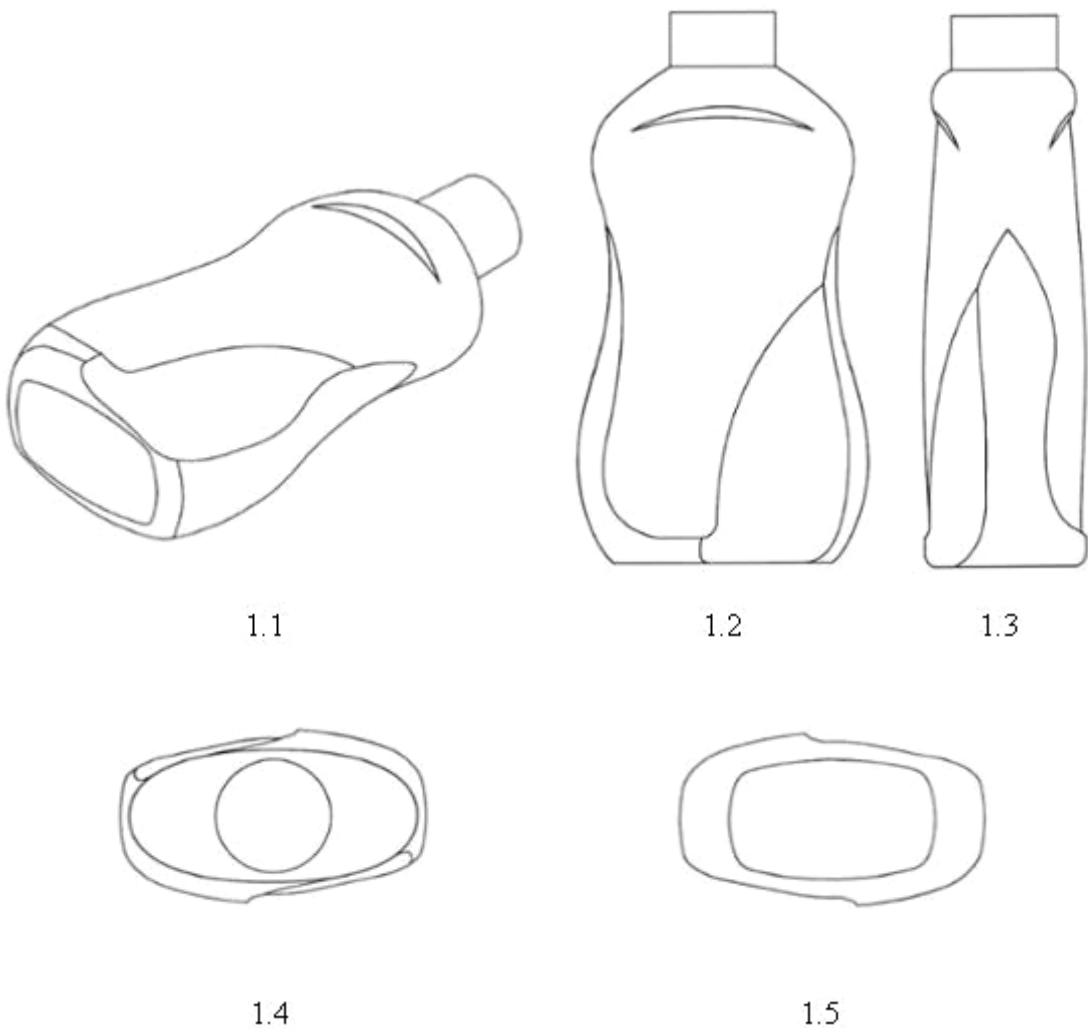

**CÔNG BÁO SỞ HỮU CÔNG NGHIỆP SỐ 413 TẬP A – QUYỀN 2 (08.2022)**

- (11) **45154**
- (21) 3-2022-00314 (28) 1
- (54) **BAO GÓI SẢN PHẨM** (51) **09-05**
- (22) 22/02/2022 (43) 25/08/2022
- (73) **CÔNG TY TNHH THƯƠNG MẠI QUỐC TẾ TIÊN PHONG (VN)**  
Số nhà 203, đường Hùng Vương, thị trấn Bát Xát, huyện Bát Xát, tỉnh Lào Cai
- (72) 1. NGUYỄN ANH TUYẾN (VN)  
2. BÙI VĂN KHÔI (VN)
- (55)



1.1



1.2

- (11) **45155**  
(21) 3-2022-00378 (28) 1  
(54) **BÌNH GIỮ NHIỆT** (51) **07-07**  
(22) 28/02/2022 (43) 25/08/2022  
(73) **CÔNG TY CỔ PHẦN BÓNG ĐÈN PHÍCH NƯỚC RẠNG ĐÔNG (VN)**  
87-89 phố Hạ Đình, phường Thanh Xuân Trung, quận Thanh Xuân, thành phố Hà Nội  
(72) Trần Trung Tường (VN)  
(55)



1.1



1.2



1.3



1.4



1.5



1.6

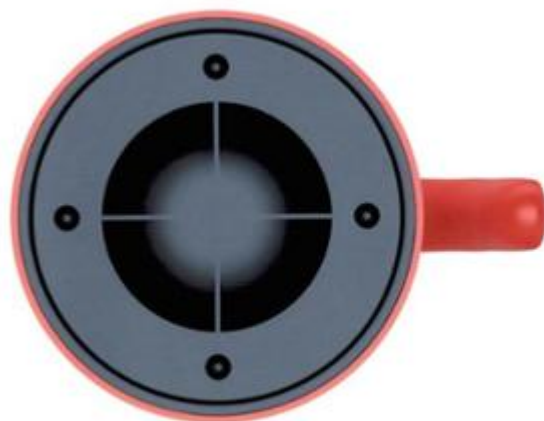

1.7

**CÔNG BÁO SỞ HỮU CÔNG NGHIỆP SỐ 413 TẬP A – QUYỀN 2 (08.2022)**

- (11) **45156**
- (21) 3-2022-00391 (28) 1
- (54) **NHÃN SẢN PHẨM** (51) **19-08**
- (22) 28/02/2022 (43) 25/08/2022
- (73) **CÔNG TY CỔ PHẦN SỮA VIỆT NAM (VN)**  
10 Tân Trào, phường Tân Phú, quận 7, thành phố Hồ Chí Minh
- (72) LENNART CORNELIUS SCHABERG (DE)
- (74) Công ty cổ phần Sở hữu trí tuệ BROSS và Cộng sự (BROSS & PARTNERS., JSC)
- (55)



(11) **45157**

(21) 3-2022-00420

(28) 1

(54) **ĐÈN CHIẾU XOAY GÓC**

(51) **26-05**

(22) 08/03/2022

(43) 25/08/2022

(73) **CÔNG TY CỔ PHẦN LUMI VIỆT NAM (VN)**

38 Đỗ Đức Dục, phường Mỹ Trì, quận Nam Từ Liêm, thành phố Hà Nội

(72) 1. NGUYỄN TUẤN ANH (VN)

2. NGUYỄN ĐỨC TÀI (VN)

(55)



1.1

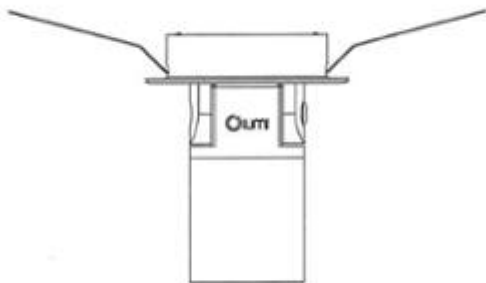

1.2

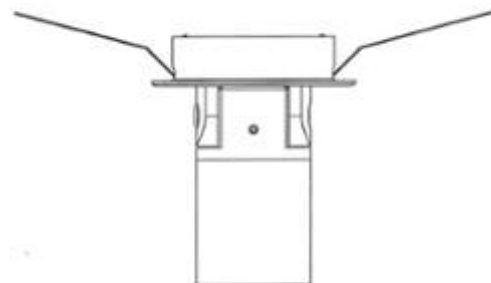

1.3

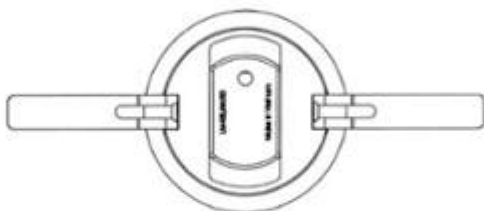

1.4

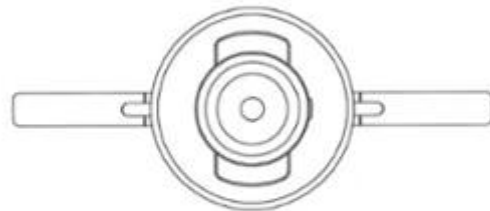

1.5

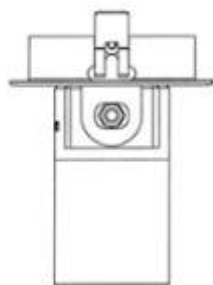

1.6

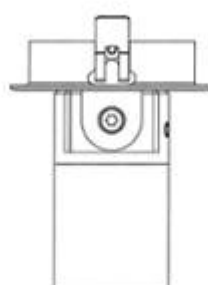

1.7

**CÔNG BÁO SỞ HỮU CÔNG NGHIỆP SỐ 413 TẬP A – QUYỀN 2 (08.2022)**

- (11) **45158**  
(21) 3-2022-00424 (28) 1  
(54) **BAO GÓI** (51) **09-05**  
(22) 08/03/2022 (43) 25/08/2022  
(73) **CÔNG TY TNHH NAM PHƯƠNG V.N (VN)**  
124 Lê Lai, phường 3, quận Gò Vấp, thành phố Hồ Chí Minh  
(72) Hoàng Thị Minh Hiếu (VN)  
(74) Công ty Luật TNHH Phạm và Liên danh (PHAM & ASSOCIATES)  
(55)



1.1



1.2



**CÔNG BÁO SỞ HỮU CÔNG NGHIỆP SỐ 413 TẬP A – QUYỀN 2 (08.2022)**

- (11) **45159**  
(21) 3-2022-00440 (28) 1  
(54) **MÁY SẤY ĐA NĂNG** (51) **15-03; 15-99**  
(22) 11/03/2022 (43) 25/08/2022  
(73) **CÔNG TY CỔ PHẦN CÁNH ĐỒNG VÀNG LẠNG SƠN (VN)**  
Số 156, đường Bà Triệu, phường Hoàng Văn Thụ, thành phố Lạng Sơn, tỉnh Lạng Sơn  
(72) Nông Ngọc Trung (VN)  
(74) Công ty TNHH Sở hữu trí tuệ IPS Việt Nam (VIET NAM IPS INTERPRO CO., LTD)  
(55)



1.1



1.2



1.3

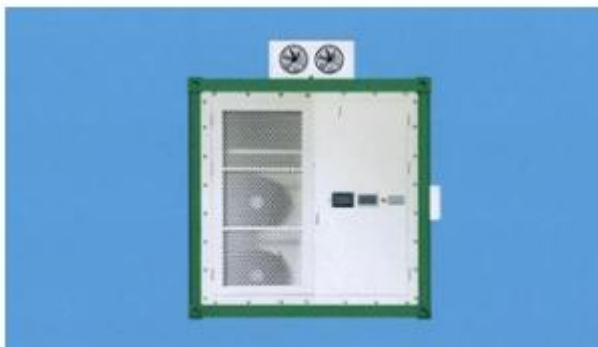

1.4

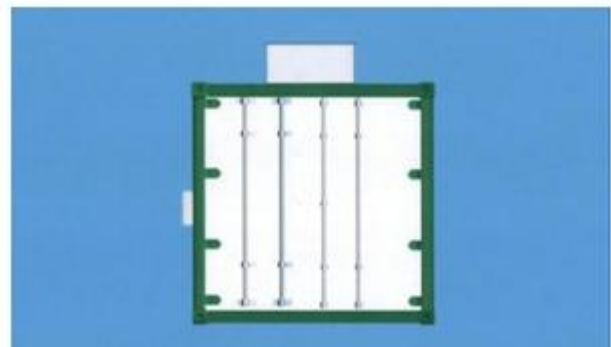

1.5

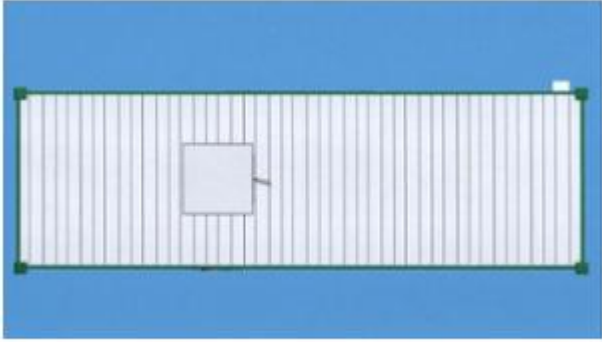

1.6

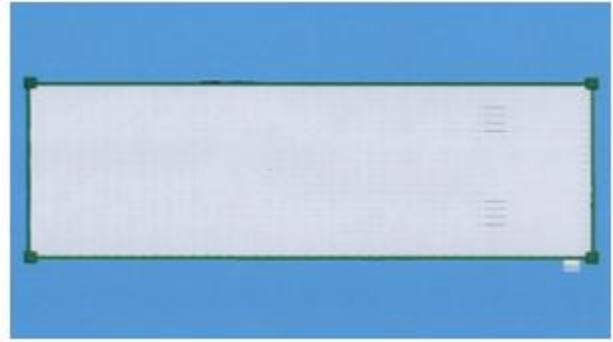

1.7

**CÔNG BÁO SỞ HỮU CÔNG NGHIỆP SỐ 413 TẬP A – QUYỀN 2 (08.2022)**

- (11) **45160**  
(21) 3-2022-00463 (28) 1  
(54) **HỘP** (51) **09-03**  
(22) 15/03/2022 (43) 25/08/2022  
(73) **CÔNG TNHH THỰC PHẨM DELTA D'ASIA (VN)**  
107 đường 2, tổ 3, KP 1, phường Tăng Nhơn Phú B, thành phố Thủ Đức, thành phố Hồ Chí Minh  
(72) Lương Thị Thanh (VN)  
(74) **CÔNG TY TNHH SỞ HỮU TRÍ TUỆ SETHACO (SETHACO IP CO.,LTD)**  
(55)



1.1



1.2

**CÔNG BÁO SỞ HỮU CÔNG NGHIỆP SỐ 413 TẬP A – QUYỀN 2 (08.2022)**

(11) **45161**

(21) 3-2022-00552

(28) 1

(54) **CỘT XÂY DỰNG**

(51) **25-02**

(22) 29/03/2022

(43) 25/08/2022

(73) **NGUYỄN XUÂN THỦY (VN)**

Tổ 3, khu 10, phường Bãi Cháy, thành phố Hạ Long, tỉnh Quảng Ninh

(72) Nguyễn Xuân Thủy (VN)

(55)

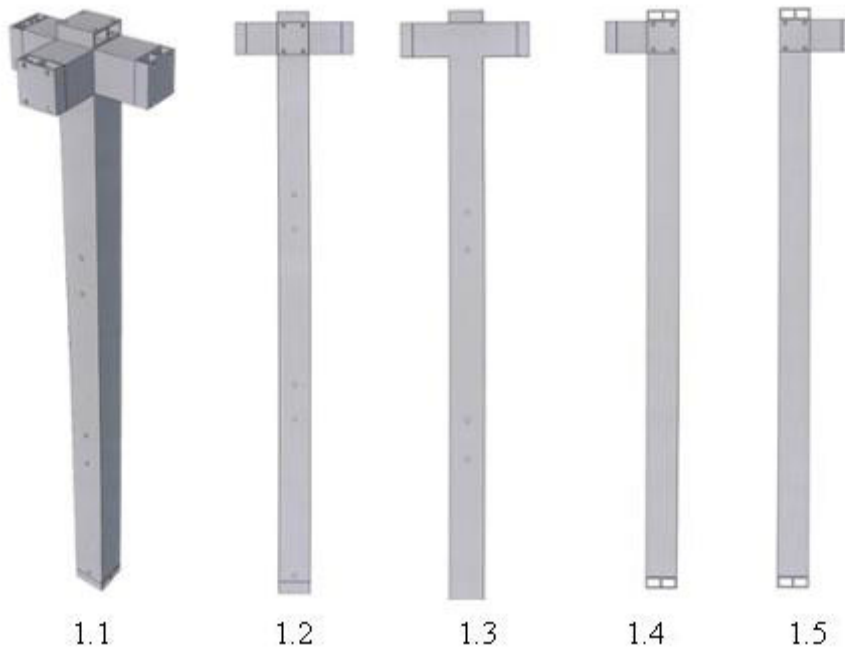

**CÔNG BÁO SỞ HỮU CÔNG NGHIỆP SỐ 413 TẬP A – QUYỀN 2 (08.2022)**

(11) **45162**

(21) 3-2022-00553

(28) 1

(54) **CỘT XÂY DỰNG**

(51) **25-02**

(22) 29/03/2022

(43) 25/08/2022

(73) **NGUYỄN XUÂN THỦY (VN)**

Tổ 3, khu 10, phường Bãi Cháy, thành phố Hạ Long, tỉnh Quảng Ninh

(72) Nguyễn Xuân Thủy (VN)

(55)



1.1



1.2



1.3



1.4



1.5



1.6



1.7

(11) **45163**

(21) 3-2022-00554

(28) 1

(54) **BẢN MẪ LẮP GHÉP**

(51) **25-02**

(22) 29/03/2022

(43) 25/08/2022

(73) **NGUYỄN XUÂN THỦY (VN)**

Tổ 3, khu 10, phường Bãi Cháy, thành phố Hạ Long, tỉnh Quảng Ninh

(72) Nguyễn Xuân Thủy (VN)

(55)



1.1



1.2



1.3

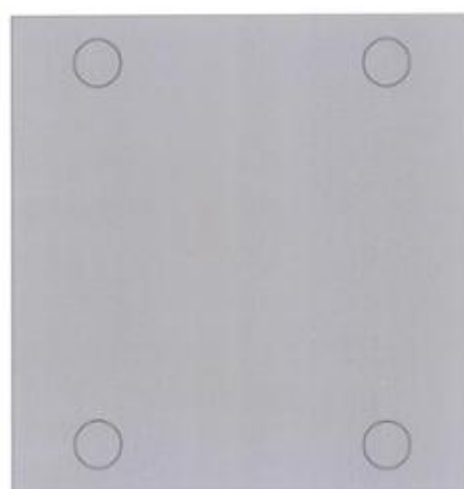

1.4



1.5

**CÔNG BÁO SỞ HỮU CÔNG NGHIỆP SỐ 413 TẬP A – QUYỀN 2 (08.2022)**

(11) **45164**

(21) 3-2022-00555

(28) 1

(54) **DÀM XÂY DỰNG**

(51) **25-02**

(22) 29/03/2022

(43) 25/08/2022

(73) **NGUYỄN XUÂN THỦY (VN)**

Tổ 3, khu 10, phường Bãi Cháy, thành phố Hạ Long, tỉnh Quảng Ninh

(72) Nguyễn Xuân Thủy (VN)

(55)



1.1



1.3



1.2



1.4



**CÔNG BÁO SỞ HỮU CÔNG NGHIỆP SỐ 413 TẬP A – QUYỀN 2 (08.2022)**

(11) **45165**

(21) 3-2022-00556

(28) 1

(54) **CỘT XÂY DỰNG**

(51) **25-02**

(22) 29/03/2022

(43) 25/08/2022

(73) **NGUYỄN XUÂN THỦY (VN)**

Tổ 3, khu 10, phường Bãi Cháy, thành phố Hạ Long, tỉnh Quảng Ninh

(72) Nguyễn Xuân Thủy (VN)

(55)



1.1



1.2

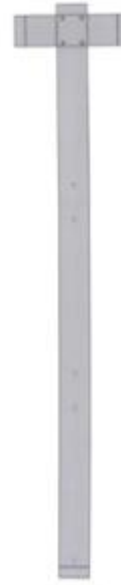

1.3

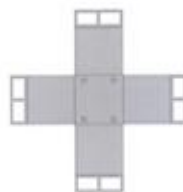

1.4

- (11) **45166**  
(21) 3-2022-00651 (28) 3  
(54) **VẢI** (51) **05-05**  
(22) 07/04/2022 (43) 25/08/2022  
(73) **KARL LAGERFELD B.V. (NL)**  
Herengracht 182, 1016 BR Amsterdam, The Netherlands  
(72) Hun Kim (NL)  
(74) Công ty TNHH Trường Xuân (AGELESS CO.,LTD.)  
(55)

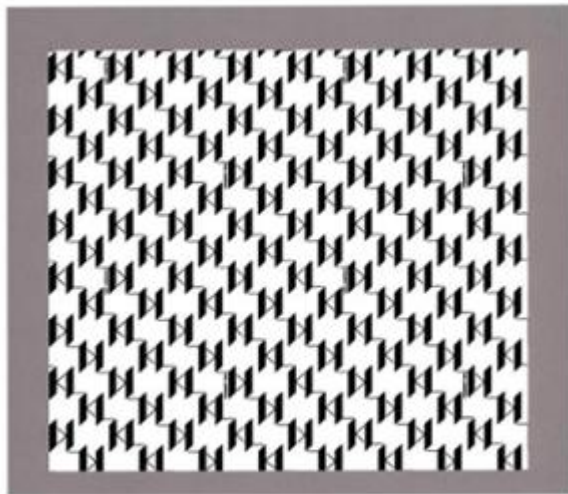

1.1

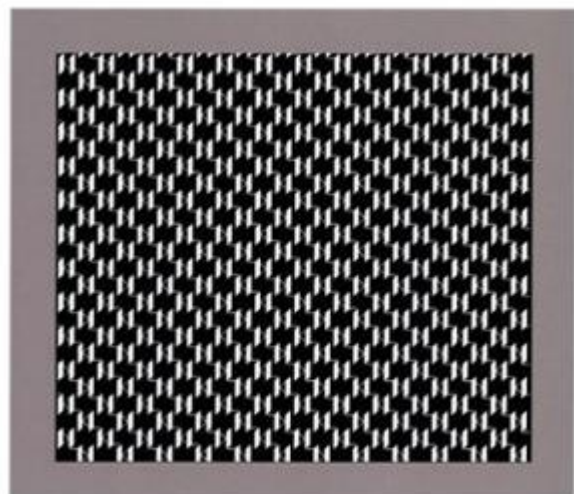

2.1

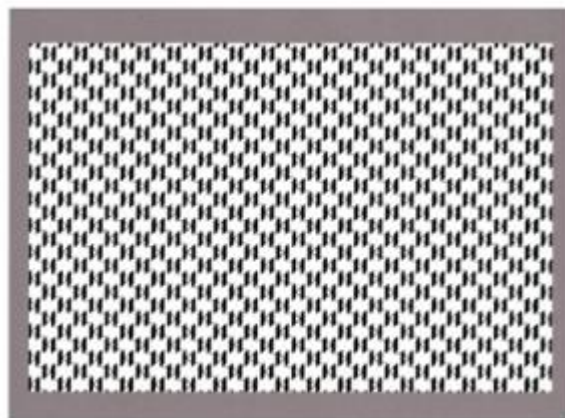

3.1

**CÔNG BÁO SỞ HỮU CÔNG NGHIỆP SỐ 413 TẬP A – QUYỀN 2 (08.2022)**

(11) **45167**

(21) 3-2022-00672

(28) 1

(54) **TAY NẮM**

(51) **08-06**

(22) 12/04/2022

(43) 25/08/2022

(73) **ĐẶNG TRẦN THỦY (VN)**

NO6B-LK46A khu đất dịch vụ Vạn Phúc, phường Vạn Phúc, quận Hà Đông, thành phố Hà Nội

(72) Đặng Trần Thủy (VN)

(55)



1.1



1.2



1.3



1.4



1.5



1.6



1.7

(11) **45168**

(21) 3-2022-00674

(28) 1

(54) **TAI NGHE**

(51) **14-01**

(22) 12/04/2022

(43) 25/08/2022

(30) 202130694639.5 22/10/2021 CN;

(73) **SHENZHEN SHOKZ CO., LTD. (CN)**

Floors 1-4, Factory Building 26, Shancheng Industrial Park, Shiyan Street, Bao'an District, Shenzhen, Guangdong, China

(72) 1. ZHONG LEI (CN)

2. CAI ZHI (CN)

3. HUANG SUNJIE (CN)

4. YAN ZETENG (CN)

5. CHEN QIAN (CN)

6. CHENG PIYOU (CN)

7. WANG YUEQIANG (CN)

(74) Công ty TNHH Trường Xuân (AGELESS CO.,LTD.)

(55)



1.1



1.2



1.3



1.4

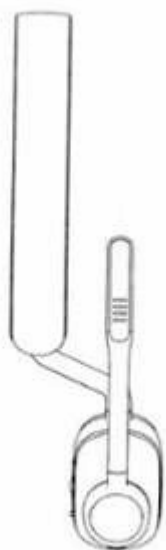

1.5



1.6

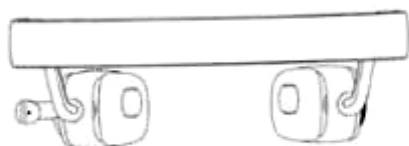

1.7



1.8

- (11) **45169**  
(21) 3-2022-00675 (28) 1  
(54) **GIÁ GẮN MÀN HÌNH** (51) **14-99**  
(22) 12/04/2022 (43) 25/08/2022  
(73) **IWORKHUB LIMITED (CN)**  
Room D, 10/F., Tower A, Billion Centre, 1 Wang Kwong Road, Kowloon Bay,  
Kowloon, Hong Kong China  
(72) 1. HAO XU (CN)  
2. YONGYI XIONG (CN)  
(74) Văn phòng Luật sư Ân Nam (ANNAM IP & LAW)  
(55)

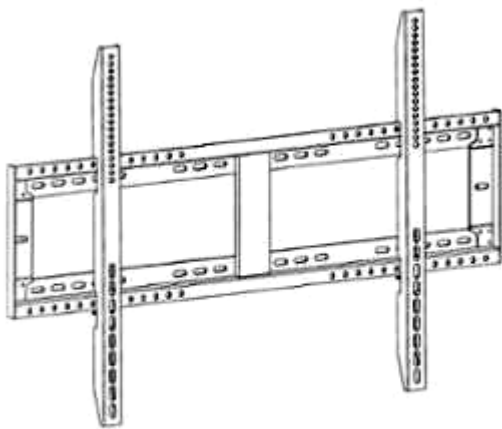

1.1

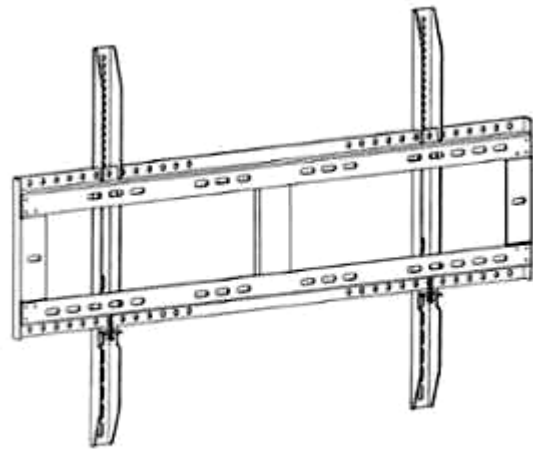

1.2

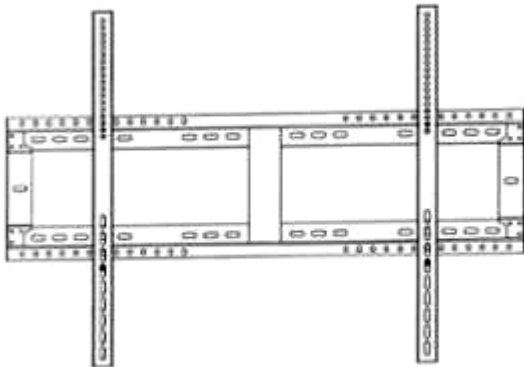

1.3

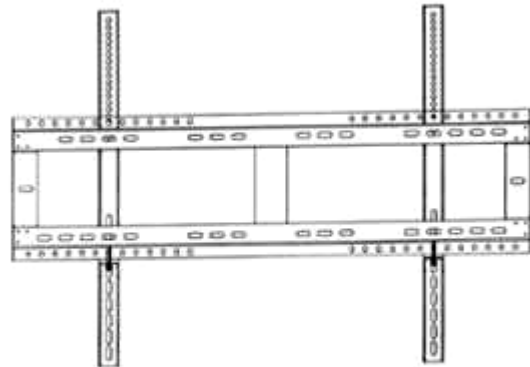

1.4



1.5



1.6



1.7



1.8

**CÔNG BÁO SỞ HỮU CÔNG NGHIỆP SỐ 413 TẬP A – QUYỀN 2 (08.2022)**

(11) **45170**

(21) 3-2022-00676

(28) 1

(54) **GIÁ GẮN MÀN HÌNH**

(51) **14-99**

(22) 12/04/2022

(43) 25/08/2022

(73) **IWORKHUB LIMITED (CN)**

Room D, 10/F., Tower A, Billion Centre, 1 Wang Kwong Road, Kowloon Bay, Kowloon, Hong Kong China

(72) 1. HAO XU (CN)

2. YONGYI XIONG (CN)

(74) Văn phòng Luật sư Ân Nam (ANNAM IP & LAW)

(55)

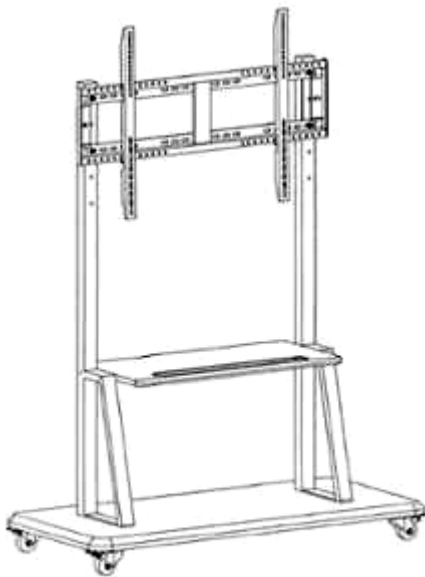

1.1

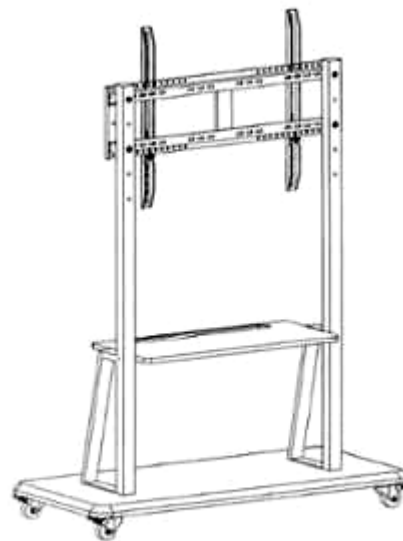

1.2

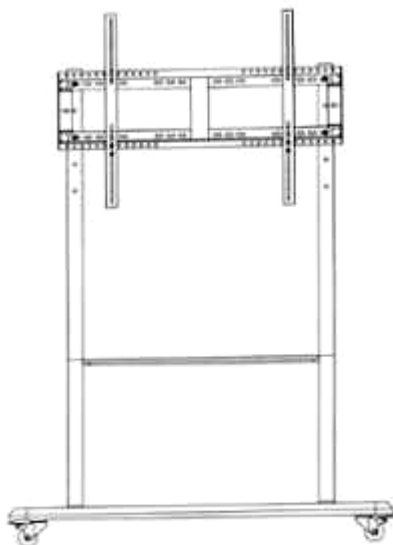

1.3

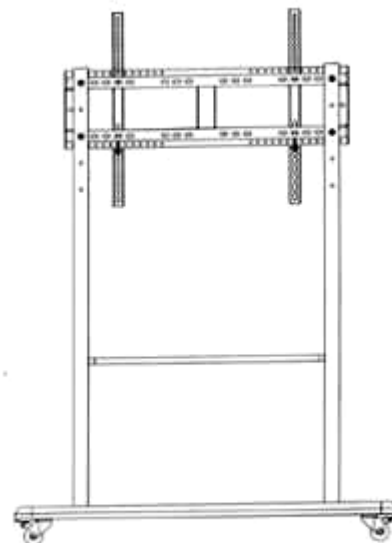

1.4



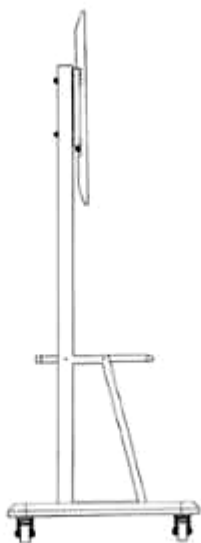

1.5



1.6

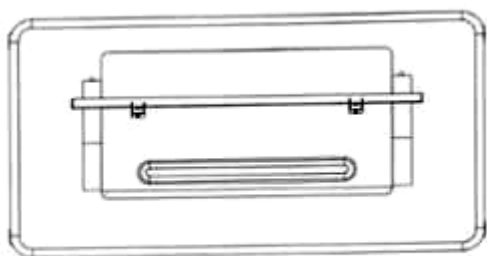

1.7

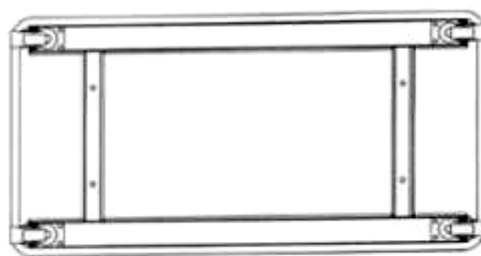

1.8

**CÔNG BÁO SỞ HỮU CÔNG NGHIỆP SỐ 413 TẬP A – QUYỀN 2 (08.2022)**

- (11) **45171**  
(21) 3-2022-00678 (28) 1  
(54) **DỤNG CỤ TRỒNG CÂY** (51) **11-02**  
(22) 13/04/2022 (43) 25/08/2022  
(73) **CÔNG TY TNHH THƯƠNG MẠI VÀ DỊCH VỤ THỊNH NGỌC LINH (VN)**  
Thôn Đường 10, xã Khánh An, huyện Yên Khánh, tỉnh Ninh Bình  
(72) Nguyễn Huy Bình (VN)  
(74) Công ty TNHH Sở hữu trí tuệ IPS Việt Nam (VIET NAM IPS INTERPRO CO., LTD)  
(55)



1.1



1.2



1.3



1.4



1.5



1.6



1.7

**CÔNG BÁO SỞ HỮU CÔNG NGHIỆP SỐ 413 TẬP A – QUYỀN 2 (08.2022)**

- (11) **45172**  
(21) 3-2022-00679 (28) 1  
(54) **THANH KIM LOẠI ĐỊNH HÌNH** (51) **25-01**  
(22) 13/04/2022 (43) 25/08/2022  
(73) **CÔNG TY CỔ PHẦN CAD GROUP (VN)**  
Số 8 ngõ 81, phố Trạm, phường Long Biên, quận Long Biên, thành phố Hà Nội  
(72) Lâm Viết An (VN)  
(74) Công ty TNHH Sở hữu trí tuệ Gia Việt (GIAVIET CO., LTD.)  
(55)

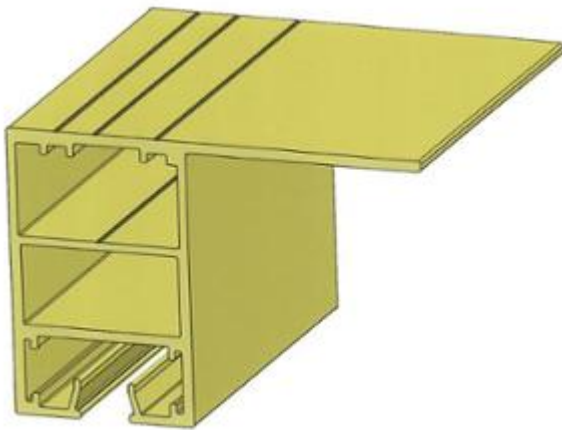

1.1

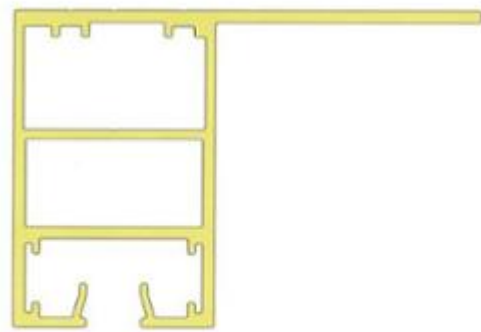

1.2

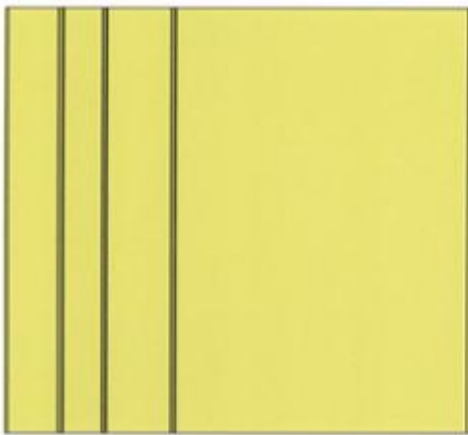

1.3



1.4

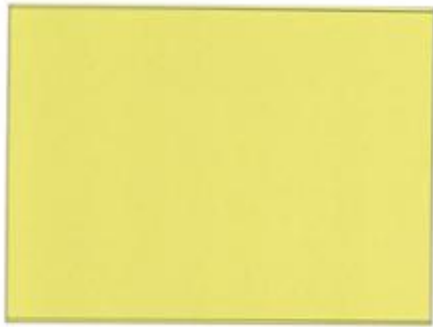

1.5

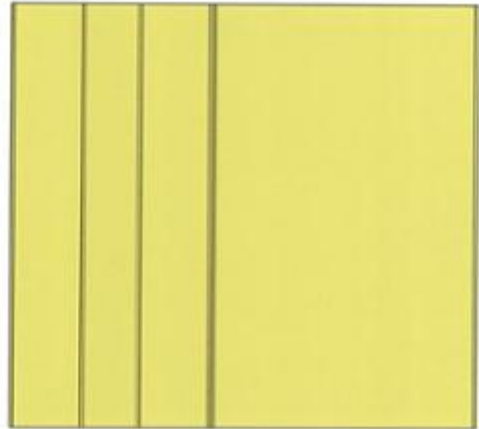

1.6

**CÔNG BÁO SỞ HỮU CÔNG NGHIỆP SỐ 413 TẬP A – QUYỀN 2 (08.2022)**

(11) **45173**

(21) 3-2022-00680

(28) 1

(54) **THANH KIM LOẠI ĐỊNH HÌNH**

(51) **25-01**

(22) 13/04/2022

(43) 25/08/2022

(73) **CÔNG TY CỔ PHẦN CAD GROUP (VN)**

Số 8 ngõ 81, phố Trạm, phường Long Biên, quận Long Biên, thành phố Hà Nội

(72) Lâm Viết An (VN)

(74) Công ty TNHH Sở hữu trí tuệ Gia Việt (GIAVIET CO., LTD.)

(55)

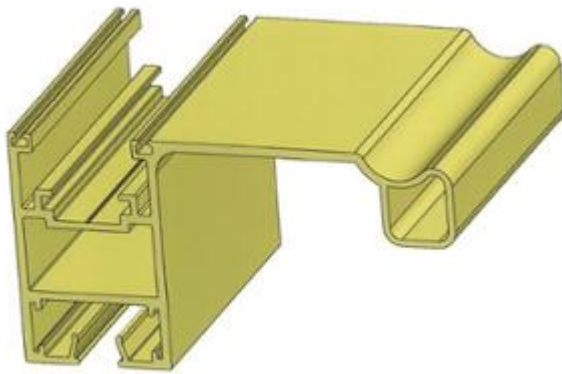

1.1

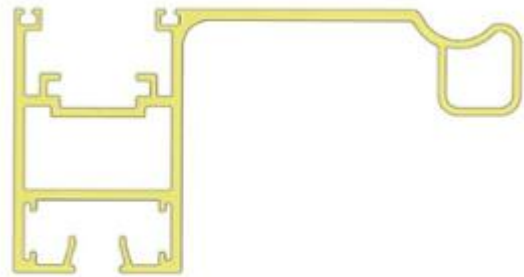

1.2



1.3

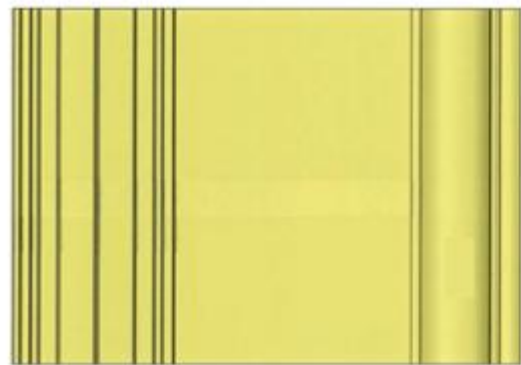

1.4



1.5



1.6

**CÔNG BÁO SỞ HỮU CÔNG NGHIỆP SỐ 413 TẬP A – QUYỀN 2 (08.2022)**

- (11) **45174**  
(21) 3-2022-00681 (28) 1  
(54) **THANH KIM LOẠI ĐỊNH HÌNH** (51) **25-01**  
(22) 13/04/2022 (43) 25/08/2022  
(73) **CÔNG TY CỔ PHẦN CAD GROUP (VN)**  
Số 8 ngõ 81, phố Trạm, phường Long Biên, quận Long Biên, thành phố Hà Nội  
(72) Lâm Viết An (VN)  
(74) Công ty TNHH Sở hữu trí tuệ Gia Việt (GIAVIET CO., LTD.)  
(55)

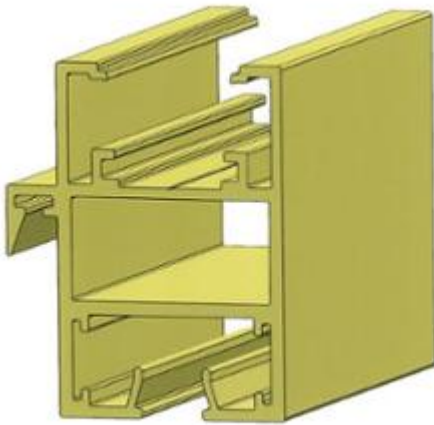

1.1

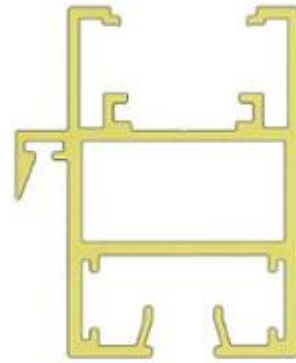

1.2



1.3



1.4



1.5

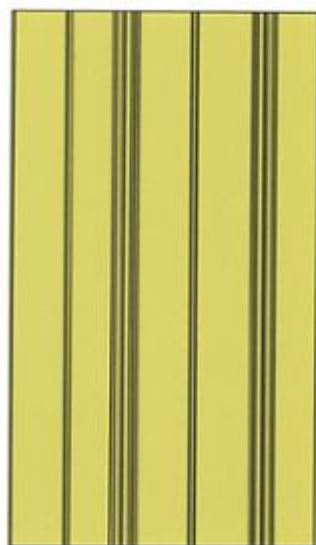

1.6



- (11) **45175**  
(21) 3-2022-00684 (28) 1  
(54) **THANH KIM LOẠI ĐỊNH HÌNH** (51) **25-01**  
(22) 13/04/2022 (43) 25/08/2022  
(73) **CÔNG TY CỔ PHẦN CAD GROUP (VN)**  
Số 8 ngõ 81, phố Trạm, phường Long Biên, quận Long Biên, thành phố Hà Nội  
(72) Lâm Viết An (VN)  
(74) Công ty TNHH Sở hữu trí tuệ Gia Việt (GIAVIET CO., LTD.)  
(55)

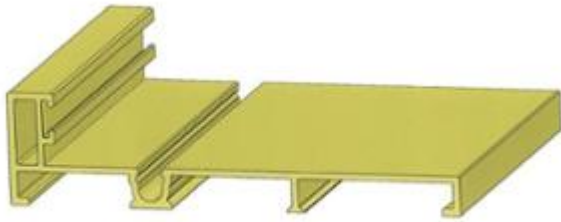

1.1

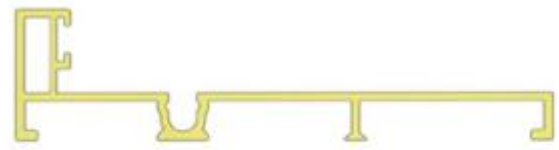

1.2

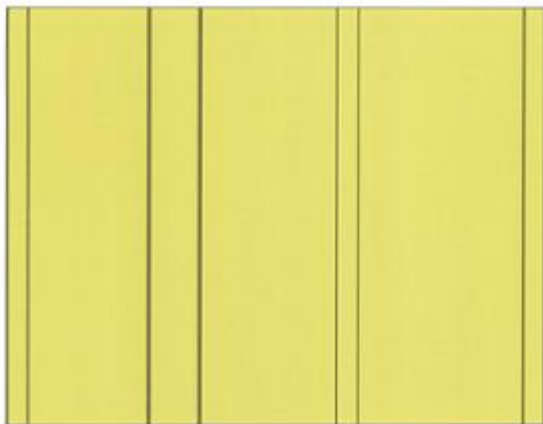

1.3



1.4



1.5



1.6

- (11) **45176**  
(21) 3-2022-00685 (28) 1  
(54) **KẾT KHÓA** (51) **06-04**  
(22) 13/04/2022 (43) 25/08/2022  
(30) 29/811,471 14/10/2021 US;  
(73) **MASTER LOCK COMPANY LLC (US)**  
6744 S. Howell Avenue, Oak Creek, Wisconsin 53154, United States of America  
(72) 1. CORNELIUS ROBERT O'ROURKE (US)  
2. ERIC DOUGLAS SANFORD (US)  
3. EVAN SPARKS (US)  
4. MONTEL CARUTHERS (US)  
5. CRIS SMYCZEK (US)  
6. KAYLI MOHELNITZKY (US)  
(74) Công ty Luật TNHH T&G (TGVN)  
(55)



1.1



1.2



1.3



1.4

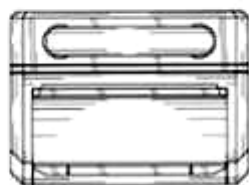

1.5

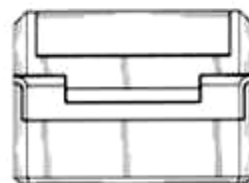

1.6

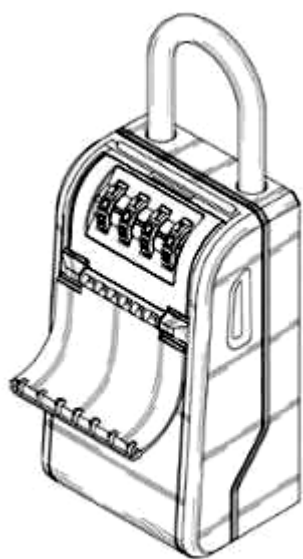

1.7

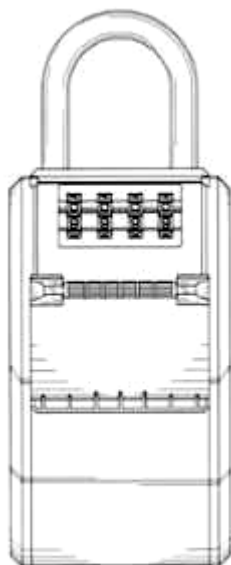

1.8



1.9

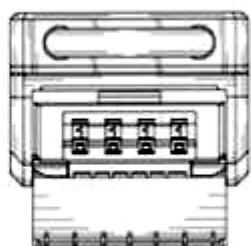

1.10



1.11

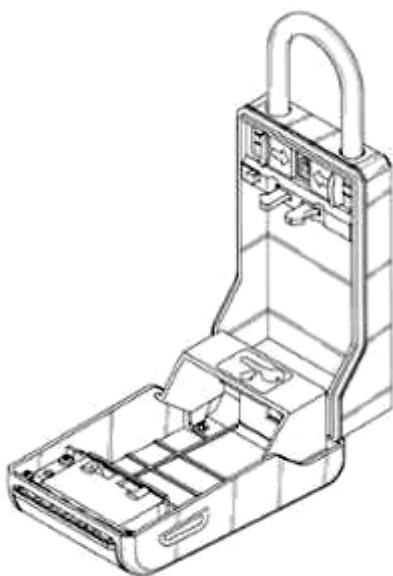

1.12

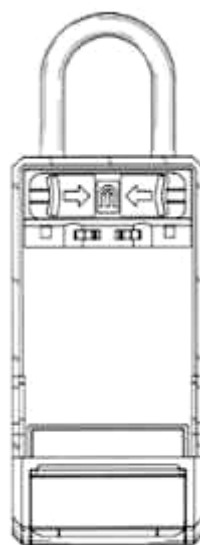

1.13



1.14

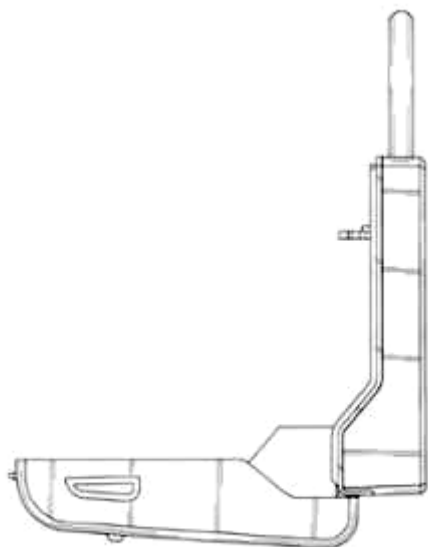

1.15

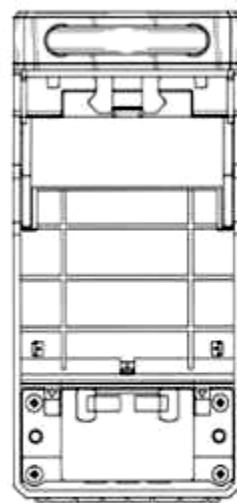

1.16

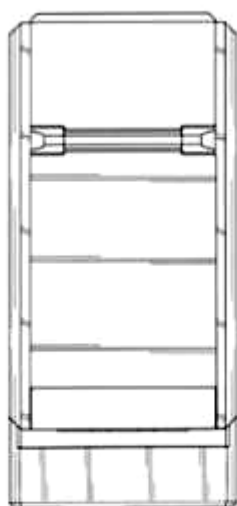

1.17

**CÔNG BÁO SỞ HỮU CÔNG NGHIỆP SỐ 413 TẬP A – QUYỀN 2 (08.2022)**

- (11) **45177**  
(21) 3-2022-00687 (28) 3  
(54) **LÒ VI SÓNG** (51) **07-02**  
(22) 13/04/2022 (43) 25/08/2022  
(73) **PANASONIC INTELLECTUAL PROPERTY MANAGEMENT CO., LTD.**  
(JP)  
1-61, Shiromi 2-chome, Chuo-ku, Osaka-shi, Osaka 540-6207 Japan  
(72) 1. HITOMI NISHIO (JP)  
2. YURINA KATAOKA (JP)  
3. NAOKI FUDETANI (JP)  
(74) Công ty TNHH một thành viên Sở hữu trí tuệ VCCI (VCCI-IP CO.,LTD)  
(55)

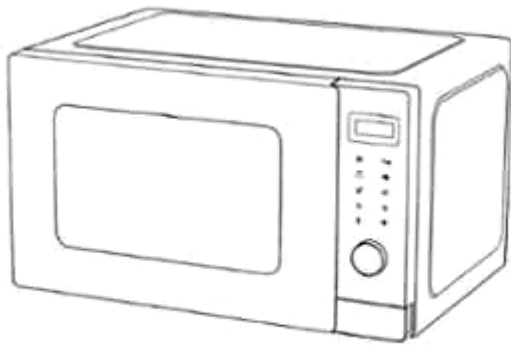

1.1

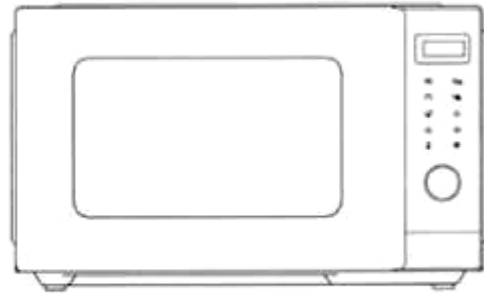

1.2

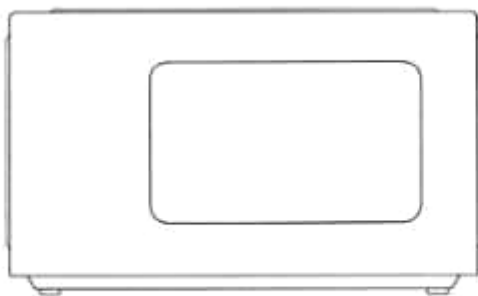

1.3

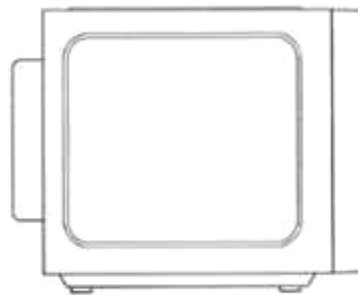

1.4

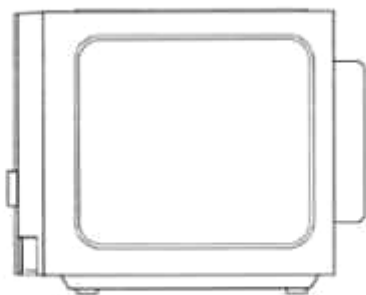

1.5

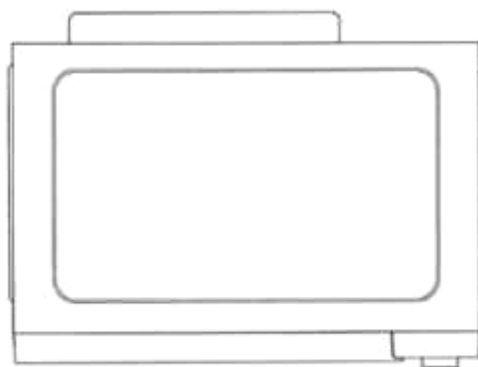

1.6

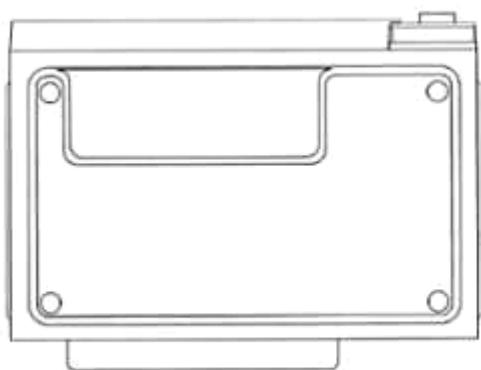

1.7

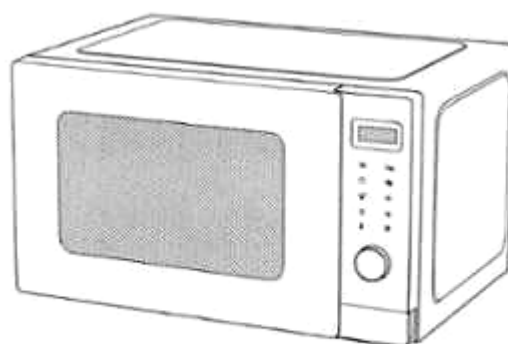

1.8

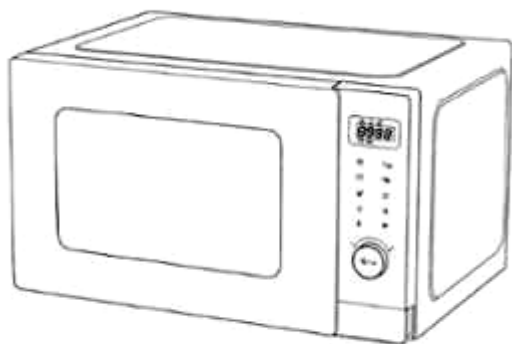

1.9



2.1

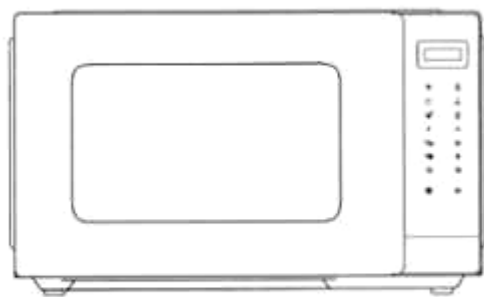

2.2

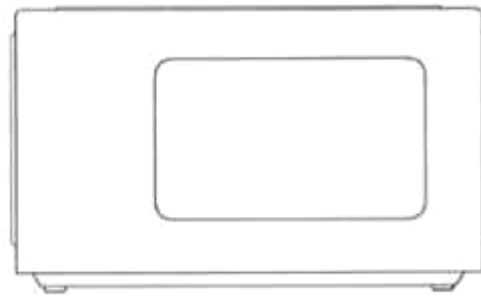

2.3

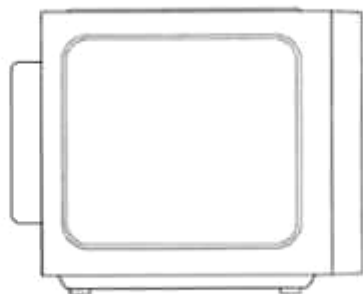

2.4

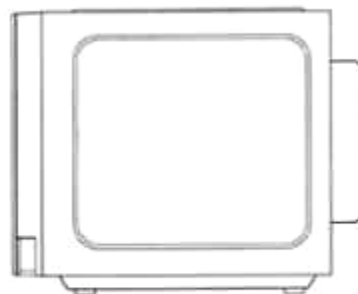

2.5

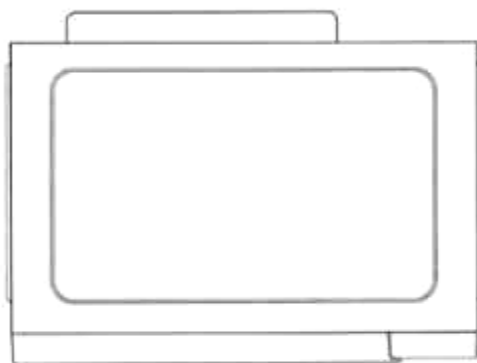

2.6

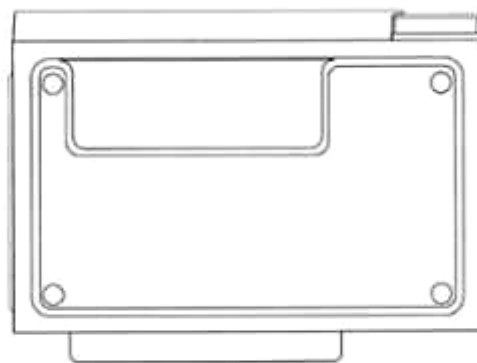

2.7



2.8



2.9

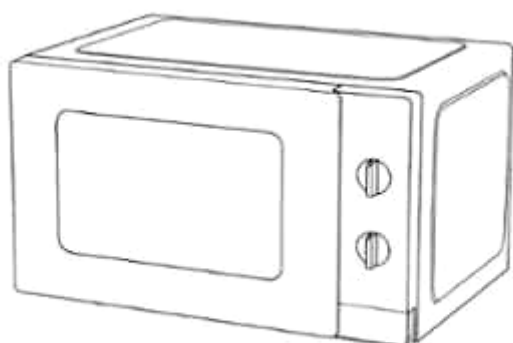

3.1

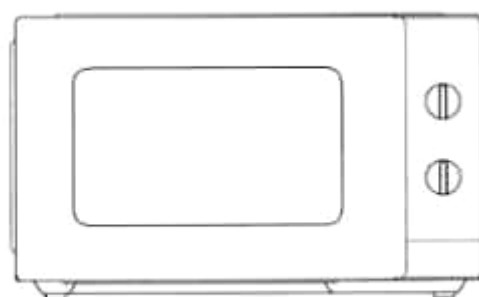

3.2

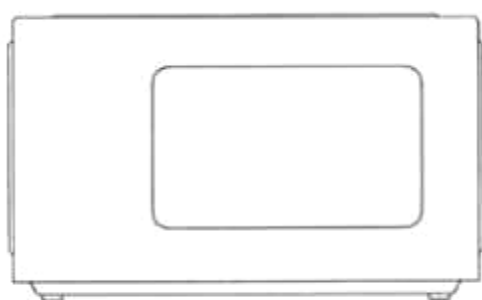

3.3

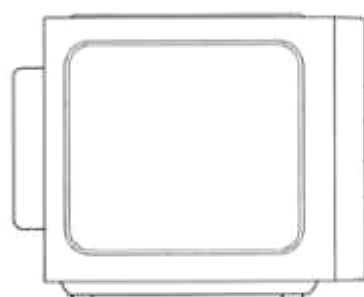

3.4



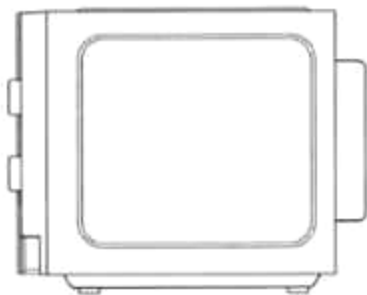

3.5

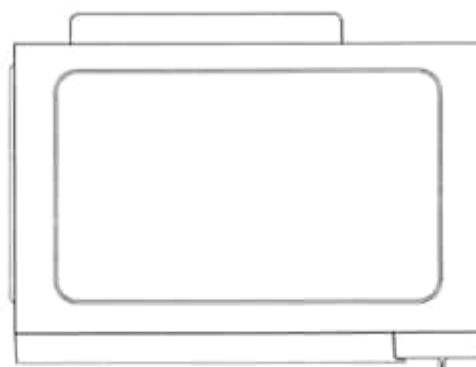

3.6

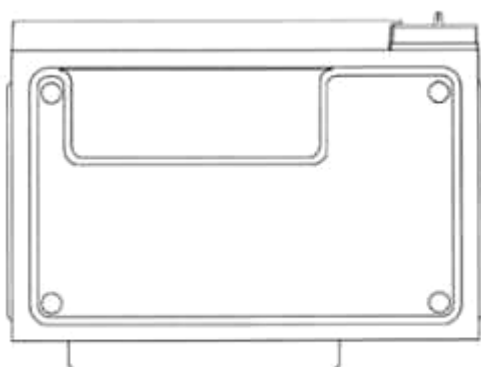

3.7

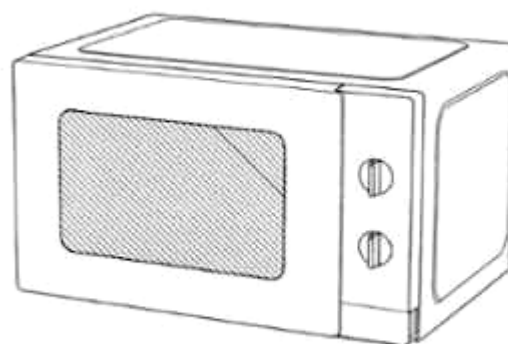

3.8

(11) **45178**

(21) 3-2022-00688

(28) 1

(54) **CẤU KIỆN RỌ BÊ TÔNG CHỐNG XÓI**

(51) **25-02**

(22) 13/04/2022

(43) 25/08/2022

(73) **CÔNG TY CỔ PHẦN KHOA HỌC CÔNG NGHỆ VIỆT NAM (VN)**

Số 6, đường 3 tháng 2, phường 8, thành phố Vũng Tàu, tỉnh Bà Rịa - Vũng Tàu

(72) Hoàng Đức Thảo (VN)

(55)

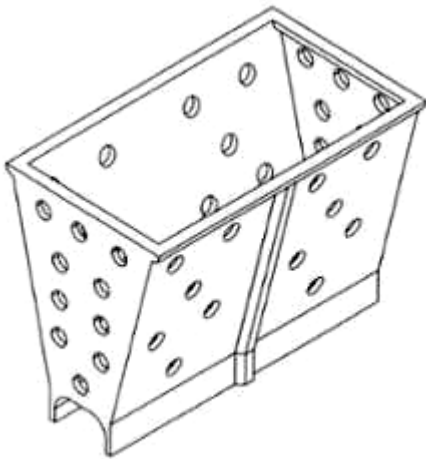

1.1

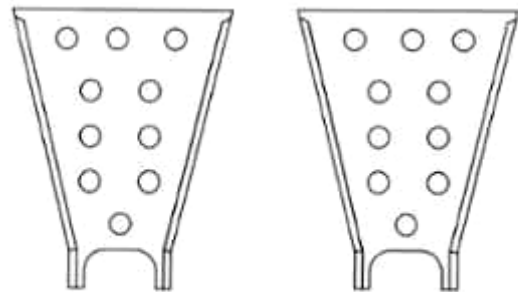

1.2

1.3

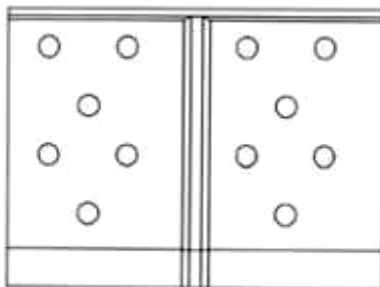

1.4

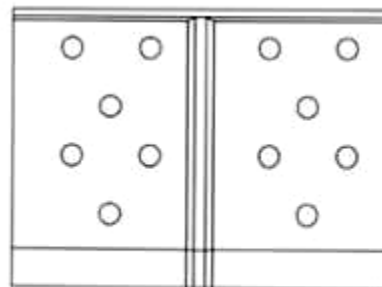

1.5

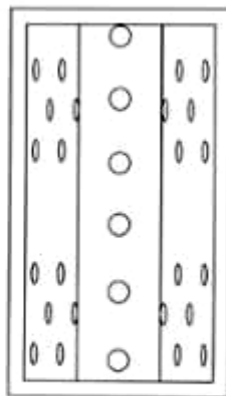

1.6

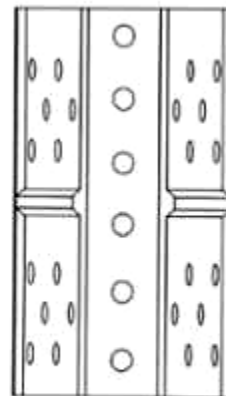

1.7

- (11) **45179**  
(21) 3-2022-00689 (28) 1  
(54) **CẤU KIỆN RỌ BÊ TÔNG CHỐNG XÓI** (51) **25-02**  
(22) 13/04/2022 (43) 25/08/2022  
(73) **CÔNG TY CỔ PHẦN KHOA HỌC CÔNG NGHỆ VIỆT NAM (VN)**  
Số 6, đường 3 tháng 2, phường 8, thành phố Vũng Tàu, tỉnh Bà Rịa - Vũng Tàu  
(72) Hoàng Đức Thảo (VN)  
(55)

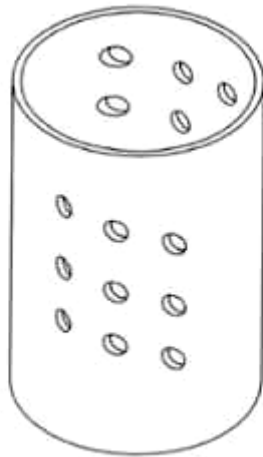

1.1

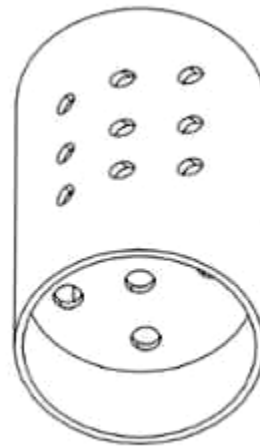

1.2

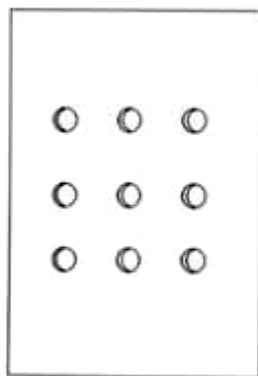

1.3

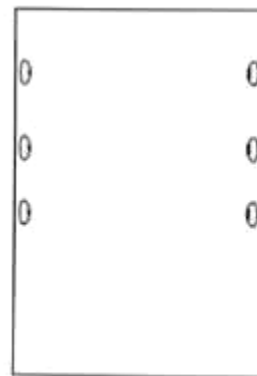

1.4

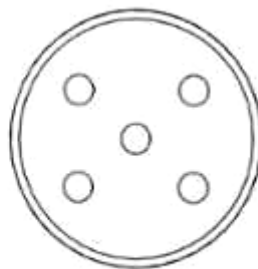

1.5

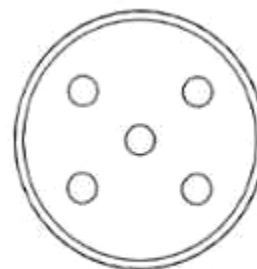

1.6

- (11) **45180**  
(21) 3-2022-00692 (28) 1  
(54) **CẤU KIỆN RỌ BÊ TÔNG CHỐNG XÓI** (51) **25-02**  
(22) 13/04/2022 (43) 25/08/2022  
(73) **CÔNG TY CỔ PHẦN KHOA HỌC CÔNG NGHỆ VIỆT NAM (VN)**  
Số 6, đường 3 tháng 2, phường 8, thành phố Vũng Tàu, tỉnh Bà Rịa - Vũng Tàu  
(72) Hoàng Đức Thảo (VN)  
(55)

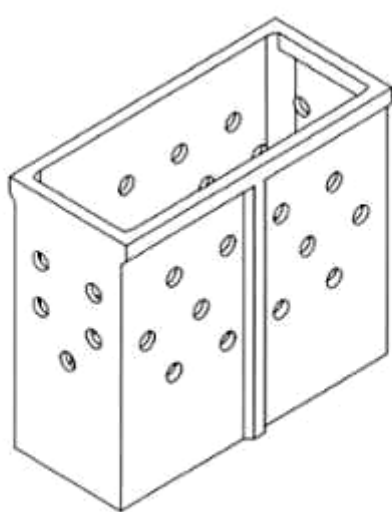

1.1

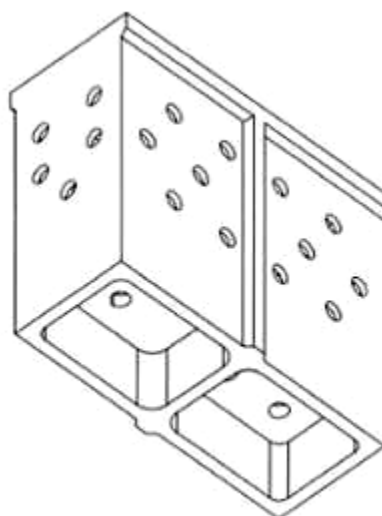

1.2

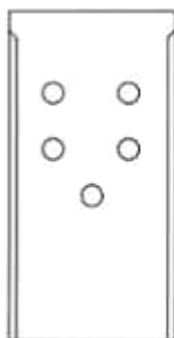

1.3

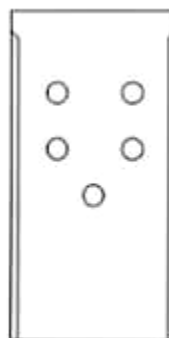

1.4

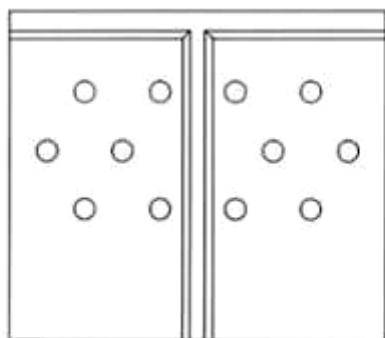

1.5

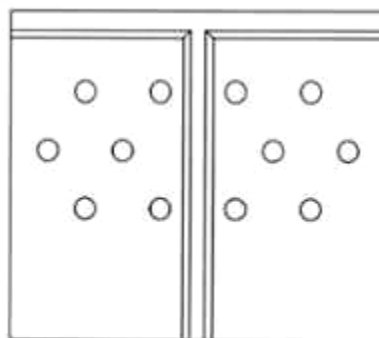

1.6

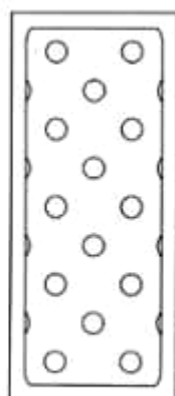

1.7

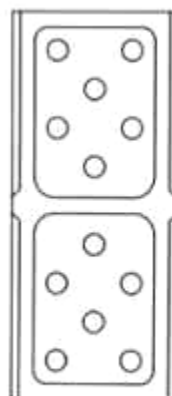

1.8

- (11) **45181**
- (21) 3-2022-00694 (28) 1
- (54) **CẤU KIỆN RỌ BÊ TÔNG CHỐNG XÓI** (51) **25-02**
- (22) 13/04/2022 (43) 25/08/2022
- (73) **CÔNG TY CỔ PHẦN KHOA HỌC CÔNG NGHỆ VIỆT NAM (VN)**  
Số 6, đường 3 tháng 2, phường 8, thành phố Vũng Tàu, tỉnh Bà Rịa - Vũng Tàu
- (72) Hoàng Đức Thảo (VN)
- (55)

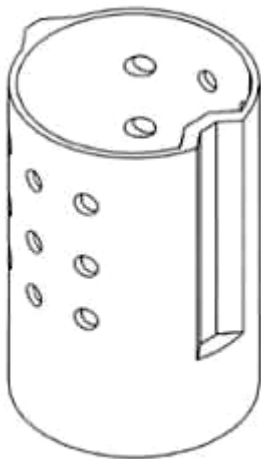

1.1

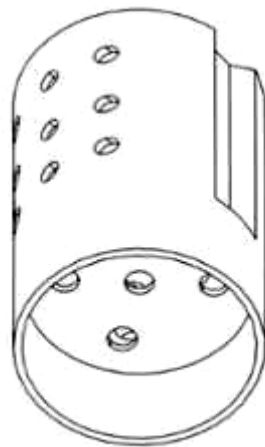

1.2

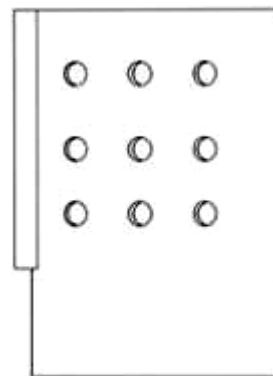

1.3

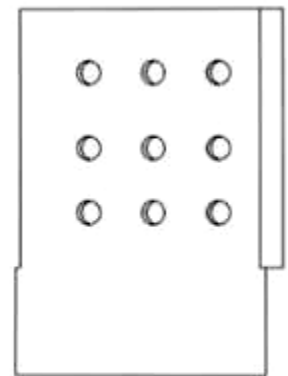

1.4

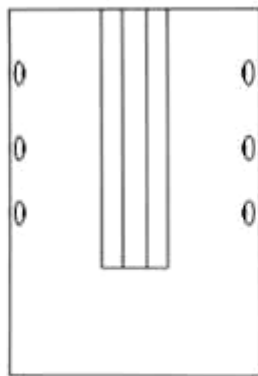

1.5

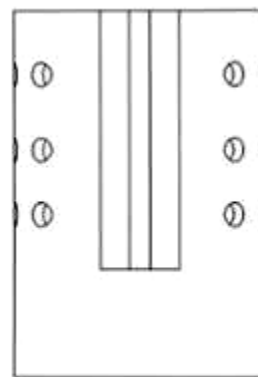

1.6

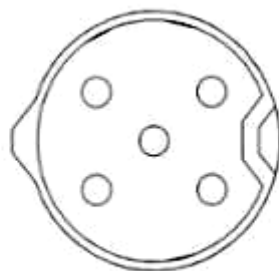

1.7

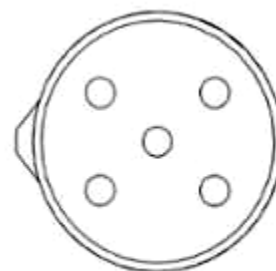

1.8

- (11) **45182**  
(21) 3-2022-00696 (28) 1  
(54) **CẤU KIỆN RỌ BÊ TÔNG CHỐNG XÓI** (51) **25-02**  
(22) 13/04/2022 (43) 25/08/2022  
(73) **CÔNG TY CỔ PHẦN KHOA HỌC CÔNG NGHỆ VIỆT NAM (VN)**  
Số 6, đường 3 tháng 2, phường 8, thành phố Vũng Tàu, tỉnh Bà Rịa - Vũng Tàu  
(72) Hoàng Đức Thảo (VN)  
(55)

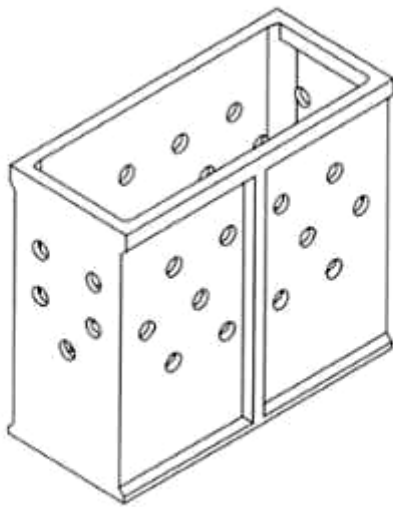

1.1

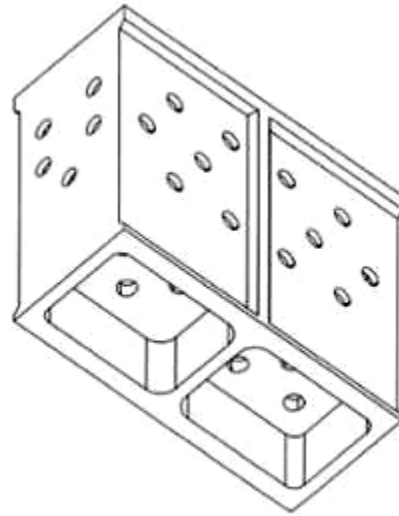

1.2

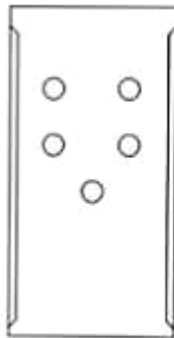

1.3

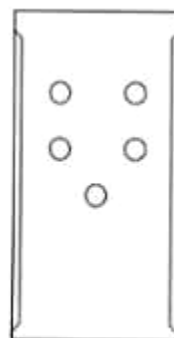

1.4

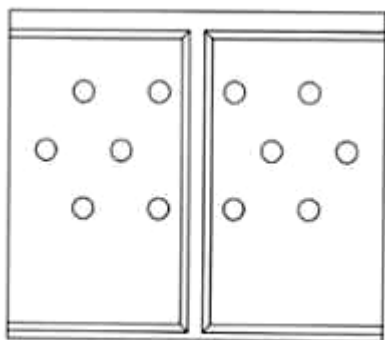

1.5

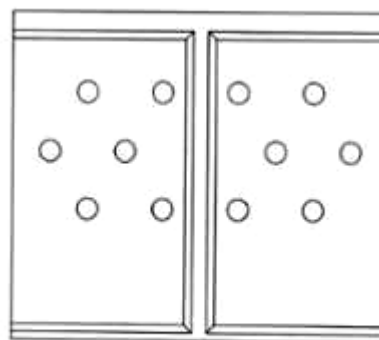

1.6

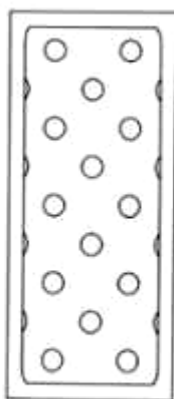

1.7

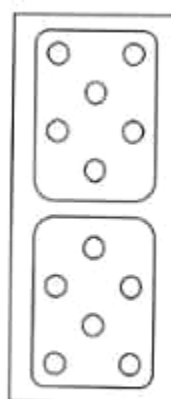

1.8



- (11) **45183**  
(21) 3-2022-00699 (28) 1  
(54) **CHÓT CÁI CỦA KHÓA** (51) **02-07**  
(22) 13/04/2022 (43) 25/08/2022  
(30) 30-2021-0049856 21/10/2021 KR;  
(73) **WOJIN PLASTIC CO., LTD (KR)**  
45, Paryasandan-ro, Jinjeop-eup, Namyangju-si, Gyeonggi-do 12017 Republic of Korea  
(72) 1. JISOOK PAIK (KR)  
2. NAN HEE PAIK (KR)  
3. JI HYE PAIK (KR)  
4. JI WON SON (KR)  
(74) Công ty TNHH Trường Xuân (AGELESS CO.,LTD.)  
(55)

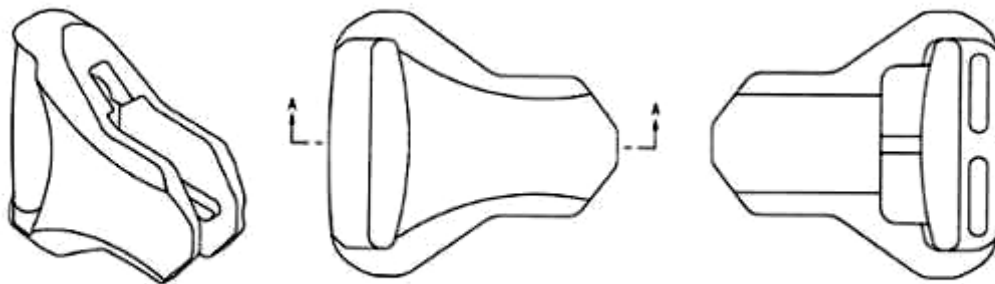

1.1

1.2

1.3



1.4

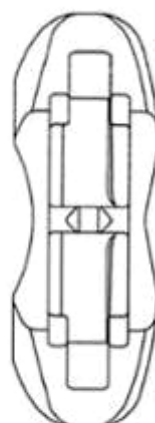

1.5

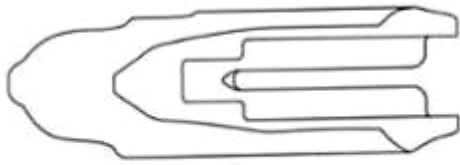

1.6

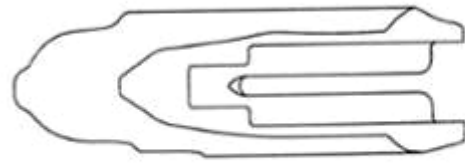

1.7

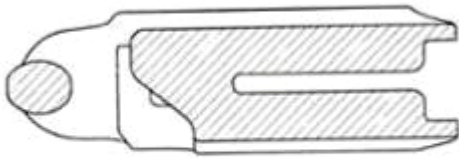

1.8

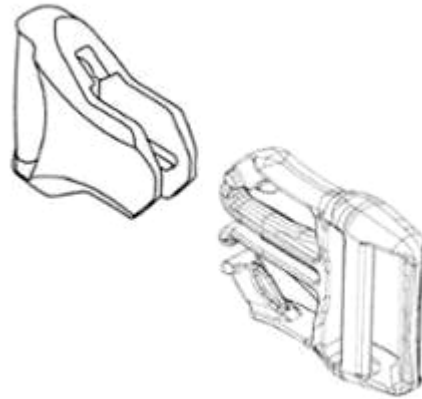

1.9

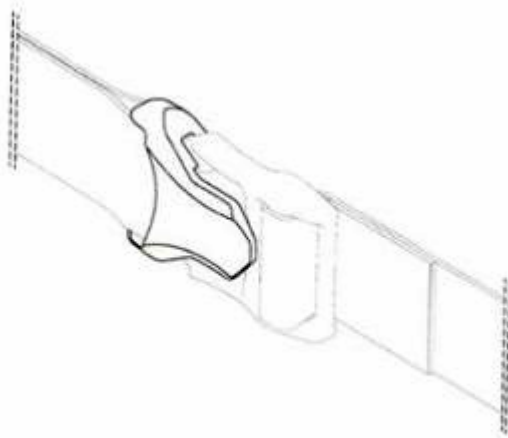

1.10

**CÔNG BÁO SỞ HỮU CÔNG NGHIỆP SỐ 413 TẬP A – QUYỀN 2 (08.2022)**

- (11) **45184**  
(21) 3-2022-00735 (28) 1  
(54) **THANH KIM LOẠI ĐỊNH HÌNH** (51) **25-01**  
(22) 14/04/2022 (43) 25/08/2022  
(73) **CÔNG TY CỔ PHẦN KENWIN (VN)**  
Tầng 4 tòa nhà VG Building, số 235 đường Nguyễn Trãi, phường Thanh Xuân  
Trung, quận Thanh Xuân, thành phố Hà Nội  
(72) Ngô Thọ Long (VN)  
(74) Công ty TNHH Sở hữu trí tuệ PADEMARK (PADEMARK CO.,LTD.)  
(55)



1.1



1.2



1.3

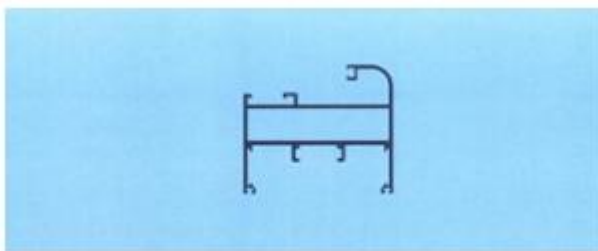

1.4

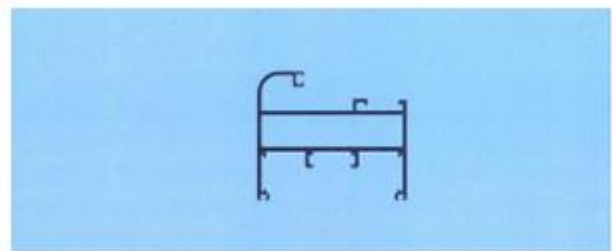

1.5



1.6

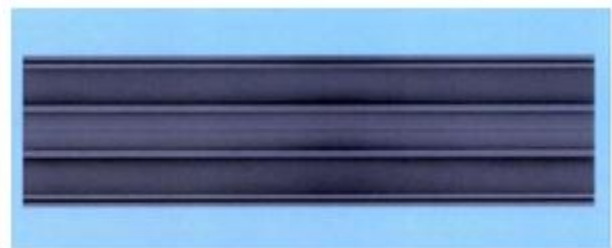

1.7

**CÔNG BÁO SỞ HỮU CÔNG NGHIỆP SỐ 413 TẬP A – QUYỀN 2 (08.2022)**

- (11) **45185**  
(21) 3-2022-00736 (28) 1  
(54) **THANH KIM LOẠI ĐỊNH HÌNH** (51) **25-01**  
(22) 14/04/2022 (43) 25/08/2022  
(73) **CÔNG TY CỔ PHẦN KENWIN (VN)**  
Tầng 4 tòa nhà VG Building, số 235 đường Nguyễn Trãi, phường Thanh Xuân  
Trung, quận Thanh Xuân, thành phố Hà Nội  
(72) Ngô Thọ Long (VN)  
(74) Công ty TNHH Sở hữu trí tuệ PADEMARK (PADEMARK CO.,LTD.)  
(55)



1.1

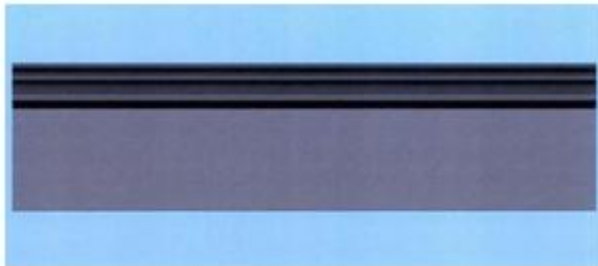

1.2



1.3

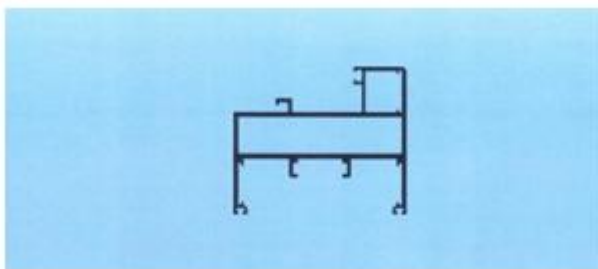

1.4

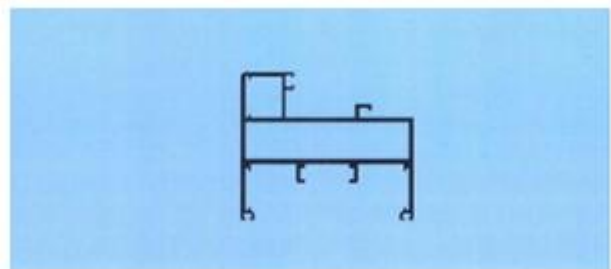

1.5



1.6



1.7

**CÔNG BÁO SỞ HỮU CÔNG NGHIỆP SỐ 413 TẬP A – QUYỀN 2 (08.2022)**

- (11) **45186**  
(21) 3-2022-00737 (28) 1  
(54) **THANH KIM LOẠI ĐỊNH HÌNH** (51) **25-01**  
(22) 14/04/2022 (43) 25/08/2022  
(73) **CÔNG TY CỔ PHẦN KENWIN (VN)**  
Tầng 4 tòa nhà VG Building, số 235 đường Nguyễn Trãi, phường Thanh Xuân  
Trung, quận Thanh Xuân, thành phố Hà Nội  
(72) Ngô Thọ Long (VN)  
(74) Công ty TNHH Sở hữu trí tuệ PADEMARK (PADEMARK CO.,LTD.)  
(55)



1.1



1.2

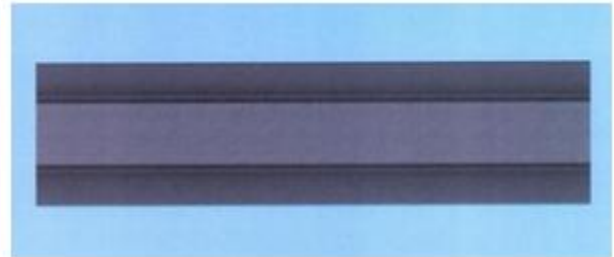

1.3

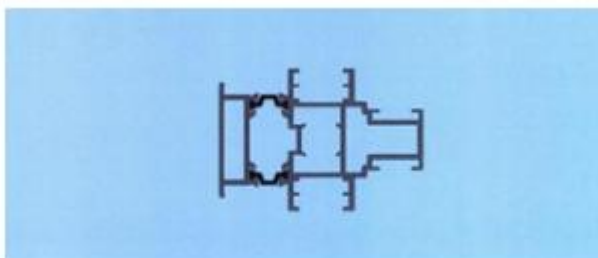

1.4

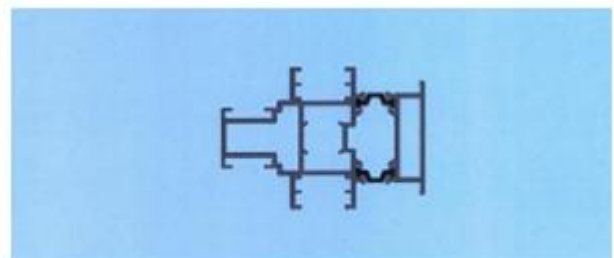

1.5



1.6



1.7

**CÔNG BÁO SỞ HỮU CÔNG NGHIỆP SỐ 413 TẬP A – QUYỀN 2 (08.2022)**

- (11) **45187**  
(21) 3-2022-00738 (28) 1  
(54) **THANH KIM LOẠI ĐỊNH HÌNH** (51) **25-01**  
(22) 14/04/2022 (43) 25/08/2022  
(73) **CÔNG TY CỔ PHẦN KENWIN (VN)**  
Tầng 4 tòa nhà VG Building, số 235 đường Nguyễn Trãi, phường Thanh Xuân  
Trung, quận Thanh Xuân, thành phố Hà Nội  
(72) Ngô Thọ Long (VN)  
(74) Công ty TNHH Sở hữu trí tuệ PADEMARK (PADEMARK CO.,LTD.)  
(55)



1.1



1.2



1.3

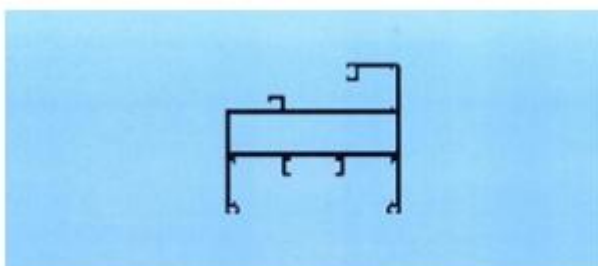

1.4

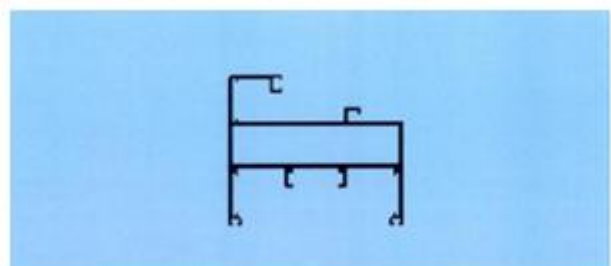

1.5



1.6

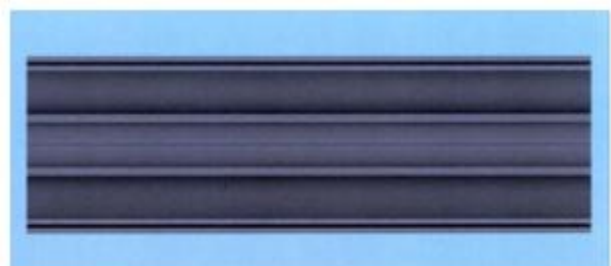

1.7



**CÔNG BÁO SỞ HỮU CÔNG NGHIỆP SỐ 413 TẬP A – QUYỀN 2 (08.2022)**

- (11) **45188**  
(21) 3-2022-00739 (28) 1  
(54) **THANH KIM LOẠI ĐỊNH HÌNH** (51) **25-01**  
(22) 14/04/2022 (43) 25/08/2022  
(73) **CÔNG TY CỔ PHẦN KENWIN (VN)**  
Tầng 4 tòa nhà VG Building, số 235 đường Nguyễn Trãi, phường Thanh Xuân  
Trung, quận Thanh Xuân, thành phố Hà Nội  
(72) Ngô Thọ Long (VN)  
(74) Công ty TNHH Sở hữu trí tuệ PADEMARK (PADEMARK CO.,LTD.)  
(55)



1.1

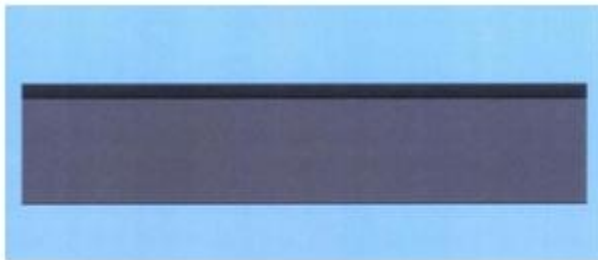

1.2



1.3

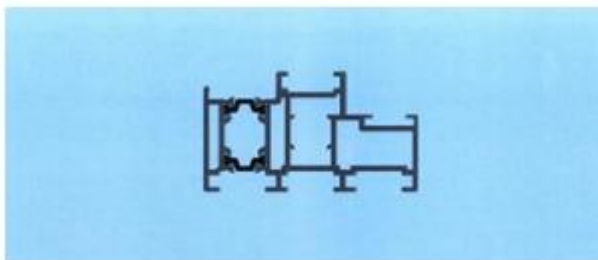

1.4

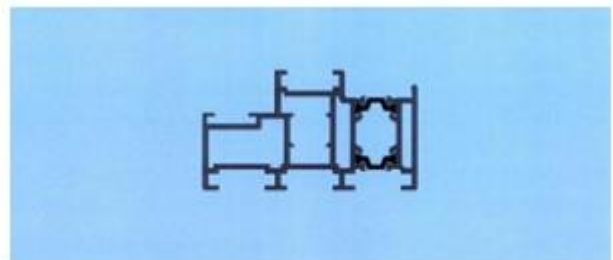

1.5



1.6



1.7

**CÔNG BÁO SỞ HỮU CÔNG NGHIỆP SỐ 413 TẬP A – QUYỀN 2 (08.2022)**

- (11) **45189**  
(21) 3-2022-00740 (28) 1  
(54) **THANH KIM LOẠI ĐỊNH HÌNH** (51) **25-01**  
(22) 14/04/2022 (43) 25/08/2022  
(73) **CÔNG TY CỔ PHẦN KENWIN (VN)**  
Tầng 4 tòa nhà VG Building, số 235 đường Nguyễn Trãi, phường Thanh Xuân  
Trung, quận Thanh Xuân, thành phố Hà Nội  
(72) Ngô Thọ Long (VN)  
(74) Công ty TNHH Sở hữu trí tuệ PADEMARK (PADEMARK CO.,LTD.)  
(55)



1.1



1.2



1.3

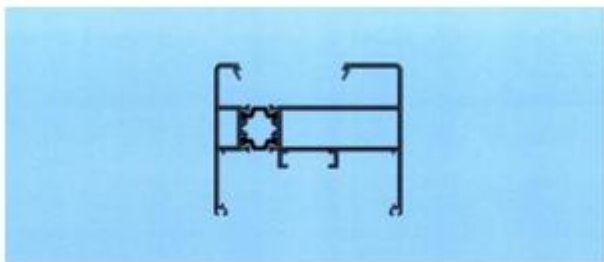

1.4

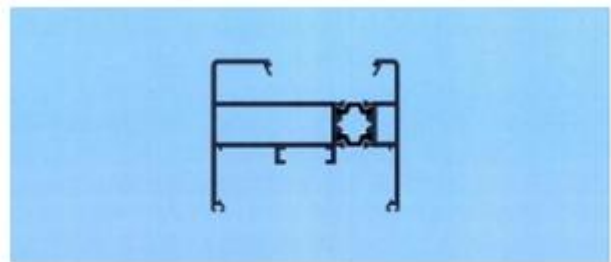

1.5



1.6



1.7



**CÔNG BÁO SỞ HỮU CÔNG NGHIỆP SỐ 413 TẬP A – QUYỀN 2 (08.2022)**

(11) **45190**

(21) 3-2022-00742

(28) 1

(54) **GẠCH**

(51) **25-01**

(22) 15/04/2022

(43) 25/08/2022

(73) **HÀ NGỌC TUÂN (VN)**

Tổ 1, thị trấn Chi Đông, huyện Mê Linh, thành phố Hà Nội

(72) Hà Ngọc Tuân (VN)

(74) Công ty Luật TNHH ELITE (ELITE LAW FIRM)

(55)

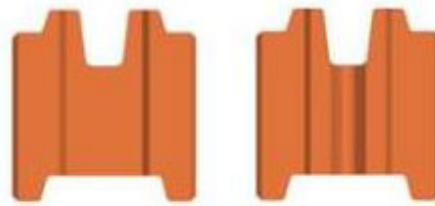

1.1

1.2

1.3



1.4

1.5

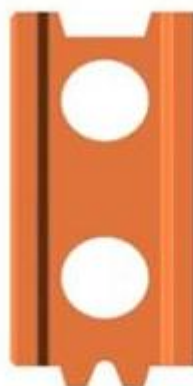
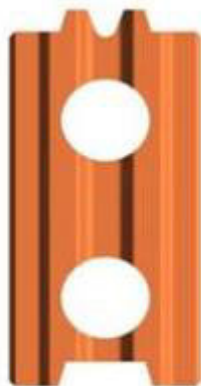

1.6

1.7

**CÔNG BÁO SỞ HỮU CÔNG NGHIỆP SỐ 413 TẬP A – QUYỀN 2 (08.2022)**

- (11) **45191**  
(21) 3-2022-00743 (28) 1  
(54) **GẠCH** (51) **25-01**  
(22) 15/04/2022 (43) 25/08/2022  
(73) **HÀ NGỌC TUÂN (VN)**  
Tổ 1, thị trấn Chi Đông, huyện Mê Linh, thành phố Hà Nội  
(72) Hà Ngọc Tuân (VN)  
(74) Công ty Luật TNHH ELITE (ELITE LAW FIRM)  
(55)



1.1



1.2



1.3



1.4



1.5

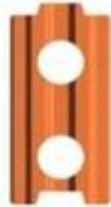

1.6



1.7

**CÔNG BÁO SỞ HỮU CÔNG NGHIỆP SỐ 413 TẬP A – QUYỀN 2 (08.2022)**

- (11) **45192**  
(21) 3-2022-00744 (28) 1  
(54) **GẠCH** (51) **25-01**  
(22) 15/04/2022 (43) 25/08/2022  
(73) **HÀ NGỌC TUÂN (VN)**  
Tổ 1, thị trấn Chi Đông, huyện Mê Linh, thành phố Hà Nội  
(72) Hà Ngọc Tuân (VN)  
(74) Công ty Luật TNHH ELITE (ELITE LAW FIRM)  
(55)

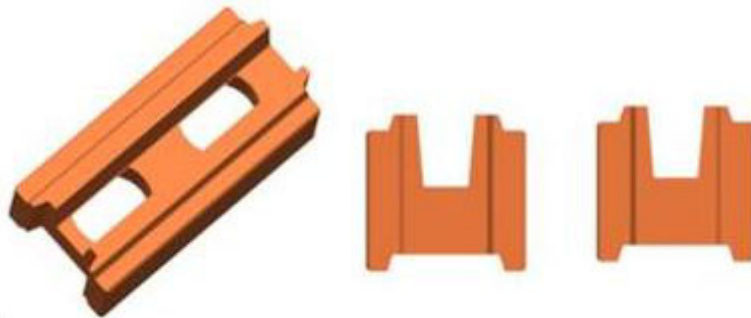

1.1

1.2

1.3

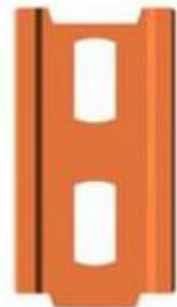
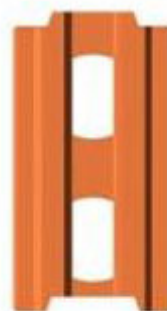
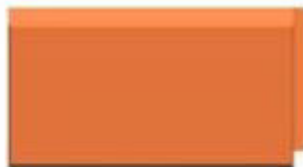

1.4

1.5

1.6

1.7

**CÔNG BÁO SỞ HỮU CÔNG NGHIỆP SỐ 413 TẬP A – QUYỀN 2 (08.2022)**

- (11) **45193**  
(21) 3-2022-00748 (28) 1  
(54) **CƠ CẤU ĐÓNG CỬA** (51) **08-06**  
(22) 15/04/2022 (43) 25/08/2022  
(73) **ĐÀO THỦY TIÊN (VN)**  
Số 11 ngõ Trung Yên, phường Hàng Bạc, quận Hoàn Kiếm, thành phố Hà Nội  
(72) Đào Thủy Tiên (VN)  
(74) Công ty TNHH Sở hữu trí tuệ Hải Hân (HAI HAN IP CO., LTD.)  
(55)



1.1



1.2



1.3



1.4



1.5



1.6



1.7

- (11) **45194**
- (21) 3-2022-00750 (28) 1
- (54) **LỖ LỌC CHO THIẾT BỊ LỌC KHÍ BẰNG XÚC TÁC QUANG** (51) **23-04**
- (22) 15/04/2022 (43) 25/08/2022
- (30) 2022-004837 09/03/2022 JP;
- (73) **TOYOKOSHO CO., LTD. (JP)**  
2-60-10, Nihonbashi-Hamacho, Chuo-ku, Tokyo 1030007, Japan
- (72) IKUTA Hiromi (JP)
- (74) Văn phòng Luật sư MINERVAS (MINERVAS)
- (55)

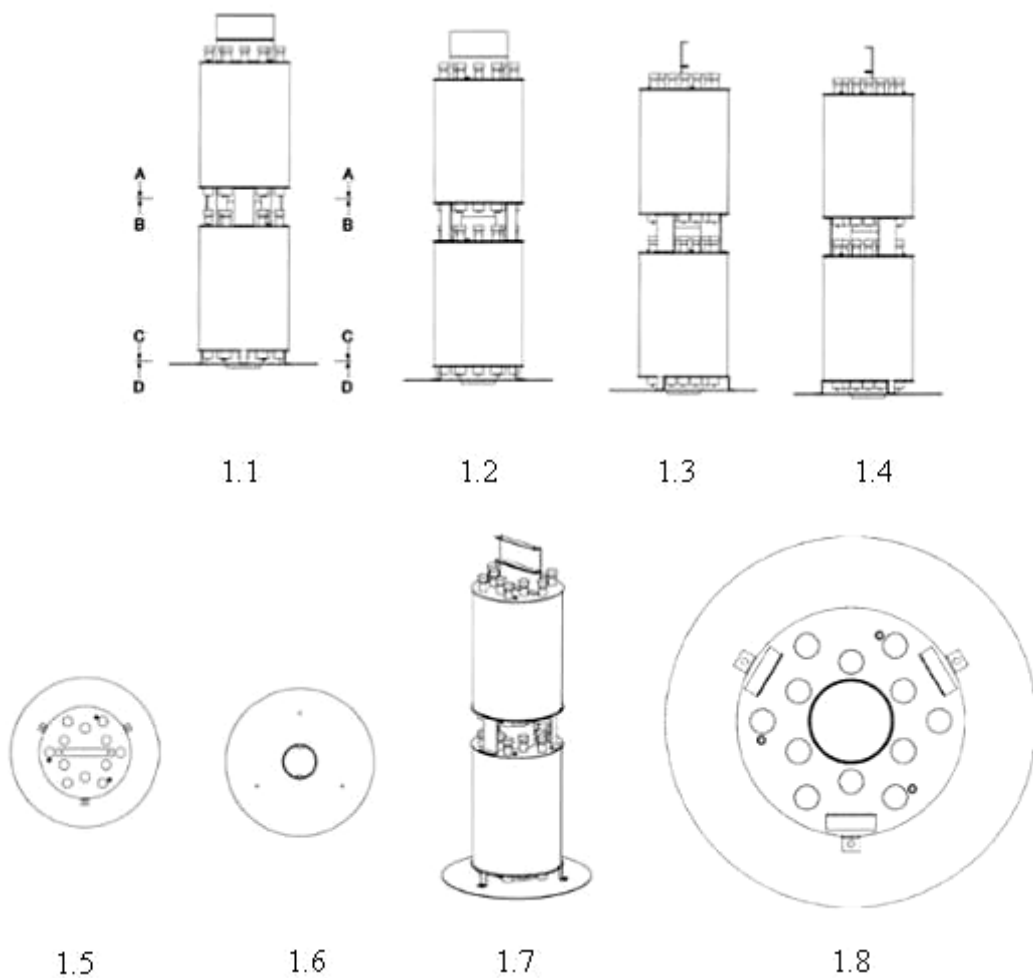



1.9



1.10

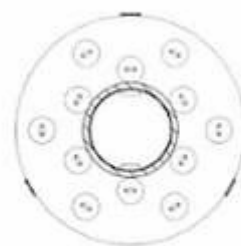

1.11



1.12

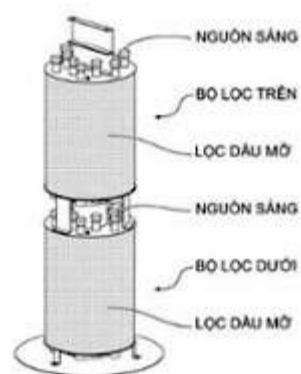

1.13

- (11) **45195**  
(21) 3-2022-00753 (28) 1  
(54) **VẬT CHỨA CHẤT DỄ BAY HƠI** (51) **22-06**  
(22) 18/04/2022 (43) 25/08/2022  
(30) 2021-022834 20/10/2021 JP;  
(73) **EARTH CORPORATION (JP)**  
12-1, Kanda-tsukasamachi 2-chome, Chiyoda-ku, Tokyo, Japan  
(72) 1. EMI HIRATSUKA (JP)  
2. MIKIHICO ATARASHI (JP)  
3. YUYA SUZUKI (JP)  
(74) Công ty Cổ phần Sở hữu công nghiệp INVESTIP (INVESTIP)  
(55)

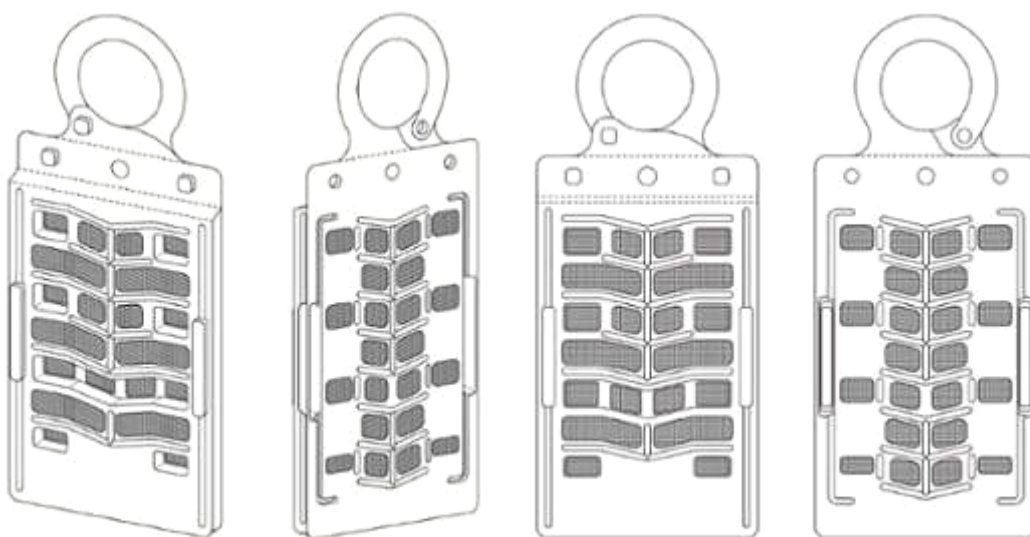

1.1

1.2

1.3

1.4



1.5

1.6

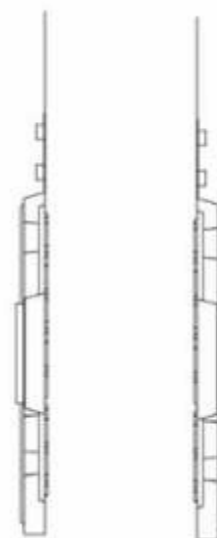

1.7

1.8



**CÔNG BÁO SỞ HỮU CÔNG NGHIỆP SỐ 413 TẬP A – QUYỀN 2 (08.2022)**

- (11) **45196**  
(21) 3-2022-00763 (28) 1  
(54) **ĐẦU NỐI VÔ TUYẾN** (51) **13-03**  
(22) 19/04/2022 (43) 25/08/2022  
(30) 30-2021-0051691 01/11/2021 KR;  
(73) **GIGALANE CO., LTD.** (KR)  
61, Dongtansandan 10-gil, Dongtan-myeon, Hwaseong-si, Gyeonggi-do, 18487,  
Republic of Korea  
(72) 1. JUNG KYUNG-HUN (KR)  
2. SONG HWA-YOON (KR)  
3. JUNG HEE-SEOK (KR)  
(74) Công ty TNHH Tâm nhìn và Liên danh (VISION & ASSOCIATES CO.LTD.)  
(55)

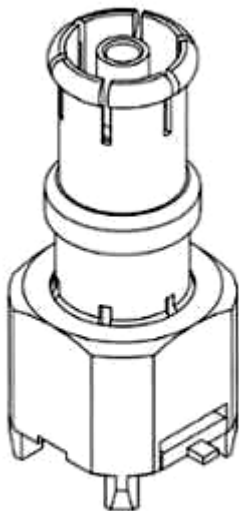

1.1

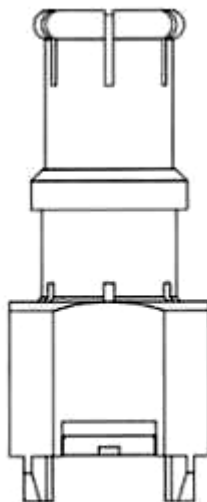

1.2

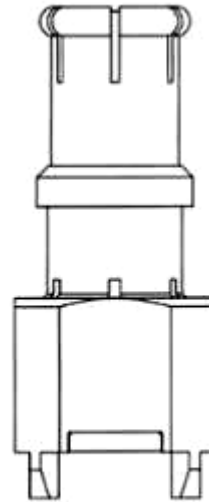

1.3

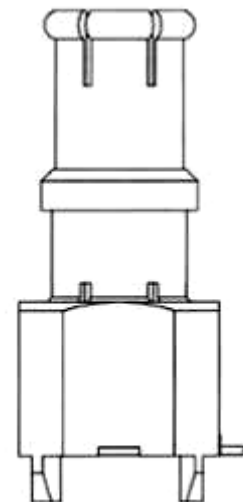

1.4

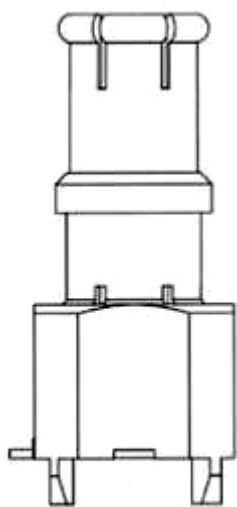

1.5

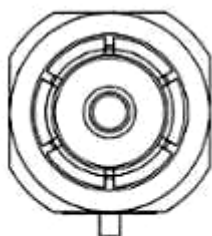

1.6



1.7

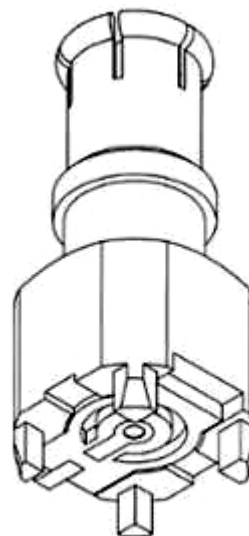

1.8

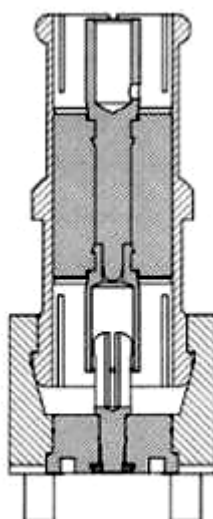

1.9

- (11) **45197**  
(21) 3-2022-00764 (28) 1  
(54) **ĐẦU NỐI VỎ TUYẾN** (51) **13-03**  
(22) 19/04/2022 (43) 25/08/2022  
(73) **GIGALANE CO., LTD. (KR)**  
61, Dongtansandan 10-gil, Dongtan-myeon, Hwaseong-si, Gyeonggi-do, 18487,  
Republic of Korea  
(72) 1. JUNG KYUNG-HUN (KR)  
2. SONG HWA-YOON (KR)  
3. JUNG HEE-SEOK (KR)  
(74) Công ty TNHH Tầm nhìn và Liên danh (VISION & ASSOCIATES CO.LTD.)  
(55)

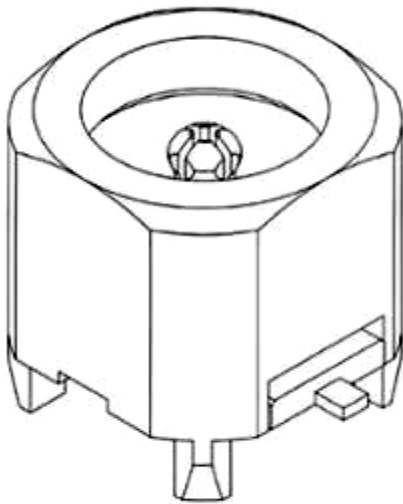

1.1

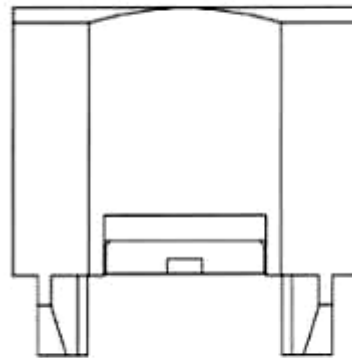

1.2

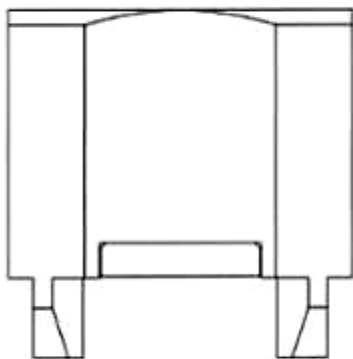

1.3

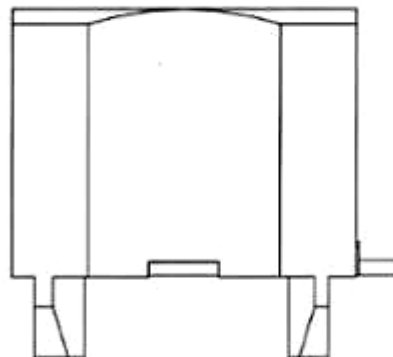

1.4

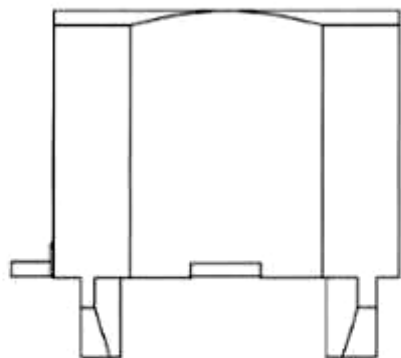

1.5

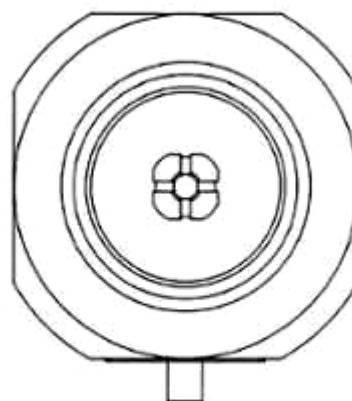

1.6

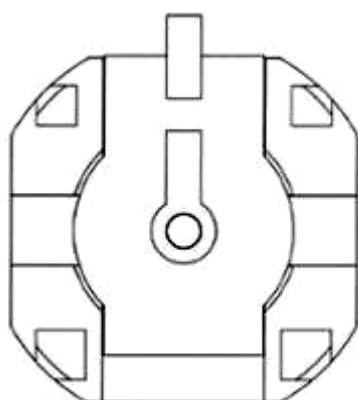

1.7

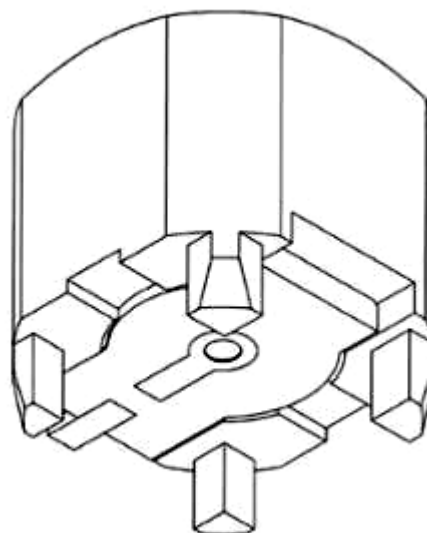

1.8

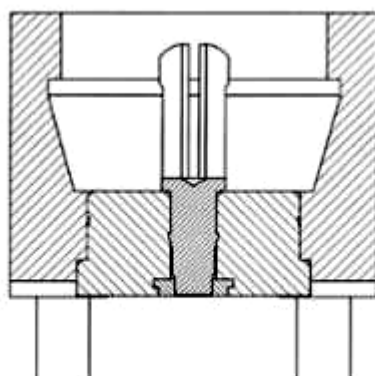

1.9

- (11) **45198**  
(21) 3-2022-00771 (28) 1  
(54) **CHỐT CÁI CỦA KHÓA** (51) **02-07**  
(22) 20/04/2022 (43) 25/08/2022  
(30) 30-2021-0051024 28/10/2021 KR;  
(73) **WOJIN PLASTIC CO., Ltd.** (KR)  
45, Paryasandan-ro, Jinjeop-eup, Namyangju-si, Gyeonggi-do 12017 Republic of Korea  
(72) 1. JISOOK PAIK (KR)  
2. NAN HEE PAIK (KR)  
3. JI HYE PAIK (KR)  
4. JI WON SON (KR)  
(74) Công ty TNHH Trường Xuân (AGELESS CO.,LTD.)  
(55)

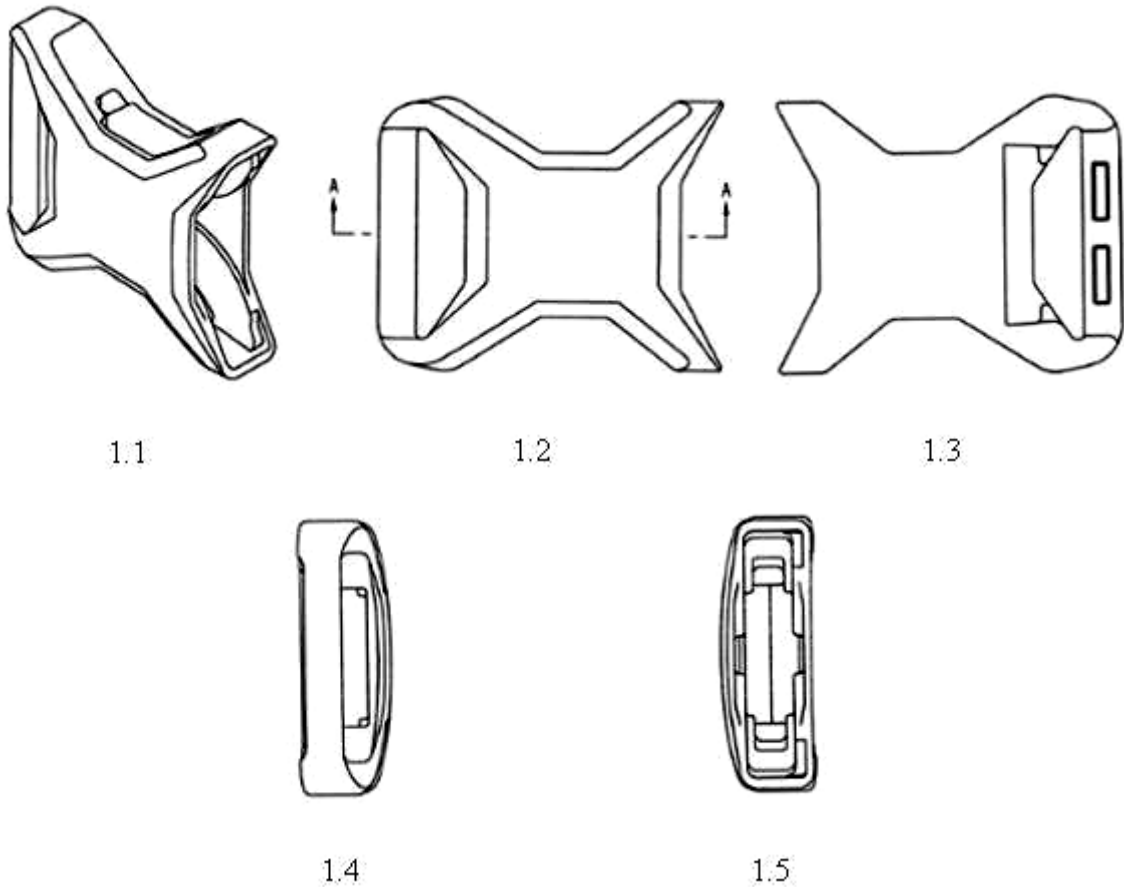

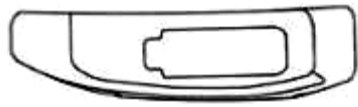

1.6

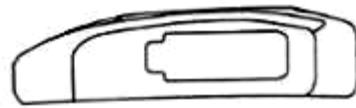

1.7

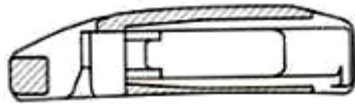

1.8

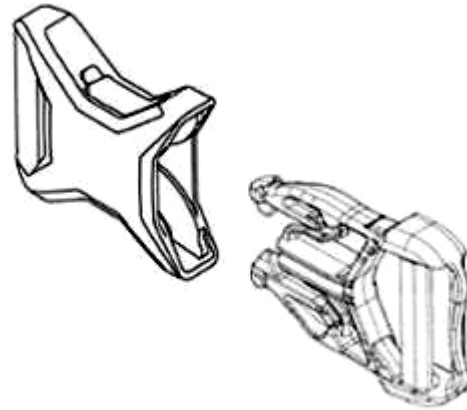

1.9

**CÔNG BÁO SỞ HỮU CÔNG NGHIỆP SỐ 413 TẬP A – QUYỀN 2 (08.2022)**

(11) **45199**

(21) 3-2022-00775

(28) 1

(54) **GHẾ**

(51) **06-01**

(22) 21/04/2022

(43) 25/08/2022

(73) **CÔNG TY TNHH KIẾN TRÚC NIWA (VN)**

Tầng 9, số 7, ngõ Chùa Nền, đường Láng, phường Láng Thượng, quận Đống Đa, thành phố Hà Nội

(72) NIWA TAKASHI (JP)

(74) Công ty Luật TNHH MINH KHUÊ (MK LAW FIRM)

(55)



1.1



1.2



1.3



1.4



1.5



1.6



1.7



**CÔNG BÁO SỞ HỮU CÔNG NGHIỆP SỐ 413 TẬP A – QUYỂN 2 (08.2022)**

- (11) **45200**
- (21) 3-2022-00799 (28) 1
- (54) **VỎ THIẾT BỊ THU PHÁT VÔ TUYẾN** (51) **14-03**
- (22) 22/04/2022 (43) 25/08/2022
- (73) **TẬP ĐOÀN CÔNG NGHIỆP – VIỆN THÔNG QUÂN ĐỘI (VN)**  
Lô D26 khu đô thị mới Cầu Giấy, phường Yên Hoà, quận Cầu Giấy, thành phố Hà Nội
- (72) 1. ĐINH VĂN HẢI (VN)  
2. LÊ TRƯỜNG GIANG (VN)  
3. HOÀNG ĐÌNH HẢI TRUYỀN (VN)  
4. KHÔNG VĂN MẠNH (VN)  
5. NGUYỄN ĐỨC THỊNH (VN)  
6. NGUYỄN TỬ MINH ĐIỆN (VN)  
7. NGUYỄN QUỐC HÙNG (VN)
- (74) Công ty TNHH NACILAW (NACILAW)
- (55)



1.1

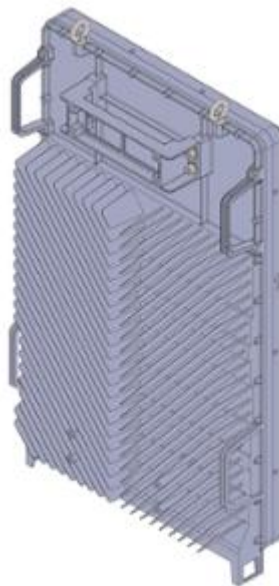

1.2



1.3

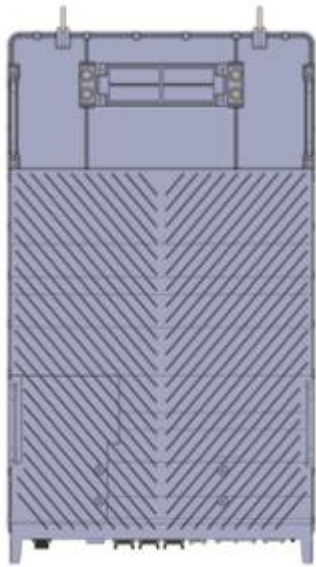

1.4



1.5



1.6

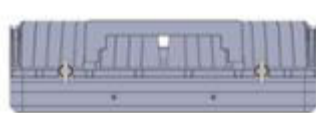

1.7



1.8

**CÔNG BÁO SỞ HỮU CÔNG NGHIỆP SỐ 413 TẬP A – QUYỀN 2 (08.2022)**

- (11) **45201**
- (21) 3-2022-00800 (28) 1
- (54) **VỎ THIẾT BỊ THU PHÁT VÔ TUYẾN** (51) **14-03**
- (22) 22/04/2022 (43) 25/08/2022
- (73) **TẬP ĐOÀN CÔNG NGHIỆP – VIỆN THÔNG QUÂN ĐỘI (VN)**  
Lô D26 khu đô thị mới Cầu Giấy, phường Yên Hoà, quận Cầu Giấy, thành phố Hà Nội
- (72) 1. NGUYỄN ĐỨC THỊNH (VN)  
2. HOÀNG ĐÌNH HẢI TRUYỀN (VN)  
3. NGUYỄN CHÍ LINH (VN)  
4. KHÔNG VĂN MẠNH (VN)  
5. ĐÌNH VĂN HẢI (VN)  
6. NGUYỄN ĐÌNH DƯƠNG (VN)  
7. NGUYỄN QUỐC HÙNG (VN)
- (74) Công ty TNHH NACILAW (NACILAW)
- (55)



1.1

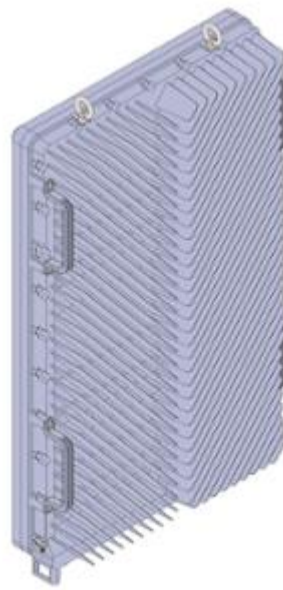

1.2



1.3



1.4



1.5



1.6

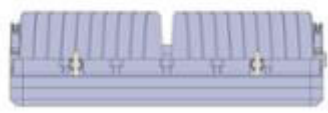

1.7



1.8

**CÔNG BÁO SỞ HỮU CÔNG NGHIỆP SỐ 413 TẬP A – QUYỀN 2 (08.2022)**

- (11) **45202**  
(21) 3-2022-00829 (28) 1  
(54) **MÁY GIA CÔNG VẬT LIỆU DẠNG TẤM** (51) **15-09**  
(22) 26/04/2022 (43) 25/08/2022  
(30) 2021-023606 29/10/2021 JP;  
(73) **GRAPHTEC CORPORATION (JP)**  
503-10 Shinano-cho, Totsuka-ku, Yokohama-shi, Kanagawa 244-8503 Japan  
(72) 1. MAYUMI SATO (JP)  
2. KAZUHIRO WATANABE (JP)  
(74) Công ty TNHH Tâm nhìn và Liên danh (VISION & ASSOCIATES CO.LTD.)  
(55)

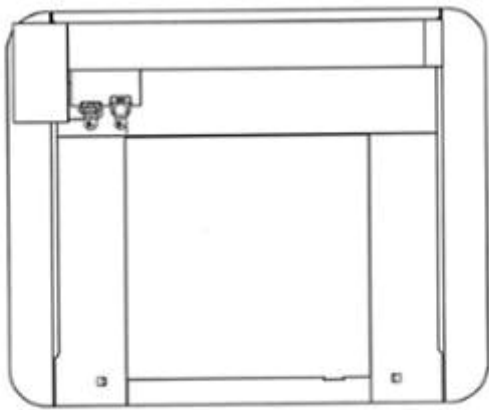

1.1

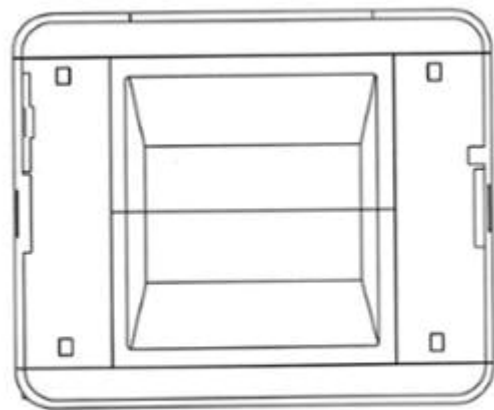

1.2

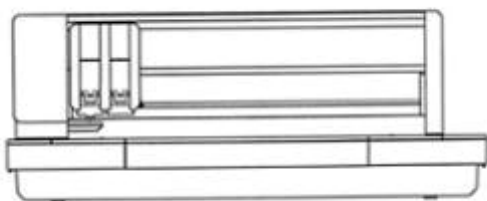

1.3

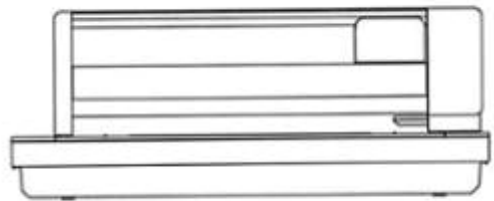

1.4

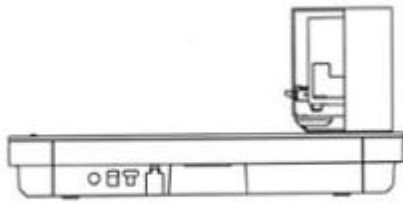

1.5

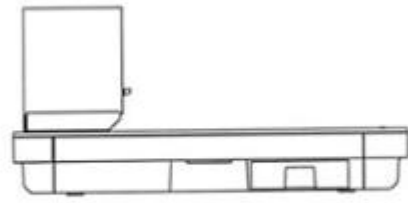

1.6

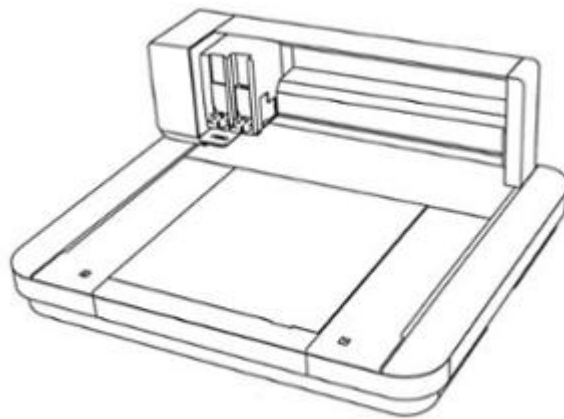

1.7

**CÔNG BÁO SỞ HỮU CÔNG NGHIỆP SỐ 413 TẬP A – QUYỀN 2 (08.2022)**

- (11) **45203**  
(21) 3-2022-00831 (28) 1  
(54) **MÁY ĐIỀU HÒA KHÔNG KHÍ** (51) **23-04**  
(22) 26/04/2022 (43) 25/08/2022  
(30) 2021-024288 08/11/2021 JP;  
(73) **MITSUBISHI ELECTRIC CORPORATION (JP)**  
7-3, Marunouchi 2-chome, Chiyoda-ku, Tokyo 100-8310, Japan  
(72) 1. IZURU HAMASAKI (JP)  
2. JANGRYUL RIM (KR)  
3. SATOSHI ARAI (JP)  
(74) Công ty TNHH Tầm nhìn và Liên danh (VISION & ASSOCIATES CO.LTD.)  
(55)

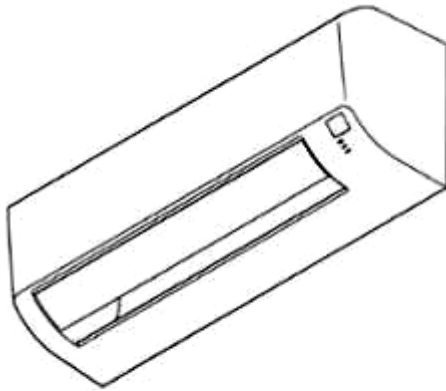

1.1

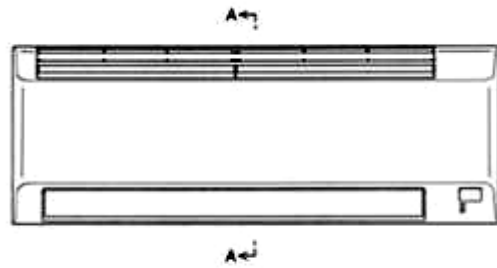

1.2



1.3



1.4

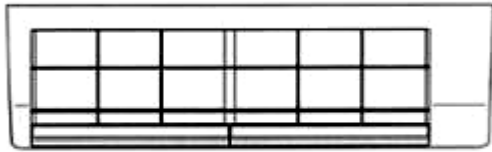

1.5

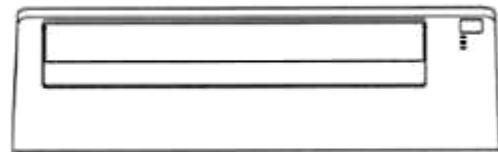

1.6



1.7



**CÔNG BÁO SỞ HỮU CÔNG NGHIỆP SỐ 413 TẬP A – QUYỀN 2 (08.2022)**

- (11) **45204**  
(21) 3-2022-00844 (28) 1  
(54) **LỌ** (51) **09-01; 09-03**  
(22) 27/04/2022 (43) 25/08/2022  
(73) **LG HOUSEHOLD & HEALTH CARE LTD. (KR)**  
58, Saemunan-ro, Jongno-gu, Seoul, Republic of Korea  
(72) LEE, Seul Ki (KR)  
(74) Công ty TNHH Tâm nhìn và Liên danh (VISION & ASSOCIATES CO.LTD.)  
(55)



1.1



1.2



1.3



1.4



1.5



1.6



1.7

**CÔNG BÁO SỞ HỮU CÔNG NGHIỆP SỐ 413 TẬP A – QUYỀN 2 (08.2022)**

- (11) **45205**  
(21) 3-2022-00851 (28) 1  
(54) **THANH KIM LOẠI ĐỊNH HÌNH** (51) **25-01**  
(22) 29/04/2022 (43) 25/08/2022  
(73) **CÔNG TY CỔ PHẦN SẢN XUẤT & THƯƠNG MẠI AG VIỆT NAM (VN)**  
Số 46/165 đường Cầu Giấy, phường Dịch Vọng, quận Cầu Giấy, thành phố Hà Nội  
(72) Nguyễn Khắc Sơn (VN)  
(74) Công ty TNHH Sở hữu trí tuệ Gia Việt (GIAVIET CO., LTD.)  
(55)

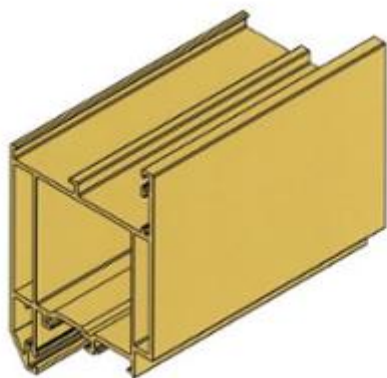

1.1



1.2



1.3



1.4



1.5



1.6

**CÔNG BÁO SỞ HỮU CÔNG NGHIỆP SỐ 413 TẬP A – QUYỀN 2 (08.2022)**

- (11) **45206**  
(21) 3-2022-00852 (28) 1  
(54) **THANH KIM LOẠI ĐỊNH HÌNH** (51) **25-01**  
(22) 29/04/2022 (43) 25/08/2022  
(73) **CÔNG TY CỔ PHẦN SẢN XUẤT & THƯƠNG MẠI AG VIỆT NAM (VN)**  
Số 46/165 đường Cầu Giấy, phường Dịch Vọng, quận Cầu Giấy, thành phố Hà Nội  
(72) Nguyễn Khắc Sơn (VN)  
(74) Công ty TNHH Sở hữu trí tuệ Gia Việt (GIAVIET CO., LTD.)  
(55)



1.1

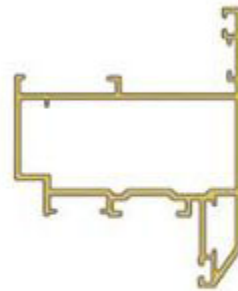

1.2



1.3



1.4

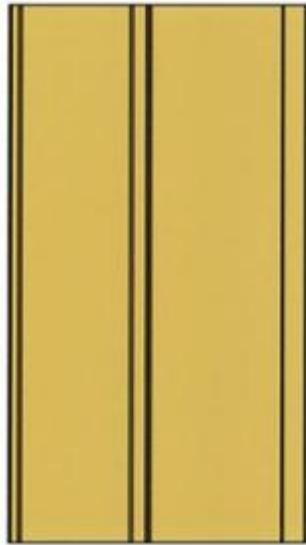

1.5

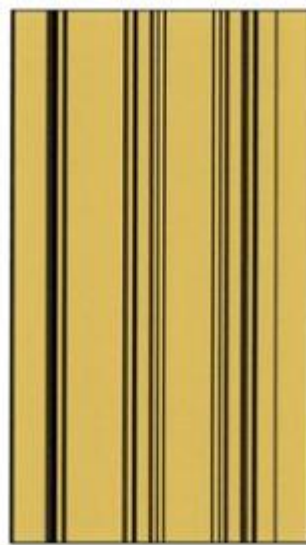

1.6

**CÔNG BÁO SỞ HỮU CÔNG NGHIỆP SỐ 413 TẬP A – QUYỀN 2 (08.2022)**

- (11) **45207**  
(21) 3-2022-00853 (28) 1  
(54) **KE GÓC** (51) **25-01**  
(22) 29/04/2022 (43) 25/08/2022  
(73) **CÔNG TY CỔ PHẦN SẢN XUẤT & THƯƠNG MẠI AG VIỆT NAM (VN)**  
Số 46/165 đường Cầu Giấy, phường Dịch Vọng, quận Cầu Giấy, thành phố Hà Nội  
(72) Nguyễn Khắc Sơn (VN)  
(74) Công ty TNHH Sở hữu trí tuệ Gia Việt (GIAVIET CO., LTD.)  
(55)

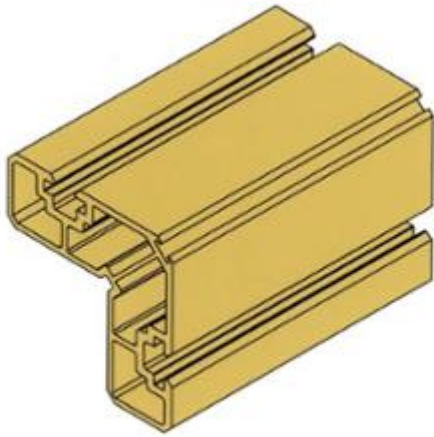

1.1

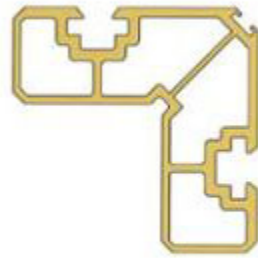

1.2

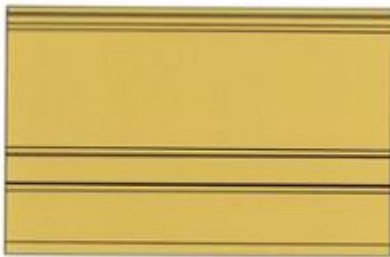

1.3



1.4

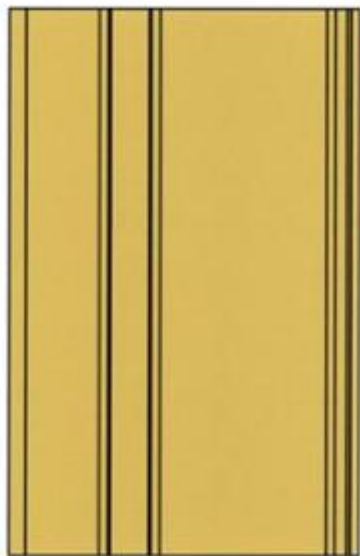

1.5

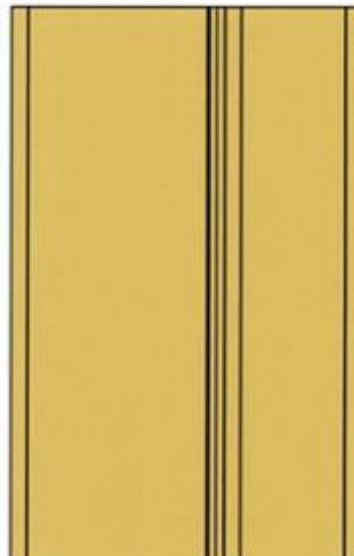

1.6



- (11) **45208**  
(21) 3-2022-00872 (28) 1  
(54) **LỌ** (51) **09-01; 09-03**  
(22) 04/05/2022 (43) 25/08/2022  
(73) **LG HOUSEHOLD & HEALTH CARE LTD. (KR)**  
58, Saemunan-ro, Jongno-gu, Seoul, Republic of Korea  
(72) LEE, Da Lin (KR)  
(74) Công ty TNHH Tâm nhìn và Liên danh (VISION & ASSOCIATES CO.LTD.)  
(55)



1.1



1.2



1.3



1.4



1.5



1.6



1.7

**CÔNG BÁO SỞ HỮU CÔNG NGHIỆP SỐ 413 TẬP A – QUYỀN 2 (08.2022)**

- (11) **45209**  
(21) 3-2022-00873 (28) 1  
(54) **LỢ** (51) **09-01; 09-03**  
(22) 04/05/2022 (43) 25/08/2022  
(73) **LG HOUSEHOLD & HEALTH CARE LTD. (KR)**  
58, Saemunan-ro, Jongno-gu, Seoul, Republic of Korea  
(72) LEE, Da Lin (KR)  
(74) Công ty TNHH Tâm nhìn và Liên danh (VISION & ASSOCIATES CO.LTD.)  
(55)



1.1

1.2

1.3

1.4

1.5



1.6



1.7

- (11) **45210**  
(21) 3-2022-00887 (28) 1  
(54) **HỘP VỆ SINH CHO THÚ CỪNG** (51) **30-02**  
(22) 06/05/2022 (43) 25/08/2022  
(30) 202130745603.5 12/11/2021 CN;  
(73) **UNICHARM CORPORATION (JP)**  
182, Shimobun, Kinsei-cho, Shikokuchuo-City, Ehime 799-0111 Japan  
(72) 1. MISATO NAKATANI (JP)  
2. YASUHIRO SASANO (JP)  
3. SHINYA KANEKO (JP)  
(74) Công ty Cổ phần Sở hữu công nghiệp INVESTIP (INVESTIP)  
(55)



1.1

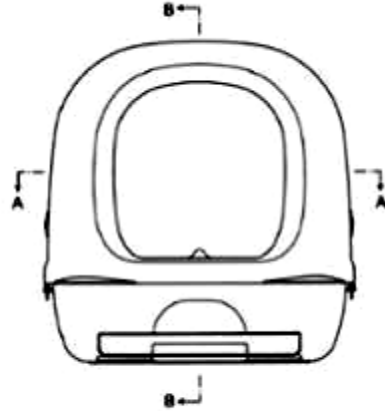

1.2

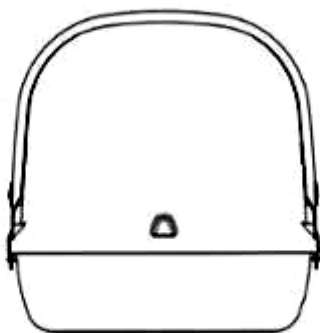

1.3

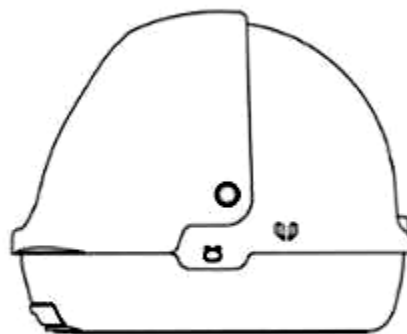

1.4

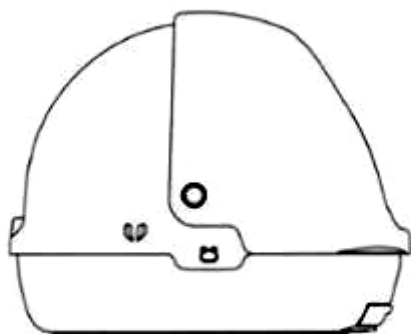

1.5

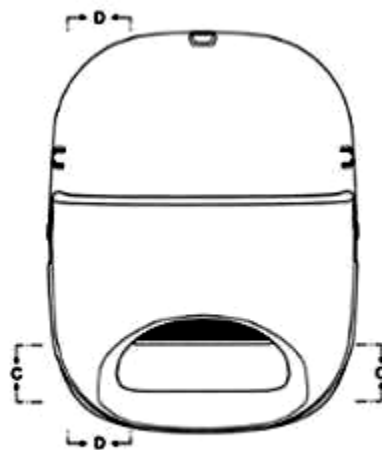

1.6



1.7

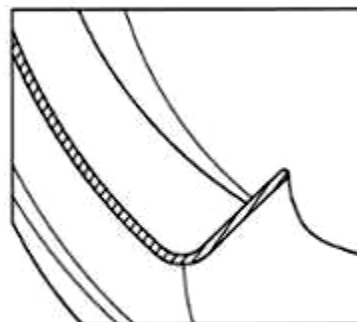

1.8

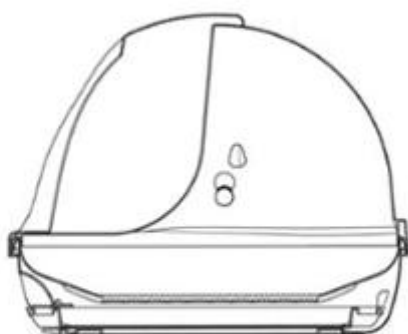

1.9



1.10

- (11) **45211**  
(21) 3-2022-00888 (28) 1  
(54) **HỘP VỆ SINH CHO THÚ CỪNG** (51) **30-02**  
(22) 06/05/2022 (43) 25/08/2022  
(30) 202130745558.3 12/11/2021 CN;  
(73) **UNICHARM CORPORATION (JP)**  
182, Shimobun, Kinsei-cho, Shikokuchuo-City, Ehime 799-0111 Japan  
(72) 1. MISATO NAKATANI (JP)  
2. YASUHIRO SASANO (JP)  
3. SHINYA KANEKO (JP)  
(74) Công ty Cổ phần Sở hữu công nghiệp INVESTIP (INVESTIP)  
(55)



1.1



1.2

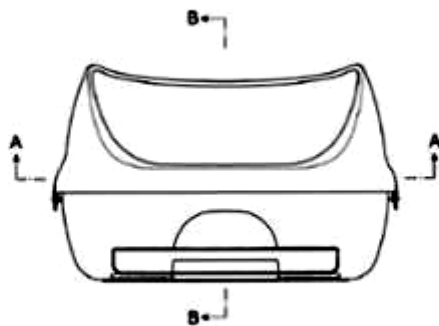

1.3

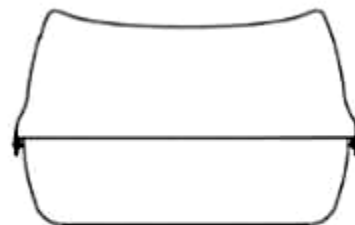

1.4

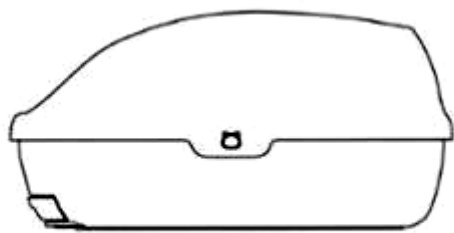

1.5

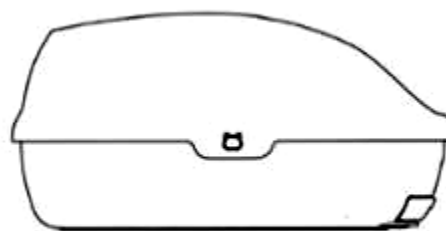

1.6

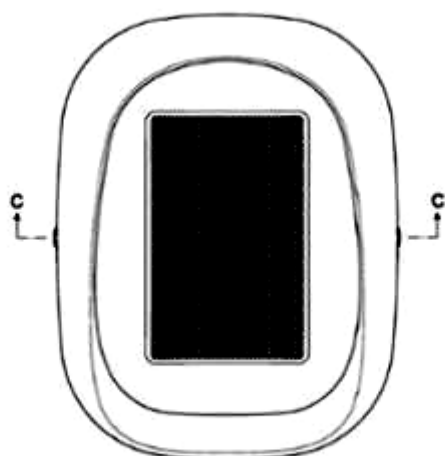

1.7



1.8

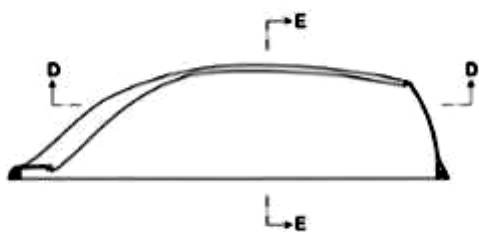

1.9

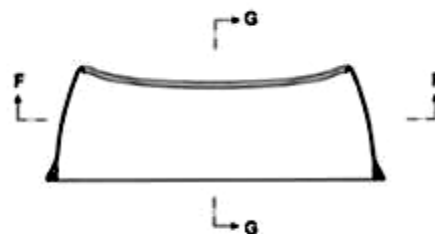

1.10



1.11



1.12

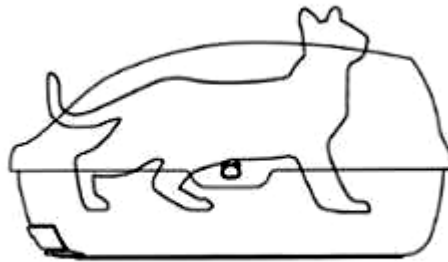

1.13



- (11) **45212**  
(21) 3-2022-00892 (28) 1  
(54) **ĐÈN CHIẾU SÁNG ĐƯỜNG PHỐ** (51) **26-03**  
(22) 06/05/2022 (43) 25/08/2022  
(73) **CÔNG TY CỔ PHẦN ĐIỆN VÀ CHIẾU SÁNG PHÚ THẮNG (VN)**  
Lô số CN1, KCN Thạch Thất, Quốc Oai, Thạch Thất, thành phố Hà Nội  
(72) Phùng Hữu Thắng (VN)  
(55)



1.1



1.2



1.3



1.4

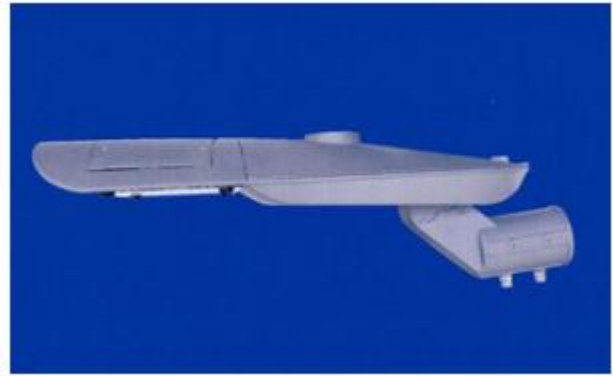

1.5



1.6



1.7

- (11) **45213**  
(21) 3-2022-00900 (28) 1  
(54) **TRẠM GIAO DỊCH TÀI CHÍNH TỰ PHỤC VỤ** (51) **20-01**  
(22) 09/05/2022 (43) 25/08/2022  
(30) A2021/01394 08/11/2021 ZA;  
(73) **TYME PTE. LIMITED** (SG)  
1 George Street, Level 10, 049145, Singapore  
(72) Ian Charles VOGT (ZA)  
(74) Công ty Luật TNHH Phạm và Liên danh (PHAM & ASSOCIATES)  
(55)

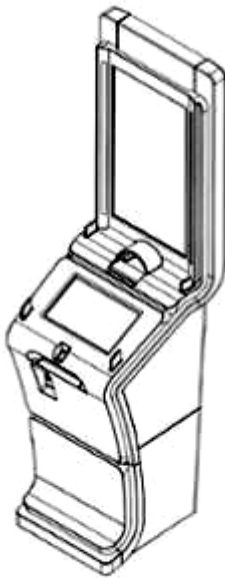

1.1

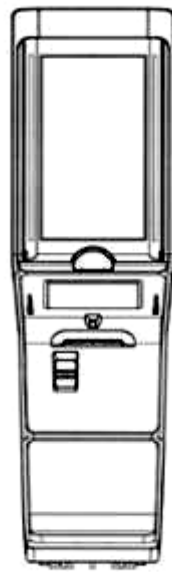

1.2

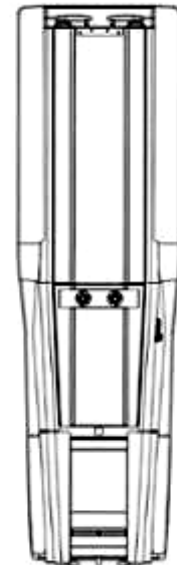

1.3

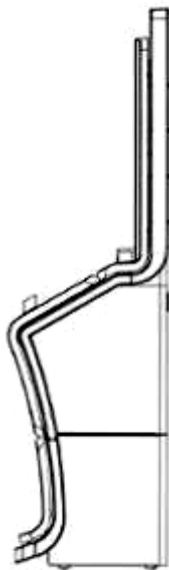

1.4



1.5



1.6



1.7

**CÔNG BÁO SỞ HỮU CÔNG NGHIỆP SỐ 413 TẬP A – QUYỀN 2 (08.2022)**

- (11) **45214**  
(21) 3-2022-00918 (28) 1  
(54) **LỌ** (51) **09-01**  
(22) 10/05/2022 (43) 25/08/2022  
(73) **LG HOUSEHOLD & HEALTH CARE LTD. (KR)**  
58, Saemunan-ro, Jongno-gu, Seoul, Republic of Korea  
(72) PARK, Suk Young (KR)  
(74) Công ty TNHH Tâm nhìn và Liên danh (VISION & ASSOCIATES CO.LTD.)  
(55)



1.1

1.2

1.3

1.4

1.5



1.6



1.7

**CÔNG BÁO SỞ HỮU CÔNG NGHIỆP SỐ 413 TẬP A – QUYỀN 2 (08.2022)**

- (11) **45215**
- (21) 3-2022-00926
- (54) **BAO GÓI**
- (22) 11/05/2022
- (73) **CÔNG TY TNHH CON CỎ VÀNG (VN)**  
23 Lô B đường số 1, phường Phú Thuận, quận 7, thành phố Hồ Chí Minh
- (72) Hoàng Mai Dẫn (VN)
- (74) Công ty TNHH một thành viên Trường Luật (Trường Luật)
- (55)
- (28) 1
- (51) **09-05**
- (43) 25/08/2022



1.1



1.2

**CÔNG BÁO SỞ HỮU CÔNG NGHIỆP SỐ 413 TẬP A – QUYỀN 2 (08.2022)**

(11) **45216**

(21) 3-2022-00928

(28) 1

(54) **BÚT BI**

(51) **19-06**

(22) 12/05/2022

(43) 25/08/2022

(73) **CÔNG TY TNHH BLUSAIGON (VN)**

129E Nguyễn Đình Chính, phường 08, quận Phú Nhuận, thành phố Hồ Chí Minh

(72) Phan Phúc Thịnh (VN)

(55)



1.1

1.2

1.3

1.4

1.5

1.6

1.7

1.8



1.9

1.10

**CÔNG BÁO SỞ HỮU CÔNG NGHIỆP SỐ 413 TẬP A – QUYỀN 2 (08.2022)**

- (11) **45217**  
(21) 3-2022-00930 (28) 1  
(54) **NHÃN SẢN PHẨM** (51) **19-08**  
(22) 12/05/2022 (43) 25/08/2022  
(73) **CÔNG TY TNHH MỘT THÀNH VIÊN THƯƠNG MẠI TỔNG HỢP CHÍNH GIANG (VN)**  
Ấp Ninh Thuận, xã Ninh Quới A, huyện Hồng Dân, tỉnh Bạc Liêu  
(72) Nguyễn Tiến Dũng (VN)  
(55)



1.1



1.2

- (11) **45218**  
(21) 3-2022-00940 (28) 1  
(54) **BỘ VI SÓNG DIỆT TẢO TRONG NUÔI TRỒNG THỦY SẢN** (51) **15-99**  
(22) 12/05/2022 (43) 25/08/2022  
(73) **CÔNG TY CỔ PHẦN RYNAN TECHNOLOGIES VIETNAM (VN)**  
Ấp Long Trị, xã Long Đức, thành phố Trà Vinh, tỉnh Trà Vinh  
(72) 1. NGUYỄN THANH MỸ (VN)  
2. PHẠM THÁI BÌNH (VN)  
3. HUỖNH LÊ NHỰT HÀO (VN)  
(74) Công ty TNHH Đại Tín và Liên Danh (DAITIN AND ASSOCIATES CO.,LTD)  
(55)

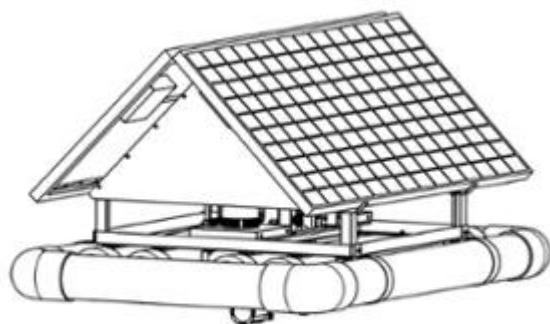

1.1



1.2



1.3

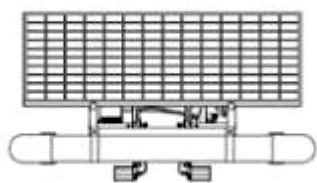

1.4

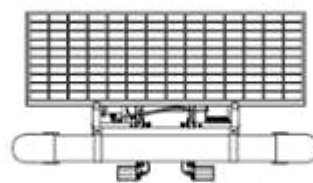

1.5



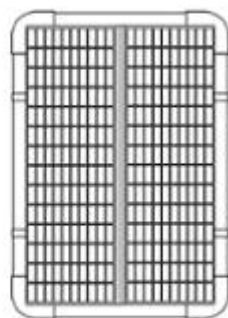

1.6

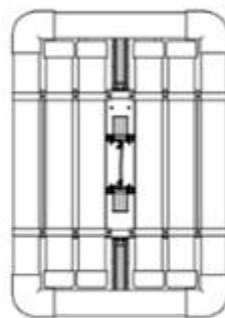

1.7

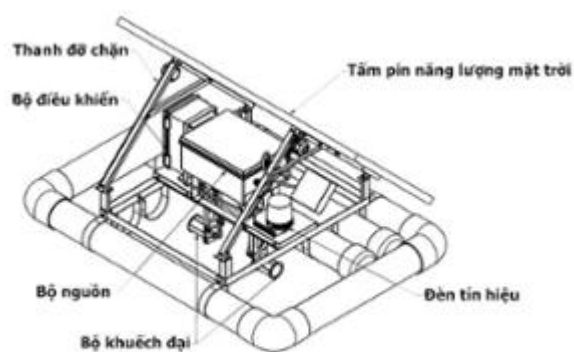

1.8

**CÔNG BÁO SỞ HỮU CÔNG NGHIỆP SỐ 413 TẬP A – QUYỀN 2 (08.2022)**

- (11) **45219**  
(21) 3-2022-00941 (28) 2  
(54) **ĐUI ĐÈN CÓ Ổ CẮM** (51) **26-05**  
(22) 12/05/2022 (43) 25/08/2022  
(73) **CÔNG TY TNHH MỘT THÀNH VIÊN SẢN XUẤT THƯƠNG MẠI ĐẠI THUẬN ĐẠT (VN)**  
114/68 Phú Thọ Hòa, phường Phú Thọ Hòa, quận Tân Phú, thành phố Hồ Chí Minh  
(72) PHAN HÙNG SƠN (VN)  
(74) Văn phòng Luật sư A Hoà (AHOA LAW OFFICE)  
(55)



1.1



1.2



1.3

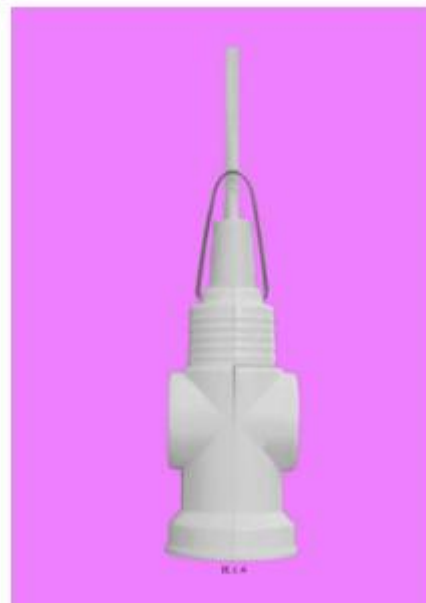

1.4



1.5



1.6



1.7



2.1



2.2



2.3



2.4



2.5

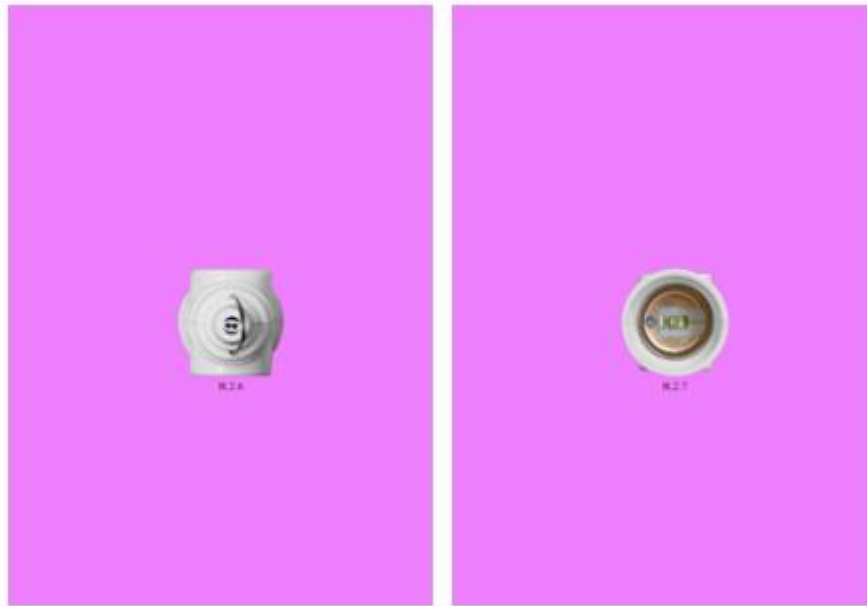

2.6

2.7

**CÔNG BÁO SỞ HỮU CÔNG NGHIỆP SỐ 413 TẬP A – QUYỀN 2 (08.2022)**

- (11) **45220**  
(21) 3-2022-00943 (28) 1  
(54) **PIN SẠC CHO XE ĐIỆN** (51) **13-02**  
(22) 13/05/2022 (43) 25/08/2022  
(30) 30-2021-0054598 16/11/2021 KR;  
(73) **MBI CO., LTD. (KR)**  
24, Wolmyeong-ro 55beon-gil, Heungdeok-gu, Cheongju-si, Chungcheongbuk-do,  
28579, Republic of Korea  
(72) YOO, Moon-Soo (KR)  
(74) Công ty Luật TNHH WINCO (WINCO LAW FIRM)  
(55)



1.1



1.2



1.3



1.4



1.5



1.6



1.7



1.8

**CÔNG BÁO SỞ HỮU CÔNG NGHIỆP SỐ 413 TẬP A – QUYỀN 2 (08.2022)**

- (11) **45221**
- (21) 3-2022-00944 (28) 1
- (54) **NHÃN SẢN PHẨM** (51) **19-08**
- (22) 13/05/2022 (43) 25/08/2022
- (73) **NGUYỄN ANH ĐỨC (VN)**  
Tiểu khu 3, thị trấn Yên Châu, huyện Yên Châu, tỉnh Sơn La
- (72) Nguyễn Anh Đức (VN)
- (55)



- (11) **45222**  
(21) 3-2022-00946 (28) 1  
(54) **THIẾT BỊ TẠO KHÍ DUNG** (51) **27-02; 27-99**  
(22) 16/05/2022 (43) 25/08/2022  
(30) 008761894 16/11/2021 EM;  
(73) **PHILIP MORRIS PRODUCTS S.A. (CH)**  
Quai Jeanrenaud 3, CH-2000 Neuchâtel, Switzerland  
(72) Kenneth Konrad Ming Chi LAM (NZ)  
(74) Công ty Luật TNHH T&G (TGVN)  
(55)



1.1



1.2



1.3



1.4



1.5





1.6



1.7

**CÔNG BÁO SỞ HỮU CÔNG NGHIỆP SỐ 413 TẬP A – QUYỀN 2 (08.2022)**

- (11) **45223**  
(21) 3-2022-00949 (28) 1  
(54) **NHÃN SẢN PHẨM** (51) **19-08**  
(22) 16/05/2022 (43) 25/08/2022  
(73) **CÔNG TY TNHH SẢN XUẤT - THƯƠNG MẠI - DỊCH VỤ MI NA (VN)**  
127 Bình Tây, phường 01, quận 6, thành phố Hồ Chí Minh  
(72) NGUYỄN HỮU HẠNH (VN)  
(74) **CÔNG TY TNHH SỞ HỮU TRÍ TUỆ SETHACO (SETHACO IP CO.,LTD)**  
(55)



(11) **45224**

(21) 3-2022-00950

(28) 1

(54) **TƯỢNG TRANG TRÍ**

(51) **11-02**

(22) 16/05/2022

(43) 25/08/2022

(73) **CÔNG TY TNHH MINH LONG I (VN)**

333 khu phố Hưng Lộc, phường Hưng Định, thành phố Thuận An, tỉnh Bình Dương

(72) Lý Ngọc Minh (VN)

(55)



1.1



1.2



1.3



1.4



1.5



1.6



1.7



1.8

**CÔNG BÁO SỞ HỮU CÔNG NGHIỆP SỐ 413 TẬP A – QUYỀN 2 (08.2022)**

- (11) **45225**  
(21) 3-2022-00954 (28) 1  
(54) **CHAI** (51) **09-01**  
(22) 16/05/2022 (43) 25/08/2022  
(73) **ZERO TO SEVEN INC. (KR)**  
(SANGAM-DONG, YTN-NEWSQUARE), 17F/18F, 76, Sangamsan-ro, Mapo-gu,  
Seoul 03926, Republic of Korea  
(72) Lee HyunJoo (KR)  
(74) Công ty Luật TNHH ROUSE Việt Nam (ROUSE LAW CO.,LTD)  
(55)

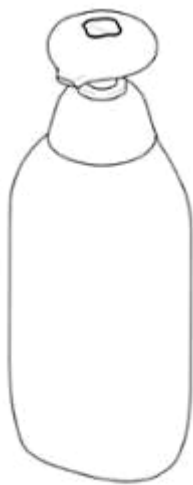

1.1

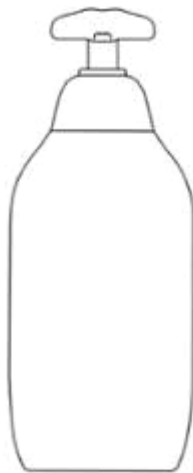

1.2

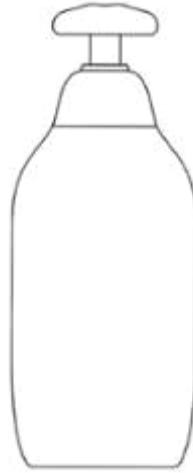

1.3



1.4



1.5

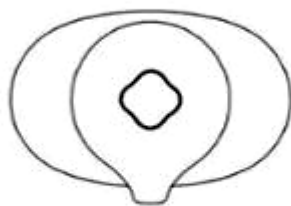

1.6



1.7

**CÔNG BÁO SỞ HỮU CÔNG NGHIỆP SỐ 413 TẬP A – QUYỀN 2 (08.2022)**

- (11) **45226**  
(21) 3-2022-00955  
(54) **HỘP ĐỰNG KEM DƯỠNG ÂM**  
(22) 16/05/2022  
(73) **ZERO TO SEVEN INC. (KR)**  
(SANGAM-DONG, YTN-NEWSQUARE), 17F/18F, 76, Sangamsan-ro, Mapo-gu, Seoul 03926, Republic of Korea  
(72) Lee HyunJoo (KR)  
(74) Công ty Luật TNHH ROUSE Việt Nam (ROUSE LAW CO.,LTD)  
(55)
- (28) 1  
(51) **09-03**  
(43) 25/08/2022



1.1

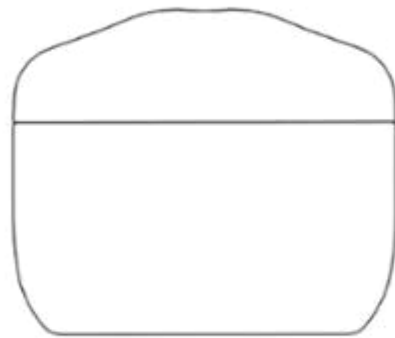

1.2

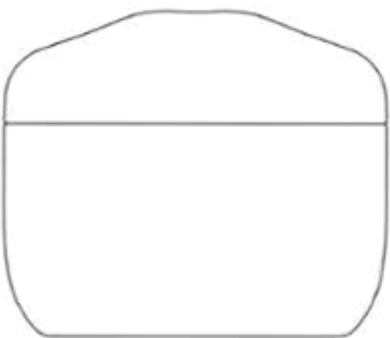

1.3

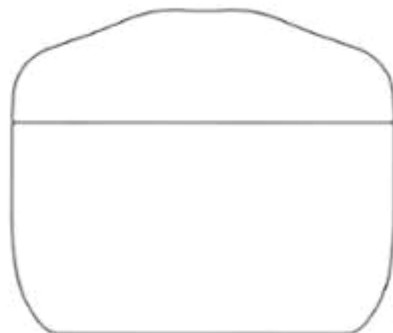

1.4

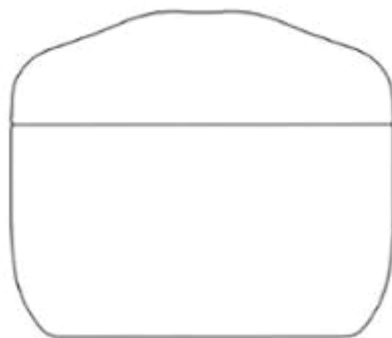

1.5

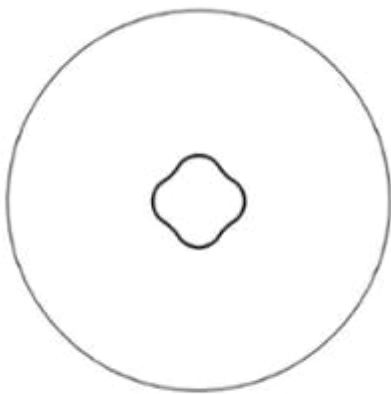

1.6

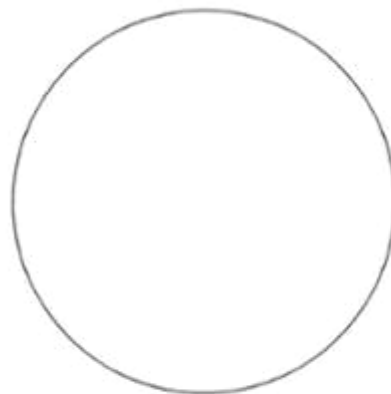

1.7

**CÔNG BÁO SỞ HỮU CÔNG NGHIỆP SỐ 413 TẬP A – QUYỀN 2 (08.2022)**

- (11) **45227**  
(21) 3-2022-00956 (28) 1  
(54) **HỘP ĐỰNG PHẦN PHỬ** (51) **09-03**  
(22) 16/05/2022 (43) 25/08/2022  
(73) **ZERO TO SEVEN INC. (KR)**  
(SANGAM-DONG, YTN-NEWSQUARE), 17F/18F, 76, Sangamsan-ro, Mapo-gu,  
Seoul 03926, Republic of Korea  
(72) Lee HyunJoo (KR)  
(74) Công ty Luật TNHH ROUSE Việt Nam (ROUSE LAW CO.,LTD)  
(55)

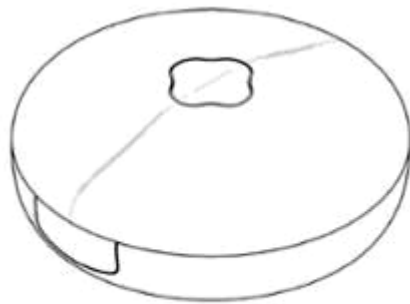

1.1

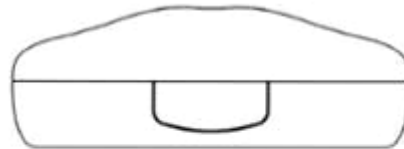

1.2



1.3



1.4



1.5



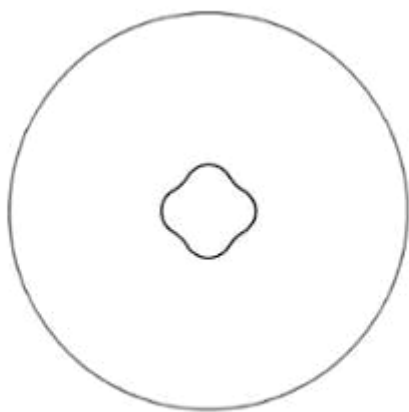

1.6



1.7

**CÔNG BÁO SỞ HỮU CÔNG NGHIỆP SỐ 413 TẬP A – QUYỀN 2 (08.2022)**

- (11) **45228**  
(21) 3-2022-00961 (28) 1  
(54) **BAO GÓI GIẤY** (51) **09-05**  
(22) 17/05/2022 (43) 25/08/2022  
(73) **TỔNG CÔNG TY GIẤY VIỆT NAM - CÔNG TY TNHH (VN)**  
25A Lý Thường Kiệt, phường Phan Chu Trinh, quận Hoàn Kiếm, thành phố Hà Nội  
(72) Tạ Quang Văn (VN)  
(55)



1.1



1.2

**CÔNG BÁO SỞ HỮU CÔNG NGHIỆP SỐ 413 TẬP A – QUYỀN 2 (08.2022)**

(11) **45229**

(21) 3-2022-00965

(28) 1

(54) **DÉP**

(51) **02-04**

(22) 18/05/2022

(43) 25/08/2022

(73) **CÔNG TY TNHH GIÀY Á CHÂU (VN)**

451/29/8 Tô Hiến Thành, phường 14, quận 10, thành phố Hồ Chí Minh

(72) Nguyễn Đình Kim (VN)

(74) Văn phòng Luật sư A Hoà (AHOA LAW OFFICE)

(55)



1.1



1.2



1.3



1.4



1.5



1.6



1.7



1.8

**CÔNG BÁO SỞ HỮU CÔNG NGHIỆP SỐ 413 TẬP A – QUYỀN 2 (08.2022)**

(11) **45230**

(21) 3-2022-00966

(28) 1

(54) **DÉP**

(51) **02-04**

(22) 18/05/2022

(43) 25/08/2022

(73) **CÔNG TY TNHH GIÀY Á CHÂU (VN)**

451/29/8 Tô Hiến Thành, phường 14, quận 10, thành phố Hồ Chí Minh

(72) Nguyễn Đình Kim (VN)

(74) Văn phòng Luật sư A Hoà (AHOA LAW OFFICE)

(55)



1.1



1.2



1.3



1.4



1.5



1.6



1.7



1.8

- (11) **45231**  
(21) 3-2022-00967 (28) 1  
(54) **ĐÈN** (51) **26-05**  
(22) 18/05/2022 (43) 25/08/2022  
(73) **CÔNG TY CỔ PHẦN BÓNG ĐÈN PHÍCH NƯỚC RẠNG ĐÔNG (VN)**  
87-89 phố Hạ Đình, phường Thanh Xuân Trung, quận Thanh Xuân, thành phố Hà Nội  
(72) Trần Trung Tường (VN)  
(55)



1.1

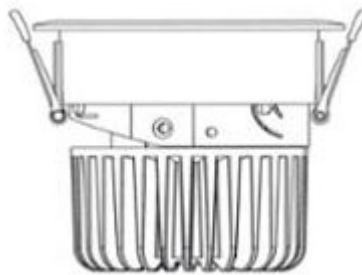

1.2

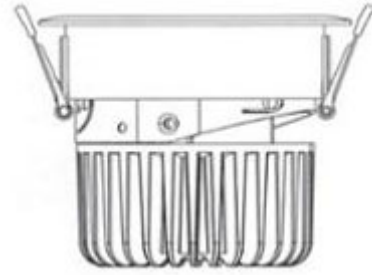

1.3

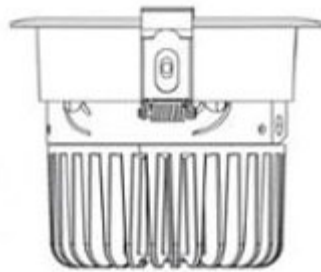

1.4

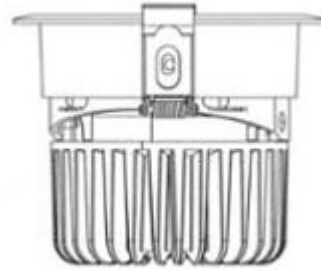

1.5

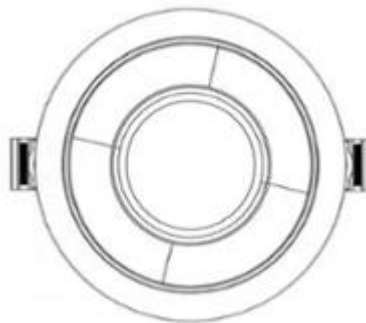

1.6

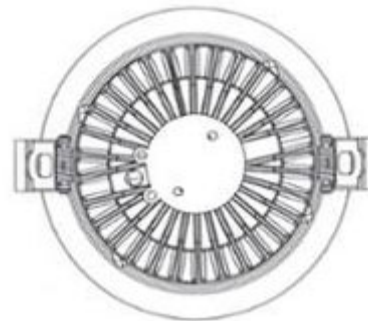

1.7

- (11) **45232**  
(21) 3-2022-00968 (28) 1  
(54) **ĐÈN** (51) **26-05**  
(22) 18/05/2022 (43) 25/08/2022  
(73) **CÔNG TY CỔ PHẦN BÓNG ĐÈN PHÍCH NƯỚC RẠNG ĐÔNG (VN)**  
87-89 phố Hạ Đình, phường Thanh Xuân Trung, quận Thanh Xuân, thành Phố Hà Nội  
(72) Trần Trung Tường (VN)  
(55)

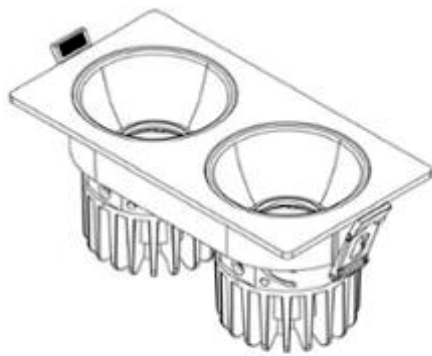

1.1

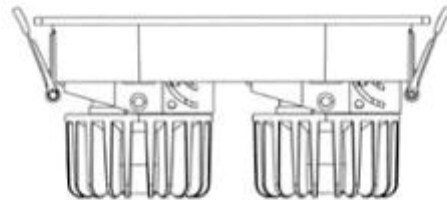

1.2

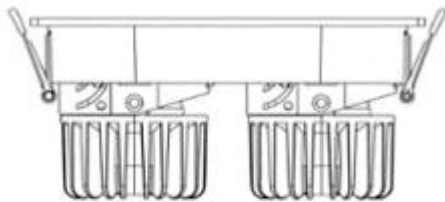

1.3

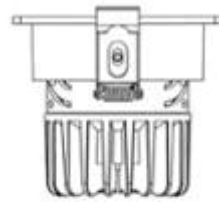

1.4

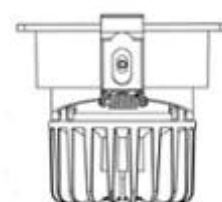

1.5

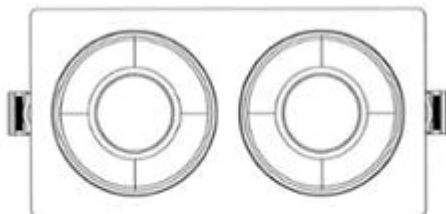

1.6

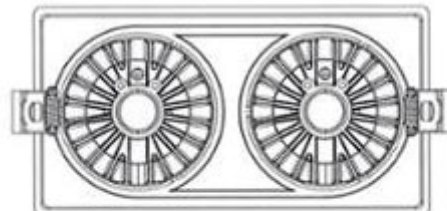

1.7

**CÔNG BÁO SỞ HỮU CÔNG NGHIỆP SỐ 413 TẬP A – QUYỀN 2 (08.2022)**

- (11) **45233**  
(21) 3-2022-00978 (28) 1  
(54) **HỘP ĐỰNG SẢN PHẨM** (51) **09-03**  
(22) 19/05/2022 (43) 25/08/2022  
(73) **CÔNG TY CỔ PHẦN SIÊU THỊ KHỎE ĐẸP (VN)**  
Số 16 Nguyễn Khả Trạc, phường Mai Dịch, quận Cầu Giấy, thành phố Hà Nội  
(72) Nguyễn Văn Quyền (VN)  
(74) Công ty TNHH Sở hữu trí tuệ ALNGUYEN (ALNGUYEN IP CO.,LTD.)  
(55)



1.1



1.2

(11) **45234**

(21) 3-2022-00980

(54) **TƯỢNG TRANG TRÍ**

(22) 20/05/2022

(73) **CÔNG TY TNHH MINH LONG I (VN)**

333 khu phố Hưng Lộc, phường Hưng Định, thành phố Thuận An, tỉnh Bình Dương

(72) Lý Ngọc Minh (VN)

(55)

(28) 1

(51) **11-02**

(43) 25/08/2022



1.1



1.2

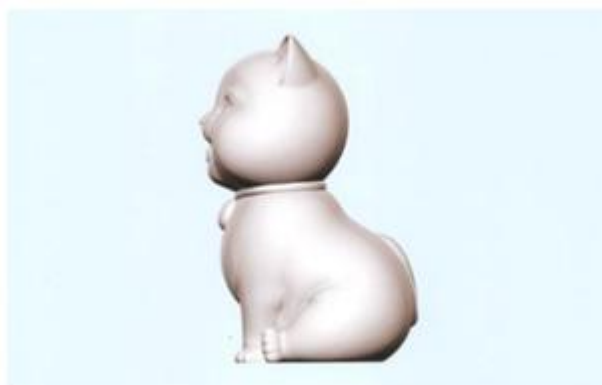

1.3



1.4

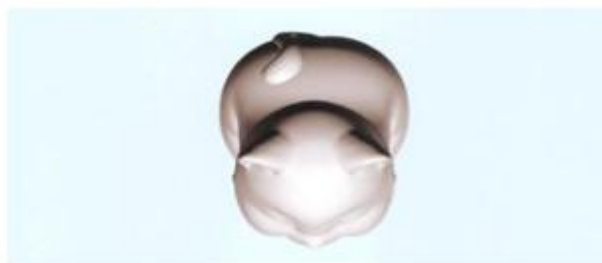

1.5



1.6





1.7



1.8

- (11) **45235**  
(21) 3-2022-00981 (28) 1  
(54) **TƯỢNG TRANG TRÍ** (51) **11-02**  
(22) 20/05/2022 (43) 25/08/2022  
(73) **CÔNG TY TNHH MINH LONG I (VN)**  
333 khu phố Hưng Lộc, phường Hưng Định, thành phố Thuận An, tỉnh Bình  
Dương  
(72) Lý Ngọc Minh (VN)  
(55)



1.1



1.2



1.3



1.4



1.5



1.6



1.7



1.8

**CÔNG BÁO SỞ HỮU CÔNG NGHIỆP SỐ 413 TẬP A – QUYỀN 2 (08.2022)**

- (11) **45236**  
(21) 3-2022-00982  
(54) **NHÃN SẢN PHẨM**  
(22) 20/05/2022  
(73) **CÔNG TY CỔ PHẦN SAMURAI VN (VN)**  
15A đường 13C, phường Bình Trị Đông B, quận Bình Tân, thành phố Hồ Chí Minh  
(72) Đặng Thị Mỹ Hạnh (VN)  
(55)
- (28) 1  
(51) **19-08**  
(43) 25/08/2022



**CÔNG BÁO SỞ HỮU CÔNG NGHIỆP SỐ 413 TẬP A – QUYỀN 2 (08.2022)**

- (11) **45237**  
(21) 3-2022-00983  
(54) **NHÃN SẢNH PHẨM**  
(22) 20/05/2022  
(73) **CÔNG TY CỔ PHẦN SAMURAI VN (VN)**  
15A đường 13C, phường Bình Trị Đông B, quận Bình Tân, thành phố Hồ Chí Minh  
(72) Đặng Thị Mỹ Hạnh (VN)  
(55)
- (28) 1  
(51) **19-08**  
(43) 25/08/2022



- (11) **45238**  
(21) 3-2022-00984 (28) 1  
(54) **BÀN DI ĐỘNG** (51) **06-03**  
(22) 20/05/2022 (43) 25/08/2022  
(30) 30-2021-0055783 22/11/2021 KR;  
(73) **KOVEA CO., LTD.** (KR)  
87, Seounsandan-ro 1-gil, Gyeyang-gu, Incheon, Republic of Korea  
(72) 1. KIM, SANG HYUN (KR)  
2. JUNG, SEUNG JO (KR)  
3. LEE, CHOONG HWAN (KR)  
4. KIM, KYUNG HAN (KR)  
(74) Công ty TNHH Quốc tế D &N (D&N INTERNATIONAL CO.,LTD.)  
(55)

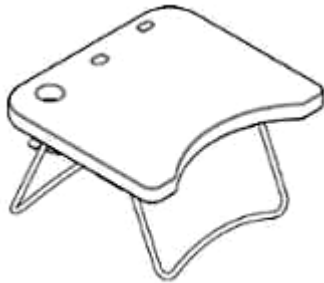

1.1

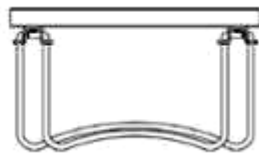

1.2

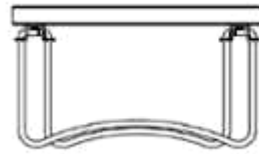

1.3



1.4



1.5



1.6

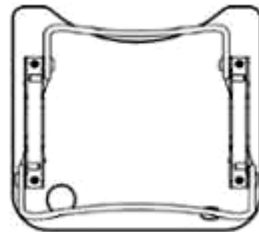

1.7

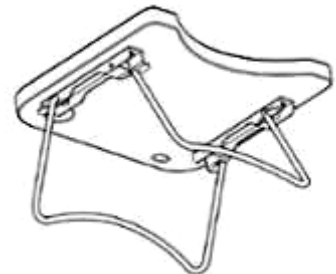

1.8



1.9

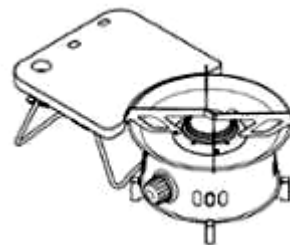

1.10

- (11) **45239**  
 (21) 3-2022-00985 (28) 1  
 (54) **ĐÈN GA DI ĐỘNG** (51) **26-02**  
 (22) 20/05/2022 (43) 25/08/2022  
 (30) 30-2021-0055785 22/11/2021 KR;  
 (73) **KOVEA CO., LTD.** (KR)  
 87, Seounsandan-ro 1-gil, Gyeyang-gu, Incheon, Republic of Korea  
 (72) 1. KIM, SANG HYUN (KR)  
 2. JUNG, SEUNG JO (KR)  
 3. LEE, CHOONG HWAN (KR)  
 4. KIM, KYUNG HAN (KR)  
 (74) Công ty TNHH Quốc tế D & N (D&N INTERNATIONAL CO.,LTD.)  
 (55)

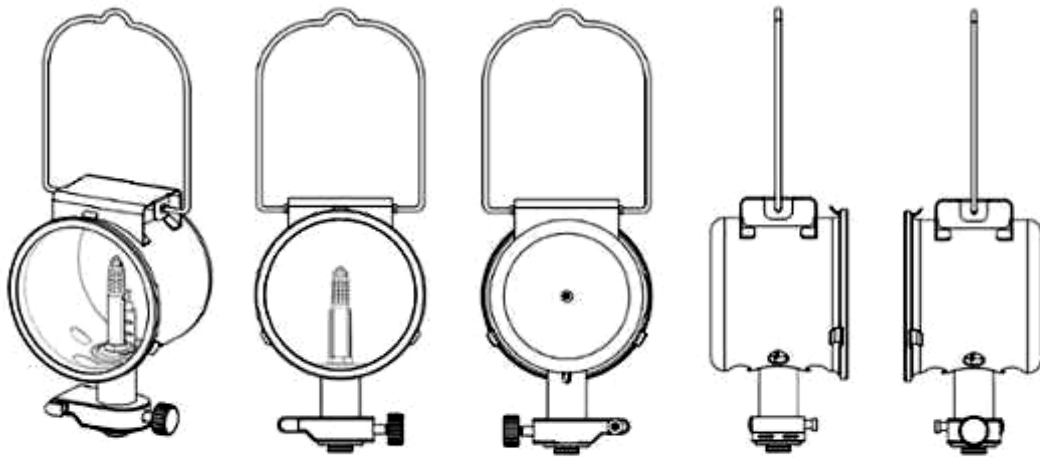

1.1

1.2

1.3

1.4

1.5

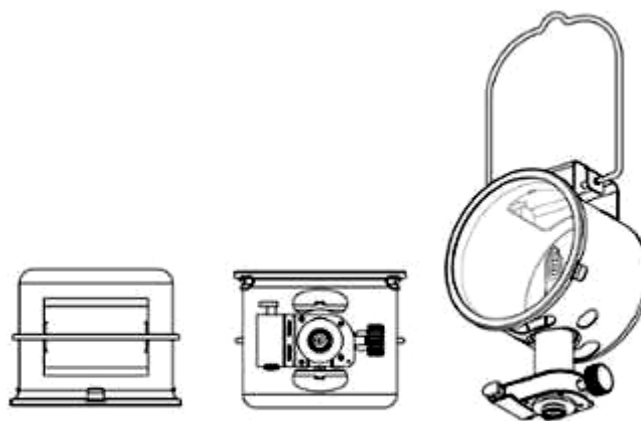

1.6

1.7

1.8

- (11) **45240**  
(21) 3-2022-00986 (28) 1  
(54) **BẾP GA DI ĐỘNG** (51) **07-02**  
(22) 20/05/2022 (43) 25/08/2022  
(30) 30-2021-0055786 22/11/2021 KR;  
(73) **KOVEA CO., LTD.** (KR)  
87, Seounsandan-ro 1-gil, Gyeyang-gu, Incheon, Republic of Korea  
(72) 1. KIM, SANG HYUN (KR)  
2. JUNG, SEUNG JO (KR)  
3. LEE, CHOONG HWAN (KR)  
4. KIM, KYUNG HAN (KR)  
(74) Công ty TNHH Quốc tế D &N (D&N INTERNATIONAL CO.,LTD.)  
(55)

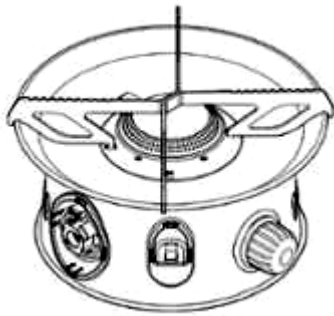

1.1

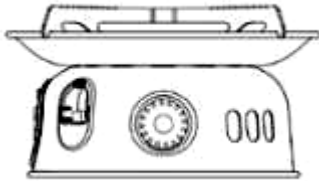

1.2

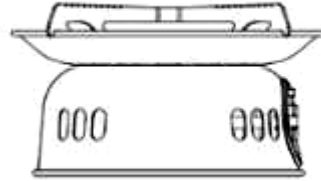

1.3

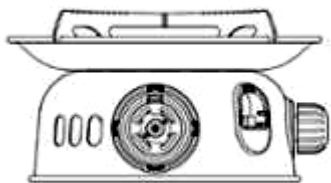

1.4

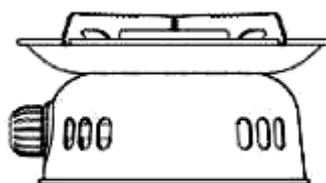

1.5



1.6



1.7

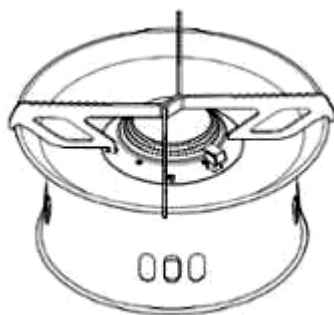

1.8



1.9

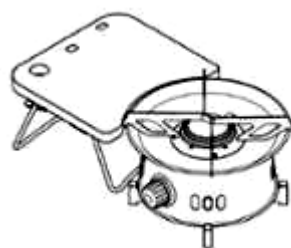

1.10



**CÔNG BÁO SỞ HỮU CÔNG NGHIỆP SỐ 413 TẬP A – QUYỀN 2 (08.2022)**

- (11) **45241**  
(21) 3-2022-00990 (28) 1  
(54) **NHÃN SẢN PHẨM** (51) **19-08**  
(22) 20/05/2022 (43) 25/08/2022  
(73) **CÔNG TY TNHH XNK NANOIL USA (VN)**  
Lô Q13 đường số 11, KCN Hải Sơn mở rộng (GD 3+4), xã Đức Hòa Hạ, huyện Đức Hòa, tỉnh Long An  
(72) Mai Xuân Quang (VN)  
(55)



**CÔNG BÁO SỞ HỮU CÔNG NGHIỆP SỐ 413 TẬP A – QUYỀN 2 (08.2022)**

- (11) **45242**  
(21) 3-2022-00991 (28) 1  
(54) **TÚI XÁCH** (51) **03-01**  
(22) 20/05/2022 (43) 25/08/2022  
(73) **CÔNG TY TNHH SHONAN VIỆT NAM (VN)**  
Thôn 3, xã Vạn Phúc, huyện Thanh Trì, thành phố Hà Nội  
(72) Nguyễn Thị Thanh Hương (VN)  
(74) Công ty TNHH Sở hữu trí tuệ Gia Việt (GIAVIET CO., LTD.)  
(55)



1.1



1.2



1.3



1.4

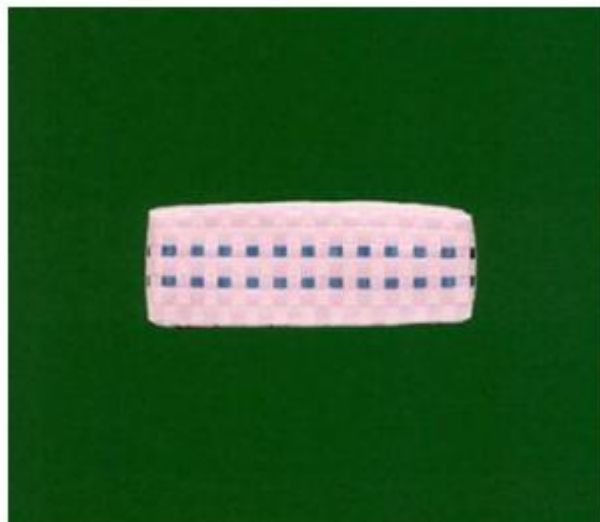

1.5

**CÔNG BÁO SỞ HỮU CÔNG NGHIỆP SỐ 413 TẬP A – QUYỀN 2 (08.2022)**

- (11) **45243**  
(21) 3-2022-00992 (28) 1  
(54) **TÚI XÁCH** (51) **03-01**  
(22) 20/05/2022 (43) 25/08/2022  
(73) **CÔNG TY TNHH SHONAN VIỆT NAM (VN)**  
Thôn 3, xã Vạn Phúc, huyện Thanh Trì, thành phố Hà Nội  
(72) Nguyễn Thị Thanh Hương (VN)  
(74) Công ty TNHH Sở hữu trí tuệ Gia Việt (GIAVIET CO., LTD.)  
(55)



1.1



1.2



1.3



1.4



1.5

**CÔNG BÁO SỞ HỮU CÔNG NGHIỆP SỐ 413 TẬP A – QUYỀN 2 (08.2022)**

- (11) **45244**  
(21) 3-2022-00996 (28) 1  
(54) **NHÃN SẢN PHẨM** (51) **19-08**  
(22) 25/05/2022 (43) 25/08/2022  
(73) **CÔNG TY CỔ PHẦN MARICO SOUTH EAST ASIA (VN)**  
Số 3, đường số 5, khu công nghiệp Sóng Thần 1, phường Dĩ An, thành phố Dĩ An,  
tỉnh Bình Dương  
(72) Trần Ngọc Lan (VN)  
(74) Công ty Luật TNHH Phạm và Liên danh (PHAM & ASSOCIATES)  
(55)



1.1



1.2

**CÔNG BÁO SỞ HỮU CÔNG NGHIỆP SỐ 413 TẬP A – QUYỀN 2 (08.2022)**

- (11) **45245**  
(21) 3-2022-00997 (28) 1  
(54) **NHÃN SẢN PHẨM** (51) **19-08**  
(22) 25/05/2022 (43) 25/08/2022  
(73) **CÔNG TY CỔ PHẦN MARICO SOUTH EAST ASIA (VN)**  
Số 3, đường số 5, khu công nghiệp Sóng Thần 1, phường Dĩ An, thành phố Dĩ An,  
tỉnh Bình Dương  
(72) Trần Ngọc Lan (VN)  
(74) Công ty Luật TNHH Phạm và Liên danh (PHAM & ASSOCIATES)  
(55)



1.1



1.2

**CÔNG BÁO SỞ HỮU CÔNG NGHIỆP SỐ 413 TẬP A – QUYỀN 2 (08.2022)**

- (11) **45246**  
(21) 3-2022-00998 (28) 1  
(54) **NHÃN SẢN PHẨM** (51) **19-08**  
(22) 25/05/2022 (43) 25/08/2022  
(73) **CÔNG TY CỔ PHẦN MARICO SOUTH EAST ASIA (VN)**  
Số 3, đường số 5, khu công nghiệp Sóng Thần 1, phường Dĩ An, thành phố Dĩ An,  
tỉnh Bình Dương  
(72) Trần Ngọc Lan (VN)  
(74) Công ty Luật TNHH Phạm và Liên danh (PHAM & ASSOCIATES)  
(55)



1.1



1.2



**CÔNG BÁO SỞ HỮU CÔNG NGHIỆP SỐ 413 TẬP A – QUYỀN 2 (08.2022)**

- (11) **45247**  
(21) 3-2022-00999 (28) 1  
(54) **BAO GÓI** (51) **09-05**  
(22) 25/05/2022 (43) 25/08/2022  
(73) **CÔNG TY CỔ PHẦN MARICO SOUTH EAST ASIA (VN)**  
Số 3, đường số 5, khu công nghiệp Sóng Thần 1, phường Dĩ An, thành phố Dĩ An,  
tỉnh Bình Dương  
(72) Trần Ngọc Lan (VN)  
(74) Công ty Luật TNHH Phạm và Liên danh (PHAM & ASSOCIATES)  
(55)



1.1



1.2

**CÔNG BÁO SỞ HỮU CÔNG NGHIỆP SỐ 413 TẬP A – QUYỀN 2 (08.2022)**

- (11) **45248**  
(21) 3-2022-01000 (28) 1  
(54) **BAO GÓI** (51) **09-05**  
(22) 25/05/2022 (43) 25/08/2022  
(73) **CÔNG TY CỔ PHẦN MARICO SOUTH EAST ASIA (VN)**  
Số 3, đường số 5, khu công nghiệp Sóng Thần 1, phường Dĩ An, thành phố Dĩ An,  
tỉnh Bình Dương  
(72) Trần Ngọc Lan (VN)  
(74) Công ty Luật TNHH Phạm và Liên danh (PHAM & ASSOCIATES)  
(55)

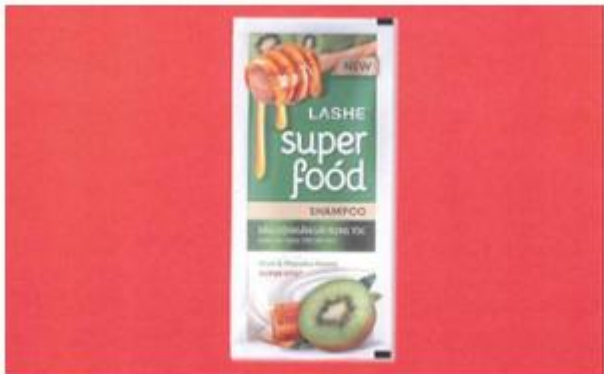

1.1



1.2

**CÔNG BÁO SỞ HỮU CÔNG NGHIỆP SỐ 413 TẬP A – QUYỀN 2 (08.2022)**

- (11) **45249**  
(21) 3-2022-01001 (28) 1  
(54) **NHÃN SẢN PHẨM** (51) **19-08**  
(22) 25/05/2022 (43) 25/08/2022  
(73) **CÔNG TY CỔ PHẦN MARICO SOUTH EAST ASIA (VN)**  
Số 3, đường số 5, khu công nghiệp Sóng Thần 1, phường Dĩ An, thành phố Dĩ An,  
tỉnh Bình Dương  
(72) Trần Ngọc Lan (VN)  
(74) Công ty Luật TNHH Phạm và Liên danh (PHAM & ASSOCIATES)  
(55)



1.1



1.2

**CÔNG BÁO SỞ HỮU CÔNG NGHIỆP SỐ 413 TẬP A – QUYỀN 2 (08.2022)**

- (11) **45250**  
(21) 3-2022-01002 (28) 1  
(54) **NHÃN SẢN PHẨM** (51) **19-08**  
(22) 25/05/2022 (43) 25/08/2022  
(73) **CÔNG TY CỔ PHẦN MARICO SOUTH EAST ASIA (VN)**  
Số 3, đường số 5, khu công nghiệp Sóng Thần 1, phường Dĩ An, thành phố Dĩ An,  
tỉnh Bình Dương  
(72) Trần Ngọc Lan (VN)  
(74) Công ty Luật TNHH Phạm và Liên danh (PHAM & ASSOCIATES)  
(55)



1.1



1.2

**CÔNG BÁO SỞ HỮU CÔNG NGHIỆP SỐ 413 TẬP A – QUYỀN 2 (08.2022)**

- (11) **45251**  
(21) 3-2022-01003 (28) 3  
(54) **BAO GÓI** (51) **09-05**  
(22) 25/05/2022 (43) 25/08/2022  
(73) **CÔNG TY CỔ PHẦN THỰC PHẨM Á CHÂU (VN)**  
Số 9/2 đường ĐT 743, khu phố 1B, phường An Phú, thành phố Thuận An, tỉnh Bình Dương  
(72) **NGUYỄN MẠNH CƯỜNG (VN)**  
(74) Văn phòng Luật sư A Hoà (AHOA LAW OFFICE)  
(55)



1.1



1.2



2.1



2.2



3.1



3.2

**CÔNG BÁO SỞ HỮU CÔNG NGHIỆP SỐ 413 TẬP A – QUYỀN 2 (08.2022)**

- (11) **45252**  
(21) 3-2022-01006 (28) 1  
(54) **NHÃN SẢN PHẨM** (51) **19-08**  
(22) 25/05/2022 (43) 25/08/2022  
(73) **PARK, NAM HEE (KR)**  
239, Sindong-gil, Namil-myeon, Geumsan-gun, Chungcheongnam-do, Republic of Korea  
(72) PARK, Nam Hee (KR)  
(74) Công ty TNHH Trường Xuân (AGELESS CO.,LTD.)  
(55)



**CÔNG BÁO SỞ HỮU CÔNG NGHIỆP SỐ 413 TẬP A – QUYỀN 2 (08.2022)**

- (11) **45253**  
(21) 3-2022-01008 (28) 1  
(54) **CHAI** (51) **09-01**  
(22) 25/05/2022 (43) 25/08/2022  
(73) **CÔNG TY CỔ PHẦN SẢN XUẤT THƯƠNG MẠI T&B (VN)**  
A43, ấp Thanh Hùng, xã Thanh Điền, huyện Châu Thành, tỉnh Tây Ninh  
(72) Giang Thành Được (VN)  
(74) **CÔNG TY TNHH SỞ HỮU TRÍ TUỆ SETHACO (SETHACO IP CO.,LTD)**  
(55)



1.1

1.2



1.3

1.4





1.5



1.6



1.7

(11) **45254**

(21) 3-2022-01009

(28) 1

(54) **CHAI**

(51) **09-01**

(22) 26/05/2022

(43) 25/08/2022

(73) **CÔNG TY TNHH VIỆT HOÀNG HUY (VN)**

Thôn 6, xã Thạch Hòa, huyện Thạch Thất, thành phố Hà Nội

(72) Đào Thị Thu Thảo (VN)

(55)

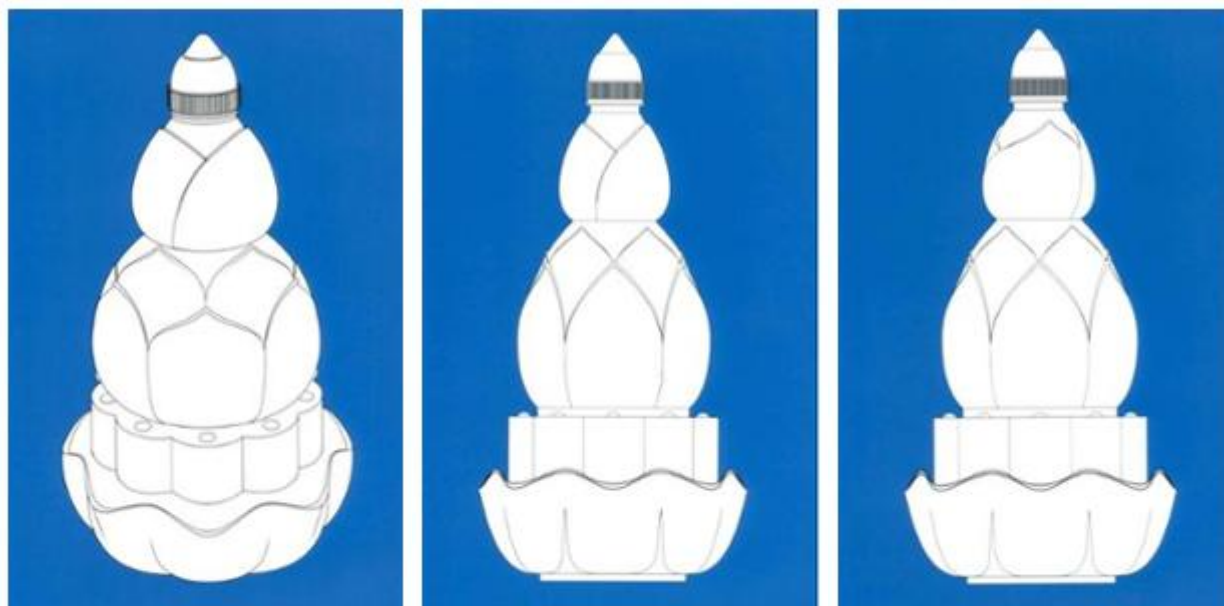

1.1

1.2

1.3

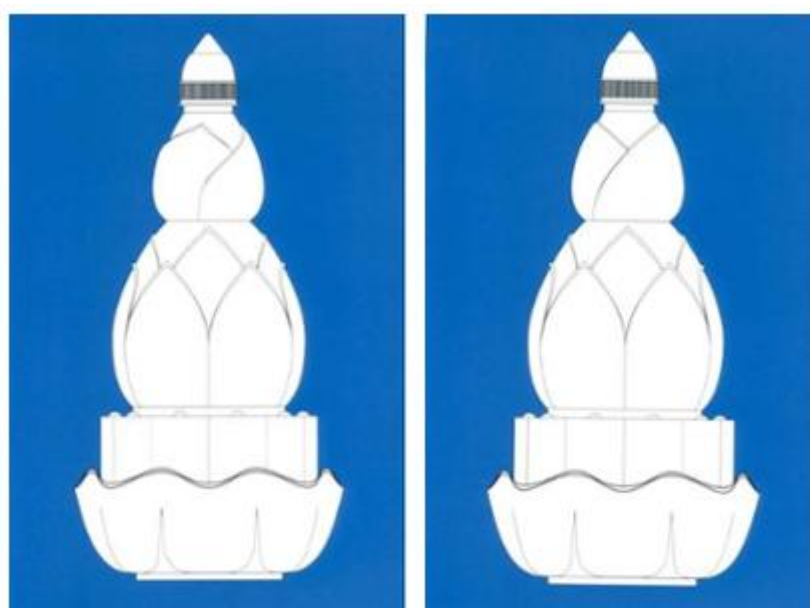

1.4

1.5



1.6



1.7

**CÔNG BÁO SỞ HỮU CÔNG NGHIỆP SỐ 413 TẬP A – QUYỀN 2 (08.2022)**

- (11) **45255**  
(21) 3-2022-01014 (28) 4  
(54) **HỘP** (51) **09-03**  
(22) 26/05/2022 (43) 25/08/2022  
(73) **CÔNG TY CỔ PHẦN LESTAR GROUP (VN)**  
Tầng 2, tòa nhà B9, khu đô thị Đại Kim - Định Công, đường Nguyễn Công Thái,  
phường Đại Kim, quận Hoàng Mai, thành phố Hà Nội  
(72) Nguyễn Hải Kiên (VN)  
(74) **CÔNG TY TNHH SỞ HỮU TRÍ TUỆ ANLIS VIỆT NAM (ANLIS IP CO.,LTD)**  
(55)



1.1



1.2



2.1



2.2



3.1



3.2



4.1



4.2

- (11) **45256**  
(21) 3-2022-01015 (28) 1  
(54) **HỘP** (51) **09-03**  
(22) 26/05/2022 (43) 25/08/2022  
(73) **ORION CORPORATION (KR)**  
13, Baekbeom-ro 90da-gil Yongsan-gu, Seoul 04369, Republic of Korea  
(72) 1. LEE, A RUEM (KR)  
2. CHOE, EUN JE (KR)  
(74) Công ty Luật TNHH quốc tế BMVN (BMVN INTERNATIONAL LLC)  
(55)



1.1



1.2

**CÔNG BÁO SỞ HỮU CÔNG NGHIỆP SỐ 413 TẬP A – QUYỀN 2 (08.2022)**

- (11) **45257**  
(21) 3-2022-01016 (28) 1  
(54) **BAO GÓI** (51) **09-05**  
(22) 26/05/2022 (43) 25/08/2022  
(73) **ORION CORPORATION (KR)**  
13, Baekbeom-ro 90da-gil Yongsan-gu, Seoul 04369, Republic of Korea  
(72) 1. NOH, SU BEEN (KR)  
2. LEE, A RUEM (KR)  
(74) Công ty Luật TNHH quốc tế BMVN (BMVN INTERNATIONAL LLC)  
(55)



1.1



1.2



**CÔNG BÁO SỞ HỮU CÔNG NGHIỆP SỐ 413 TẬP A – QUYỀN 2 (08.2022)**

- (11) **45258**  
(21) 3-2022-01017 (28) 1  
(54) **HỘP** (51) **09-03**  
(22) 26/05/2022 (43) 25/08/2022  
(73) **ORION CORPORATION (KR)**  
13, Baekbeom-ro 90da-gil Yongsan-gu, Seoul 04369, Republic of Korea  
(72) 1. NOH, SU BEEN (KR)  
2. LEE, A RUEM (KR)  
(74) Công ty Luật TNHH quốc tế BMVN (BMVN INTERNATIONAL LLC)  
(55)



1.1



1.2



**CÔNG BÁO SỞ HỮU CÔNG NGHIỆP SỐ 413 TẬP A – QUYỀN 2 (08.2022)**

- (11) **45259**  
(21) 3-2022-01024 (28) 1  
(54) **HỘP ĐỰNG SẢN PHẨM** (51) **09-03**  
(22) 27/05/2022 (43) 25/08/2022  
(73) **CÔNG TY TNHH GIA BẢO (VN)**  
Km48, quốc lộ 5, phường Việt Hòa, thành phố Hải Dương, tỉnh Hải Dương  
(72) Nguyễn Đình Dưỡng (VN)  
(74) Công ty Luật TNHH WINCO (WINCO LAW FIRM)  
(55)



1.1



1.2



1.3



1.4



1.5



1.6

**CÔNG BÁO SỞ HỮU CÔNG NGHIỆP SỐ 413 TẬP A – QUYỀN 2 (08.2022)**

(11) **45260**

(21) 3-2022-01025

(28) 1

(54) **CỐC**

(51) **07-01**

(22) 27/05/2022

(43) 25/08/2022

(73) **CÔNG TY TNHH MINH LONG I (VN)**

333 khu phố Hưng Lộc, phường Hưng Định, thành phố Thuận An, tỉnh Bình Dương

(72) Lý Ngọc Minh (VN)

(55)



1.1



1.2



1.3



1.4

**CÔNG BÁO SỞ HỮU CÔNG NGHIỆP SỐ 413 TẬP A – QUYỀN 2 (08.2022)**

- (11) **45261**
- (21) 3-2022-01028 (28) 1
- (54) **NHÃN SẢN PHẨM** (51) **19-08**
- (22) 30/05/2022 (43) 25/08/2022
- (73) **NGUYỄN THÀNH NGHĨA (VN)**  
Số nhà 819 đường Cách Mạng Tháng 8, khu phố Hiệp Bình, phường Hiệp Ninh,  
thành phố Tây Ninh, tỉnh Tây Ninh
- (72) Nguyễn Thành Nghĩa (VN)
- (74) Công ty TNHH Sở hữu trí tuệ VIPATCO (VIPATCO CO., LTD.)
- (55)



**CÔNG BÁO SỞ HỮU CÔNG NGHIỆP SỐ 413 TẬP A – QUYỀN 2 (08.2022)**

- (11) **45262**  
(21) 3-2022-01034 (28) 1  
(54) **NHÃN SẢN PHẨM** (51) **19-08**  
(22) 30/05/2022 (43) 25/08/2022  
(73) **CÔNG TY CỔ PHẦN HOÀNG GIA (VN)**  
Khu các cơ sở sản xuất công nghiệp bờ trái Sông Đà, đường Lê Thánh Tông, tổ 12,  
phường Hữu Nghị, thành phố Hòa Bình, tỉnh Hòa Bình  
(72) Lê Văn Thanh (VN)  
(55)



**CÔNG BÁO SỞ HỮU CÔNG NGHIỆP SỐ 413 TẬP A – QUYỀN 2 (08.2022)**

(11) **45263**

(21) 3-2022-01035

(28) 1

(54) **NHÃN SẢN PHẨM**

(51) **19-08**

(22) 30/05/2022

(43) 25/08/2022

(73) **CÔNG TY CỔ PHẦN HOÀNG GIA (VN)**

Khu các cơ sở sản xuất công nghiệp bờ trái Sông Đà, đường Lê Thánh Tông, tổ 12, phường Hữu Nghị, thành phố Hòa Bình, tỉnh Hòa Bình

(72) Lê Văn Thanh (VN)

(55)



**CÔNG BÁO SỞ HỮU CÔNG NGHIỆP SỐ 413 TẬP A – QUYỀN 2 (08.2022)**

- (11) **45264**  
(21) 3-2022-01038 (28) 1  
(54) **BÀN CHẢI** (51) **04-02**  
(22) 07/01/2022 (43) 25/08/2022  
(30) 008606644-0005 08/07/2021 EM;  
(73) **UNILEVER GLOBAL IP LIMITED (GB)**  
Port Sunlight Wirral, Merseyside CH62 4ZD, United Kingdom  
(72) 1. DAI XIAO GUO (CN)  
2. BARON NEIL MARTIN (GB)  
3. CAROEN ADRIAN BARCLAY (GB)  
4. BILLINGTON CHARLES PETER (GB)  
(74) Công ty TNHH Trần Hữu Nam và Đồng sự (TRAN H.N & ASS.)  
(55)



1.1



1.2



1.3



1.4



1.5



1.6



1.7

**CÔNG BÁO SỞ HỮU CÔNG NGHIỆP SỐ 413 TẬP A – QUYỀN 2 (08.2022)**

- (11) **45265**
- (21) 3-2022-01042
- (54) **NHÃN SẢN PHẨM**
- (22) 31/05/2022
- (73) **CÔNG TY CỔ PHẦN CÂY TRỒNG BÌNH CHÁNH (VN)**  
693A Kinh Dương Vương, khu phố 3, phường An Lạc, quận Bình Tân, thành phố Hồ Chí Minh
- (72) Trần Thị Tùng (VN)
- (55)
- (28) 1
- (51) **19-08**
- (43) 25/08/2022



**CÔNG BÁO SỞ HỮU CÔNG NGHIỆP SỐ 413 TẬP A – QUYỀN 2 (08.2022)**

- (11) **45266**  
(21) 3-2022-01043 (28) 1  
(54) **NHÃN SẢN PHẨM** (51) **19-08**  
(22) 31/05/2022 (43) 25/08/2022  
(73) **CÔNG TY CỔ PHẦN CÂY TRỒNG BÌNH CHÁNH (VN)**  
693A Kinh Dương Vương, khu phố 3, phường An Lạc, quận Bình Tân, thành phố Hồ Chí Minh  
(72) Trần Thị Tùng (VN)  
(55)





**CÔNG BÁO SỞ HỮU CÔNG NGHIỆP SỐ 413 TẬP A – QUYỀN 2 (08.2022)**

- (11) **45267**  
(21) 3-2022-01044 (28) 1  
(54) **NHÃN SẢN PHẨM** (51) **19-08**  
(22) 31/05/2022 (43) 25/08/2022  
(73) **CÔNG TY CỔ PHẦN CÂY TRỒNG BÌNH CHÁNH (VN)**  
693A Kinh Dương Vương, khu phố 3, phường An Lạc, quận Bình Tân, thành phố Hồ Chí Minh  
(72) Trần Thị Tùng (VN)  
(55)



- (11) **45268**  
(21) 3-2022-01046 (28) 1  
(54) **NHÃN SẢN PHẨM** (51) **19-08**  
(22) 31/05/2022 (43) 25/08/2022  
(73) **CÔNG TY CỔ PHẦN CÂY TRỒNG BÌNH CHÁNH (VN)**  
693A Kinh Dương Vương, khu phố 3, phường An Lạc, quận Bình Tân, thành phố Hồ Chí Minh  
(72) Trần Thị Tùng (VN)  
(55)

Phân bón lá NPK sinh học có chất điều hòa sinh trưởng

**ROOTS NEW** TVL 13.8

Roots Amino loại đặc biệt

**SIÊU RA RỄ CỰC MẠNH**

**CÔNG DỤNG:**

- Phát triển bộ rễ cực mạnh.
- Hạ phèn, giải độc.
- Đặc biệt phục hồi nhanh cây trồng sau ngập úng, hạn hán.

**CÁCH SỬ DỤNG:**

- *Pha lỏng 20ml/16 lít nước. (0.8 lít/600 lít nước/ha/tần)*
- *Cây con họ dưa, bầu d: 5-10ml/16 lít nước. (0.4 lít/600 lít nước/ha/tần)*
- *Định kỳ: 7-10 ngày/lần*

**THÀNH PHẦN:**  
N: 6%; P<sub>2</sub>O<sub>5</sub>: 8%; K<sub>2</sub>O: 6%;  
Axit humic: 9%; Axit aminic:  
0.12%; NAA: 0.05%.  
Phụ gia đặc biệt.

**ĐỂ XA TÂM TAY TRẺ EM**

NSX:  
HĐ :

THÀNH SẢN PHẨM

**LẮC ĐỀU CHAI TRƯỚC KHI DÙNG**  
Đơn vị sản xuất

**CTY CP CÂY TRỒNG BÌNH CHÁNH**  
693A Kinh Dương Vương, P. An Lạc, Q. Bình Tân, TP. HCM  
ĐT: 04 3672020 - 3672021 FAX: 04 3672022  
Email: namngoc@gmail.com Web: cactrongbinhchanh.com

**CÔNG BÁO SỞ HỮU CÔNG NGHIỆP SỐ 413 TẬP A – QUYỀN 2 (08.2022)**

(11) **45269**

(21) 3-2022-01047

(28) 1

(54) **BÁT**

(51) **07-01**

(22) 31/05/2022

(43) 25/08/2022

(73) **CÔNG TY TNHH MINH LONG I (VN)**

333 khu phố Hưng Lộc, phường Hưng Định, thành phố Thuận An, tỉnh Bình Dương

(72) Lý Ngọc Minh (VN)

(55)



1.1



1.2



1.3



1.4

**CÔNG BÁO SỞ HỮU CÔNG NGHIỆP SỐ 413 TẬP A – QUYỀN 2 (08.2022)**

(11) **45270**

(21) 3-2022-01048

(28) 1

(54) **BÁT**

(51) **07-01**

(22) 31/05/2022

(43) 25/08/2022

(73) **CÔNG TY TNHH MINH LONG I (VN)**

333 khu phố Hưng Lộc, phường Hưng Định, thành phố Thuận An, tỉnh Bình Dương

(72) Lý Ngọc Minh (VN)

(55)



1.1



1.2



1.3



1.4

**CÔNG BÁO SỞ HỮU CÔNG NGHIỆP SỐ 413 TẬP A – QUYỀN 2 (08.2022)**

- (11) **45271**  
(21) 3-2022-01049 (28) 1  
(54) **NHÃN SẢN PHẨM** (51) **19-08**  
(22) 31/05/2022 (43) 25/08/2022  
(73) **CÔNG TY CỔ PHẦN SỮA BÒ TƯƠI LONG THÀNH (VN)**  
Số 479/7 đường Phùng Hưng, tổ 10B, KP Long Đức 3, phường Tam Phước, thành phố Biên Hòa, tỉnh Đồng Nai  
(72) Hoàng Công Mẫn (VN)  
(55)



**CÔNG BÁO SỞ HỮU CÔNG NGHIỆP SỐ 413 TẬP A – QUYỀN 2 (08.2022)**

- (11) **45272**  
(21) 3-2022-01050 (28) 1  
(54) **NHÃN SẢN PHẨM** (51) **19-08**  
(22) 31/05/2022 (43) 25/08/2022  
(73) **CÔNG TY CỔ PHẦN SỮA BÒ TƯƠI LONG THÀNH (VN)**  
Số 479/7 đường Phùng Hưng, tổ 10B, KP Long Đức 3, phường Tam Phước, thành phố Biên Hòa, tỉnh Đồng Nai  
(72) Hoàng Công Mẫn (VN)  
(55)



**CÔNG BÁO SỞ HỮU CÔNG NGHIỆP SỐ 413 TẬP A – QUYỀN 2 (08.2022)**

- (11) **45273**  
(21) 3-2022-01054 (28) 2  
(54) **BAO GÓI** (51) **09-05**  
(22) 31/05/2022 (43) 25/08/2022  
(73) **CÔNG TY TNHH NTQM (VIỆT NAM) (VN)**  
Số 22 VSIP II-A, đường số 23, khu công nghiệp Việt Nam - Singapore II-A,  
phường Vĩnh Tân, thị xã Tân Uyên, tỉnh Bình Dương  
(72) LEE KUAN PHENG (MY)  
(74) Công ty TNHH Sở hữu trí tuệ HA VIP (HAVIP CO., LTD.)  
(55)



1.1



1.2



2.1



2.2

**CÔNG BÁO SỞ HỮU CÔNG NGHIỆP SỐ 413 TẬP A – QUYỀN 2 (08.2022)**

- (11) **45274**  
(21) 3-2022-01057 (28) 1  
(54) **TAY NẮM CỬA** (51) **08-06**  
(22) 31/05/2022 (43) 25/08/2022  
(73) **CÔNG TY CỔ PHẦN OCIMI VIỆT NAM (VN)**  
Số nhà 19D, ngõ 180 Nam Dư, tổ 19, phường Lĩnh Nam, quận Hoàng Mai, thành phố Hà Nội  
(72) Ngô Thọ Thịnh (VN)  
(74) Công ty TNHH Sở hữu trí tuệ PADEMARK (PADEMARK CO.,LTD.)  
(55)

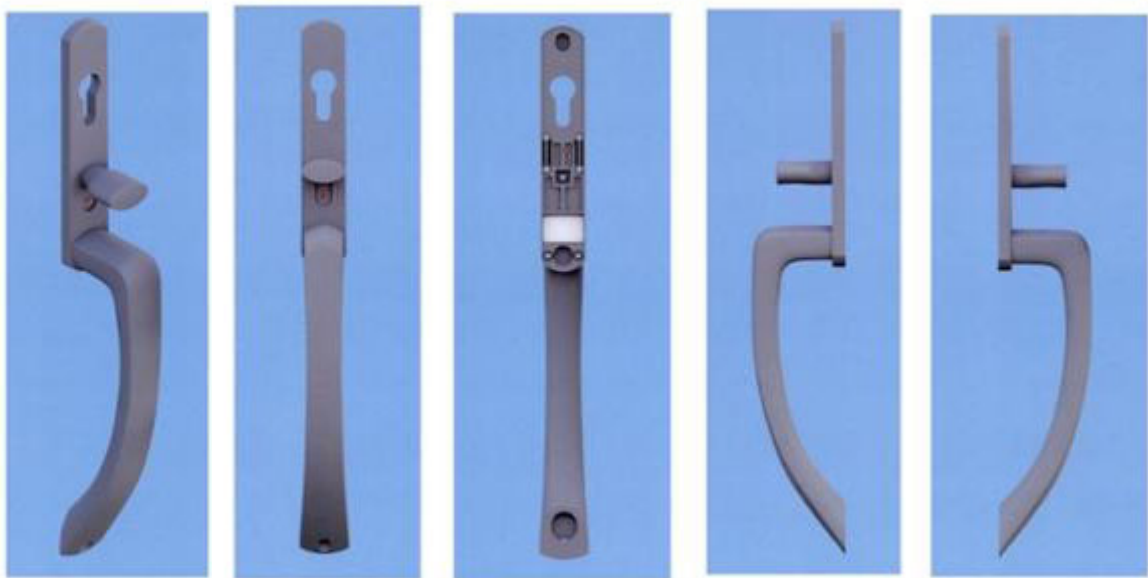

1.1

1.2

1.3

1.4

1.5

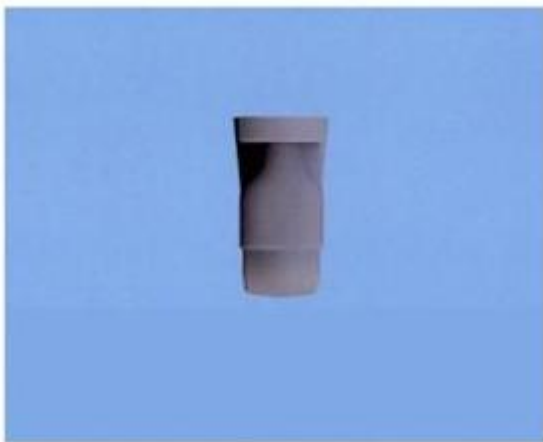

1.6



1.7



**CÔNG BÁO SỞ HỮU CÔNG NGHIỆP SỐ 413 TẬP A – QUYỀN 2 (08.2022)**

- (11) **45275**  
(21) 3-2022-01058 (28) 1  
(54) **BẢN LỀ CỬA XÉP TRƯỢT** (51) **08-06**  
(22) 31/05/2022 (43) 25/08/2022  
(73) **CÔNG TY CỔ PHẦN OCIMI VIỆT NAM (VN)**  
Số nhà 19D, ngõ 180 Nam Dư, tổ 19, phường Lĩnh Nam, quận Hoàng Mai, thành phố Hà Nội  
(72) Ngô Thọ Thịnh (VN)  
(74) Công ty TNHH Sở hữu trí tuệ PADEMARK (PADEMARK CO.,LTD.)  
(55)



1.1



1.2



1.3

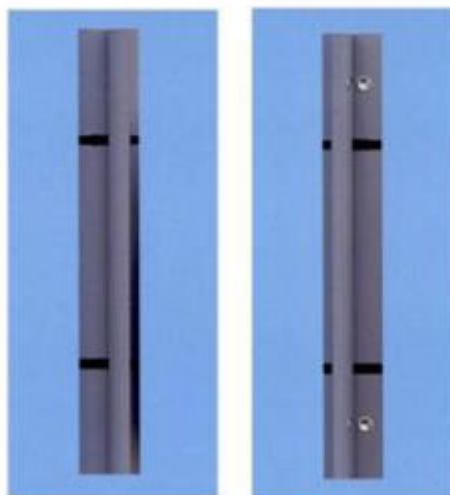

1.4

1.5



1.6



1.7

**CÔNG BÁO SỞ HỮU CÔNG NGHIỆP SỐ 413 TẬP A – QUYỀN 2 (08.2022)**

- (11) **45276**  
(21) 3-2022-01059 (28) 1  
(54) **BẢN LỀ BÁNH XE CỬA XẾP TRƯỢT** (51) **08-06**  
(22) 31/05/2022 (43) 25/08/2022  
(73) **CÔNG TY CỔ PHẦN OCIMI VIỆT NAM (VN)**  
Số nhà 19D, ngõ 180 Nam Dư, tổ 19, phường Lĩnh Nam, quận Hoàng Mai, thành phố Hà Nội  
(72) Ngô Thọ Thịnh (VN)  
(74) Công ty TNHH Sở hữu trí tuệ PADEMARK (PADEMARK CO.,LTD.)  
(55)



1.1



1.2



1.3



1.4



1.5

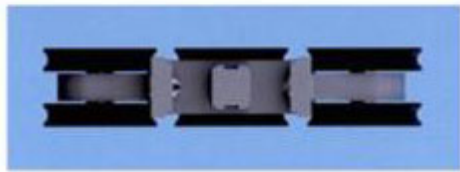

1.6



1.7

**CÔNG BÁO SỞ HỮU CÔNG NGHIỆP SỐ 413 TẬP A – QUYỀN 2 (08.2022)**

- (11) **45277**  
(21) 3-2022-01060 (28) 1  
(54) **BẢN LỀ BÁNH XE CỬA XẾP TRƯỢT** (51) **08-06**  
(22) 31/05/2022 (43) 25/08/2022  
(73) **CÔNG TY CỔ PHẦN OCIMI VIỆT NAM (VN)**  
Số nhà 19D, ngõ 180 Nam Dư, tổ 19, phường Lĩnh Nam, quận Hoàng Mai, thành phố Hà Nội  
(72) Ngô Thọ Thịnh (VN)  
(74) Công ty TNHH Sở hữu trí tuệ PADEMARK (PADEMARK CO.,LTD.)  
(55)



1.1

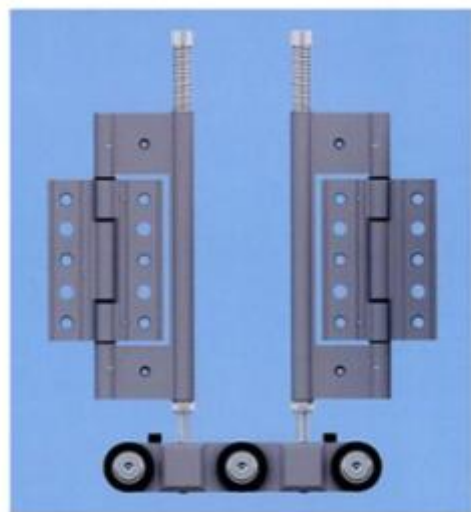

1.2

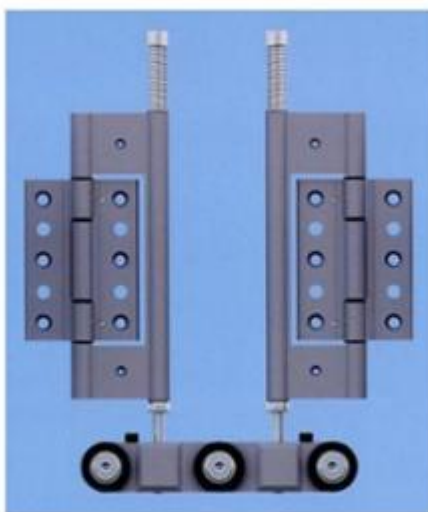

1.3



1.4



1.5

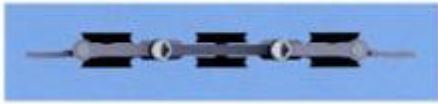

1.6

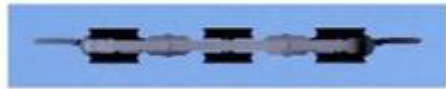

1.7

**CÔNG BÁO SỞ HỮU CÔNG NGHIỆP SỐ 413 TẬP A – QUYỀN 2 (08.2022)**

- (11) **45278**  
(21) 3-2022-01064 (28) 1  
(54) **ĐIỀU THUỐC LÁ ĐIỆN TỬ** (51) **27-02; 27-99**  
(22) 31/05/2022 (43) 25/08/2022  
(73) **KT&G CORPORATION (KR)**  
71, Beotkkot-gil, Daedeok-gu, Daejeon, Korea  
(72) KIM, Min Chul (KR)  
(74) Công ty TNHH T&T INVENMARK Sở hữu trí tuệ Quốc tế (T&T INVENMARK CO., LTD.)  
(55)



1.1

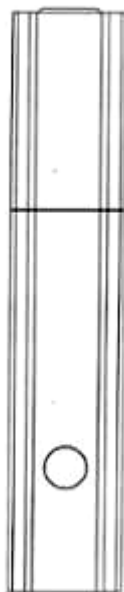

1.2



1.3



1.4



1.5



1.6



1.7

- (11) **45279**  
(21) 3-2022-01065 (28) 1  
(54) **HỘP ĐỰNG BÁNH** (51) **09-03**  
(22) 01/06/2022 (43) 25/08/2022  
(73) **CÔNG TY TNHH TM DV NGA PHÁT FOOD (VN)**  
Thửa đất số 306, tờ bản đồ số 17, khu phố Phú Thọ, phường Phú Chánh, thị xã Tân Uyên, tỉnh Bình Dương  
(72) Nguyễn Văn Sâm (VN)  
(55)



1.1

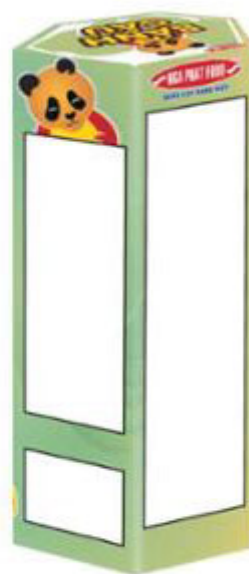

1.2



1.3



**CÔNG BÁO SỞ HỮU CÔNG NGHIỆP SỐ 413 TẬP A – QUYỀN 2 (08.2022)**

- (11) **45280**  
(21) 3-2022-01066 (28) 1  
(54) **HỘP ĐỰNG BÁNH** (51) **09-03**  
(22) 01/06/2022 (43) 25/08/2022  
(73) **CÔNG TY TNHH TM DV NGA PHÁT FOOD (VN)**  
Thửa đất số 306, tờ bản đồ số 17, khu phố Phú Thọ, phường Phú Chánh, thị xã Tân Uyên, tỉnh Bình Dương  
(72) Nguyễn Văn Sâm (VN)  
(55)



1.1



1.2



1.3

**CÔNG BÁO SỞ HỮU CÔNG NGHIỆP SỐ 413 TẬP A – QUYỀN 2 (08.2022)**

- (11) **45281**  
(21) 3-2022-01067 (28) 1  
(54) **KHÓA ĐIỆN TỬ** (51) **08-07**  
(22) 01/06/2022 (43) 25/08/2022  
(73) **CÔNG TY TNHH SIMUS (VN)**  
Thôn Phấn Sơn, xã Đồng Sơn, thành phố Bắc Giang, tỉnh Bắc Giang  
(72) Hoàng Mạnh Thắng (VN)  
(74) **CÔNG TY TRÁCH NHIỆM HỮU HẠN TƯ VẤN ĐẦU TƯ VÀ SỞ HỮU TRÍ TUỆ INTERFIVE (INTERFIVE CO., LTD)**  
(55)



1.1



1.2



1.3



1.4



1.5



1.6



1.7

**CÔNG BÁO SỞ HỮU CÔNG NGHIỆP SỐ 413 TẬP A – QUYỀN 2 (08.2022)**

- (11) **45282**  
(21) 3-2022-01070 (28) 4  
(54) **BỘ NHÃN SẢN PHẨM** (51) **19-08**  
(22) 01/06/2022 (43) 25/08/2022  
(73) **CÔNG TY CỔ PHẦN ACECOOK VIỆT NAM (VN)**  
Lô số II-3, đường số 11, nhóm CN II, khu công nghiệp Tân Bình, phường Tây  
Thạnh, quận Tân Phú, thành phố Hồ Chí Minh  
(72) Kajiwara Junichi (JP)  
(74) Công ty Luật TNHH Phạm và Liên danh (PHAM & ASSOCIATES)  
(55)



1.1



1.2



1.3



2.1



2.2



2.3

(11) **45283**

(21) 3-2022-01071

(28) 1

(54) **ĐÈN CHIẾU SÁNG**

(51) **26-03**

(22) 02/06/2022

(43) 25/08/2022

(73) **CÔNG TY CỔ PHẦN CHIẾU SÁNG ĐÔ THỊ HOÀNG GIA (VN)**

Số 157 phố Phương Mai, phường Phương Mai, quận Đống Đa, thành phố Hà Nội

(72) Hoàng Song Hà (VN)

(55)

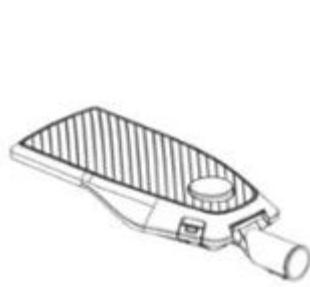

1.1



1.2



1.3



1.4



1.5



1.6



1.7

- (11) **45284**  
(21) 3-2022-01072 (28) 1  
(54) **ĐÈN CHIẾU SÁNG** (51) **26-03**  
(22) 02/06/2022 (43) 25/08/2022  
(73) **CÔNG TY CỔ PHẦN CHIẾU SÁNG ĐÔ THỊ HOÀNG GIA (VN)**  
Số 157 phố Phương Mai, phường Phương Mai, quận Đống Đa, thành phố Hà Nội  
(72) Hoàng Song Hà (VN)  
(55)



1.1

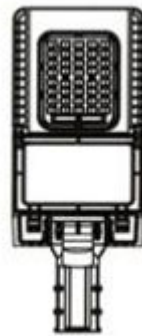

1.2

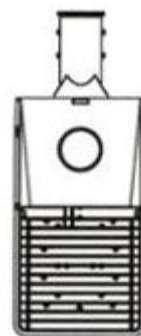

1.3



1.4



1.5



1.6



1.7

**CÔNG BÁO SỞ HỮU CÔNG NGHIỆP SỐ 413 TẬP A – QUYỀN 2 (08.2022)**

- (11) **45285**  
(21) 3-2022-01076 (28) 1  
(54) **CHAI** (51) **09-01**  
(22) 02/06/2022 (43) 25/08/2022  
(73) **HỢP TÁC XÃ KINH DOANH TỔNG HỢP HUYỆN MƯỜNG KHƯƠNG, TỈNH LÀO CAI (VN)**  
Thôn Nhân Giồng, thị trấn Mường Khương, huyện Mường Khương, tỉnh Lào Cai  
(72) Nguyễn Văn Dũng (VN)  
(74) Công ty TNHH MASTERBRAND (MASTERBRAND)  
(55)

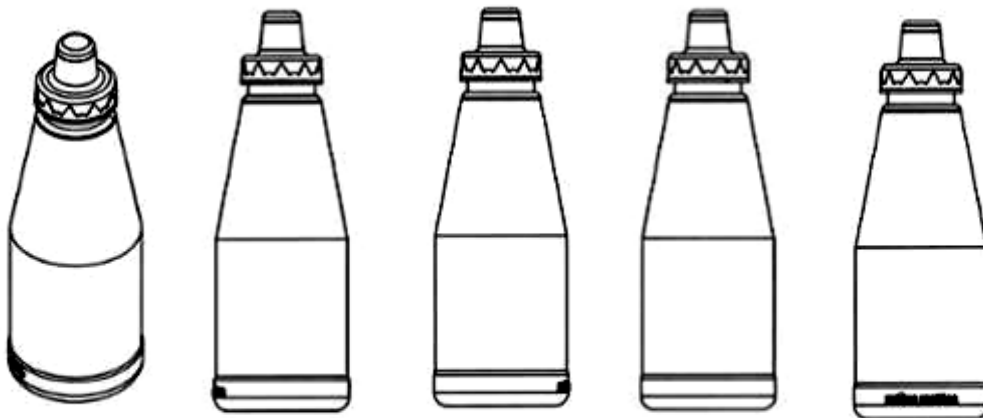

1.1

1.2

1.3

1.4

1.5

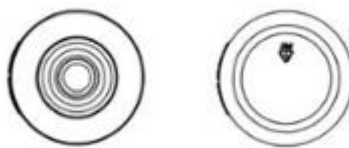

1.6

1.7

- (11) **45286**  
(21) 3-2022-01080 (28) 1  
(54) **DÂY DỪNG CHO KHÓA KÉO** (51) **02-07**  
(22) 03/06/2022 (43) 25/08/2022  
(73) **HERMES SELLIER (SOCIÉTÉ PAR ACTIONS SIMPLIFIÉE) (FR)**  
24, rue du Faubourg Saint-Honoré, F-75008 PARIS (France)  
(72) Henda GIARRATANO (FR)  
(74) Công ty Luật TNHH ROUSE Việt Nam (ROUSE LAW CO.,LTD)  
(55)

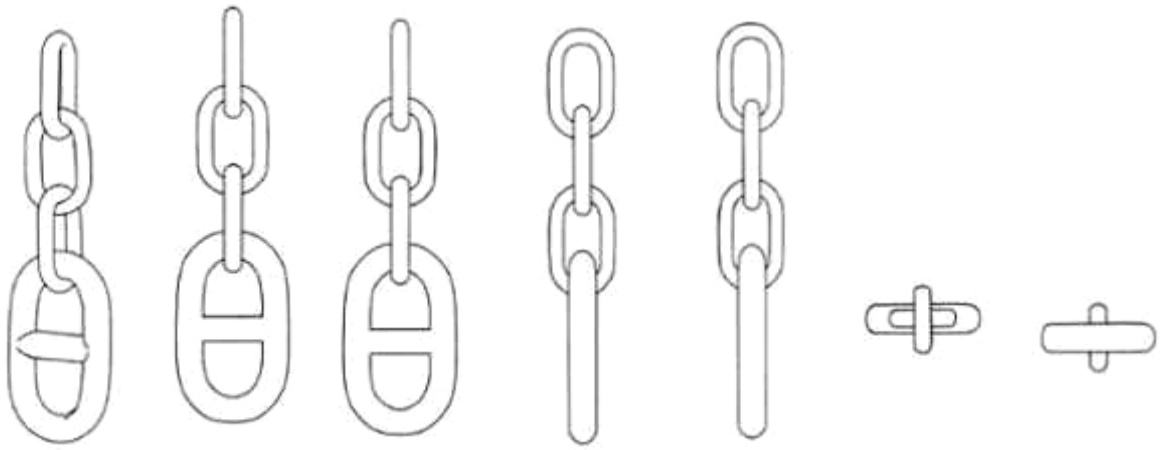

1.1

1.2

1.3

1.4

1.5

1.6

1.7

**CÔNG BÁO SỞ HỮU CÔNG NGHIỆP SỐ 413 TẬP A – QUYỀN 2 (08.2022)**

(11) **45287**

(21) 3-2022-01084

(28) 1

(54) **HỘP**

(51) **09-03**

(22) 03/06/2022

(43) 25/08/2022

(73) **CÔNG TY CỔ PHẦN VIVA CONSUMER (VN)**

50 Trần Khắc Chân, phường Tân Định, quận 1, thành phố Hồ Chí Minh

(72) Nguyễn Thị Phương Uyên (VN)

(74) **CÔNG TY TNHH KHANG LUẬT (KHANGLAW)**

(55)



1.1

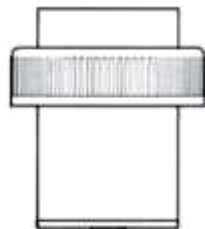

1.2

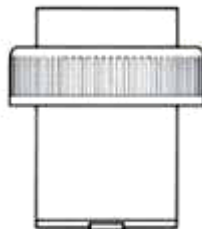

1.3

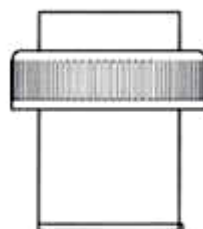

1.4

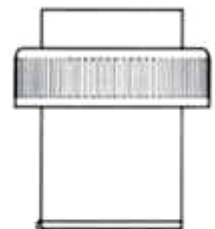

1.5

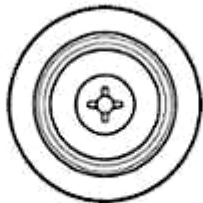

1.6

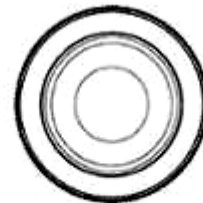

1.7

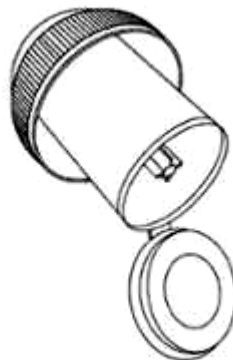

1.8



**CÔNG BÁO SỞ HỮU CÔNG NGHIỆP SỐ 413 TẬP A – QUYỀN 2 (08.2022)**

- (11) **45288**  
(21) 3-2022-01089 (28) 1  
(54) **BÌNH NƯỚC** (51) **07-07**  
(22) 06/06/2022 (43) 25/08/2022  
(30) 29/818,129 07/12/2021 US;  
(73) **DART INDUSTRIES INC. (US)**  
14901 S. Orange Blossom Trail, Orlando, Florida, 32837, United States of America  
(72) 1. TEO SOK YEE (MY)  
2. JOÃO MOREIRA DA COSTA (PT)  
(74) **CÔNG TY LUẬT TRÁCH NHIỆM HỮU HẠN AMBYS HÀ NỘI (AMBYS HANOI)**  
(55)



1.1

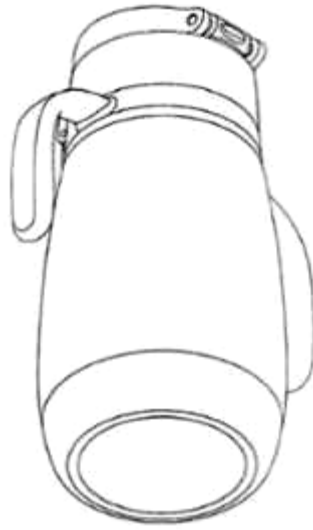

1.2

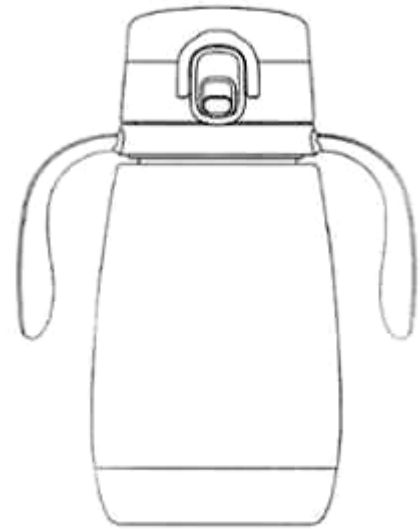

1.3

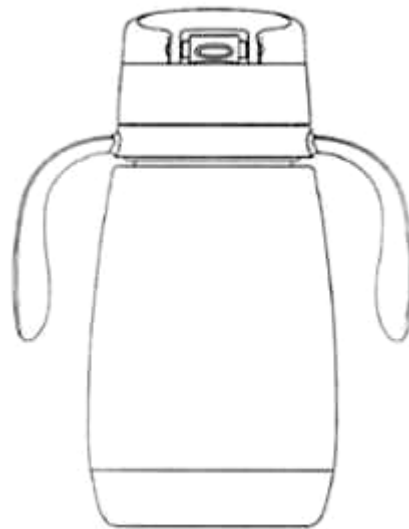

1.4

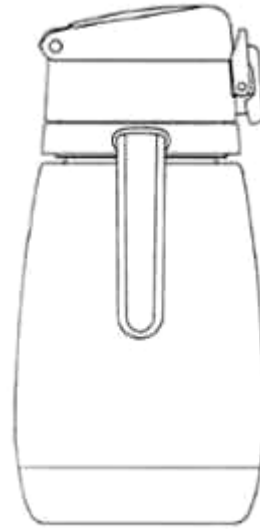

1.5

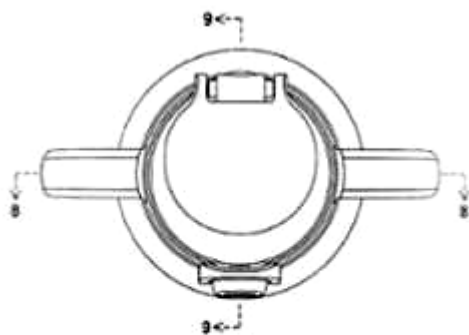

1.6

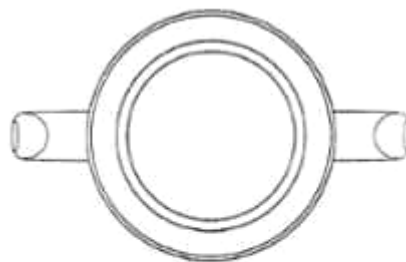

1.7

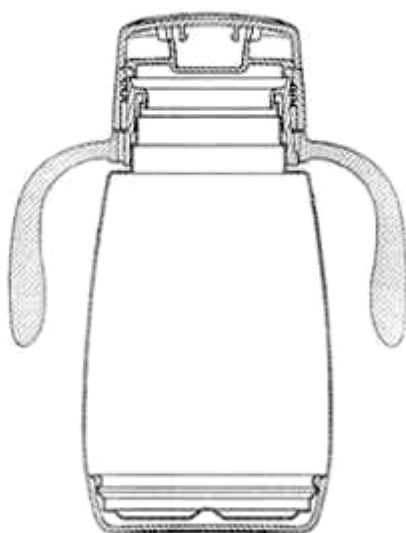

1.8

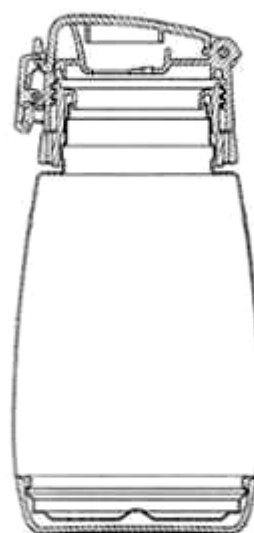

1.9

**CÔNG BÁO SỞ HỮU CÔNG NGHIỆP SỐ 413 TẬP A – QUYỀN 2 (08.2022)**

- (11) **45289**  
(21) 3-2022-01091 (28) 1  
(54) **BAO GÓI** (51) **09-05**  
(22) 06/06/2022 (43) 25/08/2022  
(73) **CÔNG TY CỔ PHẦN THƯƠNG MẠI AGH (VN)**  
P50, F5, tổ 32, tập thể Xà Phòng, phường Thanh Xuân Trung, quận Thanh Xuân,  
thành phố Hà Nội  
(72) Trần Thị Kim Tuyền (VN)  
(74) Công ty TNHH Sở hữu trí tuệ HA VIP (HAVIP CO., LTD.)  
(55)



1.1



1.2

**CÔNG BÁO SỞ HỮU CÔNG NGHIỆP SỐ 413 TẬP A – QUYỀN 2 (08.2022)**

- (11) **45290**
- (21) 3-2022-01095 (28) 1
- (54) **NHÃN SẢN PHẨM** (51) **19-08**
- (22) 07/06/2022 (43) 25/08/2022
- (73) **CÔNG TY TNHH SẢN XUẤT KINH DOANH THƯƠNG MẠI & XUẤT NHẬP KHẨU ĐẠI LỘC (VN)**  
5/4A, ấp 2, xã Tân Quý Tây, huyện Bình Chánh, thành phố Hồ Chí Minh
- (72) Lê Đăng Hoàng Phúc (VN)
- (74) Công ty TNHH Dịch vụ thương mại và sở hữu công nghiệp Song Ngọc (I.P.T.S.)
- (55)

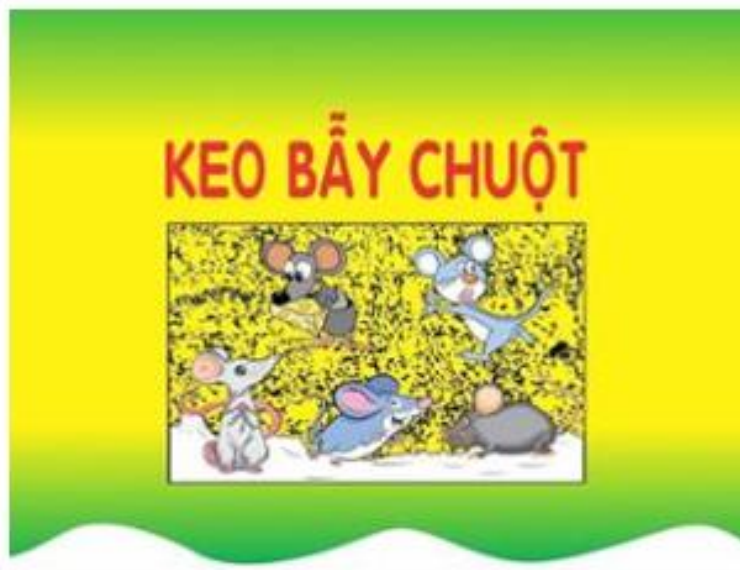

**CÔNG BÁO SỞ HỮU CÔNG NGHIỆP SỐ 413 TẬP A – QUYỀN 2 (08.2022)**

- (11) **45291**  
(21) 3-2022-01096 (28) 1  
(54) **CHAI** (51) **09-01**  
(22) 07/06/2022 (43) 25/08/2022  
(73) **CÔNG TY TNHH HÓA MỸ PHẨM NGỌC THỦY (VN)**  
101/31 Phạm Đình Hồ, phường 06, quận 6, thành phố Hồ Chí Minh  
(72) Trịnh Gia Phú (VN)  
(74) **CÔNG TY TNHH SỞ HỮU TRÍ TUỆ SETHACO (SETHACO IP CO.,LTD)**  
(55)



Hình 1: hình phối cảnh

1.1



Hình 2: hình chiếu phía trước

1.2



Hình 3: hình chiếu phía sau

1.3



Hình 4: hình chiếu bên trái, bên phải

1.4



1.5



1.6

**CÔNG BÁO SỞ HỮU CÔNG NGHIỆP SỐ 413 TẬP A – QUYỀN 2 (08.2022)**

- (11) **45292**  
(21) 3-2022-01098 (28) 1  
(54) **LỐC BIA** (51) **09-03**  
(22) 07/06/2022 (43) 25/08/2022  
(73) **TỔNG CÔNG TY CỔ PHẦN BIA - RƯỢU - NƯỚC GIẢI KHÁT SÀI GÒN (VN)**  
187 Nguyễn Chí Thanh, phường 12, quận 5, thành phố Hồ Chí Minh  
(72) Neo Gim Siong Bennett (SG)  
(74) Công ty TNHH Luật ALIAT (ALIAT LEGAL)  
(55)



1.1



1.2

**CÔNG BÁO SỞ HỮU CÔNG NGHIỆP SỐ 413 TẬP A – QUYỀN 2 (08.2022)**

- (11) **45293**  
(21) 3-2022-01100 (28) 1  
(54) **NHÃN SẢN PHẨM** (51) **19-08**  
(22) 07/06/2022 (43) 25/08/2022  
(73) **TỔNG CÔNG TY CỔ PHẦN BIA - RƯỢU - NƯỚC GIẢI KHÁT SÀI GÒN (VN)**  
187 Nguyễn Chí Thanh, phường 12, quận 5, thành phố Hồ Chí Minh  
(72) Neo Gim Siong Bennett (SG)  
(74) Công ty TNHH Luật ALIAT (ALIAT LEGAL)  
(55)



1.1



1.2



**CÔNG BÁO SỞ HỮU CÔNG NGHIỆP SỐ 413 TẬP A – QUYỀN 2 (08.2022)**

- (11) **45294**  
(21) 3-2022-01103 (28) 1  
(54) **BẢN LỀ BÁNH XE CỬA XẾP TRƯỢT** (51) **08-06**  
(22) 08/06/2022 (43) 25/08/2022  
(73) **CÔNG TY CỔ PHẦN OCIMI VIỆT NAM (VN)**  
Số nhà 19D, ngõ 180 Nam Dư, tổ 19, phường Lĩnh Nam, quận Hoàng Mai, thành phố Hà Nội  
(72) Ngô Thọ Thịnh (VN)  
(74) Công ty TNHH Sở hữu trí tuệ PADEMARK (PADEMARK CO.,LTD.)  
(55)



1.1

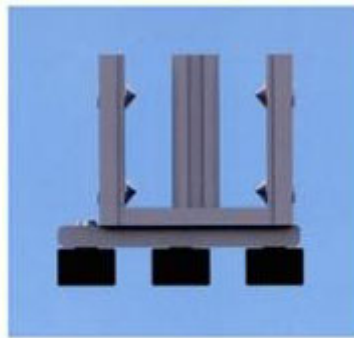

1.2

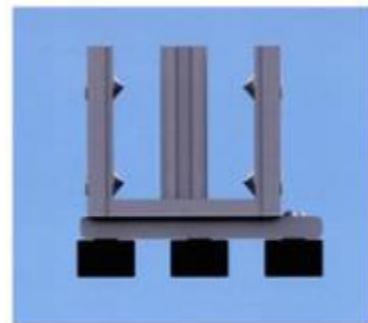

1.3

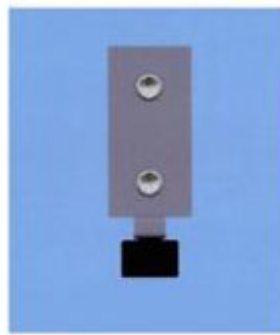

1.4

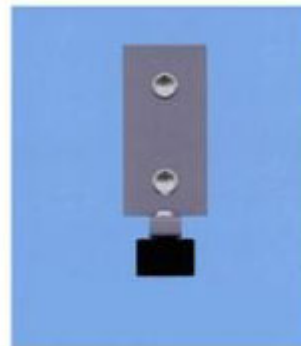

1.5



1.6



1.7

(11) **45295**

(21) 3-2022-01115

(28) 1

(54) **DÉP**

(51) **02-04**

(22) 08/06/2022

(43) 25/08/2022

(73) **CÔNG TY TNHH GIÀY Á CHÂU (VN)**

451/29/8 Tô Hiến Thành, phường 14, quận 10, thành phố Hồ Chí Minh

(72) Nguyễn Đình Kim (VN)

(74) Văn phòng Luật sư A Hoà (AHOA LAW OFFICE)

(55)



1.1



1.2



1.3



1.4



1.5



1.6



1.7



1.8

- (11) **45296**  
(21) 3-2022-01119 (28) 1  
(54) **ĐỒ CHƠI LẮP RÁP** (51) **21-01**  
(22) 09/06/2022 (43) 25/08/2022  
(30) 2021-027247 10/12/2021 JP;  
(73) **PEOPLE CO., LTD. (JP)**  
2-15-5, Higashinohonbashi, Chuo-ku, Tokyo 103-0004 Japan  
(72) Masato KIRIBUCHI (JP)  
(74) Công ty TNHH một thành viên Sở hữu trí tuệ VCCI (VCCI-IP CO.,LTD)  
(55)

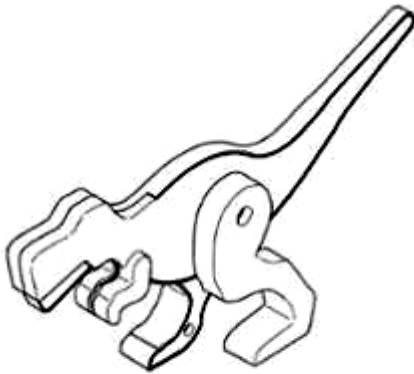

1.1

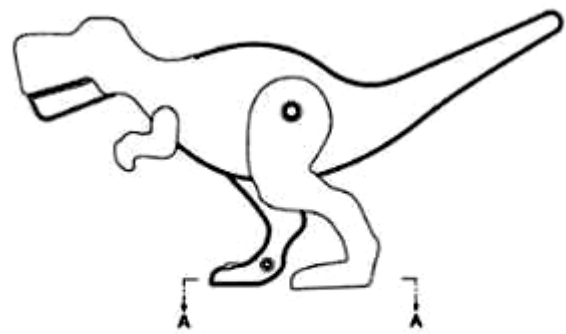

1.2

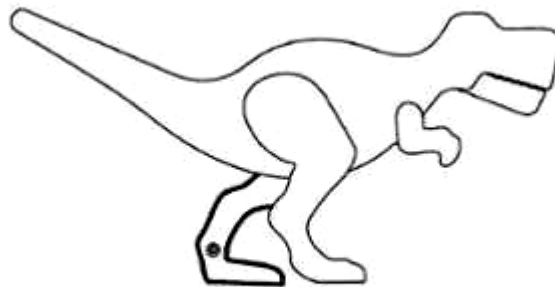

1.3

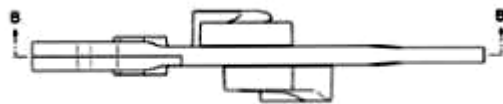

1.4

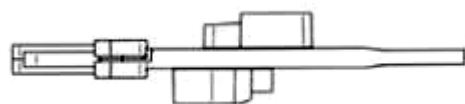

1.5

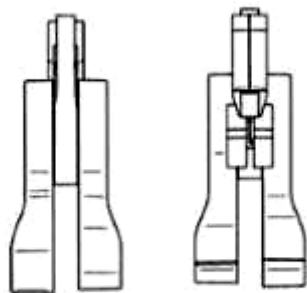

1.6

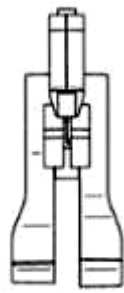

1.7

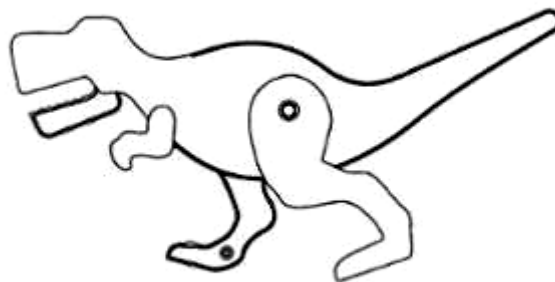

1.8



1.9

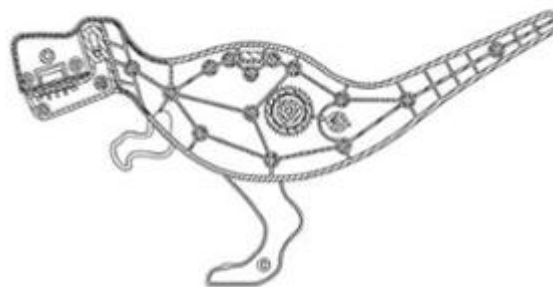

1.10

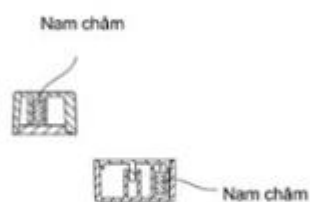

1.11

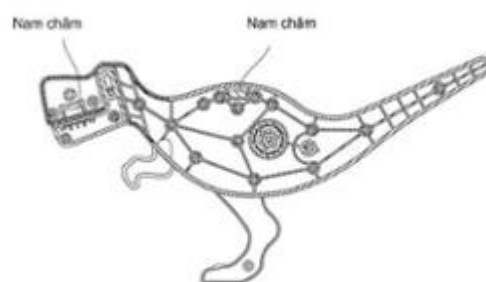

1.12

- (11) **45297**  
(21) 3-2022-01120 (28) 1  
(54) **ĐỒ CHƠI LẮP RÁP** (51) **21-01**  
(22) 09/06/2022 (43) 25/08/2022  
(30) 2021-027204 10/12/2021 JP;  
(73) **PEOPLE CO., LTD. (JP)**  
2-15-5, Higashinohonbashi, Chuo-ku, Tokyo 103-0004 Japan  
(72) Masato KIRIBUCHI (JP)  
(74) Công ty TNHH một thành viên Sở hữu trí tuệ VCCI (VCCI-IP CO.,LTD)  
(55)

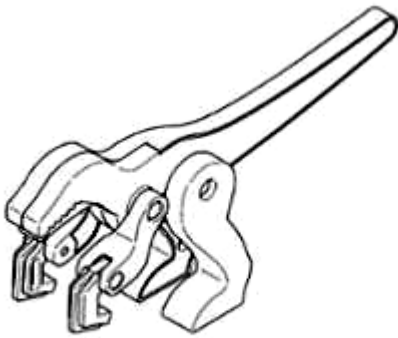

1.1

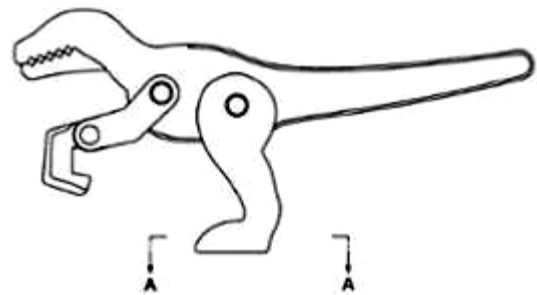

1.2

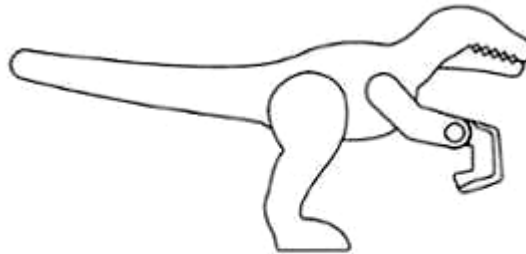

1.3

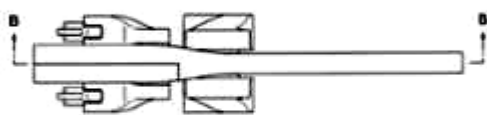

1.4



1.5

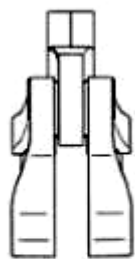

1.6

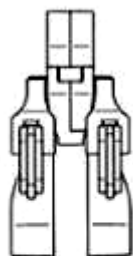

1.7

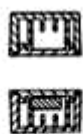

1.8

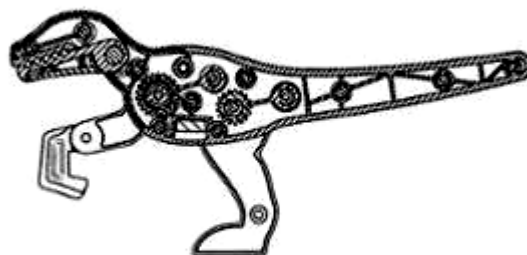

1.9



1.10



Nam châm

1.11

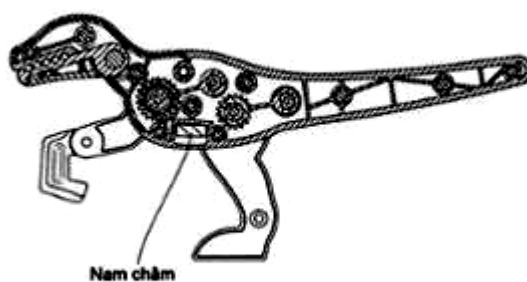

Nam châm

1.12

- (11) **45298**  
(21) 3-2022-01122 (28) 1  
(54) **ĐỒ CHƠI LẮP RÁP** (51) **21-01**  
(22) 09/06/2022 (43) 25/08/2022  
(30) 2021-027205 10/12/2021 JP;  
(73) **PEOPLE CO., LTD. (JP)**  
2-15-5, Higashinohonbashi, Chuo-ku, Tokyo 103-0004 Japan  
(72) Masato KIRIBUCHI (JP)  
(74) Công ty TNHH một thành viên Sở hữu trí tuệ VCCI (VCCI-IP CO.,LTD)  
(55)



1.1

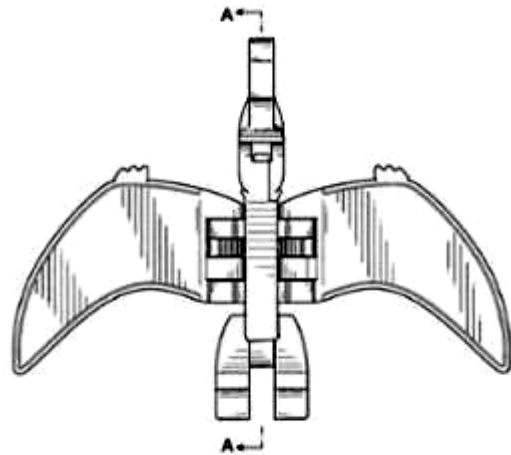

1.2

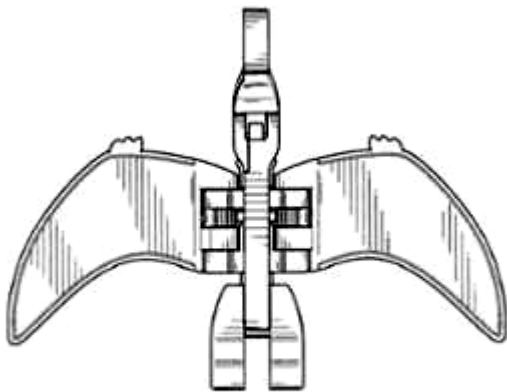

1.3

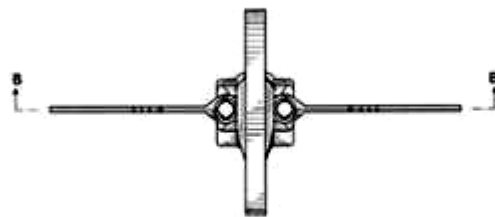

1.4



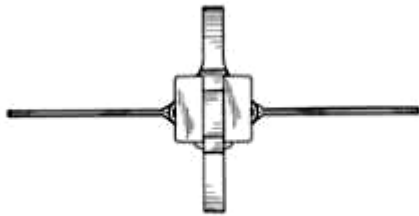

1.5

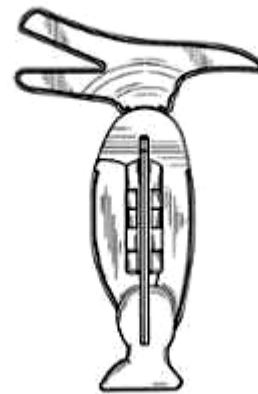

1.6

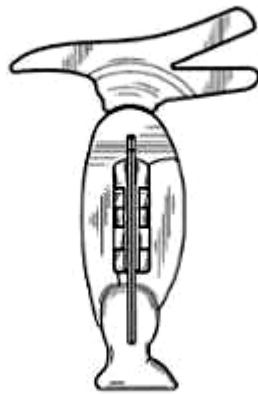

1.7

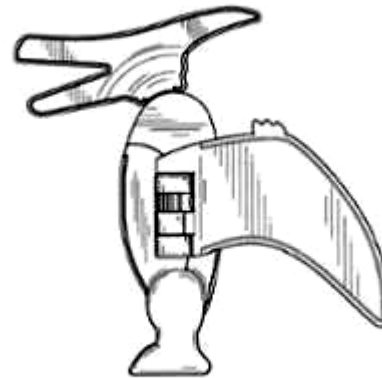

1.8

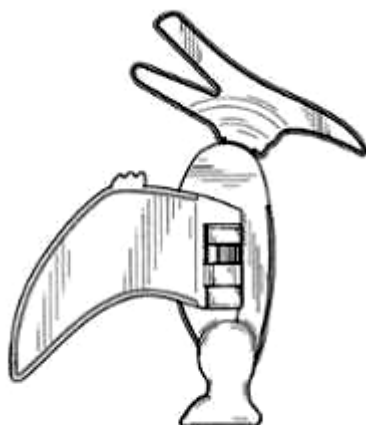

1.9

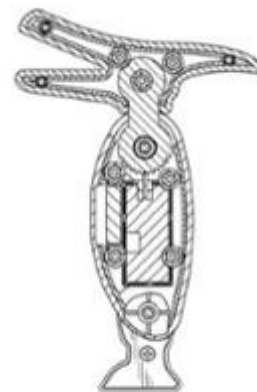

1.10

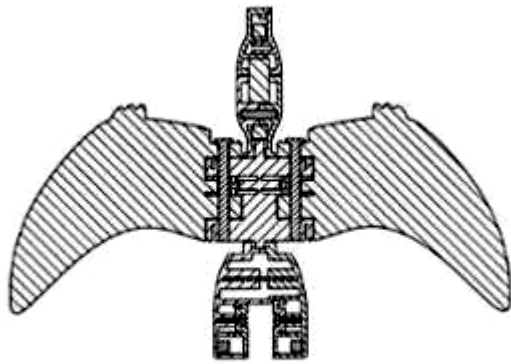

1.11

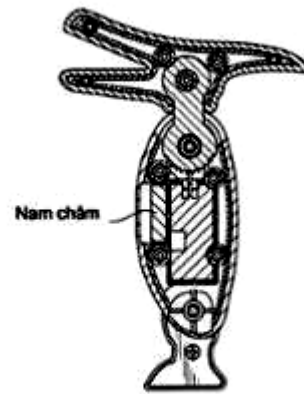

1.12

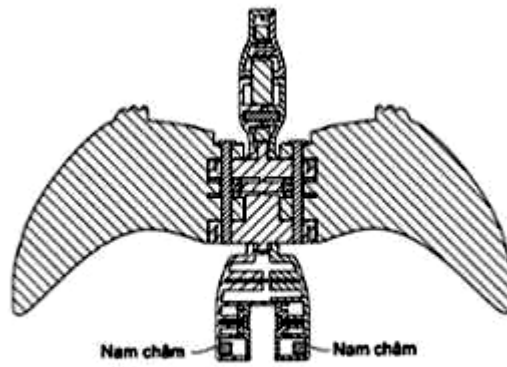

1.13

- (11) **45299**
- (21) 3-2022-01123
- (54) **ĐỒ CHƠI LẮP RÁP**
- (22) 09/06/2022
- (30) 2021-027206 10/12/2021 JP;
- (73) **PEOPLE CO., LTD. (JP)**  
2-15-5, Higashinohonbashi, Chuo-ku, Tokyo 103-0004 Japan
- (72) Masato KIRIBUCHI (JP)
- (74) Công ty TNHH một thành viên Sở hữu trí tuệ VCCI (VCCI-IP CO.,LTD)
- (55)

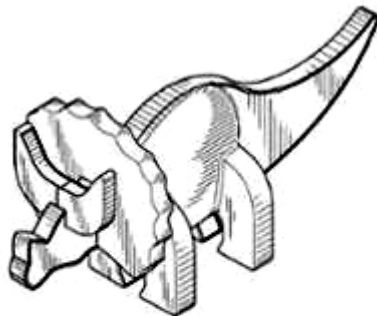

1.1

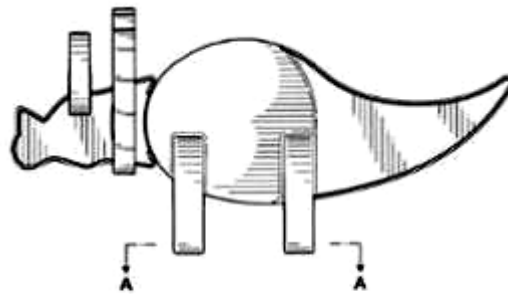

1.2

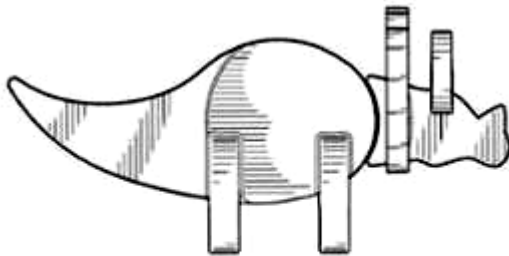

1.3

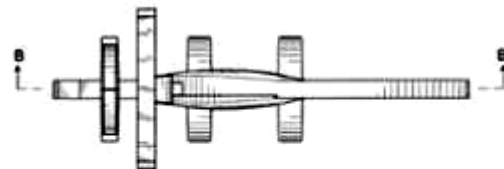

1.4

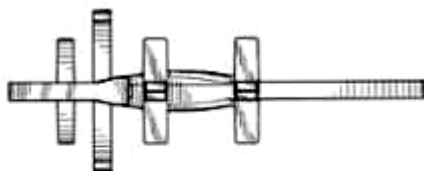

1.5



1.6

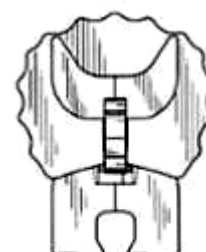

1.7

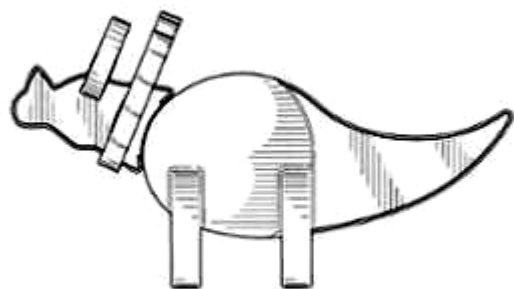

1.8



1.9

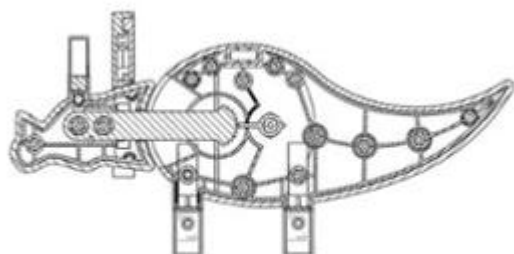

1.10

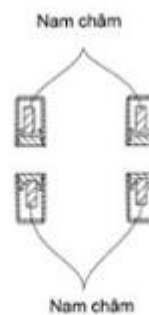

1.11

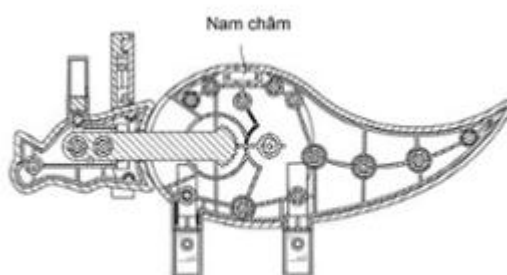

1.12

- (11) **45300**  
(21) 3-2022-01124 (28) 1  
(54) **ĐỒ CHƠI LẮP RÁP** (51) **21-01**  
(22) 09/06/2022 (43) 25/08/2022  
(30) 2021-027207 10/12/2021 JP;  
(73) **PEOPLE CO., LTD. (JP)**  
2-15-5, Higashinohonbashi, Chuo-ku, Tokyo 103-0004 Japan  
(72) Masato KIRIBUCHI (JP)  
(74) Công ty TNHH một thành viên Sở hữu trí tuệ VCCI (VCCI-IP CO.,LTD)  
(55)

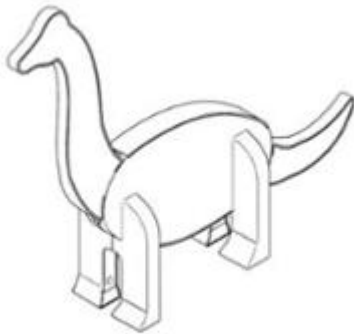

1.1

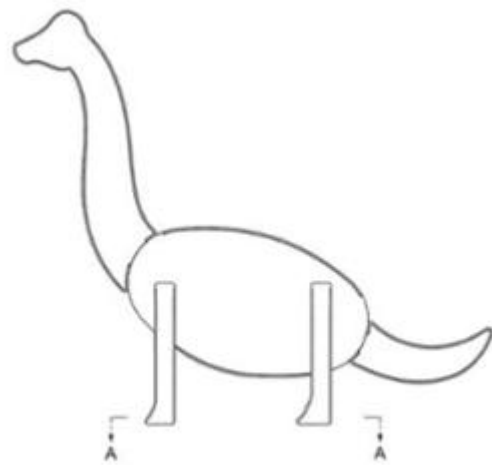

1.2

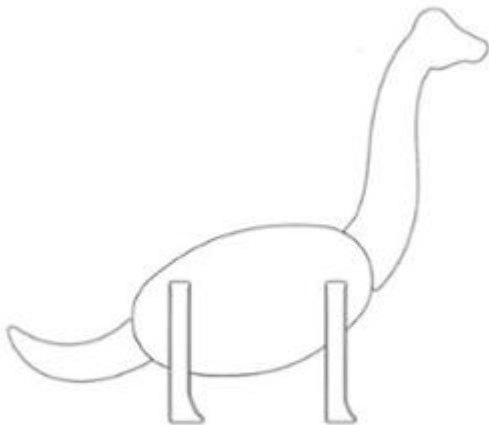

1.3

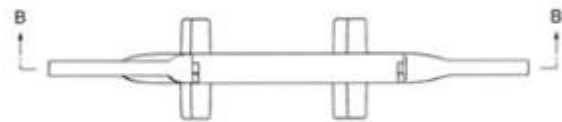

1.4

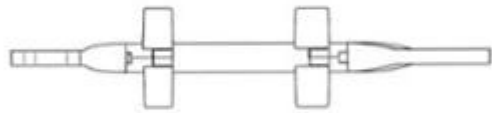

1.5

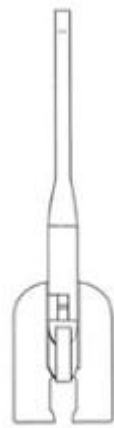

1.6



1.7



1.8

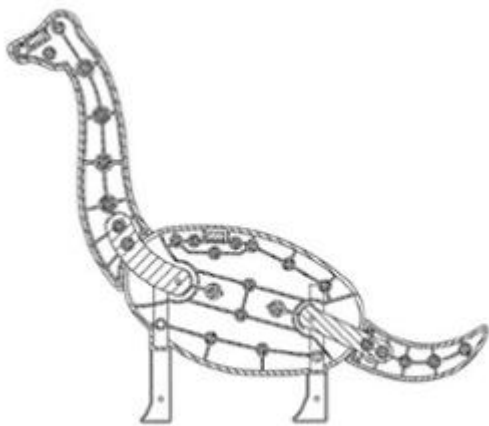

1.9

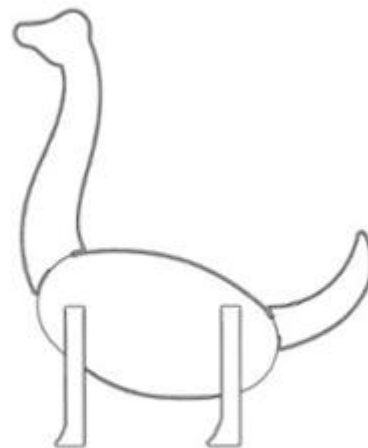

1.10



1.11

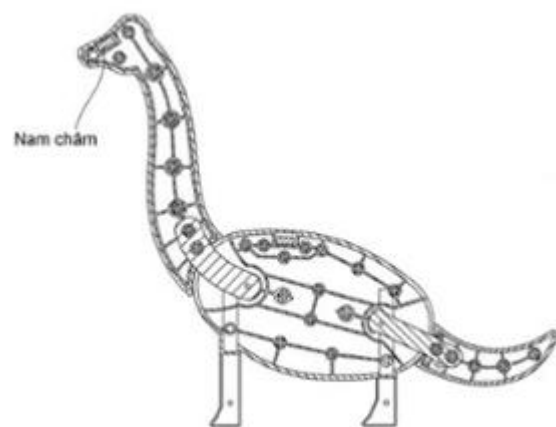

1.12

- (11) **45301**  
(21) 3-2022-01125 (28) 1  
(54) **ĐỒ CHƠI LẮP RÁP** (51) **21-01**  
(22) 09/06/2022 (43) 25/08/2022  
(30) 2021-027286 10/12/2021 JP;  
(73) **PEOPLE CO., LTD. (JP)**  
2-15-5, Higashinohonbashi, Chuo-ku, Tokyo 103-0004 Japan  
(72) Masato KIRIBUCHI (JP)  
(74) Công ty TNHH một thành viên Sở hữu trí tuệ VCCI (VCCI-IP CO.,LTD)  
(55)

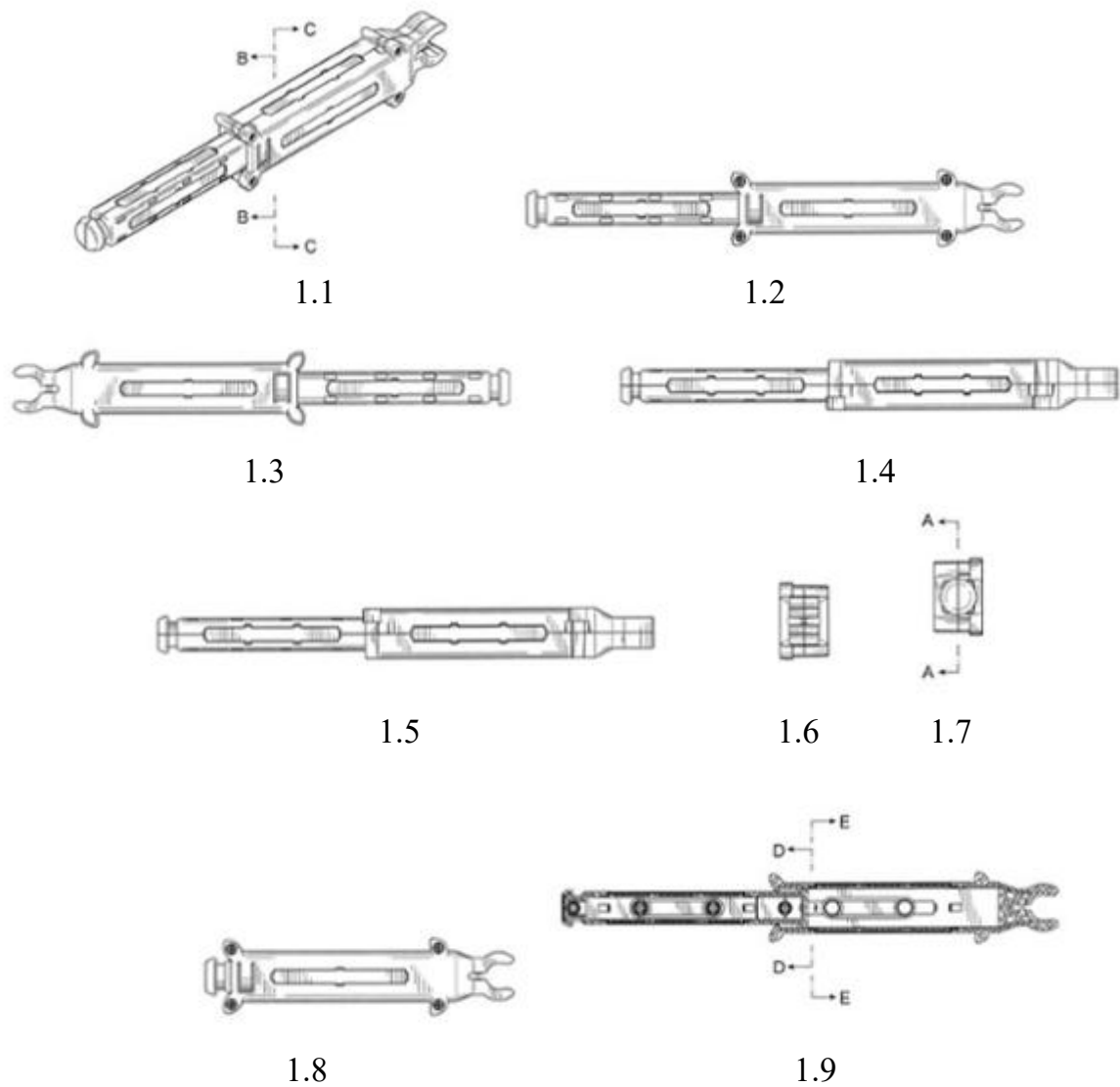

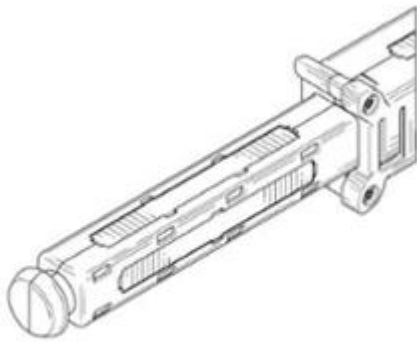

1.10

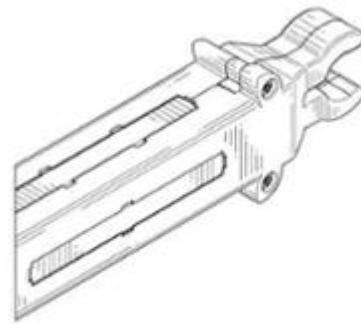

1.11

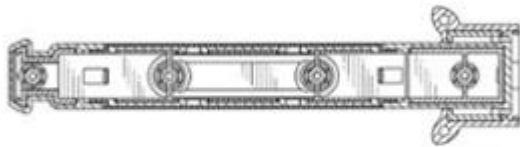

1.12

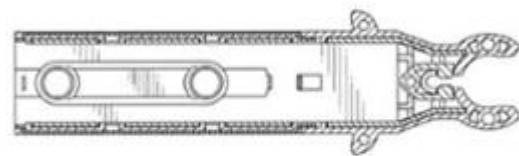

1.13

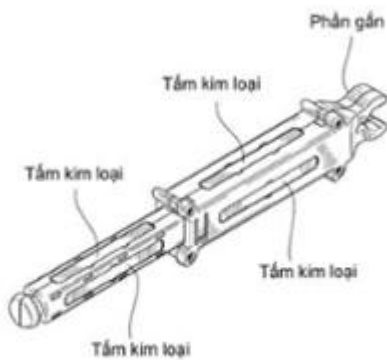

1.14

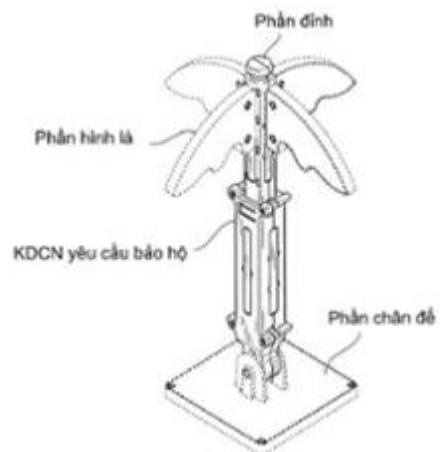

1.15



- (11) **45302**  
(21) 3-2022-01126 (28) 1  
(54) **ĐỒ CHƠI LẮP RÁP** (51) **21-01**  
(22) 09/06/2022 (43) 25/08/2022  
(30) 2021-027208 10/12/2021 JP;  
(73) **PEOPLE CO., LTD. (JP)**  
2-15-5, Higashinohonbashi, Chuo-ku, Tokyo 103-0004 Japan  
(72) Masato KIRIBUCHI (JP)  
(74) Công ty TNHH một thành viên Sở hữu trí tuệ VCCI (VCCI-IP CO.,LTD)  
(55)



1.1

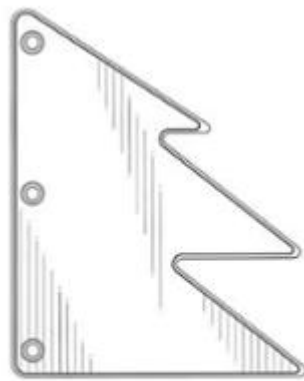

1.2

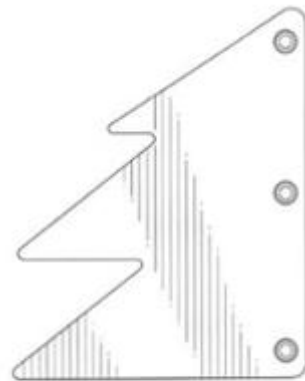

1.3



1.4



1.5



1.6



1.7

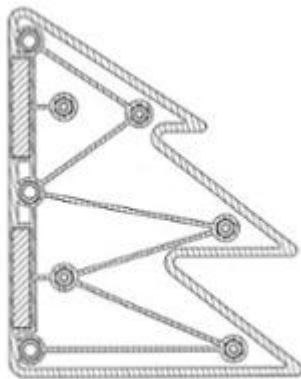

1.8

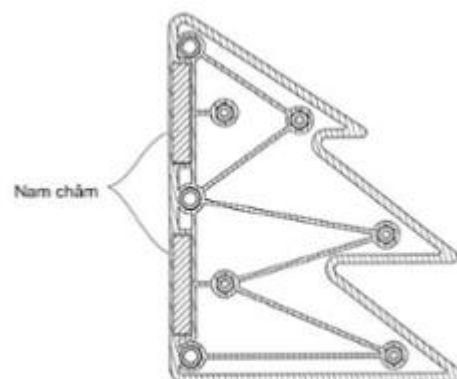

1.9

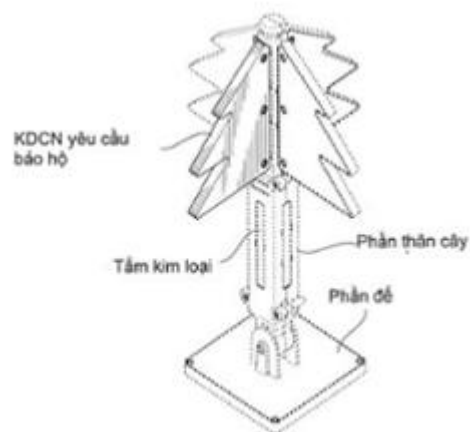

1.10

- (11) **45303**  
(21) 3-2022-01127 (28) 1  
(54) **ĐỒ CHƠI LẮP RÁP** (51) **21-01**  
(22) 09/06/2022 (43) 25/08/2022  
(30) 2021-027209 10/12/2021 JP;  
(73) **PEOPLE CO., LTD. (JP)**  
2-15-5, Higashinohonbashi, Chuo-ku, Tokyo 103-0004 Japan  
(72) Masato KIRIBUCHI (JP)  
(74) Công ty TNHH một thành viên Sở hữu trí tuệ VCCI (VCCI-IP CO.,LTD)  
(55)



1.1

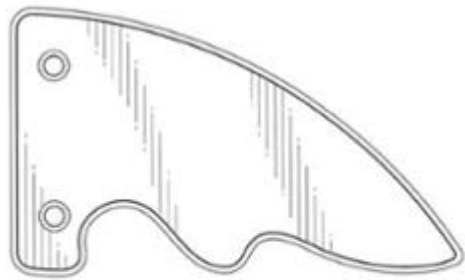

1.2

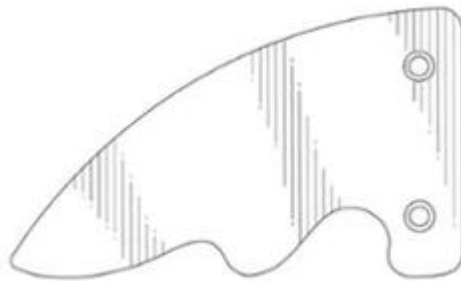

1.3



1.4



1.5



1.6



1.7

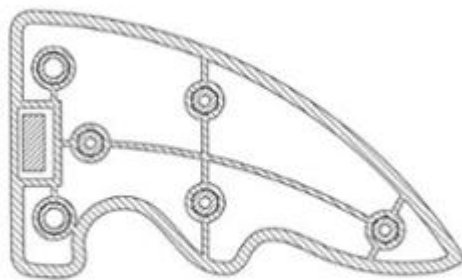

1.8

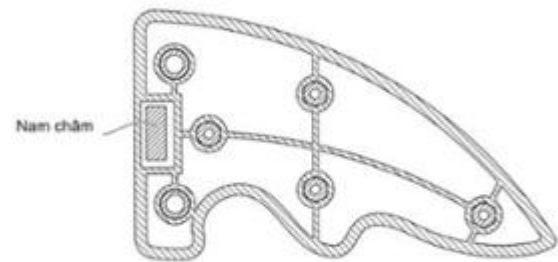

1.9

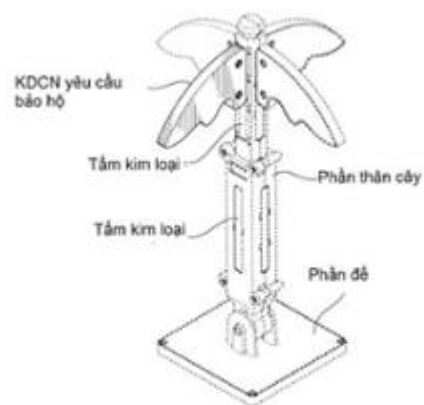

1.10

**CÔNG BÁO SỞ HỮU CÔNG NGHIỆP SỐ 413 TẬP A – QUYỀN 2 (08.2022)**

- (11) **45304**  
(21) 3-2022-01136 (28) 2  
(54) **BAO GÓI** (51) **09-05**  
(22) 10/06/2022 (43) 25/08/2022  
(73) **CÔNG TY CỔ PHẦN THỰC PHẨM Á CHÂU (VN)**  
Số 9/2 đường ĐT 743, khu phố 1B, phường An Phú, thành phố Thuận An, tỉnh Bình Dương  
(72) **NGUYỄN MẠNH CƯỜNG (VN)**  
(74) Văn phòng Luật sư A Hoà (AHOA LAW OFFICE)  
(55)



H.1.1

1.1



H.1.2

1.2



H.2.1

2.1



H.2.2

2.2

**CÔNG BÁO SỞ HỮU CÔNG NGHIỆP SỐ 413 TẬP A – QUYỀN 2 (08.2022)**

- (11) **45305**
- (21) 3-2022-01150 (28) 1
- (54) **NHÃN SẢN PHẨM** (51) **19-08**
- (22) 14/06/2022 (43) 25/08/2022
- (73) **CÔNG TY TNHH CÔNG NGHỆ NAVA VIỆT NAM (VN)**  
Số 18, ngõ 117 phố Lãng Yên, phường Thanh Lương, quận Hai Bà Trưng, thành phố Hà Nội
- (72) Nguyễn Khắc Trung (VN)
- (74) Công ty TNHH Sở hữu trí tuệ và Công nghệ Thủ đô (CAPITAL IP&T CO.LTD.)
- (55)



**CÔNG BÁO SỞ HỮU CÔNG NGHIỆP SỐ 413 TẬP A – QUYỀN 2 (08.2022)**

- (11) **45306**
- (21) 3-2022-01151 (28) 1
- (54) **NHÃN SẢN PHẨM** (51) **19-08**
- (22) 14/06/2022 (43) 25/08/2022
- (73) **CÔNG TY TNHH CÔNG NGHỆ NAVA VIỆT NAM (VN)**  
Số 18, ngõ 117 phố Lãng Yên, phường Thanh Lương, quận Hai Bà Trưng, thành phố Hà Nội
- (72) Nguyễn Khắc Trung (VN)
- (74) Công ty TNHH Sở hữu trí tuệ và Công nghệ Thủ đô (CAPITAL IP&T CO.LTD.)
- (55)



(11) **45307**

(21) 3-2022-01154

(28) 1

(54) **DÉP**

(51) **02-04**

(22) 14/06/2022

(43) 25/08/2022

(73) **CÔNG TY TNHH GIÀY Á CHÂU (VN)**

451/29/8 Tô Hiến Thành, phường 14, quận 10, thành phố Hồ Chí Minh

(72) Nguyễn Đình Kim (VN)

(74) Văn phòng Luật sư A Hoà (AHOA LAW OFFICE)

(55)



1.1



1.2

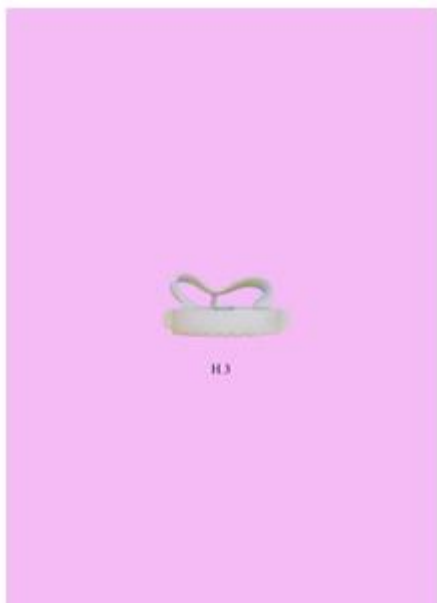

1.3



1.4





H5

1.5



H6

1.6



H7

1.7



H8

1.8

**CÔNG BÁO SỞ HỮU CÔNG NGHIỆP SỐ 413 TẬP A – QUYỀN 2 (08.2022)**

- (11) **45308**  
(21) 3-2022-01155 (28) 2  
(54) **BAO GÓI BĂNG VỆ SINH** (51) **09-05**  
(22) 14/06/2022 (43) 25/08/2022  
(73) **CÔNG TY TNHH SẢN XUẤT VÀ THƯƠNG MẠI QUỐC TẾ VIỆT SING**  
(VN)  
Cụm CN Xuân Lâm, xã Xuân Lâm, huyện Thuận Thành, tỉnh Bắc Ninh  
(72) Nguyễn Đăng Dũng (VN)  
(55)



1.1



1.2



2.1



2.2

- (11) **45309**  
(21) 3-2022-01174 (28) 1  
(54) **CHAI** (51) **09-01**  
(22) 16/06/2022 (43) 25/08/2022  
(73) **CÔNG TY TNHH ĐÔNG NAM DƯỢC BÀNG THÁI (VN)**  
416/15/3 Dương Quảng Hàm, phường 5, quận Gò Vấp, thành phố Hồ Chí Minh  
(72) Lu Xian Wei (CN)  
(74) Văn phòng Luật sư A Hoà (AHOA LAW OFFICE)  
(55)



1.1



1.2



1.3



1.4



1.5



1.6

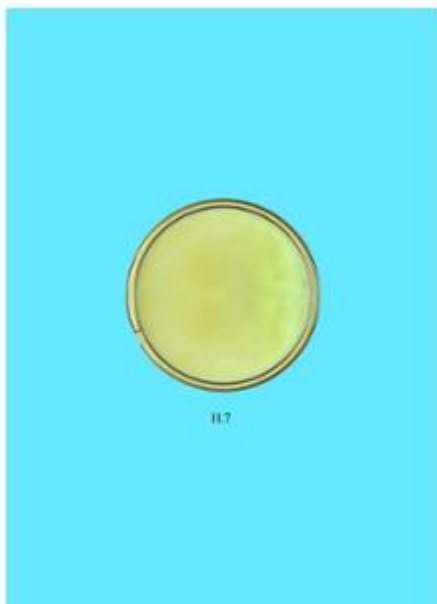

1.7



1.8

**CÔNG BÁO SỞ HỮU CÔNG NGHIỆP SỐ 413 TẬP A – QUYỀN 2 (08.2022)**

- (11) **45310**  
(21) 3-2022-01200 (28) 1  
(54) **THIẾT BỊ CHĂM SÓC DA** (51) **28-03**  
(22) 20/06/2022 (43) 25/08/2022  
(73) **LG HOUSEHOLD & HEALTH CARE LTD. (KR)**  
58, Saemunan-ro, Jongno-gu, Seoul, Republic of Korea  
(72) LEE, Seul Ki (KR)  
(74) Công ty TNHH Tâm nhìn và Liên danh (VISION & ASSOCIATES CO.LTD.)  
(55)



1.1

1.2

1.3

1.4

1.5



1.6



1.7

**CÔNG BÁO SỞ HỮU CÔNG NGHIỆP SỐ 413 TẬP A – QUYỀN 2 (08.2022)**

- (11) **45311**  
(21) 3-2022-01245 (28) 1  
(54) **CHAI** (51) **09-01**  
(22) 22/06/2022 (43) 25/08/2022  
(73) **LG HOUSEHOLD & HEALTH CARE LTD. (KR)**  
58, Saemunan-ro, Jongno-gu, Seoul, Republic of Korea  
(72) HONG, Ji Min (KR)  
(74) Công ty TNHH Tâm nhìn và Liên danh (VISION & ASSOCIATES CO.LTD.)  
(55)



1.1



1.2



1.3



1.4



1.5



1.6



1.7

**CÔNG BÁO SỞ HỮU CÔNG NGHIỆP SỐ 413 TẬP A – QUYỀN 2 (08.2022)**

- (11) **45312**  
(21) 3-2022-01246 (28) 1  
(54) **TUÝP ĐỪNG MỸ PHẨM** (51) **09-05**  
(22) 22/06/2022 (43) 25/08/2022  
(73) **LG HOUSEHOLD & HEALTH CARE LTD. (KR)**  
58, Saemunan-ro, Jongno-gu, Seoul, Republic of Korea  
(72) HONG, Ji Min (KR)  
(74) Công ty TNHH Tâm nhìn và Liên danh (VISION & ASSOCIATES CO.LTD.)  
(55)



1.1

1.2

1.3

1.4

1.5



1.6



1.7



**PHẦN II**

**SỬA ĐỔI ĐƠN**

*Ghi nhận sửa đổi đơn yêu cầu cấp Bằng độc quyền kiểu dáng công nghiệp*

Thông báo số: 14710w/TB-SHTT, ngày 27/06/2022 về việc ghi nhận sửa đổi đơn

Số Yêu cầu: SĐ3-2021-02024 Ngày nộp: 05/11/2021

Liên quan đến đơn yêu cầu cấp Bằng độc quyền kiểu dáng công nghiệp:

(21) Số đơn	(22) Ngày nộp đơn
3-2021-02303	21/09/2021

Mục sửa đổi: Tên, địa chỉ chủ đơn

Nội dung mới: Công ty TNHH một thành viên thương mại dịch vụ xuất nhập khẩu cơ khí Gia Bảo (VN)  
Khu phố 1, phường Long Phước, thị xã Phước Long, tỉnh Bình Phước

---



**PHẦN III**

**THAY ĐỔI CHỦ ĐƠN**

*Ghi nhận thay đổi chủ đơn yêu cầu cấp Bằng độc quyền Kiểu dáng công nghiệp*

Thông báo số: 15187w/TB-SHTT, ngày 30/06/2022 về việc ghi nhận thay đổi chủ đơn

Số Yêu cầu: CD3-2019-00442 Ngày nộp: 02/08/2019

Liên quan đến đơn yêu cầu cấp bằng độc quyền kiểu dáng công nghiệp:

(21) Số đơn	(22) Ngày nộp đơn
3-2018-01817	24/08/2018

Bên chuyển nhượng:

**CÔNG TY CỔ PHẦN ĐẦU TƯ VÀ PHÁT TRIỂN AN  
PHÚ APS (VN)**

Biệt thự FB42, KĐT Thiên Đường Bảo Sơn, Lê Trọng Tấn,  
xã An Khánh, huyện Hoài Đức, thành phố Hà Nội

Bên được chuyển nhượng:

**Công ty TNHH một thành viên Newstar (VN)**

Số 5, tổ 2, khu 6, phường Hồng Hà, thành phố Hạ Long,  
tỉnh Quảng Ninh

---

## **CÔNG BÁO SỞ HỮU CÔNG NGHIỆP**

*Do Cục Sở hữu trí tuệ thuộc Bộ Khoa học và Công nghệ ấn hành theo Luật Sở hữu trí tuệ số 50/2005/QH11 được Quốc hội thông qua ngày 29 tháng 11 năm 2005 và được sửa đổi bằng Luật sửa đổi, bổ sung một số điều của Luật sở hữu trí tuệ số 50/2005/QH11 được Quốc hội thông qua ngày 19 tháng 6 năm 2009.*

### ***Địa chỉ liên hệ:***

384-386 đường Nguyễn Trãi, quận Thanh Xuân,  
thành phố Hà Nội, Việt Nam  
ĐT: 024. 38583069  
Fax: 024. 38588449