

CỘNG HÒA XÃ HỘI CHỦ NGHĨA VIỆT NAM
BỘ KHOA HỌC VÀ CÔNG NGHỆ

CỤC SỞ HỮU TRÍ TUỆ

CÔNG BÁO
SỞ HỮU CÔNG NGHIỆP

TẬP A

QUYỂN 2: KIỂU DÁNG CÔNG NGHIỆP

01 - 2022

406

CỘNG HOÀ XÃ HỘI CHỦ NGHĨA VIỆT NAM
BỘ KHOA HỌC VÀ CÔNG NGHỆ
CỤC SỞ HỮU TRÍ TUỆ

CÔNG BÁO
SỞ HỮU CÔNG NGHIỆP
TẬP A

QUYỂN 2: KIỂU DÁNG CÔNG NGHIỆP

01-2022

406

HÀ NỘI

MỤC LỤC

	Trang
<u>PHẦN I:</u> Đơn yêu cầu cấp Bằng độc quyền kiểu dáng công nghiệp	7
<u>PHẦN II:</u> Sửa đổi đơn	464
<u>PHẦN III:</u> Thay đổi chủ đơn	466

CONTENTS

<u>PART I:</u> Applications for Industrial Design Patents	7
<u>PART II:</u> Amendment of Applications	464
<u>PART III:</u> Change of Applicants	466

CÔNG BÁO SỞ HỮU CÔNG NGHIỆP SỐ 406 TẬP A - QUYỂN 2 (01.2022)

MÃ SỐ HAI CHỮ CÁI THỂ HIỆN TÊN NƯỚC VÀ CÁC THỰC THỂ KHÁC TRONG CÁC TƯ LIỆU SỞ HỮU CÔNG NGHIỆP THEO TIÊU CHUẨN ST3 CỦA WIPO

AE	United Arab Emirates	CN	China	HK	Hong Kong
AF	Afganistan	CO	Colombia	HN	Honduras
AG	Antihua and Barbuda	CR	Costa Rica	HR	Croatia
AI	Anguilla	CU	Cuba	HT	Haiti
AL	Albania	CV	Cape Verde	HU	Hungary
AN	Netherlands Antilles	CY	Cyprus	ID	Indonesia
AO	Angola	CZ	Czech Republic	IE	Ireland
AR	Argentina	DE	Germany	IL	Israel
AT	Austria	DJ	Djibouti	IN	India
AU	Australia	DK	Denmark	IQ	Iraq
AW	Aruba	DM	Dominica	IR	Iran (Islamic Republic of)
BB	Barbados	DO	Dominican Republic	IS	Iceland
BD	Bangladesh	DZ	Algeria	IT	Italy
BE	Belgium	EC	Ecuador	JM	Jamaica
BF	Burkina Faso	EE	Estonia	JO	Jordan
BG	Bulgaria	EG	Egypt	JP	Japan
BH	Bahrain	ES	Spain	KE	Kenya
BI	Burundi	ET	Ethiopia	KH	Cambodia
BJ	Benin	FI	Finland	KI	Kiribati
BM	Bermuda	FJ	Fiji	KM	Comoros
BN	Brunei Darussalam	FK	Falkand Islands (Malvinas)	KN	Saint Kitts and Nevis
BO	Bolivia	FR	France	KP	Democratic People's Republic of Korea
BR	Brazil	GA	Gabon	KR	Republic of Korea
BS	Bahamas	GB	United Kingdom	KW	Kuwait
BT	Bhutan	GD	Grenada	KY	Cayman Islands
BW	Botswana	GE	Georgia	KZ	Kazakhstan
BY	Belarus	GH	Ghana	LA	Laos
BZ	Belize	GI	Gibraltar	LB	Lebanon
CA	Canada	GM	Gambia	LC	Saint Lucia
CF	Central African Republic	GN	Guinea	LI	Liechtenstein
CG	Congo	GQ	Equatorial Guinea	LK	SriLanka
CH	Switzerland	GR	Greece	LR	Liberia
CI	Côte d'Ivoire	GT	Guatemala	LS	Lesotho
CL	Chile	GW	Guinea-Bissau	LT	Lithuania
CM	Cameroon	GY	Guyana	TC	Turk and Caicos Islands
LU	Luxembourg	PA	Panama	TD	Chad
LV	Latvia	PE	Peru	TG	Togo
LY	Lybya	PG	Papua New Guinea	TH	Thailand
MA	Morocco	PH	Philippines	TN	Tunisia
MC	Monaco	PK	Pakistan	TO	Tonga
MD	Republic of Moldova	PL	Poland	TR	Turkey

CÔNG BÁO SỞ HỮU CÔNG NGHIỆP SỐ 406 TẬP A - QUYỂN 2 (01.2022)

MG	Madagascar	PT	Portugal	TT	Trinidad and Tobago
ML	Mali	PY	Paraguay	TV	Tuvalu
MM	Myanmar	QA	Qatar	TW	Taiwan, Province of China
MN	Mongolia	RO	Rumania	TZ	United Republic of Tanzania
MO	Macau	RU	Russian Federation	UA	Ukraine
MR	Mauritania	RW	Rwanda	UG	Uganda
MS	Montserrat	SA	Saudi Arabia	US	United States of America
MT	Malta	SB	Solomon Islands	UY	Uruguay
MU	Mauritius	SC	Seychelles	UZ	Uzbekistan
MV	Maldives	SD	Sudan	VA	Holy see
MW	Malawi	SE	Sweden	VC	Saint Vincent and the Grenadines
MX	Mexico	SG	Singapore	VE	Venezuela
MY	Malaysia	SH	Saint Helena	VG	Virgin Islands (British)
MZ	Mozambique	SL	Slovenia	VN	Vietnam
NA	Namibia	SK	Slovakia	VU	Vanuatu
NE	Niger	SL	Sierra Leone	WS	Samoa
NG	Nigeria	SM	San Marino	YE	Yemen
NJ	Nicaragua	SN	Senegal	YU	Yugoslavia
NL	Netherlands	SO	Somalia	ZA	South Africa
NO	Norway	SR	Suriname	ZM	Zambia
NP	Nepal	ST	Sao Tome and Principe	ZR	Zaire
NR	Nauru	SV	El Sanvador	ZW	Zimbabwe
NZ	New Zealand	SY	Syria		
OM	Oman	SZ	Swaziland		

CÁC TỔ CHỨC QUỐC TẾ

AO	African Intellectual Property Organization (OAPI)
AP	African Regional Industrial Property Organization (ARIPO)
BX	Benelux Trademark Office and Benelux Designs Office
EP	European Patent Office (EPO)
IB, WO	International Bureau of the World Intellectual Property Organization (WIPO)

NHỮNG MÃ SỐ INID TRÍCH TỪ TIÊU CHUẨN ST80 CỦA TỔ CHỨC SỞ HỮU TRÍ TUỆ THẾ GIỚI (WIPO) ĐỂ NHẬN BIẾT CÁC DỮ LIỆU THƯ MỤC DÙNG CÔNG BỐ ĐƠN VÀ BẰNG ĐỘC QUYỀN KIỂU DÁNG CÔNG NGHIỆP

- (11) Số bằng độc quyền kiểu dáng công nghiệp / Số công bố đơn
- (15) Ngày cấp
- (18) Ngày hết hạn hiệu lực của bằng độc quyền kiểu dáng công nghiệp
- (21) Số đơn
- (22) Ngày nộp đơn
- (23) Tên triển lãm, ngày và nơi triển lãm
- (28) Số phương án yêu cầu bảo hộ
- (30) Số đơn ưu tiên, ngày nộp đơn ưu tiên
- (43) Ngày công bố đơn
- (45) Ngày công bố bằng độc quyền kiểu dáng công nghiệp
- (51) Phân loại quốc tế kiểu dáng công nghiệp
- (54) Tên sản phẩm mang kiểu dáng công nghiệp
- (55) Ảnh chụp / hình vẽ kiểu dáng công nghiệp
- (57) Đặc điểm khác biệt yêu cầu bảo hộ của kiểu dáng công nghiệp
- (62) Số và ngày nộp đơn, số bằng độc quyền KDCN hoặc số công bố đơn liên quan đến tách đơn
- (71) Tên và địa chỉ của người nộp đơn
- (72) Tên của tác giả KDCN
- (73) Tên, địa chỉ của chủ bằng độc quyền KDCN
- (74) Tên của người đại diện SHCN

PHẦN I

ĐƠN YÊU CẦU CẤP BẰNG ĐỘC QUYỀN KIỂU DÁNG CÔNG NGHIỆP

- (11) **43448**
(21) 3-2019-01200 (28) 1
(54) **HỘP ĐỰNG** (51) **09-03**
(22) 17/05/2019 (43) 25/01/2022
(73) **CÔNG TY TNHH DƯỢC PHẨM KHANG LINH (VN)**
Tầng 2, tòa nhà CT2A khu đô thị mới Nghĩa Đô, phường Cổ Nhuế 1, quận Bắc Từ Liêm, thành phố Hà Nội
(72) Trịnh Thu Trang (VN)
(74) Công ty TNHH Dương và Trần (DUONG & TRAN CO., LTD)
(55)



1.1



1.2

CÔNG BÁO SỞ HỮU CÔNG NGHIỆP SỐ 406 TẬP A – QUYỀN 2 (01.2022)

- (11) **43449**
(21) 3-2019-03254 (28) 12
(54) **BỘ BÁT ĐĨA** (51) **07-01; 07-03**
(22) 12/12/2019 (43) 25/01/2022
(73) **CÔNG TY TNHH MINH LONG I (VN)**
333 khu phố Hưng Lộc, phường Hưng Định, thị xã Thuận An, tỉnh Bình Dương
(72) Lý Ngọc Minh (VN)
(55)



1.1



1.2



1.3



1.4



1.5



1.6



1.7



1.8



1.9



1.10



1.11



1.12



1.13



1.14



1.15



1.16



1.17



1.18



1.19



1.20



1.21



1.22



1.23



1.24



1.25



1.26



1.27



1.28



1.29



1.30



1.31



1.32



1.33



1.34



1.35



1.36



1.37



1.38



1.39



1.40



1.41

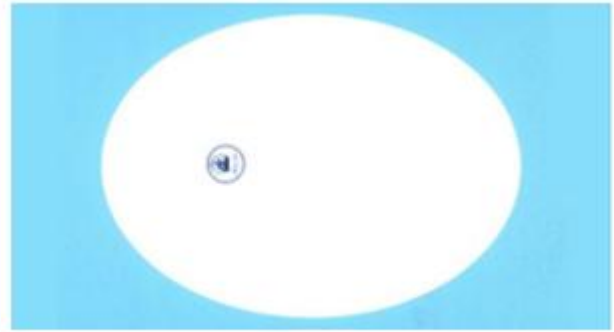

1.42



1.43



1.44



1.45



1.46



1.47



1.48



1.49



1.50



1.51



1.52



1.53



1.54



1.55



1.56



1.57



1.58



1.59



1.60



1.61



1.62



1.63



1.64



1.65



1.66



1.67



1.68



1.69



1.70



1.71



1.72



1.73



1.74

CÔNG BÁO SỞ HỮU CÔNG NGHIỆP SỐ 406 TẬP A – QUYỀN 2 (01.2022)

(11) **43450**

(21) 3-2019-03326

(28) 1

(54) **PHIN CHỨA**

(51) **07-02**

(22) 18/12/2019

(43) 25/01/2022

(73) **CÔNG TY TNHH MINH LONG I (VN)**

333 khu phố Hưng Lộc, phường Hưng Định, thị xã Thuận An, tỉnh Bình Dương

(72) Lý Ngọc Minh (VN)

(55)



1.1



1.2



1.3



1.4

- (11) **43451**
(21) 3-2020-00252 (28) 1
(54) **BỘ PHẬN CỦA MÁY DỆT** (51) **15-06**
(22) 11/10/2019 (43) 25/01/2022
(30) 006376950 12/04/2019 EM;
(73) **SANTONI S.P.A. (IT)**
Via Carlo Fenzi, 14 - 25135 BRESCIA, ITALY
(72) 1. STEFANO RIZZI (IT)
2. MARCO ANDREOLI (IT)
(74) Công ty TNHH T&T INVENMARK Sở hữu trí tuệ Quốc tế (T&T INVENMARK
CO., LTD.)
(55)



1.1



1.2



1.3

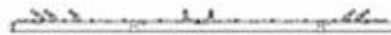

1.4



1.5



1.6



1.7

CÔNG BÁO SỞ HỮU CÔNG NGHIỆP SỐ 406 TẬP A – QUYỀN 2 (01.2022)

- (11) **43452**
(21) 3-2020-00253
(54) **BỘ PHẬN CỦA MÁY DỆT**
(22) 11/10/2019
(30) 006376950 12/04/2019 EM;
(73) **SANTONI S.P.A. (IT)**
Via Carlo Fenzi, 14 - 25135 BRESCIA, ITALY
(72) 1. STEFANO RIZZI (IT)
2. MARCO ANDREOLI (IT)
(74) Công ty TNHH T&T INVENMARK Sở hữu trí tuệ Quốc tế (T&T INVENMARK CO., LTD.)
(55)

- (28) 1
(51) **15-06**
(43) 25/01/2022

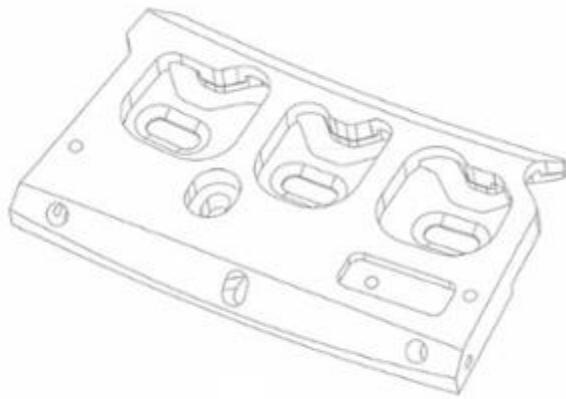

1.1



1.2



1.3



1.4



1.5

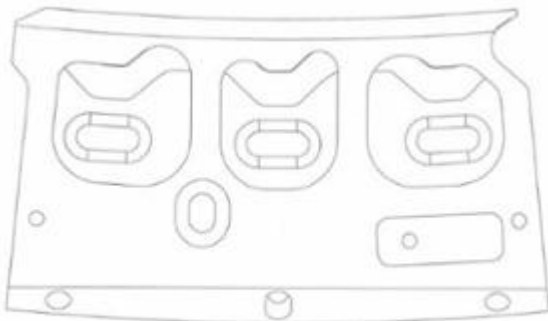

1.6

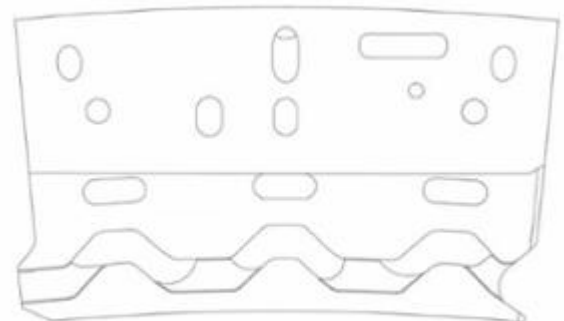

1.7

CÔNG BÁO SỞ HỮU CÔNG NGHIỆP SỐ 406 TẬP A – QUYỀN 2 (01.2022)

- (11) **43453**
(21) 3-2020-01568 (28) 11
(54) **BỘ BÁT ĐĨA** (51) **07-01**
(22) 06/07/2020 (43) 25/01/2022
(73) **CÔNG TY TNHH MINH LONG I (VN)**
333 Khu phố Hưng Lộc, phường Hưng Định, thành phố Thuận An, tỉnh Bình
Dương
(72) Lý Ngọc Minh (VN)
(55)



1.1



1.2



1.3



1.4



1.5



1.6

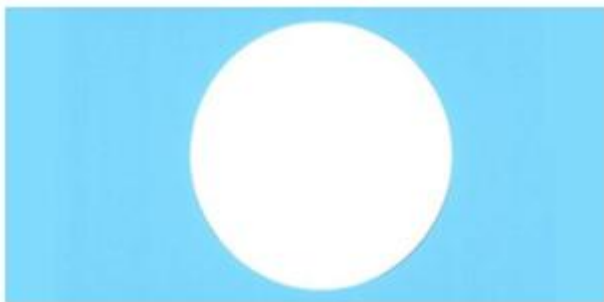

1.7



1.8



1.9



1.10



1.11



1.12



1.13

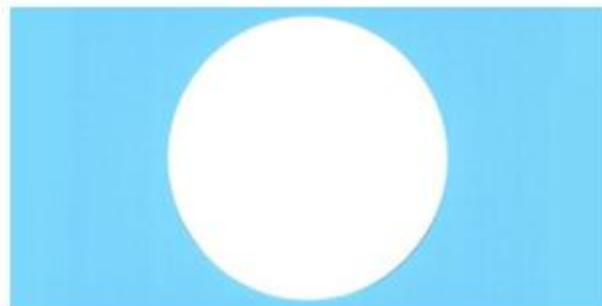

1.14



1.15



1.16



1.17



1.18



1.19



1.20

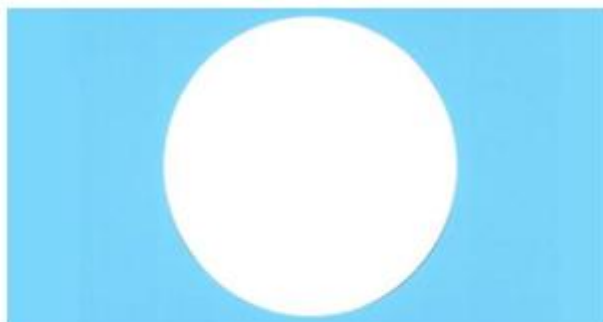

1.21



1.22



1.23



1.24



1.25



1.26



1.27

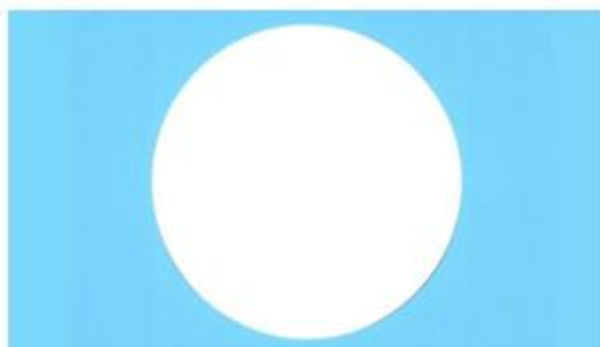

1.28



1.29



1.30



1.31



1.32



1.33



1.34



1.35



1.36



1.37



1.38



1.39



1.40



1.41



1.42



1.43



1.44



1.45



1.46



1.47



1.48



1.49



1.50



1.51



1.52



1.53



1.54



1.55



1.56



1.57



1.58



1.59



1.60

CÔNG BÁO SỞ HỮU CÔNG NGHIỆP SỐ 406 TẬP A – QUYỀN 2 (01.2022)

- (11) **43454**
(21) 3-2020-01569 (28) 11
(54) **BỘ BÁT ĐĨA** (51) **07-01**
(22) 06/07/2020 (43) 25/01/2022
(73) **CÔNG TY TNHH MINH LONG I (VN)**
333 Khu phố Hưng Lộc, phường Hưng Định, thành phố Thuận An, tỉnh Bình Dương
(72) Lý Ngọc Minh (VN)
(55)

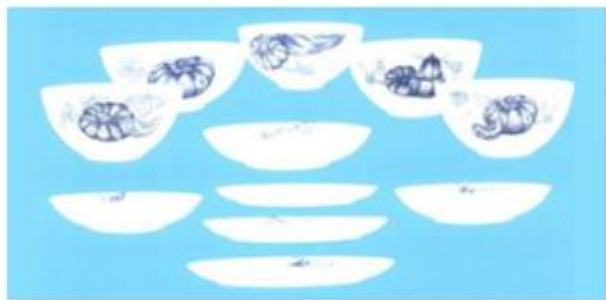

1.1



1.2



1.3



1.4



1.5



1.6



1.7

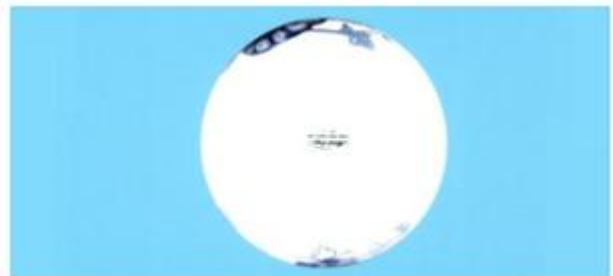

1.8



1.9



1.10



1.11



1.12



1.13

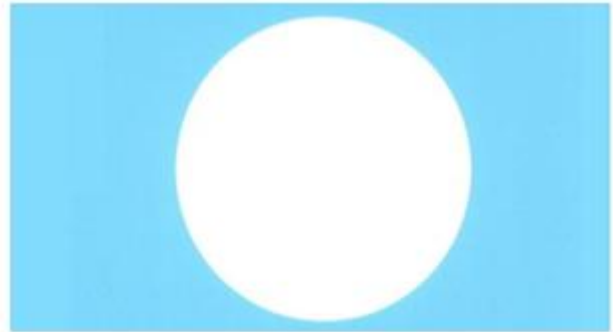

1.14



1.15



1.16



1.17



1.18



1.19



1.20

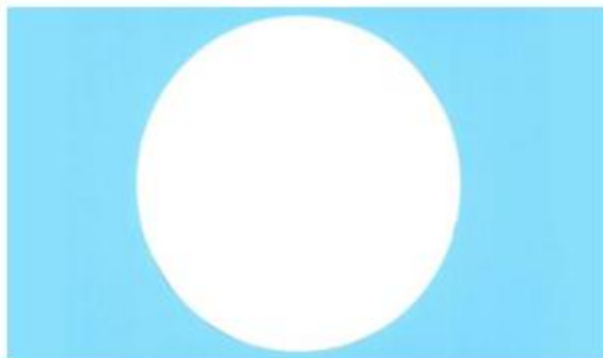

1.21



1.22



1.23



1.24



1.25



1.26



1.27

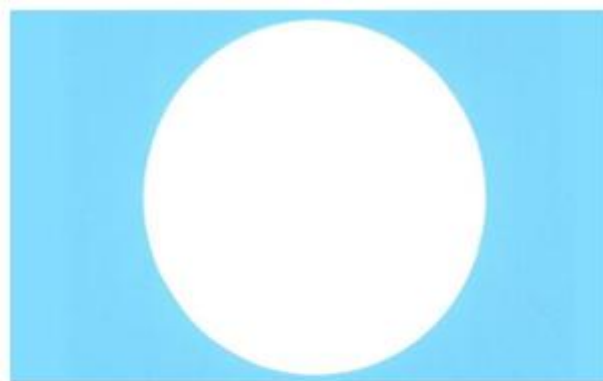

1.28



1.29



1.30



1.31



1.32



1.33



1.34

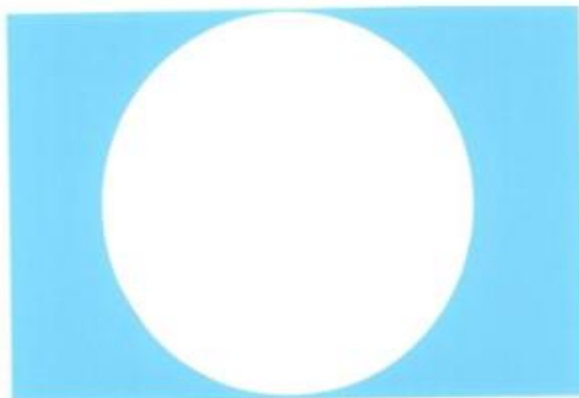

1.35



1.36



1.37



1.38



1.39



1.40



1.41



1.42



1.43



1.44



1.45



1.46



1.47



1.48



1.49



1.50



1.51



1.52



1.53



1.54



1.55



1.56



1.57



1.58



1.59



1.60

CÔNG BÁO SỞ HỮU CÔNG NGHIỆP SỐ 406 TẬP A – QUYỀN 2 (01.2022)

- (11) **43455**
(21) 3-2020-01894 (28) 1
(54) **BỘ TAI NGHE** (51) **14-01**
(22) 13/08/2020 (43) 25/01/2022
(73) **SHENZHEN VOXTECH CO., LTD. (CN)**
Floors 1-4, Factory Building 26, Shancheng Industrial Park, Shiyan Street, Bao'an District, Shenzhen, Guangdong, China
(72) 1. XINNAN MAO (CN)
2. DAN HU (CN)
3. YONGGEN WANG (CN)
4. ZHIQING LIU (CN)
(74) Công ty Luật TNHH T&G (TGVN)
(55)

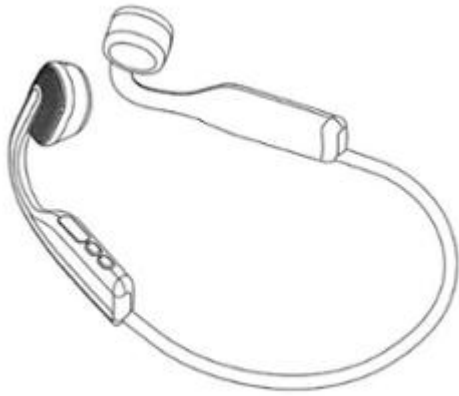

1.1



1.2



1.3



1.4



1.5

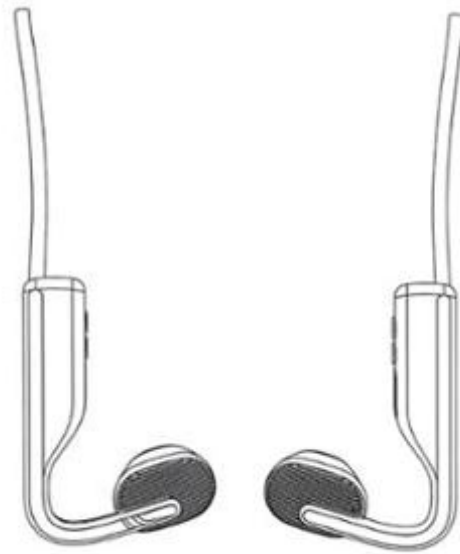

1.6

1.7



1.8



1.9

CÔNG BÁO SỞ HỮU CÔNG NGHIỆP SỐ 406 TẬP A – QUYỀN 2 (01.2022)

- (11) **43456**
(21) 3-2020-01941 (28) 1
(54) **GÓC KHUNG** (51) **08-09**
(22) 19/08/2020 (43) 25/01/2022
(73) **CÔNG TY TNHH KỸ THUẬT CƠ ĐIỆN MEE (VN)**
Lô HT-E10-6-9, đường số 19 khu công nghiệp Hiệp Phước, xã Hiệp Phước, huyện Nhà Bè, thành phố Hồ Chí Minh
(72) Nguyễn Văn Liên (VN)
(74) Công ty cổ phần Tư vấn S&B (S&B CONSULTANT., CORP.)
(55)

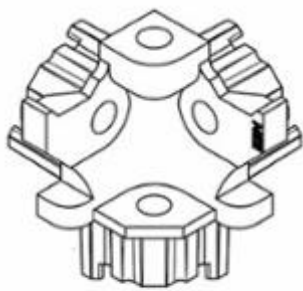

1.1

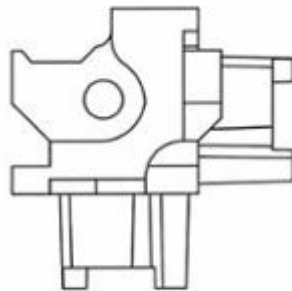

1.2

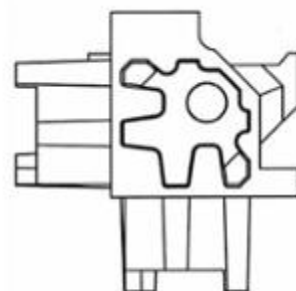

1.3

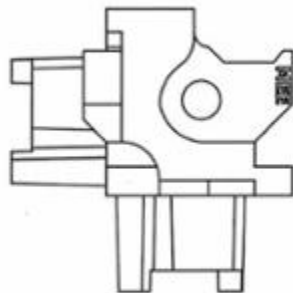

1.4

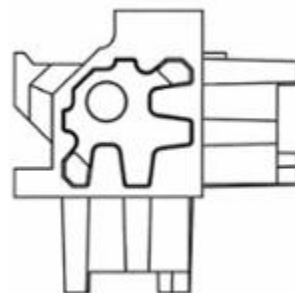

1.5

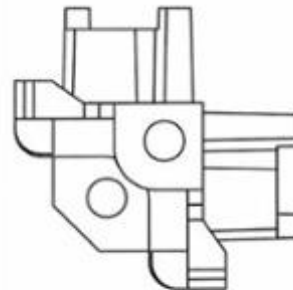

1.6

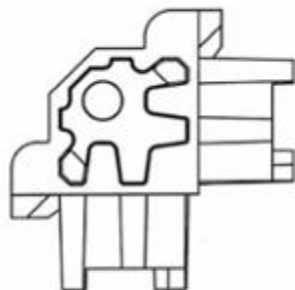

1.7

CÔNG BÁO SỞ HỮU CÔNG NGHIỆP SỐ 406 TẬP A – QUYỀN 2 (01.2022)

- (11) **43457**
(21) 3-2020-02012 (28) 1
(54) **GHẾ** (51) **06-01**
(22) 31/08/2020 (43) 25/01/2022
(73) **HTL FURNITURE (CHINA) CO., LTD. (CN)**
Wu Yujiangnan Road, Kunshan Development Zone, Jiangsu Province, China
(72) PHUA YONG TAT (SG)
(74) Công ty Luật TNHH quốc tế BMVN (BMVN INTERNATIONAL LLC)
(55)



1.1



1.2



1.3



1.4



1.5



1.6

CÔNG BÁO SỞ HỮU CÔNG NGHIỆP SỐ 406 TẬP A – QUYỀN 2 (01.2022)

- (11) **43458**
(21) 3-2020-02025 (28) 1
(54) **GHẾ SÔ-PHA** (51) **06-01**
(22) 31/08/2020 (43) 25/01/2022
(73) **HTL FURNITURE (CHINA) CO., LTD. (CN)**
Wu Yujiangnan Road, Kunshan Development Zone, Jiangsu Province, China
(72) PHUA YONG TAT (SG)
(74) Công ty Luật TNHH quốc tế BMVN (BMVN INTERNATIONAL LLC)
(55)



1.1



1.2



1.3



1.4



1.5



1.6

CÔNG BÁO SỞ HỮU CÔNG NGHIỆP SỐ 406 TẬP A – QUYỀN 2 (01.2022)

(11) **43459**

(21) 3-2020-02069

(28) 1

(54) **GHẾ**

(51) **06-01**

(22) 03/09/2020

(43) 25/01/2022

(73) **HTL FURNITURE (CHINA) CO., LTD. (CN)**

Wusong Jiangnan Road, Kunshan Development Zone, Jiangsu Province, China

(72) PHUA YONG TAT (SG)

(74) Công ty Luật TNHH quốc tế BMVN (BMVN INTERNATIONAL LLC)

(55)



1.1



1.2



1.3



1.4



1.5



1.6

CÔNG BÁO SỞ HỮU CÔNG NGHIỆP SỐ 406 TẬP A – QUYỀN 2 (01.2022)

- (11) **43460**
(21) 3-2020-02071 (28) 1
(54) **KHUNG GIƯỜNG** (51) **06-02**
(22) 03/09/2020 (43) 25/01/2022
(73) **HTL FURNITURE (CHINA) CO., LTD. (CN)**
Wusong Jiangnan Road, Kunshan Development Zone, Jiangsu Province, China
(72) PHUA YONG TAT (SG)
(74) Công ty Luật TNHH quốc tế BMVN (BMVN INTERNATIONAL LLC)
(55)



1.1



1.2



1.3



1.4



1.5

CÔNG BÁO SỞ HỮU CÔNG NGHIỆP SỐ 406 TẬP A – QUYỀN 2 (01.2022)

(11) **43461**

(21) 3-2020-02109

(28) 1

(54) **GHẾ SÔ-PHA**

(51) **06-01**

(22) 04/09/2020

(43) 25/01/2022

(73) **HTL FURNITURE (CHINA) CO., LTD. (CN)**

Wusong Jiangnan Road, Kunshan Development Zone, Jiangsu Province, China

(72) PHUA YONG TAT (SG)

(74) Công ty Luật TNHH quốc tế BMVN (BMVN INTERNATIONAL LLC)

(55)



1.1



1.2



1.3



1.4

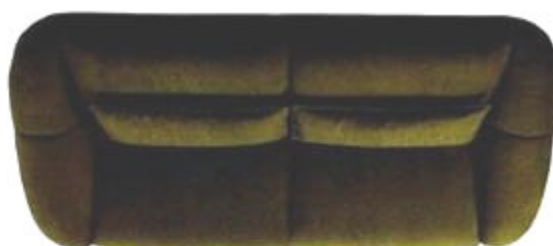

1.5

CÔNG BÁO SỞ HỮU CÔNG NGHIỆP SỐ 406 TẬP A – QUYỀN 2 (01.2022)

(11) **43462**

(21) 3-2020-02110

(28) 1

(54) **GHẾ SÔ-PHA**

(51) **06-01**

(22) 04/09/2020

(43) 25/01/2022

(73) **HTL FURNITURE (CHINA) CO., LTD. (CN)**

Wusong Jiangnan Road, Kunshan Development Zone, Jiangsu Province, China

(72) PHUA YONG TAT (SG)

(74) Công ty Luật TNHH quốc tế BMVN (BMVN INTERNATIONAL LLC)

(55)



1.1



1.2



1.3



1.4



1.5

CÔNG BÁO SỞ HỮU CÔNG NGHIỆP SỐ 406 TẬP A – QUYỀN 2 (01.2022)

(11) **43463**

(21) 3-2020-02116

(28) 1

(54) **GHẾ SÔ-PHA**

(51) **06-01**

(22) 04/09/2020

(43) 25/01/2022

(73) **HTL FURNITURE (CHINA) CO., LTD. (CN)**

Wusong Jiangnan Road, Kunshan Development Zone, Jiangsu Province, China

(72) PHUA YONG TAT (SG)

(74) Công ty Luật TNHH quốc tế BMVN (BMVN INTERNATIONAL LLC)

(55)



1.1



1.2



1.3



1.4



1.5



1.6

CÔNG BÁO SỞ HỮU CÔNG NGHIỆP SỐ 406 TẬP A – QUYỀN 2 (01.2022)

(11) **43464**

(21) 3-2020-02157

(28) 1

(54) **GHẾ SÔ-PHA**

(51) **06-01**

(22) 07/09/2020

(43) 25/01/2022

(73) **HTL FURNITURE (CHINA) CO., LTD. (CN)**

Wusong Jiangnan Road, Kunshan Development Zone, Jiangsu Province, China

(72) PHUA YONG TAT (SG)

(74) Công ty Luật TNHH quốc tế BMVN (BMVN INTERNATIONAL LLC)

(55)



1.1



1.2



1.3



1.4



1.5

CÔNG BÁO SỞ HỮU CÔNG NGHIỆP SỐ 406 TẬP A – QUYỀN 2 (01.2022)

- (11) **43465**
(21) 3-2020-02162 (28) 1
(54) **GHẾ SÔ-PHA** (51) **06-01**
(22) 07/09/2020 (43) 25/01/2022
(73) **HTL FURNITURE (CHINA) CO., LTD. (CN)**
Wusong Jiangnan Road, Kunshan Development Zone, Jiangsu Province, China
(72) PHUA YONG TAT (SG)
(74) Công ty Luật TNHH quốc tế BMVN (BMVN INTERNATIONAL LLC)
(55)



1.1



1.2



1.3



1.4



1.5



1.6

CÔNG BÁO SỞ HỮU CÔNG NGHIỆP SỐ 406 TẬP A – QUYỀN 2 (01.2022)

(11) **43466**

(21) 3-2020-02170

(28) 1

(54) **GHẾ SÔ-PHA**

(51) **06-01**

(22) 07/09/2020

(43) 25/01/2022

(73) **HTL FURNITURE (CHINA) CO., LTD. (CN)**

Wusong Jiangnan Road, Kunshan Development Zone, Jiangsu Province, China

(72) PHUA YONG TAT (SG)

(74) Công ty Luật TNHH quốc tế BMVN (BMVN INTERNATIONAL LLC)

(55)



1.1



1.2



1.3



1.4



1.5

CÔNG BÁO SỞ HỮU CÔNG NGHIỆP SỐ 406 TẬP A – QUYỀN 2 (01.2022)

(11) **43467**

(21) 3-2020-02175

(28) 1

(54) **GHẾ SÔ-PHA**

(51) **06-01**

(22) 07/09/2020

(43) 25/01/2022

(73) **HTL FURNITURE (CHINA) CO., LTD. (CN)**

Wusong Jiangnan Road, Kunshan Development Zone, Jiangsu Province, China

(72) PHUA YONG TAT (SG)

(74) Công ty Luật TNHH quốc tế BMVN (BMVN INTERNATIONAL LLC)

(55)



1.1



1.2



1.3



1.4



1.5

CÔNG BÁO SỞ HỮU CÔNG NGHIỆP SỐ 406 TẬP A – QUYỀN 2 (01.2022)

- (11) **43468**
(21) 3-2020-02178 (28) 1
(54) **GHẾ** (51) **06-01**
(22) 07/09/2020 (43) 25/01/2022
(73) **HTL FURNITURE (CHINA) CO., LTD. (CN)**
Wusong Jiangnan Road, Kunshan Development Zone, Jiangsu Province, China
(72) PHUA YONG TAT (SG)
(74) Công ty Luật TNHH quốc tế BMVN (BMVN INTERNATIONAL LLC)
(55)



1.1



1.2



1.3



1.4



1.5



1.6

CÔNG BÁO SỞ HỮU CÔNG NGHIỆP SỐ 406 TẬP A – QUYỀN 2 (01.2022)

(11) **43469**

(21) 3-2020-02180

(28) 1

(54) **GHẾ SÔ-PHA**

(51) **06-01**

(22) 07/09/2020

(43) 25/01/2022

(73) **HTL FURNITURE (CHINA) CO., LTD. (CN)**

Wusong Jiangnan Road, Kunshan Development Zone, Jiangsu Province, China

(72) PHUA YONG TAT (SG)

(74) Công ty Luật TNHH quốc tế BMVN (BMVN INTERNATIONAL LLC)

(55)



1.1



1.2



1.3



1.4



1.5



1.6

CÔNG BÁO SỞ HỮU CÔNG NGHIỆP SỐ 406 TẬP A – QUYỀN 2 (01.2022)

(11) **43470**

(21) 3-2020-02185

(28) 1

(54) **GHẾ SÔ-PHA**

(51) **06-01**

(22) 07/09/2020

(43) 25/01/2022

(73) **HTL FURNITURE (CHINA) CO., LTD. (CN)**

Wusong Jiangnan Road, Kunshan Development Zone, Jiangsu Province, China

(72) PHUA YONG TAT (SG)

(74) Công ty Luật TNHH quốc tế BMVN (BMVN INTERNATIONAL LLC)

(55)



1.1



1.2



1.3



1.4



1.5

CÔNG BÁO SỞ HỮU CÔNG NGHIỆP SỐ 406 TẬP A – QUYỀN 2 (01.2022)

(11) **43471**

(21) 3-2020-02201

(28) 1

(54) **GHẾ SÔ-PHA**

(51) **06-01**

(22) 07/09/2020

(43) 25/01/2022

(73) **HTL FURNITURE (CHINA) CO., LTD. (CN)**

Wusong Jiangnan Road, Kunshan Development Zone, Jiangsu Province, China

(72) PHUA YONG TAT (SG)

(74) Công ty Luật TNHH quốc tế BMVN (BMVN INTERNATIONAL LLC)

(55)



1.1



1.2



1.3



1.4



1.5

CÔNG BÁO SỞ HỮU CÔNG NGHIỆP SỐ 406 TẬP A – QUYỀN 2 (01.2022)

- (11) **43472**
(21) 3-2020-02205 (28) 1
(54) **GHẾ SÔ-PHA** (51) **06-01**
(22) 07/09/2020 (43) 25/01/2022
(73) **HTL FURNITURE (CHINA) CO., LTD. (CN)**
Wusong Jiangnan Road, Kunshan Development Zone, Jiangsu Province, China
(72) PHUA YONG TAT (SG)
(74) Công ty Luật TNHH quốc tế BMVN (BMVN INTERNATIONAL LLC)
(55)



1.1



1.2



1.3



1.4



1.5



1.6

CÔNG BÁO SỞ HỮU CÔNG NGHIỆP SỐ 406 TẬP A – QUYỀN 2 (01.2022)

- (11) **43473**
(21) 3-2020-02423 (28) 1
(54) **GIƯỜNG Y TẾ** (51) **06-02**
(22) 28/09/2020 (43) 25/01/2022
(73) **LÊ VIỆT BÁU (VN)**
Số 565, Quang Trung, phường Đông Vệ, thành phố Thanh Hóa
(72) Lê Việt Báu (VN)
(74) Công ty TNHH Tư vấn IPNG (IPNG CO.,LTD)
(55)



1.1



1.2



1.3



1.4

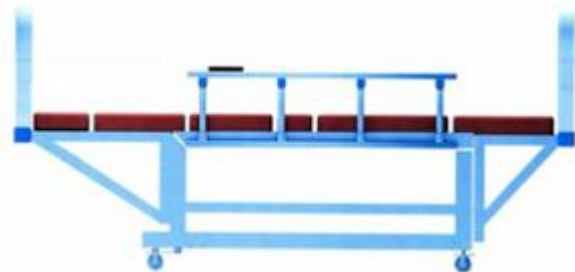

1.5

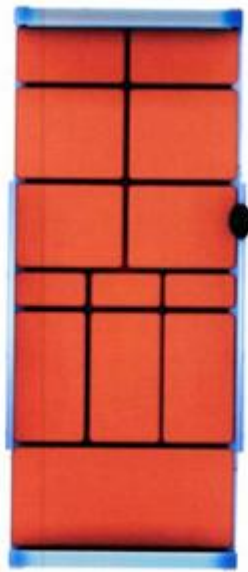

1.6



1.7



1.8



1.9



1.10

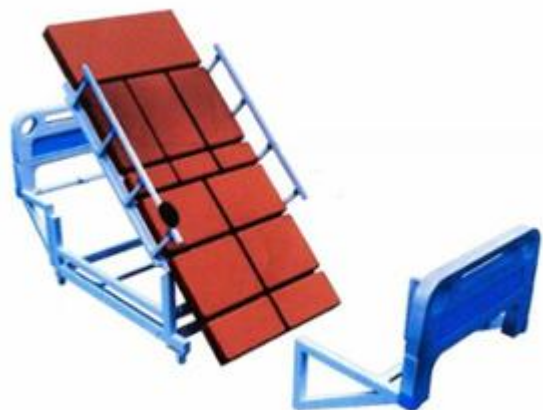

1.11

CÔNG BÁO SỞ HỮU CÔNG NGHIỆP SỐ 406 TẬP A – QUYỀN 2 (01.2022)

- (11) **43474**
(21) 3-2020-02469 (28) 1
(54) **MÁY SẢN XUẤT GẠCH** (51) **15-04**
(22) 05/10/2020 (43) 25/01/2022
(73) **CÔNG TY TNHH HỒ HOÀN CẦU (VN)**
Xóm 6, xã Quỳnh Văn, huyện Quỳnh Lưu, tỉnh Nghệ An
(72) Hồ Xuân Vinh (VN)
(55)



1.1



1.2



1.3



1.4

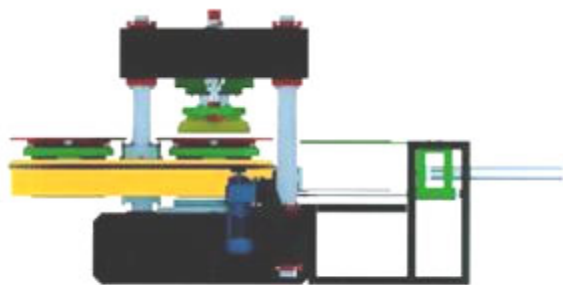

1.5

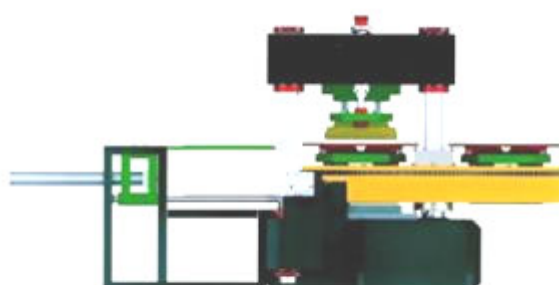

1.6

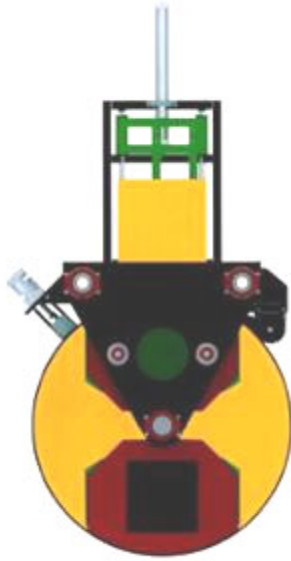

1.7

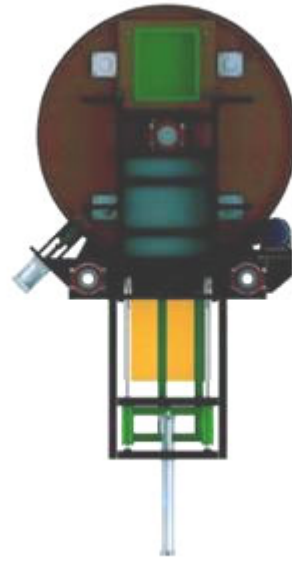

1.8

- (11) 43475
(21) 3-2020-02667 (28) 1
(54) **KỆ BÀY HÀNG** (51) **20-02**
(22) 29/10/2020 (43) 25/01/2022
(73) **CÔNG TY TNHH MỘT THÀNH VIÊN HÓA MỸ PHẨM NGỌC HIỆP (VN)**
Số 307, ấp 5, tổ NDTQ số 7, xã Lương Phú, huyện Giồng Trôm, tỉnh Bến Tre
(72) Nguyễn Thị Ngọc Hiệp (VN)
(74) Công ty TNHH Sở hữu trí tuệ Việt Nam IP (VIETNAM IP)
(55)



1.1

1.2

1.3



1.4



1.5



1.6



1.7

- (11) **43476**
(21) 3-2020-02756 (28) 1
(54) **THIẾT BỊ KẾT DÍNH VÀ TÍCH ĐẤT RỪNG NGẬP MẠN TỔNG HỢP** (51) **29-99**
(22) 12/11/2020 (43) 25/01/2022
(30) 2002003636 07/08/2020 TH;
(73) **THANAWATTH SATTABONGKOT (TH)**
99/45 moo 5 Bangplub Pak-Kret Nontaburee 11120 Thailand
(72) Thanawatth Sattabongkot (TH)
(74) Công ty TNHH Dịch vụ Sở hữu trí tuệ KENFOX (KENFOX IP SERVICE CO.,LTD.)
(55)

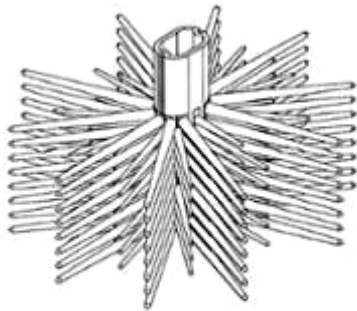

1.1

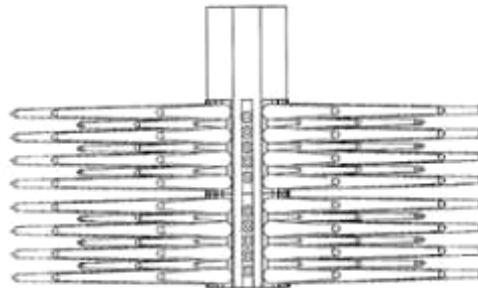

1.2

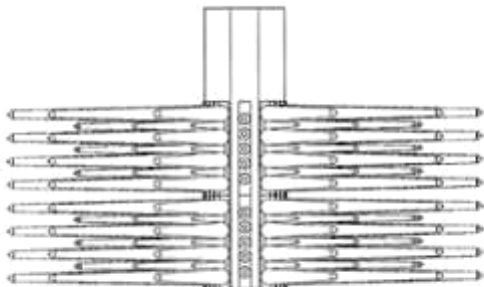

1.3



1.4



1.5

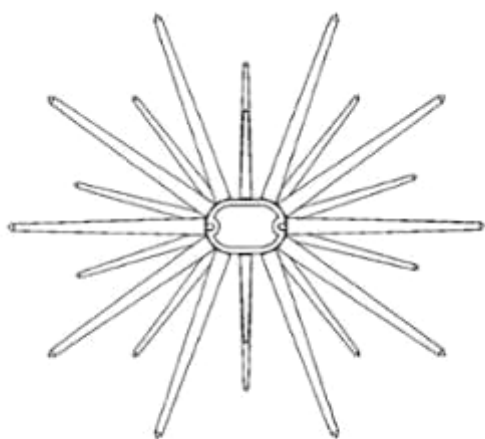

1.6

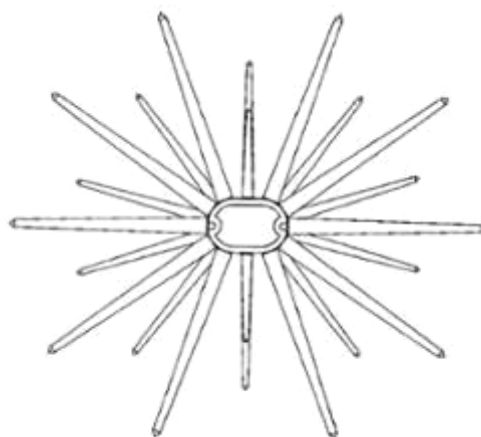

1.7

CÔNG BÁO SỞ HỮU CÔNG NGHIỆP SỐ 406 TẬP A – QUYỀN 2 (01.2022)

- (11) **43477**
(21) 3-2020-02953 (28) 1
(54) **KHẨU TRANG NHỰA** (51) **02-99; 29-02**
(22) 04/12/2020 (43) 25/01/2022
(73) **CÔNG TY TNHH IZION (VN)**
E17-Rio Vista đường D1, phường Phước Long B, quận 9, thành phố Hồ Chí Minh
(72) Nguyễn Cao Đô (VN)
(74) Công ty TNHH Tư vấn A & S (A&S CO.,LTD)
(55)



1.1



1.2



1.3



1.4



1.5

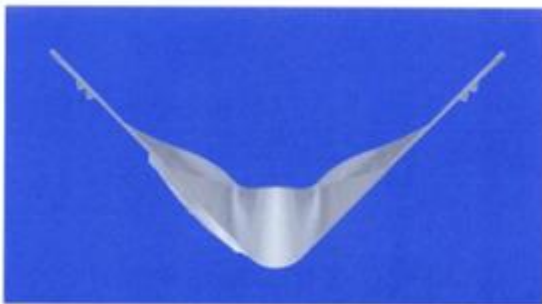

1.6

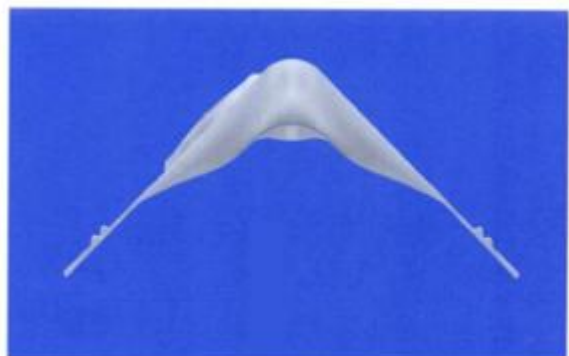

1.7

CÔNG BÁO SỞ HỮU CÔNG NGHIỆP SỐ 406 TẬP A – QUYỀN 2 (01.2022)

- (11) **43478**
(21) 3-2020-02954 (28) 1
(54) **BAO GÓI SẢN PHẨM** (51) **09-05**
(22) 07/12/2020 (43) 25/01/2022
(73) **CÔNG TY TNHH THƯƠNG MẠI CHẤN VŨ (VN)**
Số 49 đường 50, khu phố 9, khu dân cư Tân Tạo, phường Tân Tạo, quận Bình Tân,
thành phố Hồ Chí Minh
(72) Nguyễn Thị Oanh (VN)
(74) Công ty TNHH MASTERBRAND (MASTERBRAND)
(55)



1.1



1.2

CÔNG BÁO SỞ HỮU CÔNG NGHIỆP SỐ 406 TẬP A – QUYỀN 2 (01.2022)

- (11) **43479**
(21) 3-2020-02955 (28) 1
(54) **BAO GÓI SẢN PHẨM** (51) **09-05**
(22) 07/12/2020 (43) 25/01/2022
(73) **CÔNG TY TNHH THƯƠNG MẠI CHẤN VŨ (VN)**
Số 49 đường 50, khu phố 9, khu dân cư Tân Tạo, phường Tân Tạo, quận Bình Tân,
thành phố Hồ Chí Minh
(72) Nguyễn Thị Oanh (VN)
(74) Công ty TNHH MASTERBRAND (MASTERBRAND)
(55)



1.1



1.2

CÔNG BÁO SỞ HỮU CÔNG NGHIỆP SỐ 406 TẬP A – QUYỀN 2 (01.2022)

- (11) **43480**
- (21) 3-2020-02956 (28) 1
- (54) **BAO GÓI SẢN PHẨM** (51) **09-05**
- (22) 07/12/2020 (43) 25/01/2022
- (73) **CÔNG TY TNHH THƯƠNG MẠI CHẤN VŨ (VN)**
Số 49 đường 50, khu phố 9, khu dân cư Tân Tạo, phường Tân Tạo, quận Bình Tân,
thành phố Hồ Chí Minh
- (72) Nguyễn Thị Oanh (VN)
- (74) Công ty TNHH MASTERBRAND (MASTERBRAND)
- (55)



1.1



1.2

CÔNG BÁO SỞ HỮU CÔNG NGHIỆP SỐ 406 TẬP A – QUYỀN 2 (01.2022)

- (11) **43481**
(21) 3-2020-02965 (28) 1
(54) **NHÃN SẢN PHẨM SNACK GẠO** (51) **19-08**
(22) 08/12/2020 (43) 25/01/2022
(73) **CÔNG TY TNHH GẠO NGON NHẤT (VN)**
11/22 đường 10, khu phố 3, phường Bình Thuận, quận 7, thành phố Hồ Chí Minh
(72) Nguyễn Lưu Tường (VN)
(55)



CÔNG BÁO SỞ HỮU CÔNG NGHIỆP SỐ 406 TẬP A – QUYỀN 2 (01.2022)

- (11) **43482**
(21) 3-2020-02994 (28) 1
(54) **TÚI ĐỰNG TRÀ** (51) **09-05**
(22) 10/12/2020 (43) 25/01/2022
(73) **DOANH NGHIỆP TƯ NHÂN THANH MINH THÁI NGUYÊN (VN)**
Số 93, tổ 9, phường Phú Xá, thành phố Thái Nguyên, tỉnh Thái Nguyên
(72) Đỗ Thị Thanh (VN)
(74) Công ty TNHH Sở hữu trí tuệ M.I.T (M.I.T IP CO., LTD)
(55)



1.1



1.2

CÔNG BÁO SỞ HỮU CÔNG NGHIỆP SỐ 406 TẬP A – QUYỀN 2 (01.2022)

- (11) **43483**
(21) 3-2020-03071 (28) 1
(54) **HỘP** (51) **09-03**
(22) 22/12/2020 (43) 25/01/2022
(73) **CÔNG TY TNHH ĐÔNG Y TOÀN MAI (VN)**
19 đường 14, KP4, phường Linh Đông, quận Thủ Đức, thành phố Hồ Chí Minh
(72) Phạm Đức Toàn (VN)
(55)



1.1



1.2

- (11) **43484**
(21) 3-2021-00147 (28) 1
(54) **THÂN THUỐC LÁ ĐIỆN TỬ** (51) **27-99**
(22) 22/01/2021 (43) 25/01/2022
(30) 202030406101.5 23/07/2020 CN;
(73) **SHENZHEN RELX TECHNOLOGY CO., LTD.** (CN)
4F, Building 2, Wangda Industrial District, West Side Of Songbai Road, Tangtou
Community, Shiyan Street, Baoan District, Shenzhen City, Guangdong Province
518108, China
(72) 1. LIU, AIQING (CN)
2. CHEN, CHEN (CN)
(74) Công ty Luật TNHH T&G (TGVN)
(55)

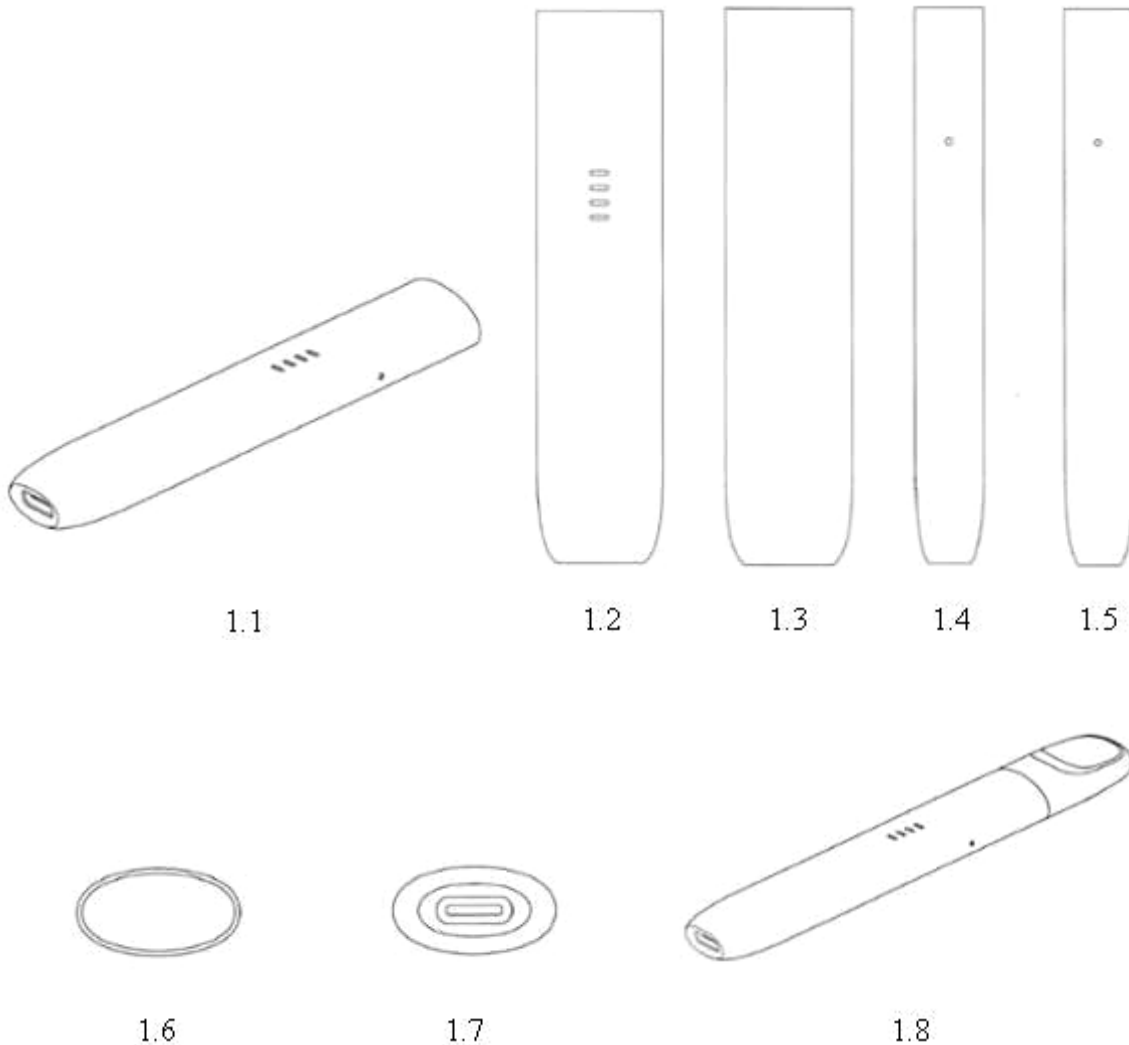



1.9



1.10



1.11



1.12



1.13



1.14

CÔNG BÁO SỞ HỮU CÔNG NGHIỆP SỐ 406 TẬP A – QUYỀN 2 (01.2022)

- (11) **43485**
(21) 3-2021-00165 (28) 3
(54) **LÒ NƯỚNG** (51) **07-02**
(22) 26/01/2021 (43) 25/01/2022
(73) **CÔNG TY CỔ PHẦN THỨC ĂN BAY (VN)**
7/3 Hồ Biểu Chánh, phường 12, quận Phú Nhuận, thành phố Hồ Chí Minh
(72) Trần Thị Phương Diễm (VN)
(74) Công ty TNHH một thành viên Trường Luật (Trường Luật)
(55)



1.1



1.2



1.3



1.4



1.5

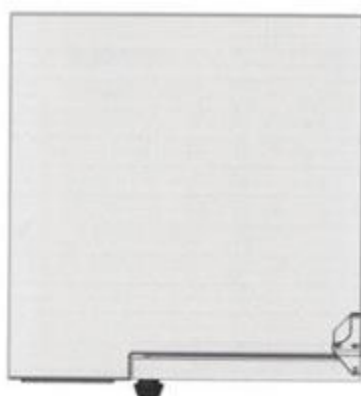

1.6

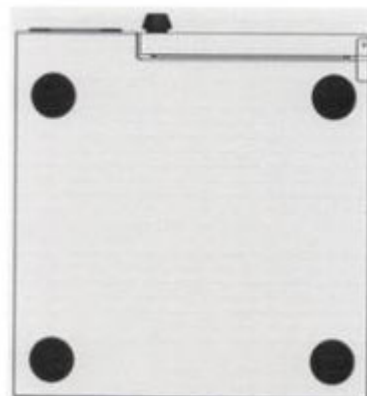

1.7



2.1



2.2



2.3



2.4



2.5

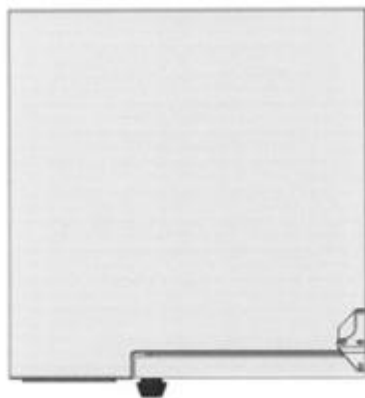

2.6

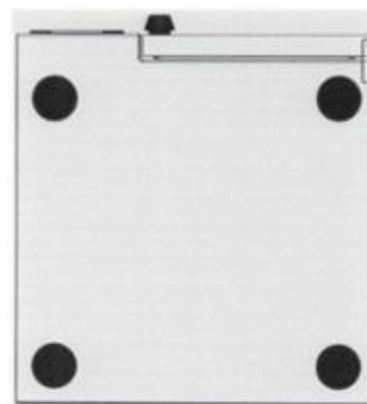

2.7



3.1



3.2



3.3



3.4



3.5

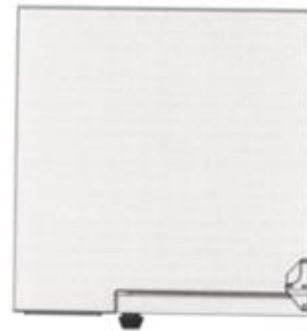

3.6

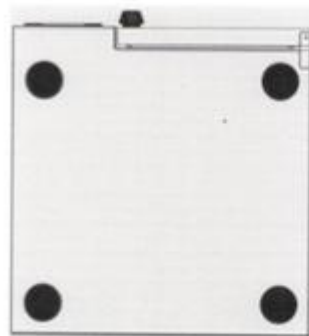

3.7

CÔNG BÁO SỞ HỮU CÔNG NGHIỆP SỐ 406 TẬP A – QUYỀN 2 (01.2022)

(11) **43486**

(21) 3-2021-00264

(28) 1

(54) **GHẾ SÔ-PHA**

(51) **06-01**

(22) 03/02/2021

(43) 25/01/2022

(73) **HTL FURNITURE (CHINA) CO., LTD. (CN)**

Wusong Jiangnan Road, Kunshan Development Zone, Jiangsu Province, China

(72) PHUA YONG TAT (SG)

(74) Công ty Luật TNHH quốc tế BMVN (BMVN INTERNATIONAL LLC)

(55)



1.1



1.2



1.3



1.4



1.5



1.6



1.7

CÔNG BÁO SỞ HỮU CÔNG NGHIỆP SỐ 406 TẬP A – QUYỀN 2 (01.2022)

- (11) **43487**
(21) 3-2021-00388 (28) 1
(54) **NẤP BÚT** (51) **19-06**
(22) 25/02/2021 (43) 25/01/2022
(30) 008152821-0007 31/08/2020 EM;
(73) **SCHWAN-STABILO SCHWANHÄUßER GMBH & CO. KG (DE)**
Schwanweg 1, 90562 Heroldsberg, Germany
(72) Diana Martin (DE)
(74) Công ty Luật TNHH ROUSE Việt Nam (ROUSE LAW CO.,LTD)
(55)



1.1



1.2



1.3



1.4



1.5



1.6



1.7

CÔNG BÁO SỞ HỮU CÔNG NGHIỆP SỐ 406 TẬP A – QUYỀN 2 (01.2022)

(11) **43488**

(21) 3-2021-00439

(28) 1

(54) **PHIN CHỨA**

(51) **07-02**

(22) 04/03/2021

(43) 25/01/2022

(73) **CÔNG TY TNHH MINH LONG I (VN)**

333 Khu phố Hưng Lộc, phường Hưng Định, thành phố Thuận An, tỉnh Bình Dương

(72) Lý Ngọc Minh (VN)

(55)



1.1



1.2



1.3



1.4

CÔNG BÁO SỞ HỮU CÔNG NGHIỆP SỐ 406 TẬP A – QUYỀN 2 (01.2022)

- (11) **43489**
(21) 3-2021-00460 (28) 1
(54) **BAO GÓI** (51) **09-05**
(22) 08/03/2021 (43) 25/01/2022
(73) **CÔNG TY TNHH MỘT THÀNH VIÊN TRỊNH VĂN PHÚ (VN)**
Số 546 Ấp Giồng Cát, xã Lương An Trà, huyện Tri Tôn, tỉnh An Giang
(72) Trịnh Văn Phú (VN)
(55)



1.1



1.2

CÔNG BÁO SỞ HỮU CÔNG NGHIỆP SỐ 406 TẬP A – QUYỀN 2 (01.2022)

(11) **43490**

(21) 3-2021-00482

(28) 1

(54) **GHẾ SÔ-PHA**

(51) **06-01**

(22) 12/03/2021

(43) 25/01/2022

(73) **HTL FURNITURE (CHINA) CO., LTD. (CN)**

Wusong Jiangnan Road, Kunshan Development Zone, Jiangsu Province, China

(72) PHUA YONG TAT (SG)

(74) Công ty Luật TNHH quốc tế BMVN (BMVN INTERNATIONAL LLC)

(55)



1.1

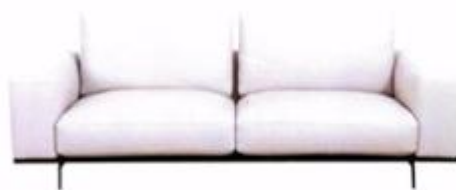

1.2



1.3



1.4



1.5

CÔNG BÁO SỞ HỮU CÔNG NGHIỆP SỐ 406 TẬP A – QUYỀN 2 (01.2022)

(11) **43491**

(21) 3-2021-00483

(28) 1

(54) **GHẾ SÔ-PHA**

(51) **06-01**

(22) 12/03/2021

(43) 25/01/2022

(73) **HTL FURNITURE (CHINA) CO., LTD. (CN)**

Wusong Jiangnan Road, Kunshan Development Zone, Jiangsu Province, China

(72) PHUA YONG TAT (SG)

(74) Công ty Luật TNHH quốc tế BMVN (BMVN INTERNATIONAL LLC)

(55)



1.1



1.2



1.3



1.4



1.5



1.6

CÔNG BÁO SỞ HỮU CÔNG NGHIỆP SỐ 406 TẬP A – QUYỀN 2 (01.2022)

(11) **43492**

(21) 3-2021-00487

(28) 1

(54) **GHẾ**

(51) **06-01**

(22) 12/03/2021

(43) 25/01/2022

(73) **HTL FURNITURE (CHINA) CO., LTD. (CN)**

Wusong Jiangnan Road, Kunshan Development Zone, Jiangsu Province, China

(72) PHUA YONG TAT (SG)

(74) Công ty Luật TNHH quốc tế BMVN (BMVN INTERNATIONAL LLC)

(55)



1.1



1.2



1.3



1.4



1.5

CÔNG BÁO SỞ HỮU CÔNG NGHIỆP SỐ 406 TẬP A – QUYỀN 2 (01.2022)

(11) **43493**

(21) 3-2021-00492

(28) 1

(54) **GHẾ SÔ-PHA**

(51) **06-01**

(22) 12/03/2021

(43) 25/01/2022

(73) **HTL FURNITURE (CHINA) CO., LTD. (CN)**

Wusong Jiangnan Road, Kunshan Development Zone, Jiangsu Province, China

(72) PHUA YONG TAT (SG)

(74) Công ty Luật TNHH quốc tế BMVN (BMVN INTERNATIONAL LLC)

(55)



1.1



1.2



1.3



1.4



1.5



1.6

CÔNG BÁO SỞ HỮU CÔNG NGHIỆP SỐ 406 TẬP A – QUYỀN 2 (01.2022)

(11) **43494**

(21) 3-2021-00493

(28) 1

(54) **GHẾ**

(51) **06-01**

(22) 12/03/2021

(43) 25/01/2022

(73) **HTL FURNITURE (CHINA) CO., LTD. (CN)**

Wusong Jiangnan Road, Kunshan Development Zone, Jiangsu Province, China

(72) PHUA YONG TAT (SG)

(74) Công ty Luật TNHH quốc tế BMVN (BMVN INTERNATIONAL LLC)

(55)



1.1



1.2



1.3



1.4



1.5



1.6

CÔNG BÁO SỞ HỮU CÔNG NGHIỆP SỐ 406 TẬP A – QUYỀN 2 (01.2022)

(11) **43495**

(21) 3-2021-00494

(28) 1

(54) **GHẾ**

(51) **06-01**

(22) 12/03/2021

(43) 25/01/2022

(73) **HTL FURNITURE (CHINA) CO., LTD. (CN)**

Wusong Jiangnan Road, Kunshan Development Zone, Jiangsu Province, China

(72) PHUA YONG TAT (SG)

(74) Công ty Luật TNHH quốc tế BMVN (BMVN INTERNATIONAL LLC)

(55)



1.1



1.2



1.3



1.4



1.5



1.6

CÔNG BÁO SỞ HỮU CÔNG NGHIỆP SỐ 406 TẬP A – QUYỀN 2 (01.2022)

(11) **43496**

(21) 3-2021-00495

(28) 1

(54) **GHẾ SÔ-PHA**

(51) **06-01**

(22) 12/03/2021

(43) 25/01/2022

(73) **HTL FURNITURE (CHINA) CO., LTD. (CN)**

Wusong Jiangnan Road, Kunshan Development Zone, Jiangsu Province, China

(72) PHUA YONG TAT (SG)

(74) Công ty Luật TNHH quốc tế BMVN (BMVN INTERNATIONAL LLC)

(55)



1.1



1.2



1.3



1.4



1.5

CÔNG BÁO SỞ HỮU CÔNG NGHIỆP SỐ 406 TẬP A – QUYỀN 2 (01.2022)

(11) **43497**

(21) 3-2021-00532

(28) 1

(54) **KHUNG GIƯỜNG**

(51) **06-02**

(22) 17/03/2021

(43) 25/01/2022

(73) **HTL FURNITURE (CHINA) CO., LTD. (CN)**

Wusong Jiangnan Road, Kunshan Development Zone, Jiangsu Province, China

(72) PHUA YONG TAT (SG)

(74) Công ty Luật TNHH quốc tế BMVN (BMVN INTERNATIONAL LLC)

(55)



1.1



1.2



1.3



1.4



1.5

CÔNG BÁO SỞ HỮU CÔNG NGHIỆP SỐ 406 TẬP A – QUYỀN 2 (01.2022)

(11) **43498**

(21) 3-2021-00533

(28) 1

(54) **GHẾ**

(51) **06-01**

(22) 17/03/2021

(43) 25/01/2022

(73) **HTL FURNITURE (CHINA) CO., LTD. (CN)**

Wusong Jiangnan Road, Kunshan Development Zone, Jiangsu Province, China

(72) PHUA YONG TAT (SG)

(74) Công ty Luật TNHH quốc tế BMVN (BMVN INTERNATIONAL LLC)

(55)



1.1



1.2



1.3



1.4



1.5

CÔNG BÁO SỞ HỮU CÔNG NGHIỆP SỐ 406 TẬP A – QUYỀN 2 (01.2022)

(11) **43499**

(21) 3-2021-00535

(28) 1

(54) **GHẾ**

(51) **06-01**

(22) 17/03/2021

(43) 25/01/2022

(73) **HTL FURNITURE (CHINA) CO., LTD. (CN)**

Wusong Jiangnan Road, Kunshan Development Zone, Jiangsu Province, China

(72) PHUA YONG TAT (SG)

(74) Công ty Luật TNHH quốc tế BMVN (BMVN INTERNATIONAL LLC)

(55)



1.1



1.2



1.3



1.4



1.5

CÔNG BÁO SỞ HỮU CÔNG NGHIỆP SỐ 406 TẬP A – QUYỀN 2 (01.2022)

(11) **43500**

(21) 3-2021-00545

(28) 1

(54) **GHẾ**

(51) **06-01**

(22) 17/03/2021

(43) 25/01/2022

(73) **HTL FURNITURE (CHINA) CO., LTD. (CN)**

Wusong Jiangnan Road, Kunshan Development Zone, Jiangsu Province, China

(72) PHUA YONG TAT (SG)

(74) Công ty Luật TNHH quốc tế BMVN (BMVN INTERNATIONAL LLC)

(55)



1.1



1.2



1.3



1.4



1.5

CÔNG BÁO SỞ HỮU CÔNG NGHIỆP SỐ 406 TẬP A – QUYỀN 2 (01.2022)

(11) **43501**

(21) 3-2021-00546

(28) 1

(54) **GHẾ**

(51) **06-01**

(22) 17/03/2021

(43) 25/01/2022

(73) **HTL FURNITURE (CHINA) CO., LTD. (CN)**

Wusong Jiangnan Road, Kunshan Development Zone, Jiangsu Province, China

(72) PHUA YONG TAT (SG)

(74) Công ty Luật TNHH quốc tế BMVN (BMVN INTERNATIONAL LLC)

(55)



1.1



1.2



1.3



1.4



1.5

CÔNG BÁO SỞ HỮU CÔNG NGHIỆP SỐ 406 TẬP A – QUYỀN 2 (01.2022)

(11) **43502**

(21) 3-2021-00557

(28) 1

(54) **GHẾ SÔ-PHA**

(51) **06-01**

(22) 17/03/2021

(43) 25/01/2022

(73) **HTL FURNITURE (CHINA) CO., LTD. (CN)**

Wusong Jiangnan Road, Kunshan Development Zone, Jiangsu Province, China

(72) PHUA YONG TAT (SG)

(74) Công ty Luật TNHH quốc tế BMVN (BMVN INTERNATIONAL LLC)

(55)



1.1



1.2



1.3



1.4



1.5



1.6

CÔNG BÁO SỞ HỮU CÔNG NGHIỆP SỐ 406 TẬP A – QUYỀN 2 (01.2022)

(11) **43503**

(21) 3-2021-00561

(28) 1

(54) **GHÉ**

(51) **06-01**

(22) 17/03/2021

(43) 25/01/2022

(73) **HTL FURNITURE (CHINA) CO., LTD. (CN)**

Wusong Jiangnan Road, Kunshan Development Zone, Jiangsu Province, China

(72) PHUA YONG TAT (SG)

(74) Công ty Luật TNHH quốc tế BMVN (BMVN INTERNATIONAL LLC)

(55)



1.1



1.2



1.3



1.4



1.5



1.6

CÔNG BÁO SỞ HỮU CÔNG NGHIỆP SỐ 406 TẬP A – QUYỀN 2 (01.2022)

(11) **43504**

(21) 3-2021-00572

(28) 1

(54) **TẤM MẶT NẠ CỦA XE MÁY**

(51) **12-16**

(22) 18/03/2021

(43) 25/01/2022

(73) **CÔNG TY CỔ PHẦN HYOSUNG VIỆT NAM (VN)**

Số 11 lô I, khu 4 ha, Phúc Xá, phường Phúc Xá, quận Ba Đình, thành phố Hà Nội

(72) Tô Xuân Hiếu (VN)

(55)



1.1



1.2



1.3



1.4



1.5



1.6



1.7

(11) **43505**

(21) 3-2021-00573

(28) 1

(54) **TẤM GẮN MẶT NẠ CỦA XE MÁY**

(51) **12-16**

(22) 18/03/2021

(43) 25/01/2022

(73) **CÔNG TY CỔ PHẦN HYOSUNG VIỆT NAM (VN)**

Số 11 lô I, khu 4 ha, Phúc Xá, phường Phúc Xá, quận Ba Đình, thành phố Hà Nội

(72) Tô Xuân Hiếu (VN)

(55)



1.1



1.2



1.3



1.4



1.5



1.6



1.7

CÔNG BÁO SỞ HỮU CÔNG NGHIỆP SỐ 406 TẬP A – QUYỀN 2 (01.2022)

(11) **43506**

(21) 3-2021-00574

(28) 1

(54) **TẮM ỐP SƯỜN CỦA XE MÁY**

(51) **12-16**

(22) 18/03/2021

(43) 25/01/2022

(73) **CÔNG TY CỔ PHẦN HYOSUNG VIỆT NAM (VN)**

Số 11 lô I, khu 4 ha, Phúc Xá, phường Phúc Xá, quận Ba Đình, thành phố Hà Nội

(72) Tô Xuân Hiếu (VN)

(55)

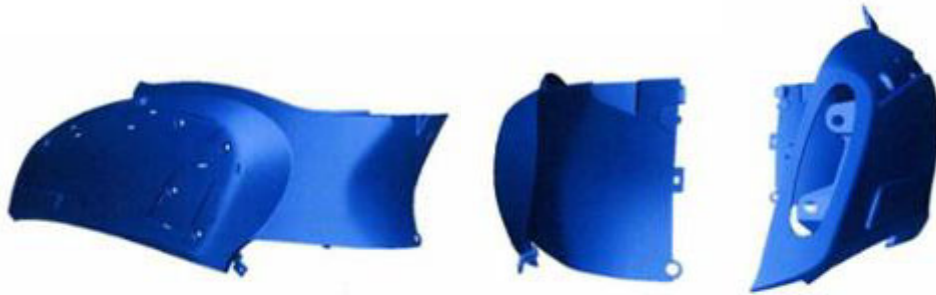

1.1

1.2

1.3



1.4

1.5



1.6

1.7

CÔNG BÁO SỞ HỮU CÔNG NGHIỆP SỐ 406 TẬP A – QUYỀN 2 (01.2022)

- (11) **43507**
(21) 3-2021-00575 (28) 1
(54) **TẮM ỐP SƯỜN CỦA XE MÁY** (51) **12-16**
(22) 18/03/2021 (43) 25/01/2022
(73) **CÔNG TY CỔ PHẦN HYOSUNG VIỆT NAM (VN)**
Số 11 lô I, khu 4 ha, Phúc Xá, phường Phúc Xá, quận Ba Đình, thành phố Hà Nội
(72) Tô Xuân Hiếu (VN)
(55)



1.1



1.2



1.3



1.4



1.5



1.6



1.7

CÔNG BÁO SỞ HỮU CÔNG NGHIỆP SỐ 406 TẬP A – QUYỀN 2 (01.2022)

(11) **43508**

(21) 3-2021-00609

(28) 1

(54) **GHẾ SÔ-PHA**

(51) **06-01**

(22) 18/03/2021

(43) 25/01/2022

(73) **HTL FURNITURE (CHINA) CO., LTD. (CN)**

Wusong Jiangnan Road, Kunshan Development Zone, Jiangsu Province, China

(72) PHUA YONG TAT (SG)

(74) Công ty Luật TNHH quốc tế BMVN (BMVN INTERNATIONAL LLC)

(55)



1.1



1.2



1.3



1.4



1.5

CÔNG BÁO SỞ HỮU CÔNG NGHIỆP SỐ 406 TẬP A – QUYỀN 2 (01.2022)

(11) **43509**

(21) 3-2021-00610

(28) 1

(54) **GHẾ SÔ-PHA**

(51) **06-01**

(22) 18/03/2021

(43) 25/01/2022

(73) **HTL FURNITURE (CHINA) CO., LTD. (CN)**

Wusong Jiangnan Road, Kunshan Development Zone, Jiangsu Province, China

(72) PHUA YONG TAT (SG)

(74) Công ty Luật TNHH quốc tế BMVN (BMVN INTERNATIONAL LLC)

(55)



1.1



1.2



1.3



1.4



1.5

CÔNG BÁO SỞ HỮU CÔNG NGHIỆP SỐ 406 TẬP A – QUYỀN 2 (01.2022)

(11) **43510**

(21) 3-2021-00611

(28) 1

(54) **GHẾ**

(51) **06-01**

(22) 18/03/2021

(43) 25/01/2022

(73) **HTL FURNITURE (CHINA) CO., LTD. (CN)**

Wusong Jiangnan Road, Kunshan Development Zone, Jiangsu Province, China

(72) PHUA YONG TAT (SG)

(74) Công ty Luật TNHH quốc tế BMVN (BMVN INTERNATIONAL LLC)

(55)



1.1



1.2



1.3



1.4



1.5

CÔNG BÁO SỞ HỮU CÔNG NGHIỆP SỐ 406 TẬP A – QUYỀN 2 (01.2022)

(11) **43511**

(21) 3-2021-00612

(28) 1

(54) **GHẾ SÔ-PHA**

(51) **06-01**

(22) 18/03/2021

(43) 25/01/2022

(73) **HTL FURNITURE (CHINA) CO., LTD. (CN)**

Wusong Jiangnan Road, Kunshan Development Zone, Jiangsu Province, China

(72) PHUA YONG TAT (SG)

(74) Công ty Luật TNHH quốc tế BMVN (BMVN INTERNATIONAL LLC)

(55)



1.1



1.2



1.3



1.4



1.5



1.6

CÔNG BÁO SỞ HỮU CÔNG NGHIỆP SỐ 406 TẬP A – QUYỀN 2 (01.2022)

(11) **43512**

(21) 3-2021-00613

(28) 1

(54) **GHẾ SÔ-PHA**

(51) **06-01**

(22) 18/03/2021

(43) 25/01/2022

(73) **HTL FURNITURE (CHINA) CO., LTD. (CN)**

Wusong Jiangnan Road, Kunshan Development Zone, Jiangsu Province, China

(72) PHUA YONG TAT (SG)

(74) Công ty Luật TNHH quốc tế BMVN (BMVN INTERNATIONAL LLC)

(55)



1.1



1.2



1.3



1.4



1.5



1.6

CÔNG BÁO SỞ HỮU CÔNG NGHIỆP SỐ 406 TẬP A – QUYỀN 2 (01.2022)

- (11) **43513**
(21) 3-2021-00642 (28) 1
(54) **NGÓI NẮNG LƯỢNG MẶT TRỜI** (51) **25-01**
(22) 18/03/2021 (43) 25/01/2022
(73) **ĐÌNH TRUNG KIÊN (VN)**
Số 10, phường Cửa Đông, quận Hoàn Kiếm, thành phố Hà Nội
(72) Đình Trung Kiên (VN)
(74) Công ty TNHH Tư vấn đầu tư và Sở hữu trí tuệ Hoàng Phi (HOANG PHI INVEST & I.P CO., LTD)
(55)



1.1



1.2



1.3



1.4



1.5

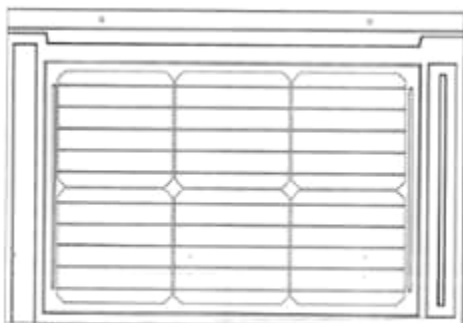

1.6

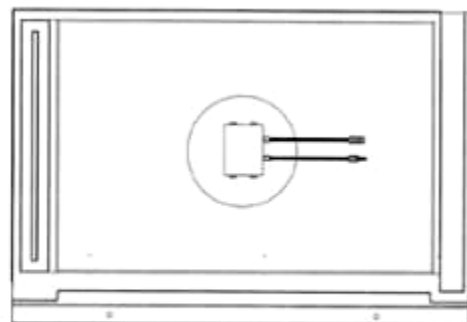

1.7

- (11) **43514**
(21) 3-2021-00644 (28) 1
(54) **BÌNH** (51) **09-02**
(22) 18/03/2021 (43) 25/01/2022
(30) 008173512-0001 18/09/2020 EM;
(73) **CASTROL LIMITED (GB)**
Technology Centre, Whitchurch Hill, Pangbourne, Reading RG8 7QR, United Kingdom
(72) 1. RICHARD CURRIE (GB)
2. SENNER KARAGÜLLE (TR)
(74) Công ty TNHH Tư vấn sở hữu trí tuệ Việt (VIET IP CO.,LTD.)
(55)

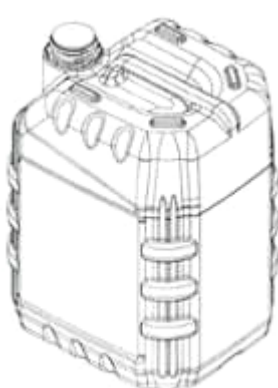

1.1

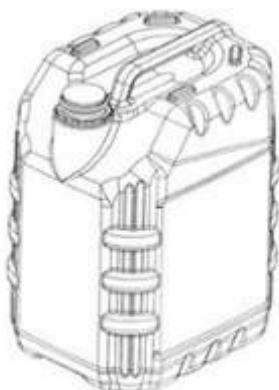

1.2

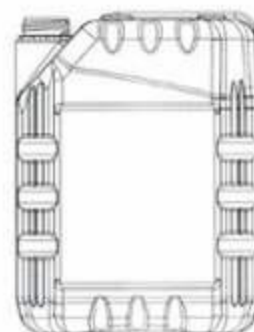

1.3

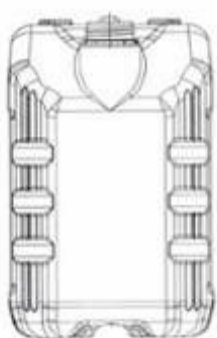

1.4

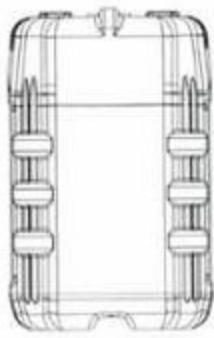

1.5

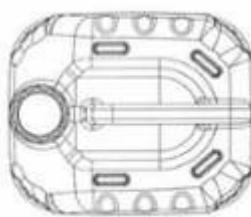

1.6

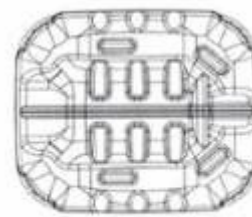

1.7

CÔNG BÁO SỞ HỮU CÔNG NGHIỆP SỐ 406 TẬP A – QUYỀN 2 (01.2022)

- (11) **43515**
(21) 3-2021-00645 (28) 1
(54) **BÌNH** (51) **09-02**
(22) 18/03/2021 (43) 25/01/2022
(30) 008173512-0002 18/09/2020 EM;
(73) **CASTROL LIMITED (GB)**
Technology Centre, Whitchurch Hill, Pangbourne, Reading RG8 7QR, United Kingdom
(72) 1. RICHARD CURRIE (GB)
2. SENER KARAGÜLLE (TR)
(74) Công ty TNHH Tư vấn sở hữu trí tuệ Việt (VIET IP CO.,LTD.)
(55)

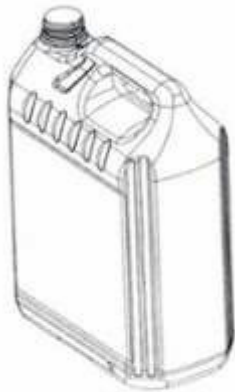

1.1



1.2

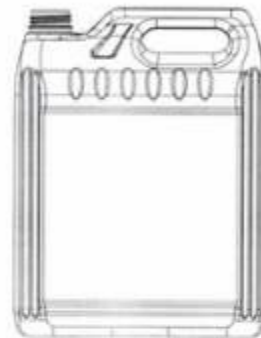

1.3



1.4



1.5

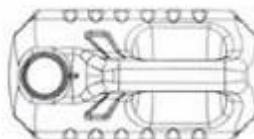

1.6

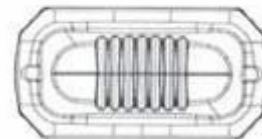

1.7

CÔNG BÁO SỞ HỮU CÔNG NGHIỆP SỐ 406 TẬP A – QUYỀN 2 (01.2022)

- (11) **43516**
(21) 3-2021-00731 (28) 1
(54) **BA LÔ** (51) **03-01**
(22) 30/03/2021 (43) 25/01/2022
(73) **CÔNG TY CỔ PHẦN XUẤT NHẬP KHẨU BÌNH TÂY (VN)**
Đường tỉnh 835, ấp 3A, xã Phước Lợi, huyện Bến Lức, tỉnh Long An
(72) Trịnh Hoàng Kim Khánh (VN)
(55)



1.1



1.2



1.3



1.4



1.5



1.6



1.7

CÔNG BÁO SỞ HỮU CÔNG NGHIỆP SỐ 406 TẬP A – QUYỀN 2 (01.2022)

- (11) **43517**
(21) 3-2021-00732 (28) 1
(54) **BA LÔ** (51) **03-01**
(22) 30/03/2021 (43) 25/01/2022
(73) **CÔNG TY CỔ PHẦN XUẤT NHẬP KHẨU BÌNH TÂY (VN)**
Đường tỉnh 835, ấp 3A, xã Phước Lợi, huyện Bến Lức, tỉnh Long An
(72) Trịnh Hoàng Kim Khánh (VN)
(55)



1.1



1.2



1.3



1.4



1.5



1.6



1.7

CÔNG BÁO SỞ HỮU CÔNG NGHIỆP SỐ 406 TẬP A – QUYỀN 2 (01.2022)

(11) **43518**

(21) 3-2021-00733

(54) **BA LÔ**

(22) 30/03/2021

(73) **CÔNG TY CỔ PHẦN XUẤT NHẬP KHẨU BÌNH TÂY (VN)**

Đường tỉnh 835, ấp 3A, xã Phước Lợi, huyện Bến Lức, tỉnh Long An

(72) Trịnh Hoàng Kim Khánh (VN)

(55)

(28) 1

(51) **03-01**

(43) 25/01/2022



1.1



1.2



1.3



1.4



1.5



1.6



1.7

CÔNG BÁO SỞ HỮU CÔNG NGHIỆP SỐ 406 TẬP A – QUYỀN 2 (01.2022)

(11) **43519**

(21) 3-2021-00734

(28) 1

(54) **BA LÔ**

(51) **03-01**

(22) 30/03/2021

(43) 25/01/2022

(73) **CÔNG TY CỔ PHẦN XUẤT NHẬP KHẨU BÌNH TÂY (VN)**

Đường tỉnh 835, ấp 3A, xã Phước Lợi, huyện Bến Lức, tỉnh Long An

(72) Trịnh Hoàng Kim Khánh (VN)

(55)



1.1



1.2



1.3



1.4



1.5



1.6



1.7

CÔNG BÁO SỞ HỮU CÔNG NGHIỆP SỐ 406 TẬP A – QUYỀN 2 (01.2022)

- (11) **43520**
(21) 3-2021-00763 (28) 1
(54) **ĐẦU PHUN NƯỚC CHỮA CHÁY** (51) **23-01**
(22) 01/04/2021 (43) 25/01/2022
(30) 30-2020-0051099 26/10/2020 KR;
(73) **KIM, JUNG GYU (KR)**
114-1003, 29, Hakdong-ro 68-gil, Gangnam-gu, Seoul, Republic of Korea
(72) KIM, Sung Woo (KR)
(74) Công ty TNHH Sở hữu trí tuệ VIPATCO (VIPATCO CO., LTD.)
(55)

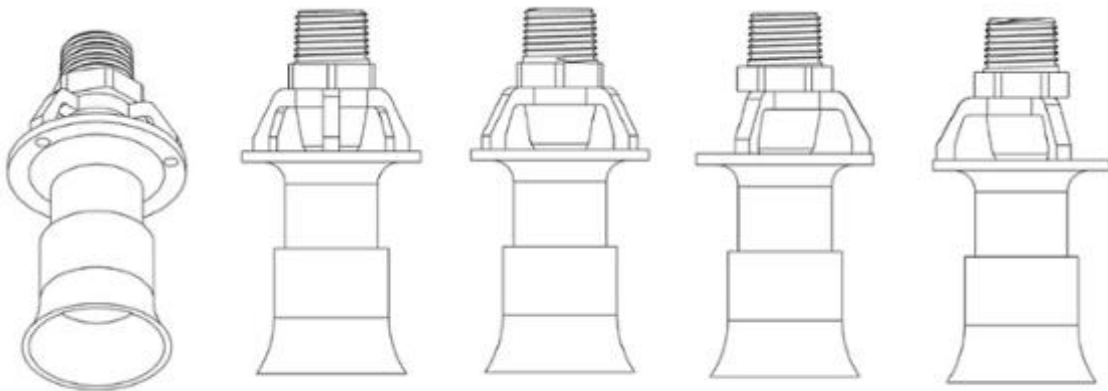

1.1

1.2

1.3

1.4

1.5



1.6



1.7

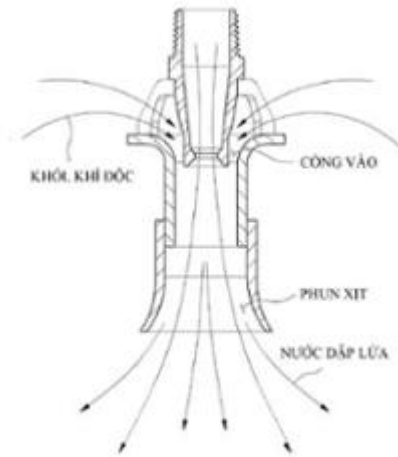

1.8

CÔNG BÁO SỞ HỮU CÔNG NGHIỆP SỐ 406 TẬP A – QUYỀN 2 (01.2022)

(11) **43521**

(21) 3-2021-00781

(28) 1

(54) **GHÉ**

(51) **06-01**

(22) 02/04/2021

(43) 25/01/2022

(73) **HTL FURNITURE (CHINA) CO., LTD. (CN)**

Wusong Jiangnan Road, Kunshan Development Zone, Jiangsu Province, China

(72) PHUA YONG TAT (SG)

(74) Công ty Luật TNHH quốc tế BMVN (BMVN INTERNATIONAL LLC)

(55)



1.1



1.2



1.3



1.4



1.5



1.6

CÔNG BÁO SỞ HỮU CÔNG NGHIỆP SỐ 406 TẬP A – QUYỀN 2 (01.2022)

- (11) **43522**
- (21) 3-2021-00846 (28) 1
- (54) **NHÃN SẢN PHẨM** (51) **19-08**
- (22) 08/04/2021 (43) 25/01/2022
- (73) **CÔNG TY CỔ PHẦN NƯỚC KHOÁNG SM (VN)**
Tổ 6 ấp An Hòa, xã An Hảo, huyện Tịnh Biên, tỉnh An Giang
- (72) Trần Kim Liên (VN)
- (55)



CÔNG BÁO SỞ HỮU CÔNG NGHIỆP SỐ 406 TẬP A – QUYỀN 2 (01.2022)

- (11) **43523**
- (21) 3-2021-00866 (28) 3
- (54) **NHÃN SẢN PHẨM** (51) **19-08**
- (22) 12/04/2021 (43) 25/01/2022
- (73) **CÔNG TY CỔ PHẦN MỸ PHẨM ĐẸP (VN)**
Tầng 12, tòa nhà HMC, 193 Đinh Tiên Hoàng, phường Đa Kao, quận 1, thành phố Hồ Chí Minh
- (72) Phan Quốc Công (VN)
- (74) Công ty TNHH Tầm nhìn và Liên danh (VISION & ASSOCIATES CO.LTD.)
- (55)

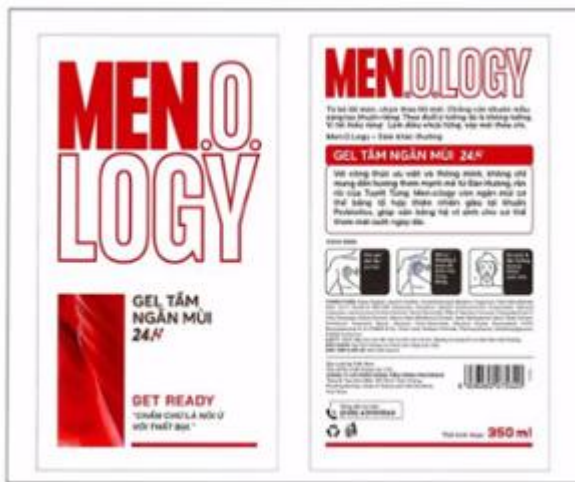

1.1

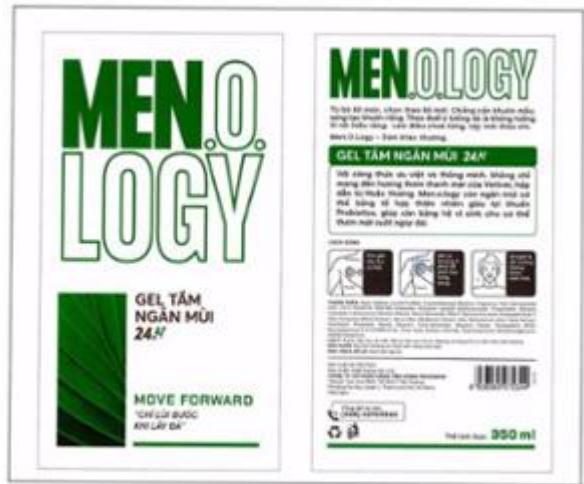

2.1

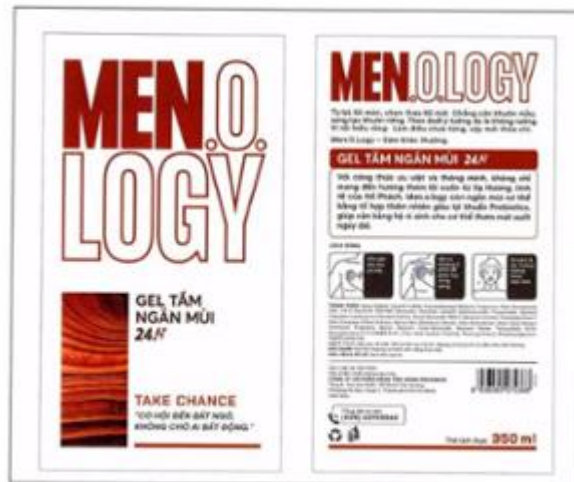

3.1

CÔNG BÁO SỞ HỮU CÔNG NGHIỆP SỐ 406 TẬP A – QUYỀN 2 (01.2022)

- (11) 43524
- (21) 3-2021-00867 (28) 3
- (54) **NHÃN SẢN PHẨM** (51) **19-08**
- (22) 12/04/2021 (43) 25/01/2022
- (73) **CÔNG TY CỔ PHẦN MỸ PHẨM ĐẸP (VN)**
Tầng 12, tòa nhà HMC, 193 Đinh Tiên Hoàng, phường Đa Kao, quận 1, thành phố Hồ Chí Minh
- (72) Phan Quốc Công (VN)
- (74) Công ty TNHH Tầm nhìn và Liên danh (VISION & ASSOCIATES CO.LTD.)
- (55)



1.1

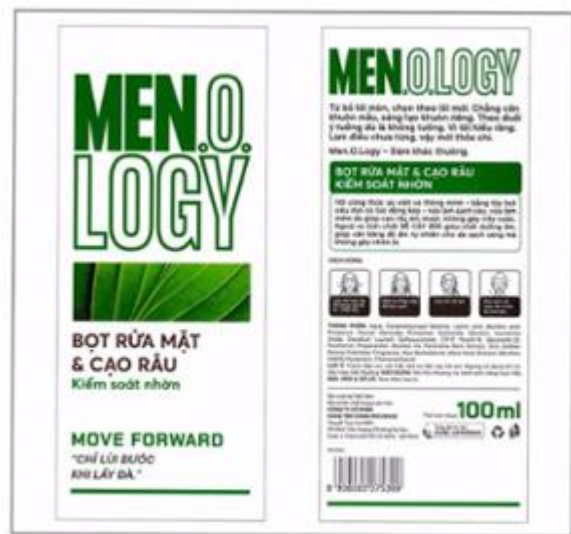

2.1

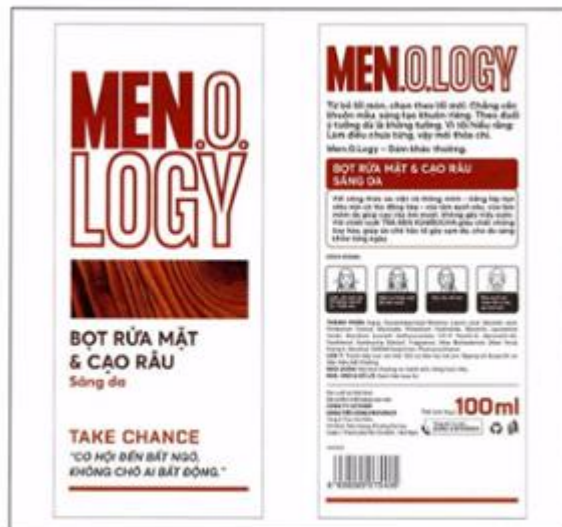

3.1

CÔNG BÁO SỞ HỮU CÔNG NGHIỆP SỐ 406 TẬP A – QUYỀN 2 (01.2022)

- (11) **43525**
(21) 3-2021-00870 (28) 1
(54) **HỘP** (51) **09-03**
(22) 13/04/2021 (43) 25/01/2022
(73) **CÔNG TY CỔ PHẦN TẬP ĐOÀN ĐẦU TƯ UNILAND (VN)**
14 Ngô Văn Năm, phường Bến Nghé, quận 1, thành phố Hồ Chí Minh
(72) Lê Văn Trung (VN)
(55)



1.1



1.2

CÔNG BÁO SỞ HỮU CÔNG NGHIỆP SỐ 406 TẬP A – QUYỀN 2 (01.2022)

- (11) **43526**
(21) 3-2021-00871 (28) 1
(54) **HỘP** (51) **09-03**
(22) 13/04/2021 (43) 25/01/2022
(73) **CÔNG TY CỔ PHẦN TẬP ĐOÀN ĐẦU TƯ UNILAND (VN)**
14 Ngô Văn Năm, phường Bến Nghé, quận 1, thành phố Hồ Chí Minh
(72) Lê Văn Trung (VN)
(55)



1.1



1.2

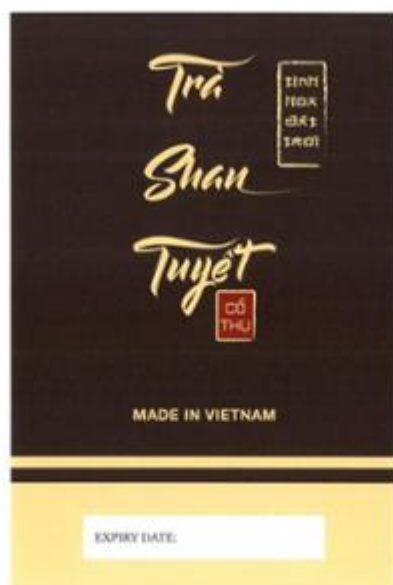

1.3

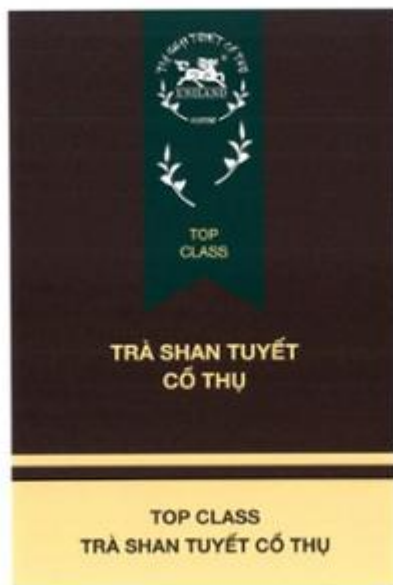

1.4



1.5



1.6



1.7

CÔNG BÁO SỞ HỮU CÔNG NGHIỆP SỐ 406 TẬP A – QUYỀN 2 (01.2022)

(11) **43527**

(21) 3-2021-00900

(54) **MŨ BẢO HIỂM**

(22) 16/04/2021

(73) **CÔNG TY CỔ PHẦN XE ĐIỆN PEGA LTT (VN)**

Tầng 8, số 1 Thái Hà, phường Trung Liệt, quận Đống Đa, thành phố Hà Nội

(72) Trương Mạnh Hà (VN)

(55)

(28) 1

(51) **02-03**

(43) 25/01/2022



1.1



1.2



1.3



1.4



1.5



1.6



1.7



1.8



1.9



1.10

(11) **43528**

(21) 3-2021-00973

(54) **CHAI ĐỰNG RƯỢU**

(22) 28/04/2021

(73) **CÔNG TY CỔ PHẦN ĐẦU TƯ THƯƠNG MẠI SAMIC (VN)**

Số 40 ngõ 35 Cát Linh, phường Cát Linh, quận Đống Đa, thành phố Hà Nội

(72) Lê Văn Minh (VN)

(55)

(28) 1

(51) **09-01**

(43) 25/01/2022



1.1



1.2



1.3



1.4

CÔNG BÁO SỞ HỮU CÔNG NGHIỆP SỐ 406 TẬP A – QUYỀN 2 (01.2022)

- (11) **43529**
(21) 3-2021-01070 (28) 1
(54) **CHAI** (51) **09-01**
(22) 07/05/2021 (43) 25/01/2022
(73) **CÔNG TY CỔ PHẦN KINH DOANH VÀ ĐẦU TƯ VIỆT HÀ (VN)**
Số 254 đường Minh Khai, phường Minh Khai, quận Hai Bà Trưng, thành phố Hà Nội
(72) Mai Xuân Sơn (VN)
(55)



1.1



1.2



1.3



1.4



1.5



1.6

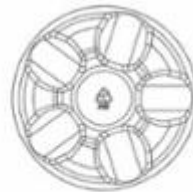

1.7

CÔNG BÁO SỞ HỮU CÔNG NGHIỆP SỐ 406 TẬP A – QUYỀN 2 (01.2022)

(11) **43530**

(21) 3-2021-01083

(28) 1

(54) **GHẾ SÔ-PHA**

(51) **06-01**

(22) 10/05/2021

(43) 25/01/2022

(73) **HTL FURNITURE (CHINA) CO., LTD. (CN)**

Wusong Jiangnan Road, Kunshan Development Zone, Jiangsu Province, China

(72) PHUA YONG TAT (SG)

(74) Công ty Luật TNHH quốc tế BMVN (BMVN INTERNATIONAL LLC)

(55)



1.1



1.2



1.3



1.4



1.5

CÔNG BÁO SỞ HỮU CÔNG NGHIỆP SỐ 406 TẬP A – QUYỀN 2 (01.2022)

(11) **43531**

(21) 3-2021-01084

(28) 1

(54) **GHẾ SÔ-PHA**

(51) **06-01**

(22) 10/05/2021

(43) 25/01/2022

(73) **HTL FURNITURE (CHINA) CO., LTD. (CN)**

Wusong Jiangnan Road, Kunshan Development Zone, Jiangsu Province, China

(72) PHUA YONG TAT (SG)

(74) Công ty Luật TNHH quốc tế BMVN (BMVN INTERNATIONAL LLC)

(55)



1.1



1.2



1.3



1.4



1.5

1.6



1.7

CÔNG BÁO SỞ HỮU CÔNG NGHIỆP SỐ 406 TẬP A – QUYỀN 2 (01.2022)

- (11) **43532**
(21) 3-2021-01085 (28) 1
(54) **GHẾ SÔ-PHA** (51) **06-01**
(22) 10/05/2021 (43) 25/01/2022
(73) **HTL FURNITURE (CHINA) CO., LTD. (CN)**
Wusong Jiangnan Road, Kunshan Development Zone, Jiangsu Province, China
(72) PHUA YONG TAT (SG)
(74) Công ty Luật TNHH quốc tế BMVN (BMVN INTERNATIONAL LLC)
(55)



1.1



1.2



1.3



1.4



1.5



1.6

CÔNG BÁO SỞ HỮU CÔNG NGHIỆP SỐ 406 TẬP A – QUYỀN 2 (01.2022)

(11) **43533**

(21) 3-2021-01086

(28) 1

(54) **GHẾ**

(51) **06-01**

(22) 10/05/2021

(43) 25/01/2022

(73) **HTL FURNITURE (CHINA) CO., LTD. (CN)**

Wusong Jiangnan Road, Kunshan Development Zone, Jiangsu Province, China

(72) PHUA YONG TAT (SG)

(74) Công ty Luật TNHH quốc tế BMVN (BMVN INTERNATIONAL LLC)

(55)



1.1



1.2



1.3



1.4



1.5



1.6

CÔNG BÁO SỞ HỮU CÔNG NGHIỆP SỐ 406 TẬP A – QUYỀN 2 (01.2022)

(11) **43534**

(21) 3-2021-01090

(28) 2

(54) **GHẾ**

(51) **06-01**

(22) 10/05/2021

(43) 25/01/2022

(73) **HTL FURNITURE (CHINA) CO., LTD. (CN)**

Wusong Jiangnan Road, Kunshan Development Zone, Jiangsu Province, China

(72) PHUA YONG TAT (SG)

(74) Công ty Luật TNHH quốc tế BMVN (BMVN INTERNATIONAL LLC)

(55)



1.1



1.2



1.3



1.4



1.5



2.1



2.2



2.3



2.4



2.5

CÔNG BÁO SỞ HỮU CÔNG NGHIỆP SỐ 406 TẬP A – QUYỀN 2 (01.2022)

(11) **43535**

(21) 3-2021-01091

(28) 1

(54) **GHẾ SÔ-PHA**

(51) **06-01**

(22) 10/05/2021

(43) 25/01/2022

(73) **HTL FURNITURE (CHINA) CO., LTD. (CN)**

Wusong Jiangnan Road, Kunshan Development Zone, Jiangsu Province, China

(72) PHUA YONG TAT (SG)

(74) Công ty Luật TNHH quốc tế BMVN (BMVN INTERNATIONAL LLC)

(55)



1.1



1.2



1.3



1.4



1.5



1.6

CÔNG BÁO SỞ HỮU CÔNG NGHIỆP SỐ 406 TẬP A – QUYỀN 2 (01.2022)

(11) **43536**

(21) 3-2021-01093

(28) 1

(54) **GHẾ SÔ-PHA**

(51) **06-01**

(22) 10/05/2021

(43) 25/01/2022

(73) **HTL FURNITURE (CHINA) CO., LTD. (CN)**

Wusong Jiangnan Road, Kunshan Development Zone, Jiangsu Province, China

(72) PHUA YONG TAT (SG)

(74) Công ty Luật TNHH quốc tế BMVN (BMVN INTERNATIONAL LLC)

(55)



1.1



1.2



1.3



1.4



1.5

CÔNG BÁO SỞ HỮU CÔNG NGHIỆP SỐ 406 TẬP A – QUYỀN 2 (01.2022)

(11) **43537**

(21) 3-2021-01094

(28) 1

(54) **GHẾ SÔ-PHA**

(51) **06-01**

(22) 10/05/2021

(43) 25/01/2022

(73) **HTL FURNITURE (CHINA) CO., LTD. (CN)**

Wusong Jiangnan Road, Kunshan Development Zone, Jiangsu Province, China

(72) PHUA YONG TAT (SG)

(74) Công ty Luật TNHH quốc tế BMVN (BMVN INTERNATIONAL LLC)

(55)



1.1



1.2



1.3



1.4



1.5



1.6

CÔNG BÁO SỞ HỮU CÔNG NGHIỆP SỐ 406 TẬP A – QUYỀN 2 (01.2022)

(11) **43538**

(21) 3-2021-01095

(28) 1

(54) **GHẾ SÔ-PHA**

(51) **06-01**

(22) 10/05/2021

(43) 25/01/2022

(73) **HTL FURNITURE (CHINA) CO., LTD. (CN)**

Wusong Jiangnan Road, Kunshan Development Zone, Jiangsu Province, China

(72) PHUA YONG TAT (SG)

(74) Công ty Luật TNHH quốc tế BMVN (BMVN INTERNATIONAL LLC)

(55)



1.1



1.2



1.3



1.4



1.5



1.6

CÔNG BÁO SỞ HỮU CÔNG NGHIỆP SỐ 406 TẬP A – QUYỀN 2 (01.2022)

(11) **43539**

(21) 3-2021-01103

(28) 1

(54) **GHÉ**

(51) **06-01**

(22) 10/05/2021

(43) 25/01/2022

(73) **HTL FURNITURE (CHINA) CO., LTD. (CN)**

Wusong Jiangnan Road, Kunshan Development Zone, Jiangsu Province, China

(72) PHUA YONG TAT (SG)

(74) Công ty Luật TNHH quốc tế BMVN (BMVN INTERNATIONAL LLC)

(55)



1.1



1.2



1.3



1.4



1.5



1.6

CÔNG BÁO SỞ HỮU CÔNG NGHIỆP SỐ 406 TẬP A – QUYỀN 2 (01.2022)

- (11) **43540**
(21) 3-2021-01109 (28) 1
(54) **GHẾ** (51) **06-01**
(22) 10/05/2021 (43) 25/01/2022
(73) **HTL FURNITURE (CHINA) CO., LTD. (CN)**
Wusong Jiangnan Road, Kunshan Development Zone, Jiangsu Province, China
(72) PHUA YONG TAT (SG)
(74) Công ty Luật TNHH quốc tế BMVN (BMVN INTERNATIONAL LLC)
(55)



1.1



1.2



1.3



1.4



1.5



1.6

CÔNG BÁO SỞ HỮU CÔNG NGHIỆP SỐ 406 TẬP A – QUYỀN 2 (01.2022)

(11) **43541**

(21) 3-2021-01110

(28) 1

(54) **GHẾ SÔ-PHA**

(51) **06-01**

(22) 10/05/2021

(43) 25/01/2022

(73) **HTL FURNITURE (CHINA) CO., LTD. (CN)**

Wusong Jiangnan Road, Kunshan Development Zone, Jiangsu Province, China

(72) PHUA YONG TAT (SG)

(74) Công ty Luật TNHH quốc tế BMVN (BMVN INTERNATIONAL LLC)

(55)



1.1



1.2



1.3



1.4



1.5



1.6

CÔNG BÁO SỞ HỮU CÔNG NGHIỆP SỐ 406 TẬP A – QUYỀN 2 (01.2022)

(11) **43542**

(21) 3-2021-01111

(28) 1

(54) **GHẾ SÔ-PHA**

(51) **06-01**

(22) 10/05/2021

(43) 25/01/2022

(73) **HTL FURNITURE (CHINA) CO., LTD. (CN)**

Wusong Jiangnan Road, Kunshan Development Zone, Jiangsu Province, China

(72) PHUA YONG TAT (SG)

(74) Công ty Luật TNHH quốc tế BMVN (BMVN INTERNATIONAL LLC)

(55)



1.1



1.2



1.3



1.4



1.5

CÔNG BÁO SỞ HỮU CÔNG NGHIỆP SỐ 406 TẬP A – QUYỀN 2 (01.2022)

(11) **43543**

(21) 3-2021-01114

(28) 1

(54) **GHẾ**

(51) **06-01**

(22) 10/05/2021

(43) 25/01/2022

(73) **HTL FURNITURE (CHINA) CO., LTD. (CN)**

Wusong Jiangnan Road, Kunshan Development Zone, Jiangsu Province, China

(72) PHUA YONG TAT (SG)

(74) Công ty Luật TNHH quốc tế BMVN (BMVN INTERNATIONAL LLC)

(55)



1.1



1.2



1.3



1.4



1.5



1.6

CÔNG BÁO SỞ HỮU CÔNG NGHIỆP SỐ 406 TẬP A – QUYỀN 2 (01.2022)

(11) **43544**

(21) 3-2021-01115

(28) 1

(54) **GHẾ**

(51) **06-01**

(22) 10/05/2021

(43) 25/01/2022

(73) **HTL FURNITURE (CHINA) CO., LTD. (CN)**

Wusong Jiangnan Road, Kunshan Development Zone, Jiangsu Province, China

(72) PHUA YONG TAT (SG)

(74) Công ty Luật TNHH quốc tế BMVN (BMVN INTERNATIONAL LLC)

(55)



1.1



1.2



1.3



1.4



1.5



1.6

CÔNG BÁO SỞ HỮU CÔNG NGHIỆP SỐ 406 TẬP A – QUYỀN 2 (01.2022)

(11) **43545**

(21) 3-2021-01116

(28) 1

(54) **GHẾ SÔ-PHA**

(51) **06-01**

(22) 10/05/2021

(43) 25/01/2022

(73) **HTL FURNITURE (CHINA) CO., LTD. (CN)**

Wusong Jiangnan Road, Kunshan Development Zone, Jiangsu Province, China

(72) PHUA YONG TAT (SG)

(74) Công ty Luật TNHH quốc tế BMVN (BMVN INTERNATIONAL LLC)

(55)



1.1



1.2



1.3



1.4



1.5



1.6

CÔNG BÁO SỞ HỮU CÔNG NGHIỆP SỐ 406 TẬP A – QUYỀN 2 (01.2022)

- (11) **43546**
(21) 3-2021-01117 (28) 1
(54) **GHẾ SÔ-PHA** (51) **06-01**
(22) 10/05/2021 (43) 25/01/2022
(73) **HTL FURNITURE (CHINA) CO., LTD. (CN)**
Wusong Jiangnan Road, Kunshan Development Zone, Jiangsu Province, China
(72) PHUA YONG TAT (SG)
(74) Công ty Luật TNHH quốc tế BMVN (BMVN INTERNATIONAL LLC)
(55)



1.1



1.2



1.3



1.4



1.5



1.6

CÔNG BÁO SỞ HỮU CÔNG NGHIỆP SỐ 406 TẬP A – QUYỀN 2 (01.2022)

(11) **43547**

(21) 3-2021-01118

(28) 1

(54) **GHẾ SÔ-PHA**

(51) **06-01**

(22) 10/05/2021

(43) 25/01/2022

(73) **HTL FURNITURE (CHINA) CO., LTD. (CN)**

Wusong Jiangnan Road, Kunshan Development Zone, Jiangsu Province, China

(72) PHUA YONG TAT (SG)

(74) Công ty Luật TNHH quốc tế BMVN (BMVN INTERNATIONAL LLC)

(55)



1.1



1.2



1.3



1.4



1.5



1.6

CÔNG BÁO SỞ HỮU CÔNG NGHIỆP SỐ 406 TẬP A – QUYỀN 2 (01.2022)

- (11) **43548**
(21) 3-2021-01122 (28) 1
(54) **GHẾ** (51) **06-01**
(22) 10/05/2021 (43) 25/01/2022
(73) **HTL FURNITURE (CHINA) CO., LTD. (CN)**
Wusong Jiangnan Road, Kunshan Development Zone, Jiangsu Province, China
(72) PHUA YONG TAT (SG)
(74) Công ty Luật TNHH quốc tế BMVN (BMVN INTERNATIONAL LLC)
(55)



1.1



1.2



1.3



1.4



1.5



1.6

CÔNG BÁO SỞ HỮU CÔNG NGHIỆP SỐ 406 TẬP A – QUYỀN 2 (01.2022)

(11) **43549**

(21) 3-2021-01124

(28) 1

(54) **GHẾ SÔ-PHA**

(51) **06-01**

(22) 10/05/2021

(43) 25/01/2022

(73) **HTL FURNITURE (CHINA) CO., LTD. (CN)**

Wusong Jiangnan Road, Kunshan Development Zone, Jiangsu Province, China

(72) PHUA YONG TAT (SG)

(74) Công ty Luật TNHH quốc tế BMVN (BMVN INTERNATIONAL LLC)

(55)



1.1



1.2



1.3



1.4



1.5



1.6

CÔNG BÁO SỞ HỮU CÔNG NGHIỆP SỐ 406 TẬP A – QUYỀN 2 (01.2022)

- (11) **43550**
(21) 3-2021-01125 (28) 1
(54) **GHẾ** (51) **06-01**
(22) 10/05/2021 (43) 25/01/2022
(73) **HTL FURNITURE (CHINA) CO., LTD. (CN)**
Wusong Jiangnan Road, Kunshan Development Zone, Jiangsu Province, China
(72) PHUA YONG TAT (SG)
(74) Công ty Luật TNHH quốc tế BMVN (BMVN INTERNATIONAL LLC)
(55)



1.1



1.2



1.3



1.4



1.5



1.6

CÔNG BÁO SỞ HỮU CÔNG NGHIỆP SỐ 406 TẬP A – QUYỀN 2 (01.2022)

(11) **43551**

(21) 3-2021-01126

(28) 1

(54) **GHẾ SÔ-PHA**

(51) **06-01**

(22) 10/05/2021

(43) 25/01/2022

(73) **HTL FURNITURE (CHINA) CO., LTD. (CN)**

Wusong Jiangnan Road, Kunshan Development Zone, Jiangsu Province, China

(72) PHUA YONG TAT (SG)

(74) Công ty Luật TNHH quốc tế BMVN (BMVN INTERNATIONAL LLC)

(55)



1.1

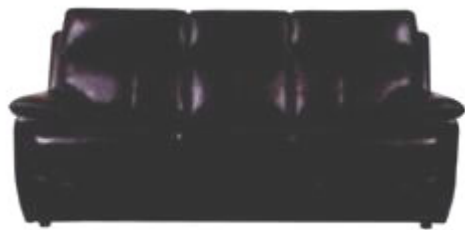

1.2



1.3



1.4



1.5

CÔNG BÁO SỞ HỮU CÔNG NGHIỆP SỐ 406 TẬP A – QUYỀN 2 (01.2022)

(11) **43552**

(21) 3-2021-01127

(28) 1

(54) **GHẾ SÔ-PHA**

(51) **06-01**

(22) 10/05/2021

(43) 25/01/2022

(73) **HTL FURNITURE (CHINA) CO., LTD. (CN)**

Wusong Jiangnan Road, Kunshan Development Zone, Jiangsu Province, China

(72) PHUA YONG TAT (SG)

(74) Công ty Luật TNHH quốc tế BMVN (BMVN INTERNATIONAL LLC)

(55)



1.1



1.2



1.3



1.4



1.5



1.6

CÔNG BÁO SỞ HỮU CÔNG NGHIỆP SỐ 406 TẬP A – QUYỀN 2 (01.2022)

(11) **43553**

(21) 3-2021-01129

(28) 1

(54) **GHẾ SÔ-PHA**

(51) **06-01**

(22) 10/05/2021

(43) 25/01/2022

(73) **HTL FURNITURE (CHINA) CO., LTD. (CN)**

Wusong Jiangnan Road, Kunshan Development Zone, Jiangsu Province, China

(72) PHUA YONG TAT (SG)

(74) Công ty Luật TNHH quốc tế BMVN (BMVN INTERNATIONAL LLC)

(55)



1.1



1.2



1.3



1.4



1.5



1.6

CÔNG BÁO SỞ HỮU CÔNG NGHIỆP SỐ 406 TẬP A – QUYỀN 2 (01.2022)

(11) **43554**

(21) 3-2021-01133

(28) 1

(54) **GHẾ**

(51) **06-01**

(22) 10/05/2021

(43) 25/01/2022

(73) **HTL FURNITURE (CHINA) CO., LTD. (CN)**

Wusong Jiangnan Road, Kunshan Development Zone, Jiangsu Province, China

(72) PHUA YONG TAT (SG)

(74) Công ty Luật TNHH quốc tế BMVN (BMVN INTERNATIONAL LLC)

(55)



1.1



1.2



1.3



1.4



1.5



1.6

CÔNG BÁO SỞ HỮU CÔNG NGHIỆP SỐ 406 TẬP A – QUYỀN 2 (01.2022)

- (11) **43555**
(21) 3-2021-01134 (28) 1
(54) **GHẾ SÔ-PHA** (51) **06-01**
(22) 10/05/2021 (43) 25/01/2022
(73) **HTL FURNITURE (CHINA) CO., LTD. (CN)**
Wusong Jiangnan Road, Kunshan Development Zone, Jiangsu Province, China
(72) PHUA YONG TAT (SG)
(74) Công ty Luật TNHH quốc tế BMVN (BMVN INTERNATIONAL LLC)
(55)



1.1



1.2



1.3



1.4



1.5

CÔNG BÁO SỞ HỮU CÔNG NGHIỆP SỐ 406 TẬP A – QUYỀN 2 (01.2022)

- (11) **43556**
(21) 3-2021-01135 (28) 1
(54) **GHẾ** (51) **06-01**
(22) 10/05/2021 (43) 25/01/2022
(73) **HTL FURNITURE (CHINA) CO., LTD. (CN)**
Wusong Jiangnan Road, Kunshan Development Zone, Jiangsu Province, China
(72) PHUA YONG TAT (SG)
(74) Công ty Luật TNHH quốc tế BMVN (BMVN INTERNATIONAL LLC)
(55)



1.1



1.2



1.3

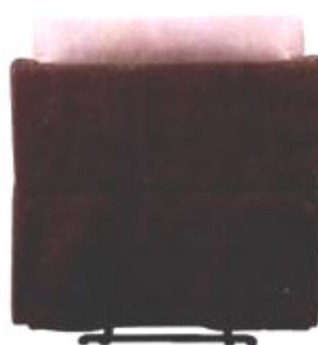

1.4



1.5



1.6

CÔNG BÁO SỞ HỮU CÔNG NGHIỆP SỐ 406 TẬP A – QUYỀN 2 (01.2022)

(11) **43557**

(21) 3-2021-01137

(28) 1

(54) **GHẾ SÔ-PHA**

(51) **06-01**

(22) 10/05/2021

(43) 25/01/2022

(73) **HTL FURNITURE (CHINA) CO., LTD. (CN)**

Wusong Jiangnan Road, Kunshan Development Zone, Jiangsu Province, China

(72) PHUA YONG TAT (SG)

(74) Công ty Luật TNHH quốc tế BMVN (BMVN INTERNATIONAL LLC)

(55)



1.1



1.2



1.3



1.4



1.5



1.6

CÔNG BÁO SỞ HỮU CÔNG NGHIỆP SỐ 406 TẬP A – QUYỀN 2 (01.2022)

(11) **43558**

(21) 3-2021-01138

(28) 1

(54) **GHẾ SÔ-PHA**

(51) **06-01**

(22) 10/05/2021

(43) 25/01/2022

(73) **HTL FURNITURE (CHINA) CO., LTD. (CN)**

Wusong Jiangnan Road, Kunshan Development Zone, Jiangsu Province, China

(72) PHUA YONG TAT (SG)

(74) Công ty Luật TNHH quốc tế BMVN (BMVN INTERNATIONAL LLC)

(55)



1.1



1.2



1.3



1.4



1.5

CÔNG BÁO SỞ HỮU CÔNG NGHIỆP SỐ 406 TẬP A – QUYỀN 2 (01.2022)

(11) **43559**

(21) 3-2021-01139

(28) 1

(54) **GHÉ**

(51) **06-01**

(22) 10/05/2021

(43) 25/01/2022

(73) **HTL FURNITURE (CHINA) CO., LTD. (CN)**

Wusong Jiangnan Road, Kunshan Development Zone, Jiangsu Province, China

(72) PHUA YONG TAT (SG)

(74) Công ty Luật TNHH quốc tế BMVN (BMVN INTERNATIONAL LLC)

(55)



1.1



1.2



1.3



1.4



1.5



1.6

CÔNG BÁO SỞ HỮU CÔNG NGHIỆP SỐ 406 TẬP A – QUYỀN 2 (01.2022)

(11) **43560**

(21) 3-2021-01140

(28) 1

(54) **GHẾ SÔ-PHA**

(51) **06-01**

(22) 10/05/2021

(43) 25/01/2022

(73) **HTL FURNITURE (CHINA) CO., LTD. (CN)**

Wusong Jiangnan Road, Kunshan Development Zone, Jiangsu Province, China

(72) PHUA YONG TAT (SG)

(74) Công ty Luật TNHH quốc tế BMVN (BMVN INTERNATIONAL LLC)

(55)



1.1



1.2



1.3



1.4



1.5



1.6

CÔNG BÁO SỞ HỮU CÔNG NGHIỆP SỐ 406 TẬP A – QUYỀN 2 (01.2022)

(11) **43561**

(21) 3-2021-01142

(28) 1

(54) **GHẾ SÔ-PHA**

(51) **06-01**

(22) 10/05/2021

(43) 25/01/2022

(73) **HTL FURNITURE (CHINA) CO., LTD. (CN)**

Wusong Jiangnan Road, Kunshan Development Zone, Jiangsu Province, China

(72) PHUA YONG TAT (SG)

(74) Công ty Luật TNHH quốc tế BMVN (BMVN INTERNATIONAL LLC)

(55)



1.1



1.2



1.3



1.4



1.5

CÔNG BÁO SỞ HỮU CÔNG NGHIỆP SỐ 406 TẬP A – QUYỀN 2 (01.2022)

(11) **43562**

(21) 3-2021-01143

(28) 1

(54) **GHÉ**

(51) **06-01**

(22) 10/05/2021

(43) 25/01/2022

(73) **HTL FURNITURE (CHINA) CO., LTD. (CN)**

Wusong Jiangnan Road, Kunshan Development Zone, Jiangsu Province, China

(72) PHUA YONG TAT (SG)

(74) Công ty Luật TNHH quốc tế BMVN (BMVN INTERNATIONAL LLC)

(55)



1.1



1.2



1.3



1.4



1.5



1.6

CÔNG BÁO SỞ HỮU CÔNG NGHIỆP SỐ 406 TẬP A – QUYỀN 2 (01.2022)

(11) **43563**

(21) 3-2021-01145

(28) 1

(54) **GHẾ SÔ-PHA**

(51) **06-01**

(22) 10/05/2021

(43) 25/01/2022

(73) **HTL FURNITURE (CHINA) CO., LTD. (CN)**

Wusong Jiangnan Road, Kunshan Development Zone, Jiangsu Province, China

(72) PHUA YONG TAT (SG)

(74) Công ty Luật TNHH quốc tế BMVN (BMVN INTERNATIONAL LLC)

(55)



1.1



1.2



1.3



1.4



1.5



1.6

CÔNG BÁO SỞ HỮU CÔNG NGHIỆP SỐ 406 TẬP A – QUYỀN 2 (01.2022)

(11) **43564**

(21) 3-2021-01146

(28) 1

(54) **GHẾ SÔ-PHA**

(51) **06-01**

(22) 10/05/2021

(43) 25/01/2022

(73) **HTL FURNITURE (CHINA) CO., LTD. (CN)**

Wusong Jiangnan Road, Kunshan Development Zone, Jiangsu Province, China

(72) PHUA YONG TAT (SG)

(74) Công ty Luật TNHH quốc tế BMVN (BMVN INTERNATIONAL LLC)

(55)



1.1



1.2



1.3



1.4



1.5

CÔNG BÁO SỞ HỮU CÔNG NGHIỆP SỐ 406 TẬP A – QUYỀN 2 (01.2022)

(11) **43565**

(21) 3-2021-01224

(28) 1

(54) **GHẾ SÔ-PHA**

(51) **06-01**

(22) 13/05/2021

(43) 25/01/2022

(73) **HTL FURNITURE (CHINA) CO., LTD. (CN)**

Wusong Jiangnan Road, Kunshan Development Zone, Jiangsu Province, China

(72) PHUA YONG TAT (SG)

(74) Công ty Luật TNHH quốc tế BMVN (BMVN INTERNATIONAL LLC)

(55)



1.1



1.2



1.3



1.4



1.5

CÔNG BÁO SỞ HỮU CÔNG NGHIỆP SỐ 406 TẬP A – QUYỀN 2 (01.2022)

(11) **43566**

(21) 3-2021-01230

(28) 1

(54) **GHẾ SÔ-PHA**

(51) **06-01**

(22) 13/05/2021

(43) 25/01/2022

(73) **HTL FURNITURE (CHINA) CO., LTD. (CN)**

Wusong Jiangnan Road, Kunshan Development Zone, Jiangsu Province, China

(72) PHUA YONG TAT (SG)

(74) Công ty Luật TNHH quốc tế BMVN (BMVN INTERNATIONAL LLC)

(55)



1.1



1.2

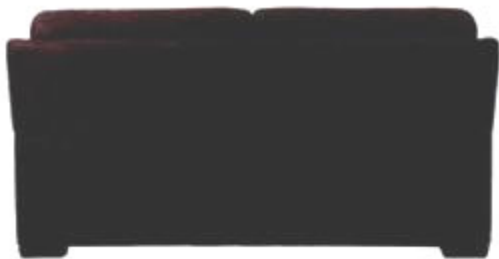

1.3



1.4



1.5

CÔNG BÁO SỞ HỮU CÔNG NGHIỆP SỐ 406 TẬP A – QUYỀN 2 (01.2022)

(11) **43567**

(21) 3-2021-01233

(28) 1

(54) **GHẾ SÔ-PHA**

(51) **06-01**

(22) 13/05/2021

(43) 25/01/2022

(73) **HTL FURNITURE (CHINA) CO., LTD. (CN)**

Wusong Jiangnan Road, Kunshan Development Zone, Jiangsu Province, China

(72) PHUA YONG TAT (SG)

(74) Công ty Luật TNHH quốc tế BMVN (BMVN INTERNATIONAL LLC)

(55)



1.1



1.2



1.3



1.4



1.5



1.6

CÔNG BÁO SỞ HỮU CÔNG NGHIỆP SỐ 406 TẬP A – QUYỀN 2 (01.2022)

(11) **43568**

(21) 3-2021-01234

(28) 2

(54) **GHẾ SÔ-PHA**

(51) **06-01**

(22) 13/05/2021

(43) 25/01/2022

(73) **HTL FURNITURE (CHINA) CO., LTD. (CN)**

Wusong Jiangnan Road, Kunshan Development Zone, Jiangsu Province, China

(72) PHUA YONG TAT (SG)

(74) Công ty Luật TNHH quốc tế BMVN (BMVN INTERNATIONAL LLC)

(55)



1.1



1.2



1.3



1.4



1.5



1.6



2.1



2.2



2.3



2.4



2.5

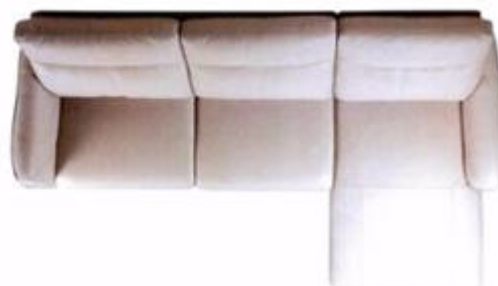

2.6

CÔNG BÁO SỞ HỮU CÔNG NGHIỆP SỐ 406 TẬP A – QUYỀN 2 (01.2022)

- (11) **43569**
(21) 3-2021-01242 (28) 1
(54) **ĐẦU CẮT TỰ ĐỘNG** (51) **15-09**
(22) 14/05/2021 (43) 25/01/2022
(73) **CÔNG TY TNHH CƠ KHÍ CÔNG NGHIỆP MIỀN NAM (VN)**
D11/11B3 đường Quách Điêu, ấp 4A, xã Vĩnh Lộc A, huyện Bình Chánh, thành phố Hồ Chí Minh
(72) Huỳnh Văn Huệ (VN)
(74) **CÔNG TY TNHH SỞ HỮU TRÍ TUỆ SETHACO (SETHACO IP CO.,LTD)**
(55)



1.1



1.2



1.3



1.4



1.5



1.6

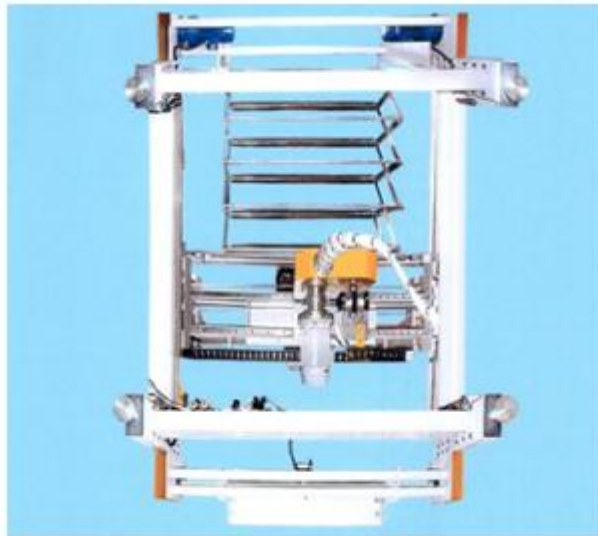

1.7

- (11) **43570**
(21) 3-2021-01246 (28) 2
(54) **GIÀY** (51) **02-04**
(22) 14/05/2021 (43) 25/01/2022
(30) 29/758,523 16/11/2020 US;
(73) **PELOTON INTERACTIVE, INC. (US)**
125 West 25th Street, 11th Floor, New York, New York 10001, United States of America
(72) 1. JASON POURE (US)
2. CAMERON BRAITHWAITE (US)
3. LEE HENDRICKSON (US)
(74) Công ty TNHH Quốc tế D & N (D&N INTERNATIONAL CO.,LTD.)
(55)



1.1



1.2



1.3



1.4



1.5

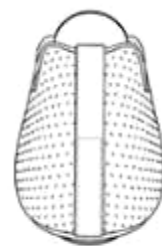

1.6



1.7



1.8

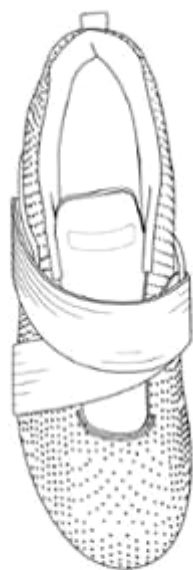

1.9

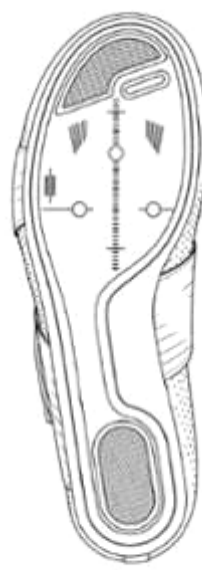

1.10

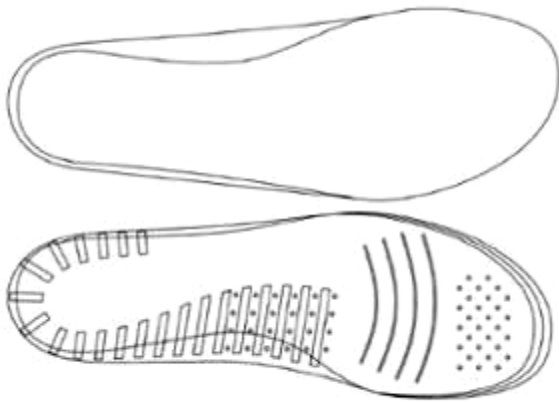

1.11



1.12



2.1



2.2



2.3



2.4



2.5

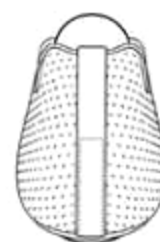

2.6



2.7



2.8



2.9

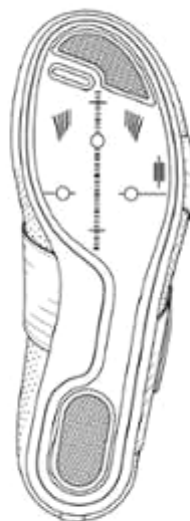

2.10

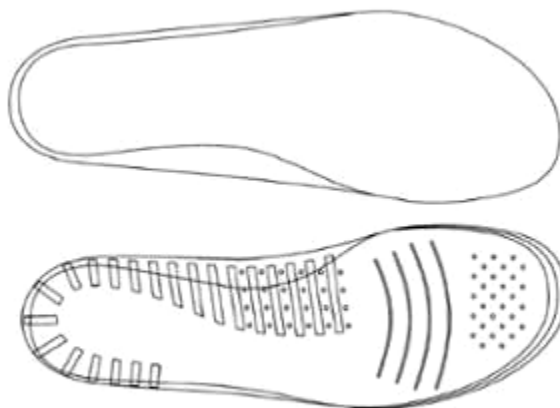

2.11

CÔNG BÁO SỞ HỮU CÔNG NGHIỆP SỐ 406 TẬP A – QUYỀN 2 (01.2022)

- (11) **43571**
(21) 3-2021-01329 (28) 2
(54) **THIẾT BỊ ĐIỀU KHIỂN DÂY KÉO TÀU** (51) **12-06**
(22) 20/05/2021 (43) 25/01/2022
(30) 008280424 23/11/2020 EM;
(73) **SVITZER A/S (DK)**
Esplanaden 50, 1263 Copenhagen K, Denmark
(72) Thomas BANGSLUND (DK)
(74) Công ty TNHH Sở hữu trí tuệ Thảo Thọ Quyển (INVENCO.,LTD)
(55)



1.1



1.2



1.3



1.4



1.5



1.6

1.7

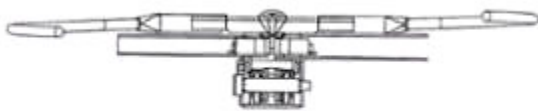

1.8



1.9

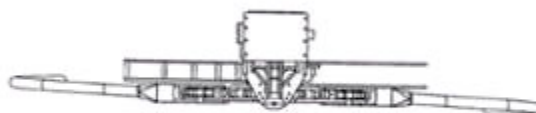

1.10



2.1



2.2



2.3



2.4



2.5



2.6



2.7



2.8



2.9

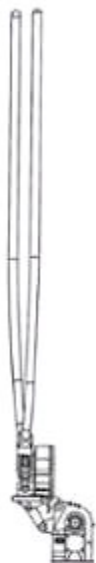

2.10



2.11



2.12



2.13

- (11) **43572**
(21) 3-2021-01343
(54) **BAO GÓI SẢN PHẨM**
(22) 24/05/2021
(73) **HỘ KINH DOANH SƠN TÙNG (VN)**
Số 24 An Dương Vương, phường 16, quận 8, thành phố Hồ Chí Minh
(72) Trần Thị Thu Sơn (VN)
(55)
- (28) 6
(51) **09-05**
(43) 25/01/2022



1.1



1.2



2.1



2.2



3.1



3.2



4.1



4.2



5.1



5.2



6.1



6.2

(11) **43573**

(21) 3-2021-01387

(54) **KHỚP NỐI**

(22) 27/05/2021

(73) **TRƯƠNG TRỤ HÒA (VN)**

58 đường Thiên Phước, phường 9, quận Tân Bình, thành phố Hồ Chí Minh

(72) Trương Trụ Hòa (VN)

(55)

(28) 1

(51) **08-08**

(43) 25/01/2022



1.1



1.2



1.3



1.4



1.5



1.6



1.7



1.8

CÔNG BÁO SỞ HỮU CÔNG NGHIỆP SỐ 406 TẬP A – QUYỀN 2 (01.2022)

- (11) **43574**
(21) 3-2021-01389 (28) 1
(54) **GHẾ** (51) **06-01**
(22) 28/05/2021 (43) 25/01/2022
(73) **HTL FURNITURE (CHINA) CO., LTD. (CN)**
Wusong Jiangnan Road, Kunshan Development Zone, Jiangsu Province, China
(72) PHUA YONG TAT (SG)
(74) Công ty Luật TNHH quốc tế BMVN (BMVN INTERNATIONAL LLC)
(55)



1.1



1.2



1.3



1.4



1.5

- (11) **43575**
(21) 3-2021-01463 (28) 1
(54) **KHẨU TRANG** (51) **29-02**
(22) 07/06/2021 (43) 25/01/2022
(30) 008313761-0001 08/12/2020 EM;
(73) **KC STRUKTUR KFT. (HU)**
9200 Mosonmagyaróvár, Szent István király út 48., Hungary
(72) Csősz Botond István (HU)
(74) Công ty Luật TNHH T&G (TGVN)
(55)



1.1



1.2



1.3

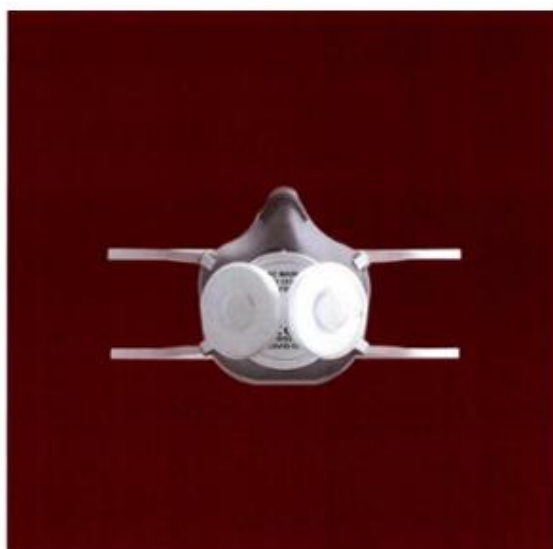

1.4

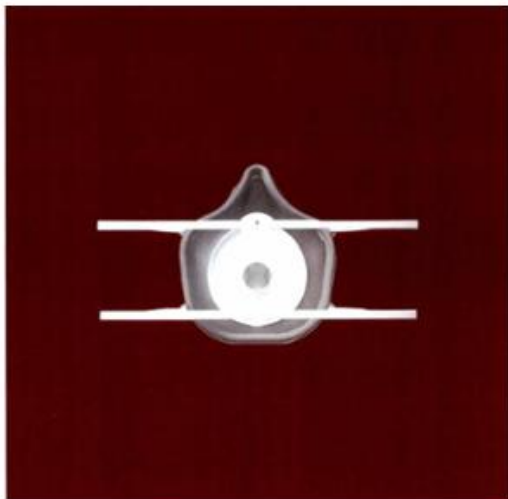

1.5

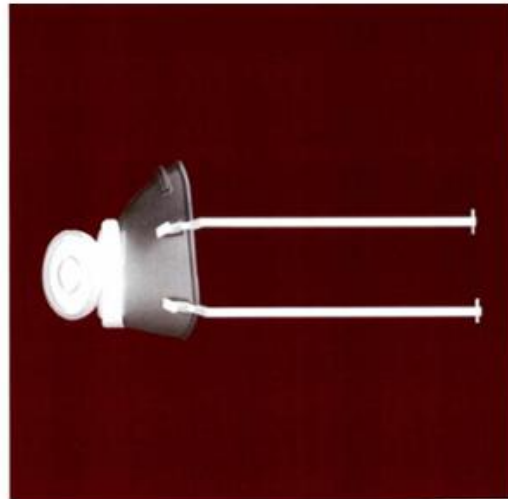

1.6

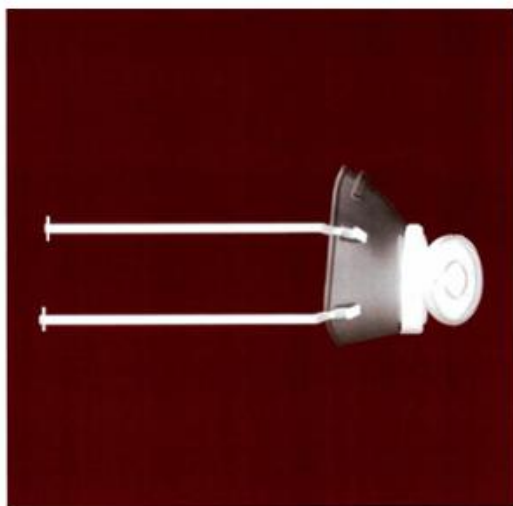

1.7



1.8



1.9



1.10

CÔNG BÁO SỞ HỮU CÔNG NGHIỆP SỐ 406 TẬP A – QUYỀN 2 (01.2022)

- (11) **43576**
(21) 3-2021-01472 (28) 1
(54) **BÀN BI-DA** (51) **21-02**
(22) 08/06/2021 (43) 25/01/2022
(73) **CÔNG TY TNHH BILLIARDS HOÀNG GIA (VN)**
306 tỉnh lộ 9, ấp 4A, xã Bình Mỹ, huyện Củ Chi, thành phố Hồ Chí Minh
(72) 1. **LÊ CAO ANH TRIẾT (VN)**
2. **HỒ HOÀNG ANH TUẤN (VN)**
(74) Công ty luật TNHH APOLAT LEGAL (APOLAT LEGAL)
(55)



1.1

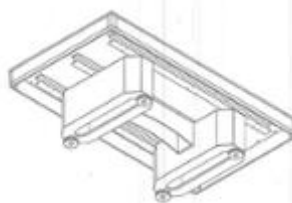

1.2

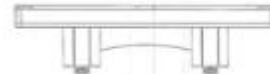

1.3

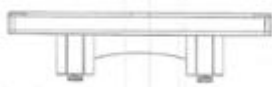

1.4

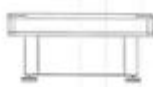

1.5

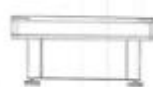

1.6



1.7

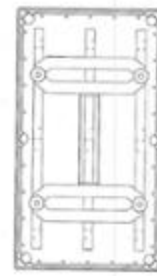

1.8

- (11) **43577**
(21) 3-2021-01551 (28) 1
(54) **THIẾT BỊ NÂNG TRỢ LỰC** (51) **15-99**
(22) 15/06/2021 (43) 25/01/2022
(73) **CÔNG TY CỔ PHẦN TAY MÁY VIỆT NAM (VN)**
Thôn Đồng Táng, xã Đồng Trúc, huyện Thạch Thất, thành phố Hà Nội
(72) 1. LÊ ĐĂNG THẮNG (VN)
2. KIỀU ĐĂNG TRƯỜNG (VN)
(74) Công ty Luật TNHH LINK&PARTNERS (LINK&PARTNERS)
(55)



1.1



1.2



1.3



1.4

1.5



1.6



1.7

CÔNG BÁO SỞ HỮU CÔNG NGHIỆP SỐ 406 TẬP A – QUYỀN 2 (01.2022)

- (11) **43578**
- (21) 3-2021-01574 (28) 1
- (54) **BAO GÓI SẢN PHẨM** (51) **09-05**
- (22) 17/06/2021 (43) 25/01/2022
- (73) **CÔNG TY TNHH SUNRISE INS (VN)**
Galleria- Nam Sài Gòn, 18A đường Nguyễn Hữu Thọ, xã Phước Kiển, huyện Nhà Bè, thành phố Hồ Chí Minh
- (72) Tô Duy Thông (VN)
- (74) Công ty TNHH Sở hữu trí tuệ IPS Việt Nam (VIET NAM IPS INTERPRO CO., LTD)
- (55)



1.1



1.2

- (11) **43579**
- (21) 3-2021-01579
- (54) **TẤ LÓT**
- (22) 18/06/2021
- (30) 202030806786.2 25/12/2020 CN;
- (73) **UNICHARM CORPORATION (JP)**
182, Shimobun, Kinsei-cho, Shikokuchuo-City, Ehime 799-0111, Japan
- (72) 1. YUSUKE KAWAKAMI (JP)
2. JUYI GAO (CN)
3. YINHUA WANG (CN)
4. LINGSHUANG ZHENG (CN)
- (74) Công ty Cổ phần Sở hữu công nghiệp INVESTIP (INVESTIP)
- (55)

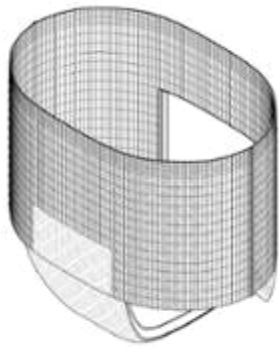

1.1

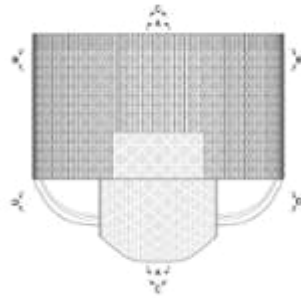

1.2



1.3



1.4

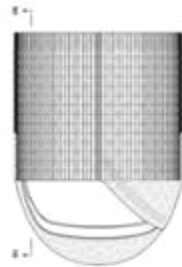

1.5

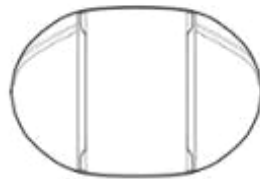

1.6

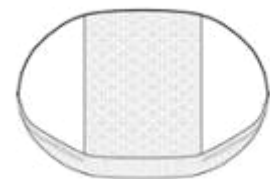

1.7

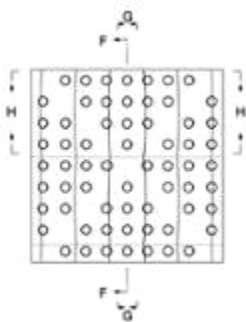

1.8

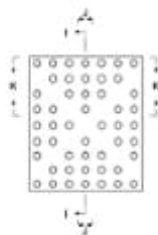

1.9



1.10



1.11

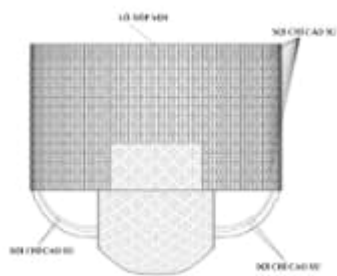

1.12

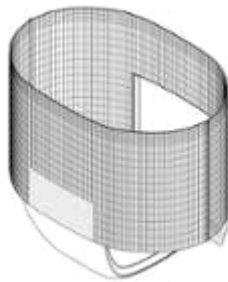

2.1

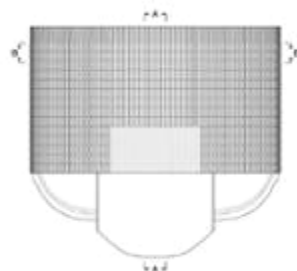

2.2



2.3

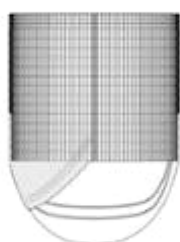

2.4

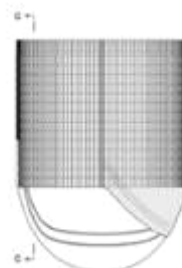

2.5

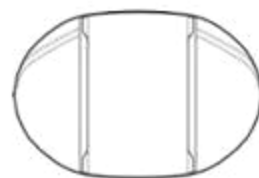

2.6

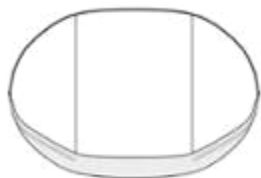

2.7

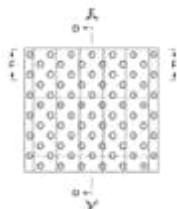

2.8



2.9

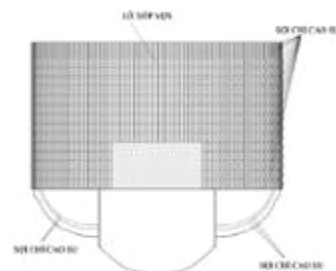

2.10

- (11) **43580**
(21) 3-2021-01616 (28) 1
(54) **MÁY XÔNG HƠI** (51) **23-03**
(22) 21/06/2021 (43) 25/01/2022
(73) **CÔNG TY CỔ PHẦN ĐẦU TƯ SẢN XUẤT VÀ XUẤT NHẬP KHẨU TOÀN PHÁT (VN)**
Tổ 3 cụm 1, ngõ 345 phố Khương Trung, phường Khương Đình, quận Thanh Xuân, thành phố Hà Nội
(72) Trịnh Anh Toàn (VN)
(74) Công ty Luật TNHH Phương Hoàng (PHOENIX LAW)
(55)



1.1

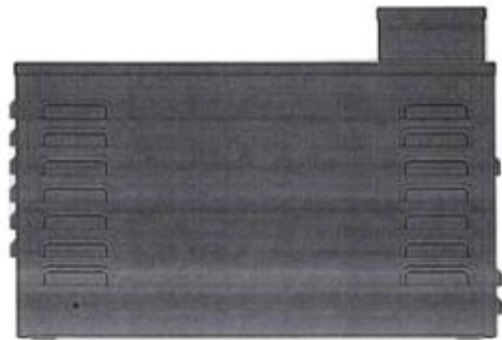

1.2

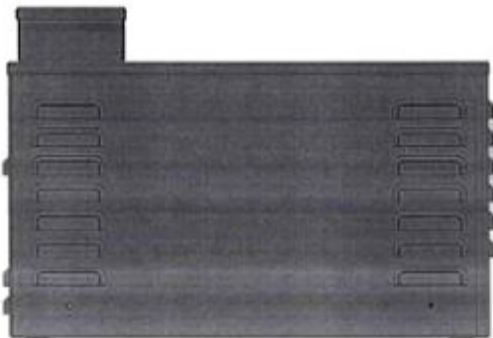

1.3



1.4



1.5



1.6



1.7

CÔNG BÁO SỞ HỮU CÔNG NGHIỆP SỐ 406 TẬP A – QUYỀN 2 (01.2022)

- (11) **43581**
(21) 3-2021-01628 (28) 5
(54) **CÔNG TẮC ĐIỆN** (51) **13-03**
(22) 22/06/2021 (43) 25/01/2022
(30) 202030822204.X 30/12/2020 CN;
(73) **PANASONIC ECO SOLUTIONS INFORMATION EQUIPMENT
(SHANGHAI) CO., LTD. (CN)**
Factory 1-3, 258 East Jiangtian Road, Songjiang District, Shanghai 201613 China
(72) SHI, Tianfang (CN)
(74) Công ty Luật TNHH ADMC (ADMC)
(55)

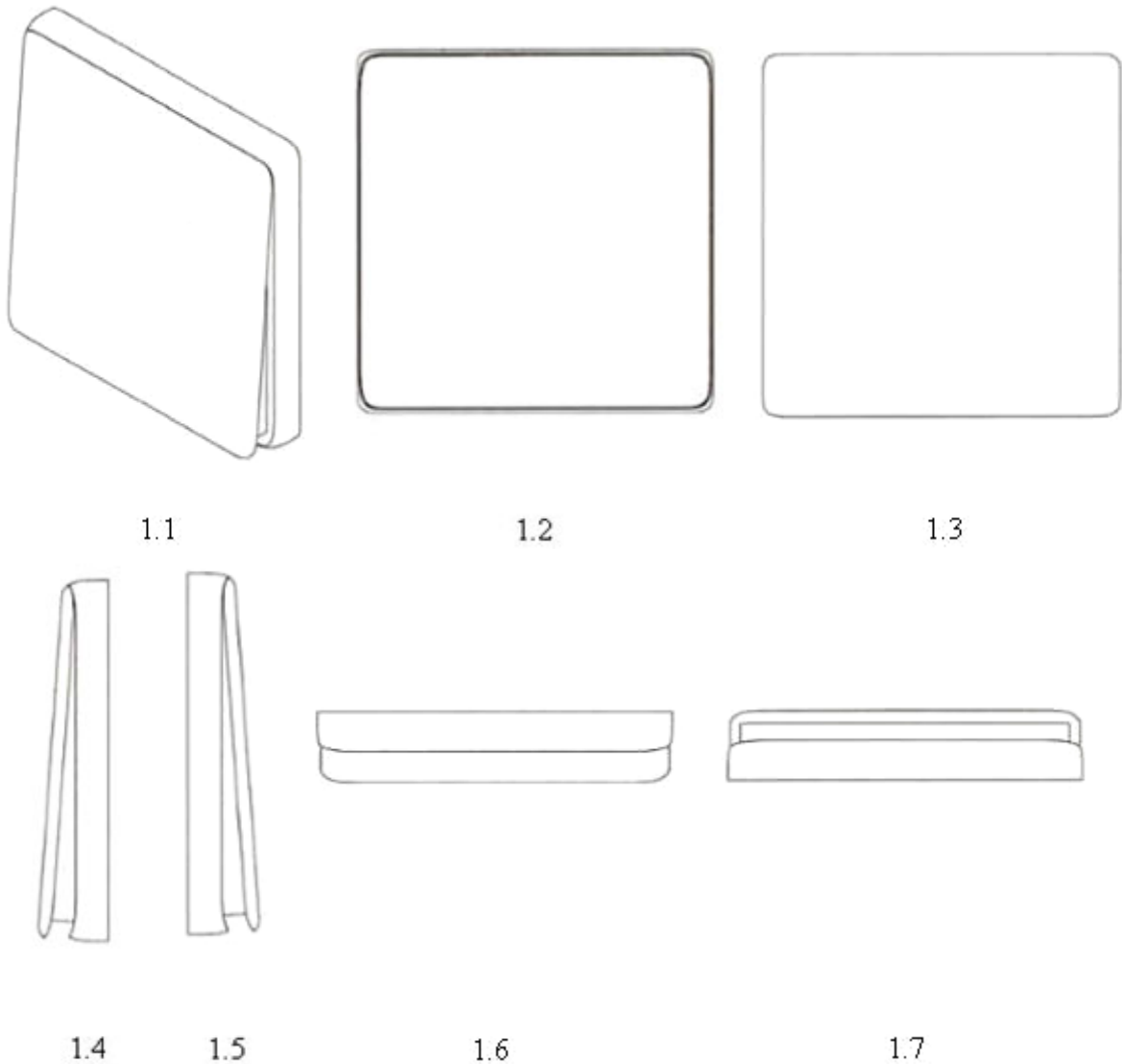

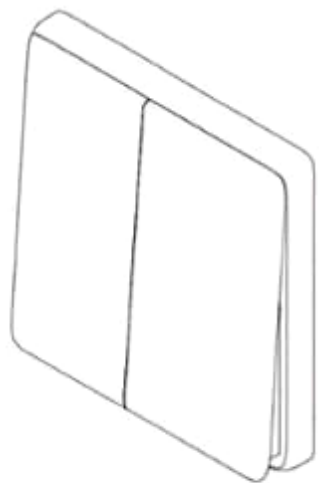

2.1

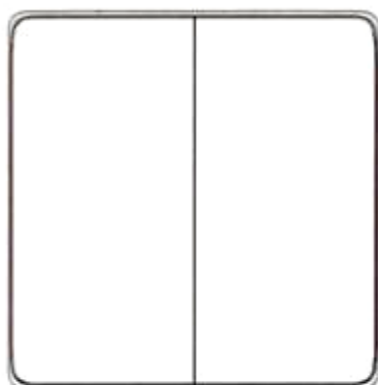

2.2



2.3

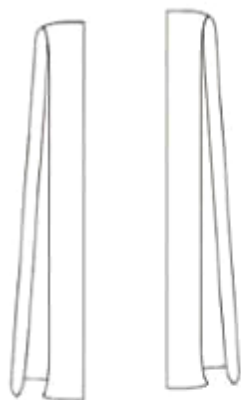

2.4

2.5



2.6

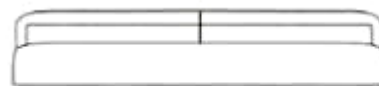

2.7

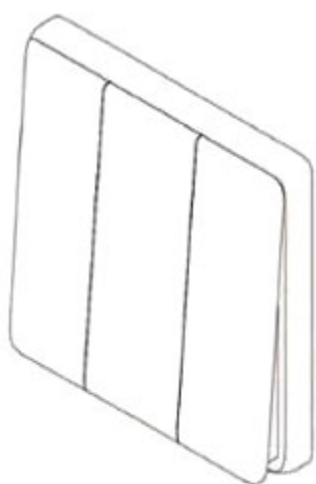

3.1

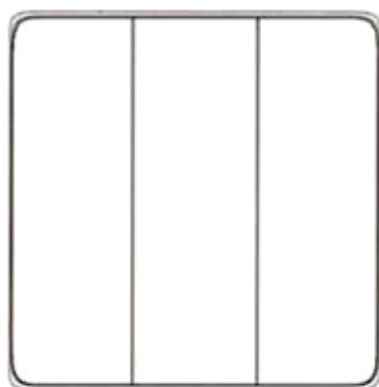

3.2



3.3



3.4

3.5



3.6



3.7

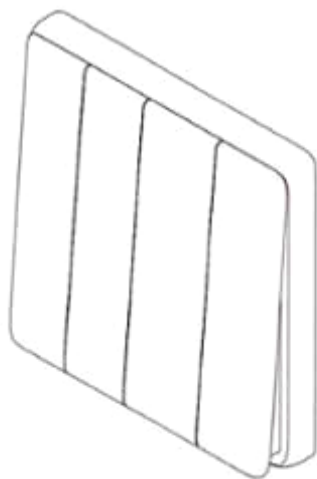

4.1

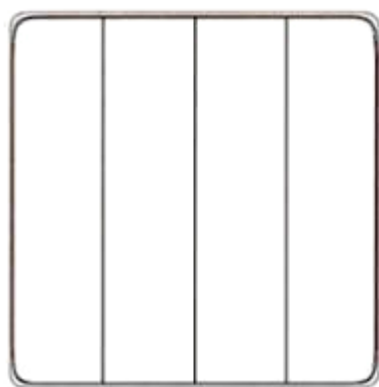

4.2



4.3

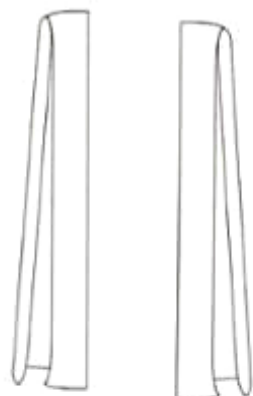

4.4

4.5

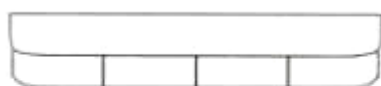

4.6



4.7

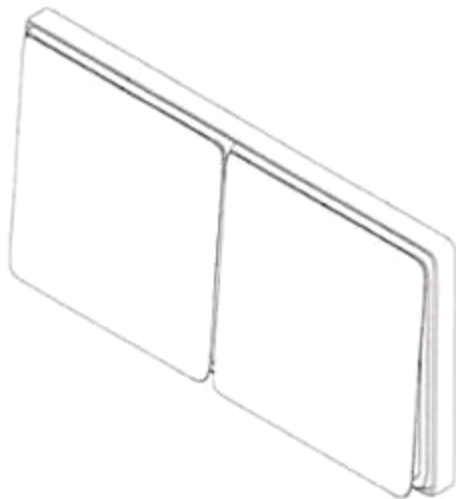

5.1



5.2

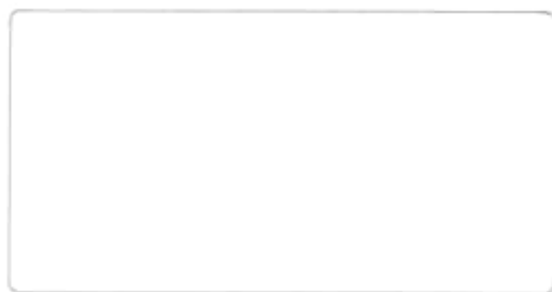

5.3



5.4

5.5



5.6



5.7

CÔNG BÁO SỞ HỮU CÔNG NGHIỆP SỐ 406 TẬP A – QUYỀN 2 (01.2022)

(11) **43582**

(21) 3-2021-01629

(28) 5

(54) **Ổ ĐIỆN**

(51) **13-03**

(22) 22/06/2021

(43) 25/01/2022

(30) 202030822222.8 30/12/2020 CN;

(73) **PANASONIC ECO SOLUTIONS INFORMATION EQUIPMENT (SHANGHAI) CO., LTD. (CN)**

Factory 1-3, 258 East Jiangtian Road, Songjiang District, Shanghai 201613 China

(72) SHI, Tianfang (CN)

(74) Công ty Luật TNHH ADMC (ADMC)

(55)

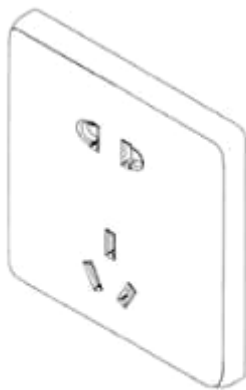

1.1

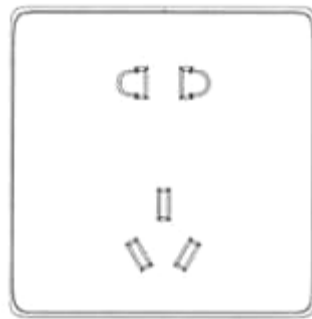

1.2



1.3



1.4



1.5



1.6



1.7

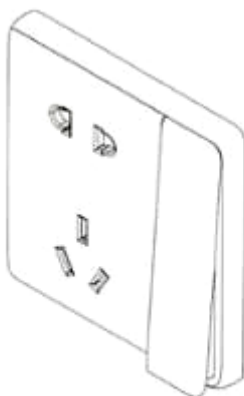

2.1

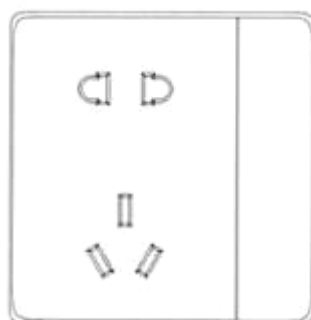

2.2



2.3

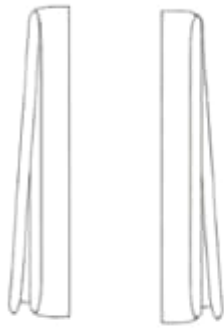

2.4

2.5



2.6



2.7

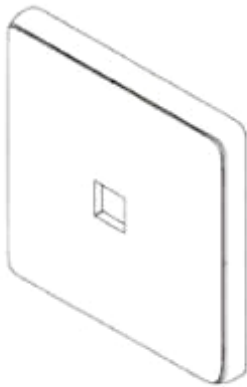

3.1

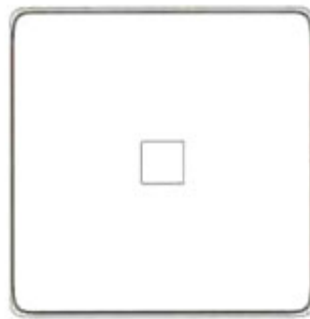

3.2



3.3

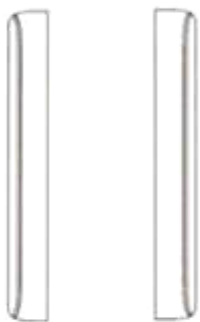

3.4

3.5



3.6



3.7



4.1

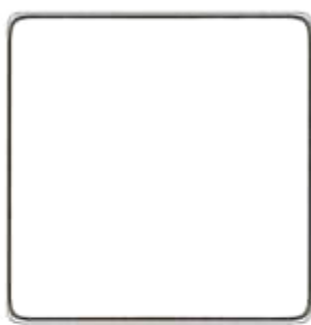

4.2



4.3



4.4



4.5



4.6



4.7

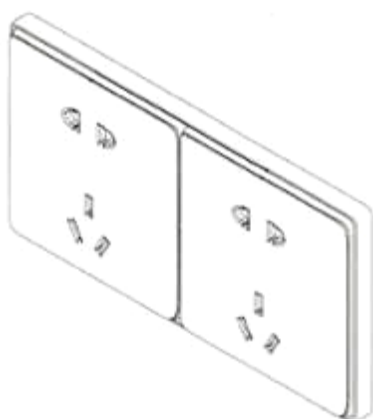

5.1

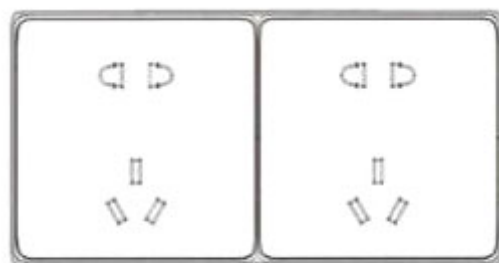

5.2

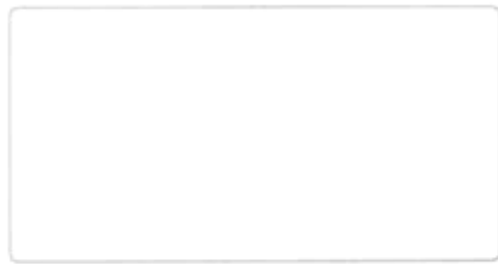

5.3



5.4



5.5



5.6



5.7

CÔNG BÁO SỞ HỮU CÔNG NGHIỆP SỐ 406 TẬP A – QUYỀN 2 (01.2022)

- (11) **43583**
- (21) 3-2021-01649 (28) 1
- (54) **NHÃN SẢN PHẨM** (51) **19-08**
- (22) 23/06/2021 (43) 25/01/2022
- (73) **CÔNG TY TNHH DỊCH VỤ VÀ CUNG CẤP THỰC PHẨM QUỐC TẾ - IFSS (VN)**
Số 2bis Nguyễn Thị Minh Khai, phường Đa Kao, quận 1, thành phố Hồ Chí Minh
- (72) **HOÀNG DƯƠNG XUÂN DŨNG (VN)**
- (55)



- (11) **43584**
(21) 3-2021-01653 (28) 1
(54) **ĐIỀU THUỐC LÁ ĐIỆN TỬ** (51) **27-01**
(22) 23/06/2021 (43) 25/01/2022
(30) 30-2021-0013166 18/03/2021 KR;
(73) **KT&G CORPORATION (KR)**
71, Beotkkot-gil, Daedeok-gu, Daejeon, Korea
(72) 1. KIM, MIN CHUL (KR)
2. SHIN, SU MI (KR)
(74) Công ty TNHH T&T INVENMARK Sở hữu trí tuệ Quốc tế (T&T INVENMARK CO., LTD.)
(55)

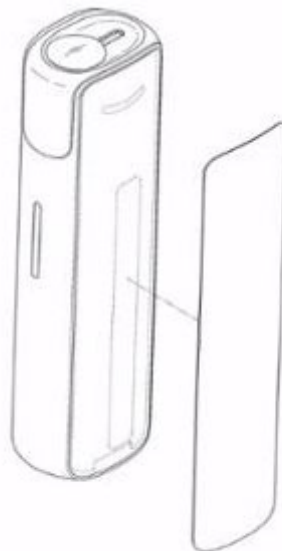
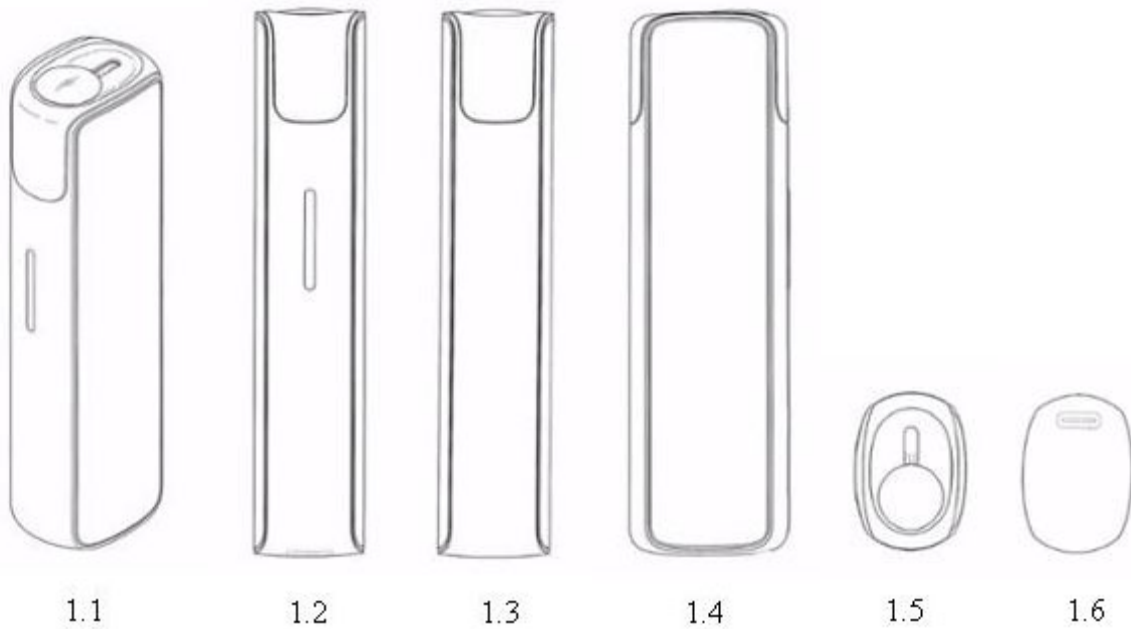

CÔNG BÁO SỞ HỮU CÔNG NGHIỆP SỐ 406 TẬP A – QUYỀN 2 (01.2022)

(11) **43585**

(21) 3-2021-01654

(28) 1

(54) **GHẾ SÔ-PHA**

(51) **06-01**

(22) 23/06/2021

(43) 25/01/2022

(73) **HTL FURNITURE (CHINA) CO., LTD. (CN)**

Wusong Jiangnan Road, Kunshan Development Zone, Jiangsu Province, China

(72) PHUA YONG TAT (SG)

(74) Công ty Luật TNHH quốc tế BMVN (BMVN INTERNATIONAL LLC)

(55)



1.1



1.2



1.3



1.4



1.5

CÔNG BÁO SỞ HỮU CÔNG NGHIỆP SỐ 406 TẬP A – QUYỀN 2 (01.2022)

- (11) **43586**
(21) 3-2021-01655 (28) 1
(54) **GHẾ** (51) **06-01**
(22) 23/06/2021 (43) 25/01/2022
(73) **HTL FURNITURE (CHINA) CO., LTD. (CN)**
Wusong Jiangnan Road, Kunshan Development Zone, Jiangsu Province, China
(72) PHUA YONG TAT (SG)
(74) Công ty Luật TNHH quốc tế BMVN (BMVN INTERNATIONAL LLC)
(55)



1.1



1.2



1.3



1.4



1.5

(11) **43587**

(21) 3-2021-01656

(28) 1

(54) **GHẾ SÔ-PHA**

(51) **06-01**

(22) 23/06/2021

(43) 25/01/2022

(73) **HTL FURNITURE (CHINA) CO., LTD. (CN)**

Wusong Jiangnan Road, Kunshan Development Zone, Jiangsu Province, China

(72) PHUA YONG TAT (SG)

(74) Công ty Luật TNHH quốc tế BMVN (BMVN INTERNATIONAL LLC)

(55)



1.1



1.2



1.3

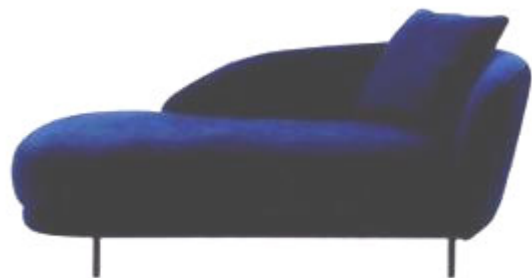

1.4



1.5



1.6

CÔNG BÁO SỞ HỮU CÔNG NGHIỆP SỐ 406 TẬP A – QUYỀN 2 (01.2022)

(11) **43588**

(21) 3-2021-01657

(28) 1

(54) **GHẾ SÔ-PHA**

(51) **06-01**

(22) 23/06/2021

(43) 25/01/2022

(73) **HTL FURNITURE (CHINA) CO., LTD. (CN)**

Wusong Jiangnan Road, Kunshan Development Zone, Jiangsu Province, China

(72) PHUA YONG TAT (SG)

(74) Công ty Luật TNHH quốc tế BMVN (BMVN INTERNATIONAL LLC)

(55)



1.1



1.2



1.3



1.4



1.5

CÔNG BÁO SỞ HỮU CÔNG NGHIỆP SỐ 406 TẬP A – QUYỀN 2 (01.2022)

- (11) **43589**
(21) 3-2021-01694 (28) 1
(54) **THƯỚC KẼ CHÂN MÀY** (51) **28-03**
(22) 25/06/2021 (43) 25/01/2022
(73) **BÙI QUỐC THẢO (VN)**
Áp Bình Thành, xã Tân Mỹ Chánh, thành phố Mỹ Tho, tỉnh Tiền Giang
(72) Bùi Quốc Thảo (VN)
(74) Văn phòng Luật sư D và T (D & T LAW OFFICE)
(55)



1.1



1.2



1.3



1.4



1.5

CÔNG BÁO SỞ HỮU CÔNG NGHIỆP SỐ 406 TẬP A – QUYỀN 2 (01.2022)

- (11) **43590**
(21) 3-2021-01698 (28) 1
(54) **NHÀ GIẤY ĐỒ CHƠI** (51) **21-01**
(22) 25/06/2021 (43) 25/01/2022
(73) **CÔNG TY CỔ PHẦN GIẢI PHÁP ĐÓNG GÓI MAGIX (VN)**
Số 02-04 Alexandre de Rhodes, phường Bến Nghé, quận 1, thành phố Hồ Chí Minh
(72) Đỗ Hữu Tân (VN)
(74) Công ty TNHH MASTERBRAND (MASTERBRAND)
(55)



1.1

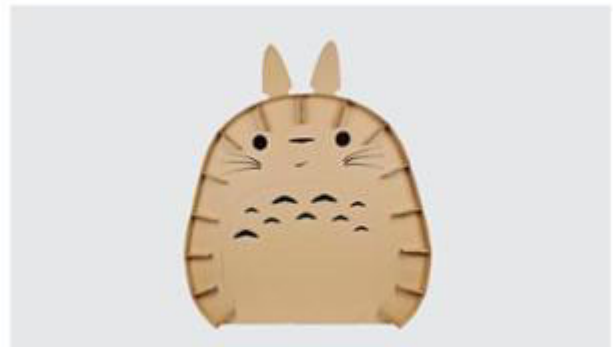

1.2



1.3



1.4



1.5



1.6

CÔNG BÁO SỞ HỮU CÔNG NGHIỆP SỐ 406 TẬP A – QUYỀN 2 (01.2022)

- (11) **43591**
(21) 3-2021-01709 (28) 1
(54) **VAN HÚT GIÓ** (51) **23-01**
(22) 29/06/2021 (43) 25/01/2022
(73) **CÔNG TY TNHH ĐẦU TƯ SẢN XUẤT THƯƠNG MẠI KIM HUY HOÀNG (VN)**
211 Trần Nãi, khu phố 3, phường An Khánh, thành phố Thủ Đức, thành phố Hồ Chí Minh
(72) NGUYỄN THANH MAI (VN)
(74) Công ty TNHH Tư vấn đầu tư và Sở hữu trí tuệ Hoàng Phi (HOANG PHI INVEST & I.P CO., LTD)
(55)



1.1



1.2



1.3



1.4

CÔNG BÁO SỞ HỮU CÔNG NGHIỆP SỐ 406 TẬP A – QUYỀN 2 (01.2022)

(11) **43592**

(21) 3-2021-01718

(28) 1

(54) **NỆM**

(51) **06-09**

(22) 29/06/2021

(43) 25/01/2022

(73) **CÔNG TY TNHH LAMELL (VN)**

Quốc lộ 56, Ấp Bắc 2, xã Hòa Long, thành phố Bà Rịa, tỉnh Bà Rịa - Vũng Tàu

(72) La Yên Nhi (VN)

(74) **CÔNG TY TNHH KHANG LUẬT (KHANGLAW)**

(55)



1.1



1.2



1.3



1.4



1.5



1.6



1.7

CÔNG BÁO SỞ HỮU CÔNG NGHIỆP SỐ 406 TẬP A – QUYỀN 2 (01.2022)

- (11) **43593**
(21) 3-2021-01746 (28) 1
(54) **HỘP ĐỰNG THỰC PHẨM** (51) **09-03**
(22) 01/07/2021 (43) 25/01/2022
(30) 30-2021-0026311 02/06/2021 KR;
(73) **CJ CHEILJEDANG CORPORATION (KR)**
(Ssangnim-dong) 330, Dongho-ro, Jung-gu, Seoul 04560 Republic of Korea
(72) 1. CHOI, HYE MIN (KR)
2. LEE, BYUNG KOOK (KR)
(74) Công ty Luật TNHH ROUSE Việt Nam (ROUSE LAW CO.,LTD)
(55)



1.1



1.2



1.3



1.4



1.5



1.6



1.7

CÔNG BÁO SỞ HỮU CÔNG NGHIỆP SỐ 406 TẬP A – QUYỀN 2 (01.2022)

- (11) **43594**
(21) 3-2021-01747 (28) 1
(54) **HỘP ĐỰNG THỰC PHẨM** (51) **09-03**
(22) 01/07/2021 (43) 25/01/2022
(30) 30-2021-0026312 02/06/2021 KR;
(73) **CJ CHEILJEDANG CORPORATION (KR)**
(Ssangnim-dong) 330, Dongho-ro, Jung-gu, Seoul 04560 Republic of Korea
(72) 1. CHOI, HYE MIN (KR)
2. LEE, BYUNG KOOK (KR)
(74) Công ty Luật TNHH ROUSE Việt Nam (ROUSE LAW CO.,LTD)
(55)



1.1



1.2



1.3



1.4



1.5



1.6



1.7

- (11) **43595**
(21) 3-2021-01757 (28) 1
(54) **CHAI** (51) **09-01**
(22) 02/07/2021 (43) 25/01/2022
(73) **HIỆP HỘI RƯỢU BÀU ĐÁ BÌNH ĐỊNH (VN)**
Thôn Cù Lâm, xã Nhơn Lộc, thị xã An Nhơn, tỉnh Bình Định
(72) Lê Văn Thương (VN)
(55)



1.1



1.2



1.3



1.4



1.5



1.6

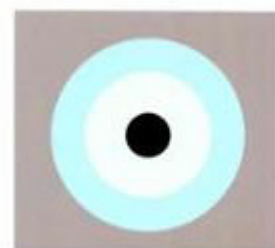

1.7

CÔNG BÁO SỞ HỮU CÔNG NGHIỆP SỐ 406 TẬP A – QUYỀN 2 (01.2022)

- (11) **43596**
(21) 3-2021-01823 (28) 1
(54) **DÉP** (51) **02-04**
(22) 13/07/2021 (43) 25/01/2022
(30) 29/766,344 14/01/2021 US;
(73) **CROCS, INC. (US)**
13601 Via Varra, Broomfield, Colorado 80020, United States of America
(72) MAYHEW, Alexander (US)
(74) Công ty Luật TNHH quốc tế BMVN (BMVN INTERNATIONAL LLC)
(55)



1.1



1.2



1.3



1.4



1.5



1.6



1.7

CÔNG BÁO SỞ HỮU CÔNG NGHIỆP SỐ 406 TẬP A – QUYỀN 2 (01.2022)

- | | | | |
|------|---|------|--------------|
| (11) | 43597 | | |
| (21) | 3-2021-01833 | (28) | 2 |
| (54) | NHÃN SẢN PHẨM | (51) | 19-08 |
| (22) | 15/07/2021 | (43) | 25/01/2022 |
| (73) | NGÔ THỊ DIỆU HIỀN (VN)
297/28 Lạc Long Quân, phường 3, quận 11, thành phố Hồ Chí Minh | | |
| (72) | Ngô Thị Diệu Hiền (VN) | | |
| (74) | Văn phòng Luật sư D và T (D & T LAW OFFICE) | | |
| (55) | | | |



1.1



1.2



2.1



2.2

(11) **43598**

(21) 3-2021-01859

(54) **ĐỆM CAO SU GIẢM CHẤN**

(22) 19/07/2021

(73) **HOÀNG VĂN DŨNG (VN)**

Số nhà 04 ngõ 09, La Thạch, Phương Đình, huyện Đan Phượng, thành phố Hà Nội

(72) Hoàng Văn Dũng (VN)

(55)

(28) 1

(51) **12-16**

(43) 25/01/2022



1.1



1.2



1.3



1.4



1.5

CÔNG BÁO SỞ HỮU CÔNG NGHIỆP SỐ 406 TẬP A – QUYỀN 2 (01.2022)

- (11) **43599**
(21) 3-2021-01895 (28) 1
(54) **NHÃN SẢN PHẨM** (51) **19-08**
(22) 21/07/2021 (43) 25/01/2022
(73) **TỔNG CÔNG TY CỔ PHẦN BIA-RƯỢU-NƯỚC GIẢI KHÁT HÀ NỘI (VN)**
Số 183, phố Hoàng Hoa Thám, phường Ngọc Hà, quận Ba Đình, thành phố Hà Nội
(72) Lê Minh Đức (VN)
(74) Công ty TNHH tư vấn Sở hữu trí tuệ IPFLAME (IPFLAME CO.,LTD)
(55)



1.1



1.2

- (11) **43600**
- (21) 3-2021-01897 (28) 1
- (54) **TỦ LẠNH** (51) **15-07**
- (22) 21/07/2021 (43) 25/01/2022
- (30) 2021-001269 22/01/2021 JP;
- (73) **MITSUBISHI ELECTRIC CORPORATION (JP)**
7-3, Marunouchi 2-chome, Chiyoda-ku, Tokyo 100-8310, Japan
- (72) 1. SHINGO KAWAKAMI (JP)
2. TAKANORI HIKIMA (JP)
3. ALESSANDRO DADONE (IT)
4. TAKANORI IKEGAYA (JP)
5. MARIKO TOBITA (JP)
- (74) Công ty TNHH Tầm nhìn và Liên danh (VISION & ASSOCIATES CO.LTD.)
- (55)

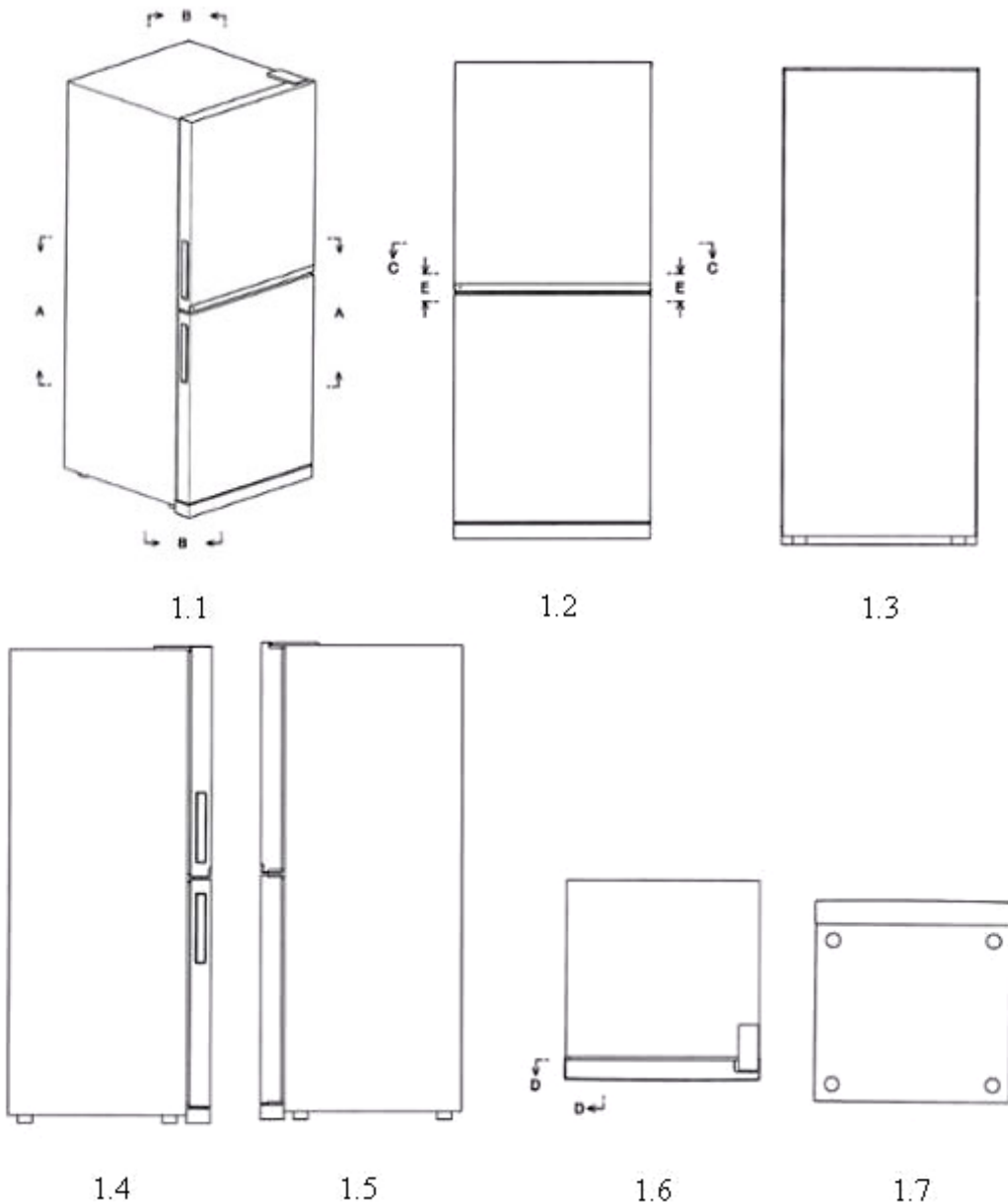

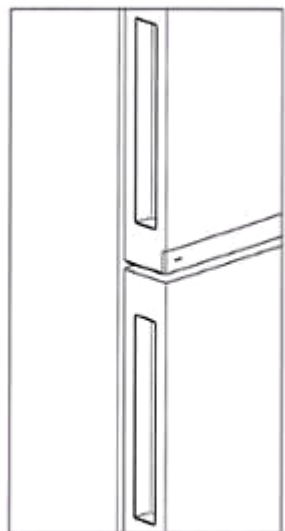

1.8

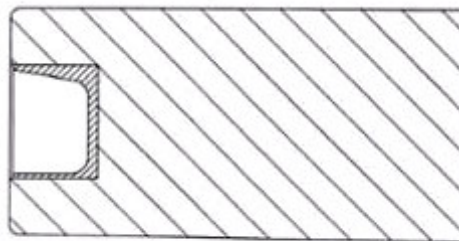

1.9



1.10

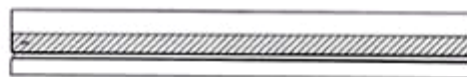

1.11

CÔNG BÁO SỞ HỮU CÔNG NGHIỆP SỐ 406 TẬP A – QUYỀN 2 (01.2022)

- (11) **43601**
(21) 3-2021-01901 (28) 1
(54) **NHÃN SẢN PHẨM** (51) **19-08**
(22) 21/07/2021 (43) 25/01/2022
(73) **CÔNG TY TRÁCH NHIỆM HỮU HẠN MÔI TRƯỜNG VIỆT Á (VN)**
72 Đường số 27, phường Hiệp Bình Chánh, thành phố Thủ Đức, thành phố Hồ Chí Minh
(72) Lê Văn Duẩn Em (VN)
(55)



CÔNG BÁO SỞ HỮU CÔNG NGHIỆP SỐ 406 TẬP A – QUYỀN 2 (01.2022)

- (11) **43602**
- (21) 3-2021-01905 (28) 1
- (54) **NHÃN SẢN PHẨM** (51) **19-08**
- (22) 22/07/2021 (43) 25/01/2022
- (73) **CÔNG TY TNHH ĐẦU TƯ SẢN XUẤT NAM PHÁT (VN)**
Thôn 3, xã Vạn Phúc, huyện Thanh Trì, thành phố Hà Nội
- (72) Nguyễn Mạnh Diện (VN)
- (55)



CÔNG BÁO SỞ HỮU CÔNG NGHIỆP SỐ 406 TẬP A – QUYỀN 2 (01.2022)

- (11) **43603**
(21) 3-2021-01908 (28) 1
(54) **MÓC TREO ĐỒ CHO XE GẮN MÁY** (51) **08-07**
(22) 22/07/2021 (43) 25/01/2022
(73) **HỘ KINH DOANH HÙNG CƯỜNG (VN)**
71/33 Lãnh Binh Thăng, phường 12, quận 11, thành phố Hồ Chí Minh
(72) Lưu Chí Hùng (VN)
(74) Công ty TNHH IPVC (IP.VC CO.,LTD)
(55)



1.1



1.2

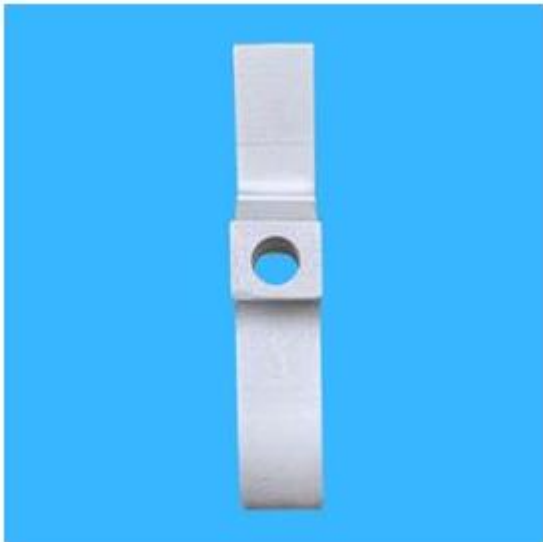

1.3



1.4



1.5



1.6



1.7

- (11) **43604**
(21) 3-2021-01915 (28) 1
(54) **THIẾT BỊ ĐIỀU CHỈNH DÂY ĐAI** (51) **08-07**
(22) 23/07/2021 (43) 25/01/2022
(30) 30-2021-0004461 28/01/2021 KR;
(73) **WOJIN PLASTIC CO., LTD (KR)**
45, Paryasandan-ro, Jinjeop-eup, Namyangju-si, Gyeonggi-do 12017 Republic of Korea
(72) 1. JISOOK PAIK (KR)
2. NAN HEE PAIK (KR)
3. JI HYE PAIK (KR)
4. JI WON SON (KR)
(74) Công ty TNHH Trường Xuân (AGELESS CO.,LTD.)
(55)

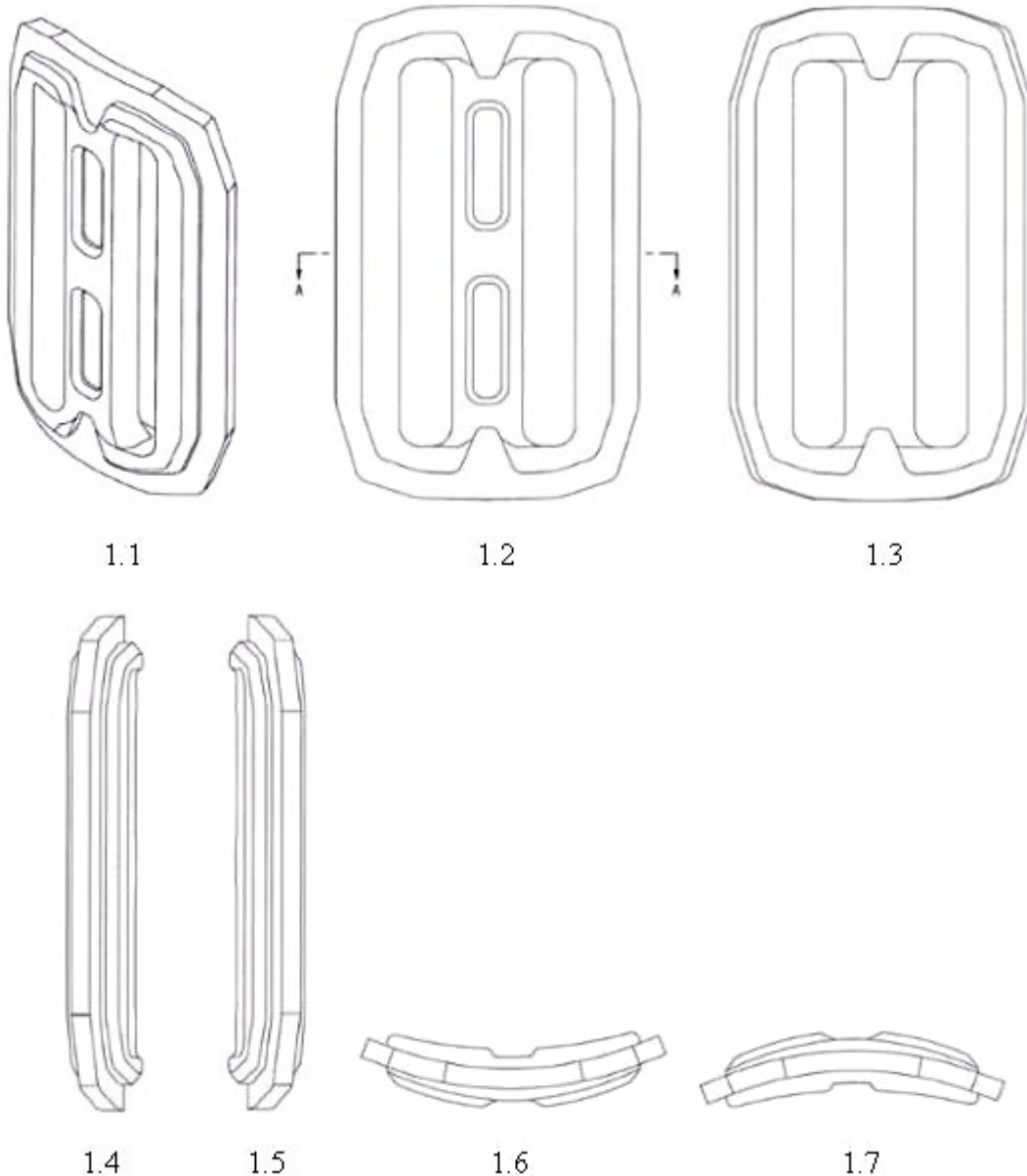



1.8

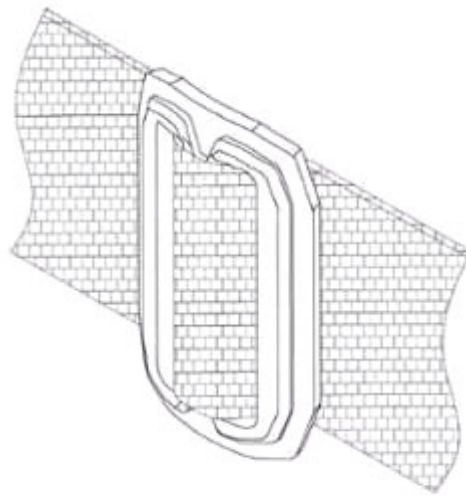

1.9

CÔNG BÁO SỞ HỮU CÔNG NGHIỆP SỐ 406 TẬP A – QUYỀN 2 (01.2022)

- (11) **43605**
(21) 3-2021-01916 (28) 1
(54) **THIẾT BỊ ĐIỀU CHỈNH DÂY ĐAI** (51) **08-07**
(22) 23/07/2021 (43) 25/01/2022
(30) 30-2021-0004460 28/01/2021 KR;
(73) **WOJIN PLASTIC CO., LTD (KR)**
45, Paryasandan-ro, Jinjeop-eup, Namyangju-si, Gyeonggi-do 12017 Republic of Korea
(72) 1. JISOOK PAIK (KR)
2. NAN HEE PAIK (KR)
3. JI HYE PAIK (KR)
4. JI WON SON (KR)
(74) Công ty TNHH Trường Xuân (AGELESS CO.,LTD.)
(55)

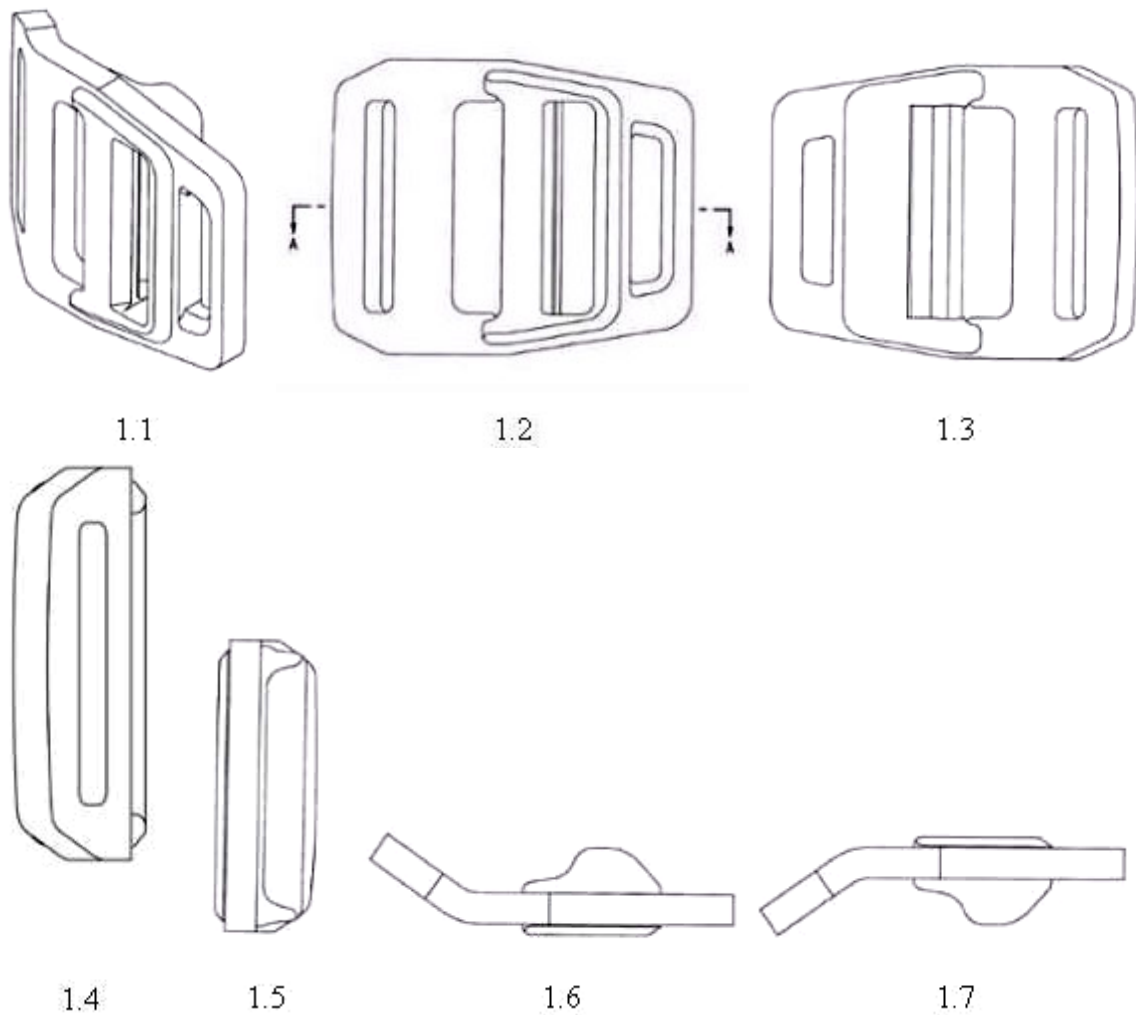

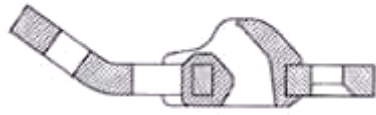

1.8

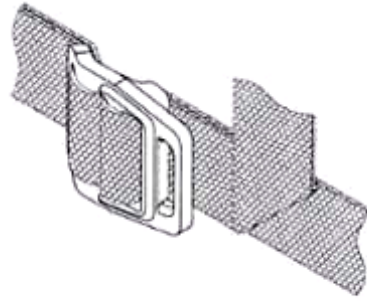

1.9

(11) **43606**

(21) 3-2021-01917

(28) 1

(54) **MÁY XE SỢI**

(51) **15-06; 15-99**

(22) 26/07/2021

(43) 25/01/2022

(73) **CÔNG TY TNHH HỒ HOÀN CẦU (VN)**

Xóm 6, xã Quỳnh Văn, huyện Quỳnh Lưu, tỉnh Nghệ An

(72) Hồ Xuân Vinh (VN)

(55)



1.1



1.2



1.3



1.4



1.5



1.6



1.7



1.8

(11) **43607**

(21) 3-2021-01918

(28) 1

(54) **MÁY SẤY THÙNG QUAY**

(51) **15-03; 15-05**

(22) 26/07/2021

(43) 25/01/2022

(73) **CÔNG TY TNHH HỒ HOÀN CẦU (VN)**

Xóm 6, xã Quỳnh Văn, huyện Quỳnh Lưu, tỉnh Nghệ An

(72) Hồ Xuân Vinh (VN)

(55)

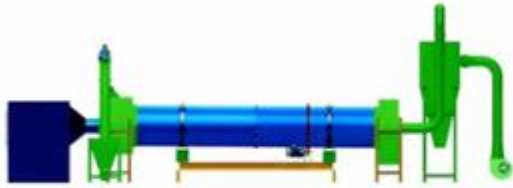

1.1

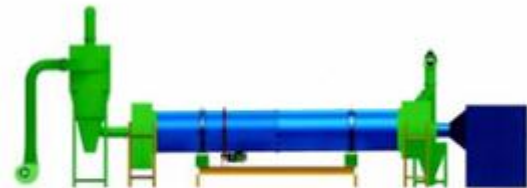

1.2

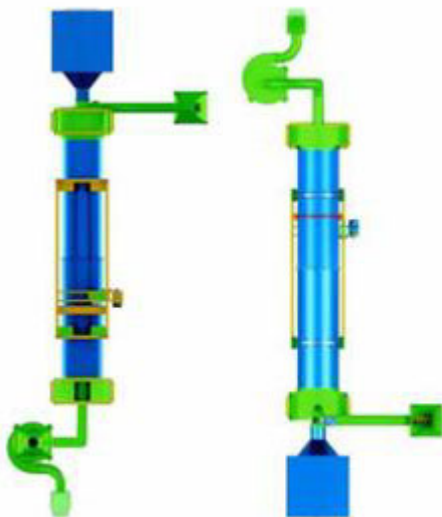

1.3

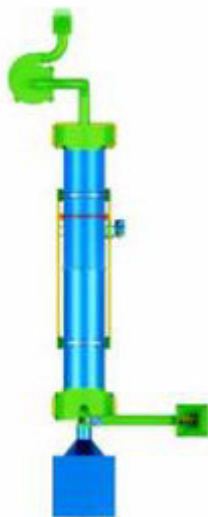

1.4



1.5



1.6



1.7



1.8

CÔNG BÁO SỞ HỮU CÔNG NGHIỆP SỐ 406 TẬP A – QUYỀN 2 (01.2022)

- (11) **43608**
(21) 3-2021-01932 (28) 1
(54) **KHAY ĐỂ XẾP ĐẶT TÀI LIỆU** (51) **19-02**
(22) 28/07/2021 (43) 25/01/2022
(30) 30-2021-0005553 02/02/2021 KR;
(73) **DOCHEON JEONG (KR)**
502, 55, Seongsan-ro 4an-gil, Mapo-gu, Seoul, Republic of Korea
(72) **DOCHEON JEONG (KR)**
(74) Công ty Luật TNHH ROUSE Việt Nam (ROUSE LAW CO.,LTD)
(55)

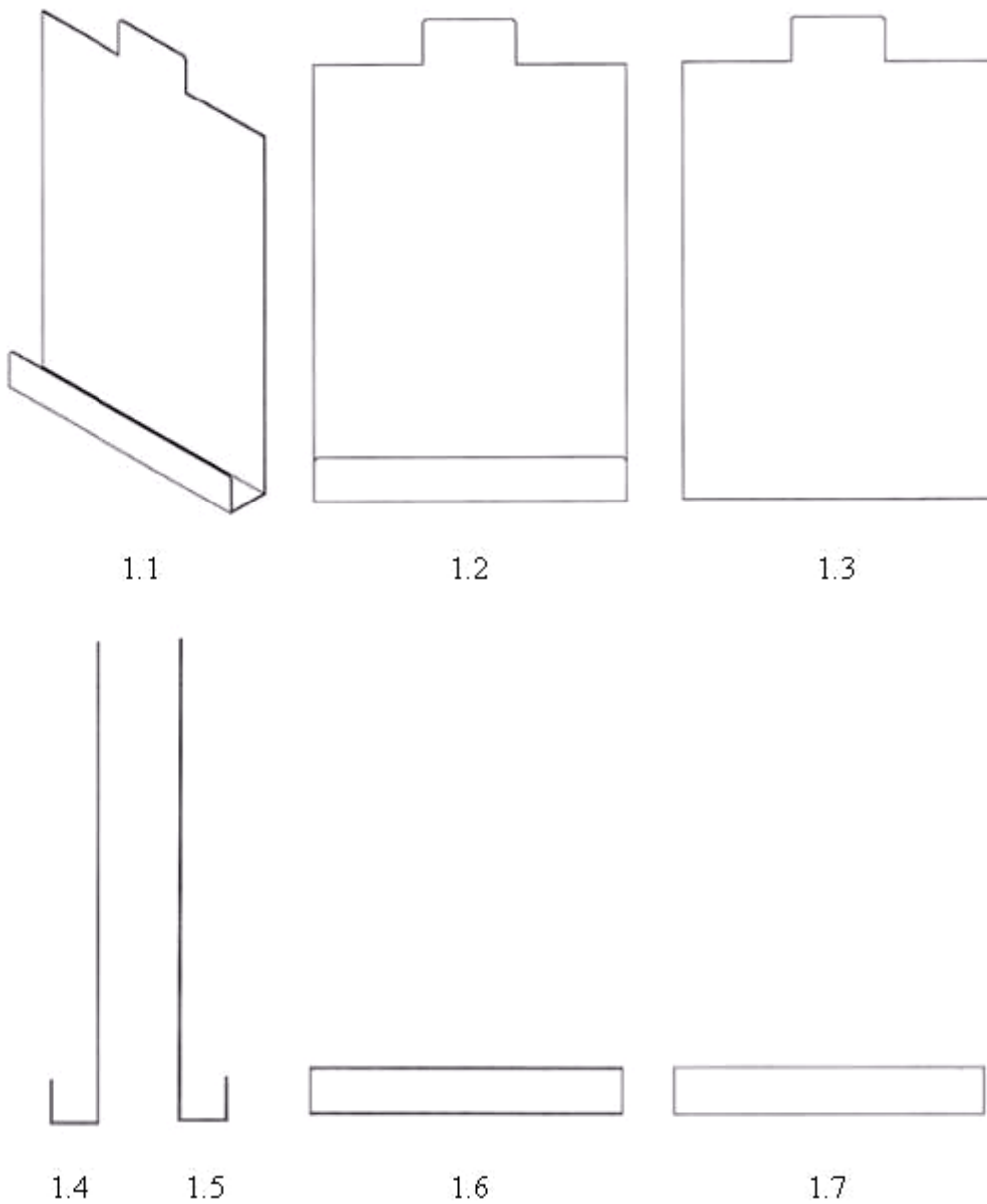

CÔNG BÁO SỞ HỮU CÔNG NGHIỆP SỐ 406 TẬP A – QUYỀN 2 (01.2022)

- (11) **43609**
(21) 3-2021-01936 (28) 1
(54) **GIÀY THỂ THAO** (51) **02-04**
(22) 28/07/2021 (43) 25/01/2022
(30) 29/768,321 28/01/2021 US;
(73) **ROTHY'S, INC. (US)**
501 Pacific Avenue, San Francisco CA, 94133 United States of America
(72) 1. WILLIAM ROTH MARTIN (US)
2. LA VION GIBSON (US)
3. MATTHEW TAYLOR (GB)
(74) Công ty TNHH Tầm nhìn và Liên danh (VISION & ASSOCIATES CO.LTD.)
(55)



1.1

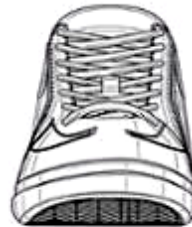

1.2



1.3

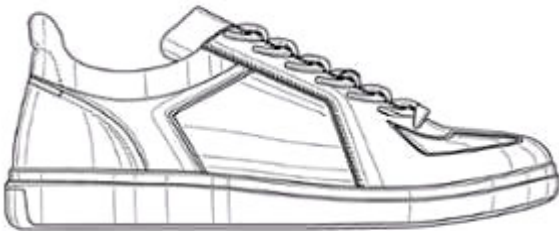

1.4

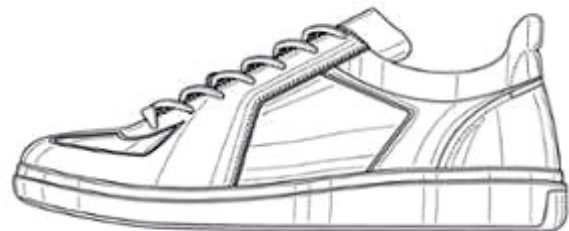

1.5



1.6



1.7

- (11) **43610**
(21) 3-2021-01963 (28) 1
(54) **KHÓA** (51) **02-07**
(22) 30/07/2021 (43) 25/01/2022
(30) 30-2021-0006702 09/02/2021 KR;
(73) **WOJIN PLASTIC CO., LTD (KR)**
45, Paryasandan-ro, Jinjeop-eup, Namyangju-si, Gyeonggi-do 12017 Republic of Korea
(72) 1. JISOOK PAIK (KR)
2. NAN HEE PAIK (KR)
3. JI HYE PAIK (KR)
4. JI WON SON (KR)
(74) Công ty TNHH Trường Xuân (AGELESS CO.,LTD.)
(55)

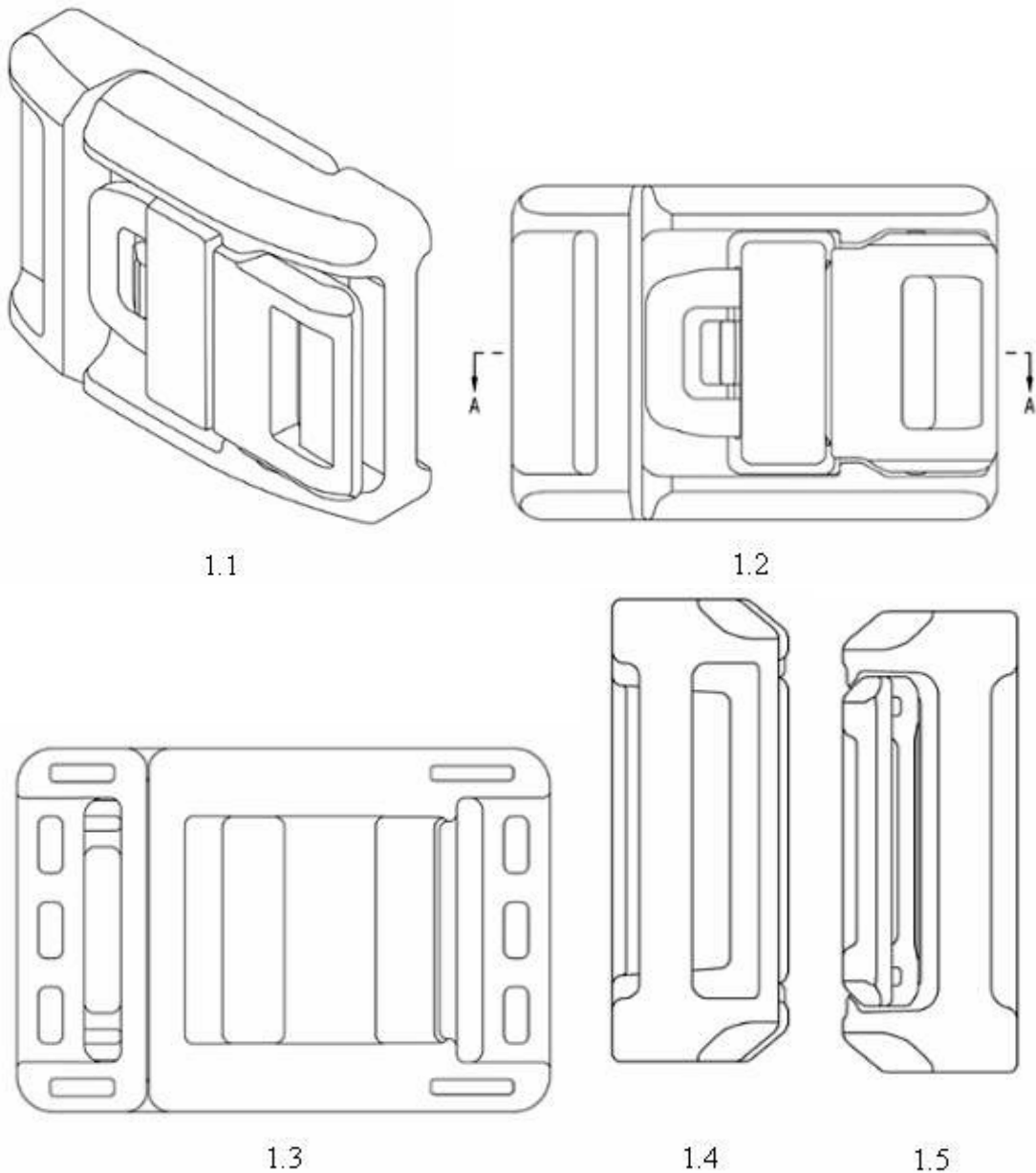

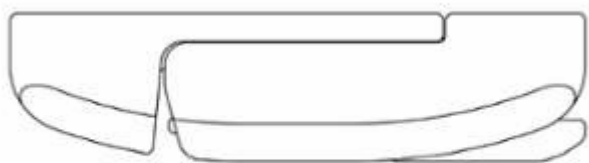

1.6

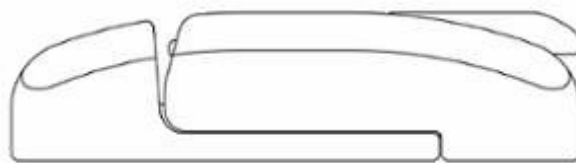

1.7

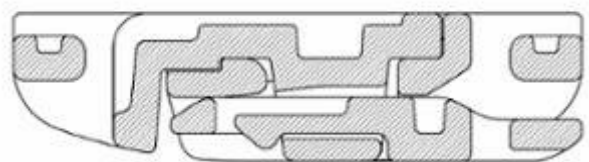

1.8

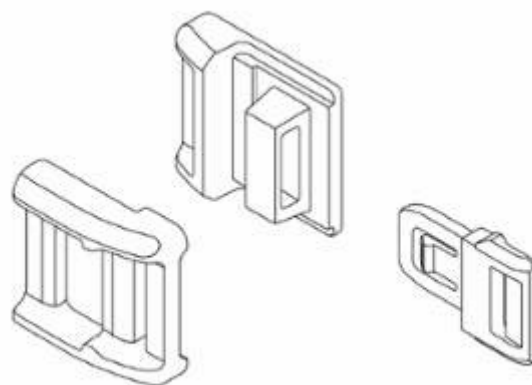

1.9

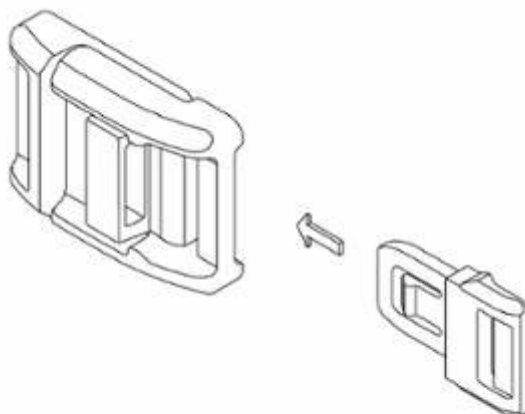

1.10

CÔNG BÁO SỞ HỮU CÔNG NGHIỆP SỐ 406 TẬP A – QUYỀN 2 (01.2022)

- (11) **43611**
(21) 3-2021-01995 (28) 1
(54) **BAO GÓI CUỘN GIẤY VỆ SINH** (51) **09-05**
(22) 04/08/2021 (43) 25/01/2022
(73) **CÔNG TY TNHH ĐẦU TƯ THƯƠNG MẠI VÀ PHÁT TRIỂN HƯNG PHÁT (VN)**
Xóm Trại, xã Quất Lưu, huyện Bình Xuyên, tỉnh Vĩnh Phúc
(72) Nguyễn Văn Coóng (VN)
(74) Công ty TNHH Tư vấn IPNG (IPNG CO.,LTD)
(55)



1.1



1.2



1.3

CÔNG BÁO SỞ HỮU CÔNG NGHIỆP SỐ 406 TẬP A – QUYỀN 2 (01.2022)

- (11) **43612**
(21) 3-2021-02007 (28) 1
(54) **THIẾT BỊ LÀM SẠCH SÀN** (51) **15-05**
(22) 06/08/2021 (43) 25/01/2022
(30) 29/775,348 23/03/2021 US;
(73) **BISSELL INC (US)**
2345 Walker Avenue NW, Grand Rapids, MI 49544, USA
(72) 1. MACKENZIE L. KNAPP (US)
2. DENNIS J. WROBLESKI (US)
(74) Công ty TNHH Sở hữu trí tuệ Thảo Quyên (INVENCO.,LTD)
(55)



1.1



1.2



1.3



1.4



1.5



1.6

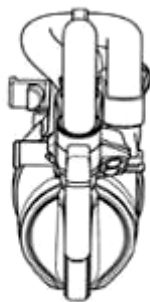

1.7



1.8

CÔNG BÁO SỞ HỮU CÔNG NGHIỆP SỐ 406 TẬP A – QUYỀN 2 (01.2022)

- (11) **43613**
(21) 3-2021-02009 (28) 1
(54) **BAO GÓI GIẤY VỆ SINH** (51) **09-05**
(22) 06/08/2021 (43) 25/01/2022
(73) **CÔNG TY TNHH TIẾN HIỆU (VN)**
Số 9, phố Cầu Gỗ, phường Hàng Bạc, quận Hoàn Kiếm, thành phố Hà Nội
(72) Đinh Thị Kim Định (VN)
(74) Công ty Luật TNHH VIETTHINK (VIETTHINK LAW FIRM)
(55)



1.1



1.2

CÔNG BÁO SỞ HỮU CÔNG NGHIỆP SỐ 406 TẬP A – QUYỀN 2 (01.2022)

- (11) **43614**
(21) 3-2021-02084 (28) 1
(54) **ĐỒ CHỨA** (51) **07-99; 09-01**
(22) 16/08/2021 (43) 25/01/2022
(30) 29/771,082 19/02/2021 US;
(73) **MERRILEE KICK (US)**
2114 McDaniel Drive, Carrollton, Texas 75006 USA
(72) Merrilee Kick (US)
(74) Công ty Luật TNHH ROUSE Việt Nam (ROUSE LAW CO.,LTD)
(55)

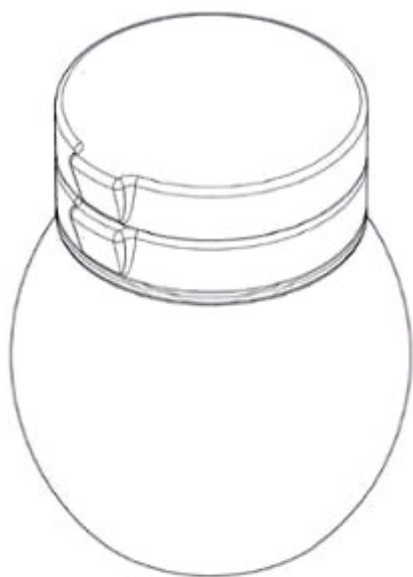

1.1

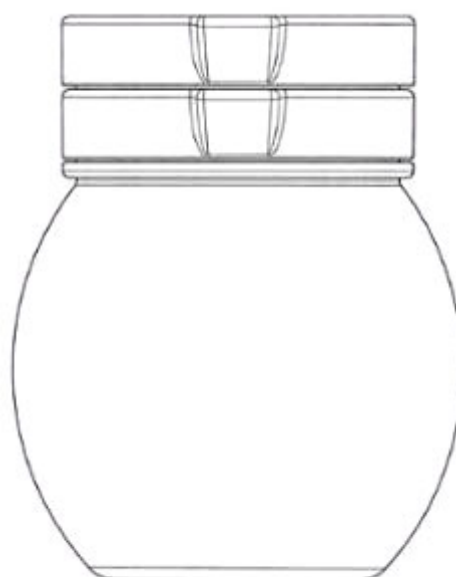

1.2

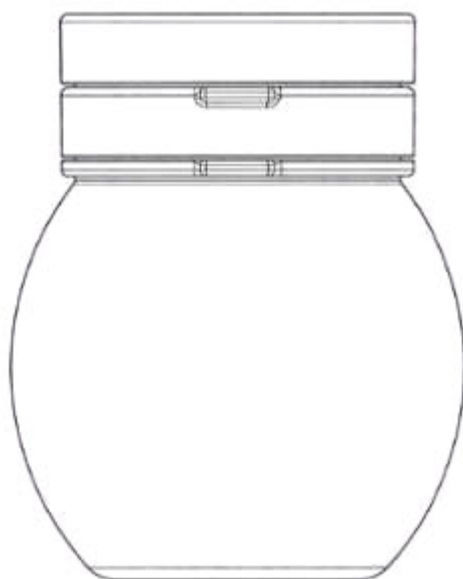

1.3

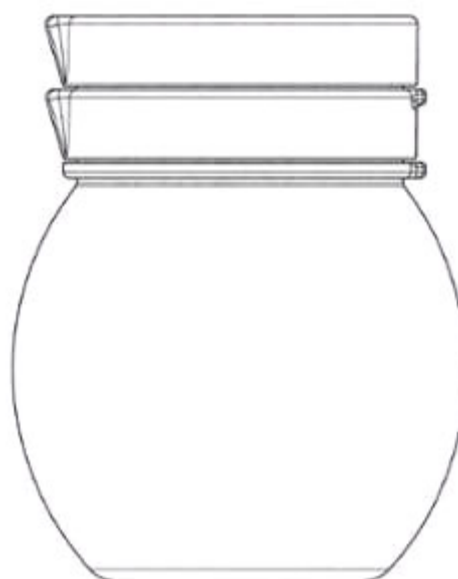

1.4

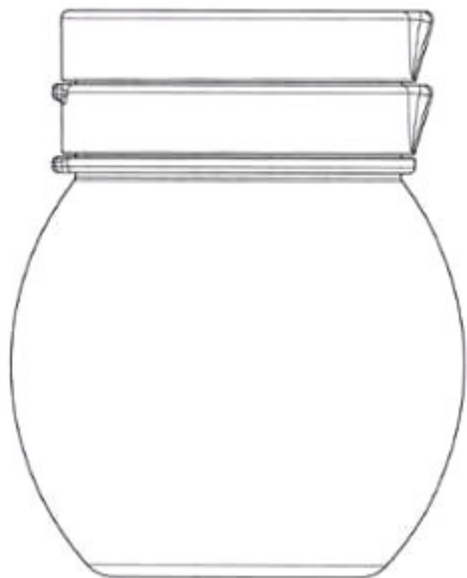

1.5

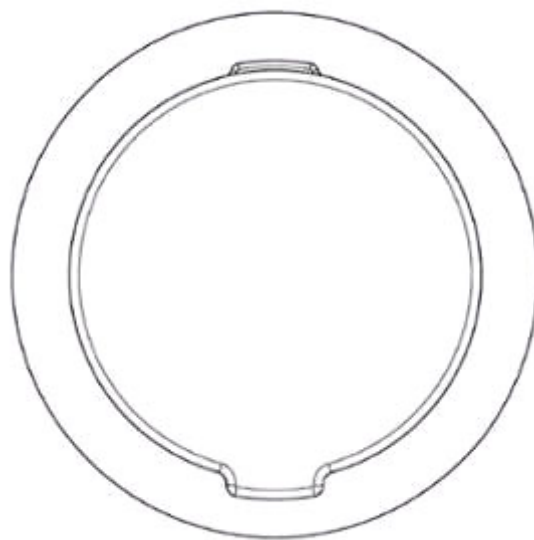

1.6

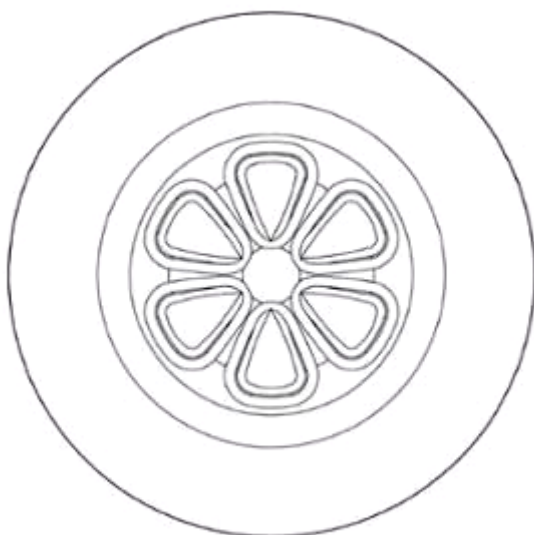

1.7



1.8

- (11) **43615**
(21) 3-2021-02087 (28) 1
(54) **CẤU KIỆN NHÀ MÁI VÒM LẮP GHÉP** (51) **25-02**
(22) 17/08/2021 (43) 25/01/2022
(73) **CÔNG TY CỔ PHẦN KHOA HỌC CÔNG NGHỆ VIỆT NAM (VN)**
Số 6 đường 3 tháng 2, phường 8, thành phố Vũng Tàu, tỉnh Bà Rịa - Vũng Tàu
(72) Hoàng Đức Thảo (VN)
(55)

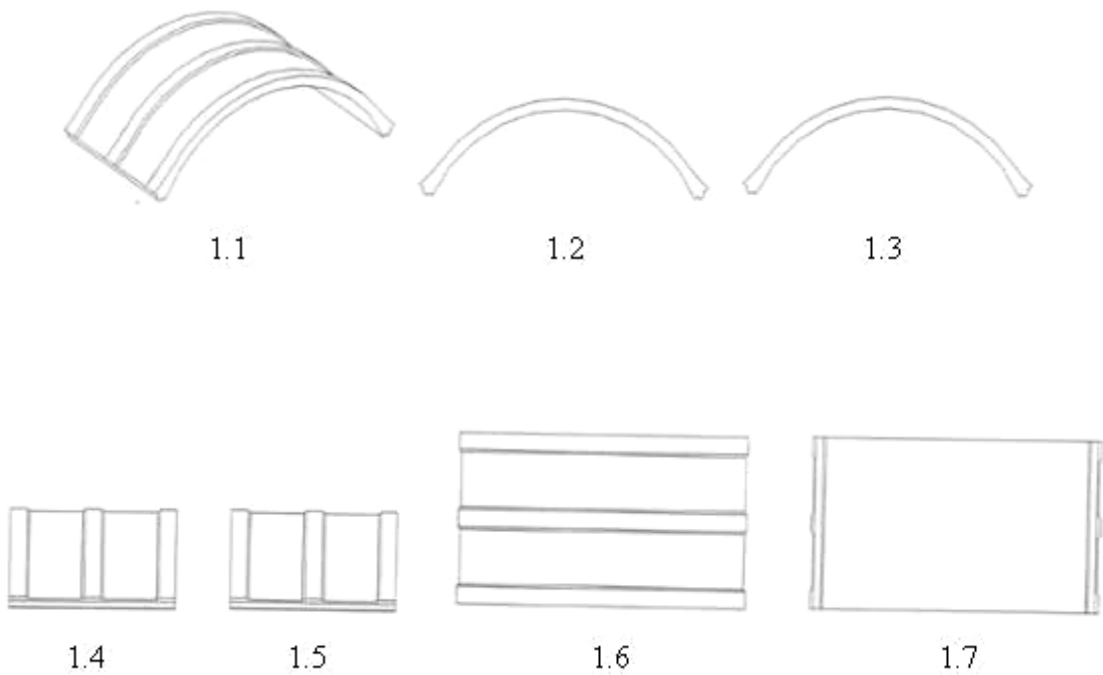

- (11) **43616**
(21) 3-2021-02088 (28) 1
(54) **CẤU KIỆN NHÀ MÁI VÒM LẮP GHÉP** (51) **25-02**
(22) 17/08/2021 (43) 25/01/2022
(73) **CÔNG TY CỔ PHẦN KHOA HỌC CÔNG NGHỆ VIỆT NAM (VN)**
Số 6 đường 3 tháng 2, phường 8, thành phố Vũng Tàu, tỉnh Bà Rịa - Vũng Tàu
(72) Hoàng Đức Thảo (VN)
(55)



1.1



1.2



1.3



1.4



1.5



1.6



1.7

- (11) **43617**
(21) 3-2021-02089 (28) 1
(54) **CẤU KIỆN NHÀ MÁI VÒM LẤP GHÉP** (51) **25-02**
(22) 17/08/2021 (43) 25/01/2022
(73) **CÔNG TY CỔ PHẦN KHOA HỌC CÔNG NGHỆ VIỆT NAM (VN)**
Số 6 đường 3 tháng 2, phường 8, thành phố Vũng Tàu, tỉnh Bà Rịa - Vũng Tàu
(72) Hoàng Đức Thảo (VN)
(55)

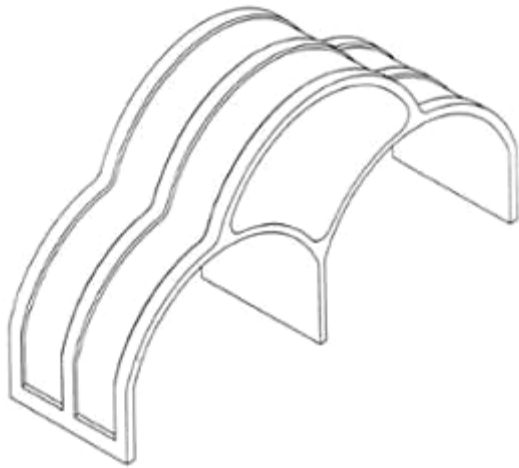

1.1

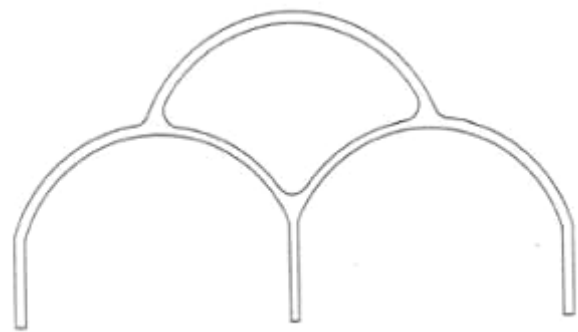

1.2

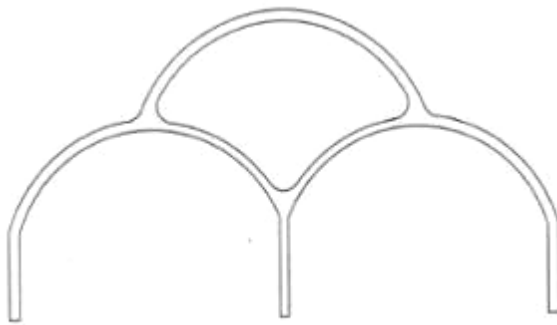

1.3



1.4



1.5



1.6



1.7

(11) **43618**

(21) 3-2021-02090

(28) 1

(54) **CẤU KIỆN NHÀ MÁI VÒM LẤP GHÉP**

(51) **25-02**

(22) 17/08/2021

(43) 25/01/2022

(73) **CÔNG TY CỔ PHẦN KHOA HỌC CÔNG NGHỆ VIỆT NAM (VN)**

Số 6 đường 3 tháng 2, phường 8, thành phố Vũng Tàu, tỉnh Bà Rịa - Vũng Tàu

(72) Hoàng Đức Thảo (VN)

(55)



1.1



1.2



1.3



1.4

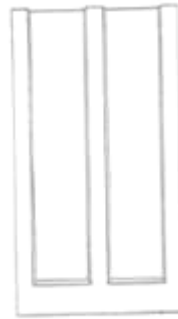

1.5



1.6



1.7

CÔNG BÁO SỞ HỮU CÔNG NGHIỆP SỐ 406 TẬP A – QUYỀN 2 (01.2022)

- (11) **43619**
(21) 3-2021-02093 (28) 1
(54) **KHUNG LỒNG NUÔI THỦY SẢN** (51) **30-02**
(22) 18/08/2021 (43) 25/01/2022
(73) **CÔNG TY TNHH MỘT THÀNH VIÊN DỊCH VỤ VÀ CÔNG NGHỆ NUÔI TRỒNG THỦY SẢN (VN)**
Số nhà 16, ngõ 2A, đường Bùi Huy Bích, xóm 16, xã Hưng Lộc, thành phố Vinh, tỉnh Nghệ An
(72) Hoàng Văn Hợi (VN)
(55)



1.1



1.2



1.3



1.4

CÔNG BÁO SỞ HỮU CÔNG NGHIỆP SỐ 406 TẬP A – QUYỀN 2 (01.2022)

(11) **43620**

(21) 3-2021-02095

(28) 1

(54) **THANH KHUNG TRẦN NHÀ**

(51) **25-01**

(22) 18/08/2021

(43) 25/01/2022

(73) **CÔNG TY CỔ PHẦN CÔNG NGHIỆP VĨNH TUỜNG (VN)**

Lô C23a, Khu công nghiệp Hiệp Phước, xã Hiệp Phước, huyện Nhà Bè, thành phố Hồ Chí Minh

(72) 1. LÊ ANH TUẤN (VN)

2. NGUYỄN DUY KHÁNH (VN)

3. LÊ XUÂN TUẤN (VN)

(74) Văn phòng Luật sư A Hoà (AHOA LAW OFFICE)

(55)



1.1

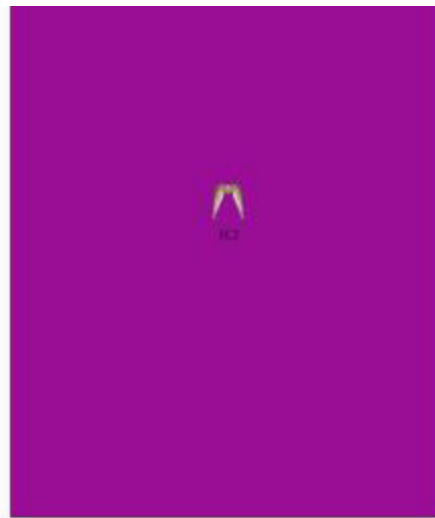

1.2

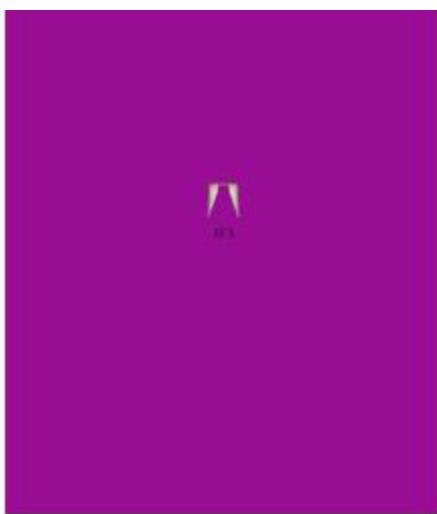

1.3

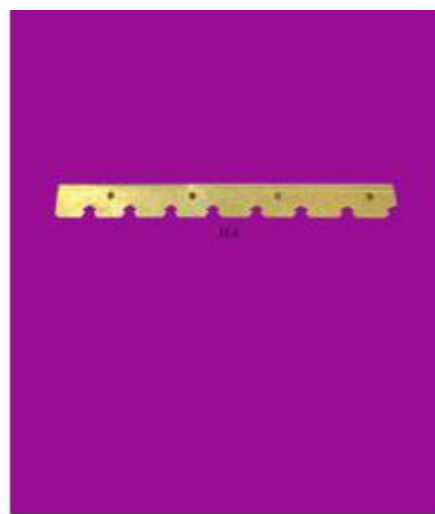

1.4

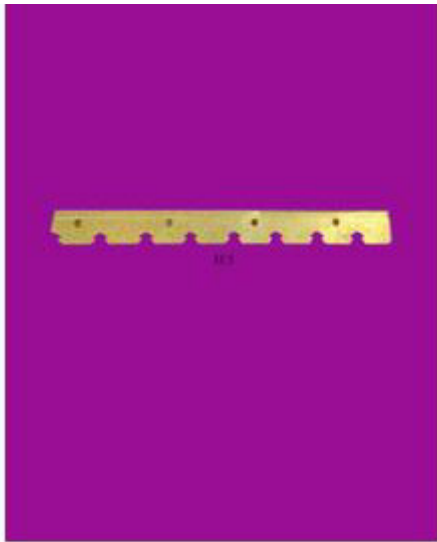

1.5



1.6



1.7



1.8

- (11) **43621**
(21) 3-2021-02097 (28) 1
(54) **THIẾT BỊ ĐIỀU CHỈNH DÂY ĐAI** (51) **08-07**
(22) 18/08/2021 (43) 25/01/2022
(30) 30-2021-0009117 23/02/2021 KR;
(73) **WOOJIN PLASTIC CO., LTD (KR)**
45, Paryasandan-ro, Jinjeop-eup, Namyangju-si, Gyeonggi-do 12017 Republic of Korea
(72) 1. JISOOK PAIK (KR)
2. NAN HEE PAIK (KR)
3. JI HYE PAIK (KR)
4. JI WON SON (KR)
(74) Công ty TNHH Trường Xuân (AGELESS CO.,LTD.)
(55)



1.1

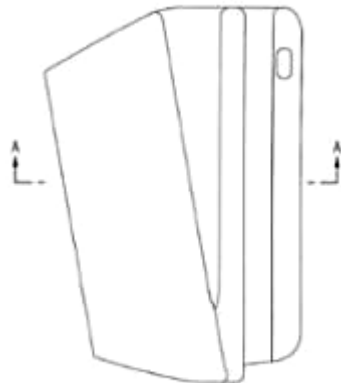

1.2



1.3



1.4



1.5



1.6



1.7

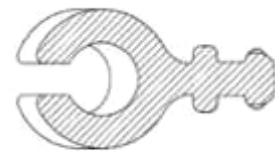

1.8

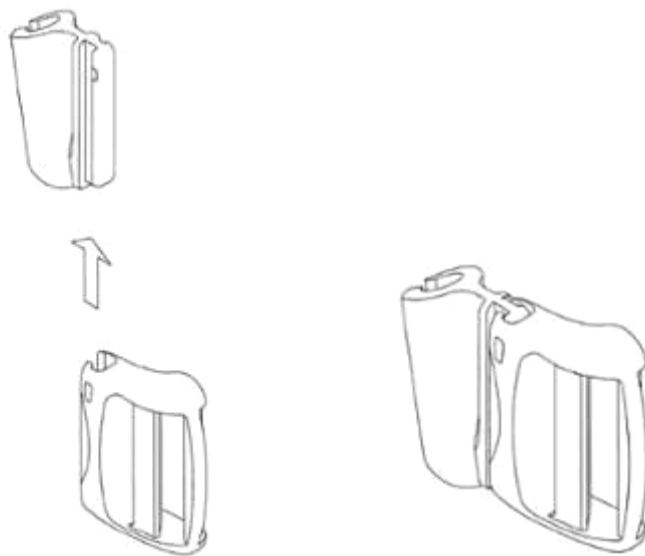

1.9

1.10



1.11

- (11) **43622**
(21) 3-2021-02098 (28) 1
(54) **THIẾT BỊ ĐIỀU CHỈNH DÂY ĐAI** (51) **08-07**
(22) 18/08/2021 (43) 25/01/2022
(30) 30-2021-0008932 23/02/2021 KR;
(73) **WOOJIN PLASTIC CO., LTD (KR)**
45, Paryasandan-ro, Jinjeop-eup, Namyangju-si, Gyeonggi-do 12017 Republic of Korea
(72) 1. JISOOK PAIK (KR)
2. NAN HEE PAIK (KR)
3. JI HYE PAIK (KR)
4. JI WON SON (KR)
(74) Công ty TNHH Trường Xuân (AGELESS CO.,LTD.)
(55)

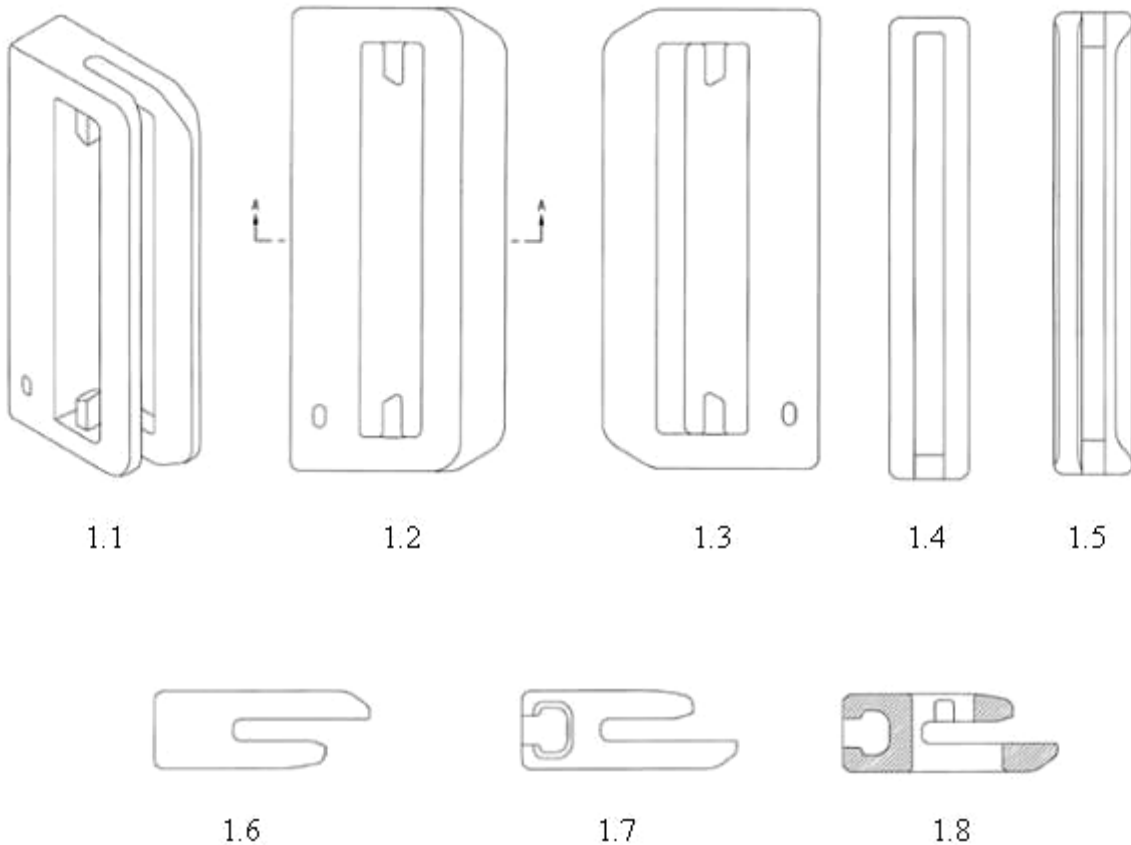

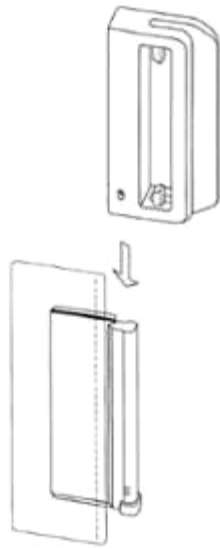

1.9

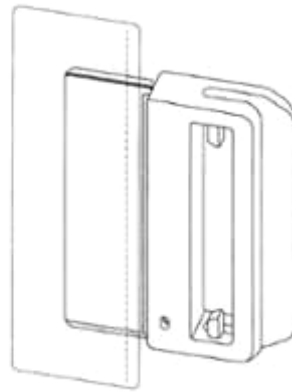

1.10

- (11) **43623**
(21) 3-2021-02099 (28) 1
(54) **KHÓA** (51) **02-07**
(22) 18/08/2021 (43) 25/01/2022
(30) 30-2021-0009111 23/02/2021 KR;
(73) **WOJIN PLASTIC CO., LTD (KR)**
45, Paryasandan-ro, Jinjeop-eup, Namyangju-si, Gyeonggi-do 12017 Republic of Korea
(72) 1. JISOOK PAIK (KR)
2. NAN HEE PAIK (KR)
3. JI HYE PAIK (KR)
4. JI WON SON (KR)
(74) Công ty TNHH Trường Xuân (AGELESS CO.,LTD.)
(55)



1.1

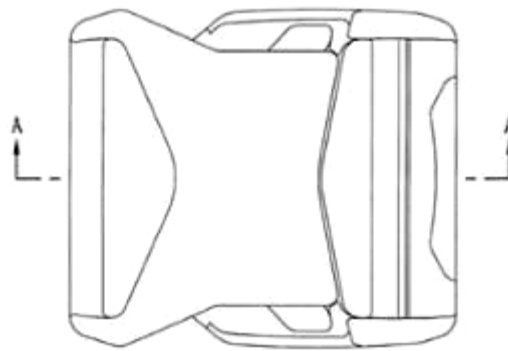

1.2

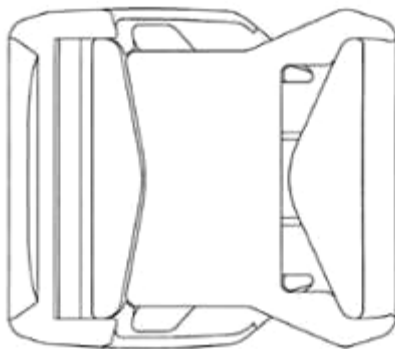

1.3



1.4



1.5



1.6



1.7



1.8

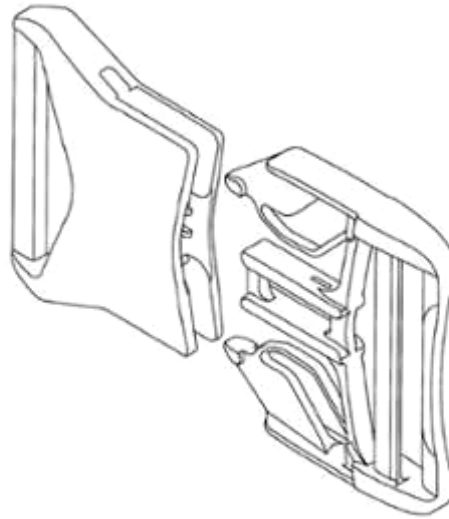

1.9

CÔNG BÁO SỞ HỮU CÔNG NGHIỆP SỐ 406 TẬP A – QUYỀN 2 (01.2022)

- (11) **43624**
(21) 3-2021-02105 (28) 1
(54) **DÉP** (51) **02-04**
(22) 19/08/2021 (43) 25/01/2022
(30) 29/771,365 22/02/2021 US;
(73) **CROCS, INC. (US)**
13601 Via Varra, Broomfield, Colorado 80020, United States of America
(72) Alexander Jacob MAYHEW (US)
(74) Công ty Luật TNHH quốc tế BMVN (BMVN INTERNATIONAL LLC)
(55)



1.1



1.2



1.3



1.4



1.5



1.6



1.7

CÔNG BÁO SỞ HỮU CÔNG NGHIỆP SỐ 406 TẬP A – QUYỀN 2 (01.2022)

- (11) **43625**
(21) 3-2021-02126 (28) 1
(54) **DÉP** (51) **02-04**
(22) 20/08/2021 (43) 25/01/2022
(30) 29/771,356 22/02/2021 US;
(73) **CROCS, INC. (US)**
13601 Via Varra, Broomfield, Colorado 80020, United States of America
(72) Alexander Jacob MAYHEW (US)
(74) Công ty Luật TNHH quốc tế BMVN (BMVN INTERNATIONAL LLC)
(55)



1.1



1.2



1.3



1.4



1.5



1.6



1.7

CÔNG BÁO SỞ HỮU CÔNG NGHIỆP SỐ 406 TẬP A – QUYỀN 2 (01.2022)

- (11) **43626**
(21) 3-2021-02127 (28) 1
(54) **DÉP** (51) **02-04**
(22) 20/08/2021 (43) 25/01/2022
(30) 29/771,369 22/02/2021 US;
(73) **CROCS, INC. (US)**
13601 Via Varra, Broomfield, Colorado 80020, United States of America
(72) Alexander Jacob MAYHEW (US)
(74) Công ty Luật TNHH quốc tế BMVN (BMVN INTERNATIONAL LLC)
(55)



1.1



1.2



1.3



1.4



1.5



1.6



1.7

(11) **43627**

(21) 3-2021-02181

(28) 1

(54) **GHẾ**

(51) **06-01**

(22) 26/08/2021

(43) 25/01/2022

(73) **CÔNG TY TNHH KIẾN TRÚC & XÂY DỰNG SMA STUDIO (VN)**
Số 44A19, tổ 3, phường Nghĩa Tân, quận Cầu Giấy, thành phố Hà Nội

(72) Nguyễn Phương Chi (VN)

(74) Công ty TNHH Tư vấn Quốc Dân (NACILAW)

(55)



1.1



1.2



1.3



1.4



1.5



1.6



1.7

- (11) **43628**
(21) 3-2021-02183 (28) 1
(54) **THIẾT BỊ KIỂM TRA ĐỘ TRỄ ĐÁP ỨNG CỦA CÁNH LÁI THIẾT BỊ BAY** (51) **10-05**
(22) 27/08/2021 (43) 25/01/2022
(73) **TẬP ĐOÀN CÔNG NGHIỆP – VIỆN THÔNG QUÂN ĐỘI (VN)**
Lô D26 khu đô thị mới Cầu Giấy, phường Yên Hoà, quận Cầu Giấy, thành phố Hà Nội
(72) Hà Thị Hồng Yến (VN)
(74) Công ty TNHH Tư vấn Quốc Dân (NACILAW)
(55)

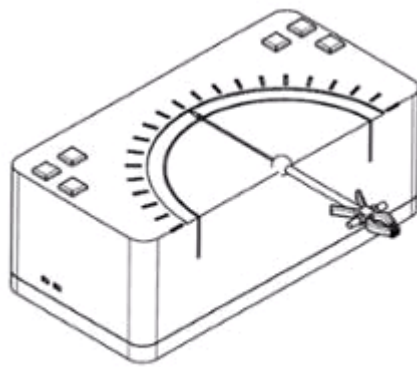

1.1

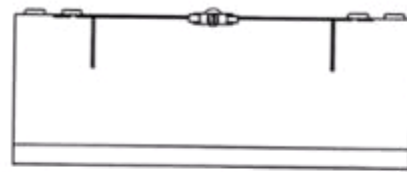

1.2



1.3

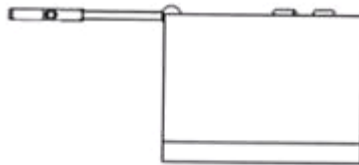

1.4

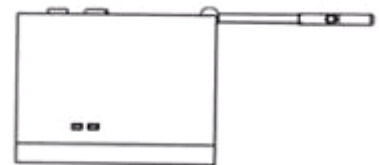

1.5

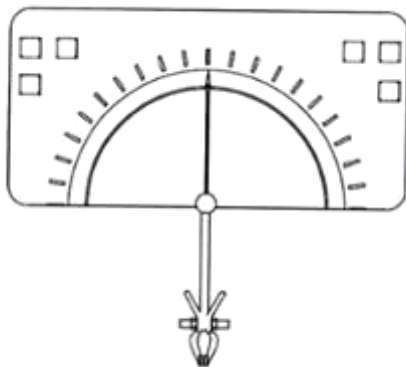

1.6

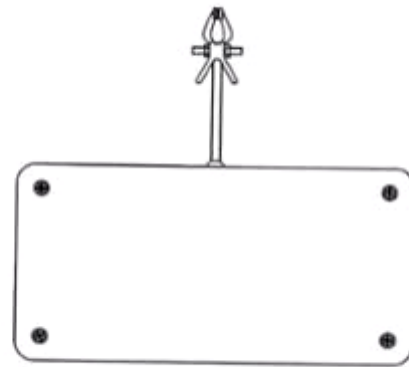

1.7

- (11) **43629**
(21) 3-2021-02184 (28) 1
(54) **CHAI** (51) **09-01**
(22) 27/08/2021 (43) 25/01/2022
(30) 29/778,179 12/04/2021 US;
(73) **DART INDUSTRIES INC. (US)**
14901 S. Orange Blossom Trail, Orlando, Florida 32837, United States of America
(72) Teo Sok Yee (MY)
(74) **CÔNG TY LUẬT TRÁCH NHIỆM HỮU HẠN AMBYS HÀ NỘI (AMBYS HANOI)**
(55)



1.1



1.2

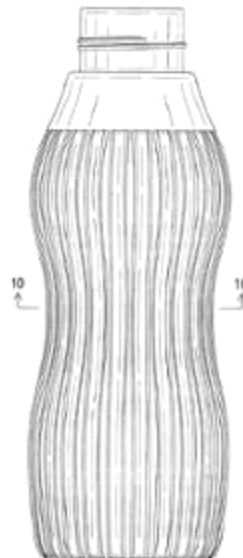

1.3



1.4



1.5



1.6

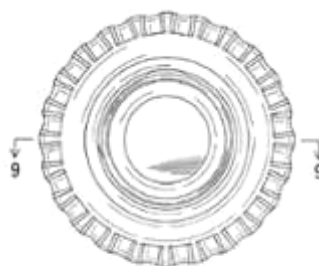

1.7

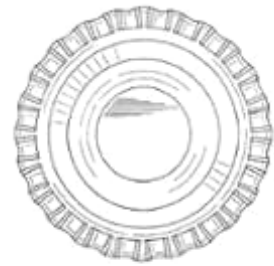

1.8

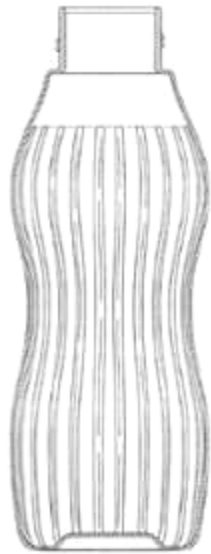

1.9

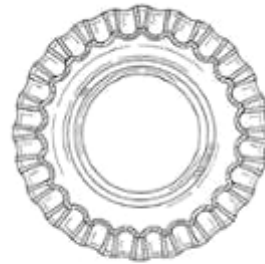

1.10

- (11) **43630**
(21) 3-2021-02191 (28) 1
(54) **BỘ PHẬN TẮM TƯỜNG RỒNG LẮP GHÉP** (51) **25-02**
(22) 27/08/2021 (43) 25/01/2022
(73) **NGUYỄN XUÂN THỦY (VN)**
Tổ 3, khu 10, phường Bãi Cháy, thành phố Hạ Long, tỉnh Quảng Ninh
(72) Nguyễn Xuân Thủy (VN)
(55)



1.1



1.2



1.3

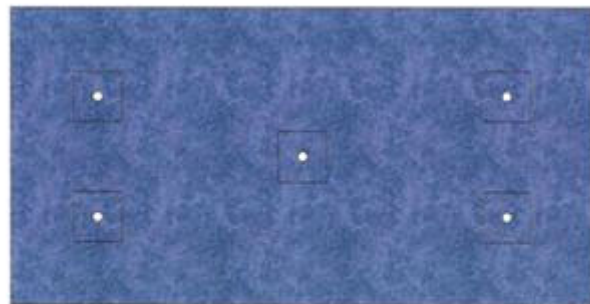

1.4

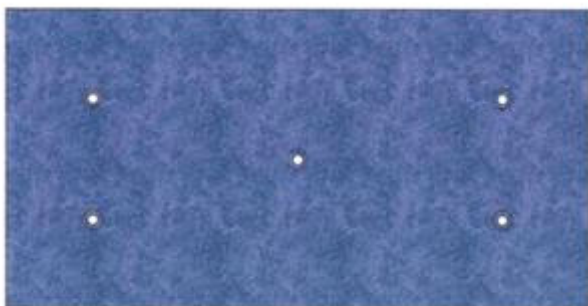

1.5



1.6

- (11) **43631**
(21) 3-2021-02192 (28) 1
(54) **TẤM TƯỜNG RỒNG LẮP GHÉP** (51) **25-02**
(22) 27/08/2021 (43) 25/01/2022
(73) **NGUYỄN XUÂN THỦY (VN)**
Tổ 3, khu 10, phường Bãi Cháy, thành phố Hạ Long, tỉnh Quảng Ninh
(72) Nguyễn Xuân Thủy (VN)
(55)



1.1



1.2



1.3



1.4



1.5



1.6

- (11) **43632**
(21) 3-2021-02193 (28) 1
(54) **BỘ PHẬN TẤM TƯỜNG RỒNG LẮP GHÉP** (51) **25-02**
(22) 27/08/2021 (43) 25/01/2022
(73) **NGUYỄN XUÂN THỦY (VN)**
Tổ 3, khu 10, phường Bãi Cháy, thành phố Hạ Long, tỉnh Quảng Ninh
(72) Nguyễn Xuân Thủy (VN)
(55)



1.1



1.2



1.3

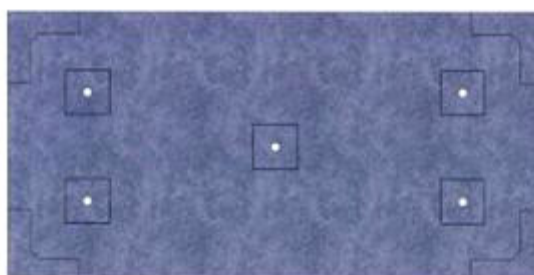

1.4



1.5



1.6

CÔNG BÁO SỞ HỮU CÔNG NGHIỆP SỐ 406 TẬP A – QUYỀN 2 (01.2022)

- (11) **43633**
(21) 3-2021-02206 (28) 1
(54) **CABIN GHẾ NẰM XE Ô TÔ** (51) **12-16**
(22) 31/08/2021 (43) 25/01/2022
(73) **CÔNG TY TNHH SKYBUS (VN)**
404 Hà Huy Giáp, phường Thạnh Lộc, quận 12, thành phố Hồ Chí Minh
(72) Huỳnh Tấn Lộc (VN)
(74) Công ty Cổ phần PHANLAW VIETNAM (PHANLAW VIETNAM JSC)
(55)



1.1

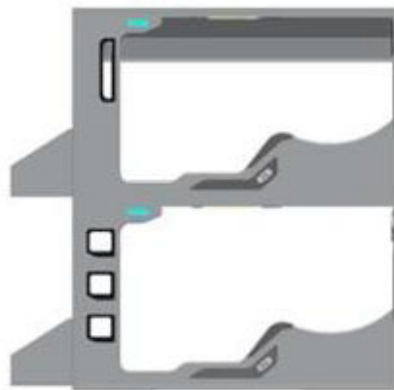

1.2

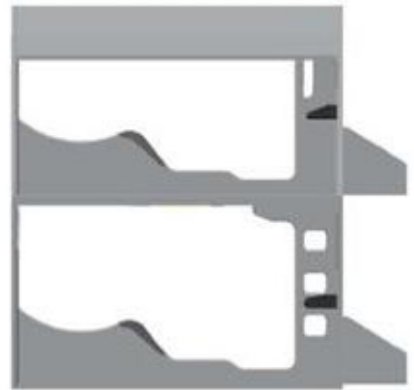

1.3

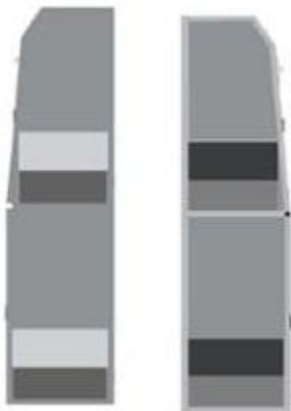

1.4

1.5



1.6



1.7



1.8

- (11) **43634**
(21) 3-2021-02208 (28) 1
(54) **Ô TÔ ĐỒ CHƠI** (51) **21-01**
(22) 01/09/2021 (43) 25/01/2022
(30) 008453450 05/03/2021 EM;
(73) **FERRARI S.P.A. (IT)**
Via Emilia Est 1163, MODENA, Italy
(72) Mattia BINOTTO (IT)
(74) Công ty TNHH một thành viên Sở hữu trí tuệ VCCI (VCCI-IP CO.,LTD)
(55)

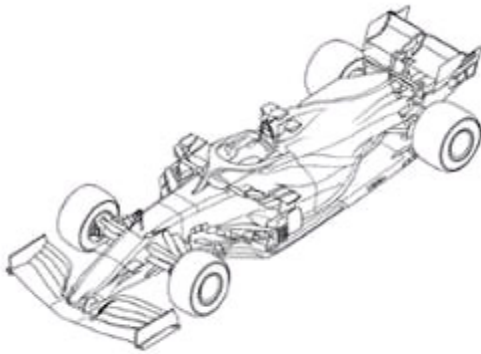

1.1

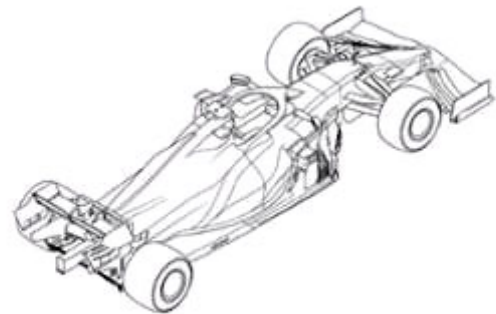

1.2

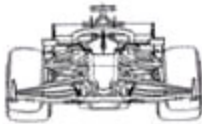

1.3

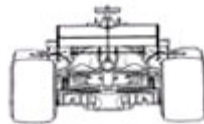

1.4

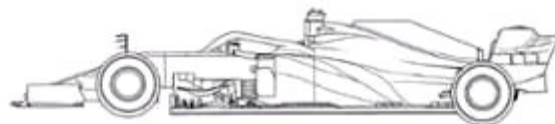

1.5

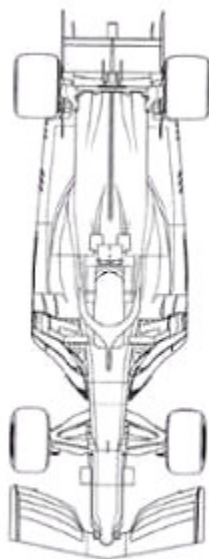

1.6



1.7

CÔNG BÁO SỞ HỮU CÔNG NGHIỆP SỐ 406 TẬP A – QUYỀN 2 (01.2022)

- (11) **43635**
(21) 3-2021-02209 (28) 1
(54) **Ô TÔ** (51) **12-08**
(22) 01/09/2021 (43) 25/01/2022
(30) 008453435 05/03/2021 EM;
(73) **FERRARI S.P.A. (IT)**
Via Emilia Est 1163, MODENA, Italy
(72) Mattia BINOTTO (IT)
(74) Công ty TNHH một thành viên Sở hữu trí tuệ VCCI (VCCI-IP CO.,LTD)
(55)

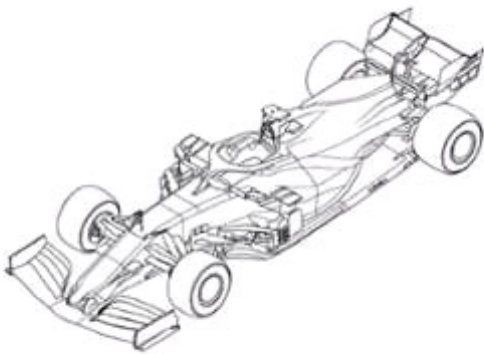

1.1

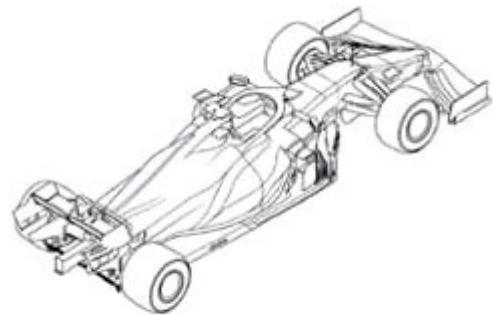

1.2

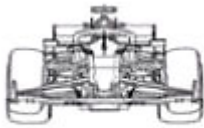

1.3

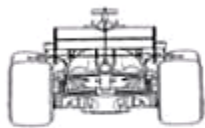

1.4

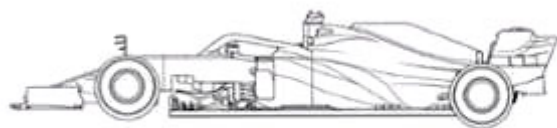

1.5

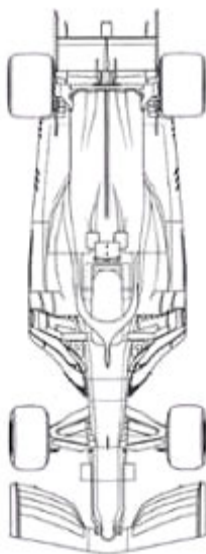

1.6



1.7

- (11) **43636**
(21) 3-2021-02259 (28) 1
(54) **THIẾT BỊ PHÒNG ĐIỆN KHỬ KHUẨN** (51) **23-01**
(22) 13/09/2021 (43) 25/01/2022
(30) 2021-016641 30/07/2021 JP;
(73) **PANASONIC INTELLECTUAL PROPERTY MANAGEMENT CO., LTD.**
(JP)
1-61, Shiromi 2-chome, Chuo-ku, Osaka-shi, Osaka 540-6207 Japan
(72) 1. YOHEI ISHIGAMI (JP)
2. MAKOTO IMAI (JP)
3. HIDETOSHI HATA (JP)
4. TAKAFUMI OMORI (JP)
5. TETSUNORI AONO (JP)
6. KENJI OGURA (JP)
7. YUKI TAKIGAWA (JP)
(74) Công ty TNHH một thành viên Sở hữu trí tuệ VCCI (VCCI-IP CO.,LTD)
(55)

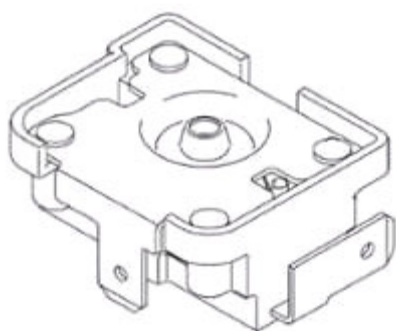

1.1

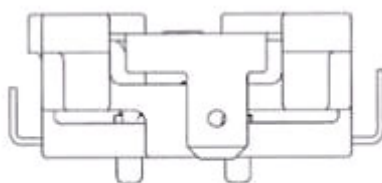

1.2

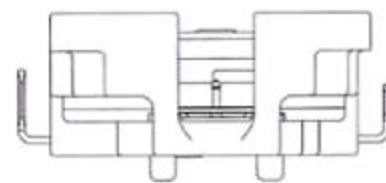

1.3

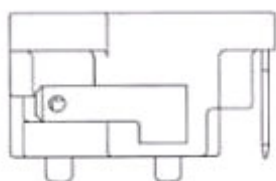

1.4

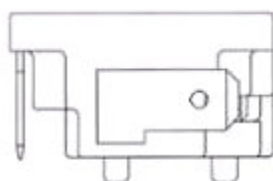

1.5

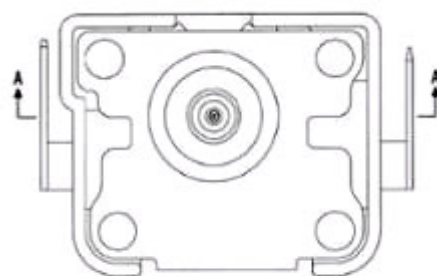

1.6

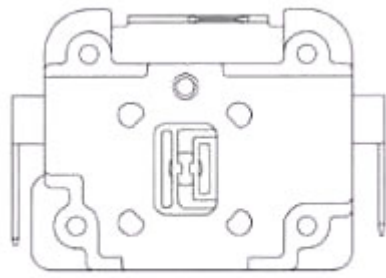

1.7

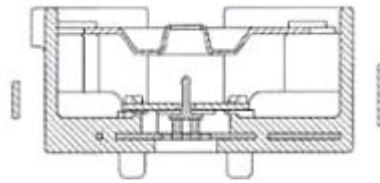

1.8

CÔNG BÁO SỞ HỮU CÔNG NGHIỆP SỐ 406 TẬP A – QUYỀN 2 (01.2022)

- (11) **43637**
(21) 3-2021-02260 (28) 1
(54) **BỒN CHỨA CHẤT THẢI** (51) **23-01; 23-99**
(22) 14/09/2021 (43) 25/01/2022
(73) **CÔNG TY CỔ PHẦN QUỐC TẾ SATA (VN)**
Nhà số 9, ngách 32/98, TDP Đông 6, đường Cổ Nhuế, phường Cổ Nhuế 2, quận
Bắc Từ Liêm, thành phố Hà Nội
(72) 1. BIÊN VĂN BÂY (VN)
2. NGUYỄN VĂN THANH (VN)
3. TRẦN VĂN THẮNG (VN)
4. TRỊNH THỊ PHƯỢNG (VN)
5. LÊ THỊ HẰNG (VN)
(74) Công ty TNHH Tư vấn IPNG (IPNG CO.,LTD)
(55)



1.1



1.2



1.3



1.4



1.5



1.6



1.7

CÔNG BÁO SỞ HỮU CÔNG NGHIỆP SỐ 406 TẬP A – QUYỂN 2 (01.2022)

- (11) **43638**
(21) 3-2021-02273
(54) **LÒ ĐỐT RÁC THẢI**
(22) 15/09/2021
(73) **CÔNG TY CỔ PHẦN TẬP ĐOÀN CÔNG NGHỆ T-TECH VIỆT NAM (VN)**
Tầng 24, tòa nhà Vinaconex 9, đường Phạm Hùng, phường Mỹ Trì, quận Nam Từ Liêm, thành phố Hà Nội
(72) Nguyễn Đình Trọng (VN)
(55)
- (28) 1
(51) **23-99**
(43) 25/01/2022

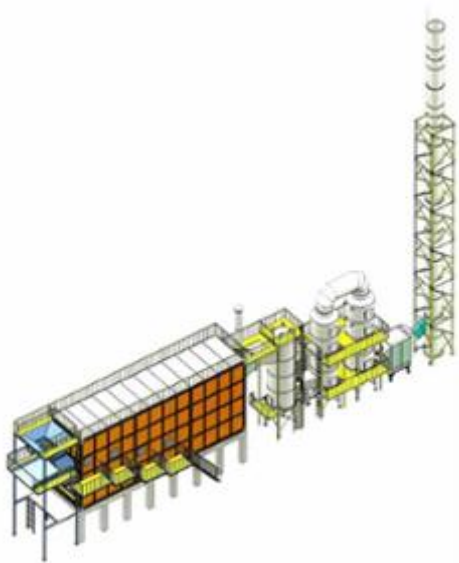

1.1

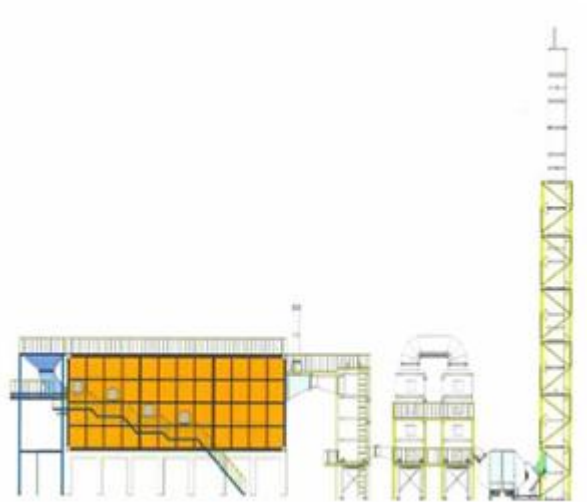

1.2

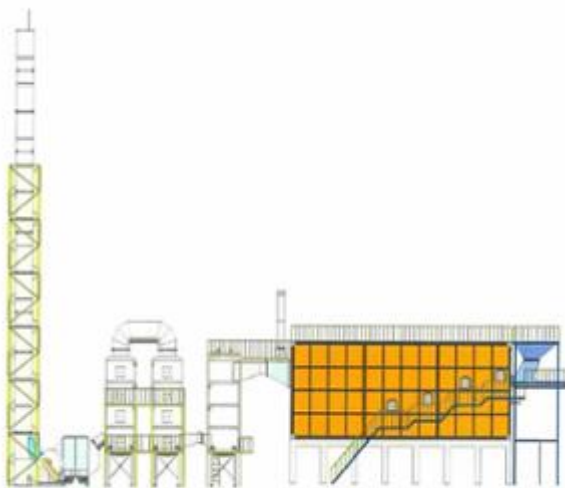

1.3

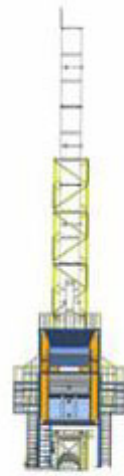

1.4

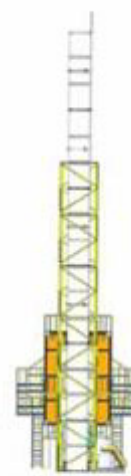

1.5

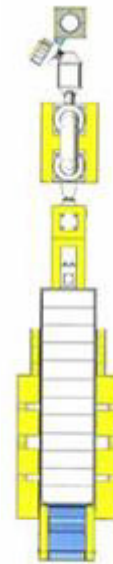

1.6



1.7

CÔNG BÁO SỞ HỮU CÔNG NGHIỆP SỐ 406 TẬP A – QUYỂN 2 (01.2022)

- (11) **43639**
(21) 3-2021-02274 (28) 1
(54) **LÒ ĐỐT RÁC THẢI** (51) **23-99**
(22) 15/09/2021 (43) 25/01/2022
(73) **CÔNG TY CỔ PHẦN TẬP ĐOÀN CÔNG NGHỆ T-TECH VIỆT NAM (VN)**
Tầng 24, tòa nhà Vinaconex 9, đường Phạm Hùng, phường Mỹ Trì, quận Nam Từ Liêm, thành phố Hà Nội
(72) Nguyễn Đình Trọng (VN)
(55)

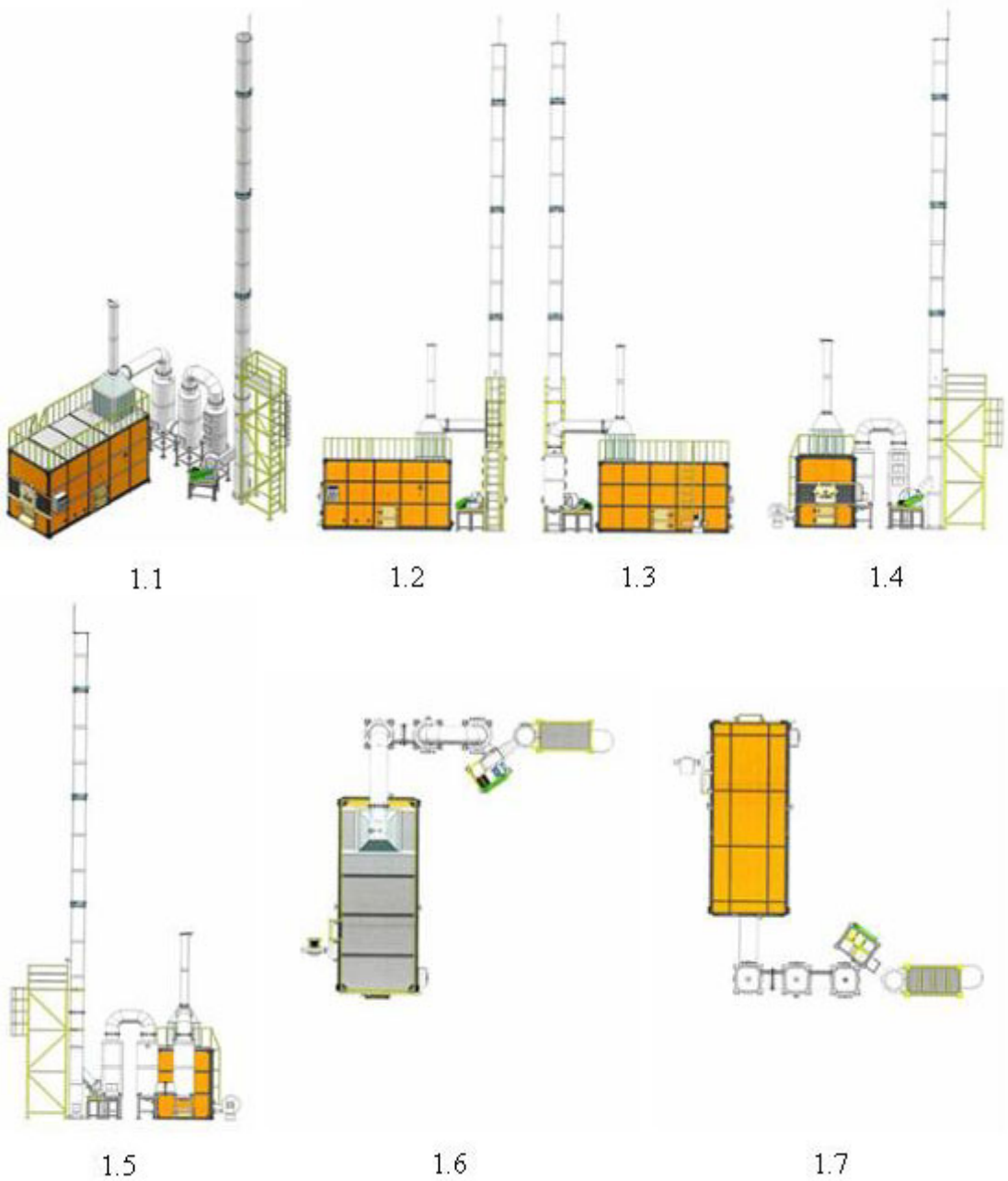

CÔNG BÁO SỞ HỮU CÔNG NGHIỆP SỐ 406 TẬP A – QUYỀN 2 (01.2022)

- (11) **43640**
(21) 3-2021-02275 (28) 1
(54) **LÒ ĐỐT RÁC THẢI** (51) **23-99**
(22) 15/09/2021 (43) 25/01/2022
(73) **CÔNG TY CỔ PHẦN TẬP ĐOÀN CÔNG NGHỆ T-TECH VIỆT NAM (VN)**
Tầng 24, tòa nhà Vinaconex 9, đường Phạm Hùng, phường Mỹ Trì, quận Nam Từ Liêm, thành phố Hà Nội
(72) Nguyễn Đình Trọng (VN)
(55)



1.1



1.2

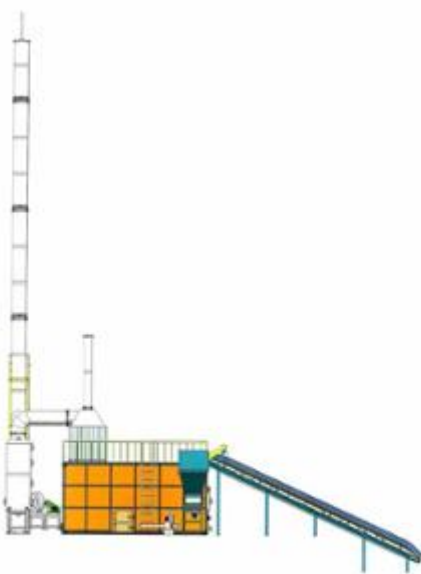

1.3



1.4

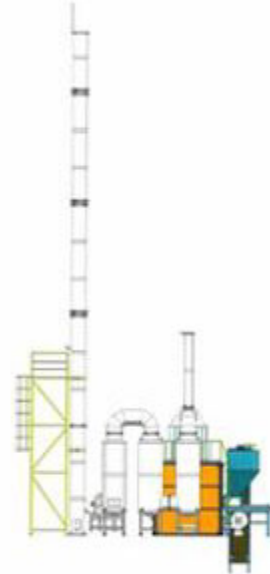

1.5

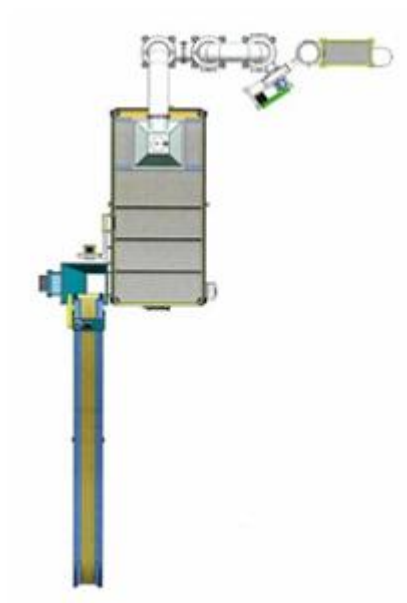

1.6

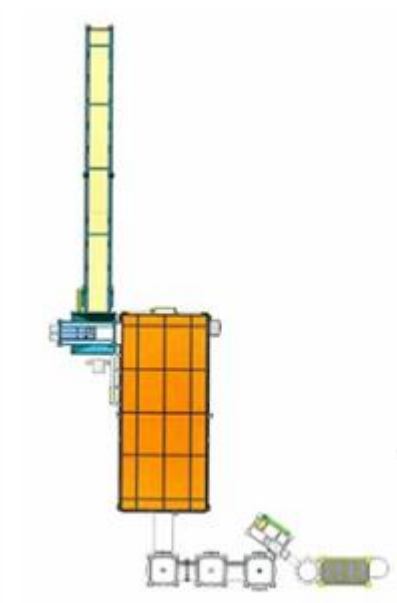

1.7

(11) **43641**

(21) 3-2021-02293

(28) 1

(54) **KHUNG LỒNG NUÔI THỦY SẢN**

(51) **30-02**

(22) 17/09/2021

(43) 25/01/2022

(73) **CÔNG TY TNHH MỘT THÀNH VIÊN DỊCH VỤ VÀ CÔNG NGHỆ NUÔI TRỒNG THỦY SẢN (VN)**

Số nhà 16, ngõ 2A, đường Bùi Huy Bích, xóm 16, xã Hưng Lộc, thành phố Vinh, tỉnh Nghệ An

(72) Hoàng Văn Hợi (VN)

(55)



1.1



1.2



1.3



1.4

CÔNG BÁO SỞ HỮU CÔNG NGHIỆP SỐ 406 TẬP A – QUYỀN 2 (01.2022)

- (11) **43642**
- (21) 3-2021-02298 (28) 1
- (54) **THIẾT BỊ QUANG PHỔ PHÁT HIỆN NHANH COVID-19** (51) **24-01**
- (22) 20/09/2021 (43) 25/01/2022
- (73) **CÔNG TY CỔ PHẦN BKAV (VN)**
Tầng 2 tòa nhà HH1, khu đô thị Yên Hòa, phường Yên Hòa, quận Cầu Giấy, thành phố Hà Nội
- (72) 1. **VŨ THANH THẮNG (VN)**
2. **HOÀNG MẠNH CƯỜNG (VN)**
- (55)



1.1



1.2



1.3



1.4



1.5

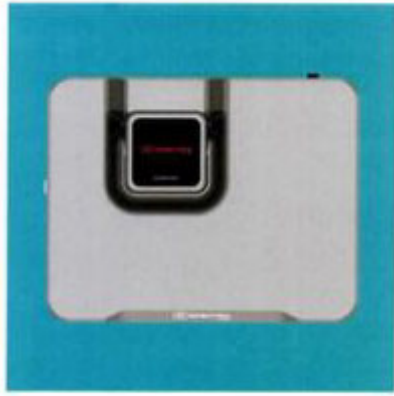

1.6

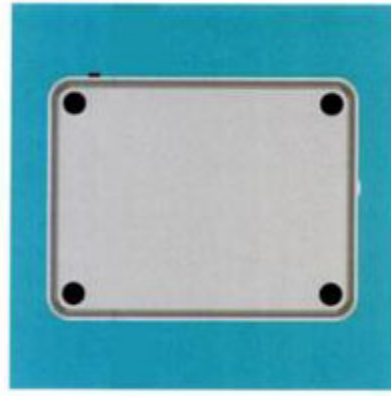

1.7

CÔNG BÁO SỞ HỮU CÔNG NGHIỆP SỐ 406 TẬP A – QUYỀN 2 (01.2022)

- (11) **43643**
(21) 3-2021-02342 (28) 1
(54) **THÙNG ĐỰNG SƠN** (51) **09-02**
(22) 13/07/2020 (43) 25/01/2022
(73) **CÔNG TY TNHH THƯƠNG MẠI SẢN XUẤT VẬT LIỆU XÂY DỰNG HUY HOÀNG (VN)**
Thôn Tranh Ngoài, xã Thúc Kháng, huyện Bình Giang, tỉnh Hải Dương
(72) Vũ Đức Bàn (VN)
(74) Công ty TNHH Sở hữu trí tuệ ALNGUYEN (ALNGUYEN IP CO.,LTD.)
(55)



1.1



1.2



1.3



1.4

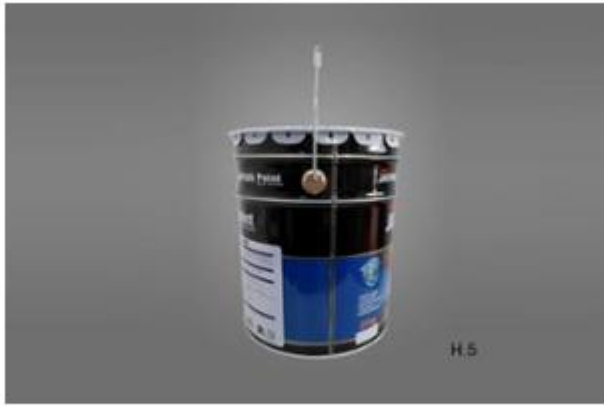

H.5

1.5



H.6

1.6



H.7

1.7

CÔNG BÁO SỞ HỮU CÔNG NGHIỆP SỐ 406 TẬP A – QUYỀN 2 (01.2022)

- (11) **43644**
(21) 3-2021-02343 (28) 1
(54) **THÙNG ĐỰNG SƠN** (51) **09-02**
(22) 13/07/2020 (43) 25/01/2022
(73) **CÔNG TY TNHH THƯƠNG MẠI SẢN XUẤT VẬT LIỆU XÂY DỰNG HUY HOÀNG (VN)**
Thôn Tranh Ngoài, xã Thúc Kháng, huyện Bình Giang, tỉnh Hải Dương
(72) Vũ Đức Bàn (VN)
(74) Công ty TNHH Sở hữu trí tuệ ALNGUYEN (ALNGUYEN IP CO.,LTD.)
(55)



1.1



1.2



1.3



1.4



1.5



1.6



1.7

CÔNG BÁO SỞ HỮU CÔNG NGHIỆP SỐ 406 TẬP A – QUYỀN 2 (01.2022)

- (11) **43645**
(21) 3-2021-02344 (28) 1
(54) **THÙNG ĐỰNG SƠN** (51) **09-02**
(22) 13/07/2020 (43) 25/01/2022
(73) **CÔNG TY TNHH THƯƠNG MẠI SẢN XUẤT VẬT LIỆU XÂY DỰNG HUY HOÀNG (VN)**
Thôn Tranh Ngoài, xã Thúc Kháng, huyện Bình Giang, tỉnh Hải Dương
(72) Vũ Đức Bàn (VN)
(74) Công ty TNHH Sở hữu trí tuệ ALNGUYEN (ALNGUYEN IP CO.,LTD.)
(55)



1.1



1.2



1.3



1.4



1.5



1.6



1.7

CÔNG BÁO SỞ HỮU CÔNG NGHIỆP SỐ 406 TẬP A – QUYỀN 2 (01.2022)

- (11) **43646**
(21) 3-2021-02345 (28) 1
(54) **THÙNG ĐỰNG SƠN** (51) **09-02**
(22) 13/07/2020 (43) 25/01/2022
(73) **CÔNG TY TNHH THƯƠNG MẠI SẢN XUẤT VẬT LIỆU XÂY DỰNG HUY HOÀNG (VN)**
Thôn Tranh Ngoài, xã Thúc Kháng, huyện Bình Giang, tỉnh Hải Dương
(72) Vũ Đức Bàn (VN)
(74) Công ty TNHH Sở hữu trí tuệ ALNGUYEN (ALNGUYEN IP CO.,LTD.)
(55)



1.1



1.2



1.3



1.4



H.5

1.5



H.6

1.6



H.7

1.7

CÔNG BÁO SỞ HỮU CÔNG NGHIỆP SỐ 406 TẬP A – QUYỀN 2 (01.2022)

- (11) **43647**
(21) 3-2021-02368 (28) 1
(54) **THIẾT BỊ TÍCH HỢP TRUYỀN THANH KỸ THUẬT SỐ** (51) **14-03**
(22) 28/09/2021 (43) 25/01/2022
(73) **CÔNG TY CỔ PHẦN CÔNG NGHỆ SAVIS (VN)**
Tầng 9, tòa nhà Việt Á, số 9 Duy Tân, phường Dịch Vọng Hậu, quận Cầu Giấy,
thành phố Hà Nội
(72) Hoàng Nguyên Vân (VN)
(55)



1.1



1.2



1.3



1.4



1.5



1.6



1.7



1.8

CÔNG BÁO SỞ HỮU CÔNG NGHIỆP SỐ 406 TẬP A – QUYỀN 2 (01.2022)

- (11) **43648**
(21) 3-2021-02369 (28) 1
(54) **ĐẦU THU KỸ THUẬT SỐ** (51) **14-03**
(22) 28/09/2021 (43) 25/01/2022
(73) **CÔNG TY CỔ PHẦN CÔNG NGHỆ SAVIS (VN)**
Tầng 9, tòa nhà Việt Á, số 9 Duy Tân, phường Dịch Vọng Hậu, quận Cầu Giấy,
thành phố Hà Nội
(72) Hoàng Nguyên Vân (VN)
(55)



1.1



1.2



1.3

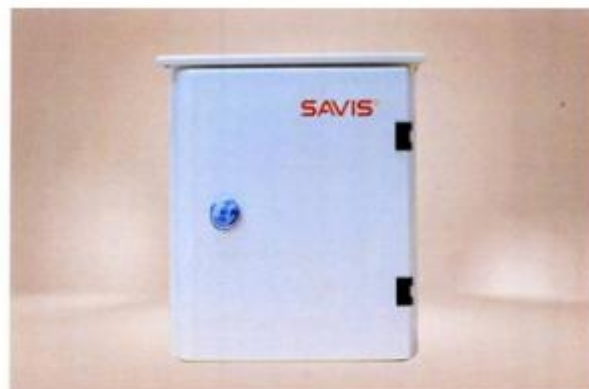

1.4



1.5



1.6



1.7



1.8



1.9

- (11) **43649**
(21) 3-2021-02411 (28) 2
(54) **BAO ĐỰNG** (51) **09-05**
(22) 05/10/2021 (43) 25/01/2022
(73) **ORIHIRO ENGINEERING CO., LTD. (JP)**
478-3 Kannari, Tomioka-shi, Gunma 370-2463, Japan
(72) TSURUTA Orihiro (JP)
(74) **CÔNG TY LUẬT TRÁCH NHIỆM HỮU HẠN AMBYS HÀ NỘI (AMBYS HANOI)**
(55)

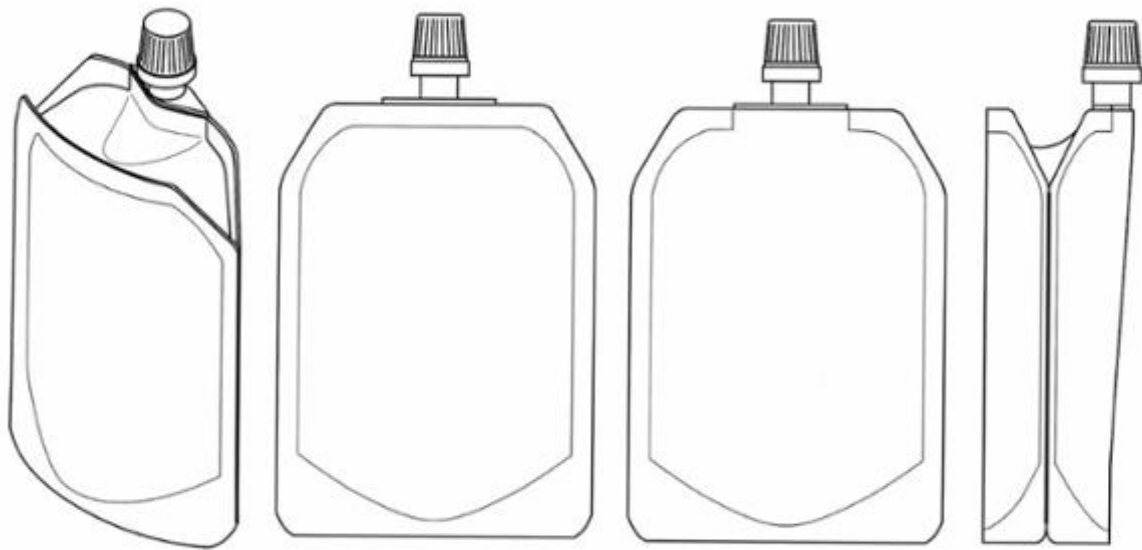

1.1

1.2

1.3

1.4



1.5

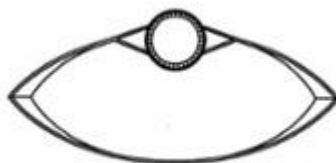

1.6



1.7

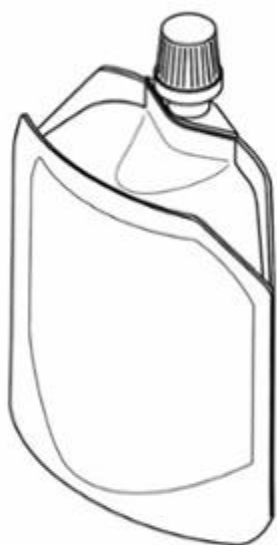

2.1

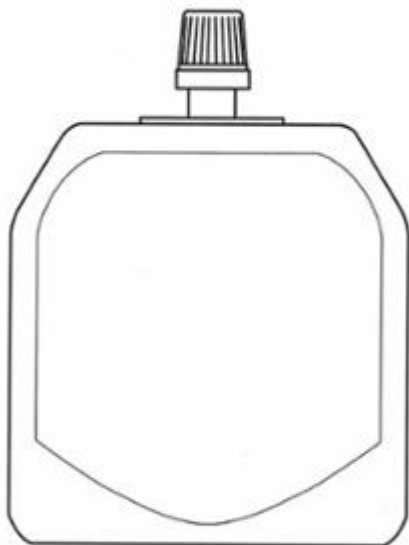

2.2

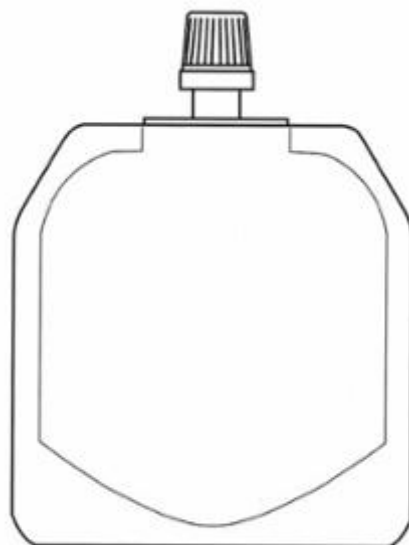

2.3

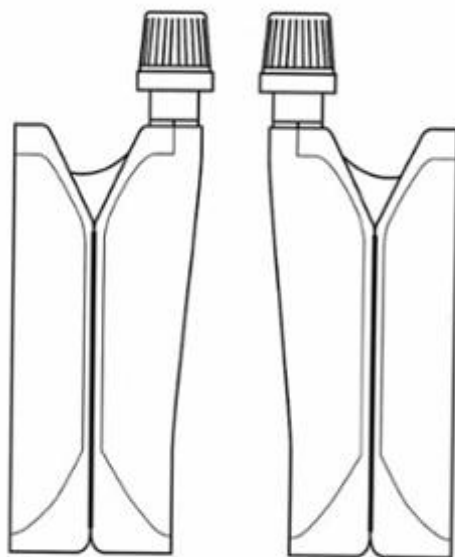

2.4

2.5

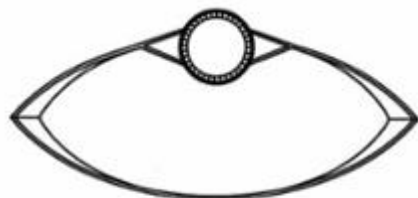

2.6



2.7

CÔNG BÁO SỞ HỮU CÔNG NGHIỆP SỐ 406 TẬP A – QUYỀN 2 (01.2022)

- (11) **43650**
(21) 3-2021-02412 (28) 2
(54) **BAO ĐỰNG** (51) **09-05**
(22) 05/10/2021 (43) 25/01/2022
(73) **ORIHIRO ENGINEERING CO., LTD. (JP)**
478-3 Kannari, Tomioka-shi, Gunma 370-2463, Japan
(72) TSURUTA Orihiro (JP)
(74) **CÔNG TY LUẬT TRÁCH NHIỆM HỮU HẠN AMBYS HÀ NỘI (AMBYS HANOI)**
(55)

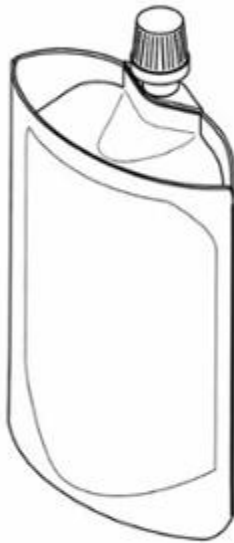

1.1

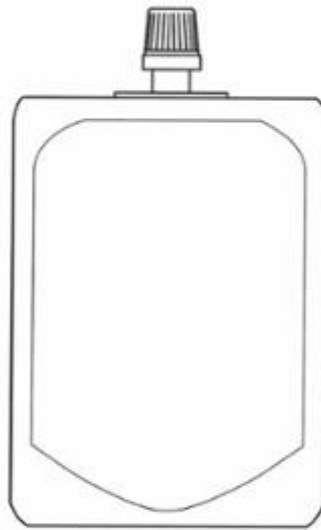

1.2

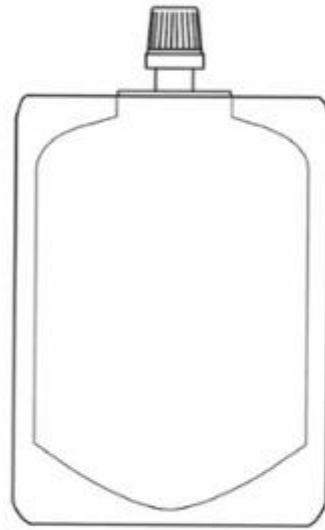

1.3

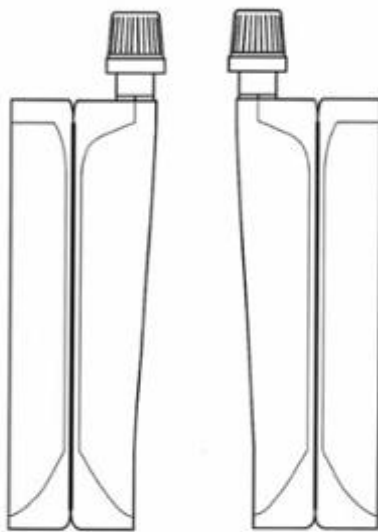

1.4

1.5

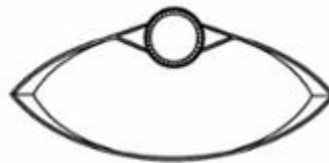

1.6



1.7

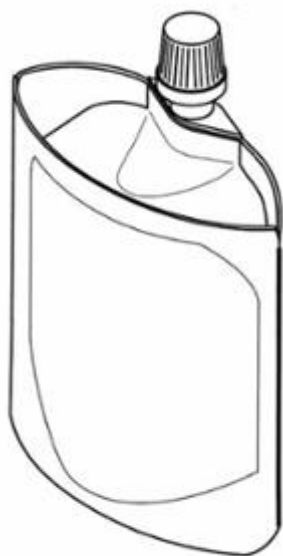

2.1

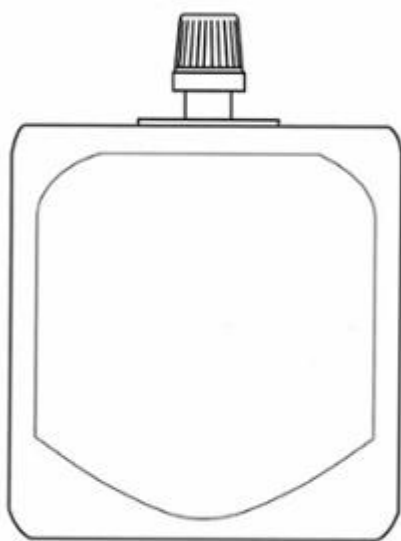

2.2

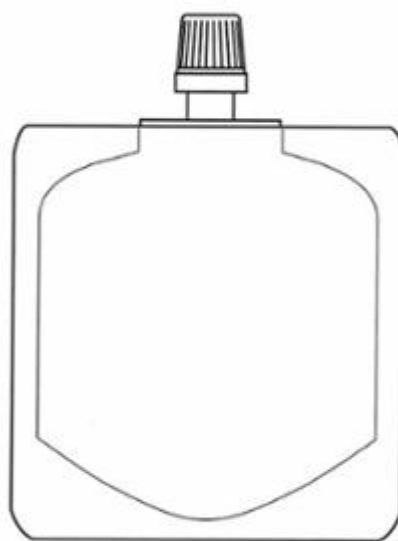

2.3

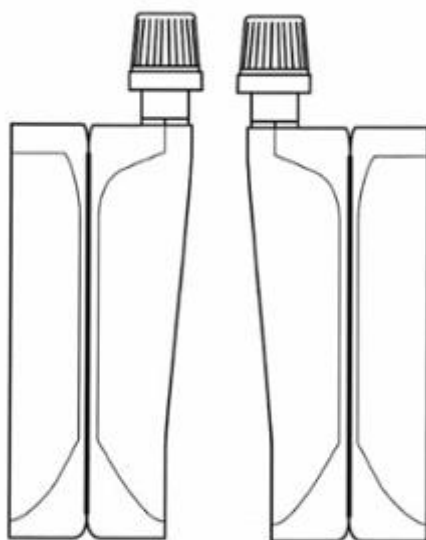

2.4

2.5

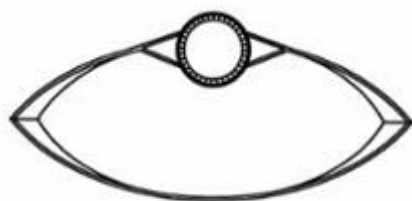

2.6



2.7

- (11) **43651**
(21) 3-2021-02413 (28) 2
(54) **BAO ĐỰNG** (51) **09-05**
(22) 05/10/2021 (43) 25/01/2022
(73) **ORIHIRO ENGINEERING CO., LTD. (JP)**
478-3 Kannari, Tomioka-shi, Gunma 370-2463, Japan
(72) TSURUTA Orihiro (JP)
(74) **CÔNG TY LUẬT TRÁCH NHIỆM HỮU HẠN AMBYS HÀ NỘI (AMBYS HANOI)**
(55)

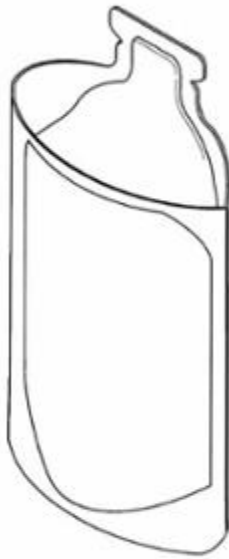

1.1

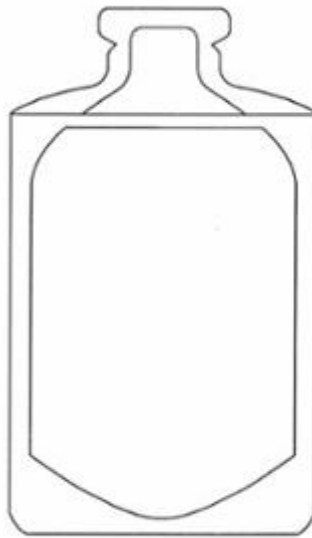

1.2

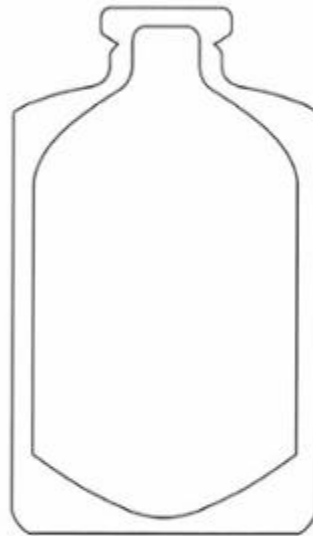

1.3

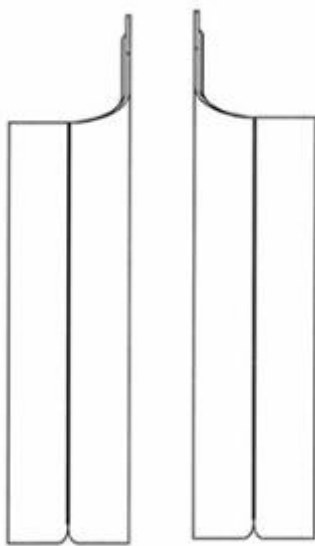

1.4

1.5



1.6



1.7

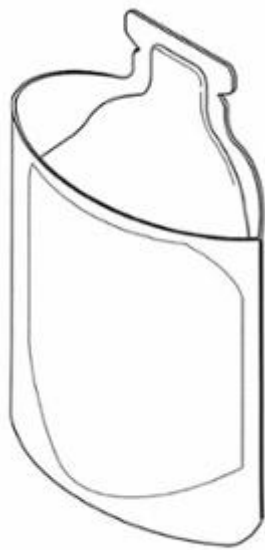

2.1

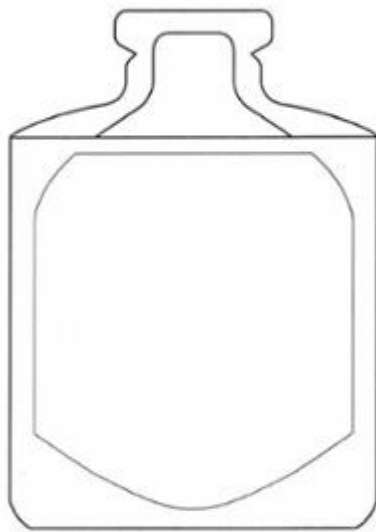

2.2

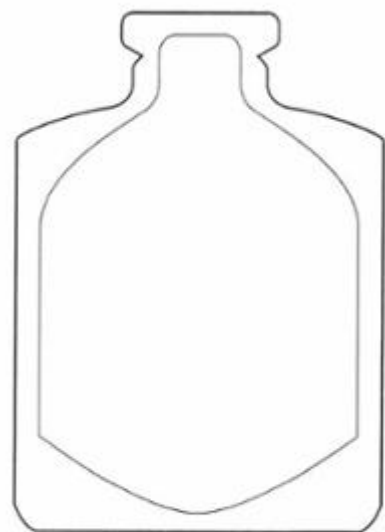

2.3

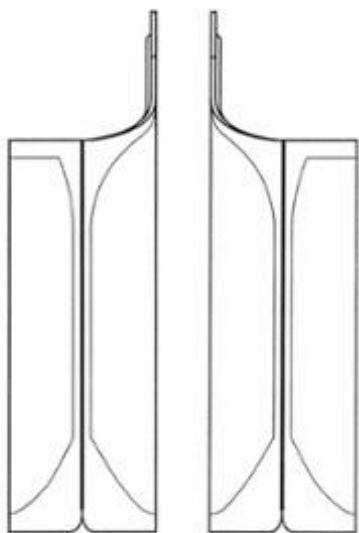

2.4

2.5



2.6



2.7

CÔNG BÁO SỞ HỮU CÔNG NGHIỆP SỐ 406 TẬP A – QUYỀN 2 (01.2022)

- (11) **43652**
(21) 3-2021-02415 (28) 1
(54) **CÁNH TAY RÔ BỐT** (51) **15-99**
(22) 05/10/2021 (43) 25/01/2022
(30) 21-E1009-0101 23/08/2021 MY;
(73) **AT SYSTECH SDN BHD (MY)**
NO. 10, JALAN INDUSTRI SMD, TAMAN PERINDUSTRIAN SMD,
KUNDANG, 48020 RAWANG, SELANGOR, MALAYSIA
(72) Tan Weng Liang (MY)
(74) Công ty TNHH Tầm nhìn và Liên danh (VISION & ASSOCIATES CO.LTD.)
(55)

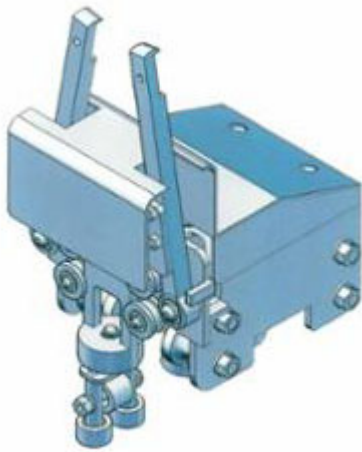

1.1



1.2

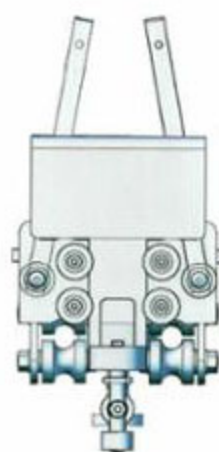

1.3

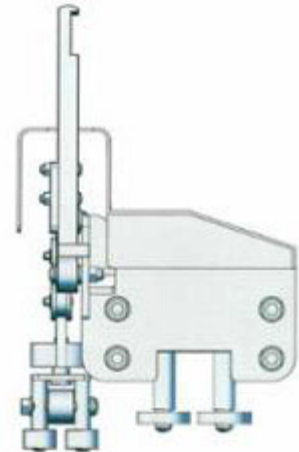

1.4

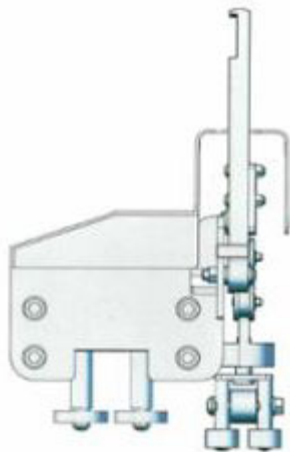

1.5

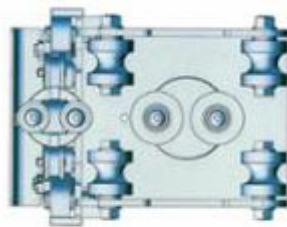

1.6

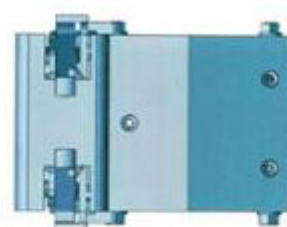

1.7

CÔNG BÁO SỞ HỮU CÔNG NGHIỆP SỐ 406 TẬP A – QUYỀN 2 (01.2022)

- (11) **43653**
(21) 3-2021-02440 (28) 1
(54) **BỘ CHUYỂN ĐỔI CỬA LÒA QUAY** (51) **25-01**
(22) 08/10/2021 (43) 25/01/2022
(73) **CÔNG TY CỔ PHẦN TẬP ĐOÀN EUROVIEW (VN)**
Số 150 đường Cổ Bi, xã cổ Bi, huyện Gia Lâm, thành phố Hà Nội
(72) Nguyễn Thị Trung Thủy (VN)
(74) Công ty TNHH Sở hữu trí tuệ Gia Việt (GIAVIET CO., LTD.)
(55)

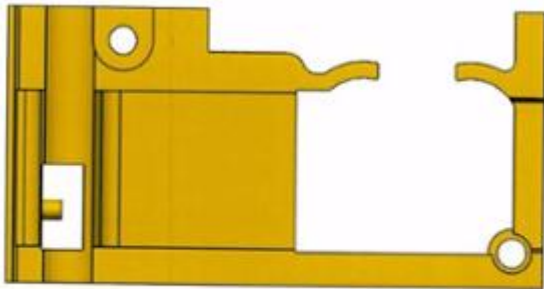

1.1

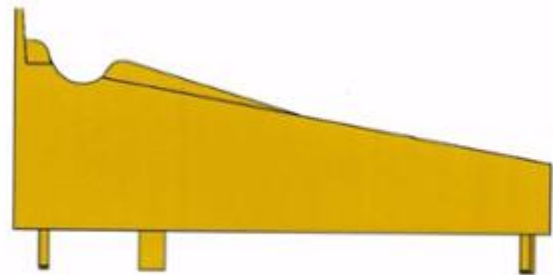

1.2

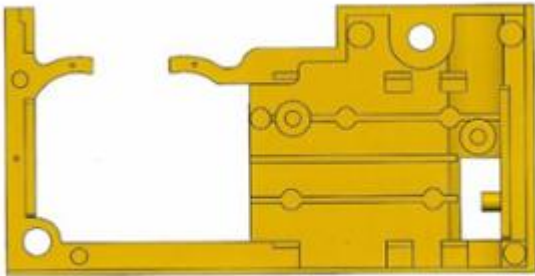

1.3

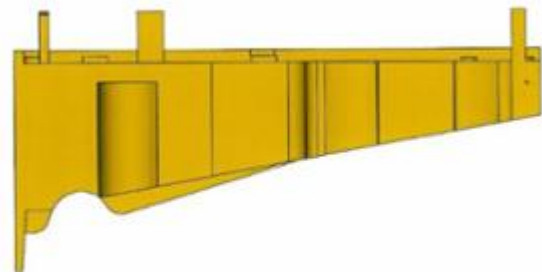

1.4

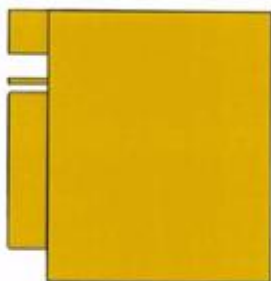

1.5

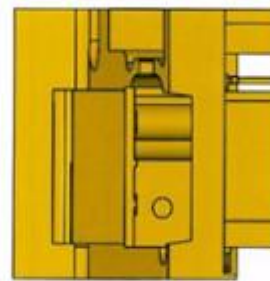

1.6

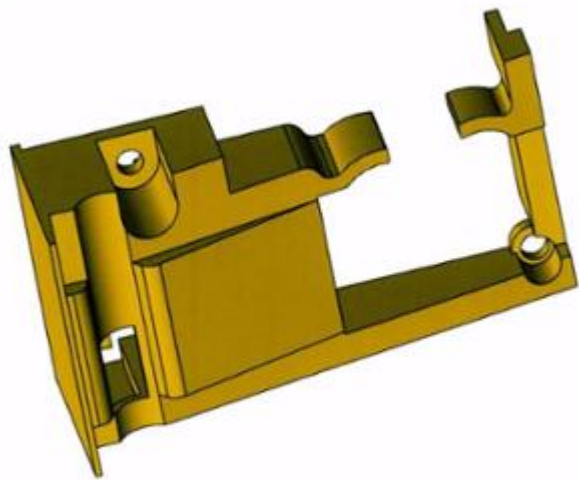

1.7

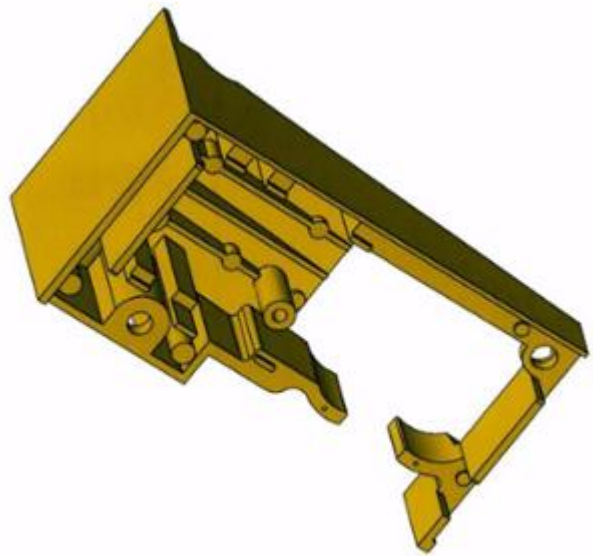

1.8

- (11) **43654**
(21) 3-2021-02441 (28) 1
(54) **BỘ CHUYỂN ĐỔI CỬA LÙA QUAY** (51) **25-01**
(22) 08/10/2021 (43) 25/01/2022
(73) **CÔNG TY CỔ PHẦN TẬP ĐOÀN EUROVIEW (VN)**
Số 150 đường cô Bi, xã Cổ Bi, huyện Gia Lâm, thành phố Hà Nội
(72) Nguyễn Thị Trung Thủy (VN)
(74) Công ty TNHH Sở hữu trí tuệ Gia Việt (GIAVIET CO., LTD.)
(55)

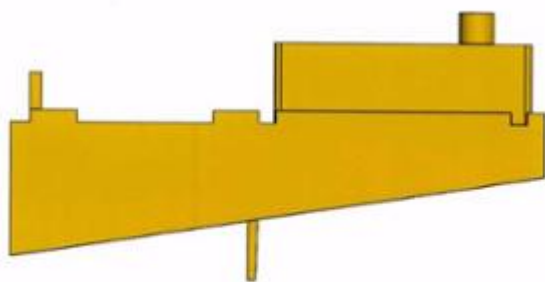

1.1

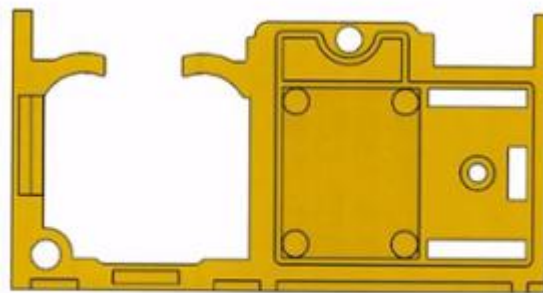

1.2

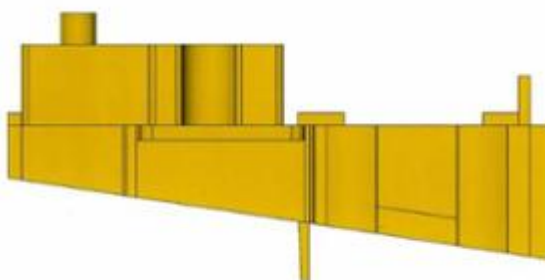

1.3

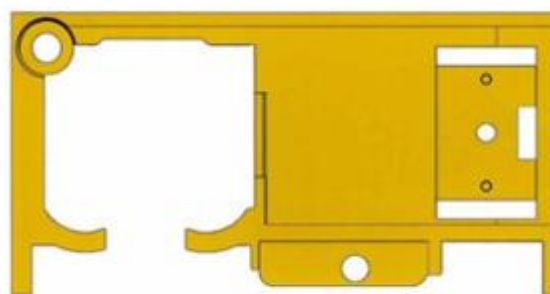

1.4

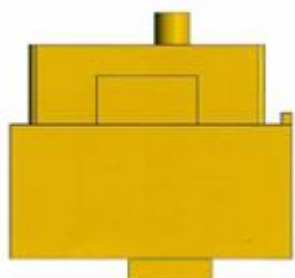

1.5

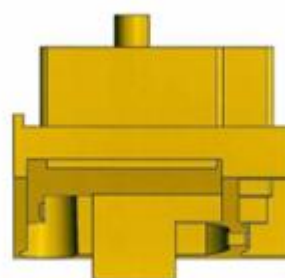

1.6

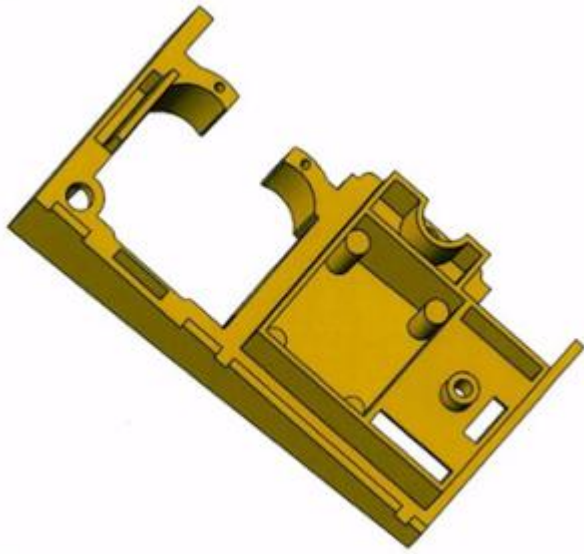

1.7

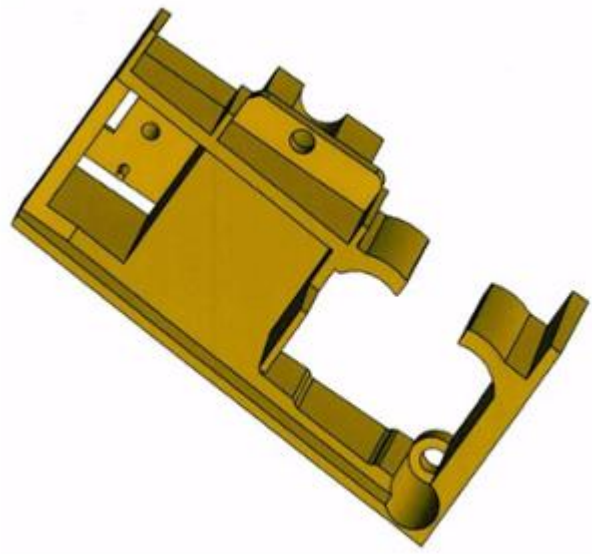

1.8

CÔNG BÁO SỞ HỮU CÔNG NGHIỆP SỐ 406 TẬP A – QUYỀN 2 (01.2022)

(11) **43655**

(21) 3-2021-02466

(28) 1

(54) **GHẾ SÔ-PHA**

(51) **06-01**

(22) 11/10/2021

(43) 25/01/2022

(73) **HTL FURNITURE (CHINA) CO., LTD. (CN)**

Wusong Jiangnan Road, Kunshan Development Zone, Jiangsu Province, China

(72) PHUA YONG TAT (SG)

(74) Công ty Luật TNHH quốc tế BMVN (BMVN INTERNATIONAL LLC)

(55)



1.1



1.2



1.3



1.4



1.5

CÔNG BÁO SỞ HỮU CÔNG NGHIỆP SỐ 406 TẬP A – QUYỀN 2 (01.2022)

(11) **43656**

(21) 3-2021-02467

(28) 1

(54) **GHẾ SÔ-PHA**

(51) **06-01**

(22) 11/10/2021

(43) 25/01/2022

(73) **HTL FURNITURE (CHINA) CO., LTD. (CN)**

Wusong Jiangnan Road, Kunshan Development Zone, Jiangsu Province, China

(72) PHUA YONG TAT (SG)

(74) Công ty Luật TNHH quốc tế BMVN (BMVN INTERNATIONAL LLC)

(55)



1.1



1.2



1.3



1.4



1.5



1.6

CÔNG BÁO SỞ HỮU CÔNG NGHIỆP SỐ 406 TẬP A – QUYỀN 2 (01.2022)

(11) **43657**

(21) 3-2021-02468

(28) 1

(54) **GHẾ SÔ-PHA**

(51) **06-01**

(22) 11/10/2021

(43) 25/01/2022

(73) **HTL FURNITURE (CHINA) CO., LTD. (CN)**

Wusong Jiangnan Road, Kunshan Development Zone, Jiangsu Province, China

(72) PHUA YONG TAT (SG)

(74) Công ty Luật TNHH quốc tế BMVN (BMVN INTERNATIONAL LLC)

(55)



1.1



1.2



1.3



1.4



1.5

CÔNG BÁO SỞ HỮU CÔNG NGHIỆP SỐ 406 TẬP A – QUYỀN 2 (01.2022)

(11) **43658**

(21) 3-2021-02469

(28) 1

(54) **GHẾ SÔ-PHA**

(51) **06-01**

(22) 11/10/2021

(43) 25/01/2022

(73) **HTL FURNITURE (CHINA) CO., LTD. (CN)**

Wusong Jiangnan Road, Kunshan Development Zone, Jiangsu Province, China

(72) PHUA YONG TAT (SG)

(74) Công ty Luật TNHH quốc tế BMVN (BMVN INTERNATIONAL LLC)

(55)



1.1



1.2



1.3



1.4



1.5

CÔNG BÁO SỞ HỮU CÔNG NGHIỆP SỐ 406 TẬP A – QUYỀN 2 (01.2022)

(11) **43659**

(21) 3-2021-02470

(28) 1

(54) **GHẾ SÔ-PHA**

(51) **06-01**

(22) 11/10/2021

(43) 25/01/2022

(73) **HTL FURNITURE (CHINA) CO., LTD. (CN)**

Wusong Jiangnan Road, Kunshan Development Zone, Jiangsu Province, China

(72) PHUA YONG TAT (SG)

(74) Công ty Luật TNHH quốc tế BMVN (BMVN INTERNATIONAL LLC)

(55)



1.1



1.2



1.3



1.4



1.5

CÔNG BÁO SỞ HỮU CÔNG NGHIỆP SỐ 406 TẬP A – QUYỀN 2 (01.2022)

(11) **43660**

(21) 3-2021-02471

(28) 1

(54) **GHẾ SÔ-PHA**

(51) **06-01**

(22) 11/10/2021

(43) 25/01/2022

(73) **HTL FURNITURE (CHINA) CO., LTD. (CN)**

Wusong Jiangnan Road, Kunshan Development Zone, Jiangsu Province, China

(72) PHUA YONG TAT (SG)

(74) Công ty Luật TNHH quốc tế BMVN (BMVN INTERNATIONAL LLC)

(55)



1.1



1.2



1.3



1.4



1.5

CÔNG BÁO SỞ HỮU CÔNG NGHIỆP SỐ 406 TẬP A – QUYỀN 2 (01.2022)

(11) **43661**

(21) 3-2021-02472

(28) 1

(54) **KHUNG GIƯỜNG**

(51) **06-02**

(22) 11/10/2021

(43) 25/01/2022

(73) **HTL FURNITURE (CHINA) CO., LTD. (CN)**

Wusong Jiangnan Road, Kunshan Development Zone, Jiangsu Province, China

(72) PHUA YONG TAT (SG)

(74) Công ty Luật TNHH quốc tế BMVN (BMVN INTERNATIONAL LLC)

(55)



1.1



1.2



1.3



1.4



1.5

CÔNG BÁO SỞ HỮU CÔNG NGHIỆP SỐ 406 TẬP A – QUYỀN 2 (01.2022)

(11) **43662**

(21) 3-2021-02473

(28) 1

(54) **KHUNG GIƯỜNG**

(51) **06-02**

(22) 11/10/2021

(43) 25/01/2022

(73) **HTL FURNITURE (CHINA) CO., LTD. (CN)**

Wusong Jiangnan Road, Kunshan Development Zone, Jiangsu Province, China

(72) PHUA YONG TAT (SG)

(74) Công ty Luật TNHH quốc tế BMVN (BMVN INTERNATIONAL LLC)

(55)



1.1



1.2



1.3



1.4



1.5

CÔNG BÁO SỞ HỮU CÔNG NGHIỆP SỐ 406 TẬP A – QUYỀN 2 (01.2022)

(11) **43663**

(21) 3-2021-02474

(28) 1

(54) **GHẾ SÔ-PHA**

(51) **06-01**

(22) 11/10/2021

(43) 25/01/2022

(73) **HTL FURNITURE (CHINA) CO., LTD. (CN)**

Wusong Jiangnan Road, Kunshan Development Zone, Jiangsu Province, China

(72) PHUA YONG TAT (SG)

(74) Công ty Luật TNHH quốc tế BMVN (BMVN INTERNATIONAL LLC)

(55)



1.1



1.2



1.3



1.4



1.5



1.6

CÔNG BÁO SỞ HỮU CÔNG NGHIỆP SỐ 406 TẬP A – QUYỀN 2 (01.2022)

- (11) **43664**
- (21) 3-2021-02553 (28) 1
- (54) **NHÃN SẢN PHẨM NƯỚC UỐNG TINH KHIẾT** (51) **19-08**
- (22) 18/10/2021 (43) 25/01/2022
- (73) **NGUYỄN THỊ TRUNG THÁI (VN)**
Số 126 đường 17/4 thị trấn Liên Hương, huyện Tuy Phong, tỉnh Bình Thuận
- (72) Nguyễn Thị Trung Thái (VN)
- (55)

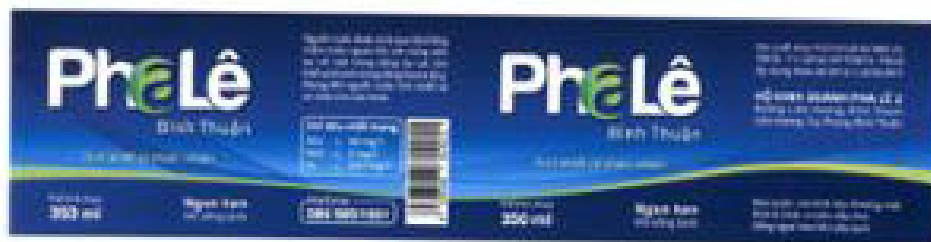

CÔNG BÁO SỞ HỮU CÔNG NGHIỆP SỐ 406 TẬP A – QUYỀN 2 (01.2022)

- (11) **43665**
- (21) 3-2021-02555 (28) 1
- (54) **NHÃN SẢN PHẨM** (51) **19-08**
- (22) 18/10/2021 (43) 25/01/2022
- (73) **CÔNG TY TNHH THỰC PHẨM SUNRISE (VN)**
Lô F6 đường số 3, KCN Hải Sơn (GD 3+4), xã Đức Hòa Hạ, huyện Đức Hoà, tỉnh Long An
- (72) Lai Vĩ Hùng (VN)
- (74) Công ty TNHH một thành viên Trường Luật (Trường Luật)
- (55)



CÔNG BÁO SỞ HỮU CÔNG NGHIỆP SỐ 406 TẬP A – QUYỀN 2 (01.2022)

- (11) **43666**
(21) 3-2021-02556 (28) 1
(54) **NHÃN SẢN PHẨM** (51) **19-08**
(22) 18/10/2021 (43) 25/01/2022
(73) **CÔNG TY TNHH SẢN XUẤT THƯƠNG MẠI NĂNG LƯỢNG AQUAVINA**
(VN)
117/27 ấp 5, xã Xuân Thới Thượng, huyện Hóc Môn, thành phố Hồ Chí Minh
(72) Lê Ngọc Hưng (VN)
(74) Công ty TNHH một thành viên Trường Luật (Trường Luật)
(55)

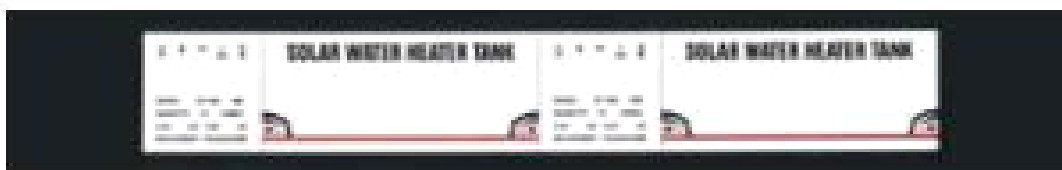

CÔNG BÁO SỞ HỮU CÔNG NGHIỆP SỐ 406 TẬP A – QUYỀN 2 (01.2022)

(11) **43667**

(21) 3-2021-02557

(54) **HỮ ĐỰNG THỰC PHẨM**

(22) 18/10/2021

(73) **CÔNG TY TNHH MINH LONG I (VN)**

333 Khu phố Hưng Lộc, phường Hưng Định, thị xã Thuận An, tỉnh Bình Dương

(72) Lý Ngọc Minh (VN)

(55)

(28) 1

(51) **07-01**

(43) 25/01/2022



1.1



1.2



1.3



1.4

CÔNG BÁO SỞ HỮU CÔNG NGHIỆP SỐ 406 TẬP A – QUYỀN 2 (01.2022)

- (11) **43668**
(21) 3-2021-02558 (28) 1
(54) **CHAI ĐỰNG CHẤT LỎNG** (51) **09-01**
(22) 18/10/2021 (43) 25/01/2022
(73) **CÔNG TY TNHH MINH LONG I (VN)**
333 Khu phố Hưng Lộc, phường Hưng Định, thành phố Thuận An, tỉnh Bình
Dương
(72) Lý Ngọc Minh (VN)
(55)



1.1



1.2



1.3



1.4

(11) **43669**

(21) 3-2021-02559

(28) 1

(54) **ẨM**

(51) **07-01**

(22) 18/10/2021

(43) 25/01/2022

(73) **CÔNG TY TNHH MINH LONG I (VN)**

333 Khu phố Hưng Lộc, phường Hưng Định, thị xã Thuận An, tỉnh Bình Dương

(72) Lý Ngọc Minh (VN)

(55)



1.1



1.2



1.3



1.4



1.5



1.6



1.7

- (11) **43670**
(21) 3-2021-02560 (28) 1
(54) **TƯỢNG TRANG TRÍ** (51) **11-02**
(22) 18/10/2021 (43) 25/01/2022
(73) **CÔNG TY TNHH MINH LONG I (VN)**
333 Khu phố Hưng Lộc, phường Hưng Định, thành phố Thuận An, tỉnh Bình
Dương
(72) Lý Ngọc Minh (VN)
(55)



1.1



1.2



1.3



1.4



1.5



1.6



1.7



1.8

(11) **43671**

(21) 3-2021-02561

(28) 1

(54) **TƯỢNG TRANG TRÍ**

(51) **11-02**

(22) 18/10/2021

(43) 25/01/2022

(73) **CÔNG TY TNHH MINH LONG I (VN)**

333 Khu phố Hưng Lộc, phường Hưng Định, thành phố Thuận An, tỉnh Bình Dương

(72) Lý Ngọc Minh (VN)

(55)



1.1



1.2



1.3



1.4



1.5



1.6



1.7



1.8

CÔNG BÁO SỞ HỮU CÔNG NGHIỆP SỐ 406 TẬP A – QUYỀN 2 (01.2022)

- (11) **43672**
(21) 3-2021-02588 (28) 2
(54) **MẮC TREO** (51) **06-08**
(22) 19/10/2021 (43) 25/01/2022
(30) 6134456 30/04/2021 GB; 6134455 30/04/2021 GB;
(73) **TAM PLASTIK VE KALIP SANAYI TICARET LIMITED SIRKETI (TR)**
Kavakil Mah. Deniz Aktas Cad. No: 32, Beylikduzu, Istanbul 34520, Turkey
(72) TEZSEZER, Gökhan (TR)
(74) Công ty TNHH Trường Xuân (AGELESS CO.,LTD.)
(55)



1.1

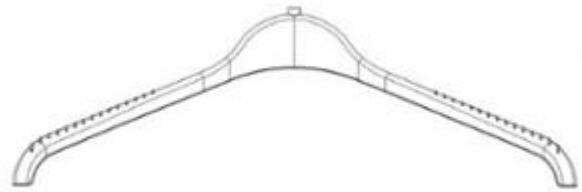

1.2

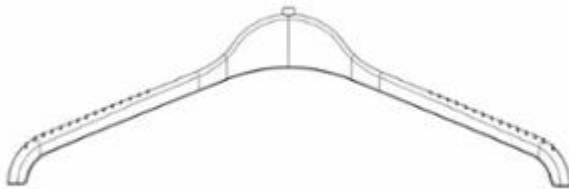

1.3



1.4



1.5



1.6



1.7



2.1

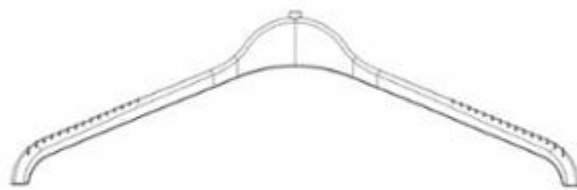

2.2

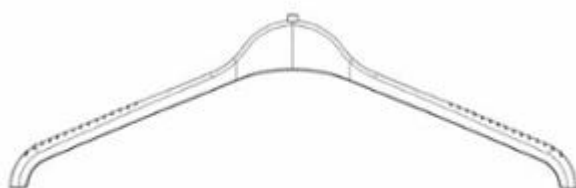

2.3

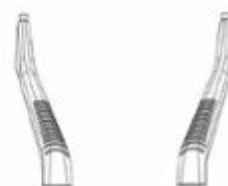

2.4

2.5



2.6



2.7

CÔNG BÁO SỞ HỮU CÔNG NGHIỆP SỐ 406 TẬP A – QUYỀN 2 (01.2022)

(11) **43673**

(21) 3-2021-02599

(28) 1

(54) **MÁY LỌC NƯỚC**

(51) **23-01**

(22) 20/10/2021

(43) 25/01/2022

(73) **CÔNG TY TNHH NƯỚC THÔNG MINH WATERSMART (VN)**

Lô 05-TT01, khu đô thị Thành phố Giao lưu, phường Cổ Nhuế 1, quận Bắc Từ Liêm, thành phố Hà Nội

(72) Nguyễn Phương Quý (VN)

(55)



1.1



1.2

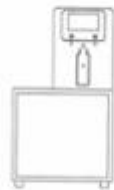

1.3



1.4

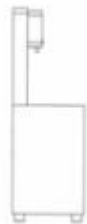

1.5



1.6

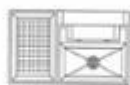

1.7



1.8

- (11) **43674**
(21) 3-2021-02600 (28) 2
(54) **HỘP** (51) **09-03**
(22) 20/10/2021 (43) 25/01/2022
(73) **NGUYỄN THỊ THU HOA (VN)**
Tân Thành, thị trấn Thanh Sơn, huyện Thanh Sơn, tỉnh Phú Thọ
(72) Nguyễn Thị Thu Hoa (VN)
(74) Công ty TNHH Sở hữu trí tuệ WITIP Việt Nam (WITIP CO., LTD.)
(55)



1.1



1.2



2.1



2.2

CÔNG BÁO SỞ HỮU CÔNG NGHIỆP SỐ 406 TẬP A – QUYỀN 2 (01.2022)

- (11) **43675**
(21) 3-2021-02601 (28) 2
(54) **BỘ NHÃN SẢN PHẨM** (51) **19-08**
(22) 20/10/2021 (43) 25/01/2022
(73) **NGUYỄN THỊ THU HOA (VN)**
Tân Thành, thị trấn Thanh Sơn, huyện Thanh Sơn, tỉnh Phú Thọ
(72) Nguyễn Thị Thu Hoa (VN)
(74) Công ty TNHH Sở hữu trí tuệ WITIP Việt Nam (WITIP CO., LTD.)
(55)



1.1



2.1

CÔNG BÁO SỞ HỮU CÔNG NGHIỆP SỐ 406 TẬP A – QUYỀN 2 (01.2022)

- (11) **43676**
- (21) 3-2021-02602 (28) 1
- (54) **BAO GÓI** (51) **09-05**
- (22) 20/10/2021 (43) 25/01/2022
- (73) **NGUYỄN THỊ THU HOA (VN)**
Tân Thành, thị trấn Thanh Sơn, huyện Thanh Sơn, tỉnh Phú Thọ
- (72) Nguyễn Thị Thu Hoa (VN)
- (74) Công ty TNHH Sở hữu trí tuệ WITIP Việt Nam (WITIP CO., LTD.)
- (55)



1.1



1.2

(11) **43677**

(21) 3-2021-02603

(28) 1

(54) **TẤM ĐÉ**

(51) **07-02**

(22) 20/10/2021

(43) 25/01/2022

(73) **CÔNG TY TNHH MINH LONG I (VN)**

333 Khu phố Hưng Lộc, phường Hưng Định, thành phố Thuận An, tỉnh Bình Dương

(72) Lý Ngọc Minh (VN)

(55)



1.1



1.2



1.3



1.4



1.5

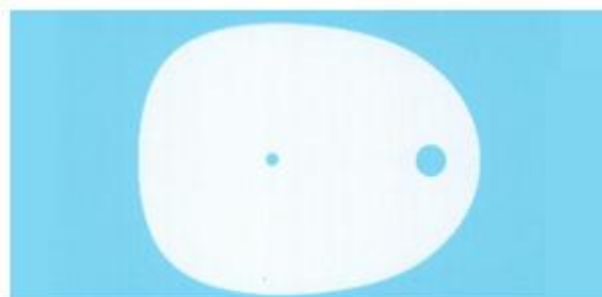

1.6

CÔNG BÁO SỞ HỮU CÔNG NGHIỆP SỐ 406 TẬP A – QUYỀN 2 (01.2022)

- (11) **43678**
(21) 3-2021-02604 (28) 1
(54) **HỆ THỐNG ĐO THÂN NHIỆT THÔNG MINH** (51) **10-04**
(22) 20/10/2021 (43) 25/01/2022
(73) **CÔNG TY CỔ PHẦN RYNAN TECHNOLOGIES VIETNAM (VN)**
Áp Long Trị, xã Long Đức, thành phố Trà Vinh, tỉnh Trà Vinh
(72) 1. NGUYỄN THANH MỸ (VN)
2. PHAN MINH QUÝ (VN)
3. TRẦN QUỐC TOẢN (VN)
4. HỒNG QUỐC CƯỜNG (VN)
5. ĐỒNG NGỌC TRANG (VN)
6. TRẦN TRUNG TÍN (VN)
7. LÊ THANH TRIỀU (VN)
8. THÁI NGUYỄN HOÀI THIÊN (VN)
9. NGUYỄN ANH THÔNG (VN)
10. BÙI TẤN ĐẠT (VN)
(74) Công ty TNHH Đại Tín và Liên Danh (DAITIN AND ASSOCIATES CO.,LTD)
(55)

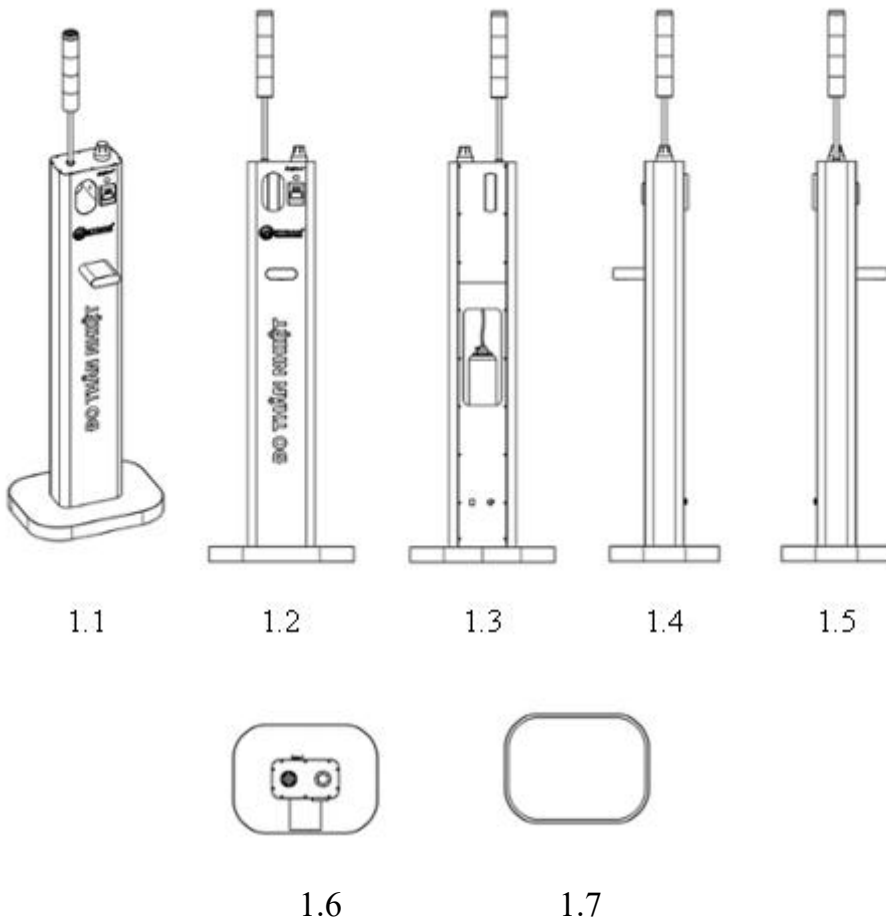

CÔNG BÁO SỞ HỮU CÔNG NGHIỆP SỐ 406 TẬP A – QUYỀN 2 (01.2022)

- (11) **43679**
(21) 3-2021-02605 (28) 1
(54) **BỘ PIN** (51) **13-02**
(22) 06/02/2020 (43) 25/01/2022
(30) 29/704,572 05/09/2019 US; 29/704,577 05/09/2019 US; 29/704,575 05/09/2019 US;
(73) **TECHTRONIC CORDLESS GP (US)**
100 Innovation Way, Anderson, SC 29621, United States of America
(72) Clint Cagle (US)
(74) Công ty TNHH Tầm nhìn và Liên danh (VISION & ASSOCIATES CO.LTD.)
(55)



1.1

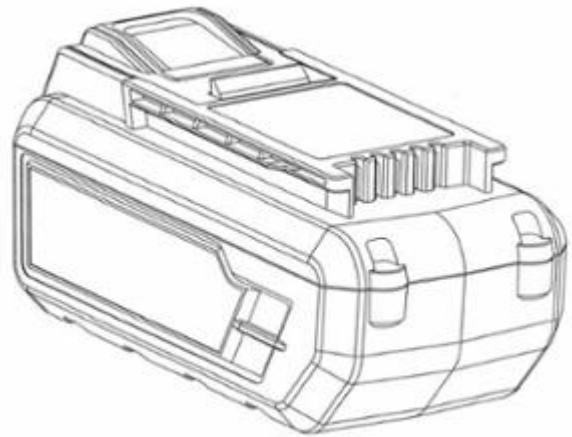

1.2

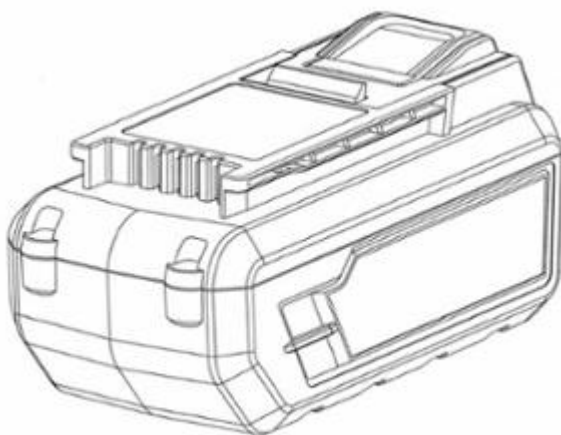

1.3

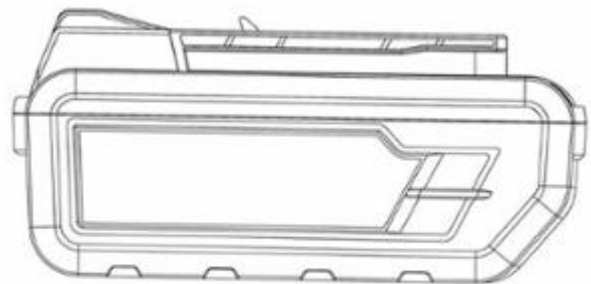

1.4

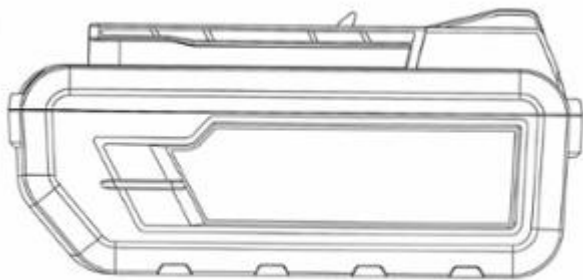

1.5



1.6

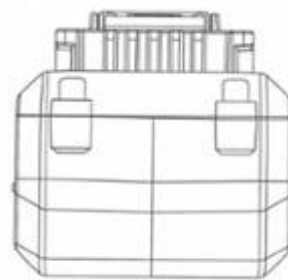

1.7

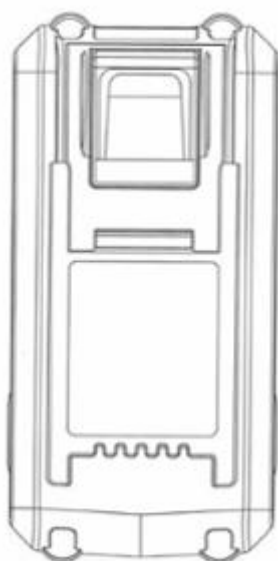

1.8

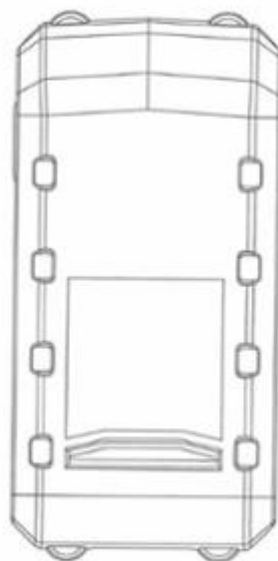

1.9

CÔNG BÁO SỞ HỮU CÔNG NGHIỆP SỐ 406 TẬP A – QUYỂN 2 (01.2022)

- (11) **43680**
- (21) 3-2021-02609 (28) 1
- (54) **NHÃN SẢN PHẨM** (51) **19-08**
- (22) 20/10/2021 (43) 25/01/2022
- (73) **CÔNG TY TNHH ASIAN VN GROUP (VN)**
114/2A Nguyễn Thị Đặng, phường Tân Thới Hiệp, quận 12, thành phố Hồ Chí Minh
- (72) Phạm Văn Phong (VN)
- (55)



CÔNG BÁO SỞ HỮU CÔNG NGHIỆP SỐ 406 TẬP A – QUYỀN 2 (01.2022)

- (11) **43681**
- (21) 3-2021-02610 (28) 1
- (54) **NHÃN SẢN PHẨM** (51) **19-08**
- (22) 20/10/2021 (43) 25/01/2022
- (73) **CÔNG TY TNHH ASIAN VN GROUP (VN)**
114/2A Nguyễn Thị Đặng, phường Tân Thới Hiệp, quận 12, thành phố Hồ Chí Minh
- (72) Phạm Văn Phong (VN)
- (55)



CÔNG BÁO SỞ HỮU CÔNG NGHIỆP SỐ 406 TẬP A – QUYỀN 2 (01.2022)

- (11) **43682**
- (21) 3-2021-02611 (28) 1
- (54) **NHÃN SẢN PHẨM** (51) **19-08**
- (22) 20/10/2021 (43) 25/01/2022
- (73) **CÔNG TY TNHH ASIAN VN GROUP (VN)**
114/2A Nguyễn Thị Đặng, phường Tân Thới Hiệp, quận 12, thành phố Hồ Chí Minh
- (72) Phạm Văn Phong (VN)
- (55)

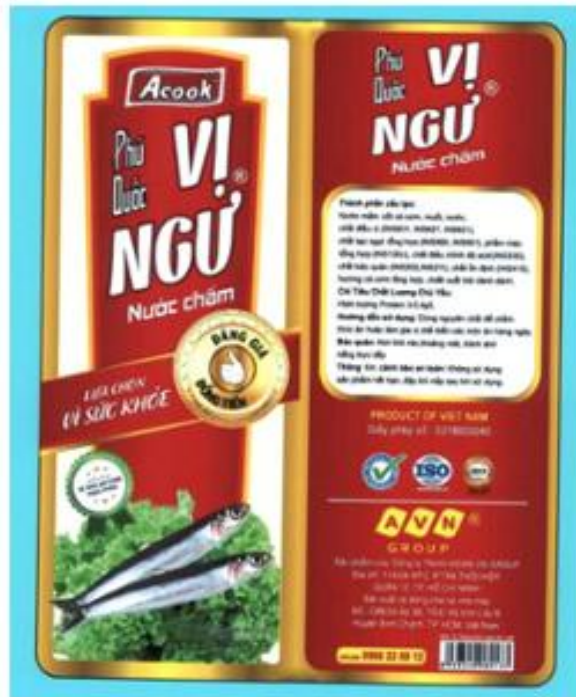

CÔNG BÁO SỞ HỮU CÔNG NGHIỆP SỐ 406 TẬP A – QUYỀN 2 (01.2022)

- (11) **43683**
- (21) 3-2021-02612 (28) 1
- (54) **MÁY LÁI CƠ - ĐIỆN DẠNG CHUYỂN ĐỘNG TỊNH TIẾN DÙNG CHO THIẾT BỊ BAY** (51) **12-07; 12-99**
- (22) 20/10/2021 (43) 25/01/2022
- (73) **TẬP ĐOÀN CÔNG NGHIỆP - VIỆN THÔNG QUÂN ĐỘI (VN)**
Lô D26 khu đô thị mới Cầu Giấy, phường Yên Hòa, quận Cầu Giấy, thành phố Hà Nội
- (72) 1. LÊ KIM BẢO (VN)
2. PHẠM VĂN ĐỊNH (VN)
3. TRẦN QUỐC TOẢN (VN)
4. NGUYỄN DUY TÙNG (VN)
5. NGUYỄN PHẠM TUÂN (VN)
- (74) Công ty TNHH NACILAW (NACILAW)
- (55)

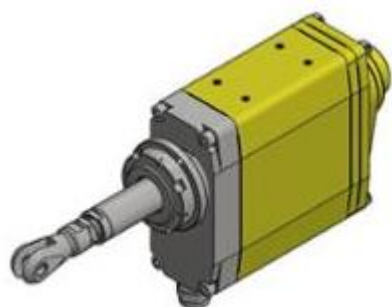

1.1

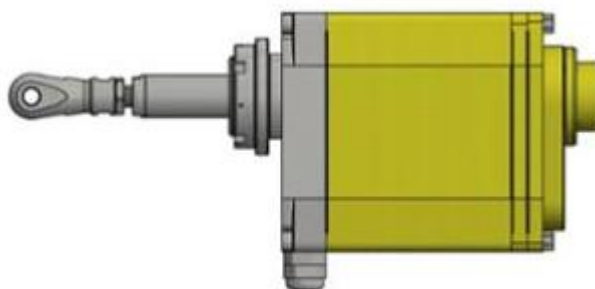

1.2

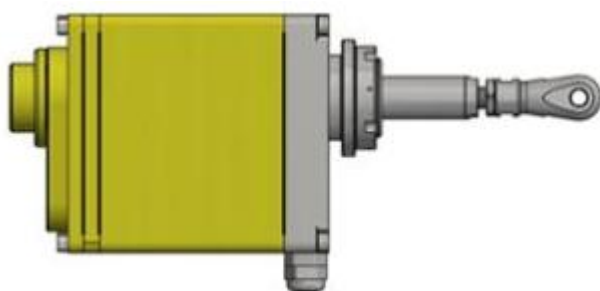

1.3



1.4



1.5



1.6

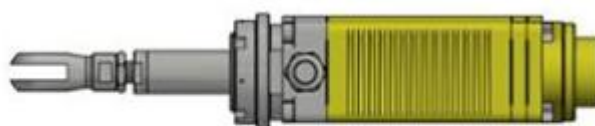

1.7

- (11) **43684**
(21) 3-2021-02613 (28) 1
(54) **ĐÈN CHIẾU SÁNG** (51) **26-03**
(22) 21/10/2021 (43) 25/01/2022
(73) **CÔNG TY CỔ PHẦN CHIẾU SÁNG ĐÔ THỊ HOÀNG GIA (VN)**
Số 157 phố Phương Mai, phường Phương Mai, quận Đống Đa, thành phố Hà Nội
(72) Hoàng Song Hà (VN)
(55)



1.1



1.2



1.3



1.4



1.5



1.6



1.7

CÔNG BÁO SỞ HỮU CÔNG NGHIỆP SỐ 406 TẬP A – QUYỀN 2 (01.2022)

- (11) **43685**
(21) 3-2021-02615 (28) 1
(54) **THIẾT BỊ CHỨNG MINH LỰC CẢN CỦA NƯỚC** (51) **19-07**
(22) 21/10/2021 (43) 25/01/2022
(73) **CÔNG TY TNHH THIẾT BỊ GIÁO DỤC THÔNG MINH KHANG THỊNH (VN)**
Số 62, Phan Đình Giót, phường Phương Liệt, quận Thanh Xuân, thành phố Hà Nội
(72) Trần Dương Đạo (VN)
(74) Công ty TNHH Sở hữu trí tuệ Tầm Nhìn Mới (FRESHVIEW CO., LTD.)
(55)

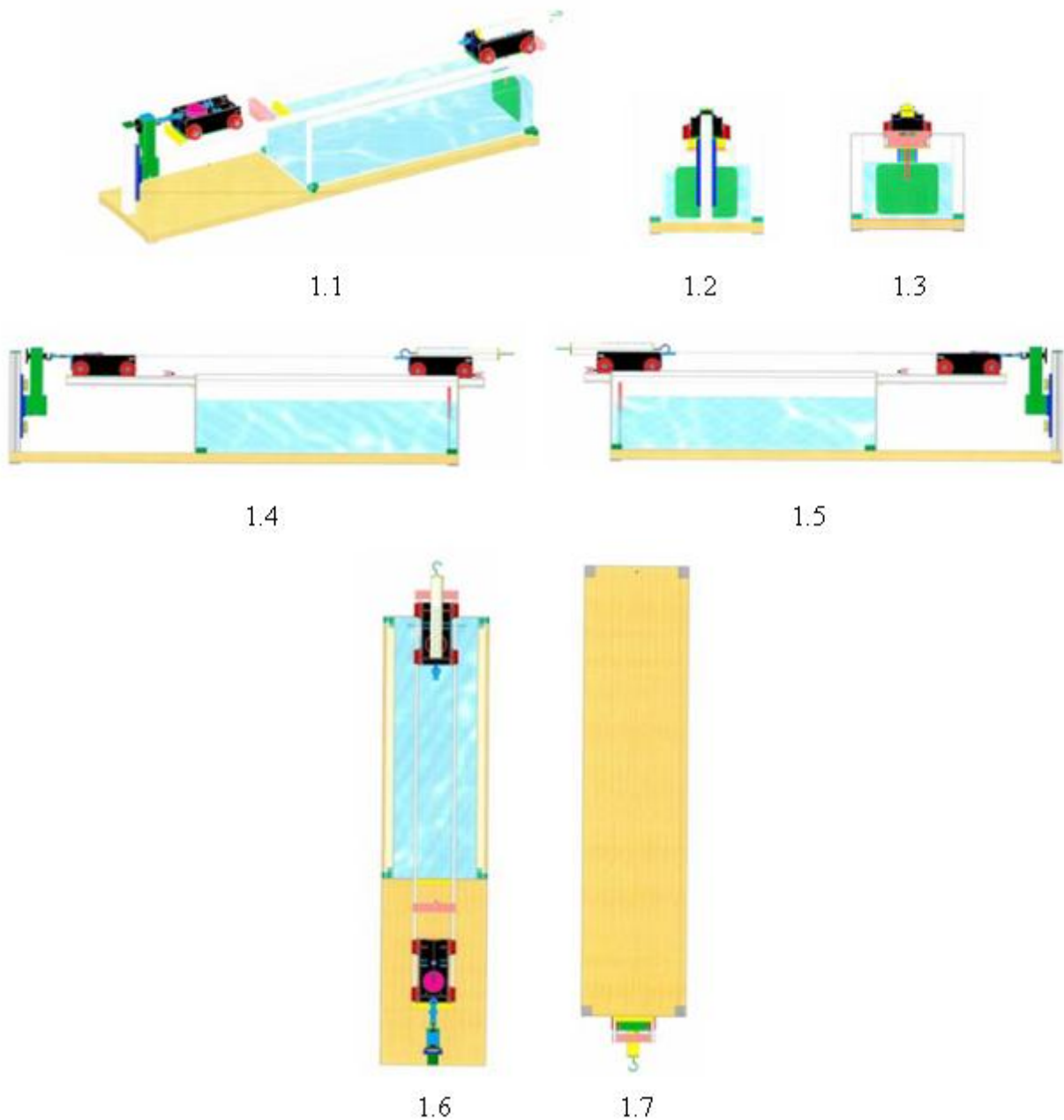

- (11) **43686**
(21) 3-2021-02616 (28) 1
(54) **THIẾT BỊ CHỨNG MINH ĐỘ GIẢN CỦA Lò XO** (51) **19-07**
(22) 21/10/2021 (43) 25/01/2022
(73) **CÔNG TY TNHH THIẾT BỊ GIÁO DỤC THÔNG MINH KHANG THỊNH (VN)**
Số 62, Phan Đình Giót, phường Phương Liệt, quận Thanh Xuân, thành phố Hà Nội
(72) Trần Dương Đạo (VN)
(74) Công ty TNHH Sở hữu trí tuệ Tầm Nhìn Mới (FRESHVIEW CO., LTD.)
(55)



1.1



1.2



1.3



1.4



1.5



1.6



1.7

- (11) **43687**
(21) 3-2021-02620 (28) 1
(54) **GHẾ MÁT XA** (51) **06-01; 28-03**
(22) 21/10/2021 (43) 25/01/2022
(73) **OSIM INTERNATIONAL PTE LTD (SG)**
65 UBI AVENUE 1, SINGAPORE 408939
(72) CAI Weijie (SG)
(74) Công ty Luật TNHH quốc tế BMVN (BMVN INTERNATIONAL LLC)
(55)



1.1



1.2



1.3



1.4

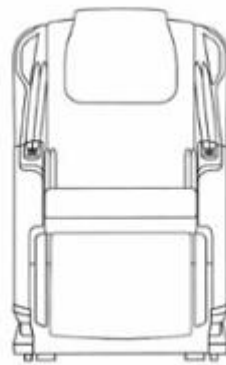

1.5

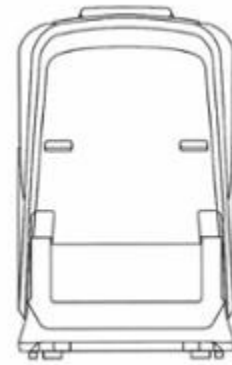

1.6



1.7

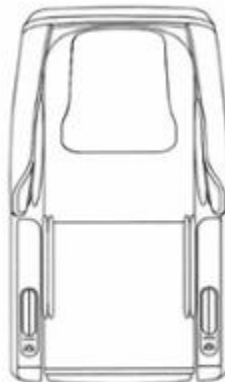

1.8

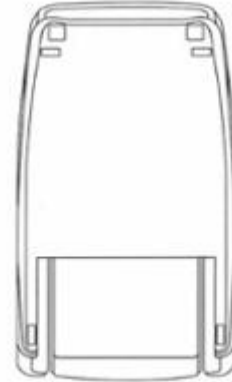

1.9

CÔNG BÁO SỞ HỮU CÔNG NGHIỆP SỐ 406 TẬP A – QUYỀN 2 (01.2022)

- (11) **43688**
- (21) 3-2021-02625 (28) 1
- (54) **NHÃN SẢN PHẨM** (51) **19-08**
- (22) 22/10/2021 (43) 25/01/2022
- (73) **CÔNG TY CỔ PHẦN BỘT GIẶT NET (VN)**
Đường D4, khu công nghiệp Lộc An - Bình Sơn, xã Bình Sơn, huyện Long Thành,
tỉnh Đồng Nai
- (72) Thái Thị Hồng Yến (VN)
- (74) Công ty TNHH Sở hữu trí tuệ INVENTIO (INVENTIO CO.,LTD)
- (55)



1.1



1.2

CÔNG BÁO SỞ HỮU CÔNG NGHIỆP SỐ 406 TẬP A – QUYỀN 2 (01.2022)

- (11) **43689**
(21) 3-2021-02626 (28) 1
(54) **NHÃN SẢN PHẨM** (51) **19-08**
(22) 22/10/2021 (43) 25/01/2022
(73) **CÔNG TY CỔ PHẦN BỘT GIẶT NET (VN)**
Đường D4, khu công nghiệp Lộc An - Bình Sơn, xã Bình Sơn, huyện Long Thành,
tỉnh Đồng Nai
(72) Thái Thị Hồng Yên (VN)
(74) Công ty TNHH Sở hữu trí tuệ INVENTIO (INVENTIO CO.,LTD)
(55)



1.1



1.2

(11) **43690**

(21) 3-2021-02627

(54) **HỘP**

(22) 22/10/2021

(73) **HỘ KINH DOANH AN VĨNH PHÁT (VN)**

R23/39/36 Cư xá Phú Lâm A, phường 12, quận 06, thành phố Hồ Chí Minh

(72) Khuu Sở Dinh (VN)

(55)

(28) 1

(51) **09-03**

(43) 25/01/2022



1.1



1.2



1.3



1.4



1.5

CÔNG BÁO SỞ HỮU CÔNG NGHIỆP SỐ 406 TẬP A – QUYỀN 2 (01.2022)

- (11) **43691**
(21) 3-2021-02630 (28) 1
(54) **BAO BÌ GẠO** (51) **09-05**
(22) 22/10/2021 (43) 25/01/2022
(73) **CÔNG TY CỔ PHẦN TẬP ĐOÀN GIỐNG CÂY TRỒNG VIỆT NAM (VN)**
Số 1 Lương Đình Cửa, phường Phương Mai, quận Đống Đa, thành phố Hà Nội
(72) Trần Kim Liên (VN)
(55)



1.1



1.2

CÔNG BÁO SỞ HỮU CÔNG NGHIỆP SỐ 406 TẬP A – QUYỂN 2 (01.2022)

- (11) **43692**
(21) 3-2021-02631 (28) 1
(54) **BAO BÌ GẠO** (51) **09-05**
(22) 22/10/2021 (43) 25/01/2022
(73) **CÔNG TY CỔ PHẦN TẬP ĐOÀN GIỐNG CÂY TRỒNG VIỆT NAM (VN)**
Số 1 Lương Đình Cửa, phường Phương Mai, quận Đống Đa, thành phố Hà Nội
(72) Trần Kim Liên (VN)
(55)



1.1



1.2

CÔNG BÁO SỞ HỮU CÔNG NGHIỆP SỐ 406 TẬP A – QUYỀN 2 (01.2022)

- (11) **43693**
(21) 3-2021-02632 (28) 1
(54) **HỘP ĐỰNG** (51) **09-03**
(22) 22/10/2021 (43) 25/01/2022
(73) **NGUYỄN HOÀNG HUY (VN)**
Số 50 Thống Nhất, phường Lê Thanh Nghị, thành phố Hải Dương, tỉnh Hải Dương
(72) Nguyễn Hoàng Huy (VN)
(55)



1.1



1.2



1.3



1.4



1.5



1.6



1.7



1.8

CÔNG BÁO SỞ HỮU CÔNG NGHIỆP SỐ 406 TẬP A – QUYỀN 2 (01.2022)

- (11) **43694**
(21) 3-2021-02633 (28) 1
(54) **THANH KIM LOẠI ĐỊNH HÌNH** (51) **25-01**
(22) 22/10/2021 (43) 25/01/2022
(73) **CÔNG TY TNHH MTV ĐĂNG QUANG (VN)**
Đường Trường Chinh, khu phố 1, phường Phú Tài, thành phố Phan Thiết, tỉnh Bình Thuận
(72) Võ Trường Thọ (VN)
(74) **CÔNG TY TNHH KHANG LUẬT (KHANGLAW)**
(55)

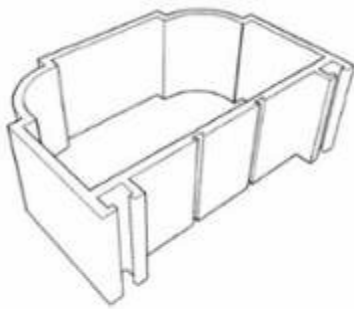

1.1



1.2



1.3



1.4

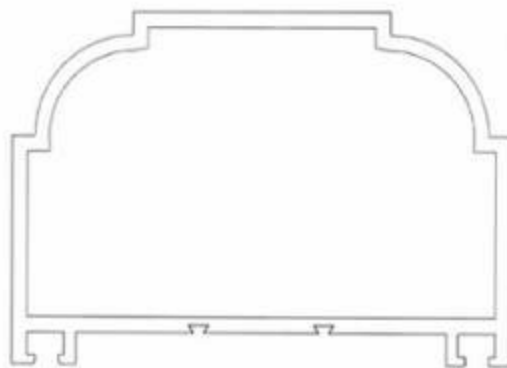

1.5

CÔNG BÁO SỞ HỮU CÔNG NGHIỆP SỐ 406 TẬP A – QUYỀN 2 (01.2022)

- (11) **43695**
(21) 3-2021-02634 (28) 1
(54) **THANH KIM LOẠI ĐỊNH HÌNH** (51) **25-01**
(22) 22/10/2021 (43) 25/01/2022
(73) **CÔNG TY TNHH MTV ĐĂNG QUANG (VN)**
Đường Trường Chinh, khu phố 1, phường Phú Tài, thành phố Phan Thiết, tỉnh Bình Thuận
(72) Võ Trường Thọ (VN)
(74) **CÔNG TY TNHH KHANG LUẬT (KHANGLAW)**
(55)

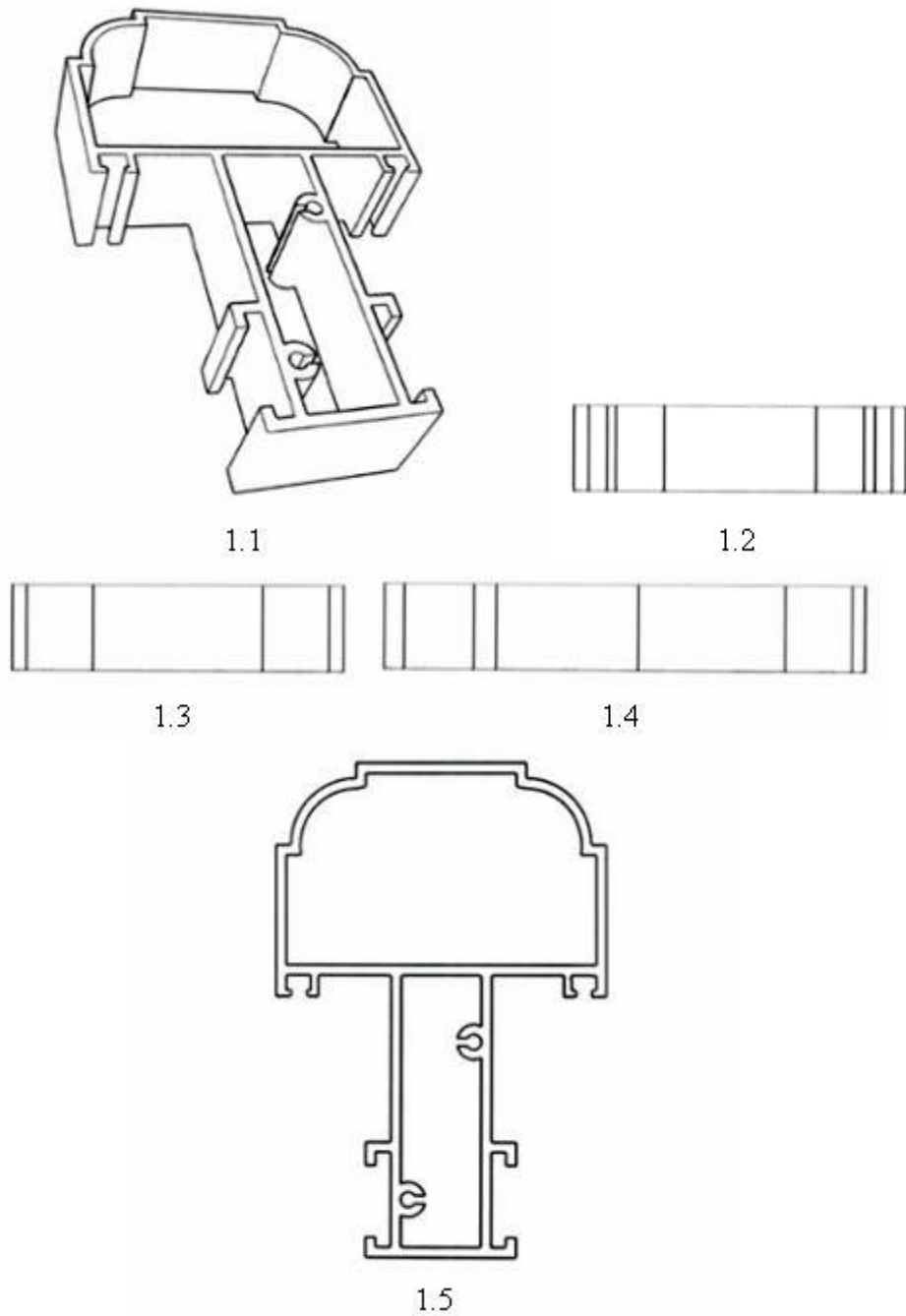

CÔNG BÁO SỞ HỮU CÔNG NGHIỆP SỐ 406 TẬP A – QUYỀN 2 (01.2022)

- (11) **43696**
(21) 3-2021-02635 (28) 1
(54) **THIẾT BỊ PHÂN TÍCH NỒNG ĐỘ KHÍ THÔNG MINH** (51) **10-04; 10-05**
(22) 22/10/2021 (43) 25/01/2022
(73) **CÔNG TY CỔ PHẦN RYNAN TECHNOLOGIES VIETNAM (VN)**
Ấp Long Trị, xã Long Đức, thành phố Trà Vinh, tỉnh Trà Vinh
(72) 1. NGUYỄN THANH MỸ (VN)
2. NGUYỄN VĂN TIỀN (VN)
3. NGUYỄN THANH DUY (VN)
4. ĐOÀN QUỐC NAM (VN)
5. TÔ HUỖNH NGỌC DUY (VN)
(74) Công ty TNHH Đại Tín và Liên Danh (DAITIN AND ASSOCIATES CO.,LTD)
(55)

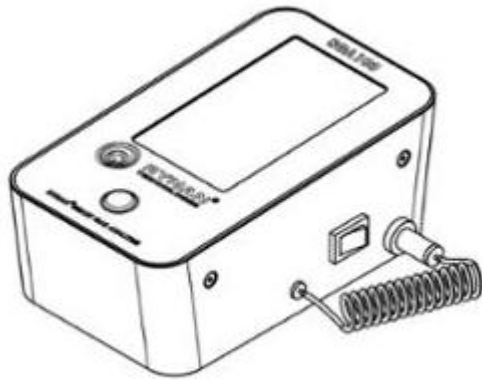

1.1

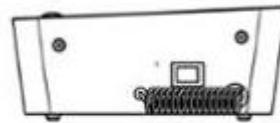

1.2



1.3

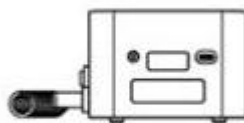

1.4



1.5



1.6

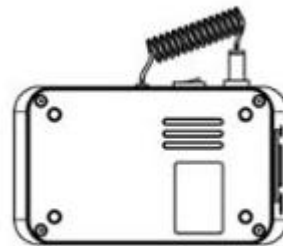

1.7

CÔNG BÁO SỞ HỮU CÔNG NGHIỆP SỐ 406 TẬP A – QUYỀN 2 (01.2022)

- (11) **43697**
(21) 3-2021-02636 (28) 2
(54) **NHÃN SẢN PHẨM** (51) **19-08**
(22) 22/10/2021 (43) 25/01/2022
(73) **HUỶNH ĐĂNG TRIỀU (VN)**
186C khu phố 3, phường 7, thành phố Bến Tre, tỉnh Bến Tre
(72) Huỳnh Đăng Triều (VN)
(74) Văn phòng Luật sư D và T (D & T LAW OFFICE)
(55)



1.1



1.2



2.1



2.2

CÔNG BÁO SỞ HỮU CÔNG NGHIỆP SỐ 406 TẬP A – QUYỀN 2 (01.2022)

- (11) **43698**
(21) 3-2021-02639 (28) 1
(54) **HỘP ĐỰNG SẢN PHẨM** (51) **09-03**
(22) 22/10/2021 (43) 25/01/2022
(73) **CÔNG TY TNHH SX & TM XUẤT NHẬP KHẨU GIA BẢO (VN)**
86C đường Nguyễn Trãi, thị trấn Quảng Phú, huyện Cư M'gar, tỉnh Đắk Lắk
(72) Hồ Duy Linh (VN)
(74) Công ty TNHH Tư vấn Nhiệt tâm và Cộng sự (NT & PARTNERS CO.,LTD.)
(55)



1.1



1.2

CÔNG BÁO SỞ HỮU CÔNG NGHIỆP SỐ 406 TẬP A – QUYỀN 2 (01.2022)

- (11) **43699**
(21) 3-2021-02640 (28) 1
(54) **BAO GÓI SẢN PHẨM** (51) **09-05**
(22) 22/10/2021 (43) 25/01/2022
(73) **CÔNG TY TNHH SX & TM XUẤT NHẬP KHẨU GIA BẢO (VN)**
86C đường Nguyễn Trãi, thị trấn Quảng Phú, huyện Cư M'gar, tỉnh Đắk Lắk
(72) Hồ Duy Linh (VN)
(74) Công ty TNHH Tư vấn Nhiệt tâm và Cộng sự (NT & PARTNERS CO.,LTD.)
(55)



1.1



1.2

CÔNG BÁO SỞ HỮU CÔNG NGHIỆP SỐ 406 TẬP A – QUYỀN 2 (01.2022)

- (11) **43700**
(21) 3-2021-02641 (28) 1
(54) **BAO GÓI SẢN PHẨM** (51) **09-05**
(22) 22/10/2021 (43) 25/01/2022
(73) **CÔNG TY TNHH SX & TM XUẤT NHẬP KHẨU GIA BẢO (VN)**
86C đường Nguyễn Trãi, thị trấn Quảng Phú, huyện Cư M'gar, tỉnh Đắk Lắk
(72) Hồ Duy Linh (VN)
(74) Công ty TNHH Tư vấn Nhiệt tâm và Cộng sự (NT & PARTNERS CO.,LTD.)
(55)



1.1



1.2

CÔNG BÁO SỞ HỮU CÔNG NGHIỆP SỐ 406 TẬP A – QUYỀN 2 (01.2022)

- (11) **43701**
(21) 3-2021-02643 (28) 1
(54) **THIẾT BỊ ĐỌC CHỈ SỐ ĐỒNG HỒ NƯỚC** (51) **10-04**
(22) 22/10/2021 (43) 25/01/2022
(73) **CÔNG TY CỔ PHẦN THIẾT BỊ CÔNG NGHIỆP HỮU HỒNG (VN)**
157-159 Xuân Hồng, phường 12, quận Tân Bình, thành phố Hồ Chí Minh
(72) Trịnh Quốc Tài (VN)
(74) Công ty TNHH NACILAW (NACILAW)
(55)

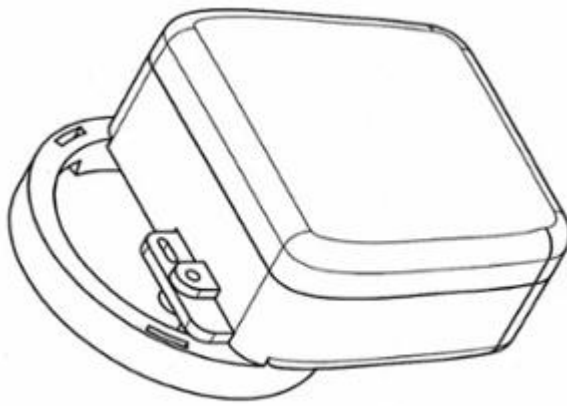

1.1

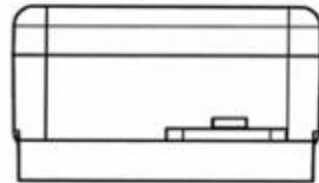

1.2



1.3

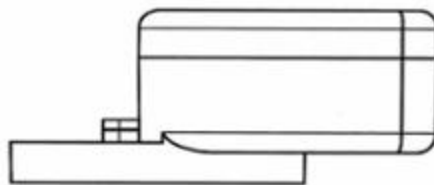

1.4

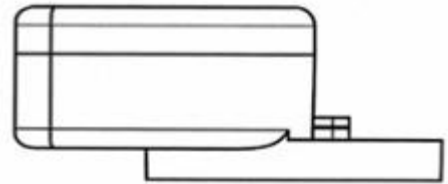

1.5



1.6



1.7

CÔNG BÁO SỞ HỮU CÔNG NGHIỆP SỐ 406 TẬP A – QUYỀN 2 (01.2022)

- (11) **43702**
(21) 3-2021-02645 (28) 1
(54) **TÀU THỦY** (51) **12-06**
(22) 22/10/2021 (43) 25/01/2022
(73) **CÔNG TY CỔ PHẦN THIẾT KẾ VÀ SẢN XUẤT TÀU CALYPSO (VN)**
180C Hai Bà Trưng, phường Đa Kao, quận 1, thành phố Hồ Chí Minh
(72) Trần Tuấn Vũ (VN)
(55)



1.1



1.2



1.3

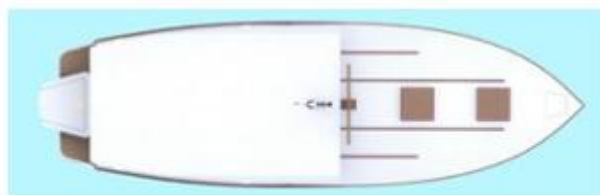

1.4



1.5



1.6



1.7

- (11) **43703**
(21) 3-2021-02650 (28) 1
(54) **DỤNG CỤ TÁCH NƯỚC RÁC THẢI HỮU CƠ** (51) **09-09; 23-99**
(22) 25/10/2021 (43) 25/01/2022
(73) **CÔNG TY CỔ PHẦN THƯƠNG MẠI VÀ DỊCH VỤ HÀNH TINH XANH**
(VN)
Số 44, khu A, ngõ 109 đường Trường Chinh, phường Phương Liệt, quận Thanh Xuân, thành phố Hà Nội
(72) Nguyễn Đức Nghĩa (VN)
(55)



CÔNG BÁO SỞ HỮU CÔNG NGHIỆP SỐ 406 TẬP A – QUYỀN 2 (01.2022)

- (11) **43704**
(21) 3-2021-02651 (28) 1
(54) **THÙNG ĐỰNG RÁC** (51) **09-09**
(22) 25/10/2021 (43) 25/01/2022
(73) **CÔNG TY CỔ PHẦN THƯƠNG MẠI VÀ DỊCH VỤ HÀNH TINH XANH (VN)**
Số 44, khu A, ngõ 109 đường Trường Chinh, phường Phương Liệt, quận Thanh Xuân, thành phố Hà Nội
(72) Nguyễn Đức Nghĩa (VN)
(55)



1.1



1.2



1.3



1.4



1.5



1.6



1.7



1.8

CÔNG BÁO SỞ HỮU CÔNG NGHIỆP SỐ 406 TẬP A – QUYỀN 2 (01.2022)

- (11) **43705**
(21) 3-2021-02652 (28) 1
(54) **TÀU THỦY** (51) **12-06**
(22) 25/10/2021 (43) 25/01/2022
(73) **CÔNG TY CỔ PHẦN THIẾT KẾ VÀ SẢN XUẤT TÀU CALYPSO (VN)**
180C Hai Bà Trưng, phường Đa Kao, quận 1, thành phố Hồ Chí Minh
(72) Trần Tuấn Vũ (VN)
(55)



1.1



1.2

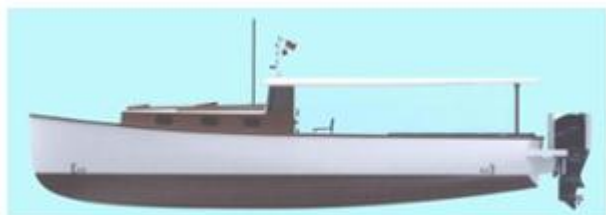

1.3

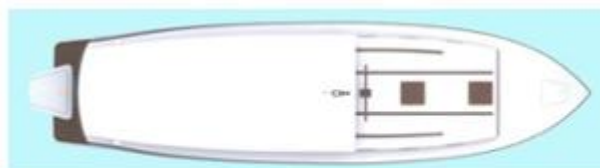

1.4



1.5



1.6



1.7

CÔNG BÁO SỞ HỮU CÔNG NGHIỆP SỐ 406 TẬP A – QUYỀN 2 (01.2022)

- (11) **43706**
- (21) 3-2021-02654 (28) 1
- (54) **ĐIỆN THOẠI DI ĐỘNG** (51) **14-03**
- (22) 25/10/2021 (43) 25/01/2022
- (30) 30-2021-0020865 29/04/2021 KR;
- (73) **SAMSUNG ELECTRONICS CO., LTD. (KR)**
129, Samsung-ro, Yeongtong-gu, Suwon-si, Gyeonggi-do 16677, Republic of Korea
- (72) 1. LEE, JINHOO (KR)
2. LEE, JUNWON (KR)
3. KIM, NAMSU (KR)
4. KIM, KANGMOON (KR)
5. MYUNG, JIEUN (KR)
6. LEE, DAHYUN (KR)
7. KANG, BOSOON (KR)
8. LIM, JIYUN (KR)
9. JIN, JUNHO (KR)
- (74) Công ty Luật TNHH WINCO (WINCO LAW FIRM)
- (55)

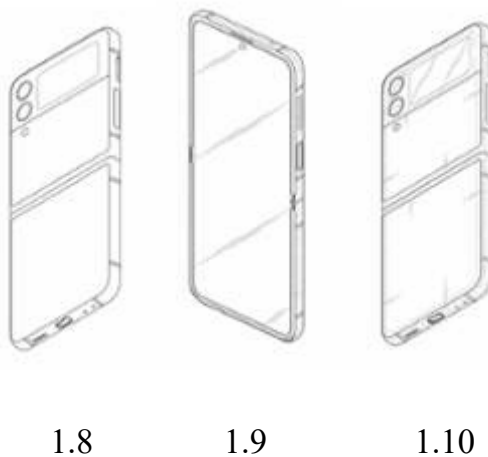
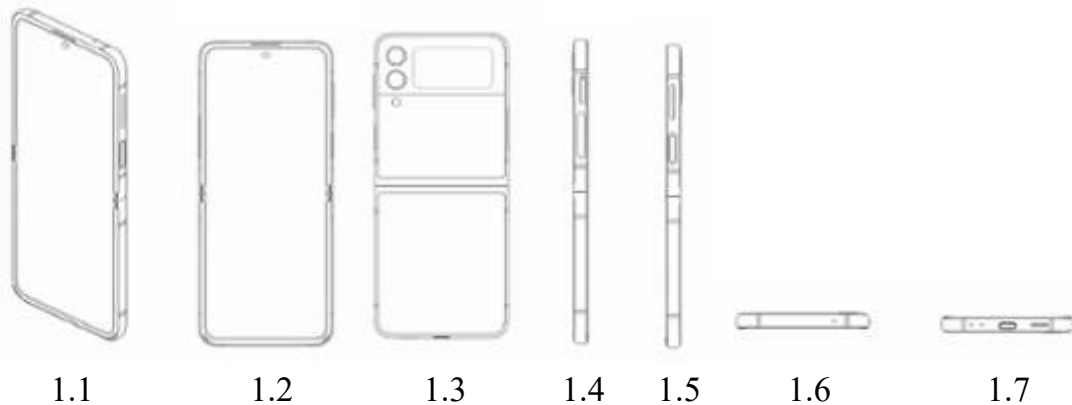

CÔNG BÁO SỞ HỮU CÔNG NGHIỆP SỐ 406 TẬP A – QUYỀN 2 (01.2022)

- (11) **43707**
- (21) 3-2021-02655 (28) 1
- (54) **ĐIỆN THOẠI DI ĐỘNG** (51) **14-03**
- (22) 25/10/2021 (43) 25/01/2022
- (30) 30-2021-0020864 29/04/2021 KR;
- (73) **SAMSUNG ELECTRONICS CO., LTD. (KR)**
129, Samsung-ro, Yeongtong-gu, Suwon-si, Gyeonggi-do 16677, Republic of Korea
- (72) 1. LEE, JINHOO (KR)
2. LEE, JUNWON (KR)
3. KIM, NAMSU (KR)
4. KIM, KANGMOON (KR)
5. LEE, DAHYUN (KR)
6. MYUNG, JIEUN (KR)
7. KANG, BOSOON (KR)
8. JIN, JUNHO (KR)
9. LIM, JIYUN (KR)
- (74) Công ty Luật TNHH WINCO (WINCO LAW FIRM)
- (55)



1.1



1.2



1.3



1.4



1.5



1.6



1.7



1.8



1.9

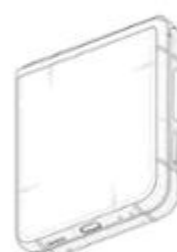

1.10

CÔNG BÁO SỞ HỮU CÔNG NGHIỆP SỐ 406 TẬP A – QUYỀN 2 (01.2022)

- (11) **43708**
- (21) 3-2021-02656 (28) 1
- (54) **ĐIỆN THOẠI DI ĐỘNG** (51) **14-03**
- (22) 25/10/2021 (43) 25/01/2022
- (30) 30-2021-0020863 29/04/2021 KR;
- (73) **SAMSUNG ELECTRONICS CO., LTD. (KR)**
129, Samsung-ro, Yeongtong-gu, Suwon-si, Gyeonggi-do 16677, Republic of Korea
- (72) 1. LEE, JUNWON (KR)
2. LEE, JINHOO (KR)
3. KIM, NAMSU (KR)
4. KIM, KANGMOON (KR)
5. MYUNG, JIEUN (KR)
6. LEE, DAHYUN (KR)
7. JIN, JUNHO (KR)
8. LIM, JIYUN (KR)
9. KANG, BOSOON (KR)
- (74) Công ty Luật TNHH WINCO (WINCO LAW FIRM)
- (55)

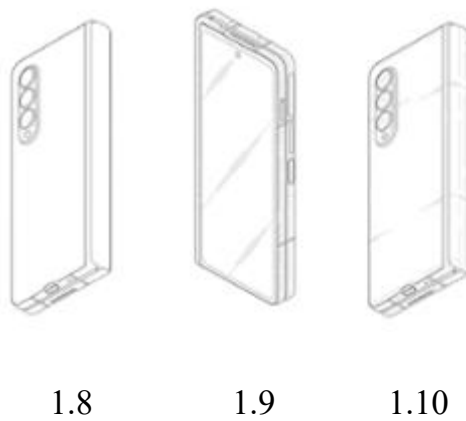
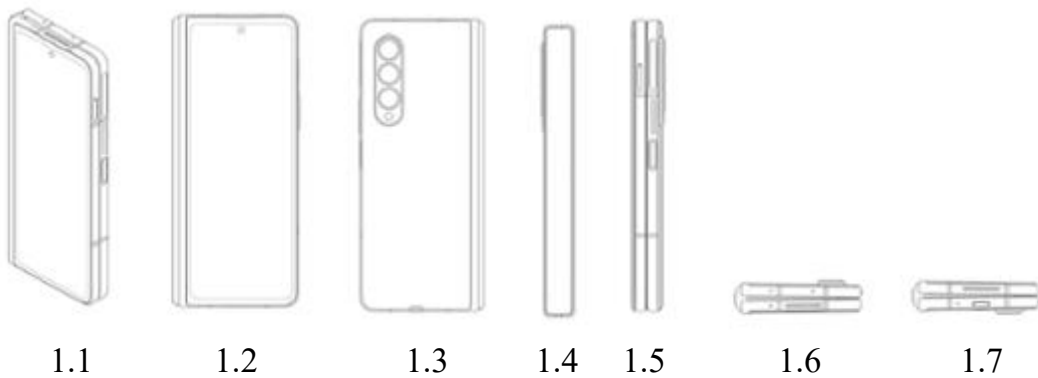

CÔNG BÁO SỞ HỮU CÔNG NGHIỆP SỐ 406 TẬP A – QUYỀN 2 (01.2022)

- (11) **43709**
(21) 3-2021-02657 (28) 1
(54) **ĐIỆN THOẠI DI ĐỘNG** (51) **14-03**
(22) 25/10/2021 (43) 25/01/2022
(30) 30-2021-0020862 29/04/2021 KR;
(73) **SAMSUNG ELECTRONICS CO., LTD. (KR)**
129, Samsung-ro, Yeongtong-gu, Suwon-si, Gyeonggi-do 16677, Republic of Korea
(72) 1. LEE, JUNWON (KR)
2. LEE, JINHOO (KR)
3. KIM, NAMSU (KR)
4. KIM, KANGMOON (KR)
5. MYUNG, JIEUN (KR)
6. LEE, DAHYUN (KR)
7. JIN, JUNHO (KR)
8. LIM, JIYUN (KR)
9. KANG, BOSOON (KR)
(74) Công ty Luật TNHH WINCO (WINCO LAW FIRM)
(55)

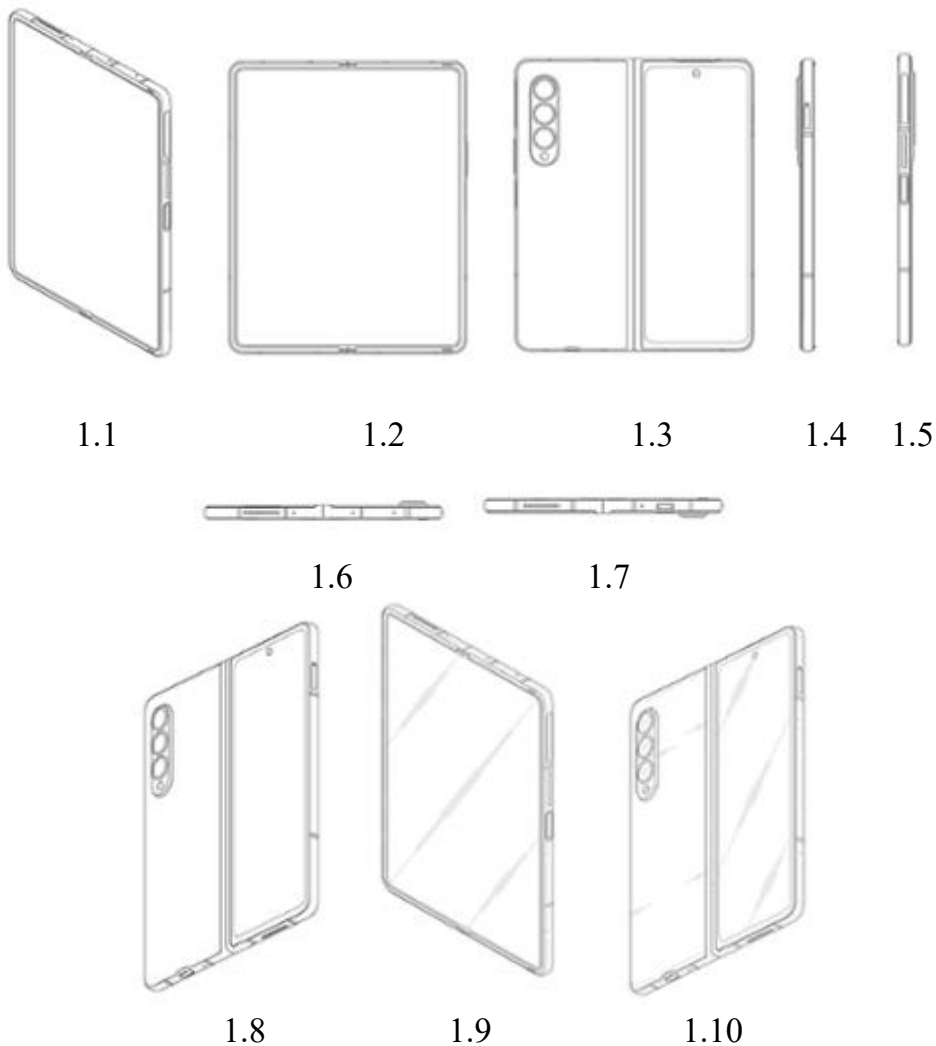

CÔNG BÁO SỞ HỮU CÔNG NGHIỆP SỐ 406 TẬP A – QUYỀN 2 (01.2022)

- (11) **43710**
(21) 3-2021-02659 (28) 1
(54) **HỘP ĐỰNG** (51) **09-03**
(22) 27/03/2019 (43) 25/01/2022
(30) 970009839 12/02/2019 WO;
(73) **FRIESLANDCAMPINA NEDERLAND B.V. (NL)**
Stationsplein 4,3818 LE AMERSFOORT, The Netherlands
(72) Tim Siro (SG)
(74) Công ty TNHH Trường Xuân (AGELESS CO.,LTD.)
(55)



1.1

1.2

1.3



1.4

1.5

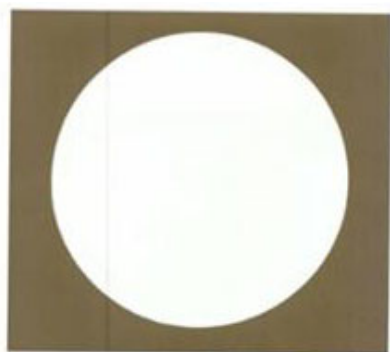

1.6



1.7

CÔNG BÁO SỞ HỮU CÔNG NGHIỆP SỐ 406 TẬP A – QUYỀN 2 (01.2022)

- (11) **43711**
(21) 3-2021-02667 (28) 1
(54) **NÚT NHỰA ĐẬY BỊT TAY CẦM** (51) **08-08**
(22) 25/10/2021 (43) 25/01/2022
(73) **CÔNG TY TNHH SẢN XUẤT THƯƠNG MẠI DỊCH VỤ HAI THI (VN)**
14/13/39 Thân Nhân Trung, phường 13, quận Tân Bình, thành phố Hồ Chí Minh
(72) Trần Đình Thi (VN)
(74) Công ty Luật TNHH LEADCONSULT (LEADCONSULT)
(55)



1.1

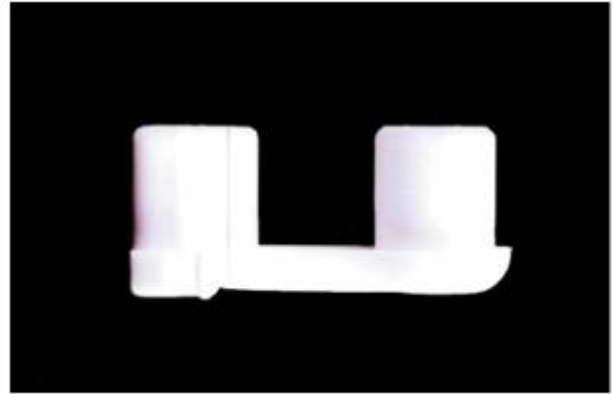

1.2



1.3



1.4



1.5



1.6

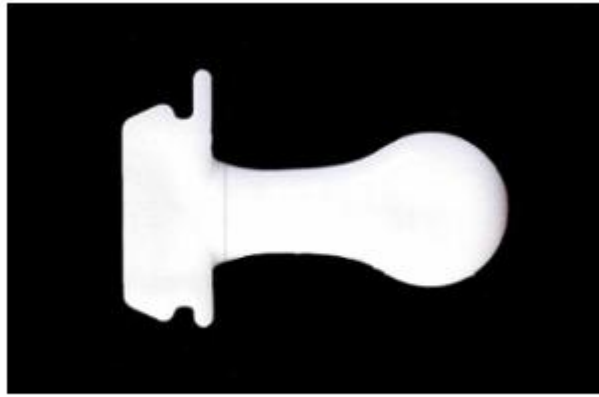

1.7

CÔNG BÁO SỞ HỮU CÔNG NGHIỆP SỐ 406 TẬP A – QUYỀN 2 (01.2022)

- (11) **43712**
(21) 3-2021-02670 (28) 1
(54) **BAO GÓI ĐỰNG SẢN PHẨM** (51) **09-05**
(22) 25/10/2021 (43) 25/01/2022
(73) **CÔNG TY CỔ PHẦN SIMBA CEMENT GROUP (VN)**
Số 86 đường 27, phường Linh Đông, thành phố Thủ Đức, thành phố Hồ Chí Minh
(72) Lê Đức Cảnh (VN)
(74) **CÔNG TY TNHH SỞ HỮU TRÍ TUỆ SETHACO (SETHACO IP CO.,LTD)**
(55)



Ảnh 1: ảnh tiền khai

1.1



Ảnh 2: ảnh tổng thể

1.2

CÔNG BÁO SỞ HỮU CÔNG NGHIỆP SỐ 406 TẬP A – QUYỀN 2 (01.2022)

- (11) **43713**
(21) 3-2021-02672 (28) 1
(54) **CHAI** (51) **09-01**
(22) 25/10/2021 (43) 25/01/2022
(73) **CÔNG TY CỔ PHẦN HÀNG TIÊU DÙNG MASAN (VN)**
Tầng 12, tòa nhà MPlaza Saigon, số 39 Lê Duẩn, phường Bến Nghé, quận 1, thành phố Hồ Chí Minh
(72) Nguyễn Hoàng Yên (VN)
(74) Công ty cổ phần Sở hữu trí tuệ BROSS và Cộng sự (BROSS & PARTNERS., JSC)
(55)



1.1



1.2



1.3



1.4



1.5



1.6



1.7

CÔNG BÁO SỞ HỮU CÔNG NGHIỆP SỐ 406 TẬP A – QUYỀN 2 (01.2022)

- (11) **43714**
(21) 3-2021-02673 (28) 1
(54) **BAO GÓI** (51) **09-05**
(22) 25/10/2021 (43) 25/01/2022
(73) **CÔNG TY CỔ PHẦN THỰC PHẨM Á CHÂU (VN)**
Số 9/2 đường ĐT 743, khu phố 1B, phường An Phú, thành phố Thuận An, tỉnh Bình Dương
(72) **NGUYỄN MẠNH CƯỜNG (VN)**
(74) Văn phòng Luật sư A Hoà (AHOA LAW OFFICE)
(55)



1.1



1.2

CÔNG BÁO SỞ HỮU CÔNG NGHIỆP SỐ 406 TẬP A – QUYỀN 2 (01.2022)

- (11) **43715**
(21) 3-2021-02675 (28) 1
(54) **XE MÁY** (51) **12-11**
(22) 26/10/2021 (43) 25/01/2022
(30) 2021-009294 30/04/2021 JP;
(73) **HONDA MOTOR CO., LTD. (JP)**
1-1, Minami-Aoyama 2-Chome, Minato-ku, Tokyo, 107-8556 Japan
(72) 1. MAURIZIO CARBONARA (IT)
2. TAKASHI TAKIZAWA (JP)
(74) Công ty Luật TNHH Phạm và Liên danh (PHAM & ASSOCIATES)
(55)



1.1



1.2



1.3



1.4



1.5



1.6



1.7



1.8



1.9

(11) **43716**

(21) 3-2021-02679

(28) 1

(54) **ĐÈN LED**

(51) **26-03**

(22) 26/10/2021

(43) 25/01/2022

(73) **CÔNG TY CỔ PHẦN SLIGHTING VIỆT NAM (VN)**

Số 168, đường K2, phường Cầu Diễn, quận Nam Từ Liêm, thành phố Hà Nội

(72) Lê Ngọc Quỳnh (VN)

(74) Công ty TNHH Sở hữu trí tuệ Việt Á (VIET A IP CO.,LTD)

(55)



1.1

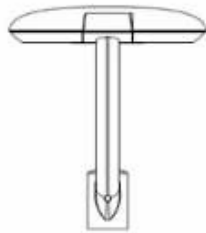

1.2



1.3



1.4



1.5

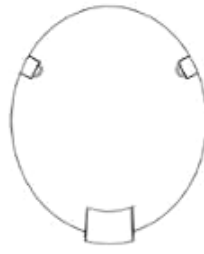

1.6



1.7

CÔNG BÁO SỞ HỮU CÔNG NGHIỆP SỐ 406 TẬP A – QUYỀN 2 (01.2022)

(11) **43717**

(21) 3-2021-02680

(28) 1

(54) **ĐÈN LED**

(51) **26-03**

(22) 26/10/2021

(43) 25/01/2022

(73) **CÔNG TY CỔ PHẦN SLIGHTING VIỆT NAM (VN)**

Số 168, đường K2, phường Cầu Diễn, quận Nam Từ Liêm, thành phố Hà Nội

(72) Lê Ngọc Quỳnh (VN)

(74) Công ty TNHH Sở hữu trí tuệ Việt Á (VIET A IP CO.,LTD)

(55)



1.1



1.2



1.3



1.4



1.5

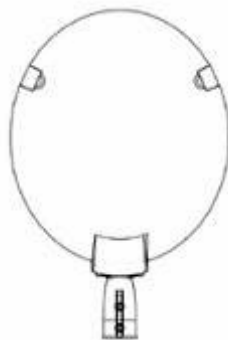

1.6



1.7

CÔNG BÁO SỞ HỮU CÔNG NGHIỆP SỐ 406 TẬP A – QUYỀN 2 (01.2022)

- (11) **43718**
(21) 3-2021-02681 (28) 1
(54) **THIẾT BỊ NHẬN DẠNG CÁ NHÂN** (51) **10-05**
(22) 26/10/2021 (43) 25/01/2022
(30) 2021-009562 07/05/2021 JP;
(73) **MITSUBISHI ELECTRIC CORPORATION (JP)**
7-3, Marunouchi 2-chome, Chiyoda-ku, Tokyo 100-8310, Japan
(72) Tatsunari KATAOKA (JP)
(74) Công ty TNHH Tầm nhìn và Liên danh (VISION & ASSOCIATES CO.LTD.)
(55)

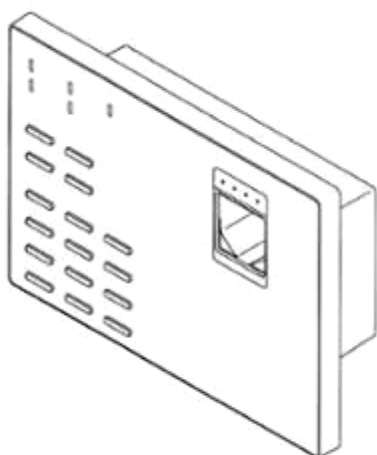

1.1

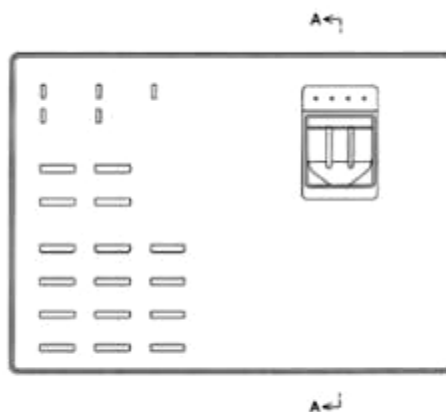

1.2

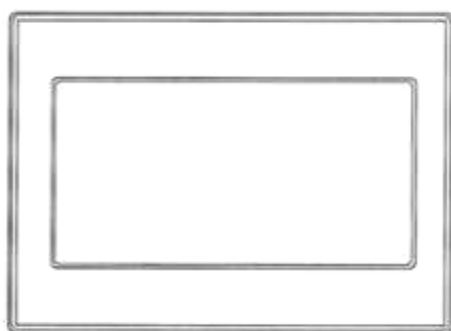

1.3

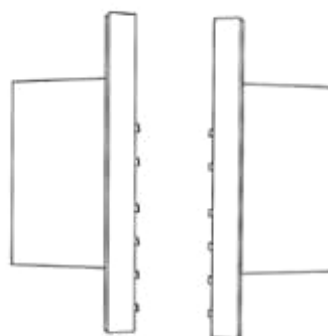

1.4

1.5



1.6



1.7

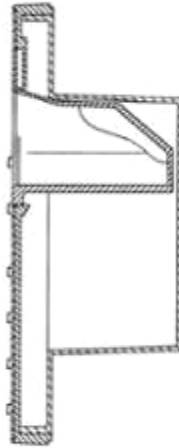

1.8

CÔNG BÁO SỞ HỮU CÔNG NGHIỆP SỐ 406 TẬP A – QUYỀN 2 (01.2022)

- (11) **43719**
(21) 3-2021-02683 (28) 1
(54) **LỌ ĐỰNG SON MÔI** (51) **28-02**
(22) 27/10/2021 (43) 25/01/2022
(73) **LG HOUSEHOLD & HEALTH CARE LTD. (KR)**
58, Saemunan-ro, Jongno-gu, Seoul, Republic of Korea
(72) KIM, Joung Eun (KR)
(74) Công ty TNHH Tâm nhìn và Liên danh (VISION & ASSOCIATES CO.LTD.)
(55)

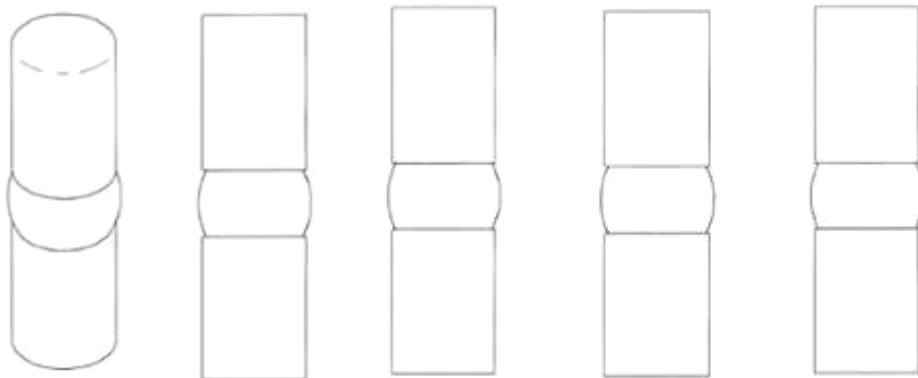

1.1

1.2

1.3

1.4

1.5



1.6



1.7



1.8

- (11) **43720**
(21) 3-2021-02688 (28) 1
(54) **BỘ GÁ CHO THIẾT BỊ ĐO** (51) **10-04**
(22) 29/10/2021 (43) 25/01/2022
(73) 1. **TRƯỜNG ĐẠI HỌC BÁCH KHOA – ĐẠI HỌC QUỐC GIA THÀNH PHỐ HỒ CHÍ MINH (VN)**
268 đường Lý Thường Kiệt, phường 14, quận 10, thành phố Hồ Chí Minh
2. **ĐẠI HỌC QUỐC GIA THÀNH PHỐ HỒ CHÍ MINH (VN)**
Phường Linh Trung, thành phố Thủ Đức, thành phố Hồ Chí Minh
(72) 1. **NGÔ KHÁNH HIẾU (VN)**
2. **LÊ BÁ QUỐC (VN)**
3. **LÊ QUỲNH NHƯ (VN)**
4. **PHẠM QUỐC HÙNG (VN)**
(55)

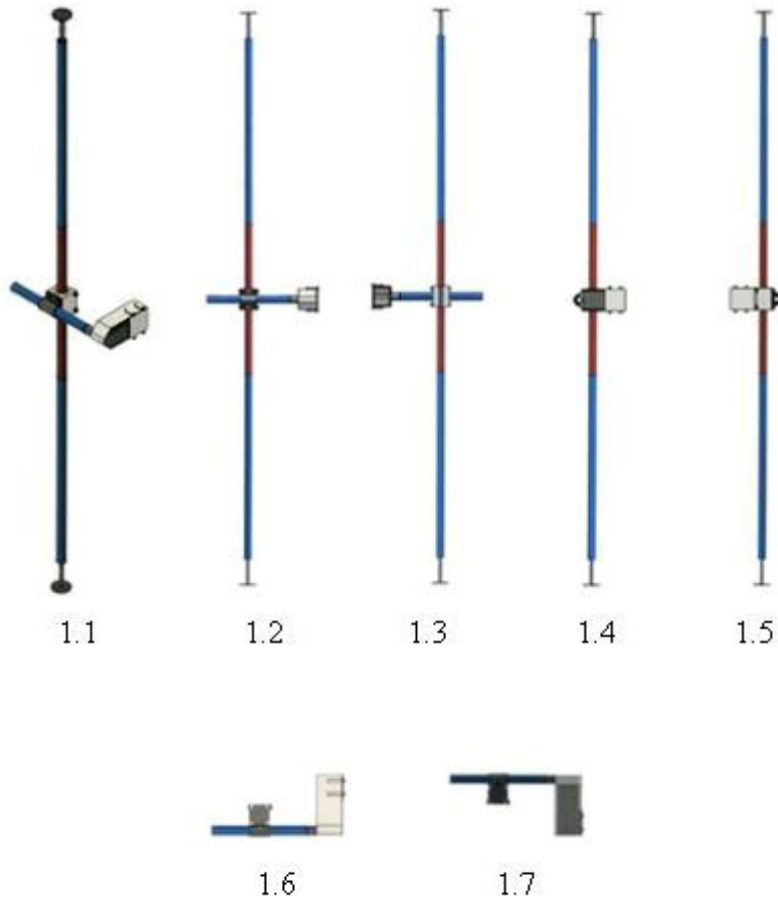

- (11) **43721**
(21) 3-2021-02689 (28) 1
(54) **BÌNH** (51) **07-07**
(22) 29/10/2021 (43) 25/01/2022
(30) 2021-009301 30/04/2021 JP;
(73) **HAYATO WATANABE (JP)**
11-24, Yuda 1-chome, Kofu-shi, Yamanashi Japan
(72) Hayato WATANABE (JP)
(74) Công ty TNHH một thành viên Sở hữu trí tuệ VCCI (VCCI-IP CO.,LTD)
(55)



1.1



1.2



1.3



1.4



1.5



1.6

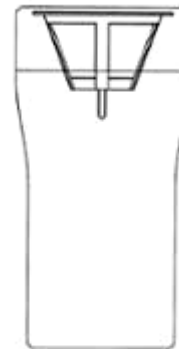

1.7

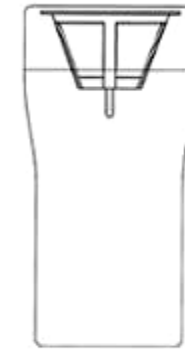

1.8



1.9



1.10



1.11

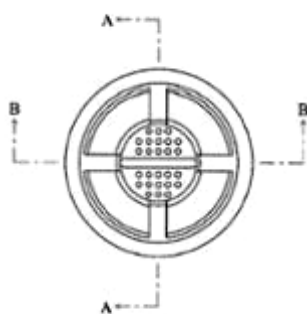

1.12



1.13



1.14

- (11) **43722**
(21) 3-2021-02696 (28) 1
(54) **CHẬU RỬA** (51) **23-02**
(22) 29/10/2021 (43) 25/01/2022
(30) 008536098-0001 11/05/2021 EM;
(73) **HANSGROHE SE (DE)**
Austr. 5 - 9, 77761 Schiltach, Germany
(72) Laura Somaglino (IT)
(74) Công ty TNHH Trường Xuân (AGELESS CO.,LTD.)
(55)



1.1



1.2



1.3



1.4



1.5



1.6



1.7

- (11) **43723**
(21) 3-2021-02697 (28) 1
(54) **CHẬU RỬA** (51) **23-02**
(22) 29/10/2021 (43) 25/01/2022
(30) 008536098-0002 11/05/2021 EM;
(73) **HANSGROHE SE (DE)**
Austr. 5 - 9, 77761 Schiltach, Germany
(72) Laura Somaglino (IT)
(74) Công ty TNHH Trường Xuân (AGELESS CO.,LTD.)
(55)



1.1



1.2



1.3



1.4



1.5

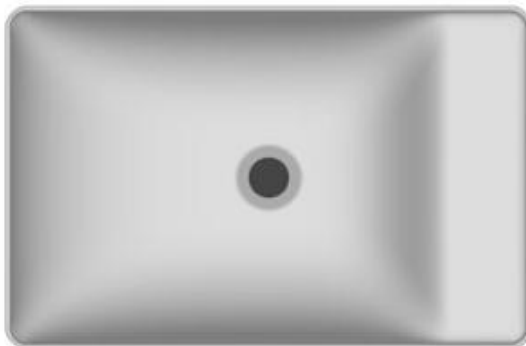

1.6



1.7

CÔNG BÁO SỞ HỮU CÔNG NGHIỆP SỐ 406 TẬP A – QUYỀN 2 (01.2022)

- (11) **43724**
(21) 3-2021-02698 (28) 1
(54) **CHẬU RỬA** (51) **23-02**
(22) 29/10/2021 (43) 25/01/2022
(30) 008536098-0003 11/05/2021 EM;
(73) **HANSGROHE SE (DE)**
Austr. 5 - 9, 77761 Schiltach, Germany
(72) Laura Somaglino (IT)
(74) Công ty TNHH Trường Xuân (AGELESS CO.,LTD.)
(55)



1.1



1.2



1.3



1.4



1.5



1.6

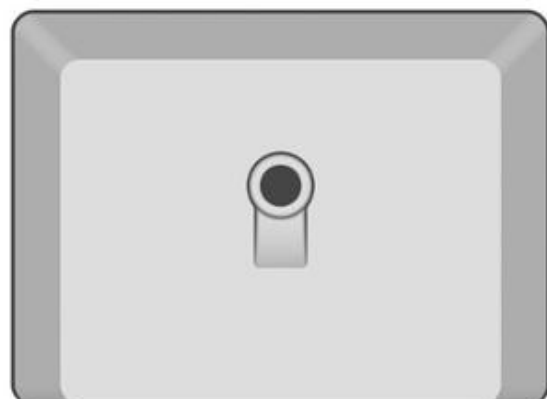

1.7

CÔNG BÁO SỞ HỮU CÔNG NGHIỆP SỐ 406 TẬP A – QUYỀN 2 (01.2022)

- (11) **43725**
(21) 3-2021-02699 (28) 1
(54) **HỘP ĐỰNG** (51) **09-03**
(22) 29/10/2021 (43) 25/01/2022
(73) **CÔNG TY TNHH NTPM (VIỆT NAM) (VN)**
Số 22 VSIP II-A, đường số 23, khu công nghiệp Việt Nam – Singapore II-A,
phường Vĩnh Tân, thị xã Tân Uyên, tỉnh Bình Dương
(72) LEE KUAN PHENG (MY)
(74) Công ty TNHH Sở hữu trí tuệ HA VIP (HAVIP CO., LTD.)
(55)



1.1



1.2

CÔNG BÁO SỞ HỮU CÔNG NGHIỆP SỐ 406 TẬP A – QUYỀN 2 (01.2022)

(11) **43726**

(21) 3-2021-02700

(28) 1

(54) **XE MÁY ĐIỆN**

(51) **12-11**

(22) 01/11/2021

(43) 25/01/2022

(73) **CÔNG TY TNHH SUFAT VIỆT NAM (VN)**

KCN Phố Nối B, xã Nghĩa Hiệp, huyện Yên Mỹ, tỉnh Hưng Yên

(72) Phạm Cường (VN)

(55)



1.1



1.2



1.3



1.4



1.5



1.6



1.7

CÔNG BÁO SỞ HỮU CÔNG NGHIỆP SỐ 406 TẬP A – QUYỀN 2 (01.2022)

- (11) **43727**
(21) 3-2021-02701 (28) 1
(54) **THÙNG ĐỰNG** (51) **09-03**
(22) 01/11/2021 (43) 25/01/2022
(73) **TỔNG CÔNG TY CỔ PHẦN BIA – RƯỢU – NƯỚC GIẢI KHÁT HÀ NỘI**
(VN)
Số 183, phố Hoàng Hoa Thám, phường Ngọc Hà, quận Ba Đình, thành phố Hà Nội
(72) Lê Minh Đức (VN)
(74) Công ty TNHH tư vấn Sở hữu trí tuệ IPFLAME (IPFLAME CO.,LTD)
(55)



1.1

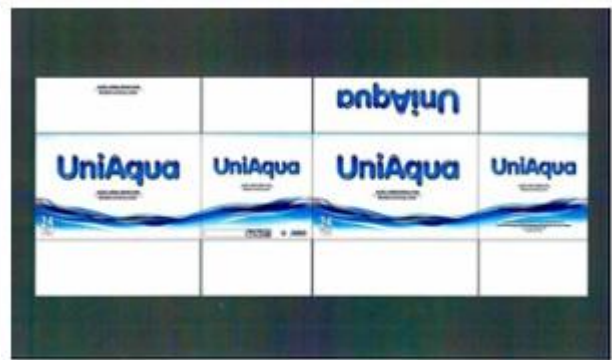

1.2

CÔNG BÁO SỞ HỮU CÔNG NGHIỆP SỐ 406 TẬP A – QUYỀN 2 (01.2022)

- (11) **43728**
- (21) 3-2021-02702 (28) 1
- (54) **NHÃN SẢN PHẨM** (51) **19-08**
- (22) 01/11/2021 (43) 25/01/2022
- (73) **TỔNG CÔNG TY CỔ PHẦN BIA – RƯỢU – NƯỚC GIẢI KHÁT HÀ NỘI (VN)**
Số 183, phố Hoàng Hoa Thám, phường Ngọc Hà, quận Ba Đình, thành phố Hà Nội
- (72) Lê Minh Đức (VN)
- (74) Công ty TNHH tư vấn Sở hữu trí tuệ IPFLAME (IPFLAME CO.,LTD)
- (55)



CÔNG BÁO SỞ HỮU CÔNG NGHIỆP SỐ 406 TẬP A – QUYỀN 2 (01.2022)

- (11) **43729**
(21) 3-2021-02703 (28) 1
(54) **BÀN CHẢI ĐÁNH RĂNG** (51) **04-02**
(22) 01/11/2021 (43) 25/01/2022
(73) **CÔNG TY TNHH SẢN XUẤT THƯƠNG MẠI MỸ NGUYỄN (VN)**
580/32 Âu Cơ, phường 14, quận Tân Bình, thành phố Hồ Chí Minh
(72) Trần Chí Đức (VN)
(55)

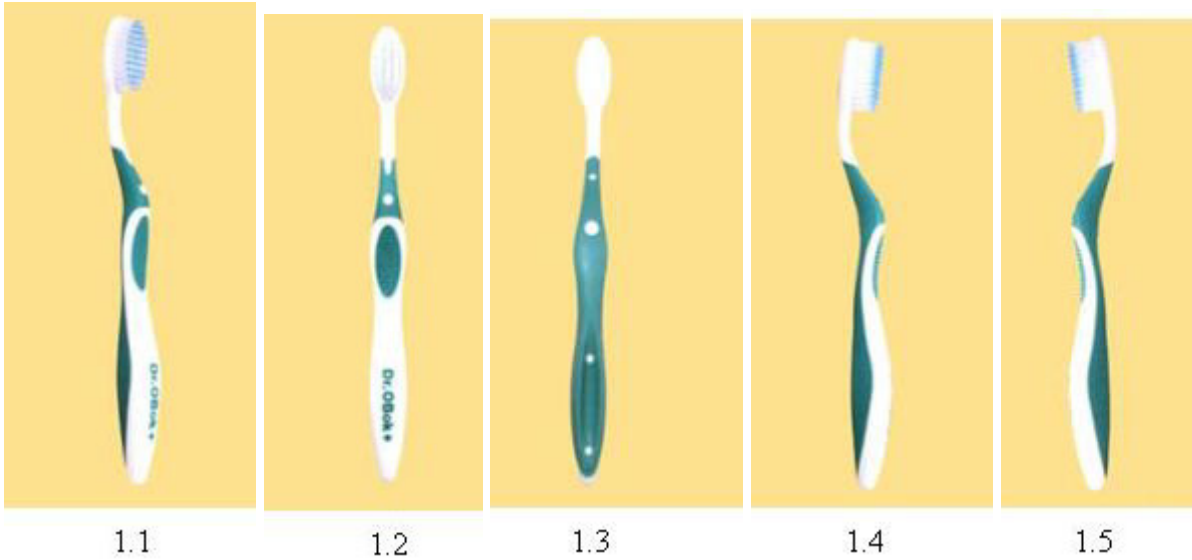

CÔNG BÁO SỞ HỮU CÔNG NGHIỆP SỐ 406 TẬP A – QUYỀN 2 (01.2022)

- (11) **43730**
(21) 3-2021-02704 (28) 1
(54) **BÀN CHẢI ĐÁNH RĂNG** (51) **04-02**
(22) 01/11/2021 (43) 25/01/2022
(73) **CÔNG TY TNHH SẢN XUẤT THƯƠNG MẠI MỸ NGUYỄN (VN)**
580/32 Âu Cơ, phường 14, quận Tân Bình, thành phố Hồ Chí Minh
(72) Trần Chí Đức (VN)
(55)



1.1

1.2

1.3

1.4

1.5



1.6



1.7

CÔNG BÁO SỞ HỮU CÔNG NGHIỆP SỐ 406 TẬP A – QUYỀN 2 (01.2022)

(11) **43731**

(21) 3-2021-02706

(28) 1

(54) **LON BIA**

(51) **09-03**

(22) 01/11/2021

(43) 25/01/2022

(73) **CÔNG TY TNHH MỘT THÀNH VIÊN MASAN BREWERY
DISTRIBUTION (VN)**

Tầng 10 tòa nhà Central Plaza, 17 Lê Duẩn, phường Bến Nghé, quận 1, thành phố Hồ Chí Minh.

(72) Nguyễn Hoàng Yên (VN)

(74) Công ty TNHH sở hữu trí tuệ AGL (AGL IP)

(55)



1.1



1.2



1.3



1.4



1.5



1.6

CÔNG BÁO SỞ HỮU CÔNG NGHIỆP SỐ 406 TẬP A – QUYỀN 2 (01.2022)

- (11) **43732**
- (21) 3-2021-02708 (28) 1
- (54) **NHÃN SẢN PHẨM** (51) **19-08**
- (22) 01/11/2021 (43) 25/01/2022
- (73) **CÔNG TY TNHH QUẢNG TRÂN (VN)**
Số 408, quốc lộ 1A, ấp An Trạch, xã An Hiệp, huyện Châu Thành, tỉnh Sóc Trăng
- (72) Lương Văn Côn (VN)
- (74) **CÔNG TY TNHH SỞ HỮU TRÍ TUỆ SETHACO (SETHACO IP CO.,LTD)**
- (55)



CÔNG BÁO SỞ HỮU CÔNG NGHIỆP SỐ 406 TẬP A – QUYỀN 2 (01.2022)

- (11) **43733**
(21) 3-2021-02711 (28) 1
(54) **HỘP ĐỰNG THẠCH** (51) **09-03**
(22) 02/11/2021 (43) 25/01/2022
(73) **CÔNG TY CỔ PHẦN CHẾ BIẾN THỰC PHẨM CAO BẰNG (VN)**
(NR ông Nguyễn Văn Phúc), thôn Thượng Thôn, xã Đông Tiến, huyện Yên Phong, tỉnh Bắc Ninh
(72) Trần Thị Vượng (VN)
(74) Công ty TNHH Sở hữu trí tuệ và Công nghệ Thủ đô (CAPITAL IP&T CO.LTD.)
(55)



1.1



1.2

- (11) **43734**
- (21) 3-2021-02714
- (54) **LỢ**
- (22) 03/11/2021
- (30) 30-2021-0023768 18/05/2021 KR;
- (73) **AMOREPACIFIC CORPORATION (KR)**
100, Hangang-daero, Yongsan-gu, Seoul, Republic of Korea
- (72) SHIN, Min Kyung (KR)
- (74) Công ty Luật TNHH T&G (TGVN)
- (55)
- (28) 1
- (51) **09-01**
- (43) 25/01/2022

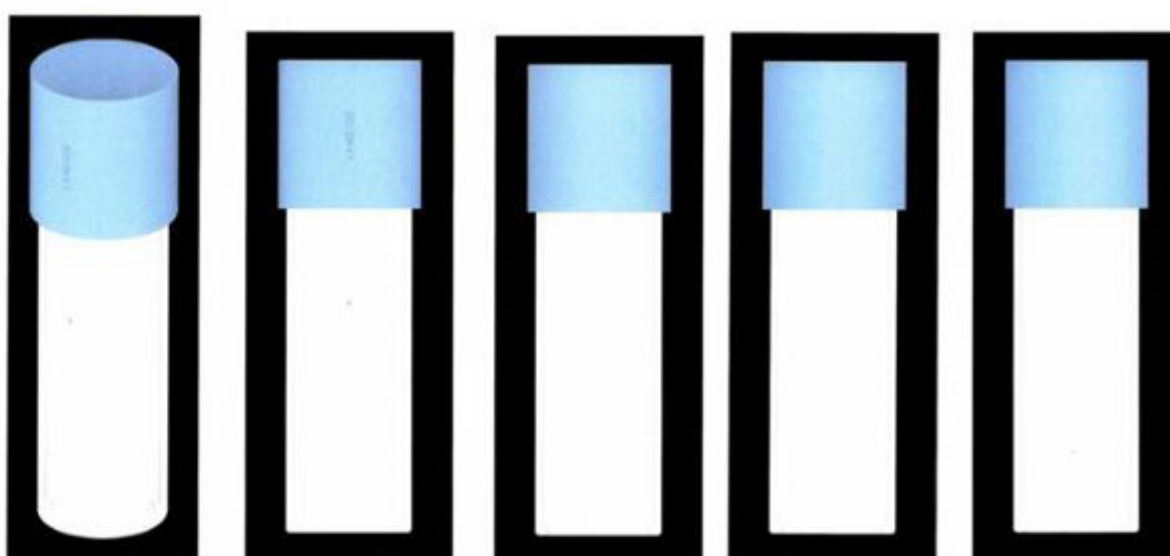

1.1

1.2

1.3

1.4

1.5



1.6

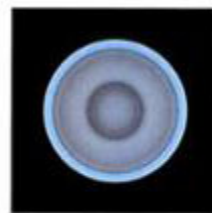

1.7

CÔNG BÁO SỞ HỮU CÔNG NGHIỆP SỐ 406 TẬP A – QUYỀN 2 (01.2022)

- (11) **43735**
- (21) 3-2021-02716 (28) 1
- (54) **BAO GÓI SẢN PHẨM** (51) **09-05**
- (22) 03/11/2021 (43) 25/01/2022
- (73) **CƠ SỞ PHÚC MƠ (VN)**
Thôn Hoàng Trung, xã Hồng Dương, huyện Thanh Oai, thành phố Hà Nội
- (72) Lê Văn Bình (VN)
- (74) Công ty Luật TNHH WINCO (WINCO LAW FIRM)
- (55)



1.1



1.2

CÔNG BÁO SỞ HỮU CÔNG NGHIỆP SỐ 406 TẬP A – QUYỀN 2 (01.2022)

(11) **43736**

(21) 3-2021-02718

(28) 1

(54) **ĐÈN CHIẾU SÁNG**

(51) **26-03**

(22) 03/11/2021

(43) 25/01/2022

(73) **CÔNG TY CỔ PHẦN CHIẾU SÁNG ĐÔ THỊ HOÀNG GIA (VN)**

Số 157 phố Phương Mai, phường Phương Mai, quận Đống Đa, thành phố Hà Nội

(72) Hoàng Song Hà (VN)

(55)



1.1



1.2



1.3



1.4



1.5



1.6



1.7

CÔNG BÁO SỞ HỮU CÔNG NGHIỆP SỐ 406 TẬP A – QUYỀN 2 (01.2022)

- (11) 43737
(21) 3-2021-02719 (28) 1
(54) **NHÃN SẢN PHẨM** (51) 19-08
(22) 04/11/2021 (43) 25/01/2022
(73) **CÔNG TY TNHH MỘT THÀNH VIÊN KEM CHÂU ĐỐC - SÀI GÒN (VN)**
Số 622 Thủ Khoa Huân, phường Châu Phú B, thành phố Châu Đốc, tỉnh An Giang
(72) Tạ Thị Thu Thủy (VN)
(55)



CÔNG BÁO SỞ HỮU CÔNG NGHIỆP SỐ 406 TẬP A – QUYỀN 2 (01.2022)

- (11) **43738**
- (21) 3-2021-02720 (28) 1
- (54) **NHÃN SẢN PHẨM** (51) **19-08**
- (22) 04/11/2021 (43) 25/01/2022
- (73) **CÔNG TY TNHH MỘT THÀNH VIÊN KEM CHÂU ĐỐC - SÀI GÒN (VN)**
Số 622 Thủ Khoa Huân, phường Châu Phú B, thành phố Châu Đốc, tỉnh An Giang
- (72) Tạ Thị Thu Thủy (VN)
- (55)



1/2022

CÔNG BÁO SỞ HỮU CÔNG NGHIỆP SỐ 406 TẬP A – QUYỀN 2 (01.2022)

- (11) **43739**
(21) 3-2021-02727 (28) 1
(54) **BAO GÓI** (51) **09-05**
(22) 05/11/2021 (43) 25/01/2022
(73) **CÔNG TY CỔ PHẦN ACECOOK VIỆT NAM (VN)**
Lô số II-3, đường số 11, nhóm CN II, khu công nghiệp Tân Bình, phường Tây
Thạnh, quận Tân Phú, thành phố Hồ Chí Minh
(72) Kajiwara Junichi (JP)
(74) Công ty Luật TNHH Phạm và Liên danh (PHAM & ASSOCIATES)
(55)

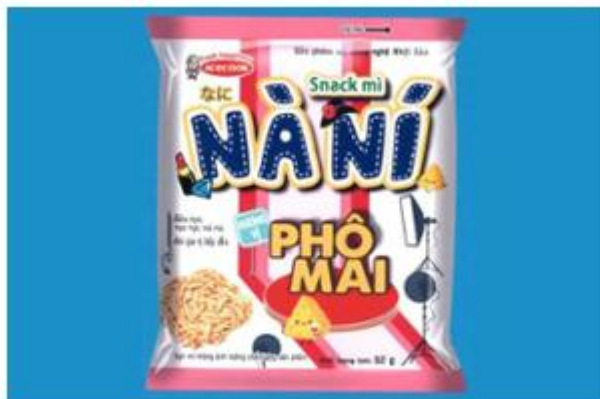

1.1



1.2

CÔNG BÁO SỞ HỮU CÔNG NGHIỆP SỐ 406 TẬP A – QUYỀN 2 (01.2022)

- (11) **43740**
(21) 3-2021-02728 (28) 1
(54) **BAO GÓI** (51) **09-05**
(22) 05/11/2021 (43) 25/01/2022
(73) **CÔNG TY CỔ PHẦN ACECOOK VIỆT NAM (VN)**
Lô số II-3, đường số 11, nhóm CN II, khu công nghiệp Tân Bình, phường Tây
Thạnh, quận Tân Phú, thành phố Hồ Chí Minh
(72) Kajiwara Junichi (JP)
(74) Công ty Luật TNHH Phạm và Liên danh (PHAM & ASSOCIATES)
(55)



1.1



1.2

CÔNG BÁO SỞ HỮU CÔNG NGHIỆP SỐ 406 TẬP A – QUYỀN 2 (01.2022)

- (11) **43741**
(21) 3-2021-02729 (28) 1
(54) **BAO GÓI** (51) **09-05**
(22) 05/11/2021 (43) 25/01/2022
(73) **CÔNG TY CỔ PHẦN ACECOOK VIỆT NAM (VN)**
Lô số II-3, đường số 11, nhóm CN II, khu công nghiệp Tân Bình, phường Tây
Thạnh, quận Tân Phú, thành phố Hồ Chí Minh
(72) Kajiwara Junichi (JP)
(74) Công ty Luật TNHH Phạm và Liên danh (PHAM & ASSOCIATES)
(55)



1.1

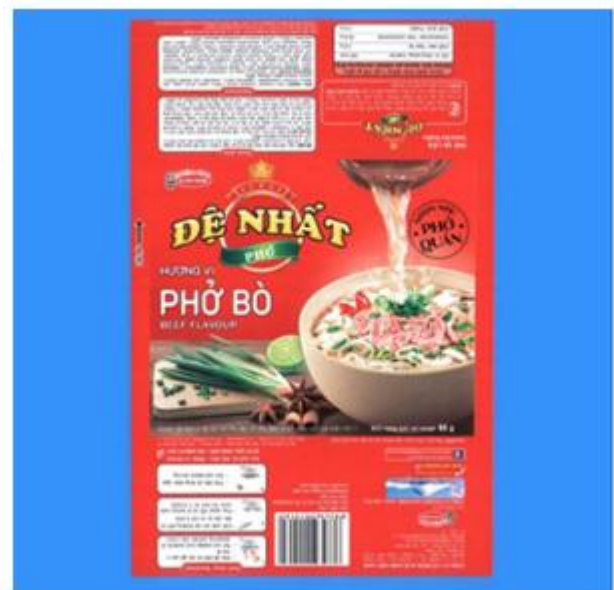

1.2

CÔNG BÁO SỞ HỮU CÔNG NGHIỆP SỐ 406 TẬP A – QUYỀN 2 (01.2022)

- (11) **43742**
(21) 3-2021-02730 (28) 1
(54) **BAO GÓI** (51) **09-05**
(22) 05/11/2021 (43) 25/01/2022
(73) **CÔNG TY CỔ PHẦN ACECOOK VIỆT NAM (VN)**
Lô số II-3, đường số 11, nhóm CN II, khu công nghiệp Tân Bình, phường Tây
Thạnh, quận Tân Phú, thành phố Hồ Chí Minh
(72) Kajiwara Junichi (JP)
(74) Công ty Luật TNHH Phạm và Liên danh (PHAM & ASSOCIATES)
(55)



1.1

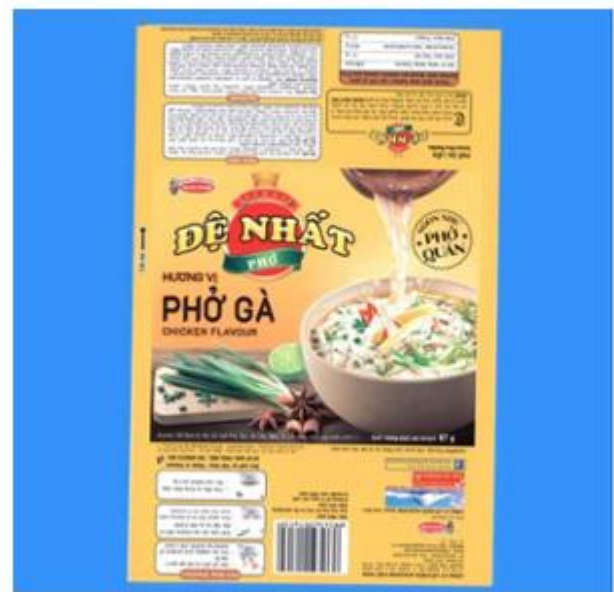

1.2

CÔNG BÁO SỞ HỮU CÔNG NGHIỆP SỐ 406 TẬP A – QUYỀN 2 (01.2022)

- (11) **43743**
- (21) 3-2021-02731 (28) 1
- (54) **BAO GÓI** (51) **09-05**
- (22) 05/11/2021 (43) 25/01/2022
- (73) **CÔNG TY CỔ PHẦN ACECOOK VIỆT NAM (VN)**
Lô số II-3, đường số 11, nhóm CN II, khu công nghiệp Tân Bình, phường Tây
Thạnh, quận Tân Phú, thành phố Hồ Chí Minh
- (72) Kajiwara Junichi (JP)
- (74) Công ty Luật TNHH Phạm và Liên danh (PHAM & ASSOCIATES)
- (55)



1.1

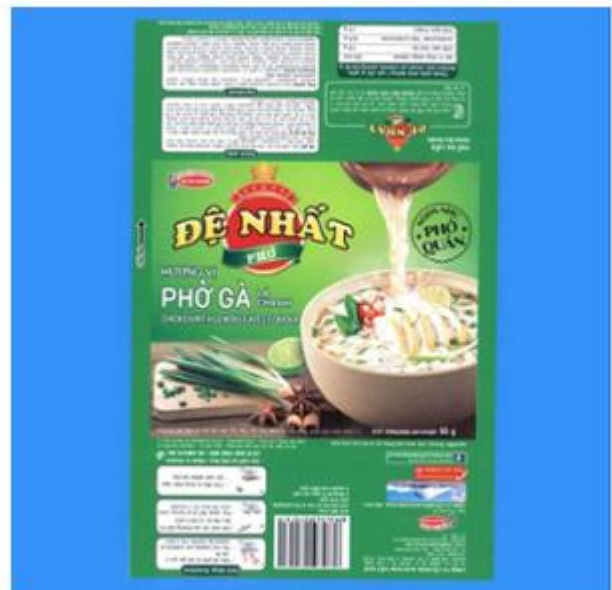

1.2

CÔNG BÁO SỞ HỮU CÔNG NGHIỆP SỐ 406 TẬP A – QUYỀN 2 (01.2022)

- (11) **43744**
- (21) 3-2021-02732 (28) 1
- (54) **BAO GÓI** (51) **09-05**
- (22) 05/11/2021 (43) 25/01/2022
- (73) **CÔNG TY CỔ PHẦN ACECOOK VIỆT NAM (VN)**
Lô số II-3, đường số 11, nhóm CN II, khu công nghiệp Tân Bình, phường Tây
Thạnh, quận Tân Phú, thành phố Hồ Chí Minh
- (72) Kajiwara Junichi (JP)
- (74) Công ty Luật TNHH Phạm và Liên danh (PHAM & ASSOCIATES)
- (55)



1.1

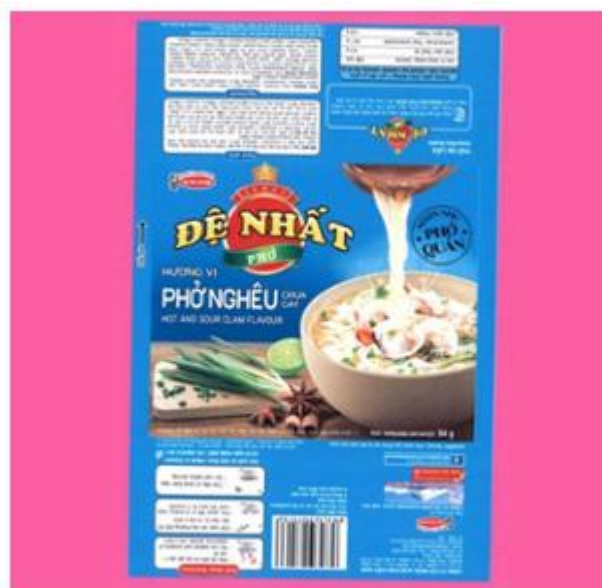

1.2

- (11) 43745
(21) 3-2021-02733 (28) 1
(54) **BAO GÓI** (51) **09-05**
(22) 05/11/2021 (43) 25/01/2022
(73) **CÔNG TY CỔ PHẦN ACECOOK VIỆT NAM (VN)**
Lô số II-3, đường số 11, nhóm CN II, khu công nghiệp Tân Bình, phường Tây
Thạnh, quận Tân Phú, thành phố Hồ Chí Minh
(72) Kajiwara Junichi (JP)
(74) Công ty Luật TNHH Phạm và Liên danh (PHAM & ASSOCIATES)
(55)



1.1



1.2

CÔNG BÁO SỞ HỮU CÔNG NGHIỆP SỐ 406 TẬP A – QUYỀN 2 (01.2022)

- (11) **43746**
(21) 3-2021-02734 (28) 1
(54) **BAO GÓI** (51) **09-05**
(22) 05/11/2021 (43) 25/01/2022
(73) **CÔNG TY CỔ PHẦN ACECOOK VIỆT NAM (VN)**
Lô số II-3, đường số 11, nhóm CN II, khu công nghiệp Tân Bình, phường Tây
Thạnh, quận Tân Phú, thành phố Hồ Chí Minh
(72) Kajiwara Junichi (JP)
(74) Công ty Luật TNHH Phạm và Liên danh (PHAM & ASSOCIATES)
(55)



1.1



1.2

CÔNG BÁO SỞ HỮU CÔNG NGHIỆP SỐ 406 TẬP A – QUYỀN 2 (01.2022)

- (11) 43747
(21) 3-2021-02735 (28) 1
(54) **BAO GÓI** (51) **09-05**
(22) 05/11/2021 (43) 25/01/2022
(73) **CÔNG TY CỔ PHẦN ACECOOK VIỆT NAM (VN)**
Lô số II-3, đường số 11, nhóm CN II, khu công nghiệp Tân Bình, phường Tây
Thạnh, quận Tân Phú, thành phố Hồ Chí Minh
(72) Kajiwara Junichi (JP)
(74) Công ty Luật TNHH Phạm và Liên danh (PHAM & ASSOCIATES)
(55)



1.1



1.2

- (11) 43748
(21) 3-2021-02736 (28) 1
(54) **BAO GÓI** (51) **09-05**
(22) 05/11/2021 (43) 25/01/2022
(73) **CÔNG TY CỔ PHẦN ACECOOK VIỆT NAM (VN)**
Lô số II-3, đường số 11, nhóm CN II, khu công nghiệp Tân Bình, phường Tây
Thạnh, quận Tân Phú, thành phố Hồ Chí Minh
(72) Kajiwara Junichi (JP)
(74) Công ty Luật TNHH Phạm và Liên danh (PHAM & ASSOCIATES)
(55)



1.1



1.2

CÔNG BÁO SỞ HỮU CÔNG NGHIỆP SỐ 406 TẬP A – QUYỀN 2 (01.2022)

- (11) **43749**
(21) 3-2021-02737 (28) 1
(54) **BAO GÓI** (51) **09-05**
(22) 05/11/2021 (43) 25/01/2022
(73) **CÔNG TY CỔ PHẦN ACECOOK VIỆT NAM (VN)**
Lô số II-3, đường số 11, nhóm CN II, khu công nghiệp Tân Bình, phường Tây
Thạnh, quận Tân Phú, thành phố Hồ Chí Minh
(72) Kajiwara Junichi (JP)
(74) Công ty Luật TNHH Phạm và Liên danh (PHAM & ASSOCIATES)
(55)



1.1



1.2

CÔNG BÁO SỞ HỮU CÔNG NGHIỆP SỐ 406 TẬP A – QUYỀN 2 (01.2022)

- (11) **43750**
(21) 3-2021-02738 (28) 1
(54) **BAO GÓI** (51) **09-05**
(22) 05/11/2021 (43) 25/01/2022
(73) **CÔNG TY CỔ PHẦN ACECOOK VIỆT NAM (VN)**
Lô số II-3, đường số 11, nhóm CN II, khu công nghiệp Tân Bình, phường Tây
Thạnh, quận Tân Phú, thành phố Hồ Chí Minh
(72) Kajiwara Junichi (JP)
(74) Công ty Luật TNHH Phạm và Liên danh (PHAM & ASSOCIATES)
(55)



1.1



1.2

CÔNG BÁO SỞ HỮU CÔNG NGHIỆP SỐ 406 TẬP A – QUYỀN 2 (01.2022)

- (11) **43751**
(21) 3-2021-02739 (28) 1
(54) **BAO GÓI** (51) **09-05**
(22) 05/11/2021 (43) 25/01/2022
(73) **CÔNG TY CỔ PHẦN ACECOOK VIỆT NAM (VN)**
Lô số II-3, đường số 11, nhóm CN II, khu công nghiệp Tân Bình, phường Tây
Thạnh, quận Tân Phú, thành phố Hồ Chí Minh
(72) Kajiwara Junichi (JP)
(74) Công ty Luật TNHH Phạm và Liên danh (PHAM & ASSOCIATES)
(55)



1.1



1.2

CÔNG BÁO SỞ HỮU CÔNG NGHIỆP SỐ 406 TẬP A – QUYỀN 2 (01.2022)

- (11) **43752**
(21) 3-2021-02740 (28) 1
(54) **BAO GÓI** (51) **09-05**
(22) 05/11/2021 (43) 25/01/2022
(73) **CÔNG TY CỔ PHẦN ACECOOK VIỆT NAM (VN)**
Lô số II-3, đường số 11, nhóm CN II, khu công nghiệp Tân Bình, phường Tây
Thạnh, quận Tân Phú, thành phố Hồ Chí Minh
(72) Kajiwara Junichi (JP)
(74) Công ty Luật TNHH Phạm và Liên danh (PHAM & ASSOCIATES)
(55)



1.1



1.2

CÔNG BÁO SỞ HỮU CÔNG NGHIỆP SỐ 406 TẬP A – QUYỀN 2 (01.2022)

- (11) **43753**
(21) 3-2021-02741 (28) 1
(54) **THIẾT BỊ CẤP NGUỒN** (51) **13-01; 13-02**
(22) 05/11/2021 (43) 25/01/2022
(30) 2021-009827 11/05/2021 JP;
(73) **HONDA MOTOR CO., LTD. (JP)**
1-1, Minami-Aoyama 2-chome, Minato-ku, Tokyo, 107-8556 Japan
(72) Kazuto OYA (JP)
(74) Công ty Luật TNHH Phạm và Liên danh (PHAM & ASSOCIATES)
(55)



1.1



1.2



1.3



1.4



1.5



1.6



1.7



1.8



1.9



1.10

CÔNG BÁO SỞ HỮU CÔNG NGHIỆP SỐ 406 TẬP A – QUYỀN 2 (01.2022)

- (11) **43754**
(21) 3-2021-02742 (28) 1
(54) **HỘP ĐỰNG SẢN PHẨM** (51) **09-03**
(22) 05/11/2021 (43) 25/01/2022
(73) **CÔNG TY TNHH DƯỢC PHẨM THIÊN ÂN (VN)**
M1-17, khu đô thị Trung Hòa Nhân Chính, phường Trung Hòa, quận Cầu Giấy,
thành phố Hà Nội
(72) Nguyễn Thị Phương (VN)
(74) Công ty Luật TNHH WINCO (WINCO LAW FIRM)
(55)



1.1



1.2

(11) **43755**

(21) 3-2021-02755

(28) 1

(54) **THÙNG LOA**

(51) **14-01**

(22) 08/11/2021

(43) 25/01/2022

(73) **LÊ TRỌNG HIỆP (VN)**

Phòng 902, chung cư 195 phố Đội Cấn, phường Đội Cấn, quận Ba Đình, thành phố Hà Nội

(72) Lê Trọng Hiệp (VN)

(55)



1.1



1.2



1.3



1.4

Sau ← → Trước

Trước ← → Sau

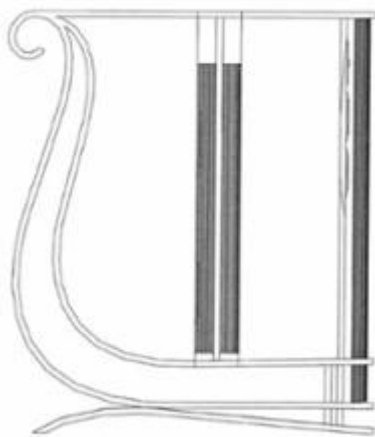

1.5

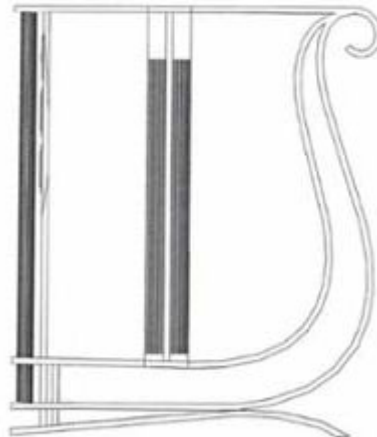

1.6



1.7



1.8

(11) **43756**

(21) 3-2021-02756

(28) 1

(54) **THÙNG LOA**

(51) **14-01**

(22) 08/11/2021

(43) 25/01/2022

(73) **LÊ TRỌNG HIỆP (VN)**

Phòng 902, chung cư 195 phố Đội Cấn, phường Đội Cấn, quận Ba Đình, thành phố Hà Nội

(72) Lê Trọng Hiệp (VN)

(55)

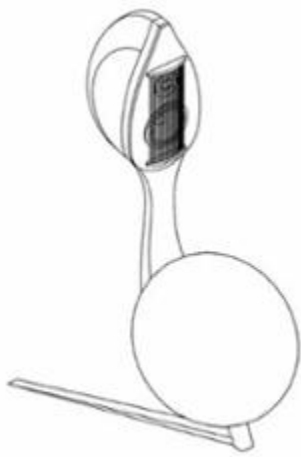

1.1

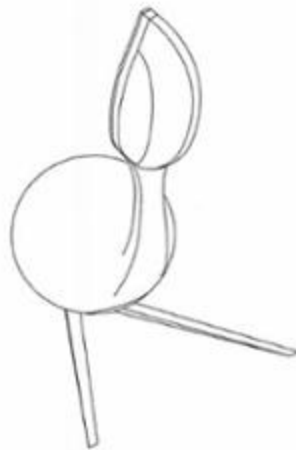

1.2

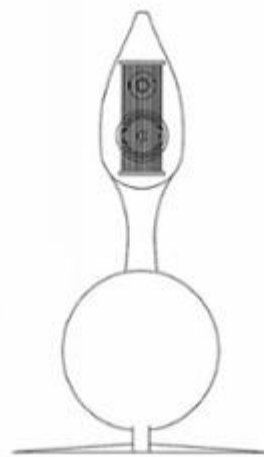

1.3



1.4

Trước ← → Sau

Sau ← → Trước



1.6



1.5



1.8

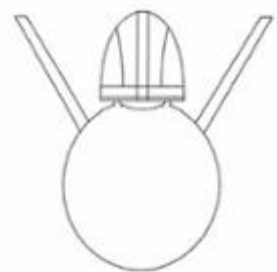

1.7

(11) **43757**

(21) 3-2021-02757

(28) 1

(54) **THÙNG LOA**

(51) **14-01**

(22) 08/11/2021

(43) 25/01/2022

(73) **LÊ TRỌNG HIỆP (VN)**

Phòng 902, chung cư 195 phố Đội Cấn, phường Đội Cấn, quận Ba Đình, thành phố Hà Nội

(72) Lê Trọng Hiệp (VN)

(55)

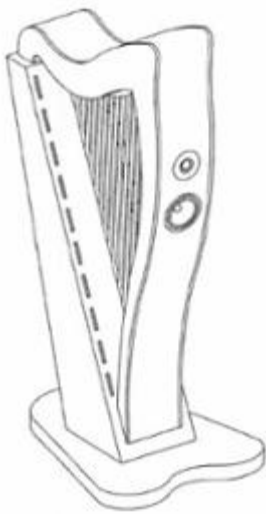

1.1



1.2



1.3



1.4

Trước ← → Sau

Sau ← → Trước



1.6



1.5

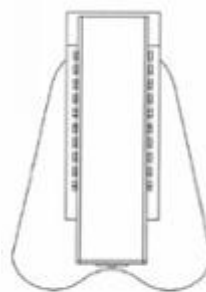

1.7



1.8

CÔNG BÁO SỞ HỮU CÔNG NGHIỆP SỐ 406 TẬP A – QUYỀN 2 (01.2022)

(11) **43758**

(21) 3-2021-02764

(28) 1

(54) **NẤP PHIN**

(51) **07-02**

(22) 18/12/2019

(43) 25/01/2022

(73) **CÔNG TY TNHH MINH LONG I (VN)**

333 khu phố Hưng Lộc, phường Hưng Định, thành phố Thuận An, tỉnh Bình Dương

(72) Lý Ngọc Minh (VN)

(55)



1.1



1.2



1.3



1.4

CÔNG BÁO SỞ HỮU CÔNG NGHIỆP SỐ 406 TẬP A – QUYỀN 2 (01.2022)

(11) **43759**

(21) 3-2021-02765

(28) 1

(54) **ĐĨA LÓT**

(51) **07-01; 07-02**

(22) 18/12/2019

(43) 25/01/2022

(73) **CÔNG TY TNHH MINH LONG I (VN)**

333 khu phố Hưng Lộc, phường Hưng Định, thành phố Thuận An, tỉnh Bình Dương

(72) Lý Ngọc Minh (VN)

(55)



1.1



1.2



1.3



1.4

CÔNG BÁO SỞ HỮU CÔNG NGHIỆP SỐ 406 TẬP A – QUYỀN 2 (01.2022)

- (11) **43760**
(21) 3-2021-02766 (28) 1
(54) **TÁCH** (51) **07-01; 07-02**
(22) 18/12/2019 (43) 25/01/2022
(73) **CÔNG TY TNHH MINH LONG I (VN)**
333 khu phố Hưng Lộc, phường Hưng Định, thành phố Thuận An, tỉnh Bình
Dương
(72) Lý Ngọc Minh (VN)
(55)



1.1



1.2



1.3



1.4



1.5



1.6



1.7

(11) **43761**

(21) 3-2021-02767

(28) 1

(54) **THANH CHẶN**

(51) **07-02**

(22) 18/12/2019

(43) 25/01/2022

(73) **CÔNG TY TNHH MINH LONG I (VN)**

333 khu phố Hưng Lộc, phường Hưng Định, thành phố Thuận An, tỉnh Bình Dương

(72) Lý Ngọc Minh (VN)

(55)



1.1



1.2



1.3



1.4

CÔNG BÁO SỞ HỮU CÔNG NGHIỆP SỐ 406 TẬP A – QUYỀN 2 (01.2022)

(11) **43762**

(21) 3-2021-02768

(28) 1

(54) **VỈ LƯỢC**

(51) **07-02**

(22) 18/12/2019

(43) 25/01/2022

(73) **CÔNG TY TNHH MINH LONG I (VN)**

333 khu phố Hưng Lộc, phường Hưng Định, thành phố Thuận An, tỉnh Bình Dương

(72) Lý Ngọc Minh (VN)

(55)



1.1



1.2

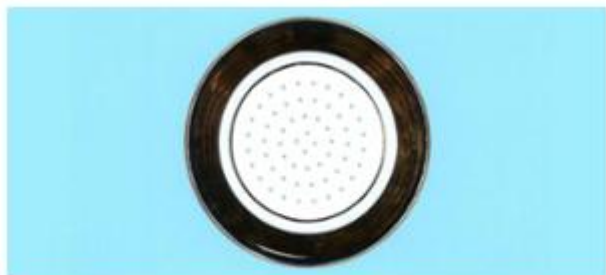

1.3



1.4

CÔNG BÁO SỞ HỮU CÔNG NGHIỆP SỐ 406 TẬP A – QUYỀN 2 (01.2022)

(11) **43763**

(21) 3-2021-02769

(28) 1

(54) **DÉP**

(51) **02-04**

(22) 08/11/2021

(43) 25/01/2022

(73) **CÔNG TY TNHH BÌNH TIÊN BIÊN HÒA (VN)**

Lô 101/2 khu công nghiệp Amata, phường Long Bình, thành phố Biên Hòa, tỉnh Đồng Nai

(72) Lai Khiêm (VN)

(74) Công ty TNHH Tư vấn sở hữu trí tuệ Việt (VIET IP CO.,LTD.)

(55)



1.1



1.2



1.3



1.4



1.5



1.6



1.7

CÔNG BÁO SỞ HỮU CÔNG NGHIỆP SỐ 406 TẬP A – QUYỀN 2 (01.2022)

- (11) **43764**
(21) 3-2021-02771 (28) 1
(54) **HỘ ĐỰNG RƯỢU** (51) **09-03**
(22) 09/11/2021 (43) 25/01/2022
(73) **HỘ KINH DOANH PHẠM VĂN HẢO (VN)**
Áp Hải Hưng, xã Tân Lập, huyện Tân Thạnh, tỉnh Long An
(72) Phạm Văn Hảo (VN)
(74) Công ty Cổ phần Sở hữu công nghiệp INVESTIP (INVESTIP)
(55)



1.1



1.2

(11) **43765**

(21) 3-2021-02772

(28) 1

(54) **ĐÈN BÀN**

(51) **26-05**

(22) 09/11/2021

(43) 25/01/2022

(73) **CÔNG TY CỔ PHẦN BÓNG ĐÈN PHÍCH NƯỚC RẠNG ĐÔNG (VN)**
87-89 phố Hạ Đình, phường Thanh Xuân Trung, quận Thanh Xuân, thành phố Hà Nội

(72) Trần Trung Tường (VN)

(55)



1.1



1.2

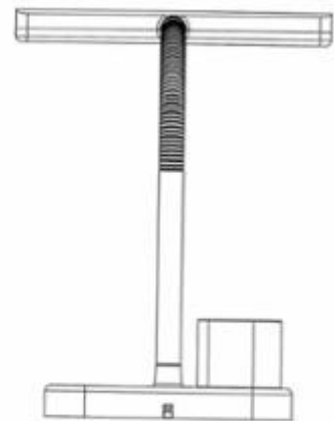

1.3



1.4



1.5

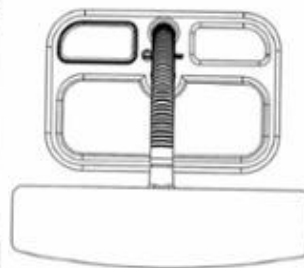

1.6



1.7

CÔNG BÁO SỞ HỮU CÔNG NGHIỆP SỐ 406 TẬP A – QUYỀN 2 (01.2022)

- (11) **43766**
(21) 3-2021-02773 (28) 1
(54) **ĐÈN** (51) **26-05**
(22) 09/11/2021 (43) 25/01/2022
(73) **CÔNG TY CỔ PHẦN BÓNG ĐÈN PHÍCH NƯỚC RẠNG ĐÔNG (VN)**
87-89 phố Hạ Đình, phường Thanh Xuân Trung, quận Thanh Xuân, thành phố Hà Nội
(72) Trần Trung Tường (VN)
(55)



1.1

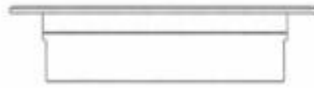

1.2



1.3



1.4



1.5



1.6



1.7

CÔNG BÁO SỞ HỮU CÔNG NGHIỆP SỐ 406 TẬP A – QUYỀN 2 (01.2022)

- (11) **43767**
(21) 3-2021-02774 (28) 2
(54) **ĐÈN** (51) **26-05**
(22) 09/11/2021 (43) 25/01/2022
(73) **CÔNG TY CỔ PHẦN BÓNG ĐÈN PHÍCH NƯỚC RẠNG ĐÔNG (VN)**
87-89 phố Hạ Đình, phường Thanh Xuân Trung, quận Thanh Xuân, thành phố Hà Nội
(72) Trần Trung Tường (VN)
(55)



1.1



1.2

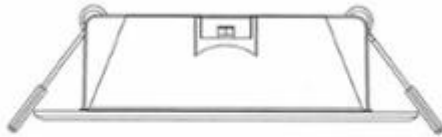

1.3

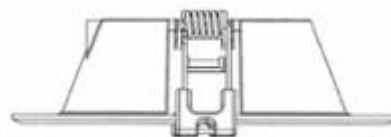

1.4

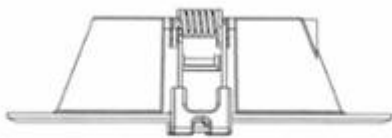

1.5



1.6

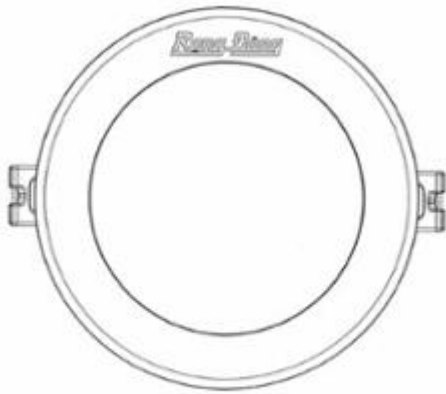

1.7

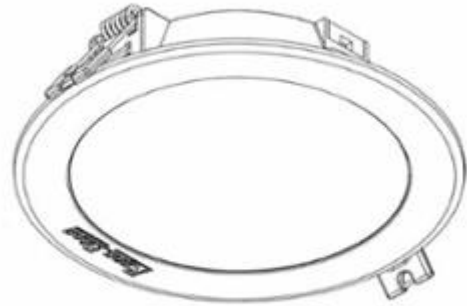

2.1



2.2

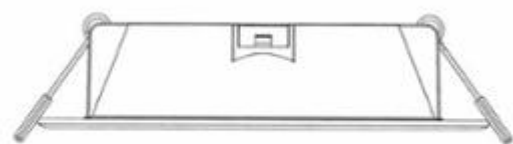

2.3

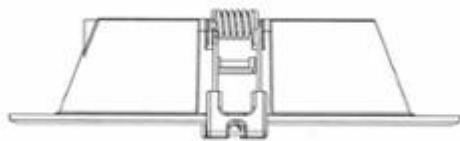

2.4

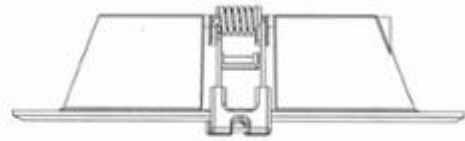

2.5



2.6

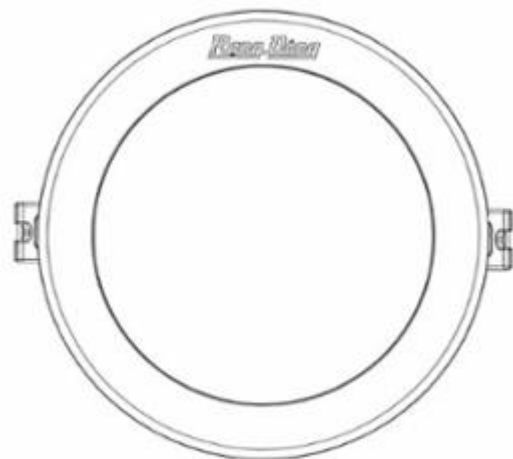

2.7

CÔNG BÁO SỞ HỮU CÔNG NGHIỆP SỐ 406 TẬP A – QUYỀN 2 (01.2022)

- (11) **43768**
- (21) 3-2021-02779 (28) 1
- (54) **NHÃN SẢN PHẨM** (51) **19-08**
- (22) 09/11/2021 (43) 25/01/2022
- (73) **TỔNG CÔNG TY CỔ PHẦN BIA – RƯỢU – NƯỚC GIẢI KHÁT SÀI GÒN (VN)**
187 Nguyễn Chí Thanh, phường 12, quận 5, thành phố Hồ Chí Minh
- (72) Neo Gim Siong Bennett (SG)
- (74) Công ty TNHH Tư vấn ALIATLEGAL (ALIAT LEGAL)
- (55)



1.1



1.2

CÔNG BÁO SỞ HỮU CÔNG NGHIỆP SỐ 406 TẬP A – QUYỀN 2 (01.2022)

- (11) **43769**
(21) 3-2021-02781 (28) 1
(54) **THÙNG BIA** (51) **09-03**
(22) 09/11/2021 (43) 25/01/2022
(73) **TỔNG CÔNG TY CỔ PHẦN BIA – RƯỢU – NƯỚC GIẢI KHÁT SÀI GÒN (VN)**
187 Nguyễn Chí Thanh, phường 12, quận 5, thành phố Hồ Chí Minh
(72) Neo Gim Siong Bennett (SG)
(74) Công ty TNHH Tư vấn ALIATLEGAL (ALIAT LEGAL)
(55)



1.1



1.2

CÔNG BÁO SỞ HỮU CÔNG NGHIỆP SỐ 406 TẬP A – QUYỀN 2 (01.2022)

- (11) **43770**
(21) 3-2021-02782 (28) 1
(54) **LON BIA** (51) **09-03**
(22) 09/11/2021 (43) 25/01/2022
(73) **TỔNG CÔNG TY CỔ PHẦN BIA – RƯỢU – NƯỚC GIẢI KHÁT SÀI GÒN (VN)**
187 Nguyễn Chí Thanh, phường 12, quận 5, thành phố Hồ Chí Minh
(72) Neo Gim Siong Bennett (SG)
(74) Công ty TNHH Tư vấn ALIATLEGAL (ALIAT LEGAL)
(55)



1.1



1.2



1.3



1.4



1.5



1.6



1.7

CÔNG BÁO SỞ HỮU CÔNG NGHIỆP SỐ 406 TẬP A – QUYỀN 2 (01.2022)

- (11) 43771
(21) 3-2021-02784 (28) 1
(54) BAO GÓI (51) 09-05
(22) 10/11/2021 (43) 25/01/2022
(73) CÔNG TY TNHH NAM PHƯƠNG V.N (VN)
124 Lê Lai, phường 3, quận Gò Vấp, thành phố Hồ Chí Minh
(72) Hoàng Thị Minh Hiếu (VN)
(74) Công ty Luật TNHH Phạm và Liên danh (PHAM & ASSOCIATES)
(55)



1.1



1.2

CÔNG BÁO SỞ HỮU CÔNG NGHIỆP SỐ 406 TẬP A – QUYỀN 2 (01.2022)

- (11) **43772**
(21) 3-2021-02785 (28) 1
(54) **HỘP** (51) **09-03**
(22) 10/11/2021 (43) 25/01/2022
(73) **CÔNG TY TNHH NAM PHƯƠNG V.N (VN)**
124 Lê Lai, phường 03, quận Gò Vấp, thành phố Hồ Chí Minh
(72) Hoàng Thị Minh Hiếu (VN)
(74) Công ty Luật TNHH Phạm và Liên danh (PHAM & ASSOCIATES)
(55)



1.1



1.2

CÔNG BÁO SỞ HỮU CÔNG NGHIỆP SỐ 406 TẬP A – QUYỀN 2 (01.2022)

- (11) **43773**
(21) 3-2021-02789 (28) 1
(54) **MÁY NHẬN ĐIỆN KHUÔN MẶT** (51) **14-02**
(22) 31/07/2020 (43) 25/01/2022
(30) 202030108355.9 26/03/2020 CN;
(73) **SHENZHEN SENSETIME TECHNOLOGY CO., LTD.** (CN)
Room 201, Building A, No. 1, Qianwan Road, Qianhai Shenzhen-Hongkong
Modern Service Industry Cooperation Zone, Shenzhen, Guangdong, China 518000
(72) 1. LI, CHENG (CN)
2. LI, JUNQIANG (CN)
3. LI, WANZHI (CN)
4. LIN, PEICAI (CN)
(74) Công ty TNHH Dịch vụ Sở hữu trí tuệ KENFOX (KENFOX IP SERVICE
CO.,LTD.)
(55)

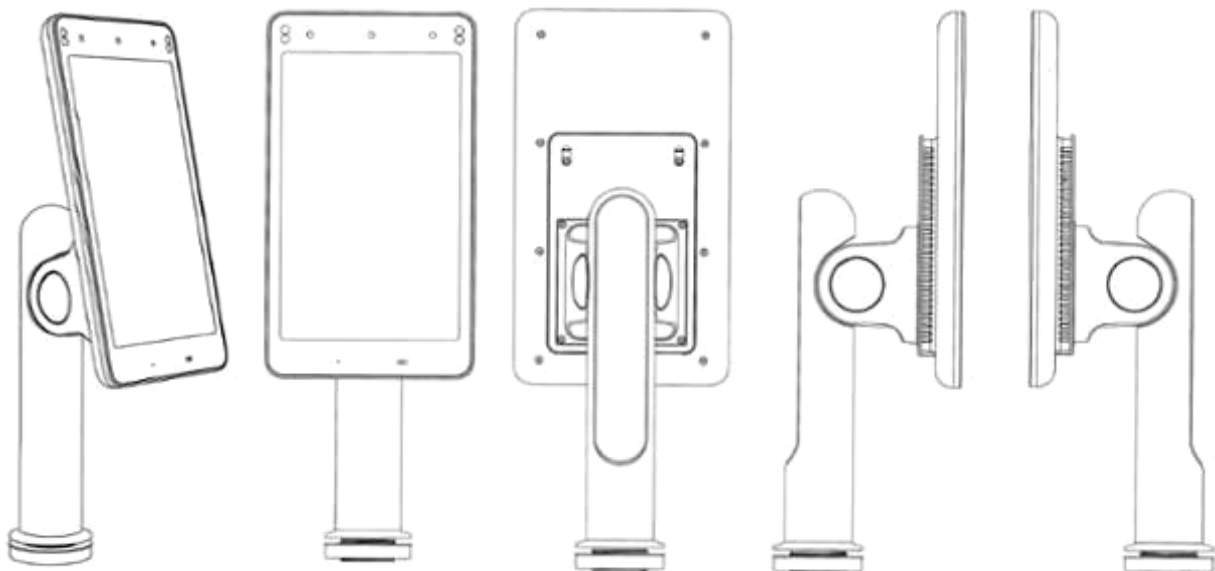

1.1

1.2

1.3

1.4

1.5



1.6

1.7

CÔNG BÁO SỞ HỮU CÔNG NGHIỆP SỐ 406 TẬP A – QUYỀN 2 (01.2022)

- (11) **43774**
(21) 3-2021-02792 (28) 1
(54) **THIẾT BỊ KHỬ TRÙNG BẰNG TIA CỰC TÍM, CẦM TAY** (51) **24-01**
(22) 10/11/2021 (43) 25/01/2022
(30) 110304107 06/08/2021 TW;
(73) **GOLDENSUNDA TECHNOLOGY CO., LTD. (TW)**
10F., No. 2, Baosheng Rd., Yonghe Dist., New Taipei City 234, Taiwan
(72) 1. LIAO CHI-YAO (TW)
2. MAO LI-LI (TW)
3. LIAO YU-LUNG (TW)
4. HUANG YU-TING (TW)
5. LI YEN-CHIAO (TW)
(74) Công ty TNHH Trần Hữu Nam và Đồng sự (TRAN H.N & ASS.)
(55)

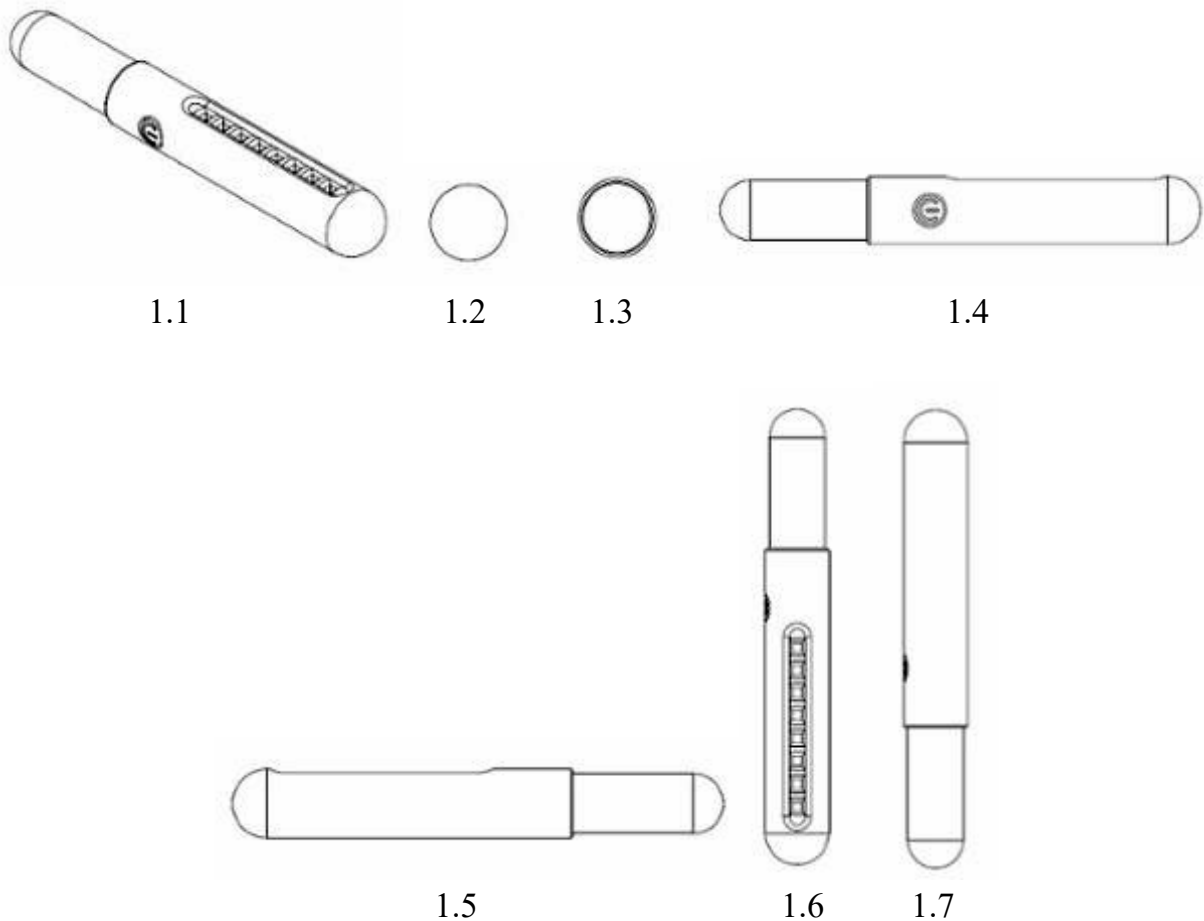

CÔNG BÁO SỞ HỮU CÔNG NGHIỆP SỐ 406 TẬP A – QUYỀN 2 (01.2022)

- (11) 43775
(21) 3-2021-02826
(54) **TÚI ĐỰNG TRÀ**
(22) 12/11/2021
(73) **CÔNG TY CP PHÁT TRIỂN NÔNG NGHIỆP CÁCH TÂN (VN)**
Xóm Công Đồn, xã Cổ Lũng, huyện Phú Lương, tỉnh Thái Nguyên
(72) Nguyễn Chí Công (VN)
(74) Công ty TNHH Sở hữu trí tuệ INNETCO-Hoàng Phúc (INNETCO CO., LTD)
(55)
- (28) 3
(51) 09-05
(43) 25/01/2022



1.1



1.2



2.1



2.2



3.1



3.2

CÔNG BÁO SỞ HỮU CÔNG NGHIỆP SỐ 406 TẬP A – QUYỀN 2 (01.2022)

- (11) **43776**
(21) 3-2021-02830 (28) 1
(54) **BAO GÓI** (51) **09-05**
(22) 12/11/2021 (43) 25/01/2022
(73) **CÔNG TY CỔ PHẦN THỰC PHẨM Á CHÂU (VN)**
Số 9/2 đường ĐT 743, khu phố 1B, phường An Phú, thành phố Thuận An, tỉnh Bình Dương
(72) **NGUYỄN MẠNH CƯỜNG (VN)**
(74) Văn phòng Luật sư A Hoà (AHOA LAW OFFICE)
(55)



1.1



1.2

CÔNG BÁO SỞ HỮU CÔNG NGHIỆP SỐ 406 TẬP A – QUYỀN 2 (01.2022)

- (11) 43777
(21) 3-2021-02831 (28) 1
(54) BAO GÓI (51) 09-05
(22) 12/11/2021 (43) 25/01/2022
(73) CÔNG TY CỔ PHẦN THỰC PHẨM Á CHÂU (VN)
Số 9/2 đường ĐT 743, khu phố 1B, phường An Phú, thành phố Thuận An, tỉnh Bình Dương
(72) NGUYỄN MẠNH CƯỜNG (VN)
(74) Văn phòng Luật sư A Hoà (AHOA LAW OFFICE)
(55)



H.1

1.1



H.2

1.2

CÔNG BÁO SỞ HỮU CÔNG NGHIỆP SỐ 406 TẬP A – QUYỀN 2 (01.2022)

- (11) **43778**
(21) 3-2021-02832 (28) 1
(54) **ĐỂ TẢN NHIỆT CHO ĐÈN LED** (51) **26-05**
(22) 12/11/2021 (43) 25/01/2022
(73) **CÔNG TY TNHH THIẾT BỊ ĐIỆN MỸ QUANG (VN)**
Thôn Du Nội, xã Mai Lâm, huyện Đông Anh, thành phố Hà Nội
(72) Thảo Thị Chà (VN)
(74) Công ty TNHH Sở hữu trí tuệ Hải Hân (HAI HAN IP CO., LTD.)
(55)



1.1



1.2



1.3



1.4



1.5

- (11) **43779**
(21) 3-2021-02833 (28) 1
(54) **GIÁ ĐỒ CHẬU TRỒNG CÂY** (51) **11-02**
(22) 15/11/2021 (43) 25/01/2022
(73) **TRẦN THANH LIÊM (VN)**
102/20 Bình Long, phường Phú Thạnh, quận Tân Phú, thành phố Hồ Chí Minh
(72) Trần Thanh Liêm (VN)
(74) Văn phòng Luật sư D và T (D & T LAW OFFICE)
(55)

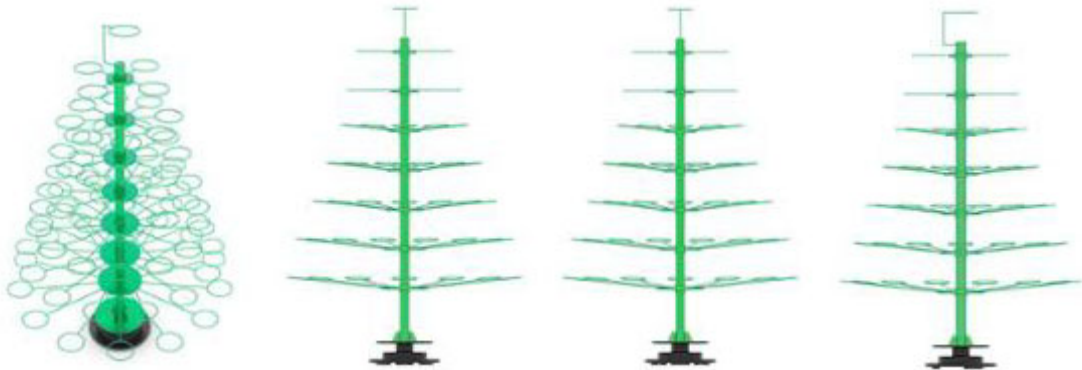

1.1

1.2

1.3

1.4



1.5



1.6

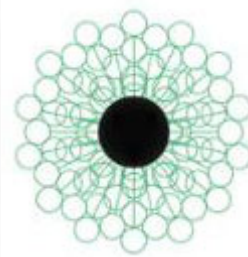

1.7

CÔNG BÁO SỞ HỮU CÔNG NGHIỆP SỐ 406 TẬP A – QUYỀN 2 (01.2022)

- (11) **43780**
(21) 3-2021-02834 (28) 1
(54) **MÁY TRỘN KHÍ THÔNG MINH** (51) **23-01**
(22) 15/11/2021 (43) 25/01/2022
(73) **CÔNG TY CỔ PHẦN RYNAN TECHNOLOGIES VIETNAM (VN)**
Áp Long Trị, xã Long Đức, thành phố Trà Vinh, tỉnh Trà Vinh
(72) 1. NGUYỄN THANH MỸ (VN)
2. TÔ HUỖNH NGỌC DUY (VN)
3. PHẠM THÁI BÌNH (VN)
4. PHAN MINH QUÝ (VN)
5. NGUYỄN KHẮC NHỰT (VN)
(74) Công ty TNHH Đại Tín và Liên Danh (DAITIN AND ASSOCIATES CO.,LTD)
(55)

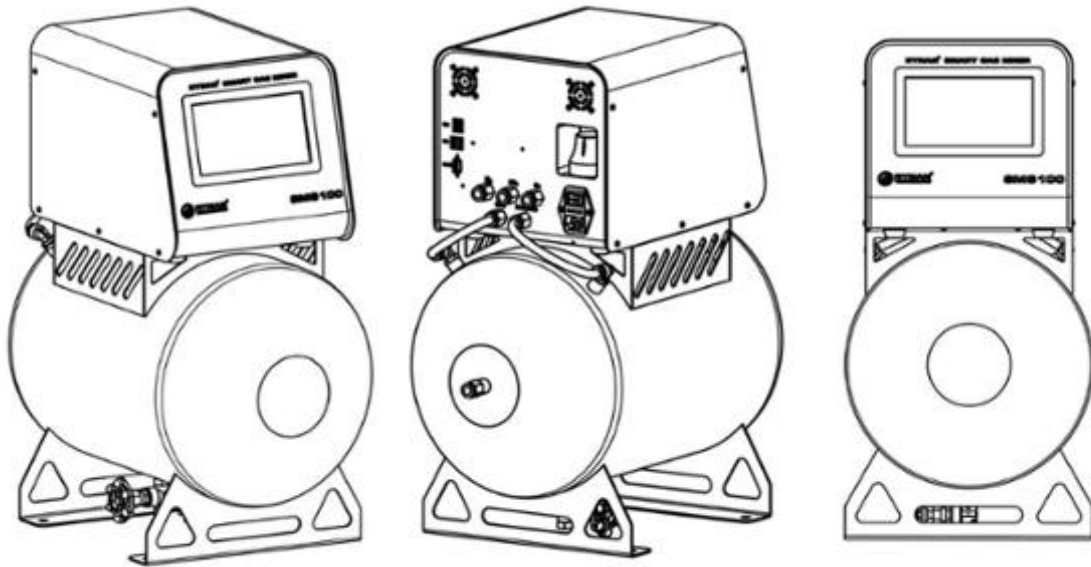

1.1

1.2

1.3

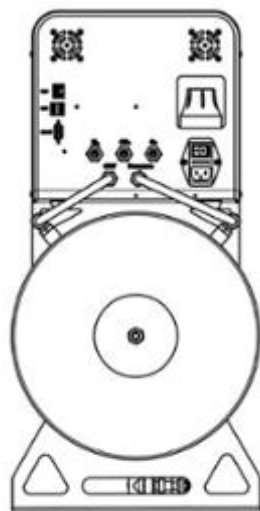

1.4

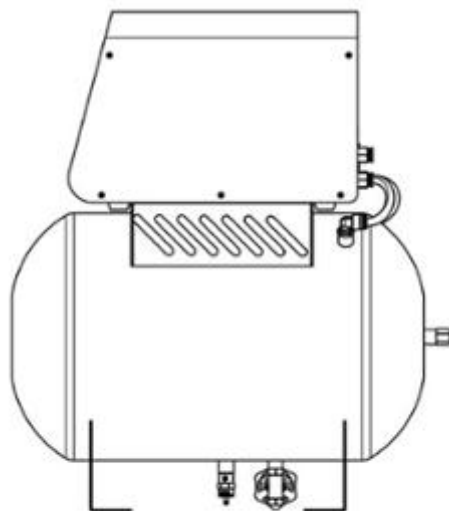

1.5

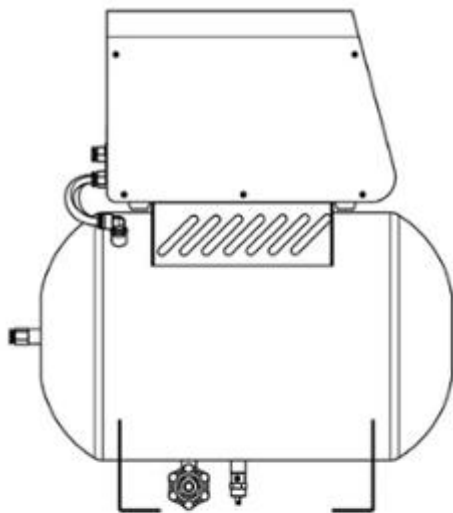

1.6



1.7

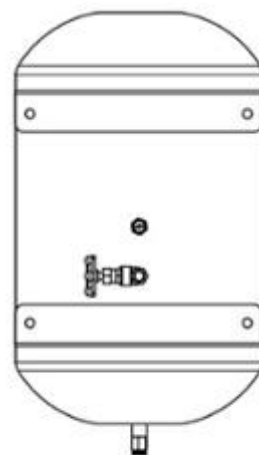

1.8

CÔNG BÁO SỞ HỮU CÔNG NGHIỆP SỐ 406 TẬP A – QUYỀN 2 (01.2022)

- (11) **43781**
(21) 3-2021-02836 (28) 1
(54) **THIẾT BỊ ĐIỀU KHIỂN MÁY LỌC NƯỚC** (51) **23-01**
(22) 16/11/2021 (43) 25/01/2022
(73) **CÔNG TY CỔ PHẦN KAROFI R&D (VN)**
Số 5C, ngách 184/85 Trần Khát Chân, phường Thanh Lương, quận Hai Bà Trưng,
thành phố Hà Nội
(72) Ngô Thị Thanh Hải (VN)
(55)



1.1



1.2



1.3



1.4



1.5

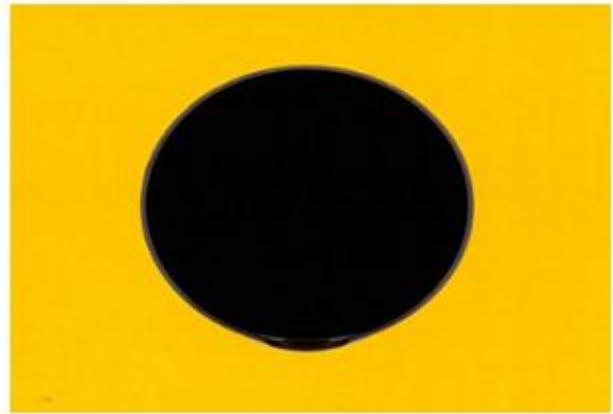

1.6



1.7

CÔNG BÁO SỞ HỮU CÔNG NGHIỆP SỐ 406 TẬP A – QUYỀN 2 (01.2022)

- (11) **43782**
(21) 3-2021-02837 (28) 1
(54) **BAO BÌ** (51) **09-05**
(22) 16/11/2021 (43) 25/01/2022
(73) **CÔNG TY TNHH ĐƯỜNG NGỌC BÍCH (VN)**
Số 114, ấp An Thạnh, xã Mỹ An Hưng B, huyện Lấp Vò, tỉnh Đồng Tháp
(72) Nguyễn Thanh Tâm (VN)
(74) **CÔNG TY LUẬT TNHH AGL (AGL LAW)**
(55)



1.1



1.2



1.3

CÔNG BÁO SỞ HỮU CÔNG NGHIỆP SỐ 406 TẬP A – QUYỀN 2 (01.2022)

- (11) **43783**
(21) 3-2021-02838 (28) 1
(54) **BAO BÌ** (51) **09-05**
(22) 16/11/2021 (43) 25/01/2022
(73) **CÔNG TY TNHH ĐƯỜNG NGỌC BÍCH (VN)**
Số 114, ấp An Thạnh, xã Mỹ An Hưng B, huyện Lập Vò, tỉnh Đồng Tháp
(72) Nguyễn Thanh Tâm (VN)
(74) **CÔNG TY LUẬT TNHH AGL (AGL LAW)**
(55)



1.1



1.2



1.3

CÔNG BÁO SỞ HỮU CÔNG NGHIỆP SỐ 406 TẬP A – QUYỀN 2 (01.2022)

- (11) **43784**
(21) 3-2021-02841 (28) 2
(54) **BAO GÓI BĂNG VỆ SINH** (51) **09-05**
(22) 16/11/2021 (43) 25/01/2022
(73) **CÔNG TY CỔ PHẦN DIANA UNICHARM (VN)**
Khu công nghiệp Vĩnh Tuy, đường Lĩnh Nam, phường Vĩnh Hưng, quận Hoàng
Mai, thành phố Hà Nội
(72) Đỗ Anh Tú (VN)
(74) Công ty TNHH Sở hữu trí tuệ và Công nghệ Thủ đô (CAPITAL IP&T CO.LTD.)
(55)



1.1



1.2



2.1



2.2

CÔNG BÁO SỞ HỮU CÔNG NGHIỆP SỐ 406 TẬP A – QUYỀN 2 (01.2022)

- (11) **43785**
- (21) 3-2021-02842 (28) 1
- (54) **NHÃN SẢN PHẨM** (51) **19-08**
- (22) 16/11/2021 (43) 25/01/2022
- (73) **CÔNG TY TNHH XUẤT NHẬP KHẨU LANGARDEN (VN)**
Số 5, ngõ 1, phố Đồng Me, phường Mễ Trì, quận Nam Từ Liêm, thành phố Hà Nội
- (72) Đặng Lan Hương (VN)
- (74) Công ty TNHH Sở hữu trí tuệ và Công nghệ Thủ đô (CAPITAL IP&T CO.LTD.)
- (55)



CÔNG BÁO SỞ HỮU CÔNG NGHIỆP SỐ 406 TẬP A – QUYỀN 2 (01.2022)

(11) **43786**

(21) 3-2021-02858

(54) **MÁY LỌC KHÔNG KHÍ**

(22) 17/11/2021

(73) **CÔNG TY CỔ PHẦN QUỐC TẾ SƠN HÀ (VN)**

Lô CN1, cụm công nghiệp Từ Liêm, phường Minh Khai, quận Bắc Từ Liêm, thành phố Hà Nội

(72) Lê Vĩnh Sơn (VN)

(74) Công ty TNHH Tư vấn IPNG (IPNG CO.,LTD)

(55)

(28) 1

(51) **23-04**

(43) 25/01/2022



1.1



1.2



1.3



1.4



1.5



1.6

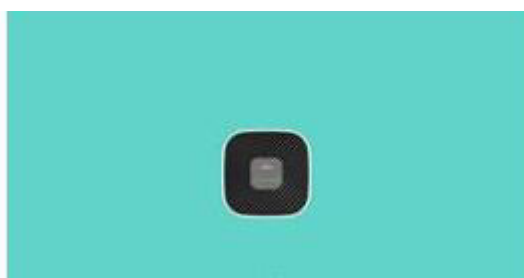

1.7

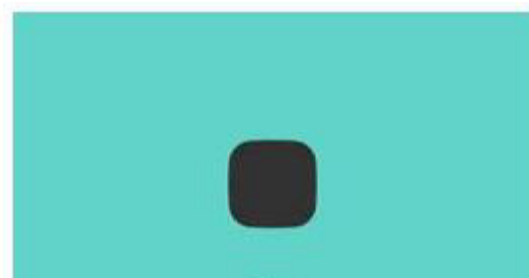

1.8

CÔNG BÁO SỞ HỮU CÔNG NGHIỆP SỐ 406 TẬP A – QUYỀN 2 (01.2022)

(11) **43787**

(21) 3-2021-02859

(28) 1

(54) **MÁY LỌC KHÔNG KHÍ**

(51) **23-04**

(22) 17/11/2021

(43) 25/01/2022

(73) **CÔNG TY CÀ PHÂN QUỐC TẾ SƠN HÀ (VN)**

Lô CN1, cụm công nghiệp Từ Liêm, phường Minh Khai, quận Bắc Từ Liêm, thành phố Hà Nội

(72) Lê Vĩnh Sơn (VN)

(74) Công ty TNHH Tư vấn IPNG (IPNG CO.,LTD)

(55)



1.1



1.2



1.3



1.4



1.5



1.6



1.7

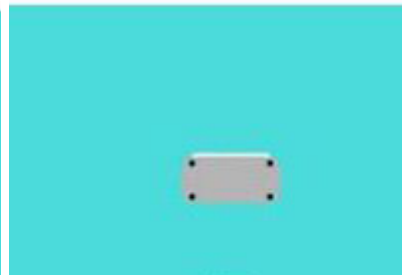

1.8

CÔNG BÁO SỞ HỮU CÔNG NGHIỆP SỐ 406 TẬP A – QUYỀN 2 (01.2022)

- (11) **43788**
(21) 3-2021-02860 (28) 1
(54) **BẢNG ĐIỀU KHIỂN** (51) **13-03**
(22) 17/11/2021 (43) 25/01/2022
(73) **CÔNG TY CỔ PHẦN ĐẦU TƯ SẢN XUẤT VÀ XUẤT NHẬP KHẨU TOÀN PHÁT (VN)**
Tổ 3 cụm 1, ngõ 345 phố Khương Trung, phường Khương Đình, quận Thanh Xuân, thành phố Hà Nội
(72) Trịnh Anh Toàn (VN)
(74) Công ty Luật TNHH Phương Hoàng (PHOENIX LAW)
(55)



1.1



1.2



1.3



1.4



1.5



1.6

1.7

- (11) **43789**
(21) 3-2021-02861 (28) 1
(54) **BẢNG ĐIỀU KHIỂN** (51) **13-03**
(22) 17/11/2021 (43) 25/01/2022
(73) **CÔNG TY CỔ PHẦN ĐẦU TƯ SẢN XUẤT VÀ XUẤT NHẬP KHẨU TOÀN PHÁT (VN)**
Tổ 3 cụm 1, ngõ 345 phố Khương Trung, phường Khương Đình, quận Thanh Xuân, thành phố Hà Nội
(72) Trịnh Anh Toàn (VN)
(74) Công ty Luật TNHH Phương Hoàng (PHOENIX LAW)
(55)



1.1



1.2



1.3



1.4



1.5



1.6



1.7

(11) **43790**

(21) 3-2021-02862

(28) 1

(54) **MÁY ĐÚC ỒNG LY TÂM**

(51) **15-04; 15-09**

(22) 17/11/2021

(43) 25/01/2022

(73) **CÔNG TY TNHH HỒ HOÀN CẦU (VN)**

Xóm 6, xã Quỳnh Văn, huyện Quỳnh Lưu, tỉnh Nghệ An

(72) Hồ Xuân Vinh (VN)

(55)



1.1



1.2

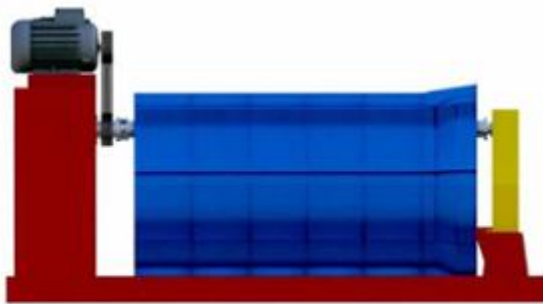

1.3

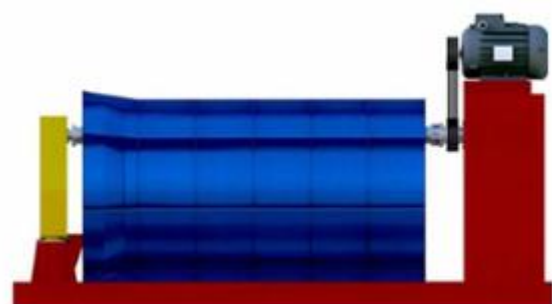

1.4

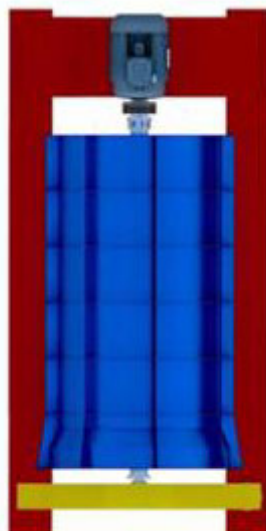

1.5

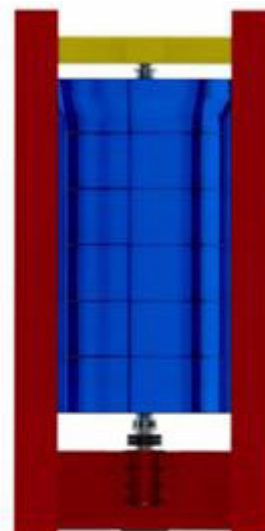

1.6

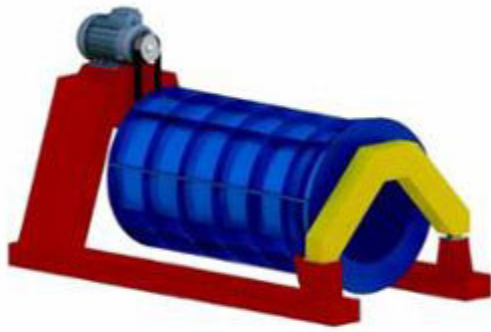

1.7

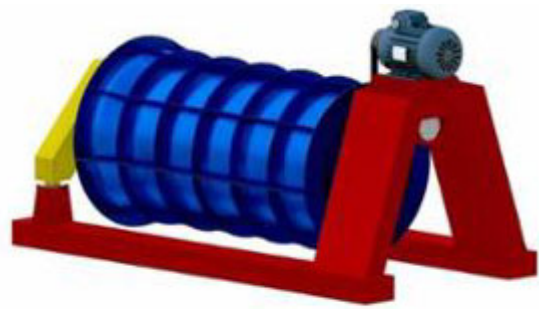

1.8

CÔNG BÁO SỞ HỮU CÔNG NGHIỆP SỐ 406 TẬP A – QUYỀN 2 (01.2022)

- (11) **43791**
(21) 3-2021-02872 (28) 1
(54) **MÁY ĐO QUANG PHỔ THÔNG MINH** (51) **10-04**
(22) 17/11/2021 (43) 25/01/2022
(73) **CÔNG TY CỔ PHẦN RYNAN TECHNOLOGIES VIETNAM (VN)**
Áp Long Trì, xã Long Đức, thành phố Trà Vinh, tỉnh Trà Vinh
(72) 1. NGUYỄN THANH MỸ (VN)
2. TÔ HUỖNH NGỌC DUY (VN)
3. PHẠM THÁI BÌNH (VN)
4. PHAN MINH QUÝ (VN)
5. TRẦN NHẬT TRƯỜNG (VN)
(74) Công ty TNHH Đại Tín và Liên Danh (DAITIN AND ASSOCIATES CO.,LTD)
(55)

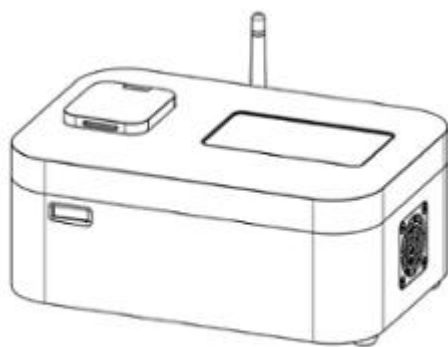

1.1

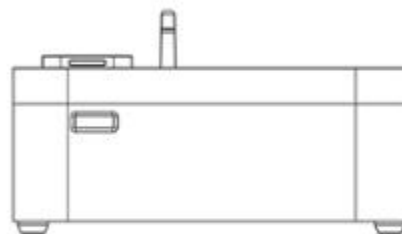

1.2

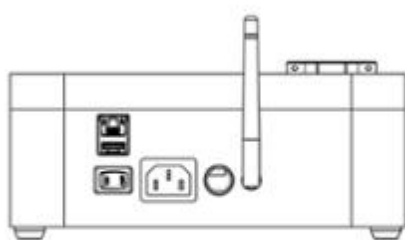

1.3

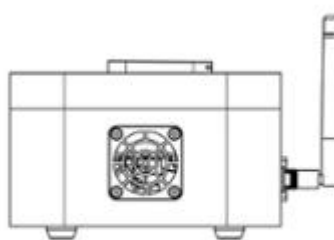

1.4

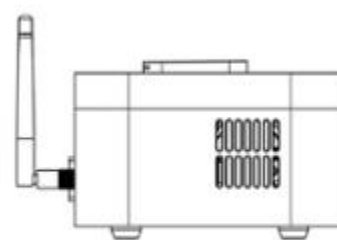

1.5

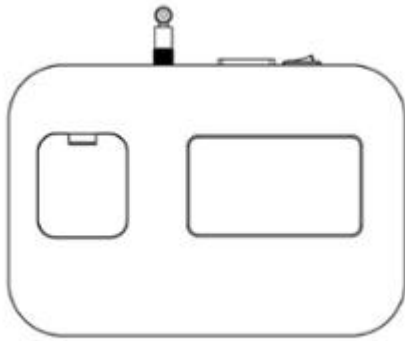

1.6

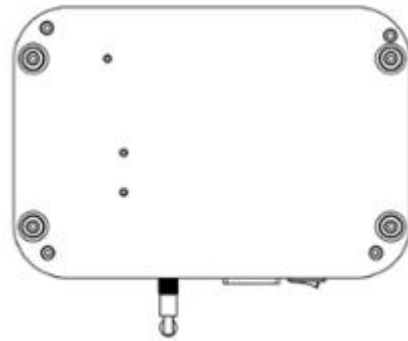

1.7

- (11) **43792**
(21) 3-2021-02875 (28) 1
(54) **CHẬU RỬA TAY** (51) **23-02**
(22) 18/11/2021 (43) 25/01/2022
(30) 2021-010883 24/05/2021 JP;
(73) **YOSHIMOTO TRADING CO., LTD. (JP)**
10-16, Minamisenba 1-chome, Chuo-ku, Osaka-shi, Osaka 542-0081 Japan
(72) Akiyoshi YOSHIMOTO (JP)
(74) Công ty Luật TNHH Phạm và Liên danh (PHAM & ASSOCIATES)
(55)

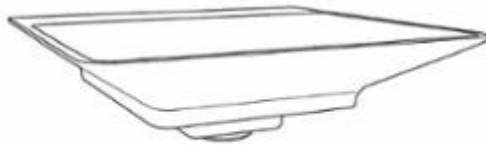

1.1



1.2



1.3



1.4

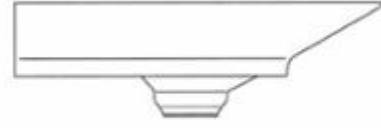

1.5



1.6

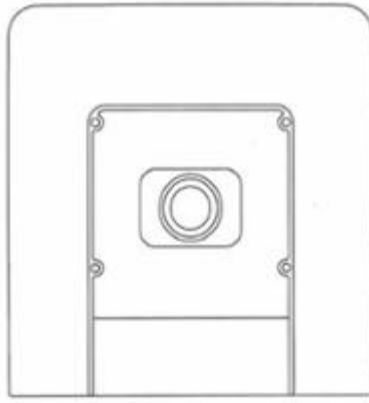

1.7

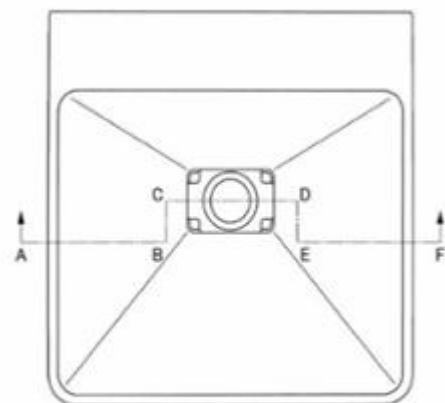

1.8



1.9



1.10



1.11



1.12



1.13



1.14

- (11) **43793**
(21) 3-2021-02876 (28) 1
(54) **CHẬU RỬA** (51) **23-02**
(22) 18/11/2021 (43) 25/01/2022
(30) 2021-010882 24/05/2021 JP;
(73) **YOSHIMOTO TRADING CO., LTD. (JP)**
10-16, Minamisenba 1-chome, Chuo-ku, Osaka-shi, Osaka 542-0081 Japan
(72) Akiyoshi YOSHIMOTO (JP)
(74) Công ty Luật TNHH Phạm và Liên danh (PHAM & ASSOCIATES)
(55)



1.1



1.2



1.3

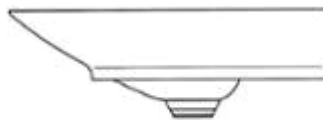

1.4

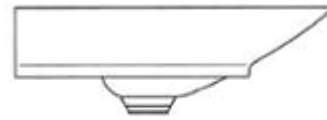

1.5

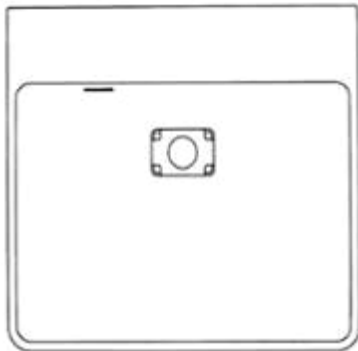

1.6

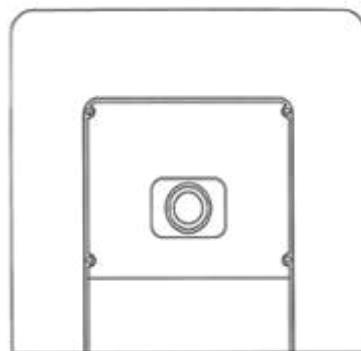

1.7

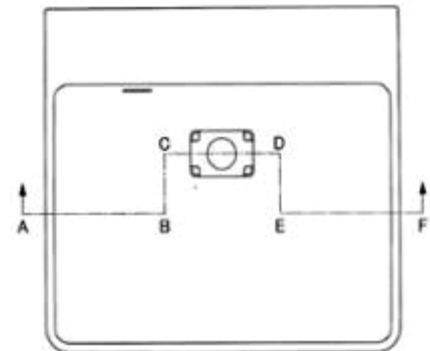

1.8



1.9



1.10



1.11



1.12



1.13



1.14

CÔNG BÁO SỞ HỮU CÔNG NGHIỆP SỐ 406 TẬP A – QUYỀN 2 (01.2022)

- (11) **43794**
(21) 3-2021-02877 (28) 1
(54) **THIẾT BỊ XOA BÓP ÁP LỰC ÂM** (51) **28-03**
(22) 18/11/2021 (43) 25/01/2022
(30) 110304036 03/08/2021 TW;
(73) **BIBOTING INTERNATIONAL CO., LTD (TW)**
8F., No.66-7, Sec. 2, Nankan Rd., Luzhu Dist., Taoyuan City 338, Taiwan
(72) 1. SHIH-TA LIU (TW)
2. PO-CHANG LIU (TW)
3. PEI-EN LEE (TW)
(74) Công ty TNHH Đại Tín và Liên Danh (DAITIN AND ASSOCIATES CO.,LTD)
(55)

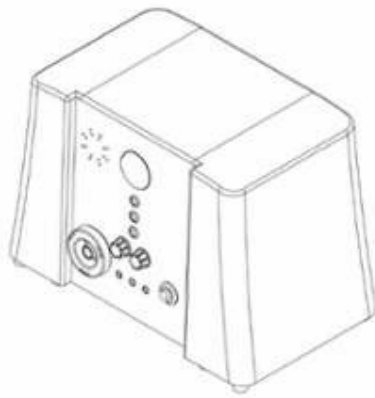

1.1

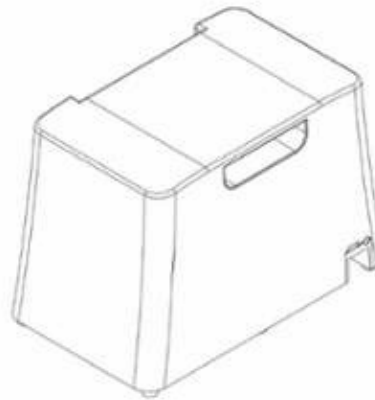

1.2

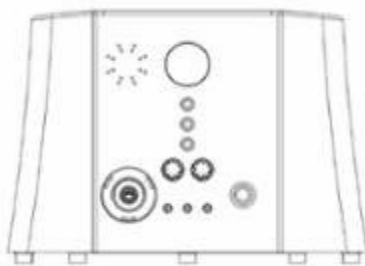

1.3



1.4



1.5



1.6



1.7

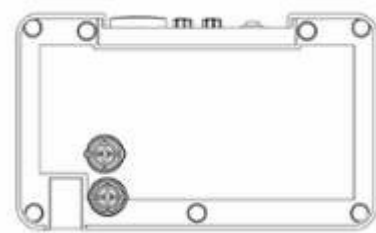

1.8

CÔNG BÁO SỞ HỮU CÔNG NGHIỆP SỐ 406 TẬP A – QUYỀN 2 (01.2022)

- (11) **43795**
(21) 3-2021-02879 (28) 1
(54) **LỌ** (51) **09-01**
(22) 18/11/2021 (43) 25/01/2022
(73) **LG HOUSEHOLD & HEALTH CARE LTD. (KR)**
58, Saemunan-ro, Jongno-gu, Seoul, Republic of Korea
(72) 1. CHOI, SONG (KR)
2. CHO, JI HYE (KR)
(74) Công ty TNHH Tâm nhìn và Liên danh (VISION & ASSOCIATES CO.LTD.)
(55)



1.1

1.2

1.3

1.4

1.5

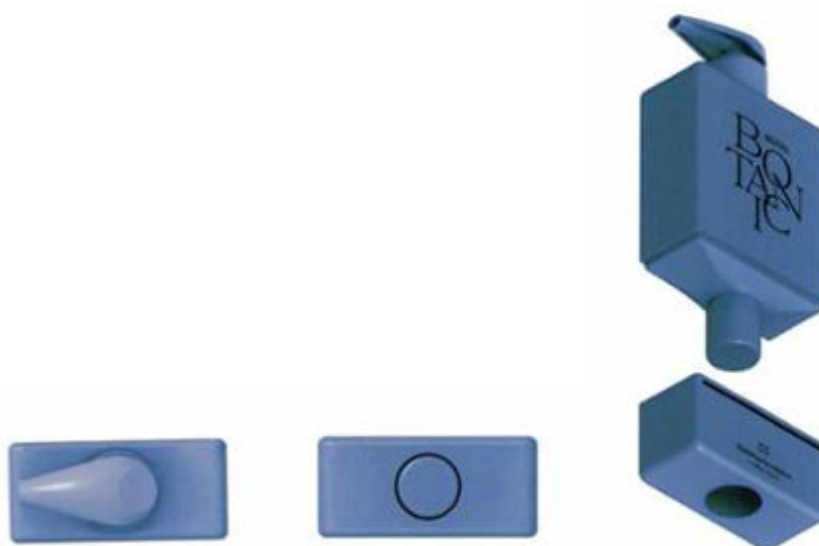

1.6

1.7

1.8

CÔNG BÁO SỞ HỮU CÔNG NGHIỆP SỐ 406 TẬP A – QUYỀN 2 (01.2022)

- (11) **43796**
(21) 3-2021-02880 (28) 1
(54) **HỘP** (51) **09-03**
(22) 18/11/2021 (43) 25/01/2022
(73) **LG HOUSEHOLD & HEALTH CARE LTD. (KR)**
58, Saemunan-ro, Jongno-gu, Seoul, Republic of Korea
(72) PARK, Suk Young (KR)
(74) Công ty TNHH Tầm nhìn và Liên danh (VISION & ASSOCIATES CO.LTD.)
(55)



1.1



1.2



1.3



1.4



1.5



1.6



1.7

CÔNG BÁO SỞ HỮU CÔNG NGHIỆP SỐ 406 TẬP A – QUYỀN 2 (01.2022)

- (11) **43797**
(21) 3-2021-02883 (28) 1
(54) **HỘP ĐỰNG SỮA GẠO LỨT** (51) **09-03**
(22) 19/11/2021 (43) 25/01/2022
(73) **CÔNG TY CỔ PHẦN MÍA ĐƯỜNG LAM SƠN (VN)**
Thị trấn Lam Sơn, huyện Thọ Xuân, tỉnh Thanh Hóa
(72) Lê Văn Tân (VN)
(74) Công ty Luật TNHH Phạm và Liên danh (PHAM & ASSOCIATES)
(55)



1.1



1.2



1.3



1.4



1.5



1.6



1.7

CÔNG BÁO SỞ HỮU CÔNG NGHIỆP SỐ 406 TẬP A – QUYỀN 2 (01.2022)

(11) **43798**

(21) 3-2021-02914

(28) 1

(54) **GHẾ MÁT XA**

(51) **06-01**

(22) 23/11/2021

(43) 25/01/2022

(73) **FUAN CITY GUOHENG INDUSTRY LIMITED (CN)**

No. 10, Guancun West Road, Chengnan Street, Fu'an City, Ningde City, Fujian, 355000, China

(72) Wenhui YE (CN)

(74) Công ty TNHH Sáng chế ACTIP (ACTIP PATENT LIMITED)

(55)



1.1



1.2



1.3



1.4



1.5



1.6



1.7



1.8



1.9



1.10

PHẦN II

SỬA ĐỔI ĐƠN

Ghi nhận sửa đổi đơn yêu cầu cấp Bằng độc quyền kiểu dáng công nghiệp

Thông báo số: 33127w/TB-SHTT, ngày 21/12/2021 về việc ghi nhận sửa đổi đơn

Số Yêu cầu: SĐ3-2021-01961 Ngày nộp: 27/10/2021

Liên quan đến đơn yêu cầu cấp Bằng độc quyền kiểu dáng công nghiệp:

(21) Số đơn	(22) Ngày nộp đơn
3-2019-01200	17/05/2019

Mục sửa đổi: Đại diện sở hữu công nghiệp

Nội dung mới: Công ty TNHH Dương và Trần(DUONG & TRAN CO., LTD)
Số 85, phố Ngô Gia Tự, phường Đức Giang, quận Long Biên, TP. Hà
nội

Thông báo số: 33150w/TB-SHTT, ngày 23/12/2021 về việc ghi nhận sửa đổi đơn

Số Yêu cầu: SĐ3-2021-02107 Ngày nộp: 16/11/2021

Liên quan đến đơn yêu cầu cấp Bằng độc quyền kiểu dáng công nghiệp:

(21) Số đơn	(22) Ngày nộp đơn
3-2020-02965	08/12/2020
3-2021-00120	19/01/2021

Mục sửa đổi: Tên, địa chỉ chủ đơn

Nội dung mới: Công Ty TNHH Gạo Ngon Nhất (VN)
11/22 đường 10, khu phố 3, phường Bình Thuận, quận 7, thành phố Hồ
Chí Minh

CÔNG BÁO SỞ HỮU CÔNG NGHIỆP SỐ 406 TẬP A – QUYỀN 2 (01.2022)

Thông báo số: 33149w/TB-SHTT, ngày 23/12/2021 về việc ghi nhận sửa đổi đơn

Số Yêu cầu: SĐ3-2021-01361 Ngày nộp: 30/06/2021

Liên quan đến đơn yêu cầu cấp Bằng độc quyền kiểu dáng công nghiệp:

(21) Số đơn	(22) Ngày nộp đơn
3-2021-00298	05/02/2021
3-2021-00299	05/02/2021
3-2021-00300	05/02/2021
3-2021-00301	05/02/2021
3-2021-00302	05/02/2021
3-2021-00303	05/02/2021
3-2021-00304	05/02/2021

Mục sửa đổi: Đại diện sở hữu công nghiệp

Nội dung mới: Văn phòng Luật sư D và T(D & T LAW OFFICE)
Căn hộ A-5-71, tầng 5 Officetel, RiverGate Residence, 151-155 Bến
Vân Đồn, phường 06, quận 4, thành phố Hồ Chí Minh

PHẦN III

THAY ĐỔI CHỦ ĐƠN

Ghi nhận thay đổi chủ đơn yêu cầu cấp Bằng độc quyền Kiểu dáng công nghiệp

Thông báo số: 30377w/TB-SHTT, ngày 25/11/2021 về việc ghi nhận thay đổi chủ đơn

Số Yêu cầu: CD3-2021-00768 Ngày nộp: 17/06/2021

Liên quan đến đơn yêu cầu cấp bằng độc quyền kiểu dáng công nghiệp:

(21) Số đơn	(22) Ngày nộp đơn
3-2019-01166	13/05/2019

Bên chuyển nhượng: HUAWEI TECHNOLOGIES CO., LTD. (CN)
Huawei Administration Building, Bantian, Longgang
District, Shenzhen, Guangdong 518129, P.R. China

Bên được chuyển nhượng: Honor Device Co., Ltd. (CN)
Suite 3401, Unit A, Building 6, Shum Yip Sky Park, No.
8089, Hongli West Road, Xiangmihu Street, Futian District,
Shenzhen, Guangdong 518040, People's Republic of China

CÔNG BÁO SỞ HỮU CÔNG NGHIỆP

Do Cục Sở hữu trí tuệ thuộc Bộ Khoa học và Công nghệ ấn hành theo Luật Sở hữu trí tuệ số 50/2005/QH11 được Quốc hội thông qua ngày 29 tháng 11 năm 2005 và được sửa đổi bằng Luật sửa đổi, bổ sung một số điều của Luật sở hữu trí tuệ số 50/2005/QH11 được Quốc hội thông qua ngày 19 tháng 6 năm 2009.

Địa chỉ liên hệ:

384-386 đường Nguyễn Trãi, quận Thanh Xuân,
thành phố Hà Nội, Việt Nam
ĐT: 024. 38583069
Fax: 024. 38588449