

CỘNG HÒA XÃ HỘI CHỦ NGHĨA VIỆT NAM
BỘ KHOA HỌC VÀ CÔNG NGHỆ

CỤC SỞ HỮU TRÍ TUỆ

CÔNG BÁO
SỞ HỮU CÔNG NGHIỆP

TẬP A

QUYỂN 2: KIỂU DÁNG CÔNG NGHIỆP

11 - 2021

404

CỘNG HOÀ XÃ HỘI CHỦ NGHĨA VIỆT NAM
BỘ KHOA HỌC VÀ CÔNG NGHỆ
CỤC SỞ HỮU TRÍ TUỆ

CÔNG BÁO
SỞ HỮU CÔNG NGHIỆP
TẬP A

QUYỂN 2: KIỂU DÁNG CÔNG NGHIỆP

11-2021

404

HÀ NỘI

MỤC LỤC

	Trang
<u>PHẦN I:</u> Đơn yêu cầu cấp Bằng độc quyền kiểu dáng công nghiệp	7
<u>PHẦN II:</u> Sửa đổi đơn	448

CONTENTS

<u>PART I:</u> Applications for Industrial Design Patents	7
<u>PART II:</u> Amendment of Applications	448

CÔNG BÁO SỞ HỮU CÔNG NGHIỆP SỐ 404 TẬP A - QUYỂN 2 (11.2021)

MÃ SỐ HAI CHỮ CÁI THỂ HIỆN TÊN NƯỚC VÀ CÁC THỰC THỂ KHÁC TRONG CÁC TƯ LIỆU SỞ HỮU CÔNG NGHIỆP THEO TIÊU CHUẨN ST3 CỦA WIPO

AE	United Arab Emirates	CN	China	HK	Hong Kong
AF	Afganistan	CO	Colombia	HN	Honduras
AG	Antihua and Barbuda	CR	Costa Rica	HR	Croatia
AI	Anguilla	CU	Cuba	HT	Haiti
AL	Albania	CV	Cape Verde	HU	Hungary
AN	Netherlands Antilles	CY	Cyprus	ID	Indonesia
AO	Angola	CZ	Czech Republic	IE	Ireland
AR	Argentina	DE	Germany	IL	Israel
AT	Austria	DJ	Djibouti	IN	India
AU	Australia	DK	Denmark	IQ	Iraq
AW	Aruba	DM	Dominica	IR	Iran (Islamic Republic of)
BB	Barbados	DO	Dominican Republic	IS	Iceland
BD	Bangladesh	DZ	Algeria	IT	Italy
BE	Belgium	EC	Ecuador	JM	Jamaica
BF	Burkina Faso	EE	Estonia	JO	Jordan
BG	Bulgaria	EG	Egypt	JP	Japan
BH	Bahrain	ES	Spain	KE	Kenya
BI	Burundi	ET	Ethiopia	KH	Cambodia
BJ	Benin	FI	Finland	KI	Kiribati
BM	Bermuda	FJ	Fiji	KM	Comoros
BN	Brunei Darussalam	FK	Falkand Islands (Malvinas)	KN	Saint Kitts and Nevis
BO	Bolivia	FR	France	KP	Democratic People's Republic of Korea
BR	Brazil	GA	Gabon	KR	Republic of Korea
BS	Bahamas	GB	United Kingdom	KW	Kuwait
BT	Bhutan	GD	Grenada	KY	Cayman Islands
BW	Botswana	GE	Georgia	KZ	Kazakhstan
BY	Belarus	GH	Ghana	LA	Laos
BZ	Belize	GI	Gibraltar	LB	Lebanon
CA	Canada	GM	Gambia	LC	Saint Lucia
CF	Central African Republic	GN	Guinea	LI	Liechtenstein
CG	Congo	GQ	Equatorial Guinea	LK	SriLanka
CH	Switzerland	GR	Greece	LR	Liberia
CI	Côte d'Ivoire	GT	Guatemala	LS	Lesotho
CL	Chile	GW	Guinea-Bissau	LT	Lithuania
CM	Cameroon	GY	Guyana	TC	Turk and Caicos Islands
LU	Luxembourg	PA	Panama	TD	Chad
LV	Latvia	PE	Peru	TG	Togo
LY	Lybya	PG	Papua New Guinea	TH	Thailand
MA	Morocco	PH	Philippines	TN	Tunisia
MC	Monaco	PK	Pakistan	TO	Tonga
MD	Republic of Moldova	PL	Poland	TR	Turkey

CÔNG BÁO SỞ HỮU CÔNG NGHIỆP SỐ 404 TẬP A - QUYỂN 2 (11.2021)

MG	Madagascar	PT	Portugal	TT	Trinidad and Tobago
ML	Mali	PY	Paraguay	TV	Tuvalu
MM	Myanmar	QA	Qatar	TW	Taiwan, Province of China
MN	Mongolia	RO	Rumania	TZ	United Republic of Tanzania
MO	Macau	RU	Russian Federation	UA	Ukraine
MR	Mauritania	RW	Rwanda	UG	Uganda
MS	Montserrat	SA	Saudi Arabia	US	United States of America
MT	Malta	SB	Solomon Islands	UY	Uruguay
MU	Mauritius	SC	Seychelles	UZ	Uzbekistan
MV	Maldives	SD	Sudan	VA	Holy see
MW	Malawi	SE	Sweden	VC	Saint Vincent and the Grenadines
MX	Mexico	SG	Singapore	VE	Venezuela
MY	Malaysia	SH	Saint Helena	VG	Virgin Islands (British)
MZ	Mozambique	SL	Slovenia	VN	Vietnam
NA	Namibia	SK	Slovakia	VU	Vanuatu
NE	Niger	SL	Sierra Leone	WS	Samoa
NG	Nigeria	SM	San Marino	YE	Yemen
NJ	Nicaragua	SN	Senegal	YU	Yugoslavia
NL	Netherlands	SO	Somalia	ZA	South Africa
NO	Norway	SR	Suriname	ZM	Zambia
NP	Nepal	ST	Sao Tome and Principe	ZR	Zaire
NR	Nauru	SV	El Sanvador	ZW	Zimbabwe
NZ	New Zealand	SY	Syria		
OM	Oman	SZ	Swaziland		

CÁC TỔ CHỨC QUỐC TẾ

AO	African Intellectual Property Organization (OAPI)
AP	African Regional Industrial Property Organization (ARIPO)
BX	Benelux Trademark Office and Benelux Designs Office
EP	European Patent Office (EPO)
IB, WO	International Bureau of the World Intellectual Property Organization (WIPO)

NHỮNG MÃ SỐ INID TRÍCH TỪ TIÊU CHUẨN ST80 CỦA TỔ CHỨC SỞ HỮU TRÍ TUỆ THẾ GIỚI (WIPO) ĐỂ NHẬN BIẾT CÁC DỮ LIỆU THƯ MỤC DÙNG CÔNG BỐ ĐƠN VÀ BẰNG ĐỘC QUYỀN KIỂU DÁNG CÔNG NGHIỆP

- (11) Số bằng độc quyền kiểu dáng công nghiệp / Số công bố đơn
- (15) Ngày cấp
- (18) Ngày hết hạn hiệu lực của bằng độc quyền kiểu dáng công nghiệp
- (21) Số đơn
- (22) Ngày nộp đơn
- (23) Tên triển lãm, ngày và nơi triển lãm
- (28) Số phương án yêu cầu bảo hộ
- (30) Số đơn ưu tiên, ngày nộp đơn ưu tiên
- (43) Ngày công bố đơn
- (45) Ngày công bố bằng độc quyền kiểu dáng công nghiệp
- (51) Phân loại quốc tế kiểu dáng công nghiệp
- (54) Tên sản phẩm mang kiểu dáng công nghiệp
- (55) Ảnh chụp / hình vẽ kiểu dáng công nghiệp
- (57) Đặc điểm khác biệt yêu cầu bảo hộ của kiểu dáng công nghiệp
- (62) Số và ngày nộp đơn, số bằng độc quyền KDCN hoặc số công bố đơn liên quan đến tách đơn
- (71) Tên và địa chỉ của người nộp đơn
- (72) Tên của tác giả KDCN
- (73) Tên, địa chỉ của chủ bằng độc quyền KDCN
- (74) Tên của người đại diện SHCN

PHẦN I

ĐƠN YÊU CẦU CẤP BẰNG ĐỘC QUYỀN KIỂU DÁNG CÔNG NGHIỆP

- (11) **42901**
- (21) 3-2019-00363 (28) 1
- (54) **BÀN CHẢI ĐÁNH RĂNG** (51) **04-02**
- (22) 01/02/2019 (43) 25/11/2021
- (30) 30-2018-0041037 03/09/2018 KR;
- (73) 1. **OH SE IN** (KR)
359, Seobusaneopdo-ro, Jeongeup-si, Jeollabuk-do, Republic of Korea
2. **PARK MYUNG HEE** (KR)
162-903 Els Apt., Jamsil-dong, Songpa-gu, Seoul, Republic of Korea
3. **CHOI KWAN LAK** (KR)
508-1604 Dongbu-centreville Apt., Suji-gu, Yongin-si, Gyeonggi-do, Republic of Korea
- (72) 1. OH SE IN (KR)
2. PARK MYUNG HEE (KR)
3. CHOI KWAN LAK (KR)
- (74) Công ty TNHH Trà và cộng sự (TRA & ASSOCIATES CO.,LTD)
- (55)

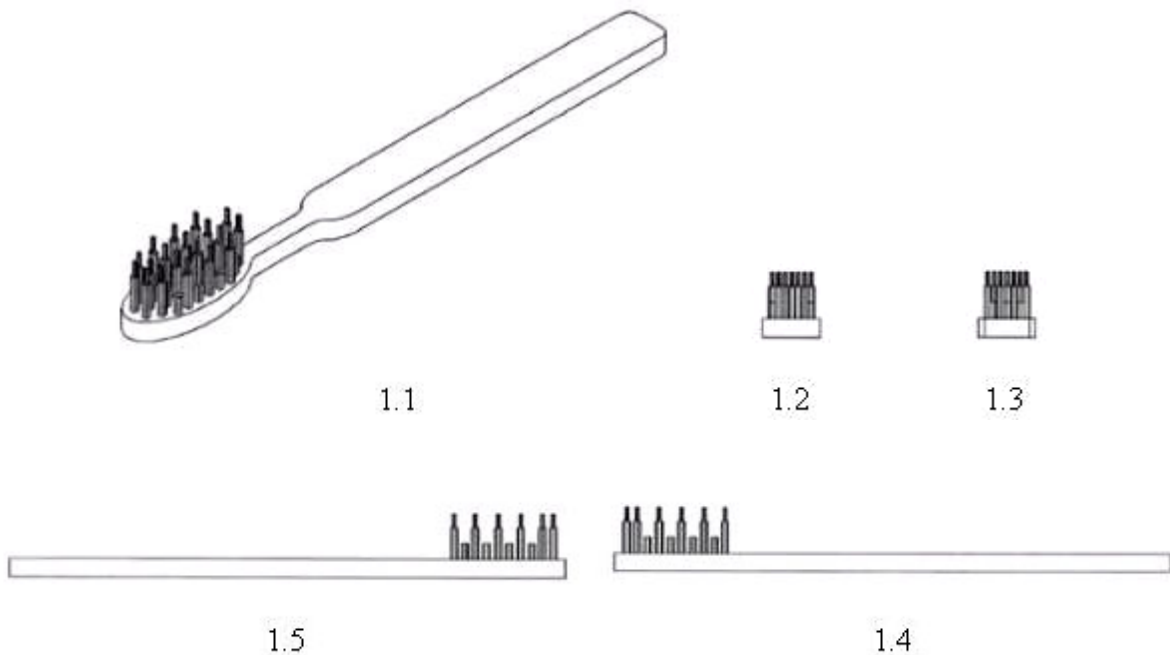



1.6



1.7

- (11) **42902**
(21) 3-2019-01937 (28) 1
(54) **THIẾT BỊ ĐIỀU KHIỂN TAI NGHE** (51) **14-01**
(22) 31/07/2019 (43) 25/11/2021
(30) 201930057284.1 31/01/2019 CN;
(73) **HUAWEI TECHNOLOGIES CO., LTD. (CN)**
Huawei Administration Building, Bantian, Longgang District, Shenzhen,
Guangdong 518129, P. R. China
(72) 1. ZHAO, YING (CN)
2. CLERC, BERTRAND (FR)
3. LIN, CHENXI (CN)
4. JEONG, SANGHYUN (KR)
(74) Công ty Cổ phần Sở hữu công nghiệp INVESTIP (INVESTIP)
(55)

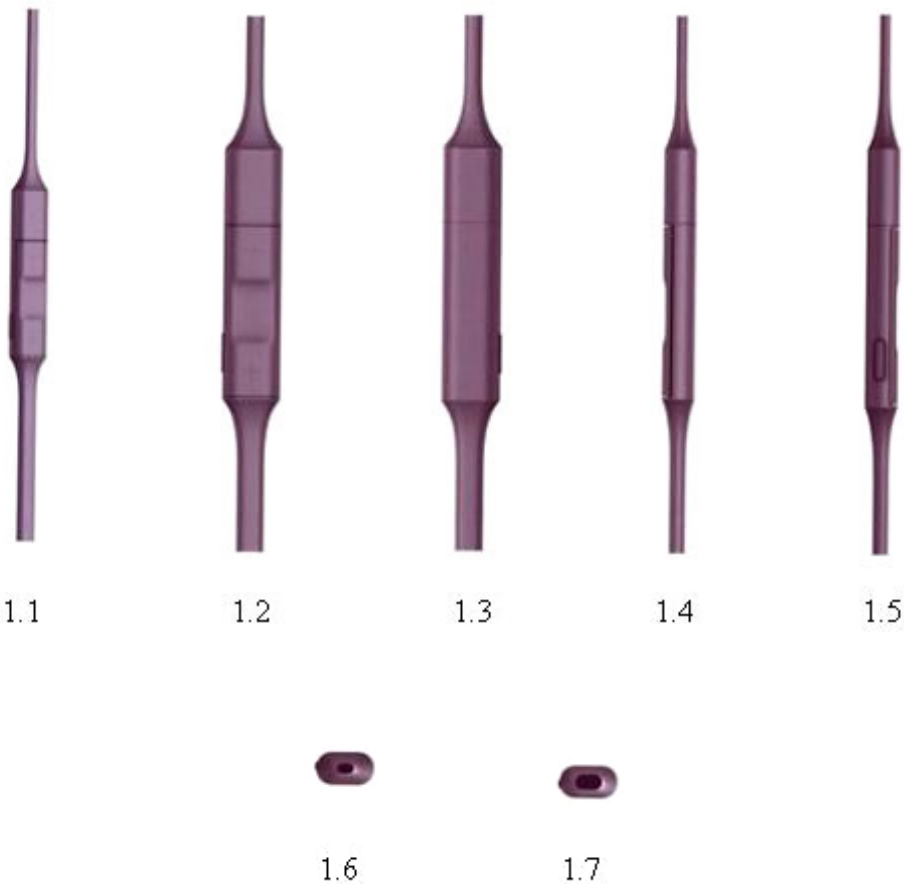



1.8



1.9



1.10



1.11



1.12

CÔNG BÁO SỞ HỮU CÔNG NGHIỆP SỐ 404 TẬP A – QUYỀN 2 (11.2021)

- (11) **42903**
(21) 3-2019-02759 (28) 1
(54) **THIẾT BỊ HÚT BÙN HAI CÁNH DI ĐỘNG** (51) **15-02; 15-99**
(22) 30/10/2019 (43) 25/11/2021
(73) **CÔNG TY CỔ PHẦN CÔNG NGHỆ NƯỚC CPT (VN)**
Nhà số 7, gác 96, tổ 5C, phường Định Công, quận Hoàng Mai, thành phố Hà Nội
(72) Nguyễn Thành Tấn (VN)
(55)

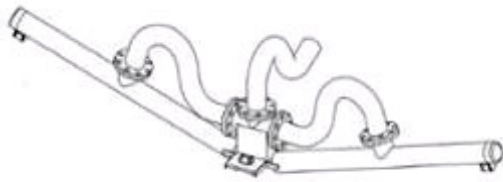

1.1

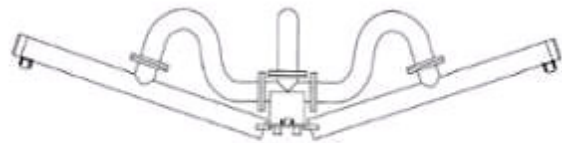

1.2

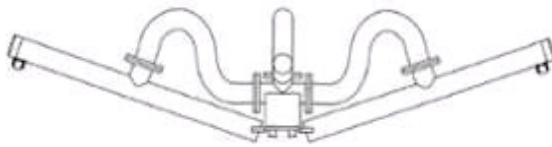

1.3

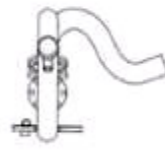

1.4

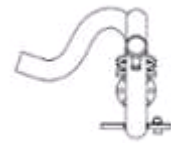

1.5

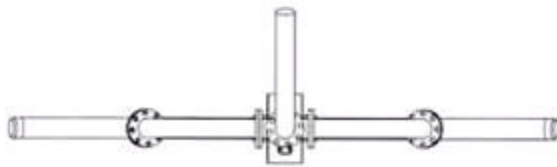

1.6

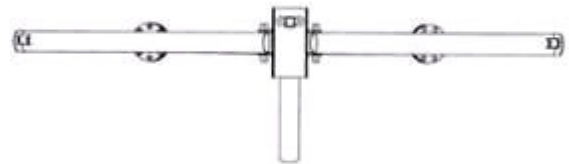

1.7

- (11) **42904**
(21) 3-2019-03113 (28) 9
(54) **BỘ BÁT ĐĨA** (51) **07-01; 07-03**
(22) 03/12/2019 (43) 25/11/2021
(73) **CÔNG TY TNHH MINH LONG I (VN)**
333 khu phố Hưng Lộc, phường Hưng Định, thị xã Thuận An, tỉnh Bình Dương
(72) Lý Ngọc Minh (VN)
(55)



1.1



1.2



1.3



1.4



1.5



1.6

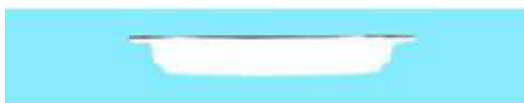

1.7



1.8



1.9



1.10

1.11

1.12



1.13

1.14

1.15

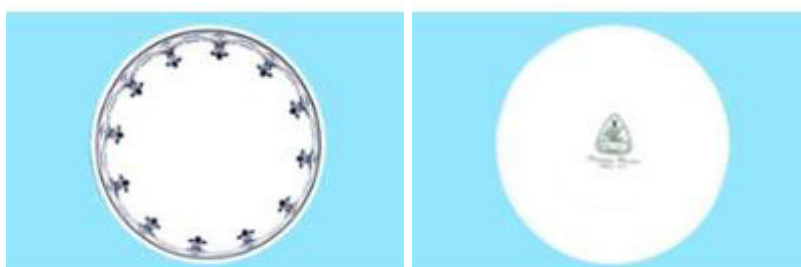

1.16

1.17



1.18

1.19

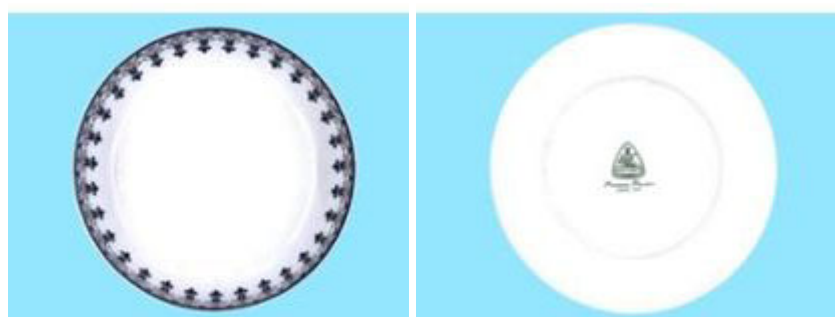

1.20

1.21



1.22

1.23



1.24



1.25

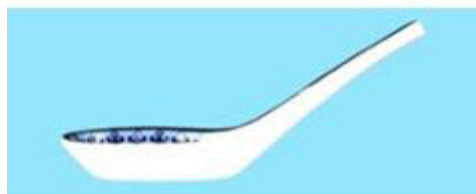

1.26

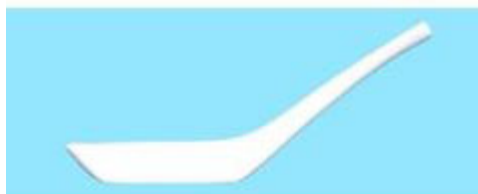

1.27



1.28



1.29

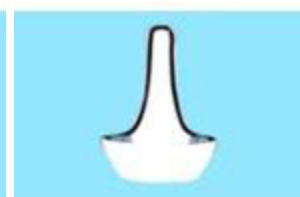

1.30

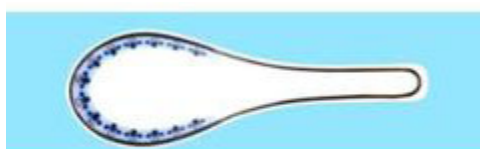

1.31



1.32



1.33



1.34



1.35



1.36



1.37



1.38



1.39



1.40



1.41



1.42



1.43



1.44



1.45

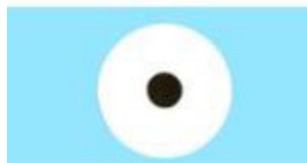

1.46

(11) **42905**

(21) 3-2020-00175

(28) 1

(54) **CÀNG XÔNG MŨI**

(51) **24-02**

(22) 20/01/2020

(43) 25/11/2021

(73) **HOÀNG LAN PHƯƠNG (VN)**

Số 9-P11 tập thể Trương Định, phường Trương Mai, quận Hoàng Mai, thành phố Hà Nội

(72) Hoàng Lan Phương (VN)

(74) Công ty Luật TNHH SIPCO (SIPCO LAWYERS & IP AGENTS)

(55)



1.1

1.2

1.3

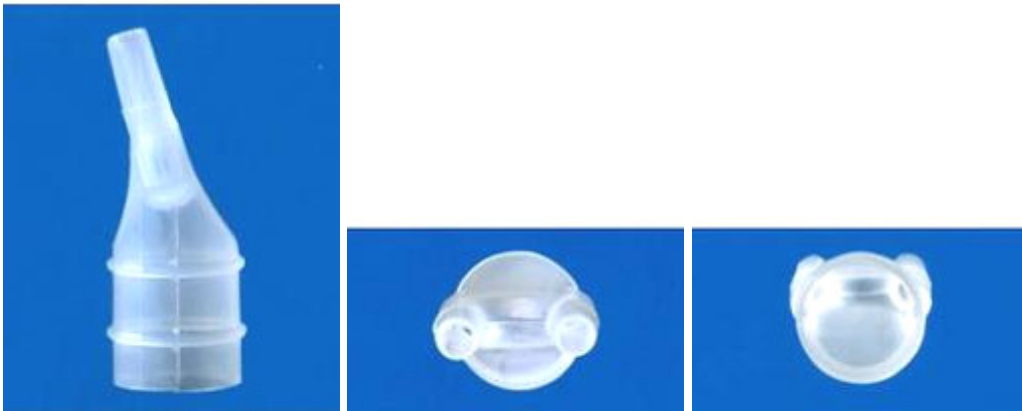

1.4

1.5

1.6

CÔNG BÁO SỞ HỮU CÔNG NGHIỆP SỐ 404 TẬP A – QUYỀN 2 (11.2021)

- (11) **42906**
(21) 3-2020-00176 (28) 1
(54) **CÀNG XÔNG HỌNG** (51) **24-02**
(22) 20/01/2020 (43) 25/11/2021
(73) **HOÀNG LAN PHƯƠNG (VN)**
Số 9-P11 tập thể Trương Định, phường Trương Mai, quận Hoàng Mai, thành phố Hà Nội
(72) Hoàng Lan Phương (VN)
(74) Công ty Luật TNHH SIPCO (SIPCO LAWYERS & IP AGENTS)
(55)



1.1



1.2



1.3



1.4



1.5



1.6

- (11) **42907**
- (21) 3-2020-00516 (28) 1
- (54) **HỘP ĐỰNG** (51) **03-01; 14-01**
- (22) 09/03/2020 (43) 25/11/2021
- (30) 29/705,726 13/09/2019 US;
- (73) **APPLE INC. (US)**
One Apple Park Way, Cupertino, California 95014, United States of America
- (72) 1. JODY AKANA (US)
2. JULIAN JAEDE (DE)
3. RICO ZORKENDORFER (DE)
4. M. EVANS HANKEY (US)
5. CLEMENT TISSANDIER (FR)
6. EUGENE ANTONY WHANG (CA)
7. JEREMY BATAILLOU (FR)
8. RICHARD P. HOWARTH (GB)
9. BARTLEY K. ANDRE (US)
10. SUNG-HO TAN (US)
11. SHOTA AOYAGI (JP)
12. JONATHAN P. IVE (GB)
13. PETER RUSSELL-CLARKE (AU)
14. MOLLY ANDERSON (GB)
15. MARKUS DIEBEL (DE)
16. BENJAMIN ANDREW SHAFFER (US)
17. MARINE C. BATAILLE (FR)
18. ANTHONY MICHAEL ASHCROFT (FR)
19. JULIAN HOENIG (AT)
20. DUNCAN ROBERT KERR (GB)
- (74) Công ty TNHH Lê & Lê (LE & LE)
- (55)

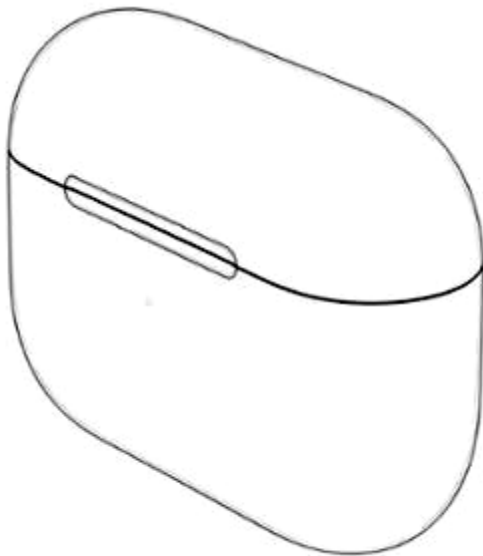

1.1

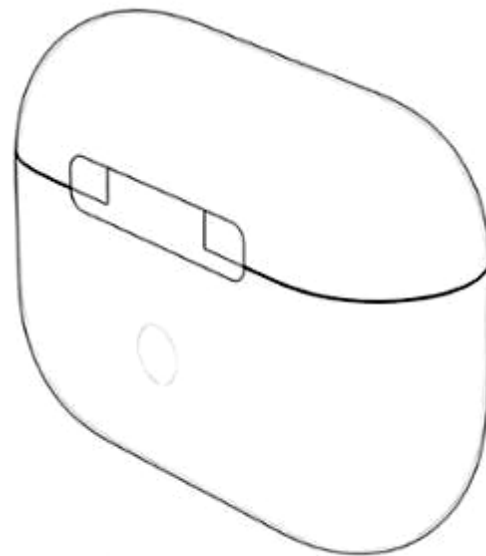

1.2

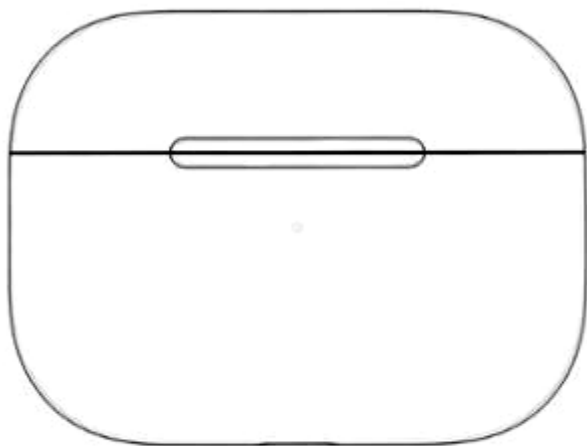

1.3

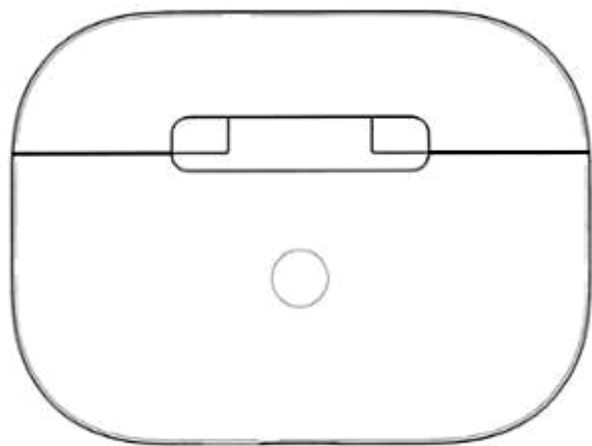

1.4



1.5



1.6



1.7



1.8

- (11) **42908**
(21) 3-2020-01131 (28) 1
(54) **VỢT TENNIS** (51) **21-02**
(22) 15/05/2020 (43) 25/11/2021
(73) **NGUYỄN ĐỨC MẠNH (VN)**
Xóm 3, thôn Liên Trung, xã Tân Hà, huyện Lâm Hà, tỉnh Lâm Đồng
(72) Nguyễn Đức Mạnh (VN)
(74) Công ty TNHH một thành viên Trường Luật (Trường Luật)
(55)



1.1



1.2



1.3



1.4



1.5



1.6



1.7

CÔNG BÁO SỞ HỮU CÔNG NGHIỆP SỐ 404 TẬP A – QUYỀN 2 (11.2021)

- (11) **42909**
(21) 3-2020-01513 (28) 1
(54) **GẠCH LẤP GHÉP** (51) **25-01**
(22) 30/06/2020 (43) 25/11/2021
(73) **NGUYỄN QUYẾT TỐI (VN)**
Tổ 18, phường Ngọc Thụy, quận Long Biên, thành phố Hà Nội
(72) Nguyễn Quyết Tối (VN)
(74) Công ty Luật TNHH Phạm và Liên danh (PHAM & ASSOCIATES)
(55)

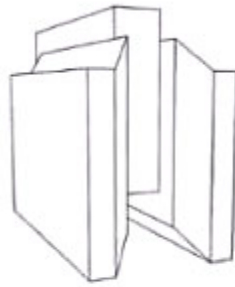

1.1

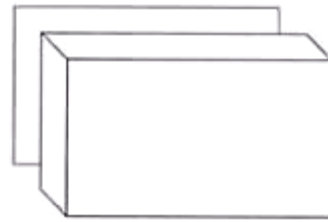

1.2

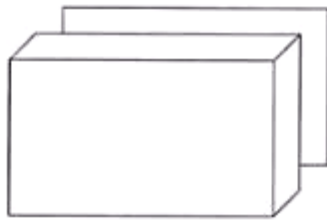

1.3



1.4



1.5

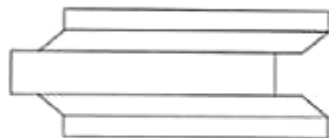

1.6

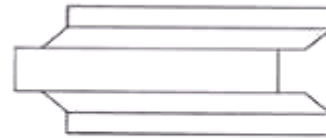

1.7

CÔNG BÁO SỞ HỮU CÔNG NGHIỆP SỐ 404 TẬP A – QUYỀN 2 (11.2021)

- (11) **42910**
(21) 3-2020-01654 (28) 1
(54) **HỘP BAO GÓI SẢN PHẨM** (51) **09-03**
(22) 20/07/2020 (43) 25/11/2021
(73) **CÔNG TY CỔ PHẦN DƯỢC CƯỜNG THỊNH (VN)**
Thửa đất số 480, tờ khai bản đồ số 92, khu phố Đông, phường Vĩnh Phú, thị xã Thuận An, tỉnh Bình Dương
(72) Nguyễn Thị Lê (VN)
(74) Công ty TNHH Sở hữu trí tuệ Toàn Cầu (GLOBAL IP CO., LTD.)
(55)



1.1



1.2

- (11) **42911**
(21) 3-2020-01707 (28) 1
(54) **MŨ BẢO HIỂM** (51) **02-03**
(22) 24/07/2020 (43) 25/11/2021
(30) 007570684 29/01/2020 EM;
(73) **LOCATELLI S.P.A. (IT)**
Via Della Resistenza, 5/A, I-24030 Almenno San Bartolomeo (Bergamo), Italy
(72) LOCATELLI Antonio (IT)
(74) Công ty TNHH Sở hữu trí tuệ ALNGUYEN (ALNGUYEN IP CO.,LTD.)
(55)



1.1



1.2



1.3



1.4



1.5



1.6



1.7

CÔNG BÁO SỞ HỮU CÔNG NGHIỆP SỐ 404 TẬP A – QUYỀN 2 (11.2021)

(11) **42912**

(21) 3-2020-01940

(28) 1

(54) **KHUNG**

(51) **08-09**

(22) 19/08/2020

(43) 25/11/2021

(73) **CÔNG TY TNHH KỸ THUẬT CƠ ĐIỆN MEE (VN)**

Lô HT-E10-6-9, đường số 19 khu công nghiệp Hiệp Phước, xã Hiệp Phước, huyện Nhà Bè, thành phố Hồ Chí Minh

(72) Nguyễn Văn Liên (VN)

(74) Công ty cổ phần Tư vấn S&B (S&B CONSULTANT., CORP.)

(55)

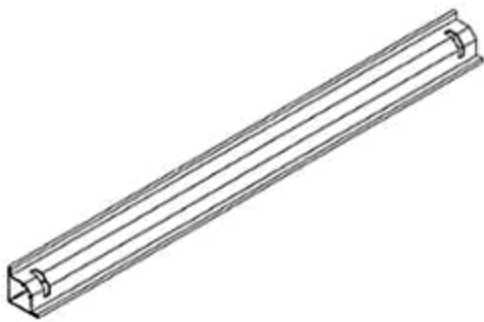

1.1



1.2



1.3



1.4



1.5



1.6



1.7

CÔNG BÁO SỞ HỮU CÔNG NGHIỆP SỐ 404 TẬP A – QUYỀN 2 (11.2021)

(11) **42913**

(21) 3-2020-02009

(28) 1

(54) **GHẾ SÔ-PHA**

(51) **06-01**

(22) 31/08/2020

(43) 25/11/2021

(73) **HTL FURNITURE (CHINA) CO., LTD. (CN)**

Wu Yujiangnan Road, Kunshan Development Zone, Jiangsu Province, China

(72) PHUA YONG TAT (SG)

(74) Công ty Luật TNHH quốc tế BMVN (BMVN INTERNATIONAL LLC)

(55)



1.1



1.2



1.3



1.4



1.5



1.6

CÔNG BÁO SỞ HỮU CÔNG NGHIỆP SỐ 404 TẬP A – QUYỀN 2 (11.2021)

(11) **42914**

(21) 3-2020-02011

(28) 1

(54) **GHẾ SÔ-PHA**

(51) **06-01**

(22) 31/08/2020

(43) 25/11/2021

(73) **HTL FURNITURE (CHINA) CO., LTD. (CN)**

Wu Yujiangnan Road, Kunshan Development Zone, Jiangsu Province, China

(72) PHUA YONG TAT (SG)

(74) Công ty Luật TNHH quốc tế BMVN (BMVN INTERNATIONAL LLC)

(55)



1.1



1.2



1.3



1.4



1.5

CÔNG BÁO SỞ HỮU CÔNG NGHIỆP SỐ 404 TẬP A – QUYỀN 2 (11.2021)

(11) **42915**

(21) 3-2020-02016

(28) 1

(54) **GHẾ SÔ-PHA**

(51) **06-01**

(22) 31/08/2020

(43) 25/11/2021

(73) **HTL FURNITURE (CHINA) CO., LTD. (CN)**

Wu Yujiangnan Road, Kunshan Development Zone, Jiangsu Province, China

(72) PHUA YONG TAT (SG)

(74) Công ty Luật TNHH quốc tế BMVN (BMVN INTERNATIONAL LLC)

(55)



1.1



1.2



1.3



1.4



1.5



1.6

CÔNG BÁO SỞ HỮU CÔNG NGHIỆP SỐ 404 TẬP A – QUYỀN 2 (11.2021)

(11) **42916**

(21) 3-2020-02019

(28) 1

(54) **GHẾ SÔ-PHA**

(51) **06-01**

(22) 31/08/2020

(43) 25/11/2021

(73) **HTL FURNITURE (CHINA) CO., LTD. (CN)**

Wu Yujiangnan Road, Kunshan Development Zone, Jiangsu Province, China

(72) PHUA YONG TAT (SG)

(74) Công ty Luật TNHH quốc tế BMVN (BMVN INTERNATIONAL LLC)

(55)



1.1



1.2



1.3



1.4

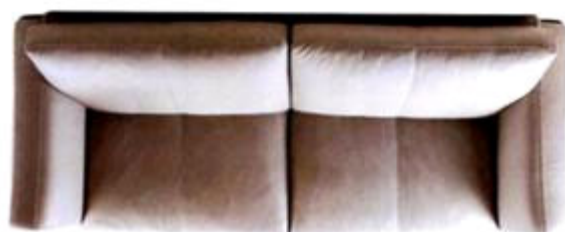

1.5

CÔNG BÁO SỞ HỮU CÔNG NGHIỆP SỐ 404 TẬP A – QUYỀN 2 (11.2021)

(11) **42917**

(21) 3-2020-02068

(28) 1

(54) **GHẾ SÔ-PHA**

(51) **06-01**

(22) 03/09/2020

(43) 25/11/2021

(73) **HTL FURNITURE (CHINA) CO., LTD. (CN)**

Wusong Jiangnan Road, Kunshan Development Zone, Jiangsu Province, China

(72) PHUA YONG TAT (SG)

(74) Công ty Luật TNHH quốc tế BMVN (BMVN INTERNATIONAL LLC)

(55)



1.1



1.2



1.3



1.4



1.5

CÔNG BÁO SỞ HỮU CÔNG NGHIỆP SỐ 404 TẬP A – QUYỀN 2 (11.2021)

(11) **42918**

(21) 3-2020-02075

(28) 1

(54) **GHẾ SÔ-PHA**

(51) **06-01**

(22) 03/09/2020

(43) 25/11/2021

(73) **HTL FURNITURE (CHINA) CO., LTD. (CN)**

Wusong Jiangnan Road, Kunshan Development Zone, Jiangsu Province, China

(72) PHUA YONG TAT (SG)

(74) Công ty Luật TNHH quốc tế BMVN (BMVN INTERNATIONAL LLC)

(55)



1.1



1.2



1.3



1.4



1.5



1.6

CÔNG BÁO SỞ HỮU CÔNG NGHIỆP SỐ 404 TẬP A – QUYỀN 2 (11.2021)

(11) **42919**

(21) 3-2020-02079

(28) 1

(54) **GHẾ SÔ-PHA**

(51) **06-01**

(22) 03/09/2020

(43) 25/11/2021

(73) **HTL FURNITURE (CHINA) CO., LTD. (CN)**

Wusong Jiangnan Road, Kunshan Development Zone, Jiangsu Province, China

(72) PHUA YONG TAT (SG)

(74) Công ty Luật TNHH quốc tế BMVN (BMVN INTERNATIONAL LLC)

(55)



1.1



1.2



1.3



1.4



1.5

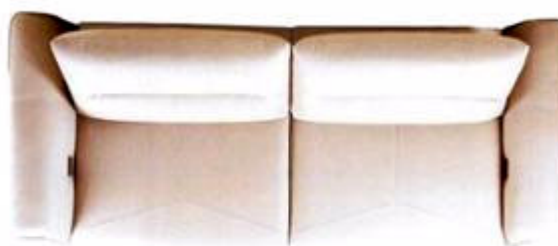

1.6

CÔNG BÁO SỞ HỮU CÔNG NGHIỆP SỐ 404 TẬP A – QUYỀN 2 (11.2021)

(11) **42920**

(21) 3-2020-02080

(28) 1

(54) **GHẾ SÔ-PHA**

(51) **06-01**

(22) 03/09/2020

(43) 25/11/2021

(73) **HTL FURNITURE (CHINA) CO., LTD. (CN)**

Wusong Jiangnan Road, Kunshan Development Zone, Jiangsu Province, China

(72) PHUA YONG TAT (SG)

(74) Công ty Luật TNHH quốc tế BMVN (BMVN INTERNATIONAL LLC)

(55)



1.1



1.2



1.3



1.4



1.5



1.6

CÔNG BÁO SỞ HỮU CÔNG NGHIỆP SỐ 404 TẬP A – QUYỀN 2 (11.2021)

(11) **42921**

(21) 3-2020-02120

(28) 1

(54) **GHẾ SÔ-PHA**

(51) **06-01**

(22) 04/09/2020

(43) 25/11/2021

(73) **HTL FURNITURE (CHINA) CO., LTD. (CN)**

Wusong Jiangnan Road, Kunshan Development Zone, Jiangsu Province, China

(72) PHUA YONG TAT (SG)

(74) Công ty Luật TNHH quốc tế BMVN (BMVN INTERNATIONAL LLC)

(55)



1.1



1.2



1.3



1.4

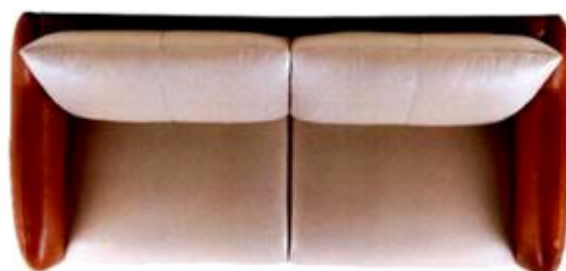

1.5

CÔNG BÁO SỞ HỮU CÔNG NGHIỆP SỐ 404 TẬP A – QUYỀN 2 (11.2021)

(11) **42922**

(21) 3-2020-02121

(28) 1

(54) **GHẾ SÔ-PHA**

(51) **06-01**

(22) 04/09/2020

(43) 25/11/2021

(73) **HTL FURNITURE (CHINA) CO., LTD. (CN)**

Wusong Jiangnan Road, Kunshan Development Zone, Jiangsu Province, China

(72) PHUA YONG TAT (SG)

(74) Công ty Luật TNHH quốc tế BMVN (BMVN INTERNATIONAL LLC)

(55)



1.1



1.2



1.3



1.4



1.5

CÔNG BÁO SỞ HỮU CÔNG NGHIỆP SỐ 404 TẬP A – QUYỀN 2 (11.2021)

(11) **42923**

(21) 3-2020-02123

(28) 1

(54) **GHẾ SÔ-PHA**

(51) **06-01**

(22) 04/09/2020

(43) 25/11/2021

(73) **HTL FURNITURE (CHINA) CO., LTD. (CN)**

Wusong Jiangnan Road, Kunshan Development Zone, Jiangsu Province, China

(72) PHUA YONG TAT (SG)

(74) Công ty Luật TNHH quốc tế BMVN (BMVN INTERNATIONAL LLC)

(55)



1.1



1.2



1.3



1.4



1.5

CÔNG BÁO SỞ HỮU CÔNG NGHIỆP SỐ 404 TẬP A – QUYỀN 2 (11.2021)

(11) **42924**

(21) 3-2020-02127

(28) 1

(54) **GHẾ SÔ-PHA**

(51) **06-01**

(22) 04/09/2020

(43) 25/11/2021

(73) **HTL FURNITURE (CHINA) CO., LTD. (CN)**

Wusong Jiangnan Road, Kunshan Development Zone, Jiangsu Province, China

(72) PHUA YONG TAT (SG)

(74) Công ty Luật TNHH quốc tế BMVN (BMVN INTERNATIONAL LLC)

(55)



1.1



1.2



1.3



1.4



1.5

CÔNG BÁO SỞ HỮU CÔNG NGHIỆP SỐ 404 TẬP A – QUYỀN 2 (11.2021)

(11) **42925**

(21) 3-2020-02131

(28) 1

(54) **GHẾ SÔ-PHA**

(51) **06-01**

(22) 04/09/2020

(43) 25/11/2021

(73) **HTL FURNITURE (CHINA) CO., LTD. (CN)**

Wusong Jiangnan Road, Kunshan Development Zone, Jiangsu Province, China

(72) PHUA YONG TAT (SG)

(74) Công ty Luật TNHH quốc tế BMVN (BMVN INTERNATIONAL LLC)

(55)



1.1



1.2



1.3



1.4



1.5



1.6



1.7

CÔNG BÁO SỞ HỮU CÔNG NGHIỆP SỐ 404 TẬP A – QUYỀN 2 (11.2021)

(11) **42926**

(21) 3-2020-02159

(28) 1

(54) **GHẾ SÔ-PHA**

(51) **06-01**

(22) 07/09/2020

(43) 25/11/2021

(73) **HTL FURNITURE (CHINA) CO., LTD. (CN)**

Wusong Jiangnan Road, Kunshan Development Zone, Jiangsu Province, China

(72) PHUA YONG TAT (SG)

(74) Công ty Luật TNHH quốc tế BMVN (BMVN INTERNATIONAL LLC)

(55)



1.1



1.2



1.3



1.4



1.5

CÔNG BÁO SỞ HỮU CÔNG NGHIỆP SỐ 404 TẬP A – QUYỀN 2 (11.2021)

(11) **42927**

(21) 3-2020-02182

(28) 1

(54) **GHẾ SÔ-PHA**

(51) **06-01**

(22) 07/09/2020

(43) 25/11/2021

(73) **HTL FURNITURE (CHINA) CO., LTD. (CN)**

Wusong Jiangnan Road, Kunshan Development Zone, Jiangsu Province, China

(72) PHUA YONG TAT (SG)

(74) Công ty Luật TNHH quốc tế BMVN (BMVN INTERNATIONAL LLC)

(55)



1.1



1.2



1.3



1.4



1.5

CÔNG BÁO SỞ HỮU CÔNG NGHIỆP SỐ 404 TẬP A – QUYỀN 2 (11.2021)

(11) **42928**

(21) 3-2020-02188

(28) 1

(54) **GHẾ SÔ-PHA**

(51) **06-01**

(22) 07/09/2020

(43) 25/11/2021

(73) **HTL FURNITURE (CHINA) CO., LTD. (CN)**

Wusong Jiangnan Road, Kunshan Development Zone, Jiangsu Province, China

(72) PHUA YONG TAT (SG)

(74) Công ty Luật TNHH quốc tế BMVN (BMVN INTERNATIONAL LLC)

(55)



1.1



1.2



1.3



1.4



1.5

CÔNG BÁO SỞ HỮU CÔNG NGHIỆP SỐ 404 TẬP A – QUYỀN 2 (11.2021)

- (11) **42929**
(21) 3-2020-02404 (28) 4
(54) **HỘP** (51) **09-03**
(22) 25/09/2020 (43) 25/11/2021
(73) **CÔNG TY CỔ PHẦN TẬP ĐOÀN THIÊN LONG (VN)**
Lô 6-8-10-12 đường số 3, khu công nghiệp Tân Tạo, quận Bình Tân, thành phố Hồ Chí Minh
(72) Cô Gia Thọ (VN)
(74) Công ty TNHH Tư vấn sở hữu trí tuệ Việt (VIET IP CO.,LTD.)
(55)



1.1



1.2



2.1



2.2



3.1



3.2



4.1



4.2

- (11) **42930**
(21) 3-2020-02477 (28) 1
(54) **BÌNH CHỨA** (51) **07-07**
(22) 14/06/2017 (43) 25/11/2021
(30) 2016-027942 22/12/2016 JP;
(73) **NISSHIN FOODS INC. (JP)**
25, Kanda-Nishiki-cho 1-chome, Chiyoda-ku, Tokyo 101-8441 Japan
(72) 1. MASATO OMURA (JP)
2. MICHIIRO SAKAKIBARA (JP)
3. SHUHEI YAMAZAKI (JP)
(74) Công ty Cổ phần Sở hữu công nghiệp INVESTIP (INVESTIP)
(55)



1.1

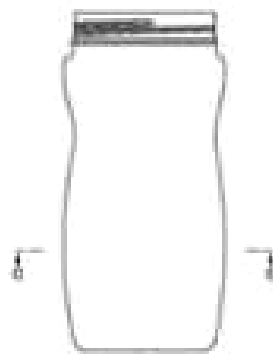

1.2



1.3



1.4



1.5



1.6



1.7

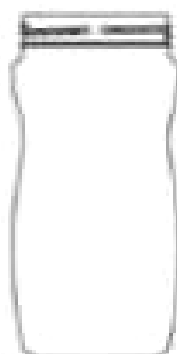

1.8

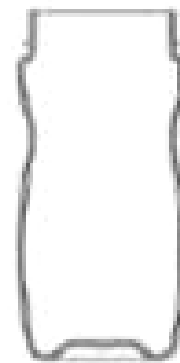

1.9

CÔNG BÁO SỞ HỮU CÔNG NGHIỆP SỐ 404 TẬP A – QUYỀN 2 (11.2021)

- (11) **42931**
(21) 3-2020-02596 (28) 1
(54) **ĐIỆN THOẠI DI ĐỘNG** (51) **14-03**
(22) 19/10/2020 (43) 25/11/2021
(30) 202030173082.6 24/04/2020 CN;
(73) **VIVO MOBILE COMMUNICATION CO., LTD. (CN)**
No.168 Jinghai East Rd., Chang'an, Dongguan, Guangdong 523863, China
(72) 1. FENG YU (CN)
2. AN REN (CN)
3. ZIHAN CHEN (CN)
(74) Công ty cổ phần Tư vấn S&B (S&B CONSULTANT., CORP.)
(55)

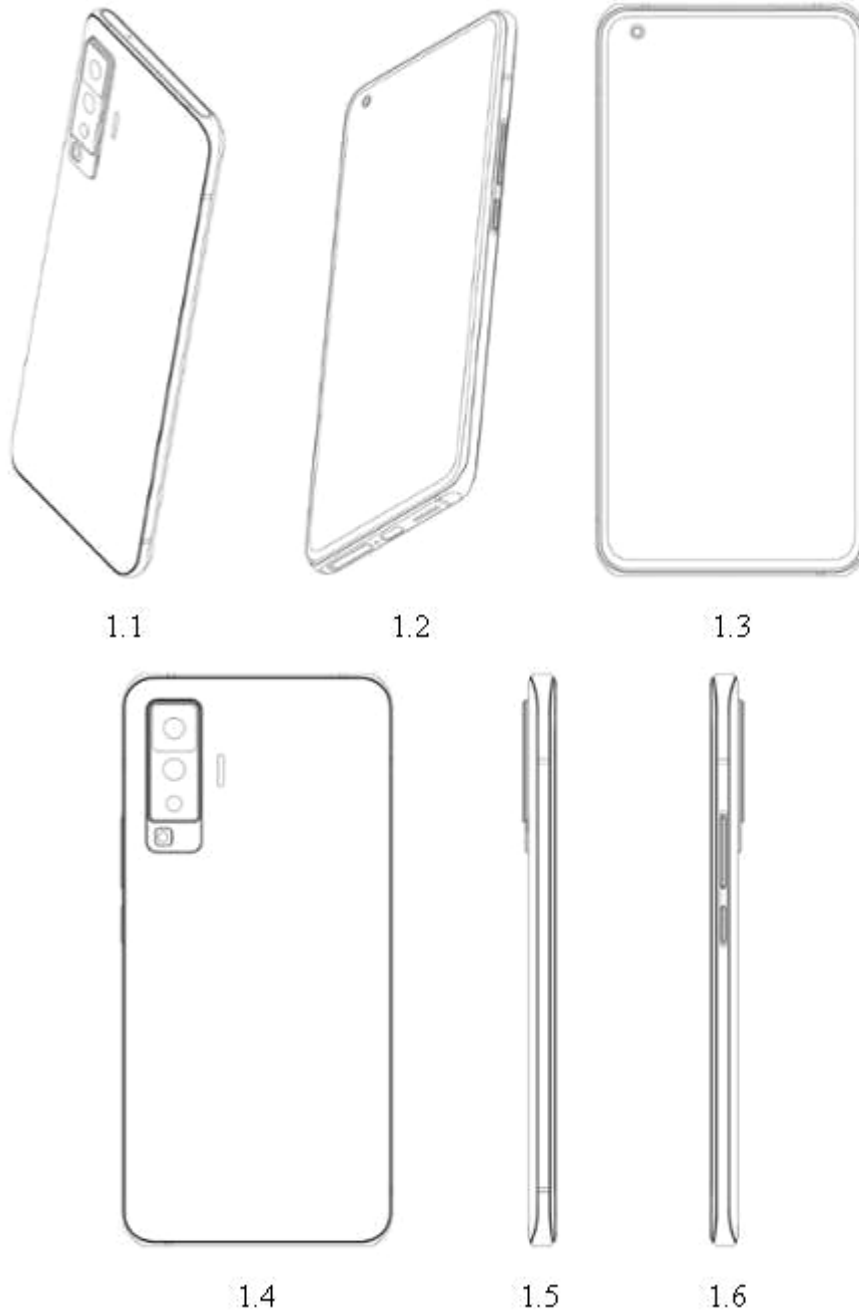



1.7



1.8



1.9



1.10



1.11



1.12



1.13



1.14



1.15



1.16

- (11) **42932**
(21) 3-2020-02639 (28) 1
(54) **THỨC ĂN CHO VẬT NUÔI** (51) **01-06**
(22) 26/10/2020 (43) 25/11/2021
(30) 29/733,294 30/04/2020 US;
(73) **SPECTRUM BRANDS, INC. (US)**
3001 Deming Way, Middleton, Wisconsin 53562, United States of America
(72) 1. VAN EYK, GREGORY (US)
2. POTTER, TIFFANY DAWN (US)
3. KENDRICK, VICTORIA GRAY (US)
(74) Công ty TNHH Sở hữu trí tuệ Thảo Thọ Quyển (INVENCO.,LTD)
(55)

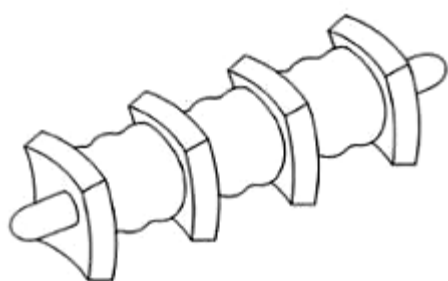

1.1

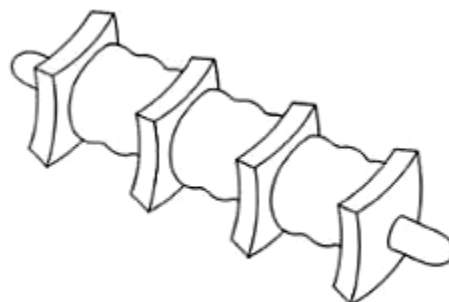

1.2



1.3



1.4

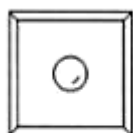

1.5

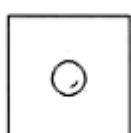

1.6



1.7



1.8

(11) **42933**

(21) 3-2020-02857

(28) 7

(54) **TẤM LỢP MÁI NHÀ**

(51) **25-01**

(22) 26/11/2020

(43) 25/11/2021

(73) **CÔNG TY TNHH MÁY THÉP VIỆT (VN)**

291 Hoàng Sa, phường Tân Định, quận 1, thành phố Hồ Chí Minh

(72) Kiều Huỳnh Sơn (VN)

(55)

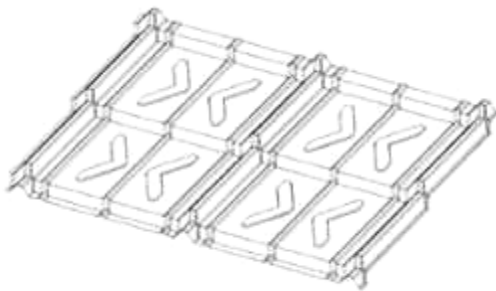

1.1

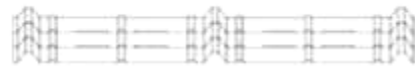

1.2



1.3

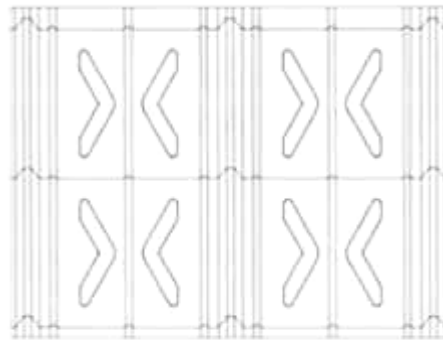

1.4

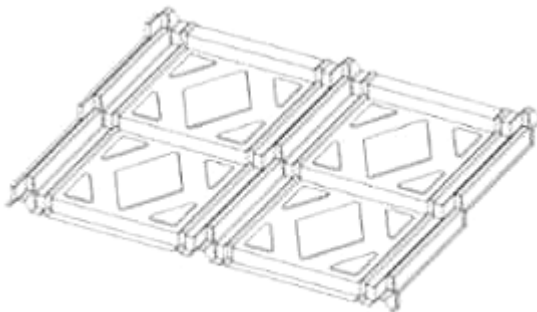

2.1



2.2



2.3

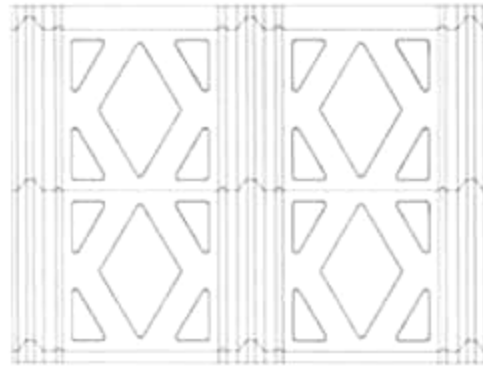

2.4

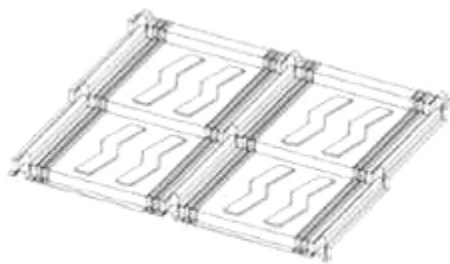

3.1



3.2



3.3

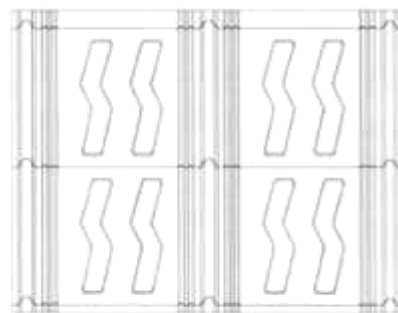

3.4

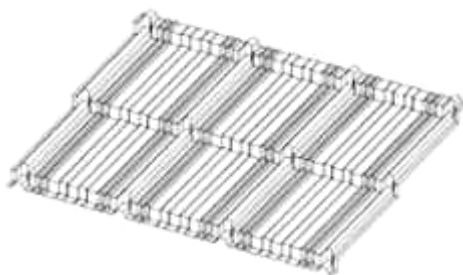

4.1



4.2



4.3

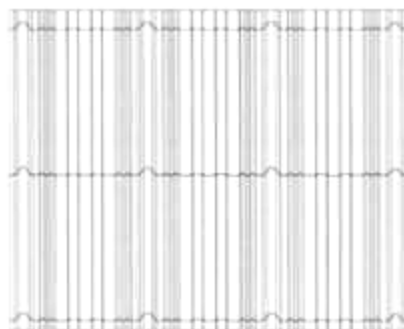

4.4

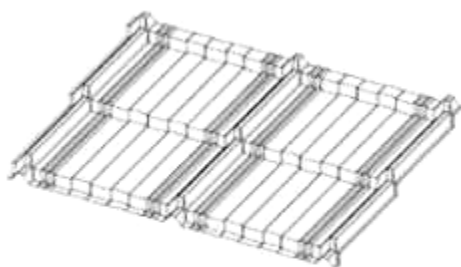

5.1



5.2



5.3

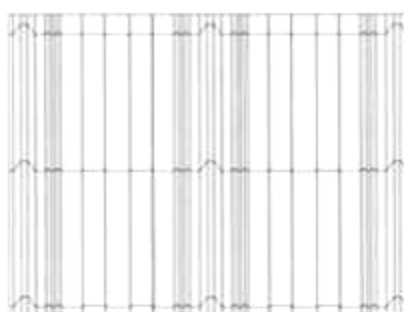

5.4



6.1

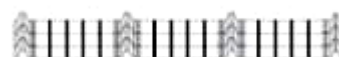

6.2



6.3

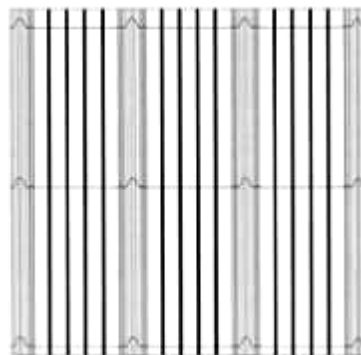

6.4



7.1



7.2



7.3

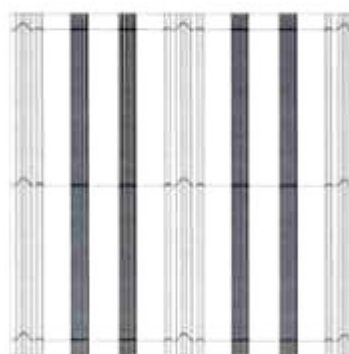

7.4

CÔNG BÁO SỞ HỮU CÔNG NGHIỆP SỐ 404 TẬP A – QUYỀN 2 (11.2021)

- (11) **42934**
(21) 3-2020-02998 (28) 1
(54) **THANH KIM LOẠI ĐỊNH HÌNH** (51) **25-01**
(22) 11/12/2020 (43) 25/11/2021
(73) **CÔNG TY TNHH SẢN XUẤT THƯƠNG MẠI TRẦN QUANG ÁNH (VN)**
59/8 Ấp 7, xã Xuân Thới Thượng, huyện Hóc Môn, thành phố Hồ Chí Minh
(72) Trần Quang Ánh (VN)
(74) Công ty TNHH Sở hữu trí tuệ PADEMARK (PADEMARK CO.,LTD.)
(55)



1.1



1.2



1.3

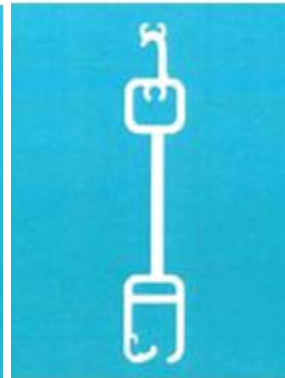

1.4

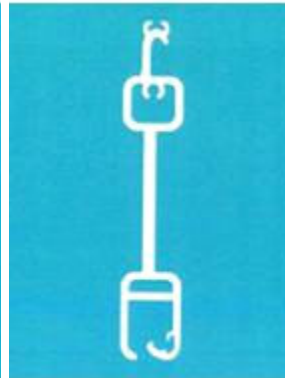

1.5



1.6



1.7

- (11) **42935**
(21) 3-2020-03019 (28) 3
(54) **BỘ TRỘN KHÍ NANO OXY TINH KHIẾT VÀO NƯỚC** (51) **23-01**
(22) 14/12/2020 (43) 25/11/2021
(73) **CÔNG TY CỔ PHẦN RYNAN TECHNOLOGIES VIETNAM (VN)**
Áp Long Trị, xã Long Đức, thành phố Trà Vinh, tỉnh Trà Vinh
(72) 1. NGUYỄN THANH MỸ (VN)
2. TRẦN QUỐC TOẢN (VN)
3. VÕ VŨ KHANH (VN)
4. VÕ QUỐC VIỆT (VN)
5. NGUYỄN KHẮC NHỰT (VN)
(74) Công ty TNHH Đại Tín và Liên Danh (DAITIN AND ASSOCIATES CO.,LTD)
(55)

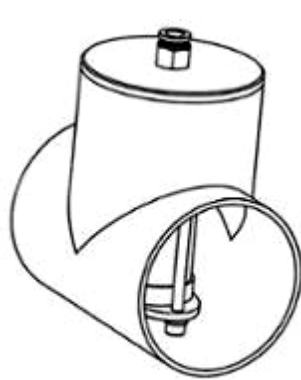

1.1

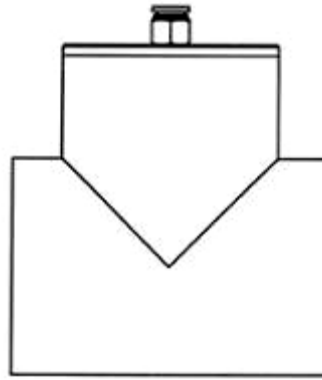

1.2

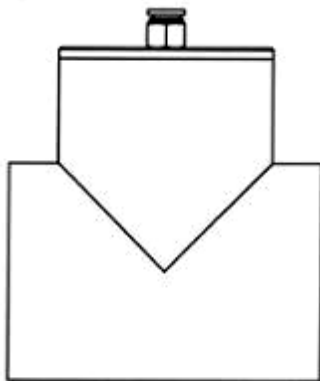

1.3

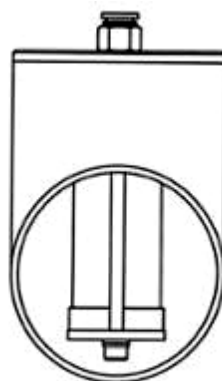

1.4

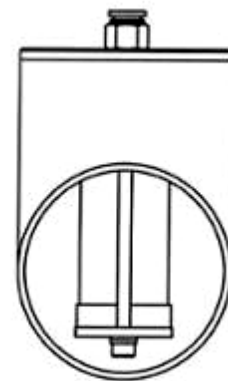

1.5

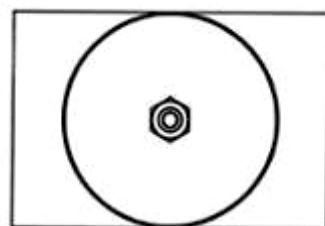

1.6



1.7

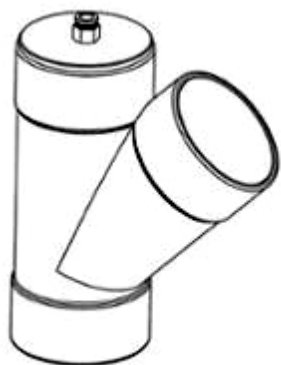

2.1

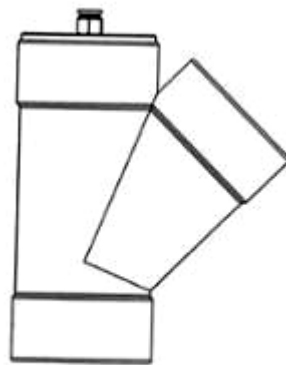

2.2

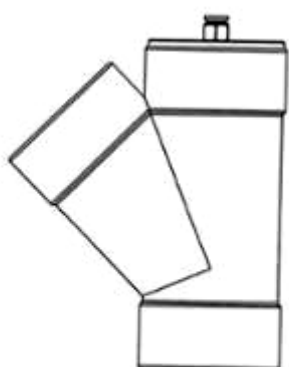

2.3

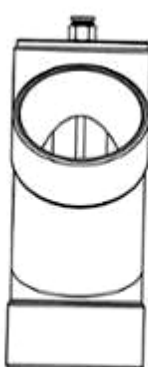

2.4



2.5

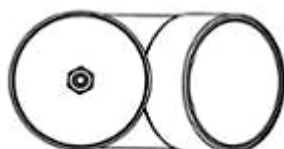

2.6



2.7

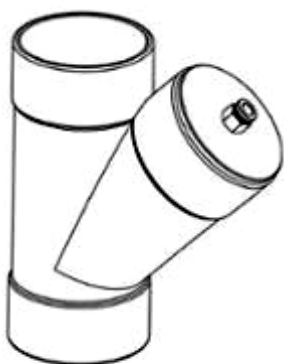

3.1

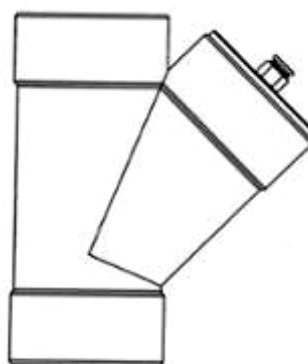

3.2

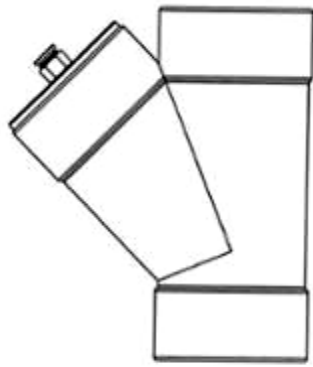

3.3

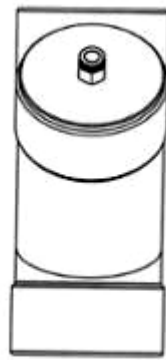

3.4



3.5



3.6

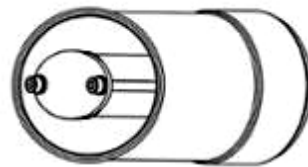

3.7

CÔNG BÁO SỞ HỮU CÔNG NGHIỆP SỐ 404 TẬP A – QUYỀN 2 (11.2021)

- (11) **42936**
(21) 3-2020-03039 (28) 1
(54) **THANH NHÔM ĐỊNH HÌNH** (51) **25-01**
(22) 16/12/2020 (43) 25/11/2021
(73) **CÔNG TY CỔ PHẦN TẬP ĐOÀN AUSTEC (VN)**
Số 46, phố Trần Bình, phường Mai Dịch, quận Cầu Giấy, thành phố Hà Nội
(72) Vũ Quỳnh Uyên (VN)
(74) Công ty Luật TNHH SMARTLAW (SMARTLAW LEGAL SERVICE CO.,LTD.)
(55)



1.1



1.2



1.3



1.4



1.5



1.6



1.7

CÔNG BÁO SỞ HỮU CÔNG NGHIỆP SỐ 404 TẬP A – QUYỀN 2 (11.2021)

- (11) **42937**
(21) 3-2020-03069 (28) 1
(54) **ĐIỆN THOẠI DI ĐỘNG** (51) **14-03**
(22) 21/12/2020 (43) 25/11/2021
(30) 202030540519.5 11/09/2020 CN;
(73) **ONEPLUS TECHNOLOGY (SHENZHEN) CO., LTD.** (CN)
Room 201, Building A, No.1 Qianwan Road 1, Qianhai Shenzhen-Hong Kong
Cooperation Zone, Shenzhen, Guangdong, China
(72) 1. HAORAN LIU (CN)
2. MINGJIE TANG (CN)
3. YUAN ZHUANG (CN)
(74) Công ty TNHH Tư vấn IPNG (IPNG CO.,LTD)
(55)

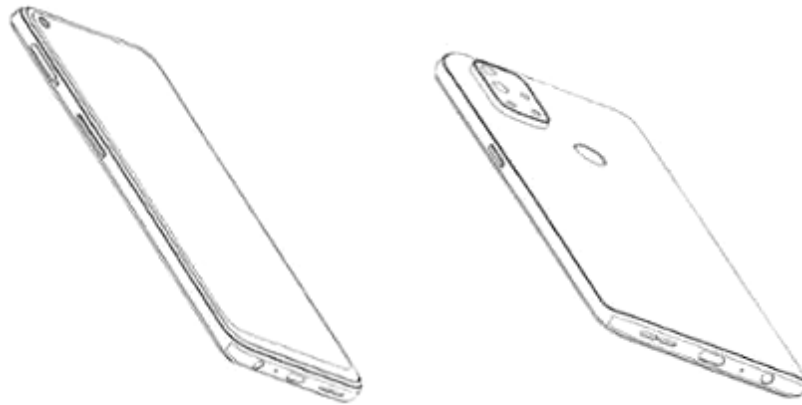

1.1

1.2

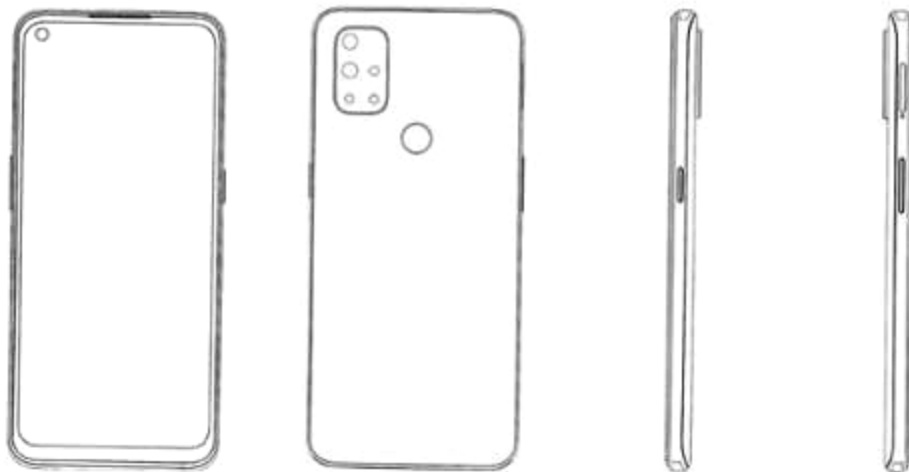

1.3

1.4

1.5

1.6

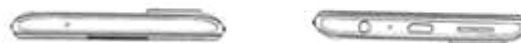

1.7

1.8

CÔNG BÁO SỞ HỮU CÔNG NGHIỆP SỐ 404 TẬP A – QUYỀN 2 (11.2021)

- (11) **42938**
(21) 3-2020-03110 (28) 2
(54) **CUVET CHỨA CHẤT RẮN CHỈ THỊ MÀU CHẤT HỮU CƠ TRONG NUÔI TRỒNG THỦY SẢN** (51) **24-02**
(22) 24/12/2020 (43) 25/11/2021
(73) **CÔNG TY CỔ PHẦN RYNAN TECHNOLOGIES VIETNAM (VN)**
Ấp Long Trị, xã Long Đức, thành phố Trà Vinh, tỉnh Trà Vinh
(72) 1. NGUYỄN THANH MỸ (VN)
2. PHẠM THIÊN TRƯỜNG (VN)
3. TRẦN QUỐC TOẢN (VN)
4. NGUYỄN TRƯỜNG VIỆT THƯ (VN)
(74) Công ty TNHH Đại Tín và Liên Danh (DAITIN AND ASSOCIATES CO.,LTD)
(55)

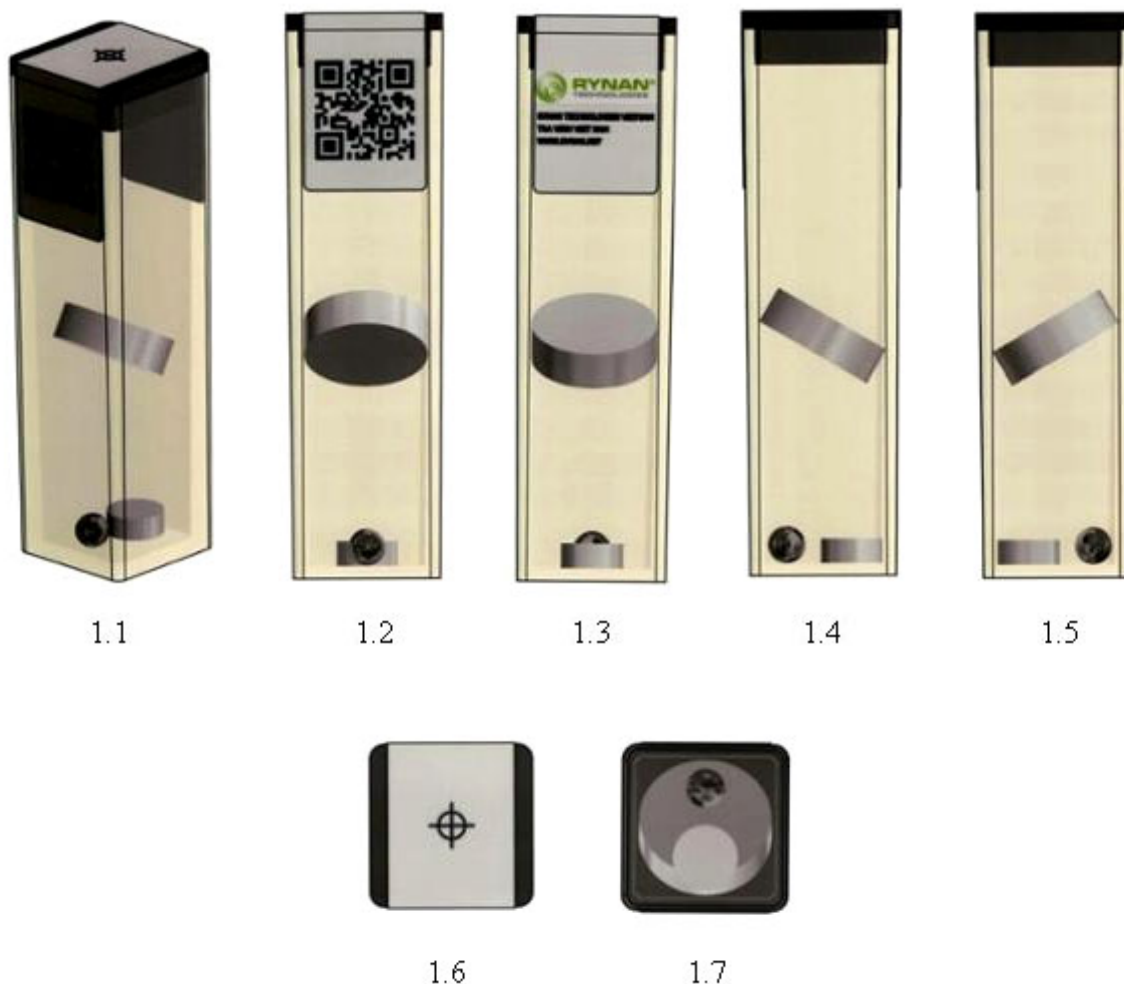



2.1



2.2



2.3



2.4



2.5



2.6



2.7

CÔNG BÁO SỞ HỮU CÔNG NGHIỆP SỐ 404 TẬP A – QUYỀN 2 (11.2021)

- (11) **42939**
(21) 3-2020-03145 (28) 1
(54) **DÉP** (51) **02-04**
(22) 28/12/2020 (43) 25/11/2021
(73) **CÔNG TY TNHH SẢN XUẤT THƯƠNG MẠI XUẤT NHẬP KHẨU ĐỨC HOA (VN)**
Tỉnh lộ 830, ấp 3, xã An Thạnh, huyện Bến Lức, tỉnh Long An
(72) Trần Đức (VN)
(55)



1.1



1.2



1.3



1.4



1.5



1.6

(11) **42940**

(21) 3-2021-00006

(28) 1

(54) **CẤU KIỆN RỌ BÊ TÔNG CHỐNG XÓI**

(51) **25-02**

(22) 05/01/2021

(43) 25/11/2021

(73) **CÔNG TY CỔ PHẦN KHOA HỌC CÔNG NGHỆ VIỆT NAM (VN)**

Số 6 đường 3 tháng 2, phường 8, thành phố Vũng Tàu, tỉnh Bà Rịa - Vũng Tàu

(72) Hoàng Đức Thảo (VN)

(55)

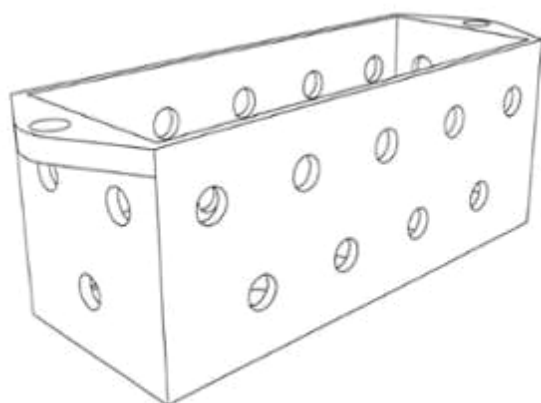

1.1

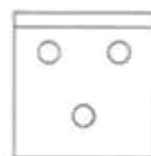

1.2

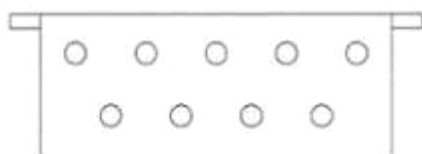

1.3

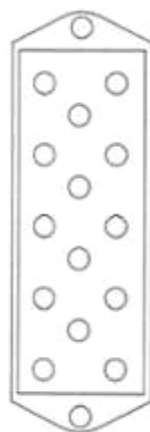

1.4

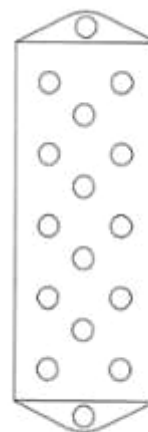

1.5

(11) **42941**

(21) 3-2021-00007

(28) 1

(54) **CẤU KIỆN RỌ BÊ TÔNG CHỐNG XÓI**

(51) **25-02**

(22) 05/01/2021

(43) 25/11/2021

(73) **CÔNG TY CỔ PHẦN KHOA HỌC CÔNG NGHỆ VIỆT NAM (VN)**

Số 6 đường 3 tháng 2, phường 8, thành phố Vũng Tàu, tỉnh Bà Rịa - Vũng Tàu

(72) Hoàng Đức Thảo (VN)

(55)

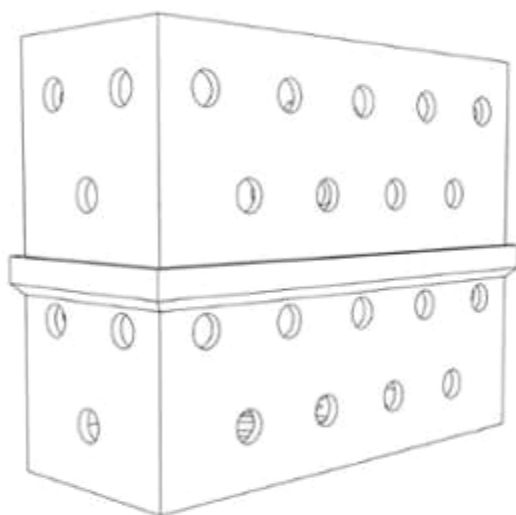

1.1

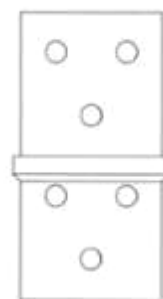

1.2

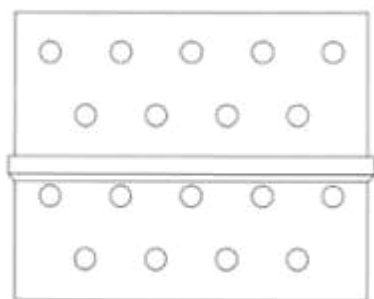

1.3

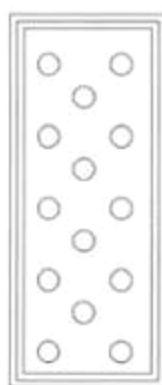

1.4



1.5

(11) **42942**

(21) 3-2021-00008

(28) 1

(54) **CẤU KIỆN RỌ BÊ TÔNG CHỐNG XÓI**

(51) **25-02**

(22) 05/01/2021

(43) 25/11/2021

(73) **CÔNG TY CỔ PHẦN KHOA HỌC CÔNG NGHỆ VIỆT NAM (VN)**

Số 6 đường 3 tháng 2, phường 8, thành phố Vũng Tàu, tỉnh Bà Rịa - Vũng Tàu

(72) Hoàng Đức Thảo (VN)

(55)

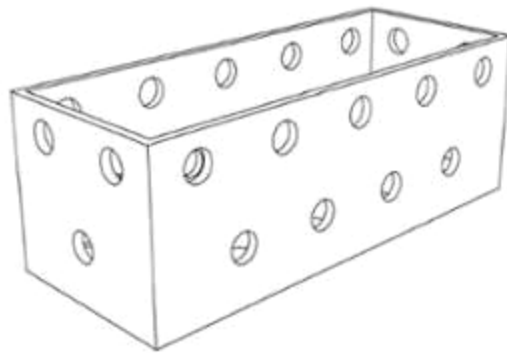

1.1

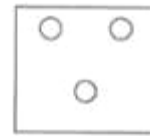

1.2



1.3

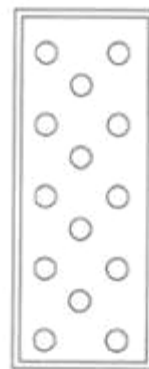

1.4

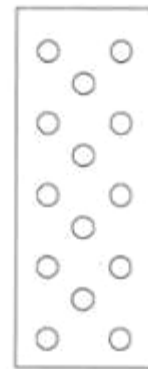

1.5

- (11) **42943**
(21) 3-2021-00046 (28) 2
(54) **THUỐC LÁ ĐIỆN TỬ** (51) **27-99**
(22) 11/01/2021 (43) 25/11/2021
(30) 202030368637.2 09/07/2020 CN;
(73) **SHENZHEN RELX TECHNOLOGY CO., LTD.** (CN)
4F, Building 2, Wangda Industrial District, West Side Of Songbai Road, Tangtou
Community, Shiyan Street, Baoan District, Shenzhen City, Guangdong Province
518108, China
(72) 1. LIU, AIQING (CN)
2. CHEN, CHEN (CN)
(74) Công ty Luật TNHH T&G (TGVN)
(55)

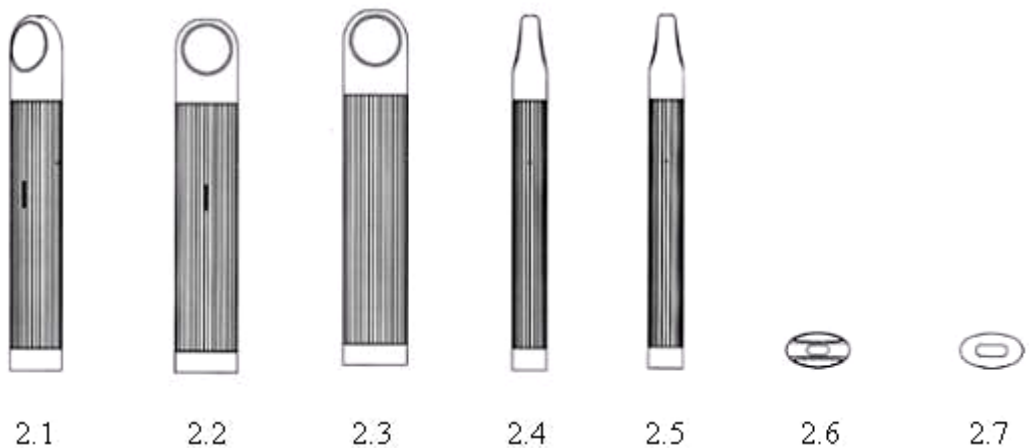
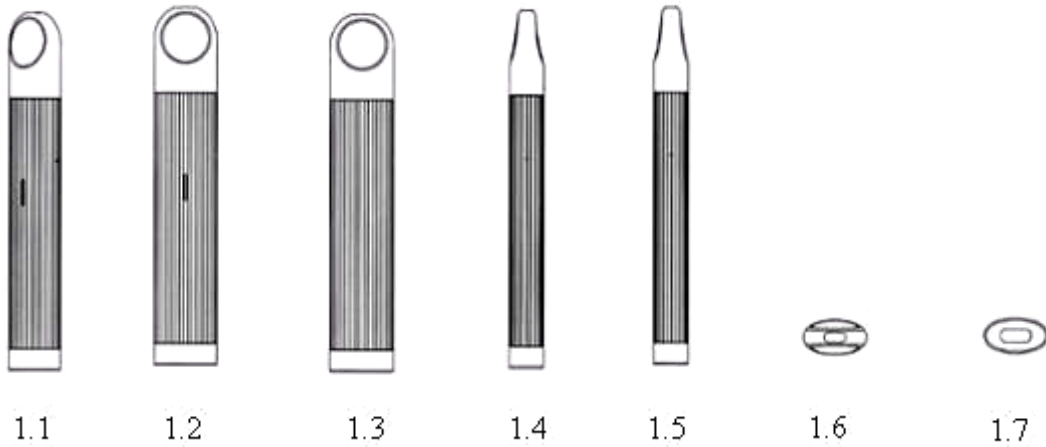

CÔNG BÁO SỞ HỮU CÔNG NGHIỆP SỐ 404 TẬP A – QUYỀN 2 (11.2021)

- (11) **42944**
(21) 3-2021-00083 (28) 1
(54) **DÉP** (51) **02-04**
(22) 14/01/2021 (43) 25/11/2021
(73) **CÔNG TY TNHH SẢN XUẤT THƯƠNG MẠI XUẤT NHẬP KHẨU ĐỨC HOA (VN)**
Tỉnh lộ 830, ấp 3, xã An Thạnh, huyện Bến Lức, tỉnh Long An
(72) Trần Đức (VN)
(74) Công ty Cổ phần PHANLAW VIETNAM (PHANLAW VIETNAM JSC)
(55)



1.1



1.2



1.3



1.4



1.5



1.6



1.7

CÔNG BÁO SỞ HỮU CÔNG NGHIỆP SỐ 404 TẬP A – QUYỀN 2 (11.2021)

- (11) **42945**
(21) 3-2021-00084 (28) 1
(54) **DÉP** (51) **02-04**
(22) 14/01/2021 (43) 25/11/2021
(73) **CÔNG TY TNHH SẢN XUẤT THƯƠNG MẠI XUẤT NHẬP KHẨU ĐỨC HOA (VN)**
Tỉnh lộ 830, ấp 3, xã An Thạnh, huyện Bến Lức, tỉnh Long An
(72) Trần Đức (VN)
(74) Công ty Cổ phần PHANLAW VIETNAM (PHANLAW VIETNAM JSC)
(55)



1.1



1.2



1.3



1.4



1.5



1.6



1.7

CÔNG BÁO SỞ HỮU CÔNG NGHIỆP SỐ 404 TẬP A – QUYỀN 2 (11.2021)

- (11) **42946**
(21) 3-2021-00085 (28) 1
(54) **DÉP** (51) **02-04**
(22) 14/01/2021 (43) 25/11/2021
(73) **CÔNG TY TNHH SẢN XUẤT THƯƠNG MẠI XUẤT NHẬP KHẨU ĐỨC HOA (VN)**
Tỉnh lộ 830, ấp 3, xã An Thạnh, huyện Bến Lức, tỉnh Long An
(72) Trần Đức (VN)
(74) Công ty Cổ phần PHANLAW VIETNAM (PHANLAW VIETNAM JSC)
(55)



1.1



1.2



1.3



1.4



1.5



1.6



1.7

CÔNG BÁO SỞ HỮU CÔNG NGHIỆP SỐ 404 TẬP A – QUYỀN 2 (11.2021)

- (11) **42947**
(21) 3-2021-00086 (28) 1
(54) **DÉP** (51) **02-04**
(22) 14/01/2021 (43) 25/11/2021
(73) **CÔNG TY TNHH SẢN XUẤT THƯƠNG MẠI XUẤT NHẬP KHẨU ĐỨC HOA (VN)**
Tỉnh lộ 830, ấp 3, xã An Thạnh, huyện Bến Lức, tỉnh Long An
(72) Trần Đức (VN)
(74) Công ty Cổ phần PHANLAW VIETNAM (PHANLAW VIETNAM JSC)
(55)



1.1



1.2



1.3



1.4



1.5



1.6



1.7

CÔNG BÁO SỞ HỮU CÔNG NGHIỆP SỐ 404 TẬP A – QUYỀN 2 (11.2021)

- (11) **42948**
(21) 3-2021-00105 (28) 1
(54) **DÉP** (51) **02-04**
(22) 15/01/2021 (43) 25/11/2021
(73) **CÔNG TY TNHH SẢN XUẤT THƯƠNG MẠI XUẤT NHẬP KHẨU ĐỨC HOA (VN)**
Tỉnh lộ 830, ấp 3, xã An Thạnh, huyện Bến Lức, tỉnh Long An
(72) Trần Đức (VN)
(74) Công ty TNHH MASTERBRAND (MASTERBRAND)
(55)



1.1



1.2



1.3



1.4



1.5



1.6



1.7

CÔNG BÁO SỞ HỮU CÔNG NGHIỆP SỐ 404 TẬP A – QUYỀN 2 (11.2021)

(11) **42949**

(21) 3-2021-00118

(28) 1

(54) **THANH NHÔM ĐỊNH HÌNH**

(51) **25-01**

(22) 18/01/2021

(43) 25/11/2021

(73) **CÔNG TY CỔ PHẦN HYUNDAI ALUMINIUM VINA (VN)**

Số 1/17 phố Nhị Châu, phường Nhị Châu, thành phố Hải Dương, tỉnh Hải Dương

(72) Nguyễn Thị Nguyễn (VN)

(55)

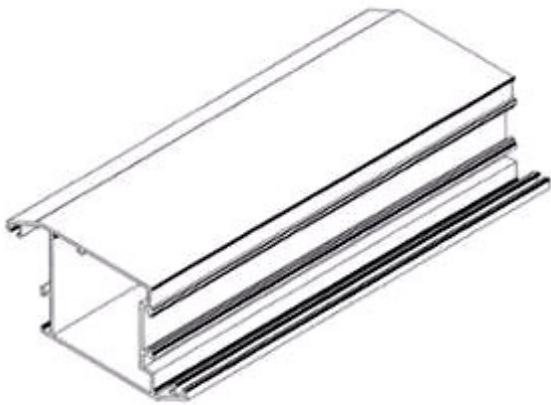

1.1

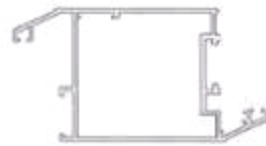

1.2

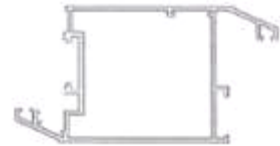

1.3

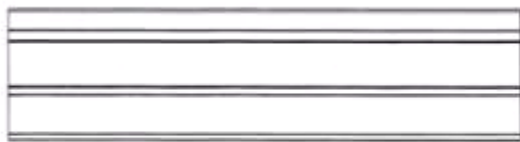

1.4

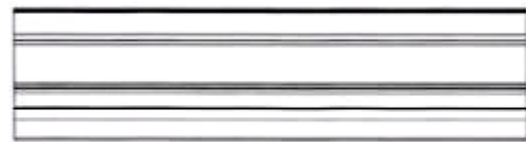

1.5

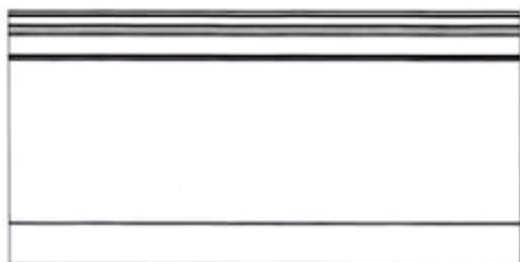

1.6

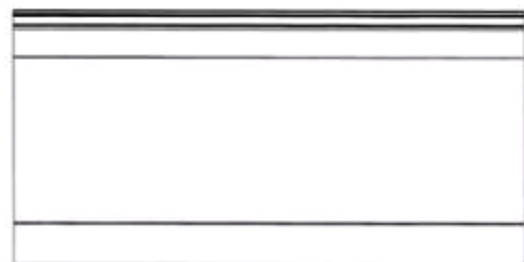

1.7

CÔNG BÁO SỞ HỮU CÔNG NGHIỆP SỐ 404 TẬP A – QUYỀN 2 (11.2021)

- (11) **42950**
(21) 3-2021-00119 (28) 1
(54) **THANH NHÔM ĐỊNH HÌNH** (51) **25-01**
(22) 18/01/2021 (43) 25/11/2021
(73) **CÔNG TY CỔ PHẦN HYUNDAI ALUMINIUM VINA (VN)**
Số 1/17 phố Nhị Châu, phường Nhị Châu, thành phố Hải Dương, tỉnh Hải Dương
(72) Nguyễn Thị Nguyễn (VN)
(55)

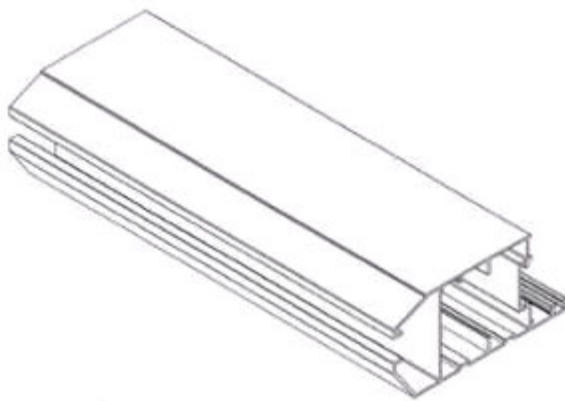

1.1



1.2

1.3

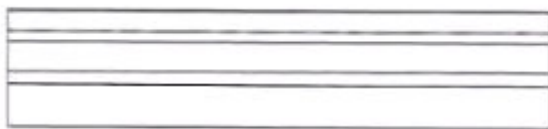

1.4



1.5

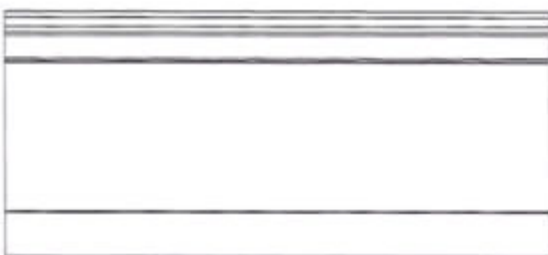

1.6

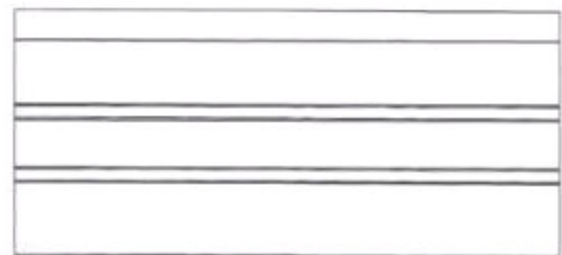

1.7

CÔNG BÁO SỞ HỮU CÔNG NGHIỆP SỐ 404 TẬP A – QUYỀN 2 (11.2021)

- (11) **42951**
(21) 3-2021-00161 (28) 1
(54) **XE BUÝT** (51) **12-08**
(22) 25/01/2021 (43) 25/11/2021
(73) **CÔNG TY CỔ PHẦN THÀNH CÔNG MOTOR VIỆT NAM (VN)**
Khu công nghiệp Gián Khẩu, xã Gia Trán, huyện Gia Viễn, tỉnh Ninh Bình
(72) Lê Ngọc Đức (VN)
(74) Công ty TNHH Tầm nhìn và Liên danh (VISION & ASSOCIATES CO.LTD.)
(55)



1.1



1.2



1.3



1.4

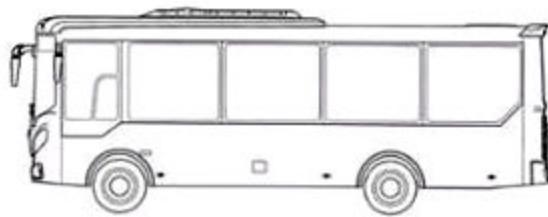

1.5

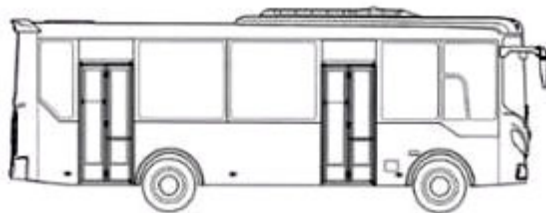

1.6



1.7

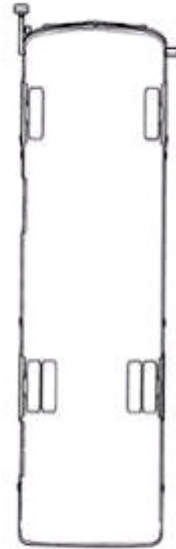

1.8

CÔNG BÁO SỞ HỮU CÔNG NGHIỆP SỐ 404 TẬP A – QUYỀN 2 (11.2021)

- (11) **42952**
(21) 3-2021-00367 (28) 1
(54) **DÉP** (51) **02-04**
(22) 22/02/2021 (43) 25/11/2021
(73) **CÔNG TY TNHH SẢN XUẤT - THƯƠNG MẠI - DỊCH VỤ VIỆT THẮNG (VN)**
Lô D 3A, khu công nghiệp, xã Ea Đar, huyện Ea Kar, tỉnh Đắk Lắk
(72) Nguyễn Thị Dung (VN)
(74) Công ty TNHH Sở hữu trí tuệ ALNGUYEN (ALNGUYEN IP CO.,LTD.)
(55)



1.1



1.2



1.3



1.4



1.5



1.6



1.7

CÔNG BÁO SỞ HỮU CÔNG NGHIỆP SỐ 404 TẬP A – QUYỀN 2 (11.2021)

- (11) **42953**
(21) 3-2021-00386 (28) 1
(54) **BÚT** (51) **19-06**
(22) 25/02/2021 (43) 25/11/2021
(30) 008152821-0001 31/08/2020 EM;
(73) **SCHWAN-STABILO SCHWANHÄUßER GMBH & CO. KG (DE)**
Schwanweg 1, 90562 Heroldsberg, Germany
(72) Diana Martin (DE)
(74) Công ty Luật TNHH ROUSE Việt Nam (ROUSE LAW CO.,LTD)
(55)



1.1



1.2



1.3



1.4



1.5



1.6



1.7

- (11) **42954**
(21) 3-2021-00387 (28) 1
(54) **BỘ PHẬN LÓT TAY DÙNG CHO BÚT** (51) **19-06**
(22) 25/02/2021 (43) 25/11/2021
(30) 008152821-0005 31/08/2020 EM;
(73) **SCHWAN-STABILO SCHWANHÄUßER GMBH & CO. KG (DE)**
Schwanweg 1, 90562 Heroldsberg, Germany
(72) Diana Martin (DE)
(74) Công ty Luật TNHH ROUSE Việt Nam (ROUSE LAW CO.,LTD)
(55)



1.1



1.2



1.3



1.4



1.5



1.6



1.7

CÔNG BÁO SỞ HỮU CÔNG NGHIỆP SỐ 404 TẬP A – QUYỀN 2 (11.2021)

- (11) **42955**
(21) 3-2021-00442 (28) 1
(54) **VỎ BỌC BẢO VỆ DÙNG CHO MÁY TÍNH BẢNG** (51) **03-01; 14-02**
(22) 04/03/2021 (43) 25/11/2021
(73) **SHENZHEN HONGGAODA INDUSTRY CO., LTD. (CN)**
Bldg. C, No. 161 Pinghu Avenue, Pinghu Community, Pinghu Street, Longgang District, Shenzhen, Guangdong, China
(72) **JIANHUI LI (CN)**
(74) Công ty TNHH Dịch vụ Sở hữu trí tuệ BIG5 (BIG5 IP CO.,LTD)
(55)

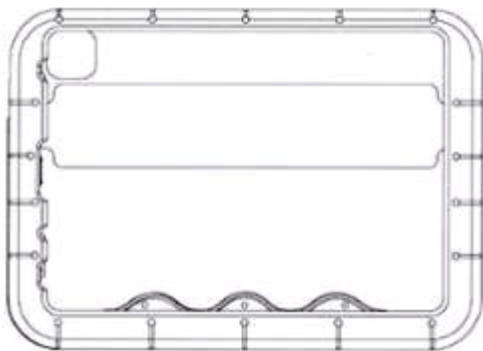

1.1

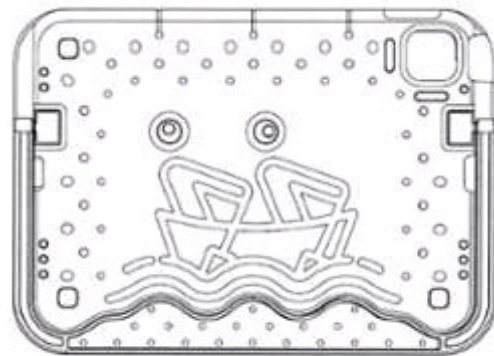

1.2



1.3



1.4

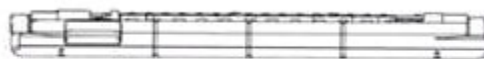

1.5



1.6

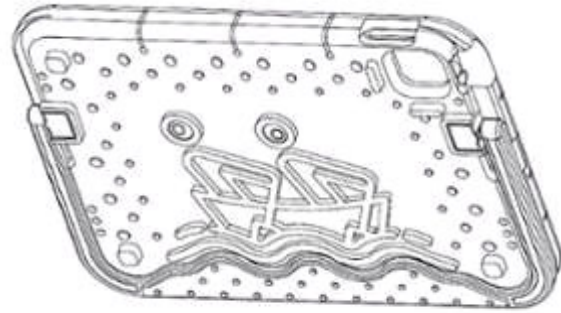

1.7

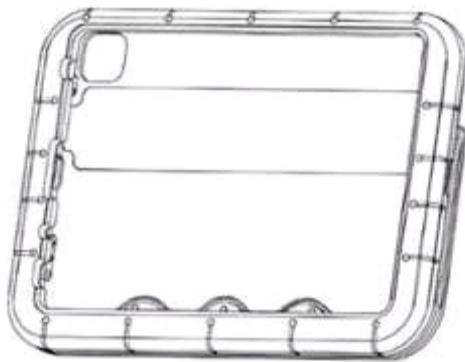

1.8

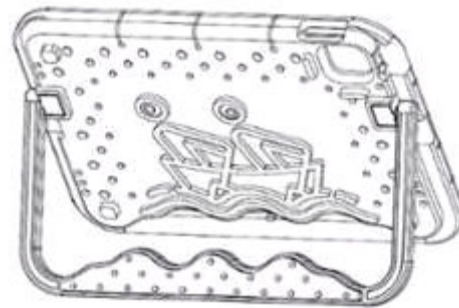

1.9

CÔNG BÁO SỞ HỮU CÔNG NGHIỆP SỐ 404 TẬP A – QUYỀN 2 (11.2021)

(11) **42956**

(21) 3-2021-00587

(28) 1

(54) **GHẾ**

(51) **06-01**

(22) 18/03/2021

(43) 25/11/2021

(73) **HTL FURNITURE (CHINA) CO., LTD. (CN)**

Wusong Jiangnan Road, Kunshan Development Zone, Jiangsu Province, China

(72) PHUA YONG TAT (SG)

(74) Công ty Luật TNHH quốc tế BMVN (BMVN INTERNATIONAL LLC)

(55)



1.1



1.2



1.3



1.4



1.5

CÔNG BÁO SỞ HỮU CÔNG NGHIỆP SỐ 404 TẬP A – QUYỀN 2 (11.2021)

(11) **42957**

(21) 3-2021-00602

(28) 1

(54) **GHẾ**

(51) **06-01**

(22) 18/03/2021

(43) 25/11/2021

(73) **HTL FURNITURE (CHINA) CO., LTD. (CN)**

Wusong Jiangnan Road, Kunshan Development Zone, Jiangsu Province, China

(72) PHUA YONG TAT (SG)

(74) Công ty Luật TNHH quốc tế BMVN (BMVN INTERNATIONAL LLC)

(55)



1.1



1.2



1.3



1.4



1.5

CÔNG BÁO SỞ HỮU CÔNG NGHIỆP SỐ 404 TẬP A – QUYỀN 2 (11.2021)

- (11) **42958**
(21) 3-2021-00692 (28) 1
(54) **DỤNG CỤ MÁT XA MẶT** (51) **28-03**
(22) 23/03/2021 (43) 25/11/2021
(73) **G1 PARTNERS CO., LTD. (KR)**
E/508,30, Songdomirae-ro, Yeonsu-gu, Incheon, Republic of Korea
(72) WHI, Seong Beom (KR)
(74) Công ty TNHH Sáng chế ACTIP (ACTIP PATENT LIMITED)
(55)



1.1



1.2



1.3

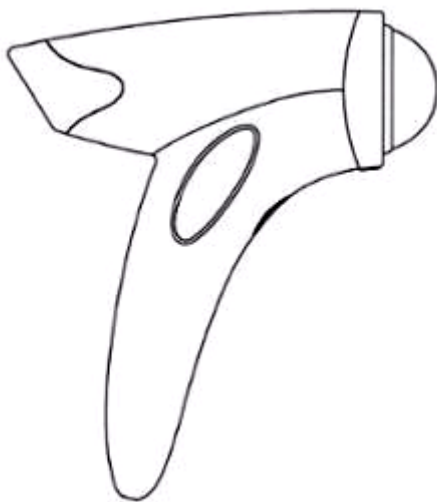

1.4

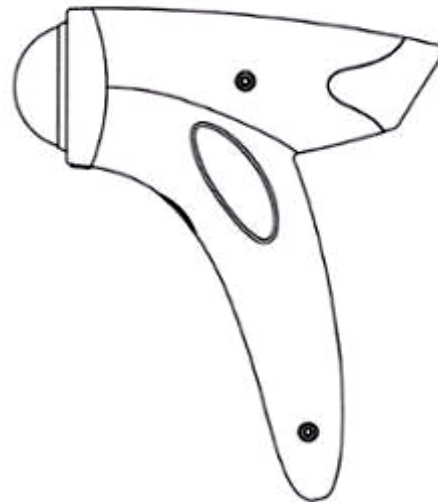

1.5



1.6



1.7

CÔNG BÁO SỞ HỮU CÔNG NGHIỆP SỐ 404 TẬP A – QUYỀN 2 (11.2021)

(11) **42959**

(21) 3-2021-00694

(54) **MÁY HÀN TỰ ĐỘNG**

(22) 24/03/2021

(73) **CÔNG TY TNHH BẢO CHI (VN)**

Tổ 7, thị trấn Chi Đông, huyện Mê Linh, thành phố Hà Nội

(72) Hoàng Anh Dũng (VN)

(74) Công ty Luật TNHH Việt An (VIET AN LAW FIRM)

(55)

(28) 1

(51) **15-09**

(43) 25/11/2021

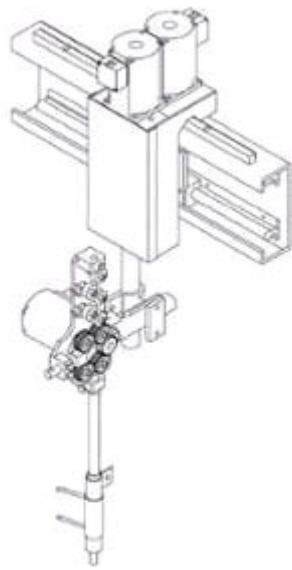

1.1

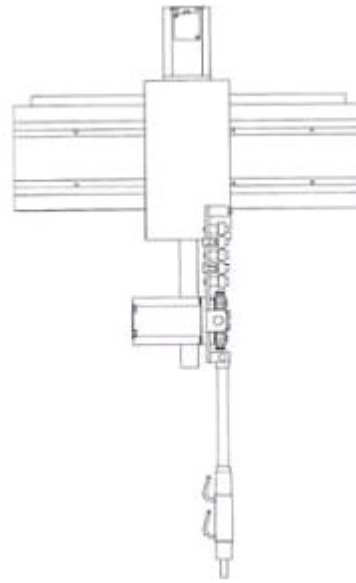

1.2

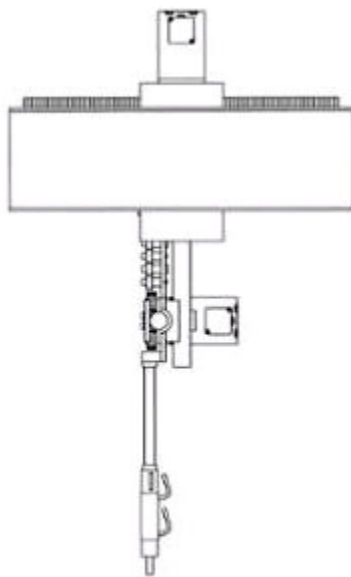

1.3

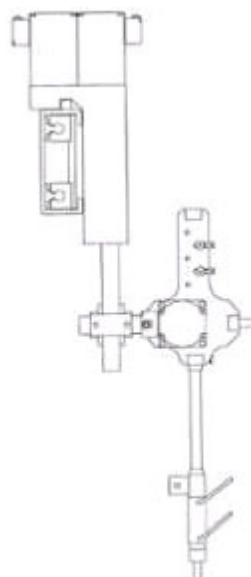

1.4

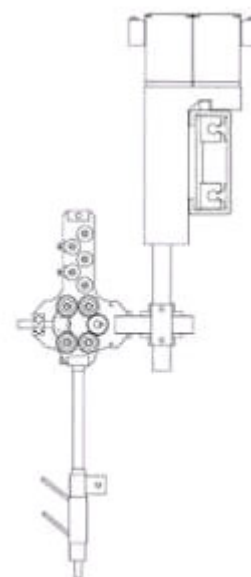

1.5

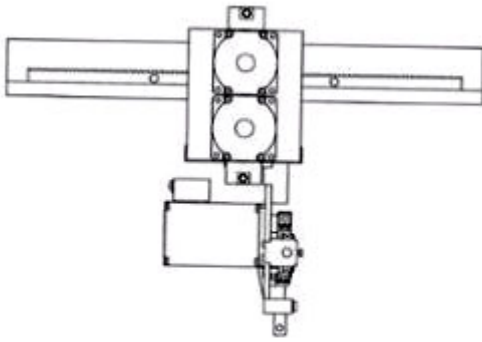

1.6

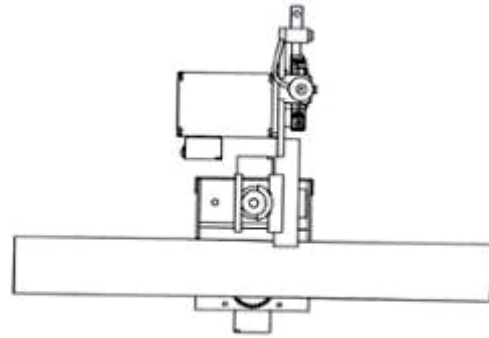

1.7

(11) **42960**

(21) 3-2021-00709

(28) 1

(54) **CÁU KIỆN CHẴN SÓNG BÊ TÔNG ĐÚC SẴN**

(51) **25-02**

(22) 26/03/2021

(43) 25/11/2021

(73) **CÔNG TY CỔ PHẦN KHOA HỌC CÔNG NGHỆ VIỆT NAM (VN)**

Số 6 đường 3 tháng 2, phường 8, thành phố Vũng Tàu, tỉnh Bà Rịa - Vũng Tàu

(72) Hoàng Đức Thảo (VN)

(55)

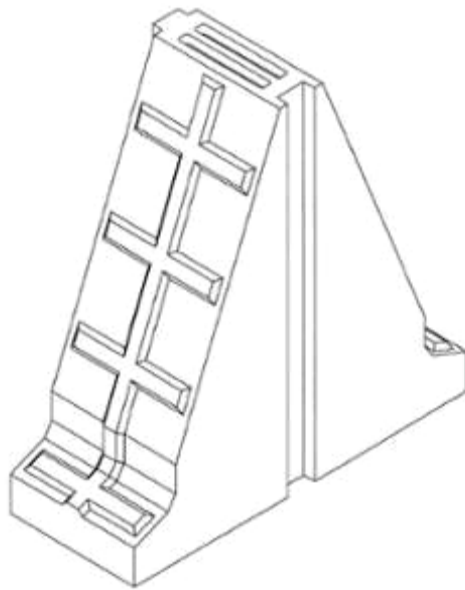

1.1

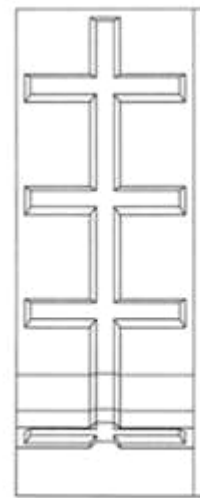

1.2

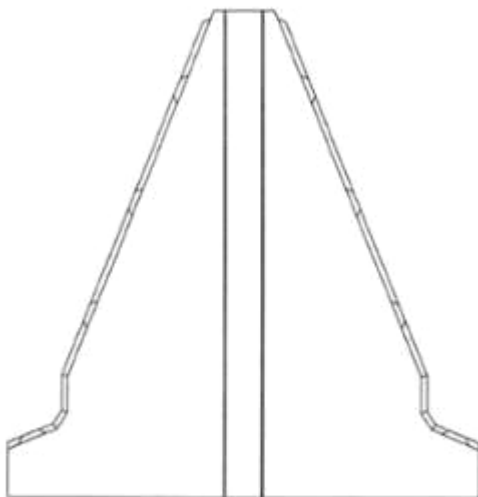

1.3

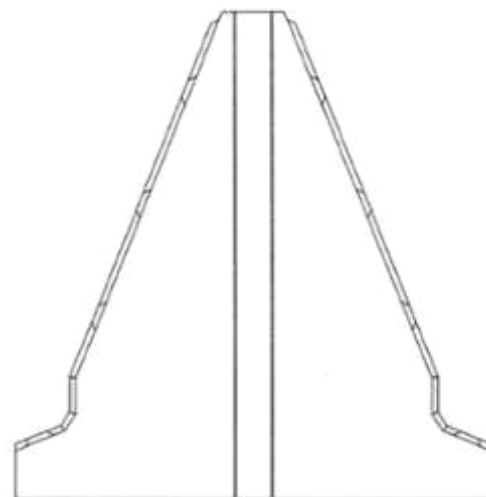

1.4

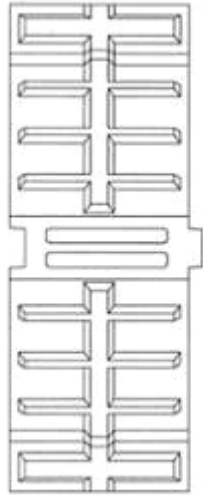

1.5

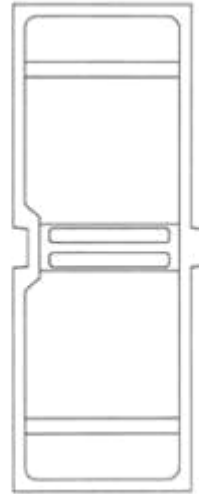

1.6

CÔNG BÁO SỞ HỮU CÔNG NGHIỆP SỐ 404 TẬP A – QUYỀN 2 (11.2021)

- (11) **42961**
(21) 3-2021-00712 (28) 1
(54) **BAO THUỐC LÁ** (51) **09-03**
(22) 26/03/2021 (43) 25/11/2021
(73) **GULBAHAR TOBACCO INTERNATIONAL FZE (AE)**
P.O. Box 61401, Jebel Ali Free Zone, Dubai, United Arab Emirates
(72) Vakhid Ulla Khabibi (RU)
(74) Công ty TNHH Sở hữu trí tuệ Trần & Trần (TRAN & TRAN CO., LTD.)
(55)



1.1

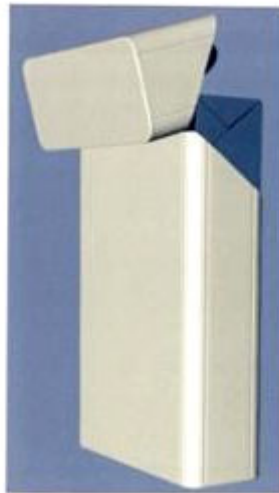

1.2



1.3



1.4



1.5



1.6



1.7

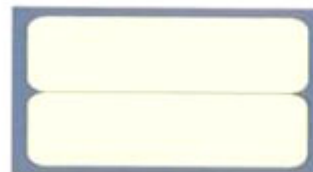

1.8

CÔNG BÁO SỞ HỮU CÔNG NGHIỆP SỐ 404 TẬP A – QUYỀN 2 (11.2021)

- (11) **42962**
(21) 3-2021-00753 (28) 5
(54) **HỘP** (51) **09-03**
(22) 31/03/2021 (43) 25/11/2021
(73) **CÔNG TY CỔ PHẦN THỰC PHẨM AIWADO (VN)**
Lầu 9, tòa nhà Centre Point, 106 Nguyễn Văn Trỗi, phường 8, quận Phú Nhuận,
thành phố Hồ Chí Minh
(72) Nguyễn Văn Mạnh (VN)
(55)



1.1



1.2



2.1



2.2



3.1



3.2



4.1



4.2



5.1



5.2

- (11) **42963**
(21) 3-2021-00771 (28) 1
(54) **CẤU KIỆN TẠO RỔNG CHO SÀN BÊ TÔNG CỐT THÉP** (51) **25-01**
(22) 02/04/2021 (43) 25/11/2021
(73) **CÔNG TY CỔ PHẦN THIẾT KẾ XÂY DỰNG LASTING (VN)**
Số 5, phố Hải Trung, phường Hồng Hải, thành phố Hạ Long, tỉnh Quảng Ninh
(72) Nguyễn Tiến Hiệp (VN)
(55)

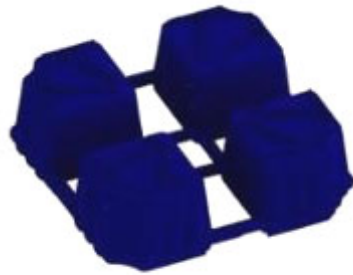

1.1



1.2



1.3



1.4

- (11) **42964**
(21) 3-2021-00832 (28) 1
(54) **DỤNG CỤ ĐỤC DỪA** (51) **07-04**
(22) 07/04/2021 (43) 25/11/2021
(30) 2002004956 30/10/2020 TH;
(73) **K FRESH CO., LTD. (TH)**
No. 98/38 moo 6, Bangmuangmai sub-district, Muang samutprakarn district,
Samutprakarn 10270, Thailand
(72) 1. KEMTAS MANUSRUNGSRI (TH)
2. WARAPORN MANUSRUNGSRI (TH)
(74) Công ty TNHH Trà và cộng sự (TRA & ASSOCIATES CO.,LTD)
(55)

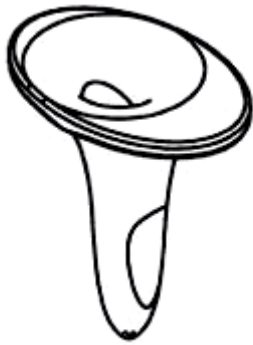

1.1

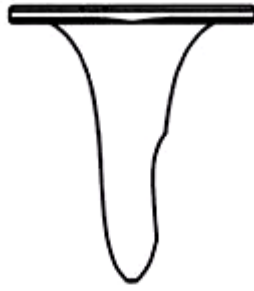

1.2

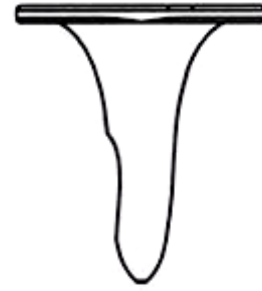

1.3



1.4



1.5

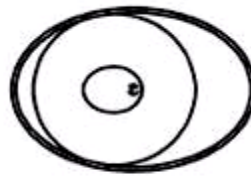

1.6

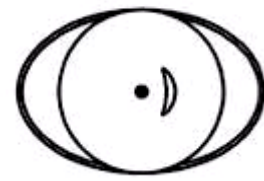

1.7

- (11) **42965**
(21) 3-2021-00833 (28) 1
(54) **BỘ PHẬN CỦA DỤNG CỤ KHOAN DỪA** (51) **07-04**
(22) 07/04/2021 (43) 25/11/2021
(30) 2002004957 30/10/2020 TH;
(73) **K FRESH CO., LTD. (TH)**
No. 98/38 moo 6, Bangmuangmai sub-district, Muang samutprakarn district,
Samutprakarn 10270, Thailand
(72) 1. KEMTAS MANUSRUNGSRI (TH)
2. WARAPORN MANUSRUNGSRI (TH)
(74) Công ty TNHH Trà và cộng sự (TRA & ASSOCIATES CO.,LTD)
(55)

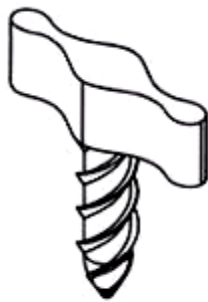

1.1

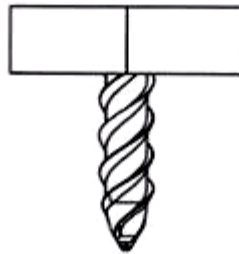

1.2

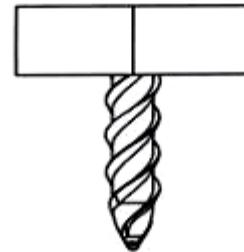

1.3



1.4



1.5



1.6



1.7

- (11) **42966**
(21) 3-2021-00834 (28) 1
(54) **BỘ PHẬN CỦA DỤNG CỤ KHOAN DỪA** (51) **07-04**
(22) 07/04/2021 (43) 25/11/2021
(30) 2002004958 30/10/2020 TH;
(73) **K FRESH CO., LTD. (TH)**
No. 98/38 moo 6, Bangmuangmai sub-district, Muang samutprakarn district,
Samutprakarn 10270, Thailand
(72) 1. KEMTAS MANUSRUNGSRI (TH)
2. WARAPORN MANUSRUNGSRI (TH)
(74) Công ty TNHH Trà và cộng sự (TRA & ASSOCIATES CO.,LTD)
(55)

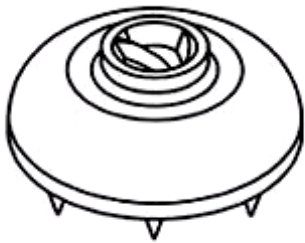

1.1

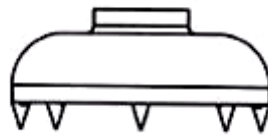

1.2

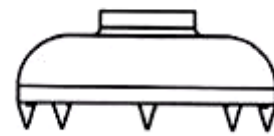

1.3

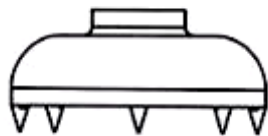

1.4

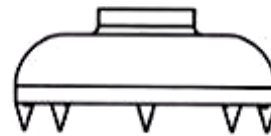

1.5

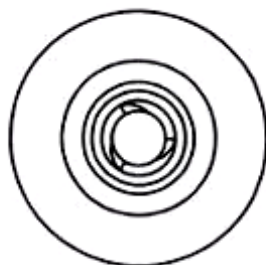

1.6

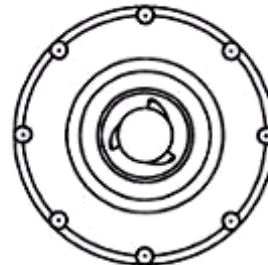

1.7

- (11) **42967**
(21) 3-2021-00835 (28) 1
(54) **KHÓA CỬA DỤNG CỤ KHOAN DỪA** (51) **07-04**
(22) 07/04/2021 (43) 25/11/2021
(30) 2002004959 30/10/2020 TH;
(73) **K FRESH CO., LTD. (TH)**
No. 98/38 moo 6, Bangmuangmai sub-district, Muang samutprakarn district,
Samutprakarn 10270, Thailand
(72) 1. KEMTAS MANUSRUNGSRI (TH)
2. WARAPORN MANUSRUNGSRI (TH)
(74) Công ty TNHH Trà và cộng sự (TRA & ASSOCIATES CO.,LTD)
(55)



1.1



1.2

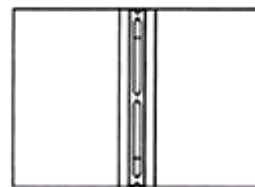

1.3



1.4

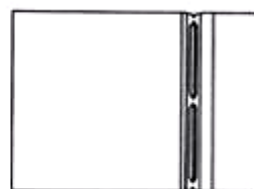

1.5

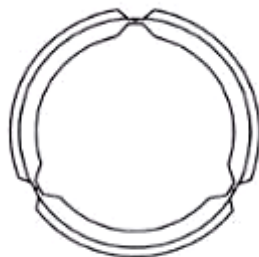

1.6

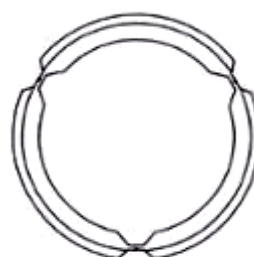

1.7

- (11) **42968**
(21) 3-2021-00845 (28) 1
(54) **NỒI NẤU ĐIỆN** (51) **07-02**
(22) 08/04/2021 (43) 25/11/2021
(30) 202030599107.9 09/10/2020 CN;
(73) **FOSHAN SHUNDE MIDEA ELECTRICAL HEATING APPLIANCES
MANUFACTURING CO., LTD. (CN)**
San Le Road #19, Beijiao, Shunde, Foshan, Guangdong Province 528311, China
(72) 1. TANG, WENWANG (CN)
2. XU, SHOUCHEG (CN)
(74) Công ty TNHH Dịch vụ Sở hữu trí tuệ KENFOX (KENFOX IP SERVICE
CO.,LTD.)
(55)



1.1



1.2



1.3



1.4



1.5



1.6



1.7

CÔNG BÁO SỞ HỮU CÔNG NGHIỆP SỐ 404 TẬP A – QUYỀN 2 (11.2021)

- (11) **42969**
(21) 3-2021-00852 (28) 1
(54) **NỒI NẤU ĐIỆN** (51) **07-02**
(22) 09/04/2021 (43) 25/11/2021
(30) 202030600428.6 10/10/2020 CN;
(73) **FOSHAN SHUNDE MIDEA ELECTRICAL HEATING APPLIANCES
MANUFACTURING CO., LTD. (CN)**
San Le Road #19, Beijiao, Shunde, Foshan, Guangdong Province 528311, China
(72) 1. TANG, WENWANG (CN)
2. XU, SHOUCHEG (CN)
(74) Công ty TNHH Dịch vụ Sở hữu trí tuệ KENFOX (KENFOX IP SERVICE
CO.,LTD.)
(55)



1.1



1.2



1.3



1.4



1.5



1.6



1.7

CÔNG BÁO SỞ HỮU CÔNG NGHIỆP SỐ 404 TẬP A – QUYỀN 2 (11.2021)

- (11) **42970**
(21) 3-2021-00853 (28) 1
(54) **NỒI CHIÊN KHÔNG DẦU** (51) **07-02**
(22) 09/04/2021 (43) 25/11/2021
(30) 202030612714.4 15/10/2020 CN;
(73) **GUANGDONG MIDEA CONSUMER ELECTRIC MANUFACTURING CO., LTD. (CN)**
San Le Road #19, Beijiao, Shunde, Foshan, Guangdong 528311, China
(72) WANG, Jingjing (CN)
(74) Công ty TNHH Dịch vụ Sở hữu trí tuệ KENFOX (KENFOX IP SERVICE CO.,LTD.)
(55)



1.1



1.2



1.3



1.4



1.5



1.6



1.7

CÔNG BÁO SỞ HỮU CÔNG NGHIỆP SỐ 404 TẬP A – QUYỀN 2 (11.2021)

- (11) **42971**
(21) 3-2021-00855 (28) 1
(54) **NHÃN SẢN PHẨM** (51) **19-08**
(22) 09/04/2021 (43) 25/11/2021
(73) **HỢP TÁC XÃ CHẾ BIẾN THƯƠNG MẠI DỊCH VỤ NUÔI TRỒNG THỦY SẢN CÁI BÁT (VN)**
Ấp Cái Bát, xã Hòa Mỹ, huyện Cái Nước, tỉnh Cà Mau
(72) Trần Sỹ Nhân (VN)
(74) Công ty TNHH Sở hữu trí tuệ HA VIP (HAVIP CO., LTD.)
(55)



(11) **42972**

(21) 3-2021-00932

(28) 2

(54) **CỎ NHÂN TẠO**

(51) **11-04**

(22) 22/04/2021

(43) 25/11/2021

(30) 202030627348.X 21/10/2020 CN;

(73) **QINGDAO BELLINTURF INDUSTRIAL CO., LTD. (CN)**

The South of Youshibo Village, Beiguan Office, Jiaozhou Qingdao, Shandong, China

(72) Kang Yu (CN)

(74) Công ty Luật TNHH WINCO (WINCO LAW FIRM)

(55)



1.1



1.2

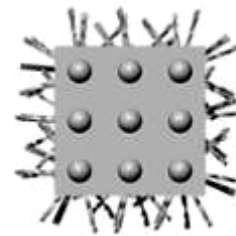

1.3

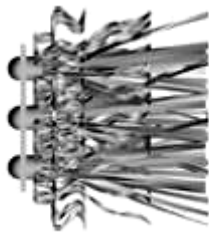

1.4

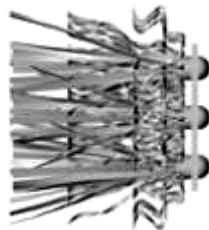

1.5

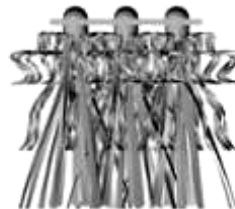

1.6



1.7

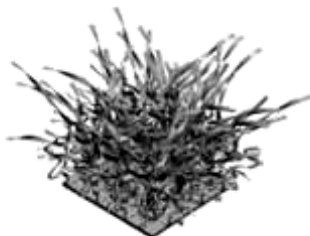

2.1

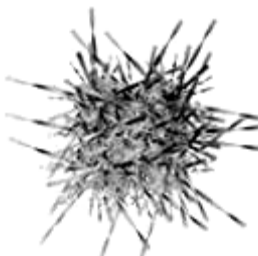

2.2

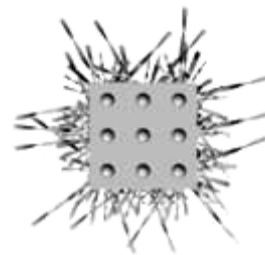

2.3



2.4

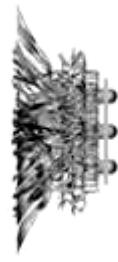

2.5



2.6



2.7

CÔNG BÁO SỞ HỮU CÔNG NGHIỆP SỐ 404 TẬP A – QUYỀN 2 (11.2021)

- (11) **42973**
(21) 3-2021-00967 (28) 1
(54) **NHÃN SẢN PHẨM** (51) **19-08**
(22) 27/04/2021 (43) 25/11/2021
(73) **CÔNG TY TNHH SẢN XUẤT CÀ PHÊ CAO NGUYÊN (VN)**
22F đường số 11A, ấp 2, xã Tân Kiên, huyện Bình Chánh, thành phố Hồ Chí Minh
(72) **TRẦN KIM THANH (VN)**
(74) Công ty TNHH Tư vấn Quốc Dân (NACILAW)
(55)



- (11) **42974**
(21) 3-2021-00975 (28) 1
(54) **KHẨU TRANG** (51) **29-02**
(22) 28/04/2021 (43) 25/11/2021
(30) 2020-023976 06/11/2020 JP;
(73) **HISAMITSU PHARMACEUTICAL CO., INC. (JP)**
408, Tashirodaikan-machi, Tosu-shi, Saga 841-0017 Japan
(72) 1. EIJI MAEDA (JP)
2. KIYOTAKA TAKADA (JP)
(74) Công ty TNHH một thành viên Sở hữu trí tuệ VCCI (VCCI-IP CO.,LTD)
(55)

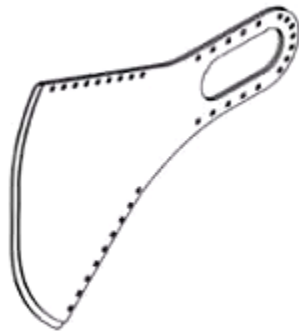

1.1

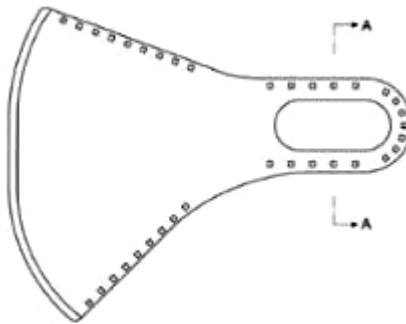

1.2

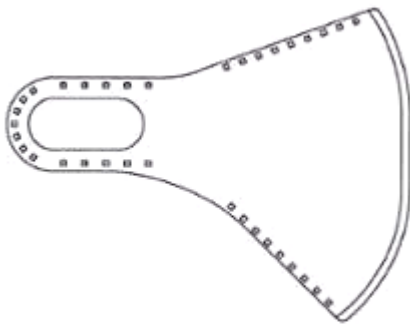

1.3



1.4



1.5



1.6



1.7

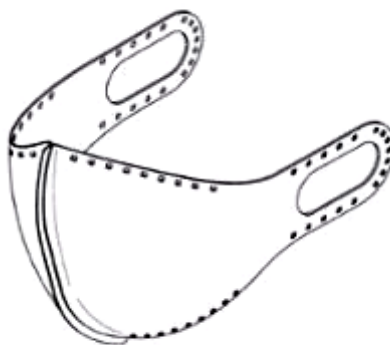

1.8

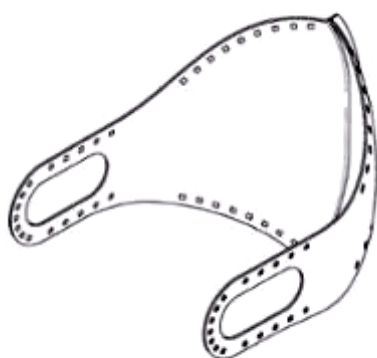

1.9



1.10



1.11

- (11) **42975**
- (21) 3-2021-00976
- (54) **KHẪU TRANG**
- (22) 28/04/2021
- (30) 2020-023978 06/11/2020 JP;
- (73) **HISAMITSU PHARMACEUTICAL CO., INC. (JP)**
408, Tashirodaikan-machi, Tosu-shi, Saga 841-0017 Japan
- (72) 1. EIJI MAEDA (JP)
2. KIYOTAKA TAKADA (JP)
- (74) Công ty TNHH một thành viên Sở hữu trí tuệ VCCI (VCCI-IP CO.,LTD)
- (55)

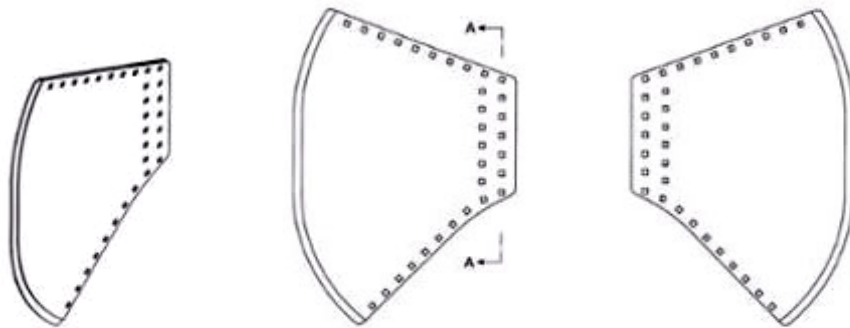

1.1

1.2

1.3



1.4



1.5



1.6



1.7



1.8

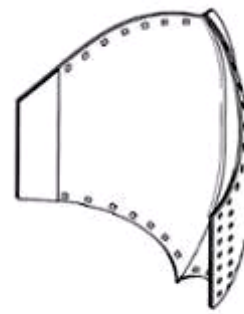

1.9



1.10

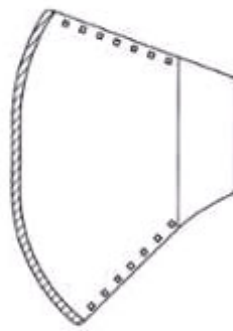

1.11



1.12

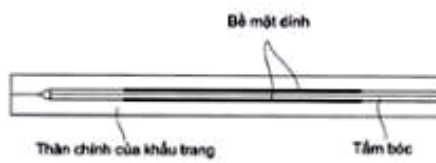

1.13



1.14

- (11) **42976**
(21) 3-2021-01013 (28) 1
(54) **MÁY IN** (51) **18-02**
(22) 29/04/2021 (43) 25/11/2021
(30) 2020-023945 06/11/2020 JP;
(73) **BROTHER INDUSTRIES, LTD. (JP)**
15-1 Naeshiro-cho, Mizuho-ku, Nagoya-shi, Aichi-ken, Japan
(72) 1. TAKAHIRO MOTOYAMA (JP)
2. TOSHIYA INADA (JP)
3. MASAYOSHI MITA (JP)
(74) Công ty TNHH Ban Ca (BANCA)
(55)

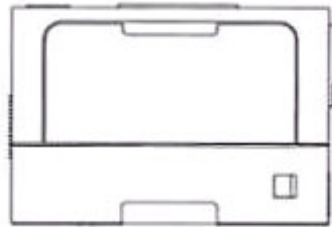

1.1

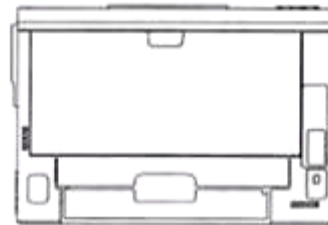

1.2

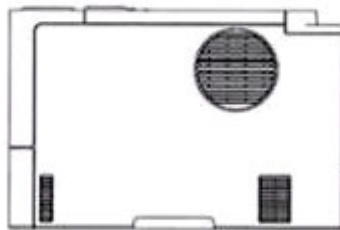

1.3

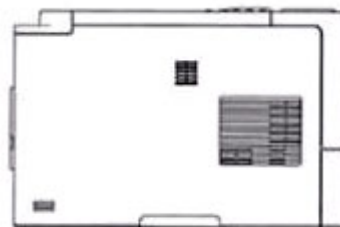

1.4

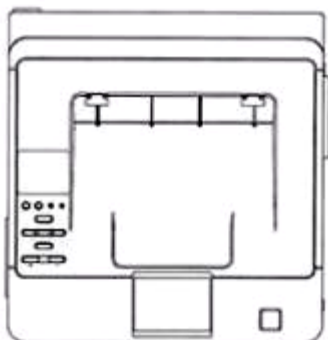

1.5

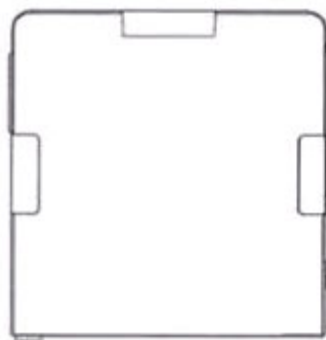

1.6

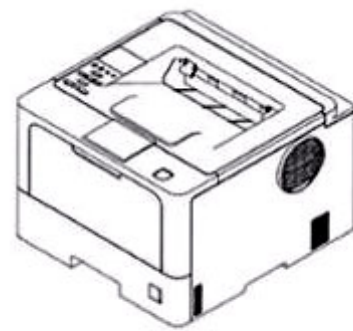

1.7

- (11) **42977**
(21) 3-2021-01022 (28) 1
(54) **HỘP ĐỰNG** (51) **03-01; 14-01**
(22) 04/05/2021 (43) 25/11/2021
(30) 29/757,989 11/11/2020 US;
(73) **APPLE INC. (US)**
One Apple Park Way, Cupertino, California 95014, United States of America
(72) 1. JODY AKANA (US)
2. MOLLY ANDERSON (GB)
3. BARTLEY K. ANDRE (US)
4. SHOTA AOYAGI (JP)
5. ANTHONY MICHAEL ASHCROFT (FR)
6. MARINE C. BATAILLE (FR)
7. JEREMY BATAILLOU (FR)
8. ABIDUR RAHMAN CHOWDHURY (GB)
9. CLARA GENEVIEVE MARINE COURTAIGNE (FR)
10. MARKUS DIEBEL (DE)
11. JONATHAN GOMEZ GARCIA (FR)
12. M. EVANS HANKEY (US)
13. RICHARD P. HOWARTH (GB)
14. JONATHAN P. IVE (GB)
15. JULIAN JAEDE (DE)
16. DUNCAN ROBERT KERR (GB)
17. PETER RUSSELL-CLARKE (AU)
18. BENJAMIN ANDREW SHAFFER (US)
19. JOE SUNG-HO TAN (US)
20. CLEMENT TISSANDIER (FR)
21. EUGENE ANTONY WHANG (CA)
(74) Công ty TNHH Lê & Lê (LE & LE)
(55)

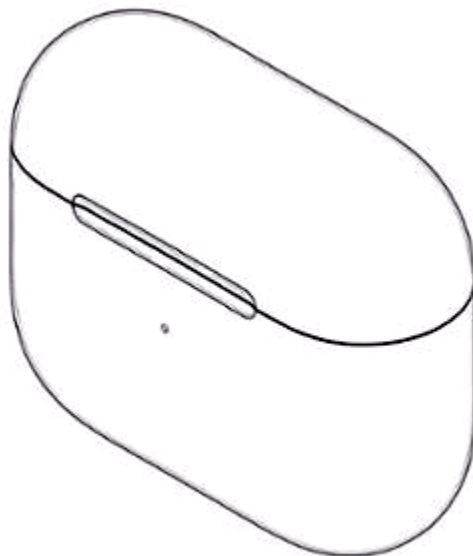

1.1

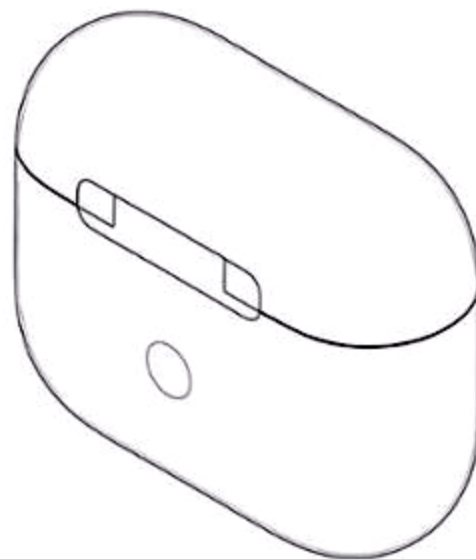

1.2

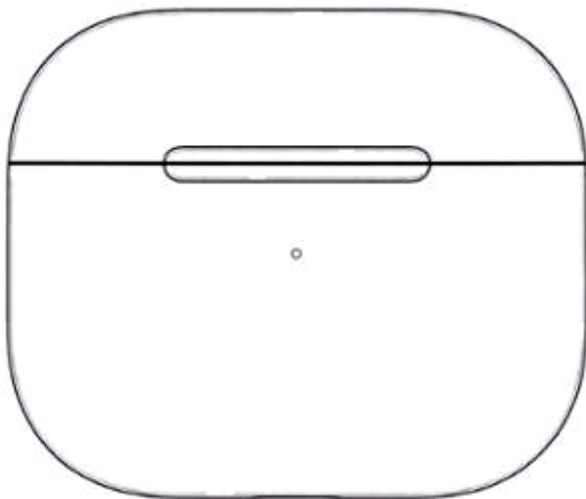

1.3

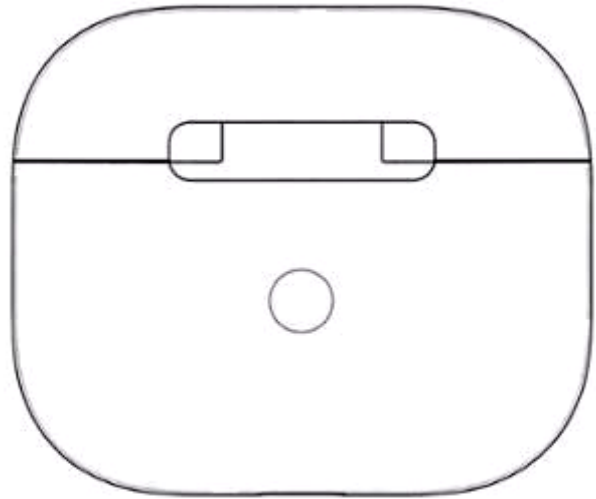

1.4



1.5



1.6

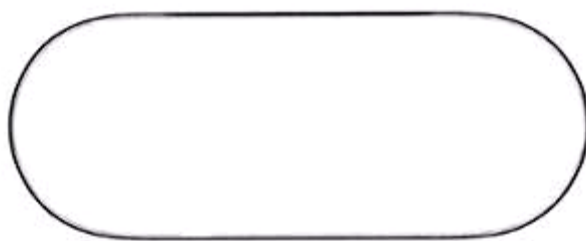

1.7



1.8

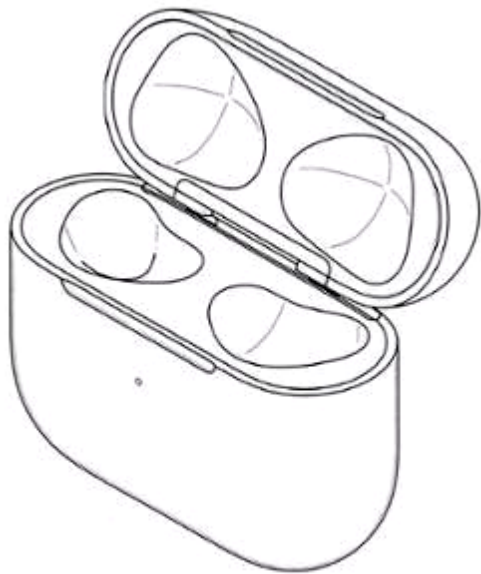

1.9

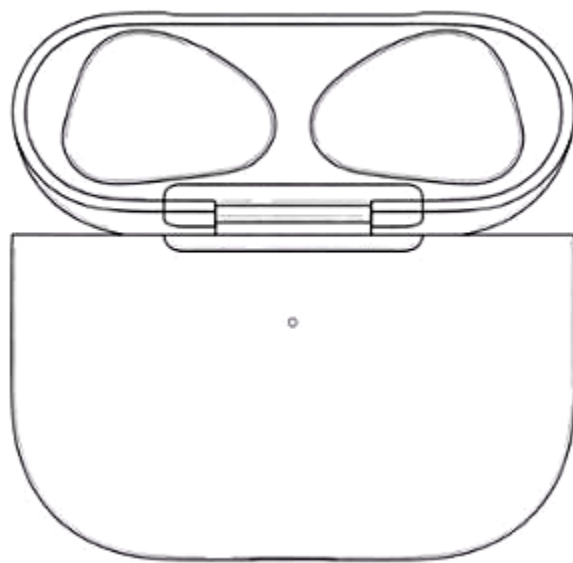

1.10

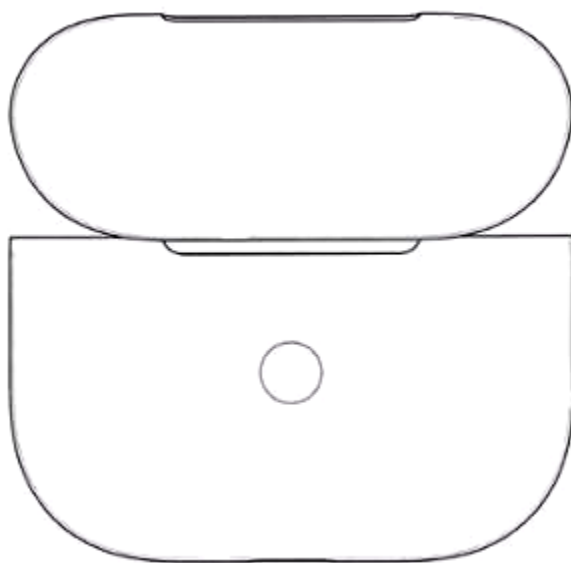

1.11

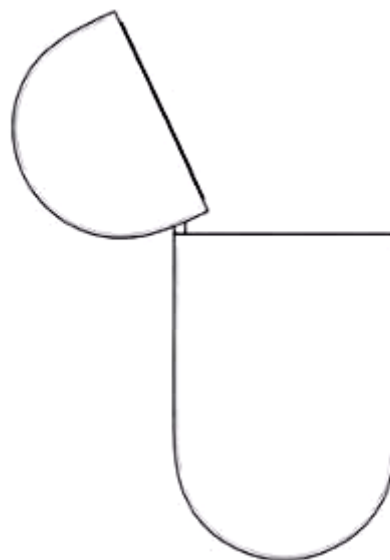

1.12

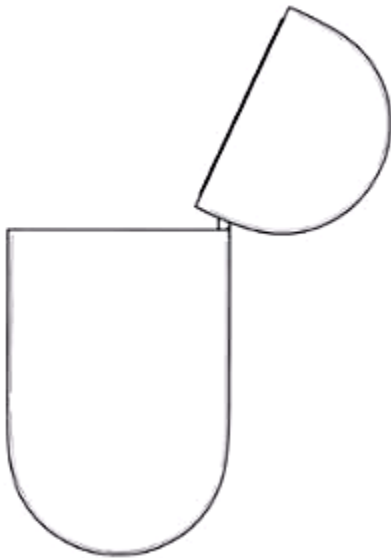

1.13

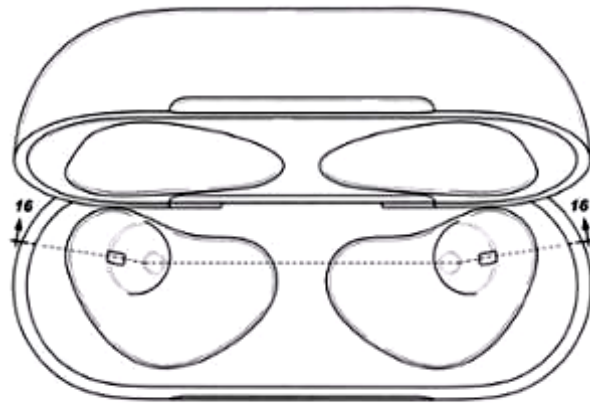

1.14



1.15

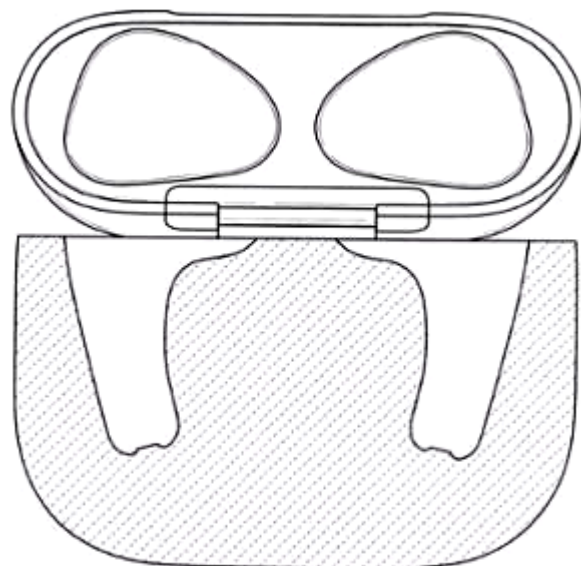

1.16

- (11) **42978**
(21) 3-2021-01023 (28) 1
(54) **HỘP ĐỰNG TAI NGHE** (51) **03-01; 14-01**
(22) 04/05/2021 (43) 25/11/2021
(30) 29/757,989 11/11/2020 US;
(73) **APPLE INC. (US)**
One Apple Park Way, Cupertino, California 95014, United States of America
(72) 1. JODY AKANA (US)
2. MOLLY ANDERSON (GB)
3. BARTLEY K. ANDRE (US)
4. SHOTA AOYAGI (JP)
5. ANTHONY MICHAEL ASHCROFT (FR)
6. MARINE C. BATAILLE (FR)
7. JEREMY BATAILLOU (FR)
8. ABIDUR RAHMAN CHOWDHURY (GB)
9. CLARA GENEVIEVE MARINE COURTAIGNE (FR)
10. MARKUS DIEBEL (DE)
11. JONATHAN GOMEZ GARCIA (FR)
12. M. EVANS HANKEY (US)
13. RICHARD P. HOWARTH (GB)
14. JONATHAN P. IVE (GB)
15. JULIAN JAEDE (DE)
16. DUNCAN ROBERT KERR (GB)
17. PETER RUSSELL-CLARKE (AU)
18. BENJAMIN ANDREW SHAFFER (US)
19. JOE SUNG-HO TAN (US)
20. CLEMENT TISSANDIER (FR)
21. EUGENE ANTONY WHANG (CA)
(74) Công ty TNHH Lê & Lê (LE & LE)
(55)



1.1

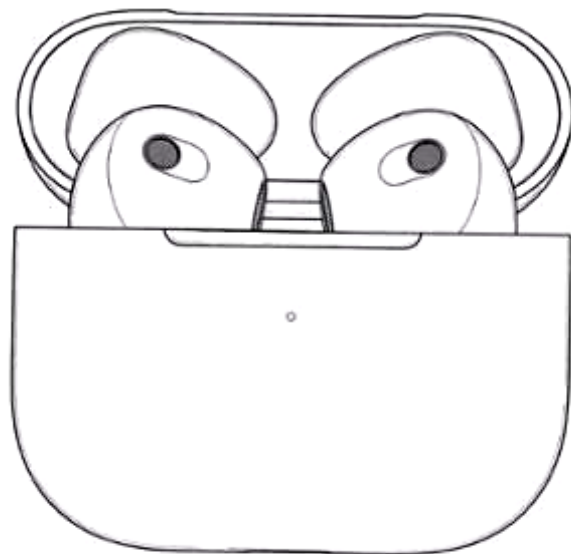

1.2

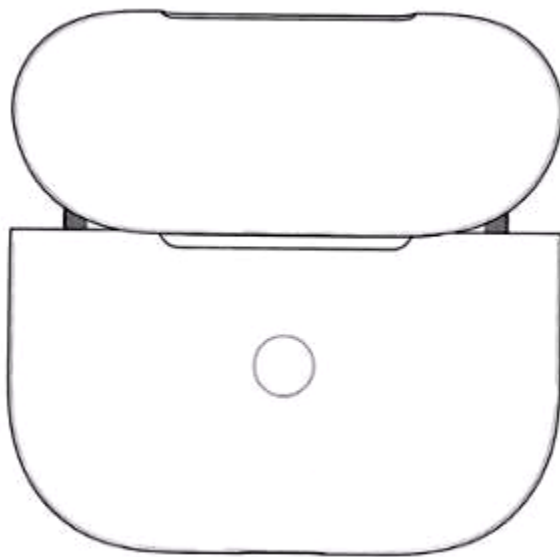

1.3

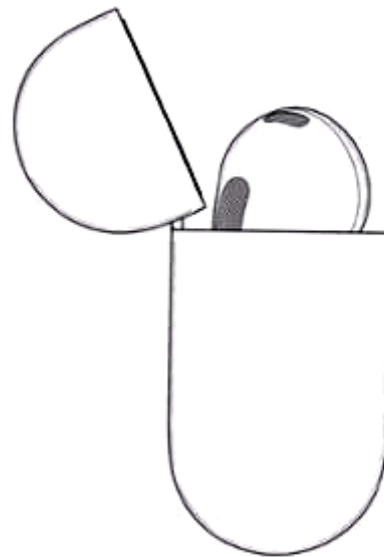

1.4

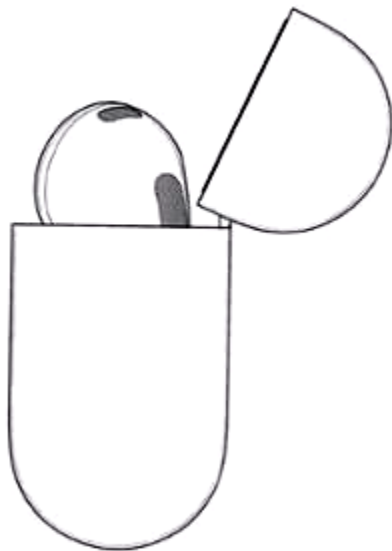

1.5

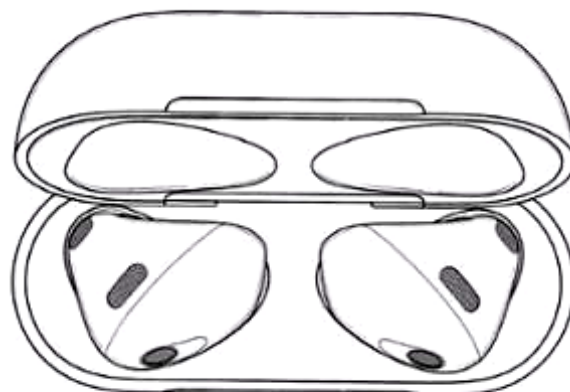

1.6



1.7

CÔNG BÁO SỞ HỮU CÔNG NGHIỆP SỐ 404 TẬP A – QUYỀN 2 (11.2021)

- (11) **42979**
(21) 3-2021-01044 (28) 1
(54) **NHÃN SẢN PHẨM** (51) **19-08**
(22) 05/05/2021 (43) 25/11/2021
(73) **CÔNG TY CỔ PHẦN SỮA VIỆT NAM (VN)**
Số 10 Tân Trào, phường Tân Phú, quận 7, thành phố Hồ Chí Minh
(72) Nguyễn Đức Duy (VN)
(74) Công ty TNHH sở hữu trí tuệ AGL (AGL IP)
(55)



CÔNG BÁO SỞ HỮU CÔNG NGHIỆP SỐ 404 TẬP A – QUYỀN 2 (11.2021)

(11) **42980**

(21) 3-2021-01063

(28) 1

(54) **CHẬU RỬA**

(51) **23-02**

(22) 07/05/2021

(43) 25/11/2021

(73) **CÔNG TY CỔ PHẦN THƯƠNG MẠI VIGLACERA (VN)**

Tầng 1, tòa nhà Viglacera, số 1 Đại lộ Thăng Long, phường Mễ Trì, quận Nam Từ Liêm, thành phố Hà Nội

(72) Phạm Ngọc Đường (VN)

(55)

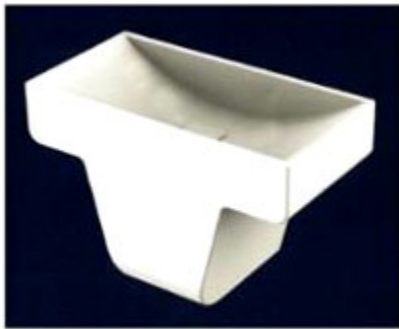

1.1



1.2



1.3



1.4



1.5



1.6

CÔNG BÁO SỞ HỮU CÔNG NGHIỆP SỐ 404 TẬP A – QUYỀN 2 (11.2021)

- (11) **42981**
(21) 3-2021-01292 (28) 1
(54) **THANH KIM LOẠI ĐỊNH HÌNH** (51) **25-01**
(22) 18/05/2021 (43) 25/11/2021
(73) **CÔNG TY CỔ PHẦN KENWIN (VN)**
Tầng 4 tòa nhà VG Building, số 235 đường Nguyễn Trãi, phường Thanh Xuân
Trung, quận Thanh Xuân, thành phố Hà Nội
(72) Ngô Thọ Long (VN)
(74) Công ty TNHH Sở hữu trí tuệ PADEMARK (PADEMARK CO.,LTD.)
(55)

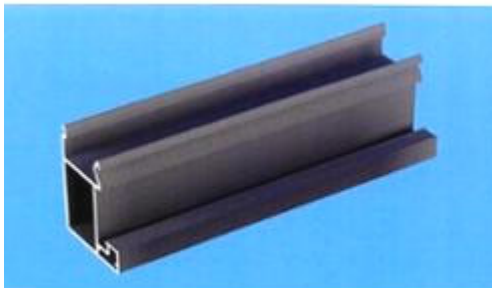

1.1

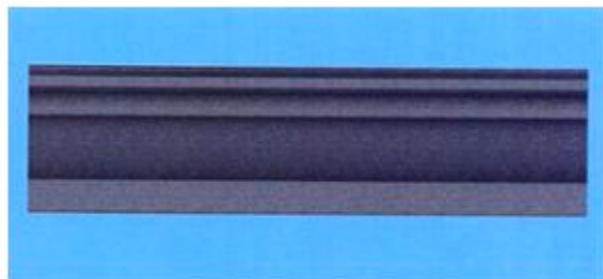

1.2

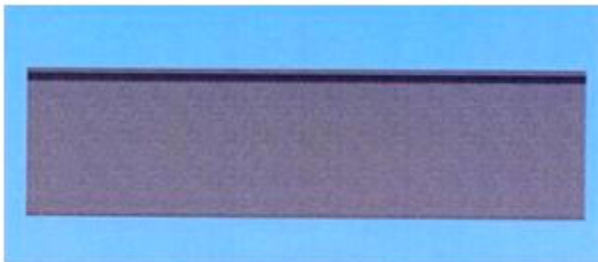

1.3

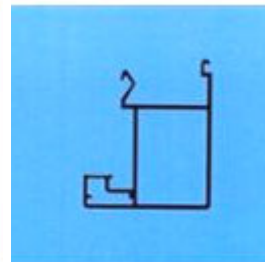

1.4

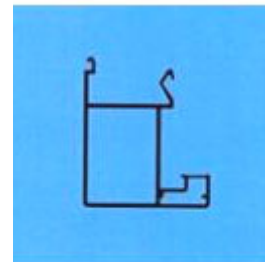

1.5



1.6

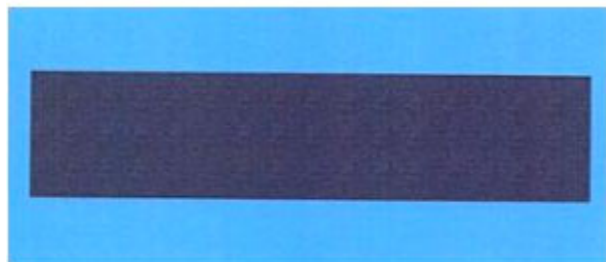

1.7

CÔNG BÁO SỞ HỮU CÔNG NGHIỆP SỐ 404 TẬP A – QUYỀN 2 (11.2021)

- (11) **42982**
(21) 3-2021-01293 (28) 1
(54) **THANH KIM LOẠI ĐỊNH HÌNH** (51) **25-01**
(22) 18/05/2021 (43) 25/11/2021
(73) **CÔNG TY CỔ PHẦN KENWIN (VN)**
Tầng 4 tòa nhà VG Building, số 235 đường Nguyễn Trãi, phường Thanh Xuân
Trung, quận Thanh Xuân, thành phố Hà Nội
(72) Ngô Thọ Long (VN)
(74) Công ty TNHH Sở hữu trí tuệ PADEMARK (PADEMARK CO.,LTD.)
(55)



1.1



1.2



1.3

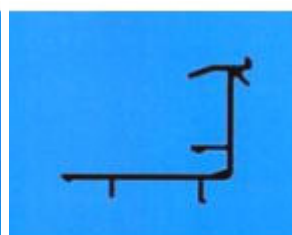

1.4

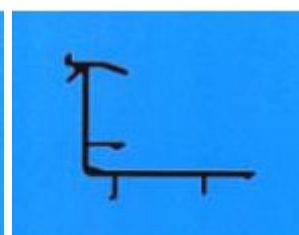

1.5

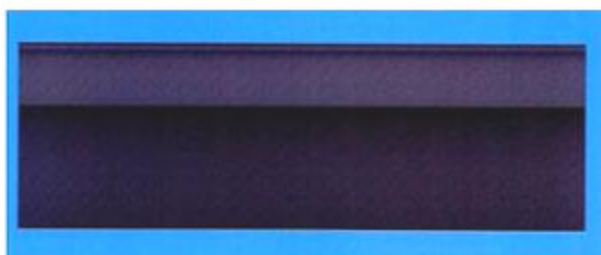

1.6

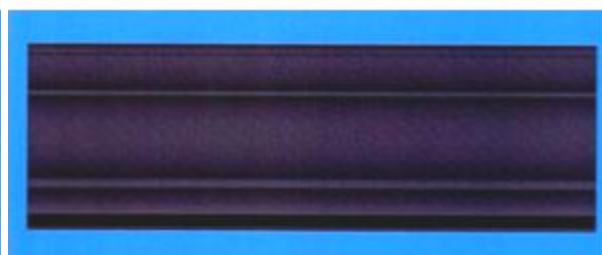

1.7

CÔNG BÁO SỞ HỮU CÔNG NGHIỆP SỐ 404 TẬP A – QUYỀN 2 (11.2021)

- (11) **42983**
(21) 3-2021-01294 (28) 1
(54) **THANH KIM LOẠI ĐỊNH HÌNH** (51) **25-01**
(22) 18/05/2021 (43) 25/11/2021
(73) **CÔNG TY CỔ PHẦN KENWIN (VN)**
Tầng 4 tòa nhà VG Building, số 235 đường Nguyễn Trãi, phường Thanh Xuân
Trung, quận Thanh Xuân, thành phố Hà Nội
(72) Ngô Thọ Long (VN)
(74) Công ty TNHH Sở hữu trí tuệ PADEMARK (PADEMARK CO.,LTD.)
(55)

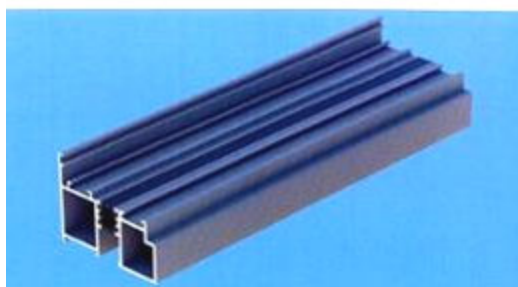

1.1

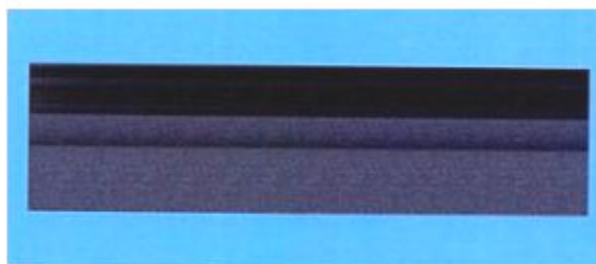

1.2



1.3

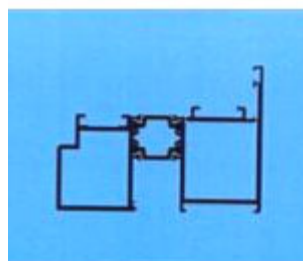

1.4

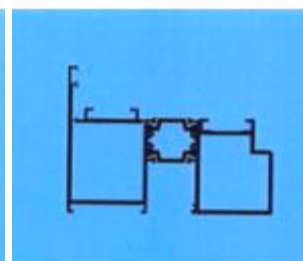

1.5

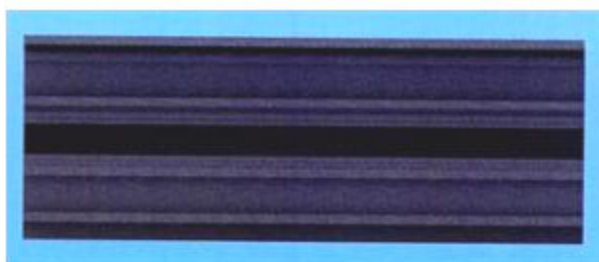

1.6



1.7

CÔNG BÁO SỞ HỮU CÔNG NGHIỆP SỐ 404 TẬP A – QUYỀN 2 (11.2021)

- (11) **42984**
(21) 3-2021-01295 (28) 1
(54) **THANH KIM LOẠI ĐỊNH HÌNH** (51) **25-01**
(22) 18/05/2021 (43) 25/11/2021
(73) **CÔNG TY CỔ PHẦN KENWIN (VN)**
Tầng 4 tòa nhà VG Building, số 235 đường Nguyễn Trãi, phường Thanh Xuân
Trung, quận Thanh Xuân, thành phố Hà Nội
(72) Ngô Thọ Long (VN)
(74) Công ty TNHH Sở hữu trí tuệ PADEMARK (PADEMARK CO.,LTD.)
(55)

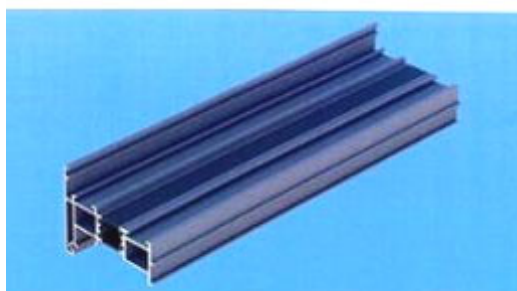

1.1

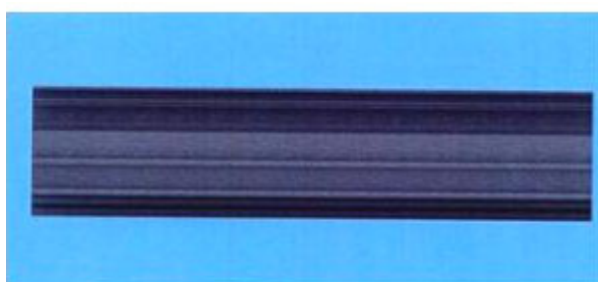

1.2

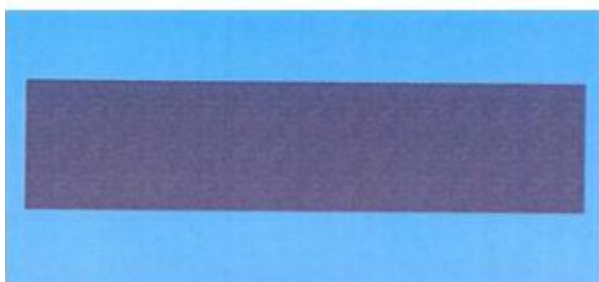

1.3

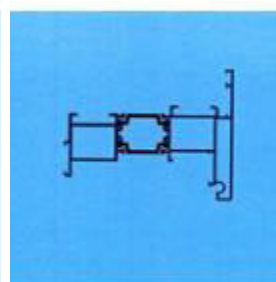

1.4

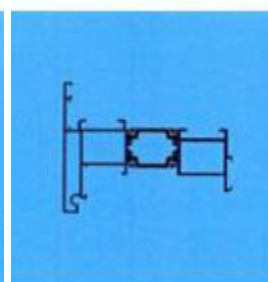

1.5

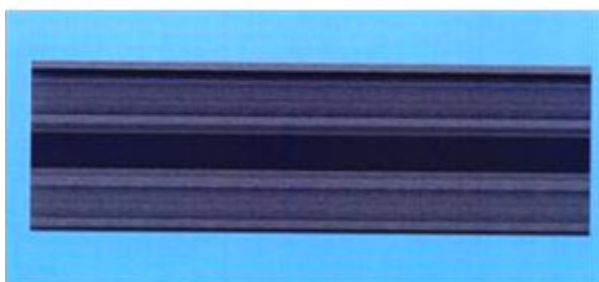

1.6

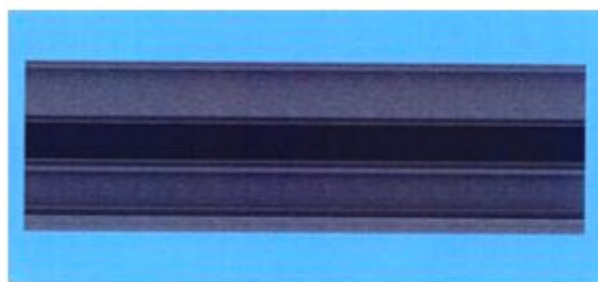

1.7

CÔNG BÁO SỞ HỮU CÔNG NGHIỆP SỐ 404 TẬP A – QUYỀN 2 (11.2021)

- (11) **42985**
(21) 3-2021-01296 (28) 1
(54) **THANH KIM LOẠI ĐỊNH HÌNH** (51) **25-01**
(22) 18/05/2021 (43) 25/11/2021
(73) **CÔNG TY CỔ PHẦN KENWIN (VN)**
Tầng 4 tòa nhà VG Building, số 235 đường Nguyễn Trãi, phường Thanh Xuân
Trung, quận Thanh Xuân, thành phố Hà Nội
(72) Ngô Thọ Long (VN)
(74) Công ty TNHH Sở hữu trí tuệ PADEMARK (PADEMARK CO.,LTD.)
(55)

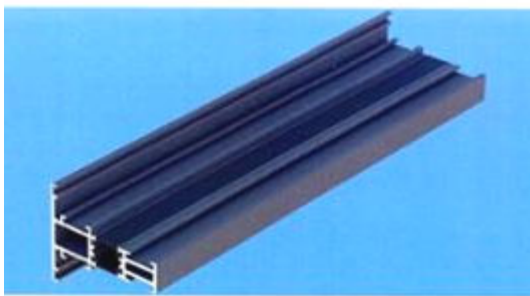

1.1

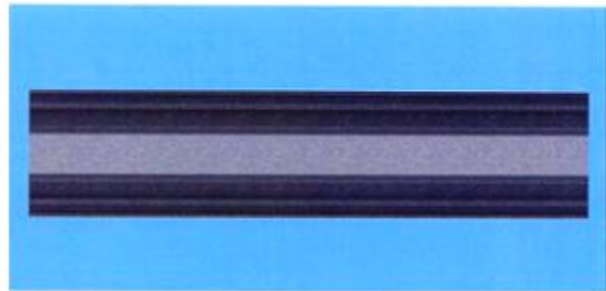

1.2

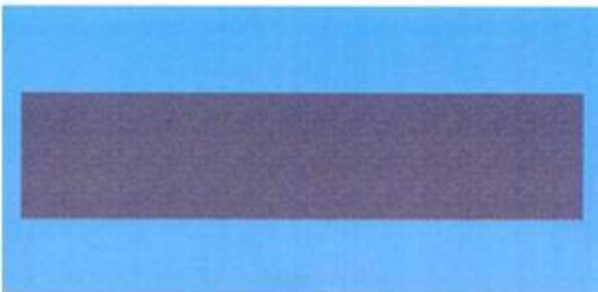

1.3

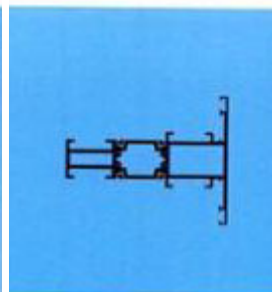

1.4

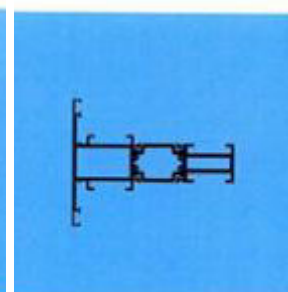

1.5

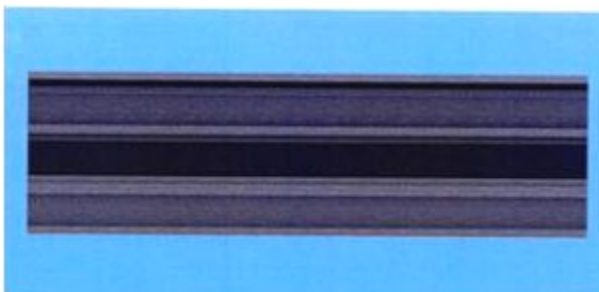

1.6

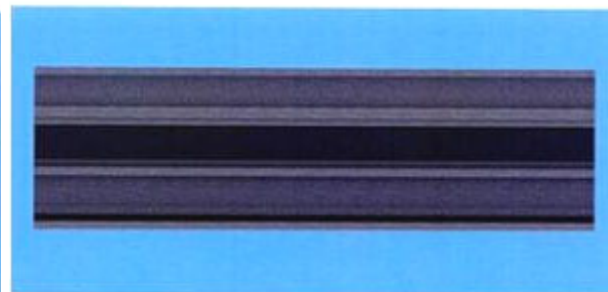

1.7

CÔNG BÁO SỞ HỮU CÔNG NGHIỆP SỐ 404 TẬP A – QUYỀN 2 (11.2021)

- (11) **42986**
(21) 3-2021-01297 (28) 1
(54) **THANH KIM LOẠI ĐỊNH HÌNH** (51) **25-01**
(22) 18/05/2021 (43) 25/11/2021
(73) **CÔNG TY CỔ PHẦN KENWIN (VN)**
Tầng 4 tòa nhà VG Building, số 235 đường Nguyễn Trãi, phường Thanh Xuân
Trung, quận Thanh Xuân, thành phố Hà Nội
(72) Ngô Thọ Long (VN)
(74) Công ty TNHH Sở hữu trí tuệ PADEMARK (PADEMARK CO.,LTD.)
(55)

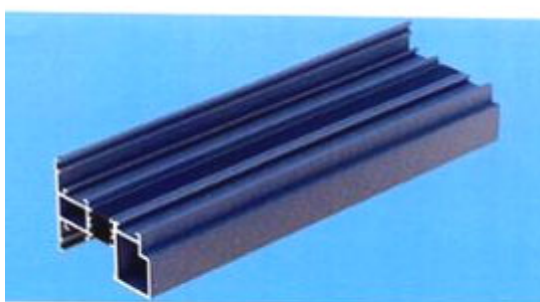

1.1

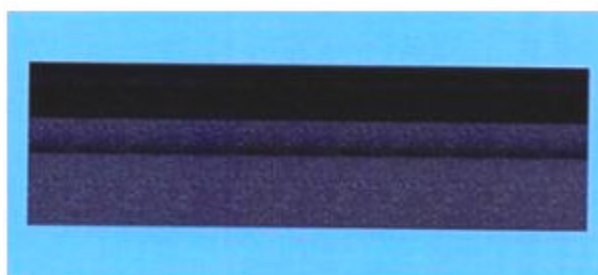

1.2

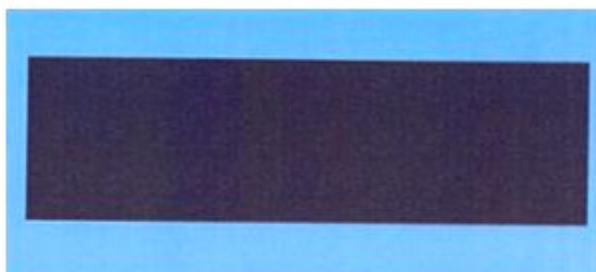

1.3

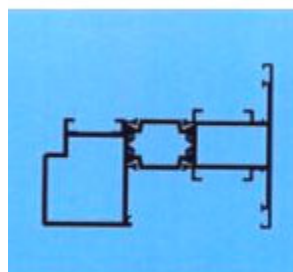

1.4

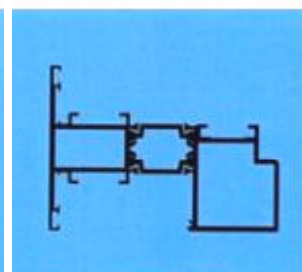

1.5

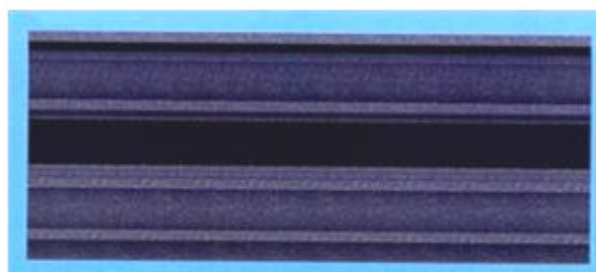

1.6



1.7

CÔNG BÁO SỞ HỮU CÔNG NGHIỆP SỐ 404 TẬP A – QUYỀN 2 (11.2021)

(11) **42987**

(21) 3-2021-01348

(28) 1

(54) **XE MÔ TÔ**

(51) **12-11**

(22) 24/05/2021

(43) 25/11/2021

(73) **LIANG XINMIN (CN)**

No. 39, Danya Road, Zeguo Town, Wenling City, Zhejiang Province, China

(72) Liang Xinmin (CN)

(74) Công ty TNHH Trường Xuân (AGELESS CO.,LTD.)

(55)



1.1



1.2



1.3



1.4



1.5



1.6



1.7

CÔNG BÁO SỞ HỮU CÔNG NGHIỆP SỐ 404 TẬP A – QUYỀN 2 (11.2021)

- (11) **42988**
(21) 3-2021-01351 (28) 10
(54) **HỘP** (51) **09-03**
(22) 24/05/2021 (43) 25/11/2021
(73) **CÔNG TY CỔ PHẦN THỰC PHẨM Á CHÂU (VN)**
Số 9/2 đường ĐT 743, khu phố 1B, phường An Phú, thành phố Thuận An, tỉnh Bình Dương
(72) NGUYỄN MẠNH CƯỜNG (VN)
(74) Văn phòng Luật sư A Hoà (AHOA LAW OFFICE)
(55)



1.1



1.2



2.1



2.2



3.1



3.2



4.1



4.2



5.1



5.2



6.1



6.2



7.1



7.2



8.1

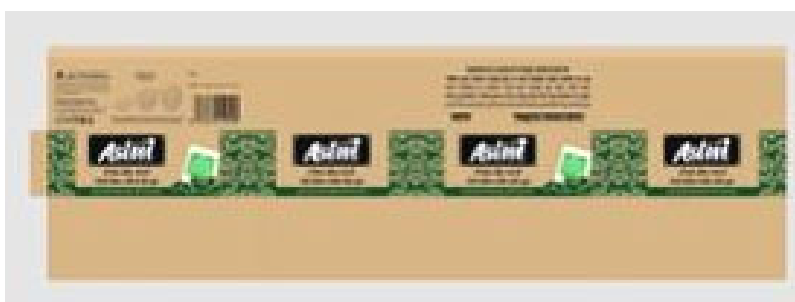

8.2



9.1



9.2



10.1



10.2

CÔNG BÁO SỞ HỮU CÔNG NGHIỆP SỐ 404 TẬP A – QUYỀN 2 (11.2021)

- (11) **42989**
(21) 3-2021-01377 (28) 1
(54) **GIÀY** (51) **02-04**
(22) 26/05/2021 (43) 25/11/2021
(30) 008302152-0004 02/12/2020 EM;
(73) **DECATHLON (FR)**
4, Boulevard de Mons, F-59650 Villeneuve d'Ascq, France
(72) Pierre DUQUENOY (FR)
(74) Công ty Luật TNHH T&G (TGVN)
(55)



1.1



1.2



1.3



1.4



1.5



1.6



1.7

CÔNG BÁO SỞ HỮU CÔNG NGHIỆP SỐ 404 TẬP A – QUYỀN 2 (11.2021)

- (11) **42990**
(21) 3-2021-01379 (28) 1
(54) **GIÀY** (51) **02-04**
(22) 26/05/2021 (43) 25/11/2021
(30) 008302152-0002 02/12/2020 EM;
(73) **DECATHLON (FR)**
4, Boulevard de Mons, F-59650 Villeneuve d'Ascq, France
(72) Pierre DUQUENOY (FR)
(74) Công ty Luật TNHH T&G (TGVN)
(55)



1.1



1.2



1.3



1.4



1.5



1.6



1.7

- (11) **42991**
(21) 3-2021-01403 (28) 1
(54) **BỘ SẠC ĐIỆN** (51) **13-02**
(22) 31/05/2021 (43) 25/11/2021
(30) 29/779,636 20/04/2021 US;
(73) **TECHTRONIC CORDLESS GP (US)**
100 Innovation Way, Anderson, SC 29621, United States of America
(72) 1. JOSEPH SEXTON (US)
2. SHUANG LIN (CN)
(74) Công ty TNHH Tầm nhìn và Liên danh (VISION & ASSOCIATES CO.LTD.)
(55)

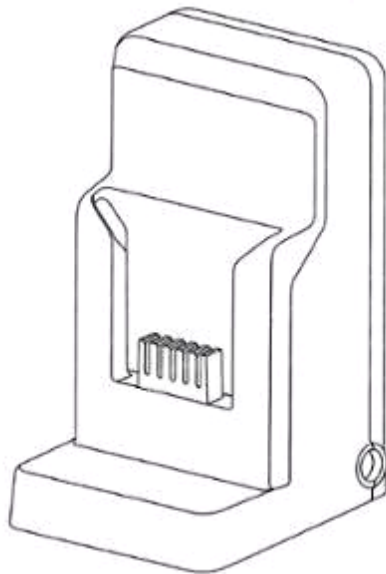

1.1

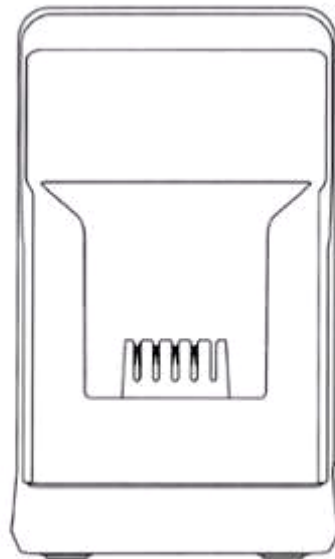

1.2

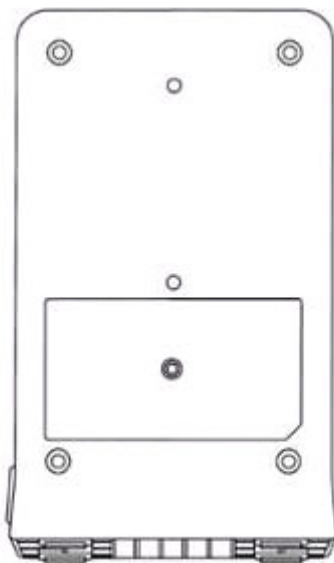

1.3

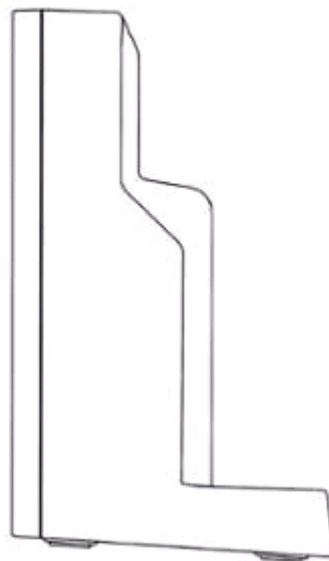

1.4

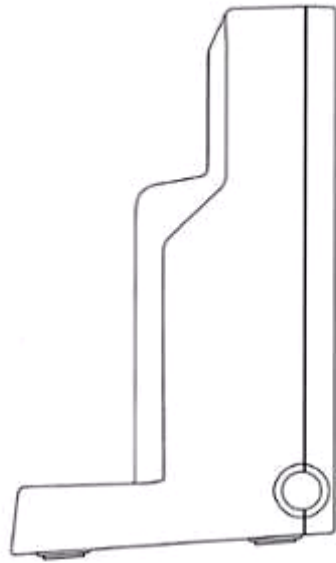

1.5

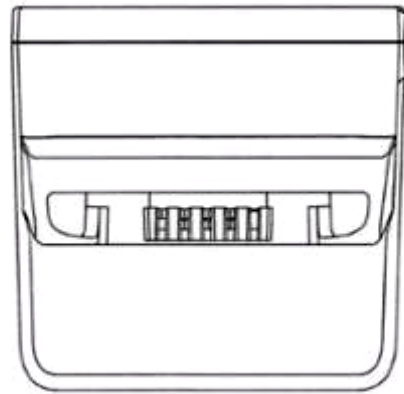

1.6

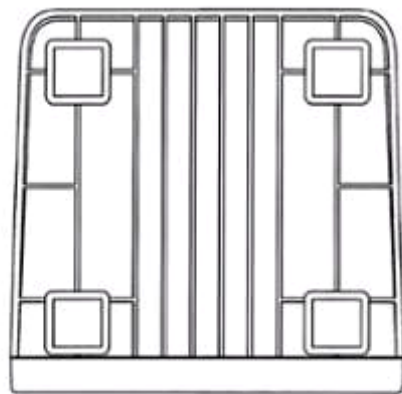

1.7

- (11) **42992**
(21) 3-2021-01412 (28) 1
(54) **KẸP ĐIỀU CHỈNH DÂY** (51) **21-04**
(22) 01/06/2021 (43) 25/11/2021
(30) 30-2020-0059294 03/12/2020 KR;
(73) **WOJIN PLASTIC CO., LTD (KR)**
45, Paryasandan-ro, Jinjeop-eup, Namyangju-si, Gyeonggi-do 12017 Republic of Korea
(72) 1. JISOOK PAIK (KR)
2. NAN HEE PAIK (KR)
3. JI HYE PAIK (KR)
4. JI WON SON (KR)
(74) Công ty TNHH Trường Xuân (AGELESS CO.,LTD.)
(55)



1.1



1.2

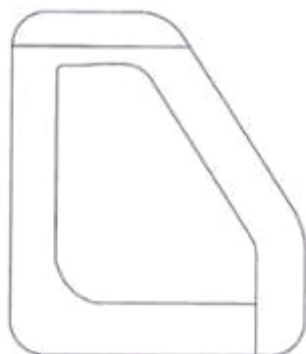

1.3

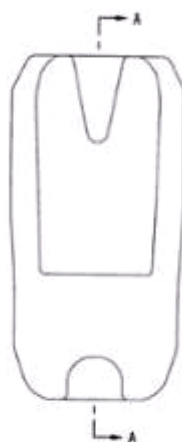

1.4



1.5

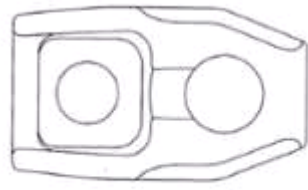

1.6

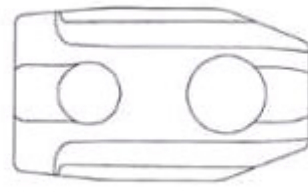

1.7

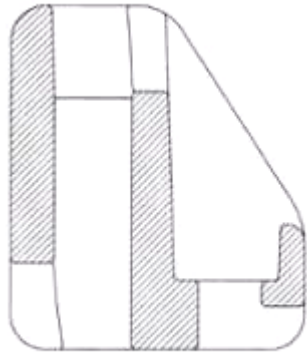

1.8



1.9

CÔNG BÁO SỞ HỮU CÔNG NGHIỆP SỐ 404 TẬP A – QUYỀN 2 (11.2021)

(11) **42993**

(21) 3-2021-01437

(28) 3

(54) **BỘ GHẾ SÔ-PHA**

(51) **06-01**

(22) 03/06/2021

(43) 25/11/2021

(73) **CÔNG TY CỔ PHẦN KIẾN TRÚC NỘI THẤT ĐỒNG GIA (VN)**

Số 66 Thượng Thanh, phường Thượng Thanh, quận Long Biên, thành phố Hà Nội

(72) Đồng Minh Hậu (VN)

(74) Công ty TNHH Sở hữu trí tuệ HA VIP (HAVIP CO., LTD.)

(55)



1

1.1



1.2



1.3



1.4



1.5



1.6



1.7



2.1



2.2



2.3



2.4



2.5



2.6



2.7

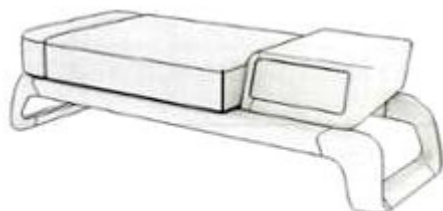

3.1



3.2



3.3



3.4



3.5



3.6



3.7

CÔNG BÁO SỞ HỮU CÔNG NGHIỆP SỐ 404 TẬP A – QUYỀN 2 (11.2021)

- (11) **42994**
(21) 3-2021-01453 (28) 1
(54) **ĐIỀU THUỐC LÁ ĐIỆN TỬ** (51) **27-02**
(22) 04/06/2021 (43) 25/11/2021
(30) 30-2020-0059522 03/12/2020 KR;
(73) **KT & G CORPORATION (KR)**
71, Beotkkot-gil, Daedeok-gu, Daejeon, Korea
(72) KIM, Min Chul (KR)
(74) Công ty TNHH T&T INVENMARK Sở hữu trí tuệ Quốc tế (T&T INVENMARK CO., LTD.)
(55)



1.1



1.2



1.3



1.4



1.5



1.6



1.7



1.8

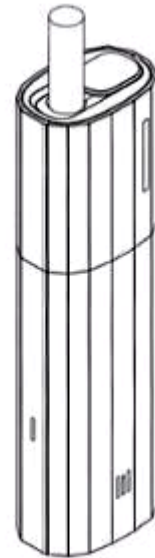

1.9

CÔNG BÁO SỞ HỮU CÔNG NGHIỆP SỐ 404 TẬP A – QUYỀN 2 (11.2021)

(11) **42995**

(21) 3-2021-01455

(28) 1

(54) **LỌ**

(51) **09-01**

(22) 04/06/2021

(43) 25/11/2021

(73) **CÔNG TY CỔ PHẦN TẬP ĐOÀN THIÊN LONG (VN)**

Lô 6-8-10-12 đường số 3, khu công nghiệp Tân Tạo, quận Bình Tân, thành phố Hồ Chí Minh

(72) Cô Gia Thọ (VN)

(74) Công ty TNHH Tư vấn sở hữu trí tuệ Việt (VIET IP CO.,LTD.)

(55)

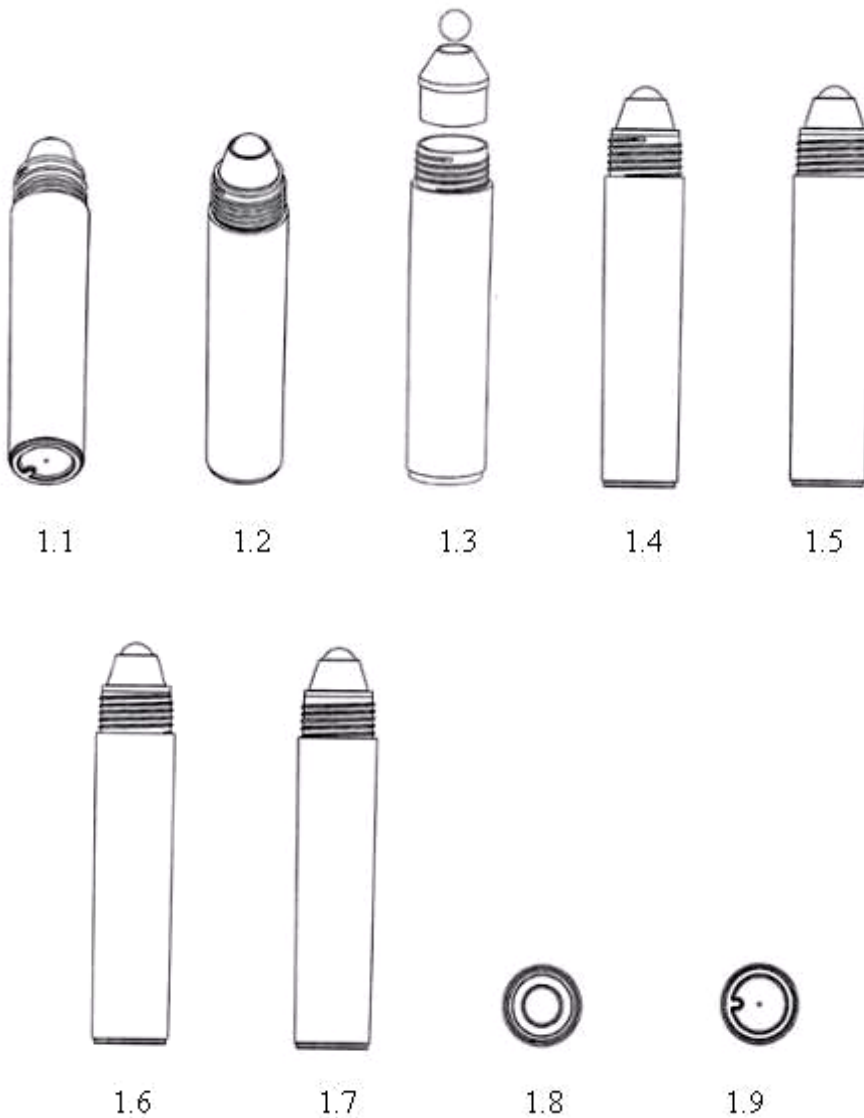

- (11) **42996**
(21) 3-2021-01488 (28) 5
(54) **CHAI** (51) **09-01**
(22) 08/06/2021 (43) 25/11/2021
(73) **SOCIÉTÉ DES PRODUITS NESTLÉ S.A. (CH)**
1800 Vevey, Switzerland
(72) **PHẠM BẢO THẮNG (VN)**
(74) Công ty TNHH Ban Ca (BANCA)
(55)



1.1



1.2



1.3



1.4



1.5

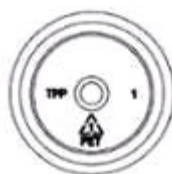

1.6

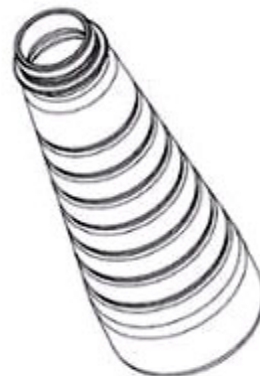

1.7



2.1



2.2



2.3



2.4



2.5



2.6

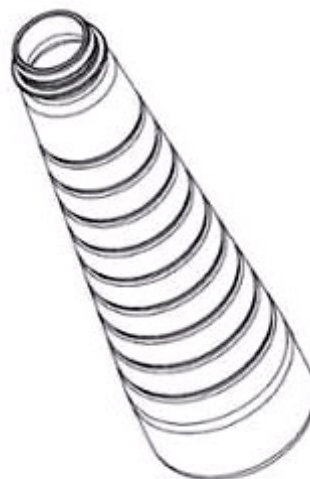

2.7



3.1



3.2



3.3



3.4



3.5



3.6

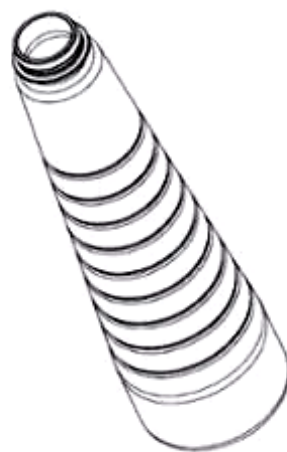

3.7



4.1



4.2



4.3



4.4



4.5



4.6

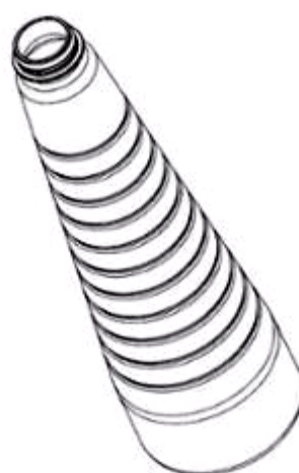

4.7



5.1



5.2



5.3



5.4



5.5



5.6



5.7

(11) **42997**

(21) 3-2021-01491

(28) 1

(54) **KÈ VÒM**

(51) **25-02**

(22) 09/06/2021

(43) 25/11/2021

(73) **CÔNG TY CỔ PHẦN KHOA HỌC CÔNG NGHỆ VIỆT NAM (VN)**

Số 6 đường 3 tháng 2, phường 8, thành phố Vũng Tàu, tỉnh Bà Rịa - Vũng Tàu

(72) Hoàng Đức Thảo (VN)

(55)

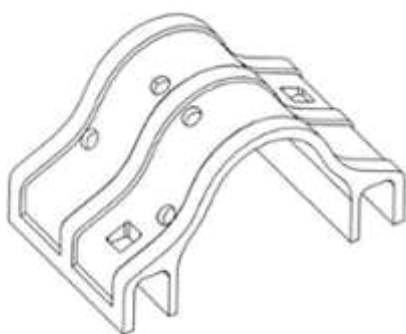

1.1



1.2



1.3



1.4



1.5

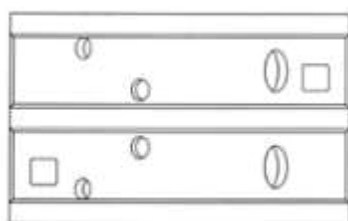

1.6

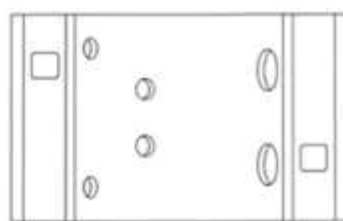

1.7

(11) **42998**

(21) 3-2021-01493

(28) 1

(54) **KÈ VÒM**

(51) **25-02**

(22) 09/06/2021

(43) 25/11/2021

(73) **CÔNG TY CỔ PHẦN KHOA HỌC CÔNG NGHỆ VIỆT NAM (VN)**

Số 6 đường 3 tháng 2, phường 8, thành phố Vũng Tàu, tỉnh Bà Rịa - Vũng Tàu

(72) Hoàng Đức Thảo (VN)

(55)

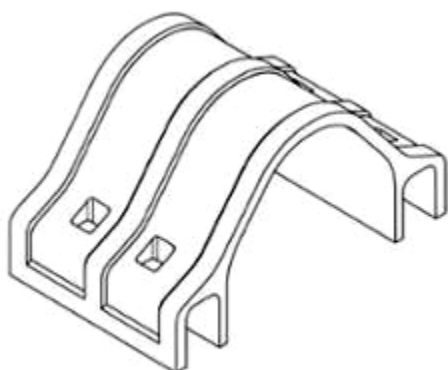

1.1



1.2



1.3

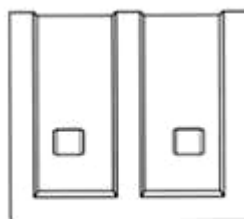

1.4

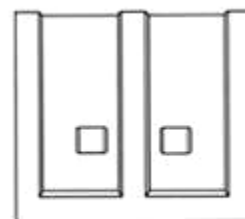

1.5

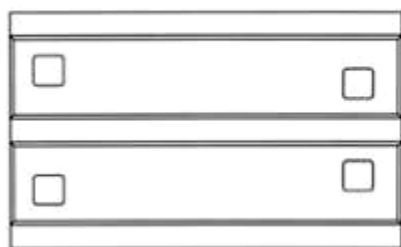

1.6



1.7

(11) **42999**

(21) 3-2021-01494

(28) 1

(54) **KÈ VÒM**

(51) **25-02**

(22) 09/06/2021

(43) 25/11/2021

(73) **CÔNG TY CỔ PHẦN KHOA HỌC CÔNG NGHỆ VIỆT NAM (VN)**

Số 6 đường 3 tháng 2, phường 8, thành phố Vũng Tàu, tỉnh Bà Rịa Vũng Tàu

(72) Hoàng Đức Thảo (VN)

(55)

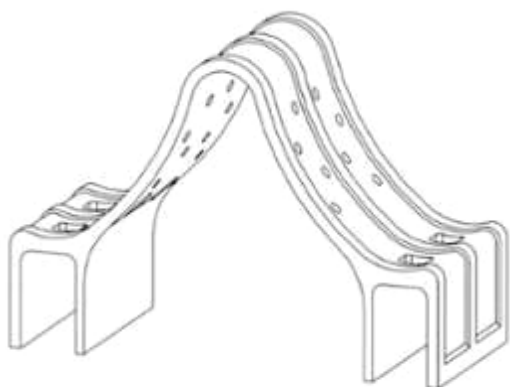

1.1



1.2



1.3



1.4

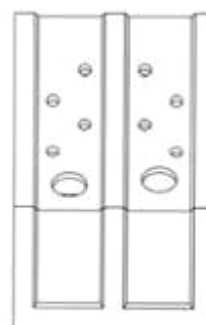

1.5

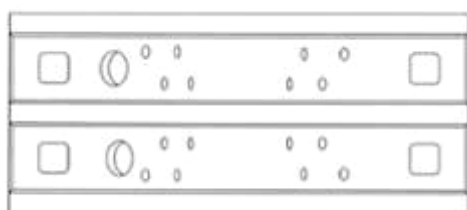

1.6

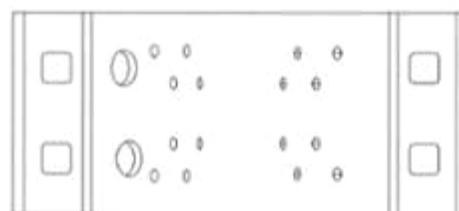

1.7

(11) **43000**

(21) 3-2021-01505

(28) 1

(54) **CHÂN CHẬU RỬA**

(51) **23-02**

(22) 10/06/2021

(43) 25/11/2021

(73) **CÔNG TY TNHH TOKO ASIA (VN)**

Thôn Tạ Hạ, xã Chính Nghĩa, huyện Kim Động, tỉnh Hưng Yên

(72) **NGUYỄN HÙNG ANH (VN)**

(55)



1.1



1.2



1.3

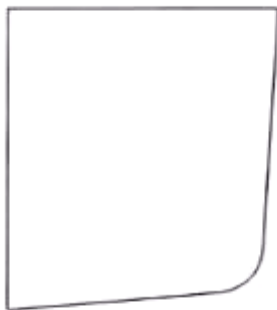

1.4

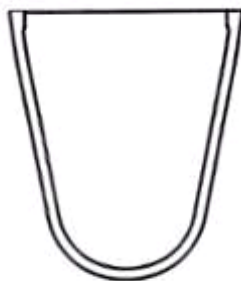

1.5



1.6

(11) **43001**

(21) 3-2021-01506

(28) 1

(54) **CHẬU RỬA**

(51) **23-02**

(22) 10/06/2021

(43) 25/11/2021

(73) **CÔNG TY TNHH TOKO ASIA (VN)**

Thôn Tạ Hạ, xã Chính Nghĩa, huyện Kim Động, tỉnh Hưng Yên

(72) **NGUYỄN HÙNG ANH (VN)**

(55)

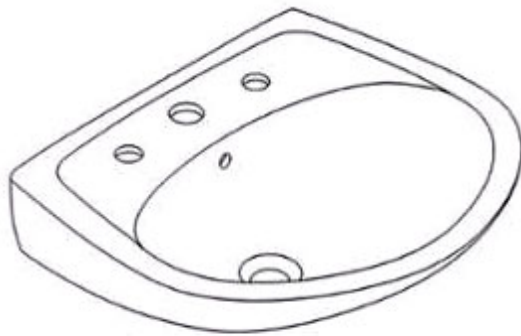

1.1



1.2

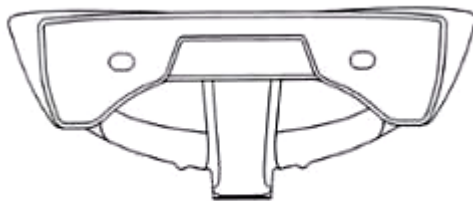

1.3

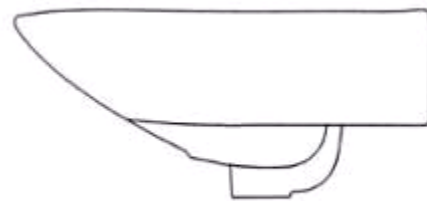

1.4

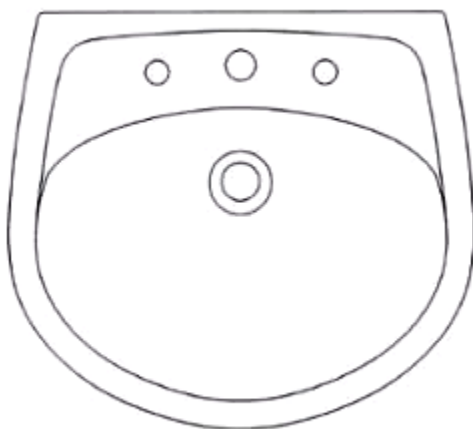

1.5

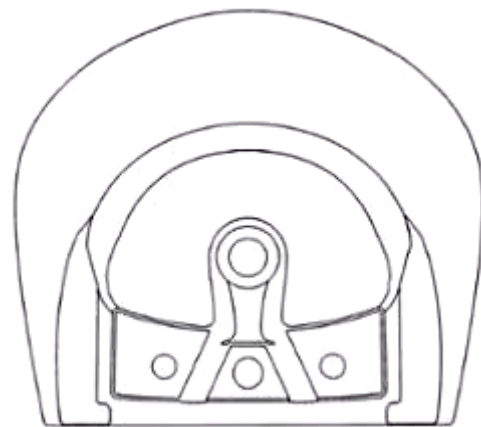

1.6

(11) **43002**

(21) 3-2021-01507

(28) 1

(54) **CHÂN CHẬU RỬA**

(51) **23-02**

(22) 10/06/2021

(43) 25/11/2021

(73) **CÔNG TY TNHH TOKO ASIA (VN)**

Thôn Tạ Hạ, xã Chính Nghĩa, huyện Kim Động, tỉnh Hưng Yên

(72) NGUYỄN HÙNG ANH (VN)

(55)



1.1



1.2



1.3



1.4



1.5



1.6

(11) **43003**

(21) 3-2021-01510

(28) 1

(54) **KẾT NƯỚC**

(51) **23-02**

(22) 10/06/2021

(43) 25/11/2021

(73) **CÔNG TY TNHH TOKO ASIA (VN)**

Thôn Tạ Hạ, xã Chính Nghĩa, huyện Kim Động, tỉnh Hưng Yên

(72) **NGUYỄN HÙNG ANH (VN)**

(55)

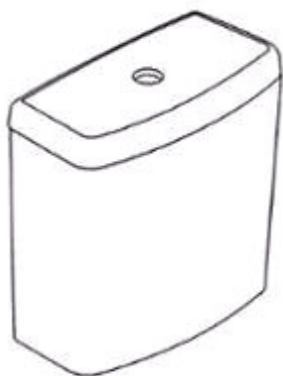

1.1

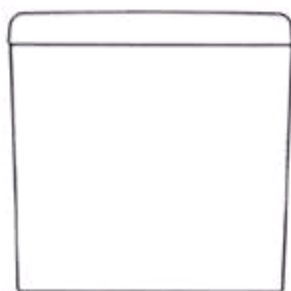

1.2

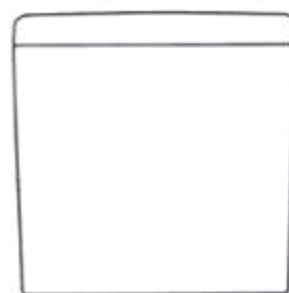

1.3



1.4

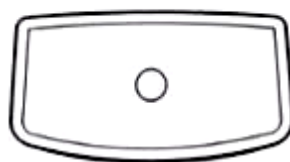

1.5



1.6

CÔNG BÁO SỞ HỮU CÔNG NGHIỆP SỐ 404 TẬP A – QUYỀN 2 (11.2021)

(11) **43004**

(21) 3-2021-01511

(28) 1

(54) **BỒN CẦU**

(51) **23-02**

(22) 10/06/2021

(43) 25/11/2021

(73) **CÔNG TY TNHH TOKO ASIA (VN)**

Thôn Tạ Hạ, xã Chính Nghĩa, huyện Kim Động, tỉnh Hưng Yên

(72) **NGUYỄN HÙNG ANH (VN)**

(55)



1.1

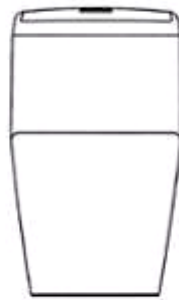

1.2



1.3

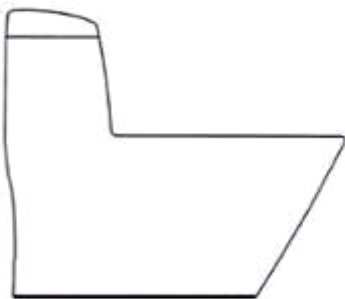

1.4



1.5

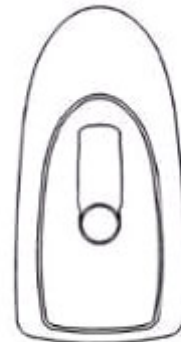

1.6

CÔNG BÁO SỞ HỮU CÔNG NGHIỆP SỐ 404 TẬP A – QUYỀN 2 (11.2021)

(11) **43005**

(21) 3-2021-01512

(28) 1

(54) **BỒN CẦU**

(51) **23-02**

(22) 10/06/2021

(43) 25/11/2021

(73) **CÔNG TY TNHH TOKO ASIA (VN)**

Thôn Tạ Hạ, xã Chính Nghĩa, huyện Kim Động, tỉnh Hưng Yên

(72) **NGUYỄN HÙNG ANH (VN)**

(55)



1.1



1.2

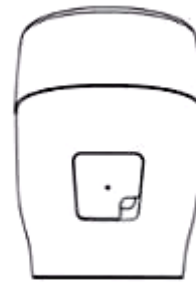

1.3

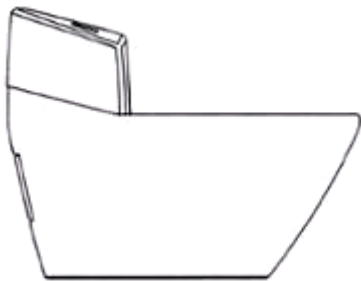

1.4



1.5



1.6

(11) **43006**

(21) 3-2021-01513

(28) 1

(54) **BỒN CẦU**

(51) **23-02**

(22) 10/06/2021

(43) 25/11/2021

(73) **CÔNG TY TNHH TOKO ASIA (VN)**

Thôn Tạ Hạ, xã Chính Nghĩa, huyện Kim Động, tỉnh Hưng Yên

(72) NGUYỄN HÙNG ANH (VN)

(55)



1.1



1.2



1.3

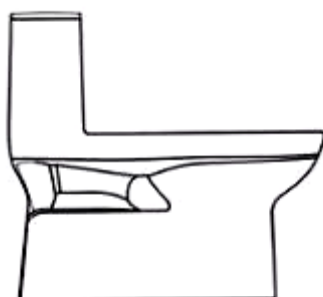

1.4



1.5

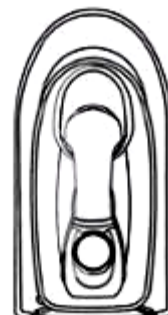

1.6

(11) **43007**

(21) 3-2021-01517

(28) 1

(54) **CÁNH CỬA TỦ LẠNH**

(51) **15-07**

(22) 11/06/2021

(43) 25/11/2021

(73) **CÔNG TY TNHH PANASONIC APPLIANCES VIỆT NAM (VN)**

Lô B6, khu công nghiệp Thăng Long, xã Võng La, huyện Đông Anh, thành phố Hà Nội

(72) 1. ELIE LEE LE QUN (MY)

2. KENTARO TOKURIKI (JP)

3. TAN CHIEN SHIUNG (MY)

(74) Công ty TNHH Sở hữu trí tuệ HA VIP (HAVIP CO., LTD.)

(55)

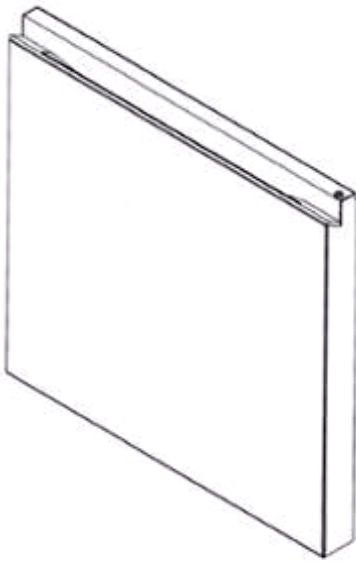

1.1

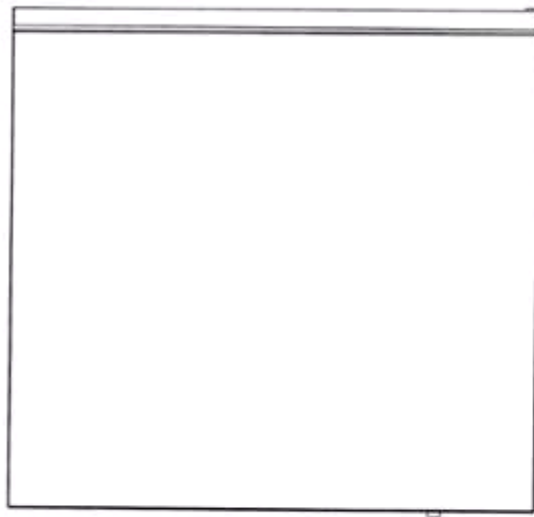

1.2

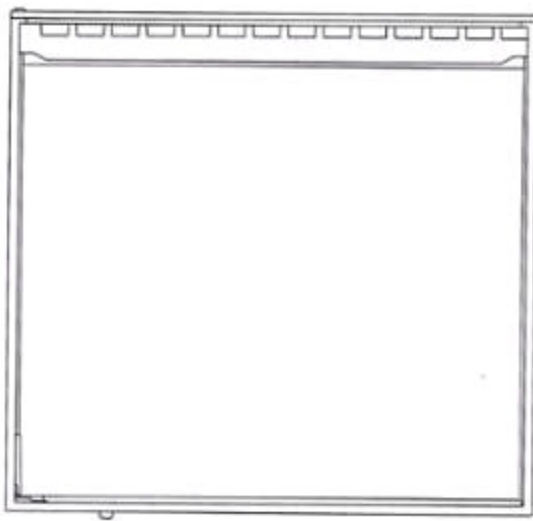

1.3



1.4



1.5

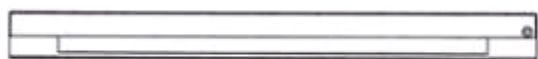

1.6



1.7

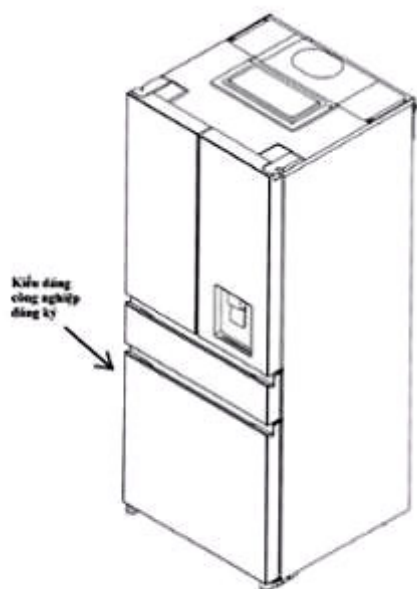

1.8

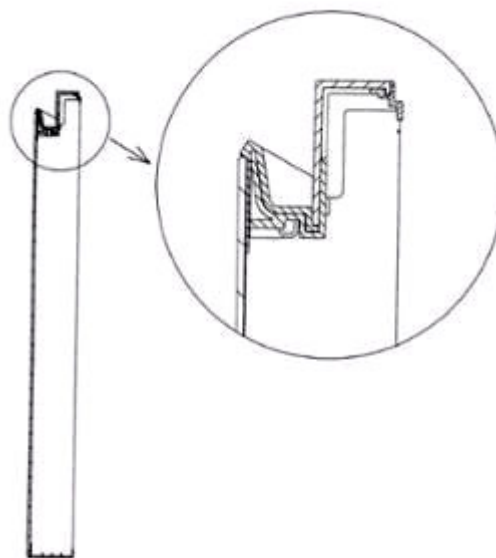

1.9

CÔNG BÁO SỞ HỮU CÔNG NGHIỆP SỐ 404 TẬP A – QUYỀN 2 (11.2021)

(11) **43008**

(21) 3-2021-01519

(28) 1

(54) **TỦ LẠNH**

(51) **15-07**

(22) 11/06/2021

(43) 25/11/2021

(73) **CÔNG TY TNHH PANASONIC APPLIANCES VIỆT NAM (VN)**

Lô B6, khu công nghiệp Thăng Long, xã Võng La, huyện Đông Anh, thành phố Hà Nội

(72) 1. ELIE LEE LE QUN (MY)

2. KENTARO TOKURIKI (JP)

3. TAN CHIEN SHIUNG (MY)

(74) Công ty TNHH Sở hữu trí tuệ HA VIP (HAVIP CO., LTD.)

(55)

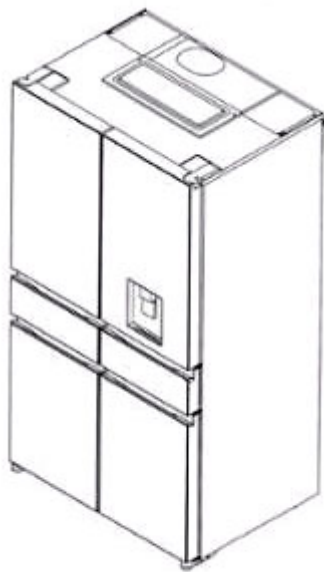

1.1

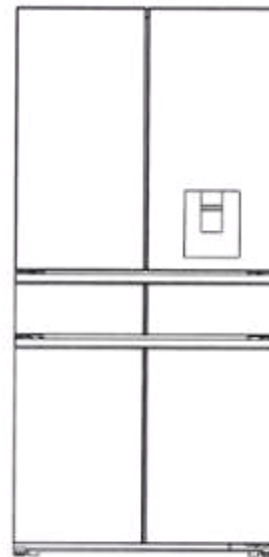

1.2



1.3

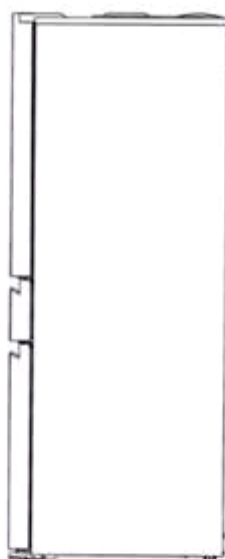

1.4

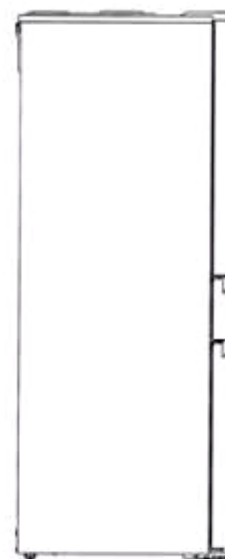

1.5

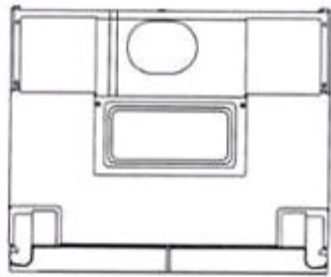

1.6

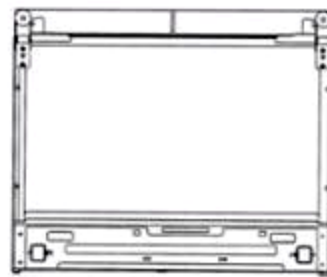

1.7

CÔNG BÁO SỞ HỮU CÔNG NGHIỆP SỐ 404 TẬP A – QUYỀN 2 (11.2021)

(11) **43009**

(21) 3-2021-01537

(28) 1

(54) **BỒN CẦU**

(51) **23-02**

(22) 14/06/2021

(43) 25/11/2021

(73) **CÔNG TY CỔ PHẦN THƯƠNG MẠI VIGLACERA (VN)**

Tầng 1, tòa nhà Viglacera, số 1 Đại lộ Thăng Long, phường Mễ Trì, quận Nam Từ Liêm, thành phố Hà Nội

(72) Nilo Gioacchini (IT)

(55)



1.1



1.2



1.3



1.4



1.6



1.5

CÔNG BÁO SỞ HỮU CÔNG NGHIỆP SỐ 404 TẬP A – QUYỀN 2 (11.2021)

(11) **43010**

(21) 3-2021-01542

(28) 1

(54) **BỒN CẦU**

(51) **23-02**

(22) 14/06/2021

(43) 25/11/2021

(73) **CÔNG TY CỔ PHẦN THƯƠNG MẠI VIGLACERA (VN)**

Tầng 1, tòa nhà Viglacera, số 1 Đại lộ Thăng Long, phường Mỹ Trì, quận Nam Từ Liêm, thành phố Hà Nội

(72) Phạm Ngọc Đường (VN)

(55)



1.1



1.2



1.3



1.4



1.6



1.5

CÔNG BÁO SỞ HỮU CÔNG NGHIỆP SỐ 404 TẬP A – QUYỀN 2 (11.2021)

(11) **43011**

(21) 3-2021-01545

(28) 1

(54) **BỒN CẦU**

(51) **23-02**

(22) 14/06/2021

(43) 25/11/2021

(73) **CÔNG TY CỔ PHẦN THƯƠNG MẠI VIGLACERA (VN)**

Tầng 1, tòa nhà Viglacera, số 1 Đại lộ Thăng Long, phường Mỹ Trì, quận Nam Từ Liêm, thành phố Hà Nội

(72) Phạm Ngọc Đường (VN)

(55)



1.1



1.2



1.3



1.4



1.6



1.5

CÔNG BÁO SỞ HỮU CÔNG NGHIỆP SỐ 404 TẬP A – QUYỀN 2 (11.2021)

- (11) **43012**
(21) 3-2021-01575 (28) 2
(54) **XE ĐIỆN** (51) **12-11**
(22) 17/06/2021 (43) 25/11/2021
(30) 202030781938.8 18/12/2020 CN;
(73) **NINE INTELLIGENT (CHANGZHOU) TECH CO.,LTD. (CN)**
1 xingben road, xinbei district, changzhou city, jiangsu province 213000, China
(72) 1. SHAO, JINBO (CN)
2. CHENG, PENG (CN)
3. LIU, LEI (CN)
4. TANG, JUN (CN)
(74) Công ty TNHH Trường Xuân (AGELESS CO.,LTD.)
(55)



1.1



1.2



1.3



1.4



1.5



1.6

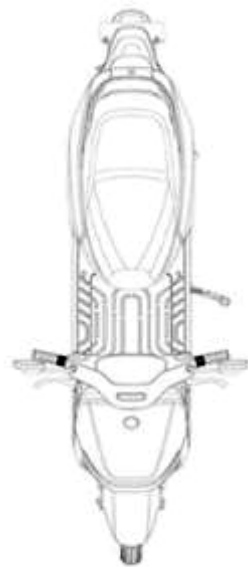

1.7



1.8



2.1



2.2



2.3



2.4



2.5



2.6



2.7



2.8

- (11) **43013**
(21) 3-2021-01606 (28) 1
(54) **BÌNH SỮA** (51) **07-01**
(22) 21/06/2021 (43) 25/11/2021
(30) 2020-027772 23/12/2020 JP;
(73) **PIGEON CORPORATION (JP)**
4-4, Nihonbashi Hisamatsu-cho, Chuo-ku, Tokyo, Japan
(72) 1. TAKANORI OTA (JP)
2. MEGUMI FUJIWARA (JP)
3. SATOSHI KOYAMA (JP)
(74) **CÔNG TY LUẬT TRÁCH NHIỆM HỮU HẠN AMBYS HÀ NỘI (AMBYS HANOI)**
(55)



1.1

1.2

1.3



1.4

1.5

1.6

- (11) **43014**
(21) 3-2021-01607 (28) 1
(54) **NÚM BÌNH SỮA** (51) **07-01**
(22) 21/06/2021 (43) 25/11/2021
(30) 2020-027771 23/12/2020 JP;
(73) **PIGEON CORPORATION (JP)**
4-4, Nihonbashi Hisamatsu-cho, Chuo-ku, Tokyo, Japan
(72) 1. SATORU SAITO (JP)
2. AKIKO MUNEZAWA (JP)
3. MEGUMI FUJIWARA (JP)
4. SATOSHI KOYAMA (JP)
(74) **CÔNG TY LUẬT TRÁCH NHIỆM HỮU HẠN AMBYS HÀ NỘI (AMBYS HANOI)**
(55)



1.1



1.2



1.3



1.4



1.5



1.6

CÔNG BÁO SỞ HỮU CÔNG NGHIỆP SỐ 404 TẬP A – QUYỀN 2 (11.2021)

- (11) **43015**
(21) 3-2021-01633 (28) 1
(54) **BỒN TỰ HOẠI** (51) **23-99**
(22) 22/06/2021 (43) 25/11/2021
(73) **NGUYỄN DOÃN THIỆU (VN)**
113 Thống Nhất, thị Trấn Liên Nghĩa, huyện Đức Trọng, tỉnh Lâm Đồng
(72) Nguyễn Doãn Thiệu (VN)
(55)



1.1



1.2



1.3



1.4



1.5



1.6



1.7

- (11) **43016**
(21) 3-2021-01636 (28) 2
(54) **CẤU KIỆN KÈ LẤP GHÉP** (51) **25-02**
(22) 23/06/2021 (43) 25/11/2021
(73) **CÔNG TY CỔ PHẦN KHOA HỌC CÔNG NGHỆ VIỆT NAM (VN)**
Số 6 đường 3 tháng 2, phường 8, thành phố Vũng Tàu, tỉnh Bà Rịa - Vũng Tàu
(72) Hoàng Đức Thảo (VN)
(55)

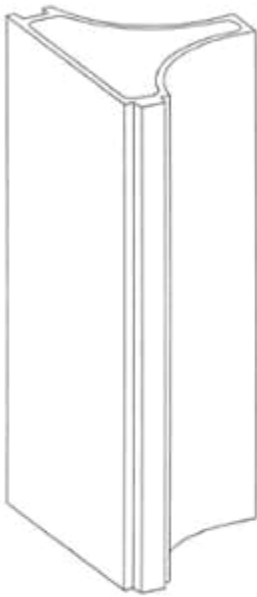

1.1



1.2



1.3



1.4



1.5

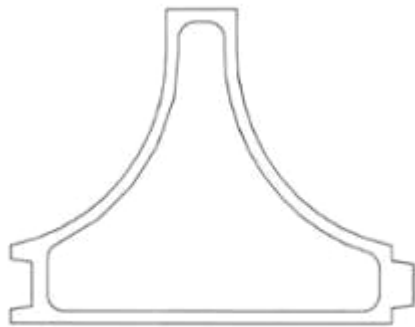

1.6

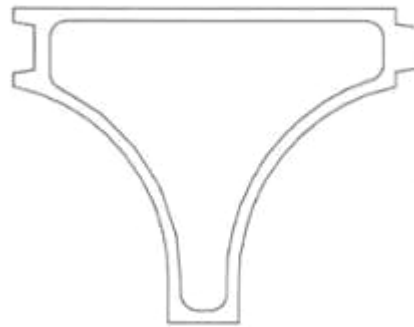

1.7

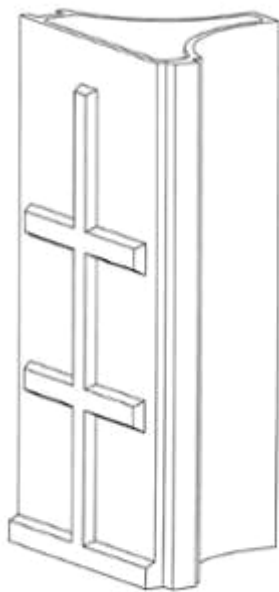

2.1

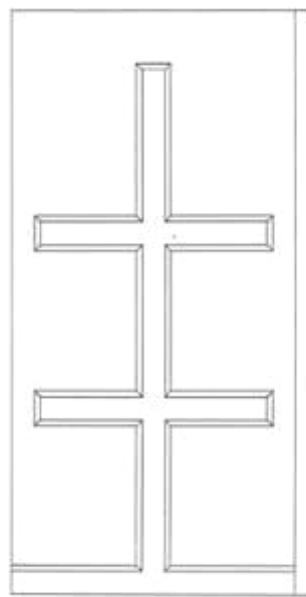

2.2

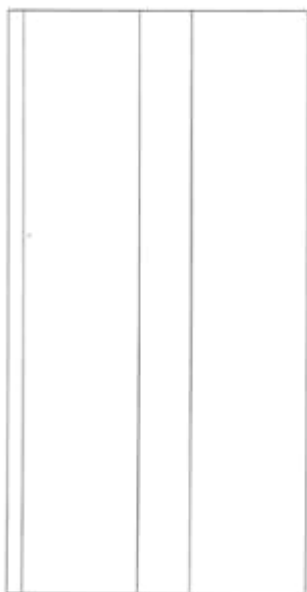

2.3

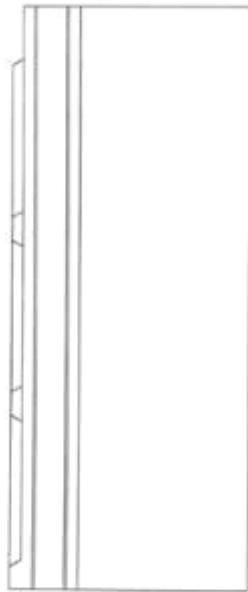

2.4



2.5

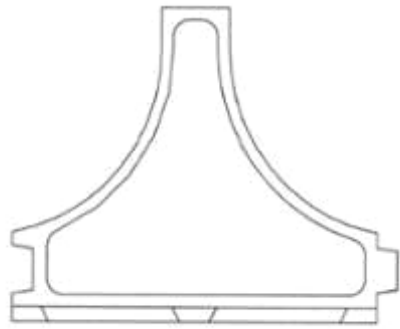

2.6

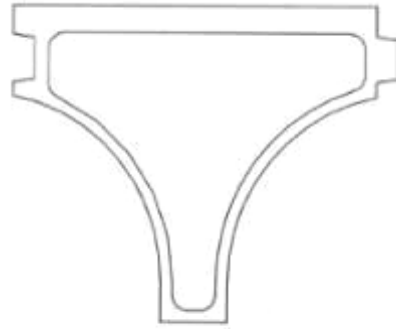

2.7

(11) **43017**

(21) 3-2021-01638

(28) 1

(54) **TẤM KIM LOẠI**

(51) **15-99**

(22) 23/06/2021

(43) 25/11/2021

(73) 1. **ĐẠI HỌC QUỐC GIA THÀNH PHỐ HỒ CHÍ MINH (VN)**

phường Linh Trung, thành phố Thủ Đức, thành phố Hồ Chí Minh

2. **TRƯỜNG ĐẠI HỌC BÁCH KHOA - ĐẠI HỌC QUỐC GIA THÀNH PHỐ HỒ CHÍ MINH (VN)**

268 Lý Thường Kiệt, phường 14, quận 10, thành phố Hồ Chí Minh

(72) 1. **LÊ TẤT HIÊN (VN)**

2. **NGUYỄN DUY ANH (VN)**

(55)

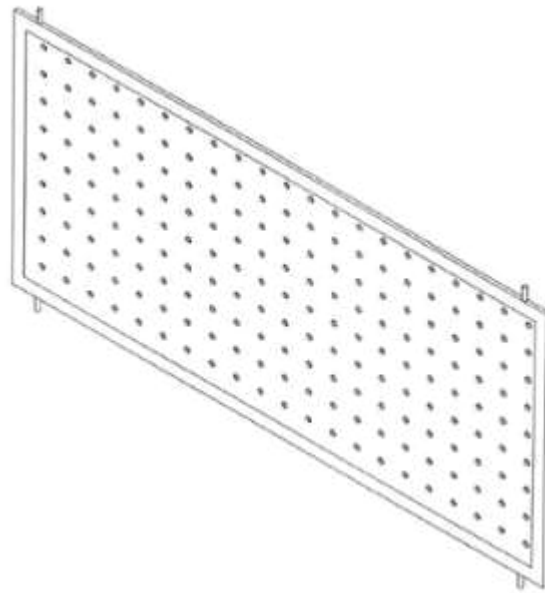

1.1



1.2



1.3

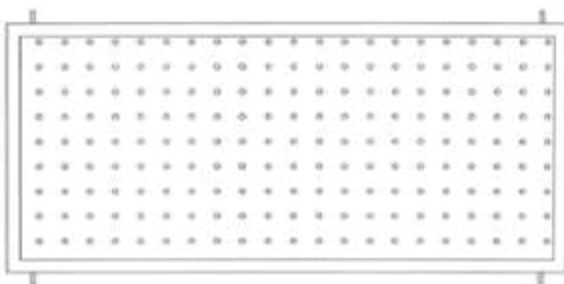

1.4

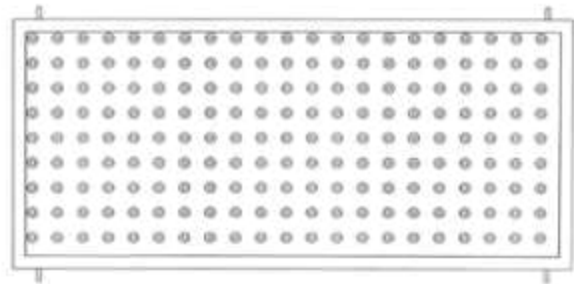

1.5

CÔNG BÁO SỞ HỮU CÔNG NGHIỆP SỐ 404 TẬP A – QUYỀN 2 (11.2021)

(11) **43018**

(21) 3-2021-01639

(28) 1

(54) **THANH KHUNG TRẦN NHÀ**

(51) **25-01**

(22) 23/06/2021

(43) 25/11/2021

(73) **CÔNG TY CỔ PHẦN CÔNG NGHIỆP VĨNH TUỜNG (VN)**

Lô C23a, Khu công nghiệp Hiệp Phước, xã Hiệp Phước, huyện Nhà Bè, Thành phố Hồ Chí Minh

(72) 1. NGUYỄN TRUNG KIÊN (VN)

2. HUỖNH HIẾU LIÊM (VN)

(74) Văn phòng Luật sư A Hoà (AHOA LAW OFFICE)

(55)



1.1



1.2



1.3



1.4



1.5



1.6



1.7

- (11) **43019**
(21) 3-2021-01648 (28) 3
(54) **BÌNH CHỨA** (51) **09-01**
(22) 23/06/2021 (43) 25/11/2021
(30) 29/763,813 24/12/2020 US;
(73) **UNILEVER GLOBAL IP LIMITED (GB)**
Port Sunlight, Wirral, Merseyside, CH62 4ZD, United Kingdom
(72) 1. WEIR CHRISTOPHER PAUL (GB)
2. HANSEN NATASCHA DIWANI (DK)
3. KING JAMIE MARK (GB)
4. PEAKE JESSICA FRANCES SOPHIA (GB)
(74) Công ty TNHH Trần Hữu Nam và Đồng sự (TRAN H.N & ASS.)
(55)

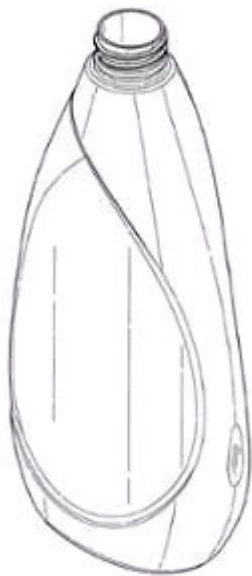

1.1

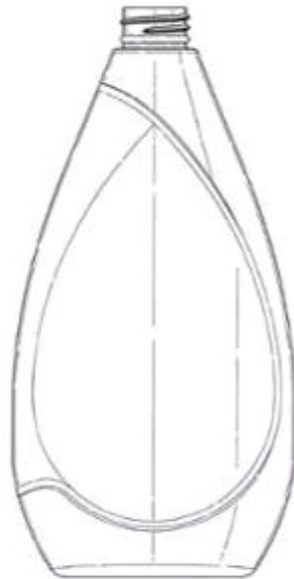

1.2

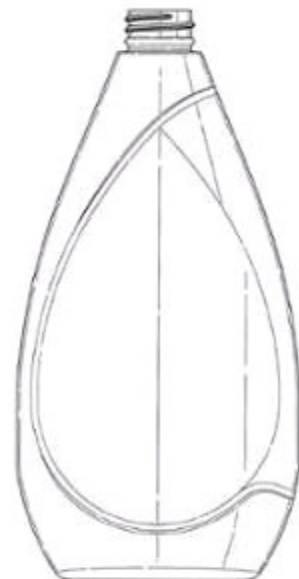

1.3



1.4



1.5

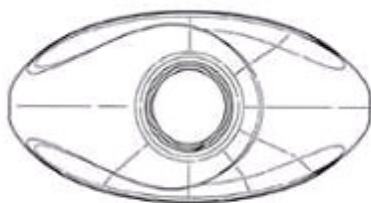

1.6

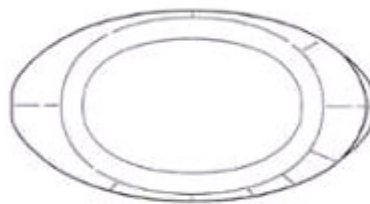

1.7



2.1

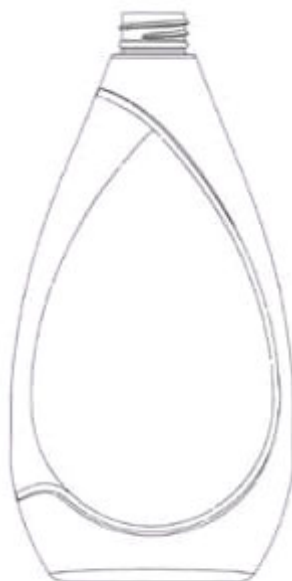

2.2

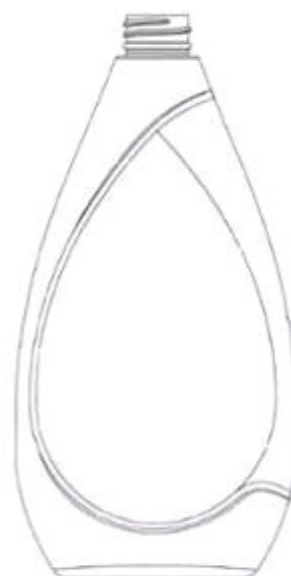

2.3



2.4



2.5



2.6

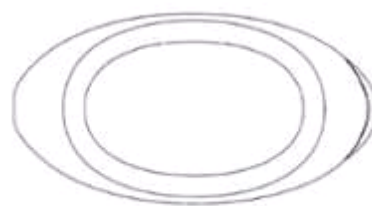

2.7

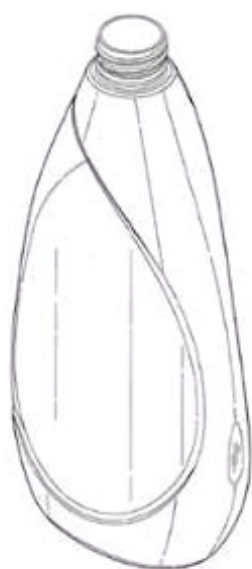

3.1

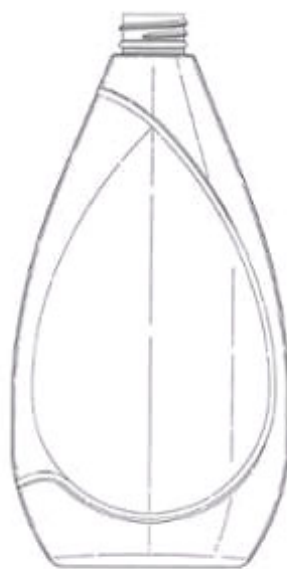

3.2

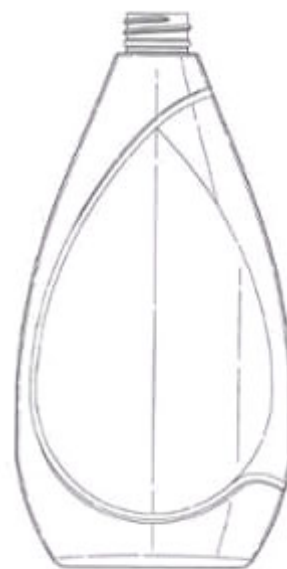

3.3



3.4



3.5

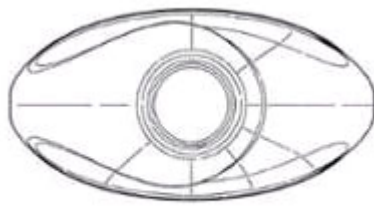

3.6

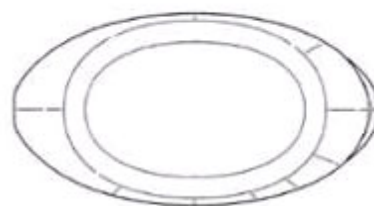

3.7

CÔNG BÁO SỞ HỮU CÔNG NGHIỆP SỐ 404 TẬP A – QUYỀN 2 (11.2021)

- (11) **43020**
(21) 3-2021-01688 (28) 1
(54) **MÁY DÒ KIM** (51) **10-05**
(22) 25/06/2021 (43) 25/11/2021
(73) **HASHIMA CO., LTD. (JP)**
3-18, Higashi Kinpo-cho, Gifu-City, Gifu, Japan
(72) OTSUKA, Masayuki (JP)
(74) Công ty TNHH Tầm nhìn và Liên danh (VISION & ASSOCIATES CO.LTD.)
(55)



1.1

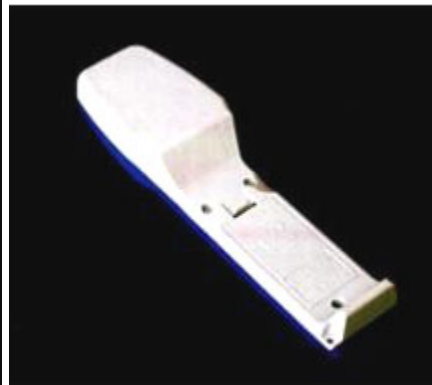

1.2



1.3



1.4



1.5

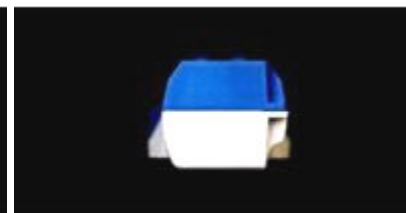

1.6



1.7



1.8

CÔNG BÁO SỞ HỮU CÔNG NGHIỆP SỐ 404 TẬP A – QUYỀN 2 (11.2021)

- (11) **43021**
(21) 3-2021-01689 (28) 1
(54) **MÁY DÒ KIM** (51) **10-05**
(22) 25/06/2021 (43) 25/11/2021
(30) 2021-005583 18/03/2021 JP;
(73) **HASHIMA CO., LTD.** (JP)
3-18, Higashi Kinpo-cho, Gifu-City, Gifu, Japan
(72) OTSUKA, Masayuki (JP)
(74) Công ty TNHH Tầm nhìn và Liên danh (VISION & ASSOCIATES CO.LTD.)
(55)



1.1



1.2



1.3



1.4



1.5



1.6



1.7

CÔNG BÁO SỞ HỮU CÔNG NGHIỆP SỐ 404 TẬP A – QUYỀN 2 (11.2021)

- (11) **43022**
(21) 3-2021-01691 (28) 2
(54) **THANH KIM LOẠI ĐỊNH HÌNH** (51) **25-01**
(22) 25/06/2021 (43) 25/11/2021
(73) **CÔNG TY CỔ PHẦN CÔNG NGHIỆP VẠN PHÁT HƯNG (VN)**
Lô R1A, đường số 6 khu công nghiệp Long Hậu, xã Long Hậu, huyện Cần Giuộc,
tỉnh Long An
(72) **NGÔ THỊ HUỆ (VN)**
(74) Công ty Cổ phần PHANLAW VIETNAM (PHANLAW VIETNAM JSC)
(55)



1.1



1.2



1.3



1.4



1.5



1.6



1.7

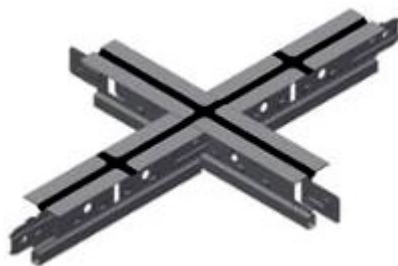

1.8



1.9



2.1



2.2



2.3



2.4



2.5



2.6



2.7



2.8

- (11) **43023**
(21) 3-2021-01692 (28) 1
(54) **THANH KIM LOẠI ĐỊNH HÌNH** (51) **25-01**
(22) 25/06/2021 (43) 25/11/2021
(73) **CÔNG TY CỔ PHẦN CÔNG NGHIỆP VẠN PHÁT HƯNG (VN)**
Lô R1A, đường số 6 khu công nghiệp Long Hậu, xã Long Hậu, huyện Cần Giuộc,
tỉnh Long An
(72) **NGÔ THỊ HUỆ (VN)**
(74) Công ty Cổ phần PHANLAW VIETNAM (PHANLAW VIETNAM JSC)
(55)



1.1



1.2



1.3



1.4



1.5



1.6



1.7



1.8

CÔNG BÁO SỞ HỮU CÔNG NGHIỆP SỐ 404 TẬP A – QUYỀN 2 (11.2021)

- (11) **43024**
(21) 3-2021-01693 (28) 2
(54) **THANH KIM LOẠI ĐỊNH HÌNH** (51) **25-01**
(22) 25/06/2021 (43) 25/11/2021
(73) **CÔNG TY CỔ PHẦN CÔNG NGHIỆP VẠN PHÁT HƯNG (VN)**
Lô R1A, đường số 6 khu công nghiệp Long Hậu, xã Long Hậu, huyện Cần Giuộc,
tỉnh Long An
(72) **NGÔ THỊ HUỆ (VN)**
(74) Công ty Cổ phần PHANLAW VIETNAM (PHANLAW VIETNAM JSC)
(55)



1.1



1.2



1.3



1.4



1.5



1.6



1.7



1.8



1.9



2.1



2.2



2.3



2.4



2.5



2.6



2.7



2.8



2.9



2.10

CÔNG BÁO SỞ HỮU CÔNG NGHIỆP SỐ 404 TẬP A – QUYỀN 2 (11.2021)

- (11) **43025**
(21) 3-2021-01695 (28) 1
(54) **THANH KIM LOẠI ĐỊNH HÌNH** (51) **25-01**
(22) 25/06/2021 (43) 25/11/2021
(73) **CÔNG TY CỔ PHẦN CÔNG NGHIỆP VẠN PHÁT HƯNG (VN)**
Lô R1A, đường số 6 khu công nghiệp Long Hậu, xã Long Hậu, huyện Cần Giuộc,
tỉnh Long An
(72) **NGÔ THỊ HUỆ (VN)**
(74) Công ty Cổ phần PHANLAW VIETNAM (PHANLAW VIETNAM JSC)
(55)



1.1



1.2



1.3



1.4



1.5



1.6



1.7



1.8

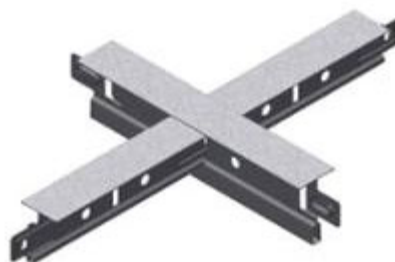

1.9

CÔNG BÁO SỞ HỮU CÔNG NGHIỆP SỐ 404 TẬP A – QUYỀN 2 (11.2021)

- (11) **43026**
(21) 3-2021-01696 (28) 2
(54) **THANH KIM LOẠI ĐỊNH HÌNH** (51) **25-01**
(22) 25/06/2021 (43) 25/11/2021
(73) **CÔNG TY CỔ PHẦN CÔNG NGHIỆP VẠN PHÁT HƯNG (VN)**
Lô R1A, đường số 6 khu công nghiệp Long Hậu, xã Long Hậu, huyện Cần Giuộc,
tỉnh Long An
(72) **NGÔ THỊ HUỆ (VN)**
(74) Công ty Cổ phần PHANLAW VIETNAM (PHANLAW VIETNAM JSC)
(55)



1.1



1.2



1.3



1.4



1.5



1.6



1.7



1.8



1.9



2.1



2.2



2.3



2.4



2.5



2.6



2.7



2.8



2.9



2.10

CÔNG BÁO SỞ HỮU CÔNG NGHIỆP SỐ 404 TẬP A – QUYỀN 2 (11.2021)

- (11) **43027**
(21) 3-2021-01697 (28) 1
(54) **THANH KIM LOẠI ĐỊNH HÌNH** (51) **25-01**
(22) 25/06/2021 (43) 25/11/2021
(73) **CÔNG TY CỔ PHẦN CÔNG NGHIỆP VẠN PHÁT HƯNG (VN)**
Lô R1A, đường số 6 khu công nghiệp Long Hậu, xã Long Hậu, huyện Cần Giuộc,
tỉnh Long An
(72) **NGÔ THỊ HUỆ (VN)**
(74) Công ty Cổ phần PHANLAW VIETNAM (PHANLAW VIETNAM JSC)
(55)



1.1



1.2



1.3



1.4



1.5



1.6



1.7



1.8



1.9

- (11) **43028**
(21) 3-2021-01783 (28) 1
(54) **KHUNG DỪNG CHO TẮM CHẨN MẶT** (51) **29-02**
(22) 07/07/2021 (43) 25/11/2021
(30) 2021-003925 25/02/2021 JP;
(73) **PLUS CORPORATION (JP)**
1-28, Toranomom 4-chome, Minato-ku, Tokyo, JAPAN
(72) 1. KATA UEYA (JP)
2. AKIKO TANAKA (JP)
3. HAYATO HORIE (JP)
(74) Công ty Luật TNHH Phạm và Liên danh (PHAM & ASSOCIATES)
(55)



1.1



1.2



1.3



1.4



1.5



1.6



1.7



1.8

- (11) **43029**
(21) 3-2021-01784 (28) 1
(54) **DỤNG CỤ LÀM ƯỚT ĐẦU NGÓN TAY** (51) **19-99**
(22) 07/07/2021 (43) 25/11/2021
(30) 2021-001793 28/01/2021 JP;
(73) **PLUS CORPORATION (JP)**
1-28, Toranomom 4-chome, Minato-ku, Tokyo, JAPAN
(72) 1. MARIKA YAMAMORI (JP)
2. YASUHIRO YAMAMOTO (JP)
3. HAYATO HORIE (JP)
(74) Công ty Luật TNHH Phạm và Liên danh (PHAM & ASSOCIATES)
(55)



1.1

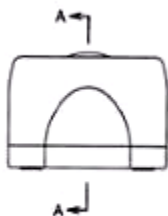

1.2



1.3



1.4



1.5



1.6



1.7

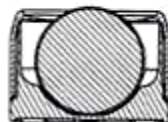

1.8

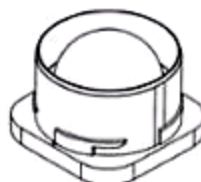

1.9

- (11) **43030**
(21) 3-2021-01788 (28) 1
(54) **THIẾT BỊ DÒ ÂM THANH** (51) **10-05**
(22) 07/07/2021 (43) 25/11/2021
(30) 2021-000486 12/01/2021 JP;
(73) **ELECOM CO., LTD.** (JP)
1-1, Fushimi-machi 4-chome, Chuo-ku, Osaka-shi, Osaka, Japan
(72) 1. KEITA SATO (JP)
2. OSAMU IWAMOTO (JP)
3. TAKEHIRO KANEKO (JP)
4. RYOSUKE HIROHATA (JP)
(74) Công ty TNHH Sở hữu trí tuệ HA VIP (HAVIP CO., LTD.)
(55)

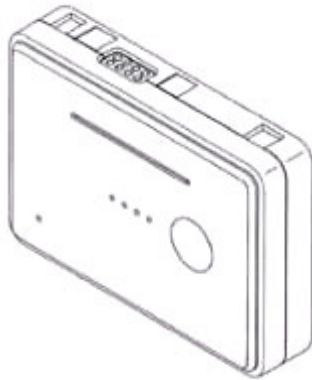

1.1



1.2

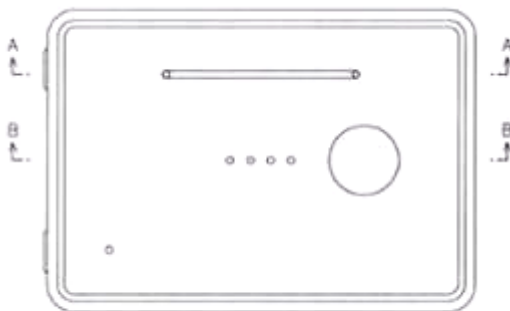

1.3

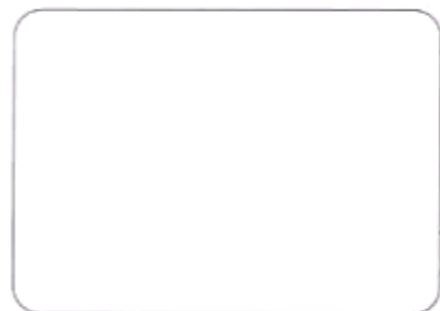

1.4

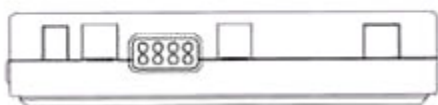

1.5



1.6



1.7



1.8

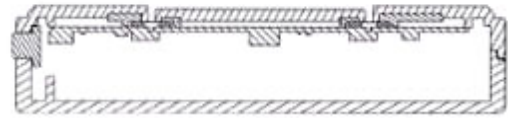

1.9

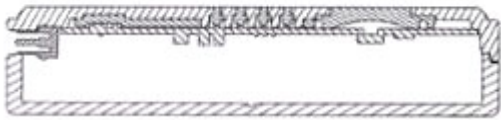

1.10

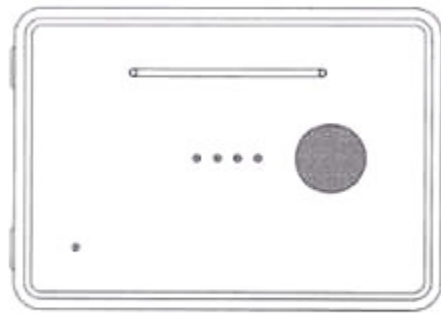

1.11

CÔNG BÁO SỞ HỮU CÔNG NGHIỆP SỐ 404 TẬP A – QUYỀN 2 (11.2021)

- (11) **43031**
(21) 3-2021-01820 (28) 1
(54) **CHAI** (51) **09-01**
(22) 13/07/2021 (43) 25/11/2021
(73) **CÔNG TY TNHH DẦU NHỚT TỐT (VN)**
50/64 Lê Thị Hồng, phường 17, quận Gò Vấp, thành phố Hồ Chí Minh
(72) Nguyễn Đức Hùng (VN)
(55)



1.1



1.2



1.3



1.4



1.5



1.6

CÔNG BÁO SỞ HỮU CÔNG NGHIỆP SỐ 404 TẬP A – QUYỀN 2 (11.2021)

- (11) **43032**
(21) 3-2021-01821 (28) 1
(54) **CHAI** (51) **09-01**
(22) 13/07/2021 (43) 25/11/2021
(73) **CÔNG TY TNHH DẦU NHỚT TỐT (VN)**
50/64 Lê Thị Hồng, phường 17, quận Gò Vấp, thành phố Hồ Chí Minh
(72) Nguyễn Đức Hùng (VN)
(55)



1.1



1.2



1.3



1.4



1.5



1.6

(11) **43033**

(21) 3-2021-01837

(28) 1

(54) **CHẢO**

(51) **07-02**

(22) 15/07/2021

(43) 25/11/2021

(73) **DR. HOWS CO., LTD. (KR)**

97, Neunggil-ro, Danwon-gu, Ansan-si, Gyeonggi-do 15420 Republic of Korea

(72) LEE, Myeong Jae (KR)

(74) **CÔNG TY LUẬT TRÁCH NHIỆM HỮU HẠN AMBYS HÀ NỘI (AMBYS HANOI)**

(55)

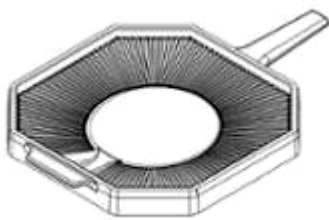

1.1

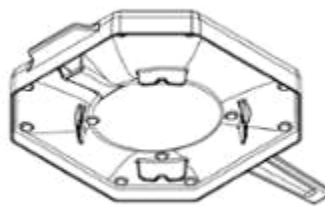

1.2



1.3



1.4



1.5



1.6

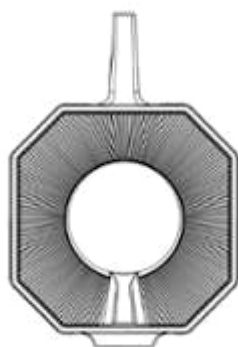

1.7

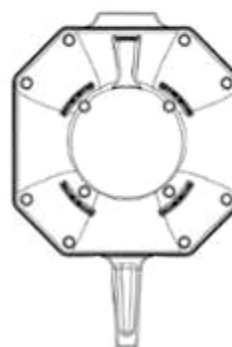

1.8

CÔNG BÁO SỞ HỮU CÔNG NGHIỆP SỐ 404 TẬP A – QUYỀN 2 (11.2021)

- (11) **43034**
(21) 3-2021-01839 (28) 1
(54) **MÁY ĐIỀU KHIỂN PHUN CHÍNH XÁC CHẤT LỎNG** (51) **15-99**
(22) 15/07/2021 (43) 25/11/2021
(30) 2021-000946 19/01/2021 JP;
(73) **MUSASHI ENGINEERING, INC. (JP)**
1-11-6, Iguchi, Mitaka-shi, Tokyo, Japan
(72) Kazumasa Ikushima (JP)
(74) Công ty Luật TNHH ROUSE Việt Nam (ROUSE LAW CO.,LTD)
(55)

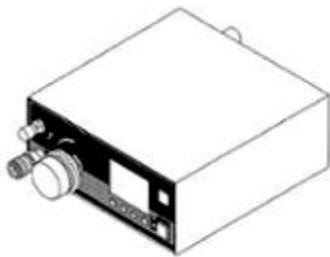

1.1



1.2



1.3



1.4



1.5



1.6

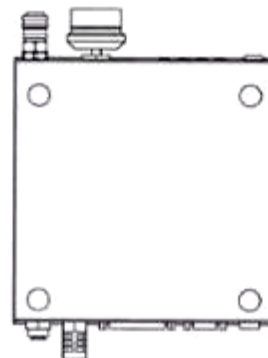

1.7

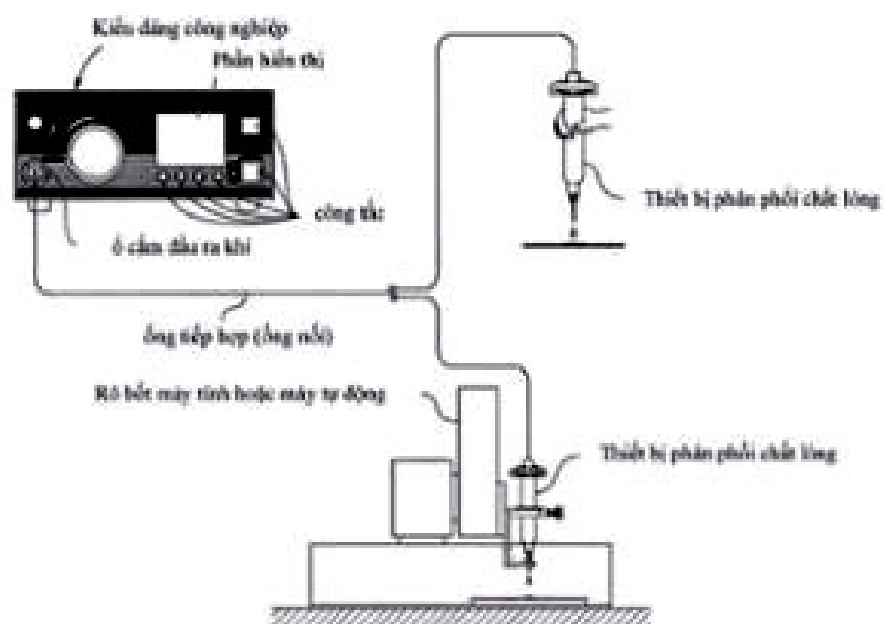

1.8

- (11) **43035**
(21) 3-2021-01867 (28) 1
(54) **BAO BÌ HẠT GIỐNG** (51) **09-05**
(22) 19/07/2021 (43) 25/11/2021
(73) **CÔNG TY CỔ PHẦN TẬP ĐOÀN GIỐNG CÂY TRỒNG VIỆT NAM (VN)**
Số 1 Lương Đình Cửa, phường Phương Mai, quận Đống Đa, thành phố Hà Nội
(72) Trần Kim Liên (VN)
(55)



1.1

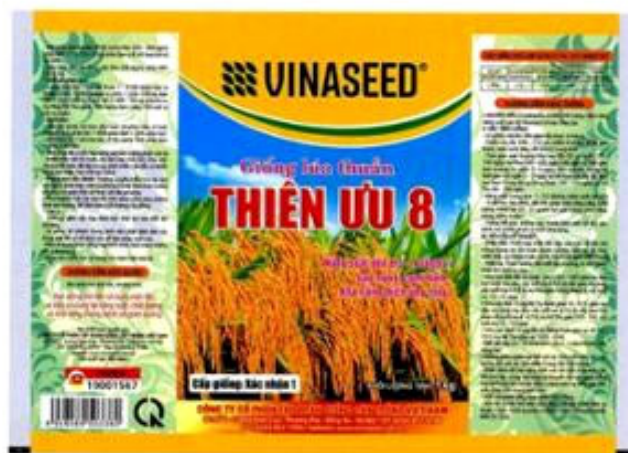

1.2

- (11) **43036**
(21) 3-2021-01868 (28) 1
(54) **BAO BÌ HẠT GIỐNG** (51) **09-05**
(22) 19/07/2021 (43) 25/11/2021
(73) **CÔNG TY CỔ PHẦN TẬP ĐOÀN GIỐNG CÂY TRỒNG VIỆT NAM (VN)**
Số 1 Lương Đình Cửa, phường Phương Mai, quận Đống Đa, thành phố Hà Nội
(72) Trần Kim Liên (VN)
(55)



1.1



1.2

CÔNG BÁO SỞ HỮU CÔNG NGHIỆP SỐ 404 TẬP A – QUYỂN 2 (11.2021)

- (11) **43037**
(21) 3-2021-01869 (28) 1
(54) **BAO BÌ HẠT GIỐNG** (51) **09-05**
(22) 19/07/2021 (43) 25/11/2021
(73) **CÔNG TY CỔ PHẦN TẬP ĐOÀN GIỐNG CÂY TRỒNG VIỆT NAM (VN)**
Số 1 Lương Đình Cửa, phường Phương Mai, quận Đống Đa, thành phố Hà Nội
(72) Trần Kim Kiên (VN)
(55)



1.1



1.2

CÔNG BÁO SỞ HỮU CÔNG NGHIỆP SỐ 404 TẬP A – QUYỀN 2 (11.2021)

- (11) **43038**
(21) 3-2021-01870 (28) 1
(54) **BAO BÌ HẠT GIỐNG** (51) **09-05**
(22) 19/07/2021 (43) 25/11/2021
(73) **CÔNG TY CỔ PHẦN TẬP ĐOÀN GIỐNG CÂY TRỒNG VIỆT NAM (VN)**
Số 1 Lương Đình Cửa, phường Phương Mai, quận Đống Đa, thành phố Hà Nội
(72) Trần Kim Liên (VN)
(55)



1.1

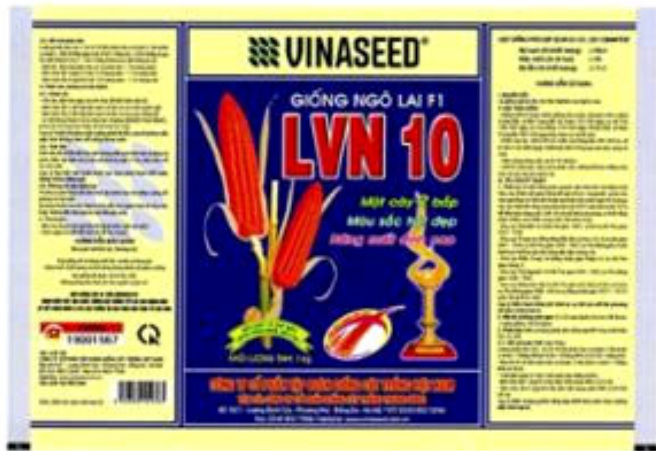

1.2

CÔNG BÁO SỞ HỮU CÔNG NGHIỆP SỐ 404 TẬP A – QUYỀN 2 (11.2021)

- (11) **43039**
(21) 3-2021-01871 (28) 1
(54) **BAO BÌ HẠT GIỐNG** (51) **09-05**
(22) 19/07/2021 (43) 25/11/2021
(73) **CÔNG TY CỔ PHẦN TẬP ĐOÀN GIỐNG CÂY TRỒNG VIỆT NAM (VN)**
Số 1 Lương Đình Cửa, phường Phương Mai, quận Đống Đa, thành phố Hà Nội
(72) Trần Kim Liên (VN)
(55)



1.1



1.2

CÔNG BÁO SỞ HỮU CÔNG NGHIỆP SỐ 404 TẬP A – QUYỀN 2 (11.2021)

- (11) **43040**
(21) 3-2021-01872 (28) 1
(54) **BAO BÌ HẠT GIỐNG** (51) **09-05**
(22) 19/07/2021 (43) 25/11/2021
(73) **CÔNG TY CỔ PHẦN TẬP ĐOÀN GIỐNG CÂY TRỒNG VIỆT NAM (VN)**
Số 1 Lương Đình Cửa, phường Phương Mai, quận Đống Đa, thành phố Hà Nội
(72) Trần Kim Liên (VN)
(55)



1.1



1.2

CÔNG BÁO SỞ HỮU CÔNG NGHIỆP SỐ 404 TẬP A – QUYỀN 2 (11.2021)

- (11) **43041**
(21) 3-2021-01873 (28) 1
(54) **BAO BÌ HẠT GIỐNG** (51) **09-05**
(22) 19/07/2021 (43) 25/11/2021
(73) **CÔNG TY CỔ PHẦN TẬP ĐOÀN GIỐNG CÂY TRỒNG VIỆT NAM (VN)**
Số 1 Lương Đình Cửa, phường Phương Mai, quận Đống Đa, thành phố Hà Nội
(72) Trần Kim Liên (VN)
(55)



1.1



1.2

CÔNG BÁO SỞ HỮU CÔNG NGHIỆP SỐ 404 TẬP A – QUYỀN 2 (11.2021)

- (11) **43042**
(21) 3-2021-01874 (28) 1
(54) **BAO BÌ HẠT GIỐNG** (51) **09-05**
(22) 19/07/2021 (43) 25/11/2021
(73) **CÔNG TY CỔ PHẦN TẬP ĐOÀN GIỐNG CÂY TRỒNG VIỆT NAM (VN)**
Số 1 Lương Đình Cửa, phường Phương Mai, quận Đống Đa, thành phố Hà Nội
(72) Trần Kim Liên (VN)
(55)



1.1



1.2

- (11) **43043**
(21) 3-2021-01875 (28) 1
(54) **BAO BÌ GẠO** (51) **09-05**
(22) 19/07/2021 (43) 25/11/2021
(73) **CÔNG TY CỔ PHẦN TẬP ĐOÀN GIỐNG CÂY TRỒNG VIỆT NAM (VN)**
Số 1 Lương Đình Cửa, phường Phương Mai, quận Đống Đa, thành phố Hà Nội
(72) Trần Kim Liên (VN)
(55)



1.1



1.2

CÔNG BÁO SỞ HỮU CÔNG NGHIỆP SỐ 404 TẬP A – QUYỀN 2 (11.2021)

- (11) **43044**
(21) 3-2021-01876 (28) 1
(54) **HỘP ĐỰNG GẠO** (51) **09-03**
(22) 19/07/2021 (43) 25/11/2021
(73) **CÔNG TY CỔ PHẦN TẬP ĐOÀN GIỐNG CÂY TRỒNG VIỆT NAM (VN)**
Số 1 Lương Đình Cửa, phường Phương Mai, quận Đống Đa, thành phố Hà Nội
(72) Trần Kim Liên (VN)
(55)



1.1



1.2

CÔNG BÁO SỞ HỮU CÔNG NGHIỆP SỐ 404 TẬP A – QUYỀN 2 (11.2021)

- (11) **43045**
(21) 3-2021-01877 (28) 1
(54) **BAO BÌ GẠO** (51) **09-05**
(22) 19/07/2021 (43) 25/11/2021
(73) **CÔNG TY CỔ PHẦN TẬP ĐOÀN GIỐNG CÂY TRỒNG VIỆT NAM (VN)**
Số 1 Lương Đình Cửa, phường Phương Mai, quận Đống Đa, thành phố Hà Nội
(72) Trần Kim Liên (VN)
(55)



1.1



1.2

CÔNG BÁO SỞ HỮU CÔNG NGHIỆP SỐ 404 TẬP A – QUYỀN 2 (11.2021)

- (11) **43046**
(21) 3-2021-01878 (28) 1
(54) **HỘP ĐỰNG GẠO** (51) **09-03**
(22) 19/07/2021 (43) 25/11/2021
(73) **CÔNG TY CỔ PHẦN TẬP ĐOÀN GIỐNG CÂY TRỒNG VIỆT NAM (VN)**
Số 1 Lương Đình Cửa, phường Phương Mai, quận Đống Đa, thành phố Hà Nội
(72) Trần Kim Liên (VN)
(55)

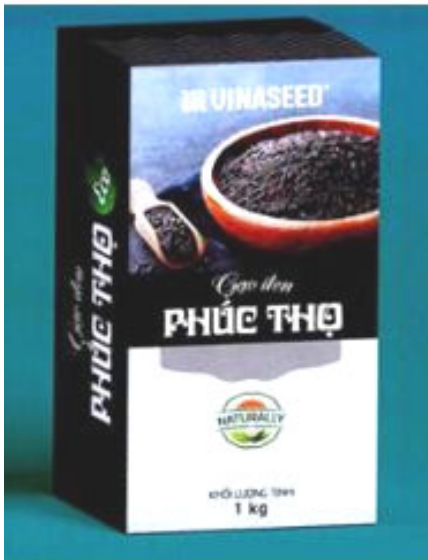

1.1



1.2

CÔNG BÁO SỞ HỮU CÔNG NGHIỆP SỐ 404 TẬP A – QUYỀN 2 (11.2021)

- (11) **43047**
(21) 3-2021-01879 (28) 1
(54) **HỘP ĐỰNG GẠO** (51) **09-03**
(22) 19/07/2021 (43) 25/11/2021
(73) **CÔNG TY CỔ PHẦN TẬP ĐOÀN GIỐNG CÂY TRỒNG VIỆT NAM (VN)**
Số 1 Lương Đình Cửa, phường Phương Mai, quận Đống Đa, thành phố Hà Nội
(72) Trần Kim Liên (VN)
(55)



1.1



1.2

CÔNG BÁO SỞ HỮU CÔNG NGHIỆP SỐ 404 TẬP A – QUYỀN 2 (11.2021)

- (11) **43048**
(21) 3-2021-01880 (28) 1
(54) **BAO BÌ GẠO** (51) **09-05**
(22) 19/07/2021 (43) 25/11/2021
(73) **CÔNG TY CỔ PHẦN TẬP ĐOÀN GIỐNG CÂY TRỒNG VIỆT NAM (VN)**
Số 1 Lương Đình Cửa, phường Phương Mai, quận Đống Đa, thành phố Hà Nội
(72) Trần Kim Liên (VN)
(55)



1.1



1.2

CÔNG BÁO SỞ HỮU CÔNG NGHIỆP SỐ 404 TẬP A – QUYỀN 2 (11.2021)

- (11) **43049**
(21) 3-2021-01881 (28) 1
(54) **BAO BÌ GẠO** (51) **09-05**
(22) 19/07/2021 (43) 25/11/2021
(73) **CÔNG TY CỔ PHẦN TẬP ĐOÀN GIỐNG CÂY TRỒNG VIỆT NAM (VN)**
Số 1 Lương Đình Cửa, phường Phương Mai, quận Đống Đa, thành phố Hà Nội
(72) Trần Kim Liên (VN)
(55)



1.1



1.2

CÔNG BÁO SỞ HỮU CÔNG NGHIỆP SỐ 404 TẬP A – QUYỀN 2 (11.2021)

- (11) **43050**
(21) 3-2021-01882 (28) 1
(54) **BAO BÌ GẠO** (51) **09-05**
(22) 19/07/2021 (43) 25/11/2021
(73) **CÔNG TY CỔ PHẦN TẬP ĐOÀN GIỐNG CÂY TRỒNG VIỆT NAM (VN)**
Số 1 Lương Đình Cửa, phường Phương Mai, quận Đống Đa, thành phố Hà Nội
(72) Trần Kim Liên (VN)
(55)



1.1



1.2

CÔNG BÁO SỞ HỮU CÔNG NGHIỆP SỐ 404 TẬP A – QUYỀN 2 (11.2021)

- (11) **43051**
(21) 3-2021-01883 (28) 1
(54) **BAO BÌ GẠO** (51) **09-05**
(22) 19/07/2021 (43) 25/11/2021
(73) **CÔNG TY CỔ PHẦN TẬP ĐOÀN GIỐNG CÂY TRỒNG VIỆT NAM (VN)**
Số 1 Lương Đình Cửa, phường Phương Mai, quận Đống Đa, thành phố Hà Nội
(72) Trần Kim Liên (VN)
(55)



1.1



1.2

- (11) **43052**
(21) 3-2021-01890 (28) 1
(54) **GHẾ SÔ PHA** (51) **06-01**
(22) 20/07/2021 (43) 25/11/2021
(30) 29/767,291 21/01/2021 US;
(73) **NOBLE HOUSE HOME FURNISHINGS, LLC (US)**
21325 Superior Street, Chatsworth, California 91311, United States of America
(72) Mineli Khodagholi (US)
(74) Công ty TNHH Tầm nhìn và Liên danh (VISION & ASSOCIATES CO.LTD.)
(55)



1.1

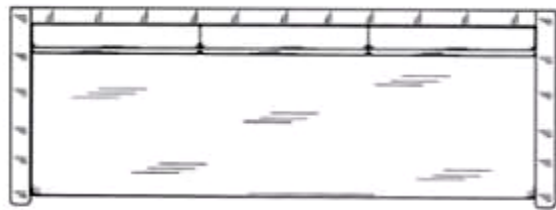

1.2

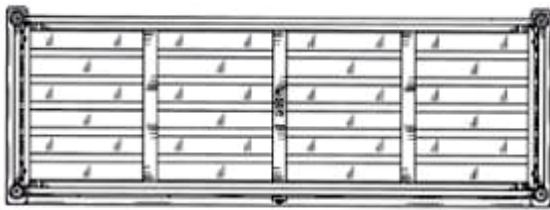

1.3

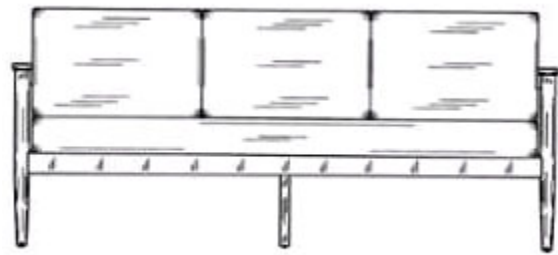

1.4

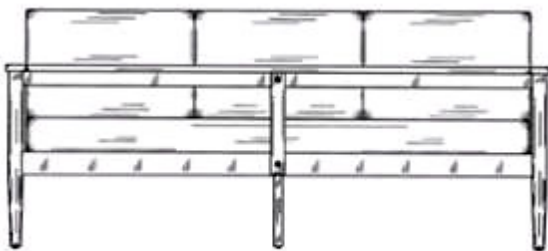

1.5

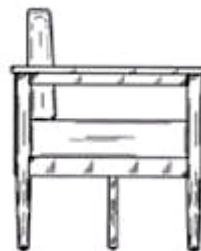

1.6



1.7

CÔNG BÁO SỞ HỮU CÔNG NGHIỆP SỐ 404 TẬP A – QUYỀN 2 (11.2021)

- (11) **43053**
(21) 3-2021-01893 (28) 1
(54) **GHẾ** (51) **06-01**
(22) 20/07/2021 (43) 25/11/2021
(30) 29/767,281 21/01/2021 US;
(73) **NOBLE HOUSE HOME FURNISHINGS, LLC (US)**
21325 Superior Street, Chatsworth, California 91311, United States of America
(72) Mineli Khodagholi (US)
(74) Công ty TNHH Tầm nhìn và Liên danh (VISION & ASSOCIATES CO.LTD.)
(55)



1.1

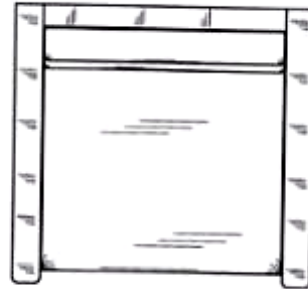

1.2

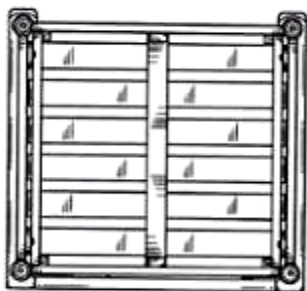

1.3

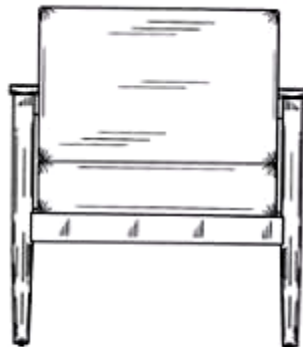

1.4



1.5



1.6

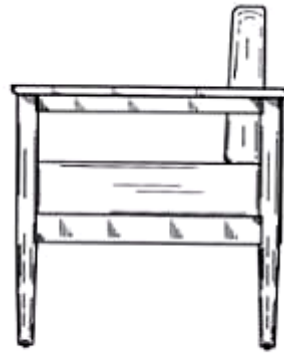

1.7

CÔNG BÁO SỞ HỮU CÔNG NGHIỆP SỐ 404 TẬP A – QUYỀN 2 (11.2021)

- (11) **43054**
(21) 3-2021-01894 (28) 1
(54) **GHẾ ĐÔI** (51) **06-01**
(22) 20/07/2021 (43) 25/11/2021
(30) 29/767,288 21/01/2021 US;
(73) **NOBLE HOUSE HOME FURNISHINGS, LLC (US)**
21325 Superior Street, Chatsworth, California 91311, United States of America
(72) Mineli Khodagholi (US)
(74) Công ty TNHH Tầm nhìn và Liên danh (VISION & ASSOCIATES CO.LTD.)
(55)

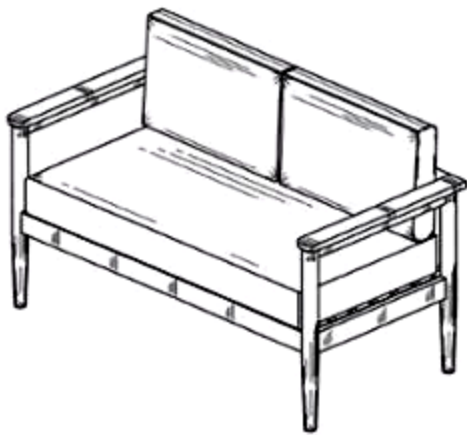

1.1

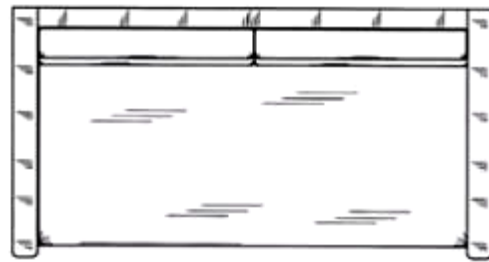

1.2

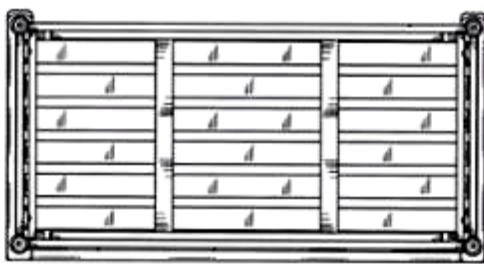

1.3

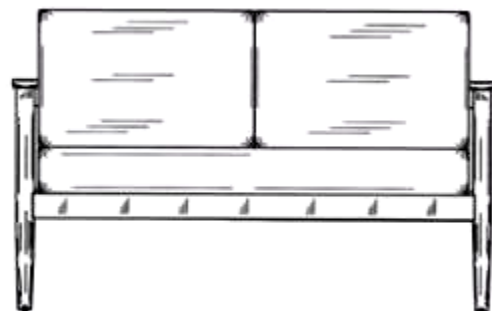

1.4

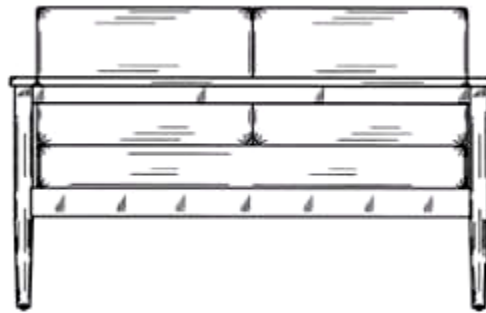

1.5

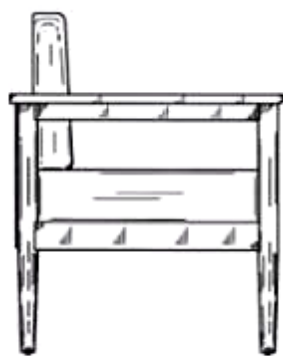

1.6

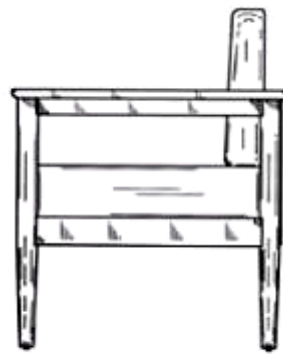

1.7

CÔNG BÁO SỞ HỮU CÔNG NGHIỆP SỐ 404 TẬP A – QUYỀN 2 (11.2021)

- (11) **43055**
(21) 3-2021-01898 (28) 1
(54) **ĐÈN** (51) **26-05**
(22) 21/07/2021 (43) 25/11/2021
(73) **CÔNG TY CỔ PHẦN BÓNG ĐÈN PHÍCH NƯỚC RẠNG ĐÔNG (VN)**
87-89 phố Hạ Đình, phường Thanh Xuân Trung, quận Thanh Xuân, thành phố Hà Nội
(72) Trần Trung Tường (VN)
(55)



1.1



1.2



1.3



1.4



1.5



1.6



1.7

CÔNG BÁO SỞ HỮU CÔNG NGHIỆP SỐ 404 TẬP A – QUYỀN 2 (11.2021)

- (11) **43056**
(21) 3-2021-01907 (28) 1
(54) **THIẾT BỊ NHẬN DẠNG CÁ NHÂN** (51) **10-05**
(22) 22/07/2021 (43) 25/11/2021
(30) 2021-006584 30/03/2021 JP;
(73) **MITSUBISHI ELECTRIC CORPORATION (JP)**
7-3, Marunouchi 2-chome, Chiyoda-ku, Tokyo 100-8310, Japan
(72) Tatsunari KATAOKA (JP)
(74) Công ty TNHH Tầm nhìn và Liên danh (VISION & ASSOCIATES CO.LTD.)
(55)

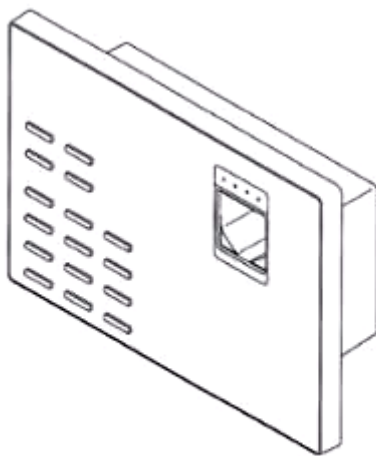

1.1

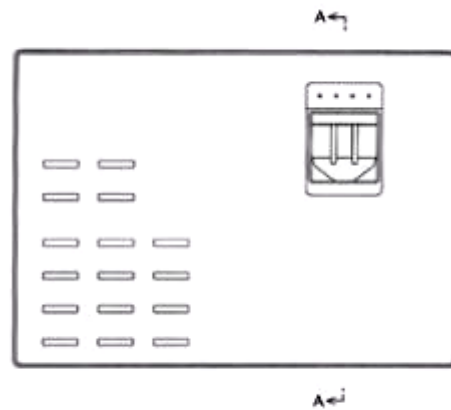

1.2

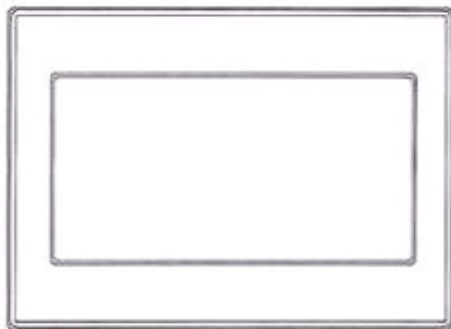

1.3

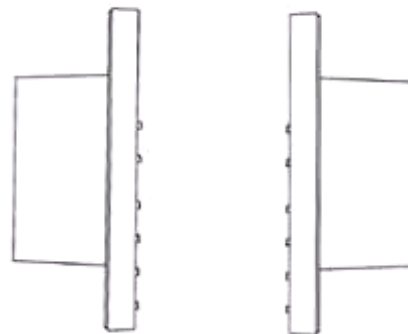

1.4

1.5

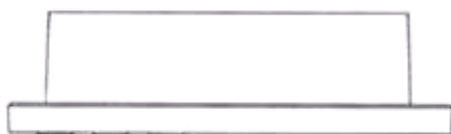

1.6



1.7

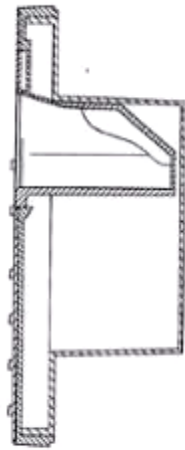

1.8

- (11) **43057**
(21) 3-2021-01911 (28) 2
(54) **THỨC ĂN CHO VẬT NUÔI** (51) **01-06**
(22) 23/07/2021 (43) 25/11/2021
(30) 29/767,709 25/01/2021 US;
(73) **SPECTRUM BRANDS, INC. (US)**
3001 Deming Way, Middleton, Wisconsin 53562, United States of America
(72) 1. TIFFANY DAWN POTTER (US)
2. ALLYSE MCCANN (US)
(74) Công ty TNHH Sở hữu trí tuệ Thảo Thọ Quyên (INVENCO.,LTD)
(55)

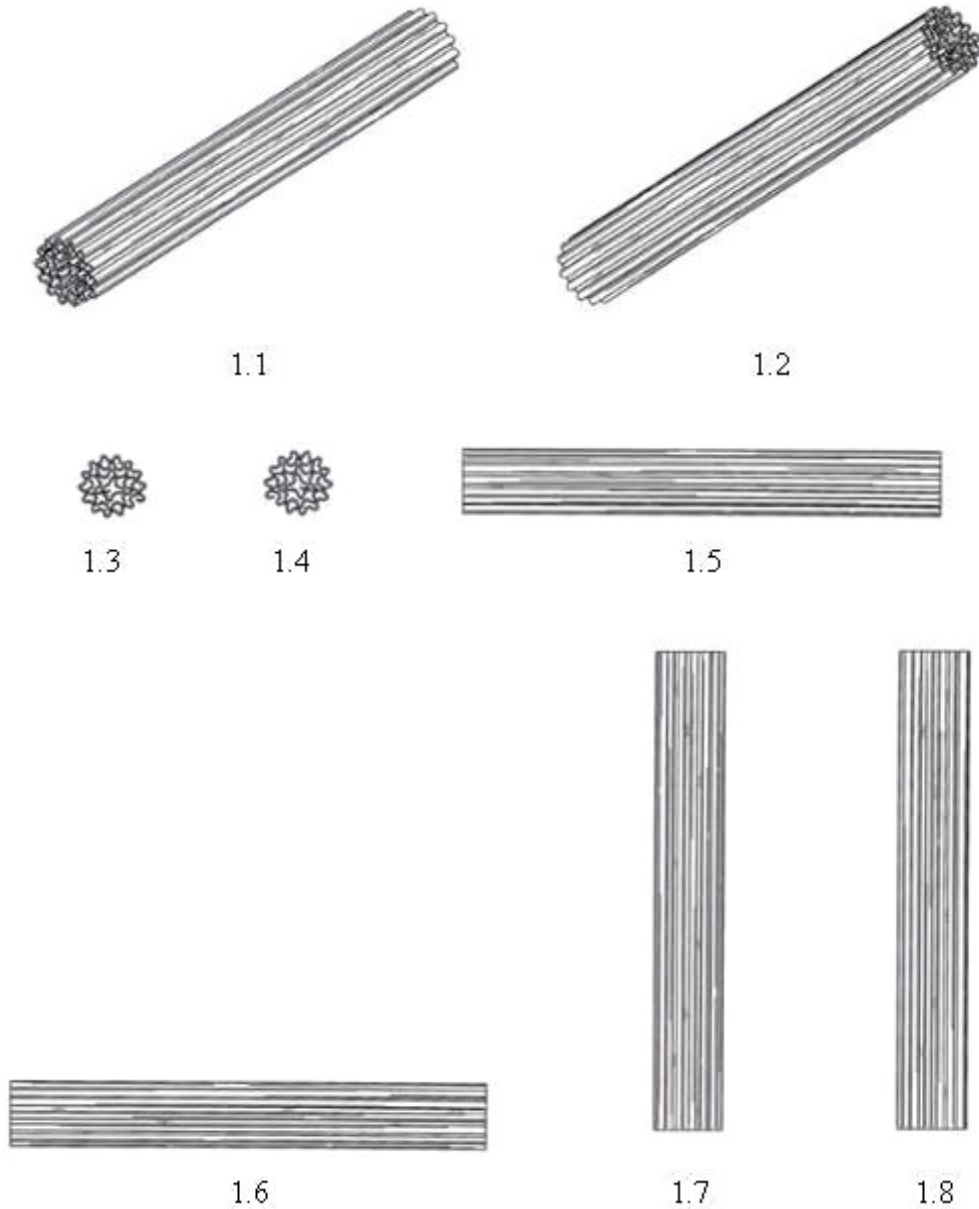



2.1



2.2



2.3



2.4



2.5



2.6



2.7



2.8

CÔNG BÁO SỞ HỮU CÔNG NGHIỆP SỐ 404 TẬP A – QUYỀN 2 (11.2021)

- (11) **43058**
(21) 3-2021-01962 (28) 5
(54) **HỘP BAO CAO SU** (51) **09-03**
(22) 30/07/2021 (43) 25/11/2021
(73) **CÔNG TY TNHH THIẾT BỊ & VẬT TƯ Y TẾ DONGKUK (VN)**
Căn LK03-122, khu đô thị C2 Gamuda Gardens, phường Trần Phú, quận Hoàng
Mai, thành phố Hà Nội
(72) Lê Hồng Phú (VN)
(74) **CÔNG TY TRÁCH NHIỆM HỮU HẠN TƯ VẤN ĐẦU TƯ VÀ SỞ HỮU TRÍ
TUỆ INTERFIVE (INTERFIVE CO., LTD)**
(55)



H1.1



H1.2



H2.1



H2.2



H3.1



H3.2



H4.1



H4.2



H5.1



H5.2

CÔNG BÁO SỞ HỮU CÔNG NGHIỆP SỐ 404 TẬP A – QUYỀN 2 (11.2021)

- (11) **43059**
- (21) 3-2021-01970 (28) 4
- (54) **BAO GÓI ĐỰNG THỰC PHẨM** (51) **09-05**
- (22) 02/08/2021 (43) 25/11/2021
- (73) **AGRICULTURAL CORP. HUMANWELL CO. (KR)**
2F, Na-dong, 130, Noi-gil, Nongong-eup, Dalseong-gun, Daegu 42975 Republic of Korea
- (72) SUK, Yong Do (KR)
- (74) Công ty TNHH Tâm nhìn và Liên danh (VISION & ASSOCIATES CO.LTD.)
- (55)



1.1



1.2



1.3

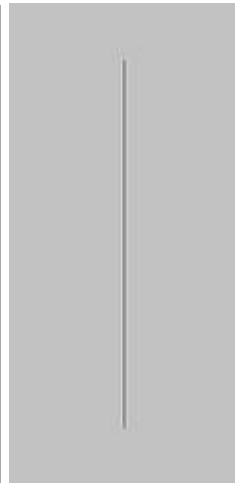

1.4

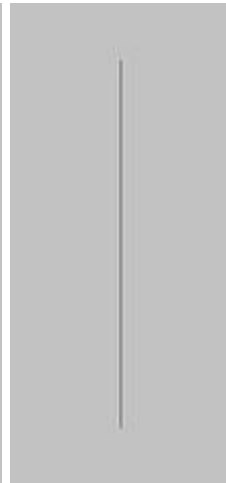

1.5



1.6

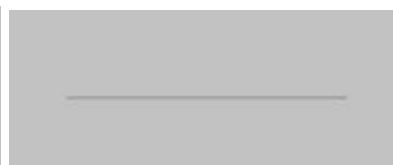

1.7



2.1



2.2



2.3

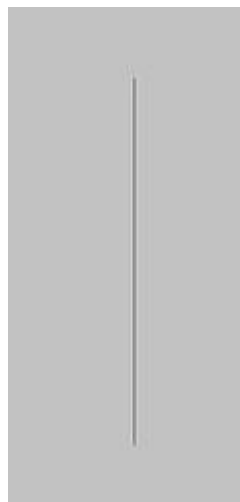

2.4

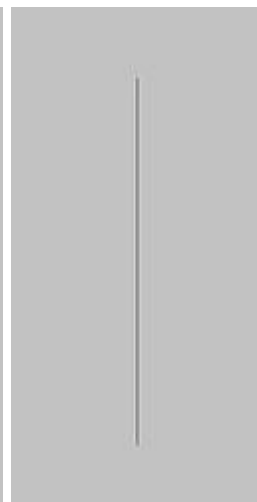

2.5



2.6

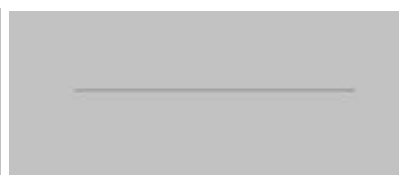

2.7



3.1



3.2



3.3

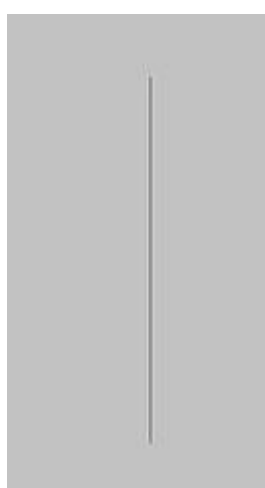

3.4

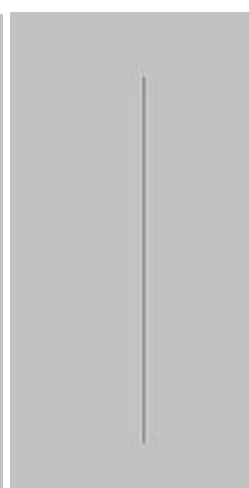

3.5



3.6



3.7



4.1



4.2



4.3

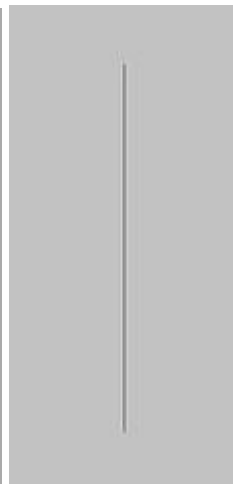

4.4



4.5

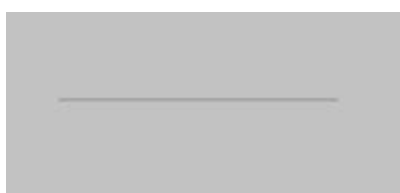

4.6



4.7

- (11) **43060**
(21) 3-2021-01996 (28) 3
(54) **GHẾ XÔ PHA** (51) **06-01**
(22) 05/08/2021 (43) 25/11/2021
(30) 202130335520.9 02/06/2021 CN;
(73) **ZINUS INC. (KR)**
8th Floor (Yatap-Dong, Amigo Tower), 10, Yatap-ro, 81 beon-gil, Bundang-gu,
Seongnam-si, Gyeonggi-do, Republic of Korea
(72) 1. MUNHAN BAE (KR)
2. NAEUN GU (KR)
3. MINHONG KIM (KR)
4. KYUNGIL CHUNG (KR)
(74) Công ty TNHH Trà và cộng sự (TRA & ASSOCIATES CO.,LTD)
(55)



1.1



1.2



1.3

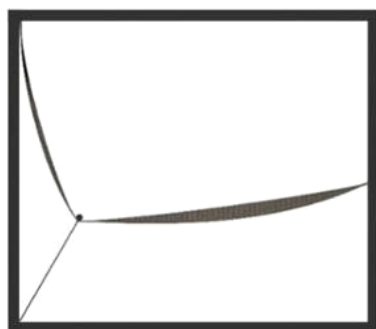

1.4



1.5



1.6



2.1



2.2



2.3

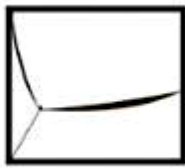

2.4



2.5

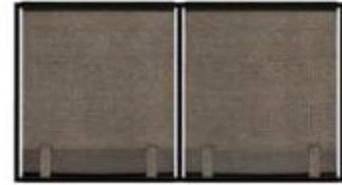

2.6



3.1



3.2



3.3



3.4



3.5



3.6

(11) **43061**

(21) 3-2021-01997

(28) 1

(54) **GHẾ DÀI**

(51) **06-01**

(22) 05/08/2021

(43) 25/11/2021

(30) 202130335499.2 02/06/2021 CN;

(73) **ZINUS INC. (KR)**

8th Floor (Yatap-Dong, Amigo Tower), 10, Yatap-ro, 81 beon-gil, Bundang-gu, Seongnam-si, Gyeonggi-do, Republic of Korea

(72) 1. MUNHAN BAE (KR)

2. NAEUN GU (KR)

3. MINHONG KIM (KR)

4. KYUNGIL CHUNG (KR)

(74) Công ty TNHH Trà và cộng sự (TRA & ASSOCIATES CO.,LTD)

(55)



1.1



1.2



1.3



1.4



1.5



1.6

- (11) **43062**
(21) 3-2021-01998 (28) 2
(54) **GHẾ** (51) **06-01**
(22) 05/08/2021 (43) 25/11/2021
(30) 202130335514.3 02/06/2021 CN;
(73) **ZINUS INC. (KR)**
8th Floor (Yatap-Dong, Amigo Tower), 10, Yatap-ro, 81 beon-gil, Bundang-gu,
Seongnam-si, Gyeonggi-do, Republic of Korea
(72) 1. MUNHAN BAE (KR)
2. NAEUN GU (KR)
3. MINHONG KIM (KR)
4. KYUNGIL CHUNG (KR)
(74) Công ty TNHH Trà và cộng sự (TRA & ASSOCIATES CO.,LTD)
(55)



1.1



1.2



1.3



1.4



1.5



1.6



2.1



2.2



2.3



2.4



2.5



2.6

- (11) **43063**
(21) 3-2021-02000 (28) 2
(54) **ĐÈN BẮT CÔN TRÙNG** (51) **22-06**
(22) 05/08/2021 (43) 25/11/2021
(30) 202130107398.X 25/02/2021 CN;
(73) **TECHTRONIC CORDLESS GP (US)**
100 Innovation Way, Anderson, SC 29621 United States of America
(72) 1. ADIS SABIC (AU)
2. HAI RU CHEN (CN)
(74) Công ty TNHH Tầm nhìn và Liên danh (VISION & ASSOCIATES CO.LTD.)
(55)



1.1

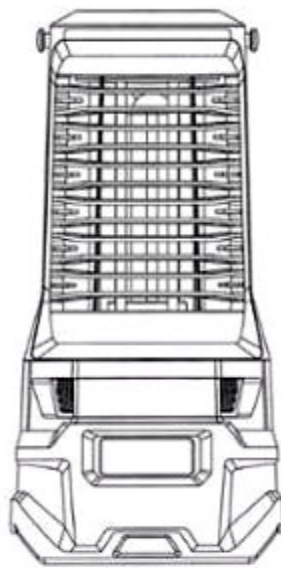

1.2

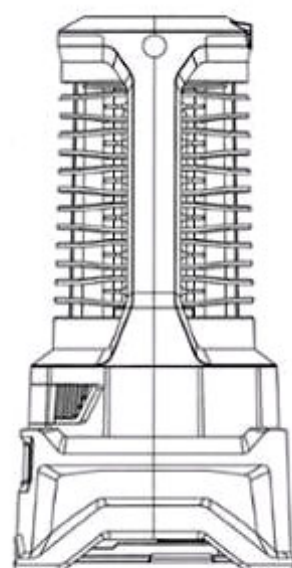

1.3

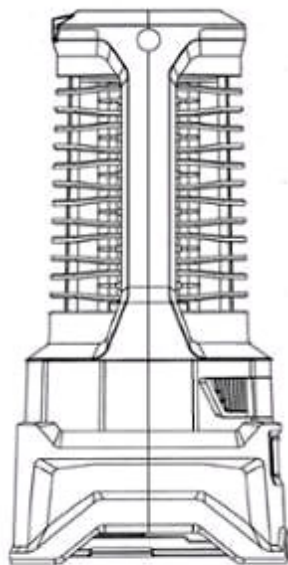

1.4

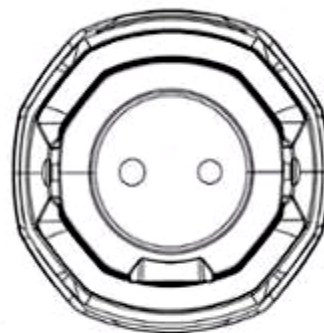

1.5

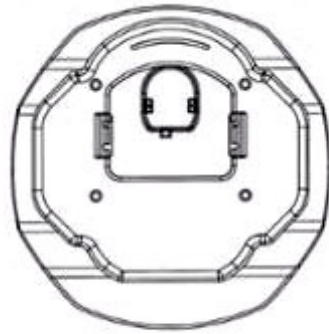

1.6

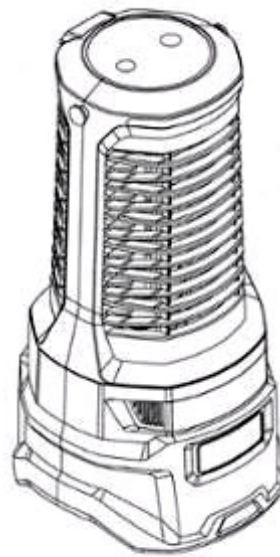

1.7



2.1

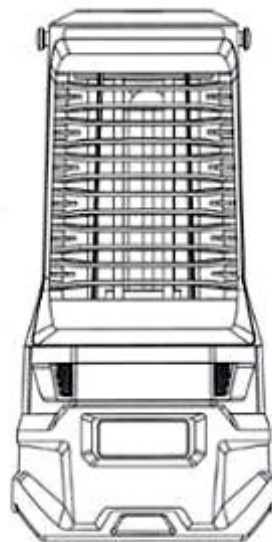

2.2

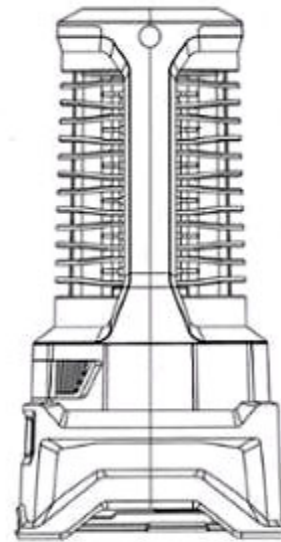

2.3

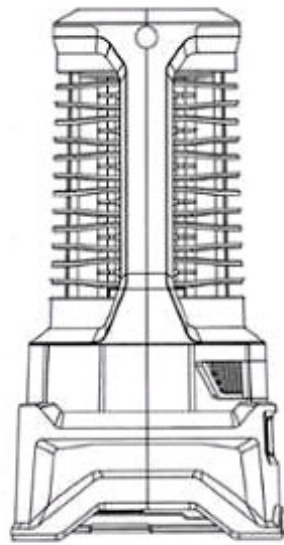

2.4

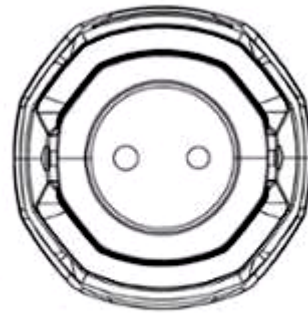

2.5

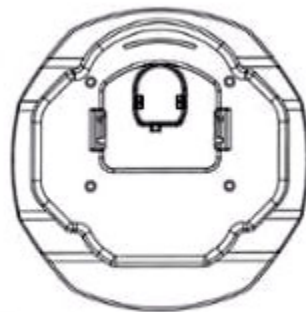

2.6

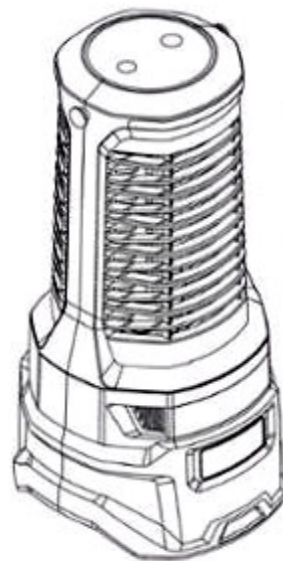

2.7

CÔNG BÁO SỞ HỮU CÔNG NGHIỆP SỐ 404 TẬP A – QUYỀN 2 (11.2021)

- (11) **43064**
(21) 3-2021-02001 (28) 3
(54) **NHÃN SẢN PHẨM BIA** (51) **19-08**
(22) 06/08/2021 (43) 25/11/2021
(73) **CÔNG TY TNHH TOÀN CẦU BEVERAGE (VN)**
Số 8B đường Ngô Quyền, khu 4, phường Cẩm Thượng, thành phố Hải Dương, tỉnh Hải Dương
(72) Nguyễn Thế Phương (VN)
(74) Công ty TNHH Sở hữu trí tuệ M.I.T (M.I.T IP CO., LTD)
(55)



1.1



1.2



2.1



2.2



3.1



3.2

- (11) **43065**
(21) 3-2021-02005 (28) 1
(54) **HỘP CHỨA** (51) **09-01**
(22) 06/08/2021 (43) 25/11/2021
(30) 29/773,169 08/03/2021 US;
(73) **COLGATE-PALMOLIVE COMPANY (US)**
300 Park Avenue, New York, New York 10022, United States of America
(72) 1. SCOTT BECKERMAN (US)
2. RENEE MARIE RIETHMILLER (US)
(74) Văn phòng Luật sư Ân Nam (ANNAM IP & LAW)
(55)

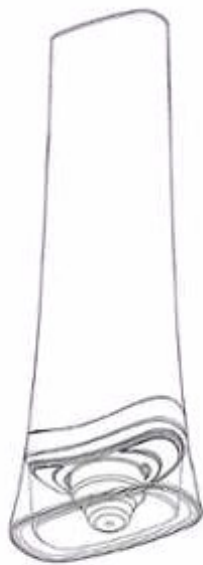

1.1



1.2



1.3

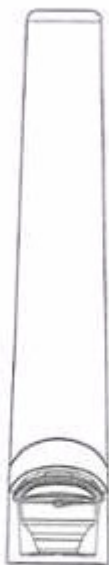

1.4



1.5



1.6



1.7

- (11) **43066**
(21) 3-2021-02006 (28) 1
(54) **CHÂN LÀM SẠCH** (51) **15-05**
(22) 06/08/2021 (43) 25/11/2021
(30) 29,775,346 23/03/2021 US;
(73) **BISSELL INC. (US)**
2345 Walker Avenue NW, Grand Rapids, MI 49544, USA
(72) 1. MACKENZIE L. KNAPP (US)
2. DENNIS J. WROBLESKI (US)
(74) Công ty TNHH Sở hữu trí tuệ Thảo Quyên (INVENCO.,LTD)
(55)

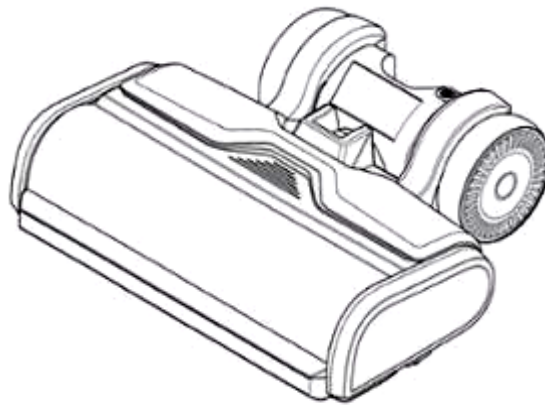

1.1

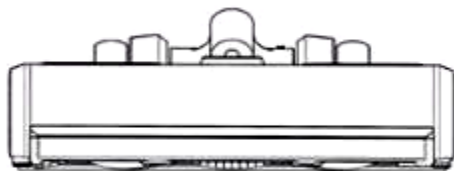

1.2



1.3

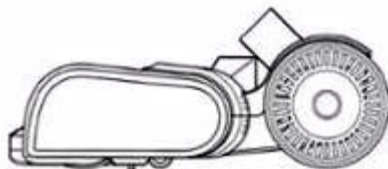

1.4

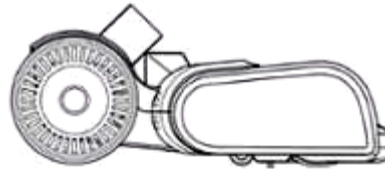

1.5

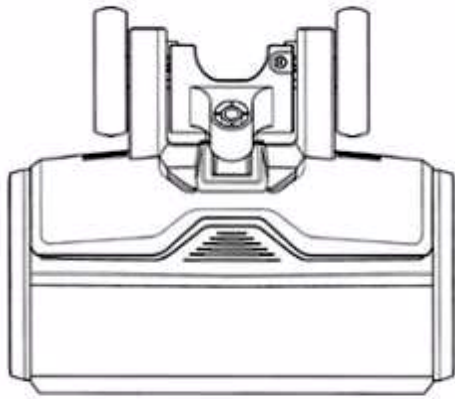

1.6

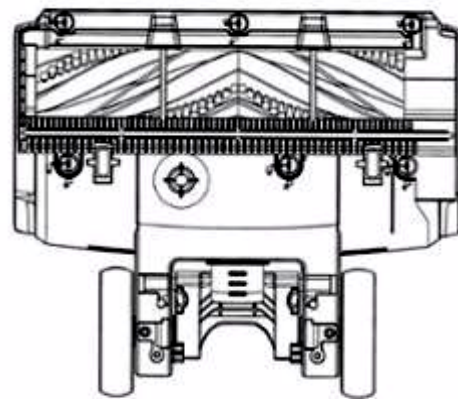

1.7

CÔNG BÁO SỞ HỮU CÔNG NGHIỆP SỐ 404 TẬP A – QUYỀN 2 (11.2021)

- (11) **43067**
(21) 3-2021-02010 (28) 1
(54) **Ô TÔ** (51) **12-08**
(22) 09/08/2021 (43) 25/11/2021
(30) DM/213968 09/02/2021 WO;
(73) **FERRARI S.P.A. (IT)**
Via Emilia Est 1163, MODENA, Italy
(72) Flavio MANZONI (IT)
(74) Công ty TNHH một thành viên Sở hữu trí tuệ VCCI (VCCI-IP CO.,LTD)
(55)



1.1

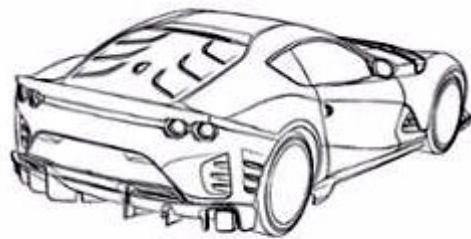

1.2



1.3



1.4



1.5



1.6

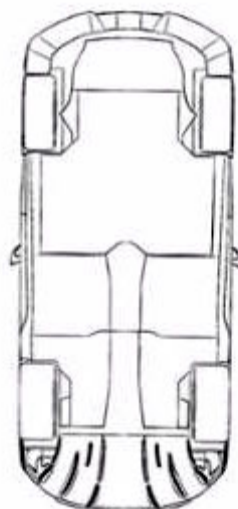

1.7

CÔNG BÁO SỞ HỮU CÔNG NGHIỆP SỐ 404 TẬP A – QUYỀN 2 (11.2021)

- (11) **43068**
(21) 3-2021-02011 (28) 1
(54) **Ô TÔ** (51) **12-08**
(22) 09/08/2021 (43) 25/11/2021
(30) DM/213968 09/02/2021 WO;
(73) **FERRARI S.P.A. (IT)**
Via Emilia Est 1163, MODENA, Italy
(72) Flavio MANZONI (IT)
(74) Công ty TNHH một thành viên Sở hữu trí tuệ VCCI (VCCI-IP CO.,LTD)
(55)

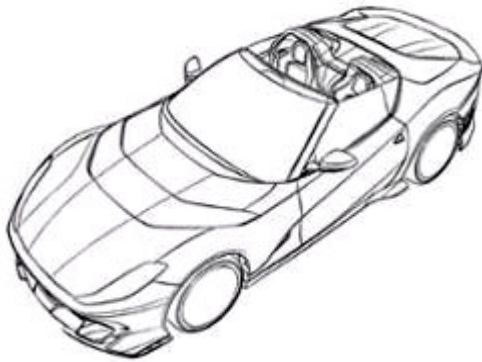

1.1

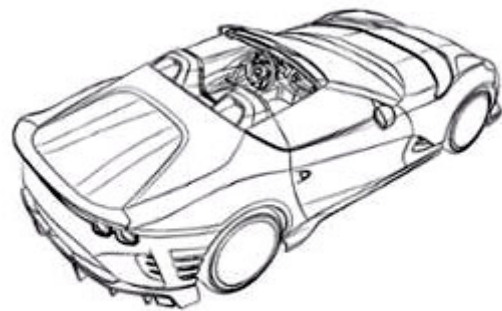

1.2



1.3

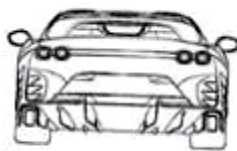

1.4

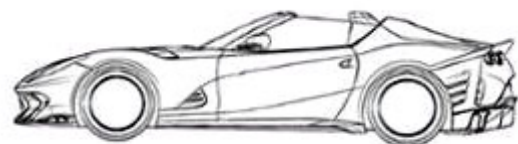

1.5

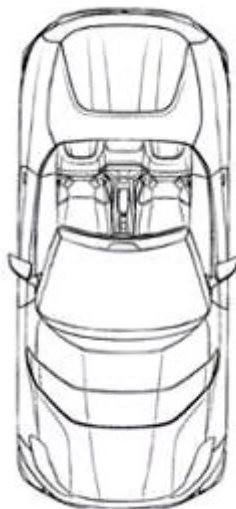

1.6

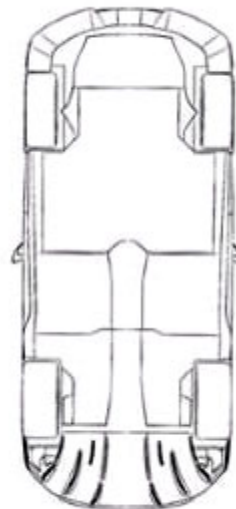

1.7

CÔNG BÁO SỞ HỮU CÔNG NGHIỆP SỐ 404 TẬP A – QUYỀN 2 (11.2021)

- (11) **43069**
(21) 3-2021-02012 (28) 1
(54) **Ô TÔ** (51) **12-08**
(22) 09/08/2021 (43) 25/11/2021
(30) DM/213968 09/02/2021 WO;
(73) **FERRARI S.P.A. (IT)**
Via Emilia Est 1163, MODENA, Italy
(72) Flavio MANZONI (IT)
(74) Công ty TNHH một thành viên Sở hữu trí tuệ VCCI (VCCI-IP CO.,LTD)
(55)

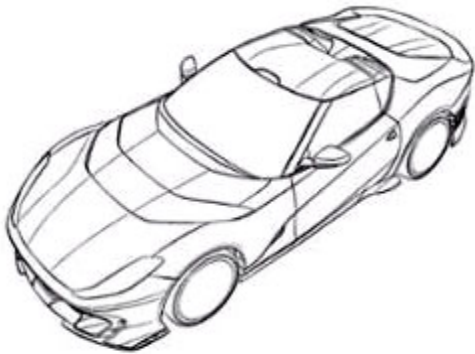

1.1

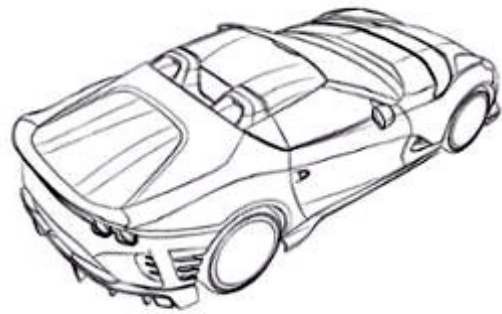

1.2



1.3



1.4

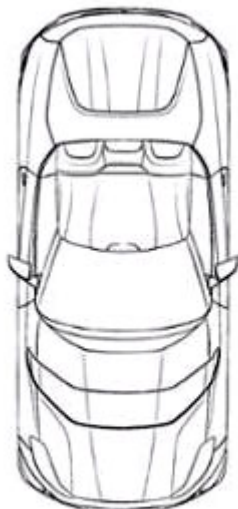
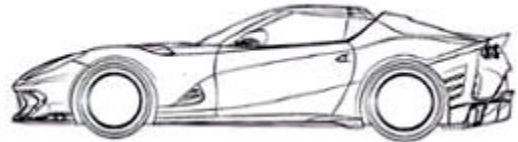

1.6

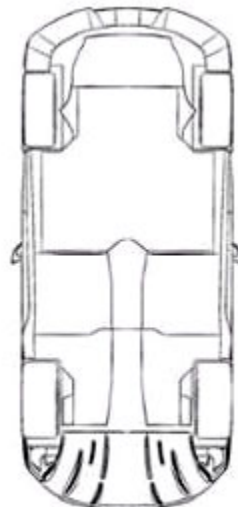

1.7

CÔNG BÁO SỞ HỮU CÔNG NGHIỆP SỐ 404 TẬP A – QUYỀN 2 (11.2021)

- (11) **43070**
(21) 3-2021-02013 (28) 1
(54) **Ô TÔ ĐỒ CHƠI** (51) **21-01**
(22) 09/08/2021 (43) 25/11/2021
(30) DM/213994 09/02/2021 WO;
(73) **FERRARI S.P.A. (IT)**
Via Emilia Est 1163, MODENA, Italy
(72) Flavio MANZONI (IT)
(74) Công ty TNHH một thành viên Sở hữu trí tuệ VCCI (VCCI-IP CO.,LTD)
(55)



1.1

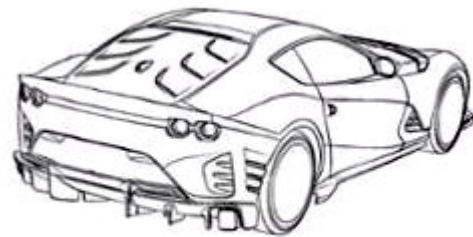

1.2



1.3

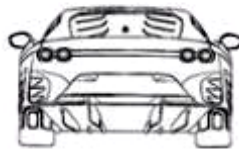

1.4

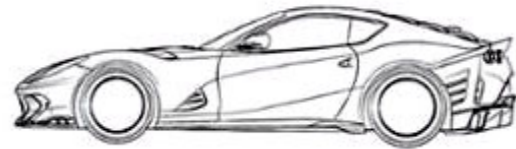

1.5



1.6

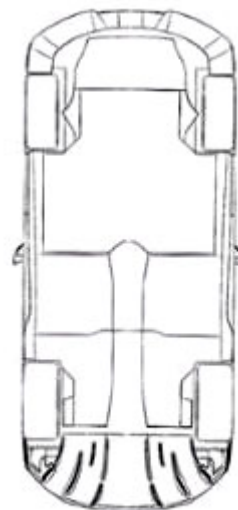

1.7

CÔNG BÁO SỞ HỮU CÔNG NGHIỆP SỐ 404 TẬP A – QUYỀN 2 (11.2021)

- (11) **43071**
(21) 3-2021-02014 (28) 1
(54) **Ô TÔ ĐỒ CHƠI** (51) **21-01**
(22) 09/08/2021 (43) 25/11/2021
(30) DM/213994 09/02/2021 WO;
(73) **FERRARI S.P.A. (IT)**
Via Emilia Est 1163, MODENA, Italy
(72) Flavio MANZONI (IT)
(74) Công ty TNHH một thành viên Sở hữu trí tuệ VCCI (VCCI-IP CO.,LTD)
(55)

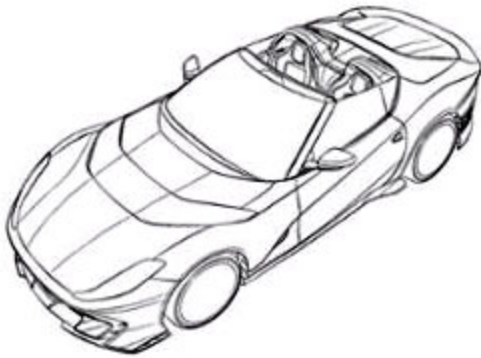

1.1

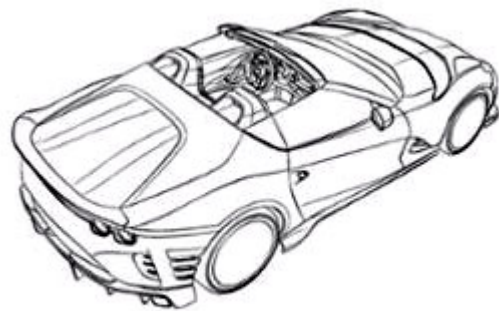

1.2



1.3



1.4

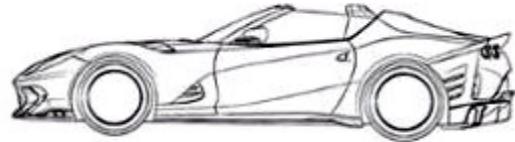

1.5

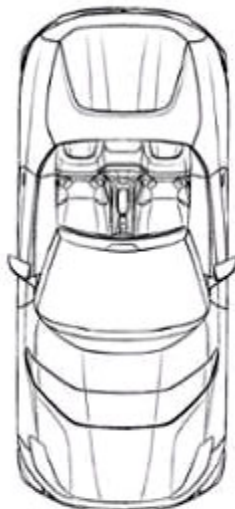

1.6

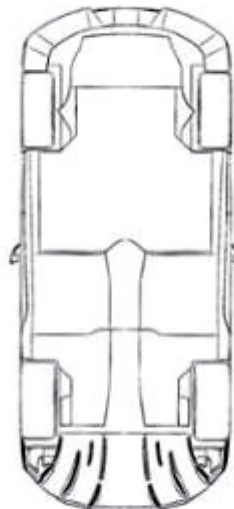

1.7

CÔNG BÁO SỞ HỮU CÔNG NGHIỆP SỐ 404 TẬP A – QUYỀN 2 (11.2021)

- (11) **43072**
(21) 3-2021-02015 (28) 1
(54) **Ô TÔ ĐỒ CHƠI** (51) **21-01**
(22) 09/08/2021 (43) 25/11/2021
(30) DM/213994 09/02/2021 WO;
(73) **FERRARI S.P.A. (IT)**
Via Emilia Est 1163, MODENA, Italy
(72) Flavio MANZONI (IT)
(74) Công ty TNHH một thành viên Sở hữu trí tuệ VCCI (VCCI-IP CO.,LTD)
(55)

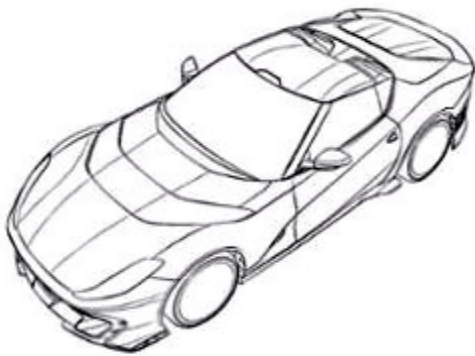

1.1

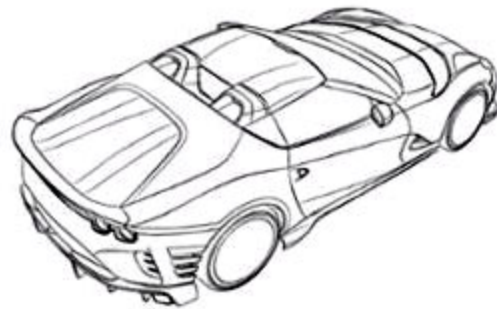

1.2



1.3

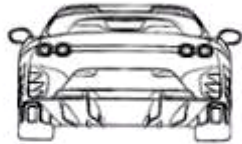

1.4

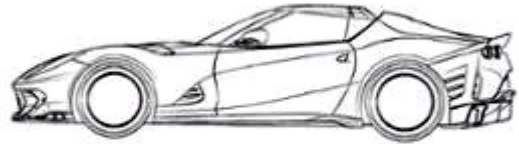

1.5

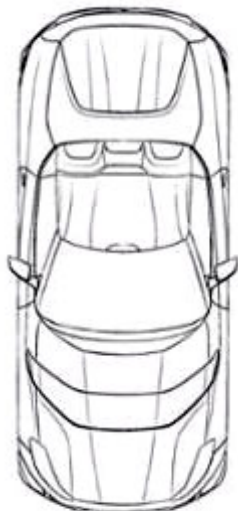

1.6

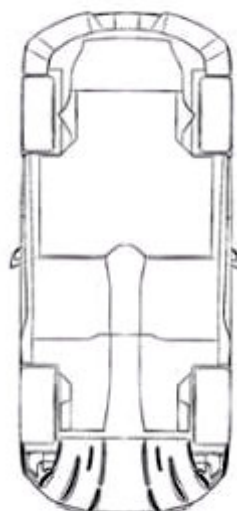

1.7

CÔNG BÁO SỞ HỮU CÔNG NGHIỆP SỐ 404 TẬP A – QUYỀN 2 (11.2021)

(11) **43073**

(21) 3-2021-02046

(28) 1

(54) **TRẠM OXY VÀ KHÍ NÉN Y TẾ**

(51) **24-01**

(22) 11/08/2021

(43) 25/11/2021

(73) **CÔNG TY CỔ PHẦN CÔNG NGHỆ CHẾ BIẾN CÁC SẢN PHẨM THIÊN NHIÊN (VN)**

Số 63, đường Giải Phóng, phường Đồng Tâm, quận Hai Bà Trưng, thành phố Hà Nội

(72) 1. **VŨ ĐÌNH TIẾN (VN)**

2. **VŨ DUY HÙNG (VN)**

(55)

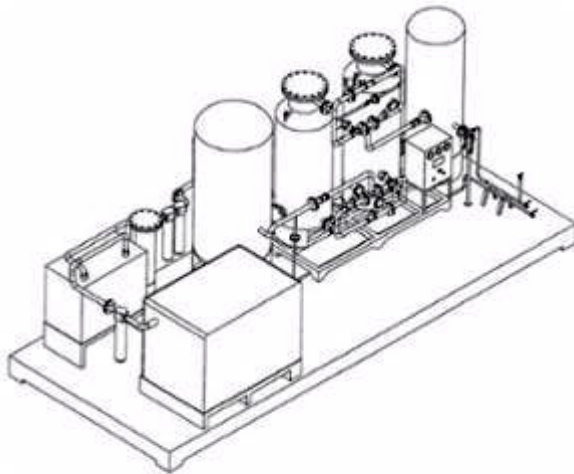

1.1

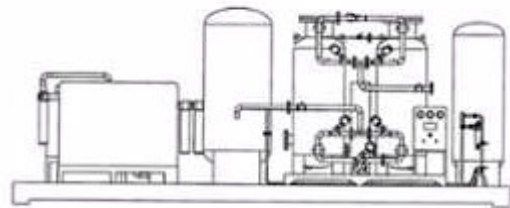

1.2

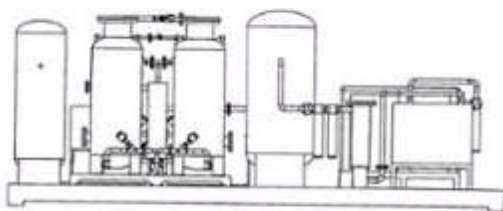

1.3

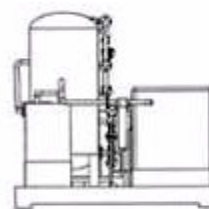

1.4

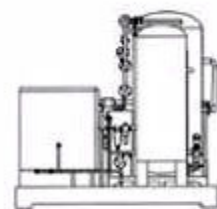

1.5

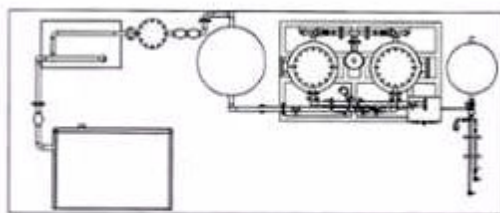

1.6

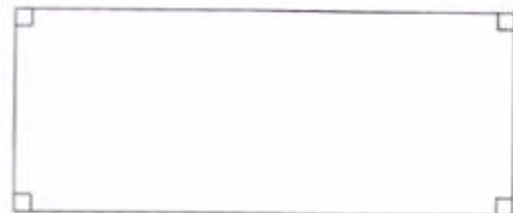

1.7

CÔNG BÁO SỞ HỮU CÔNG NGHIỆP SỐ 404 TẬP A – QUYỀN 2 (11.2021)

- (11) **43074**
- (21) 3-2021-02057 (28) 1
- (54) **NHÃN SẢN PHẨM** (51) **19-08**
- (22) 11/09/2020 (43) 25/11/2021
- (73) **CÔNG TY TNHH SẢN XUẤT VÀ THƯƠNG MẠI HÒA HƯNG (VN)**
Số 163, quốc lộ 80, ấp Phú Long, xã Tân Phú Đông, thành phố Sa Đéc, tỉnh Đồng Tháp
- (72) Nguyễn Ngọc Vân Anh (VN)
- (74) Công ty TNHH một thành viên Trường Luật (Trường Luật)
- (55)



CÔNG BÁO SỞ HỮU CÔNG NGHIỆP SỐ 404 TẬP A – QUYỀN 2 (11.2021)

- (11) **43075**
- (21) 3-2021-02058 (28) 1
- (54) **NHÃN SẢN PHẨM** (51) **19-08**
- (22) 11/09/2020 (43) 25/11/2021
- (73) **CÔNG TY TNHH SẢN XUẤT VÀ THƯƠNG MẠI HÒA HƯNG (VN)**
Số 163, quốc lộ 80, ấp Phú Long, xã Tân Phú Đông, thành phố Sa Đéc, tỉnh Đồng Tháp
- (72) Nguyễn Ngọc Vân Anh (VN)
- (74) Công ty TNHH một thành viên Trường Luật (Trường Luật)
- (55)

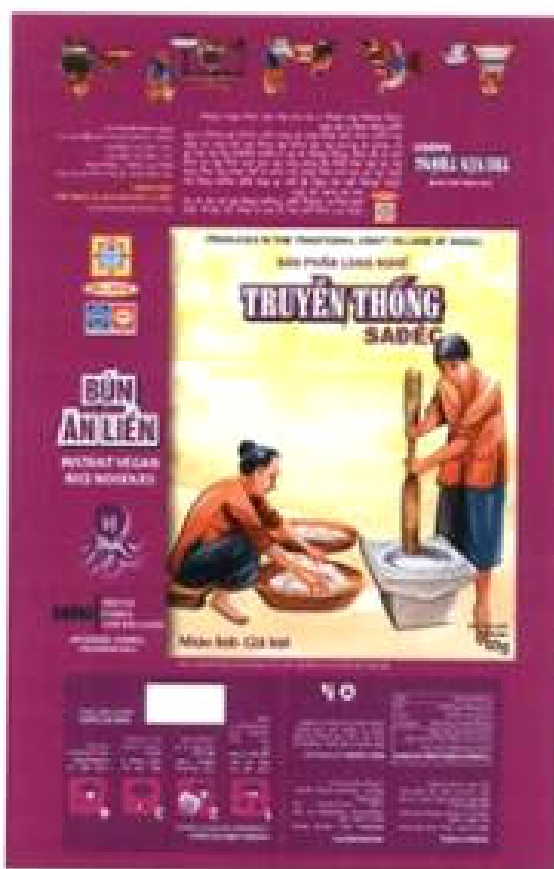

CÔNG BÁO SỞ HỮU CÔNG NGHIỆP SỐ 404 TẬP A – QUYỂN 2 (11.2021)

- (11) **43076**
- (21) 3-2021-02059 (28) 1
- (54) **NHÃN SẢN PHẨM** (51) **19-08**
- (22) 11/09/2020 (43) 25/11/2021
- (73) **CÔNG TY TNHH SẢN XUẤT VÀ THƯƠNG MẠI HÒA HƯNG (VN)**
Số 163, quốc lộ 80, ấp Phú Long, xã Tân Phú Đông, thành phố Sa Đéc, tỉnh Đồng Tháp
- (72) Nguyễn Ngọc Vân Anh (VN)
- (74) Công ty TNHH một thành viên Trường Luật (Trường Luật)
- (55)



CÔNG BÁO SỞ HỮU CÔNG NGHIỆP SỐ 404 TẬP A – QUYỂN 2 (11.2021)

- (11) **43077**
- (21) 3-2021-02060 (28) 1
- (54) **NHÃN SẢN PHẨM** (51) **19-08**
- (22) 11/09/2020 (43) 25/11/2021
- (73) **CÔNG TY TNHH SẢN XUẤT VÀ THƯƠNG MẠI HÒA HƯNG (VN)**
Số 163, quốc lộ 80, ấp Phú Long, xã Tân Phú Đông, thành phố Sa Đéc, tỉnh Đồng Tháp
- (72) Nguyễn Ngọc Vân Anh (VN)
- (74) Công ty TNHH một thành viên Trường Luật (Trường Luật)
- (55)



CÔNG BÁO SỞ HỮU CÔNG NGHIỆP SỐ 404 TẬP A – QUYỀN 2 (11.2021)

- (11) **43078**
(21) 3-2021-02061 (28) 1
(54) **NHÃN SẢN PHẨM** (51) **19-08**
(22) 11/09/2020 (43) 25/11/2021
(73) **CÔNG TY TNHH SẢN XUẤT VÀ THƯƠNG MẠI HÒA HƯNG (VN)**
Số 163, quốc lộ 80, ấp Phú Long, xã Tân Phú Đông, thành phố Sa Đéc, tỉnh Đồng Tháp
(72) Nguyễn Ngọc Vân Anh (VN)
(74) Công ty TNHH một thành viên Trường Luật (Trường Luật)
(55)



CÔNG BÁO SỞ HỮU CÔNG NGHIỆP SỐ 404 TẬP A – QUYỀN 2 (11.2021)

- (11) **43079**
- (21) 3-2021-02062 (28) 1
- (54) **NHÃN SẢN PHẨM** (51) **19-08**
- (22) 11/09/2020 (43) 25/11/2021
- (73) **CÔNG TY TNHH SẢN XUẤT VÀ THƯƠNG MẠI HÒA HƯNG (VN)**
Số 163, quốc lộ 80, ấp Phú Long, xã Tân Phú Đông, thành phố Sa Đéc, tỉnh Đồng Tháp
- (72) Nguyễn Ngọc Vân Anh (VN)
- (74) Công ty TNHH một thành viên Trường Luật (Trường Luật)
- (55)



CÔNG BÁO SỞ HỮU CÔNG NGHIỆP SỐ 404 TẬP A – QUYỀN 2 (11.2021)

- (11) **43080**
- (21) 3-2021-02063 (28) 1
- (54) **NHÃN SẢN PHẨM** (51) **19-08**
- (22) 11/09/2020 (43) 25/11/2021
- (73) **CÔNG TY TNHH SẢN XUẤT VÀ THƯƠNG MẠI HÒA HƯNG (VN)**
Số 163, quốc lộ 80, ấp Phú Long, xã Tân Phú Đông, thành phố Sa Đéc, tỉnh Đồng Tháp
- (72) Nguyễn Ngọc Vân Anh (VN)
- (74) Công ty TNHH một thành viên Trường Luật (Trường Luật)
- (55)



CÔNG BÁO SỞ HỮU CÔNG NGHIỆP SỐ 404 TẬP A – QUYỀN 2 (11.2021)

- (11) **43081**
(21) 3-2021-02065 (28) 1
(54) **NHÃN SẢN PHẨM** (51) **19-08**
(22) 13/08/2021 (43) 25/11/2021
(73) **CÔNG TY TNHH THƯỜNG MẠI VI NA PHÁT (VN)**
Số 04 Ngô Sĩ Liên, phường Đồng Đa, thành phố Quy Nhơn, tỉnh Bình Định
(72) Trần Thị Mi (VN)
(74) Công ty cổ phần FAS INVEST (FAS INVEST JSC)
(55)



1.1



1.2

CÔNG BÁO SỞ HỮU CÔNG NGHIỆP SỐ 404 TẬP A – QUYỀN 2 (11.2021)

(11) **43082**

(21) 3-2021-02066

(28) 1

(54) **GIÀY**

(51) **02-04**

(22) 13/08/2021

(43) 25/11/2021

(73) **CÔNG TY TNHH BÌNH TIÊN BIÊN HÒA (VN)**

Lô 101/2 khu công nghiệp Amata, phường Long Bình, thành phố Biên Hòa, tỉnh Đồng Nai

(72) Lai Khiêm (VN)

(74) Công ty TNHH Tư vấn sở hữu trí tuệ Việt (VIET IP CO.,LTD.)

(55)



1.1



1.2



1.3



1.4



1.5



1.6



1.7

CÔNG BÁO SỞ HỮU CÔNG NGHIỆP SỐ 404 TẬP A – QUYỀN 2 (11.2021)

(11) **43083**

(21) 3-2021-02067

(28) 1

(54) **GIÀY**

(51) **02-04**

(22) 13/08/2021

(43) 25/11/2021

(73) **CÔNG TY TNHH BÌNH TIÊN BIÊN HÒA (VN)**

Lô 101/2 Khu công nghiệp Amata, phường Long Bình, thành phố Biên Hòa, tỉnh Đồng Nai

(72) Lai Khiêm (VN)

(74) Công ty TNHH Tư vấn sở hữu trí tuệ Việt (VIET IP CO.,LTD.)

(55)



1.1



1.2



1.3



1.4



1.5



1.6



1.7

CÔNG BÁO SỞ HỮU CÔNG NGHIỆP SỐ 404 TẬP A – QUYỀN 2 (11.2021)

(11) **43084**

(21) 3-2021-02068

(28) 1

(54) **GIÀY**

(51) **02-04**

(22) 13/08/2021

(43) 25/11/2021

(73) **CÔNG TY TNHH BÌNH TIÊN BIÊN HÒA (VN)**

Lô 101/2 Khu công nghiệp Amata, phường Long Bình, thành phố Biên Hòa, tỉnh Đồng Nai

(72) Lai Khiêm (VN)

(74) Công ty TNHH Tư vấn sở hữu trí tuệ Việt (VIET IP CO.,LTD.)

(55)



1.1



1.2



1.3



1.4



1.5



1.6



1.7

CÔNG BÁO SỞ HỮU CÔNG NGHIỆP SỐ 404 TẬP A – QUYỀN 2 (11.2021)

(11) **43085**

(21) 3-2021-02069

(28) 1

(54) **ĐÉ GIÀY**

(51) **02-04**

(22) 13/08/2021

(43) 25/11/2021

(73) **CÔNG TY TNHH BÌNH TIÊN BIÊN HÒA (VN)**

Lô 101/2 Khu công nghiệp Amata, phường Long Bình, thành phố Biên Hòa, tỉnh Đồng Nai

(72) Lai Khiêm (VN)

(74) Công ty TNHH Tư vấn sở hữu trí tuệ Việt (VIET IP CO.,LTD.)

(55)



1.1



1.2



1.3



1.4



1.5



1.6



1.7

CÔNG BÁO SỞ HỮU CÔNG NGHIỆP SỐ 404 TẬP A – QUYỀN 2 (11.2021)

- (11) **43086**
(21) 3-2021-02096 (28) 1
(54) **DÉP** (51) **02-04**
(22) 18/08/2021 (43) 25/11/2021
(30) 29/771,133 19/02/2021 US;
(73) **CROCS, INC. (US)**
13601 Via Varra, Broomfield, Colorado 80020, United States of America
(72) Federico FONGHER (IT)
(74) Công ty Luật TNHH quốc tế BMVN (BMVN INTERNATIONAL LLC)
(55)



1.1



1.2



1.3



1.4



1.5



1.6



1.7

CÔNG BÁO SỞ HỮU CÔNG NGHIỆP SỐ 404 TẬP A – QUYỀN 2 (11.2021)

- (11) **43087**
(21) 3-2021-02104 (28) 1
(54) **DÉP** (51) **02-04**
(22) 19/08/2021 (43) 25/11/2021
(30) 29/771,367 22/02/2021 US;
(73) **CROCS, INC. (US)**
13601 Via Varra, Broomfield, Colorado 80020, United States of America
(72) Alexander Jacob MAYHEW (US)
(74) Công ty Luật TNHH quốc tế BMVN (BMVN INTERNATIONAL LLC)
(55)



1.1



1.2



1.3



1.4



1.5



1.6



1.7

CÔNG BÁO SỞ HỮU CÔNG NGHIỆP SỐ 404 TẬP A – QUYỀN 2 (11.2021)

- (11) **43088**
(21) 3-2021-02106 (28) 3
(54) **BÌNH GAS** (51) **23-01**
(22) 19/08/2021 (43) 25/11/2021
(73) **CÔNG TY CỔ PHẦN KINH DOANH KHÍ MIỀN NAM (VN)**
Lầu 4, PetroVietNam Tower, số 1-5 Lê Duẩn, phường Bến Nghé, quận 1, thành phố Hồ Chí Minh
(72) Nguyễn Cao Đệ (VN)
(74) Công ty TNHH một thành viên Trường Luật (Trường Luật)
(55)

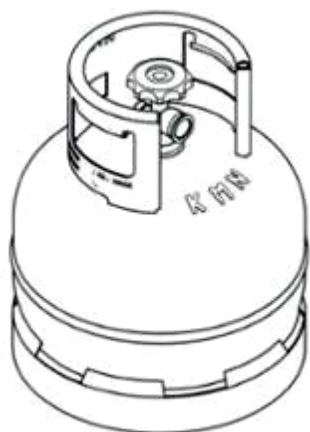

1.1

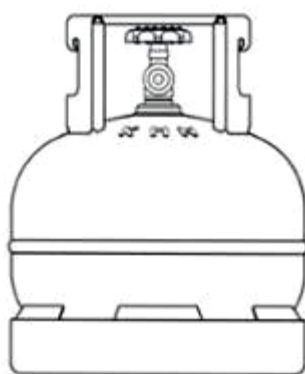

1.2

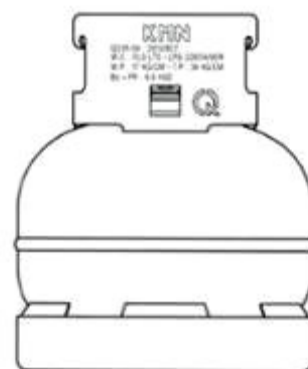

1.3

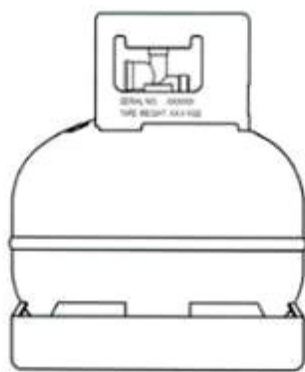

1.4

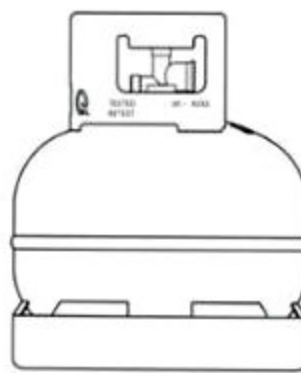

1.5



1.6



1.7

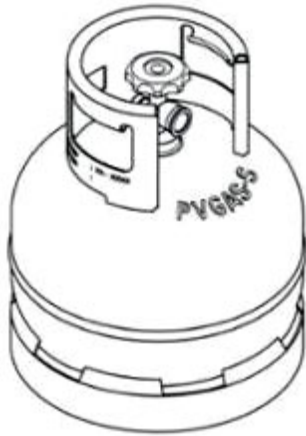

2.1

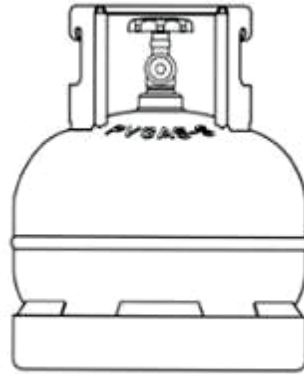

2.2

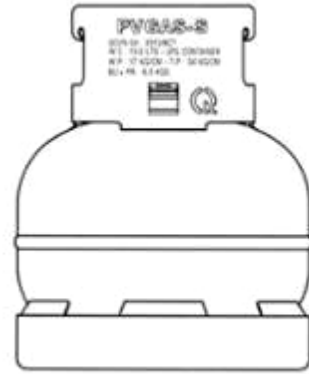

2.3

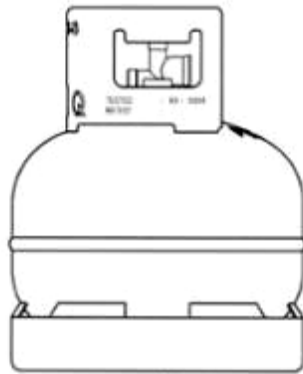

2.5

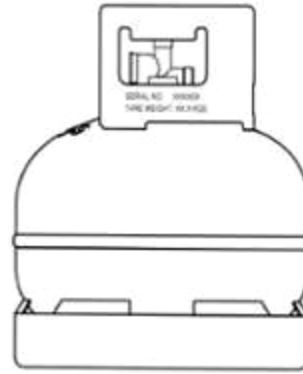

2.4



2.6

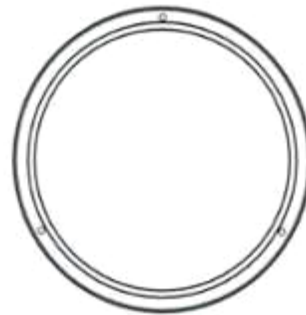

2.7

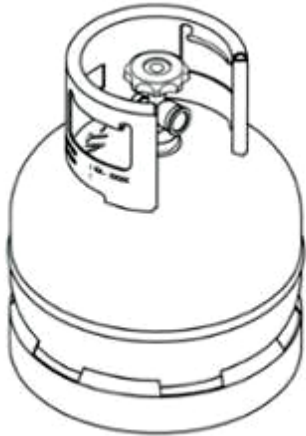

3.1

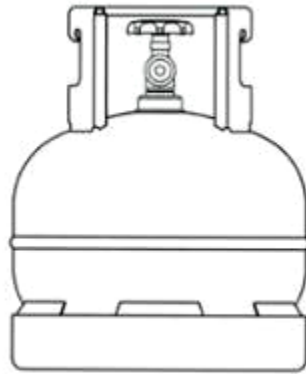

3.2

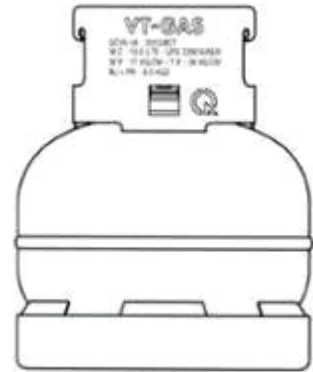

3.3

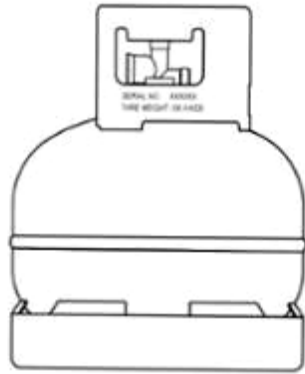

3.4

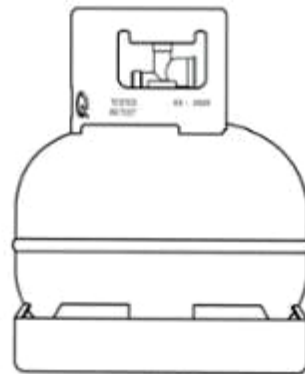

3.5



3.6



3.7

CÔNG BÁO SỞ HỮU CÔNG NGHIỆP SỐ 404 TẬP A – QUYỀN 2 (11.2021)

- (11) **43089**
(21) 3-2021-02108 (28) 8
(54) **BÌNH GAS** (51) **23-01**
(22) 19/08/2021 (43) 25/11/2021
(73) **CÔNG TY CỔ PHẦN KINH DOANH KHÍ MIỀN NAM (VN)**
Lầu 4, PetroVietNam Tower, số 1-5 Lê Duẩn, phường Bến Nghé, quận 1, thành phố Hồ Chí Minh
(72) Nguyễn Cao Đệ (VN)
(74) Công ty TNHH một thành viên Trường Luật (Trường Luật)
(55)

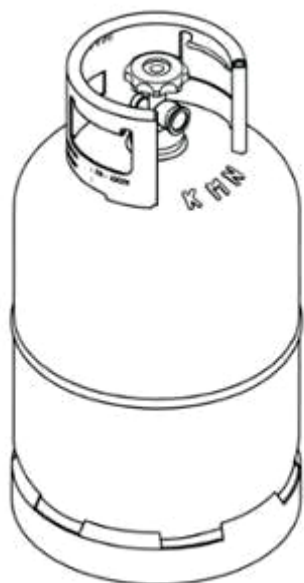

1.1

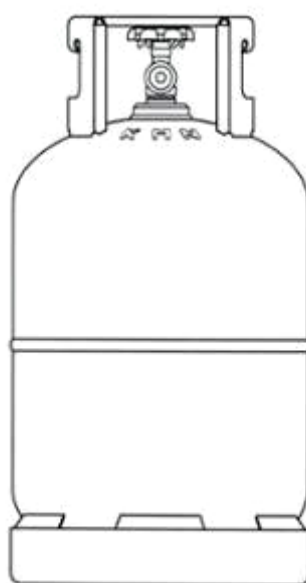

1.2

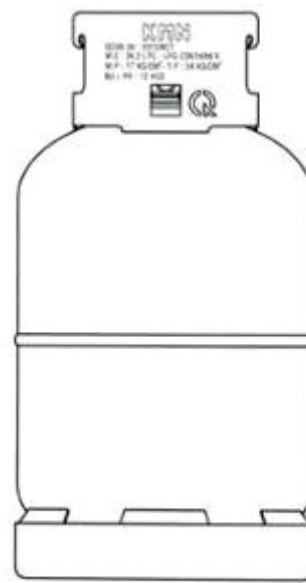

1.3

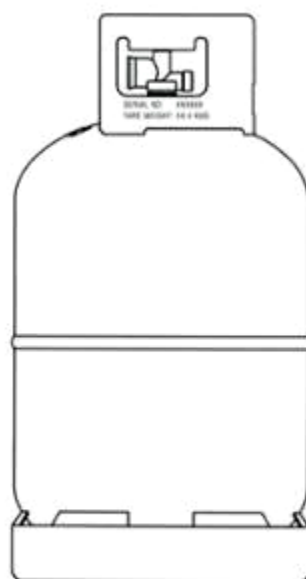

1.4

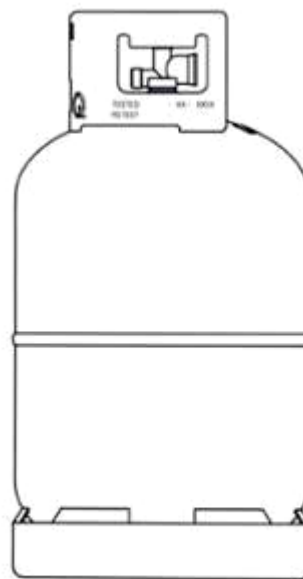

1.5



1.6



1.7

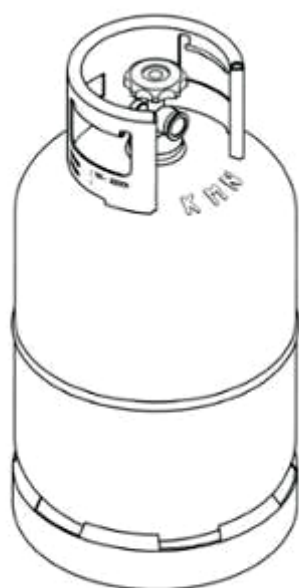

2.1

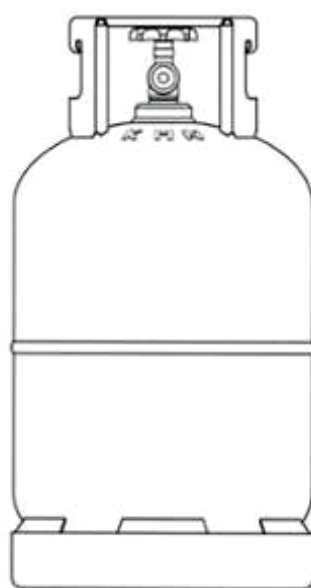

2.2



2.3

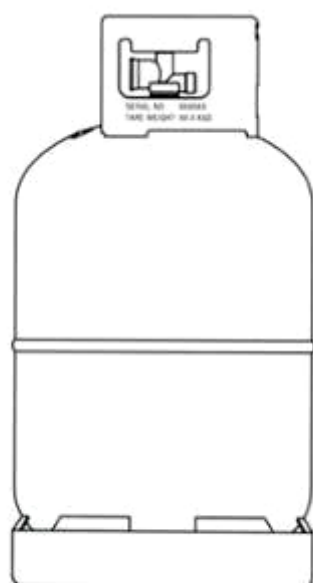

2.4

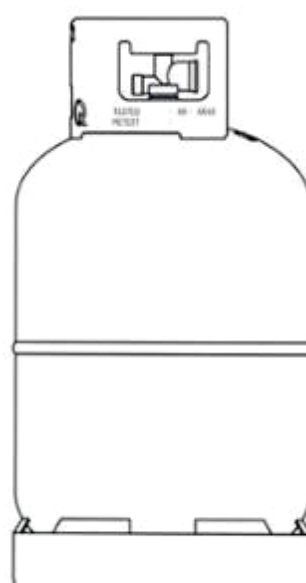

2.5



2.6



2.7

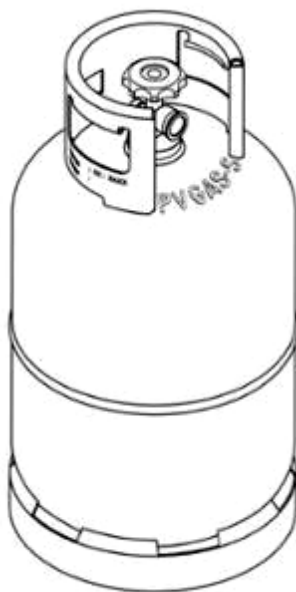

3.1



3.2



3.3

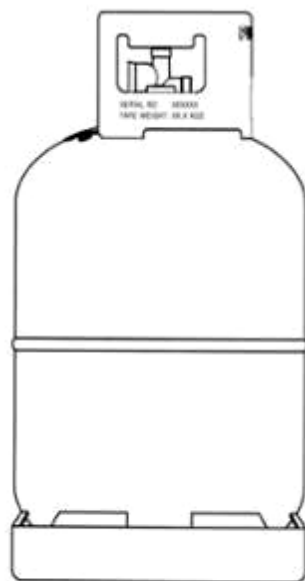

3.4

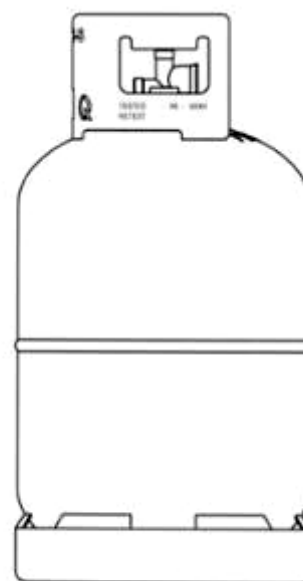

3.5



3.6

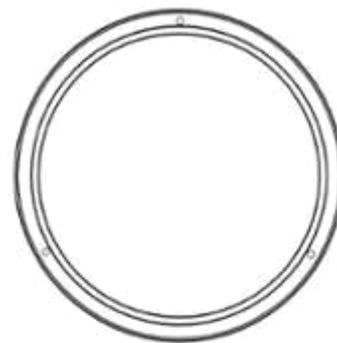

3.7

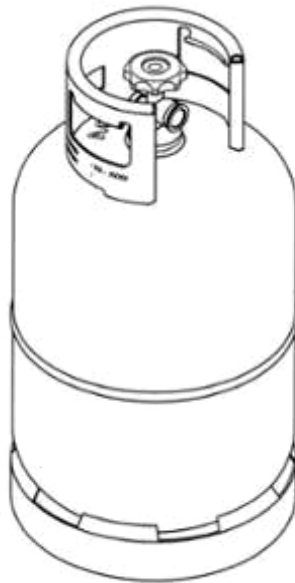

4.1

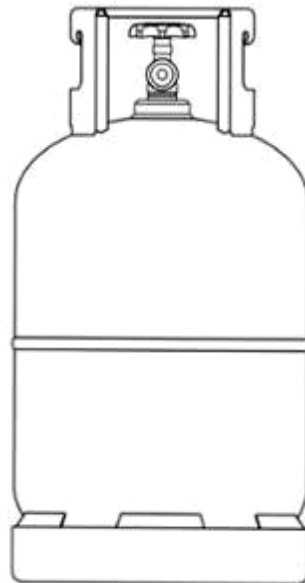

4.2

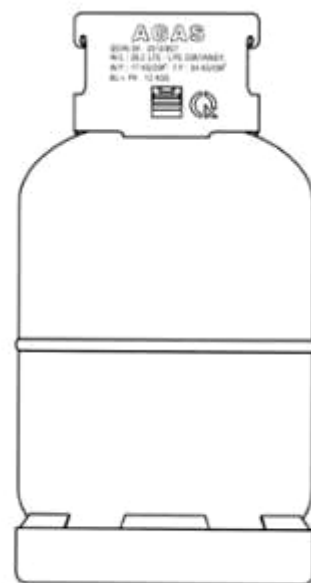

4.3

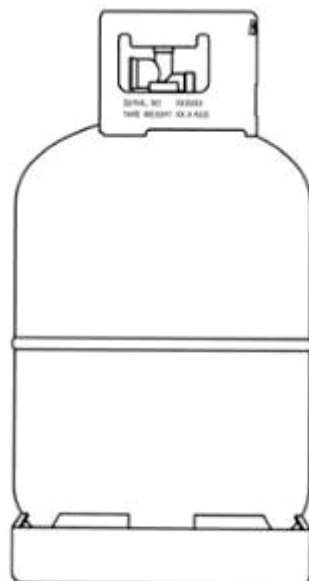

4.4

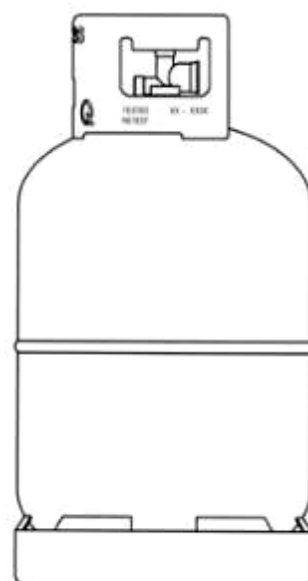

4.5



4.6



4.7

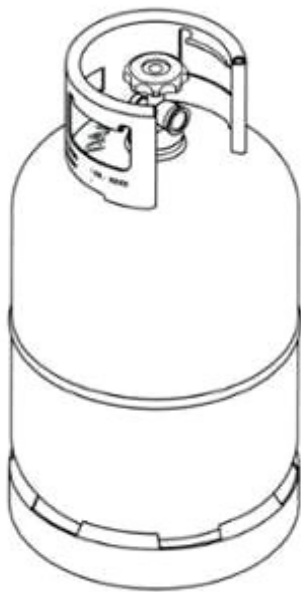

5.1

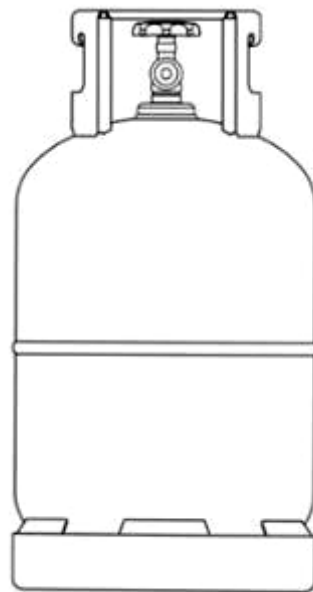

5.2

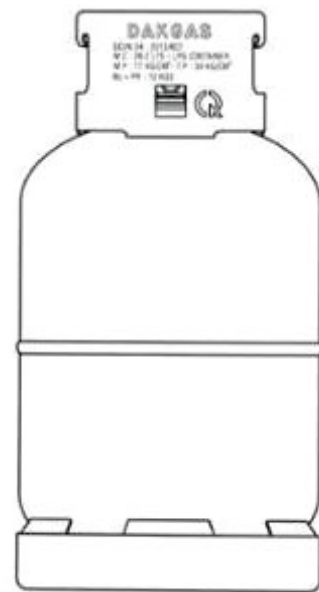

5.3

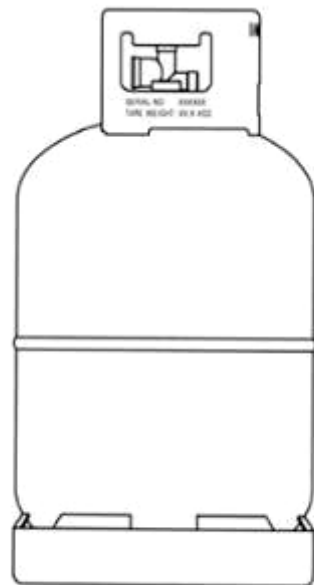

5.4

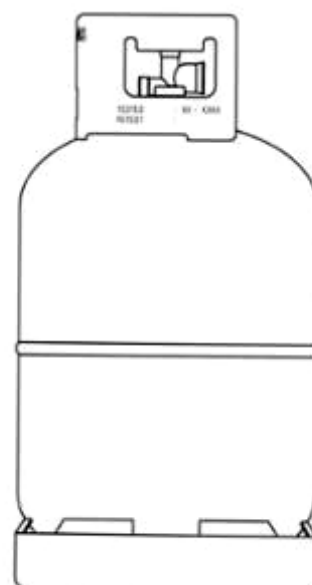

5.5



5.6

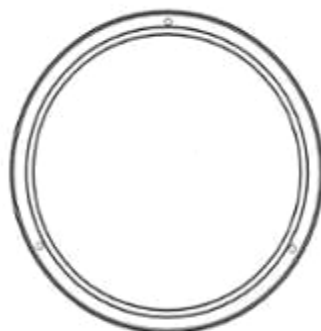

5.7

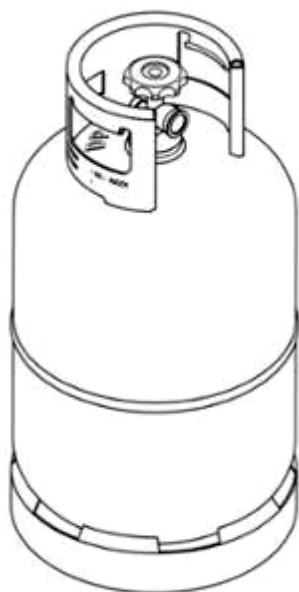

6.1

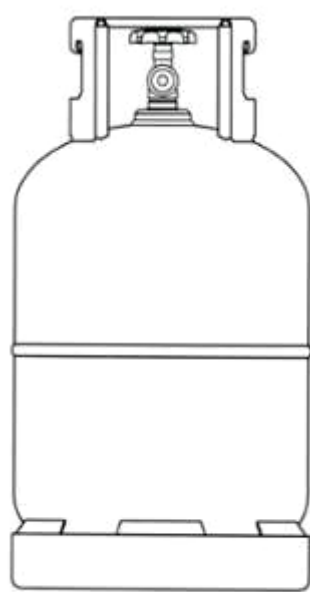

6.2

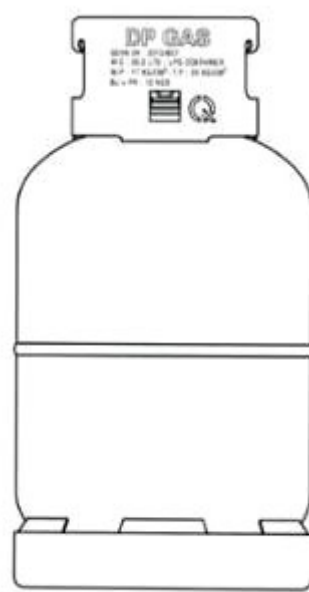

6.3

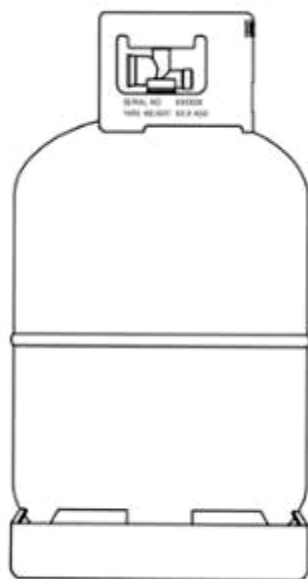

6.4

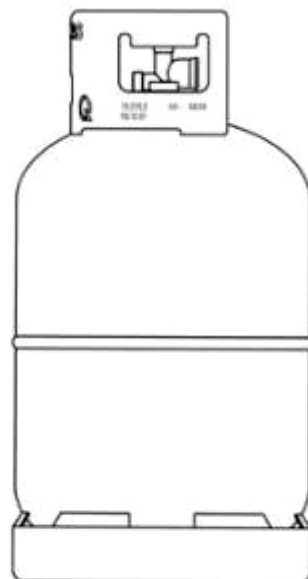

6.5



6.6



6.7

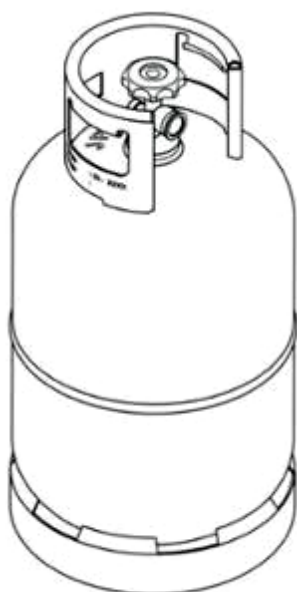

7.1

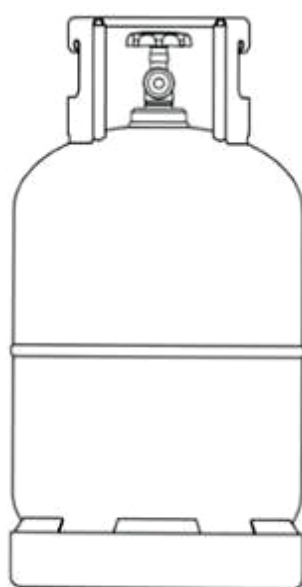

7.2



7.3

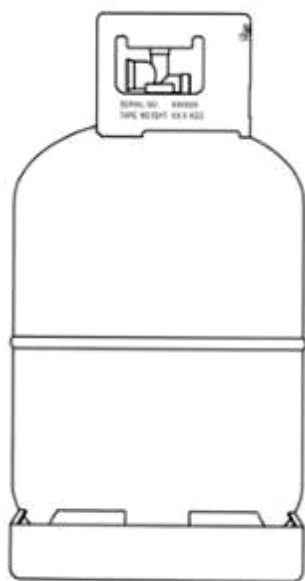

7.4



7.5



7.6



7.7

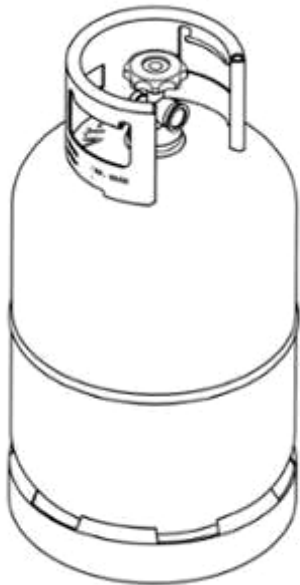

8.1

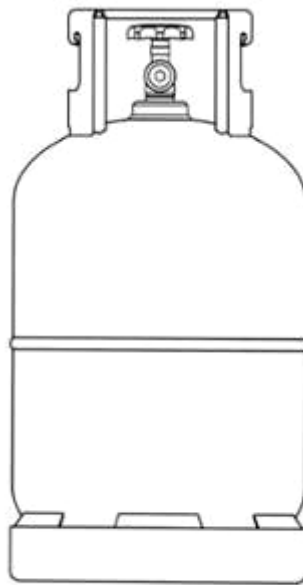

8.2

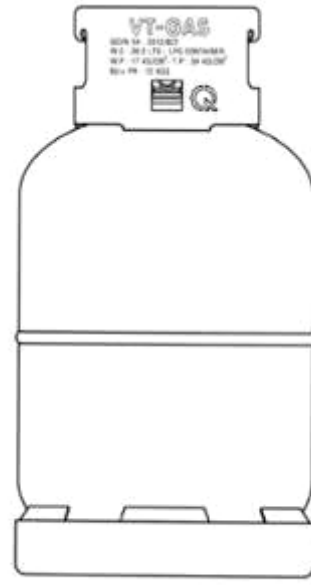

8.3

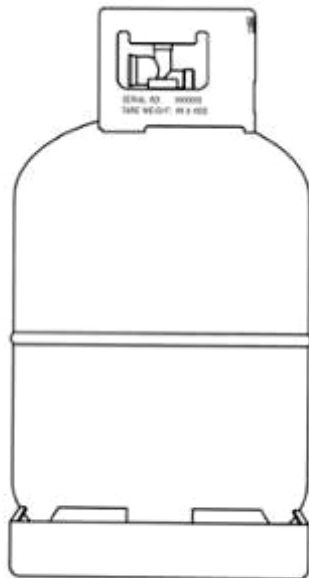

8.4

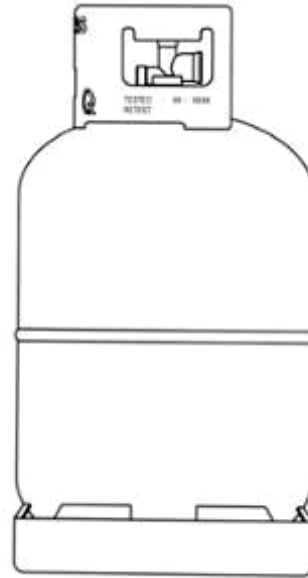

8.5

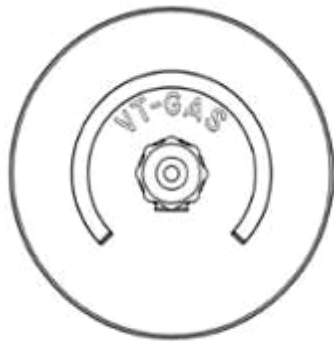

8.6

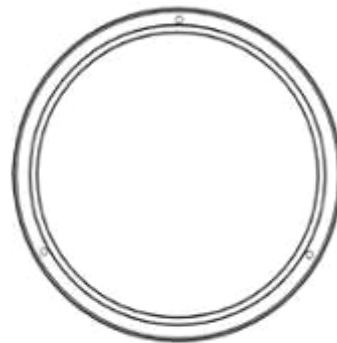

8.7

CÔNG BÁO SỞ HỮU CÔNG NGHIỆP SỐ 404 TẬP A – QUYỀN 2 (11.2021)

- (11) **43090**
(21) 3-2021-02109 (28) 3
(54) **BÌNH GAS** (51) **23-01**
(22) 19/08/2021 (43) 25/11/2021
(73) **CÔNG TY CỔ PHẦN KINH DOANH KHÍ MIỀN NAM (VN)**
Lầu 4, PetroVietNam Tower, số 1-5 Lê Duẩn, phường Bến Nghé, quận 1, thành phố Hồ Chí Minh
(72) Nguyễn Cao Đệ (VN)
(74) Công ty TNHH một thành viên Trường Luật (Trường Luật)
(55)

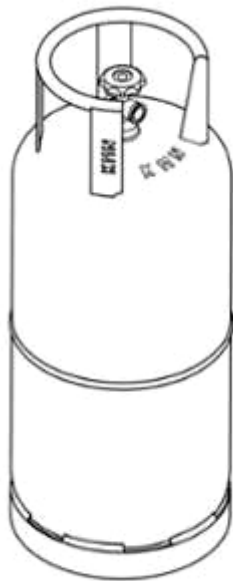

1.1



1.2



1.3



1.4



1.5



1.6



1.7

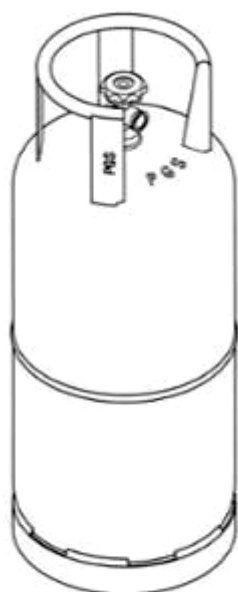

2.1



2.2



2.3



2.4

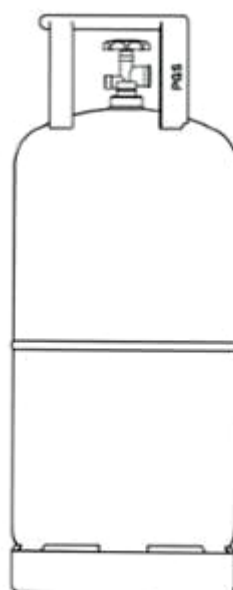

2.5



2.6



2.7



3.1



3.2



3.3



3.4

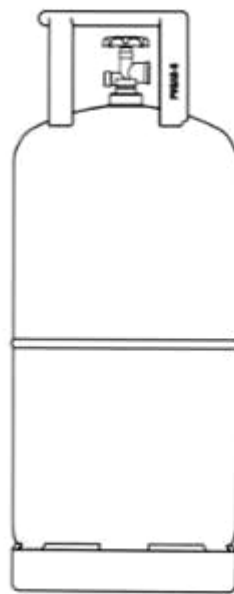

3.5



3.6



3.7

- (11) **43091**
(21) 3-2021-02110 (28) 12
(54) **BÌNH GAS** (51) **23-01**
(22) 19/08/2021 (43) 25/11/2021
(73) **CÔNG TY CỔ PHẦN KINH DOANH KHÍ MIỀN NAM (VN)**
Lầu 4, PetroVietNam Tower, số 1-5 Lê Duẩn, phường Bến Nghé, quận 1, thành phố Hồ Chí Minh
(72) Nguyễn Cao Đệ (VN)
(74) Công ty TNHH một thành viên Trường Luật (Trường Luật)
(55)

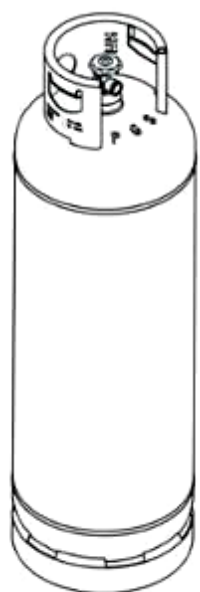

1.1



1.2



1.3



1.4



1.5



1.6



1.7

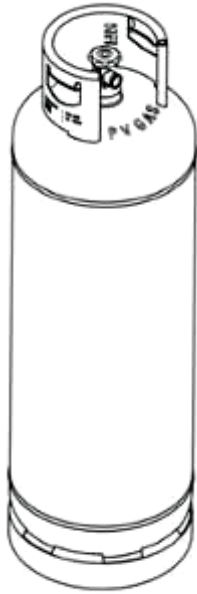

2.1



2.2



2.3



2.4

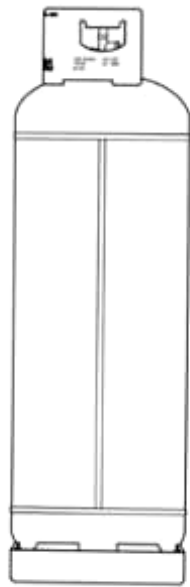

2.5



2.6



2.7

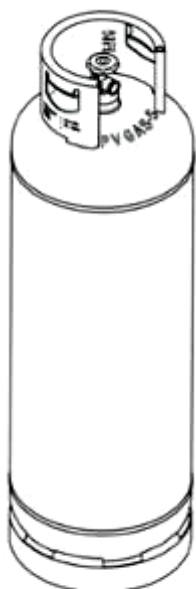

3.1



3.2



3.3



3.4



3.5



3.6



3.7



4.1



4.2



4.3



4.4



4.5



4.6



4.7



5.1



5.2



5.3



5.4



5.5



5.6



5.7

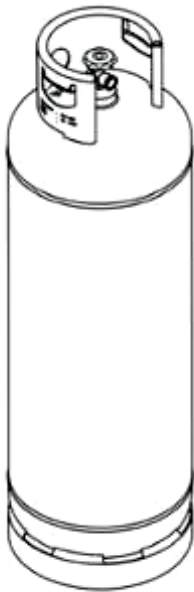

6.1



6.2



6.3



6.4

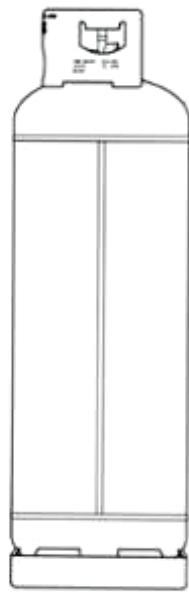

6.5



6.6



6.7

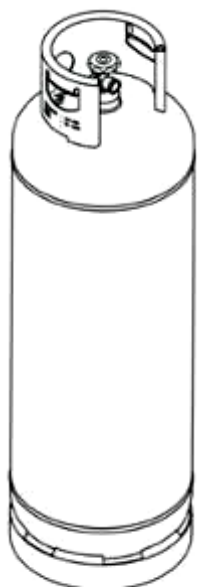

7.1



7.2



7.3



7.4



7.5



7.6



7.7

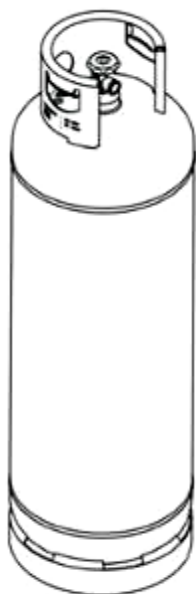

8.1



8.2



8.3



8.4



8.5



8.6



8.7



9.1



9.2



9.3



9.4



9.5



9.6



9.7

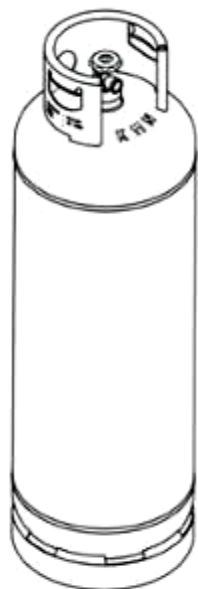

10.1



10.2



10.3



10.4

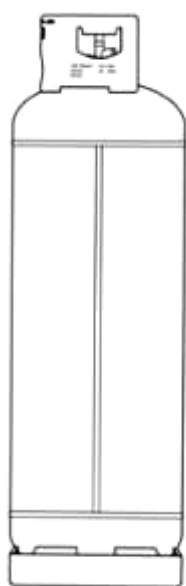

10.5



10.6



10.7



11.1



11.3



11.2



11.4



11.5



11.6



11.7

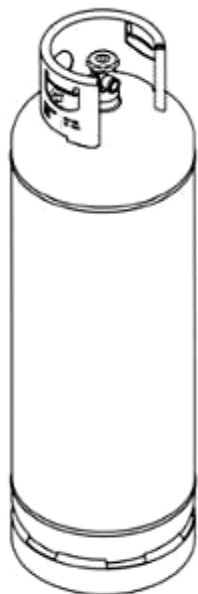

12.1



12.2



12.3



12.4



12.5



12.6



12.7

- (11) **43092**
(21) 3-2021-02111 (28) 1
(54) **CỐC ĐỰNG MẪU** (51) **24-02**
(22) 19/08/2021 (43) 25/11/2021
(30) 30-2021-0014598 26/03/2021 KR;
(73) **BIONLIFESCIENCE CO., LTD. (KR)**
(11901) A-601, 19, Sanmaru-ro, Guri-si, Gyeonggi-do, Republic of Korea
(72) 1. GOH, CHANG WOOK (KR)
2. KIM, BONG YOON (KR)
3. JEONG, JOONG HWAN (KR)
(74) Công ty TNHH Trường Xuân (AGELESS CO.,LTD.)
(55)

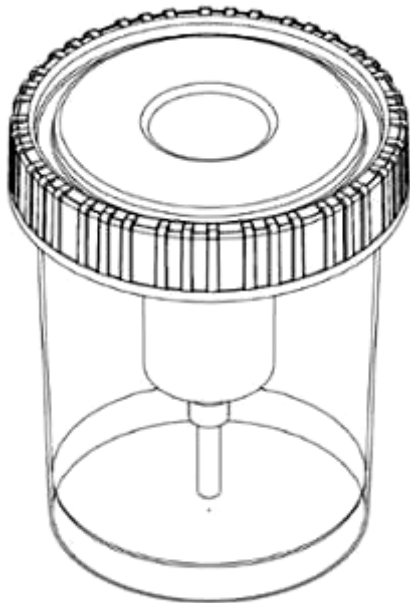

1.1

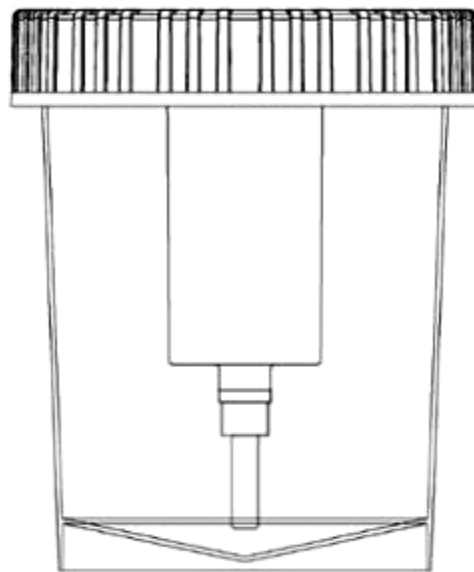

1.2

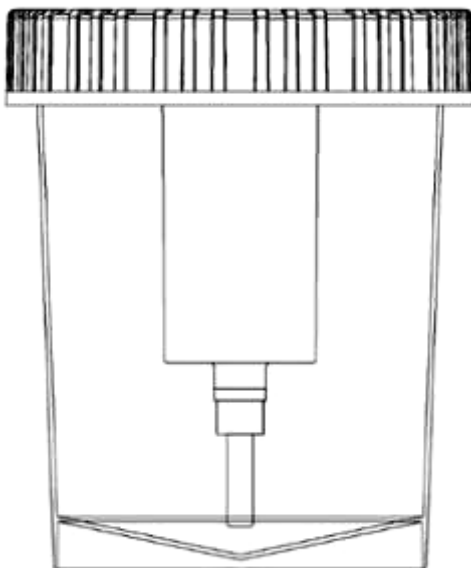

1.3

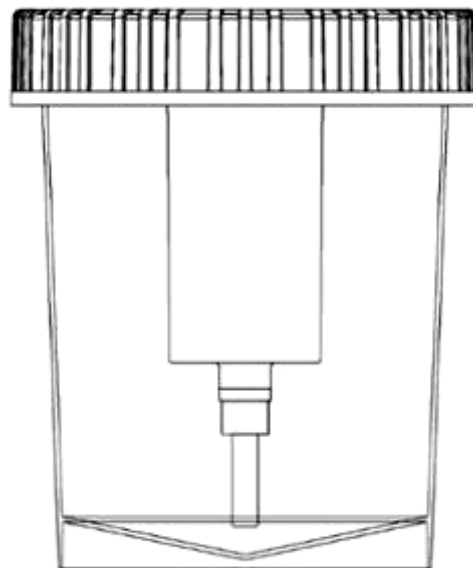

1.4

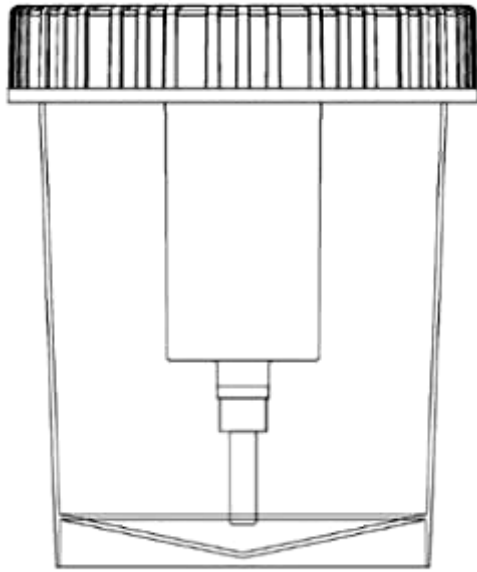

1.5

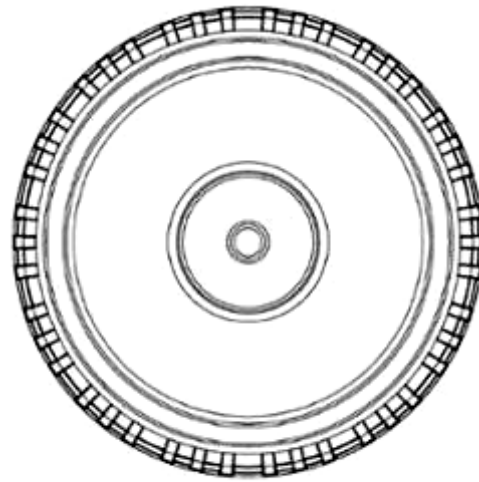

1.6

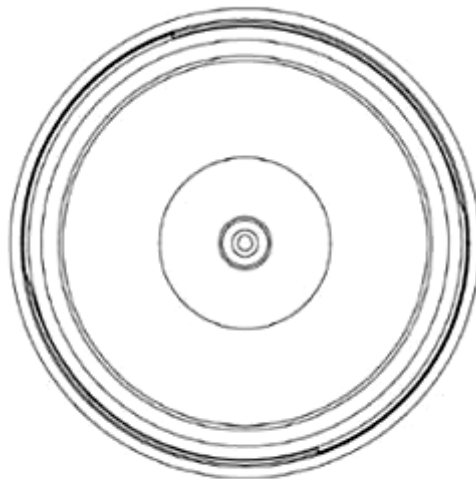

1.7



1.8

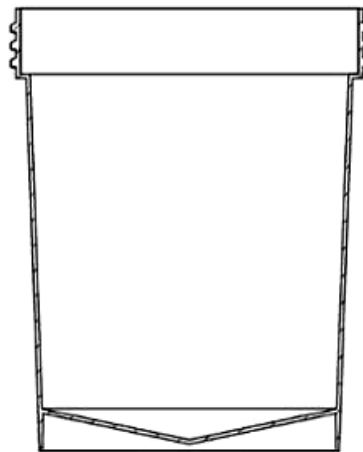

1.9

CÔNG BÁO SỞ HỮU CÔNG NGHIỆP SỐ 404 TẬP A – QUYỀN 2 (11.2021)

- (11) **43093**
(21) 3-2021-02112 (28) 1
(54) **HỘP ĐỰNG DAO KÉO** (51) **07-07**
(22) 19/08/2021 (43) 25/11/2021
(30) 30-2021-0016508 06/04/2021 KR;
(73) **LOCK & LOCK CO., LTD** (KR)
104, Sapgyocheon-ro, Seonjang-myeon, Asan-si, Chungcheongnam-do, Republic
of Korea
(72) KIM, Seon Jeong (KR)
(74) Công ty TNHH Tầm nhìn và Liên danh (VISION & ASSOCIATES CO.LTD.)
(55)

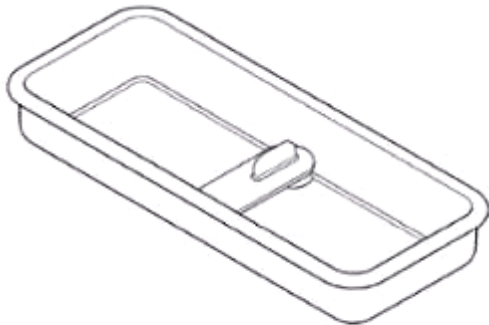

1.1



1.2



1.3



1.4



1.5

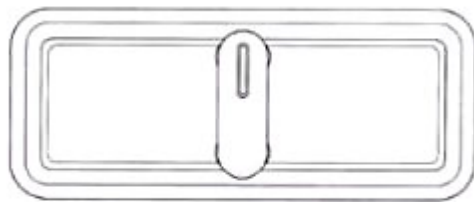

1.6

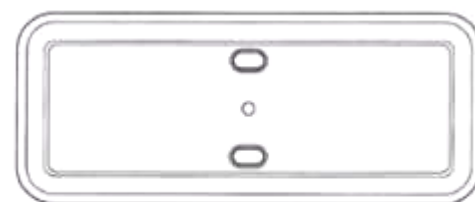

1.7

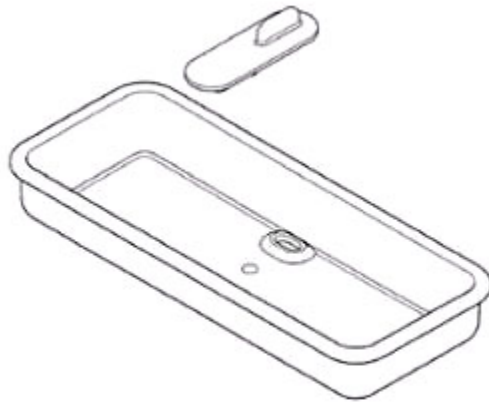

1.8

CÔNG BÁO SỞ HỮU CÔNG NGHIỆP SỐ 404 TẬP A – QUYỀN 2 (11.2021)

- (11) **43094**
(21) 3-2021-02113 (28) 1
(54) **HỘP ĐỰNG BỎNG NGÔ** (51) **07-01**
(22) 19/08/2021 (43) 25/11/2021
(30) 30-2021-0017005 08/04/2021 KR;
(73) **LOCK & LOCK CO., LTD (KR)**
104, Sapgyocheon-ro, Seonjang-myeon, Asan-si, Chungcheongnam-do, Republic
of Korea
(72) SHIM, Dong Seop (KR)
(74) Công ty TNHH Tâm nhìn và Liên danh (VISION & ASSOCIATES CO.LTD.)
(55)

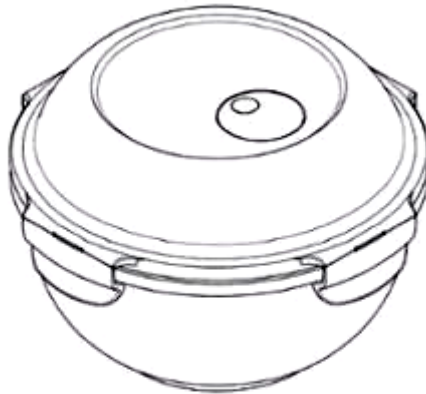

1.1

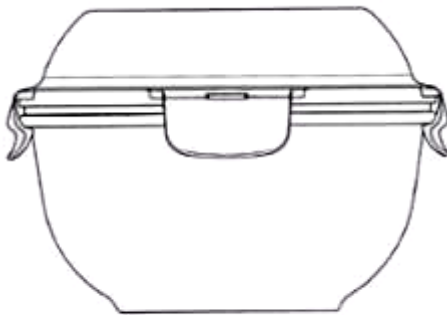

1.2

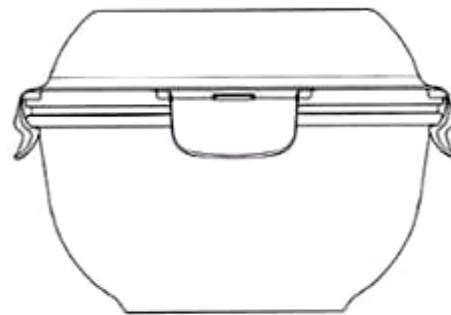

1.3

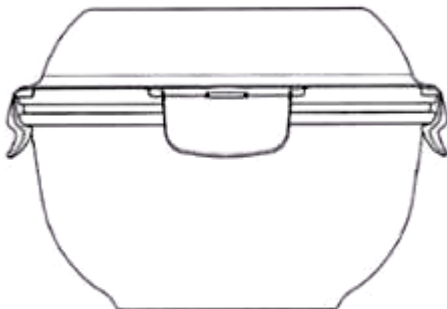

1.4

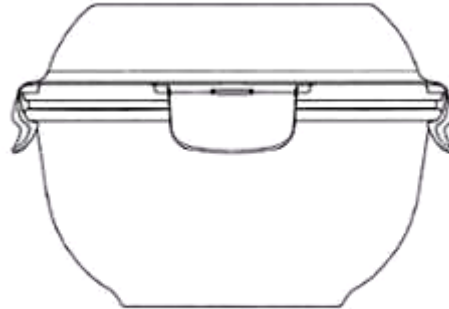

1.5

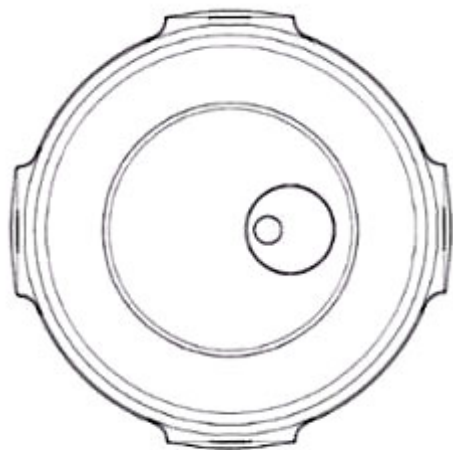

1.6

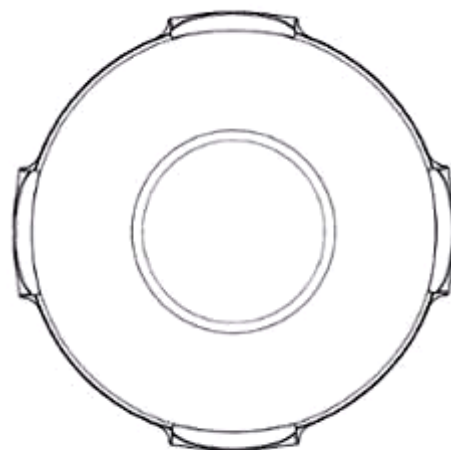

1.7

- (11) **43095**
(21) 3-2021-02116 (28) 1
(54) **DỤNG CỤ NẤU ĂN** (51) **07-02**
(22) 20/08/2021 (43) 25/11/2021
(30) 29/772,149 26/02/2021 US;
(73) **FRONTLINE ADVANCE, LLC (US)**
1070 S Kimball Avenue, Suite 121, Southlake, TX 76092, United States of America
(72) 1. JEFFREY R. WEILERT (US)
2. ALEXANDER K. MAGHSADI (US)
(74) Công ty Luật TNHH T&G (TGVN)
(55)

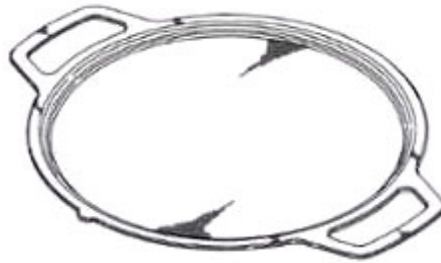

1.1



1.2



1.3



1.4



1.5



1.6

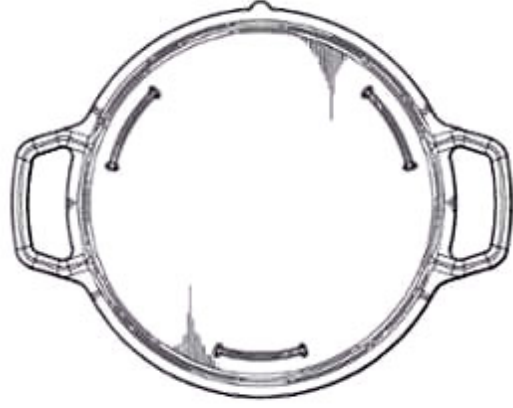

1.7



1.8

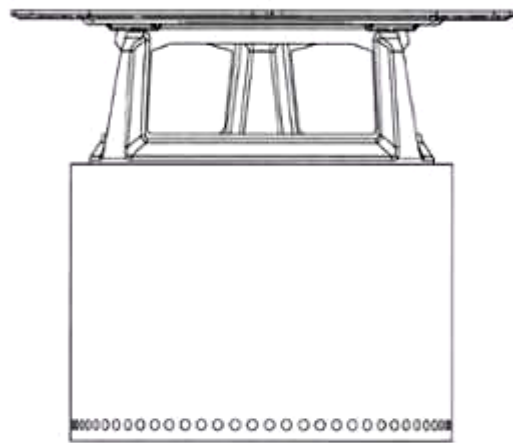

1.9

- (11) **43096**
(21) 3-2021-02117 (28) 1
(54) **DỤNG CỤ NẤU ĂN** (51) **07-02**
(22) 20/08/2021 (43) 25/11/2021
(30) 29/772,105 26/02/2021 US;
(73) **FRONTLINE ADVANCE, LLC (US)**
1070 S Kimball Avenue, Suite 121, Southlake, TX 76092, United States of America
(72) 1. JEFFREY R. WEILERT (US)
2. ALEXANDER K. MAGHSADI (US)
(74) Công ty Luật TNHH T&G (TGVN)
(55)

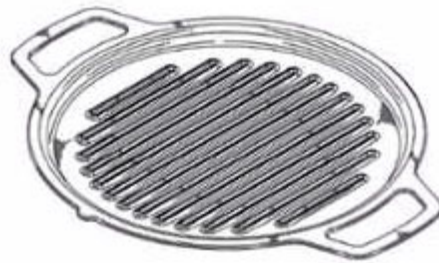

1.1



1.2



1.3



1.4



1.5



1.6



1.7



1.8

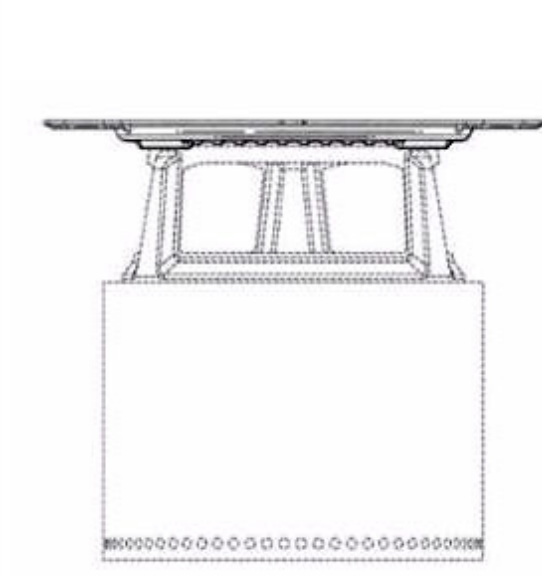

1.9

- (11) **43097**
(21) 3-2021-02118 (28) 1
(54) **DỤNG CỤ NẤU ĂN** (51) **07-02**
(22) 20/08/2021 (43) 25/11/2021
(30) 29/772,154 26/02/2021 US;
(73) **FRONTLINE ADVANCE, LLC (US)**
1070 S Kimball Avenue, Suite 121, Southlake, TX 76092, United States of America
(72) 1. JEFFREY R. WEILERT (US)
2. ALEXANDER K. MAGHSADI (US)
(74) Công ty Luật TNHH T&G (TGVN)
(55)

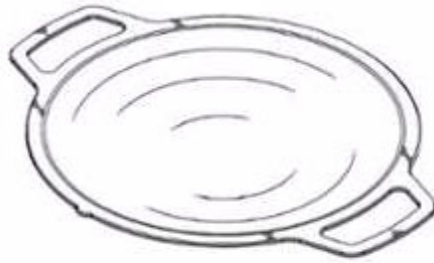

1.1



1.2

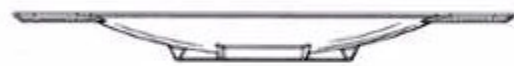

1.3



1.4

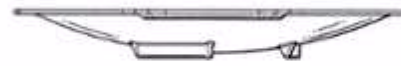

1.5

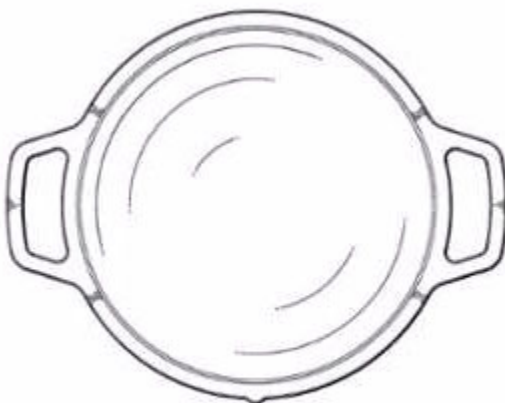

1.6

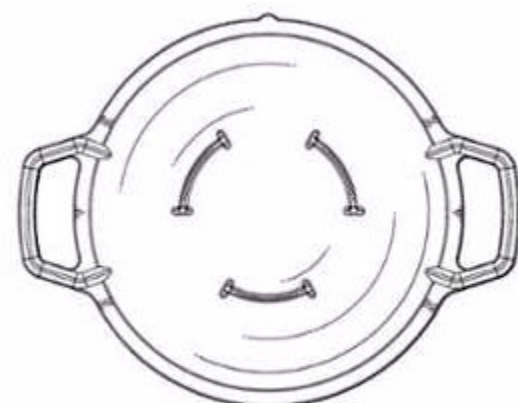

1.7

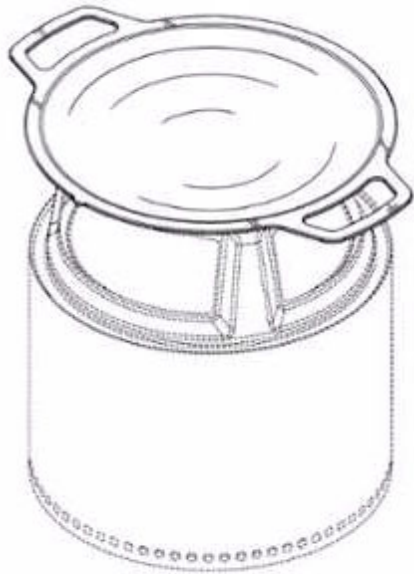

1.8

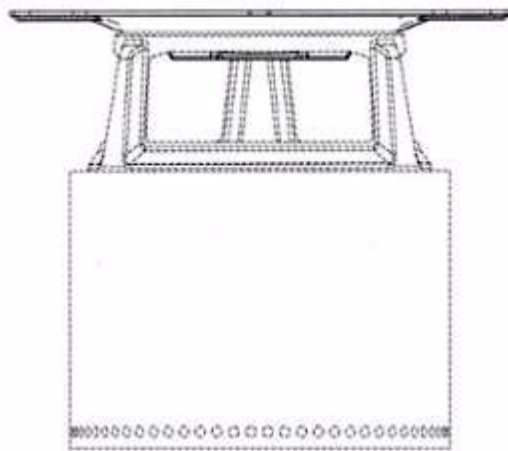

1.9

- (11) **43098**
(21) 3-2021-02119 (28) 1
(54) **GIÁ ĐỖ CHO DỤNG CỤ NẤU ĂN** (51) **07-02**
(22) 20/08/2021 (43) 25/11/2021
(30) 29/772,111 26/02/2021 US;
(73) **FRONTLINE ADVANCE, LLC (US)**
1070 S Kimball Avenue, Suite 121, Southlake, TX 76092, United States of America
(72) 1. JEFFREY R. WEILERT (US)
2. ALEXANDER K. MAGHSADI (US)
(74) Công ty Luật TNHH T&G (TGVN)
(55)



1.1

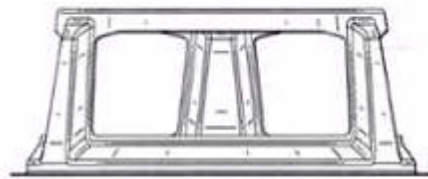

1.2

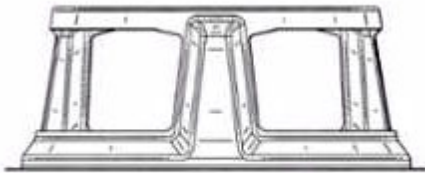

1.3

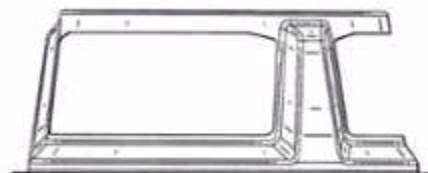

1.4

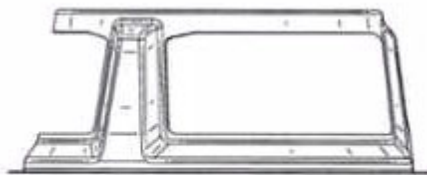

1.5



1.6



1.7



1.8

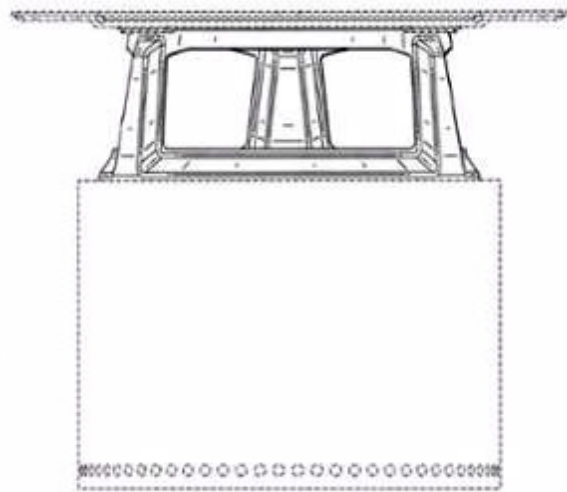

1.9

CÔNG BÁO SỞ HỮU CÔNG NGHIỆP SỐ 404 TẬP A – QUYỀN 2 (11.2021)

- (11) **43099**
(21) 3-2021-02120 (28) 1
(54) **BỒN TỰ HOẠI** (51) **23-99**
(22) 20/08/2021 (43) 25/11/2021
(73) **CÔNG TY CP QUỐC TẾ TẬP ĐOÀN AN PHÁT (VN)**
Số 104 Trần Nhân Tông, khu phố 2, thị trấn Vĩnh Trụ, huyện Lý Nhân, tỉnh Hà Nam
(72) Nguyễn Văn Thọ (VN)
(74) Công ty TNHH Dịch vụ Sở hữu trí tuệ GREENIP (GREENIP CO., LTD)
(55)



1.1



1.2



1.3



1.4



1.5



1.6



1.7

CÔNG BÁO SỞ HỮU CÔNG NGHIỆP SỐ 404 TẬP A – QUYỀN 2 (11.2021)

- (11) **43100**
(21) 3-2021-02122 (28) 1
(54) **BỘ SẠC VÀ XẢ PIN** (51) **13-02**
(22) 20/08/2021 (43) 25/11/2021
(30) 2021-003775 24/02/2021 JP;
(73) **HONDA MOTOR CO., LTD. (JP)**
1-1, Minami-Aoyama 2-chome, Minato-ku, Tokyo, 107-8556 Japan
(72) Kosuke YONETA (JP)
(74) Công ty Luật TNHH Phạm và Liên danh (PHAM & ASSOCIATES)
(55)



1.1



1.2



1.3



1.4



1.5



1.6



1.7



1.8



1.9



1.10

(11) **43101**

(21) 3-2021-02123

(28) 1

(54) **LỚP XE**

(51) **12-15**

(22) 20/08/2021

(43) 25/11/2021

(30) 202130102926.2 23/02/2021 CN;

(73) **COOPER TIRE & RUBBER COMPANY (US)**

701 Lima Avenue, Findlay, Ohio 45840, United States of America

(72) Jason Q. Fu (CN)

(74) **CÔNG TY LUẬT TRÁCH NHIỆM HỮU HẠN AMBYS HÀ NỘI (AMBYS HANOI)**

(55)

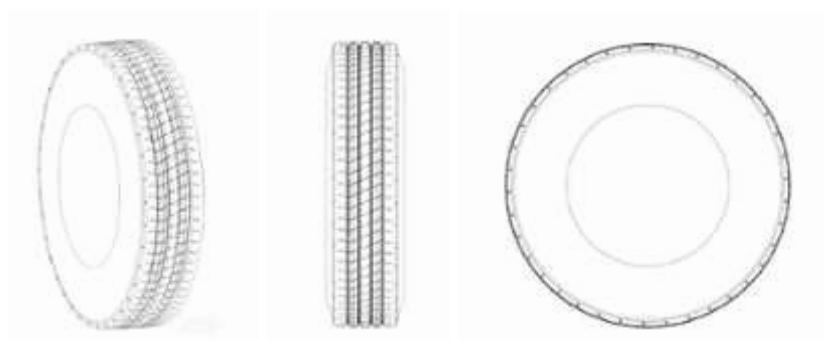

1.1

1.2

1.3

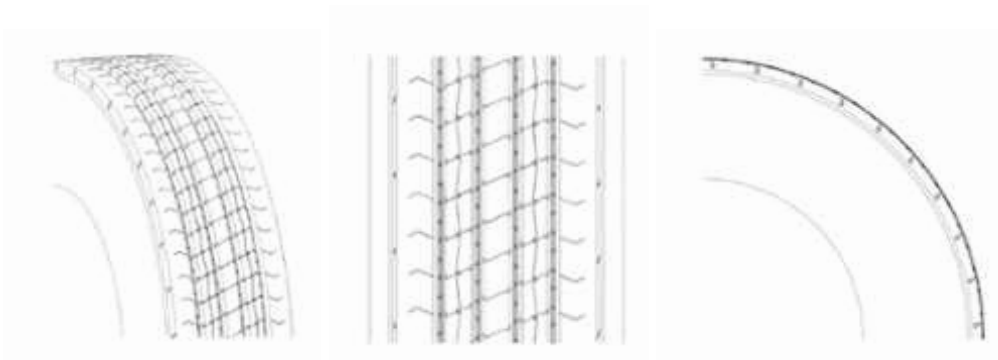

1.4

1.5

1.6

- (11) **43102**
(21) 3-2021-02131 (28) 1
(54) **CỐC ĐO LƯỜNG NẤU ĂN** (51) **07-02**
(22) 20/08/2021 (43) 25/11/2021
(30) 30-2021-0017006 08/04/2021 KR;
(73) **LOCK & LOCK CO., LTD** (KR)
104, Sapgyocheon-ro, Seonjang-myeon, Asan-si, Chungcheongnam-do, Republic
of Korea
(72) SHIM, Dong Seop (KR)
(74) Công ty TNHH Tầm nhìn và Liên danh (VISION & ASSOCIATES CO.LTD.)
(55)

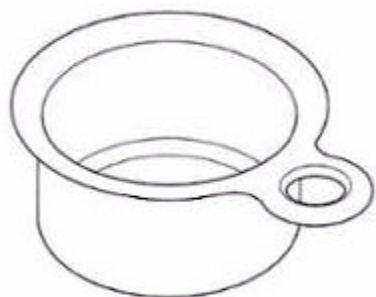

1.1



1.2



1.3



1.4



1.5

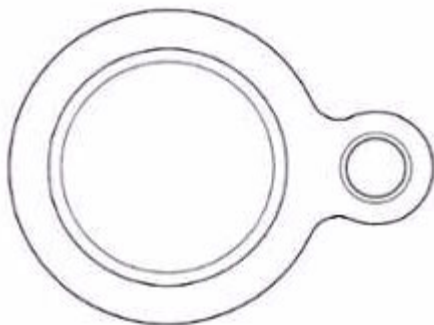

1.6

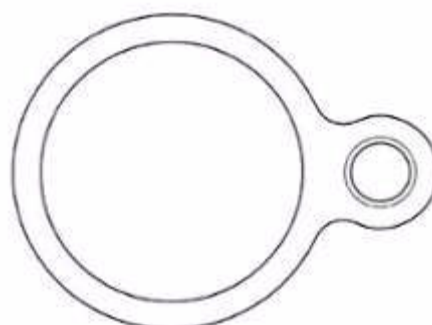

1.7

CÔNG BÁO SỞ HỮU CÔNG NGHIỆP SỐ 404 TẬP A – QUYỀN 2 (11.2021)

- (11) **43103**
(21) 3-2021-02132 (28) 1
(54) **THÙNG ĐỰNG GẠO** (51) **07-07**
(22) 20/08/2021 (43) 25/11/2021
(30) 30-2021-0025073 27/05/2021 KR;
(73) **LOCK & LOCK CO., LTD** (KR)
104, Sapgyocheon-ro, Seonjang-myeon, Asan-si, Chungcheongnam-do, Republic
of Korea
(72) JEON, Beom Sik (KR)
(74) Công ty TNHH Tầm nhìn và Liên danh (VISION & ASSOCIATES CO.LTD.)
(55)

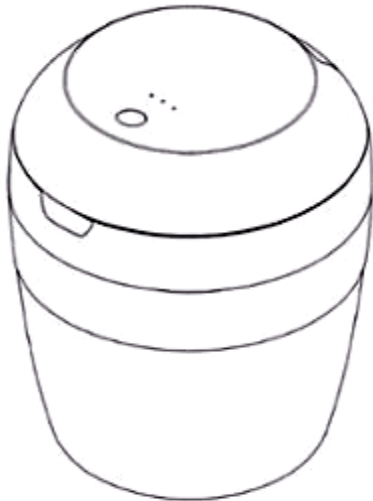

1.1



1.2

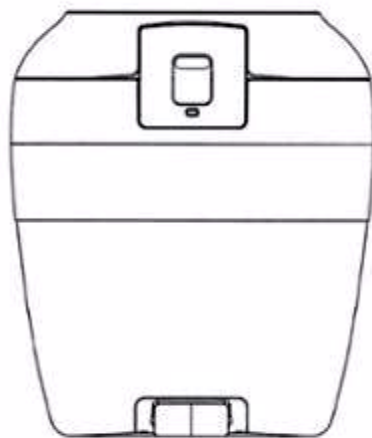

1.3

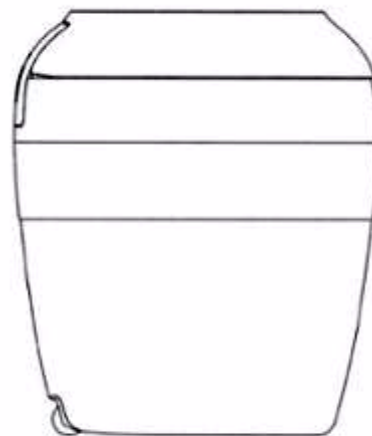

1.4



1.5



1.6

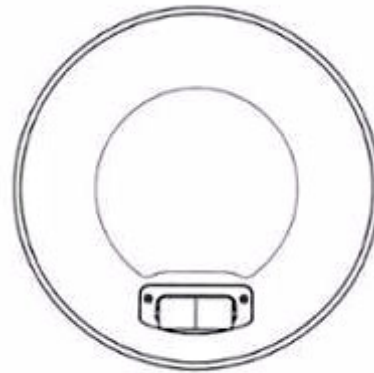

1.7

- (11) **43104**
(21) 3-2021-02133 (28) 1
(54) **MÁY TIỆT TRỪNG VÀ SẤY KHÔ** (51) **15-05**
(22) 20/08/2021 (43) 25/11/2021
(30) 30-2021-0025072 27/05/2021 KR;
(73) **LOCK & LOCK CO., LTD (KR)**
104, Sapgyocheon-ro, Seonjang-myeon, Asan-si, Chungcheongnam-do, Republic of Korea
(72) JEON, Beom Sik (KR)
(74) Công ty TNHH Tầm nhìn và Liên danh (VISION & ASSOCIATES CO.LTD.)
(55)



1.1

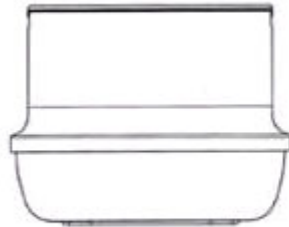

1.2

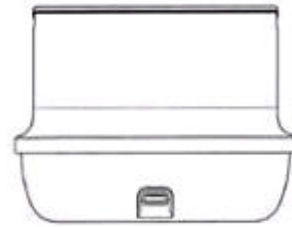

1.3

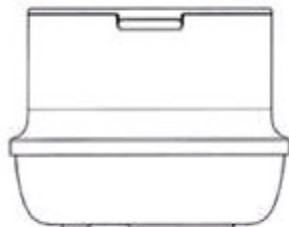

1.4

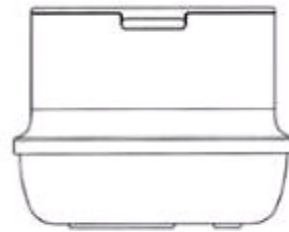

1.5

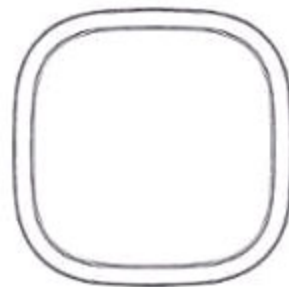

1.6

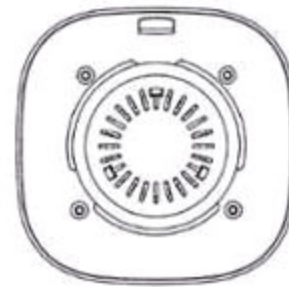

1.7

- (11) **43105**
(21) 3-2021-02135 (28) 1
(54) **THIẾT BỊ TIẾT TRỪNG THÓT** (51) **15-05**
(22) 20/08/2021 (43) 25/11/2021
(30) 30-2021-0021847 06/05/2021 KR;
(73) **LOCK & LOCK CO., LTD (KR)**
104, Sapgyocheon-ro, Seonjang-myeon, Asan-si, Chungcheongnam-do, Republic
of Korea
(72) YOU, Sung Ik (KR)
(74) Công ty TNHH Tầm nhìn và Liên danh (VISION & ASSOCIATES CO.LTD.)
(55)

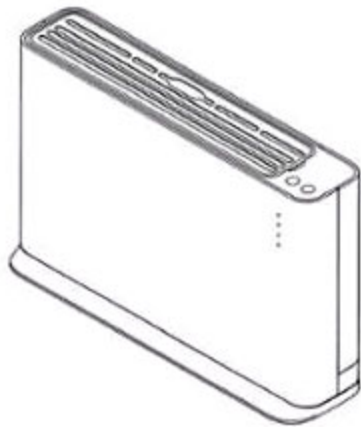

1.1



1.2

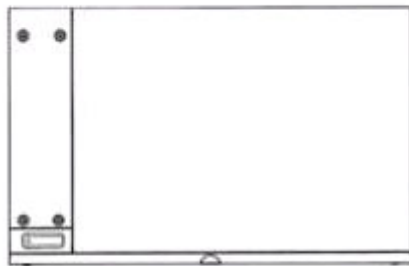

1.3



1.4

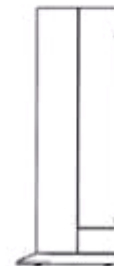

1.5

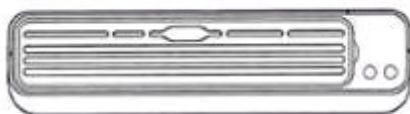

1.6



1.7

(11) **43106**

(21) 3-2021-02136

(28) 1

(54) **NẤP NỒI**

(51) **07-02**

(22) 20/08/2021

(43) 25/11/2021

(30) 30-2021-0022062 07/05/2021 KR;

(73) **LOCK & LOCK CO., LTD (KR)**

104, Sapgyocheon-ro, Seonjang-myeon, Asan-si, Chungcheongnam-do, Republic of Korea

(72) KIM, Kwang Ik (KR)

(74) Công ty TNHH Tầm nhìn và Liên danh (VISION & ASSOCIATES CO.LTD.)

(55)

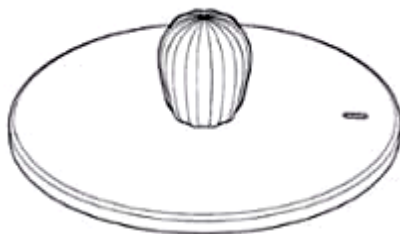

1.1

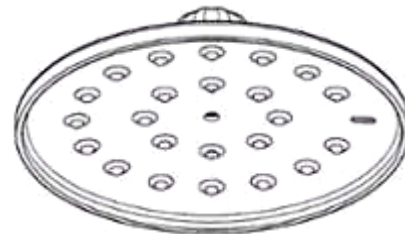

1.2

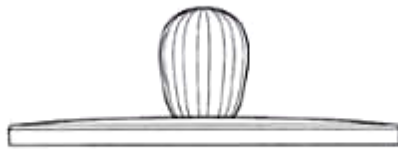

1.3

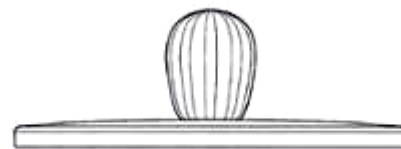

1.4

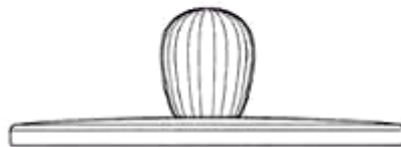

1.5

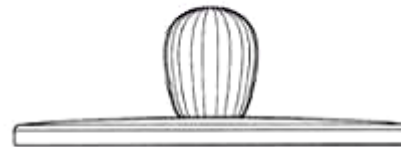

1.6

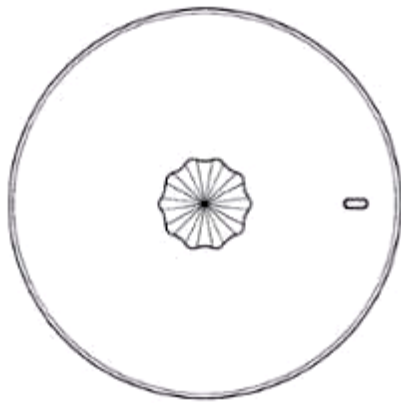

1.7

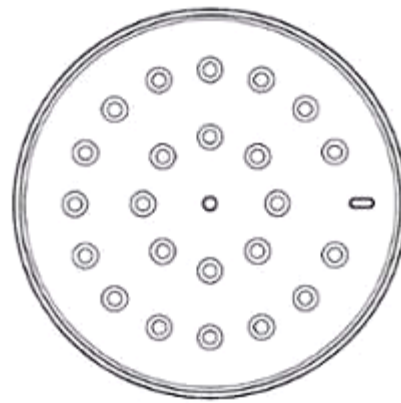

1.8

- (11) **43107**
(21) 3-2021-02137 (28) 1
(54) **TÚI ĐỰNG HỘP CƠM** (51) **09-05**
(22) 20/08/2021 (43) 25/11/2021
(30) 30-2021-0023030 13/05/2021 KR;
(73) **LOCK & LOCK CO., LTD (KR)**
104, Sapgyocheon-ro, Seonjang-myeon, Asan-si, Chungcheongnam-do, Republic
of Korea
(72) OH, Eun Seong (KR)
(74) Công ty TNHH Tầm nhìn và Liên danh (VISION & ASSOCIATES CO.LTD.)
(55)



1.1



1.2



1.3



1.4



1.5



1.6



1.7



1.8

CÔNG BÁO SỞ HỮU CÔNG NGHIỆP SỐ 404 TẬP A – QUYỀN 2 (11.2021)

- (11) **43108**
(21) 3-2021-02138 (28) 1
(54) **TAY CẦM NỖI** (51) **07-02**
(22) 20/08/2021 (43) 25/11/2021
(30) 30-2021-0022063 07/05/2021 KR;
(73) **LOCK & LOCK CO., LTD (KR)**
104, Sapgyocheon-ro, Seonjang-myeon, Asan-si, Chungcheongnam-do, Republic of Korea
(72) KIM, Kwang Ik (KR)
(74) Công ty TNHH Tầm nhìn và Liên danh (VISION & ASSOCIATES CO.LTD.)
(55)



1.1



1.2



1.3



1.4

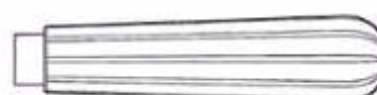

1.5



1.6



1.7

- (11) **43109**
(21) 3-2021-02139 (28) 1
(54) **THÙNG ĐỰNG CHẤT THẢI THỰC PHẨM** (51) **09-09**
(22) 20/08/2021 (43) 25/11/2021
(30) 30-2021-0025069 27/05/2021 KR;
(73) **LOCK & LOCK CO., LTD** (KR)
104, Sapgyocheon-ro, Seonjang-myeon, Asan-si, Chungcheongnam-do, Republic of Korea
(72) YOU, Sung Ik (KR)
(74) Công ty TNHH Tầm nhìn và Liên danh (VISION & ASSOCIATES CO.LTD.)
(55)



1.1



1.2



1.3

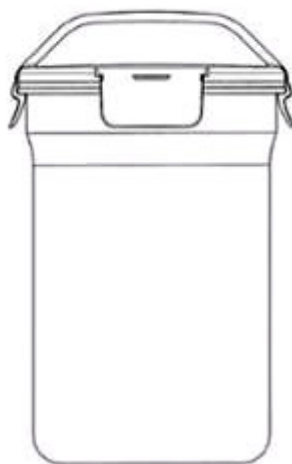

1.4

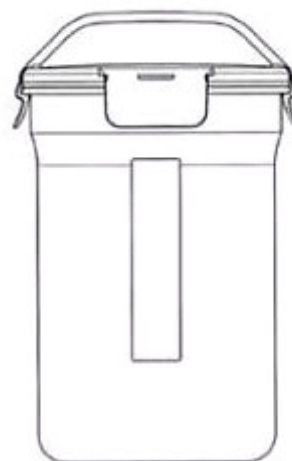

1.5

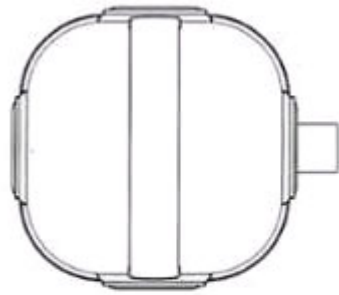

1.6

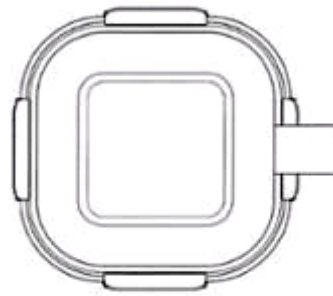

1.7

CÔNG BÁO SỞ HỮU CÔNG NGHIỆP SỐ 404 TẬP A – QUYỀN 2 (11.2021)

- (11) **43110**
(21) 3-2021-02140 (28) 1
(54) **CỐC** (51) **07-01**
(22) 20/08/2021 (43) 25/11/2021
(30) 30-2021-0025067 27/05/2021 KR;
(73) **LOCK & LOCK CO., LTD (KR)**
104, Sapgyocheon-ro, Seonjang-myeon, Asan-si, Chungcheongnam-do, Republic of Korea
(72) SONG, Ga Young (KR)
(74) Công ty TNHH Tầm nhìn và Liên danh (VISION & ASSOCIATES CO.LTD.)
(55)



1.1



1.2



1.3



1.4



1.5

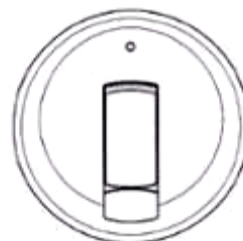

1.6



1.7

- (11) **43111**
(21) 3-2021-02141 (28) 1
(54) **NẮP THÙNG ĐỰNG CHẤT THẢI THỰC PHẨM** (51) **09-09**
(22) 20/08/2021 (43) 25/11/2021
(30) 30-2021-0025070 27/05/2021 KR;
(73) **LOCK & LOCK CO., LTD** (KR)
104, Sapgyocheon-ro, Seonjang-myeon, Asan-si, Chungcheongnam-do, Republic of Korea
(72) YOU, Sung Ik (KR)
(74) Công ty TNHH Tầm nhìn và Liên danh (VISION & ASSOCIATES CO.LTD.)
(55)

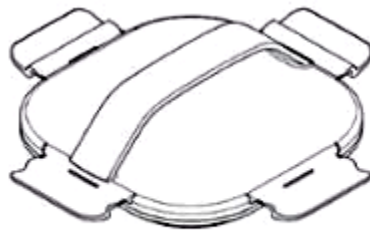

1.1



1.2



1.3



1.4



1.5

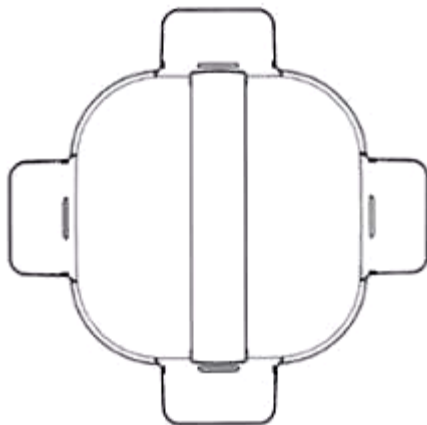

1.6

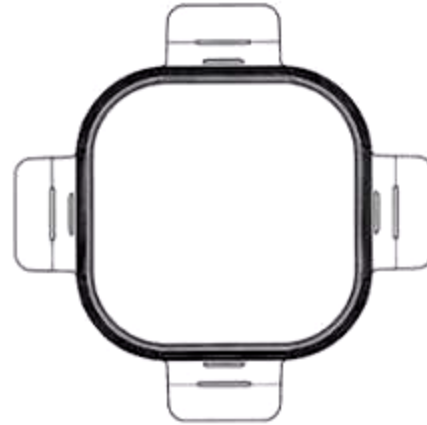

1.7

- (11) **43112**
(21) 3-2021-02142 (28) 1
(54) **NẮP CỐC** (51) **09-07**
(22) 20/08/2021 (43) 25/11/2021
(30) 30-2021-0025071 27/05/2021 KR;
(73) **LOCK & LOCK CO., LTD (KR)**
104, Sapgyocheon-ro, Seonjang-myeon, Asan-si, Chungcheongnam-do, Republic of Korea
(72) JEON, Beom Sik (KR)
(74) Công ty TNHH Tầm nhìn và Liên danh (VISION & ASSOCIATES CO.LTD.)
(55)

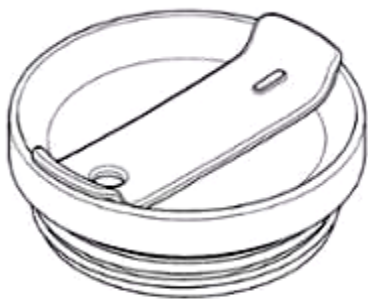

1.1

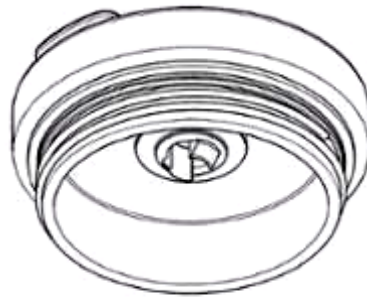

1.2



1.3



1.4



1.5



1.6

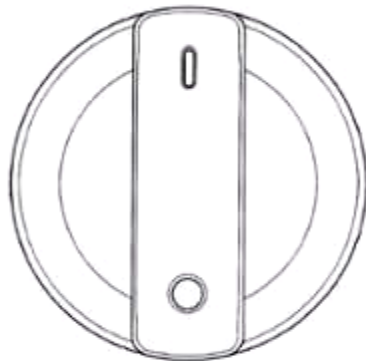

1.7

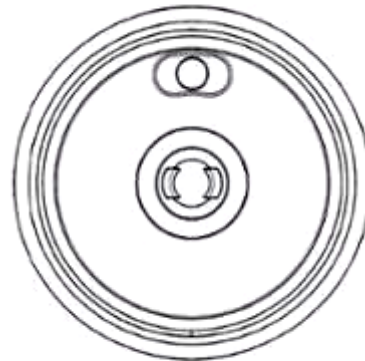

1.8

CÔNG BÁO SỞ HỮU CÔNG NGHIỆP SỐ 404 TẬP A – QUYỀN 2 (11.2021)

(11) **43113**

(21) 3-2021-02144

(28) 1

(54) **KHUNG GIƯỜNG**

(51) **06-02**

(22) 23/08/2021

(43) 25/11/2021

(73) **HTL FURNITURE (CHINA) CO., LTD. (CN)**

Wusong Jiangnan Road, Kunshan Development Zone, Jiangsu Province, China

(72) PHUA YONG TAT (SG)

(74) Công ty Luật TNHH quốc tế BMVN (BMVN INTERNATIONAL LLC)

(55)



1.1



1.2



1.3



1.4



1.5

CÔNG BÁO SỞ HỮU CÔNG NGHIỆP SỐ 404 TẬP A – QUYỀN 2 (11.2021)

- (11) **43114**
(21) 3-2021-02149 (28) 1
(54) **CAN** (51) **09-02**
(22) 23/08/2021 (43) 25/11/2021
(73) **CÔNG TY TNHH VICO (VN)**
Số 94, đường 208 An Đông, An Dương, thành phố Hải Phòng
(72) Nguyễn Mộng Lân (VN)
(74) Công ty TNHH Sở hữu trí tuệ Thảo Thọ Quyển (INVENCO.,LTD)
(55)



1.1



1.2



1.3



1.4



1.5



1.6



1.7

(11) **43115**

(21) 3-2021-02150

(28) 1

(54) **MÁY THỞ**

(51) **24-01**

(22) 23/08/2021

(43) 25/11/2021

(73) **CÔNG TY CỔ PHẦN MEIKO AUTOMATION (VN)**

Tầng 1, nhà EMS 2, Lô CN9, khu công nghiệp Thạch Thất - Quốc Oai, xã Phùng Xá, huyện Thạch Thất, thành phố Hà Nội

(72) Nguyễn Văn Thuận (VN)

(55)



1.1



1.2



1.3



1.4



1.5



1.6



1.7

CÔNG BÁO SỞ HỮU CÔNG NGHIỆP SỐ 404 TẬP A – QUYỀN 2 (11.2021)

- (11) **43116**
(21) 3-2021-02151 (28) 1
(54) **NỒI CHIÊN KHÔNG DẦU** (51) **07-02**
(22) 23/08/2021 (43) 25/11/2021
(30) 30-2021-0031195 30/06/2021 KR;
(73) **LOCK & LOCK CO., LTD (KR)**
104, Sapgyocheon-ro, Seonjang-myeon, Asan-si, Chungcheongnam-do, Republic of Korea
(72) 1. KIM, KWANG IK (KR)
2. SHIM, DONG SEOP (KR)
(74) Công ty TNHH Tầm nhìn và Liên danh (VISION & ASSOCIATES CO.LTD.)
(55)

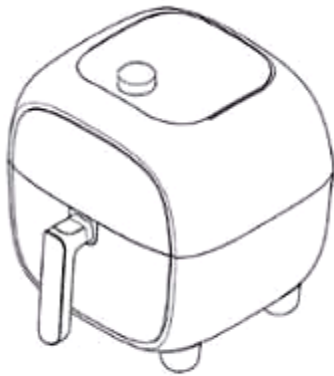

1.1

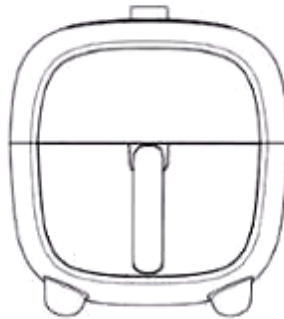

1.2

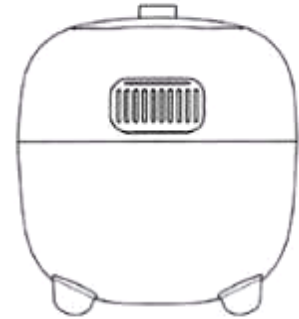

1.3



1.4



1.5

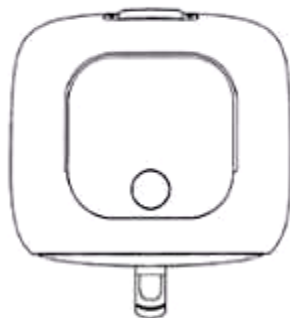

1.6

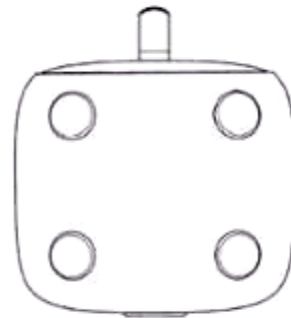

1.7

- (11) **43117**
(21) 3-2021-02152 (28) 1
(54) **KHAY NẤU CHO BẾP TỪ** (51) **07-02**
(22) 23/08/2021 (43) 25/11/2021
(30) 30-2021-0031194 30/06/2021 KR;
(73) **LOCK & LOCK CO., LTD** (KR)
104, Sapgyocheon-ro, Seonjang-myeon, Asan-si, Chungcheongnam-do, Republic of Korea
(72) LEE, Youn Jung (KR)
(74) Công ty TNHH Tầm nhìn và Liên danh (VISION & ASSOCIATES CO.LTD.)
(55)

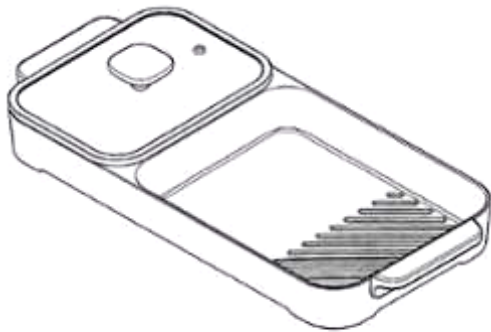

1.1

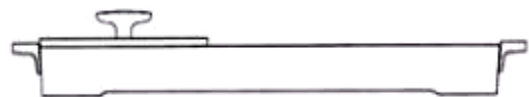

1.2

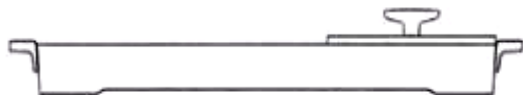

1.3

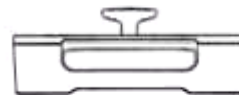

1.4

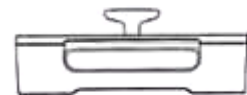

1.5

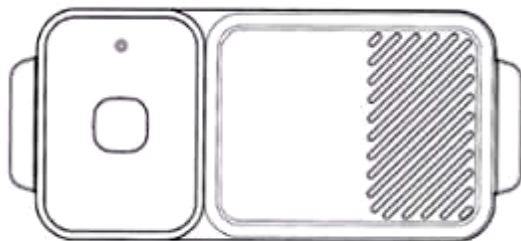

1.6

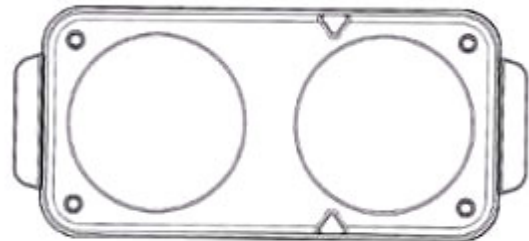

1.7

- (11) **43118**
(21) 3-2021-02153 (28) 1
(54) **BẾP TỪ** (51) **07-02**
(22) 23/08/2021 (43) 25/11/2021
(30) 30-2021-0031193 30/06/2021 KR;
(73) **LOCK & LOCK CO., LTD** (KR)
104, Sapgyocheon-ro, Seonjang-myeon, Asan-si, Chungcheongnam-do, Republic
of Korea
(72) LEE, Youn Jung (KR)
(74) Công ty TNHH Tầm nhìn và Liên danh (VISION & ASSOCIATES CO.LTD.)
(55)

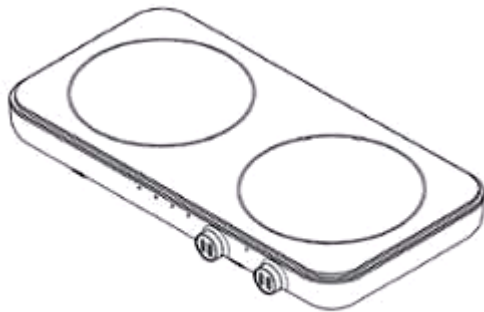

1.1



1.2



1.3



1.4



1.5

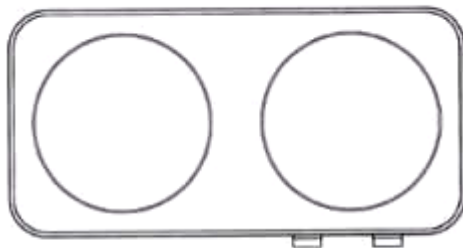

1.6

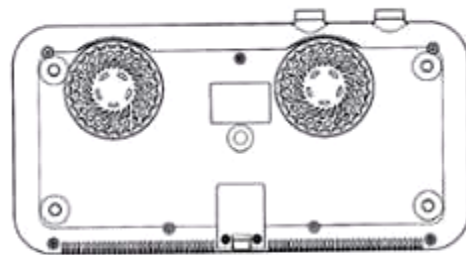

1.7

(11) **43119**

(21) 3-2021-02158

(28) 1

(54) **KHAY NUÔI DẾ**

(51) **30-06**

(22) 24/08/2021

(43) 25/11/2021

(73) **CÔNG TY TNHH CRICKET ONE (VN)**

383/3/51 đường Quang Trung , phường 10, quận Gò Vấp, thành phố Hồ Chí Minh

(72) 1. ĐẶNG CAO NAM (VN)

2. ĐẶNG CAO MINH (VN)

(55)



1.1

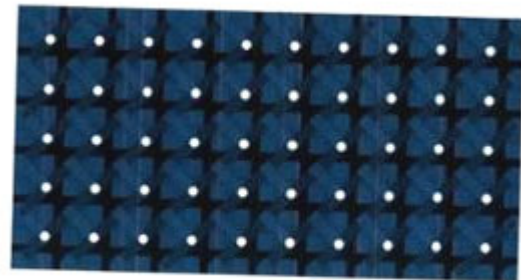

1.2

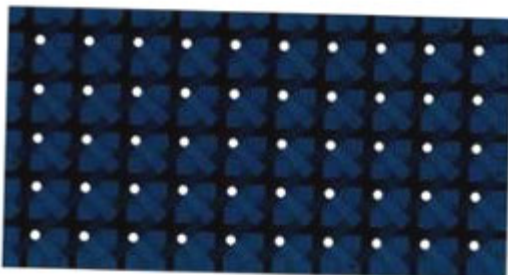

1.3



1.4



1.5



1.6



1.7

(11) **43120**

(21) 3-2021-02159

(28) 1

(54) **HỘP BÀN CỜ**

(51) **09-03**

(22) 24/08/2021

(43) 25/11/2021

(73) **BÙI MINH TUẤN (VN)**

104 Võ Liêm Sơn, phường 4, quận 8, thành phố Hồ Chí Minh

(72) Bùi Minh Tuấn (VN)

(74) Công ty Luật TNHH Tư vấn Quốc tế (INDOCHINE COUNSEL)

(55)

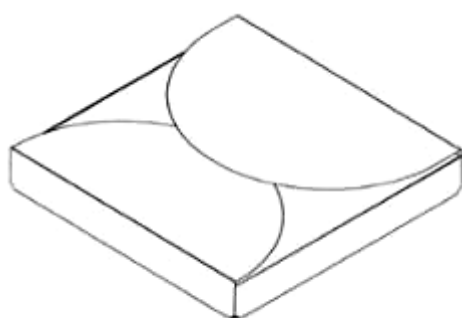

1.1

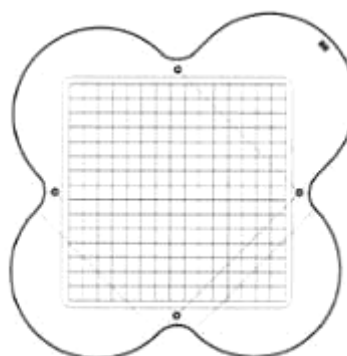

1.2

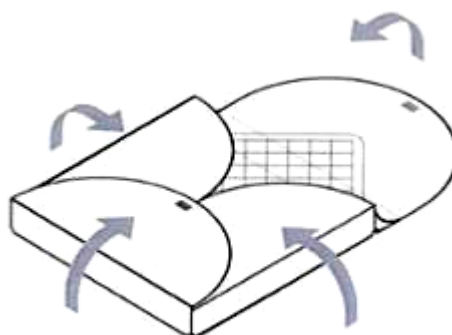

1.3

CÔNG BÁO SỞ HỮU CÔNG NGHIỆP SỐ 404 TẬP A – QUYỀN 2 (11.2021)

- (11) **43121**
(21) 3-2021-02160 (28) 1
(54) **KHÓA** (51) **08-07**
(22) 24/08/2021 (43) 25/11/2021
(30) 202130257263.1 29/04/2021 CN;
(73) **SIEMENS LTD., CHINA (CN)**
7, Wangjing Zhonghuan Nanlu, Chaoyang District 100102 Beijing, P.R. China,
China
(72) 1. QI YU (DE)
2. CHEN KE JIE (CN)
(74) Công ty TNHH Sở hữu trí tuệ Việt Nam IP (VIETNAM IP)
(55)

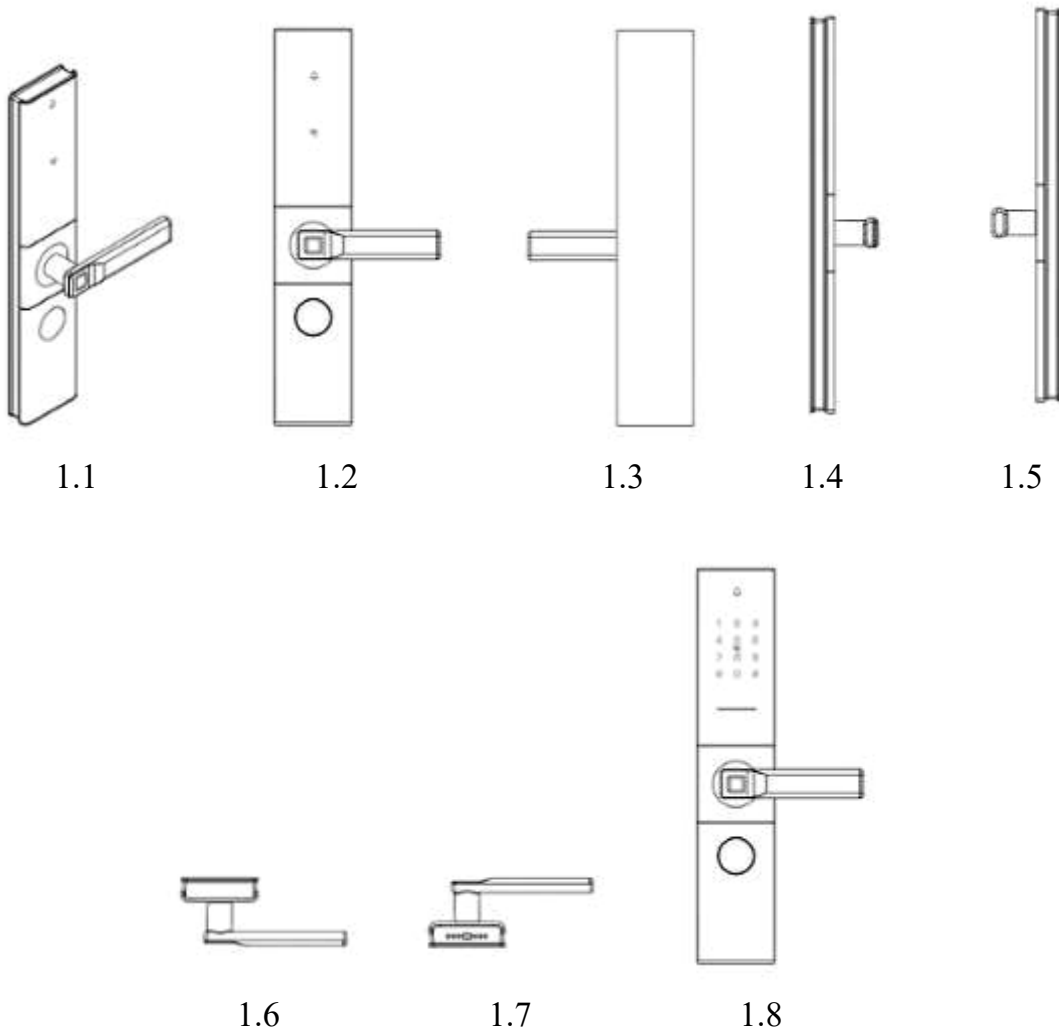

CÔNG BÁO SỞ HỮU CÔNG NGHIỆP SỐ 404 TẬP A – QUYỀN 2 (11.2021)

(11) **43122**

(21) 3-2021-02161

(28) 1

(54) **TỦ ĐIỆN**

(51) **13-03**

(22) 24/08/2021

(43) 25/11/2021

(73) **CÔNG TY CỔ PHẦN NHM SÔNG CÔNG (VN)**

Nhà số 2, ngõ 23, đường cách mạng tháng 10, phường Bách Quang, thành phố Sông Công, tỉnh Thái Nguyên

(72) Nguyễn Mạnh Hùng (VN)

(74) Công ty TNHH Sáng chế ACTIP (ACTIP PATENT LIMITED)

(55)

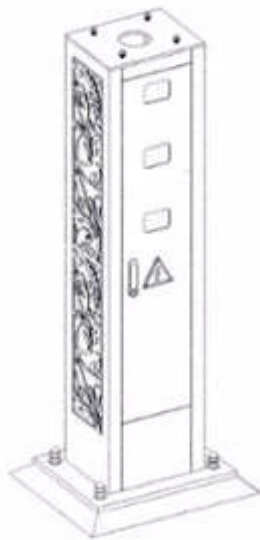

1.1

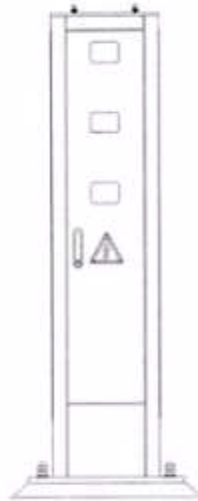

1.2

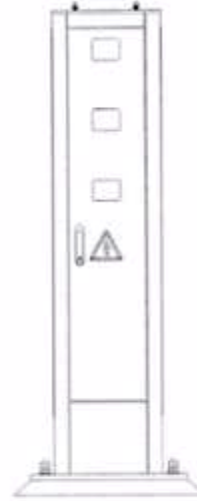

1.3



1.4



1.5

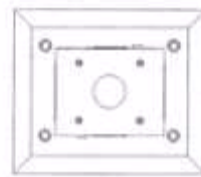

1.6

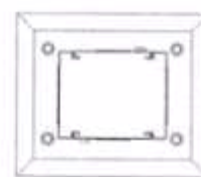

1.7

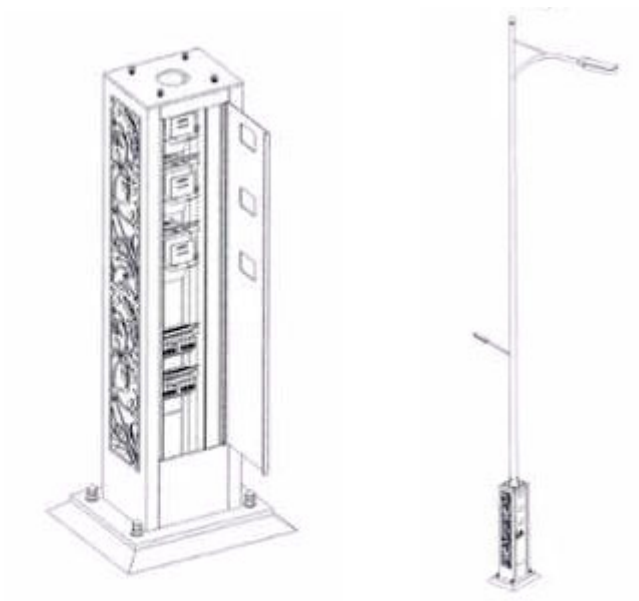

1.8

1.9

CÔNG BÁO SỞ HỮU CÔNG NGHIỆP SỐ 404 TẬP A – QUYỀN 2 (11.2021)

- (11) **43123**
- (21) 3-2021-02169 (28) 1
- (54) **THIẾT BỊ ĐA NĂNG SỬ DỤNG TRONG NUÔI TÔM THÂM CANH** (51) **23-01**
- (22) 26/08/2021 (43) 25/11/2021
- (73) **CÔNG TY CỔ PHẦN RYNAN TECHNOLOGIES VIETNAM (VN)**
Ấp Long Trị, xã Long Đức, thành phố Trà Vinh, tỉnh Trà Vinh
- (72) 1. NGUYỄN THANH MỸ (VN)
2. TRẦN QUỐC TOÀN (VN)
3. VÕ VŨ KHANH (VN)
4. VÕ QUỐC VIỆT (VN)
5. HUỖNH LÊ NHỰT HÀO (VN)
- (74) Công ty TNHH Đại Tín và Liên Danh (DAITIN AND ASSOCIATES CO.,LTD)
- (55)

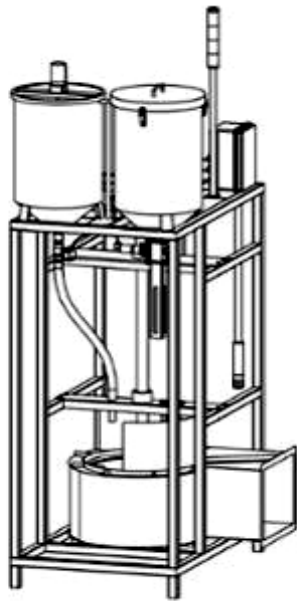

1.1

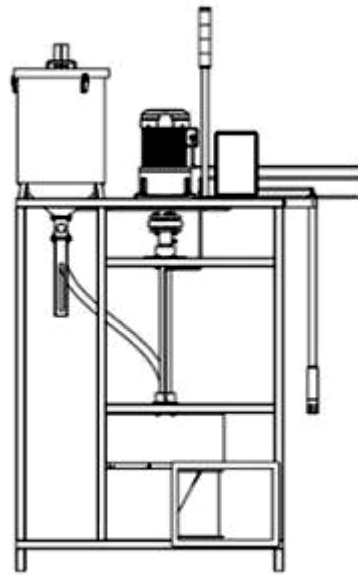

1.2

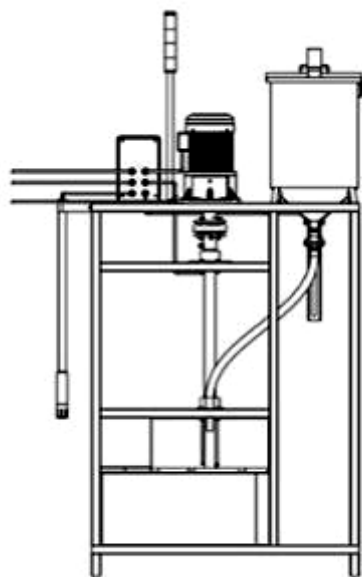

1.3

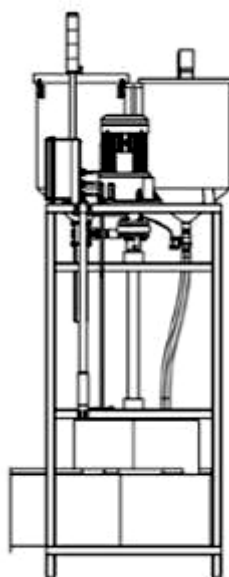

1.4

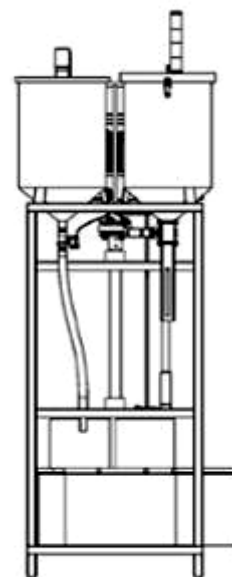

1.5

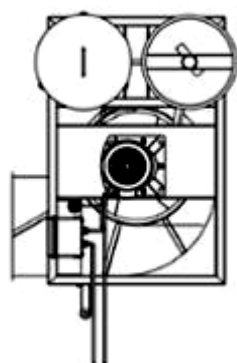

1.6

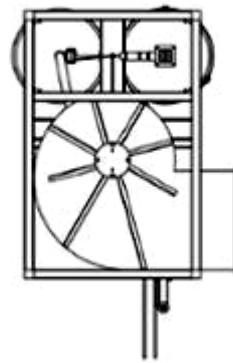

1.7

CÔNG BÁO SỞ HỮU CÔNG NGHIỆP SỐ 404 TẬP A – QUYỀN 2 (11.2021)

(11) **43124**

(21) 3-2021-02172

(28) 1

(54) **XE MÔ TÔ**

(51) **12-11**

(22) 26/08/2021

(43) 25/11/2021

(73) **SANYANG MOTOR CO., LTD. (TW)**

No. 184, Keng Tzu Kou, Shang Keng Village, Hsin Fong Shiang, Hsinchu County
304, TAIWAN

(72) Kuang-Shih HUANG (TW)

(74) Công ty TNHH Trường Xuân (AGELESS CO.,LTD.)

(55)



1.1



1.2



1.3



1.4



1.5



1.6



1.7



1.8



1.9

- (11) **43125**
- (21) 3-2021-02173 (28) 1
- (54) **GIÁ ĐỠ ĐIỀU KHIỂN TỪ XA CỦA PHƯƠNG TIỆN LÀM VIỆC** (51) **15-03**
- (22) 26/08/2021 (43) 25/11/2021
- (30) 2021-012031 04/06/2021 JP;
- (73) **ISEKI & CO., LTD. (JP)**
700 Umaki-cho, Matsuyama-shi, Ehime-ken, JAPAN
- (72) 1. YUTA SUSUKI (JP)
2. KAZUYUKI FUJIMOTO (JP)
3. HIKARU OSANO (JP)
4. MANABU TAKAHASHI (JP)
5. KANAKO YAMADA (JP)
6. SATOSHI KATO (JP)
7. YUMI YOSHIDA (JP)
8. AKIRA OKIMOTO (JP)
- (74) **CÔNG TY LUẬT TRÁCH NHIỆM HỮU HẠN AMBYS HÀ NỘI (AMBYS HANOI)**
- (55)

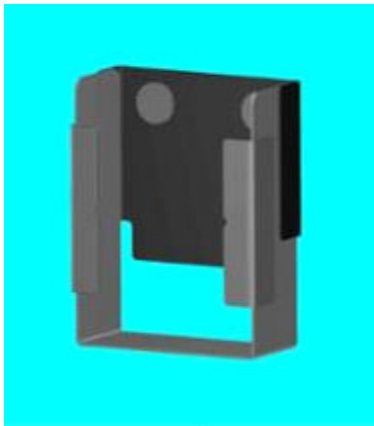

1.1

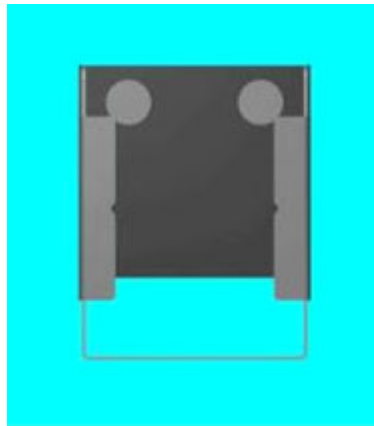

1.2

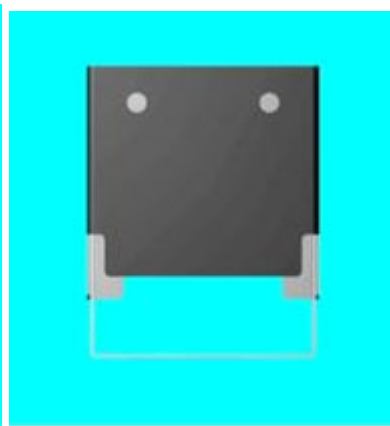

1.3

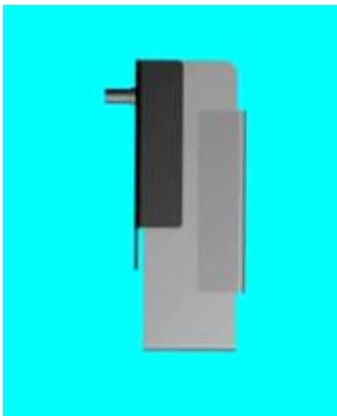

1.4

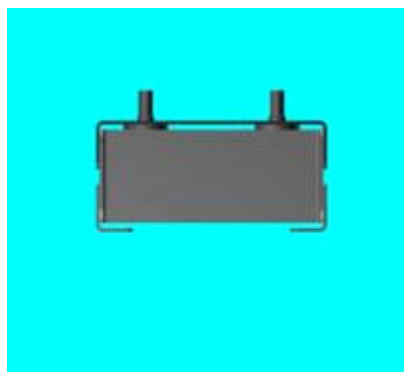

1.5

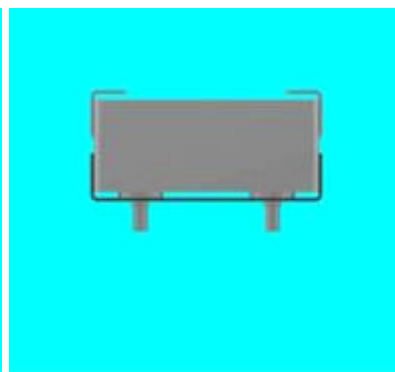

1.6

CÔNG BÁO SỞ HỮU CÔNG NGHIỆP SỐ 404 TẬP A – QUYỀN 2 (11.2021)

- (11) **43126**
(21) 3-2021-02174 (28) 1
(54) **ĐIỀU KHIỂN TỪ XA CỦA PHƯƠNG TIỆN LÀM VIỆC** (51) **15-03**
(22) 26/08/2021 (43) 25/11/2021
(30) 2021-012033 04/06/2021 JP;
(73) **ISEKI & CO., LTD. (JP)**
700 Umaki-cho, Matsuyama-shi, Ehime-ken, Japan
(72) 1. YUTA SUSUKI (JP)
2. KAZUYUKI FUJIMOTO (JP)
(74) **CÔNG TY LUẬT TRÁCH NHIỆM HỮU HẠN AMBYS HÀ NỘI (AMBYS HANOI)**
(55)

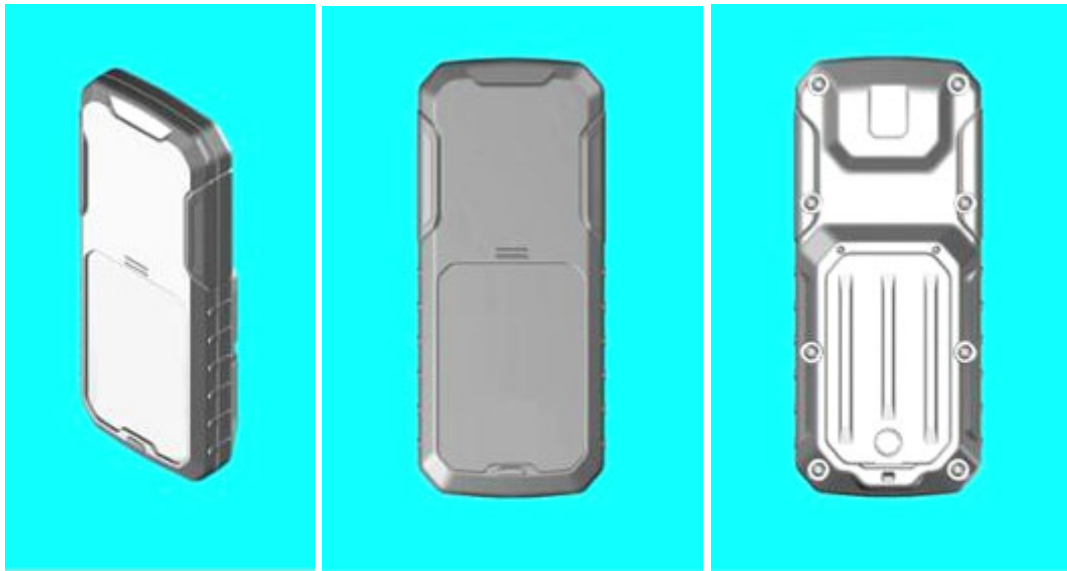

1.1

1.2

1.3

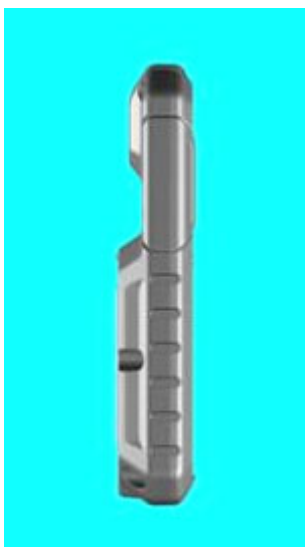

1.4



1.5



1.6

CÔNG BÁO SỞ HỮU CÔNG NGHIỆP SỐ 404 TẬP A – QUYỀN 2 (11.2021)

- (11) **43127**
(21) 3-2021-02176 (28) 1
(54) **ĐẦU NỐI ĐIỆN** (51) **13-03**
(22) 26/08/2021 (43) 25/11/2021
(30) 30-2021-0036973 04/08/2021 KR;
(73) **GTG SOLUTION CO., LTD (KR)**
2F, 57, Bongusunhwan-ro, Siheung-si, Gyeonggi-do, 15047 Republic of Korea
(72) Lim, Jong gae (KR)
(74) Công ty TNHH Tầm nhìn và Liên danh (VISION & ASSOCIATES CO.LTD.)
(55)

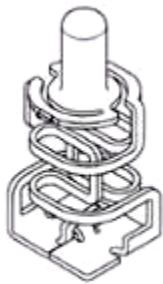

1.1

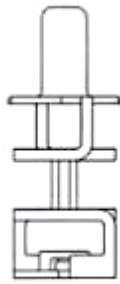

1.2

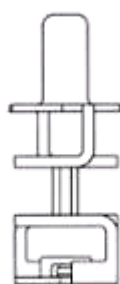

1.3

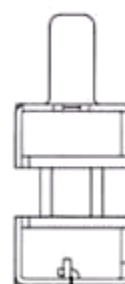

1.4

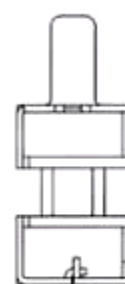

1.5



1.6

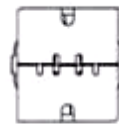

1.7

- (11) **43128**
(21) 3-2021-02177 (28) 1
(54) **ĐẦU NỐI ĐIỆN** (51) **13-03**
(22) 26/08/2021 (43) 25/11/2021
(30) 30-2021-0039893 23/08/2021 KR;
(73) **GTG SOLUTION CO., LTD (KR)**
2F, 57, Bongusunhwan-ro, Siheung-si, Gyeonggi-do, 15047 Republic of Korea
(72) Lim, Jong gae (KR)
(74) Công ty TNHH Tầm nhìn và Liên danh (VISION & ASSOCIATES CO.LTD.)
(55)

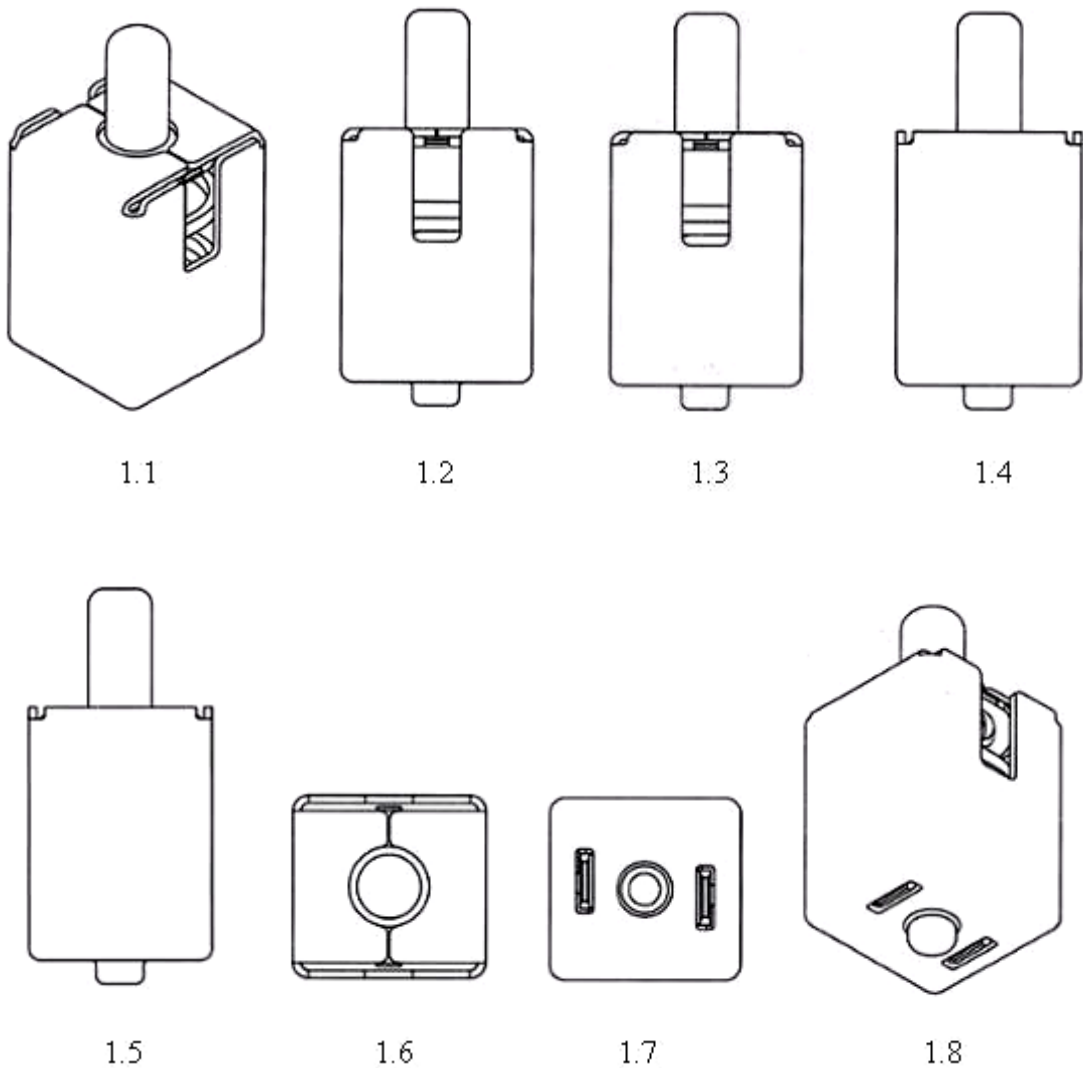

CÔNG BÁO SỞ HỮU CÔNG NGHIỆP SỐ 404 TẬP A – QUYỀN 2 (11.2021)

- (11) **43129**
(21) 3-2021-02178 (28) 1
(54) **KHÓA** (51) **08-07**
(22) 26/08/2021 (43) 25/11/2021
(30) 202130257200.6 29/04/2021 CN;
(73) **SIEMENS LTD., CHINA** (CN)
7, Wangjing Zhonghuan Nanlu, Chaoyang District 100102 Beijing, P.R. China,
China
(72) 1. QI YU (DE)
2. CHEN KE JIE (CN)
(74) Công ty TNHH Sở hữu trí tuệ Việt Nam IP (VIETNAM IP)
(55)

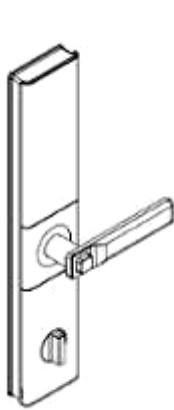

1.1

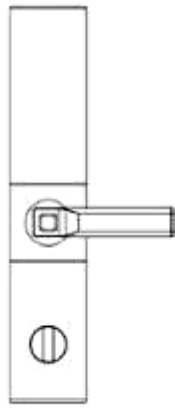

1.2

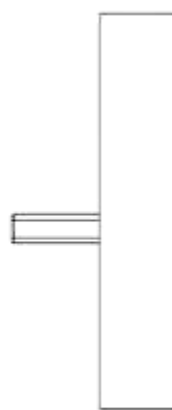

1.3

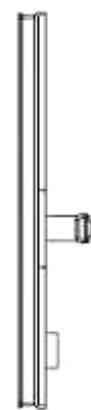

1.4



1.5



1.6

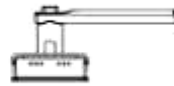

1.7

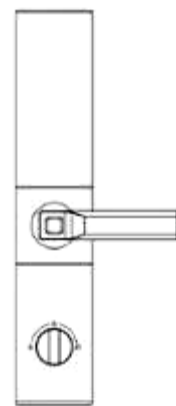

1.8

CÔNG BÁO SỞ HỮU CÔNG NGHIỆP SỐ 404 TẬP A – QUYỀN 2 (11.2021)

(11) **43130**

(21) 3-2021-02185

(28) 1

(54) **GHẾ SÔ-PHA**

(51) **06-01**

(22) 27/08/2021

(43) 25/11/2021

(73) **HTL FURNITURE (CHINA) CO., LTD. (CN)**

Wusong Jiangnan Road, Kunshan Development Zone, Jiangsu Province, China

(72) PHUA YONG TAT (SG)

(74) Công ty Luật TNHH quốc tế BMVN (BMVN INTERNATIONAL LLC)

(55)



1.1



1.2



1.3



1.4



1.5



1.6

CÔNG BÁO SỞ HỮU CÔNG NGHIỆP SỐ 404 TẬP A – QUYỀN 2 (11.2021)

(11) **43131**

(21) 3-2021-02187

(28) 1

(54) **GHẾ**

(51) **06-01**

(22) 27/08/2021

(43) 25/11/2021

(73) **HTL FURNITURE (CHINA) CO., LTD. (CN)**

Wusong Jiangnan Road, Kunshan Development Zone, Jiangsu Province, China

(72) PHUA YONG TAT (SG)

(74) Công ty Luật TNHH quốc tế BMVN (BMVN INTERNATIONAL LLC)

(55)



1.1



1.2



1.3



1.4



1.5

CÔNG BÁO SỞ HỮU CÔNG NGHIỆP SỐ 404 TẬP A – QUYỀN 2 (11.2021)

(11) **43132**

(21) 3-2021-02188

(28) 1

(54) **GHẾ SÔ-PHA**

(51) **06-01**

(22) 27/08/2021

(43) 25/11/2021

(73) **HTL FURNITURE (CHINA) CO., LTD. (CN)**

Wusong Jiangnan Road, Kunshan Development Zone, Jiangsu Province, China

(72) PHUA YONG TAT (SG)

(74) Công ty Luật TNHH quốc tế BMVN (BMVN INTERNATIONAL LLC)

(55)



1.1



1.2



1.3



1.4



1.5

CÔNG BÁO SỞ HỮU CÔNG NGHIỆP SỐ 404 TẬP A – QUYỀN 2 (11.2021)

(11) **43133**

(21) 3-2021-02189

(28) 1

(54) **GHẾ SÔ-PHA**

(51) **06-01**

(22) 27/08/2021

(43) 25/11/2021

(73) **HTL FURNITURE (CHINA) CO., LTD. (CN)**

Wusong Jiangnan Road, Kunshan Development Zone, Jiangsu Province, China

(72) PHUA YONG TAT (SG)

(74) Công ty Luật TNHH quốc tế BMVN (BMVN INTERNATIONAL LLC)

(55)



1.1



1.2



1.3



1.4



1.5

CÔNG BÁO SỞ HỮU CÔNG NGHIỆP SỐ 404 TẬP A – QUYỀN 2 (11.2021)

(11) **43134**

(21) 3-2021-02190

(28) 1

(54) **GHẾ SÔ-PHA**

(51) **06-01**

(22) 27/08/2021

(43) 25/11/2021

(73) **HTL FURNITURE (CHINA) CO., LTD. (CN)**

Wusong Jiangnan Road, Kunshan Development Zone, Jiangsu Province, China

(72) PHUA YONG TAT (SG)

(74) Công ty Luật TNHH quốc tế BMVN (BMVN INTERNATIONAL LLC)

(55)



1.1



1.2



1.3



1.4



1.5

CÔNG BÁO SỞ HỮU CÔNG NGHIỆP SỐ 404 TẬP A – QUYỀN 2 (11.2021)

- (11) **43135**
(21) 3-2021-02194 (28) 1
(54) **HỘP ĐỰNG** (51) **09-03**
(22) 27/08/2021 (43) 25/11/2021
(73) **CÔNG TY CỔ PHẦN THỰC PHẨM AIWADO (VN)**
Lầu 9, tòa nhà Centre Point, 106 Nguyễn Văn Trỗi, phường 08, quận Phú Nhuận,
thành phố Hồ Chí Minh
(72) Lê Vĩnh Sơn (VN)
(74) **CÔNG TY TNHH SỞ HỮU TRÍ TUỆ ANLIS VIỆT NAM (ANLIS IP CO.,LTD)**
(55)



1.1



1.2



1.3



1.4



1.5



1.6



1.7

(11) **43136**

(21) 3-2021-02195

(28) 1

(54) **KHỚP NỐI ĐƯỜNG ỐNG**

(51) **23-01**

(22) 30/08/2021

(43) 25/11/2021

(73) **TOZEN CORPORATION (JP)**

8-4 Asahi, Yoshikawa, Saitama, Japan

(72) Hitoshi MUROI (JP)

(74) Công ty TNHH Quốc tế D & N (D&N INTERNATIONAL CO.,LTD.)

(55)



1.1

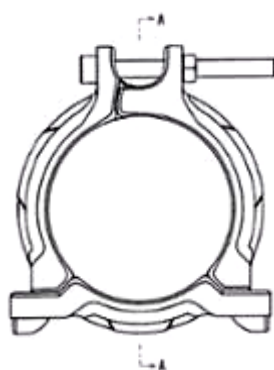

1.2

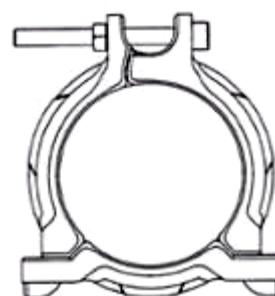

1.3



1.4

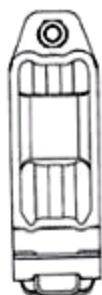

1.5



1.6

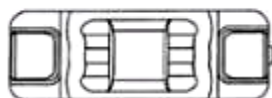

1.7

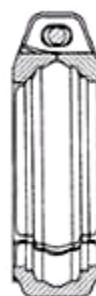

1.8

- (11) **43137**
(21) 3-2021-02196 (28) 1
(54) **CHI TIẾT KHỚP NỐI ĐƯỜNG ỐNG** (51) **23-01**
(22) 30/08/2021 (43) 25/11/2021
(73) **TOZEN CORPORATION (JP)**
8-4 Asahi, Yoshikawa, Saitama, Japan
(72) Hitoshi MUROI (JP)
(74) Công ty TNHH Quốc tế D &N (D&N INTERNATIONAL CO.,LTD.)
(55)



1.1



1.2



1.3

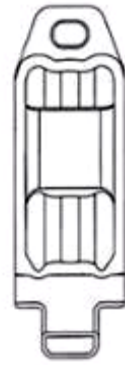

1.4



1.5



1.6



1.7



1.8

- (11) **43138**
(21) 3-2021-02197 (28) 1
(54) **CHI TIẾT KHỚP NỐI ĐƯỜNG ỐNG** (51) **23-01**
(22) 30/08/2021 (43) 25/11/2021
(73) **TOZEN CORPORATION (JP)**
8-4 Asahi, Yoshikawa, Saitama, Japan
(72) Hitoshi MUROI (JP)
(74) Công ty TNHH Quốc tế D & N (D&N INTERNATIONAL CO.,LTD.)
(55)

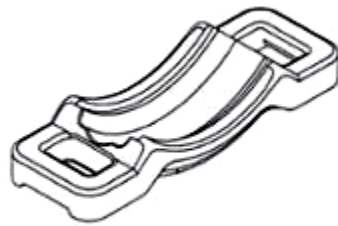

1.1

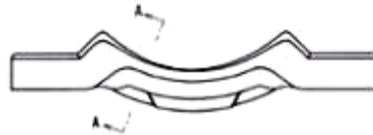

1.2



1.3

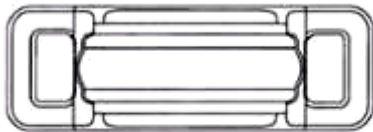

1.4

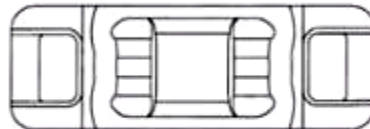

1.5



1.6

CÔNG BÁO SỞ HỮU CÔNG NGHIỆP SỐ 404 TẬP A – QUYỀN 2 (11.2021)

- (11) **43139**
(21) 3-2021-02199 (28) 1
(54) **CUỘN PHẢN QUANG** (51) **10-04**
(22) 30/08/2021 (43) 25/11/2021
(73) **CÔNG TY TNHH ĐẦU TƯ VÀ PHÁT TRIỂN CÔNG NGHỆ ĐỨC VIỆT**
(VN)
P520, CT3A-X2, Bắc Linh Đàm, phường Hoàng Liệt, quận Hoàng Mai, thành phố Hà Nội
(72) Trần Hữu Đức (VN)
(55)



1.1



1.2



1.3



1.4



1.5



1.6



1.7



1.8

- (11) **43140**
(21) 3-2021-02211 (28) 1
(54) **MÁY MAY** (51) **15-06**
(22) 06/09/2021 (43) 25/11/2021
(30) 29/773,217 08/03/2021 US;
(73) **SINGER SOURCING LIMITED LLC (US)**
1714 Heil Quaker Boulevard, LaVergne, TN 37086, United States of America
(72) 1. FRANCISCO JAVIER BARQUIN (US)
2. JEFF JUSKOWICH (US)
(74) Công ty Luật TNHH T&G (TGVN)
(55)



1.1

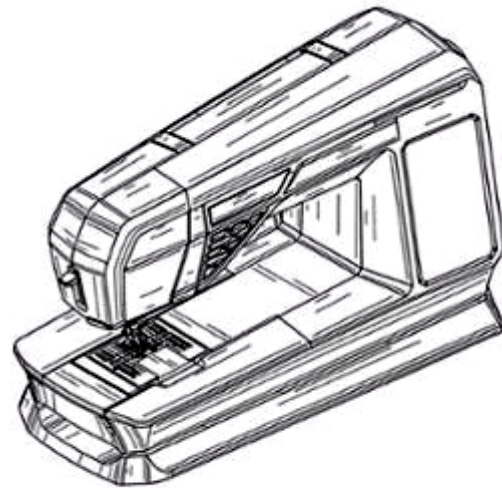

1.2

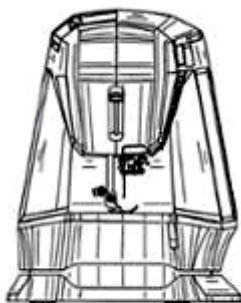

1.3



1.4

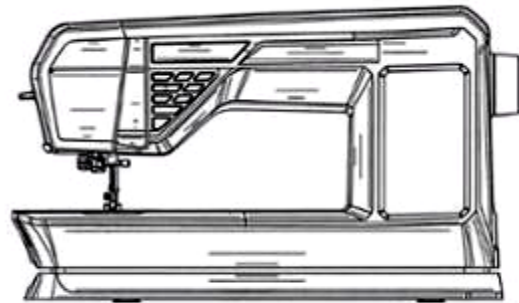

1.5

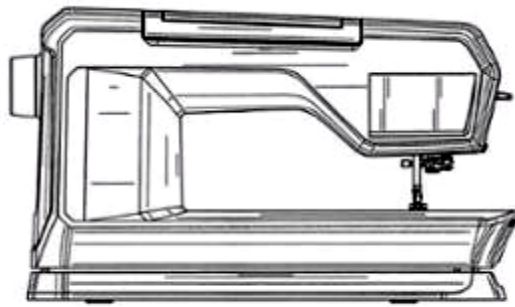

1.6

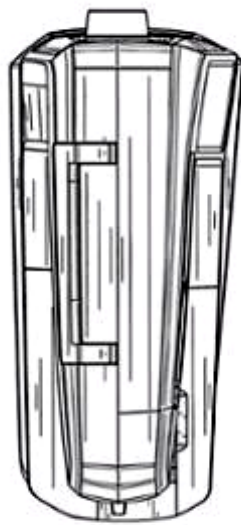

1.7

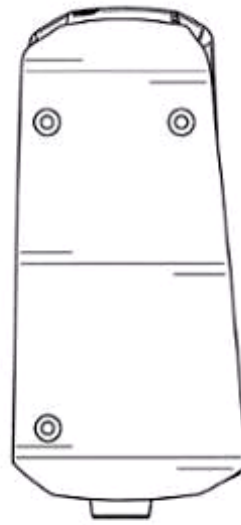

1.8

CÔNG BÁO SỞ HỮU CÔNG NGHIỆP SỐ 404 TẬP A – QUYỀN 2 (11.2021)

- (11) **43141**
- (21) 3-2021-02214 (28) 1
- (54) **KHỚP NỐI ỐNG** (51) **23-01**
- (22) 07/09/2021 (43) 25/11/2021
- (30) 2021-006809 31/03/2021 JP;
- (73) **TOYOX CO., LTD** (JP)
4371 Maezawa, Kurobe-shi, Toyama, Japan
- (72) Akihiro Inagaki (JP)
- (74) Công ty Luật TNHH Phạm và Liên danh (PHAM & ASSOCIATES)
- (55)



1.1

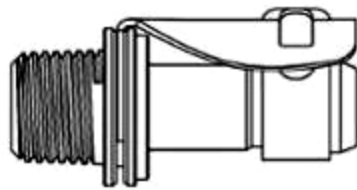

1.2

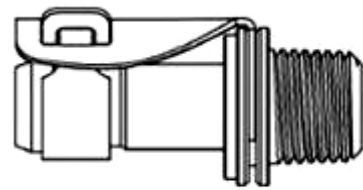

1.3

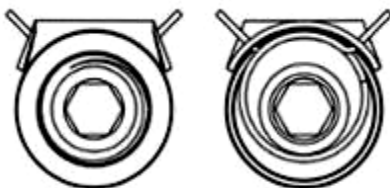

1.4

1.5

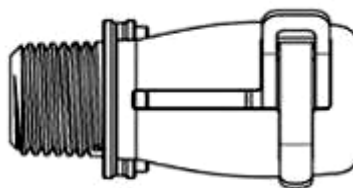

1.6

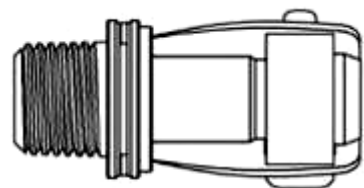

1.7

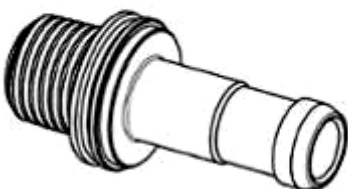

1.8



1.9

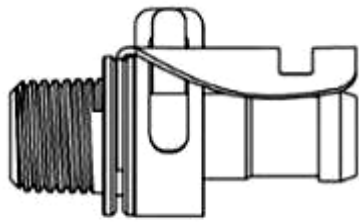

1.10

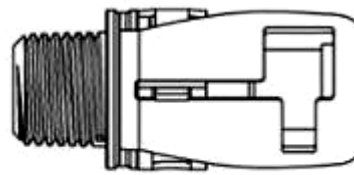

1.11

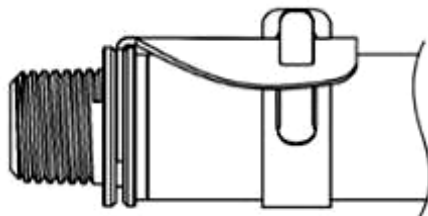

1.12

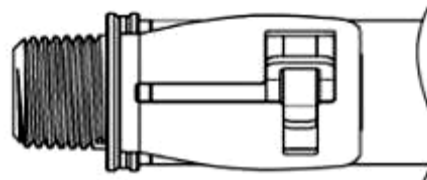

1.13

CÔNG BÁO SỞ HỮU CÔNG NGHIỆP SỐ 404 TẬP A – QUYỀN 2 (11.2021)

- (11) **43142**
(21) 3-2021-02220 (28) 1
(54) **BỘ GIẢM XÓC** (51) **12-16**
(22) 07/09/2021 (43) 25/11/2021
(73) **MENG KAH AUTO PARTS TRADING SDN. BHD. (MY)**
40, Jalan TPP5, Taman Perindustrian Putra, 47130 Puchong, Selangor, Malaysia
(72) Lee Cong Quan (MY)
(74) Công ty TNHH Trường Xuân (AGELESS CO.,LTD.)
(55)



1.1

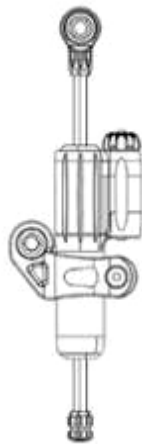

1.2



1.3



1.4

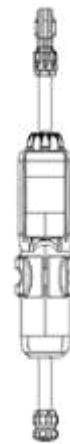

1.5



1.6



1.7

CÔNG BÁO SỞ HỮU CÔNG NGHIỆP SỐ 404 TẬP A – QUYỂN 2 (11.2021)

- (11) **43143**
(21) 3-2021-02221 (28) 1
(54) **BAO GÓI BỘT CANH** (51) **09-05**
(22) 07/09/2021 (43) 25/11/2021
(73) **CÔNG TY TNHH THD TRADING VIỆT NAM (VN)**
Số nhà 270, ngõ 36 đường Lê Trọng Tấn, tổ 4, phường La Khê, quận Hà Đông,
thành phố Hà Nội
(72) Vũ Văn Dương (VN)
(74) Công ty TNHH Sở hữu trí tuệ M.I.T (M.I.T IP CO., LTD)
(55)



1.1



1.2

CÔNG BÁO SỞ HỮU CÔNG NGHIỆP SỐ 404 TẬP A – QUYỀN 2 (11.2021)

(11) **43144**

(21) 3-2021-02222

(28) 1

(54) **GHẾ SÔ-PHA**

(51) **06-01**

(22) 08/09/2021

(43) 25/11/2021

(73) **HTL FURNITURE (CHINA) CO., LTD. (CN)**

Wusong Jiangnan Road, Kunshan Development Zone, Jiangsu Province, China

(72) PHUA YONG TAT (SG)

(74) Công ty Luật TNHH quốc tế BMVN (BMVN INTERNATIONAL LLC)

(55)



1.1



1.2



1.3



1.4



1.5



1.6

CÔNG BÁO SỞ HỮU CÔNG NGHIỆP SỐ 404 TẬP A – QUYỀN 2 (11.2021)

- (11) **43145**
(21) 3-2021-02223 (28) 1
(54) **GHẾ SÔ-PHA** (51) **06-01**
(22) 08/09/2021 (43) 25/11/2021
(73) **HTL FURNITURE (CHINA) CO., LTD. (CN)**
Wusong Jiangnan Road, Kunshan Development Zone, Jiangsu Province, China
(72) PHUA YONG TAT (SG)
(74) Công ty Luật TNHH quốc tế BMVN (BMVN INTERNATIONAL LLC)
(55)



1.1



1.2



1.3



1.4



1.5



1.6

CÔNG BÁO SỞ HỮU CÔNG NGHIỆP SỐ 404 TẬP A – QUYỀN 2 (11.2021)

(11) **43146**

(21) 3-2021-02224

(28) 1

(54) **GHẾ SÔ-PHA**

(51) **06-01**

(22) 08/09/2021

(43) 25/11/2021

(73) **HTL FURNITURE (CHINA) CO., LTD. (CN)**

Wusong Jiangnan Road, Kunshan Development Zone, Jiangsu Province, China

(72) PHUA YONG TAT (SG)

(74) Công ty Luật TNHH quốc tế BMVN (BMVN INTERNATIONAL LLC)

(55)



1.1



1.2



1.3



1.4



1.5



1.6

CÔNG BÁO SỞ HỮU CÔNG NGHIỆP SỐ 404 TẬP A – QUYỀN 2 (11.2021)

(11) **43147**

(21) 3-2021-02225

(28) 1

(54) **GHẾ SÔ-PHA**

(51) **06-01**

(22) 08/09/2021

(43) 25/11/2021

(73) **HTL FURNITURE (CHINA) CO., LTD. (CN)**

Wusong Jiangnan Road, Kunshan Development Zone, Jiangsu Province, China

(72) PHUA YONG TAT (SG)

(74) Công ty Luật TNHH quốc tế BMVN (BMVN INTERNATIONAL LLC)

(55)



1.1



1.2



1.3



1.4



1.5



1.6

CÔNG BÁO SỞ HỮU CÔNG NGHIỆP SỐ 404 TẬP A – QUYỀN 2 (11.2021)

- (11) **43148**
(21) 3-2021-02226 (28) 1
(54) **GHẾ SÔ-PHA** (51) **06-01**
(22) 08/09/2021 (43) 25/11/2021
(73) **HTL FURNITURE (CHINA) CO., LTD. (CN)**
Wusong Jiangnan Road, Kunshan Development Zone, Jiangsu Province, China
(72) PHUA YONG TAT (SG)
(74) Công ty Luật TNHH quốc tế BMVN (BMVN INTERNATIONAL LLC)
(55)



1.1



1.2



1.3



1.4



1.5



1.6

CÔNG BÁO SỞ HỮU CÔNG NGHIỆP SỐ 404 TẬP A – QUYỀN 2 (11.2021)

(11) **43149**

(21) 3-2021-02227

(28) 1

(54) **GHẾ SÔ-PHA**

(51) **06-01**

(22) 08/09/2021

(43) 25/11/2021

(73) **HTL FURNITURE (CHINA) CO., LTD. (CN)**

Wusong Jiangnan Road, Kunshan Development Zone, Jiangsu Province, China

(72) PHUA YONG TAT (SG)

(74) Công ty Luật TNHH quốc tế BMVN (BMVN INTERNATIONAL LLC)

(55)



1.1



1.2



1.3



1.4



1.5

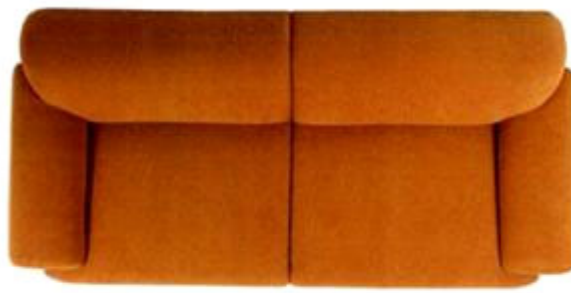

1.6

CÔNG BÁO SỞ HỮU CÔNG NGHIỆP SỐ 404 TẬP A – QUYỀN 2 (11.2021)

- (11) **43150**
(21) 3-2021-02241 (28) 1
(54) **THIẾT BỊ VẬN CHUYỂN** (51) **15-99**
(22) 08/09/2021 (43) 25/11/2021
(30) 2021-011089 26/05/2021 JP;
(73) **FUJI CORPORATION (JP)**
19, Chausuyama, Yamamachi, Chiryu-shi, Aichi-ken, 472-8686 Japan
(72) **YAMAZAKI, Yusuke (JP)**
(74) Công ty TNHH Trường Xuân (AGELESS CO.,LTD.)
(55)

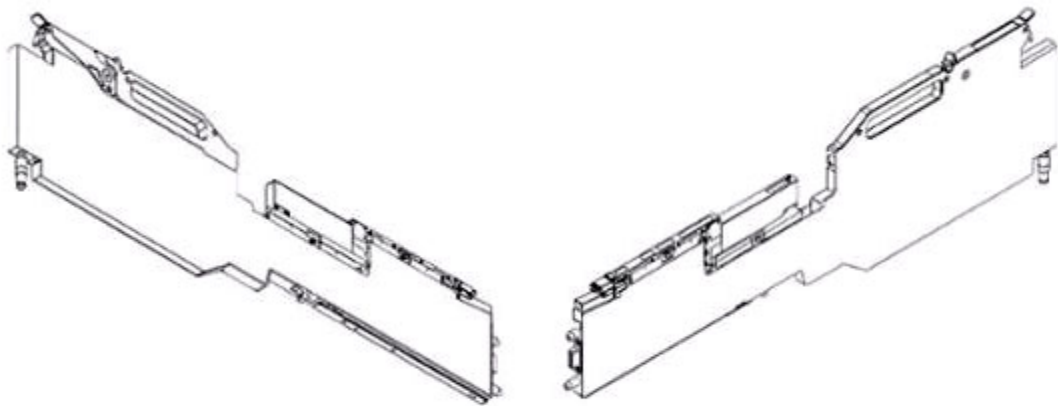

1.1

1.2

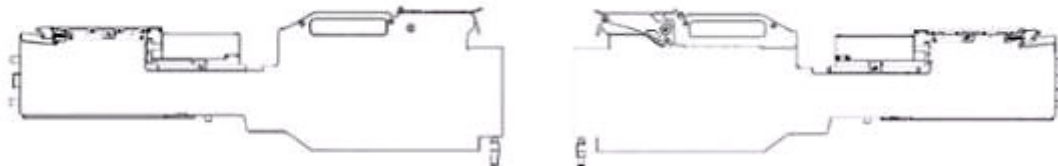

1.3

1.4



1.5



1.6



1.7



1.8

CÔNG BÁO SỞ HỮU CÔNG NGHIỆP SỐ 404 TẬP A – QUYỀN 2 (11.2021)

- (11) **43151**
(21) 3-2021-02242 (28) 1
(54) **THIẾT BỊ VẬN CHUYỂN** (51) **15-99**
(22) 08/09/2021 (43) 25/11/2021
(30) 2021-011090 26/05/2021 JP;
(73) **FUJI CORPORATION (JP)**
19, Chausuyama, Yamamachi, Chiryu-shi, Aichi-ken, 472-8686 Japan
(72) **YAMAZAKI, Yusuke (JP)**
(74) Công ty TNHH Trường Xuân (AGELESS CO.,LTD.)
(55)

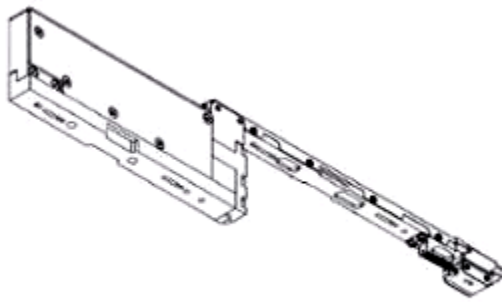

1.1

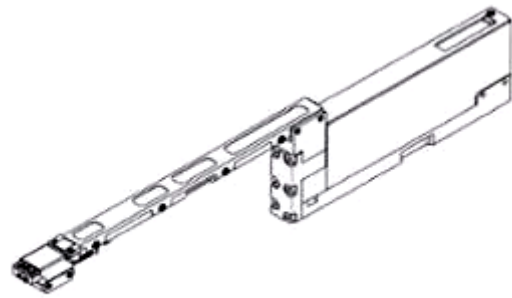

1.2

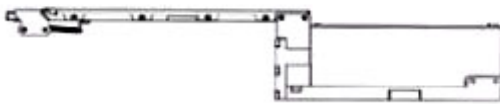

1.3

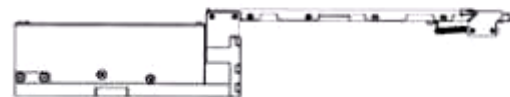

1.4



1.5



1.6



1.7

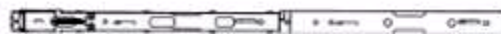

1.8

CÔNG BÁO SỞ HỮU CÔNG NGHIỆP SỐ 404 TẬP A – QUYỀN 2 (11.2021)

- (11) **43152**
(21) 3-2021-02243 (28) 1
(54) **HỘP** (51) **07-07**
(22) 08/09/2021 (43) 25/11/2021
(30) 30-2021-0026075 01/06/2021 KR;
(73) **LOCK & LOCK CO., LTD** (KR)
104, Sapgyocheon-ro, Seonjang-myeon, Asan-si, Chungcheongnam-do, Republic
of Korea
(72) KIM, Kwang Ik (KR)
(74) Công ty TNHH Tầm nhìn và Liên danh (VISION & ASSOCIATES CO.LTD.)
(55)



1.1



1.2



1.3

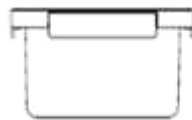

1.4



1.5



1.6



1.7

CÔNG BÁO SỞ HỮU CÔNG NGHIỆP SỐ 404 TẬP A – QUYỀN 2 (11.2021)

- (11) **43153**
(21) 3-2021-02244 (28) 1
(54) **HỆ THỐNG PHUỘC NHÚN** (51) **12-16**
(22) 09/09/2021 (43) 25/11/2021
(73) **CÔNG TY TNHH LEON LEGION (VN)**
269 đường Liên Phường, phường Phước Long B, thành phố Thủ Đức, thành phố Hồ Chí Minh
(72) Hoàng Xuân Thành (VN)
(74) Công ty TNHH Tư vấn đầu tư và Sở hữu trí tuệ Hoàng Phi (HOANG PHI INVEST & I.P CO., LTD)
(55)



1.1



1.2



1.3



1.4



1.5



1.6



1.7

CÔNG BÁO SỞ HỮU CÔNG NGHIỆP SỐ 404 TẬP A – QUYỀN 2 (11.2021)

- (11) **43154**
(21) 3-2021-02245 (28) 1
(54) **XE ĐẠP SỬ DỤNG ĐIỆN** (51) **12-11**
(22) 09/09/2021 (43) 25/11/2021
(73) **CÔNG TY TNHH LEON LEGION (VN)**
269 đường Liên Phường, phường Phước Long B, thành phố Thủ Đức, thành phố Hồ Chí Minh
(72) Hoàng Xuân Thành (VN)
(74) Công ty TNHH Tư vấn đầu tư và Sở hữu trí tuệ Hoàng Phi (HOANG PHI INVEST & I.P CO., LTD)
(55)



1.1



1.2



1.3



1.4



1.5



1.6



1.7

CÔNG BÁO SỞ HỮU CÔNG NGHIỆP SỐ 404 TẬP A – QUYỀN 2 (11.2021)

(11) **43155**

(21) 3-2021-02247

(54) **KẸP GIỮ ĐIỆN THOẠI DI ĐỘNG**

(22) 09/09/2021

(73) **GIVI SPA (IT)**

Via G. Ungaretti, 48, 25020 Flero (BS), Italy

(72) Visenzi Giuseppe (IT)

(74) Công ty Cổ phần Sở hữu công nghiệp INVESTIP (INVESTIP)

(55)

(28) 1

(51) **14-99**

(43) 25/11/2021



1.1



1.2



1.3

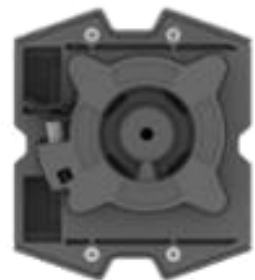

1.4



1.5



1.6



1.7



1.8

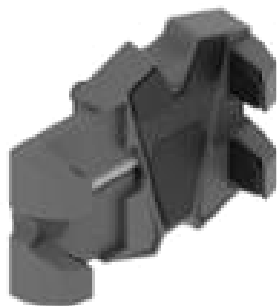

1.9



1.10

CÔNG BÁO SỞ HỮU CÔNG NGHIỆP SỐ 404 TẬP A – QUYỀN 2 (11.2021)

- (11) **43156**
- (21) 3-2021-02248 (28) 1
- (54) **THIẾT BỊ THÔNG MINH DÙNG QUÉT VÀ ĐỌC MÃ VẠCH** (51) **14-02**
- (22) 09/09/2021 (43) 25/11/2021
- (73) **CÔNG TY CỔ PHẦN RYNAN TECHNOLOGIES VIETNAM (VN)**
Ấp Long Trì, xã Long Đức, thành phố Trà Vinh, tỉnh Trà Vinh
- (72) 1. NGUYỄN THANH MỸ (VN)
2. TRẦN QUỐC TOẢN (VN)
3. NGUYỄN VĂN TIỀN (VN)
4. LÂM THANH TUẤN (VN)
5. BÙI MINH CHÂU (VN)
6. PHẠM THÁI BÌNH (VN)
- (74) Công ty TNHH Đại Tín và Liên Danh (DAITIN AND ASSOCIATES CO.,LTD)
- (55)

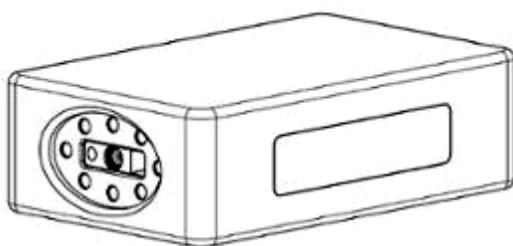

1.1

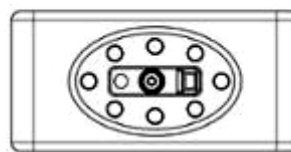

1.2



1.3

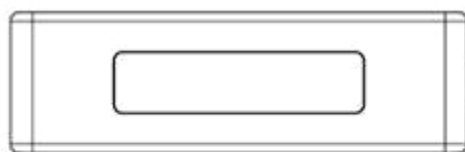

1.4

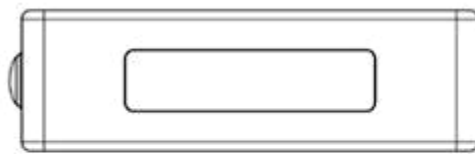

1.5



1.6

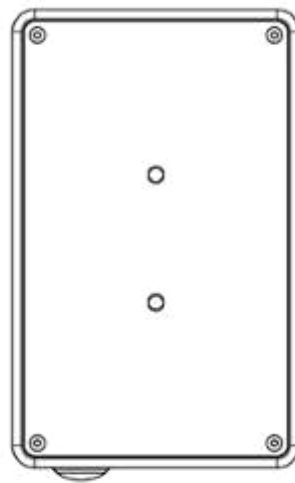

1.7

CÔNG BÁO SỞ HỮU CÔNG NGHIỆP SỐ 404 TẬP A – QUYỀN 2 (11.2021)

- (11) **43157**
(21) 3-2021-02253 (28) 1
(54) **XE ĐẠP SỬ DỤNG ĐIỆN** (51) **12-11**
(22) 10/09/2021 (43) 25/11/2021
(73) **CÔNG TY TNHH LEON LEGION (VN)**
269 đường Liên Phường, phường Phước Long B, quận 9, thành phố Hồ Chí Minh
(72) Hoàng Xuân Thành (VN)
(74) Công ty Luật TNHH Việt An (VIET AN LAW FIRM)
(55)



1.1



1.2



1.3



1.4



1.5



1.6



1.7

(11) **43158**

(21) 3-2021-02254

(28) 1

(54) **LOA**

(51) **14-01**

(22) 10/09/2021

(43) 25/11/2021

(73) **BMB (SHANGHAI) INTERNATIONAL CORP. (CN)**

6010 Yongxin building, No.887 Huaihai Middle Road, Shanghai, China

(72) Akio Shindate (JP)

(74) Công ty Luật TNHH T&G (TGVN)

(55)

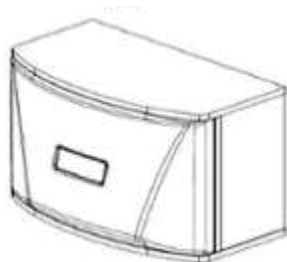

1.1



1.2



1.3



1.4



1.5



1.6



1.7

CÔNG BÁO SỞ HỮU CÔNG NGHIỆP SỐ 404 TẬP A – QUYỀN 2 (11.2021)

- (11) **43159**
(21) 3-2021-02261 (28) 1
(54) **TÚI BÁNH** (51) **09-05**
(22) 14/09/2021 (43) 25/11/2021
(73) **CÔNG TY CỔ PHẦN BÁNH KẸO TRÀNG AN.3- VIỆT NAM (VN)**
Khu A, khu CN Bim Sơn, phường Bắc Sơn, thị xã Bim Sơn, tỉnh Thanh Hóa
(72) Trịnh Sỹ (VN)
(74) Công ty TNHH Sở hữu trí tuệ Việt Nam IP (VIETNAM IP)
(55)



1.1



1.2

CÔNG BÁO SỞ HỮU CÔNG NGHIỆP SỐ 404 TẬP A – QUYỀN 2 (11.2021)

- (11) **43160**
- (21) 3-2021-02262 (28) 1
- (54) **BAO GÓI BÁNH** (51) **09-05**
- (22) 14/09/2021 (43) 25/11/2021
- (73) **CÔNG TY CỔ PHẦN BÁNH KẸO TRÀNG AN.3- VIỆT NAM (VN)**
Khu A, khu CN Bim Sơn, phường Bắc Sơn, thị xã Bim Sơn, tỉnh Thanh Hóa
- (72) Trịnh Sỹ (VN)
- (74) Công ty TNHH Sở hữu trí tuệ Việt Nam IP (VIETNAM IP)
- (55)



1.1



1.2

(11) **43161**

(21) 3-2021-02268

(28) 1

(54) **LỢ**

(51) **09-01**

(22) 14/09/2021

(43) 25/11/2021

(73) **CÔNG TY CỔ PHẦN TẬP ĐOÀN THIÊN LONG (VN)**

Lô 6-8-10-12 đường số 3, khu công nghiệp Tân Tạo, quận Bình Tân, thành phố Hồ Chí Minh

(72) Cô Gia Thọ (VN)

(74) Công ty TNHH Tư vấn sở hữu trí tuệ Việt (VIET IP CO.,LTD.)

(55)



1.1



1.2



1.3



1.4



1.5



1.6



1.7



1.8



1.9

CÔNG BÁO SỞ HỮU CÔNG NGHIỆP SỐ 404 TẬP A – QUYỀN 2 (11.2021)

- (11) **43162**
(21) 3-2021-02271 (28) 1
(54) **BỒN CHỨA NƯỚC** (51) **23-01**
(22) 14/09/2021 (43) 25/11/2021
(73) **CÔNG TY CỔ PHẦN QUỐC TẾ SATA (VN)**
Nhà số 9, ngách 32/98, TDP Đông 6, đường Cổ Nhuế, phường Cổ Nhuế 2, quận
Bắc Từ Liêm, thành phố Hà Nội
(72) 1. BIÊN VĂN BÂY (VN)
2. NGUYỄN VĂN THANH (VN)
3. TRẦN VĂN THẮNG (VN)
4. TRỊNH THỊ PHƯỢNG (VN)
5. LÊ THỊ HẰNG (VN)
(74) Công ty TNHH Tư vấn IPNG (IPNG CO.,LTD)
(55)



1.1



1.2



1.3



1.4



1.5



1.6



1.7

CÔNG BÁO SỞ HỮU CÔNG NGHIỆP SỐ 404 TẬP A – QUYỀN 2 (11.2021)

- (11) **43163**
(21) 3-2021-02272 (28) 1
(54) **BỒN CHỨA NƯỚC** (51) **23-01**
(22) 14/09/2021 (43) 25/11/2021
(73) **CÔNG TY CỔ PHẦN QUỐC TẾ SATA (VN)**
Nhà số 9, ngách 32/98, TDP Đông 6, đường Cổ Nhuế, phường Cổ Nhuế 2, quận
Bắc Từ Liêm, thành phố Hà Nội
(72) 1. BIỆN VĂN BẢY (VN)
2. NGUYỄN VĂN THANH (VN)
3. TRẦN VĂN THẮNG (VN)
4. TRỊNH THỊ PHƯỢNG (VN)
5. LÊ THỊ HẰNG (VN)
(74) Công ty TNHH Tư vấn IPNG (IPNG CO.,LTD)
(55)



1.1



1.2



1.3



1.4



1.5



1.6



1.7

CÔNG BÁO SỞ HỮU CÔNG NGHIỆP SỐ 404 TẬP A – QUYỀN 2 (11.2021)

- (11) **43164**
(21) 3-2021-02277 (28) 1
(54) **MÁY TẠO ĐỘ ẨM** (51) **23-04**
(22) 15/09/2021 (43) 25/11/2021
(30) 30-2021-0012596 16/03/2021 KR;
(73) **COWAY CO., LTD.** (KR)
136-23, Yugumagoksa-ro, Yugu-eup, Gongju-si, Choongcheongnam-do, Korea
(72) 1. JEON, JUNGJAE (KR)
2. PARK, EUNG KYU (KR)
3. SHIN, SUMIN (KR)
(74) Công ty TNHH Tư vấn Luật ALIAT (ALIAT LEGAL)
(55)

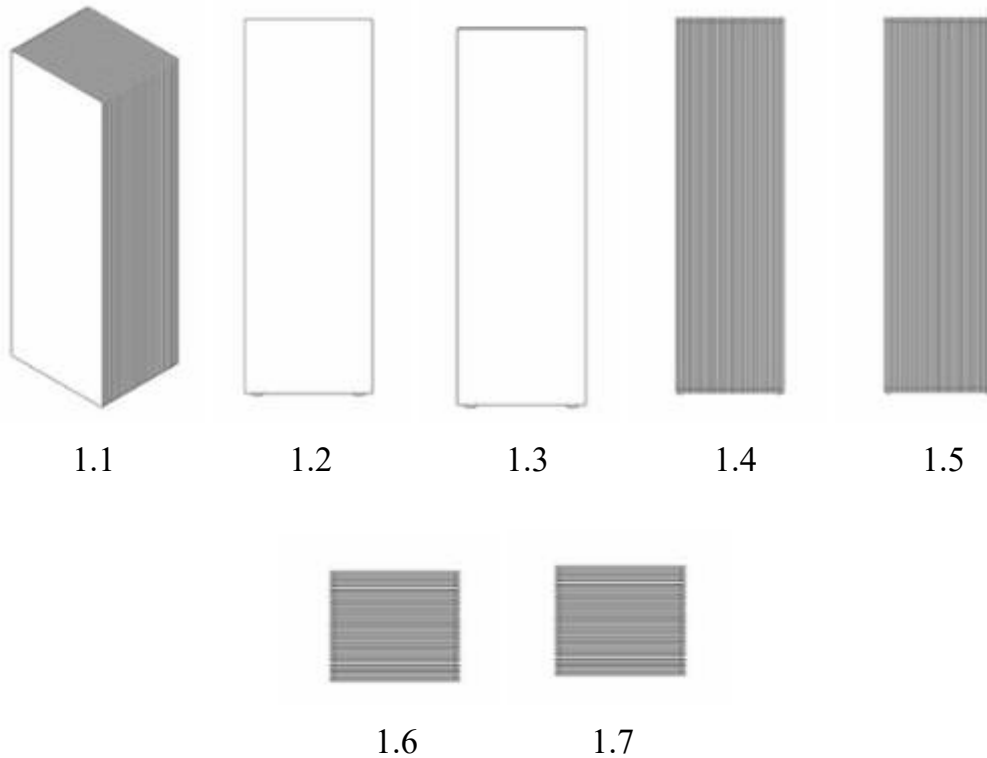

CÔNG BÁO SỞ HỮU CÔNG NGHIỆP SỐ 404 TẬP A – QUYỀN 2 (11.2021)

- (11) **43165**
(21) 3-2021-02278 (28) 1
(54) **NẤP HỘP** (51) **09-07**
(22) 15/09/2021 (43) 25/11/2021
(73) **CÔNG TY CỔ PHẦN CÔNG NGHỆ THỰC PHẨM CHÂU Á (VN)**
Số 8 đường TS15 khu công nghiệp Tiên Sơn, xã Hoàn Sơn, huyện Tiên Du, tỉnh
Bắc Ninh
(72) Lê Hoàng Minh (VN)
(74) Công ty Luật TNHH Phạm và Liên danh (PHAM & ASSOCIATES)
(55)



1.1



1.2



1.3



1.4



1.5



1.6



1.7

- (11) **43166**
(21) 3-2021-02280 (28) 1
(54) **ĐÈN** (51) **26-05**
(22) 15/09/2021 (43) 25/11/2021
(73) **CÔNG TY CỔ PHẦN BÓNG ĐÈN PHÍCH NƯỚC RẠNG ĐÔNG (VN)**
87-89 phố Hạ Đình, phường Thanh Xuân Trung, quận Thanh Xuân, thành phố Hà Nội
(72) Trần Trung Tường (VN)
(55)

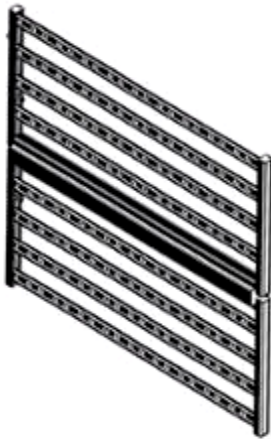

1.1

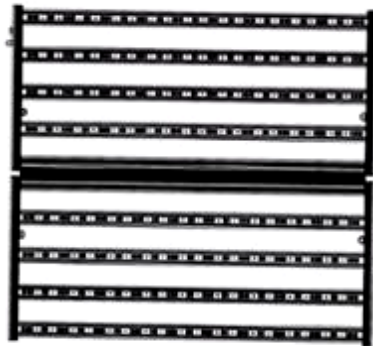

1.2

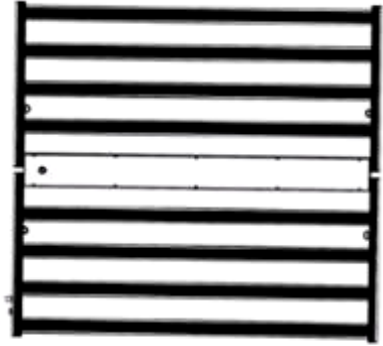

1.3



1.4

1.5



1.6



1.7

- (11) **43167**
(21) 3-2021-02281 (28) 1
(54) **BÓNG ĐÈN** (51) **26-04**
(22) 15/09/2021 (43) 25/11/2021
(73) **CÔNG TY CỔ PHẦN BÓNG ĐÈN PHÍCH NƯỚC RẠNG ĐÔNG (VN)**
87-89 phố Hạ Đình, phường Thanh Xuân Trung, quận Thanh Xuân, thành phố Hà Nội
(72) Trần Trung Tường (VN)
(55)

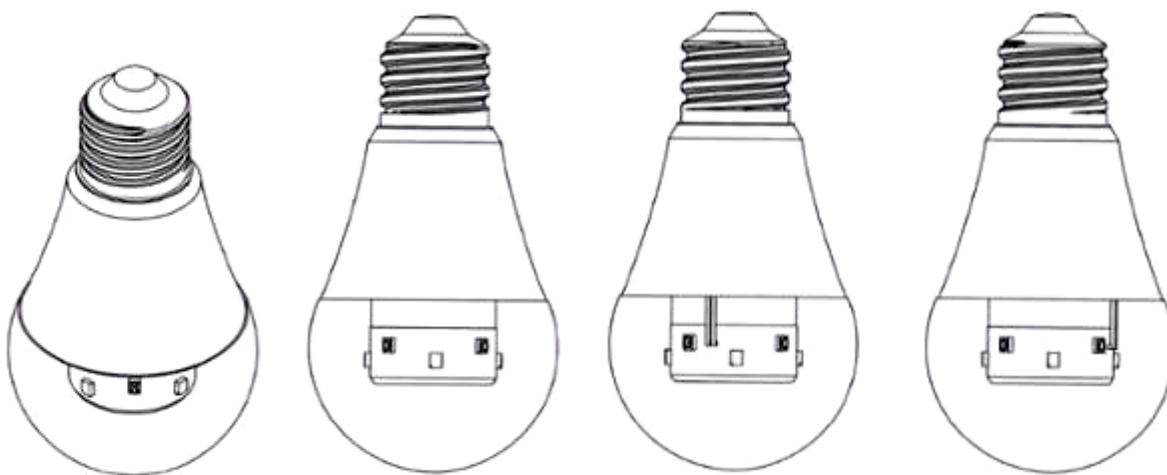

1.1

1.2

1.3

1.4

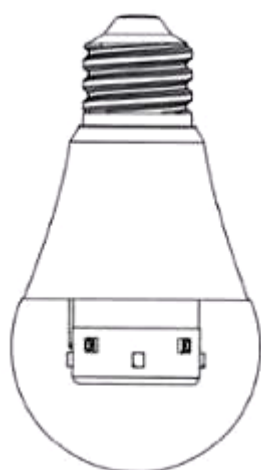

1.5



1.6



1.7

- (11) **43168**
(21) 3-2021-02282 (28) 1
(54) **BÌNH GIỮ NHIỆT** (51) **07-07**
(22) 15/09/2021 (43) 25/11/2021
(73) **CÔNG TY CỔ PHẦN BÓNG ĐÈN PHÍCH NƯỚC RẠNG ĐÔNG (VN)**
87-89 phố Hạ Đình, phường Thanh Xuân Trung, quận Thanh Xuân, thành phố Hà Nội
(72) Trần Trung Tường (VN)
(55)



1.1



1.2

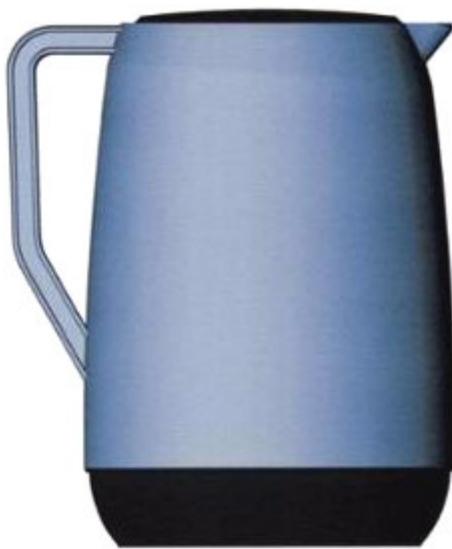

1.3



1.4



1.5

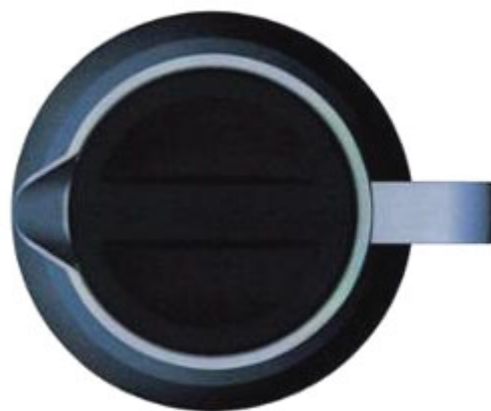

1.6

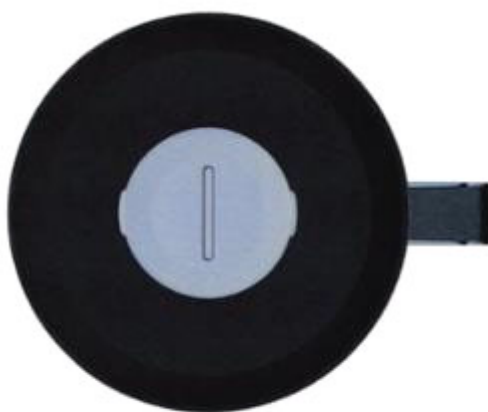

1.7

- (11) **43169**
(21) 3-2021-02283 (28) 1
(54) **PHÍCH** (51) **07-07**
(22) 15/09/2021 (43) 25/11/2021
(73) **CÔNG TY CỔ PHẦN BÓNG ĐÈN PHÍCH NƯỚC RẠNG ĐÔNG (VN)**
87-89 phố Hạ Đình, phường Thanh Xuân Trung, quận Thanh Xuân, thành phố Hà Nội
(72) Trần Trung Tường (VN)
(55)



1.1



1.2



1.3



1.4



1.5



1.6

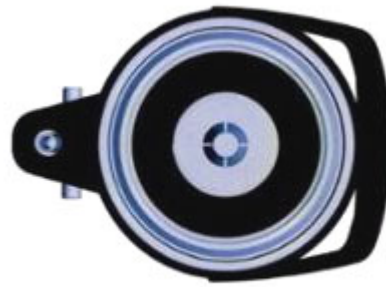

1.7

CÔNG BÁO SỞ HỮU CÔNG NGHIỆP SỐ 404 TẬP A – QUYỀN 2 (11.2021)

- (11) **43170**
(21) 3-2021-02284 (28) 1
(54) **BỒN CHỨA NƯỚC** (51) **23-01**
(22) 16/09/2021 (43) 25/11/2021
(73) **CÔNG TY CP QUỐC TẾ TẬP ĐOÀN AN PHÁT (VN)**
Số 104 Trần Nhân Tông, khu phố 2, thị trấn Vĩnh Trụ, huyện Lý Nhân, tỉnh Hà Nam
(72) Nguyễn Văn Thọ (VN)
(74) Công ty TNHH Dịch vụ Sở hữu trí tuệ GREENIP (GREENIP CO., LTD)
(55)



1.1



1.2



1.3



1.4



1.5



1.6



1.7

CÔNG BÁO SỞ HỮU CÔNG NGHIỆP SỐ 404 TẬP A – QUYỀN 2 (11.2021)

- (11) **43171**
(21) 3-2021-02285 (28) 1
(54) **THANH ĐÁY** (51) **25-01**
(22) 16/09/2021 (43) 25/11/2021
(73) **CÔNG TY CỔ PHẦN THIẾT BỊ ĐIỆN TỬ QUANG MINH (VN)**
Tổ dân phố số 7, thị trấn Quang Minh, huyện Mê Linh, thành phố Hà Nội
(72) Bùi Minh Tuấn (VN)
(74) Công ty TNHH Tư vấn Quốc Dân (NACILAW)
(55)

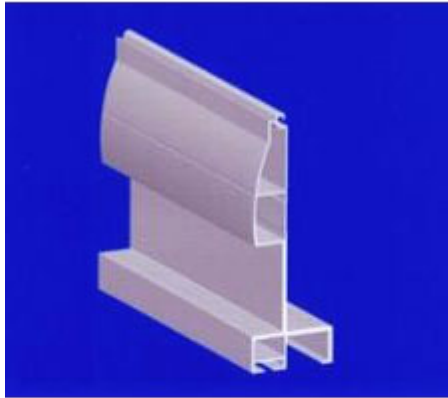

1.1



1.2



1.3

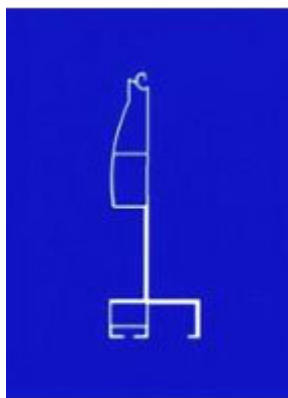

1.4

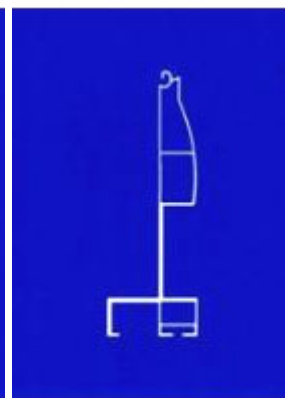

1.5



1.6



1.7

CÔNG BÁO SỞ HỮU CÔNG NGHIỆP SỐ 404 TẬP A – QUYỀN 2 (11.2021)

- (11) **43172**
(21) 3-2021-02286 (28) 1
(54) **LỌ** (51) **09-03**
(22) 16/09/2021 (43) 25/11/2021
(73) **LG HOUSEHOLD & HEALTH CARE LTD. (KR)**
58, Saemunan-ro, Jongno-gu, Seoul, Republic of Korea
(72) **CHOI, Jae Eun (KR)**
(74) Công ty TNHH Tâm nhìn và Liên danh (VISION & ASSOCIATES CO.LTD.)
(55)



1.1



1.2



1.3



1.4



1.5



1.6



1.7

CÔNG BÁO SỞ HỮU CÔNG NGHIỆP SỐ 404 TẬP A – QUYỀN 2 (11.2021)

(11) **43173**

(21) 3-2021-02287

(28) 1

(54) **LỌ**

(51) **09-01**

(22) 16/09/2021

(43) 25/11/2021

(73) **LG HOUSEHOLD & HEALTH CARE LTD. (KR)**

58, Saemunan-ro, Jongno-gu, Seoul, Republic of Korea

(72) CHOI, Jae Eun (KR)

(74) Công ty TNHH Tâm nhìn và Liên danh (VISION & ASSOCIATES CO.LTD.)

(55)



1.1



1.2



1.3



1.4



1.5



1.6



1.7



1.8

- (11) **43174**
(21) 3-2021-02289 (28) 1
(54) **DỤNG CỤ XOA BÓP** (51) **28-03**
(22) 17/09/2021 (43) 25/11/2021
(73) **PARK MIN GYU (KR)**
1503, Top Family, 56-1, Bujeon-ro, Busanjin-gu, Busan, Republic of Korea
(72) **PARK MIN GYU (KR)**
(74) Công ty TNHH Dịch thuật sáng chế PROINVEN (PROINVEN CO.,LTD.)
(55)



1.1

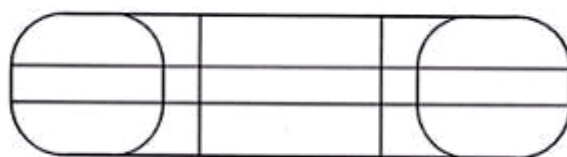

1.2

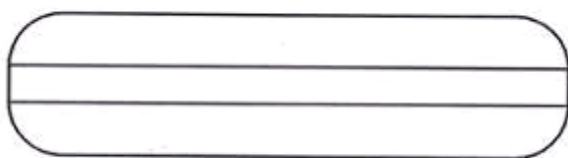

1.3

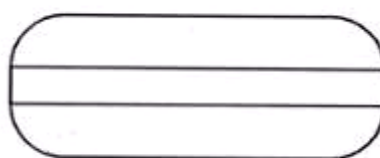

1.4

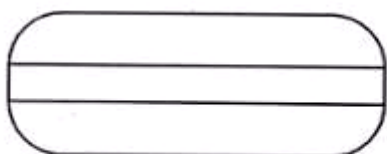

1.5

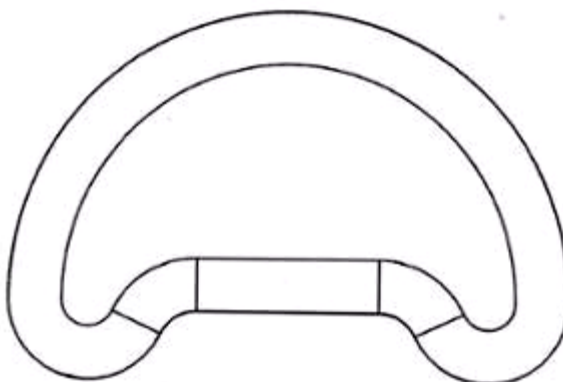

1.6

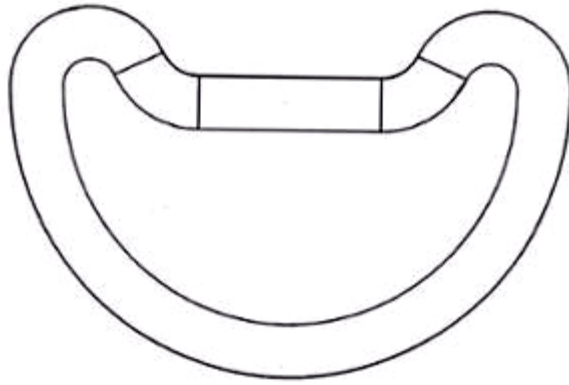

1.7

CÔNG BÁO SỞ HỮU CÔNG NGHIỆP SỐ 404 TẬP A – QUYỀN 2 (11.2021)

- (11) **43175**
(21) 3-2021-02291 (28) 1
(54) **ĐIỆN THOẠI DI ĐỘNG** (51) **14-03**
(22) 17/09/2021 (43) 25/11/2021
(30) 202130320543.2 27/05/2021 CN;
(73) **VIVO MOBILE COMMUNICATION CO., LTD.** (CN)
No.1, vivo Road, Chang'an, Dongguan, Guangdong 523863, China
(72) Junhao LIN (CN)
(74) Công ty TNHH Đại Tín và Liên Danh (DAITIN AND ASSOCIATES CO.,LTD)
(55)



1.1



1.2



1.3



1.4



1.5



1.6



1.7

1.8



1.9



1.10



1.11



1.12



1.13



1.14



1.15



1.16

CÔNG BÁO SỞ HỮU CÔNG NGHIỆP SỐ 404 TẬP A – QUYỀN 2 (11.2021)

- (11) **43176**
(21) 3-2021-02295 (28) 1
(54) **HỘP** (51) **09-03**
(22) 20/09/2021 (43) 25/11/2021
(73) **ORION CORPORATION (KR)**
13, Baekbeom-ro 90da-gil, Yongsan-gu, Seoul 04369, Republic of Korea
(72) 1. LEE, A REUM (KR)
2. CHOE, EUN JE (KR)
(74) Công ty Luật TNHH quốc tế BMVN (BMVN INTERNATIONAL LLC)
(55)



1.1



1.2

CÔNG BÁO SỞ HỮU CÔNG NGHIỆP SỐ 404 TẬP A – QUYỀN 2 (11.2021)

- (11) **43177**
(21) 3-2021-02296 (28) 1
(54) **HỘP** (51) **09-03**
(22) 20/09/2021 (43) 25/11/2021
(73) **ORION CORPORATION (KR)**
13, Baekbeom-ro 90da-gil, Yongsan-gu, Seoul 04369, Republic of Korea
(72) 1. LEE, A REUM (KR)
2. CHOE, EUN JE (KR)
(74) Công ty Luật TNHH quốc tế BMVN (BMVN INTERNATIONAL LLC)
(55)



1.1



1.2

CÔNG BÁO SỞ HỮU CÔNG NGHIỆP SỐ 404 TẬP A – QUYỀN 2 (11.2021)

- (11) **43178**
(21) 3-2021-02297
(54) **MÁY OXY DÒNG CAO**
(22) 20/09/2021
(73) **CÔNG TY CỔ PHẦN BKAV (VN)**
Tầng 2 tòa nhà HH1, khu đô thị Yên Hòa, phường Yên Hòa, quận Cầu Giấy, thành phố Hà Nội
(72) 1. **VŨ THANH THẮNG (VN)**
2. **HOÀNG MẠNH CƯỜNG (VN)**
(55)
- (28) 1
(51) **24-01**
(43) 25/11/2021

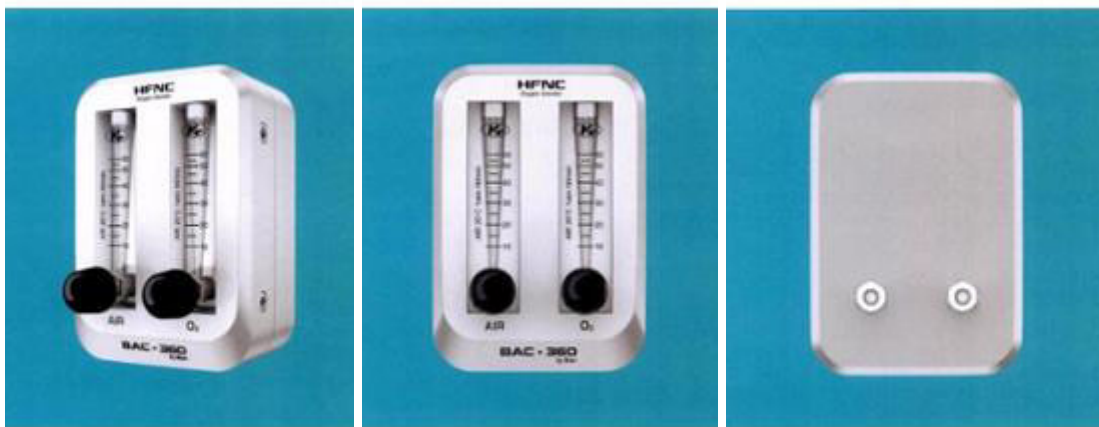

1.1

1.2

1.3

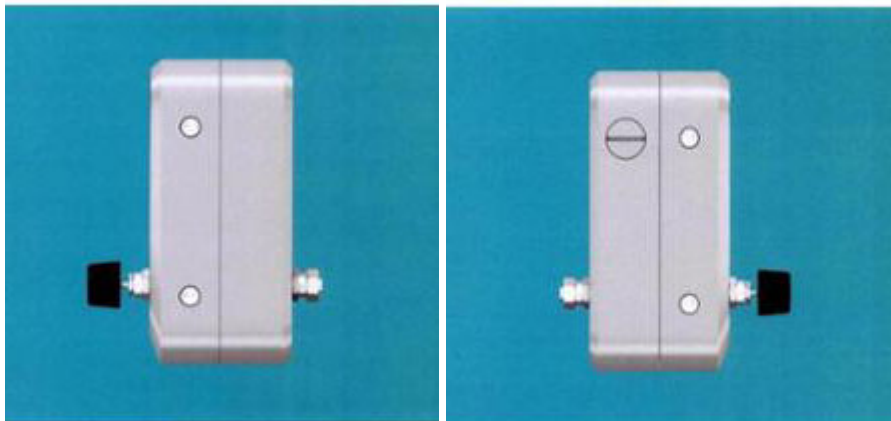

1.4

1.5



1.6



1.7

CÔNG BÁO SỞ HỮU CÔNG NGHIỆP SỐ 404 TẬP A – QUYỀN 2 (11.2021)

- (11) **43179**
- (21) 3-2021-02301 (28) 1
- (54) **NHÃN SẢN PHẨM** (51) **19-08**
- (22) 20/09/2021 (43) 25/11/2021
- (73) **CÔNG TY CỔ PHẦN DƯỢC PHẨM SINGCARE (VN)**
Số 8A, ngách 42/133 phố Thịnh Liệt, phường Thịnh Liệt, quận Hoàng Mai, thành phố Hà Nội
- (72) Lê Đại Thành (VN)
- (74) Công ty TNHH Tư vấn Quốc Dân (NACILAW)
- (55)



CÔNG BÁO SỞ HỮU CÔNG NGHIỆP SỐ 404 TẬP A – QUYỀN 2 (11.2021)

- (11) **43180**
(21) 3-2021-02303 (28) 1
(54) **MÁY CẮT TÁCH HẠT ĐIỀU TỰ ĐỘNG** (51) **15-03**
(22) 21/09/2021 (43) 25/11/2021
(73) **CÔNG TY TNHH MỘT THÀNH VIÊN THƯƠNG MẠI DỊCH VỤ XUẤT NHẬP KHẨU CƠ KHÍ GIA BẢO (VN)**
Khu phố 1, phường Long Phước, thị xã Phước Long, tỉnh Bình Dương
(72) Nguyễn Văn Liên (VN)
(55)

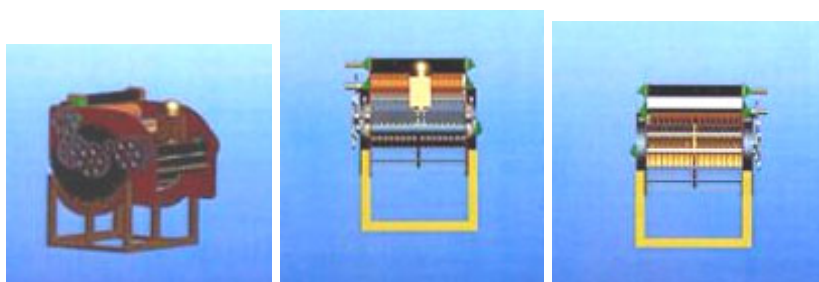

1.1

1.2

1.3

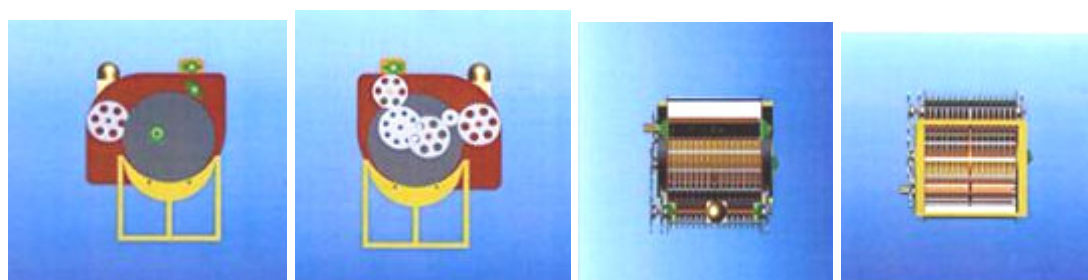

1.4

1.5

1.6

1.7

CÔNG BÁO SỞ HỮU CÔNG NGHIỆP SỐ 404 TẬP A – QUYỀN 2 (11.2021)

(11) **43181**

(21) 3-2021-02308

(28) 1

(54) **LÒ ĐỐT**

(51) **23-99**

(22) 21/09/2021

(43) 25/11/2021

(73) **CÔNG TY CỔ PHẦN CƠ KHÍ VINA NHA TRANG (VN)**

Lô A7 - A10, cụm công nghiệp Diên Phú, Diên Khánh, tỉnh Khánh Hòa

(72) Nguyễn Văn Hoàng (VN)

(74) Công ty TNHH Trường Xuân (AGELESS CO.,LTD.)

(55)



1.1



1.2



1.3



1.4



1.5



1.6



1.7



1.8

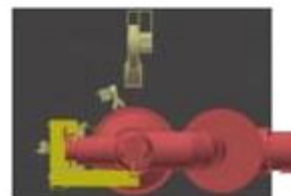

1.9

- (11) **43182**
(21) 3-2021-02309 (28) 1
(54) **VÀNH BÁNH XE** (51) **12-16**
(22) 31/07/2020 (43) 25/11/2021
(73) **MENG KAH AUTO PARTS TRADING SDN. BHD. (MY)**
40, Jalan TPP5, Taman Perindustrian Putra, 47130 Puchong, Selangor, Malaysia
(72) LEE CONG QUAN (MY)
(74) Công ty TNHH Trường Xuân (AGELESS CO.,LTD.)
(55)



1.1



1.2

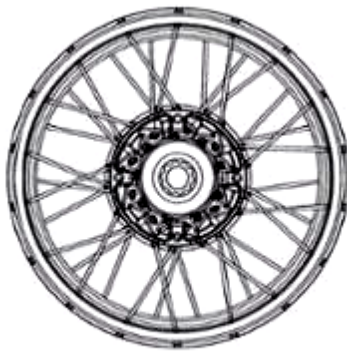

1.3



1.4



1.5

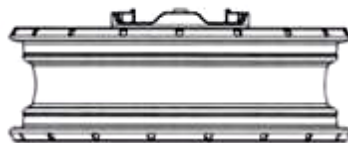

1.6



1.7

CÔNG BÁO SỞ HỮU CÔNG NGHIỆP SỐ 404 TẬP A – QUYỀN 2 (11.2021)

(11) **43183**

(21) 3-2021-02310

(28) 1

(54) **ÁO KHOÁC**

(51) **02-02**

(22) 21/09/2021

(43) 25/11/2021

(73) **CÔNG TY CỔ PHẦN THỜI TRANG K'S CLOSET (VN)**

Số 20, ngách 77/21, ngõ 77, đường Lãng Yên, phường Thanh Lương, quận Hai Bà Trưng, thành phố Hà Nội

(72) Nguyễn Hải Yến (VN)

(55)



1.1



1.2



1.3



1.4



1.5



1.6

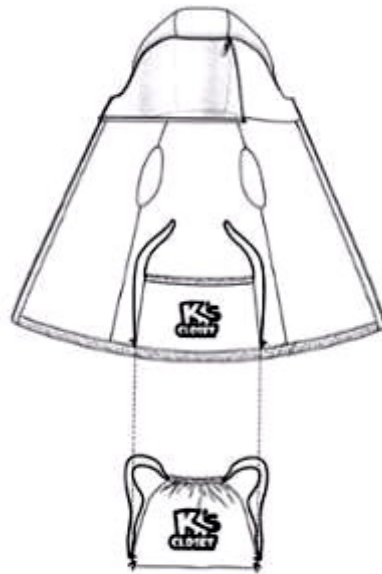

1.7

CÔNG BÁO SỞ HỮU CÔNG NGHIỆP SỐ 404 TẬP A – QUYỀN 2 (11.2021)

- (11) **43184**
(21) 3-2021-02312 (28) 1
(54) **BAO GÓI** (51) **09-05**
(22) 21/09/2021 (43) 25/11/2021
(73) **CERIOTI HOLDING S.A. (LU)**
23, Rue Aldringen L-1118 Luxembourg
(72) Lê Thị Ánh Phương (VN)
(74) Công ty TNHH Tầm nhìn và Liên danh (VISION & ASSOCIATES CO.LTD.)
(55)



1.1



1.2

CÔNG BÁO SỞ HỮU CÔNG NGHIỆP SỐ 404 TẬP A – QUYỀN 2 (11.2021)

- (11) **43185**
(21) 3-2021-02332 (28) 1
(54) **HỘP ĐỰNG** (51) **09-03**
(22) 23/09/2021 (43) 25/11/2021
(73) **CÔNG TY TNHH NTPM (VIỆT NAM) (VN)**
Số 22 VSIP II-A, đường số 23, khu công nghiệp Việt Nam – Singapore II-A,
phường Vĩnh Tân, thị xã Tân Uyên, tỉnh Bình Dương
(72) LEE KUAN PHENG (MY)
(74) Công ty TNHH Sở hữu trí tuệ HA VIP (HAVIP CO., LTD.)
(55)



1.1



1.2

CÔNG BÁO SỞ HỮU CÔNG NGHIỆP SỐ 404 TẬP A – QUYỀN 2 (11.2021)

- (11) **43186**
(21) 3-2021-02334 (28) 1
(54) **HỘP ĐỰNG** (51) **09-03**
(22) 23/09/2021 (43) 25/11/2021
(73) **CÔNG TY TNHH NTPM (VIỆT NAM) (VN)**
Số 22 VSIP II-A, đường số 23, khu công nghiệp Việt Nam – Singapore II-A,
phường Vĩnh Tân, thị xã Tân Uyên, tỉnh Bình Dương
(72) LEE KUAN PHENG (MY)
(74) Công ty TNHH Sở hữu trí tuệ HA VIP (HAVIP CO., LTD.)
(55)



1.1



1.2

CÔNG BÁO SỞ HỮU CÔNG NGHIỆP SỐ 404 TẬP A – QUYỀN 2 (11.2021)

- (11) **43187**
(21) 3-2021-02335 (28) 1
(54) **HỘP ĐỰNG** (51) **09-03**
(22) 23/09/2021 (43) 25/11/2021
(73) **CÔNG TY TNHH NTPM (VIỆT NAM) (VN)**
Số 22 VSIP II-A, đường số 23, khu công nghiệp Việt Nam – Singapore II-A,
phường Vĩnh Tân, thị xã Tân Uyên, tỉnh Bình Dương
(72) LEE KUAN PHENG (MY)
(74) Công ty TNHH Sở hữu trí tuệ HA VIP (HAVIP CO., LTD.)
(55)



1.1



1.2

CÔNG BÁO SỞ HỮU CÔNG NGHIỆP SỐ 404 TẬP A – QUYỀN 2 (11.2021)

- (11) **43188**
(21) 3-2021-02337 (28) 1
(54) **HỘP ĐỰNG** (51) **09-03**
(22) 23/09/2021 (43) 25/11/2021
(73) **CÔNG TY TNHH NTPM (VIỆT NAM) (VN)**
Số 22 VSIP II-A, đường số 23, khu công nghiệp Việt Nam – Singapore II-A,
phường Vĩnh Tân, thị xã Tân Uyên, tỉnh Bình Dương
(72) LEE KUAN PHENG (MY)
(74) Công ty TNHH Sở hữu trí tuệ HA VIP (HAVIP CO., LTD.)
(55)



1.1



1.2

CÔNG BÁO SỞ HỮU CÔNG NGHIỆP SỐ 404 TẬP A – QUYỀN 2 (11.2021)

- (11) **43189**
(21) 3-2021-02338 (28) 1
(54) **HỘP ĐIỀU KHIỂN** (51) **10-05**
(22) 23/09/2021 (43) 25/11/2021
(73) **VIỆN NGHIÊN CỨU VÀ ỨNG DỤNG CÔNG NGHỆ CAO HÒA LẠC (VN)**
Khu công nghệ cao Hòa Lạc, Km 29 Đại lộ Thăng Long, xã Thạch Hoà, huyện
Thạch Thất, thành phố Hà Nội
(72) Nguyễn Đình Mạnh (VN)
(55)



1.1



1.2



1.3



1.4



1.5



1.6



1.7



1.8

CÔNG BÁO SỞ HỮU CÔNG NGHIỆP SỐ 404 TẬP A – QUYỀN 2 (11.2021)

- (11) **43190**
(21) 3-2021-02358 (28) 3
(54) **HỘP** (51) **09-03**
(22) 24/09/2021 (43) 25/11/2021
(73) **CÔNG TY CỔ PHẦN NOVA NUTRITION & WELLNESS (VN)**
Số 3.01, TM-DV18, lầu 3, khối tháp V5-V6, khu chung cư kết hợp thương mại,
văn phòng lô V (Sunrise City, Khu South Towers), 23 Nguyễn Hữu Thọ, phường
Tân Hưng, quận 7, thành phố Hồ Chí Minh
(72) Trần Thị Thu (VN)
(74) Công ty cổ phần Sở hữu trí tuệ BROSS và Cộng sự (BROSS & PARTNERS., JSC)
(55)



1.1



1.2



2.1



2.2



3.1



3.2

CÔNG BÁO SỞ HỮU CÔNG NGHIỆP SỐ 404 TẬP A – QUYỀN 2 (11.2021)

- (11) **43191**
(21) 3-2021-02364 (28) 2
(54) **NẮP ĐỘNG CƠ CỦA MÁY NÔNG NGHIỆP** (51) **15-03**
(22) 27/09/2021 (43) 25/11/2021
(30) 2021-016333 28/07/2021 JP;
(73) **KUBOTA CORPORATION (JP)**
2-47, Shikitsuhigashi 1-chome, Naniwa-ku, Osaka-shi, Osaka 5568601, Japan
(72) Takamasa MAEDA (JP)
(74) Công ty TNHH một thành viên Sở hữu trí tuệ VCCI (VCCI-IP CO.,LTD)
(55)



1.1



1.2



1.3



1.4



1.5



1.6



2.1



2.2



2.3



2.4



2.5



2.6

- (11) **43192**
(21) 3-2021-02365 (28) 1
(54) **MÁY NÔNG NGHIỆP** (51) **15-03**
(22) 27/09/2021 (43) 25/11/2021
(30) 2021-016332 28/07/2021 JP;
(73) **KUBOTA CORPORATION (JP)**
2-47, Shikitsuhigashi 1-chome, Naniwa-ku, Osaka-shi, Osaka 5568601, Japan
(72) 1. TAKAMASA MAEDA (JP)
2. JUNTA KUWAE (JP)
3. HIROYUKI SAKAI (JP)
(74) Công ty TNHH một thành viên Sở hữu trí tuệ VCCI (VCCI-IP CO.,LTD)
(55)



1.1



1.2



1.3



1.4

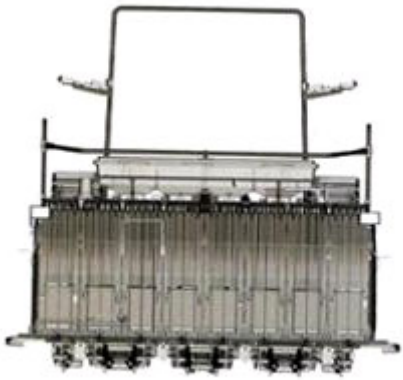

1.5

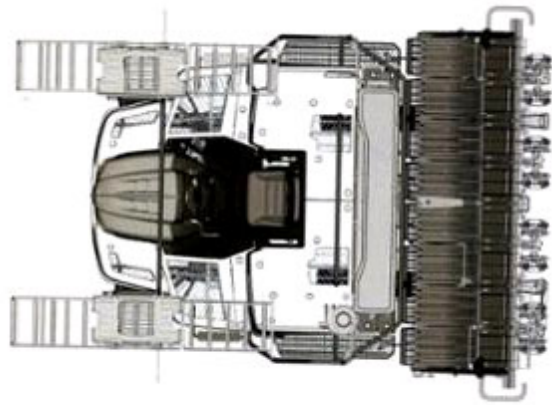

1.6

CÔNG BÁO SỞ HỮU CÔNG NGHIỆP SỐ 404 TẬP A – QUYỀN 2 (11.2021)

- (11) **43193**
(21) 3-2021-02370 (28) 1
(54) **THANH NHÔM ĐỊNH HÌNH** (51) **25-01**
(22) 28/09/2021 (43) 25/11/2021
(73) **CÔNG TY CỔ PHẦN HYUNDAI ALUMINIUM VINA (VN)**
Số 1/17 phố Nhị Châu, phường Nhị Châu, thành phố Hải Dương, tỉnh Hải Dương
(72) Nguyễn Thị Nguyễn (VN)
(55)

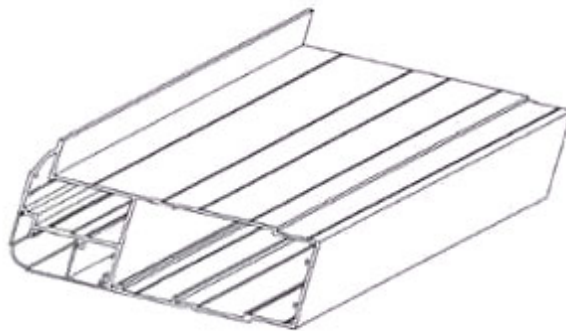

1.1



1.2



1.3

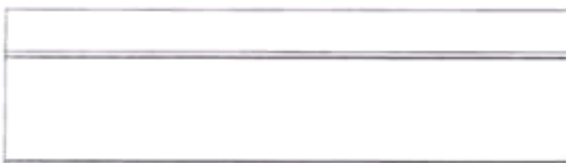

1.4

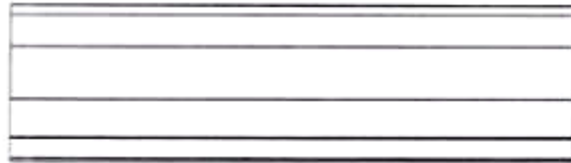

1.5

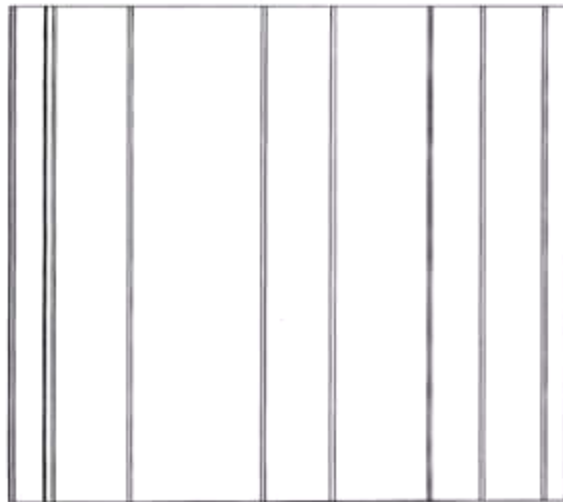

1.6

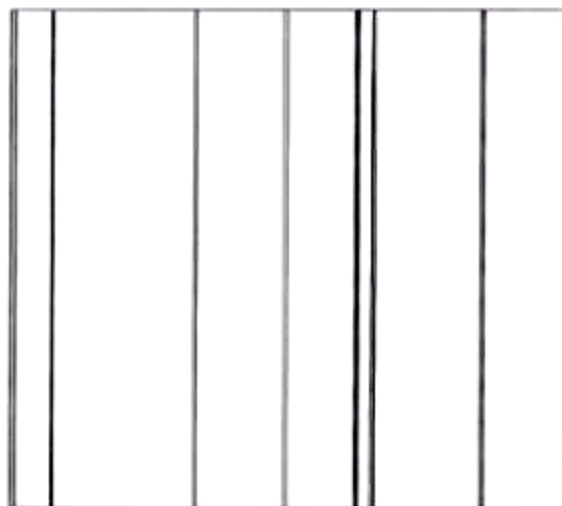

1.7

CÔNG BÁO SỞ HỮU CÔNG NGHIỆP SỐ 404 TẬP A – QUYỀN 2 (11.2021)

- (11) **43194**
(21) 3-2021-02373 (28) 1
(54) **ĐIỀU KHIỂN TỪ XA** (51) **14-03**
(22) 28/09/2021 (43) 25/11/2021
(73) **CÔNG TY CP ÁNH SÁNG SỐ HUEPRESS (VN)**
Số 50 ngõ 73 đường Nguyễn Trãi, phường Khương Trung, quận Thanh Xuân,
thành phố Hà Nội
(72) Thiều Minh Đức (VN)
(74) **CÔNG TY TRÁCH NHIỆM HỮU HẠN TƯ VẤN ĐẦU TƯ VÀ SỞ HỮU TRÍ**
TUỆ INTERFIVE (INTERFIVE CO., LTD)
(55)



CÔNG BÁO SỞ HỮU CÔNG NGHIỆP SỐ 404 TẬP A – QUYỀN 2 (11.2021)

- (11) **43195**
(21) 3-2021-02374 (28) 1
(54) **ĐIỀU KHIỂN TỪ XA** (51) **14-03**
(22) 28/09/2021 (43) 25/11/2021
(73) **CÔNG TY CP ÁNH SÁNG SỐ HUEPRESS (VN)**
Số 50 ngõ 73 đường Nguyễn Trãi, phường Khương Trung, quận Thanh Xuân,
thành phố Hà Nội
(72) Thiều Minh Đức (VN)
(74) **CÔNG TY TRÁCH NHIỆM HỮU HẠN TƯ VẤN ĐẦU TƯ VÀ SỞ HỮU TRÍ**
TUỆ INTERFIVE (INTERFIVE CO., LTD)
(55)



1.1



1.2

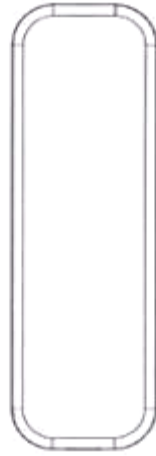

1.3



1.4



1.5

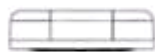

1.6



1.7

- (11) 43196
(21) 3-2021-02385 (28) 1
(54) NHÃN SẢN PHẨM (51) 19-08
(22) 29/09/2021 (43) 25/11/2021
(73) CÔNG TY CỔ PHẦN TẬP ĐOÀN THAICOM (VN)
Thôn Ngọc Lịch, xã Trung Trác, huyện Văn Lâm, tỉnh Hưng Yên
(72) Trần Văn Khanh (VN)
(55)



CÔNG BÁO SỞ HỮU CÔNG NGHIỆP SỐ 404 TẬP A – QUYỂN 2 (11.2021)

- (11) **43197**
(21) 3-2021-02386 (28) 1
(54) **NHÃN SẢN PHẨM** (51) **19-08**
(22) 29/09/2021 (43) 25/11/2021
(73) **CÔNG TY CỔ PHẦN TẬP ĐOÀN THAICOM (VN)**
Thôn Ngọc Lịch, xã Trung Trác, huyện Văn Lâm, tỉnh Hưng Yên
(72) Trần Văn Khanh (VN)
(55)



CÔNG BÁO SỞ HỮU CÔNG NGHIỆP SỐ 404 TẬP A – QUYỀN 2 (11.2021)

- (11) **43198**
(21) 3-2021-02409 (28) 6
(54) **BỘ NHÃN SẢN PHẨM** (51) **19-08**
(22) 04/10/2021 (43) 25/11/2021
(73) **NGUYỄN THỊ THU HOA (VN)**
Tân Thành, thị trấn Thanh Sơn, huyện Thanh Sơn, tỉnh Phú Thọ
(72) Nguyễn Thị Thu Hoa (VN)
(74) Công ty TNHH Sở hữu trí tuệ WITIP Việt Nam (WITIP CO., LTD.)
(55)



1.1



1.2



1.3



2.1



2.2



2.3



3.1



3.2



3.3

CÔNG BÁO SỞ HỮU CÔNG NGHIỆP SỐ 404 TẬP A – QUYỀN 2 (11.2021)

- (11) **43199**
(21) 3-2021-02421 (28) 1
(54) **NHÃN SẢN PHẨM** (51) **19-08**
(22) 06/10/2021 (43) 25/11/2021
(73) **CÔNG TY TNHH THỰC PHẨM VÀ NƯỚC GIẢI KHÁT JOY (VN)**
Lô VII-2.5 đường số 5, KCN Tân Đông Hiệp B, phường Tân Đông Hiệp, thành phố Dĩ An, tỉnh Bình Dương
(72) Bùi Chí Sỹ (VN)
(74) **CÔNG TY TNHH SỞ HỮU TRÍ TUỆ SETHACO (SETHACO IP CO.,LTD)**
(55)



CÔNG BÁO SỞ HỮU CÔNG NGHIỆP SỐ 404 TẬP A – QUYỀN 2 (11.2021)

- (11) **43200**
(21) 3-2021-02446 (28) 1
(54) **THANH KIM LOẠI ĐỊNH HÌNH** (51) **25-01**
(22) 08/10/2021 (43) 25/11/2021
(73) **CÔNG TY CỔ PHẦN CAD GROUP (VN)**
Số 8 ngõ 81, phố Trạm, phường Long Biên, quận Long Biên, thành phố Hà Nội
(72) Lâm Viết An (VN)
(74) Công ty TNHH Sở hữu trí tuệ Gia Việt (GIAVIET CO., LTD.)
(55)

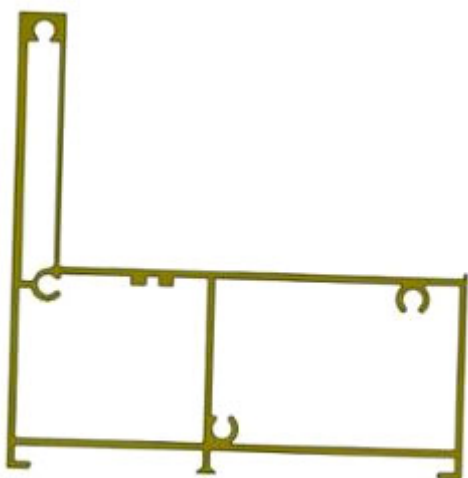

1.1

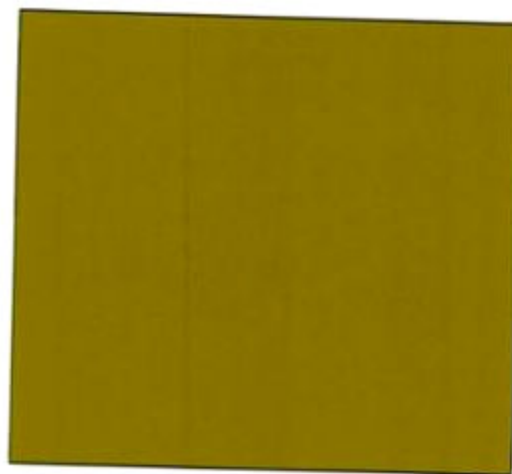

1.2

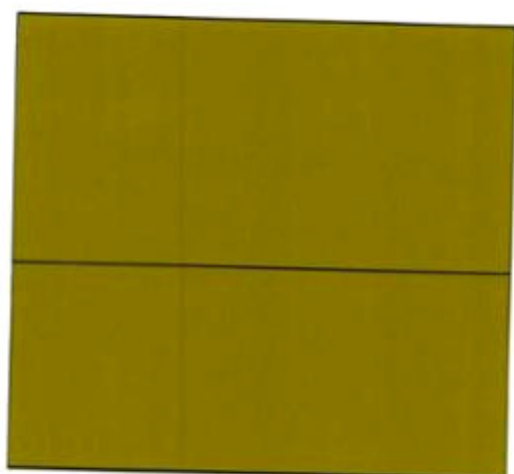

1.3

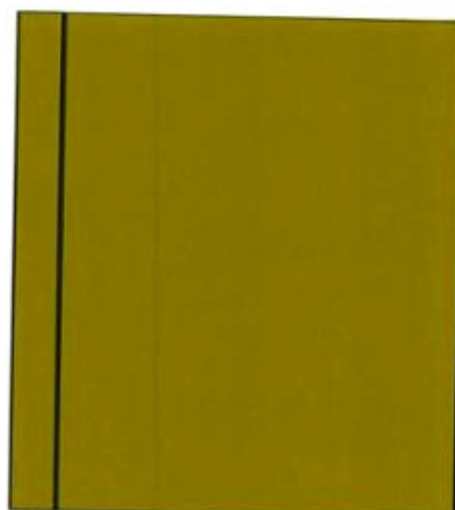

1.4

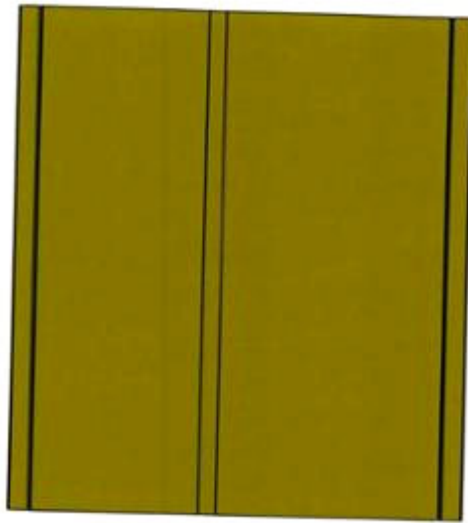

1.5

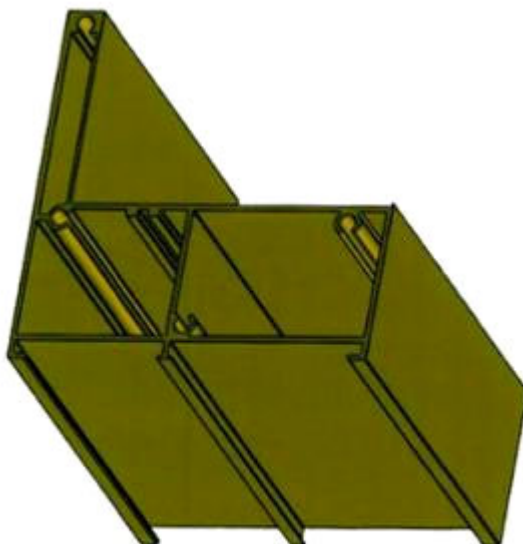

1.6

CÔNG BÁO SỞ HỮU CÔNG NGHIỆP SỐ 404 TẬP A – QUYỀN 2 (11.2021)

- (11) **43201**
(21) 3-2021-02447 (28) 1
(54) **THANH KIM LOẠI ĐỊNH HÌNH** (51) **25-01**
(22) 08/10/2021 (43) 25/11/2021
(73) **CÔNG TY CỔ PHẦN CAD GROUP (VN)**
Số 8 ngõ 81, phố Trạm, phường Long Biên, quận Long Biên, thành phố Hà Nội
(72) Lâm Viết An (VN)
(74) Công ty TNHH Sở hữu trí tuệ Gia Việt (GIAVIET CO., LTD.)
(55)

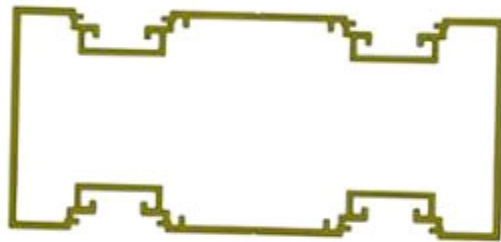

1.1



1.2

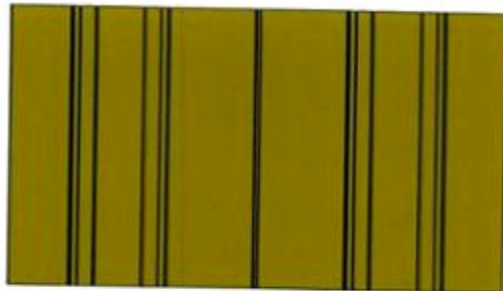

1.3

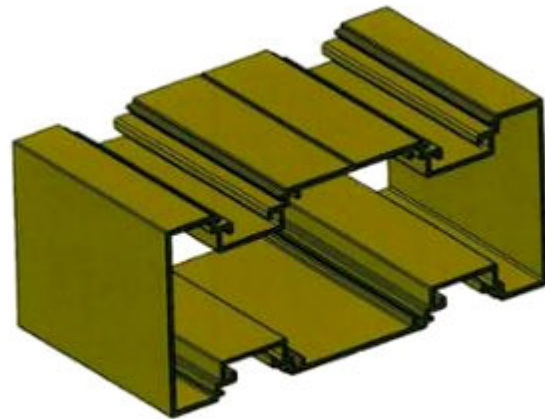

1.4

CÔNG BÁO SỞ HỮU CÔNG NGHIỆP SỐ 404 TẬP A – QUYỀN 2 (11.2021)

- (11) **43202**
(21) 3-2021-02448 (28) 1
(54) **THANH KIM LOẠI ĐỊNH HÌNH** (51) **25-01**
(22) 08/10/2021 (43) 25/11/2021
(73) **CÔNG TY CỔ PHẦN CAD GROUP (VN)**
Số 8 ngõ 81, phố Trạm, phường Long Biên, quận Long Biên, thành phố Hà Nội
(72) Lâm Viết An (VN)
(74) Công ty TNHH Sở hữu trí tuệ Gia Việt (GIAVIET CO., LTD.)
(55)

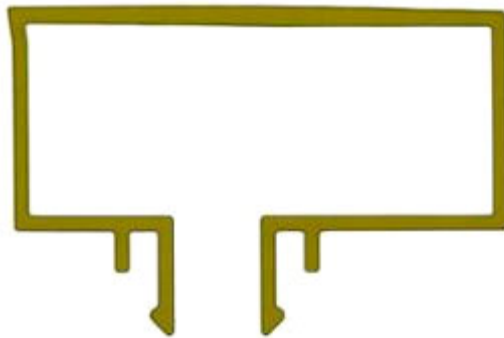

1.1



1.2

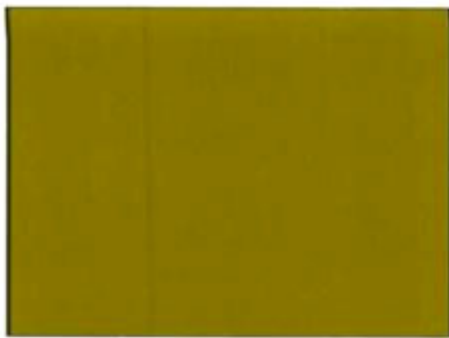

1.3

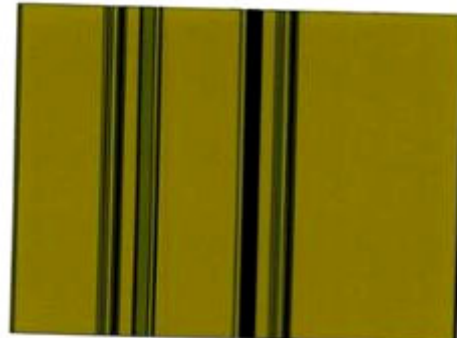

1.4

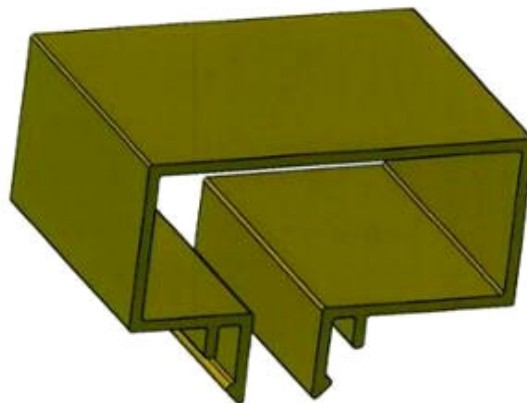

1.5

CÔNG BÁO SỞ HỮU CÔNG NGHIỆP SỐ 404 TẬP A – QUYỂN 2 (11.2021)

- (11) **43203**
(21) 3-2021-02465 (28) 1
(54) **NHÃN SẢN PHẨM** (51) **19-08**
(22) 08/10/2021 (43) 25/11/2021
(73) **CÔNG TY TNHH DỊCH VỤ VÀ CUNG CẤP THỰC PHẨM QUỐC TẾ - IFSS (VN)**
Số 2Bis Nguyễn Thị Minh Khai, phường Đa Kao, quận 1, thành phố Hồ Chí Minh
(72) Hoàng Dương Xuân Dũng (VN)
(55)



CÔNG BÁO SỞ HỮU CÔNG NGHIỆP SỐ 404 TẬP A – QUYỀN 2 (11.2021)

- (11) **43204**
(21) 3-2021-02512 (28) 1
(54) **BAO GÓI NGŨ CỐC ĂN LIỀN** (51) **09-05**
(22) 14/10/2021 (43) 25/11/2021
(73) **CÔNG TY TRÁCH NHIỆM HỮU HẠN THANH AN (VN)**
P809 tầng 8, tòa nhà Plaschem, số 562 đường Nguyễn Văn Cừ, phường Gia Thụy,
quận Long Biên, thành phố Hà Nội
(72) Tạ Bá Thuyết (VN)
(74) Công ty TNHH Sở hữu trí tuệ và Công nghệ Thủ đô (CAPITAL IP&T CO.LTD.)
(55)



1.1



1.2

CÔNG BÁO SỞ HỮU CÔNG NGHIỆP SỐ 404 TẬP A – QUYỀN 2 (11.2021)

- (11) **43205**
(21) 3-2021-02513 (28) 1
(54) **BAO GÓI TẤ GIẤY TRẺ EM** (51) **09-05**
(22) 14/10/2021 (43) 25/11/2021
(73) **CÔNG TY CỔ PHẦN DIANA UNICHARM (VN)**
Khu công nghiệp Vĩnh Tuy, đường Lĩnh Nam, phường Vĩnh Hưng, quận Hoàng
Mai, thành phố Hà Nội
(72) Đỗ Anh Tú (VN)
(74) Công ty TNHH Sở hữu trí tuệ và Công nghệ Thủ đô (CAPITAL IP&T CO.LTD.)
(55)



1.1



1.2

CÔNG BÁO SỞ HỮU CÔNG NGHIỆP SỐ 404 TẬP A – QUYỀN 2 (11.2021)

- (11) **43206**
(21) 3-2021-02514 (28) 1
(54) **BAO GÓI TẤ GIẤY TRẺ EM** (51) **09-05**
(22) 14/10/2021 (43) 25/11/2021
(73) **CÔNG TY CỔ PHẦN DIANA UNICHARM (VN)**
Khu công nghiệp Vĩnh Tuy, đường Lĩnh Nam, phường Vĩnh Hưng, quận Hoàng
Mai, thành phố Hà Nội
(72) Đỗ Anh Tú (VN)
(74) Công ty TNHH Sở hữu trí tuệ và Công nghệ Thủ đô (CAPITAL IP&T CO.LTD.)
(55)



1.1



1.2

CÔNG BÁO SỞ HỮU CÔNG NGHIỆP SỐ 404 TẬP A – QUYỀN 2 (11.2021)

- (11) **43207**
(21) 3-2021-02515 (28) 1
(54) **BAO GÓI TẤ GIẤY TRẺ EM** (51) **09-05**
(22) 14/10/2021 (43) 25/11/2021
(73) **CÔNG TY CỔ PHẦN DIANA UNICHARM (VN)**
Khu công nghiệp Vĩnh Tuy, đường Lĩnh Nam, phường Vĩnh Hưng, quận Hoàng
Mai, thành phố Hà Nội
(72) Đỗ Anh Tú (VN)
(74) Công ty TNHH Sở hữu trí tuệ và Công nghệ Thủ đô (CAPITAL IP&T CO.LTD.)
(55)



1.1



1.2

CÔNG BÁO SỞ HỮU CÔNG NGHIỆP SỐ 404 TẬP A – QUYỂN 2 (11.2021)

- (11) **43208**
(21) 3-2021-02590 (28) 1
(54) **TÚI KẸO** (51) **09-05**
(22) 19/10/2021 (43) 25/11/2021
(73) **CÔNG TY CỔ PHẦN BÁNH KẸO TRÀNG AN. 3 - VIỆT NAM (VN)**
Khu A, khu CN Bim Sơn, phường Bắc Sơn, thị xã Bim Sơn, tỉnh Thanh Hóa
(72) Trịnh Sỹ (VN)
(74) Công ty TNHH Sở hữu trí tuệ Việt Nam IP (VIETNAM IP)
(55)



1.1



1.2

PHẦN II

SỬA ĐỔI ĐƠN

Ghi nhận sửa đổi đơn yêu cầu cấp Bằng độc quyền kiểu dáng công nghiệp

Thông báo số: 24894w/TB-SHTT, ngày 08/10/2021 về việc ghi nhận sửa đổi đơn

Số Yêu cầu: SĐ3-2020-01111 Ngày nộp: 03/08/2020

Liên quan đến đơn yêu cầu cấp Bằng độc quyền kiểu dáng công nghiệp:

(21) Số đơn	(22) Ngày nộp đơn
3-2019-03385	23/12/2019
3-2020-00151	17/01/2020

Mục sửa đổi: Đại diện sở hữu công nghiệp

Nội dung mới: Công ty TNHH Tư vấn IPNG(IPNG CO.,LTD)
Số nhà 40, ngõ 38, phố Phúc Xá, phường Phúc Xá, quận Ba Đình,
TP. Hà Nội

Thông báo số: 24948w/TB-SHTT, ngày 08/10/2021 về việc ghi nhận sửa đổi đơn

Số Yêu cầu: SĐ3-2021-00807 Ngày nộp: 14/04/2021

Liên quan đến đơn yêu cầu cấp Bằng độc quyền kiểu dáng công nghiệp:

(21) Số đơn	(22) Ngày nộp đơn
3-2019-03212	09/12/2019
3-2019-03213	09/12/2019

Mục sửa đổi: Tên, địa chỉ chủ đơn

Nội dung mới: ZEPP, INC. (US)
10050 North Wolfe Road, Suite Sw1-180, Cupertino, CA 95014,
UNITED STATES OF AMERICA

ANHUI HUAMI INFORMATION TECHNOLOGY CO., LTD.
(CN)

Bldg. H8, 2nd Sec. of Hefei Innovation Ind. Park, No. 2800
Chuangxin Ave., Gaoxin District, Hefei, Anhui 230088, China

Thông báo số: 25655w/TB-SHTT, ngày 18/10/2021 về việc ghi nhận sửa đổi đơn

Số Yêu cầu: SĐ3-2021-00840 Ngày nộp: 16/04/2021

Liên quan đến đơn yêu cầu cấp Bằng độc quyền kiểu dáng công nghiệp:

(21) Số đơn	(22) Ngày nộp đơn
3-2020-01590	09/07/2020

Mục sửa đổi: Bổ sung 01 phương án

Nội dung mới: Bổ sung phương án 1

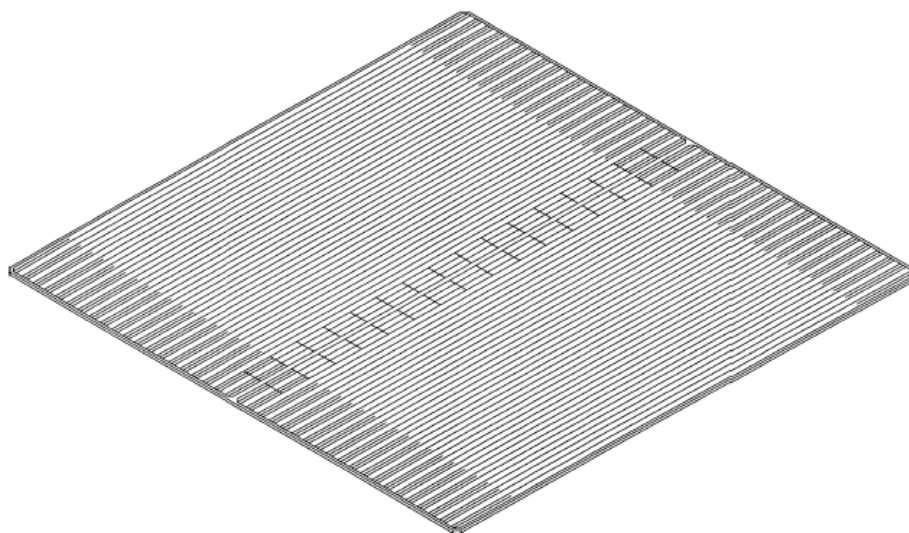

Hình 1.1

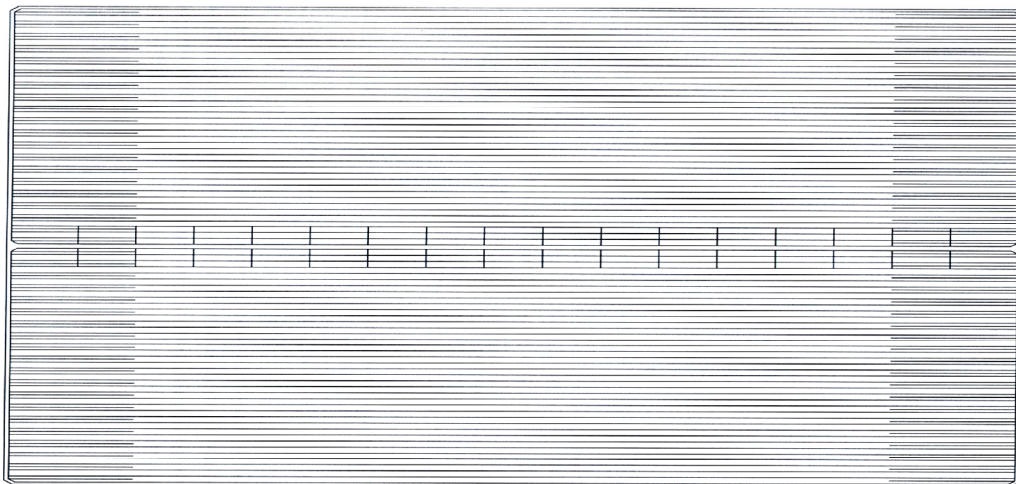

Hình 1.2



Hình 1.3



Hình 1.4

Hình 1.5

Hình 1.6

Hình 1.7

Thông báo số: 25653w/TB-SHTT, ngày 18/10/2021 về việc ghi nhận sửa đổi đơn

Số Yêu cầu: SD3-2021-00878 Ngày nộp: 23/04/2021

Liên quan đến đơn yêu cầu cấp Bằng độc quyền kiểu dáng công nghiệp:

(21) Số đơn	(22) Ngày nộp đơn
3-2020-02282	15/09/2020

Mục sửa đổi: Tên, địa chỉ chủ đơn

Nội dung mới: Legrand Intelligent Electrical (Huizhou) Co., Ltd. (CN)
Factory Bldg. B1-B3, No. 39 East Hechang No. 6 Road, ZhongKai
Hi-tech Industrial Development Park, HuiZhou, GuangDong, China

Thông báo số: 25654w/TB-SHTT, ngày 18/10/2021 về việc ghi nhận sửa đổi đơn

Số Yêu cầu: SD3-2021-00870 Ngày nộp: 22/04/2021

Liên quan đến đơn yêu cầu cấp Bằng độc quyền kiểu dáng công nghiệp:

(21) Số đơn	(22) Ngày nộp đơn
3-2020-01939	19/08/2020

Mục sửa đổi: Tên, địa chỉ chủ đơn

Nội dung mới: Legrand Intelligent Electrical (Huizhou) Co., Ltd. (CN)
Factory Bldg. B1-B3, No. 39 East Hechang No. 6 Road, ZhongKai
Hi-tech Industrial Development Park, HuiZhou, GuangDong, China

Thông báo số: 25649w/TB-SHTT, ngày 18/10/2021 về việc ghi nhận sửa đổi đơn

Số Yêu cầu: SD3-2021-01421 Ngày nộp: 08/07/2021

Liên quan đến đơn yêu cầu cấp Bằng độc quyền kiểu dáng công nghiệp:

(21) Số đơn	(22) Ngày nộp đơn
3-2020-03039	16/12/2020

Mục sửa đổi: Tên, địa chỉ chủ đơn

Nội dung mới: CÔNG TY CỔ PHẦN TẬP ĐOÀN AUSTEC (VN)
Số 46, phố Trần Bình, phường Mai Dịch, quận Cầu Giấy, thành phố
Hà Nội

Thông báo số: 26053w/TB-SHTT, ngày 22/10/2021 về việc ghi nhận sửa đổi đơn

Số Yêu cầu: SD3-2019-00708 Ngày nộp: 29/05/2019

Liên quan đến đơn yêu cầu cấp Bằng độc quyền kiểu dáng công nghiệp:

(21) Số đơn	(22) Ngày nộp đơn
3-2018-00838	23/04/2018

Mục sửa đổi: Bổ sung 02 phương án

Nội dung mới: Bổ sung phương án 03, 04

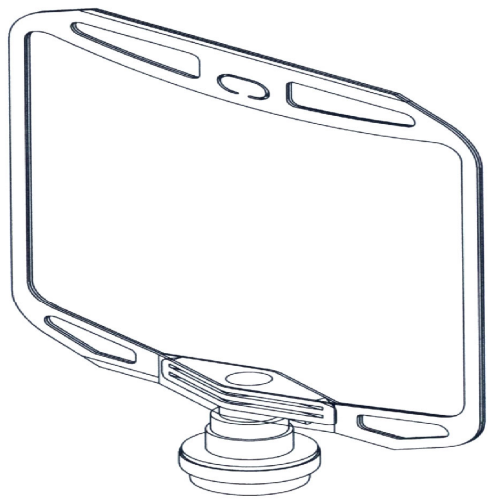

Hình 3.1

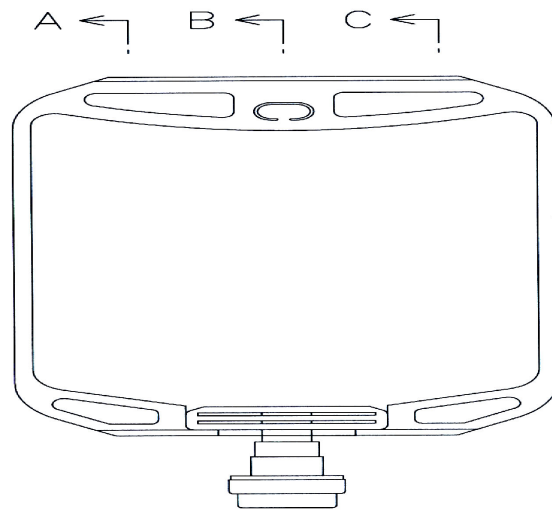

Hình 3.2

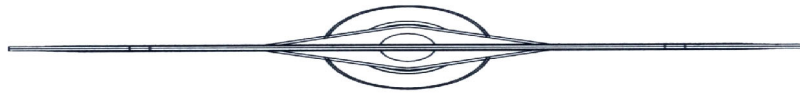

Hình 3.3



Hình 3.4



Hình 3.5



Hình 3.6

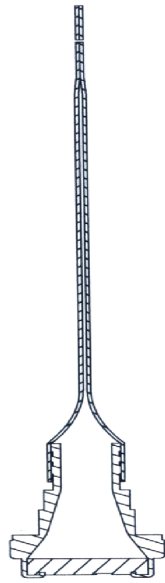

Hình 3.7



Hình 3.8

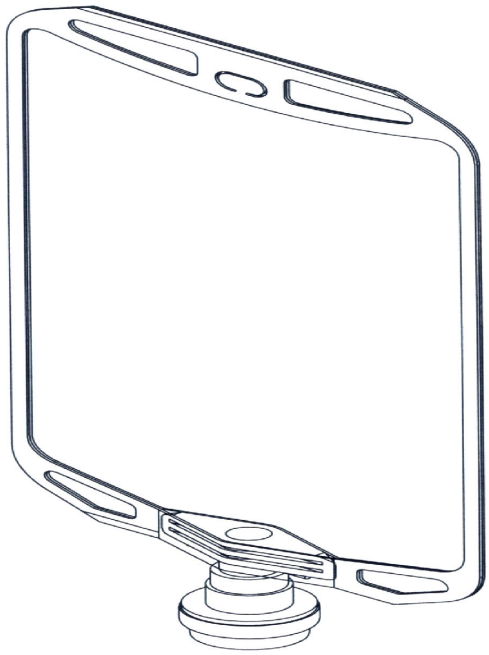

Hình 4.1

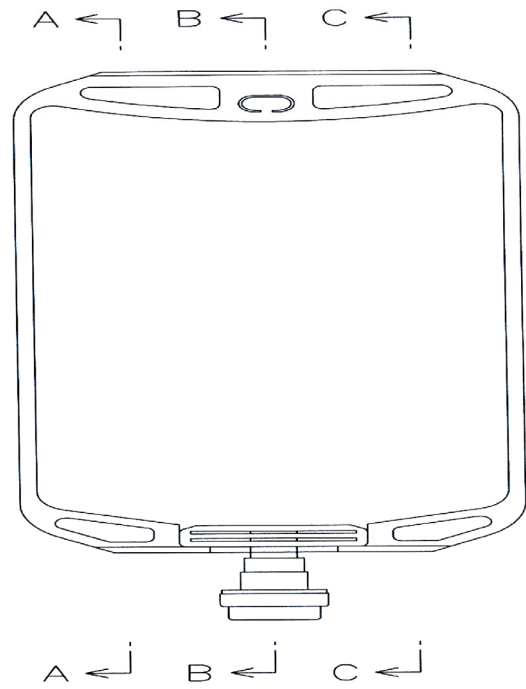

Hình 4.2



Hình 4.3



Hình 4.4



Hình 4.6

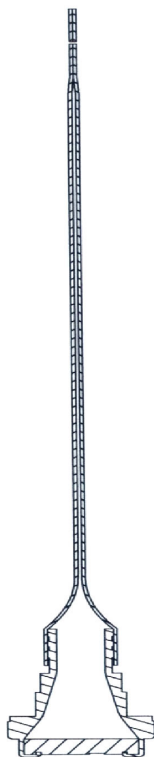

Hình 4.7



Hình 4.8

CÔNG BÁO SỞ HỮU CÔNG NGHIỆP

Do Cục Sở hữu trí tuệ thuộc Bộ Khoa học và Công nghệ ấn hành theo Luật Sở hữu trí tuệ số 50/2005/QH11 được Quốc hội thông qua ngày 29 tháng 11 năm 2005 và được sửa đổi bằng Luật sửa đổi, bổ sung một số điều của Luật sở hữu trí tuệ số 50/2005/QH11 được Quốc hội thông qua ngày 19 tháng 6 năm 2009.

Địa chỉ liên hệ:

384-386 đường Nguyễn Trãi, quận Thanh Xuân,
thành phố Hà Nội, Việt Nam
ĐT: 024. 38583069
Fax: 024. 38588449