

CỘNG HÒA XÃ HỘI CHỦ NGHĨA VIỆT NAM
BỘ KHOA HỌC VÀ CÔNG NGHỆ

CỤC SỞ HỮU TRÍ TUỆ

CÔNG BÁO
SỞ HỮU CÔNG NGHIỆP

TẬP A

QUYỂN 2: KIỂU DÁNG CÔNG NGHIỆP

10 - 2021

403

CỘNG HOÀ XÃ HỘI CHỦ NGHĨA VIỆT NAM
BỘ KHOA HỌC VÀ CÔNG NGHỆ
CỤC SỞ HỮU TRÍ TUỆ

CÔNG BÁO
SỞ HỮU CÔNG NGHIỆP
TẬP A

QUYỂN 2: KIỂU DÁNG CÔNG NGHIỆP

10-2021

403

HÀ NỘI

MỤC LỤC

	Trang
<u>PHẦN I:</u> Đơn yêu cầu cấp Bằng độc quyền kiểu dáng công nghiệp	7
<u>PHẦN II:</u> Sửa đổi đơn	310
<u>PHẦN III:</u> Thay đổi chủ đơn	312

CONTENTS

<u>PART I:</u> Applications for Industrial Design Patents	7
<u>PART II:</u> Amendment of Applications	310
<u>PART III:</u> Change of Applicants	312

CÔNG BÁO SỞ HỮU CÔNG NGHIỆP SỐ 403 TẬP A - QUYỂN 2 (10.2021)

MÃ SỐ HAI CHỮ CÁI THỂ HIỆN TÊN NƯỚC VÀ CÁC THỰC THỂ KHÁC TRONG CÁC TƯ LIỆU SỞ HỮU CÔNG NGHIỆP THEO TIÊU CHUẨN ST3 CỦA WIPO

AE	United Arab Emirates	CN	China	HK	Hong Kong
AF	Afganistan	CO	Colombia	HN	Honduras
AG	Antihua and Barbuda	CR	Costa Rica	HR	Croatia
AI	Anguilla	CU	Cuba	HT	Haiti
AL	Albania	CV	Cape Verde	HU	Hungary
AN	Netherlands Antilles	CY	Cyprus	ID	Indonesia
AO	Angola	CZ	Czech Republic	IE	Ireland
AR	Argentina	DE	Germany	IL	Israel
AT	Austria	DJ	Djibouti	IN	India
AU	Australia	DK	Denmark	IQ	Iraq
AW	Aruba	DM	Dominica	IR	Iran (Islamic Republic of)
BB	Barbados	DO	Dominican Republic	IS	Iceland
BD	Bangladesh	DZ	Algeria	IT	Italy
BE	Belgium	EC	Ecuador	JM	Jamaica
BF	Burkina Faso	EE	Estonia	JO	Jordan
BG	Bulgaria	EG	Egypt	JP	Japan
BH	Bahrain	ES	Spain	KE	Kenya
BI	Burundi	ET	Ethiopia	KH	Cambodia
BJ	Benin	FI	Finland	KI	Kiribati
BM	Bermuda	FJ	Fiji	KM	Comoros
BN	Brunei Darussalam	FK	Falkand Islands (Malvinas)	KN	Saint Kitts and Nevis
BO	Bolivia	FR	France	KP	Democratic People's Republic of Korea
BR	Brazil	GA	Gabon	KR	Republic of Korea
BS	Bahamas	GB	United Kingdom	KW	Kuwait
BT	Bhutan	GD	Grenada	KY	Cayman Islands
BW	Botswana	GE	Georgia	KZ	Kazakhstan
BY	Belarus	GH	Ghana	LA	Laos
BZ	Belize	GI	Gibraltar	LB	Lebanon
CA	Canada	GM	Gambia	LC	Saint Lucia
CF	Central African Republic	GN	Guinea	LI	Liechtenstein
CG	Congo	GQ	Equatorial Guinea	LK	SriLanka
CH	Switzerland	GR	Greece	LR	Liberia
CI	Côte d'Ivoire	GT	Guatemala	LS	Lesotho
CL	Chile	GW	Guinea-Bissau	LT	Lithuania
CM	Cameroon	GY	Guyana	TC	Turk and Caicos Islands
LU	Luxembourg	PA	Panama	TD	Chad
LV	Latvia	PE	Peru	TG	Togo
LY	Lybya	PG	Papua New Guinea	TH	Thailand
MA	Morocco	PH	Philippines	TN	Tunisia
MC	Monaco	PK	Pakistan	TO	Tonga
MD	Republic of Moldova	PL	Poland	TR	Turkey

CÔNG BÁO SỞ HỮU CÔNG NGHIỆP SỐ 403 TẬP A - QUYỂN 2 (10.2021)

MG	Madagascar	PT	Portugal	TT	Trinidad and Tobago
ML	Mali	PY	Paraguay	TV	Tuvalu
MM	Myanmar	QA	Qatar	TW	Taiwan, Province of China
MN	Mongolia	RO	Rumania	TZ	United Republic of Tanzania
MO	Macau	RU	Russian Federation	UA	Ukraine
MR	Mauritania	RW	Rwanda	UG	Uganda
MS	Montserrat	SA	Saudi Arabia	US	United States of America
MT	Malta	SB	Solomon Islands	UY	Uruguay
MU	Mauritius	SC	Seychelles	UZ	Uzbekistan
MV	Maldives	SD	Sudan	VA	Holy see
MW	Malawi	SE	Sweden	VC	Saint Vincent and the Grenadines
MX	Mexico	SG	Singapore	VE	Venezuela
MY	Malaysia	SH	Saint Helena	VG	Virgin Islands (British)
MZ	Mozambique	SL	Slovenia	VN	Vietnam
NA	Namibia	SK	Slovakia	VU	Vanuatu
NE	Niger	SL	Sierra Leone	WS	Samoa
NG	Nigeria	SM	San Marino	YE	Yemen
NJ	Nicaragua	SN	Senegal	YU	Yugoslavia
NL	Netherlands	SO	Somalia	ZA	South Africa
NO	Norway	SR	Suriname	ZM	Zambia
NP	Nepal	ST	Sao Tome and Principe	ZR	Zaire
NR	Nauru	SV	El Sanvador	ZW	Zimbabwe
NZ	New Zealand	SY	Syria		
OM	Oman	SZ	Swaziland		

CÁC TỔ CHỨC QUỐC TẾ

AO	African Intellectual Property Organization (OAPI)
AP	African Regional Industrial Property Organization (ARIPO)
BX	Benelux Trademark Office and Benelux Designs Office
EP	European Patent Office (EPO)
IB, WO	International Bureau of the World Intellectual Property Organization (WIPO)

NHỮNG MÃ SỐ INID TRÍCH TỪ TIÊU CHUẨN ST80 CỦA TỔ CHỨC SỞ HỮU TRÍ TUỆ THẾ GIỚI (WIPO) ĐỂ NHẬN BIẾT CÁC DỮ LIỆU THƯ MỤC DÙNG CÔNG BỐ ĐƠN VÀ BẰNG ĐỘC QUYỀN KIỂU DÁNG CÔNG NGHIỆP

- (11) Số bằng độc quyền kiểu dáng công nghiệp / Số công bố đơn
- (15) Ngày cấp
- (18) Ngày hết hạn hiệu lực của bằng độc quyền kiểu dáng công nghiệp
- (21) Số đơn
- (22) Ngày nộp đơn
- (23) Tên triển lãm, ngày và nơi triển lãm
- (28) Số phương án yêu cầu bảo hộ
- (30) Số đơn ưu tiên, ngày nộp đơn ưu tiên
- (43) Ngày công bố đơn
- (45) Ngày công bố bằng độc quyền kiểu dáng công nghiệp
- (51) Phân loại quốc tế kiểu dáng công nghiệp
- (54) Tên sản phẩm mang kiểu dáng công nghiệp
- (55) Ảnh chụp / hình vẽ kiểu dáng công nghiệp
- (57) Đặc điểm khác biệt yêu cầu bảo hộ của kiểu dáng công nghiệp
- (62) Số và ngày nộp đơn, số bằng độc quyền KDCN hoặc số công bố đơn liên quan đến tách đơn
- (71) Tên và địa chỉ của người nộp đơn
- (72) Tên của tác giả KDCN
- (73) Tên, địa chỉ của chủ bằng độc quyền KDCN
- (74) Tên của người đại diện SHCN

PHẦN I

ĐƠN YÊU CẦU CẤP BẰNG ĐỘC QUYỀN KIỂU DÁNG CÔNG NGHIỆP

- (11) **42681**
(21) 3-2019-01597 (28) 1
(54) **GẠCH LÁT NỀN** (51) **25-01**
(22) 24/06/2019 (43) 25/10/2021
(73) **VÕ NHƯ THẮNG (VN)**
K294/40 Nguyễn Lương Bằng, phường Hòa Khánh Bắc, quận Liên Chiểu, thành phố Đà Nẵng
(72) Võ Như Thắng (VN)
(55)

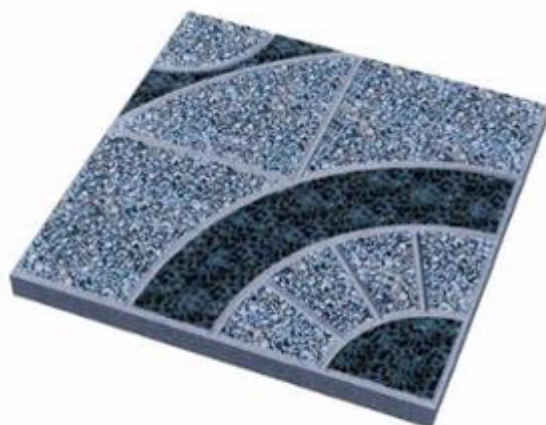

1.1



1.2



1.3



1.4



1.5

CÔNG BÁO SỞ HỮU CÔNG NGHIỆP SỐ 403 TẬP A – QUYỀN 2 (10.2021)

- (11) **42682**
- (21) 3-2019-01884 (28) 1
- (54) **TAI NGHE** (51) **14-01**
- (22) 26/07/2019 (43) 25/10/2021
- (30) 201930045615.X 26/01/2019 CN;
- (73) **HUAWEI TECHNOLOGIES CO., LTD. (CN)**
Huawei Administration Building, Bantian, Longgang District, Shenzhen,
Guangdong 518129, P. R. China
- (72) 1. LIN, CHENXI (CN)
2. ZHAO, YING (CN)
3. JEONG, SANGHYUN (KR)
4. CLERC, BERTRAND (FR)
- (74) Công ty Cổ phần Sở hữu công nghiệp INVESTIP (INVESTIP)
- (55)



1.1

1.2

1.3



1.4



1.5



1.6



1.7

- (11) **42683**
(21) 3-2019-01927 (28) 1
(54) **BAO NANG** (51) **09-05**
(22) 30/07/2019 (43) 25/10/2021
(30) 006120549-0001 30/01/2019 EM;
(73) **UNILEVER N.V. (NL)**
Weena 455 3013 AL Rotterdam The Netherlands
(72) 1. MEINI LIANG (CN)
2. JUN SHEN (CN)
(74) Công ty TNHH Trần Hữu Nam và Đồng sự (TRAN H.N & ASS.)
(55)

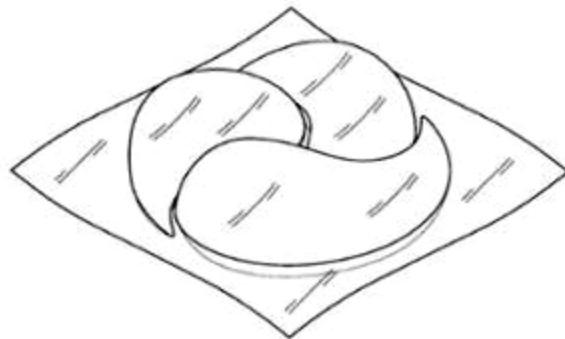

1.1



1.2

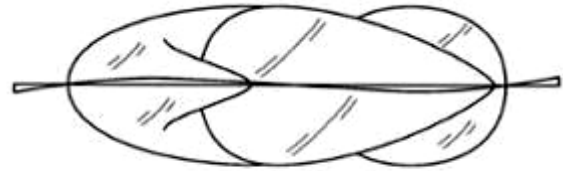

1.3

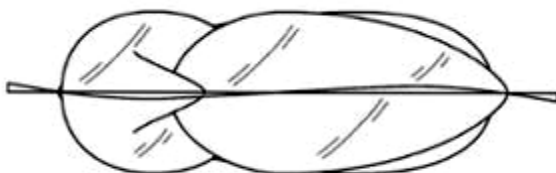

1.4



1.5

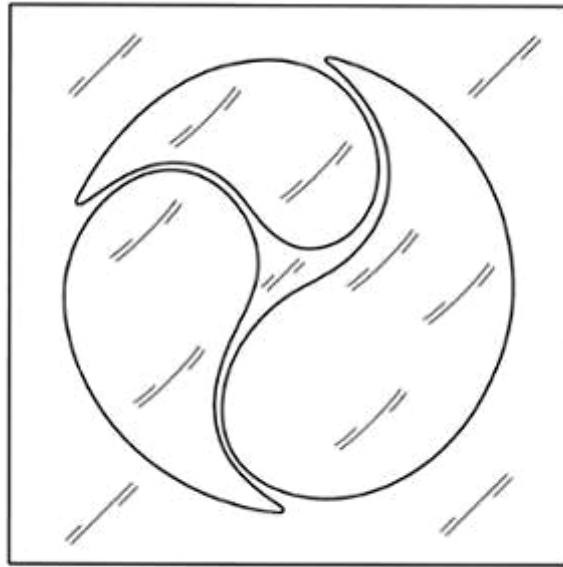

1.6

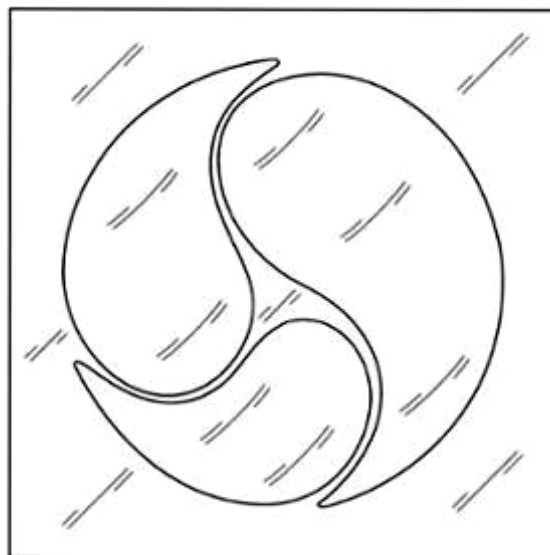

1.7

CÔNG BÁO SỞ HỮU CÔNG NGHIỆP SỐ 403 TẬP A – QUYỀN 2 (10.2021)

(11) **42684**

(21) 3-2019-03385

(28) 1

(54) **TỦ**

(51) **06-04**

(22) 23/12/2019

(43) 25/10/2021

(73) **CÔNG TY TNHH NỘI THẤT ZIP (VN)**

Số 5, lô A, tập thể trường Trung học Nông Nghiệp, phố Vũ Hữu, phường Thanh Xuân Bắc, quận Thanh Xuân, thành phố Hà Nội

(72) Nguyễn Mai Linh (VN)

(74) Công ty TNHH Tư vấn IPNG (IPNG CO.,LTD)

(55)



1.1



1.2



1.3

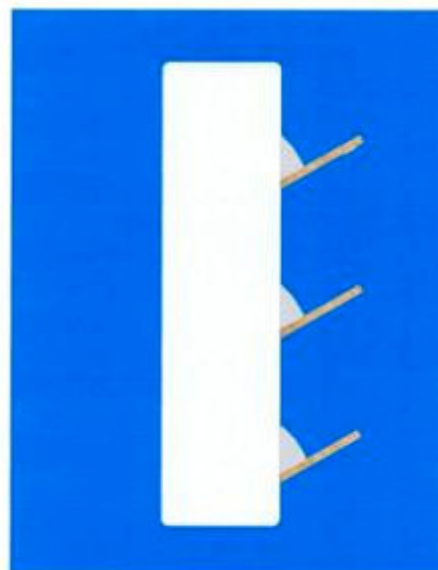

1.4

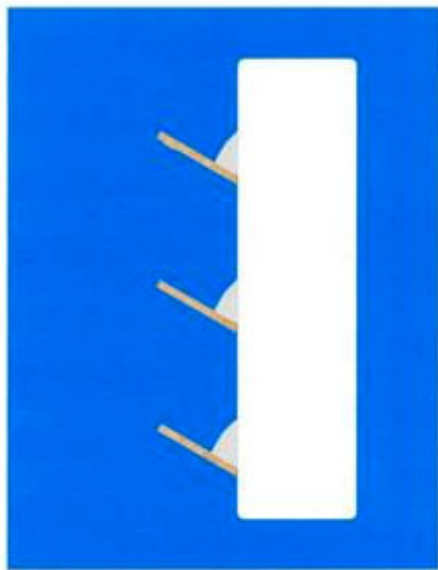

1.5



1.6



1.7



1.8

CÔNG BÁO SỞ HỮU CÔNG NGHIỆP SỐ 403 TẬP A – QUYỀN 2 (10.2021)

- (11) **42685**
(21) 3-2020-01116 (28) 1
(54) **BỘ HÓA HƠI** (51) **27-99**
(22) 14/05/2020 (43) 25/10/2021
(30) 29/713,290 14/11/2019 US;
(73) **JUUL LABS, INC. (US)**
560 20th Street, Building 104, San Francisco, CA 94107 United States of America
(72) 1. BRANDON CHEUNG (US)
2. CARLOS A. DOMINGUEZ (US)
3. DYLAN E. ENTELIS (US)
4. MATTHEW J. MALONE (US)
5. JAMES MONSEES (US)
6. ZACHARY T. SCOTT (US)
7. JOHN TRAVIS WETTROTH (US)
(74) Công ty TNHH Tầm nhìn và Liên danh (VISION & ASSOCIATES CO.LTD.)
(55)

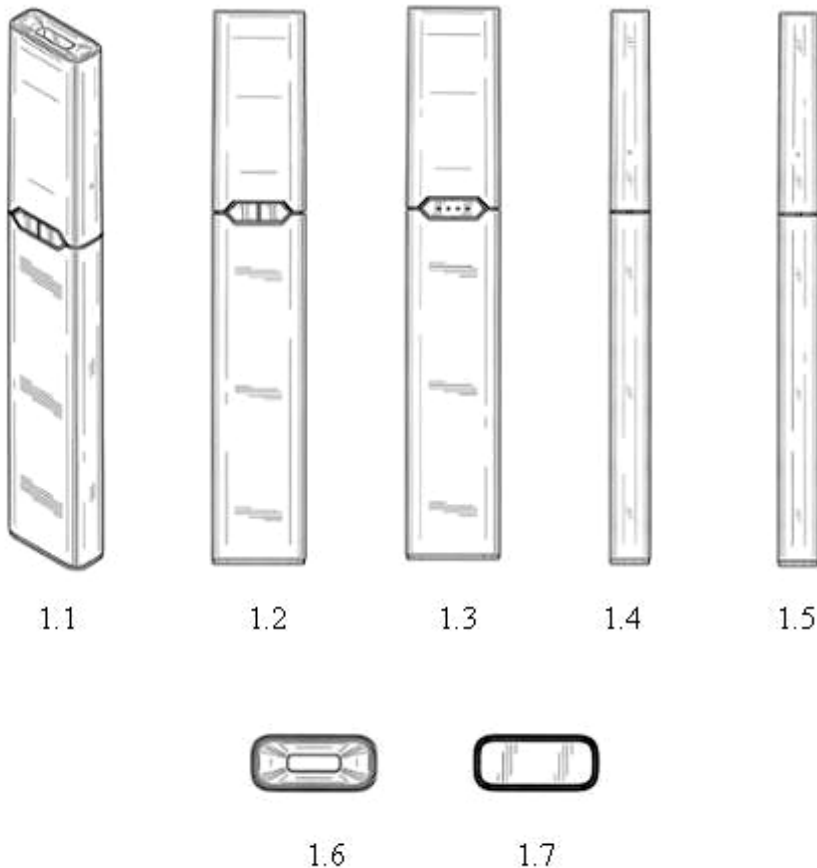

CÔNG BÁO SỞ HỮU CÔNG NGHIỆP SỐ 403 TẬP A – QUYỀN 2 (10.2021)

- (11) **42686**
(21) 3-2020-01117 (28) 1
(54) **BỘ HÓA HƠI** (51) **27-99**
(22) 14/05/2020 (43) 25/10/2021
(30) 29/713,291 14/11/2019 US;
(73) **JUUL LABS, INC. (US)**
560 20th Street, Building 104, San Francisco, CA 94107 United States of America
(72) 1. BRANDON CHEUNG (US)
2. CARLOS A. DOMINGUEZ (US)
3. DYLAN E. ENTELIS (US)
4. MATTHEW J. MALONE (US)
5. JAMES MONSEES (US)
6. ZACHARY T. SCOTT (US)
7. JOHN TRAVIS WETTROTH (US)
(74) Công ty TNHH Tầm nhìn và Liên danh (VISION & ASSOCIATES CO.LTD.)
(55)



1.1



1.2



1.3



1.4



1.5



1.6

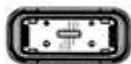

1.7



1.8

(11) **42687**

(21) 3-2020-01367

(54) **QUẠT GIÓ**

(22) 11/06/2020

(73) **TRƯƠNG TRỤ HÒA (VN)**

58 đường Thiên Phước, phường 9, quận Tân Bình, thành phố Hồ Chí Minh

(72) Trương Trụ Hòa (VN)

(55)

(28) 1

(51) **15-02**

(43) 25/10/2021



1.1



1.2



1.3



1.4



1.5



1.6



1.7



1.8

- (11) **42688**
(21) 3-2020-01368 (28) 1
(54) **MÁY BƠM GIÓ** (51) **15-02**
(22) 11/06/2020 (43) 25/10/2021
(73) **TRƯƠNG TRỤ HÒA (VN)**
58 đường Thiên Phước, phường 9, quận Tân Bình, thành phố Hồ Chí Minh
(72) Trương Trụ Hòa (VN)
(55)



1.1



1.2



1.3



1.4



1.5



1.6



1.7



1.8

CÔNG BÁO SỞ HỮU CÔNG NGHIỆP SỐ 403 TẬP A – QUYỀN 2 (10.2021)

(11) **42689**

(21) 3-2020-01640

(28) 1

(54) **NGÓI RÌA**

(51) **25-01**

(22) 17/07/2020

(43) 25/10/2021

(73) **CÔNG TY TNHH FUJI STAR ROOF (VN)**

Lô CN04+08, khu công nghiệp Đồng Văn III, phường Đồng Văn, thị xã Duy Tiên, tỉnh Hà Nam

(72) Kazuhito Hirai (JP)

(74) Công ty TNHH Tư vấn đầu tư và Sở hữu trí tuệ Hoàng Phi (HOANG PHI INVEST & I.P CO., LTD)

(55)

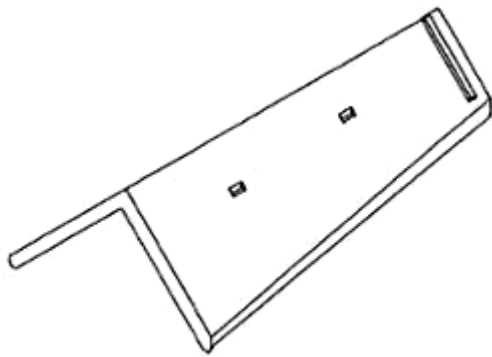

1.1



1.2



1.3



1.4



1.5

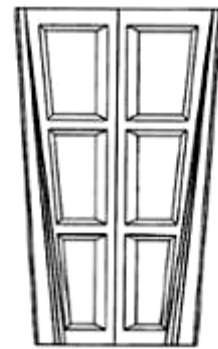

1.6

CÔNG BÁO SỞ HỮU CÔNG NGHIỆP SỐ 403 TẬP A – QUYỀN 2 (10.2021)

- (11) **42690**
- (21) 3-2020-01769 (28) 1
- (54) **BỘ CHUYỂN ĐỔI TÍN HIỆU SỐ** (51) **14-03**
- (22) 30/07/2020 (43) 25/10/2021
- (73) **TẬP ĐOÀN CÔNG NGHIỆP - VIỆN THÔNG QUÂN ĐỘI (VN)**
Lô D26, khu ĐTM Cầu Giấy, phường Yên Hòa, quận Cầu Giấy, thành phố Hà Nội
- (72) 1. ĐINH VĂN HẢI (VN)
2. NGUYỄN ĐÌNH DƯƠNG (VN)
3. HOÀNG ĐÌNH HẢI TRUYỀN (VN)
4. NGUYỄN CHÍ LINH (VN)
5. KHÔNG VĂN MẠNH (VN)
6. PHÍ NGỌC TÚ (VN)
7. HOÀNG TIẾN TRUNG (VN)
8. NGUYỄN TỬ MINH ĐIỆN (VN)
- (74) Công ty TNHH Tư vấn Quốc Dân (NACILAW)
- (55)

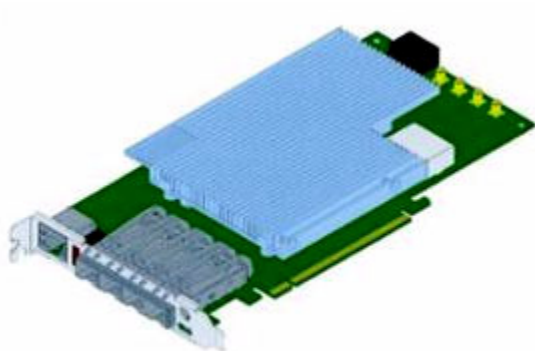

1.1

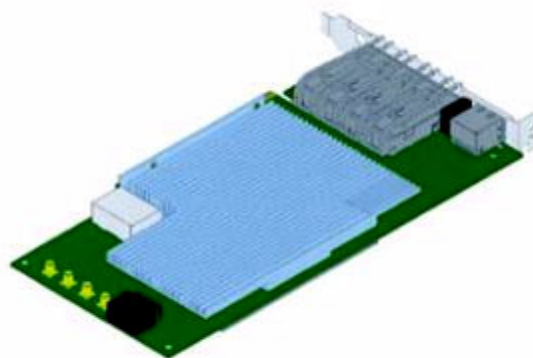

1.2



1.3



1.4



1.5



1.6

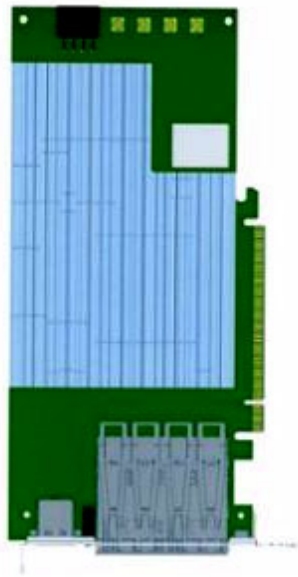

1.7

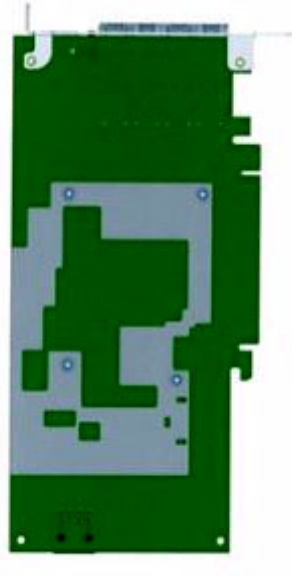

1.8

CÔNG BÁO SỞ HỮU CÔNG NGHIỆP SỐ 403 TẬP A – QUYỀN 2 (10.2021)

- (11) **42691**
(21) 3-2020-01909 (28) 1
(54) **ĐÁY BỒN ĐỰNG NƯỚC** (51) **23-01**
(22) 17/08/2020 (43) 25/10/2021
(73) **CÔNG TY TNHH CƠ KHÍ XÂY DỰNG VÀ KINH DOANH THƯƠNG MẠI CÔNG HÀ (VN)**
Lô CN20-1, khu công nghiệp Yên Phong, xã Long Châu, huyện Yên Phong, tỉnh Bắc Ninh
(72) Nguyễn Văn Công (VN)
(74) Công ty TNHH Tư vấn IPNG (IPNG CO.,LTD)
(55)

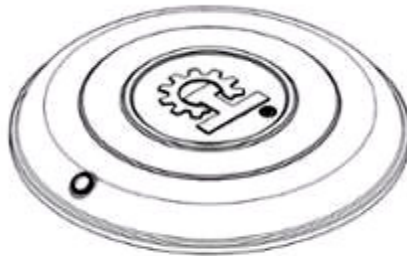

1.1



1.2



1.3



1.4



1.5



1.6

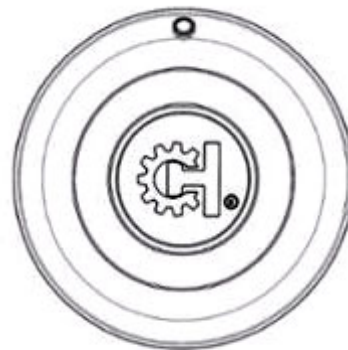

1.7

- (11) **42692**
(21) 3-2020-01910 (28) 1
(54) **ĐÁY BỒN ĐỰNG NƯỚC** (51) **23-01**
(22) 17/08/2020 (43) 25/10/2021
(73) **CÔNG TY TNHH CƠ KHÍ XÂY DỰNG VÀ KINH DOANH THƯƠNG MẠI CÔNG HÀ (VN)**
Lô CN20-1, khu công nghiệp Yên Phong, xã Long Châu, huyện Yên Phong, tỉnh Bắc Ninh
(72) Nguyễn Văn Công (VN)
(74) Công ty TNHH Tư vấn IPNG (IPNG CO.,LTD)
(55)

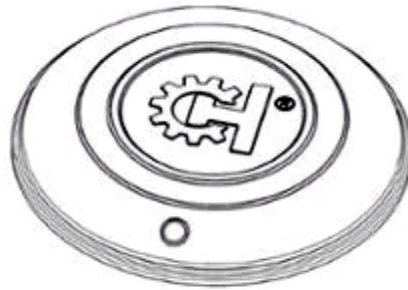

1.1



1.2



1.3



1.4



1.5

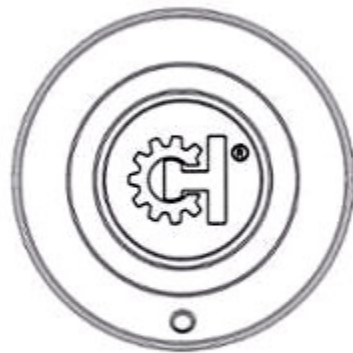

1.6

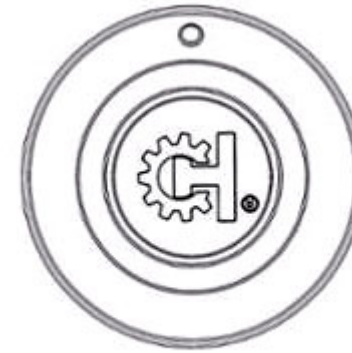

1.7

CÔNG BÁO SỞ HỮU CÔNG NGHIỆP SỐ 403 TẬP A – QUYỀN 2 (10.2021)

- (11) **42693**
(21) 3-2020-02237 (28) 1
(54) **ĐÈN DỪNG CHO XE CỘ** (51) **26-06**
(22) 10/09/2020 (43) 25/10/2021
(73) **DONGGUAN SENLO PHOTOELECTRIC TECHNOLOGY CO., LTD. (CN)**
Room 918, No. 6, Mulun Chuangxin Road, Changping Town, Dongguan,
Guangdong 523570, China
(72) LEHE LUO (CN)
(74) Công ty TNHH Tư vấn IPNG (IPNG CO.,LTD)
(55)

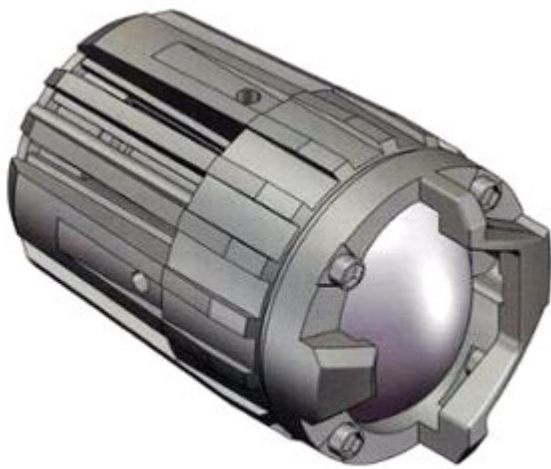

1.1



1.2



1.3

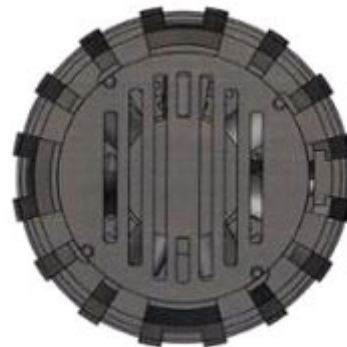

1.4



1.6



1.5



1.7



1.8

CÔNG BÁO SỞ HỮU CÔNG NGHIỆP SỐ 403 TẬP A – QUYỀN 2 (10.2021)

- (11) **42694**
(21) 3-2020-02487 (28) 1
(54) **XE ĐẠP GẤP** (51) **12-11**
(22) 06/10/2020 (43) 25/10/2021
(73) **NGUYỄN XUÂN HÙNG (VN)**
T2804 Tổ hợp nhà đa năng 28 tầng Làng Quốc tế Thăng Long, phường Dịch Vọng,
quận Cầu Giấy, thành phố Hà Nội
(72) Nguyễn Xuân Hùng (VN)
(74) Công ty Luật TNHH MINH KHUÊ (MK LAW FIRM)
(55)



1.1

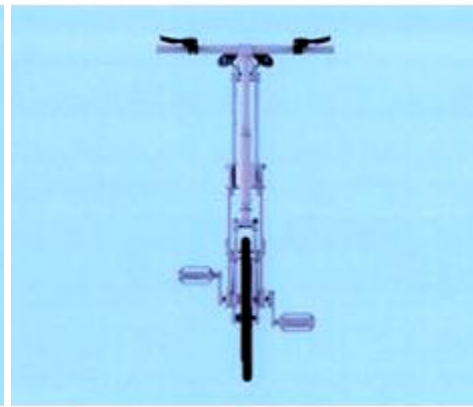

1.2



1.3



1.4



1.5

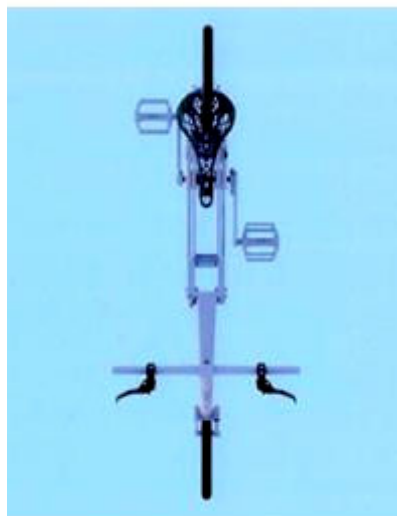

1.6

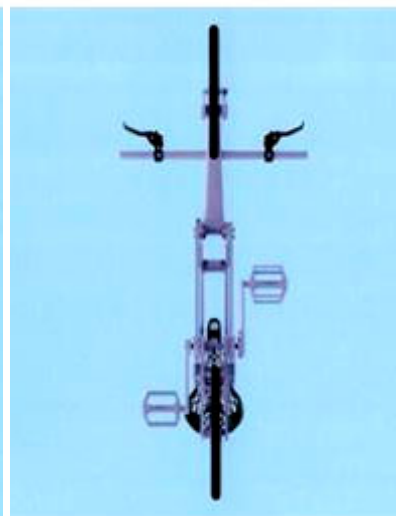

1.7

CÔNG BÁO SỞ HỮU CÔNG NGHIỆP SỐ 403 TẬP A – QUYỀN 2 (10.2021)

- (11) **42695**
(21) 3-2020-02542 (28) 1
(54) **RAY TREO CỬA LỬA** (51) **25-01**
(22) 13/10/2020 (43) 25/10/2021
(73) **CÔNG TY TNHH SẢN XUẤT VÀ THƯƠNG MẠI ICIMINE (VN)**
28A Nguyễn Việt Xuân, phường Khương Mai, quận Thanh Xuân, thành phố Hà Nội
(72) Chu Minh Quang (VN)
(55)



1.1

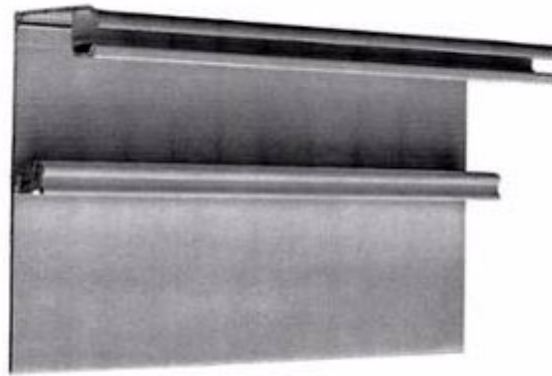

1.2



1.3

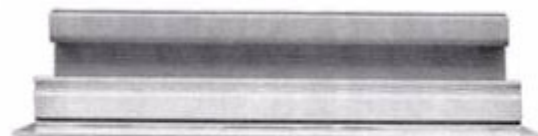

1.4

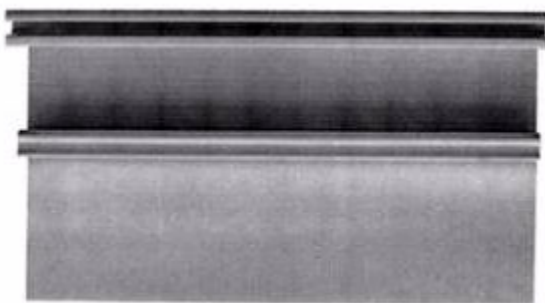

1.5

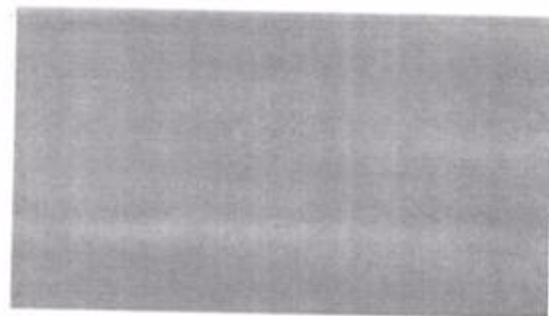

1.6

- (11) **42696**
(21) 3-2020-02638 (28) 1
(54) **NỒI NẤU ĐIỆN** (51) **07-02**
(22) 26/10/2020 (43) 25/10/2021
(30) 202030239630.0 21/05/2020 CN;
(73) **FOSHAN SHUNDE MIDEA ELECTRICAL HEATING APPLIANCES
MANUFACTURING CO., LTD. (CN)**
San Le Road #19, Beijiao, Shunde, Foshan, Guangdong Province 528311, China
(72) 1. GUO, JIAJIA (CN)
2. TANG, WENWANG (CN)
3. XU, SHOUCHEG (CN)
(74) Công ty TNHH Dịch vụ Sở hữu trí tuệ KENFOX (KENFOX IP SERVICE
CO.,LTD.)
(55)



1.1



1.2



1.3

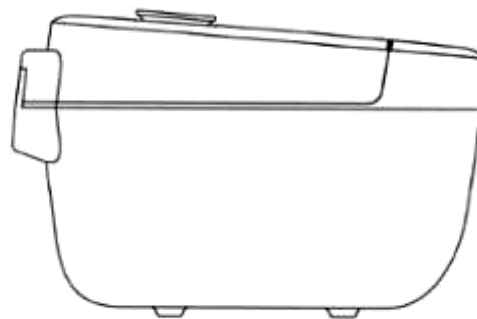

1.4

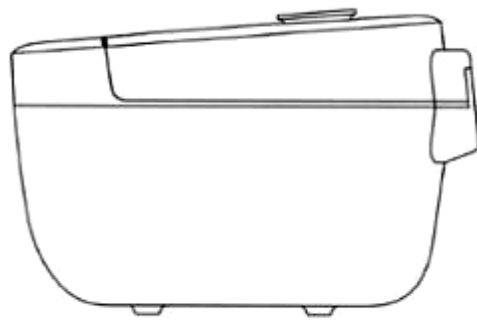

1.5



1.6

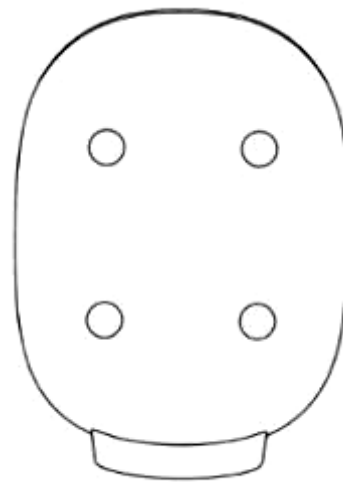

1.7

(11) **42697**

(21) 3-2020-02825

(28) 1

(54) **ĐÈN CHIẾU SÁNG**

(51) **26-03**

(22) 23/11/2020

(43) 25/10/2021

(73) **CÔNG TY TNHH SẢN XUẤT THƯƠNG MẠI VÀ XÂY DỰNG THIÊN MINH (VN)**

Số 75A đường số 17, phường Hiệp Bình Chánh, quận Thủ Đức, thành phố Hồ Chí Minh

(72) Trần Thị Huê (VN)

(74) Công ty TNHH một thành viên Trường Luật (Trường Luật)

(55)

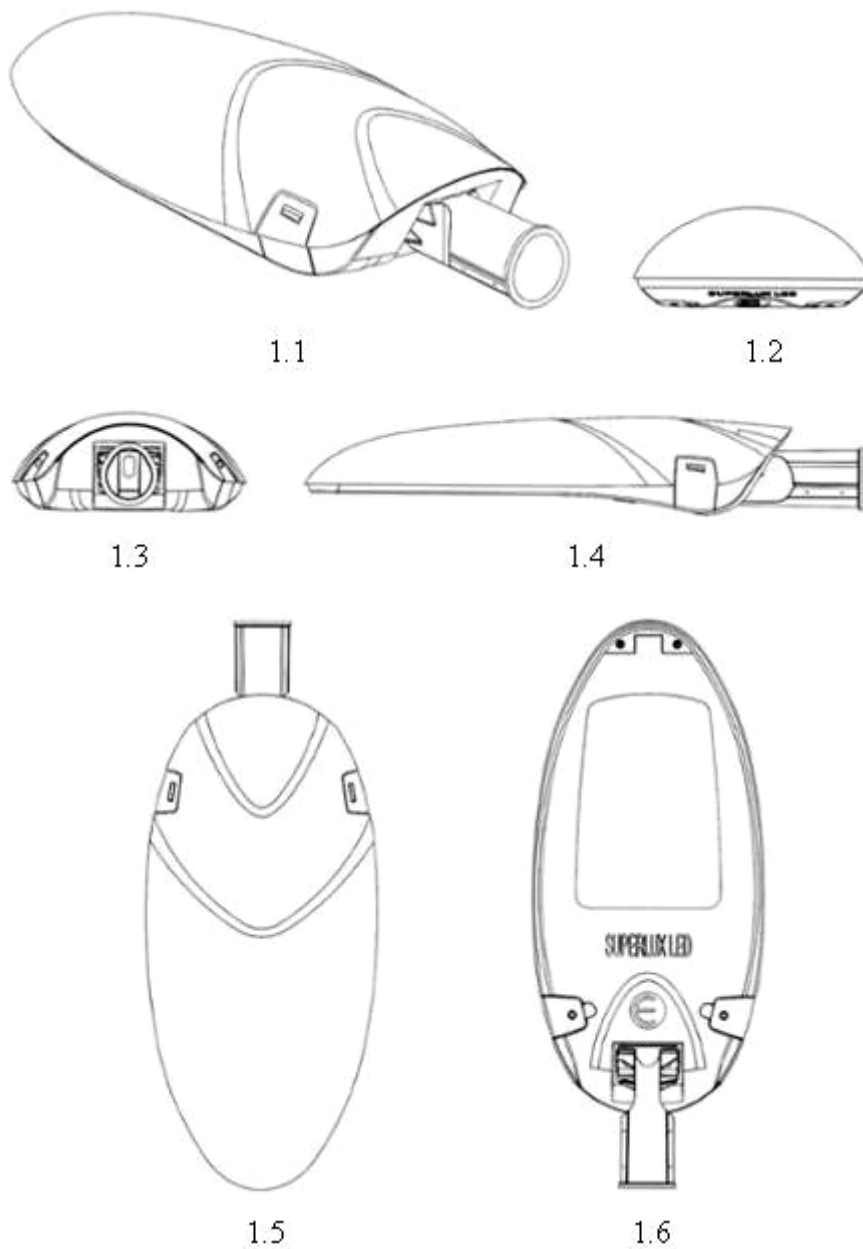

- (11) **42698**
(21) 3-2020-02831 (28) 3
(54) **CHAI** (51) **09-01**
(22) 24/11/2020 (43) 25/10/2021
(30) 008004709-0003 15/06/2020 EM; 008004709-0005 15/06/2020 EM; 008004709-0004 15/06/2020 EM;
(73) **UNILEVER N.V. (NL)**
Weena 455 3013 AL Rotterdam The Netherlands
(72) **GILBERT Thomas Peter (GB)**
(74) Công ty TNHH Trần Hữu Nam và Đồng sự (TRAN H.N & ASS.)
(55)



1.1



1.2



1.3



1.4



1.5



1.6



1.7



2.1



2.2



2.3



2.4



2.5



2.6



2.7



3.1



3.2



3.3



3.4

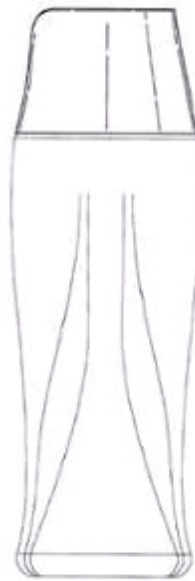

3.5



3.6

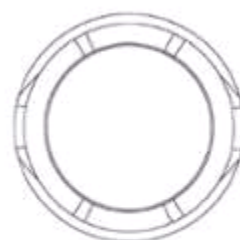

3.7

- (11) **42699**
(21) 3-2020-02843
(54) **KHỐI THOÁT NƯỚC MƯA**
(22) 24/11/2020
(73) **CÔNG TY TNHH XÂY DỰNG LÂM PHẠM (VN)**
Nhà số 1, LK1, Vinaconex 21 phố Ba La, phường Phú La, quận Hà Đông, thành phố Hà Nội
(72) Lâm Minh Đức (VN)
(74) Công ty TNHH Lê & Lê (LE & LE)
(55)
- (28) 1
(51) **23-01; 25-02**
(43) 25/10/2021

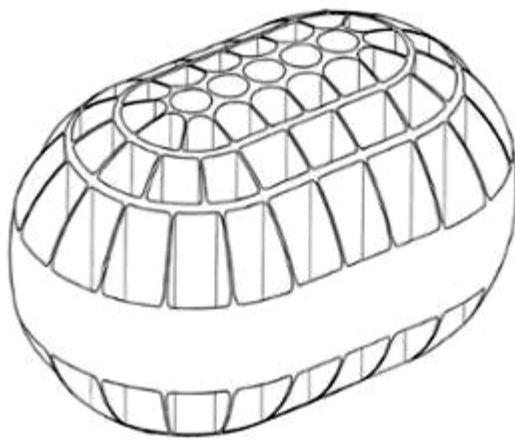

1.1



1.2

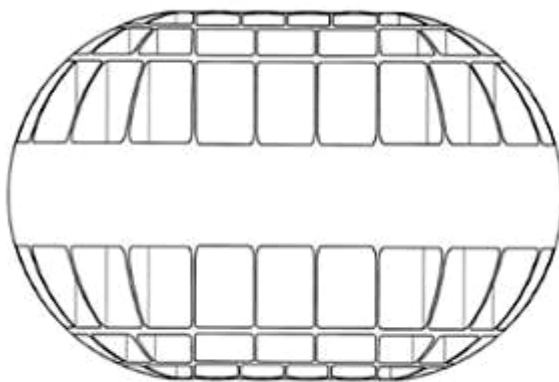

1.3

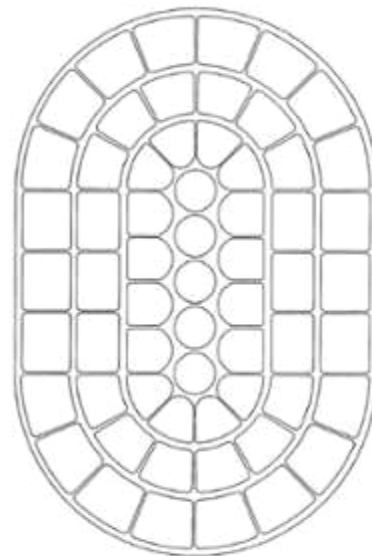

1.4

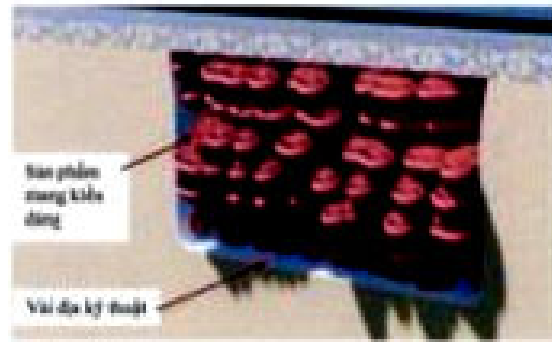

1.5

CÔNG BÁO SỞ HỮU CÔNG NGHIỆP SỐ 403 TẬP A – QUYỀN 2 (10.2021)

(11) **42700**

(21) 3-2020-02924

(28) 1

(54) **BẾP CỒN**

(51) **07-02**

(22) 03/12/2020

(43) 25/10/2021

(73) **CÔNG TY TNHH MỘT THÀNH VIÊN VŨ KHẢI (VN)**
95/10 Tôn Đản, phường 14, quận 4, thành phố Hồ Chí Minh

(72) Trương Thế Khải (VN)

(74) Công ty Luật TNHH WINCO (WINCO LAW FIRM)

(55)



1.1



1.2



1.3



1.4



1.5



1.6



1.7

- (11) **42701**
(21) 3-2020-02983 (28) 1
(54) **VẬT GIỮ THẺ** (51) **03-01**
(22) 10/12/2020 (43) 25/10/2021
(30) 29/743,840 24/07/2020 US;
(73) **APPLE INC. (US)**
One Apple Park Way, Cupertino, California 95014, United States of America
(72) 1. JODY AKANA (US)
2. MOLLY ANDERSON (GB)
3. BARTLEY K. ANDRE (US)
4. SHOTA AOYAGI (JP)
5. ANTHONY MICHAEL ASHCROFT (FR)
6. MARINE C. BATAILLE (FR)
7. JEREMY BATAILLOU (FR)
8. ABIDUR RAHMAN CHOWDHURY (GB)
9. CLARA GENEVIEVE MARINE COURTAIGNE (FR)
10. MARKUS DIEBEL (DE)
11. JONATHAN GOMEZ GARCIA (FR)
12. M. EVANS HANKEY (US)
13. RICHARD P. HOWARTH (GB)
14. JONATHAN P. IVE (GB)
15. JULIAN JAEDE (DE)
16. DUNCAN ROBERT KERR (GB)
17. PETER RUSSELL-CLARKE (AU)
18. BENJAMIN ANDREW SHAFFER (US)
19. JOE SUNG-HO TAN (US)
20. CLEMENT TISSANDIER (FR)
21. EUGENE ANTONY WHANG (CA)
(74) Công ty TNHH Lê & Lê (LE & LE)
(55)

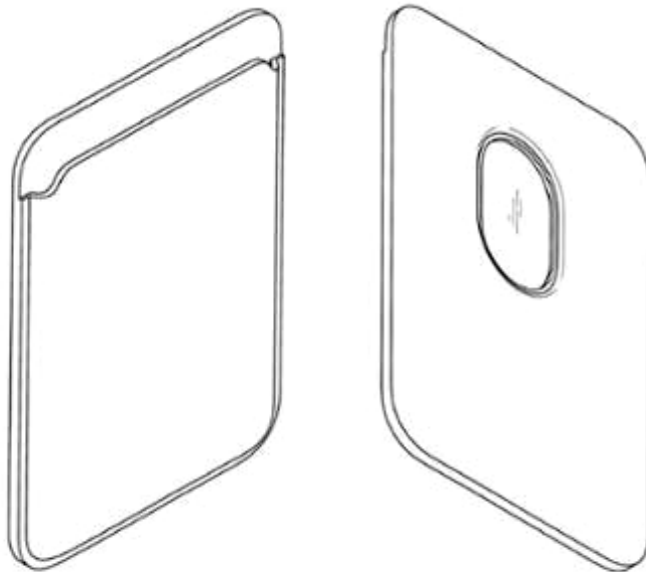

1.1

1.2



1.3

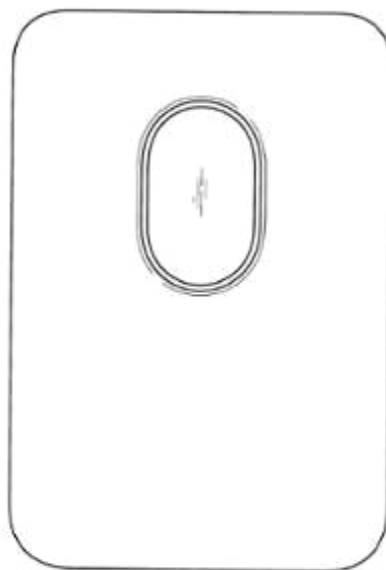

1.4



1.5



1.6



1.7

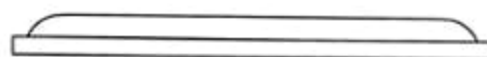

1.8

- (11) **42702**
(21) 3-2020-02984 (28) 1
(54) **VẬT GIỮ THẺ** (51) **03-01**
(22) 10/12/2020 (43) 25/10/2021
(30) 29/743,840 24/07/2020 US;
(73) **APPLE INC. (US)**
One Apple Park Way, Cupertino, California 95014, United States of America
(72) 1. JODY AKANA (US)
2. MOLLY ANDERSON (GB)
3. BARTLEY K. ANDRE (US)
4. SHOTA AOYAGI (JP)
5. ANTHONY MICHAEL ASHCROFT (FR)
6. MARINE C. BATAILLE (FR)
7. JEREMY BATAILLOU (FR)
8. ABIDUR RAHMAN CHOWDHURY (GB)
9. CLARA GENEVIEVE MARINE COURTAIGNE (FR)
10. MARKUS DIEBEL (DE)
11. JONATHAN GOMEZ GARCIA (FR)
12. M. EVANS HANKEY (US)
13. RICHARD P. HOWARTH (GB)
14. JONATHAN P. IVE (GB)
15. JULIAN JAEDE (DE)
16. DUNCAN ROBERT KERR (GB)
17. PETER RUSSELL-CLARKE (AU)
18. BENJAMIN ANDREW SHAFFER (US)
19. JOE SUNG-HO TAN (US)
20. CLEMENT TISSANDIER (FR)
21. EUGENE ANTONY WHANG (CA)
(74) Công ty TNHH Lê & Lê (LE & LE)
(55)

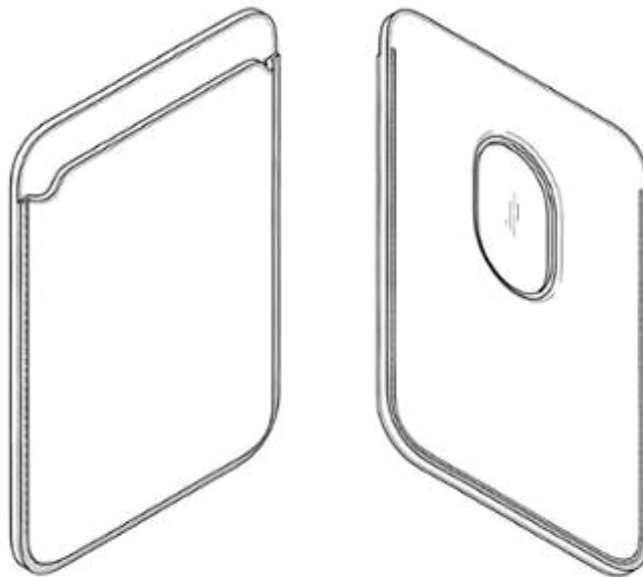

1.1

1.2

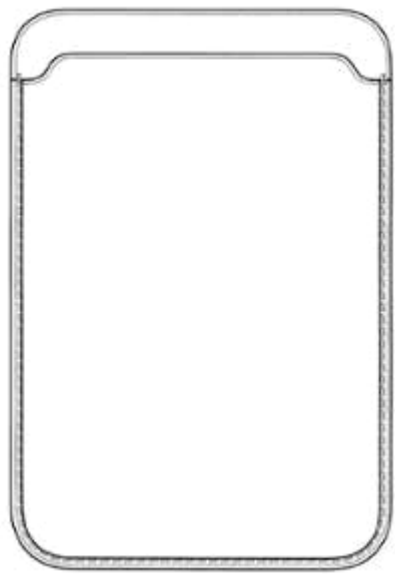

1.3

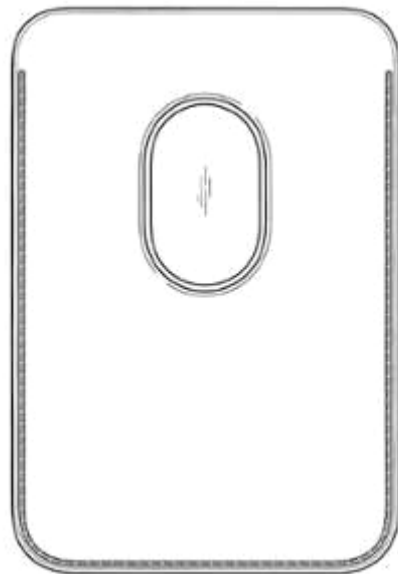

1.4

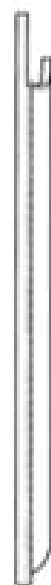

1.5



1.6



1.7

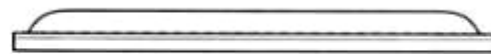

1.8

CÔNG BÁO SỞ HỮU CÔNG NGHIỆP SỐ 403 TẬP A – QUYỀN 2 (10.2021)

(11) **42703**

(21) 3-2020-03070

(28) 1

(54) **GHẾ SÔ-PHA**

(51) **06-01**

(22) 21/12/2020

(43) 25/10/2021

(73) **HTL FURNITURE (CHINA) CO., LTD. (CN)**

Wusong Jiangnan Road, Kunshan Development Zone, Jiangsu Province, China

(72) PHUA YONG TAT (SG)

(74) Công ty Luật TNHH quốc tế BMVN (BMVN INTERNATIONAL LLC)

(55)



1.1



1.2



1.3



1.4



1.5



1.6

- (11) **42704**
- (21) 3-2020-03075 (28) 1
- (54) **BỘ SẠC** (51) **13-02**
- (22) 22/12/2020 (43) 25/10/2021
- (30) 29/739,332 24/06/2020 US;
- (73) **APPLE INC. (US)**
One Apple Park Way, Cupertino, California 95014, United States of America
- (72) 1. JODY AKANA (US)
2. MOLLY ANDERSON (GB)
3. BARTLEY K. ANDRE (US)
4. SHOTA AOYAGI (JP)
5. ANTHONY MICHAEL ASHCROFT (FR)
6. MARINE C. BATAILLE (FR)
7. JEREMY BATAILLOU (FR)
8. ABIDUR RAHMAN CHOWDHURY (GB)
9. CLARA GENEVIEVE MARINE COURTAIGNE (FR)
10. MARKUS DIEBEL (DE)
11. JONATHAN GOMEZ GARCIA (FR)
12. M. EVANS HANKEY (US)
13. RICHARD P. HOWARTH (GB)
14. JONATHAN P. IVE (GB)
15. JULIAN JAEDE (DE)
16. DUNCAN ROBERT KERR (GB)
17. PETER RUSSELL-CLARKE (AU)
18. BENJAMIN ANDREW SHAFFER (US)
19. JOE SUNG-HO TAN (US)
20. CLEMENT TISSANDIER (FR)
21. EUGENE ANTONY WHANG (CA)
- (74) Công ty TNHH Lê & Lê (LE & LE)
- (55)

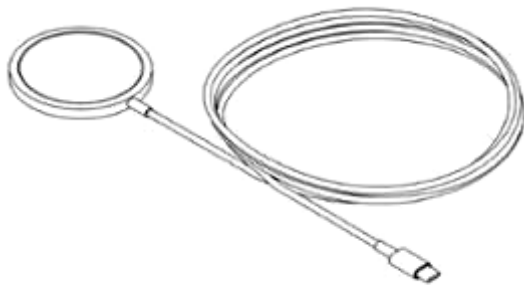

1.1



1.2



1.3



1.4



1.5



1.6

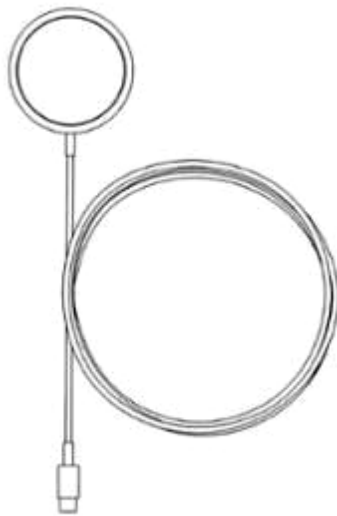

1.7

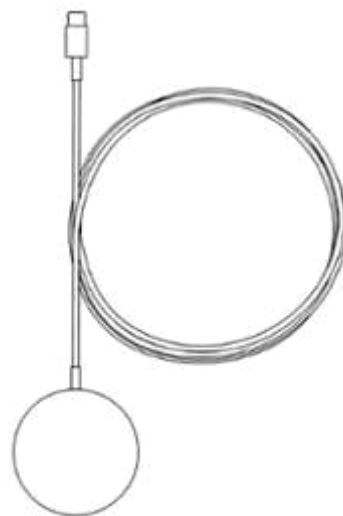

1.8

- (11) **42705**
- (21) 3-2020-03076 (28) 1
- (54) **BỘ SẠC** (51) **13-02**
- (22) 22/12/2020 (43) 25/10/2021
- (30) 29/739,333 24/06/2020 US;
- (73) **APPLE INC. (US)**
One Apple Park Way, Cupertino, California 95014, United States of America
- (72) 1. JODY AKANA (US)
2. MOLLY ANDERSON (GB)
3. BARTLEY K. ANDRE (US)
4. SHOTA AOYAGI (JP)
5. ANTHONY MICHAEL ASHCROFT (FR)
6. MARINE C. BATAILLE (FR)
7. JEREMY BATAILLOU (FR)
8. ABIDUR RAHMAN CHOWDHURY (GB)
9. CLARA GENEVIEVE MARINE COURTAIGNE (FR)
10. MARKUS DIEBEL (DE)
11. JONATHAN GOMEZ GARCIA (FR)
12. M. EVANS HANKEY (US)
13. RICHARD P. HOWARTH (GB)
14. JONATHAN P. IVE (GB)
15. JULIAN JAEDE (DE)
16. DUNCAN ROBERT KERR (GB)
17. PETER RUSSELL-CLARKE (AU)
18. BENJAMIN ANDREW SHAFFER (US)
19. JOE SUNG-HO TAN (US)
20. CLEMENT TISSANDIER (FR)
21. EUGENE ANTONY WHANG (CA)
- (74) Công ty TNHH Lê & Lê (LE & LE)
- (55)

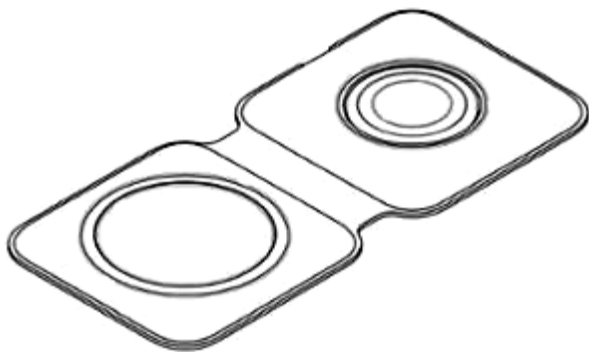

1.1

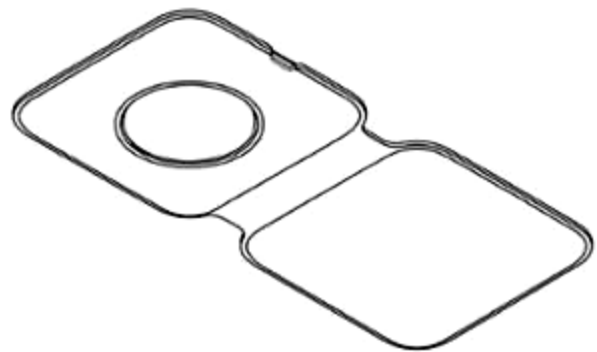

1.2



1.3



1.4



1.5



1.6

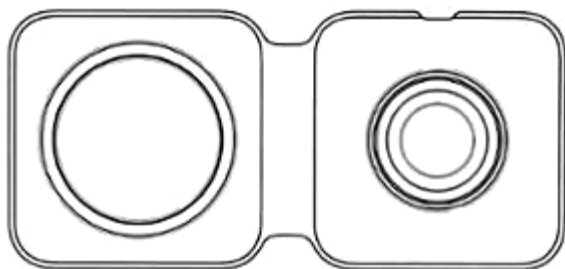

1.7



1.8

(11) **42706**

(21) 3-2021-00003

(28) 2

(54) **CẤU KIỆN RỌ BÊ TÔNG CHỐNG XÓI**

(51) **25-02**

(22) 05/01/2021

(43) 25/10/2021

(73) **CÔNG TY CỔ PHẦN KHOA HỌC CÔNG NGHỆ VIỆT NAM (VN)**

Số 6 đường 3 tháng 2, phường 8, thành phố Vũng Tàu, tỉnh Bà Rịa - Vũng Tàu

(72) Hoàng Đức Thảo (VN)

(55)

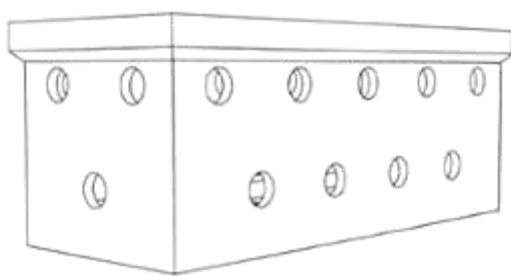

1.1

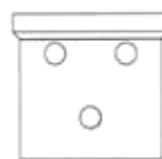

1.2

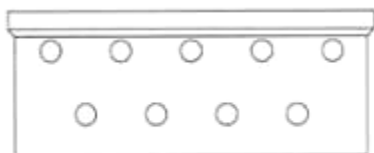

1.3

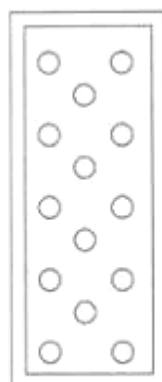

1.4

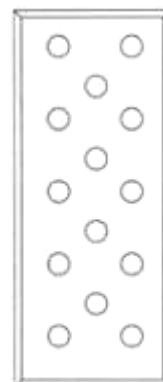

1.5

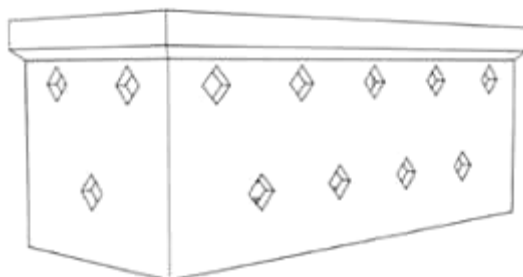

2.1

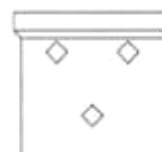

2.2

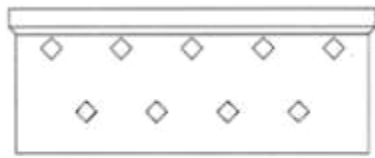

2.3

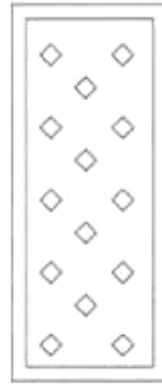

2.4



2.5

(11) **42707**

(21) 3-2021-00004

(28) 2

(54) **CÁU KIẾN RỌ BÊ TÔNG CHỐNG XÓI**

(51) **25-02**

(22) 05/01/2021

(43) 25/10/2021

(73) **CÔNG TY CỔ PHẦN KHOA HỌC CÔNG NGHỆ VIỆT NAM (VN)**

Số 6 đường 3 tháng 2, phường 8, thành phố Vũng Tàu, tỉnh Bà Rịa - Vũng Tàu

(72) Hoàng Đức Thảo (VN)

(55)



1.1

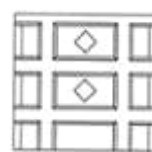

1.2

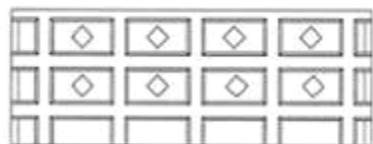

1.3



1.4



1.5

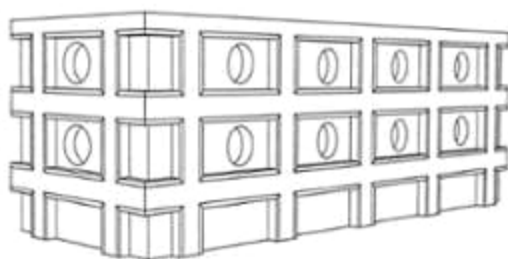

2.1

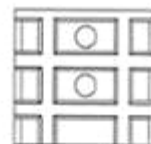

2.2

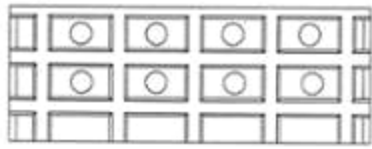

2.3

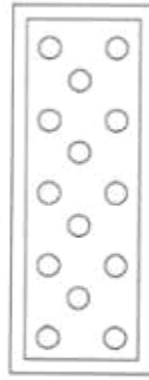

2.4



2.5

(11) **42708**

(21) 3-2021-00005

(28) 2

(54) **CẤU KIỆN RỌ BÊ TÔNG CHỐNG XÓI**

(51) **25-02**

(22) 05/01/2021

(43) 25/10/2021

(73) **CÔNG TY CỔ PHẦN KHOA HỌC CÔNG NGHỆ VIỆT NAM (VN)**

Số 6 đường 3 tháng 2, phường 8, thành phố Vũng Tàu, tỉnh Bà Rịa - Vũng Tàu

(72) Hoàng Đức Thảo (VN)

(55)

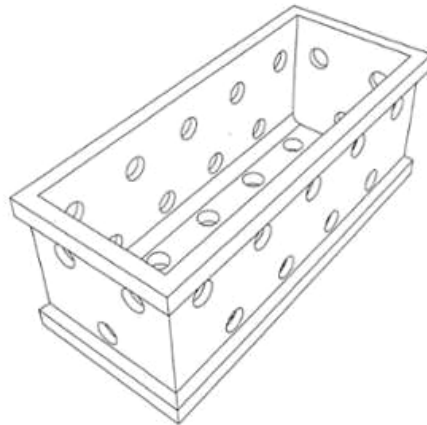

1.1

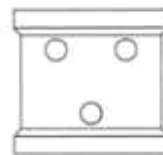

1.2

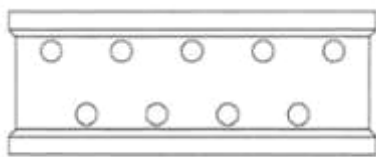

1.3

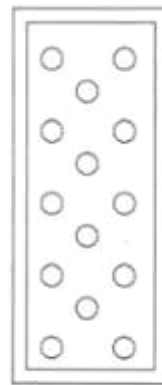

1.4

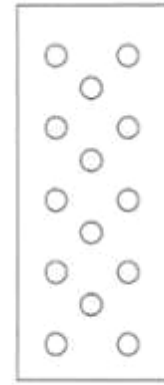

1.5

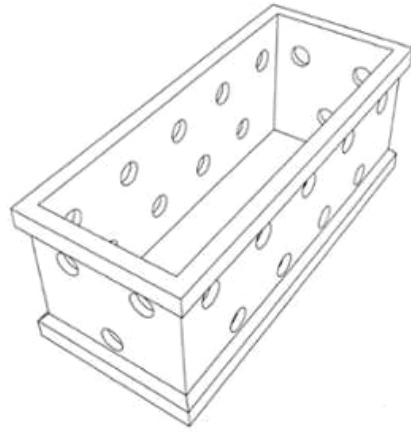

2.1

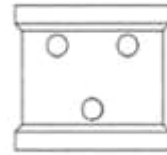

2.2

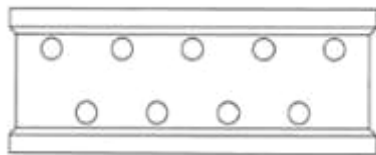

2.3

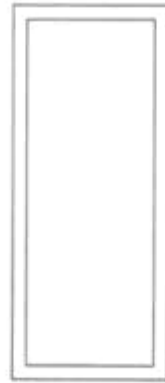

2.4



2.5

CÔNG BÁO SỞ HỮU CÔNG NGHIỆP SỐ 403 TẬP A – QUYỀN 2 (10.2021)

(11) **42709**

(21) 3-2021-00033

(28) 1

(54) **THIẾT BỊ RÓT CHẤT LỎNG TỰ ĐỘNG**

(51) **23-01**

(22) 08/01/2021

(43) 25/10/2021

(73) **TRƯƠNG THÀNH LỄ (VN)**

355 Nguyễn Thái Học, phường Hòa Thuận, thành phố Cao Lãnh, tỉnh Đồng Tháp

(72) Trương Thành Lễ (VN)

(55)



1.1



1.2



1.3



1.4



1.5



1.6



1.7

- (11) **42710**
(21) 3-2021-00024 (28) 1
(54) **RỔ** (51) **07-07**
(22) 07/01/2021 (43) 25/10/2021
(73) **CÔNG TY TNHH MỘT THÀNH VIÊN SẢN XUẤT THƯƠNG MẠI XUẤT NHẬP KHẨU THẮNG LỢI (VN)**
Số 334D đường Mã Lò, khu phố 6, phường Bình Trị Đông A, quận Bình Tân, thành phố Hồ Chí Minh
(72) Tô Lợi Thành (VN)
(74) Công ty Cổ phần PHANLAW VIETNAM (PHANLAW VIETNAM JSC)
(55)

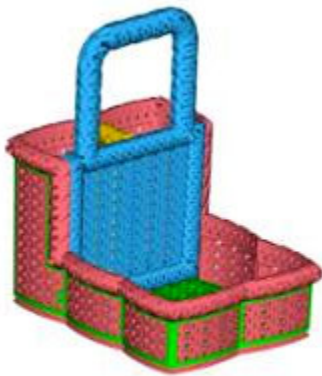

1.1



1.2



1.3

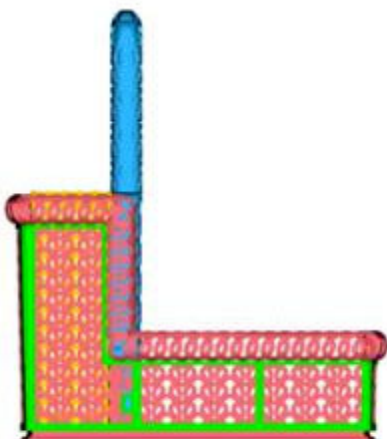

1.4

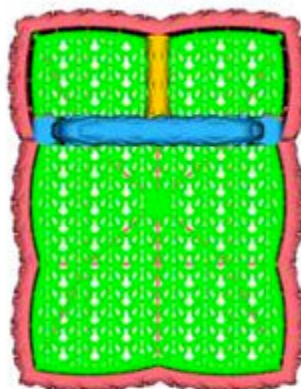

1.5

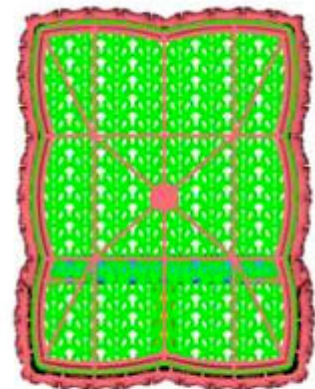

1.6

- (11) **42711**
(21) 3-2021-00025 (28) 1
(54) **RỔ** (51) **07-07**
(22) 07/01/2021 (43) 25/10/2021
(73) **CÔNG TY TNHH MỘT THÀNH VIÊN SẢN XUẤT THƯƠNG MẠI XUẤT NHẬP KHẨU THẮNG LỢI (VN)**
Số 334D đường Mã Lò, khu phố 6, phường Bình Trị Đông A, quận Bình Tân, thành phố Hồ Chí Minh
(72) Tô Lợi Thành (VN)
(74) Công ty Cổ phần PHANLAW VIETNAM (PHANLAW VIETNAM JSC)
(55)



1.1

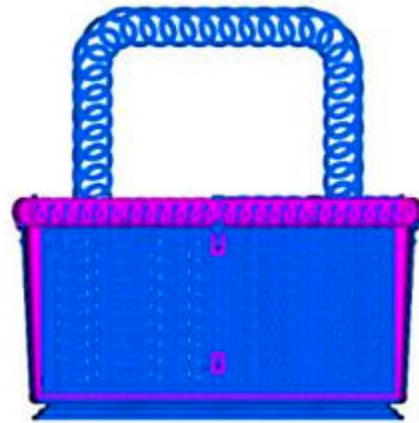

1.2



1.3



1.4



1.5

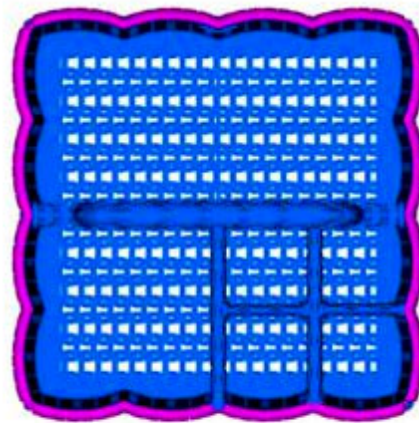

1.6

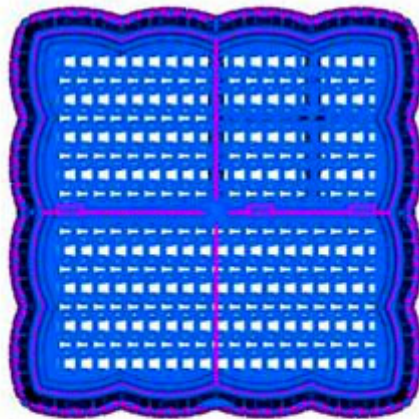

1.7

- (11) **42712**
(21) 3-2021-00150 (28) 1
(54) **BỘ SẠC** (51) **13-02**
(22) 22/01/2021 (43) 25/10/2021
(30) 29/743,901 24/07/2020 US;
(73) **APPLE INC. (US)**
One Apple Park Way, Cupertino, California 95014, United States of America
(72) 1. JODY AKANA (US)
2. MOLLY ANDERSON (GB)
3. BARTLEY K. ANDRE (US)
4. SHOTA AOYAGI (JP)
5. ANTHONY MICHAEL ASHCROFT (FR)
6. MARINE C. BATAILLE (FR)
7. JEREMY BATAILLOU (FR)
8. ABIDUR RAHMAN CHOWDHURY (GB)
9. CLARA GENEVIEVE MARINE COURTAIGNE (FR)
10. MARKUS DIEBEL (DE)
11. JONATHAN GOMEZ GARCIA (FR)
12. M. EVANS HANKEY (US)
13. RICHARD P. HOWARTH (GB)
14. JONATHAN P. IVE (GB)
15. JULIAN JAEDE (DE)
16. DUNCAN ROBERT KERR (GB)
17. PETER RUSSELL-CLARKE (AU)
18. BENJAMIN ANDREW SHAFFER (US)
19. JOE SUNG-HO TAN (US)
20. CLEMENT TISSANDIER (FR)
21. EUGENE ANTONY WHANG (CA)
(74) Công ty TNHH Lê & Lê (LE & LE)
(55)

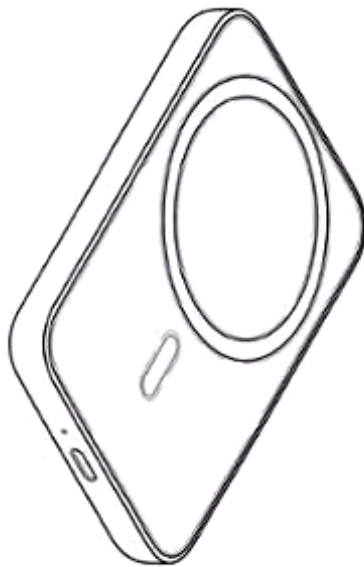

1.1

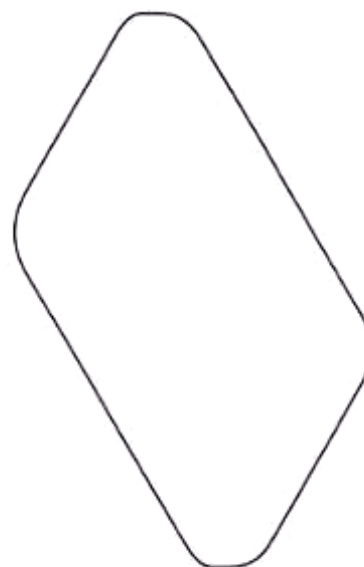

1.2



1.3



1.4

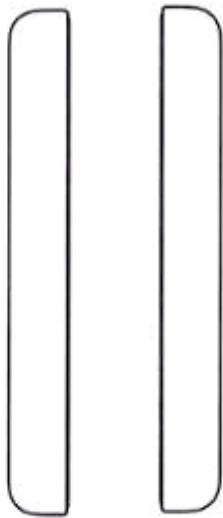

1.5

1.6

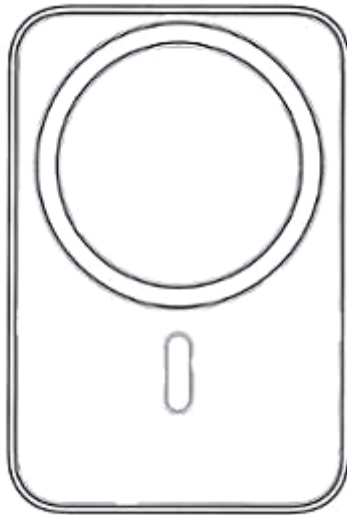

1.7

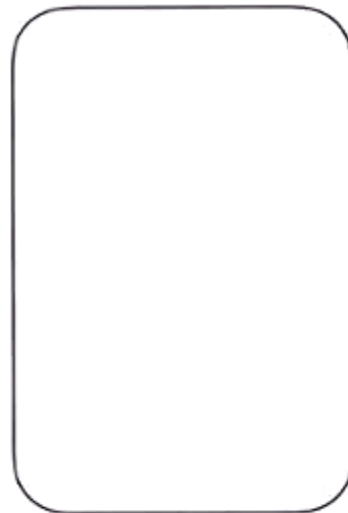

1.8

(11) **42713**

(21) 3-2021-00144

(28) 1

(54) **QUẠT TRẦN**

(51) **23-04**

(22) 22/01/2021

(43) 25/10/2021

(73) **CÔNG TY CỔ PHẦN ĐIỆN CƠ THỐNG NHẤT (VN)**

Số 164, phố Nguyễn Đức Cảnh, phường Tương Mai, quận Hoàng Mai, thành phố Hà Nội

(72) Lê Tuấn Sơn (VN)

(74) Công ty TNHH IPVC (IP.VC CO.,LTD)

(55)



1.1



1.2



1.3



1.4



1.5



1.6

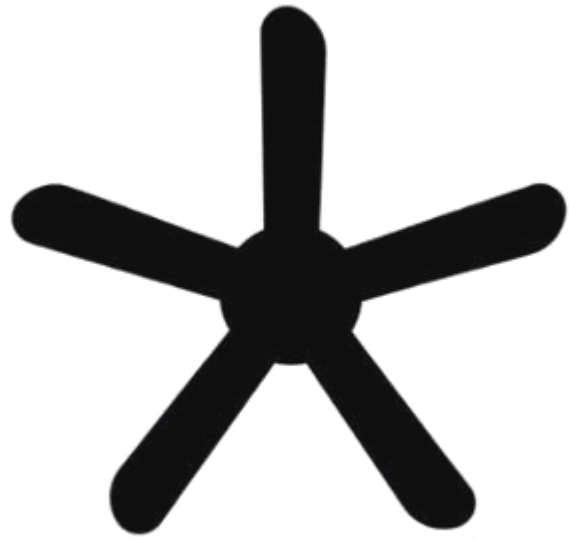

1.7



1.8

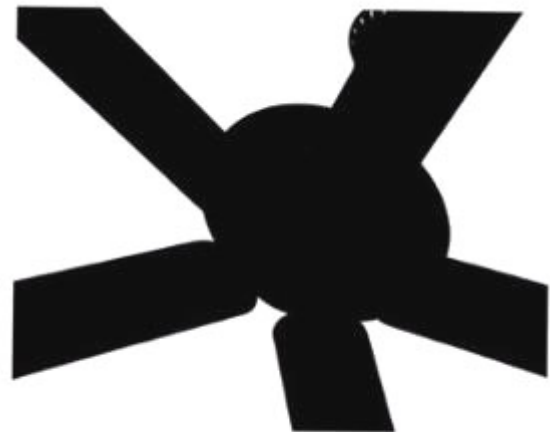

1.9

- (11) **42714**
(21) 3-2021-00145 (28) 1
(54) **QUẠT** (51) **23-04**
(22) 22/01/2021 (43) 25/10/2021
(73) **CÔNG TY CỔ PHẦN ĐIỆN CƠ THỐNG NHẤT (VN)**
Số 164, phố Nguyễn Đức Cảnh, phường Tương Mai, quận Hoàng Mai, thành phố Hà Nội
(72) Lê Tuấn Sơn (VN)
(74) Công ty TNHH IPVC (IP.VC CO.,LTD)
(55)



1.1

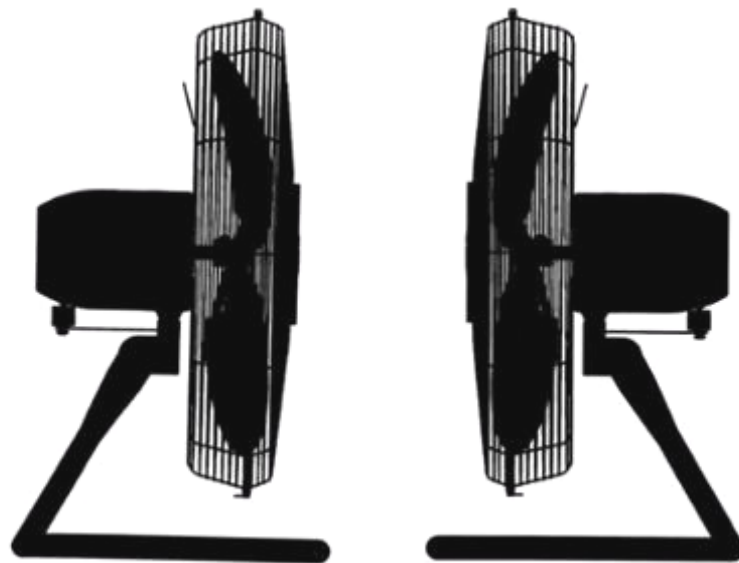

1.2

1.3



1.4



1.5

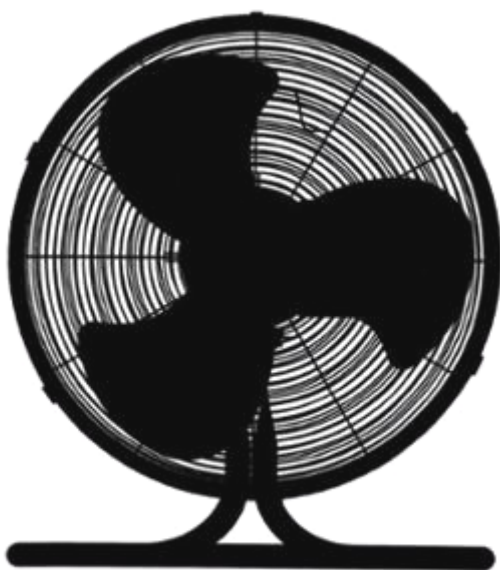

1.6



1.7

- (11) **42715**
(21) 3-2021-00225 (28) 1
(54) **HỘP MỰC** (51) **16-03; 18-02**
(22) 29/01/2021 (43) 25/10/2021
(30) 2020-015850 30/07/2020 JP;
(73) **BROTHER INDUSTRIES, LTD. (JP)**
15-1 Naeshiro-cho, Mizuho-ku, Nagoya-shi, Aichi-ken, Japan
(72) 1. YUWEN WANG (JP)
2. KAZUAKI OOKA (JP)
3. MASAYOSHI MITA (JP)
(74) Công ty TNHH Ban Ca (BANCA)
(55)

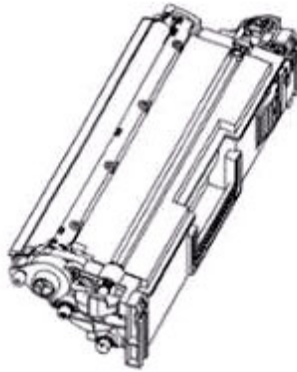

1.1

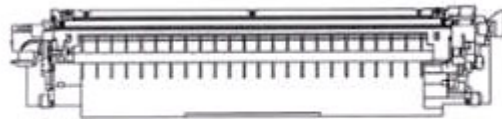

1.2



1.3

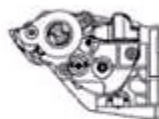

1.4

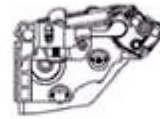

1.5

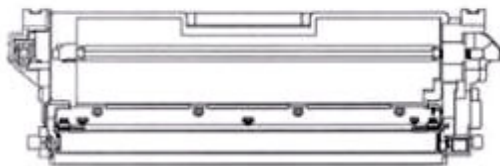

1.6

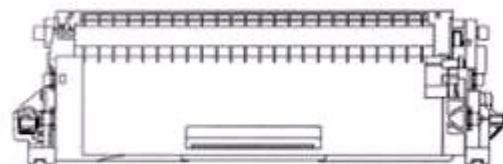

1.7

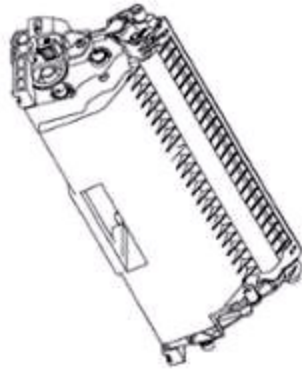

1.8

CÔNG BÁO SỞ HỮU CÔNG NGHIỆP SỐ 403 TẬP A – QUYỀN 2 (10.2021)

- (11) 42716
(21) 3-2021-00372 (28) 2
(54) **TÚI ĐỰNG SỦI CẢO** (51) **09-05**
(22) 22/02/2021 (43) 25/10/2021
(73) **CÔNG TY TNHH FOSECA VIỆT NAM (VN)**
Số 18 đường 10, KCN, đô thị và dịch vụ VSIP Bắc Ninh, xã Đại Đồng, huyện Tiên
Du, tỉnh Bắc Ninh
(72) Park Soyoung (KR)
(74) Công ty TNHH Sở hữu trí tuệ M.I.T (M.I.T IP CO., LTD)
(55)



1.1



1.2



2.1



2.2

CÔNG BÁO SỞ HỮU CÔNG NGHIỆP SỐ 403 TẬP A – QUYỀN 2 (10.2021)

- (11) **42717**
(21) 3-2021-00394 (28) 1
(54) **CHẬU RỬA MẶT** (51) **23-02**
(22) 25/02/2021 (43) 25/10/2021
(30) 2020-028334 25/12/2020 JP;
(73) **LIXIL CORPORATION (JP)**
2-1-1 Ojima, Koto-ku, Tokyo 136-8535, Japan
(72) Hiroshi KOBAYASHI (JP)
(74) Công ty TNHH Tầm nhìn và Liên danh (VISION & ASSOCIATES CO.LTD.)
(55)

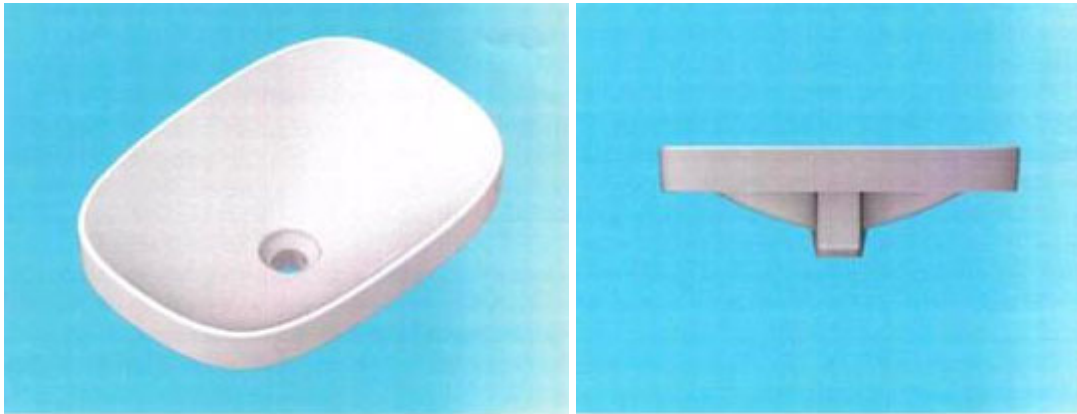

1.1

1.2



1.3

1.4

1.5

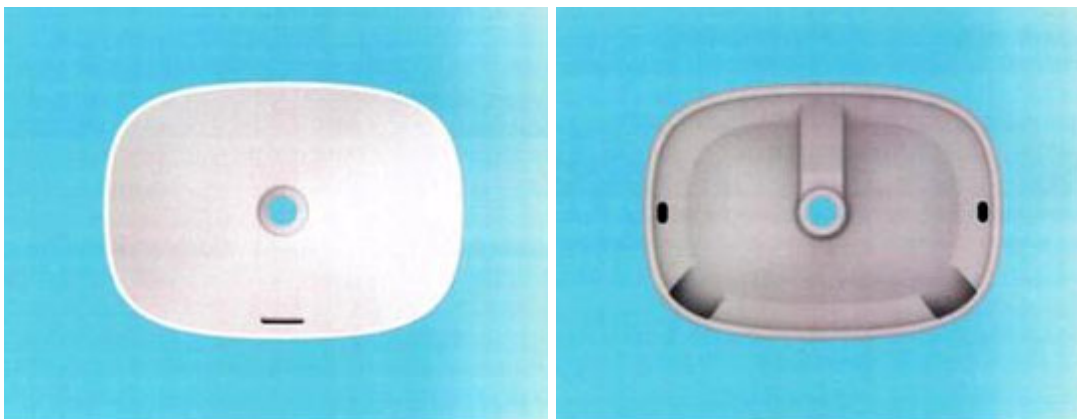

1.6

1.7

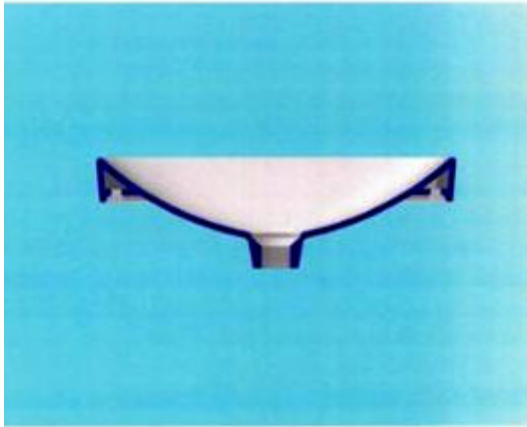

1.8

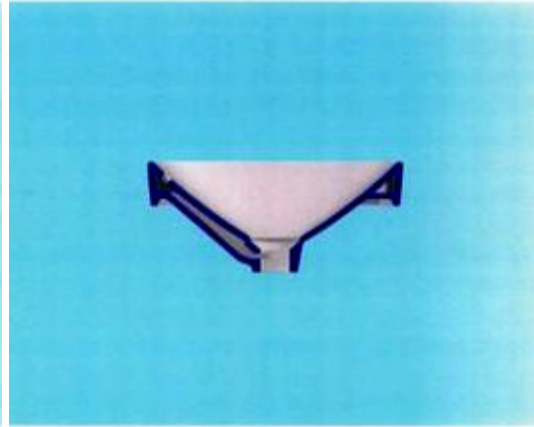

1.9

- (11) **42718**
(21) 3-2021-00398 (28) 1
(54) **CẤU KIỆN LÁT MÁI** (51) **25-01**
(22) 26/02/2021 (43) 25/10/2021
(73) **CÔNG TY CỔ PHẦN KHOA HỌC CÔNG NGHỆ VIỆT NAM (VN)**
Số 6, đường 3/2, phường 8, thành phố Vũng Tàu, tỉnh Bà Rịa - Vũng Tàu
(72) Hoàng Đức Thảo (VN)
(55)

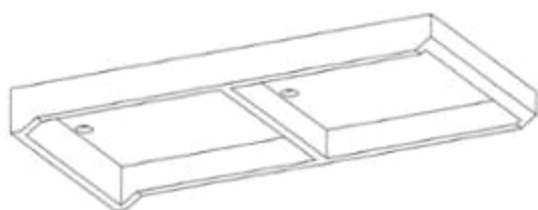

1.1

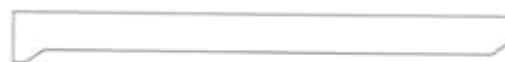

1.2

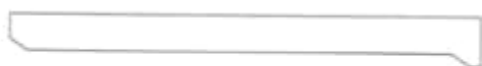

1.3



1.4



1.5

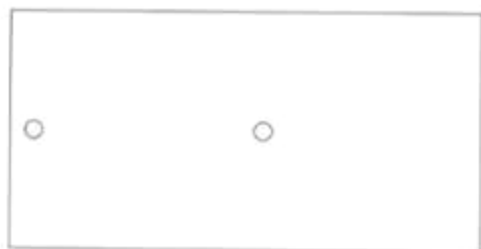

1.6

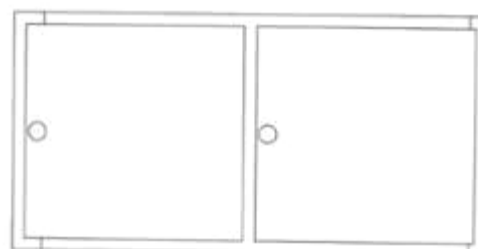

1.7

CÔNG BÁO SỞ HỮU CÔNG NGHIỆP SỐ 403 TẬP A – QUYỀN 2 (10.2021)

- (11) **42719**
(21) 3-2021-00444 (28) 1
(54) **KHUNG XE HAI BÁNH** (51) **12-16**
(22) 04/03/2021 (43) 25/10/2021
(30) 332730-001 24/09/2020 IN;
(73) **REVOLTA MOTORS PRIVATE LIMITED (IN)**
No.224,13th A Cross, 2nd A Main Yelahanka New Town, Bangalore - 560064 - India
(72) 1. ALOK DAS (IN)
2. VIJAY K PRAVEEN (IN)
3. LAKSHMISH GANGADHAR (IN)
4. NITIN RANADE (IN)
(74) **CÔNG TY TRÁCH NHIỆM HỮU HẠN TƯ VẤN ĐẦU TƯ VÀ SỞ HỮU TRÍ TUỆ INTERFIVE (INTERFIVE CO., LTD)**
(55)

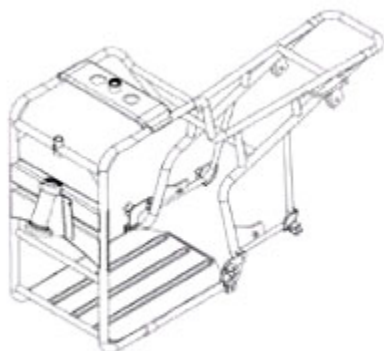

1.1

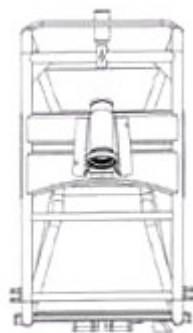

1.2



1.3

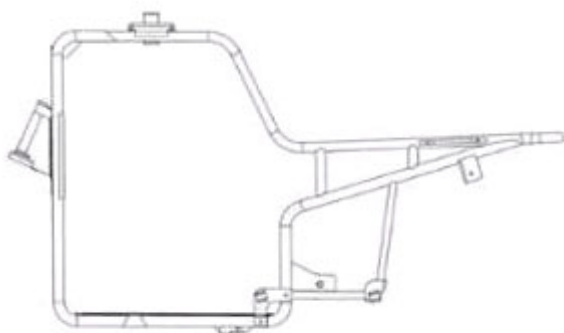

1.4

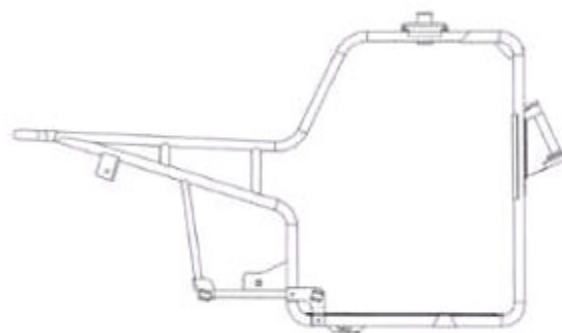

1.5

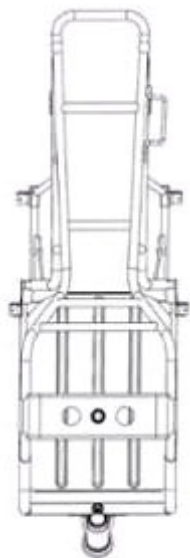

1.6

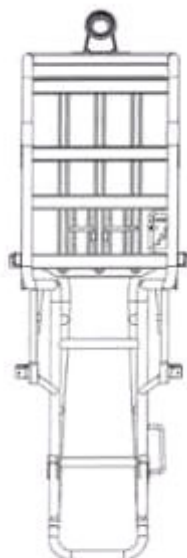

1.7



1.8

- (11) **42720**
(21) 3-2021-00448 (28) 1
(54) **HỆ THỐNG THU NƯỚC NGĂN MÙI** (51) **23-01**
(22) 19/07/2019 (43) 25/10/2021
(73) **CÔNG TY TNHH MỘT THÀNH VIÊN THOÁT NƯỚC ĐÔ THỊ THÀNH PHỐ HỒ CHÍ MINH (VN)**
04 Nguyễn Thiện Thuật, phường 24, quận Bình Thạnh, thành phố Hồ Chí Minh
(72) 1. BÙI VĂN TRƯỜNG (VN)
2. TRẦN VĂN CHÍ (VN)
3. TRẦN MINH TRÍ (VN)
(74) Công ty Luật TNHH ELITE (ELITE LAW FIRM)
(55)

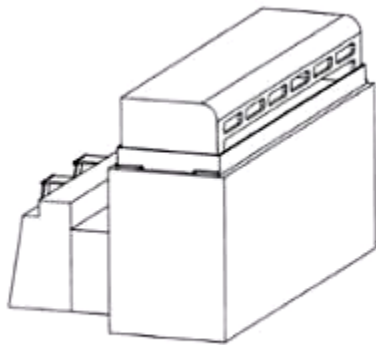

1.1

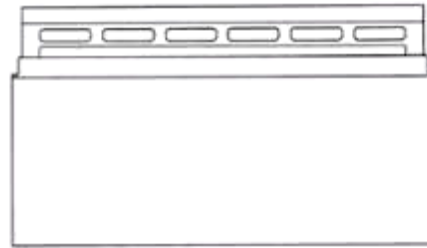

1.2

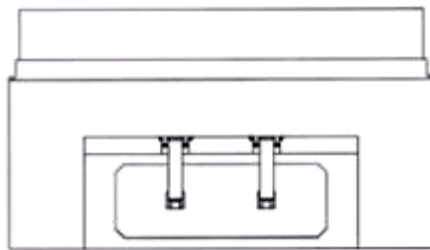

1.3

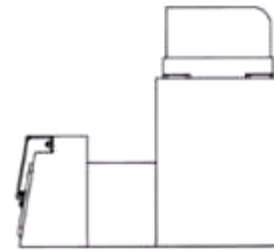

1.4

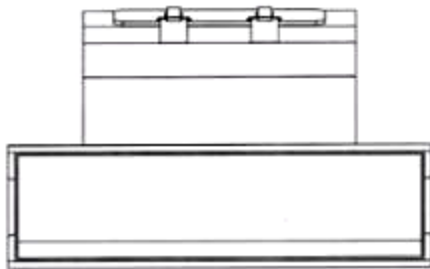

1.5

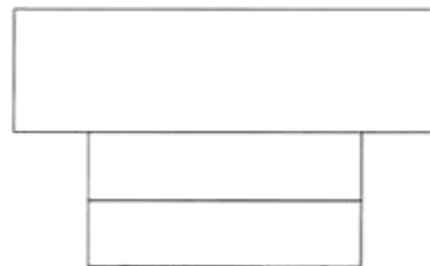

1.6

- (11) **42721**
(21) 3-2021-00683 (28) 1
(54) **KÉO TỈA CÂY** (51) **08-03**
(22) 22/03/2021 (43) 25/10/2021
(30) 202030587940.1 29/09/2020 CN;
(73) **TECHTRONIC CORDLESS GP (US)**
100 Innovation Way, Anderson, SC 29621, United States of America
(72) 1. LI KWONG WING (CN)
2. LAM KWOK FAN (CN)
3. WONG KAR TAT (CN)
(74) Công ty TNHH Tầm nhìn và Liên danh (VISION & ASSOCIATES CO.LTD.)
(55)

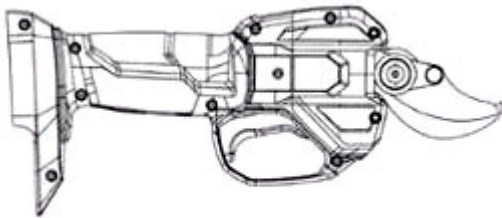

1.1

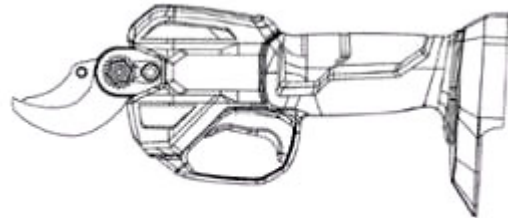

1.2



1.3

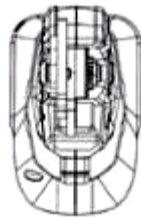

1.4

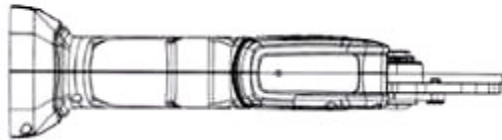

1.5

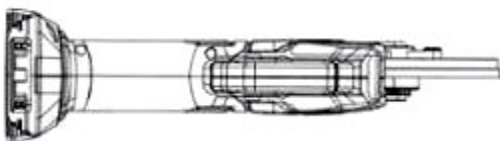

1.6

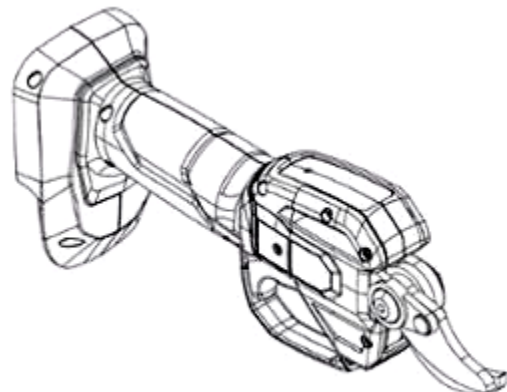

1.7

CÔNG BÁO SỞ HỮU CÔNG NGHIỆP SỐ 403 TẬP A – QUYỀN 2 (10.2021)

- (11) **42722**
(21) 3-2021-00684 (28) 1
(54) **KÉO TỈA CÂY** (51) **08-03**
(22) 22/03/2021 (43) 25/10/2021
(30) 202030587940.1 29/09/2020 CN;
(73) **TECHTRONIC CORDLESS GP (US)**
100 Innovation Way, Anderson, SC 29621, United States of America
(72) 1. LI KWONG WING (CN)
2. LAM KWOK FAN (CN)
3. WONG KAR TAT (CN)
(74) Công ty TNHH Tầm nhìn và Liên danh (VISION & ASSOCIATES CO.LTD.)
(55)

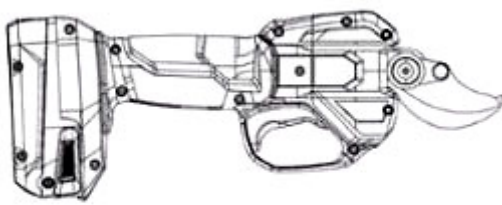

1.1

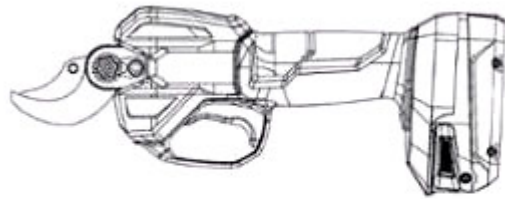

1.2



1.3

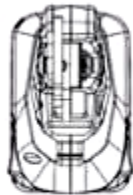

1.4

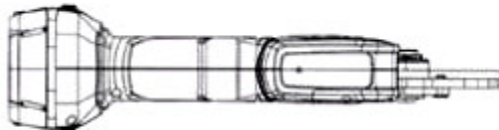

1.5

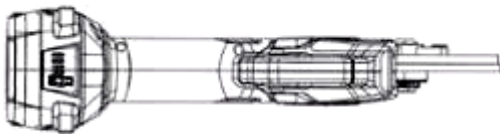

1.6

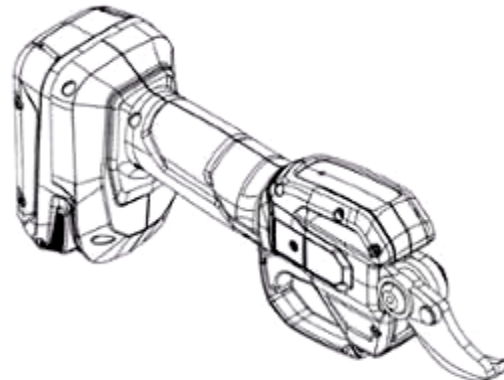

1.7

- (11) **42723**
(21) 3-2021-00685 (28) 1
(54) **KÉO TỈA CÂY** (51) **08-03**
(22) 22/03/2021 (43) 25/10/2021
(30) 202030587940.1 29/09/2020 CN;
(73) **TECHTRONIC CORDLESS GP (US)**
100 Innovation Way, Anderson, SC 29621, United States of America
(72) 1. LI KWONG WING (CN)
2. LAM KWOK FAN (CN)
3. WONG KAR TAT (CN)
(74) Công ty TNHH Tầm nhìn và Liên danh (VISION & ASSOCIATES CO.LTD.)
(55)

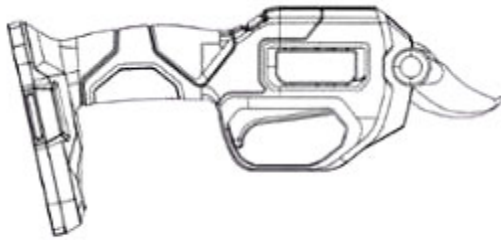

1.1



1.2



1.3

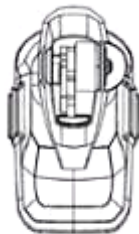

1.4

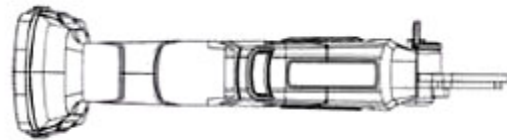

1.5

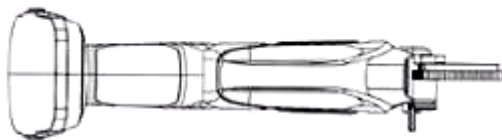

1.6

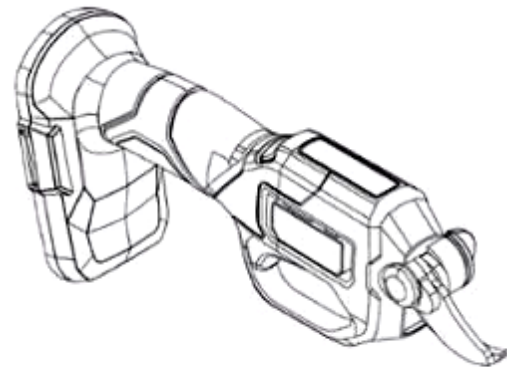

1.7

CÔNG BÁO SỞ HỮU CÔNG NGHIỆP SỐ 403 TẬP A – QUYỀN 2 (10.2021)

- (11) **42724**
(21) 3-2021-00686 (28) 1
(54) **KÉO TỈA CÂY** (51) **08-03**
(22) 22/03/2021 (43) 25/10/2021
(30) 202030587940.1 29/09/2020 CN;
(73) **TECHTRONIC CORDLESS GP (US)**
100 Innovation Way, Anderson, SC 29621, United States of America
(72) 1. LI KWONG WING (CN)
2. LAM KWOK FAN (CN)
3. WONG KAR TAT (CN)
(74) Công ty TNHH Tầm nhìn và Liên danh (VISION & ASSOCIATES CO.LTD.)
(55)

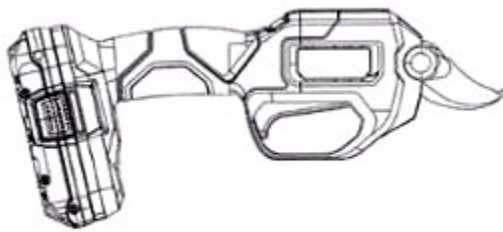

1.1

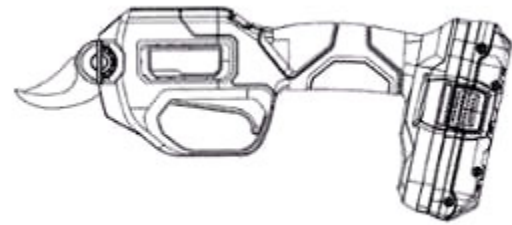

1.2



1.3



1.4



1.5

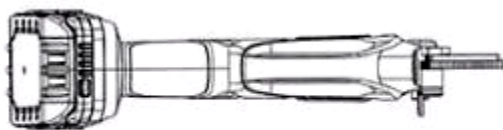

1.6

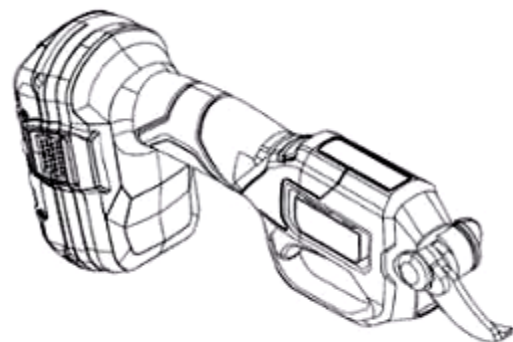

1.7

- (11) **42725**
(21) 3-2021-00687 (28) 1
(54) **KÉO TỈA CÂY** (51) **08-03**
(22) 22/03/2021 (43) 25/10/2021
(30) 202030587940.1 29/09/2020 CN;
(73) **TECHTRONIC CORDLESS GP (US)**
100 Innovation Way, Anderson, SC 29621, United States of America
(72) 1. LI KWONG WING (CN)
2. LAM KWOK FAN (CN)
3. WONG KAR TAT (CN)
(74) Công ty TNHH Tầm nhìn và Liên danh (VISION & ASSOCIATES CO.LTD.)
(55)

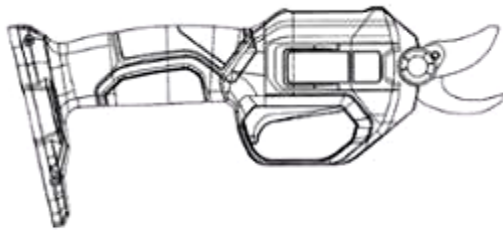

1.1

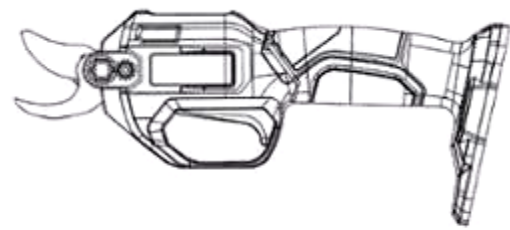

1.2



1.3

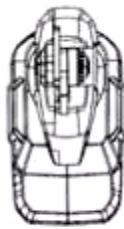

1.4

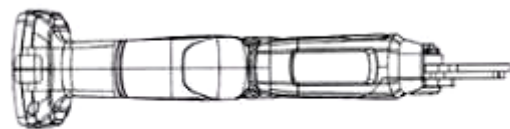

1.5

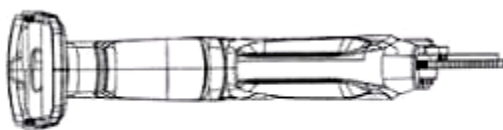

1.6

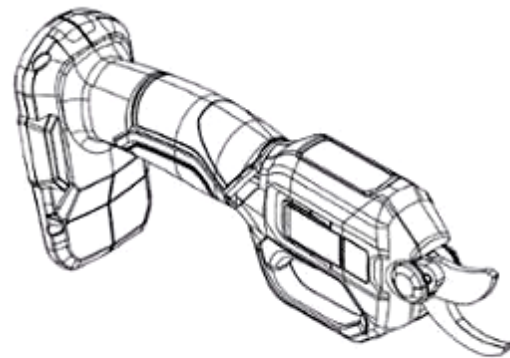

1.7

CÔNG BÁO SỞ HỮU CÔNG NGHIỆP SỐ 403 TẬP A – QUYỀN 2 (10.2021)

- (11) **42726**
(21) 3-2021-00688 (28) 1
(54) **KÉO TỈA CÂY** (51) **08-03**
(22) 22/03/2021 (43) 25/10/2021
(30) 202030587940.1 29/09/2020 CN;
(73) **TECHTRONIC CORDLESS GP (US)**
100 Innovation Way, Anderson, SC 29621, United States of America
(72) 1. LI KWONG WING (CN)
2. LAM KWOK FAN (CN)
3. WONG KAR TAT (CN)
(74) Công ty TNHH Tầm nhìn và Liên danh (VISION & ASSOCIATES CO.LTD.)
(55)

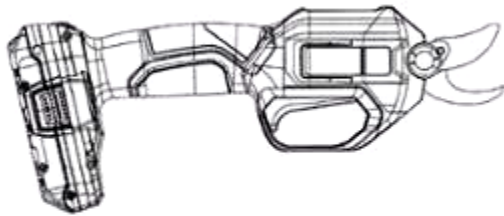

1.1

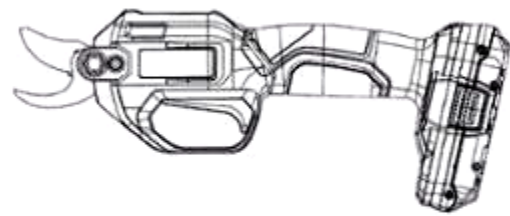

1.2

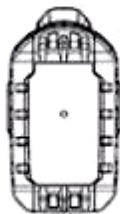

1.3

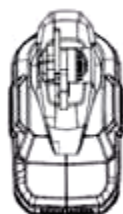

1.4

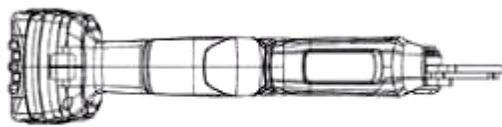

1.5

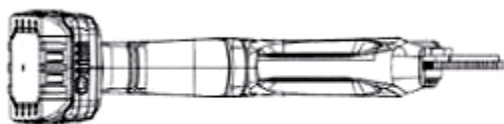

1.6

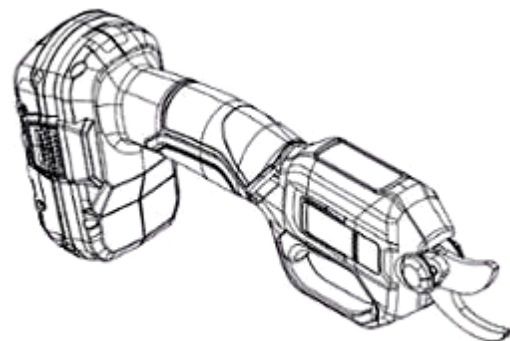

1.7

CÔNG BÁO SỞ HỮU CÔNG NGHIỆP SỐ 403 TẬP A – QUYỀN 2 (10.2021)

- (11) **42727**
(21) 3-2021-00768 (28) 1
(54) **PHỤ KIỆN CHỐNG ĐỔ NGANG XE MÁY** (51) **12-16**
(22) 01/04/2021 (43) 25/10/2021
(73) **HOÀNG TUẤN ANH (VN)**
Tổ 1, khu 8, phường Thanh Sơn, thành phố Uông Bí, tỉnh Quảng Ninh
(72) Hoàng Tuấn Anh (VN)
(74) Công ty TNHH tư vấn THB (THB CONSULTING CO.,LTD)
(55)

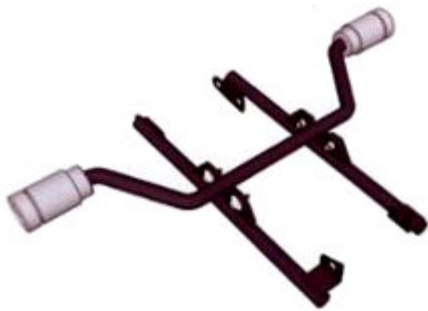

1.1

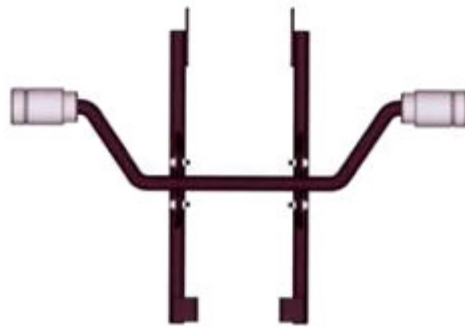

1.2



1.3



1.4

1.5



1.6



1.7

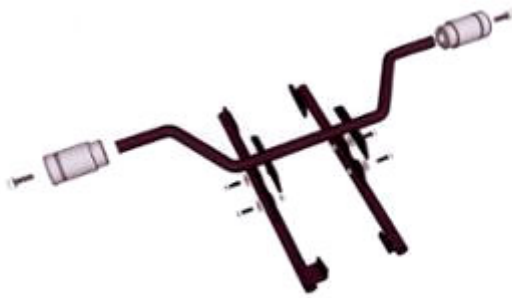

1.8

CÔNG BÁO SỞ HỮU CÔNG NGHIỆP SỐ 403 TẬP A – QUYỀN 2 (10.2021)

- (11) **42728**
(21) 3-2021-00797 (28) 1
(54) **BA LÔ** (51) **03-01**
(22) 05/04/2021 (43) 25/10/2021
(30) 008197461-0001 07/10/2020 EM;
(73) **DECATHLON (FR)**
Service Juridique PI 4, Boulevard de Mons, F-59650 Villeneuve d'Ascq, Francia
(72) Clément PAREL (FR)
(74) Công ty Luật TNHH T&G (TGVN)
(55)



1.1



1.2



1.3



1.4



1.5



1.6



1.7

CÔNG BÁO SỞ HỮU CÔNG NGHIỆP SỐ 403 TẬP A – QUYỀN 2 (10.2021)

- (11) **42729**
(21) 3-2021-00798 (28) 1
(54) **BA LÔ** (51) **03-01**
(22) 05/04/2021 (43) 25/10/2021
(30) 008197461-0002 07/10/2020 EM;
(73) **DECATHLON (FR)**
Service Juridique PI 4, Boulevard de Mons, F-59650 Villeneuve d'Ascq, Francia
(72) Clément PAREL (FR)
(74) Công ty Luật TNHH T&G (TGVN)
(55)



1.1



1.2



1.3



1.4



1.5



1.6



1.7

CÔNG BÁO SỞ HỮU CÔNG NGHIỆP SỐ 403 TẬP A – QUYỀN 2 (10.2021)

- (11) **42730**
(21) 3-2021-00799 (28) 1
(54) **BA LÔ** (51) **03-01**
(22) 05/04/2021 (43) 25/10/2021
(30) 008200299-0001 09/10/2020 EM;
(73) **DECATHLON (FR)**
Service Juridique PI 4, Boulevard de Mons, F-59650 Villeneuve d'Ascq, Francia
(72) Clément PAREL (FR)
(74) Công ty Luật TNHH T&G (TGVN)
(55)



1.1



1.2



1.3



1.4



1.5



1.6



1.7

CÔNG BÁO SỞ HỮU CÔNG NGHIỆP SỐ 403 TẬP A – QUYỀN 2 (10.2021)

- (11) **42731**
(21) 3-2021-00800 (28) 1
(54) **BA LÔ** (51) **03-01**
(22) 05/04/2021 (43) 25/10/2021
(30) 008200299-0002 09/10/2020 EM;
(73) **DECATHLON (FR)**
Service Juridique PI 4, Boulevard de Mons, F-59650 Villeneuve d'Ascq, Francia
(72) Clément PAREL (FR)
(74) Công ty Luật TNHH T&G (TGVN)
(55)



1.1



1.2



1.3



1.4



1.5



1.6



1.7

CÔNG BÁO SỞ HỮU CÔNG NGHIỆP SỐ 403 TẬP A – QUYỀN 2 (10.2021)

- (11) **42732**
(21) 3-2021-00801 (28) 1
(54) **BA LÔ** (51) **03-01**
(22) 05/04/2021 (43) 25/10/2021
(30) 008200299-0003 09/10/2020 EM;
(73) **DECATHLON (FR)**
Service Juridique PI 4, Boulevard de Mons, F-59650 Villeneuve d'Ascq, Francia
(72) Clément PAREL (FR)
(74) Công ty Luật TNHH T&G (TGVN)
(55)



1.1



1.2



1.3



1.4



1.5



1.6



1.7

CÔNG BÁO SỞ HỮU CÔNG NGHIỆP SỐ 403 TẬP A – QUYỀN 2 (10.2021)

- (11) **42733**
(21) 3-2021-00846 (28) 1
(54) **NHÃN SẢN PHẨM** (51) **19-08**
(22) 08/04/2021 (43) 25/10/2021
(73) **CÔNG TY CỔ PHẦN NƯỚC KHOÁNG SM (VN)**
Tổ 6 ấp An Hòa, xã An Hảo, huyện Tịnh Biên, tỉnh An Giang
(72) Trần Kim Liên (VN)
(55)



CÔNG BÁO SỞ HỮU CÔNG NGHIỆP SỐ 403 TẬP A – QUYỀN 2 (10.2021)

- (11) 42734
(21) 3-2021-00857 (28) 1
(54) **HỘP ĐỰNG GĂNG TAY** (51) **09-03**
(22) 09/04/2021 (43) 25/10/2021
(73) **CÔNG TY TNHH ALKA GLUTA VIETNAM (VN)**
440/13/69 Thống Nhất, phường 16, quận Gò Vấp, thành phố Hồ Chí Minh
(72) **NGÔ THỊ THANH HUYỀN (VN)**
(74) Công ty Cổ phần Sở hữu trí tuệ Việt Mỹ (VIET MY IPC)
(55)



1.1



1.2

CÔNG BÁO SỞ HỮU CÔNG NGHIỆP SỐ 403 TẬP A – QUYỀN 2 (10.2021)

- (11) **42735**
(21) 3-2021-00941 (28) 1
(54) **DỤNG CỤ TẬP THỂ DỤC** (51) **21-02**
(22) 26/04/2021 (43) 25/10/2021
(73) **PHAN, MINH VAN (US)**
9306 Lily Avenue, Fountain Valley, California 92708, United States of America
(72) Phan, Minh Van (VN)
(74) Công ty TNHH Tư vấn - Dịch thuật - Sở hữu trí tuệ Á Đông (Á Đông IP CONSULTANCY CO.,LTD.)
(55)



1.1



1.2



1.3



1.4



1.5

CÔNG BÁO SỞ HỮU CÔNG NGHIỆP SỐ 403 TẬP A – QUYỀN 2 (10.2021)

(11) **42736**

(21) 3-2021-01050

(28) 1

(54) **BÌNH NƯỚC NÓNG**

(51) **23-03**

(22) 06/05/2021

(43) 25/10/2021

(73) **CÔNG TY CỔ PHẦN QUỐC TẾ SƠN HÀ (VN)**

Lô CN1 cụm công nghiệp Từ Liêm, phường Minh Khai, quận Bắc Từ Liêm, thành phố Hà Nội

(72) Lê Vĩnh Sơn (VN)

(74) Công ty TNHH Tư vấn IPNG (IPNG CO.,LTD)

(55)



1.1



1.2

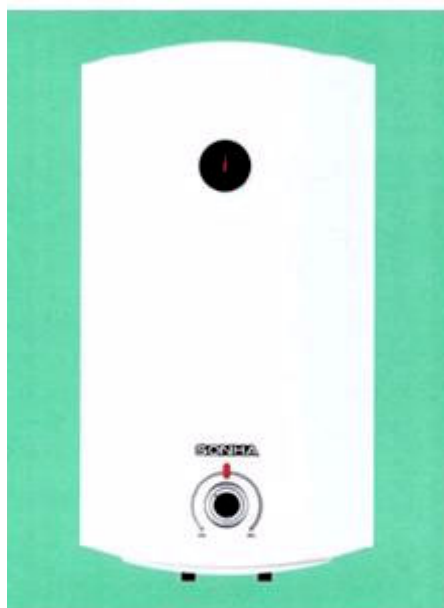

1.3



1.4

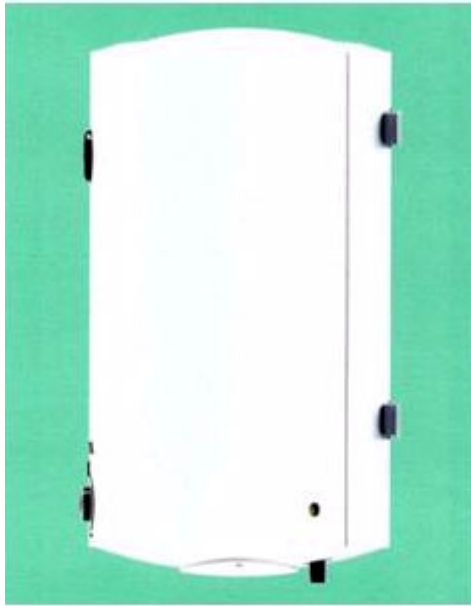

1.5

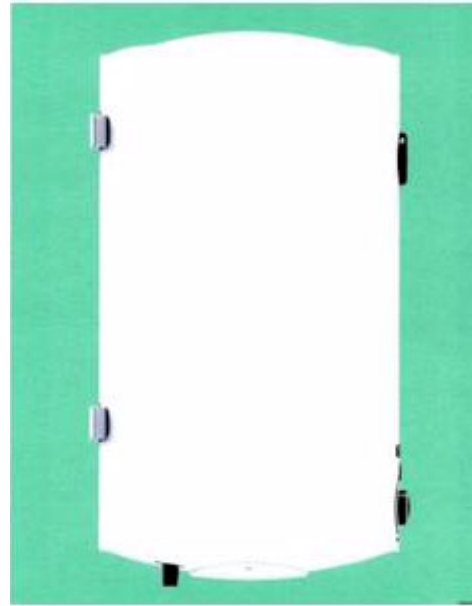

1.6

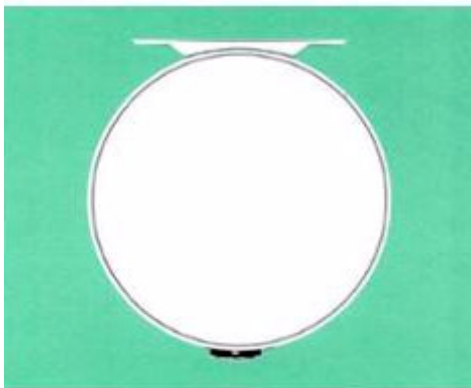

1.7

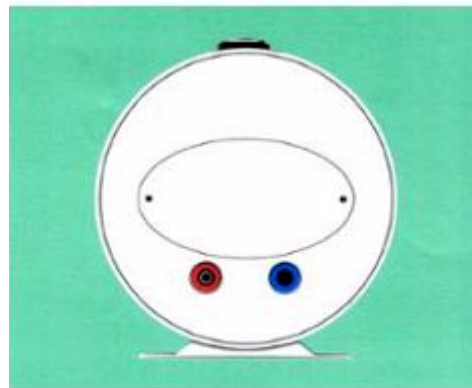

1.8

(11) **42737**

(21) 3-2021-01051

(54) **MÁY LỌC KHÔNG KHÍ**

(22) 06/05/2021

(73) **CÔNG TY CỔ PHẦN QUỐC TẾ SƠN HÀ (VN)**

Lô CN1 cụm công nghiệp Từ Liêm, phường Minh Khai, quận Bắc Từ Liêm, thành phố Hà Nội

(72) Lê Vĩnh Sơn (VN)

(74) Công ty TNHH Tư vấn IPNG (IPNG CO.,LTD)

(55)

(28) 1

(51) **23-04**

(43) 25/10/2021



1.1



1.2

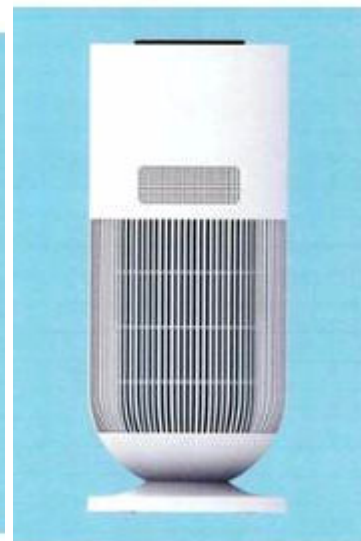

1.3



1.4



1.5

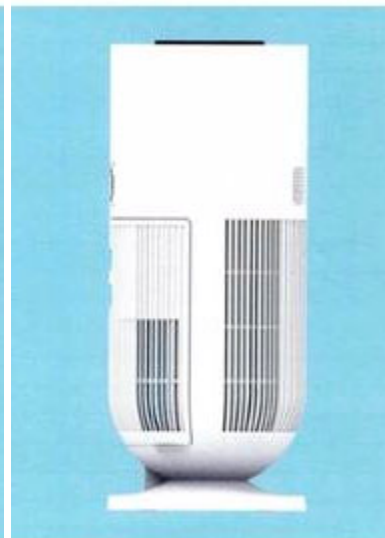

1.6



1.7

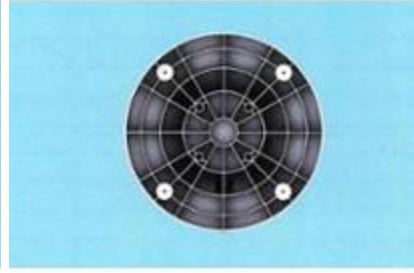

1.8

CÔNG BÁO SỞ HỮU CÔNG NGHIỆP SỐ 403 TẬP A – QUYỀN 2 (10.2021)

(11) **42738**

(21) 3-2021-01052

(28) 1

(54) **MÁY TẠO ION KIỀM**

(51) **23-01**

(22) 06/05/2021

(43) 25/10/2021

(73) **CÔNG TY CỔ PHẦN QUỐC TẾ SƠN HÀ (VN)**

Lô CN1 cụm công nghiệp Từ Liêm, phường Minh Khai, quận Bắc Từ Liêm, thành phố Hà Nội

(72) Lê Vĩnh Sơn (VN)

(74) Công ty TNHH Tư vấn IPNG (IPNG CO.,LTD)

(55)



1.1



1.2



1.3



1.4

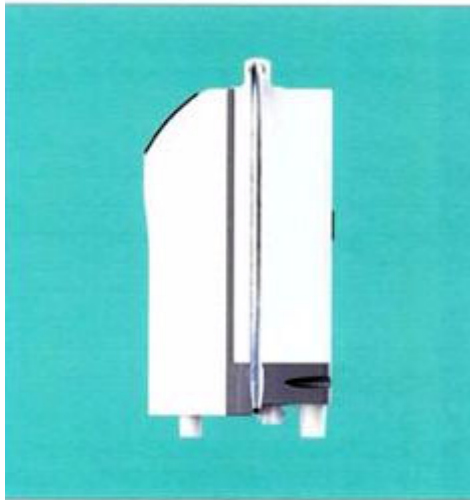

1.5



1.6

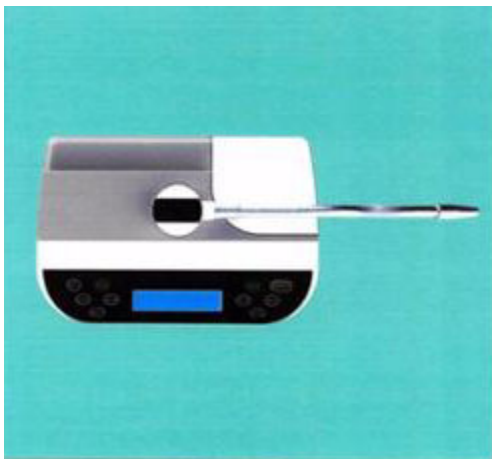

1.7

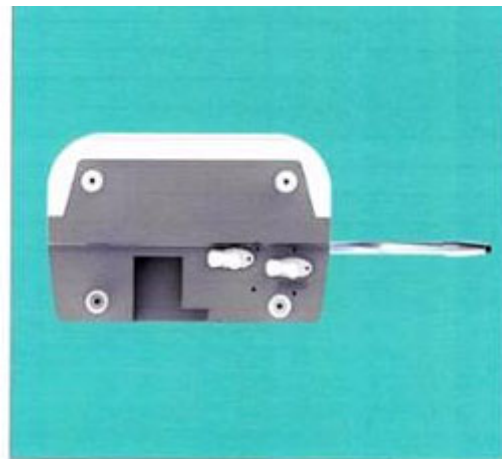

1.8

CÔNG BÁO SỞ HỮU CÔNG NGHIỆP SỐ 403 TẬP A – QUYỀN 2 (10.2021)

- (11) **42739**
(21) 3-2021-01239 (28) 1
(54) **CHÂN NÂNG** (51) **12-05**
(22) 13/05/2021 (43) 25/10/2021
(73) **CÔNG TY TNHH NGUYỄN DUY (VN)**
3 đường số 15, KP3, phường Tân Kiểng, quận 7, thành phố Hồ Chí Minh
(72) Nguyễn Thị Ngọc Tuyết (VN)
(74) Công ty TNHH một thành viên Trường Luật (Trường Luật)
(55)

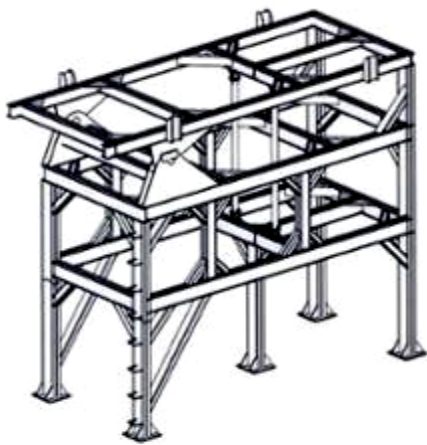

1.1

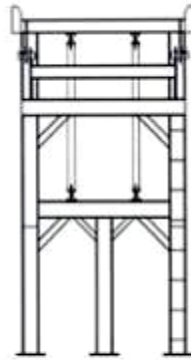

1.2

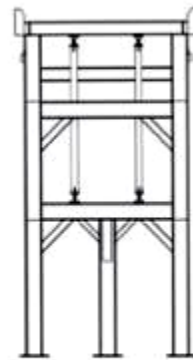

1.3

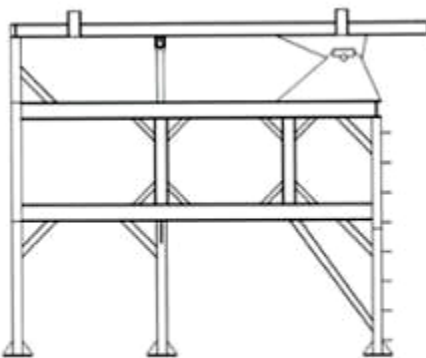

1.4

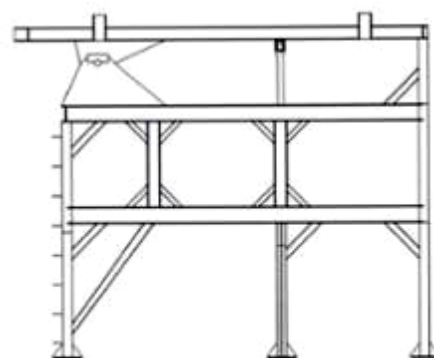

1.5

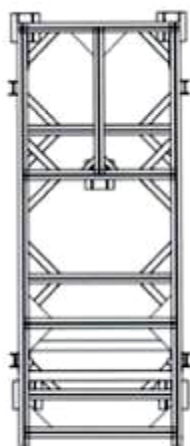

1.6

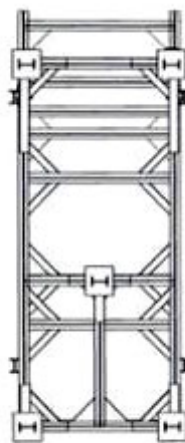

1.7

CÔNG BÁO SỞ HỮU CÔNG NGHIỆP SỐ 403 TẬP A – QUYỀN 2 (10.2021)

- (11) **42740**
(21) 3-2021-01241 (28) 1
(54) **CHAI** (51) **09-02**
(22) 13/05/2021 (43) 25/10/2021
(73) **CÔNG TY CỔ PHẦN D-SHINING (VN)**
7C Nguyễn Ngọc Phương, phường 19, quận Bình Thạnh, thành phố Hồ Chí Minh
(72) Nguyễn Thái Dương (VN)
(74) Văn phòng Luật sư D và T (D & T LAW OFFICE)
(55)



1.1



1.2



1.3



1.4



1.5



1.6



1.7

- (11) **42741**
(21) 3-2021-01270 (28) 3
(54) **HỘP** (51) **09-03**
(22) 17/05/2021 (43) 25/10/2021
(73) **CÔNG TY TNHH SẢN XUẤT THƯƠNG MẠI DỊCH VỤ TÂN TUỜNG KHANG (VN)**
Lô F1 & F2, đường D2 và N5, khu công nghiệp Nam Tân Uyên, phường Khánh Bình, thị xã Tân Uyên, tỉnh Bình Dương
(72) Nìm Dùmng Chiếng (VN)
(74) Văn phòng Luật sư D và T (D & T LAW OFFICE)
(55)



1.1



1.2



1.3



1.4



1.5



1.6



1.7



1.8



2.1



2.2



2.3



2.4



2.5



2.6



2.7



2.8



3.1



3.2



3.3



3.4



3.5



3.6



3.7



3.8

CÔNG BÁO SỞ HỮU CÔNG NGHIỆP SỐ 403 TẬP A – QUYỀN 2 (10.2021)

- (11) **42742**
(21) 3-2021-01290 (28) 1
(54) **KHỐI PHẠO NỔI** (51) **22-05**
(22) 18/05/2021 (43) 25/10/2021
(73) **CÔNG TY TNHH THƯƠNG MẠI XUẤT NHẬP KHẨU VĨ TUYẾN (VN)**
Số 656 đường Hùng Vương, phường Hải Yên, thành phố Móng Cái, tỉnh Quảng Ninh
(72) Trần Văn Út (VN)
(74) Công ty TNHH Tư vấn IPNG (IPNG CO.,LTD)
(55)



1.1



1.2



1.3



1.4



1.5



1.6



1.7



1.8

CÔNG BÁO SỞ HỮU CÔNG NGHIỆP SỐ 403 TẬP A – QUYỀN 2 (10.2021)

- (11) **42743**
(21) 3-2021-01291 (28) 1
(54) **KHỐI PHAO NỔI** (51) **22-05**
(22) 18/05/2021 (43) 25/10/2021
(73) **CÔNG TY TNHH THƯƠNG MẠI XUẤT NHẬP KHẨU VĨ TUYẾN (VN)**
Số 656 đường Hùng Vương, phường Hải Yên, thành phố Móng Cái, tỉnh Quảng
Ninh
(72) Trần Văn Út (VN)
(74) Công ty TNHH Tư vấn IPNG (IPNG CO.,LTD)
(55)



1.1

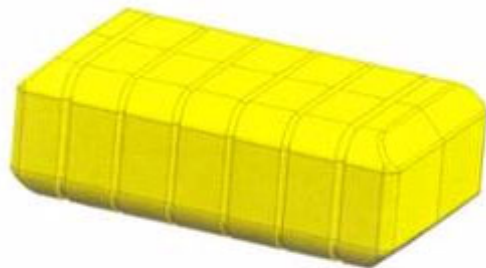

1.2



1.3



1.4



1.5



1.6

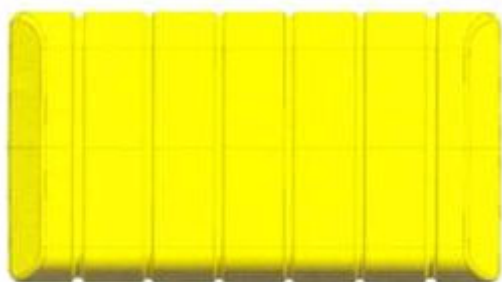

1.7

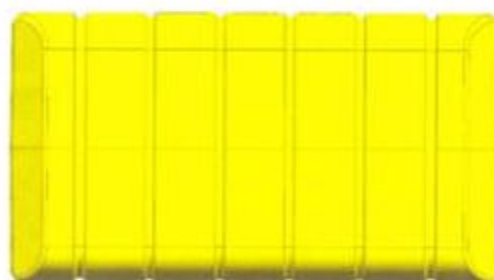

1.8

CÔNG BÁO SỞ HỮU CÔNG NGHIỆP SỐ 403 TẬP A – QUYỀN 2 (10.2021)

- (11) **42744**
(21) 3-2021-01309 (28) 1
(54) **CẢN SAU CỦA Ô TÔ** (51) **12-16**
(22) 19/05/2021 (43) 25/10/2021
(73) **CÔNG TY CỔ PHẦN TẬP ĐOÀN THÀNH CÔNG (VN)**
CN1, khu công nghiệp Nguyên Khê, xã Nguyên Khê, huyện Đông Anh, thành phố Hà Nội
(72) Nguyễn Thị Hồng Ngọc (VN)
(74) Công ty Luật TNHH Việt An (VIET AN LAW FIRM)
(55)



1.1



1.2



1.3



1.4



1.5



1.6



1.7



1.8



1.9

CÔNG BÁO SỞ HỮU CÔNG NGHIỆP SỐ 403 TẬP A – QUYỀN 2 (10.2021)

- (11) **42745**
(21) 3-2021-01328 (28) 1
(54) **BAO ĐỰNG CHÌA KHÓA Ô TÔ** (51) **03-01**
(22) 20/05/2021 (43) 25/10/2021
(73) **CÔNG TY CỔ PHẦN AUT VIỆT NAM (VN)**
99B Nguyễn Ngọc Nại, phường Khương Mai, quận Thanh Xuân, thành phố Hà Nội
(72) Trần Vũ Châu Thành (VN)
(74) Công ty TNHH Tư vấn Quốc Dân (NACILAW)
(55)

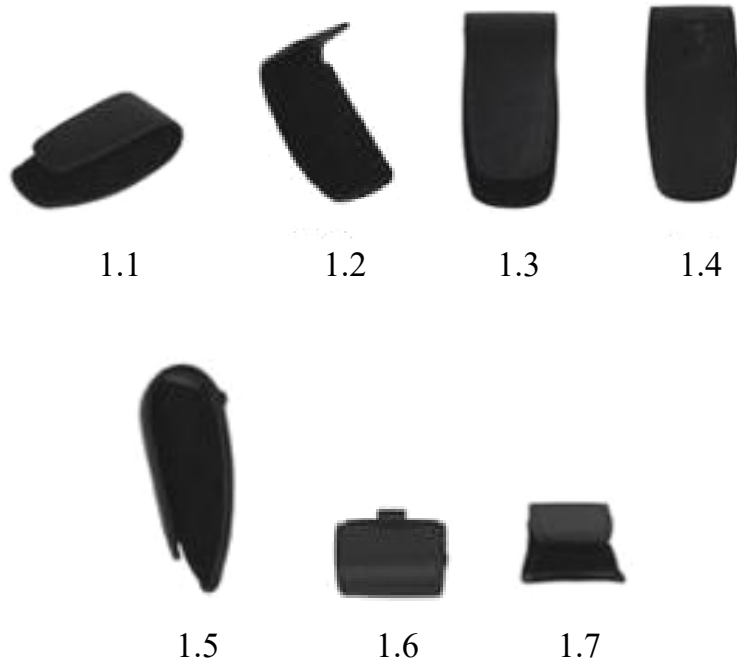

CÔNG BÁO SỞ HỮU CÔNG NGHIỆP SỐ 403 TẬP A – QUYỀN 2 (10.2021)

- (11) **42746**
(21) 3-2021-01341 (28) 1
(54) **NHÀ VỆ SINH KHÔNG DÙNG NƯỚC** (51) **25-03**
(22) 21/05/2021 (43) 25/10/2021
(73) **TRUNG TÂM NHIỆT ĐỐI VIỆT – NGA (VN)**
Số 63 Nguyễn Văn Huyền, phường Nghĩa Đô, quận Cầu Giấy, thành phố Hà Nội
(72) Đặng Thị Hồng Phương (VN)
(74) Công ty Luật TNHH Việt An (VIET AN LAW FIRM)
(55)



1.1



1.2



1.3



1.4



1.5



1.6

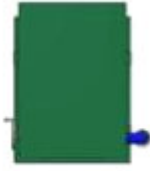

1.7

CÔNG BÁO SỞ HỮU CÔNG NGHIỆP SỐ 403 TẬP A – QUYỀN 2 (10.2021)

- (11) **42747**
(21) 3-2021-01371 (28) 1
(54) **TÚI ĐỰNG KHẨU TRANG** (51) **09-05**
(22) 25/05/2021 (43) 25/10/2021
(73) **CÔNG TY TNHH ALKA GLUTA VIETNAM (VN)**
440/13/69 Thống Nhất, phường 16, quận Gò Vấp, thành phố Hồ Chí Minh
(72) **NGÔ THỊ THANH HUYỀN (VN)**
(74) Công ty Cổ phần Sở hữu trí tuệ Việt Mỹ (VIET MY IPC)
(55)



1.1



1.2

CÔNG BÁO SỞ HỮU CÔNG NGHIỆP SỐ 403 TẬP A – QUYỀN 2 (10.2021)

- (11) **42748**
(21) 3-2021-01378 (28) 1
(54) **GIÀY** (51) **02-04**
(22) 26/05/2021 (43) 25/10/2021
(30) 008302152-0003 02/12/2020 EM;
(73) **DECATHLON (FR)**
4, Boulevard de Mons, F-59650 Villeneuve d'Ascq, France
(72) Pierre DUQUENOY (FR)
(74) Công ty Luật TNHH T&G (TGVN)
(55)



1.1



1.2



1.3



1.4



1.5



1.6



1.7

- (11) **42749**
(21) 3-2021-01396 (28) 1
(54) **MÁY LỌC KHÔNG KHÍ** (51) **23-04**
(22) 31/05/2021 (43) 25/10/2021
(30) 30-2020-0058768 01/12/2020 KR;
(73) **COWAY CO., LTD.** (KR)
136-23, Yugumagoksa-ro, Yugu-eup, Gongju-si, Choongcheongnam-do, Korea
(72) 1. JEON, JUNGJAE (KR)
2. PARK, EUNG KYU (KR)
3. KIM, GA HEE (KR)
4. SHIN, SUMIN (KR)
(74) Công ty TNHH Tư vấn ALIATLEGAL (ALIAT LEGAL)
(55)



1.1



1.2



1.3



1.4



1.5

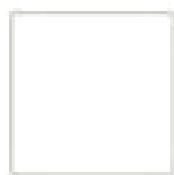

1.6

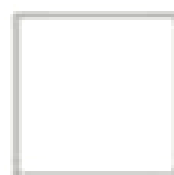

1.7

CÔNG BÁO SỞ HỮU CÔNG NGHIỆP SỐ 403 TẬP A – QUYỀN 2 (10.2021)

(11) **42750**

(21) 3-2021-01452

(28) 1

(54) **GIÁ TREO MẮC ÁO**

(51) **06-06**

(22) 04/06/2021

(43) 25/10/2021

(73) **LÂM TẤN LỢI (VN)**

42 đường 332, Phạm Hùng, phường 5, quận 8, thành phố Hồ Chí Minh

(72) Lâm Tấn Lợi (VN)

(74) Công ty TNHH Sở hữu trí tuệ INVENTIO (INVENTIO CO.,LTD)

(55)



1.1

1.2

1.3

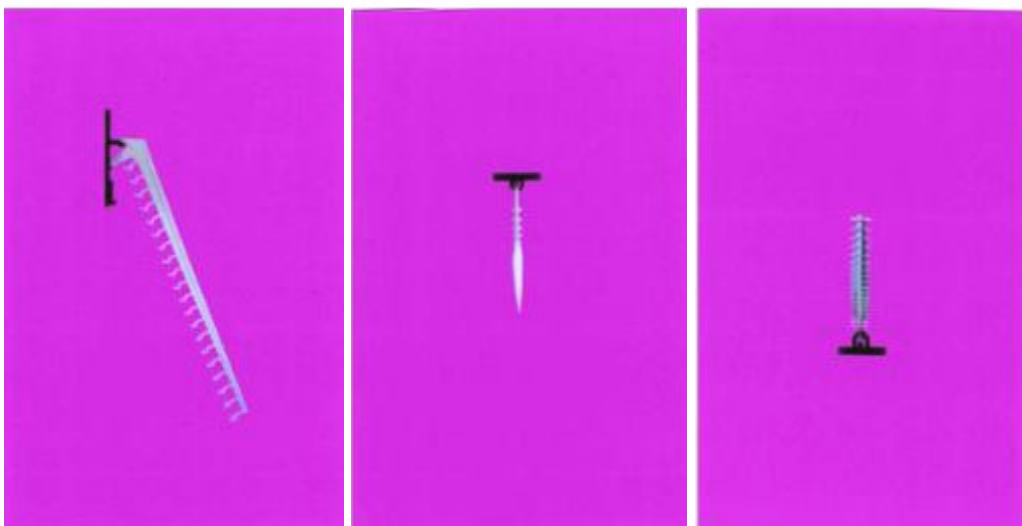

1.4

1.5

1.6

- (11) **42751**
(21) 3-2021-01486 (28) 1
(54) **HỘP** (51) **09-03**
(22) 08/06/2021 (43) 25/10/2021
(73) **CÔNG TY TNHH SẢN XUẤT THƯƠNG MẠI DỊCH VỤ TÂN TUỜNG KHANG (VN)**
Lô F1 & F2, đường D2 và N5, khu công nghiệp Nam Tân Uyên, phường Khánh Bình, thị xã Tân Uyên, tỉnh Bình Dương
(72) Nìm Dùng Chiếng (VN)
(74) Văn phòng Luật sư D và T (D & T LAW OFFICE)
(55)



1.1



1.2



1.3



1.4



1.5



1.6



1.7



1.8

- (11) **42752**
(21) 3-2021-01481 (28) 1
(54) **CHI TIẾT GẮN KHUNG ĐỖ** (51) **08-08**
(22) 08/06/2021 (43) 25/10/2021
(30) 30-2021-0022096 07/05/2021 KR;
(73) **SEUNG JIN IND. CO., LTD. (KR)**
Sihwa Industrial Complex 5 Ba 612 (Seonggok-dong), 9, Cheomdan-ro
181beonan-gil, Danwon-gu, Ansan-si, Gyeonggi-do 15619 Republic of Korea
(72) JUNG, Woon Taek (KR)
(74) Công ty Cổ phần Sở hữu công nghiệp INVESTIP (INVESTIP)
(55)

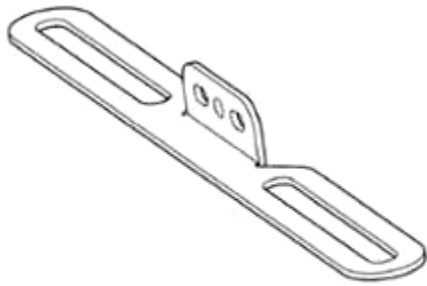

1.1



1.2



1.3



1.4



1.5



1.6



1.7

CÔNG BÁO SỞ HỮU CÔNG NGHIỆP SỐ 403 TẬP A – QUYỀN 2 (10.2021)

(11) **42753**

(21) 3-2021-01518

(28) 1

(54) **TỦ LẠNH**

(51) **15-07**

(22) 11/06/2021

(43) 25/10/2021

(73) **CÔNG TY TNHH PANASONIC APPLIANCES VIỆT NAM (VN)**

Lô B6, khu công nghiệp Thăng Long, xã Võng La, huyện Đông Anh, thành phố Hà Nội

(72) 1. ELIE LEE LE QUN (MY)

2. KENTARO TOKURIKI (JP)

3. TAN CHIEN SHIUNG (MY)

(74) Công ty TNHH Sở hữu trí tuệ HA VIP (HAVIP CO., LTD.)

(55)

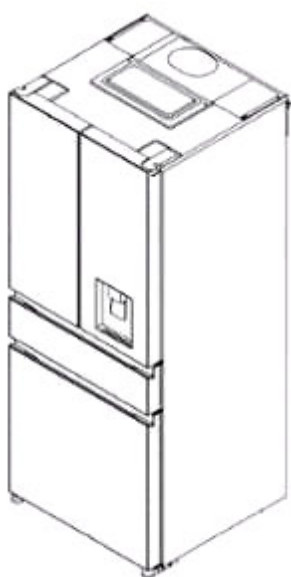

1.1

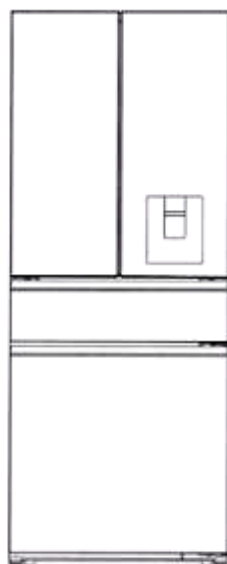

1.2



1.3

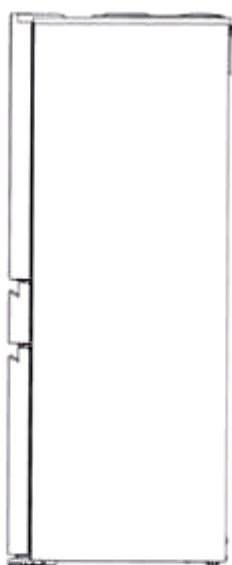

1.4

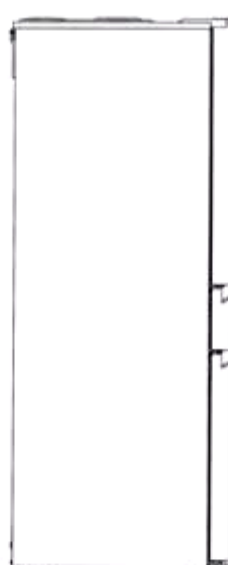

1.5

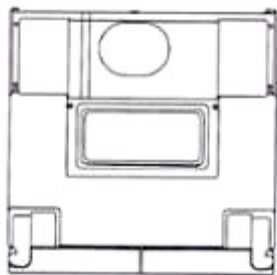

1.6

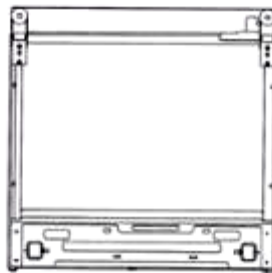

1.7

CÔNG BÁO SỞ HỮU CÔNG NGHIỆP SỐ 403 TẬP A – QUYỀN 2 (10.2021)

(11) **42754**

(21) 3-2021-01530

(28) 1

(54) **BỒN CẦU**

(51) **23-02**

(22) 14/06/2021

(43) 25/10/2021

(73) **CÔNG TY CỔ PHẦN THƯƠNG MẠI VIGLACERA (VN)**

Tầng 1, tòa nhà Viglacera, số 1 Đại lộ Thăng Long, phường Mỹ Trì, quận Nam Từ Liêm, thành phố Hà Nội

(72) Phạm Ngọc Đường (VN)

(55)



1.1



1.2



1.3



1.4



1.5



1.6

CÔNG BÁO SỞ HỮU CÔNG NGHIỆP SỐ 403 TẬP A – QUYỀN 2 (10.2021)

(11) **42755**

(21) 3-2021-01531

(28) 1

(54) **BỒN CẦU**

(51) **23-02**

(22) 14/06/2021

(43) 25/10/2021

(73) **CÔNG TY CỔ PHẦN THƯƠNG MẠI VIGLACERA (VN)**

Tầng 1, tòa nhà Viglacera, số 1 Đại lộ Thăng Long, phường Mỹ Trì, quận Nam Từ Liêm, thành phố Hà Nội

(72) Phạm Ngọc Đường (VN)

(55)



1.1



1.2



1.3



1.4



1.5



1.6

CÔNG BÁO SỞ HỮU CÔNG NGHIỆP SỐ 403 TẬP A – QUYỀN 2 (10.2021)

(11) **42756**

(21) 3-2021-01532

(28) 1

(54) **BỒN CẦU**

(51) **23-02**

(22) 14/06/2021

(43) 25/10/2021

(73) **CÔNG TY CỔ PHẦN THƯƠNG MẠI VIGLACERA (VN)**

Tầng 1, tòa nhà Viglacera, số 1 Đại lộ Thăng Long, phường Mỹ Trì, quận Nam Từ Liêm, thành phố Hà Nội

(72) Hoàng Thạch Nam (VN)

(55)



1.1



1.2



1.3



1.4



1.5



1.6

CÔNG BÁO SỞ HỮU CÔNG NGHIỆP SỐ 403 TẬP A – QUYỀN 2 (10.2021)

(11) **42757**

(21) 3-2021-01533

(28) 1

(54) **BỒN CẦU**

(51) **23-02**

(22) 14/06/2021

(43) 25/10/2021

(73) **CÔNG TY CỔ PHẦN THƯƠNG MẠI VIGLACERA (VN)**

Tầng 1, tòa nhà Viglacera, số 1 Đại lộ Thăng Long, phường Mỹ Trì, quận Nam Từ Liêm, thành phố Hà Nội

(72) Phạm Tiến Đạt (VN)

(55)



1.1



1.2



1.3



1.4



1.5



1.6

CÔNG BÁO SỞ HỮU CÔNG NGHIỆP SỐ 403 TẬP A – QUYỀN 2 (10.2021)

- (11) **42758**
(21) 3-2021-01534 (28) 1
(54) **BỒN CẦU** (51) **23-02**
(22) 14/06/2021 (43) 25/10/2021
(73) **CÔNG TY CỔ PHẦN THƯƠNG MẠI VIGLACERA (VN)**
Tầng 1, tòa nhà Viglacera, số 1 Đại lộ Thăng Long, phường Mỹ Trì, quận Nam Từ Liêm, thành phố Hà Nội
(72) Phạm Ngọc Đường (VN)
(55)



1.1



1.2



1.3



1.4



1.5



1.6

CÔNG BÁO SỞ HỮU CÔNG NGHIỆP SỐ 403 TẬP A – QUYỀN 2 (10.2021)

(11) **42759**

(21) 3-2021-01535

(28) 1

(54) **BỒN CẦU**

(51) **23-02**

(22) 14/06/2021

(43) 25/10/2021

(73) **CÔNG TY CỔ PHẦN THƯƠNG MẠI VIGLACERA (VN)**

Tầng 1, tòa nhà Viglacera, số 1 Đại lộ Thăng Long, phường Mỹ Trì, quận Nam Từ Liêm, thành phố Hà Nội

(72) Phạm Tiến Đạt (VN)

(55)



1.1



1.2

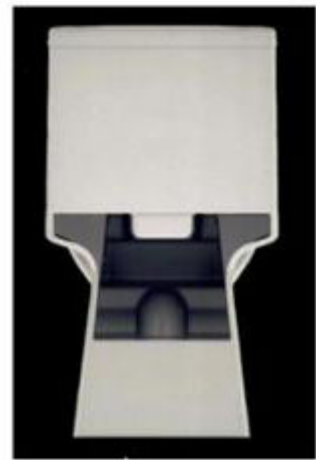

1.3



1.4



1.5



1.6

CÔNG BÁO SỞ HỮU CÔNG NGHIỆP SỐ 403 TẬP A – QUYỀN 2 (10.2021)

(11) **42760**

(21) 3-2021-01536

(28) 1

(54) **BỒN CẦU**

(51) **23-02**

(22) 14/06/2021

(43) 25/10/2021

(73) **CÔNG TY CỔ PHẦN THƯƠNG MẠI VIGLACERA (VN)**

Tầng 1, tòa nhà Viglacera, số 1 Đại lộ Thăng Long, phường Mỹ Trì, quận Nam Từ Liêm, thành phố Hà Nội

(72) Phạm Ngọc Đường (VN)

(55)



1.1



1.2



1.3



1.4



1.5



1.6

CÔNG BÁO SỞ HỮU CÔNG NGHIỆP SỐ 403 TẬP A – QUYỀN 2 (10.2021)

(11) **42761**

(21) 3-2021-01538

(28) 1

(54) **CHẬU RỬA**

(51) **23-02**

(22) 14/06/2021

(43) 25/10/2021

(73) **CÔNG TY CỔ PHẦN THƯƠNG MẠI VIGLACERA (VN)**

Tầng 1, tòa nhà Viglacera, số 1 Đại lộ Thăng Long, phường Mễ Trì, quận Nam Từ Liêm, thành phố Hà Nội

(72) Phạm Ngọc Đường (VN)

(55)



1.1

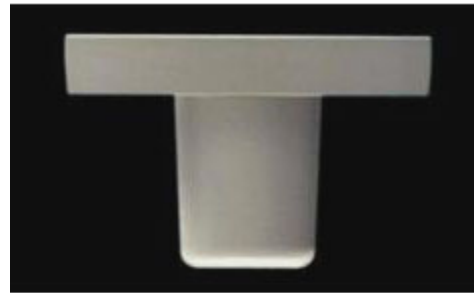

1.2



1.3



1.4



1.5

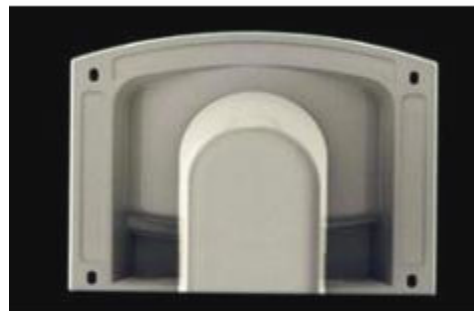

1.6

CÔNG BÁO SỞ HỮU CÔNG NGHIỆP SỐ 403 TẬP A – QUYỀN 2 (10.2021)

(11) **42762**

(21) 3-2021-01539

(28) 1

(54) **CHẬU RỬA**

(51) **23-02**

(22) 14/06/2021

(43) 25/10/2021

(73) **CÔNG TY CỔ PHẦN THƯƠNG MẠI VIGLACERA (VN)**

Tầng 1, tòa nhà Viglacera, số 1 Đại lộ Thăng Long, phường Mễ Trì, quận Nam Từ Liêm, thành phố Hà Nội

(72) Phạm Ngọc Đường (VN)

(55)



1.1



1.2



1.3



1.4



1.5

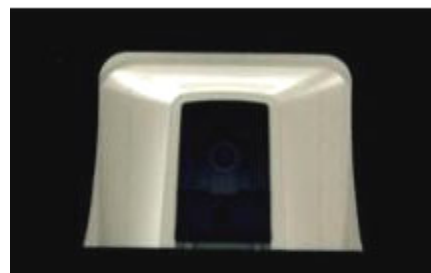

1.6

CÔNG BÁO SỞ HỮU CÔNG NGHIỆP SỐ 403 TẬP A – QUYỀN 2 (10.2021)

(11) **42763**

(21) 3-2021-01540

(28) 1

(54) **CHẬU RỬA**

(51) **23-02**

(22) 14/06/2021

(43) 25/10/2021

(73) **CÔNG TY CỔ PHẦN THƯƠNG MẠI VIGLACERA (VN)**

Tầng 1, tòa nhà Viglacera, số 1 Đại lộ Thăng Long, phường Mỹ Trì, quận Nam Từ Liêm, thành phố Hà Nội

(72) Phạm Ngọc Đường (VN)

(55)



1.1



1.2



1.3



1.4



1.5

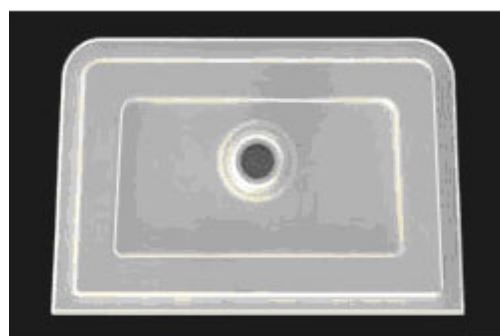

1.6

CÔNG BÁO SỞ HỮU CÔNG NGHIỆP SỐ 403 TẬP A – QUYỀN 2 (10.2021)

(11) **42764**

(21) 3-2021-01541

(28) 1

(54) **CHẬU RỬA**

(51) **23-02**

(22) 14/06/2021

(43) 25/10/2021

(73) **CÔNG TY CỔ PHẦN THƯƠNG MẠI VIGLACERA (VN)**

Tầng 1, tòa nhà Viglacera, số 1 Đại lộ Thăng Long, phường Mỹ Trì, quận Nam Từ Liêm, thành phố Hà Nội

(72) Phạm Ngọc Đường (VN)

(55)



1.1

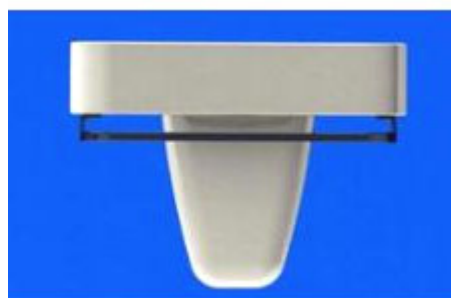

1.2

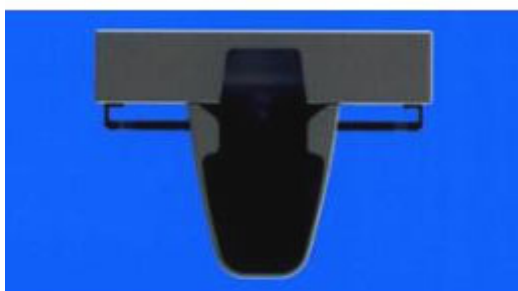

1.3



1.4



1.5



1.6

CÔNG BÁO SỞ HỮU CÔNG NGHIỆP SỐ 403 TẬP A – QUYỀN 2 (10.2021)

(11) **42765**

(21) 3-2021-01543

(28) 1

(54) **BỒN CẦU**

(51) **23-02**

(22) 14/06/2021

(43) 25/10/2021

(73) **CÔNG TY CỔ PHẦN THƯƠNG MẠI VIGLACERA (VN)**

Tầng 1, tòa nhà Viglacera, số 1 Đại lộ Thăng Long, phường Mỹ Trì, quận Nam Từ Liêm, thành phố Hà Nội

(72) Phạm Ngọc Đường (VN)

(55)



1.1



1.2



1.3



1.4



1.5



1.6

CÔNG BÁO SỞ HỮU CÔNG NGHIỆP SỐ 403 TẬP A – QUYỀN 2 (10.2021)

- (11) **42766**
(21) 3-2021-01544 (28) 1
(54) **BỒN CẦU** (51) **23-02**
(22) 14/06/2021 (43) 25/10/2021
(73) **CÔNG TY CỔ PHẦN THƯƠNG MẠI VIGLACERA (VN)**
Tầng 1, tòa nhà Viglacera, số 1 Đại lộ Thăng Long, phường Mỹ Trì, quận Nam Từ Liêm, thành phố Hà Nội
(72) Phạm Ngọc Đường (VN)
(55)



1.1



1.2



1.3



1.4



1.5



1.6

- (11) **42767**
(21) 3-2021-01562
(54) **ĐIỀU THUỐC LÁ ĐIỆN TỬ**
(22) 15/06/2021
(30) 30-2020-0062626 16/12/2020 KR;
(73) **KT & G CORPORATION (KR)**
71, Beotkkot-gil, Daedeok-gu, Daejeon, Korea
(72) 1. SONG, HO JIN (KR)
2. KIM, MIN CHUL (KR)
3. SHIN, SU MI (KR)
(74) Công ty TNHH T&T INVENMARK Sở hữu trí tuệ Quốc tế (T&T INVENMARK CO., LTD.)
(55)



1.1

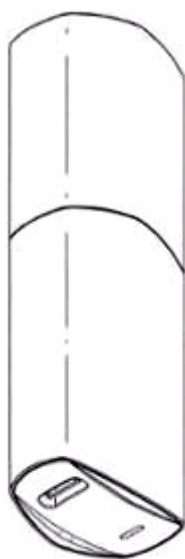

1.2



1.3



1.4

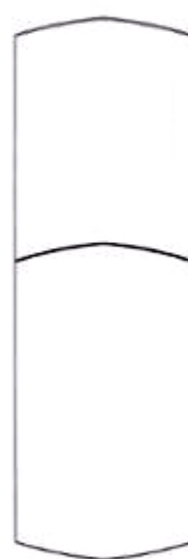

1.5



1.6



1.7



1.8

- (11) **42768**
(21) 3-2021-01549 (28) 2
(54) **BÀN CHẢI** (51) **04-02**
(22) 15/06/2021 (43) 25/10/2021
(30) 008450456-0002 04/03/2021 EM; 008450456-0001 04/03/2021 EM;
(73) **UNILEVER GLOBAL IP LIMITED (GB)**
Port Sunlight Wirral, Merseyside CH62 4ZD, United Kingdom
(72) ZHOU Heting (CN)
(74) Công ty TNHH Trần Hữu Nam và Đồng sự (TRAN H.N & ASS.)
(55)

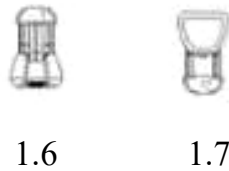



2.1



2.2



2.3



2.4



2.5



2.6



2.7

CÔNG BÁO SỞ HỮU CÔNG NGHIỆP SỐ 403 TẬP A – QUYỀN 2 (10.2021)

- (11) **42769**
(21) 3-2021-01550 (28) 4
(54) **BÀN CHẢI** (51) **04-02**
(22) 15/06/2021 (43) 25/10/2021
(30) 008451306-0001 04/03/2021 EM; 008451306-0004 04/03/2021 EM; 008451306-0003 04/03/2021 EM; 008451306-0002 04/03/2021 EM;
(73) **UNILEVER GLOBAL IP LIMITED (GB)**
Port Sunlight Wirral, Merseyside CH62 4ZD, United Kingdom
(72) 1. SHENG SAIHONG (CN)
2. TANG SHIH LING CRISTINA (TW)
3. ZHOU HETING (CN)
(74) Công ty TNHH Trần Hữu Nam và Đồng sự (TRAN H.N & ASS.)
(55)



1.1



1.2



1.3



1.4



1.5



1.6



1.7



2.1



2.2



2.3



2.4



2.5



2.6



2.7



3.1



3.2



3.3



3.4



3.5



3.6



3.7



4.1



4.2



4.3



4.4



4.5



4.6



4.7

CÔNG BÁO SỞ HỮU CÔNG NGHIỆP SỐ 403 TẬP A – QUYỀN 2 (10.2021)

- (11) **42770**
(21) 3-2021-01576 (28) 1
(54) **CHAI** (51) **09-01**
(22) 17/06/2021 (43) 25/10/2021
(73) **CÔNG TY TNHH GBS QUỐC TẾ (VN)**
Số 28, ngõ 157, phố Chùa Láng, phường Láng Thượng, quận Đống Đa, thành phố Hà Nội
(72) Hồ Quang Khôi (VN)
(74) Công ty TNHH tư vấn HDS (HDS ADVISORY CO.,LTD.)
(55)



1.1

1.2

1.3

1.4



1.5



1.6



1.7

- (11) **42771**
(21) 3-2021-01577 (28) 1
(54) **MÁY SÀNG RUNG CONG** (51) **15-99**
(22) 17/06/2021 (43) 25/10/2021
(73) **CÔNG TY CỔ PHẦN CƠ KHÍ MẠO KHÊ - VINACOMIN (VN)**
Khu Quang Trung, phường Mạo Khê, thị xã Đông Triều, tỉnh Quảng Ninh
(72) 1. NGUYỄN HẢI LONG (VN)
2. ĐẶNG VĂN PHỐI (VN)
3. VƯƠNG QUỐC HÀ (VN)
(74) Công ty TNHH Sở hữu trí tuệ VIPATCO (VIPATCO CO., LTD.)
(55)



1.1

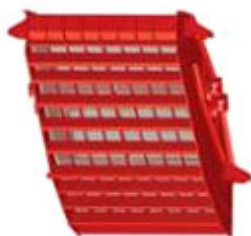

1.2



1.3



1.4



1.5



1.6

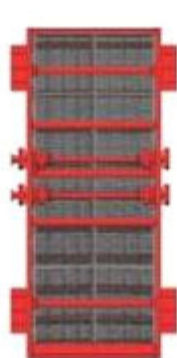

1.7

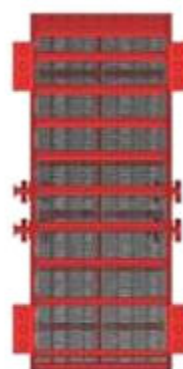

1.8

CÔNG BÁO SỞ HỮU CÔNG NGHIỆP SỐ 403 TẬP A – QUYỀN 2 (10.2021)

- (11) 42772
(21) 3-2021-01590 (28) 1
(54) BAO GÓI (51) 09-05
(22) 18/06/2021 (43) 25/10/2021
(73) CÔNG TY TNHH XUẤT NHẬP KHẨU PHÂN BÓN TRƯỜNG PHÁT - USA (VN)
50/3B Quốc Lộ 1A, ấp Nam Lân, xã Bà Điểm, huyện Hóc Môn, thành phố Hồ Chí Minh
(72) Phạm Văn Chinh (VN)
(74) Công ty TNHH một thành viên Trường Luật (Trường Luật)
(55)



1.1



1.2

CÔNG BÁO SỞ HỮU CÔNG NGHIỆP SỐ 403 TẬP A – QUYỀN 2 (10.2021)

- (11) **42773**
- (21) 3-2021-01591 (28) 1
- (54) **NHÃN SẢN PHẨM** (51) **19-08**
- (22) 18/06/2021 (43) 25/10/2021
- (73) **CÔNG TY TNHH XUẤT NHẬP KHẨU PHÂN BÓN TRƯỜNG PHÁT - USA**
(VN)
50/3B Quốc lộ 1A, ấp Nam Lân, xã Bà Điểm, huyện Hóc Môn, thành phố Hồ Chí Minh
- (72) Phạm Văn Chinh (VN)
- (74) Công ty TNHH một thành viên Trường Luật (Trường Luật)
- (55)



- (11) 42774
(21) 3-2021-01580
(54) **MÁY LỌC NƯỚC**
(22) 18/06/2021
(73) **CÔNG TY CỔ PHẦN CÔNG NGHỆ MÔI TRƯỜNG SYL (VN)**
Số 51 ngõ 221 Tôn Đức Thắng, phường Hàng Bột, quận Đống Đa, thành phố Hà Nội
(72) Trần Vũ Thành (VN)
(55)
- (28) 1
(51) **23-01**
(43) 25/10/2021

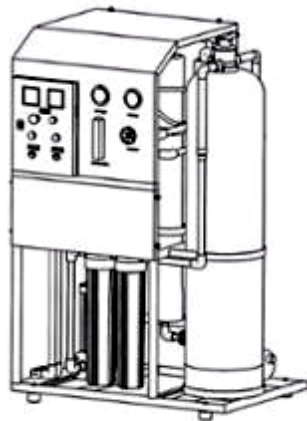

1.1

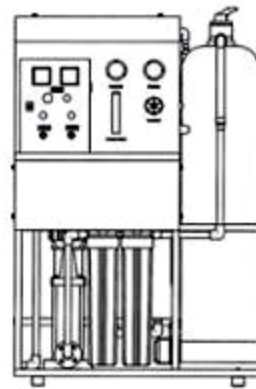

1.2

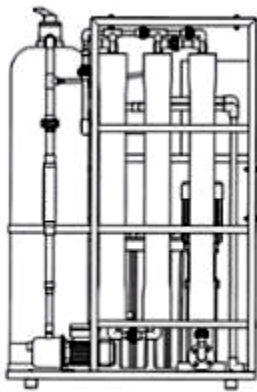

1.3

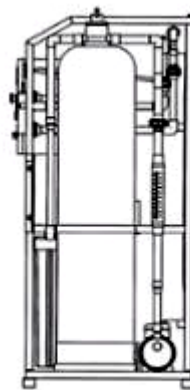

1.4

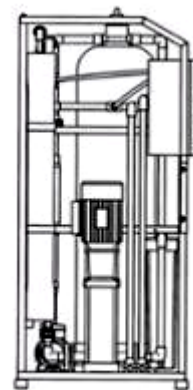

1.5

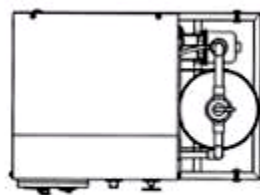

1.6

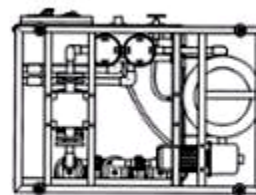

1.7

(11) **42775**

(21) 3-2021-01581

(54) **MÁY LỌC NƯỚC**

(22) 18/06/2021

(73) **CÔNG TY CỔ PHẦN CÔNG NGHỆ MÔI TRƯỜNG SYL (VN)**

Số 51 ngõ 221 Tôn Đức Thắng, phường Hàng Bột, quận Đống Đa, thành phố Hà Nội

(72) Trần Vũ Thành (VN)

(55)

(28) 1

(51) **23-01**

(43) 25/10/2021

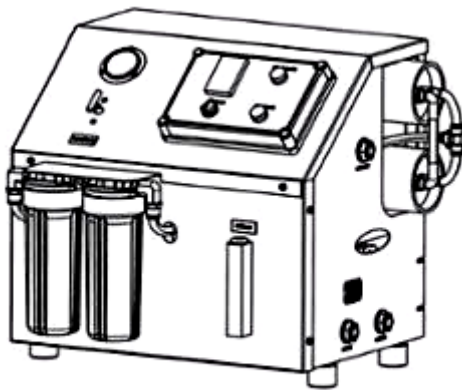

1.1

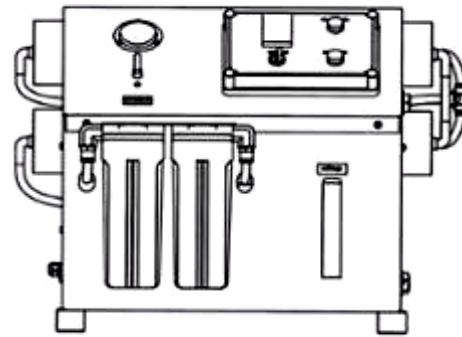

1.2

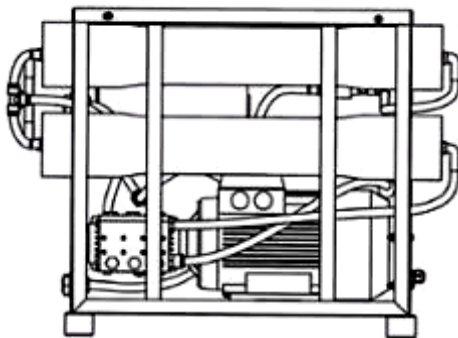

1.3

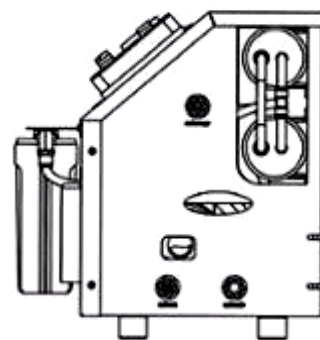

1.4

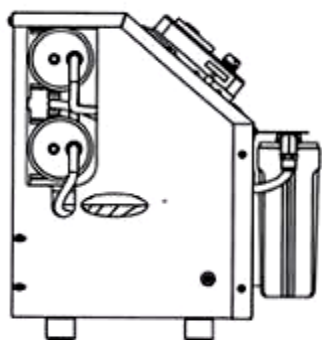

1.5

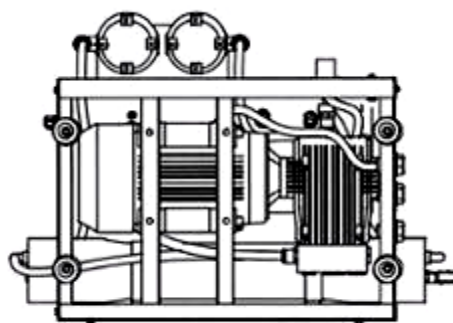

1.6

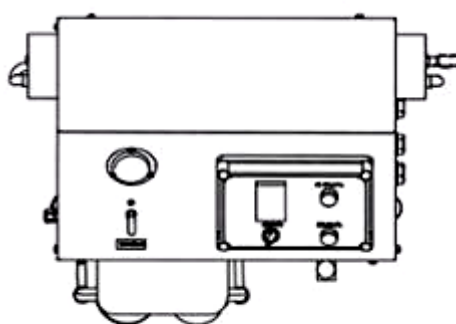

1.7

(11) **42776**

(21) 3-2021-01582

(54) **MÁY LỌC NƯỚC**

(22) 18/06/2021

(73) **CÔNG TY CỔ PHẦN CÔNG NGHỆ MÔI TRƯỜNG SYL (VN)**

Số 51 ngõ 221 Tôn Đức Thắng, phường Hàng Bột, quận Đống Đa, thành phố Hà Nội

(72) Trần Vũ Thành (VN)

(55)

(28) 1

(51) **23-01**

(43) 25/10/2021

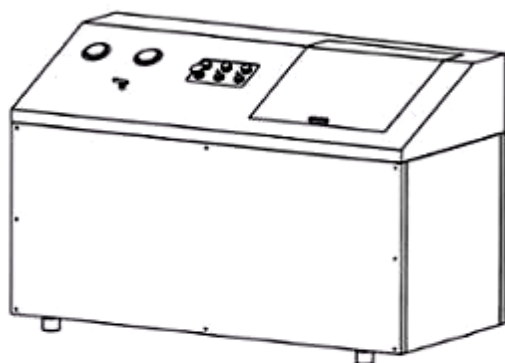

1.1

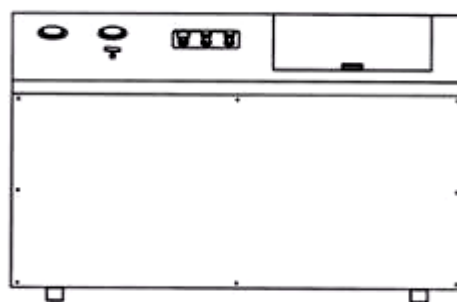

1.2

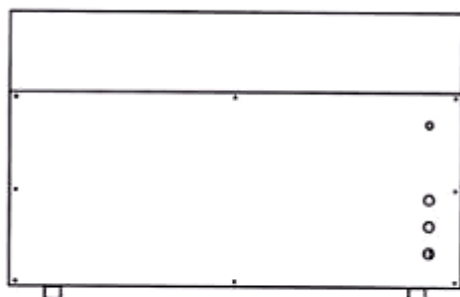

1.3

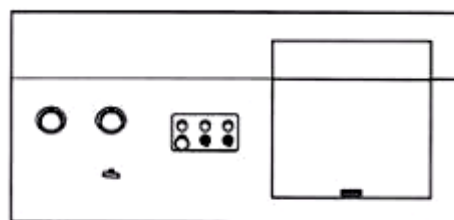

1.4

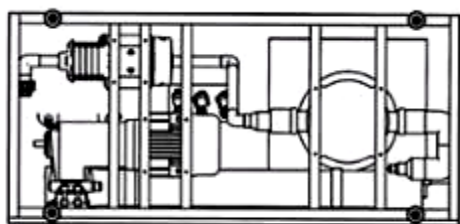

1.5

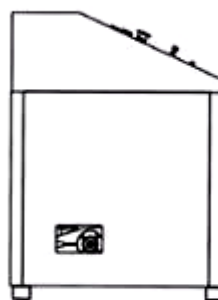

1.6

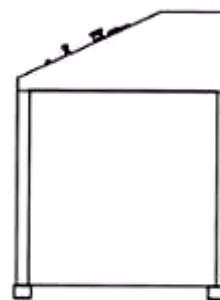

1.7

(11) **42777**

(21) 3-2021-01620

(28) 1

(54) **KÉO**

(51) **08-03**

(22) 21/06/2021

(43) 25/10/2021

(73) **CHEN FEIHONG (CN)**

No.39, Lane 2, Huanhu East Road, Jiangcheng District, Yangjiang, Guangdong, China

(72) CHEN Feihong (CN)

(74) **CÔNG TY TRÁCH NHIỆM HỮU HẠN TƯ VẤN ĐẦU TƯ VÀ SỞ HỮU TRÍ TUỆ INTERFIVE (INTERFIVE CO., LTD)**

(55)



H1



H2



H3



H4



H5



H6



H7

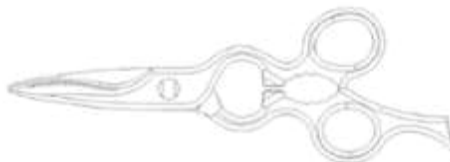

H8

- (11) 42778
(21) 3-2021-01622 (28) 1
(54) **GIÁ ĐỖ KÍNH CHẮN GIÓ XE MÁY** (51) 12-16
(22) 21/06/2021 (43) 25/10/2021
(73) **CÔNG TY TNHH SẢN XUẤT - THƯƠNG MẠI - DỊCH VỤ ĐÀI PHONG**
(VN)
Số 4, đường số 3B, phường An Lạc A, quận Bình Tân, thành phố Hồ Chí Minh
(72) HÀ QUẢNG CHÁNH (VN)
(74) Công ty Cổ phần PHANLAW VIETNAM (PHANLAW VIETNAM JSC)
(55)



1.1

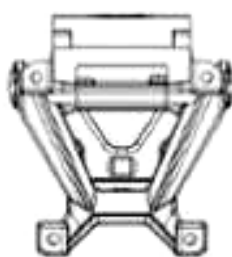

1.2

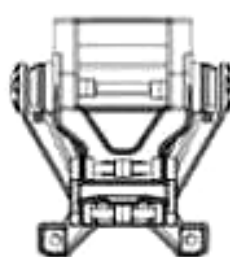

1.3

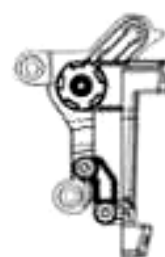

1.4

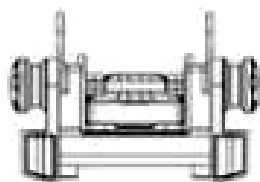

1.5

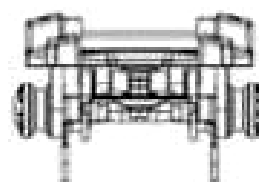

1.6

- (11) **42779**
(21) 3-2021-01623 (28) 1
(54) **DỤNG CỤ THU GOM MẪU NƯỚC BỌT** (51) **24-02**
(22) 21/06/2021 (43) 25/10/2021
(30) 29/763,663 23/12/2020 US;
(73) **LIFE TECHNOLOGIES CORPORATION (US)**
5823 Newton Drive, Carlsbad, CA 92008, United States of America
(72) 1. SYRUS JAFFE (US)
2. ANGIE CHENG (US)
3. SCOTT MICHELHAUGH (US)
(74) Công ty TNHH Tầm nhìn và Liên danh (VISION & ASSOCIATES CO.LTD.)
(55)

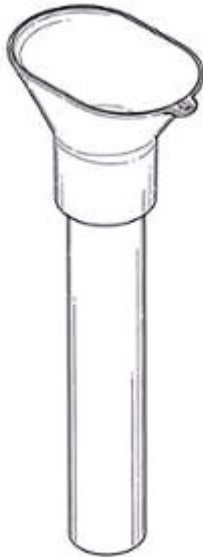

1.1



1.2



1.3

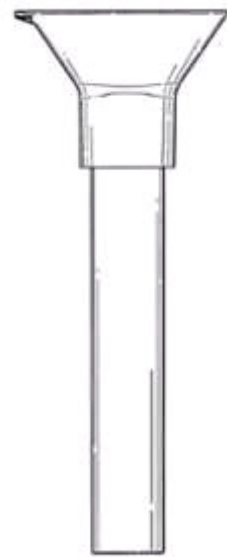

1.4



1.5



1.6

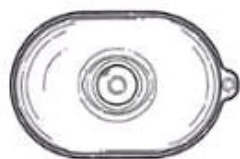

1.7



1.8



1.9

- (11) **42780**
(21) 3-2021-01624 (28) 1
(54) **KÍNH CHẮN GIÓ XE MÁY** (51) **12-16**
(22) 21/06/2021 (43) 25/10/2021
(73) **CÔNG TY TNHH SẢN XUẤT - THƯƠNG MẠI - DỊCH VỤ ĐÀI PHONG (VN)**
Số 4, đường số 3B, phường An Lạc A, quận Bình Tân, thành phố Hồ Chí Minh
(72) **HÀ QUẢNG CHÁNH (VN)**
(74) Công ty Cổ phần PHANLAW VIETNAM (PHANLAW VIETNAM JSC)
(55)

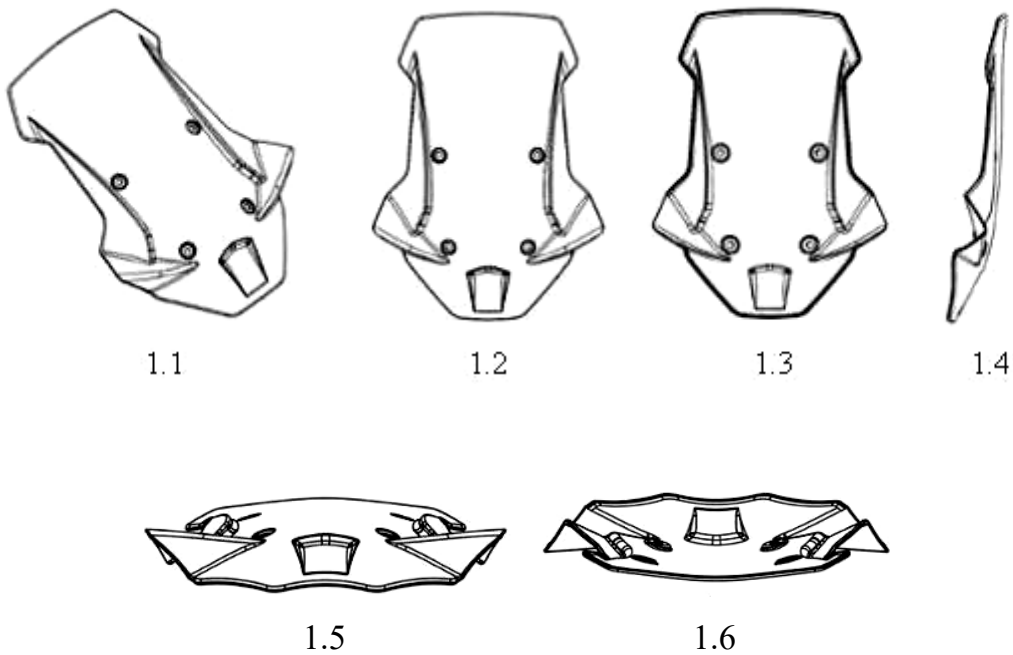

- (11) **42781**
(21) 3-2021-01634 (28) 1
(54) **TAI NGHE** (51) **14-01**
(22) 23/06/2021 (43) 25/10/2021
(30) 29/763,656 23/12/2020 US;
(73) **APPLE INC. (US)**
One Apple Park Way, Cupertino, California 95014, United States of America
(72) 1. RYAN OTT (US)
2. ROBERT BOYD (US)
3. DUY P. LE (US)
4. JEFFREY SCOTT CROYLE (US)
5. MATTHEW PHILLIP CASEBOLT (US)
6. MATTHEW VINCENT COSTELLO (US)
7. JAMES SWASEY (US)
8. GUILLAUME RAOULT (FR)
9. CHRISTOPHER KUH (DE)
10. ROBERT BRUNNER (US)
(74) Công ty TNHH Lê & Lê (LE & LE)
(55)

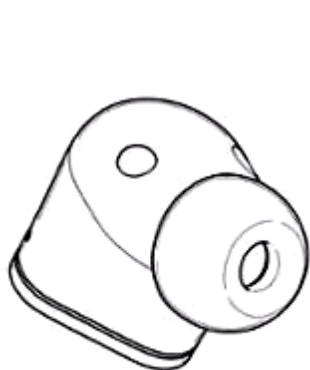

1.1



1.2

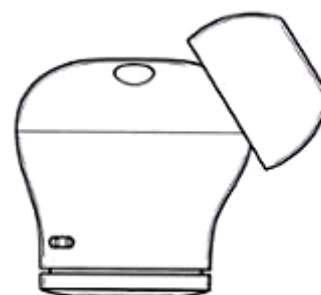

1.3

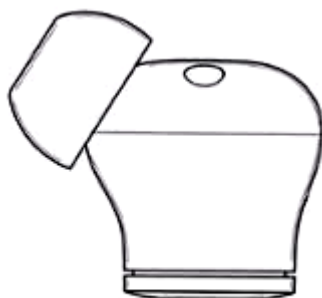

1.4



1.5



1.6

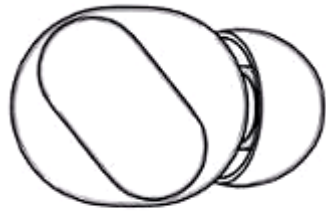

1.7

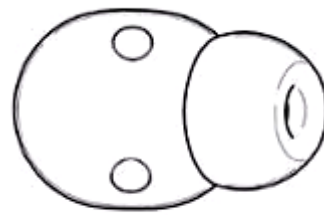

1.8

- (11) **42782**
- (21) 3-2021-01635 (28) 1
- (54) **HỘP ĐỰNG** (51) **03-01**
- (22) 23/06/2021 (43) 25/10/2021
- (30) 29/763,657 23/12/2020 US;
- (73) **APPLE INC. (US)**
One Apple Park Way, Cupertino, California 95014, United States of America
- (72) 1. KJELL FERDINAND EKMAN (US)
2. CHRISTINA J. SMIECHOWSKI (US)
3. DUY P. LE (US)
4. JEFFREY SCOTT CROYLE (US)
5. MATTHEW PHILLIP CASEBOLT (US)
6. MATTHEW VINCENT COSTELLO (US)
7. RYAN OTT (US)
8. ROBERT BOYD (US)
9. JAMES SWASEY (US)
10. GUILLAUME RAOULT (FR)
11. CHRISTOPHER KUH (DE)
12. ROBERT BRUNNER (US)
- (74) Công ty TNHH Lê & Lê (LE & LE)
- (55)



1.1

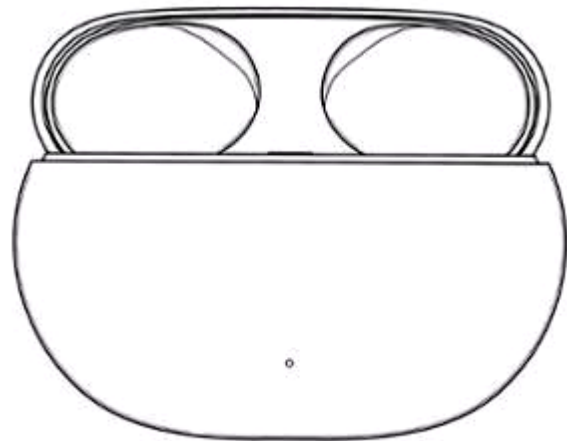

1.2

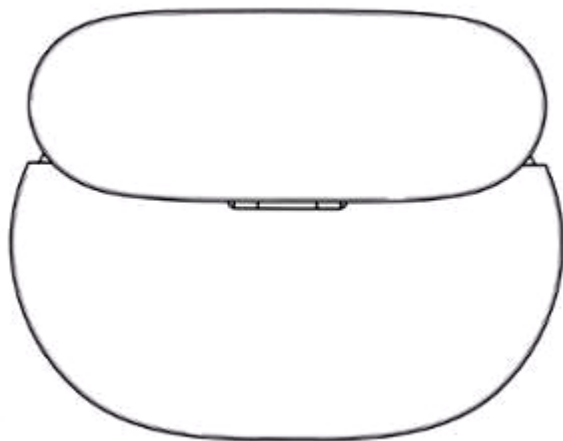

1.3

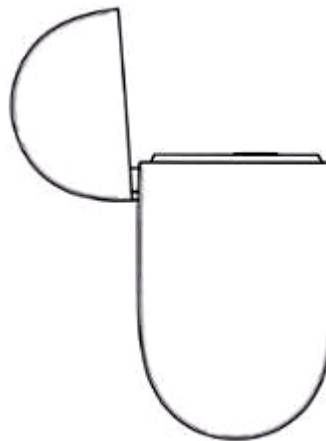

1.4

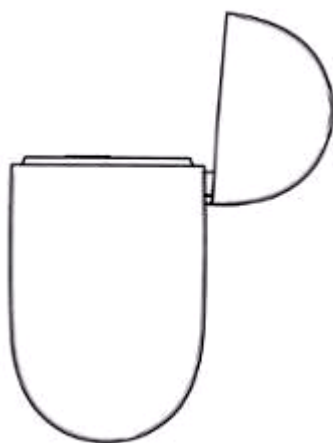

1.5

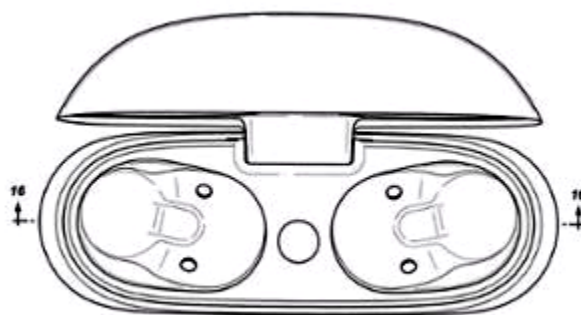

1.6

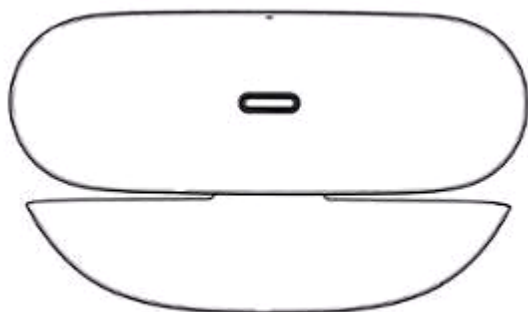

1.7

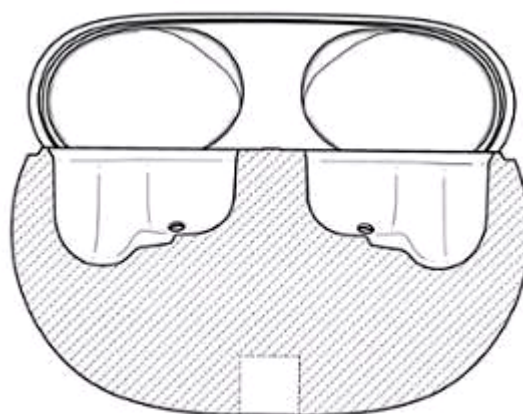

1.8

CÔNG BÁO SỞ HỮU CÔNG NGHIỆP SỐ 403 TẬP A – QUYỀN 2 (10.2021)

- (11) **42783**
(21) 3-2021-01637 (28) 1
(54) **KHÓA KẾT ĐIỆN TỬ** (51) **08-07**
(22) 23/06/2021 (43) 25/10/2021
(73) **NGUYỄN HUY CÔNG (VN)**
Thôn Hợp Nhất, Dương Liễu, huyện Hoài Đức, thành phố Hà Nội
(72) Nguyễn Huy Công (VN)
(74) Công ty Luật TNHH Phượng Hoàng (PHOENIX LAW)
(55)



1.1

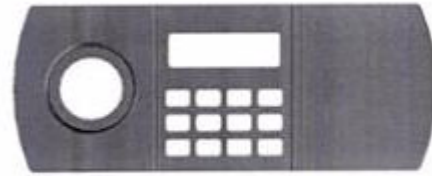

1.2



1.3



1.4



1.5



1.6



1.7

CÔNG BÁO SỞ HỮU CÔNG NGHIỆP SỐ 403 TẬP A – QUYỀN 2 (10.2021)

- (11) **42784**
(21) 3-2021-01662 (28) 1
(54) **THIẾT BỊ TRỊ LIỆU BÀN CHÂN** (51) **24-01**
(22) 24/06/2021 (43) 25/10/2021
(73) **FUTUREVITA HEATH GROUP LIMITED (US)**
Suite 700, Office 40, 90 State Street, Albany, New York, U.S.A
(72) ANLIN HE (US)
(74) Công ty TNHH Sở hữu trí tuệ VIPATCO (VIPATCO CO., LTD.)
(55)



1.1



1.2



1.3



1.4



1.5



1.6



1.7

CÔNG BÁO SỞ HỮU CÔNG NGHIỆP SỐ 403 TẬP A – QUYỀN 2 (10.2021)

- (11) 42785
(21) 3-2021-01812
(54) **BỘ LIÊN LẠC HỮU TUYẾN HÀM LÒ**
(22) 12/07/2021
(73) **CÔNG TY TNHH MTV PHÁT TRIỂN CÔNG NGHỆ ĐIỆN TỬ, TỰ ĐỘNG HÓA (VN)**
156A đường Quán Thánh, phường Quán Thánh, quận Ba Đình, thành phố Hà Nội
(72) Nguyễn Xuân Đồng (VN)
(55)
- (28) 1
(51) 14-03
(43) 25/10/2021



1.1



1.2



1.3



1.5



1.4

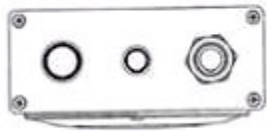

1.6

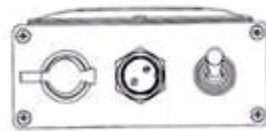

1.7

CÔNG BÁO SỞ HỮU CÔNG NGHIỆP SỐ 403 TẬP A – QUYỀN 2 (10.2021)

- (11) **42786**
- (21) 3-2021-01834
- (54) **NHÃN SẢN PHẨM**
- (22) 15/07/2021
- (73) **NGÔ THỊ DIỆU HIỀN (VN)**
297/28 Lạc Long Quân, phường 3, quận 11, thành phố Hồ Chí Minh
- (72) Ngô Thị Diệu Hiền (VN)
- (74) Văn phòng Luật sư D và T (D & T LAW OFFICE)
- (55)



1.1



1.2



2.1



2.2



3.1



3.2

CÔNG BÁO SỞ HỮU CÔNG NGHIỆP SỐ 403 TẬP A – QUYỀN 2 (10.2021)

- (11) **42787**
(21) 3-2021-01835 (28) 1
(54) **NHÃN SẢN PHẨM** (51) **19-08**
(22) 15/07/2021 (43) 25/10/2021
(73) **NGÔ THỊ DIỆU HIỀN (VN)**
297/28 Lạc Long Quân, phường 3, quận 11, thành phố Hồ Chí Minh
(72) Ngô Thị Diệu Hiền (VN)
(74) Văn phòng Luật sư D và T (D & T LAW OFFICE)
(55)

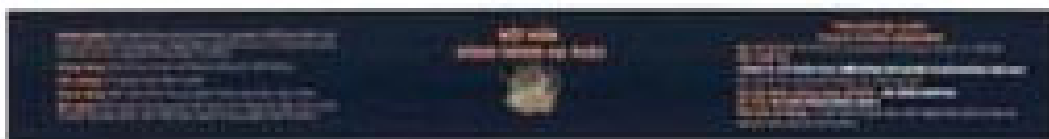

1.1



1.2

CÔNG BÁO SỞ HỮU CÔNG NGHIỆP SỐ 403 TẬP A – QUYỀN 2 (10.2021)

- (11) **42788**
(21) 3-2021-01831 (28) 1
(54) **MÁY XĂM THẨM MỸ** (51) **28-03**
(22) 15/07/2021 (43) 25/10/2021
(73) **PHÙNG VĂN LÂN (VN)**
Thôn Vực, xã Thanh Liệt, huyện Thanh Trì, thành phố Hà Nội
(72) **PHÙNG VĂN LÂN (VN)**
(74) Công ty TNHH Dịch vụ Sở hữu trí tuệ GREENIP (GREENIP CO., LTD)
(55)



CÔNG BÁO SỞ HỮU CÔNG NGHIỆP SỐ 403 TẬP A – QUYỀN 2 (10.2021)

- (11) **42789**
(21) 3-2021-01842 (28) 1
(54) **DÉP** (51) **02-04**
(22) 16/07/2021 (43) 25/10/2021
(73) **CÔNG TY TNHH SẢN XUẤT THƯƠNG MẠI XUẤT NHẬP KHẨU ĐỨC HOA (VN)**
Tỉnh lộ 830, ấp 3, xã An Thạnh, huyện Bến Lức, tỉnh Long An
(72) Trần Đức (VN)
(74) Công ty TNHH Sở hữu trí tuệ Đại Diện (IPACO.,LTD.)
(55)

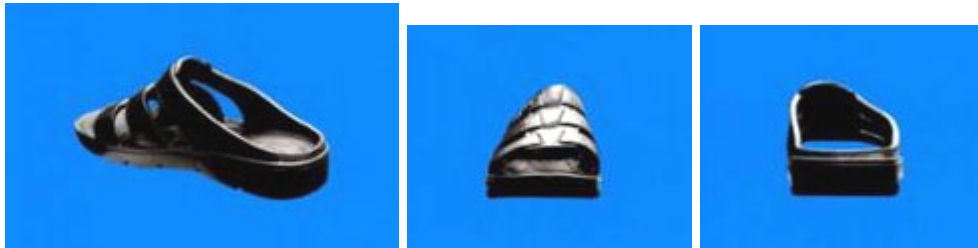

1.1

1.2

1.3

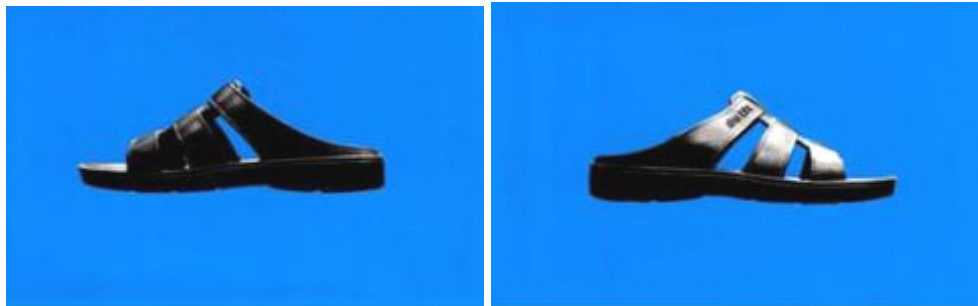

1.4

1.5

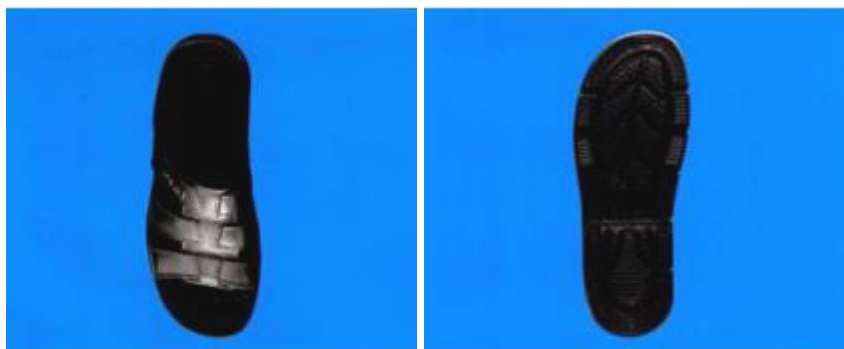

1.6

1.7

(11) **42790**

(21) 3-2021-01848

(28) 1

(54) **BUỒNG LẤY MẪU XÉT NGHIỆM DI ĐỘNG**

(51) **25-03**

(22) 16/07/2021

(43) 25/10/2021

(73) **CÔNG TY CỔ PHẦN SẢN XUẤT VÀ PHÁT TRIỂN CÔNG NGHIỆP VIỆT NHẬT (VN)**

Lô 46B, khu công nghiệp Quang Minh, thị trấn Quang Minh, huyện Mê Linh, thành phố Hà Nội

(72) 1. NGUYỄN HỮU HẢI (VN)

2. ĐẶNG VĂN THĂNG (VN)

(74) Công ty Luật TNHH ELITE (ELITE LAW FIRM)

(55)



1.1



1.2



1.3



1.4



1.5

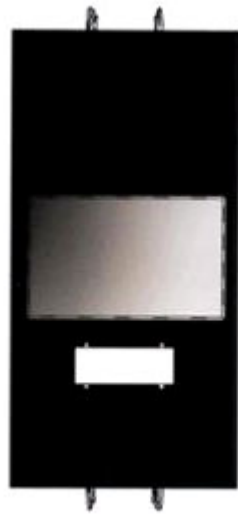

1.6

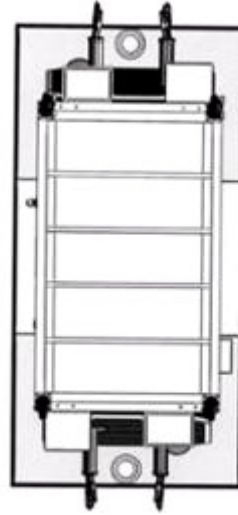

1.7

CÔNG BÁO SỞ HỮU CÔNG NGHIỆP SỐ 403 TẬP A – QUYỀN 2 (10.2021)

- (11) **42791**
(21) 3-2021-01899 (28) 1
(54) **ĐÈN** (51) **26-05**
(22) 21/07/2021 (43) 25/10/2021
(73) **CÔNG TY CỔ PHẦN BÓNG ĐÈN PHÍCH NƯỚC RẠNG ĐÔNG (VN)**
87-89 phố Hạ Đình, phường Thanh Xuân Trung, quận Thanh Xuân, thành phố Hà Nội
(72) Trần Trung Tường (VN)
(55)

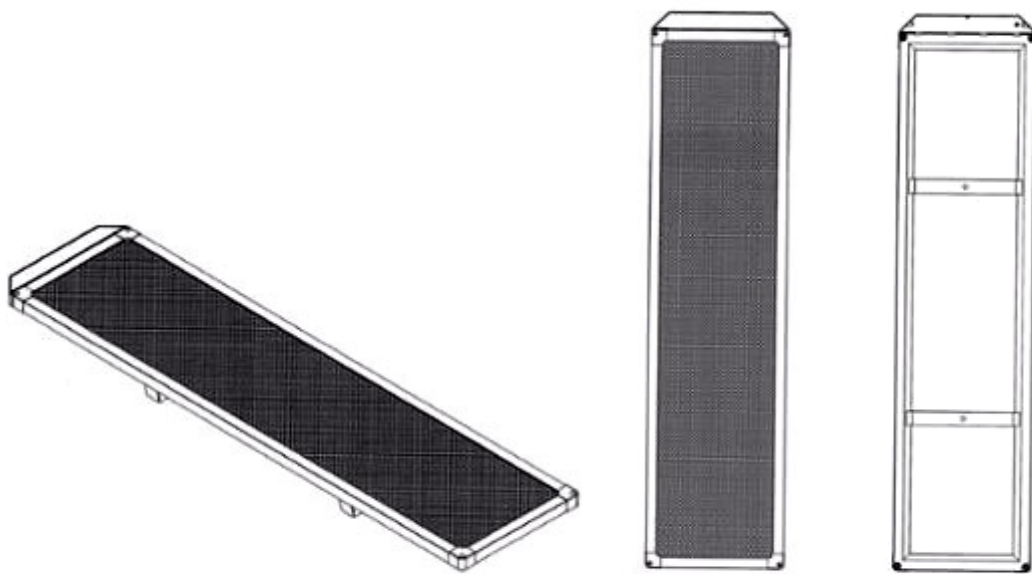

1.1

1.2

1.3

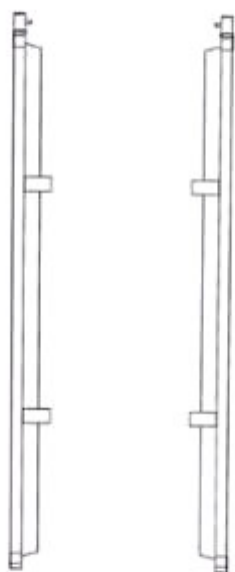

1.4

1.5

1.6

1.7

CÔNG BÁO SỞ HỮU CÔNG NGHIỆP SỐ 403 TẬP A – QUYỀN 2 (10.2021)

- (11) **42792**
(21) 3-2021-01900 (28) 1
(54) **ĐÈN** (51) **26-05**
(22) 21/07/2021 (43) 25/10/2021
(73) **CÔNG TY CỔ PHẦN BÓNG ĐÈN PHÍCH NƯỚC RẠNG ĐÔNG (VN)**
87-89 phố Hạ Đình, phường Thanh Xuân Trung, quận Thanh Xuân, thành phố Hà Nội
(72) Trần Trung Tường (VN)
(55)

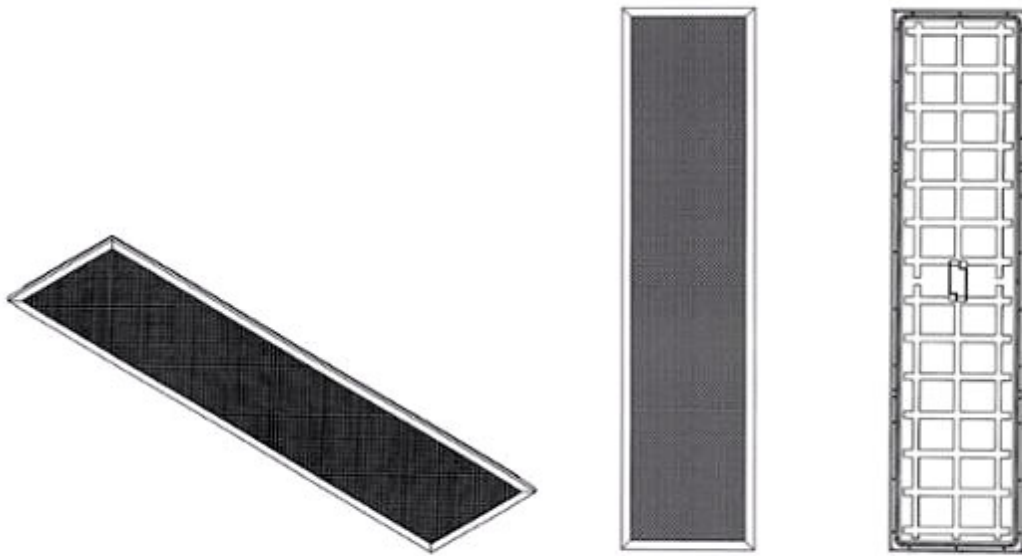

1.1

1.2

1.3

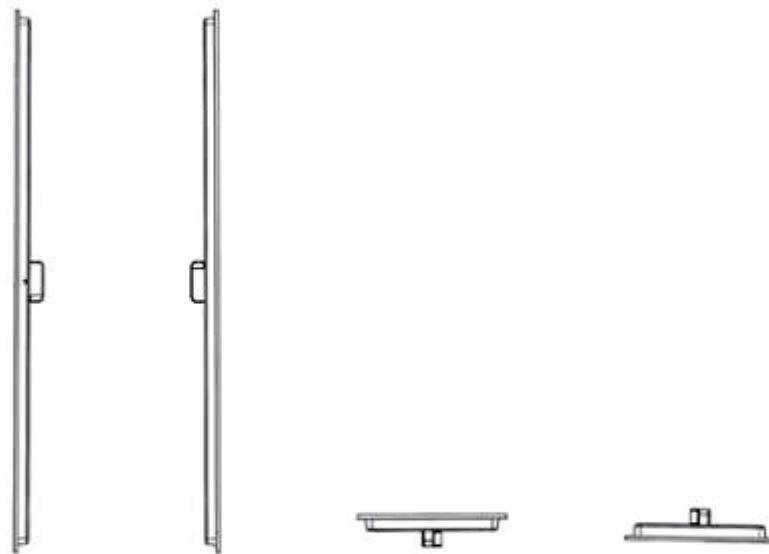

1.4

1.5

1.6

1.7

CÔNG BÁO SỞ HỮU CÔNG NGHIỆP SỐ 403 TẬP A – QUYỀN 2 (10.2021)

- (11) **42793**
(21) 3-2021-01896 (28) 1
(54) **THÙNG ĐỰNG** (51) **09-03**
(22) 21/07/2021 (43) 25/10/2021
(73) **TỔNG CÔNG TY CỔ PHẦN BIA-RƯỢU-NƯỚC GIẢI KHÁT HÀ NỘI (VN)**
Số 183, phố Hoàng Hoa Thám, phường Ngọc Hà, quận Ba Đình, thành phố Hà Nội
(72) Lê Minh Đức (VN)
(74) Công ty TNHH tư vấn Sở hữu trí tuệ IPFLAME (IPFLAME CO.,LTD)
(55)



1.1



1.2

CÔNG BÁO SỞ HỮU CÔNG NGHIỆP SỐ 403 TẬP A – QUYỀN 2 (10.2021)

(11) **42794**

(21) 3-2021-01906

(54) **VIÊN NGÓI**

(22) 22/07/2021

(73) **CÔNG TY CỔ PHẦN TAKAO VIỆT NAM (VN)**

Lô B6, khu công nghiệp Trung Hà, xã Dân Quyền, huyện Tam Nông, tỉnh Phú Thọ

(72) Tạ Hùng Sinh (VN)

(55)

(28) 1

(51) **25-01**

(43) 25/10/2021



1.1



1.2



1.3



1.4



1.5



1.6



1.7

CÔNG BÁO SỞ HỮU CÔNG NGHIỆP SỐ 403 TẬP A – QUYỀN 2 (10.2021)

- (11) **42795**
(21) 3-2021-01909 (28) 1
(54) **NHÃN SẢN PHẨM** (51) **19-08**
(22) 23/07/2021 (43) 25/10/2021
(73) **CÔNG TY TNHH SƠN KOVA (VN)**
Lô 32 khu Liên Cơ, phường Cầu Diễn, quận Nam Từ Liêm, thành phố Hà Nội
(72) Ngô Sỹ Quang (VN)
(74) Công ty Luật TNHH VIETTHINK (VIETTHINK LAW FIRM)
(55)



1.1



1.2

CÔNG BÁO SỞ HỮU CÔNG NGHIỆP SỐ 403 TẬP A – QUYỀN 2 (10.2021)

- (11) **42796**
(21) 3-2021-01914 (28) 1
(54) **NẮP BỒN CẦU** (51) **23-02**
(22) 23/07/2021 (43) 25/10/2021
(73) **DAELIM B&CO CO., LTD. (KR)**
52, Gongdan-ro, Seongsan-gu, Changwon-si, Gyeongsangnam-do, Republic of Korea
(72) TAE SIK, KANG (KR)
(74) Công ty TNHH Đại Tín và Liên Danh (DAITIN AND ASSOCIATES CO.,LTD)
(55)



1.1



1.2

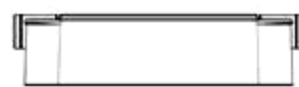

1.3



1.4



1.5

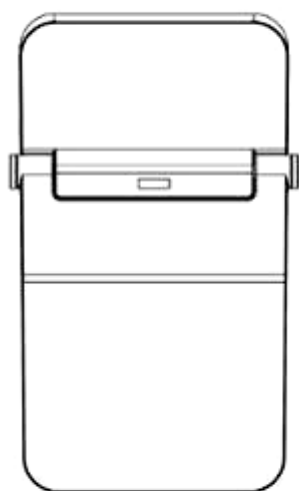

1.6

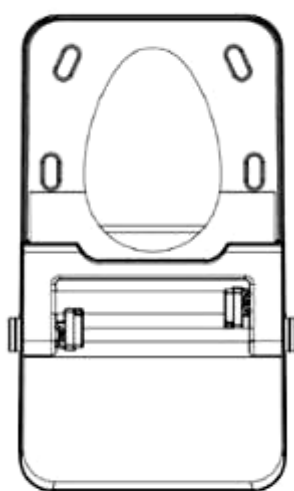

1.7



1.8

CÔNG BÁO SỞ HỮU CÔNG NGHIỆP SỐ 403 TẬP A – QUYỀN 2 (10.2021)

- (11) **42797**
(21) 3-2021-01919 (28) 1
(54) **KỆ SÁCH ĐỂ BÀN** (51) **06-04**
(22) 26/07/2021 (43) 25/10/2021
(73) **VÕ MINH HẠNH (VN)**
225/3 Võ Thị Sáu, phường Thăng Tam, thành phố Vũng Tàu, tỉnh Bà Rịa - Vũng Tàu
(72) Võ Minh Hạnh (VN)
(74) Công ty TNHH Tư vấn Luật ALIAT (ALIAT LEGAL)
(55)

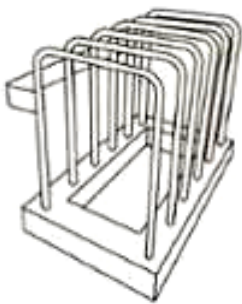

1.1

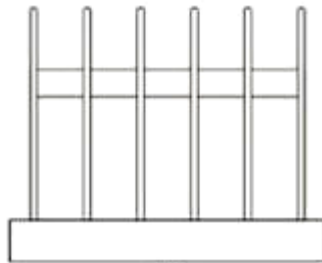

1.2

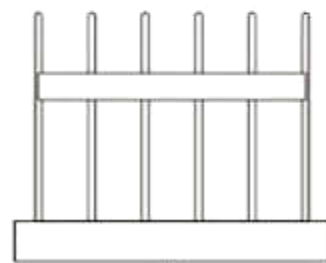

1.3

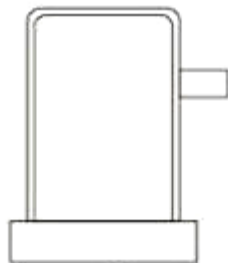

1.4

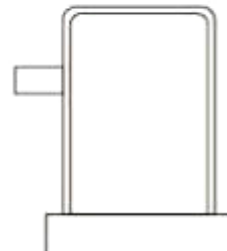

1.5

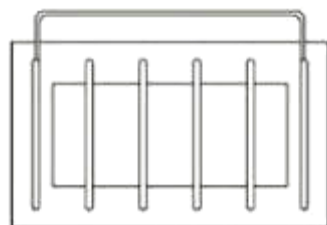

1.6

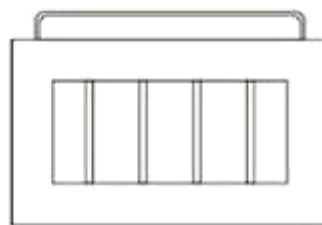

1.7

(11) **42798**

(21) 3-2021-01921

(54) **GIÁ ĐỠ**

(22) 27/07/2021

(73) **CÔNG TY TNHH ĐẦU TƯ CẢNH PHONG (VN)**

Lô O17 đường số 4, CCN Hải Sơn Đức Hòa Đông, xã Đức Hòa Đông, huyện Đức Hòa, tỉnh Long An

(72) Lư Chí Lương (VN)

(55)

(28) 1

(51) **08-08**

(43) 25/10/2021



1.1

1.2

1.3

1.4



1.5



1.6



1.7

CÔNG BÁO SỞ HỮU CÔNG NGHIỆP SỐ 403 TẬP A – QUYỀN 2 (10.2021)

- (11) **42799**
(21) 3-2021-01924 (28) 1
(54) **CHAI ĐỰNG CÓ NẮP** (51) **09-01**
(22) 27/07/2021 (43) 25/10/2021
(73) **CÔNG TY TNHH SẢN XUẤT THƯƠNG MẠI BAO BÌ MINH KHANG (VN)**
297/15 Lê Đức Thọ, phường 17, quận Gò Vấp, thành phố Hồ Chí Minh
(72) Vương Tuấn Anh (VN)
(74) Công ty TNHH Sở hữu trí tuệ Đông Dương (DONG DUONG IP CO.,LTD)
(55)



1.1



1.2



1.3



1.4



1.5



1.6



1.7

CÔNG BÁO SỞ HỮU CÔNG NGHIỆP SỐ 403 TẬP A – QUYỀN 2 (10.2021)

- (11) **42800**
(21) 3-2021-01929 (28) 1
(54) **MÁY LỌC KHÔNG KHÍ** (51) **23-04**
(22) 27/07/2021 (43) 25/10/2021
(30) 2021-004870 10/03/2021 JP;
(73) **SHARP KABUSHIKI KAISHA (JP)**
1 Takumi-cho, Sakai-ku, Sakai City, Osaka 590-8522, Japan
(72) 1. TADAHIKO SAIMEN (JP)
2. TAKEO KOIKE (JP)
(74) Công ty TNHH một thành viên Sở hữu trí tuệ VCCI (VCCI-IP CO.,LTD)
(55)



1.1



1.2



1.3



1.4



1.5



1.6

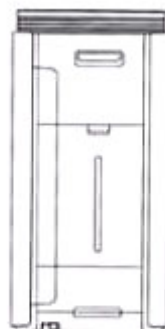

1.7



1.8

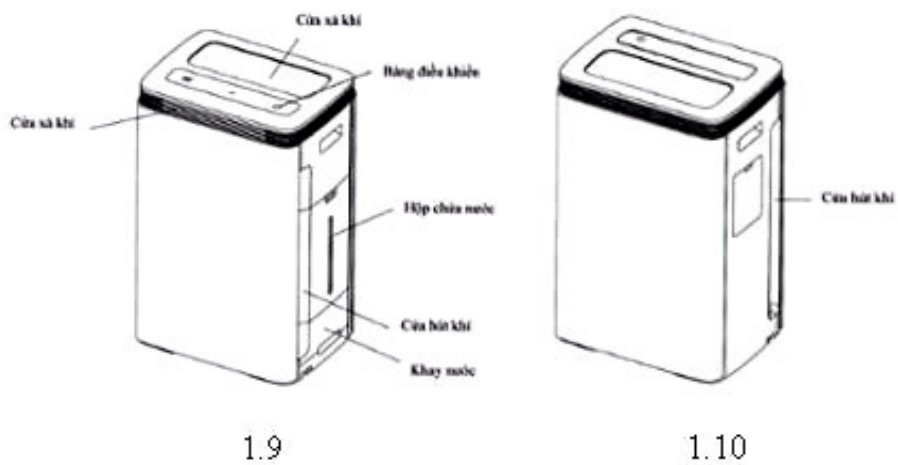

- (11) **42801**
(21) 3-2021-01930 (28) 1
(54) **MÁY LỌC KHÔNG KHÍ** (51) **23-04**
(22) 27/07/2021 (43) 25/10/2021
(30) 2021-007232 06/04/2021 JP;
(73) **DAIKIN INDUSTRIES, LTD.** (JP)
UMEDA CENTER BUILDING, 4-12, Nakazaki-Nishi 2-chome, Kita-ku, Osaka-shi, Osaka-fu, Japan
(72) 1. KIRIKO HIGASHIYAMA (JP)
2. MANA YAMASHITA (JP)
(74) Công ty TNHH một thành viên Sở hữu trí tuệ VCCI (VCCI-IP CO.,LTD)
(55)

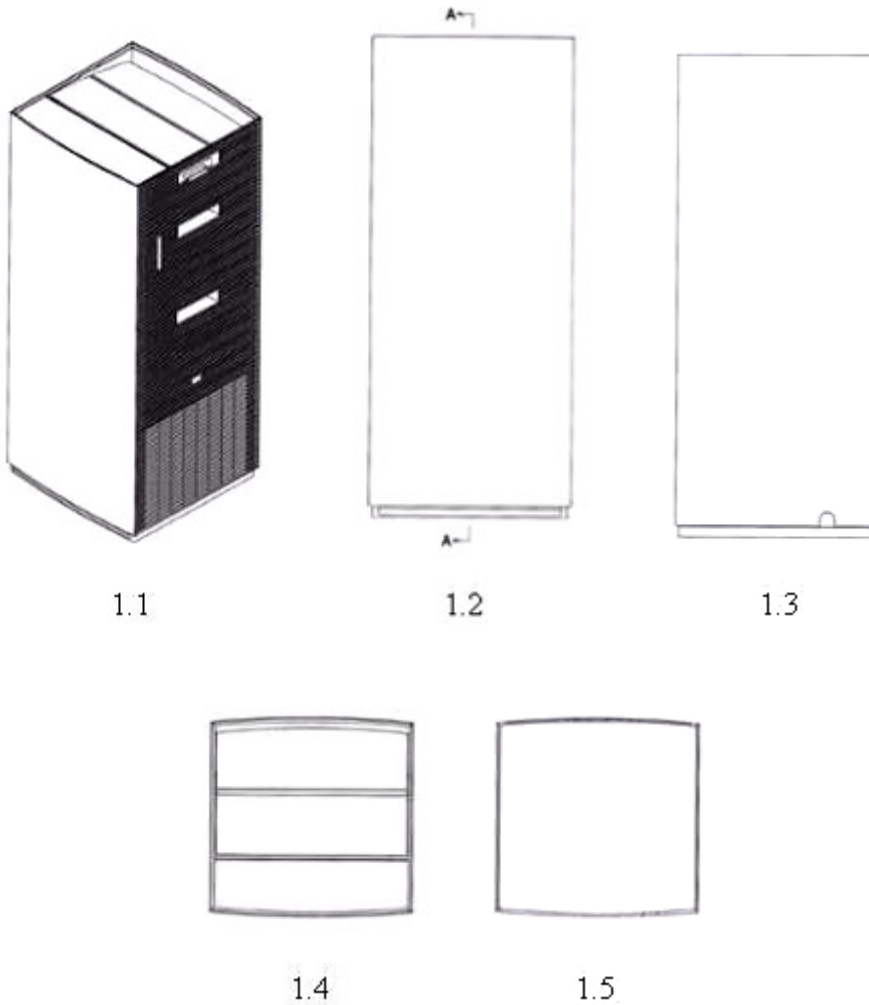



1.6



1.7

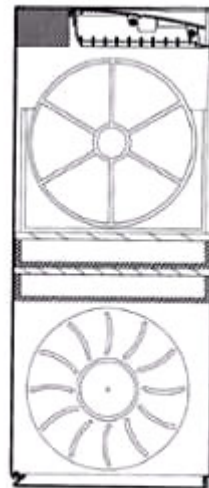

1.8

(11) **42802**

(21) 3-2021-01922

(28) 1

(54) **THIẾT BỊ LẤY MẪU**

(51) **24-02**

(22) 27/07/2021

(43) 25/10/2021

(73) **BIONLIFESCIENCE CO., LTD. (KR)**

(11901) A-601, 19, Sanmaru-ro, Guri-si, Gyeonggi-do, Republic of Korea

(72) 1. GOH, CHANG WOOK (KR)

2. KIM, BONG YOON (KR)

3. JEONG, JOONG HWAN (KR)

(74) Công ty TNHH Trường Xuân (AGELESS CO.,LTD.)

(55)

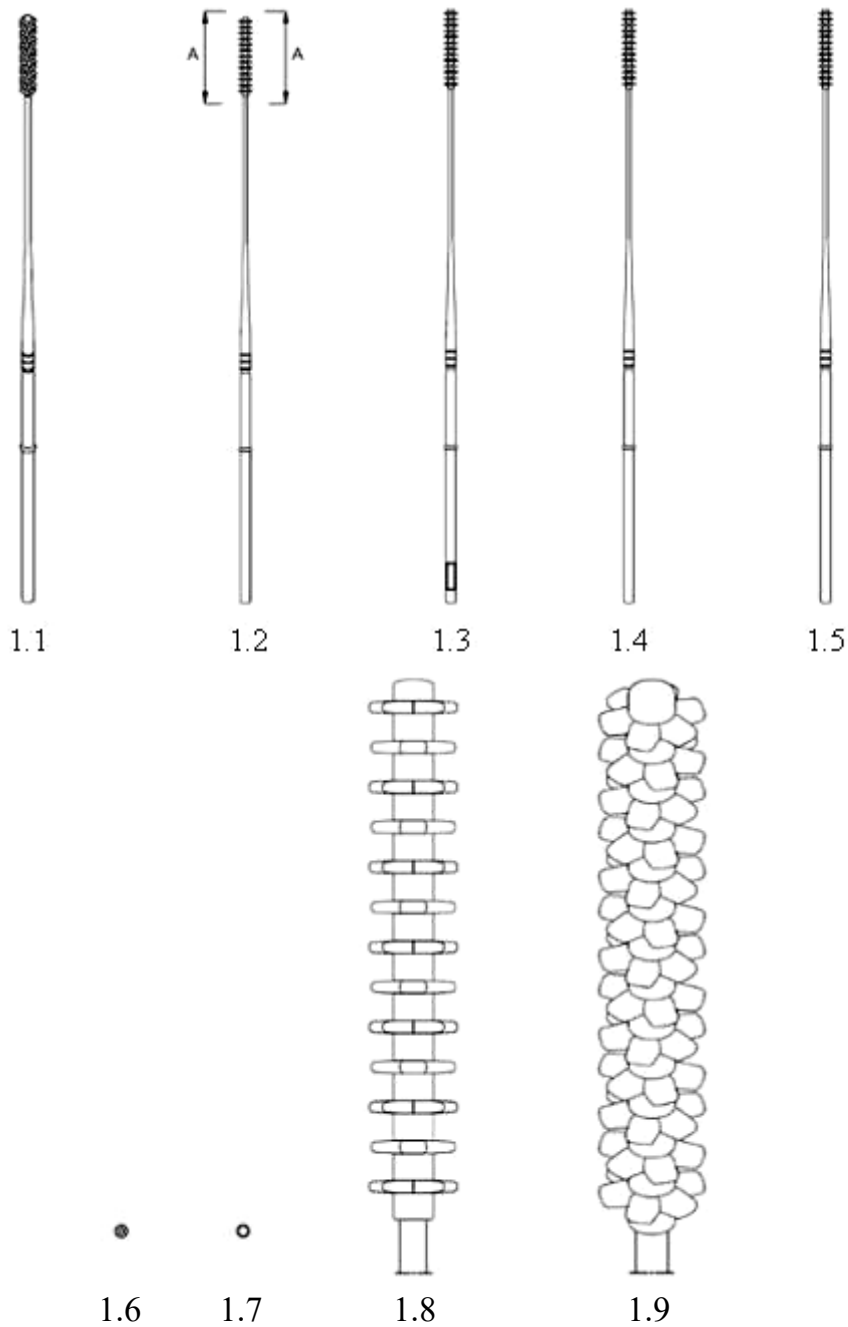

(11) **42803**

(21) 3-2021-01923

(28) 1

(54) **THIẾT BỊ LẤY MẪU**

(51) **24-02**

(22) 27/07/2021

(43) 25/10/2021

(73) **BIONLIFESCIENCE CO., LTD. (KR)**

(11901) A-601, 19, Sanmaru-ro, Guri-si, Gyeonggi-do, Republic of Korea

(72) 1. GOH, CHANG WOOK (KR)

2. KIM, BONG YOON (KR)

3. JEONG, JOONG HWAN (KR)

(74) Công ty TNHH Trường Xuân (AGELESS CO.,LTD.)

(55)

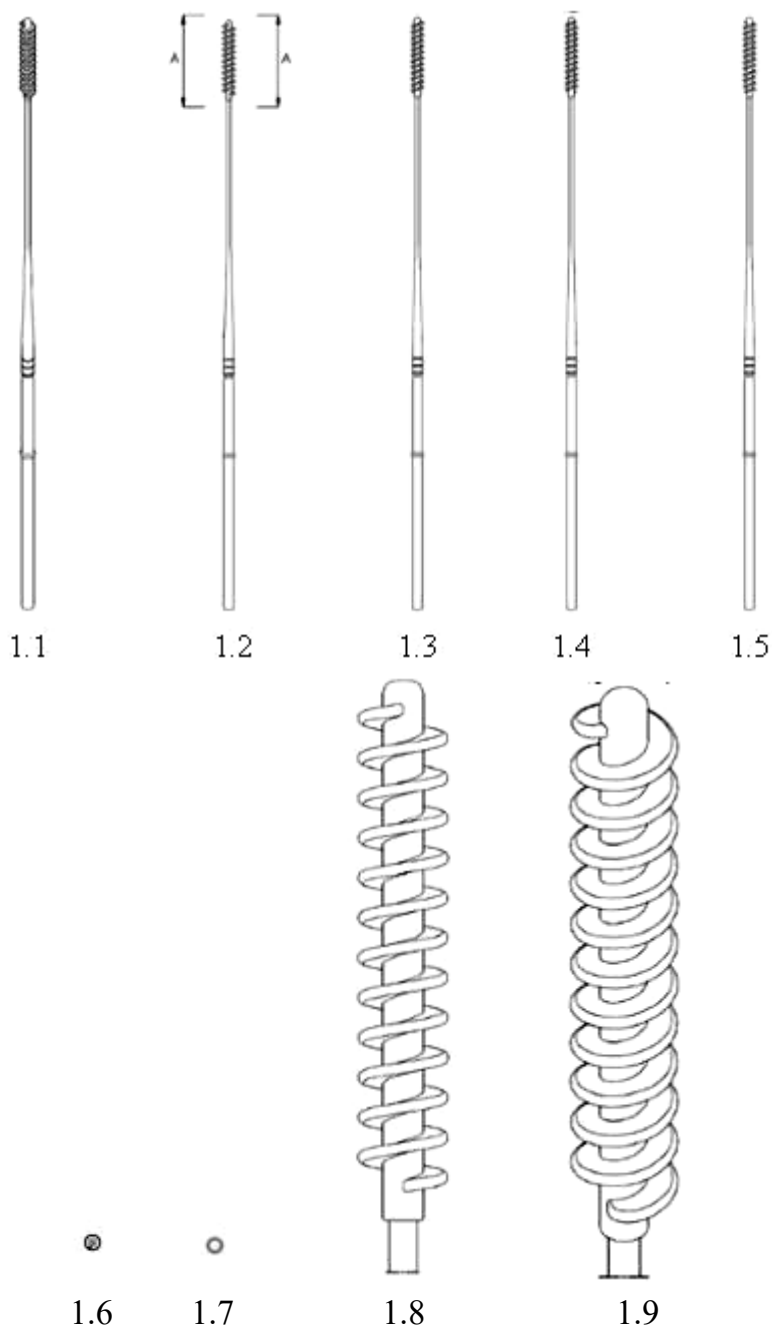

- (11) **42804**
(21) 3-2021-01926 (28) 1
(54) **ỐNG XẢ** (51) **12-16**
(22) 27/07/2021 (43) 25/10/2021
(30) 008442354-0001 23/02/2021 EM;
(73) **IGOR AKRAPOVIČ (SI)**
Rožna Dolina C.VIII/10A, SI-1000 Ljubljana, Slovenia
(72) 1. IGOR AKRAPOVIČ (SI)
2. ERMIN KOSOVEL (SI)
(74) Công ty TNHH Đại Tín và Liên Danh (DAITIN AND ASSOCIATES CO.,LTD)
(55)



1.1



1.2



1.3



1.4



1.5



1.6



1.7



1.8

CÔNG BÁO SỞ HỮU CÔNG NGHIỆP SỐ 403 TẬP A – QUYỀN 2 (10.2021)

- (11) **42805**
(21) 3-2021-01927 (28) 2
(54) **NHÃN SẢN PHẨM** (51) **19-08**
(22) 27/07/2021 (43) 25/10/2021
(73) **CÔNG TY TNHH SƠN KOVA (VN)**
Lô 32 khu Liên Cơ, phường Cầu Diễn, quận Nam Từ Liêm, thành phố Hà Nội
(72) Ngô Sỹ Quang (VN)
(74) Công ty Luật TNHH VIETTHINK (VIETTHINK LAW FIRM)
(55)

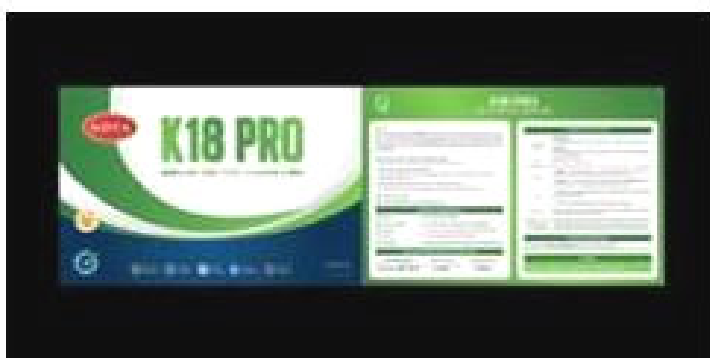

1.1



1.2



2.1



2.2

- (11) **42806**
(21) 3-2021-01928 (28) 2
(54) **NHÃN SẢN PHẨM** (51) **19-08**
(22) 27/07/2021 (43) 25/10/2021
(73) **CÔNG TY TNHH SƠN KOVA (VN)**
Lô 32 khu Liên Cơ, phường Cầu Diễn, quận Nam Từ Liêm, thành phố Hà Nội
(72) Ngô Sỹ Quang (VN)
(74) Công ty Luật TNHH VIETTHINK (VIETTHINK LAW FIRM)
(55)



1.1



1.2



2.1



2.2

CÔNG BÁO SỞ HỮU CÔNG NGHIỆP SỐ 403 TẬP A – QUYỀN 2 (10.2021)

- (11) **42807**
(21) 3-2021-01934 (28) 1
(54) **MÁY HỦY TÀI LIỆU** (51) **18-99**
(22) 28/07/2021 (43) 25/10/2021
(30) 202130400309.0 28/06/2021 CN;
(73) **MAOXIN HARDWARE PRODUCTS (SHENZHEN) CO., LTD. (CN)**
No.20, First Industrial Zone, Li Song Lang Community, Gongming Office,
Guangming New District, Shenzhen City, Guangdong Province, China
(72) SHIKAI, LUO (TW)
(74) Công ty TNHH Đại Tín và Liên Danh (DAITIN AND ASSOCIATES CO.,LTD)
(55)



1.1



1.2



1.3



1.4



1.5



1.6



1.7



1.8

- (11) **42808**
(21) 3-2021-01935 (28) 1
(54) **MÁY HỦY TÀI LIỆU** (51) **18-99**
(22) 28/07/2021 (43) 25/10/2021
(30) 202130400301.4 28/06/2021 CN;
(73) **MAOXIN HARDWARE PRODUCTS (SHENZHEN) CO., LTD. (CN)**
No.20, First Industrial Zone, Li Song Lang Community, Gongming Office,
Guangming New District, Shenzhen City, Guangdong Province, China
(72) SHIKAI, LUO (TW)
(74) Công ty TNHH Đại Tín và Liên Danh (DAITIN AND ASSOCIATES CO.,LTD)
(55)



1.1



1.2



1.3



1.4



1.5

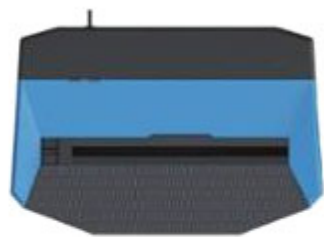

1.6



1.7

- (11) **42809**
(21) 3-2021-01941 (28) 1
(54) **CÁNH TAY RÔ BỐT CỘNG TÁC** (51) **15-99**
(22) 29/07/2021 (43) 25/10/2021
(73) **ĐỖ TRẦN THẮNG (VN)**
225 Giảng Võ, quận Đống Đa, thành phố Hà Nội
(72) Đỗ Trần Thắng (VN)
(55)



1.1



1.2



1.3



1.4



1.5



1.6



1.7

- (11) **42810**
 (21) 3-2021-01942 (28) 2
 (54) **BĂNG VỆ SINH** (51) **24-04**
 (22) 29/07/2021 (43) 25/10/2021
 (30) 202130179655.0 31/03/2021 CN;
 (73) **UNICHARM CORPORATION (JP)**
 182, Shimobun, Kinsei-cho, Shikokuchuo-City, Ehime 7990111, Japan
 (72) 1. AKIRA HASHINO (JP)
 2. RANIDA KONTHIENG (TH)
 3. MANTHANA WANASBODEE (TH)
 (74) Công ty Cổ phần Sở hữu công nghiệp INVESTIP (INVESTIP)
 (55)



1.1



1.2



1.3



1.4



1.5



1.6



1.7



1.8

(11) **42811**

(21) 3-2021-01948

(28) 1

(54) **KÈ VÒM**

(51) **25-02**

(22) 30/07/2021

(43) 25/10/2021

(73) **CÔNG TY CỔ PHẦN KHOA HỌC CÔNG NGHỆ VIỆT NAM (VN)**

Số 6 đường 3 tháng 2, phường 8, thành phố Vũng Tàu, tỉnh Bà Rịa - Vũng Tàu

(72) Hoàng Đức Thảo (VN)

(55)

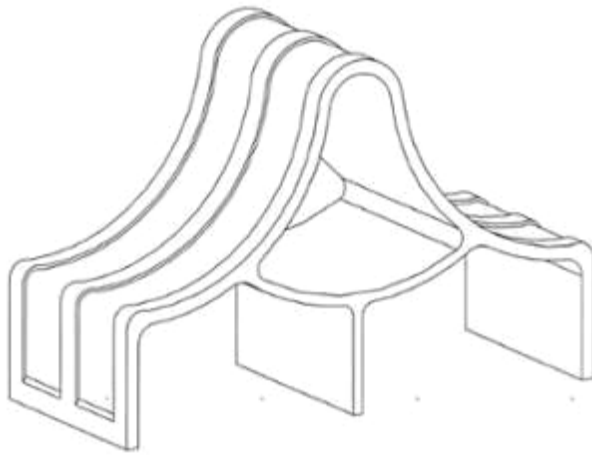

1.1

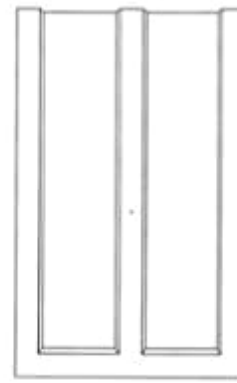

1.2



1.3

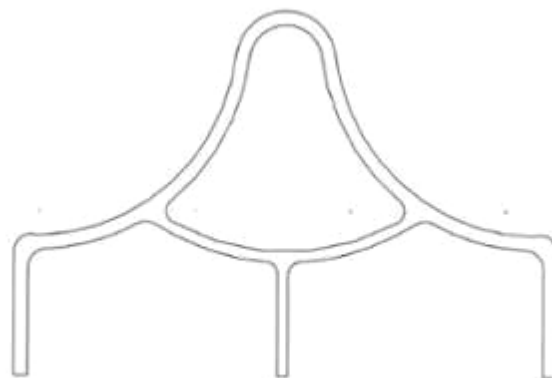

1.4

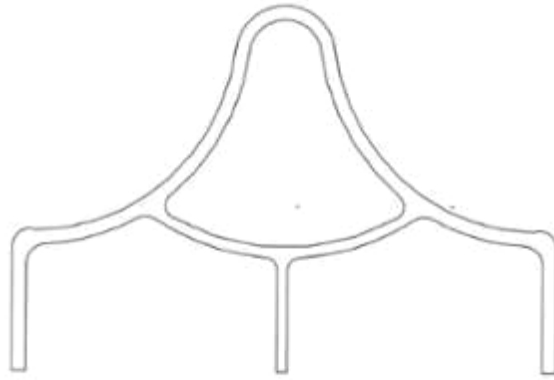

1.5

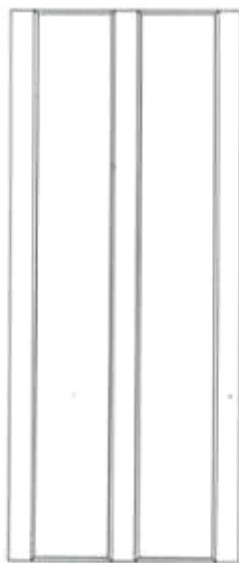

1.6



1.7

(11) **42812**

(21) 3-2021-01957

(28) 1

(54) **KÈ VÒM**

(51) **25-02**

(22) 30/07/2021

(43) 25/10/2021

(73) **CÔNG TY CỔ PHẦN KHOA HỌC CÔNG NGHỆ VIỆT NAM (VN)**

Số 6 đường 3 tháng 2, phường 8, thành phố Vũng Tàu, tỉnh Bà Rịa - Vũng Tàu

(72) Hoàng Đức Thảo (VN)

(55)

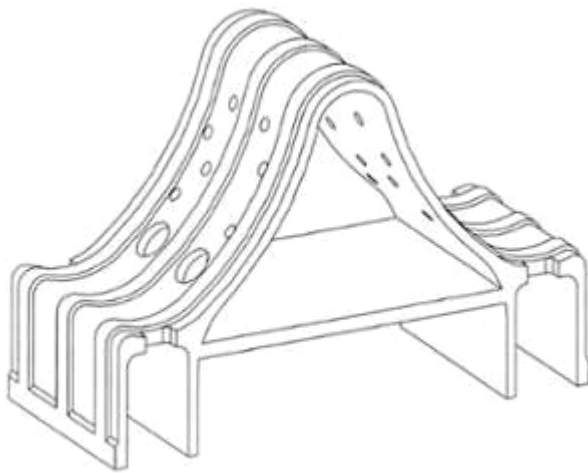

1.1

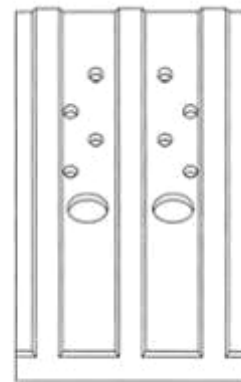

1.2



1.3

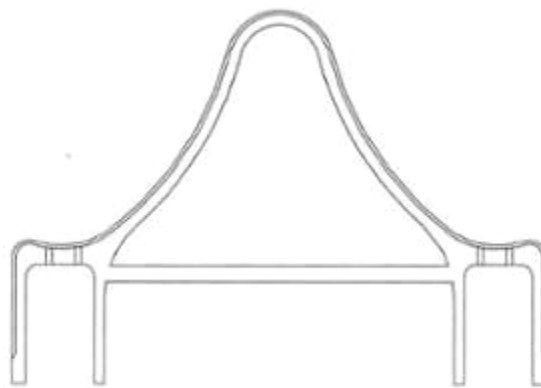

1.4

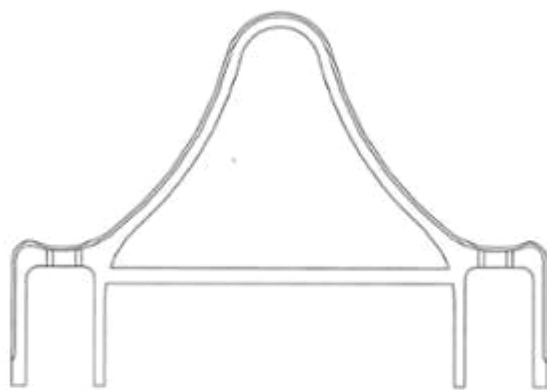

1.5

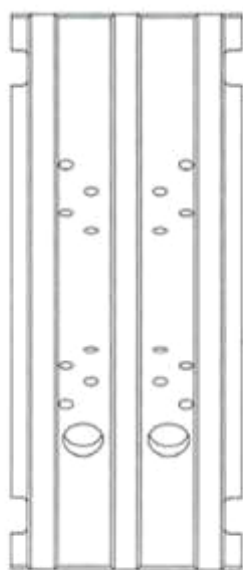

1.6

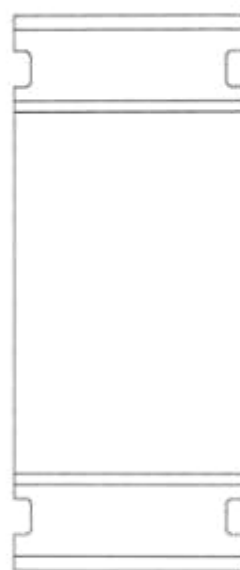

1.7

(11) **42813**

(21) 3-2021-01958

(28) 1

(54) **KÈ VÒM**

(51) **25-02**

(22) 30/07/2021

(43) 25/10/2021

(73) **CÔNG TY CỔ PHẦN KHOA HỌC CÔNG NGHỆ VIỆT NAM (VN)**

Số 6 đường 3 tháng 2, phường 8, thành phố Vũng Tàu, tỉnh Bà Rịa - Vũng Tàu

(72) Hoàng Đức Thảo (VN)

(55)

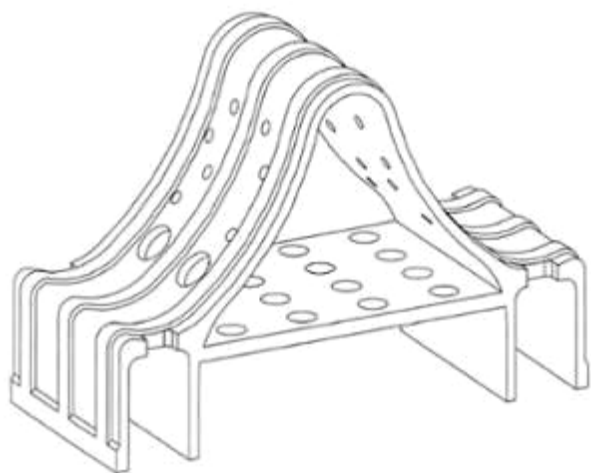

1.1

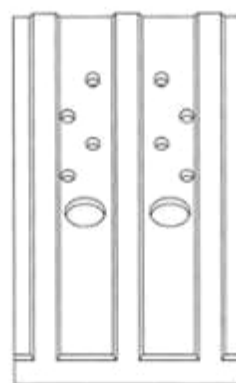

1.2



1.3

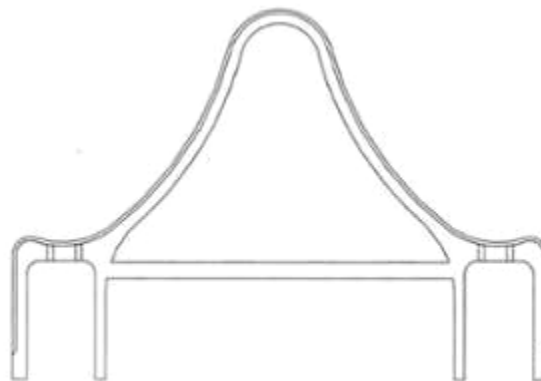

1.4

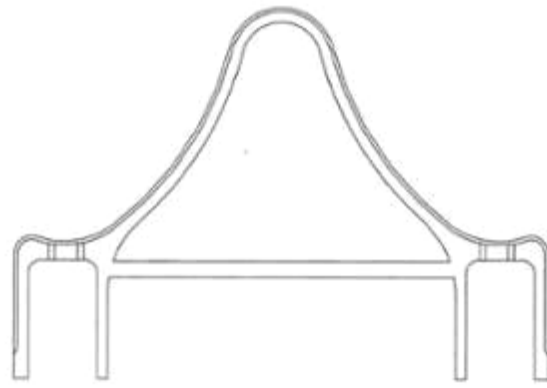

1.5

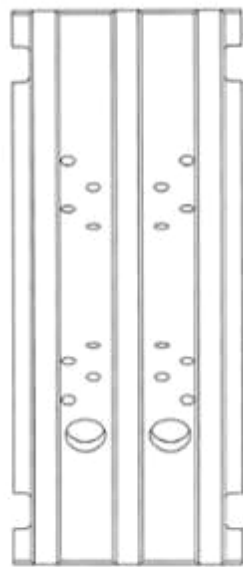

1.6

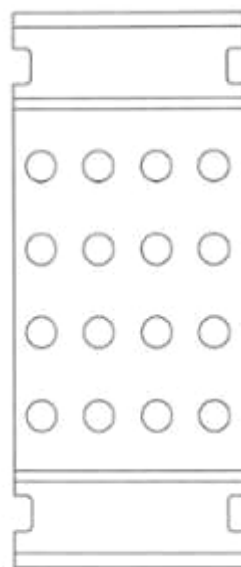

1.7

CÔNG BÁO SỞ HỮU CÔNG NGHIỆP SỐ 403 TẬP A – QUYỀN 2 (10.2021)

- (11) **42814**
(21) 3-2021-01944 (28) 1
(54) **MÁY LỌC KHÔNG KHÍ** (51) **23-04**
(22) 30/07/2021 (43) 25/10/2021
(73) **DONGGUAN JINGNUO ENVIRONMENT SCIENCE AND TECHNOLOGY INC. (CN)**
#2, Limin Road, Jinxiaotang, Zhutang Village, Fenggang Town, Dongguan City, Guangdong, China
(72) 1. FEI, ZUO (CN)
2. RUI, CHEN (CN)
3. TIANWEN, WU (CN)
(74) Công ty TNHH Sáng chế ACTIP (ACTIP PATENT LIMITED)
(55)



1.1



1.2



1.3



1.4



1.5



1.6



1.7

CÔNG BÁO SỞ HỮU CÔNG NGHIỆP SỐ 403 TẬP A – QUYỀN 2 (10.2021)

- (11) **42815**
(21) 3-2021-01945 (28) 1
(54) **MÁY LỌC KHÔNG KHÍ** (51) **23-04**
(22) 30/07/2021 (43) 25/10/2021
(73) **DONGGUAN JINGNUO ENVIRONMENT SCIENCE AND TECHNOLOGY INC. (CN)**
#2, Limin Road, Jinxiaotang, Zhutang Village, Fenggang Town, Dongguan City, Guangdong, China
(72) 1. FEI, ZUO (CN)
2. RUI, CHEN (CN)
3. TIANWEN, WU (CN)
(74) Công ty TNHH Sáng chế ACTIP (ACTIP PATENT LIMITED)
(55)



1.1



1.2



1.3



1.4



1.5



1.6



1.7

CÔNG BÁO SỞ HỮU CÔNG NGHIỆP SỐ 403 TẬP A – QUYỀN 2 (10.2021)

- (11) **42816**
- (21) 3-2021-01961 (28) 1
- (54) **HỘP BAO CAO SU** (51) **09-03**
- (22) 30/07/2021 (43) 25/10/2021
- (73) **CÔNG TY TNHH THIẾT BỊ & VẬT TƯ Y TẾ DONGKUK (VN)**
Căn LK03-122, khu đô thị C2 Gamuda Gardens, phường Trần Phú, quận Hoàng
Mai, thành phố Hà Nội
- (72) Lê Hồng Phú (VN)
- (74) **CÔNG TY TRÁCH NHIỆM HỮU HẠN TƯ VẤN ĐẦU TƯ VÀ SỞ HỮU TRÍ
TUỆ INTERFIVE (INTERFIVE CO., LTD)**
- (55)



1.1



1.2

CÔNG BÁO SỞ HỮU CÔNG NGHIỆP SỐ 403 TẬP A – QUYỀN 2 (10.2021)

- (11) **42817**
(21) 3-2021-01967 (28) 1
(54) **HỘP** (51) **09-03**
(22) 02/08/2021 (43) 25/10/2021
(73) **CÔNG TY TNHH SẢN XUẤT - THƯƠNG MẠI TBM - MINH PHÁT (VN)**
141-143 Xóm Đất, phường 8, quận 11, thành phố Hồ Chí Minh
(72) Dịp Văn Minh (VN)
(74) Công ty TNHH Dịch vụ thương mại và sở hữu công nghiệp Song Ngọc (I.P.T.S.)
(55)



1.1



1.2



1.3

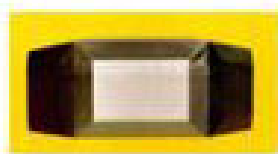

1.4



1.5

CÔNG BÁO SỞ HỮU CÔNG NGHIỆP SỐ 403 TẬP A – QUYỀN 2 (10.2021)

(11) **42818**

(21) 3-2021-01969

(28) 1

(54) **MÁY IN**

(51) **18-02**

(22) 03/10/2019

(43) 25/10/2021

(30) 2019-007321 04/04/2019 JP;

(73) **BROTHER INDUSTRIES, LTD. (JP)**

15-1 Naeshiro-cho, Mizuho-ku, Nagoya-shi, Aichi-ken, Japan

(72) Toshiya INADA (JP)

(74) Công ty TNHH Ban Ca (BANCA)

(55)

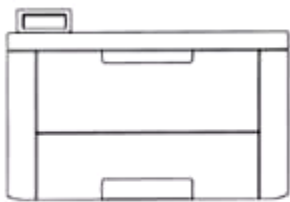

1.1

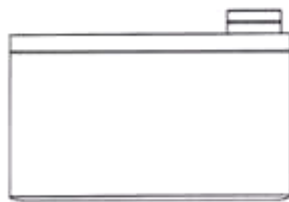

1.2

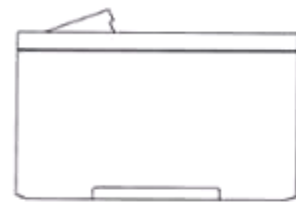

1.3

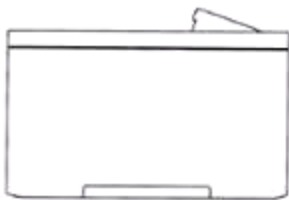

1.4

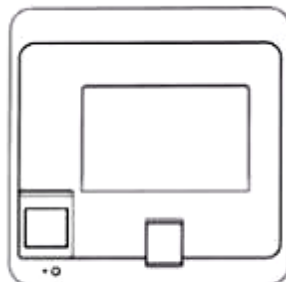

1.5



1.6

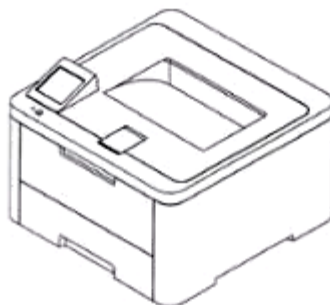

1.7

- (11) **42819**
(21) 3-2021-01968 (28) 2
(54) **XE ĐẨY** (51) **12-02**
(22) 02/08/2021 (43) 25/10/2021
(30) 29/794,401 11/06/2021 US;
(73) **OLYMPIA TOOLS INTERNATIONAL, INC. (US)**
929 North Grand Ave, Covina, California 91724, United States of America
(72) 1. JONATHAN S. BECKWITH (US)
2. CECIL WILSON (US)
(74) Công ty Luật TNHH WINCO (WINCO LAW FIRM)
(55)



1.1



1.2



1.3



1.4



1.5



1.6

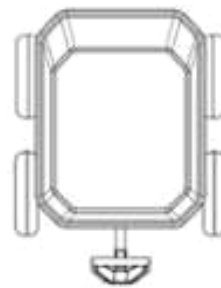

1.7

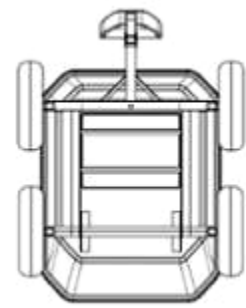

1.8

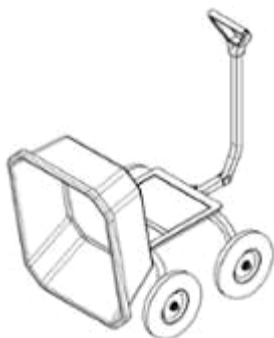

1.9



1.10

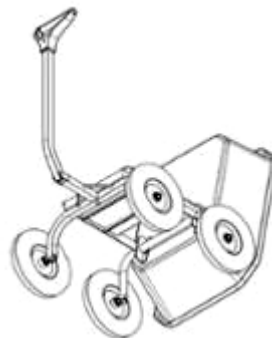

1.11



2.1



2.2



2.3



2.4



2.5



2.6

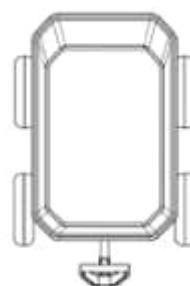

2.7

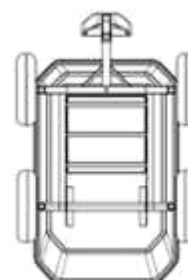

2.8



2.9



2.10

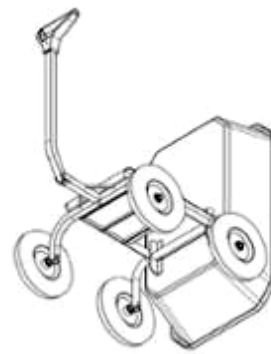

2.11

CÔNG BÁO SỞ HỮU CÔNG NGHIỆP SỐ 403 TẬP A – QUYỀN 2 (10.2021)

- (11) **42820**
(21) 3-2021-01993 (28) 2
(54) **ĐÉ GIÀY** (51) **02-04**
(22) 04/08/2021 (43) 25/10/2021
(30) 008443170-0004 25/02/2021 EM; 008443170-0003 25/02/2021 EM;
(73) **DECATHLON (FR)**
4, Boulevard de Mons, F-59650 Villeneuve d'Ascq, France
(72) Céline GOBLIN (FR)
(74) Công ty Luật TNHH T&G (TGVN)
(55)



1.1



1.2



1.3



1.4



1.5



1.6



1.7



1.8



2.1



2.2



2.3



2.4



2.5



2.6



2.7



2.8

CÔNG BÁO SỞ HỮU CÔNG NGHIỆP SỐ 403 TẬP A – QUYỀN 2 (10.2021)

- (11) **42821**
(21) 3-2021-01994 (28) 2
(54) **GIÀY** (51) **02-04**
(22) 04/08/2021 (43) 25/10/2021
(30) 008443170-0002 25/02/2021 EM; 008443170-0001 25/02/2021 EM;
(73) **DECATHLON (FR)**
4, Boulevard de Mons, F-59650 Villeneuve d'Ascq, France
(72) Céline GOBLIN (FR)
(74) Công ty Luật TNHH T&G (TGVN)
(55)



1.1



1.2



1.3



1.4



1.5



1.6



1.7



2.1



2.2



2.3



2.4



2.5



2.6



2.7

CÔNG BÁO SỞ HỮU CÔNG NGHIỆP SỐ 403 TẬP A – QUYỀN 2 (10.2021)

- (11) **42822**
(21) 3-2021-01990 (28) 1
(54) **TRẠM SẠC VÀ THAY THỂ DÙNG CHO PIN DI ĐỘNG** (51) **13-02**
(22) 04/08/2021 (43) 25/10/2021
(30) 2021-002701 08/02/2021 JP;
(73) **HONDA MOTOR CO., LTD. (JP)**
1-1, Minami-Aoyama 2-chome, Minato-ku, Tokyo, 107-8556 Japan
(72) Yu SAITSU (JP)
(74) Công ty Luật TNHH Phạm và Liên danh (PHAM & ASSOCIATES)
(55)



1.1



1.2



1.3



1.4



1.5



1.6



1.7



1.8



1.9



1.10



1.11

CÔNG BÁO SỞ HỮU CÔNG NGHIỆP SỐ 403 TẬP A – QUYỀN 2 (10.2021)

- (11) **42823**
- (21) 3-2021-01999 (28) 1
- (54) **HỘP** (51) **09-03**
- (22) 05/08/2021 (43) 25/10/2021
- (73) **CÔNG TY CỔ PHẦN CÔNG NGHỆ CAO DƯỢC (VN)**
 Liên kè TT 28-41, khu đô thị Văn Phú, phường Phú La, quận Hà Đông, thành phố Hà Nội
- (72) Nguyễn Thế Toàn (VN)
- (74) Công ty TNHH Sở hữu trí tuệ PADEMARK (PADEMARK CO.,LTD.)
- (55)

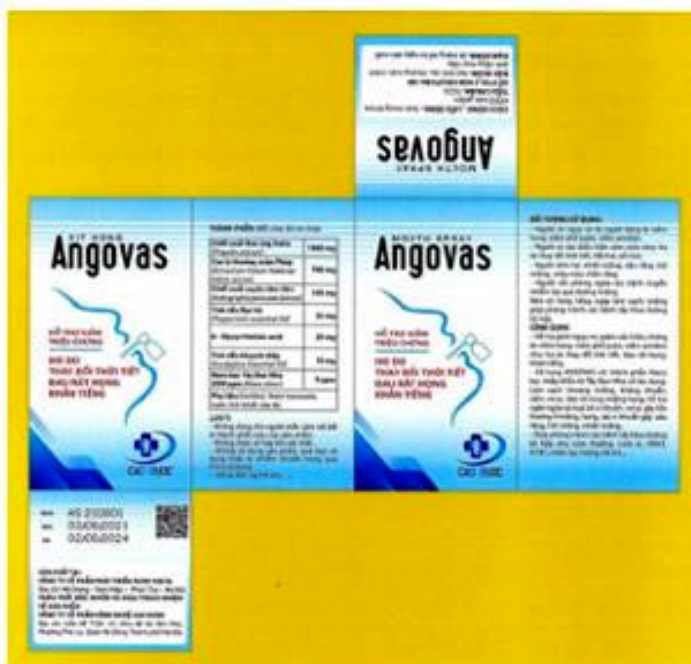

1.1



1.2

CÔNG BÁO SỞ HỮU CÔNG NGHIỆP SỐ 403 TẬP A – QUYỀN 2 (10.2021)

- (11) **42824**
(21) 3-2021-01972 (28) 1
(54) **NHÃN SẢN PHẨM** (51) **19-08**
(22) 03/08/2021 (43) 25/10/2021
(73) **CÔNG TY TNHH ĐẠI DƯƠNG Ý TƯỞNG (VN)**
Y10 đường Hồng Lĩnh, phường 15, quận 10, thành phố Hồ Chí Minh
(72) Lâm Quang Thành Chung (VN)
(74) **CÔNG TY LUẬT TNHH KHÔI NGỌC (KHOI NGOC LAW COMPANY LTD)**
(55)



CÔNG BÁO SỞ HỮU CÔNG NGHIỆP SỐ 403 TẬP A – QUYỀN 2 (10.2021)

- (11) **42825**
(21) 3-2021-01973 (28) 1
(54) **NHÃN SẢN PHẨM** (51) **19-08**
(22) 03/08/2021 (43) 25/10/2021
(73) **CÔNG TY TNHH ĐẠI DƯƠNG Ý TƯỞNG (VN)**
Y10 đường Hồng Lĩnh, phường 15, quận 10, thành phố Hồ Chí Minh
(72) Lâm Quang Thành Chung (VN)
(74) **CÔNG TY LUẬT TNHH KHÔI NGỌC (KHOI NGOC LAW COMPANY LTD)**
(55)

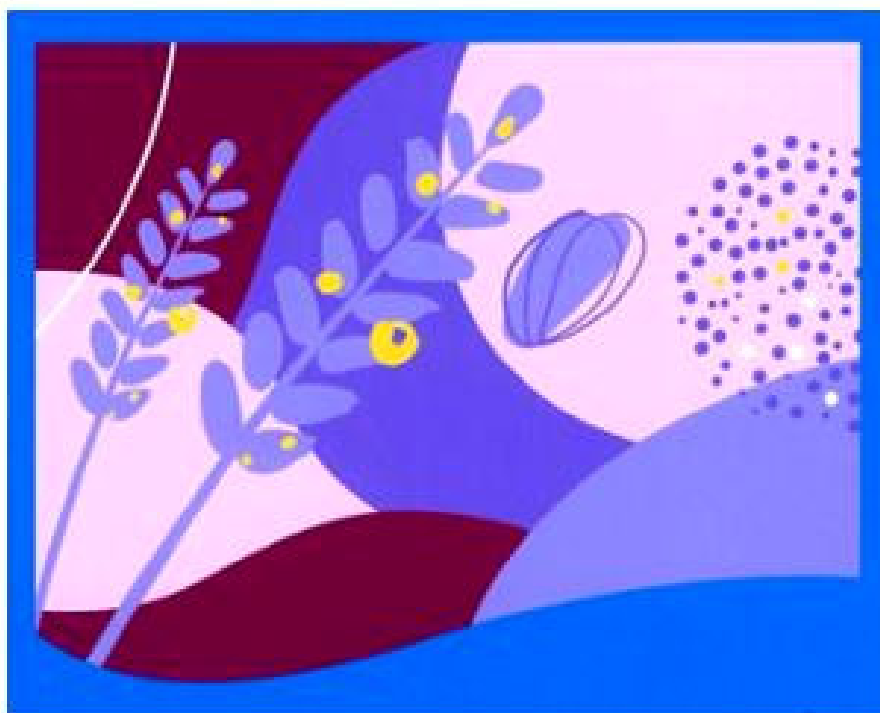

CÔNG BÁO SỞ HỮU CÔNG NGHIỆP SỐ 403 TẬP A – QUYỀN 2 (10.2021)

- (11) **42826**
(21) 3-2021-01974 (28) 1
(54) **NHÃN SẢN PHẨM** (51) **19-08**
(22) 03/08/2021 (43) 25/10/2021
(73) **CÔNG TY TNHH ĐẠI DƯƠNG Ý TƯỞNG (VN)**
Y10 đường Hồng Lĩnh, phường 15, quận 10, thành phố Hồ Chí Minh
(72) Lâm Quang Thành Chung (VN)
(74) **CÔNG TY LUẬT TNHH KHÔI NGỌC (KHOI NGOC LAW COMPANY LTD)**
(55)



CÔNG BÁO SỞ HỮU CÔNG NGHIỆP SỐ 403 TẬP A – QUYỀN 2 (10.2021)

- (11) **42827**
(21) 3-2021-01975 (28) 1
(54) **NHÃN SẢN PHẨM** (51) **19-08**
(22) 03/08/2021 (43) 25/10/2021
(73) **CÔNG TY TNHH ĐẠI DƯƠNG Ý TƯỞNG (VN)**
Y10 đường Hồng Lĩnh, phường 15, quận 10, thành phố Hồ Chí Minh
(72) Lâm Quang Thành Chung (VN)
(74) **CÔNG TY LUẬT TNHH KHÔI NGỌC (KHOI NGOC LAW COMPANY LTD)**
(55)



CÔNG BÁO SỞ HỮU CÔNG NGHIỆP SỐ 403 TẬP A – QUYỀN 2 (10.2021)

- (11) **42828**
(21) 3-2021-01976 (28) 1
(54) **NHÃN SẢN PHẨM** (51) **19-08**
(22) 03/08/2021 (43) 25/10/2021
(73) **CÔNG TY TNHH ĐẠI DƯƠNG Ý TƯỞNG (VN)**
Y10 đường Hồng Lĩnh, phường 15, quận 10, thành phố Hồ Chí Minh
(72) Lâm Quang Thành Chung (VN)
(74) **CÔNG TY LUẬT TNHH KHÔI NGỌC (KHOI NGOC LAW COMPANY LTD)**
(55)



CÔNG BÁO SỞ HỮU CÔNG NGHIỆP SỐ 403 TẬP A – QUYỀN 2 (10.2021)

- (11) **42829**
(21) 3-2021-01977 (28) 1
(54) **NHÃN SẢN PHẨM** (51) **19-08**
(22) 03/08/2021 (43) 25/10/2021
(73) **CÔNG TY TNHH ĐẠI DƯƠNG Ý TƯỞNG (VN)**
Y10 đường Hồng Lĩnh, phường 15, quận 10, thành phố Hồ Chí Minh
(72) Lâm Quang Thành Chung (VN)
(74) **CÔNG TY LUẬT TNHH KHÔI NGỌC (KHOI NGOC LAW COMPANY LTD)**
(55)



CÔNG BÁO SỞ HỮU CÔNG NGHIỆP SỐ 403 TẬP A – QUYỀN 2 (10.2021)

- (11) **42830**
(21) 3-2021-01978 (28) 1
(54) **NHÃN SẢN PHẨM** (51) **19-08**
(22) 03/08/2021 (43) 25/10/2021
(73) **CÔNG TY TNHH ĐẠI DƯƠNG Ý TƯỞNG (VN)**
Y10 đường Hồng Lĩnh, phường 15, quận 10, thành phố Hồ Chí Minh
(72) Lâm Quang Thành Chung (VN)
(74) **CÔNG TY LUẬT TNHH KHÔI NGỌC (KHOI NGOC LAW COMPANY LTD)**
(55)



CÔNG BÁO SỞ HỮU CÔNG NGHIỆP SỐ 403 TẬP A – QUYỀN 2 (10.2021)

- (11) **42831**
(21) 3-2021-01979 (28) 1
(54) **NHÃN SẢN PHẨM** (51) **19-08**
(22) 03/08/2021 (43) 25/10/2021
(73) **CÔNG TY TNHH ĐẠI DƯƠNG Ý TƯỞNG (VN)**
Y10 đường Hồng Lĩnh, phường 15, quận 10, thành phố Hồ Chí Minh
(72) Lâm Quang Thành Chung (VN)
(74) **CÔNG TY LUẬT TNHH KHÔI NGỌC (KHOI NGOC LAW COMPANY LTD)**
(55)



CÔNG BÁO SỞ HỮU CÔNG NGHIỆP SỐ 403 TẬP A – QUYỀN 2 (10.2021)

- (11) **42832**
(21) 3-2021-01980 (28) 1
(54) **NHÃN SẢN PHẨM** (51) **19-08**
(22) 03/08/2021 (43) 25/10/2021
(73) **CÔNG TY TNHH ĐẠI DƯƠNG Ý TƯỞNG (VN)**
Y10 đường Hồng Lĩnh, phường 15, quận 10, thành phố Hồ Chí Minh
(72) Lâm Quang Thành Chung (VN)
(74) **CÔNG TY LUẬT TNHH KHÔI NGỌC (KHOI NGOC LAW COMPANY LTD)**
(55)



CÔNG BÁO SỞ HỮU CÔNG NGHIỆP SỐ 403 TẬP A – QUYỀN 2 (10.2021)

- (11) **42833**
(21) 3-2021-01981 (28) 1
(54) **NHÃN SẢN PHẨM** (51) **19-08**
(22) 03/08/2021 (43) 25/10/2021
(73) **CÔNG TY TNHH ĐẠI DƯƠNG Ý TƯỞNG (VN)**
Y10 đường Hồng Lĩnh, phường 15, quận 10, thành phố Hồ Chí Minh
(72) Lâm Quang Thành Chung (VN)
(74) **CÔNG TY LUẬT TNHH KHÔI NGỌC (KHOI NGOC LAW COMPANY LTD)**
(55)



CÔNG BÁO SỞ HỮU CÔNG NGHIỆP SỐ 403 TẬP A – QUYỀN 2 (10.2021)

- (11) **42834**
(21) 3-2021-01982 (28) 1
(54) **NHÃN SẢN PHẨM** (51) **19-08**
(22) 03/08/2021 (43) 25/10/2021
(73) **CÔNG TY TNHH ĐẠI DƯƠNG Ý TƯỞNG (VN)**
Y10 đường Hồng Lĩnh, phường 15, quận 10, thành phố Hồ Chí Minh
(72) Lâm Quang Thành Chung (VN)
(74) **CÔNG TY LUẬT TNHH KHÔI NGỌC (KHOI NGOC LAW COMPANY LTD)**
(55)



CÔNG BÁO SỞ HỮU CÔNG NGHIỆP SỐ 403 TẬP A – QUYỀN 2 (10.2021)

- (11) **42835**
(21) 3-2021-01983 (28) 1
(54) **NHÃN SẢN PHẨM** (51) **19-08**
(22) 03/08/2021 (43) 25/10/2021
(73) **CÔNG TY TNHH ĐẠI DƯƠNG Ý TƯỞNG (VN)**
Y10 đường Hồng Lĩnh, phường 15, quận 10, thành phố Hồ Chí Minh
(72) Lâm Quang Thành Chung (VN)
(74) **CÔNG TY LUẬT TNHH KHÔI NGỌC (KHOI NGOC LAW COMPANY LTD)**
(55)

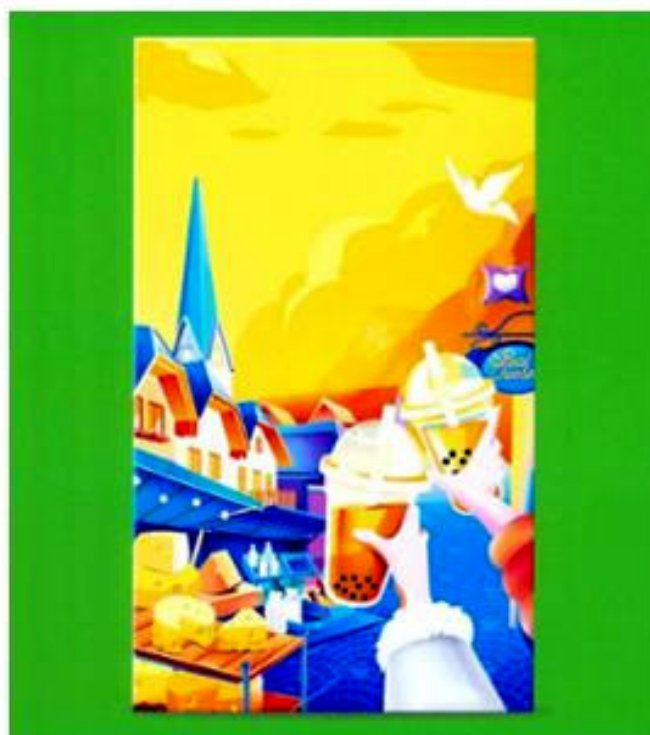

CÔNG BÁO SỞ HỮU CÔNG NGHIỆP SỐ 403 TẬP A – QUYỀN 2 (10.2021)

- (11) **42836**
- (21) 3-2021-01984 (28) 1
- (54) **NHÃN SẢN PHẨM** (51) **19-08**
- (22) 03/08/2021 (43) 25/10/2021
- (73) **CÔNG TY TNHH ĐẠI DƯƠNG Ý TƯỞNG (VN)**
Y10 đường Hồng Lĩnh, phường 15, quận 10, thành phố Hồ Chí Minh
- (72) Lâm Quang Thành Chung (VN)
- (74) **CÔNG TY LUẬT TNHH KHÔI NGỌC (KHOI NGOC LAW COMPANY LTD)**
- (55)



CÔNG BÁO SỞ HỮU CÔNG NGHIỆP SỐ 403 TẬP A – QUYỀN 2 (10.2021)

- (11) **42837**
(21) 3-2021-01985 (28) 1
(54) **NHÃN SẢN PHẨM** (51) **19-08**
(22) 03/08/2021 (43) 25/10/2021
(73) **CÔNG TY TNHH ĐẠI DƯƠNG Ý TƯỞNG (VN)**
Y10 đường Hồng Lĩnh, phường 15, quận 10, thành phố Hồ Chí Minh
(72) Lâm Quang Thành Chung (VN)
(74) **CÔNG TY LUẬT TNHH KHÔI NGỌC (KHOI NGOC LAW COMPANY LTD)**
(55)



CÔNG BÁO SỞ HỮU CÔNG NGHIỆP SỐ 403 TẬP A – QUYỀN 2 (10.2021)

- (11) **42838**
(21) 3-2021-01986 (28) 1
(54) **NHÃN SẢN PHẨM** (51) **19-08**
(22) 03/08/2021 (43) 25/10/2021
(73) **CÔNG TY TNHH ĐẠI DƯƠNG Ý TƯỞNG (VN)**
Y10 đường Hồng Lĩnh, phường 15, quận 10, thành phố Hồ Chí Minh
(72) Lâm Quang Thành Chung (VN)
(74) **CÔNG TY LUẬT TNHH KHÔI NGỌC (KHOI NGOC LAW COMPANY LTD)**
(55)



CÔNG BÁO SỞ HỮU CÔNG NGHIỆP SỐ 403 TẬP A – QUYỀN 2 (10.2021)

- (11) **42839**
(21) 3-2021-01987 (28) 1
(54) **NHÃN SẢN PHẨM** (51) **19-08**
(22) 03/08/2021 (43) 25/10/2021
(73) **CÔNG TY TNHH ĐẠI DƯƠNG Ý TƯỞNG (VN)**
Y10 đường Hồng Lĩnh, phường 15, quận 10, thành phố Hồ Chí Minh
(72) Lâm Quang Thành Chung (VN)
(74) **CÔNG TY LUẬT TNHH KHÔI NGỌC (KHOI NGOC LAW COMPANY LTD)**
(55)



CÔNG BÁO SỞ HỮU CÔNG NGHIỆP SỐ 403 TẬP A – QUYỀN 2 (10.2021)

- (11) **42840**
(21) 3-2021-01988 (28) 1
(54) **NHÃN SẢN PHẨM** (51) **19-08**
(22) 03/08/2021 (43) 25/10/2021
(73) **CÔNG TY TNHH ĐẠI DƯƠNG Ý TƯỞNG (VN)**
Y10 đường Hồng Lĩnh, phường 15, quận 10, thành phố Hồ Chí Minh
(72) Lâm Quang Thành Chung (VN)
(74) **CÔNG TY LUẬT TNHH KHÔI NGỌC (KHOI NGOC LAW COMPANY LTD)**
(55)



CÔNG BÁO SỞ HỮU CÔNG NGHIỆP SỐ 403 TẬP A – QUYỀN 2 (10.2021)

- (11) **42841**
(21) 3-2021-01989 (28) 1
(54) **THÙNG XE CHỖ TIỀN** (51) **06-04; 12-16**
(22) 03/08/2021 (43) 25/10/2021
(73) **CÔNG TY CỔ PHẦN ĐẦU TƯ VÀ PHÁT TRIỂN NGÂN LỰC (VN)**
Tầng 6 số 263 Cầu Giấy, phường Dịch Vọng, quận Cầu Giấy, thành phố Hà Nội
(72) Hà Trung Nghĩa (VN)
(55)

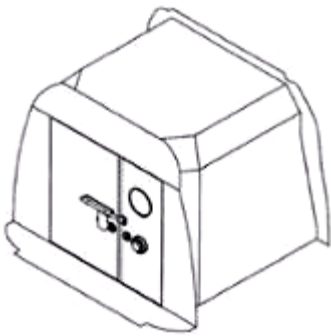

1.1

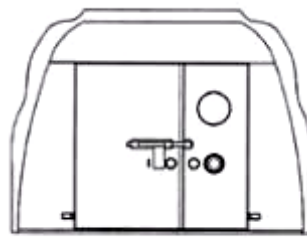

1.2



1.3

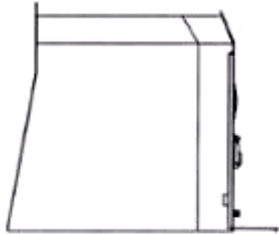

1.4

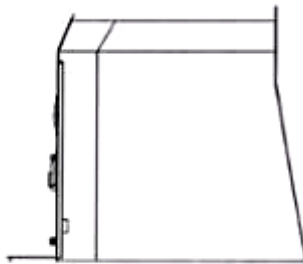

1.5

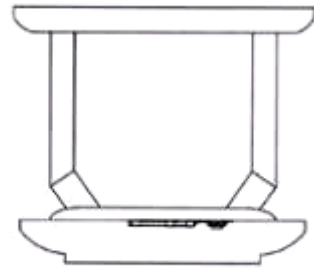

1.6

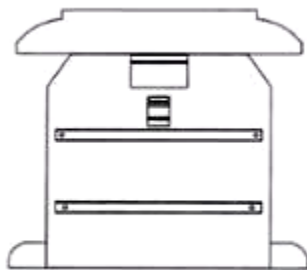

1.7



1.8

CÔNG BÁO SỞ HỮU CÔNG NGHIỆP SỐ 403 TẬP A – QUYỀN 2 (10.2021)

- (11) **42842**
(21) 3-2021-02008 (28) 2
(54) **BAO GÓI GIẤY VỆ SINH** (51) **09-05**
(22) 06/08/2021 (43) 25/10/2021
(73) **CÔNG TY TNHH TIẾN HIỆU (VN)**
Số 9, phố Cầu Gỗ, phường Hàng Bạc, quận Hoàn Kiếm, thành phố Hà Nội
(72) Đinh Thị Kim Định (VN)
(74) Công ty Luật TNHH VIETTHINK (VIETTHINK LAW FIRM)
(55)



1.1



1.2



2.1



2.2

CÔNG BÁO SỞ HỮU CÔNG NGHIỆP SỐ 403 TẬP A – QUYỀN 2 (10.2021)

- (11) **42843**
(21) 3-2021-02018 (28) 1
(54) **TẤM GHI TÊN THƯƠNG HIỆU** (51) **09-03**
(22) 09/08/2021 (43) 25/10/2021
(30) 30-2021-0011465 09/03/2021 KR;
(73) **AE KYUNG INDUSTRIAL CO., LTD (KR)**
188, Yanghwa-ro, Mapo-gu, Seoul, Republic of Korea
(72) Sujung Hong (KR)
(74) Công ty TNHH Sở hữu trí tuệ Thảo Thọ Quyển (INVENCO.,LTD)
(55)

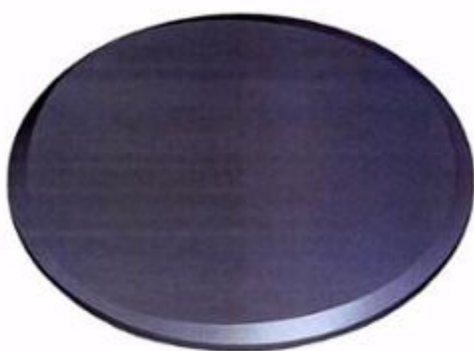

1.1



1.2



1.3



1.4



1.5



1.6

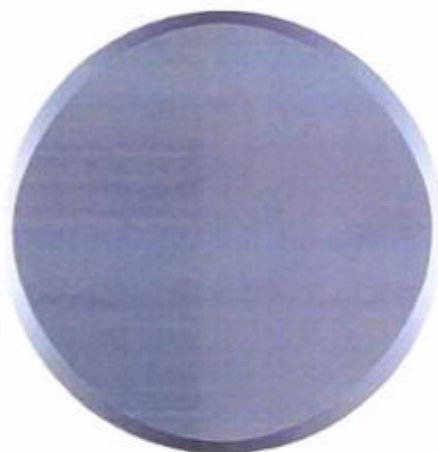

1.7

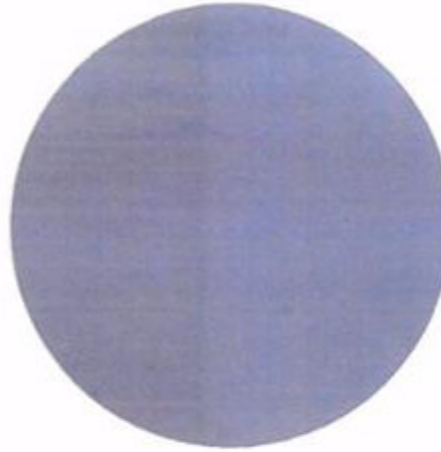

1.8

CÔNG BÁO SỞ HỮU CÔNG NGHIỆP SỐ 403 TẬP A – QUYỀN 2 (10.2021)

- (11) **42844**
(21) 3-2021-02021 (28) 1
(54) **THIẾT BỊ ĐIỀU KHIỂN TỪ XA** (51) **14-03**
(22) 09/08/2021 (43) 25/10/2021
(73) **CÔNG TY CỔ PHẦN TẬP ĐOÀN CASPER VIỆT NAM (VN)**
B17-18, khu CNĐT, TP Xanh, phường Cầu Diễn, quận Nam Từ Liêm, thành phố Hà Nội
(72) Nguyễn Viết Chung (VN)
(74) Công ty TNHH Sở hữu trí tuệ Bình Minh (SUNRISE IP CO.,LTD.)
(55)



1.1



1.2



1.3



1.4



1.5



1.6



1.7

CÔNG BÁO SỞ HỮU CÔNG NGHIỆP SỐ 403 TẬP A – QUYỀN 2 (10.2021)

- (11) **42845**
(21) 3-2021-02016 (28) 1
(54) **BAO GÓI** (51) **09-05**
(22) 09/08/2021 (43) 25/10/2021
(73) **CƠ SỞ SX-KD BỘT THỰC PHẨM LÊ HÀ (VN)**
Tổ 5, ấp Tân Hựu, xã Tân Nhuận Đông, huyện Châu Thành, tỉnh Đồng Tháp
(72) Hà Thị Mười Một (VN)
(74) **CÔNG TY TNHH SỞ HỮU TRÍ TUỆ SETHACO (SETHACO IP CO.,LTD)**
(55)



1.1



1.2

- (11) **42846**
(21) 3-2021-02027 (28) 1
(54) **THỨC ĂN CHO VẬT NUÔI** (51) **01-06**
(22) 26/10/2020 (43) 25/10/2021
(30) 29/733,294 30/04/2020 US;
(73) **SPECTRUM BRANDS, INC. (US)**
3001 Deming Way, Middleton, Wisconsin 53562, United States of America
(72) 1. VAN EYK, GREGORY (US)
2. POTTER, TIFFANY DAWN (US)
3. KENDRICK, VICTORIA GRAY (US)
(74) Công ty TNHH Sở hữu trí tuệ Thảo Thọ Quyển (INVENCO.,LTD)
(55)

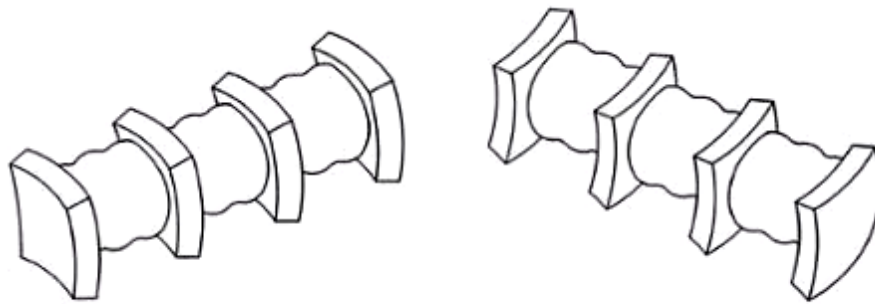

1.1

1.2



1.3

1.4

1.5



1.6

1.7

1.8

CÔNG BÁO SỞ HỮU CÔNG NGHIỆP SỐ 403 TẬP A – QUYỀN 2 (10.2021)

(11) **42847**

(21) 3-2021-02029

(28) 1

(54) **CHẬU RỬA**

(51) **23-02**

(22) 10/08/2021

(43) 25/10/2021

(73) **CÔNG TY CỔ PHẦN THƯƠNG MẠI VIGLACERA (VN)**

Tầng 3, tòa nhà Viglacera, số 1 Đại lộ Thăng Long, phường Mỹ Trì, quận Nam Từ Liêm, thành phố Hà Nội

(72) Phạm Ngọc Đường (VN)

(55)



1.1

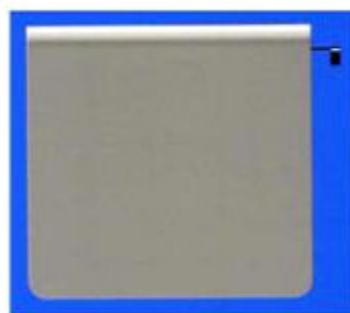

1.2

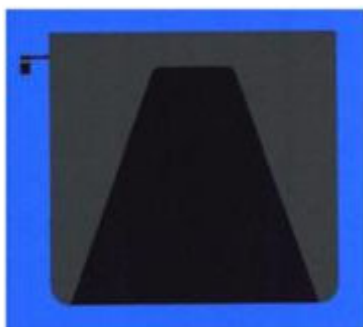

1.3



1.4



1.5

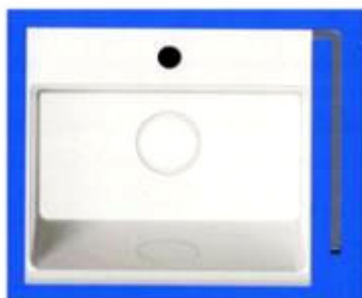

1.6



1.7

CÔNG BÁO SỞ HỮU CÔNG NGHIỆP SỐ 403 TẬP A – QUYỀN 2 (10.2021)

(11) **42848**

(21) 3-2021-02030

(28) 1

(54) **CHẬU RỬA**

(51) **23-02**

(22) 10/08/2021

(43) 25/10/2021

(73) **CÔNG TY CỔ PHẦN THƯƠNG MẠI VIGLACERA (VN)**

Tầng 3, tòa nhà Viglacera, số 1 Đại lộ Thăng Long, phường Mỹ Trì, quận Nam Từ Liêm, thành phố Hà Nội

(72) Phạm Ngọc Đường (VN)

(55)



1.1

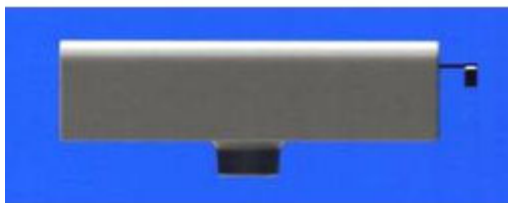

1.2

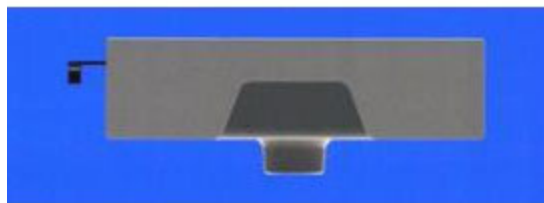

1.3

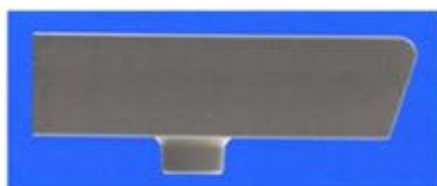

1.4



1.5



1.6

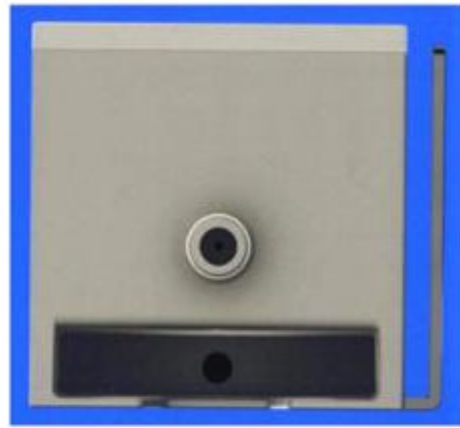

1.7

CÔNG BÁO SỞ HỮU CÔNG NGHIỆP SỐ 403 TẬP A – QUYỀN 2 (10.2021)

(11) **42849**

(21) 3-2021-02031

(28) 1

(54) **BỒN CẦU**

(51) **23-02**

(22) 10/08/2021

(43) 25/10/2021

(73) **CÔNG TY CỔ PHẦN THƯƠNG MẠI VIGLACERA (VN)**

Tầng 3, tòa nhà Viglacera, số 1 Đại lộ Thăng Long, phường Mỹ Trì, quận Nam Từ Liêm, thành phố Hà Nội

(72) Phạm Ngọc Đường (VN)

(55)



1.1



1.2



1.3



1.4



1.5



1.6

CÔNG BÁO SỞ HỮU CÔNG NGHIỆP SỐ 403 TẬP A – QUYỀN 2 (10.2021)

(11) **42850**

(21) 3-2021-02032

(28) 1

(54) **BỒN CẦU**

(51) **23-02**

(22) 10/08/2021

(43) 25/10/2021

(73) **CÔNG TY CỔ PHẦN THƯƠNG MẠI VIGLACERA (VN)**

Tầng 3, tòa nhà Viglacera, số 1 Đại lộ Thăng Long, phường Mỹ Trì, quận Nam Từ Liêm, thành phố Hà Nội

(72) Phạm Ngọc Đường (VN)

(55)



1.1



1.2



1.3



1.4



1.5



1.6

CÔNG BÁO SỞ HỮU CÔNG NGHIỆP SỐ 403 TẬP A – QUYỀN 2 (10.2021)

(11) **42851**

(21) 3-2021-02033

(28) 1

(54) **CHẬU RỬA**

(51) **23-02**

(22) 10/08/2021

(43) 25/10/2021

(73) **CÔNG TY CỔ PHẦN THƯƠNG MẠI VIGLACERA (VN)**

Tầng 3, tòa nhà Viglacera, số 1 Đại lộ Thăng Long, phường Mễ Trì, quận Nam Từ Liêm, thành phố Hà Nội

(72) Phạm Ngọc Đường (VN)

(55)



1.1



1.2



1.3



1.4



1.5



1.6

CÔNG BÁO SỞ HỮU CÔNG NGHIỆP SỐ 403 TẬP A – QUYỀN 2 (10.2021)

(11) **42852**

(21) 3-2021-02034

(28) 1

(54) **CHẬU RỬA**

(51) **23-02**

(22) 10/08/2021

(43) 25/10/2021

(73) **CÔNG TY CỔ PHẦN THƯƠNG MẠI VIGLACERA (VN)**

Tầng 3, tòa nhà Viglacera, số 1 Đại lộ Thăng Long, phường Mỹ Trì, quận Nam Từ Liêm, thành phố Hà Nội

(72) Phạm Ngọc Đường (VN)

(55)



1.1



1.2



1.3



1.4



1.5



1.6

CÔNG BÁO SỞ HỮU CÔNG NGHIỆP SỐ 403 TẬP A – QUYỀN 2 (10.2021)

(11) **42853**

(21) 3-2021-02035

(28) 1

(54) **BỒN CẦU**

(51) **23-02**

(22) 10/08/2021

(43) 25/10/2021

(73) **CÔNG TY CỔ PHẦN THƯƠNG MẠI VIGLACERA (VN)**

Tầng 3, tòa nhà Viglacera, số 1 Đại lộ Thăng Long, phường Mỹ Trì, quận Nam Từ Liêm, thành phố Hà Nội

(72) Mai Văn Thiêm (VN)

(55)



1.1



1.2



1.3



1.4



1.5



1.6

CÔNG BÁO SỞ HỮU CÔNG NGHIỆP SỐ 403 TẬP A – QUYỀN 2 (10.2021)

(11) **42854**

(21) 3-2021-02036

(28) 1

(54) **BỒN CẦU**

(51) **23-02**

(22) 10/08/2021

(43) 25/10/2021

(73) **CÔNG TY CỔ PHẦN THƯƠNG MẠI VIGLACERA (VN)**

Tầng 3, tòa nhà Viglacera, số 1 Đại lộ Thăng Long, phường Mỹ Trì, quận Nam Từ Liêm, thành phố Hà Nội

(72) Phạm Ngọc Đường (VN)

(55)



1.1



1.2



1.3



1.4



1.5



1.6

CÔNG BÁO SỞ HỮU CÔNG NGHIỆP SỐ 403 TẬP A – QUYỀN 2 (10.2021)

(11) **42855**

(21) 3-2021-02037

(28) 1

(54) **BỒN CẦU**

(51) **23-02**

(22) 10/08/2021

(43) 25/10/2021

(73) **CÔNG TY CỔ PHẦN THƯƠNG MẠI VIGLACERA (VN)**

Tầng 3, tòa nhà Viglacera, số 1 Đại lộ Thăng Long, phường Mỹ Trì, quận Nam Từ Liêm, thành phố Hà Nội

(72) Phạm Ngọc Đường (VN)

(55)



1.1



1.2



1.3



1.4



1.5



1.6

CÔNG BÁO SỞ HỮU CÔNG NGHIỆP SỐ 403 TẬP A – QUYỀN 2 (10.2021)

(11) **42856**

(21) 3-2021-02038

(28) 1

(54) **BỒN CẦU**

(51) **23-02**

(22) 10/08/2021

(43) 25/10/2021

(73) **CÔNG TY CỔ PHẦN THƯƠNG MẠI VIGLACERA (VN)**

Tầng 3, tòa nhà Viglacera, số 1 Đại lộ Thăng Long, phường Mỹ Trì, quận Nam Từ Liêm, thành phố Hà Nội

(72) Phạm Ngọc Đường (VN)

(55)



1.1



1.2



1.3



1.4



1.5



1.6

- (11) **42857**
(21) 3-2021-02040 (28) 1
(54) **ĐỒNG HỒ THÔNG MINH** (51) **10-02**
(22) 11/08/2021 (43) 25/10/2021
(30) 202130289264.4 14/05/2021 CN;
(73) **HANNSTAR DISPLAY CORPORATION (TW)**
4F, No.15, Ln 168, Xing Shan Rd., Neihu Dist., Taipei City, Taiwan
(72) 1. PEI-I HSU (TW)
2. CHUN-YUAN HSIEH (TW)
3. CHIN CHEN (TW)
4. JUN-JIA HUANG (TW)
5. LI-FU HO (TW)
6. KUO-YUAN LIN (TW)
7. MENG-LING YANG (TW)
(74) Công ty Luật TNHH WINCO (WINCO LAW FIRM)
(55)

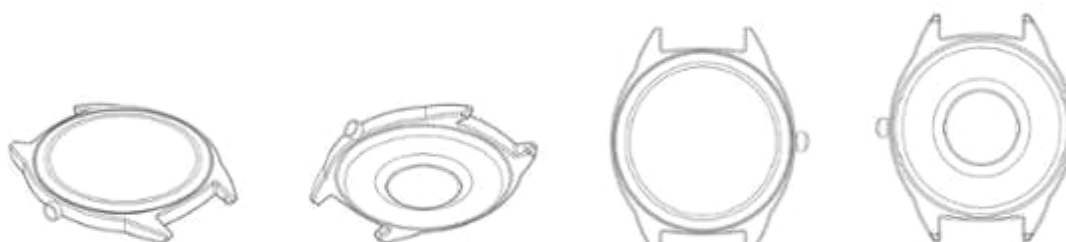

1.1

1.2

1.3

1.4



1.5

1.6

1.7

1.8

CÔNG BÁO SỞ HỮU CÔNG NGHIỆP SỐ 403 TẬP A – QUYỀN 2 (10.2021)

(11) **42858**

(21) 3-2021-02041

(28) 1

(54) **GHẾ SÔ-PHA**

(51) **06-01**

(22) 11/08/2021

(43) 25/10/2021

(73) **HTL FURNITURE (CHINA) CO., LTD. (CN)**

Wusong Jiangnan Road, Kunshan Development Zone, Jiangsu Province, China

(72) PHUA YONG TAT (SG)

(74) Công ty Luật TNHH quốc tế BMVN (BMVN INTERNATIONAL LLC)

(55)



1.1



1.2



1.3



1.4



1.5



1.6

CÔNG BÁO SỞ HỮU CÔNG NGHIỆP SỐ 403 TẬP A – QUYỀN 2 (10.2021)

(11) **42859**

(21) 3-2021-02042

(28) 1

(54) **GHẾ SÔ-PHA**

(51) **06-01**

(22) 11/08/2021

(43) 25/10/2021

(73) **HTL FURNITURE (CHINA) CO., LTD. (CN)**

Wusong Jiangnan Road, Kunshan Development Zone, Jiangsu Province, China

(72) PHUA YONG TAT (SG)

(74) Công ty Luật TNHH quốc tế BMVN (BMVN INTERNATIONAL LLC)

(55)



1.1



1.2



1.3



1.4



1.5

CÔNG BÁO SỞ HỮU CÔNG NGHIỆP SỐ 403 TẬP A – QUYỀN 2 (10.2021)

(11) **42860**

(21) 3-2021-02043

(28) 1

(54) **GHẾ SÔ-PHA**

(51) **06-01**

(22) 11/08/2021

(43) 25/10/2021

(73) **HTL FURNITURE (CHINA) CO., LTD. (CN)**

Wusong Jiangnan Road, Kunshan Development Zone, Jiangsu Province, China

(72) PHUA YONG TAT (SG)

(74) Công ty Luật TNHH quốc tế BMVN (BMVN INTERNATIONAL LLC)

(55)



1.1



1.2



1.3



1.4



1.5

CÔNG BÁO SỞ HỮU CÔNG NGHIỆP SỐ 403 TẬP A – QUYỀN 2 (10.2021)

(11) **42861**

(21) 3-2021-02044

(28) 1

(54) **GHẾ SÔ-PHA**

(51) **06-01**

(22) 11/08/2021

(43) 25/10/2021

(73) **HTL FURNITURE (CHINA) CO., LTD. (CN)**

Wusong Jiangnan Road, Kunshan Development Zone, Jiangsu Province, China

(72) PHUA YONG TAT (SG)

(74) Công ty Luật TNHH quốc tế BMVN (BMVN INTERNATIONAL LLC)

(55)



1.1



1.2



1.3



1.4



1.5

- (11) **42862**
 (21) 3-2021-02055 (28) 1
 (54) **HỆ THỐNG CẤP THỨC ĂN VIÊN VÀ OXY CHO NUÔI TÔM THÂM CANH** (51) **15-03; 15-99; 30-03**
 (22) 12/08/2021 (43) 25/10/2021
 (73) **CÔNG TY CỔ PHẦN RYNAN TECHNOLOGIES VIETNAM (VN)**
 Ấp Long Trị, xã Long Đức, thành phố Trà Vinh, tỉnh Trà Vinh
 (72) 1. NGUYỄN THANH MỸ (VN)
 2. TRẦN QUỐC TOẢN (VN)
 3. VÕ VŨ KHANH (VN)
 4. VÕ QUỐC VIỆT (VN)
 (74) Công ty TNHH Đại Tín và Liên Danh (DAITIN AND ASSOCIATES CO.,LTD)
 (55)

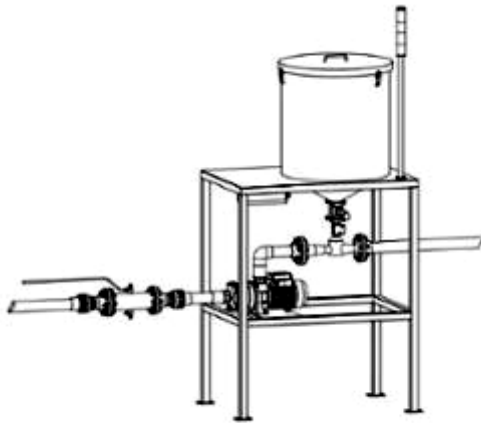

1.1

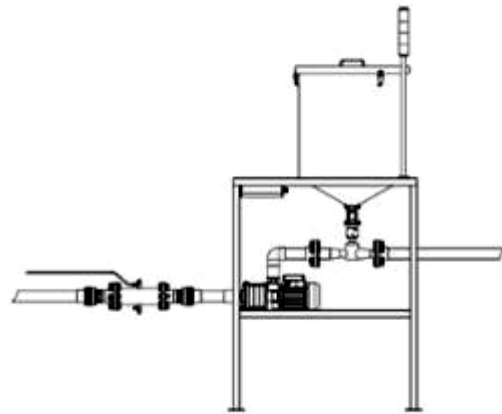

1.2

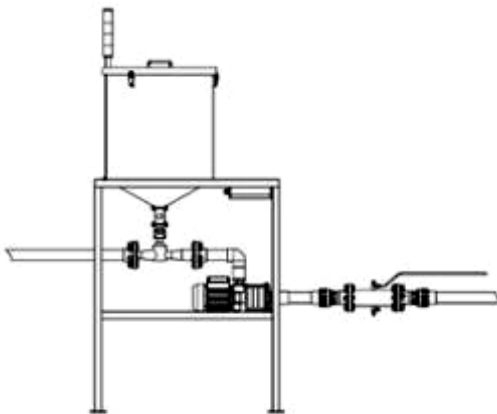

1.3

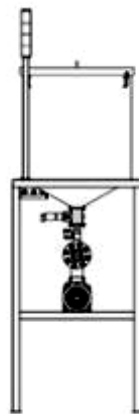

1.4

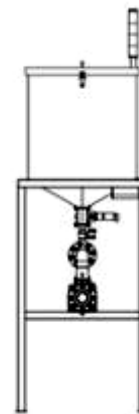

1.5

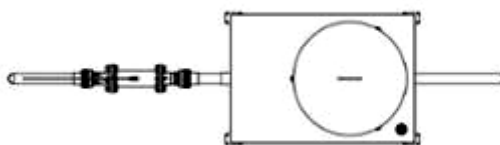

1.6

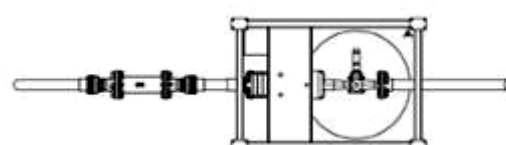

1.7

(11) **42863**

(21) 3-2021-02073

(54) **ĐÈN**

(22) 13/08/2021

(73) **CÔNG TY CỔ PHẦN BÓNG ĐÈN PHÍCH NƯỚC RẠNG ĐÔNG (VN)**

87-89 phố Hạ Đình, phường Thanh Xuân Trung, quận Thanh Xuân, thành phố Hà Nội

(72) Trần Trung Tường (VN)

(55)

(28) 1

(51) **26-05**

(43) 25/10/2021

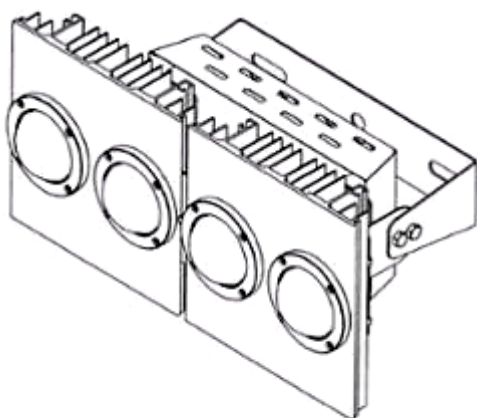

1.1

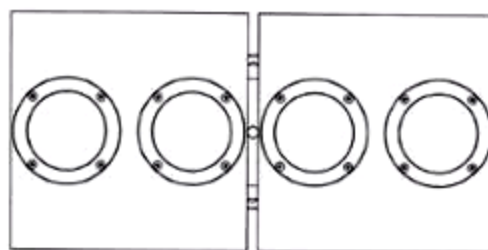

1.2

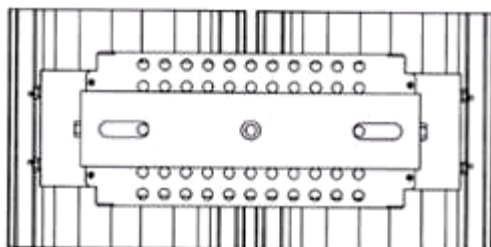

1.3

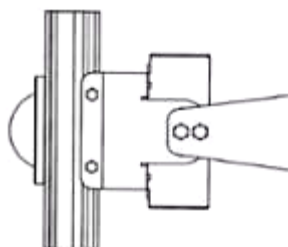

1.4

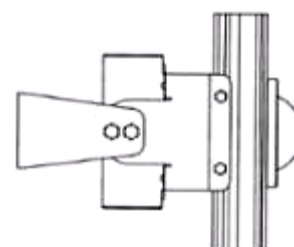

1.5

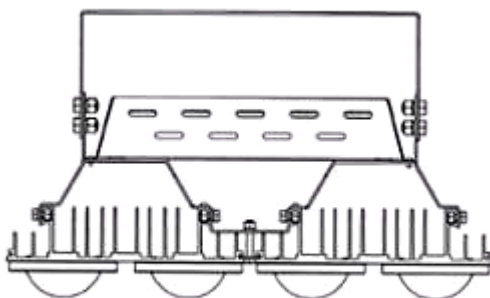

1.6

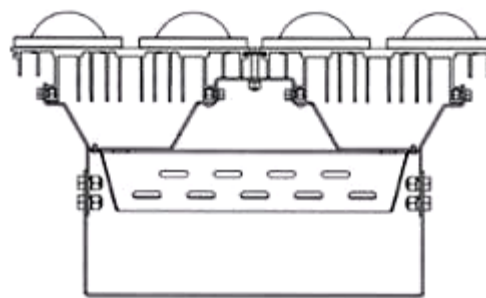

1.7

CÔNG BÁO SỞ HỮU CÔNG NGHIỆP SỐ 403 TẬP A – QUYỀN 2 (10.2021)

- (11) **42864**
(21) 3-2021-02074 (28) 1
(54) **GIÁ ĐỖ** (51) **08-08; 26-99**
(22) 13/08/2021 (43) 25/10/2021
(73) **CÔNG TY CỔ PHẦN BÓNG ĐÈN PHÍCH NƯỚC RẠNG ĐÔNG (VN)**
87-89 phố Hạ Đình, phường Thanh Xuân Trung, quận Thanh Xuân, thành phố Hà Nội
(72) Trần Trung Tường (VN)
(55)

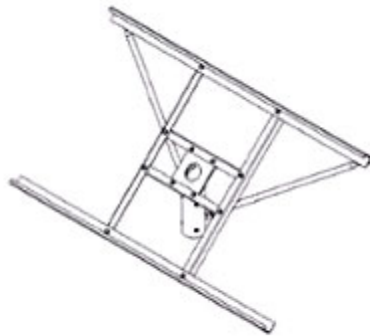

1.1

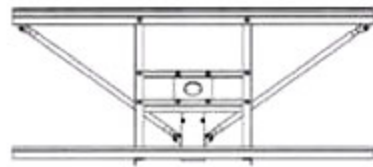

1.2

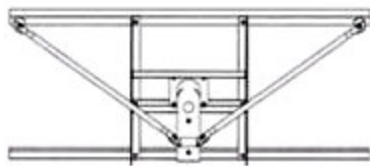

1.3



1.4

1.5

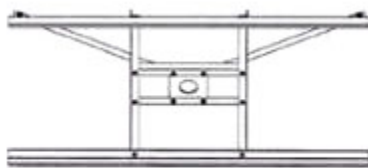

1.6

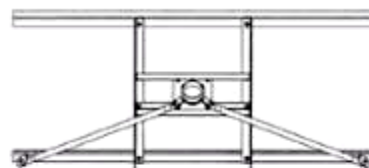

1.7

- (11) **42865**
(21) 3-2021-02075 (28) 2
(54) **GIÁ ĐỖ** (51) **08-08; 26-99**
(22) 13/08/2021 (43) 25/10/2021
(73) **CÔNG TY CỔ PHẦN BÓNG ĐÈN PHÍCH NƯỚC RẠNG ĐÔNG (VN)**
87-89 phố Hạ Đình, phường Thanh Xuân Trung, quận Thanh Xuân, thành phố Hà Nội
(72) Trần Trung Tường (VN)
(55)



1.1

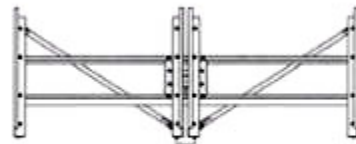

1.2

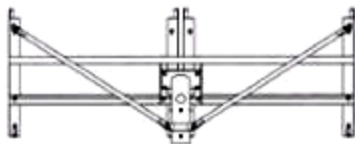

1.3



1.4



1.5

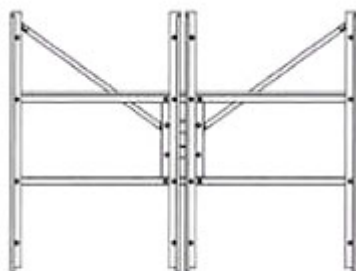

1.6

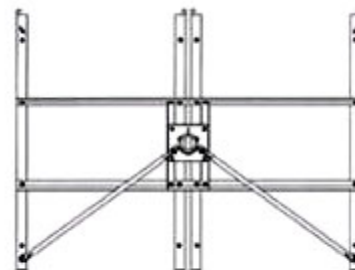

1.7



2.1

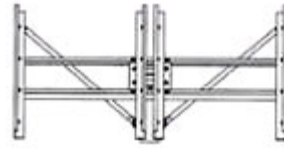

2.2

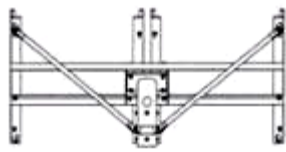

2.3



2.4

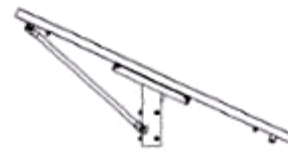

2.5



2.6

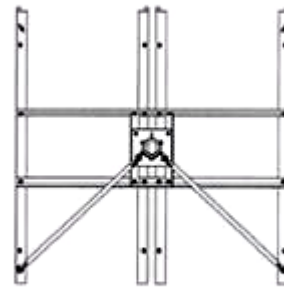

2.7

CÔNG BÁO SỞ HỮU CÔNG NGHIỆP SỐ 403 TẬP A – QUYỀN 2 (10.2021)

(11) **42866**

(21) 3-2021-02064

(28) 1

(54) **KHUNG GIƯỜNG**

(51) **06-02**

(22) 13/08/2021

(43) 25/10/2021

(73) **HTL FURNITURE (CHINA) CO., LTD. (CN)**

Wusong Jiangnan Road, Kunshan Development Zone, Jiangsu Province, China

(72) PHUA YONG TAT (SG)

(74) Công ty Luật TNHH quốc tế BMVN (BMVN INTERNATIONAL LLC)

(55)



1.1



1.2



1.3



1.4



1.5

CÔNG BÁO SỞ HỮU CÔNG NGHIỆP SỐ 403 TẬP A – QUYỀN 2 (10.2021)

- (11) **42867**
(21) 3-2021-02070 (28) 1
(54) **HỘP ĐỰNG KHẨU TRANG** (51) **09-03**
(22) 13/08/2021 (43) 25/10/2021
(73) **CÔNG TY CỔ PHẦN HABIMEC VIỆT NAM (VN)**
Lô 24 Khu công nghiệp Quang Minh, xã Kim Hoa, huyện Mê Linh, thành phố Hà Nội
(72) Lê Thị Thu Hà (VN)
(74) Công ty TNHH Sở hữu trí tuệ Việt Nam IP (VIETNAM IP)
(55)



1.1



1.2

CÔNG BÁO SỞ HỮU CÔNG NGHIỆP SỐ 403 TẬP A – QUYỀN 2 (10.2021)

- (11) **42868**
- (21) 3-2021-02072 (28) 1
- (54) **THIẾT BỊ CẤP THỨC ĂN, OXY PHÂN TỬ VÀ TẠO DÒNG NƯỚC CHO NUÔI TÔM THÂM CANH** (51) **15-03; 15-99; 30-03**
- (22) 13/08/2021 (43) 25/10/2021
- (73) **CÔNG TY CỔ PHẦN RYNAN TECHNOLOGIES VIETNAM (VN)**
Ấp Long Trị, xã Long Đức, thành phố Trà Vinh, tỉnh Trà Vinh
- (72) 1. NGUYỄN THANH MỸ (VN)
2. TRẦN QUỐC TOẢN (VN)
3. VÕ VŨ KHANH (VN)
4. VÕ QUỐC VIỆT (VN)
5. HUỖNH LÊ NHỰT HÀO (VN)
- (74) Công ty TNHH Đại Tín và Liên Danh (DAITIN AND ASSOCIATES CO.,LTD)
- (55)

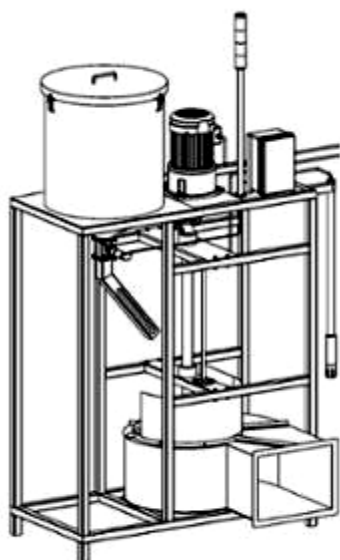

1.1

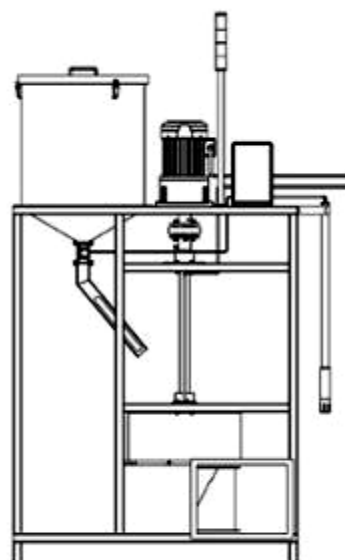

1.2

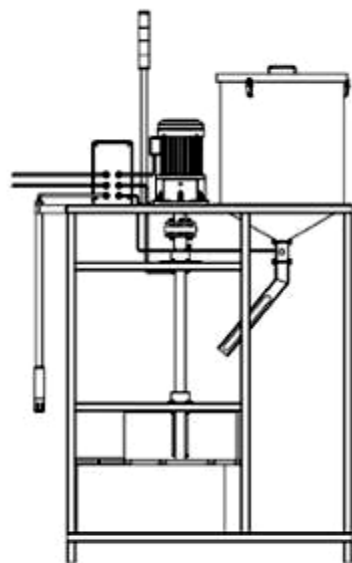

1.3

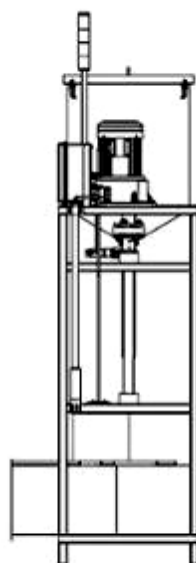

1.4

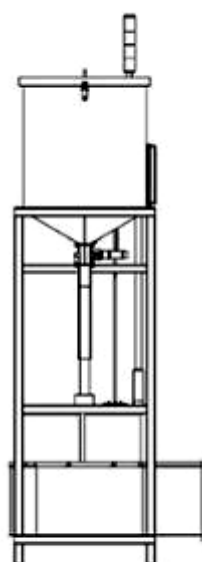

1.5

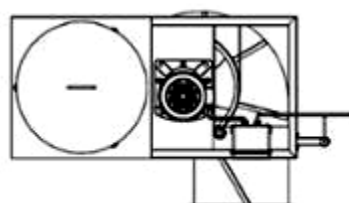

1.6

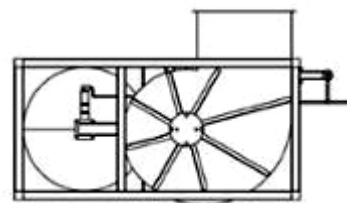

1.7

CÔNG BÁO SỞ HỮU CÔNG NGHIỆP SỐ 403 TẬP A – QUYỀN 2 (10.2021)

- (11) **42869**
(21) 3-2021-02076 (28) 2
(54) **ĐẦU GẬY ĐÁNH GÔN** (51) **21-02**
(22) 16/08/2021 (43) 25/10/2021
(73) **DONGGUAN YICHENG PRECISION MOLD CO., LTD. (CN)**
No.1548 Meijingzhong Rd., Dalang Town, Dongguan City, Guangdong Province,
523000, China
(72) CHU, Ming-Chou (CN)
(74) Công ty TNHH Sáng chế ACTIP (ACTIP PATENT LIMITED)
(55)



1.1

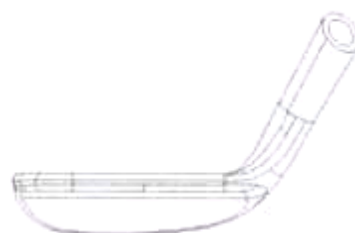

1.2



1.3



1.4

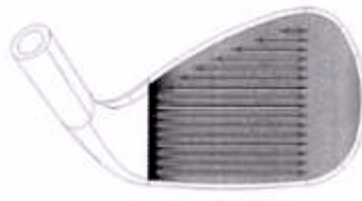

1.5



1.6



1.7



1.8



2.1

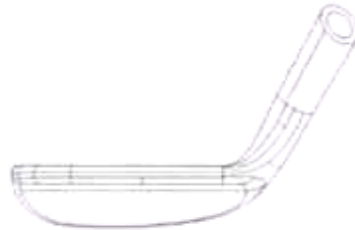

2.2



2.3



2.4

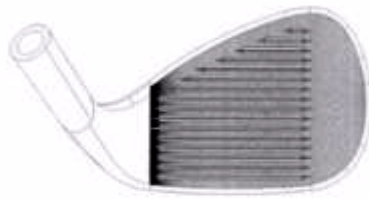

2.5



2.6



2.7



2.8

CÔNG BÁO SỞ HỮU CÔNG NGHIỆP SỐ 403 TẬP A – QUYỀN 2 (10.2021)

- (11) **42870**
(21) 3-2021-02077 (28) 1
(54) **NHÃN SẢN PHẨM** (51) **19-08**
(22) 16/08/2021 (43) 25/10/2021
(73) **CÔNG TY CỔ PHẦN CHẾ BIẾN THỰC PHẨM CAO BẰNG (VN)**
(NR ông Nguyễn Văn Phúc), thôn Thượng Thôn, xã Đông Tiến, huyện Yên Phong,
tỉnh Bắc Ninh
(72) Trần Thị Vượng (VN)
(74) Công ty TNHH Sở hữu trí tuệ và Công nghệ Thủ đô (CAPITAL IP&T CO.LTD.)
(55)



CÔNG BÁO SỞ HỮU CÔNG NGHIỆP SỐ 403 TẬP A – QUYỀN 2 (10.2021)

- (11) **42871**
(21) 3-2021-02078 (28) 1
(54) **NHÃN SẢN PHẨM** (51) **19-08**
(22) 16/08/2021 (43) 25/10/2021
(73) **CÔNG TY CỔ PHẦN CHẾ BIẾN THỰC PHẨM CAO BẰNG (VN)**
(NR ông Nguyễn Văn Phúc), thôn Thượng Thôn, xã Đông Tiến, huyện Yên Phong, tỉnh Bắc Ninh
(72) Trần Thị Vượng (VN)
(74) Công ty TNHH Sở hữu trí tuệ và Công nghệ Thủ đô (CAPITAL IP&T CO.LTD.)
(55)

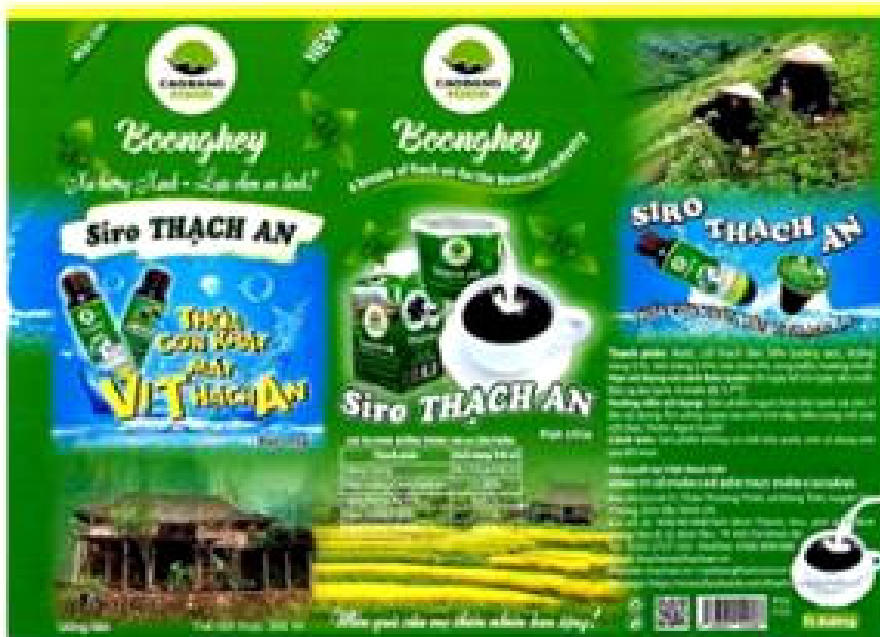

CÔNG BÁO SỞ HỮU CÔNG NGHIỆP SỐ 403 TẬP A – QUYỀN 2 (10.2021)

- (11) **42872**
(21) 3-2021-02079 (28) 1
(54) **NHÃN SẢN PHẨM** (51) **19-08**
(22) 16/08/2021 (43) 25/10/2021
(73) **CÔNG TY CỔ PHẦN CHẾ BIẾN THỰC PHẨM CAO BẰNG (VN)**
(NR ông Nguyễn Văn Phúc), thôn Thượng Thôn, xã Đông Tiến, huyện Yên Phong,
tỉnh Bắc Ninh
(72) Trần Thị Vượng (VN)
(74) Công ty TNHH Sở hữu trí tuệ và Công nghệ Thủ đô (CAPITAL IP&T CO.LTD.)
(55)

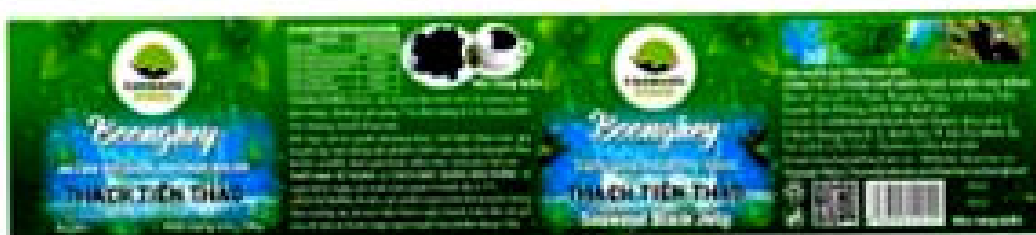

CÔNG BÁO SỞ HỮU CÔNG NGHIỆP SỐ 403 TẬP A – QUYỀN 2 (10.2021)

(11) **42873**

(21) 3-2021-02082

(28) 1

(54) **ĐÈN LED**

(51) **26-05**

(22) 16/08/2021

(43) 25/10/2021

(73) **CÔNG TY CỔ PHẦN CÔNG NGHỆ AKASHIC (VN)**

Số 1, ngách 69B/33, đường Hoàng Văn Thái, phường Khương Trung, quận Thanh Xuân, thành phố Hà Nội

(72) 1. LÊ NGUYỄN TÀI (VN)

2. LÊ VIỆT PHƯƠNG (VN)

3. NGUYỄN TUẤN ANH (VN)

(74) Công ty TNHH Sở hữu trí tuệ Trần & Trần (TRAN & TRAN CO., LTD.)

(55)

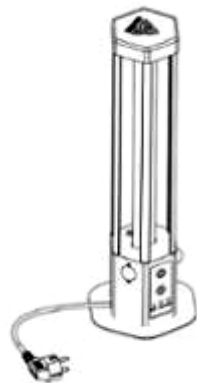

1.1



1.2

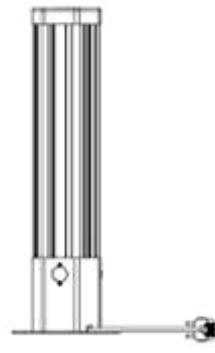

1.3

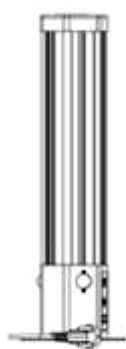

1.4

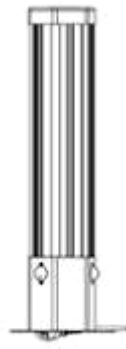

1.5



1.6



1.7

CÔNG BÁO SỞ HỮU CÔNG NGHIỆP SỐ 403 TẬP A – QUYỀN 2 (10.2021)

- (11) **42874**
(21) 3-2021-02085 (28) 1
(54) **THIẾT BỊ ĐỖ XE CÓ CHÂN CHỐNG ĐIỆN** (51) **12-16**
(22) 17/08/2021 (43) 25/10/2021
(73) **HUNG-YUAN LIN (TW)**
No. 22, Ln. 21, Heping St., Taishan Dist., New Taipei City, Taiwan
(72) Hung-Yuan LIN (TW)
(74) Công ty TNHH Sở hữu trí tuệ HA VIP (HAVIP CO., LTD.)
(55)

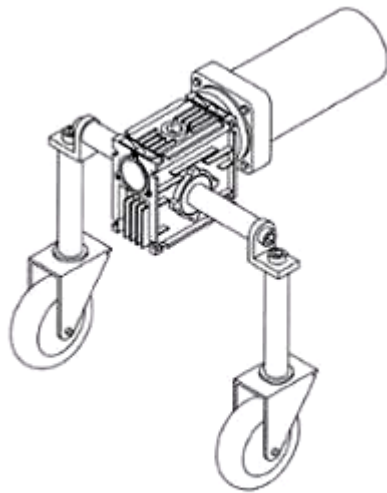

1.1

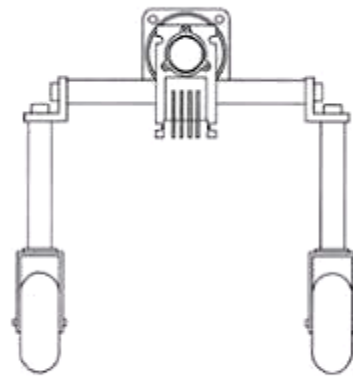

1.2

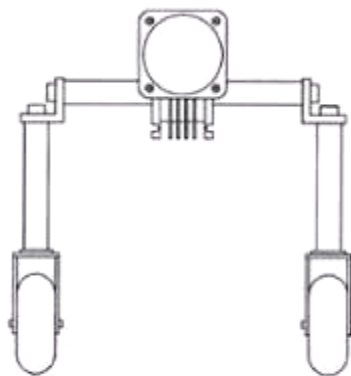

1.3

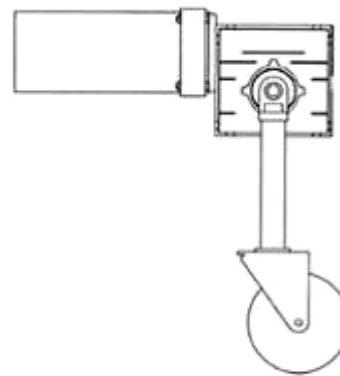

1.4

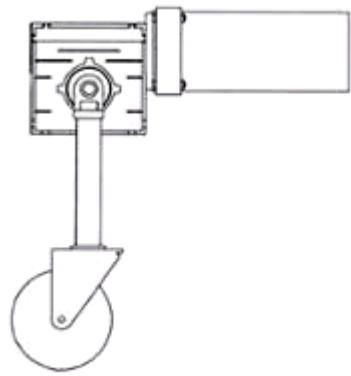

1.5

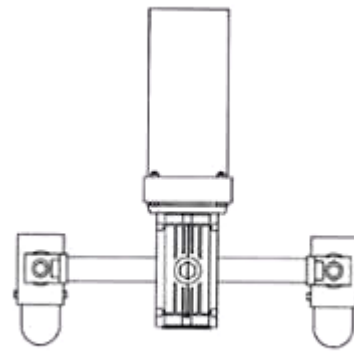

1.6

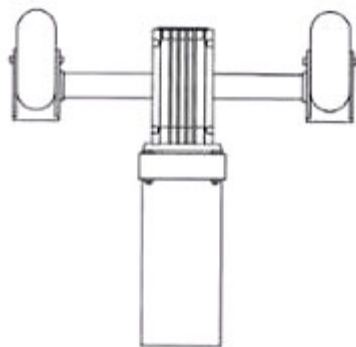

1.7

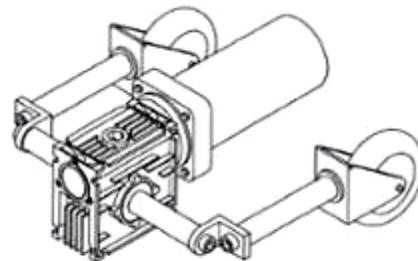

1.8

CÔNG BÁO SỞ HỮU CÔNG NGHIỆP SỐ 403 TẬP A – QUYỀN 2 (10.2021)

- (11) **42875**
(21) 3-2021-02101 (28) 1
(54) **HỘP ĐỰNG** (51) **09-03**
(22) 19/08/2021 (43) 25/10/2021
(73) **CÔNG TY TNHH THƯƠNG MẠI VÀ SẢN XUẤT HOÀNG MAI (VN)**
Số 17 Hàng Bún, phường Nguyễn Trung Trực, quận Ba Đình, thành phố Hà Nội
(72) Trần Sỹ Trực (VN)
(74) Công ty TNHH Sở hữu trí tuệ HA VIP (HAVIP CO., LTD.)
(55)



1.1



1.2

CÔNG BÁO SỞ HỮU CÔNG NGHIỆP SỐ 403 TẬP A – QUYỀN 2 (10.2021)

- (11) **42876**
(21) 3-2021-02102 (28) 1
(54) **HỘP ĐỰNG** (51) **09-03**
(22) 19/08/2021 (43) 25/10/2021
(73) **CÔNG TY TNHH THƯƠNG MẠI VÀ SẢN XUẤT HOÀNG MAI (VN)**
Số 17 Hàng Bún, phường Nguyễn Trung Trực, quận Ba Đình, thành phố Hà Nội
(72) Trần Sỹ Trực (VN)
(74) Công ty TNHH Sở hữu trí tuệ HA VIP (HAVIP CO., LTD.)
(55)



1.1



1.2

CÔNG BÁO SỞ HỮU CÔNG NGHIỆP SỐ 403 TẬP A – QUYỀN 2 (10.2021)

- (11) **42877**
(21) 3-2021-02129 (28) 1
(54) **BAO GÓI SẢN PHẨM** (51) **09-05**
(22) 20/08/2021 (43) 25/10/2021
(73) **CÔNG TY TNHH GIẤY MYLAN (VN)**
Số 19B/5, phố Nguyễn Văn Cừ, phường Ngọc Lâm, quận Long Biên, thành phố Hà Nội
(72) Nguyễn Thị Dung (VN)
(74) Công ty TNHH Tư vấn Nhiệt tâm và Cộng sự (NT & PARTNERS CO.,LTD.)
(55)



1.1



1.2

CÔNG BÁO SỞ HỮU CÔNG NGHIỆP SỐ 403 TẬP A – QUYỀN 2 (10.2021)

- (11) **42878**
(21) 3-2021-02130 (28) 1
(54) **BAO GÓI SẢN PHẨM** (51) **09-05**
(22) 20/08/2021 (43) 25/10/2021
(73) **CÔNG TY TNHH GIẤY MYLAN (VN)**
Số 19B/5, phố Nguyễn Văn Cừ, phường Ngọc Lâm, quận Long Biên, thành phố Hà Nội
(72) Nguyễn Thị Dung (VN)
(74) Công ty TNHH Tư vấn Nhiệt tâm và Cộng sự (NT & PARTNERS CO.,LTD.)
(55)



1.1



1.2

CÔNG BÁO SỞ HỮU CÔNG NGHIỆP SỐ 403 TẬP A – QUYỀN 2 (10.2021)

(11) **42879**

(21) 3-2021-02134

(28) 1

(54) **HỘP**

(51) **09-03**

(22) 20/08/2021

(43) 25/10/2021

(73) **LG HOUSEHOLD & HEALTH CARE LTD. (KR)**

58, Saemunan-ro, Jongno-gu, Seoul, Republic of Korea

(72) LEE, Hyun Seung (KR)

(74) Công ty TNHH Tâm nhìn và Liên danh (VISION & ASSOCIATES CO.LTD.)

(55)



1.1



1.2



1.3



1.4



1.5



1.6



1.7

CÔNG BÁO SỞ HỮU CÔNG NGHIỆP SỐ 403 TẬP A – QUYỀN 2 (10.2021)

- (11) **42880**
(21) 3-2021-02155 (28) 1
(54) **LỢ** (51) **09-01**
(22) 23/08/2021 (43) 25/10/2021
(73) **LG HOUSEHOLD & HEALTH CARE LTD. (KR)**
58, Saemunan-ro, Jongno-gu, Seoul, Republic of Korea
(72) PARK, Suk Young (KR)
(74) Công ty TNHH Tâm nhìn và Liên danh (VISION & ASSOCIATES CO.LTD.)
(55)



1.1



1.2



1.3



1.4



1.5



1.6



1.7

- (11) **42881**
(21) 3-2021-01675 (28) 1
(54) **THIẾT BỊ TRỊ LIỆU TÀN SỐ CAO** (51) **24-01**
(22) 25/06/2021 (43) 25/10/2021
(30) 30-2021-0015871 01/04/2021 KR;
(73) **CLASSYS INC. (KR)**
240, Teheran-ro, Gangnam-gu, Seoul, 06221, Republic of Korea
(72) Jin Yong KIM (KR)
(74) Văn phòng Luật sư Ân Nam (ANNAM IP & LAW)
(55)

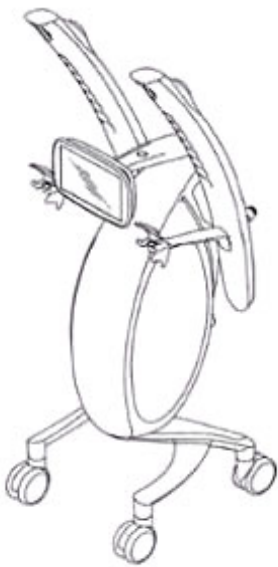

1.1



1.2



1.3



1.4



1.5

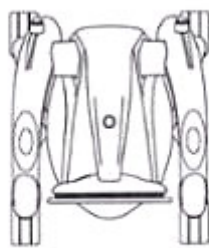

1.6

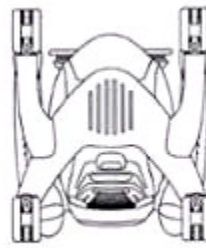

1.7

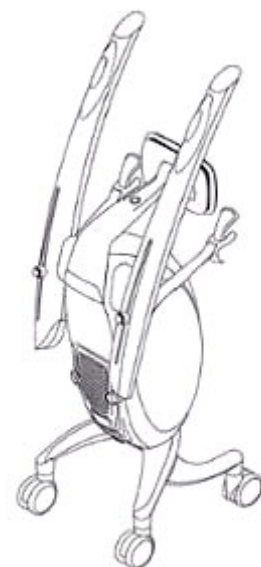

1.8

- (11) **42882**
(21) 3-2021-01676 (28) 1
(54) **THIẾT BỊ SIÊU ÂM TRỊ LIỆU** (51) **24-01**
(22) 25/06/2021 (43) 25/10/2021
(30) 30-2021-0015880 01/04/2021 KR;
(73) **CLASSYS INC. (KR)**
240, Teheran-ro, Gangnam-gu, Seoul, 06221, Korea (South)
(72) Jin Yong KIM (KR)
(74) Văn phòng Luật sư Ân Nam (ANNAM IP & LAW)
(55)



1.1

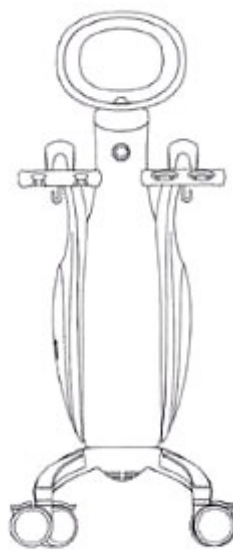

1.2

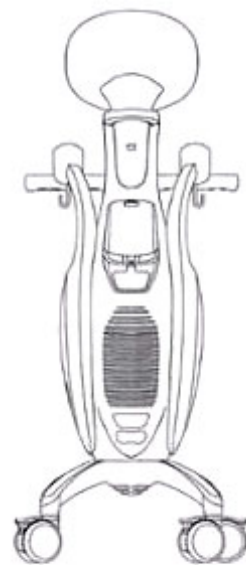

1.3



1.4

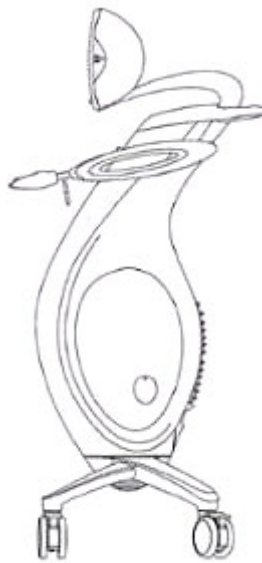

1.5

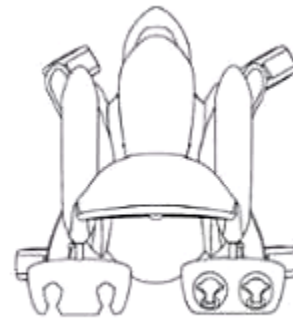

1.6

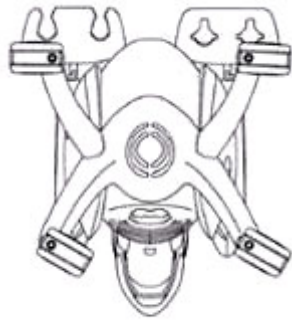

1.7



1.8

CÔNG BÁO SỞ HỮU CÔNG NGHIỆP SỐ 403 TẬP A – QUYỀN 2 (10.2021)

- (11) **42883**
(21) 3-2021-01677 (28) 1
(54) **TAY CẦM CHO THIẾT BỊ TRỊ LIỆU TÀN SỐ CAO** (51) **24-01**
(22) 25/06/2021 (43) 25/10/2021
(30) 30-2021-0015875 01/04/2021 KR;
(73) **CLASSYS INC. (KR)**
240, Teheran-ro, Gangnam-gu, Seoul, 06221, Korea (South)
(72) Jin Yong KIM (KR)
(74) Văn phòng Luật sư Ân Nam (ANNAM IP & LAW)
(55)

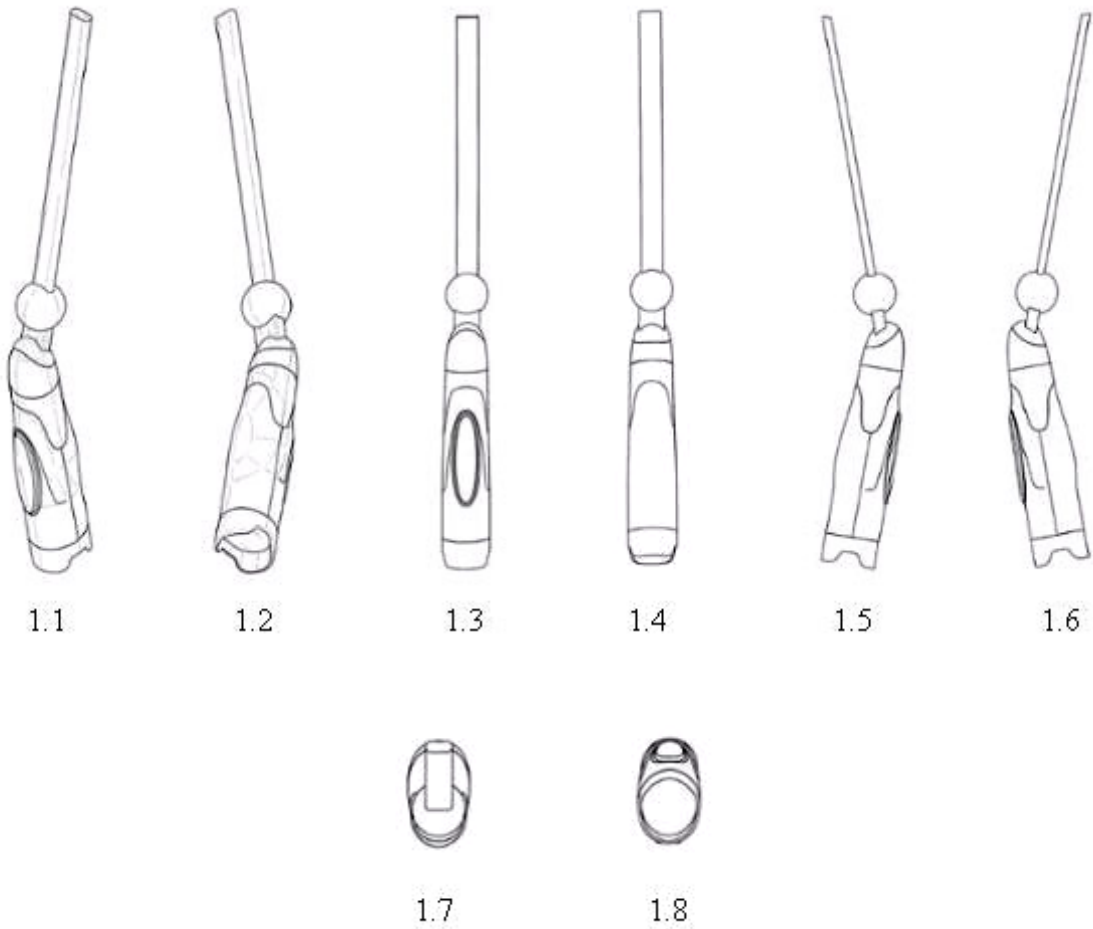

- (11) **42884**
(21) 3-2021-01678 (28) 1
(54) **TAY CẦM CHO THIẾT BỊ SIÊU ÂM TRỊ LIỆU** (51) **24-01**
(22) 25/06/2021 (43) 25/10/2021
(30) 30-2021-0015886 01/04/2021 KR;
(73) **CLASSYS INC. (KR)**
240, Teheran-ro, Gangnam-gu, Seoul, 06221, Korea (South)
(72) Jin Yong KIM (KR)
(74) Văn phòng Luật sư Ân Nam (ANNAM IP & LAW)
(55)

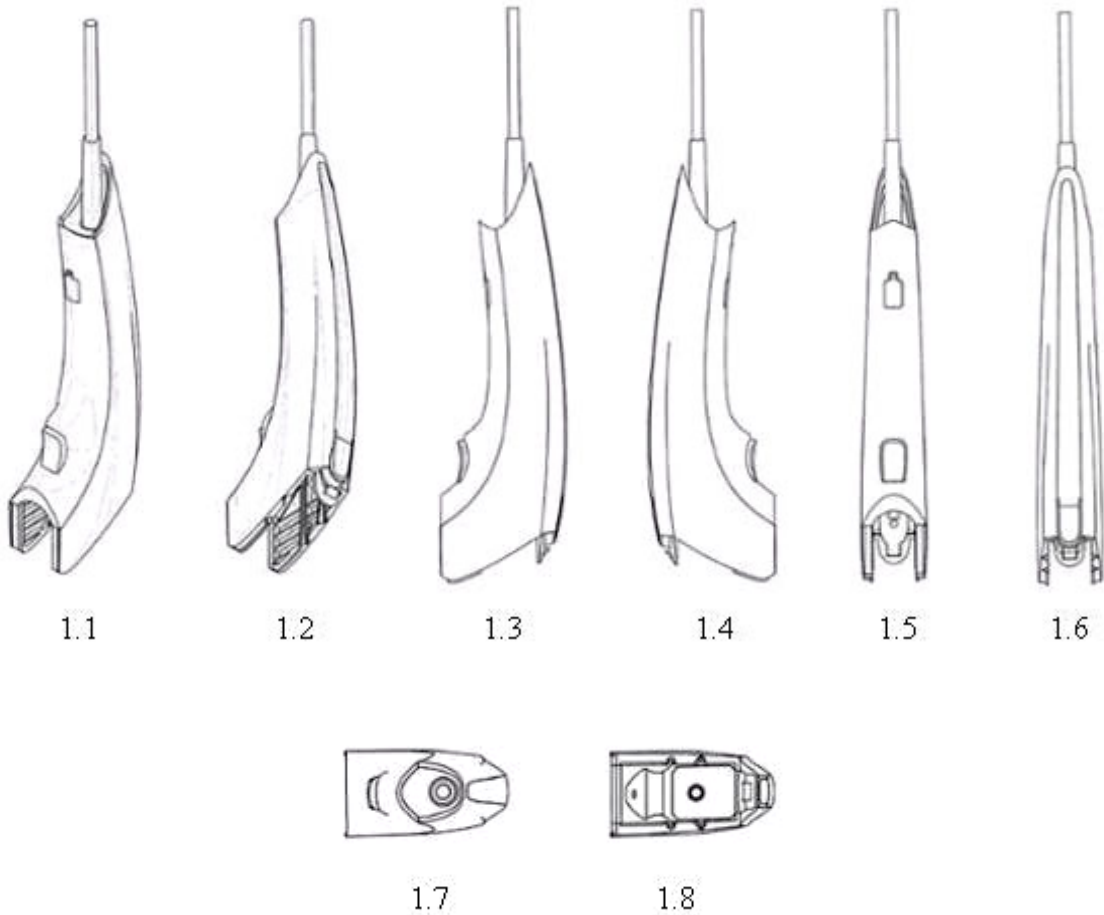

CÔNG BÁO SỞ HỮU CÔNG NGHIỆP SỐ 403 TẬP A – QUYỀN 2 (10.2021)

- (11) **42885**
(21) 3-2021-01679 (28) 1
(54) **ĐẦU CHO THIẾT BỊ TRỊ LIỆU TẦN SỐ CAO** (51) **24-01**
(22) 25/06/2021 (43) 25/10/2021
(30) 30-2021-0015876 01/04/2021 KR;
(73) **CLASSYS INC. (KR)**
240, Teheran-ro, Gangnam-gu, Seoul, 06221, Republic of Korea
(72) Jin Yong KIM (KR)
(74) Văn phòng Luật sư Ân Nam (ANNAM IP & LAW)
(55)

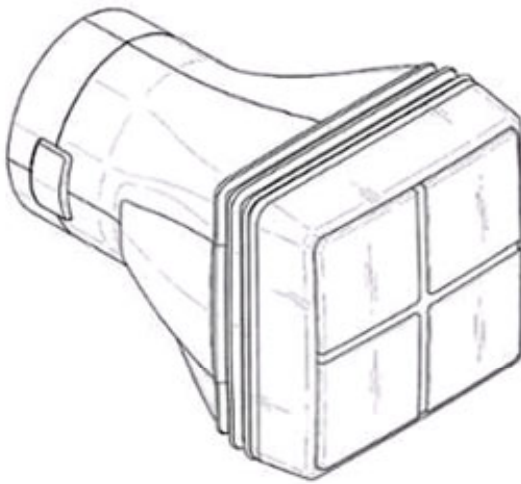

1.1

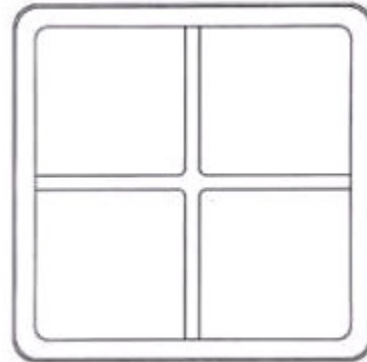

1.2

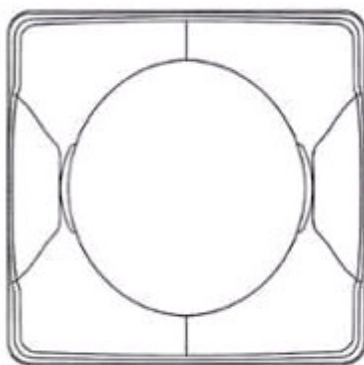

1.3

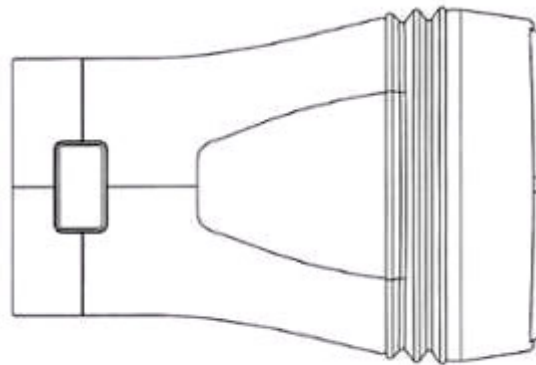

1.4

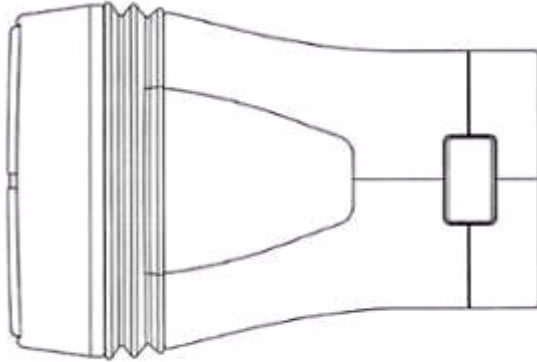

1.5

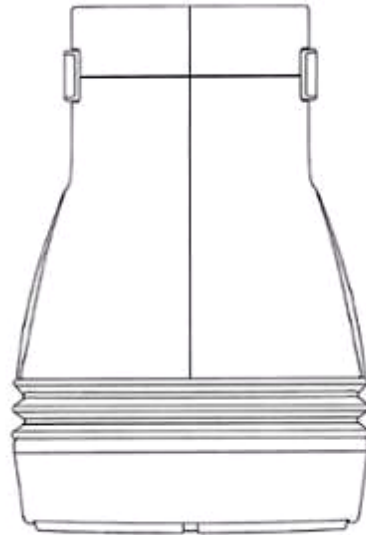

1.6

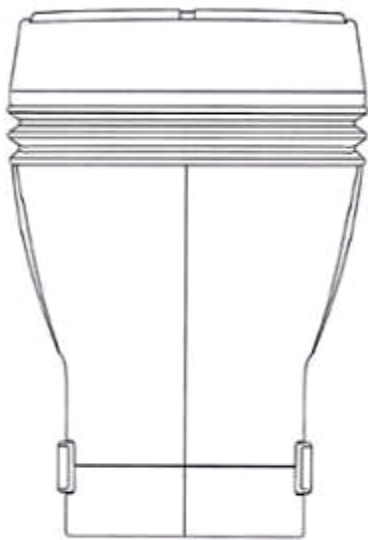

1.7

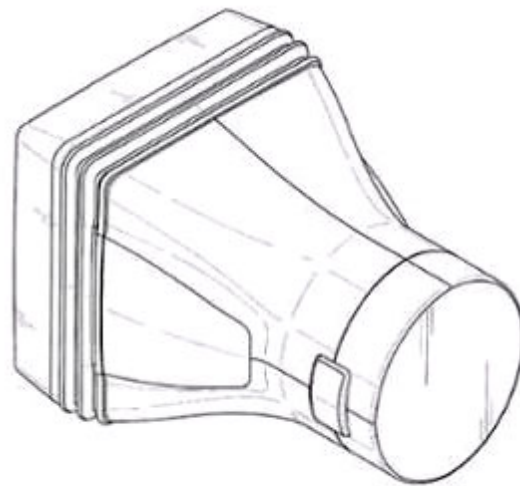

1.8

- (11) **42886**
(21) 3-2021-01680 (28) 1
(54) **ĐẦU CHO THIẾT BỊ TRỊ LIỆU TẦN SỐ CAO** (51) **24-01**
(22) 25/06/2021 (43) 25/10/2021
(30) 30-2021-0015877 01/04/2021 KR;
(73) **CLASSYS INC. (KR)**
240, Teheran-ro, Gangnam-gu, Seoul, 06221, Republic of Korea
(72) Jin Yong KIM (KR)
(74) Văn phòng Luật sư Ân Nam (ANNAM IP & LAW)
(55)

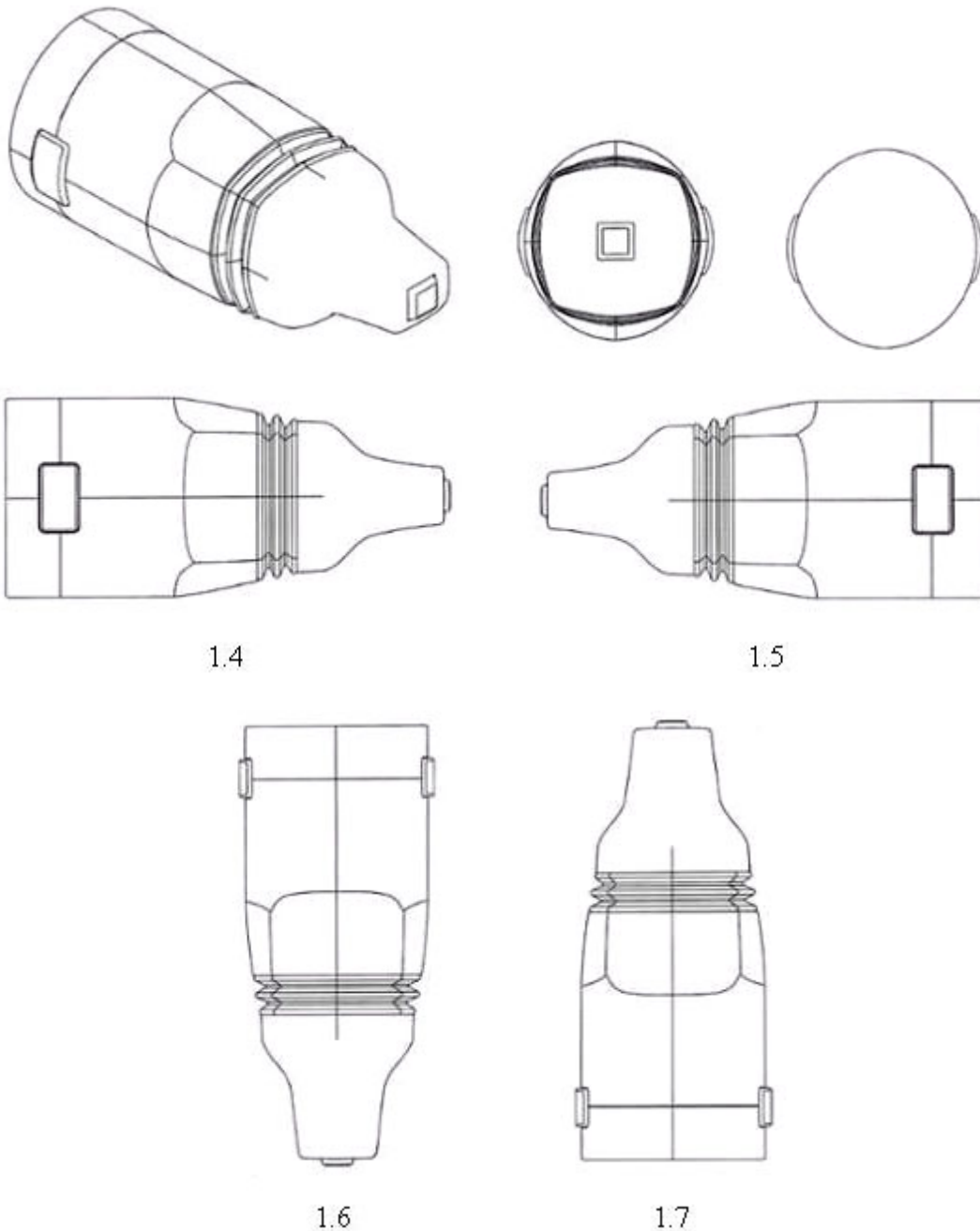

- (11) **42887**
(21) 3-2021-01681 (28) 1
(54) **ĐẦU CHO THIẾT BỊ TRỊ LIỆU TẦN SỐ CAO** (51) **24-01**
(22) 25/06/2021 (43) 25/10/2021
(30) 30-2021-0015878 01/04/2021 KR;
(73) **CLASSYS INC. (KR)**
240, Teheran-ro, Gangnam-gu, Seoul, 06221, Republic of Korea
(72) Jin Yong KIM (KR)
(74) Văn phòng Luật sư Ân Nam (ANNAM IP & LAW)
(55)

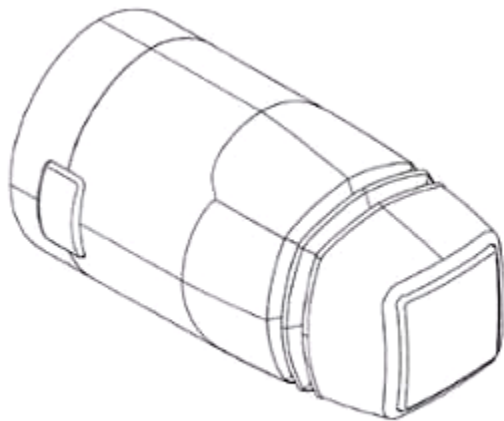

1.1

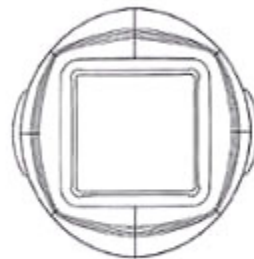

1.2



1.3

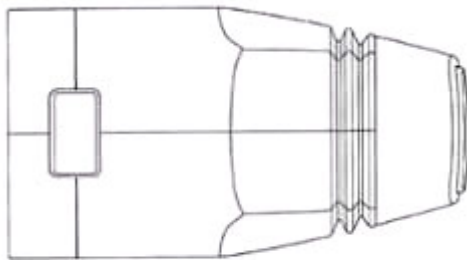

1.4

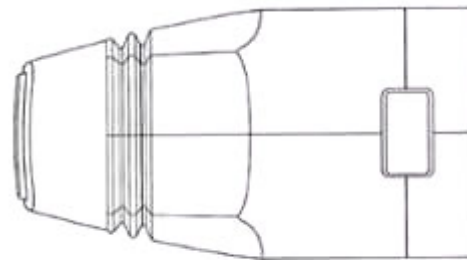

1.5

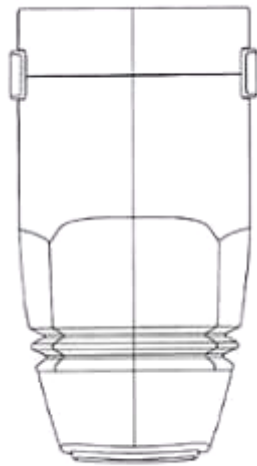

1.6

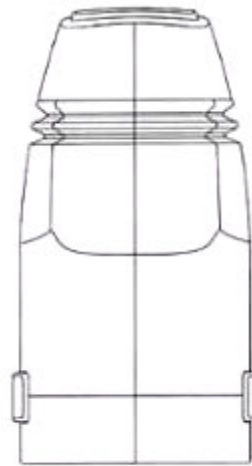

1.7

- (11) **42888**
(21) 3-2021-01682 (28) 1
(54) **ĐẦU CHO THIẾT BỊ TRỊ LIỆU TẦN SỐ CAO** (51) **24-01**
(22) 25/06/2021 (43) 25/10/2021
(30) 30-2021-0015879 01/04/2021 KR;
(73) **CLASSYS INC. (KR)**
240, Teheran-ro, Gangnam-gu, Seoul, 06221, Republic of Korea
(72) Jin Yong KIM (KR)
(74) Văn phòng Luật sư Ân Nam (ANNAM IP & LAW)
(55)

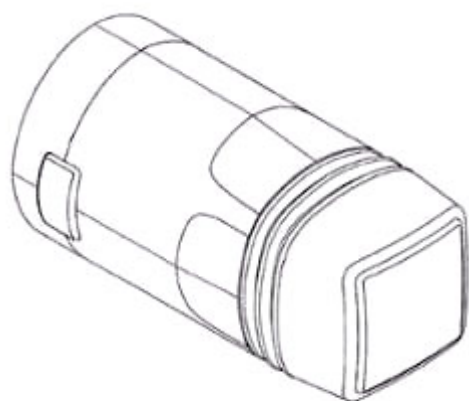

1.1



1.2



1.3

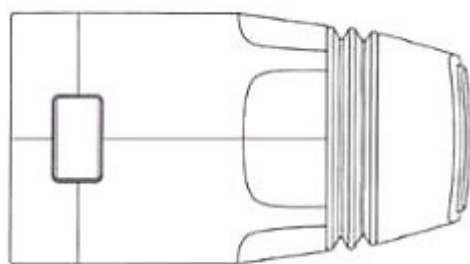

1.4

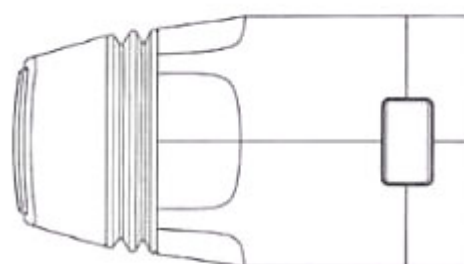

1.5

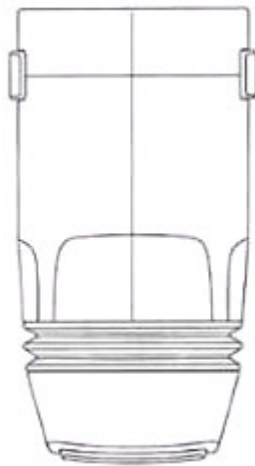

1.6

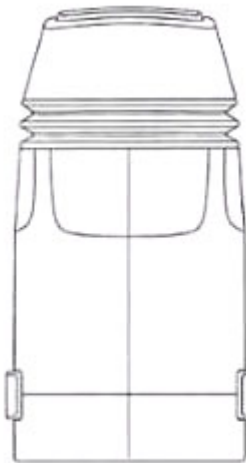

1.7

- (11) **42889**
(21) 3-2021-01683 (28) 1
(54) **ĐẦU CHO THIẾT BỊ SIÊU ÂM TRỊ LIỆU** (51) **24-01**
(22) 25/06/2021 (43) 25/10/2021
(30) 30-2021-0015883 01/04/2021 KR;
(73) **CLASSYS INC. (KR)**
240, Teheran-ro, Gangnam-gu, Seoul, 06221, Republic of Korea
(72) Jin Yong KIM (KR)
(74) Văn phòng Luật sư Ân Nam (ANNAM IP & LAW)
(55)

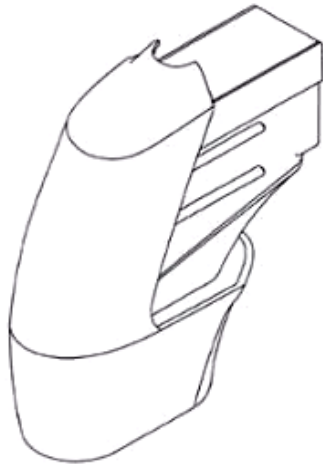

1.1



1.2

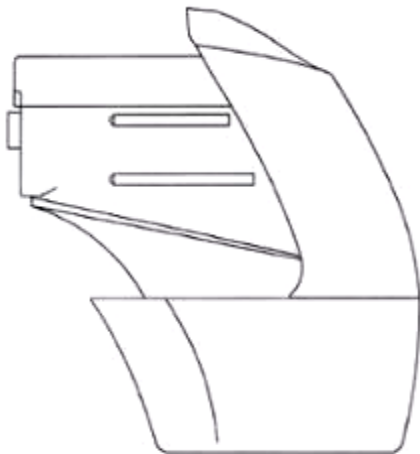

1.3



1.4



1.5

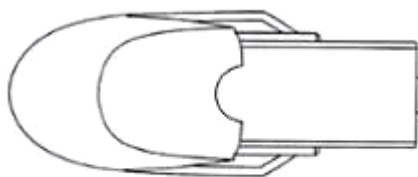

1.6



1.7

- (11) **42890**
(21) 3-2021-01684 (28) 1
(54) **ĐẦU CHO THIẾT BỊ SIÊU ÂM TRỊ LIỆU** (51) **24-01**
(22) 25/06/2021 (43) 25/10/2021
(30) 30-2021-0015884 01/04/2021 KR;
(73) **CLASSYS INC. (KR)**
240, Teheran-ro, Gangnam-gu, Seoul, 06221, Republic of Korea
(72) Jin Yong KIM (KR)
(74) Văn phòng Luật sư Ân Nam (ANNAM IP & LAW)
(55)

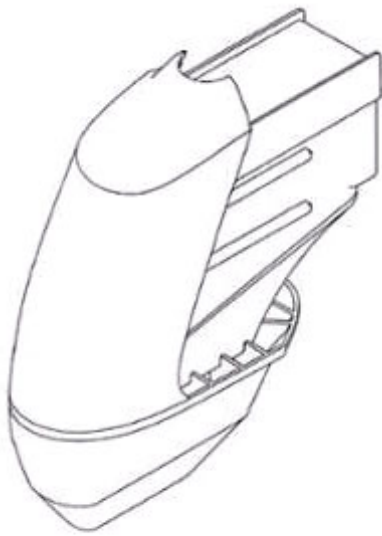

1.1



1.2

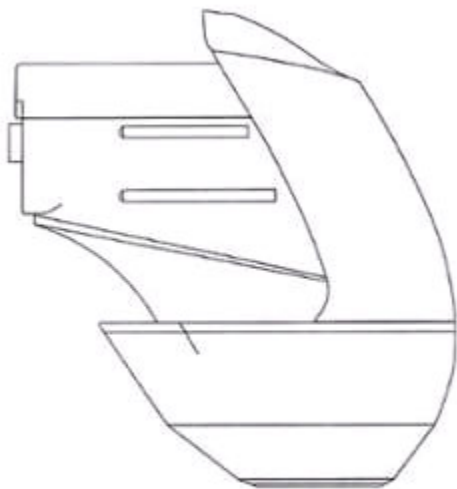

1.3



1.4

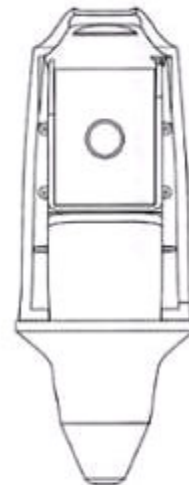

1.5

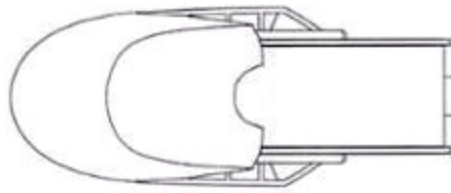

1.6

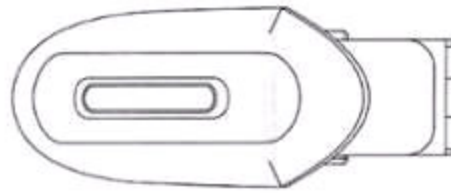

1.7

- (11) **42891**
(21) 3-2021-01685 (28) 1
(54) **ĐẦU CHO THIẾT BỊ SIÊU ÂM TRỊ LIỆU** (51) **24-01**
(22) 25/06/2021 (43) 25/10/2021
(30) 30-2021-0015885 01/04/2021 KR;
(73) **CLASSYS INC. (KR)**
240, Teheran-ro, Gangnam-gu, Seoul, 06221, Republic of Korea
(72) Jin Yong KIM (KR)
(74) Văn phòng Luật sư Ân Nam (ANNAM IP & LAW)
(55)

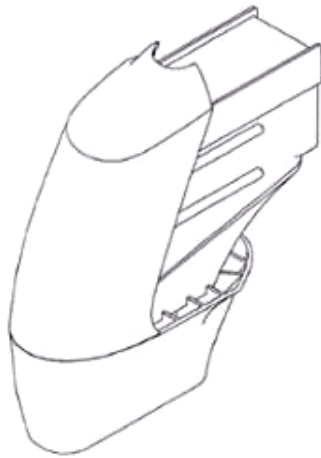

1.1



1.2

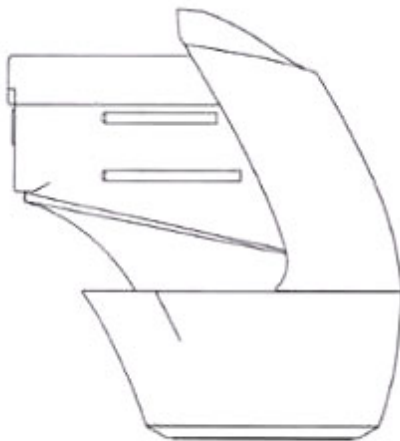

1.3



1.4



1.5

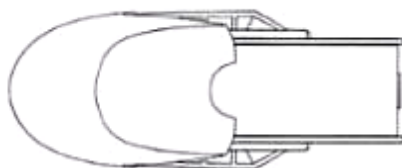

1.6



1.7

- (11) **42892**
(21) 3-2021-01686 (28) 1
(54) **ĐẦU CHO THIẾT BỊ SIÊU ÂM TRỊ LIỆU** (51) **24-01**
(22) 25/06/2021 (43) 25/10/2021
(30) 30-2021-0015887 01/04/2021 KR;
(73) **CLASSYS INC. (KR)**
240, Teheran-ro, Gangnam-gu, Seoul, 06221, Republic of Korea
(72) Jin Yong KIM (KR)
(74) Văn phòng Luật sư Ân Nam (ANNAM IP & LAW)
(55)

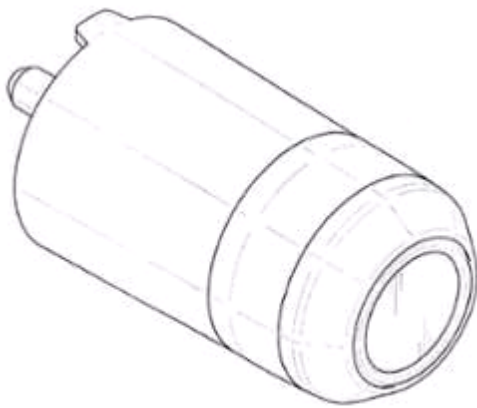

1.1

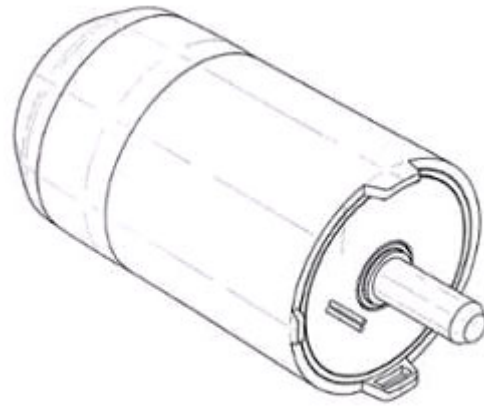

1.2

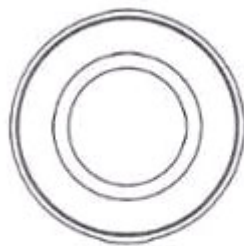

1.3



1.4

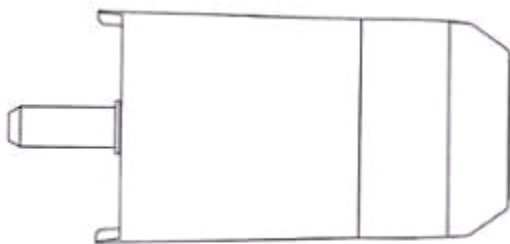

1.5

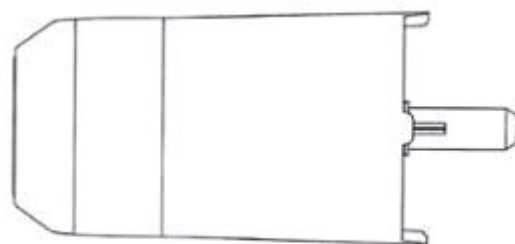

1.6



1.7



1.8

CÔNG BÁO SỞ HỮU CÔNG NGHIỆP SỐ 403 TẬP A – QUYỀN 2 (10.2021)

- (11) **42893**
- (21) 3-2021-01687 (28) 1
- (54) **BAO GÓI SẢN PHẨM** (51) **09-05**
- (22) 25/06/2021 (43) 25/10/2021
- (73) **CÔNG TY TNHH NÔNG VIỆT (VN)**
Số 3, ngách 53/20, đường Vũ Xuân Thiều, phường Sài Đồng, quận Long Biên, thành phố Hà Nội
- (72) Nguyễn Văn Hùng (VN)
- (74) Công ty cổ phần Sở hữu trí tuệ BROSS và Cộng sự (BROSS & PARTNERS., JSC)
- (55)



1.1



1.2

- (11) **42894**
(21) 3-2021-01690 (28) 1
(54) **ĐỆM CAO SU GIẢM CHẤN** (51) **12-16**
(22) 25/06/2021 (43) 25/10/2021
(73) **CÔNG TY TNHH KINH DOANH THƯƠNG MẠI HOÀNG HUY (VN)**
Thôn 6, xã Phú Cát, huyện Quốc Oai, thành phố Hà Nội
(72) Hoàng Văn Huy (VN)
(74) Công ty TNHH Sở hữu trí tuệ Mặt trời mới (NEWSUN IPCO.,LTD.)
(55)

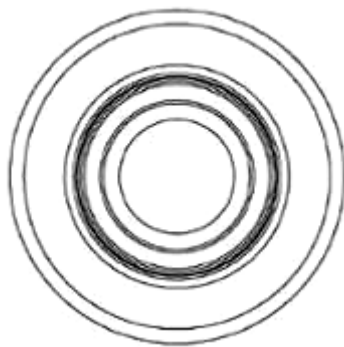

1.1

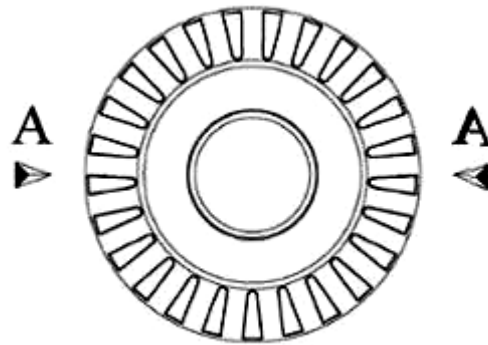

1.2



1.3

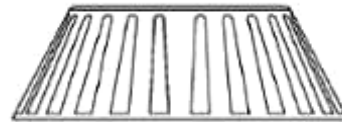

1.4

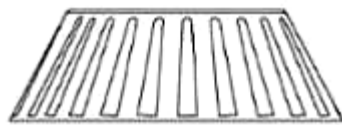

1.5



1.6

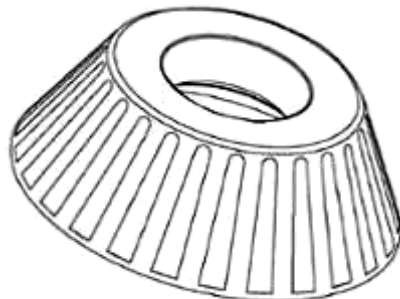

1.7

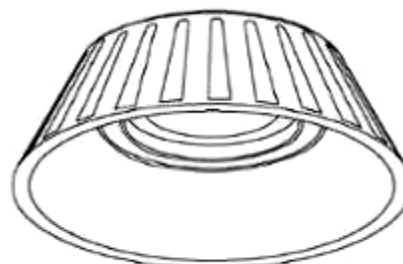

1.8



1.9



1.10

(11) **42895**

(21) 3-2021-01701

(28) 1

(54) **CHAI**

(51) **09-01**

(22) 28/06/2021

(43) 25/10/2021

(73) **CÔNG TY CỔ PHẦN TẬP ĐOÀN VIHAMARK (VN)**

Lô N3-6, KCN Đồng Văn II, phường Đồng Văn, thị xã Duy Tiên, tỉnh Hà Nam

(72) Nguyễn Thiên Thắng (VN)

(55)



1.1



1.2



1.3



1.4



1.5



1.6

CÔNG BÁO SỞ HỮU CÔNG NGHIỆP SỐ 403 TẬP A – QUYỀN 2 (10.2021)

(11) **42896**

(21) 3-2021-01707

(28) 1

(54) **THÁP ĐUA BI GỖ**

(51) **21-01**

(22) 29/06/2021

(43) 25/10/2021

(73) **CÔNG TY TNHH SD (VN)**

Khu phố 3, phường 9, thành phố Mỹ Tho, tỉnh Tiền Giang

(72) Nguyễn Văn Dũng (VN)

(74) Công ty Luật Hợp danh bản quyền Quốc tế (CIS LAW FIRM)

(55)

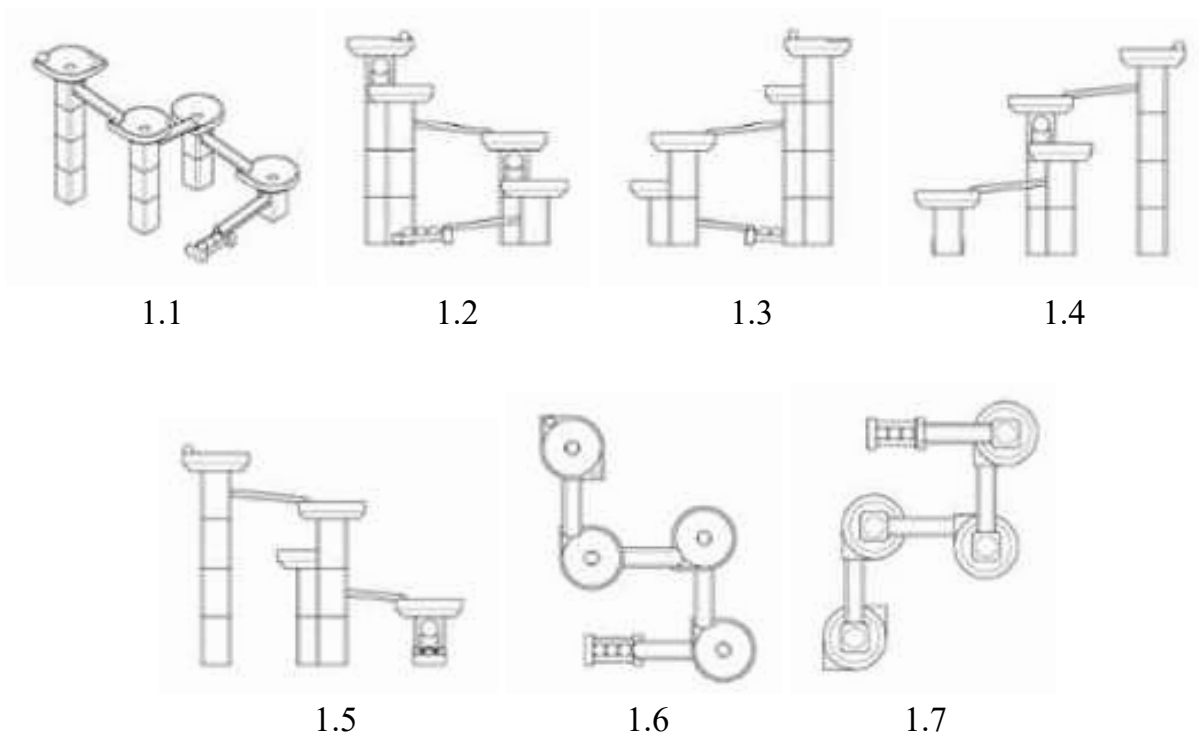

- (11) **42897**
(21) 3-2021-01762 (28) 1
(54) **THANH NHÔM** (51) **25-01**
(22) 05/07/2021 (43) 25/10/2021
(73) **THÂN ĐỨC NGHĨA (VN)**
32 đường D4, phường Chánh Nghĩa, thành phố Thủ Dầu Một, tỉnh Bình Dương
(72) **THÂN ĐỨC NGHĨA (VN)**
(74) **CÔNG TY LUẬT TNHH AGL (AGL LAW)**
(55)

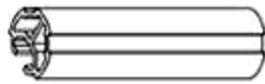

1.1



1.2



1.3

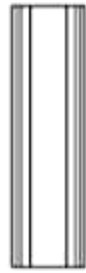

1.4



1.5

- (11) **42898**
(21) 3-2021-01777 (28) 2
(54) **VỎ BỌC DỤNG CỤ LÀM SẠCH** (51) **07-05**
(22) 06/07/2021 (43) 25/10/2021
(30) 2021-000366 08/01/2021 JP; 2021-000361 08/01/2021 JP;
(73) 1. **NITOMS, INC.** (JP)
12-4, Higashi-Shinagawa 4-chome, Shinagawa-ku, Tokyo 140-0002 Japan
2. **NITTO DENKO CORPORATION** (JP)
1-2, Shimohozumi 1-chome, Ibaraki-shi, Osaka 567-8680 Japan
(72) Fumie SHIBATA (JP)
(74) Công ty Cổ phần Sở hữu công nghiệp INVESTIP (INVESTIP)
(55)

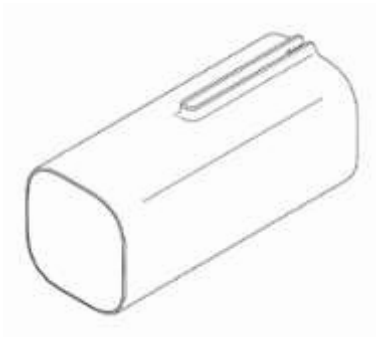

1.1

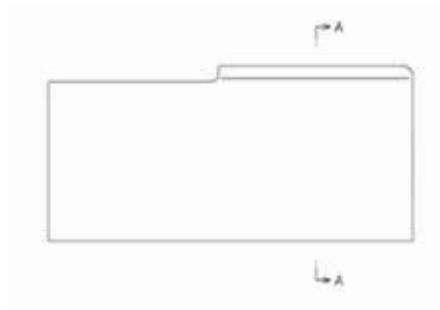

1.2



1.3



1.4



1.5



1.6

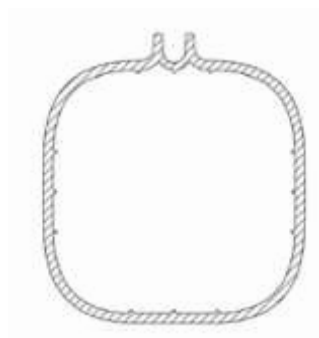

1.7



1.8

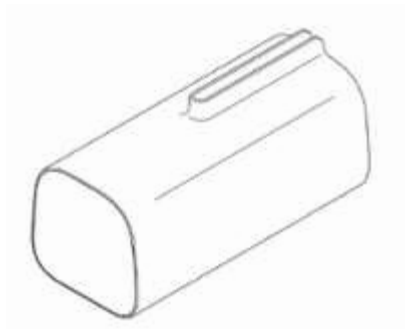

1.1

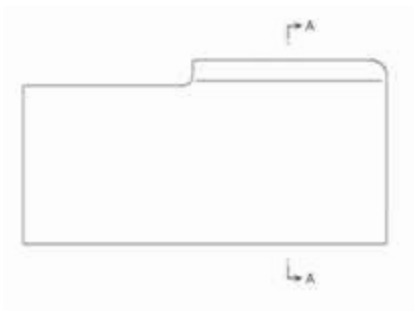

1.2



1.3



1.4



1.5

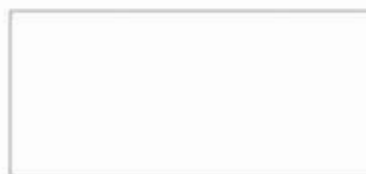

1.6

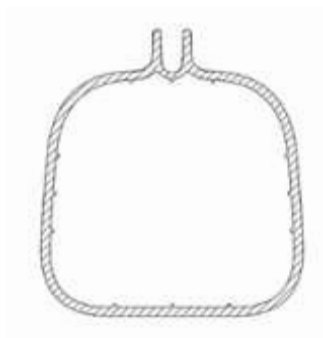

1.7



1.8

- (11) **42899**
- (21) 3-2021-01778 (28) 1
- (54) **CON LĂN HỖ TRỢ DÙNG CHO DỤNG CỤ LÀM SẠCH** (51) **07-05**
- (22) 06/07/2021 (43) 25/10/2021
- (30) 2021-000364 08/01/2021 JP;
- (73) 1. **NITOMS, INC.** (JP)
 12-4, Higashi-Shinagawa 4-chome, Shinagawa-ku, Tokyo 140-0002 Japan
 2. **NITTO DENKO CORPORATION** (JP)
 1-2, Shimohozumi 1-chome, Ibaraki-shi, Osaka 567-8680 Japan
- (72) Fumie SHIBATA (JP)
- (74) Công ty Cổ phần Sở hữu công nghiệp INVESTIP (INVESTIP)
- (55)

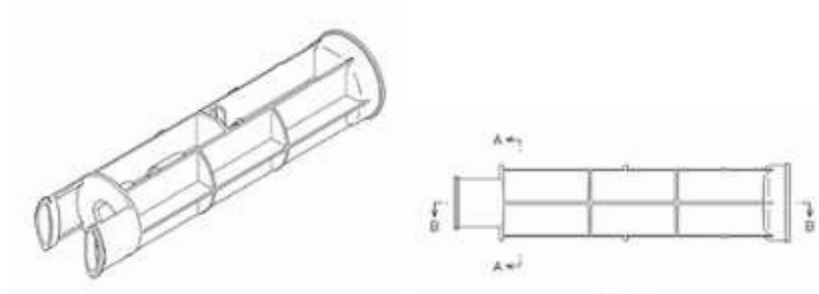

1.1

1.2

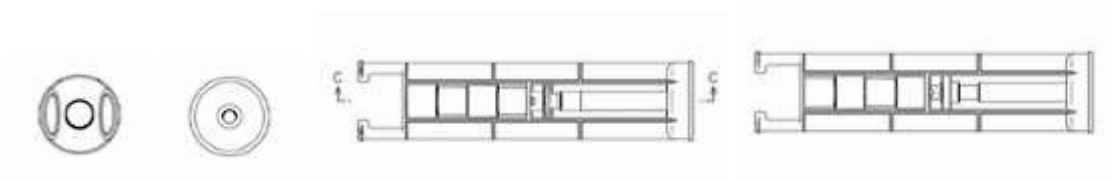

1.3

1.4

1.5

1.6

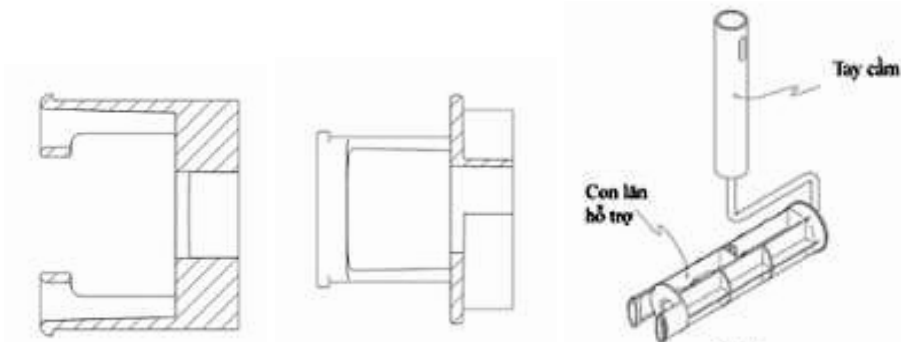

1.7

1.8

1.9

CÔNG BÁO SỞ HỮU CÔNG NGHIỆP SỐ 403 TẬP A – QUYỀN 2 (10.2021)

- (11) **42900**
(21) 3-2021-01797 (28) 1
(54) **MÁY PHAY CNC BA TRỤC** (51) **15-09**
(22) 09/07/2021 (43) 25/10/2021
(73) 1. **SỞ KHOA HỌC VÀ CÔNG NGHỆ THÀNH PHỐ HỒ CHÍ MINH (VN)**
244 Điện Biên Phủ, phường Võ Thị Sáu, quận 3, thành phố Hồ Chí Minh
2. **PHÒNG THÍ NGHIỆM TRỌNG ĐIỂM ĐIỀU KHIỂN SỐ VÀ KỸ THUẬT
HỆ THỐNG (VN)**
Nhà C6, trường Đại học Bách Khoa - 268 Lý Thường Kiệt, phường 14, quận 10,
thành phố Hồ Chí Minh
(72) 1. **BÙI THANH LUÂN (VN)**
2. **ĐỖ ĐỨC ĐẠT (VN)**
(55)

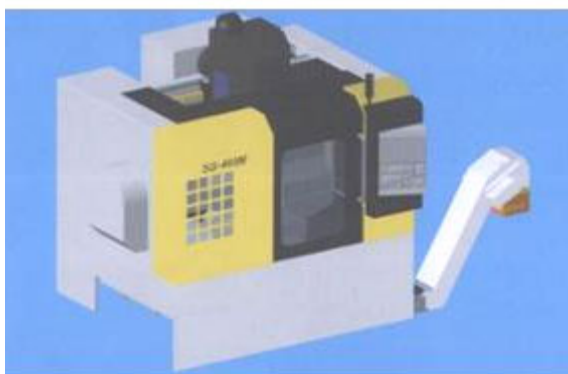

1.1



1.2



1.3

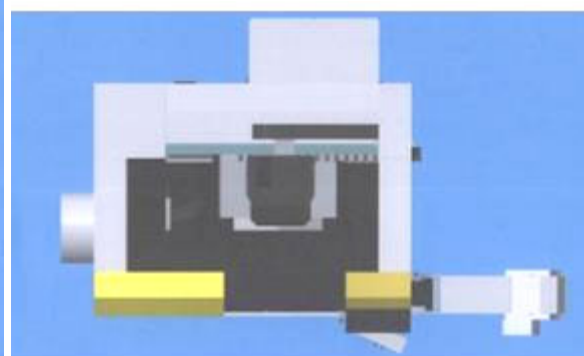

1.4

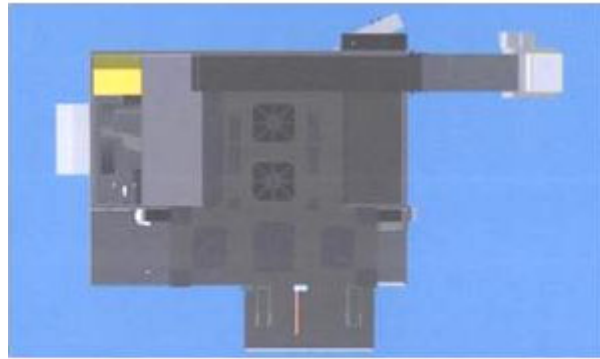

1.5

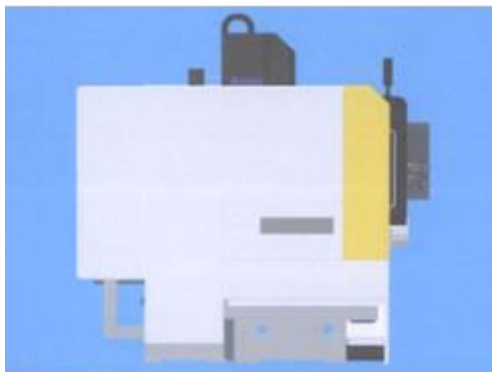

1.6

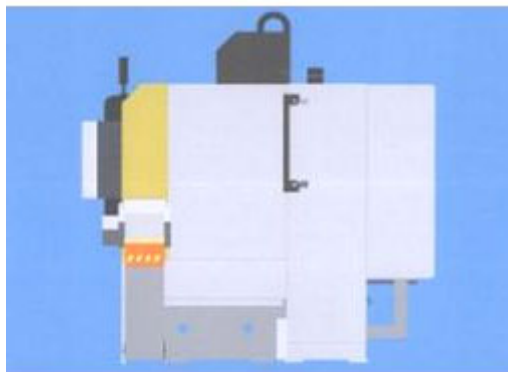

1.7

PHẦN II

SỬA ĐỔI ĐƠN

Ghi nhận sửa đổi đơn yêu cầu cấp Bằng độc quyền kiểu dáng công nghiệp

Thông báo số: 22008w/TB-SHTT, ngày 14/09/2021 về việc ghi nhận sửa đổi đơn

Số Yêu cầu: SD3-2021-01223 Ngày nộp: 16/06/2021

Liên quan đến đơn yêu cầu cấp Bằng độc quyền kiểu dáng công nghiệp:

(21) Số đơn	(22) Ngày nộp đơn
3-2019-02986	21/11/2019
3-2019-03211	09/12/2019
3-2020-00512	06/03/2020

Mục sửa đổi: Tên, địa chỉ chủ đơn

Nội dung mới: Công ty cổ phần tập đoàn Bách Tường Phát (VN)
Tầng 5, khu văn phòng, tòa NO1-T4 Tower, chung cư Phú Mỹ
Complex, khu Ngoại Giao Đoàn, phường Xuân Tảo, quận Bắc Từ
Liêm, thành phố Hà Nội

Thông báo số: 22295w/TB-SHTT, ngày 16/09/2021 về việc ghi nhận sửa đổi đơn

Số Yêu cầu: SD3-2021-01238 Ngày nộp: 17/06/2021

Liên quan đến đơn yêu cầu cấp Bằng độc quyền kiểu dáng công nghiệp:

(21) Số đơn	(22) Ngày nộp đơn
3-2020-01747	29/07/2020

Mục sửa đổi: Thay bộ hình phương án 10 và phương án 11

Nội dung mới: **Thay bộ hình phương án 10 và phương án 11**

THÀNH PHẦN (INGREDIENTS):
Cao lứt, bột gạo thơm, bột gạo nếp trắng (140%), dầu mè hoa (0,2%), nước, muối.

Giá trị dinh dưỡng (NUTRITION FACTS):
Giá trị dinh dưỡng trong 100g (Serving size see package 100g)

Hàm lượng (Content)	341,00kcal
Chất béo (Fat)	0,2g
Chất đạm (Protein)	9g
Carbohydrate	80g

BẢO QUẢN (STORAGE):
Bảo quản ở nơi khô ráo, tránh ánh nắng trực tiếp, tránh để gần hóa chất hoặc các phẩm có mùi mạnh. Nên chế biến ngay khi mở bao bì.

(Store in dry and cool place. Avoid exposure to direct sunlight, chemicals or products with strong odors. Use as soon as the packaging is opened.)

HÀNG SẢN XUẤT
SẢN XUẤT TẠI (MANUFACTURED BY):
CÔNG TY TNHH HƯƠNG HỒNG
163, Quốc lộ 80, Ấp Phú Long, Xã Tân Phú Đông, TP. Sóc Trăng, Tỉnh Đồng Tháp
TEL: (084) 277.3801143
FAX: (084) 277.3800949
EMAIL: congtyhuanghong@gmail.com
WEB: huanghong.vn

PHỞ GẠO LỨT
RED RICE NOODLES

PHỞ GẠO LỨT
RED RICE NOODLES

KHÔNG
HÀM THE
FORMOL
CHẤT BẢO QUẢN

Khối lượng tịnh
Net weight
200g

SẢN PHẨM LÀNG NGHỀ TRUYỀN THỐNG SÀ ĐÉC
PRODUCED IN THE TRADITIONAL CRAFT VILLAGE OF SÀ ĐÉC

PHỞ GẠO LỨT
RED RICE NOODLES

KHÔNG
HÀM THE
FORMOL
CHẤT BẢO QUẢN

HƯỚNG DẪN SỬ DỤNG (COOKING INSTRUCTIONS):
Cho vào nồi nước đang sôi, nấu khoảng 5-6 phút. Vớt ra. Xả ngay nước lạnh. Để ráo và trộn đều với ít dầu ăn trước khi chế biến món ăn.

Put noodles in boiling water and cook for 5-6 minutes. Take out. Rinse with cold water. Shake well and add a little oil before preparing your dish.

Phụ đính với:
The rice noodles can be use with:

- Lẩu Hot pot
- Xào trộn Stir-fry rice
- Nấu Soup

Barcode: 8 936018 001383

TCOM Production No. 119992028
(Số seri của tờ in ấn in pack)
MEX (MFI)
HSD (DOP)

H. 10

THÀNH PHẦN (INGREDIENTS):
Cao lứt, bột gạo thơm, bột gạo nếp trắng (140%), dầu mè hoa (0,2%), nước, muối.

Giá trị dinh dưỡng (NUTRITION FACTS):
Giá trị dinh dưỡng trong 100g (Serving size see package 100g)

Hàm lượng (Content)	341,00kcal
Chất béo (Fat)	0,2g
Chất đạm (Protein)	9g
Carbohydrate	80g

BẢO QUẢN (STORAGE):
Bảo quản ở nơi khô ráo, tránh ánh nắng trực tiếp, tránh để gần hóa chất hoặc các phẩm có mùi mạnh. Nên chế biến ngay khi mở bao bì.

(Store in dry and cool place. Avoid exposure to direct sunlight, chemicals or products with strong odors. Use as soon as the packaging is opened.)

HÀNG SẢN XUẤT
SẢN XUẤT TẠI (MANUFACTURED BY):
CÔNG TY TNHH HƯƠNG HỒNG
163, Quốc lộ 80, Ấp Phú Long, Xã Tân Phú Đông, TP. Sóc Trăng, Tỉnh Đồng Tháp
TEL: (084) 277.3801143
FAX: (084) 277.3800949
EMAIL: congtyhuanghong@gmail.com
WEB: huanghong.vn

HỦ TIẾU GẠO LỨT
RED RICE NOODLES

HỦ TIẾU GẠO LỨT
RED RICE NOODLES

KHÔNG
HÀM THE
FORMOL
CHẤT BẢO QUẢN

Khối lượng tịnh
Net weight
200g

SẢN PHẨM LÀNG NGHỀ TRUYỀN THỐNG SÀ ĐÉC
PRODUCED IN THE TRADITIONAL CRAFT VILLAGE OF SÀ ĐÉC

HỦ TIẾU GẠO LỨT
RED RICE NOODLES

KHÔNG
HÀM THE
FORMOL
CHẤT BẢO QUẢN

HƯỚNG DẪN SỬ DỤNG (COOKING INSTRUCTIONS):
Cho vào nồi nước đang sôi, nấu khoảng 4-6 phút. Vớt ra. Xả ngay nước lạnh. Để ráo và trộn đều với ít dầu ăn trước khi chế biến món ăn.

Put noodles in boiling water and cook for 4-6 minutes. Take out. Rinse with cold water. Shake well and add a little oil before preparing your dish.

Phụ đính với:
The rice noodles can be use with:

- Lẩu Hot pot
- Xào trộn Stir-fry rice
- Nấu Soup

Barcode: 8 936018 001880

TCOM Production No. 119992028
(Số seri của tờ in ấn in pack)
MEX (MFI)
HSD (DOP)

H. 11

PHẦN III

THAY ĐỔI CHỦ ĐƠN

Ghi nhận thay đổi chủ đơn yêu cầu cấp Bằng độc quyền Kiểu dáng công nghiệp

Thông báo số: 20914w/TB-SHTT, ngày 30/08/2021 về việc ghi nhận thay đổi chủ đơn

Số Yêu cầu: CD3-2021-00493 Ngày nộp: 26/03/2021

Liên quan đến đơn yêu cầu cấp bằng độc quyền kiểu dáng công nghiệp:

(21) Số đơn	(22) Ngày nộp đơn
3-2021-00017	06/01/2021

Bên chuyển nhượng: CÔNG TY CỔ PHẦN BIA - RƯỢU HẢI ĐÀ (VN)
Đường Ngô Quyền, khu 4, phường Cẩm Thượng, thành phố Hải Dương, tỉnh Hải Dương

Bên được chuyển nhượng: Công ty TNHH Toàn Cầu Beverage (VN)
Số 8B đường Ngô Quyền, khu 4, phường Cẩm Thượng, thành phố Hải Dương, tỉnh Hải Dương

Thông báo số: 21979w/TB-SHTT, ngày 14/09/2021 về việc ghi nhận thay đổi chủ đơn

Số Yêu cầu: CD3-2020-00324 Ngày nộp: 25/05/2020

Liên quan đến đơn yêu cầu cấp bằng độc quyền kiểu dáng công nghiệp:

(21) Số đơn	(22) Ngày nộp đơn
3-2019-02651	21/10/2019

Bên chuyển nhượng: CÔNG TY TNHH THƯƠNG MẠI MỸ PHẨM PHƯƠNG NAM (VN)
169/18 - 169/20 đường Liên khu 5-6, phường Bình Hưng Hòa B, quận Bình Tân, thành phố Hồ Chí Minh

Bên được chuyển nhượng: CÔNG TY TNHH SẢN XUẤT THƯƠNG MẠI XUẤT NHẬP KHẨU NGÂN VIỆT (VN)
169/18 - 169/20 đường Liên khu 5-6, phường Bình Hưng Hòa B, quận Bình Tân, thành phố Hồ Chí Minh

Thông báo số: 22089w/TB-SHTT, ngày 14/09/2021 về việc ghi nhận thay đổi chủ đơn

Số Yêu cầu: CD3-2021-00426 Ngày nộp: 26/02/2021

Liên quan đến đơn yêu cầu cấp bằng độc quyền kiểu dáng công nghiệp:

(21) Số đơn	(22) Ngày nộp đơn
3-2019-02849	11/11/2019

Bên chuyển nhượng: CÔNG TY CỔ PHẦN THIẾT BỊ NHIỆT ĐÔNG Á (VN)
Lô C9, khu công nghiệp Tây Bắc Ga, phường Đông Thọ,
thành phố Thanh Hóa, tỉnh Thanh Hóa

Bên được chuyển nhượng: Cục Quân nhu - Tổng cục Hậu cần (VN)
Số 5 Nguyễn Tri Phương, phường Quán Thánh, quận Ba
Đình, thành phố Hà Nội

CÔNG BÁO SỞ HỮU CÔNG NGHIỆP

Do Cục Sở hữu trí tuệ thuộc Bộ Khoa học và Công nghệ ấn hành theo Luật Sở hữu trí tuệ số 50/2005/QH11 được Quốc hội thông qua ngày 29 tháng 11 năm 2005 và được sửa đổi bằng Luật sửa đổi, bổ sung một số điều của Luật sở hữu trí tuệ số 50/2005/QH11 được Quốc hội thông qua ngày 19 tháng 6 năm 2009.

Địa chỉ liên hệ:

384-386 đường Nguyễn Trãi, quận Thanh Xuân,
thành phố Hà Nội, Việt Nam
ĐT: 024. 38583069
Fax: 024. 38588449