

CỘNG HÒA XÃ HỘI CHỦ NGHĨA VIỆT NAM
BỘ KHOA HỌC VÀ CÔNG NGHỆ

CỤC SỞ HỮU TRÍ TUỆ

CÔNG BÁO
SỞ HỮU CÔNG NGHIỆP

TẬP A

QUYỂN 2: KIỂU DÁNG CÔNG NGHIỆP

09 - 2021

402

CỘNG HOÀ XÃ HỘI CHỦ NGHĨA VIỆT NAM
BỘ KHOA HỌC VÀ CÔNG NGHỆ
CỤC SỞ HỮU TRÍ TUỆ

CÔNG BÁO
SỞ HỮU CÔNG NGHIỆP
TẬP A

QUYỂN 2: KIỂU DÁNG CÔNG NGHIỆP

09-2021

402

HÀ NỘI

MỤC LỤC

	Trang
<u>PHẦN I:</u> Đơn yêu cầu cấp Bằng độc quyền kiểu dáng công nghiệp	7-235

CONTENTS

<u>PART I:</u> Applications for Industrial Design Patents	
---	--

CÔNG BÁO SỞ HỮU CÔNG NGHIỆP SỐ 402 TẬP A - QUYỂN 2 (09.2021)

MÃ SỐ HAI CHỮ CÁI THỂ HIỆN TÊN NƯỚC VÀ CÁC THỰC THỂ KHÁC TRONG CÁC TƯ LIỆU SỞ HỮU CÔNG NGHIỆP THEO TIÊU CHUẨN ST3 CỦA WIPO

AE	United Arab Emirates	CN	China	HK	Hong Kong
AF	Afganistan	CO	Colombia	HN	Honduras
AG	Antihua and Barbuda	CR	Costa Rica	HR	Croatia
AI	Anguilla	CU	Cuba	HT	Haiti
AL	Albania	CV	Cape Verde	HU	Hungary
AN	Netherlands Antilles	CY	Cyprus	ID	Indonesia
AO	Angola	CZ	Czech Republic	IE	Ireland
AR	Argentina	DE	Germany	IL	Israel
AT	Austria	DJ	Djibouti	IN	India
AU	Australia	DK	Denmark	IQ	Iraq
AW	Aruba	DM	Dominica	IR	Iran (Islamic Republic of)
BB	Barbados	DO	Dominican Republic	IS	Iceland
BD	Bangladesh	DZ	Algeria	IT	Italy
BE	Belgium	EC	Ecuador	JM	Jamaica
BF	Burkina Faso	EE	Estonia	JO	Jordan
BG	Bulgaria	EG	Egypt	JP	Japan
BH	Bahrain	ES	Spain	KE	Kenya
BI	Burundi	ET	Ethiopia	KH	Cambodia
BJ	Benin	FI	Finland	KI	Kiribati
BM	Bermuda	FJ	Fiji	KM	Comoros
BN	Brunei Darussalam	FK	Falkand Islands (Malvinas)	KN	Saint Kitts and Nevis
BO	Bolivia	FR	France	KP	Democratic People's Republic of Korea
BR	Brazil	GA	Gabon	KR	Republic of Korea
BS	Bahamas	GB	United Kingdom	KW	Kuwait
BT	Bhutan	GD	Grenada	KY	Cayman Islands
BW	Botswana	GE	Georgia	KZ	Kazakhstan
BY	Belarus	GH	Ghana	LA	Laos
BZ	Belize	GI	Gibraltar	LB	Lebanon
CA	Canada	GM	Gambia	LC	Saint Lucia
CF	Central African Republic	GN	Guinea	LI	Liechtenstein
CG	Congo	GQ	Equatorial Guinea	LK	SriLanka
CH	Switzerland	GR	Greece	LR	Liberia
CI	Côte d'Ivoire	GT	Guatemala	LS	Lesotho
CL	Chile	GW	Guinea-Bissau	LT	Lithuania
CM	Cameroon	GY	Guyana	TC	Turk and Caicos Islands
LU	Luxembourg	PA	Panama	TD	Chad
LV	Latvia	PE	Peru	TG	Togo
LY	Lybya	PG	Papua New Guinea	TH	Thailand
MA	Morocco	PH	Philippines	TN	Tunisia
MC	Monaco	PK	Pakistan	TO	Tonga
MD	Republic of Moldova	PL	Poland	TR	Turkey

CÔNG BÁO SỞ HỮU CÔNG NGHIỆP SỐ 402 TẬP A - QUYỂN 2 (09.2021)

MG	Madagascar	PT	Portugal	TT	Trinidad and Tobago
ML	Mali	PY	Paraguay	TV	Tuvalu
MM	Myanmar	QA	Qatar	TW	Taiwan, Province of China
MN	Mongolia	RO	Rumania	TZ	United Republic of Tanzania
MO	Macau	RU	Russian Federation	UA	Ukraine
MR	Mauritania	RW	Rwanda	UG	Uganda
MS	Montserrat	SA	Saudi Arabia	US	United States of America
MT	Malta	SB	Solomon Islands	UY	Uruguay
MU	Mauritius	SC	Seychelles	UZ	Uzbekistan
MV	Maldives	SD	Sudan	VA	Holy see
MW	Malawi	SE	Sweden	VC	Saint Vincent and the Grenadines
MX	Mexico	SG	Singapore	VE	Venezuela
MY	Malaysia	SH	Saint Helena	VG	Virgin Islands (British)
MZ	Mozambique	SL	Slovenia	VN	Vietnam
NA	Namibia	SK	Slovakia	VU	Vanuatu
NE	Niger	SL	Sierra Leone	WS	Samoa
NG	Nigeria	SM	San Marino	YE	Yemen
NJ	Nicaragua	SN	Senegal	YU	Yugoslavia
NL	Netherlands	SO	Somalia	ZA	South Africa
NO	Norway	SR	Suriname	ZM	Zambia
NP	Nepal	ST	Sao Tome and Principe	ZR	Zaire
NR	Nauru	SV	El Sanvador	ZW	Zimbabwe
NZ	New Zealand	SY	Syria		
OM	Oman	SZ	Swaziland		

CÁC TỔ CHỨC QUỐC TẾ

AO	African Intellectual Property Organization (OAPI)
AP	African Regional Industrial Property Organization (ARIPO)
BX	Benelux Trademark Office and Benelux Designs Office
EP	European Patent Office (EPO)
IB, WO	International Bureau of the World Intellectual Property Organization (WIPO)

NHỮNG MÃ SỐ INID TRÍCH TỪ TIÊU CHUẨN ST80 CỦA TỔ CHỨC SỞ HỮU TRÍ TUỆ THẾ GIỚI (WIPO) ĐỂ NHẬN BIẾT CÁC DỮ LIỆU THƯ MỤC DÙNG CÔNG BỐ ĐƠN VÀ BẰNG ĐỘC QUYỀN KIỂU DÁNG CÔNG NGHIỆP

- (11) Số bằng độc quyền kiểu dáng công nghiệp / Số công bố đơn
- (15) Ngày cấp
- (18) Ngày hết hạn hiệu lực của bằng độc quyền kiểu dáng công nghiệp
- (21) Số đơn
- (22) Ngày nộp đơn
- (23) Tên triển lãm, ngày và nơi triển lãm
- (28) Số phương án yêu cầu bảo hộ
- (30) Số đơn ưu tiên, ngày nộp đơn ưu tiên
- (43) Ngày công bố đơn
- (45) Ngày công bố bằng độc quyền kiểu dáng công nghiệp
- (51) Phân loại quốc tế kiểu dáng công nghiệp
- (54) Tên sản phẩm mang kiểu dáng công nghiệp
- (55) Ảnh chụp / hình vẽ kiểu dáng công nghiệp
- (57) Đặc điểm khác biệt yêu cầu bảo hộ của kiểu dáng công nghiệp
- (62) Số và ngày nộp đơn, số bằng độc quyền KDCN hoặc số công bố đơn liên quan đến tách đơn
- (71) Tên và địa chỉ của người nộp đơn
- (72) Tên của tác giả KDCN
- (73) Tên, địa chỉ của chủ bằng độc quyền KDCN
- (74) Tên của người đại diện SHCN

PHẦN I

ĐƠN YÊU CẦU CẤP BẰNG ĐỘC QUYỀN KIỂU DÁNG CÔNG NGHIỆP

(11) **42511**

(21) 3-2019-02396

(28) 2

(54) **TÂM TRANG TRÍ**

(51) **05-06**

(22) 20/09/2019

(43) 27/09/2021

(30) US 29/684,353 20/03/2019 US; US 29/684,336 20/03/2019 US;

(73) **DONGGUAN SHICHANG METALS FACTORY LTD. (CN)**

Xiaobin Village, Chang'an Town, Dongguan City

(72) Chen-Kang Lin (TW)

(74) Công ty cổ phần Tư vấn S&B (S&B CONSULTANT., CORP.)

(55)

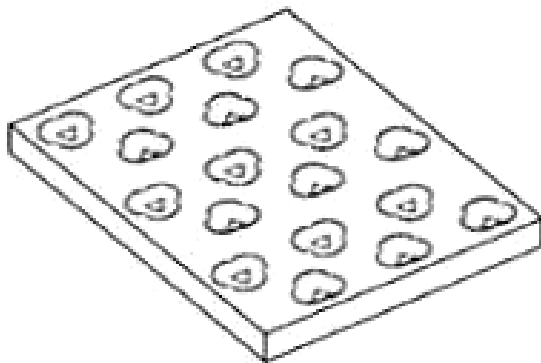

1.1



1.2

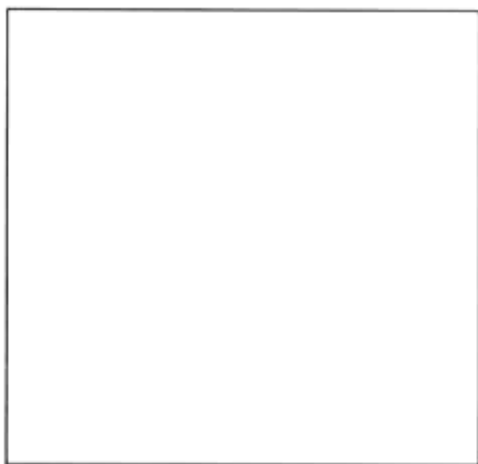

1.3



1.4



1.5

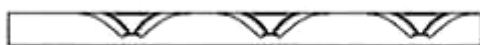

1.6



1.7



2.1

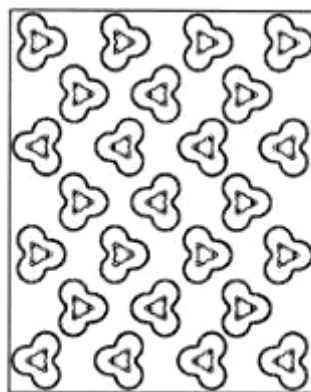

2.2



2.3



2.4



2.5

CÔNG BÁO SỞ HỮU CÔNG NGHIỆP SỐ 402 TẬP A – QUYỀN 2 (09.2021)

(11) **42512**

(21) 3-2019-03456

(28) 1

(54) **GHẾ SÔ-PHA**

(51) **06-01**

(22) 27/12/2019

(43) 27/09/2021

(73) **HTL FURNITURE (CHINA) CO., LTD. (CN)**

Wu Yujiangnan Road, Kunshan Development Zone, Jiangsu Province, China

(72) PHUA YONG TAT (SG)

(74) Công ty Luật TNHH quốc tế BMVN (BMVN INTERNATIONAL LLC)

(55)



1.1



1.2



1.3



1.4



1.5



1.6



1.7

CÔNG BÁO SỞ HỮU CÔNG NGHIỆP SỐ 402 TẬP A – QUYỀN 2 (09.2021)

- (11) **42513**
(21) 3-2020-00001 (28) 1
(54) **THANH NHÔM ĐỊNH HÌNH** (51) **25-01**
(22) 02/01/2020 (43) 27/09/2021
(73) **CÔNG TY TNHH HOPO QUỐC TẾ (VN)**
Số nhà 23 ngách 27 ngõ 139 đường Nguyễn Ngọc Vũ, phường Trung Hoà, quận Cầu Giấy, thành phố Hà Nội
(72) GAO YANHONG (CN)
(55)

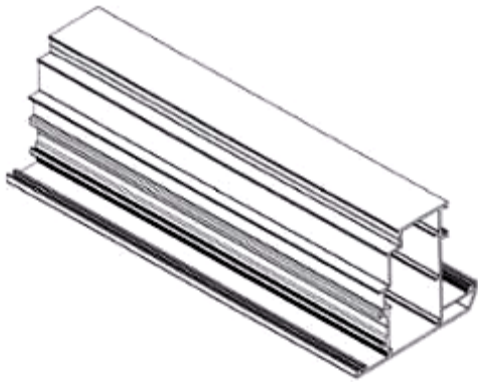

1.1

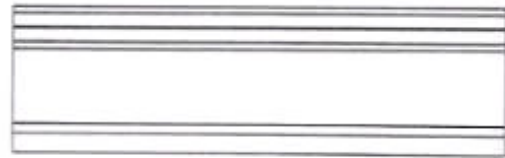

1.2

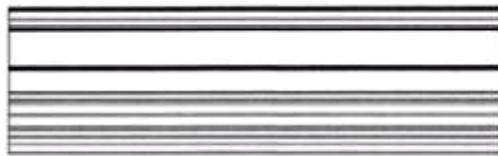

1.3

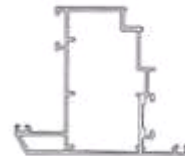

1.4



1.5



1.6

CÔNG BÁO SỞ HỮU CÔNG NGHIỆP SỐ 402 TẬP A – QUYỀN 2 (09.2021)

(11) **42514**

(21) 3-2020-00002

(54) **THANH NHÔM ĐỊNH HÌNH**

(22) 02/01/2020

(73) **CÔNG TY TNHH HOPO QUỐC TẾ (VN)**

Số nhà 23 ngách 27 ngõ 139 đường Nguyễn Ngọc Vũ, phường Trung Hoà, quận Cầu Giấy, thành phố Hà Nội

(72) GAO YANHONG (CN)

(55)

(28) 1

(51) **25-01**

(43) 27/09/2021

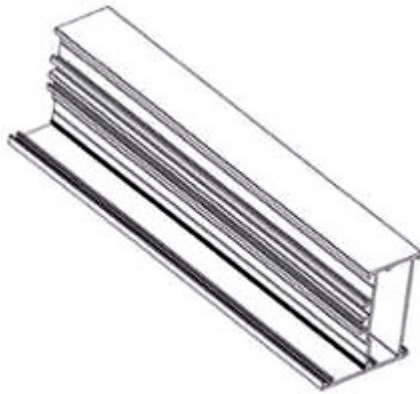

1.1



1.2

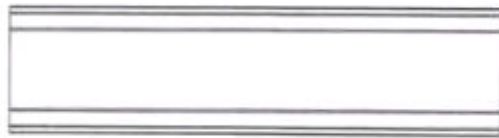

1.3



1.4



1.5



1.6

CÔNG BÁO SỞ HỮU CÔNG NGHIỆP SỐ 402 TẬP A – QUYỀN 2 (09.2021)

- (11) **42515**
(21) 3-2020-00003 (28) 1
(54) **THANH NHÔM ĐỊNH HÌNH** (51) **25-01**
(22) 02/01/2020 (43) 27/09/2021
(73) **CÔNG TY TNHH HOPO QUỐC TẾ (VN)**
Số nhà 23 ngách 27 ngõ 139 đường Nguyễn Ngọc Vũ, phường Trung Hoà, quận Cầu Giấy, thành phố Hà Nội
(72) GAO YANHONG (CN)
(55)



1.1

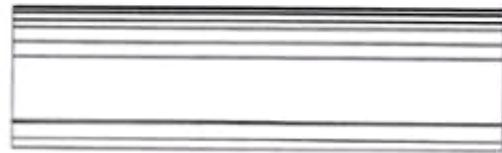

1.2



1.3



1.4



1.5



1.6

- (11) **42516**
(21) 3-2020-00004 (28) 1
(54) **THANH NHÔM ĐỊNH HÌNH** (51) **25-01**
(22) 02/01/2020 (43) 27/09/2021
(73) **CÔNG TY TNHH HOPO QUỐC TẾ (VN)**
Số nhà 23 ngách 27 ngõ 139 đường Nguyễn Ngọc Vũ, phường Trung Hoà, quận Cầu Giấy, thành phố Hà Nội
(72) GAO YANHONG (CN)
(55)

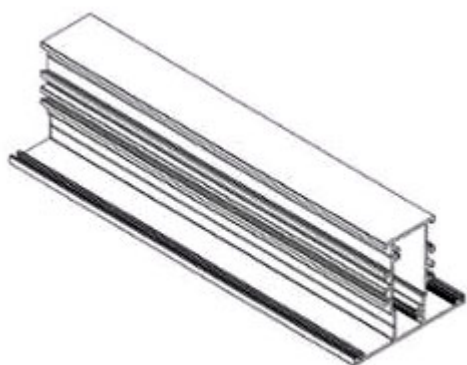

1.1



1.2



1.3



1.4



1.5



1.6

CÔNG BÁO SỞ HỮU CÔNG NGHIỆP SỐ 402 TẬP A – QUYỀN 2 (09.2021)

- (11) **42517**
(21) 3-2020-00005 (28) 1
(54) **THANH NHÔM ĐỊNH HÌNH** (51) **25-01**
(22) 02/01/2020 (43) 27/09/2021
(73) **CÔNG TY TNHH HOPO QUỐC TẾ (VN)**
Số nhà 23 ngách 27 ngõ 139 đường Nguyễn Ngọc Vũ, phường Trung Hoà, quận Cầu Giấy, thành phố Hà Nội
(72) GAO YANHONG (CN)
(55)



1.1

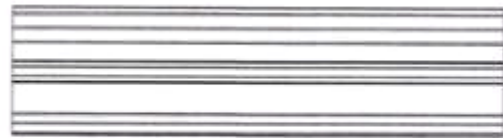

1.3

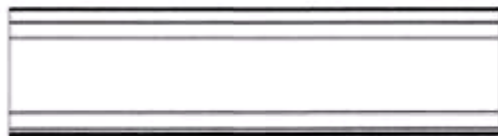

1.2

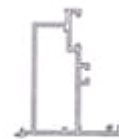

1.4



1.5



1.6

(11) **42518**

(21) 3-2020-00825

(28) 1

(54) **BÌNH ĐUN NÓNG LẠNH**

(51) **23-03**

(22) 15/04/2020

(43) 27/09/2021

(73) **CÔNG TY TRÁCH NHIỆM HỮU HẠN ĐIỆN KHÍ TRUNG NHẤT (VIỆT NAM) (VN)**

Lô 14 - đường số 2 – khu chế xuất Sài Gòn Linh Trung, phường Linh Trung, quận Thủ Đức, thành phố Hồ Chí Minh

(72) CHEN MINH CHI (TW)

(74) Công ty Cổ phần Sở hữu công nghiệp INVESTIP (INVESTIP)

(55)



1.1

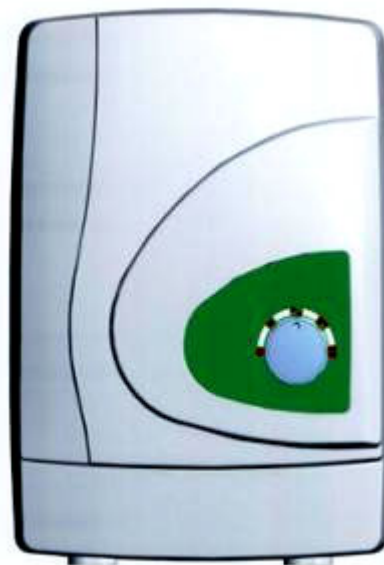

1.2



1.3



1.4



1.5



1.6



1.7

CÔNG BÁO SỞ HỮU CÔNG NGHIỆP SỐ 402 TẬP A – QUYỀN 2 (09.2021)

- (11) **42519**
(21) 3-2020-01682 (28) 1
(54) **THANH NHÔM ĐỊNH HÌNH** (51) **09-06; 25-01**
(22) 22/07/2020 (43) 27/09/2021
(73) **CÔNG TY TNHH HOPO QUỐC TẾ (VN)**
Số nhà 23 ngách 27 ngõ 139 đường Nguyễn Ngọc Vũ, phường Trung Hoà, quận Cầu Giấy, thành phố Hà Nội
(72) Châu Đình An (CN)
(55)



1.1



1.2



1.3

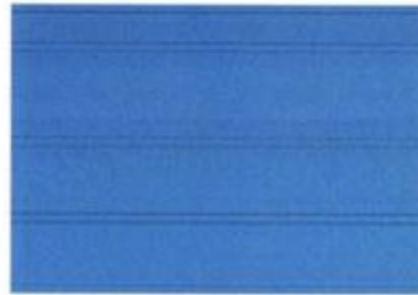

1.4



1.5



1.6

CÔNG BÁO SỞ HỮU CÔNG NGHIỆP SỐ 402 TẬP A – QUYỀN 2 (09.2021)

- (11) **42520**
(21) 3-2020-01684 (28) 1
(54) **THANH NHÔM ĐỊNH HÌNH** (51) **25-01**
(22) 22/07/2020 (43) 27/09/2021
(73) **CÔNG TY TNHH HOPO QUỐC TẾ (VN)**
Số nhà 23 ngách 27 ngõ 139 đường Nguyễn Ngọc Vũ, phường Trung Hoà, quận Cầu Giấy, thành phố Hà Nội
(72) Châu Đình An (CN)
(55)



1.1



1.2



1.3



1.4



1.5

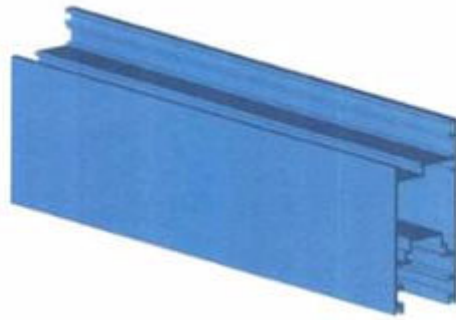

1.6

CÔNG BÁO SỞ HỮU CÔNG NGHIỆP SỐ 402 TẬP A – QUYỀN 2 (09.2021)

- (11) **42521**
(21) 3-2020-01688 (28) 2
(54) **THANH NHÔM ĐỊNH HÌNH** (51) **25-01**
(22) 22/07/2020 (43) 27/09/2021
(73) **CÔNG TY TNHH HOPO QUỐC TẾ (VN)**
Số nhà 23 ngách 27 ngõ 139 đường Nguyễn Ngọc Vũ, phường Trung Hoà, quận Cầu Giấy, thành phố Hà Nội
(72) Châu Đình An (CN)
(55)



1.1



1.2



1.3



1.4



1.5



1.6



2.1



2.2



2.3



2.4

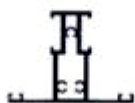

2.5



2.6

- (11) **42522**
(21) 3-2020-01689 (28) 2
(54) **THANH NHÔM ĐỊNH HÌNH** (51) **25-01**
(22) 22/07/2020 (43) 27/09/2021
(73) **CÔNG TY TNHH HOPO QUỐC TẾ (VN)**
Số nhà 23 ngách 27 ngõ 139 đường Nguyễn Ngọc Vũ, phường Trung Hoà, quận Cầu Giấy, thành phố Hà Nội
(72) Châu Đình An (CN)
(55)



1.1



1.2



1.3



1.4

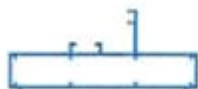

1.5



1.6



2.1



2.2



2.3



2.4

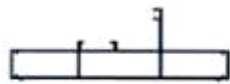

2.5



2.6

CÔNG BÁO SỞ HỮU CÔNG NGHIỆP SỐ 402 TẬP A – QUYỀN 2 (09.2021)

- (11) **42523**
(21) 3-2020-02836 (28) 1
(54) **MOAY-O** (51) **12-16**
(22) 24/11/2020 (43) 27/09/2021
(73) **MENG KAH AUTO PARTS TRADING SDN. BHD. (MY)**
40, Jalan TPP5, Taman Perindustrian Putra, 47130 Puchong, Selangor, Malaysia
(72) LEE CONG QUAN (MY)
(74) Công ty TNHH Trường Xuân (AGELESS CO.,LTD.)
(55)



1.1



1.2



1.3



1.4



1.5



1.6



1.7



1.8

CÔNG BÁO SỞ HỮU CÔNG NGHIỆP SỐ 402 TẬP A – QUYỀN 2 (09.2021)

- (11) **42524**
(21) 3-2020-02837 (28) 1
(54) **MOAY-O** (51) **12-16**
(22) 24/11/2020 (43) 27/09/2021
(73) **MENG KAH AUTO PARTS TRADING SDN. BHD. (MY)**
40, Jalan TPP5, Taman Perindustrian Putra, 47130 Puchong, Selangor, Malaysia
(72) LEE CONG QUAN (MY)
(74) Công ty TNHH Trường Xuân (AGELESS CO.,LTD.)
(55)



1.1

1.2

1.3



1.4

1.5

1.6



1.7

1.8

CÔNG BÁO SỞ HỮU CÔNG NGHIỆP SỐ 402 TẬP A – QUYỀN 2 (09.2021)

- (11) **42525**
(21) 3-2020-02838 (28) 1
(54) **MOAY-O** (51) **12-16**
(22) 24/11/2020 (43) 27/09/2021
(73) **MENG KAH AUTO PARTS TRADING SDN. BHD. (MY)**
40, Jalan TPP5, Taman Perindustrian Putra, 47130 Puchong, Selangor, Malaysia
(72) LEE CONG QUAN (MY)
(74) Công ty TNHH Trường Xuân (AGELESS CO.,LTD.)
(55)



1.1



1.2



1.3



1.4



1.5



1.6



1.7



1.8

CÔNG BÁO SỞ HỮU CÔNG NGHIỆP SỐ 402 TẬP A – QUYỀN 2 (09.2021)

- (11) **42526**
(21) 3-2020-02839 (28) 1
(54) **MOAY-O** (51) **12-16**
(22) 24/11/2020 (43) 27/09/2021
(73) **MENG KAH AUTO PARTS TRADING SDN. BHD. (MY)**
40, Jalan TPP5, Taman Perindustrian Putra, 47130 Puchong, Selangor, Malaysia
(72) LEE CONG QUAN (MY)
(74) Công ty TNHH Trường Xuân (AGELESS CO.,LTD.)
(55)



1.1



1.2



1.3



1.4



1.5



1.6



1.7



1.8

CÔNG BÁO SỞ HỮU CÔNG NGHIỆP SỐ 402 TẬP A – QUYỀN 2 (09.2021)

- (11) **42527**
(21) 3-2020-02840 (28) 1
(54) **MOAY-O** (51) **12-16**
(22) 24/11/2020 (43) 27/09/2021
(73) **MENG KAH AUTO PARTS TRADING SDN. BHD. (MY)**
40, Jalan TPP5, Taman Perindustrian Putra, 47130 Puchong, Selangor, Malaysia
(72) LEE CONG QUAN (MY)
(74) Công ty TNHH Trường Xuân (AGELESS CO.,LTD.)
(55)



1.1



1.2



1.3



1.4



1.5



1.6



1.7

CÔNG BÁO SỞ HỮU CÔNG NGHIỆP SỐ 402 TẬP A – QUYỀN 2 (09.2021)

(11) **42528**

(21) 3-2020-02841

(28) 1

(54) **MOAY-O**

(51) **12-16**

(22) 24/11/2020

(43) 27/09/2021

(73) **MENG KAH AUTO PARTS TRADING SDN. BHD. (MY)**

40, Jalan TPP5, Taman Perindustrian Putra, 47130 Puchong, Selangor, Malaysia

(72) LEE CONG QUAN (MY)

(74) Công ty TNHH Trường Xuân (AGELESS CO.,LTD.)

(55)



1.1



1.2



1.3



1.4



1.5



1.6



1.7



1.8

CÔNG BÁO SỞ HỮU CÔNG NGHIỆP SỐ 402 TẬP A – QUYỀN 2 (09.2021)

(11) **42529**

(21) 3-2020-02932

(28) 1

(54) **GHẾ SÔ-PHA**

(51) **06-01**

(22) 03/12/2020

(43) 27/09/2021

(73) **HTL FURNITURE (CHINA) CO., LTD. (CN)**

Wusong Jiangnan Road, Kunshan Development Zone, Jiangsu Province, China

(72) PHUA YONG TAT (SG)

(74) Công ty Luật TNHH quốc tế BMVN (BMVN INTERNATIONAL LLC)

(55)



1.1



1.2



1.3



1.4



1.5



1.6

(11) **42530**

(21) 3-2020-03007

(54) **GỐI ĐỠ LƯNG**

(22) 14/12/2020

(73) **NGUYỄN THỊ TƯƠI (VN)**

342 Hoàng Hoa Thám, phường 1, quận Gò Vấp, thành phố Hồ Chí Minh

(72) Nguyễn Thị Tươi (VN)

(55)

(28) 1

(51) **06-09**

(43) 27/09/2021



1.1



1.2



1.3



1.4



1.5



1.6



1.7

- (11) **42531**
(21) 3-2020-03060 (28) 1
(54) **CHAI** (51) **09-01**
(22) 21/12/2020 (43) 27/09/2021
(73) **CÔNG TY CỔ PHẦN CÔNG NGHỆ QUỐC TẾ SÂM TIẾN VUA (VN)**
151 Trần Huy Liệu, phường 8, quận Phú Nhuận, thành phố Hồ Chí Minh
(72) Nguyễn Mạnh Hùng (VN)
(55)



1.1



1.2



1.3



1.4



1.5

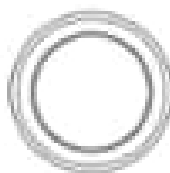

1.6

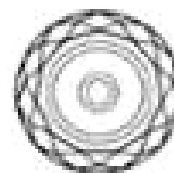

1.7

CÔNG BÁO SỞ HỮU CÔNG NGHIỆP SỐ 402 TẬP A – QUYỀN 2 (09.2021)

- (11) **42532**
- (21) 3-2020-03109 (28) 1
- (54) **AO NUÔI TÔM SIÊU THÂM CANH VỚI HỆ THỐNG CẤP KHÍ NANO OXY** (51) **30-02**
- (22) 24/12/2020 (43) 27/09/2021
- (73) **CÔNG TY CỔ PHẦN RYNAN TECHNOLOGIES VIETNAM (VN)**
Ấp Long Trị, xã Long Đức, thành phố Trà Vinh, tỉnh Trà Vinh
- (72) 1. NGUYỄN THANH MỸ (VN)
2. TRẦN QUỐC TOẢN (VN)
3. ÔNG VỒ VŨ KHANH (VN)
4. VỒ QUỐC VIỆT (VN)
5. NGUYỄN KHẮC NHỰT (VN)
6. BÙI MINH CHÂU (VN)
7. HỒNG QUỐC CƯỜNG (VN)
8. TÔ HUỖNH NGỌC DUY (VN)
- (74) Công ty TNHH Đại Tín và Liên Danh (DAITIN AND ASSOCIATES CO.,LTD)
- (55)

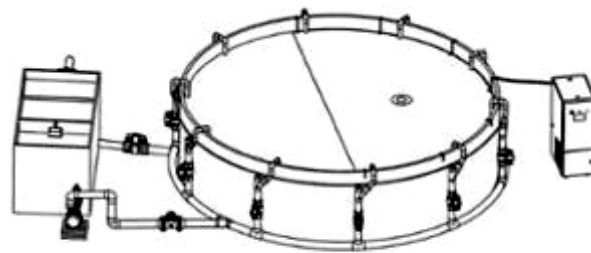

1.1

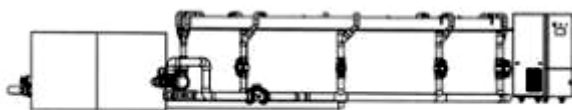

1.2

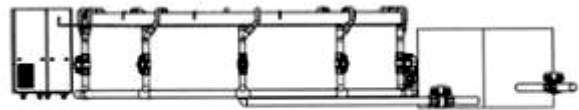

1.3



1.4

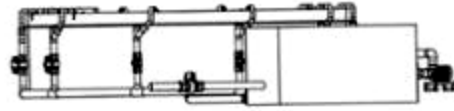

1.5

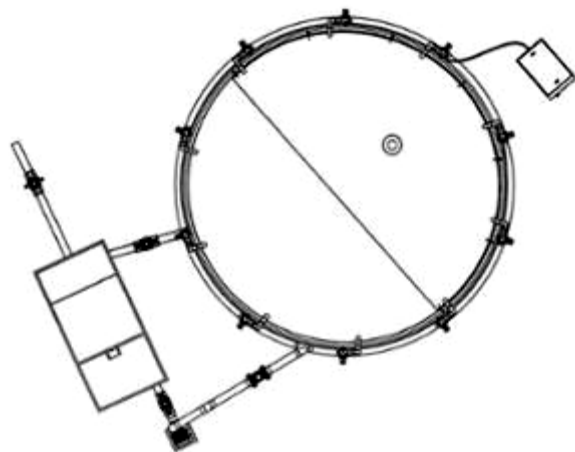

1.6

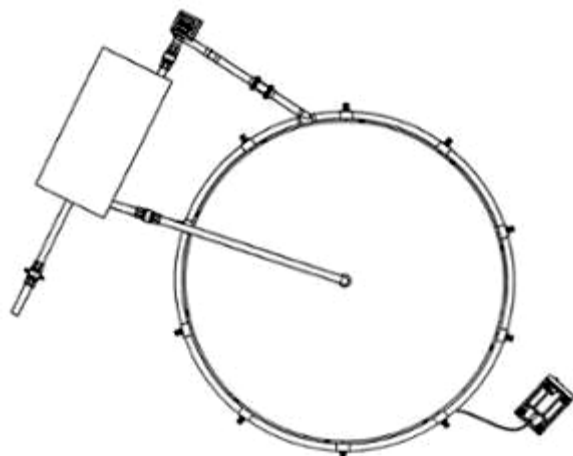

1.7

- (11) **42533**
(21) 3-2020-03143 (28) 1
(54) **HỘP ĐỰNG KẸO** (51) **09-03**
(22) 28/12/2020 (43) 27/09/2021
(73) **GENERAL CANDY CO., LTD. (TH)**
51/3 Soi Chaengwattana 41, Chaengwattana Road, Pakkred, Nonthaburi 11120,
Thailand
(72) Paisal Angkhasekvilai (TH)
(74) Công ty TNHH Sáng chế ACTIP (ACTIP PATENT LIMITED)
(55)

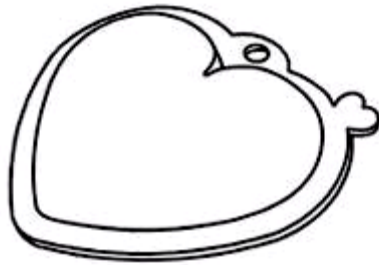

1.1



1.2



1.3

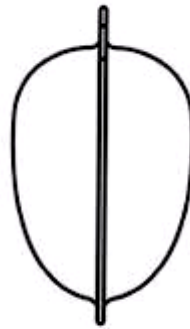

1.4



1.5

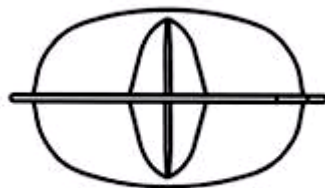

1.6

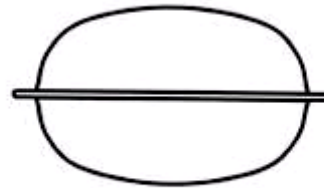

1.7

CÔNG BÁO SỞ HỮU CÔNG NGHIỆP SỐ 402 TẬP A – QUYỀN 2 (09.2021)

- (11) **42534**
(21) 3-2021-00055 (28) 2
(54) **AO NUÔI TÔM SIÊU THÂM CANH VỚI HỆ THỐNG CẤP KHÍ NANO OXY** (51) **30-02**
(22) 11/01/2021 (43) 27/09/2021
(73) **CÔNG TY CỔ PHẦN RYNAN TECHNOLOGIES VIETNAM (VN)**
Ấp Long Trị, xã Long Đức, thành phố Trà Vinh, tỉnh Trà Vinh
(72) 1. NGUYỄN THANH MỸ (VN)
2. TRẦN QUỐC TOẢN (VN)
3. VÕ VŨ KHANH (VN)
4. VÕ QUỐC VIỆT (VN)
5. NGUYỄN KHẮC NHỰT (VN)
6. BÙI MINH CHÂU (VN)
7. HỒNG QUỐC CƯỜNG (VN)
8. TÔ HUỖNH NGỌC DUY (VN)
(74) Công ty TNHH Đại Tín và Liên Danh (DAITIN AND ASSOCIATES CO.,LTD)
(55)

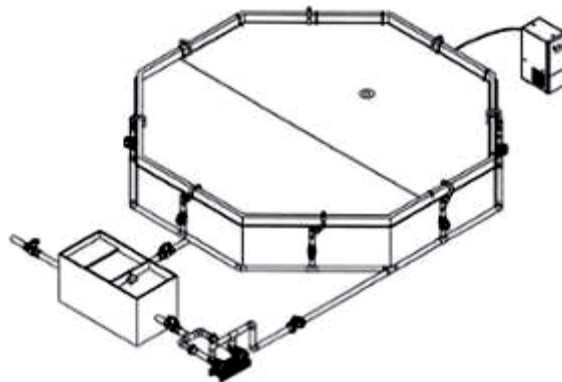

1.1



1.2

1.3

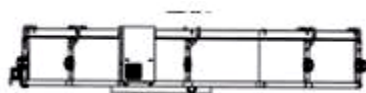

1.4



1.5

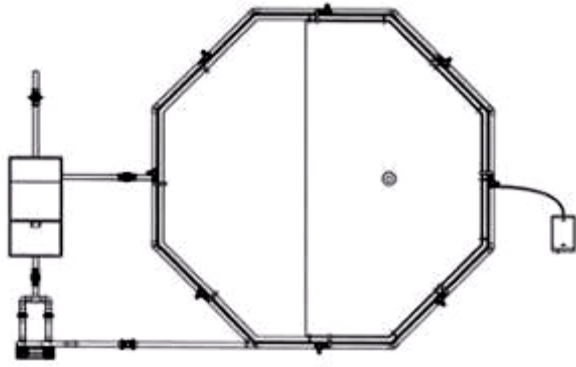

1.6

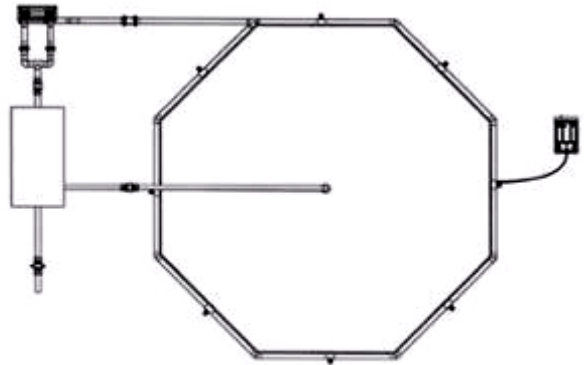

1.7

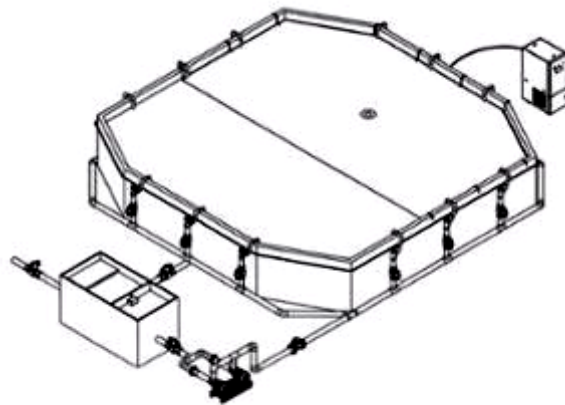

2.1

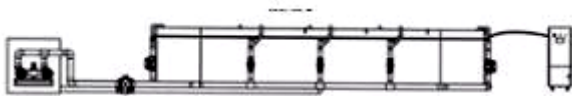

2.2

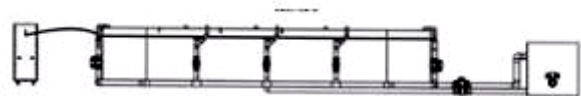

2.3

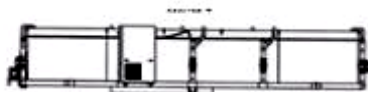

2.4



2.5

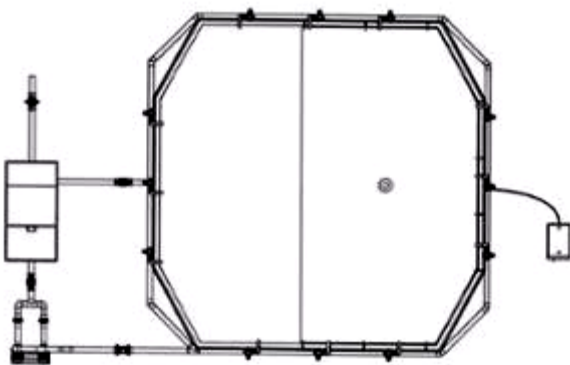

2.6

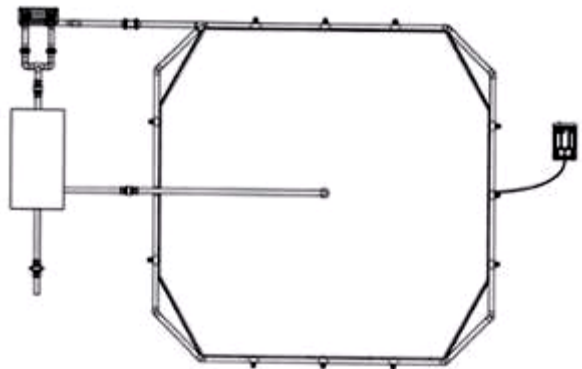

2.7

CÔNG BÁO SỞ HỮU CÔNG NGHIỆP SỐ 402 TẬP A – QUYỀN 2 (09.2021)

- (11) **42535**
(21) 3-2021-00176 (28) 1
(54) **CHÂN BÀN** (51) **06-03**
(22) 26/01/2021 (43) 27/09/2021
(73) **PHẠM TÍN THÀNH (VN)**
Thôn Tân Lập, xã Tam Hải, huyện Núi Thành, tỉnh Quảng Nam
(72) Phạm Tín Thành (VN)
(74) Công ty TNHH Tư vấn đầu tư và Sở hữu trí tuệ Hoàng Phi (HOANG PHI INVEST & I.P CO., LTD)
(55)

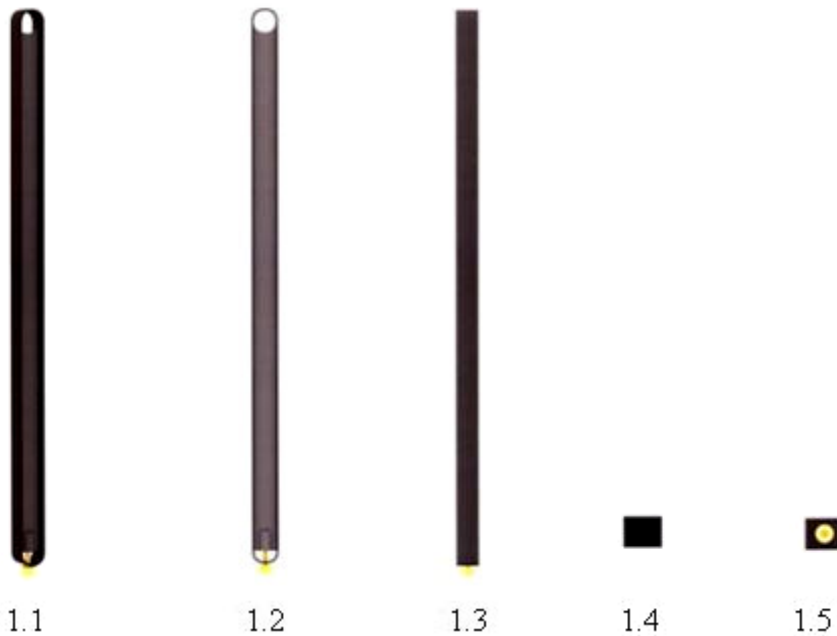

CÔNG BÁO SỞ HỮU CÔNG NGHIỆP SỐ 402 TẬP A – QUYỀN 2 (09.2021)

- (11) **42536**
(21) 3-2021-00178 (28) 1
(54) **BÚT** (51) **19-06**
(22) 26/01/2021 (43) 27/09/2021
(30) 2002004530 05/10/2020 TH;
(73) **DOUBLE A (1991) PUBLIC COMPANY LIMITED (TH)**
1 Moo2, Thatoom, Srimahaphote, Prachinburi, Thailand
(72) Hyo Jin KIM (KR)
(74) Công ty Luật TNHH T&G (TGVN)
(55)



1.1



1.2



1.3



1.4



1.5



1.6



1.7

CÔNG BÁO SỞ HỮU CÔNG NGHIỆP SỐ 402 TẬP A – QUYỀN 2 (09.2021)

(11) **42537**

(21) 3-2021-00479

(28) 1

(54) **KHUNG GIƯỜNG**

(51) **06-02**

(22) 12/03/2021

(43) 27/09/2021

(73) **HTL FURNITURE (CHINA) CO., LTD. (CN)**

Wusong Jiangnan Road, Kunshan Development Zone, Jiangsu Province, China

(72) PHUA YONG TAT (SG)

(74) Công ty Luật TNHH quốc tế BMVN (BMVN INTERNATIONAL LLC)

(55)



1.1



1.2



1.3



1.4



1.5

CÔNG BÁO SỞ HỮU CÔNG NGHIỆP SỐ 402 TẬP A – QUYỀN 2 (09.2021)

(11) **42538**

(21) 3-2021-00739

(28) 1

(54) **THANH NHÔM ĐỊNH HÌNH**

(51) **25-01**

(22) 30/03/2021

(43) 27/09/2021

(73) **CÔNG TY TNHH SHUANG YING VIỆT NAM (VN)**

Km 17+100 Quốc lộ 32 thôn Cao Trung, xã Đức Giang, huyện Hoài Đức, thành phố Hà Nội

(72) Wang Jihua (CN)

(55)

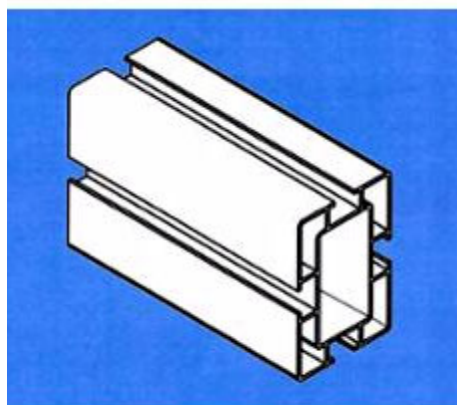

1.1



1.2

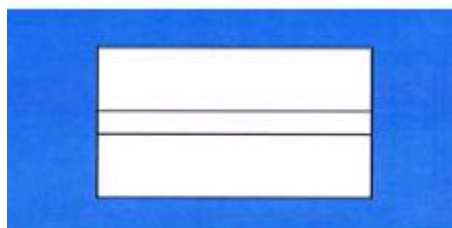

1.3

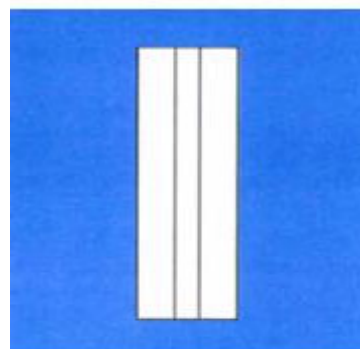

1.4

CÔNG BÁO SỞ HỮU CÔNG NGHIỆP SỐ 402 TẬP A – QUYỀN 2 (09.2021)

- (11) **42539**
(21) 3-2021-00812 (28) 1
(54) **THANH CÀI CỬA BÚT** (51) **19-06**
(22) 05/04/2021 (43) 27/09/2021
(73) **CÔNG TY CỔ PHẦN TẬP ĐOÀN THIÊN LONG (VN)**
Lô 6-8-10-12 đường số 3, khu công nghiệp Tân Tạo, quận Bình Tân, thành phố Hồ Chí Minh
(72) Cô Gia Thọ (VN)
(74) Công ty TNHH Tư vấn sở hữu trí tuệ Việt (VIET IP CO.,LTD.)
(55)



1.1



1.2



1.3



1.4



1.5



1.6



1.7



1.8

CÔNG BÁO SỞ HỮU CÔNG NGHIỆP SỐ 402 TẬP A – QUYỀN 2 (09.2021)

- (11) **42540**
- (21) 3-2021-00885
- (54) **TÚI ĐỰNG KHẨU TRANG**
- (22) 14/04/2021
- (73) **CÔNG TY TNHH ALKA GLUTA VIETNAM (VN)**
440/13/69 Thống Nhất, phường 16, quận Gò Vấp, thành phố Hồ Chí Minh
- (72) Ngô Thị Thanh Huyền (VN)
- (74) Công ty Cổ phần Sở hữu trí tuệ Việt Mỹ (VIET MY IPC)
- (55)
- (28) 1
- (51) **09-05**
- (43) 27/09/2021



1.1



1.2

CÔNG BÁO SỞ HỮU CÔNG NGHIỆP SỐ 402 TẬP A – QUYỀN 2 (09.2021)

- | | | | |
|------|---|------|--------------|
| (11) | 42541 | | |
| (21) | 3-2021-00918 | (28) | 1 |
| (54) | HỘP NẤM LINH CHI | (51) | 09-03 |
| (22) | 20/04/2021 | (43) | 27/09/2021 |
| (73) | CÔNG TY TNHH XUẤT NHẬP KHẨU VÀ KINH DOANH VHP (VN)
Số 17/331 phố Trần Khát Trân, phường Thanh Nhân, quận Hai Bà Trưng, thành phố Hà Nội | | |
| (72) | Đào Thị Gấm (VN) | | |
| (55) | | | |



1.1



1.2



1.3



1.4



1.5



1.6



1.7

- (11) **42542**
(21) 3-2021-00922 (28) 1
(54) **ĐỒ CHƠI LẮP RÁP** (51) **21-01**
(22) 20/04/2021 (43) 27/09/2021
(73) **COSTAS SISAMOS (CY)**
Kerinias 34, Ipsonnas Limassol 4184 Cyprus
(72) Costas Sisamos (CY)
(74) Công ty TNHH Quốc tế D &N (D&N INTERNATIONAL CO.,LTD.)
(55)

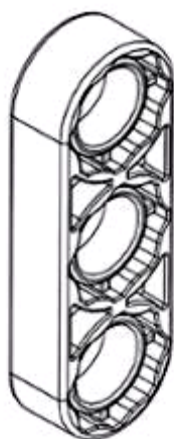

1.1



1.2



1.3



1.4

CÔNG BÁO SỞ HỮU CÔNG NGHIỆP SỐ 402 TẬP A – QUYỀN 2 (09.2021)

- (11) **42543**
(21) 3-2021-00954 (28) 1
(54) **ĐỒ CHƠI** (51) **21-01**
(22) 26/04/2021 (43) 27/09/2021
(30) 008505309 15/04/2021 EM;
(73) **ZEYUAN GUO (CN)**
No.3, Lane 3, Hongqi North Road, Ganggang, Fengxiang Street, Chenghai District,
Shantou City, Guangdong Province, China
(72) Zeyuan Guo (CN)
(74) Công ty TNHH Tư vấn IPNG (IPNG CO.,LTD)
(55)



1.1



1.2



1.3



1.4



1.5



1.6



1.7



1.8

CÔNG BÁO SỞ HỮU CÔNG NGHIỆP SỐ 402 TẬP A – QUYỀN 2 (09.2021)

- (11) 42544
- (21) 3-2021-00970 (28) 1
- (54) **BAO GÓI ĐỰNG THỰC PHẨM** (51) **09-05**
- (22) 27/04/2021 (43) 27/09/2021
- (30) 30-2021-0014010 23/03/2021 KR;
- (73) **CJ CHEILJEDANG CORPORATION (KR)**
(Ssangnim-dong) 330, Dongho-ro, Jung-gu, Seoul 04560, Republic of Korea
- (72) 1. SONG, WOO JUNG (KR)
2. LEE, SEUNG PYO (KR)
- (74) Công ty Luật TNHH ROUSE Việt Nam (ROUSE LAW CO.,LTD)
- (55)



1.1



1.2



1.3



1.4



1.5



1.6



1.7

(11) **42545**

(21) 3-2021-00971

(54) **THANH NHÔM ĐỊNH HÌNH**

(22) 27/04/2021

(73) **CÔNG TY TNHH THIẾT BỊ GIÁO DỤC TÂN HÀ (VN)**

Thôn Nghĩa Lộ, xã Chỉ Đạo, huyện Văn Lâm, tỉnh Hưng Yên

(72) Lê Hồng Bách (VN)

(55)

(28) 1

(51) **25-01**

(43) 27/09/2021

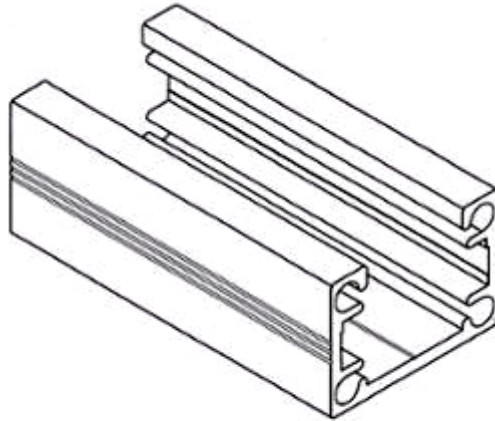

1.1

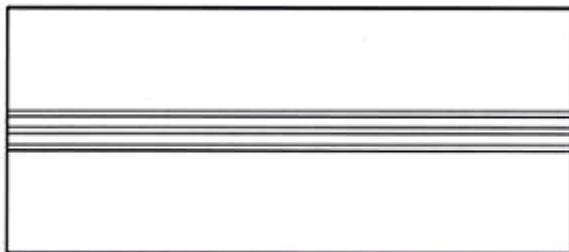

1.2

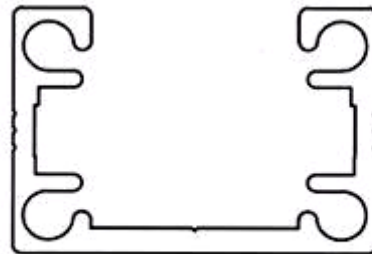

1.3

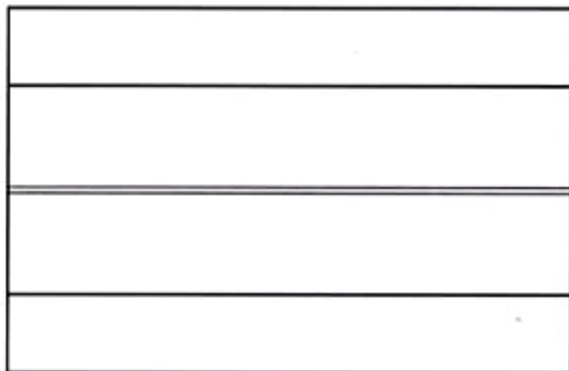

1.4

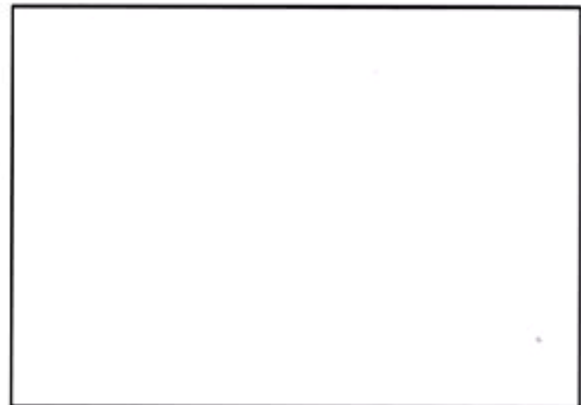

1.5

CÔNG BÁO SỞ HỮU CÔNG NGHIỆP SỐ 402 TẬP A – QUYỀN 2 (09.2021)

- (11) **42546**
(21) 3-2021-00972 (28) 1
(54) **HỘP** (51) **09-03**
(22) 28/04/2021 (43) 27/09/2021
(73) **CÔNG TY TNHH NAM PHƯƠNG V.N (VN)**
124 Lê Lai, phường 3, quận Gò Vấp, thành phố Hồ Chí Minh
(72) Hoàng Thị Minh Hiếu (VN)
(74) Công ty Luật TNHH Phạm và Liên danh (PHAM & ASSOCIATES)
(55)



1.1



1.2

- (11) **42547**
(21) 3-2021-01037 (28) 1
(54) **THIẾT BỊ NẤU ĂN** (51) **07-02**
(22) 05/05/2021 (43) 27/09/2021
(30) 202030671805.5 06/11/2020 CN;
(73) **GUANGDONG MIDEA CONSUMER ELECTRIC MANUFACTURING CO., LTD. (CN)**
San Le Road #19, Beijiao, Shunde, Foshan, Guangdong 528311, China
(72) FAN, Weijian (CN)
(74) Công ty TNHH Dịch vụ Sở hữu trí tuệ KENFOX (KENFOX IP SERVICE CO.,LTD.)
(55)



1.1



1.2



1.3



1.4

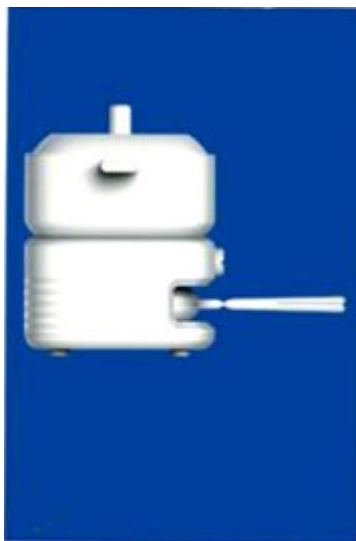

1.5



1.6



1.7



1.8

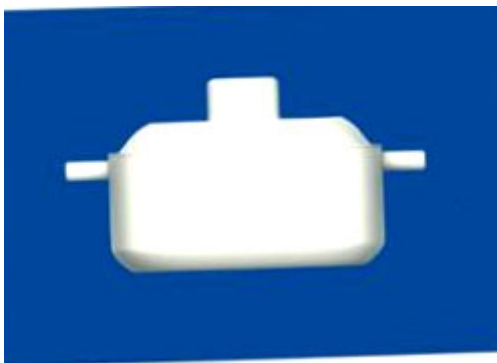

1.9

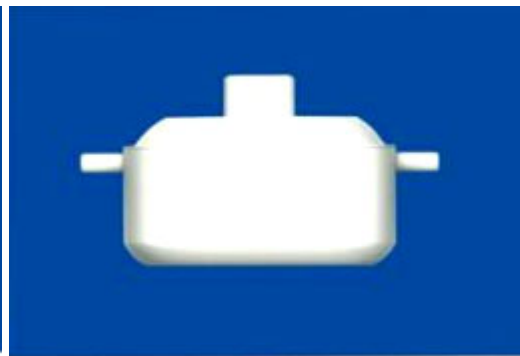

1.10



1.11



1.12



1.13



1.14



1.15



1.16



1.17

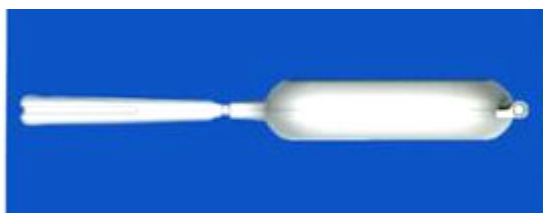

1.18



1.19



1.20



1.21



1.22



1.23



1.24

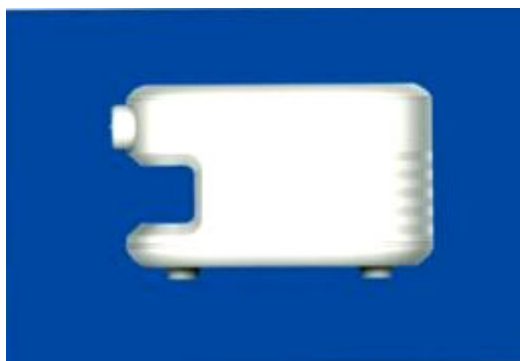

1.25



1.26



1.27



1.28

- (11) **42548**
(21) 3-2021-01192 (28) 1
(54) **BÌNH ĐỰNG NƯỚC** (51) **07-07**
(22) 13/05/2021 (43) 27/09/2021
(73) **CÔNG TY CỔ PHẦN TÂN PHÚ VIỆT NAM (VN)**
314 Lũy Bán Bích, phường Hoà Thạnh, quận Tân Phú, thành phố Hồ Chí Minh
(72) Hoàng Anh Tuấn (VN)
(74) Công ty Luật TNHH Việt An (VIET AN LAW FIRM)
(55)

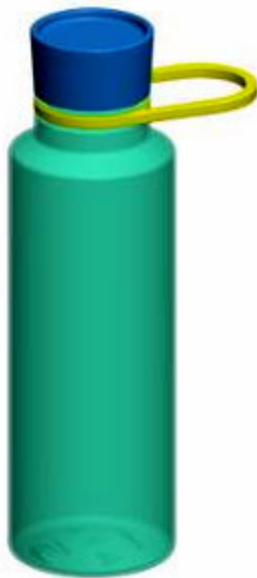

1.1

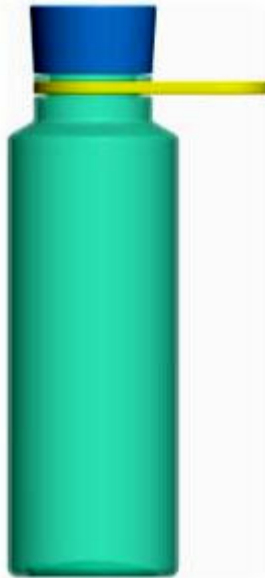

1.2



1.3



1.4

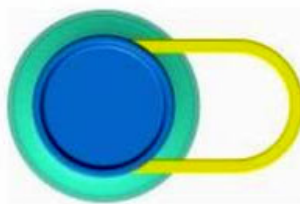

1.5



1.6



1.7

- (11) **42549**
(21) 3-2021-01194 (28) 1
(54) **BÌNH ĐỰNG NƯỚC** (51) **07-07**
(22) 13/05/2021 (43) 27/09/2021
(73) **CÔNG TY CỔ PHẦN TÂN PHÚ VIỆT NAM (VN)**
314 Lũy Bán Bích, phường Hoà Thạnh, quận Tân Phú, thành phố Hồ Chí Minh
(72) Hoàng Anh Tuấn (VN)
(74) Công ty Luật TNHH Việt An (VIET AN LAW FIRM)
(55)



1.1



1.2



1.3



1.4

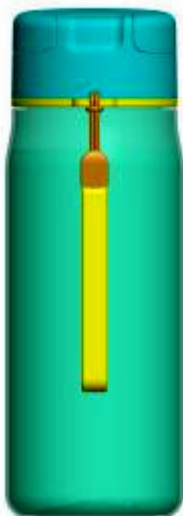

1.5



1.6



1.7



1.8

CÔNG BÁO SỞ HỮU CÔNG NGHIỆP SỐ 402 TẬP A – QUYỀN 2 (09.2021)

- (11) **42550**
(21) 3-2021-01251 (28) 1
(54) **GHẾ MÁT XA** (51) **06-01**
(22) 14/05/2021 (43) 27/09/2021
(73) **AIDEPINGFANG HEALTH TECHNOLOGY (SHANGHAI) CO., LTD. (CN)**
Rm. D247, 2/F, Building 3, No. 2118 Guanghua Rd., Minhang Dist., Shanghai,
China
(72) Okamoto Yuichi (CN)
(74) Công ty cổ phần Sở hữu trí tuệ BROSS và Cộng sự (BROSS & PARTNERS., JSC)
(55)



1.1

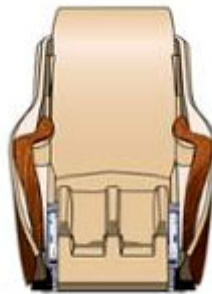

1.2



1.3



1.4



1.5



1.6



1.7

CÔNG BÁO SỞ HỮU CÔNG NGHIỆP SỐ 402 TẬP A – QUYỀN 2 (09.2021)

- (11) **42551**
(21) 3-2021-01304 (28) 1
(54) **ĐÈN CẢNH BÁO** (51) **10-06**
(22) 19/05/2021 (43) 27/09/2021
(73) **CÔNG TY CỔ PHẦN EOH (VN)**
298/3 Điện Biên Phủ, phường 17, quận Bình Thạnh, thành phố Hồ Chí Minh
(72) 1. LÊ HỒNG LONG (VN)
2. HUỖNH VĂN HẬU (VN)
3. NGUYỄN MINH KHẢI (VN)
(55)



1.1



1.2



1.3



1.5



1.4

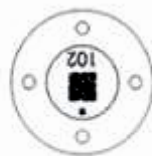

1.6



1.7

CÔNG BÁO SỞ HỮU CÔNG NGHIỆP SỐ 402 TẬP A – QUYỀN 2 (09.2021)

- (11) **42552**
(21) 3-2021-01311 (28) 1
(54) **KHUNG VÕNG** (51) **06-02**
(22) 19/05/2021 (43) 27/09/2021
(73) **CÔNG TY TRÁCH NHIỆM HỮU HẠN SẢN XUẤT THƯƠNG MẠI VÀ DỊCH VỤ CSN HOLDINGS (VN)**
45/2D Điện Biên Phủ, phường 15, quận Bình Thạnh, thành phố Hồ Chí Minh
(72) Huỳnh Chí Linh (VN)
(74) Công ty Cổ phần PHANLAW VIETNAM (PHANLAW VIETNAM JSC)
(55)

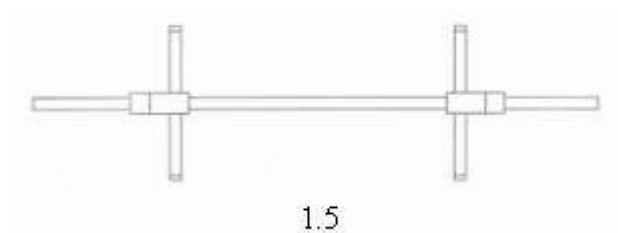
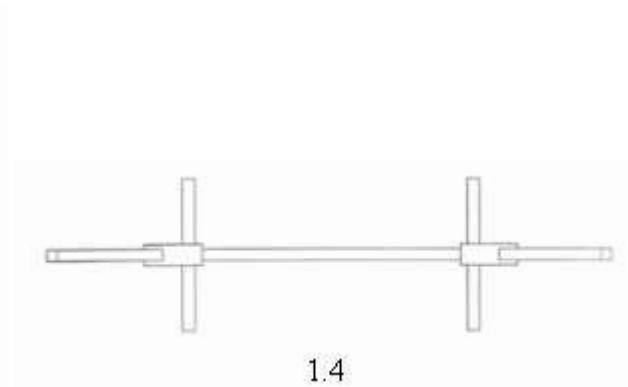
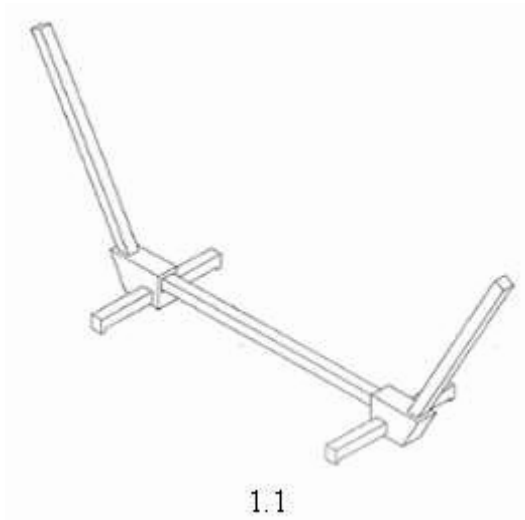

CÔNG BÁO SỞ HỮU CÔNG NGHIỆP SỐ 402 TẬP A – QUYỀN 2 (09.2021)

- (11) **42553**
(21) 3-2021-01365 (28) 1
(54) **HỆ THỐNG HÒA TAN OXY PHÂN TỬ VÀO TRONG NƯỚC** (51) **23-01**
(22) 25/05/2021 (43) 27/09/2021
(73) **CÔNG TY CỔ PHẦN RYNAN TECHNOLOGIES VIETNAM (VN)**
Ấp Long Trị, xã Long Đức, thành phố Trà Vinh, tỉnh Trà Vinh
(72) 1. NGUYỄN THANH MỸ (VN)
2. TRẦN QUỐC TOẢN (VN)
3. VÕ VŨ KHANH (VN)
4. PHẠM HOÀNG LƯƠNG (VN)
(74) Công ty TNHH Đại Tín và Liên Danh (DAITIN AND ASSOCIATES CO.,LTD)
(55)

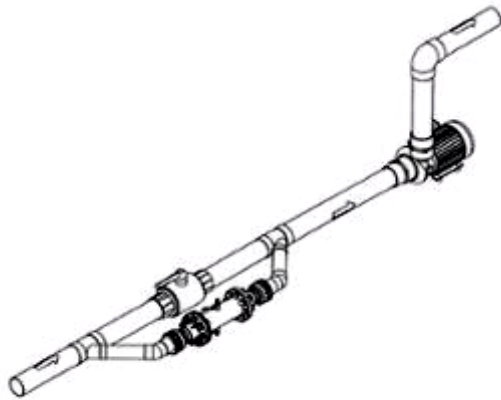

1.1



1.2

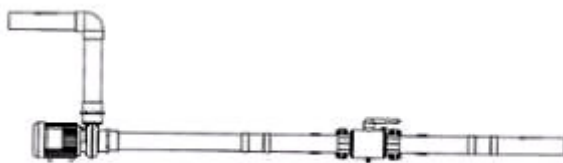

1.3



1.4



1.5

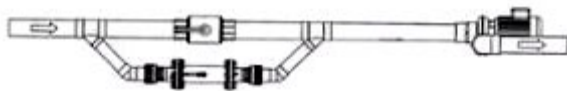

1.6

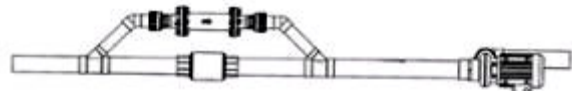

1.7

(11) **42554**

(21) 3-2021-01374

(28) 1

(54) **NÊM NHỰA CÂN BẰNG ỐP LÁT GẠCH**

(51) **08-08**

(22) 26/05/2021

(43) 27/09/2021

(73) **NGUYỄN XUÂN THỦY (VN)**

Tổ 3, khu 10, phường Bãi Cháy, thành phố Hạ Long, tỉnh Quảng Ninh

(72) Nguyễn Xuân Thủy (VN)

(55)

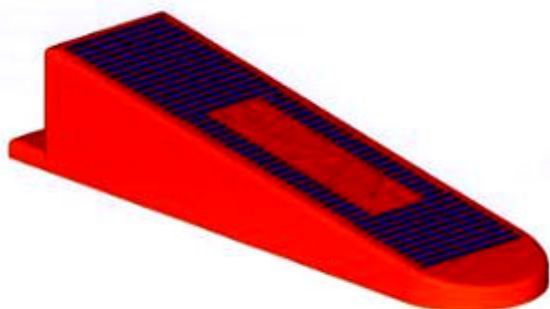

1.1



1.2



1.3

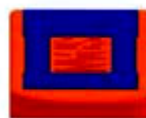

1.4



1.5

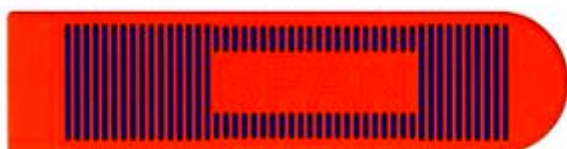

1.6



1.7

- (11) **42555**
(21) 3-2021-01375 (28) 1
(54) **KE NHỰA CÂN BẰNG ỐP LÁT GẠCH** (51) **08-08**
(22) 26/05/2021 (43) 27/09/2021
(73) **NGUYỄN XUÂN THỦY (VN)**
Tổ 3, khu 10, phường Bãi Cháy, thành phố Hạ Long, tỉnh Quảng Ninh
(72) Nguyễn Xuân Thủy (VN)
(55)



1.1



1.2

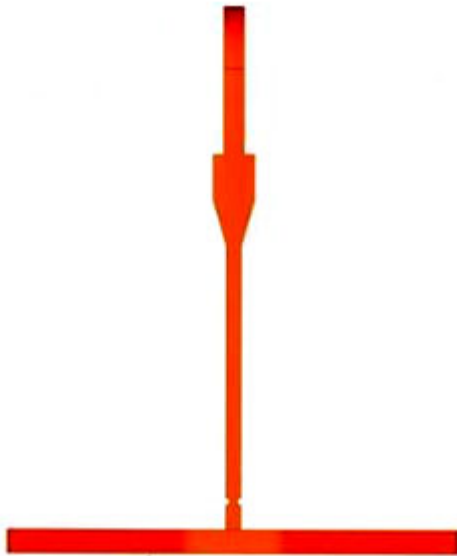

1.3

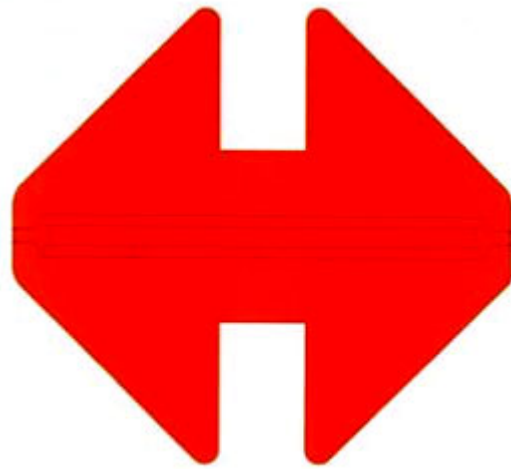

1.4



1.5

CÔNG BÁO SỞ HỮU CÔNG NGHIỆP SỐ 402 TẬP A – QUYỀN 2 (09.2021)

- (11) **42556**
(21) 3-2021-01393 (28) 1
(54) **HỘP ĐỰNG THỰC PHẨM** (51) **09-03**
(22) 28/05/2021 (43) 27/09/2021
(30) 30-2020-0059564 03/12/2020 KR;
(73) **LOCK & LOCK CO., LTD (KR)**
104, Sapgyocheon-ro, Seonjang-myeon, Asan-si, Chungcheongnam-do, Republic of Korea
(72) LEE, Kyung Mee (KR)
(74) Công ty TNHH Tầm nhìn và Liên danh (VISION & ASSOCIATES CO.LTD.)
(55)



1.1

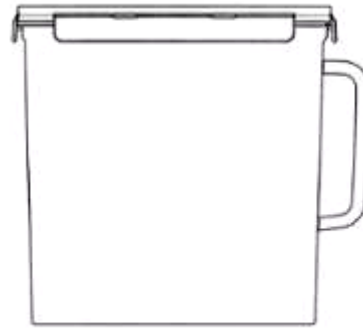

1.2

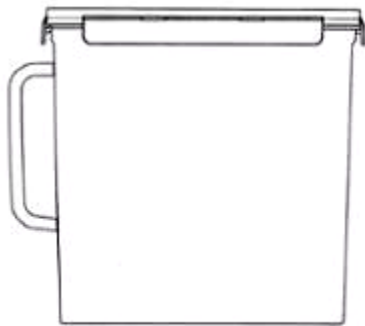

1.3



1.4

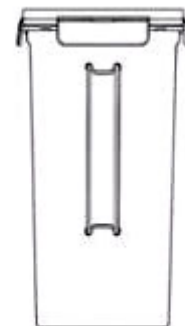

1.5



1.6



1.7

CÔNG BÁO SỞ HỮU CÔNG NGHIỆP SỐ 402 TẬP A – QUYỀN 2 (09.2021)

- (11) **42557**
(21) 3-2021-01394 (28) 1
(54) **BÌNH** (51) **07-07**
(22) 28/05/2021 (43) 27/09/2021
(30) 30-2020-0059565 03/12/2020 KR;
(73) **LOCK & LOCK CO., LTD (KR)**
104, Sapgyocheon-ro, Seonjang-myeon, Asan-si, Chungcheongnam-do, Republic of Korea
(72) SHIM, Dong Seop (KR)
(74) Công ty TNHH Tầm nhìn và Liên danh (VISION & ASSOCIATES CO.LTD.)
(55)



1.1

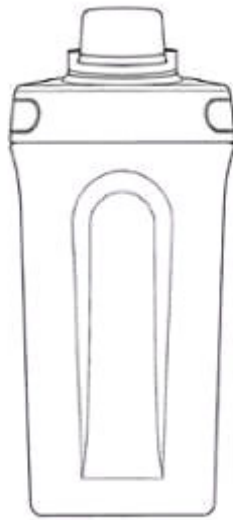

1.2

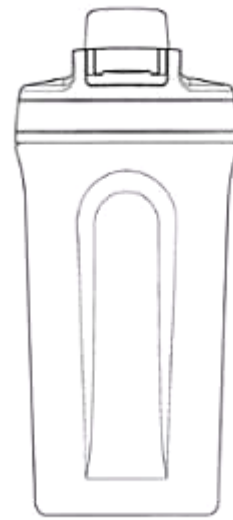

1.3

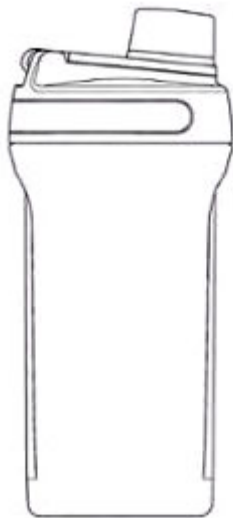

1.4

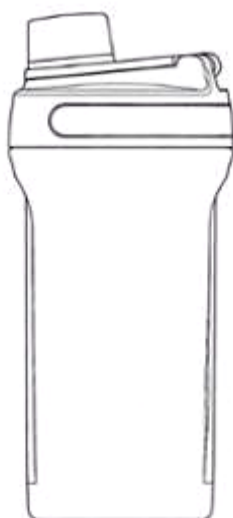

1.5



1.6



1.7

- (11) **42558**
(21) 3-2021-01395 (28) 1
(54) **TỦ LẠNH CHO CHẤT THẢI THỰC PHẨM** (51) **15-07**
(22) 28/05/2021 (43) 27/09/2021
(30) 30-2020-0059566 03/12/2020 KR;
(73) **LOCK & LOCK CO., LTD (KR)**
104, Sapgyocheon-ro, Seonjang-myeon, Asan-si, Chungcheongnam-do, Republic of Korea
(72) SHIM, Dong Seop (KR)
(74) Công ty TNHH Tầm nhìn và Liên danh (VISION & ASSOCIATES CO.LTD.)
(55)

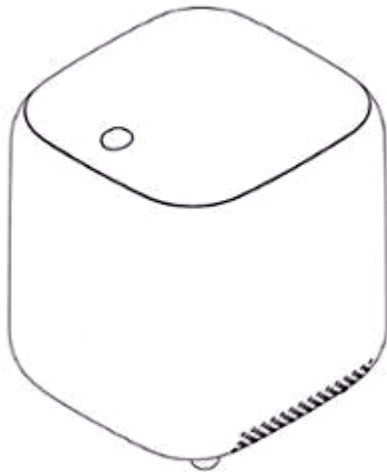

1.1

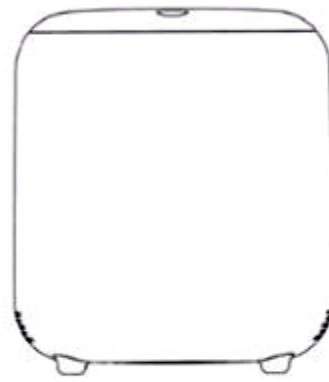

1.2



1.3



1.4

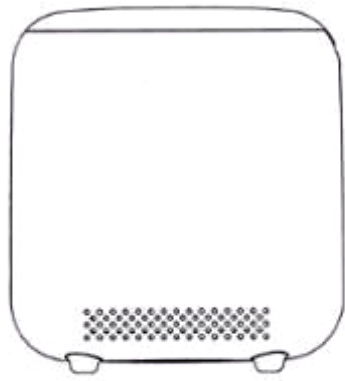

1.5



1.6

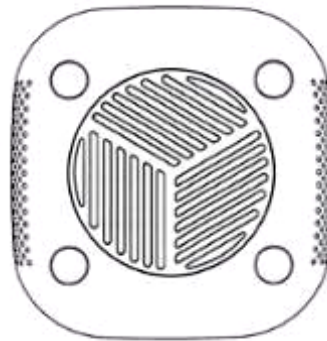

1.7

- (11) **42559**
(21) 3-2021-01397 (28) 2
(54) **GẠCH LÁT** (51) **25-01**
(22) 31/05/2021 (43) 27/09/2021
(73) **CÔNG TY TNHH MỘT THÀNH VIÊN SẢN XUẤT BÊ TÔNG ĐÚC SẴN VÀ VẬT LIỆU XÂY DỰNG LIÊN PHƯỚC THÀNH (VN)**
Số 19A9, khu phố Bình Khởi, phường 6, thành phố Bến Tre, tỉnh Bến Tre
(72) Nguyễn Hữu Phước (VN)
(74) Công ty TNHH Sở hữu trí tuệ Việt Nam IP (VIETNAM IP)
(55)

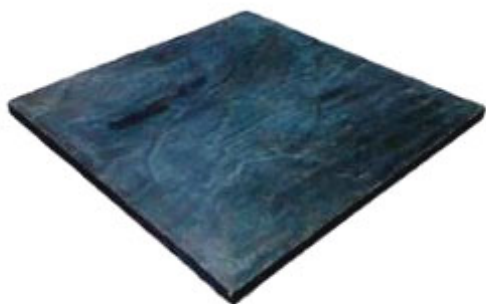

1.1



1.2



1.3



1.4

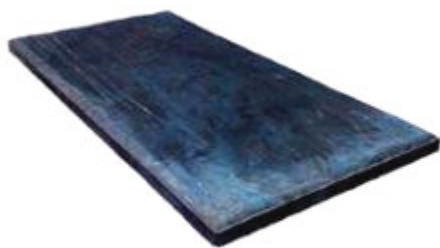

2.1



2.2



2.4



2.5



2.3

- (11) **42560**
(21) 3-2021-01429 (28) 1
(54) **BÌNH** (51) **07-07**
(22) 02/06/2021 (43) 27/09/2021
(30) 30-2020-0060205 07/12/2020 KR;
(73) **LOCK & LOCK CO., LTD (KR)**
104, Sapgyocheon-ro, Seonjang-myeon, Asan-si, Chungcheongnam-do, Republic
of Korea
(72) LEE, Youn Jung (KR)
(74) Công ty TNHH Tầm nhìn và Liên danh (VISION & ASSOCIATES CO.LTD.)
(55)

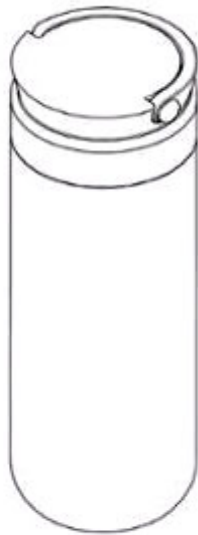

1.1



1.2



1.3



1.4



1.5



1.6



1.7

- (11) **42561**
(21) 3-2021-01430 (28) 1
(54) **NẮP HỘP ĐỰNG THỰC PHẨM** (51) **09-07**
(22) 02/06/2021 (43) 27/09/2021
(30) 30-2020-0063169 18/12/2020 KR;
(73) **LOCK & LOCK CO., LTD (KR)**
104, Sapgyocheon-ro, Seonjang-myeon, Asan-si, Chungcheongnam-do, Republic of Korea
(72) LEE, Youn Jung (KR)
(74) Công ty TNHH Tầm nhìn và Liên danh (VISION & ASSOCIATES CO.LTD.)
(55)

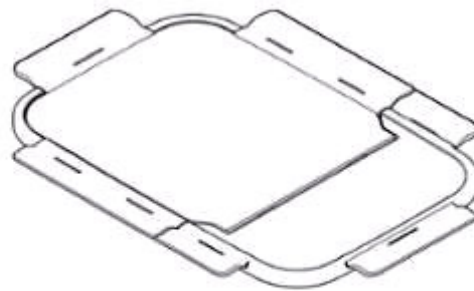

1.1



1.2



1.3



1.4



1.5

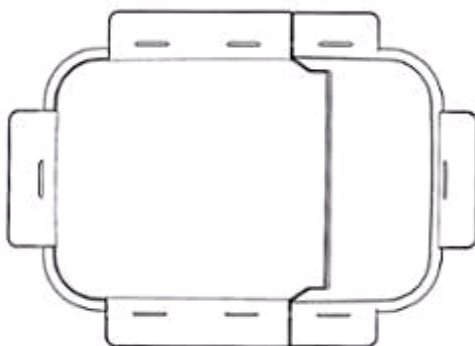

1.6

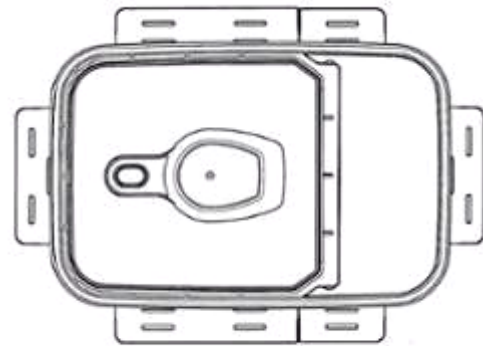

1.7

- (11) **42562**
(21) 3-2021-01431 (28) 1
(54) **NẤP HỘP ĐỰNG THỰC PHẨM** (51) **09-07**
(22) 02/06/2021 (43) 27/09/2021
(30) 30-2020-0063631 21/12/2020 KR;
(73) **LOCK & LOCK CO., LTD (KR)**
104, Sapgyocheon-ro, Seonjang-myeon, Asan-si, Chungcheongnam-do, Republic of Korea
(72) LEE, Kyung Mee (KR)
(74) Công ty TNHH Tầm nhìn và Liên danh (VISION & ASSOCIATES CO.LTD.)
(55)

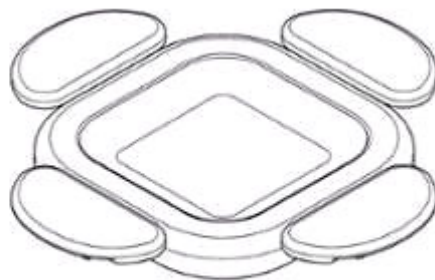

1.1



1.2



1.3



1.4



1.5

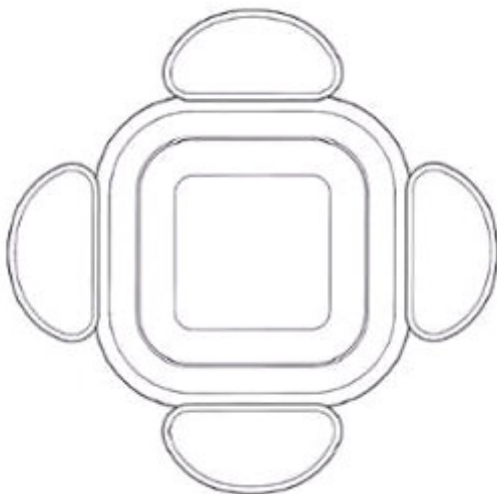

1.6

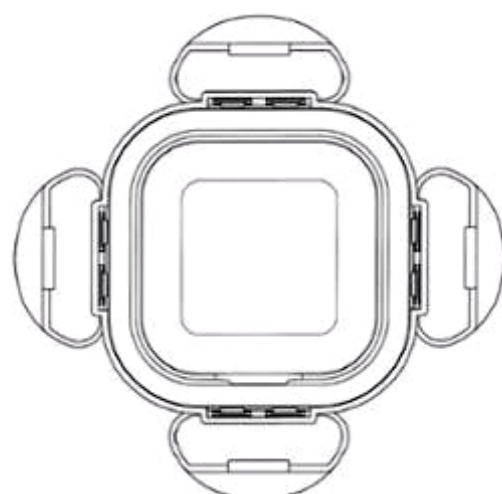

1.7

- (11) **42563**
(21) 3-2021-01432 (28) 1
(54) **BÌNH** (51) **07-07**
(22) 02/06/2021 (43) 27/09/2021
(30) 30-2020-0064191 22/12/2020 KR;
(73) **LOCK & LOCK CO., LTD (KR)**
104, Sapgyocheon-ro, Seonjang-myeon, Asan-si, Chungcheongnam-do, Republic
of Korea
(72) LEE, Kyung Mee (KR)
(74) Công ty TNHH Tầm nhìn và Liên danh (VISION & ASSOCIATES CO.LTD.)
(55)



1.1



1.2



1.3



1.4



1.5



1.6

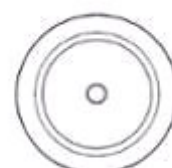

1.7

- (11) **42564**
- (21) 3-2021-01441
- (54) **VỈ NƯỚNG**
- (22) 03/06/2021
- (30) 30-2021-0000487 06/01/2021 KR;
- (73) **LEE CHAEHWAN (KR)**
45-11, Bangchon-ro, Dong-gu, Daegu, Republic of Korea
- (72) Lee Chaehwan (KR)
- (74) Công ty TNHH Tầm nhìn và Liên danh (VISION & ASSOCIATES CO.LTD.)
- (55)

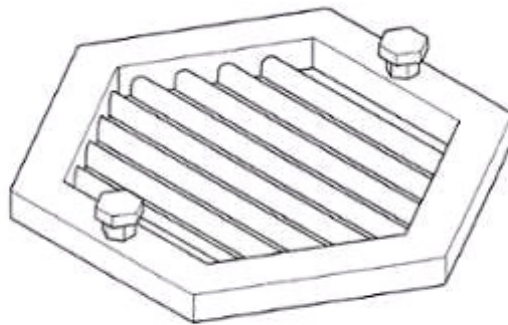

1.1

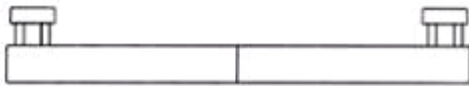

1.2

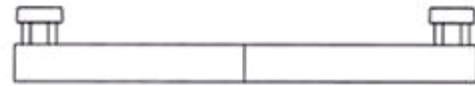

1.3

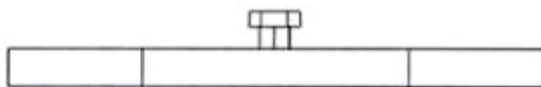

1.4

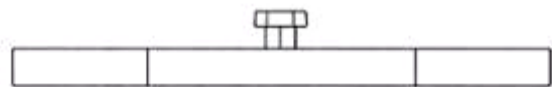

1.5

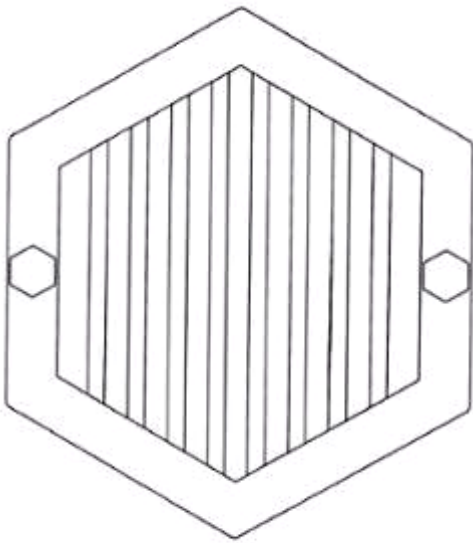

1.6

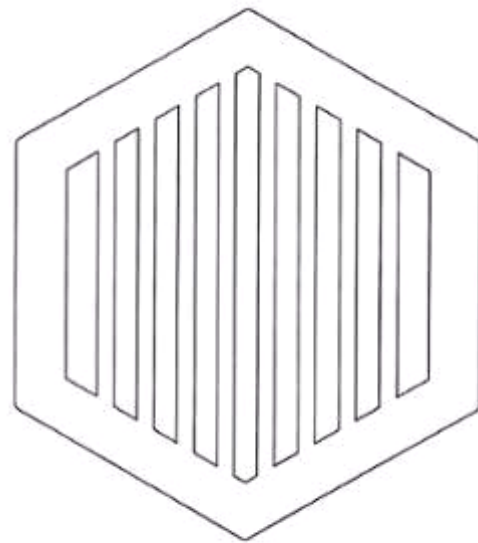

1.7

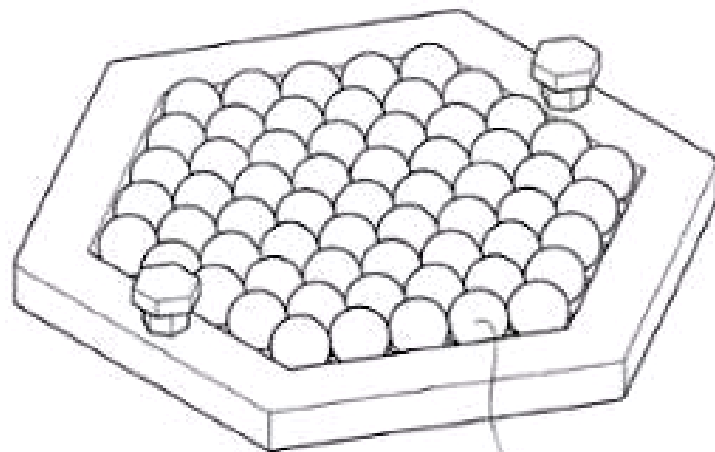

KDCN sử dụng ký

Các hạt bình đẳng, gang hoặc thép không gỉ

1.8

- (11) **42565**
(21) 3-2021-01442 (28) 1
(54) **VỈ NƯỚNG** (51) **07-02**
(22) 03/06/2021 (43) 27/09/2021
(30) 30-2021-0000499 06/01/2021 KR;
(73) **LEE CHAEHWAN (KR)**
45-11, Bangchon-ro, Dong-gu, Daegu, Republic of Korea
(72) Lee Chaehwan (KR)
(74) Công ty TNHH Tầm nhìn và Liên danh (VISION & ASSOCIATES CO.LTD.)
(55)

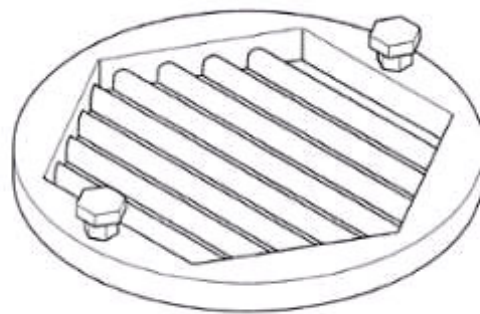

1.1

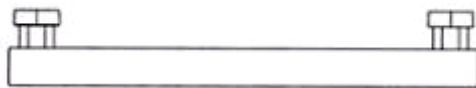

1.2



1.3

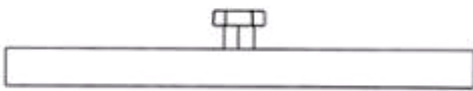

1.4

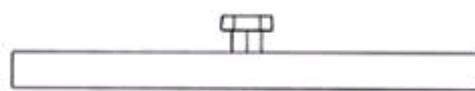

1.5

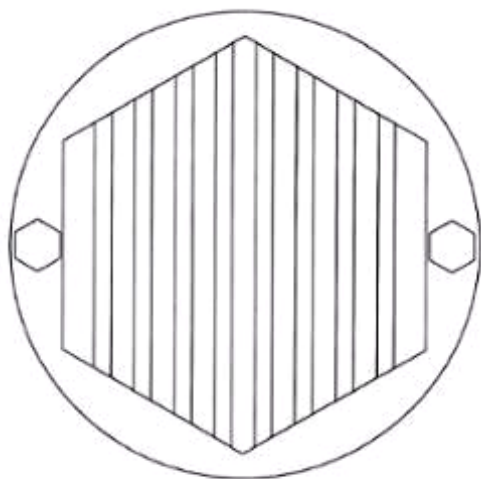

1.6

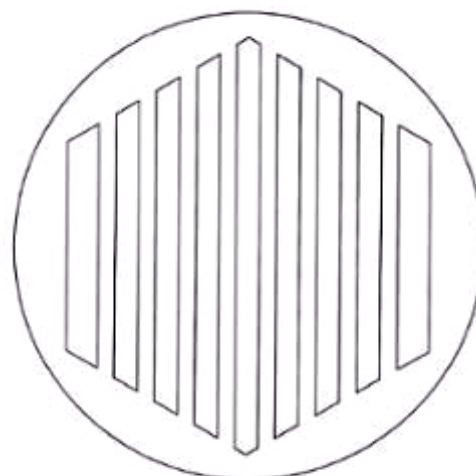

1.7

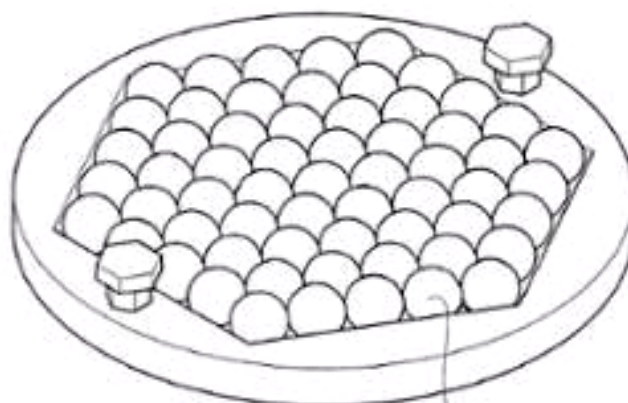

KDCN xin đăng ký

Các hạt bằng đồng, gang hoặc thép không gỉ

1.8

CÔNG BÁO SỞ HỮU CÔNG NGHIỆP SỐ 402 TẬP A – QUYỀN 2 (09.2021)

- (11) **42566**
(21) 3-2021-01443 (28) 1
(54) **HỘP ĐỰNG THỰC PHẨM** (51) **09-03**
(22) 03/06/2021 (43) 27/09/2021
(30) 30-2021-0002886 19/01/2021 KR;
(73) **LOCK & LOCK CO., LTD (KR)**
104, Sapgyocheon-ro, Seonjang-myeon, Asan-si, Chungcheongnam-do, Republic of Korea
(72) KIM, Seon Jeong (KR)
(74) Công ty TNHH Tầm nhìn và Liên danh (VISION & ASSOCIATES CO.LTD.)
(55)

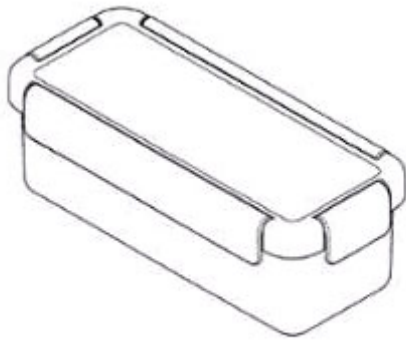

1.1

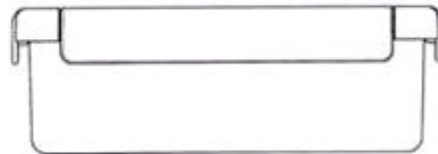

1.2

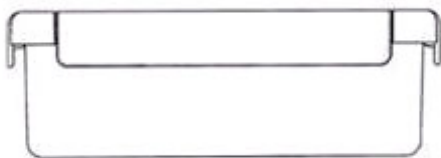

1.3

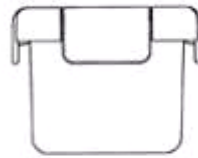

1.4

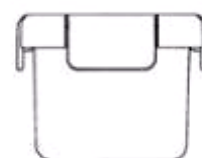

1.5



1.6

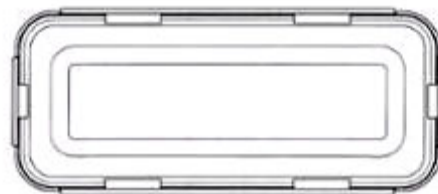

1.7

- (11) **42567**
(21) 3-2021-01444 (28) 1
(54) **HỘP ĐỰNG THỰC PHẨM** (51) **09-03**
(22) 03/06/2021 (43) 27/09/2021
(30) 30-2021-0002887 19/01/2021 KR;
(73) **LOCK & LOCK CO., LTD (KR)**
104, Sapgyocheon-ro, Seonjang-myeon, Asan-si, Chungcheongnam-do, Republic
of Korea
(72) KIM, Seon Jeong (KR)
(74) Công ty TNHH Tầm nhìn và Liên danh (VISION & ASSOCIATES CO.LTD.)
(55)

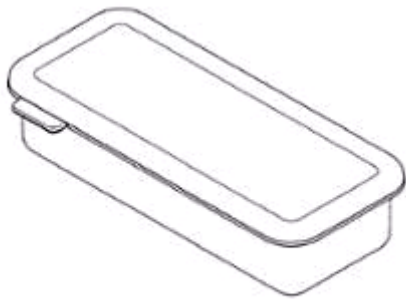

1.1

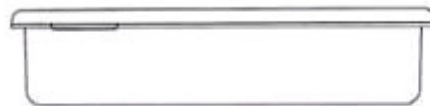

1.2



1.3



1.4



1.5

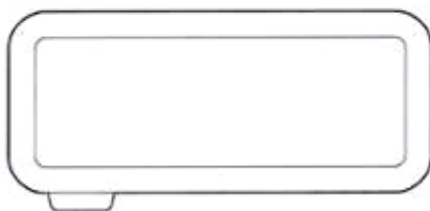

1.6

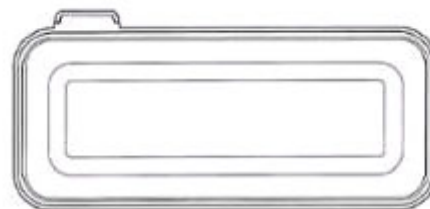

1.7

CÔNG BÁO SỞ HỮU CÔNG NGHIỆP SỐ 402 TẬP A – QUYỀN 2 (09.2021)

- (11) **42568**
(21) 3-2021-01445 (28) 1
(54) **HỘP ĐỰNG THỰC PHẨM** (51) **09-03**
(22) 03/06/2021 (43) 27/09/2021
(30) 30-2021-0002888 19/01/2021 KR;
(73) **LOCK & LOCK CO., LTD (KR)**
104, Sapgyocheon-ro, Seonjang-myeon, Asan-si, Chungcheongnam-do, Republic of Korea
(72) KIM, Seon Jeong (KR)
(74) Công ty TNHH Tầm nhìn và Liên danh (VISION & ASSOCIATES CO.LTD.)
(55)

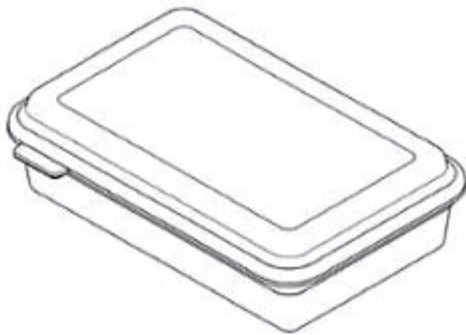

1.1



1.2



1.3



1.4



1.5

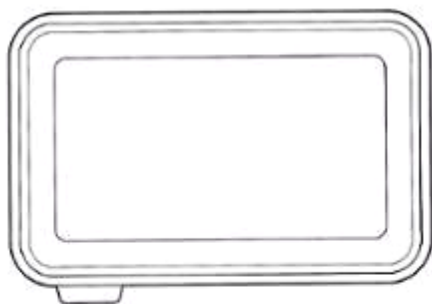

1.6

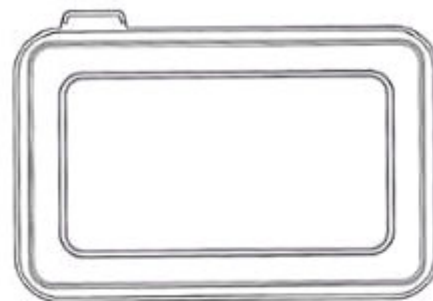

1.7

- (11) **42569**
(21) 3-2021-01446 (28) 1
(54) **CHẢO RÁN** (51) **07-02**
(22) 03/06/2021 (43) 27/09/2021
(30) 30-2021-0010855 05/03/2021 KR;
(73) **LOCK & LOCK CO., LTD (KR)**
104, Sapgyocheon-ro, Seonjang-myeon, Asan-si, Chungcheongnam-do, Republic of Korea
(72) JEON, Beom Sik (KR)
(74) Công ty TNHH Tầm nhìn và Liên danh (VISION & ASSOCIATES CO.LTD.)
(55)

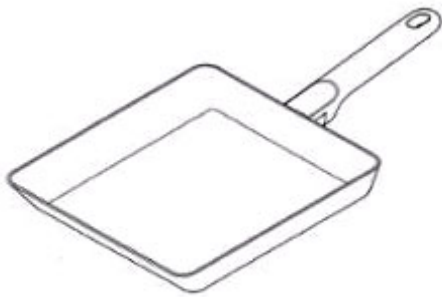

1.1



1.2



1.3



1.4

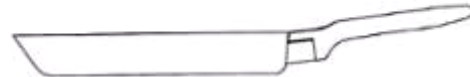

1.5

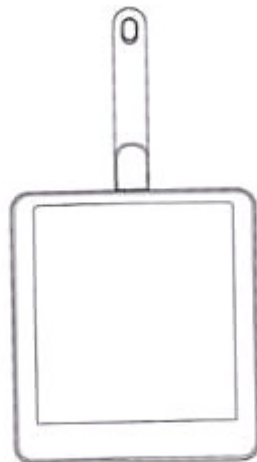

1.6

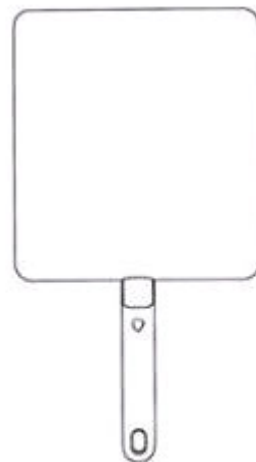

1.7

- (11) **42570**
(21) 3-2021-01447 (28) 1
(54) **HỘP ĐỰNG KHAY ĐÁ** (51) **07-07**
(22) 03/06/2021 (43) 27/09/2021
(30) 30-2021-0015262 30/03/2021 KR;
(73) **LOCK & LOCK CO., LTD (KR)**
104, Sapgyocheon-ro, Seonjang-myeon, Asan-si, Chungcheongnam-do, Republic of Korea
(72) KIM, Kwang Ik (KR)
(74) Công ty TNHH Tầm nhìn và Liên danh (VISION & ASSOCIATES CO.LTD.)
(55)

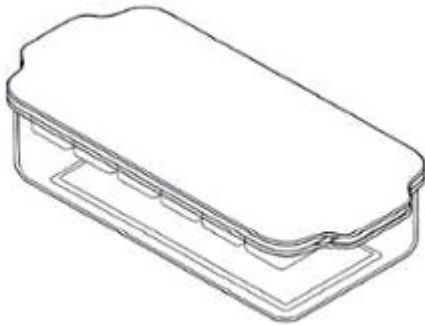

1.1

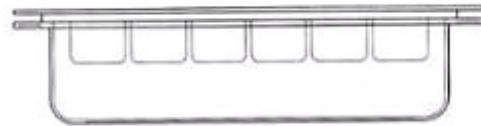

1.2

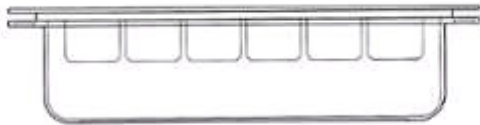

1.3



1.4



1.5



1.6

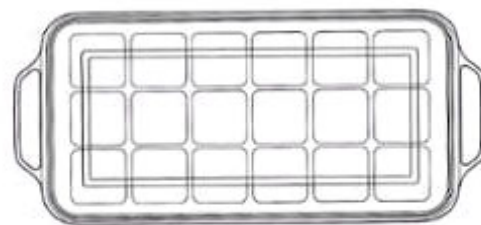

1.7

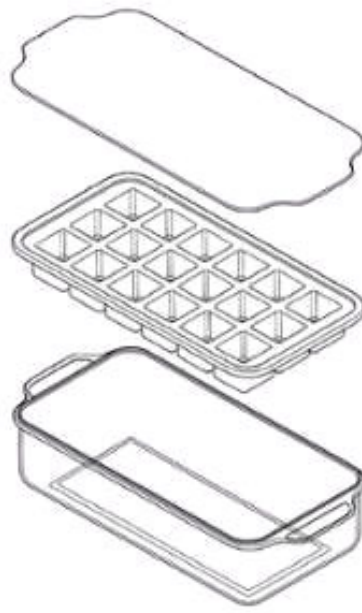

1.8

CÔNG BÁO SỞ HỮU CÔNG NGHIỆP SỐ 402 TẬP A – QUYỀN 2 (09.2021)

- (11) **42571**
(21) 3-2021-01458 (28) 1
(54) **KHAY ĐÁ** (51) **07-07**
(22) 04/06/2021 (43) 27/09/2021
(30) 30-2021-0015263 30/03/2021 KR;
(73) **LOCK & LOCK CO., LTD** (KR)
104, Sapgyocheon-ro, Seonjang-myeon, Asan-si, Chungcheongnam-do, Republic
of Korea
(72) KIM, Kwang Ik (KR)
(74) Công ty TNHH Tầm nhìn và Liên danh (VISION & ASSOCIATES CO.LTD.)
(55)



1.1



1.2



1.3



1.4



1.5

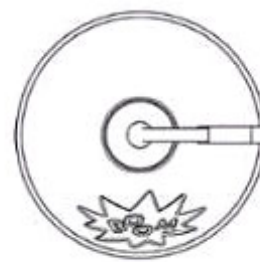

1.6



1.7



1.8

- (11) **42572**
(21) 3-2021-01459 (28) 1
(54) **KHAY ĐÁ** (51) **07-07**
(22) 04/06/2021 (43) 27/09/2021
(30) 30-2021-0015264 30/03/2021 KR;
(73) **LOCK & LOCK CO., LTD (KR)**
104, Sapgyocheon-ro, Seonjang-myeon, Asan-si, Chungcheongnam-do, Republic of Korea
(72) KIM, Kwang Ik (KR)
(74) Công ty TNHH Tầm nhìn và Liên danh (VISION & ASSOCIATES CO.LTD.)
(55)

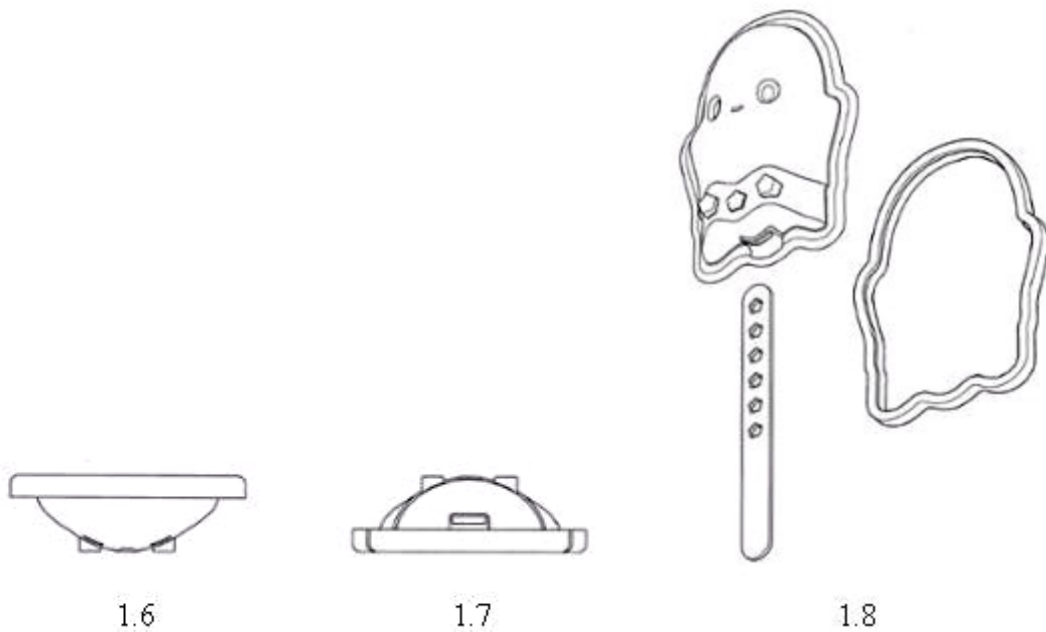
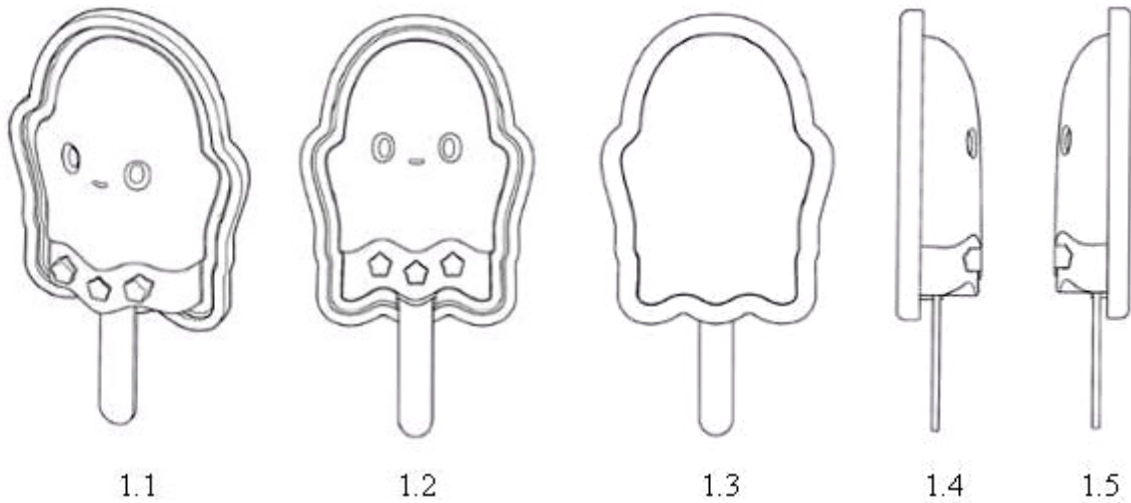

- (11) **42573**
(21) 3-2021-01460 (28) 1
(54) **KHAY ĐÁ** (51) **07-07**
(22) 04/06/2021 (43) 27/09/2021
(30) 30-2021-0015265 30/03/2021 KR;
(73) **LOCK & LOCK CO., LTD (KR)**
104, Sapgyocheon-ro, Seonjang-myeon, Asan-si, Chungcheongnam-do, Republic of Korea
(72) KIM, Kwang Ik (KR)
(74) Công ty TNHH Tầm nhìn và Liên danh (VISION & ASSOCIATES CO.LTD.)
(55)

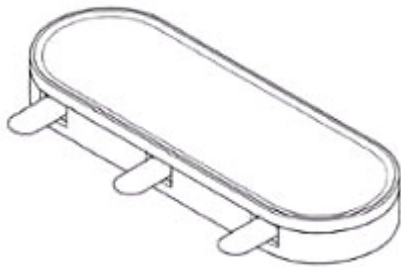

1.1

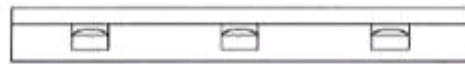

1.2



1.3

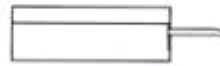

1.4

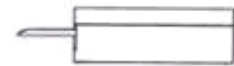

1.5

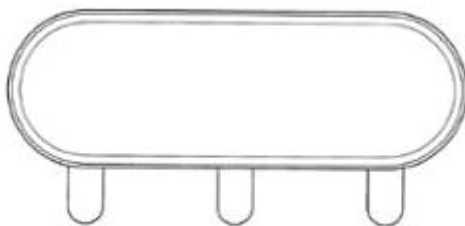

1.6

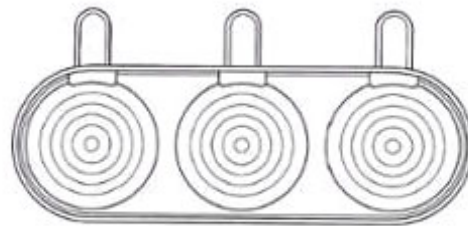

1.7

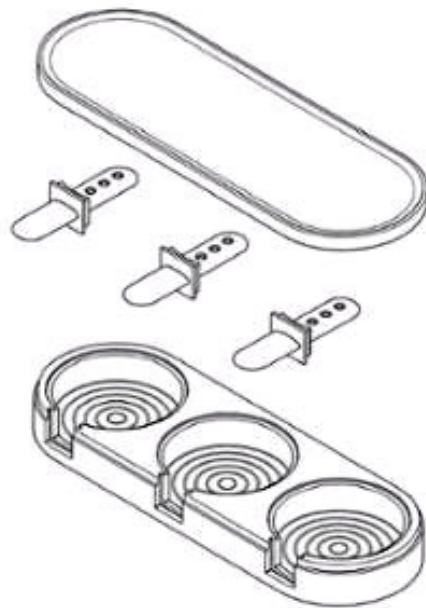

1.8

CÔNG BÁO SỞ HỮU CÔNG NGHIỆP SỐ 402 TẬP A – QUYỀN 2 (09.2021)

(11) **42574**

(21) 3-2021-01503

(28) 1

(54) **BỂ SỤC**

(51) **23-02**

(22) 10/06/2021

(43) 27/09/2021

(73) **BÙI DƯƠNG HẢI SƠN (VN)**

Lô LKN1, khu đô thị biển An Viên, thành phố Nha Trang, tỉnh Khánh Hòa

(72) Bùi Dương Hải Sơn (VN)

(55)

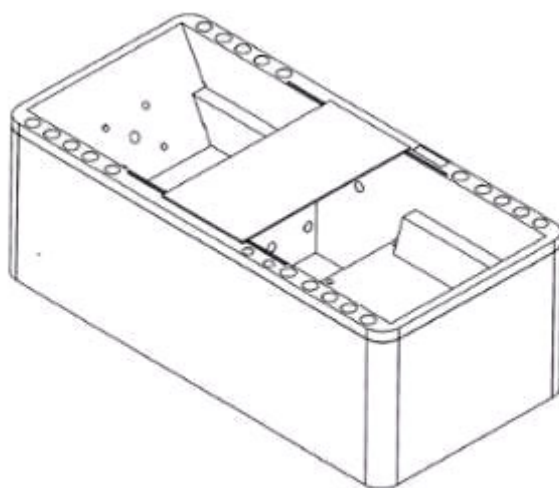

1.1



1.2



1.3

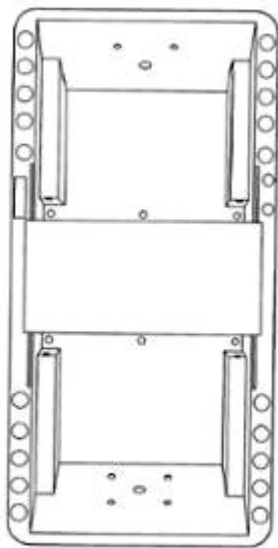

1.4



1.5

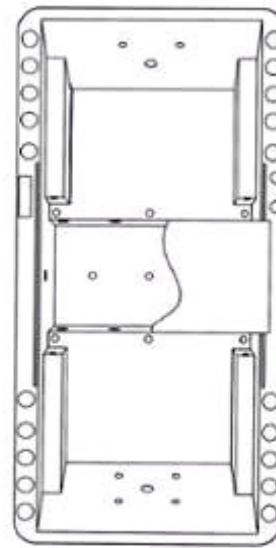

1.6

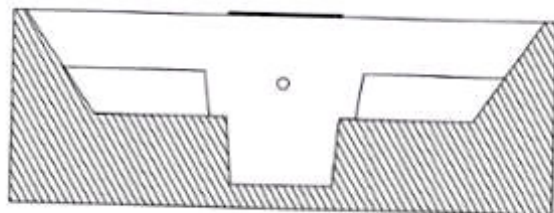

MẶT CẮT A - A

1.7

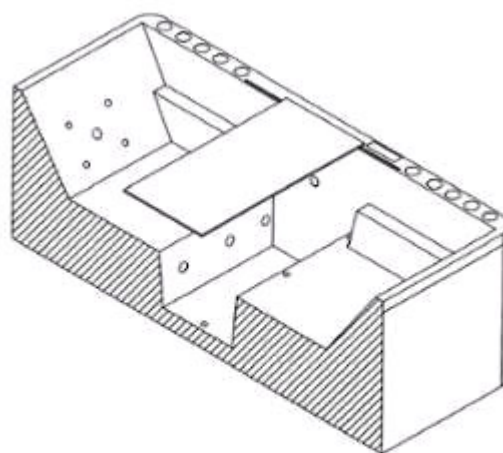

MẶT CẮT B - B

1.8

- (11) **42575**
(21) 3-2021-01515 (28) 1
(54) **THANH KIM LOẠI ĐỊNH HÌNH** (51) **25-01**
(22) 11/06/2021 (43) 27/09/2021
(73) **ĐOÀN VĂN DŨNG (VN)**
Khu phố Phước Kiểng, thị trấn Hiệp Phước, huyện Nhơn Trạch, tỉnh Đồng Nai
(72) **ĐOÀN VĂN DŨNG (VN)**
(74) Công ty Luật Hợp danh bản quyền Quốc tế (CIS LAW FIRM)
(55)

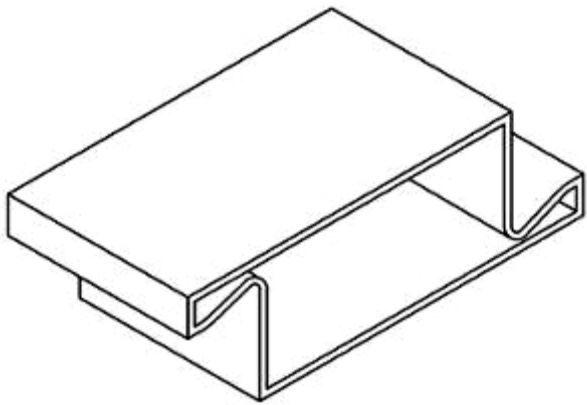

1.1



1.2



1.3

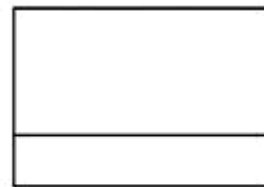

1.4

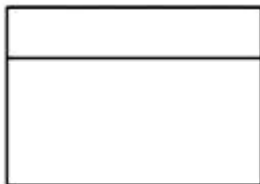

1.5



1.6



- (11) **42576**
(21) 3-2021-01516 (28) 1
(54) **BỘ PHẬN LẤY NƯỚC BÊN NGOÀI CỦA TỦ LẠNH** (51) **15-07**
(22) 11/06/2021 (43) 27/09/2021
(73) **CÔNG TY TNHH PANASONIC APPLIANCES VIỆT NAM (VN)**
Lô B6, khu công nghiệp Thăng Long, xã Võng La, huyện Đông Anh, thành phố Hà Nội
(72) 1. ELIE LEE LE QUN (MY)
2. KENTARO TOKURIKI (JP)
3. TAN CHIEN SHIUNG (MY)
(74) Công ty TNHH Sở hữu trí tuệ HA VIP (HAVIP CO., LTD.)
(55)

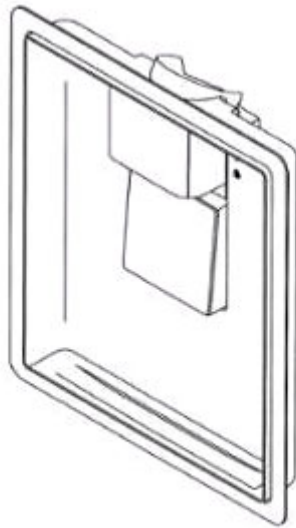

1.1

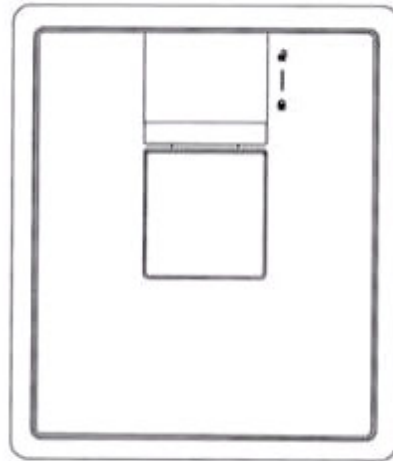

1.2

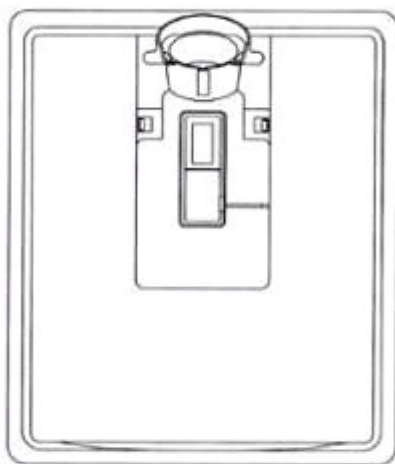

1.3



1.4

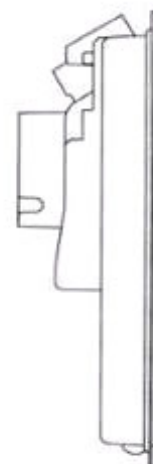

1.5

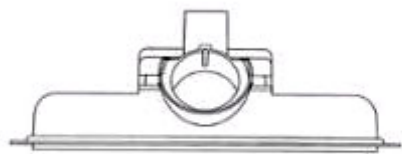

1.6

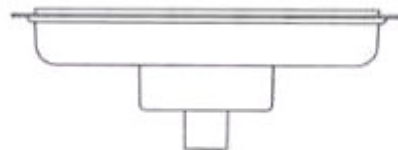

1.7

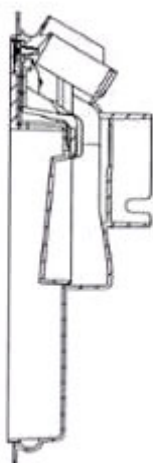

1.8

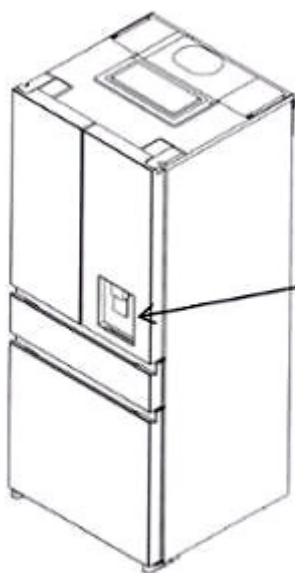

1.9

Kiểu dáng công nghiệp đăng ký

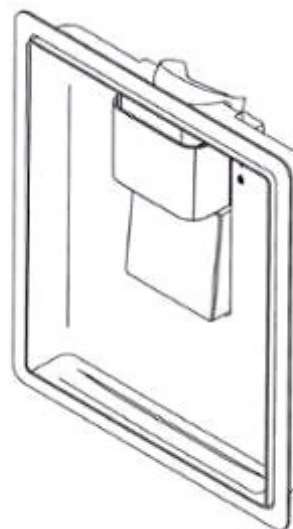

1.10

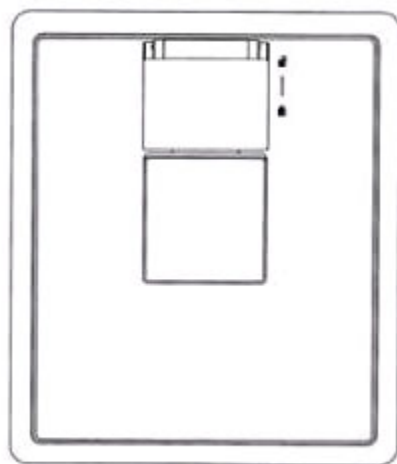

1.11

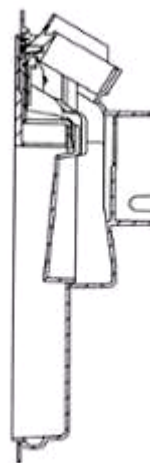

1.12

CÔNG BÁO SỞ HỮU CÔNG NGHIỆP SỐ 402 TẬP A – QUYỀN 2 (09.2021)

- (11) **42577**
(21) 3-2021-01546 (28) 1
(54) **THIẾT BỊ ĐẦU CUỐI** (51) **14-02; 14-03**
(22) 14/06/2021 (43) 27/09/2021
(30) 202030783367.1 18/12/2020 CN;
(73) **FUJIAN LANDI COMMERCIAL EQUIPMENT CO.,LTD. (CN)**
Building 17, Section A, Software Park, No.89 Software Road, Gulou District,
Fuzhou, Fujian, China
(72) 1. HUIFANG, CAI (CN)
2. LUMING, YE (CN)
3. DENGXI, LI (CN)
4. HAIYOU, LI (CN)
5. DE, SHI (CN)
(74) Công ty TNHH Tâm nhìn và Liên danh (VISION & ASSOCIATES CO.LTD.)
(55)

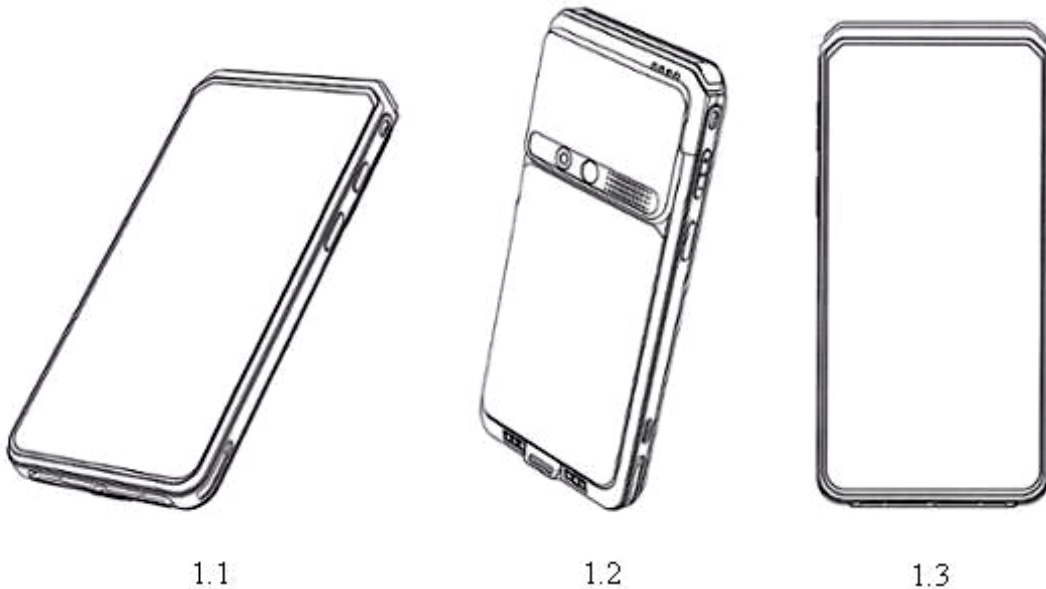

1.4

1.5

1.6



1.7



1.8

CÔNG BÁO SỞ HỮU CÔNG NGHIỆP SỐ 402 TẬP A – QUYỀN 2 (09.2021)

- (11) **42578**
(21) 3-2021-01547 (28) 1
(54) **THIẾT BỊ ĐẦU CUỐI** (51) **14-02; 14-03**
(22) 14/06/2021 (43) 27/09/2021
(30) 202030785328.5 18/12/2020 CN;
(73) **FUJIAN LANDI COMMERCIAL EQUIPMENT CO.,LTD.** (CN)
Building 17, Section A, Software Park, No.89 Software Road, Gulou District,
Fuzhou, Fujian, China
(72) 1. HUIFANG, CAI (CN)
2. LUMING, YE (CN)
3. DENGXI, LI (CN)
4. HAIYOU, LI (CN)
5. DE, SHI (CN)
(74) Công ty TNHH Tâm nhìn và Liên danh (VISION & ASSOCIATES CO.LTD.)
(55)

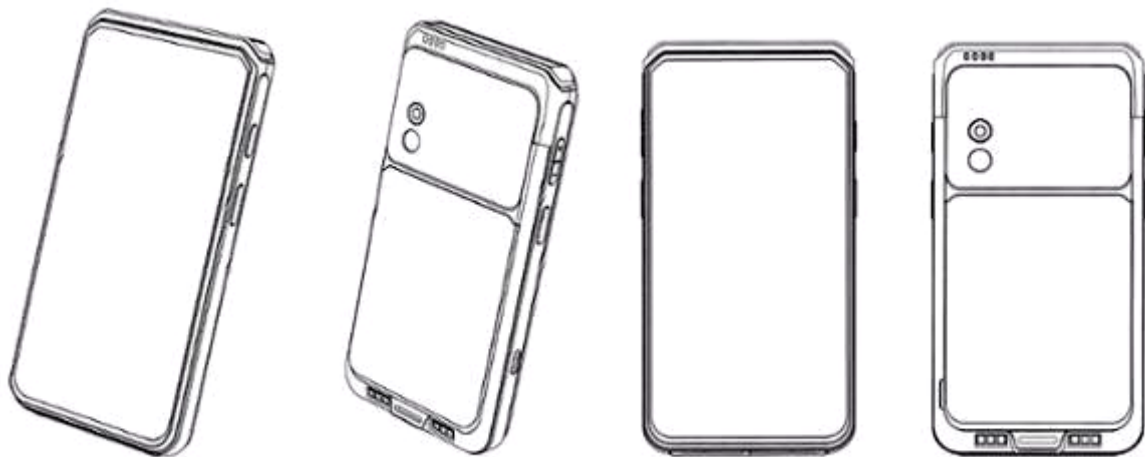

1.1

1.2

1.3

1.4



1.5

1.6

1.7

1.8

CÔNG BÁO SỞ HỮU CÔNG NGHIỆP SỐ 402 TẬP A – QUYỀN 2 (09.2021)

- (11) **42579**
(21) 3-2021-01554 (28) 1
(54) **PHỤ KIỆN CỦA GIƯỜNG** (51) **06-02**
(22) 15/06/2021 (43) 27/09/2021
(30) 202130269433.8 07/05/2021 CN;
(73) **XIA MEN MINT FURNITURE CO., LTD. (CN)**
No. 200, Zhuangshangli, Silin Village, Wuxian Town, TongAn District, Xiamen,
Fujian, China
(72) Aihua HOU (CN)
(74) Công ty Luật TNHH WINCO (WINCO LAW FIRM)
(55)



1.1



1.2



1.3



1.4



1.5



1.6



1.7

CÔNG BÁO SỞ HỮU CÔNG NGHIỆP SỐ 402 TẬP A – QUYỀN 2 (09.2021)

- (11) **42580**
(21) 3-2021-01556 (28) 1
(54) **PHỤ KIỆN CỦA GIƯỜNG** (51) **06-02**
(22) 15/06/2021 (43) 27/09/2021
(30) 202130269435.7 07/05/2021 CN;
(73) **XIA MEN MINT FURNITURE CO., LTD. (CN)**
No. 200, Zhuangshangli, Silin Village, Wuxian Town, TongAn District, Xiamen,
Fujian, China
(72) Aihua HOU (CN)
(74) Công ty Luật TNHH WINCO (WINCO LAW FIRM)
(55)



1.1



1.2



1.3



1.4



1.5



1.6



1.7

CÔNG BÁO SỞ HỮU CÔNG NGHIỆP SỐ 402 TẬP A – QUYỀN 2 (09.2021)

- (11) **42581**
(21) 3-2021-01557 (28) 1
(54) **PHỤ KIỆN CỦA GIƯỜNG** (51) **06-02**
(22) 15/06/2021 (43) 27/09/2021
(30) 202130269114.7 07/05/2021 CN;
(73) **XIA MEN MINT FURNITURE CO., LTD. (CN)**
No. 200, Zhuangshangli, Silin Village, Wuxian Town, TongAn District, Xiamen,
Fujian, China
(72) Aihua HOU (CN)
(74) Công ty Luật TNHH WINCO (WINCO LAW FIRM)
(55)



1.1



1.2



1.3



1.4

1.5



1.6



1.7

CÔNG BÁO SỞ HỮU CÔNG NGHIỆP SỐ 402 TẬP A – QUYỀN 2 (09.2021)

- (11) **42582**
(21) 3-2021-01567 (28) 1
(54) **NỒI CƠM ĐIỆN** (51) **07-02**
(22) 16/06/2021 (43) 27/09/2021
(30) 2020-027154 17/12/2020 JP;
(73) **TOSHIBA LIFESTYLE PRODUCTS & SERVICES CORPORATION (JP)**
25-1, Ekimae-honcho, Kawasaki-ku, Kawasaki-shi, Kanagawa, Japan
(72) Hiroshi Takenaka (JP)
(74) Công ty TNHH một thành viên Sở hữu trí tuệ VCCI (VCCI-IP CO.,LTD)
(55)



1.1



1.2



1.3



1.4



1.5



1.6



1.7

CÔNG BÁO SỞ HỮU CÔNG NGHIỆP SỐ 402 TẬP A – QUYỀN 2 (09.2021)

- (11) **42583**
(21) 3-2021-01615 (28) 1
(54) **MÁY XÔNG HƠI** (51) **23-03**
(22) 21/06/2021 (43) 27/09/2021
(73) **CÔNG TY CỔ PHẦN ĐẦU TƯ SẢN XUẤT VÀ XUẤT NHẬP KHẨU TOÀN PHÁT (VN)**
Tổ 3 cụm 1, ngõ 345 phố Khương Trung, phường Khương Đình, quận Thanh Xuân, thành phố Hà Nội
(72) Trịnh Anh Toàn (VN)
(74) Công ty Luật TNHH Phượng Hoàng (PHOENIX LAW)
(55)



1.1

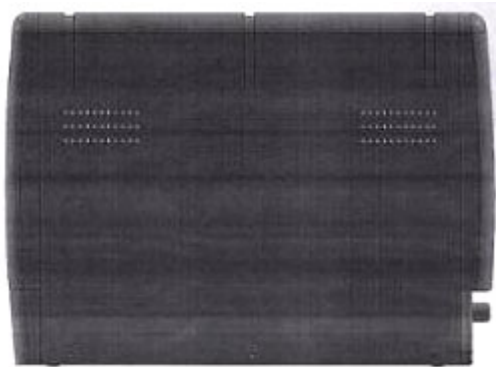

1.2

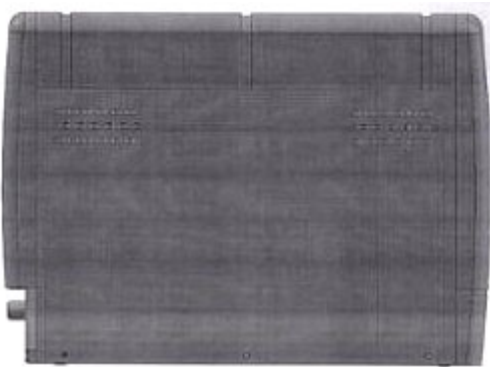

1.3



1.4



1.5



1.6

1.7

CÔNG BÁO SỞ HỮU CÔNG NGHIỆP SỐ 402 TẬP A – QUYỀN 2 (09.2021)

- (11) **42584**
(21) 3-2021-01630 (28) 1
(54) **THIẾT BỊ KHỬ MÙI CHỨA CHẤT LÀM THƠM MÁT KHÔNG KHÍ** (51) **23-04**
(22) 22/06/2021 (43) 27/09/2021
(30) 2020-028367 25/12/2020 JP;
(73) **EARTH CORPORATION (JP)**
12-1, Kanda-tsukasamachi 2-chome, Chiyoda-ku, Tokyo, Japan
(72) Kengo TAKAHATA (JP)
(74) Công ty Cổ phần Sở hữu công nghiệp INVESTIP (INVESTIP)
(55)

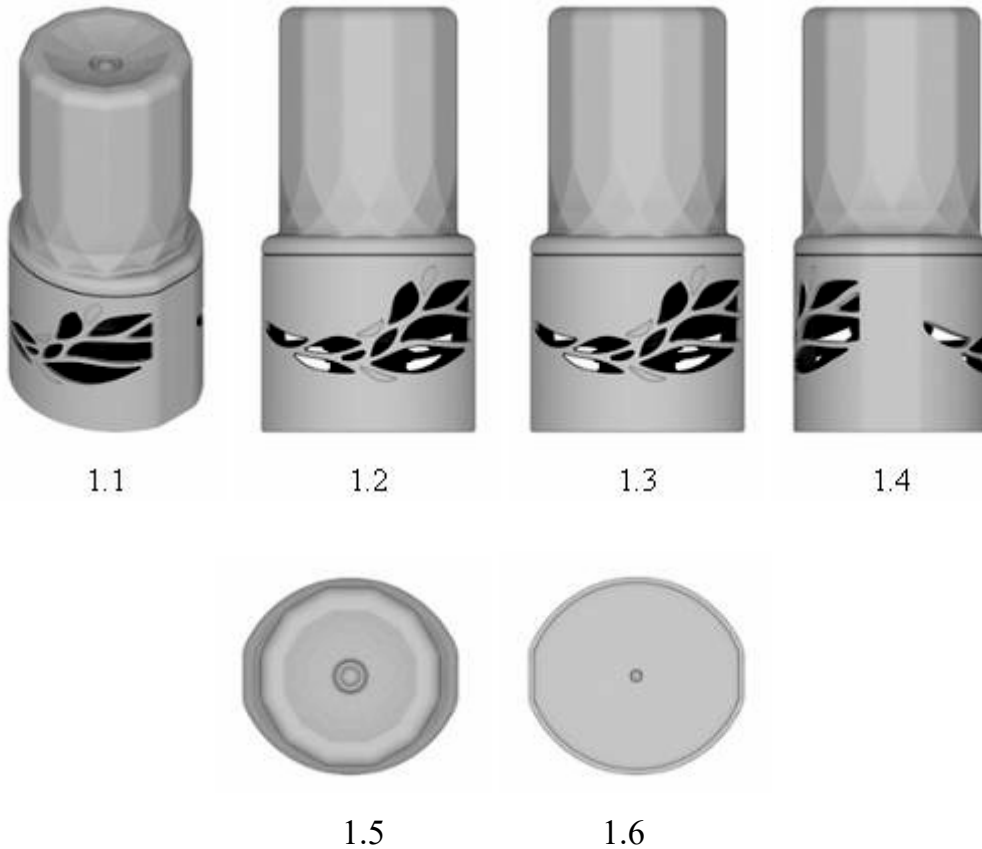

- (11) **42585**
(21) 3-2021-01631 (28) 1
(54) **THIẾT BỊ KHỬ MÙI CHỨA CHẤT LÀM SẠCH KHÔNG KHÍ** (51) **23-04; 23-99**
(22) 22/06/2021 (43) 27/09/2021
(30) 2021-002576 05/02/2021 JP;
(73) **EARTH CORPORATION (JP)**
12-1, Kanda-tsukasamachi 2-chome, Chiyoda-ku, Tokyo, Japan
(72) Kengo TAKAHATA (JP)
(74) Công ty Cổ phần Sở hữu công nghiệp INVESTIP (INVESTIP)
(55)



1.1



1.2



1.3



1.4



1.5



1.6



1.7



1.8

- (11) **42586**
(21) 3-2021-01645 (28) 1
(54) **HỘP Ổ ĐIỆN ÂM TƯỜNG** (51) **13-03**
(22) 23/06/2021 (43) 27/09/2021
(73) **NGUYỄN XUÂN THỦY (VN)**
Tổ 3, khu 10, phường Bãi Cháy, thành phố Hạ Long, tỉnh Quảng Ninh
(72) Nguyễn Xuân Thủy (VN)
(55)

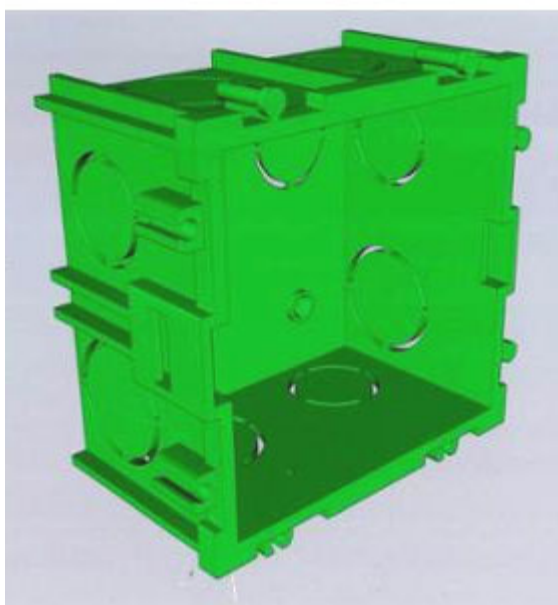

1.1

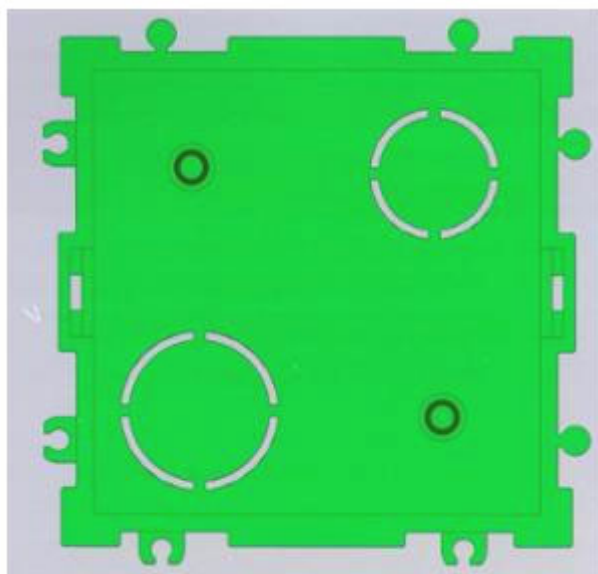

1.2

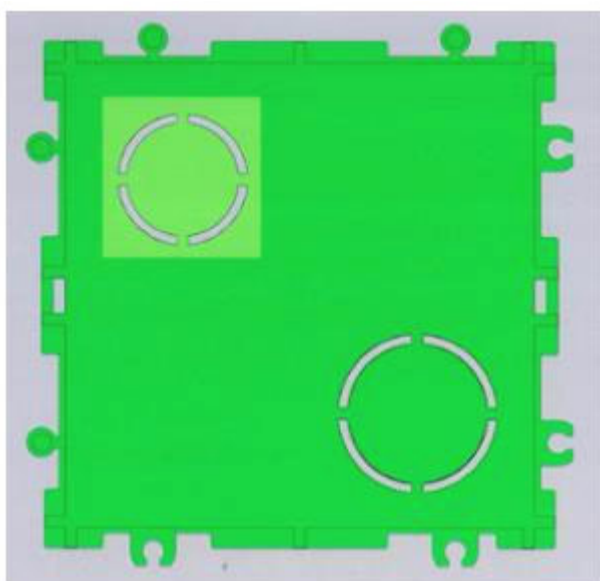

1.3

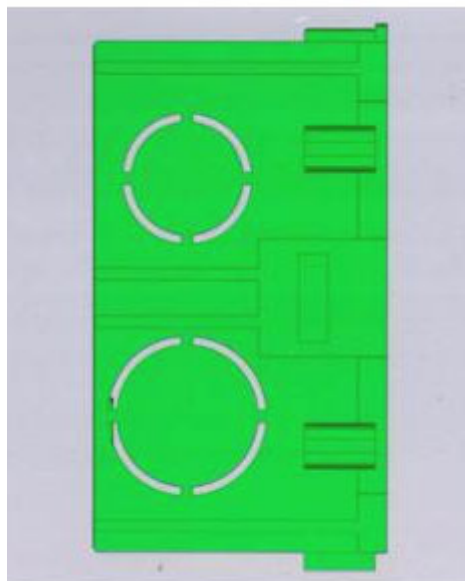

1.4

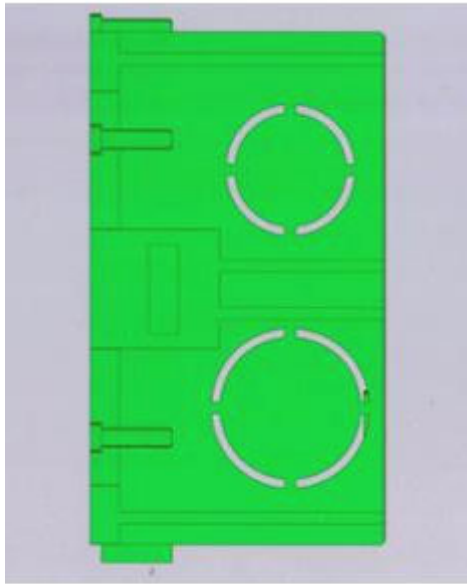

1.5

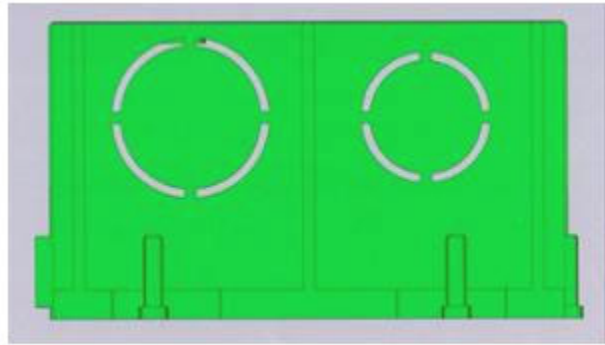

1.6

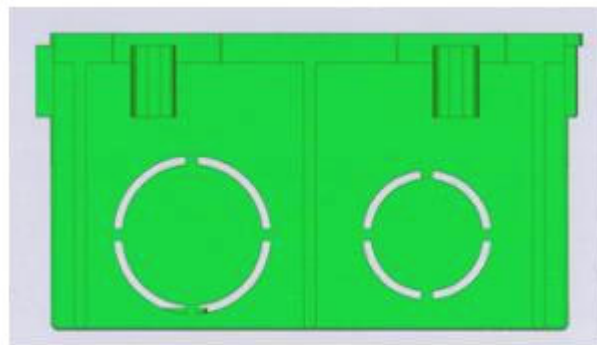

1.7

CÔNG BÁO SỞ HỮU CÔNG NGHIỆP SỐ 402 TẬP A – QUYỂN 2 (09.2021)

- (11) **42587**
(21) 3-2021-01650 (28) 1
(54) **NHÃN SẢN PHẨM** (51) **19-08**
(22) 23/06/2021 (43) 27/09/2021
(73) **CÔNG TY TNHH DỊCH VỤ VÀ CUNG CẤP THỰC PHẨM QUỐC TẾ - IFSS (VN)**
Số 2bis Nguyễn Thị Minh Khai, phường Đa Kao, quận 1, thành phố Hồ Chí Minh
(72) **HOÀNG DƯƠNG XUÂN DŨNG (VN)**
(55)



CÔNG BÁO SỞ HỮU CÔNG NGHIỆP SỐ 402 TẬP A – QUYỂN 2 (09.2021)

- (11) **42588**
- (21) 3-2021-01651 (28) 1
- (54) **NHÃN SẢN PHẨM** (51) **19-08**
- (22) 23/06/2021 (43) 27/09/2021
- (73) **CÔNG TY TNHH DỊCH VỤ VÀ CUNG CẤP THỰC PHẨM QUỐC TẾ - IFSS (VN)**
Số 2bis Nguyễn Thị Minh Khai, phường Đa Kao, quận 1, thành phố Hồ Chí Minh
- (72) **HOÀNG DƯƠNG XUÂN DŨNG (VN)**
- (55)



CÔNG BÁO SỞ HỮU CÔNG NGHIỆP SỐ 402 TẬP A – QUYỀN 2 (09.2021)

(11) **42589**

(21) 3-2021-01652

(28) 1

(54) **MÁY LỌC NƯỚC**

(51) **23-01**

(22) 23/06/2021

(43) 27/09/2021

(73) **CÔNG TY CỔ PHẦN KAROFI HOLDING (VN)**

Số 12, lô TT1A, khu đô thị mới Tây Nam Hồ Linh Đàm, phường Hoàng Liệt, quận Hoàng Mai, thành phố Hà Nội

(72) Ngô Thị Thanh Hải (VN)

(55)



1.1



1.2



1.3

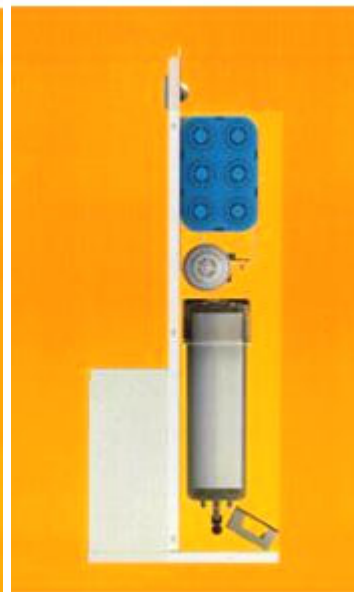

1.4

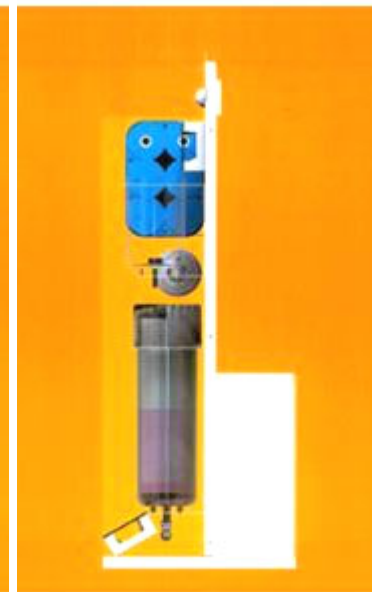

1.5



1.6



1.7

CÔNG BÁO SỞ HỮU CÔNG NGHIỆP SỐ 402 TẬP A – QUYỀN 2 (09.2021)

- (11) **42590**
(21) 3-2021-01659 (28) 1
(54) **MŨ BẢO HIỂM** (51) **02-03**
(22) 24/06/2021 (43) 27/09/2021
(73) **CÔNG TY TNHH SẢN XUẤT THƯƠNG MẠI KỸ THUẬT Á CHÂU (VN)**
38 Lương Trúc Đàm, phường Hiệp Tân, quận Tân Phú, thành phố Hồ Chí Minh
(72) **MAI VĂN THUẬN (VN)**
(74) Công ty TNHH Sở hữu trí tuệ Việt Á (VIET A IP CO.,LTD)
(55)



1.1



1.2



1.3



1.4



1.5



1.6



1.7

- (11) **42591**
(21) 3-2021-01660 (28) 1
(54) **ĐÈN** (51) **26-05**
(22) 24/06/2021 (43) 27/09/2021
(73) **CÔNG TY CỔ PHẦN BÓNG ĐÈN PHÍCH NƯỚC RẠNG ĐÔNG (VN)**
87-89 phố Hạ Đình, phường Thanh Xuân Trung, quận Thanh Xuân, thành phố Hà Nội
(72) Trần Trung Tường (VN)
(55)

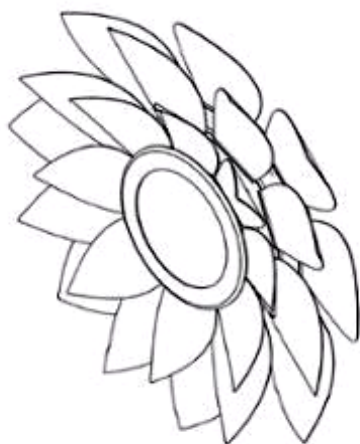

1.1

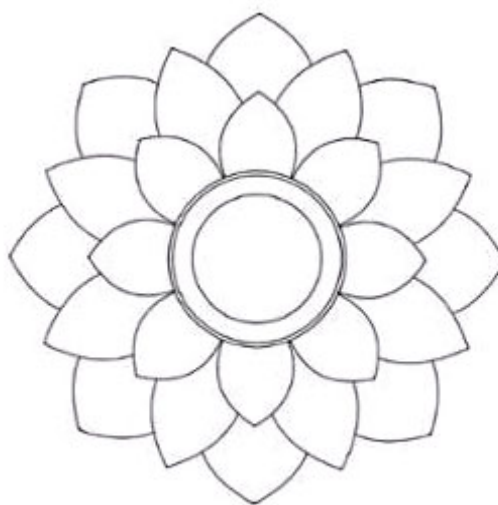

1.2

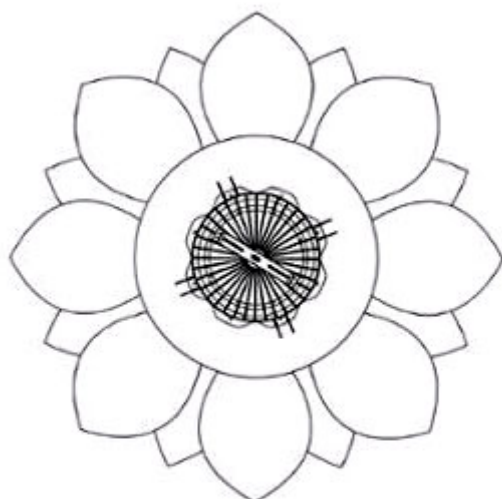

1.3

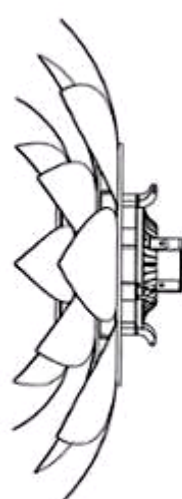

1.4

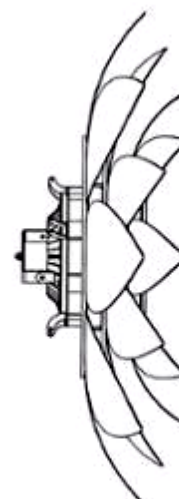

1.5

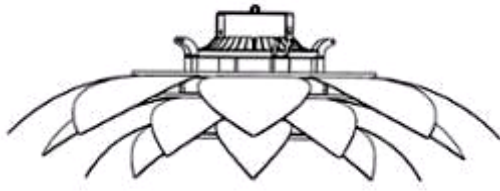

1.6

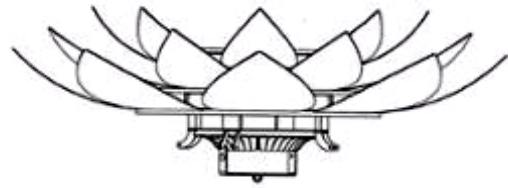

1.7

- (11) **42592**
(21) 3-2021-01661 (28) 1
(54) **ĐÈN** (51) **26-03**
(22) 24/06/2021 (43) 27/09/2021
(73) **CÔNG TY CỔ PHẦN BÓNG ĐÈN PHÍCH NƯỚC RẠNG ĐÔNG (VN)**
87-89 phố Hạ Đình, phường Thanh Xuân Trung, quận Thanh Xuân, thành phố Hà Nội
(72) Trần Trung Tường (VN)
(55)

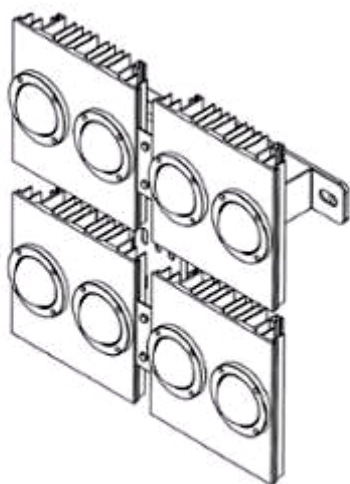

1.1

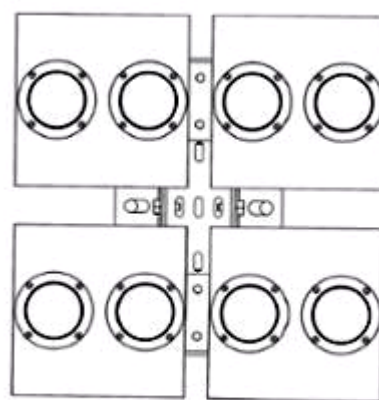

1.2

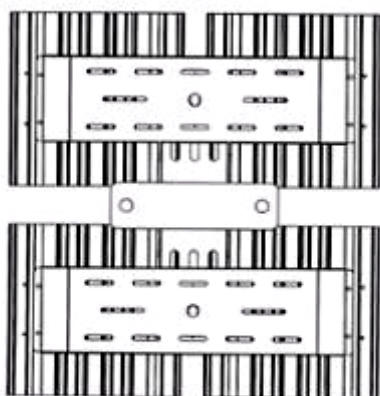

1.3

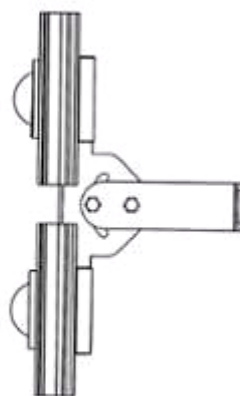

1.4

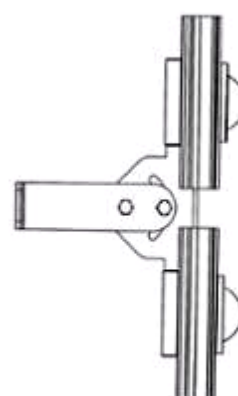

1.5

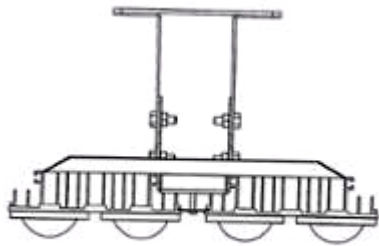

1.6

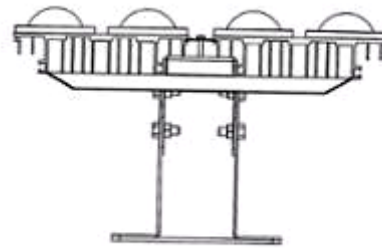

1.7

CÔNG BÁO SỞ HỮU CÔNG NGHIỆP SỐ 402 TẬP A – QUYỀN 2 (09.2021)

- (11) **42593**
- (21) 3-2021-01666 (28) 1
- (54) **NHÃN SẢN PHẨM** (51) **19-08**
- (22) 24/06/2021 (43) 27/09/2021
- (73) **CÔNG TY TNHH XUẤT NHẬP KHẨU PHÂN BÓN TRƯỜNG PHÁT - USA**
(VN)
50/3B quốc lộ 1A, ấp Nam Lân, xã Bà Điểm, huyện Hóc Môn, thành phố Hồ Chí Minh
- (72) Phạm Văn Chinh (VN)
- (74) Công ty TNHH một thành viên Trường Luật (Trường Luật)
- (55)



CÔNG BÁO SỞ HỮU CÔNG NGHIỆP SỐ 402 TẬP A – QUYỂN 2 (09.2021)

- (11) **42594**
- (21) 3-2021-01667 (28) 1
- (54) **NHÃN SẢN PHẨM** (51) **19-08**
- (22) 24/06/2021 (43) 27/09/2021
- (73) **CÔNG TY TNHH XUẤT NHẬP KHẨU PHÂN BÓN TRƯỜNG PHÁT - USA**
(VN)
50/3B quốc lộ 1A, ấp Nam Lân, xã Bà Điểm, huyện Hóc Môn, thành phố Hồ Chí Minh
- (72) Phạm Văn Chinh (VN)
- (74) Công ty TNHH một thành viên Trường Luật (Trường Luật)
- (55)



CÔNG BÁO SỞ HỮU CÔNG NGHIỆP SỐ 402 TẬP A – QUYỀN 2 (09.2021)

- (11) **42595**
(21) 3-2021-01668 (28) 1
(54) **HỘP ĐỰNG SẢN PHẨM** (51) **09-03**
(22) 24/06/2021 (43) 27/09/2021
(73) **DƯƠNG TUẤN ANH (VN)**
Tổ 2, phường Tây Sơn, thành phố Tam Điệp, tỉnh Ninh Bình
(72) Dương Tuấn Anh (VN)
(55)



1.1



1.2

- (11) **42596**
(21) 3-2021-01669 (28) 1
(54) **BAO THUỐC LÁ** (51) **09-03**
(22) 24/06/2021 (43) 27/09/2021
(73) **GULBAHAR TOBACCO INTERNATIONAL FZE (AE)**
P.O. Box 61401, Jebel Ali Free Zone, Dubai, United Arab Emirates
(72) Vakhid Ulla Khabibi (RU)
(74) Công ty TNHH Sở hữu trí tuệ Trần & Trần (TRAN & TRAN CO., LTD.)
(55)

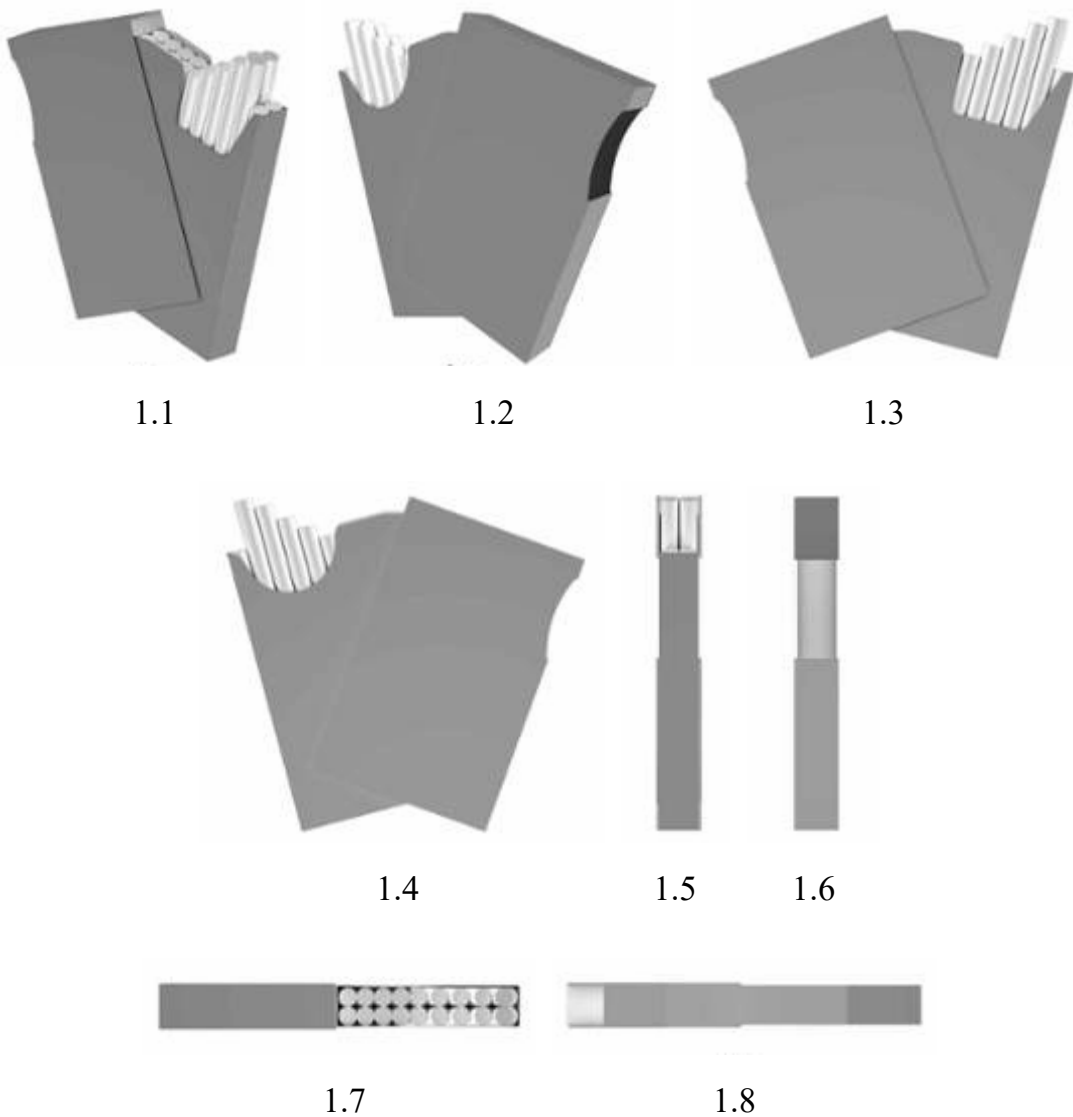



1.9



1.10



1.11

CÔNG BÁO SỞ HỮU CÔNG NGHIỆP SỐ 402 TẬP A – QUYỀN 2 (09.2021)

- (11) **42597**
(21) 3-2021-01670 (28) 1
(54) **MŨ BẢO HIỂM** (51) **02-03**
(22) 24/06/2021 (43) 27/09/2021
(73) **CÔNG TY TNHH SẢN XUẤT THƯƠNG MẠI KỸ THUẬT Á CHÂU (VN)**
38 Lương Trúc Đàm, phường Hiệp Tân, quận Tân Phú, thành phố Hồ Chí Minh
(72) **MAI VĂN THUẬN (VN)**
(74) Công ty TNHH Sở hữu trí tuệ Việt Á (VIET A IP CO.,LTD)
(55)



1.1



1.2



1.3



1.4



1.5



1.6



1.7

CÔNG BÁO SỞ HỮU CÔNG NGHIỆP SỐ 402 TẬP A – QUYỀN 2 (09.2021)

- (11) **42598**
(21) 3-2021-01671 (28) 1
(54) **MŨ BẢO HIỂM** (51) **02-03**
(22) 24/06/2021 (43) 27/09/2021
(73) **CÔNG TY TNHH SẢN XUẤT THƯƠNG MẠI KỸ THUẬT Á CHÂU (VN)**
38 Lương Trúc Đàm, phường Hiệp Tân, quận Tân Phú, thành phố Hồ Chí Minh
(72) **MAI VĂN THUẬN (VN)**
(74) Công ty TNHH Sở hữu trí tuệ Việt Á (VIET A IP CO.,LTD)
(55)



1.1



1.2



1.3



1.4



1.5



1.6



1.7

CÔNG BÁO SỞ HỮU CÔNG NGHIỆP SỐ 402 TẬP A – QUYỀN 2 (09.2021)

- (11) **42599**
(21) 3-2021-01672 (28) 1
(54) **HỘP ĐỰNG SẢN PHẨM** (51) **09-03**
(22) 25/06/2021 (43) 27/09/2021
(73) **DƯƠNG TUẤN ANH (VN)**
Tổ 2, phường Tây Sơn, thành phố Tam Điệp, tỉnh Ninh Bình
(72) Dương Tuấn Anh (VN)
(55)



1.1



1.2

CÔNG BÁO SỞ HỮU CÔNG NGHIỆP SỐ 402 TẬP A – QUYỀN 2 (09.2021)

- (11) **42600**
(21) 3-2021-01673 (28) 1
(54) **HỘP ĐỰNG SẢN PHẨM** (51) **09-03**
(22) 25/06/2021 (43) 27/09/2021
(73) **DƯƠNG TUẤN ANH (VN)**
Tổ 2, phường Tây Sơn, thành phố Tam Điệp, tỉnh Ninh Bình
(72) Dương Tuấn Anh (VN)
(55)



1.1



1.2

CÔNG BÁO SỞ HỮU CÔNG NGHIỆP SỐ 402 TẬP A – QUYỀN 2 (09.2021)

- (11) **42601**
(21) 3-2021-01674 (28) 1
(54) **NHÃN SẢN PHẨM** (51) **19-08**
(22) 25/06/2021 (43) 27/09/2021
(73) **CÔNG TY TNHH ASIAN VN GROUP (VN)**
114/2A Nguyễn Thị Đặng, phường Tân Thới Hiệp, quận 12, thành phố Hồ Chí Minh
(72) Phạm Văn Phong (VN)
(55)



CÔNG BÁO SỞ HỮU CÔNG NGHIỆP SỐ 402 TẬP A – QUYỀN 2 (09.2021)

- (11) **42602**
(21) 3-2021-01702 (28) 4
(54) **BAO GÓI** (51) **09-05**
(22) 28/06/2021 (43) 27/09/2021
(73) **CÔNG TY CỔ PHẦN BỘT GIẶT LIX (VN)**
Số 3, đường số 2, khu phố 4, phường Linh Trung, thành phố Thủ Đức, Thành phố Hồ Chí Minh
(72) CAO THÀNH TÍN (VN)
(74) Văn phòng Luật sư A Hoà (AHOA LAW OFFICE)
(55)





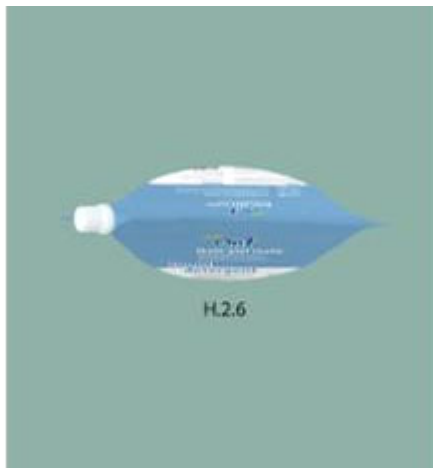

H.2.6

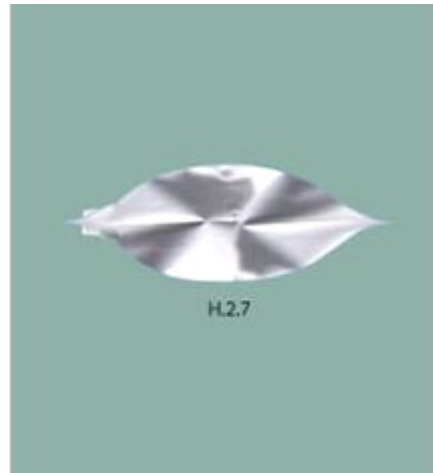

H.2.7



H.3.1



H.3.2



H.3.3



H.3.4



H.3.5



H.3.6



H.3.7



H.4.1



H.4.2



H.4.3



H.4.4



H.4.5



CÔNG BÁO SỞ HỮU CÔNG NGHIỆP SỐ 402 TẬP A – QUYỀN 2 (09.2021)

(11) **42603**

(21) 3-2021-01703

(28) 1

(54) **NGÓI**

(51) **25-01**

(22) 28/06/2021

(43) 27/09/2021

(73) **CÔNG TY CỔ PHẦN VẬT LIỆU XÂY DỰNG SECOIN (VN)**

Số 59 Hàng Chuối, phường Phạm Đình Hổ, quận Hai Bà Trưng, thành phố Hà Nội

(72) Đinh Hồng Kỳ (VN)

(74) Công ty TNHH Sở hữu trí tuệ Gia Việt (GIAVIET CO., LTD.)

(55)

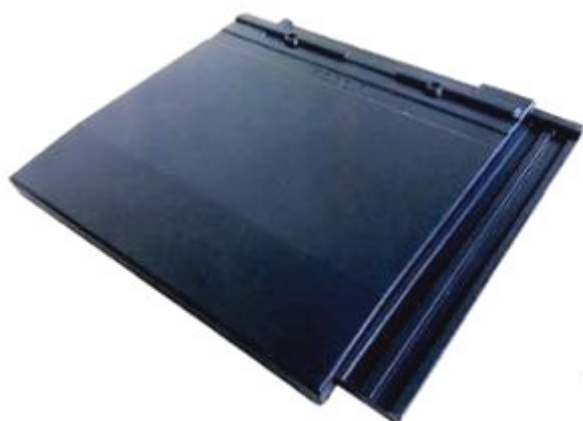

1.1



1.2



1.3



1.4



1.5



1.6



1.7

- (11) **42604**
(21) 3-2021-01708 (28) 1
(54) **TÚI Đựng SẢN PHẨM XÂY DỰNG** (51) **09-05**
(22) 29/06/2021 (43) 27/09/2021
(73) **CÔNG TY CỔ PHẦN BAO BÌ HÀ TIÊN (VN)**
Khu phố Tám Thước, thị trấn Kiên Lương, huyện Kiên Lương, tỉnh Kiên Giang
(72) Nguyễn Văn Cường (VN)
(74) Công ty cổ phần FAS INVEST (FAS INVEST JSC)
(55)

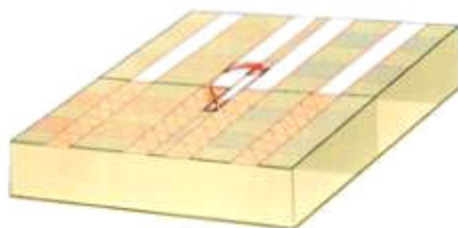

1.1



1.2



1.3

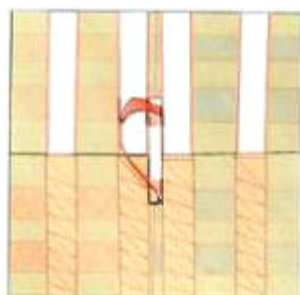

1.4

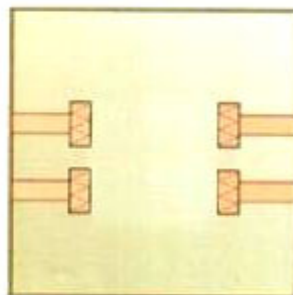

1.5

CÔNG BÁO SỞ HỮU CÔNG NGHIỆP SỐ 402 TẬP A – QUYỀN 2 (09.2021)

- (11) **42605**
(21) 3-2021-01719 (28) 2
(54) **NHÃN SẢN PHẨM** (51) **19-08**
(22) 30/06/2021 (43) 27/09/2021
(73) **CÔNG TY CỔ PHẦN BỘT GIẶT LIX (VN)**
Số 3, đường số 2, khu phố 4, phường Linh Trung, thành phố Thủ Đức, thành phố Hồ Chí Minh
(72) CAO THÀNH TÍN (VN)
(74) Văn phòng Luật sư A Hoà (AHOA LAW OFFICE)
(55)



H.1



H.2

CÔNG BÁO SỞ HỮU CÔNG NGHIỆP SỐ 402 TẬP A – QUYỀN 2 (09.2021)

- (11) **42606**
(21) 3-2021-01720 (28) 2
(54) **NHÃN SẢN PHẨM** (51) **19-08**
(22) 30/06/2021 (43) 27/09/2021
(73) **CÔNG TY CỔ PHẦN BỘT GIẶT LIX (VN)**
Số 3, đường số 2, khu phố 4, phường Linh Trung, thành phố Thủ Đức, thành phố Hồ Chí Minh
(72) CAO THÀNH TÍN (VN)
(74) Văn phòng Luật sư A Hoà (AHOA LAW OFFICE)
(55)



CÔNG BÁO SỞ HỮU CÔNG NGHIỆP SỐ 402 TẬP A – QUYỀN 2 (09.2021)

- (11) **42607**
(21) 3-2021-01721 (28) 2
(54) **NHÃN SẢN PHẨM** (51) **19-08**
(22) 30/06/2021 (43) 27/09/2021
(73) **CÔNG TY CỔ PHẦN BỘT GIẶT LIX (VN)**
Số 3, đường số 2, khu phố 4, phường Linh Trung, thành phố Thủ Đức, thành phố Hồ Chí Minh
(72) CAO THÀNH TÍN (VN)
(74) Văn phòng Luật sư A Hoà (AHOA LAW OFFICE)
(55)



H.1



H.2

CÔNG BÁO SỞ HỮU CÔNG NGHIỆP SỐ 402 TẬP A – QUYỀN 2 (09.2021)

- (11) **42608**
(21) 3-2021-01722 (28) 1
(54) **BAO GÓI BĂNG VỆ SINH** (51) **09-05**
(22) 30/06/2021 (43) 27/09/2021
(73) **CÔNG TY TNHH SẢN XUẤT VÀ THƯƠNG MẠI HIỆU HUYỀN (VN)**
Thôn Nhuệ, xã Đức Thượng, huyện Hoài Đức, thành phố Hà Nội
(72) Nguyễn Văn Chính (VN)
(74) Công ty TNHH Tư vấn đầu tư và chuyển giao công nghệ (INVESTCONSULT)
(55)



1.1



1.2

(11) **42609**

(21) 3-2021-01728

(28) 1

(54) **MÁY TÁCH SỢI CÂY TỰ ĐỘNG**

(51) **15-03**

(22) 30/06/2021

(43) 27/09/2021

(73) **CÔNG TY TNHH HỒ HOÀN CẦU (VN)**

Xóm 6, xã Quỳnh Văn, huyện Quỳnh Lưu, tỉnh Nghệ An

(72) Hồ Xuân Vinh (VN)

(55)



1.1



1.2

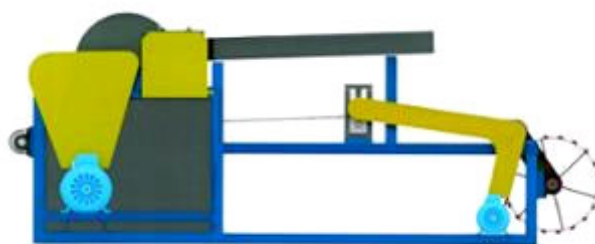

1.3

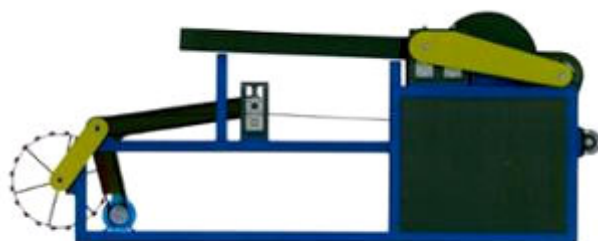

1.4



1.5



1.6

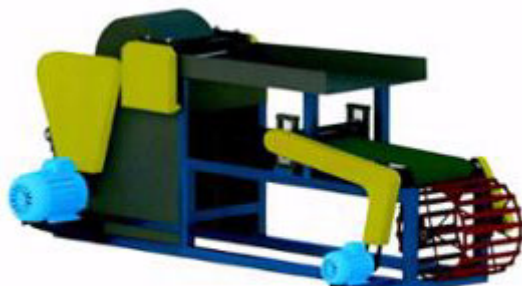

1.7



1.8

CÔNG BÁO SỞ HỮU CÔNG NGHIỆP SỐ 402 TẬP A – QUYỀN 2 (09.2021)

- (11) **42610**
(21) 3-2021-01731 (28) 1
(54) **HỘP** (51) **09-03**
(22) 01/07/2021 (43) 27/09/2021
(73) **CÔNG TY TNHH YẾN GIA ĐÌNH NHA TRANG (VN)**
Số 114 Thống Nhất, phường Vạn Thắng, thành phố Nha Trang, tỉnh Khánh Hòa
(72) Ngô Tổng Vinh (VN)
(74) Công ty TNHH Tư vấn sở hữu trí tuệ Việt (VIET IP CO.,LTD.)
(55)

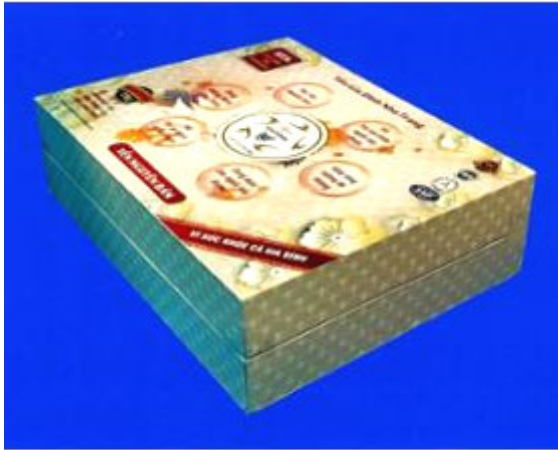

1.1



1.2



1.3



1.4

CÔNG BÁO SỞ HỮU CÔNG NGHIỆP SỐ 402 TẬP A – QUYỀN 2 (09.2021)

- (11) **42611**
(21) 3-2021-01732 (28) 1
(54) **LON BIA** (51) **09-03**
(22) 01/07/2021 (43) 27/09/2021
(73) **CƠ SỞ SẢN XUẤT BIA BIVA (VN)**
Ô4 ấp Bắc 2, xã Hòa Long, thành phố Bà Rịa, tỉnh Bà Rịa - Vũng Tàu
(72) **VŨ TUẤN CHÂU (VN)**
(74) **CÔNG TY TNHH SỞ HỮU TRÍ TUỆ SETHACO (SETHACO IP CO.,LTD)**
(55)

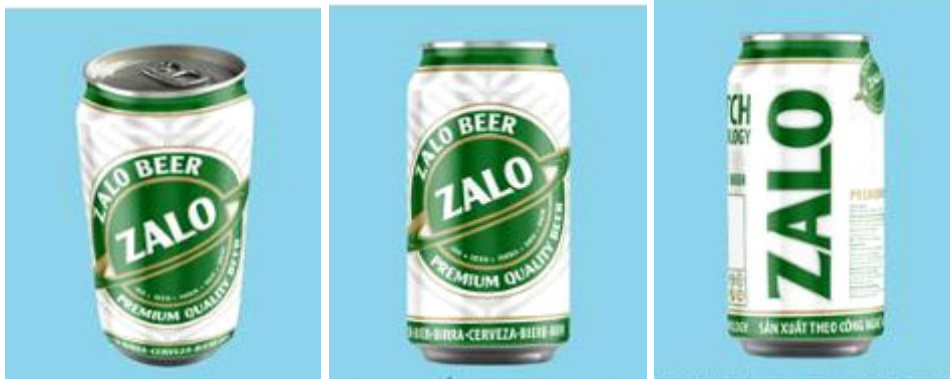

1.1

1.2

1.3



1.4

1.5

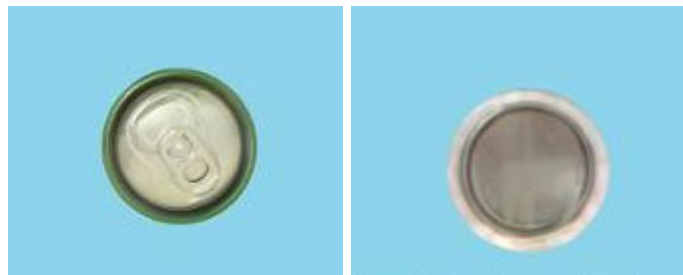

1.6

1.7

CÔNG BÁO SỞ HỮU CÔNG NGHIỆP SỐ 402 TẬP A – QUYỀN 2 (09.2021)

- (11) **42612**
(21) 3-2021-01733 (28) 1
(54) **THÙNG BIA** (51) **09-03**
(22) 01/07/2021 (43) 27/09/2021
(73) **CƠ SỞ SẢN XUẤT BIA BIVA (VN)**
Ô4 ấp Bắc 2, xã Hòa Long, thành phố Bà Rịa, tỉnh Bà Rịa - Vũng Tàu
(72) **VŨ TUẤN CHÂU (VN)**
(74) **CÔNG TY TNHH SỞ HỮU TRÍ TUỆ SETHACO (SETHACO IP CO.,LTD)**
(55)



1.1



1.2



1.3



1.4

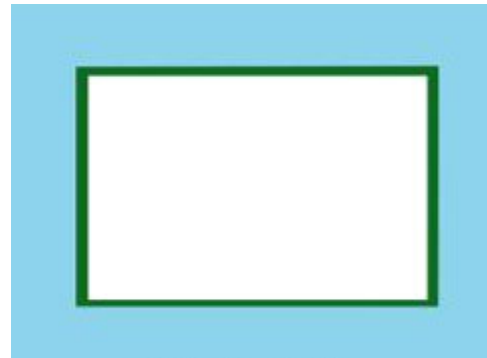

1.5

CÔNG BÁO SỞ HỮU CÔNG NGHIỆP SỐ 402 TẬP A – QUYỀN 2 (09.2021)

- (11) **42613**
(21) 3-2021-01734 (28) 1
(54) **BAO GÓI** (51) **09-05**
(22) 01/07/2021 (43) 27/09/2021
(73) **CÔNG TY CỔ PHẦN BỘT GIẶT LIX (VN)**
Số 3, đường số 2, khu phố 4, phường Linh Trung, thành phố Thủ Đức, Thành phố Hồ Chí Minh
(72) CAO THÀNH TÍN (VN)
(74) Văn phòng Luật sư A Hoà (AHOA LAW OFFICE)
(55)





CÔNG BÁO SỞ HỮU CÔNG NGHIỆP SỐ 402 TẬP A – QUYỀN 2 (09.2021)

- (11) **42614**
(21) 3-2021-01736 (28) 1
(54) **Ô TÔ** (51) **12-08**
(22) 01/07/2021 (43) 27/09/2021
(30) 2021-000051 05/01/2021 JP;
(73) **TOYOTA JIDOSHA KABUSHIKI KAISHA (JP)**
1, Toyota-cho, Toyota-shi, Aichi-ken, 471-8571 JAPAN
(72) 1. MASAKI OKUE (JP)
2. MASANORI KINOSHITA (JP)
3. TAKESHI OGAWA (JP)
4. HIRONAMI HAGA (JP)
5. HISAYUKI TASHIRO (JP)
(74) Công ty TNHH một thành viên Sở hữu trí tuệ VCCI (VCCI-IP CO.,LTD)
(55)



1.1



1.2



1.3



1.4



1.5



1.6



1.7



1.8

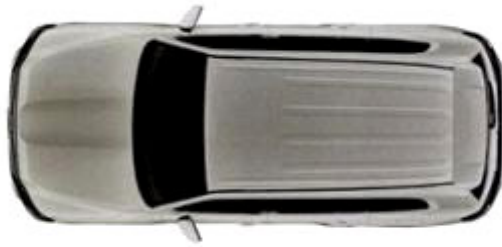

1.9

- (11) **42615**
(21) 3-2021-01737 (28) 1
(54) **BỘ ĐÈN PHÍA TRƯỚC CỦA Ô TÔ** (51) **26-06**
(22) 01/07/2021 (43) 27/09/2021
(30) 2021-000052 05/01/2021 JP;
(73) **TOYOTA JIDOSHA KABUSHIKI KAISHA (JP)**
1, Toyota-cho, Toyota-shi, Aichi-ken, 471-8571 JAPAN
(72) Takeshi OGAWA (JP)
(74) Công ty TNHH một thành viên Sở hữu trí tuệ VCCI (VCCI-IP CO.,LTD)
(55)



1.1



1.2

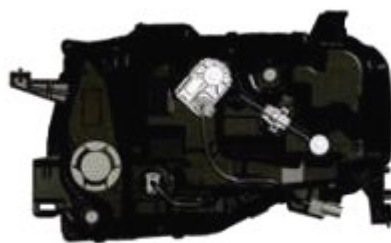

1.3

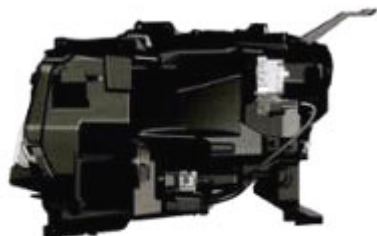

1.4



1.5



1.6



1.7

- (11) **42616**
(21) 3-2021-01738 (28) 1
(54) **BỘ ĐÈN PHÍA TRƯỚC CỦA Ô TÔ** (51) **26-06**
(22) 01/07/2021 (43) 27/09/2021
(30) 2021-000053 05/01/2021 JP;
(73) **TOYOTA JIDOSHA KABUSHIKI KAISHA (JP)**
1, Toyota-cho, Toyota-shi, Aichi-ken, 471-8571 JAPAN
(72) 1. HIRONAMI HAGA (JP)
2. TAKESHI OGAWA (JP)
(74) Công ty TNHH một thành viên Sở hữu trí tuệ VCCI (VCCI-IP CO.,LTD)
(55)



1.1



1.2



1.3

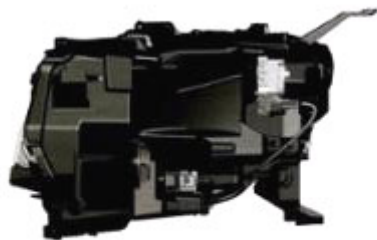

1.4



1.5



1.6



1.7

CÔNG BÁO SỞ HỮU CÔNG NGHIỆP SỐ 402 TẬP A – QUYỀN 2 (09.2021)

- (11) **42617**
(21) 3-2021-01739 (28) 1
(54) **LƯỚI TẢN NHIỆT PHÍA TRƯỚC CỦA XE Ô TÔ** (51) **12-16**
(22) 01/07/2021 (43) 27/09/2021
(30) 2021-000054 05/01/2021 JP;
(73) **TOYOTA JIDOSHA KABUSHIKI KAISHA (JP)**
1, Toyota-cho, Toyota-shi, Aichi-ken, 471-8571 JAPAN
(72) 1. TAKESHI OGAWA (JP)
2. HIRONAMI HAGA (JP)
(74) Công ty TNHH một thành viên Sở hữu trí tuệ VCCI (VCCI-IP CO.,LTD)
(55)



1.1



1.2



1.3



1.4



1.5



1.6



1.7

CÔNG BÁO SỞ HỮU CÔNG NGHIỆP SỐ 402 TẬP A – QUYỀN 2 (09.2021)

- (11) **42618**
(21) 3-2021-01740 (28) 1
(54) **TẮM HẮM XUNG PHÍA TRƯỚC CỦA XE Ô TÔ** (51) **12-16**
(22) 01/07/2021 (43) 27/09/2021
(30) 2021-000055 05/01/2021 JP;
(73) **TOYOTA JIDOSHA KABUSHIKI KAISHA (JP)**
1, Toyota-cho, Toyota-shi, Aichi-ken, 471-8571 JAPAN
(72) Takeshi OGAWA (JP)
(74) Công ty TNHH một thành viên Sở hữu trí tuệ VCCI (VCCI-IP CO.,LTD)
(55)



1.1



1.2



1.3



1.4



1.5



1.6



1.7

- (11) **42619**
(21) 3-2021-01741 (28) 1
(54) **TẮM HẮM XUNG PHÍA TRƯỚC CỦA XE Ô TÔ** (51) **12-16**
(22) 01/07/2021 (43) 27/09/2021
(30) 2021-000056 05/01/2021 JP;
(73) **TOYOTA JIDOSHA KABUSHIKI KAISHA (JP)**
1, Toyota-cho, Toyota-shi, Aichi-ken, 471-8571 JAPAN
(72) 1. MASAKI MUROMOTO (JP)
2. HIRONAMI HAGA (JP)
(74) Công ty TNHH một thành viên Sở hữu trí tuệ VCCI (VCCI-IP CO.,LTD)
(55)



1.1



1.2

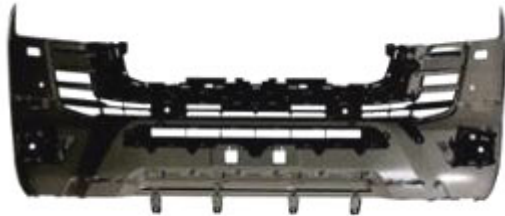

1.3



1.4



1.5



1.6



1.7

- (11) **42620**
(21) 3-2021-01742 (28) 1
(54) **BỘ ĐÈN PHÍA SAU CỦA Ô TÔ** (51) **26-06**
(22) 01/07/2021 (43) 27/09/2021
(30) 2021-000057 05/01/2021 JP;
(73) **TOYOTA JIDOSHA KABUSHIKI KAISHA (JP)**
1, Toyota-cho, Toyota-shi, Aichi-ken, 471-8571 JAPAN
(72) 1. KAZUNORI UEDA (JP)
2. HISAYUKI TASHIRO (JP)
(74) Công ty TNHH một thành viên Sở hữu trí tuệ VCCI (VCCI-IP CO.,LTD)
(55)



1.1



1.2

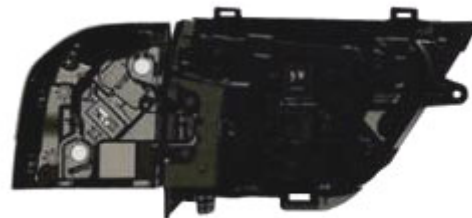

1.3



1.4



1.5



1.6



1.7

CÔNG BÁO SỞ HỮU CÔNG NGHIỆP SỐ 402 TẬP A – QUYỀN 2 (09.2021)

- (11) **42621**
(21) 3-2021-01743 (28) 1
(54) **TẮM HÃM XUNG PHÍA SAU CỦA Ô TÔ** (51) **12-16**
(22) 01/07/2021 (43) 27/09/2021
(30) 2021-000058 05/01/2021 JP;
(73) **TOYOTA JIDOSHA KABUSHIKI KAISHA (JP)**
1, Toyota-cho, Toyota-shi, Aichi-ken, 471-8571 JAPAN
(72) 1. KAZUNORI UEDA (JP)
2. HISAYUKI TASHIRO (JP)
(74) Công ty TNHH một thành viên Sở hữu trí tuệ VCCI (VCCI-IP CO.,LTD)
(55)



1.1



1.2



1.3



1.4



1.5



1.6



1.7

- (11) **42622**
(21) 3-2021-01744 (28) 1
(54) **TẮM HÃM XUNG PHÍA SAU CỦA Ô TÔ** (51) **12-16**
(22) 01/07/2021 (43) 27/09/2021
(30) 2021-000059 05/01/2021 JP;
(73) **TOYOTA JIDOSHA KABUSHIKI KAISHA (JP)**
1, Toyota-cho, Toyota-shi, Aichi-ken, 471-8571 JAPAN
(72) 1. MANABU KOJIMA (JP)
2. KAZUNORI UEDA (JP)
(74) Công ty TNHH một thành viên Sở hữu trí tuệ VCCI (VCCI-IP CO.,LTD)
(55)



1.1



1.2



1.3



1.4



1.5



1.6



1.7

- (11) **42623**
(21) 3-2021-01745 (28) 1
(54) **BẢNG ĐIỀU KHIỂN CỦA Ô TÔ** (51) **12-16**
(22) 01/07/2021 (43) 27/09/2021
(30) 2021-000060 05/01/2021 JP;
(73) **TOYOTA JIDOSHA KABUSHIKI KAISHA (JP)**
1, Toyota-cho, Toyota-shi, Aichi-ken, 471-8571 JAPAN
(72) 1. TAKUTO YAMAGAMI (JP)
2. TOMOKO NISHIKAWA (JP)
(74) Công ty TNHH một thành viên Sở hữu trí tuệ VCCI (VCCI-IP CO.,LTD)
(55)



1.1



1.2



1.3



1.4



1.5



1.6



1.7

- (11) **42624**
(21) 3-2021-01748 (28) 1
(54) **NHÃN SẢN PHẨM** (51) **19-08**
(22) 01/07/2021 (43) 27/09/2021
(73) **CÔNG TY TNHH THƯƠNG MẠI DỊCH VỤ KHÂM TÍN (VN)**
284/11 Cô Bắc, phường Cô Giang, quận 1, thành phố Hồ Chí Minh
(72) Trần Văn Tường (VN)
(74) Công ty Luật TNHH SIPCO (SIPCO LAWYERS & IP AGENTS)
(55)



1.1



1.2

- (11) **42625**
(21) 3-2021-01749 (28) 1
(54) **NHÃN SẢN PHẨM** (51) **19-08**
(22) 01/07/2021 (43) 27/09/2021
(73) **CÔNG TY TNHH THƯƠNG MẠI DỊCH VỤ KHÂM TÍN (VN)**
284/11 Cô Bắc, phường Cô Giang, quận 1, thành phố Hồ Chí Minh
(72) Trần Văn Tường (VN)
(74) Công ty Luật TNHH SIPCO (SIPCO LAWYERS & IP AGENTS)
(55)



1.1



1.2

- (11) **42626**
(21) 3-2021-01752 (28) 1
(54) **BAO GÓI** (51) **09-05**
(22) 01/07/2021 (43) 27/09/2021
(73) **ORION CORPORATION (KR)**
13, Baekbeom-ro 90da-gil, Yongsan-gu, Seoul 04369, Republic of Korea
(72) 1. LEE, A REUM (KR)
2. CHOE, EUN JE (KR)
(74) Công ty Luật TNHH quốc tế BMVN (BMVN INTERNATIONAL LLC)
(55)



1.1



1.2

CÔNG BÁO SỞ HỮU CÔNG NGHIỆP SỐ 402 TẬP A – QUYỀN 2 (09.2021)

- (11) **42627**
(21) 3-2021-01753 (28) 1
(54) **BAO GÓI** (51) **09-05**
(22) 01/07/2021 (43) 27/09/2021
(73) **ORION CORPORATION (KR)**
13, Baekbeom-ro 90da-gil, Yongsan-gu, Seoul 04369, Republic of Korea
(72) 1. LEE, A REUM (KR)
2. CHOE, EUN JE (KR)
(74) Công ty Luật TNHH quốc tế BMVN (BMVN INTERNATIONAL LLC)
(55)



1.1



1.2

CÔNG BÁO SỞ HỮU CÔNG NGHIỆP SỐ 402 TẬP A – QUYỀN 2 (09.2021)

- (11) **42628**
(21) 3-2021-01754 (28) 1
(54) **BAO GÓI** (51) **09-05**
(22) 01/07/2021 (43) 27/09/2021
(73) **ORION CORPORATION (KR)**
13, Baekbeom-ro 90da-gil, Yongsan-gu, Seoul 04369, Republic of Korea
(72) 1. LEE, A REUM (KR)
2. CHOE, EUN JE (KR)
(74) Công ty Luật TNHH quốc tế BMVN (BMVN INTERNATIONAL LLC)
(55)



1.1



1.2

CÔNG BÁO SỞ HỮU CÔNG NGHIỆP SỐ 402 TẬP A – QUYỀN 2 (09.2021)

- (11) **42629**
(21) 3-2021-01755 (28) 1
(54) **NHÃN SẢN PHẨM** (51) **19-08**
(22) 02/07/2021 (43) 27/09/2021
(73) **CÔNG TY CỔ PHẦN THÁI DƯƠNG (VN)**
Cụm công nghiệp Lại Yên, xã Lại Yên, huyện Hoài Đức, thành phố Hà Nội
(72) Nguyễn Duy Lộc (VN)
(55)



CÔNG BÁO SỞ HỮU CÔNG NGHIỆP SỐ 402 TẬP A – QUYỀN 2 (09.2021)

- (11) **42630**
(21) 3-2021-01758 (28) 1
(54) **Ổ CẮM** (51) **13-03**
(22) 02/07/2021 (43) 27/09/2021
(73) **CÔNG TY CỔ PHẦN BÓNG ĐÈN PHÍCH NƯỚC RẠNG ĐÔNG (VN)**
87-89 phố Hạ Đình, phường Thanh Xuân Trung, quận Thanh Xuân, thành phố Hà Nội
(72) Trần Trung Tường (VN)
(55)

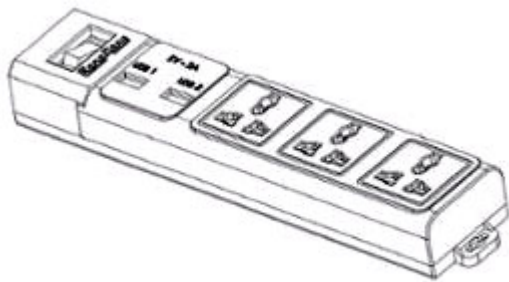

1.1

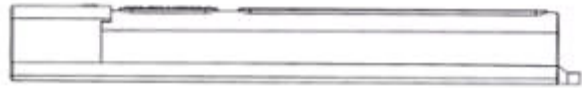

1.2



1.3



1.4



1.5

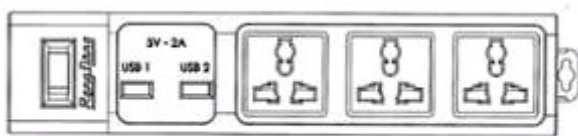

1.6



1.7

(11) **42631**

(21) 3-2021-01759

(28) 1

(54) **Ổ CẮM**

(51) **13-03**

(22) 02/07/2021

(43) 27/09/2021

(73) **CÔNG TY CỔ PHẦN BÓNG ĐÈN PHÍCH NƯỚC RẠNG ĐÔNG (VN)**
87-89 phố Hạ Đình, phường Thanh Xuân Trung, quận Thanh Xuân, thành phố Hà Nội

(72) Trần Trung Tường (VN)

(55)

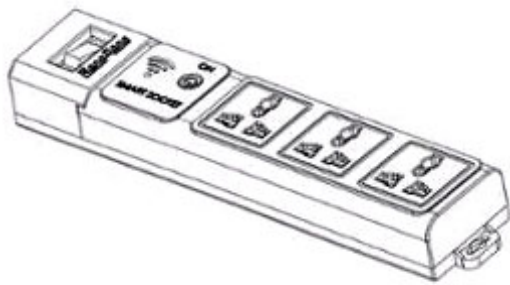

1.1

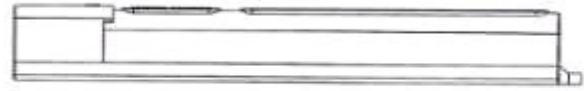

1.2



1.3



1.4

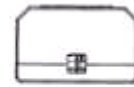

1.5

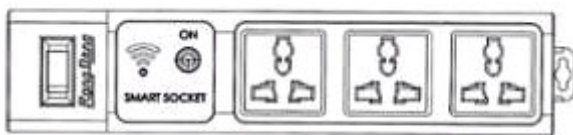

1.6



1.7

CÔNG BÁO SỞ HỮU CÔNG NGHIỆP SỐ 402 TẬP A – QUYỀN 2 (09.2021)

- (11) **42632**
(21) 3-2021-01760 (28) 1
(54) **Ổ CẮM** (51) **13-03**
(22) 02/07/2021 (43) 27/09/2021
(73) **CÔNG TY CỔ PHẦN BÓNG ĐÈN PHÍCH NƯỚC RẠNG ĐÔNG (VN)**
87-89 phố Hạ Đình, phường Thanh Xuân Trung, quận Thanh Xuân, thành phố Hà Nội
(72) Trần Trung Tường (VN)
(55)

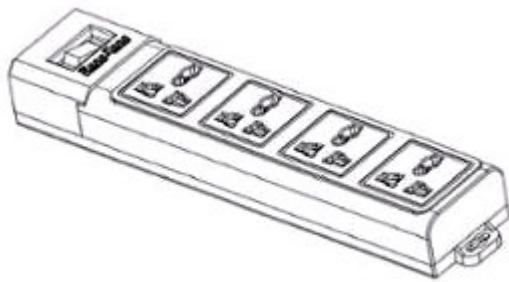

1.1

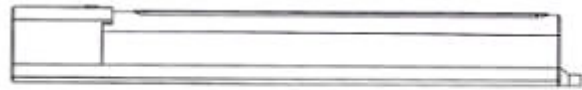

1.2



1.3



1.4

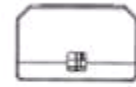

1.5

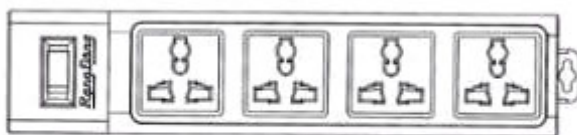

1.6



1.7

- (11) **42633**
(21) 3-2021-01763 (28) 1
(54) **CHAI ĐỰNG RƯỢU** (51) **09-01**
(22) 05/07/2021 (43) 27/09/2021
(30) 30-2021-0010912 05/03/2021 KR;
(73) **E HAN LEE (KR)**
12-7, Chiljeon-gil, Bangsan-myeon, Yanggu-gun, Gangwon-do, Republic of Korea
(72) E Han LEE (KR)
(74) Công ty Luật TNHH Phạm và Liên danh (PHAM & ASSOCIATES)
(55)



1.1



1.2



1.3



1.4



1.5



1.6



1.7

CÔNG BÁO SỞ HỮU CÔNG NGHIỆP SỐ 402 TẬP A – QUYỀN 2 (09.2021)

- (11) **42634**
(21) 3-2021-01764 (28) 1
(54) **CHAI ĐỰNG RƯỢU** (51) **09-01**
(22) 05/07/2021 (43) 27/09/2021
(30) 30-2021-0010897 05/03/2021 KR;
(73) **E HAN LEE (KR)**
12-7, Chiljeon-gil, Bangsan-myeon, Yanggu-gun, Gangwon-do, Republic of Korea
(72) E Han LEE (KR)
(74) Công ty Luật TNHH Phạm và Liên danh (PHAM & ASSOCIATES)
(55)

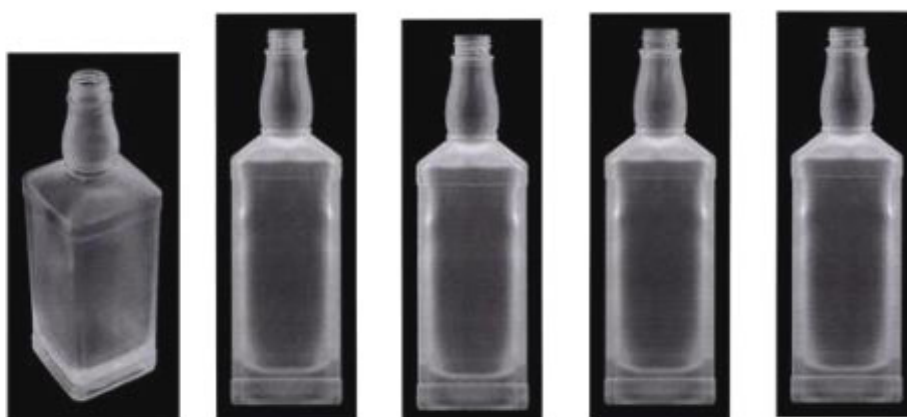

1.1

1.2

1.3

1.4

1.5



1.6

1.7

- (11) **42635**
(21) 3-2021-01769 (28) 1
(54) **KHẨU TRANG** (51) **02-99**
(22) 05/07/2021 (43) 27/09/2021
(30) 2021-005372 16/03/2021 JP;
(73) **KOKEN LTD. (JP)**
7, Yonban-cho, Chiyoda-ku, Tokyo 102-8459, Japan
(72) 1. TAGUCHI, SEIJI (JP)
2. ISHIKAWA, SHINGO (JP)
(74) Công ty TNHH một thành viên Sở hữu trí tuệ VCCI (VCCI-IP CO.,LTD)
(55)



1.1



1.2



1.3



1.4



1.5



1.6



1.7

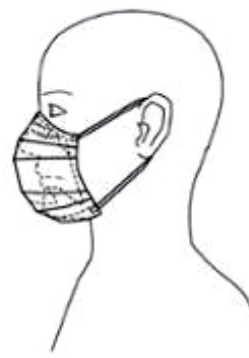

1.8

CÔNG BÁO SỞ HỮU CÔNG NGHIỆP SỐ 402 TẬP A – QUYỀN 2 (09.2021)

- (11) **42636**
(21) 3-2021-01770 (28) 1
(54) **THIẾT BỊ ĐIỀU KHIỂN ĐIỀU HÒA** (51) **14-03**
(22) 05/07/2021 (43) 27/09/2021
(73) **TỔNG CÔNG TY VIỄN THÔNG MOBIFONE (VN)**
Số 01 phố Phạm Văn Bạch, phường Yên Hoà, quận Cầu Giấy, thành phố Hà Nội
(72) Trịnh Tuấn Hải (VN)
(74) Công ty TNHH Tư vấn đầu tư và Sở hữu trí tuệ Hoàng Phi (HOANG PHI INVEST & I.P CO., LTD)
(55)

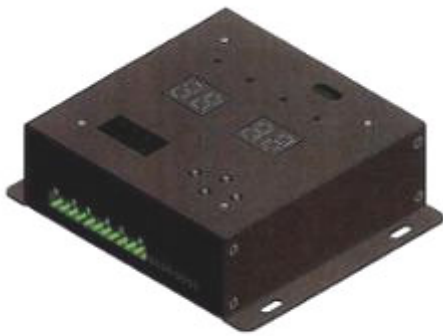

1.1



1.2



1.3



1.4



1.5



1.6



1.7

CÔNG BÁO SỞ HỮU CÔNG NGHIỆP SỐ 402 TẬP A – QUYỀN 2 (09.2021)

- (11) **42637**
(21) 3-2021-01771 (28) 1
(54) **THIẾT BỊ GIÁM SÁT** (51) **14-02; 14-03**
(22) 05/07/2021 (43) 27/09/2021
(73) **TỔNG CÔNG TY VIỄN THÔNG MOBIFONE (VN)**
Số 01 phố Phạm Văn Bạch, phường Yên Hoà, quận Cầu Giấy, thành phố Hà Nội
(72) Trịnh Tuấn Hải (VN)
(74) Công ty TNHH Tư vấn đầu tư và Sở hữu trí tuệ Hoàng Phi (HOANG PHI INVEST & I.P CO., LTD)
(55)



1.1



1.2



1.3



1.4



1.5



1.6



1.7

CÔNG BÁO SỞ HỮU CÔNG NGHIỆP SỐ 402 TẬP A – QUYỀN 2 (09.2021)

- (11) **42638**
(21) 3-2021-01772 (28) 1
(54) **THIẾT BỊ GIÁM SÁT TẬP TRUNG** (51) **14-02; 14-03**
(22) 05/07/2021 (43) 27/09/2021
(73) **TỔNG CÔNG TY VIỄN THÔNG MOBIFONE (VN)**
Số 01 phố Phạm Văn Bạch, phường Yên Hoà, quận Cầu Giấy, thành phố Hà Nội
(72) Trịnh Tuấn Hải (VN)
(74) Công ty TNHH Tư vấn đầu tư và Sở hữu trí tuệ Hoàng Phi (HOANG PHI INVEST & I.P CO., LTD)
(55)



1.1



1.2



1.3

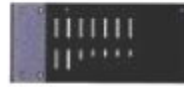

1.4



1.5



1.6



1.7

CÔNG BÁO SỞ HỮU CÔNG NGHIỆP SỐ 402 TẬP A – QUYỀN 2 (09.2021)

- (11) **42639**
(21) 3-2021-01773 (28) 1
(54) **THIẾT BỊ QUẢN LÝ ĐẦU ĐỌC THẺ TỪ** (51) **14-02**
(22) 05/07/2021 (43) 27/09/2021
(73) **TỔNG CÔNG TY VIỄN THÔNG MOBIFONE (VN)**
Số 01 phố Phạm Văn Bạch, phường Yên Hoà, quận Cầu Giấy, thành phố Hà Nội
(72) Trịnh Tuấn Hải (VN)
(74) Công ty TNHH Tư vấn đầu tư và Sở hữu trí tuệ Hoàng Phi (HOANG PHI INVEST & I.P CO., LTD)
(55)

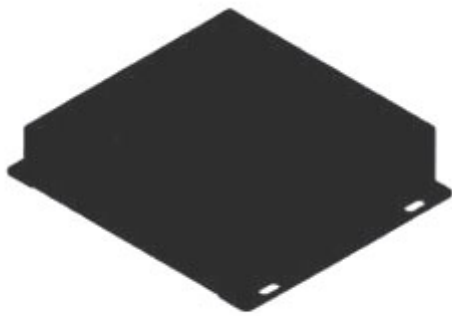

1.1



1.2



1.3



1.4



1.5



1.6

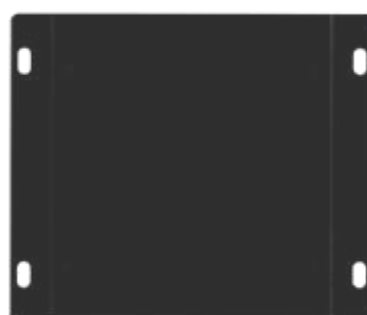

1.7

CÔNG BÁO SỞ HỮU CÔNG NGHIỆP SỐ 402 TẬP A – QUYỀN 2 (09.2021)

- (11) **42640**
(21) 3-2021-01776 (28) 1
(54) **TAY CẦM KẸP DỤNG CỤ NẤU NƯỚNG** (51) **07-02**
(22) 05/07/2021 (43) 27/09/2021
(73) **ROBERT J. SKVORECZ (US)**
PO Box 723, Kinnelon, NJ 07405, United States of America
(72) Robert J. Skvorecz (US)
(74) Công ty TNHH Sáng chế ACTIP (ACTIP PATENT LIMITED)
(55)

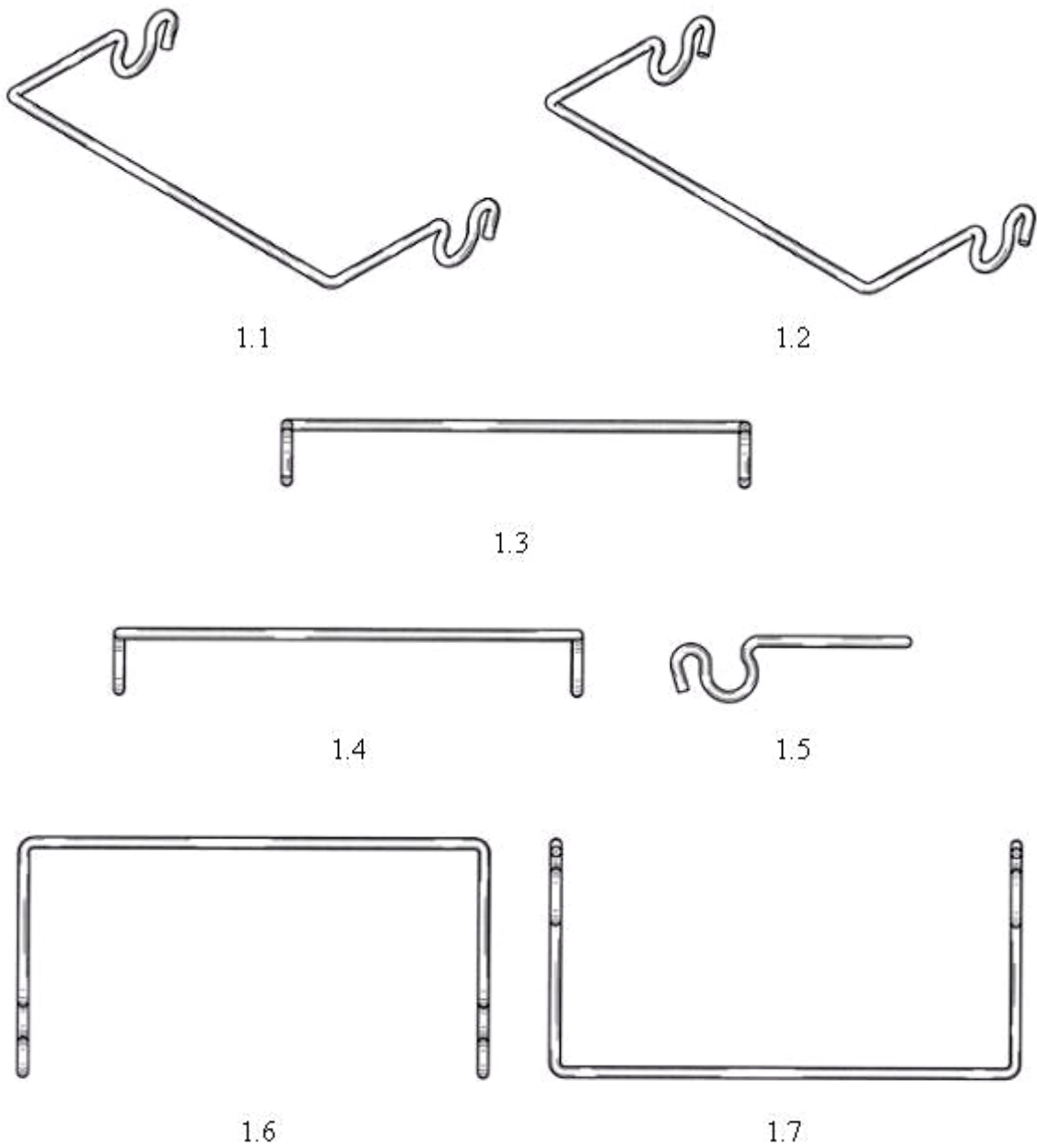

- (11) **42641**
(21) 3-2021-01780 (28) 1
(54) **THÙNG ĐỰNG SƠN** (51) **09-02**
(22) 06/07/2021 (43) 27/09/2021
(30) 30-2021-0013329 19/03/2021 KR;
(73) **FRSI CORP. (KR)**
Jeonnam Techno Park, Knowledge Industry Center-dong 315-ho, 13,
Yulchonsandan 4-ro, Haeryongmyeon, Suncheon-si, Jeollanam-do, Republic of
Korea
(72) Sang-Hoon SEO (KR)
(74) Công ty TNHH Sở hữu trí tuệ PADEMARK (PADEMARK CO.,LTD.)
(55)



1.1



1.2



1.3



1.4

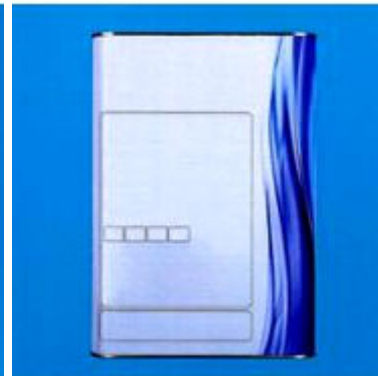

1.5

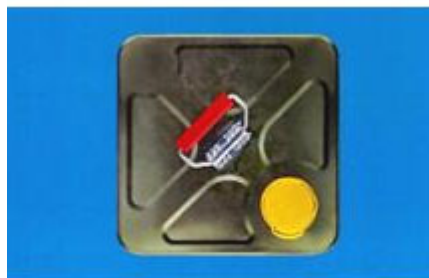

1.6



1.7

CÔNG BÁO SỞ HỮU CÔNG NGHIỆP SỐ 402 TẬP A – QUYỀN 2 (09.2021)

- (11) **42642**
(21) 3-2021-01781 (28) 1
(54) **THÙNG ĐỰNG SƠN** (51) **09-02**
(22) 06/07/2021 (43) 27/09/2021
(30) 30-2021-0013328 19/03/2021 KR;
(73) **FRSI CORP. (KR)**
Jeonnam Techno Park, Knowledge Industry Center-dong 315-ho, 13,
Yulchonsandan 4-ro, Haeryongmyeon, Suncheon-si, Jeollanam-do, Republic of
Korea
(72) Sang-Hoon SEO (KR)
(74) Công ty TNHH Sở hữu trí tuệ PADEMARK (PADEMARK CO.,LTD.)
(55)



1.1



1.2



1.3



1.4



1.5



1.6



1.7

CÔNG BÁO SỞ HỮU CÔNG NGHIỆP SỐ 402 TẬP A – QUYỀN 2 (09.2021)

- (11) **42643**
(21) 3-2021-01785 (28) 1
(54) **THIẾT BỊ ĐIỀU KHIỂN TỪ XA** (51) **14-03**
(22) 07/07/2021 (43) 27/09/2021
(73) **CÔNG TY CỔ PHẦN TẬP ĐOÀN CASPER VIỆT NAM (VN)**
B17-18, Khu CNĐT, TP Xanh, phường Cầu Diễn, quận Nam Từ Liêm, thành phố Hà Nội
(72) Nguyễn Viết Chung (VN)
(74) Công ty TNHH Sở hữu trí tuệ Bình Minh (SUNRISE IP CO.,LTD.)
(55)



1.1



1.2



1.3



1.4



1.5



1.6



1.7

- (11) **42644**
(21) 3-2021-01790 (28) 2
(54) **VÀNH BÁNH XE** (51) **12-16**
(22) 07/07/2021 (43) 27/09/2021
(73) **MENG KAH AUTO PARTS TRADING SDN. BHD. (MY)**
40, Jalan TPP5, Taman Perindustrian Putra, 47130 Puchong, Selangor, Malaysia
(72) Lee Cong Quan (MY)
(74) Công ty TNHH Trường Xuân (AGELESS CO.,LTD.)
(55)



1.1



1.2



1.3



1.4

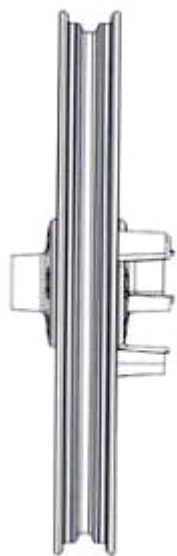

1.5



1.6

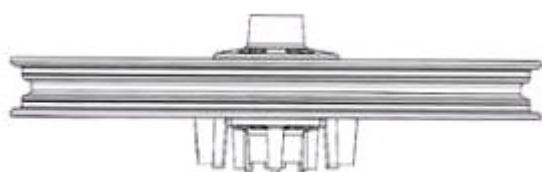

1.7

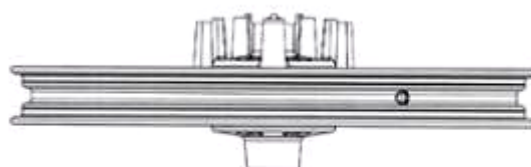

1.8

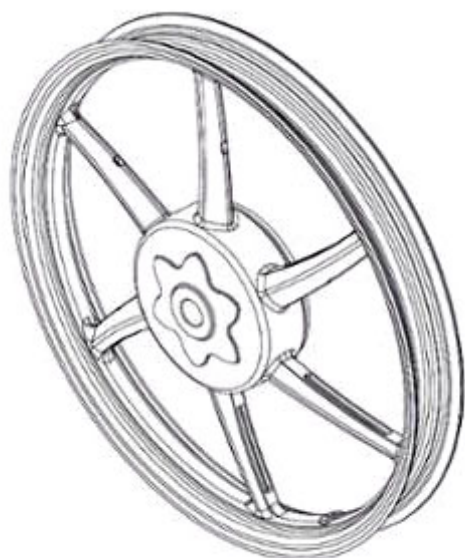

2.1



2.2



2.3



2.4



2.5



2.6



2.7



2.8

CÔNG BÁO SỞ HỮU CÔNG NGHIỆP SỐ 402 TẬP A – QUYỀN 2 (09.2021)

- (11) **42645**
(21) 3-2021-01791 (28) 1
(54) **THANH NHÔM ĐỊNH HÌNH** (51) **25-01**
(22) 08/07/2021 (43) 27/09/2021
(73) **CÔNG TY CỔ PHẦN THƯƠNG MẠI NHÔM VĨNH HƯNG (VN)**
Số 12, Lô C-TT14 Kiến Hưng Luxury, phường Kiến Hưng, quận Hà Đông, thành phố Hà Nội
(72) Lê Khắc Ngân (VN)
(74) Công ty TNHH Tư vấn IPNG (IPNG CO.,LTD)
(55)

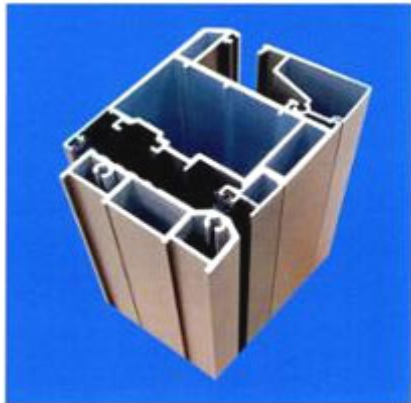

1.1



1.2



1.3



1.4



1.5

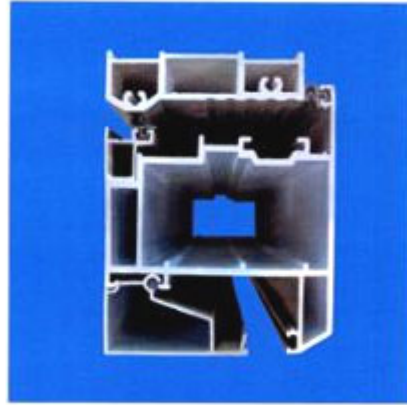

1.6

- (11) **42646**
(21) 3-2021-01793 (28) 1
(54) **CÀNG GỌNG KÍNH ĐEO MẮT** (51) **16-06**
(22) 09/07/2021 (43) 27/09/2021
(73) **PARK MIN GYU (KR)**
1503, Top Family, 56-1, Bujeon-ro, Busanjin-gu, Busan, Republic of Korea
(72) **PARK MIN GYU (KR)**
(74) Công ty TNHH Dịch thuật sáng chế PROINVEN (PROINVEN CO.,LTD.)
(55)

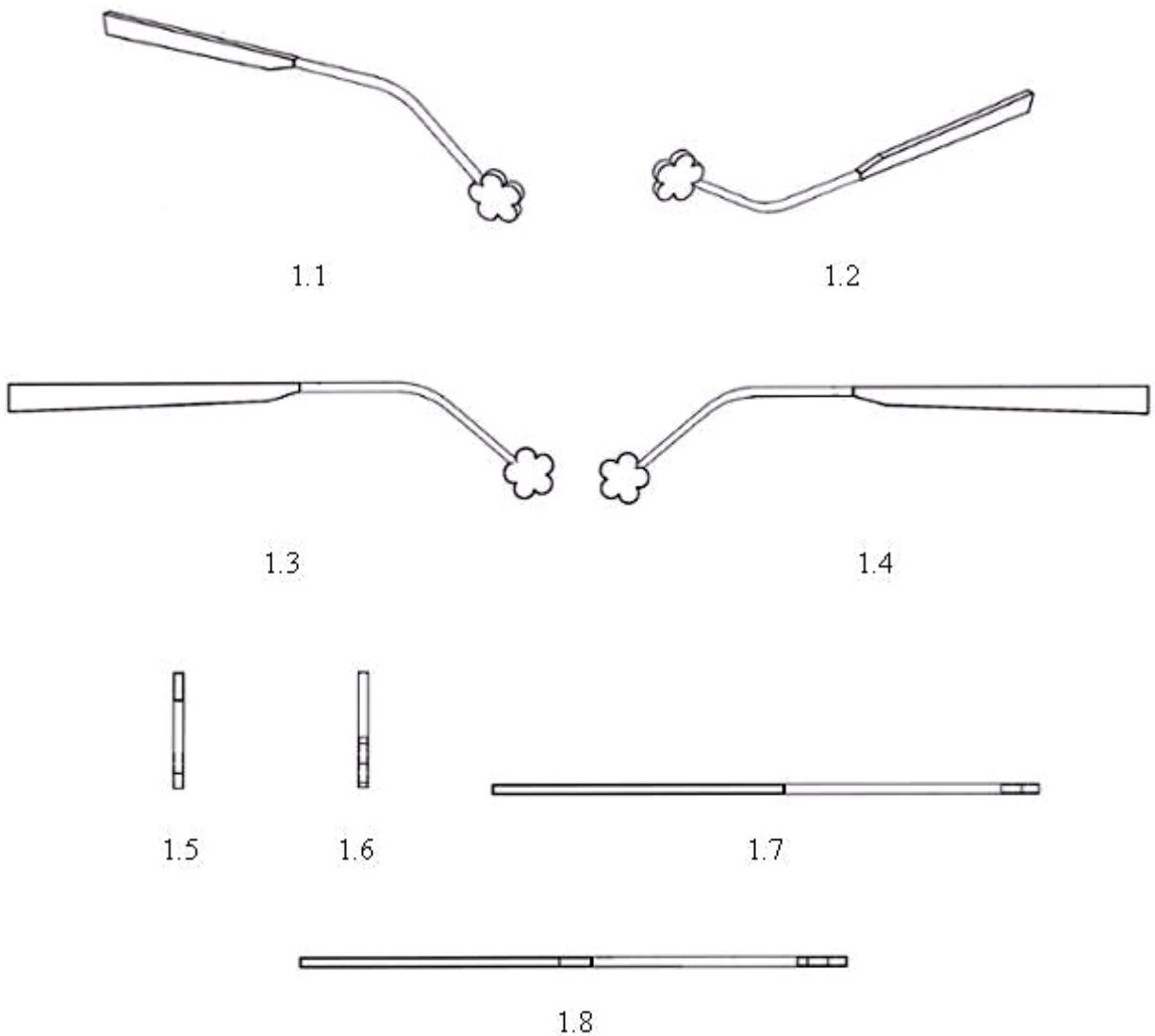

- (11) **42647**
(21) 3-2021-01794 (28) 1
(54) **CÀNG GỌNG KÍNH ĐEO MẮT** (51) **16-06**
(22) 09/07/2021 (43) 27/09/2021
(73) **PARK MIN GYU (KR)**
1503, Top Family, 56-1, Bujeon-ro, Busanjin-gu, Busan, Republic of Korea
(72) **PARK MIN GYU (KR)**
(74) Công ty TNHH Dịch thuật sáng chế PROINVEN (PROINVEN CO.,LTD.)
(55)

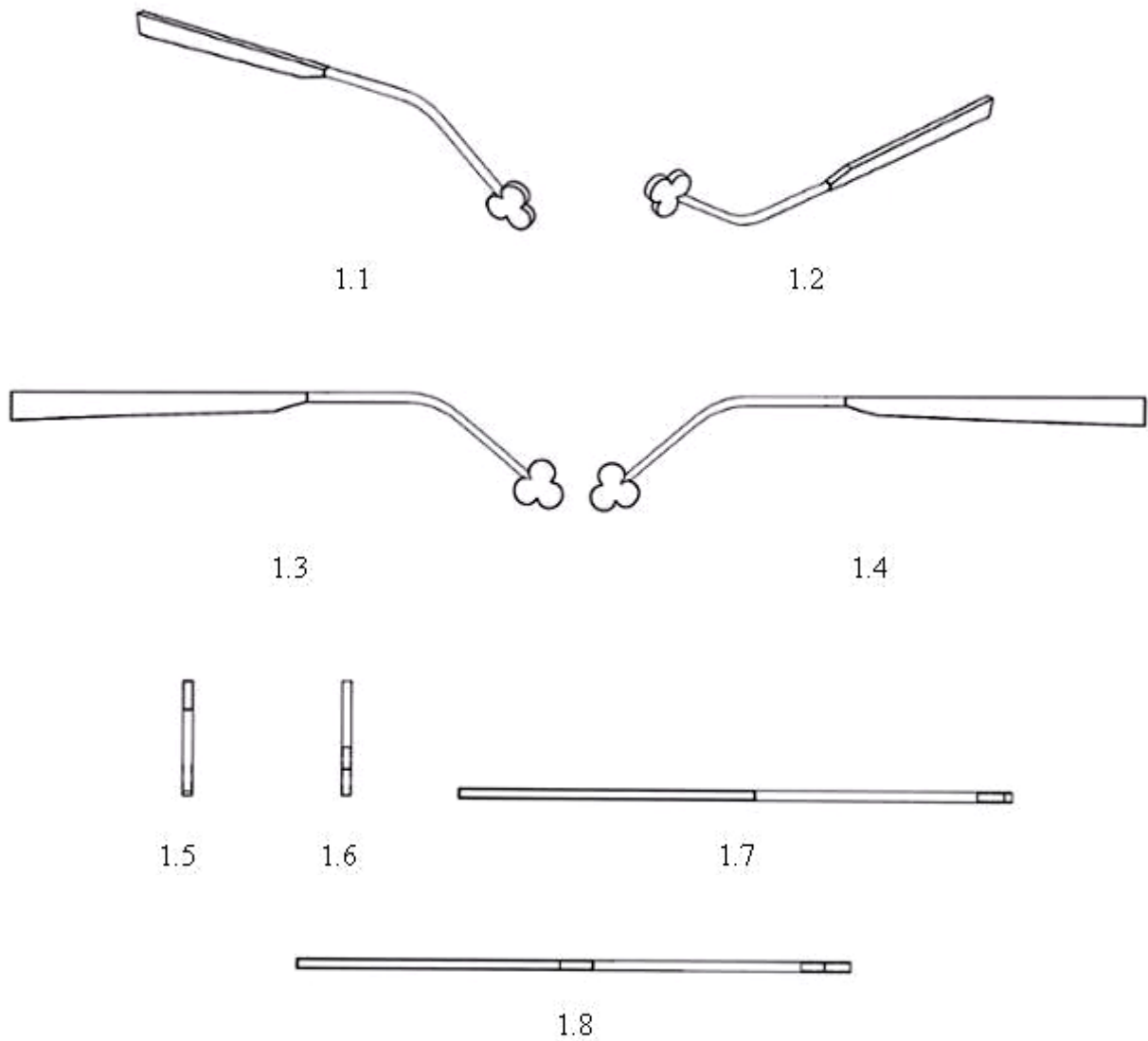

- (11) **42648**
(21) 3-2021-01795 (28) 1
(54) **CÀNG GỌNG KÍNH ĐEO MẮT** (51) **16-06**
(22) 09/07/2021 (43) 27/09/2021
(73) **PARK MIN GYU (KR)**
1503, Top Family, 56-1, Bujeon-ro, Busanjin-gu, Busan, Republic of Korea
(72) **PARK MIN GYU (KR)**
(74) Công ty TNHH Dịch thuật sáng chế PROINVEN (PROINVEN CO.,LTD.)
(55)

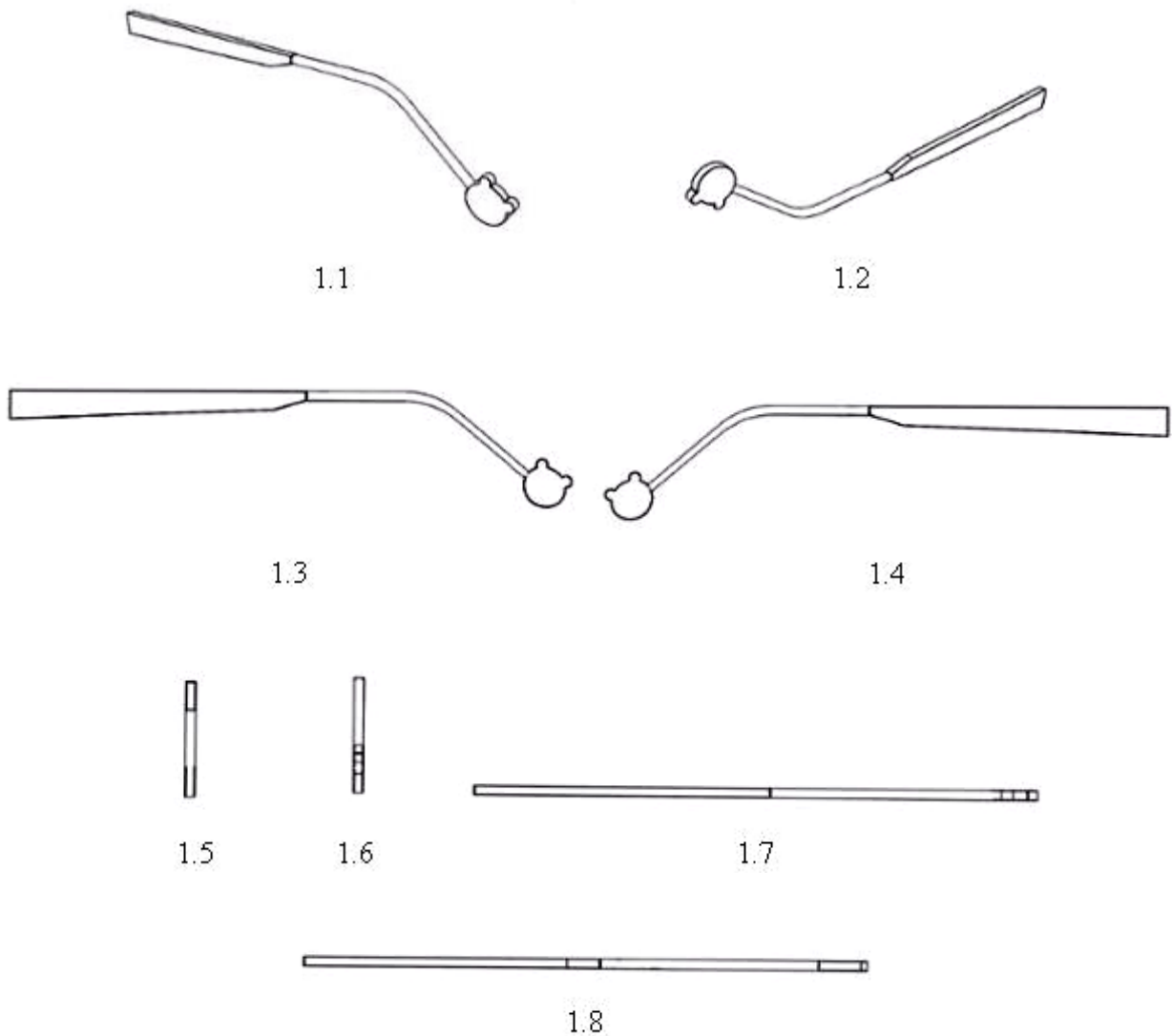

- (11) **42649**
(21) 3-2021-01796 (28) 1
(54) **CÀNG GỌNG KÍNH ĐEO MẮT** (51) **16-06**
(22) 09/07/2021 (43) 27/09/2021
(73) **PARK MIN GYU (KR)**
1503, Top Family, 56-1, Bujeon-ro, Busanjin-gu, Busan, Republic of Korea
(72) **PARK MIN GYU (KR)**
(74) Công ty TNHH Dịch thuật sáng chế PROINVEN (PROINVEN CO.,LTD.)
(55)

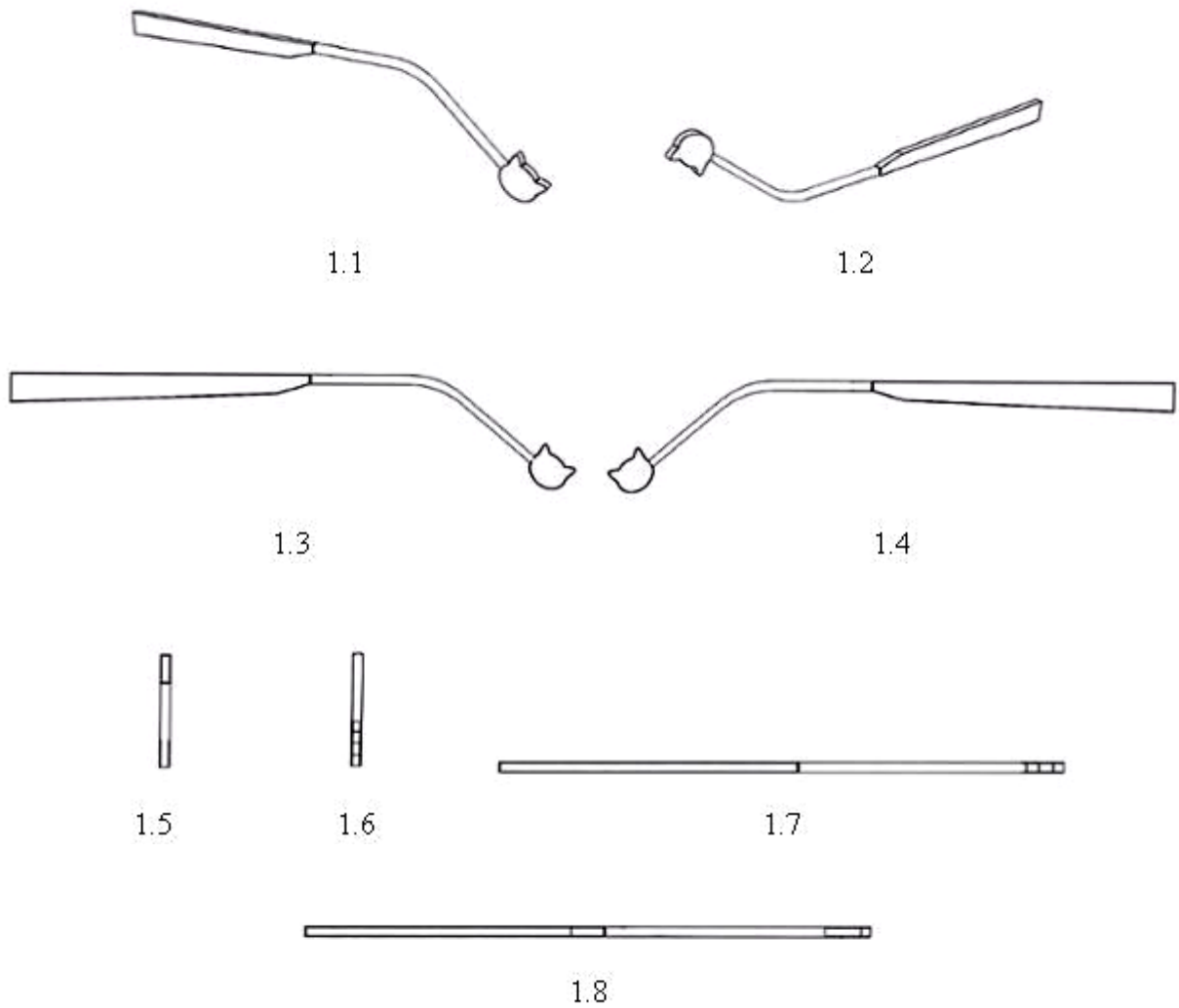

- (11) **42650**
(21) 3-2021-01798 (28) 1
(54) **HỘP ĐỰNG THUỐC** (51) **09-03**
(22) 09/07/2021 (43) 27/09/2021
(73) **VŨ THỊ PHƯƠNG (VN)**
Khu ĐT Dệt May, phường Năng Tĩnh, thành phố Nam Định, tỉnh Nam Định
(72) Vũ Thị Phương (VN)
(55)



1.1



1.2

CÔNG BÁO SỞ HỮU CÔNG NGHIỆP SỐ 402 TẬP A – QUYỀN 2 (09.2021)

- (11) **42651**
(21) 3-2021-01799 (28) 1
(54) **HỘP ĐỰNG THUỐC** (51) **09-03**
(22) 09/07/2021 (43) 27/09/2021
(73) **VŨ THỊ PHƯƠNG (VN)**
Khu ĐT Dệt May, phường Năng Tĩnh, thành phố Nam Định, tỉnh Nam Định
(72) Vũ Thị Phương (VN)
(55)



1.1



1.2

CÔNG BÁO SỞ HỮU CÔNG NGHIỆP SỐ 402 TẬP A – QUYỀN 2 (09.2021)

- (11) **42652**
(21) 3-2021-01802 (28) 1
(54) **BAO THUỐC LÁ** (51) **09-03**
(22) 09/07/2021 (43) 27/09/2021
(73) **CÔNG TY TNHH MỘT THÀNH VIÊN THUỐC LÁ ĐỒNG THÁP (VN)**
Số 10, Nguyễn Sinh Sắc, ấp Phú Long, xã Tân Phú Đông, thành phố Sa Đéc, tỉnh
Đồng Tháp
(72) Huỳnh Văn Kha (VN)
(74) Công ty TNHH Sở hữu trí tuệ Tầm Nhìn Mới (FRESHVIEW CO., LTD.)
(55)



1.1



1.2

CÔNG BÁO SỞ HỮU CÔNG NGHIỆP SỐ 402 TẬP A – QUYỀN 2 (09.2021)

- (11) **42653**
(21) 3-2021-01803 (28) 1
(54) **BÀN** (51) **06-03**
(22) 09/07/2021 (43) 27/09/2021
(73) **CÔNG TY CỔ PHẦN GIẢI PHÁP NỘI THẤT FUT GROUP (VN)**
Số nhà 126, lô 14 La Casta, KĐT mới Văn Phú, phường Phú La, quận Hà Đông,
thành phố Hà Nội
(72) Nguyễn Tuấn Hải (VN)
(55)



1.1



1.2

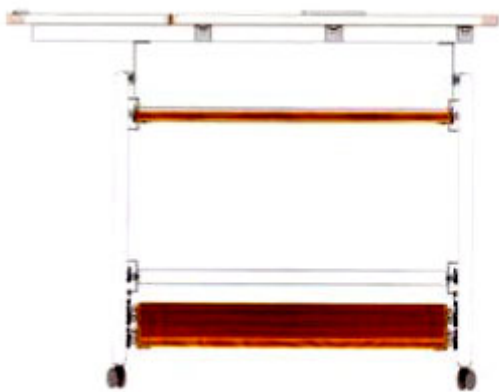

1.3

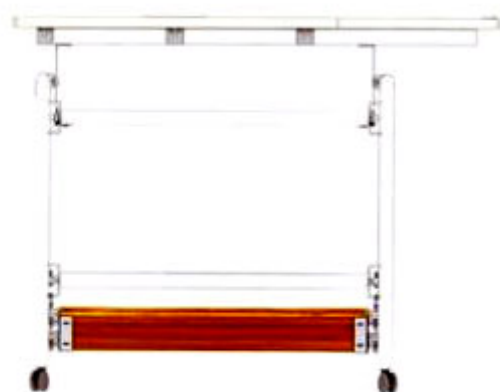

1.4



1.5



1.6

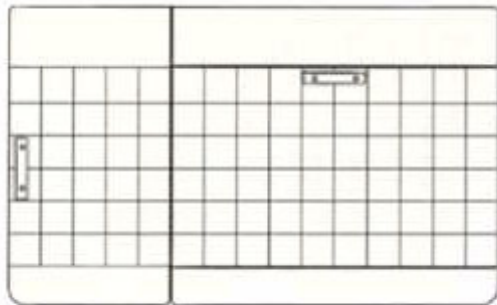

1.7

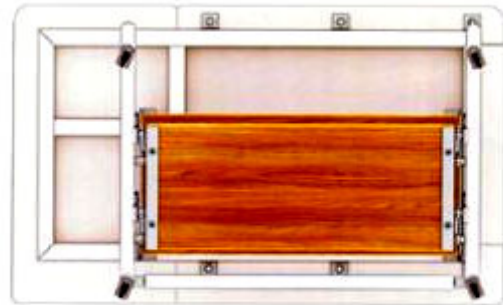

1.8

CÔNG BÁO SỞ HỮU CÔNG NGHIỆP SỐ 402 TẬP A – QUYỀN 2 (09.2021)

(11) **42654**

(21) 3-2021-01804

(54) **BÀN**

(22) 09/07/2021

(73) **CÔNG TY CỔ PHẦN GIẢI PHÁP NỘI THẤT FUT GROUP (VN)**

Số nhà 126, lô 14 La Casta, KĐT mới Văn Phú, phường Phú La, quận Hà Đông, thành phố Hà Nội

(72) Nguyễn Tuấn Hải (VN)

(55)

(28) 1

(51) **06-03**

(43) 27/09/2021



1.1



1.2



1.3

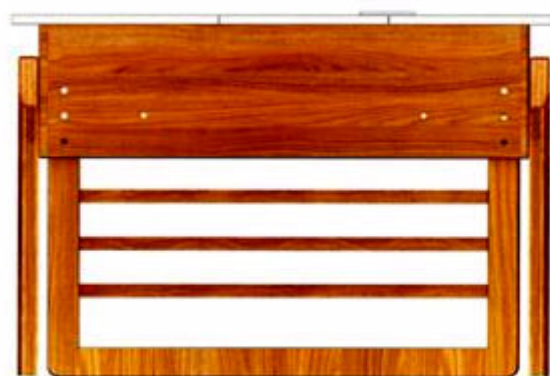

1.4



1.5



1.6

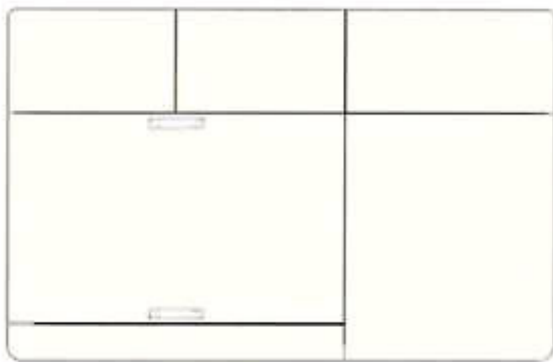

1.7



1.8

CÔNG BÁO SỞ HỮU CÔNG NGHIỆP SỐ 402 TẬP A – QUYỀN 2 (09.2021)

- (11) **42655**
(21) 3-2021-01805 (28) 1
(54) **GHẾ** (51) **06-01**
(22) 09/07/2021 (43) 27/09/2021
(73) **CÔNG TY CỔ PHẦN GIẢI PHÁP NỘI THẤT FUT GROUP (VN)**
Số nhà 126, lô 14 La Casta, KĐT mới Văn Phú, phường Phú La, quận Hà Đông,
thành phố Hà Nội
(72) Nguyễn Tuấn Hải (VN)
(55)



1.1



1.2



1.3



1.4



1.5



1.6



1.7

CÔNG BÁO SỞ HỮU CÔNG NGHIỆP SỐ 402 TẬP A – QUYỀN 2 (09.2021)

(11) **42656**

(21) 3-2021-01806

(54) **GHẾ**

(22) 09/07/2021

(73) **CÔNG TY CỔ PHẦN GIẢI PHÁP NỘI THẤT FUT GROUP (VN)**

Số nhà 126, lô 14 La Casta, KĐT mới Văn Phú, phường Phú La, quận Hà Đông, thành phố Hà Nội

(72) Nguyễn Tuấn Hải (VN)

(55)

(28) 1

(51) **06-01**

(43) 27/09/2021



1.1



1.2



1.3



1.4



1.5



1.6



1.7

- (11) **42657**
(21) 3-2021-01807 (28) 1
(54) **CẤU KIỆN TẠO RỔNG CHO SÀN BÊ TÔNG** (51) **25-01; 25-02**
(22) 12/07/2021 (43) 27/09/2021
(73) **NGUYỄN XUÂN THỦY (VN)**
Tổ 3, khu 10, phường Bãi Cháy, thành phố Hạ Long, tỉnh Quảng Ninh
(72) Nguyễn Xuân Thủy (VN)
(55)

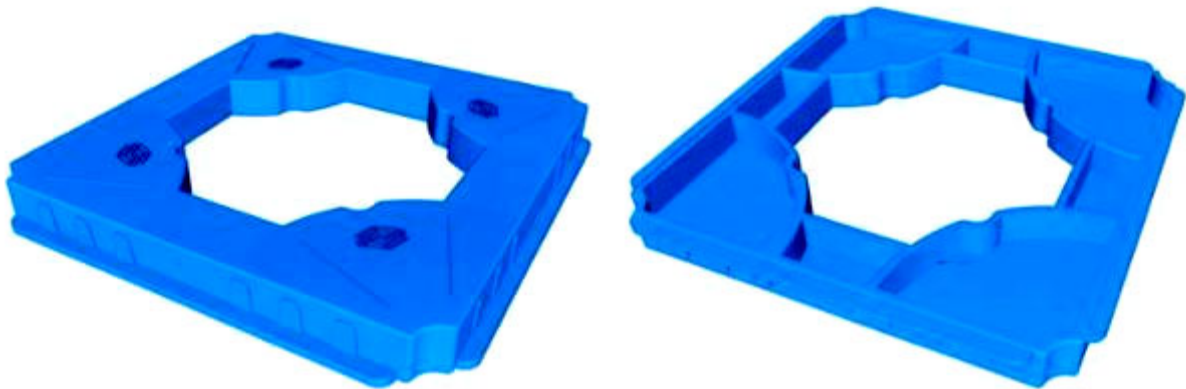

1.1

1.2



1.3

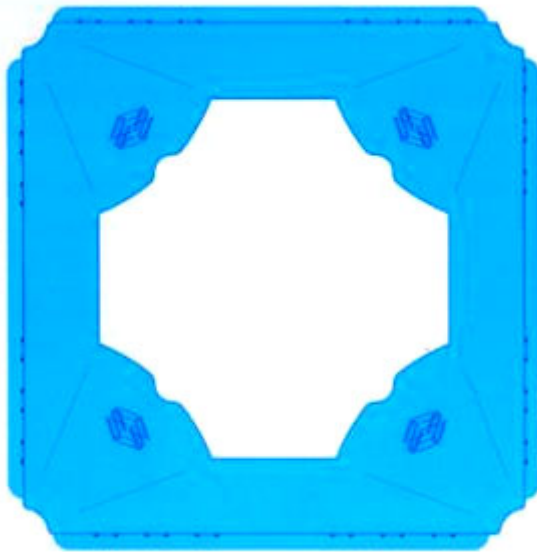

1.4



1.5

- (11) **42658**
(21) 3-2021-01808 (28) 1
(54) **CẤU KIỆN TẠO RỔNG CHO SÀN BÊ TÔNG** (51) **25-01; 25-02**
(22) 12/07/2021 (43) 27/09/2021
(73) **NGUYỄN XUÂN THỦY (VN)**
Tổ 3, khu 10, phường Bãi Cháy, thành phố Hạ Long, tỉnh Quảng Ninh
(72) Nguyễn Xuân Thủy (VN)
(55)



1.1



1.2

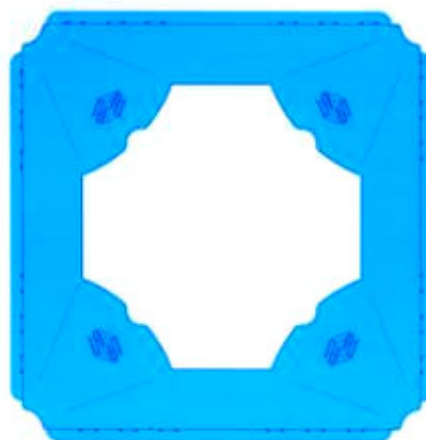

1.3

CÔNG BÁO SỞ HỮU CÔNG NGHIỆP SỐ 402 TẬP A – QUYỀN 2 (09.2021)

- (11) **42659**
(21) 3-2021-01810 (28) 1
(54) **HỘP ĐỰNG** (51) **09-03**
(22) 12/07/2021 (43) 27/09/2021
(73) **CÔNG TY CỔ PHẦN SỮA QUỐC TẾ (VN)**
Km 29, Quốc lộ 6, xã Trường Yên, huyện Chương Mỹ, thành phố Hà Nội
(72) Đặng Phạm Minh Loan (VN)
(74) Công ty TNHH Đại Tín và Liên Danh (DAITIN AND ASSOCIATES CO.,LTD)
(55)



1.1



1.2

CÔNG BÁO SỞ HỮU CÔNG NGHIỆP SỐ 402 TẬP A – QUYỀN 2 (09.2021)

- (11) **42660**
(21) 3-2021-01811 (28) 1
(54) **BAO GÓI** (51) **09-05**
(22) 12/07/2021 (43) 27/09/2021
(73) **HỢP TÁC XÃ DỊCH VỤ, SẢN XUẤT LÚA TÔM TRÍ LỰC (VN)**
Áp 5, xã Trí Lực, huyện Thới Bình, tỉnh Cà Mau
(72) Lê Quốc Triệu (VN)
(74) Công ty TNHH Sở hữu trí tuệ HA VIP (HAVIP CO., LTD.)
(55)



1.1



1.2

- (11) **42661**
(21) 3-2021-01815 (28) 1
(54) **LỌ** (51) **09-03**
(22) 12/07/2021 (43) 27/09/2021
(73) **LG HOUSEHOLD & HEALTH CARE LTD. (KR)**
58, Saemunan-ro, Jongno-gu, Seoul, Republic of Korea
(72) LEE, Hye Jin (KR)
(74) Công ty TNHH Tâm nhìn và Liên danh (VISION & ASSOCIATES CO.LTD.)
(55)

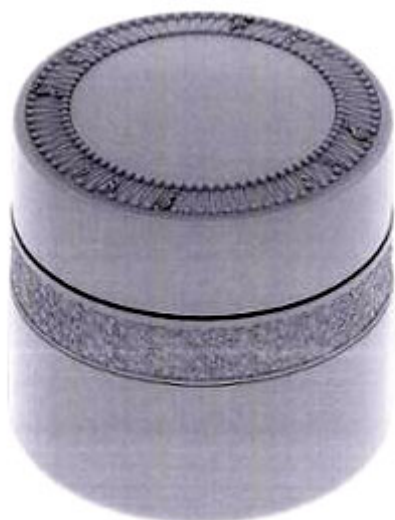

1.1

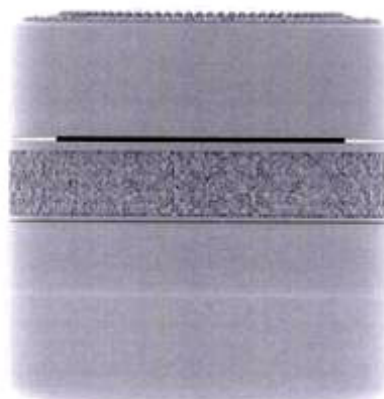

1.2

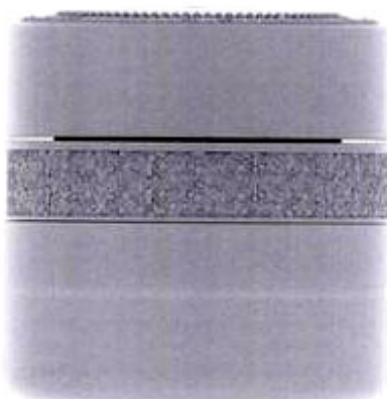

1.3

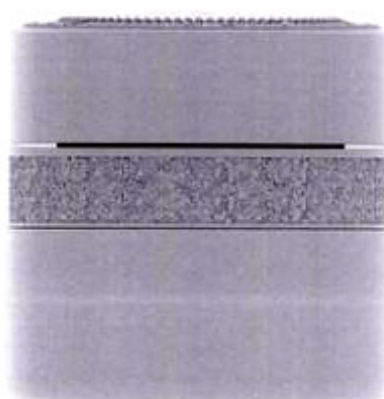

1.4

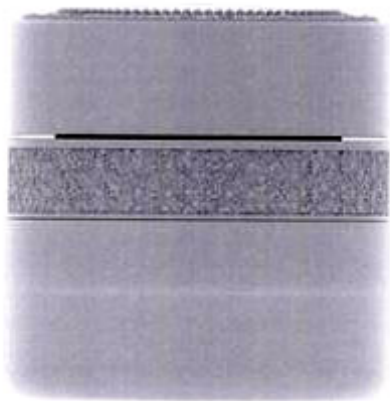

1.5

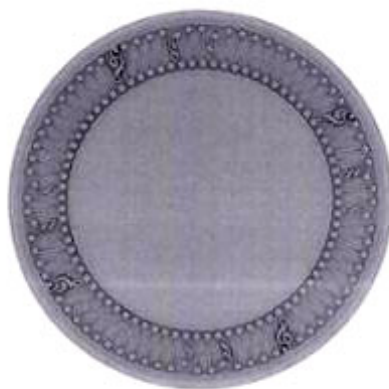

1.6

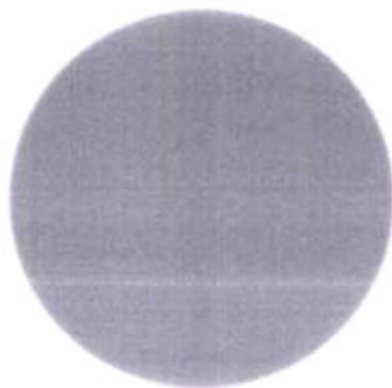

1.7

CÔNG BÁO SỞ HỮU CÔNG NGHIỆP SỐ 402 TẬP A – QUYỀN 2 (09.2021)

- (11) **42662**
(21) 3-2021-01824 (28) 1
(54) **NHÃN SẢN PHẨM** (51) **19-08**
(22) 14/07/2021 (43) 27/09/2021
(73) **CÔNG TY TNHH ĐẦU TƯ THƯƠNG MẠI VÀ XUẤT NHẬP KHẨU HC**
(VN)
Số 522, Minh Khai, phường Vĩnh Tuy, quận Hai Bà Trưng, thành phố Hà Nội
(72) Nguyễn Thị Huyền Châu (VN)
(55)



CÔNG BÁO SỞ HỮU CÔNG NGHIỆP SỐ 402 TẬP A – QUYỂN 2 (09.2021)

- (11) **42663**
(21) 3-2021-01825 (28) 1
(54) **NHÃN SẢN PHẨM** (51) **19-08**
(22) 14/07/2021 (43) 27/09/2021
(73) **CÔNG TY TRÁCH NHIỆM HỮU HẠN MỘT THÀNH VIÊN SMART BIO VIỆT NAM (VN)**
Số 39 Trần Khánh Dư, phường Tân Lợi, thành phố Buôn Ma Thuột, tỉnh Đắk Lắk
(72) Bùi Duy Hải (VN)
(55)

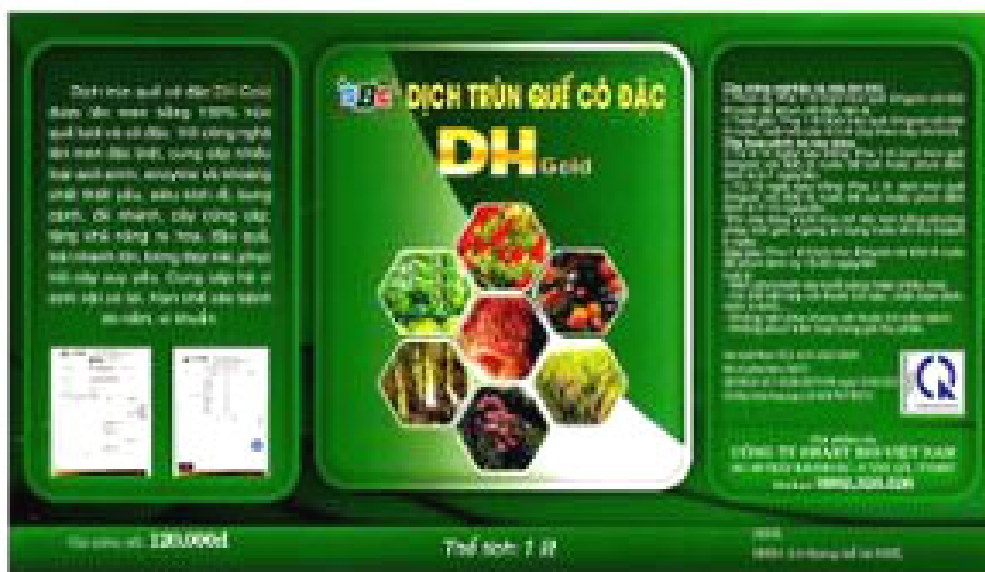

- (11) **42664**
(21) 3-2021-01826 (28) 1
(54) **LÒ THIÊU** (51) **23-99**
(22) 14/07/2021 (43) 27/09/2021
(73) **CÔNG TY CP NĂNG LƯỢNG VÀ MÔI TRƯỜNG BÁCH KHOA HÀ NỘI (VN)**
Khu đất ao phần tư, đường cảng Khuyến Lương, tổ 15, phường Yên Sở, quận Hoàng Mai, thành phố Hà Nội
(72) Nguyễn Đức Quyền (VN)
(74) Công ty TNHH Sáng chế ACTIP (ACTIP PATENT LIMITED)
(55)

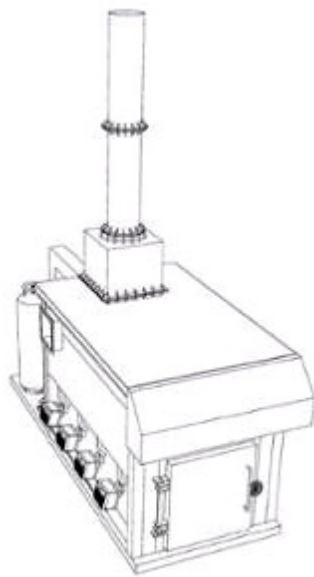

1.1

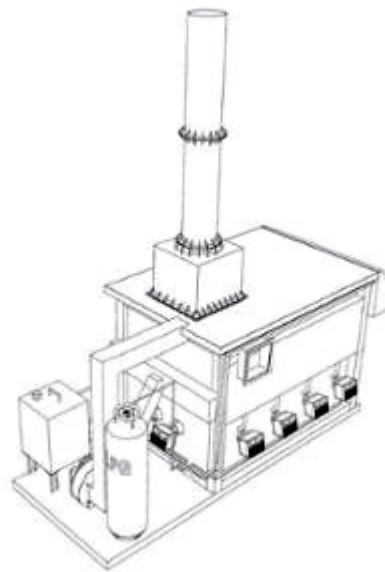

1.2

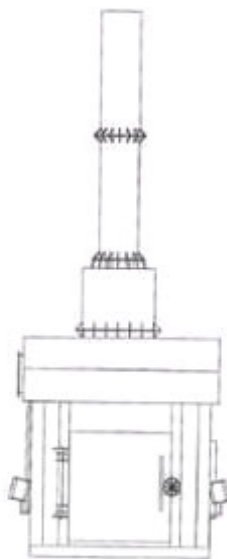

1.3

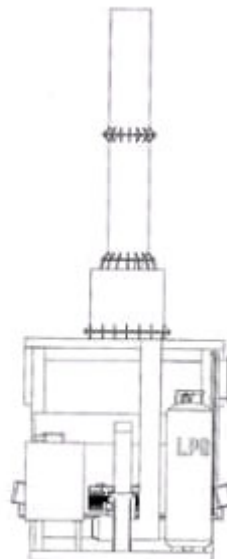

1.4

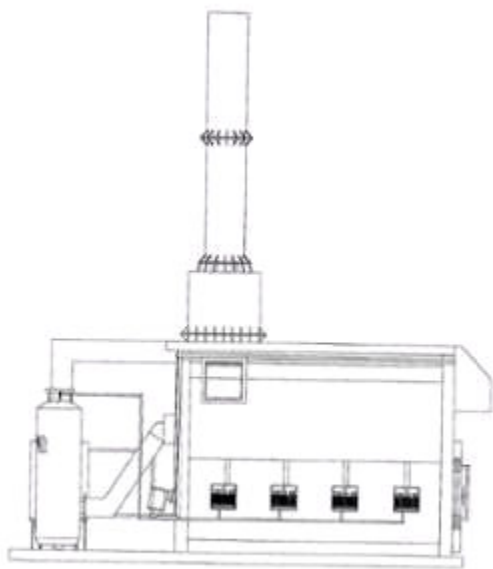

1.5

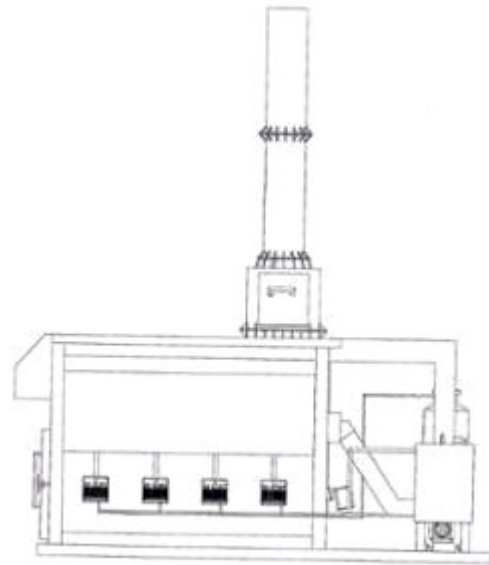

1.6

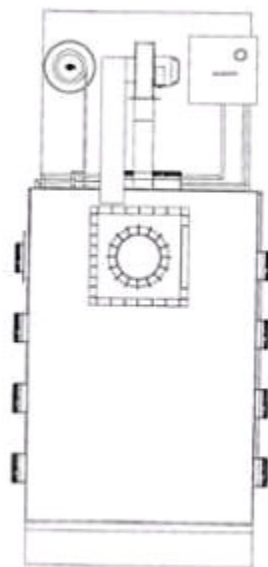

1.7

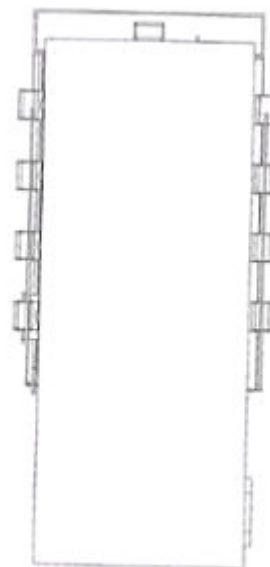

1.8

(11) **42665**

(21) 3-2021-01828

(54) **MÁY XẼ THÂN CÂY CHUỐI**

(22) 14/07/2021

(73) **CÔNG TY TNHH HỒ HOÀN CẦU (VN)**

Xóm 6, xã Quỳnh Văn, huyện Quỳnh Lưu, tỉnh Nghệ An

(72) Hồ Xuân Vinh (VN)

(55)

(28) 1

(51) **15-03**

(43) 27/09/2021



1.1

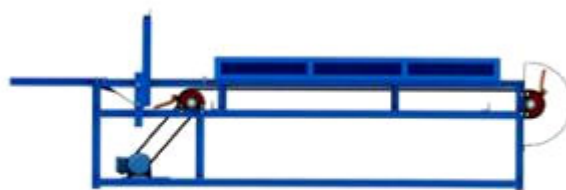

1.2



1.3



1.4



1.5



1.6



1.7



1.8

- (11) **42666**
(21) 3-2021-01830 (28) 2
(54) **HỘP ĐỰNG** (51) **09-03**
(22) 14/07/2021 (43) 27/09/2021
(73) **CÔNG TY CỔ PHẦN ĐẦU TƯ VÀ THƯƠNG MẠI DNA (VN)**
Số nhà 25 ngõ 6 phố Phương Mai, phường Phương Mai, quận Đống Đa, thành phố Hà Nội
(72) Bùi Trọng Lịch (VN)
(55)



1.1



1.2



2.1



2.2

CÔNG BÁO SỞ HỮU CÔNG NGHIỆP SỐ 402 TẬP A – QUYỀN 2 (09.2021)

(11) **42667**

(21) 3-2021-01838

(28) 1

(54) **XE Ô TÔ**

(51) **12-08**

(22) 15/07/2021

(43) 27/09/2021

(73) **CÔNG TY TNHH SẢN XUẤT VÀ KINH DOANH VINFAST (VN)**

Khu Kinh tế Đình Vũ-Cát Hải, đảo Cát Hải, thị trấn Cát Hải, huyện Cát Hải, thành phố Hải Phòng

(72) Jaehoon Lee (NZ)

(74) **CÔNG TY LUẬT TRÁCH NHIỆM HỮU HẠN AMBYS HÀ NỘI (AMBYS HANOI)**

(55)



1.1



1.2



1.3



1.4



1.5



1.6

CÔNG BÁO SỞ HỮU CÔNG NGHIỆP SỐ 402 TẬP A – QUYỀN 2 (09.2021)

- (11) **42668**
(21) 3-2021-01841 (28) 1
(54) **DÉP** (51) **02-04**
(22) 16/07/2021 (43) 27/09/2021
(73) **CÔNG TY TNHH SẢN XUẤT THƯƠNG MẠI XUẤT NHẬP KHẨU ĐỨC HOA (VN)**
Tỉnh lộ 830, ấp 3, xã An Thạnh, huyện Bến Lức, tỉnh Long An
(72) Trần Đức (VN)
(74) Công ty TNHH Sở hữu trí tuệ Đại Diện (IPACO.,LTD.)
(55)



1.1

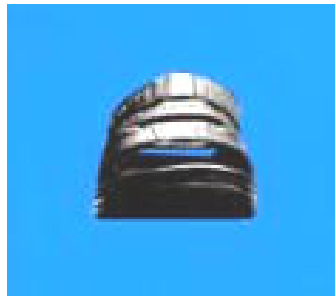

1.2



1.3



1.4



1.5



1.6



1.7

CÔNG BÁO SỞ HỮU CÔNG NGHIỆP SỐ 402 TẬP A – QUYỀN 2 (09.2021)

- (11) **42669**
(21) 3-2021-01843 (28) 1
(54) **DÉP** (51) **02-04**
(22) 16/07/2021 (43) 27/09/2021
(73) **CÔNG TY TNHH SẢN XUẤT THƯƠNG MẠI XUẤT NHẬP KHẨU ĐỨC HOA (VN)**
Tỉnh lộ 830, ấp 3, xã An Thạnh, huyện Bến Lức, tỉnh Long An
(72) Trần Đức (VN)
(74) Công ty TNHH Sở hữu trí tuệ Đại Diện (IPACO.,LTD.)
(55)



1.1

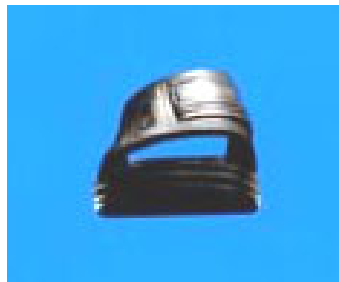

1.2

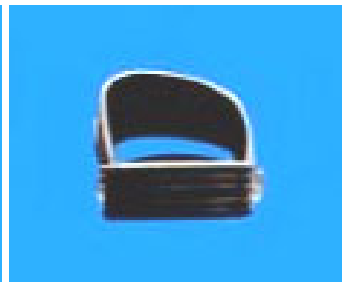

1.3



1.4



1.5



1.6



1.7

CÔNG BÁO SỞ HỮU CÔNG NGHIỆP SỐ 402 TẬP A – QUYỀN 2 (09.2021)

(11) **42670**

(21) 3-2021-01844

(28) 1

(54) **DÉP**

(51) **02-04**

(22) 16/07/2021

(43) 27/09/2021

(73) **CÔNG TY TNHH SẢN XUẤT THƯƠNG MẠI XUẤT NHẬP KHẨU ĐỨC HOA (VN)**

Tỉnh lộ 830, ấp 3, xã An Thạnh, huyện Bến Lức, tỉnh Long An

(72) Trần Đức (VN)

(74) Công ty TNHH Sở hữu trí tuệ Đại Diện (IPACO.,LTD.)

(55)



1.1



1.2

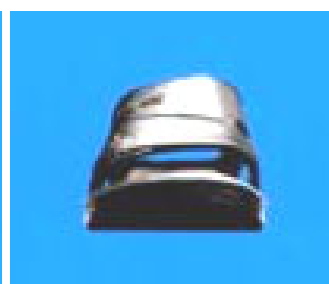

1.3



1.4



1.5



1.6



1.7

CÔNG BÁO SỞ HỮU CÔNG NGHIỆP SỐ 402 TẬP A – QUYỀN 2 (09.2021)

- (11) **42671**
(21) 3-2021-01845 (28) 1
(54) **DÉP** (51) **02-04**
(22) 16/07/2021 (43) 27/09/2021
(73) **CÔNG TY TNHH SẢN XUẤT THƯƠNG MẠI XUẤT NHẬP KHẨU ĐỨC HOA (VN)**
Tỉnh lộ 830, ấp 3, xã An Thạnh, huyện Bến Lức, tỉnh Long An
(72) Trần Đức (VN)
(74) Công ty TNHH Sở hữu trí tuệ Đại Diện (IPACO.,LTD.)
(55)



1.1

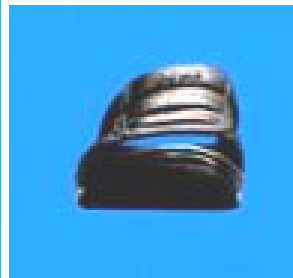

1.2



1.3



1.4



1.5



1.6



1.7

CÔNG BÁO SỞ HỮU CÔNG NGHIỆP SỐ 402 TẬP A – QUYỀN 2 (09.2021)

(11) **42672**

(21) 3-2021-01846

(28) 1

(54) **DÉP**

(51) **02-04**

(22) 16/07/2021

(43) 27/09/2021

(73) **CÔNG TY TNHH SẢN XUẤT THƯƠNG MẠI XUẤT NHẬP KHẨU ĐỨC HOA (VN)**

Tỉnh lộ 830, ấp 3, xã An Thạnh, huyện Bến Lức, tỉnh Long An

(72) Trần Đức (VN)

(74) Công ty TNHH Sở hữu trí tuệ Đại Diện (IPACO.,LTD.)

(55)



1.1



1.2



1.3



1.4



1.5



1.6



1.7

CÔNG BÁO SỞ HỮU CÔNG NGHIỆP SỐ 402 TẬP A – QUYỀN 2 (09.2021)

- (11) **42673**
(21) 3-2021-01847 (28) 1
(54) **DÉP** (51) **02-04**
(22) 16/07/2021 (43) 27/09/2021
(73) **CÔNG TY TNHH SẢN XUẤT THƯƠNG MẠI XUẤT NHẬP KHẨU ĐỨC HOA (VN)**
Tỉnh lộ 830, ấp 3, xã An Thạnh, huyện Bến Lức, tỉnh Long An
(72) Trần Đức (VN)
(74) Công ty TNHH Sở hữu trí tuệ Đại Diện (IPACO.,LTD.)
(55)



1.1



1.2



1.3



1.4



1.5



1.6



1.7

CÔNG BÁO SỞ HỮU CÔNG NGHIỆP SỐ 402 TẬP A – QUYỀN 2 (09.2021)

- (11) **42674**
(21) 3-2021-01850 (28) 1
(54) **THIẾT BỊ NGUỒN VIỄN THÔNG** (51) **14-02; 14-03**
(22) 16/07/2021 (43) 27/09/2021
(73) **TỔNG CÔNG TY VIỄN THÔNG MOBIFONE (VN)**
Số 01 phố Phạm Văn Bạch, phường Yên Hoà, quận Cầu Giấy, thành phố Hà Nội
(72) Trịnh Tuấn Hải (VN)
(74) Công ty TNHH Tư vấn đầu tư và Sở hữu trí tuệ Hoàng Phi (HOANG PHI INVEST & I.P CO., LTD)
(55)



1.1



1.2



1.3



1.4



1.5

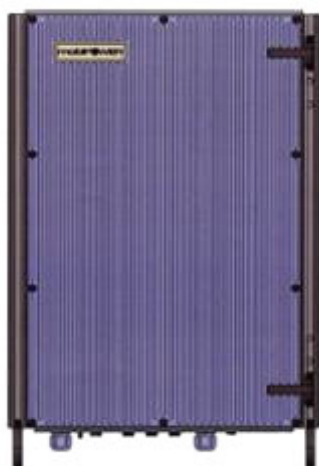

1.6



1.7

- (11) **42675**
(21) 3-2021-01860 (28) 1
(54) **BUỒNG KHỬ KHUẨN** (51) **24-01**
(22) 19/07/2021 (43) 27/09/2021
(73) **VIỆN NGHIÊN CỨU VÀ ỨNG DỤNG CÔNG NGHỆ CAO HÒA LẠC (VN)**
Khu Công nghệ cao Hòa Lạc, Km 29 đại lộ Thăng Long, xã Thạch Hoà, huyện
Thạch Thất, thành phố Hà Nội
(72) 1. NGUYỄN TRUNG THỰC (VN)
2. NGUYỄN ĐÌNH MẠNH (VN)
(55)



1.1



1.2



1.3

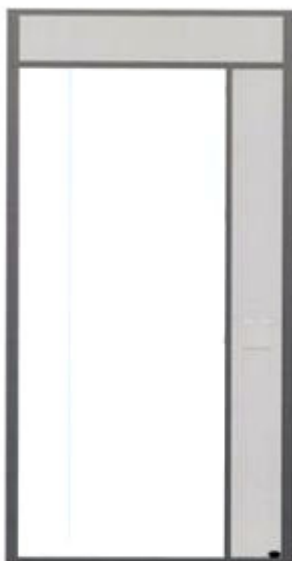

1.4



1.5



1.6



1.7

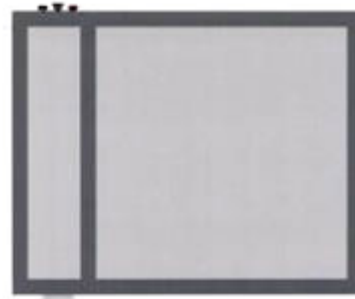

1.8

CÔNG BÁO SỞ HỮU CÔNG NGHIỆP SỐ 402 TẬP A – QUYỀN 2 (09.2021)

- (11) **42676**
(21) 3-2021-01861 (28) 2
(54) **BỘ KHÓA CỬA THÔNG MINH** (51) **08-07**
(22) 19/07/2021 (43) 27/09/2021
(73) 1. **CÔNG TY CỔ PHẦN LUMI VIỆT NAM (VN)**
38 Đỗ Đức Dục, phường Mỹ Trì, quận Nam Từ Liêm, thành phố Hà Nội
2. **CÔNG TY CỔ PHẦN KHÓA VIỆT - TIỆP (VN)**
Thị trấn Đông Anh, huyện Đông Anh, thành phố Hà Nội
(72) 1. NGUYỄN TUẤN ANH (VN)
2. NGUYỄN VĂN TUẤN (VN)
(55)



1.1

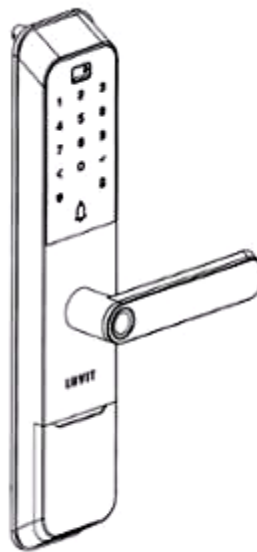

1.2

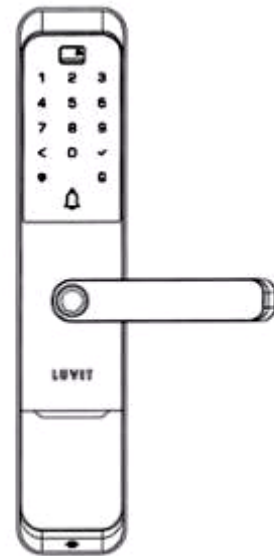

1.3

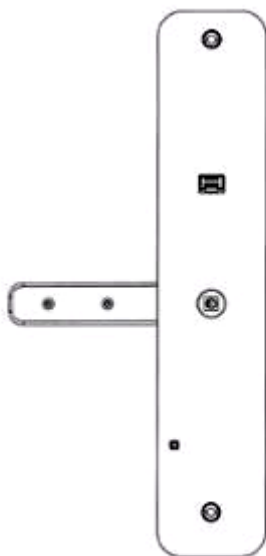

1.4

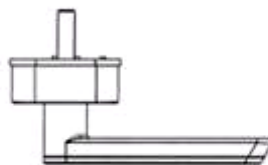

1.5

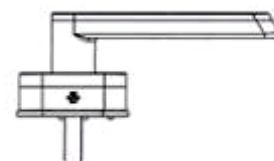

1.6

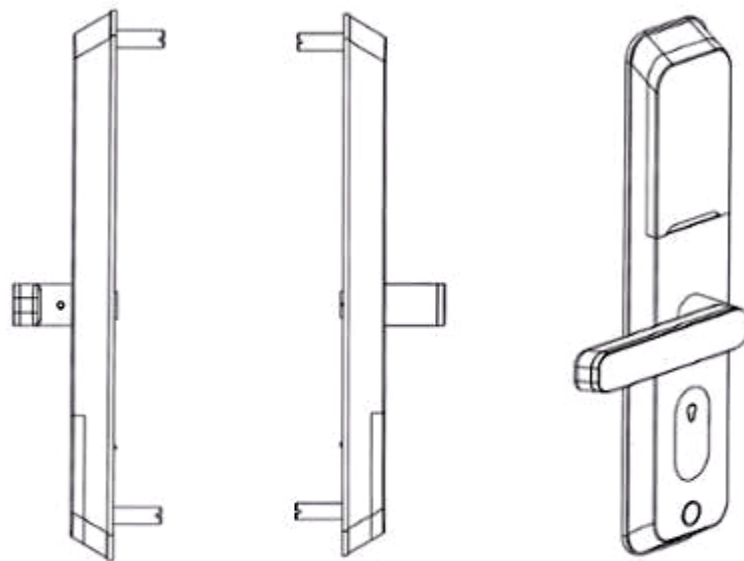

1.7

1.8

1.9

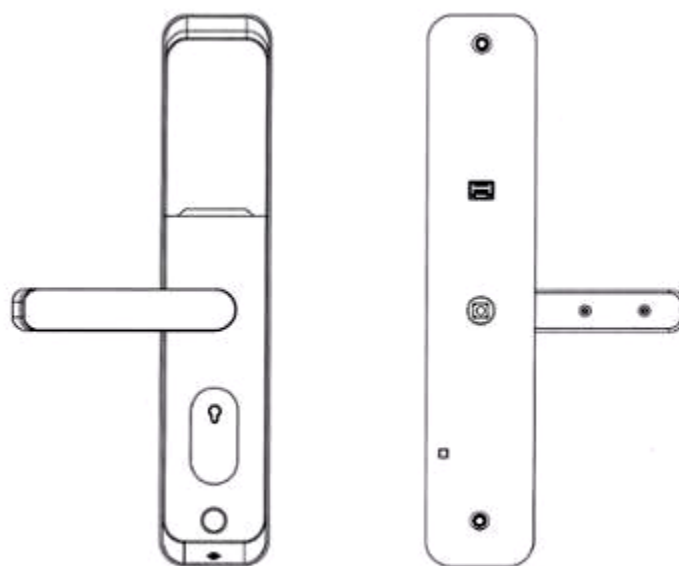

1.10

1.11

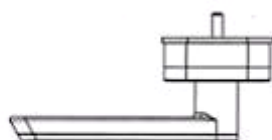

1.12

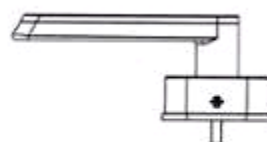

1.13



1.14

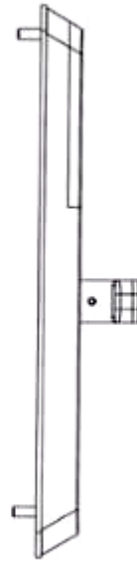

1.15

CÔNG BÁO SỞ HỮU CÔNG NGHIỆP SỐ 402 TẬP A – QUYỀN 2 (09.2021)

- (11) **42677**
(21) 3-2021-01885 (28) 1
(54) **LỌ** (51) **09-01**
(22) 19/07/2021 (43) 27/09/2021
(73) **LG HOUSEHOLD & HEALTH CARE LTD. (KR)**
58, Saemunan-ro, Jongno-gu, Seoul, Republic of Korea
(72) JEONG, Song Eun (KR)
(74) Công ty TNHH Tâm nhìn và Liên danh (VISION & ASSOCIATES CO.LTD.)
(55)



1.1



1.2



1.3



1.4



1.5



1.6



1.7

CÔNG BÁO SỞ HỮU CÔNG NGHIỆP SỐ 402 TẬP A – QUYỀN 2 (09.2021)

- (11) **42678**
(21) 3-2021-01886 (28) 1
(54) **LỌ** (51) **09-03**
(22) 19/07/2021 (43) 27/09/2021
(73) **LG HOUSEHOLD & HEALTH CARE LTD. (KR)**
58, Saemunan-ro, Jongno-gu, Seoul, Republic of Korea
(72) PARK, Suk Young (KR)
(74) Công ty TNHH Tâm nhìn và Liên danh (VISION & ASSOCIATES CO.LTD.)
(55)



1.1



1.2



1.3



1.4



1.5



1.6



1.7

CÔNG BÁO SỞ HỮU CÔNG NGHIỆP SỐ 402 TẬP A – QUYỀN 2 (09.2021)

- (11) **42679**
(21) 3-2021-01887 (28) 1
(54) **XE MÁY** (51) **12-11**
(22) 19/07/2021 (43) 27/09/2021
(30) 2021-001585 26/01/2021 JP;
(73) **HONDA MOTOR CO., LTD. (JP)**
1-1, Minami-Aoyama 2-chome, Minato-ku, Tokyo, 107-8556 Japan
(72) 1. WORAWIT CHAWALITNIMITKUL (TH)
2. JATURONG APIROMBOONSOM (TH)
(74) Công ty Luật TNHH Phạm và Liên danh (PHAM & ASSOCIATES)
(55)



1.1



1.2



1.3



1.4



1.5



1.6



1.7



1.8



1.9



1.10

- (11) **42680**
(21) 3-2021-01888 (28) 1
(54) **CỤM ĐÈN PHÍA SAU XE SCUTO** (51) **26-06**
(22) 19/07/2021 (43) 27/09/2021
(30) 2021-001637 26/01/2021 JP;
(73) **HONDA MOTOR CO., LTD. (JP)**
1-1, Minami-Aoyama 2-Chome, Minato-ku, Tokyo, 107-8556 Japan
(72) 1. JINGWEN KUANG (CN)
2. YANAN QIN (CN)
(74) Công ty Luật TNHH Phạm và Liên danh (PHAM & ASSOCIATES)
(55)



1.1



1.2



1.3



1.4



1.5



1.6



1.7



1.8

CÔNG BÁO SỞ HỮU CÔNG NGHIỆP

Do Cục Sở hữu trí tuệ thuộc Bộ Khoa học và Công nghệ ấn hành theo Luật Sở hữu trí tuệ số 50/2005/QH11 được Quốc hội thông qua ngày 29 tháng 11 năm 2005 và được sửa đổi bằng Luật sửa đổi, bổ sung một số điều của Luật sở hữu trí tuệ số 50/2005/QH11 được Quốc hội thông qua ngày 19 tháng 6 năm 2009.

Địa chỉ liên hệ:

384-386 đường Nguyễn Trãi, quận Thanh Xuân,
thành phố Hà Nội, Việt Nam
ĐT: 024. 38583069
Fax: 024. 38588449