

ISSN 0868 - 2534

CỘNG HÒA XÃ HỘI CHỦ NGHĨA VIỆT NAM  
BỘ KHOA HỌC VÀ CÔNG NGHỆ

CỤC SỞ HỮU TRÍ TUỆ

---

**CÔNG BÁO**  
**SỞ HỮU CÔNG NGHIỆP**

TẬP A

QUYỂN 2: KIỂU DÁNG CÔNG NGHIỆP

07 - 2021

400

---

HÀ NỘI

CỘNG HOÀ XÃ HỘI CHỦ NGHĨA VIỆT NAM  
BỘ KHOA HỌC VÀ CÔNG NGHỆ  
CỤC SỞ HỮU TRÍ TUỆ

---

CÔNG BÁO  
SỞ HỮU CÔNG NGHIỆP  
TẬP A

QUYỂN 2: KIỂU DÁNG CÔNG NGHIỆP

07-2021

400

---

HÀ NỘI

## MỤC LỤC

	Trang
<u>PHẦN I:</u> Đơn yêu cầu cấp Bằng độc quyền kiểu dáng công nghiệp	7
<u>PHẦN II:</u> Sửa đổi đơn	458
<u>PHẦN III:</u> Thay đổi chủ đơn	473

## CONTENTS

<u>PART I:</u> Applications for Industrial Design Patents	7
<u>PART II:</u> Amendment of Applications	458
<u>PART III:</u> Change of Applicants	473

---

**CÔNG BÁO SỞ HỮU CÔNG NGHIỆP SỐ 400 TẬP A - QUYỂN 2 (07.2021)**

**MÃ SỐ HAI CHỮ CÁI THỂ HIỆN TÊN NƯỚC VÀ CÁC THỰC THỂ KHÁC TRONG CÁC TƯ LIỆU SỞ HỮU CÔNG NGHIỆP THEO TIÊU CHUẨN ST3 CỦA WIPO**

AE	United Arab Emirates	CN	China	HK	Hong Kong
AF	Afganistan	CO	Colombia	HN	Honduras
AG	Antihua and Barbuda	CR	Costa Rica	HR	Croatia
AI	Anguilla	CU	Cuba	HT	Haiti
AL	Albania	CV	Cape Verde	HU	Hungary
AN	Netherlands Antilles	CY	Cyprus	ID	Indonesia
AO	Angola	CZ	Czech Republic	IE	Ireland
AR	Argentina	DE	Germany	IL	Israel
AT	Austria	DJ	Djibouti	IN	India
AU	Australia	DK	Denmark	IQ	Iraq
AW	Aruba	DM	Dominica	IR	Iran (Islamic Republic of)
BB	Barbados	DO	Dominican Republic	IS	Iceland
BD	Bangladesh	DZ	Algeria	IT	Italy
BE	Belgium	EC	Ecuador	JM	Jamaica
BF	Burkina Faso	EE	Estonia	JO	Jordan
BG	Bulgaria	EG	Egypt	JP	Japan
BH	Bahrain	ES	Spain	KE	Kenya
BI	Burundi	ET	Ethiopia	KH	Cambodia
BJ	Benin	FI	Finland	KI	Kiribati
BM	Bermuda	FJ	Fiji	KM	Comoros
BN	Brunei Darussalam	FK	Falkand Islands (Malvinas)	KN	Saint Kitts and Nevis
BO	Bolivia	FR	France	KP	Democratic People's Republic of Korea
BR	Brazil	GA	Gabon	KR	Republic of Korea
BS	Bahamas	GB	United Kingdom	KW	Kuwait
BT	Bhutan	GD	Grenada	KY	Cayman Islands
BW	Botswana	GE	Georgia	KZ	Kazakhstan
BY	Belarus	GH	Ghana	LA	Laos
BZ	Belize	GI	Gibraltar	LB	Lebanon
CA	Canada	GM	Gambia	LC	Saint Lucia
CF	Central African Republic	GN	Guinea	LI	Liechtenstein
CG	Congo	GQ	Equatorial Guinea	LK	SriLanka
CH	Switzerland	GR	Greece	LR	Liberia
CI	Côte d'Ivoire	GT	Guatemala	LS	Lesotho
CL	Chile	GW	Guinea-Bissau	LT	Lithuania
CM	Cameroon	GY	Guyana	TC	Turk and Caicos Islands
LU	Luxembourg	PA	Panama	TD	Chad
LV	Latvia	PE	Peru	TG	Togo
LY	Lybya	PG	Papua New Guinea	TH	Thailand
MA	Morocco	PH	Philippines	TN	Tunisia
MC	Monaco	PK	Pakistan	TO	Tonga
MD	Republic of Moldova	PL	Poland	TR	Turkey

**CÔNG BÁO SỞ HỮU CÔNG NGHIỆP SỐ 400 TẬP A - QUYỂN 2 (07.2021)**

MG	Madagascar	PT	Portugal	TT	Trinidad and Tobago
ML	Mali	PY	Paraguay	TV	Tuvalu
MM	Myanmar	QA	Qatar	TW	Taiwan, Province of China
MN	Mongolia	RO	Rumania	TZ	United Republic of Tanzania
MO	Macau	RU	Russian Federation	UA	Ukraine
MR	Mauritania	RW	Rwanda	UG	Uganda
MS	Montserrat	SA	Saudi Arabia	US	United States of America
MT	Malta	SB	Solomon Islands	UY	Uruguay
MU	Mauritius	SC	Seychelles	UZ	Uzbekistan
MV	Maldives	SD	Sudan	VA	Holy see
MW	Malawi	SE	Sweden	VC	Saint Vincent and the Grenadines
MX	Mexico	SG	Singapore	VE	Venezuela
MY	Malaysia	SH	Saint Helena	VG	Virgin Islands (British)
MZ	Mozambique	SL	Slovenia	VN	Vietnam
NA	Namibia	SK	Slovakia	VU	Vanuatu
NE	Niger	SL	Sierra Leone	WS	Samoa
NG	Nigeria	SM	San Marino	YE	Yemen
NJ	Nicaragua	SN	Senegal	YU	Yugoslavia
NL	Netherlands	SO	Somalia	ZA	South Africa
NO	Norway	SR	Suriname	ZM	Zambia
NP	Nepal	ST	Sao Tome and Principe	ZR	Zaire
NR	Nauru	SV	El Sanvador	ZW	Zimbabwe
NZ	New Zealand	SY	Syria		
OM	Oman	SZ	Swaziland		

**CÁC TỔ CHỨC QUỐC TẾ**

AO	African Intellectual Property Organization (OAPI)
AP	African Regional Industrial Property Organization (ARIPO)
BX	Benelux Trademark Office and Benelux Designs Office
EP	European Patent Office (EPO)
IB, WO	International Bureau of the World Intellectual Property Organization (WIPO)

**NHỮNG MÃ SỐ INID TRÍCH TỪ TIÊU CHUẨN ST80 CỦA TỔ CHỨC SỞ HỮU TRÍ TUỆ THẾ GIỚI (WIPO) ĐỂ NHẬN BIẾT CÁC DỮ LIỆU THƯ MỤC DÙNG CÔNG BỐ ĐƠN VÀ BẰNG ĐỘC QUYỀN KIỂU DÁNG CÔNG NGHIỆP**

- (11) Số bằng độc quyền kiểu dáng công nghiệp / Số công bố đơn
- (15) Ngày cấp
- (18) Ngày hết hạn hiệu lực của bằng độc quyền kiểu dáng công nghiệp
- (21) Số đơn
- (22) Ngày nộp đơn
- (23) Tên triển lãm, ngày và nơi triển lãm
- (28) Số phương án yêu cầu bảo hộ
- (30) Số đơn ưu tiên, ngày nộp đơn ưu tiên
- (43) Ngày công bố đơn
- (45) Ngày công bố bằng độc quyền kiểu dáng công nghiệp
- (51) Phân loại quốc tế kiểu dáng công nghiệp
- (54) Tên sản phẩm mang kiểu dáng công nghiệp
- (55) Ảnh chụp / hình vẽ kiểu dáng công nghiệp
- (57) Đặc điểm khác biệt yêu cầu bảo hộ của kiểu dáng công nghiệp
- (62) Số và ngày nộp đơn, số bằng độc quyền KDCN hoặc số công bố đơn liên quan đến tách đơn
- (71) Tên và địa chỉ của người nộp đơn
- (72) Tên của tác giả KDCN
- (73) Tên, địa chỉ của chủ bằng độc quyền KDCN
- (74) Tên của người đại diện SHCN

PHẦN I

**ĐƠN YÊU CẦU CẤP BẰNG ĐỘC QUYỀN KIỂU DÁNG CÔNG NGHIỆP**

(11) **41932**

(21) 3-2018-02875

(28) 1

(54) **CỎ NHÂN TẠO**

(51) **11-04**

(22) 28/12/2018

(43) 26/07/2021

**QINGDAO BELLINTURF INDUSTRIAL CO., LTD. (CN)**

(73) No. 8, Jilin Road, Beiguan Industrial Zone, Jiaozhou, Qingdao Shandong, 266300, China

(72) YU, Kang (CN)

(74) Công ty Cổ phần Sở hữu công nghiệp INVESTIP (INVESTIP)

(55)



1.1



1.2



1.3



1.4



1.5

**CÔNG BÁO SỞ HỮU CÔNG NGHIỆP SỐ 400 TẬP A – QUYỀN 2 (07.2021)**

(11) **41933**

(21) 3-2018-02876

(28) 1

(54) **CỔ NHÂN TẠO**

(51) **11-04**

(22) 28/12/2018

(43) 26/07/2021

**QINGDAO BELLINTURF INDUSTRIAL CO., LTD. (CN)**

(73) No. 8, Jilin Road, Beiguan Industrial Zone, Jiaozhou, Qingdao Shandong, 266300, China

(72) YU, Kang (CN)

(74) Công ty Cổ phần Sở hữu công nghiệp INVESTIP (INVESTIP)

(55)

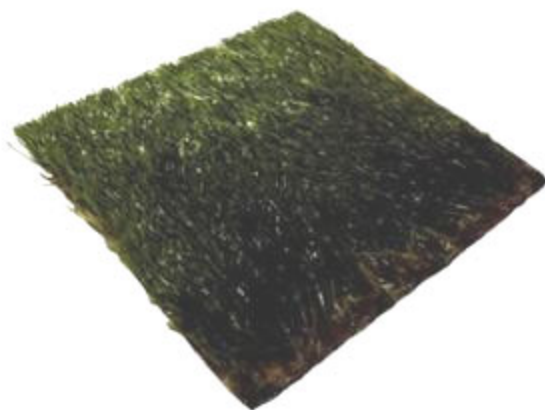

1.1



1.2



1.3



1.4



1.5



**CÔNG BÁO SỞ HỮU CÔNG NGHIỆP SỐ 400 TẬP A – QUYỀN 2 (07.2021)**

(11) **41934**

(21) 3-2018-02877

(28) 1

(54) **CỔ NHÂN TẠO**

(51) **11-04**

(22) 28/12/2018

(43) 26/07/2021

**QINGDAO BELLINTURF INDUSTRIAL CO., LTD. (CN)**

(73) No. 8, Jilin Road, Beiguan Industrial Zone, Jiaozhou, Qingdao Shandong, 266300, China

(72) YU, Kang (CN)

(74) Công ty Cổ phần Sở hữu công nghiệp INVESTIP (INVESTIP)

(55)



1.1

1.2



1.3



1.4



1.5

(11) **41935**

(21) 3-2019-02812

(54) **NHÃN**

(22) 06/11/2019

(28) 1

(51) **11-01**

(43) 26/07/2021

(73) **CÔNG TY CỔ PHẦN NGỌC TRAI HOÀNG GIA (VN)**

1158 Huỳnh Tấn Phát, KP5, phường Tân Phú, quận 7, thành phố Hồ Chí Minh

(72) Hồ Thanh Tuấn (VN)

(74) Công ty Cổ phần Sở hữu công nghiệp INVESTIP (INVESTIP)

(55)

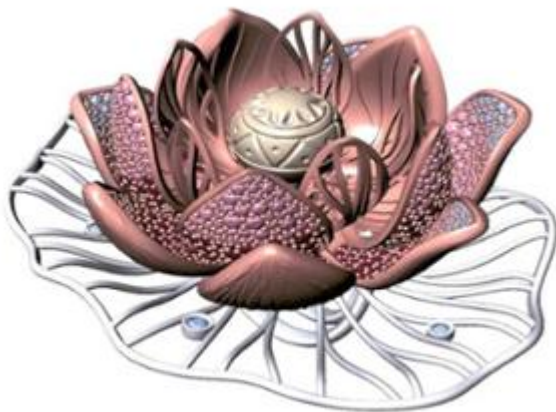

1.1



1.2



1.3



1.4



1.5

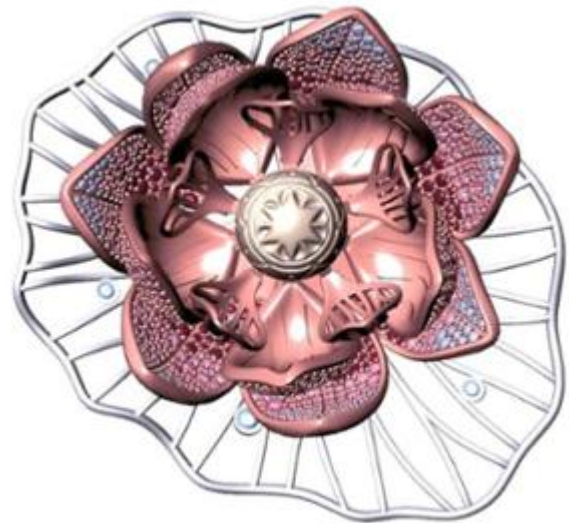

1.6

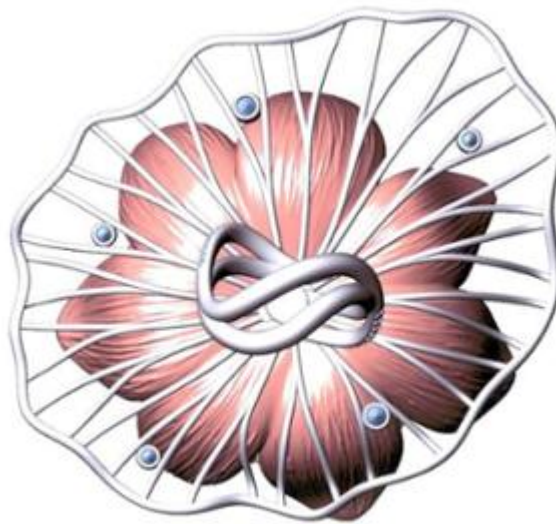

1.7

- (11) **41936**  
(21) 3-2019-03392 (28) 32  
(54) **CỐC** (51) **07-01**  
(22) 24/12/2019 (43) 26/07/2021  
(30) 29/695,988 24/06/2019 US;  
(73) **BALL CORPORATION (US)**  
10 Longs Peak Drive Broomfield, Colorado 80021, UNITED STATES  
1. JONATHAN A. WHITMORE (US)  
(72) 2. MARK A. JACOBBER (US)  
3. ANTHONY J. SCOTT (US)  
(74) Công ty TNHH Trường Xuân (AGELESS CO.,LTD.)  
(55)

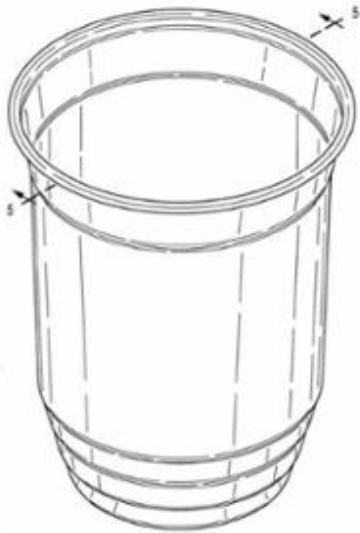

1.1



1.2

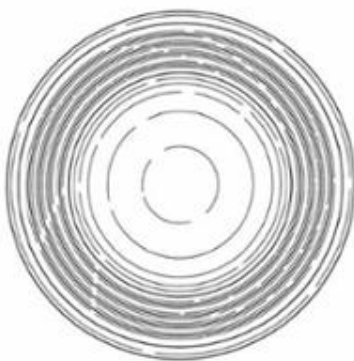

1.3

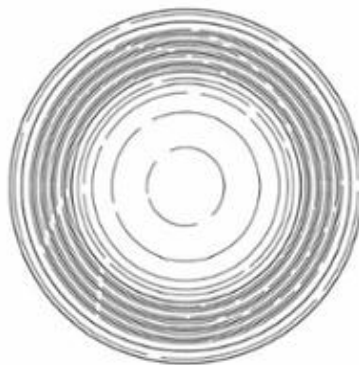

1.4

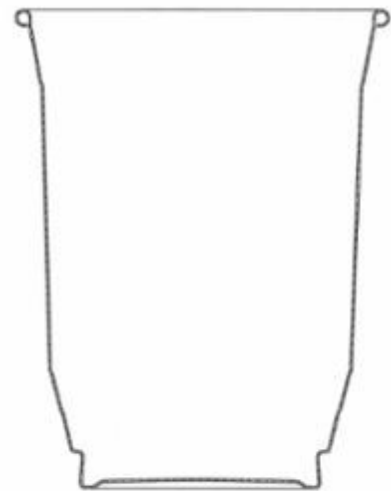

1.5

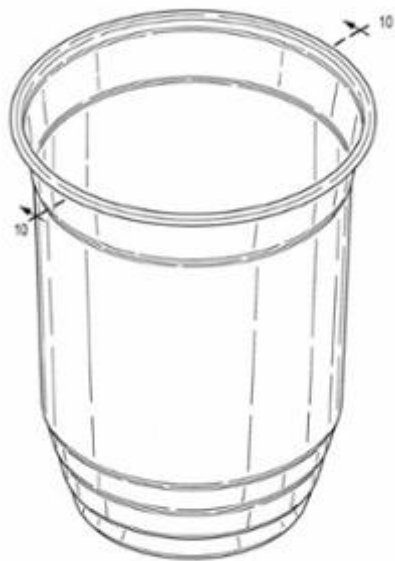

2.1



2.2

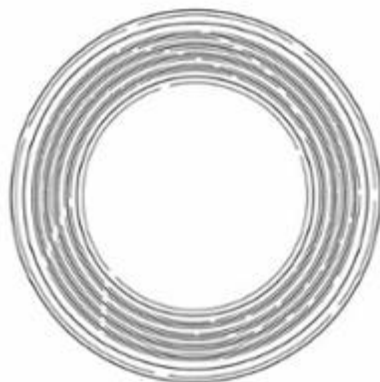

2.3

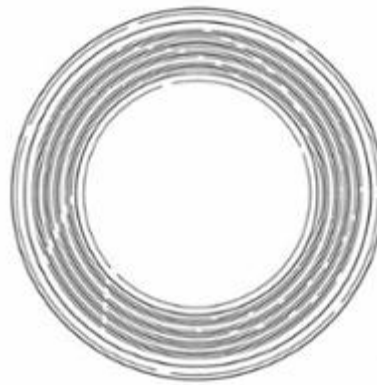

2.4

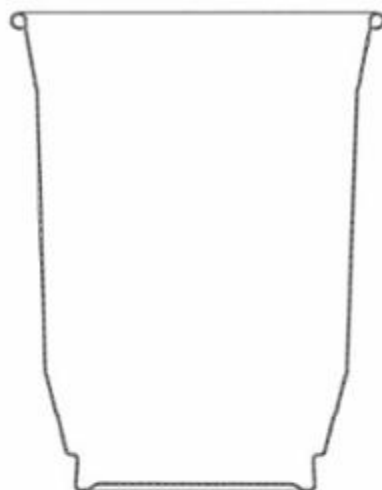

2.5

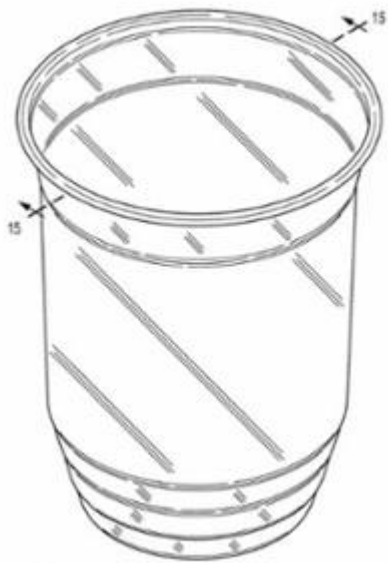

3.1

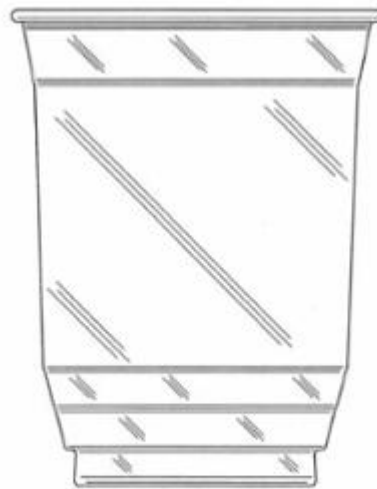

3.2

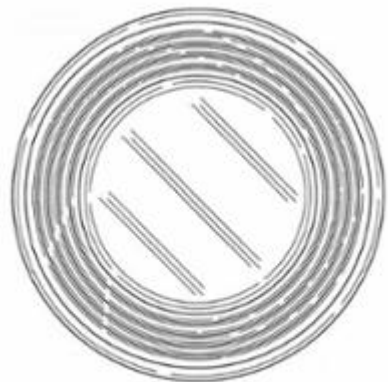

3.3

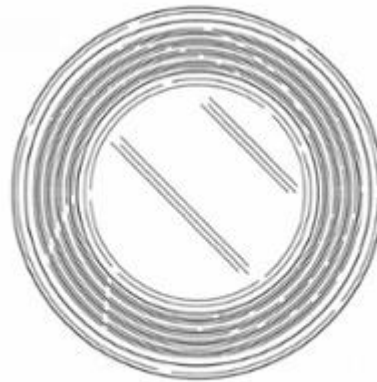

3.4

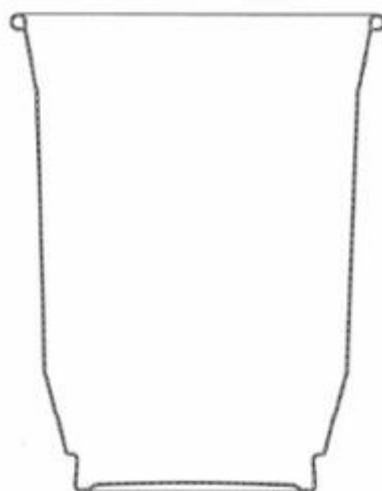

3.5

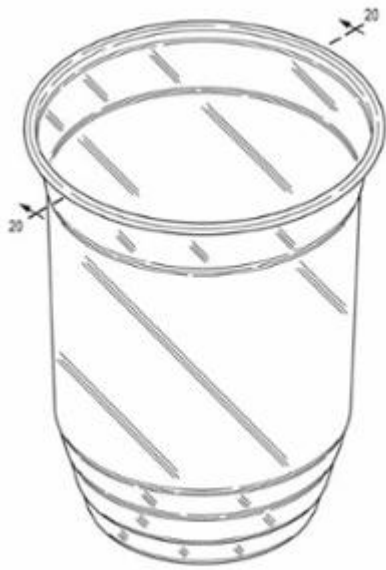

4.1

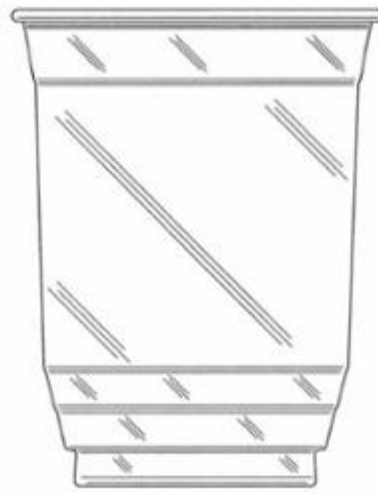

4.2

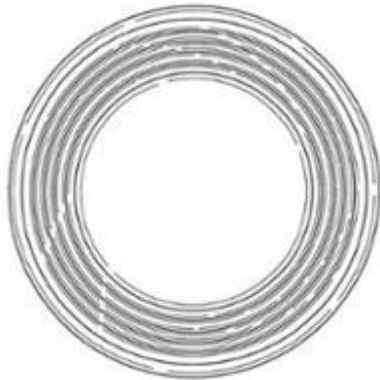

4.3

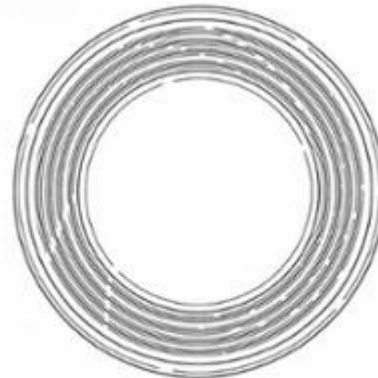

4.4

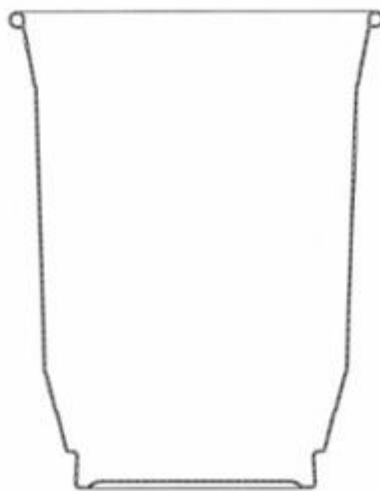

4.5

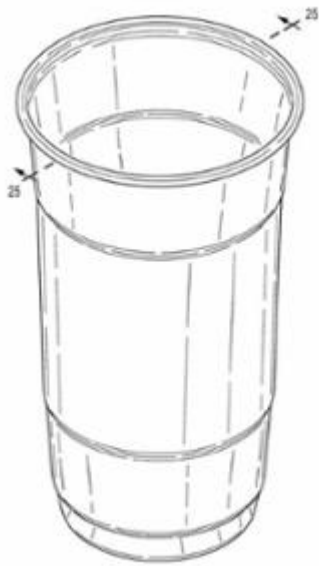

5.1

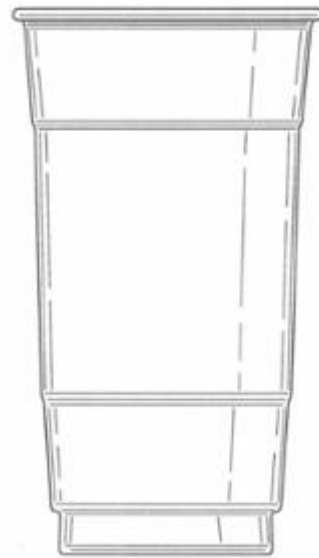

5.2

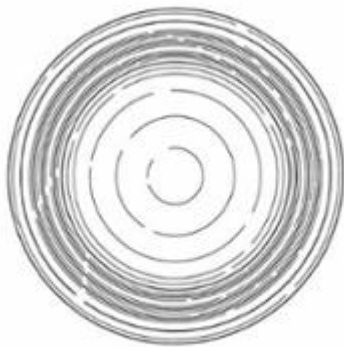

5.3

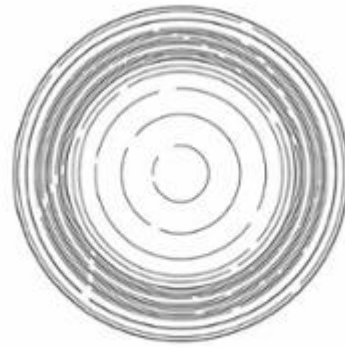

5.4

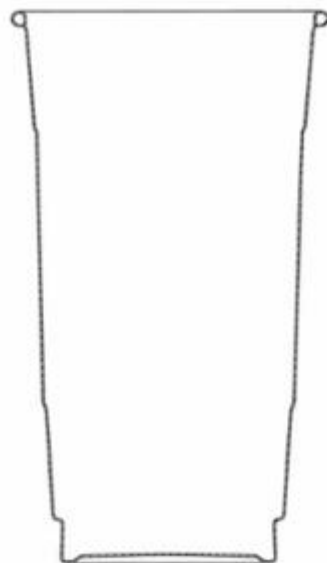

5.5



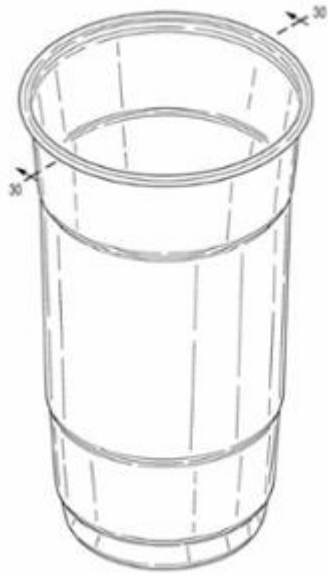

6.1

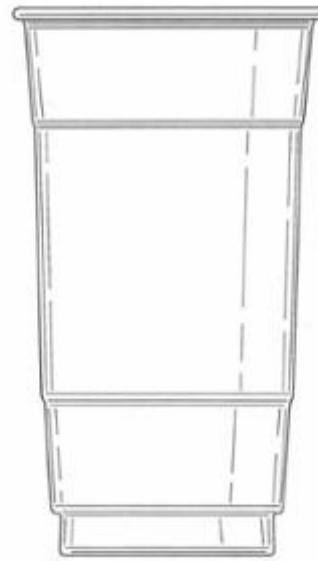

6.2

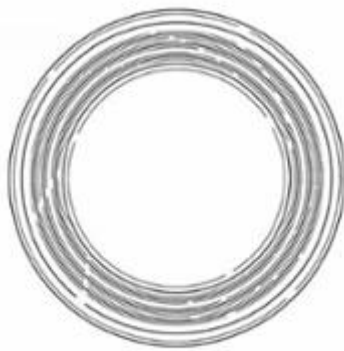

6.3

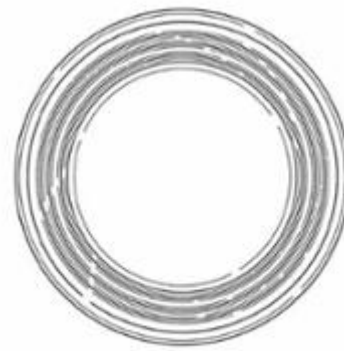

6.4

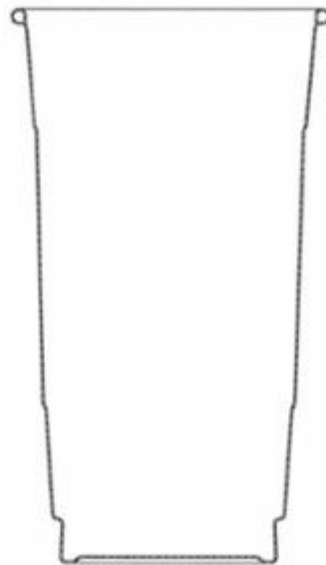

6.5

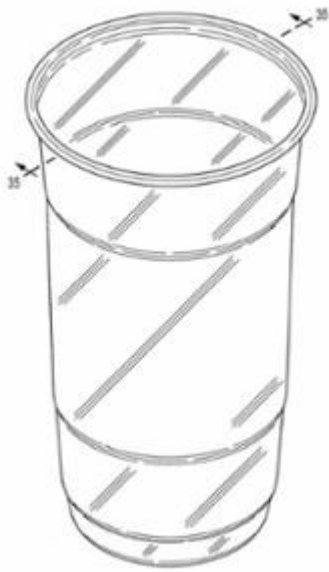

7.1

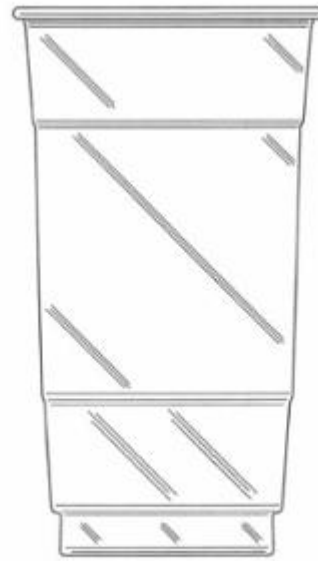

7.2

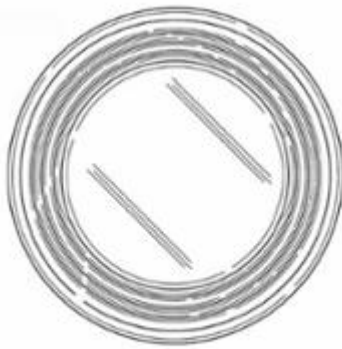

7.3

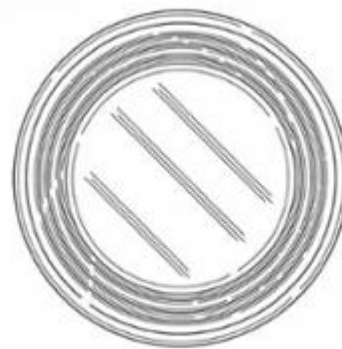

7.4

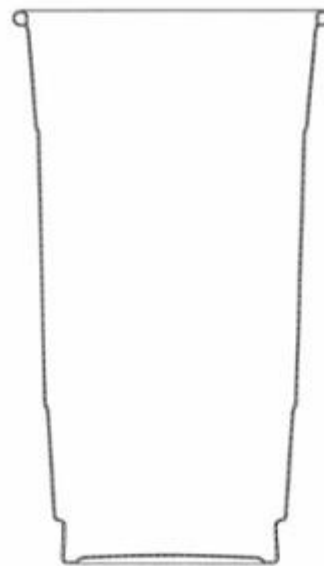

7.5

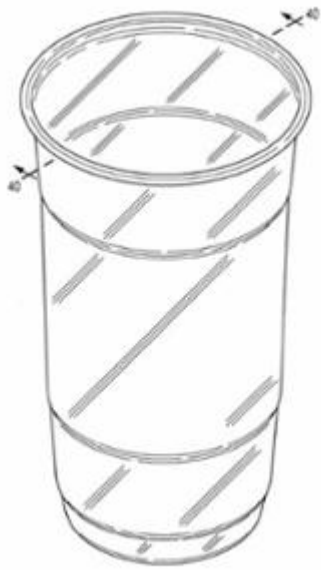

8.1

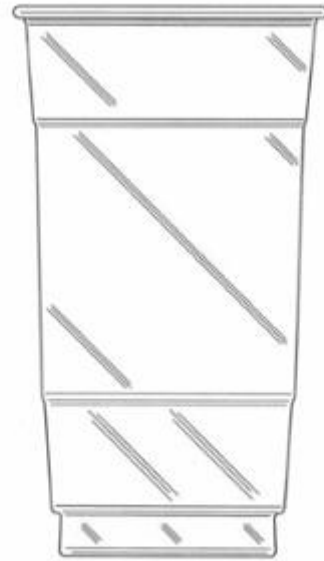

8.2

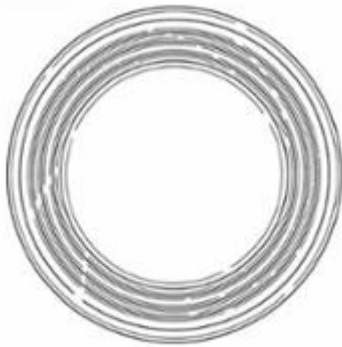

8.3

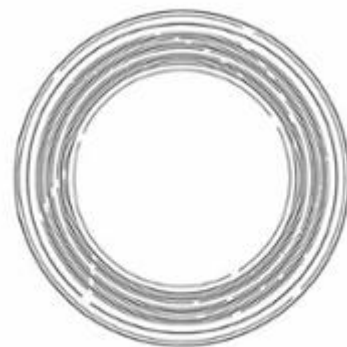

8.4

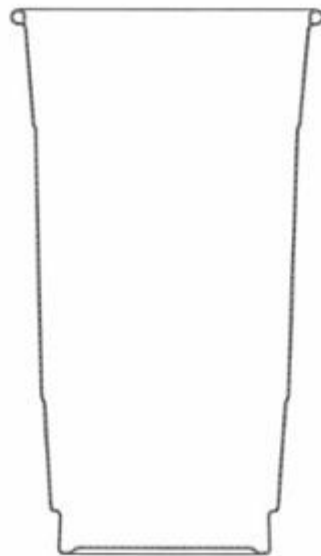

8.5

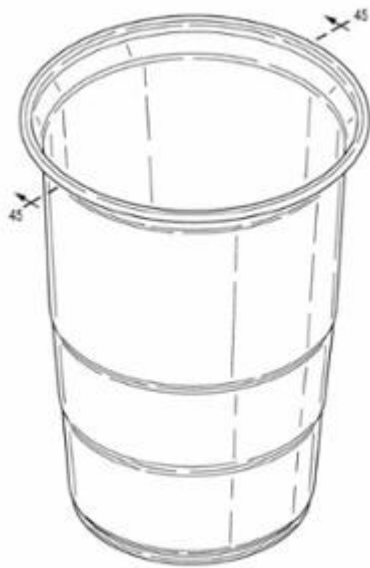

9.1

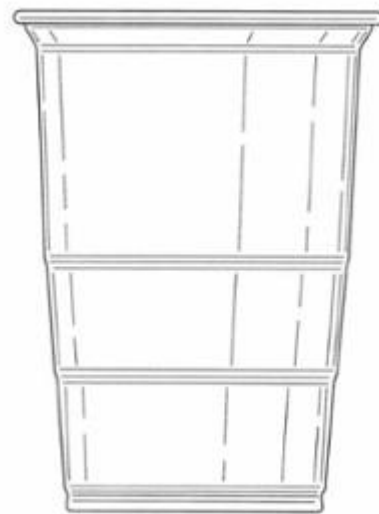

9.2

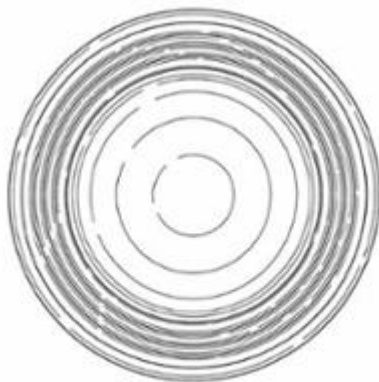

9.3

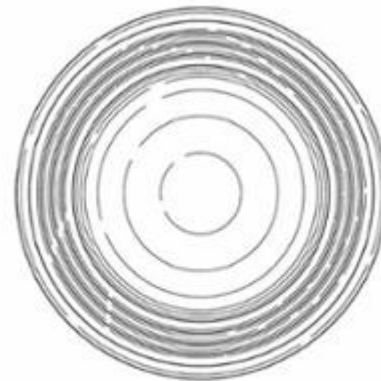

9.4

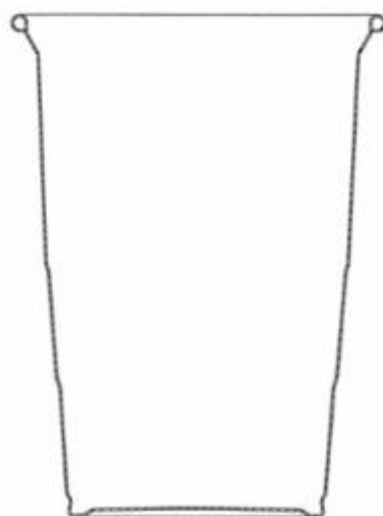

9.5

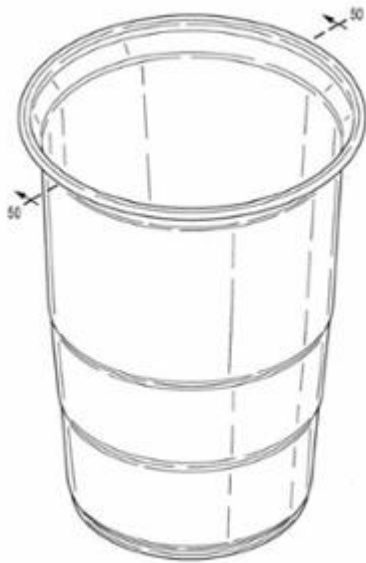

10.1

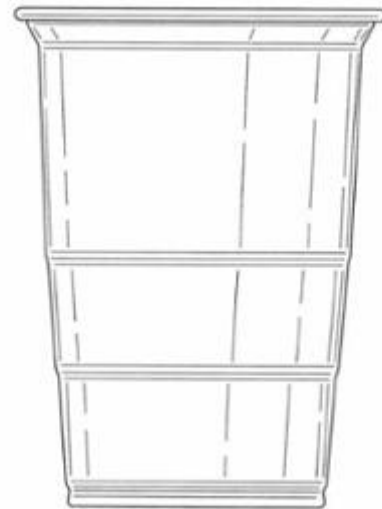

10.2

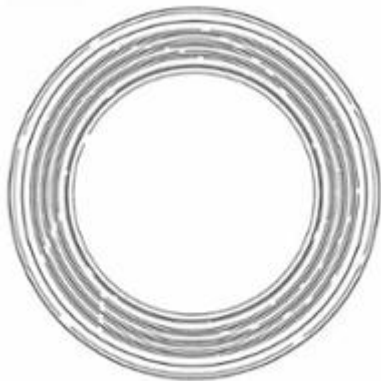

10.3

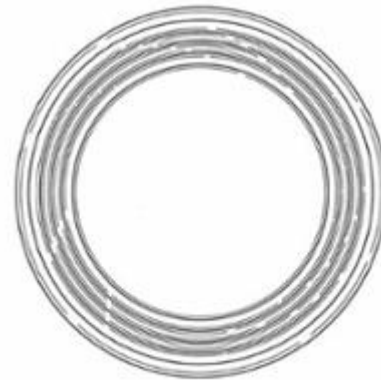

10.4

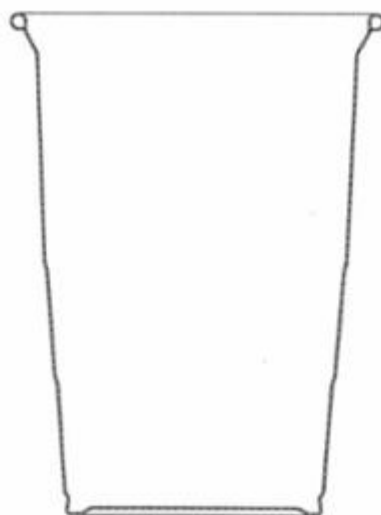

10.5

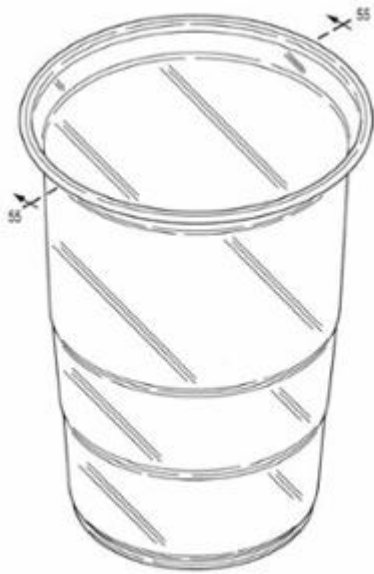

11.1



11.2

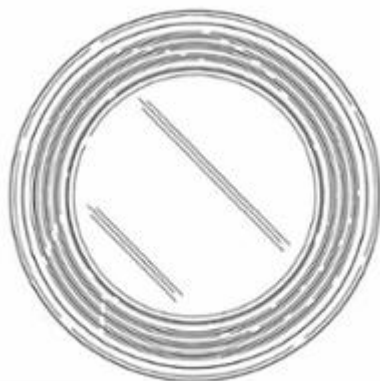

11.3

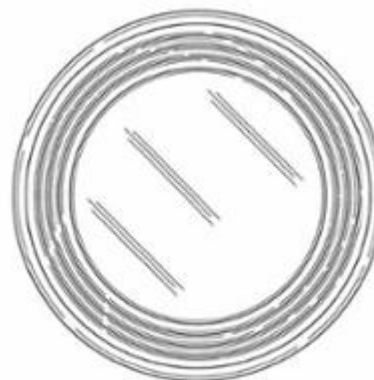

11.4

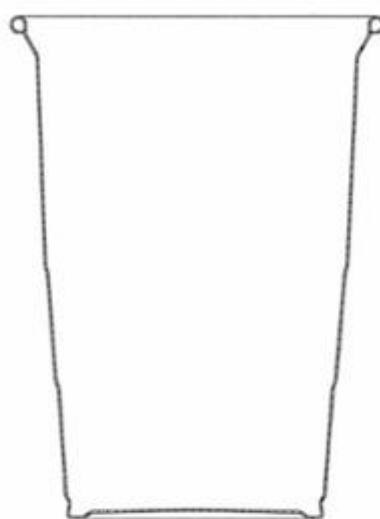

11.5

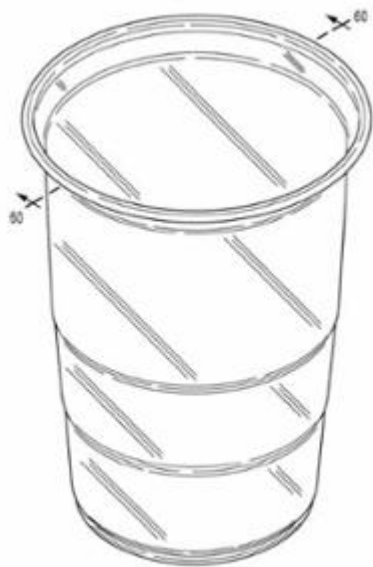

12.1



12.2

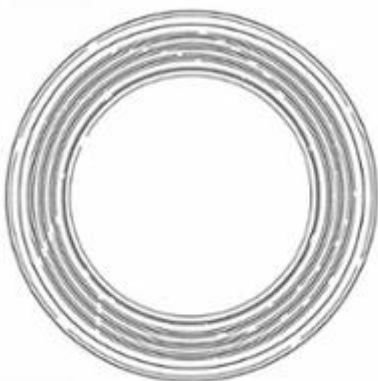

12.3

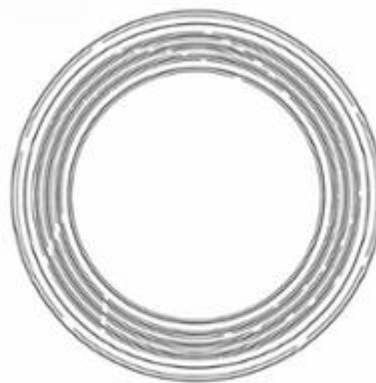

12.4

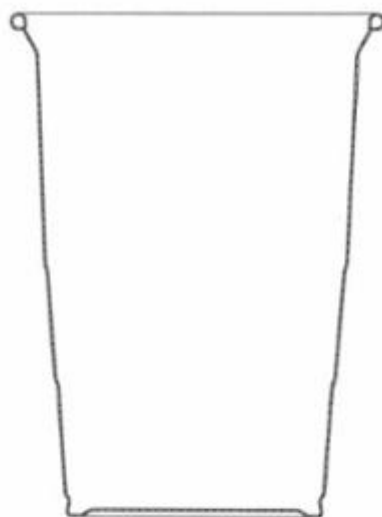

12.5

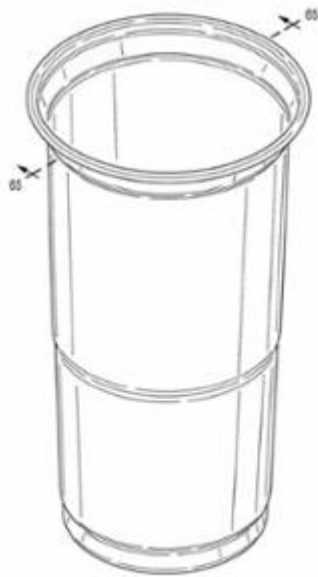

13.1

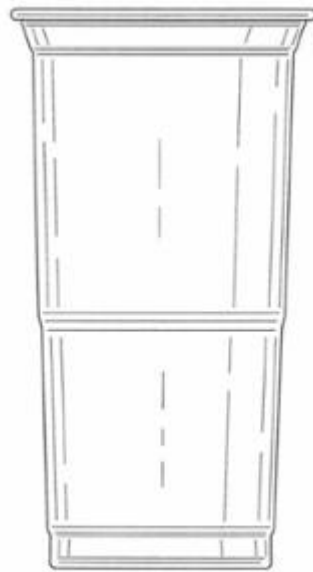

13.2

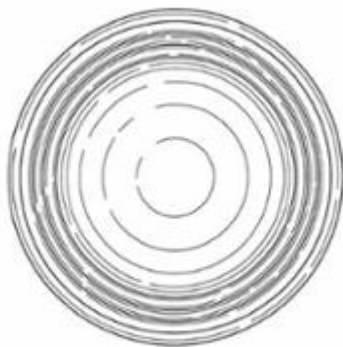

13.3

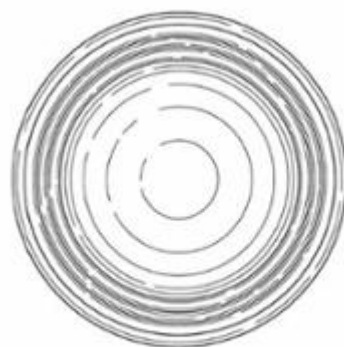

13.4

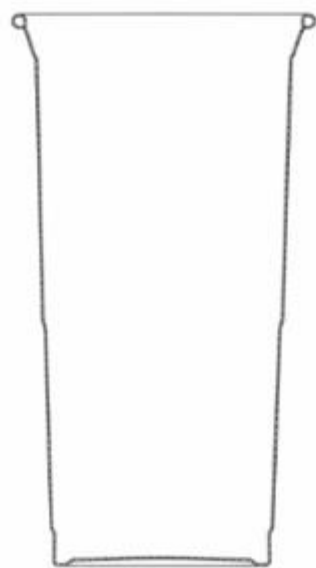

13.5



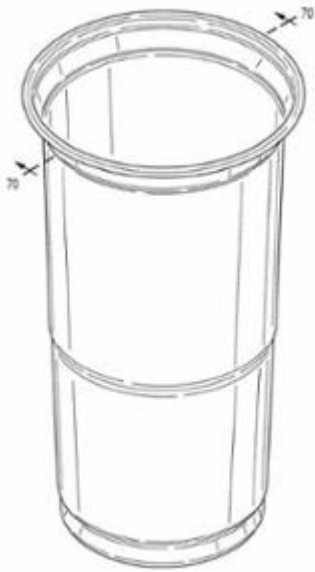

14.1

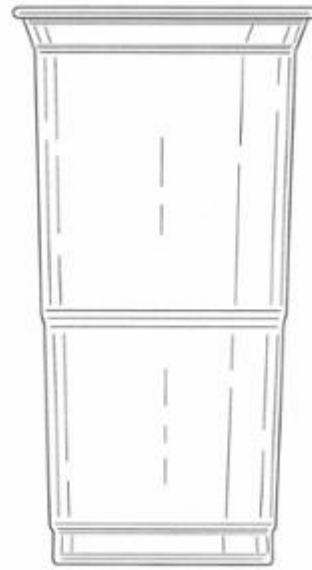

14.2



14.3

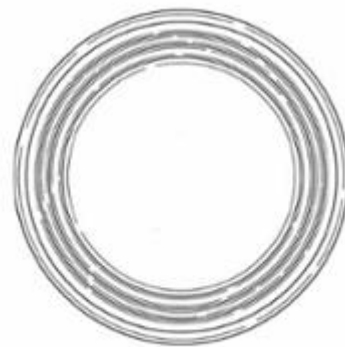

14.4

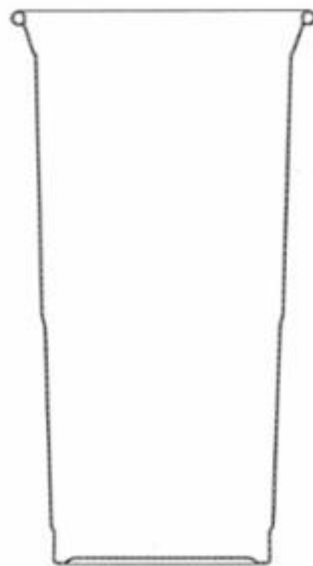

14.5

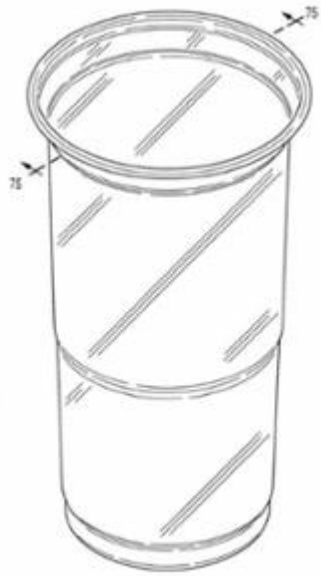

15.1

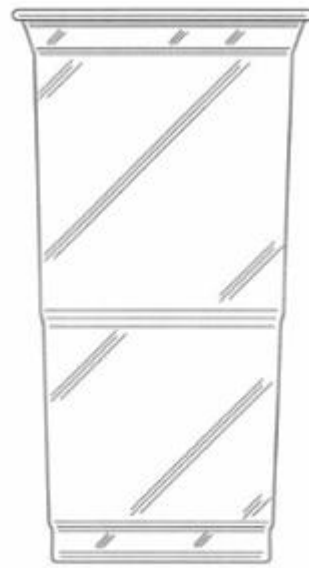

15.2



15.3

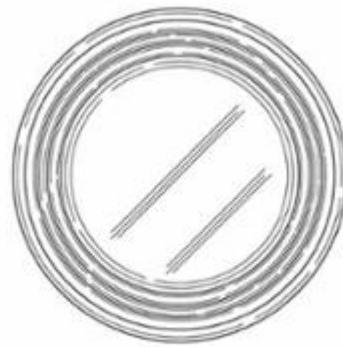

15.4

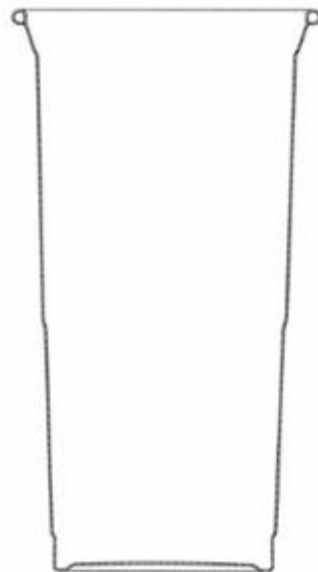

15.5

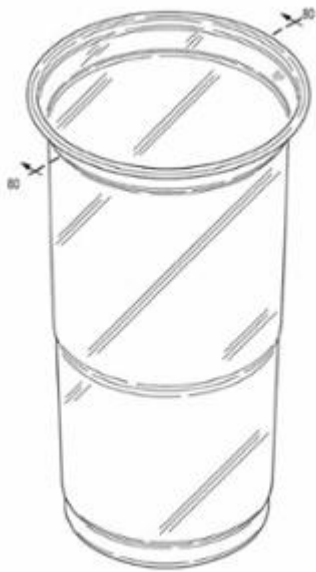

16.1

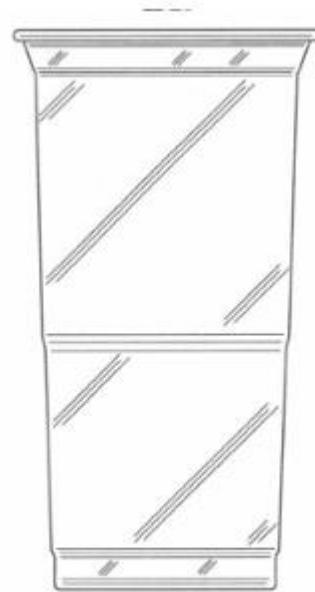

16.2

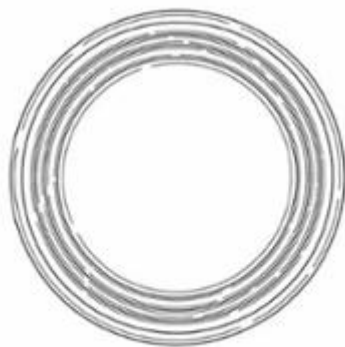

16.3



16.4

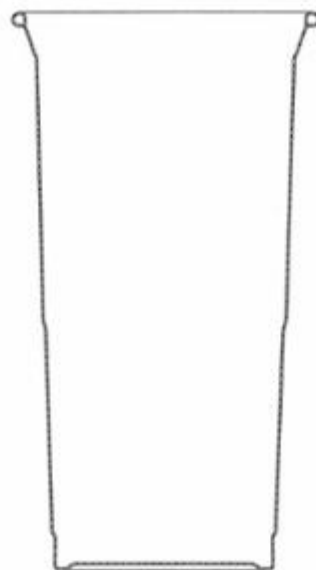

16.5



17.1



17.2

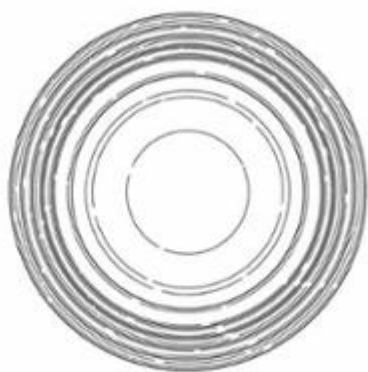

17.3

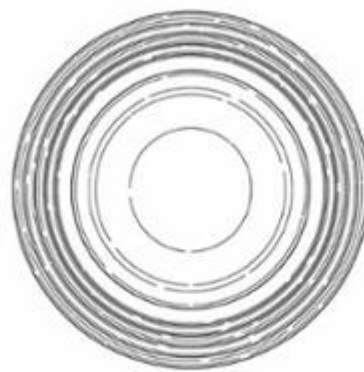

17.4

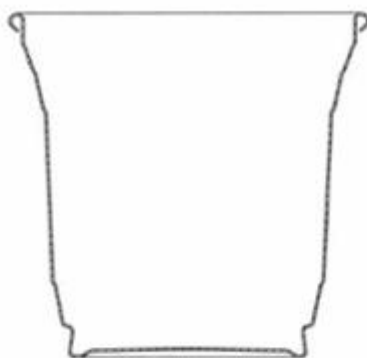

17.5



18.1



18.2



18.3



18.4

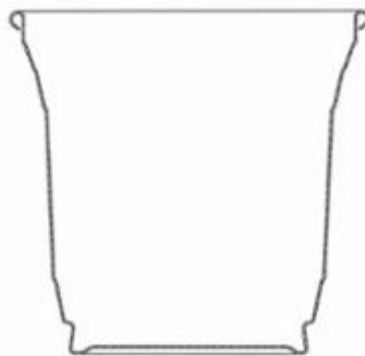

18.5



19.1



19.2



19.3



19.4

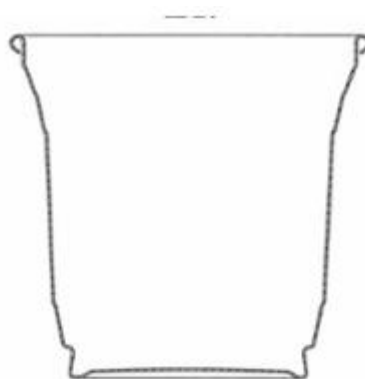

19.5



20.1



20.2

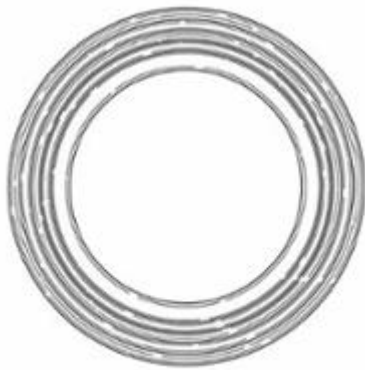

20.3

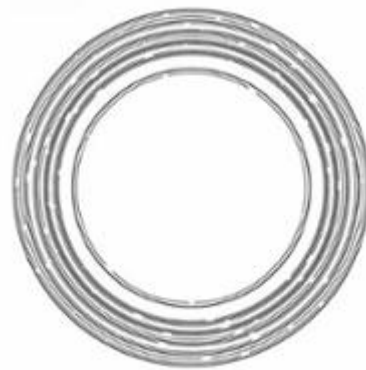

20.4

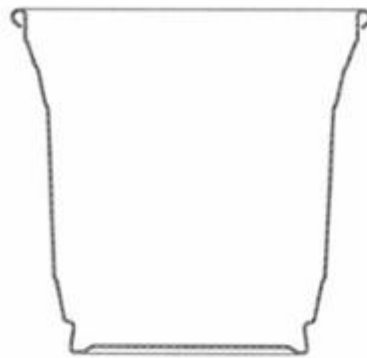

20.5

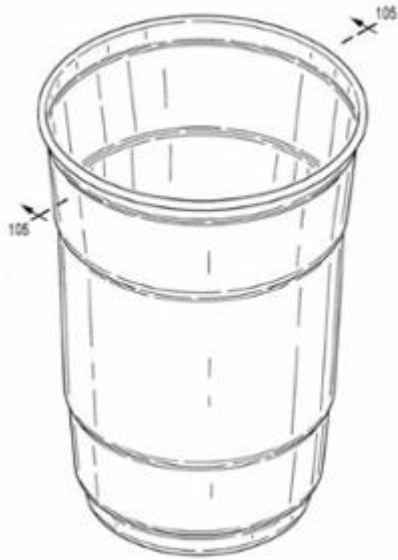

21.1

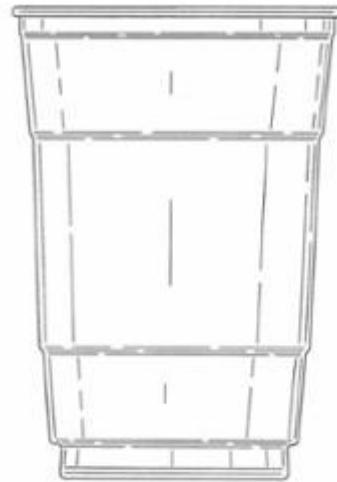

21.2

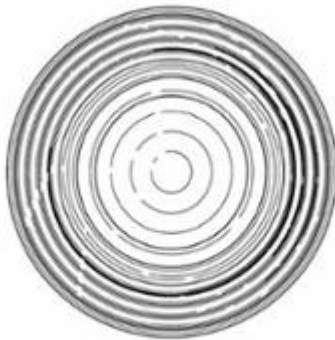

21.3

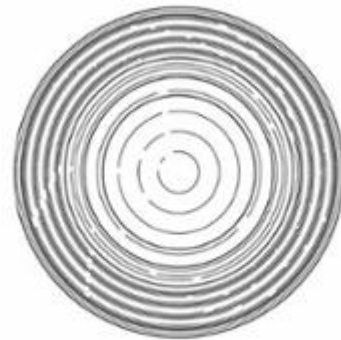

21.4

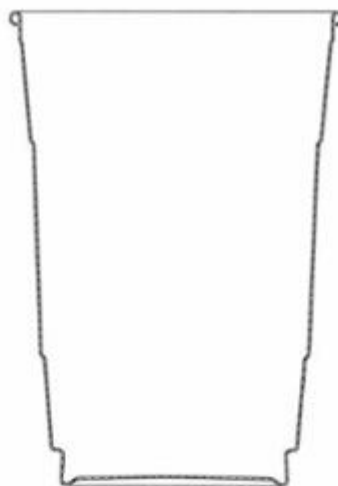

21.5



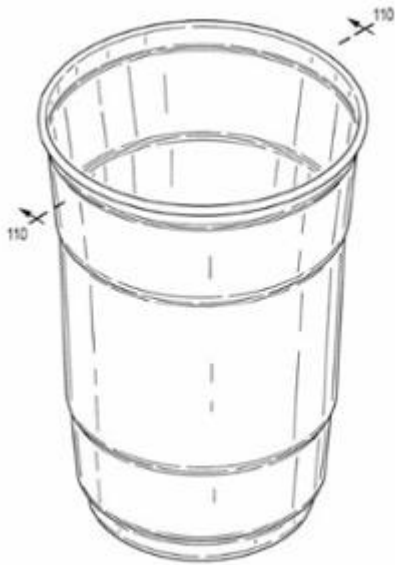

22.1

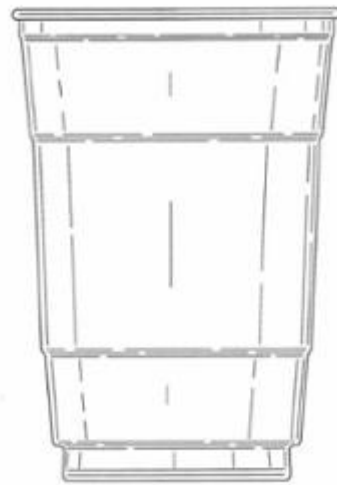

22.2



22.3



22.4

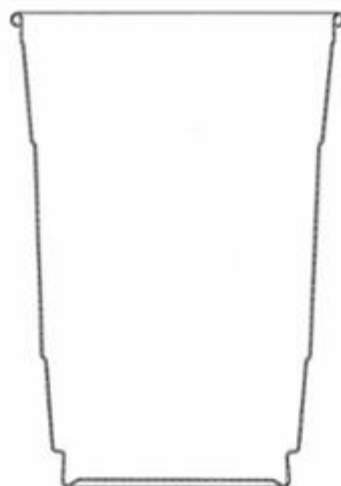

22.5

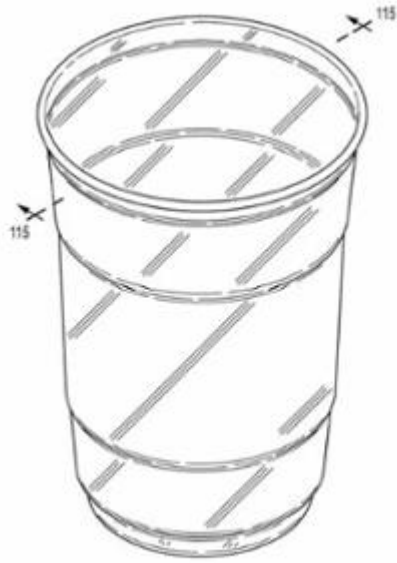

23.1



23.2



23.3

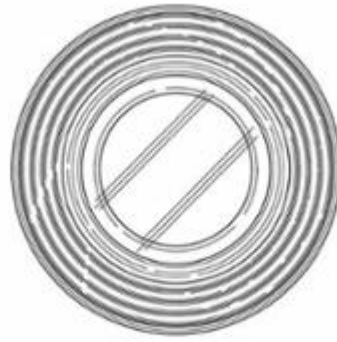

23.4

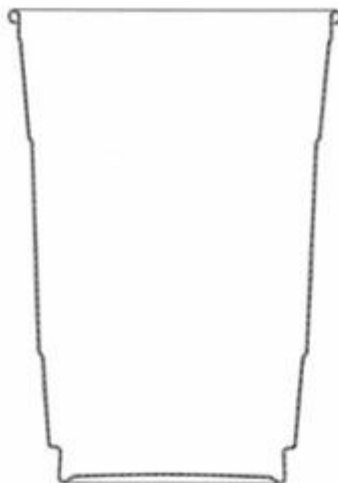

23.5

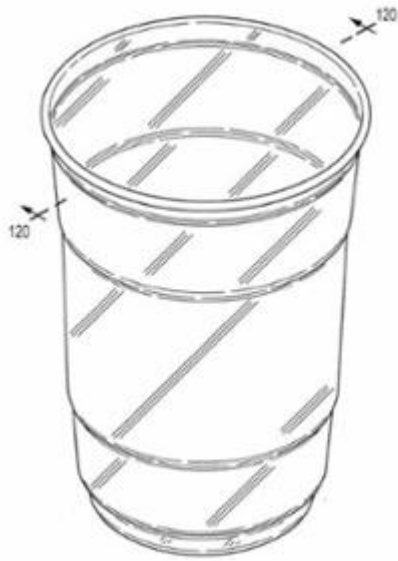

24.1

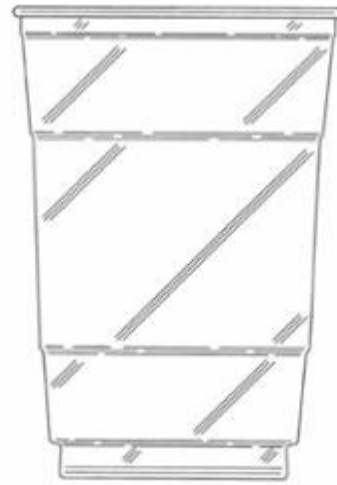

24.2



24.3

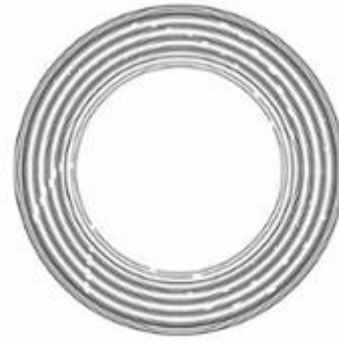

24.4

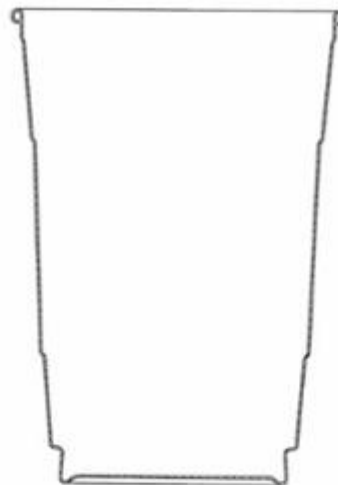

24.5



25.1

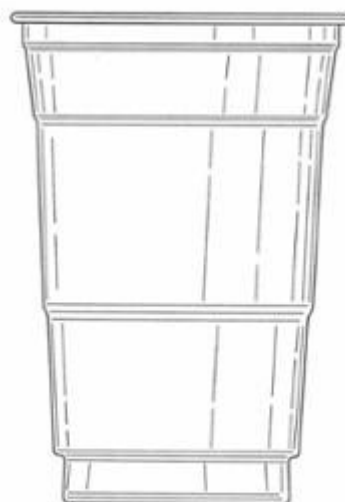

25.2

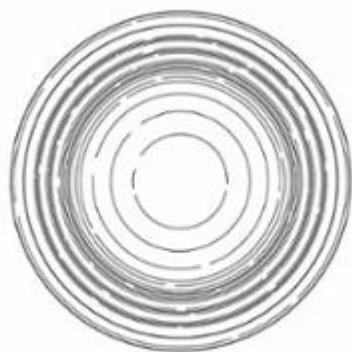

25.3

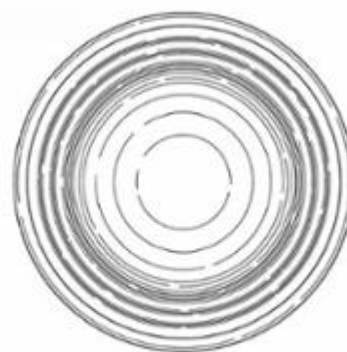

25.4

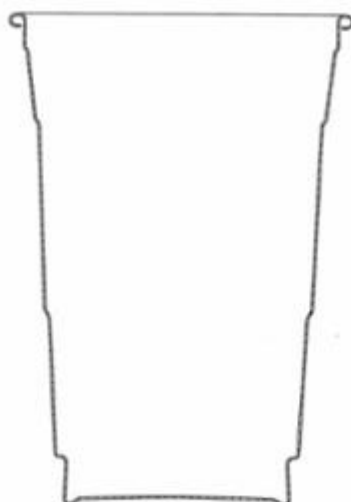

25.5

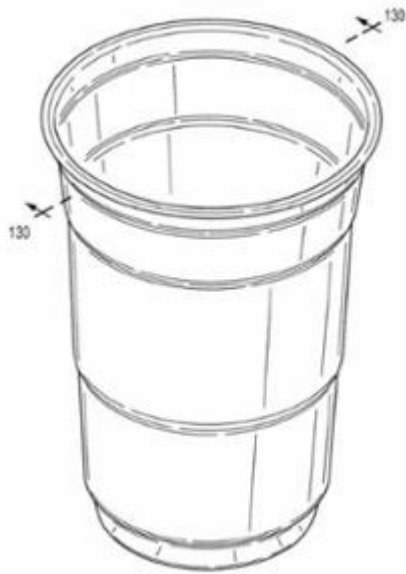

26.1

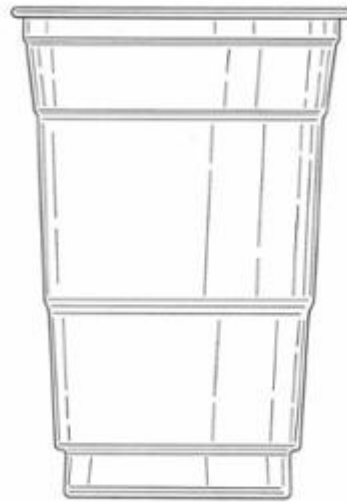

26.2

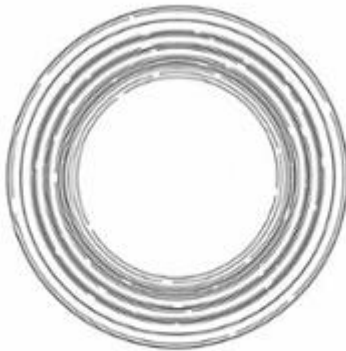

26.3

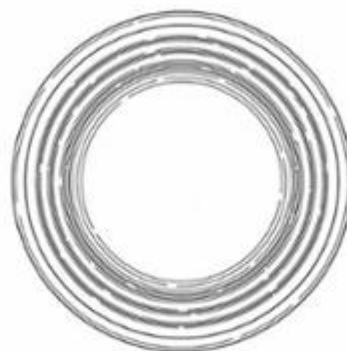

26.4

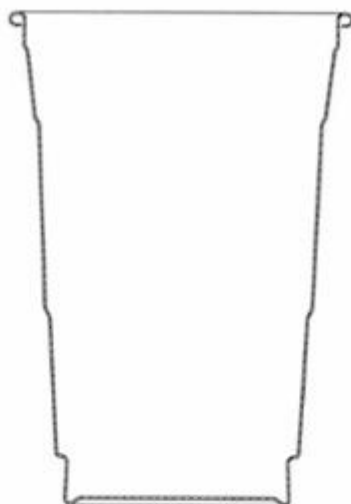

26.5

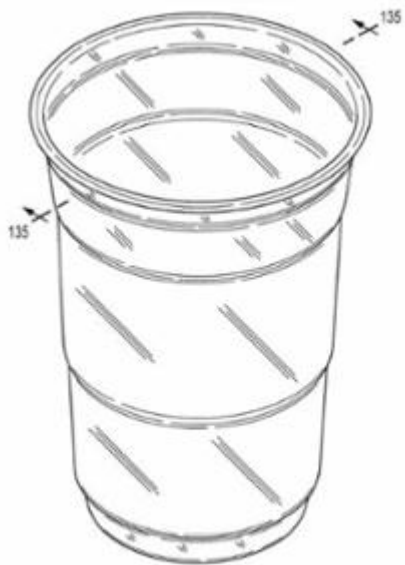

27.1

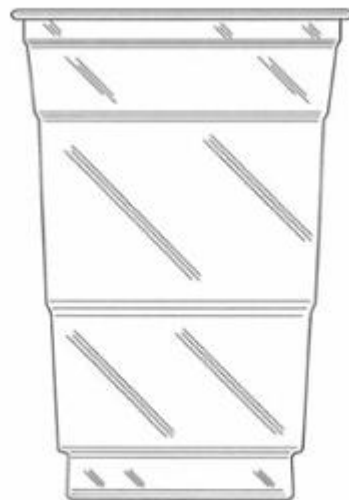

27.2



27.3



27.4

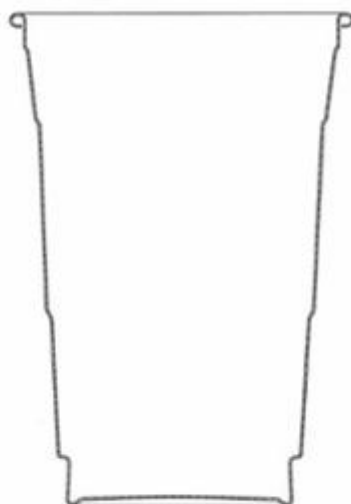

27.5

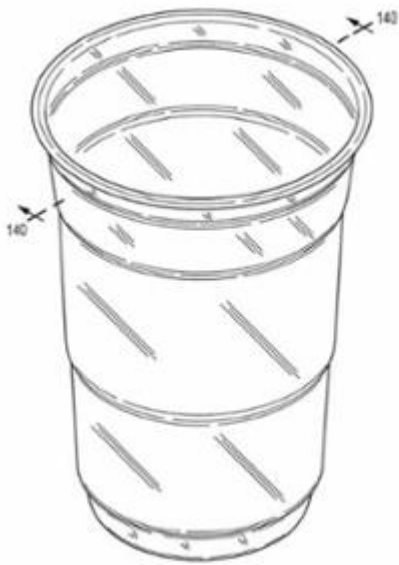

28.1

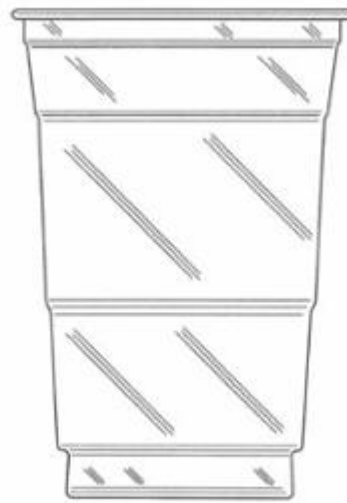

28.2

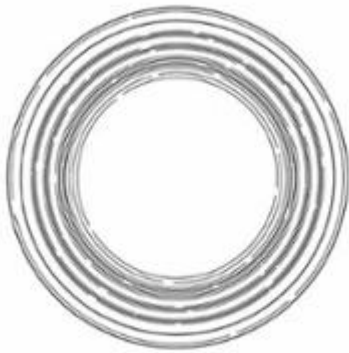

28.3

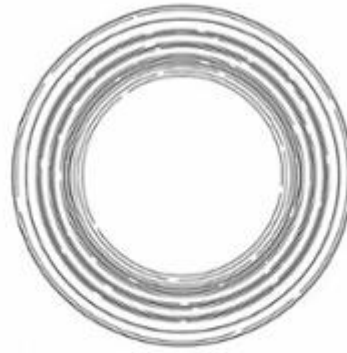

28.4

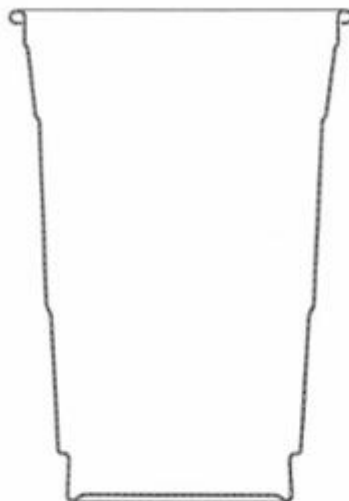

28.5

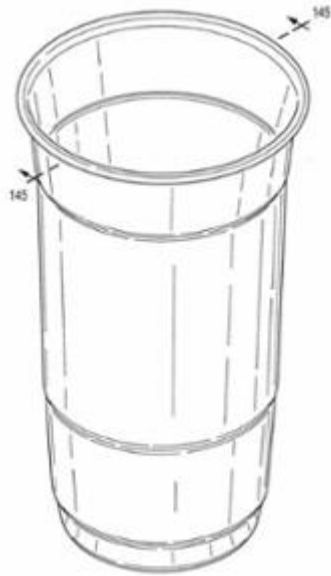

29.1

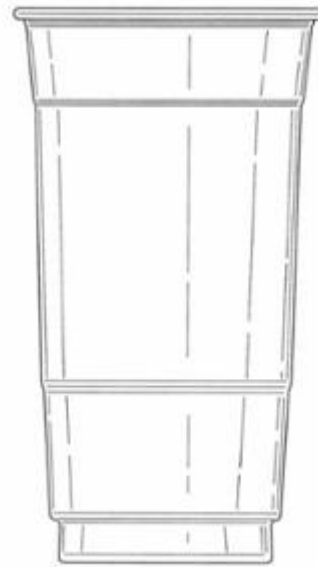

29.2

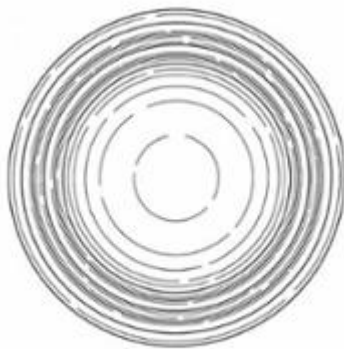

29.3

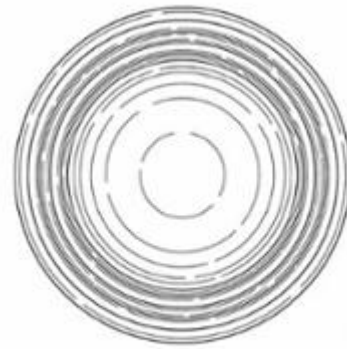

29.4

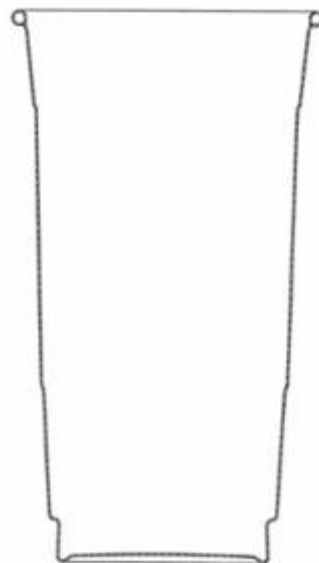

29.5



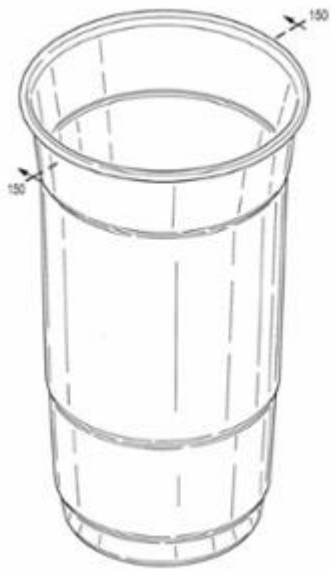

30.1

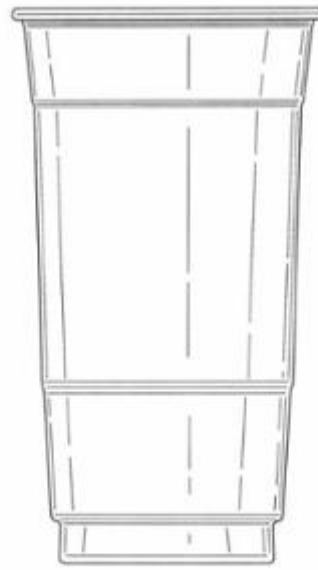

30.2

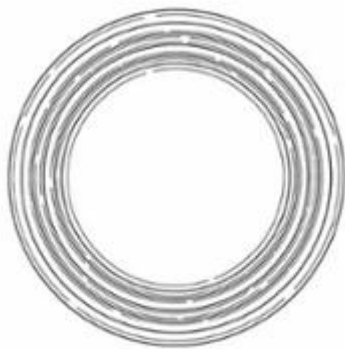

30.3

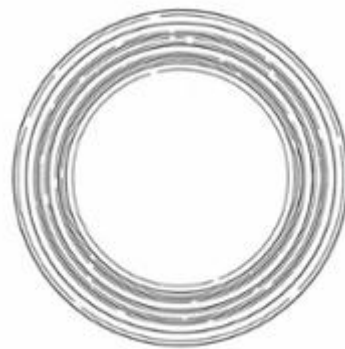

30.4

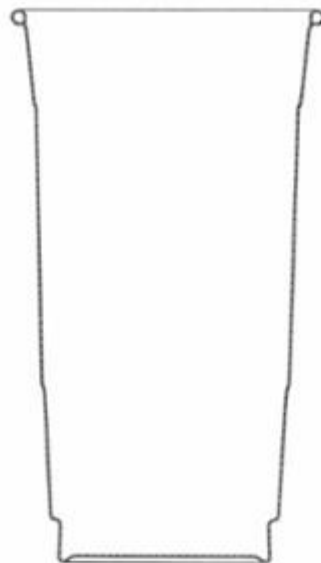

30.5



31.1

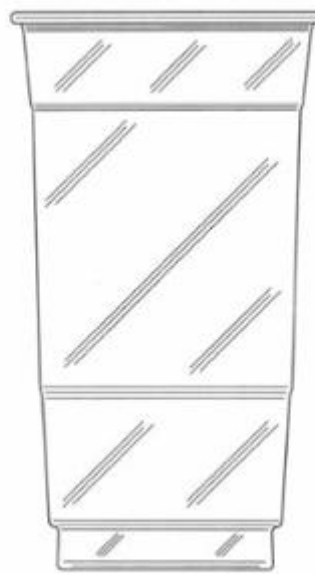

31.2

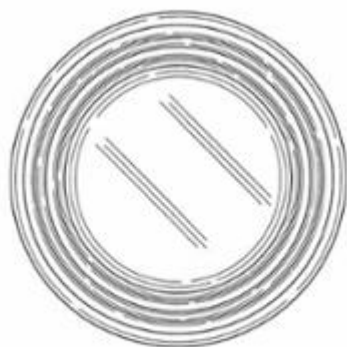

31.3

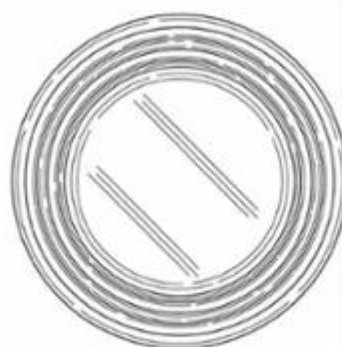

31.4

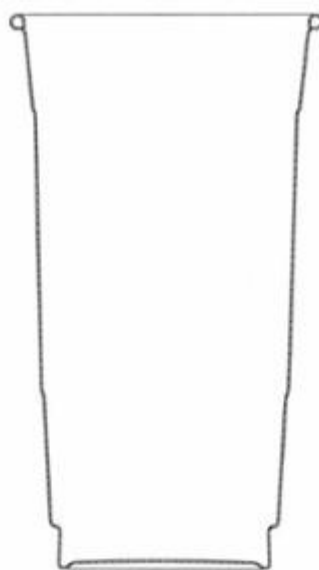

31.5



32.1

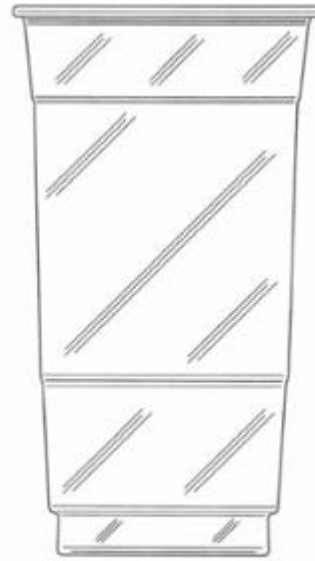

32.2

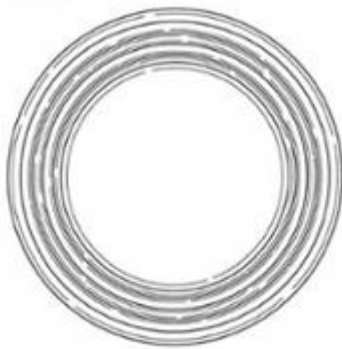

32.3

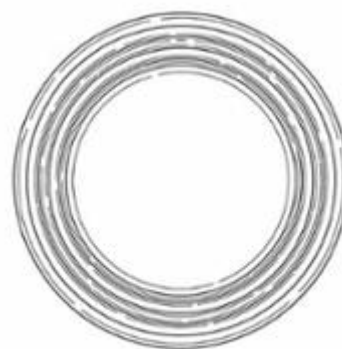

32.4

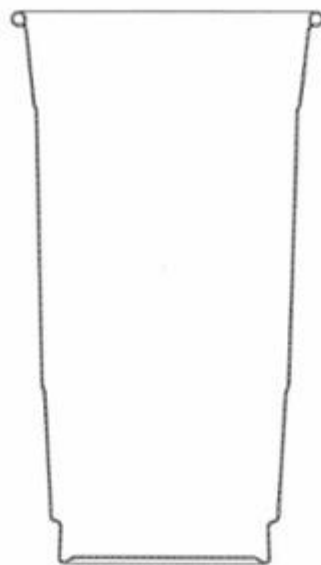

32.5

**CÔNG BÁO SỞ HỮU CÔNG NGHIỆP SỐ 400 TẬP A – QUYỀN 2 (07.2021)**

(11) **41937**

(21) 3-2019-03427

(28) 1

(54) **GHẾ SÔ-PHA**

(51) **06-01**

(22) 27/12/2019

(43) 26/07/2021

(73) **HTL FURNITURE (CHINA) CO., LTD. (CN)**

Wu Yujiangnan Road, Kunshan Development Zone, Jiangsu Province, China

(72) PHUA YONG TAT (SG)

(74) Công ty Luật TNHH quốc tế BMVN (BMVN INTERNATIONAL LLC)

(55)



1.1



1.2



1.3



1.4



1.5



1.6

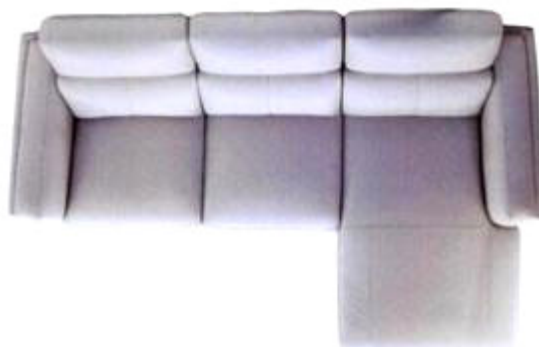

1.7

**CÔNG BÁO SỞ HỮU CÔNG NGHIỆP SỐ 400 TẬP A – QUYỀN 2 (07.2021)**

(11) **41938**

(21) 3-2019-03430

(28) 1

(54) **GHẾ SÔ-PHA**

(51) **06-01**

(22) 27/12/2019

(43) 26/07/2021

(73) **HTL FURNITURE (CHINA) CO., LTD. (CN)**

Wu Yujiangnan Road, Kunshan Development Zone, Jiangsu Province, China

(72) PHUA YONG TAT (SG)

(74) Công ty Luật TNHH quốc tế BMVN (BMVN INTERNATIONAL LLC)

(55)



1.1



1.2



1.3



1.4



1.5



1.6

**CÔNG BÁO SỞ HỮU CÔNG NGHIỆP SỐ 400 TẬP A – QUYỀN 2 (07.2021)**

(11) **41939**

(21) 3-2019-03446

(28) 1

(54) **GHẾ SÔ-PHA**

(51) **06-01**

(22) 27/12/2019

(43) 26/07/2021

(73) **HTL FURNITURE (CHINA) CO., LTD. (CN)**

Wu Yujiangnan Road, Kunshan Development Zone, Jiangsu Province, China

(72) PHUA YONG TAT (SG)

(74) Công ty Luật TNHH quốc tế BMVN (BMVN INTERNATIONAL LLC)

(55)



1.1



1.2



1.3



1.4



1.5



1.6

**CÔNG BÁO SỞ HỮU CÔNG NGHIỆP SỐ 400 TẬP A – QUYỀN 2 (07.2021)**

(11) **41940**

(21) 3-2019-03447

(28) 1

(54) **GHẾ SÔ-PHA**

(51) **06-01**

(22) 27/12/2019

(43) 26/07/2021

(73) **HTL FURNITURE (CHINA) CO., LTD. (CN)**

Wu Yujiangnan Road, Kunshan Development Zone, Jiangsu Province, China

(72) PHUA YONG TAT (SG)

(74) Công ty Luật TNHH quốc tế BMVN (BMVN INTERNATIONAL LLC)

(55)



1.1



1.2



1.3



1.4



1.5



1.6

**CÔNG BÁO SỞ HỮU CÔNG NGHIỆP SỐ 400 TẬP A – QUYỀN 2 (07.2021)**

(11) **41941**

(21) 3-2019-03449

(54) **GHẾ SÔ-PHA**

(22) 27/12/2019

(73) **HTL Furniture (China) Co., Ltd. (CN)**

Wu Yujiangnan Road, Kunshan Development Zone, Jiangsu Province, China

(72) PHUA YONG TAT (SG)

(74) Công ty Luật TNHH quốc tế BMVN (BMVN INTERNATIONAL LLC)

(55)

(28) 1

(51) **06-01**

(43) 26/07/2021



1.1



1.2



1.3



1.4



1.5



1.6



**CÔNG BÁO SỞ HỮU CÔNG NGHIỆP SỐ 400 TẬP A – QUYỀN 2 (07.2021)**

- (11) **41942**  
(21) 3-2020-00080 (28) 1  
(54) **ĐIỆN THOẠI DI ĐỘNG** (51) **14-03**  
(22) 08/01/2020 (43) 26/07/2021  
(30) 006634739 18/07/2019 EM;  
(73) **HMD GLOBAL OY (FI)**  
Bertel Jungin aukio 9, 02600 ESPOO, Finland  
(72) 1. CHENGLI HUNG (TW)  
2. KEVIN DEPAPE (GB)  
(74) Công ty cổ phần Tư vấn S&B (S&B CONSULTANT., CORP.)  
(55)

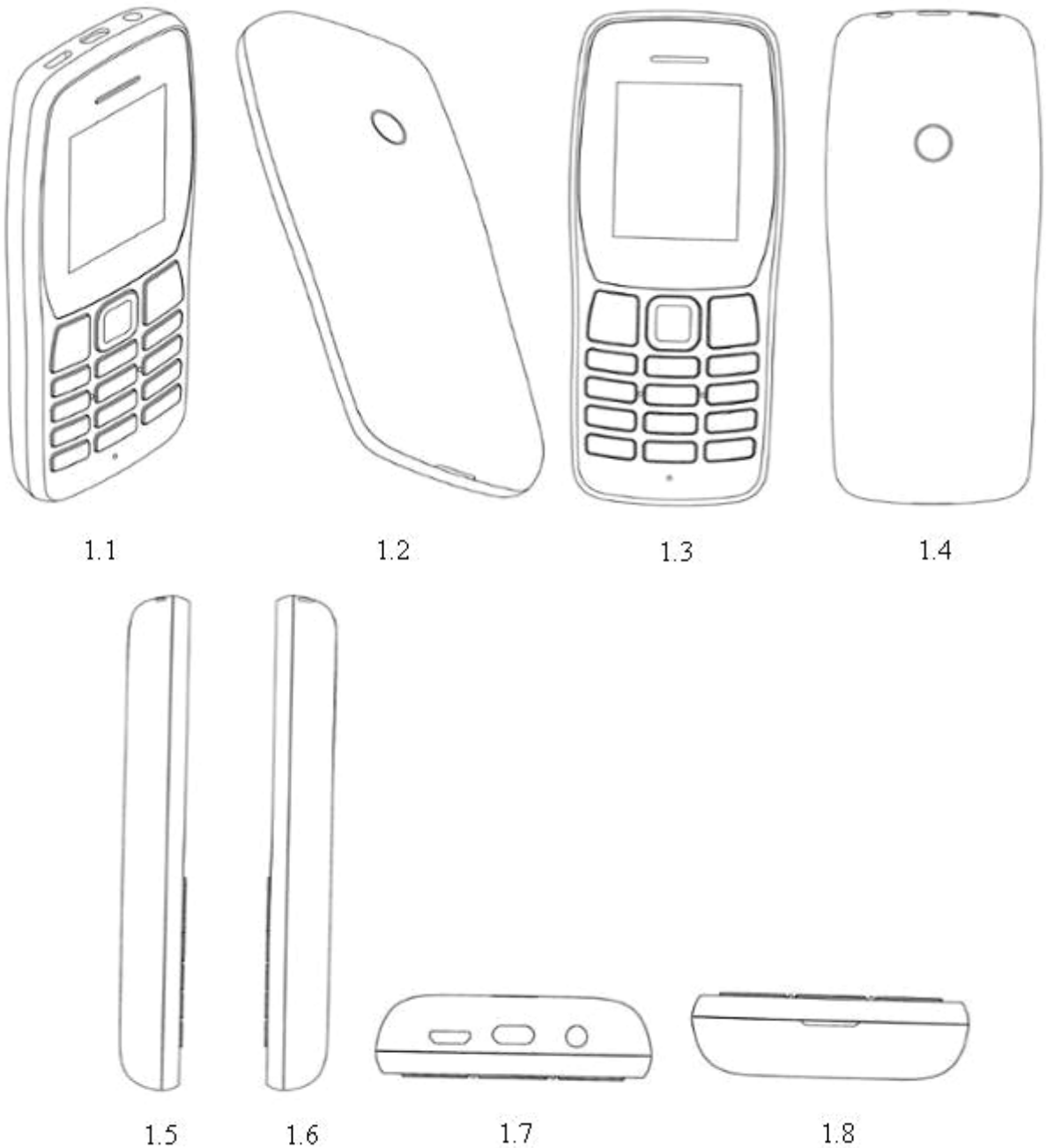

**CÔNG BÁO SỞ HỮU CÔNG NGHIỆP SỐ 400 TẬP A – QUYỀN 2 (07.2021)**

- (11) **41943**  
(21) 3-2020-00214 (28) 2  
(54) **ĐIỆN THOẠI** (51) **14-03**  
(22) 21/01/2020 (43) 26/07/2021  
(30) 201930395665.0 24/07/2019 CN;  
(73) **VIVO MOBILE COMMUNICATION CO., LTD (CN)**  
#283, BBK Road, Wusha, Chang'an, Dongguan, Guangdong 523860, China  
(72) Sunyun DU (CN)  
(74) Công ty cổ phần Sở hữu trí tuệ BROSS và Cộng sự (BROSS & PARTNERS., JSC)  
(55)

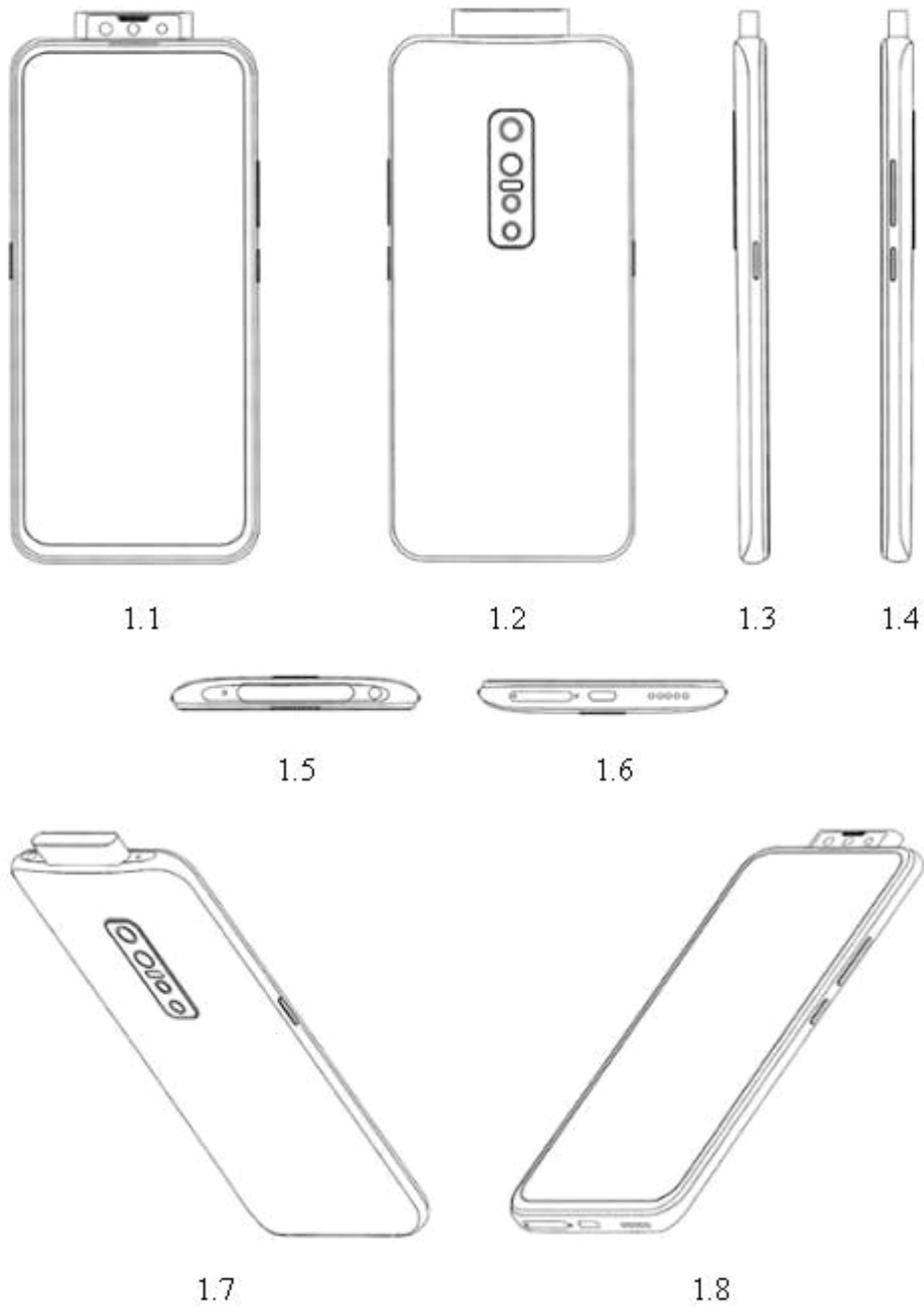



2.1



2.2



2.3



2.4



2.5



2.6



2.7

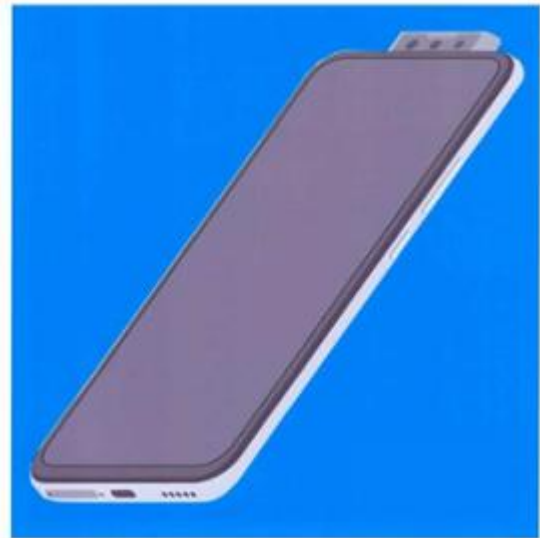

2.8

**CÔNG BÁO SỞ HỮU CÔNG NGHIỆP SỐ 400 TẬP A – QUYỀN 2 (07.2021)**

(11) **41944**

(21) 3-2020-00412

(28) 1

(54) **HỘP**

(51) **09-03**

(22) 21/02/2020

(43) 26/07/2021

**CÔNG TY TNHH KINH DOANH DƯỢC PHẨM HẬU GIANG PHARMA (VN)**

(73) Số nhà 1, ngách 1/124 Yên Lộ, tổ 13, phường Yên Nghĩa, quận Hà Đông, thành phố Hà Nội

(72) Bùi Triều Dương (VN)

(74) Công ty TNHH Sở hữu trí tuệ INNETCO-Hoàng Phúc (INNETCO CO., LTD)

(55)



1.1



1.2



1.3



1.4

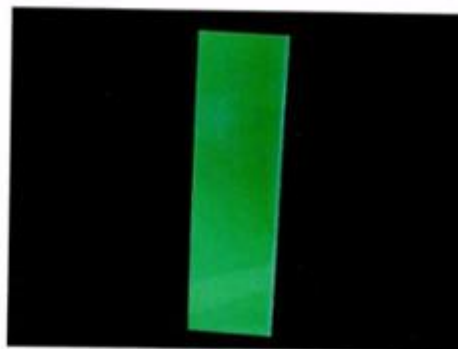

1.5

**CÔNG BÁO SỞ HỮU CÔNG NGHIỆP SỐ 400 TẬP A – QUYỀN 2 (07.2021)**

(11) **41945**

(21) 3-2020-00463

(28) 1

(54) **NHÃN SẢN PHẨM**

(51) **19-08**

(22) 28/02/2020

(43) 26/07/2021

**CÔNG TY TNHH THƯƠNG MẠI VÀ SẢN XUẤT DIỆP CHI ORGANIC**

(73) (VN)

Số nhà 10, tổ 61, khu 4, phường Bạch Đằng, thành phố Hạ Long, tỉnh Quảng Ninh

(72) Thân Dạ Cẩm Ly (VN)

(74) Công ty Luật TNHH LINK&PARTNERS (LINK&PARTNERS)

(55)



**CÔNG BÁO SỞ HỮU CÔNG NGHIỆP SỐ 400 TẬP A – QUYỀN 2 (07.2021)**

- (11) **41946**  
(21) 3-2020-00506 (28) 2  
(54) **ĐIỆN THOẠI DI ĐỘNG** (51) **14-03**  
(22) 06/03/2020 (43) 26/07/2021  
(30) 201930492241.6 06/09/2019 CN;  
**HUAWEI TECHNOLOGIES CO., LTD. (CN)**  
(73) Huawei Administration Building, Bantian, Longgang District, Shenzhen,  
Guangdong 518129, P. R. China  
1. XU, TING (CN)  
2. QI, LIJUN (CN)  
(72) 3. WANG, JIAXI (CN)  
4. YUAN, JUE (CN)  
5. XU, HAOSAN (CN)  
(74) Công ty Cổ phần Sở hữu công nghiệp INVESTIP (INVESTIP)  
(55)



1.1

1.2

1.3

1.4



1.5

1.6



1.7



1.8



2.1

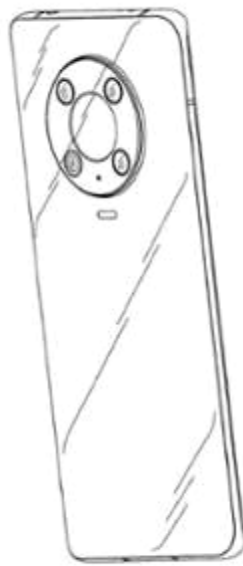

2.2

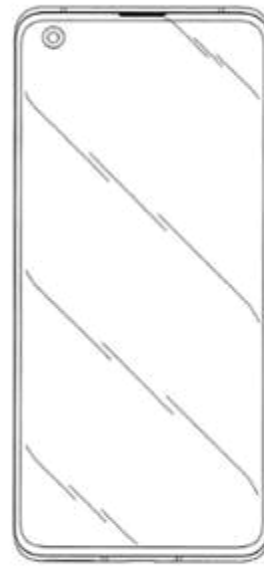

2.3

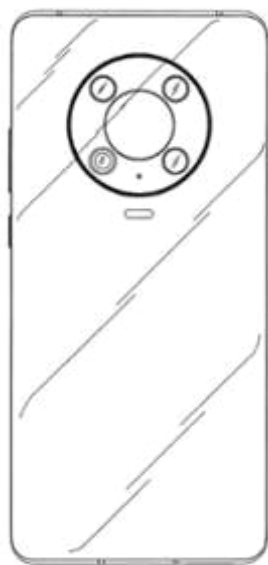

2.4



2.5



2.6



2.7



2.8



- (11) **41947**  
(21) 3-2020-00508 (28) 2  
(54) **ĐIỆN THOẠI DI ĐỘNG** (51) **14-03**  
(22) 06/03/2020 (43) 26/07/2021  
(30) 201930492265.1 06/09/2019 CN;  
**HUAWEI TECHNOLOGIES CO., LTD. (CN)**  
(73) Huawei Administration Building, Bantian, Longgang District, Shenzhen,  
Guangdong 518129, P. R. China  
1. XU, TING (CN)  
2. QI, LIJUN (CN)  
(72) 3. WANG, JIAXI (CN)  
4. YUAN, JUE (CN)  
5. XU, HAOPEN (CN)  
(74) Công ty Cổ phần Sở hữu công nghiệp INVESTIP (INVESTIP)  
(55)



1.1

1.2

1.3

1.4



1.5



1.6



1.7



1.8



2.1



2.2

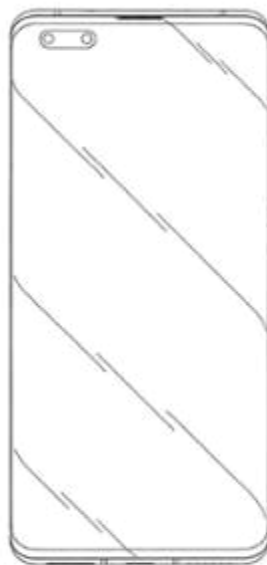

2.3

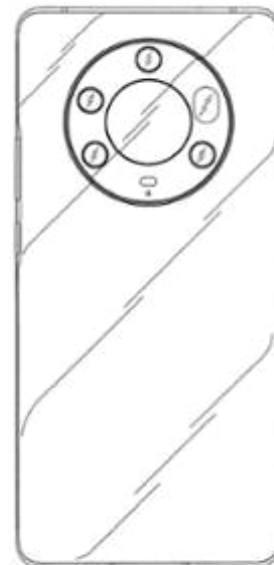

2.4



2.5



2.6



2.7



2.8

- (11) **41948**
- (21) 3-2020-00515 (28) 2
- (54) **BỘ TAI NGHE** (51) **14-01**
- (22) 09/03/2020 (43) 26/07/2021
- (30) 29/705,727 13/09/2019 US;
- (73) **Apple Inc.** (US)  
One Apple Park Way, Cupertino, California 95014, United States of America
1. JODY AKANA (US)
  2. MOLLY ANDERSON (GB)
  3. BARTLEY K. ANDRE (US)
  4. SHOTA AOYAGI (JP)
  5. ANTHONY MICHAEL ASHCROFT (FR)
  6. MARINE C. BATAILLE (FR)
  7. JEREMY BATAILLOU (FR)
  8. MARKUS DIEBEL (DE)
  9. M. EVANS HANKEY (US)
  10. JULIAN HOENIG (AT)
- (72) 11. RICHARD P. HOWARTH (GB)
12. JONATHAN P. IVE (GB)
  13. JULIAN JAEDE (DE)
  14. DUNCAN ROBERT KERR (GB)
  15. PETER RUSSELL-CLARKE (AU)
  16. BENJAMIN ANDREW SHAFFER (US)
  17. SUNG-HO TAN (US)
  18. CLEMENT TISSANDIER (FR)
  19. EUGENE ANTONY WHANG (CA)
  20. RICO ZORKENDORFER (DE)
- (74) Công ty TNHH Lê & Lê (LE & LE)
- (55)

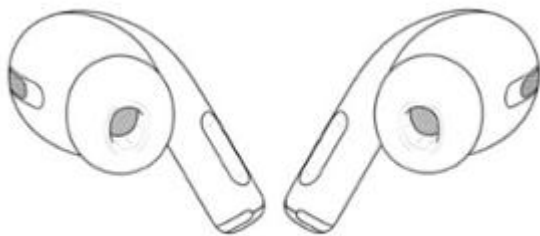

1.1

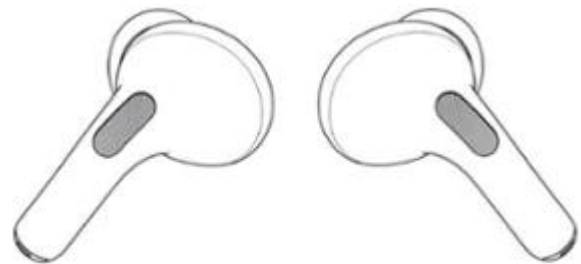

1.2

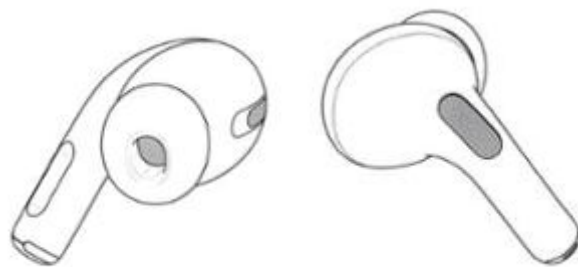

1.3

1.4



1.5



1.6



1.7



1.8



1.9



1.10



1.11



1.12



1.13



1.14



1.15



1.16



1.17



1.18

- (11) **41949**
- (21) 3-2020-00517 (28) 1
- (54) **HỘP ĐỰNG TAI NGHE** (51) **14-01**
- (22) 09/03/2020 (43) 26/07/2021
- (30) 29/705,726 13/09/2019 US;
- (73) **APPLE INC. (US)**  
One Apple Park Way, Cupertino, California 95014, United States of America
1. JODY AKANA (US)
  2. MOLLY ANDERSON (GB)
  3. BARTLEY K. ANDRE (US)
  4. SHOTA AOYAGI (JP)
  5. ANTHONY MICHAEL ASHCROFT (FR)
  6. MARINE C. BATAILLE (FR)
  7. JEREMY BATAILLOU (FR)
  8. MARKUS DIEBEL (DE)
  9. M. EVANS HANKEY (US)
  10. JULIAN HOENIG (AT)
- (72)
11. RICHARD P. HOWARTH (GB)
  12. IVE, JONATHAN P. (GB)
  13. JULIAN JAEDE (DE)
  14. DUNCAN ROBERT KERR (GB)
  15. PETER RUSSELL-CLARKE (AU)
  16. BENJAMIN ANDREW SHAFFER (US)
  17. SUNG-HO TAN (US)
  18. CLEMENT TISSANDIER (FR)
  19. EUGENE ANTONY WHANG (CA)
  20. RICO ZORKENDORFER (DE)
- (74) Công ty TNHH Lê & Lê (LE & LE)
- (55)

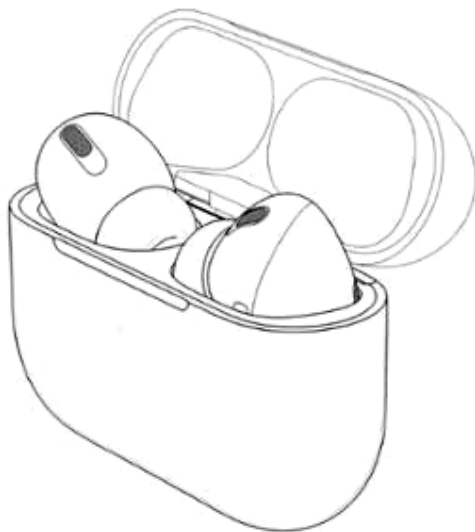

1.1

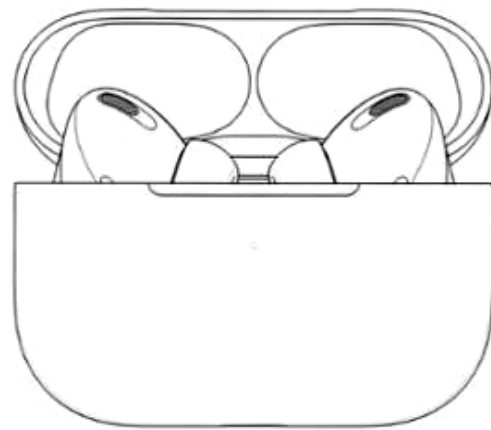

1.2

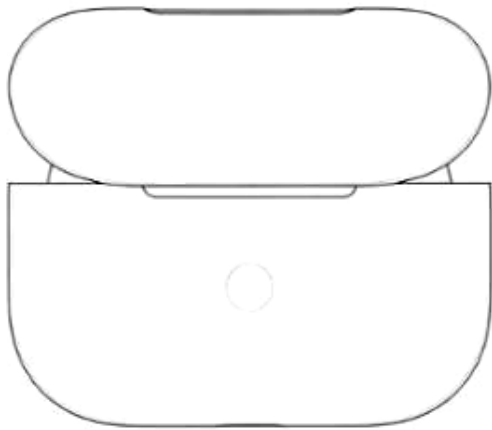

1.3

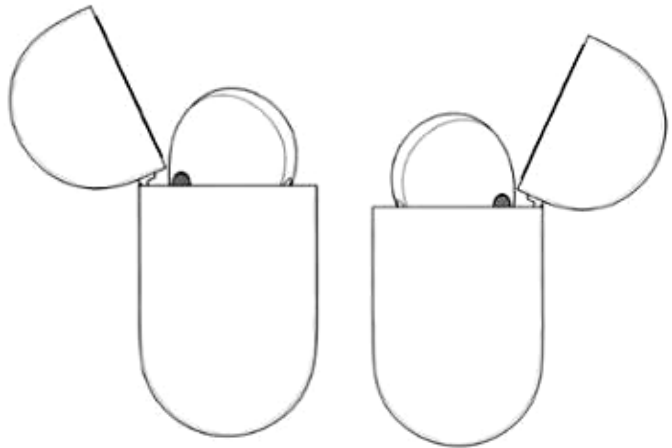

1.4

1.5

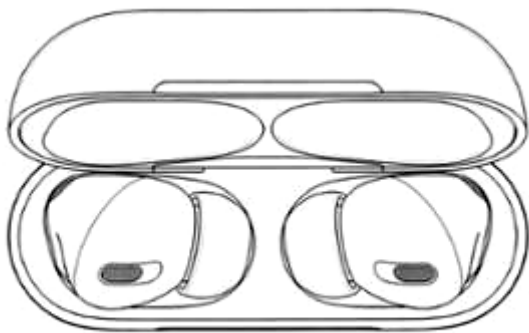

1.6

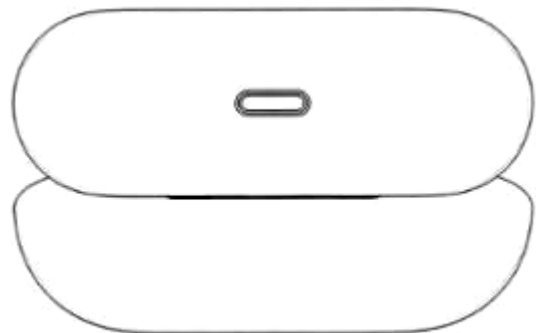

1.7

**CÔNG BÁO SỞ HỮU CÔNG NGHIỆP SỐ 400 TẬP A – QUYỀN 2 (07.2021)**

(11) **41950**

(21) 3-2020-00622

(28) 1

(54) **CHUỒNG NUÔI NHÓT ĐỘNG VẬT**

(51) **30-02**

(22) 20/03/2020

(43) 26/07/2021

**CÔNG TY TNHH CHẾ TẠO MÁY HONGYUAN HẢI PHÒNG VIỆT NAM (VN)**

(73) Lô đất L2.6, L2.12 KCN Đồ Sơn Hải Phòng, phường Ngọc Xuyên, quận Đồ Sơn, thành phố Hải Phòng

(72) Nguyễn Anh Tuấn (VN)

(74) Công ty Luật TNHH MINH KHUÊ (MK LAW FIRM)

(55)



1.4



1.6

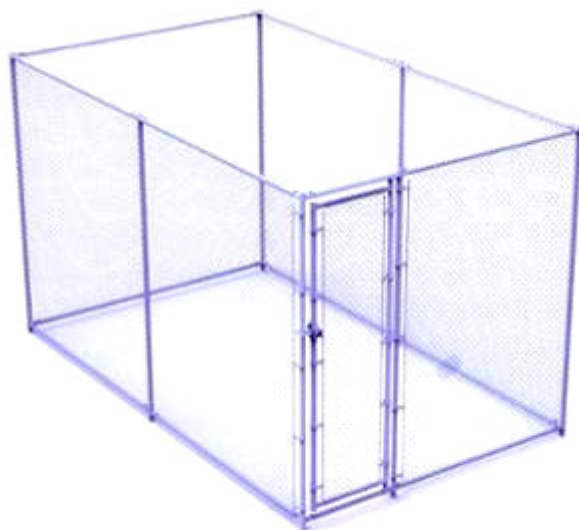

1.1

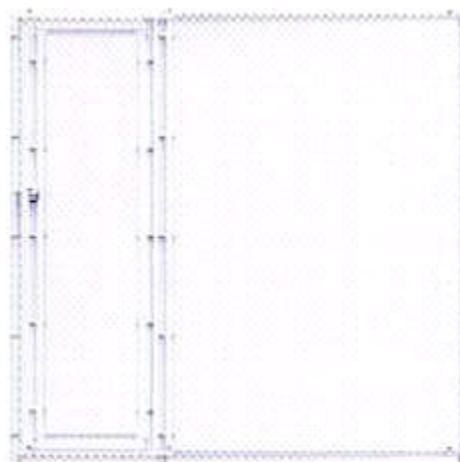

1.2

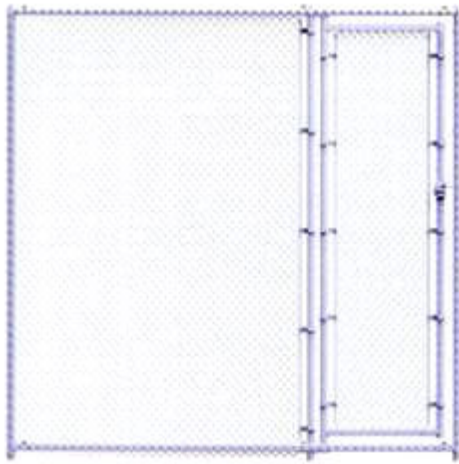

1.3

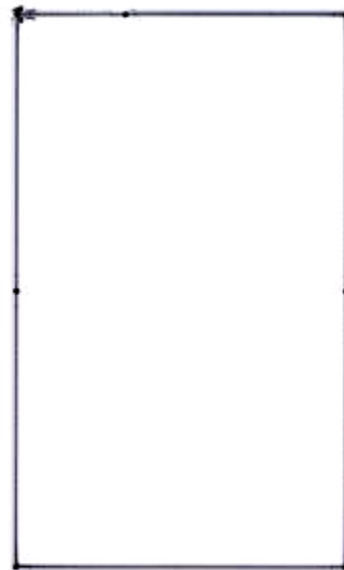

1.7

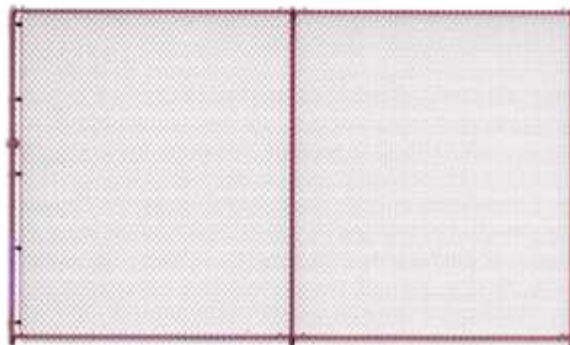

1.5



- (11) **41951**  
(21) 3-2020-01365 (28) 1  
(54) **GỐI** (51) **06-09**  
(22) 11/06/2020 (43) 26/07/2021  
(73) **CÔNG TY TNHH DƯỢC PHẨM INNOCARE (VN)**  
Số 347 đường Ý La, phường Dương Nội, quận Hà Đông, thành phố Hà Nội  
1. NGUYỄN BÁ NGHĨA (VN)  
(72) 2. HOÀNG THỊ PHƯƠNG CÚC (VN)  
3. ĐẶNG THÀNH LONG (VN)  
(74) **CÔNG TY TNHH SỞ HỮU TRÍ TUỆ ANLIS VIỆT NAM (ANLIS IP CO.,LTD)**  
(55)

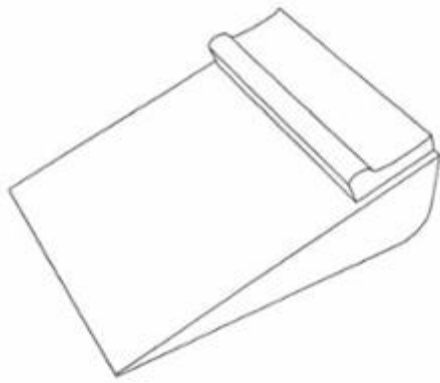

1.1



1.2



1.3



1.4



1.5



1.6

(11) **41952**

(21) 3-2020-01380

(28) 1

(54) **GẠCH BÔNG GIÓ**

(51) **25-01**

(22) 12/06/2020

(43) 26/07/2021

(73) **CÔNG TY CỔ PHẦN VĨNH CỬU (VN)**

319 Xa Lộ Hà Nội, phường An Phú, quận 2, thành phố Hồ Chí Minh

(72) Nguyễn Vui (VN)

(55)

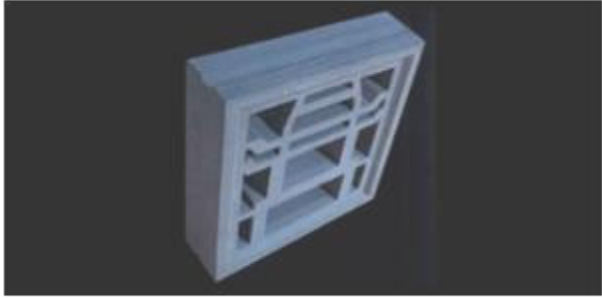

1.1



1.2



1.3



1.4



1.5



1.6



1.7

**CÔNG BÁO SỞ HỮU CÔNG NGHIỆP SỐ 400 TẬP A – QUYỀN 2 (07.2021)**

(11) **41953**

(21) 3-2020-01381

(28) 1

(54) **GẠCH BÔNG GIÓ**

(51) **25-01**

(22) 12/06/2020

(43) 26/07/2021

(73) **Công ty cổ phần Vĩnh Cửu (VN)**

319 Xa Lộ Hà Nội, phường An Phú, quận 2, thành phố Hồ Chí Minh

(72) Nguyễn Vui (VN)

(55)

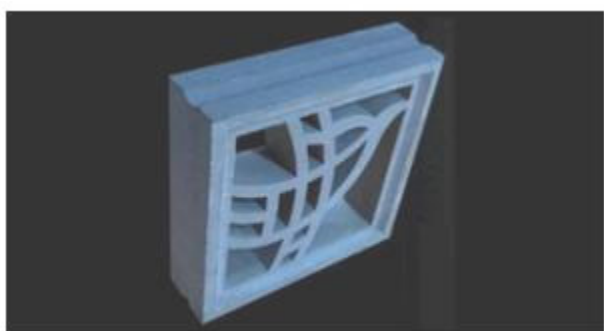

1.1



1.2



1.3



1.4



1.5



1.6



1.7

(11) **41954**

(21) 3-2020-01382

(28) 1

(54) **GẠCH BÔNG GIÓ**

(51) **25-01**

(22) 12/06/2020

(43) 26/07/2021

(73) **CÔNG TY CỔ PHẦN VĨNH CỬU (VN)**

319 Xa Lộ Hà Nội, phường An Phú, quận 2, thành phố Hồ Chí Minh

(72) Nguyễn Vui (VN)

(55)

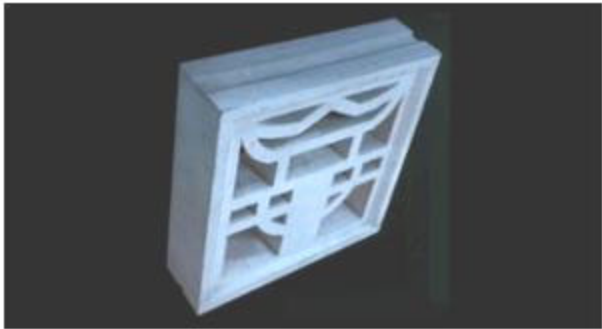

1.1



1.2



1.3



1.4



1.5



1.6



1.7

(11) **41955**

(21) 3-2020-01383

(28) 1

(54) **GẠCH BÔNG GIÓ**

(51) **25-01**

(22) 12/06/2020

(43) 26/07/2021

(73) **CÔNG TY CỔ PHẦN VĨNH CỬU (VN)**

319 Xa Lộ Hà Nội, phường An Phú, quận 2, thành phố Hồ Chí Minh

(72) Nguyễn Vui (VN)

(55)

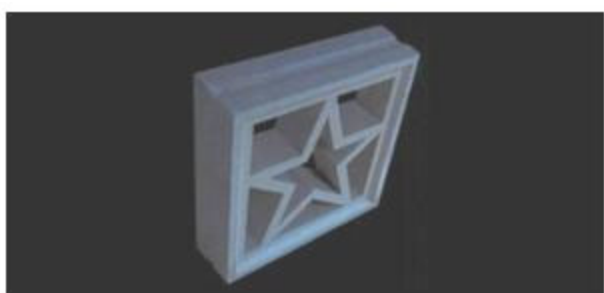

1.1



1.2



1.3



1.4



1.5



1.6



1.7

(11) **41956**

(21) 3-2020-01384

(28) 1

(54) **GẠCH BÔNG GIÓ**

(51) **25-01**

(22) 12/06/2020

(43) 26/07/2021

(73) **CÔNG TY CỔ PHẦN VĨNH CỬU (VN)**

319 Xa Lộ Hà Nội, phường An Phú, quận 2, thành phố Hồ Chí Minh

(72) Nguyễn Vui (VN)

(55)

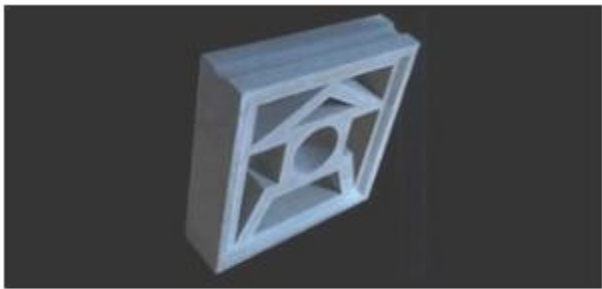

1.1



1.2



1.3



1.4



1.5



1.6

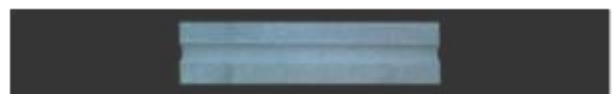

1.7

**CÔNG BÁO SỞ HỮU CÔNG NGHIỆP SỐ 400 TẬP A – QUYỀN 2 (07.2021)**

- (11) **41957**  
(21) 3-2020-01453 (28) 1  
(54) **TẮM PANEN** (51) **25-02**  
(22) 19/06/2020 (43) 26/07/2021  
(30) 201917287 19/12/2019 AU;  
(73) **BLUESCOPE STEEL LIMITED (AU)**  
Level 11, 120 Collins Street, Melbourne, Victoria 3000, AUSTRALIA  
(72) Michael Lette (AU)  
(74) Công ty TNHH một thành viên Sở hữu trí tuệ VCCI (VCCI-IP CO.,LTD)  
(55)

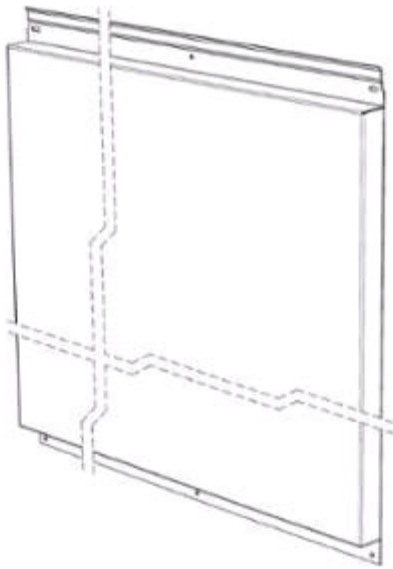

1.1

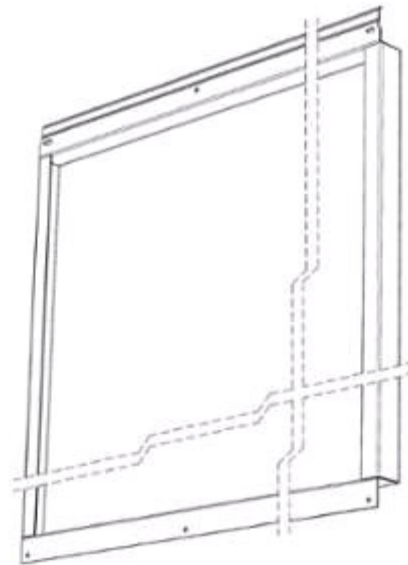

1.2

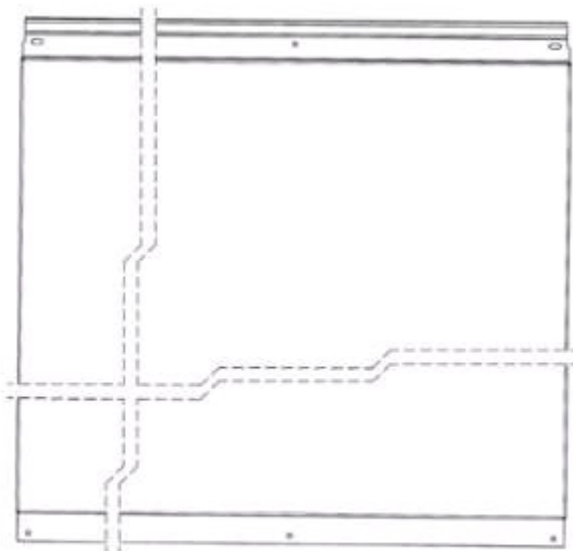

1.3

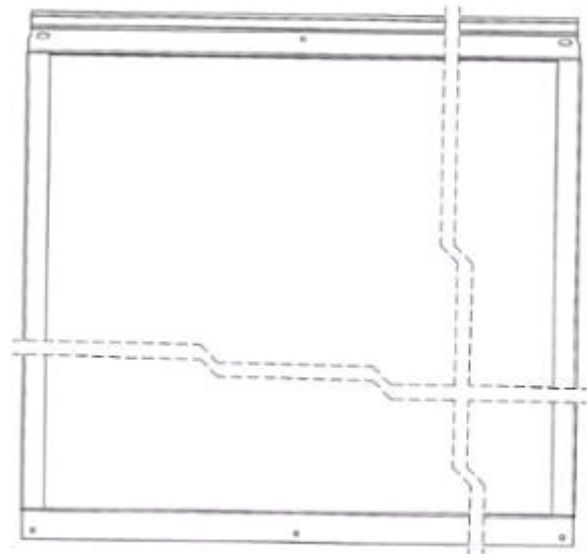

1.4



1.5



1.6



1.7



1.8

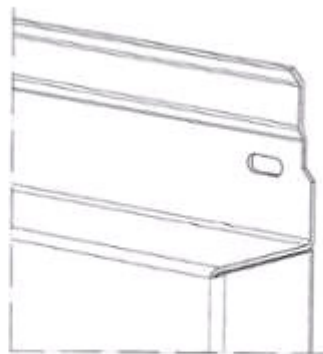

1.9

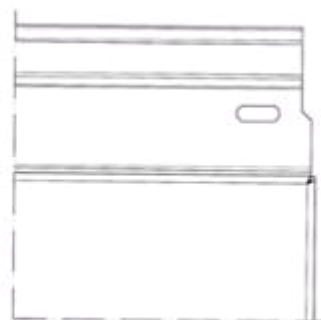

1.10



- (11) **41958**  
(21) 3-2020-01698 (28) 1  
(54) **TẤM DẪN NHIỆT** (51) **13-99**  
(22) 23/07/2020 (43) 26/07/2021  
(30) 2020-005145 16/03/2020 JP;  
(73) **SHIN-ETSU POLYMER CO., LTD. (JP)**  
1-9, Kanda-Sudacho, Chiyoda-ku, Tokyo 1010041 Japan  
(72) 1. MASAHIRO TESHIMA (JP)  
2. NOBORU NAKAFUJI (JP)  
(74) Văn phòng Luật sư Ân Nam (ANNAM IP & LAW)  
(55)

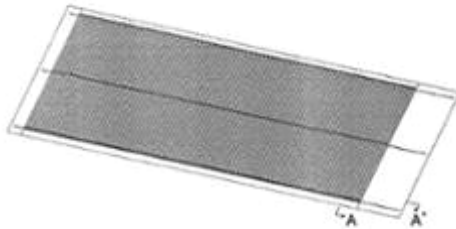

1.1



1.2



1.3



1.4

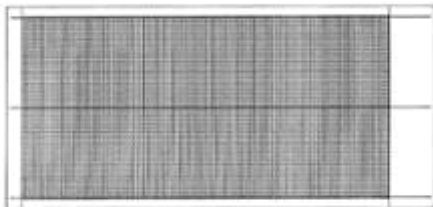

1.5

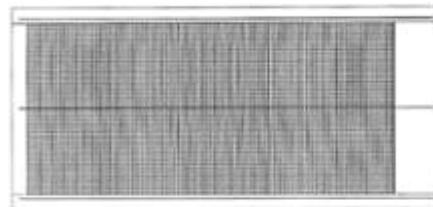

1.6

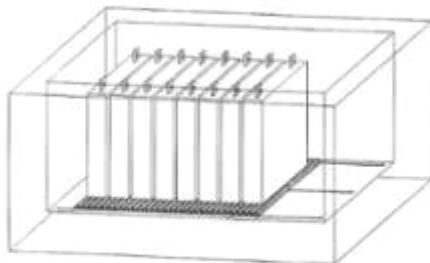

1.7

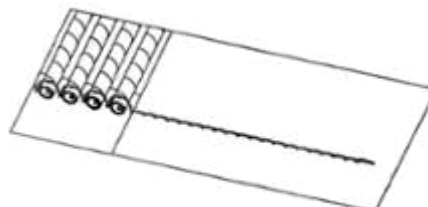

1.8

**CÔNG BÁO SỞ HỮU CÔNG NGHIỆP SỐ 400 TẬP A – QUYỀN 2 (07.2021)**

(11) **41959**

(21) 3-2020-01708

(54) **BỘ CHÉN ĐĨA**

(22) 24/07/2020

(28) 1

(51) **07-01**

(43) 26/07/2021

**CÔNG TY TNHH MINH LONG I (VN)**

(73) 333 khu phố Hưng Lộc, phường Hưng Định, thành phố Thuận An, tỉnh Bình Dương

(72) Lý Ngọc Minh (VN)

(55)



1.1



1.2



1.3



1.4



1.5



1.6



1.7

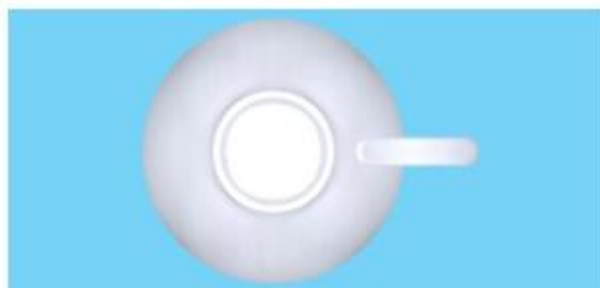

1.8



1.9



1.10



1.11



1.12

- (11) **41960**  
(21) 3-2020-01723 (28) 1  
(54) **TÚI** (51) **09-05**  
(22) 27/07/2020 (43) 26/07/2021  
(73) **CÔNG TY TNHH TMDV XNK HÀ THÀNH (VN)**  
Số 89 Dốc Mọc, xã Cao Dương, huyện Thanh Oai, thành phố Hà Nội  
(72) Đoàn Tuấn Anh (VN)  
(55)



1.1



1.2



1.3



1.4



1.5



1.6



1.7

- (11) **41961**
- (21) 3-2020-01783
- (54) **NHÃN SẢN PHẨM**
- (22) 31/07/2020
- (73) **CÔNG TY CỔ PHẦN CHĂN NUÔI C.P VIỆT NAM (VN)**  
KCN Biên Hòa II - Biên Hòa - tỉnh Đồng Nai
- (72) VITTHAWAT SATTHATHAM (TH)
- (55)
- (28) 1
- (51) **19-08**
- (43) 26/07/2021



1.1



1.2

**CÔNG BÁO SỞ HỮU CÔNG NGHIỆP SỐ 400 TẬP A – QUYỀN 2 (07.2021)**

- (11) **41962**
- (21) 3-2020-01784
- (54) **NHÃN SẢN PHẨM**
- (22) 31/07/2020
- (73) **CÔNG TY CỔ PHẦN CHĂN NUÔI C.P VIỆT NAM (VN)**  
KCN Biên Hòa II - Biên Hòa - tỉnh Đồng Nai
- (72) VITTHAWAT SATTHATHAM (TH)
- (55)
- (28) 1
- (51) **19-08**
- (43) 26/07/2021



1.1



1.2

(11) **41963**

(21) 3-2020-01876

(28) 1

(54) **VẬT TRANG TRÍ**

(51) **11-02**

(22) 11/08/2020

(43) 26/07/2021

(73) **NGUYỄN QUỐC NAM (VN)**

(73) 1248 Kha Vạn Cân, phường Linh Trung, quận Thủ Đức, thành phố Hồ Chí Minh

(72) Nguyễn Quốc Nam (VN)

(55)



1.1



1.2



1.3



**CÔNG BÁO SỞ HỮU CÔNG NGHIỆP SỐ 400 TẬP A – QUYỀN 2 (07.2021)**

(11) **41964**

(21) 3-2020-01989

(28) 1

(54) **HỘP**

(51) **09-03**

(22) 27/08/2020

(43) 26/07/2021

(73) **CÔNG TY TNHH BROTHER MART (VN)**

27 Hồ Văn Huê, phường 09, quận Phú Nhuận, thành phố Hồ Chí Minh

(72) Nguyễn Thế Dũng (VN)

(55)



1.1



1.2



1.3



1.4



1.5



1.6

**CÔNG BÁO SỞ HỮU CÔNG NGHIỆP SỐ 400 TẬP A – QUYỀN 2 (07.2021)**

(11) **41965**

(21) 3-2020-02059

(28) 1

(54) **BỘ NHÃN SẢN PHẨM BIA**

(51) **19-08**

(22) 01/09/2020

(43) 26/07/2021

**CÔNG TY TNHH MỘT THÀNH VIÊN QUÝ PHÚ LÂM (VN)**

(73) L20 Cư xá Phú Lâm A, đường Kinh Dương Vương, phường 12, quận 6, thành phố Hồ Chí Minh

(72) Nguyễn Văn Quý (VN)

(55)



1.1



1.2



1.3

**CÔNG BÁO SỞ HỮU CÔNG NGHIỆP SỐ 400 TẬP A – QUYỀN 2 (07.2021)**

(11) **41966**

(21) 3-2020-02060

(28) 1

(54) **BỘ NHÃN SẢN PHẨM BIA**

(51) **19-08**

(22) 01/09/2020

(43) 26/07/2021

**CÔNG TY TNHH MỘT THÀNH VIÊN QUÝ PHÚ LÂM (VN)**

(73) L20 Cư xá Phú Lâm A, đường Kinh Dương Vương, phường 12, quận 6, thành phố Hồ Chí Minh

(72) Nguyễn Văn Quý (VN)

(55)



1.1



1.2



1.3

**CÔNG BÁO SỞ HỮU CÔNG NGHIỆP SỐ 400 TẬP A – QUYỀN 2 (07.2021)**

- (11) **41967**  
(21) 3-2020-02063 (28) 1  
(54) **CHAI ĐỰNG RƯỢU** (51) **09-01**  
(22) 03/09/2020 (43) 26/07/2021  
(73) **CÔNG TY CỔ PHẦN ĐẦU TƯ THƯƠNG MẠI SAMIC (VN)**  
Số 40 ngõ 35 Cát Linh, phường Cát Linh, quận Đống Đa, thành phố Hà Nội  
(72) Lê Văn Minh (VN)  
(55)



1.1



1.2



1.3



1.4



1.5



1.6



1.7

**CÔNG BÁO SỞ HỮU CÔNG NGHIỆP SỐ 400 TẬP A – QUYỀN 2 (07.2021)**

(11) **41968**

(21) 3-2020-02073

(28) 1

(54) **GHẾ SÔ-PHA**

(51) **06-01**

(22) 03/09/2020

(43) 26/07/2021

(73) **HTL FURNITURE (CHINA) CO., LTD. (CN)**

Wusong Jiangnan Road, Kunshan Development Zone, Jiangsu Province, China

(72) PHUA YONG TAT (SG)

(74) Công ty Luật TNHH quốc tế BMVN (BMVN INTERNATIONAL LLC)

(55)



1.1



1.2



1.3



1.4



1.5

**CÔNG BÁO SỞ HỮU CÔNG NGHIỆP SỐ 400 TẬP A – QUYỀN 2 (07.2021)**

(11) **41969**

(21) 3-2020-02082

(28) 1

(54) **GHẾ SÔ-PHA**

(51) **06-01**

(22) 03/09/2020

(43) 26/07/2021

(73) **HTL FURNITURE (CHINA) CO., LTD. (CN)**

Wusong Jiangnan Road, Kunshan Development Zone, Jiangsu Province, China

(72) PHUA YONG TAT (SG)

(74) Công ty Luật TNHH quốc tế BMVN (BMVN INTERNATIONAL LLC)

(55)



1.1



1.2



1.3



1.4



1.5

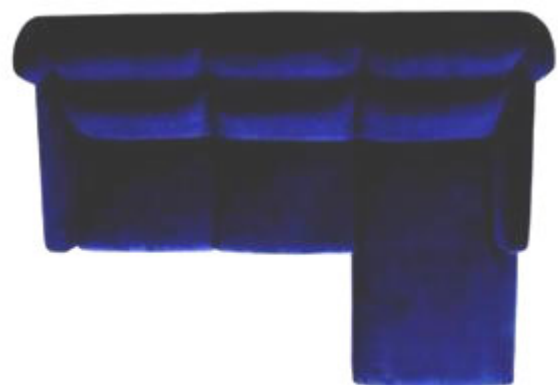

1.6

**CÔNG BÁO SỞ HỮU CÔNG NGHIỆP SỐ 400 TẬP A – QUYỀN 2 (07.2021)**

- (11) **41970**  
(21) 3-2020-02259 (28) 1  
(54) **THIẾT BỊ THU PHÁT SÓNG** (51) **14-03**  
(22) 14/09/2020 (43) 26/07/2021  
(73) **CÔNG TY CỔ PHẦN THIẾT BỊ CÔNG NGHIỆP HỮU HỒNG (VN)**  
157-159 Xuân Hồng, phường 12, quận Tân Bình, thành phố Hồ Chí Minh  
(72) Thạch Vũ Thùy Linh (VN)  
(55)



1.1



1.2



1.3



1.4



1.5



1.6



1.7



**CÔNG BÁO SỞ HỮU CÔNG NGHIỆP SỐ 400 TẬP A – QUYỀN 2 (07.2021)**

(11) **41971**

(21) 3-2020-02317

(28) 1

(54) **HỘP THUỐC**

(51) **09-03**

(22) 18/09/2020

(43) 26/07/2021

**CÔNG TY TNHH MTV THUỐC THÚ Y & CHẾ PHẨM SINH HỌC  
VEMEDIM (VN)**

(73) Khu Công nghiệp Sông Hậu, giai đoạn 1, xã Đông Phú, huyện Châu Thành, tỉnh Hậu Giang

(72) LƯU PHƯỚC HẬU (VN)

(55)



1.1



1.2

(11) **41972**

(21) 3-2020-02318

(28) 1

(54) **HỘP THUỐC**

(51) **09-03**

(22) 18/09/2020

(43) 26/07/2021

**CÔNG TY TNHH MTV THUỐC THÚ Y & CHẾ PHẨM SINH HỌC  
VEMEDIM (VN)**

(73) Khu Công nghiệp Sông Hậu, giai đoạn 1, xã Đông Phú, huyện Châu Thành, tỉnh Hậu Giang

(72) LƯU PHƯỚC HẬU (VN)

(55)



1.1



1.2

**CÔNG BÁO SỞ HỮU CÔNG NGHIỆP SỐ 400 TẬP A – QUYỀN 2 (07.2021)**

(11) **41973**

(21) 3-2020-02319

(28) 1

(54) **HỘP THUỐC**

(51) **09-03**

(22) 18/09/2020

(43) 26/07/2021

**CÔNG TY TNHH MTV THUỐC THÚ Y & CHẾ PHẨM SINH HỌC  
VEMEDIM (VN)**

(73) Khu Công nghiệp Sông Hậu, giai đoạn 1, xã Đông Phú, huyện Châu Thành, tỉnh Hậu Giang

(72) LƯU PHƯỚC HẬU (VN)

(55)



1.2



1.1

**CÔNG BÁO SỞ HỮU CÔNG NGHIỆP SỐ 400 TẬP A – QUYỀN 2 (07.2021)**

- (11) **41974**  
(21) 3-2020-02439 (28) 1  
(54) **CHAI NHỰA** (51) **09-01**  
(22) 30/09/2020 (43) 26/07/2021  
(73) **CÔNG TY CỔ PHẦN NICOTEX (VN)**  
Số 114 phố Vũ Xuân Thiều, phường Phúc Lợi, quận Long Biên, thành phố Hà Nội  
(72) Nguyễn Thành Nam (VN)  
(55)

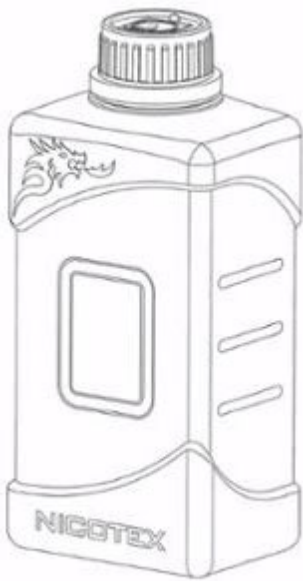

1.1



1.2



1.3

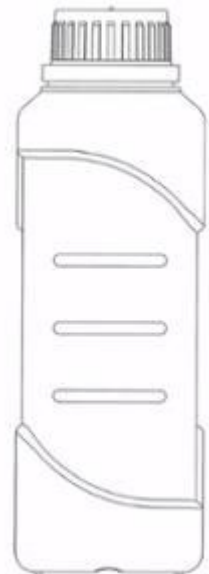

1.4



1.5

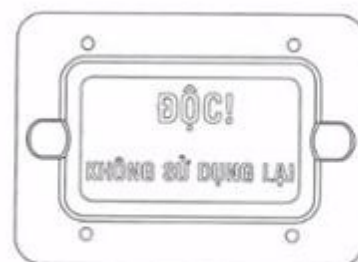

1.6

(11) **41975**

(21) 3-2020-02496

(28) 1

(54) **PHỄU HÚT SỮA**

(51) **24-02**

(22) 07/10/2020

(43) 26/07/2021

**HOÀNG THỊ NGỌC HÂN (VN)**

(73) P2304 G5 CC Five star số 02 Kim Giang, phường Kim Giang, quận Thanh Xuân, thành phố Hà Nội

(72) Hoàng Thị Ngọc Hân (VN)

(55)



1.1



1.2



1.3



1.4



1.5



1.6



1.7

(11) **41976**

(21) 3-2020-02541

(28) 1

(54) **BÀN CHẢI ĐÁNH RĂNG**

(51) **04-02**

(22) 13/10/2020

(43) 26/07/2021

**CÔNG TY TNHH SẢN XUẤT THƯƠNG MẠI LIÊN THÀNH PHÁT (VN)**

(73) D19/31 Hương Lộ 80, ấp 4, xã Vĩnh Lộc B, huyện Bình Chánh, thành phố Hồ Chí Minh

(72) LÂM WAI (VN)

(55)



1.1



1.2



1.3



1.4



1.5



1.6

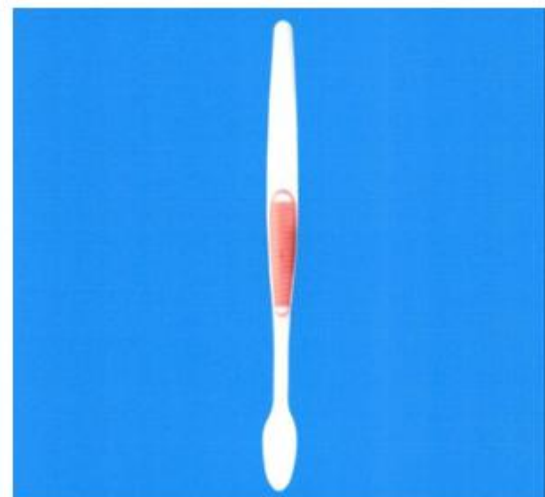

1.7

**CÔNG BÁO SỞ HỮU CÔNG NGHIỆP SỐ 400 TẬP A – QUYỀN 2 (07.2021)**

- (11) **41977**  
(21) 3-2020-02582 (28) 1  
(54) **ĐIỆN THOẠI DI ĐỘNG** (51) **14-03**  
(22) 16/10/2020 (43) 26/07/2021  
(30) 30-2020-0018525 27/04/2020 KR;  
**SAMSUNG ELECTRONICS CO., LTD. (KR)**  
(73) 129, Samsung-ro, Yeongtong-gu, Suwon-si, Gyeonggi-do 16677, Republic of Korea  
1. SONG, JUNYONG (KR)  
2. KIM, BYOUNGJIN (KR)  
(72) 3. JEONG, WOOSUNG (KR)  
4. KIM, EUNSOO (KR)  
5. CHOI, JUNGHYUN (KR)  
(74) Công ty Luật TNHH WINCO (WINCO LAW FIRM)  
(55)

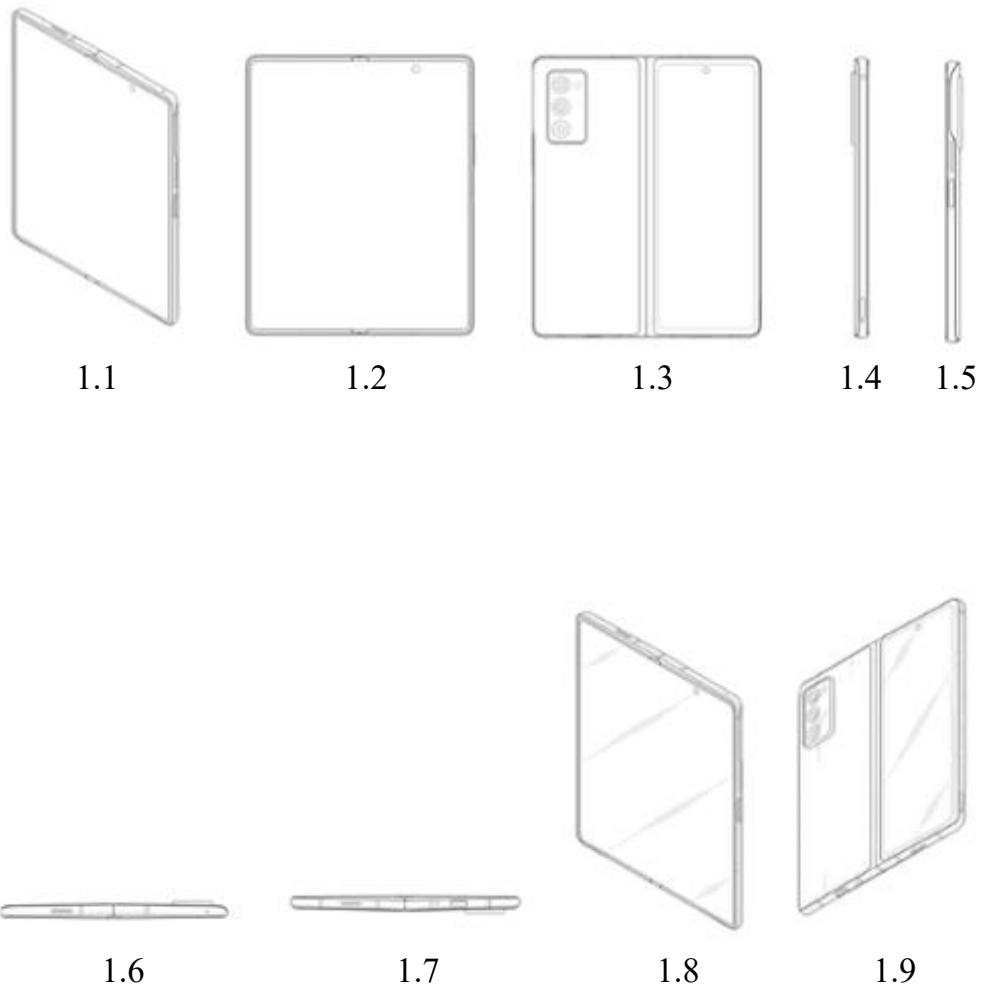

**CÔNG BÁO SỞ HỮU CÔNG NGHIỆP SỐ 400 TẬP A – QUYỀN 2 (07.2021)**

- (11) **41978**  
(21) 3-2020-02583 (28) 1  
(54) **ĐIỆN THOẠI DI ĐỘNG** (51) **14-03**  
(22) 16/10/2020 (43) 26/07/2021  
(30) 30-2020-0018531 27/04/2020 KR;  
**SAMSUNG ELECTRONICS CO., LTD. (KR)**  
(73) 129, Samsung-ro, Yeongtong-gu, Suwon-si, Gyeonggi-do 16677, Republic of Korea  
1. SONG, JUNYONG (KR)  
2. KIM, BYOUNGJIN (KR)  
(72) 3. JEONG, WOOSUNG (KR)  
4. KIM, EUNSOO (KR)  
5. CHOI, JUNGHYUN (KR)  
(74) Công ty Luật TNHH WINCO (WINCO LAW FIRM)  
(55)

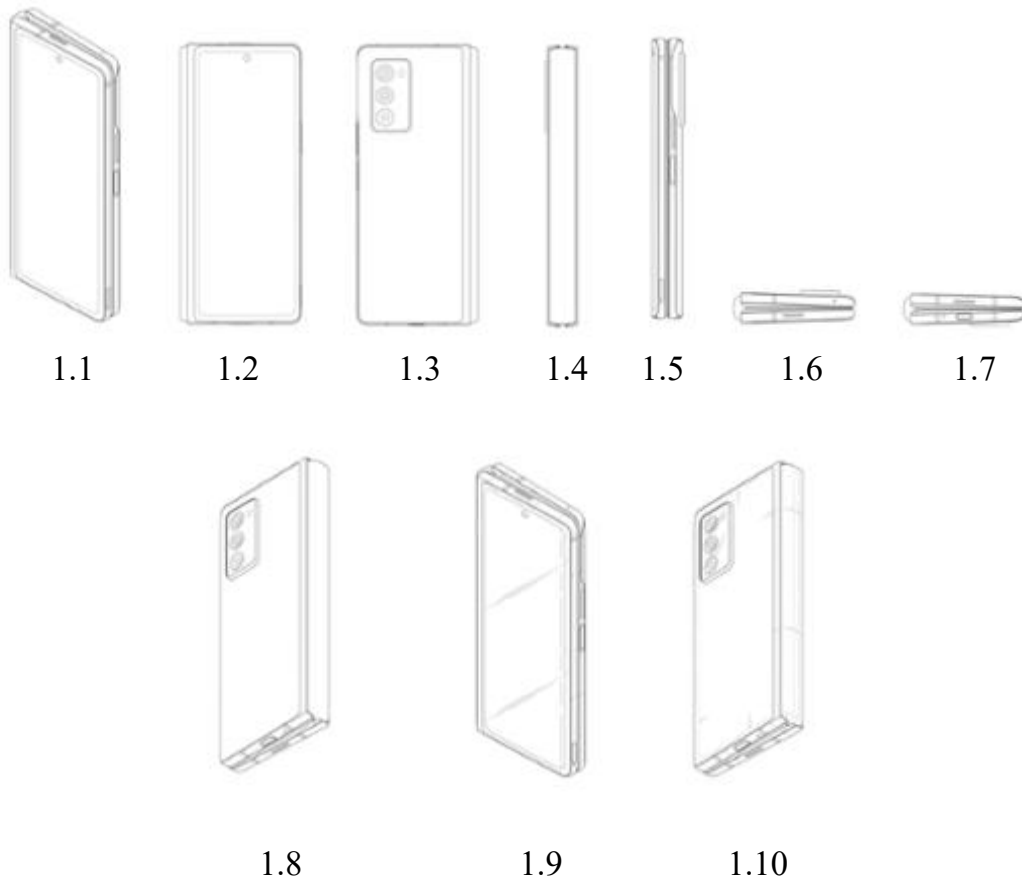



**CÔNG BÁO SỞ HỮU CÔNG NGHIỆP SỐ 400 TẬP A – QUYỀN 2 (07.2021)**

- (11) **41979**  
(21) 3-2020-02627 (28) 1  
(54) **ĐIỆN THOẠI DI ĐỘNG** (51) **14-03**  
(22) 23/10/2020 (43) 26/07/2021  
(30) 202030173084.5 24/04/2020 CN;  
(73) **VIVO MOBILE COMMUNICATION CO., LTD.** (CN)  
No.168 Jinghai East Rd., Chang'an, Dongguan, Guangdong 523863, China  
1. FENG YU (CN)  
(72) 2. AN REN (CN)  
3. XI HE (CN)  
(74) Công ty cổ phần Tư vấn S&B (S&B CONSULTANT., CORP.)  
(55)

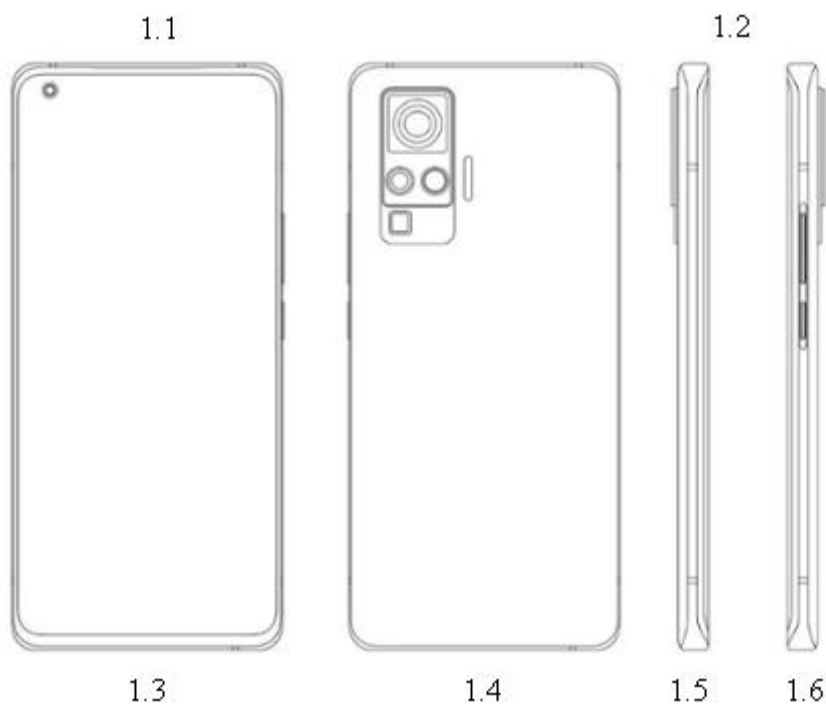
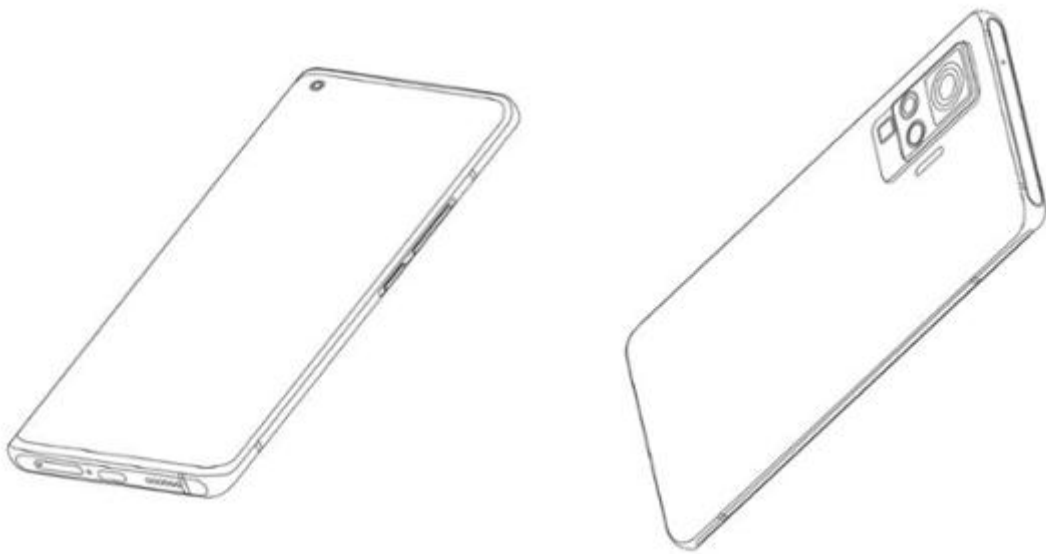



1.7



1.8



1.9



1.10



1.11



1.12



1.13



1.14



1.15



1.16

**CÔNG BÁO SỞ HỮU CÔNG NGHIỆP SỐ 400 TẬP A – QUYỀN 2 (07.2021)**

- (11) **41980**  
(21) 3-2020-02658 (28) 3  
(54) **BỘ NHÃN SẢN PHẨM** (51) **19-08**  
(22) 29/10/2020 (43) 26/07/2021  
(73) **CÔNG TY CỔ PHẦN DẦU CÁ CHÂU Á (VN)**  
Quốc lộ 80, ấp An Thạnh, xã Bình Thành, huyện Lấp Vò, tỉnh Đồng Tháp  
(72) Lê Văn Chính (VN)  
(55)



1.1



1.2



1.3



1.4

**CÔNG BÁO SỞ HỮU CÔNG NGHIỆP SỐ 400 TẬP A – QUYỀN 2 (07.2021)**

(11) **41981**

(21) 3-2020-02661

(28) 1

(54) **NHÃN SẢN PHẨM**

(51) **19-08**

(22) 29/10/2020

(43) 26/07/2021

**CÔNG TY CỔ PHẦN MUỐI VÀ THƯƠNG MẠI NAM ĐỊNH (VN)**

(73) 363 đường Trần Nhân Tông, phường Trần Hưng Đạo, thành phố Nam Định, tỉnh Nam Định

(72) Trần Thị Bình (VN)

(55)



**CÔNG BÁO SỞ HỮU CÔNG NGHIỆP SỐ 400 TẬP A – QUYỀN 2 (07.2021)**

(11) **41982**

(21) 3-2020-02724

(28) 1

(54) **CAMERA CHO MÁY TÍNH CÁ NHÂN**

(51) **16-01**

(22) 06/11/2020

(43) 26/07/2021

**SHENZHEN HENGXIN WEIYE DIGITAL CO., LTD (CN)**

(73) 6/F, B BUILDING, YONGQI INDUSTRIAL XIFA ROAD, BAOAN DISTRICT, SHENZHEN, CHINA

(72) HongBo HU (CN)

(74) Công ty TNHH Sở hữu trí tuệ Trần & Trần (TRAN & TRAN CO., LTD.)

(55)

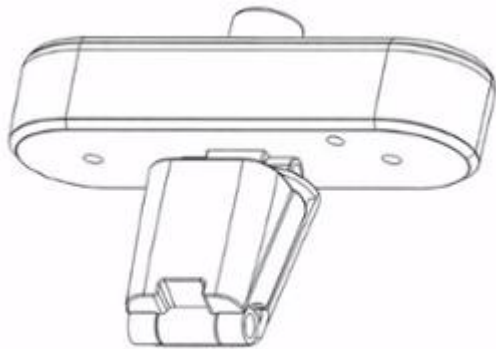

1.1

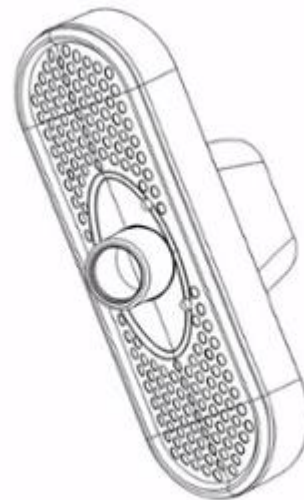

1.2

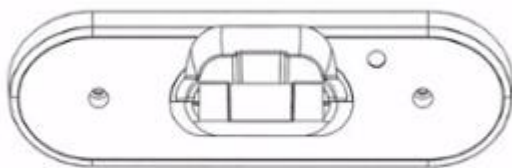

1.3

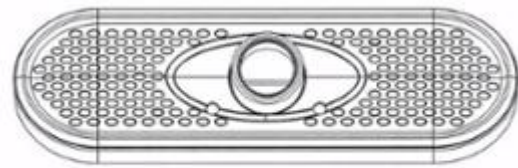

1.4

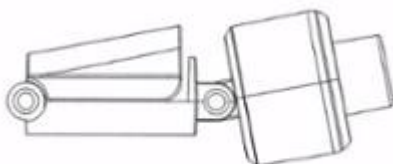

1.5

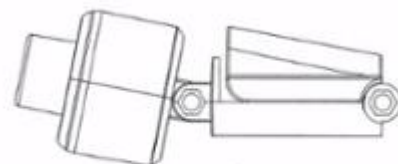

1.6

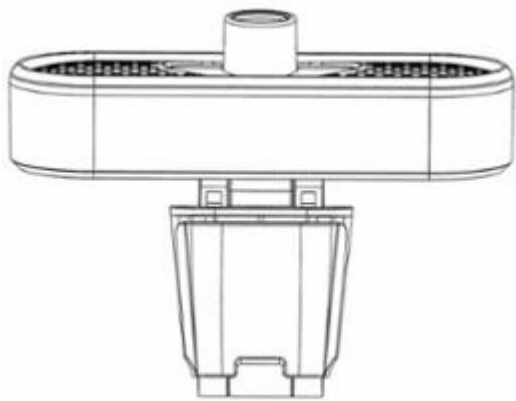

1.7

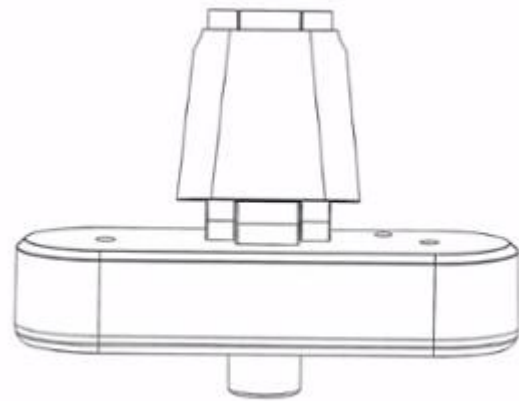

1.8

**CÔNG BÁO SỞ HỮU CÔNG NGHIỆP SỐ 400 TẬP A – QUYỀN 2 (07.2021)**

(11) **41983**

(21) 3-2020-02725

(28) 1

(54) **CAMERA CHO MÁY TÍNH CÁ NHÂN**

(51) **16-01**

(22) 06/11/2020

(43) 26/07/2021

**SHENZHEN HENGXIN WEIYE DIGITAL CO., LTD (CN)**

(73) 6/F, B BUILDING, YONGQI INDUSTRIAL XIFA ROAD, BAOAN DISTRICT, SHENZHEN, CHINA

(72) HongBo HU (CN)

(74) Công ty TNHH Sở hữu trí tuệ Trần & Trần (TRAN & TRAN CO., LTD.)

(55)

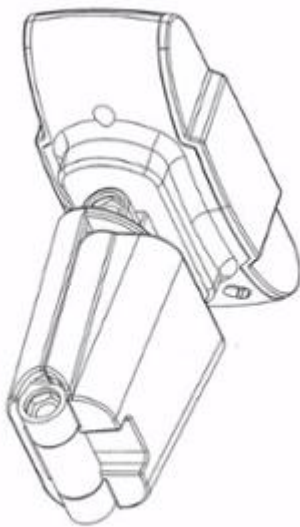

1.1

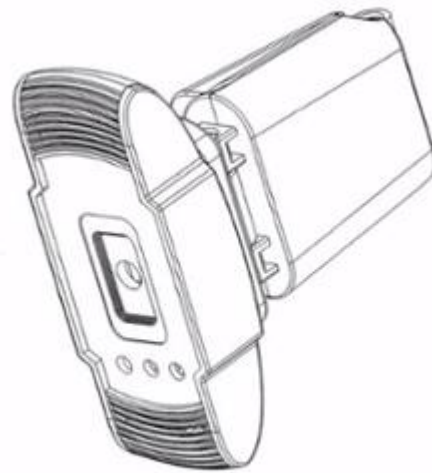

1.2

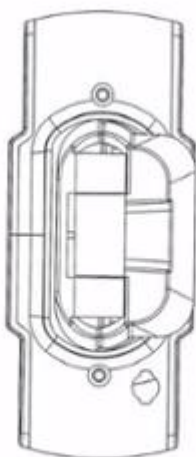

1.3

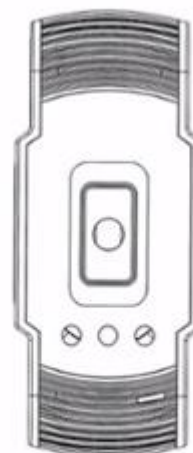

1.4

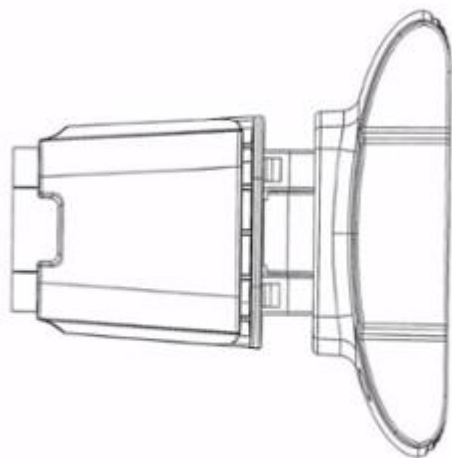

1.5

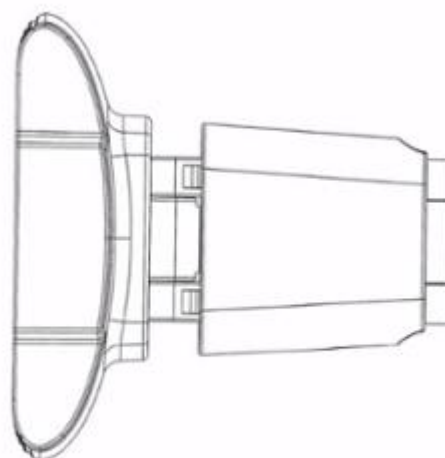

1.6



1.7

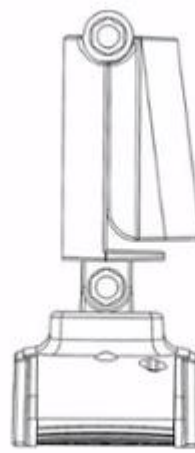

1.8



- (11) **41984**  
(21) 3-2020-02729 (28) 1  
(54) **BÌNH SỮA TRẺ EM** (51) **07-01**  
(22) 09/11/2020 (43) 26/07/2021  
(30) 30-2020-0040935 31/08/2020 KR;  
(73) **ESTUEN INC. (KR)**  
256, Sangidaehak-ro, Siheung-si, Gyeonggi-do, 15079, Republic of Korea  
(72) Kui Hyun, Hwang (KR)  
(74) Công ty Luật TNHH T&G (TGVN)  
(55)

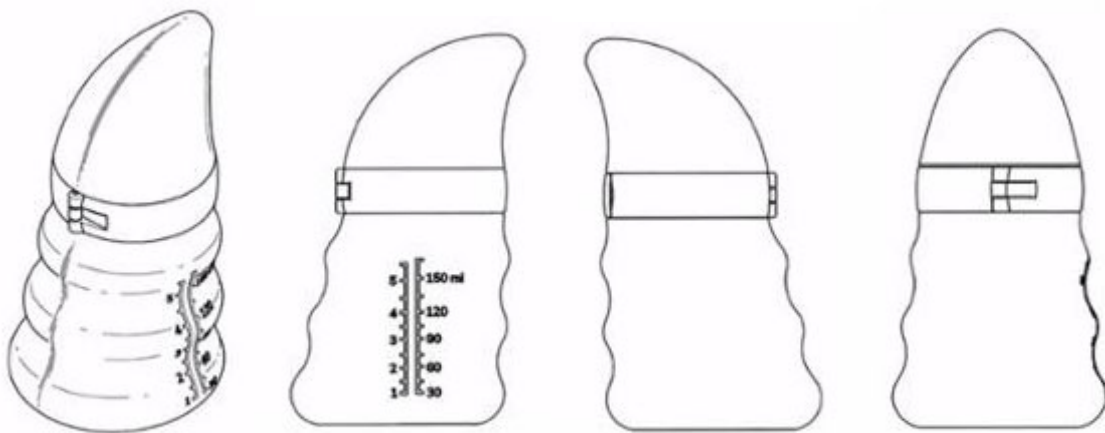

1.1

1.2

1.3

1.4

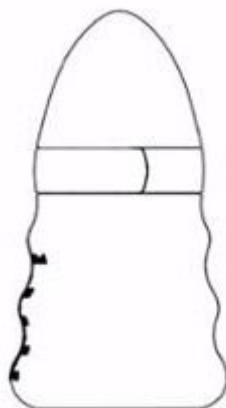

1.5



1.6



1.7



1.8

**CÔNG BÁO SỞ HỮU CÔNG NGHIỆP SỐ 400 TẬP A – QUYỀN 2 (07.2021)**

- (11) **41985**  
(21) 3-2020-02730 (28) 1  
(54) **ĐIỆN THOẠI DI ĐỘNG** (51) **14-03**  
(22) 09/11/2020 (43) 26/07/2021  
(30) 007876768 08/05/2020 EM;  
(73) **HMD GLOBAL OY (FI)**  
Bertel Jungin aukio 9, 02600 ESPOO, Finland  
(72) Richard Choi (CN)  
(74) Công ty cổ phần Tư vấn S&B (S&B CONSULTANT., CORP.)  
(55)

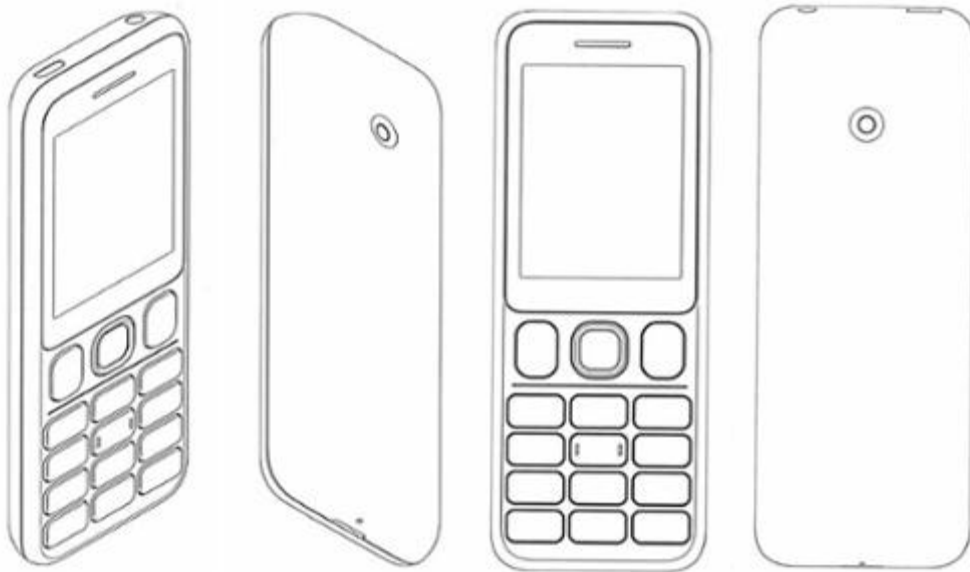

1.1

1.2

1.3

1.4

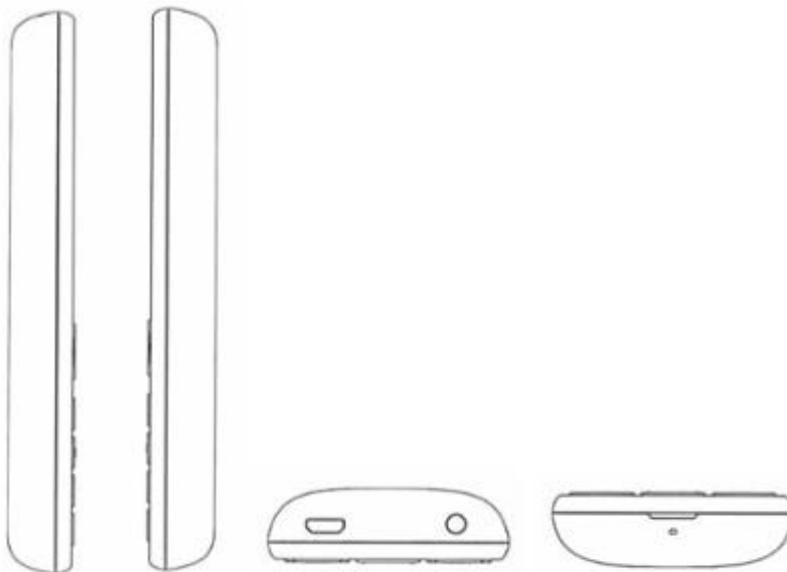

1.5

1.6

1.7

1.8

**CÔNG BÁO SỞ HỮU CÔNG NGHIỆP SỐ 400 TẬP A – QUYỀN 2 (07.2021)**

- (11) **41986**  
(21) 3-2020-02731 (28) 1  
(54) **ĐIỆN THOẠI DI ĐỘNG** (51) **14-03**  
(22) 09/11/2020 (43) 26/07/2021  
(30) 007875570 08/05/2020 EM;  
(73) **HMD GLOBAL OY (FI)**  
Bertel Jungin aukio 9, 02600 ESPOO, Finland  
(72) Richard Choi (CN)  
(74) Công ty cổ phần Tư vấn S&B (S&B CONSULTANT., CORP.)  
(55)



1.1

1.2

1.3

1.4



1.5



1.6



1.7



1.8

**CÔNG BÁO SỞ HỮU CÔNG NGHIỆP SỐ 400 TẬP A – QUYỀN 2 (07.2021)**

- (11) **41987**  
(21) 3-2020-02739 (28) 1  
(54) **BAO GÓI** (51) **09-05**  
(22) 10/11/2020 (43) 26/07/2021  
(73) **CÔNG TY TNHH MỘT THÀNH VIÊN TRỊNH VĂN PHÚ (VN)**  
Số 546 ấp Giồng Cát, xã Lương An Trà, huyện Tri Tôn, tỉnh An Giang  
(72) **TRỊNH VĂN PHÚ (VN)**  
(55)



1.1



1.2

**CÔNG BÁO SỞ HỮU CÔNG NGHIỆP SỐ 400 TẬP A – QUYỀN 2 (07.2021)**

(11) **41988**

(21) 3-2020-02741

(28) 1

(54) **CHAI**

(51) **09-01**

(22) 11/11/2020

(43) 26/07/2021

**CÔNG TY TNHH MỘT THÀNH VIÊN THỰC PHẨM VÀ NƯỚC GIẢI KHÁT NAM VIỆT (VN)**

(73) Số 994/1C, đường Nguyễn Thị Minh Khai, khu phố Tân Thắng, phường Tân Bình, thành phố Dĩ An, tỉnh Bình Dương

(72) **BÙI THỊ HẬU (VN)**

(74) **CÔNG TY TNHH SỞ HỮU TRÍ TUỆ SETHACO (SETHACO IP CO.,LTD)**

(55)



1.1



1.2



1.3



1.4



1.5



1.6

**CÔNG BÁO SỞ HỮU CÔNG NGHIỆP SỐ 400 TẬP A – QUYỀN 2 (07.2021)**

(11) **41989**

(21) 3-2020-02783

(28) 1

(54) **GIÁ ĐỠ**

(51) **08-08**

(22) 16/11/2020

(43) 26/07/2021

**CÔNG TY TNHH ĐẦU TƯ CẢNH PHONG (VN)**

(73) Lô O17 đường số 4, CCN Hải Sơn Đức Hòa Đông, xã Đức Hòa Đông, huyện Đức Hòa, tỉnh Long An

(72) LƯ CHÍ LƯƠNG (VN)

(55)



1.1



1.2



1.3



1.4



1.5



1.6



1.7

**CÔNG BÁO SỞ HỮU CÔNG NGHIỆP SỐ 400 TẬP A – QUYỀN 2 (07.2021)**

(11) **41990**

(21) 3-2020-02815

(54) **VẢI**

(22) 20/11/2020

(30) 29/735,648 22/05/2020 US;

(73) **COLUMBIA SPORTSWEAR NORTH AMERICA, INC. (US)**

14375 NW Science Park Drive, Portland, OR 97229, United States of America

(72) David Reid (US)

(74) Công ty TNHH Ban Ca (BANCA)

(55)

(28) 1

(51) **05-05**

(43) 26/07/2021



1.1



1.2



1.3



1.4

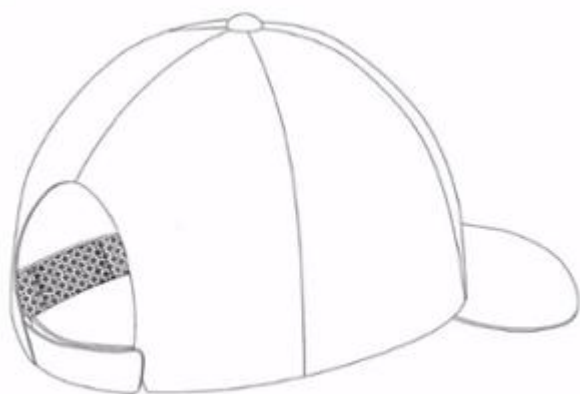

1.5



1.6

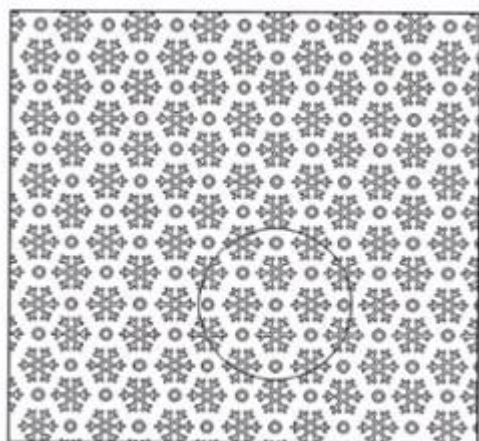

1.7

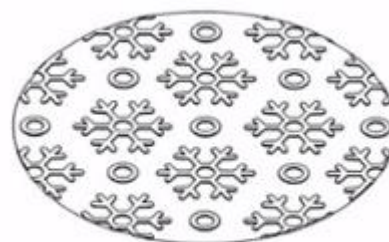

1.8



1.9



1.10



**CÔNG BÁO SỞ HỮU CÔNG NGHIỆP SỐ 400 TẬP A – QUYỀN 2 (07.2021)**

- (11) **41991**  
(21) 3-2020-02872 (28) 1  
(54) **NHÃN SẢN PHẨM** (51) **19-08**  
(22) 27/11/2020 (43) 26/07/2021  
(73) **CÔNG TY CỔ PHẦN KHỬ TRÙNG VIỆT NAM (VN)**  
29 Tôn Đức Thắng, phường Bến Nghé, quận 1, thành phố Hồ Chí Minh  
(72) Trương Công Cứ (VN)  
(74) **CÔNG TY TNHH SỞ HỮU TRÍ TUỆ SETHACO (SETHACO IP CO.,LTD)**  
(55)



**CÔNG BÁO SỞ HỮU CÔNG NGHIỆP SỐ 400 TẬP A – QUYỂN 2 (07.2021)**

- (11) **41992**  
(21) 3-2020-02873 (28) 1  
(54) **NHÃN SẢN PHẨM** (51) **19-08**  
(22) 27/11/2020 (43) 26/07/2021  
(73) **CÔNG TY CỔ PHẦN KHỬ TRÙNG VIỆT NAM (VN)**  
29 Tôn Đức Thắng, phường Bến Nghé, quận 1, thành phố Hồ Chí Minh  
(72) Trương Công Cứ (VN)  
(74) **CÔNG TY TNHH SỞ HỮU TRÍ TUỆ SETHACO (SETHACO IP CO.,LTD)**  
(55)



- (11) **41993**  
(21) 3-2020-02961 (28) 1  
(54) **DAO CẠO** (51) **28-03**  
(22) 07/12/2020 (43) 26/07/2021  
(30) 30-2020-0055905 18/11/2020 KR;  
(73) **DORCO CO., LTD. (KR)**  
36-9, Hyoryeong-ro 70-gil, Seocho-gu, Seoul 06723, Republic of Korea  
1. LEE YOUNG JIN (KR)  
(72) 2. JEONG JONG JIN (KR)  
3. HAN DA WOON (KR)  
(74) Công ty TNHH Sở hữu trí tuệ NTT (NTT IP CO.,LTD)  
(55)

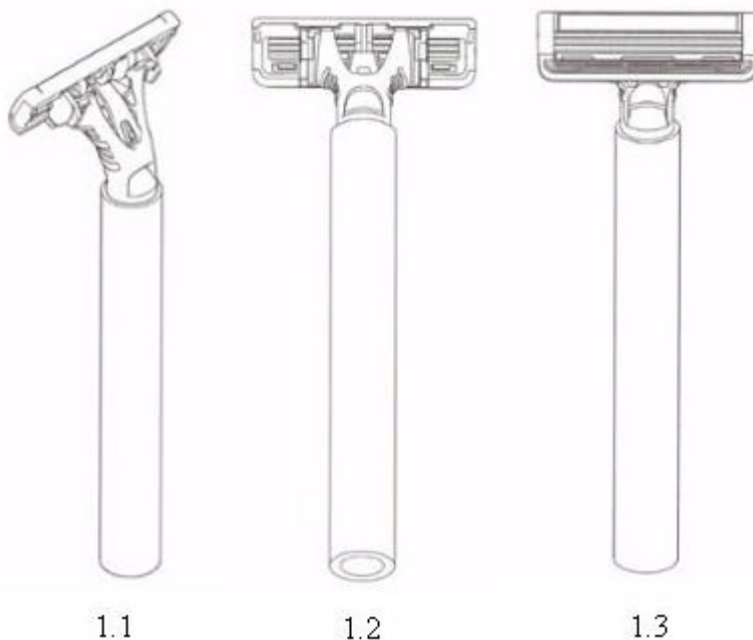

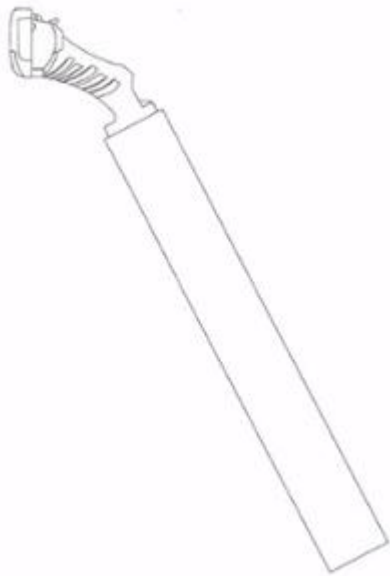

1.4

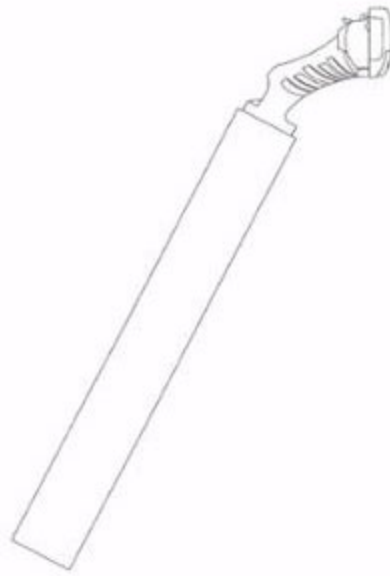

1.5

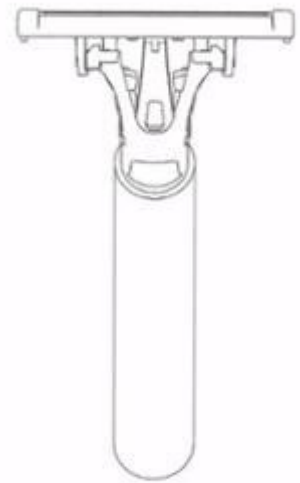

1.6

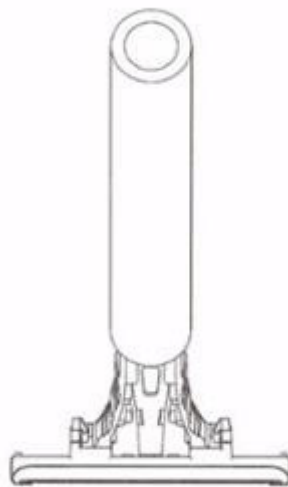

1.7

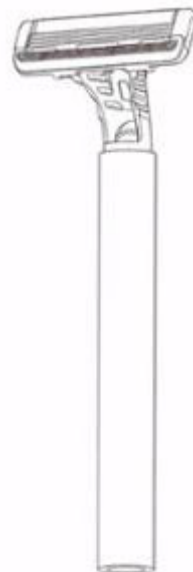

1.8

- (11) **41994**  
(21) 3-2020-02966 (28) 2  
(54) **BẾP GA DI ĐỘNG** (51) **07-02**  
(22) 08/12/2020 (43) 26/07/2021  
(30) 2020-013164 30/06/2020 JP; 2020-013163 30/06/2020 JP;  
(73) **IWATANI CORPORATION (JP)**  
6-4, Hommachi 3-chome, Chuo-ku, Osaka-shi, Osaka, Japan  
(72) Tsuyoshi Tada (JP)  
(74) Công ty TNHH Đại Tín và Liên Danh (DAITIN AND ASSOCIATES CO.,LTD)  
(55)

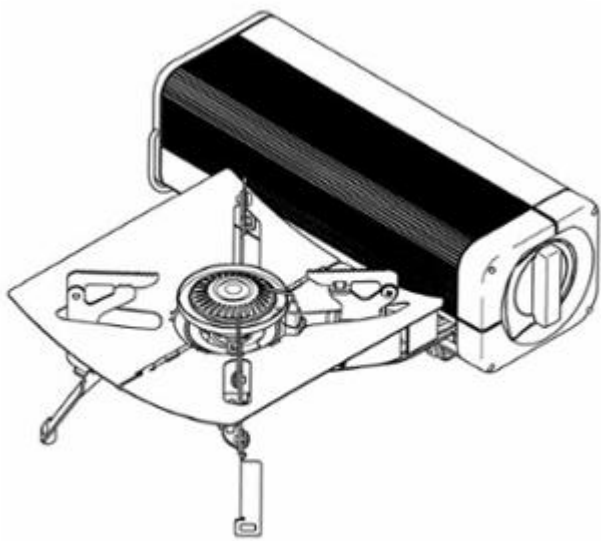

1.1

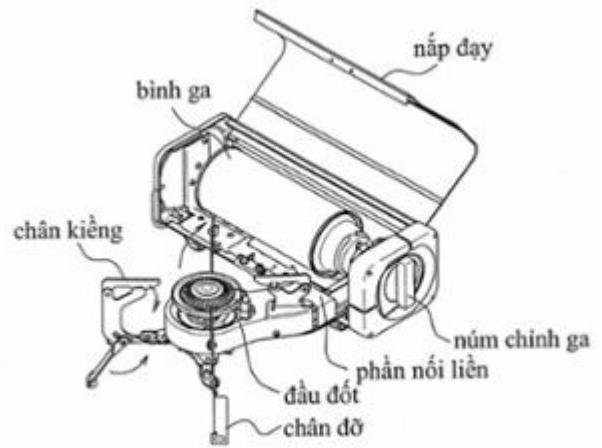

1.2

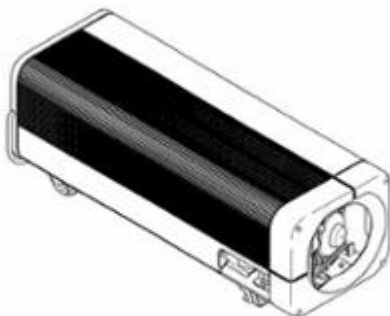

1.3

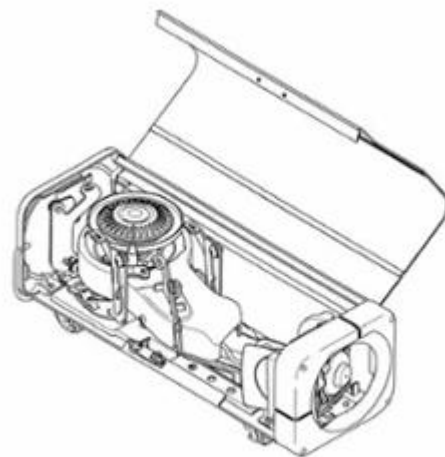

1.4

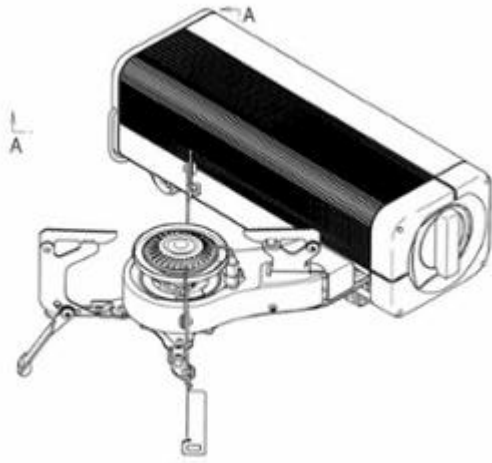

1.5

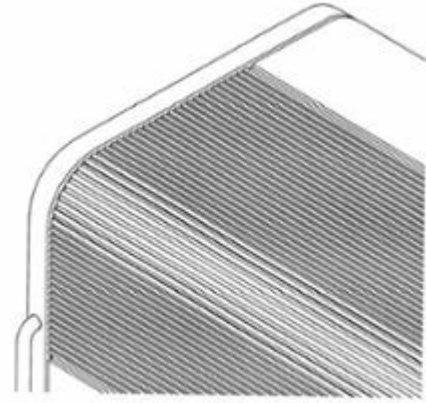

1.6

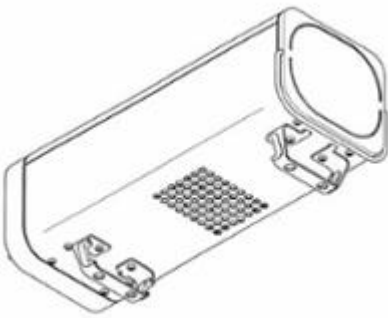

1.7



1.8



1.9

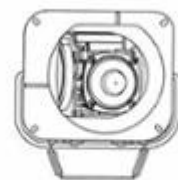

1.10



1.11

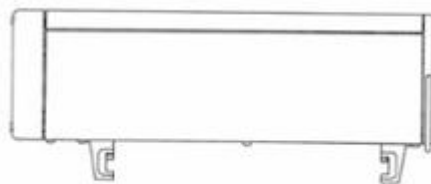

1.12

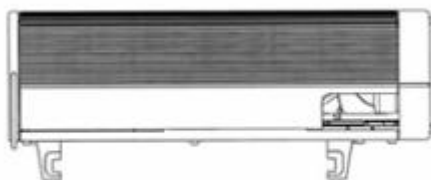

1.13

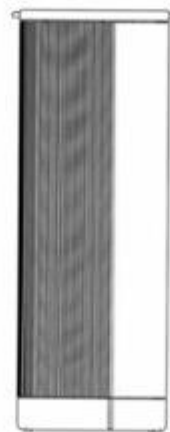

1.14

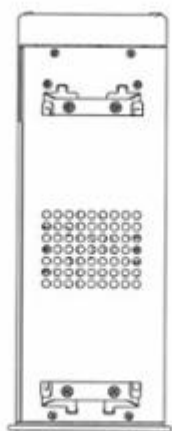

1.15

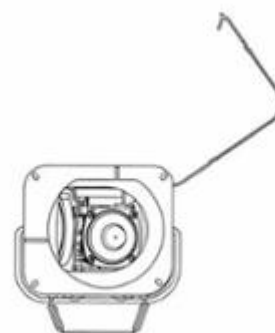

1.16



1.17

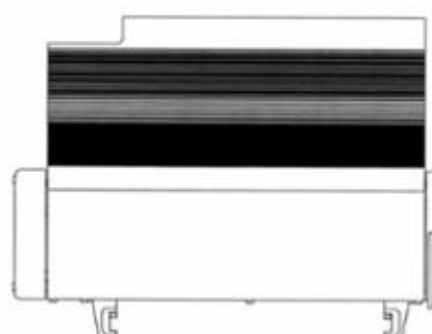

1.18

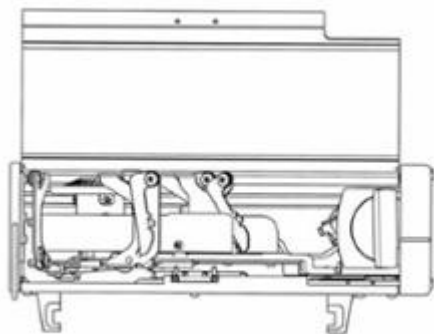

1.19

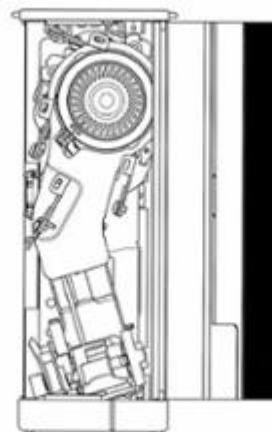

1.20

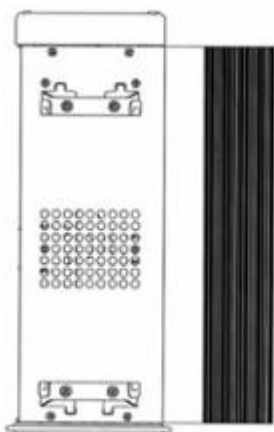

1.21

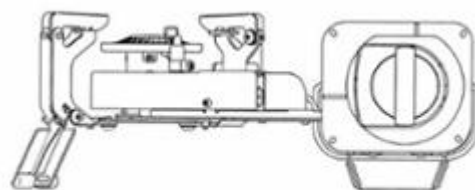

1.22

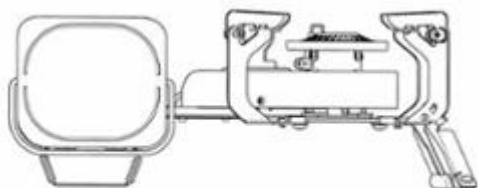

1.23

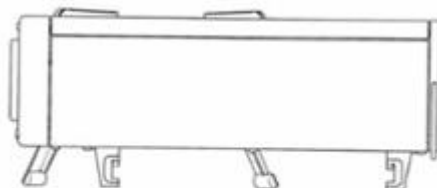

1.24



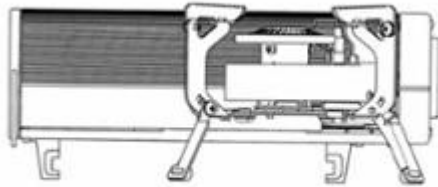

1.25

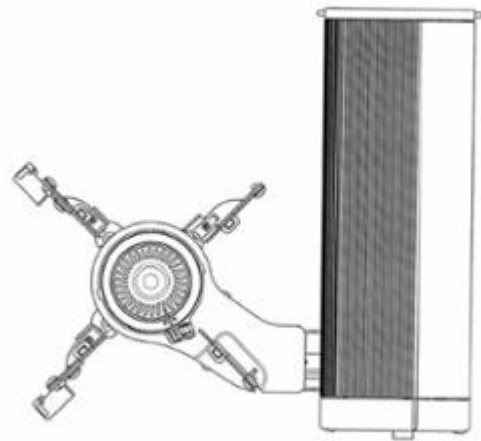

1.26

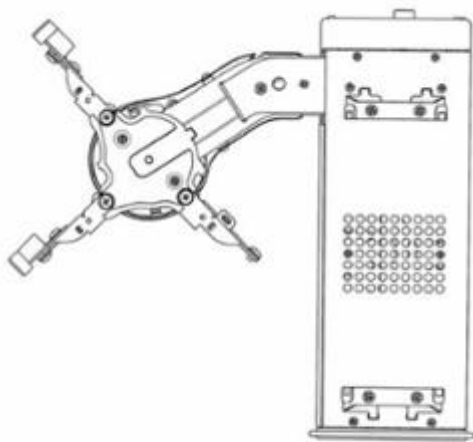

1.27

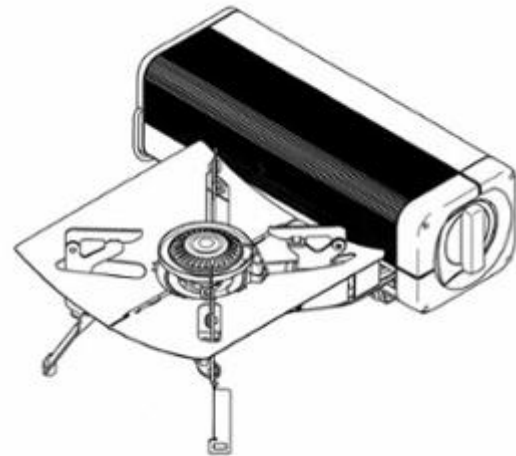

2.1

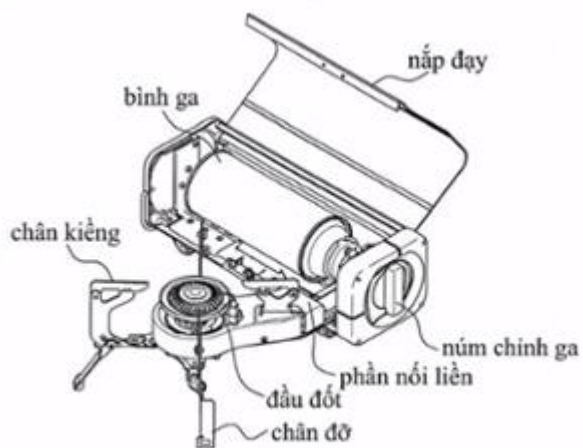

2.2

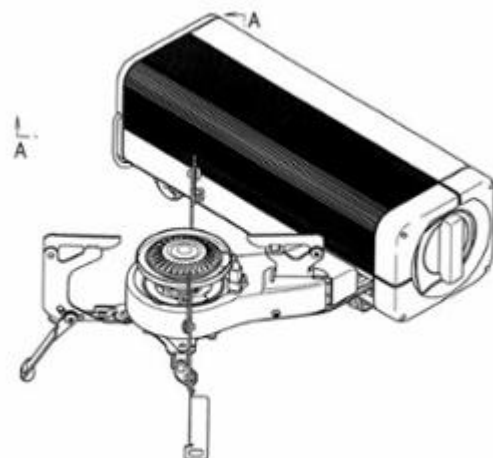

2.3

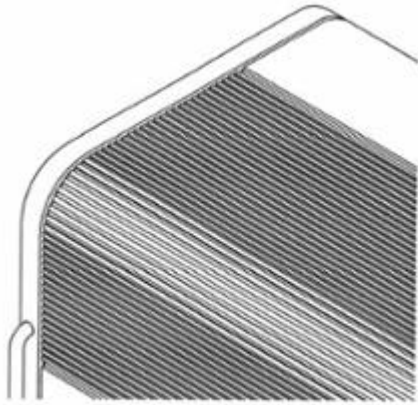

2.4



2.5

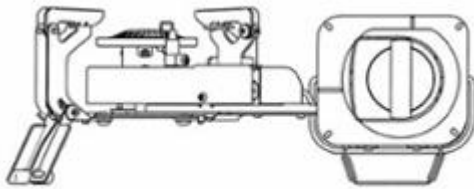

2.6

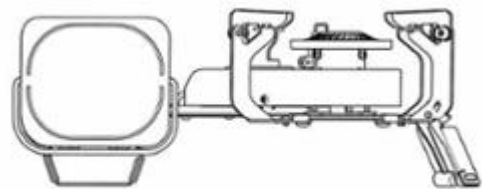

2.7

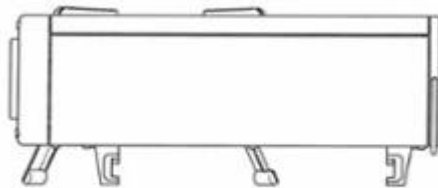

2.8

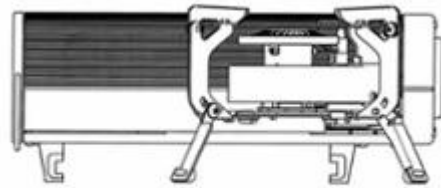

2.9

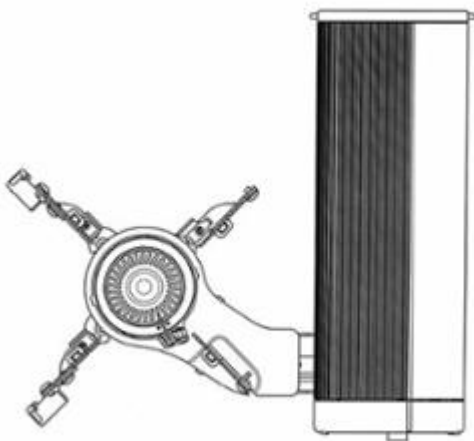

2.10

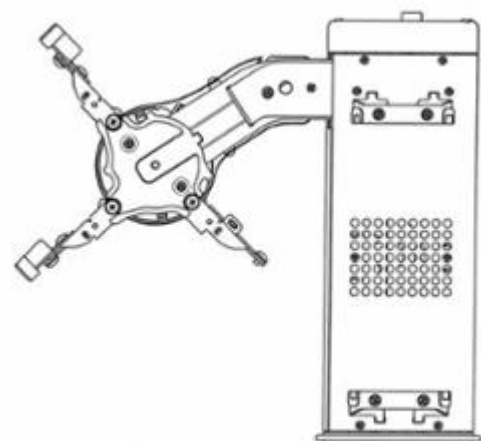

2.11

**CÔNG BÁO SỞ HỮU CÔNG NGHIỆP SỐ 400 TẬP A – QUYỀN 2 (07.2021)**

- (11) **41995**  
(21) 3-2020-03003 (28) 1  
(54) **MŨ BẢO HIỂM** (51) **02-03**  
(22) 11/12/2020 (43) 26/07/2021  
(30) 008008403 18/06/2020 EM;  
**LOCATELLI S.P.A. (IT)**  
(73) Via Della Resistenza, 5/A, I-24030 Almenno San Bartolomeo (Bergamo), Italy  
(72) LOCATELLI Antonio (IT)  
(74) Công ty TNHH Sở hữu trí tuệ ALNGUYEN (ALNGUYEN IP CO.,LTD.)  
(55)

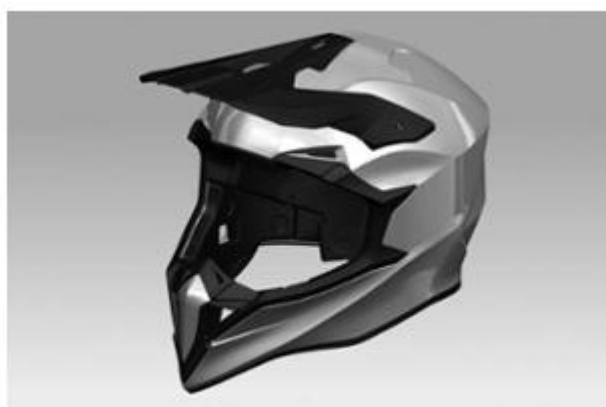

1.1



1.2



1.3

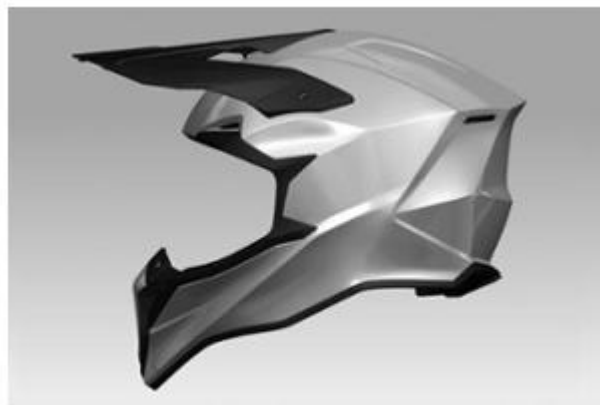

1.4

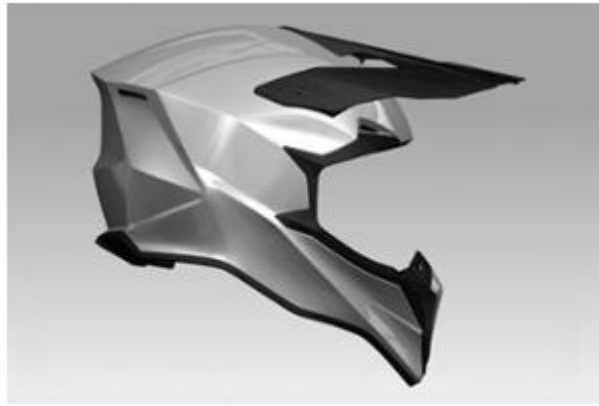

1.5



1.6



1.7

**CÔNG BÁO SỞ HỮU CÔNG NGHIỆP SỐ 400 TẬP A – QUYỀN 2 (07.2021)**

- (11) **41996**  
(21) 3-2020-03017 (28) 1  
(54) **TẮM HƯỚNG GIÓ CHO XE CỘ** (51) **12-16**  
(22) 14/12/2020 (43) 26/07/2021  
(30) 008033856-0001 07/07/2020 EM;  
(73) **IGOR AKRAPOVIČ (SI)**  
Rožna Dolina C.VIII/10A, SI-1000 Ljubljana, Slovenia  
1. IGOR AKRAPOVIČ (SI)  
2. ERMIN KOSOVEL (SI)  
(72) 3. LUKA ŽAGAR (SI)  
4. PETER ŠPRAJC (SI)  
5. JAKA KLEMENC (SI)  
(74) Công ty TNHH Đại Tín và Liên Danh (DAITIN AND ASSOCIATES CO.,LTD)  
(55)



1.1



1.2



1.3



1.4



1.5



1.6



1.7



1.8



1.9

**CÔNG BÁO SỞ HỮU CÔNG NGHIỆP SỐ 400 TẬP A – QUYỀN 2 (07.2021)**

(11) **41997**

(21) 3-2020-03020

(28) 5

(54) **CHAI ĐỰNG DẦU NHỚT**

(51) **09-01**

(22) 14/12/2020

(43) 26/07/2021

**CÔNG TY TNHH DẦU NHỜN RESSOL (VN)**

(73) Phòng 3, số 06 Nguyễn Văn Cừ nối dài, khu vực 3 Cồn Khương, phường Cái Khế, quận Ninh Kiều, thành phố Cần Thơ

(72) Trần Thị Mai Trân (VN)

(55)



1.1



1.2



1.3



1.4



1.5



1.6



1.7



2.1



2.2



2.3



2.4



2.5



2.6



2.7



3.1



3.2



3.3





3.4



3.5



3.6



3.7



4.1



4.2



4.3



4.4



4.5



4.6



4.7



5.1



5.2



5.3

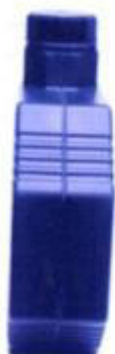

5.4



5.5

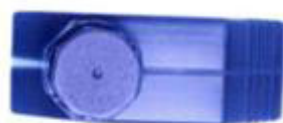

5.6



5.7

**CÔNG BÁO SỞ HỮU CÔNG NGHIỆP SỐ 400 TẬP A – QUYỀN 2 (07.2021)**

(11) **41998**

(21) 3-2020-03026

(28) 1

(54) **HÈM CỬA**

(51) **08-09**

(22) 15/12/2020

(43) 26/07/2021

**CÔNG TY TNHH ĐẦU TƯ PHÁT TRIỂN VẬT LIỆU MỚI VÀ CÔNG NGHỆ CAO H.P.T (VN)**

(73) Lô C3.1-C3.2 khu công nghệ cao Hòa Lạc, xã Hạ Bằng, huyện Thạch Thất, thành phố Hà Nội

(72) Trần Viết Cường (VN)

(74) Công ty TNHH Tư vấn đầu tư và Sở hữu trí tuệ Hoàng Phi (HOANG PHI INVEST & I.P CO., LTD)

(55)



1.1



1.2



1.3



1.4



1.5



1.6

**CÔNG BÁO SỞ HỮU CÔNG NGHIỆP SỐ 400 TẬP A – QUYỀN 2 (07.2021)**

(11) **41999**

(21) 3-2020-03064

(28) 1

(54) **KHẨU TRANG**

(51) **02-99**

(22) 21/12/2020

(43) 26/07/2021

**SKYPRO MEDICAL SUPPLIES COMPANY LIMITED (CN)**

(73) Room C1 3, 3/F, Block C, Tsing Yi Industrial Centre, 1 33 Cheung Tat Road,  
Tsing Yi, New Territories, Hong Kong

(72) Wong Suet Yi (CN)

(74) Công ty TNHH Đại Tín và Liên Danh (DAITIN AND ASSOCIATES CO.,LTD)

(55)



1.1



1.2



1.3



1.4



1.5

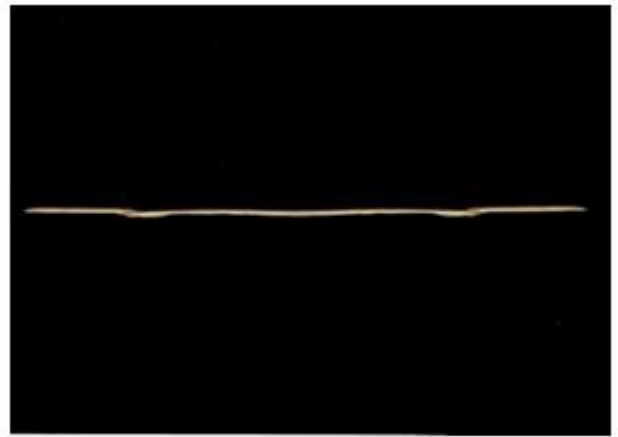

1.6

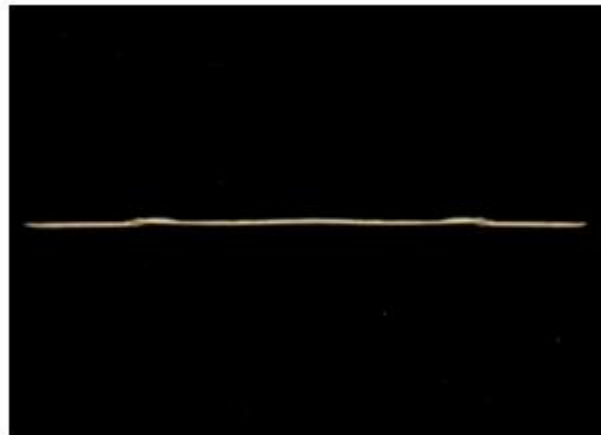

1.7

**CÔNG BÁO SỞ HỮU CÔNG NGHIỆP SỐ 400 TẬP A – QUYỀN 2 (07.2021)**

(11) **42000**

(21) 3-2020-03066

(28) 1

(54) **TẨM TRẦN TRANG TRÍ**

(51) **25-01**

(22) 21/12/2020

(43) 26/07/2021

**CÔNG TY CỔ PHẦN CÔNG NGHIỆP VĨNH TƯỜNG (VN)**

(73) Lô C23a, khu công nghiệp Hiệp Phước, xã Hiệp Phước, huyện Nhà Bè, thành phố Hồ Chí Minh

(72) Nguyễn Hữu Dương (VN)

(74) Văn phòng Luật sư A Hoà (AHOA LAW OFFICE)

(55)

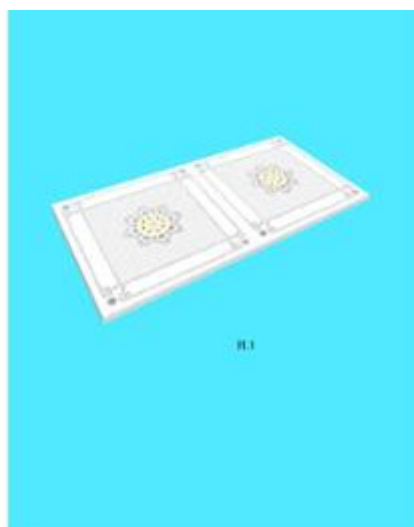

1.1

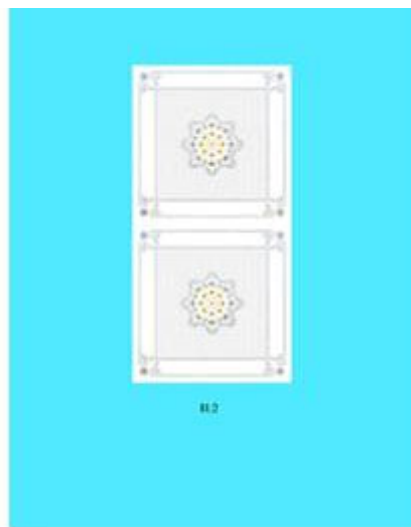

1.2

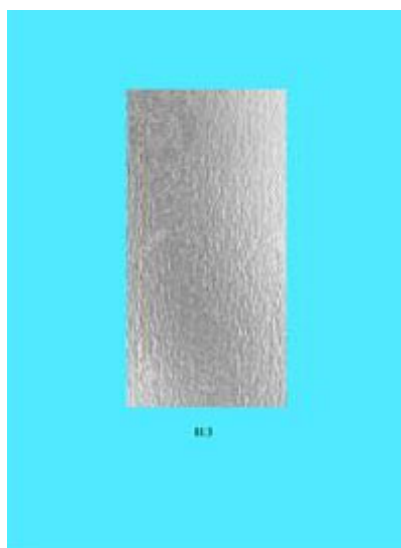

1.3

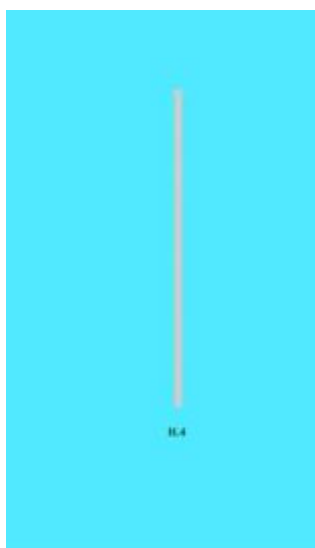

1.4



1.5

**CÔNG BÁO SỞ HỮU CÔNG NGHIỆP SỐ 400 TẬP A – QUYỀN 2 (07.2021)**

(11) **42001**

(21) 3-2020-03067

(28) 1

(54) **TẨM TRẦN TRANG TRÍ**

(51) **25-01**

(22) 21/12/2020

(43) 26/07/2021

**CÔNG TY CỔ PHẦN CÔNG NGHIỆP VĨNH TƯỜNG (VN)**

(73) Lô C23a, khu công nghiệp Hiệp Phước, xã Hiệp Phước, huyện Nhà Bè, thành phố Hồ Chí Minh

(72) Nguyễn Hữu Dương (VN)

(74) Văn phòng Luật sư A Hoà (AHOA LAW OFFICE)

(55)



1.1



1.2

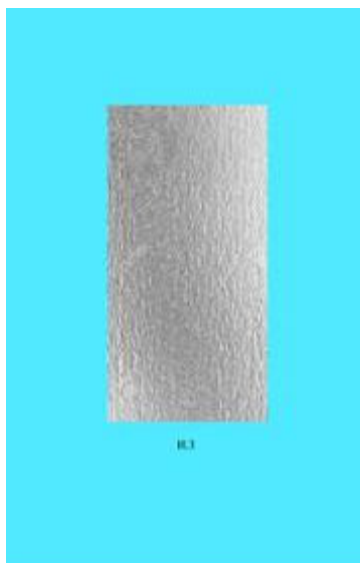

1.3

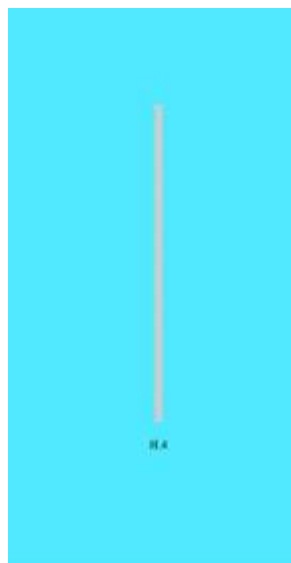

1.4



1.5

**CÔNG BÁO SỞ HỮU CÔNG NGHIỆP SỐ 400 TẬP A – QUYỀN 2 (07.2021)**

- (11) **42002**  
 (21) 3-2020-03094  
 (54) **TÚI**  
 (22) 23/12/2020  
 (73) **CÔNG TY TNHH TMDV XNK HÀ THÀNH (VN)**  
 Số 89 Dốc Mọc, xã Cao Dương, huyện Thanh Oai, thành phố Hà Nội  
 (72) Đoàn Tuấn Anh (VN)  
 (55)



1.1



1.2



1.3



1.4





1.5



1.6



1.7

**CÔNG BÁO SỞ HỮU CÔNG NGHIỆP SỐ 400 TẬP A – QUYỀN 2 (07.2021)**

(11) **42003**

(21) 3-2020-03097

(28) 1

(54) **BÀN**

(51) **06-03**

(22) 23/12/2020

(43) 26/07/2021

(73) **HTL FURNITURE (CHINA) CO., LTD. (CN)**

Wusong Jiangnan Road, Kunshan Development Zone, Jiangsu Province, China

(72) PHUA YONG TAT (SG)

(74) Công ty Luật TNHH quốc tế BMVN (BMVN INTERNATIONAL LLC)

(55)



1.1



1.2



1.3

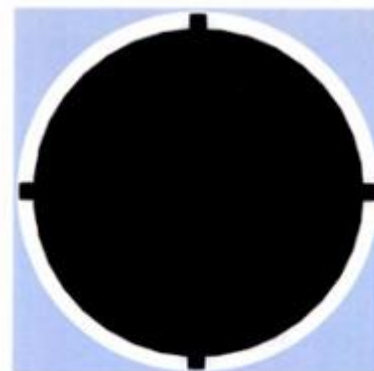

1.4

**CÔNG BÁO SỞ HỮU CÔNG NGHIỆP SỐ 400 TẬP A – QUYỀN 2 (07.2021)**

(11) **42004**

(21) 3-2020-03098

(28) 1

(54) **BÀN**

(51) **06-03**

(22) 23/12/2020

(43) 26/07/2021

(73) **HTL FURNITURE (CHINA) CO., LTD. (CN)**

Wusong Jiangnan Road, Kunshan Development Zone, Jiangsu Province, China

(72) PHUA YONG TAT (SG)

(74) Công ty Luật TNHH quốc tế BMVN (BMVN INTERNATIONAL LLC)

(55)



1.1



1.2



1.3



1.4

**CÔNG BÁO SỞ HỮU CÔNG NGHIỆP SỐ 400 TẬP A – QUYỀN 2 (07.2021)**

(11) **42005**

(21) 3-2020-03111

(28) 1

(54) **DÉP**

(51) **02-04**

(22) 24/12/2020

(43) 26/07/2021

(73) **CÔNG TY TNHH SẢN XUẤT THƯƠNG MẠI HÙ KIỆT (VN)**

Tỉnh lộ 830, ấp 8, xã Lương Hòa, huyện Bến Lức, tỉnh Long An

(72) Gíp Cao Thanh (VN)

(55)



1.1



1.2



1.3



1.4



1.5



1.6



1.7

**CÔNG BÁO SỞ HỮU CÔNG NGHIỆP SỐ 400 TẬP A – QUYỀN 2 (07.2021)**

(11) **42006**

(21) 3-2020-03112

(28) 1

(54) **DÉP**

(51) **02-04**

(22) 24/12/2020

(43) 26/07/2021

(73) **CÔNG TY TNHH SẢN XUẤT THƯƠNG MẠI HÙ KIỆT (VN)**

Tỉnh Lộ 830, ấp 8, xã Lương Hòa, huyện Bến Lức, tỉnh Long An

(72) Gịp Cao Thanh (VN)

(55)



1.1



1.2



1.3



1.4



1.5



1.6



1.7

**CÔNG BÁO SỞ HỮU CÔNG NGHIỆP SỐ 400 TẬP A – QUYỀN 2 (07.2021)**

(11) **42007**

(21) 3-2020-03148

(28) 4

(54) **CHAI ĐỰNG DẦU NHỚT**

(51) **09-02**

(22) 29/12/2020

(43) 26/07/2021

**CÔNG TY TNHH DẦU NHỜN RESSOL (VN)**

(73) Phòng 3, số 06 Nguyễn Văn Cừ nối dài, khu vực 3 Cồn Khương, phường Cái Khế, quận Ninh Kiều, thành phố Cần Thơ

(72) Trần Thị Mai Trân (VN)

(55)



1.1



1.2



1.3



1.4



1.5



1.6



1.7



2.1



2.2



2.3



2.4



2.5



2.6



2.7



3.1



3.2



3.3



3.4



3.5



3.6



3.7



4.1



4.2



4.3



4.4



4.5

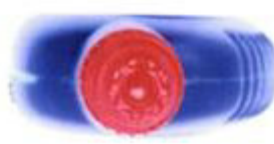

4.6



4.7



**CÔNG BÁO SỞ HỮU CÔNG NGHIỆP SỐ 400 TẬP A – QUYỀN 2 (07.2021)**

(11) **42008**

(21) 3-2020-03173

(28) 1

(54) **TƯỢNG TRANG TRÍ**

(51) **11-02**

(22) 30/12/2020

(43) 26/07/2021

**CÔNG TY CỔ PHẦN VINATAB (VN)**

(73) Số 8, ngõ 162/102, tổ 40, phường Khương Trung, quận Thanh Xuân, thành phố Hà Nội

(72) Hoàng Minh Huy (VN)

(74) Công ty TNHH Tư vấn đầu tư và Sở hữu trí tuệ Hoàng Phi (HOANG PHI INVEST & I.P CO., LTD)

(55)



1.1



1.2



1.3



1.4



1.5



1.6



1.7

- (11) **42009**  
(21) 3-2021-00011 (28) 1  
(54) **CHỖI CỌ** (51) **04-01**  
(22) 05/01/2021 (43) 26/07/2021  
(30) 29/743,059 17/07/2020 US;  
(73) **RUNWAY BLUE, LLC (US)**  
35 South Pfeifferhorn Dr., Alpine, Utah 84004, United States of America  
(72) 1. JOHN R. OMDAHL II (US)  
2. DAVID O. MEYERS (US)  
(74) Văn phòng Luật sư Ân Nam (ANNAM IP & LAW)  
(55)



1.7



1.8

**CÔNG BÁO SỞ HỮU CÔNG NGHIỆP SỐ 400 TẬP A – QUYỀN 2 (07.2021)**

- (11) **42010**  
(21) 3-2021-00015 (28) 1  
(54) **CÁN CHỖI CỌ** (51) **04-01**  
(22) 06/01/2021 (43) 26/07/2021  
(30) 29/743,059 17/07/2020 US;  
(73) **RUNWAY BLUE, LLC (US)**  
35 South Pfeifferhorn Dr., Alpine, Utah 84004, United States of America  
(72) 1. JOHN R. OMDAHL II (US)  
2. DAVID O. MEYERS (US)  
(74) Văn phòng Luật sư Ân Nam (ANNAM IP & LAW)  
(55)

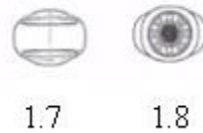
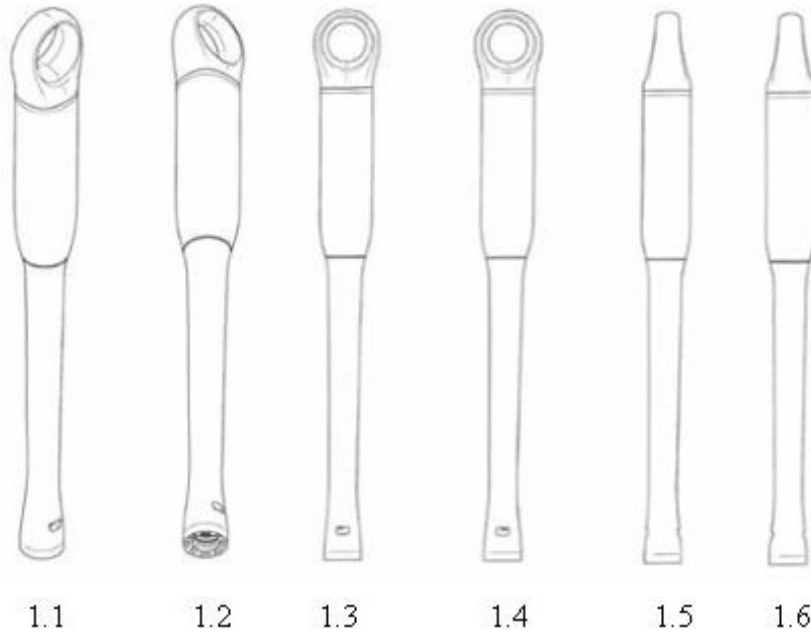

(11) **42011**

(21) 3-2021-00035

(28) 3

(54) **BỘ BÁT ĐĨA**

(51) **07-01**

(22) 08/01/2021

(43) 26/07/2021

(73) **CÔNG TY CỔ PHẦN GỐM SỨ TOÀN QUỐC (VN)**

KCN Gò Dầu, xã Phước Thái, huyện Long Thành, tỉnh Đồng Nai

(72) **WU CHING YUAN (TW)**

(55)



1.1



1.2



1.3



1.4



1.5



1.6



1.7



1.8



1.9



1.10



1.11



1.12



1.13



1.14



1.15



1.16



1.17



1.18



1.19

(11) **42012**

(21) 3-2021-00065

(54) **BỘ LỌC KHÁNG KHUẨN**

(22) 13/01/2021

(73) **CÔNG TY CỔ PHẦN ĐẦU TƯ AN LAND (VN)**

15 Nguyễn Chí Thanh, phường Cam Nghĩa, thành phố Cam Ranh, tỉnh Khánh Hòa

(72) Mai Văn An (VN)

(55)

(28) 1

(51) **29-02**

(43) 26/07/2021



1.1



1.2



1.3



1.4



1.5

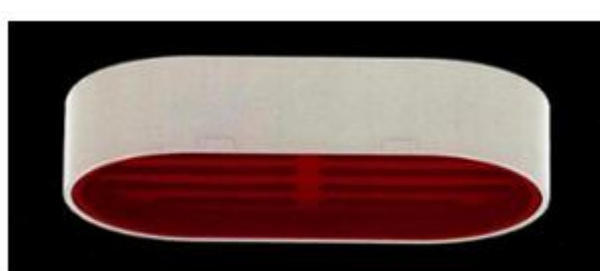

1.6



1.7



1.8

- (11) **42013**  
(21) 3-2021-00111 (28) 1  
(54) **NHÃN SẢN PHẨM** (51) **19-08**  
(22) 15/11/2019 (43) 26/07/2021  
(73) **CÔNG TY CỔ PHẦN SỮA ĐÀ LẠT (VN)**  
Số 11A, đường Cô Giang, phường 9, thành phố Đà Lạt, tỉnh Lâm Đồng  
(72) Nguyễn Văn Mạnh (VN)  
(74) Văn phòng Luật sư Hoàng Danh (Văn phòng Luật sư Hoàng Danh)  
(55)





- (11) **42014**
- (21) 3-2021-00112 (28) 1
- (54) **NHÃN SẢN PHẨM** (51) **19-08**
- (22) 15/11/2019 (43) 26/07/2021
- (73) **CÔNG TY CỔ PHẦN SỮA ĐÀ LẠT (VN)**  
Số 11A, đường Cô Giang, phường 9, thành phố Đà Lạt, tỉnh Lâm Đồng
- (72) Nguyễn Văn Mạnh (VN)
- (74) Văn phòng Luật sư Hoàng Danh (Văn phòng Luật sư Hoàng Danh)
- (55)



- (11) **42015**  
(21) 3-2021-00113 (28) 1  
(54) **NHÃN SẢN PHẨM** (51) **19-08**  
(22) 15/11/2019 (43) 26/07/2021  
(73) **CÔNG TY CỔ PHẦN SỮA ĐÀ LẠT (VN)**  
Số 11A, đường Cô Giang, phường 9, thành phố Đà Lạt, tỉnh Lâm Đồng  
(72) Nguyễn Văn Mạnh (VN)  
(74) Văn phòng Luật sư Hoàng Danh (Văn phòng Luật sư Hoàng Danh)  
(55)



- (11) **42016**
- (21) 3-2021-00114 (28) 1
- (54) **NHÃN SẢN PHẨM** (51) **19-08**
- (22) 15/11/2019 (43) 26/07/2021
- (73) **CÔNG TY CỔ PHẦN SỮA ĐÀ LẠT (VN)**  
Số 11A, đường Cô Giang, phường 9, thành phố Đà Lạt, tỉnh Lâm Đồng
- (72) Nguyễn Văn Mạnh (VN)
- (74) Văn phòng Luật sư Hoàng Danh (Văn phòng Luật sư Hoàng Danh)
- (55)



**CÔNG BÁO SỞ HỮU CÔNG NGHIỆP SỐ 400 TẬP A – QUYỀN 2 (07.2021)**

- (11) **42017**  
(21) 3-2021-00117 (28) 1  
(54) **DỤNG CỤ CHĂM SÓC RĂNG MIỆNG** (51) **04-02**  
(22) 18/01/2021 (43) 26/07/2021  
(30) 29/744845 31/07/2020 US;  
**COLGATE-PALMOLIVE COMPANY (US)**  
(73) 300 Park Avenue, New York, New York 10022, United States of America  
1. FAN GANG XIE (CN)  
(72) 2. YANMEI JI (CN)  
3. GUOQIANG LIU (CN)  
(74) Văn phòng Luật sư Ân Nam (ANNAM IP & LAW)  
(55)

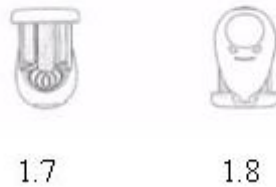

**CÔNG BÁO SỞ HỮU CÔNG NGHIỆP SỐ 400 TẬP A – QUYỀN 2 (07.2021)**

- (11) **42018**  
(21) 3-2021-00136 (28) 2  
(54) **BAO GÓI** (51) **09-05**  
(22) 21/01/2021 (43) 26/07/2021  
(30) 2020-016664 07/08/2020 JP; 2020-016663 07/08/2020 JP;  
(73) **HISAMITSU PHARMACEUTICAL CO., INC. (JP)**  
408, Tashirodaikan-machi, Tosu-shi, Saga 841-0017 Japan  
(72) 1. SAYAKA MOCHIZUKI (JP)  
2. SHIGEO KUSUMI (JP)  
(74) Công ty TNHH một thành viên Sở hữu trí tuệ VCCI (VCCI-IP CO.,LTD)  
(55)



1.1



1.2



1.3

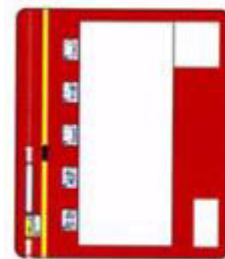

1.4



1.5



1.6



1.7



1.8



1.9



1.10



1.11



1.12



2.1



2.2



2.3



2.4



2.5



2.6



2.7



2.8



2.9



2.10

- (11) **42019**
- (21) 3-2021-00137
- (54) **HỘP**
- (22) 21/01/2021
- (30) 2020-016666 07/08/2020 JP; 2020-016665 07/08/2020 JP;
- (73) **HISAMITSU PHARMACEUTICAL CO., INC. (JP)**  
408, Tashirodaikan-machi, Tosu-shi, Saga 841-0017 Japan
- (72) 1. SAYAKA MOCHIZUKI (JP)  
2. SHIGEO KUSUMI (JP)
- (74) Công ty TNHH một thành viên Sở hữu trí tuệ VCCI (VCCI-IP CO.,LTD)
- (55)





1.13



1.14



2.1



2.2



2.3



2.4



2.5



2.6



2.7



2.8



2.9



2.10



2.11



2.12



**CÔNG BÁO SỞ HỮU CÔNG NGHIỆP SỐ 400 TẬP A – QUYỀN 2 (07.2021)**

- (11) **42020**  
(21) 3-2021-00142 (28) 2  
(54) **GIÀY** (51) **02-04**  
(22) 22/01/2021 (43) 26/07/2021  
(30) 29/743,699 23/07/2020 US;  
(73) **THE NORTH FACE APPAREL CORP. (US)**  
3411 Silverside Road, Wilmington, DE 19810, United States of America  
(72) 1. GRÉGOIRE LAVERTY (FR)  
2. CYRILLE MORANGES (FR)  
(74) Công ty Luật TNHH WINCO (WINCO LAW FIRM)  
(55)



1.1



1.2



1.3



1.4



1.5



1.6



1.7



1.8



1.9



1.10



1.11



1.12



1.13



1.14

- (11) **42021**  
(21) 3-2021-00148 (28) 1  
(54) **DỤNG CỤ HÚT SỮA** (51) **24-02**  
(22) 22/01/2021 (43) 26/07/2021  
(30) 2020-016967 14/08/2020 JP;  
**PIGEON CORPORATION (JP)**  
(73) 4-4, Nihonbashi Hisamatsu-cho, Chuo-ku, Tokyo, Japan  
(72) Xiangling CHEN (CN)  
(74) **CÔNG TY LUẬT TRÁCH NHIỆM HỮU HẠN AMBYS HÀ NỘI (AMBYS HANOI)**  
(55)



1.1



1.2



1.3



1.4



1.5



1.6

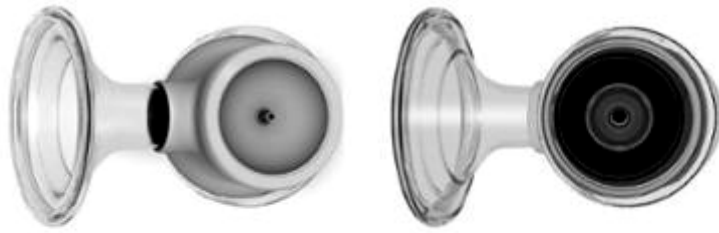

1.7

1.8

**CÔNG BÁO SỞ HỮU CÔNG NGHIỆP SỐ 400 TẬP A – QUYỀN 2 (07.2021)**

(11) **42022**

(21) 3-2021-00151

(28) 1

(54) **MŨ BẢO HIỂM**

(51) **02-03**

(22) 22/01/2021

(43) 26/07/2021

**CÔNG TY TNHH THIẾT BỊ VÀ SẢN PHẨM AN TOÀN VIỆT NAM (VN)**

(73) Lô C15, khu công nghiệp Bá Thiện II, xã Thiện Kế, huyện Bình Xuyên, tỉnh Vĩnh Phúc

(72) Hoàng Thị Na Hương (VN)

(74) Công ty Luật TNHH BIZCONSULT (BIZCONSULT LAW FIRM)

(55)



1.1



1.2



1.3



1.4



1.5



1.6



1.7



1.8

(11) **42023**

(21) 3-2021-00171

(28) 1

(54) **THANH CHẶN**

(51) **07-02**

(22) 24/07/2020

(43) 26/07/2021

**CÔNG TY TNHH MINH LONG I (VN)**

(73) 333 khu phố Hưng Lộc, phường Hưng Định, thành phố Thuận An, tỉnh Bình Dương

(72) Lý Ngọc Minh (VN)

(55)



1.1



1.2



1.3

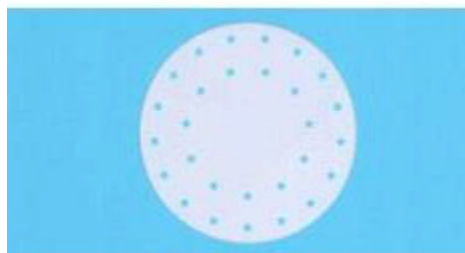

1.4

**CÔNG BÁO SỞ HỮU CÔNG NGHIỆP SỐ 400 TẬP A – QUYỀN 2 (07.2021)**

(11) **42024**

(21) 3-2021-00189

(28) 1

(54) **NHÃN SẢN PHẨM**

(51) **19-08**

(22) 27/01/2021

(43) 26/07/2021

**CÔNG TY TNHH THỰC PHẨM SUNRISE (VN)**

(73) Lô F6 Đường số 3, KCN Hải Sơn (GD 3+4), xã Đức Hòa Hạ, huyện Đức Hoà, tỉnh Long An

(72) Lai Vĩ Hùng (VN)

(74) Công ty TNHH một thành viên Trường Luật (Trường Luật)

(55)



**CÔNG BÁO SỞ HỮU CÔNG NGHIỆP SỐ 400 TẬP A – QUYỀN 2 (07.2021)**

(11) **42025**

(21) 3-2021-00191

(28) 1

(54) **NHÃN SẢN PHẨM**

(51) **19-08**

(22) 27/01/2021

(43) 26/07/2021

**CÔNG TY TNHH THỰC PHẨM SUNRISE (VN)**

(73) Lô F6 Đường số 3, KCN Hải Sơn (GD 3+4), xã Đức Hòa Hạ, huyện Đức Hoà, tỉnh Long An

(72) Lai Vĩ Hùng (VN)

(74) Công ty TNHH một thành viên Trường Luật (Trường Luật)

(55)





- (11) **42026**  
(21) 3-2021-00218 (28) 2  
(54) **THIẾT BỊ NHẬN DẠNG CÁ NHÂN** (51) **10-05**  
(22) 28/01/2021 (43) 26/07/2021  
(30) 2020-020675 29/09/2020 JP; 2020-020674 29/09/2020 JP;  
**MITSUBISHI ELECTRIC CORPORATION (JP)**  
(73) 7-3, Marunouchi 2-chome, Chiyoda-ku, Tokyo 100-8310, Japan  
(72) Tatsunari KATAOKA (JP)  
(74) Công ty TNHH Tầm nhìn và Liên danh (VISION & ASSOCIATES CO.LTD.)  
(55)

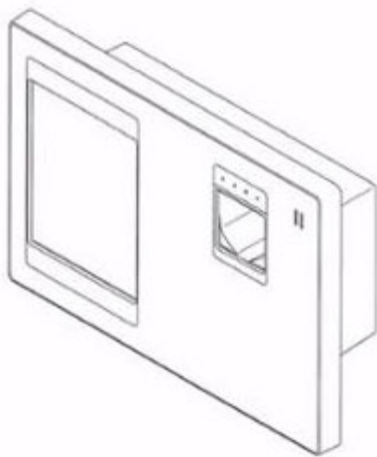

1.1

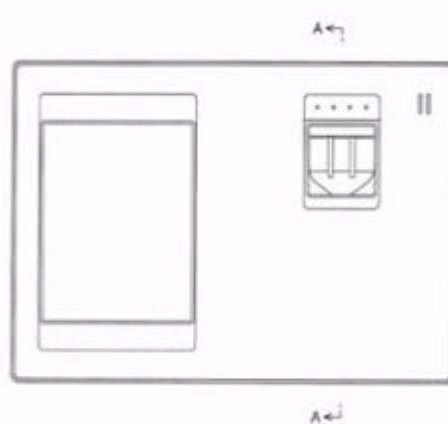

1.2

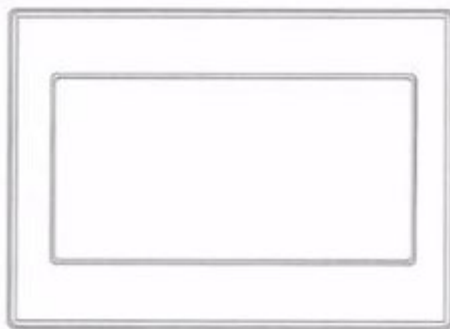

1.3

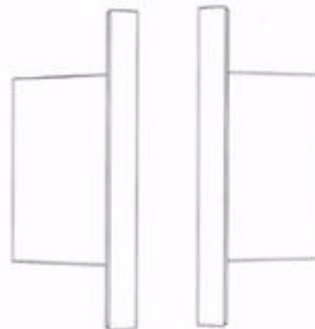

1.4

1.5



1.6



1.7



1.8

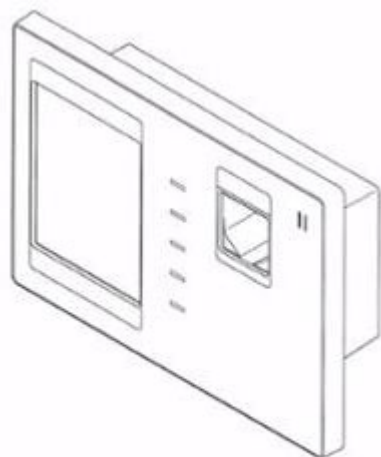

2.1

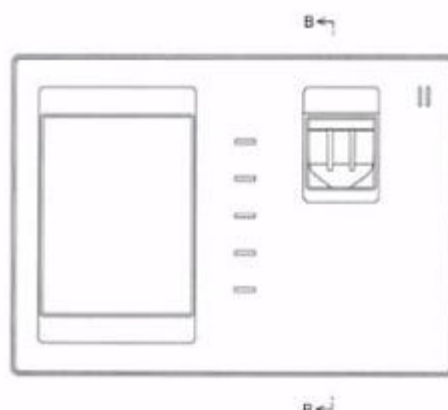

2.2

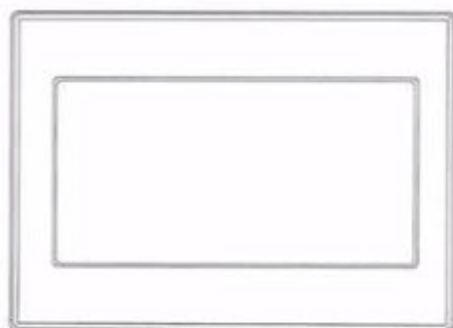

2.3

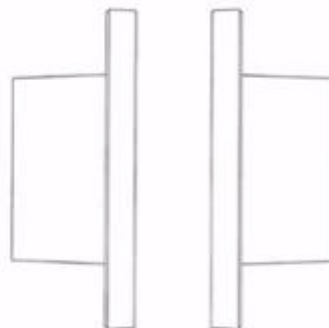

2.4

2.5



2.6



2.7



2.8

(11) **42027**

(21) 3-2021-00230

(28) 1

(54) **TÚI XÁCH**

(51) **03-01**

(22) 29/01/2021

(43) 26/07/2021

**CÔNG TY TNHH SHE VIỆT NAM (VN)**

(73) Nhà 2, A7 ngõ 51 Nguyễn Khoái, phường Bạch Đằng, quận Hai Bà Trưng, thành phố Hà Nội

(72) Nguyễn Thị Thu Hòa (VN)

(55)



1.1



1.2



1.3



1.4



1.5



1.6



1.7

**CÔNG BÁO SỞ HỮU CÔNG NGHIỆP SỐ 400 TẬP A – QUYỀN 2 (07.2021)**

- (11) **42028**  
(21) 3-2021-00236 (28) 1  
(54) **BAO GÓI** (51) **09-05**  
(22) 29/01/2021 (43) 26/07/2021  
(73) **CÔNG TY CỔ PHẦN PHÁT TRIỂN ĂM THỰC NAP (VN)**  
Xóm Kim Phúc, xã Nghi Ân, thành phố Vinh, tỉnh Nghệ An  
(72) Phạm Việt Phương (VN)  
(74) **CÔNG TY TNHH KHANG LUẬT (KHANGLAW)**  
(55)



1.1

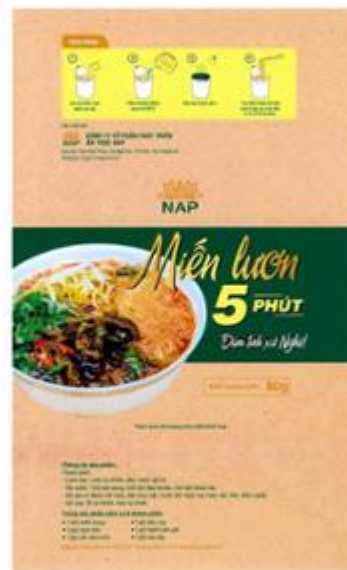

1.2

(11) **42029**

(21) 3-2021-00240

(28) 1

(54) **MÔ HÌNH LẮP GHÉP**

(51) **21-01**

(22) 02/02/2021

(43) 26/07/2021

(73) **TÔ QUANG MINH (VN)**

Xóm Trung Thành, xã Danh Thắng, huyện Hiệp Hòa, tỉnh Bắc Giang

(72) Tô Quang Minh (VN)

(55)



1.1



1.2



1.3



1.4



1.5



1.6



1.7

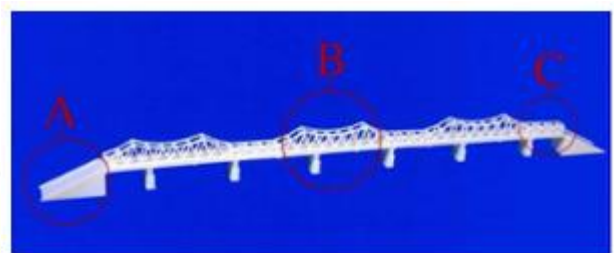

1.8



1.9



1.10



1.11

**CÔNG BÁO SỞ HỮU CÔNG NGHIỆP SỐ 400 TẬP A – QUYỀN 2 (07.2021)**

- (11) **42030**
- (21) 3-2021-00308 (28) 3
- (54) **BAO GÓI ĐỰNG THỰC PHẨM** (51) **09-05**
- (22) 30/12/2016 (43) 26/07/2021
- (73) **CJ CHEILJEDANG CORPORATION (KR)**  
(Ssangnim-dong) 330, Dongho-ro, Jung-gu, Seoul 04560 Republic of Korea
1. KIM, SAE YOON (KR)
2. KWON, HYUK LYUL (KR)
- (72) 3. SONG, CHAE WON (KR)
4. JUNG, IN SUN (KR)
5. CHOI, HYUNG KYUNG (KR)
6. HWANG, SU IM (KR)
- (74) Công ty TNHH Sở hữu công nghiệp Sao Bắc Đẩu (SAO BAC DAU IP CO.,LTD)
- (55)



1.1



1.2



1.3



1.4



1.5



1.6



1.7



2.1



2.2





2.3



2.4



2.5



2.6



2.7



3.1



3.2



3.3



3.4



3.5



3.6



3.7

**CÔNG BÁO SỞ HỮU CÔNG NGHIỆP SỐ 400 TẬP A – QUYỀN 2 (07.2021)**

- (11) **42031**
- (21) 3-2021-00309 (28) 2
- (54) **BAO GÓI ĐỰNG THỰC PHẨM** (51) **09-05**
- (22) 03/02/2017 (43) 26/07/2021
- (30) 30-2016-0044498 09/09/2016 KR; 30-2016-0044497 09/09/2016 KR;
- (73) **CJ CHEILJEDANG CORPORATION (KR)**  
(Ssangnim-dong) 330, Dongho-ro, Jung-gu, Seoul 04560 Republic of Korea
1. KIM, HEE WON (KR)  
2. AN, YEON MI (KR)
- (72) 3. LEE, EUN YOUNG (KR)  
4. LEE, HYUN JIK (KR)  
5. CHOI, HYUNG KYUNG (KR)
- (74) Công ty TNHH Sở hữu công nghiệp Sao Bắc Đẩu (SAO BAC DAU IP CO.,LTD)
- (55)



1.1



1.2



1.3



1.4



1.5



1.6



1.7



2.1



2.2



2.3



2.4



2.5



2.6



2.7

- (11) **42032**
- (21) 3-2021-00316 (28) 1
- (54) **DÂY** (51) **10-07; 11-01; 14-99; 24-99**
- (22) 08/02/2021 (43) 26/07/2021
- (30) 29/746,613 14/08/2020 US;
- (73) **APPLE INC. (US)**  
One Apple Park Way, Cupertino, California 95014, United States of America
1. JODY AKANA (US)
  2. MOLLY ANDERSON (GB)
  3. BARTLEY K. ANDRE (US)
  4. SHOTA AOYAGI (JP)
  5. ANTHONY MICHAEL ASHCROFT (FR)
  6. MARINE C. BATAILLE (FR)
  7. JEREMY BATAILLOU (FR)
  8. MARKUS DIEBEL (DE)
  9. M. EVANS HANKEY (US)
- (72) 10. JULIAN HOENIG (AT)
11. RICHARD P. HOWARTH (GB)
  12. JONATHAN P. IVE (GB)
  13. JULIAN JAEDE (DE)
  14. DUNCAN ROBERT KERR (GB)
  15. PETER RUSSELL-CLARKE (AU)
  16. BENJAMIN ANDREW SHAFFER (US)
  17. JOE SUNG-HO TAN (US)
  18. CLEMENT TISSANDIER (FR)
  19. EUGENE ANTONY WHANG (CA)
  20. RICO ZÖRKENDÖRFER (DE)
- (74) Công ty TNHH Lê & Lê (LE & LE)
- (55)



1.1



1.2



1.3



1.4



1.5



1.6



1.7



1.8



1.9

- (11) **42033**
- (21) 3-2021-00317 (28) 1
- (54) **DÂY** (51) **10-07; 11-01; 14-99; 24-99**
- (22) 08/02/2021 (43) 26/07/2021
- (30) 29/746,615 14/08/2020 US;
- (73) **APPLE INC. (US)**  
One Apple Park Way, Cupertino, California 95014, United States of America
1. JODY AKANA (US)  
2. MOLLY ANDERSON (GB)  
3. BARTLEY K. ANDRE (US)  
4. SHOTA AOYAGI (JP)  
5. ANTHONY MICHAEL ASHCROFT (FR)  
6. MARINE C. BATAILLE (FR)  
7. JEREMY BATAILLOU (FR)  
8. MARKUS DIEBEL (DE)  
9. M. EVANS HANKEY (US)
- (72) 10. JULIAN HOENIG (AT)  
11. RICHARD P. HOWARTH (GB)  
12. JONATHAN P. IVE (GB)  
13. JULIAN JAEDE (DE)  
14. DUNCAN ROBERT KERR (GB)  
15. PETER RUSSELL-CLARKE (AU)  
16. BENJAMIN ANDREW SHAFFER (US)  
17. JOE SUNG-HO TAN (US)  
18. CLEMENT TISSANDIER (FR)  
19. EUGENE ANTONY WHANG (CA)  
20. RICO ZÖRKENDÖRFER (DE)
- (74) Công ty TNHH Lê & Lê (LE & LE)
- (55)

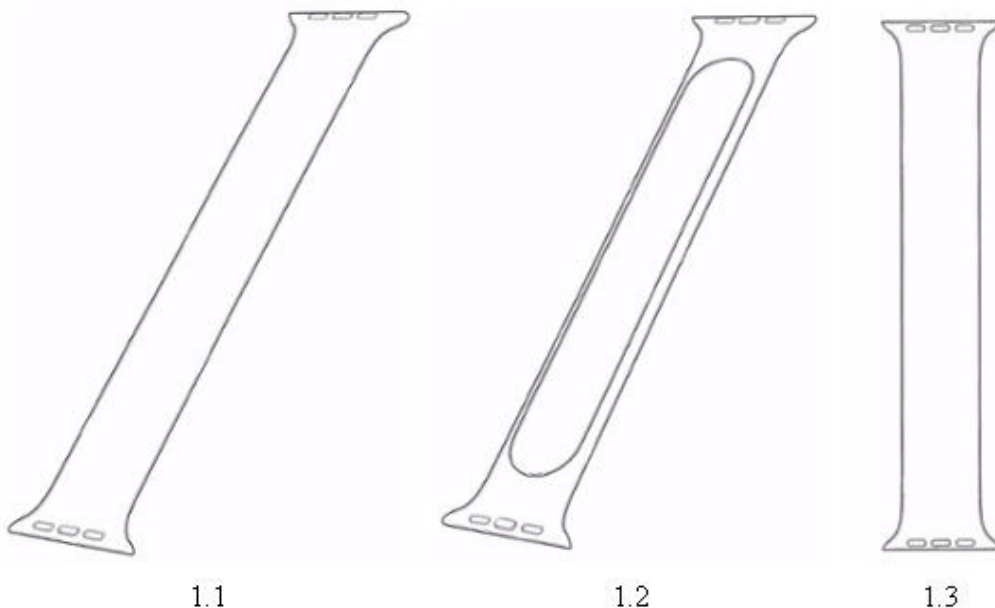





1.4



1.5



1.6



1.7



1.8



1.9

**CÔNG BÁO SỞ HỮU CÔNG NGHIỆP SỐ 400 TẬP A – QUYỀN 2 (07.2021)**

- (11) **42034**
- (21) 3-2021-00354 (28) 1
- (54) **NHÃN SẢN PHẨM** (51) **19-08**
- (22) 19/02/2021 (43) 26/07/2021
- (73) **HỘ KINH DOANH GOLDEN DRAGON'S MANH QUAN (VN)**  
Số 47, đường Thái Phiên, phường Hồng Sơn, thành phố Vinh, tỉnh Nghệ An
- (72) Trương Thị Phúc (VN)
- (55)

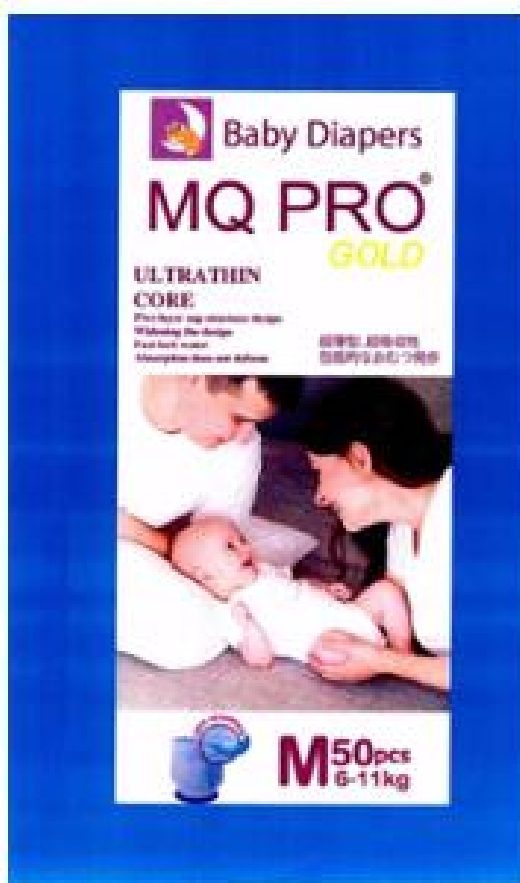

- (11) **42035**  
(21) 3-2021-00358 (28) 1  
(54) **THIẾT BỊ ĐIỆN TỬ** (51) **10-02; 10-03; 10-04; 14-01; 14-02; 14-03; 24-02**  
(22) 19/02/2021 (43) 26/07/2021  
(30) 29/747,244 20/08/2020 US;  
**APPLE INC. (US)**  
(73) One Apple Park Way, Cupertino, California 95014, United States of America  
1. JODY AKANA (US)  
2. MOLLY ANDERSON (GB)  
3. BARTLEY K. ANDRE (US)  
4. SHOTA AOYAGI (JP)  
5. ANTHONY MICHAEL ASHCROFT (FR)  
6. MARINE C. BATAILLE (FR)  
7. JEREMY BATAILLOU (FR)  
8. ABIDUR RAHMAN CHOWDHURY (GB)  
9. CLARA GENEVIEVE MARINE COURTAIGNE (FR)  
10. MARKUS DIEBEL (DE)  
11. JONATHAN GOMEZ GARCIA (FR)  
(72) 12. M. EVANS HANKEY (US)  
13. JULIAN HOENIG (AT)  
14. RICHARD P. HOWARTH (GB)  
15. JONATHAN P. FYE (GB)  
16. JULIAN JAEDE (DE)  
17. DUNCAN ROBERT KERR (GB)  
18. PETER RUSSELL-CLARKE (AU)  
19. BENJAMIN ANDREW SHAFFER (US)  
20. JOE SUNG-HO TAN (US)  
21. CLEMENT TISSANDIER (FR)  
22. EUGENE ANTONY WHANG (CA)  
23. RICO ZÖRKENDÖRFER (DE)  
(74) Công ty TNHH Lê & Lê (LE & LE)  
(55)

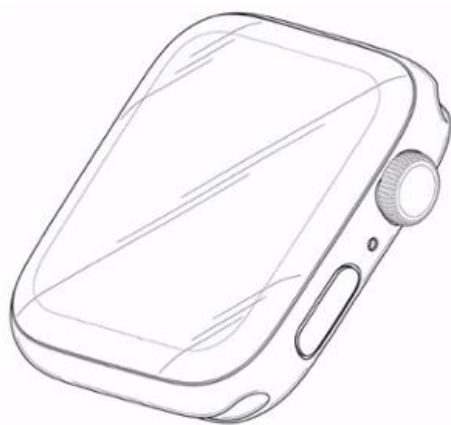

1.1

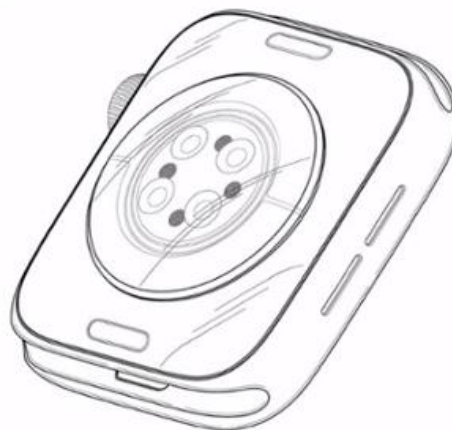

1.2



1.3



1.4

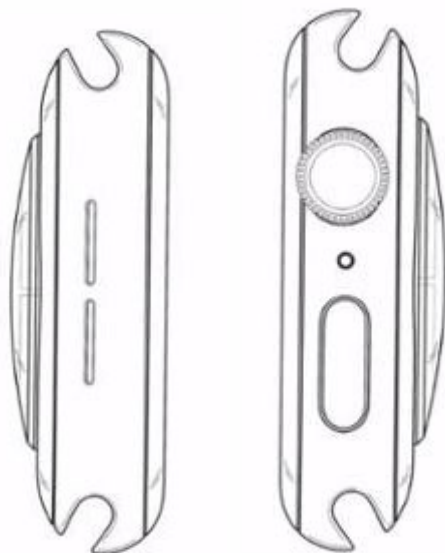

1.5

1.6

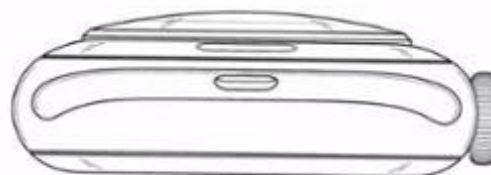

1.7

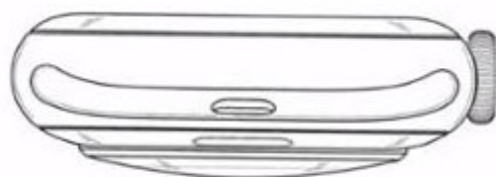

1.8



1.9

- (11) **42036**  
(21) 3-2021-00368 (28) 1  
(54) **TẤ LÓT DÙNG MỘT LẦN** (51) **02-01**  
(22) 22/02/2021 (43) 26/07/2021  
(30) 202030502570.7 28/08/2020 CN;  
**UNICHARM CORPORATION (JP)**  
(73) 182, Shimobun, Kinsei-cho, Shikokuchuo-City, Ehime 799-0111 Japan  
1. KENTO NASHIKI (JP)  
(72) 2. NAOMU MIYAMAE (JP)  
3. SATOYO MIYAJI (JP)  
(74) Công ty Cổ phần Sở hữu công nghiệp INVESTIP (INVESTIP)  
(55)

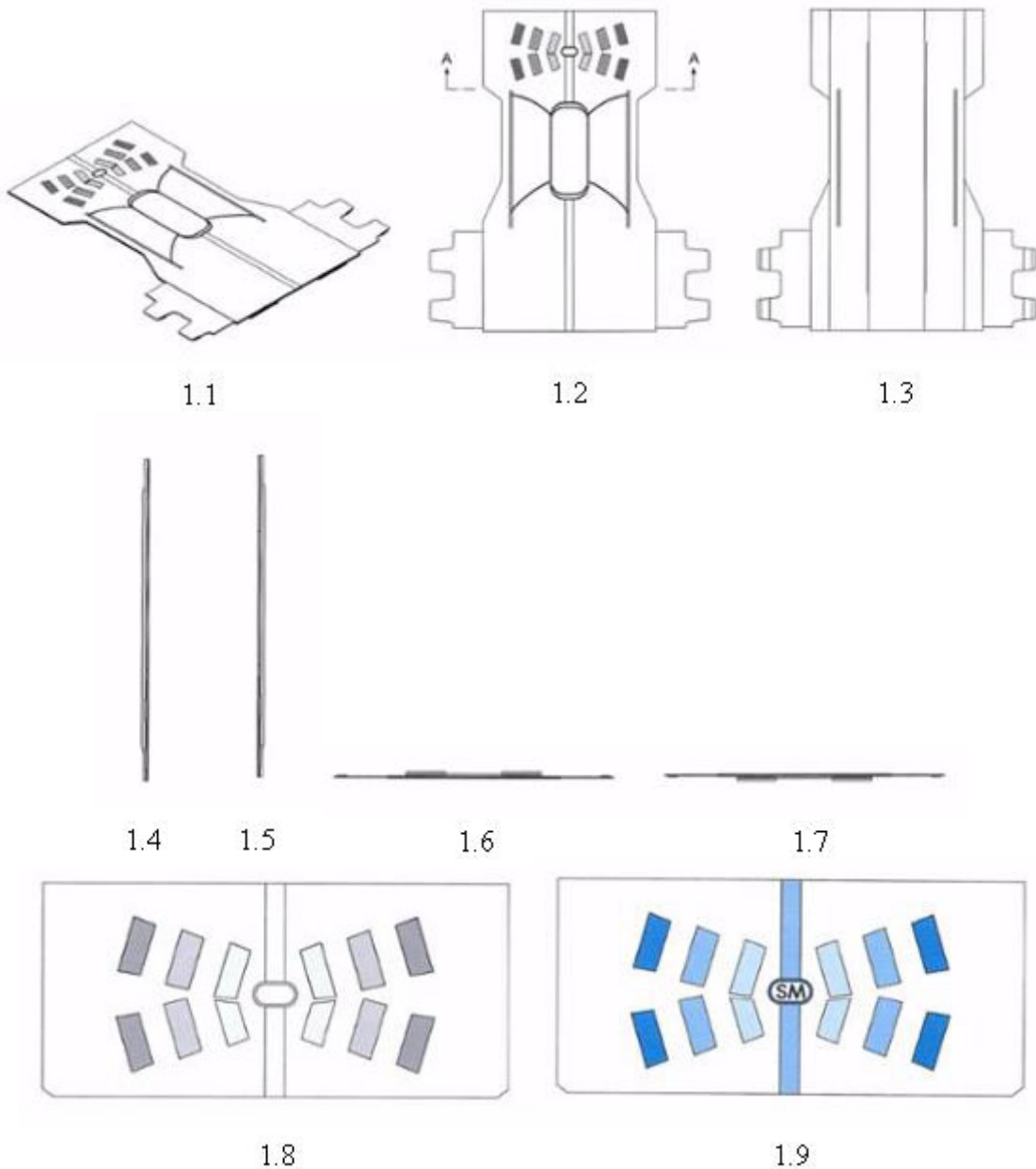

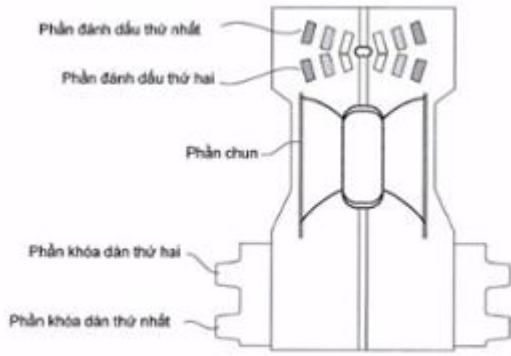

1.10

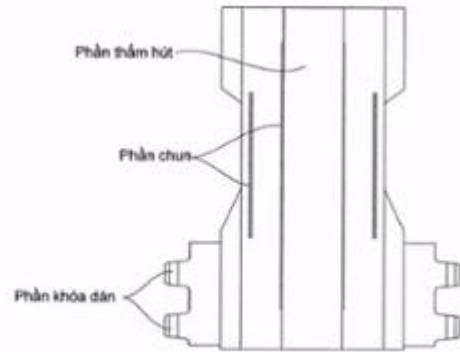

1.11

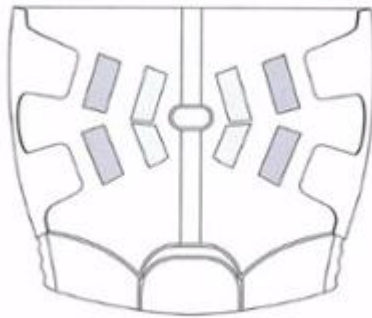

1.12

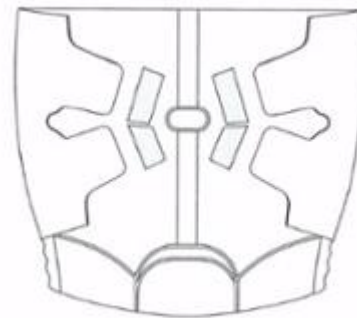

1.13

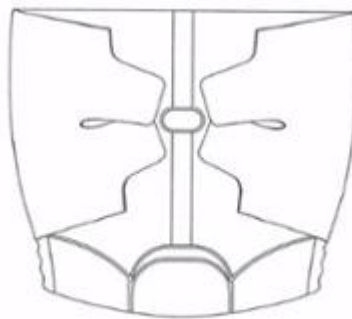

1.14

- (11) **42037**  
(21) 3-2021-00369 (28) 1  
(54) **TẤ LÓT DÙNG MỘT LẦN** (51) **02-01**  
(22) 22/02/2021 (43) 26/07/2021  
(30) 2020-018172 28/08/2020 JP;  
(73) **UNICHARM CORPORATION (JP)**  
182, Shimobun, Kinsei-cho, Shikokuchuo-City, Ehime 799-0111 Japan  
1. KENTO NASHIKI (JP)  
(72) 2. NAOMU MIYAMAE (JP)  
3. HITOMI NAKASHIMA (JP)  
(74) Công ty Cổ phần Sở hữu công nghiệp INVESTIP (INVESTIP)  
(55)

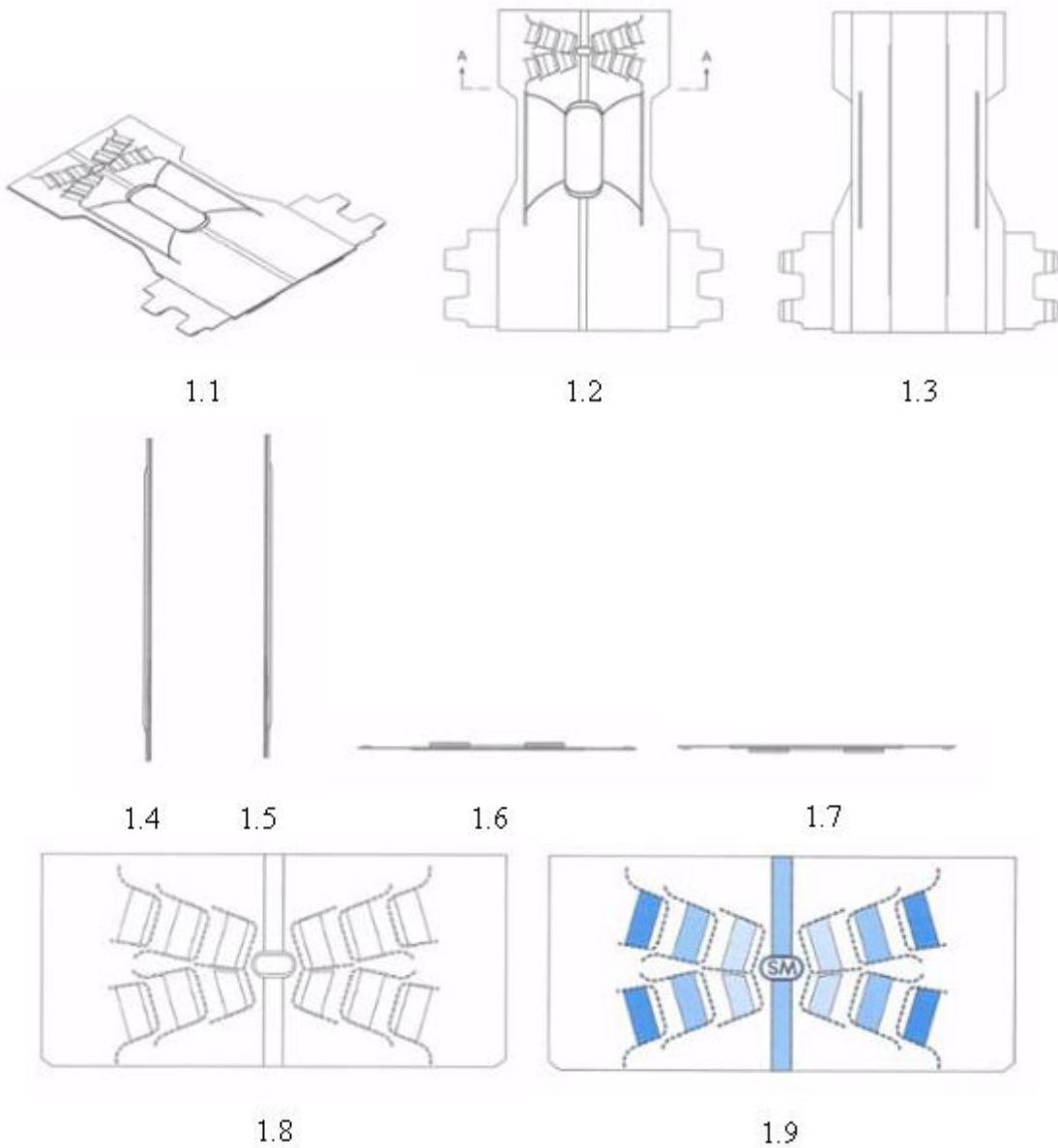

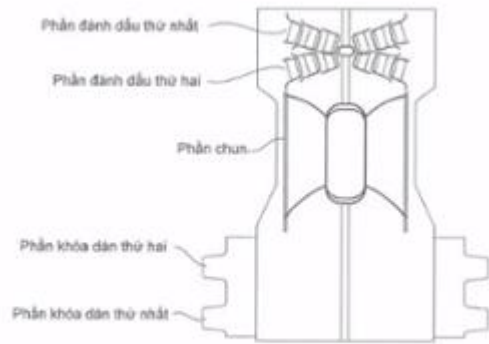

1.10

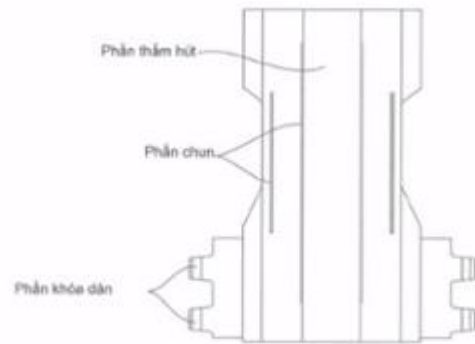

1.11

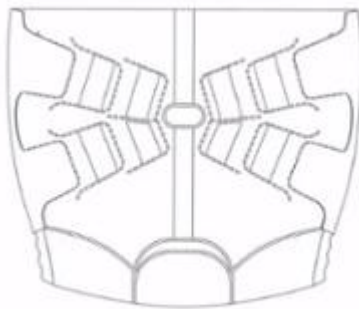

1.12

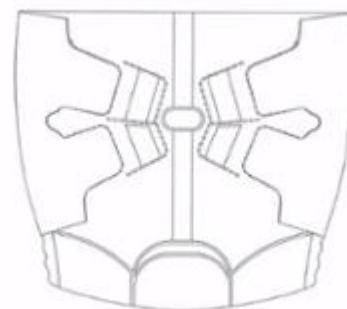

1.13

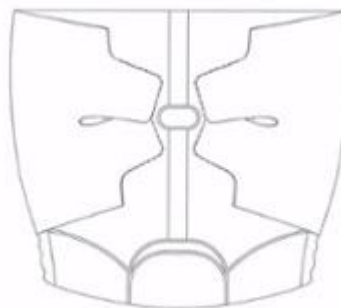

1.14



(11) **42038**

(21) 3-2021-00378

(28) 1

(54) **MÔ TƠ ĐIỆN**

(51) **13-01**

(22) 24/02/2021

(43) 26/07/2021

(30) 2002003866 27/08/2020 TH;

**PANASONIC MOTOR (THAILAND) CO., LTD. (TH)**

(73) 101 Moo 2, Teparak Road, T. Bangsaothong, A. Bangsaothong, Samutprakan 10570 THAILAND

(72) 1. ANUCHA SRICHAROEN (TH)

2. ALISA SEMJAROEN (TH)

(74) CÔNG TY LUẬT TRÁCH NHIỆM HỮU HẠN AMBYS HÀ NỘI (AMBYS HANOI)

(55)



1.1

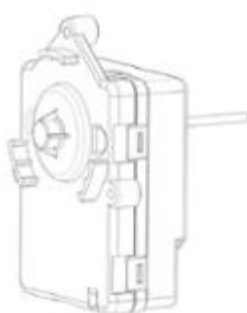

1.2

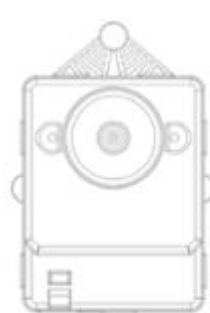

1.3

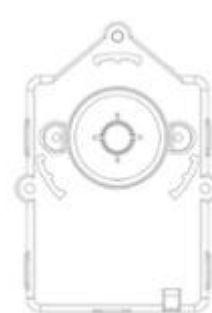

1.4

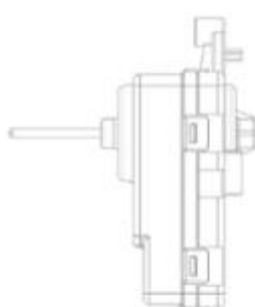

1.5

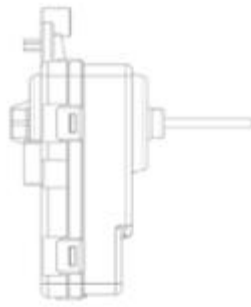

1.6

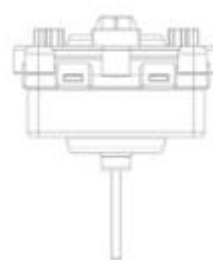

1.7



1.8

**CÔNG BÁO SỞ HỮU CÔNG NGHIỆP SỐ 400 TẬP A – QUYỀN 2 (07.2021)**

- (11) **42039**  
(21) 3-2021-00391 (28) 1  
(54) **LỘ** (51) **09-01**  
(22) 25/02/2021 (43) 26/07/2021  
(73) **LG HOUSEHOLD & HEALTH CARE LTD. (KR)**  
58, Saemunan-ro, Jongno-gu, Seoul, Republic of Korea  
(72) **PARK, Jin Won (KR)**  
(74) Công ty TNHH Tâm nhìn và Liên danh (VISION & ASSOCIATES CO.LTD.)  
(55)

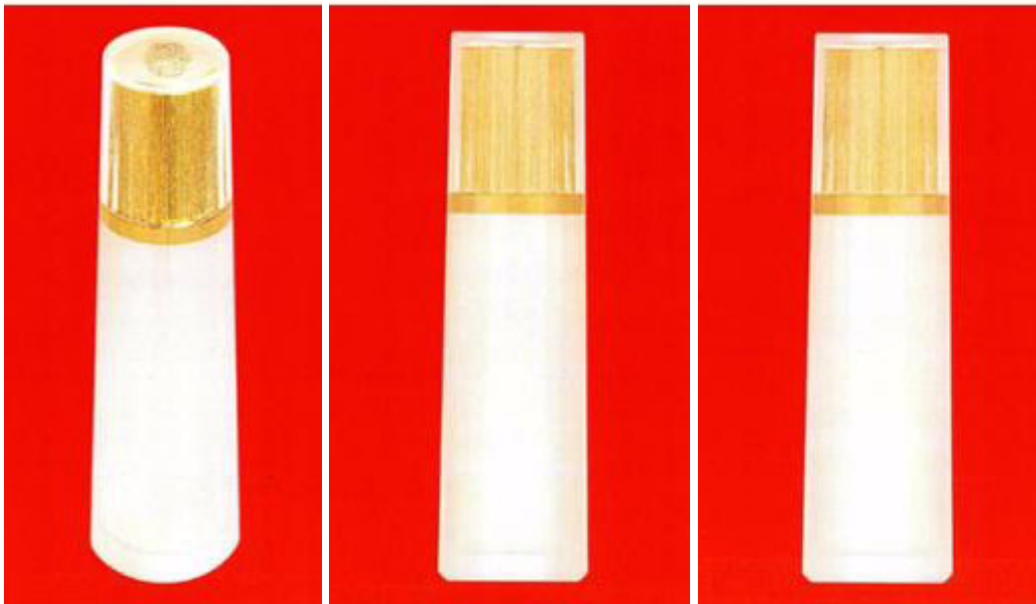

1.1

1.2

1.3

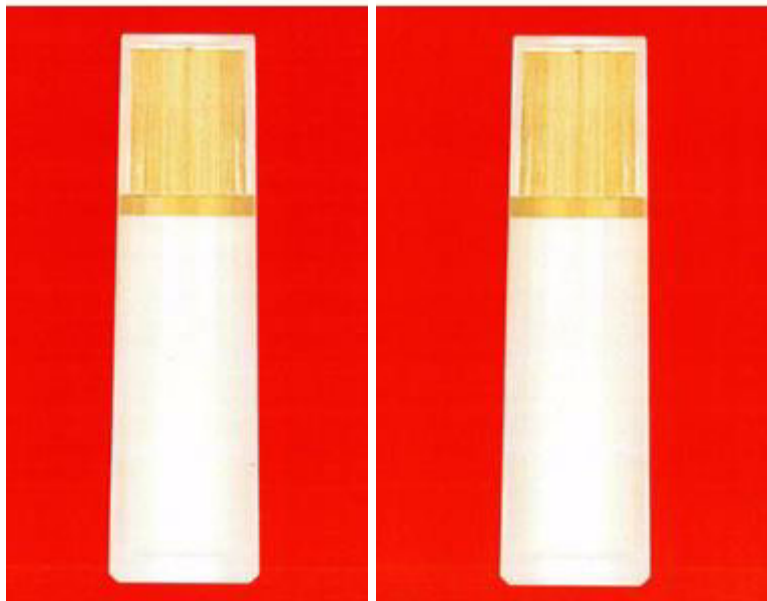

1.4

1.5



1.6



1.7

**CÔNG BÁO SỞ HỮU CÔNG NGHIỆP SỐ 400 TẬP A – QUYỀN 2 (07.2021)**

- (11) **42040**  
(21) 3-2021-00392 (28) 1  
(54) **LỖ** (51) **09-03**  
(22) 25/02/2021 (43) 26/07/2021  
(73) **LG HOUSEHOLD & HEALTH CARE LTD. (KR)**  
58, Saemunan-ro, Jongno-gu, Seoul, Republic of Korea  
(72) **PARK, Jin Won (KR)**  
(74) Công ty TNHH Tâm nhìn và Liên danh (VISION & ASSOCIATES CO.LTD.)  
(55)



1.1

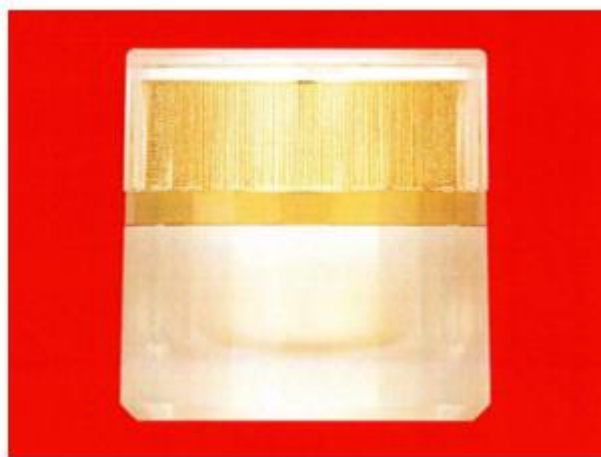

1.2

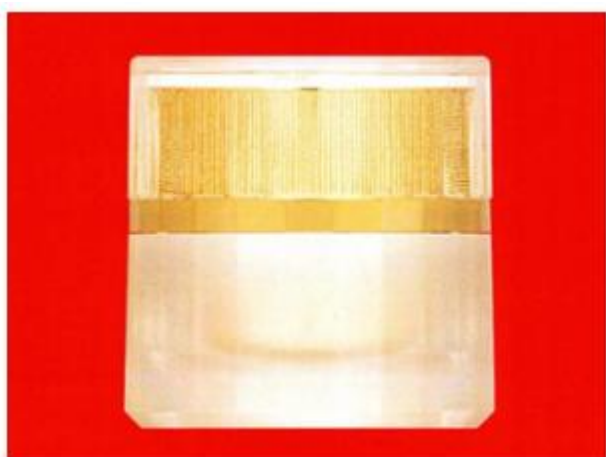

1.3

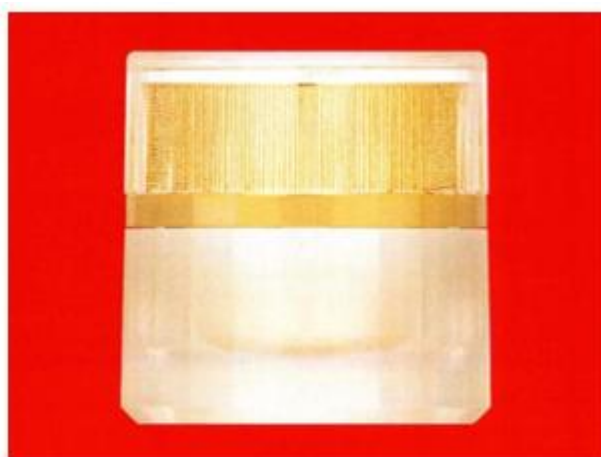

1.4

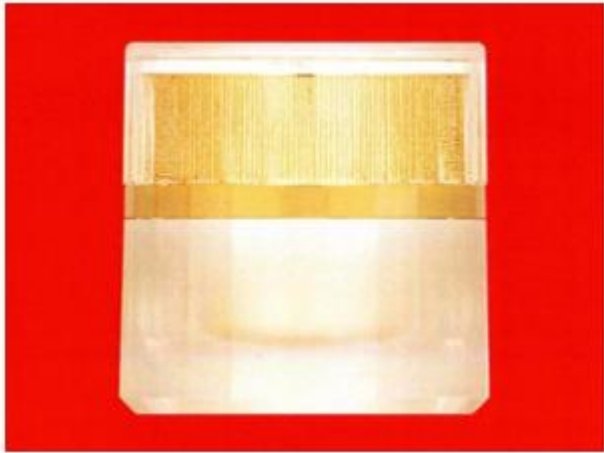

1.5

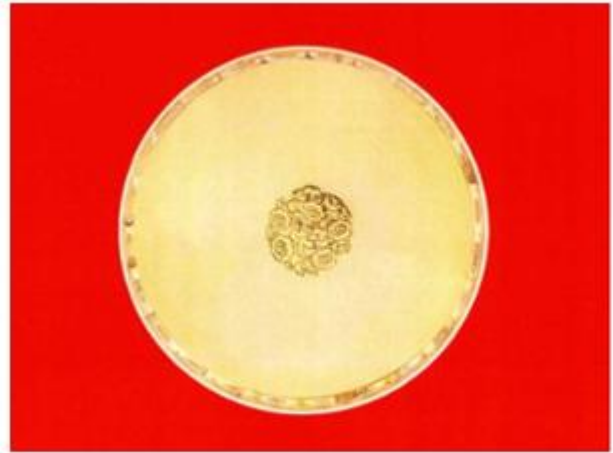

1.6



1.7

**CÔNG BÁO SỞ HỮU CÔNG NGHIỆP SỐ 400 TẬP A – QUYỀN 2 (07.2021)**

- (11) **42041**  
(21) 3-2021-00421 (28) 1  
(54) **BÌNH** (51) **07-07; 09-01**  
(22) 01/03/2021 (43) 26/07/2021  
(30) 30-2020-0041420 02/09/2020 KR;  
**LOCK & LOCK Co., Ltd (KR)**  
(73) 104, Sapgyocheon-ro, Seonjang-myeon, Asan-si, Chungcheongnam-do, Republic of Korea  
(72) KIM, Kwang Ik (KR)  
(74) Công ty TNHH Tầm nhìn và Liên danh (VISION & ASSOCIATES CO.LTD.)  
(55)



1.1



1.2



1.3



1.4



1.5



1.6



1.7

**CÔNG BÁO SỞ HỮU CÔNG NGHIỆP SỐ 400 TẬP A – QUYỀN 2 (07.2021)**

- (11) **42042**  
(21) 3-2021-00422 (28) 1  
(54) **BÌNH** (51) **07-07; 09-01**  
(22) 01/03/2021 (43) 26/07/2021  
(30) 30-2020-0041421 02/09/2020 KR;  
**LOCK & LOCK CO., LTD (KR)**  
(73) 104, Sapgyocheon-ro, Seonjang-myeon, Asan-si, Chungcheongnam-do, Republic of Korea  
(72) KIM, Kwang Ik (KR)  
(74) Công ty TNHH Tầm nhìn và Liên danh (VISION & ASSOCIATES CO.LTD.)  
(55)



1.1



1.2



1.3

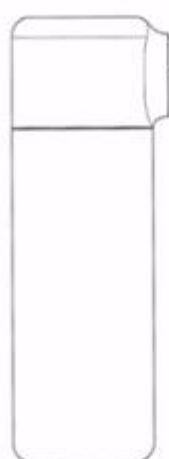

1.4



1.5



1.6



1.7

- (11) **42043**  
(21) 3-2021-00428 (28) 1  
(54) **TẮM CHẮN PHÍA TRƯỚC CỦA Ô TÔ** (51) **12-16**  
(22) 03/03/2021 (43) 26/07/2021  
(30) 2020-018975 04/09/2020 JP;  
**TOYOTA JIDOSHA KABUSHIKI KAISHA (JP)**  
(73) 1, Toyota-cho, Toyota-shi, Aichi-ken, 471-8571 JAPAN  
1. ANTHONY CHIN-PANG CHEUNG (AU)  
(72) 2. ADAM TY DEAN SMITH (AU)  
(74) Công ty TNHH một thành viên Sở hữu trí tuệ VCCI (VCCI-IP CO.,LTD)  
(55)



1.1



1.2



1.3



1.4



1.5



1.6



1.7



- (11) **42044**  
(21) 3-2021-00430 (28) 1  
(54) **LOA** (51) **14-01**  
(22) 03/03/2021 (43) 26/07/2021  
(30) 2020-022965 26/10/2020 JP;  
(73) **PIONEER CORPORATION (JP)**  
28-8, Honkomagome 2-chome, Bunkyo-ku, Tokyo, Japan  
(72) Yuki KISHIMOTO (JP)  
(74) **CÔNG TY LUẬT TRÁCH NHIỆM HỮU HẠN AMBYS HÀ NỘI (AMBYS HANOI)**  
(55)



1.1



1.2



1.3



1.4



1.5

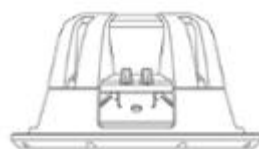

1.6

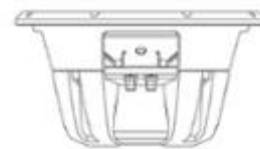

1.7

**CÔNG BÁO SỞ HỮU CÔNG NGHIỆP SỐ 400 TẬP A – QUYỀN 2 (07.2021)**

- (11) **42045**  
(21) 3-2021-00445 (28) 7  
(54) **BỘ LỌC** (51) **23-01**  
(22) 04/03/2021 (43) 26/07/2021  
(30) 202030575778.1 25/09/2020 CN;  
(73) **SMC CORPORATION (JP)**  
14-1, Sotokanda 4-chome, Chiyoda-ku, Tokyo, 1010021 JAPAN  
(72) Takayuki TANAKA (JP)  
(74) Công ty TNHH Tầm nhìn và Liên danh (VISION & ASSOCIATES CO.LTD.)  
(55)

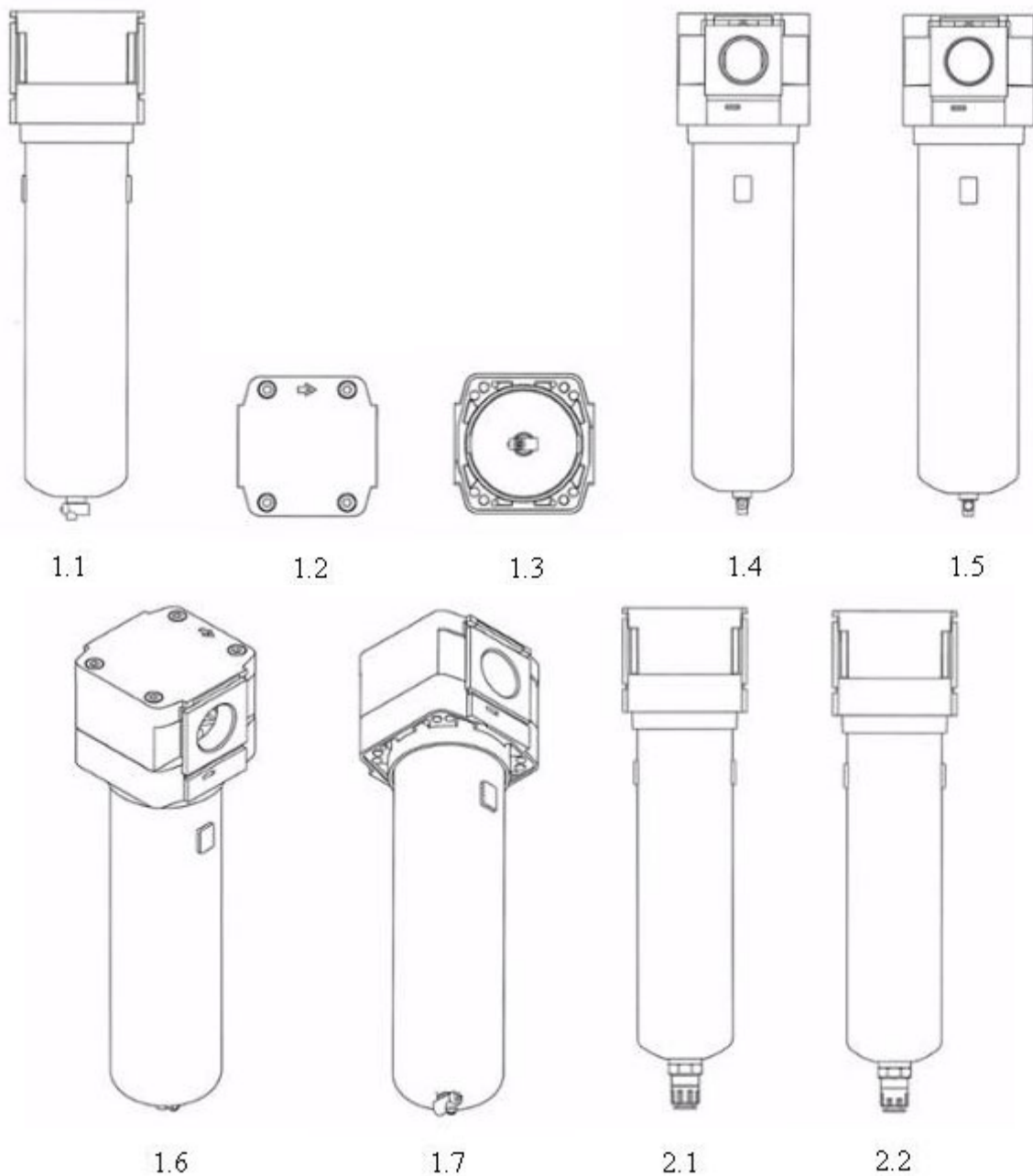

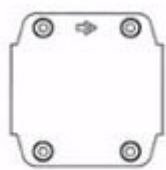

2.3



2.4



2.5



2.6

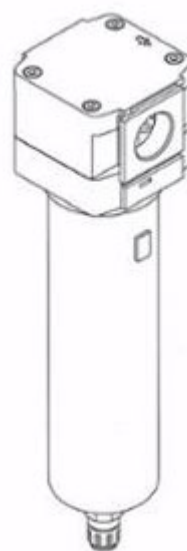

2.7



2.8

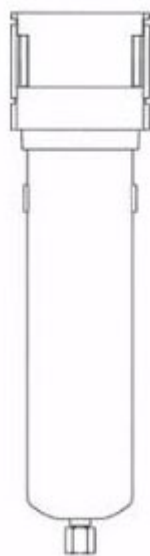

3.1



3.2



3.3



3.4



3.5

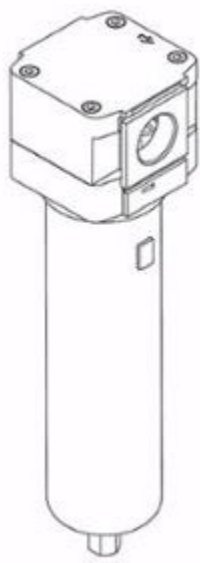

3.6

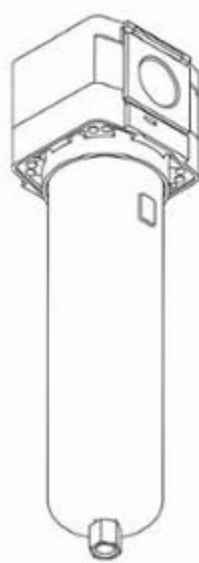

3.7



4.1

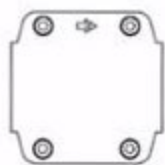

4.2



4.3

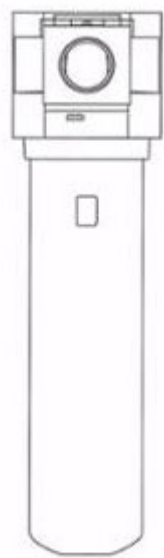

4.4

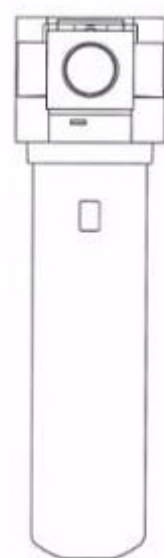

4.5

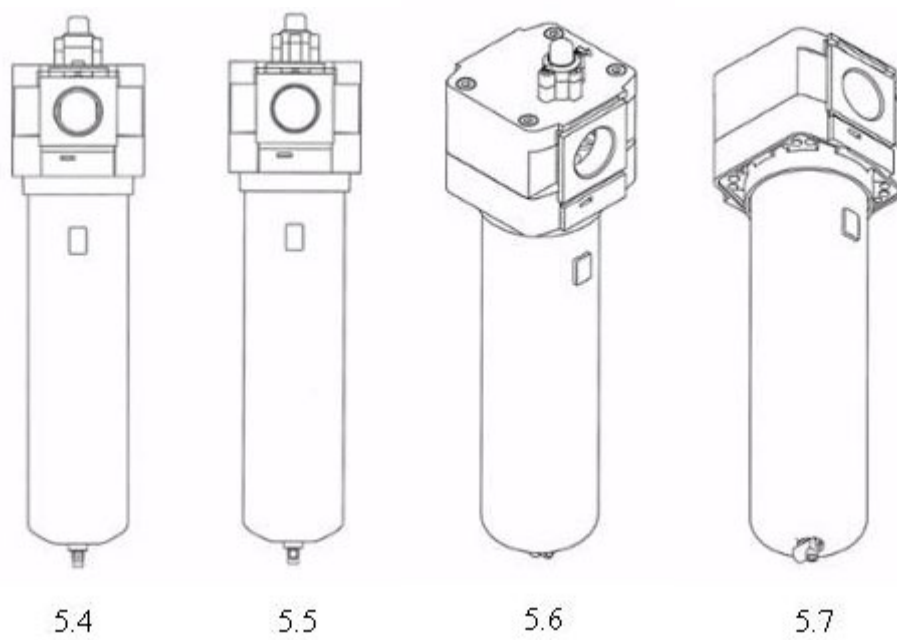
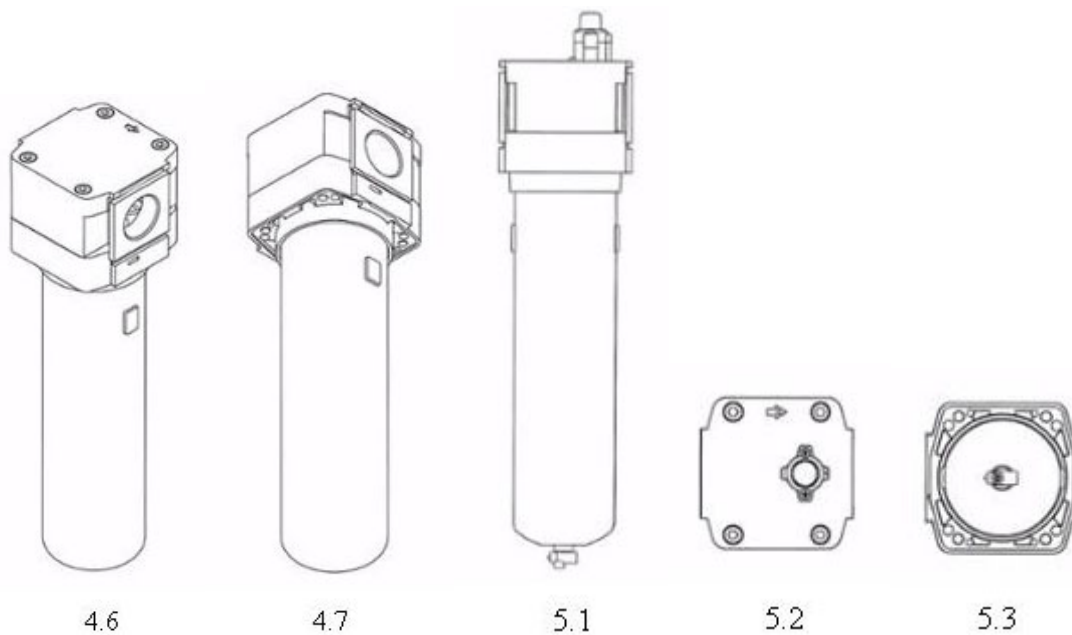

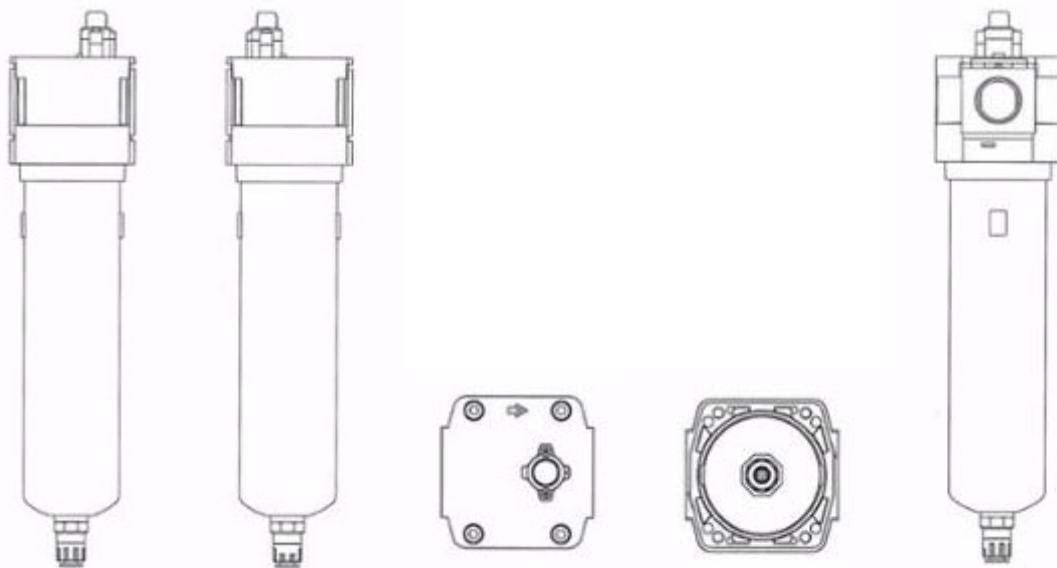

6.1

6.2

6.3

6.4

6.5

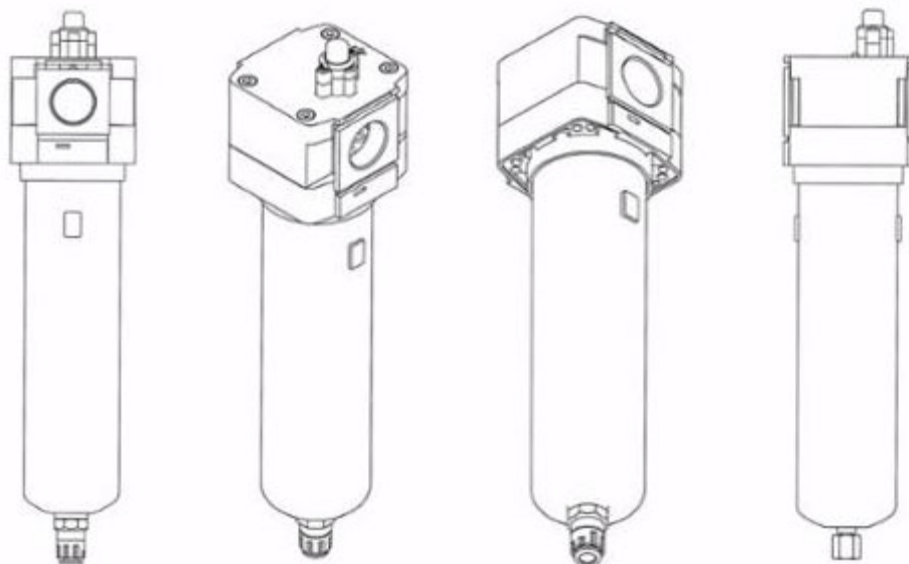

6.6

6.7

6.8

7.1



7.2



7.3



7.4



7.5

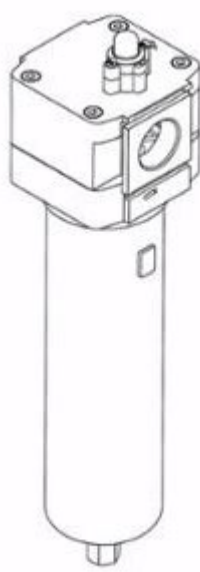

7.6



7.7

**CÔNG BÁO SỞ HỮU CÔNG NGHIỆP SỐ 400 TẬP A – QUYỀN 2 (07.2021)**

- (11) **42046**  
(21) 3-2021-00501 (28) 1  
(54) **HỘP ĐỰNG SẢN PHẨM** (51) **09-03**  
(22) 15/03/2021 (43) 26/07/2021  
**CÔNG TY CỔ PHẦN BIA QUỐC TẾ SÀI GÒN HÀ NỘI (VN)**  
(73) Số 132 Nguyễn Tuân, phường Thanh Xuân Trung, quận Thanh Xuân, thành phố Hà Nội  
(72) Nguyễn Thị Thắm (VN)  
(74) Công ty TNHH Sở hữu trí tuệ Bình Minh (SUNRISE IP CO.,LTD.)  
(55)



1.1



1.2



- (11) **42047**  
(21) 3-2021-00502 (28) 1  
(54) **KHUNG BÁNH XE** (51) **12-16**  
(22) 08/05/2020 (43) 26/07/2021  
(73) **WHEEL PROS, LLC (US)**  
5347 S. Valentina, Suite 200, Greenwood Village, Colorado 80111  
(72) John Andrew Hale (US)  
(74) Công ty cổ phần Tư vấn S&B (S&B CONSULTANT., CORP.)  
(55)



1.1



1.2



1.3

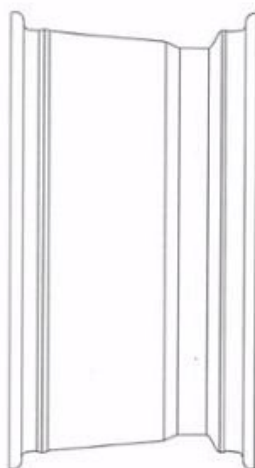

1.4

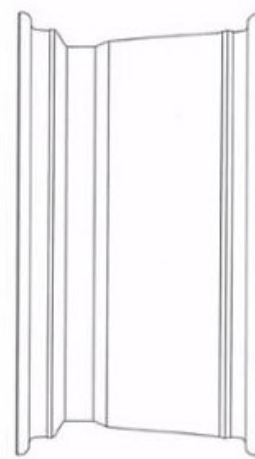

1.5

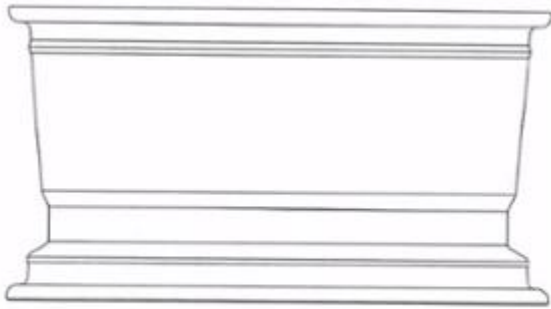

1.6

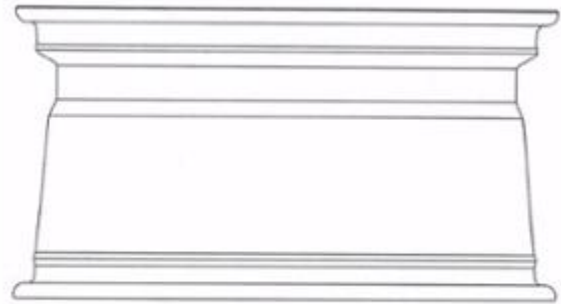

1.7

- (11) **42048**  
(21) 3-2021-00503 (28) 1  
(54) **KHUNG BÁNH XE** (51) **12-16**  
(22) 07/05/2020 (43) 26/07/2021  
(73) **WHEEL PROS, LLC (US)**  
5347 S. Valentina, Suite 200, Greenwood Village, Colorado 80111  
(72) Arthur D. Hale, Jr. (US)  
(74) Công ty cổ phần Tư vấn S&B (S&B CONSULTANT., CORP.)  
(55)

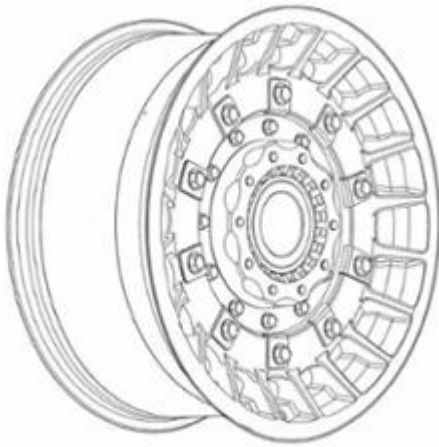

1.1

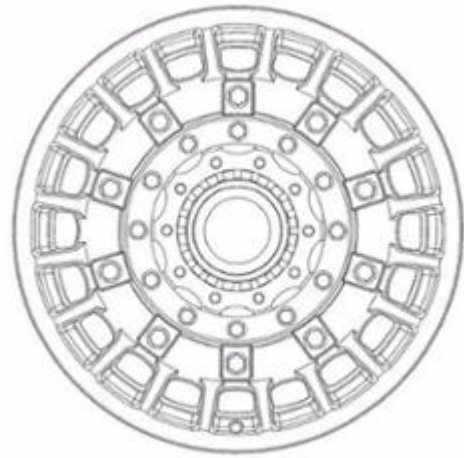

1.2

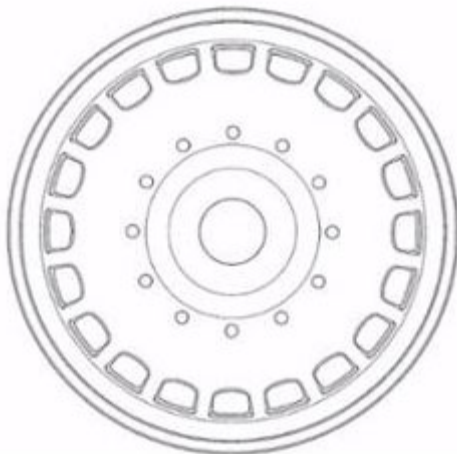

1.3

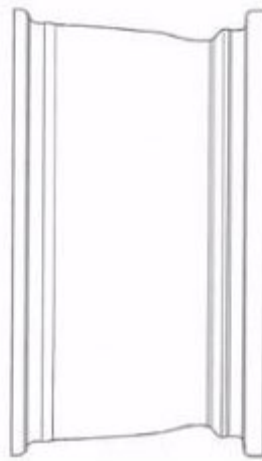

1.4

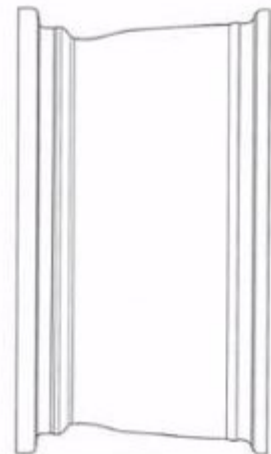

1.5

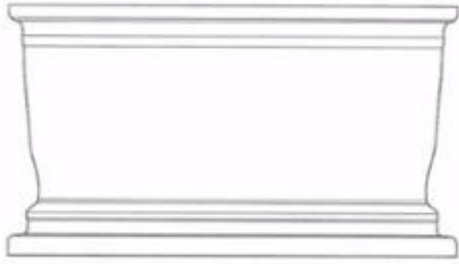

1.6

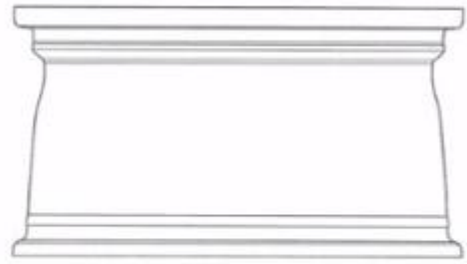

1.7

**CÔNG BÁO SỞ HỮU CÔNG NGHIỆP SỐ 400 TẬP A – QUYỀN 2 (07.2021)**

- (11) **42049**  
(21) 3-2021-00508 (28) 1  
(54) **BÌA SỔ** (51) **19-04**  
(22) 15/03/2021 (43) 26/07/2021  
(73) **CÔNG TY TNHH TRÍ MINH (VN)**  
Số 65, phố Hàng Bông, phường Hàng Gai, quận Hoàn Kiếm, thành phố Hà Nội  
(72) Trương Tuấn Nghĩa (VN)  
(74) Công ty TNHH Sở hữu trí tuệ VIPATCO (VIPATCO CO., LTD.)  
(55)



1.1

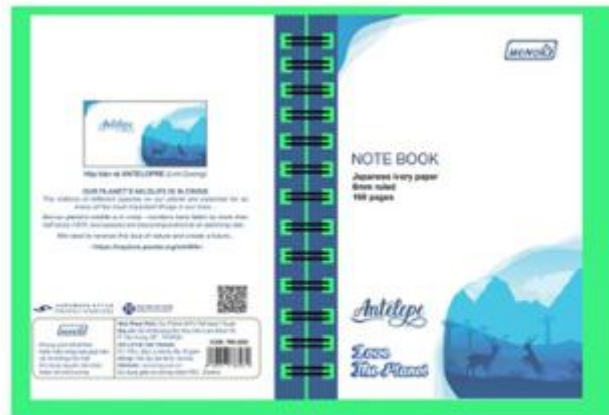

1.2

**CÔNG BÁO SỞ HỮU CÔNG NGHIỆP SỐ 400 TẬP A – QUYỀN 2 (07.2021)**

- (11) **42050**  
(21) 3-2021-00509 (28) 1  
(54) **BÌA SỔ** (51) **19-04**  
(22) 15/03/2021 (43) 26/07/2021  
(73) **CÔNG TY TNHH TRÍ MINH (VN)**  
Số 65, phố Hàng Bông, phường Hàng Gai, quận Hoàn Kiếm, thành phố Hà Nội  
(72) Trương Tuấn Nghĩa (VN)  
(74) Công ty TNHH Sở hữu trí tuệ VIPATCO (VIPATCO CO., LTD.)  
(55)



1.1



1.2

**CÔNG BÁO SỞ HỮU CÔNG NGHIỆP SỐ 400 TẬP A – QUYỀN 2 (07.2021)**

- (11) **42051**  
(21) 3-2021-00513 (28) 1  
(54) **BÌA SỔ** (51) **19-04**  
(22) 15/03/2021 (43) 26/07/2021  
(73) **CÔNG TY TNHH TRÍ MINH (VN)**  
Số 65, phố Hàng Bông, phường Hàng Gai, quận Hoàn Kiếm, thành phố Hà Nội  
(72) Trương Tuấn Nghĩa (VN)  
(74) Công ty TNHH Sở hữu trí tuệ VIPATCO (VIPATCO CO., LTD.)  
(55)



1.1

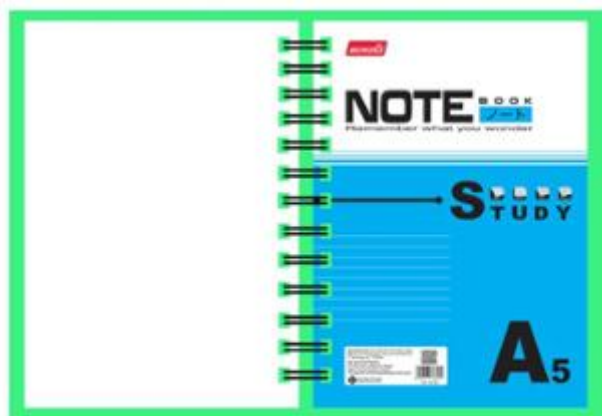

1.2

**CÔNG BÁO SỞ HỮU CÔNG NGHIỆP SỐ 400 TẬP A – QUYỀN 2 (07.2021)**

- (11) **42052**  
(21) 3-2021-00514 (28) 1  
(54) **BÌA SỔ** (51) **19-04**  
(22) 15/03/2021 (43) 26/07/2021  
(73) **CÔNG TY TNHH TRÍ MINH (VN)**  
Số 65, phố Hàng Bông, phường Hàng Gai, quận Hoàn Kiếm, thành phố Hà Nội  
(72) Trương Tuấn Nghĩa (VN)  
(74) Công ty TNHH Sở hữu trí tuệ VIPATCO (VIPATCO CO., LTD.)  
(55)



1.1



1.2



**CÔNG BÁO SỞ HỮU CÔNG NGHIỆP SỐ 400 TẬP A – QUYỀN 2 (07.2021)**

- (11) **42053**  
(21) 3-2021-00520 (28) 1  
(54) **TẤM LÓT MŨ** (51) **02-03**  
(22) 16/03/2021 (43) 26/07/2021  
(73) **CÔNG TY TNHH TƯ VẤN VÀ QUẢN LÝ HOÀNG HÀ (VN)**  
1A - Q23 Lấp Ghép Trương Định, Tương Mai, quận Hoàng Mai, thành phố Hà Nội  
(72) Hoàng Quang Cường (VN)  
(55)

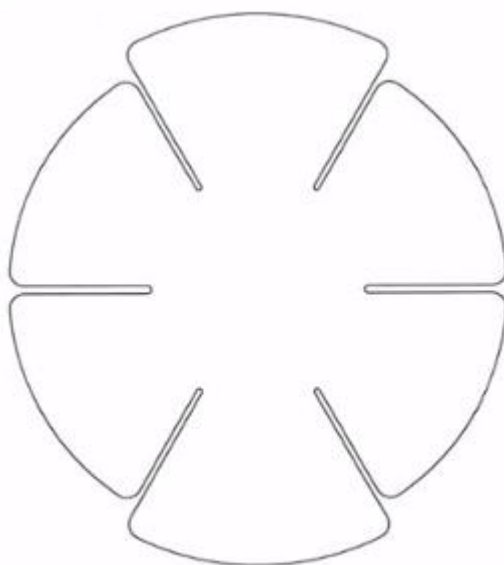

1.1

(11) **42054**

(21) 3-2021-00523

(28) 1

(54) **LỖ**

(51) **09-01**

(22) 16/03/2021

(43) 26/07/2021

(73) **LG HOUSEHOLD & HEALTH CARE LTD. (KR)**  
58, Saemunan-ro, Jongno-gu, Seoul, Republic of Korea

(72) LEE, Seul Ki (KR)

(74) Công ty TNHH Tầm nhìn và Liên danh (VISION & ASSOCIATES CO.LTD.)

(55)



1.1

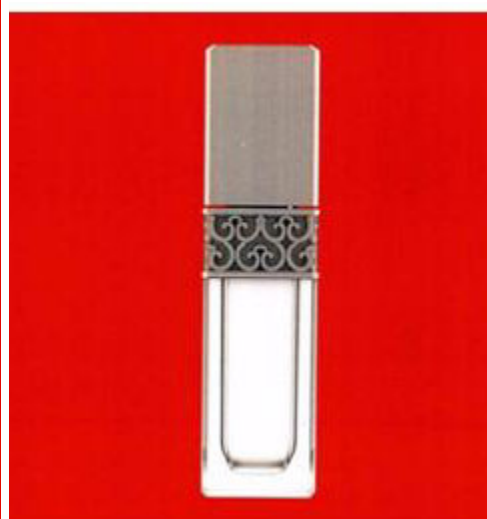

1.2



1.3



1.4



1.5



1.6



1.7

- (11) **42055**  
(21) 3-2021-00651 (28) 1  
(54) **BĂNG CÁT-SÉT DÙNG CHO MÁY IN NHÃN** (51) **18-02**  
(22) 19/03/2021 (43) 26/07/2021  
(30) 2020-020875 30/09/2020 JP;  
**BROTHER INDUSTRIES, LTD. (JP)**  
(73) 15-1 Naeshiro-cho, Mizuho-ku, Nagoya-shi, Aichi-ken, Japan  
1. SHINJI UKAI (JP)  
2. KENTARO MURAYAMA (JP)  
(72) 3. YUYA TAGAMI (JP)  
4. KOSUKE HIGASHI (JP)  
(74) Công ty TNHH Ban Ca (BANCA)  
(55)

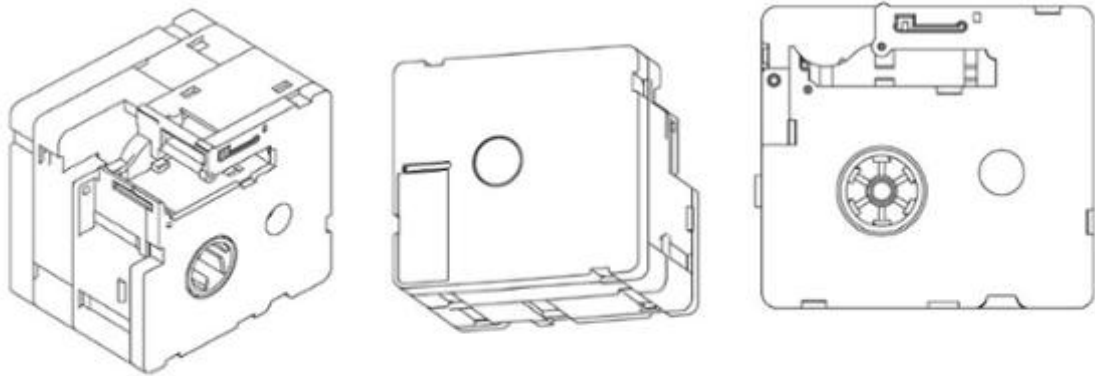

1.1

1.2

1.3

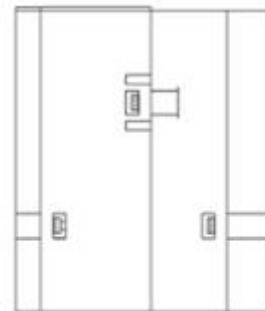
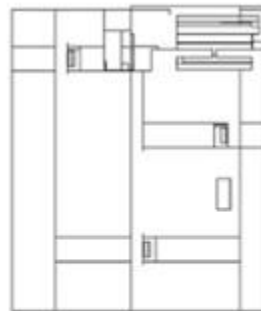
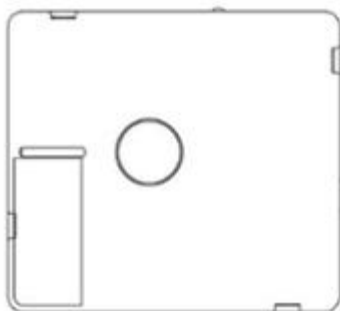

1.4

1.5

1.6



1.7

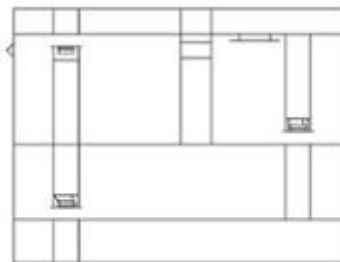

1.8

(11) **42056**

(21) 3-2021-00677

(54) **ĐÈN NGỦ CẢM BIẾN**

(22) 22/03/2021

(28) 1

(51) **26-05**

(43) 26/07/2021

**CÔNG TY CỔ PHẦN BÓNG ĐÈN PHÍCH NƯỚC RẠNG ĐÔNG (VN)**

(73) 87-89 phố Hạ Đình, phường Thanh Xuân Trung, quận Thanh Xuân, thành phố Hà Nội

(72) Trần Trung Tường (VN)

(55)

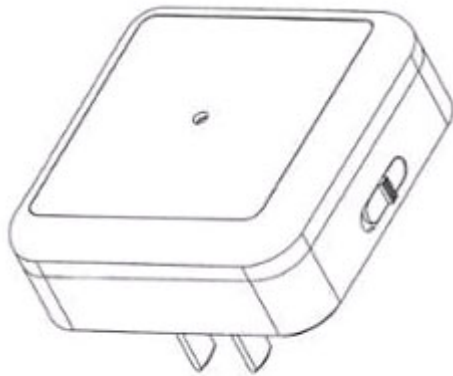

1.1

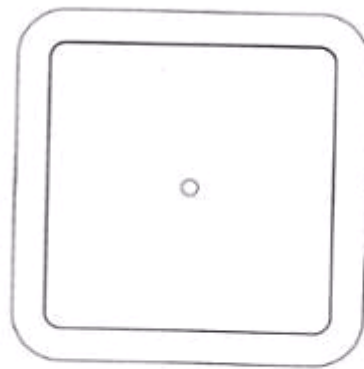

1.2

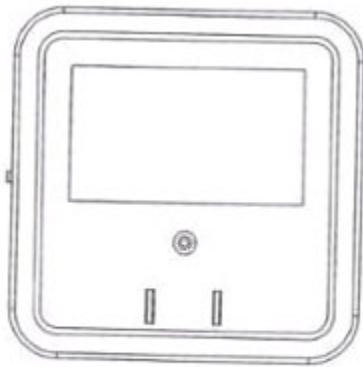

1.3

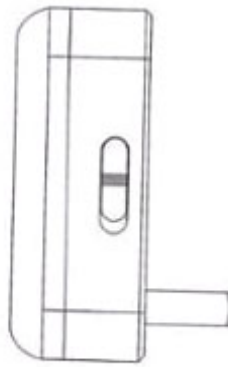

1.4

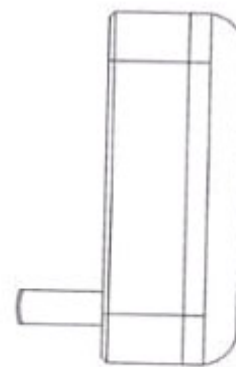

1.5

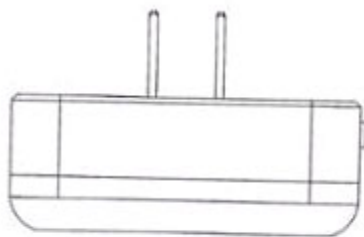

1.6

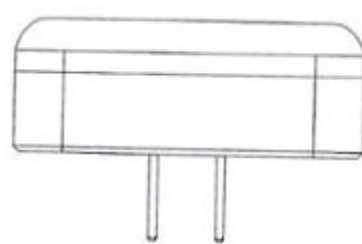

1.7

**CÔNG BÁO SỞ HỮU CÔNG NGHIỆP SỐ 400 TẬP A – QUYỀN 2 (07.2021)**

- (11) **42057**  
(21) 3-2021-00678 (28) 1  
(54) **DỤNG CỤ VỆ SINH BỒN CẦU** (51) **23-02**  
(22) 22/03/2021 (43) 26/07/2021  
(73) **NGUYỄN NGỌC AN (VN)**  
651 Ngô Quyền, phường Vĩnh Lạc, thành phố Rạch Giá, tỉnh Kiên Giang  
(72) Nguyễn Ngọc An (VN)  
(74) Công ty Luật Hợp danh bản quyền Quốc tế (CIS LAW FIRM)  
(55)



1.1



1.2

1.3



1.4



1.5



1.6



1.7

**CÔNG BÁO SỞ HỮU CÔNG NGHIỆP SỐ 400 TẬP A – QUYỀN 2 (07.2021)**

(11) **42058**

(21) 3-2021-00689

(28) 1

(54) **MÁY IN**

(51) **18-02**

(22) 22/03/2021

(43) 26/07/2021

(30) 2020-021391 06/10/2020 JP;

(73) **BROTHER INDUSTRIES, LTD. (JP)**

15-1 Naeshiro-cho, Mizuho-ku, Nagoya-shi, Aichi-ken, Japan

(72) 1. TAKAHIRO MOTOYAMA (JP)

2. NOBUYUKI IWAI (JP)

(74) Công ty TNHH Ban Ca (BANCA)

(55)

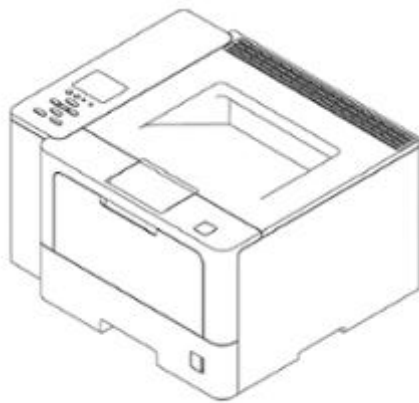

1.1

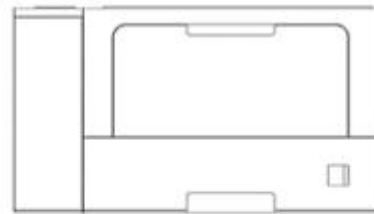

1.2

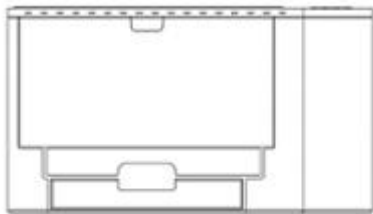

1.3



1.4



1.5

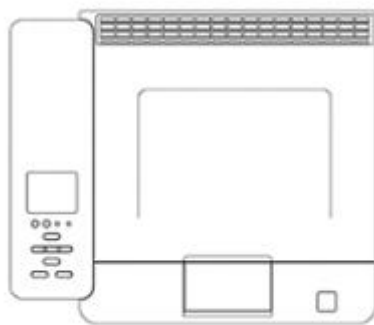

1.6

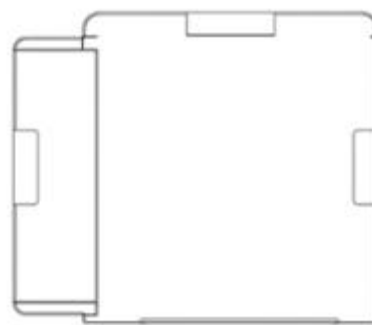

1.7

**CÔNG BÁO SỞ HỮU CÔNG NGHIỆP SỐ 400 TẬP A – QUYỀN 2 (07.2021)**

- (11) **42059**  
(21) 3-2021-00690 (28) 2  
(54) **XE ĐẠP ĐIỆN** (51) **12-11**  
(22) 22/03/2021 (43) 26/07/2021  
(30) 202030631135.4 22/10/2020 CN;  
**YADEA TECHNOLOGY GROUP CO.,LTD (CN)**  
(73) Dongsheng Road, Dacheng Industrial Zone, Anzhen, Xishan District, Wuxi,  
Jiangsu, China  
1. FAN, RUI (CN)  
(72) 2. LIN, JINGYU (CN)  
3. MO, JIAJUN (CN)  
4. SHEN, BIN (CN)  
(74) Công ty TNHH Sáng chế ACTIP (ACTIP PATENT LIMITED)  
(55)



1.1



1.2



1.3



1.4





1.5



1.6



1.7



1.8



2.1



2.2



2.3



2.4



2.5



2.6



2.7



2.8

**CÔNG BÁO SỞ HỮU CÔNG NGHIỆP SỐ 400 TẬP A – QUYỀN 2 (07.2021)**

- |      |   |      |              |
|------|---|------|--------------|
| (11) | <b>42060</b>  |      |              |
| (21) | 3-2021-00691  | (28) | 6            |
| (54) | <b>VỈ ĐỰNG NHÃN VÀNG</b>  | (51) | <b>09-05</b> |
| (22) | 22/03/2021  | (43) | 26/07/2021   |
|      | <b>CÔNG TY TNHH BẢO TÍN MINH CHÂU (VN)</b>                                  |      |              |
| (73) | Số 29 Trần Nhân Tông, phường Nguyễn Du, quận Hai Bà Trưng, thành phố Hà Nội |      |              |
| (72) | Vũ Minh Châu (VN)   |      |              |
| (55) |   |      |              |



1.1



1.2



1.3



1.4



1.5

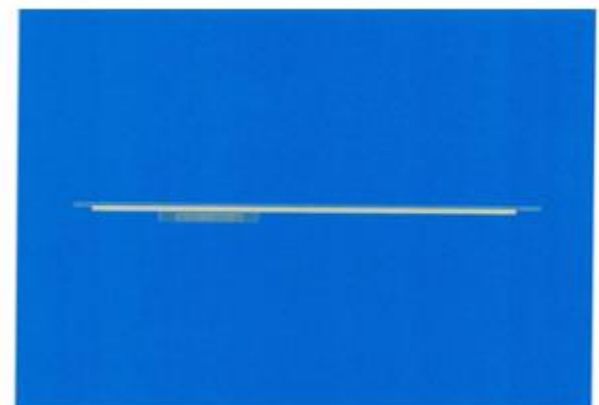

1.6

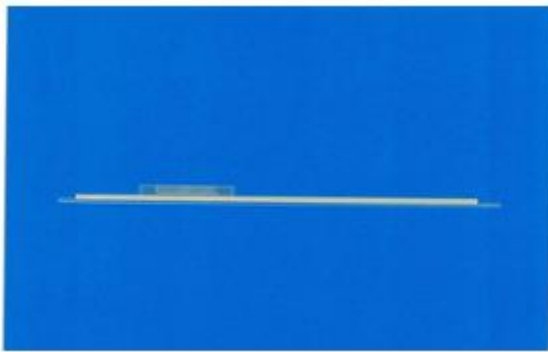

1.7



2.1



2.2



2.3



2.4



2.5



2.6

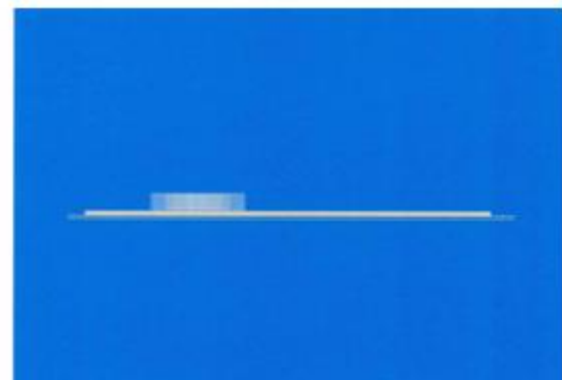

2.7



3.1



3.2



3.3

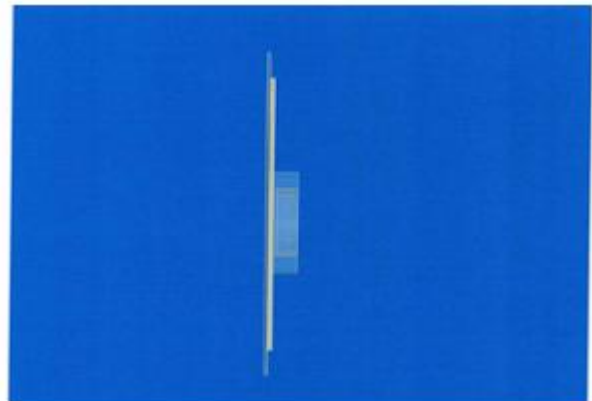

3.4



3.5

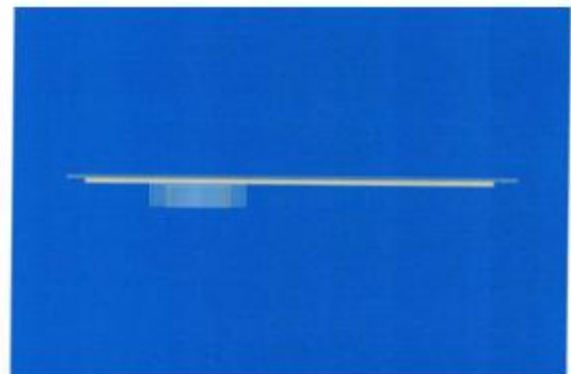

3.6

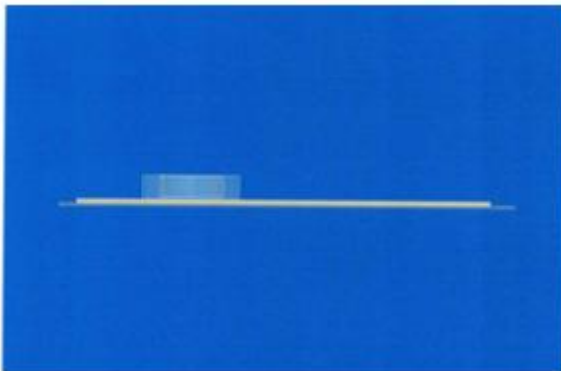

3.7

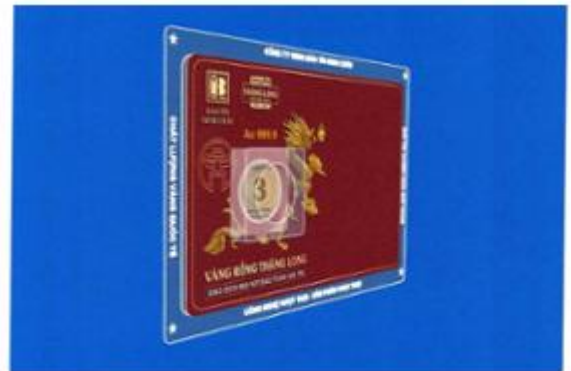

4.1



4.2



4.3

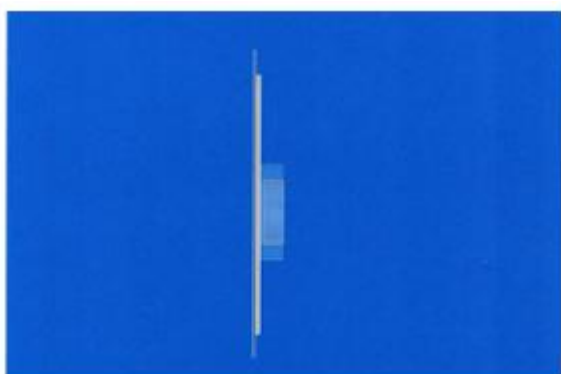

4.4



4.5

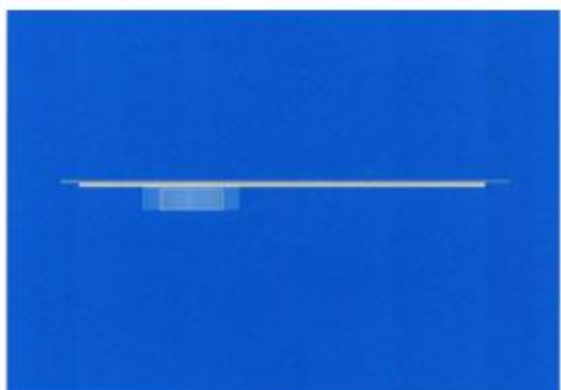

4.6

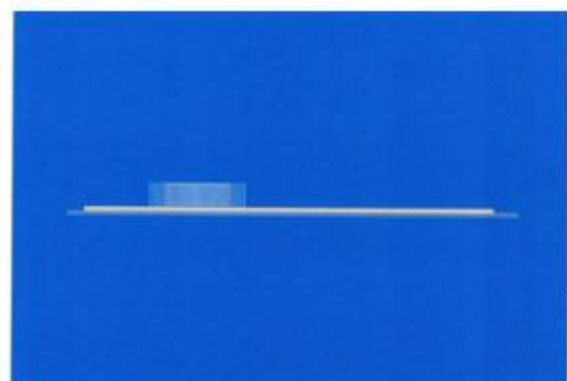

4.7



5.1



5.2



5.3



5.4

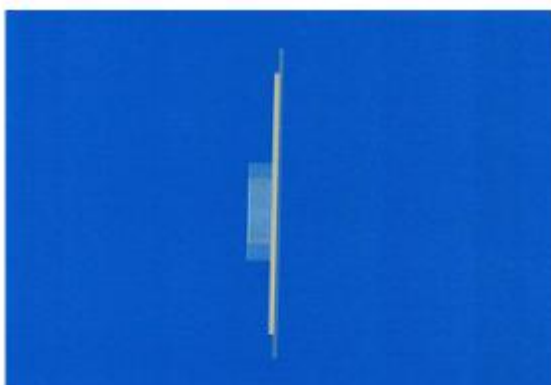

5.5

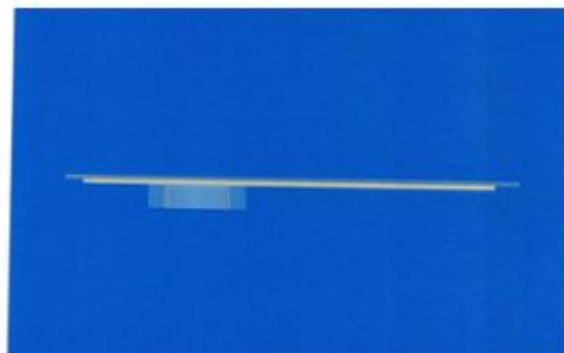

5.6

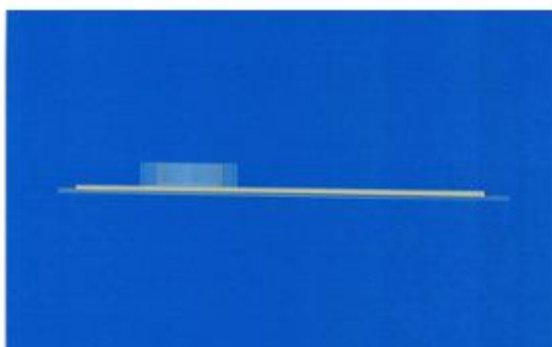

5.7



6.1



6.2



6.3

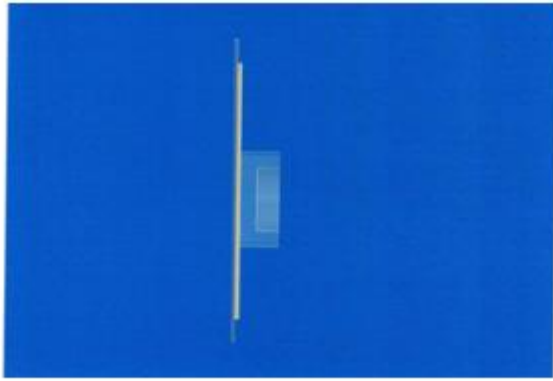

6.4

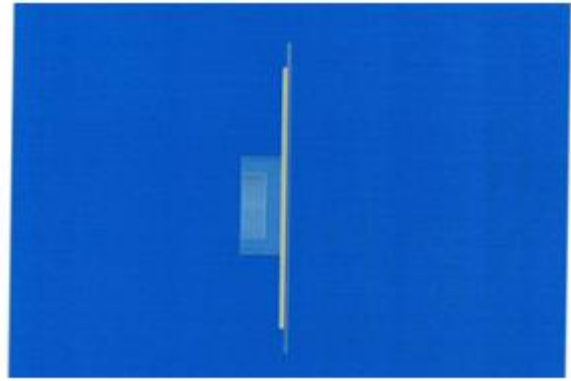

6.5

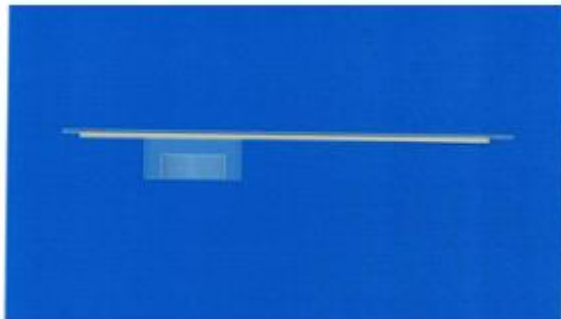

6.6

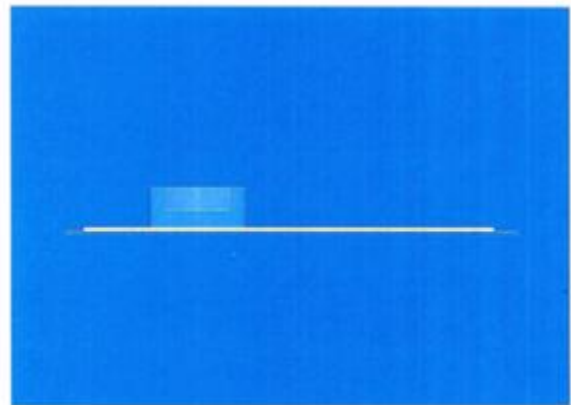

6.7



**CÔNG BÁO SỞ HỮU CÔNG NGHIỆP SỐ 400 TẬP A – QUYỀN 2 (07.2021)**

- (11) **42061**  
(21) 3-2021-00695 (28) 1  
(54) **BÌNH** (51) **09-01**  
(22) 24/03/2021 (43) 26/07/2021  
(73) **CÔNG TY CỔ PHẦN SẢN XUẤT NHỰA DUY TÂN (VN)**  
298 Hồ Học Lãm, phường An Lạc, quận Bình Tân, thành phố Hồ Chí Minh  
(72) Trần Đức Xuyên (VN)  
(74) Công ty TNHH Sở hữu trí tuệ INVENTIO (INVENTIO CO.,LTD)  
(55)



1.1



1.2



1.3



1.4



1.5



1.6

**CÔNG BÁO SỞ HỮU CÔNG NGHIỆP SỐ 400 TẬP A – QUYỀN 2 (07.2021)**

- (11) **42062**
- (21) 3-2021-00698 (28) 1
- (54) **NHÃN SẢN PHẨM** (51) **19-08**
- (22) 24/03/2021 (43) 26/07/2021
- (73) **VIỆN HÓA HỌC CÁC HỢP CHẤT THIÊN NHIÊN (VN)**  
18 Hoàng Quốc Việt, quận Cầu Giấy, thành phố Hà Nội
- (72) Hoàng Đại Tuấn (VN)
- (74) Công ty TNHH Sở hữu trí tuệ ALNGUYEN (ALNGUYEN IP CO.,LTD.)
- (55)

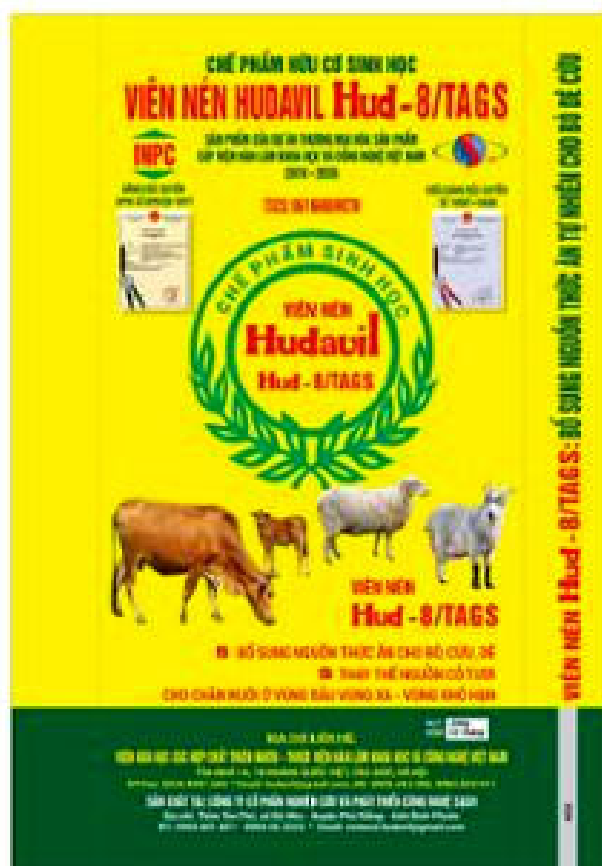

**CÔNG BÁO SỞ HỮU CÔNG NGHIỆP SỐ 400 TẬP A – QUYỀN 2 (07.2021)**

- (11) **42063**
- (21) 3-2021-00699 (28) 1
- (54) **NHÃN SẢN PHẨM** (51) **19-08**
- (22) 24/03/2021 (43) 26/07/2021
- (73) **VIỆN HÓA HỌC CÁC HỢP CHẤT THIÊN NHIÊN (VN)**  
18 Hoàng Quốc Việt, quận Cầu Giấy, thành phố Hà Nội
- (72) Hoàng Đại Tuấn (VN)
- (74) Công ty TNHH Sở hữu trí tuệ ALNGUYEN (ALNGUYEN IP CO.,LTD.)
- (55)



**CÔNG BÁO SỞ HỮU CÔNG NGHIỆP SỐ 400 TẬP A – QUYỀN 2 (07.2021)**

- (11) **42064**  
(21) 3-2021-00700 (28) 1  
(54) **ĐIỀU HÒA KHÔNG KHÍ** (51) **23-04**  
(22) 24/03/2021 (43) 26/07/2021  
(30) 2020-025228 24/11/2020 JP;  
(73) **BROTHER INDUSTRIES, LTD. (JP)**  
15-1 Naeshiro-cho, Mizuho-ku, Nagoya-shi, Aichi-ken, Japan  
(72) Tatsuya ISHII (JP)  
(74) Công ty TNHH Ban Ca (BANCA)  
(55)

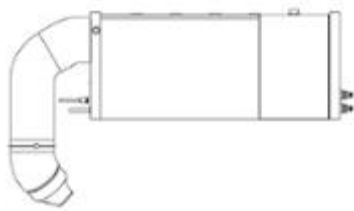

1.1

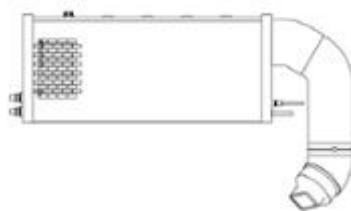

1.2

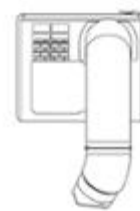

1.3

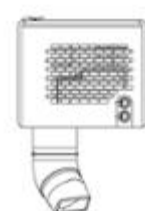

1.4

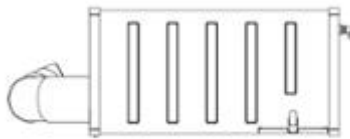

1.5



1.6

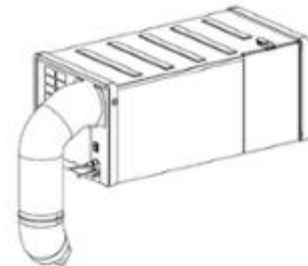

1.7



1.8



1.9

**CÔNG BÁO SỞ HỮU CÔNG NGHIỆP SỐ 400 TẬP A – QUYỀN 2 (07.2021)**

- (11) **42065**  
(21) 3-2021-00703 (28) 1  
(54) **THƯỚC KẼ CHÂN MÀY** (51) **28-03**  
(22) 25/03/2021 (43) 26/07/2021  
(73) **BÙI QUỐC THẢO (VN)**  
Áp Bình Thành, xã Tân Mỹ Chánh, thành phố Mỹ Tho, tỉnh Tiền Giang  
(72) Bùi Quốc Thảo (VN)  
(74) Văn phòng Luật sư D và T (D & T LAW OFFICE)  
(55)



1.1



1.2



1.3



1.4



1.5



1.6



1.7



1.8

(11) **42066**

(21) 3-2021-00715

(28) 1

(54) **MÁY TÁCH SỢI TỪ LÁ DỨA**

(51) **15-03**

(22) 29/03/2021

(43) 26/07/2021

(73) **CÔNG TY TNHH HỒ HOÀN CẦU (VN)**

Xóm 6, xã Quỳnh Văn, huyện Quỳnh Lưu, tỉnh Nghệ An

(72) Hồ Xuân Vinh (VN)

(55)



1.1



1.2



1.3



1.4



1.5



1.6



1.7



1.8

**CÔNG BÁO SỞ HỮU CÔNG NGHIỆP SỐ 400 TẬP A – QUYỀN 2 (07.2021)**

(11) **42067**

(21) 3-2021-00722

(28) 1

(54) **GHẾ ĐIỆN**

(51) **06-01**

(22) 29/03/2021

(43) 26/07/2021

**1. CÔNG TY TNHH MOTOMOTION VIỆT NAM (VN)**

Xưởng C-1B-D1 đến C-1B-D4A và C-1B-B5 đến C-1B-B8, Lô C-1B-CN, đường DE4, KCN Mỹ Phước 3, phường Thới Hòa, thị xã Bến Cát, tỉnh Bình Dương

(73)

**2. HHC CHANGZHOU CORP. (CN)**

No. 61 Xinggang Road, Zhonglou Economic Development Zone, Changzhou, Jiangsu, P.R. China

(72)

1. CHIH-HSIUNG LIU (ZA)

2. MEI JUN XU (CN)

(74)

Công ty TNHH Tư vấn đầu tư và Sở hữu trí tuệ Hoàng Phi (HOANG PHI INVEST & I.P CO., LTD)

(55)



1.1



1.2



1.3



1.4



1.5



1.6



1.7



1.8



1.9



1.10



**CÔNG BÁO SỞ HỮU CÔNG NGHIỆP SỐ 400 TẬP A – QUYỀN 2 (07.2021)**

(11) **42068**

(21) 3-2021-00726

(54) **BA LÔ**

(22) 30/03/2021

(73) **CÔNG TY CỔ PHẦN XUẤT NHẬP KHẨU BÌNH TÂY (VN)**

Đường tỉnh 835, ấp 3A, xã Phước Lợi, huyện Bến Lức, tỉnh Long An

(72) Trần Thị Ngọc Trinh (VN)

(55)

(28) 1

(51) **03-01**

(43) 26/07/2021



1.1



1.2



1.3



1.4



1.5



1.6



1.7

**CÔNG BÁO SỞ HỮU CÔNG NGHIỆP SỐ 400 TẬP A – QUYỀN 2 (07.2021)**

(11) **42069**

(21) 3-2021-00727

(54) **BA LÔ**

(22) 30/03/2021

(73) **CÔNG TY CỔ PHẦN XUẤT NHẬP KHẨU BÌNH TÂY (VN)**

Đường tỉnh 835, ấp 3A, xã Phước Lợi, huyện Bến Lức, tỉnh Long An

(72) Trần Thị Ngọc Trinh (VN)

(55)

(28) 1

(51) **03-01**

(43) 26/07/2021



1.1



1.2



1.3



1.4



1.5



1.6



1.7

**CÔNG BÁO SỞ HỮU CÔNG NGHIỆP SỐ 400 TẬP A – QUYỀN 2 (07.2021)**

(11) 42070

(21) 3-2021-00728

(54) BA LÔ

(22) 30/03/2021

(73) **CÔNG TY CỔ PHẦN XUẤT NHẬP KHẨU BÌNH TÂY (VN)**

Đường tỉnh 835, ấp 3A, xã Phước Lợi, huyện Bến Lức, tỉnh Long An

(72) Trần Thị Ngọc Trinh (VN)

(55)

(28) 1

(51) 03-01

(43) 26/07/2021



1.1



1.2



1.3



1.4



1.5



1.6



1.7

**CÔNG BÁO SỞ HỮU CÔNG NGHIỆP SỐ 400 TẬP A – QUYỀN 2 (07.2021)**

(11) **42071**

(21) 3-2021-00729

(54) **BA LÔ**

(22) 30/03/2021

(73) **CÔNG TY CỔ PHẦN XUẤT NHẬP KHẨU BÌNH TÂY (VN)**

Đường tỉnh 835, ấp 3A, xã Phước Lợi, huyện Bến Lức, tỉnh Long An

(72) Trần Thị Ngọc Trinh (VN)

(55)

(28) 1

(51) **03-01**

(43) 26/07/2021



1.1



1.2



1.3



1.4



1.5



1.6



1.7



**CÔNG BÁO SỞ HỮU CÔNG NGHIỆP SỐ 400 TẬP A – QUYỀN 2 (07.2021)**

(11) **42072**

(21) 3-2021-00730

(54) **BA LÔ**

(22) 30/03/2021

(73) **CÔNG TY CỔ PHẦN XUẤT NHẬP KHẨU BÌNH TÂY (VN)**

Đường tỉnh 835, ấp 3A, xã Phước Lợi, huyện Bến Lức, tỉnh Long An

(72) Trần Thị Ngọc Trinh (VN)

(55)

(28) 1

(51) **03-01**

(43) 26/07/2021



1.1



1.2



1.3



1.4



1.5



1.6



1.7

**CÔNG BÁO SỞ HỮU CÔNG NGHIỆP SỐ 400 TẬP A – QUYỀN 2 (07.2021)**

(11) 42073

(21) 3-2021-00735

(54) BA LÔ

(22) 30/03/2021

(73) **CÔNG TY CỔ PHẦN XUẤT NHẬP KHẨU BÌNH TÂY (VN)**

Đường tỉnh 835, ấp 3A, xã Phước Lợi, huyện Bến Lức, tỉnh Long An

(72) Nguyễn Thị Ngọc Hải (VN)

(55)

(28) 1

(51) 03-01

(43) 26/07/2021



1.1



1.2



1.3



1.4



1.5



1.6



1.7

**CÔNG BÁO SỞ HỮU CÔNG NGHIỆP SỐ 400 TẬP A – QUYỀN 2 (07.2021)**

(11) 42074

(21) 3-2021-00736

(54) BA LÔ

(22) 30/03/2021

(73) CÔNG TY CỔ PHẦN XUẤT NHẬP KHẨU BÌNH TÂY (VN)

Đường tỉnh 835, ấp 3A, xã Phước Lợi, huyện Bến Lức, tỉnh Long An

(72) Nguyễn Thị Ngọc Hải (VN)

(55)

(28) 1

(51) 03-01

(43) 26/07/2021



1.1



1.2



1.3



1.4



1.5



1.6



1.7

**CÔNG BÁO SỞ HỮU CÔNG NGHIỆP SỐ 400 TẬP A – QUYỀN 2 (07.2021)**

(11) **42075**

(21) 3-2021-00737

(54) **BA LÔ**

(22) 30/03/2021

(73) **CÔNG TY CỔ PHẦN XUẤT NHẬP KHẨU BÌNH TÂY (VN)**

Đường tỉnh 835, ấp 3A, xã Phước Lợi, huyện Bến Lức, tỉnh Long An

(72) Nguyễn Thị Ngọc Hải (VN)

(55)

(28) 1

(51) **03-01**

(43) 26/07/2021



1.1



1.2



1.3



1.4



1.5



1.6



1.7



**CÔNG BÁO SỞ HỮU CÔNG NGHIỆP SỐ 400 TẬP A – QUYỀN 2 (07.2021)**

(11) **42076**

(21) 3-2021-00738

(54) **BA LÔ**

(22) 30/03/2021

(73) **CÔNG TY CỔ PHẦN XUẤT NHẬP KHẨU BÌNH TÂY (VN)**

Đường tỉnh 835, ấp 3A, xã Phước Lợi, huyện Bến Lức, tỉnh Long An

(72) Nguyễn Thị Ngọc Hải (VN)

(55)

(28) 1

(51) **03-01**

(43) 26/07/2021



1.1



1.2



1.3



1.4



1.5



1.6



1.7

- (11) 42077  
(21) 3-2021-00760  
(54) **NHÃN SẢN PHẨM**  
(22) 31/03/2021  
(30) 30-2020-0056032 19/11/2020 KR;  
(73) **BINGGRAE CO., LTD.** (KR)  
45, Dasansunhwan-ro, Namyangju-si, Gyeonggi-do, Republic of Korea  
(72) CHEON YE HEE (KR)  
(74) Công ty TNHH Trường Xuân (AGELESS CO.,LTD.)  
(55)
- (28) 1  
(51) 19-08  
(43) 26/07/2021



1.1



1.2



1.3

**CÔNG BÁO SỞ HỮU CÔNG NGHIỆP SỐ 400 TẬP A – QUYỀN 2 (07.2021)**

- (11) **42078**  
(21) 3-2021-00765 (28) 1  
(54) **CHẬU RỬA MẶT** (51) **23-02**  
(22) 20/11/2018 (43) 26/07/2021  
(30) 2018-011307 23/05/2018 JP;  
(73) **LIXIL CORPORATION (Business Entity ID Number: 0106-01-004914) (JP)**  
2-1-1 Ojima, Koto-ku, Tokyo 136-8535, Japan  
(72) 1. KANOKO MISAWA (JP)  
2. HIROSHI KOBAYASHI (JP)  
(74) Công ty TNHH Tâm nhìn và Liên danh (VISION & ASSOCIATES CO.LTD.)  
(55)



1.1



1.2

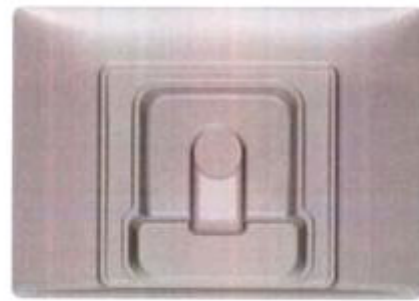

1.3



1.4



1.5



1.6



1.7

**CÔNG BÁO SỞ HỮU CÔNG NGHIỆP SỐ 400 TẬP A – QUYỀN 2 (07.2021)**

- (11) **42079**  
(21) 3-2021-00766 (28) 1  
(54) **CHẬU RỬA MẶT** (51) **23-02**  
(22) 20/11/2018 (43) 26/07/2021  
(30) 2018-011308 23/05/2018 JP;  
(73) **LIXIL CORPORATION (Business Entity ID Number: 0106-01 -004914) (JP)**  
2-1-1 Ojima, Koto-ku, Tokyo 136-8535, Japan  
(72) Hiroshi KOBAYASHI (JP)  
(74) Công ty TNHH Tầm nhìn và Liên danh (VISION & ASSOCIATES CO.LTD.)  
(55)



1.1



1.2



1.3



1.4



1.5



1.6



1.7

- (11) **42080**  
(21) 3-2021-00791 (28) 1  
(54) **MẮC TREO** (51) **06-08**  
(22) 02/04/2021 (43) 26/07/2021  
(30) 008403091-0001 15/01/2021 EM;  
(73) **TAM PLASTIK VE KALIP SAN. TIC. LTD. STI (TR)**  
Kavakil Mah. Deniz Aktas Cad. No: 32, Beylikduzu, Istanbul 34520, Turkey  
(72) Gokhan Tezsezer (TR)  
(74) Công ty TNHH Trường Xuân (AGELESS CO.,LTD.)  
(55)



1.1



1.2

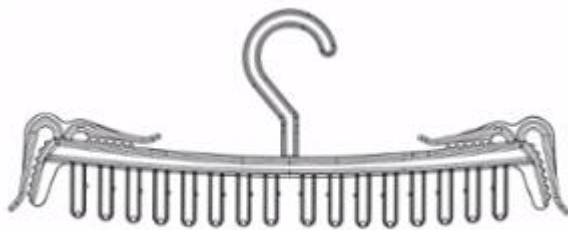

1.3



1.4



1.5



1.6



1.7

**CÔNG BÁO SỞ HỮU CÔNG NGHIỆP SỐ 400 TẬP A – QUYỀN 2 (07.2021)**

- (11) **42081**  
(21) 3-2021-00794 (28) 1  
(54) **CHAI** (51) **09-01**  
(22) 02/04/2021 (43) 26/07/2021  
(30) 008193940-0001 02/10/2020 EM;  
(73) **UNILEVER GLOBAL IP LIMITED (UK)**  
Port Sunlight Wirral, Merseyside CH62 4ZD, United Kingdom  
1. CHONG HEESOP (US)  
2. ESCOBAR JIMENEZ MARIANA (MX)  
(72) 3. MAK MICHELLE C (US)  
4. MALHOTRA AKRITI (IN)  
5. HAINAUT LAURENT JEAN-MARIE (US)  
6. LEONE MARCO (IT)  
(74) Công ty TNHH Trần Hữu Nam và Đồng sự (TRAN H.N & ASS.)  
(55)

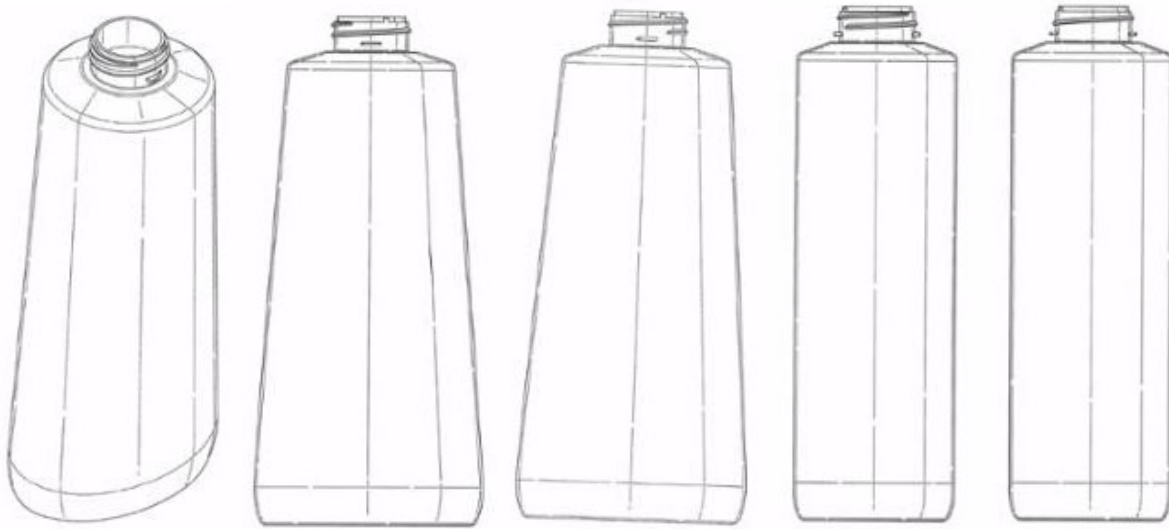

1.1

1.2

1.3

1.4

1.5



1.6



1.7

- (11) **42082**  
(21) 3-2021-00795 (28) 2  
(54) **CHAI** (51) **09-01**  
(22) 02/04/2021 (43) 26/07/2021  
(30) 008193114-0002 02/10/2020 EM; 008193114-0001 02/10/2020 EM;  
(73) **UNILEVER GLOBAL IP LIMITED (UK)**  
Port Sunlight Wirral, Merseyside CH62 4ZD, United Kingdom  
1. CHONG HEESOP (US)  
2. ESCOBAR JIMENEZ MARIANA (MX)  
(72) 3. MALHOTRA AKRITI (IN)  
4. MAK MICHELLE C (US)  
5. HAINAUT LAURENT JEAN-MARIE (US)  
6. LEONE MARCO (IT)  
(74) Công ty TNHH Trần Hữu Nam và Đồng sự (TRAN H.N & ASS.)  
(55)

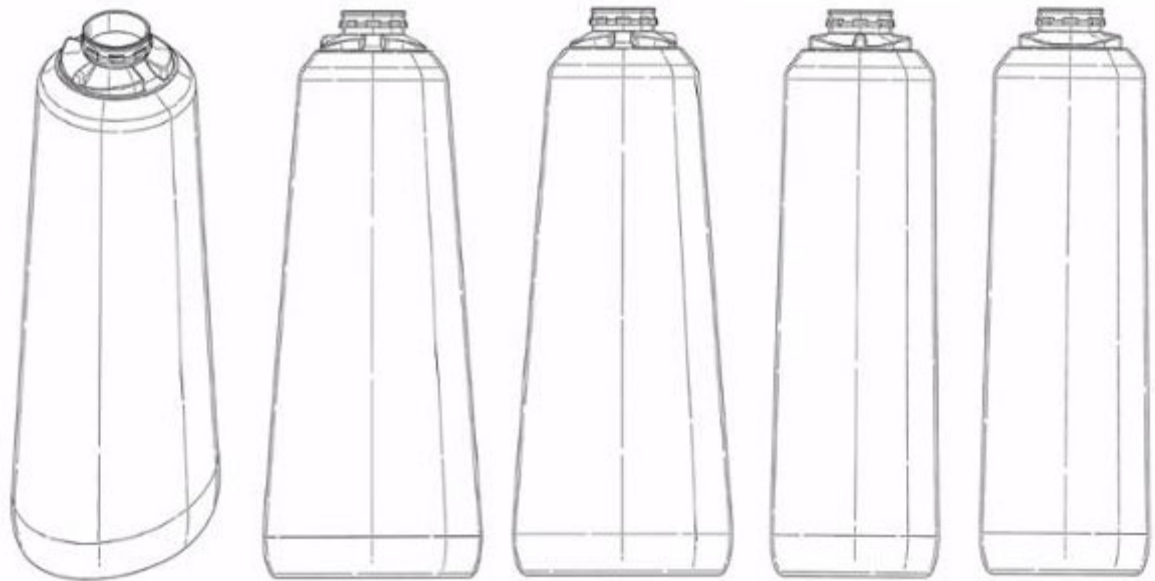

1.1

1.2

1.3

1.4

1.5

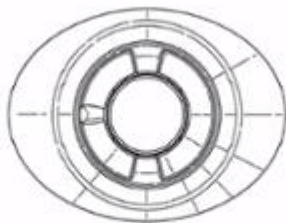

1.6



1.7





2.1



2.2

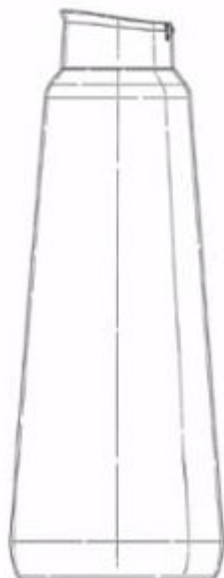

2.3



2.4



2.5

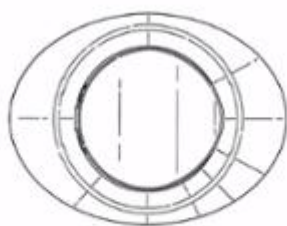

2.6

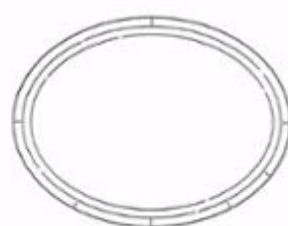

2.7

**CÔNG BÁO SỞ HỮU CÔNG NGHIỆP SỐ 400 TẬP A – QUYỀN 2 (07.2021)**

- (11) **42083**  
(21) 3-2021-00802 (28) 1  
(54) **CỬA** (51) **08-03**  
(22) 05/04/2021 (43) 26/07/2021  
(30) 2020-021441 06/10/2020 JP;  
**TAKAGI CO., LTD. (JP)**  
(73) 2341-1, Tsukanome, Sanjo-shi, Niigata, 955-8655 Japan  
(72) Shinya NOZAKI (JP)  
(74) Công ty Cổ phần Sở hữu công nghiệp INVESTIP (INVESTIP)  
(55)

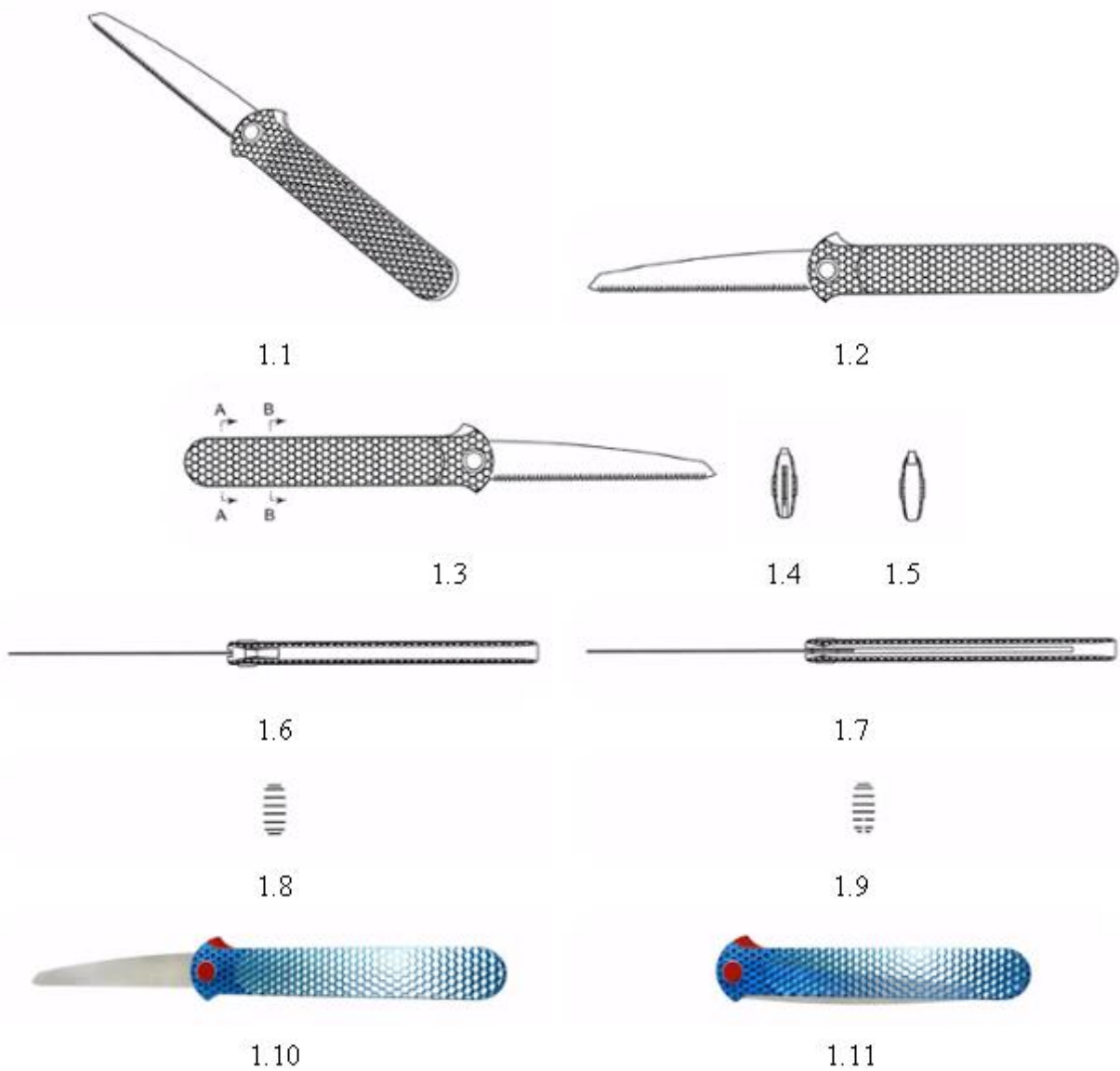

- (11) **42084**  
(21) 3-2021-00803 (28) 1  
(54) **MÁY CẠO RÂU** (51) **28-03**  
(22) 05/04/2021 (43) 26/07/2021  
(30) 202030597103.7 09/10/2020 CN;  
**XIAOFU JIANG (CN)**  
(73) 1B402, Room402, Block 1B, SongHeRuiYuan, Road 4 Xitou industry, Songgang Town, Bao'An District, Shenzhen, Guangdong, China  
(72) Xiaofu Jiang (CN)  
(74) Công ty TNHH Đại Tín và Liên Danh (DAITIN AND ASSOCIATES CO.,LTD)  
(55)

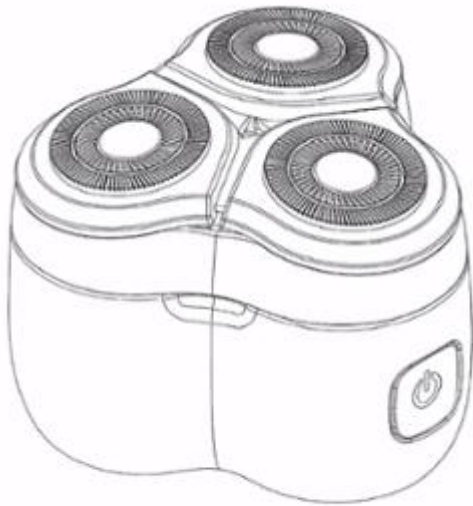

1.1

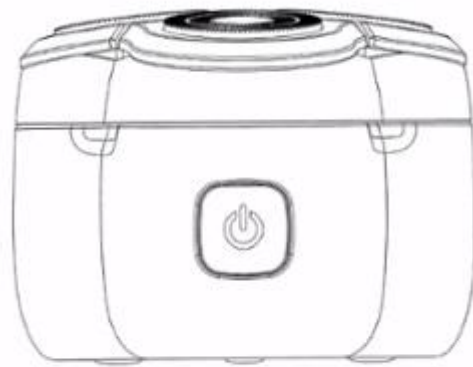

1.2

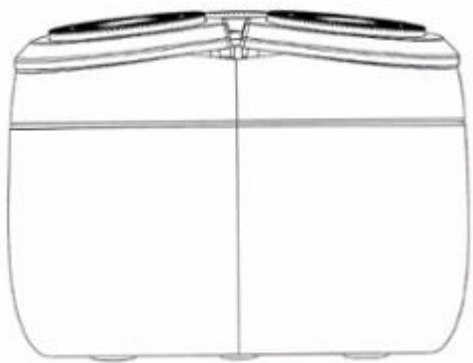

1.3

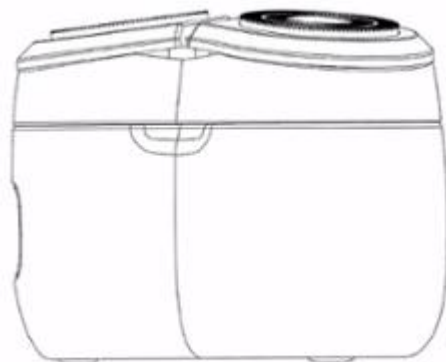

1.4

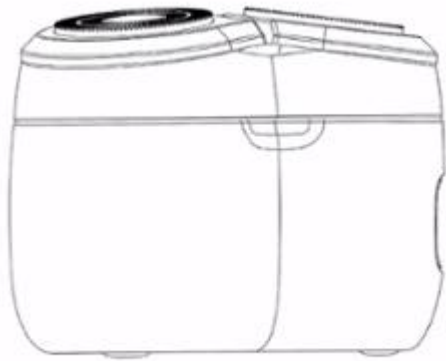

1.5

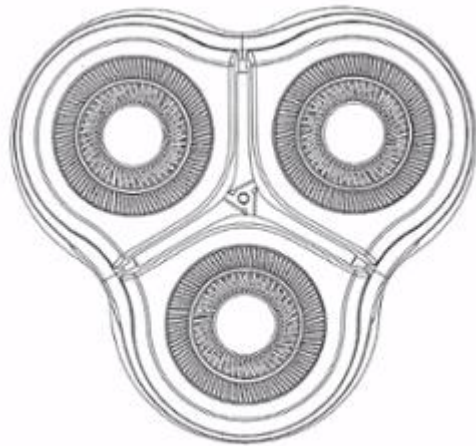

1.6

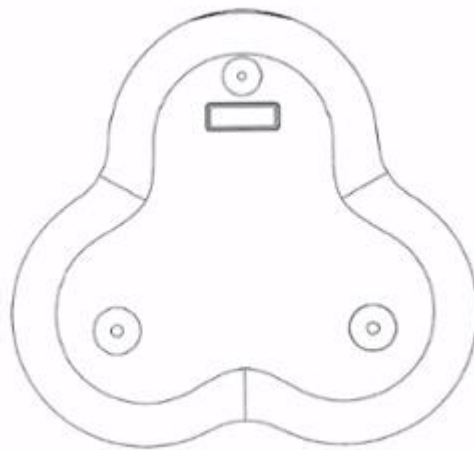

1.7

**CÔNG BÁO SỞ HỮU CÔNG NGHIỆP SỐ 400 TẬP A – QUYỀN 2 (07.2021)**

- (11) **42085**  
(21) 3-2021-00804 (28) 1  
(54) **LÒ NUNG RÁC** (51) **23-99**  
(22) 05/04/2021 (43) 26/07/2021  
(73) **ĐOÀN QUYẾT TIẾN (VN)**  
Tổ 4, khu phố Bình Tây, phường Hưng Chiến, thị xã Bình Long, tỉnh Bình Phước  
(72) Đoàn Quyết Tiến (VN)  
(74) Công ty TNHH Tư vấn - Dịch thuật - Sở hữu trí tuệ Á Đông (Á Đông IP CONSULTANCY CO.,LTD.)  
(55)

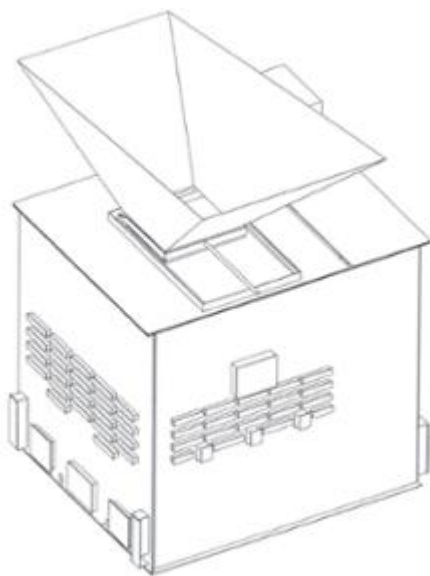

1.1

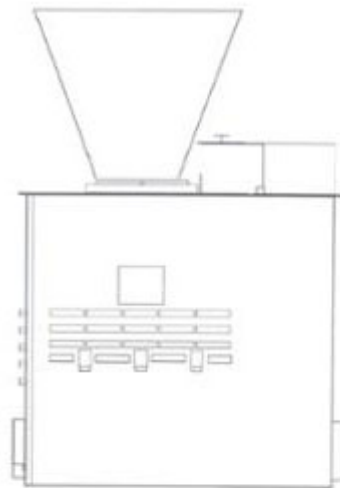

1.2

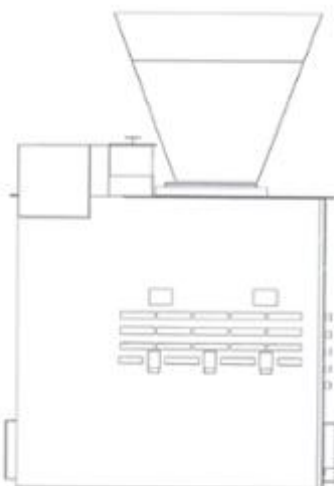

1.3

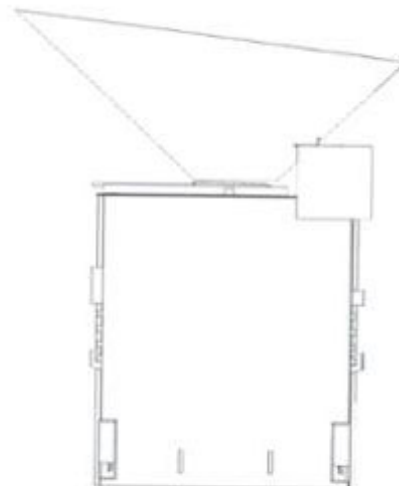

1.4

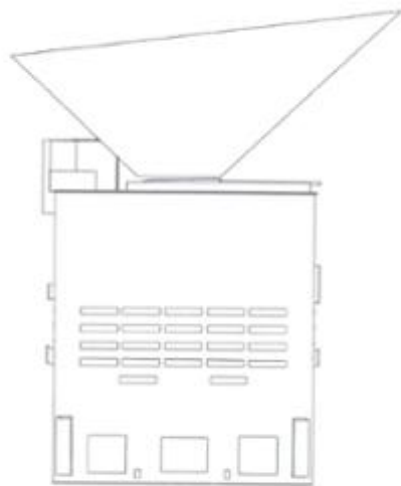

1.5

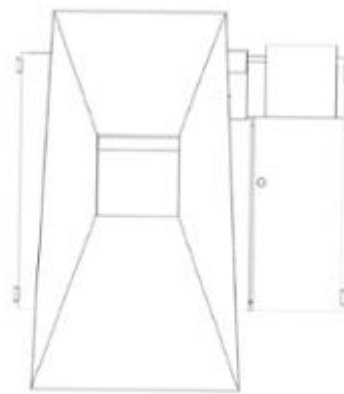

1.6

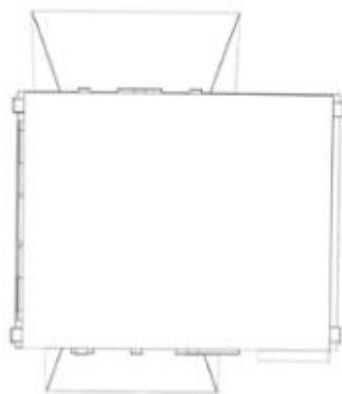

1.7

**CÔNG BÁO SỞ HỮU CÔNG NGHIỆP SỐ 400 TẬP A – QUYỀN 2 (07.2021)**

- (11) **42086**  
(21) 3-2021-00821 (28) 1  
(54) **CỐC ĐỰNG ĐỒ ĂN NHANH** (51) **07-01**  
(22) 06/04/2021 (43) 26/07/2021  
(30) 008280697 24/11/2020 EM;  
(73) **MUSHIE & CO (US)**  
7842 Vickijohn Dr, Houston, TX 77071, United States of America  
(72) Henrik Hjulmand Jensen (DK)  
(74) Công ty TNHH Trà và cộng sự (TRA & ASSOCIATES CO.,LTD)  
(55)



1.1

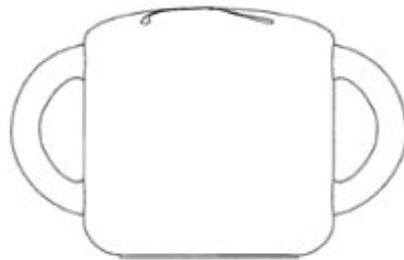

1.2

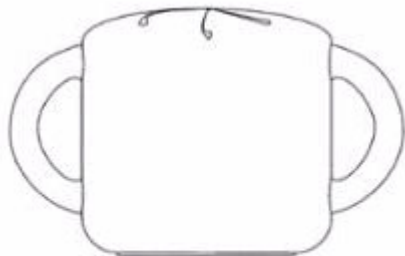

1.3



1.4



1.5

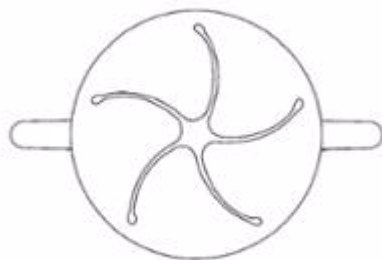

1.6

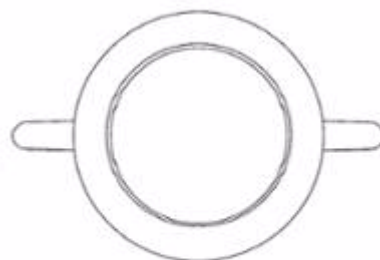

1.7

- (11) **42087**  
(21) 3-2021-00822 (28) 1  
(54) **NÚM VÚ GIẢ** (51) **24-04**  
(22) 06/04/2021 (43) 26/07/2021  
(30) 008282834 24/11/2020 EM;  
(73) **FB GROUP APS (DK)**  
Omega 9, Soefsten, Hinnerup, Denmark  
(72) Henrik Hjulmand Jensen (DK)  
(74) Công ty TNHH Trà và cộng sự (TRA & ASSOCIATES CO.,LTD)  
(55)

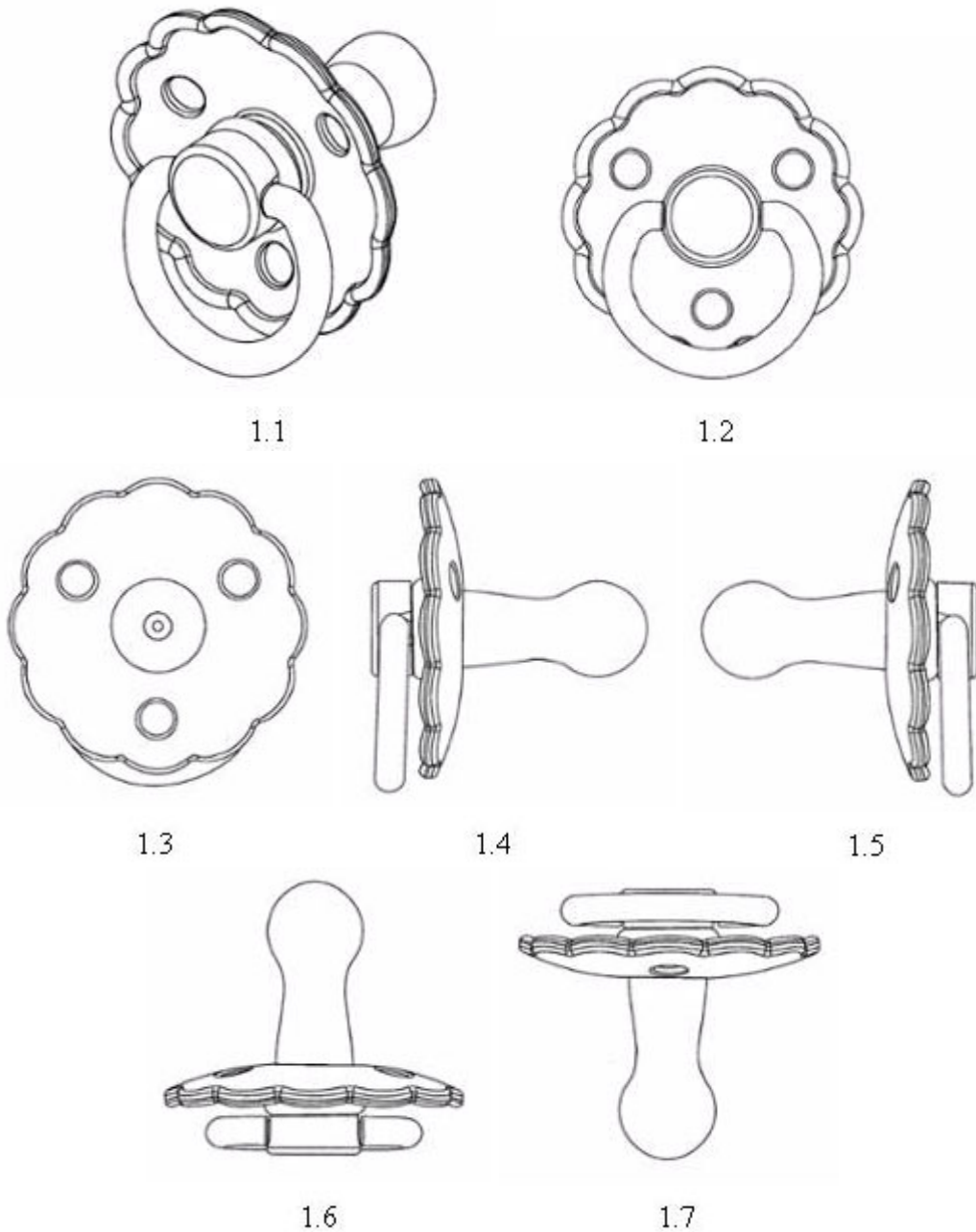



**CÔNG BÁO SỞ HỮU CÔNG NGHIỆP SỐ 400 TẬP A – QUYỀN 2 (07.2021)**

- (11) **42088**  
(21) 3-2021-00823 (28) 1  
(54) **LỌ ĐỰNG MỸ PHẨM** (51) **09-01**  
(22) 06/04/2021 (43) 26/07/2021  
(30) 30-2021-0003091 20/01/2021 KR;  
(73) **BARAM INTERNATIONAL CO.,LTD.** (KR)  
12F, 317, Dosan-daero, Gangnam-gu, Seoul, Republic of Korea  
(72) Min, Seul Ki (NZ)  
(74) Công ty TNHH Sáng chế ACTIP (ACTIP PATENT LIMITED)  
(55)

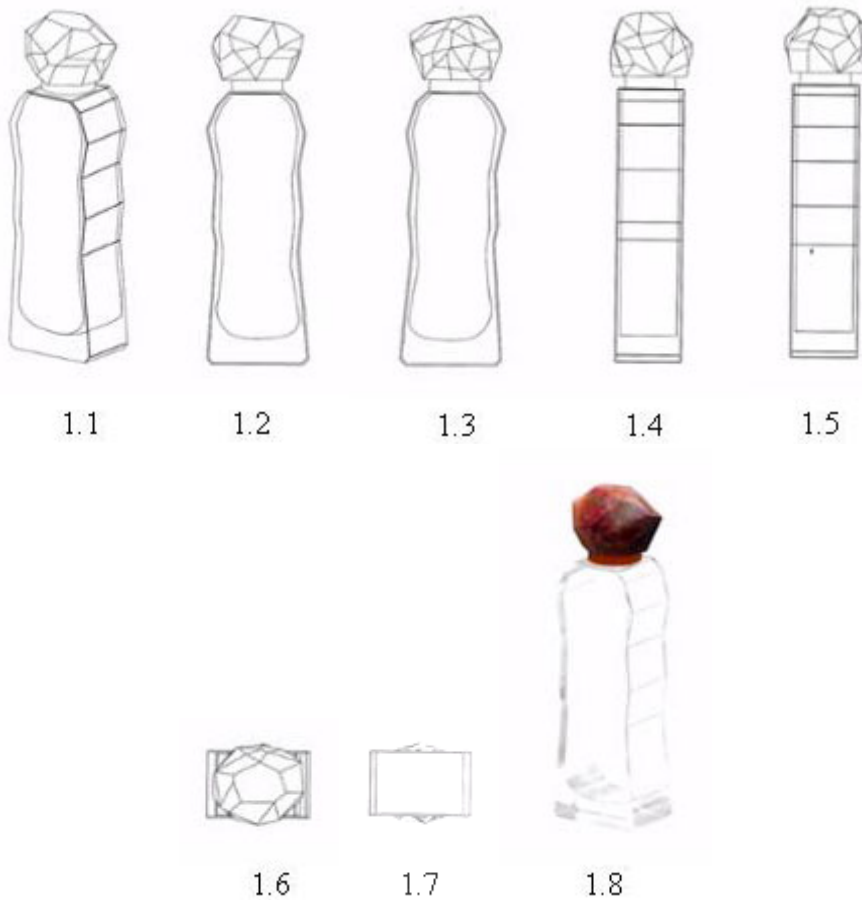

- (11) **42089**  
(21) 3-2021-00824 (28) 1  
(54) **LỌ ĐỰNG MỸ PHẨM** (51) **09-01; 28-02**  
(22) 06/04/2021 (43) 26/07/2021  
(30) 30-2021-0003083 20/01/2021 KR;  
**BARAM INTERNATIONAL CO.,LTD. (KR)**  
(73) 12F, 317, Dosan-daero, Gangnam-gu, Seoul, Republic of Korea  
(72) Min, Seul Ki (NZ)  
(74) Công ty TNHH Sáng chế ACTIP (ACTIP PATENT LIMITED)  
(55)

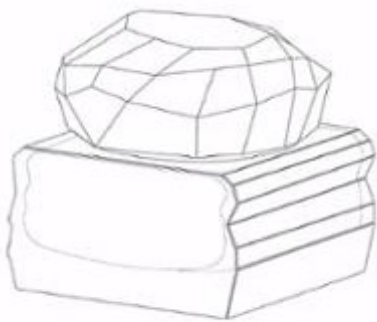

1.1



1.2

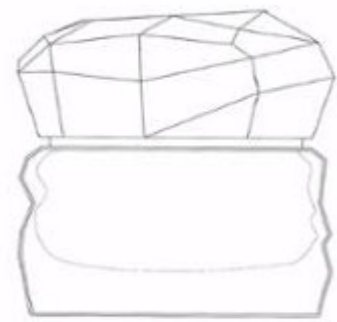

1.3



1.4

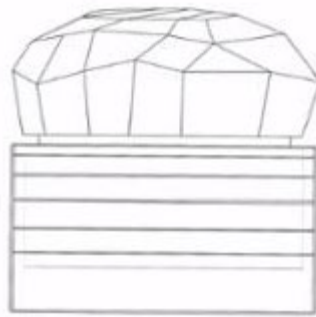

1.5

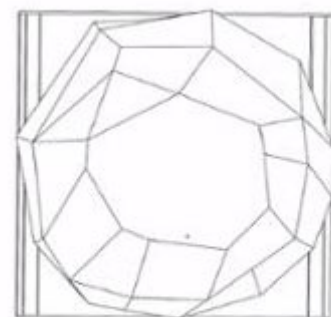

1.6



1.7



1.8

(11) **42090**

(21) 3-2021-00825

(28) 1

(54) **TƯỢNG**

(51) **11-02**

(22) 06/04/2021

(43) 26/07/2021

(73) **CÔNG TY TNHH QUỐC TẾ SALA (VN)**

25 đường số 6, khu Z756, phường 12, quận 10, thành phố Hồ Chí Minh

(72) Trương Huệ Khương (VN)

(74) Công ty cổ phần FAS INVEST (FAS INVEST JSC)

(55)



1.1



1.2



1.3



1.4



1.5



1.6



1.7

**CÔNG BÁO SỞ HỮU CÔNG NGHIỆP SỐ 400 TẬP A – QUYỀN 2 (07.2021)**

(11) **42091**

(21) 3-2021-00830

(28) 1

(54) **MÁY LỌC NƯỚC**

(51) **23-01**

(22) 07/04/2021

(43) 26/07/2021

**CÔNG TY CỔ PHẦN KAROFI HOLDING (VN)**

(73) Số 12, lô TT1A, khu đô thị mới Tây Nam Hồ Linh Đàm, phường Hoàng Liệt, quận Hoàng Mai, thành phố Hà Nội

(72) Ngô Thị Thanh Hải (VN)

(55)



1.1



1.2



1.3



1.4



1.5



1.6

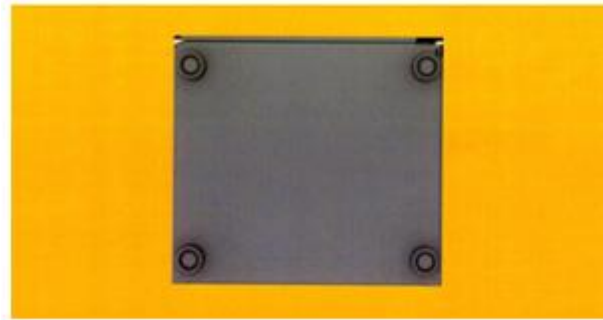

1.7

- (11) **42092**  
(21) 3-2021-00841 (28) 1  
(54) **KHUNG CHO THIẾT BỊ CHIẾU SÁNG** (51) **26-99**  
(22) 08/04/2021 (43) 26/07/2021  
(30) 30-2021-0015640 31/03/2021 KR;  
**C&C SOLUTION CO., LTD (KR)**  
(73) 62-6, Noksansaneopjung-ro, Gangseo-gu, Busan, 46751, Republic of Korea  
1. SOOJUNG HONG (KR)  
(72) 2. SUNG MIN HONG (KR)  
3. SE MYUNG OH (KR)  
(74) Công ty Luật TNHH WINCO (WINCO LAW FIRM)  
(55)



1.1



1.2



1.3



1.4



1.5



1.6



1.7



1.8



1.9

- (11) **42093**  
(21) 3-2021-00844 (28) 1  
(54) **TẤM ỐP PHÍA SAU XE MÁY** (51) **12-16**  
(22) 08/04/2021 (43) 26/07/2021  
(30) 2020-022531 20/10/2020 JP;  
(73) **HONDA MOTOR CO., LTD. (JP)**  
1-1, Minami-Aoyama 2-chome, Minato-ku, Tokyo, 107-8556 Japan  
(72) 1. TAKESHI FUTAMATA (JP)  
2. TAKURO KITADE (JP)  
(74) Công ty Luật TNHH Phạm và Liên danh (PHAM & ASSOCIATES)  
(55)



1.1



1.2



1.3



1.4



1.5



1.6





1.7



1.8



1.9



1.10



1.11

(11) **42094**

(21) 3-2021-00848

(54) **THÙNG XE MÔ TÔ**

(22) 08/04/2021

(73) **GIVI SPA (IT)**

(73) Via G. Ungaretti, 48, 25020 Flero (BS), Italy

(72) Visenzi Giuseppe (IT)

(74) Công ty Cổ phần Sở hữu công nghiệp INVESTIP (INVESTIP)

(55)

(28) 1

(51) **12-16**

(43) 26/07/2021



1.1



1.2



1.3



1.4



1.5



1.6



1.7



1.8

**CÔNG BÁO SỞ HỮU CÔNG NGHIỆP SỐ 400 TẬP A – QUYỀN 2 (07.2021)**

- (11) **42095**  
(21) 3-2021-00850 (28) 1  
(54) **BÃY CÔN TRÙNG CÓ ĐỘC** (51) **22-06**  
(22) 08/04/2021 (43) 26/07/2021  
(30) 2020-023231 28/10/2020 JP;  
(73) **FUMAKILLA LIMITED (JP)**  
11, Kandamikura-cho, Chiyoda-ku, Tokyo 101-8606, Japan  
(72) 1. SHINYA KAWAMURA (JP)  
2. KEN WAKATSUKI (JP)  
(74) Công ty TNHH Tầm nhìn và Liên danh (VISION & ASSOCIATES CO.LTD.)  
(55)



1.1



1.2



1.3



1.4



1.5

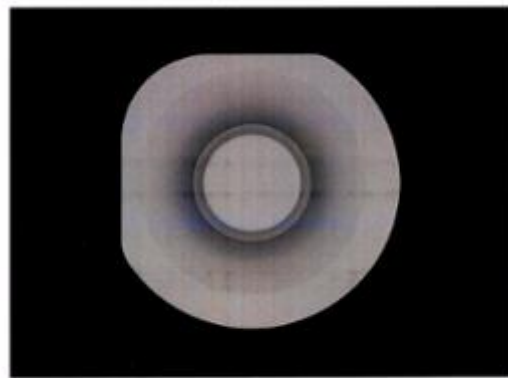

1.6



1.7



1.8



1.9



1.10

**CÔNG BÁO SỞ HỮU CÔNG NGHIỆP SỐ 400 TẬP A – QUYỀN 2 (07.2021)**

- (11) **42096**  
(21) 3-2021-00851 (28) 1  
(54) **BÃY CÔN TRỪNG CÓ ĐỘC** (51) **22-06**  
(22) 08/04/2021 (43) 26/07/2021  
(30) 2020-023230 28/10/2020 JP;  
(73) **FUMAKILLA LIMITED (JP)**  
11, Kandamikura-cho, Chiyoda-ku, Tokyo 101-8606, Japan  
(72) 1. TAKASHI SUGIYAMA (JP)  
2. KEN WAKATSUKI (JP)  
(74) Công ty TNHH Tầm nhìn và Liên danh (VISION & ASSOCIATES CO.LTD.)  
(55)



1.1

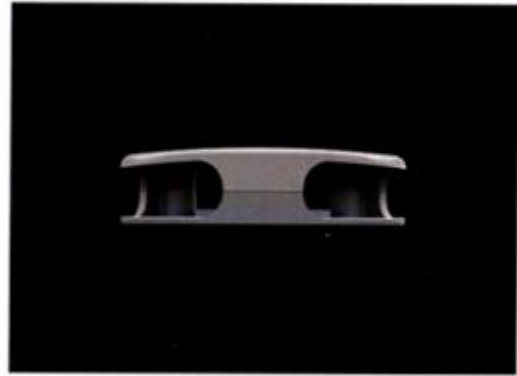

1.2

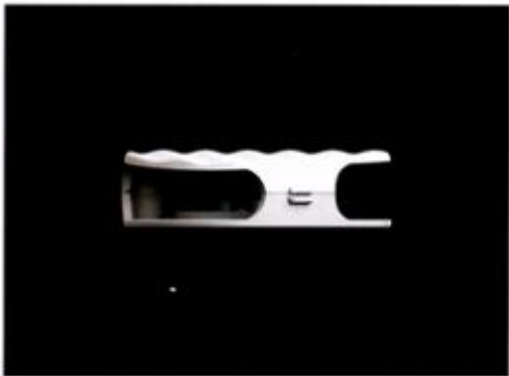

1.3



1.4

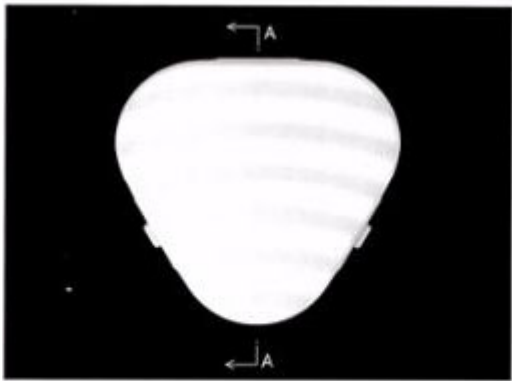

1.5

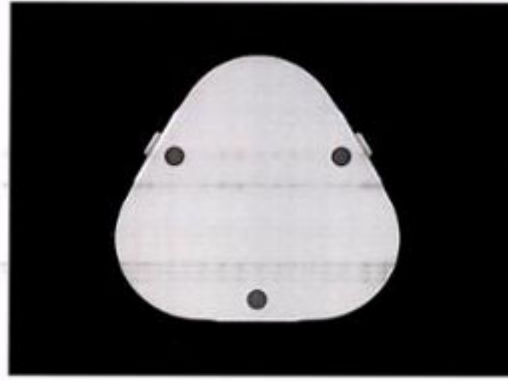

1.6

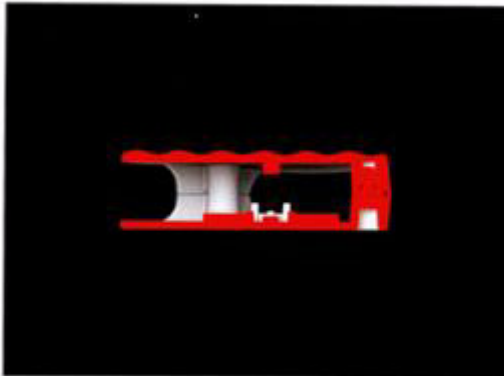

1.7



1.8



1.9



1.10



1.11

**CÔNG BÁO SỞ HỮU CÔNG NGHIỆP SỐ 400 TẬP A – QUYỀN 2 (07.2021)**

(11) **42097**

(21) 3-2021-00858

(28) 1

(54) **NAN CỬA**

(51) **25-02**

(22) 09/04/2021

(43) 26/07/2021

(73) **CÔNG TY CỔ PHẦN IWAKY VIỆT NAM (VN)**

Xóm 2, thôn Hòa Phú, xã Hòa Thạch, huyện Quốc Oai, thành phố Hà Nội

(72) Phạm Văn Hưng (VN)

(74) Công ty TNHH MASTERBRAND (MASTERBRAND)

(55)

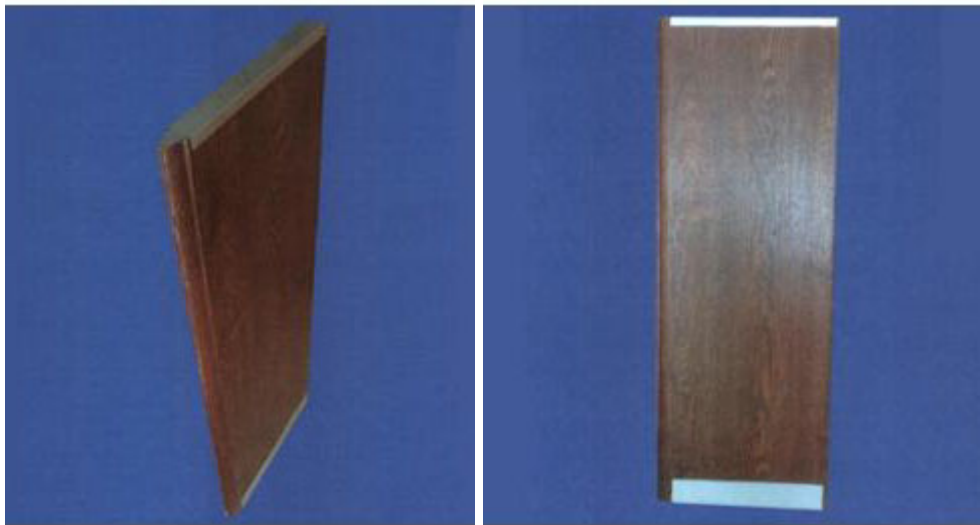

1.1

1.2



1.3

1.4

1.5



1.6

1.7

(11) **42098**

(21) 3-2021-00859

(28) 1

(54) **NAN CỬA**

(51) **25-02**

(22) 09/04/2021

(43) 26/07/2021

(73) **CÔNG TY CỔ PHẦN IWAKY VIỆT NAM (VN)**

Xóm 2, thôn Hòa Phú, xã Hòa Thạch, huyện Quốc Oai, thành phố Hà Nội

(72) Phạm Văn Hưng (VN)

(74) Công ty TNHH MASTERBRAND (MASTERBRAND)

(55)



1.1



1.2



1.3

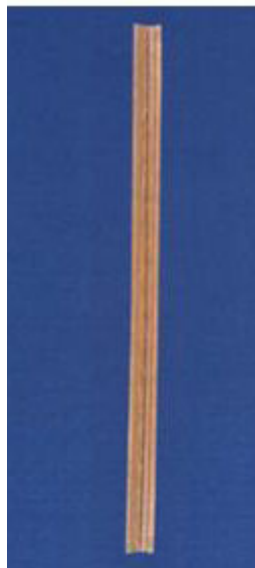

1.4

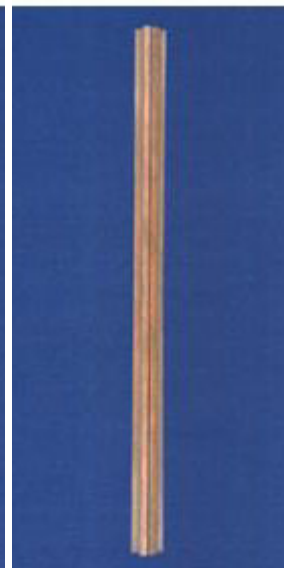

1.5



1.6



1.7



(11) **42099**

(21) 3-2021-00860

(28) 1

(54) **NAN CỬA**

(51) **25-02**

(22) 09/04/2021

(43) 26/07/2021

(73) **CÔNG TY CỔ PHẦN IWAKY VIỆT NAM (VN)**

Xóm 2, thôn Hòa Phú, xã Hòa Thạch, huyện Quốc Oai, thành phố Hà Nội

(72) Phạm Văn Hưng (VN)

(74) Công ty TNHH MASTERBRAND (MASTERBRAND)

(55)

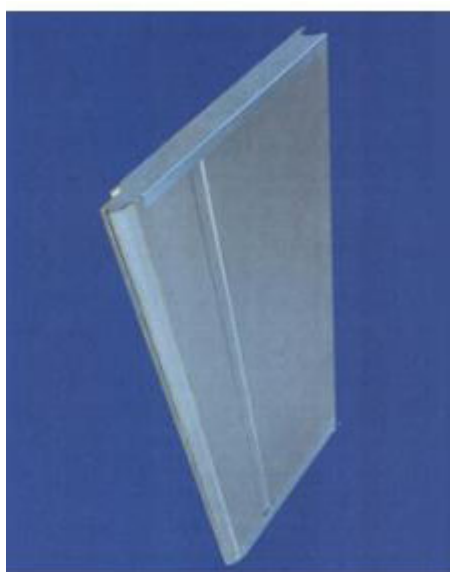

1.1



1.2



1.3



1.4



1.5



1.6



1.7

- |      |   |      |              |
|------|---|------|--------------|
| (11) | <b>42100</b>  |      |              |
| (21) | 3-2021-00861  | (28) | 1            |
| (54) | <b>DỤNG CỤ PHÂN PHỐI DUNG DỊCH KHỬ TRÙNG</b>            | (51) | <b>24-01</b> |
| (22) | 12/04/2021  | (43) | 26/07/2021   |
| (30) | 2020-026103 03/12/2020 JP;                              |      |              |
|      | <b>PLUS CORPORATION (JP)</b>                            |      |              |
| (73) | 1-28, Toranomom 4-chome, Minato-ku, Tokyo, JAPAN        |      |              |
|      | 1. TAKESHI MATSUKAWA (JP)                               |      |              |
| (72) | 2. MARI TAKENAKA (JP)                                   |      |              |
|      | 3. HAYATO HORIE (JP)                                    |      |              |
| (74) | Công ty Luật TNHH Phạm và Liên danh (PHAM & ASSOCIATES) |      |              |
| (55) |   |      |              |



1.1

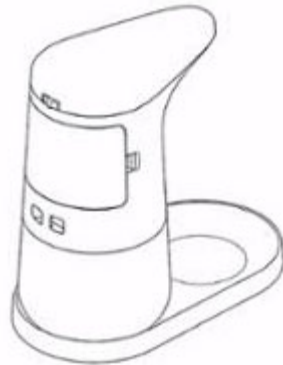

1.2

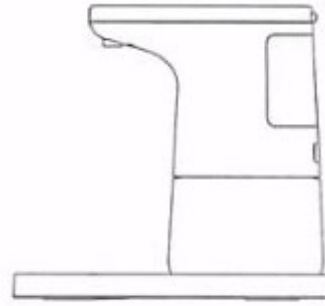

1.3

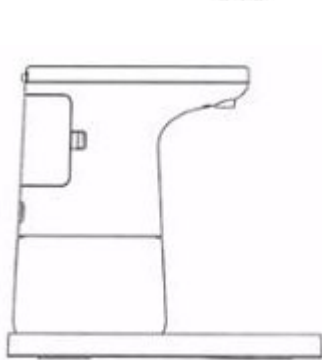

1.4

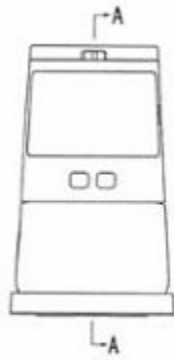

1.5

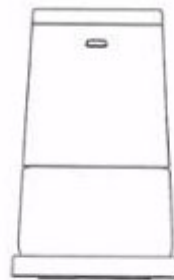

1.6

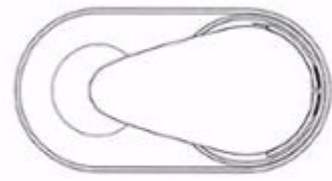

1.7



1.8

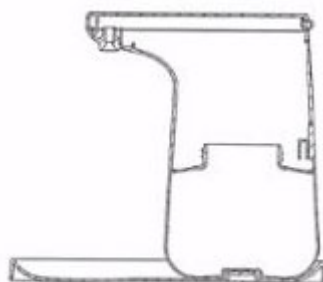

1.9



1.10

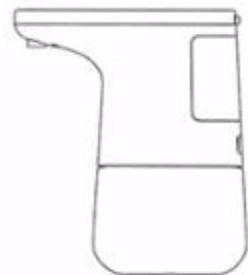

1.11

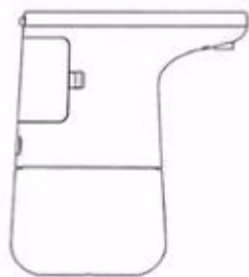

1.12

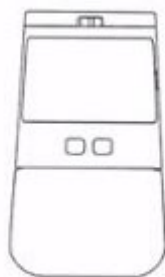

1.13



1.14



1.15

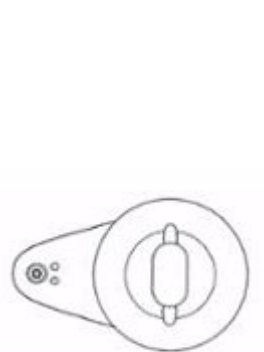

1.16

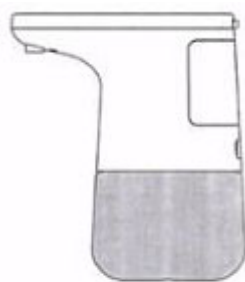

1.17

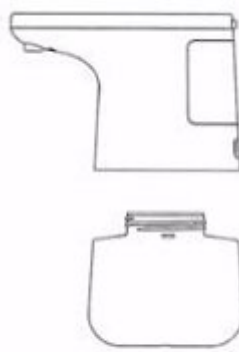

1.18



1.19



1.20

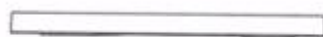

1.21



1.22



1.23



1.24

- (11) **42101**  
 (21) 3-2021-00862 (28) 1  
 (54) **KHUNG DÙNG CHO TẮM CHẨN MẶT VÀ TẮM CHẨN MIỆNG** (51) **29-02**  
 (22) 12/04/2021 (43) 26/07/2021  
 (30) 2020-023144 27/10/2020 JP;  
 (73) **PLUS CORPORATION (JP)**  
 1-28, Toranomom 4-chome, Minato-ku, Tokyo, JAPAN  
 (72) 1. MITSURU WAKABAYASHI (JP)  
 2. YASUAKI OGASAWARA (JP)  
 (74) Công ty Luật TNHH Phạm và Liên danh (PHAM & ASSOCIATES)  
 (55)

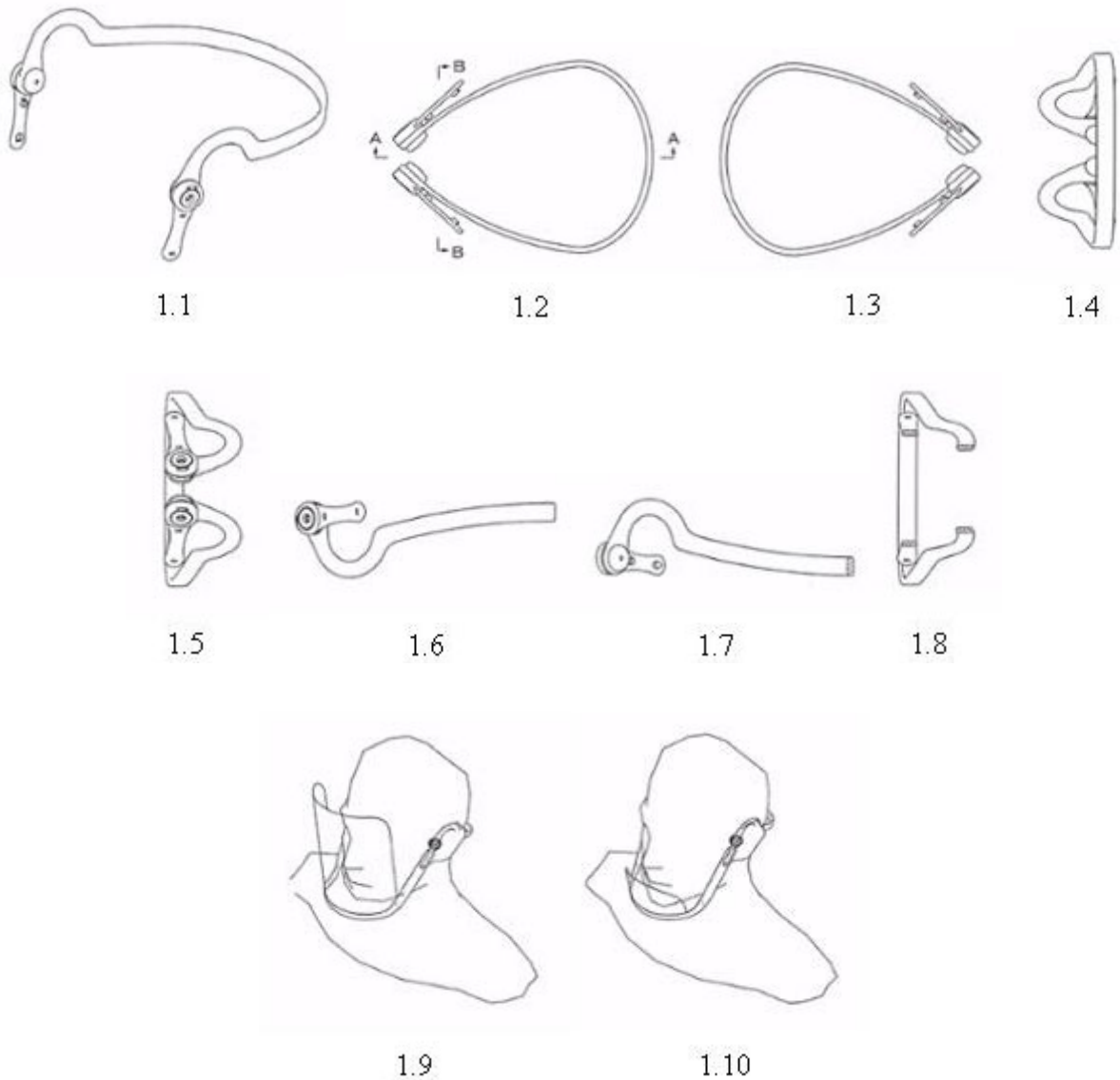

**CÔNG BÁO SỞ HỮU CÔNG NGHIỆP SỐ 400 TẬP A – QUYỀN 2 (07.2021)**

- (11) **42102**  
(21) 3-2021-00863 (28) 1  
(54) **ĐẦU THU TÍN HIỆU KHÔNG DÂY** (51) **14-03**  
(22) 12/04/2021 (43) 26/07/2021  
(73) **CÔNG TY TNHH ĐẦU TƯ THƯƠNG MẠI TÂN CƯỜNG (VN)**  
Số 26 Đại Cồ Việt, phường Lê Đại Hành, quận Hai Bà Trưng, thành phố Hà Nội  
(72) Lê Minh Tân (VN)  
(74) **CÔNG TY TNHH SỞ HỮU TRÍ TUỆ AZURE VIỆT NAM (AZURE IP CO.,LTD)**  
(55)

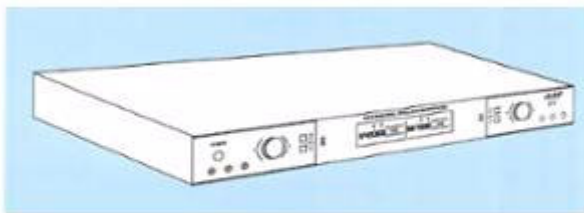

1.1



1.2

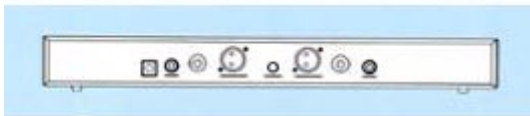

1.3

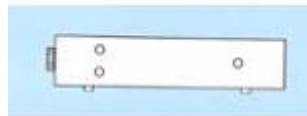

1.4



1.5



1.6



1.7

- (11) **42103**  
(21) 3-2021-00875 (28) 1  
(54) **HỘP ĐỰNG MỸ PHẨM** (51) **09-03; 28-02**  
(22) 13/04/2021 (43) 26/07/2021  
(30) 30-2021-0006957 09/02/2021 KR;  
**BARAM INTERNATIONAL CO.,LTD. (KR)**  
(73) 12F, 317, Dosan-daero, Gangnam-gu, Seoul, Republic of Korea  
(72) Min, Seul Ki (NZ)  
(74) Công ty TNHH Sáng chế ACTIP (ACTIP PATENT LIMITED)  
(55)

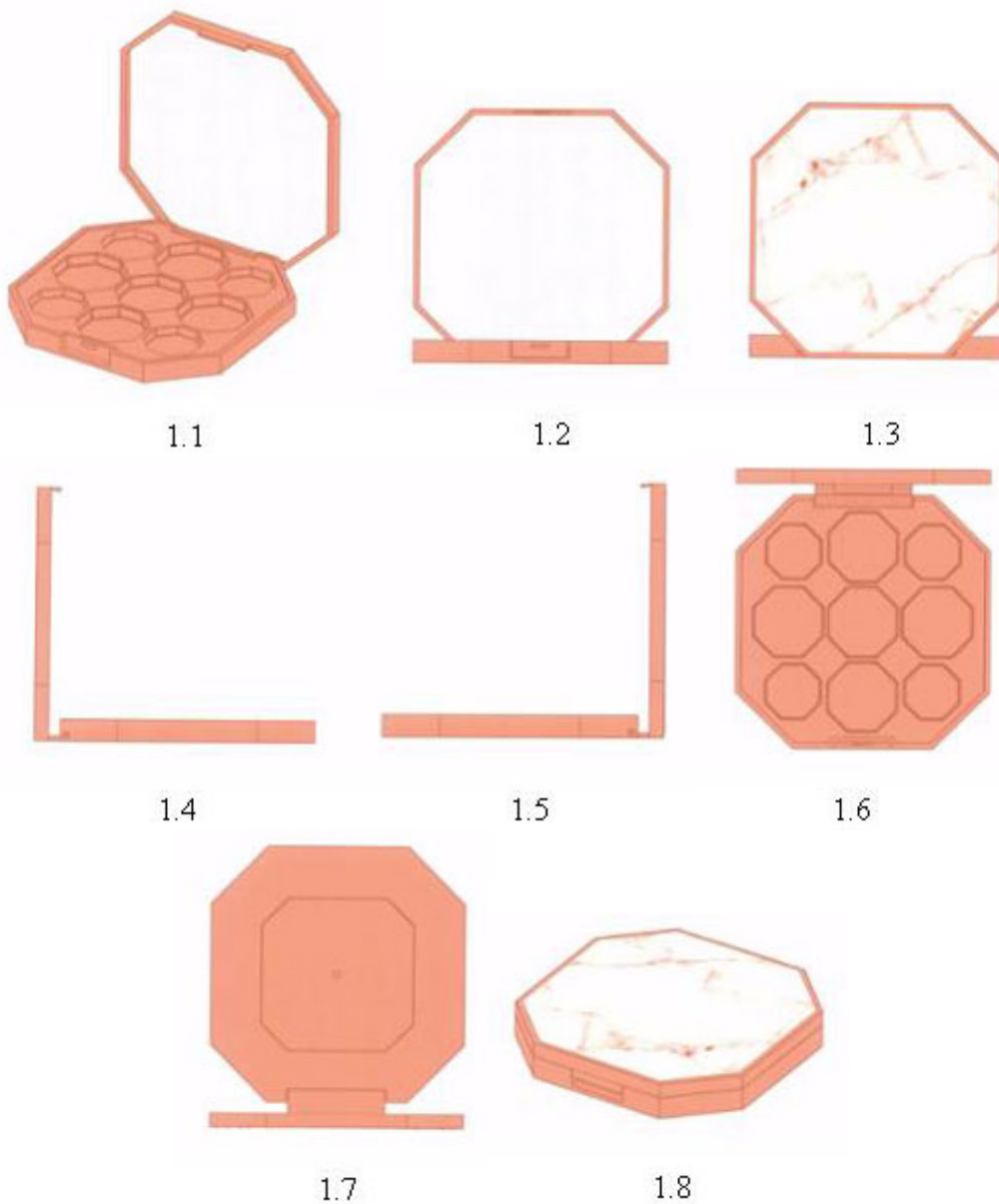

- (11) **42104**  
(21) 3-2021-00897 (28) 1  
(54) **BỘ SẠC ĐIỆN** (51) **13-02**  
(22) 15/04/2021 (43) 26/07/2021  
(30) 29/757,218 04/11/2020 US;  
(73) **TECHTRONIC CORDLESS GP (US)**  
100 Innovation Way, Anderson, SC 29621, United States of America  
(72) 1. RYAN BLOOMER (US)  
2. WILLIAM JACOB KOZLOWSKI JR. (US)  
(74) Công ty TNHH Tầm nhìn và Liên danh (VISION & ASSOCIATES CO.LTD.)  
(55)

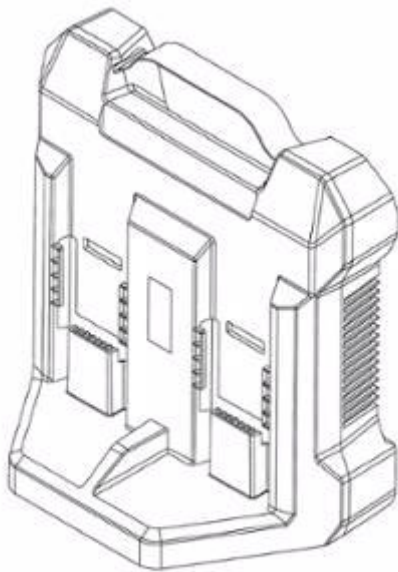

1.1

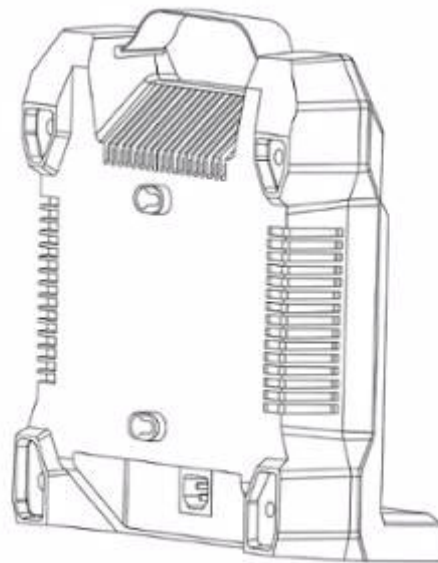

1.2

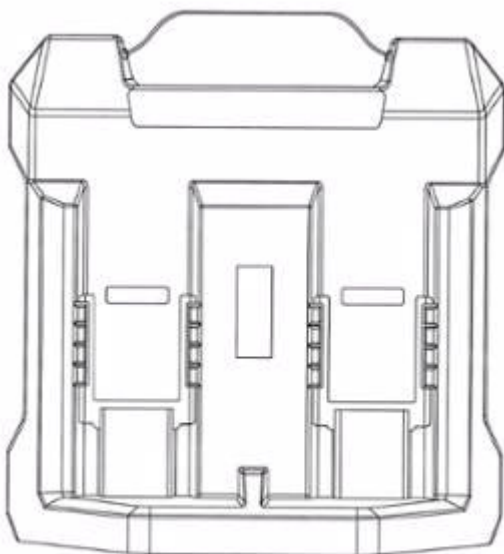

1.3

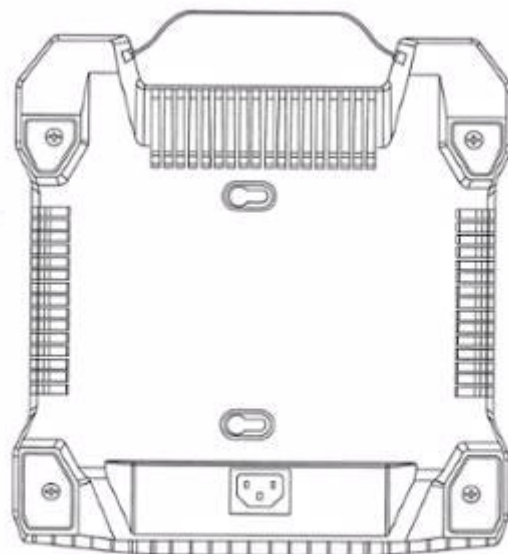

1.4

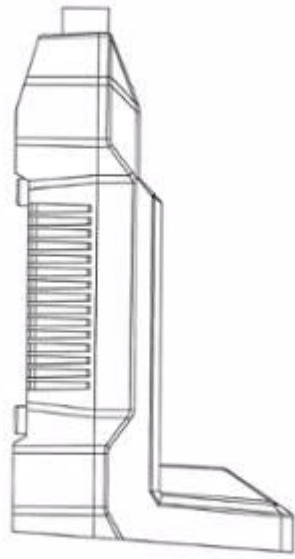

1.5

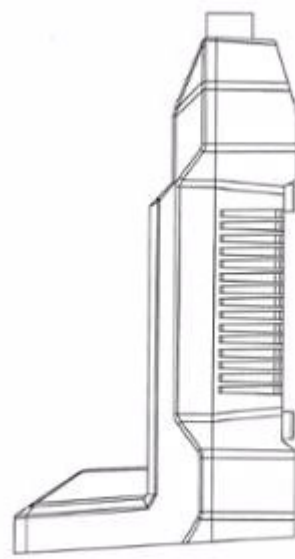

1.6

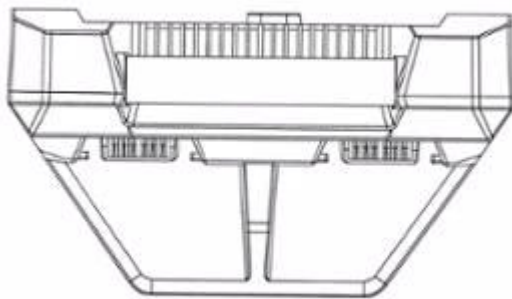

1.7

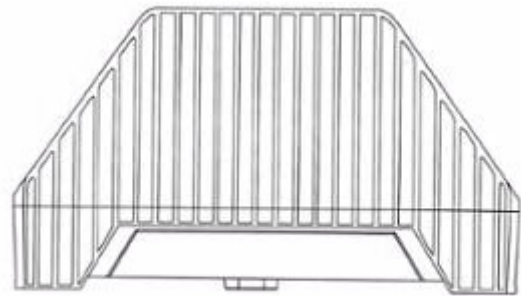

1.8



**CÔNG BÁO SỞ HỮU CÔNG NGHIỆP SỐ 400 TẬP A – QUYỀN 2 (07.2021)**

- (11) **42105**  
(21) 3-2021-00898 (28) 1  
(54) **THƯỚC KẼ CHÂN MÀY** (51) **28-03**  
(22) 15/04/2021 (43) 26/07/2021  
(73) **BÙI QUỐC THẢO (VN)**  
Áp Bình Thành, xã Tân Mỹ Chánh, thành phố Mỹ Tho, tỉnh Tiền Giang  
(72) Bùi Quốc Thảo (VN)  
(74) Văn phòng Luật sư D và T (D & T LAW OFFICE)  
(55)



1.1



1.2



1.3



1.4

1.5



1.6



1.7

**CÔNG BÁO SỞ HỮU CÔNG NGHIỆP SỐ 400 TẬP A – QUYỀN 2 (07.2021)**

- (11) **42106**  
(21) 3-2021-00899 (28) 1  
(54) **THƯỚC KẼ CHÂN MÀY** (51) **28-03**  
(22) 15/04/2021 (43) 26/07/2021  
(73) **BÙI QUỐC THẢO (VN)**  
    Áp Bình Thành, xã Tân Mỹ Chánh, thành phố Mỹ Tho, tỉnh Tiền Giang  
(72) Bùi Quốc Thảo (VN)  
(74) Văn phòng Luật sư D và T (D & T LAW OFFICE)  
(55)

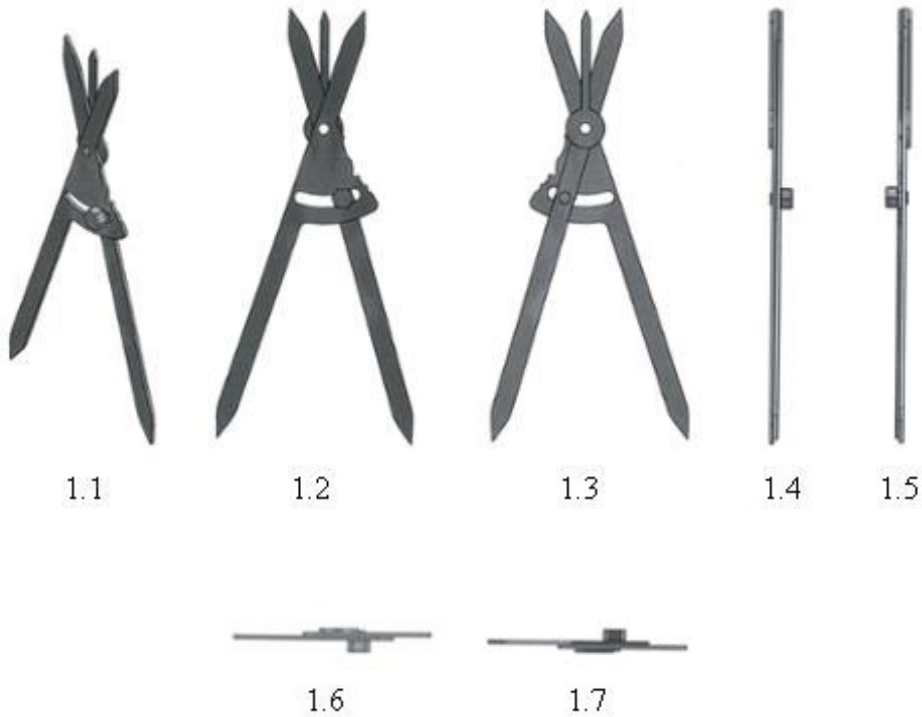

**CÔNG BÁO SỞ HỮU CÔNG NGHIỆP SỐ 400 TẬP A – QUYỀN 2 (07.2021)**

- (11) **42107**  
(21) 3-2021-00905 (28) 1  
(54) **MÁY LÀM SẠCH SÀN** (51) **15-05**  
(22) 16/04/2021 (43) 26/07/2021  
(30) 29/755,253 19/10/2020 US;  
(73) **TECHTRONIC CORDLESS GP (US)**  
100 Innovation Way, Anderson, SC 29621, United States of America  
1. DOUGLAS RUKAVINA (US)  
(72) 2. GREGORY CLARK (US)  
3. MOHAMMED IRFAN (GB)  
(74) Công ty TNHH Tầm nhìn và Liên danh (VISION & ASSOCIATES CO.LTD.)  
(55)



1.1



1.2

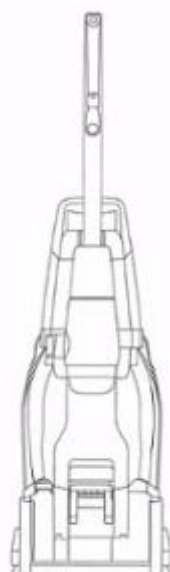

1.3



1.4

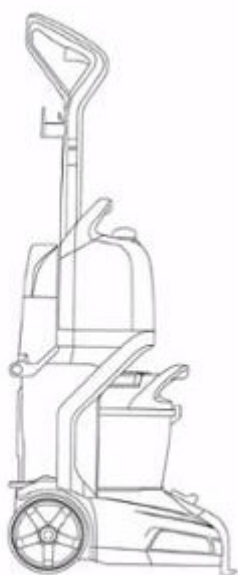

1.5

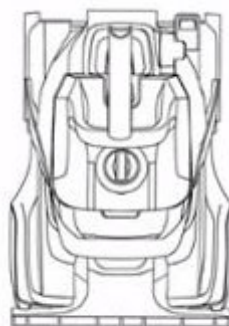

1.6

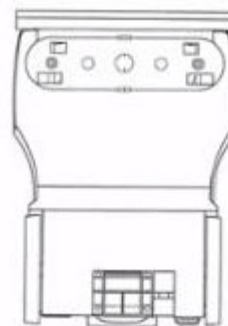

1.7

**CÔNG BÁO SỞ HỮU CÔNG NGHIỆP SỐ 400 TẬP A – QUYỀN 2 (07.2021)**

(11) **42108**

(21) 3-2021-00906

(28) 1

(54) **MÁY THỔI KHÍ**

(51) **23-04**

(22) 19/04/2021

(43) 26/07/2021

**PANASONIC INTELLECTUAL PROPERTY MANAGEMENT CO., LTD.**

(73) (JP)

1-61, Shiromi 2-chome, Chuo-ku, Osaka-shi, Osaka 540-6207 Japan

1. MASAYUKI HIROKAWA (JP)

2. QUANG VINH TRAN (VN)

(72) 3. YOSHIOMI TAKADA (JP)

4. TERUAKI YASUNISHI (JP)

(74) Công ty Luật TNHH Phạm và Liên danh (PHAM & ASSOCIATES)

(55)

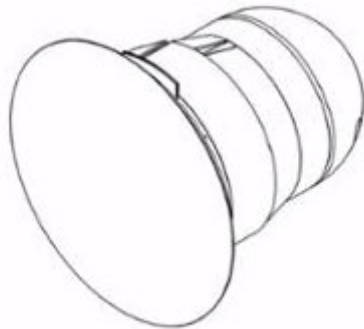

1.1

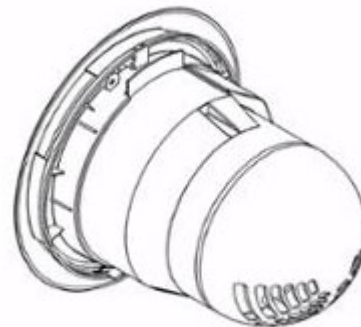

1.2

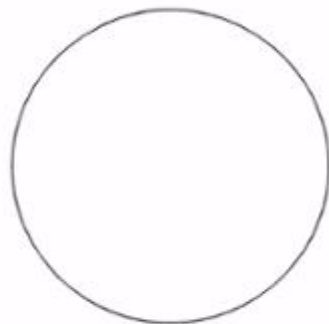

1.3



1.4

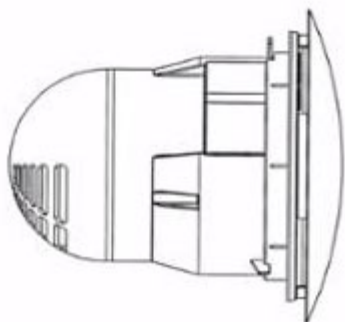

1.5

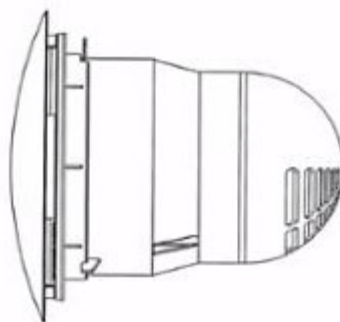

1.6

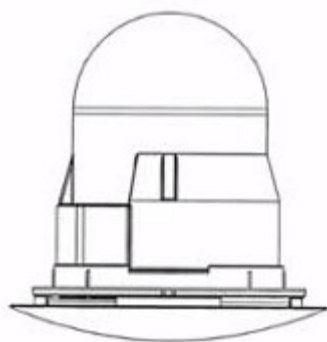

1.7



1.8

- (11) **42109**  
(21) 3-2021-00907 (28) 1  
(54) **BỘ ĐIỀU KHIỂN DÙNG CHO THIẾT BỊ ĐIỆN TỬ** (51) **14-03**  
(22) 19/04/2021 (43) 26/07/2021  
(30) 2020-023510 30/10/2020 JP;  
(73) **SONY INTERACTIVE ENTERTAINMENT INC. (JP)**  
1-7-1 Konan, Minato-ku, Tokyo, Japan  
(72) Taichi NOKUO (JP)  
(74) Công ty Luật TNHH Phạm và Liên danh (PHAM & ASSOCIATES)  
(55)



1.1



1.2



1.3



1.4



1.5

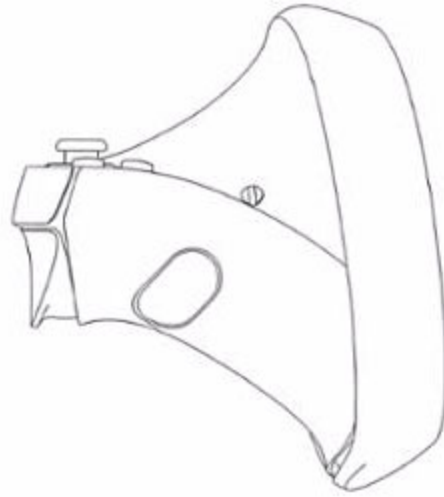

1.6

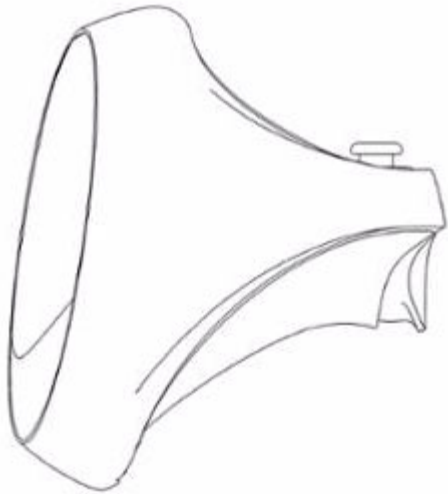

1.7



1.8

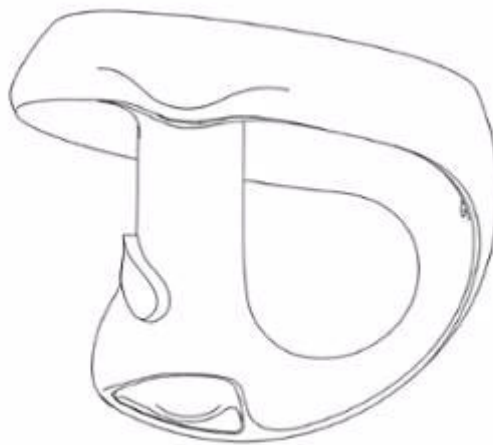

1.9

- (11) **42110**  
(21) 3-2021-00911 (28) 1  
(54) **KHÓA KÉO** (51) **02-07**  
(22) 19/04/2021 (43) 26/07/2021  
(30) 202030671267.X 06/11/2020 CN;  
**YIXING DELIN GARMENTS TECHNOLOGY CO., LTD. (CN)**  
(73) North of Weier Road, Wudong Village, Zhangzhu Town, Yixing City, Jiangsu Province, China  
(72) Linsong Lu (CN)  
(74) CÔNG TY TRÁCH NHIỆM HỮU HẠN TƯ VẤN ĐẦU TƯ VÀ SỞ HỮU TRÍ TUỆ INTERFIVE (INTERFIVE CO., LTD)  
(55)



1.1



1.2



1.3



1.4



1.5



1.6



1.7



**CÔNG BÁO SỞ HỮU CÔNG NGHIỆP SỐ 400 TẬP A – QUYỀN 2 (07.2021)**

(11) **42111**

(21) 3-2021-00915

(28) 1

(54) **HỘP**

(51) **09-03**

(22) 19/04/2021

(43) 26/07/2021

**TRẦN PHAN MINH THÙY (VN)**

(73) 413/7/1b Lê Văn Quới, phường Bình Trị Đông A, quận Bình Tân, thành phố Hồ Chí Minh

(72) Trần Phan Minh Thùy (VN)

(55)



1.1



1.2

**CÔNG BÁO SỞ HỮU CÔNG NGHIỆP SỐ 400 TẬP A – QUYỀN 2 (07.2021)**

(11) **42112**

(21) 3-2021-00916

(28) 1

(54) **QUẠT**

(51) **23-04**

(22) 19/04/2021

(43) 26/07/2021

(73) **CTY TNHH ĐIỆN GIA DỤNG HOÀNH KIẾN ĐẠT - LONG AN (VN)**

KCN Hải Sơn, ấp Bình Tiên 2, xã Đức Hòa Hạ, huyện Đức Hòa, tỉnh Long An

(72) **Dur Học Minh (VN)**

(74) **Công ty cổ phần FAS INVEST (FAS INVEST JSC)**

(55)



1.1



1.2



1.3



1.4



1.5



1.6



1.7

**CÔNG BÁO SỞ HỮU CÔNG NGHIỆP SỐ 400 TẬP A – QUYỀN 2 (07.2021)**

- (11) **42113**  
(21) 3-2021-00917 (28) 1  
(54) **TÚI ĐỰNG NẤM LINH CHI** (51) **09-05**  
(22) 20/04/2021 (43) 26/07/2021  
**CÔNG TY TNHH XUẤT NHẬP KHẨU VÀ KINH DOANH VHP (VN)**  
(73) Số 17/331 phố Trần Khát Trân, phường Thanh Nhân, quận Hai Bà Trưng, thành phố Hà Nội  
(72) Đào Thị Gấm (VN)  
(55)



1.1



1.2

**CÔNG BÁO SỞ HỮU CÔNG NGHIỆP SỐ 400 TẬP A – QUYỀN 2 (07.2021)**

- (11) **42114**  
(21) 3-2021-00921 (28) 1  
(54) **HỘP ĐỰNG** (51) **09-03**  
(22) 20/04/2021 (43) 26/07/2021  
(73) **NGUYỄN THỊ HƯƠNG (VN)**  
Cả Cổ, xã Thạnh Phú, huyện Thạnh Hóa, tỉnh Long An  
(72) Nguyễn Thị Hương (VN)  
(74) **CÔNG TY TNHH SỞ HỮU TRÍ TUỆ ANLIS VIỆT NAM (ANLIS IP CO.,LTD)**  
(55)



1.1



1.2

**CÔNG BÁO SỞ HỮU CÔNG NGHIỆP SỐ 400 TẬP A – QUYỀN 2 (07.2021)**

- (11) **42115**  
(21) 3-2021-00925 (28) 1  
(54) **BÚT** (51) **19-06**  
(22) 20/04/2021 (43) 26/07/2021  
(73) **HỘ KINH DOANH BẠCH NGỌC (VN)**  
958/ 43C Lò Gốm, phường 8, quận 6, thành phố Hồ Chí Minh  
(72) Trần Huệ Ngọc (VN)  
(74) **CÔNG TY TNHH SỞ HỮU TRÍ TUỆ SETHACO (SETHACO IP CO.,LTD)**  
(55)

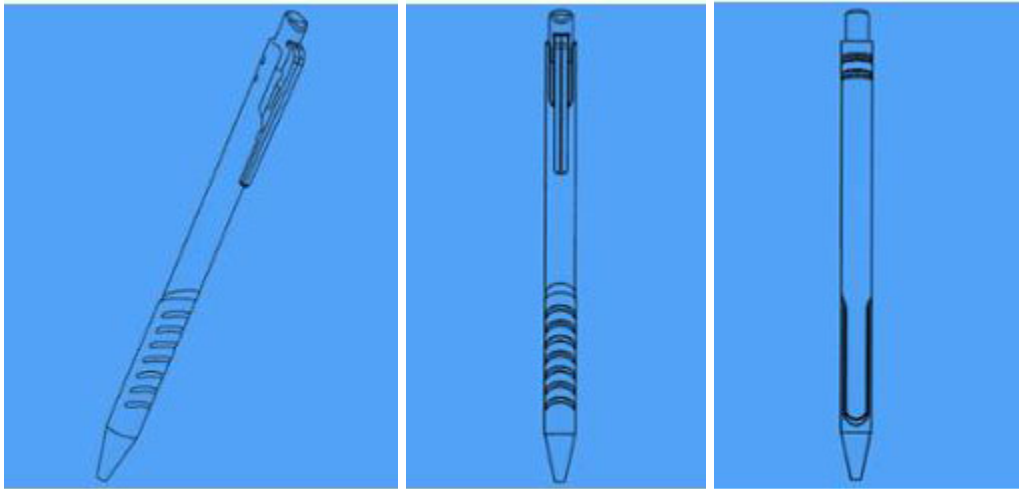

1.1

1.2

1.3

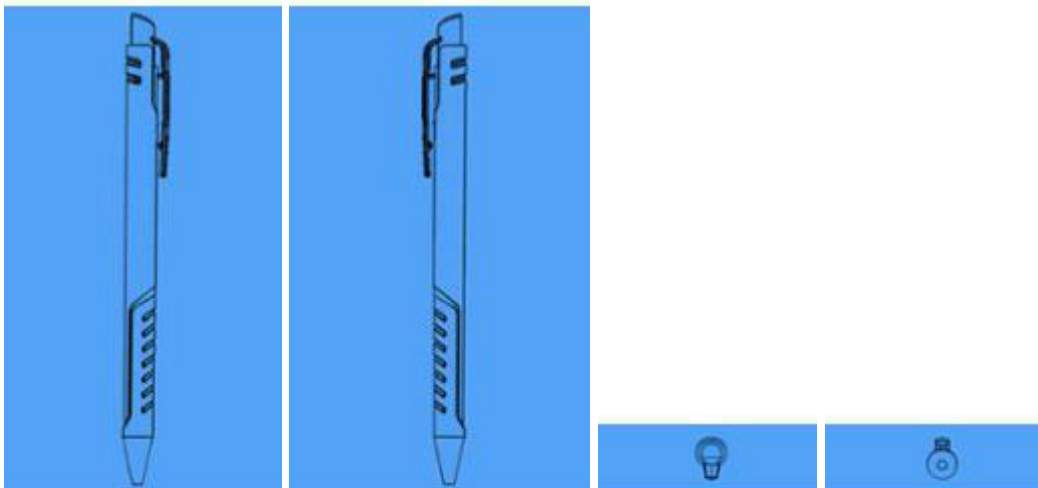

1.4

1.5

1.6

1.7

- (11) **42116**
- (21) 3-2021-00927
- (54) **VAN ĐIỆN TỬ**
- (22) 20/04/2021
- (30) 202030686622.0 13/11/2020 CN;
- (73) **SMC CORPORATION (JP)**  
14-1, Sotokanda 4-chome, Chiyoda-ku, Tokyo, 1010021 JAPAN
- 1. MASARU YOSHIDA (JP)
- (72) 2. KENICHI MATSUMURA (JP)
- 3. KODAI YOSHINAGA (JP)
- (74) Công ty TNHH Tầm nhìn và Liên danh (VISION & ASSOCIATES CO.LTD.)
- (55)

- (28) 1
- (51) **23-01**
- (43) 26/07/2021

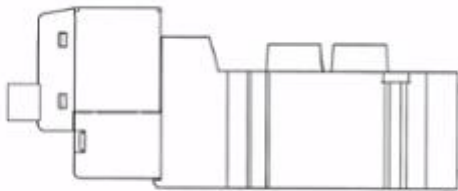

1.1

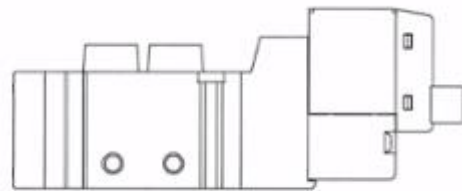

1.2

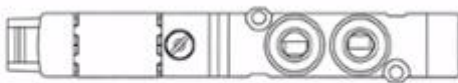

1.3



1.4



1.5



1.6

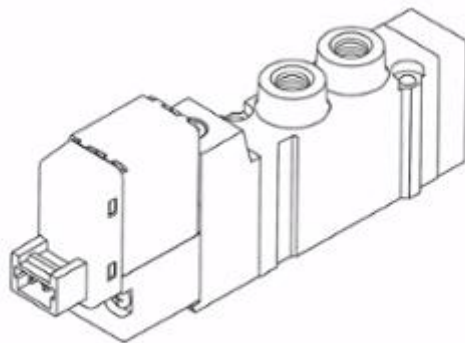

1.7

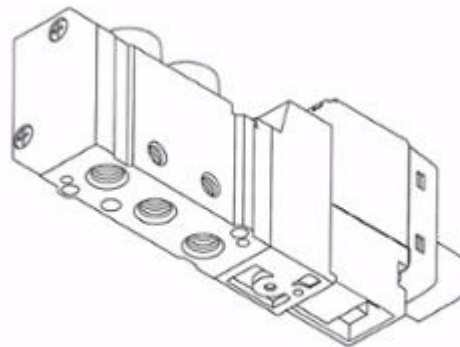

1.8

- (11) **42117**  
(21) 3-2021-00928 (28) 1  
(54) **VAN ĐIỆN TỬ** (51) **23-01**  
(22) 20/04/2021 (43) 26/07/2021  
(30) 202030686622.0 13/11/2020 CN;  
(73) **SMC CORPORATION (JP)**  
14-1, Sotokanda 4-chome, Chiyoda-ku, Tokyo, 1010021 JAPAN  
1. MASARU YOSHIDA (JP)  
(72) 2. KENICHI MATSUMURA (JP)  
3. KODAI YOSHINAGA (JP)  
(74) Công ty TNHH Tầm nhìn và Liên danh (VISION & ASSOCIATES CO.LTD.)  
(55)

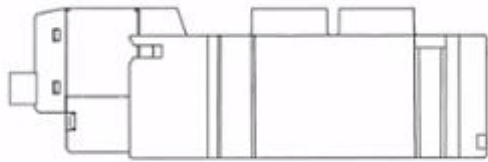

1.1

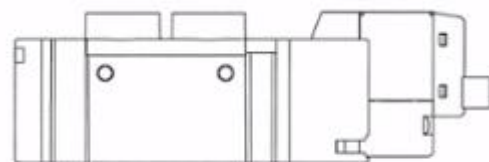

1.2



1.3



1.4

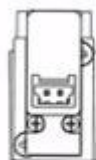

1.5



1.6

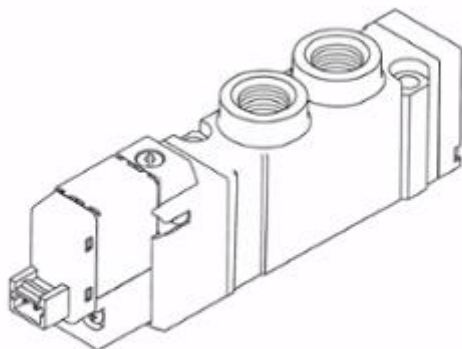

1.7

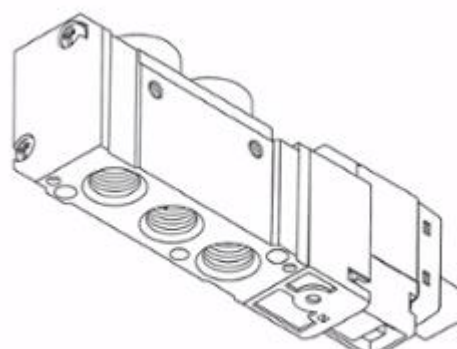

1.8

- (11) **42118**  
(21) 3-2021-00929 (28) 1  
(54) **VAN ĐIỆN TỬ** (51) **23-01**  
(22) 20/04/2021 (43) 26/07/2021  
(30) 202030686622.0 13/11/2020 CN;  
(73) **SMC CORPORATION (JP)**  
14-1, Sotokanda 4-chome, Chiyoda-ku, Tokyo, 1010021 JAPAN  
1. MASARU YOSHIDA (JP)  
(72) 2. KENICHI MATSUMURA (JP)  
3. KODAI YOSHINAGA (JP)  
(74) Công ty TNHH Tầm nhìn và Liên danh (VISION & ASSOCIATES CO.LTD.)  
(55)

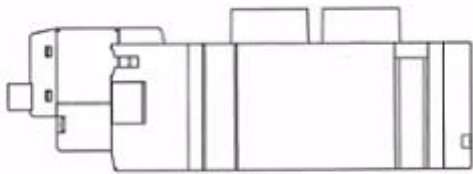

1.1

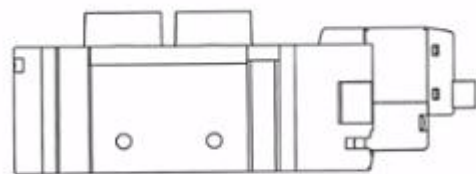

1.2



1.3



1.4

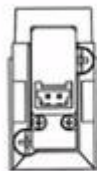

1.5

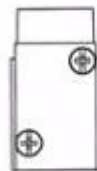

1.6

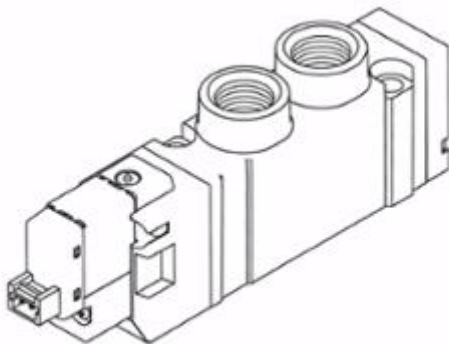

1.7

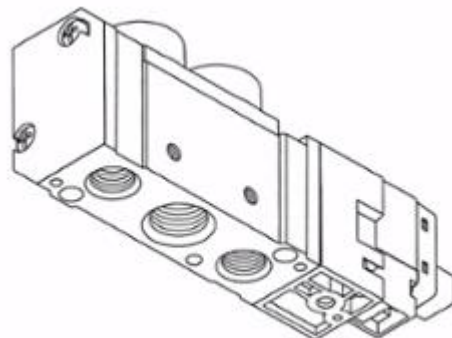

1.8



**CÔNG BÁO SỞ HỮU CÔNG NGHIỆP SỐ 400 TẬP A – QUYỀN 2 (07.2021)**

(11) **42119**

(21) 3-2021-00930

(28) 1

(54) **THÙNG ĐỰNG**

(51) **09-03**

(22) 20/04/2021

(43) 26/07/2021

**HỢP TÁC XÃ DỊCH VỤ NÔNG NGHIỆP LÝ VĂN LÂM (VN)**

(73) Lô 05, đường N19, khu đô thị Bạch Đằng, ấp Bà Điều, xã Lý Văn Lâm, thành phố Cà Mau, tỉnh Cà Mau

(72) Trần Sỹ Nhân (VN)

(74) Công ty TNHH Sở hữu trí tuệ HA VIP (HAVIP CO., LTD.)

(55)



1.1



1.2

**CÔNG BÁO SỞ HỮU CÔNG NGHIỆP SỐ 400 TẬP A – QUYỀN 2 (07.2021)**

- (11) **42120**  
(21) 3-2021-00931 (28) 1  
(54) **XE SCUTO** (51) **12-11**  
(22) 22/04/2021 (43) 26/07/2021  
(30) 2020-023305 29/10/2020 JP;  
(73) **HONDA MOTOR CO., LTD. (JP)**  
1-1, Minami-Aoyama 2-chome, Minato-ku, Tokyo, 107-8556 Japan  
(72) 1. AKIRA KIMURA (JP)  
2. SHINJI NAGANO (JP)  
(74) Công ty Luật TNHH Phạm và Liên danh (PHAM & ASSOCIATES)  
(55)



1.1



1.2



1.3



1.4



1.5



1.6



1.7



1.8



1.9



1.10

**CÔNG BÁO SỞ HỮU CÔNG NGHIỆP SỐ 400 TẬP A – QUYỀN 2 (07.2021)**

- (11) **42121**  
(21) 3-2021-00933 (28) 1  
(54) **THIẾT BỊ GIẢM XÓC** (51) **12-16**  
(22) 22/04/2021 (43) 26/07/2021  
(73) **MENG KAH AUTO PARTS TRADING SDN. BHD. (MY)**  
40, Jalan TPP5, Taman Perindustrian Putra, 47130 Puchong, Selangor, Malaysia  
(72) LEE Cong Quan (MY)  
(74) Công ty TNHH Trường Xuân (AGELESS CO.,LTD.)  
(55)

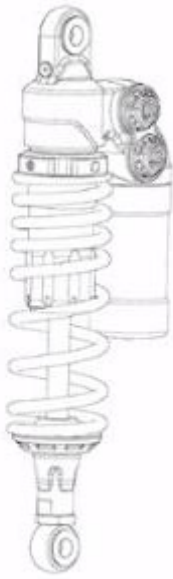

1.1

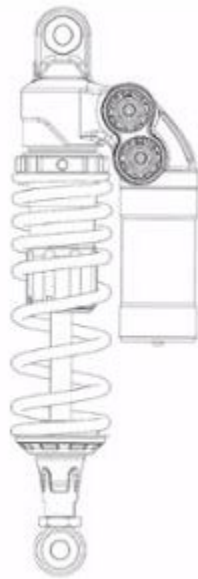

1.2

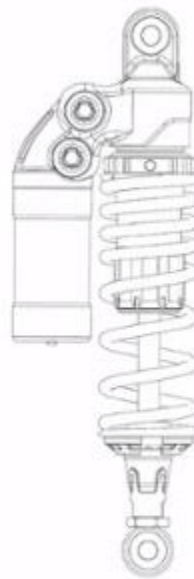

1.3



1.4



1.5

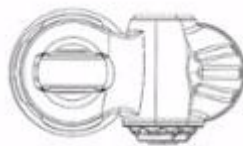

1.6

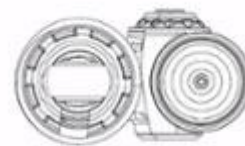

1.7

**CÔNG BÁO SỞ HỮU CÔNG NGHIỆP SỐ 400 TẬP A – QUYỀN 2 (07.2021)**

- (11) **42122**  
(21) 3-2021-00934 (28) 1  
(54) **KẸP PHANH** (51) **12-16**  
(22) 22/04/2021 (43) 26/07/2021  
(73) **MENG KAH AUTO PARTS TRADING SDN. BHD. (MY)**  
40, Jalan TPP5, Taman Perindustrian Putra, 47130 Puchong, Selangor, Malaysia  
(72) LEE Cong Quan (MY)  
(74) Công ty TNHH Trường Xuân (AGELESS CO.,LTD.)  
(55)



1.1



1.2



1.3



1.4

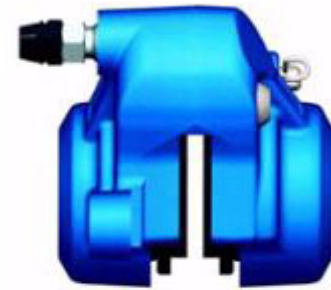

1.5

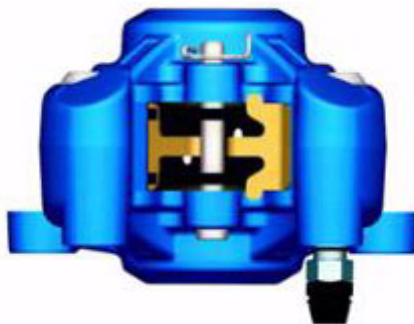

1.6



1.7

**CÔNG BÁO SỞ HỮU CÔNG NGHIỆP SỐ 400 TẬP A – QUYỀN 2 (07.2021)**

- (11) **42123**  
(21) 3-2021-00935 (28) 1  
(54) **BAO GÓI** (51) **09-05**  
(22) 22/04/2021 (43) 26/07/2021  
(73) **CÔNG TY TNHH NAM PHƯƠNG V.N (VN)**  
124 Lê Lai, phường 03, quận Gò Vấp, thành phố Hồ Chí Minh  
(72) Hoàng Thị Minh Hiếu (VN)  
(74) Công ty Luật TNHH Phạm và Liên danh (PHAM & ASSOCIATES)  
(55)



1.1



1.2

**CÔNG BÁO SỞ HỮU CÔNG NGHIỆP SỐ 400 TẬP A – QUYỀN 2 (07.2021)**

- (11) **42124**  
(21) 3-2021-00936 (28) 3  
(54) **MÁY HÚT BỤI CẦM TAY** (51) **15-05**  
(22) 22/04/2021 (43) 26/07/2021  
(30) 202030631478.0 22/10/2020 CN;  
**ZHUICHUANG TECHNOLOGY (SUZHOU) CO., LTD. (CN)**  
(73) E3, Building 16, No. 2288, Wuzhong Avenue, Yuexi, Wuzhong District, Suzhou City, Jiangsu Province, China  
1. JIANG, NAN (CN)  
2. XIE, XIAOYE (CN)  
(72) 3. DOU, CHUNYANG (CN)  
4. NIE, NING (CN)  
(74) Công ty TNHH IPCELLS & Công Sự (IPCELLS & ASSOCIATED CO.,LTD)  
(55)



1.1



1.2



1.3



1.4



1.5



1.6



1.7



1.8



2.1



2.2



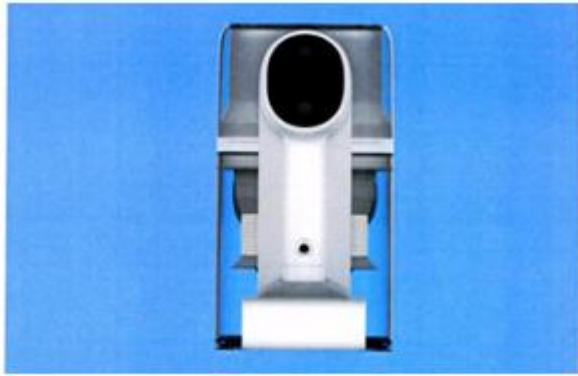

2.3

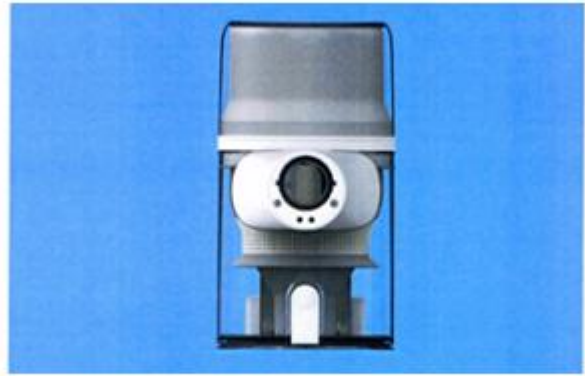

2.4

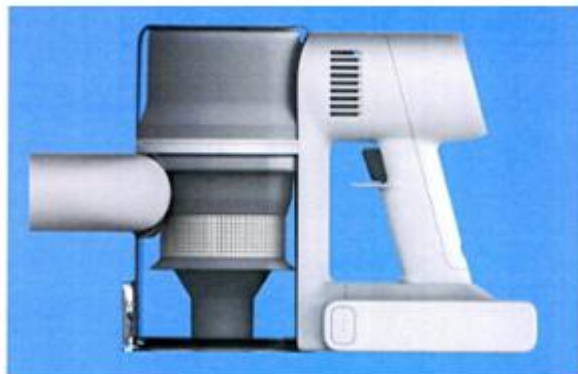

2.5

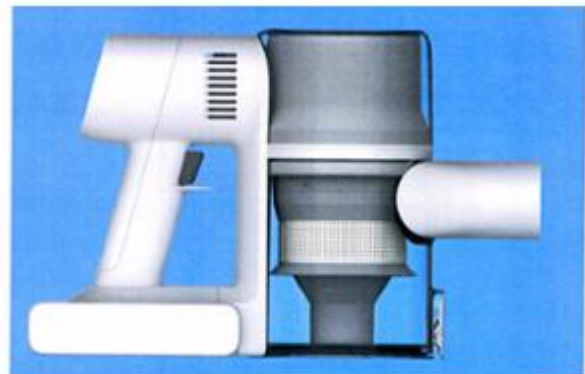

2.6



2.7



2.8



3.1



3.2



3.3



3.4

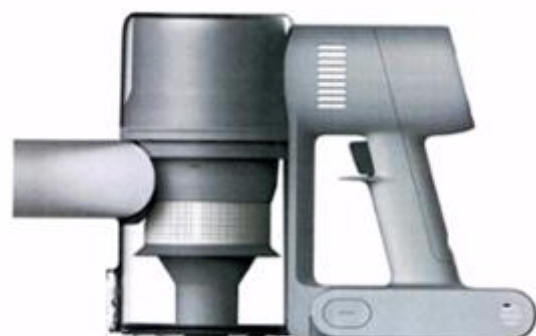

3.5



3.6



3.7



3.8

- (11) **42125**  
(21) 3-2021-00937 (28) 1  
(54) **DỤNG CỤ XOA BÓP** (51) **28-03**  
(22) 23/04/2021 (43) 26/07/2021  
(30) 30-2020-0054143 10/11/2020 KR;  
**EUI SHIN HONG (KR)**  
(73) 111-1104, E-comfortable world Apt., 113 Landmark-ro, Yeonsu-gu, Incheon  
22021 Republic of Korea  
(72) Eui Shin HONG (KR)  
(74) Công ty Luật TNHH Phạm và Liên danh (PHAM & ASSOCIATES)  
(55)

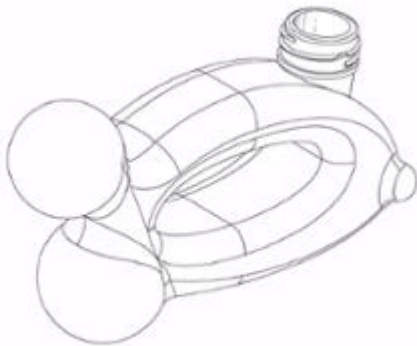

1.1

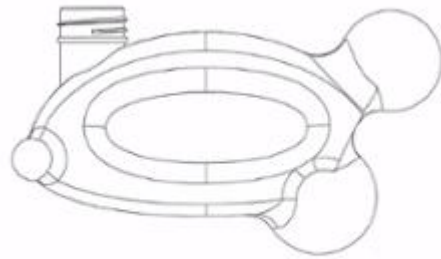

1.2

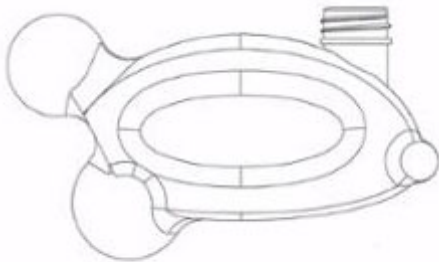

1.3



1.4



1.5

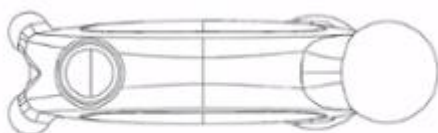

1.6

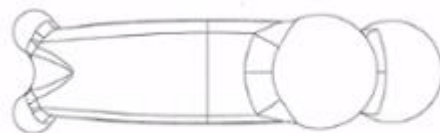

1.7

**CÔNG BÁO SỞ HỮU CÔNG NGHIỆP SỐ 400 TẬP A – QUYỀN 2 (07.2021)**

- (11) **42126**  
(21) 3-2021-00938 (28) 1  
(54) **BAO GÓI TẤ QUẦN** (51) **09-05**  
(22) 23/04/2021 (43) 26/07/2021  
**CÔNG TY TNHH SẢN XUẤT VÀ THƯƠNG MẠI QUỐC TẾ VIỆT SING**  
(73) (VN)  
Cụm CN Xuân Lâm, xã Xuân Lâm, huyện Thuận Thành, tỉnh Bắc Ninh  
(72) Nguyễn Đăng Dũng (VN)  
(55)



1.1



1.2

**CÔNG BÁO SỞ HỮU CÔNG NGHIỆP SỐ 400 TẬP A – QUYỀN 2 (07.2021)**

- (11) **42127**  
(21) 3-2021-00942 (28) 1  
(54) **TRẠM SẠC CHO XE ĐIỆN** (51) **13-02**  
(22) 26/04/2021 (43) 26/07/2021  
(30) 202015851 27/10/2020 AU;  
**TRITIUM HOLDINGS PTY LTD (AU)**  
(73) Unit 1, 31 Archimedes Place, Murarrie QLD 4172, Australia  
(72) Shelley Ellen Farrell (AU)  
(74) Công ty Luật TNHH T&G (TGVN)  
(55)

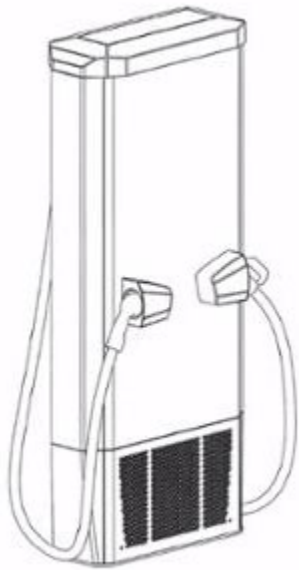

1.1

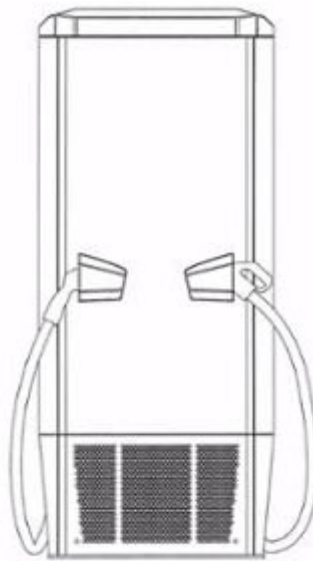

1.2

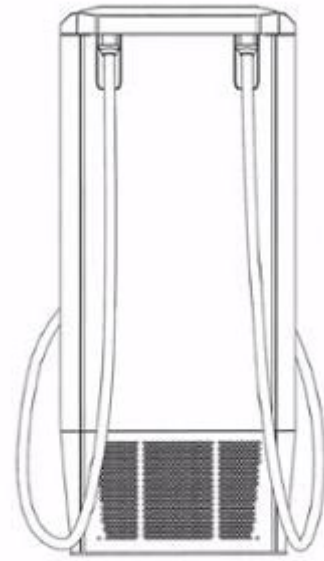

1.3

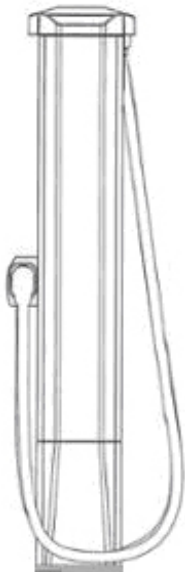

1.4



1.5

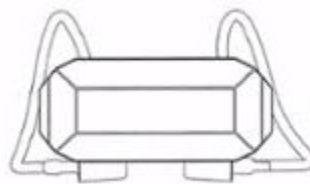

1.6

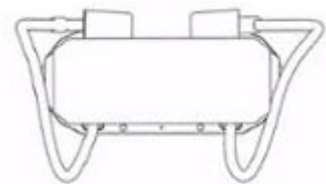

1.7

- (11) **42128**  
(21) 3-2021-00946 (28) 1  
(54) **TAI NGHE** (51) **14-01**  
(22) 26/04/2021 (43) 26/07/2021  
(30) 202030715708.1 25/11/2020 CN;  
**SHENZHEN HONGRUNFA INDUSTRIAL CO. LTD (CN)**  
(73) 3A1005, Phase 1, Manjinghua xiyuelihuating, Nanlian Community, Longgang Street, Longgang District, Shenzhen, China  
(72) HONG ZHANG (CN)  
(74) Công ty TNHH Trà và cộng sự (TRA & ASSOCIATES CO.,LTD)  
(55)



1.1



1.2



1.3



1.4



1.5



1.6



1.7

**CÔNG BÁO SỞ HỮU CÔNG NGHIỆP SỐ 400 TẬP A – QUYỀN 2 (07.2021)**

- (11) **42129**  
(21) 3-2021-00947 (28) 1  
(54) **HỘP SẠC TAI NGHE** (51) **13-02**  
(22) 26/04/2021 (43) 26/07/2021  
(30) 202030715708.1 25/11/2020 CN;  
**SHENZHEN HONGRUNFA INDUSTRIAL CO. LTD (CN)**  
(73) 3A1005, Phase 1, Manjinghua xiyuelihuating, Nanlian Community, Longgang Street, Longgang District, Shenzhen, China  
(72) HONG ZHANG (CN)  
(74) Công ty TNHH Trà và cộng sự (TRA & ASSOCIATES CO.,LTD)  
(55)



1.1



1.2



1.3



1.4

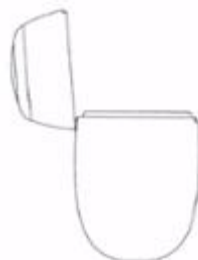

1.5

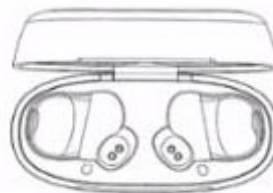

1.6



1.7

(11) **42130**

(21) 3-2021-00948

(28) 1

(54) **BAO GÓI**

(51) **09-05**

(22) 26/04/2021

(43) 26/07/2021

(73) **CÔNG TY GIẤY ÁNH DƯƠNG (VN)**

Thôn Doãn Thượng, xã Xuân Lâm, huyện Thuận Thành, tỉnh Bắc Ninh

(72) Đinh Tuấn Tráng (VN)

(74) Công ty TNHH Sở hữu trí tuệ Việt Á (VIET A IP CO.,LTD)

(55)



1.1



1.2



**CÔNG BÁO SỞ HỮU CÔNG NGHIỆP SỐ 400 TẬP A – QUYỀN 2 (07.2021)**

(11) **42131**

(21) 3-2021-00950

(28) 1

(54) **BAO GÓI**

(51) **09-05**

(22) 26/04/2021

(43) 26/07/2021

(73) **CÔNG TY GIẤY ÁNH DƯƠNG (VN)**

Thôn Doãn Thượng, xã Xuân Lâm, huyện Thuận Thành, tỉnh Bắc Ninh

(72) Đinh Tuấn Tráng (VN)

(74) Công ty TNHH Sở hữu trí tuệ Việt Á (VIET A IP CO.,LTD)

(55)



1.1



1.2

**CÔNG BÁO SỞ HỮU CÔNG NGHIỆP SỐ 400 TẬP A – QUYỀN 2 (07.2021)**

(11) **42132**

(21) 3-2021-00951

(28) 1

(54) **BAO GÓI**

(51) **09-05**

(22) 26/04/2021

(43) 26/07/2021

(73) **CÔNG TY GIẤY ÁNH DƯƠNG (VN)**

Thôn Doãn Thượng, xã Xuân Lâm, huyện Thuận Thành, tỉnh Bắc Ninh

(72) Đinh Tuấn Tráng (VN)

(74) Công ty TNHH Sở hữu trí tuệ Việt Á (VIET A IP CO.,LTD)

(55)



1.1



1.2

(11) **42133**

(21) 3-2021-00952

(28) 1

(54) **BAO GÓI**

(51) **09-05**

(22) 26/04/2021

(43) 26/07/2021

(73) **CÔNG TY GIẤY ÁNH DƯƠNG (VN)**

Thôn Doãn Thượng, xã Xuân Lâm, huyện Thuận Thành, tỉnh Bắc Ninh

(72) Đinh Tuấn Tráng (VN)

(74) Công ty TNHH Sở hữu trí tuệ Việt Á (VIET A IP CO.,LTD)

(55)



1.1



1.2

**CÔNG BÁO SỞ HỮU CÔNG NGHIỆP SỐ 400 TẬP A – QUYỀN 2 (07.2021)**

(11) **42134**

(21) 3-2021-00953

(28) 1

(54) **BAO GÓI**

(51) **09-05**

(22) 26/04/2021

(43) 26/07/2021

(73) **CÔNG TY GIẤY ÁNH DƯƠNG (VN)**

Thôn Doãn Thượng, xã Xuân Lâm, huyện Thuận Thành, tỉnh Bắc Ninh

(72) Đinh Tuấn Tráng (VN)

(74) Công ty TNHH Sở hữu trí tuệ Việt Á (VIET A IP CO.,LTD)

(55)



1.1



1.2

**CÔNG BÁO SỞ HỮU CÔNG NGHIỆP SỐ 400 TẬP A – QUYỀN 2 (07.2021)**

- (11) **42135**  
(21) 3-2021-00957 (28) 1  
(54) **NHÃN SẢN PHẨM** (51) **19-08**  
(22) 27/04/2021 (43) 26/07/2021  
(73) **BÙI NGỌC TÚ (VN)**  
Xóm Chùa, xã Khôi Kỳ, huyện Đại Từ, tỉnh Thái Nguyên  
(72) Bùi Ngọc Tú (VN)  
(55)



**CÔNG BÁO SỞ HỮU CÔNG NGHIỆP SỐ 400 TẬP A – QUYỀN 2 (07.2021)**

- (11) **42136**  
(21) 3-2021-00958 (28) 1  
(54) **NHÃN SẢN PHẨM** (51) **19-08**  
(22) 27/04/2021 (43) 26/07/2021  
(73) **CÔNG TY CỔ PHẦN THÁI DƯƠNG (VN)**  
Cụm công nghiệp Lại Yên, xã Lại Yên, huyện Hoài Đức, thành phố Hà Nội  
(72) Nguyễn Duy Lộc (VN)  
(55)



**CÔNG BÁO SỞ HỮU CÔNG NGHIỆP SỐ 400 TẬP A – QUYỀN 2 (07.2021)**

- (11) **42137**  
(21) 3-2021-00959 (28) 1  
(54) **NHÃN SẢN PHẨM** (51) **19-08**  
(22) 27/04/2021 (43) 26/07/2021  
(73) **CÔNG TY CỔ PHẦN THÁI DƯƠNG (VN)**  
Cụm công nghiệp Lại Yên, xã Lại Yên, huyện Hoài Đức, thành phố Hà Nội  
(72) Nguyễn Duy Lộc (VN)  
(55)



**CÔNG BÁO SỞ HỮU CÔNG NGHIỆP SỐ 400 TẬP A – QUYỀN 2 (07.2021)**

- (11) **42138**  
(21) 3-2021-00960 (28) 1  
(54) **NHÃN SẢN PHẨM** (51) **19-08**  
(22) 27/04/2021 (43) 26/07/2021  
(73) **CÔNG TY CỔ PHẦN THÁI DƯƠNG (VN)**  
Cụm công nghiệp Lại Yên, xã Lại Yên, huyện Hoài Đức, thành phố Hà Nội  
(72) Nguyễn Duy Lộc (VN)  
(55)





**CÔNG BÁO SỞ HỮU CÔNG NGHIỆP SỐ 400 TẬP A – QUYỀN 2 (07.2021)**

- (11) **42139**  
(21) 3-2021-00961 (28) 1  
(54) **NHÃN SẢN PHẨM** (51) **19-08**  
(22) 27/04/2021 (43) 26/07/2021  
(73) **CÔNG TY CỔ PHẦN THÁI DƯƠNG (VN)**  
Cụm công nghiệp Lại Yên, xã Lại Yên, huyện Hoài Đức, thành phố Hà Nội  
(72) Nguyễn Duy Lộc (VN)  
(55)



**CÔNG BÁO SỞ HỮU CÔNG NGHIỆP SỐ 400 TẬP A – QUYỀN 2 (07.2021)**

- (11) **42140**  
(21) 3-2021-00962 (28) 1  
(54) **NHÃN SẢN PHẨM** (51) **19-08**  
(22) 27/04/2021 (43) 26/07/2021  
(73) **CÔNG TY CỔ PHẦN THÁI DƯƠNG (VN)**  
Cụm công nghiệp Lại Yên, xã Lại Yên, huyện Hoài Đức, thành phố Hà Nội  
(72) Nguyễn Duy Lộc (VN)  
(55)

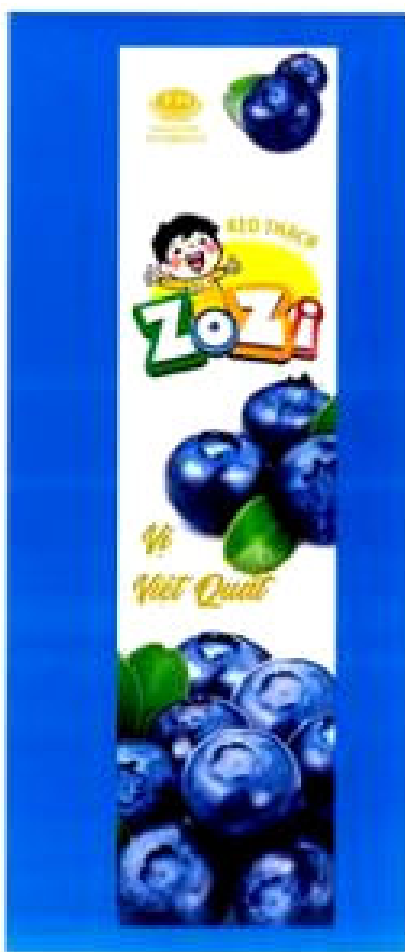

**CÔNG BÁO SỞ HỮU CÔNG NGHIỆP SỐ 400 TẬP A – QUYỀN 2 (07.2021)**

- (11) **42141**  
(21) 3-2021-00963 (28) 1  
(54) **BAO BÌ** (51) **09-05**  
(22) 27/04/2021 (43) 26/07/2021  
(73) **CÔNG TY TNHH SWISSFERTZ VIỆT NAM (VN)**  
68A đường số 11, phường Tân Kiểng, quận 7, thành phố Hồ Chí Minh  
(72) Bùi Minh Trường (VN)  
(55)



1.1



1.2

**CÔNG BÁO SỞ HỮU CÔNG NGHIỆP SỐ 400 TẬP A – QUYỀN 2 (07.2021)**

- (11) **42142**  
(21) 3-2021-00964 (28) 1  
(54) **NHÃN SẢN PHẨM** (51) **19-08**  
(22) 27/04/2021 (43) 26/07/2021  
(73) **CÔNG TY CỔ PHẦN THỰC PHẨM DINH DƯỠNG ĐẠI VIỆT (VN)**  
579/25 Quang Trung, phường 11, quận Gò Vấp, thành phố Hồ Chí Minh  
(72) Nguyễn Quang Hồng Phúc (VN)  
(55)



**CÔNG BÁO SỞ HỮU CÔNG NGHIỆP SỐ 400 TẬP A – QUYỀN 2 (07.2021)**

(11) **42143**

(21) 3-2021-00965

(28) 1

(54) **NHÃN SẢN PHẨM**

(51) **19-08**

(22) 27/04/2021

(43) 26/07/2021

**CÔNG TY TNHH DỊCH VỤ VÀ CUNG CẤP THỰC PHẨM QUỐC TẾ IFSS**

(73) (VN)

Số 2 Bis Nguyễn Thị Minh Khai, phường Đa Kao, quận 1, thành phố Hồ Chí Minh

(72) Hoàng Dương Xuân Dũng (VN)

(55)



**CÔNG BÁO SỞ HỮU CÔNG NGHIỆP SỐ 400 TẬP A – QUYỀN 2 (07.2021)**

- (11) **42144**  
(21) 3-2021-00966 (28) 1  
(54) **ĐỂ GIÀY** (51) **02-04**  
(22) 27/04/2021 (43) 26/07/2021  
(30) 2020-023467 30/10/2020 JP;  
**YONEX CO., LTD. (JP)**  
(73) 3-23-13 Yushima, Bunkyo-ku, Tokyo 1138543 Japan  
(72) Tomokazu KAI (JP)  
(74) Công ty TNHH một thành viên Sở hữu trí tuệ VCCI (VCCI-IP CO.,LTD)  
(55)



1.1



1.2



1.3



1.4



1.5



1.6



1.7



1.8

**CÔNG BÁO SỞ HỮU CÔNG NGHIỆP SỐ 400 TẬP A – QUYỀN 2 (07.2021)**

- (11) **42145**  
(21) 3-2021-00968 (28) 1  
(54) **CAN** (51) **09-02**  
(22) 27/04/2021 (43) 26/07/2021  
(73) **CÔNG TY CỔ PHẦN HÓA DẦU MEKONG (VN)**  
Áp 3, xã An Thạnh, huyện Bến Lức, tỉnh Long An  
(72) Lê Nguyễn Khoa (VN)  
(74) Công ty TNHH sở hữu trí tuệ AGL (AGL IP)  
(55)



1.1



1.2



1.3



1.4



1.5



1.6





1.7



1.8

**CÔNG BÁO SỞ HỮU CÔNG NGHIỆP SỐ 400 TẬP A – QUYỀN 2 (07.2021)**

(11) **42146**

(21) 3-2021-00969

(28) 1

(54) **NHÃN SẢN PHẨM**

(51) **19-08**

(22) 27/04/2021

(43) 26/07/2021

**GOLDEN TIME CHEMICAL (JIANGSU) CO., LTD. (CN)**

(73) No.88, Panyao Road, Nanjing Chemical Industry Park, Jiangsu Province, People's Republic of China

(72) Qiuqiang Chen (CN)

(74) Công ty TNHH Trà và cộng sự (TRA & ASSOCIATES CO.,LTD)

(55)



**CÔNG BÁO SỞ HỮU CÔNG NGHIỆP SỐ 400 TẬP A – QUYỀN 2 (07.2021)**

- (11) **42147**  
(21) 3-2021-00974 (28) 1  
(54) **BAO ĐỰNG GẠO** (51) **09-05**  
(22) 28/04/2021 (43) 26/07/2021  
(73) **TỔNG CÔNG TY LƯƠNG THỰC MIỀN BẮC (VN)**  
Số 6, phố Ngô Quyền, phường Lý Thái Tổ, quận Hoàn Kiếm, thành phố Hà Nội  
(72) Nguyễn Xuân Hồng (VN)  
(74) Công ty cổ phần Tư vấn S&B (S&B CONSULTANT., CORP.)  
(55)



1.1



1.2



1.3

**CÔNG BÁO SỞ HỮU CÔNG NGHIỆP SỐ 400 TẬP A – QUYỀN 2 (07.2021)**

- (11) **42148**  
(21) 3-2021-00977 (28) 1  
(54) **XE BA BÁNH** (51) **12-11**  
(22) 28/04/2021 (43) 26/07/2021  
(30) 202030658767.X 03/11/2020 CN;  
(73) **RINDA KOMASATO (JP)**  
South side of Building 2, 261 Sanyou Road, Minhang District, Shanghai, China  
(72) RINDA KOMASATO (JP)  
(74) **CÔNG TY LUẬT TRÁCH NHIỆM HỮU HẠN AMBYS HÀ NỘI (AMBYS HANOI)**  
(55)



1.1



1.2



1.3



1.4



1.5



1.6

- (11) **42149**  
(21) 3-2021-00982 (28) 1  
(54) **TAI NGHE** (51) **14-01**  
(22) 28/04/2021 (43) 26/07/2021  
(30) 202030709008.1 20/11/2020 CN;  
**SHENZHEN VOXTECH CO., LTD. (CN)**  
(73) Floors 1-4, Factory Building 26, Shancheng Industrial Park, Shiyan Street, Bao'an District, Shenzhen, Guangdong, China  
1. HAOFENG ZHANG (CN)  
2. YONGJIAN LI (CN)  
(72) 3. LEI ZHANG (CN)  
4. LEI TANG (CN)  
5. ZEYING ZHENG (CN)  
6. YUNBIN CHEN (CN)  
(74) Công ty TNHH Trường Xuân (AGELESS CO.,LTD.)  
(55)

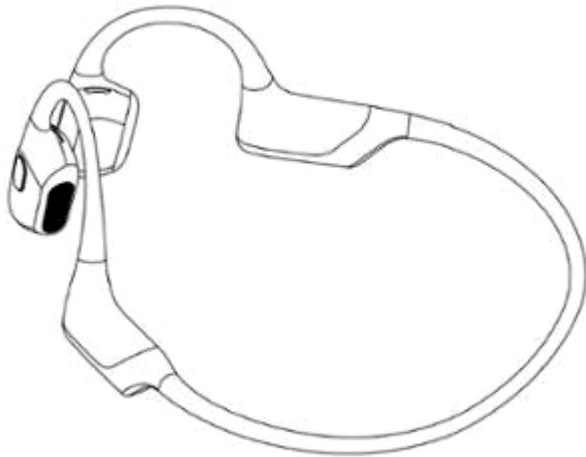

1.1

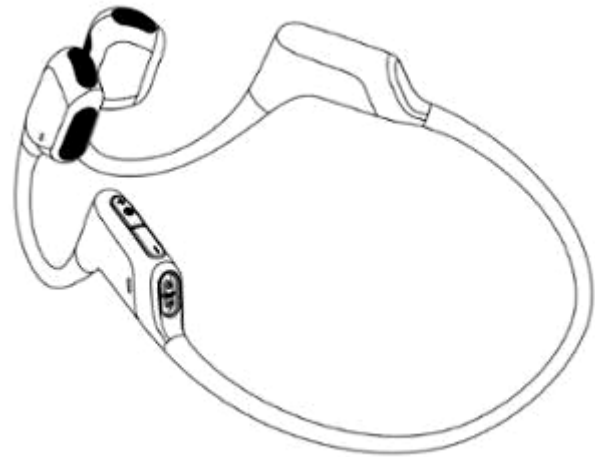

1.2



1.3



1.4

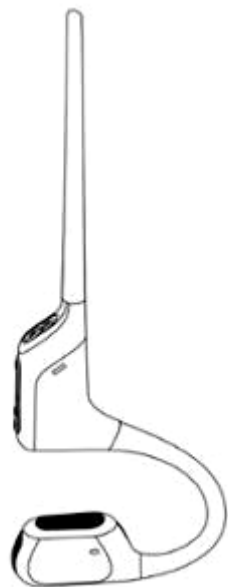

1.5

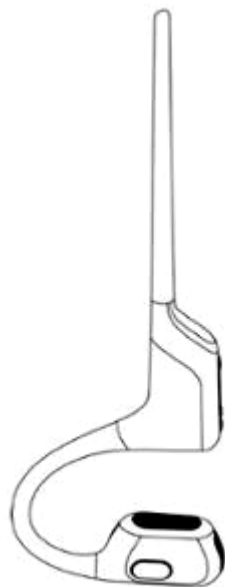

1.6

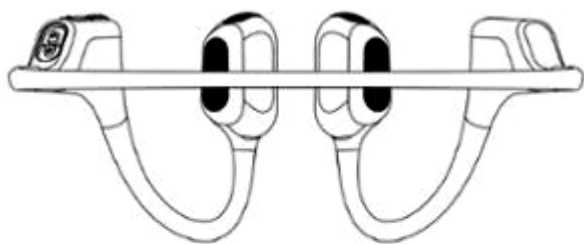

1.7

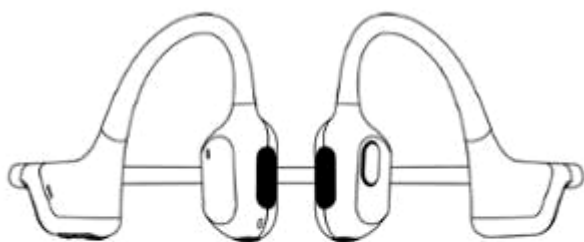

1.8

- (11) **42150**  
(21) 3-2021-00987 (28) 1  
(54) **BÌNH** (51) **07-07; 09-01**  
(22) 28/04/2021 (43) 26/07/2021  
(30) 30-2020-0051949 29/10/2020 KR;  
**LOCK & LOCK CO., LTD (KR)**  
(73) 104, Sapgyocheon-ro, Seonjang-myeon, Asan-si, Chungcheongnam-do, Republic of Korea  
(72) KIM, Kwang Ik (KR)  
(74) Công ty TNHH Tầm nhìn và Liên danh (VISION & ASSOCIATES CO.LTD.)  
(55)

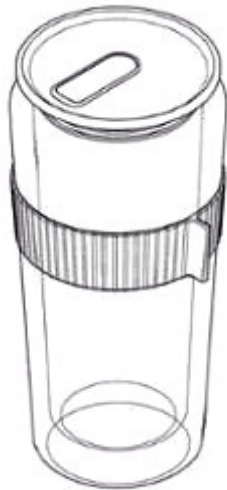

1.1

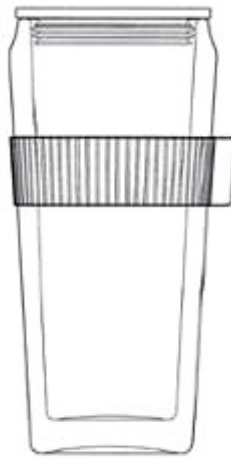

1.2

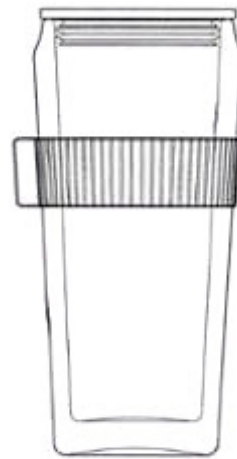

1.3

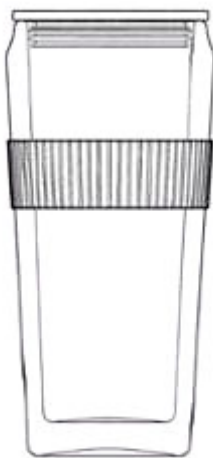

1.4

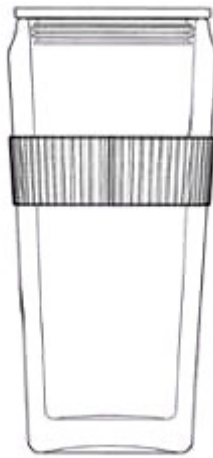

1.5



1.6

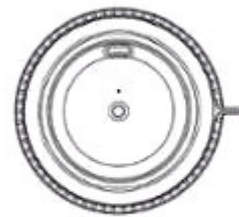

1.7



- (11) **42151**  
(21) 3-2021-00988 (28) 1  
(54) **BÌNH** (51) **07-07; 09-01**  
(22) 28/04/2021 (43) 26/07/2021  
(30) 30-2020-0051951 29/10/2020 KR;  
**LOCK & LOCK CO., LTD (KR)**  
(73) 104, Sapgyocheon-ro, Seonjang-myeon, Asan-si, Chungcheongnam-do, Republic of Korea  
(72) KIM, Kwang Ik (KR)  
(74) Công ty TNHH Tầm nhìn và Liên danh (VISION & ASSOCIATES CO.LTD.)  
(55)

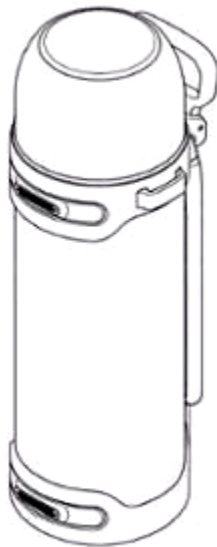

1.1

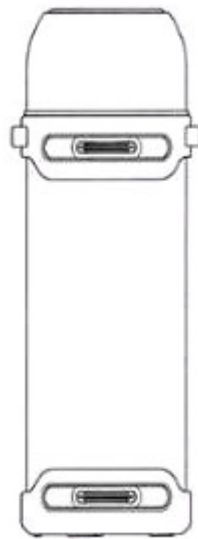

1.2



1.3

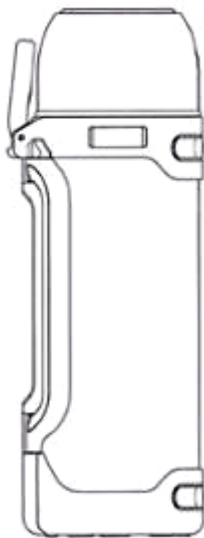

1.4

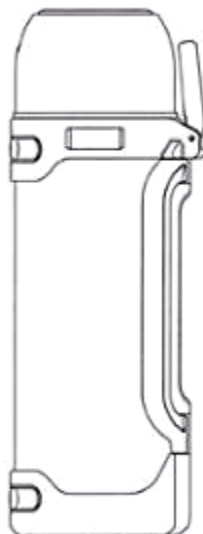

1.5



1.6



1.7

**CÔNG BÁO SỞ HỮU CÔNG NGHIỆP SỐ 400 TẬP A – QUYỀN 2 (07.2021)**

- (11) **42152**  
(21) 3-2021-00989 (28) 1  
(54) **BÌNH** (51) **07-07; 09-01**  
(22) 28/04/2021 (43) 26/07/2021  
(30) 30-2020-0051952 29/10/2020 KR;  
**LOCK & LOCK CO., LTD (KR)**  
(73) 104, Sapgyocheon-ro, Seonjang-myeon, Asan-si, Chungcheongnam-do, Republic of Korea  
(72) KIM, Kwang Ik (KR)  
(74) Công ty TNHH Tầm nhìn và Liên danh (VISION & ASSOCIATES CO.LTD.)  
(55)



1.1



1.2



1.3



1.4

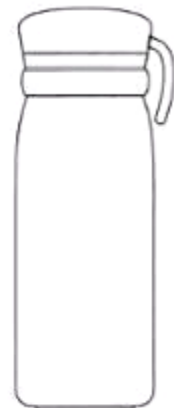

1.5



1.6



1.7

**CÔNG BÁO SỞ HỮU CÔNG NGHIỆP SỐ 400 TẬP A – QUYỀN 2 (07.2021)**

- (11) **42153**  
(21) 3-2021-00990 (28) 1  
(54) **BÌNH** (51) **07-07; 09-01**  
(22) 28/04/2021 (43) 26/07/2021  
(30) 30-2020-0051953 29/10/2020 KR;  
**LOCK & LOCK CO., LTD (KR)**  
(73) 104, Sapgyocheon-ro, Seonjang-myeon, Asan-si, Chungcheongnam-do, Republic of Korea  
(72) KIM, Kwang Ik (KR)  
(74) Công ty TNHH Tầm nhìn và Liên danh (VISION & ASSOCIATES CO.LTD.)  
(55)



1.1



1.2



1.3



1.4



1.5



1.6



1.7

- (11) **42154**  
(21) 3-2021-00991 (28) 1  
(54) **BÌNH** (51) **07-07; 09-01**  
(22) 28/04/2021 (43) 26/07/2021  
(30) 30-2020-0051954 29/10/2020 KR;  
**LOCK & LOCK CO., LTD (KR)**  
(73) 104, Sapgyocheon-ro, Seonjang-myeon, Asan-si, Chungcheongnam-do, Republic of Korea  
(72) LEE, Kyung Mee (KR)  
(74) Công ty TNHH Tầm nhìn và Liên danh (VISION & ASSOCIATES CO.LTD.)  
(55)

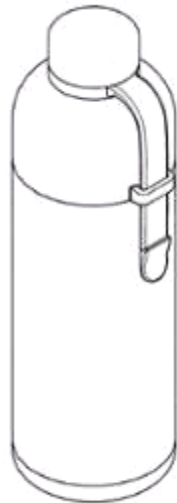

1.1



1.2



1.3



1.4



1.5



1.6

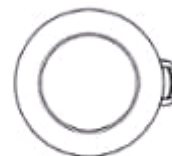

1.7

- (11) **42155**  
(21) 3-2021-00992 (28) 1  
(54) **NẮP BÌNH** (51) **09-07**  
(22) 28/04/2021 (43) 26/07/2021  
(30) 30-2020-0052082 30/10/2020 KR;  
**LOCK & LOCK CO., LTD (KR)**  
(73) 104, Sapgyocheon-ro, Seonjang-myeon, Asan-si, Chungcheongnam-do, Republic of Korea  
(72) LEE, Kyung Mee (KR)  
(74) Công ty TNHH Tầm nhìn và Liên danh (VISION & ASSOCIATES CO.LTD.)  
(55)



1.1



1.2



1.3

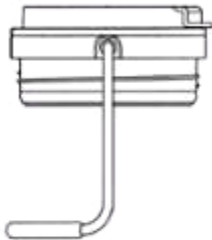

1.4

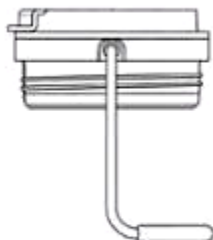

1.5

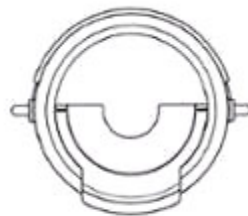

1.6

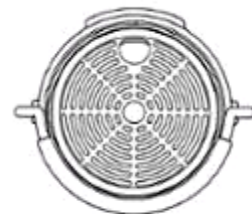

1.7

**CÔNG BÁO SỞ HỮU CÔNG NGHIỆP SỐ 400 TẬP A – QUYỀN 2 (07.2021)**

- (11) **42156**  
(21) 3-2021-00993 (28) 1  
(54) **NẮP BÌNH** (51) **09-07**  
(22) 28/04/2021 (43) 26/07/2021  
(30) 30-2020-0052083 30/10/2020 KR;  
**LOCK & LOCK CO., LTD (KR)**  
(73) 104, Sapgyocheon-ro, Seonjang-myeon, Asan-si, Chungcheongnam-do, Republic of Korea  
(72) LEE, Kyung Mee (KR)  
(74) Công ty TNHH Tầm nhìn và Liên danh (VISION & ASSOCIATES CO.LTD.)  
(55)



1.1



1.2



1.3



1.4



1.5



1.6



1.7

- (11) **42157**  
(21) 3-2021-00994 (28) 1  
(54) **HỘP CƠM GIỮ NHIỆT** (51) **07-07**  
(22) 28/04/2021 (43) 26/07/2021  
(30) 30-2020-0052085 30/10/2020 KR;  
**LOCK &. LOCK CO., LTD (KR)**  
(73) 104, Sapgyocheon-ro, Seonjang-myeon, Asan-si, Chungcheongnam-do, Republic of Korea  
(72) KIM, Kwang Ik (KR)  
(74) Công ty TNHH Tầm nhìn và Liên danh (VISION & ASSOCIATES CO.LTD.)  
(55)



1.1

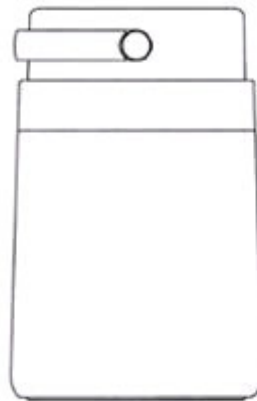

1.2

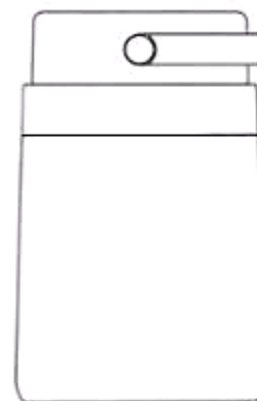

1.3

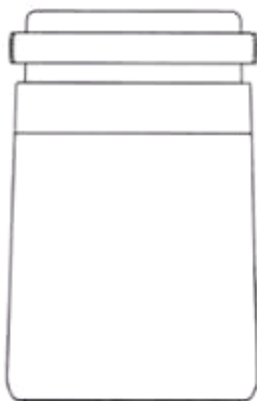

1.4

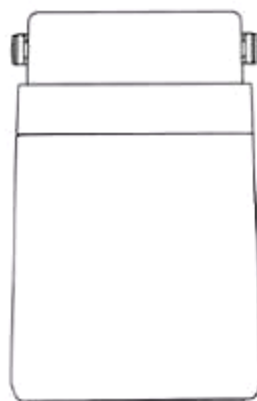

1.5



1.6

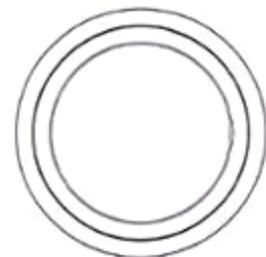

1.7

- (11) **42158**  
(21) 3-2021-00995 (28) 1  
(54) **CỐC** (51) **07-01**  
(22) 28/04/2021 (43) 26/07/2021  
(30) 30-2020-0052086 30/10/2020 KR;  
**LOCK & LOCK CO., LTD (KR)**  
(73) 104, Sapgyocheon-ro, Seonjang-myeon, Asan-si, Chungcheongnam-do, Republic of Korea  
(72) KIM, Kwang Ik (KR)  
(74) Công ty TNHH Tầm nhìn và Liên danh (VISION & ASSOCIATES CO.LTD.)  
(55)

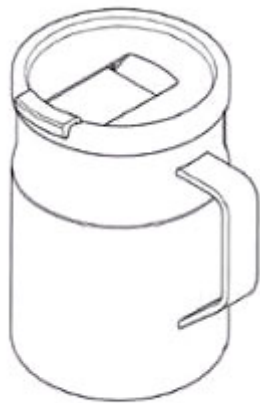

1.1



1.2



1.3

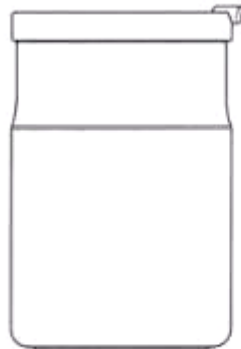

1.4

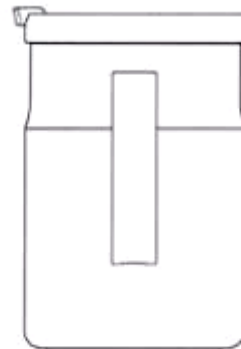

1.5

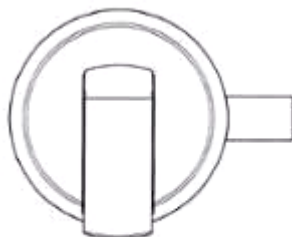

1.6

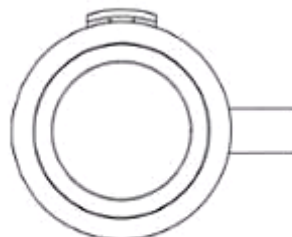

1.7



- (11) **42159**  
(21) 3-2021-00996 (28) 1  
(54) **BÌNH** (51) **07-07; 09-01**  
(22) 28/04/2021 (43) 26/07/2021  
(30) 30-2020-0053559 06/11/2020 KR;  
**LOCK & LOCK CO., LTD (KR)**  
(73) 104, Sapgyocheon-ro, Seonjang-myeon, Asan-si, Chungcheongnam-do, Republic of Korea  
(72) KIM, Kwang Ik (KR)  
(74) Công ty TNHH Tầm nhìn và Liên danh (VISION & ASSOCIATES CO.LTD.)  
(55)



1.1

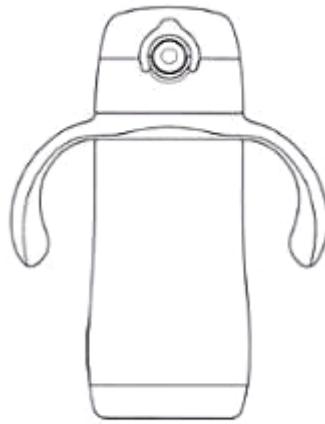

1.2

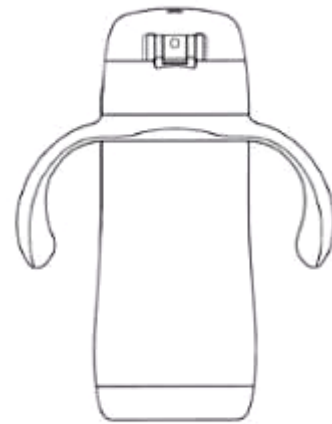

1.3



1.4



1.5



1.6



1.7

- (11) **42160**  
(21) 3-2021-00997 (28) 1  
(54) **BÌNH** (51) **07-07; 09-01**  
(22) 28/04/2021 (43) 26/07/2021  
(30) 30-2020-0053560 06/11/2020 KR;  
**LOCK & LOCK CO., LTD (KR)**  
(73) 104, Sapgyocheon-ro, Seonjang-myeon, Asan-si, Chungcheongnam-do, Republic of Korea  
(72) KIM, Kwang Ik (KR)  
(74) Công ty TNHH Tầm nhìn và Liên danh (VISION & ASSOCIATES CO.LTD.)  
(55)



1.1

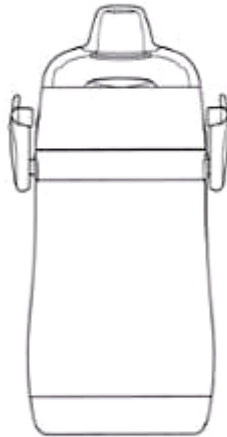

1.2

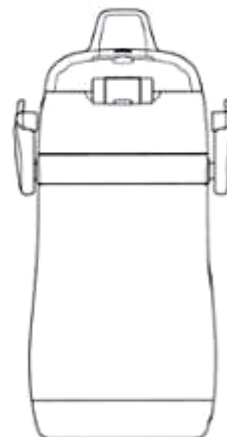

1.3



1.4



1.5

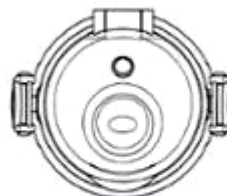

1.6



1.7

(11) **42161**

(21) 3-2021-00998

(28) 1

(54) **MÁY ĐƯA VÕNG**

(51) **15-99**

(22) 29/04/2021

(43) 26/07/2021

**CÔNG TY CỔ PHẦN TƯƠNG LAI VIỆT (VN)**

(73) Số 43 đường 72, ấp Đình, xã Tân Phú Trung, huyện Củ Chi, thành phố Hồ Chí Minh

(72) 1. PHẠM TRƯỜNG SANG (VN)

2. VÕ MINH THẠNH (VN)

(55)



1.1



1.2



1.3

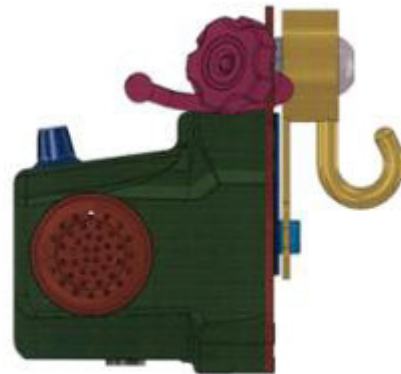

1.4

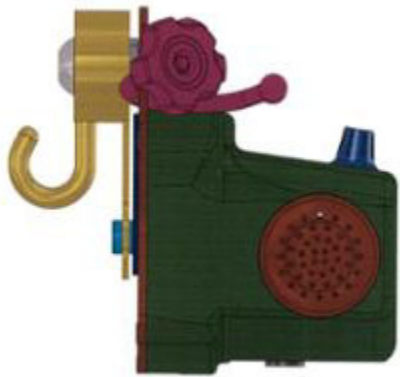

1.5



1.6



1.7



1.8



1.9

**CÔNG BÁO SỞ HỮU CÔNG NGHIỆP SỐ 400 TẬP A – QUYỀN 2 (07.2021)**

- (11) **42162**  
(21) 3-2021-01000 (28) 1  
(54) **DỤNG CỤ CẮT VÀ LÀM KÍN CỬA THÙNG RÁC** (51) **09-09**  
(22) 29/04/2021 (43) 26/07/2021  
(30) 30-2020-0051857 29/10/2020 KR;  
**JANIBELL, INC. (US)**  
(73) 12000 Jersey Court. Unit 103, Rancho Cucamonga, CA 91730 U.S.A  
(72) KIM, Bum Kee (US)  
(74) Công ty TNHH Sở hữu trí tuệ VIPATCO (VIPATCO CO., LTD.)  
(55)

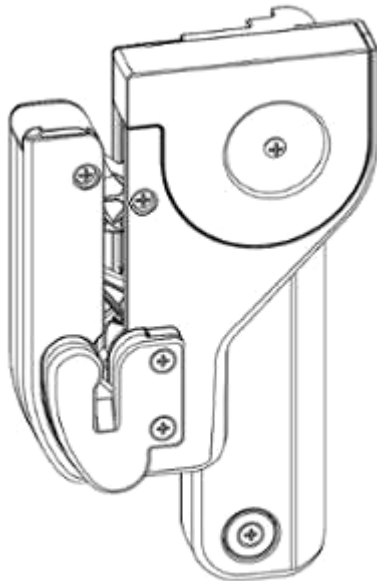

1.1

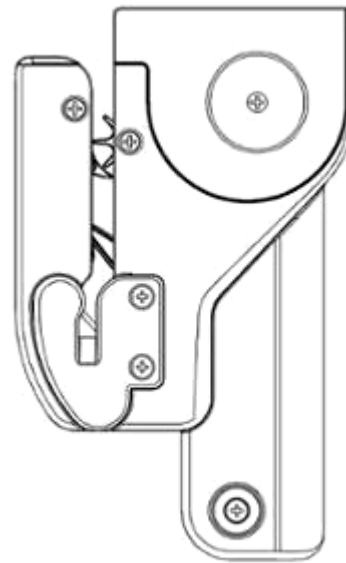

1.2

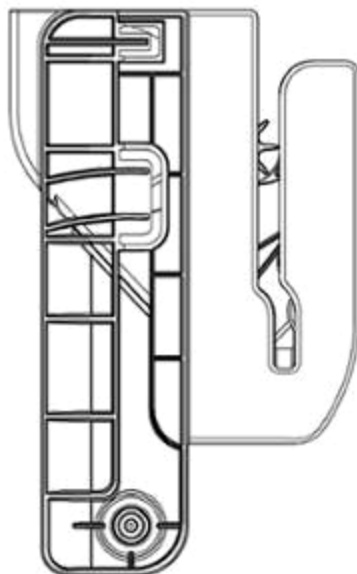

1.3

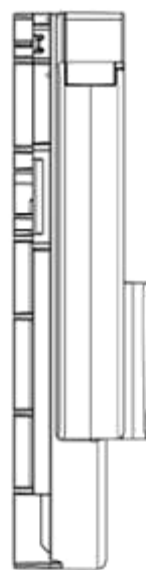

1.4

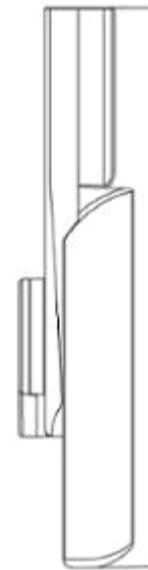

1.5

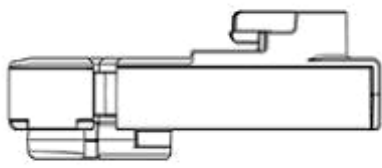

1.6

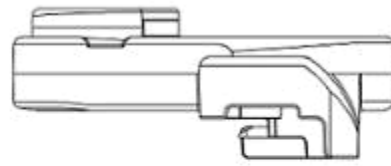

1.7



1.8

**CÔNG BÁO SỞ HỮU CÔNG NGHIỆP SỐ 400 TẬP A – QUYỀN 2 (07.2021)**

- (11) **42163**  
(21) 3-2021-01001 (28) 1  
(54) **CAN** (51) **09-02**  
(22) 29/04/2021 (43) 26/07/2021  
(73) **CÔNG TY CỔ PHẦN METAL AND PLASTIC PACKAGING (VN)**  
Lô E11, E12, KCN Cầu Tràm, xã Long Trạch, huyện Cần Đức, Long An  
(72) Nguyễn Minh Trí (VN)  
(74) Công ty TNHH Tư vấn sở hữu trí tuệ Việt (VIET IP CO.,LTD.)  
(55)



1.1



1.2



1.3



1.4



1.5



1.6



1.7

**CÔNG BÁO SỞ HỮU CÔNG NGHIỆP SỐ 400 TẬP A – QUYỀN 2 (07.2021)**

- (11) **42164**  
(21) 3-2021-01002 (28) 1  
(54) **HỘP ĐỰNG THỰC PHẨM BẢO VỆ SỨC KHỎE** (51) **09-03**  
(22) 29/04/2021 (43) 26/07/2021  
(73) **VŨ THỊ PHƯƠNG (VN)**  
Khu ĐT Dệt May, phường Năng Tĩnh, thành phố Nam Định, tỉnh Nam Định  
(72) Vũ Thị Phương (VN)  
(55)



1.1



1.2



**CÔNG BÁO SỞ HỮU CÔNG NGHIỆP SỐ 400 TẬP A – QUYỀN 2 (07.2021)**

- (11) **42165**  
(21) 3-2021-01003 (28) 1  
(54) **HỘP ĐỰNG THỰC PHẨM BẢO VỆ SỨC KHỎE** (51) **09-03**  
(22) 29/04/2021 (43) 26/07/2021  
(73) **VŨ THỊ PHƯƠNG (VN)**  
Khu ĐT Dệt May, phường Năng Tĩnh, thành phố Nam Định, tỉnh Nam Định  
(72) Vũ Thị Phương (VN)  
(55)



1.1



1.2

**CÔNG BÁO SỞ HỮU CÔNG NGHIỆP SỐ 400 TẬP A – QUYỀN 2 (07.2021)**

(11) **42166**

(21) 3-2021-01006

(28) 2

(54) **BỘ NHÃN SẢN PHẨM**

(51) **19-08**

(22) 29/04/2021

(43) 26/07/2021

**CÔNG TY CỔ PHẦN THỰC PHẨM BÌNH TÂY (VN)**

(73) Khu A, lô L01-03-05-07-09A đường số 8, KCX Tân Thuận, phường Tân Thuận Đông, quận 7, thành phố Hồ Chí Minh

(72) Lê Thị Giàu (VN)

(74) Công ty TNHH Sở hữu trí tuệ PADEMARK (PADEMARK CO.,LTD.)

(55)



1.1



1.2



1.3

**CÔNG BÁO SỞ HỮU CÔNG NGHIỆP SỐ 400 TẬP A – QUYỀN 2 (07.2021)**

(11) **42167**

(21) 3-2021-01007

(28) 2

(54) **BỘ NHÃN SẢN PHẨM**

(51) **19-08**

(22) 29/04/2021

(43) 26/07/2021

**CÔNG TY CỔ PHẦN THỰC PHẨM BÌNH TÂY (VN)**

(73) Khu A, lô L01-03-05-07-09A đường số 8, KCX Tân Thuận, phường Tân Thuận Đông, quận 7, thành phố Hồ Chí Minh

(72) Lê Thị Giàu (VN)

(74) Công ty TNHH Sở hữu trí tuệ PADEMARK (PADEMARK CO.,LTD.)

(55)



1.1



1.2

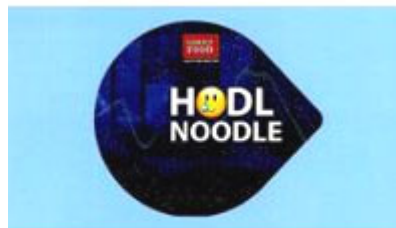

1.3

- (11) **42168**  
(21) 3-2021-01009 (28) 1  
(54) **MÁY IN** (51) **18-02**  
(22) 29/04/2021 (43) 26/07/2021  
(30) 2020-023941 06/11/2020 JP;  
**BROTHER INDUSTRIES, LTD. (JP)**  
(73) 15-1 Naeshiro-cho, Mizuho-ku, Nagoya-shi, Aichi-ken, Japan  
1. TAKAHIRO MOTOYAMA (JP)  
(72) 2. TOSHIYA INADA (JP)  
3. TAKAHIRO MOTOYAMA (JP)  
(74) Công ty TNHH Ban Ca (BANCA)  
(55)



1.1

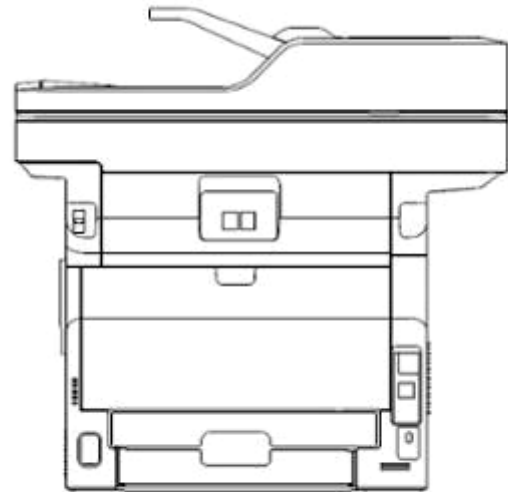

1.2

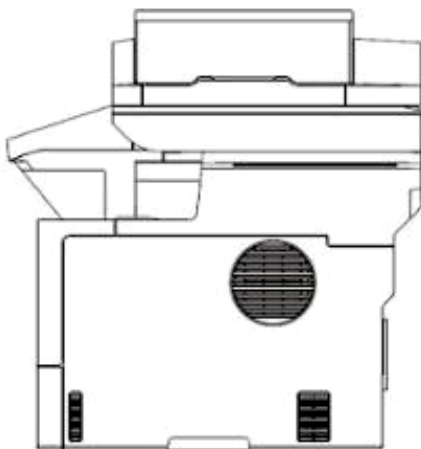

1.3

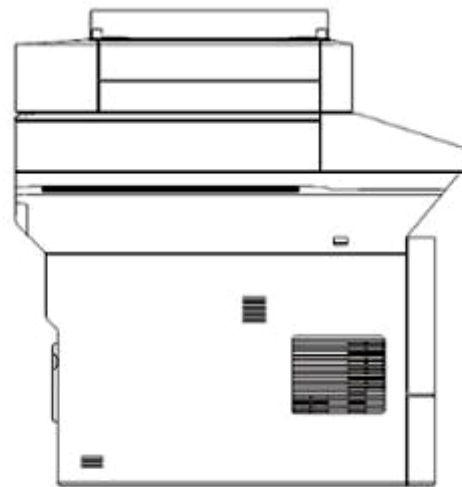

1.4

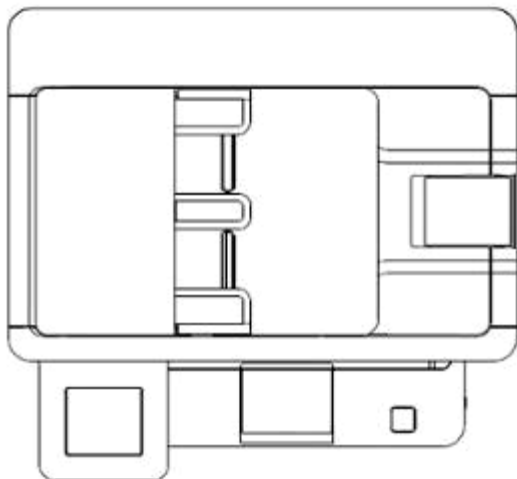

1.5

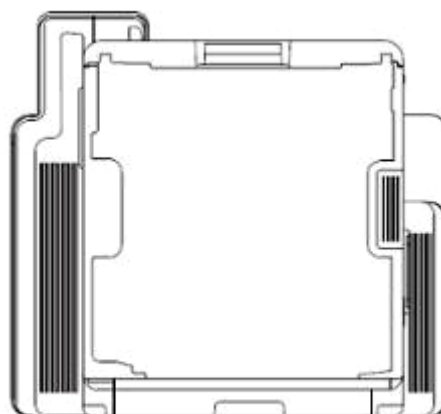

1.6



1.7

- (11) **42169**  
(21) 3-2021-01016 (28) 1  
(54) **BÀN** (51) **06-03**  
(22) 29/04/2021 (43) 26/07/2021  
(73) **CÔNG TY TNHH KIẾN TRÚC & XÂY DỰNG SMA STUDIO (VN)**  
Số 44A19, tổ 3, phường Nghĩa Tân, quận Cầu Giấy, thành phố Hà Nội  
(72) Nguyễn Phương Chi (VN)  
(74) Công ty TNHH Tư vấn Quốc Dân (NACI CO., LTD)  
(55)



1.1



1.2



1.3



1.4



1.5

**CÔNG BÁO SỞ HỮU CÔNG NGHIỆP SỐ 400 TẬP A – QUYỀN 2 (07.2021)**

(11) **42170**

(21) 3-2021-01018

(28) 1

(54) **GHẾ**

(51) **06-01**

(22) 29/04/2021

(43) 26/07/2021

(73) **CÔNG TY TNHH KIẾN TRÚC & XÂY DỰNG SMA STUDIO (VN)**  
Số 44A19, tổ 3, phường Nghĩa Tân, quận Cầu Giấy, thành phố Hà Nội

(72) Nguyễn Phương Chi (VN)

(74) Công ty TNHH Tư vấn Quốc Dân (NACI CO., LTD)

(55)



1.1



1.2



1.3



1.4



1.5



1.6



1.7

**CÔNG BÁO SỞ HỮU CÔNG NGHIỆP SỐ 400 TẬP A – QUYỀN 2 (07.2021)**

(11) **42171**

(21) 3-2021-01019

(28) 1

(54) **GIƯỜNG**

(51) **06-02**

(22) 29/04/2021

(43) 26/07/2021

(73) **CÔNG TY TNHH KIẾN TRÚC & XÂY DỰNG SMA STUDIO (VN)**

Số 44A19, tổ 3, phường Nghĩa Tân, quận Cầu Giấy, thành phố Hà Nội

(72) Nguyễn Phương Chi (VN)

(74) Công ty TNHH Tư vấn Quốc Dân (NACI CO., LTD)

(55)



1.1



1.2



1.3



1.4



1.5





1.6



1.7

**CÔNG BÁO SỞ HỮU CÔNG NGHIỆP SỐ 400 TẬP A – QUYỀN 2 (07.2021)**

- (11) 42172  
(21) 3-2021-01021  
(54) **TRẠM QUAN TRẮC TỰ ĐỘNG KHÔNG KHÍ**  
(22) 04/05/2021  
(73) **CÔNG TY CỔ PHẦN CÔNG NGHỆ THÔNG MINH VÀ SÁNG TẠO (VN)**  
213 Nguyễn Tất Thành, phường Thanh Bình, quận Hải Châu, thành phố Đà Nẵng  
(72) Phạm Kim Sơn (VN)  
(55)  
(28) 1  
(51) 10-04  
(43) 26/07/2021



1.1



1.2



1.3



1.4



1.5



1.6



1.7

- (11) **42173**  
(21) 3-2021-01032 (28) 1  
(54) **BÚT** (51) **19-06**  
(22) 04/05/2021 (43) 26/07/2021  
(30) 30-2021-0017593 13/04/2021 KR;  
**DONG-A PENCIL CO., LTD. (KR)**  
(73) 4th Floor, Parkland Building, 601, Eonju-ro, Gangnam-gu, Seoul 06109, Republic of Korea  
(72) KIM, Hakjae (KR)  
(74) Công ty Luật TNHH ELITE (ELITE LAW FIRM)  
(55)



1.1



1.2

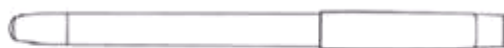

1.3



1.4



1.5

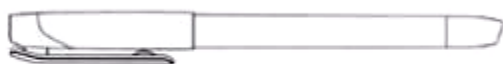

1.6



1.7

- (11) **42174**
- (21) 3-2021-01033
- (54) **CHẬU RỬA**
- (22) 05/05/2021
- (30) 2020-024830 18/11/2020 JP;
- (73) **YOSHIMOTO TRADING CO., LTD. (JP)**  
10-16, Minamisenba 1-chome, Chuo-ku, Osaka-shi, Osaka 542-0081 Japan
- (72) Akiyoshi YOSHIMOTO (JP)
- (74) Công ty Luật TNHH Phạm và Liên danh (PHAM & ASSOCIATES)
- (55)

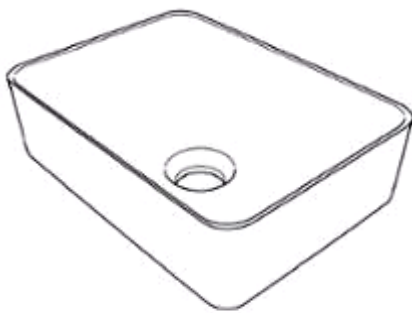

1.1



1.2



1.3

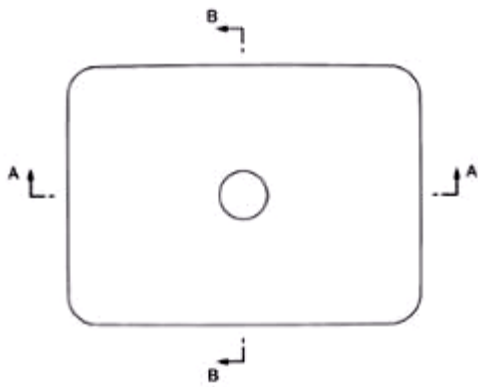

1.4



1.5

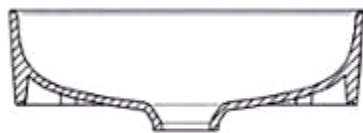

1.6

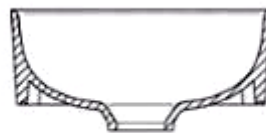

1.7



1.8

- (11) **42175**  
(21) 3-2021-01034 (28) 1  
(54) **CHẬU RỬA** (51) **23-02**  
(22) 05/05/2021 (43) 26/07/2021  
(30) 2020-024831 18/11/2020 JP;  
**YOSHIMOTO TRADING CO., LTD. (JP)**  
(73) 10-16, Minamisenba 1-chome, Chuo-ku, Osaka-shi, Osaka 542-0081 Japan  
(72) Akiyoshi YOSHIMOTO (JP)  
(74) Công ty Luật TNHH Phạm và Liên danh (PHAM & ASSOCIATES)  
(55)



1.1



1.2



1.3

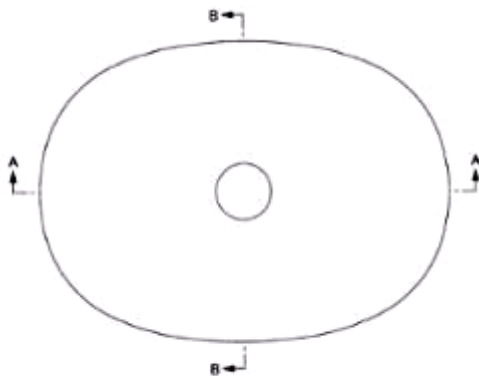

1.4



1.5

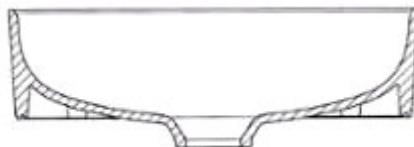

1.6

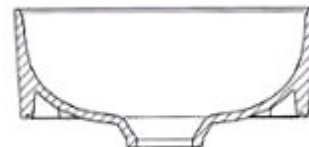

1.7



1.8

**CÔNG BÁO SỞ HỮU CÔNG NGHIỆP SỐ 400 TẬP A – QUYỀN 2 (07.2021)**

- (11) **42176**  
(21) 3-2021-01035 (28) 1  
(54) **CHẬU RỬA** (51) **23-02**  
(22) 05/05/2021 (43) 26/07/2021  
(30) 2020-024773 17/11/2020 JP;  
**YOSHIMOTO TRADING CO., LTD. (JP)**  
(73) 10-16, Minamisenba 1-chome, Chuo-ku, Osaka-shi, Osaka 542-0081 Japan  
(72) Akiyoshi YOSHIMOTO (JP)  
(74) Công ty Luật TNHH Phạm và Liên danh (PHAM & ASSOCIATES)  
(55)

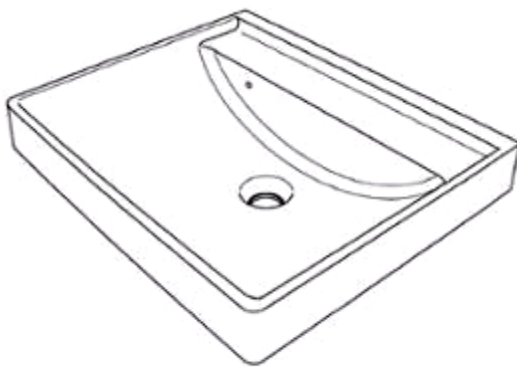

1.1

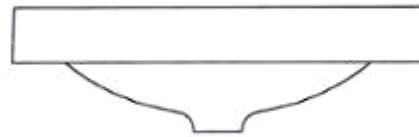

1.2



1.3

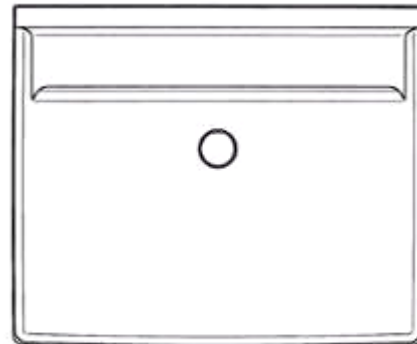

1.4



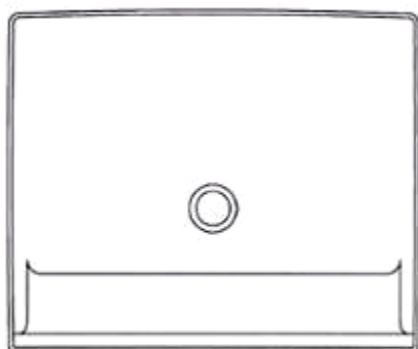

1.5

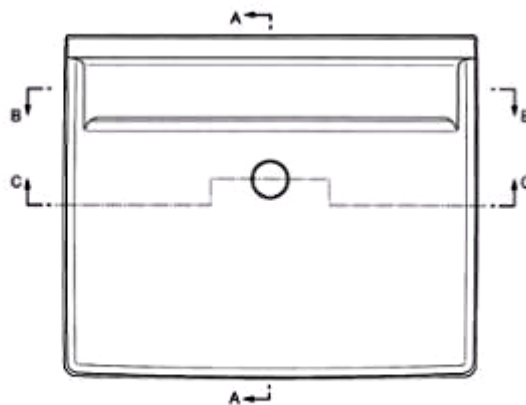

1.6



1.7



1.8



1.9



1.10

**CÔNG BÁO SỞ HỮU CÔNG NGHIỆP SỐ 400 TẬP A – QUYỀN 2 (07.2021)**

- (11) **42177**  
(21) 3-2021-01036 (28) 1  
(54) **DỤNG CỤ ẪN DẶM** (51) **07-01**  
(22) 05/05/2021 (43) 26/07/2021  
(30) 2021-003823 24/02/2021 JP;  
(73) **RICHELL CORPORATION (JP)**  
136 Mizuhashi sakuragi, Toyama-shi, Toyama, Japan  
(72) Makiko NAKATSUJI (JP)  
(74) Công ty Luật TNHH Phạm và Liên danh (PHAM & ASSOCIATES)  
(55)



1.1



1.2



1.3



1.4



1.5



1.6



1.7



1.8



1.9



1.10



1.11



1.12



1.13



1.14

**CÔNG BÁO SỞ HỮU CÔNG NGHIỆP SỐ 400 TẬP A – QUYỀN 2 (07.2021)**

(11) **42178**

(21) 3-2021-01042

(28) 1

(54) **MỐI NỐI**

(51) **08-08**

(22) 05/05/2021

(43) 26/07/2021

(73) **BENEL SINGAPORE PTE LTD (SG)**

59 Loyang Way, Singapore 508750

(72) Susiana Tjiu (SG)

(74) Công ty TNHH Trường Xuân (AGELESS CO.,LTD.)

(55)

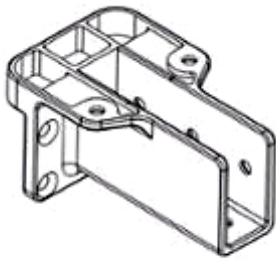

1.1

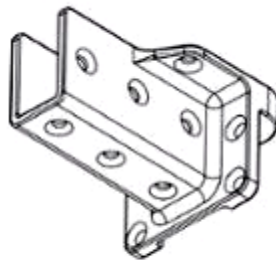

1.2

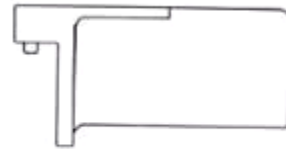

1.3

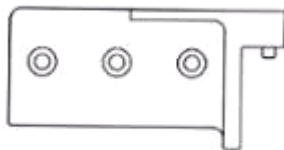

1.4

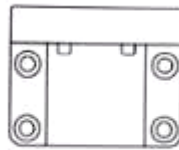

1.5

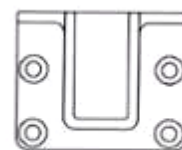

1.6

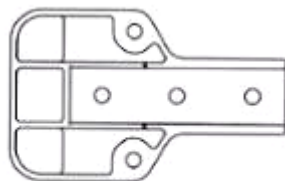

1.7

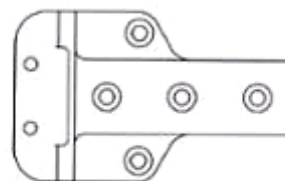

1.8

**CÔNG BÁO SỞ HỮU CÔNG NGHIỆP SỐ 400 TẬP A – QUYỀN 2 (07.2021)**

(11) **42179**

(21) 3-2021-01043

(28) 1

(54) **MỐI NỐI**

(51) **08-08**

(22) 05/05/2021

(43) 26/07/2021

(73) **BENEL SINGAPORE PTE LTD (SG)**

59 Loyang Way, Singapore 508750

(72) Susiana Tjiu (SG)

(74) Công ty TNHH Trường Xuân (AGELESS CO.,LTD.)

(55)

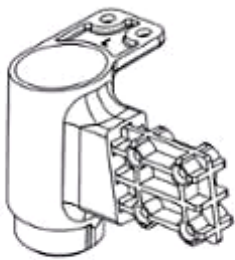

1.1

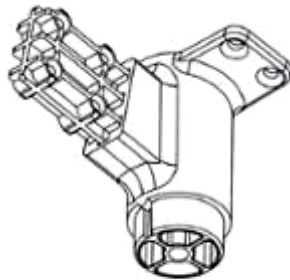

1.2

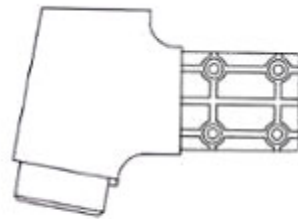

1.3

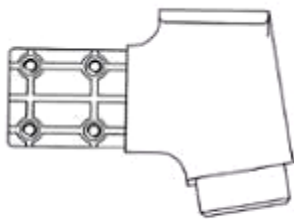

1.4

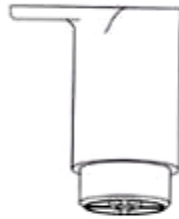

1.5

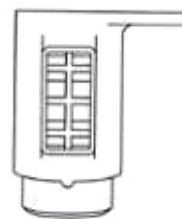

1.6

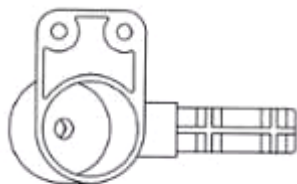

1.7

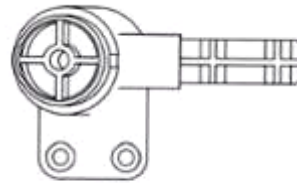

1.8

**CÔNG BÁO SỞ HỮU CÔNG NGHIỆP SỐ 400 TẬP A – QUYỀN 2 (07.2021)**

- (11) **42180**  
(21) 3-2021-01048 (28) 1  
(54) **BAO GÓI** (51) **09-05**  
(22) 06/05/2021 (43) 26/07/2021  
(73) **CÔNG TY TRÁCH NHIỆM HỮU HẠN HẠT GIỐNG C.P. VIỆT NAM (VN)**  
Lô I-4, đường số 1, KCN Định Quán, xã La Ngà, huyện Định Quán, tỉnh Đồng Nai  
(72) Wara Rojsirisup (TH)  
(74) **CÔNG TY TNHH SỞ HỮU TRÍ TUỆ SETHACO (SETHACO IP CO.,LTD)**  
(55)



1.1



1.2

**CÔNG BÁO SỞ HỮU CÔNG NGHIỆP SỐ 400 TẬP A – QUYỀN 2 (07.2021)**

- (11) **42181**  
(21) 3-2021-01049 (28) 1  
(54) **BAO GÓI** (51) **09-05**  
(22) 06/05/2021 (43) 26/07/2021  
(73) **CÔNG TY TRÁCH NHIỆM HỮU HẠN HẠT GIỐNG C.P. VIỆT NAM (VN)**  
Lô I-4, đường số 1, KCN Định Quán, xã La Ngà, huyện Định Quán, tỉnh Đồng Nai  
(72) Wara Rojsirisup (TH)  
(74) **CÔNG TY TNHH SỞ HỮU TRÍ TUỆ SETHACO (SETHACO IP CO.,LTD)**  
(55)



1.1



1.2

**CÔNG BÁO SỞ HỮU CÔNG NGHIỆP SỐ 400 TẬP A – QUYỀN 2 (07.2021)**

(11) **42182**

(21) 3-2021-01053

(28) 2

(54) **NHÃN**

(51) **11-01**

(22) 07/05/2021

(43) 26/07/2021

**CÔNG TY TNHH BẢO TÍN MINH CHÂU (VN)**

(73) Số 29 Trần Nhân Tông, phường Nguyễn Du, quận Hai Bà Trưng, thành phố Hà Nội

(72) Vũ Minh Châu (VN)

(55)



1.1



1.2



1.3



1.4



1.5



1.6



1.7



1.8



2.1



2.2



2.3



2.4



2.5



2.6



2.7



2.8



**CÔNG BÁO SỞ HỮU CÔNG NGHIỆP SỐ 400 TẬP A – QUYỀN 2 (07.2021)**

- (11) **42183**  
 (21) 3-2021-01055 (28) 6  
 (54) **VỈ ĐỰNG NHÃN VÀNG** (51) **09-05**  
 (22) 07/05/2021 (43) 26/07/2021  
**CÔNG TY TNHH BẢO TÍN MINH CHÂU (VN)**  
 (73) Số 29 Trần Nhân Tông, phường Nguyễn Du, quận Hai Bà Trưng, thành phố Hà Nội  
 (72) Vũ Minh Châu (VN)  
 (55)



1.1



1.2



1.3

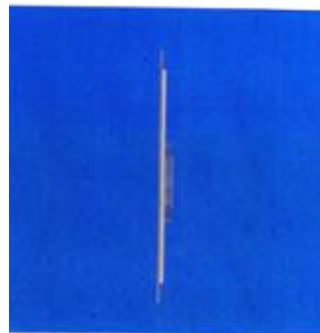

1.4



1.5



1.6



1.7



2.1



2.2



2.3



2.4

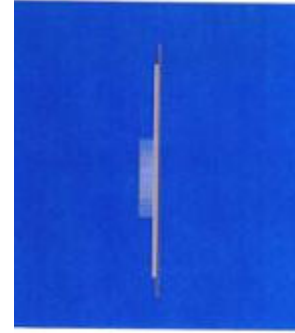

2.5

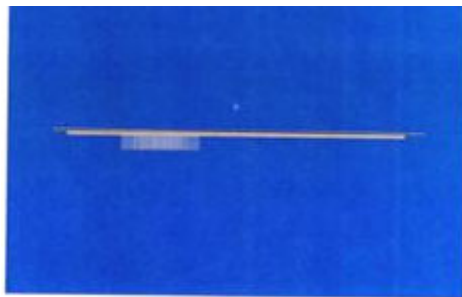

2.6

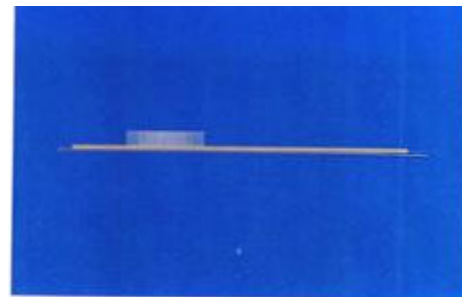

2.7



3.1



3.2



3.3

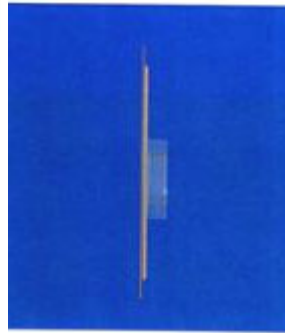

3.4

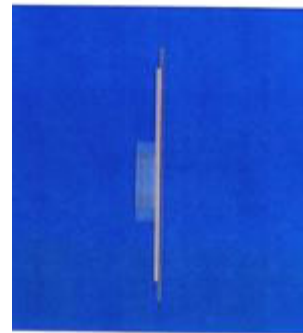

3.5

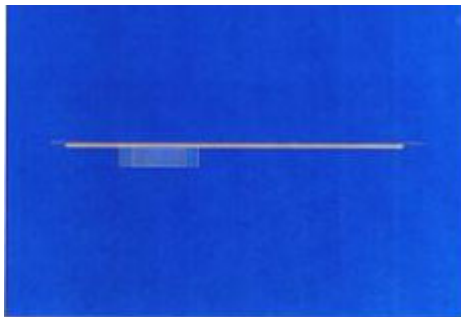

3.6

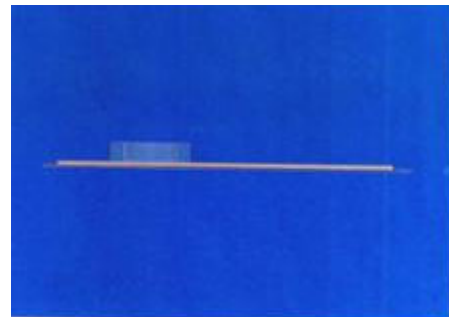

3.7



4.1



4.2



4.3

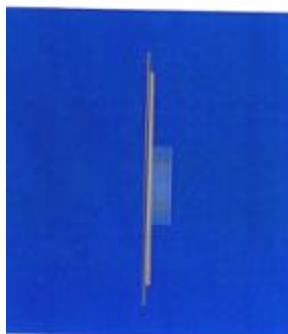

4.4

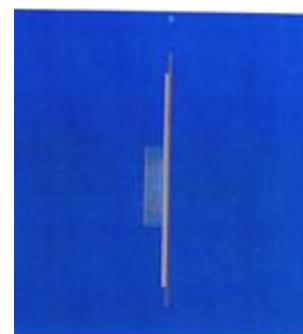

4.5

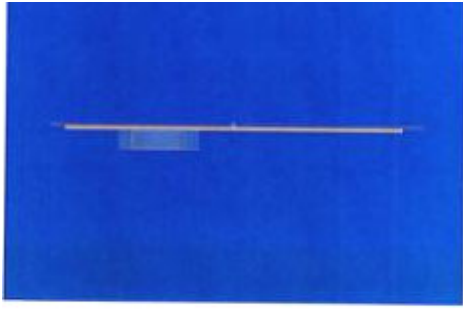

4.6

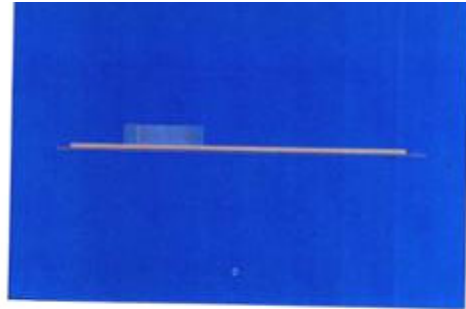

4.7



5.1



5.2



5.3



5.4

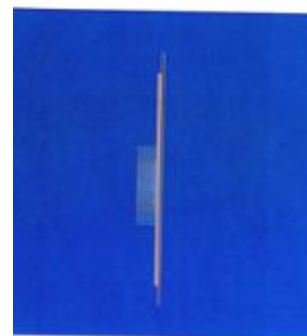

5.5

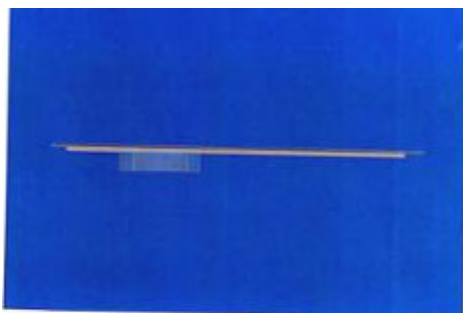

5.6

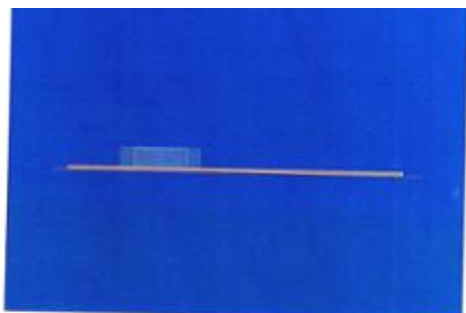

5.7



6.1



6.2



6.3

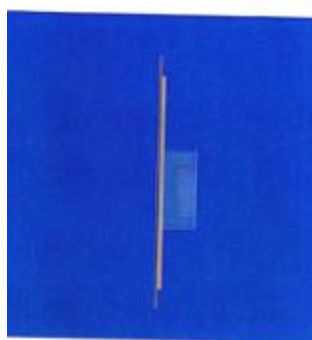

6.4



6.5

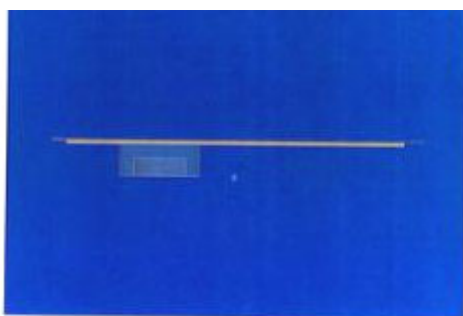

6.6

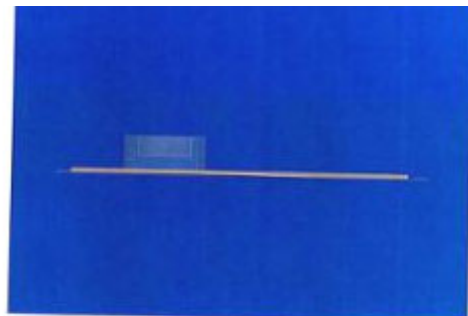

6.7

**CÔNG BÁO SỞ HỮU CÔNG NGHIỆP SỐ 400 TẬP A – QUYỀN 2 (07.2021)**

- (11) **42184**  
 (21) 3-2021-01056 (28) 6  
 (54) **VỈ ĐỰNG NHÃN VÀNG** (51) **09-05**  
 (22) 07/05/2021 (43) 26/07/2021  
**CÔNG TY TNHH BẢO TÍN MINH CHÂU (VN)**  
 (73) Số 29 Trần Nhân Tông, phường Nguyễn Du, quận Hai Bà Trưng, thành phố Hà Nội  
 (72) Vũ Minh Châu (VN)  
 (55)

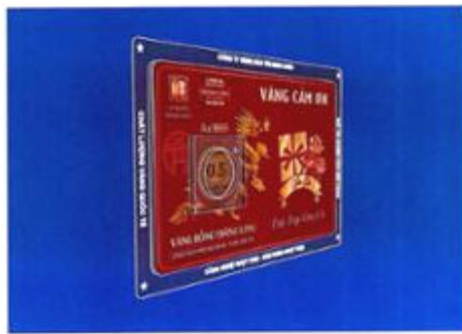

1.1



1.2



1.3



1.4



1.5



1.6

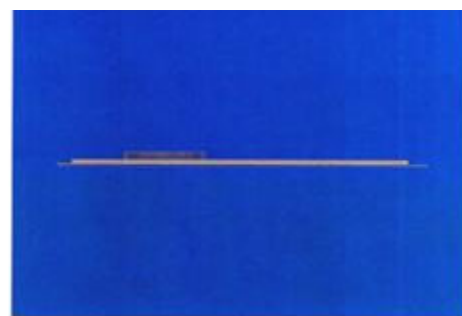

1.7



2.1



2.2



2.3



2.4



2.5

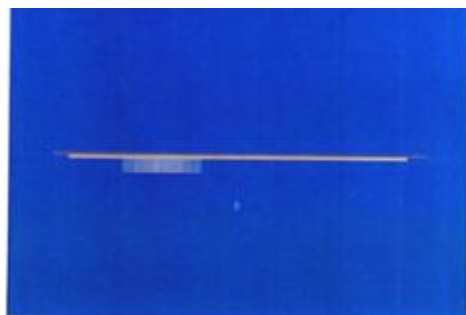

2.6

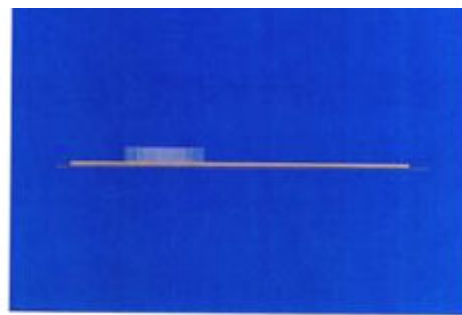

2.7



3.1



3.2



3.3



3.4



3.5

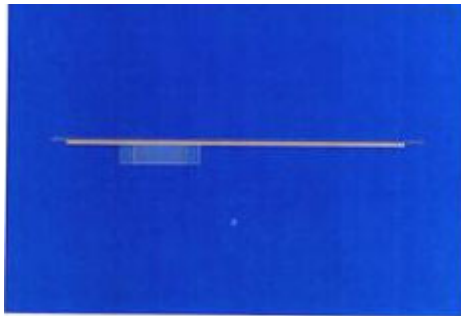

3.6

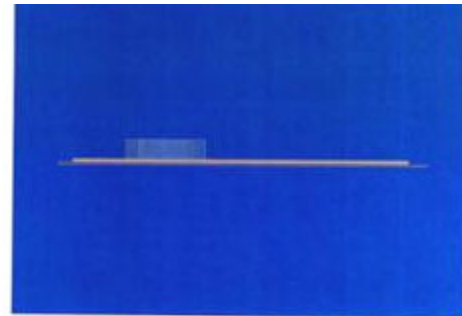

3.7



4.1



4.2



4.3

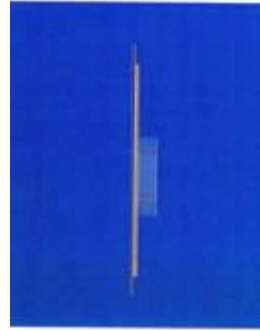

4.4

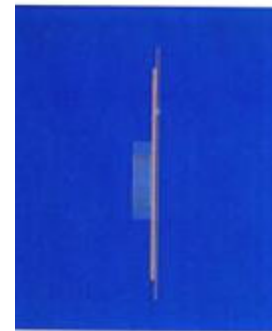

4.5



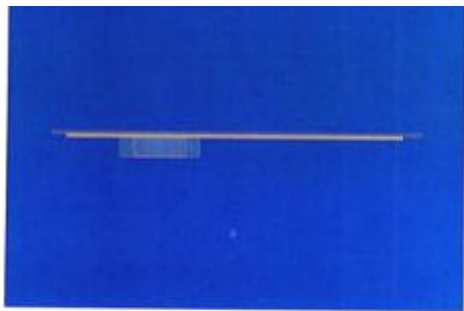

4.6

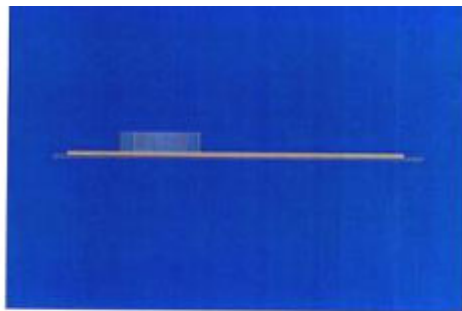

4.7



5.1



5.2



5.3



5.4



5.5

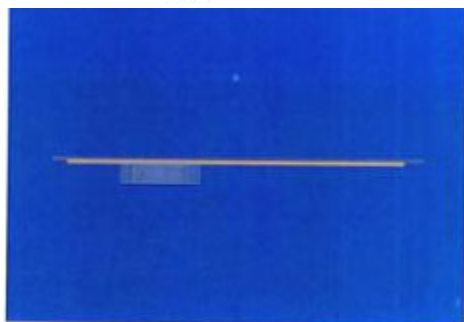

5.6

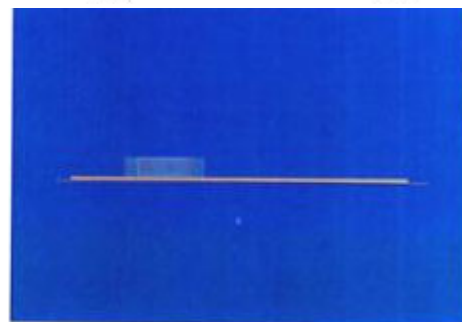

5.7



6.1



6.2



6.3

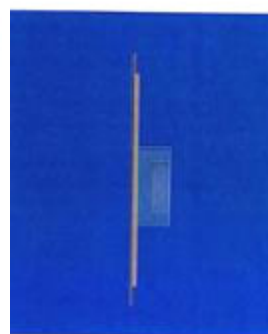

6.4



6.5

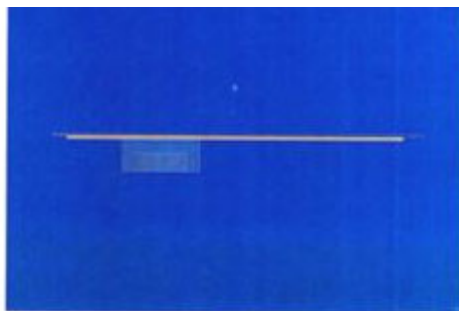

6.6

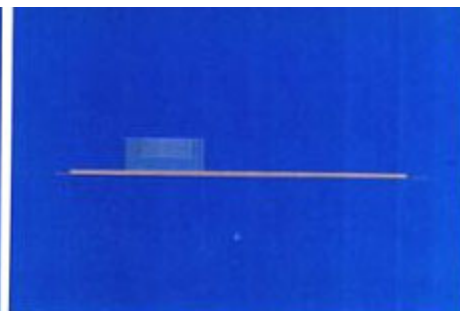

6.7

**CÔNG BÁO SỞ HỮU CÔNG NGHIỆP SỐ 400 TẬP A – QUYỀN 2 (07.2021)**

(11) **42185**

(21) 3-2021-01069

(28) 1

(54) **BỒN CẦU XẢ NƯỚC**

(51) **23-02**

(22) 07/05/2021

(43) 26/07/2021

- (73) 1. **NGUYỄN VĂN NAM (VN)**  
12 đường số 1 khu phố 2, phường Tân Phú, quận 7, thành phố Hồ Chí Minh  
2. **NGUYỄN NHẬT QUANG (VN)**  
11 Ngõ Đức Kế, phường Bến Nghé, quận 1, thành phố Hồ Chí Minh
- (72) 1. **NGUYỄN VĂN NAM (VN)**  
2. **NGUYỄN NHẬT QUANG (VN)**

(55)

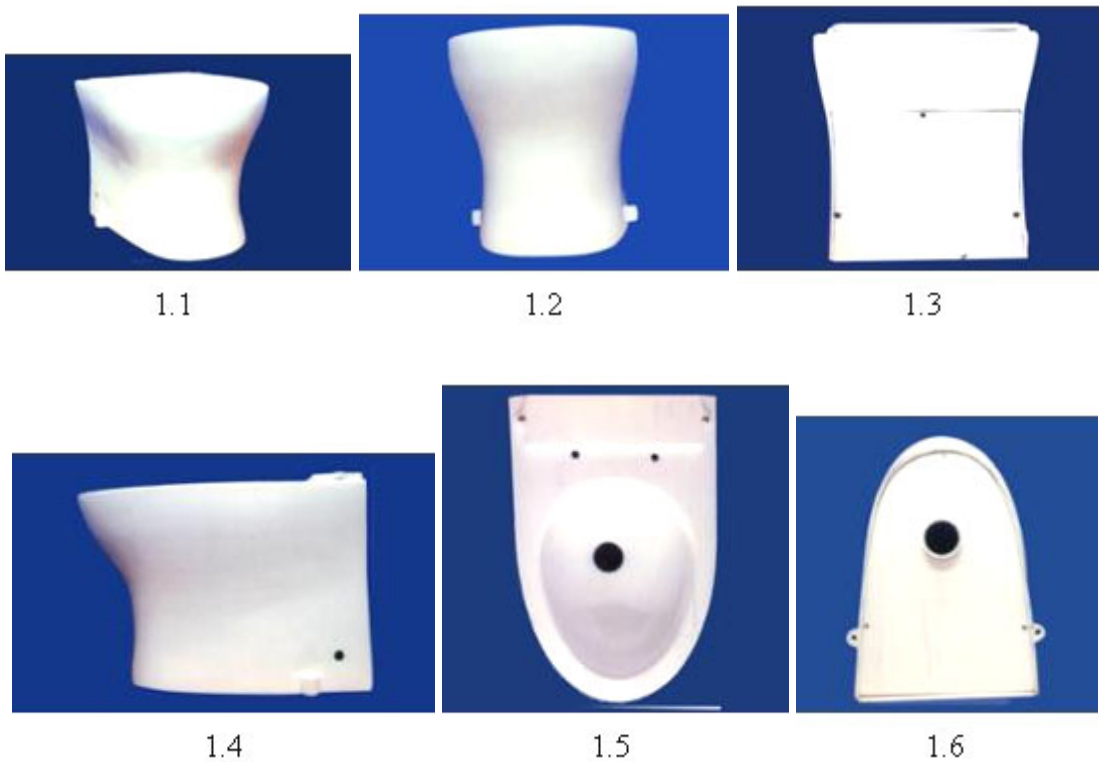

**CÔNG BÁO SỞ HỮU CÔNG NGHIỆP SỐ 400 TẬP A – QUYỀN 2 (07.2021)**

(11) **42186**

(21) 3-2021-01073

(28) 1

(54) **NHÃN SẢN PHẨM**

(51) **19-08**

(22) 10/05/2021

(43) 26/07/2021

**CÔNG TY TNHH ĐẦU TƯ PHÁT TRIỂN THƯƠNG MẠI VÀ DỊCH VỤ  
ĐẠT LINH HƯƠNG (VN)**

(73) Số 345 đường Nguyễn Văn Cừ, phường Võ Cường, thành phố Bắc Ninh, tỉnh Bắc Ninh

(72) Nguyễn Việt Hùng (VN)

(55)



**CÔNG BÁO SỞ HỮU CÔNG NGHIỆP SỐ 400 TẬP A – QUYỀN 2 (07.2021)**

- (11) **42187**  
(21) 3-2021-01148 (28) 1  
(54) **LỚP XE** (51) **12-15**  
(22) 10/05/2021 (43) 26/07/2021  
(30) 29/758,101 12/11/2020 US;  
(73) **COOPER TIRE & RUBBER COMPANY (US)**  
701 Lima Avenue, Findlay, Ohio, 45840, United States of America  
(72) Jason Q. Fu (CN)  
(74) **CÔNG TY LUẬT TRÁCH NHIỆM HỮU HẠN AMBYS HÀ NỘI (AMBYS HANOI)**  
(55)

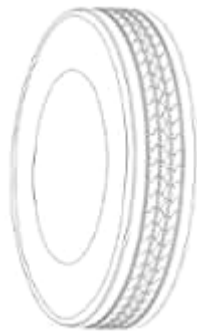

1.1



1.2



1.3



1.4

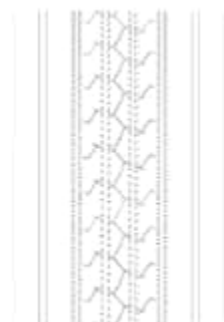

1.5



1.6

**CÔNG BÁO SỞ HỮU CÔNG NGHIỆP SỐ 400 TẬP A – QUYỀN 2 (07.2021)**

- (11) **42188**  
(21) 3-2021-01153 (28) 2  
(54) **NHÃN SẢN PHẨM** (51) **19-08**  
(22) 10/05/2021 (43) 26/07/2021  
(73) **CÔNG TY CỔ PHẦN D- SHINING (VN)**  
7C Nguyễn Ngọc Phương, phường 19, quận Bình Thạnh, thành phố Hồ Chí Minh  
(72) Nguyễn Thái Dương (VN)  
(74) Văn phòng Luật sư D và T (D & T LAW OFFICE)  
(55)



1.1



1.2



2.1



2.2

**CÔNG BÁO SỞ HỮU CÔNG NGHIỆP SỐ 400 TẬP A – QUYỀN 2 (07.2021)**

- (11) **42189**  
(21) 3-2021-01154 (28) 1  
(54) **NHÃN SẢN PHẨM** (51) **19-08**  
(22) 10/05/2021 (43) 26/07/2021  
(73) **CÔNG TY CỔ PHẦN D- SHINING (VN)**  
7C Nguyễn Ngọc Phương, phường 19, quận Bình Thạnh, thành phố Hồ Chí Minh  
(72) Nguyễn Thái Dương (VN)  
(74) Văn phòng Luật sư D và T (D & T LAW OFFICE)  
(55)



1.1



1.2

**CÔNG BÁO SỞ HỮU CÔNG NGHIỆP SỐ 400 TẬP A – QUYỀN 2 (07.2021)**

(11) **42190**

(21) 3-2021-01159

(28) 1

(54) **DÉP**

(51) **02-04**

(22) 11/05/2021

(43) 26/07/2021

**CÔNG TY TNHH SẢN XUẤT THƯƠNG MẠI XUẤT NHẬP KHẨU ĐỨC**

(73) **HOA (VN)**

Tỉnh lộ 830, ấp 3, xã An Thạnh, huyện Bến Lức, tỉnh Long An

(72) Từ Thiếu Linh (VN)

(74) Công ty TNHH Sở hữu trí tuệ Đại Diện (IPACO.,LTD.)

(55)

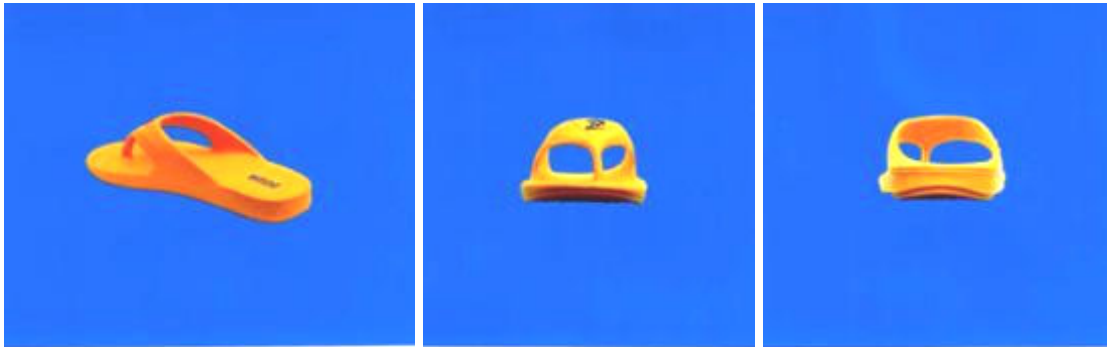

1.1

1.2

1.3

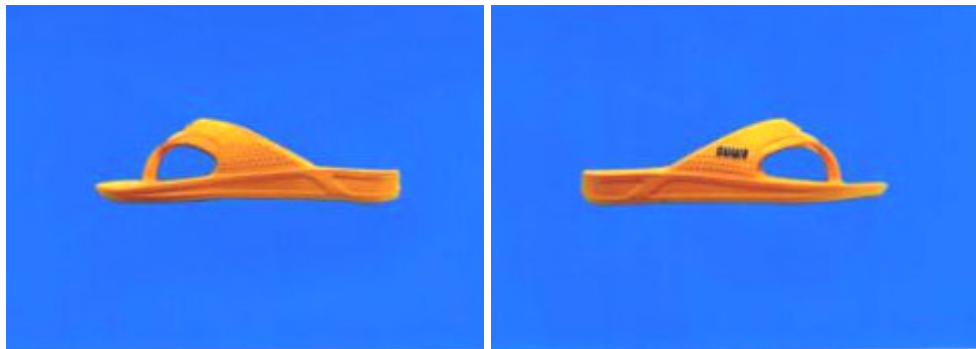

1.4

1.5

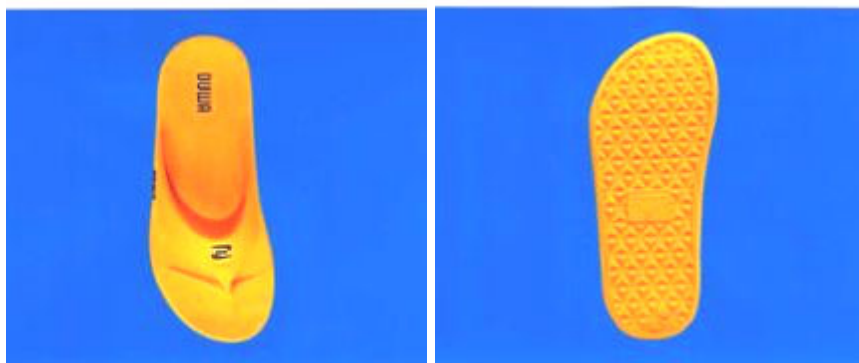

1.6

1.7



**CÔNG BÁO SỞ HỮU CÔNG NGHIỆP SỐ 400 TẬP A – QUYỀN 2 (07.2021)**

(11) **42191**

(21) 3-2021-01160

(28) 1

(54) **DÉP**

(51) **02-04**

(22) 11/05/2021

(43) 26/07/2021

**CÔNG TY TNHH SẢN XUẤT THƯƠNG MẠI XUẤT NHẬP KHẨU ĐỨC**

(73) **HOA (VN)**

Tỉnh lộ 830, ấp 3, xã An Thạnh, huyện Bến Lức, tỉnh Long An

(72) Từ Thiếu Linh (VN)

(74) Công ty TNHH Sở hữu trí tuệ Đại Diện (IPACO.,LTD.)

(55)

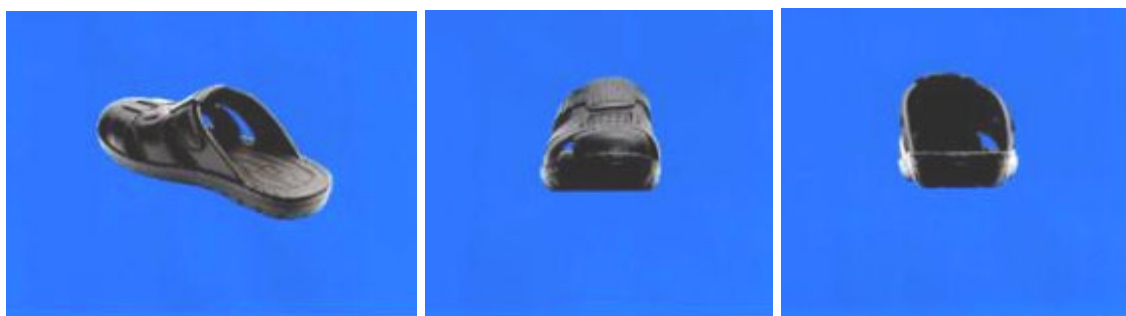

1.1

1.2

1.3

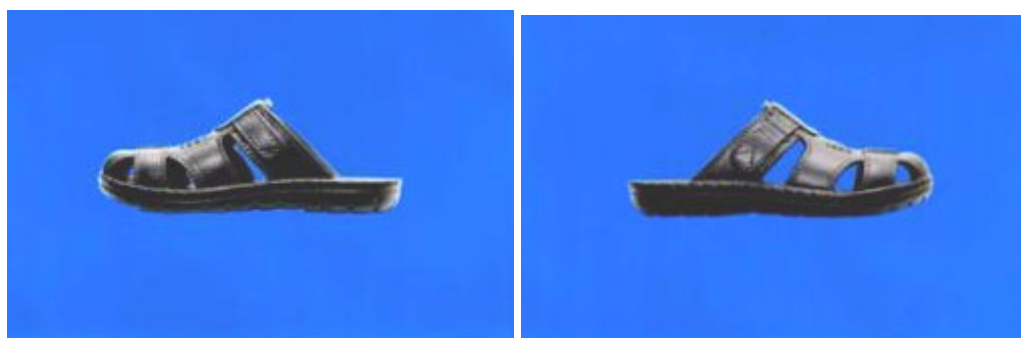

1.4

1.5



1.6

1.7

**CÔNG BÁO SỞ HỮU CÔNG NGHIỆP SỐ 400 TẬP A – QUYỀN 2 (07.2021)**

(11) **42192**

(21) 3-2021-01161

(28) 1

(54) **DÉP**

(51) **02-04**

(22) 11/05/2021

(43) 26/07/2021

**CÔNG TY TNHH SẢN XUẤT THƯƠNG MẠI XUẤT NHẬP KHẨU ĐỨC**

(73) **HOA (VN)**

Tỉnh lộ 830, ấp 3, xã An Thạnh, huyện Bến Lức, tỉnh Long An

(72) Từ Thiếu Linh (VN)

(74) Công ty TNHH Sở hữu trí tuệ Đại Diện (IPACO.,LTD.)

(55)

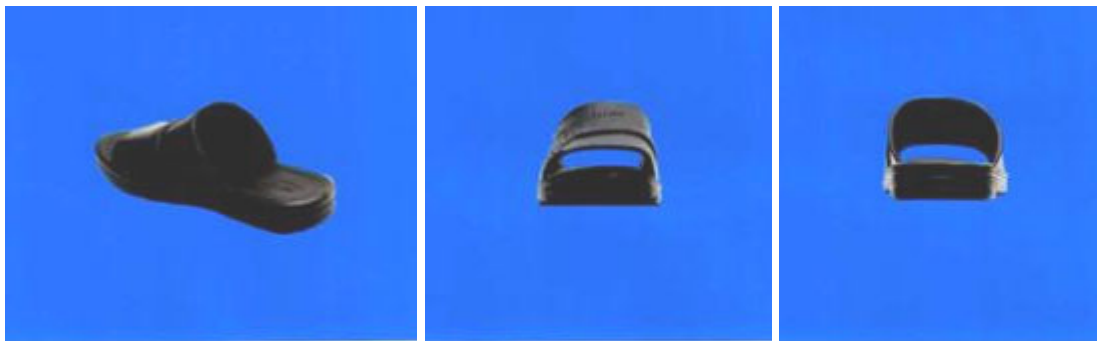

1.1

1.2

1.3

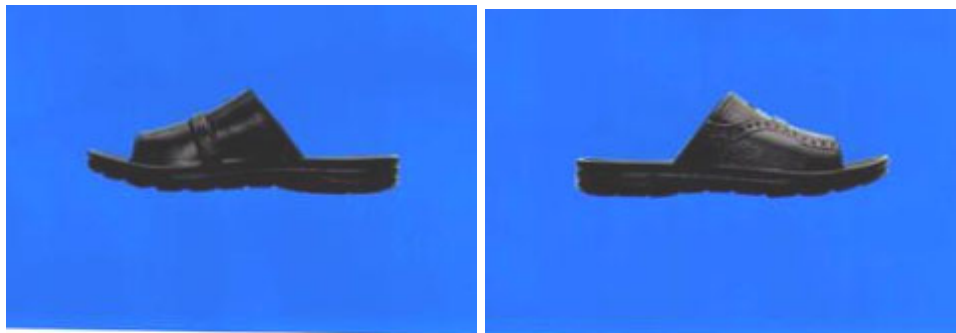

1.4

1.5



1.6

1.7

**CÔNG BÁO SỞ HỮU CÔNG NGHIỆP SỐ 400 TẬP A – QUYỀN 2 (07.2021)**

(11) **42193**

(21) 3-2021-01162

(28) 1

(54) **DÉP**

(51) **02-04**

(22) 11/05/2021

(43) 26/07/2021

**CÔNG TY TNHH SẢN XUẤT THƯƠNG MẠI XUẤT NHẬP KHẨU ĐỨC**

(73) **HOA (VN)**

Tỉnh lộ 830, ấp 3, xã An Thạnh, huyện Bến Lức, tỉnh Long An

(72) Từ Thiếu Linh (VN)

(74) Công ty TNHH Sở hữu trí tuệ Đại Diện (IPACO.,LTD.)

(55)



1.1

1.2

1.3

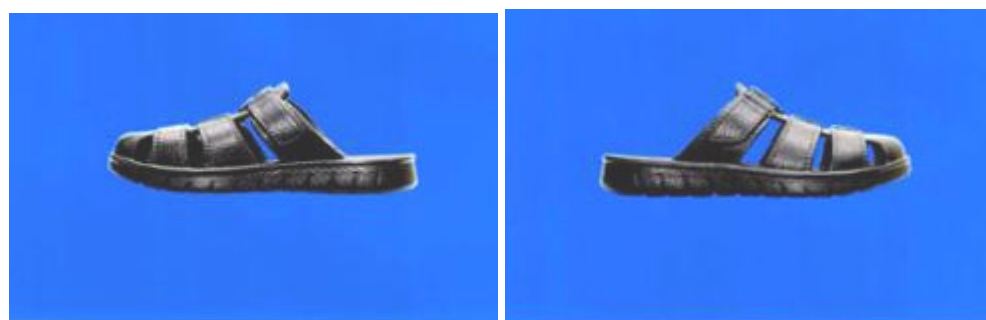

1.4

1.5



1.6

1.7

**CÔNG BÁO SỞ HỮU CÔNG NGHIỆP SỐ 400 TẬP A – QUYỀN 2 (07.2021)**

(11) **42194**

(21) 3-2021-01163

(28) 1

(54) **DÉP**

(51) **02-04**

(22) 11/05/2021

(43) 26/07/2021

**CÔNG TY TNHH SẢN XUẤT THƯƠNG MẠI XUẤT NHẬP KHẨU ĐỨC**

(73) **HOA (VN)**

Tỉnh lộ 830, ấp 3, xã An Thạnh, huyện Bến Lức, tỉnh Long An

(72) Từ Thiếu Linh (VN)

(74) Công ty TNHH Sở hữu trí tuệ Đại Diện (IPACO.,LTD.)

(55)



1.1

1.2

1.3

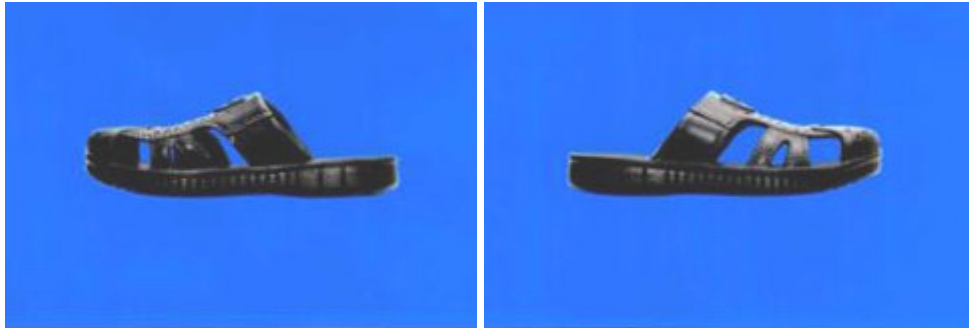

1.4

1.5

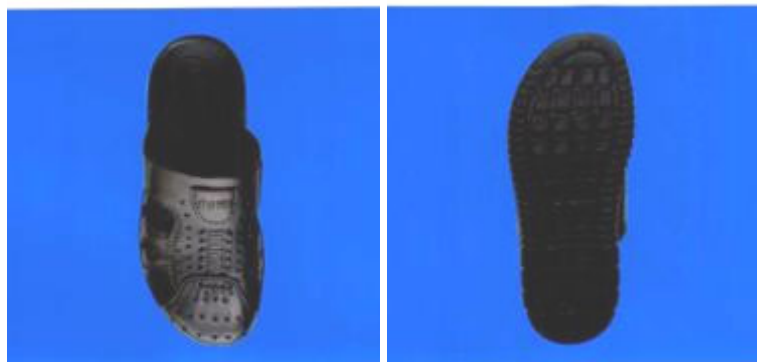

1.6

1.7

**CÔNG BÁO SỞ HỮU CÔNG NGHIỆP SỐ 400 TẬP A – QUYỀN 2 (07.2021)**

(11) **42195**

(21) 3-2021-01164

(28) 1

(54) **DÉP**

(51) **02-04**

(22) 11/05/2021

(43) 26/07/2021

**CÔNG TY TNHH SẢN XUẤT THƯƠNG MẠI XUẤT NHẬP KHẨU ĐỨC**

(73) **HOA (VN)**

Tỉnh lộ 830, ấp 3, xã An Thạnh, huyện Bến Lức, tỉnh Long An

(72) Từ Thiếu Linh (VN)

(74) Công ty TNHH Sở hữu trí tuệ Đại Diện (IPACO.,LTD.)

(55)

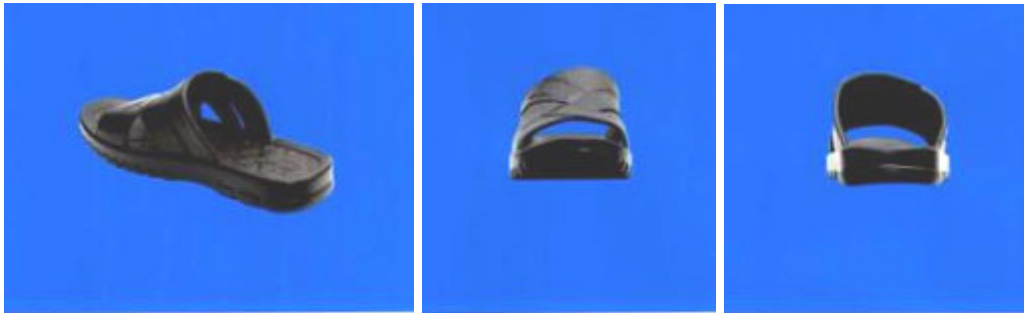

1.1

1.2

1.3

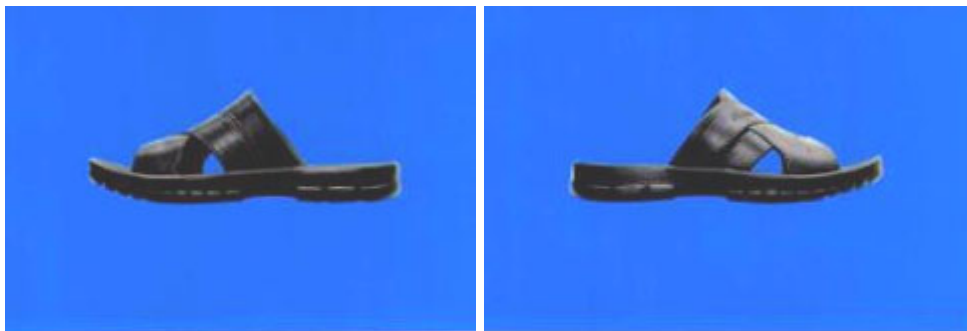

1.4

1.5



1.6

1.7

**CÔNG BÁO SỞ HỮU CÔNG NGHIỆP SỐ 400 TẬP A – QUYỀN 2 (07.2021)**

(11) **42196**

(21) 3-2021-01165

(28) 1

(54) **DÉP**

(51) **02-04**

(22) 11/05/2021

(43) 26/07/2021

**CÔNG TY TNHH SẢN XUẤT THƯƠNG MẠI XUẤT NHẬP KHẨU ĐỨC**

(73) **HOA (VN)**

Tỉnh lộ 830, ấp 3, xã An Thạnh, huyện Bến Lức, tỉnh Long An

(72) Từ Thiếu Linh (VN)

(74) Công ty TNHH Sở hữu trí tuệ Đại Diện (IPACO.,LTD.)

(55)



1.1

1.2

1.3

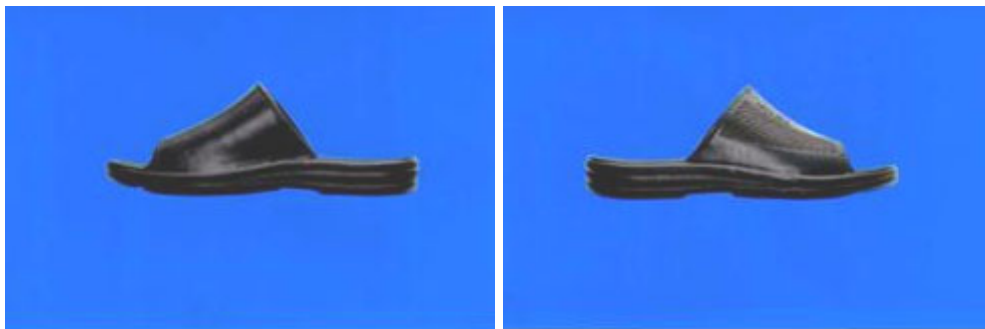

1.4

1.5



1.6

1.7

**CÔNG BÁO SỞ HỮU CÔNG NGHIỆP SỐ 400 TẬP A – QUYỀN 2 (07.2021)**

(11) **42197**

(21) 3-2021-01166

(28) 1

(54) **DÉP**

(51) **02-04**

(22) 11/05/2021

(43) 26/07/2021

**CÔNG TY TNHH SẢN XUẤT THƯƠNG MẠI XUẤT NHẬP KHẨU ĐỨC**

(73) **HOA (VN)**

Tỉnh lộ 830, ấp 3, xã An Thạnh, huyện Bến Lức, tỉnh Long An

(72) Từ Thiếu Linh (VN)

(74) Công ty TNHH Sở hữu trí tuệ Đại Diện (IPACO.,LTD.)

(55)



1.1

1.2

1.3

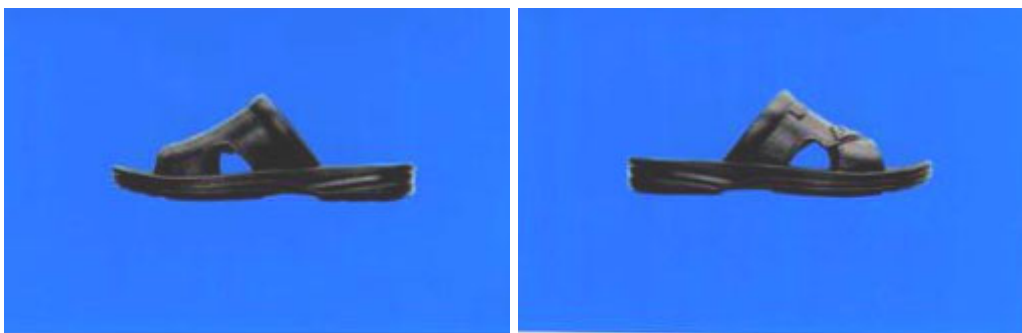

1.4

1.5

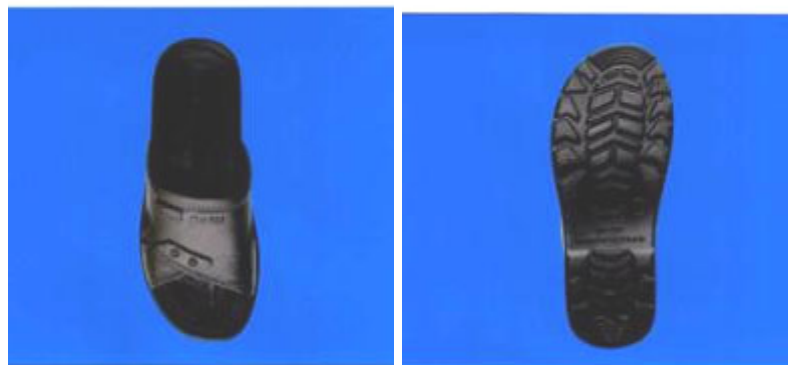

1.6

1.7

**CÔNG BÁO SỞ HỮU CÔNG NGHIỆP SỐ 400 TẬP A – QUYỀN 2 (07.2021)**

(11) **42198**

(21) 3-2021-01167

(28) 1

(54) **GIÀY**

(51) **02-04**

(22) 11/05/2021

(43) 26/07/2021

**CÔNG TY TNHH SẢN XUẤT THƯƠNG MẠI XUẤT NHẬP KHẨU ĐỨC**

(73) **HOA (VN)**

Tỉnh lộ 830, ấp 3, xã An Thạnh, huyện Bến Lức, tỉnh Long An

(72) Từ Thiếu Linh (VN)

(74) Công ty TNHH Sở hữu trí tuệ Đại Diện (IPACO.,LTD.)

(55)



1.1



1.2



1.3



1.4



1.5



1.6



1.7



**CÔNG BÁO SỞ HỮU CÔNG NGHIỆP SỐ 400 TẬP A – QUYỀN 2 (07.2021)**

(11) **42199**

(21) 3-2021-01168

(28) 1

(54) **GIÀY**

(51) **02-04**

(22) 11/05/2021

(43) 26/07/2021

**CÔNG TY TNHH SẢN XUẤT THƯƠNG MẠI XUẤT NHẬP KHẨU ĐỨC**

(73) **HOA (VN)**

Tỉnh lộ 830, ấp 3, xã An Thạnh, huyện Bến Lức, tỉnh Long An

(72) Từ Thiếu Linh (VN)

(74) Công ty TNHH Sở hữu trí tuệ Đại Diện (IPACO.,LTD.)

(55)



1.1

1.2

1.3

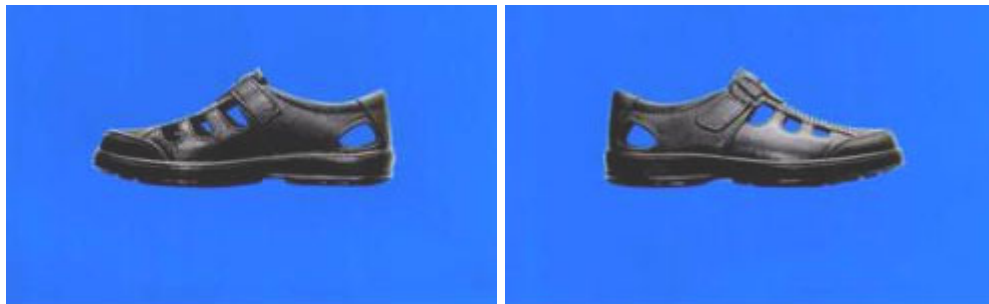

1.4

1.5



1.6

1.7

**CÔNG BÁO SỞ HỮU CÔNG NGHIỆP SỐ 400 TẬP A – QUYỀN 2 (07.2021)**

- (11) **42200**  
(21) 3-2021-01173 (28) 1  
(54) **CỬA GIƯỜNG TẦNG** (51) **06-02**  
(22) 11/05/2021 (43) 26/07/2021  
(73) **VŨ QUỐC TUẤN (VN)**  
27/24/15 Điện Biên Phủ, phường 15, quận Bình Thạnh, thành phố Hồ Chí Minh  
(72) Vũ Quốc Tuấn (VN)  
(55)

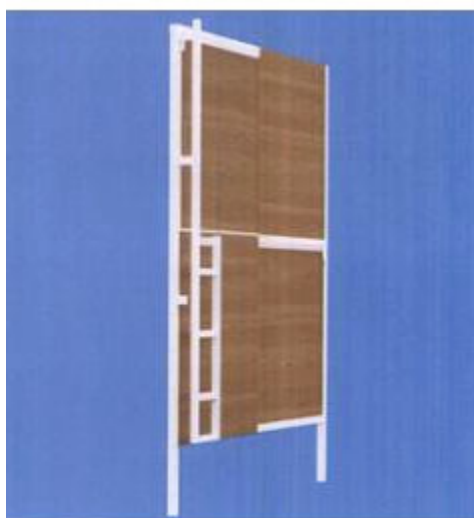

1.1

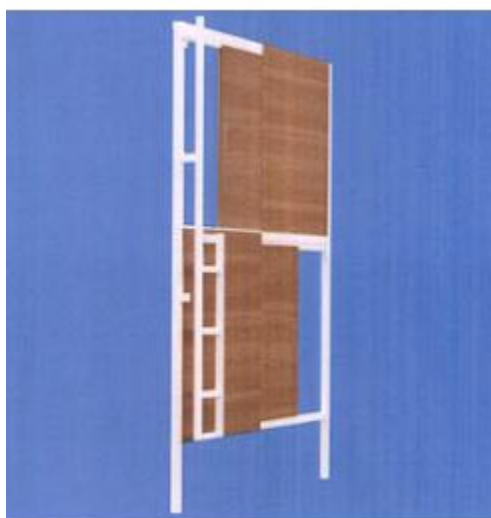

1.2

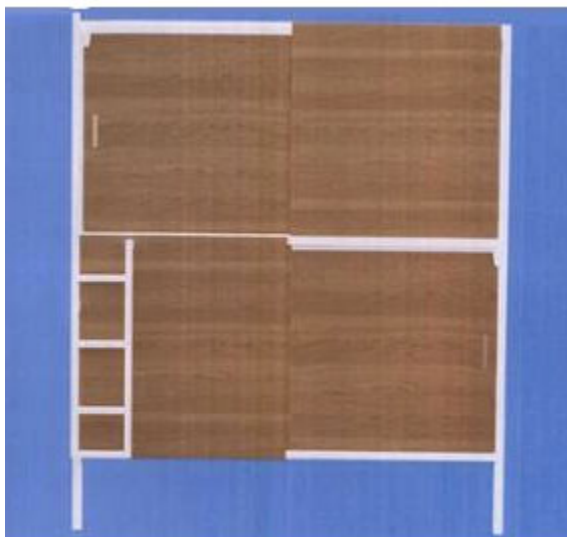

1.3

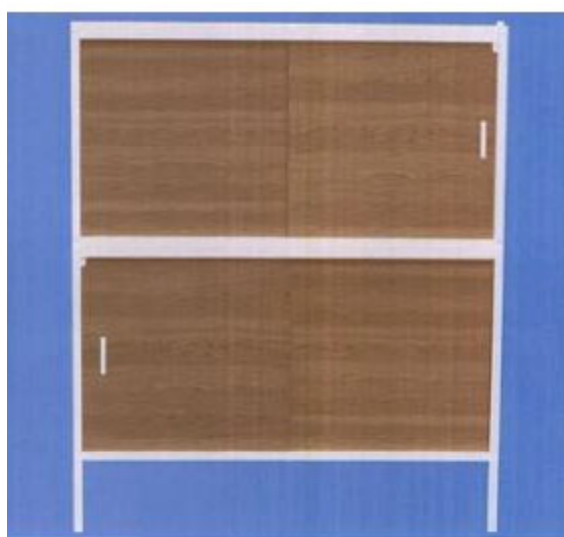

1.4

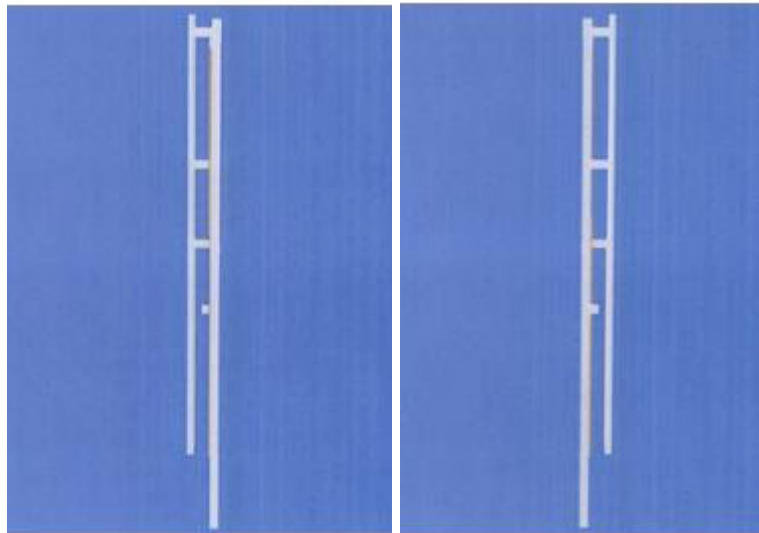

1.5

1.6



1.7



1.8

**CÔNG BÁO SỞ HỮU CÔNG NGHIỆP SỐ 400 TẬP A – QUYỂN 2 (07.2021)**

(11) **42201**

(21) 3-2021-01174

(28) 1

(54) **KỆ TỦ**

(51) **06-04**

(22) 11/05/2021

(43) 26/07/2021

(73) **VŨ QUỐC TUẤN (VN)**

27/24/15 Điện Biên Phủ, phường 15, quận Bình Thạnh, thành phố Hồ Chí Minh

(72) Vũ Quốc Tuấn (VN)

(55)



1.1



1.2



1.3

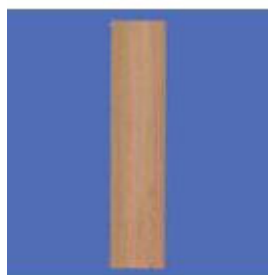

1.4

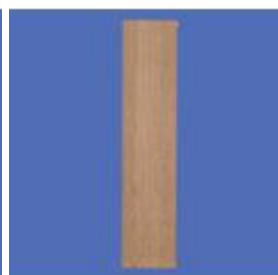

1.5



1.6



1.7

**CÔNG BÁO SỞ HỮU CÔNG NGHIỆP SỐ 400 TẬP A – QUYỀN 2 (07.2021)**

(11) **42202**

(21) 3-2021-01175

(28) 1

(54) **CHAI**

(51) **09-01**

(22) 11/05/2021

(43) 26/07/2021

**CÔNG TY CỔ PHẦN MỸ PHẨM ĐẸP (VN)**

(73) Tầng 12, tòa nhà HMC, 193 Đinh Tiên Hoàng, phường Đa Kao, quận 1, thành phố Hồ Chí Minh

(72) Phan Quốc Công (VN)

(74) Công ty TNHH Tâm nhìn và Liên danh (VISION & ASSOCIATES CO.LTD.)

(55)

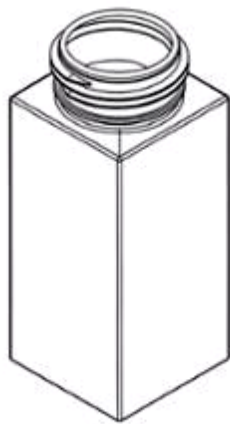

1.1



1.2



1.3



1.4



1.5

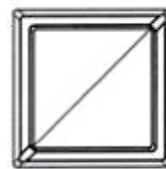

1.6



1.7

**CÔNG BÁO SỞ HỮU CÔNG NGHIỆP SỐ 400 TẬP A – QUYỀN 2 (07.2021)**

(11) **42203**

(21) 3-2021-01176

(28) 1

(54) **CHAI**

(51) **09-01**

(22) 11/05/2021

(43) 26/07/2021

**CÔNG TY CỔ PHẦN MỸ PHẨM ĐẸP (VN)**

(73) Tầng 12, tòa nhà HMC, 193 Đinh Tiên Hoàng, phường Đa Kao, quận 1, thành phố Hồ Chí Minh

(72) Phan Quốc Công (VN)

(74) Công ty TNHH Tầm nhìn và Liên danh (VISION & ASSOCIATES CO.LTD.)

(55)

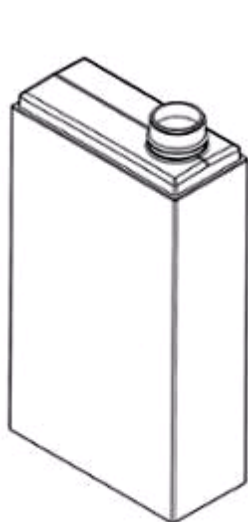

1.1



1.2

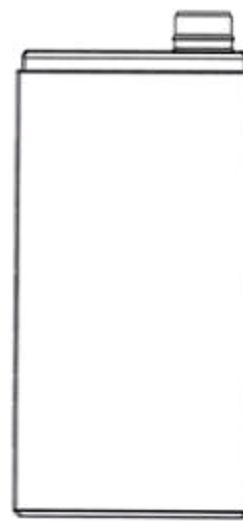

1.3



1.4



1.5

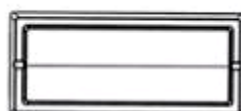

1.6



1.7

**CÔNG BÁO SỞ HỮU CÔNG NGHIỆP SỐ 400 TẬP A – QUYỀN 2 (07.2021)**

(11) **42204**

(21) 3-2021-01177

(28) 1

(54) **CHAI**

(51) **09-01**

(22) 11/05/2021

(43) 26/07/2021

**CÔNG TY CỔ PHẦN MỸ PHẨM ĐẸP (VN)**

(73) Tầng 12, tòa nhà HMC, 193 Đinh Tiên Hoàng, phường Đa Kao, quận 1, thành phố Hồ Chí Minh

(72) Phan Quốc Công (VN)

(74) Công ty TNHH Tầm nhìn và Liên danh (VISION & ASSOCIATES CO.LTD.)

(55)

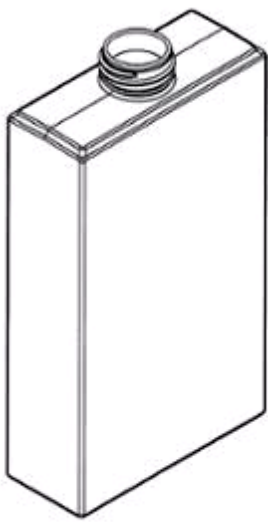

1.1



1.2

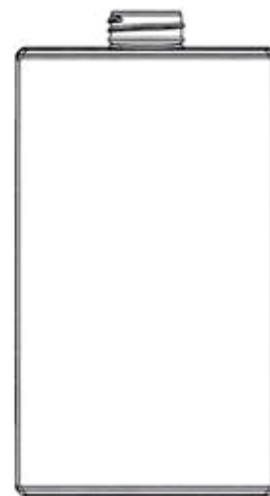

1.3



1.4



1.5



1.6



1.7

**CÔNG BÁO SỞ HỮU CÔNG NGHIỆP SỐ 400 TẬP A – QUYỀN 2 (07.2021)**

(11) **42205**

(21) 3-2021-01178

(28) 1

(54) **NẤP CHAI**

(51) **09-07**

(22) 11/05/2021

(43) 26/07/2021

**CÔNG TY CỔ PHẦN MỸ PHẨM ĐẸP (VN)**

(73) Tầng 12, tòa nhà HMC, 193 Đinh Tiên Hoàng, phường Đa Kao, quận 1, thành phố Hồ Chí Minh

(72) Phan Quốc Công (VN)

(74) Công ty TNHH Tầm nhìn và Liên danh (VISION & ASSOCIATES CO.LTD.)

(55)

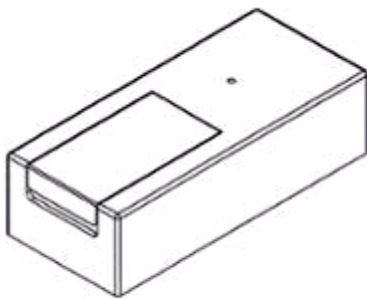

1.1



1.2



1.3



1.4



1.5

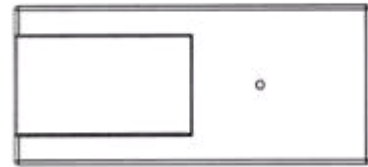

1.6



**CÔNG BÁO SỞ HỮU CÔNG NGHIỆP SỐ 400 TẬP A – QUYỀN 2 (07.2021)**

(11) **42206**

(21) 3-2021-01182

(28) 1

(54) **BAO GÓI**

(51) **09-05**

(22) 12/05/2021

(43) 26/07/2021

**CÔNG TY TNHH NTPM (VIỆT NAM) (VN)**

(73) Số 22 VSIP II-A, đường số 23, khu công nghiệp Việt Nam - Singapore II-A, phường Vĩnh Tân, thị xã Tân Uyên, tỉnh Bình Dương

(72) LEE KUAN PHENG (MY)

(74) Công ty TNHH Sở hữu trí tuệ HA VIP (HAVIP CO., LTD.)

(55)



1.1



1.2

**CÔNG BÁO SỞ HỮU CÔNG NGHIỆP SỐ 400 TẬP A – QUYỀN 2 (07.2021)**

- (11) **42207**  
(21) 3-2021-01183 (28) 1  
(54) **NỒI** (51) **07-02**  
(22) 12/05/2021 (43) 26/07/2021  
(30) 30-2020-0055696 17/11/2020 KR;  
**LOCK & LOCK CO., LTD (KR)**  
(73) 104, Sapgyocheon-ro, Seonjang-myeon, Asan-si, Chungcheongnam-do, Republic of Korea  
1. YOU, SUNG IK (KR)  
(72) 2. NAM, SOO JUNG (KR)  
(74) Công ty TNHH Tầm nhìn và Liên danh (VISION & ASSOCIATES CO.LTD.)  
(55)



1.1



1.2



1.3



1.4



1.5

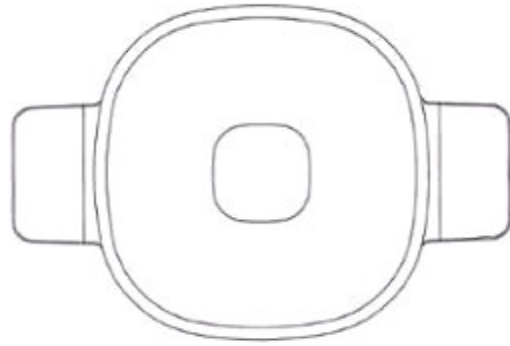

1.6

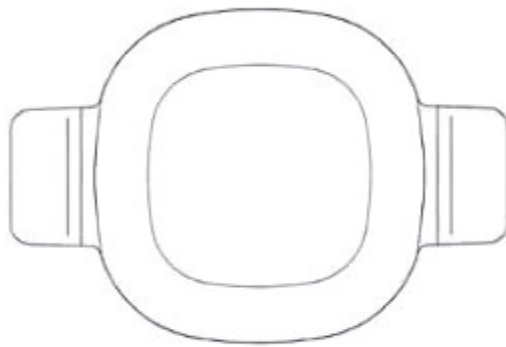

1.7

- (11) **42208**  
(21) 3-2021-01184 (28) 1  
(54) **NẮP NỒI** (51) **07-02**  
(22) 12/05/2021 (43) 26/07/2021  
(30) 30-2020-0055695 17/11/2020 KR;  
**LOCK & LOCK CO., LTD (KR)**  
(73) 104, Sapgyocheon-ro, Seonjang-myeon, Asan-si, Chungcheongnam-do, Republic of Korea  
1. YOU, SUNG IK (KR)  
(72) 2. NAM, SOO JUNG (KR)  
(74) Công ty TNHH Tầm nhìn và Liên danh (VISION & ASSOCIATES CO.LTD.)  
(55)



1.1



1.2



1.3



1.4



1.5



1.6



1.7

**CÔNG BÁO SỞ HỮU CÔNG NGHIỆP SỐ 400 TẬP A – QUYỀN 2 (07.2021)**

- (11) **42209**  
(21) 3-2021-01185 (28) 1  
(54) **NỒI** (51) **07-02**  
(22) 12/05/2021 (43) 26/07/2021  
(30) 30-2020-0055697 17/11/2020 KR;  
**LOCK & LOCK CO., LTD (KR)**  
(73) 104, Sapgyocheon-ro, Seonjang-myeon, Asan-si, Chungcheongnam-do, Republic of Korea  
1. YOU, SUNG IK (KR)  
(72) 2. NAM, SOO JUNG (KR)  
(74) Công ty TNHH Tầm nhìn và Liên danh (VISION & ASSOCIATES CO.LTD.)  
(55)

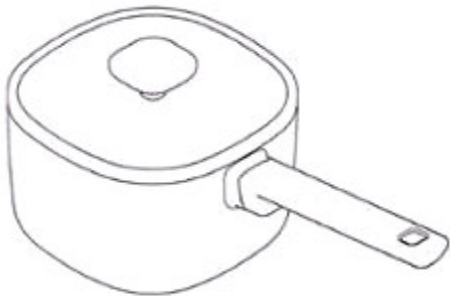

1.1

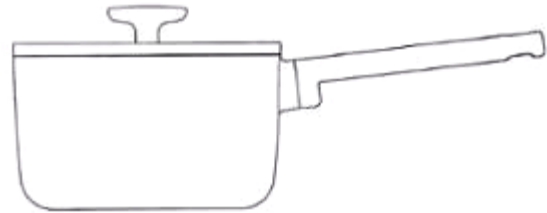

1.2

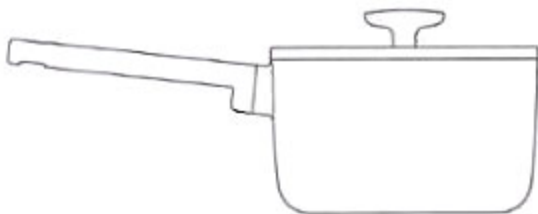

1.3

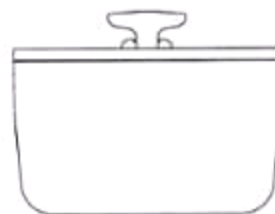

1.4

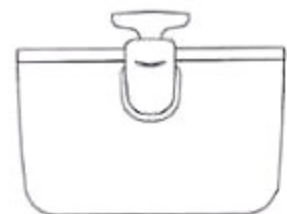

1.5

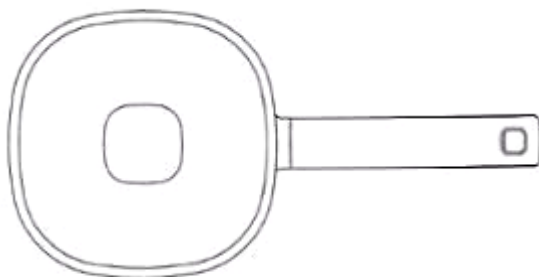

1.6

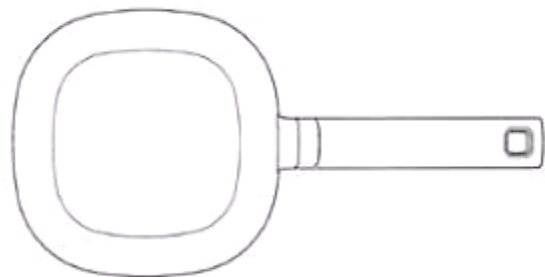

1.7

**CÔNG BÁO SỞ HỮU CÔNG NGHIỆP SỐ 400 TẬP A – QUYỀN 2 (07.2021)**

(11) **42210**

(21) 3-2021-01189

(54) **BÌNH ĐỰNG NƯỚC**

(22) 12/05/2021

(73) **CÔNG TY TNHH THƯƠNG MẠI VÀ CUNG ỨNG DỊCH VỤ TAD (VN)**

Số 54 Hàm Tử Quan, phường Chương Dương, quận Hoàn Kiếm, thành phố Hà Nội

(72) Nguyễn Thanh Dũng (VN)

(74) Công ty Luật TNHH ELITE (ELITE LAW FIRM)

(55)

(28) 1

(51) **07-07**

(43) 26/07/2021



1.1



1.2



1.3



1.4



1.5



1.6



1.7

**CÔNG BÁO SỞ HỮU CÔNG NGHIỆP SỐ 400 TẬP A – QUYỀN 2 (07.2021)**

- (11) 42211  
(21) 3-2021-01191  
(54) **NHÃN SẢN PHẨM**  
(22) 12/05/2021  
(73) **CÔNG TY CỔ PHẦN D-SHINING (VN)**  
7C Nguyễn Ngọc Phương, phường 19, quận Bình Thạnh, thành phố Hồ Chí Minh  
(72) Nguyễn Thái Dương (VN)  
(74) Văn phòng Luật sư D và T (D & T LAW OFFICE)  
(55)
- (28) 3  
(51) 19-08  
(43) 26/07/2021



1.1



1.2



2.1



2.2



3.1



3.2



**CÔNG BÁO SỞ HỮU CÔNG NGHIỆP SỐ 400 TẬP A – QUYỀN 2 (07.2021)**

(11) **42212**

(21) 3-2021-01217

(28) 1

(54) **GHẾ**

(51) **06-01**

(22) 13/05/2021

(43) 26/07/2021

(73) **HTL FURNITURE (CHINA) CO., LTD. (CN)**

Wusong Jiangnan Road, Kunshan Development Zone, Jiangsu Province, China

(72) PHUA YONG TAT (SG)

(74) Công ty Luật TNHH quốc tế BMVN (BMVN INTERNATIONAL LLC)

(55)



1.1



1.2



1.3



1.4



1.5



1.6

**CÔNG BÁO SỞ HỮU CÔNG NGHIỆP SỐ 400 TẬP A – QUYỀN 2 (07.2021)**

(11) **42213**

(21) 3-2021-01222

(28) 1

(54) **GHẾ**

(51) **06-01**

(22) 13/05/2021

(43) 26/07/2021

(73) **HTL FURNITURE (CHINA) CO., LTD. (CN)**

Wusong Jiangnan Road, Kunshan Development Zone, Jiangsu Province, China

(72) PHUA YONG TAT (SG)

(74) Công ty Luật TNHH quốc tế BMVN (BMVN INTERNATIONAL LLC)

(55)



1.1



1.2



1.3



1.4



1.5



1.6

**CÔNG BÁO SỞ HỮU CÔNG NGHIỆP SỐ 400 TẬP A – QUYỀN 2 (07.2021)**

(11) **42214**

(21) 3-2021-01229

(54) **GHẾ**

(22) 13/05/2021

(28) 1

(51) **06-01**

(43) 26/07/2021

(73) **HTL FURNITURE (CHINA) CO., LTD. (CN)**

Wusong Jiangnan Road, Kunshan Development Zone, Jiangsu Province, China

(72) PHUA YONG TAT (SG)

(74) Công ty Luật TNHH quốc tế BMVN (BMVN INTERNATIONAL LLC)

(55)



1.1



1.2



1.3



1.4



1.5



1.6

**CÔNG BÁO SỞ HỮU CÔNG NGHIỆP SỐ 400 TẬP A – QUYỀN 2 (07.2021)**

- (11) **42215**  
(21) 3-2021-01235 (28) 1  
(54) **BÌNH ĐUN BẰNG ĐIỆN** (51) **07-02**  
(22) 13/05/2021 (43) 26/07/2021  
(30) 202030716301.0 24/11/2020 CN;  
**GUANGDONG MIDEA CONSUMER ELECTRIC MANUFACTURING**  
(73) **CO., LTD. (CN)**  
San Le Road #19, Beijiao, Shunde, Foshan, Guangdong 528311, China  
(72) 1. LU, WENQUAN (CN)  
2. WU, CHENGLONG (CN)  
(74) Công ty TNHH Dịch vụ Sở hữu trí tuệ KENFOX (KENFOX IP SERVICE  
CO.,LTD.)  
(55)



1.1



1.2



1.3



1.4



1.5



1.6



1.7

**CÔNG BÁO SỞ HỮU CÔNG NGHIỆP SỐ 400 TẬP A – QUYỂN 2 (07.2021)**

- (11) **42216**  
(21) 3-2021-01237 (28) 1  
(54) **NHÃN SẢN PHẨM** (51) **19-08**  
(22) 13/05/2021 (43) 26/07/2021  
(73) **CÔNG TY CỔ PHẦN THỰC PHẨM CHAY LẠC VIỆT (VN)**  
136 Hiền Vương, phường Phú Thạnh, quận Tân Phú, thành phố Hồ Chí Minh  
(72) Nguyễn Đức Trí (VN)  
(55)

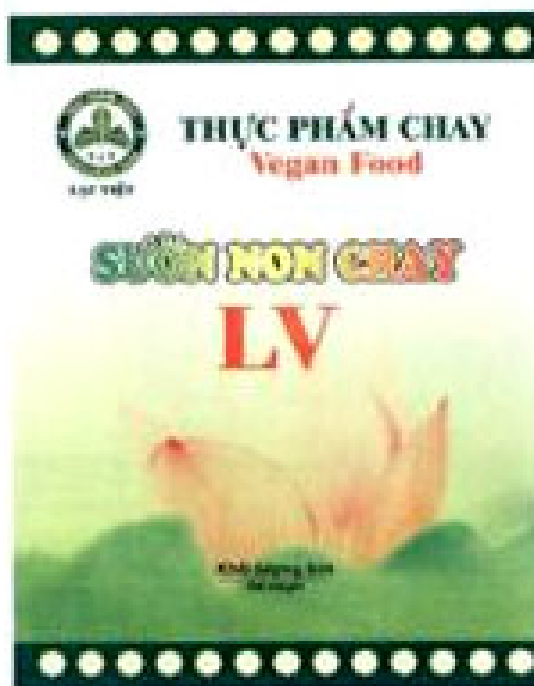

**CÔNG BÁO SỞ HỮU CÔNG NGHIỆP SỐ 400 TẬP A – QUYỀN 2 (07.2021)**

- (11) **42217**  
(21) 3-2021-01238 (28) 1  
(54) **BỘ DỤNG CỤ TẬP THỂ DỤC** (51) **21-02**  
(22) 13/05/2021 (43) 26/07/2021  
(73) **PHẠM VĂN TÂN (VN)**  
17/2B, ấp 3, xã Nhơn Đức, huyện Nhà Bè, thành phố Hồ Chí Minh  
(72) Phạm Văn Tân (VN)  
(74) Công ty TNHH Tư vấn đầu tư và Sở hữu trí tuệ Hoàng Phi (HOANG PHI INVEST & I.P CO., LTD)  
(55)



1.1



1.2



1.3



1.4



1.5



1.6



1.7

- (11) **42218**  
(21) 3-2021-01243 (28) 1  
(54) **THANH KIM LOẠI ĐỊNH HÌNH** (51) **25-01**  
(22) 14/05/2021 (43) 26/07/2021  
(73) **CÔNG TY CỔ PHẦN CAD GROUP (VN)**  
Số 8 ngõ 81, phố Trạm, phường Long Biên, quận Long Biên, thành phố Hà Nội  
(72) Lâm Viết An (VN)  
(74) Công ty TNHH Sở hữu trí tuệ Gia Việt (GIAVIET CO., LTD.)  
(55)

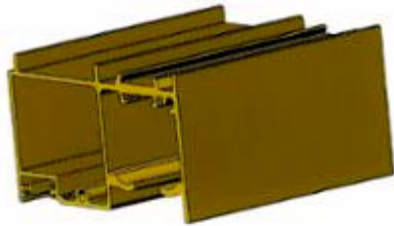

1.1

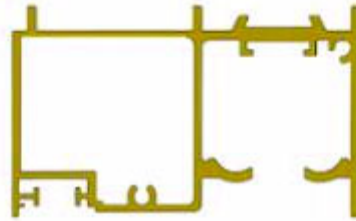

1.2



1.3



1.4

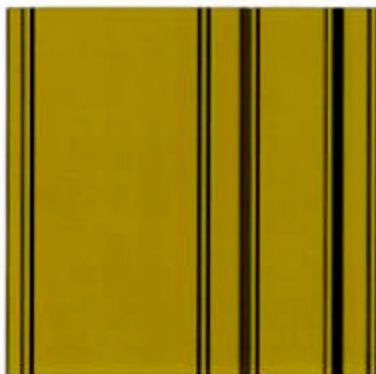

1.5

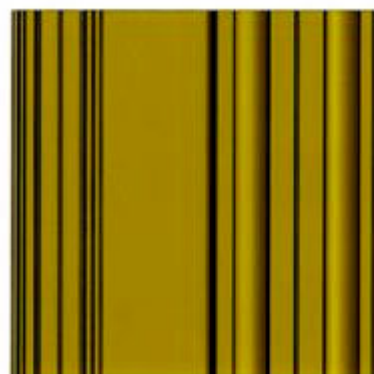

1.6



**CÔNG BÁO SỞ HỮU CÔNG NGHIỆP SỐ 400 TẬP A – QUYỀN 2 (07.2021)**

- (11) **42219**  
(21) 3-2021-01245 (28) 1  
(54) **THANH KIM LOẠI ĐỊNH HÌNH** (51) **25-01**  
(22) 14/05/2021 (43) 26/07/2021  
(73) **CÔNG TY CỔ PHẦN CAD GROUP (VN)**  
Số 8 ngõ 81, phố Trạm, phường Long Biên, quận Long Biên, thành phố Hà Nội  
(72) Lâm Viết An (VN)  
(74) Công ty TNHH Sở hữu trí tuệ Gia Việt (GIAVIET CO., LTD.)  
(55)

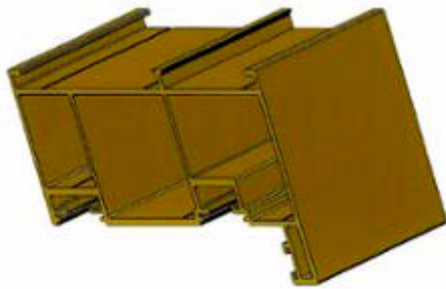

1.1

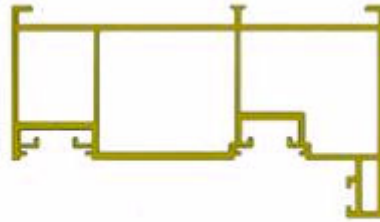

1.2



1.3



1.4



1.5



1.6

**CÔNG BÁO SỞ HỮU CÔNG NGHIỆP SỐ 400 TẬP A – QUYỀN 2 (07.2021)**

(11) 42220

(21) 3-2021-01247

(54) BAO GÓI KHĂN ƯỚT

(22) 14/05/2021

(28) 1

(51) 09-05

(43) 26/07/2021

**CÔNG TY TNHH THƯƠNG MẠI DỊCH VỤ VÀ XUẤT NHẬP KHẨU**

(73) **NGUYỄN MINH KHẢI (VN)**

41/7 ấp 7, xã Xuân Thới Thượng, huyện Hóc Môn, thành phố Hồ Chí Minh

(72) Nguyễn Trí Thông (VN)

(74) Công ty cổ phần Tư vấn S&B (S&B CONSULTANT., CORP.)

(55)



1.1



1.2



1.3



1.4



1.5



1.6



1.7



1.8

**CÔNG BÁO SỞ HỮU CÔNG NGHIỆP SỐ 400 TẬP A – QUYỀN 2 (07.2021)**

(11) **42221**

(21) 3-2021-01248

(28) 2

(54) **BAO GÓI**

(51) **09-05**

(22) 14/05/2021

(43) 26/07/2021

**CÔNG TY TNHH NTPM (VIỆT NAM) (VN)**

(73) Số 22 VSIP II-A, đường số 23, khu công nghiệp Việt Nam - Singapore II-A, phường Vĩnh Tân, thị xã Tân Uyên, tỉnh Bình Dương

(72) LEE KUAN PHENG (MY)

(74) Công ty TNHH Sở hữu trí tuệ HA VIP (HAVIP CO., LTD.)

(55)



1.1



1.2



2.1



2.2

**CÔNG BÁO SỞ HỮU CÔNG NGHIỆP SỐ 400 TẬP A – QUYỀN 2 (07.2021)**

(11) **42222**

(21) 3-2021-01249

(28) 1

(54) **NHÃN SẢN PHẨM**

(51) **19-08**

(22) 14/05/2021

(43) 26/07/2021

**CÔNG TY TNHH THỰC PHẨM SUNRISE (VN)**

(73) Lô F6 đường số 3, KCN Hải Sơn (GD 3+4), xã Đức Hòa Hạ, huyện Đức Hoà, tỉnh Long An

(72) Lai Vĩ Hùng (VN)

(74) Công ty TNHH một thành viên Trường Luật (Trường Luật)

(55)



**CÔNG BÁO SỞ HỮU CÔNG NGHIỆP SỐ 400 TẬP A – QUYỀN 2 (07.2021)**

(11) **42223**

(21) 3-2021-01250

(28) 1

(54) **XE KÉO**

(51) **12-02**

(22) 14/05/2021

(43) 26/07/2021

**CÔNG TY TNHH NHỰA ĐỨC ĐẠT (VN)**

(73) Lô 40-42 đường số 3, khu công nghiệp Tân Tạo, phường Tân Tạo A, quận Bình Tân, thành phố Hồ Chí Minh

(72) Nguyễn Thị Nghĩa (VN)

(74) Công ty TNHH Dịch vụ thương mại và sở hữu công nghiệp Song Ngọc (I.P.T.S.)

(55)



1.1



1.2



1.3



1.4



1.5



1.6

(11) **42224**

(21) 3-2021-01253

(54) **PHAO CỨU SINH**

(22) 14/05/2021

(28) 1

(51) **29-02**

(43) 26/07/2021

(73) **TRƯỜNG ĐẠI HỌC GIAO THÔNG VẬN TẢI THÀNH PHỐ HỒ CHÍ MINH (VN)**

Số 2, đường Võ Oanh, phường 25, quận Bình Thạnh, thành phố Hồ Chí Minh

(72) 1. **VŨ NGỌC BÍCH (VN)**

2. **BÙI HOÀNG SƠN (VN)**

(55)

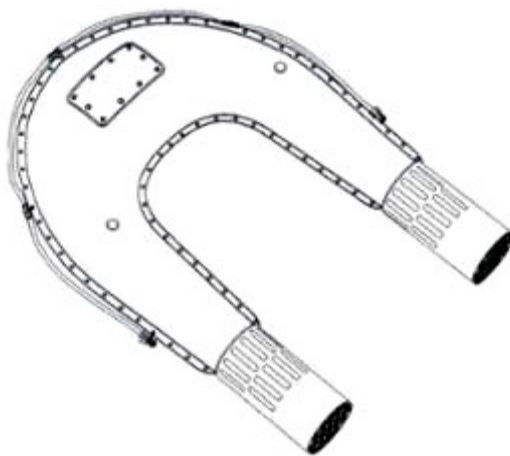

1.1

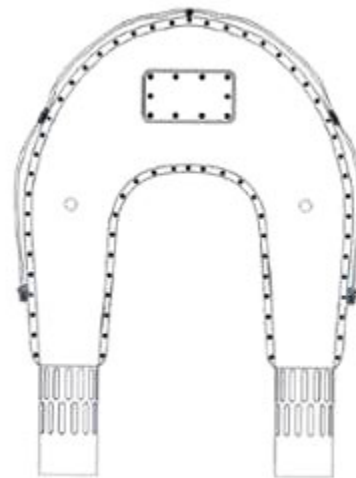

1.2



1.3



1.4



1.5



1.6

**CÔNG BÁO SỞ HỮU CÔNG NGHIỆP SỐ 400 TẬP A – QUYỀN 2 (07.2021)**

- (11) 42225  
(21) 3-2021-01254 (28) 1  
(54) BAO BÌ (51) 09-05  
(22) 14/05/2021 (43) 26/07/2021  
(73) **CÔNG TY TNHH SWISSFERTZ VIỆT NAM (VN)**  
68A đường số 11, phường Tân Kiểng, quận 7, thành phố Hồ Chí Minh  
(72) Bùi Minh Trường (VN)  
(55)



1.1



1.2



**CÔNG BÁO SỞ HỮU CÔNG NGHIỆP SỐ 400 TẬP A – QUYỀN 2 (07.2021)**

- (11) 42226  
(21) 3-2021-01255 (28) 1  
(54) BAO BÌ (51) 09-05  
(22) 14/05/2021 (43) 26/07/2021  
(73) CÔNG TY TNHH SWISSFERTZ VIỆT NAM (VN)  
68A đường số 11, phường Tân Kiểng, quận 7, thành phố Hồ Chí Minh  
(72) Bùi Minh Trường (VN)  
(55)



1.1



1.2

**CÔNG BÁO SỞ HỮU CÔNG NGHIỆP SỐ 400 TẬP A – QUYỀN 2 (07.2021)**

- (11) 42227  
(21) 3-2021-01256  
(54) BAO BÌ  
(22) 14/05/2021  
(73) CÔNG TY TNHH SWISSFERTZ VIỆT NAM (VN)  
68A đường số 11, phường Tân Kiểng, quận 7, thành phố Hồ Chí Minh  
(72) Bùi Minh Trường (VN)  
(55)
- (28) 1  
(51) 09-05  
(43) 26/07/2021



1.1



1.2

**CÔNG BÁO SỞ HỮU CÔNG NGHIỆP SỐ 400 TẬP A – QUYỂN 2 (07.2021)**

- (11) 42228  
(21) 3-2021-01259  
(54) **MŨ BẢO HỘ LAO ĐỘNG**  
(22) 17/05/2021  
(73) (VN)  
Lô D 3A, khu công nghiệp, xã Ea Đar, huyện Ea Kar, tỉnh Đắk Lắk  
(72) Nguyễn Thị Dung (VN)  
(74) Công ty TNHH Sở hữu trí tuệ ALNGUYEN (ALNGUYEN IP CO.,LTD.)  
(55)
- (28) 1  
(51) 02-03  
(43) 26/07/2021



1.1

1.2

1.3



H.4

H.5

1.4

1.5

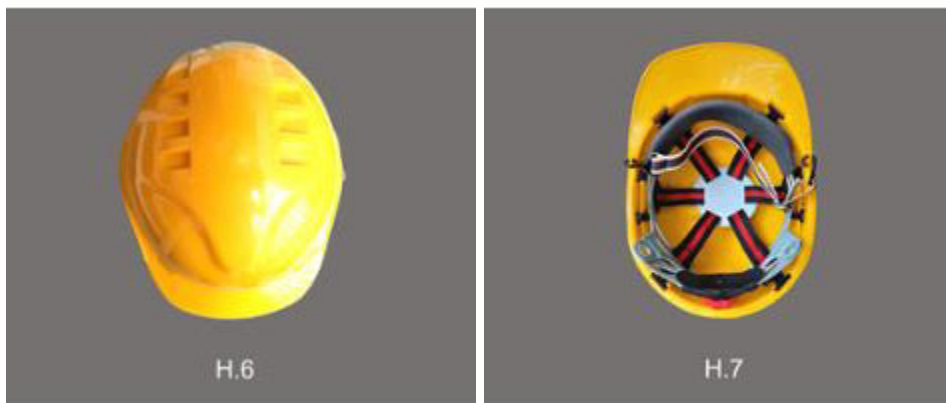

H.6

H.7

1.6

1.7

**CÔNG BÁO SỞ HỮU CÔNG NGHIỆP SỐ 400 TẬP A – QUYỀN 2 (07.2021)**

- (11) **42229**  
(21) 3-2021-01260 (28) 1  
(54) **BỘ ĐÈN PHÍA TRƯỚC CỦA Ô TÔ** (51) **26-06**  
(22) 17/05/2021 (43) 26/07/2021  
(30) 2020-026206 04/12/2020 JP;  
**DAIHATSU MOTOR CO., LTD. (JP)**  
(73) 1-1, Daihatsu-Cho, Ikeda-Shi, Osaka 563-8651 Japan  
(72) Ryohei MORIMOTO (JP)  
(74) Công ty TNHH một thành viên Sở hữu trí tuệ VCCI (VCCI-IP CO.,LTD)  
(55)



1.1



1.2



1.3



1.4



1.5



1.6



1.7

- (11) **42230**  
(21) 3-2021-01261 (28) 1  
(54) **ĐIỆN THOẠI DI ĐỘNG** (51) **14-03**  
(22) 17/05/2021 (43) 26/07/2021  
(30) 202030699170.X 18/11/2020 CN;  
**VIVO MOBILE COMMUNICATION CO., LTD. (CN)**  
(73) No.168 Jinghai East Rd., Chang'an, Dongguan, Guangdong 523863, China  
1. AN REN (CN)  
(72) 2. ZHIQIANG LI (CN)  
3. HONGZHI YAO (CN)  
4. DISHUANG LV (CN)  
(74) Công ty cổ phần Tư vấn S&B (S&B CONSULTANT., CORP.)  
(55)

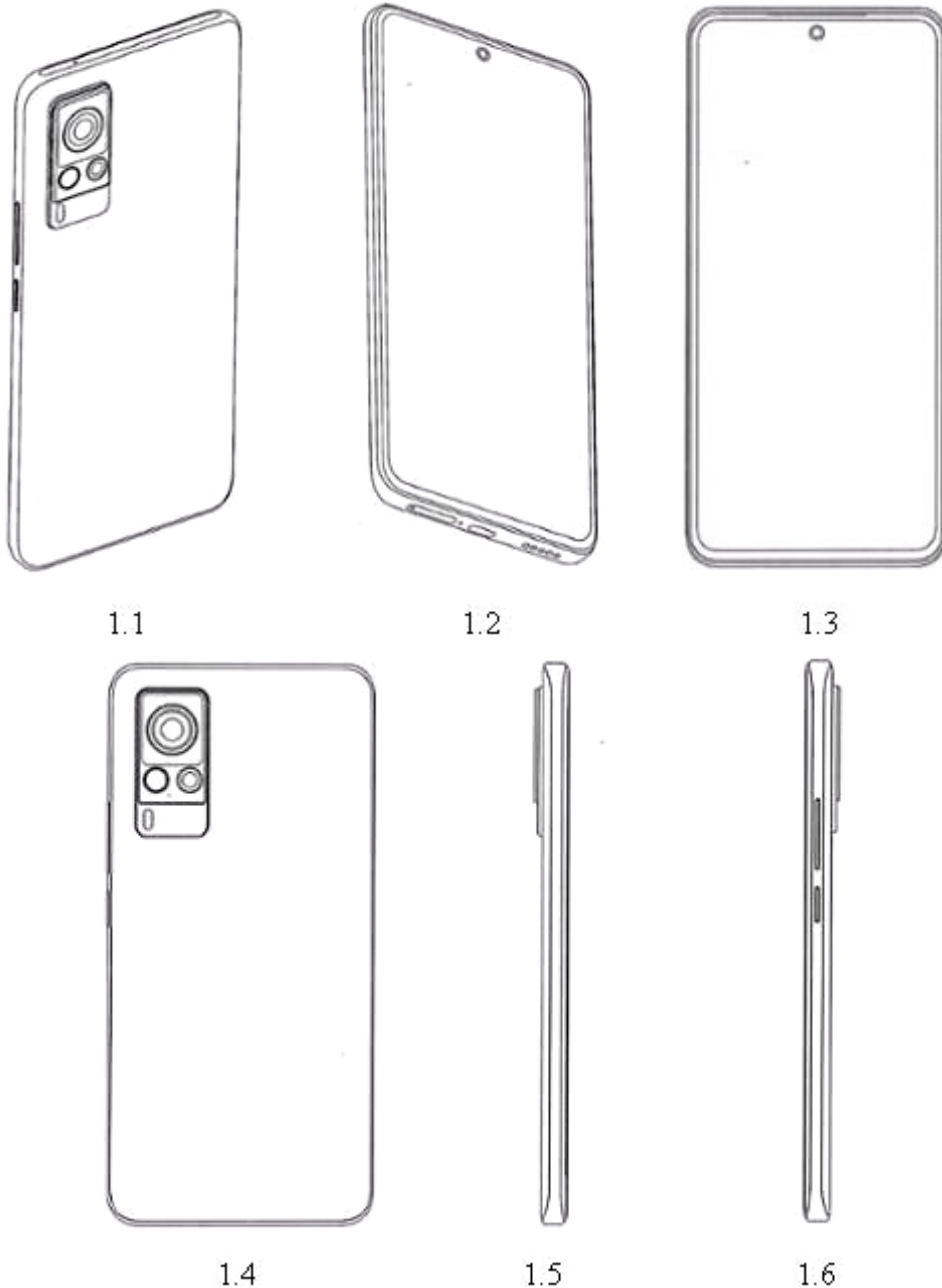



1.7



1.8



1.9



1.10



1.11



1.12



1.13



1.14



1.15



1.16

**CÔNG BÁO SỞ HỮU CÔNG NGHIỆP SỐ 400 TẬP A – QUYỀN 2 (07.2021)**

- (11) **42231**  
(21) 3-2021-01269 (28) 1  
(54) **HỘP** (51) **09-03**  
(22) 17/05/2021 (43) 26/07/2021  
(73) **ORION CORPORATION (KR)**  
13, Baekbeom-ro 90da-gil, Yongsan-gu, Seoul 04369, Republic of Korea  
(72) 1. LEE, A REUM (KR)  
2. CHOE, EUN JE (KR)  
(74) Công ty Luật TNHH quốc tế BMVN (BMVN INTERNATIONAL LLC)  
(55)



1.1



1.2

(11) **42232**

(21) 3-2021-01357

(28) 1

(54) **MÁY QUÉT VÂN TAY**

(51) **14-02**

(22) 24/05/2021

(43) 26/07/2021

**CÔNG TY TNHH MỘT THÀNH VIÊN TƯ VẤN VÀ CHUYỂN GIAO  
CÔNG NGHỆ BÁCH KHOA (VN)**

(73) Tầng 2, nhà A17, số 17 Tạ Quang Bửu, trường ĐH Bách Khoa Hà Nội, phường  
Bách Khoa, quận Hai Bà Trưng, thành phố Hà Nội

(72) Trương Đức Phúc (VN)

(74) Công ty Luật TNHH VIETTHINK (VIETTHINK LAW FIRM)

(55)



1.1



1.2



1.3



1.4



1.5



1.6



1.7





1.8



1.9



1.10



1.11



1.12



1.13



1.14

**PHẦN II**

**SỬA ĐỔI ĐƠN**

***Ghi nhận sửa đổi đơn yêu cầu cấp Bằng độc quyền kiểu dáng công nghiệp***

Thông báo số: 12257w/TB-SHTT, ngày 14/06/2021 về việc ghi nhận sửa đổi đơn

Số Yêu cầu: SĐ3-2020-01539 Ngày nộp: 30/09/2020

Liên quan đến đơn yêu cầu cấp Bằng độc quyền kiểu dáng công nghiệp:

(21) Số đơn	(22) Ngày nộp đơn
3-2019-02396	20/09/2019

Mục sửa đổi: Địa chỉ của tác giả

Nội dung mới: Sửa đổi địa chỉ của tác giả thành: XiaoBian Village, ChangAn Town, DongGuan City, GuangDong Province, CHINA 523851 (CN)

---

Thông báo số: 11570w/TB-SHTT, ngày 04/06/2021 về việc ghi nhận sửa đổi đơn

Số Yêu cầu: SĐ3-2021-00511 Ngày nộp: 05/03/2021

Liên quan đến đơn yêu cầu cấp Bằng độc quyền kiểu dáng công nghiệp:

(21) Số đơn	(22) Ngày nộp đơn
3-2021-00280	04/02/2021

Mục sửa đổi: Giảm bớt 1 tác giả

Nội dung mới: Loại bỏ tác giả Jianguang NIE khỏi danh sách các tác giả căn cứ theo danh sách các tác giả của kiểu dáng công nghiệp theo đơn ưu tiên đã nộp tại thời điểm nộp đơn

---

**CÔNG BÁO SỞ HỮU CÔNG NGHIỆP SỐ 400 TẬP A - QUYỀN 2 (07.2021)**

---

Thông báo số: 11572w/TB-SHTT, ngày 04/06/2021 về việc ghi nhận sửa đổi đơn

Số Yêu cầu: SĐ3-2021-00269 Ngày nộp: 22/01/2021

Liên quan đến đơn yêu cầu cấp Bằng độc quyền kiểu dáng công nghiệp:

(21) Số đơn	(22) Ngày nộp đơn
3-2019-03008	22/11/2019
3-2019-03009	22/11/2019

Mục sửa đổi: Tên, địa chỉ chủ đơn

Nội dung mới: NICORIO CO., LTD. (JP)  
4-10-1, Youga, Setagaya-ku, 1580097 Tokyo, Japan

---

Thông báo số: 10718w/TB-SHTT, ngày 28/05/2021 về việc ghi nhận sửa đổi đơn

Số Yêu cầu: SĐ3-2021-00944 Ngày nộp: 04/05/2021

Liên quan đến đơn yêu cầu cấp Bằng độc quyền kiểu dáng công nghiệp:

(21) Số đơn	(22) Ngày nộp đơn
3-2019-02812	06/11/2019

Mục sửa đổi: Tên, địa chỉ chủ đơn

Nội dung mới: Công ty cổ phần Ngọc Trai Hoàng Gia (VN)  
1158 Huỳnh Tấn Phát, KP5, phường Tân Phú, quận 7, TP. Hồ Chí Minh

---

Thông báo số: 11503w/TB-SHTT, ngày 03/06/2021 về việc ghi nhận sửa đổi đơn

Số Yêu cầu: SĐ3-2021-00822 Ngày nộp: 15/04/2021

Liên quan đến đơn yêu cầu cấp Bằng độc quyền kiểu dáng công nghiệp:

(21) Số đơn	(22) Ngày nộp đơn
3-2021-00703	25/03/2021

## CÔNG BÁO SỞ HỮU CÔNG NGHIỆP SỐ 400 TẬP A - QUYỀN 2 (07.2021)

Mục sửa đổi: Đại diện sở hữu công nghiệp

Nội dung mới: Văn phòng Luật sư D và T (D & T LAW OFFICE)  
Căn hộ A-5-71, tầng 5 Officetel, RiverGate Residence, 151-155 Bến  
Vân Đồn, phường 06, quận 4, thành phố Hồ Chí Minh

---

Thông báo số: 11530w/TB-SHTT, ngày 03/06/2021 về việc ghi nhận sửa đổi đơn

Số Yêu cầu: SĐ3-2021-00365 Ngày nộp: 03/02/2021

Liên quan đến đơn yêu cầu cấp Bằng độc quyền kiểu dáng công nghiệp:

(21) Số đơn	(22) Ngày nộp đơn
3-2021-00235	29/01/2021
3-2021-00236	29/01/2021

Mục sửa đổi: Đại diện sở hữu công nghiệp

Nội dung mới: CÔNG TY TNHH KHANG LUẬT(KHANGLAW)  
441/84 Lê Văn Quới, phường Bình Trị Đông A, quận Bình Tân, Thành  
phố Hồ Chí Minh

---

Thông báo số: 11554w/TB-SHTT, ngày 04/06/2021 về việc ghi nhận sửa đổi đơn

Số Yêu cầu: SĐ3-2020-01598 Ngày nộp: 12/10/2020

Liên quan đến đơn yêu cầu cấp Bằng độc quyền kiểu dáng công nghiệp:

(21) Số đơn	(22) Ngày nộp đơn
3-2020-01365	11/06/2020
3-2020-01366	11/06/2020

Mục sửa đổi: Đại diện sở hữu công nghiệp

**CÔNG BÁO SỞ HỮU CÔNG NGHIỆP SỐ 400 TẬP A - QUYỀN 2 (07.2021)**

---

Nội dung mới: CÔNG TY TNHH SỞ HỮU TRÍ TUỆ ANLIS VIỆT NAM(ANLIS IP CO.,LTD)  
Số 151, ngõ 254 Minh Khai, phường Mai Động, quận Hoàng Mai,  
Thành phố Hà Nội

---

Thông báo số: 11567w/TB-SHTT, ngày 04/06/2021 về việc ghi nhận sửa đổi đơn

Số Yêu cầu: SĐ3-2020-00887 Ngày nộp: 26/06/2020

Liên quan đến đơn yêu cầu cấp Bằng độc quyền kiểu dáng công nghiệp:

(21) Số đơn	(22) Ngày nộp đơn
3-2019-00358	01/02/2019

Mục sửa đổi: Tên, địa chỉ chủ đơn

Nội dung mới: Công ty cổ phần Eyeq Tech (VN) (VN)  
Tầng 1, tòa nhà Packsimex, 52 Đông Du, phường Bến Nghé, quận 1,  
thành phố Hồ Chí Minh

---

Thông báo số: 12052w/TB-SHTT, ngày 10/06/2021 về việc ghi nhận sửa đổi đơn

Số Yêu cầu: SĐ3-2020-00136 Ngày nộp: 10/02/2020

Liên quan đến đơn yêu cầu cấp Bằng độc quyền kiểu dáng công nghiệp:

(21) Số đơn	(22) Ngày nộp đơn
3-2018-02319	01/11/2018

Mục sửa đổi: Bổ sung phương án

Bổ sung thêm phương án thứ hai

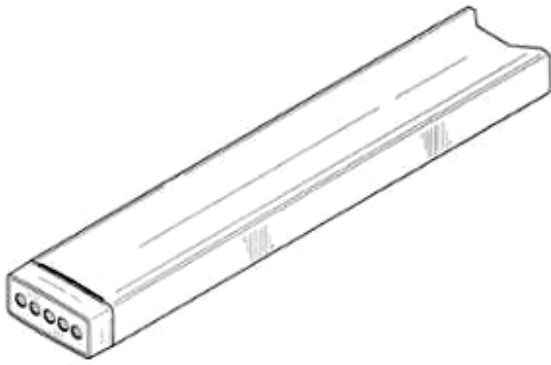

2.1

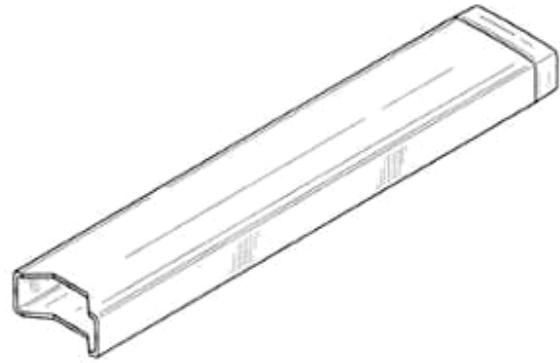

2.2



2.3

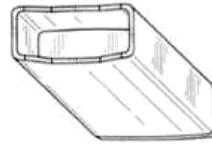

2.4



2.5



2.6



2.7



2.8



2.9



2.10

---

Thông báo số: 11782w/TB-SHTT, ngày 07/06/2021 về việc ghi nhận sửa đổi đơn

Số Yêu cầu: SĐ3-2020-00374 Ngày nộp: 19/03/2020

Liên quan đến đơn yêu cầu cấp Bằng độc quyền kiểu dáng công nghiệp:

(21) Số đơn	(22) Ngày nộp đơn
3-2019-02261	06/09/2019

Mục sửa đổi: Bổ sung phương án

Nội dung mới: Bổ sung phương án 2 và phương án 3 cho kiểu dáng công nghiệp.



2.1



2.2



3.1



3.2



**CÔNG BÁO SỞ HỮU CÔNG NGHIỆP SỐ 400 TẬP A - QUYỀN 2 (07.2021)**

Thông báo số: 12053w/TB-SHTT, ngày 10/06/2021 về việc ghi nhận sửa đổi đơn

Số Yêu cầu: SĐ3-2020-00137 Ngày nộp: 10/02/2020

Liên quan đến đơn yêu cầu cấp Bằng độc quyền kiểu dáng công nghiệp:

(21) Số đơn	(22) Ngày nộp đơn
3-2018-02318	01/11/2018

Mục sửa đổi: Bổ sung phương án

Nội dung mới: Bổ sung thêm phương án thứ hai

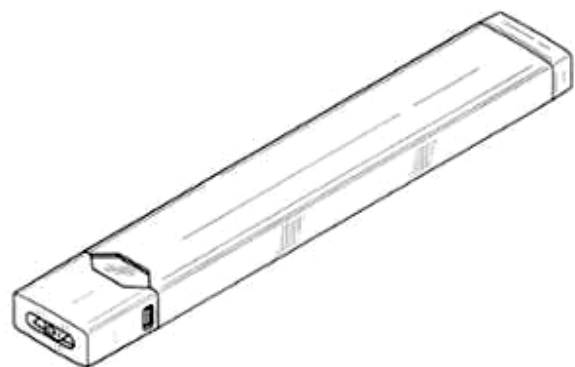
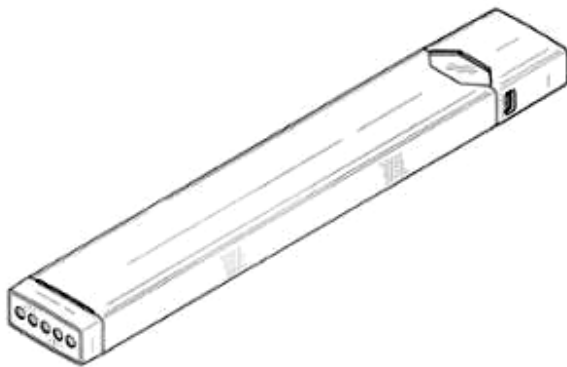

2.1

2.2



2.3

2.4



2.5



2.6



2.7



2.8

Thông báo số: 12054w/TB-SHTT, ngày 10/06/2021 về việc ghi nhận sửa đổi đơn

Số Yêu cầu: SĐ3-2021-00712 Ngày nộp: 30/03/2021

Liên quan đến đơn yêu cầu cấp Bằng độc quyền kiểu dáng công nghiệp:

(21) Số đơn	(22) Ngày nộp đơn
3-2018-02478	20/11/2018
3-2018-02479	20/11/2018
3-2020-01177	20/05/2020
3-2020-01253	27/05/2020
3-2020-02390	24/09/2020
3-2020-02419	28/09/2020
3-2020-02420	28/09/2020

**CÔNG BÁO SỞ HỮU CÔNG NGHIỆP SỐ 400 TẬP A - QUYỀN 2 (07.2021)**

3-2020-02421	28/09/2020
3-2020-02422	28/09/2020
3-2020-02781	13/11/2020

Mục sửa đổi: Tên, địa chỉ chủ đơn

Nội dung mới: LIXIL Corporation (Business Entity ID Number: 0106-01-004914) (JP)  
2-1-1 Ojima, Koto-ku, Tokyo 136-8535, Japan

Thông báo số: 12083w/TB-SHTT, ngày 11/06/2021 về việc ghi nhận sửa đổi đơn

Số Yêu cầu: SĐ3-2020-01524 Ngày nộp: 29/09/2020

Liên quan đến đơn yêu cầu cấp Bằng độc quyền kiểu dáng công nghiệp:

(21) Số đơn	(22) Ngày nộp đơn
3-2020-01223	25/05/2020

Mục sửa đổi: Bổ sung phương án

Nội dung mới: Bổ sung phương án 2



2.1



2.2



2.3



2.4



2.5



2.6



2.7



2.8



2.9



2.10

Thông báo số: 12082w/TB-SHTT, ngày 11/06/2021 về việc ghi nhận sửa đổi đơn

Số Yêu cầu: SĐ3-2020-02043 Ngày nộp: 11/12/2020

Liên quan đến đơn yêu cầu cấp Bằng độc quyền kiểu dáng công nghiệp:

(21) Số đơn	(22) Ngày nộp đơn
3-2020-00769	07/04/2020

Mục sửa đổi: Bổ sung phương án

Nội dung mới: Bổ sung phương án 2



2.1



2.2



2.3



2.4



2.5



2.6



2.7

**CÔNG BÁO SỞ HỮU CÔNG NGHIỆP SỐ 400 TẬP A - QUYỀN 2 (07.2021)**

---

Thông báo số: 12263w/TB-SHTT, ngày 14/06/2021 về việc ghi nhận sửa đổi đơn

Số Yêu cầu: SĐ3-2021-00455 Ngày nộp: 25/02/2021

Liên quan đến đơn yêu cầu cấp Bằng độc quyền kiểu dáng công nghiệp:

(21) Số đơn	(22) Ngày nộp đơn
3-2019-00913	10/04/2019
3-2019-00914	10/04/2019

Mục sửa đổi: Tên, địa chỉ chủ đơn

Nội dung mới: CARLSBERG BREWERIES A/S (DK)  
J.C. Jacobsens Gade 1,1799 Copenhagen V, Denmark

---

Thông báo số: 12262w/TB-SHTT, ngày 14/06/2021 về việc ghi nhận sửa đổi đơn

Số Yêu cầu: SĐ3-2020-02081 Ngày nộp: 18/12/2020

Liên quan đến đơn yêu cầu cấp Bằng độc quyền kiểu dáng công nghiệp:

(21) Số đơn	(22) Ngày nộp đơn
3-2019-00732	22/03/2019
3-2019-02053	15/08/2019
3-2020-00324	12/02/2020

Mục sửa đổi: Tên, địa chỉ chủ đơn

Nội dung mới: Công ty cổ phần Liwayway Việt Nam (VN)  
Số 14, đường số 5, khu công nghiệp Việt Nam - Singapore, phường  
Bình Hòa, thành phố Thuận An, tỉnh Bình Dương

---

Thông báo số: 12482w/TB-SHTT, ngày 15/06/2021 về việc ghi nhận sửa đổi đơn

Số Yêu cầu: SĐ3-2021-00378 Ngày nộp: 04/02/2021

Liên quan đến đơn yêu cầu cấp Bằng độc quyền kiểu dáng công nghiệp:

---

**CÔNG BÁO SỞ HỮU CÔNG NGHIỆP SỐ 400 TẬP A - QUYỀN 2 (07.2021)**

---

(21) Số đơn	(22) Ngày nộp đơn
3-2019-02849	11/11/2019

Mục sửa đổi: Chủ đơn, Đại diện sở hữu công nghiệp

Nội dung mới: Chủ đơn mới:

Công ty cổ phần thiết bị nhiệt Đông Á (VN)

Lô C9, khu công nghiệp Tây Bắc Ga, phường Đông Thọ, thành phố Thanh Hóa, tỉnh Thanh Hoá

Đại diện mới:

Công ty TNHH Sở hữu trí tuệ M.I.T(M.I.T IP CO., LTD)

Nhà số 8, ngõ 1060, tổ 4, phường Yên Nghĩa, quận Hà Đông, TP. Hà Nội

---



**PHẦN III**

**THAY ĐỔI CHỦ ĐƠN**

***Ghi nhận thay đổi chủ đơn yêu cầu cấp Bằng độc quyền Kiểu dáng công nghiệp***

Thông báo số: 12258w/TB-SHTT, ngày 14/06/2021 về việc ghi nhận thay đổi chủ đơn

Số Yêu cầu: CD3-2020-00301 Ngày nộp: 19/05/2020

Liên quan đến đơn yêu cầu cấp bằng độc quyền kiểu dáng công nghiệp:

(21) Số đơn	(22) Ngày nộp đơn
3-2019-00003	02/01/2019

Bên chuyển nhượng: QINGDAO BELLINTURF INDUSTRIAL CO., LTD.  
(CN)

No.8, Jilin Road, Beiguan Industrial Zone, Jiaozhou,  
Qingdao Shandong, 266300, China.

Bên được chuyển nhượng: Công ty TNHH Công nghiệp Bellinturf Việt Nam (VN)  
Lô 118B, 119A, 120A, 121A, 122A và 123A, khu công  
nghiệp Long Giang, xã Tân Lập 1, huyện Tân Phước, tỉnh  
Tiền Giang

---

Thông báo số: 12261w/TB-SHTT, ngày 14/06/2021 về việc ghi nhận thay đổi chủ đơn

Số Yêu cầu: CD3-2020-00099 Ngày nộp: 25/02/2020

Liên quan đến đơn yêu cầu cấp bằng độc quyền kiểu dáng công nghiệp:

(21) Số đơn	(22) Ngày nộp đơn
3-2018-02697	13/12/2018

Bên chuyển nhượng: GLOSTER FURNITURE LIMITED (GB)  
Narrow Quay House, Narrow Quay, Bristol BS1 4QA,  
United Kingdom

Bên được chuyển nhượng: DEDON GmbH (DE)  
Zeppelinstrasse 22, 21337 Luneburg, Germany

---

## **CÔNG BÁO SỞ HỮU CÔNG NGHIỆP**

*Do Cục Sở hữu trí tuệ thuộc Bộ Khoa học và Công nghệ ấn hành theo Luật Sở hữu trí tuệ số 50/2005/QH11 được Quốc hội thông qua ngày 29 tháng 11 năm 2005 và được sửa đổi bằng Luật sửa đổi, bổ sung một số điều của Luật sở hữu trí tuệ số 50/2005/QH11 được Quốc hội thông qua ngày 19 tháng 6 năm 2009.*

### ***Địa chỉ liên hệ:***

384-386 đường Nguyễn Trãi, quận Thanh Xuân,  
thành phố Hà Nội, Việt Nam  
ĐT: 024. 38583069  
Fax: 024. 38588449