

CỘNG HÒA XÃ HỘI CHỦ NGHĨA VIỆT NAM  
BỘ KHOA HỌC VÀ CÔNG NGHỆ

CỤC SỞ HỮU TRÍ TUỆ

CÔNG BÁO  
SỞ HỮU CÔNG NGHIỆP

TẬP A

QUYỂN 2: KIỂU DÁNG CÔNG NGHIỆP

04 - 2021

397

CỘNG HOÀ XÃ HỘI CHỦ NGHĨA VIỆT NAM  
BỘ KHOA HỌC VÀ CÔNG NGHỆ  
CỤC SỞ HỮU TRÍ TUỆ

---

CÔNG BÁO  
SỞ HỮU CÔNG NGHIỆP  
TẬP A

QUYỂN 2: KIỂU DÁNG CÔNG NGHIỆP

04-2021

397

---

HÀ NỘI

## MỤC LỤC

	Trang
<u>PHẦN I:</u> Đơn yêu cầu cấp Bằng độc quyền kiểu dáng công nghiệp	7-210

## CONTENTS

<u>PART I:</u> Applications for Industrial Design Patents	7-210
---	-------

---

**CÔNG BÁO SỞ HỮU CÔNG NGHIỆP SỐ 397 TẬP A - QUYỂN 2 (04.2020)**

**MÃ SỐ HAI CHỮ CÁI THỂ HIỆN TÊN NƯỚC VÀ CÁC THỰC THỂ KHÁC TRONG CÁC TƯ LIỆU SỞ HỮU CÔNG NGHIỆP THEO TIÊU CHUẨN ST3 CỦA WIPO**

AE	United Arab Emirates	CN	China	HK	Hong Kong
AF	Afganistan	CO	Colombia	HN	Honduras
AG	Antihua and Barbuda	CR	Costa Rica	HR	Croatia
AI	Anguilla	CU	Cuba	HT	Haiti
AL	Albania	CV	Cape Verde	HU	Hungary
AN	Netherlands Antilles	CY	Cyprus	ID	Indonesia
AO	Angola	CZ	Czech Republic	IE	Ireland
AR	Argentina	DE	Germany	IL	Israel
AT	Austria	DJ	Djibouti	IN	India
AU	Australia	DK	Denmark	IQ	Iraq
AW	Aruba	DM	Dominica	IR	Iran (Islamic Republic of)
BB	Barbados	DO	Dominican Republic	IS	Iceland
BD	Bangladesh	DZ	Algeria	IT	Italy
BE	Belgium	EC	Ecuador	JM	Jamaica
BF	Burkina Faso	EE	Estonia	JO	Jordan
BG	Bulgaria	EG	Egypt	JP	Japan
BH	Bahrain	ES	Spain	KE	Kenya
BI	Burundi	ET	Ethiopia	KH	Cambodia
BJ	Benin	FI	Finland	KI	Kiribati
BM	Bermuda	FJ	Fiji	KM	Comoros
BN	Brunei Darussalam	FK	Falkand Islands (Malvinas)	KN	Saint Kitts and Nevis
BO	Bolivia	FR	France	KP	Democratic People's Republic of Korea
BR	Brazil	GA	Gabon	KR	Republic of Korea
BS	Bahamas	GB	United Kingdom	KW	Kuwait
BT	Bhutan	GD	Grenada	KY	Cayman Islands
BW	Botswana	GE	Georgia	KZ	Kazakhstan
BY	Belarus	GH	Ghana	LA	Laos
BZ	Belize	GI	Gibraltar	LB	Lebanon
CA	Canada	GM	Gambia	LC	Saint Lucia
CF	Central African Republic	GN	Guinea	LI	Liechtenstein
CG	Congo	GQ	Equatorial Guinea	LK	SriLanka
CH	Switzerland	GR	Greece	LR	Liberia
CI	Côte d'Ivoire	GT	Guatemala	LS	Lesotho
CL	Chile	GW	Guinea-Bissau	LT	Lithuania
CM	Cameroon	GY	Guyana	TC	Turk and Caicos Islands
LU	Luxembourg	PA	Panama	TD	Chad
LV	Latvia	PE	Peru	TG	Togo
LY	Lybya	PG	Papua New Guinea	TH	Thailand
MA	Morocco	PH	Philippines	TN	Tunisia
MC	Monaco	PK	Pakistan	TO	Tonga
MD	Republic of Moldova	PL	Poland	TR	Turkey

**CÔNG BÁO SỞ HỮU CÔNG NGHIỆP SỐ 397 TẬP A - QUYỂN 2 (04.2020)**

MG	Madagascar	PT	Portugal	TT	Trinidad and Tobago
ML	Mali	PY	Paraguay	TV	Tuvalu
MM	Myanmar	QA	Qatar	TW	Taiwan, Province of China
MN	Mongolia	RO	Rumania	TZ	United Republic of Tanzania
MO	Macau	RU	Russian Federation	UA	Ukraine
MR	Mauritania	RW	Rwanda	UG	Uganda
MS	Montserrat	SA	Saudi Arabia	US	United States of America
MT	Malta	SB	Solomon Islands	UY	Uruguay
MU	Mauritius	SC	Seychelles	UZ	Uzbekistan
MV	Maldives	SD	Sudan	VA	Holy see
MW	Malawi	SE	Sweden	VC	Saint Vincent and the Grenadines
MX	Mexico	SG	Singapore	VE	Venezuela
MY	Malaysia	SH	Saint Helena	VG	Virgin Islands (British)
MZ	Mozambique	SL	Slovenia	VN	Vietnam
NA	Namibia	SK	Slovakia	VU	Vanuatu
NE	Niger	SL	Sierra Leone	WS	Samoa
NG	Nigeria	SM	San Marino	YE	Yemen
NJ	Nicaragua	SN	Senegal	YU	Yugoslavia
NL	Netherlands	SO	Somalia	ZA	South Africa
NO	Norway	SR	Suriname	ZM	Zambia
NP	Nepal	ST	Sao Tome and Principe	ZR	Zaire
NR	Nauru	SV	El Sanvador	ZW	Zimbabwe
NZ	New Zealand	SY	Syria		
OM	Oman	SZ	Swaziland		

**CÁC TỔ CHỨC QUỐC TẾ**

AO	African Intellectual Property Organization (OAPI)
AP	African Regional Industrial Property Organization (ARIPO)
BX	Benelux Trademark Office and Benelux Designs Office
EP	European Patent Office (EPO)
IB, WO	International Bureau of the World Intellectual Property Organization (WIPO)

**NHỮNG MÃ SỐ INID TRÍCH TỪ TIÊU CHUẨN ST80 CỦA TỔ CHỨC SỞ HỮU TRÍ TUỆ THẾ GIỚI (WIPO) ĐỂ NHẬN BIẾT CÁC DỮ LIỆU THƯ MỤC DÙNG CÔNG BỐ ĐƠN VÀ BẰNG ĐỘC QUYỀN KIỂU DÁNG CÔNG NGHIỆP**

- (11) Số bằng độc quyền kiểu dáng công nghiệp / Số công bố đơn
- (15) Ngày cấp
- (18) Ngày hết hạn hiệu lực của bằng độc quyền kiểu dáng công nghiệp
- (21) Số đơn
- (22) Ngày nộp đơn
- (23) Tên triển lãm, ngày và nơi triển lãm
- (28) Số phương án yêu cầu bảo hộ
- (30) Số đơn ưu tiên, ngày nộp đơn ưu tiên
- (43) Ngày công bố đơn
- (45) Ngày công bố bằng độc quyền kiểu dáng công nghiệp
- (51) Phân loại quốc tế kiểu dáng công nghiệp
- (54) Tên sản phẩm mang kiểu dáng công nghiệp
- (55) Ảnh chụp / hình vẽ kiểu dáng công nghiệp
- (57) Đặc điểm khác biệt yêu cầu bảo hộ của kiểu dáng công nghiệp
- (62) Số và ngày nộp đơn, số bằng độc quyền KDCN hoặc số công bố đơn liên quan đến tách đơn
- (71) Tên và địa chỉ của người nộp đơn
- (72) Tên của tác giả KDCN
- (73) Tên, địa chỉ của chủ bằng độc quyền KDCN
- (74) Tên của người đại diện SHCN

PHẦN I

**ĐƠN YÊU CẦU CẤP BẰNG ĐỘC QUYỀN KIỂU DÁNG CÔNG NGHIỆP**

- (11) **41291**  
(21) 3-2019-00486 (28) 1  
(54) **THIẾT BỊ CÂN VÀ TRẢI CỎ NHÂN TẠO** (51) **10-04; 15-99**  
(22) 22/02/2019 (43) 26/04/2021  
(73) **WANG FENG LING (CN)**  
No. 22 Jian Guo Men Wai Ave. Beijing 100004 P. R. China  
(72) **WANG FENG LING (CN)**  
(74) Công ty TNHH Sở hữu trí tuệ VIPATCO (VIPATCO CO., LTD.)  
(55)

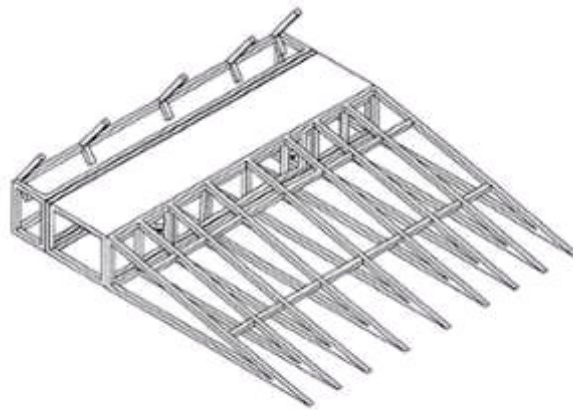

1.1



1.2

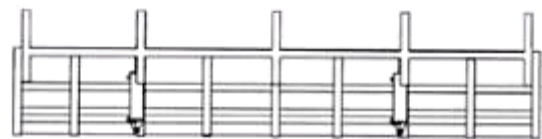

1.3



1.4



1.5

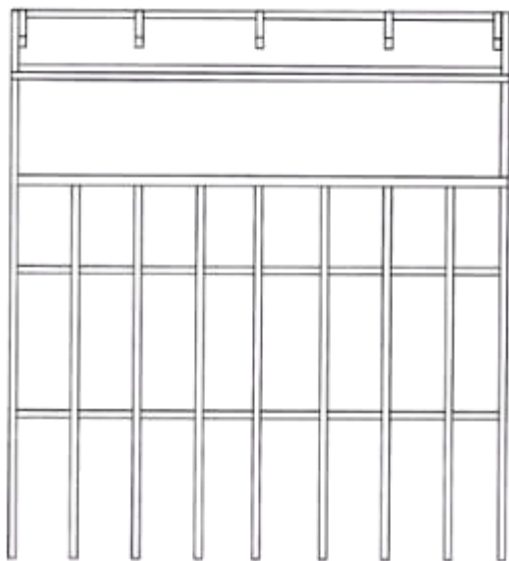

1.6

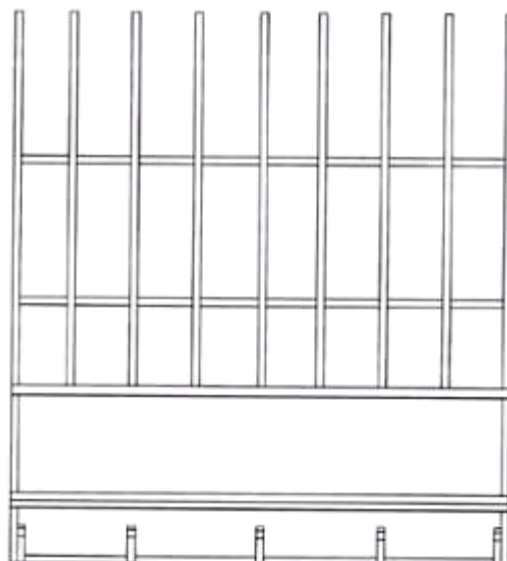

1.7



**CÔNG BÁO SỞ HỮU CÔNG NGHIỆP SỐ 397 TẬP A – QUYỀN 2 (04.2021)**

(11) **41292**

(21) 3-2019-01346

(28) 1

(54) **NỒI**

(51) **07-02**

(22) 23/05/2019

(43) 26/04/2021

(73) **CÔNG TY TNHH MINH LONG I (VN)**

333 Khu phố Hưng Lộc, phường Hưng Định, thị xã Thuận An, tỉnh Bình Dương

(72) Lý Ngọc Minh (VN)

(55)



1.1



1.2



1.3



1.4



1.5

**CÔNG BÁO SỞ HỮU CÔNG NGHIỆP SỐ 397 TẬP A – QUYỀN 2 (04.2021)**

(11) **41293**

(21) 3-2019-01347

(28) 1

(54) **NỒI**

(51) **07-02**

(22) 23/05/2019

(43) 26/04/2021

(73) **CÔNG TY TNHH MINH LONG I (VN)**

333 Khu phố Hưng Lộc, phường Hưng Định, thị xã Thuận An, tỉnh Bình Dương

(72) Lý Ngọc Minh (VN)

(55)



1.1



1.2



1.3



1.4



1.5

**CÔNG BÁO SỞ HỮU CÔNG NGHIỆP SỐ 397 TẬP A – QUYỀN 2 (04.2021)**

(11) **41294**

(21) 3-2019-02191

(54) **HỘP**

(22) 29/08/2019

(28) 1

(51) **09-03**

(43) 26/04/2021

**CÔNG TY TRÁCH NHIỆM HỮU HẠN MỘT THÀNH VIÊN KÈM SÀI GÒN (VN)**

7/7 Thành Thái, phường 14, quận 10, thành phố Hồ Chí Minh

(72) Nguyễn Thị Hải Anh (VN)

(55)



1.1



1.2



1.3



1.4

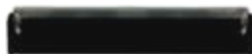

1.5



1.6



1.7



1.8

**CÔNG BÁO SỞ HỮU CÔNG NGHIỆP SỐ 397 TẬP A – QUYỀN 2 (04.2021)**

(11) **41295**

(21) 3-2019-02856

(28) 1

(54) **HỘP**

(51) **09-03**

(22) 12/11/2019

(43) 26/04/2021

**CÔNG TY TNHH THƯƠNG MẠI VÀ DỊCH VỤ BEAUTY DAILY SPA  
VIỆT NAM (VN)**

(73) A07, Lô HH06, khu đô thị Việt Hưng, phường Việt Hưng, quận Long Biên, thành phố Hà Nội

(72) Nguyễn Thị Giang (VN)

(55)

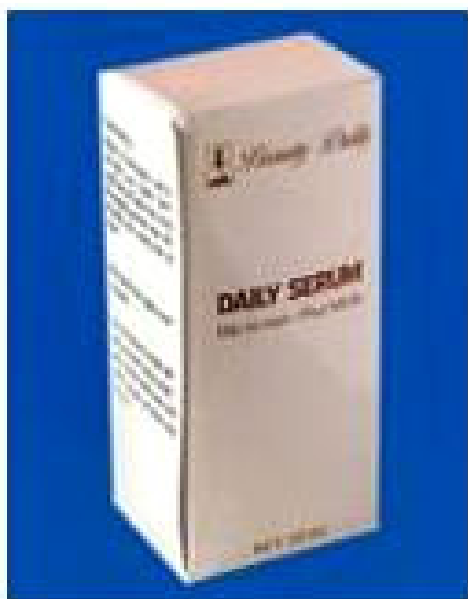

1.1



1.2

**CÔNG BÁO SỞ HỮU CÔNG NGHIỆP SỐ 397 TẬP A – QUYỀN 2 (04.2021)**

(11) **41296**

(21) 3-2019-03056

(28) 1

(54) **HỘP ĐỰNG HẢI SẢN**

(51) **09-03**

(22) 27/11/2019

(43) 26/04/2021

**CÔNG TY TNHH FISHY VIỆT NAM (VN)**

(73) Số 18 đường số 10, phường Hiệp Bình Chánh, quận Thủ Đức, thành phố Hồ Chí Minh

(72) Nguyễn Hữu Dương (VN)

(55)



1.1



1.2

**CÔNG BÁO SỞ HỮU CÔNG NGHIỆP SỐ 397 TẬP A – QUYỀN 2 (04.2021)**

(11) 41297

(21) 3-2019-03057

(54) **HỘP ĐỰNG HẢI SẢN**

(22) 27/11/2019

(28) 1

(51) **09-03**

(43) 26/04/2021

**CÔNG TY TNHH FISHY VIỆT NAM (VN)**

(73) Số 18 đường số 10, phường Hiệp Bình Chánh, quận Thủ Đức, thành phố Hồ Chí Minh

(72) Nguyễn Hữu Dương (VN)

(55)



1.1



1.2

**CÔNG BÁO SỞ HỮU CÔNG NGHIỆP SỐ 397 TẬP A – QUYỂN 2 (04.2021)**

(11) **41298**

(21) 3-2019-03058

(54) **HỘP ĐỰNG HẢI SẢN**

(22) 27/11/2019

**CÔNG TY TNHH FISHY VIỆT NAM (VN)**

(73) Số 18 đường số 10, phường Hiệp Bình Chánh, quận Thủ Đức, thành phố Hồ Chí Minh

(72) Nguyễn Hữu Dương (VN)

(55)

(28) 1

(51) **09-03**

(43) 26/04/2021



1.1



1.2



1.3



**CÔNG BÁO SỞ HỮU CÔNG NGHIỆP SỐ 397 TẬP A – QUYỀN 2 (04.2021)**

(11) **41299**

(21) 3-2019-03059

(54) **HỘP ĐỰNG HẢI SẢN**

(22) 27/11/2019

(28) 1

(51) **09-03**

(43) 26/04/2021

**CÔNG TY TNHH FISHY VIỆT NAM (VN)**

(73) Số 18 đường số 10, phường Hiệp Bình Chánh, quận Thủ Đức, thành phố Hồ Chí Minh

(72) Nguyễn Hữu Dương (VN)

(55)



1.1



1.2



1.3

(11) **41300**

(21) 3-2020-00382

(28) 1

(54) **GIÁ ĐỖ**

(51) **14-99**

(22) 19/02/2020

(43) 26/04/2021

**CÔNG TY CỔ PHẦN CUNG ỨNG CÔNG NGHỆ & GIẢI PHÁP BEPOS VN**  
(VN)

(73) Tầng 5, tòa nhà Reeco, số 98 đường Hoàng Ngân, phường Trung Hòa, quận Cầu Giấy, thành phố Hà Nội

(72) Phạm Thị Nga (VN)

(74) Công ty TNHH Trường Xuân (AGELESS CO.,LTD.)

(55)

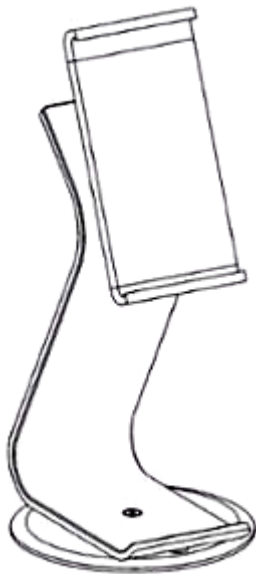

1.1

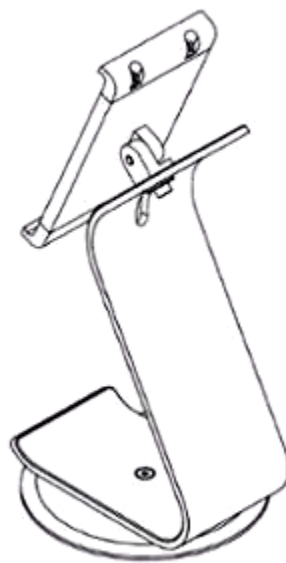

1.2

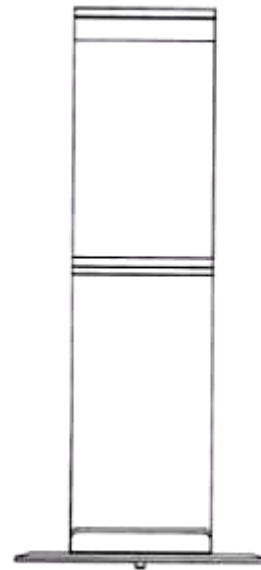

1.3

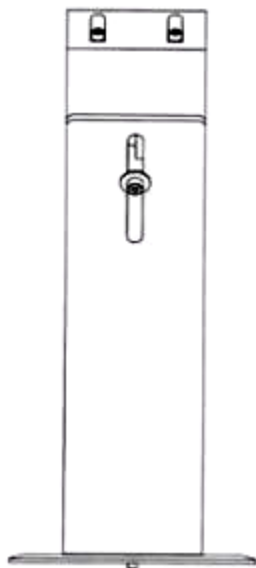

1.4



1.5



1.6

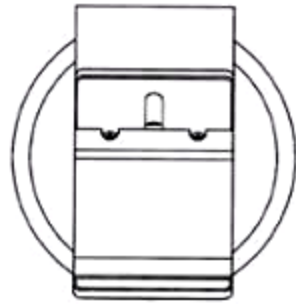

1.7

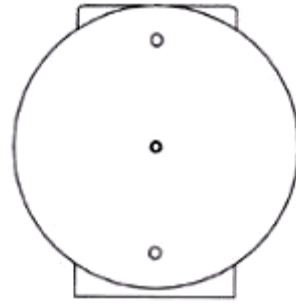

1.8

(11) **41301**

(21) 3-2020-00383

(28) 1

(54) **GIÁ ĐỒ**

(51) **14-99**

(22) 19/02/2020

(43) 26/04/2021

**CÔNG TY CỔ PHẦN CUNG ỨNG CÔNG NGHỆ & GIẢI PHÁP BEPOS VN (VN)**

(73) Tầng 5, tòa nhà Reeco, số 98 đường Hoàng Ngân, phường Trung Hòa, quận Cầu Giấy, thành phố Hà Nội

(72) Phạm Thị Nga (VN)

(74) Công ty TNHH Trường Xuân (AGELESS CO.,LTD.)

(55)

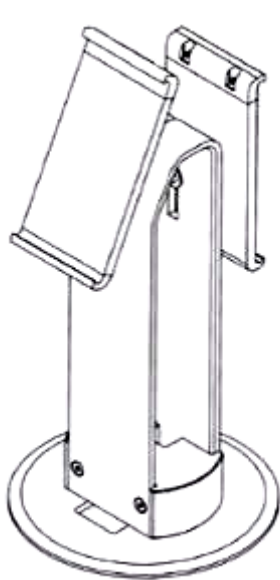

1.1

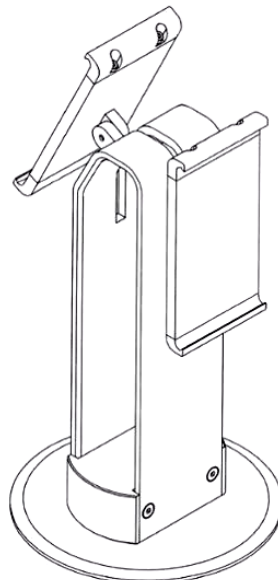

1.2

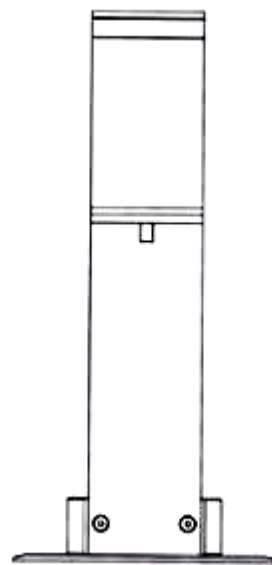

1.3

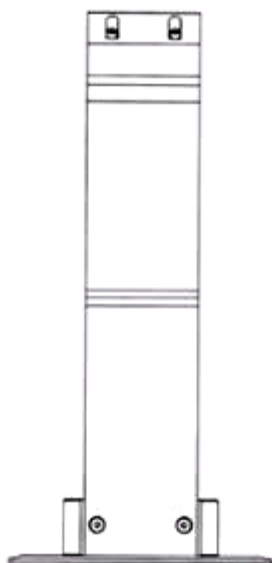

1.4

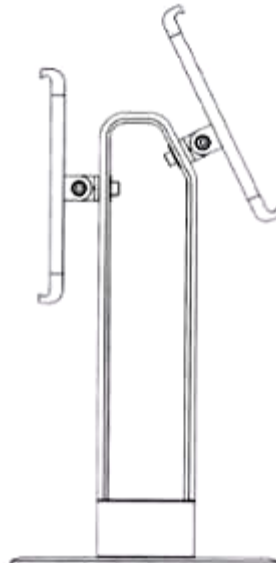

1.5

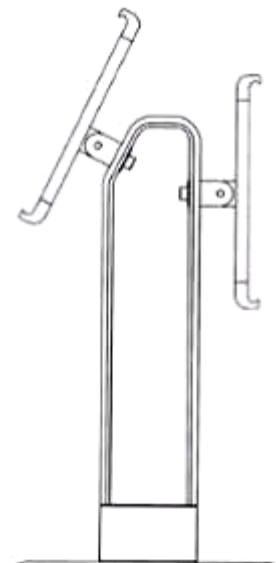

1.6

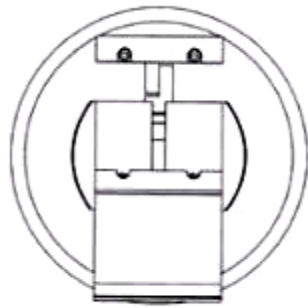

1.7

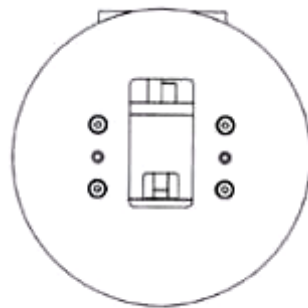

1.8

**CÔNG BÁO SỞ HỮU CÔNG NGHIỆP SỐ 397 TẬP A – QUYỀN 2 (04.2021)**

- (11) **41302**  
(21) 3-2020-00608 (28) 1  
(54) **DÂY ĐỒNG HỒ** (51) **10-07**  
(22) 19/03/2020 (43) 26/04/2021  
(30) 201930525409.9 24/09/2019 CN;  
**BEIJING XIAOMI MOBILE SOFTWARE CO., LTD. (CN)**  
(73) No. 018, Floor 8, Building 6, Yard 33, Middle Xierqi Road, Haidian District,  
Beijing 100085, China  
1. ZHANG, QIAN (CN)  
(72) 2. LI, NINGNING (CN)  
3. ZHANG, LEI (CN)  
(74) Công ty TNHH một thành viên Sở hữu trí tuệ VCCI (VCCI-IP CO.,LTD)  
(55)

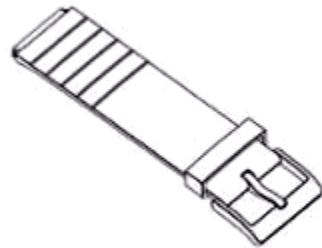

1.1

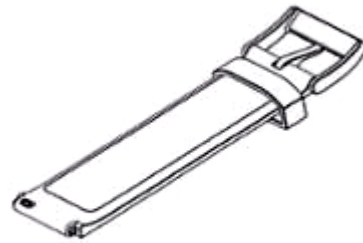

1.2



1.3

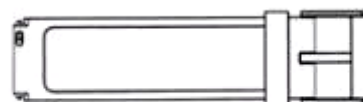

1.4



1.5



1.6



1.7



1.8

**CÔNG BÁO SỞ HỮU CÔNG NGHIỆP SỐ 397 TẬP A – QUYỀN 2 (04.2021)**

- (11) **41303**  
(21) 3-2020-00779 (28) 1  
(54) **THANH NHÔM ĐỊNH HÌNH** (51) **25-01**  
(22) 08/04/2020 (43) 26/04/2021  
(73) **CÔNG TY CỔ PHẦN ĐẦU TƯ VÀ XUẤT NHẬP KHẨU LIGHTSTAR (VN)**  
Số 46 Trần Bình, phường Mai Dịch, quận Cầu Giấy, thành phố Hà Nội  
(72) Vũ Quỳnh Uyên (VN)  
(74) Công ty Luật TNHH SMARTLAW (SMARTLAW LEGAL SERVICE CO.,LTD.)  
(55)



1.1



1.2

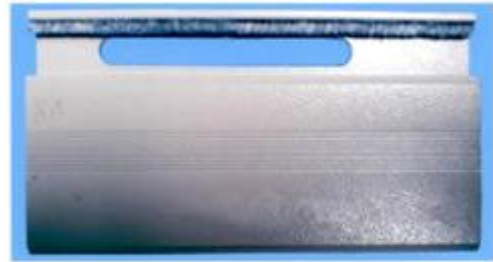

1.3

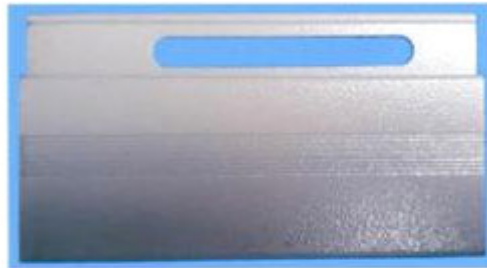

1.4



1.5



1.6



1.7

**CÔNG BÁO SỞ HỮU CÔNG NGHIỆP SỐ 397 TẬP A – QUYỀN 2 (04.2021)**

- (11) **41304**  
(21) 3-2020-01419 (28) 1  
(54) **THANH NHÔM ĐỊNH HÌNH** (51) **25-01**  
(22) 17/06/2020 (43) 26/04/2021  
(73) **CÔNG TY TNHH XUẤT NHẬP KHẨU THANH PHÚC (VN)**  
317 Nguyễn Thị Thập, phường Tân Phú, quận 7, thành phố Hồ Chí Minh  
(72) Nguyễn Văn Phúc (VN)  
(55)



1.1



1.2



1.3



1.4



1.5



1.6



**CÔNG BÁO SỞ HỮU CÔNG NGHIỆP SỐ 397 TẬP A – QUYỂN 2 (04.2021)**

- (11) **41305**  
(21) 3-2020-01563 (28) 1  
(54) **BAO BÌ** (51) **09-05**  
(22) 06/07/2020 (43) 26/04/2021  
(73) **CÔNG TY TNHH GALAXY AGRO (VN)**  
14/16 Đường 990, khu phố 4, phường Phú Hữu, quận 9, thành Phố Hồ Chí Minh  
(72) Phạm Anh Nghị (VN)  
(55)



1.1



1.2

**CÔNG BÁO SỞ HỮU CÔNG NGHIỆP SỐ 397 TẬP A – QUYỀN 2 (04.2021)**

- (11) **41306**
- (21) 3-2020-01611 (28) 1
- (54) **NHÃN SẢN PHẨM** (51) **19-08**
- (22) 13/07/2020 (43) 26/04/2021
- (73) **LÊ THỊ TỚI (VN)**  
Thôn Mễ Sơn, xã Nguyễn Trãi, huyện Thường Tín, thành phố Hà Nội
- (72) Lê Thị Tới (VN)
- (74) Công ty TNHH Sở hữu trí tuệ VIPATCO (VIPATCO CO., LTD.)
- (55)



**CÔNG BÁO SỞ HỮU CÔNG NGHIỆP SỐ 397 TẬP A – QUYỀN 2 (04.2021)**

- (11) **41307**  
(21) 3-2020-01742 (28) 4  
(54) **TẤM ỐP LƯNG CHO THIẾT BỊ ĐIỆN TỬ DI ĐỘNG** (51) **14-03**  
(22) 28/07/2020 (43) 26/04/2021  
(30) 29/723,154 04/02/2020 US;  
**GOOGLE LLC (US)**  
(73) 1600 Amphitheatre Parkway, Mountain View, California 94043, United States of America  
1. MIGUEL HARRY PUERTA (CO)  
(72) 2. ALBERTO VILLARREAL BELLO (MX)  
3. MAX YOSHIMOTO (US)  
(74) Công ty TNHH Sở hữu công nghiệp Sao Bắc Đẩu (SAO BAC DAU IP CO.,LTD)  
(55)



1.1

1.2

1.3



1.4

1.5

1.6



1.7



1.8

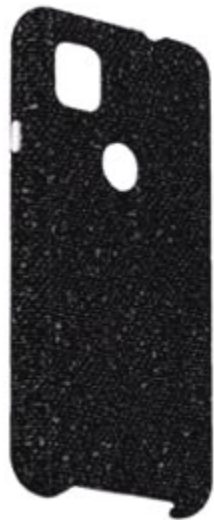

2.1



2.2



2.3



2.4



2.5



2.6



2.7



2.8



3.1



3.2



3.3

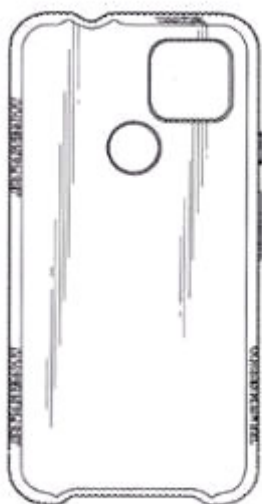

3.4



3.5



3.6



3.7

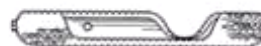

3.8



4.1



4.2



4.3

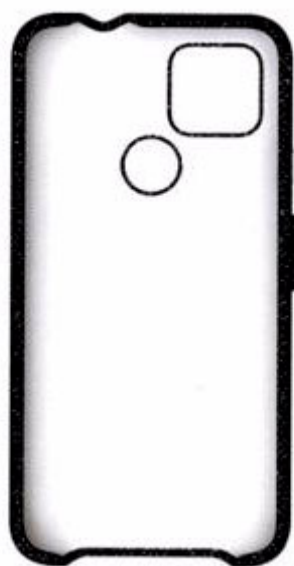

4.4



4.5



4.6



4.7



4.8

**CÔNG BÁO SỞ HỮU CÔNG NGHIỆP SỐ 397 TẬP A – QUYỀN 2 (04.2021)**

- (11) **41308**  
(21) 3-2020-01744 (28) 2  
(54) **TẤM ỐP LƯNG CHO THIẾT BỊ ĐIỆN TỬ DI ĐỘNG** (51) **14-03**  
(22) 28/07/2020 (43) 26/04/2021  
(30) 29/723,151 04/02/2020 US;  
**GOOGLE LLC (US)**  
(73) 1600 Amphitheatre Parkway, Mountain View, California 94043, United States of America  
1. MIGUEL HARRY PUERTA (CO)  
(72) 2. ALBERTO VILLARREAL BELLO (MX)  
3. MAX YOSHIMOTO (US)  
(74) Công ty TNHH Sở hữu công nghiệp Sao Bắc Đẩu (SAO BAC DAU IP CO.,LTD)  
(55)



1.1



1.2

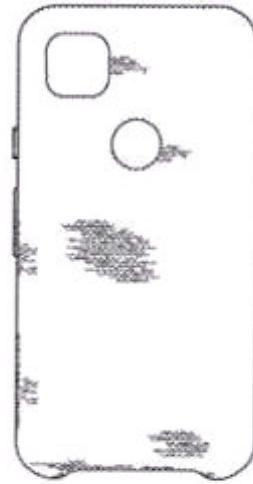

1.3

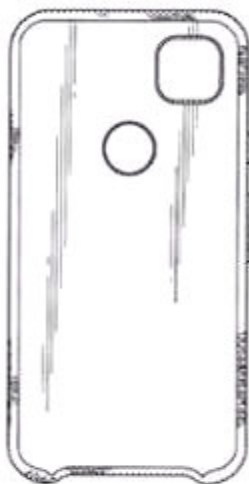

1.4



1.5



1.6

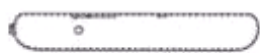

1.7



1.8



2.1



2.2



2.3

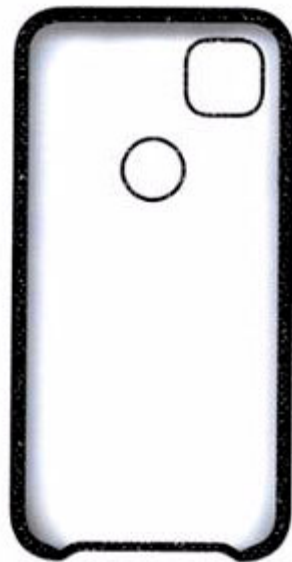

2.4



2.5



2.6



2.7



2.8



**CÔNG BÁO SỞ HỮU CÔNG NGHIỆP SỐ 397 TẬP A – QUYỀN 2 (04.2021)**

- (11) **41309**  
(21) 3-2020-01896 (28) 1  
(54) **HỘP ĐỰNG** (51) **09-05**  
(22) 13/08/2020 (43) 26/04/2021  
(30) 2020-005943 27/03/2020 JP;  
**BROTHER INDUSTRIES, LTD. (JP)**  
(73) 15-1 Naeshiro-cho, Mizuho-ku, Nagoya-shi, Aichi-ken, Japan  
(72) Izumi KATO (JP)  
(74) Công ty TNHH Ban Ca (BANCA)  
(55)

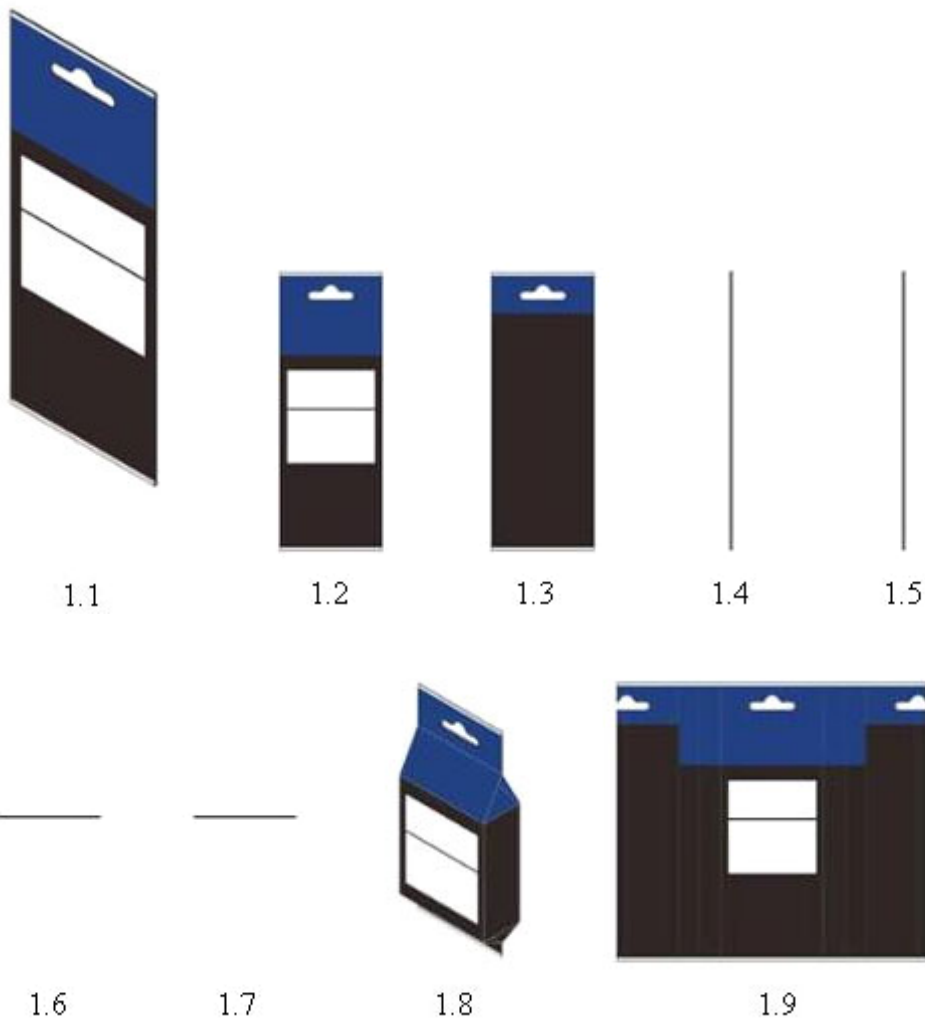

- (11) **41310**  
(21) 3-2020-01969 (28) 2  
(54) **THIẾT BỊ LẮNG TỰ ĐỘNG** (51) **23-01; 23-99**  
(22) 24/08/2020 (43) 26/04/2021  
(73) **CÔNG TY CỔ PHẦN THIẾT BỊ XỬ LÝ NƯỚC SETFIL (VN)**  
Phòng 107, nhà I9, Thanh Xuân Bắc, quận Thanh Xuân, thành phố Hà Nội  
(72) Đinh Công Hải (VN)  
(55)

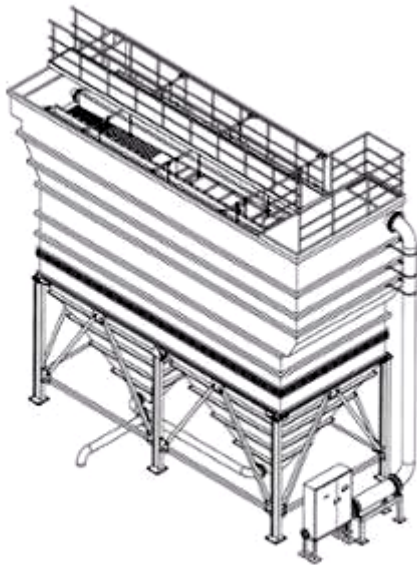

1.1

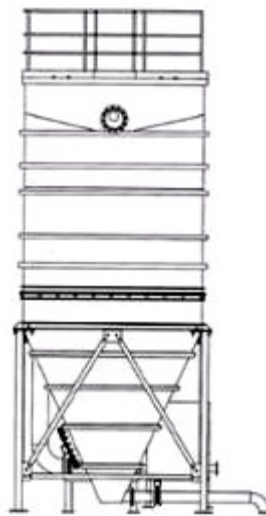

1.2



1.3

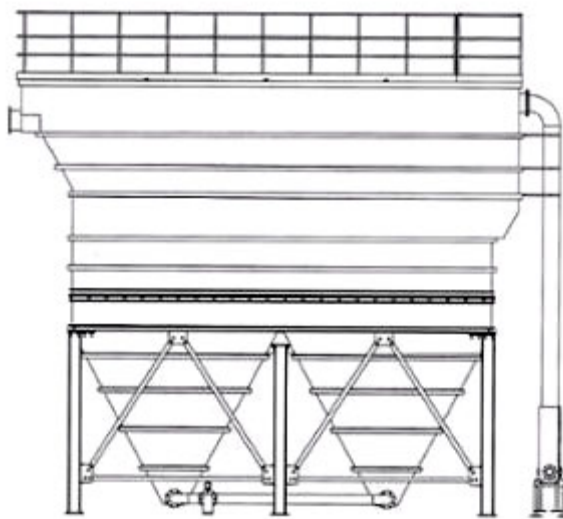

1.4

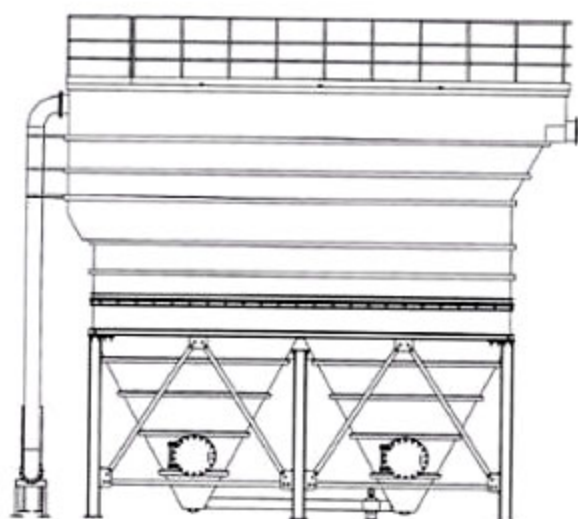

1.5

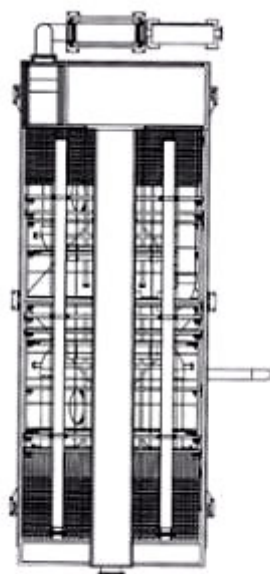

1.6

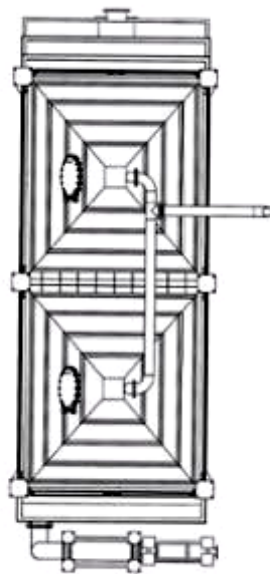

1.7

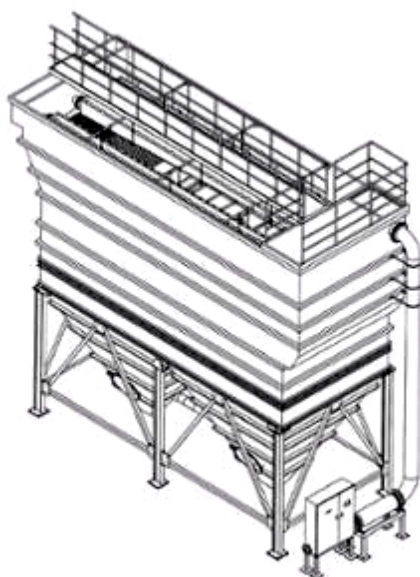

2.1

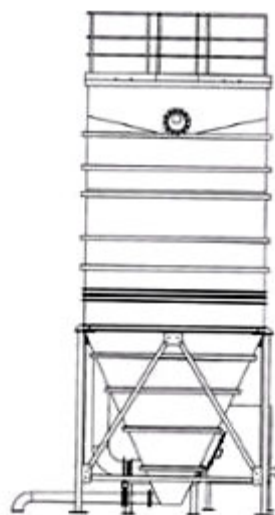

2.2

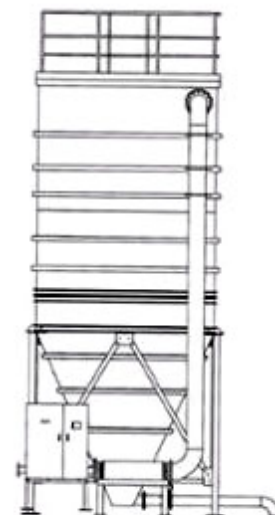

2.3

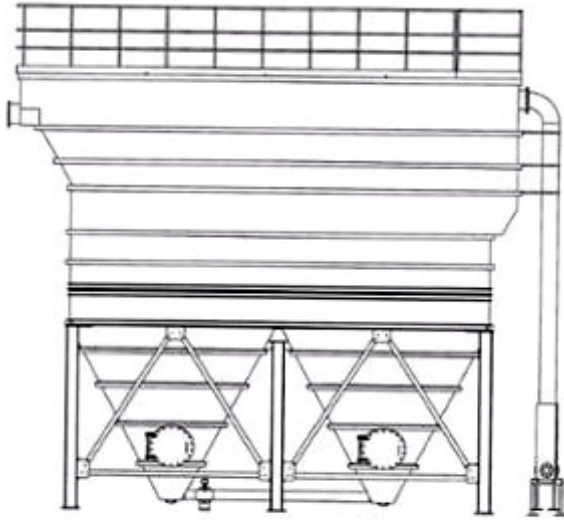

2.4

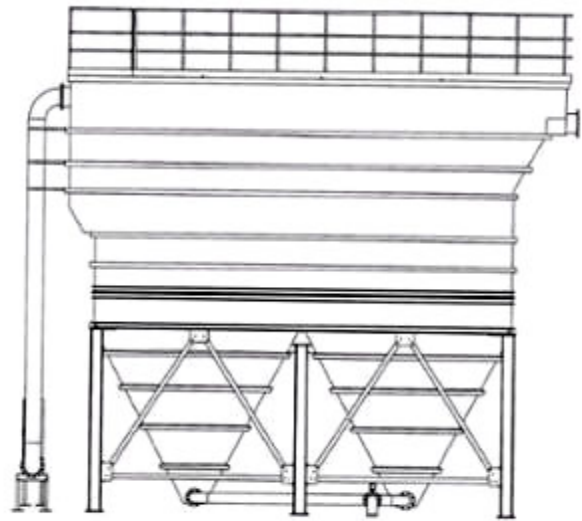

2.5

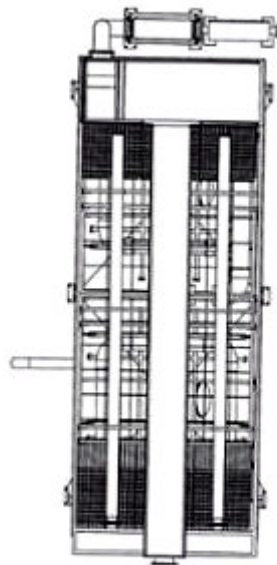

2.6

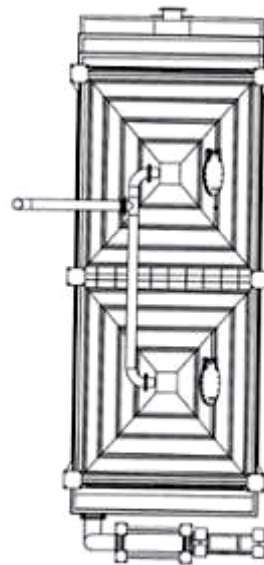

2.7

**CÔNG BÁO SỞ HỮU CÔNG NGHIỆP SỐ 397 TẬP A – QUYỀN 2 (04.2021)**

(11) **41311**

(21) 3-2020-01972

(28) 1

(54) **NẮP ĐẬY LON SỮA**

(51) **09-07**

(22) 25/08/2020

(43) 26/04/2021

**CÔNG TY TNHH MỘT THÀNH VIÊN BAO BÌ VÀ THƯƠNG MẠI  
QUANG HUY (VN)**

(73) Lô C 18/II đường 2F, khu công nghiệp Vĩnh Lộc, xã Vĩnh Lộc A, huyện Bình Chánh, Thành phố Hồ Chí Minh

(72) Trương Sỹ An (VN)

(74) Trung tâm Tư vấn phát triển thương hiệu và chất lượng (CBQ)

(55)



1.1



1.2



1.3



1.4

- (11) **41312**
- (21) 3-2020-02043 (28) 1
- (54) **THIẾT BỊ ĐẦU CUỐI TRUYỀN THÔNG** (51) **14-02; 14-03**
- (22) 31/08/2020 (43) 26/04/2021
- (73) **KUBOTA CORPORATION (JP)**  
 2-47, Shikitsuhigashi 1-chome, Naniwa-ku, Osaka-shi, Osaka 5568601, Japan
- 1. YASUYUKI YOSHIDA (JP)
- (72) 2. KEOIL JIN (KR)
- 3. NORIAKI ISHIBASHI (JP)
- (74) Công ty TNHH một thành viên Sở hữu trí tuệ VCCI (VCCI-IP CO.,LTD)
- (55)

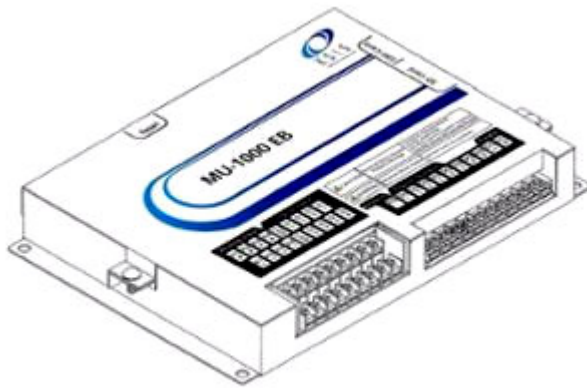

1.1

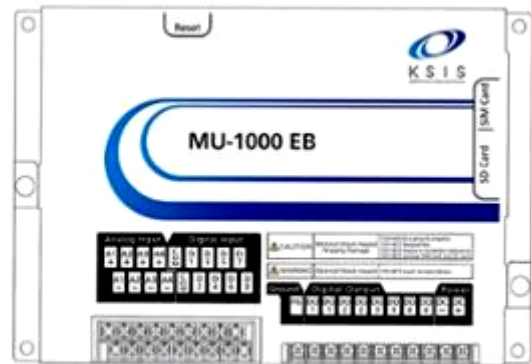

1.2



1.3



1.4



1.5



1.6

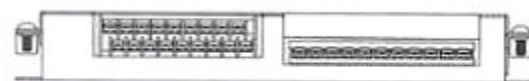

1.7

**CÔNG BÁO SỞ HỮU CÔNG NGHIỆP SỐ 397 TẬP A – QUYỀN 2 (04.2021)**

- (11) **41313**  
(21) 3-2020-02045 (28) 1  
(54) **BAO GÓI TÃ VỆ SINH** (51) **09-05**  
(22) 31/08/2020 (43) 26/04/2021  
**CÔNG TY TNHH SẢN XUẤT VÀ THƯƠNG MẠI QUỐC TẾ VIỆT SING**  
(73) (VN)  
Cụm CN Xuân Lâm, xã Xuân Lâm, huyện Thuận Thành, tỉnh Bắc Ninh  
(72) Nguyễn Đăng Dũng (VN)  
(55)



1.1



1.2

**CÔNG BÁO SỞ HỮU CÔNG NGHIỆP SỐ 397 TẬP A – QUYỀN 2 (04.2021)**

- (11) **41314**  
(21) 3-2020-02046 (28) 1  
(54) **BAO GÓI TẤ VỆ SINH** (51) **09-05**  
(22) 31/08/2020 (43) 26/04/2021  
**CÔNG TY TNHH SẢN XUẤT VÀ THƯƠNG MẠI QUỐC TẾ VIỆT SING**  
(73) (VN)  
Cụm CN Xuân Lâm, xã Xuân Lâm, huyện Thuận Thành, tỉnh Bắc Ninh  
(72) Nguyễn Đăng Dũng (VN)  
(55)



1.1



1.2



**CÔNG BÁO SỞ HỮU CÔNG NGHIỆP SỐ 397 TẬP A – QUYỀN 2 (04.2021)**

- (11) **41315**  
(21) 3-2020-02047 (28) 1  
(54) **BAO GÓI TẮ VỆ SINH** (51) **09-05**  
(22) 31/08/2020 (43) 26/04/2021  
**CÔNG TY TNHH SẢN XUẤT VÀ THƯƠNG MẠI QUỐC TẾ VIỆT SING**  
(73) (VN)  
Cụm CN Xuân Lâm, xã Xuân Lâm, huyện Thuận Thành, tỉnh Bắc Ninh  
(72) Nguyễn Đăng Dũng (VN)  
(55)



1.1



1.2

**CÔNG BÁO SỞ HỮU CÔNG NGHIỆP SỐ 397 TẬP A – QUYỀN 2 (04.2021)**

(11) **41316**

(21) 3-2020-02048

(28) 1

(54) **BAO GÓI TẤ VỆ SINH**

(51) **09-05**

(22) 31/08/2020

(43) 26/04/2021

**CÔNG TY TNHH SẢN XUẤT VÀ THƯƠNG MẠI QUỐC TẾ VIỆT SING**

(73) (VN)

Cụm CN Xuân Lâm, xã Xuân Lâm, huyện Thuận Thành, tỉnh Bắc Ninh

(72) Nguyễn Đăng Dũng (VN)

(55)



1.1

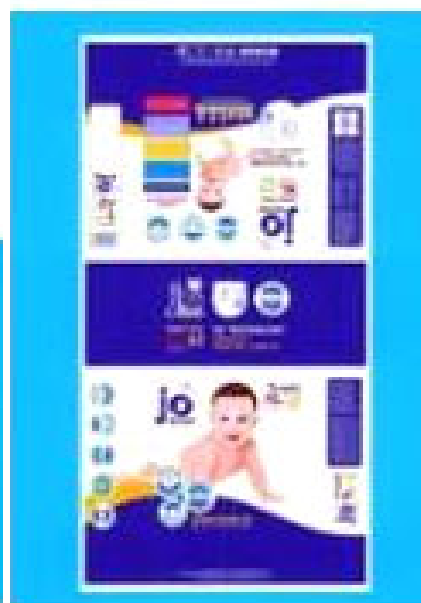

1.2

**CÔNG BÁO SỞ HỮU CÔNG NGHIỆP SỐ 397 TẬP A – QUYỀN 2 (04.2021)**

- (11) 41317  
(21) 3-2020-02049  
(54) **BAO GÓI TẤ VỆ SINH**  
(22) 31/08/2020  
(73) (VN)  
Cụm CN Xuân Lâm, xã Xuân Lâm, huyện Thuận Thành, tỉnh Bắc Ninh  
(72) Nguyễn Đăng Dũng (VN)  
(55)
- (28) 1  
(51) **09-05**  
(43) 26/04/2021  
**CÔNG TY TNHH SẢN XUẤT VÀ THƯƠNG MẠI QUỐC TẾ VIỆT SING**



1.1



1.2

(11) **41318**

(21) 3-2020-02058

(54) **XE BÁN HÀNG**

(22) 01/09/2020

(73) **CÔNG TY TNHH TNI KING COFFEE (VN)**

161 Võ Văn Tần, phường 6, quận 3, thành phố Hồ Chí Minh

(72) Lê Hoàng Diệp Thảo (VN)

(55)

(28) 1

(51) **12-02; 20-01**

(43) 26/04/2021



1.1



1.2



1.3



1.4



1.5



1.6



1.7

**CÔNG BÁO SỞ HỮU CÔNG NGHIỆP SỐ 397 TẬP A – QUYỀN 2 (04.2021)**

(11) **41319**

(21) 3-2020-02072

(28) 1

(54) **GHẾ SÔ-PHA**

(51) **06-01**

(22) 03/09/2020

(43) 26/04/2021

(73) **HTL FURNITURE (CHINA) CO., LTD. (CN)**

Wusong Jiangnan Road, Kunshan Development Zone, Jiangsu Province, China

(72) PHUA YONG TAT (SG)

(74) Công ty Luật TNHH quốc tế BMVN (BMVN INTERNATIONAL LLC)

(55)



1.1



1.2



1.3



1.4



1.5

**CÔNG BÁO SỞ HỮU CÔNG NGHIỆP SỐ 397 TẬP A – QUYỀN 2 (04.2021)**

(11) **41320**

(21) 3-2020-02118

(28) 1

(54) **GHẾ**

(51) **06-01**

(22) 04/09/2020

(43) 26/04/2021

(73) **HTL FURNITURE (CHINA) CO., LTD. (CN)**

Wusong Jiangnan Road, Kunshan Development Zone, Jiangsu Province, China

(72) PHUA YONG TAT (SG)

(74) Công ty Luật TNHH quốc tế BMVN (BMVN INTERNATIONAL LLC)

(55)



1.1



1.2



1.3



1.4



1.5

**CÔNG BÁO SỞ HỮU CÔNG NGHIỆP SỐ 397 TẬP A – QUYỀN 2 (04.2021)**

(11) **41321**

(21) 3-2020-02133

(28) 1

(54) **GHẾ**

(51) **06-01**

(22) 04/09/2020

(43) 26/04/2021

(73) **HTL FURNITURE (CHINA) CO., LTD. (CN)**

Wusong Jiangnan Road, Kunshan Development Zone, Jiangsu Province, China

(72) PHUA YONG TAT (SG)

(74) Công ty Luật TNHH quốc tế BMVN (BMVN INTERNATIONAL LLC)

(55)



1.1



1.2



1.3



1.4



1.5

**CÔNG BÁO SỞ HỮU CÔNG NGHIỆP SỐ 397 TẬP A – QUYỀN 2 (04.2021)**

- (11) **41322**  
(21) 3-2020-02383 (28) 1  
(54) **BAO GÓI GIẤY VỆ SINH** (51) **09-05**  
(22) 23/09/2020 (43) 26/04/2021  
**CÔNG TY CỔ PHẦN SAIZO VIỆT NAM (VN)**  
(73) Căn hộ số 03 - Lô NO4A, khu đô thị mới Dịch Vọng, phường Dịch Vọng, quận Cầu Giấy, thành phố Hà Nội  
(72) Nguyễn Xuân Phú (VN)  
(74) Công ty TNHH Sở hữu trí tuệ WITIP Việt Nam (WITIP CO., LTD.)  
(55)



1.1



1.2



**CÔNG BÁO SỞ HỮU CÔNG NGHIỆP SỐ 397 TẬP A – QUYỀN 2 (04.2021)**

- (11) **41323**  
(21) 3-2020-02445 (28) 1  
(54) **MÁY TÁI CHẾ RÁC THỰC PHẨM** (51) **09-09**  
(22) 30/09/2020 (43) 26/04/2021  
(73) **CÔNG TY TNHH REPURE (VN)**  
54/3A Bạch Đằng, phường 2, quận Tân Bình, thành phố Hồ Chí Minh  
(72) Lê Cát Thạch (VN)  
(74) Công ty TNHH Dịch vụ thương mại và sở hữu công nghiệp Song Ngọc (I.P.T.S.)  
(55)



1.1



1.2



1.3



1.4



1.5



1.6



1.7

- (11) **41324**  
(21) 3-2020-02509 (28) 1  
(54) **DỤNG CỤ DƯỠNG ẨM MẮT** (51) **28-02**  
(22) 08/10/2020 (43) 26/04/2021  
(73) **MIN GYU PARK (KR)**  
1503, Top Family, 56-1, Bujeon-ro, Busanjin-gu, Busan, Republic of Korea  
(72) Min Gyu Park (KR)  
(74) Công ty TNHH Tư vấn đầu tư và chuyển giao công nghệ (INVESTCONSULT)  
(55)

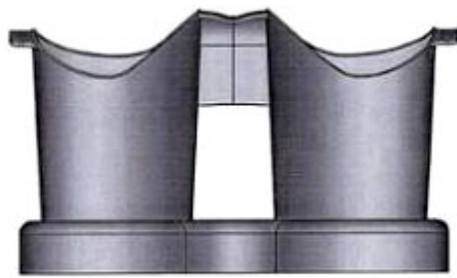

1.1

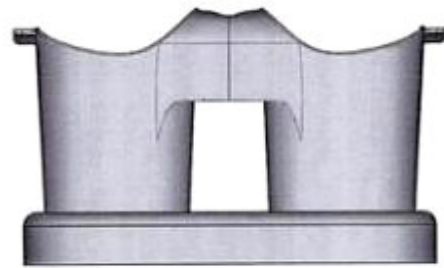

1.2



1.3



1.4



1.5



1.6



1.7



1.8

**CÔNG BÁO SỞ HỮU CÔNG NGHIỆP SỐ 397 TẬP A – QUYỀN 2 (04.2021)**

(11) **41325**

(21) 3-2020-02519

(28) 1

(54) **VÒI XỊT NƯỚC**

(51) **23-01**

(22) 09/10/2020

(43) 26/04/2021

**WATERTEC (MALAYSIA) SDN BHD (MY)**

(73) Lot 3, Jalan Halba Satu 16/16A, Section 16, 40200 Shah Alam, Selangor Darul Ehsan, Malaysia

(72) 1. LOW HAN SIN (MY)

2. MOHAMMAD ZAILANI BIN JUSOH (MY)

(74) Công ty TNHH Sở hữu trí tuệ Tâm Nhìn Mới (FRESHVIEW CO., LTD.)

(55)



1.1



1.2



1.3



1.4



1.5



1.6



1.7

**CÔNG BÁO SỞ HỮU CÔNG NGHIỆP SỐ 397 TẬP A – QUYỀN 2 (04.2021)**

(11) **41326**

(21) 3-2020-02520

(28) 1

(54) **VÒI NƯỚC**

(51) **23-01**

(22) 09/10/2020

(43) 26/04/2021

**WATERTEC (MALAYSIA) SDN BHD (MY)**

(73) Lot 3, Jalan Halba Satu 16/16A, Section 16, 40200 Shah Alam, Selangor Darul Ehsan, Malaysia

(72) 1. AFANDI BIN HAMZAH (MY)

2. LOW HAN SIN (MY)

(74) Công ty TNHH Sở hữu trí tuệ Tầm Nhìn Mới (FRESHVIEW CO., LTD.)

(55)

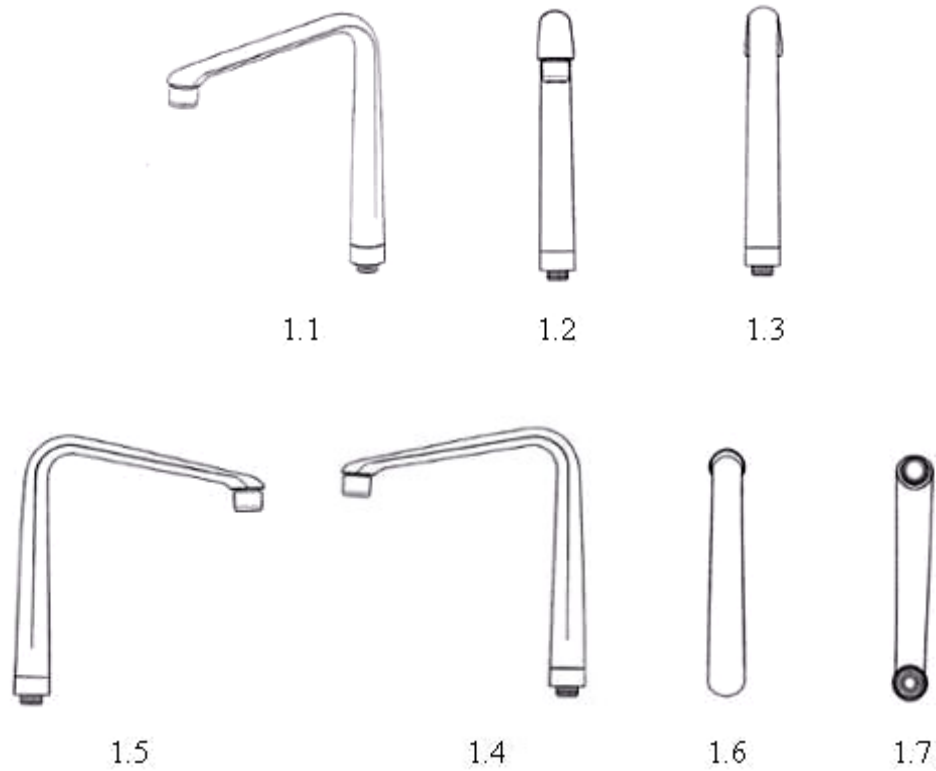

- (11) **41327**  
(21) 3-2020-02537  
(54) **DỤNG CỤ DƯỠNG ẨM MẮT**  
(22) 12/10/2020  
(73) **MIN GYU PARK (KR)**  
1503, Top Family, 56-1, Bujeon-ro, Busanjin-gu, Busan, Republic of Korea  
(72) Min Gyu Park (KR)  
(74) Công ty TNHH Tư vấn đầu tư và chuyển giao công nghệ (INVESTCONSULT)  
(55)
- (28) 1  
(51) **28-02**  
(43) 26/04/2021

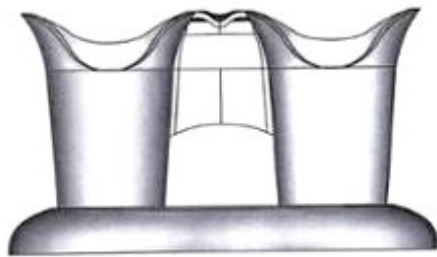

1.1

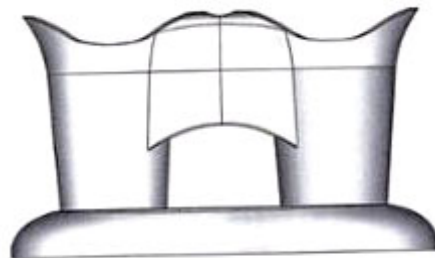

1.2



1.3



1.4



1.5

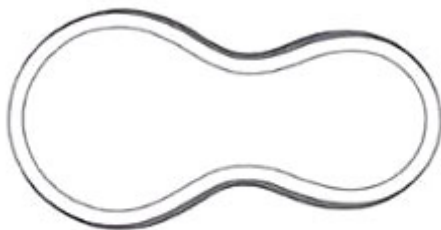

1.6



1.7



1.8

- (11) **41328**  
(21) 3-2020-02632 (28) 1  
(54) **BỘ PHẬN CỦA DỤNG CỤ KHOAN DỪA** (51) **07-04**  
(22) 23/10/2020 (43) 26/04/2021  
(30) 2002004385 28/09/2020 TH;  
**K FRESH CO., LTD. (TH)**  
(73) No. 98/38 moo 6, Bangmuangmai sub-district, Muang samutprakarn district,  
Samutprakarn 10270, Thailand  
(72) 1. KEMTAS MANUSRUNGSRI (TH)  
2. WARAPORN MANUSRUNGSRI (TH)  
(74) Công ty TNHH Trà và cộng sự (TRA & ASSOCIATES CO.,LTD)  
(55)

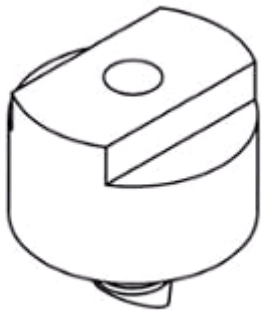

1.1

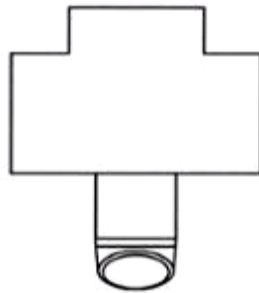

1.2

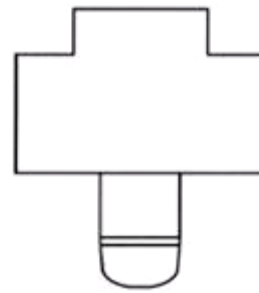

1.3

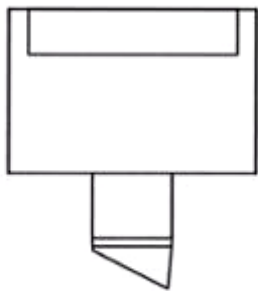

1.4

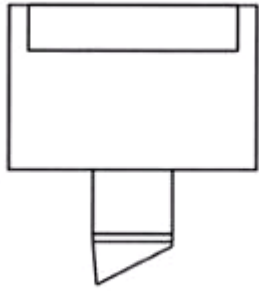

1.5

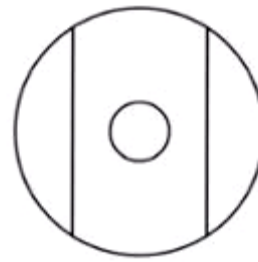

1.6



1.7

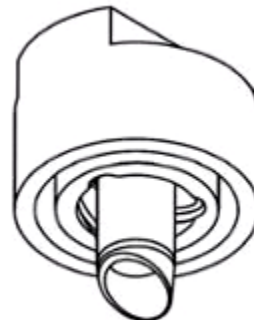

1.8

**CÔNG BÁO SỞ HỮU CÔNG NGHIỆP SỐ 397 TẬP A – QUYỀN 2 (04.2021)**

(11) **41329**

(21) 3-2020-02692

(28) 1

(54) **CẤU KIỆN KÈ LẮP GHÉP**

(51) **25-02**

(22) 04/11/2020

(43) 26/04/2021

**CÔNG TY CỔ PHẦN KHOA HỌC CÔNG NGHỆ VIỆT NAM (BUSADCO)**

(73) (VN)

Số 6 đường 3 tháng 2, phường 8, thành phố Vũng Tàu, tỉnh Bà Rịa - Vũng Tàu

(72) Hoàng Đức Thảo (VN)

(55)

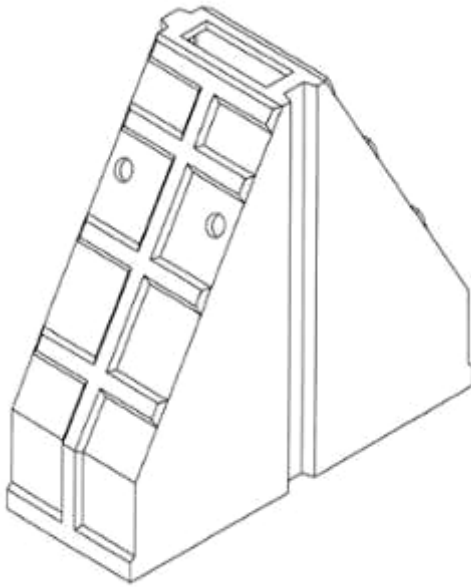

1.1

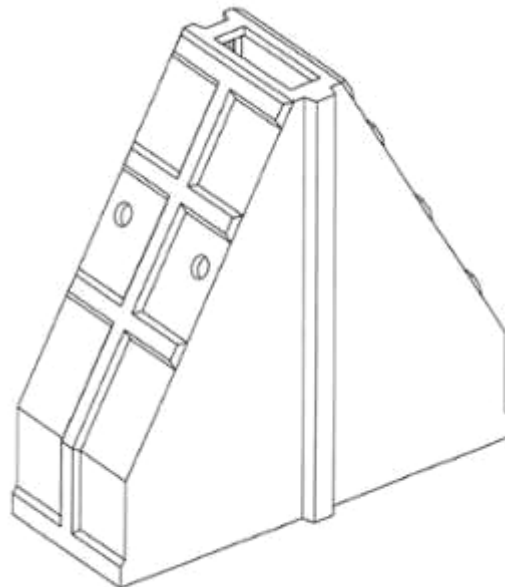

1.2



1.3



1.4

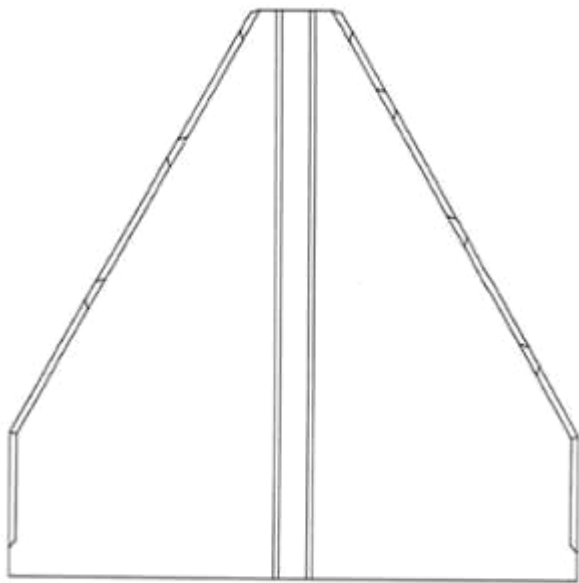

1.5

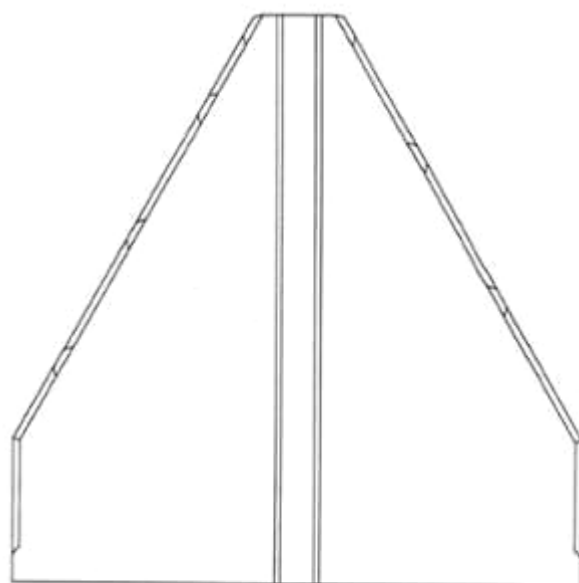

1.6

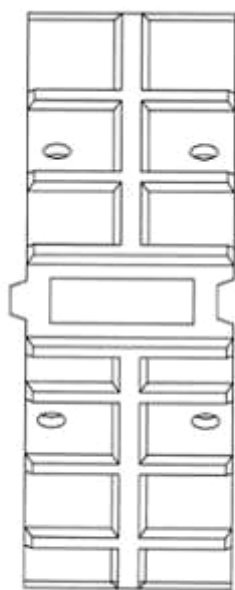

1.7

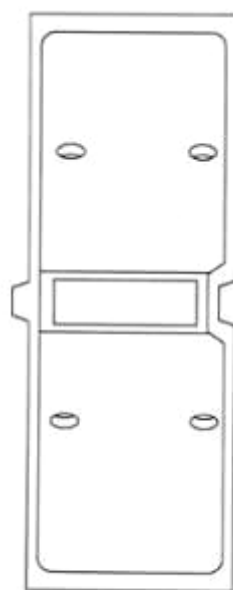

1.8



(11) **41330**

(21) 3-2020-02693

(28) 1

(54) **HÀO KỸ THUẬT**

(51) **25-02**

(22) 04/11/2020

(43) 26/04/2021

**CÔNG TY CỔ PHẦN KHOA HỌC CÔNG NGHỆ VIỆT NAM (BUSADCO)**

(73) (VN)

Số 6 đường 3 tháng 2, phường 8, thành phố Vũng Tàu, tỉnh Bà Rịa - Vũng Tàu

(72) Hoàng Đức Thảo (VN)

(55)

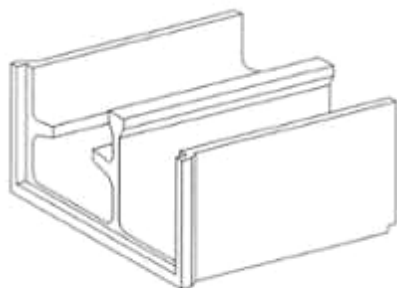

1.1



1.2



1.3



1.4



1.5

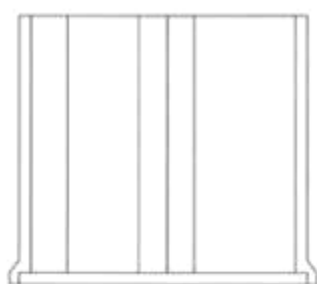

1.6



1.7

**CÔNG BÁO SỞ HỮU CÔNG NGHIỆP SỐ 397 TẬP A – QUYỀN 2 (04.2021)**

(11) **41331**

(21) 3-2020-02694

(28) 1

(54) **HÀO KỸ THUẬT**

(51) **25-02**

(22) 04/11/2020

(43) 26/04/2021

**CÔNG TY CỔ PHẦN KHOA HỌC CÔNG NGHỆ VIỆT NAM (BUSADCO)**

(73) (VN)

Số 6 đường 3 tháng 2, phường 8, thành phố Vũng Tàu, tỉnh Bà Rịa - Vũng Tàu

(72) Hoàng Đức Thảo (VN)

(55)

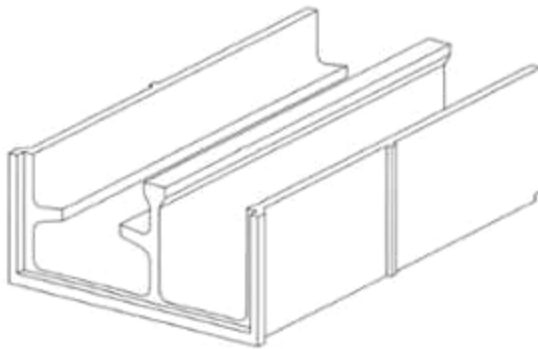

1.1



1.2



1.3



1.4



1.5

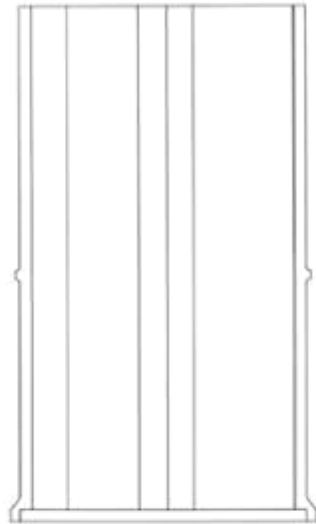

1.6



1.7

**CÔNG BÁO SỞ HỮU CÔNG NGHIỆP SỐ 397 TẬP A – QUYỀN 2 (04.2021)**

(11) **41332**

(21) 3-2020-02696

(28) 1

(54) **HÀO KỸ THUẬT**

(51) **25-02**

(22) 04/11/2020

(43) 26/04/2021

**CÔNG TY CỔ PHẦN KHOA HỌC CÔNG NGHỆ VIỆT NAM (BUSADCO)**

(73) (VN)

Số 6 đường 3 tháng 2, phường 8, thành phố Vũng Tàu, tỉnh Bà Rịa - Vũng Tàu

(72) Hoàng Đức Thảo (VN)

(55)

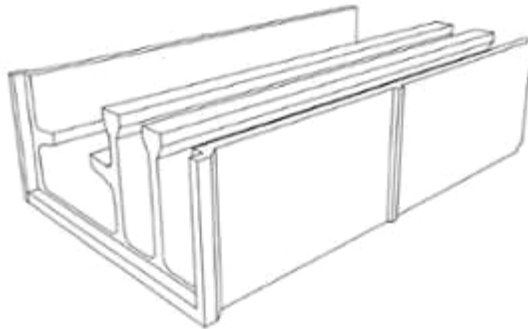

1.1



1.2



1.3



1.4



1.5

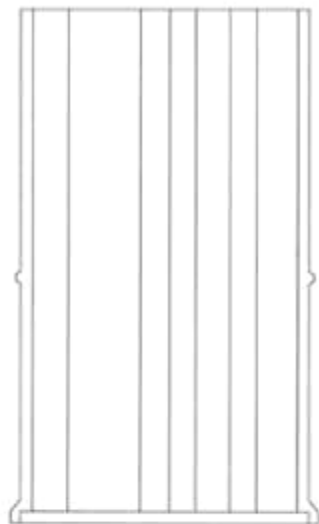

1.6



1.7

**CÔNG BÁO SỞ HỮU CÔNG NGHIỆP SỐ 397 TẬP A – QUYỀN 2 (04.2021)**

(11) **41333**

(21) 3-2020-02707

(28) 1

(54) **NGÓI**

(51) **25-01**

(22) 04/11/2020

(43) 26/04/2021

(73) **NGUYỄN NGỌC TÌNH (VN)**

Số 15 Trần Khát Chân, phường Đồng Phú, thành phố Đồng Hới, tỉnh Quảng Bình

(72) Nguyễn Ngọc Tình (VN)

(74) Công ty TNHH Tư vấn Quốc Dân (NACI CO., LTD)

(55)

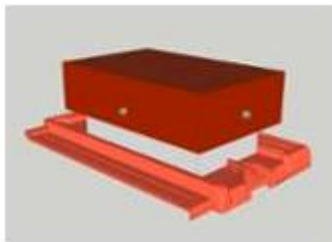

1.1

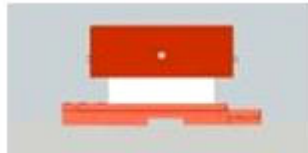

1.2

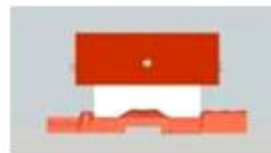

1.3

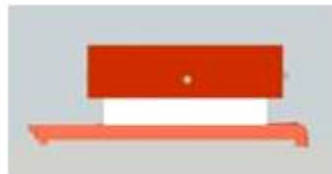

1.4



1.5

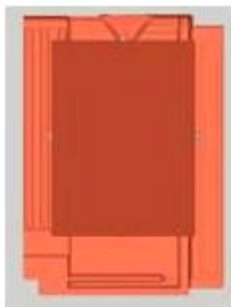

1.6



1.7

**CÔNG BÁO SỞ HỮU CÔNG NGHIỆP SỐ 397 TẬP A – QUYỀN 2 (04.2021)**

- (11) **41334**  
(21) 3-2020-02737 (28) 1  
(54) **BA LÔ** (51) **03-01**  
(22) 10/11/2020 (43) 26/04/2021  
(30) 2020-009315 12/05/2020 JP;  
**KOKUYO CO., LTD. (JP)**  
(73) 6-1-1, Oimazato-minami, Higashinari-ku, Osaka-shi, Osaka 537-8686 JAPAN  
(72) 1. KAORU KINOSHITA (JP)  
2. TAKESHI FUJIKI (JP)  
(74) Công ty Cổ phần Sở hữu công nghiệp INVESTIP (INVESTIP)  
(55)



1.1



1.2



1.3



1.4



1.5



1.6



1.7



1.8

**CÔNG BÁO SỞ HỮU CÔNG NGHIỆP SỐ 397 TẬP A – QUYỀN 2 (04.2021)**

(11) **41335**

(21) 3-2020-02765

(28) 1

(54) **HỒ THU NƯỚC**

(51) **23-99**

(22) 12/11/2020

(43) 26/04/2021

**CÔNG TY TNHH SIGEN (VN)**

(73) 106 Huyện Trần Công Chứa, phường 8, thành phố Vũng Tàu, tỉnh Bà Rịa - Vũng Tàu

(72) Hồ Viết Vê (VN)

(74) Công ty TNHH Tư vấn ALIATLEGAL (ALIAT LEGAL)

(55)

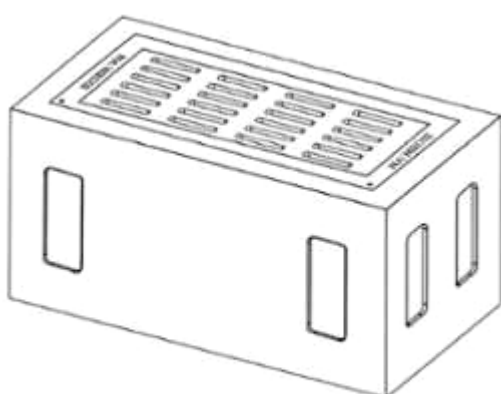

1.1

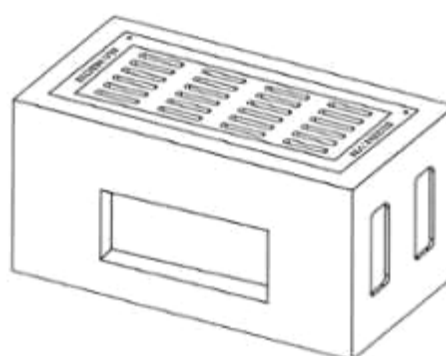

1.2



1.3



1.4

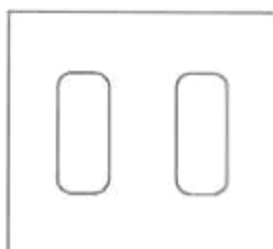

1.5

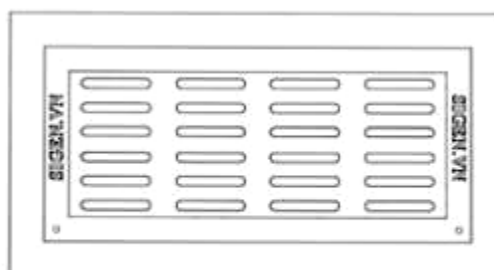

1.6





1.7

**CÔNG BÁO SỞ HỮU CÔNG NGHIỆP SỐ 397 TẬP A – QUYỀN 2 (04.2021)**

(11) **41336**

(21) 3-2020-02794

(28) 1

(54) **CHAI**

(51) **09-01**

(22) 17/11/2020

(43) 26/04/2021

**CÔNG TY CỔ PHẦN HÀNG TIÊU DÙNG MASAN (VN)**

(73) Tầng 12, tòa nhà MPlaza Saigon, số 39 Lê Duẩn, phường Bến Nghé, quận 1, thành phố Hồ Chí Minh

(72) Nguyễn Hoàng Yên (VN)

(74) Công ty cổ phần Sở hữu trí tuệ BROSS và Cộng sự (BROSS & PARTNERS., JSC)

(55)

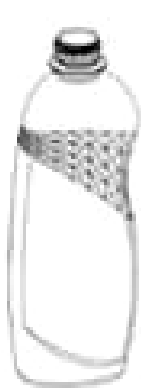

1.1

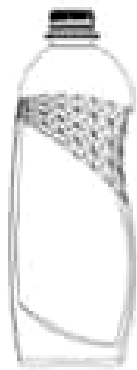

1.2

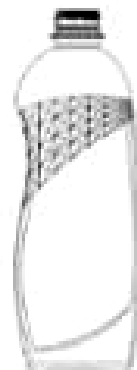

1.3



1.4



1.5

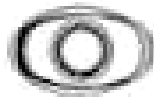

1.6



1.7

- (11) 41337  
(21) 3-2020-02862  
(54) **MÁY TUỐT LÚA**  
(22) 26/11/2020  
(73) **CÔNG TY TNHH THIẾT BỊ VÀ CÔNG NGHỆ CAO THỊNH THÀNH (VN)**  
Thôn Tụ Khoát, xã Ngũ Hiệp, huyện Thanh Trì, thành phố Hà Nội  
(72) Phan Văn Cường (VN)  
(74) Công ty TNHH Nghiên cứu và Đầu tư S&D (S&D INVEST CO., LTD)  
(55)
- (28) 1  
(51) 15-03  
(43) 26/04/2021



1.1



1.2



1.3



1.4



1.5



1.6

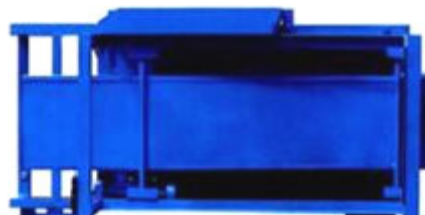

1.7

**CÔNG BÁO SỞ HỮU CÔNG NGHIỆP SỐ 397 TẬP A – QUYỀN 2 (04.2021)**

(11) **41338**

(21) 3-2020-02863

(28) 1

(54) **BỘ BÀN GHẾ XẾP**

(51) **06-05**

(22) 26/11/2020

(43) 26/04/2021

**CÔNG TY TNHH CƠ KHÍ ĐẦU TƯ XÂY DỰNG GIA HƯNG PHÁT (VN)**

(73) 2238 quốc lộ 1A, khu phố 1, phường Tân Chánh Hiệp, quận 12, thành phố Hồ Chí Minh

(72) Nguyễn Thanh Tùng (VN)

(74) Công ty TNHH Dịch vụ thương mại và sở hữu công nghiệp Song Ngọc (I.P.T.S.)

(55)



1.1



1.2



1.3



1.4



1.5



1.6



1.7



1.8



1.9

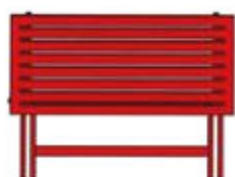

1.10



1.11



1.12

(11) **41339**

(21) 3-2020-02876

(28) 1

(54) **NÚM VÚ GIẢ**

(51) **24-04**

(22) 27/11/2020

(43) 26/04/2021

(73) **FB FAMILY APS (DK)**

Ravskaervej 38, Soften, 8382 Hinnerup, Denmark

(72) Henrik Hjulmand Jensen (DK)

(74) Công ty TNHH Trà và cộng sự (TRA & ASSOCIATES CO.,LTD)

(55)

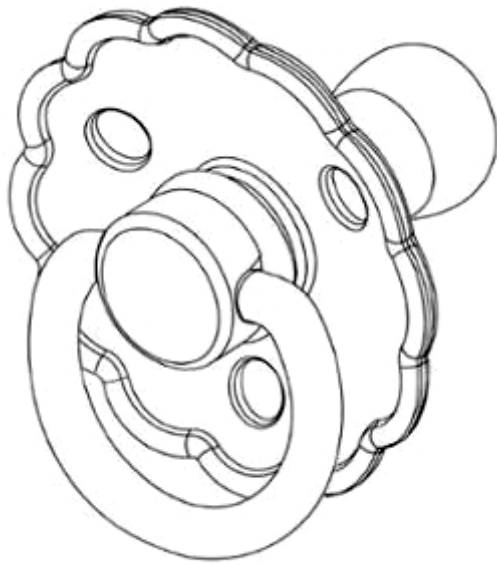

1.1

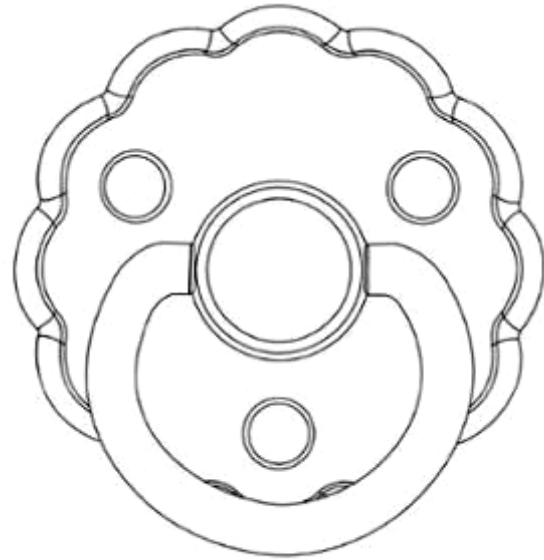

1.2

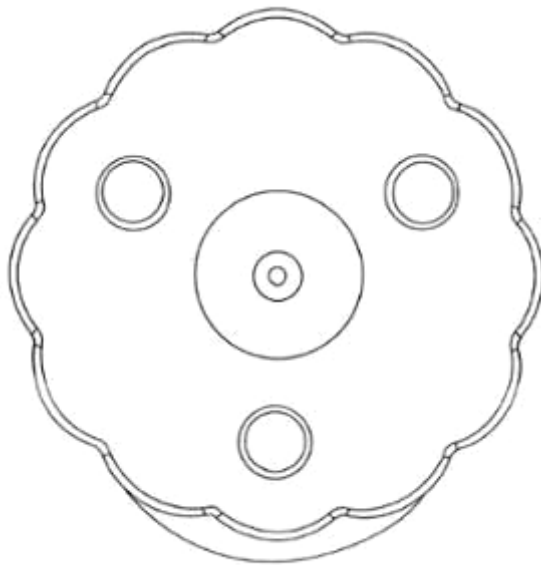

1.3

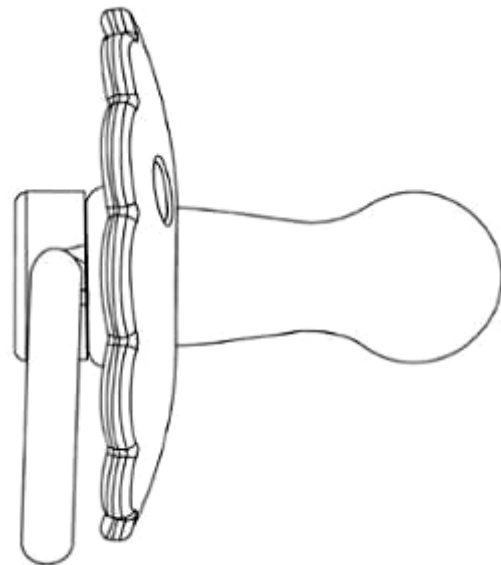

1.4

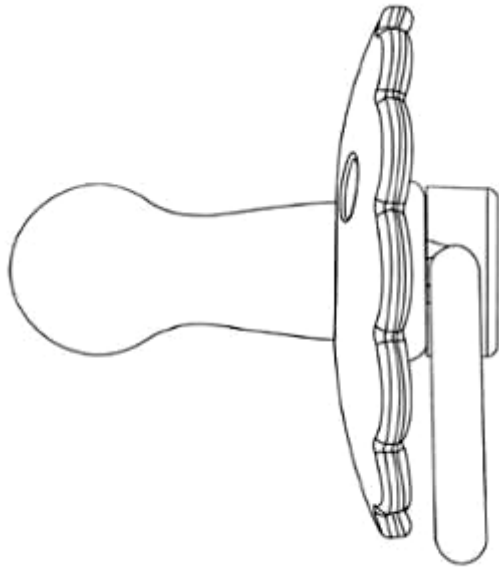

1.5

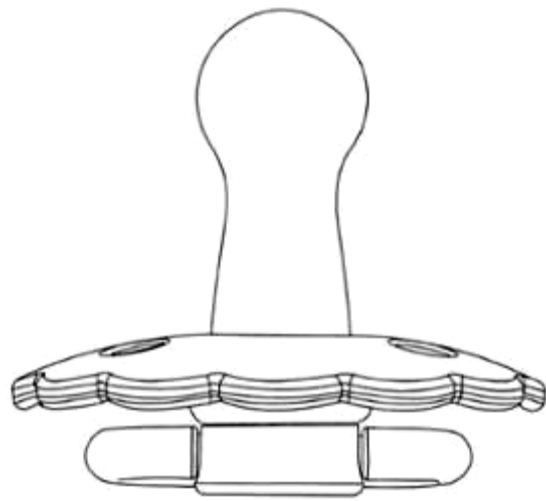

1.6

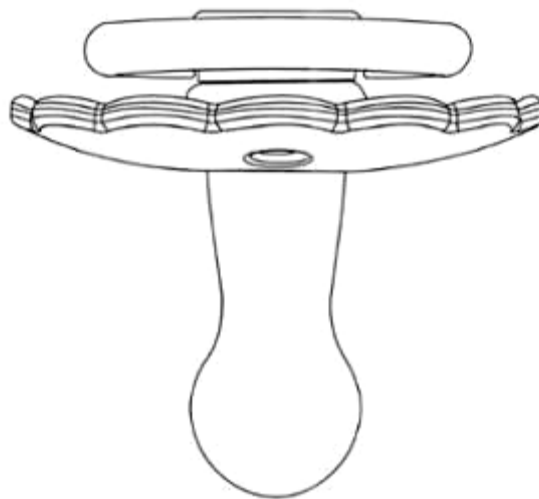

1.7

- (11) **41340**  
(21) 3-2020-02968 (28) 1  
(54) **TẮM CHẦN BẢO VỆ MẶT** (51) **29-02**  
(22) 09/12/2020 (43) 26/04/2021  
(30) 2020-011893 16/06/2020 JP;  
(73) **PLUS CORPORATION (JP)**  
1-28, Toranomom 4-chome, Minato-ku, Tokyo, JAPAN  
(72) 1. NAOYA YOSHIDA (JP)  
2. AKIKO TANAKA (JP)  
(74) Công ty Luật TNHH Phạm và Liên danh (PHAM & ASSOCIATES)  
(55)

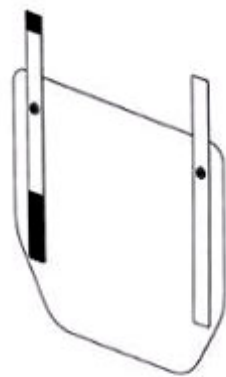

1.1



1.2



1.3



1.4



1.5



1.6



1.7



1.8



1.9



1.10



- (11) **41341**
  - (21) 3-2020-02992
  - (54) **HỘP**
  - (22) 10/12/2020
  - (30) 007999925 12/06/2020 EM;
  - (73) **PHILIP MORRIS PRODUCTS S.A. (CH)**  
Quai Jeanrenaud 3, CH-2000 Neuchâtel, Switzerland
  - (72) Hiromi Suzuki (JP)
  - (74) Công ty Luật TNHH T&G (TGVN)
  - (55)
- (28) 1
  - (51) **09-03**
  - (43) 26/04/2021

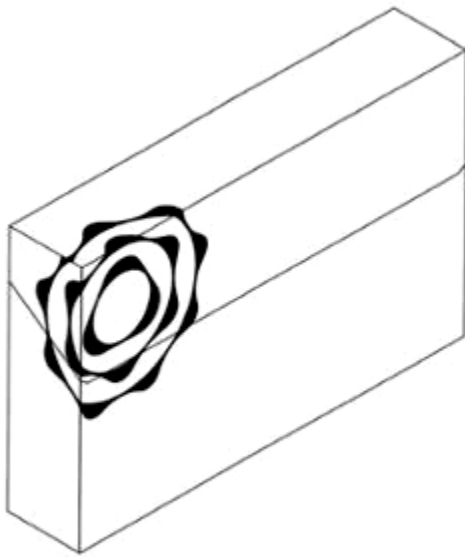

1.1

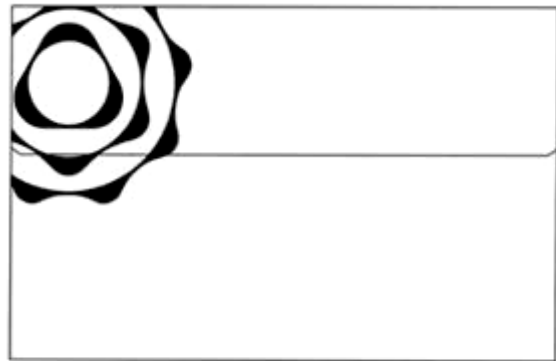

1.2

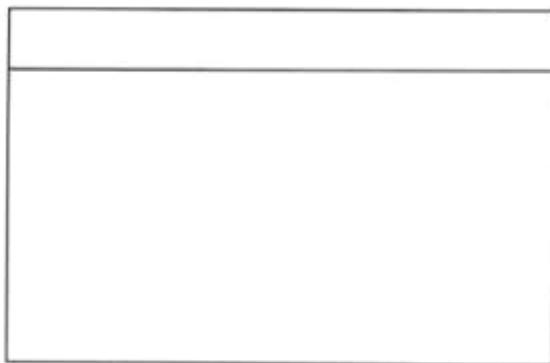

1.3



1.4



1.5



1.6



1.7

**CÔNG BÁO SỞ HỮU CÔNG NGHIỆP SỐ 397 TẬP A – QUYỀN 2 (04.2021)**

- (11) **41342**  
(21) 3-2020-02993 (28) 1  
(54) **HỘP** (51) **09-03**  
(22) 10/12/2020 (43) 26/04/2021  
(30) 007999925 12/06/2020 EM;  
(73) **PHILIP MORRIS PRODUCTS S.A. (CH)**  
Quai Jeanrenaud 3, CH-2000 Neuchâtel, Switzerland  
(72) Hiromi Suzuki (JP)  
(74) Công ty Luật TNHH T&G (TGVN)  
(55)

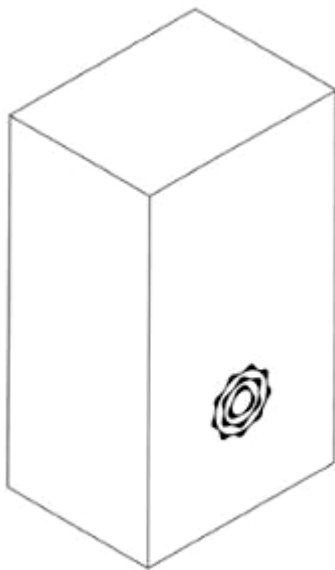

1.1

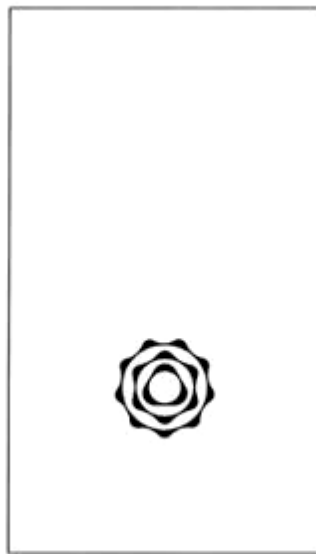

1.2



1.3



1.4



1.5



1.6



1.7

- (11) **41343**  
(21) 3-2020-03040 (28) 2  
(54) **DỤNG CỤ CHĂM SÓC RĂNG MIỆNG** (51) **04-02**  
(22) 17/12/2020 (43) 26/04/2021  
(30) 29/744650 30/07/2020 US;  
(73) **COLGATE-PALMOLIVE COMPANY (US)**  
300 Park Avenue, New York, New York 10022, United States of America  
1. EDUARDO JIMENEZ (US)  
2. DANIEL WAINLESS (US)  
(72) 3. HANNAH GORMAN (US)  
4. HOW LAU MENDEZ (US)  
(74) Văn phòng Luật sư Ân Nam (ANNAM IP & LAW)  
(55)

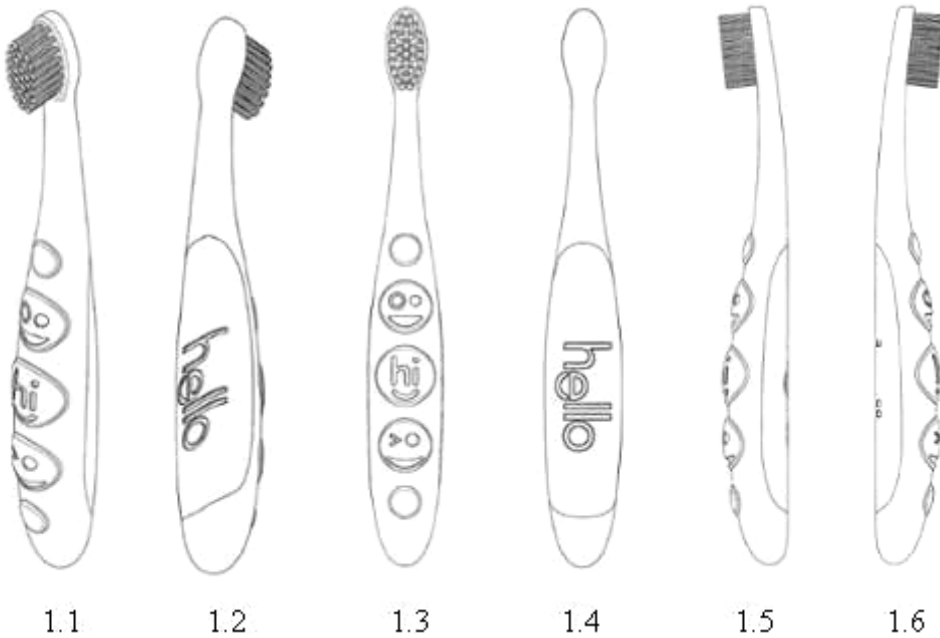



2.1



2.2



2.3



2.4



2.5



2.6



2.7



2.8

**CÔNG BÁO SỞ HỮU CÔNG NGHIỆP SỐ 397 TẬP A – QUYỀN 2 (04.2021)**

- (11) 41344  
(21) 3-2020-03048 (28) 1  
(54) **HỘP TRÀ** (51) **09-03**  
(22) 18/12/2020 (43) 26/04/2021  
(73) **TỔNG CÔNG TY CHÈ VIỆT NAM - CÔNG TY CỔ PHẦN (VN)**  
Số 92 Võ Thị Sáu, phường Thanh Nhân, quận Hai Bà Trưng, thành phố Hà Nội  
(72) Hoàng Đăng Tiến (VN)  
(74) Công ty TNHH Sở hữu trí tuệ Việt Nam IP (VIETNAM IP)  
(55)



1.1



1.2



1.3



1.5



1.6



1.4

**CÔNG BÁO SỞ HỮU CÔNG NGHIỆP SỐ 397 TẬP A – QUYỀN 2 (04.2021)**

- (11) 41345  
(21) 3-2020-03052 (28) 1  
(54) **NHÃN SẢN PHẨM CÒN THẠCH** (51) **19-08**  
(22) 18/12/2020 (43) 26/04/2021  
**CÔNG TY CỔ PHẦN TÂN NGUYÊN VĨNH THÁI (VN)**  
(73) Số 72/2 đường Trần Tấn, phường Tân Sơn Nhì, quận Tân Phú, thành phố Hồ Chí Minh  
(72) Nguyễn Đức Hoàng (VN)  
(55)





**CÔNG BÁO SỞ HỮU CÔNG NGHIỆP SỐ 397 TẬP A – QUYỀN 2 (04.2021)**

- (11) **41346**  
(21) 3-2020-03059 (28) 1  
(54) **DỤNG CỤ MÀI KÈM CẮT DA** (51) **08-05**  
(22) 21/12/2020 (43) 26/04/2021  
(73) **CÔNG TY TNHH CƠ KHÍ CHẤN PHÁT (VN)**  
145 Đặng Thúc Liêng, phường 5, quận 8, thành Phố Hồ Chí Minh  
(72) Liên Duy Lễ (VN)  
(74) Công ty TNHH Tư vấn sở hữu trí tuệ Việt (VIET IP CO.,LTD.)  
(55)



1.1



1.2



1.3



1.4



1.5



1.6



1.7



1.8

- (11) **41347**  
(21) 3-2020-03084 (28) 1  
(54) **VÒI NƯỚC** (51) **23-01**  
(22) 23/12/2020 (43) 26/04/2021  
(30) 202030359330.6 06/07/2020 CN;  
(73) **AS AMERICA, INC. (US)**  
One Centennial Avenue, Piscataway, NJ 08854, United States of America  
1. JIAN ZHANG (CN)  
(72) 2. FEN LIU (CN)  
3. EMILIE WILLIAMS (US)  
(74) Công ty Luật TNHH T&G (TGVN)  
(55)

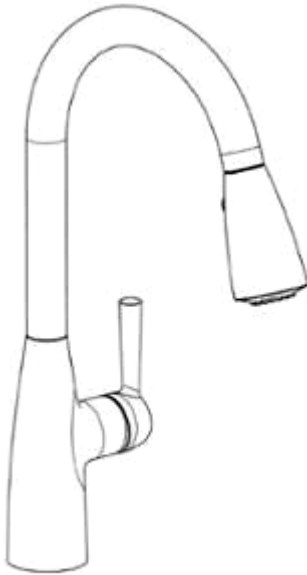

1.1



1.2

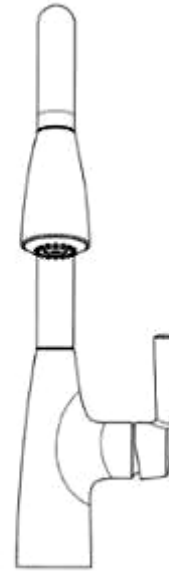

1.3

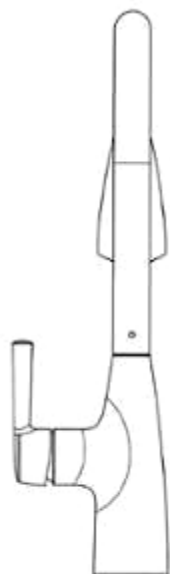

1.4

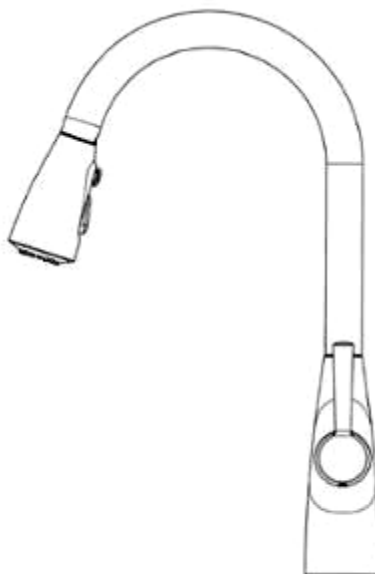

1.5

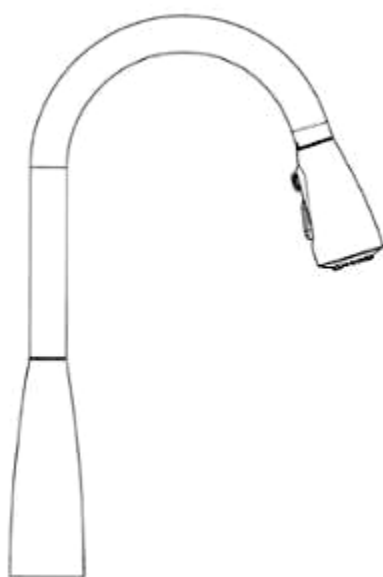

1.6

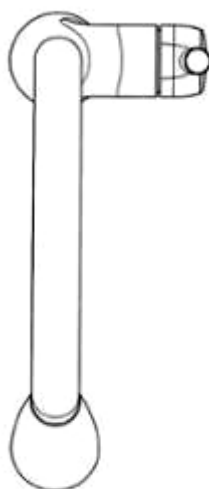

1.7

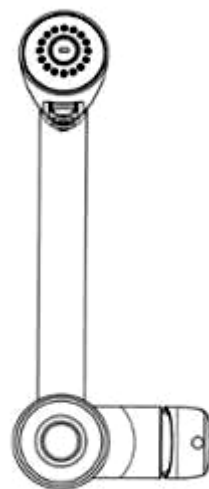

1.8

- (11) **41348**  
(21) 3-2020-03087 (28) 1  
(54) **GIÁ TREO** (51) **14-99**  
(22) 23/12/2020 (43) 26/04/2021  
(30) 202030668079.1 05/11/2020 CN;  
**XINADDA (HONG KONG) LIMITED (CN)**  
(73) Flat A811, 8/f., Ka Ming Court, 688-690 Castle Peak Road, Lai Chi Kok, K1, Hong Kong  
(72) XU BO PEI (CN)  
(74) Công ty TNHH Trường Xuân (AGELESS CO.,LTD.)  
(55)

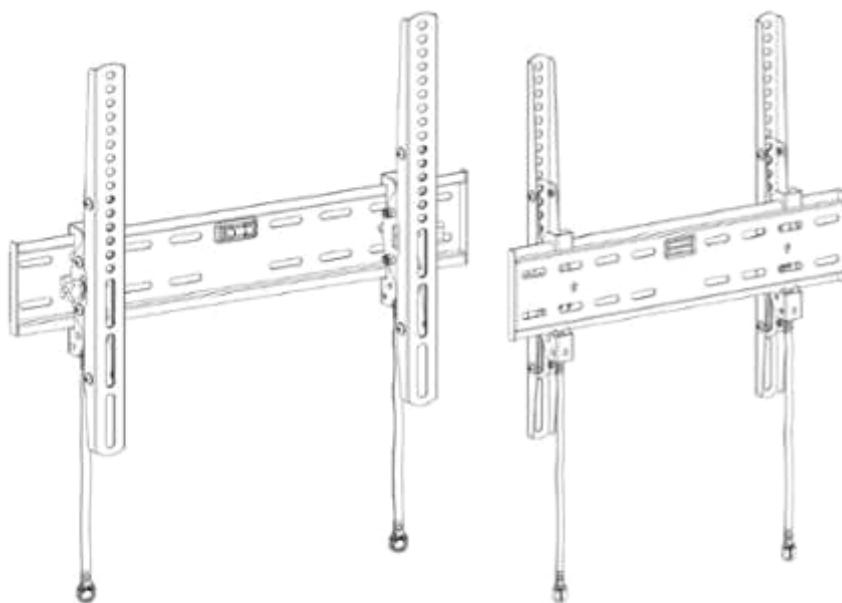

1.1

1.2

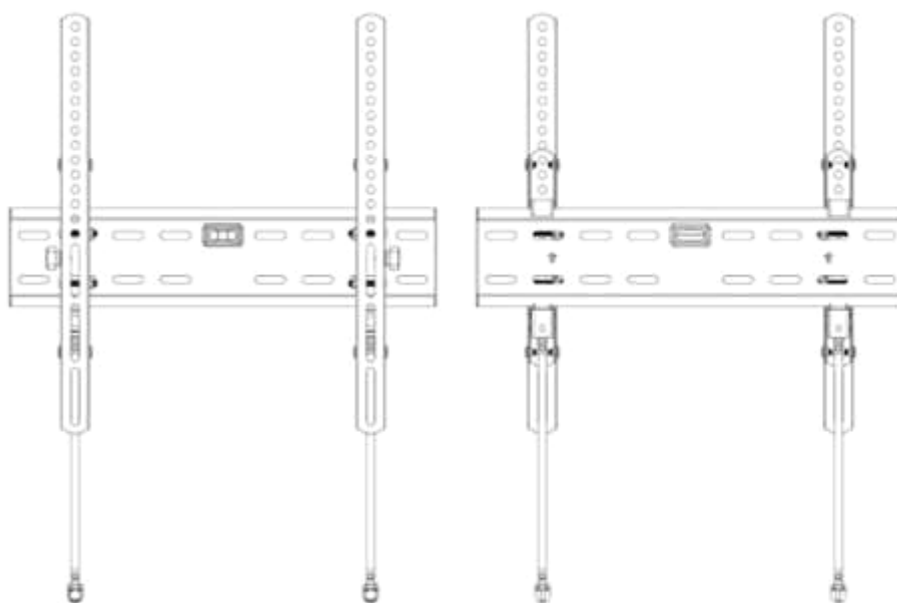

1.3

1.4



1.5



1.6



1.7



1.8

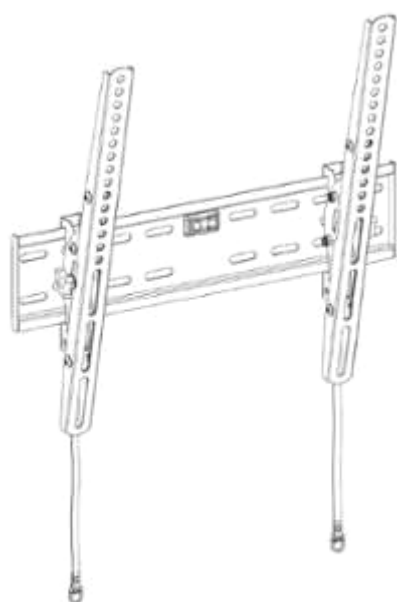

1.11

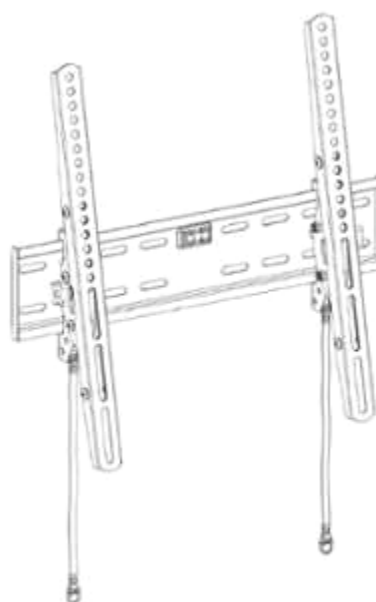

1.9

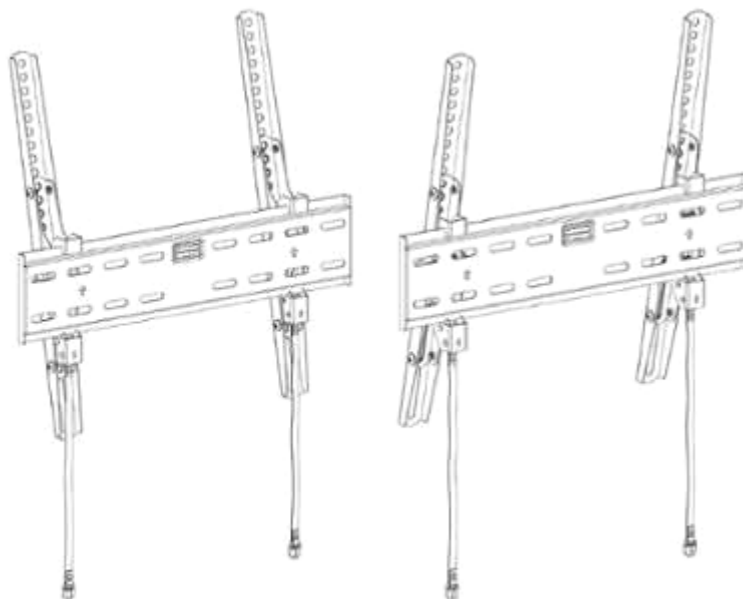

1.12

1.10

- (11) **41349**  
(21) 3-2020-03088 (28) 1  
(54) **GIÁ TREO** (51) **14-99**  
(22) 23/12/2020 (43) 26/04/2021  
(30) 202030667259.8 05/11/2020 CN;  
**XINADDA (HONG KONG) LIMITED (CN)**  
(73) Flat A811, 8/f., Ka Ming Court, 688-690 Castle Peak road, Lai Chi Kok, K1, Hong Kong  
(72) XU BO PEI (CN)  
(74) Công ty TNHH Trường Xuân (AGELESS CO.,LTD.)  
(55)

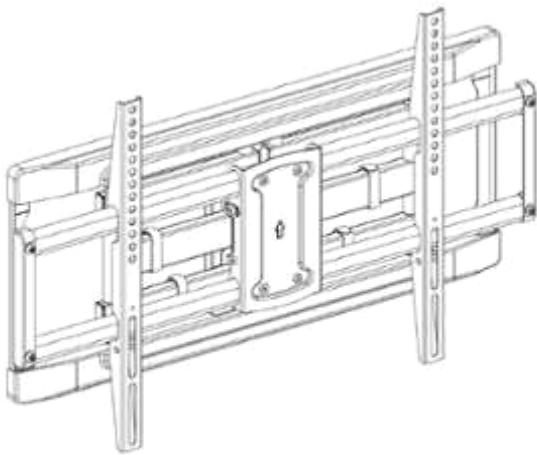

1.1

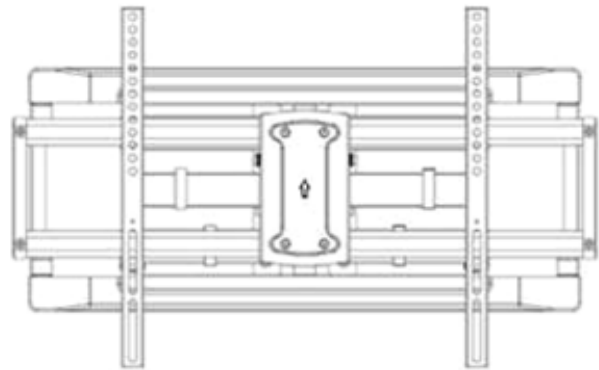

1.2

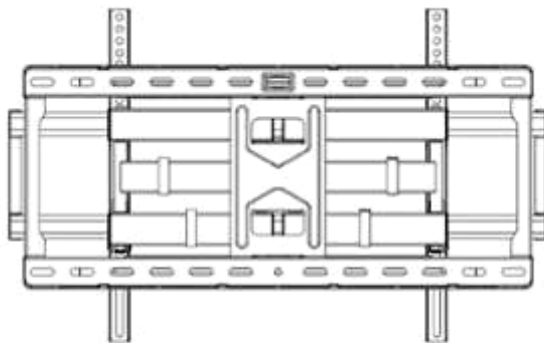

1.3



1.4



1.5





1.6



1.7

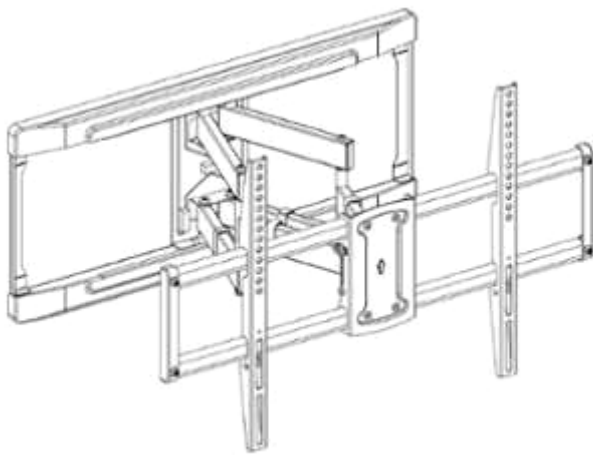

1.8

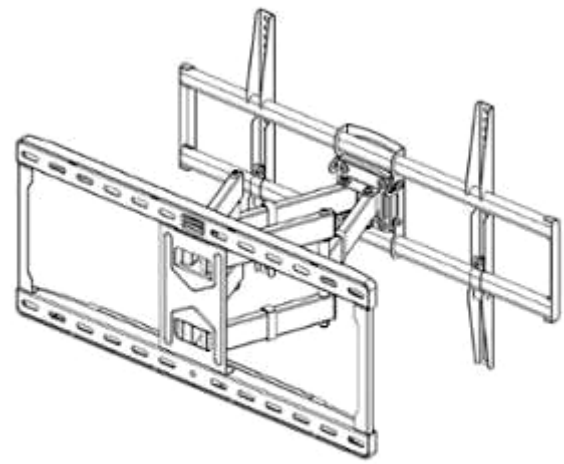

1.9

(11) **41350**

(21) 3-2020-03089

(28) 1

(54) **GIÁ TREO**

(51) **14-99**

(22) 23/12/2020

(43) 26/04/2021

**XINADDA (HONG KONG) LIMITED (CN)**

(73) Flat A811, 8/f., Ka Ming Court, 688-690 Castle Peak Road, Lai Chi Kok, K1, Hong Kong

(72) XU BO PEI (CN)

(74) Công ty TNHH Trường Xuân (AGELESS CO.,LTD.)

(55)

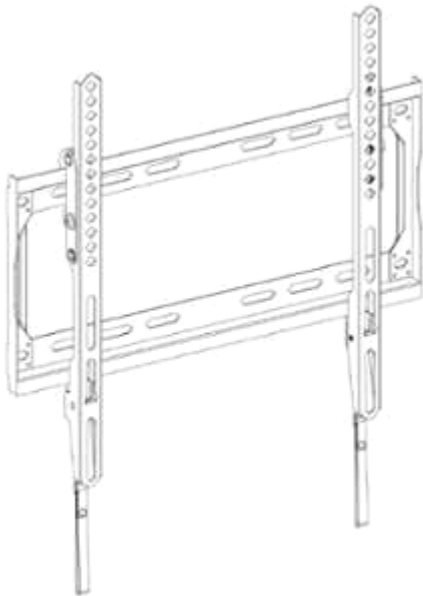

1.1

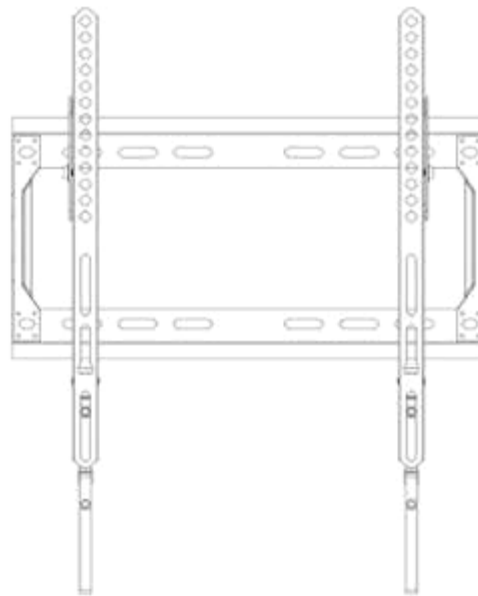

1.2

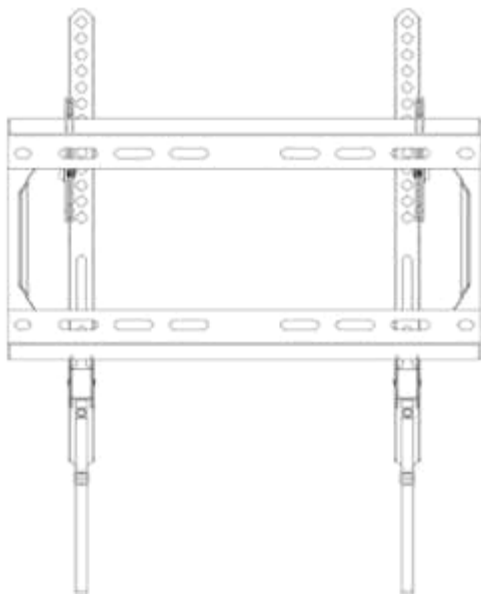

1.3



1.4



1.5



1.6



1.7



1.8

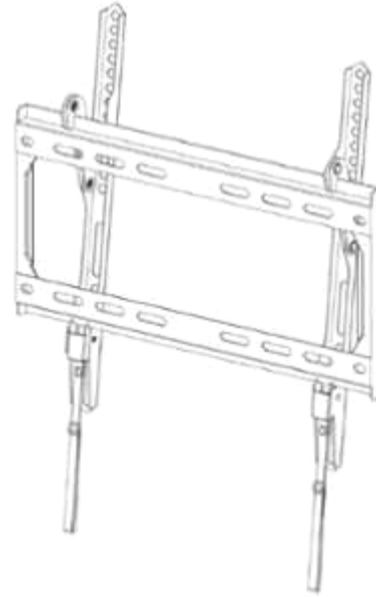

1.9

**CÔNG BÁO SỞ HỮU CÔNG NGHIỆP SỐ 397 TẬP A – QUYỀN 2 (04.2021)**

(11) **41351**

(21) 3-2020-03090

(28) 1

(54) **GIÁ TREO**

(51) **14-99**

(22) 23/12/2020

(43) 26/04/2021

**XINADDA (HONG KONG) LIMITED (CN)**

(73) Flat A811, 8/f., Ka Ming Court, 688-690 Castle Peak Road, Lai Chi Kok, K1, Hong Kong

(72) XU BO PEI (CN)

(74) Công ty TNHH Trường Xuân (AGELESS CO.,LTD.)

(55)

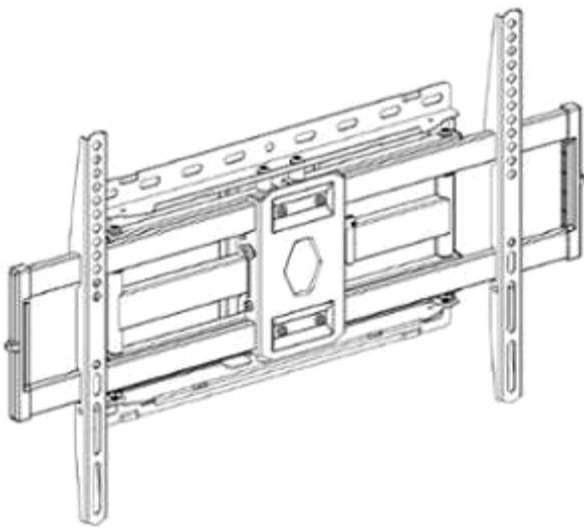

1.1

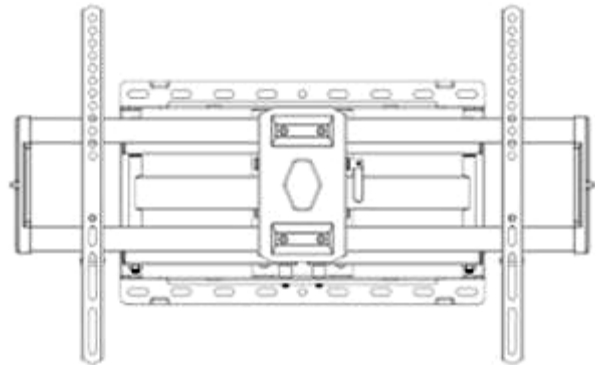

1.2

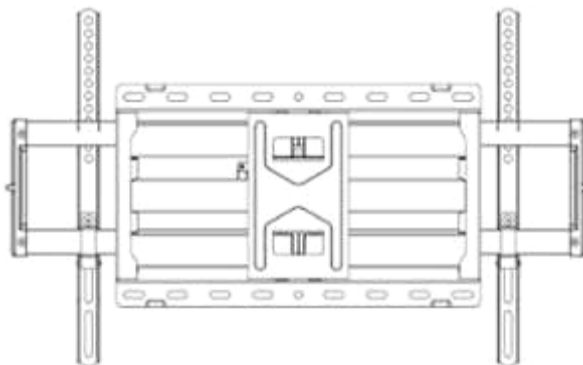

1.3



1.4



1.5



1.6

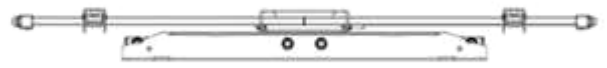

1.7

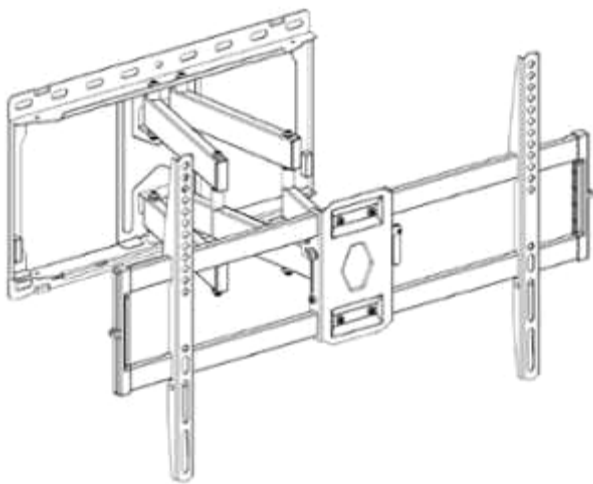

1.8

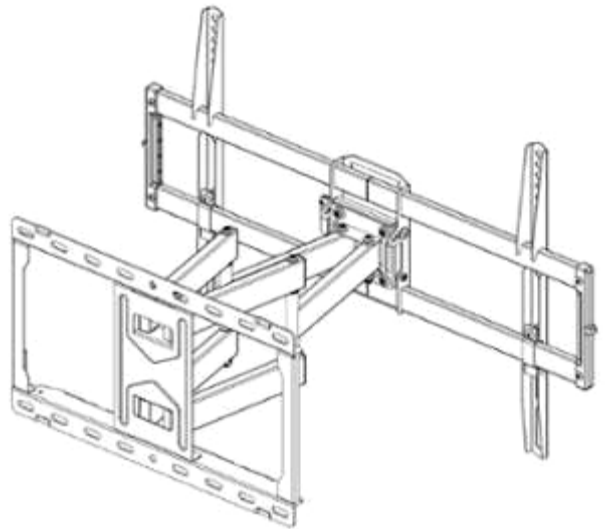

1.9

(11) **41352**

(21) 3-2020-03091

(28) 1

(54) **GIÁ TREO**

(51) **14-99**

(22) 23/12/2020

(43) 26/04/2021

**XINADDA (HONG KONG) LIMITED (CN)**

(73) flat A811, 8/f., Ka Ming Court, 688-690 Castle Peak Road, Lai Chi Kok, K1, Hong Kong

(72) XU BO PEI (CN)

(74) Công ty TNHH Trường Xuân (AGELESS CO.,LTD.)

(55)

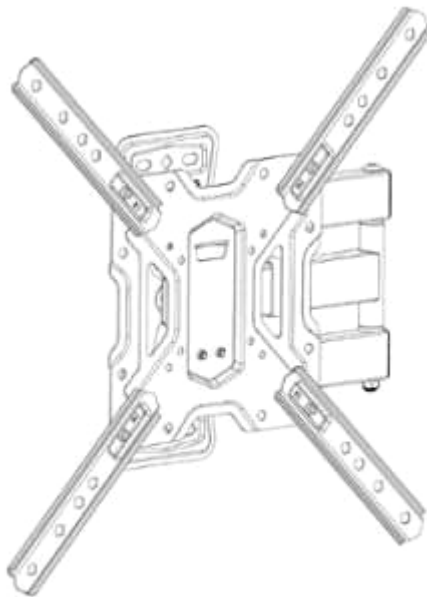

1.1

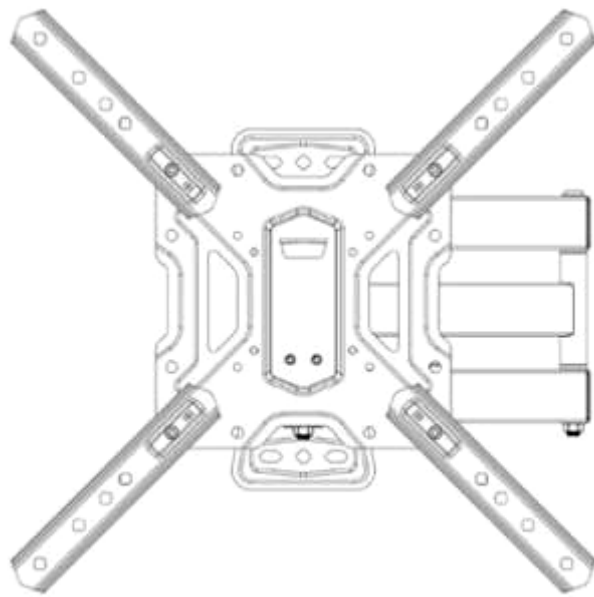

1.2

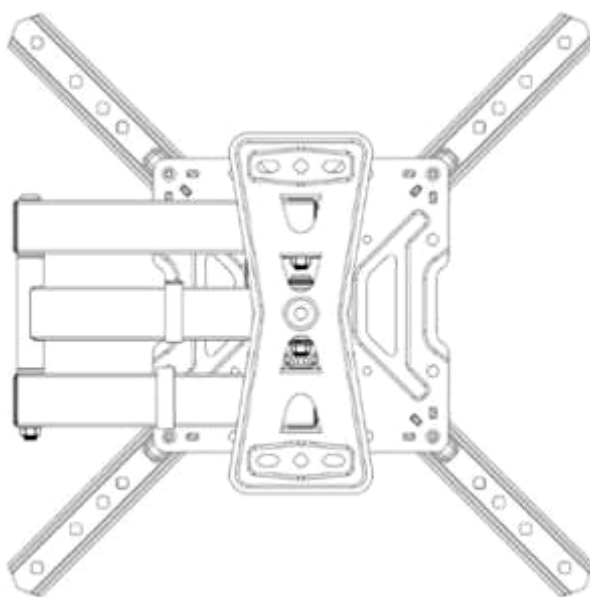

1.3



1.4



1.5

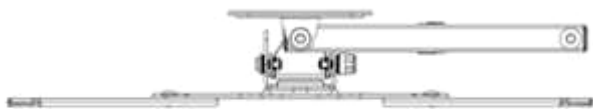

1.6

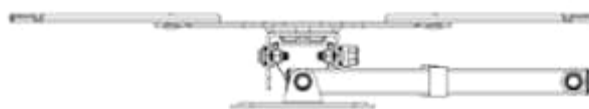

1.7

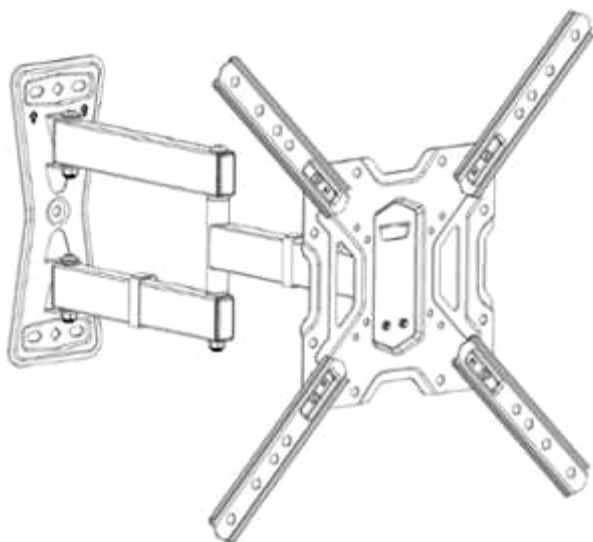

1.8

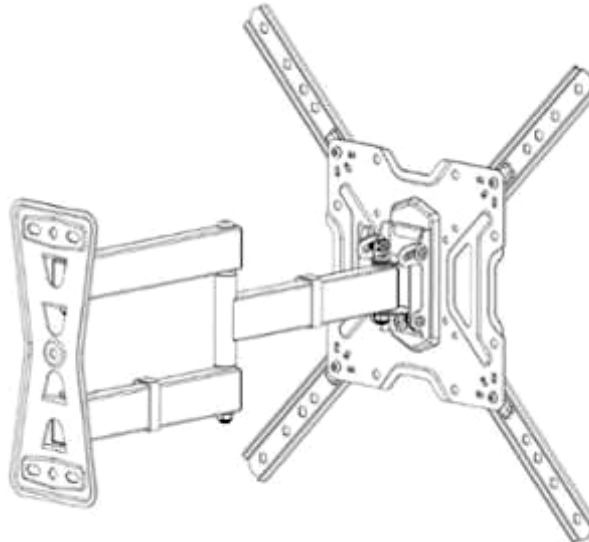

1.9

**CÔNG BÁO SỞ HỮU CÔNG NGHIỆP SỐ 397 TẬP A – QUYỀN 2 (04.2021)**

(11) **41353**

(21) 3-2020-03092

(28) 1

(54) **GIÁ TREO**

(51) **14-99**

(22) 23/12/2020

(43) 26/04/2021

**XINADDA (HONG KONG) LIMITED (CN)**

(73) Flat A811, 8/f., Ka Ming Court, 688-690 Castle Peak Road, Lai Chi Kok, K1, Hong Kong

(72) XU BO PEI (CN)

(74) Công ty TNHH Trường Xuân (AGELESS CO.,LTD.)

(55)

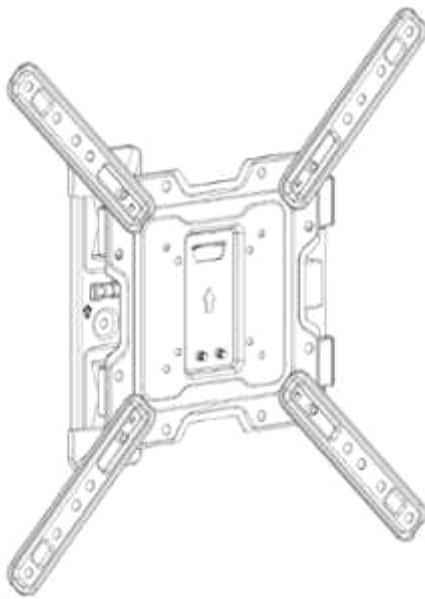

1.1

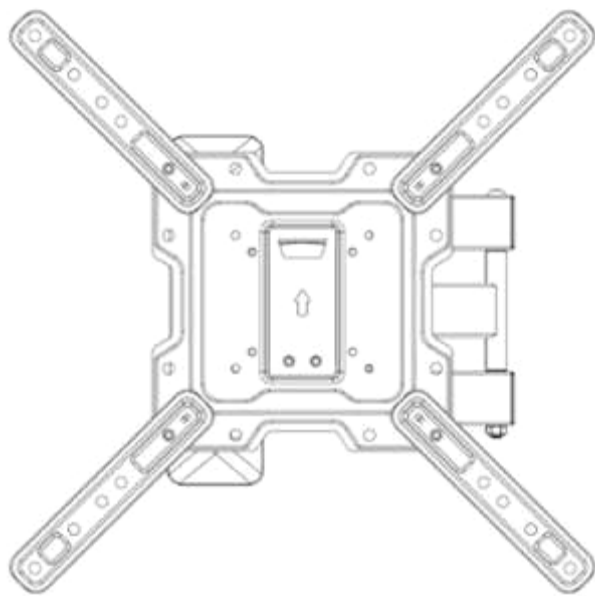

1.2

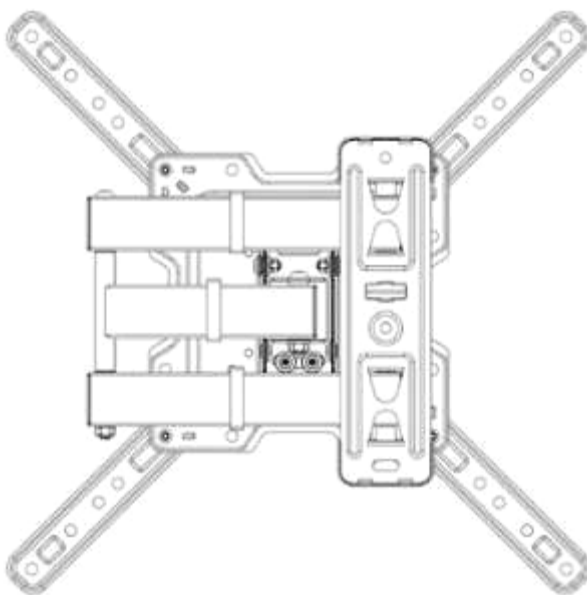

1.3



1.4



1.5



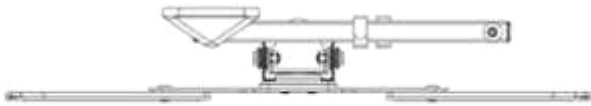

1.6

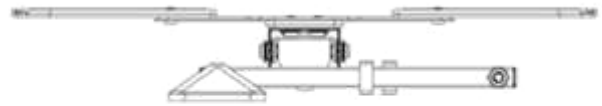

1.7

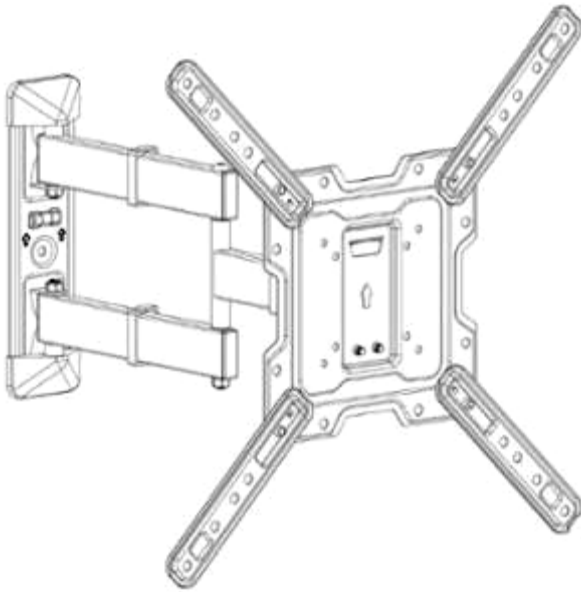

1.8

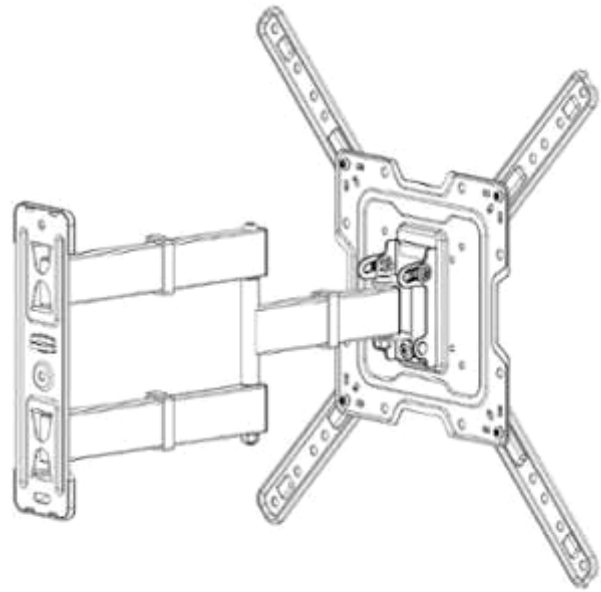

1.9

**CÔNG BÁO SỞ HỮU CÔNG NGHIỆP SỐ 397 TẬP A – QUYỀN 2 (04.2021)**

- (11) **41354**  
(21) 3-2020-03123 (28) 1  
(54) **NHÃN SẢN PHẨM** (51) **19-08**  
(22) 25/12/2020 (43) 26/04/2021  
(73) **NGUYỄN THỊ THU HOA (VN)**  
Tân Thành, thị trấn Thanh Sơn, huyện Thanh Sơn, tỉnh Phú Thọ  
(72) Nguyễn Thị Thu Hoa (VN)  
(74) Công ty TNHH Sở hữu trí tuệ WITIP Việt Nam (WITIP CO., LTD.)  
(55)



**CÔNG BÁO SỞ HỮU CÔNG NGHIỆP SỐ 397 TẬP A – QUYỀN 2 (04.2021)**

- (11) **41355**  
(21) 3-2020-03124 (28) 4  
(54) **NHÃN SẢN PHẨM** (51) **19-08**  
(22) 25/12/2020 (43) 26/04/2021  
(73) **NGUYỄN THỊ THU HOA (VN)**  
Tân Thành, thị trấn Thanh Sơn, huyện Thanh Sơn, tỉnh Phú Thọ  
(72) Nguyễn Thị Thu Hoa (VN)  
(74) Công ty TNHH Sở hữu trí tuệ WITIP Việt Nam (WITIP CO., LTD.)  
(55)



1



2



3



4

**CÔNG BÁO SỞ HỮU CÔNG NGHIỆP SỐ 397 TẬP A – QUYỀN 2 (04.2021)**

- (11) **41356**  
(21) 3-2020-03155 (28) 1  
(54) **ĐỒ CHỨA** (51) **09-03; 09-05**  
(22) 29/01/2019 (43) 26/04/2021  
(30) DM/103 812 03/08/2018 WO;  
(73) **ALPLA WERKE ALWIN LEHNER GMBH & CO. KG (AT)**  
Allmendstrasse, A-6971 Hard, Austria  
(72) Oliver Unterlechner (AT)  
(74) Công ty TNHH Sở hữu trí tuệ ALNGUYEN (ALNGUYEN IP CO.,LTD.)  
(55)



1.1



1.2



1.3



1.4



1.5



1.6

**CÔNG BÁO SỞ HỮU CÔNG NGHIỆP SỐ 397 TẬP A – QUYỀN 2 (04.2021)**

- (11) **41357**  
(21) 3-2020-03156 (28) 1  
(54) **ĐỒ CHỨA** (51) **09-03**  
(22) 29/01/2019 (43) 26/04/2021  
(30) DM/103 812 03/08/2018 WO;  
(73) **ALPLA WERKE ALWIN LEHNER GMBH & CO. KG (AT)**  
Allmendstrasse, A-6971 Hard, Austria  
(72) Oliver Unterlechner (AT)  
(74) Công ty TNHH Sở hữu trí tuệ ALNGUYEN (ALNGUYEN IP CO.,LTD.)  
(55)



1.1



1.2



1.3



1.4



1.5



1.6

- (11) **41358**  
(21) 3-2020-03157 (28) 1  
(54) **ĐỒ CHỨA** (51) **09-03; 09-05**  
(22) 29/01/2019 (43) 26/04/2021  
(30) DM/103 812 03/08/2018 WO;  
(73) **ALPLA WERKE ALWIN LEHNER GMBH & CO. KG (AT)**  
Allmendstrasse, A-6971 Hard, Austria  
(72) Oliver Unterlechner (AT)  
(74) Công ty TNHH Sở hữu trí tuệ ALNGUYEN (ALNGUYEN IP CO.,LTD.)  
(55)



1.1



1.2



1.3



1.4



1.5



1.6

- (11) **41359**  
(21) 3-2020-03158 (28) 1  
(54) **ĐỒ CHỨA** (51) **09-03; 09-05**  
(22) 29/01/2019 (43) 26/04/2021  
(30) DM/103 812 03/08/2018 WO;  
(73) **ALPLA WERKE ALWIN LEHNER GMBH & CO. KG (AT)**  
Allmendstrasse, A-6971 Hard, Austria  
(72) Oliver Unterlechner (AT)  
(74) Công ty TNHH Sở hữu trí tuệ ALNGUYEN (ALNGUYEN IP CO.,LTD.)  
(55)

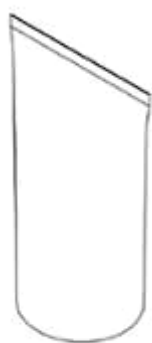

H.1

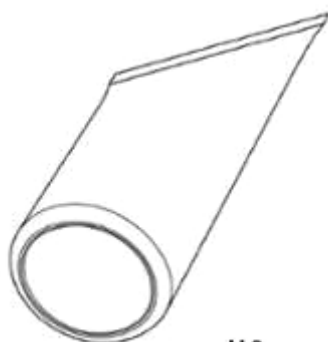

H.2



H.3



H.4



H.5



H.6

- (11) **41360**  
(21) 3-2020-03159 (28) 1  
(54) **ĐỒ CHỨA** (51) **09-03; 09-05**  
(22) 29/01/2019 (43) 26/04/2021  
(30) DM/103 812 03/08/2018 WO;  
(73) **ALPLA WERKE ALWIN LEHNER GMBH & CO. KG (AT)**  
Allmendstrasse, A-6971 Hard, Austria  
(72) Oliver Unterlechner (AT)  
(74) Công ty TNHH Sở hữu trí tuệ ALNGUYEN (ALNGUYEN IP CO.,LTD.)  
(55)

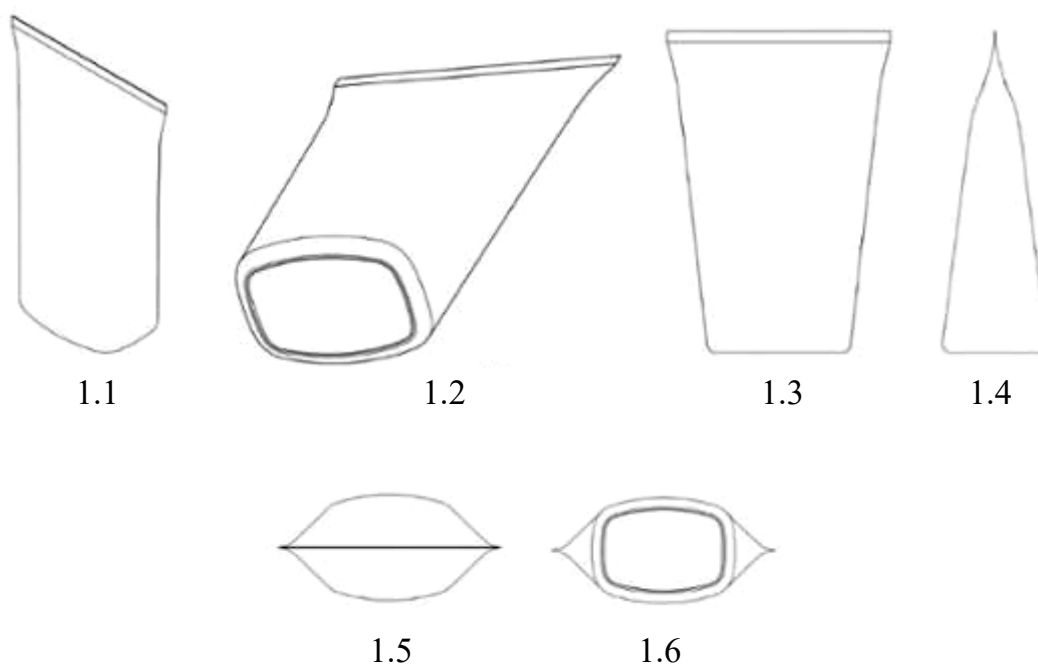



**CÔNG BÁO SỞ HỮU CÔNG NGHIỆP SỐ 397 TẬP A – QUYỀN 2 (04.2021)**

- (11) **41361**  
(21) 3-2020-03160 (28) 1  
(54) **ĐỒ CHỨA** (51) **09-03; 09-05**  
(22) 29/01/2019 (43) 26/04/2021  
(30) DM/103 812 03/08/2018 WO;  
(73) **ALPLA WERKE ALWIN LEHNER GMBH & CO. KG (AT)**  
Allmendstrasse, A-6971 Hard, Austria  
(72) Oliver Unterlechner (AT)  
(74) Công ty TNHH Sở hữu trí tuệ ALNGUYEN (ALNGUYEN IP CO.,LTD.)  
(55)



1.1



1.2



1.3



1.4



1.5



1.6

**CÔNG BÁO SỞ HỮU CÔNG NGHIỆP SỐ 397 TẬP A – QUYỀN 2 (04.2021)**

(11) **41362**

(21) 3-2020-03214

(28) 1

(54) **HỘP**

(51) **09-03**

(22) 31/12/2020

(43) 26/04/2021

**CÔNG TY CỔ PHẦN TẬP ĐOÀN THIÊN LONG (VN)**

(73) Lô 6-8-10-12 đường số 3, khu công nghiệp Tân Tạo, quận Bình Tân, thành phố Hồ Chí Minh

(72) Cô Gia Thọ (VN)

(74) Công ty TNHH Tư vấn sở hữu trí tuệ Việt (VIET IP CO.,LTD.)

(55)



1.1



1.2

**CÔNG BÁO SỞ HỮU CÔNG NGHIỆP SỐ 397 TẬP A – QUYỀN 2 (04.2021)**

(11) **41363**

(21) 3-2021-00017

(54) **NHÃN SẢN PHẨM BIA**

(22) 06/01/2021

(28) 2

(51) **19-08**

(43) 26/04/2021

**CÔNG TY CỔ PHẦN BIA - RƯỢU HẢI ĐÀ (VN)**

(73) Đường Ngô Quyền, khu 4, phường Cẩm Thượng, thành phố Hải Dương, tỉnh Hải Dương

(72) Nguyễn Thế Phương (VN)

(74) Công ty TNHH Sở hữu trí tuệ M.I.T (M.I.T IP CO., LTD)

(55)



1.1



1.2



2.1



2.2

- (11) **41364**  
(21) 3-2021-00045 (28) 1  
(54) **KHAY ĐỰNG CHẤT TẮY RỬA** (51) **15-05**  
(22) 11/01/2021 (43) 26/04/2021  
(30) WIPO96419 15/07/2020 WO;  
(73) **ELECTROLUX APPLIANCES AKTIEBOLAG (SE)**  
S:t Göransgatan143, 10545 Stockholm, Sweden  
(72) 1. ROBERTO BARBIERI (IT)  
2. ANDREA PUTAGGIO (IT)  
(74) Công ty Luật TNHH T&G (TGVN)  
(55)

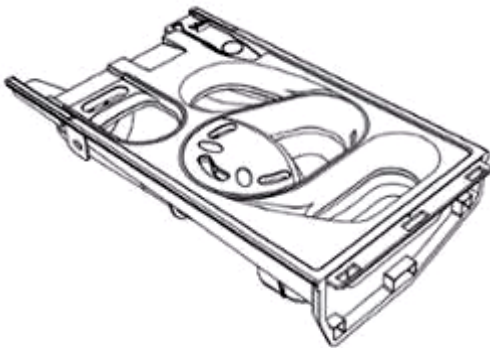

1.1

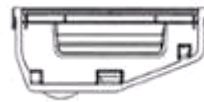

1.2



1.3

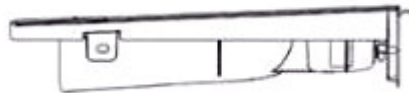

1.4



1.5

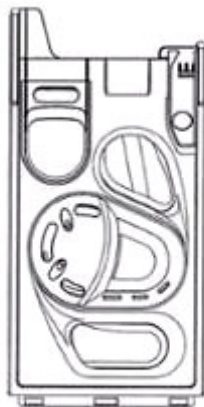

1.6

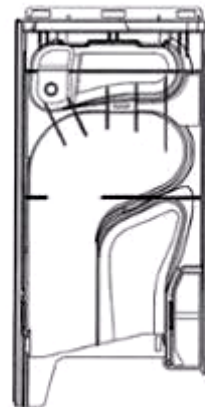

1.7

- (11) **41365**  
(21) 3-2021-00050 (28) 1  
(54) **BÌNH CHỨA** (51) **09-01**  
(22) 19/03/2019 (43) 26/04/2021  
(30) 005649563-0002 19/09/2018 EM;  
(73) **UNILEVER N.V. (NL)**  
Weena 455, 3013 AL Rotterdam, The Netherlands  
1. BOOKELMANN MATTHIJS LUCAS (NL)  
2. DEN BOER SEBASTIAAN WILHELMUS JOSEPHUS (NL)  
(72) 3. MEYER ANDREAS CHRISTIAN (DE)  
4. RAMON WILLEM (NL)  
5. VAN RIJSWIJK MARK (NL)  
(74) Công ty TNHH Trần Hữu Nam và Đồng sự (TRAN H.N & ASS.)  
(55)



1.1

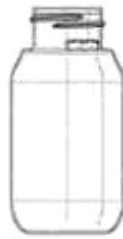

1.2



1.3



1.4

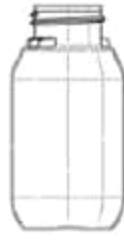

1.5



1.6



1.7

**CÔNG BÁO SỞ HỮU CÔNG NGHIỆP SỐ 397 TẬP A – QUYỀN 2 (04.2021)**

(11) **41366**

(21) 3-2021-00060

(28) 1

(54) **HỘP ĐỰNG**

(51) **09-03**

(22) 12/01/2021

(43) 26/04/2021

**CÔNG TY CỔ PHẦN THƯƠNG MẠI VÀ SẢN XUẤT THỰC PHẨM KICO**

(73) (VN)

Số 52 Hàng Bún, phường Quán Thánh, quận Ba Đình, thành phố Hà Nội

(72) Nguyễn Văn Long (VN)

(74) Công ty TNHH Sở hữu trí tuệ HA VIP (HAVIP CO., LTD.)

(55)



1.1



1.2

**CÔNG BÁO SỞ HỮU CÔNG NGHIỆP SỐ 397 TẬP A – QUYỀN 2 (04.2021)**

- (11) **41367**  
(21) 3-2021-00062 (28) 1  
(54) **THANH KIM LOẠI ĐỊNH HÌNH** (51) **25-01**  
(22) 12/01/2021 (43) 26/04/2021  
**PHẠM LÊ HÒA (VN)**  
(73) Số 20, ngõ 291, phố Khương Trung, phường Khương Trung, quận Thanh Xuân, thành phố Hà Nội  
(72) Phạm Lê Hòa (VN)  
(74) Công ty Luật TNHH VIETTHINK (VIETTHINK LAW FIRM)  
(55)

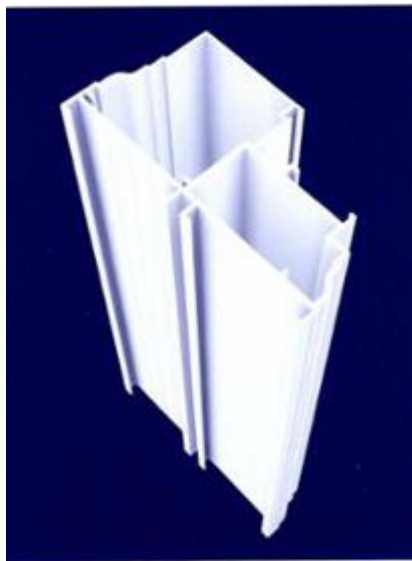

1.1



1.2

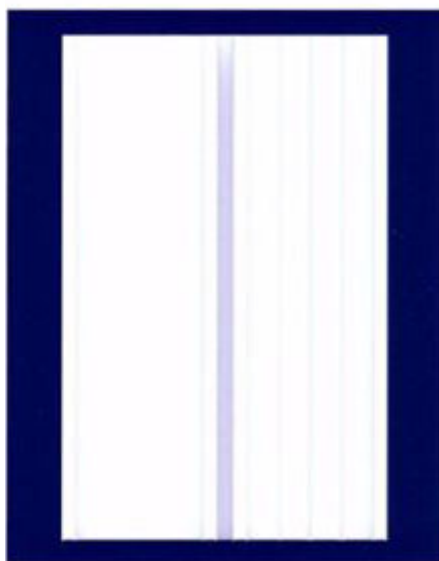

1.3

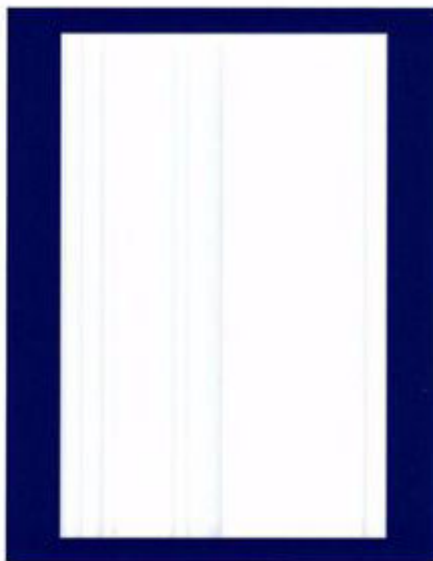

1.4

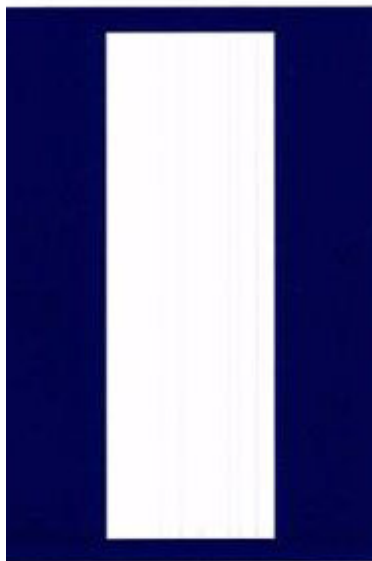

1.5

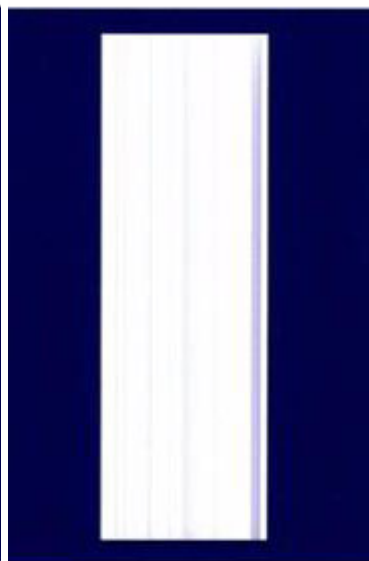

1.6

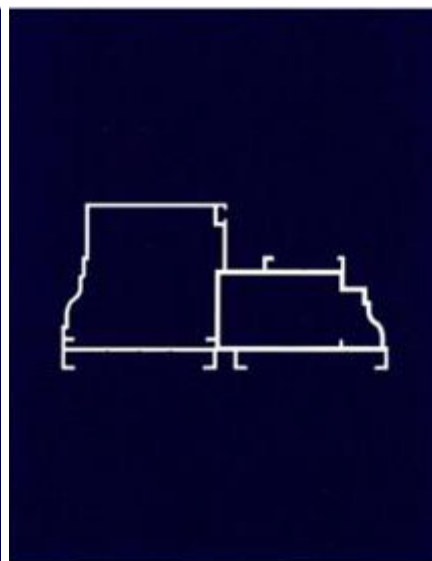

1.7



**CÔNG BÁO SỞ HỮU CÔNG NGHIỆP SỐ 397 TẬP A – QUYỀN 2 (04.2021)**

- (11) **41368**  
(21) 3-2021-00063 (28) 1  
(54) **THANH KIM LOẠI ĐỊNH HÌNH** (51) **25-01**  
(22) 12/01/2021 (43) 26/04/2021  
**PHẠM LÊ HÒA (VN)**  
(73) Số 20, ngõ 291, phố Khương Trung, phường Khương Trung, quận Thanh Xuân, thành phố Hà Nội  
(72) Phạm Lê Hòa (VN)  
(74) Công ty Luật TNHH VIETTHINK (VIETTHINK LAW FIRM)  
(55)



1.1



1.2

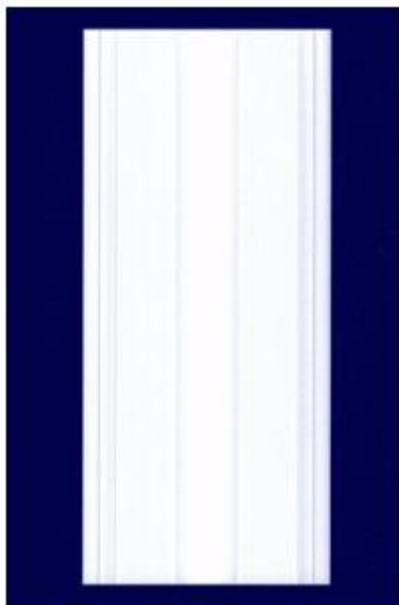

1.3

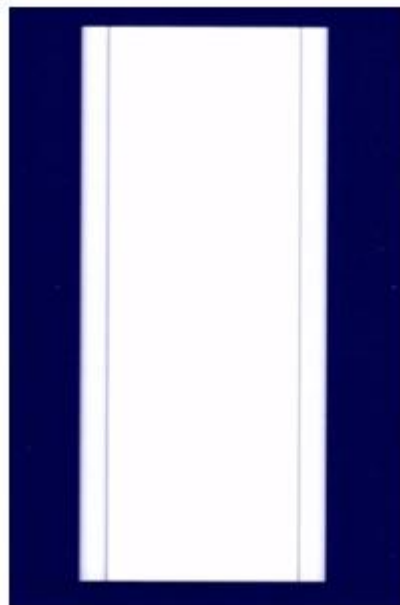

1.4

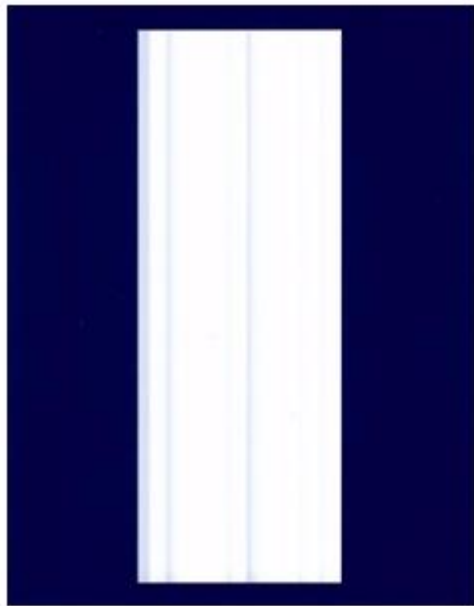

1.5

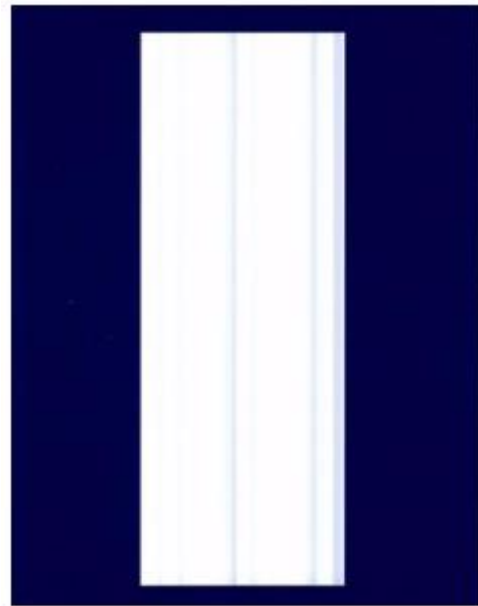

1.6



1.7

**CÔNG BÁO SỞ HỮU CÔNG NGHIỆP SỐ 397 TẬP A – QUYỀN 2 (04.2021)**

- (11) **41369**  
(21) 3-2021-00064 (28) 1  
(54) **NHÃN SẢN PHẨM** (51) **19-08**  
(22) 13/01/2021 (43) 26/04/2021  
(73) **CÔNG TY TNHH PHÁT TRIỂN CAO NGUYÊN (VN)**  
666/16/1 đường 3/2, phường 14, quận 10, thành phố Hồ Chí Minh  
(72) Trần Tất Hà (VN)  
(74) **CÔNG TY TNHH SỞ HỮU TRÍ TUỆ SETHACO (SETHACO IP CO.,LTD)**  
(55)



**CÔNG BÁO SỞ HỮU CÔNG NGHIỆP SỐ 397 TẬP A – QUYỀN 2 (04.2021)**

- (11) **41370**  
(21) 3-2021-00067 (28) 1  
(54) **THANH KIM LOẠI ĐỊNH HÌNH** (51) **25-01**  
(22) 13/01/2021 (43) 26/04/2021  
**CÔNG TY CỔ PHẦN KENWIN (VN)**  
(73) Tầng 4 tòa nhà VG Building, số 235 đường Nguyễn Trãi, phường Thanh Xuân Trung, quận Thanh Xuân, thành phố Hà Nội  
(72) Ngô Thọ Long (VN)  
(74) Công ty TNHH Sở hữu trí tuệ PADEMARK (PADEMARK CO.,LTD.)  
(55)

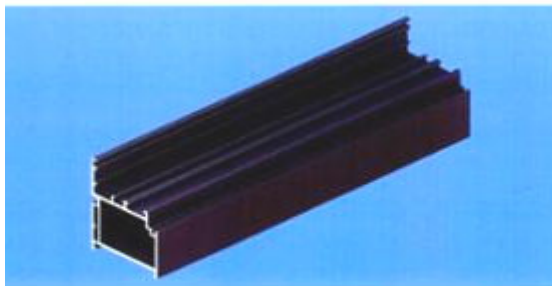

1.1



1.2



1.3

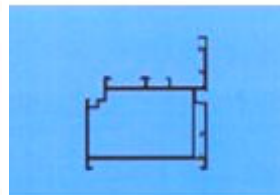

1.4

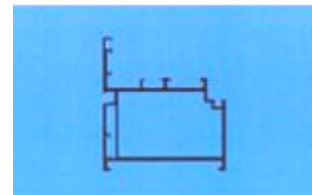

1.5



1.6



1.7

(11) **41371**

(21) 3-2021-00068

(28) 1

(54) **THANH KIM LOẠI ĐỊNH HÌNH**

(51) **25-01**

(22) 13/01/2021

(43) 26/04/2021

**CÔNG TY CỔ PHẦN KENWIN (VN)**

(73) Tầng 4 tòa nhà VG Building, số 235 đường Nguyễn Trãi, phường Thanh Xuân Trung, quận Thanh Xuân, thành phố Hà Nội

(72) Ngô Thọ Long (VN)

(74) Công ty TNHH Sở hữu trí tuệ PADEMARK (PADEMARK CO.,LTD.)

(55)

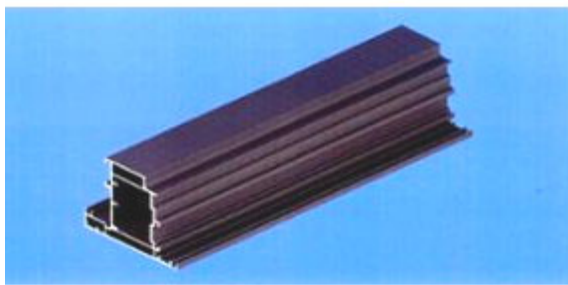

1.1



1.2



1.3

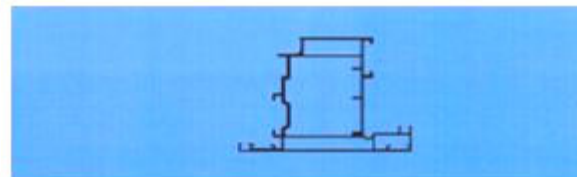

1.4

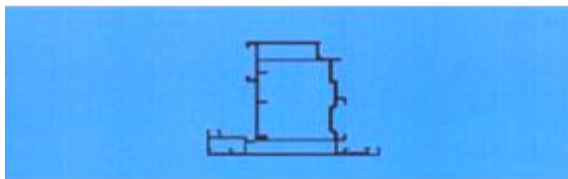

1.5

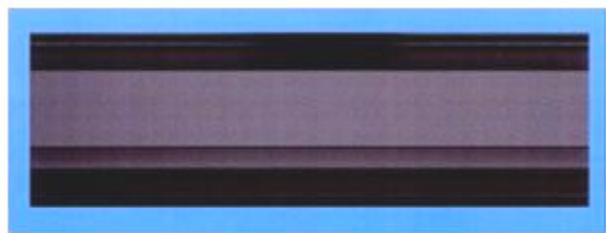

1.6

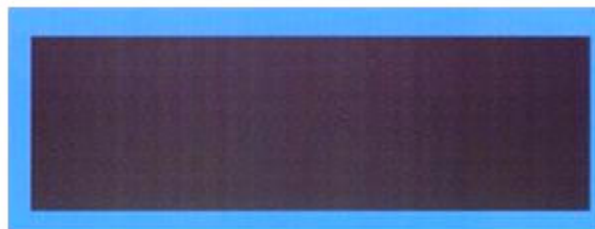

1.7

**CÔNG BÁO SỞ HỮU CÔNG NGHIỆP SỐ 397 TẬP A – QUYỀN 2 (04.2021)**

(11) **41372**

(21) 3-2021-00070

(28) 1

(54) **THANH KIM LOẠI ĐỊNH HÌNH**

(51) **25-01**

(22) 13/01/2021

(43) 26/04/2021

**CÔNG TY CỔ PHẦN KENWIN (VN)**

(73) Tầng 4 tòa nhà VG Building, số 235 đường Nguyễn Trãi, phường Thanh Xuân Trung, quận Thanh Xuân, thành phố Hà Nội

(72) Ngô Thọ Long (VN)

(74) Công ty TNHH Sở hữu trí tuệ PADEMARK (PADEMARK CO.,LTD.)

(55)

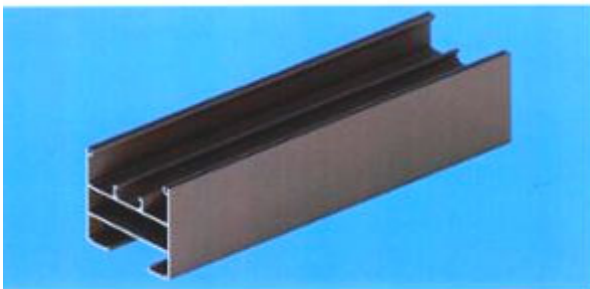

1.1



1.2



1.3

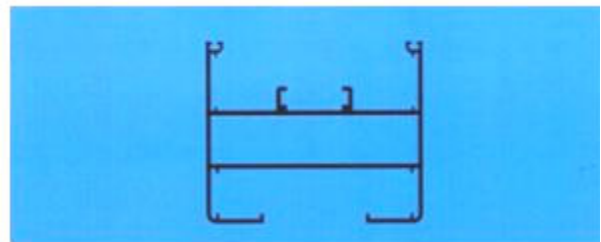

1.4

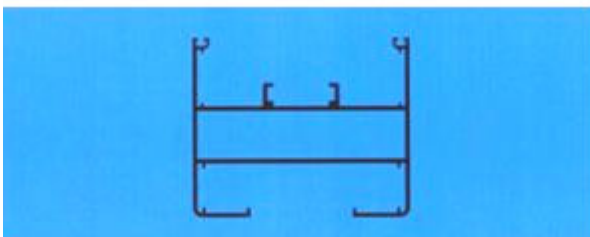

1.5

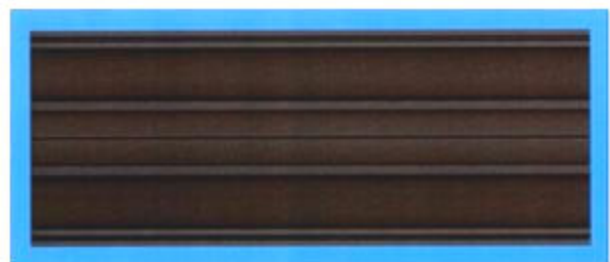

1.6

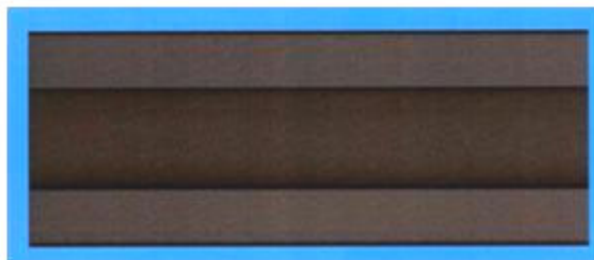

1.7

(11) **41373**

(21) 3-2021-00071

(54) **THANH KIM LOẠI ĐỊNH HÌNH**

(22) 13/01/2021

(28) 1

(51) **25-01**

(43) 26/04/2021

**CÔNG TY CỔ PHẦN KENWIN (VN)**

(73) Tầng 4 tòa nhà VG Building, số 235 đường Nguyễn Trãi, phường Thanh Xuân Trung, quận Thanh Xuân, thành phố Hà Nội

(72) Ngô Thọ Long (VN)

(74) Công ty TNHH Sở hữu trí tuệ PADEMARK (PADEMARK CO.,LTD.)

(55)

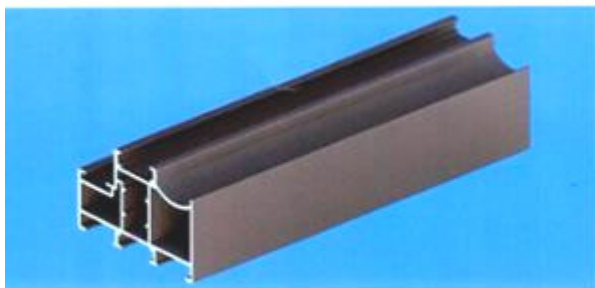

1.1



1.2



1.3

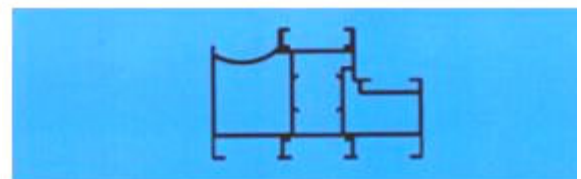

1.4

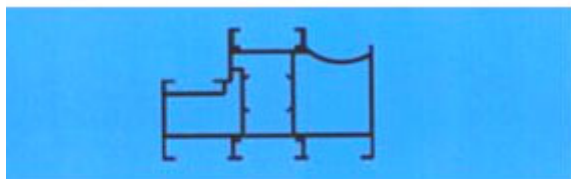

1.5



1.6

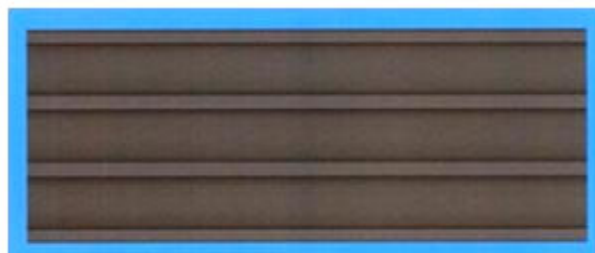

1.7

**CÔNG BÁO SỞ HỮU CÔNG NGHIỆP SỐ 397 TẬP A – QUYỀN 2 (04.2021)**

- (11) **41374**  
(21) 3-2021-00073 (28) 1  
(54) **THANH KIM LOẠI ĐỊNH HÌNH** (51) **25-01**  
(22) 13/01/2021 (43) 26/04/2021  
**CÔNG TY CỔ PHẦN KENWIN (VN)**  
(73) Tầng 4 tòa nhà VG Building, số 235 đường Nguyễn Trãi, phường Thanh Xuân Trung, quận Thanh Xuân, thành phố Hà Nội  
(72) Ngô Thọ Long (VN)  
(74) Công ty TNHH Sở hữu trí tuệ PADEMARK (PADEMARK CO.,LTD.)  
(55)

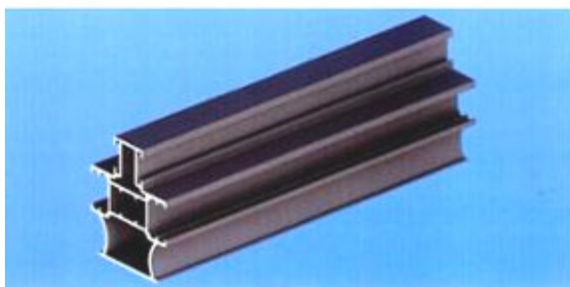

1.1



1.2



1.3

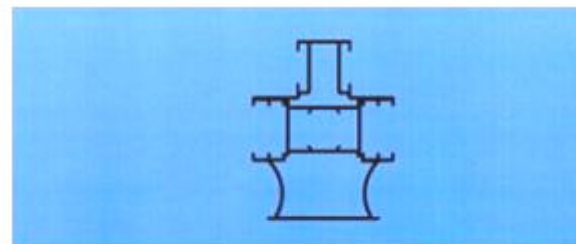

1.4

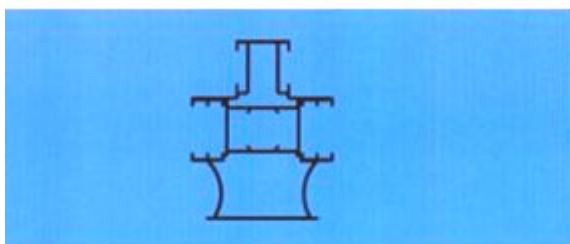

1.5



1.6

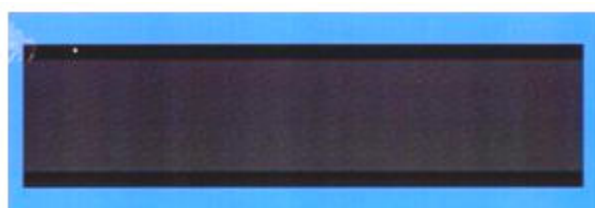

1.7



**CÔNG BÁO SỞ HỮU CÔNG NGHIỆP SỐ 397 TẬP A – QUYỀN 2 (04.2021)**

- (11) **41375**  
(21) 3-2021-00074 (28) 1  
(54) **THANH KIM LOẠI ĐỊNH HÌNH** (51) **25-01**  
(22) 13/01/2021 (43) 26/04/2021  
**CÔNG TY CỔ PHẦN KENWIN (VN)**  
(73) Tầng 4 tòa nhà VG Building, số 235 đường Nguyễn Trãi, phường Thanh Xuân Trung, quận Thanh Xuân, thành phố Hà Nội  
(72) Ngô Thọ Long (VN)  
(74) Công ty TNHH Sở hữu trí tuệ PADEMARK (PADEMARK CO.,LTD.)  
(55)

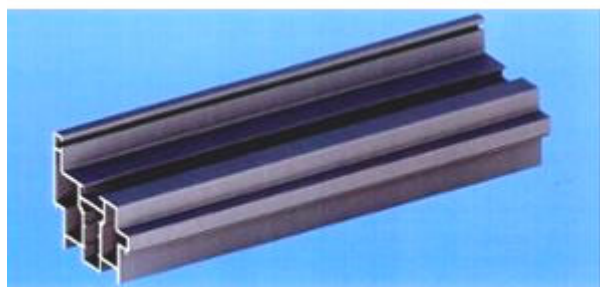

1.1



1.2



1.3

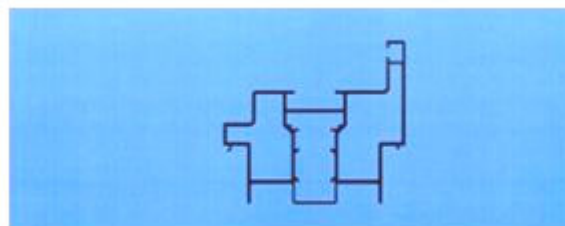

1.4

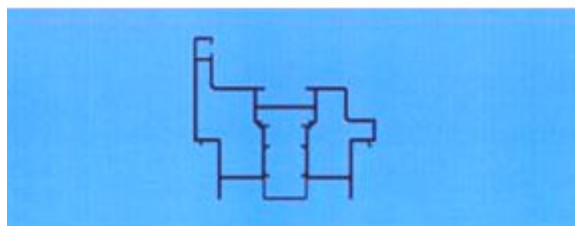

1.5



1.6



1.7

**CÔNG BÁO SỞ HỮU CÔNG NGHIỆP SỐ 397 TẬP A – QUYỀN 2 (04.2021)**

(11) **41376**

(21) 3-2021-00075

(54) **THANH KIM LOẠI ĐỊNH HÌNH**

(22) 13/01/2021

(28) 1

(51) **25-01**

(43) 26/04/2021

**CÔNG TY CỔ PHẦN KENWIN (VN)**

(73) Tầng 4 tòa nhà VG Building, số 235 đường Nguyễn Trãi, phường Thanh Xuân Trung, quận Thanh Xuân, thành phố Hà Nội

(72) Ngô Thọ Long (VN)

(74) Công ty TNHH Sở hữu trí tuệ PADEMARK (PADEMARK CO.,LTD.)

(55)

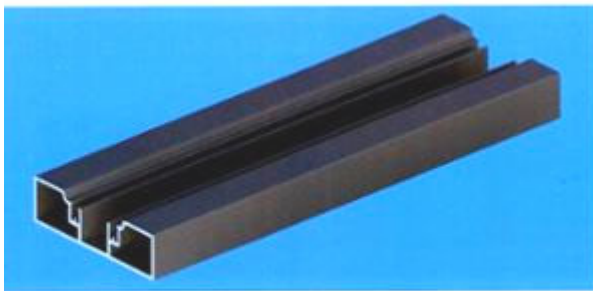

1.1



1.2



1.3

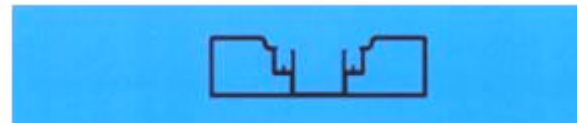

1.4

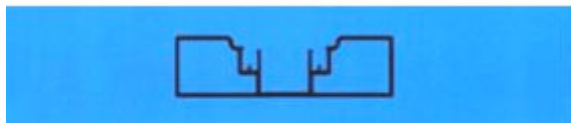

1.5

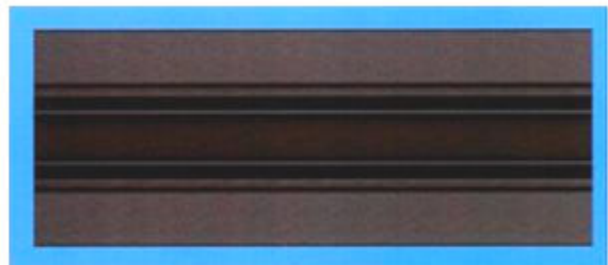

1.6

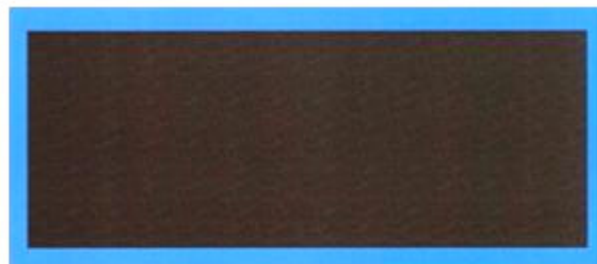

1.7

(11) **41377**

(21) 3-2021-00076

(54) **THANH KIM LOẠI ĐỊNH HÌNH**

(22) 13/01/2021

(28) 1

(51) **25-01**

(43) 26/04/2021

**CÔNG TY CỔ PHẦN KENWIN (VN)**

(73) Tầng 4 tòa nhà VG Building, số 235 đường Nguyễn Trãi, phường Thanh Xuân Trung, quận Thanh Xuân, thành phố Hà Nội

(72) Ngô Thọ Long (VN)

(74) Công ty TNHH Sở hữu trí tuệ PADEMARK (PADEMARK CO.,LTD.)

(55)

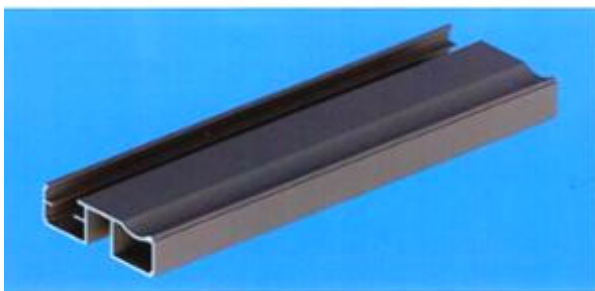

1.1



1.2



1.3



1.4



1.5

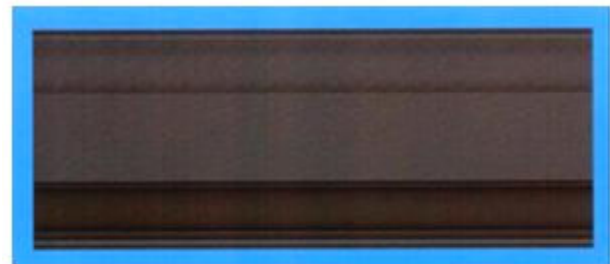

1.6

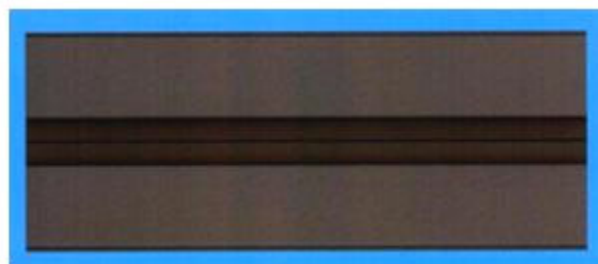

1.7

**CÔNG BÁO SỞ HỮU CÔNG NGHIỆP SỐ 397 TẬP A – QUYỀN 2 (04.2021)**

- (11) **41378**  
(21) 3-2021-00081 (28) 1  
(54) **Ô TÔ** (51) **12-08**  
(22) 14/01/2021 (43) 26/04/2021  
(30) 008042873 15/07/2020 EM;  
(73) **FERRARI S.P.A. (IT)**  
Via Emilia Est 1163, MODENA, Italy  
(72) Flavio MANZONI (IT)  
(74) Công ty TNHH một thành viên Sở hữu trí tuệ VCCI (VCCI-IP CO.,LTD)  
(55)



1.1



1.2



1.3

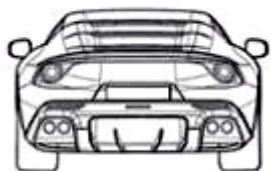

1.4

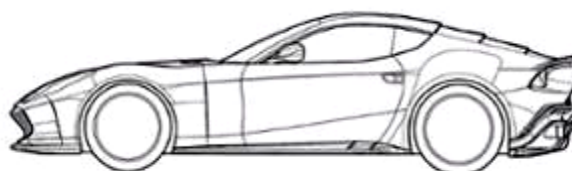

1.5



1.6

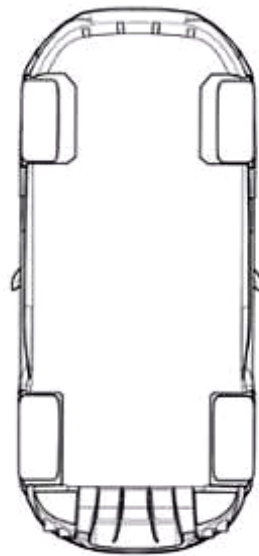

1.7

**CÔNG BÁO SỞ HỮU CÔNG NGHIỆP SỐ 397 TẬP A – QUYỀN 2 (04.2021)**

- (11) **41379**  
(21) 3-2021-00082 (28) 1  
(54) **Ô TÔ ĐỒ CHƠI** (51) **21-01**  
(22) 14/01/2021 (43) 26/04/2021  
(30) 008042139 15/07/2020 EM;  
(73) **FERRARI S.P.A. (IT)**  
Via Emilia Est 1163, MODENA, Italy  
(72) Flavio MANZONI (IT)  
(74) Công ty TNHH một thành viên Sở hữu trí tuệ VCCI (VCCI-IP CO.,LTD)  
(55)

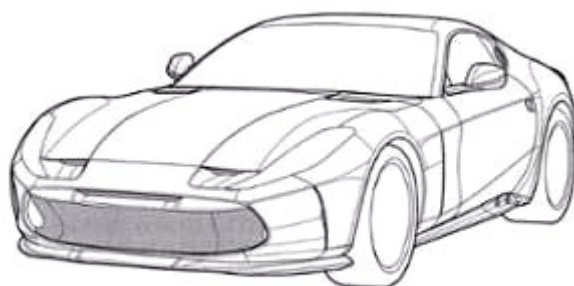

1.1

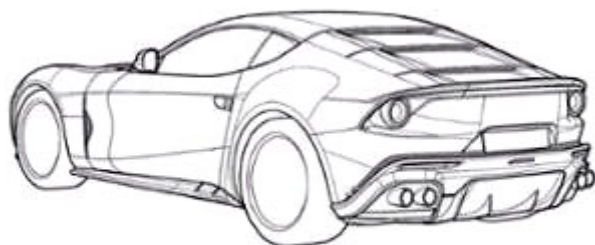

1.2



1.3



1.4

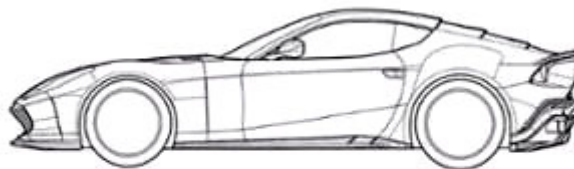

1.5



1.6

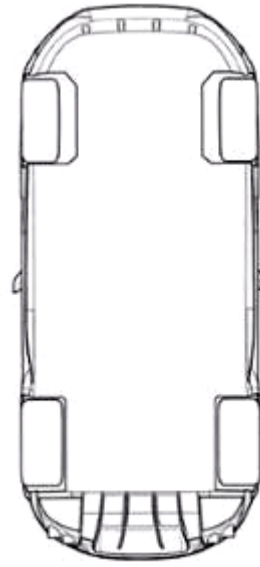

1.7

- (11) **41380**  
(21) 3-2021-00087 (28) 1  
(54) **DỤNG CỤ ĐẨY HÀM DƯỚI** (51) **24-02**  
(22) 14/01/2021 (43) 26/04/2021  
(30) 202013871 15/07/2020 AU;  
(73) **PEACEFULSLEEP PTY LTD (AU)**  
13 Endeavour Drive Maribyrnong VIC, 3032, Australia  
(72) 1. HOANG NGUYEN (AU)  
2. THANH THUY HO (AU)  
(74) Công ty Luật TNHH VIETTHINK (VIETTHINK LAW FIRM)  
(55)

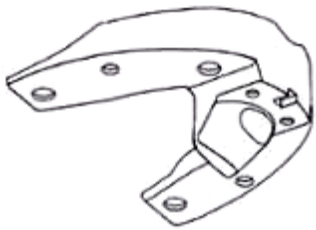

1.1



1.2



1.3



1.4



1.5

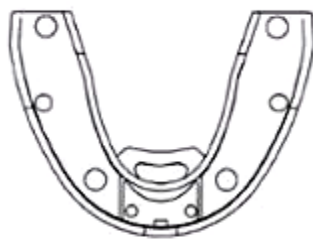

1.6

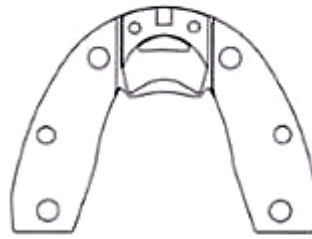

1.7



- (11) **41381**  
(21) 3-2021-00088 (28) 1  
(54) **DỤNG CỤ ĐẨY HÀM DƯỚI** (51) **24-02**  
(22) 14/01/2021 (43) 26/04/2021  
(30) 202013871 15/07/2020 AU;  
(73) **PEACEFULSLEEP PTY LTD (AU)**  
13 Endeavour Drive Maribyrnong VIC, 3032, Australia  
(72) 1. HOANG NGUYEN (AU)  
2. THANH THUY HO (AU)  
(74) Công ty Luật TNHH VIETTHINK (VIETTHINK LAW FIRM)  
(55)

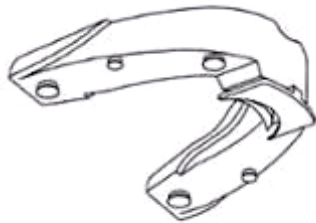

1.1



1.2



1.3



1.4

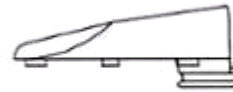

1.5



1.6

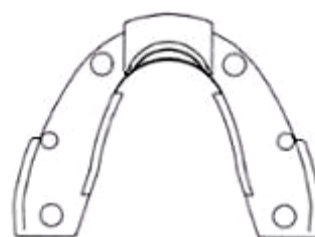

1.7

- (11) **41382**  
(21) 3-2021-00089 (28) 1  
(54) **DỤNG CỤ ĐẨY HÀM DƯỚI** (51) **24-02**  
(22) 14/01/2021 (43) 26/04/2021  
(30) 202013871 15/07/2020 AU;  
(73) **PEACEFULSLEEP PTY LTD (AU)**  
13 Endeavour Drive Maribyrnong VIC, 3032, Australia  
(72) 1. HOANG NGUYEN (AU)  
2. THANH THUY HO (AU)  
(74) Công ty Luật TNHH VIETTHINK (VIETTHINK LAW FIRM)  
(55)



1.1



1.2



1.3



1.4



1.5

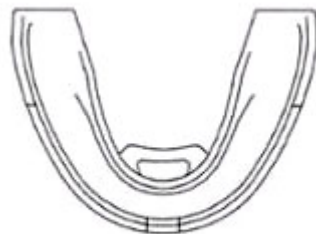

1.6

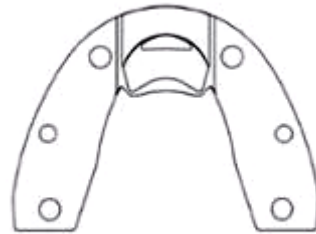

1.7

**CÔNG BÁO SỞ HỮU CÔNG NGHIỆP SỐ 397 TẬP A – QUYỀN 2 (04.2021)**

- (11) **41383**  
(21) 3-2021-00124 (28) 1  
(54) **HỘP** (51) **09-03**  
(22) 20/01/2021 (43) 26/04/2021  
(73) **HỘ KINH DOANH NGÔ KHOAN (VN)**  
Số 93 Hoàng Hoa Thám, khóm 10, phường 6, thành phố Trà Vinh, tỉnh Trà Vinh  
(72) Ngô Đạt Hòa (VN)  
(74) Công ty TNHH MASTERBRAND (MASTERBRAND)  
(55)

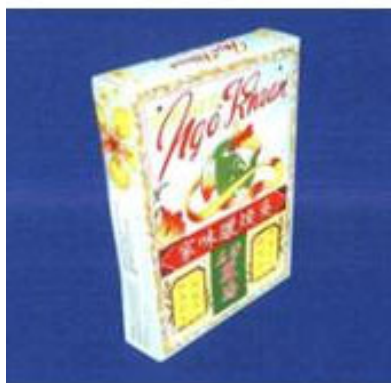

1.1



1.2

(11) **41384**

(21) 3-2021-00128

(54) **MÁY LỌC NƯỚC**

(22) 20/01/2021

(73) **CÔNG TY TNHH CÔNG NGHỆ VIETDREAM (VN)**

Số 535 đường Nam Cao, phường Tân Phú, quận 9, thành phố Hồ Chí Minh

(72) Nguyễn Thanh Tuấn (VN)

(55)

(28) 1

(51) **23-01**

(43) 26/04/2021

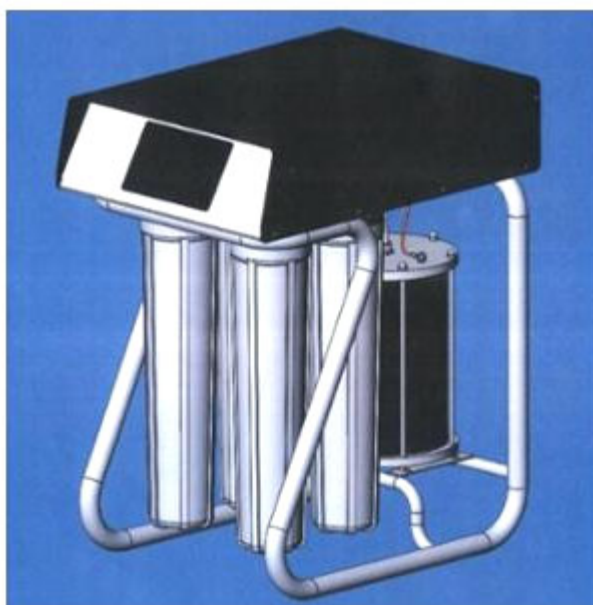

1.1

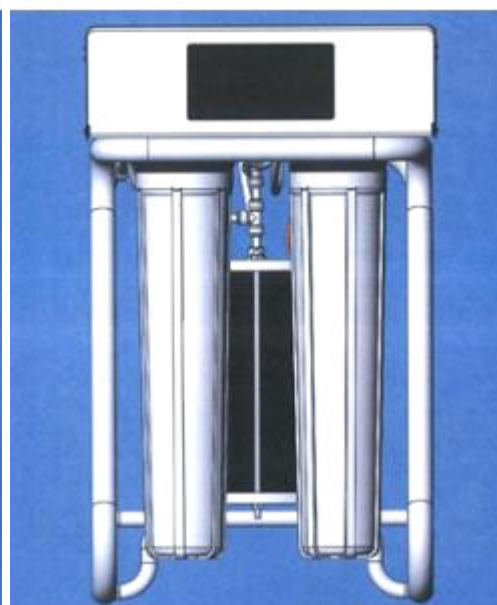

1.2

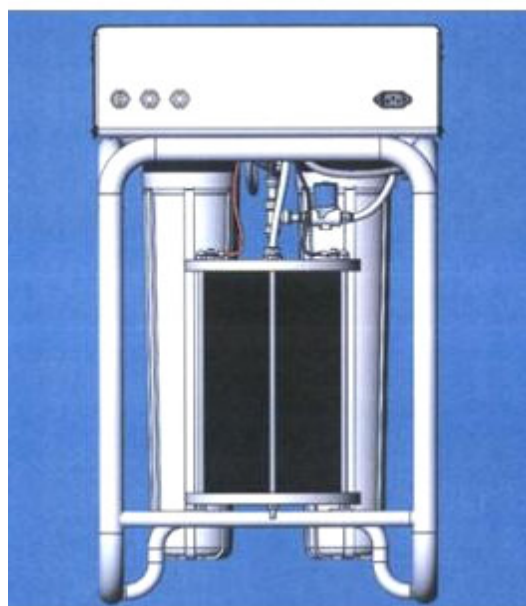

1.3

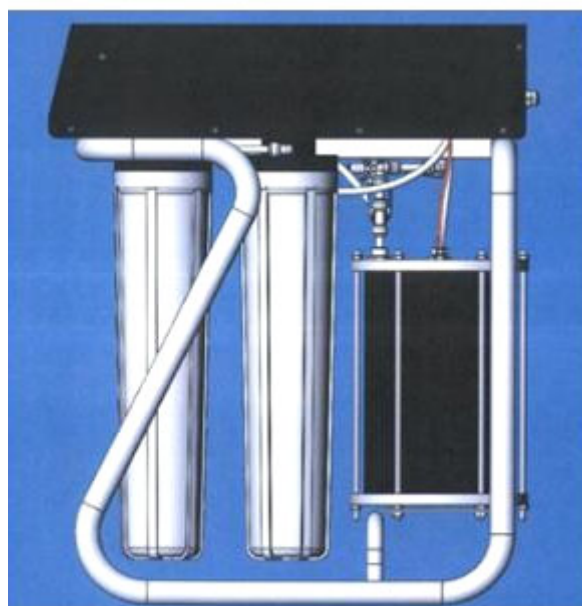

1.4

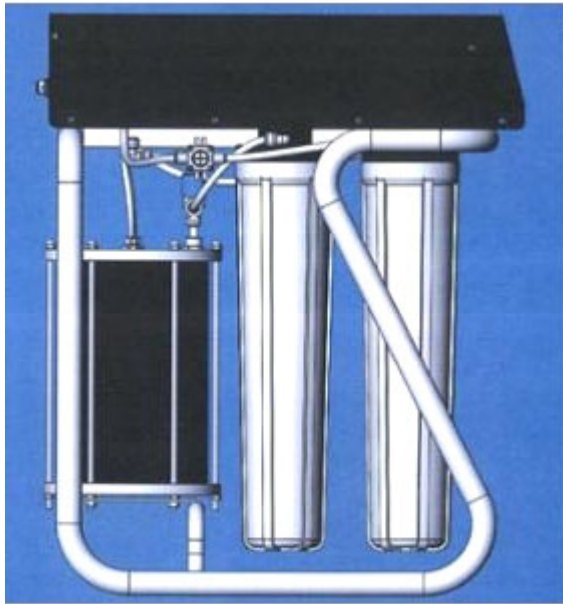

1.5

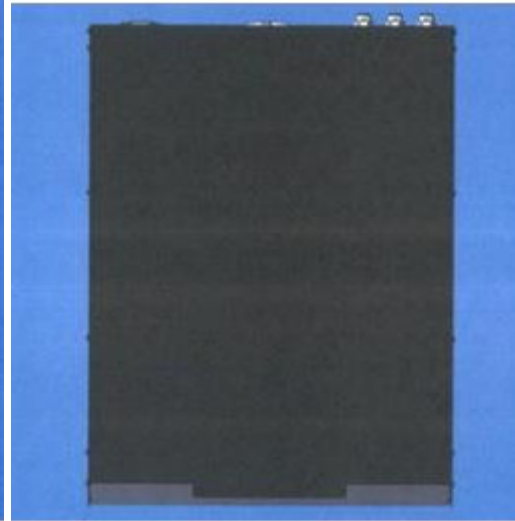

1.6

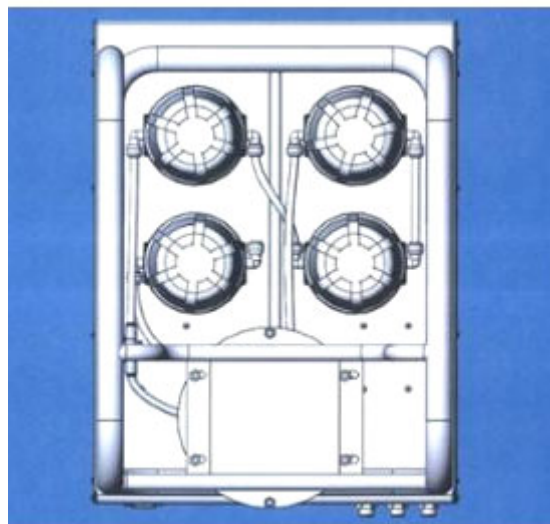

1.7

- (11) **41385**  
(21) 3-2021-00130 (28) 1  
(54) **MÁY CẠO RÂU** (51) **28-03**  
(22) 20/01/2021 (43) 26/04/2021  
(30) 202030462911.2 14/08/2020 CN;  
**XIAOFU JIANG (CN)**  
(73) 1B402, Room402, Block 1B, SongHeRuiYuan, Road 4 Xitou industry, Songgang Town, Bao'An District, Shenzhen, Guangdong, China  
(72) Xiaofu Jiang (CN)  
(74) Công ty TNHH Đại Tín và Liên Danh (DAITIN AND ASSOCIATES CO.,LTD)  
(55)

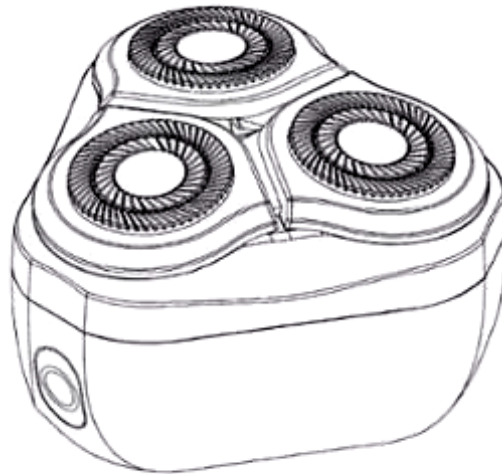

1.1

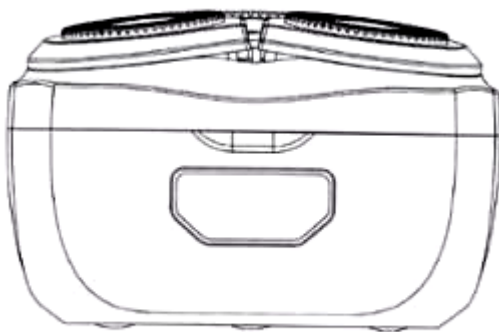

1.2

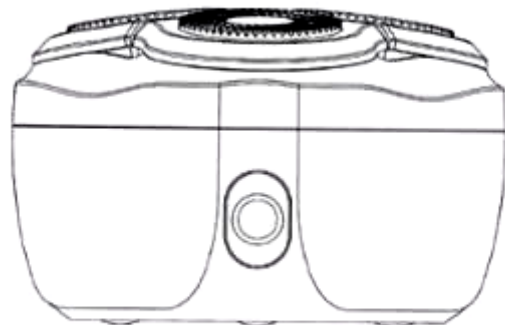

1.3

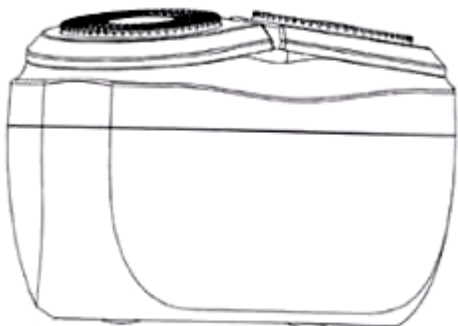

1.4

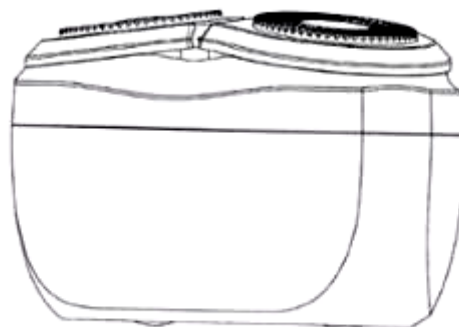

1.5

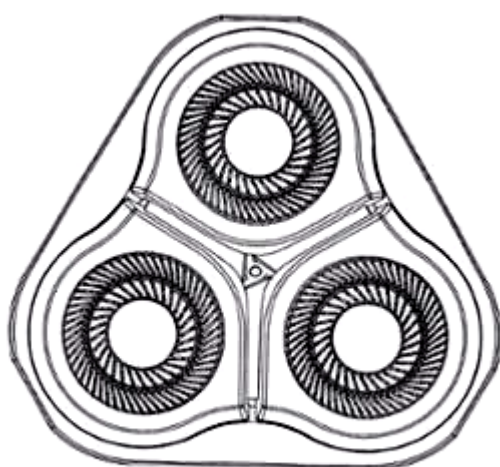

1.6

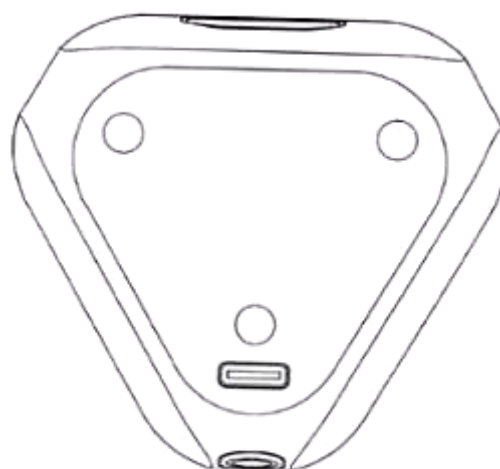

1.7

**CÔNG BÁO SỞ HỮU CÔNG NGHIỆP SỐ 397 TẬP A – QUYỀN 2 (04.2021)**

(11) **41386**

(21) 3-2021-00131

(28) 1

(54) **HỘP ĐỰNG**

(51) **09-03**

(22) 20/01/2021

(43) 26/04/2021

**CÔNG TY TNHH GOLDEN HEALTH USA (VN)**

(73) 30A Đường số 5, khu dân cư Trung Sơn, xã Bình Hưng, huyện Bình Chánh, thành phố Hồ Chí Minh

(72) Huỳnh Minh Trung (VN)

(74) Công ty TNHH Đại Tín và Liên Danh (DAITIN AND ASSOCIATES CO.,LTD)

(55)



1.1



1.2



**CÔNG BÁO SỞ HỮU CÔNG NGHIỆP SỐ 397 TẬP A – QUYỀN 2 (04.2021)**

(11) **41387**

(21) 3-2021-00132

(28) 1

(54) **HỘP ĐỰNG**

(51) **09-03**

(22) 20/01/2021

(43) 26/04/2021

**CÔNG TY TNHH GOLDEN HEALTH USA (VN)**

(73) 30A Đường số 5, khu dân cư Trung Sơn, xã Bình Hưng, huyện Bình Chánh, thành phố Hồ Chí Minh

(72) Huỳnh Minh Trung (VN)

(74) Công ty TNHH Đại Tín và Liên Danh (DAITIN AND ASSOCIATES CO.,LTD)

(55)



1.1



1.2

**CÔNG BÁO SỞ HỮU CÔNG NGHIỆP SỐ 397 TẬP A – QUYỀN 2 (04.2021)**

(11) **41388**

(21) 3-2021-00133

(28) 1

(54) **HỘP ĐỰNG**

(51) **09-03**

(22) 20/01/2021

(43) 26/04/2021

**CÔNG TY TNHH GOLDEN HEALTH USA (VN)**

(73) 30A Đường số 5, khu dân cư Trung Sơn, xã Bình Hưng, huyện Bình Chánh, thành phố Hồ Chí Minh

(72) Huỳnh Minh Trung (VN)

(74) Công ty TNHH Đại Tín và Liên Danh (DAITIN AND ASSOCIATES CO.,LTD)

(55)



1.1



1.2

**CÔNG BÁO SỞ HỮU CÔNG NGHIỆP SỐ 397 TẬP A – QUYỀN 2 (04.2021)**

(11) **41389**

(21) 3-2021-00134

(28) 1

(54) **HỘP ĐỰNG**

(51) **09-03**

(22) 20/01/2021

(43) 26/04/2021

**CÔNG TY TNHH GOLDEN HEALTH USA (VN)**

(73) 30A Đường số 5, khu dân cư Trung Sơn, xã Bình Hưng, huyện Bình Chánh, thành phố Hồ Chí Minh

(72) Huỳnh Minh Trung (VN)

(74) Công ty TNHH Đại Tín và Liên Danh (DAITIN AND ASSOCIATES CO.,LTD)

(55)



1.1



1.2

**CÔNG BÁO SỞ HỮU CÔNG NGHIỆP SỐ 397 TẬP A – QUYỀN 2 (04.2021)**

(11) **41390**

(21) 3-2021-00140

(28) 1

(54) **CHAI**

(51) **09-01**

(22) 21/01/2021

(43) 26/04/2021

**CÔNG TY TNHH CÁNH ĐỒNG VÀNG (VN)**

(73) 57-59 đường số 3, khu phố 8, phường Trường Thọ, quận Thủ Đức, thành phố Hồ Chí Minh

(72) Lê Kim Khánh (VN)

(74) Công ty TNHH Sở hữu trí tuệ INVENTIO (INVENTIO CO.,LTD)

(55)



1.1



1.2



1.3



1.4



1.5



1.6

**CÔNG BÁO SỞ HỮU CÔNG NGHIỆP SỐ 397 TẬP A – QUYỀN 2 (04.2021)**

(11) **41391**

(21) 3-2021-00141

(28) 1

(54) **CHAI**

(51) **09-01**

(22) 21/01/2021

(43) 26/04/2021

**CÔNG TY TNHH CÁNH ĐỒNG VÀNG (VN)**

(73) 57-59 đường số 3, khu phố 8, phường Trường Thọ, quận Thủ Đức, thành phố Hồ Chí Minh

(72) Lê Kim Khánh (VN)

(74) Công ty TNHH Sở hữu trí tuệ INVENTIO (INVENTIO CO.,LTD)

(55)



1.1



1.2



1.3



1.4



1.5



1.6

- (11) **41392**  
(21) 3-2021-00152 (28) 4  
(54) **ĐẦU THAY THỂ CHO DỤNG CỤ CHĂM SÓC RĂNG MIỆNG** (51) **04-02**  
(22) 22/01/2021 (43) 26/04/2021  
(30) 29/744982 03/08/2020 US;  
(73) **COLGATE-PALMOLIVE COMPANY (US)**  
300 Park Avenue, New York, New York 10022, United States of America  
1. EDUARDO JIMENEZ (US)  
(72) 2. AL AQUANZA SPROSTA (US)  
3. XIANGJI DING (CN)  
4. YANMEI JI (CN)  
(74) Văn phòng Luật sư Ân Nam (ANNAM IP & LAW)  
(55)

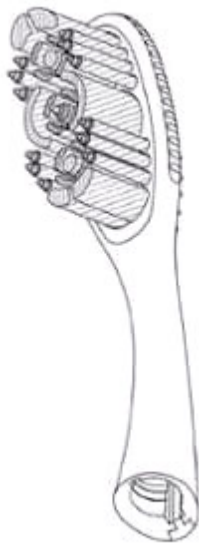

1.1



1.2



1.3



1.4



1.5



1.6



1.7



1.8



2.1



2.2



2.3



2.4

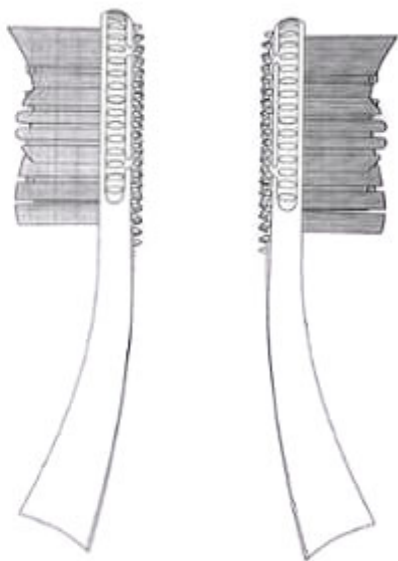

2.5

2.6



2.7



2.8

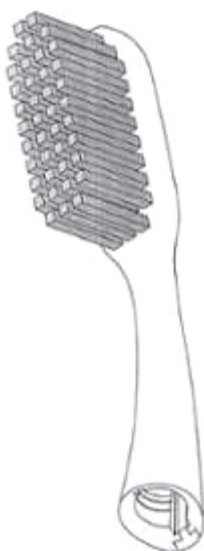

3.1



3.2



3.3



3.4





3.5



3.6



3.7



3.8



4.1



4.2



4.3



4.4

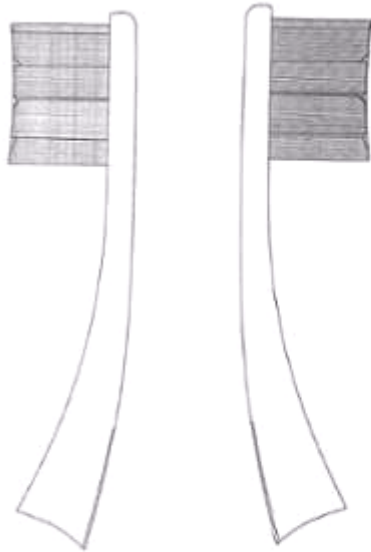

4.5

4.6

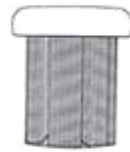

4.7



4.8

**CÔNG BÁO SỞ HỮU CÔNG NGHIỆP SỐ 397 TẬP A – QUYỀN 2 (04.2021)**

(11) **41393**

(21) 3-2021-00153

(28) 1

(54) **HỘP**

(51) **09-03**

(22) 22/01/2021

(43) 26/04/2021

**CÔNG TY CỔ PHẦN TẬP ĐOÀN THIÊN LONG (VN)**

(73) Lô 6-8-10-12 đường số 3, khu công nghiệp Tân Tạo, quận Bình Tân, thành phố Hồ Chí Minh

(72) Cô Gia Thọ (VN)

(74) Công ty TNHH Tư vấn sở hữu trí tuệ Việt (VIET IP CO.,LTD.)

(55)



1.1



1.2

**CÔNG BÁO SỞ HỮU CÔNG NGHIỆP SỐ 397 TẬP A – QUYỀN 2 (04.2021)**

(11) **41394**

(21) 3-2021-00154

(28) 1

(54) **HỘP**

(51) **09-03**

(22) 22/01/2021

(43) 26/04/2021

**CÔNG TY TNHH NHÀ NƯỚC MỘT THÀNH VIÊN YẾN SÀO KHÁNH HÒA (VN)**

248 Thống Nhất, phường Phương Sơn, thành phố Nha Trang, tỉnh Khánh Hòa

(72) Lê Hữu Hoàng (VN)

(74) Công ty TNHH Tư vấn sở hữu trí tuệ Việt (VIET IP CO.,LTD.)

(55)



1.1

1.2

**CÔNG BÁO SỞ HỮU CÔNG NGHIỆP SỐ 397 TẬP A – QUYỀN 2 (04.2021)**

- (11) **41395**  
(21) 3-2021-00163 (28) 1  
(54) **BAO GÓI** (51) **09-05**  
(22) 25/01/2021 (43) 26/04/2021  
(73) **CƠ SỞ SẢN XUẤT MIỀN ĐÔNG SẠCH QUYỀN THIẾT (VN)**  
Thôn Thị Nội, xã Tân Hòa, huyện Quốc Oai, thành phố Hà Nội  
(72) Vương Xuân Quyền (VN)  
(55)



1.1



1.2

(11) **41396**

(21) 3-2021-00164

(54) **THIẾT BỊ XỬ LÝ RÁC**

(22) 26/01/2021

(28) 1

(51) **23-99**

(43) 26/04/2021

(73) 1. **NGUYỄN TUẤN ANH (VN)**

254 đường 30/4, phường Thanh Bình, thành phố Biên Hòa, tỉnh Đồng Nai

2. **TRẦN THỊ MINH HẠNH (VN)**

254 đường 30/4, phường Thanh Bình, thành phố Biên Hòa, tỉnh Đồng Nai

(72) 1. **NGUYỄN TUẤN ANH (VN)**

2. **TRẦN THỊ MINH HẠNH (VN)**

(55)

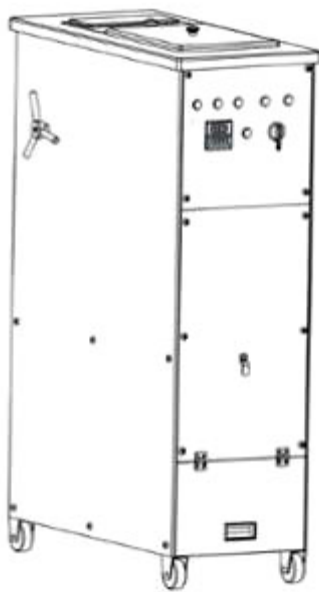

1.1



1.2



1.3

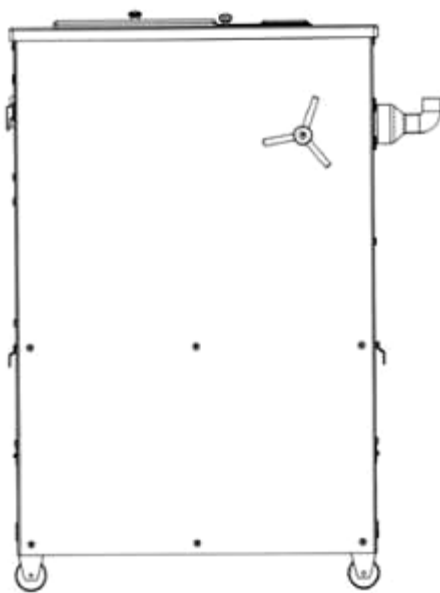

1.4

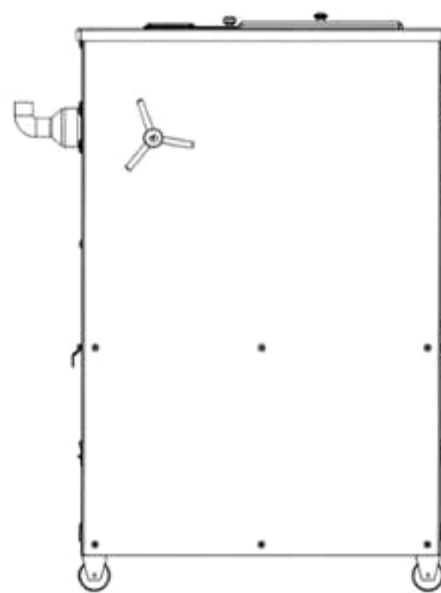

1.5



1.6



1.7

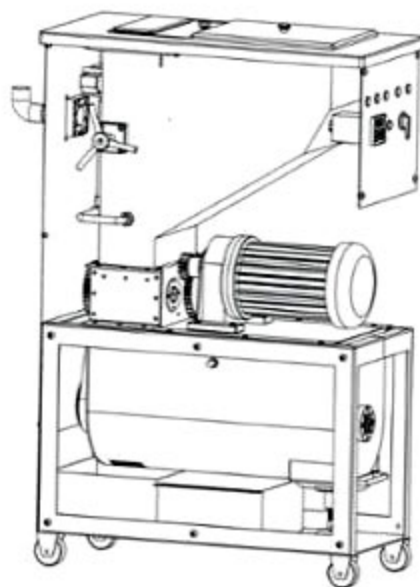

1.8

**CÔNG BÁO SỞ HỮU CÔNG NGHIỆP SỐ 397 TẬP A – QUYỀN 2 (04.2021)**

(11) **41397**

(21) 3-2021-00177

(28) 1

(54) **KỆ TI VI**

(51) **06-04**

(22) 26/01/2021

(43) 26/04/2021

(73) **PHẠM TÍN THÀNH (VN)**

Thôn Tân Lập, xã Tam Hải, huyện Núi Thành, tỉnh Quảng Nam

(72) Phạm Tín Thành (VN)

(74) Công ty TNHH Tư vấn đầu tư và Sở hữu trí tuệ Hoàng Phi (HOANG PHI INVEST & I.P CO., LTD)

(55)



1.1



1.2



1.3



1.4

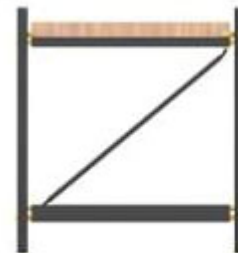

1.5



1.6



1.7



(11) **41398**

(21) 3-2021-00193

(54) **THÙNG XE MÔ TÔ**

(22) 27/01/2021

(73) **GIVI SPA (IT)**

Via G. Ungaretti, 48, 25020 Flero (BS), Italy

(72) Visenzi Giuseppe (IT)

(74) Công ty Cổ phần Sở hữu công nghiệp INVESTIP (INVESTIP)

(55)

(28) 1

(51) **12-16**

(43) 26/04/2021

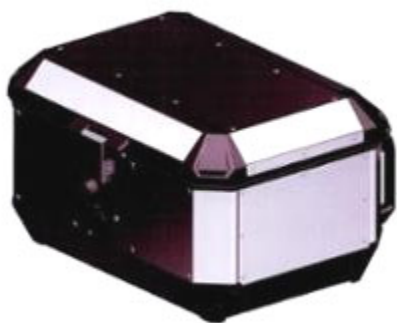

1.1



1.2



1.3



1.4



1.5



1.6



1.7



1.8



1.9

**CÔNG BÁO SỞ HỮU CÔNG NGHIỆP SỐ 397 TẬP A – QUYỀN 2 (04.2021)**

- (11) **41399**  
(21) 3-2021-00197 (28) 3  
(54) **NHÃN SẢN PHẨM** (51) **19-08**  
(22) 27/01/2021 (43) 26/04/2021  
(73) **CERIOTI HOLDING S.A. (LU)**  
23, Rue Aldringen L-1118 Luxembourg  
(72) Lê Thị Ánh Phương (VN)  
(74) Công ty TNHH Tầm nhìn và Liên danh (VISION & ASSOCIATES CO.LTD.)  
(55)



1



2



3

**CÔNG BÁO SỞ HỮU CÔNG NGHIỆP SỐ 397 TẬP A – QUYỀN 2 (04.2021)**

(11) **41400**

(21) 3-2021-00199

(28) 1

(54) **GHẾ SÔ-PHA**

(51) **06-01**

(22) 27/01/2021

(43) 26/04/2021

(73) **HTL FURNITURE (CHINA) CO., LTD. (CN)**

Wusong Jiangnan Road, Kunshan Development Zone, Jiangsu Province, China

(72) PHUA YONG TAT (SG)

(74) Công ty Luật TNHH quốc tế BMVN (BMVN INTERNATIONAL LLC)

(55)



1.1



1.2



1.3



1.4



1.5

**CÔNG BÁO SỞ HỮU CÔNG NGHIỆP SỐ 397 TẬP A – QUYỀN 2 (04.2021)**

(11) **41401**

(21) 3-2021-00201

(28) 1

(54) **DÉP**

(51) **02-04**

(22) 27/01/2021

(43) 26/04/2021

(73) **CÔNG TY TNHH GIÀY Á CHÂU (VN)**

451/29/8 Tô Hiến Thành, phường 14, quận 10, thành phố Hồ Chí Minh

(72) Nguyễn Đình Kim (VN)

(74) Văn phòng Luật sư A Hoà (AHOA LAW OFFICE)

(55)

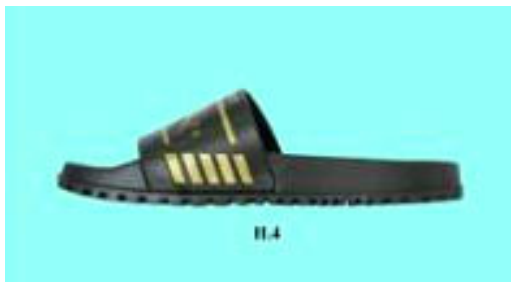

**CÔNG BÁO SỞ HỮU CÔNG NGHIỆP SỐ 397 TẬP A – QUYỀN 2 (04.2021)**

- (11) **41402**  
(21) 3-2021-00202 (28) 1  
(54) **NẮP ĐẬY** (51) **09-07**  
(22) 27/01/2021 (43) 26/04/2021  
(73) **TRẦN VĂN TÍN (VN)**  
Áp 2, xã Tân Hiệp, huyện Phú Giáo, tỉnh Bình Dương  
(72) Trần Văn Tín (VN)  
(74) Văn phòng Luật sư A Hoà (AHOA LAW OFFICE)  
(55)



H.1



H.2



H.3



H.4



H.5



H.6

**CÔNG BÁO SỞ HỮU CÔNG NGHIỆP SỐ 397 TẬP A – QUYỀN 2 (04.2021)**

- (11) **41403**  
(21) 3-2021-00208 (28) 1  
(54) **KHUÔN BỒN CHỨA NƯỚC** (51) **23-01**  
(22) 28/01/2021 (43) 26/04/2021  
(73) **CÔNG TY CỔ PHẦN NHỰA SAO VIỆT (VN)**  
Tổ 12, ấp Hội Thạnh, xã Xuân Hiệp, huyện Trà Ôn, tỉnh Vĩnh Long  
(72) Nguyễn Phú Thi (VN)  
(74) Công ty TNHH Tư vấn - Dịch thuật - Sở hữu trí tuệ Á Đông (Á Đông IP  
CONSULTANCY CO.,LTD.)  
(55)



1.1



1.2



1.3



1.4



1.5



1.6



1.7

- (11) **41404**  
(21) 3-2021-00215 (28) 1  
(54) **GIỎ ĐỰNG RÁC** (51) **09-09**  
(22) 28/01/2021 (43) 26/04/2021  
(73) **CÔNG TY CỔ PHẦN GIẢI PHÁP CÔNG NGHỆ THUẬN THIÊN (VN)**  
136 Nguyễn Văn Công, phường 3, quận Gò Vấp, thành phố Hồ Chí Minh  
(72) Thân Thế Hào (VN)  
(74) Công ty TNHH Sở hữu trí tuệ Thảo Thọ Quyển (INVENCO.,LTD)  
(55)



1.1



1.2



1.3



1.4



1.5



1.6



1.7



**CÔNG BÁO SỞ HỮU CÔNG NGHIỆP SỐ 397 TẬP A – QUYỀN 2 (04.2021)**

- (11) **41405**  
(21) 3-2021-00216 (28) 1  
(54) **CỔ NỐI ỐNG** (51) **23-01**  
(22) 28/01/2021 (43) 26/04/2021  
(73) **CÔNG TY CỔ PHẦN GIẢI PHÁP CÔNG NGHỆ THUẬN THIÊN (VN)**  
136 Nguyễn Văn Công, phường 3, quận Gò Vấp, thành phố Hồ Chí Minh  
(72) Thân Thế Hào (VN)  
(74) Công ty TNHH Sở hữu trí tuệ Thảo Thọ Quyển (INVENCO.,LTD)  
(55)



1.1



1.2



1.3



1.4



1.5



1.6



1.7

- (11) **41406**  
(21) 3-2021-00222 (28) 1  
(54) **HỘP ĐỰNG THUỐC** (51) **09-03**  
(22) 29/01/2021 (43) 26/04/2021  
**VŨ THỊ PHƯƠNG (VN)**  
(73) Khu ĐT Dệt May, phường Năng Tĩnh, thành phố Nam Định, tỉnh Nam Định  
(72) Vũ Thị Phương (VN)  
(55)



1.1



1.2

- (11) **41407**  
(21) 3-2021-00223 (28) 1  
(54) **HỘP ĐỰNG THUỐC** (51) **09-03**  
(22) 29/01/2021 (43) 26/04/2021  
(73) **VŨ THỊ PHƯƠNG (VN)**  
Khu ĐT Dệt May, phường Năng Tĩnh, thành phố Nam Định, tỉnh Nam Định  
(72) Vũ Thị Phương (VN)  
(55)



1.1



1.2

- (11) **41408**  
(21) 3-2021-00224 (28) 1  
(54) **HỘP ĐỰNG THUỐC** (51) **09-03**  
(22) 29/01/2021 (43) 26/04/2021  
**VŨ THỊ PHƯƠNG (VN)**  
(73) Khu DT Dệt May, phường Năng Tĩnh, thành phố Nam Định, tỉnh Nam Định  
(72) Vũ Thị Phương (VN)  
(55)



1.1



1.2

- (11) **41409**  
(21) 3-2021-00232 (28) 2  
(54) **VAN ĐIỆN TỬ** (51) **23-01**  
(22) 29/01/2021 (43) 26/04/2021  
(30) 2020-019023 07/09/2020 JP; 2020-019022 07/09/2020 JP;  
(73) **SMC CORPORATION (JP)**  
14-1, Sotokanda 4-chome, Chiyoda-ku, Tokyo, 1010021 JAPAN  
(72) Akira ENZAKI (JP)  
(74) Công ty TNHH Tầm nhìn và Liên danh (VISION & ASSOCIATES CO.LTD.)  
(55)

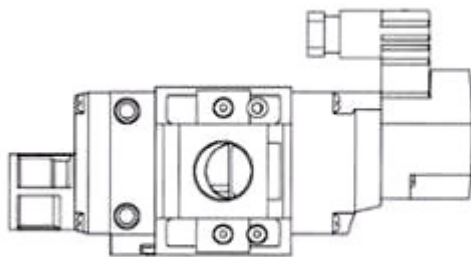

1.1

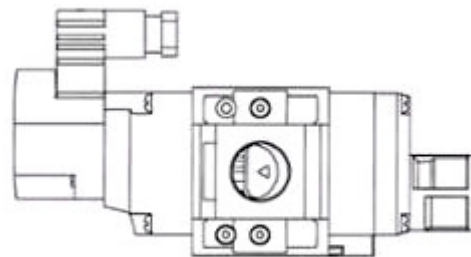

1.2

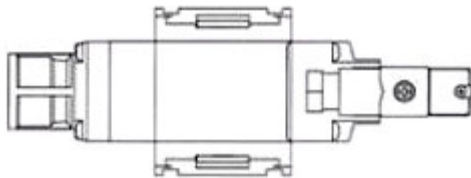

1.3

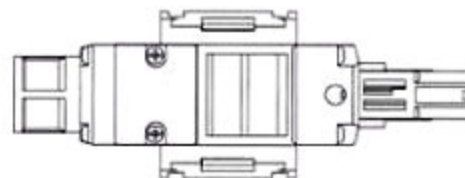

1.4

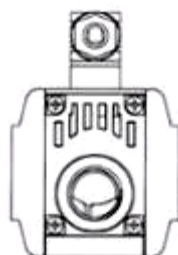

1.5

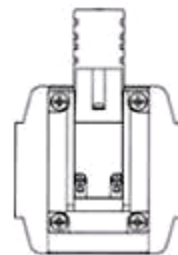

1.6

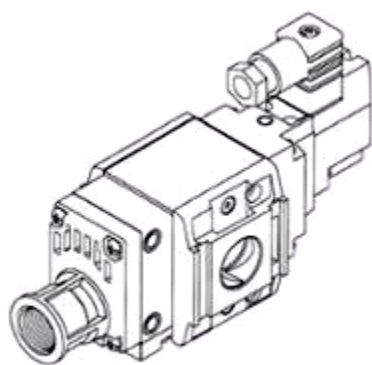

1.7

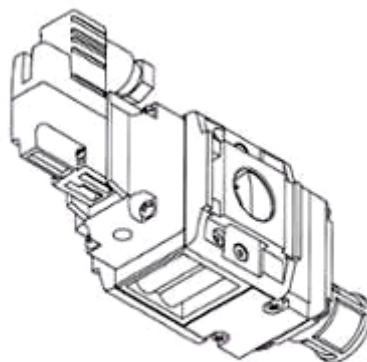

1.8

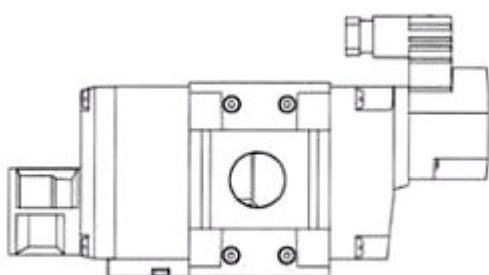

2.1

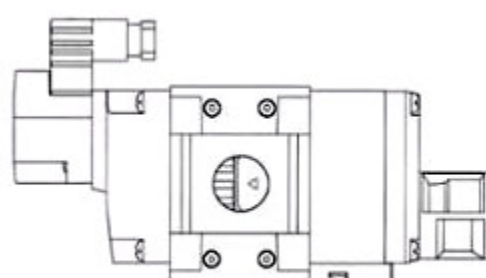

2.2

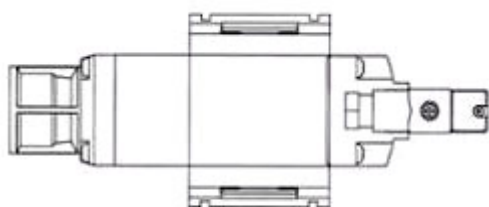

2.3

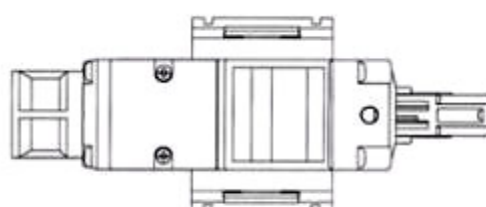

2.4

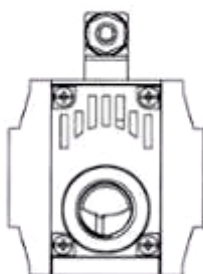

2.5

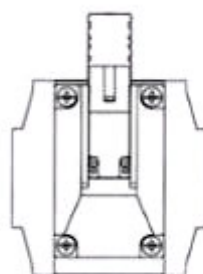

2.6

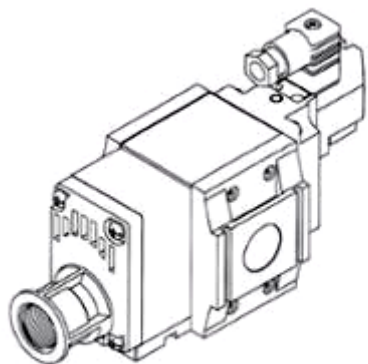

2.7

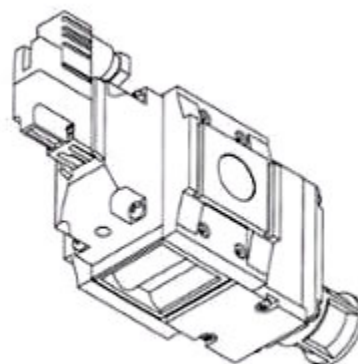

2.8

**CÔNG BÁO SỞ HỮU CÔNG NGHIỆP SỐ 397 TẬP A – QUYỀN 2 (04.2021)**

(11) **41410**

(21) 3-2021-00233

(28) 1

(54) **HỘP**

(51) **09-03**

(22) 29/01/2021

(43) 26/04/2021

**CÔNG TY TNHH MỘT THÀNH VIÊN THƯƠNG MẠI HÓA MỸ PHẨM  
NAM ANH KHƯƠNG (VN)**

(73) Số 11/B6, khu phố Bình Thuận 2, phường Thuận Giao, thành phố Thuận An, tỉnh Bình Dương

(72) Lê Văn Khương (VN)

(55)



1.1



1.2



1.3



1.4



1.5



1.6



1.7



- (11) **41411**  
(21) 3-2021-00234 (28) 1  
(54) **CON DẦU LẮN CÓ DAO MỞ BÌ THU'** (51) **19-02**  
(22) 29/01/2021 (43) 26/04/2021  
(30) 29/746,871 18/08/2020 US;  
(73) **PLUS CORPORATION (JP)**  
1-28, Toranomom 4-Chome, Minato-ku, Tokyo, 105-0001, Japan  
1. KOTA UEYA (JP)  
(72) 2. TOSHIHIRO OHIRA (JP)  
3. HAYATO HORIE (JP)  
(74) Văn phòng Luật sư Ân Nam (ANNAM IP & LAW)  
(55)

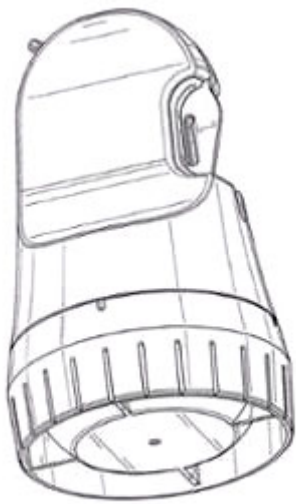

1.1



1.2

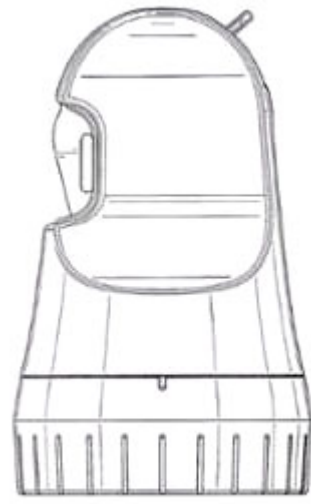

1.3

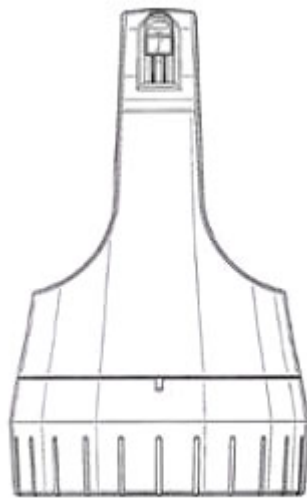

1.4

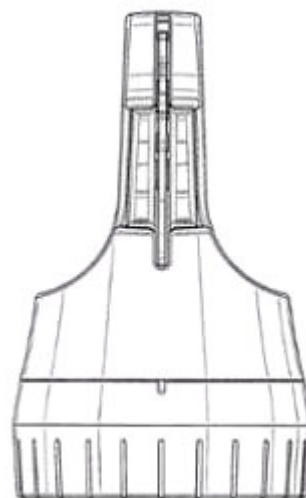

1.5

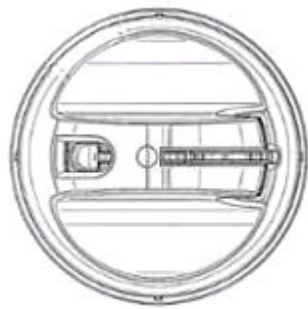

1.6



1.7



1.8

(11) **41412**

(21) 3-2021-00237

(28) 1

(54) **ĐỀ GIÀY**

(51) **02-04**

(22) 29/01/2021

(43) 26/04/2021

**CÔNG TY TNHH BÌNH TIÊN BIÊN HÒA (VN)**

(73) Lô 101/2 và lô 101/11, khu công nghiệp Amata, phường Long Bình, thành phố Biên Hòa, tỉnh Đồng Nai

(72) Lai Khiêm (VN)

(74) Công ty TNHH Tư vấn sở hữu trí tuệ Việt (VIET IP CO.,LTD.)

(55)



1.1



1.2



1.3



1.4



1.5



1.6



1.7

(11) **41413**

(21) 3-2021-00241

(54) **MÔ HÌNH LẮP GHEP**

(22) 02/02/2021

(73) **TÔ QUANG MINH (VN)**

Xóm Trung Thành, xã Danh Thắng, huyện Hiệp Hòa, tỉnh Bắc Giang

(72) Tô Quang Minh (VN)

(55)

(28) 1

(51) **21-01**

(43) 26/04/2021



1.1



1.2



1.3

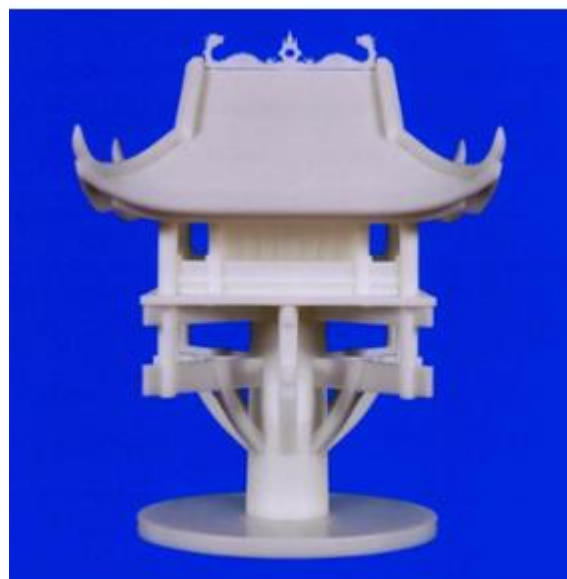

1.4



1.5

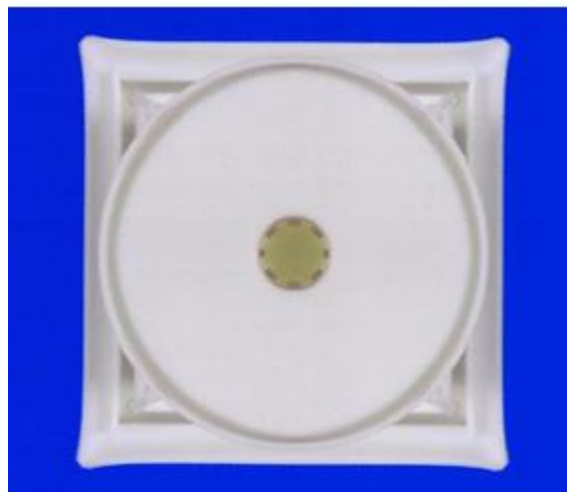

1.6

**CÔNG BÁO SỞ HỮU CÔNG NGHIỆP SỐ 397 TẬP A – QUYỀN 2 (04.2021)**

- (11) **41414**  
(21) 3-2021-00253 (28) 1  
(54) **BAO BÌ SẢN PHẨM** (51) **09-05**  
(22) 02/02/2021 (43) 26/04/2021  
**CÔNG TY CỔ PHẦN ĐẦU TƯ KINH DOANH XUẤT NHẬP KHẨU ST**  
(73) (VN)  
Căn hộ số C3-30.OT12, tòa Central 3 Vinhomes Central Park, 720A Điện Biên Phủ, phường 22, quận Bình Thạnh, thành phố Hồ Chí Minh  
(72) TRẦN NGỌC THU (VN)  
(74) Công ty TNHH Tư vấn đầu tư và Sở hữu trí tuệ Hoàng Phi (HOANG PHI INVEST & I.P CO., LTD)  
(55)



1.1



1.2

(11) **41415**

(21) 3-2021-00257

(28) 1

(54) **MÁY CẤP LIỆU**

(51) **15-04; 15-99**

(22) 02/02/2021

(43) 26/04/2021

**CÔNG TY CỔ PHẦN THIẾT KẾ CÔNG NGHIỆP VÀ HỆ THỐNG KỸ**

(73) **THUẬT LILAMA 69-3 (VN)**

Cao Xá, xã Cao An, huyện Cẩm Giàng, tỉnh Hải Dương

(72) Nguyễn Vũ Trường (VN)

(74) Công ty TNHH Sở hữu trí tuệ PADEMARK (PADEMARK CO.,LTD.)

(55)

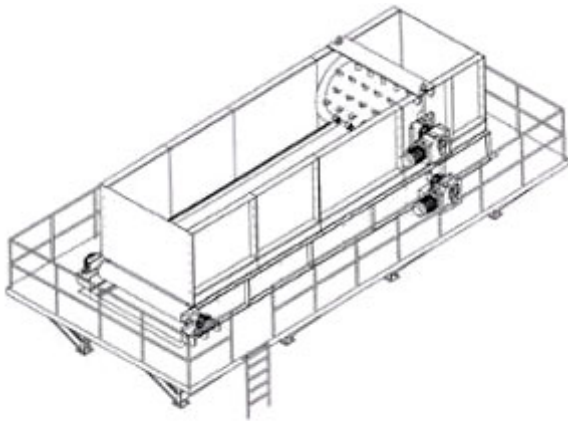

1.1

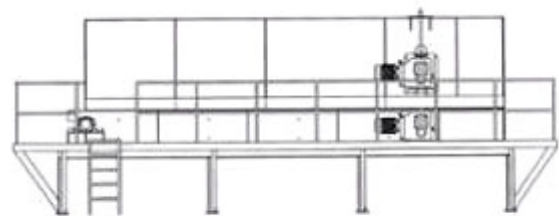

1.2

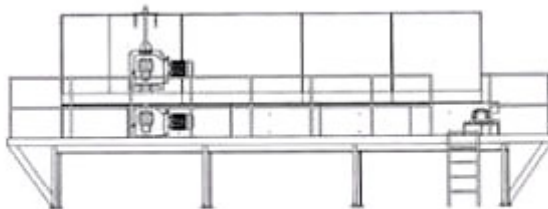

1.3

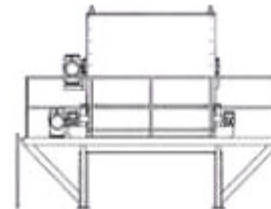

1.4

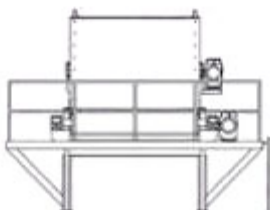

1.5

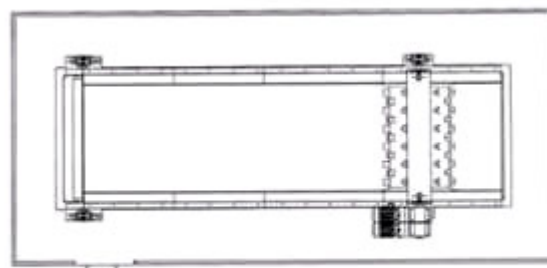

1.6

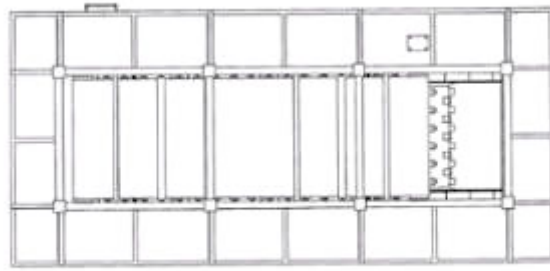

1.7



**CÔNG BÁO SỞ HỮU CÔNG NGHIỆP SỐ 397 TẬP A – QUYỀN 2 (04.2021)**

(11) **41416**

(21) 3-2021-00265

(28) 1

(54) **GHẾ SÔ-PHA**

(51) **06-01**

(22) 03/02/2021

(43) 26/04/2021

(73) **HTL FURNITURE (CHINA) CO., LTD. (CN)**

Wusong Jiangnan Road, Kunshan Development Zone, Jiangsu Province, China

(72) PHUA YONG TAT (SG)

(74) Công ty Luật TNHH quốc tế BMVN (BMVN INTERNATIONAL LLC)

(55)



1.1



1.2



1.3



1.4



1.5

**CÔNG BÁO SỞ HỮU CÔNG NGHIỆP SỐ 397 TẬP A – QUYỀN 2 (04.2021)**

(11) **41417**

(21) 3-2021-00266

(28) 1

(54) **GHẾ**

(51) **06-01**

(22) 03/02/2021

(43) 26/04/2021

(73) **HTL FURNITURE (CHINA) CO., LTD. (CN)**

Wusong Jiangnan Road, Kunshan Development Zone, Jiangsu Province, China

(72) PHUA YONG TAT (SG)

(74) Công ty Luật TNHH quốc tế BMVN (BMVN INTERNATIONAL LLC)

(55)



1.1



1.2



1.3



1.4



1.5

**CÔNG BÁO SỞ HỮU CÔNG NGHIỆP SỐ 397 TẬP A – QUYỀN 2 (04.2021)**

(11) **41418**

(21) 3-2021-00269

(28) 1

(54) **GHẾ**

(51) **06-01**

(22) 03/02/2021

(43) 26/04/2021

(73) **HTL FURNITURE (CHINA) CO., LTD. (CN)**

Wusong Jiangnan Road, Kunshan Development Zone, Jiangsu Province, China

(72) PHUA YONG TAT (SG)

(74) Công ty Luật TNHH quốc tế BMVN (BMVN INTERNATIONAL LLC)

(55)



1.1



1.2



1.3



1.4



1.5

**CÔNG BÁO SỞ HỮU CÔNG NGHIỆP SỐ 397 TẬP A – QUYỀN 2 (04.2021)**

- (11) **41419**  
(21) 3-2021-00271 (28) 1  
(54) **GHẾ** (51) **06-01**  
(22) 03/02/2021 (43) 26/04/2021  
(73) **HTL FURNITURE (CHINA) CO., LTD. (CN)**  
Wusong Jiangnan Road, Kunshan Development Zone, Jiangsu Province, China  
(72) PHUA YONG TAT (SG)  
(74) Công ty Luật TNHH quốc tế BMVN (BMVN INTERNATIONAL LLC)  
(55)



1.1



1.2



1.3



1.4



1.5

- (11) **41420**  
(21) 3-2021-00272 (28) 1  
(54) **THIẾT BỊ CHĂM SÓC DA ĐẦU** (51) **28-03**  
(22) 03/02/2021 (43) 26/04/2021  
(30) 30-2020-0036738 06/08/2020 KR;  
(73) **LG ELECTRONICS INC. (KR)**  
128, Yeoui-daero, Yeongdeungpo-gu, Seoul, Republic of Korea  
1. SANGHOON YOON (KR)  
(72) 2. MINJI SEO (KR)  
3. GAYEONG LEE (KR)  
(74) Công ty TNHH Tầm nhìn và Liên danh (VISION & ASSOCIATES CO.LTD.)  
(55)



1.1



1.2

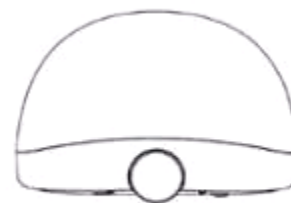

1.3



1.4



1.5

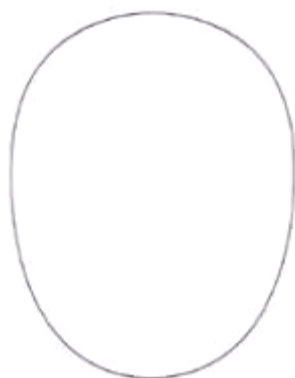

1.6



1.7

- (11) **41421**  
(21) 3-2021-00273 (28) 1  
(54) **THIẾT BỊ TRỊ LIỆU BẰNG ÁNH SÁNG** (51) **24-01**  
(22) 03/02/2021 (43) 26/04/2021  
(30) 30-2020-0036963 07/08/2020 KR;  
(73) **LG ELECTRONICS INC. (KR)**  
128, Yeoui-daero, Yeongdeungpo-gu, Seoul, Republic of Korea  
(72) Sanghoon Yoon (KR)  
(74) Công ty TNHH Tầm nhìn và Liên danh (VISION & ASSOCIATES CO.LTD.)  
(55)

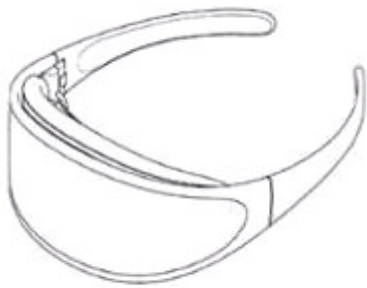

1.1

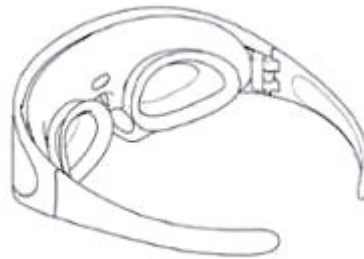

1.2



1.3



1.4



1.5

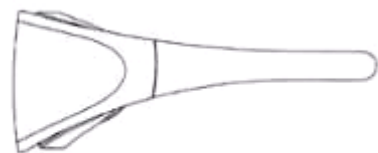

1.6



1.7



1.8

**CÔNG BÁO SỞ HỮU CÔNG NGHIỆP SỐ 397 TẬP A – QUYỀN 2 (04.2021)**

(11) **41422**

(21) 3-2021-00275

(28) 1

(54) **CHAI**

(51) **09-01**

(22) 04/02/2021

(43) 26/04/2021

**CÔNG TY CỔ PHẦN DƯỢC NATURE VIỆT NAM (VN)**

(73) 19 đường 18, khu phố 3, phường Linh Chiểu, quận Thủ Đức, thành phố Hồ Chí Minh

(72) Mai Thùy Linh (VN)

(74) Công ty TNHH Tư vấn Phạm Anh Nguyên (ANPHAMCO CO.,LTD.)

(55)



1.1



1.2



1.3

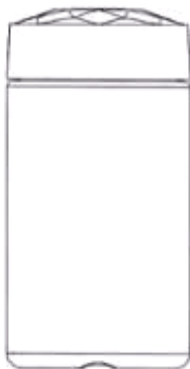

1.4



1.5



1.6



1.7

**CÔNG BÁO SỞ HỮU CÔNG NGHIỆP SỐ 397 TẬP A – QUYỀN 2 (04.2021)**

(11) 41423

(21) 3-2021-00276

(54) CHAI

(22) 04/02/2021

(73) **CÔNG TY CỔ PHẦN TẬP ĐOÀN BROTHER (VN)**

27 Hồ Văn Huê, phường 09, quận Phú Nhuận, thành phố Hồ Chí Minh

(72) Nguyễn Anh Tuấn (VN)

(55)

(28) 1

(51) 09-01; 09-02

(43) 26/04/2021



1.1



1.2



1.3



1.4



1.5



1.6



1.7



**CÔNG BÁO SỞ HỮU CÔNG NGHIỆP SỐ 397 TẬP A – QUYỀN 2 (04.2021)**

- (11) **41424**  
(21) 3-2021-00280 (28) 1  
(54) **ĐIỆN THOẠI DI ĐỘNG** (51) **14-03**  
(22) 04/02/2021 (43) 26/04/2021  
(30) 202030453095.9 11/08/2020 CN;  
(73) **VIVO MOBILE COMMUNICATION CO., LTD.** (CN)  
No.168 Jinghai East Rd., Chang'an, Dongguan, Guangdong 523863, China  
(72) 1. JIANGUANG NIE (CN)  
2. FENG ZHU (CN)  
(74) Công ty cổ phần Tư vấn S&B (S&B CONSULTANT., CORP.)  
(55)

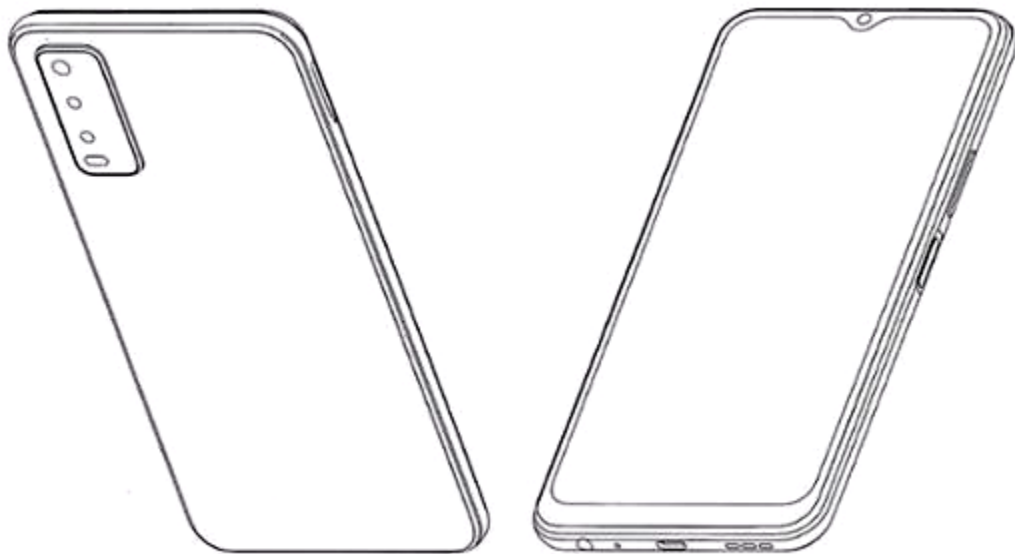

1.1

1.2



1.3

1.4

1.5

1.6



1.7



1.8



1.9



1.10



1.11



1.12



1.13



1.14



1.15



1.16

**CÔNG BÁO SỞ HỮU CÔNG NGHIỆP SỐ 397 TẬP A – QUYỀN 2 (04.2021)**

(11) **41425**

(21) 3-2021-00294

(28) 1

(54) **XE Ô TÔ**

(51) **12-08**

(22) 05/02/2021

(43) 26/04/2021

**NISSAN JIDOSHA KABUSHIKI KAISHA (ALSO TRADING AS NISSAN MOTOR CO., LTD.) (JP)**

2, Takara-cho, Kanagawa-ku, Yokohama-shi, Kanagawa 221-0023, Japan

(72) 1. KAZUNORI MURABAYASHI (JP)

2. GIOVANNY ARROBA (US)

(74) **CÔNG TY LUẬT TRÁCH NHIỆM HỮU HẠN AMBYS HÀ NỘI (AMBYS HANOI)**

(55)



1.1



1.2



1.3



1.4



1.5



1.6



1.7



1.8

**CÔNG BÁO SỞ HỮU CÔNG NGHIỆP SỐ 397 TẬP A – QUYỀN 2 (04.2021)**

(11) **41426**

(21) 3-2021-00295

(28) 1

(54) **XE Ô TÔ**

(51) **12-08**

(22) 05/02/2021

(43) 26/04/2021

**NISSAN JIDOSHA KABUSHIKI KAISHA (ALSO TRADING AS NISSAN MOTOR CO., LTD.) (JP)**

2, Takara-cho, Kanagawa-ku, Yokohama-shi, Kanagawa 221-0023, Japan

(72) 1. GIOVANNY ARROBA (US)

2. KAZUNORI MURABAYASHI (JP)

(74) **CÔNG TY LUẬT TRÁCH NHIỆM HỮU HẠN AMBYS HÀ NỘI (AMBYS HANOI)**

(55)



1.1



1.2



1.3



1.4



1.5



1.6



1.7



1.8

- (11) 41427  
(21) 3-2021-00310 (28) 1  
(54) **HỘP TẠO RỔNG CHO SÀN BÊ TÔNG** (51) **25-02**  
(22) 08/02/2021 (43) 26/04/2021  
(73) **CÔNG TY TNHH THƯƠNG MẠI DỊCH VỤ TÍN THÀNH PHÁT (VN)**  
số 1/118 Cát Cụt, phường Hồ Nam, quận Lê Chân, thành phố Hải Phòng  
(72) Nguyễn Viết Thành (VN)  
(55)



1.1



1.2

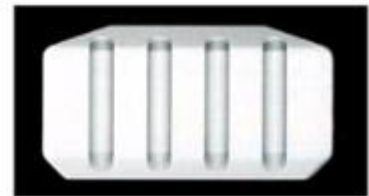

1.3



1.4



1.5

**CÔNG BÁO SỞ HỮU CÔNG NGHIỆP SỐ 397 TẬP A – QUYỀN 2 (04.2021)**

(11) **41428**

(21) 3-2021-00318

(28) 1

(54) **DÉP**

(51) **02-04**

(22) 08/02/2021

(43) 26/04/2021

**CÔNG TY TNHH BÌNH TIÊN BIÊN HÒA (VN)**

(73) Lô 101/2 và lô 101/11, khu công nghiệp Amata, phường Long Bình, thành phố Biên Hòa, tỉnh Đồng Nai

(72) Lai Khiêm (VN)

(74) Công ty TNHH Tư vấn sở hữu trí tuệ Việt (VIET IP CO.,LTD.)

(55)



1.1



1.2



1.3



1.4



1.5



1.6



1.7

**CÔNG BÁO SỞ HỮU CÔNG NGHIỆP SỐ 397 TẬP A – QUYỀN 2 (04.2021)**

(11) **41429**

(21) 3-2021-00321

(54) **HỘP ĐỰNG THỰC PHẨM**

(22) 09/02/2021

**LOCK & LOCK CO., LTD (KR)**

(73) 104, Sapgyocheon-ro, Seonjang-myeon, Asan-si, Chungcheongnam-do, Republic of Korea

(72) SONG, Ga Young (KR)

(74) Công ty TNHH Tâm nhìn và Liên danh (VISION & ASSOCIATES CO.LTD.)

(55)

(28) 1

(51) **09-03**

(43) 26/04/2021



1.1

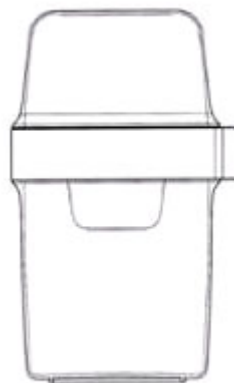

1.2

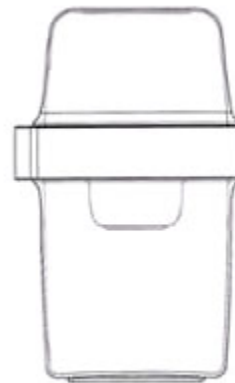

1.3

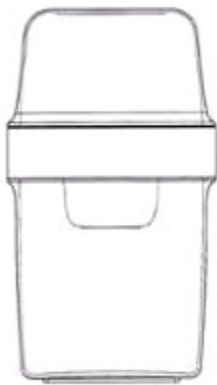

1.4

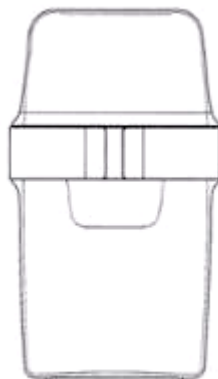

1.5



1.6



1.7

**CÔNG BÁO SỞ HỮU CÔNG NGHIỆP SỐ 397 TẬP A – QUYỀN 2 (04.2021)**

(11) **41430**

(21) 3-2021-00322

(28) 1

(54) **NẮP HỘ ĐỪNG THỰC PHẨM**

(51) **09-07**

(22) 09/02/2021

(43) 26/04/2021

**LOCK & LOCK CO., LTD (KR)**

(73) 104, Sapgyocheon-ro, Seonjang-myeon, Asan-si, Chungcheongnam-do, Republic of Korea

(72) LEE, Youn Jung (KR)

(74) Công ty TNHH Tầm nhìn và Liên danh (VISION & ASSOCIATES CO.LTD.)

(55)



1.1



1.2



1.3



1.4



1.5



1.6

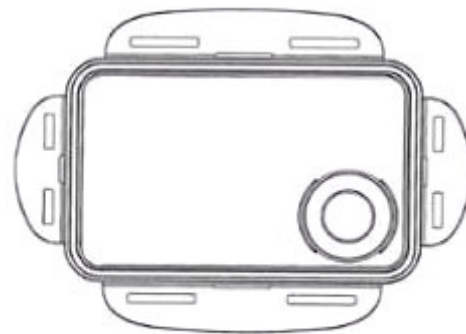

1.7



- (11) **41431**  
(21) 3-2021-00323 (28) 1  
(54) **BÌNH** (51) **09-01**  
(22) 09/02/2021 (43) 26/04/2021  
(30) 30-2020-0037938 13/08/2020 KR;  
**LOCK & LOCK CO., LTD (KR)**  
(73) 104, Sapgyocheon-ro, Seonjang-myeon, Asan-si, Chungcheongnam-do, Republic of Korea  
(72) KIM, Kwang Ik (KR)  
(74) Công ty TNHH Tầm nhìn và Liên danh (VISION & ASSOCIATES CO.LTD.)  
(55)

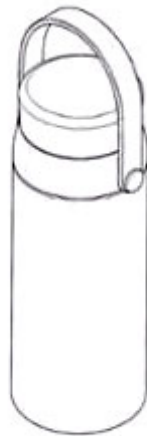

1.1

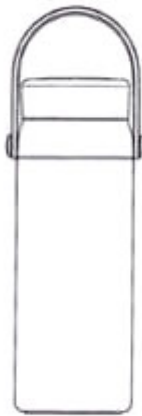

1.2



1.3

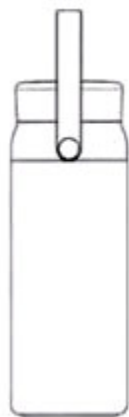

1.4

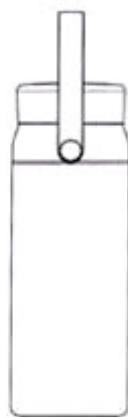

1.5



1.6



1.7

**CÔNG BÁO SỞ HỮU CÔNG NGHIỆP SỐ 397 TẬP A – QUYỀN 2 (04.2021)**

- (11) **41432**  
(21) 3-2021-00324 (28) 1  
(54) **BÌNH** (51) **09-01**  
(22) 09/02/2021 (43) 26/04/2021  
(30) 30-2020-0037939 13/08/2020 KR;  
**LOCK & LOCK CO., LTD (KR)**  
(73) 104, Sapgyocheon-ro, Seonjang-myeon, Asan-si, Chungcheongnam-do, Republic of Korea  
(72) KIM, Kwang Ik (KR)  
(74) Công ty TNHH Tầm nhìn và Liên danh (VISION & ASSOCIATES CO.LTD.)  
(55)

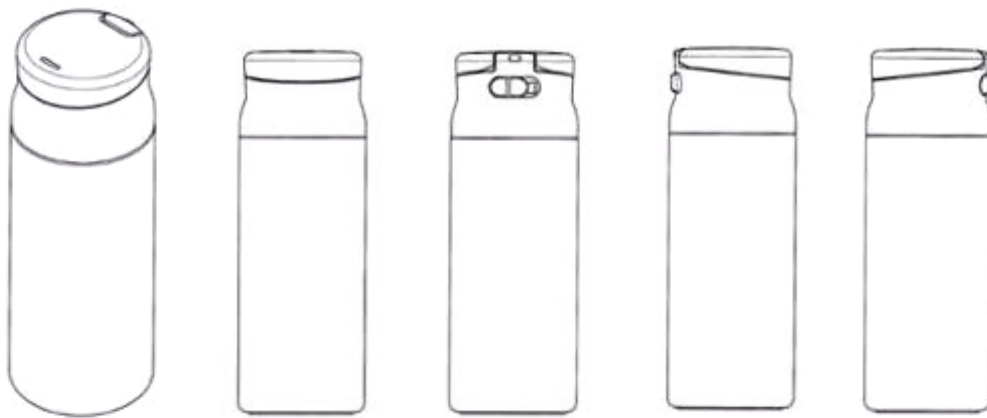

1.1

1.2

1.3

1.4

1.5



1.6



1.7

**CÔNG BÁO SỞ HỮU CÔNG NGHIỆP SỐ 397 TẬP A – QUYỀN 2 (04.2021)**

- (11) **41433**  
(21) 3-2021-00325 (28) 1  
(54) **BÌNH** (51) **09-01**  
(22) 09/02/2021 (43) 26/04/2021  
(30) 30-2020-0037940 13/08/2020 KR;  
**LOCK & LOCK CO., LTD (KR)**  
(73) 104, Sapgyocheon-ro, Seonjang-myeon, Asan-si, Chungcheongnam-do, Republic of Korea  
(72) KIM, Kwang Ik (KR)  
(74) Công ty TNHH Tầm nhìn và Liên danh (VISION & ASSOCIATES CO.LTD.)  
(55)



1.1



1.2



1.3



1.4



1.5



1.6



1.7

**CÔNG BÁO SỞ HỮU CÔNG NGHIỆP SỐ 397 TẬP A – QUYỀN 2 (04.2021)**

- (11) **41434**  
(21) 3-2021-00333 (28) 1  
(54) **BÌNH** (51) **07-01; 09-01**  
(22) 09/02/2021 (43) 26/04/2021  
(30) 30-2020-0037945 13/08/2020 KR;  
**LOCK & LOCK CO., LTD (KR)**  
(73) 104, Sapgyocheon-ro, Seonjang-myeon, Asan-si, Chungcheongnam-do, Republic of Korea  
(72) KIM, Kwang Ik (KR)  
(74) Công ty TNHH Tầm nhìn và Liên danh (VISION & ASSOCIATES CO.LTD.)  
(55)



1.1



1.2



1.3



1.4



1.5



1.6



1.7

**CÔNG BÁO SỞ HỮU CÔNG NGHIỆP SỐ 397 TẬP A – QUYỀN 2 (04.2021)**

- (11) **41435**  
(21) 3-2021-00334 (28) 1  
(54) **CÁN TAY CÀM CHO NỒI** (51) **07-02**  
(22) 09/02/2021 (43) 26/04/2021  
(30) 30-2020-0037936 13/08/2020 KR;  
**LOCK & LOCK CO., LTD (KR)**  
(73) 104, Sapgyocheon-ro, Seonjang-myeon, Asan-si, Chungcheongnam-do, Republic of Korea  
(72) SONG, Ga Young (KR)  
(74) Công ty TNHH Tầm nhìn và Liên danh (VISION & ASSOCIATES CO.LTD.)  
(55)

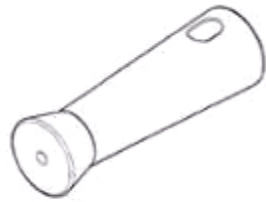

1.1



1.2



1.3



1.4



1.5



1.6



1.7

**CÔNG BÁO SỞ HỮU CÔNG NGHIỆP SỐ 397 TẬP A – QUYỀN 2 (04.2021)**

- (11) **41436**  
(21) 3-2021-00335 (28) 1  
(54) **CÁN TAY CẦM CHO NỒI** (51) **07-02**  
(22) 09/02/2021 (43) 26/04/2021  
(30) 30-2020-0037937 13/08/2020 KR;  
**LOCK & LOCK CO., LTD (KR)**  
(73) 104, Sapgyocheon-ro, Seonjang-myeon, Asan-si, Chungcheongnam-do, Republic of Korea  
(72) SONG, Ga Young (KR)  
(74) Công ty TNHH Tầm nhìn và Liên danh (VISION & ASSOCIATES CO.LTD.)  
(55)

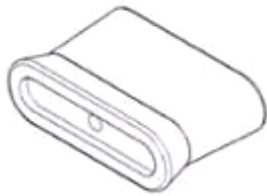

1.1



1.2



1.3



1.4

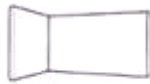

1.5



1.6



1.7

- (11) **41437**  
(21) 3-2021-00336 (28) 1  
(54) **THÂN NỒI** (51) **07-02**  
(22) 09/02/2021 (43) 26/04/2021  
(30) 30-2020-0037935 13/08/2020 KR;  
**LOCK & LOCK CO., LTD (KR)**  
(73) 104, Sapgyocheon-ro, Seonjang-myeon, Asan-si, Chungcheongnam-do, Republic of Korea  
(72) SONG, Ga Young (KR)  
(74) Công ty TNHH Tầm nhìn và Liên danh (VISION & ASSOCIATES CO.LTD.)  
(55)



1.1

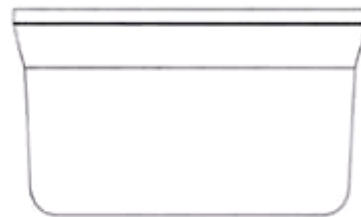

1.2

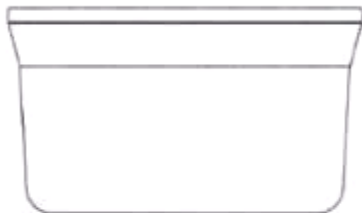

1.3

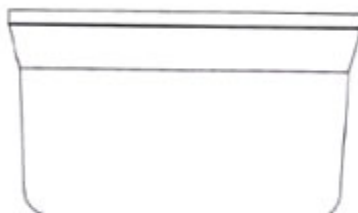

1.4

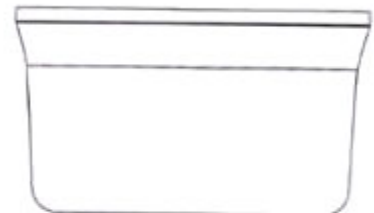

1.5



1.6

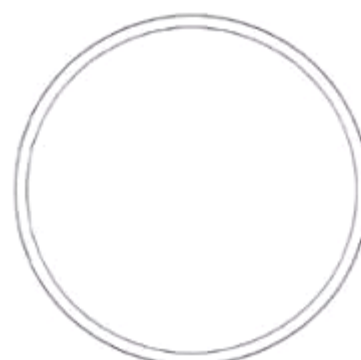

1.7

(11) **41438**

(21) 3-2021-00345

(28) 1

(54) **BĂNG VỆ SINH**

(51) **24-04**

(22) 18/02/2021

(43) 26/04/2021

(73) **DAIO PAPER CORPORATION (JP)**

2-60, Mishimakamiya-cho, Shikokuchuo-shi, Ehime 799-0492, Japan

1. PAILIN CHITSCANG (TH)

(72) 2. ANGKANA NA LAMPOON (TH)

3. IKUYA WATANABE (JP)

(74) Công ty cổ phần Tư vấn S&B (S&B CONSULTANT., CORP.)

(55)

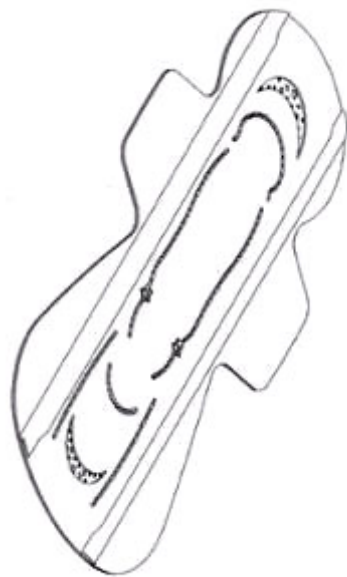

1.1

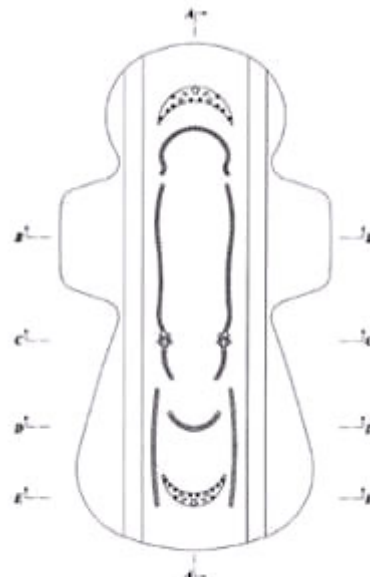

1.2



1.3



1.4



1.5





1.6



1.7



1.8



1.9



1.10

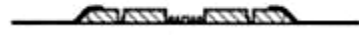

1.11



1.12

(11) **41439**

(21) 3-2021-00346

(28) 1

(54) **BĂNG VỆ SINH**

(51) **24-04**

(22) 18/02/2021

(43) 26/04/2021

(73) **DAIO PAPER CORPORATION (JP)**

2-60, Mishimakamiya-cho, Shikokuchuo-shi, Ehime 799-0492, Japan

1. PAILIN CHITSCANG (TH)

(72) 2. ANGKANA NA LAMPOON (TH)

3. IKUYA WATANABE (JP)

(74) Công ty cổ phần Tư vấn S&B (S&B CONSULTANT., CORP.)

(55)



1.1

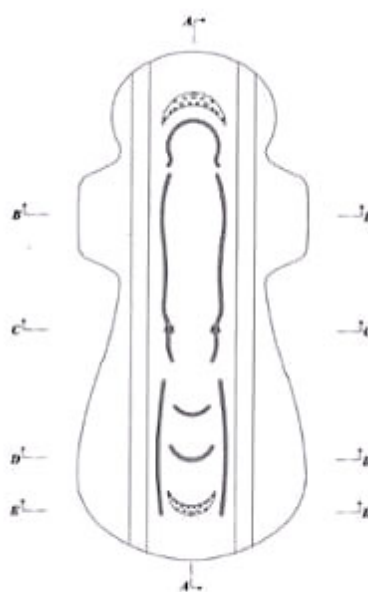

1.2



1.3



1.4



1.5

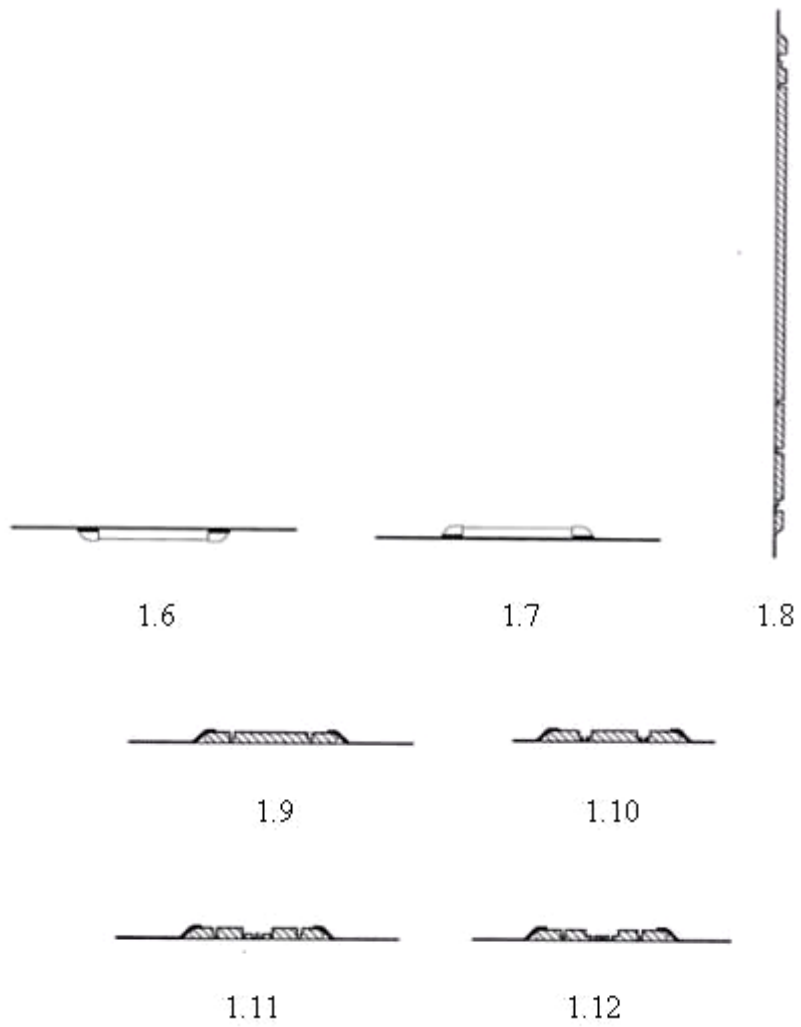

**CÔNG BÁO SỞ HỮU CÔNG NGHIỆP SỐ 397 TẬP A – QUYỀN 2 (04.2021)**

(11) **41440**

(21) 3-2021-00347

(28) 1

(54) **BÌNH**

(51) **07-01**

(22) 18/02/2021

(43) 26/04/2021

**LOCK & LOCK CO., LTD (KR)**

(73) 104, Sapgyocheon-ro, Seonjang-myeon, Asan-si, Chungcheongnam-do, Republic of Korea

(72) KIM, Kwang Ik (KR)

(74) Công ty TNHH Tâm nhìn và Liên danh (VISION & ASSOCIATES CO.LTD.)

(55)



1.1



1.2



1.3



1.4



1.5



1.6



1.7

(11) **41441**

(21) 3-2021-00348

(28) 1

(54) **ĐUI ĐÈN CẢM BIẾN CHUYỂN ĐỘNG**

(51) **26-05**

(22) 19/02/2021

(43) 26/04/2021

**CÔNG TY CỔ PHẦN BÓNG ĐÈN PHÍCH NƯỚC RẠNG ĐÔNG (VN)**

(73) 87-89 phố Hạ Đình, phường Thanh Xuân Trung, quận Thanh Xuân, thành phố Hà Nội

(72) Trần Trung Tường (VN)

(55)

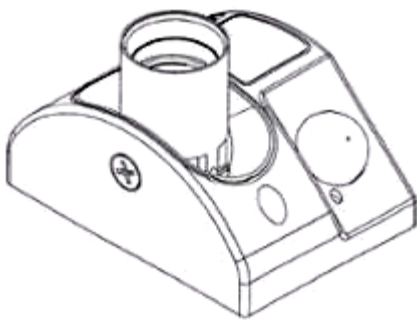

1.1

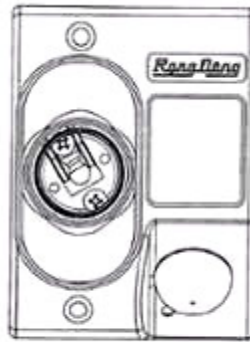

1.2

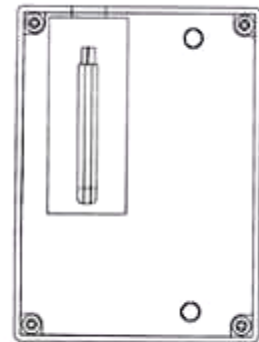

1.3

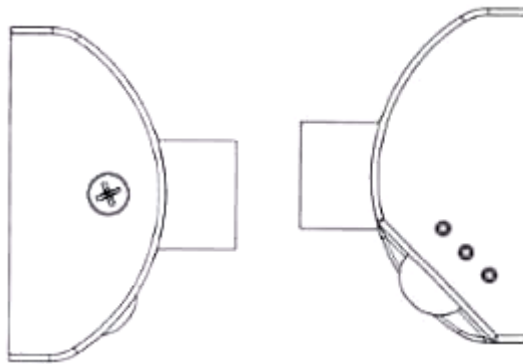

1.4

1.5

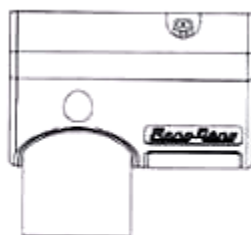

1.6

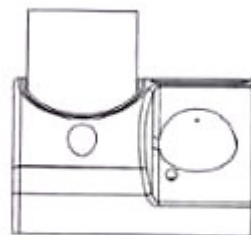

1.7

**CÔNG BÁO SỞ HỮU CÔNG NGHIỆP SỐ 397 TẬP A – QUYỀN 2 (04.2021)**

(11) **41442**

(21) 3-2021-00350

(28) 1

(54) **BỘ NGUỒN**

(51) **13-02; 13-03**

(22) 19/02/2021

(43) 26/04/2021

**CÔNG TY CỔ PHẦN BÓNG ĐÈN PHÍCH NƯỚC RẠNG ĐÔNG (VN)**

(73) 87-89 phố Hạ Đình, phường Thanh Xuân Trung, quận Thanh Xuân, thành phố Hà Nội

(72) Trần Trung Tường (VN)

(55)

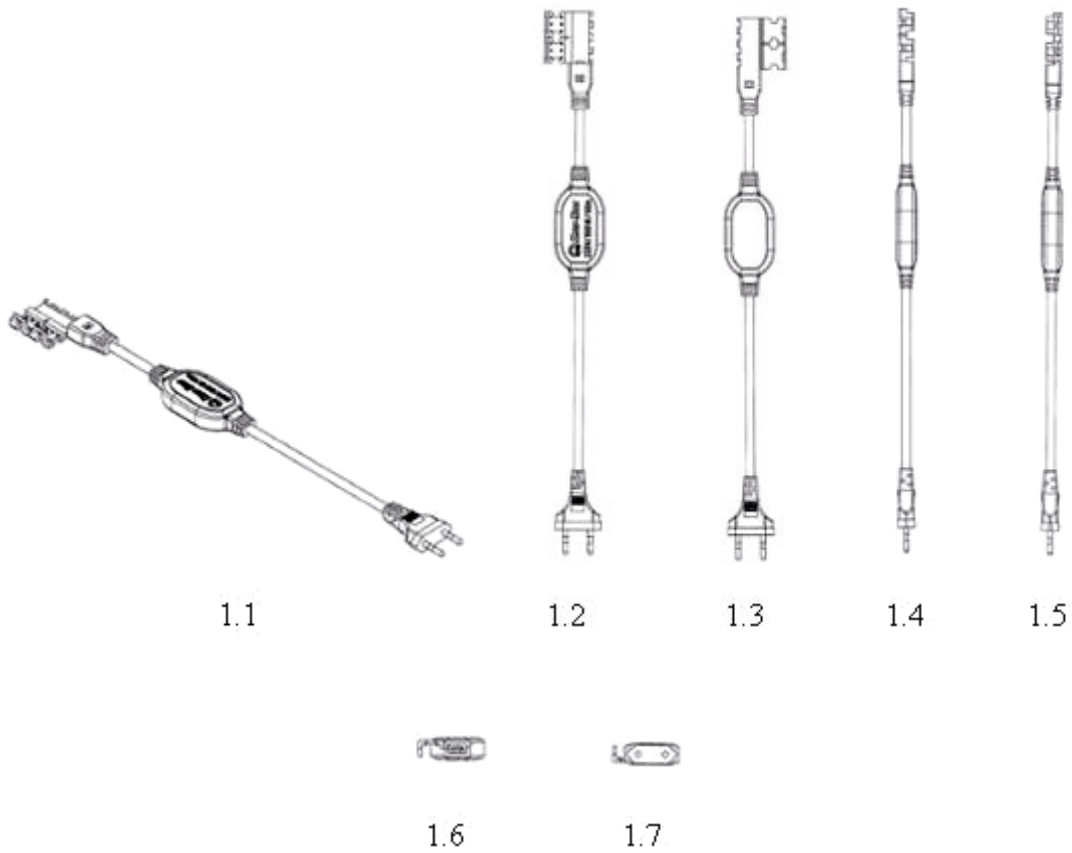

**CÔNG BÁO SỞ HỮU CÔNG NGHIỆP SỐ 397 TẬP A – QUYỀN 2 (04.2021)**

- (11) 41443  
(21) 3-2021-00355 (28) 1  
(54) **HỘP ĐỰNG ĐỒ UỐNG** (51) **09-03**  
(22) 19/02/2021 (43) 26/04/2021  
**CÔNG TY TRÁCH NHIỆM HỮU HẠN THANH AN (VN)**  
(73) P809 tầng 8, tòa nhà Plaschem, số 562 đường Nguyễn Văn Cừ, phường Gia Thụy, quận Long Biên, thành phố Hà Nội  
(72) Tạ Bá Thuyết (VN)  
(74) Công ty TNHH Sở hữu trí tuệ và Công nghệ Thủ đô (CAPITAL IP&T CO.LTD.)  
(55)



1.1



1.2



**CÔNG BÁO SỞ HỮU CÔNG NGHIỆP SỐ 397 TẬP A – QUYỀN 2 (04.2021)**

- (11) 41444  
(21) 3-2021-00356 (28) 1  
(54) **HỘP ĐỰNG ĐỒ UỐNG** (51) **09-03**  
(22) 19/02/2021 (43) 26/04/2021  
**CÔNG TY TRÁCH NHIỆM HỮU HẠN THANH AN (VN)**  
(73) P809 tầng 8, tòa nhà Plaschem, số 562 đường Nguyễn Văn Cừ, phường Gia Thụy, quận Long Biên, thành phố Hà Nội  
(72) Tạ Bá Thuyết (VN)  
(74) Công ty TNHH Sở hữu trí tuệ và Công nghệ Thủ đô (CAPITAL IP&T CO.LTD.)  
(55)



1.1



1.2

**CÔNG BÁO SỞ HỮU CÔNG NGHIỆP SỐ 397 TẬP A – QUYỀN 2 (04.2021)**

- (11) 41445  
(21) 3-2021-00357 (28) 1  
(54) **HỘP ĐỰNG ĐỒ UỐNG** (51) **09-03**  
(22) 19/02/2021 (43) 26/04/2021  
**CÔNG TY TRÁCH NHIỆM HỮU HẠN THANH AN (VN)**  
(73) P809 tầng 8, tòa nhà Plaschem, số 562 đường Nguyễn Văn Cừ, phường Gia Thụy, quận Long Biên, thành phố Hà Nội  
(72) Tạ Bá Thuyết (VN)  
(74) Công ty TNHH Sở hữu trí tuệ và Công nghệ Thủ đô (CAPITAL IP&T CO.LTD.)  
(55)



1.1



1.2

## **CÔNG BÁO SỞ HỮU CÔNG NGHIỆP**

*Do Cục Sở hữu trí tuệ thuộc Bộ Khoa học và Công nghệ ấn hành theo Luật Sở hữu trí tuệ số 50/2005/QH11 được Quốc hội thông qua ngày 29 tháng 11 năm 2005 và được sửa đổi bằng Luật sửa đổi, bổ sung một số điều của Luật sở hữu trí tuệ số 50/2005/QH11 được Quốc hội thông qua ngày 19 tháng 6 năm 2009.*

### ***Địa chỉ liên hệ:***

384-386 đường Nguyễn Trãi, quận Thanh Xuân,  
thành phố Hà Nội, Việt Nam  
ĐT: 024. 38583069  
Fax: 024. 38588449