

CỘNG HÒA XÃ HỘI CHỦ NGHĨA VIỆT NAM
BỘ KHOA HỌC VÀ CÔNG NGHỆ

CỤC SỞ HỮU TRÍ TUỆ

CÔNG BÁO
SỞ HỮU CÔNG NGHIỆP

TẬP A

QUYỂN 2: KIỂU DÁNG CÔNG NGHIỆP

02 - 2021

395

**CỘNG HOÀ XÃ HỘI CHỦ NGHĨA VIỆT NAM
BỘ KHOA HỌC VÀ CÔNG NGHỆ
CỤC SỞ HỮU TRÍ TUỆ**

**CÔNG BÁO
SỞ HỮU CÔNG NGHIỆP
TẬP A**

QUYỂN 2: KIỂU DÁNG CÔNG NGHIỆP

02-2021

395

HÀ NỘI

MỤC LỤC

	Trang
<u>PHẦN I:</u> Đơn yêu cầu cấp Bằng độc quyền kiểu dáng công nghiệp	7-341

CONTENTS

<u>PART I:</u> Applications for Industrial Design Patents	7-341
---	-------

CÔNG BÁO SỞ HỮU CÔNG NGHIỆP SỐ 395 TẬP A - QUYỂN 2 (02.2020)

MÃ SỐ HAI CHỮ CÁI THỂ HIỆN TÊN NƯỚC VÀ CÁC THỰC THỂ KHÁC TRONG CÁC TƯ LIỆU SỞ HỮU CÔNG NGHIỆP THEO TIÊU CHUẨN ST3 CỦA WIPO

AE	United Arab Emirates	CN	China	HK	Hong Kong
AF	Afganistan	CO	Colombia	HN	Honduras
AG	Antihua and Barbuda	CR	Costa Rica	HR	Croatia
AI	Anguilla	CU	Cuba	HT	Haiti
AL	Albania	CV	Cape Verde	HU	Hungary
AN	Netherlands Antilles	CY	Cyprus	ID	Indonesia
AO	Angola	CZ	Czech Republic	IE	Ireland
AR	Argentina	DE	Germany	IL	Israel
AT	Austria	DJ	Djibouti	IN	India
AU	Australia	DK	Denmark	IQ	Iraq
AW	Aruba	DM	Dominica	IR	Iran (Islamic Republic of)
BB	Barbados	DO	Dominican Republic	IS	Iceland
BD	Bangladesh	DZ	Algeria	IT	Italy
BE	Belgium	EC	Ecuador	JM	Jamaica
BF	Burkina Faso	EE	Estonia	JO	Jordan
BG	Bulgaria	EG	Egypt	JP	Japan
BH	Bahrain	ES	Spain	KE	Kenya
BI	Burundi	ET	Ethiopia	KH	Cambodia
BJ	Benin	FI	Finland	KI	Kiribati
BM	Bermuda	FJ	Fiji	KM	Comoros
BN	Brunei Darussalam	FK	Falkand Islands (Malvinas)	KN	Saint Kitts and Nevis
BO	Bolivia	FR	France	KP	Democratic People's Republic of Korea
BR	Brazil	GA	Gabon	KR	Republic of Korea
BS	Bahamas	GB	United Kingdom	KW	Kuwait
BT	Bhutan	GD	Grenada	KY	Cayman Islands
BW	Botswana	GE	Georgia	KZ	Kazakhstan
BY	Belarus	GH	Ghana	LA	Laos
BZ	Belize	GI	Gibraltar	LB	Lebanon
CA	Canada	GM	Gambia	LC	Saint Lucia
CF	Central African Republic	GN	Guinea	LI	Liechtenstein
CG	Congo	GQ	Equatorial Guinea	LK	SriLanka
CH	Switzerland	GR	Greece	LR	Liberia
CI	Côte d'Ivoire	GT	Guatemala	LS	Lesotho
CL	Chile	GW	Guinea-Bissau	LT	Lithuania
CM	Cameroon	GY	Guyana	TC	Turk and Caicos Islands
LU	Luxembourg	PA	Panama	TD	Chad
LV	Latvia	PE	Peru	TG	Togo
LY	Lybya	PG	Papua New Guinea	TH	Thailand
MA	Morocco	PH	Philippines	TN	Tunisia
MC	Monaco	PK	Pakistan	TO	Tonga
MD	Republic of Moldova	PL	Poland	TR	Turkey

CÔNG BÁO SỞ HỮU CÔNG NGHIỆP SỐ 395 TẬP A - QUYỂN 2 (02.2020)

MG	Madagascar	PT	Portugal	TT	Trinidad and Tobago
ML	Mali	PY	Paraguay	TV	Tuvalu
MM	Myanmar	QA	Qatar	TW	Taiwan, Province of China
MN	Mongolia	RO	Rumania	TZ	United Republic of Tanzania
MO	Macau	RU	Russian Federation	UA	Ukraine
MR	Mauritania	RW	Rwanda	UG	Uganda
MS	Montserrat	SA	Saudi Arabia	US	United States of America
MT	Malta	SB	Solomon Islands	UY	Uruguay
MU	Mauritius	SC	Seychelles	UZ	Uzbekistan
MV	Maldives	SD	Sudan	VA	Holy see
MW	Malawi	SE	Sweden	VC	Saint Vincent and the Grenadines
MX	Mexico	SG	Singapore	VE	Venezuela
MY	Malaysia	SH	Saint Helena	VG	Virgin Islands (British)
MZ	Mozambique	SL	Slovenia	VN	Vietnam
NA	Namibia	SK	Slovakia	VU	Vanuatu
NE	Niger	SL	Sierra Leone	WS	Samoa
NG	Nigeria	SM	San Marino	YE	Yemen
NJ	Nicaragua	SN	Senegal	YU	Yugoslavia
NL	Netherlands	SO	Somalia	ZA	South Africa
NO	Norway	SR	Suriname	ZM	Zambia
NP	Nepal	ST	Sao Tome and Principe	ZR	Zaire
NR	Nauru	SV	El Sanvador	ZW	Zimbabwe
NZ	New Zealand	SY	Syria		
OM	Oman	SZ	Swaziland		

CÁC TỔ CHỨC QUỐC TẾ

AO	African Intellectual Property Organization (OAPI)
AP	African Regional Industrial Property Organization (ARIPO)
BX	Benelux Trademark Office and Benelux Designs Office
EP	European Patent Office (EPO)
IB, WO	International Bureau of the World Intellectual Property Organization (WIPO)

NHỮNG MÃ SỐ INID TRÍCH TỪ TIÊU CHUẨN ST80 CỦA TỔ CHỨC SỞ HỮU TRÍ TUỆ THẾ GIỚI (WIPO) ĐỂ NHẬN BIẾT CÁC DỮ LIỆU THƯ MỤC DÙNG CÔNG BỐ ĐƠN VÀ BẰNG ĐỘC QUYỀN KIỂU DÁNG CÔNG NGHIỆP

- (11) Số bằng độc quyền kiểu dáng công nghiệp / Số công bố đơn
- (15) Ngày cấp
- (18) Ngày hết hạn hiệu lực của bằng độc quyền kiểu dáng công nghiệp
- (21) Số đơn
- (22) Ngày nộp đơn
- (23) Tên triển lãm, ngày và nơi triển lãm
- (28) Số phương án yêu cầu bảo hộ
- (30) Số đơn ưu tiên, ngày nộp đơn ưu tiên
- (43) Ngày công bố đơn
- (45) Ngày công bố bằng độc quyền kiểu dáng công nghiệp
- (51) Phân loại quốc tế kiểu dáng công nghiệp
- (54) Tên sản phẩm mang kiểu dáng công nghiệp
- (55) Ảnh chụp / hình vẽ kiểu dáng công nghiệp
- (57) Đặc điểm khác biệt yêu cầu bảo hộ của kiểu dáng công nghiệp
- (62) Số và ngày nộp đơn, số bằng độc quyền KDCN hoặc số công bố đơn liên quan đến tách đơn
- (71) Tên và địa chỉ của người nộp đơn
- (72) Tên của tác giả KDCN
- (73) Tên, địa chỉ của chủ bằng độc quyền KDCN
- (74) Tên của người đại diện SHCN

PHẦN I

ĐƠN YÊU CẦU CẤP BẰNG ĐỘC QUYỀN KIỂU DÁNG CÔNG NGHIỆP

- (11) **40851**
(21) 3-2020-03074 (28) 1
(54) **NHÃN SẢN PHẨM** (51) **19-08**
(22) 22/12/2020 (43) 25/02/2021
(73) **CÔNG TY TNHH HUDOCO VIỆT NAM (VN)**
Thôn Minh Hoà 4, xã Minh Khai, huyện Hoài Đức, thành phố Hà Nội
(72) Đỗ Thị Thắng (VN)
(74) Công ty TNHH Sở hữu trí tuệ HA VIP (HAVIP CO., LTD.)
(55)



CÔNG BÁO SỞ HỮU CÔNG NGHIỆP SỐ 395 TẬP A – QUYỀN 2 (02.2021)

- (11) **40852**
- (21) 3-2020-03073 (28) 1
- (54) **NHÃN SẢN PHẨM** (51) **19-08**
- (22) 22/12/2020 (43) 25/02/2021
- CÔNG TY TNHH HUDOCO VIỆT NAM (VN)**
- (73) Thôn Minh Hoà 4, xã Minh Khai, huyện Hoài Đức, thành phố Hà Nội
- (72) Đỗ Thị Thắng (VN)
- (74) Công ty TNHH Sở hữu trí tuệ HA VIP (HAVIP CO., LTD.)
- (55)



CÔNG BÁO SỞ HỮU CÔNG NGHIỆP SỐ 395 TẬP A – QUYỀN 2 (02.2021)

- (11) **40853**
(21) 3-2020-03072 (28) 1
(54) **BAO GÓI** (51) **09-05**
(22) 22/12/2020 (43) 25/02/2021
(73) **HỘ KINH DOANH NGUYỄN THỊ PHÚ (VN)**
Thỏ Tang, huyện Vĩnh Tường, tỉnh Vĩnh Phúc
(72) Nguyễn Thị Phú (VN)
(74) Công ty TNHH Tư vấn IPNG (IPNG CO.,LTD)
(55)



1.1



1.2

- (11) **40854**
(21) 3-2020-03068 (28) 2
(54) **NỒI CƠM ĐIỆN** (51) **07-02**
(22) 21/12/2020 (43) 25/02/2021
(30) 30-2020-0061074 10/12/2020 KR; 30-2020-0061070 10/12/2020 KR;
(73) **CUCKOO ELECTRONICS CO., LTD. (KR)**
14, Yusangongdan 2-gil, Yangsan-si, Gyeongsangnam-do, Republic of Korea
(72) Jeon Sung eun (KR)
(74) Công ty TNHH Sáng chế ACTIP (ACTIP PATENT LIMITED)
(55)



1.1



1.2



1.3

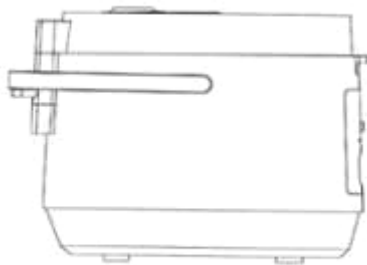

1.4

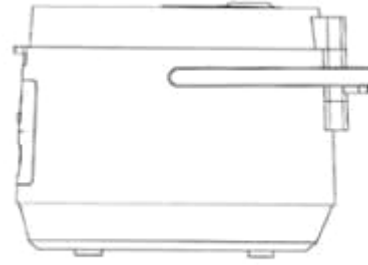

1.5



1.6



1.7

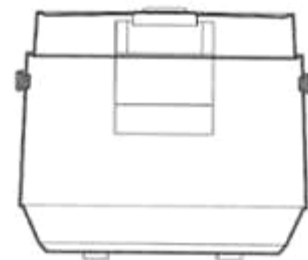

1.8



2.1



2.2



2.3

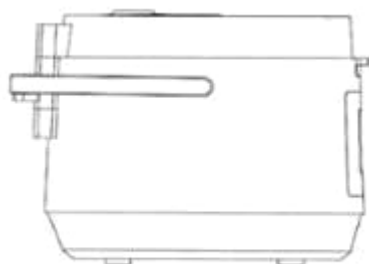

2.4



2.5



2.6



2.7



2.8

CÔNG BÁO SỞ HỮU CÔNG NGHIỆP SỐ 395 TẬP A – QUYỀN 2 (02.2021)

(11) **40855**

(21) 3-2020-03065

(28) 1

(54) **BẾP NƯỚNG**

(51) **07-02**

(22) 21/12/2020

(43) 25/02/2021

NGUYỄN ĐỨC NGHIÊM (VN)

(73) Số nhà 6A ngõ 31, đường Phan Trọng Tuệ, thị trấn Văn Điển, huyện Thanh Trì, thành phố Hà Nội

(72) Nguyễn Đức Nghiêm (VN)

(55)

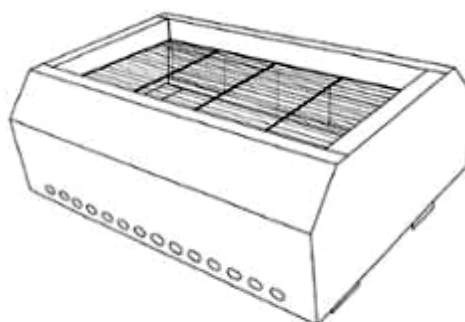

1.1

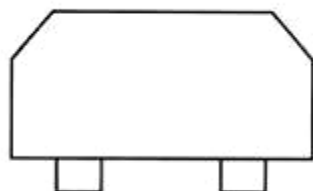

1.2

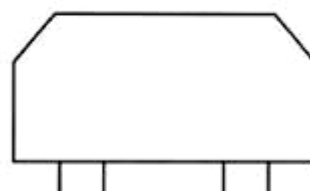

1.3

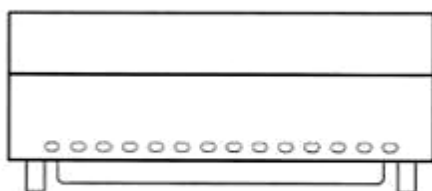

1.4

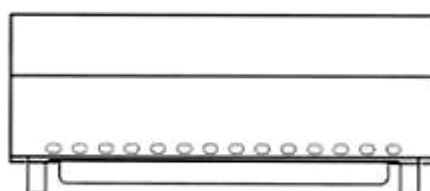

1.5

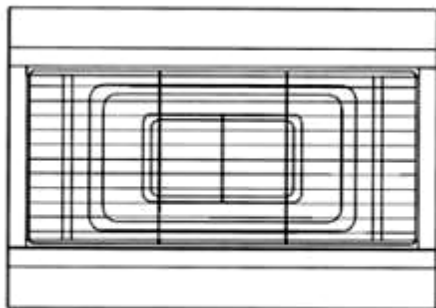

1.6

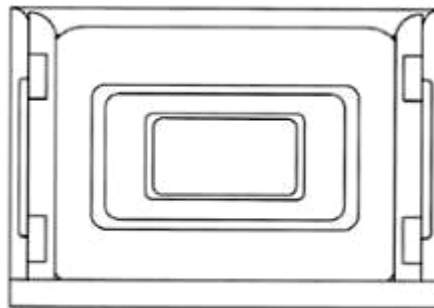

1.7

CÔNG BÁO SỞ HỮU CÔNG NGHIỆP SỐ 395 TẬP A – QUYỀN 2 (02.2021)

(11) **40856**

(21) 3-2020-03058

(28)

(54) **XI PHÔNG THOÁT NƯỚC**

(51) **23-01**

(22) 21/12/2020

(43) 25/02/2021

CÔNG TY TNHH HIWIN HONGKONG (VN)

(73) Thôn Phú Vinh, xã An Khánh, huyện Hoài Đức, thành phố Hà Nội, Việt Nam

(72) Nguyễn Hà Thu (VN)

(74) Công ty TNHH Tư vấn đầu tư và Sở hữu trí tuệ Hoàng Phi (HOANG PHI INVEST & I.P CO., LTD)

(55)



1.1



1.2



1.3



1.4



1.5

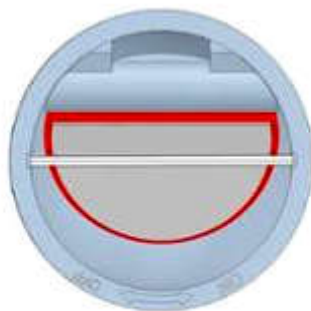

1.6



1.7

(11) **40857**

(21) 3-2020-03055

(28) 1

(54) **ROBOT ĐỒ CHƠI**

(51) **21-01**

(22) 18/12/2020

(43) 25/02/2021

(73) **CÔNG TY TNHH GRAPHICSMINER VIETNAM (VN)**

220/25 Thống Nhất, phường 10, quận Gò Vấp, thành phố Hồ Chí Minh, Việt Nam.

1. HOÀNG MINH PHƯƠNG (VN)

(72) 2. ĐÀM MINH TUẤN (VN)

3. HUỲNH QUỐC PHÚ (VN)

(55)

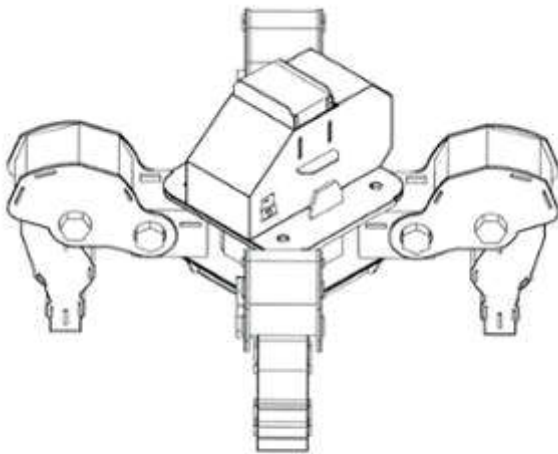

1.1

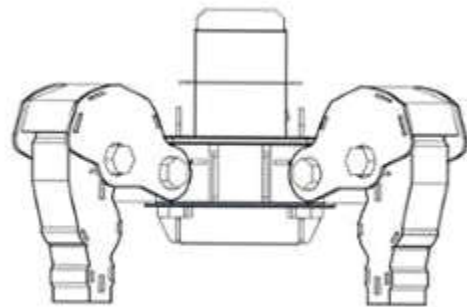

1.2

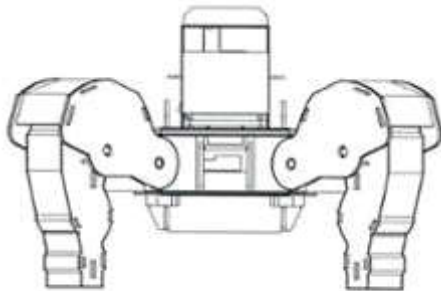

1.3

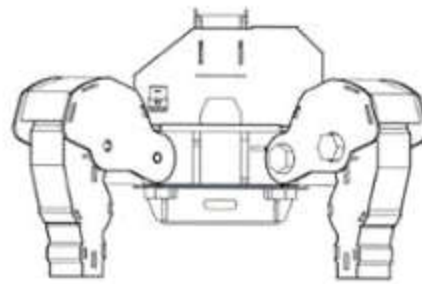

1.4

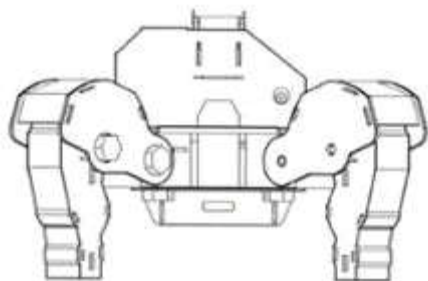

1.5

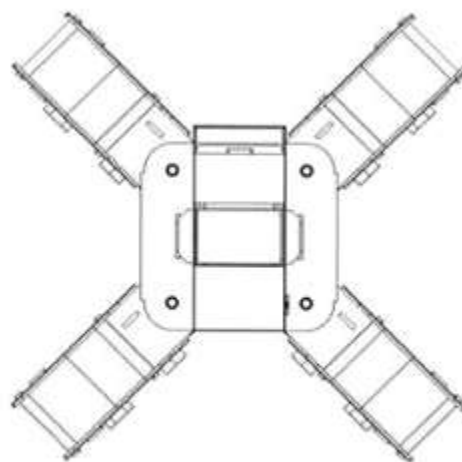

1.6

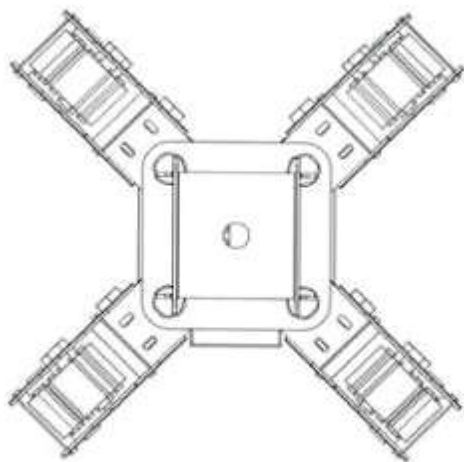

1.7

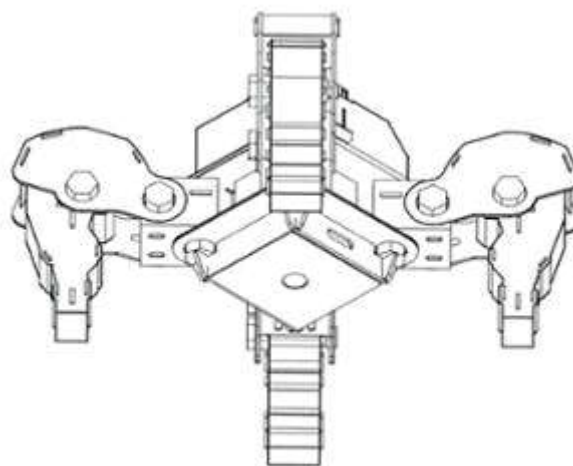

1.8

CÔNG BÁO SỞ HỮU CÔNG NGHIỆP SỐ 395 TẬP A – QUYỀN 2 (02.2021)

- (11) **40858**
(21) 3-2020-03054 (28) 1
(54) **BAO GÓI ĐỰNG GẠO** (51) **09-05**
(22) 18/12/2020 (43) 25/02/2021
(73) **CÔNG TY TNHH SẢN XUẤT THƯƠNG MẠI DỊCH VỤ BA ĐỦ (VN)**
Số 25/10, Võ Ngọc Quận, phường 6, thành phố Tân An, tỉnh Long An
(72) Nguyễn Thanh Hải (VN)
(74) Công ty Cổ phần Sở hữu công nghiệp INVESTIP (INVESTIP)
(55)



1.1



1.2

CÔNG BÁO SỞ HỮU CÔNG NGHIỆP SỐ 395 TẬP A – QUYỀN 2 (02.2021)

- (11) **40859**
(21) 3-2020-03053 (28) 1
(54) **CHAI** (51) **09-01**
(22) 18/12/2020 (43) 25/02/2021
(73) **CÔNG TY TNHH HÓA MỸ PHẨM NGỌC THỦY (VN)**
101/31 Phạm Đình Hồ, phường 06, quận 6, thành phố Hồ Chí Minh
(72) Trịnh Gia Phú (VN)
(74) **CÔNG TY TNHH SỞ HỮU TRÍ TUỆ SETHACO (SETHACO IP CO.,LTD)**
(55)



1.1

1.2

1.3



1.4

1.5

CÔNG BÁO SỞ HỮU CÔNG NGHIỆP SỐ 395 TẬP A – QUYỀN 2 (02.2021)

- (11) **40860**
(21) 3-2020-03044 (28) 1
(54) **XE MÔ TÔ** (51) **12-11**
(22) 17/12/2020 (43) 25/02/2021
(30) 202030314472.0 18/06/2020 CN;
XIAMEN XIASHING MOTORCYCLE CO., LTD. (CN)
(73) No. 99 Xibin Road, Xinglin, Jimei District, Xiamen, Fujian 361022, China
1. JUNFENG CHENG (CN)
2. ZHIBIN YANG (CN)
(72) 3. SONGJIE WU (CN)
4. YOUBIN HUANG (CN)
(74) Công ty TNHH Trường Xuân (AGELESS CO.,LTD.)
(55)



1.1



1.2



1.3

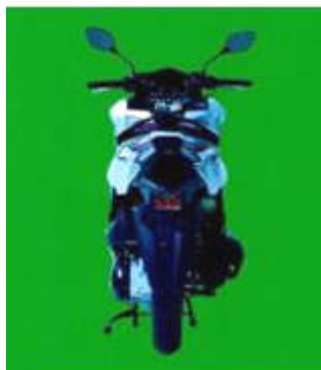

1.4



1.5



1.6



1.7

- (11) **40861**
(21) 3-2020-03042 (28) 1
(54) **HỘP** (51) **09-03**
(22) 17/12/2020 (43) 25/02/2021
(73) **NGUYỄN ĐÌNH TÀI (VN)**
78/12 Tôn Thất Thuyết, phường 16, quận 4, thành phố Hồ Chí Minh
(72) Nguyễn Đình Tài (VN)
(55)



1.1

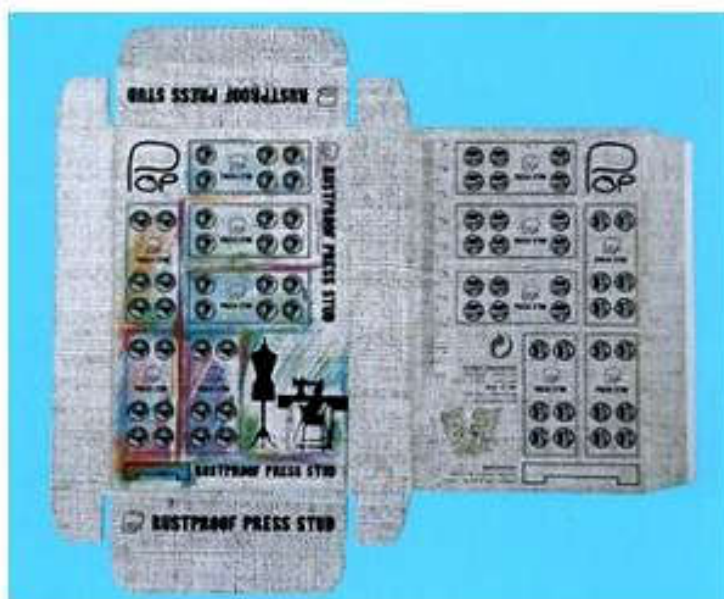

1.2

CÔNG BÁO SỞ HỮU CÔNG NGHIỆP SỐ 395 TẬP A – QUYỀN 2 (02.2021)

- (11) **40862**
(21) 3-2020-03036 (28) 1
(54) **HỘP ĐỰNG THỰC PHẨM BẢO VỆ SỨC KHỎE** (51) **09-03**
(22) 16/12/2020 (43) 25/02/2021
(73) **VŨ THỊ PHƯƠNG (VN)**
Khu ĐT Dệt May, phường Năng Tĩnh, thành phố Nam Định, tỉnh Nam Định
(72) Vũ Thị Phương (VN)
(55)



1.1



1.2

- | | | | |
|------|---|------|--------------|
| (11) | 40863 | | |
| (21) | 3-2020-03035 | (28) | 1 |
| (54) | HỘP ĐỰNG THUỐC | (51) | 09-03 |
| (22) | 16/12/2020 | (43) | 25/02/2021 |
| (73) | VŨ THỊ PHƯƠNG (VN) | | |
| | Khu ĐT Dệt May, phường Năng Tĩnh, thành phố Nam Định, tỉnh Nam Định | | |
| (72) | Vũ Thị Phương (VN) | | |
| (55) | | | |



1.1

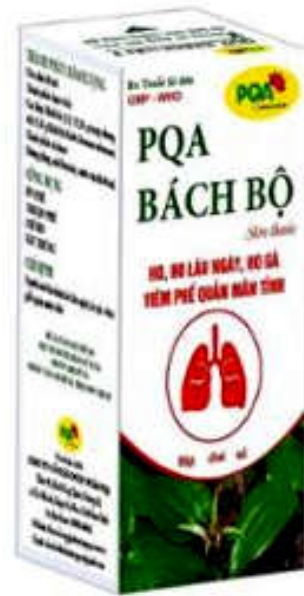

1.2

- (11) **40864**
(21) 3-2020-03034 (28) 1
(54) **HỘP ĐỰNG THUỐC** (51) **09-03**
(22) 16/12/2020 (43) 25/02/2021
VŨ THỊ PHƯƠNG (VN)
(73) Khu ĐT Dệt May, phường Năng Tĩnh, thành phố Nam Định, tỉnh Nam Định
(72) Vũ Thị Phương (VN)
(55)



1.1

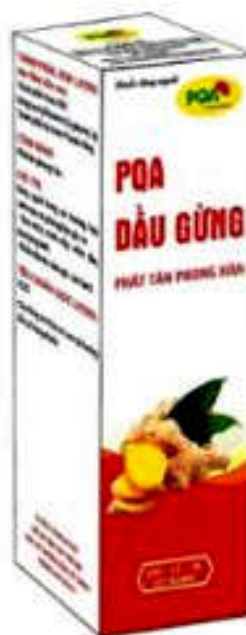

1.2

- (11) **40865**
(21) 3-2020-03033 (28) 1
(54) **HỘP ĐỰNG THUỐC** (51) **09-03**
(22) 16/12/2020 (43) 25/02/2021
VŨ THỊ PHƯƠNG (VN)
(73) Khu ĐT Dệt May, phường Năng Tĩnh, thành phố Nam Định, tỉnh Nam Định
(72) Vũ Thị Phương (VN)
(55)



1.1



1.2

- (11) **40866**
- (21) 3-2020-03032 (28) 1
- (54) **HỘP ĐỰNG THỰC PHẨM BẢO VỆ SỨC KHỎE** (51) **09-03**
- (22) 16/12/2020 (43) 25/02/2021
- VŨ THỊ PHƯƠNG (VN)**
- (73) Khu ĐT Dệt May, phường Năng Tĩnh, thành phố Nam Định, tỉnh Nam Định
- (72) Vũ Thị Phương (VN)
- (55)



1.1



1.2

- (11) **40867**
(21) 3-2020-03031 (28) 1
(54) **HỘP ĐỰNG THỰC PHẨM BẢO VỆ SỨC KHỎE** (51) **09-03**
(22) 16/12/2020 (43) 25/02/2021
VŨ THỊ PHƯƠNG (VN)
(73) Khu ĐT Dệt May, phường Năng Tĩnh, thành phố Nam Định, tỉnh Nam Định
(72) Vũ Thị Phương (VN)
(55)



1.1



1.2

- (11) **40868**
(21) 3-2020-03030 (28) 1
(54) **HỘP ĐỰNG THỰC PHẨM BẢO VỆ SỨC KHỎE** (51) **09-03**
(22) 16/12/2020 (43) 25/02/2021
VŨ THỊ PHƯƠNG (VN)
(73) Khu ĐT Dệt May, phường Năng Tĩnh, thành phố Nam Định, tỉnh Nam Định
(72) Vũ Thị Phương (VN)
(55)



1.1



1.2

- (11) **40869**
(21) 3-2020-03027 (28) 1
(54) **ĐỂ MÁY SẤY TÓC** (51) **28-03**
(22) 15/12/2020 (43) 25/02/2021
(30) 30-2020-0027138 16/06/2020 KR;
YOUNG-SE, KIM (KR)
(73) 736ho,234, Hwangsaoul-ro, Bundang-gu, Seongnam-si, Gyeonggi-do, 13595,
Republic of Korea
(72) Young-se, KIM (KR)
(74) Văn phòng Luật sư Ân Nam (ANNAM IP & LAW)
(55)

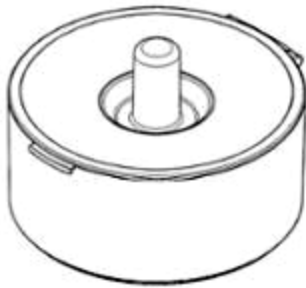

1.1

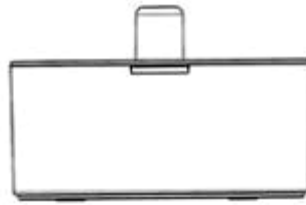

1.2

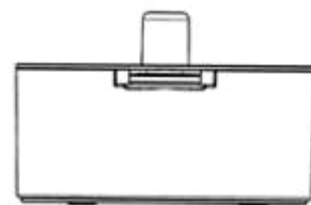

1.3

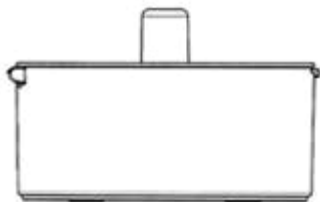

1.4

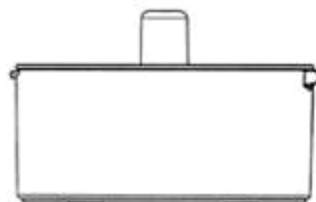

1.5

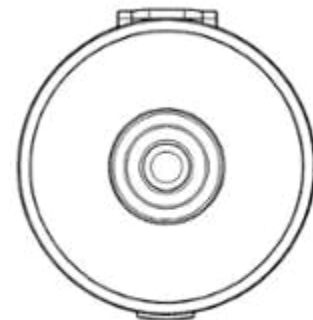

1.6

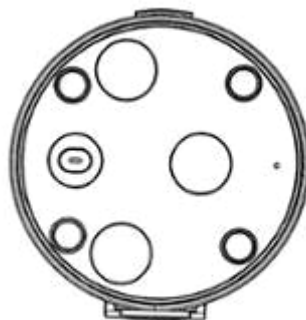

1.7



1.8

CÔNG BÁO SỞ HỮU CÔNG NGHIỆP SỐ 395 TẬP A – QUYỀN 2 (02.2021)

(11) **40870**

(21) 3-2020-03023

(28) 2

(54) **HỘP ĐỰNG TRÀ**

(51) **09-03**

(22) 15/12/2020

(43) 25/02/2021

CÔNG TY CỔ PHẦN THƯƠNG MẠI DỊCH VỤ DƯỢC LIỆU NAM LONG (VN)

(73) Số 65/5S, đường Tân Xuân- Trung Chánh 2, ấp Mỹ Hòa 3, xã Tân Xuân, huyện Hóc Môn, thành phố Hồ Chí Minh

(72) Trần Văn Lâm (VN)

(55)



1.1



1.2



2.1



2.2

- (11) **40871**
- (21) 3-2020-03021 (28) 1
- (54) **CÀNG KÍNH ĐEO MẮT** (51) **16-06**
- (22) 14/12/2020 (43) 25/02/2021
- (30) 2020-011842 15/06/2020 JP;
- 1. **JINS HOLDINGS INC.** (JP)
26-4 Kawaharamachi 2-chome, Maebashi-shi, Gunma 371-0046 Japan
- (73) 2. **TSUBOTA LABORATORY, INC.** (JP)
304 Toshin Shinanomachi-ekimae Bldg., 34 Shinanomachi, Shinjuku-ku, Tokyo
160-0016 Japan
- (72) Daisuke KANEDA (JP)
- (74) Công ty TNHH Tâm nhìn và Liên danh (VISION & ASSOCIATES CO.LTD.)
- (55)

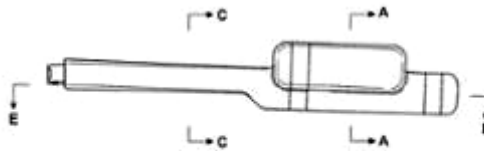

1.1



1.2



1.3



1.4



1.5



1.6

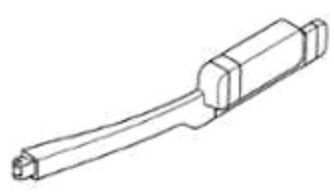

1.7

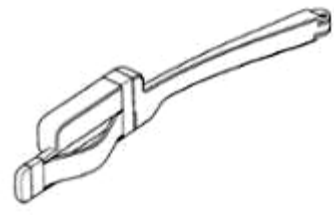

1.8



1.9

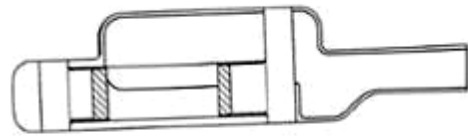

1.10



1.11

**Bộ phận chứa linh kiện
điện tử bên trong**

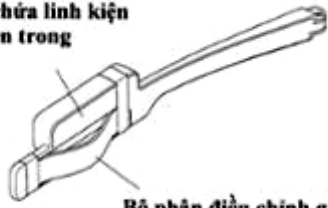

**Bộ phận điều chỉnh giúp căng kính
vừa vặn với người đeo**

1.12



KDCN

**Bộ phận chứa linh kiện
điện tử bên trong**

1.13



1.14



1.15

- (11) **40872**
(21) 3-2020-03018 (28) 1
(54) **TẮM HƯỚNG GIÓ CHO XE CỘ** (51) **12-16**
(22) 14/12/2020 (43) 25/02/2021
(30) 008149447-0001 27/08/2020 EM;
(73) **IGOR AKRAPOVIČ** (SI)
Rožna Dolina C.VIII/10A, SI-1000 Ljubljana, Slovenia
1. IGOR AKRAPOVIČ (SI)
2. ERMIN KOSOVEL (SI)
(72) 3. BOŠTJAN VEBER (SI)
4. DEJAN KASTELIC (SI)
5. PRIMOŽ TOPLIKAR (SI)
(74) Công ty TNHH Đại Tín và Liên Danh (DAITIN AND ASSOCIATES CO.,LTD)
(55)



1.1



1.2



1.3



1.4



1.5



1.6



1.7



1.8

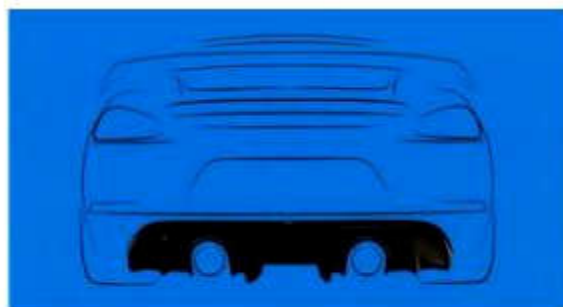

1.9

CÔNG BÁO SỞ HỮU CÔNG NGHIỆP SỐ 395 TẬP A – QUYỀN 2 (02.2021)

- (11) **40873**
(21) 3-2020-03012 (28) 1
(54) **BAO GỐI KHĂN ƯỚT** (51) **09-05**
(22) 14/12/2020 (43) 25/02/2021
CÔNG TY TNHH SẢN XUẤT VÀ THƯƠNG MẠI QUỐC TẾ VIỆT SING
(73) (VN)
Cụm CN Xuân Lâm, xã Xuân Lâm, huyện Thuận Thành, tỉnh Bắc Ninh
(72) Nguyễn Đăng Dũng (VN)
(55)



1.1



1.2

- (11) **40874**
(21) 3-2020-03011 (28) 1
(54) **ỐNG XẢ** (51) **12-16**
(22) 14/12/2020 (43) 25/02/2021
(30) 008151773-0001 28/08/2020 EM;
(73) **IGOR AKRAPOVIČ (SI)**
Rožna Dolina C.VIII/10A, SI-1000 Ljubljana, Slovenia
1. IGOR AKRAPOVIČ (SI)
2. DEJAN GRUBAR (SI)
3. MARKO ZIMŠEK (SI)
(72) 4. ROMAN HAFNAR (SI)
5. ERMIN KOSOVEL (SI)
6. URBAN POTOČNIK (SI)
(74) Công ty TNHH Đại Tín và Liên Danh (DAITIN AND ASSOCIATES CO.,LTD)
(55)



1.1



1.2



1.3



1.4



1.5



1.6



1.7



1.8

- (11) **40875**
(21) 3-2020-03010 (28) 1
(54) **ỐNG XẢ** (51) **12-16**
(22) 14/12/2020 (43) 25/02/2021
(30) 008149942-0001 28/08/2020 EM;
(73) **IGOR AKRAPOVIČ (SI)**
Rožna Dolina C.VIII/10A, SI-1000 Ljubljana, Slovenia
1. IGOR AKRAPOVIČ (SI)
2. DEJAN GRUBAR (SI)
(72) 3. ŽANE SEDEVČIČ (SI)
4. ERMIN KOSOVEL (SI)
5. URBAN POTOČNIK (SI)
(74) Công ty TNHH Đại Tín và Liên Danh (DAITIN AND ASSOCIATES CO.,LTD)
(55)



1.1



1.2



1.3



1.4



1.5



1.6



1.7



1.8

- (11) **40876**
(21) 3-2020-03009 (28) 1
(54) **ĐUÔI ỐNG XẢ** (51) **12-16**
(22) 14/12/2020 (43) 25/02/2021
(30) 008033468-0002 07/07/2020 EM;
(73) **IGOR AKRAPOVIČ** (SI)
Rožna Dolina C.VIII/10A, SI-1000 Ljubljana, Slovenia
1. IGOR AKRAPOVIČ (SI)
2. ERMIN KOSOVEL (SI)
3. PRIMOŽ HAUPTMAN (SI)
(72) 4. PETER ŠPRAJC (SI)
5. JAKA KLEMENC (SI)
6. BOŠTJAN VEBER (SI)
(74) Công ty TNHH Đại Tín và Liên Danh (DAITIN AND ASSOCIATES CO.,LTD)
(55)



1.1



1.2



1.3



1.4



1.5



1.6



1.7



1.8

- (11) **40877**
(21) 3-2020-03008 (28) 1
(54) **ĐUÔI ỐNG XẢ** (51) **12-16**
(22) 14/12/2020 (43) 25/02/2021
(30) 008033468-0001 07/07/2020 EM;
(73) **IGOR AKRAPOVIČ** (SI)
Rožna Dolina C.VIII/10A, SI-1000 Ljubljana, Slovenia
1. IGOR AKRAPOVIČ (SI)
2. ERMIN KOSOVEL (SI)
3. PRIMOŽ HAUPTMAN (SI)
(72) 4. PETER ŠPRAJC (SI)
5. JAKA KLEMENC (SI)
6. VEBER BOŠTJAN (SI)
(74) Công ty TNHH Đại Tín và Liên Danh (DAITIN AND ASSOCIATES CO.,LTD)
(55)



1.1



1.2



1.3



1.4



1.5



1.6



1.7



1.8

CÔNG BÁO SỞ HỮU CÔNG NGHIỆP SỐ 395 TẬP A – QUYỀN 2 (02.2021)

- (11) **40878**
(21) 3-2020-03006 (28) 1
(54) **THANH KIM LOẠI ĐỊNH HÌNH** (51) **25-01**
(22) 11/12/2020 (43) 25/02/2021
PHẠM LÊ HÒA (VN)
(73) Số 20, ngõ 291, phố Khương Trung, phường Khương Trung, quận Thanh Xuân, thành phố Hà Nội
(72) Phạm Lê Hòa (VN)
(74) Công ty Luật TNHH VIETTHINK (VIETTHINK LAW FIRM)
(55)



1.1

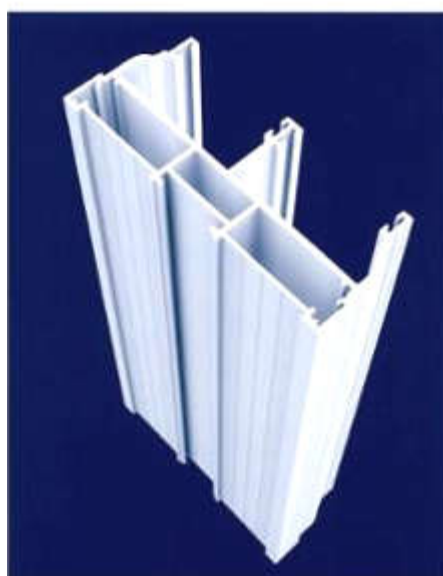

1.2

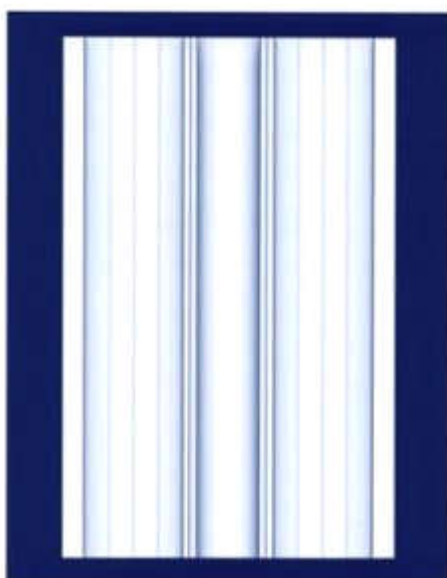

1.3

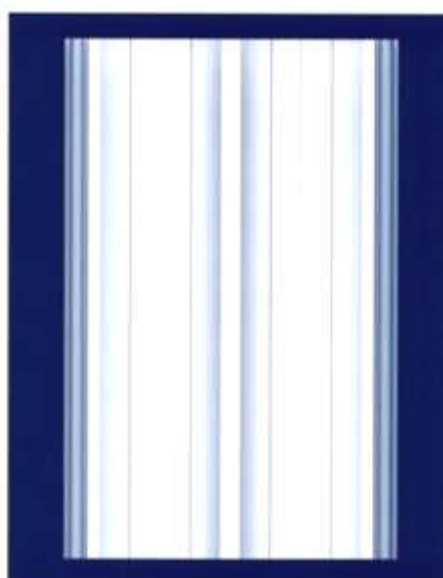

1.4

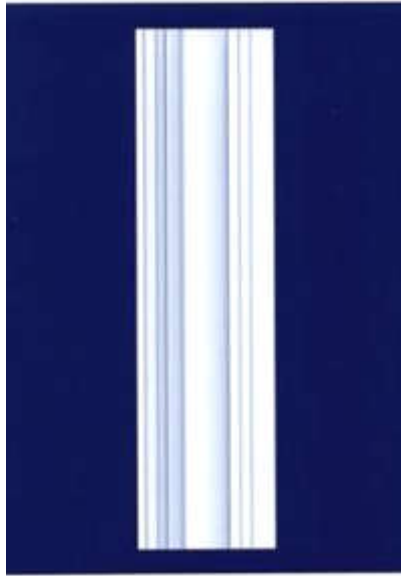

1.5

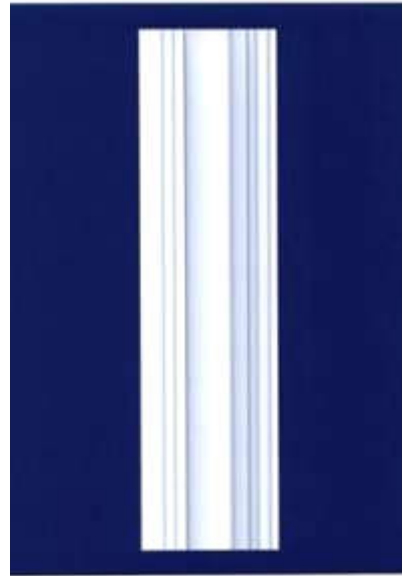

1.6



1.7

CÔNG BÁO SỞ HỮU CÔNG NGHIỆP SỐ 395 TẬP A – QUYỀN 2 (02.2021)

- (11) **40879**
(21) 3-2020-03005 (28) 1
(54) **THANH KIM LOẠI ĐỊNH HÌNH** (51) **25-01**
(22) 11/12/2020 (43) 25/02/2021
PHẠM LÊ HÒA (VN)
(73) Số 20, ngõ 291, phố Khương Trung, phường Khương Trung, quận Thanh Xuân, thành phố Hà Nội
(72) Phạm Lê Hòa (VN)
(74) Công ty Luật TNHH VIETTHINK (VIETTHINK LAW FIRM)
(55)

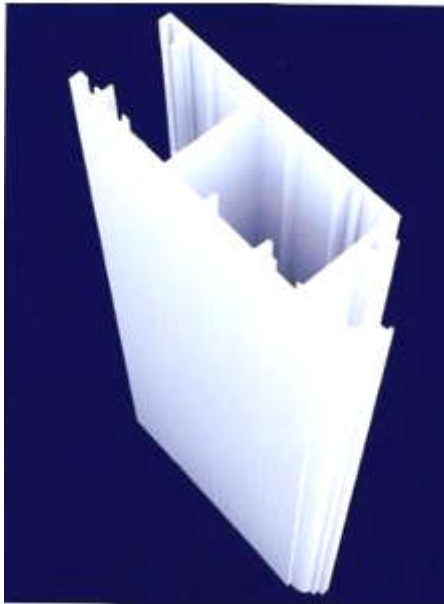

1.1

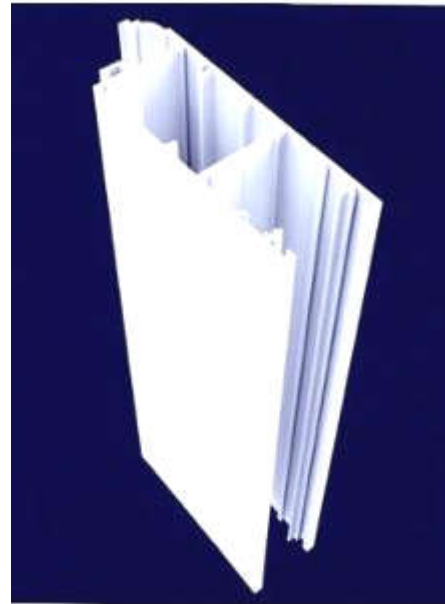

1.2

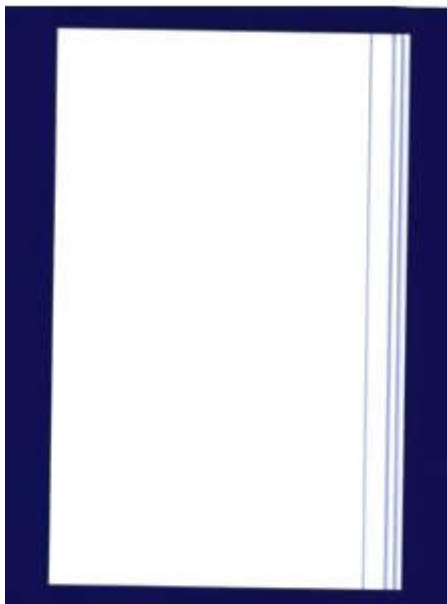

1.3

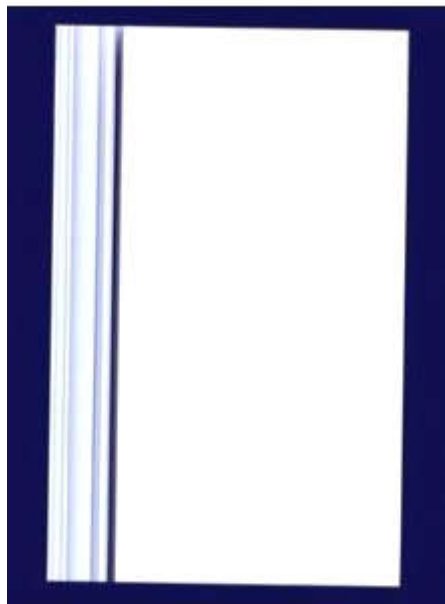

1.4

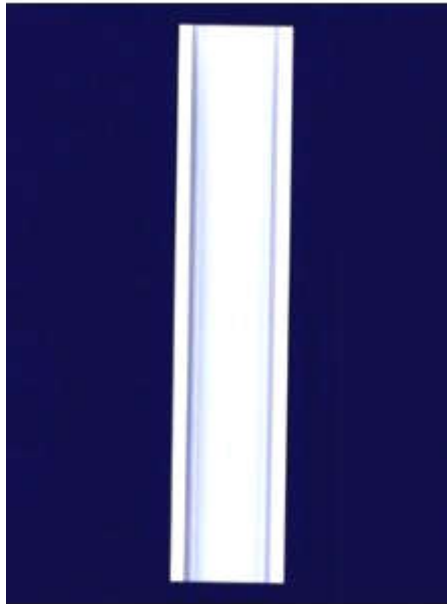

1.5

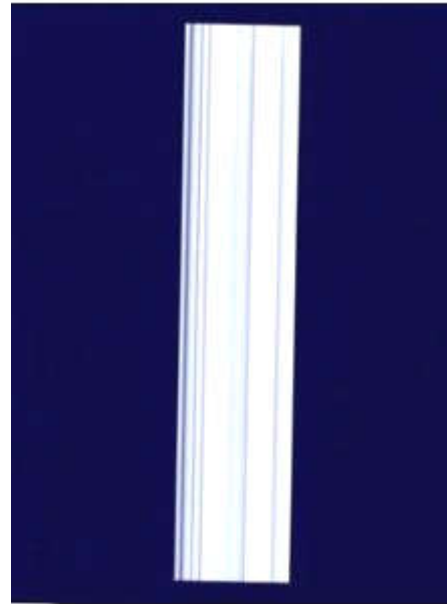

1.6

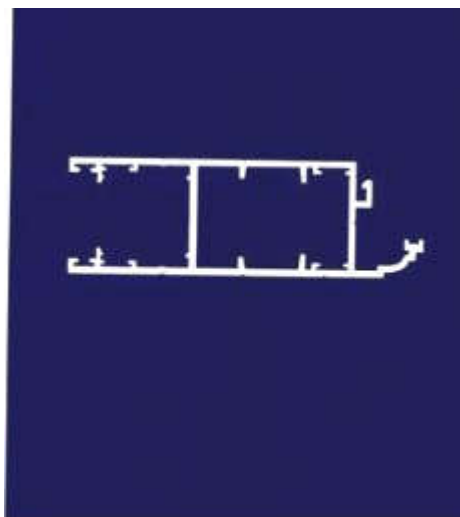

1.7

CÔNG BÁO SỞ HỮU CÔNG NGHIỆP SỐ 395 TẬP A – QUYỀN 2 (02.2021)

- (11) **40880**
(21) 3-2020-03004 (28) 1
(54) **THANH KIM LOẠI ĐỊNH HÌNH** (51) **25-01**
(22) 11/12/2020 (43) 25/02/2021
PHẠM LÊ HÒA (VN)
(73) Số 20, ngõ 291, phố Khương Trung, phường Khương Trung, quận Thanh Xuân, thành phố Hà Nội
(72) Phạm Lê Hòa (VN)
(74) Công ty Luật TNHH VIETTHINK (VIETTHINK LAW FIRM)
(55)



1.1



1.2

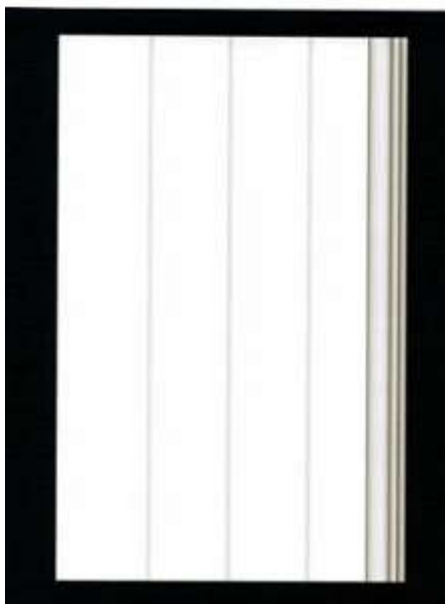

1.3



1.4



1.5



1.6

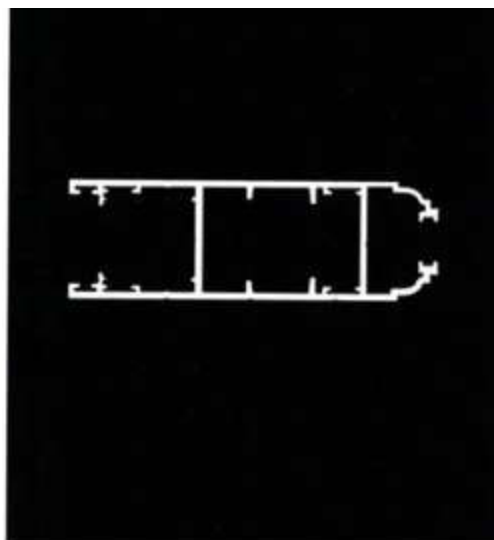

1.7

CÔNG BÁO SỞ HỮU CÔNG NGHIỆP SỐ 395 TẬP A – QUYỀN 2 (02.2021)

- (11) **40881**
(21) 3-2020-03001 (28) 1
(54) **HỘP ĐỰNG SẢN PHẨM** (51) **09-03**
(22) 11/12/2020 (43) 25/02/2021
CÔNG TY TNHH TRỊNH TRUNG L.A (VN)
(73) Lô L16-17 đường số 7, KCN Hải Sơn (GD 3+4), xã Đức Hòa Hạ, huyện Đức Hoà, tỉnh Long An
(72) Nguyễn Đình Chức (VN)
(74) Công ty TNHH Tư vấn đầu tư và Sở hữu trí tuệ Hoàng Phi (HOANG PHI INVEST & I.P CO., LTD)
(55)



1.1



1.2

CÔNG BÁO SỞ HỮU CÔNG NGHIỆP SỐ 395 TẬP A – QUYỀN 2 (02.2021)

(11) **40882**

(21) 3-2020-03000

(28) 1

(54) **CHAI**

(51) **09-01**

(22) 11/12/2020

(43) 25/02/2021

CÔNG TY CỔ PHẦN MARICO SOUTH EAST ASIA (VN)

(73) Số 3, đường số 5, khu công nghiệp Sóng Thần 1, phường Dĩ An, thành phố Dĩ An, tỉnh Bình Dương

(72) Lương Hữu Khánh (VN)

(74) Công ty cổ phần FAS INVEST (FAS INVEST JSC)

(55)



1.1

1.2

1.3



1.4

1.5

CÔNG BÁO SỞ HỮU CÔNG NGHIỆP SỐ 395 TẬP A – QUYỀN 2 (02.2021)

- (11) **40883**
- (21) 3-2020-02997
- (54) **HỘP**
- (22) 11/12/2020
- (28) 1
- (51) **09-03**
- (43) 25/02/2021
- CÔNG TY TNHH THƯƠNG MẠI SẢN XUẤT VẠN THỊNH (VN)**
- (73) Số 5-7-9-11 đường Huỳnh Lan Khanh, phường 2, quận Tân Bình, thành phố Hồ Chí Minh
- (72) Phan Thiện Ân (VN)
- (74) **CÔNG TY TNHH SỞ HỮU TRÍ TUỆ SETHACO (SETHACO IP CO.,LTD)**
- (55)



1.1



1.2



1.3



1.4



1.5



1.6

CÔNG BÁO SỞ HỮU CÔNG NGHIỆP SỐ 395 TẬP A – QUYỀN 2 (02.2021)

- (11) **40884**
(21) 3-2020-02995 (28) 1
(54) **HỘP** (51) **09-03**
(22) 10/12/2020 (43) 25/02/2021
(73) **ORION CORPORATION (KR)**
13, Baekbeom-ro 90da-gil, Yongsan-gu, Seoul 04369, Republic of Korea
(72) 1. LEE, A REUM (KR)
2. CHOE, EUN JE (KR)
(74) Công ty Luật TNHH quốc tế BMVN (BMVN INTERNATIONAL LLC)
(55)



1.1



1.2



1.3



1.4



1.5



1.6



1.7



1.8

(11) **40885**

(21) 3-2020-02988

(28) 1

(54) **BAO GÓI**

(51) **09-05**

(22) 10/12/2020

(43) 25/02/2021

CÔNG TY CỔ PHẦN THỰC PHẨM GIA ĐÌNH AN CO (VN)

(73) Lô M, đường số 10, cụm công nghiệp Lợi Bình Nhơn, xã Lợi Bình Nhơn, thành phố Tân An, tỉnh Long An

(72) Hứa Cao Trí (VN)

(74) Công ty TNHH Sở hữu trí tuệ INVENTIO (INVENTIO CO.,LTD)

(55)



1.1



1.2

CÔNG BÁO SỞ HỮU CÔNG NGHIỆP SỐ 395 TẬP A – QUYỀN 2 (02.2021)

(11) **40886**

(21) 3-2020-02987

(28) 4

(54) **NHÃN SẢN PHẨM**

(51) **19-08**

(22) 10/12/2020

(43) 25/02/2021

CÔNG TY CỔ PHẦN THỰC PHẨM GIA ĐÌNH AN CO (VN)

(73) Lô M, đường số 10, cụm công nghiệp Lợi Bình Nhơn, xã Lợi Bình Nhơn, thành phố Tân An, tỉnh Long An

(72) Hứa Cao Trí (VN)

(74) Công ty TNHH Sở hữu trí tuệ INVENTIO (INVENTIO CO.,LTD)

(55)



1.1



1.2



2.1



2.2



3.1



3.2



4.1



4.2

(11) **40887**

(21) 3-2020-02985

(28) 1

(54) **XE MÁY ĐIỆN**

(51) **12-11**

(22) 10/12/2020

(43) 25/02/2021

SUPERSOCO INTELLIGENT TECHNOLOGY (SHANGHAI) CO., LTD
(CN)

(73) Building 2, no. 3089, Huqingping Road, Zhaoxiang Town, Qingpu District,
Shanghai, 201799 China

(72) XIE YUXIAN (CN)

(74) Công ty TNHH Dịch vụ Sở hữu trí tuệ BIG5 (BIG5 IP CO.,LTD)

(55)



1.1



1.2



1.3



1.4



1.5



1.6



1.7



1.8

- (11) **40888**
(21) 3-2020-02976 (28) 1
(54) **HỘP ĐỰNG DỤNG CỤ** (51) **09-03**
(22) 09/12/2020 (43) 25/02/2021
(30) 109303882 15/07/2020 TW; 109303880 15/07/2020 TW;
MING SHIN TOOLS CO., LTD. (TW)
(73) 31F.-2, No. 236, Shizheng N. 2nd Rd., Xitun Dist., Taichung City 407, Taiwan
(72) YUNG-SHUN CHEN (TW)
(74) Văn phòng Luật sư Ân Nam (ANNAM IP & LAW)
(55)

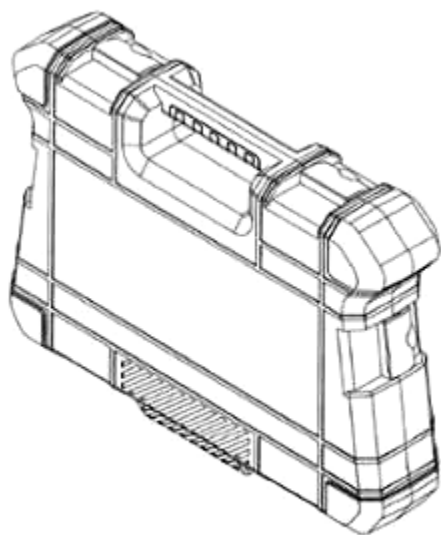

1.1

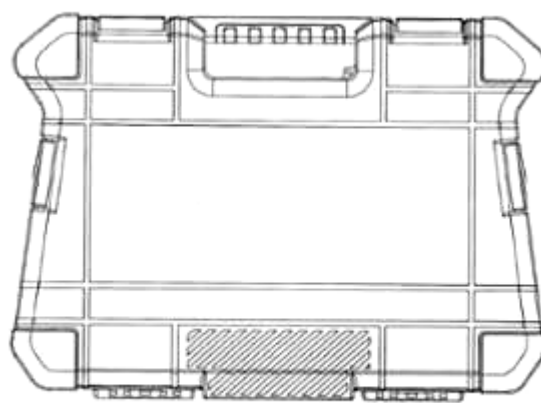

1.2

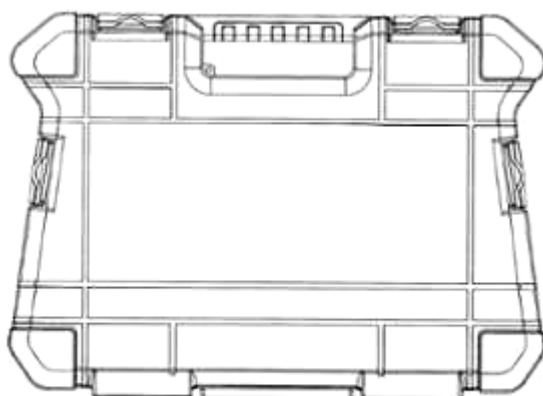

1.3

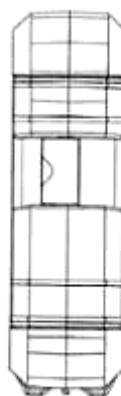

1.4

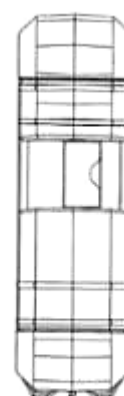

1.5



1.6



1.7

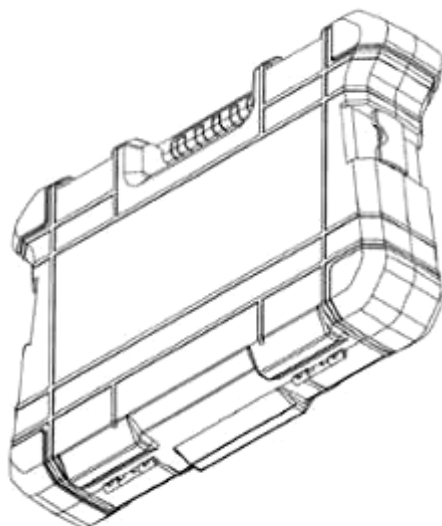

1.8

CÔNG BÁO SỞ HỮU CÔNG NGHIỆP SỐ 395 TẬP A – QUYỀN 2 (02.2021)

(11) **40889**

(21) 3-2020-02972

(28) 1

(54) **HỘP ĐỰNG**

(51) **09-03**

(22) 09/12/2020

(43) 25/02/2021

(73) **CÔNG TY TNHH LẬP THIÊN (VN)**

Lầu 9, số 14 Phan Tôn, phường Đakao, quận 1, thành phố Hồ Chí Minh

(72) Nguyễn Thanh Tùng (VN)

(55)



1.1



1.2

CÔNG BÁO SỞ HỮU CÔNG NGHIỆP SỐ 395 TẬP A – QUYỀN 2 (02.2021)

(11) **40890**

(21) 3-2020-02971

(28) 1

(54) **HỘP ĐỰNG**

(51) **09-03**

(22) 09/12/2020

(43) 25/02/2021

(73) **CÔNG TY TNHH LẬP THIÊN (VN)**

Lầu 9, số 14 Phan Tôn, phường Đakao, quận 1, thành phố Hồ Chí Minh

(72) Nguyễn Thanh Tùng (VN)

(55)



1.1



1.2

(11) **40891**

(21) 3-2020-02970

(28) 1

(54) **HỘP ĐỰNG**

(51) **09-03**

(22) 09/12/2020

(43) 25/02/2021

(73) **CÔNG TY TNHH LẬP THIÊN (VN)**

Lầu 9, số 14 Phan Tôn, phường Đakao, quận 1, thành phố Hồ Chí Minh

(72) Nguyễn Thanh Tùng (VN)

(55)



1.1



1.2

- (11) **40892**
(21) 3-2020-02964 (28) 1
(54) **CHAI** (51) **09-01**
(22) 07/12/2020 (43) 25/02/2021
(73) **SUNTORY HOLDINGS LIMITED (JP)**
1-40, Dojimahama 2-chome, Kita-ku, Osaka-shi, Osaka 530-8203 Japan
1. YUZO SHIMIZU (JP)
(72) 2. NAOTO MATSUTAKE (JP)
3. ALISTAIR SAYERS (NZ)
(74) Công ty TNHH Tầm nhìn và Liên danh (VISION & ASSOCIATES CO.LTD.)
(55)



1.1



1.2



1.3

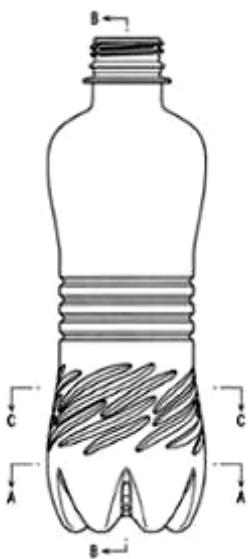

1.4

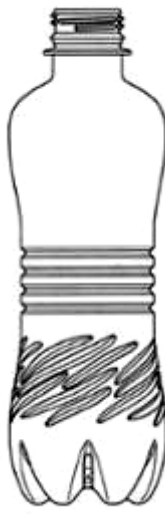

1.5



1.6

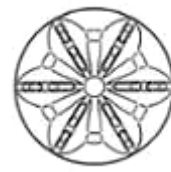

1.7



1.8

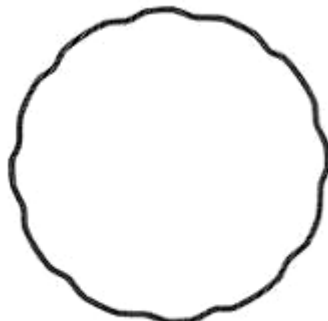

1.9



1.10

(11) **40893**

(21) 3-2020-02958

(28) 1

(54) **BÌNH GIỮ NHIỆT**

(51) **07-07**

(22) 07/12/2020

(43) 25/02/2021

CÔNG TY CỔ PHẦN BÓNG ĐÈN PHÍCH NƯỚC RẠNG ĐÔNG (VN)

(73) 87-89 phố Hạ Đình, phường Thanh Xuân Trung, quận Thanh Xuân, thành phố Hà Nội

(72) Trần Trung Tường (VN)

(55)

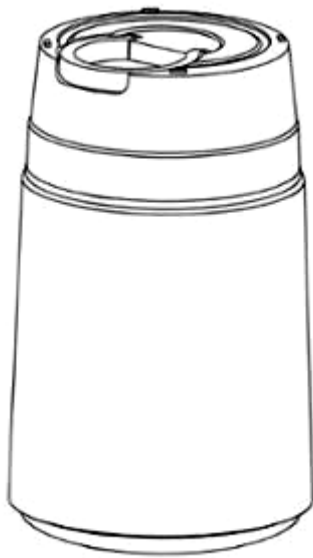

1.1

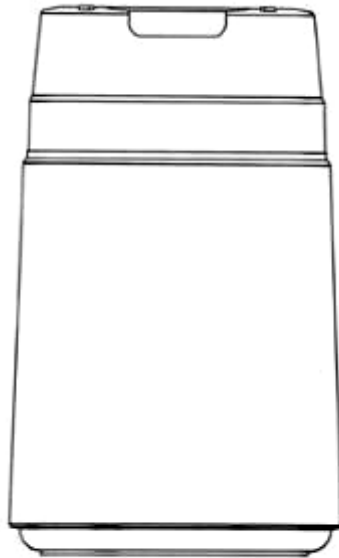

1.2

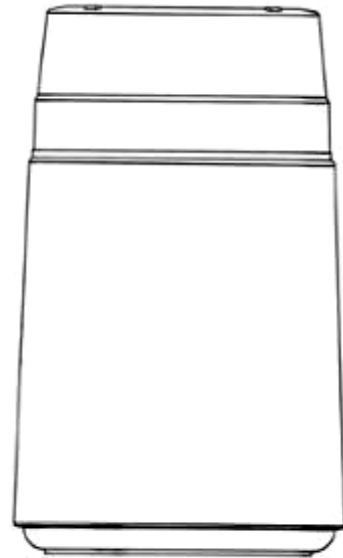

1.3

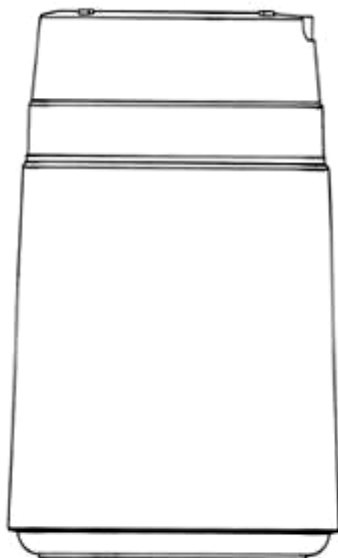

1.4

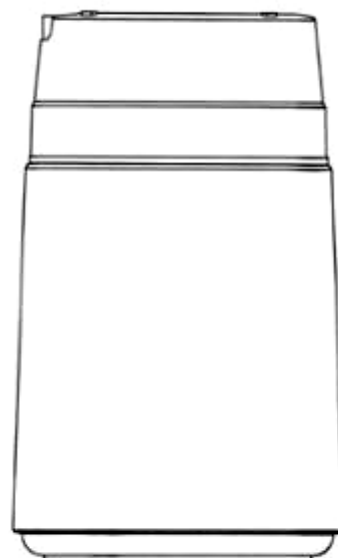

1.5

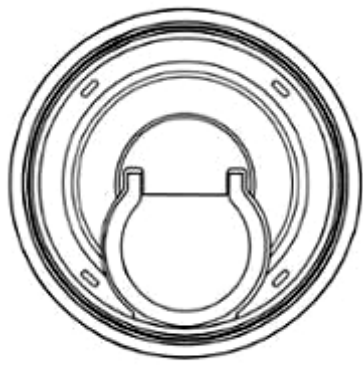

1.6

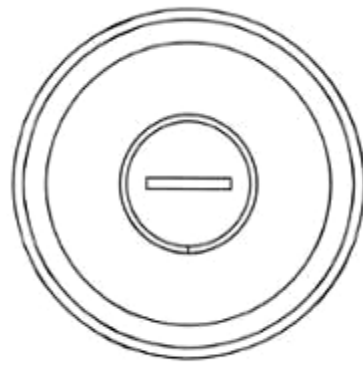

1.7

(11) **40894**

(21) 3-2020-02957

(28) 1

(54) **PHÍCH**

(51) **07-07**

(22) 07/12/2020

(43) 25/02/2021

CÔNG TY CỔ PHẦN BÓNG ĐÈN PHÍCH NƯỚC RẠNG ĐÔNG (VN)

(73) 87-89 phố Hạ Đình, phường Thanh Xuân Trung, quận Thanh Xuân, thành phố Hà Nội

(72) Trần Trung Tường (VN)

(55)



1.1



1.2

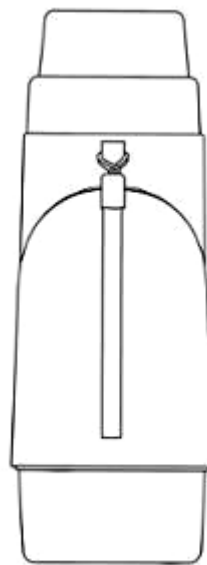

1.3

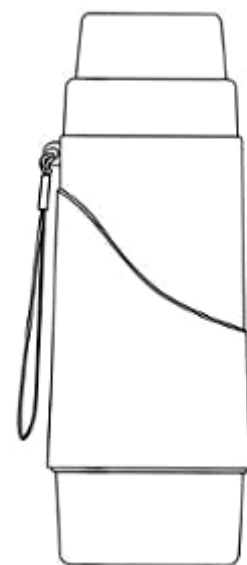

1.4



1.5



1.6



1.7

- (11) **40895**
(21) 3-2020-02946 (28) 1
(54) **VÒNG ĐỆM** (51) **08-08**
(22) 04/12/2020 (43) 25/02/2021
(30) 202030332209.4 24/06/2020 CN;
BUTTON INTERNATIONAL CO., LTD. (TW)
(73) 2F., No. 8, Alley 30, Lane 358, Rueiguang Rd., Neihu District, Taipei City 11492, Taiwan
1. TSAI, DENG-KUEI (TW)
(72) 2. LU, CHU-CHUN (TW)
3. CHEN, CHUNG-LUNG (TW)
(74) Công ty TNHH Trường Xuân (AGELESS CO.,LTD.)
(55)

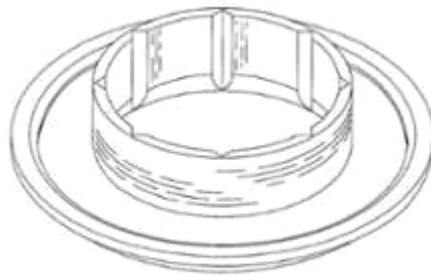

1.1



1.2



1.3



1.4



1.5

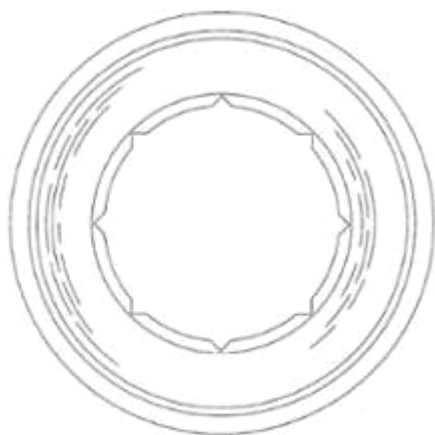

1.6



1.7

- (11) **40896**
(21) 3-2020-02929 (28) 1
(54) **THIẾT BỊ LẤY MẪU** (51) **24-02**
(22) 03/12/2020 (43) 25/02/2021
(30) 30-2020-0027422 17/06/2020 KR;
BIONLIFESCIENCE CO., LTD. (KR)
(73) (11901) A-601,19, Sanmaru-ro, Guri-si, Gyeonggi-do, Republic of Korea
1. GOH, CHANG WOOK (KR)
(72) 2. KIM, BONG YOON (KR)
3. JEONG, JOONG HWAN (KR)
(74) Công ty TNHH Trường Xuân (AGELESS CO.,LTD.)
(55)

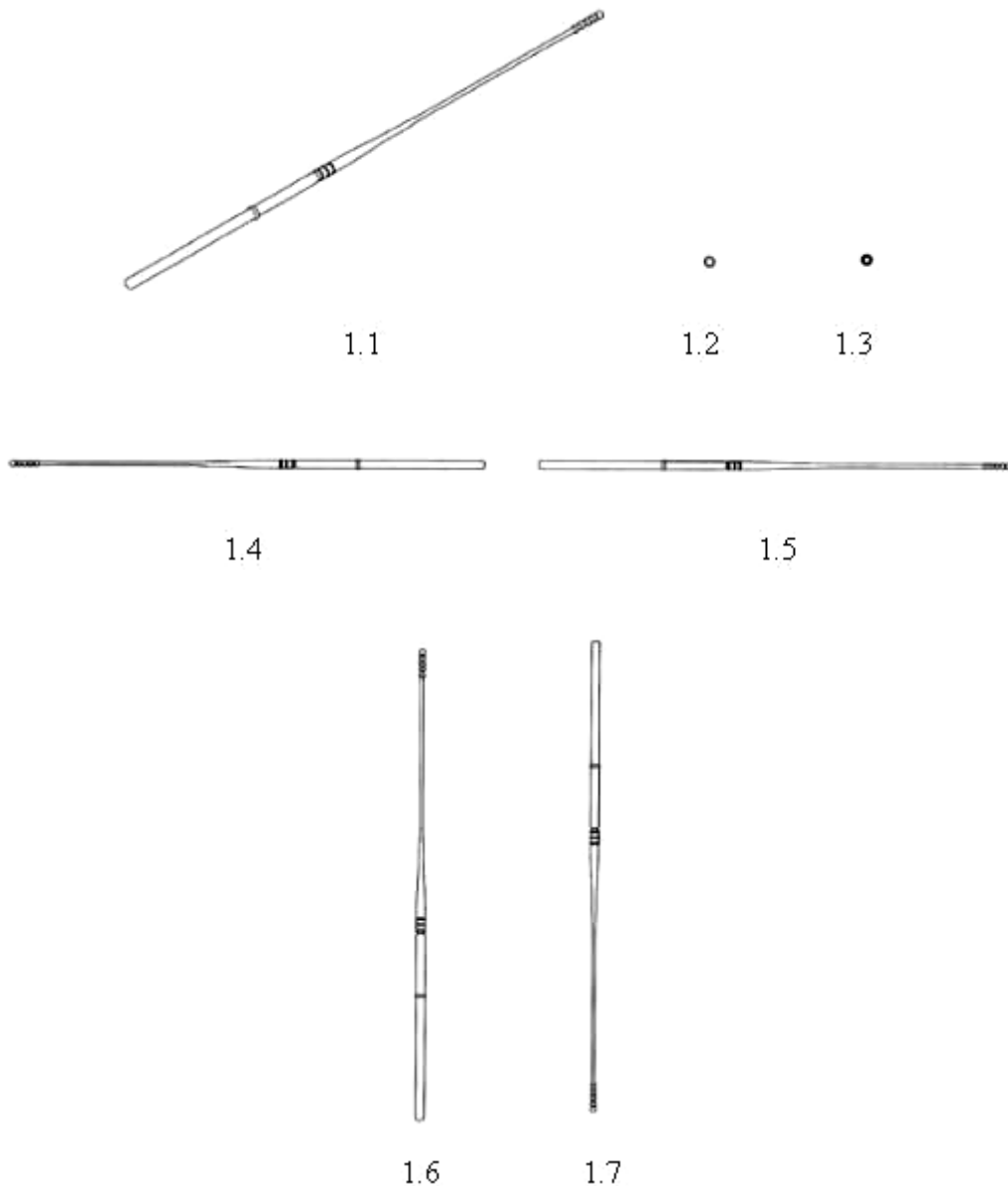

CÔNG BÁO SỞ HỮU CÔNG NGHIỆP SỐ 395 TẬP A – QUYỀN 2 (02.2021)

(11) **40897**

(21) 3-2020-02927

(28) 1

(54) **DÉP**

(51) **02-04**

(22) 03/12/2020

(43) 25/02/2021

(73) **CÔNG TY TNHH GIÀY Á CHÂU (VN)**

451/29/8 Tô Hiến Thành, phường 14, quận 10, thành phố Hồ Chí Minh

(72) Nguyễn Đình Kim (VN)

(74) Văn phòng Luật sư A Hoà (AHOA LAW OFFICE)

(55)



1.1



1.2



1.3



1.4



1.5



1.6



1.7

CÔNG BÁO SỞ HỮU CÔNG NGHIỆP SỐ 395 TẬP A – QUYỀN 2 (02.2021)

- (11) **40898**
(21) 3-2020-02923 (28) 1
(54) **BAO GÓI** (51) **09-05**
(22) 02/12/2020 (43) 25/02/2021
(73) **ORION CORPORATION (KR)**
13, Baekbeom-ro 90da-gil, Yongsan-gu, Seoul 04369, Republic of Korea
(72) 1. LEE, A REUM (KR)
2. CHOE, EUN JE (KR)
(74) Công ty Luật TNHH quốc tế BMVN (BMVN INTERNATIONAL LLC)
(55)



1.1



1.2

CÔNG BÁO SỞ HỮU CÔNG NGHIỆP SỐ 395 TẬP A – QUYỀN 2 (02.2021)

(11) **40899**

(21) 3-2020-02919

(28) 1

(54) **KHÓA KHUÔN TỰ ĐỘNG**

(51) **08-07**

(22) 02/12/2020

(43) 25/02/2021

(73) **CÔNG TY TNHH ĐẦU TƯ SẢN XUẤT THƯƠNG MẠI KIM HUY HOÀNG**
(VN)

211 Trần Nãi, khu phố 3, phường Bình An, quận 2, thành phố Hồ Chí Minh

(72) NGUYỄN THANH MAI (VN)

(74) Công ty TNHH Tư vấn đầu tư và Sở hữu trí tuệ Hoàng Phi (HOANG PHI INVEST & I.P CO., LTD)

(55)

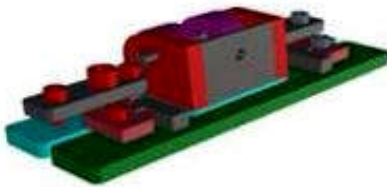

1.1

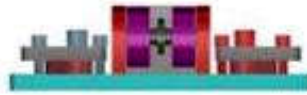

1.2



1.3



1.4



1.5

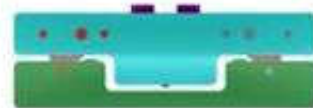

1.6

CÔNG BÁO SỞ HỮU CÔNG NGHIỆP SỐ 395 TẬP A – QUYỀN 2 (02.2021)

(11) **40900**

(21) 3-2020-02918

(28) 1

(54) **KHÓA KHUÔN TỰ ĐỘNG**

(51) **08-07**

(22) 02/12/2020

(43) 25/02/2021

(73) **CÔNG TY TNHH ĐẦU TƯ SẢN XUẤT THƯƠNG MẠI KIM HUY HOÀNG**
(VN)

211 Trần Nãi, khu phố 3, phường Bình An, quận 2, thành phố Hồ Chí Minh

(72) **NGUYỄN THANH MAI (VN)**

(74) Công ty TNHH Tư vấn đầu tư và Sở hữu trí tuệ Hoàng Phi (HOANG PHI INVEST & I.P CO., LTD)

(55)



1.1



1.2



1.3



1.4



1.5



1.6

CÔNG BÁO SỞ HỮU CÔNG NGHIỆP SỐ 395 TẬP A – QUYỀN 2 (02.2021)

- (11) **40901**
(21) 3-2020-02916 (28) 1
(54) **BAO GÓI** (51) **09-05**
(22) 02/12/2020 (43) 25/02/2021
(73) **HỘ KINH DOANH SƠN TÙNG (VN)**
Số 24 An Dương Vương, phường 16, quận 8, thành phố Hồ Chí Minh
(72) Nguyễn Lạc Hoàng Hải (VN)
(55)



1.1



1.2

CÔNG BÁO SỞ HỮU CÔNG NGHIỆP SỐ 395 TẬP A – QUYỀN 2 (02.2021)

(11) **40902**

(21) 3-2020-02915

(28) 1

(54) **BAO GÓI**

(51) **09-05**

(22) 02/12/2020

(43) 25/02/2021

(73) **HỘ KINH DOANH SƠN TÙNG (VN)**

Số 24 An Dương Vương, phường 16, quận 8, thành phố Hồ Chí Minh

(72) Nguyễn Lạc Hoàng Hải (VN)

(55)



1.1



1.2

CÔNG BÁO SỞ HỮU CÔNG NGHIỆP SỐ 395 TẬP A – QUYỀN 2 (02.2021)

- (11) **40903**
(21) 3-2020-02914 (28) 1
(54) **BAO GÓI** (51) **09-05**
(22) 02/12/2020 (43) 25/02/2021
(73) **HỘ KINH DOANH SƠN TÙNG (VN)**
Số 24 An Dương Vương, phường 16, quận 8, thành phố Hồ Chí Minh
(72) Nguyễn Lạc Hoàng Hải (VN)
(55)

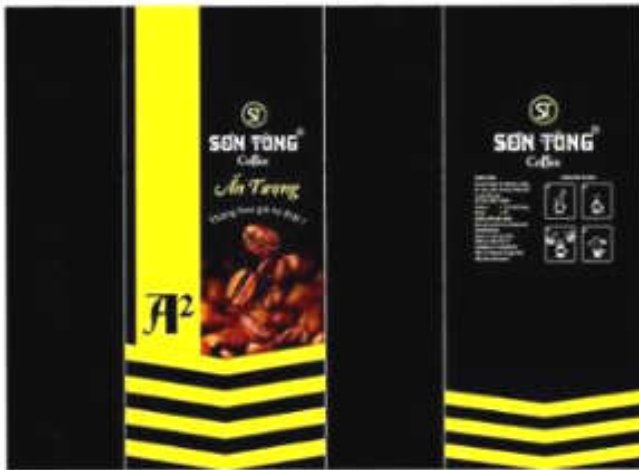

1.1



1.2

CÔNG BÁO SỞ HỮU CÔNG NGHIỆP SỐ 395 TẬP A – QUYỀN 2 (02.2021)

(11) **40904**

(21) 3-2020-02912

(28) 1

(54) **GIÀY**

(51) **02-04**

(22) 01/12/2020

(43) 25/02/2021

CÔNG TY TNHH BÌNH TIÊN BIÊN HÒA (VN)

(73) Lô 101/2 và lô 101/11, khu công nghiệp Amata, phường Long Bình, thành phố Biên Hòa, tỉnh Đồng Nai

(72) Lai Khiêm (VN)

(74) Công ty TNHH Tư vấn sở hữu trí tuệ Việt (VIET IP CO.,LTD.)

(55)



1.1



1.2



1.3



1.4



1.5



1.6



1.7

CÔNG BÁO SỞ HỮU CÔNG NGHIỆP SỐ 395 TẬP A – QUYỀN 2 (02.2021)

(11) **40905**

(21) 3-2020-02911

(28) 1

(54) **GIÀY**

(51) **02-04**

(22) 01/12/2020

(43) 25/02/2021

CÔNG TY TNHH BÌNH TIÊN BIÊN HÒA (VN)

(73) Lô 101/2 và lô 101/11, khu công nghiệp Amata, phường Long Bình, thành phố Biên Hòa, tỉnh Đồng Nai

(72) Lai Khiêm (VN)

(74) Công ty TNHH Tư vấn sở hữu trí tuệ Việt (VIET IP CO.,LTD.)

(55)



1.1



1.2



1.3



1.5



1.4



1.6



1.7

CÔNG BÁO SỞ HỮU CÔNG NGHIỆP SỐ 395 TẬP A – QUYỀN 2 (02.2021)

(11) **40906**

(21) 3-2020-02910

(28) 1

(54) **GIÀY**

(51) **02-04**

(22) 01/12/2020

(43) 25/02/2021

CÔNG TY TNHH BÌNH TIÊN BIÊN HÒA (VN)

(73) Lô 101/2 và lô 101/11, khu công nghiệp Amata, phường Long Bình, thành phố Biên Hòa, tỉnh Đồng Nai

(72) Lai Khiêm (VN)

(74) Công ty TNHH Tư vấn sở hữu trí tuệ Việt (VIET IP CO.,LTD.)

(55)



1.1



1.2



1.3



1.4



1.5



1.6



1.7

CÔNG BÁO SỞ HỮU CÔNG NGHIỆP SỐ 395 TẬP A – QUYỀN 2 (02.2021)

(11) **40907**

(21) 3-2020-02909

(28) 1

(54) **GIÀY**

(51) **02-04**

(22) 01/12/2020

(43) 25/02/2021

CÔNG TY TNHH BÌNH TIÊN BIÊN HÒA (VN)

(73) Lô 101/2 và lô 101/11, khu công nghiệp Amata, phường Long Bình, thành phố Biên Hòa, tỉnh Đồng Nai

(72) Lai Khiêm (VN)

(74) Công ty TNHH Tư vấn sở hữu trí tuệ Việt (VIET IP CO.,LTD.)

(55)



1.1



1.2



1.3



1.5



1.4



1.6



1.7

CÔNG BÁO SỞ HỮU CÔNG NGHIỆP SỐ 395 TẬP A – QUYỀN 2 (02.2021)

(11) **40908**

(21) 3-2020-02908

(28) 1

(54) **GIÀY**

(51) **02-04**

(22) 01/12/2020

(43) 25/02/2021

CÔNG TY TNHH BÌNH TIÊN BIÊN HÒA (VN)

(73) Lô 101/2 và lô 101/11, khu công nghiệp Amata, phường Long Bình, thành phố Biên Hòa, tỉnh Đồng Nai

(72) Lai Khiêm (VN)

(74) Công ty TNHH Tư vấn sở hữu trí tuệ Việt (VIET IP CO.,LTD.)

(55)



1.1



1.2



1.3



1.5



1.4



1.6



1.7

- (11) **40909**
(21) 3-2020-02901 (28) 1
(54) **BAO GÓI TRÀ** (51) **09-05**
(22) 01/12/2020 (43) 25/02/2021
(73) **HỘ KINH DOANH NGUYỄN THỊ MINH (VN)**
772A Trần Phú, phường Lộc Tiến, thành phố Bảo Lộc, tỉnh Lâm Đồng
(72) Nguyễn Thị Minh (VN)
(55)



1.1



1.2

CÔNG BÁO SỞ HỮU CÔNG NGHIỆP SỐ 395 TẬP A – QUYỀN 2 (02.2021)

(11) **40910**

(21) 3-2020-02890

(28) 1

(54) **HỘP**

(51) **09-03**

(22) 01/12/2020

(43) 25/02/2021

CÔNG TY TNHH SẢN XUẤT DƯỢC MỸ PHẨM NHẬT VIỆT KHANG
(VN)

(73) A15 Khu Little Village đường số 22, phường Hiệp Bình Chánh, quận Thủ Đức, thành phố Hồ Chí Minh

(72) Tạ Thị Như Thủy (VN)

(74) CÔNG TY TNHH KHANG LUẬT (KHANGLAW)

(55)

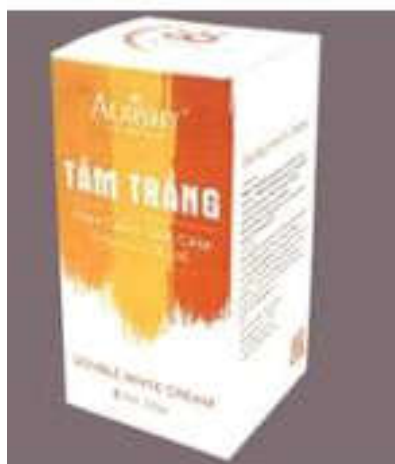

1.1



1.2

- (11) **40911**
(21) 3-2020-02889 (28) 1
(54) **NẮP ĐỒ CHỨA** (51) **09-07**
(22) 30/11/2020 (43) 25/02/2021
(30) 30-2020-0024316 01/06/2020 KR;
BIONLIFESCIENCE CO., LTD. (KR)
(73) (11901) A-601, 19, Sanmaru-ro, Guri-si, Gyeonggi-do, Republic of Korea
1. GOH, CHANG WOOK (KR)
(72) 2. KIM, BONG YOON (KR)
3. JEONG, JOONG HWAN (KR)
(74) Công ty TNHH Trường Xuân (AGELESS CO.,LTD.)
(55)

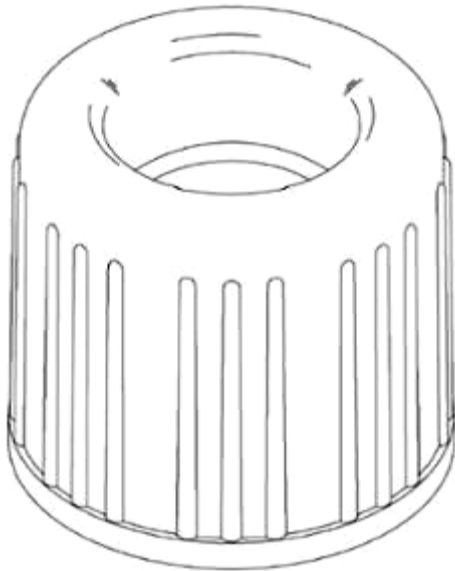

1.1

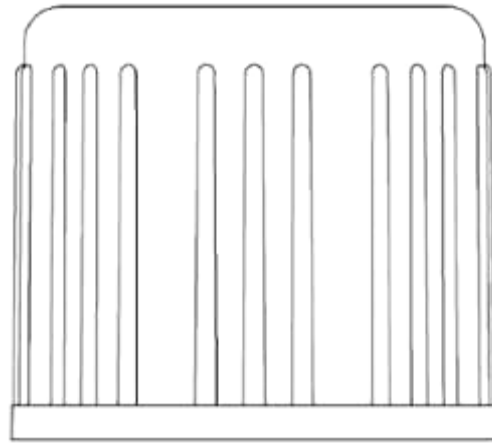

1.2

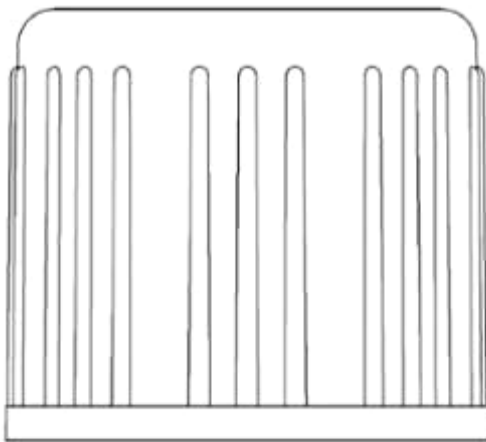

1.3

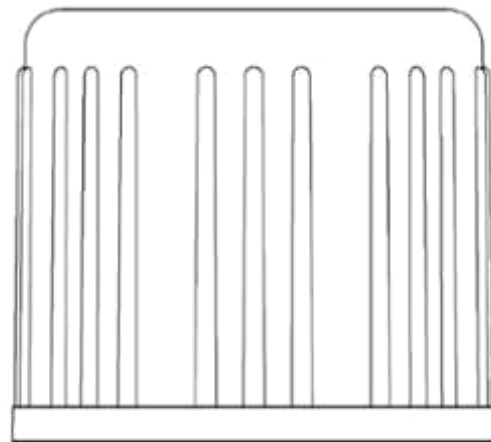

1.4

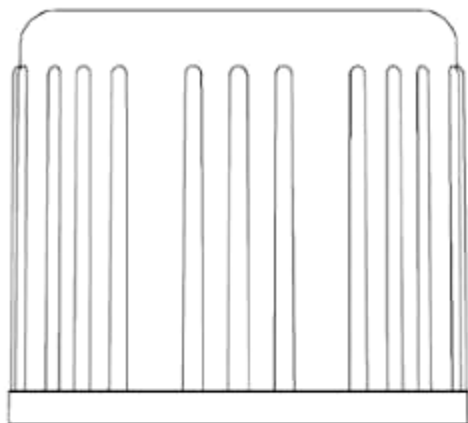

1.5

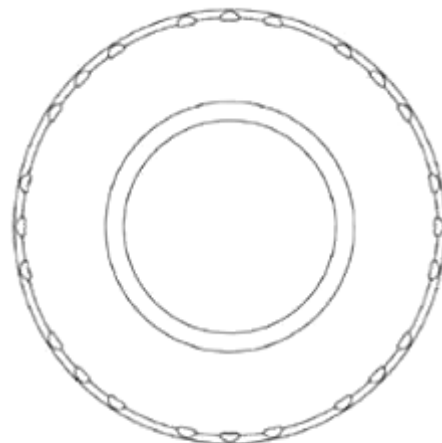

1.6

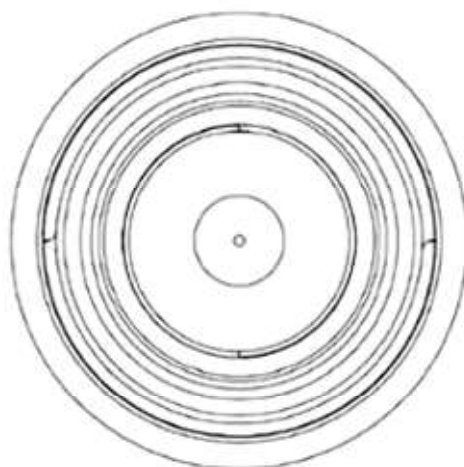

1.7

- (11) **40912**
(21) 3-2020-02888 (28) 1
(54) **NẮP ĐỒ CHỨA** (51) **09-07**
(22) 30/11/2020 (43) 25/02/2021
(30) 30-2020-0024315 01/06/2020 KR;
BIONLIFESCIENCE CO., LTD. (KR)
(73) (11901) A-601, 19, Sanmaru-ro, Guri-si, Gyeonggi-do, Republic of Korea
1. GOH, CHANG WOOK (KR)
(72) 2. KIM, BONG YOON (KR)
3. JEONG, JOONG HWAN (KR)
(74) Công ty TNHH Trường Xuân (AGELESS CO.,LTD.)
(55)

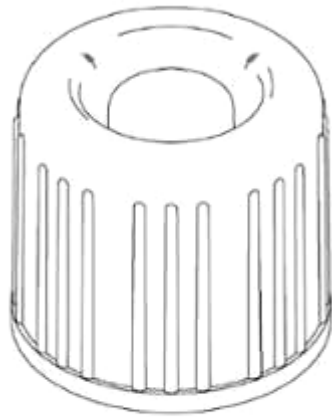

1.1

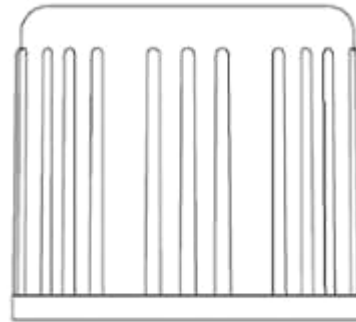

1.2

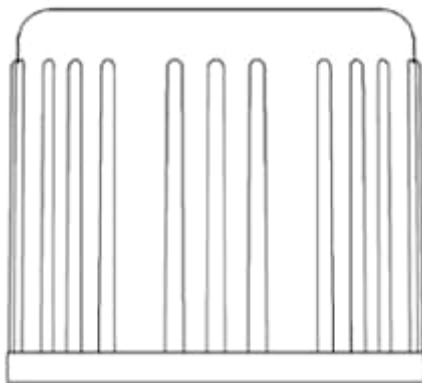

1.3

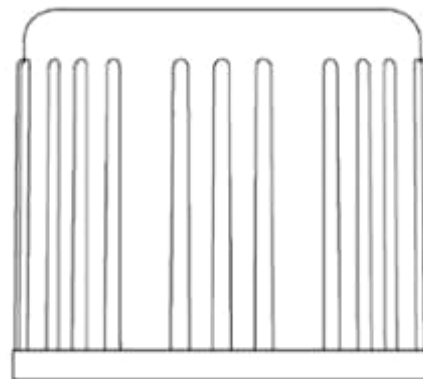

1.4

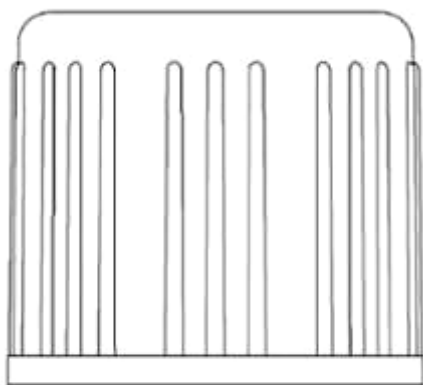

1.5

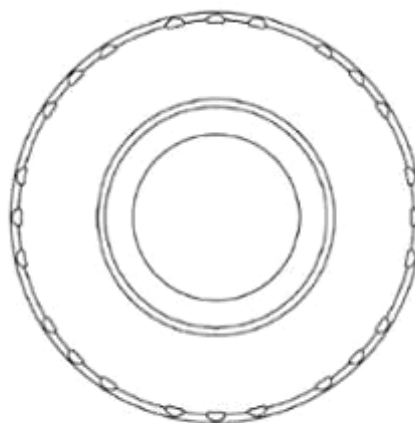

1.6

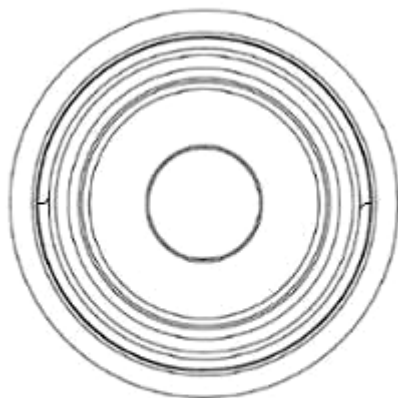

1.7

CÔNG BÁO SỞ HỮU CÔNG NGHIỆP SỐ 395 TẬP A – QUYỀN 2 (02.2021)

- (11) **40913**
(21) 3-2020-02887 (28) 1
(54) **HỘP ĐỰNG** (51) **09-03**
(22) 30/11/2020 (43) 25/02/2021
SMSBIO CO., LTD. (KR)
(73) B Dong, 87-8, Geumbok-gil, Jeongnam-myeon, Hwaseong-si, Gyeonggi-do 18513 Republic of Korea
(72) LEE, Ban Seok (KR)
(74) CÔNG TY LUẬT TRÁCH NHIỆM HỮU HẠN AMBYS HÀ NỘI (AMBYS HANOI)
(55)



1.1



1.2



1.3

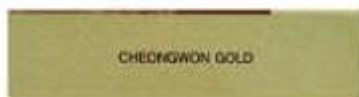

1.4



1.5



1.6



1.7

CÔNG BÁO SỞ HỮU CÔNG NGHIỆP SỐ 395 TẬP A – QUYỀN 2 (02.2021)

(11) **40914**

(21) 3-2020-02886

(28) 1

(54) **HỘP ĐỰNG**

(51) **09-03**

(22) 30/11/2020

(43) 25/02/2021

SMSBIO CO., LTD. (KR)

(73) B Dong, 87-8, Geumbok-gil, Jeongnam-myeon, Hwaseong-si, Gyeonggi-do 18513 Republic of Korea

(72) LEE, Ban Seok (KR)

(74) CÔNG TY LUẬT TRÁCH NHIỆM HỮU HẠN AMBYS HÀ NỘI (AMBYS HANOI)

(55)



1.1



1.2



1.3



1.4



1.5



1.6



1.7

CÔNG BÁO SỞ HỮU CÔNG NGHIỆP SỐ 395 TẬP A – QUYỀN 2 (02.2021)

(11) **40915**

(21) 3-2020-02885

(28) 1

(54) **HỘP ĐỰNG**

(51) **09-03**

(22) 30/11/2020

(43) 25/02/2021

SMSBIO CO., LTD. (KR)

(73) B Dong, 87-8, Geumbok-gil, Jeongnam-myeon, Hwaseong-si, Gyeonggi-do 18513
Republic of Korea

(72) LEE, Ban Seok (KR)

(74) **CÔNG TY LUẬT TRÁCH NHIỆM HỮU HẠN AMBYS HÀ NỘI (AMBYS
HANOI)**

(55)



1.1



1.2



1.3



1.4



1.5



1.6

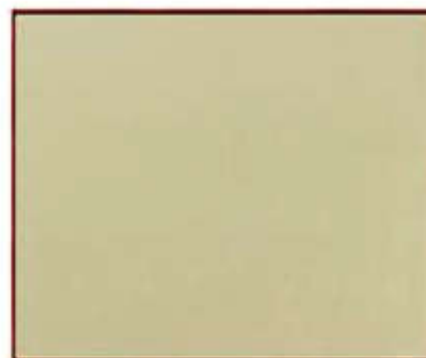

1.7

- (11) **40916**
(21) 3-2020-02883 (28) 1
(54) **HỘP ĐỰNG THUỐC** (51) **09-03**
(22) 30/11/2020 (43) 25/02/2021
VŨ THỊ PHƯƠNG (VN)
(73) Khu DT Dệt May, phường Năng Tĩnh, thành phố Nam Định, tỉnh Nam Định
(72) Vũ Thị Phương (VN)
(55)



1.1



1.2

- (11) **40917**
(21) 3-2020-02882 (28) 1
(54) **HỘP ĐỰNG THUỐC** (51) **09-03**
(22) 30/11/2020 (43) 25/02/2021
(73) **VŨ THỊ PHƯƠNG (VN)**
Khu ĐT Dệt May, phường Năng Tĩnh, thành phố Nam Định, tỉnh Nam Định
(72) Vũ Thị Phương (VN)
(55)



1.1



1.2

- (11) **40918**
(21) 3-2020-02881 (28) 1
(54) **HỘP ĐỰNG THUỐC** (51) **09-03**
(22) 30/11/2020 (43) 25/02/2021
VŨ THỊ PHƯƠNG (VN)
(73) Khu ĐT Dệt May, phường Năng Tĩnh, thành phố Nam Định, tỉnh Nam Định
(72) Vũ Thị Phương (VN)
(55)



1.1



1.2

- (11) **40919**
(21) 3-2020-02880 (28) 1
(54) **HỘP ĐỰNG THUỐC** (51) **09-03**
(22) 30/11/2020 (43) 25/02/2021
VŨ THỊ PHƯƠNG (VN)
(73) Khu ĐT Dệt May, phường Năng Tĩnh, thành phố Nam Định, tỉnh Nam Định
(72) Vũ Thị Phương (VN)
(55)



1.1



1.2

- (11) **40920**
(21) 3-2020-02879 (28) 1
(54) **HỘP ĐỰNG THUỐC** (51) **09-03**
(22) 30/11/2020 (43) 25/02/2021
VŨ THỊ PHƯƠNG (VN)
(73) Khu ĐT Dệt May, phường Năng Tĩnh, thành phố Nam Định, tỉnh Nam Định
(72) Vũ Thị Phương (VN)
(55)



1.1



1.2

CÔNG BÁO SỞ HỮU CÔNG NGHIỆP SỐ 395 TẬP A – QUYỀN 2 (02.2021)

- (11) **40921**
(21) 3-2020-02871 (28) 1
(54) **HỘP ĐỰNG THIẾT BỊ ĐIỀU KHIỂN** (51) **13-03**
(22) 27/11/2020 (43) 25/02/2021
(73) **CÔNG TY CỔ PHẦN BREEDLIFE (VN)**
Số 12 lô E, đường Vạn Phúc, phường Liễu Giai, quận Ba Đình, thành phố Hà Nội
(72) Nguyễn Đạo Hưng (VN)
(74) Công ty TNHH Tư vấn đầu tư và Sở hữu trí tuệ Hoàng Phi (HOANG PHI INVEST & I.P CO., LTD)
(55)

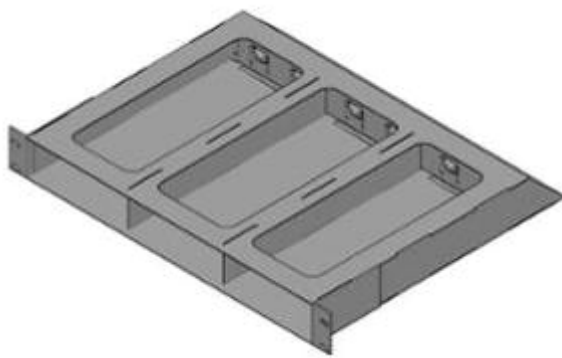

1.1



1.2



1.3



1.4

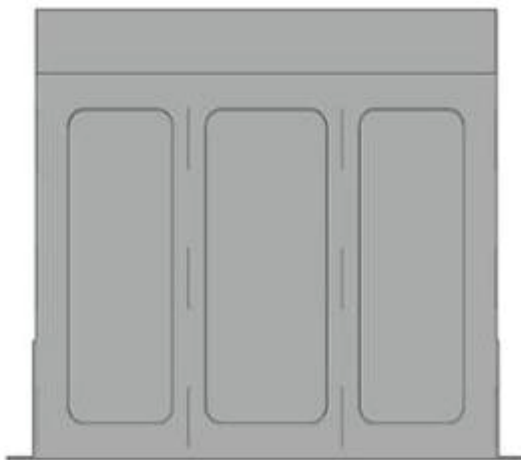

1.5

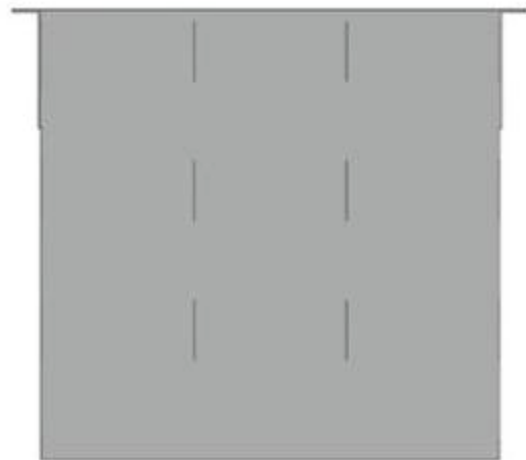

1.6

(11) **40922**

(21) 3-2020-02867

(28) 1

(54) **ĐÈN LED**

(51) **26-05**

(22) 27/11/2020

(43) 25/02/2021

**CÔNG TY CỔ PHẦN CÔNG NGHIỆP VÀ THIẾT BỊ CHIẾU SÁNG
DUHAL (VN)**

(73) Lô 30-31, cụm công nghiệp Tân Mỹ Chánh, phường 9, thành phố Mỹ Tho, tỉnh Tiền Giang

(72) Đỗ Lâm (VN)

(74) Công ty Cổ phần Sở hữu công nghiệp INVESTIP (INVESTIP)

(55)

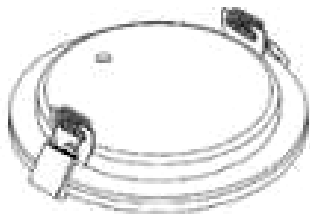

1.1



1.2



1.3

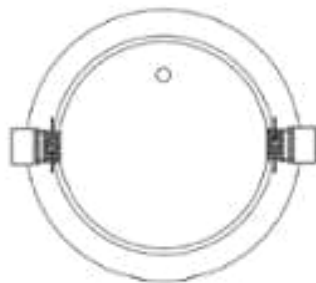

1.4

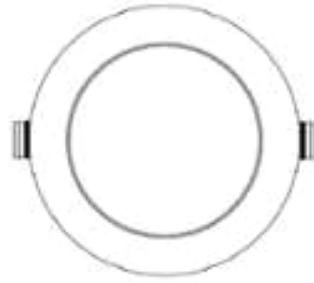

1.5

(11) **40923**

(21) 3-2020-02866

(28) 1

(54) **ĐÈN LED**

(51) **26-05**

(22) 27/11/2020

(43) 25/02/2021

**CÔNG TY CỔ PHẦN CÔNG NGHIỆP VÀ THIẾT BỊ CHIẾU SÁNG
DUHAL (VN)**

(73) Lô 30-31, cụm công nghiệp Tân Mỹ Chánh, phường 9, thành phố Mỹ Tho, tỉnh Tiền Giang

(72) Đỗ Lâm (VN)

(74) Công ty Cổ phần Sở hữu công nghiệp INVESTIP (INVESTIP)

(55)

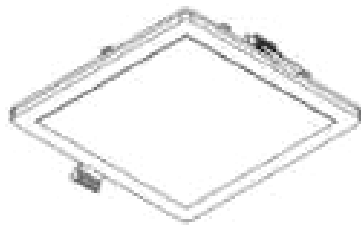

1.1



1.2



1.3

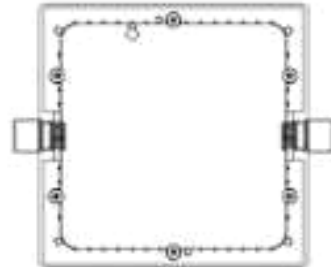

1.4

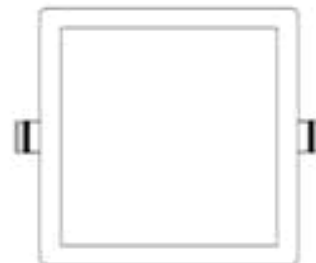

1.5

CÔNG BÁO SỞ HỮU CÔNG NGHIỆP SỐ 395 TẬP A – QUYỀN 2 (02.2021)

- (11) **40924**
- (21) 3-2020-02864 (28) 1
- (54) **NHÃN SẢN PHẨM** (51) **19-08**
- (22) 27/11/2020 (43) 25/02/2021
- CƠ SỞ GIẤY NHẬT XIÊM (VN)**
- (73) Khu Dương Ổ, phường Phong Khê, thành phố Bắc Ninh, tỉnh Bắc Ninh
- (72) Nguyễn Văn Nhật (VN)
- (55)



CÔNG BÁO SỞ HỮU CÔNG NGHIỆP SỐ 395 TẬP A – QUYỀN 2 (02.2021)

- (11) **40925**
(21) 3-2020-02852 (28) 1
(54) **HỘP** (51) **09-03**
(22) 26/11/2020 (43) 25/02/2021
(73) **HỢP TÁC XÃ CAM SÀNH PHÚ NÔNG (VN)**
Số 18, ấp Trường Nghĩa, xã Thới Hòa, huyện Trà Ôn, tỉnh Vĩnh Long
(72) Nguyễn Thanh Trúc (VN)
(55)



1.1



1.2

- (11) **40926**
(21) 3-2020-02848 (28) 1
(54) **Ô TÔ ĐỒ CHƠI** (51) **21-01**
(22) 25/11/2020 (43) 25/02/2021
(30) 007968094 26/05/2020 EM;
(73) **FERRARI S.P.A. (IT)**
Via Emilia Est 1163, MODENA, Italy
(72) Flavio MANZONI (IT)
(74) Công ty TNHH một thành viên Sở hữu trí tuệ VCCI (VCCI-IP CO.,LTD)
(55)



1.1



1.2



1.3

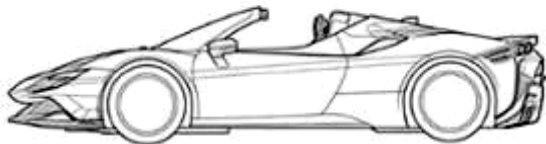

1.4

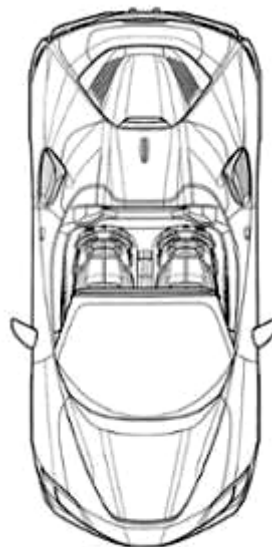

1.5

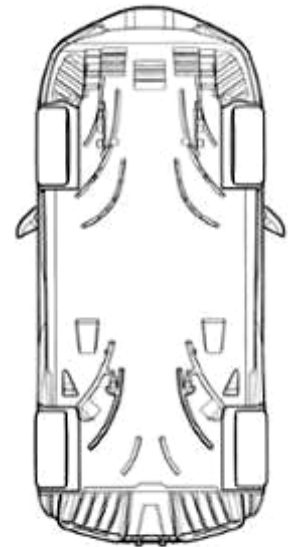

1.6

CÔNG BÁO SỞ HỮU CÔNG NGHIỆP SỐ 395 TẬP A – QUYỀN 2 (02.2021)

- (11) **40927**
- (21) 3-2020-02847
- (54) **Ô TÔ**
- (22) 25/11/2020
- (30) 007971676 26/05/2020 EM;
- (73) **FERRARI S.P.A. (IT)**
Via Emilia Est 1163, MODENA, Italy
- (72) Flavio MANZONI (IT)
- (74) Công ty TNHH một thành viên Sở hữu trí tuệ VCCI (VCCI-IP CO.,LTD)
- (55)

- (28) 1
- (51) **12-08**
- (43) 25/02/2021



1.1



1.2

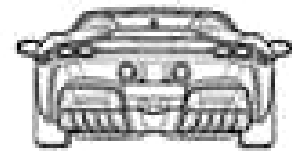

1.3

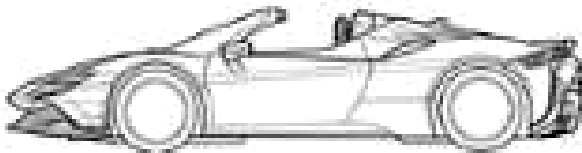

1.4

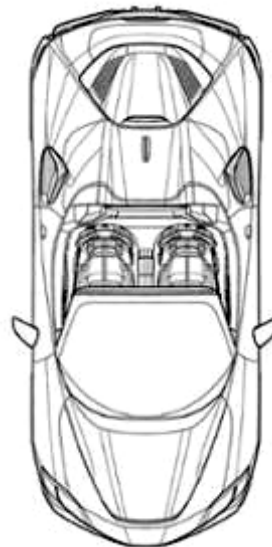

1.5

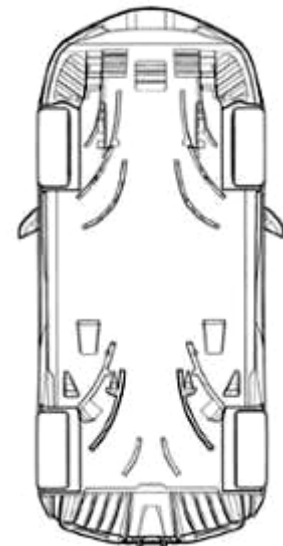

1.6

CÔNG BÁO SỞ HỮU CÔNG NGHIỆP SỐ 395 TẬP A – QUYỀN 2 (02.2021)

- (11) **40928**
(21) 3-2020-02846 (28) 1
(54) **MÁY BÁN THỰC PHẨM MÁT** (51) **20-02**
(22) 25/11/2020 (43) 25/02/2021
(73) **CÔNG TY CỔ PHẦN RYNAN TECHNOLOGIES VIETNAM (VN)**
Ấp Long Trị, xã Long Đức, thành phố Trà Vinh, tỉnh Trà Vinh
1. NGUYỄN THANH MỸ (VN)
2. TRẦN QUỐC TOẢN (VN)
3. HỒNG QUỐC CƯỜNG (VN)
4. NGUYỄN MINH CHÂU (VN)
5. ĐÀO THANH TUẤN (VN)
(72) 6. VÕ VŨ KHANH (VN)
7. PHẠM THÁI BÌNH (VN)
8. TÔ HUỖNH NGỌC DUY (VN)
9. VÕ QUỐC VIỆT (VN)
10. BÙI TẤN ĐẠT (VN)
11. NGUYỄN ANH THÔNG (VN)
12. NGUYỄN KHẮC NHỰT (VN)
(74) Công ty TNHH Đại Tín và Liên Danh (DAITIN AND ASSOCIATES CO.,LTD)
(55)

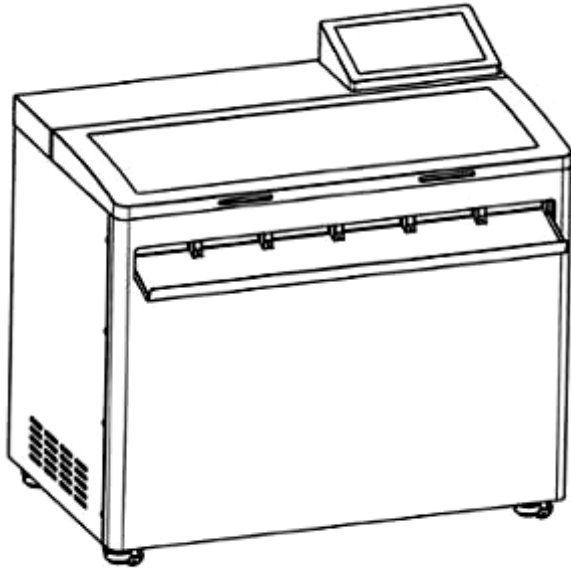

1.1

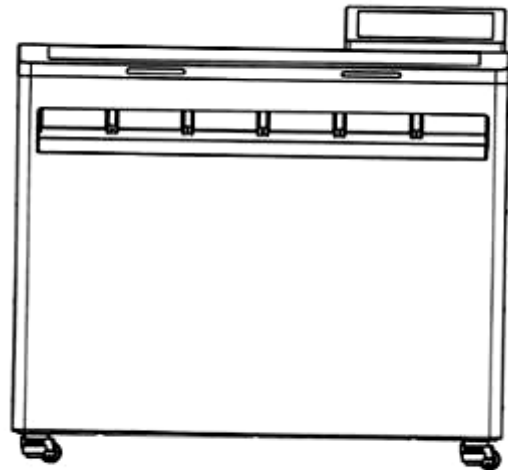

1.2

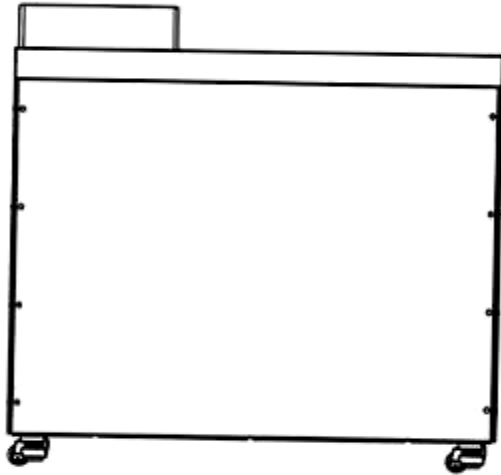

1.3

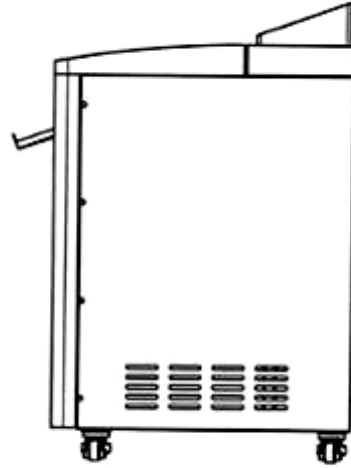

1.4

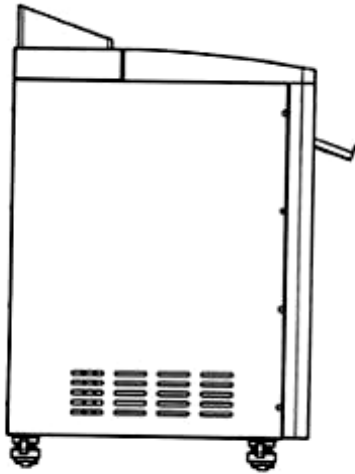

1.5

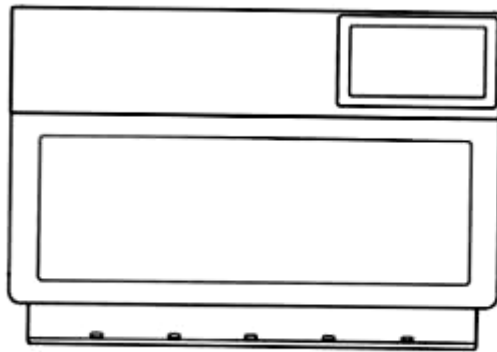

1.6

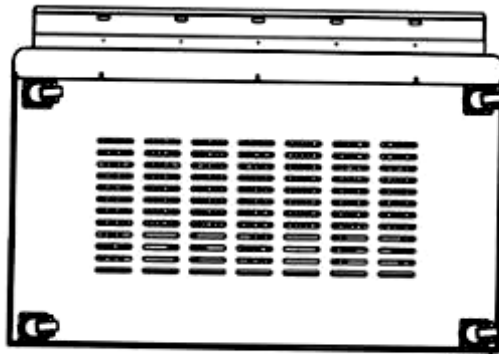

1.7

CÔNG BÁO SỞ HỮU CÔNG NGHIỆP SỐ 395 TẬP A – QUYỀN 2 (02.2021)

(11) **40929**

(21) 3-2020-02834

(28) 1

(54) **HỘP**

(51) **09-03**

(22) 24/11/2020

(43) 25/02/2021

CÔNG TY TNHH DƯỢC PHẨM MEPHARCO (VN)

(73) Số 45, ngõ 175/5, phố Định Công, phường Định Công, quận Hoàng Mai, thành phố Hà Nội

(72) Nguyễn Thế Toàn (VN)

(74) Công ty TNHH Sở hữu trí tuệ PADEMARK (PADEMARK CO.,LTD.)

(55)



1.1



1.2

(11) **40930**

(21) 3-2020-02833

(28) 1

(54) **NẮP HỘP ĐỰNG KHĂN ƯỚT**

(51) **09-07**

(22) 24/11/2020

(43) 25/02/2021

NGUYỄN THỊ MAI DUNG (VN)

(73) 985/11 Hương lộ 2, khu phố 8, phường Bình Trị Đông A, quận Bình Tân, thành phố Hồ Chí Minh

(72) Nguyễn Thị Mai Dung (VN)

(55)



1.1



1.2



1.3



1.4



1.5



1.6



17

(11) **40931**

(21) 3-2020-02829

(28) 3

(54) **ĐÈN ÓP TRẦN**

(51) **26-05**

(22) 24/11/2020

(43) 25/02/2021

CÔNG TY CỔ PHẦN BÓNG ĐÈN PHÍCH NƯỚC RẠNG ĐÔNG (VN)

(73) 87-89 phố Hạ Đình, phường Thanh Xuân Trung, quận Thanh Xuân, thành phố Hà Nội

(72) Trần Trung Tường (VN)

(55)



1.1



1.2



1.3

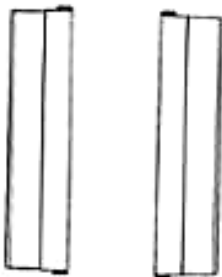

1.4

1.5

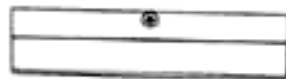

1.6



1.7



2.1

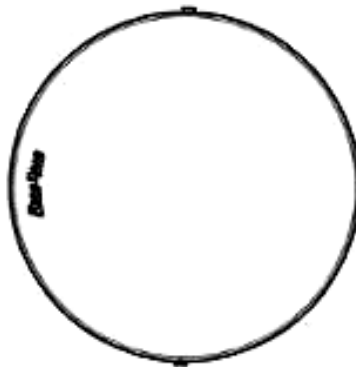

2.2



2.3

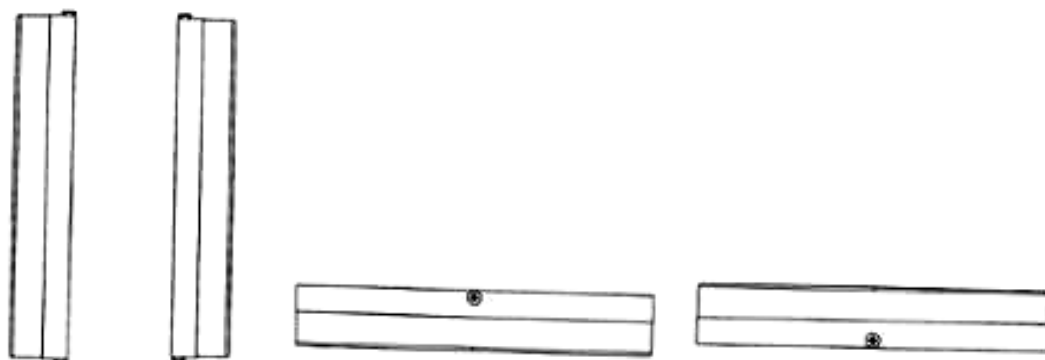

2.4

2.5

2.6

2.7



3.1

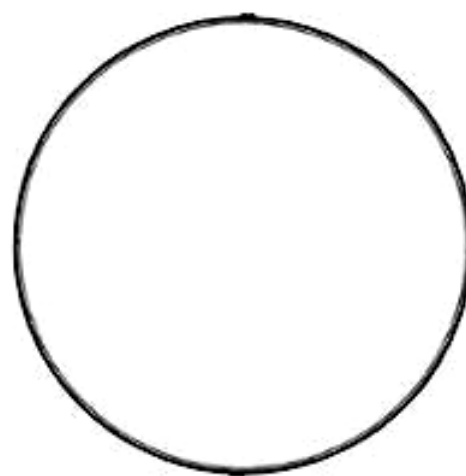

3.2

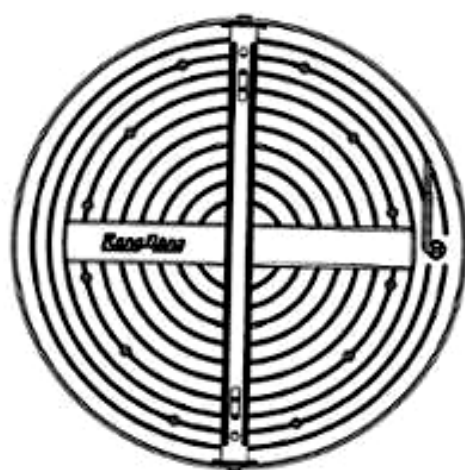

3.3

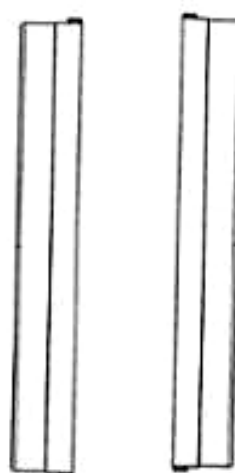

3.4

3.5



3.6



3.7

(11) **40932**

(21) 3-2020-02828

(28) 3

(54) **ĐÈN ÓP TRẦN**

(51) **26-05**

(22) 24/11/2020

(43) 25/02/2021

CÔNG TY CỔ PHẦN BÓNG ĐÈN PHÍCH NƯỚC RẠNG ĐÔNG (VN)

(73) 87-89 phố Hạ Đình, phường Thanh Xuân Trung, quận Thanh Xuân, thành phố Hà Nội

(72) Trần Trung Tường (VN)

(55)

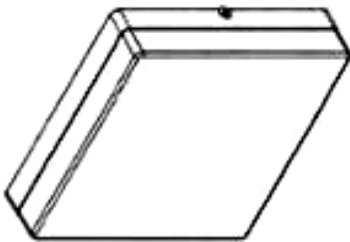

1.1

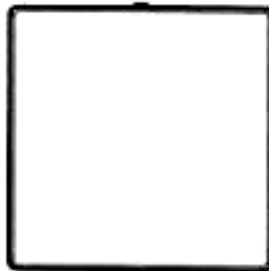

1.2



1.3



1.4



1.5



1.6



1.7

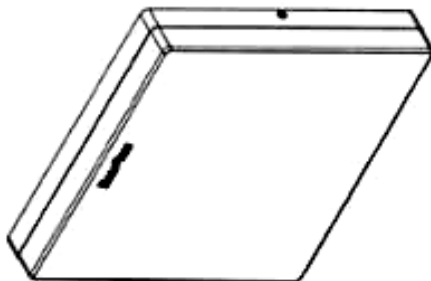

2.1



2.2



2.3



2.4



2.5

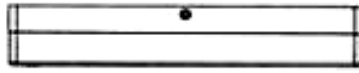

2.6

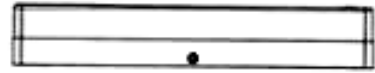

2.7

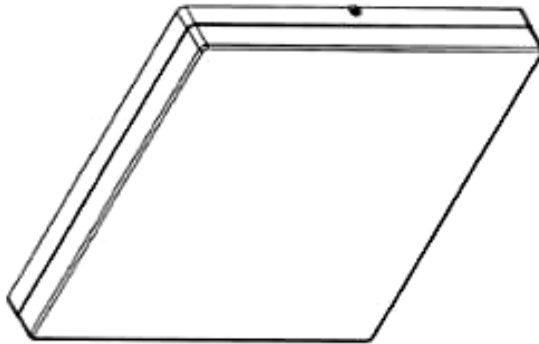

3.1

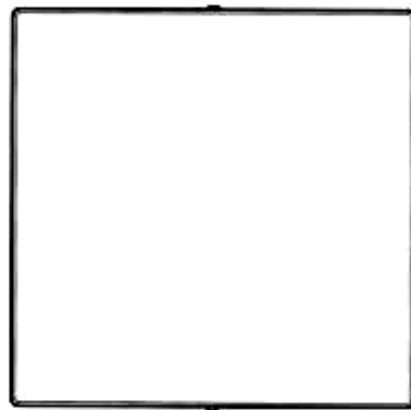

3.2

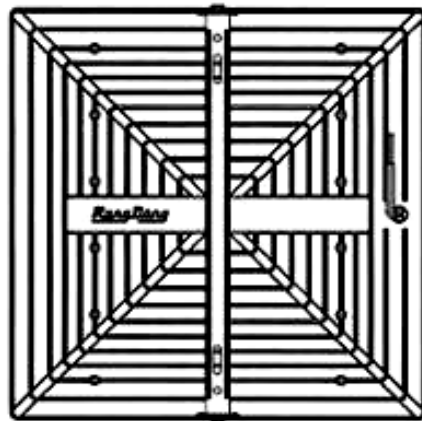

3.3



3.4



3.5

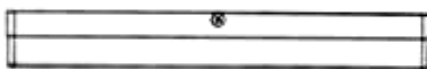

3.6



3.7

(11) **40933**

(21) 3-2020-02827

(28) 1

(54) **BAO GÓI**

(51) **09-05**

(22) 23/11/2020

(43) 25/02/2021

CÔNG TY CỔ PHẦN BÁNH KẸO HẢI HÀ (VN)

(73) Số 25-27 đường Trương Định, phường Trương Định, quận Hai Bà Trưng, thành phố Hà Nội

(72) Bùi Thị Thanh Hương (VN)

(74) Công ty TNHH Sở hữu trí tuệ INNETCO-Hoàng Phúc (INNETCO CO., LTD)

(55)



1.1



1.2

CÔNG BÁO SỞ HỮU CÔNG NGHIỆP SỐ 395 TẬP A – QUYỀN 2 (02.2021)

(11) **40934**

(21) 3-2020-02826

(28) 1

(54) **BAO GÓI**

(51) **09-05**

(22) 23/11/2020

(43) 25/02/2021

CÔNG TY CỔ PHẦN THỰC PHẨM THIÊN HƯƠNG (VN)

(73) Số 1, đường Lê Đức Thọ, khu phố 2, phường Tân Thới Hiệp, quận 12, thành phố Hồ Chí Minh

(72) Nguyễn Văn Hà (VN)

(74) Công ty TNHH Tâm nhìn và Liên danh (VISION & ASSOCIATES CO.LTD.)

(55)



1.1



1.2

CÔNG BÁO SỞ HỮU CÔNG NGHIỆP SỐ 395 TẬP A – QUYỀN 2 (02.2021)

- (11) **40935**
(21) 3-2020-02824 (28) 1
(54) **ĐẠI KHỞI THỦY TÍCH HỢP VAN** (51) **23-01**
(22) 23/11/2020 (43) 25/02/2021
(73) **CÔNG TY TRÁCH NHIỆM HỮU HẠN THẢO TÍN VŨ (VN)**
131/1 Lê Lợi, phường 3, quận Gò Vấp, thành phố Hồ Chí Minh
(72) Nguyễn Hồng Cẩm Yên (VN)
(74) Công ty Cổ phần Sở hữu công nghiệp INVESTIP (INVESTIP)
(55)



1.1



1.2



1.3



1.4



1.5



1.6



1.7

CÔNG BÁO SỞ HỮU CÔNG NGHIỆP SỐ 395 TẬP A – QUYỀN 2 (02.2021)

- (11) **40936**
(21) 3-2020-02823 (28) 1
(54) **BAO GÓI BỘT NGŨ CỐC** (51) **09-05**
(22) 23/11/2020 (43) 25/02/2021
CÔNG TY TRÁCH NHIỆM HỮU HẠN THANH AN (VN)
(73) P809 tầng 8, tòa nhà Plaschem, số 562 đường Nguyễn Văn Cừ, phường Gia Thụy, quận Long Biên, thành phố Hà Nội
(72) Tạ Bá Thuyết (VN)
(74) Công ty TNHH Sở hữu trí tuệ và Công nghệ Thủ đô (CAPITAL IP&T CO.LTD.)
(55)



1.1



1.2

- (11) 40937
(21) 3-2020-02822 (28) 2
(54) **BAO GÓI YẾN MẠCH** (51) **09-05**
(22) 23/11/2020 (43) 25/02/2021
CÔNG TY TRÁCH NHIỆM HỮU HẠN THANH AN (VN)
(73) P809 tầng 8, tòa nhà Plaschem, số 562 đường Nguyễn Văn Cừ, phường Gia Thụy, quận Long Biên, thành phố Hà Nội
(72) Tạ Bá Thuyết (VN)
(74) Công ty TNHH Sở hữu trí tuệ và Công nghệ Thủ đô (CAPITAL IP&T CO.LTD.)
(55)



1.1



1.2



2.1



2.2

- (11) **40938**
(21) 3-2020-02819 (28) 1
(54) **MIẾNG DÁN DA** (51) **28-03**
(22) 20/11/2020 (43) 25/02/2021
(30) 30-2020-0022153 20/05/2020 KR;
CLASSYS INC. (KR)
(73) 240, Teheran-ro, Gangnam-gu, Seoul, 06221, Korea (South)
(72) Sin Woo PARK (KR)
(74) Văn phòng Luật sư Ân Nam (ANNAM IP & LAW)
(55)



1.1

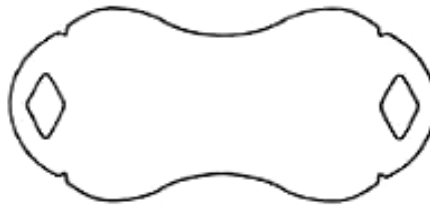

1.2



1.3



1.4



1.5



1.6



1.7

CÔNG BÁO SỞ HỮU CÔNG NGHIỆP SỐ 395 TẬP A – QUYỀN 2 (02.2021)

- (11) **40939**
- (21) 3-2020-02818 (28) 1
- (54) **NHÃN SẢN PHẨM** (51) **19-08**
- (22) 20/11/2020 (43) 25/02/2021
- CÔNG TY TNHH CHEMLUBE VIỆT NAM (VN)**
- (73) Số 35, phố Trúc Bạch, Phường Trúc Bạch, Quận Ba Đình, Thành phố Hà Nội
- (72) Đặng Thị Huỳnh Nga (VN)
- (74) Công ty TNHH Tư vấn đầu tư và Sở hữu trí tuệ Hoàng Phi (HOANG PHI INVEST & I.P CO., LTD)
- (55)



(11) **40940**

(21) 3-2020-02806

(28) 1

(54) **THIẾT BỊ HÚT MÙI TRONG NHÀ BẾP**

(51) **23-04**

(22) 19/11/2020

(43) 25/02/2021

CÔNG TY TNHH ONP - VIỆT NAM (VN)

(73) Số 38, đường Hàm Nghi, khu phố Thiên Bình, phường Tam Phước, thành phố Biên Hoà, tỉnh Đồng Nai

(72) Patrick Floyd Mcneal (US)

(74) Công ty TNHH Tư vấn sở hữu trí tuệ Việt (VIET IP CO.,LTD.)

(55)

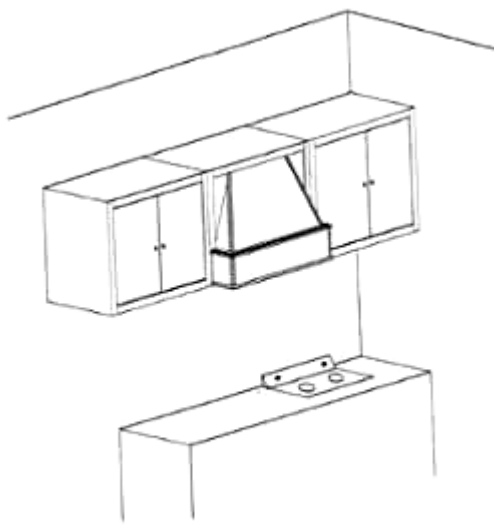

1.1

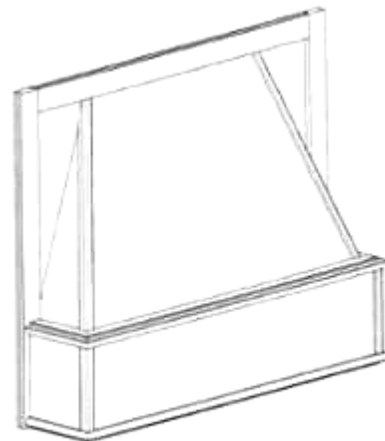

1.2

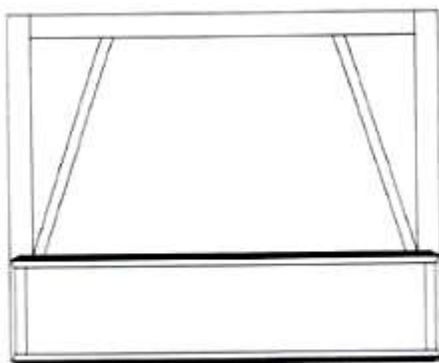

1.3

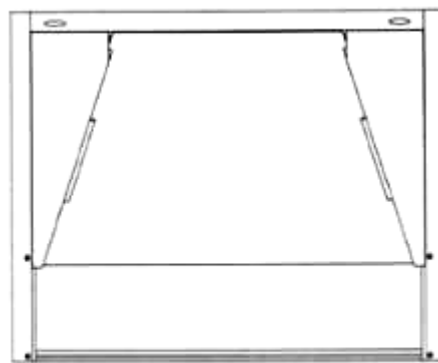

1.4



1.5



1.6



1.7

CÔNG BÁO SỞ HỮU CÔNG NGHIỆP SỐ 395 TẬP A – QUYỀN 2 (02.2021)

- (11) **40941**
(21) 3-2020-02805 (28) 1
(54) **NHÃN SẢN PHẨM** (51) **19-08**
(22) 19/11/2020 (43) 25/02/2021
(73) **CÔNG TY TNHH HUDOCO VIỆT NAM (VN)**
Thôn Minh Hoà 4, xã Minh Khai, huyện Hoài Đức, thành phố Hà Nội
(72) **Đỗ Thị Thắng (VN)**
(74) Công ty TNHH Sở hữu trí tuệ HA VIP (HAVIP CO., LTD.)
(55)



(11) **40942**

(21) 3-2020-02804

(54) **MÁY HÀN TỰ ĐỘNG**

(22) 19/11/2020

(73) **CÔNG TY TNHH BẢO CHI (VN)**

(73) Tổ 7, thị trấn Chi Đông, huyện Mê Linh, thành phố Hà Nội

(72) Hoàng Anh Dũng (VN)

(74) Công ty Luật TNHH Việt An (VIET AN LAW FIRM)

(55)

(28) 1

(51) **15-09**

(43) 25/02/2021

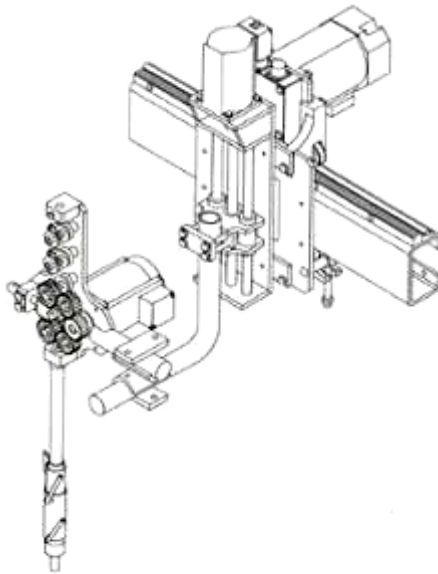

1.1

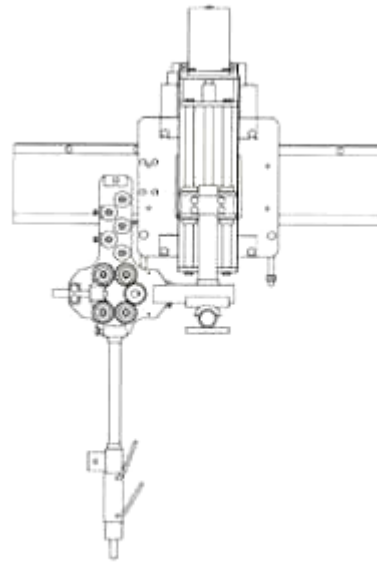

1.2

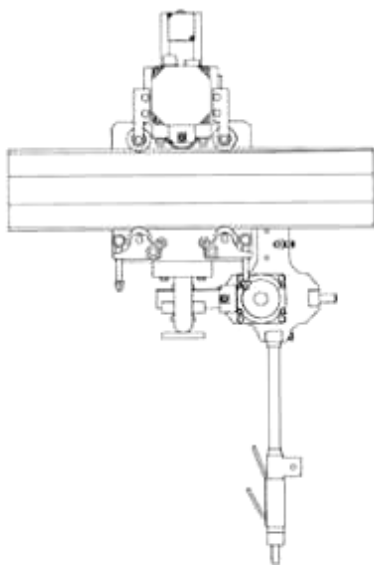

1.3

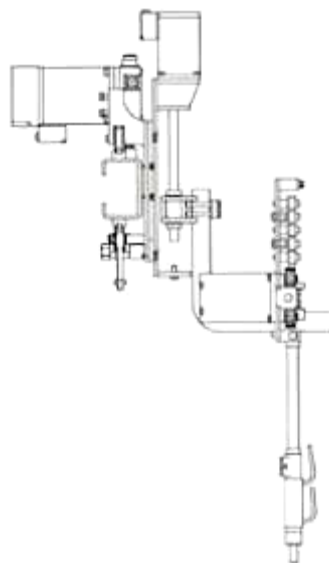

1.4

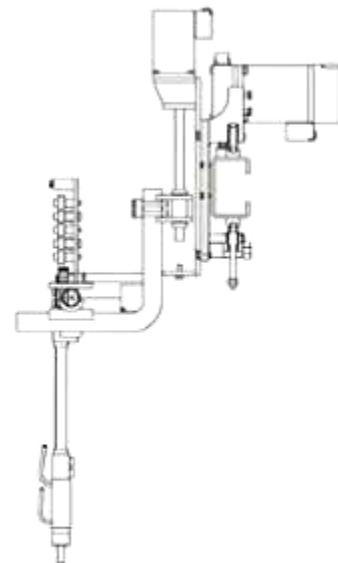

1.5

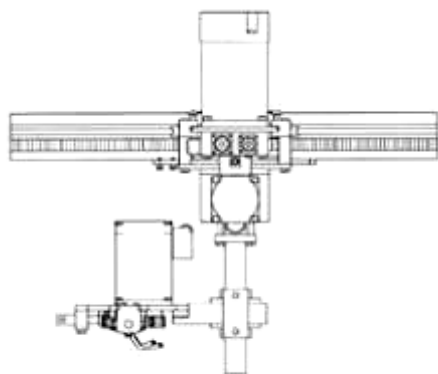

1.6

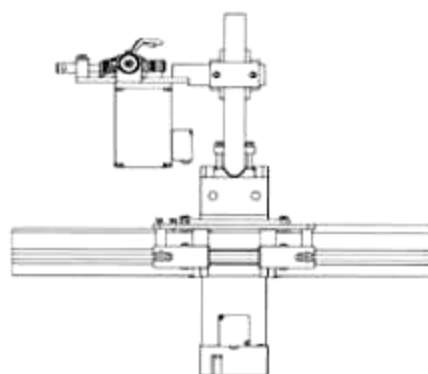

1.7

CÔNG BÁO SỞ HỮU CÔNG NGHIỆP SỐ 395 TẬP A – QUYỀN 2 (02.2021)

- (11) **40943**
(21) 3-2020-02796 (28) 1
(54) **NHÃN SẢN PHẨM** (51) **19-08**
(22) 18/11/2020 (43) 25/02/2021
CÔNG TY CỔ PHẦN BIA QUỐC TẾ SÀI GÒN HÀ NỘI (VN)
(73) Số 132 Nguyễn Tuân, phường Thanh Xuân Trung, quận Thanh Xuân, thành phố Hà Nội
(72) Nguyễn Thị Thắm (VN)
(74) Công ty TNHH Sở hữu trí tuệ Bình Minh (SUNRISE IP CO.,LTD.)
(55)



CÔNG BÁO SỞ HỮU CÔNG NGHIỆP SỐ 395 TẬP A – QUYỀN 2 (02.2021)

- (11) **40944**
(21) 3-2020-02788 (28) 1
(54) **MŨI ÉP ĐẤT TẠO LỖ ĐỒ BÊ TÔNG** (51) **08-01**
(22) 16/11/2020 (43) 25/02/2021
(73) **ĐỒNG QUANG THÀ (VN)**
Áp 7, xã Vị Trung, huyện Vị Thủy, tỉnh Hậu Giang
(72) Đồng Quang Thà (VN)
(74) Công ty cổ phần FAS INVEST (FAS INVEST JSC)
(55)

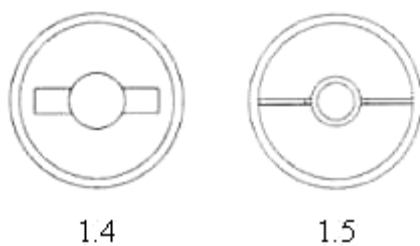
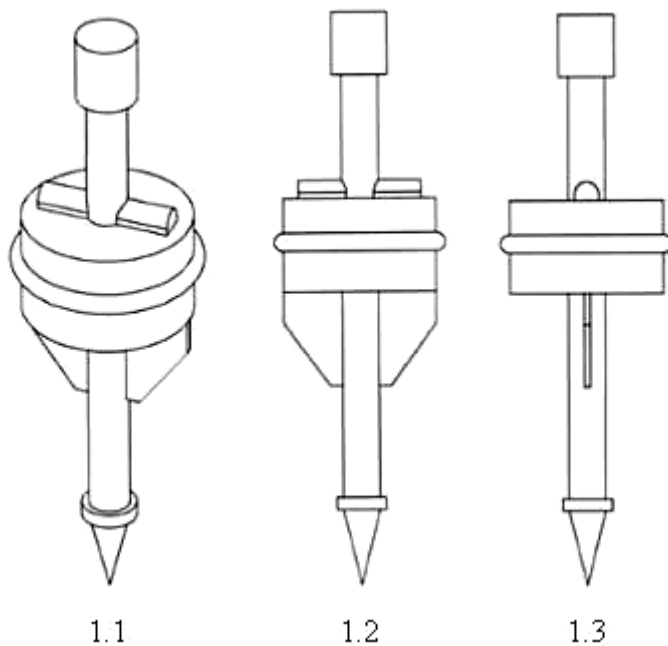

CÔNG BÁO SỞ HỮU CÔNG NGHIỆP SỐ 395 TẬP A – QUYỀN 2 (02.2021)

- (11) **40945**
(21) 3-2020-02786 (28) 1
(54) **ĐÈN CHIẾU SÁNG** (51) **26-05**
(22) 16/11/2020 (43) 25/02/2021
(73) **CÔNG TY CỔ PHẦN CÔNG NGHIỆP LẠNH HƯNG TRÍ (VN)**
51 Trần Phú, phường 04, quận 5, thành phố Hồ Chí Minh
(72) Lâm Thái Bảo (VN)
(74) Công ty TNHH Dịch vụ thương mại và sở hữu công nghiệp Song Ngọc (I.P.T.S.)
(55)



1.1

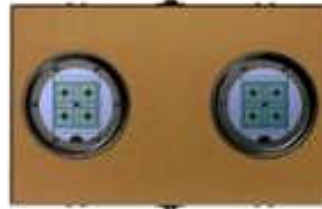

1.2

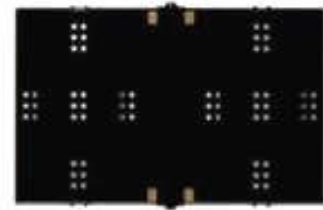

1.3



1.4



1.5

- (11) **40946**
(21) 3-2020-02782 (28) 1
(54) **BỘ NGẮT MẠCH DÙNG CHO KHUÔN LẮP RÁP ĐỂ GIÀY** (51) **13-03**
(22) 13/11/2020 (43) 25/02/2021
TAE KWANG INDUSTRIAL CO., LTD. (KR)
(73) (An-dong) 26, Gimhae-daero 2635 beon-gil, Gimhae-si, Gyeongsangnam-do, Republic of Korea
1. HUK IK JUN (KR)
(72) 2. YU HYUN JUN (KR)
3. LEE MYUNG SEOK (KR)
(74) Công ty TNHH Nghiên cứu và Tư vấn chuyển giao công nghệ và đầu tư (CONCETTI)
(55)

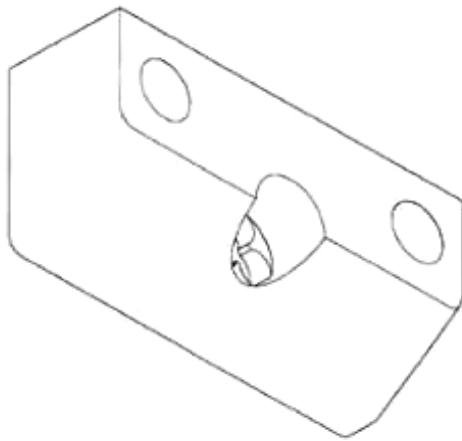

1.1

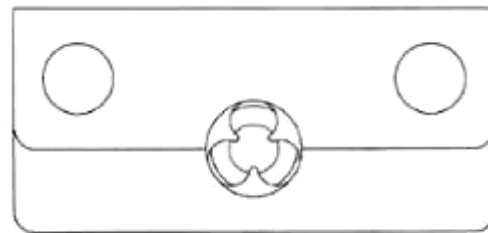

1.2

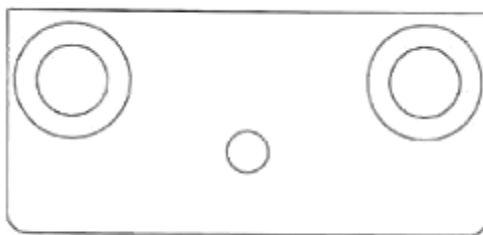

1.3



1.4



1.5

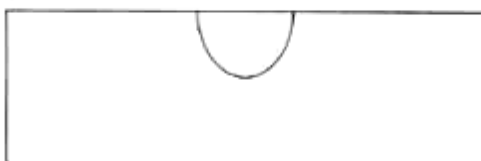

1.6



1.7

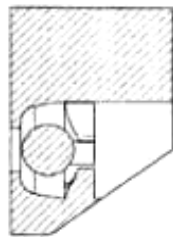

1.8

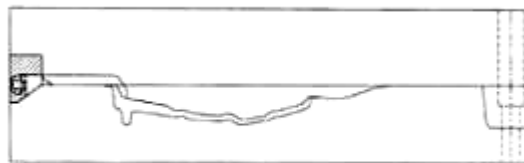

1.9

CÔNG BÁO SỞ HỮU CÔNG NGHIỆP SỐ 395 TẬP A – QUYỀN 2 (02.2021)

- (11) **40947**
(21) 3-2020-02777 (28) 1
(54) **LỌ** (51) **09-01**
(22) 13/11/2020 (43) 25/02/2021
(73) **LG HOUSEHOLD & HEALTH CARE LTD. (KR)**
58, Saemunan-ro, Jongno-gu, Seoul, Republic of Korea
(72) LEE, Hye Jin (KR)
(74) Công ty TNHH Tầm nhìn và Liên danh (VISION & ASSOCIATES CO.LTD.)
(55)



1.1



1.2



1.3



1.4



1.5



1.6



1.7

CÔNG BÁO SỞ HỮU CÔNG NGHIỆP SỐ 395 TẬP A – QUYỀN 2 (02.2021)

- (11) **40948**
(21) 3-2020-02771 (28) 1
(54) **KẸP** (51) **08-08**
(22) 13/11/2020 (43) 25/02/2021
(30) 202030215962.5 13/05/2020 CN;
(73) **CHIEN-TING LIN (TW)**
12704 Marquardt Ave., Santa Fe Springs, CA 90670, United States of America
(72) **CHIEN-TING LIN (TW)**
(74) Công ty Luật TNHH WINCO (WINCO LAW FIRM)
(55)



1.1



1.2



1.3

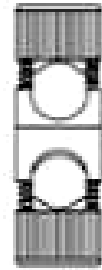

1.4

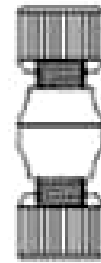

1.5



1.6



1.7



1.8

CÔNG BÁO SỞ HỮU CÔNG NGHIỆP SỐ 395 TẬP A – QUYỀN 2 (02.2021)

- (11) **40949**
(21) 3-2020-02770 (28) 1
(54) **KHAY** (51) **09-03**
(22) 13/11/2020 (43) 25/02/2021
(30) 202030215988.X 13/05/2020 CN;
(73) **CHIEN-TING LIN (TW)**
12704 Marquardt Ave., Santa Fe Springs, CA 90670, United States of America
(72) **CHIEN-TING LIN (TW)**
(74) Công ty Luật TNHH WINCO (WINCO LAW FIRM)
(55)



1.1



1.2



1.3



1.4



1.5



1.6

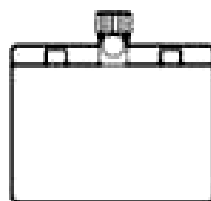

1.7

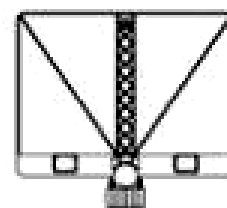

1.8

- (11) **40950**
(21) 3-2020-02766 (28) 1
(54) **BAO GÓI** (51) **09-03; 09-05**
(22) 12/11/2020 (43) 25/02/2021
(30) 30-2020-0021155 14/05/2020 KR;
(73) **COUPANG CORP. (KR)**
(05510) 18F, 570, Songpa-daero, Songpa-gu, Seoul, Republic of Korea
(72) 1. LEE, YOON HYUNG (KR)
2. SON, YOO LEE (KR)
(74) Công ty TNHH Tâm nhìn và Liên danh (VISION & ASSOCIATES CO.LTD.)
(55)

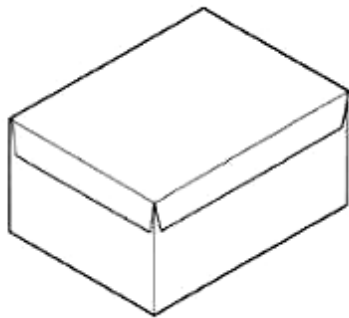

1.1

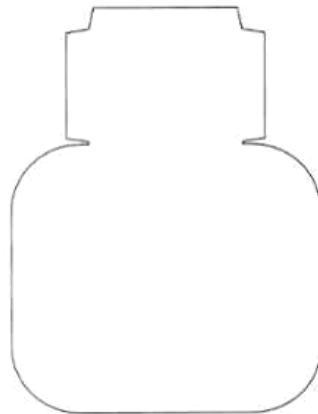

1.2

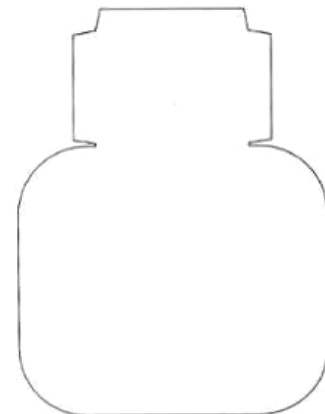

1.3

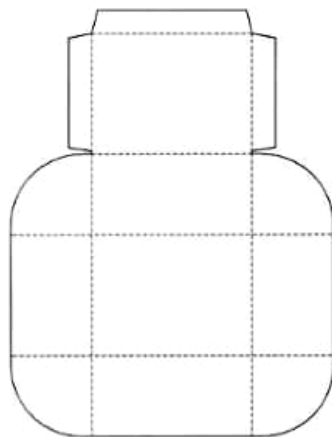

1.4

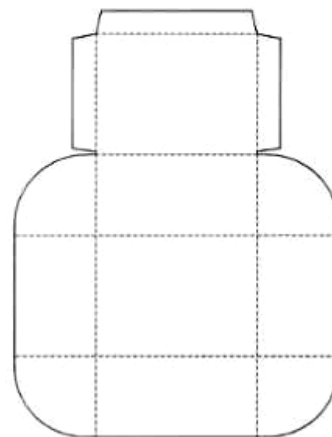

1.5

(11) **40951**

(21) 3-2020-02758

(28) 1

(54) **ĐÈN LED**

(51) **26-05**

(22) 12/11/2020

(43) 25/02/2021

**CÔNG TY CỔ PHẦN CÔNG NGHIỆP VÀ THIẾT BỊ CHIẾU SÁNG
DUHAL (VN)**

(73) Lô 30-31, cụm công nghiệp Tân Mỹ Chánh, phường 9, thành phố Mỹ Tho, tỉnh Tiền Giang

(72) Đỗ Lâm (VN)

(74) Công ty Cổ phần Sở hữu công nghiệp INVESTIP (INVESTIP)

(55)

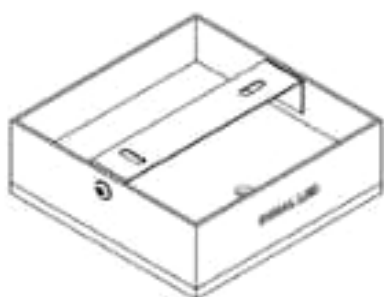

1.1



1.2



1.3



1.4

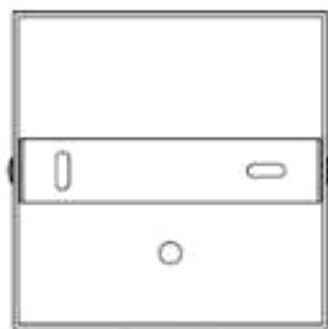

1.5



1.6

(11) **40952**

(21) 3-2020-02757

(28) 1

(54) **ĐÈN LED**

(51) **26-05**

(22) 12/11/2020

(43) 25/02/2021

**CÔNG TY CỔ PHẦN CÔNG NGHIỆP VÀ THIẾT BỊ CHIẾU SÁNG
DUHAL (VN)**

(73) Lô 30-31, cụm công nghiệp Tân Mỹ Chánh, phường 9, thành phố Mỹ Tho, tỉnh Tiền Giang

(72) Đỗ Lâm (VN)

(74) Công ty Cổ phần Sở hữu công nghiệp INVESTIP (INVESTIP)

(55)

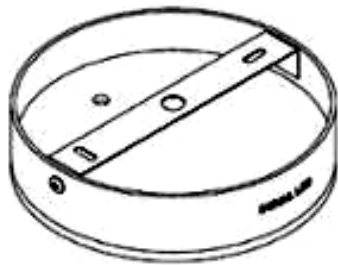

1.1



1.2



1.3



1.4

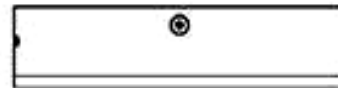

1.5

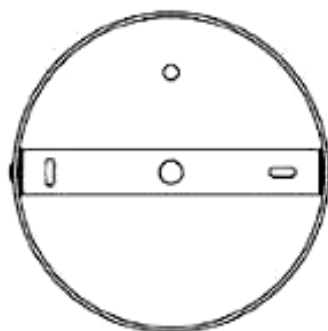

1.6

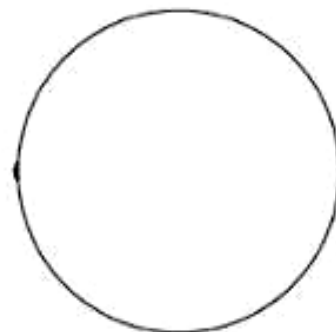

1.7

- (11) **40953**
(21) 3-2020-02736 (28) 1
(54) **CHÂN ĐỂ DÙNG CHO THIẾT BỊ ĐIỆN TỬ** (51) **14-02**
(22) 10/11/2020 (43) 25/02/2021
(30) 2020-010090 22/05/2020 JP;
(73) **SONY INTERACTIVE ENTERTAINMENT INC. (JP)**
1-7-1 Konan, Minato-ku, Tokyo, Japan
(72) Yujin MORISAWA (JP)
(74) Công ty Luật TNHH Phạm và Liên danh (PHAM & ASSOCIATES)
(55)

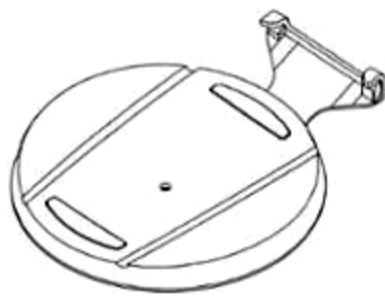

1.1

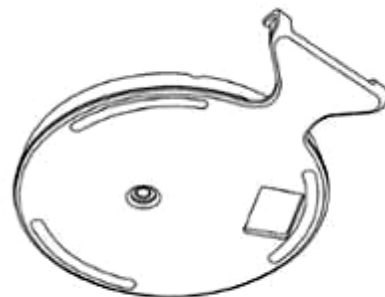

1.2



1.3



1.4



1.5



1.6

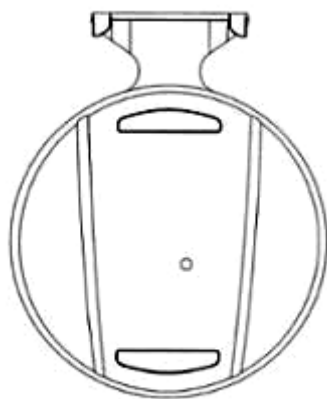

1.7



1.8



1.9



1.10

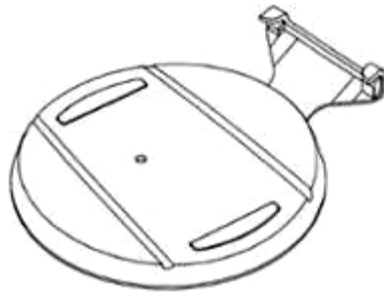

1.11



1.12



1.13



1.14



1.15



1.16



1.17



1.18



1.19



1.20

- (11) **40954**
(21) 3-2020-02735 (28) 1
(54) **CHÂN ĐỂ DÙNG CHO THIẾT BỊ ĐIỆN TỬ** (51) **14-02**
(22) 10/11/2020 (43) 25/02/2021
(30) 2020-010089 22/05/2020 JP;
(73) **SONY INTERACTIVE ENTERTAINMENT INC. (JP)**
1-7-1 Konan, Minato-ku, Tokyo, Japan
(72) Yujin MORISAWA (JP)
(74) Công ty Luật TNHH Phạm và Liên danh (PHAM & ASSOCIATES)
(55)

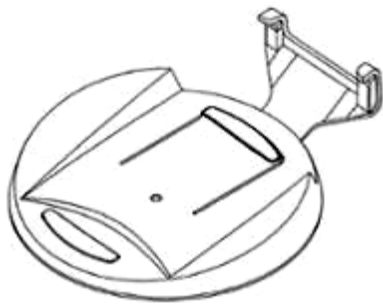

1.1



1.2



1.3

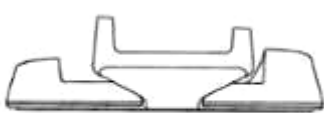

1.4



1.5



1.6

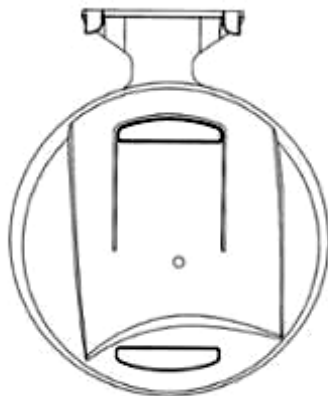

1.7

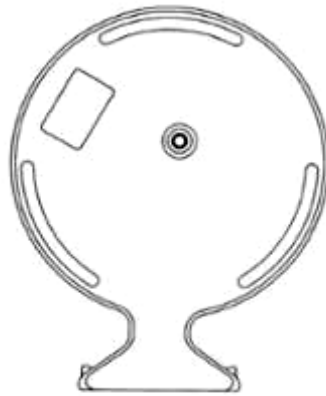

1.8



1.9



1.10

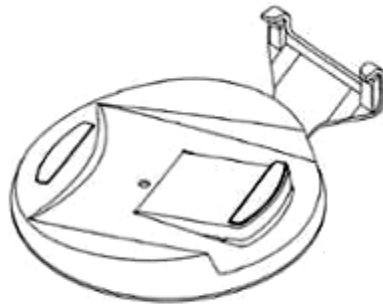

1.11

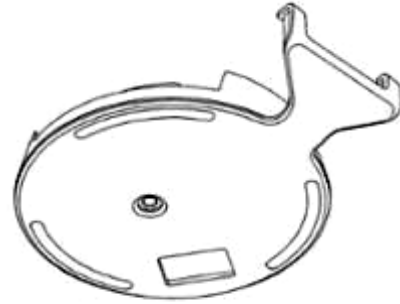

1.12



1.13



1.14



1.15



1.16

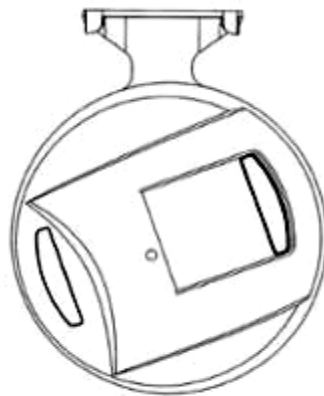

1.17

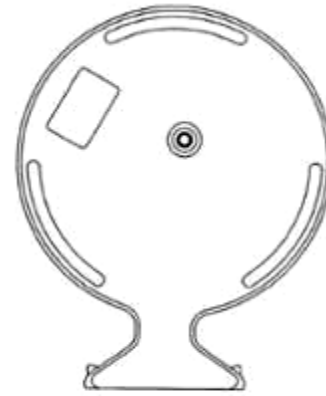

1.18



1.19

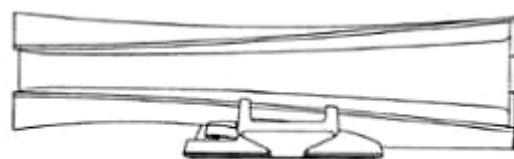

1.20

- (11) **40955**
(21) 3-2020-02733 (28) 1
(54) **MŨ BẢO HIỂM** (51) **02-03**
(22) 10/11/2020 (43) 25/02/2021
(30) 202030400121.1 21/07/2020 CN;
FOSHAN CITY NANHAI YONGHENG HELMET MANUFACTURING CO., LTD. (CN)
(73) Yannan Industrial Area, Longgao Rd., Jiujiang, Nanhai, Foshan City, Guangdong, China
(72) CHEN YEQIANG (CN)
(74) Công ty Luật TNHH WINCO (WINCO LAW FIRM)
(55)



1.1



1.2



1.3



1.4



1.5



1.6



1.7

- (11) **40956**
(21) 3-2020-02732 (28) 1
(54) **MŨ BẢO HIỂM** (51) **02-03**
(22) 10/11/2020 (43) 25/02/2021
(30) 202030399162.3 21/07/2020 CN;
FOSHAN CITY NANHAI YONGHENG HELMET MANUFACTURING CO., LTD. (CN)
(73) Yannan Industrial Area, Longgao Rd., Jiujiang, Nanhai, Foshan City, Guangdong, China
(72) CHEN YEQIANG (CN)
(74) Công ty Luật TNHH WINCO (WINCO LAW FIRM)
(55)



1.1



1.2



1.3

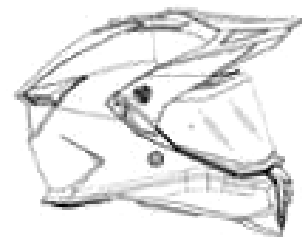

1.4

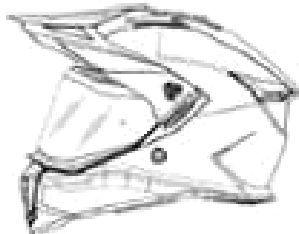

1.5



1.6



1.7

- (11) **40957**
(21) 3-2020-02728 (28) 2
(54) **VỎ THIẾT BỊ ĐIỆN TỬ** (51) **14-02**
(22) 09/11/2020 (43) 25/02/2021
(30) 2020-010088 22/05/2020 JP; 2020-010086 22/05/2020 JP;
SONY INTERACTIVE ENTERTAINMENT INC. (JP)
(73) 1-7-1 Konan, Minato-ku, Tokyo, Japan
(72) Yujin MORISAWA (JP)
(74) Công ty Luật TNHH Phạm và Liên danh (PHAM & ASSOCIATES)
(55)

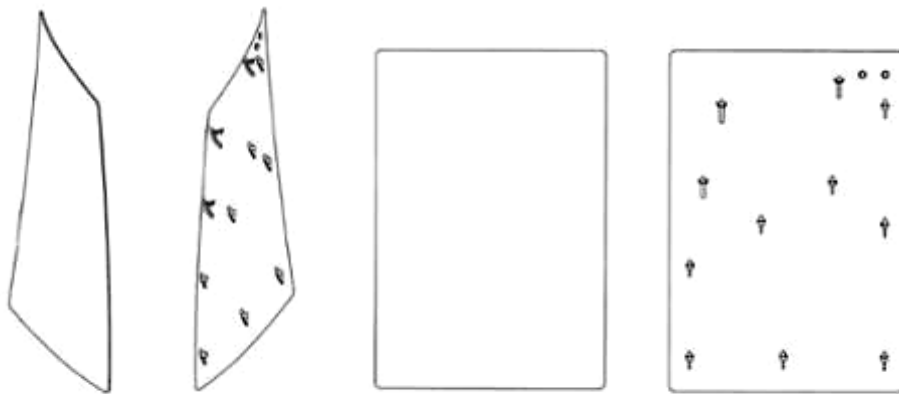

1.1 1.2 1.3 1.4



1.5 1.6 1.7 1.8



1.9 1.10



2.1



2.2



2.3



2.4



2.5

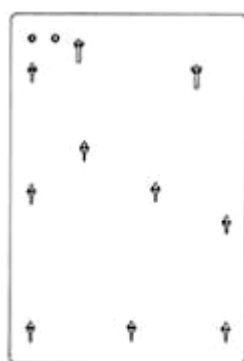

2.6



2.7



2.8



2.9



2.10



2.11

CÔNG BÁO SỞ HỮU CÔNG NGHIỆP SỐ 395 TẬP A – QUYỀN 2 (02.2021)

- (11) **40958**
(21) 3-2020-02726 (28) 1
(54) **CỐC KIM LOẠI** (51) **07-01**
(22) 06/11/2020 (43) 25/02/2021
(30) 29/738,834 19/06/2020 US;
(73) **SILGAN CONTAINERS LLC (US)**
21600 Oxnard Street, Suite 1600, Woodland Hills, California 91367, USA
1. ROWDY HOLSTINE (US)
(72) 2. GERALD BAKER (US)
3. JOHN PHILLIPS (US)
(74) Công ty TNHH T&T INVENMARK Sở hữu trí tuệ Quốc tế (T&T INVENMARK
CO., LTD.)
(55)

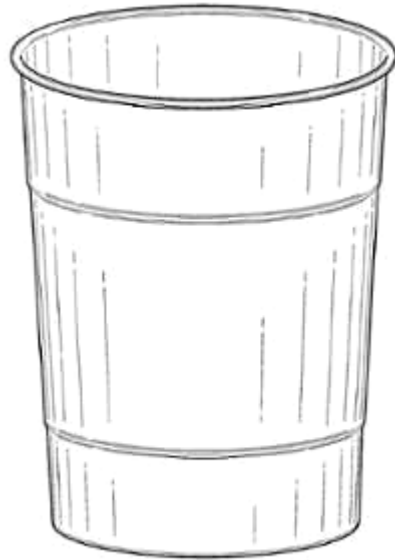

1.1

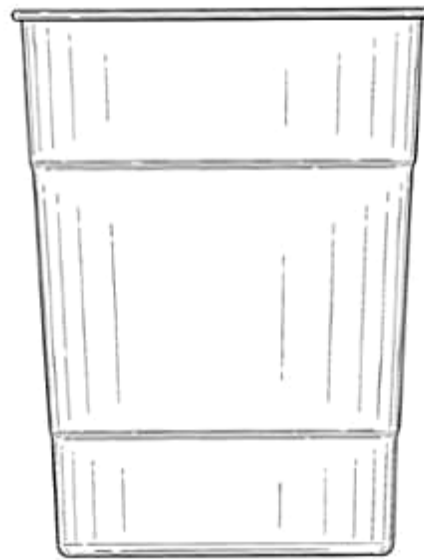

1.2

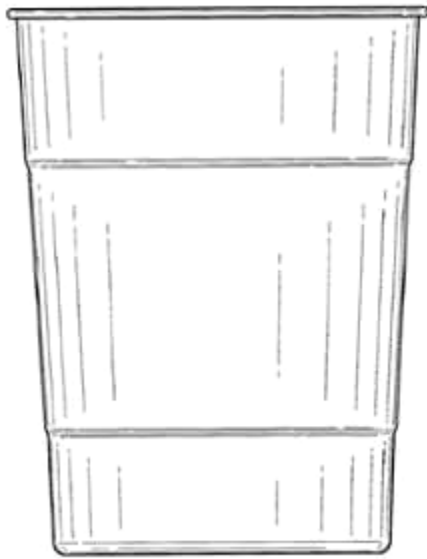

1.3

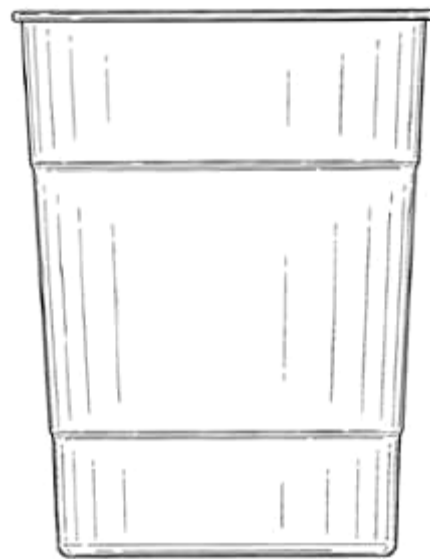

1.4

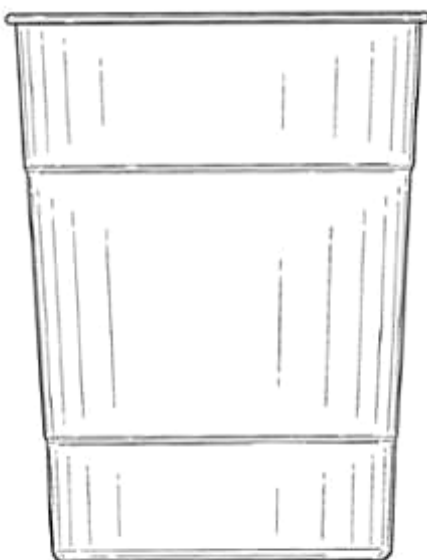

1.5



1.6



1.7

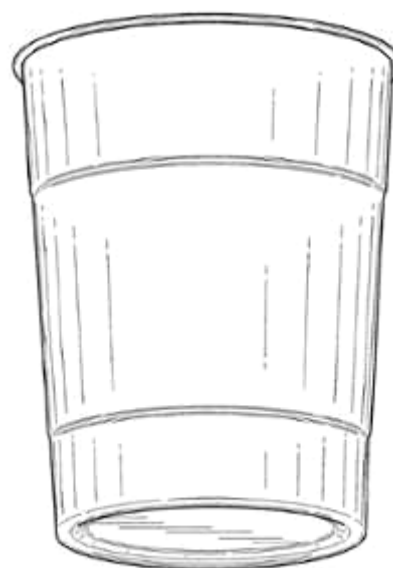

1.8

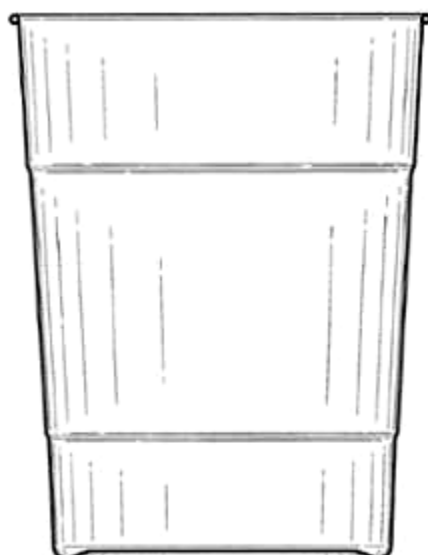

1.9



1.10

- (11) **40959**
- (21) 3-2020-02720 (28) 1
- (54) **THIẾT BỊ THÔNG MINH QUAN TRẮC NƯỚC AO NUÔI, THEO DÕI BỆNH VÀ PHÁT TRIỂN CỦA TÔM** (51) **10-04; 30-99**
- (22) 06/11/2020 (43) 25/02/2021
- (73) **CÔNG TY CỔ PHẦN RYNAN TECHNOLOGIES VIETNAM (VN)**
Ấp Long Trị, xã Long Đức, thành phố Trà Vinh, tỉnh Trà Vinh
1. NGUYỄN THANH MỸ (VN)
 2. TRẦN QUỐC TOẢN (VN)
 3. BÙI TẤN ĐẠT (VN)
 4. HỒ VĂN DANH (VN)
 5. ĐOÀN MINH TRƯỜNG (VN)
- (72) 6. HỒNG QUỐC CƯỜNG (VN)
7. PHẠM HOÀNG LƯỢNG (VN)
8. ĐỒNG NGỌC TRANG (VN)
9. LÊ THANH TRIỀU (VN)
10. SƠN HOÀNG PHƯƠNG (VN)
- (74) Công ty TNHH Đại Tín và Liên Danh (DAITIN AND ASSOCIATES CO.,LTD)
- (55)



1.1



1.2



1.3



1.4



1.5



1.6

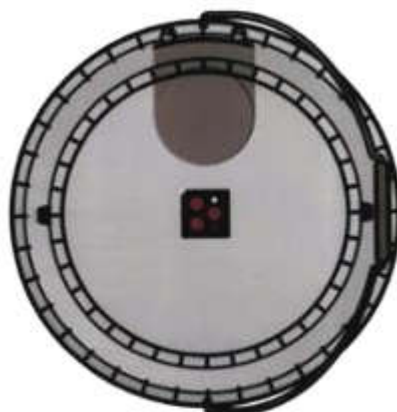

1.7

CÔNG BÁO SỞ HỮU CÔNG NGHIỆP SỐ 395 TẬP A – QUYỂN 2 (02.2021)

- (11) **40960**
(21) 3-2020-02713 (28) 1
(54) **TÚI KẸO** (51) **09-05**
(22) 05/11/2020 (43) 25/02/2021
(73) **CÔNG TY CỔ PHẦN BÁNH KẸO TRÀNG AN .3 - VIỆT NAM (VN)**
Khu A, khu CN Bim Sơn, phường Bắc Sơn, thị xã Bim Sơn, tỉnh Thanh Hóa
(72) Trịnh Sỹ (VN)
(74) Công ty TNHH Sở hữu trí tuệ Việt Nam IP (VIETNAM IP)
(55)



1.1



1.2

- (11) **40961**
(21) 3-2020-02712 (28) 2
(54) **TÚI KẸO** (51) **09-05**
(22) 05/11/2020 (43) 25/02/2021
(73) **CÔNG TY CỔ PHẦN BÁNH KẸO TRÀNG AN .3- VIỆT NAM (VN)**
Khu A, khu CN Bim Sơn, phường Bắc Sơn, thị xã Bim Sơn, tỉnh Thanh Hóa
(72) Trịnh Sỹ (VN)
(74) Công ty TNHH Sở hữu trí tuệ Việt Nam IP (VIETNAM IP)
(55)



1.1



1.2



2.1



2.2

- (11) **40962**
(21) 3-2020-02711 (28) 1
(54) **VỎ THIẾT BỊ ĐIỆN TỬ** (51) **14-02**
(22) 05/11/2020 (43) 25/02/2021
(30) 2020-010087 22/05/2020 JP;
(73) **SONY INTERACTIVE ENTERTAINMENT INC. (JP)**
1-7-1 Konan, Minato-ku, Tokyo, Japan
(72) Yujin MORISAWA (JP)
(74) Công ty Luật TNHH Phạm và Liên danh (PHAM & ASSOCIATES)
(55)

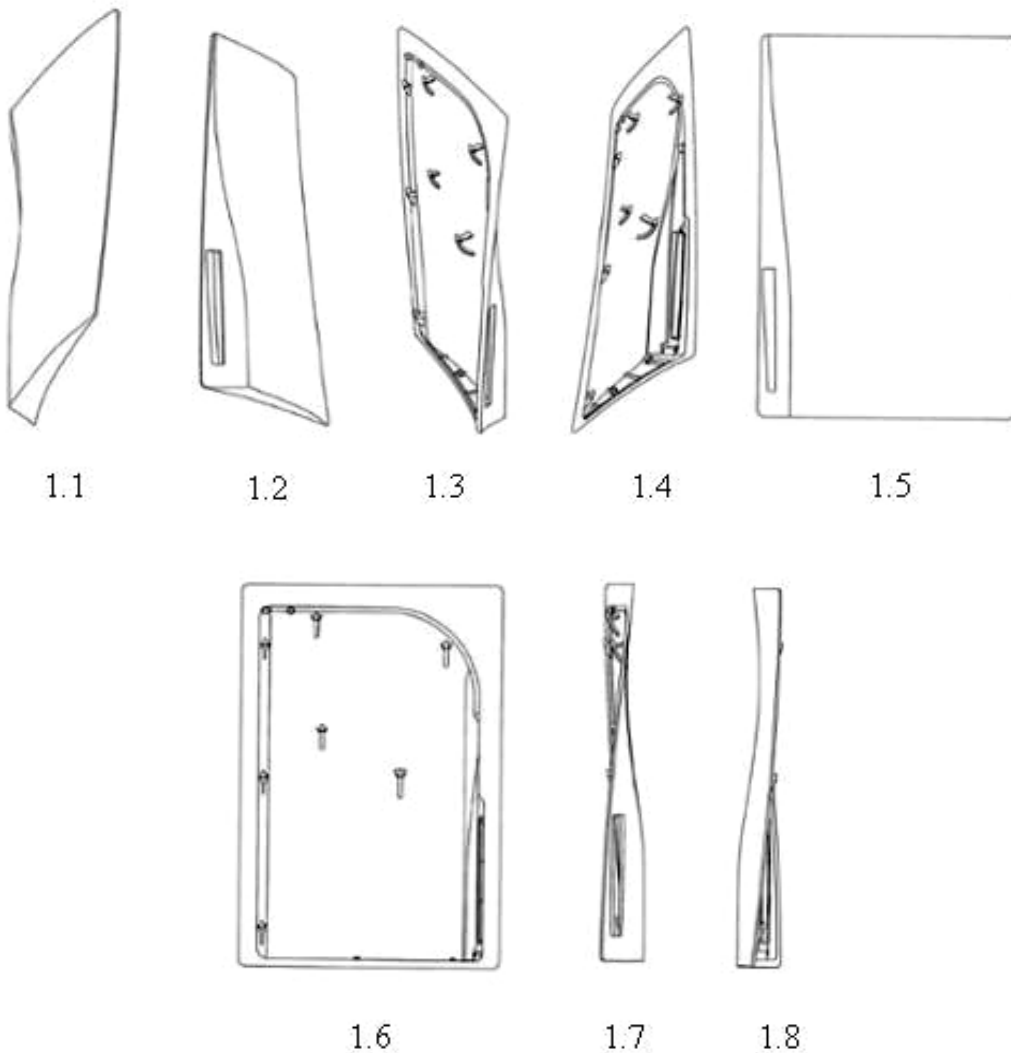



1.9



1.10



1.11

- (11) **40963**
(21) 3-2020-02710 (28) 1
(54) **THIẾT BỊ ĐIỆN TỬ** (51) **14-02**
(22) 05/11/2020 (43) 25/02/2021
(30) 2020-010085 22/05/2020 JP;
(73) **SONY INTERACTIVE ENTERTAINMENT INC. (JP)**
1-7-1 Konan, Minato-ku, Tokyo, Japan
(72) Yujin MORISAWA (JP)
(74) Công ty Luật TNHH Phạm và Liên danh (PHAM & ASSOCIATES)
(55)

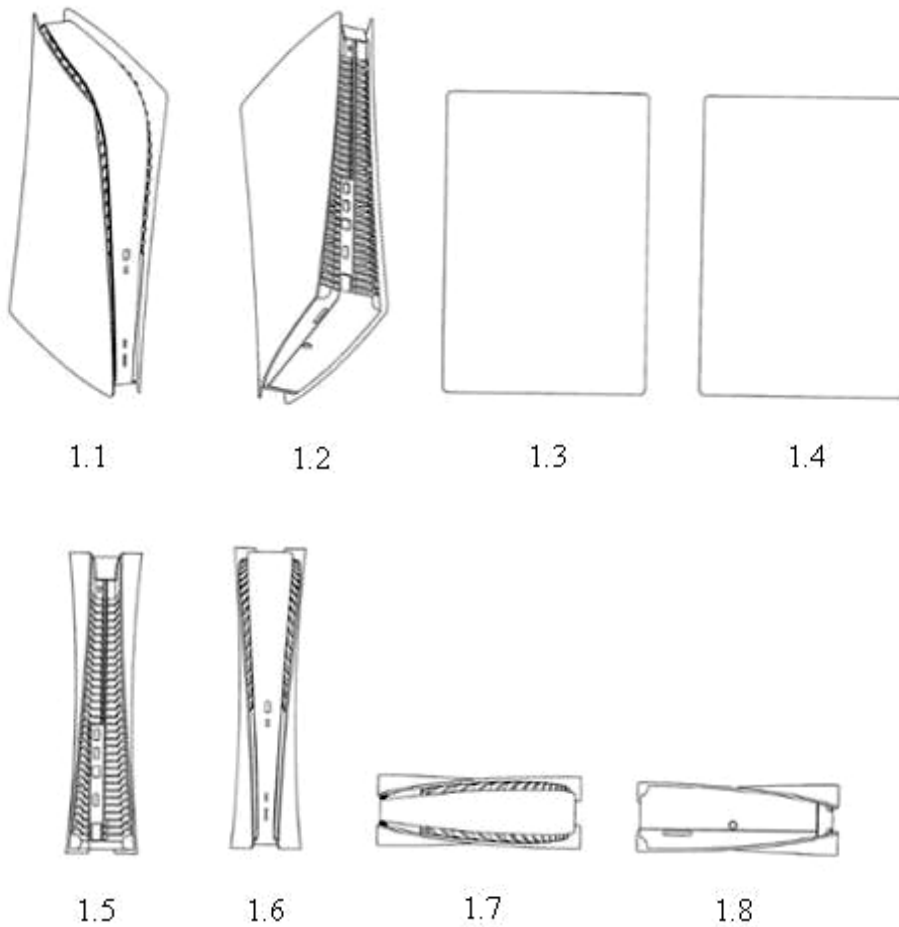

- (11) **40964**
- (21) 3-2020-02698 (28) 1
- (54) **BAO GÓI** (51) **09-05**
- (22) 04/11/2020 (43) 25/02/2021
- CÔNG TY TNHH MỘT THÀNH VIÊN PHÂN BÓN TRƯỜNG NGUYỄN**
- (73) (VN)
Số 541, ấp Cây Châm, xã Vĩnh Tế, thành phố Châu Đốc, tỉnh An Giang
- (72) Nguyễn Viết Lễ (VN)
- (74) Công ty TNHH một thành viên Trường Luật (Trường Luật)
- (55)



1.1

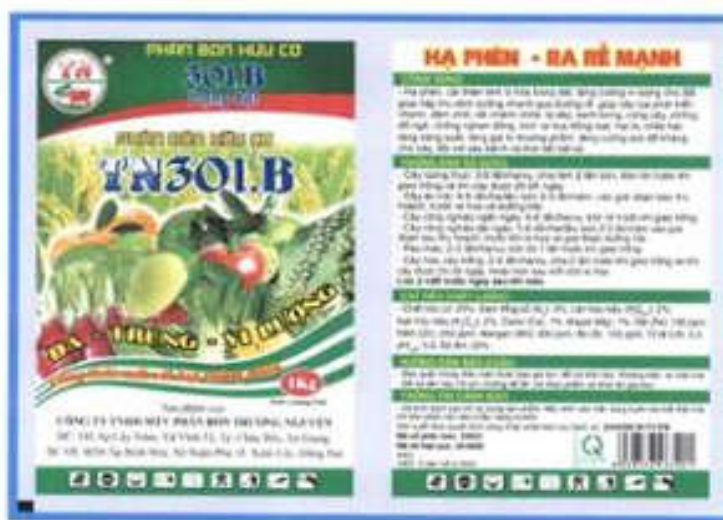

1.2

CÔNG BÁO SỞ HỮU CÔNG NGHIỆP SỐ 395 TẬP A – QUYỀN 2 (02.2021)

- (11) 40965
(21) 3-2020-02697 (28) 1
(54) BAO GÓI (51) 09-05
(22) 04/11/2020 (43) 25/02/2021
(73) **CÔNG TY TRÁCH NHIỆM HỮU HẠN CON CÒ VÀNG (VN)**
23 Lô B đường số 1, phường Phú Thuận, quận 7, thành phố Hồ Chí Minh
(72) Hoàng Mai Dẫn (VN)
(74) Công ty TNHH một thành viên Trường Luật (Trường Luật)
(55)



1.1



1.2

- (11) **40966**
(21) 3-2020-02674 (28) 1
(54) **THIẾT BỊ ĐIỀU HỢP** (51) **13-02; 13-03**
(22) 30/10/2020 (43) 25/02/2021
(30) 29/754,088 06/10/2020 US;
GOOGLE LLC (US)
(73) 1600 Amphitheatre Parkway, Mountain View, California 94043, United States of America
1. DONGKYU LEE (KR)
2. SUNG KYUN BAI (KR)
(72) 3. MAJ ISABELLE OLSSON (SE)
4. ÉTIENNE BÉRUBÉ (CA)
(74) Công ty Luật TNHH ROUSE Việt Nam (ROUSE LAW CO.,LTD)
(55)

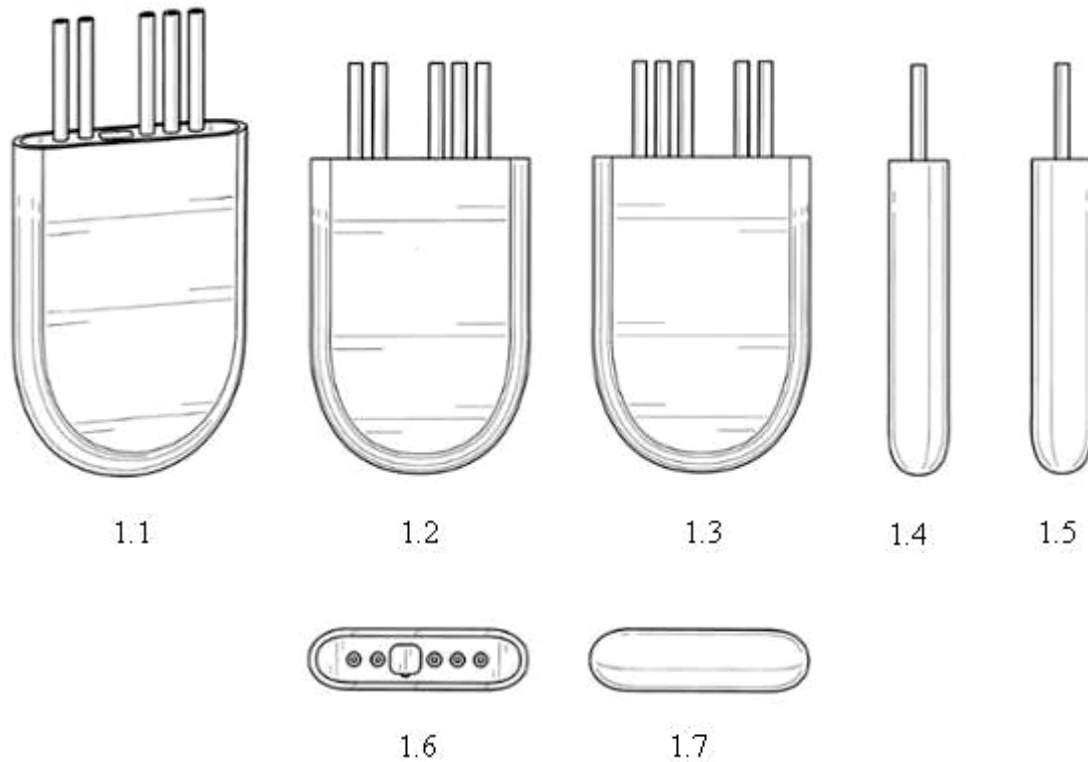

CÔNG BÁO SỞ HỮU CÔNG NGHIỆP SỐ 395 TẬP A – QUYỀN 2 (02.2021)

(11) **40967**

(21) 3-2020-02653

(28) 1

(54) **XE MÔ TÔ**

(51) **12-11**

(22) 28/10/2020

(43) 25/02/2021

SANYANG MOTOR CO., LTD. (TW)

(73) No. 184, Keng Tzu Kou, Shang Keng Village, Hsin Fong Shiang, Hsinchu County
304, TAIWAN

(72) Yung-Chin LAI (TW)

(74) Công ty TNHH Trường Xuân (AGELESS CO.,LTD.)

(55)



1.1



1.2



1.3



1.4



1.5



1.6



1.7



1.8



1.9

CÔNG BÁO SỞ HỮU CÔNG NGHIỆP SỐ 395 TẬP A – QUYỀN 2 (02.2021)

(11) **40968**

(21) 3-2020-02650

(54) **THÂN DỤNG CỤ LỌC CÀ PHÊ**

(22) 28/10/2020

CÔNG TY TNHH MINH LONG I (VN)

(73) 333 khu phố Hưng Lộc, phường Hưng Định, thành phố Thuận An, tỉnh Bình Dương

(72) LÝ NGỌC MINH (VN)

(55)

(28) 1

(51) **07-02**

(43) 25/02/2021



1.1



1.2



1.3



1.4

CÔNG BÁO SỞ HỮU CÔNG NGHIỆP SỐ 395 TẬP A – QUYỀN 2 (02.2021)

- (11) **40969**
- (21) 3-2020-02647 (28) 1
- (54) **NHÃN SẢN PHẨM** (51) **19-08**
- (22) 27/10/2020 (43) 25/02/2021
- (73) **HỘ KINH DOANH NGUYỄN THỊ HOA (VN)**
Ấp 9, xã Lương Hòa, huyện Bến Lức, tỉnh Long An
- (72) Hồ Văn Dũng (VN)
- (74) Công ty Cổ phần Sở hữu công nghiệp INVESTIP (INVESTIP)
- (55)



CÔNG BÁO SỞ HỮU CÔNG NGHIỆP SỐ 395 TẬP A – QUYỀN 2 (02.2021)

- (11) **40970**
(21) 3-2020-02646 (28) 3
(54) **NHÃN SẢN PHẨM** (51) **19-08**
(22) 27/10/2020 (43) 25/02/2021
(73) **HỘ KINH DOANH NGUYỄN THỊ HOA (VN)**
Áp 9, xã Lương Hòa, huyện Bến Lức, tỉnh Long An
(72) Hồ Văn Dũng (VN)
(74) Công ty Cổ phần Sở hữu công nghiệp INVESTIP (INVESTIP)
(55)



1



2



3

- (11) **40971**
(21) 3-2020-02645 (28) 4
(54) **NHÃN SẢN PHẨM** (51) **19-08**
(22) 27/10/2020 (43) 25/02/2021
(73) **HỘ KINH DOANH NGUYỄN THỊ HOA (VN)**
 Áp 9, xã Lương Hòa, huyện Bến Lức, tỉnh Long An
(72) Hồ Văn Dũng (VN)
(74) Công ty Cổ phần Sở hữu công nghiệp INVESTIP (INVESTIP)
(55)



1



2



3



4

CÔNG BÁO SỞ HỮU CÔNG NGHIỆP SỐ 395 TẬP A – QUYỀN 2 (02.2021)

- (11) **40972**
(21) 3-2020-02644 (28) 1
(54) **HỘP ĐỰNG THIẾT BỊ ĐIỀU KHIỂN** (51) **13-03**
(22) 27/10/2020 (43) 25/02/2021
(73) **CÔNG TY CỔ PHẦN BREEDLIFE (VN)**
Số 12 lô E, đường Vạn Phúc, phường Liễu Giai, quận Ba Đình, thành phố Hà Nội
(72) Nguyễn Đạo Hưng (VN)
(74) Công ty TNHH Tư vấn đầu tư và Sở hữu trí tuệ Hoàng Phi (HOANG PHI INVEST & I.P CO., LTD)
(55)

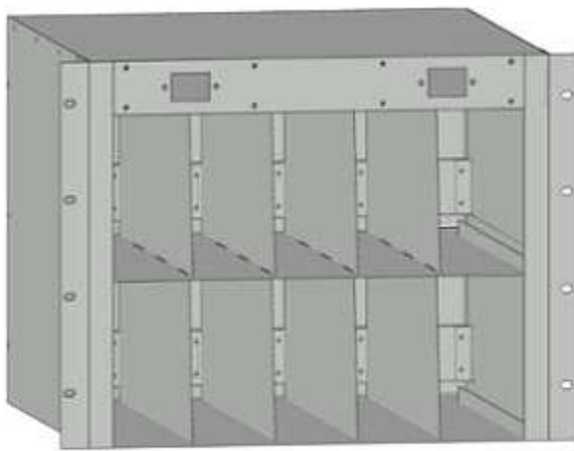

1.1

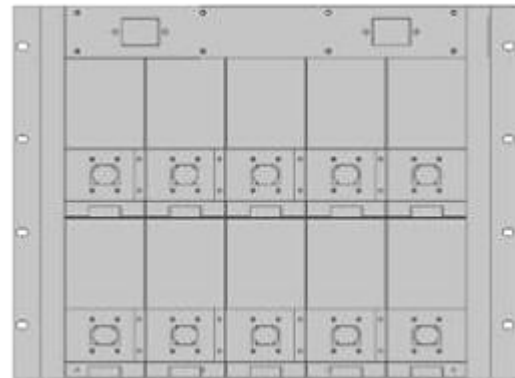

1.2

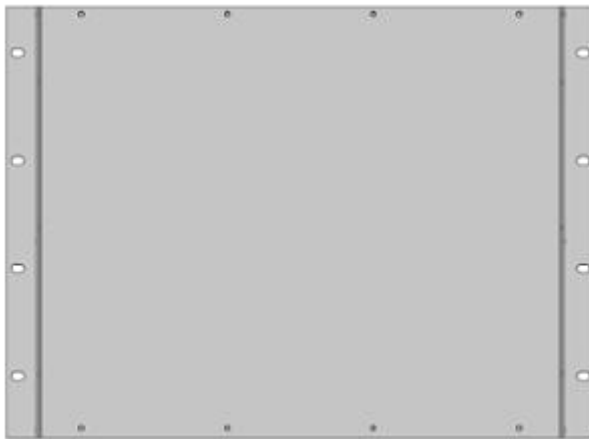

1.3

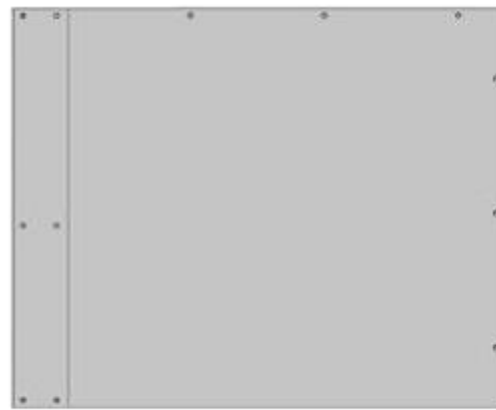

1.4

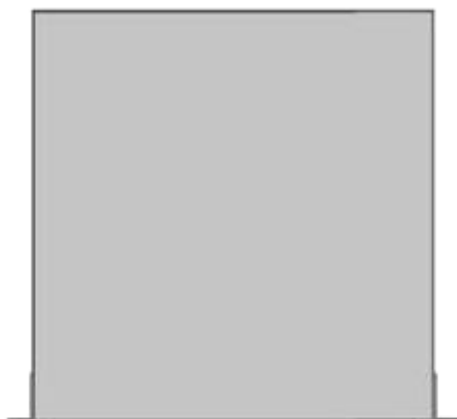

1.5

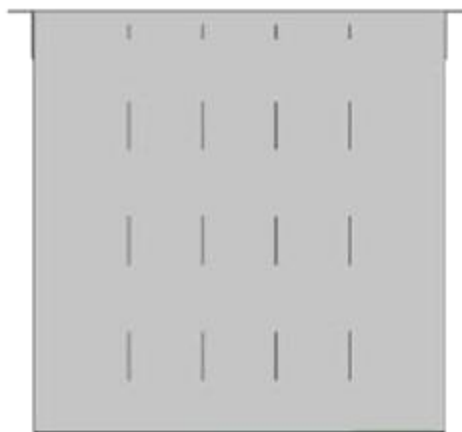

1.6

(11) **40973**

(21) 3-2020-02641

(28) 1

(54) **MÁY CẤP PHÔI**

(51) **15-99**

(22) 26/10/2020

(43) 25/02/2021

CÔNG TY CỔ PHẦN KỸ THUẬT TEMAS (VN)

(73) Số 17, khu X5, ngõ 60, phố Dương Khuê, phường Mỹ Đình 2, quận Nam Từ Liêm, thành phố Hà Nội

(72) Trần Đức Hiếu (VN)

(74) Công ty TNHH Sở hữu trí tuệ HA VIP (HAVIP CO., LTD.)

(55)

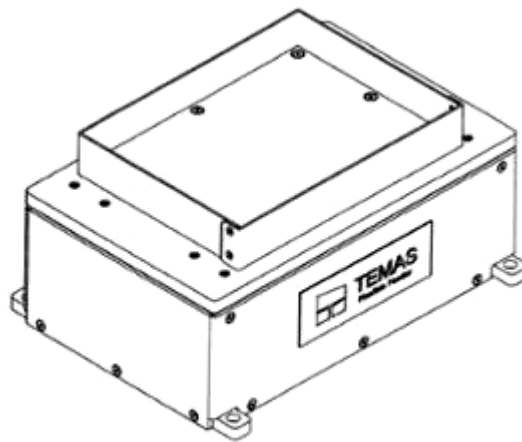

1.1

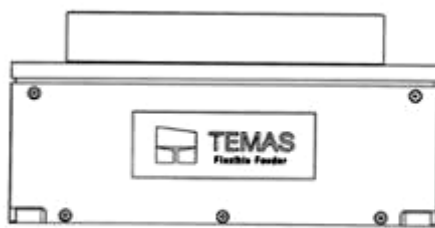

1.2

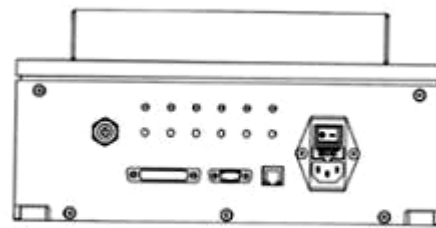

1.3

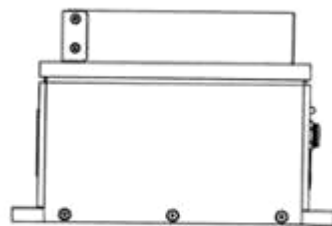

1.4

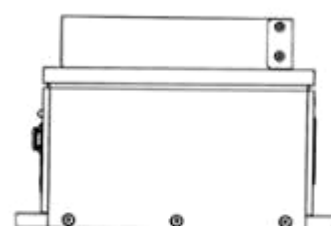

1.5

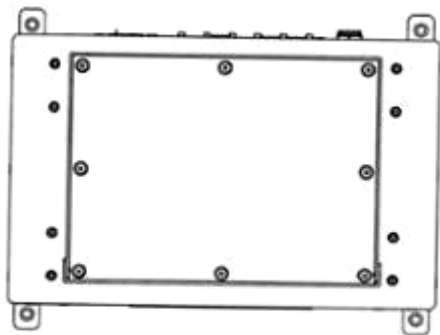

1.6

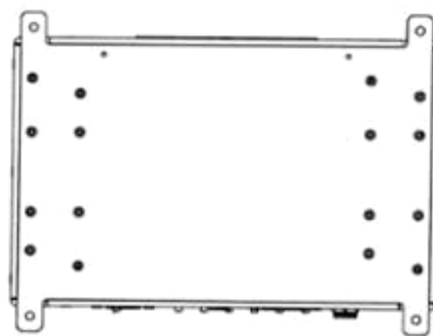

1.7

CÔNG BÁO SỞ HỮU CÔNG NGHIỆP SỐ 395 TẬP A – QUYỀN 2 (02.2021)

- (11) **40974**
(21) 3-2020-02626 (28) 1
(54) **DỤNG CỤ HỖ TRỢ ĐÓT SÓNG CỎ** (51) **24-04**
(22) 23/10/2020 (43) 25/02/2021
(73) **PHAN, MINH VAN (US)**
9306 Lily Avenue, Fountain Valley, California 92708, United States of America
(72) **PHAN, MINH VAN (VN)**
(74) Công ty TNHH Tư vấn - Dịch thuật - Sở hữu trí tuệ Á Đông (Á Đông IP
CONSULTANCY CO.,LTD.)
(55)



1.1

1.2

1.3



1.4

1.5

1.6

1.7

CÔNG BÁO SỞ HỮU CÔNG NGHIỆP SỐ 395 TẬP A – QUYỀN 2 (02.2021)

- (11) **40975**
(21) 3-2020-02615 (28) 1
(54) **NHÃN SẢN PHẨM** (51) **19-08**
(22) 22/10/2020 (43) 25/02/2021
(73) **CÔNG TY TNHH THÁI HUY LONG (VN)**
544/5 Hương lộ 2, phường Bình Trị Đông, quận Bình Tân, thành phố Hồ Chí Minh
(72) **THÁI ĐỐC MINH (VN)**
(55)



(11) **40976**

(21) 3-2020-02605

(28) 1

(54) **HỘP**

(51) **09-03**

(22) 20/10/2020

(43) 25/02/2021

CÔNG TY TNHH SẢN XUẤT THƯƠNG MẠI DỊCH VỤ TÂN TUỜNG KHANG (VN)

(73) Lô F1 & F2, đường D2 và N5, khu công nghiệp Nam Tân Uyên, phường Khánh Bình, thị xã Tân Uyên, tỉnh Bình Dương

(72) Nìm Dùng Chiếng (VN)

(55)



1.1



1.2



1.3



1.4

CÔNG BÁO SỞ HỮU CÔNG NGHIỆP SỐ 395 TẬP A – QUYỀN 2 (02.2021)

(11) **40977**

(21) 3-2020-02604

(28) 1

(54) **HỘP**

(51) **09-03**

(22) 20/10/2020

(43) 25/02/2021

CÔNG TY TNHH SẢN XUẤT THƯƠNG MẠI DỊCH VỤ TÂN TƯỜNG KHANG (VN)

(73) Lô F1 & F2, đường D2 và N5, khu công nghiệp Nam Tân Uyên, phường Khánh Bình, thị xã Tân Uyên, tỉnh Bình Dương

(72) Nìm Dùng Chiếng (VN)

(55)



1.1



1.2



1.3



1.4

(11) **40978**

(21) 3-2020-02603

(54) **HỘP**

(22) 20/10/2020

(28) 1

(51) **09-03**

(43) 25/02/2021

CÔNG TY TNHH SẢN XUẤT THƯƠNG MẠI DỊCH VỤ TÂN TƯỜNG KHANG (VN)

(73) Lô F1 & F2, đường D2 và N5, khu công nghiệp Nam Tân Uyên, phường Khánh Bình, thị xã Tân Uyên, tỉnh Bình Dương

(72) Nìm Dùng Chiếng (VN)

(55)



1.1



1.2



1.3



1.4



1.5



1.6

(11) **40979**

(21) 3-2020-02602

(28) 1

(54) **HỘP**

(51) **09-03**

(22) 20/10/2020

(43) 25/02/2021

CÔNG TY TNHH SẢN XUẤT THƯƠNG MẠI DỊCH VỤ TÂN TƯỜNG KHANG (VN)

(73) Lô F1 & F2, đường D2 và N5, khu công nghiệp Nam Tân Uyên, phường Khánh Bình, thị xã Tân Uyên, tỉnh Bình Dương

(72) Nìm Dùmng Chiểng (VN)

(55)



1.1



1.2



1.3



1.4



1.5



1.6



1.7

(11) **40980**

(21) 3-2020-02601

(28) 1

(54) **HỘP**

(51) **09-03**

(22) 20/10/2020

(43) 25/02/2021

CÔNG TY TNHH SẢN XUẤT THƯƠNG MẠI DỊCH VỤ TÂN TUỜNG KHANG (VN)

(73) Lô F1 & F2, đường D2 và N5, khu công nghiệp Nam Tân Uyên, phường Khánh Bình, thị xã Tân Uyên, tỉnh Bình Dương

(72) Nìm Dùng Chiếng (VN)

(55)



1.1



1.2



1.3



1.4



1.5



1.6



1.7

CÔNG BÁO SỞ HỮU CÔNG NGHIỆP SỐ 395 TẬP A – QUYỀN 2 (02.2021)

(11) **40981**

(21) 3-2020-02599

(28) 1

(54) **HỘP**

(51) **09-03**

(22) 19/10/2020

(43) 25/02/2021

(73) **LG HOUSEHOLD & HEALTH CARE LTD. (KR)**

58, Saemunan-ro, Jongno-gu, Seoul, Republic of Korea

(72) LEE, Hye Jin (KR)

(74) Công ty TNHH Tầm nhìn và Liên danh (VISION & ASSOCIATES CO.LTD.)

(55)



1.1



1.2



1.3



1.4



1.5



1.6



1.7



1.8

- (11) **40982**
(21) 3-2020-02592 (28) 1
(54) **NẤP HỘP ĐỰNG THỰC PHẨM** (51) **09-07**
(22) 16/10/2020 (43) 25/02/2021
(30) 30-2020-0028589 24/06/2020 KR;
LOCK & LOCK CO., LTD (KR)
(73) 104, Sapgyocheon-ro, Seonjang-myeon, Asan-si, Chungcheongnam-do, Republic of Korea
(72) SONG, Ga Young (KR)
(74) Công ty TNHH Tầm nhìn và Liên danh (VISION & ASSOCIATES CO.LTD.)
(55)

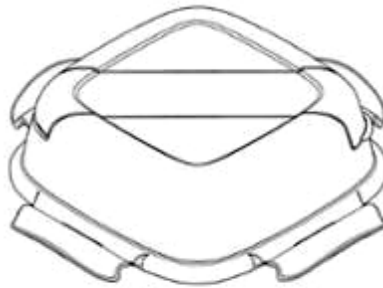

1.1



1.2



1.3



1.4



1.5

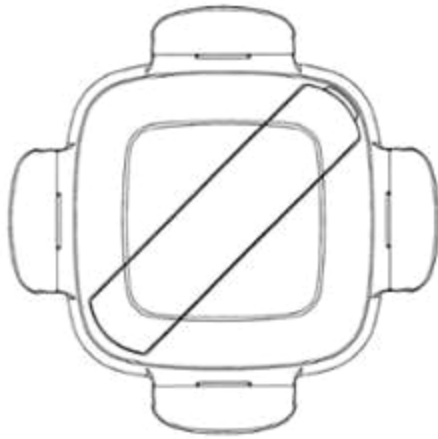

1.6

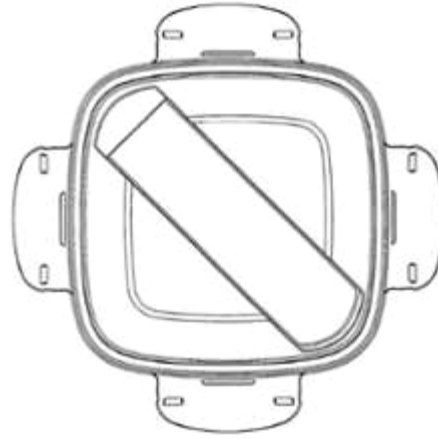

1.7

- (11) **40983**
(21) 3-2020-02591 (28) 1
(54) **HỘP ĐỰNG THỰC PHẨM** (51) **09-03**
(22) 16/10/2020 (43) 25/02/2021
(30) 30-2020-0028588 24/06/2020 KR;
LOCK & LOCK CO., LTD (KR)
(73) 104, Sapgyocheon-ro, Seonjang-myeon, Asan-si, Chungcheongnam-do, Republic of Korea
(72) SONG, Ga Young (KR)
(74) Công ty TNHH Tầm nhìn và Liên danh (VISION & ASSOCIATES CO.LTD.)
(55)



1.1



1.2



1.3



1.4



1.5



1.6

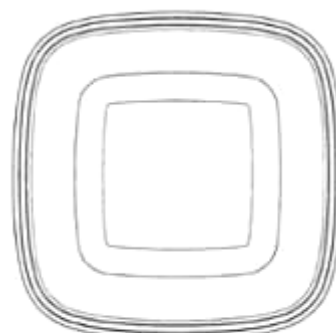

1.7

CÔNG BÁO SỞ HỮU CÔNG NGHIỆP SỐ 395 TẬP A – QUYỀN 2 (02.2021)

- (11) **40984**
(21) 3-2020-02588 (28) 1
(54) **LON ĐỰNG THỰC PHẨM VÀ ĐỒ UỐNG** (51) **09-03**
(22) 16/10/2020 (43) 25/02/2021
(30) 007817788-0001 17/04/2020 EM;
(73) **CROWN PACKAGING TECHNOLOGY, INC. (US)**
11535 South Central Avenue, Alsip, Illinois 60803 United States of America
(72) 1. JOSEPH SMITH (GB)
2. THOMAS ALEXANDER GROVES (GB)
(74) CÔNG TY LUẬT TNHH IP MAX (IPMAX LAW FIRM)
(55)



1.1



1.2



1.3



1.4



1.5



1.6

CÔNG BÁO SỞ HỮU CÔNG NGHIỆP SỐ 395 TẬP A – QUYỀN 2 (02.2021)

- (11) **40985**
(21) 3-2020-02577 (28) 1
(54) **HỘP ĐỰNG** (51) **09-03**
(22) 15/10/2020 (43) 25/02/2021
(73) **CÔNG TY TNHH DƯỢC PHẨM VÀ THƯƠNG MẠI THÀNH CÔNG (VN)**
Km 6 + 200, quốc lộ 38, phường Hạp Lĩnh, thành phố Bắc Ninh, tỉnh Bắc Ninh
(72) Thái Ly (VN)
(74) Công ty TNHH Đại Tín và Liên Danh (DAITIN AND ASSOCIATES CO.,LTD)
(55)



1.1



1.2

- (11) **40986**
(21) 3-2020-02562 (28) 6
(54) **HỘP ĐỰNG TAI NGHE** (51) **09-03**
(22) 14/10/2020 (43) 25/02/2021
(30) 202030150946.2 15/04/2020 CN;
HUAWEI TECHNOLOGIES CO., LTD. (CN)
(73) Huawei Administration Building, Bantian, Longgang District, Shenzhen,
Guangdong 518129, P. R. China
1. ZHAO, YING (CN)
(72) 2. DIAO, GUOFEI (CN)
(74) Công ty Cổ phần Sở hữu công nghiệp INVESTIP (INVESTIP)
(55)

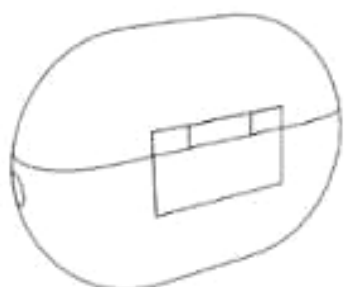

1.1

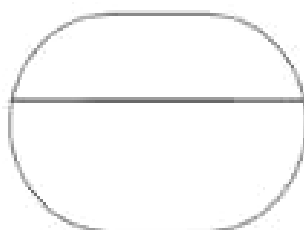

1.2

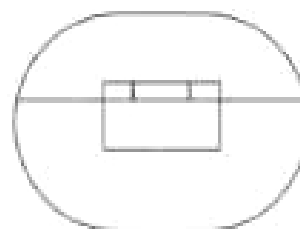

1.3



1.4

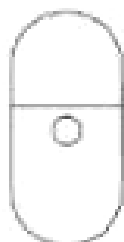

1.5



1.6



1.7



2.1

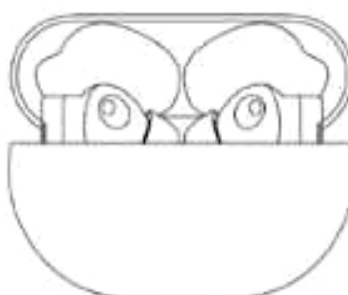

2.2

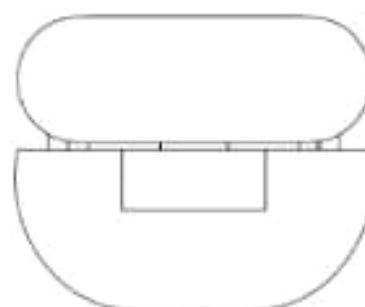

2.3

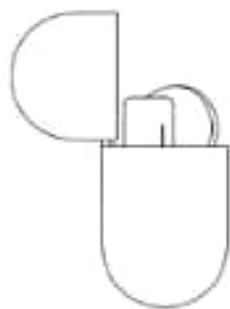

2.4

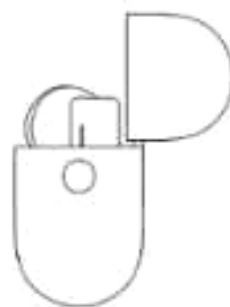

2.5

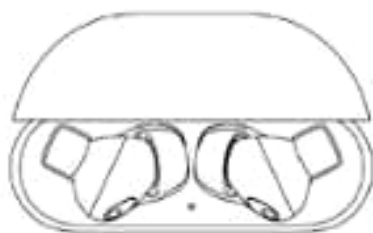

2.6



2.7



3.1

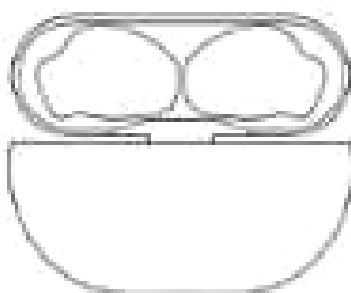

3.2

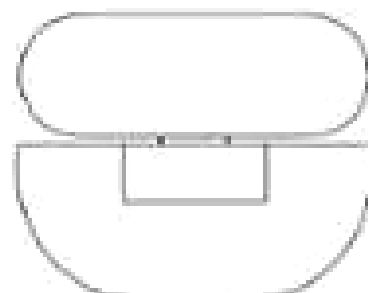

3.3

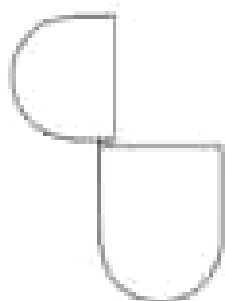

3.4

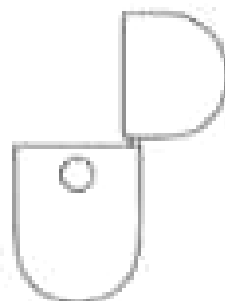

3.5

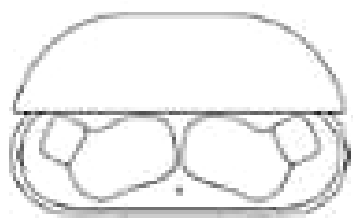

3.6



3.7



4.1



4.2



4.3



4.4



4.5



4.6



4.7



5.1



5.2



5.3



5.4

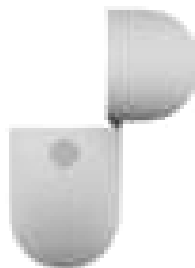

5.5

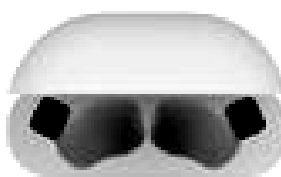

5.6



5.7

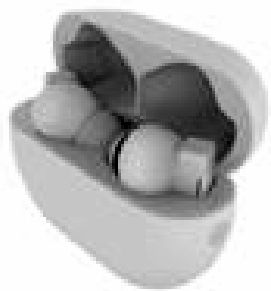

6.1



6.2

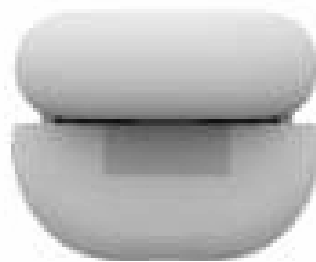

6.3



6.4



6.5

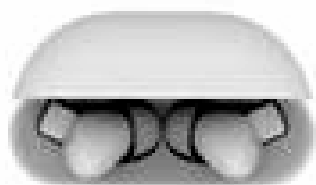

6.6



6.7

- (11) **40987**
(21) 3-2020-02561 (28) 1
(54) **ĐẦU THAY THỂ CHO DỤNG CỤ CHĂM SÓC RĂNG MIỆNG** (51) **04-02**
(22) 14/10/2020 (43) 25/02/2021
(30) 29/733,212 30/04/2020 US;
(73) **COLGATE-PALMOLIVE COMPANY (US)**
300 Park Avenue, New York, New York 10022, United States of America
1. JIANG ZHOU (CN)
2. FAN GANG XIE (CN)
(72) 3. YANMEI JI (CN)
4. GUOQIANG LIU (CN)
5. WEN JIN XI (CN)
(74) Văn phòng Luật sư Ân Nam (ANNAM IP & LAW)
(55)

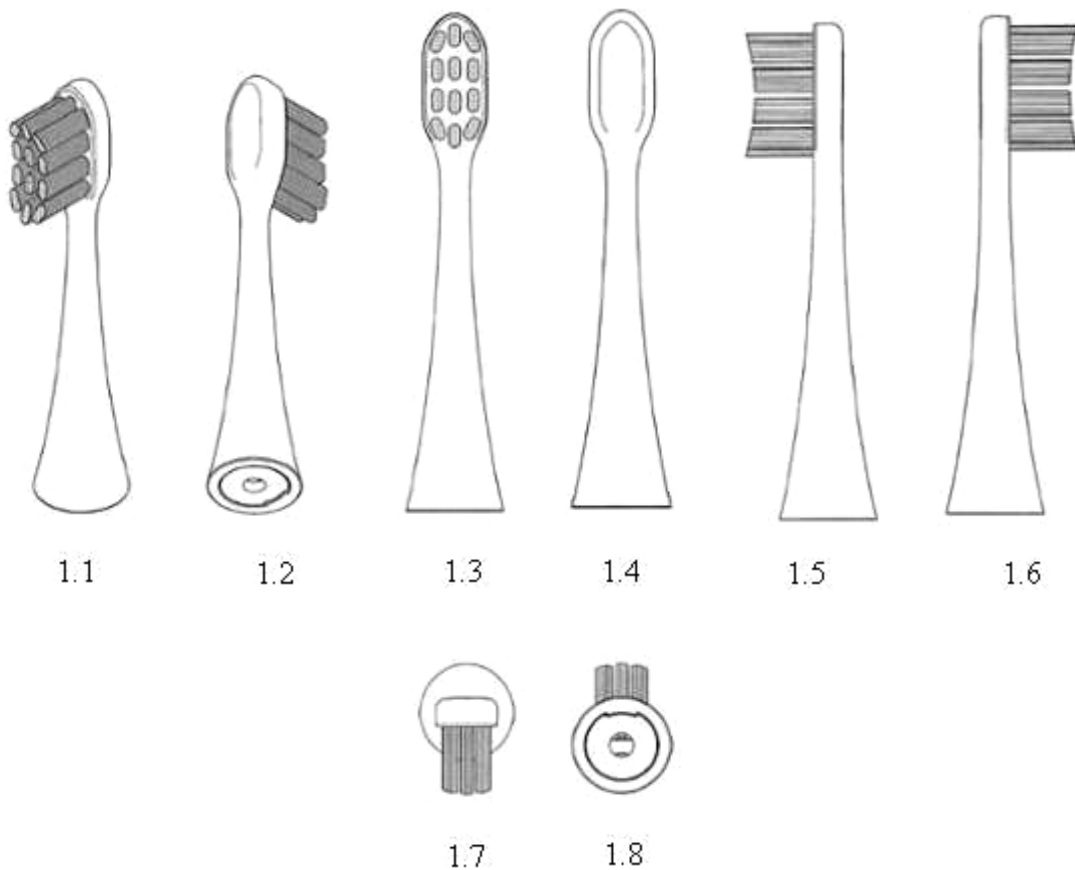

- (11) **40988**
(21) 3-2020-02560 (28) 1
(54) **ĐẦU THAY THỂ CHO DỤNG CỤ CHĂM SÓC RĂNG MIỆNG** (51) **04-02**
(22) 14/10/2020 (43) 25/02/2021
(30) 29/733,208 30/04/2020 US;
(73) **COLGATE-PALMOLIVE COMPANY (US)**
300 Park Avenue, New York, New York 10022, United States of America
1. JIANG ZHOU (CN)
2. YANMEI JI (CN)
(72) 3. FAN GANG XIE (CN)
4. GUOQIANG LIU (CN)
5. WEN JIN ZI (CN)
(74) Văn phòng Luật sư Ân Nam (ANNAM IP & LAW)
(55)

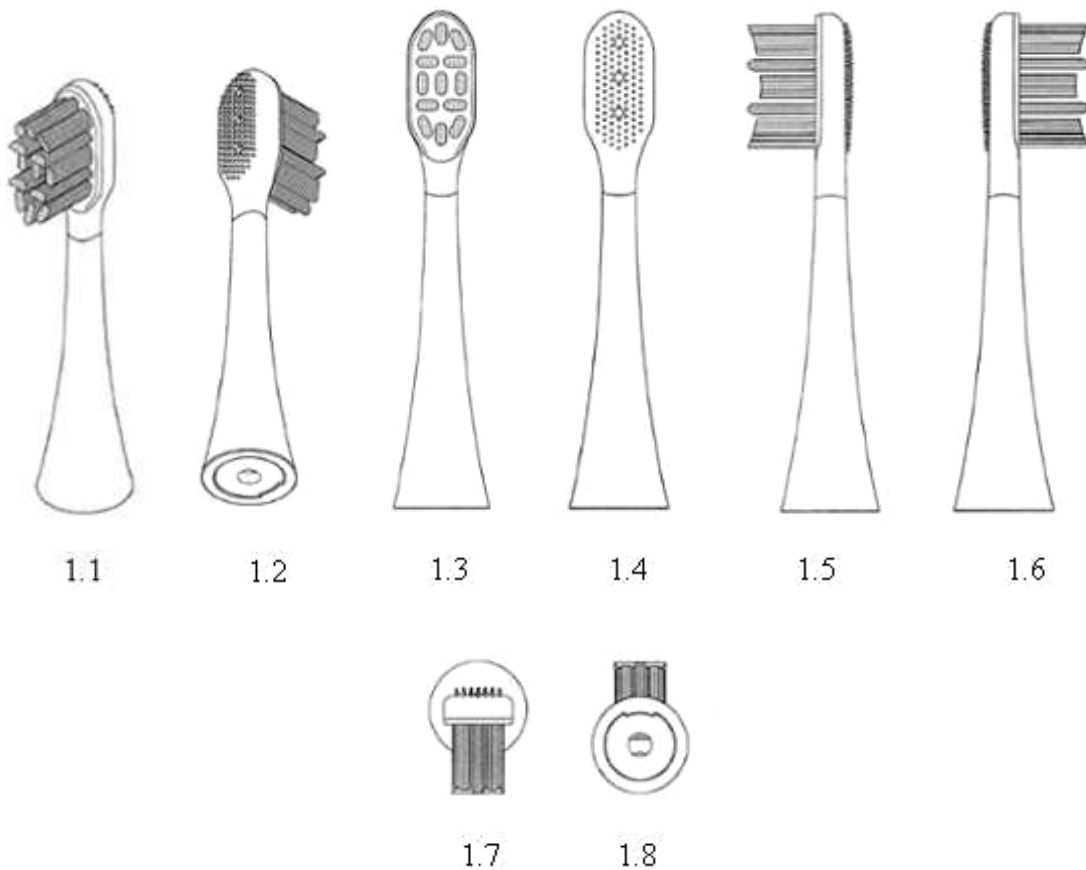

- (11) **40989**
(21) 3-2020-02504 (28) 1
(54) **TẤM TRANG TRÍ** (51) **05-06**
(22) 21/11/2018 (43) 25/02/2021
(30) 29/648,478 22/05/2018 US;
(73) **BERRY GLOBAL, INC. (US)**
101 Oakley Street, Evansville, IN 47710, United States of America
(72) 1. RALPH A. MOODY, III (US)
2. KANG ZHEN CHEN (CN)
(74) Công ty Luật TNHH T&G (TGVN)
(55)

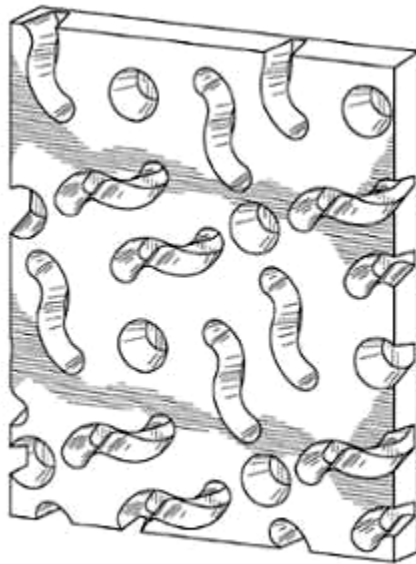

1.1

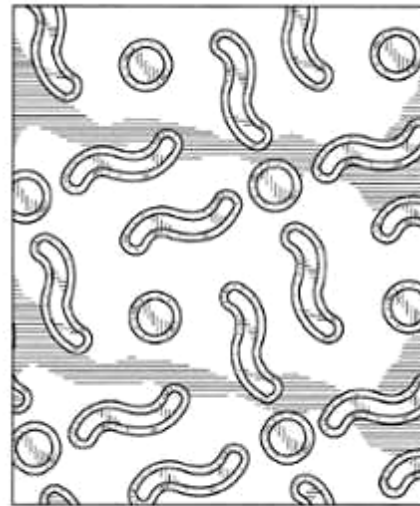

1.2



1.3

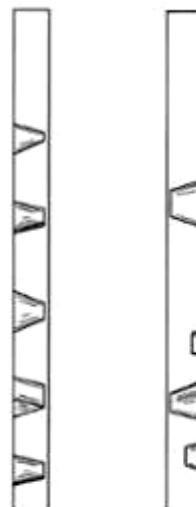

1.4

1.5



1.6



1.7

- (11) **40990**
(21) 3-2020-02503 (28) 1
(54) **TẤM TRANG TRÍ** (51) **05-06**
(22) 21/11/2018 (43) 25/02/2021
(30) 29/648,478 22/05/2018 US;
(73) **BERRY GLOBAL, INC. (US)**
101 Oakley Street, Evansville, IN 47710, United States of America
(72) 1. RALPH A. MOODY, III (US)
2. KANG ZHEN CHEN (CN)
(74) Công ty Luật TNHH T&G (TGVN)
(55)

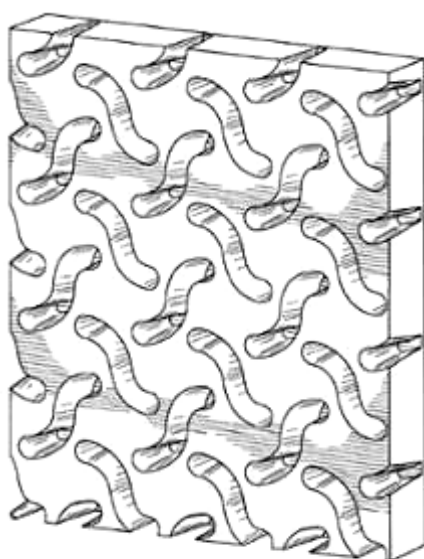

1.1

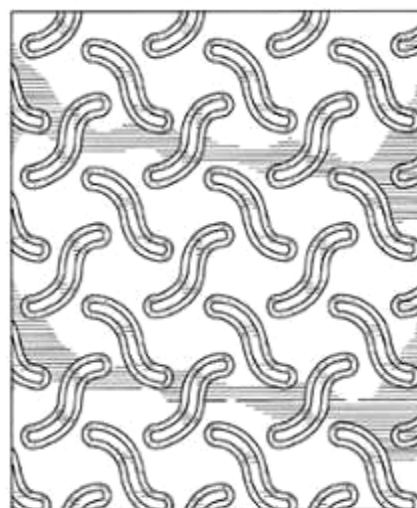

1.2



1.3



1.4



1.5

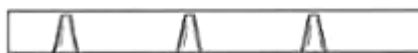

1.6



1.7

(11) **40991**

(21) 3-2020-02476

(28) 1

(54) **TAI NGHE**

(51) **14-01**

(22) 05/10/2020

(43) 25/02/2021

(30) 202030145838.6 14/04/2020 CN;

HUAWEI TECHNOLOGIES CO., LTD. (CN)

(73) Huawei Administration Building, Bantian, Longgang District, Shenzhen, Guangdong 518129, P. R. China

(72) 1. ZHAO, YING (CN)

2. DIAO, GUOFEI (CN)

(74) Công ty Cổ phần Sở hữu công nghiệp INVESTIP (INVESTIP)

(55)



1.1



1.2



1.3



1.4



1.5



1.6



1.7



1.8

- (11) **40992**
(21) 3-2020-02468 (28) 1
(54) **MÁ PHANH ĐĨA** (51) **12-16**
(22) 05/10/2020 (43) 25/02/2021
(30) 2020-007188 06/04/2020 JP;
NISSIN KOGYO CO., LTD. (JP)
(73) 801 Kazawa, Tomi-city, Nagano, 3890514 Japan
(72) ATSUTA, Daiki (JP)
(74) Công ty TNHH Sở hữu trí tuệ Vàng (GINTASSET CO., LTD.)
(55)

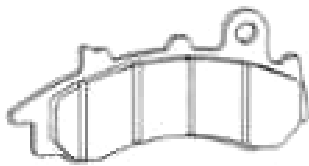

1.1



1.2



1.3



1.4



1.5



1.6



1.7



1.8

- (11) **40993**
(21) 3-2020-02467 (28) 1
(54) **MÁ PHANH ĐĨA** (51) **12-16**
(22) 05/10/2020 (43) 25/02/2021
(30) 2020-007189 06/04/2020 JP;
(73) **NISSIN KOGYO CO., LTD.** (JP)
801 Kazawa, Tomi-city, Nagano, 3890514 Japan
(72) **ATSUTA, Daiki** (JP)
(74) Công ty TNHH Sở hữu trí tuệ Vàng (**GINTASSET CO., LTD.**)
(55)

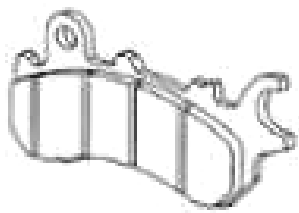

1.1

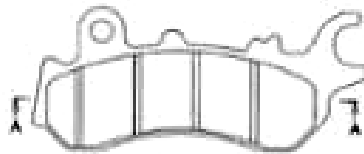

1.2



1.3



1.4



1.5



1.6



1.7



1.8

CÔNG BÁO SỞ HỮU CÔNG NGHIỆP SỐ 395 TẬP A – QUYỀN 2 (02.2021)

- (11) **40994**
(21) 3-2020-02466 (28) 1
(54) **XE ĐẠP ĐIỆN** (51) **12-11**
(22) 02/10/2020 (43) 25/02/2021
(30) 202030164038.9 21/04/2020 CN;
YADEA TECHNOLOGY GROUP CO.,LTD (CN)
(73) Dongsheng Road, Dacheng Industrial Zone, Anzhen, Xishan District, Wuxi,
Jiangsu, China
1. SHEN, BIN (CN)
(72) 2. WU, HUI (CN)
(74) Công ty TNHH Sáng chế ACTIP (ACTIP PATENT LIMITED)
(55)



1.1



1.2



1.3



1.4



1.5



1.6



1.7



1.8

- (11) **40995**
(21) 3-2020-02461 (28) 1
(54) **TAI NGHE** (51) **14-01**
(22) 02/10/2020 (43) 25/02/2021
(30) 202030145864.9 14/04/2020 CN;
HUAWEI TECHNOLOGIES CO., LTD. (CN)
(73) Huawei Administration Building, Bantian, Longgang District, Shenzhen,
Guangdong 518129, P. R. China
1. ZHAO, YING (CN)
(72) 2. DIAO, GUOFEI (CN)
3. PARK, DONGHYEOK (KR)
(74) Công ty Cổ phần Sở hữu công nghiệp INVESTIP (INVESTIP)
(55)



1.1

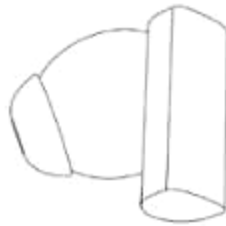

1.2



1.3



1.4



1.5



1.6



1.7



1.8

(11) **40996**

(21) 3-2020-02442

(28) 1

(54) **THIẾT BỊ LỌC KHÔNG KHÍ**

(51) **23-04**

(22) 30/09/2020

(43) 25/02/2021

TẬP ĐOÀN CÔNG NGHIỆP - VIỆN THÔNG QUÂN ĐỘI (VN)

(73) Lô D26 Khu đô thị mới Cầu Giấy, phường Yên Hoà, quận Cầu Giấy, thành phố Hà Nội

1. TRẦN NGỌC THẠCH (VN)

2. ĐINH VĂN DUY (VN)

(72) 3. NGUYỄN TIẾN TÙNG (VN)

4. PHẠM THANH TUẤN (VN)

(74) Công ty TNHH Tư vấn Quốc Dân (NACI CO., LTD)

(55)

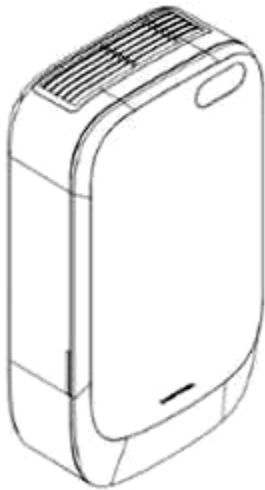

1.1



1.2

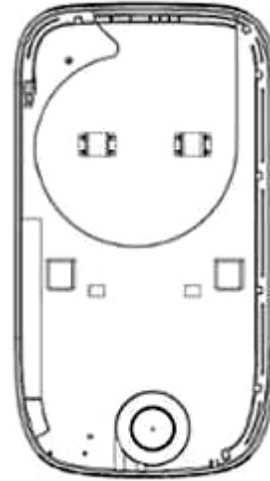

1.3



1.4



1.5

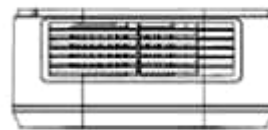

1.6

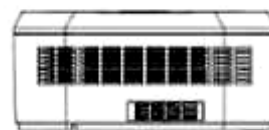

1.7

(11) **40997**

(21) 3-2020-02417

(28) 1

(54) **BỆ TÌ TAY**

(51) **06-01**

(22) 28/09/2020

(43) 25/02/2021

(30) 202030316069.1 18/06/2020 CN;

EMOMO TECHNOLOGY CO., LTD. (CN)

(73) West of 4/F, Yonghe Industry Building, No. 8 Jilong Road, Baoan District, Shenzhen, Guangdong 518100, China

(72) 1. WENJI TANG (CN)

2. JEFFREY S. COLLIER (US)

(74) Công ty TNHH Quốc tế D&N (D&N INTERNATIONAL CO.,LTD.)

(55)

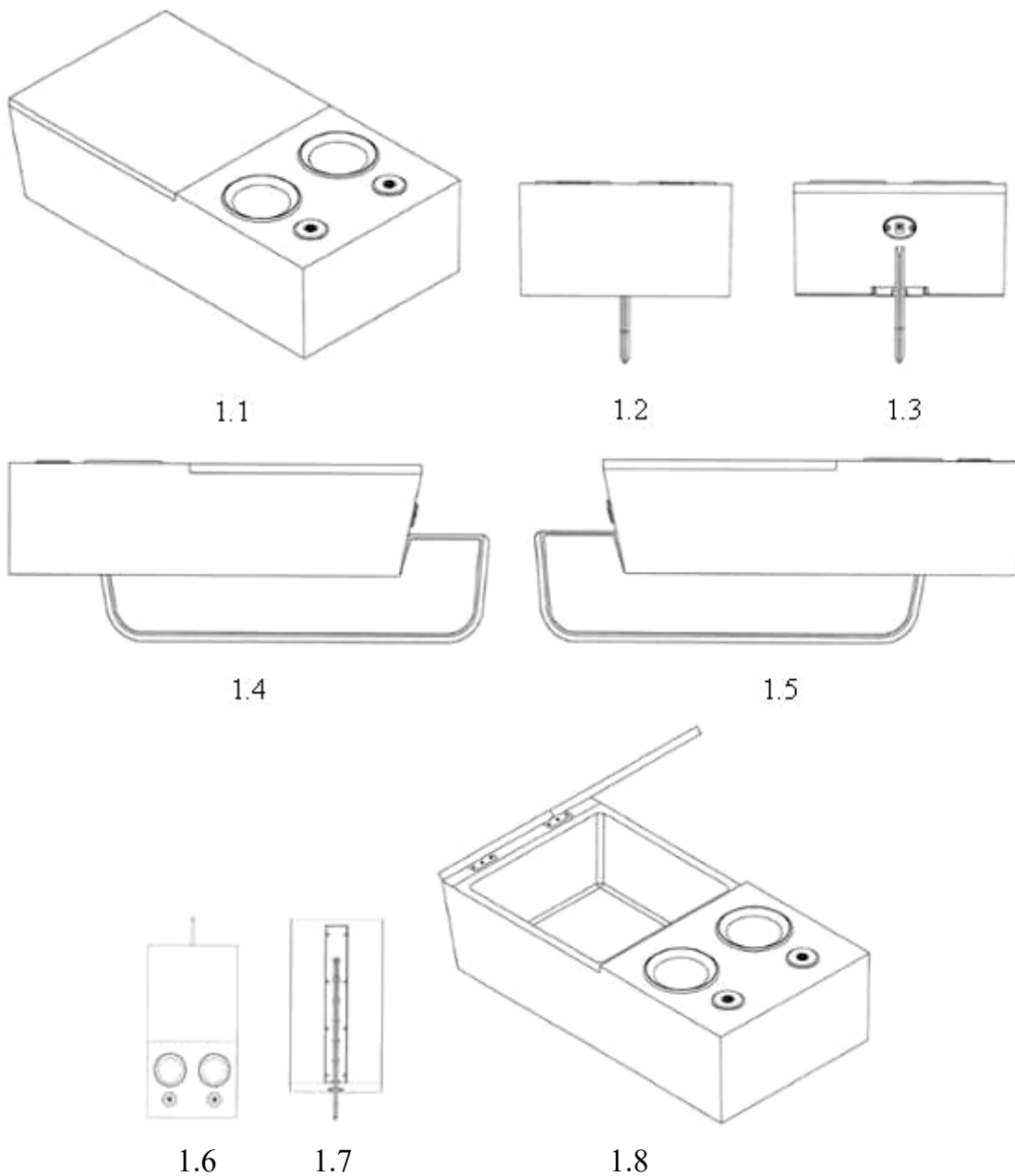

CÔNG BÁO SỞ HỮU CÔNG NGHIỆP SỐ 395 TẬP A – QUYỀN 2 (02.2021)

- (11) **40998**
(21) 3-2020-02416 (28) 1
(54) **BỆ TÌ TAY** (51) **06-01**
(22) 28/09/2020 (43) 25/02/2021
(30) 202030315328.9 18/06/2020 CN;
EMOMO TECHNOLOGY CO., LTD. (CN)
(73) West of 4/F, Yonghe Industry Building, No. 8 Jilong Road, Baoan District,
Shenzhen, Guangdong 518100, China
1. WENJI TANG (CN)
(72) 2. JEFFREY S. COLLIER (US)
(74) Công ty TNHH Quốc tế D&N (D&N INTERNATIONAL CO.,LTD.)
(55)

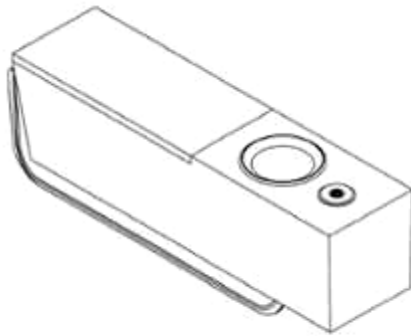

1.1



1.2

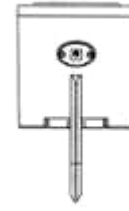

1.3

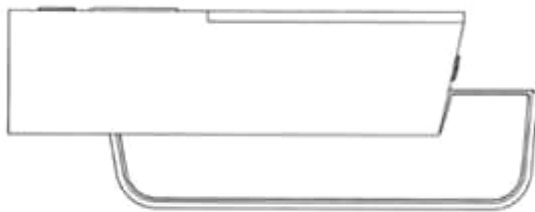

1.4



1.5



1.6



1.7

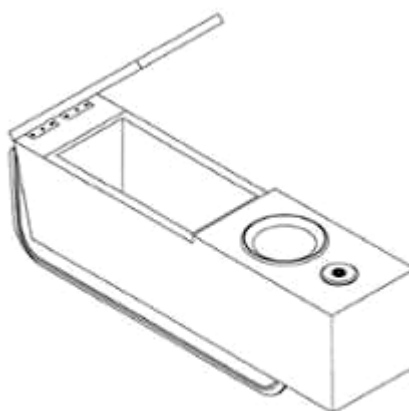

1.8

- (11) **40999**
(21) 3-2020-02387 (28) 1
(54) **TAY CẦM CỦA DỤNG CỤ CHĂM SÓC RĂNG MIỆNG** (51) **28-03**
(22) 24/09/2020 (43) 25/02/2021
(30) 29/733,204 30/04/2020 US;
(73) **COLGATE-PALMOLIVE COMPANY (US)**
300 Park Avenue, New York, New York 10022, United States of America
1. JIANG ZHOU (CN)
2. FAN GANG XIE (CN)
(72) 3. YANMEI JI (CN)
4. GUOQIANG LIU (CN)
5. WEN JIN XI (CN)
(74) Văn phòng Luật sư Ân Nam (ANNAM IP & LAW)
(55)

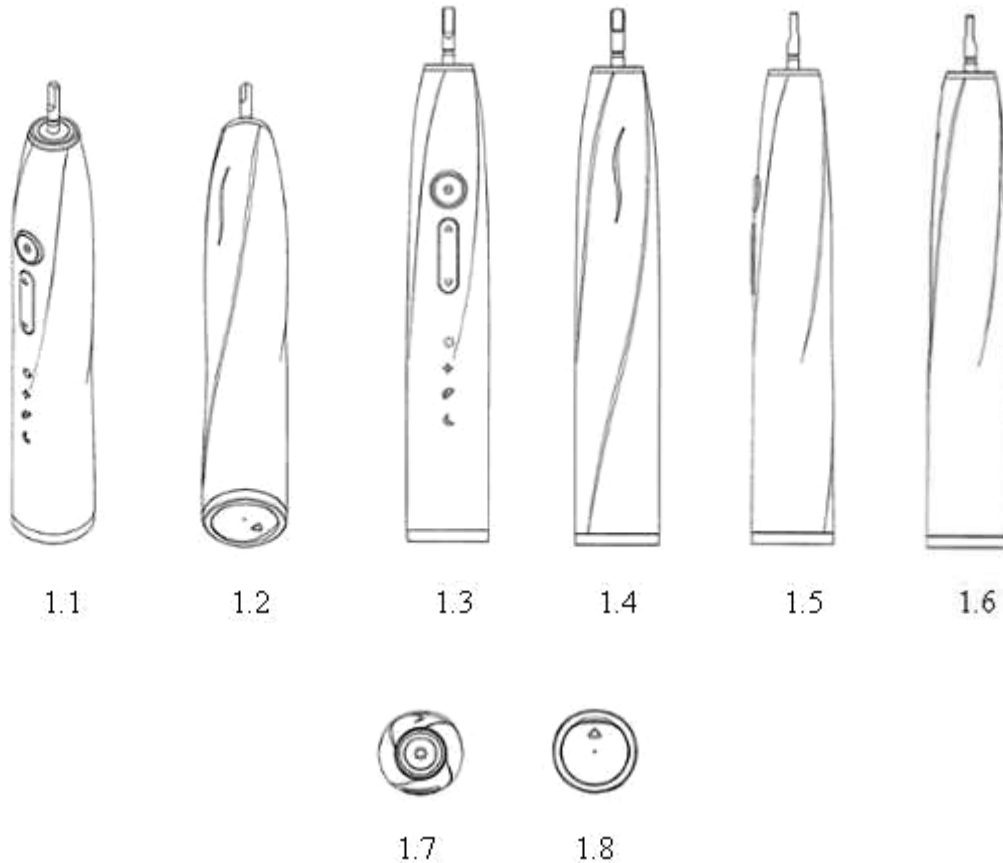

CÔNG BÁO SỞ HỮU CÔNG NGHIỆP SỐ 395 TẬP A – QUYỀN 2 (02.2021)

(11) **41000**

(21) 3-2020-02378

(28) 1

(54) **PIN**

(51) **13-02**

(22) 23/09/2020

(43) 25/02/2021

CÔNG TY CỔ PHẦN PHƯƠNG TIỆN ĐIỆN THÔNG MINH SELEX (VN)

(73) Nhà B26, BT6, khu đô thị Văn Quán, phường Văn Quán, quận Hà Đông, thành phố Hà Nội

1. ĐÀO DUY TUẤN (VN)

2. PHAN THANH BÌNH (VN)

(72) 3. ĐẶNG HUY HOÀNG (VN)

4. NGUYỄN HỮU PHƯỚC NGUYỄN (VN)

(74) Công ty Luật TNHH Tư vấn Quốc tế (INDOCHINE COUNSEL)

(55)



1.1



1.2



1.3



1.4



1.5



1.6



1.7

- (11) **41001**
(21) 3-2020-02369 (28) 1
(54) **MÁY ĐIỀU HÒA NHIỆT ĐỘ** (51) **23-04**
(22) 23/09/2020 (43) 25/02/2021
(30) 2020-005660 25/03/2020 JP;
DAIKIN INDUSTRIES, LTD. (JP)
(73) UMEDA CENTER BUILDING, 4-12, Nakazaki-Nishi 2-chome, Kita-ku, Osaka-shi, Osaka-fu, Japan
(72) Takaaki SANAGI (JP)
(74) Công ty TNHH một thành viên Sở hữu trí tuệ VCCI (VCCI-IP CO.,LTD)
(55)

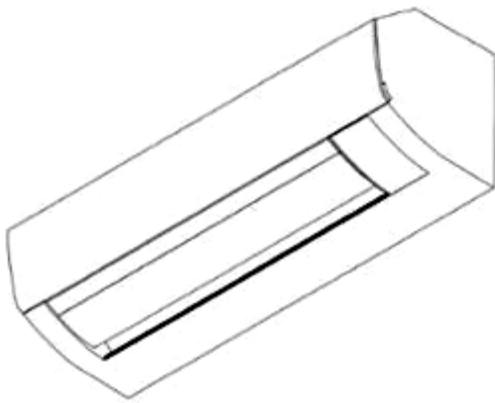

1.1

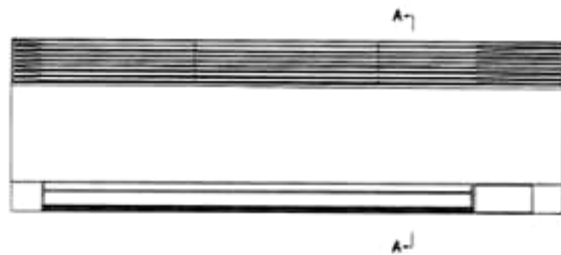

1.2



1.3



1.4



1.5



1.6



1.7



1.8

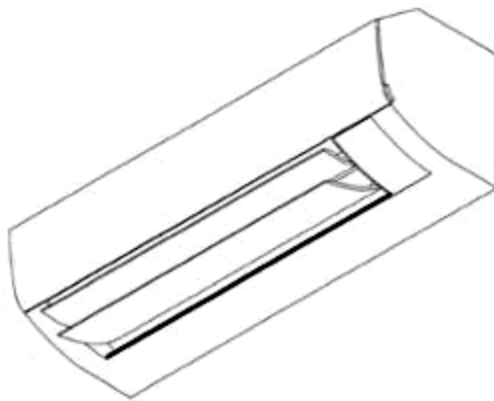

1.9

CÔNG BÁO SỞ HỮU CÔNG NGHIỆP SỐ 395 TẬP A – QUYỀN 2 (02.2021)

(11) **41002**

(21) 3-2020-02367

(28) 1

(54) **BÚT**

(51) **19-06**

(22) 22/09/2020

(43) 25/02/2021

CÔNG TY CỔ PHẦN TẬP ĐOÀN THIÊN LONG (VN)

(73) Lô 6-8-10-12 đường số 3, khu công nghiệp Tân Tạo, quận Bình Tân, thành phố Hồ Chí Minh

(72) Cô Gia Thọ (VN)

(74) Công ty TNHH Tư vấn sở hữu trí tuệ Việt (VIET IP CO.,LTD.)

(55)



1.1



1.2



1.3



1.4



1.5



1.6



1.7

CÔNG BÁO SỞ HỮU CÔNG NGHIỆP SỐ 395 TẬP A – QUYỀN 2 (02.2021)

- (11) **41003**
(21) 3-2020-02366 (28) 1
(54) **BẢNG CHỮ SỐ** (51) **19-07; 21-01**
(22) 22/09/2020 (43) 25/02/2021
(73) **CÔNG TY TNHH MTV SD (VN)**
Khu phố 3, phường 9, thành phố Mỹ Tho, tỉnh Tiền Giang
(72) Nguyễn Văn Dũng (VN)
(74) Công ty Luật Hợp danh bản quyền Quốc tế (CIS LAW FIRM)
(55)



1.1



1.2



1.3



1.4



1.5



1.6



1.7

(11) **41004**

(21) 3-2020-02362

(54) **CHAI ĐỰNG NƯỚC**

(22) 22/09/2020

(73) **CÔNG TY TNHH SẢN XUẤT THƯƠNG MẠI AQUA CRYSTAL (VN)**

94 đường 218 Cao Lỗ, phường 4, quận 8, thành phố Hồ Chí Minh

(72) **LÊ VIỆT EM (VN)**

(55)

(28) 1

(51) **09-01**

(43) 25/02/2021



1.1



1.2

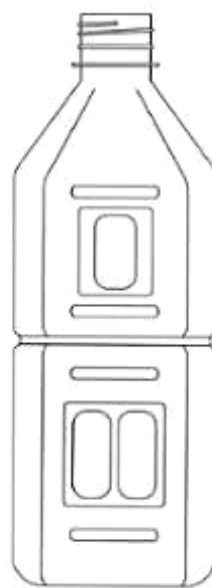

1.3



1.4



1.5

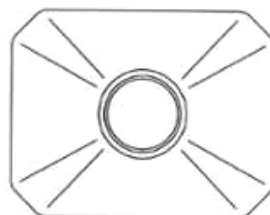

1.6

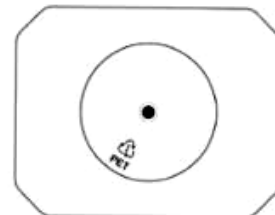

1.7

- (11) **41005**
(21) 3-2020-02349 (28) 1
(54) **KHUNG MẮC VÕNG** (51) **06-02**
(22) 21/09/2020 (43) 25/02/2021
(73) **CÔNG TY TNHH THƯƠNG MẠI SẢN XUẤT TRANG SI (VN)**
D6/643, ấp 3, xã Bình Lợi, huyện Bình Chánh, thành phố Hồ Chí Minh
(72) NGUYỄN KỲ TRUNG (VN)
(74) Công ty TNHH Sở hữu trí tuệ Đông Dương (DONG DUONG IP CO.,LTD)
(55)

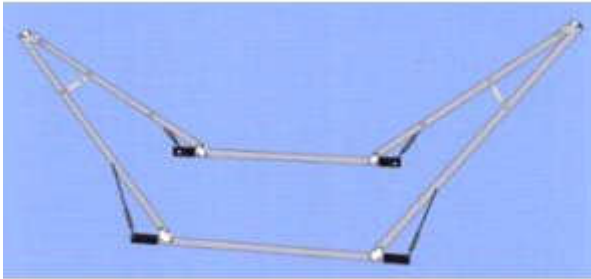

1.1

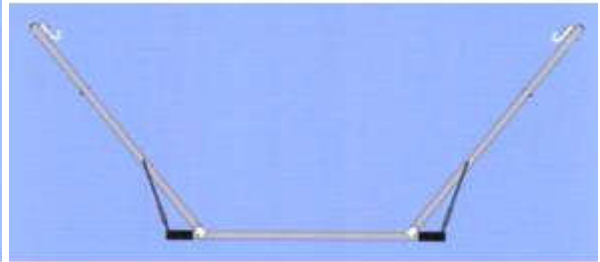

1.2

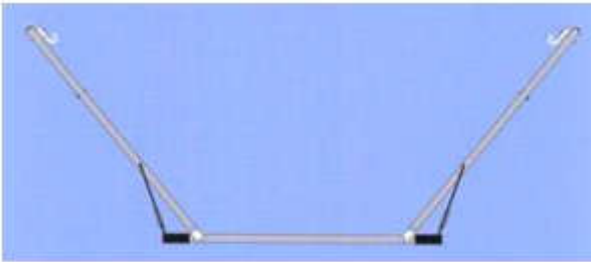

1.3



1.4



1.5

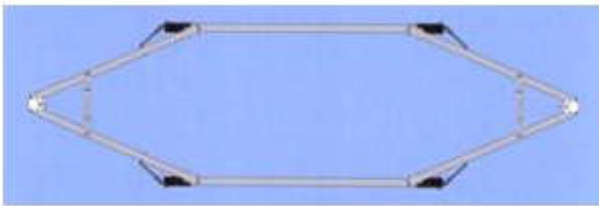

1.6

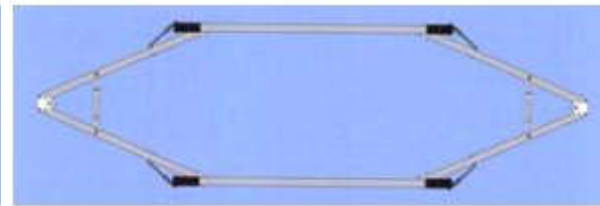

1.7

CÔNG BÁO SỞ HỮU CÔNG NGHIỆP SỐ 395 TẬP A – QUYỀN 2 (02.2021)

- (11) **41006**
(21) 3-2020-02332 (28) 1
(54) **HỘP** (51) **09-03**
(22) 18/09/2020 (43) 25/02/2021
(73) **CÔNG TY CỔ PHẦN XUẤT NHẬP KHẨU BẾN TRE (VN)**
Lô K, CCN-TTCN Phong Năm, xã Phong Năm, huyện Giồng Trôm, tỉnh Bến Tre
(72) Lý Ngọc Trân (VN)
(74) Công ty TNHH Tư vấn sở hữu trí tuệ Việt (VIET IP CO.,LTD.)
(55)



1.1



1.2



1.3



1.4



1.5



1.6



1.7

CÔNG BÁO SỞ HỮU CÔNG NGHIỆP SỐ 395 TẬP A – QUYỀN 2 (02.2021)

- (11) **41007**
(21) 3-2020-02331 (28) 1
(54) **HỘP** (51) **09-03**
(22) 18/09/2020 (43) 25/02/2021
(73) **CÔNG TY CỔ PHẦN XUẤT NHẬP KHẨU BẾN TRE (VN)**
Lô K, CCN-TTCN Phong Năm, xã Phong Năm, huyện Giồng Trôm, tỉnh Bến Tre
(72) Lý Ngọc Trân (VN)
(74) Công ty TNHH Tư vấn sở hữu trí tuệ Việt (VIET IP CO.,LTD.)
(55)



1.1

1.2

1.3



1.4

1.5

1.6

1.7

(11) **41008**

(21) 3-2020-02325

(28) 1

(54) **NHÀ LƯU ĐỘNG**

(51) **25-03**

(22) 18/09/2020

(43) 25/02/2021

1. **ĐOÀN XUÂN KHA (VN)**

(73) Ấp Tân Hữu, xã Xuân Thành, huyện Xuân Lộc, tỉnh Đồng Nai

2. **NGUYỄN THANH SƠN (VN)**

Ấp Tân Hạnh, xã Xuân Bảo, huyện Cẩm Mỹ, tỉnh Đồng Nai

(72) 1. **ĐOÀN XUÂN KHA (VN)**

2. **NGUYỄN THANH SƠN (VN)**

(74) Công ty TNHH Tư vấn đầu tư và Sở hữu trí tuệ Hoàng Phi (HOANG PHI INVEST & I.P CO., LTD)

(55)



1.1



1.2



1.3



1.4



1.5

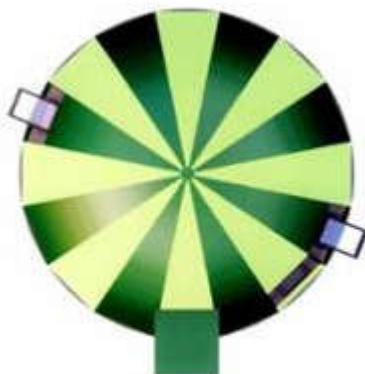

1.6



1.7

(11) **41009**

(21) 3-2020-02304

(28) 1

(54) **MÁY XÔNG HƠI**

(51) **23-03**

(22) 17/09/2020

(43) 25/02/2021

CÔNG TY CỔ PHẦN ĐẦU TƯ SẢN XUẤT VÀ XUẤT NHẬP KHẨU TOÀN PHÁT (VN)

(73) Tổ 3 cụm 1, ngõ 345 phố Khương Trung, phường Khương Đình, quận Thanh Xuân, thành phố Hà Nội

(72) Trịnh Anh Toàn (VN)

(74) Công ty Luật TNHH Phượng Hoàng (PHOENIX LAW)

(55)



1.1



1.2

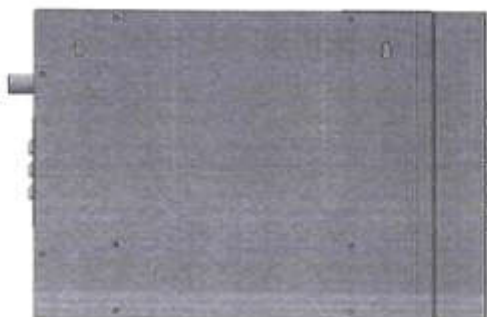

1.3



1.4



1.5



1.6



1.7

CÔNG BÁO SỞ HỮU CÔNG NGHIỆP SỐ 395 TẬP A – QUYỀN 2 (02.2021)

(11) **41010**

(21) 3-2020-02303

(28) 1

(54) **MÁY BÁN HÀNG TỰ ĐỘNG**

(51) **20-01**

(22) 17/09/2020

(43) 25/02/2021

(73) **CÔNG TY CỔ PHẦN TỰ ĐỘNG HÓA TÂN PHÁT (VN)**

Số 189 đường Phan Trọng Tuệ, xã Thanh Liệt, huyện Thanh Trì, thành phố Hà Nội

(72) Nguyễn Quốc Đạt (VN)

(74) Công ty Luật TNHH Phạm và Liên danh (PHAM & ASSOCIATES)

(55)



1.1



1.2



1.3



1.4



1.5



1.6



1.7

(11) **41011**

(21) 3-2020-02286

(28) 1

(54) **THIẾT BỊ ĐUN NƯỚC**

(51) **23-03**

(22) 15/09/2020

(43) 25/02/2021

ATLANTIC SOCIETE FRANCAISE DE DEVELOPPEMENT

(73) **THERMIQUE (FR)**

44 Boulevard des Etats-Unis – 85000 LA ROCHE-SUR-YON, France

(72) Amaury MALHERE (FR)

(74) Công ty Luật TNHH Phạm và Liên danh (PHAM & ASSOCIATES)

(55)

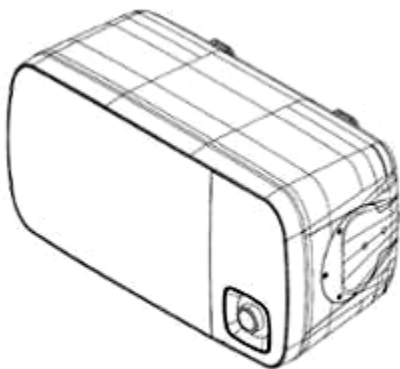

1.1

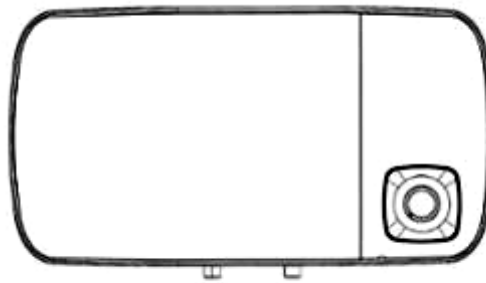

1.2

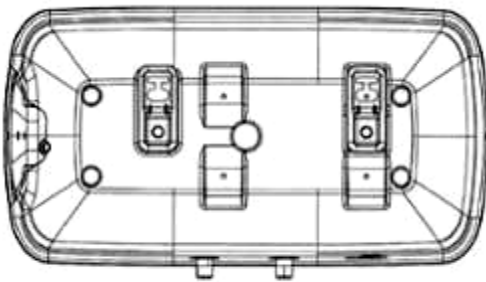

1.3

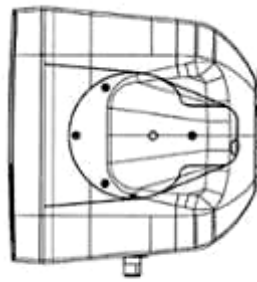

1.4

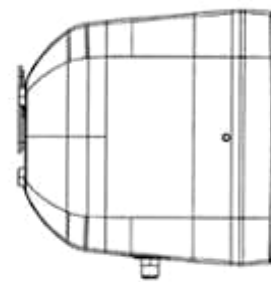

1.5

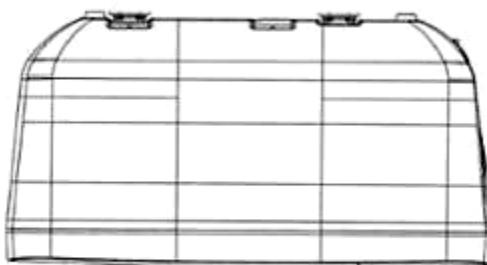

1.6

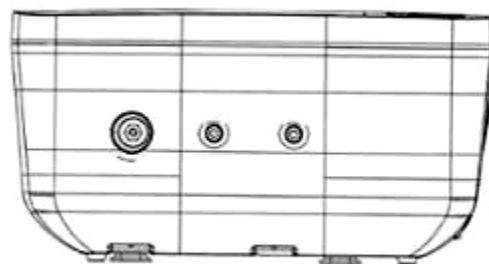

1.7

CÔNG BÁO SỞ HỮU CÔNG NGHIỆP SỐ 395 TẬP A – QUYỀN 2 (02.2021)

- (11) **41012**
(21) 3-2020-02283 (28) 1
(54) **XE BA BÁNH** (51) **12-11**
(22) 15/09/2020 (43) 25/02/2021
(30) 202030102070.4 17/03/2020 CN;
(73) **ADIVA (SHANGHAI) TRADING CO., LTD. (CN)**
South side of Building 2, 261 Sanyou Road, Minhang District, Shanghai, China
(72) **KOMASATO RINDA (JP)**
(74) **CÔNG TY LUẬT TRÁCH NHIỆM HỮU HẠN AMBYS HÀ NỘI (AMBYS HANOI)**
(55)



1.1



1.2



1.3



1.4



1.5



1.6

(11) **41013**

(21) 3-2020-02247

(28) 1

(54) **MÁY TRỘN BỘT TRÁT TƯỜNG**

(51) **15-04**

(22) 11/09/2020

(43) 25/02/2021

(73) **CÔNG TY TNHH HỒ HOÀN CẦU (VN)**

Xóm 6, xã Quỳnh Văn, huyện Quỳnh Lưu, tỉnh Nghệ An

(72) Hồ Xuân Vinh (VN)

(55)



1.1



1.2



1.3

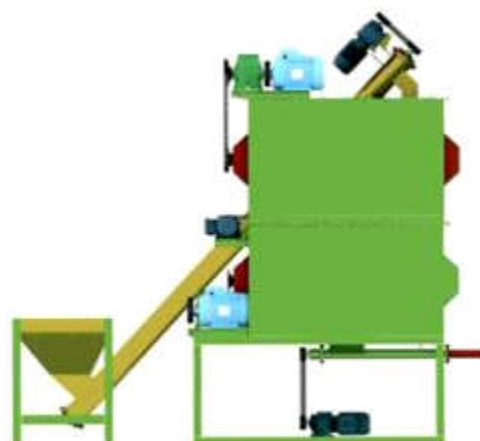

1.4



1.5



1.6

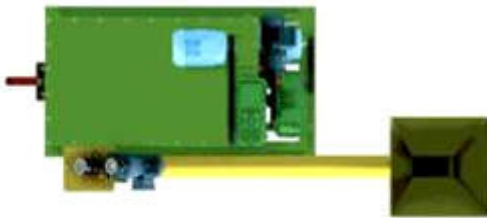

1.7



1.8

CÔNG BÁO SỞ HỮU CÔNG NGHIỆP SỐ 395 TẬP A – QUYỀN 2 (02.2021)

(11) **41014**

(21) 3-2020-02246

(28) 1

(54) **MÁY SẢN XUẤT GẠCH**

(51) **15-04**

(22) 11/09/2020

(43) 25/02/2021

(73) **CÔNG TY TNHH HỒ HOÀN CẦU (VN)**

Xóm 6, xã Quỳnh Văn, huyện Quỳnh Lưu, tỉnh Nghệ An

(72) Hồ Xuân Vinh (VN)

(55)



1.1



1.2

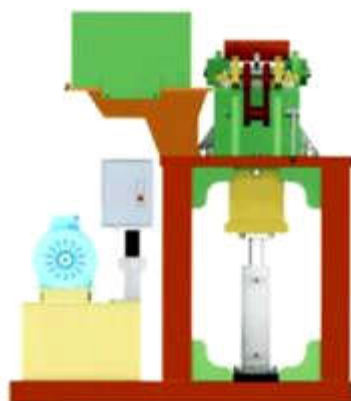

1.3

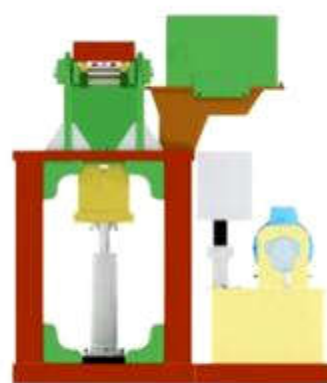

1.4



1.5



1.6

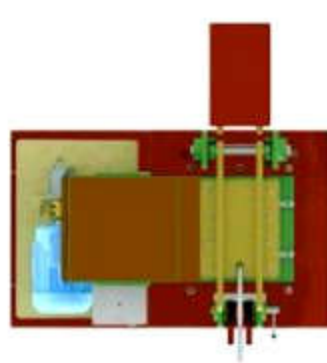

1.7

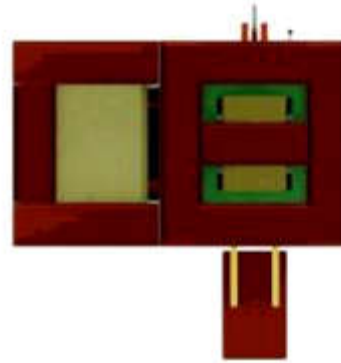

1.8

CÔNG BÁO SỞ HỮU CÔNG NGHIỆP SỐ 395 TẬP A – QUYỀN 2 (02.2021)

- (11) **41015**
(21) 3-2020-02044 (28) 1
(54) **ĐIỀU THUỐC LÁ ĐIỆN TỬ** (51) **27-01**
(22) 31/08/2020 (43) 25/02/2021
(30) KR 30-2020-0009732 04/03/2020 KR;
KT&G CORPORATION (KR)
(73) 71, Beotkkot-gil, Daedeok-gu, Daejeon, Korea
(72) KIM, Min Chul (KR)
(74) Công ty TNHH T&T INVENMARK Sở hữu trí tuệ Quốc tế (T&T INVENMARK CO., LTD.)
(55)

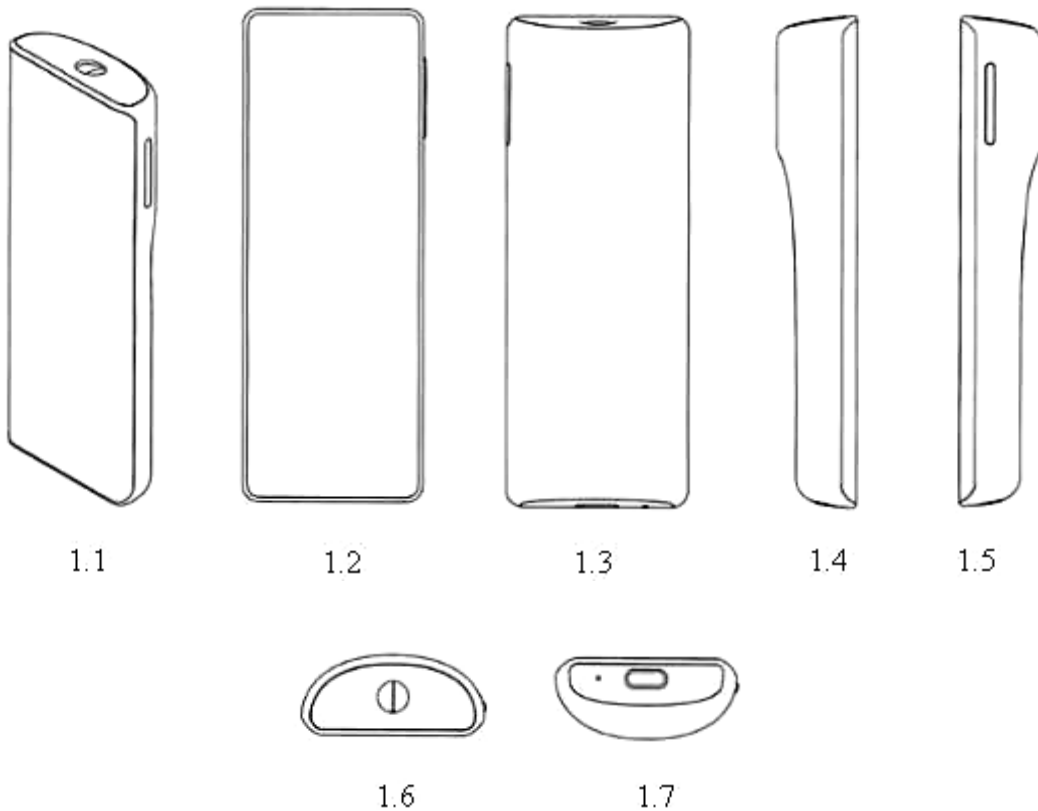

- (11) **41016**
(21) 3-2020-02040 (28) 1
(54) **XE MÁY** (51) **12-11**
(22) 31/08/2020 (43) 25/02/2021
(30) 2020-004055 02/03/2020 JP;
(73) **HONDA MOTOR CO., LTD. (JP)**
1-1, Minami-Aoyama 2-chome, Minato-ku, Tokyo, 107-8556 Japan
1. DAISUKE KURIKI (JP)
(72) 2. YOSHIYUKI ISHIGURI (JP)
3. JUN TANAKA (JP)
(74) Công ty Luật TNHH Phạm và Liên danh (PHAM & ASSOCIATES)
(55)



1.1



1.2



1.3



1.4



1.5



1.6



1.7



1.8



1.9

CÔNG BÁO SỞ HỮU CÔNG NGHIỆP SỐ 395 TẬP A – QUYỀN 2 (02.2021)

- (11) **41017**
(21) 3-2020-02003 (28) 1
(54) **BỘ ĐỒ CHƠI GẮN TƯỜNG** (51) **21-01**
(22) 28/08/2020 (43) 25/02/2021
CÔNG TY TNHH 314A (VN)
(73) Số 32A, ngõ 358/25 Bùi Xương Trạch, phường Khương Đình, quận Thanh Xuân, thành phố Hà Nội
(72) **TRẦN VĂN TUẤN (VN)**
(74) **CÔNG TY LUẬT TNHH T2H (T2H LIMITED LIABILITY LAW COMPANY)**
(55)

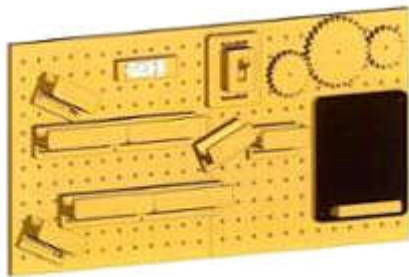

1.1

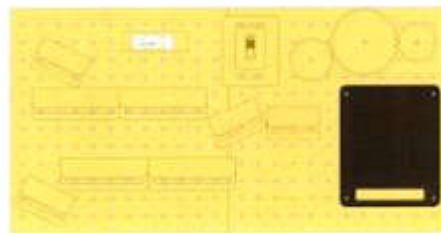

1.2



1.3



1.4



1.5



1.6



1.7

CÔNG BÁO SỞ HỮU CÔNG NGHIỆP SỐ 395 TẬP A – QUYỀN 2 (02.2021)

- (11) **41018**
(21) 3-2020-01998 (28) 1
(54) **XE MÁY** (51) **12-11**
(22) 28/08/2020 (43) 25/02/2021
(30) 2020-003795 28/02/2020 JP;
(73) **YAMAHA HATSUDOKI KABUSHIKI KAISHA (JP)**
2500 Shingai, Iwata-shi, Shizuoka-ken 438-8501, Japan
(72) 1. TANARAT DECHUDOMSUB (TH)
2. CHARNCHAI JARNGPRASERT (TH)
(74) Công ty TNHH Tư vấn - Đầu tư N.T.K. (N.T.K. CO., LTD.)
(55)



1.1



1.2



1.3



1.4



1.5



1.6



1.7



1.8

CÔNG BÁO SỞ HỮU CÔNG NGHIỆP SỐ 395 TẬP A – QUYỀN 2 (02.2021)

- (11) **41019**
(21) 3-2020-01997 (28) 1
(54) **XE MÁY** (51) **12-11**
(22) 28/08/2020 (43) 25/02/2021
(30) 2020-003794 28/02/2020 JP;
(73) **YAMAHA HATSUDOKI KABUSHIKI KAISHA (JP)**
2500 Shingai, Iwata-shi, Shizuoka-ken 438-8501, Japan
(72) Tadashi INOSE (JP)
(74) Công ty TNHH Tư vấn - Đầu tư N.T.K. (N.T.K. CO., LTD.)
(55)



1.1



1.2



1.3



1.4



1.5



1.6



1.7



1.8

- (11) **41020**
(21) 3-2020-01988 (28) 1
(54) **THIẾT BỊ LÀM MÁT CỔ** (51) **24-04**
(22) 27/08/2020 (43) 25/02/2021
(30) 2020-003895 28/02/2020 JP;
FUJITSU GENERAL LIMITED (JP)
(73) 3-3-17, Suenaga, Takatsu-ku, Kawasaki-shi, Kanagawa, 213-8502, Japan
(72) Shogo MATSUMOTO (JP)
(74) **CÔNG TY LUẬT TRÁCH NHIỆM HỮU HẠN AMBYS HÀ NỘI (AMBYS HANOI)**
(55)



1.1



1.2



1.3



1.4

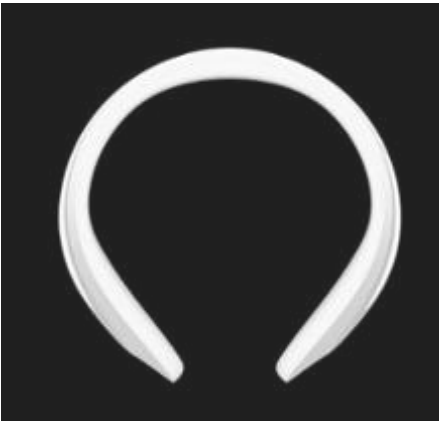

1.5



1.6

CÔNG BÁO SỞ HỮU CÔNG NGHIỆP SỐ 395 TẬP A – QUYỀN 2 (02.2021)

(11) **41021**

(21) 3-2020-01979

(28) 1

(54) **GHẾ**

(51) **06-01**

(22) 20/12/2019

(43) 25/02/2021

CÔNG TY TNHH NỘI THẤT ZIP (VN)

(73) Số 5, lô A, tập thể trường Trung học Nông Nghiệp, phố Vũ Hữu, phường Thanh Xuân Bắc, quận Thanh Xuân, thành phố Hà Nội

(72) Nguyễn Mai Linh (VN)

(74) Công ty TNHH Tư vấn IPNG (IPNG CO.,LTD)

(55)



1.1

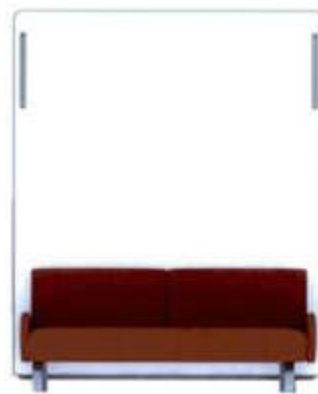

1.2

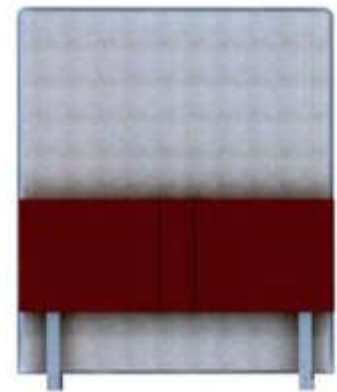

1.3



1.4



1.5



1.6



1.7



1.8

- (11) **41022**
(21) 3-2020-01966 (28) 1
(54) **NHÃN SẢN PHẨM** (51) **19-08**
(22) 24/08/2020 (43) 25/02/2021
(73) **NGUYỄN ANH TUẤN (VN)**
12/18A Lam Sơn, phường 2, quận Tân Bình, thành phố Hồ Chí Minh
(72) Nguyễn Anh Tuấn (VN)
(55)



1.1



1.2

CÔNG BÁO SỞ HỮU CÔNG NGHIỆP SỐ 395 TẬP A – QUYỀN 2 (02.2021)

- (11) **41023**
(21) 3-2020-01965 (28) 1
(54) **BAO GÓI** (51) **09-05**
(22) 24/08/2020 (43) 25/02/2021
(73) **NGUYỄN ANH TUẤN (VN)**
12/18A Lam Sơn, phường 2, quận Tân Bình, thành phố Hồ Chí Minh
(72) Nguyễn Anh Tuấn (VN)
(55)

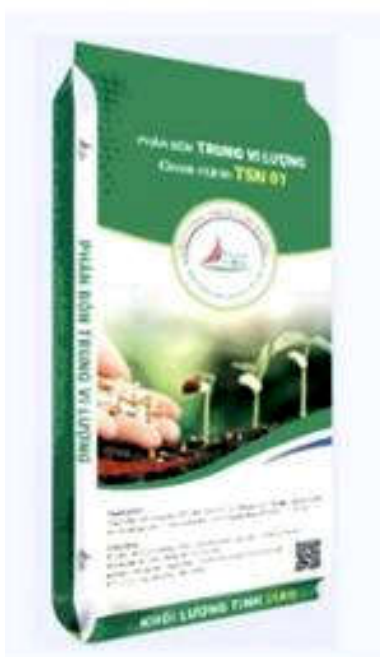

1.1

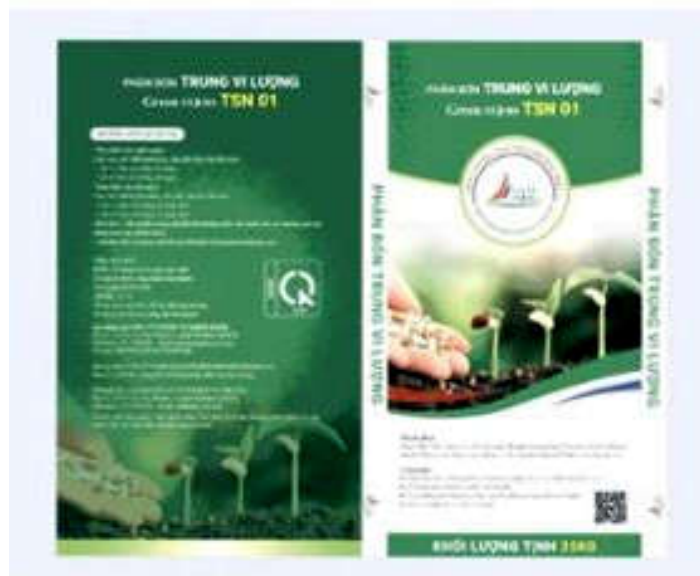

1.2

CÔNG BÁO SỞ HỮU CÔNG NGHIỆP SỐ 395 TẬP A – QUYỀN 2 (02.2021)

- (11) **41024**
(21) 3-2020-01963 (28) 1
(54) **BAO GÓI** (51) **09-05**
(22) 24/08/2020 (43) 25/02/2021
(73) **NGUYỄN ANH TUẤN (VN)**
12/18A Lam Sơn, phường 2, quận Tân Bình, thành phố Hồ Chí Minh
(72) Nguyễn Anh Tuấn (VN)
(55)

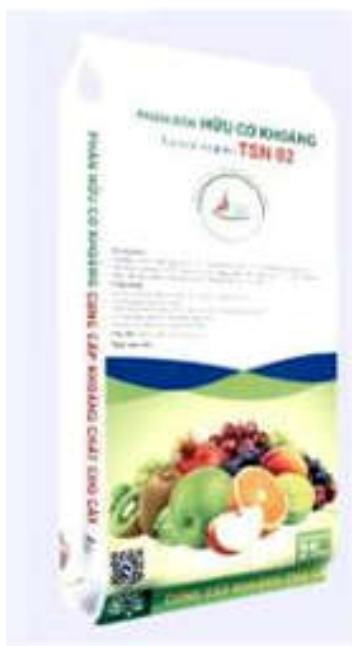

1.1



1.2

- (11) **41025**
(21) 3-2020-01955 (28) 1
(54) **MÔ-ĐUN NGÓN TAY ROBOT** (51) **15-99**
(22) 21/08/2020 (43) 25/02/2021
VÕ GIA LỘC (VN)
(73) Số nhà 35, ngách 117/69 Thái Hà, phường Trung Liệt, quận Đống Đa, thành phố Hà Nội
(72) Võ Gia Lộc (VN)
(74) Công ty TNHH Sở hữu công nghiệp Sao Bắc Đẩu (SAO BAC DAU IP CO.,LTD)
(55)

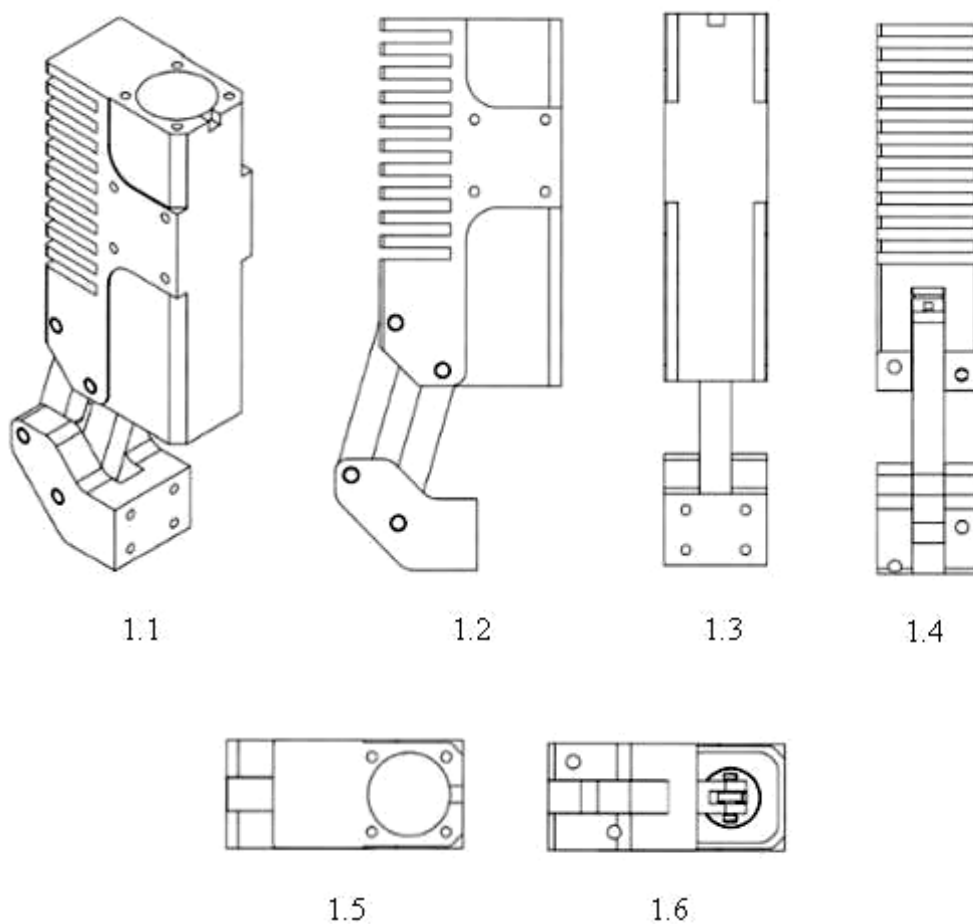

(11) **41026**

(21) 3-2020-01953

(54) **XÍCH ĐU**

(22) 21/08/2020

(28) 1

(51) **06-01**

(43) 25/02/2021

**CÔNG TY TNHH CHẾ TẠO SẢN XUẤT DỊCH VỤ THƯƠNG MẠI
HOÀNG PHÁT (VN)**

(73) 5 Nguyễn Thế Truyen, phường Tân Sơn Nhì, quận Tân Phú, thành phố Hồ Chí Minh

(72) Nguyễn Vĩnh Phát (VN)

(74) Công ty TNHH Tư vấn đầu tư và Sở hữu trí tuệ Hoàng Phi (HOANG PHI INVEST & I.P CO., LTD)

(55)



1.1



1.2



1.3



1.4



1.5



1.6



1.7

CÔNG BÁO SỞ HỮU CÔNG NGHIỆP SỐ 395 TẬP A – QUYỀN 2 (02.2021)

- (11) **41027**
(21) 3-2020-01948 (28) 1
(54) **HỘP ĐỰNG** (51) **09-03**
(22) 20/08/2020 (43) 25/02/2021
(73) **CÔNG TY CỔ PHẦN THIẾT BỊ Y TẾ SHB BẮC NINH (VN)**
Khu công nghiệp Đại Đồng, xã Hoàn Sơn, huyện Tiên Du, tỉnh Bắc Ninh
(72) Phạm Ngọc Khang (VN)
(74) Công ty TNHH Sở hữu trí tuệ Gia Việt (GIAVIET CO., LTD.)
(55)



1.1



1.2

CÔNG BÁO SỞ HỮU CÔNG NGHIỆP SỐ 395 TẬP A – QUYỀN 2 (02.2021)

- (11) **41028**
(21) 3-2020-01947 (28) 1
(54) **HỘP ĐỰNG** (51) **09-03**
(22) 20/08/2020 (43) 25/02/2021
(73) **CÔNG TY CỔ PHẦN THIẾT BỊ Y TẾ SHB BẮC NINH (VN)**
Khu công nghiệp Đại Đồng, xã Hoàn Sơn, huyện Tiên Du, tỉnh Bắc Ninh
(72) Phạm Ngọc Khang (VN)
(74) Công ty TNHH Sở hữu trí tuệ Gia Việt (GIAVIET CO., LTD.)
(55)



1.1



1.2

CÔNG BÁO SỞ HỮU CÔNG NGHIỆP SỐ 395 TẬP A – QUYỀN 2 (02.2021)

(11) **41029**

(21) 3-2020-01938

(28) 1

(54) **HỘP ĐỰNG**

(51) **09-03**

(22) 19/08/2020

(43) 25/02/2021

CÔNG TY CỔ PHẦN ONG MẬT TIỀN GIANG (VN)

(73) Tầng 5, tòa nhà Songdo, 62A Phạm Ngọc Thạch, phường 06, quận 3, thành phố Hồ Chí Minh

(72) Lê Thị Kim Phượng (VN)

(55)



1.1



1.2

CÔNG BÁO SỞ HỮU CÔNG NGHIỆP SỐ 395 TẬP A – QUYỀN 2 (02.2021)

- (11) **41030**
(21) 3-2020-01922 (28) 1
(54) **CỐC** (51) **07-01**
(22) 18/08/2020 (43) 25/02/2021
(30) 109302477 08/05/2020 TW;
(73) **ARMS GLOBAL INC (US)**
589 8th Ave 17th Fl, New York, USA, NY 10018
(72) Wen, YI-FAN (TW)
(74) Công ty TNHH Trường Xuân (AGELESS CO.,LTD.)
(55)



1.1

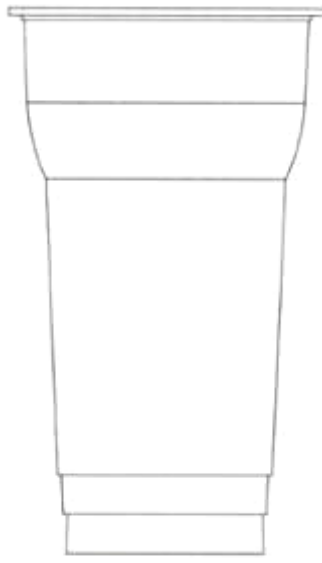

1.2



1.3



1.4

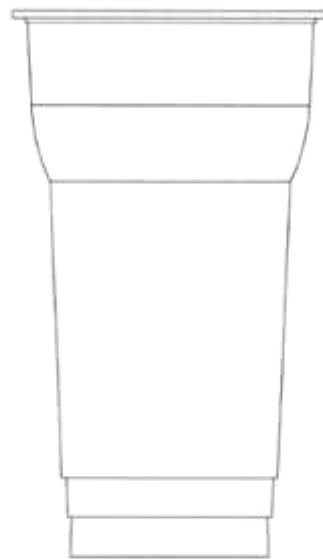

1.5

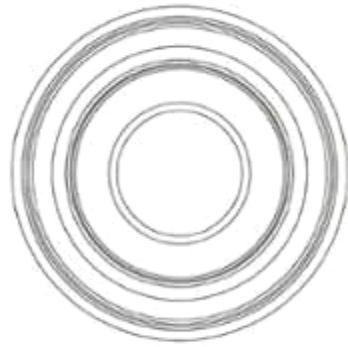

1.6

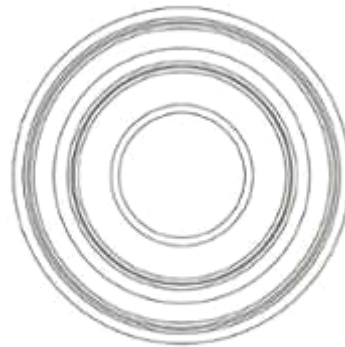

1.7

CÔNG BÁO SỞ HỮU CÔNG NGHIỆP SỐ 395 TẬP A – QUYỀN 2 (02.2021)

(11) **41031**

(21) 3-2020-01890

(28) 1

(54) **HỘP ĐÈN**

(51) **20-03**

(22) 12/08/2020

(43) 25/02/2021

CÔNG TY CỔ PHẦN BE GROUP (VN)

(73) Tầng 16, tòa nhà Sai Gon Tower, 29 Lê Duẩn, phường Bến Nghé, quận 1, thành phố Hồ Chí Minh

1. LÊ HỒNG NGỌC (VN)

2. PHAN ANH TUẤN (VN)

(72) 3. TRẦN QUỐC HOÀNG THÔNG (VN)

4. LÊ THÀNH PHÚ (VN)

(74) Công ty TNHH Tư vấn ALIATLEGAL (ALIAT LEGAL)

(55)

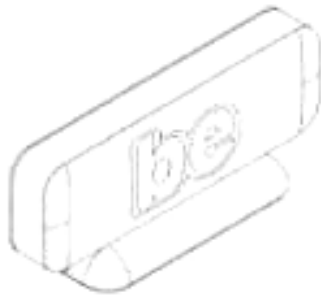

1.1



1.2



1.3



1.4

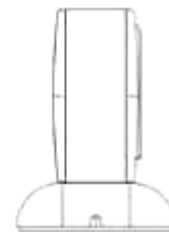

1.5



1.6



1.7

CÔNG BÁO SỞ HỮU CÔNG NGHIỆP SỐ 395 TẬP A – QUYỀN 2 (02.2021)

(11) **41032**

(21) 3-2020-01881

(28) 1

(54) **ĐÈN CHIẾU SÁNG**

(51) **26-03**

(22) 12/08/2020

(43) 25/02/2021

(73) **CÔNG TY CỔ PHẦN CHIẾU SÁNG ĐÔ THỊ HOÀNG GIA (VN)**

Số 157 phố Phương Mai, phường Phương Mai, quận Đống Đa, thành phố Hà Nội

(72) Hoàng Song Hà (VN)

(55)



1.1



1.2



1.3



1.4



1.5



1.6



1.7

- (11) **41033**
(21) 3-2020-01877 (28) 1
(54) **THIẾT BỊ CHUYỂN MẠCH** (51) **14-03**
(22) 11/08/2020 (43) 25/02/2021
VIỆN CÔNG NGHỆ THÔNG TIN - VIỆN KHOA HỌC VÀ CÔNG NGHỆ
(73) **QUÂN SỰ - BỘ QUỐC PHÒNG (VN)**
Số 17 Hoàng Sâm, Nghĩa Đô, quận Cầu Giấy, thành phố Hà Nội
(72) Thái Trung Kiên (VN)
(55)



1.1



1.2



1.3



1.4



1.5



1.6



1.7

(11) **41034**

(21) 3-2020-01871

(28) 2

(54) **BỘ CAMERA CHUÔNG CỬA**

(51) **10-06; 14-03; 16-01**

(22) 10/08/2020

(43) 25/02/2021

TẬP ĐOÀN VINGROUP - CÔNG TY CP (VN)

(73) Số 7, đường Bằng Lăng 1, khu đô thị sinh thái Vinhomes Riverside, phường Việt Hưng, quận Long Biên, thành phố Hà Nội

1. ĐÀO ĐÌNH TRỌNG (VN)

2. LẠI DUY TÂN (VN)

(72) 3. TÔNG THỊ NGÀ (VN)

4. NGUYỄN VĨNH HÀ (VN)

5. CAO SỸ DŨNG (VN)

(74) CÔNG TY LUẬT TRÁCH NHIỆM HỮU HẠN AMBYS HÀ NỘI (AMBYS HANOI)

(55)



1.1



1.2



1.3



1.4



1.5



1.6



1.7



2.1



2.2

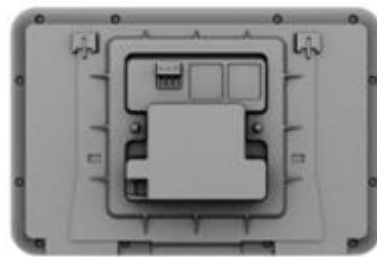

2.3



2.4



2.5



2.6



2.7



2.8

CÔNG BÁO SỞ HỮU CÔNG NGHIỆP SỐ 395 TẬP A – QUYỀN 2 (02.2021)

(11) **41035**

(21) 3-2020-01825

(28) 2

(54) **HỘP ĐỰNG SỮA**

(51) **09-03**

(22) 06/08/2020

(43) 25/02/2021

CÔNG TY CỔ PHẦN THỰC PHẨM AIWADO (VN)

(73) Phòng 908, tầng 9, tòa nhà CentrePoint, 106 Nguyễn Văn Trỗi, phường 8, quận Phú Nhuận, thành phố Hồ Chí Minh

(72) Nguyễn Huy Hồng Lam (VN)

(55)



1.1



1.2



1.3



1.4



1.5



1.6



1.7



2.1



2.2



2.3



2.4



2.5



2.6



2.7

CÔNG BÁO SỞ HỮU CÔNG NGHIỆP SỐ 395 TẬP A – QUYỀN 2 (02.2021)

(11) **41036**

(21) 3-2020-01810

(28) 1

(54) **NGÓI**

(51) **25-01**

(22) 04/08/2020

(43) 25/02/2021

(73) **CÔNG TY CỔ PHẦN GẠCH NGÓI ĐỒNG NAI (VN)**

119 Điện Biên Phủ, phường Đa Kao, quận 1, thành phố Hồ Chí Minh

(72) Nguyễn Văn Linh (VN)

(74) Công ty Cổ phần Sở hữu công nghiệp INVESTIP (INVESTIP)

(55)



1.1



1.2



1.3



1.4



1.5

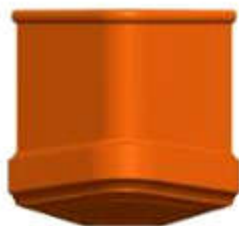

1.6



1.7

CÔNG BÁO SỞ HỮU CÔNG NGHIỆP SỐ 395 TẬP A – QUYỀN 2 (02.2021)

- (11) **41037**
(21) 3-2020-01808 (28) 1
(54) **NGÓI** (51) **25-01**
(22) 04/08/2020 (43) 25/02/2021
(73) **CÔNG TY CỔ PHẦN GẠCH NGÓI ĐỒNG NAI (VN)**
119 Điện Biên Phủ, phường Đa Kao, quận 1, thành phố Hồ Chí Minh
(72) Nguyễn Văn Linh (VN)
(74) Công ty Cổ phần Sở hữu công nghiệp INVESTIP (INVESTIP)
(55)



1.1



1.2



1.3



1.4

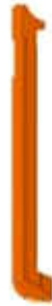

1.5



1.6



1.7

- (11) **41038**
(21) 3-2020-01806 (28) 2
(54) **BỘ NHÃN SẢN PHẨM** (51) **19-08**
(22) 04/08/2020 (43) 25/02/2021
(73) **CÔNG TY TNHH CÁ ĐEN (VN)**
208 Nguyễn Thông, phường Phú Hải, thành phố Phan Thiết, tỉnh Bình Thuận
(72) Huỳnh Văn Dung (VN)
(55)



1.1



1.2



1.3

CÔNG BÁO SỞ HỮU CÔNG NGHIỆP SỐ 395 TẬP A – QUYỀN 2 (02.2021)

(11) **41039**

(21) 3-2020-01797

(28) 1

(54) **MÁY LỌC NƯỚC**

(51) **23-01**

(22) 03/08/2020

(43) 25/02/2021

CÔNG TY CỔ PHẦN CƠ ĐIỆN LẠNH ĐẠI VIỆT (VN)

(73) Lô IV. 11, đường số 4, khu công nghiệp Tân Bình, phường Tây Thạnh, quận Tân Phú, thành phố Hồ Chí Minh

(72) Ngô Xuân Mạnh (VN)

(74) Công ty TNHH Sở hữu trí tuệ Việt Á (VIET A IP CO.,LTD)

(55)



1.1



1.2

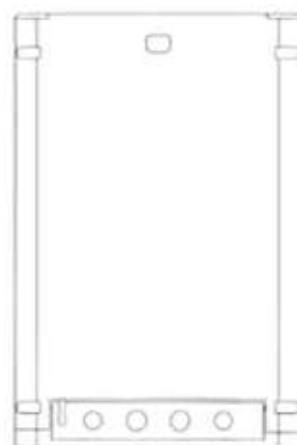

1.3

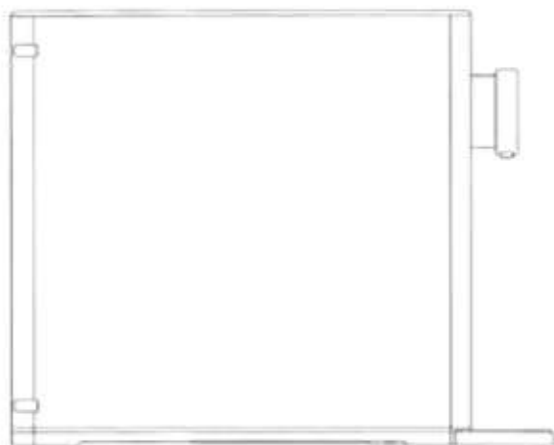

1.4

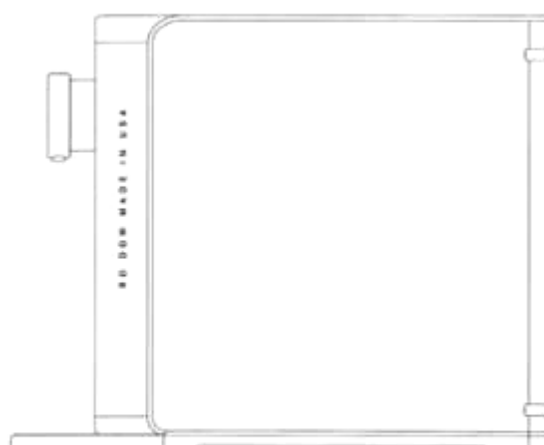

1.5



1.6

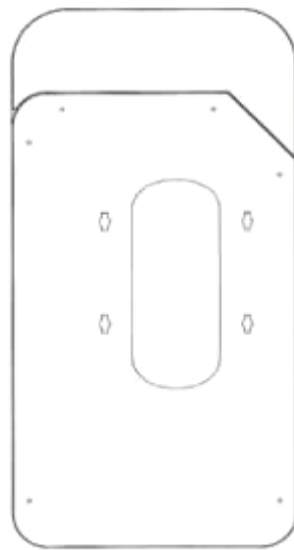

1.7

CÔNG BÁO SỞ HỮU CÔNG NGHIỆP SỐ 395 TẬP A – QUYỀN 2 (02.2021)

- (11) **41040**
- (21) 3-2020-01745 (28) 5
- (54) **THIẾT BỊ ĐIỆN TỬ DI ĐỘNG** (51) **14-03**
- (22) 28/07/2020 (43) 25/02/2021
- (30) 29/723,152 04/02/2020 US;
GOOGLE LLC (US)
- (73) 1600 Amphitheatre Parkway, Mountain View, California 94043, United States of America
1. JAEUN PARK (US)
2. XINRUI JIANG (US)
3. MIGUEL HARRY PUERTA (CO)
- (72) 4. SUNGYUN KIM (KR)
5. ALBERTO VILLARREAL BELLO (MX)
6. MAX YOSHIMOTO (US)
- (74) Công ty TNHH Sở hữu công nghiệp Sao Bắc Đẩu (SAO BAC DAU IP CO.,LTD)
- (55)

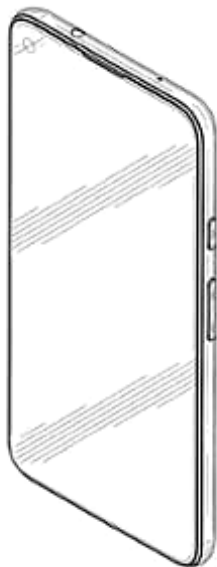

1.1



1.2



1.3



1.4



1.5



1.6



1.7



1.8



2.1



2.2



2.3



2.4



2.5



2.6



2.7



2.8



3.1

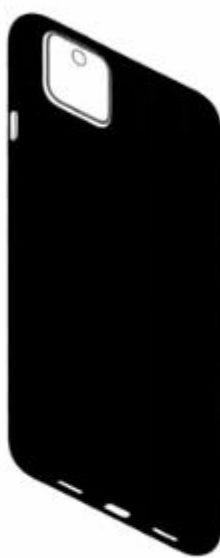

3.2

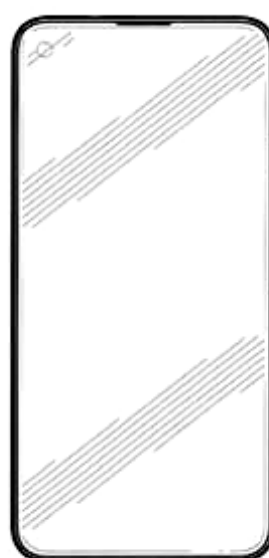

3.3



3.4



3.5



3.6



3.7



3.8

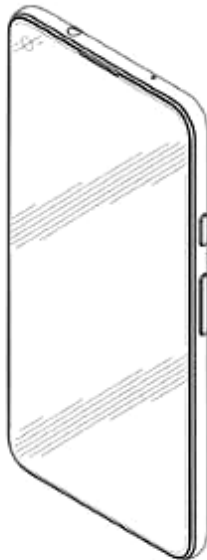

4.1

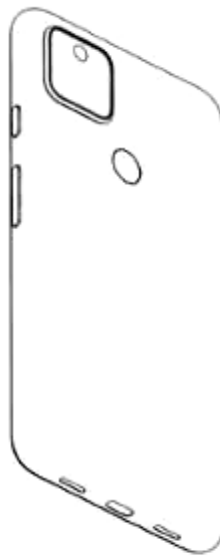

4.2



4.3

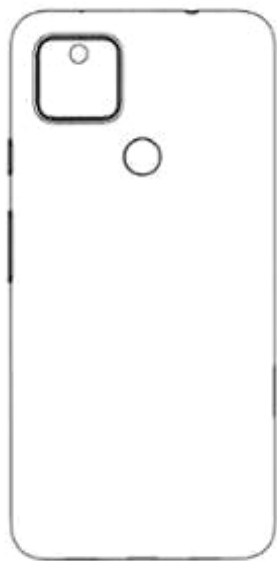

4.4



4.5



4.6



4.7



4.8

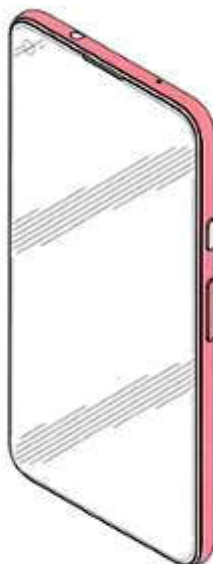

5.1



5.2



5.3



5.4



5.5



5.6



5.7



5.8

CÔNG BÁO SỞ HỮU CÔNG NGHIỆP SỐ 395 TẬP A – QUYỀN 2 (02.2021)

- (11) **41041**
- (21) 3-2020-01743 (28) 4
- (54) **THIẾT BỊ ĐIỆN TỬ DI ĐỘNG** (51) **14-03**
- (22) 28/07/2020 (43) 25/02/2021
- (30) 29/723,150 04/02/2020 US;
GOOGLE LLC (US)
- (73) 1600 Amphitheatre Parkway, Mountain View, California 94043, United States of America
1. JAEUN PARK (US)
2. XINRUI JIANG (US)
3. MIGUEL HARRY PUERTA (CO)
- (72) 4. SUNGYUN KIM (KR)
5. ALBERTO VILLARREAL BELLO (MX)
6. MAX YOSHIMOTO (US)
- (74) Công ty TNHH Sở hữu công nghiệp Sao Bắc Đẩu (SAO BAC DAU IP CO.,LTD)
- (55)



1.1



1.2



1.3



1.4



1.5



1.6



1.7



1.8



2.1



2.2



2.3



2.4



2.5



2.6



2.7



2.8



3.1



3.2



3.3



3.4



3.5



3.6



3.7



3.8



4.1



4.2



4.3

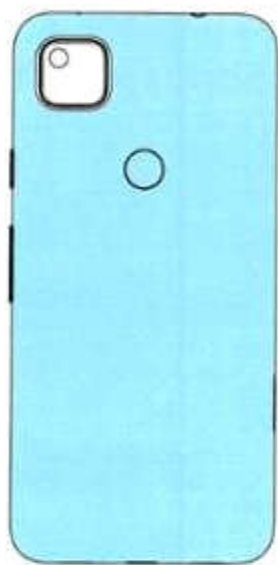

4.4



4.5



4.6



4.7



4.8

CÔNG BÁO SỞ HỮU CÔNG NGHIỆP SỐ 395 TẬP A – QUYỀN 2 (02.2021)

- (11) **41042**
- (21) 3-2020-01741 (28) 4
- (54) **THIẾT BỊ ĐIỆN TỬ DI ĐỘNG** (51) **14-03**
- (22) 28/07/2020 (43) 25/02/2021
- (30) 29/723,153 04/02/2020 US;
GOOGLE LLC (US)
- (73) 1600 Amphitheatre Parkway, Mountain View, California 94043, United States of America
1. JAEUN PARK (US)
2. XINRUI JIANG (US)
3. MIGUEL HARRY PUERTA (CO)
- (72) 4. SUNGYUN KIM (KR)
5. ALBERTO VILLARREAL BELLO (MX)
6. MAX YOSHIMOTO (US)
- (74) Công ty TNHH Sở hữu công nghiệp Sao Bắc Đẩu (SAO BAC DAU IP CO.,LTD)
- (55)



1.1



1.2



1.3



1.4



1.5



1.6



1.7



1.8



2.1



2.2



2.3



2.4



2.5



2.6



2.7



2.8



3.1



3.2



3.3



3.4



3.5



3.6



3.7



3.8



4.1



4.2



4.3



4.4



4.5



4.6



4.7



4.8

CÔNG BÁO SỞ HỮU CÔNG NGHIỆP SỐ 395 TẬP A – QUYỀN 2 (02.2021)

(11) **41043**

(21) 3-2020-01644

(28) 1

(54) **XE Ô TÔ**

(51) **12-08**

(22) 17/07/2020

(43) 25/02/2021

TẬP ĐOÀN VINGROUP - CÔNG TY CP (VN)

(73) Số 7, đường Bằng Lăng 1, khu đô thị sinh thái Vinhomes Riverside, phường Việt Hưng, quận Long Biên, thành phố Hà Nội

1. GUGLIELMO GIOVANNI CARTIA (IT)

(72) 2. DIMITRI VICEDOMINI (IT)

3. NAZZARENO EPIFANI (IT)

(74) CÔNG TY LUẬT TRÁCH NHIỆM HỮU HẠN AMBYS HÀ NỘI (AMBYS HANOI)

(55)



1.1



1.2



1.3



1.4



1.5



1.6



17

(11) **41044**

(21) 3-2020-01610

(28) 1

(54) **XE ĐẨY**

(51) **12-12**

(22) 13/07/2020

(43) 25/02/2021

CÔNG TY CỔ PHẦN ĐỒ DÙNG GIA ĐÌNH VIỆT NAM (VN)

(73) Thừa đất số 173, tờ bản đồ số B4, khu phố Bình Phước B, phường Bình Chuẩn, thành phố Thuận An, tỉnh Bình Dương

(72) Lai Trí Mộc (VN)

(74) Công ty TNHH Hùng Sơn và cộng sự (HUNG SON & PARTNERS)

(55)



1.1



1.2



1.3



1.4



1.5



1.6



1.7

(11) **41045**

(21) 3-2020-01609

(54) **NÔI TRẺ EM**

(22) 13/07/2020

(28) 1

(51) **06-02**

(43) 25/02/2021

CÔNG TY CỔ PHẦN ĐỒ DÙNG GIA ĐÌNH VIỆT NAM (VN)

(73) Thừa đất số 173, tờ bản đồ số B4, khu phố Bình Phước B, phường Bình Chuẩn, thành phố Thuận An, tỉnh Bình Dương

(72) Lai Trí Mộc (VN)

(74) Công ty TNHH Hùng Sơn và cộng sự (HUNG SON & PARTNERS)

(55)



1.1



1.2



1.3



1.4



1.5



1.6



1.7

- (11) **41046**
(21) 3-2020-01608 (28) 1
(54) **THÙNG ĐỰNG ĐỒ GIẶT** (51) **07-07**
(22) 13/07/2020 (43) 25/02/2021
CÔNG TY CỔ PHẦN ĐỒ DÙNG GIA ĐÌNH VIỆT NAM (VN)
(73) Thừa đất số 173, tờ bản đồ số B4, khu phố Bình Phước B, phường Bình Chuẩn, thành phố Thuận An, tỉnh Bình Dương
(72) Lai Trí Mộc (VN)
(74) Công ty TNHH Hùng Sơn và cộng sự (HUNG SON & PARTNERS)
(55)



1.1



1.2



1.3



1.4



1.5



1.6



1.7

CÔNG BÁO SỞ HỮU CÔNG NGHIỆP SỐ 395 TẬP A – QUYỂN 2 (02.2021)

(11) **41047**

(21) 3-2020-01594

(28) 1

(54) **TẤM VẢI**

(51) **05-05**

(22) 10/07/2020

(43) 25/02/2021

HỒ TRẦN DẠ THẢO (VN)

(73) Số 534/27 đường Rừng Sác, ấp Bình Thạnh, xã Bình Khánh, huyện Cần Giờ, thành phố Hồ Chí Minh

(72) Hồ Trần Dạ Thảo (VN)

(55)



- (11) **41048**
(21) 3-2020-01593 (28) 1
(54) **HỆ THỐNG SẢN XUẤT LINH HOẠT** (51) **15-99**
(22) 09/07/2020 (43) 25/02/2021
(73) **PHAN THÀNH DŨNG (VN)**
Xã Kỳ Bắc, huyện Kỳ Anh, tỉnh Hà Tĩnh
(72) Phan Thành Dũng (VN)
(74) Công ty TNHH Tư vấn IPNG (IPNG CO.,LTD)
(55)

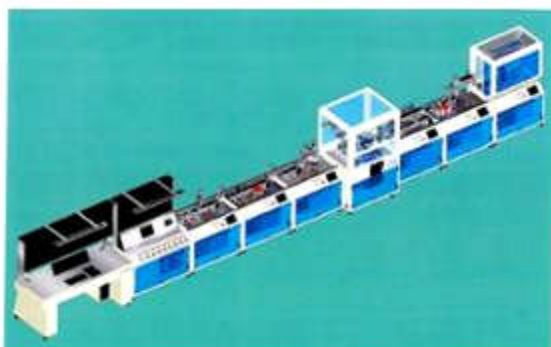

1.1

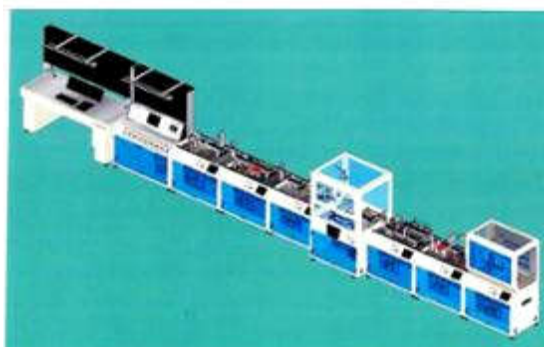

1.2



1.3



1.4

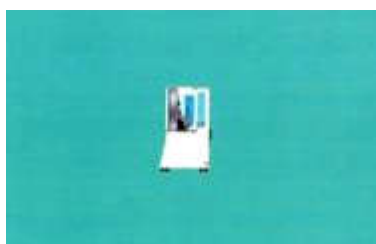

1.5



1.6



1.7

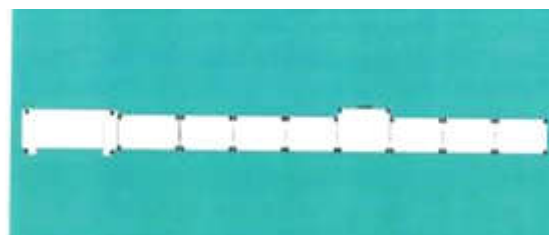

1.8

CÔNG BÁO SỞ HỮU CÔNG NGHIỆP SỐ 395 TẬP A – QUYỀN 2 (02.2021)

- (11) **41049**
(21) 3-2020-01566 (28) 1
(54) **THÙNG ĐỰNG NHO KHÔ** (51) **09-03**
(22) 06/07/2020 (43) 25/02/2021
(73) **CÔNG TY TNHH GALAXY AGRO (VN)**
14/16 Đường 990, khu phố 4, phường Phú Hữu, quận 9, thành phố Hồ Chí Minh
(72) Phạm Anh Nghị (VN)
(55)

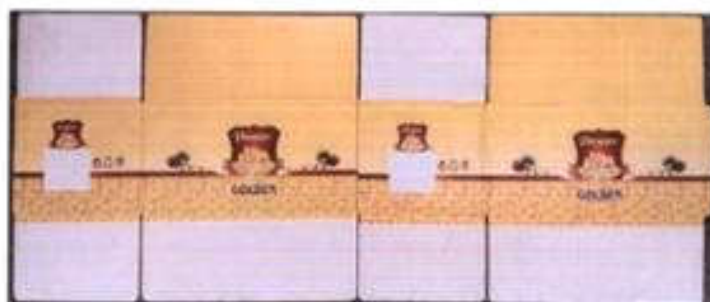

1.1



1.2

CÔNG BÁO SỞ HỮU CÔNG NGHIỆP SỐ 395 TẬP A – QUYỀN 2 (02.2021)

- (11) **41050**
(21) 3-2020-01565 (28) 1
(54) **THÙNG ĐỰNG NHO KHÔ** (51) **09-03**
(22) 06/07/2020 (43) 25/02/2021
(73) **CÔNG TY TNHH GALAXY AGRO (VN)**
14/16 Đường 990, khu phố 4, phường Phú Hữu, quận 9, thành phố Hồ Chí Minh
(72) Phạm Anh Nghị (VN)
(55)



1.1



1.2

CÔNG BÁO SỞ HỮU CÔNG NGHIỆP SỐ 395 TẬP A – QUYỀN 2 (02.2021)

- (11) **41051**
(21) 3-2020-01564 (28) 1
(54) **THÙNG ĐỰNG NHO KHÔ** (51) **09-03**
(22) 06/07/2020 (43) 25/02/2021
(73) **CÔNG TY TNHH GALAXY AGRO (VN)**
14/16 Đường 990, khu phố 4, phường Phú Hữu, quận 9, thành Phố Hồ Chí Minh
(72) Phạm Anh Nghị (VN)
(55)



1.1



1.2

(11) **41052**

(21) 3-2020-01458

(28) 1

(54) **HỆ THỐNG BẾP**

(51) **07-02**

(22) 19/06/2020

(43) 25/02/2021

(73) **BÙI ĐĂNG HÙNG (VN)**

Đội 13, thôn Địa, xã Bình Minh, huyện Thanh Oai, thành phố Hà Nội

- (72) 1. BÙI ĐĂNG HÙNG (VN)
2. NGUYỄN ĐỨC THÀNH (VN)
3. NGUYỄN SỸ HÙNG (VN)
4. LÊ VŨ QUYẾT (VN)

(55)

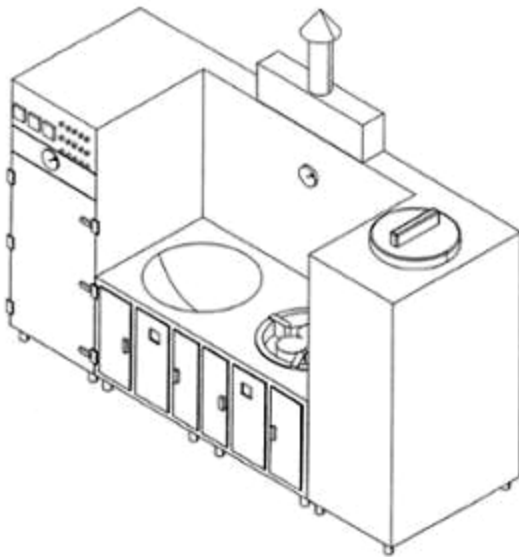

1.1

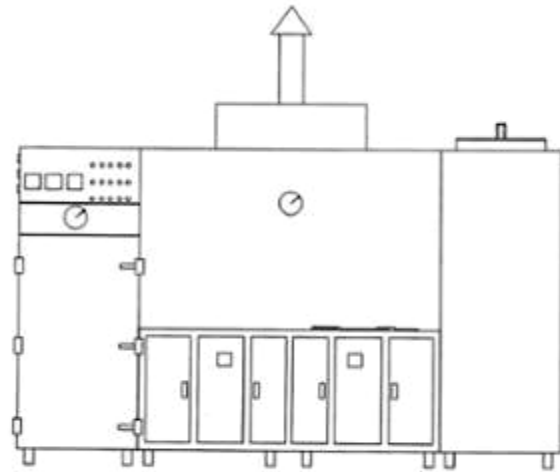

1.2

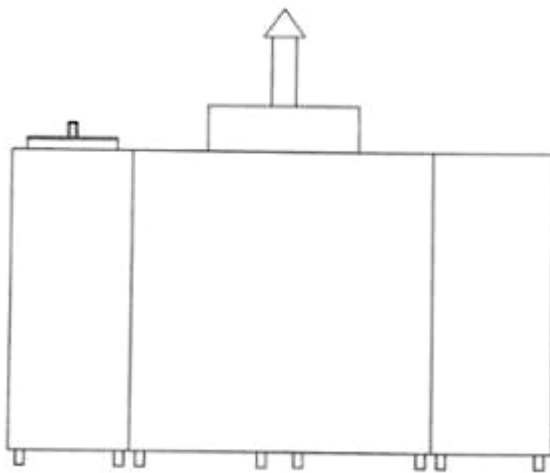

1.3

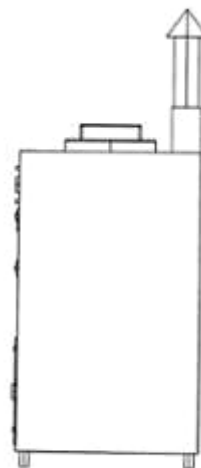

1.4

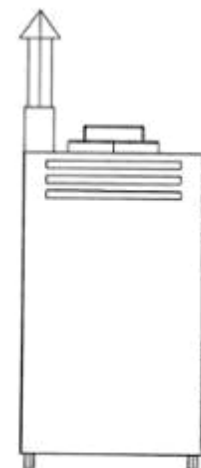

1.5

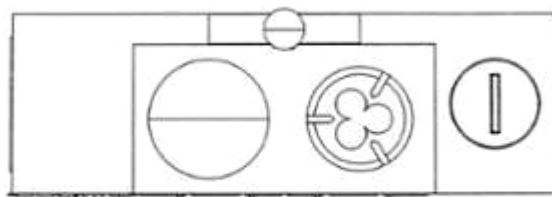

1.6

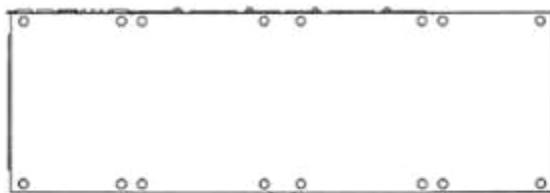

1.7

(11) **41053**

(21) 3-2020-01272

(28) 1

(54) **KHAY ĐỰNG**

(51) **07-07**

(22) 29/05/2020

(43) 25/02/2021

(73) **REALSTA LTD. (GB)**

(73) Unit A, Abbots Wharf, 93 Stainsby Road, London, E146JL, Great Britain

(72) Fuad Chowdhury (GB)

(74) CÔNG TY TRÁCH NHIỆM HỮU HẠN TƯ VẤN ĐẦU TƯ VÀ SỞ HỮU TRÍ TUỆ INTERFIVE (INTERFIVE CO., LTD)

(55)



1.1



1.2



1.3



1.4



1.5

- (11) **41054**
(21) 3-2020-00929 (28) 1
(54) **GIƯỜNG TRỊ LIỆU ÁNH SÁNG** (51) **24-01**
(22) 28/04/2020 (43) 25/02/2021
(73) **LƯƠNG VŨ ĐĂNG QUANG (VN)**
Áp 8, xã Hưng Lễ, huyện Giồng Trôm, tỉnh Bến Tre
(72) Lương Vũ Đăng Quang (VN)
(55)



1.1



1.2



1.3

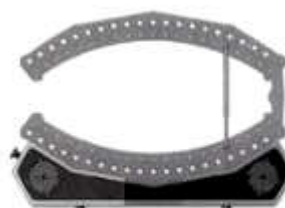

1.4



1.5

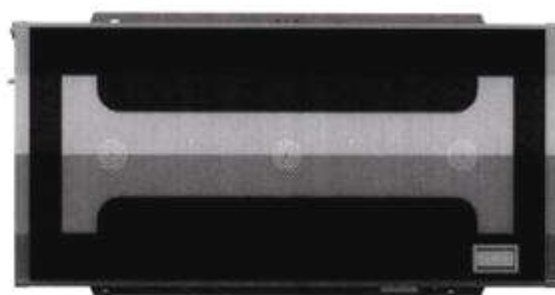

1.6

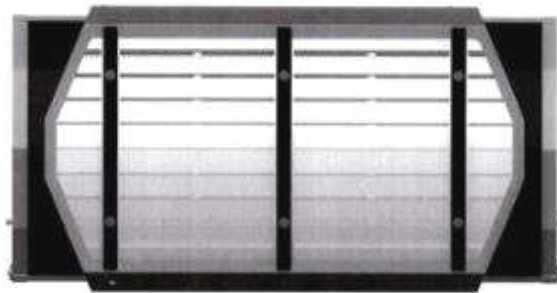

1.7

CÔNG BÁO SỞ HỮU CÔNG NGHIỆP SỐ 395 TẬP A – QUYỀN 2 (02.2021)

- (11) **41055**
(21) 3-2020-00882 (28) 1
(54) **MÁY PHUN DUNG DỊCH SÁT KHUẨN** (51) **23-02**
(22) 22/04/2020 (43) 25/02/2021
(73) **TRƯỜNG CAO ĐẲNG CÔNG NGHIỆP VÀ XÂY DỰNG (VN)**
Phường Phương Đông, thành phố Uông Bí, tỉnh Quảng Ninh
(72) Đỗ Minh Chiến (VN)
(74) Công ty TNHH Sở hữu trí tuệ VIPATCO (VIPATCO CO., LTD.)
(55)

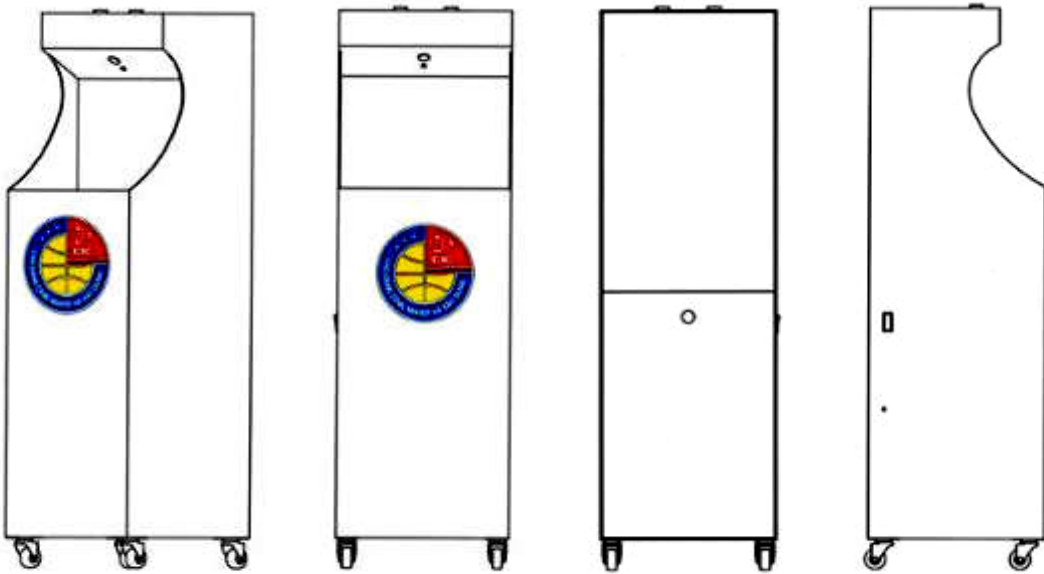

1.1

1.2

1.3

1.4



1.5

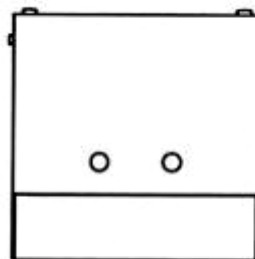

1.6

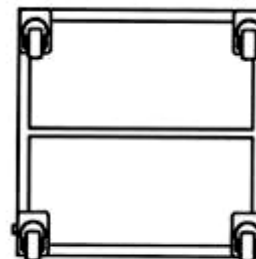

1.7

- (11) **41056**
(21) 3-2020-00804 (28) 1
(54) **NẮP NGỒI BỒN CẦU CÓ VÒI PHUN NƯỚC RỬA** (51) **23-02**
(22) 10/04/2020 (43) 25/02/2021
(30) 2019-024717 06/11/2019 JP;
TETSUZO FUKUDA (JP)
(73) 5-319, Hoo-cho 2-chome, Chikusa-ku, Nagoya-shi, Aichi 464-0057, Japan
(72) Tetsuzo FUKUDA (JP)
(74) Văn phòng Luật sư Ân Nam (ANNAM IP & LAW)
(55)



1.1



1.2



1.3



1.4



1.5



1.6



1.7



1.8



1.9

CÔNG BÁO SỞ HỮU CÔNG NGHIỆP SỐ 395 TẬP A – QUYỀN 2 (02.2021)

- (11) **41057**
- (21) 3-2020-00802 (28) 4
- (54) **HỘP SẠC TAI NGHE** (51) **13-02**
- (22) 10/04/2020 (43) 25/02/2021
- (30) 29/709,192 11/10/2019 US;
GOOGLE LLC (US)
- (73) 1600 Amphitheatre Parkway, Mountain View, California 94043, United States of America
1. REIMANN, GINA (GB)
2. MASTRANGELO, LUKE DAVID (US)
3. OLSSON, MAJ ISABELLE (SE)
4. GIRARD, IDIL (US)
- (72) 5. CAZALET, PETER MICHAEL (US)
6. CARROLL, BENJAMIN CALEB (US)
7. HAMEED, SHAMEEM (US)
8. WARAICH, SANDEEP SINGH (IN)
- (74) Công ty TNHH Sở hữu công nghiệp Sao Bắc Đẩu (SAO BAC DAU IP CO.,LTD)
- (55)



1.1



1.2



1.3

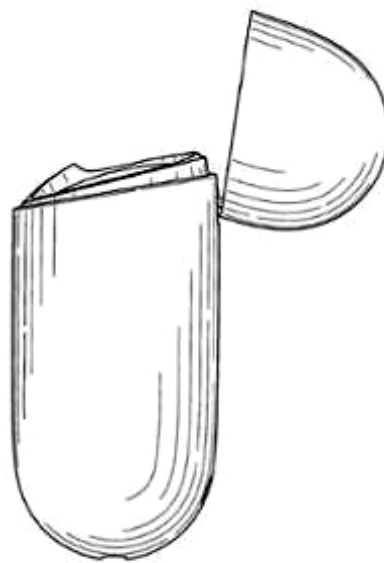

1.4



1.5

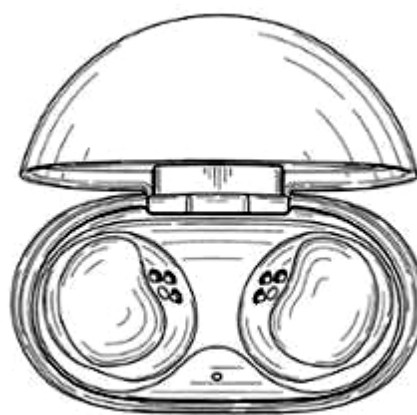

1.6

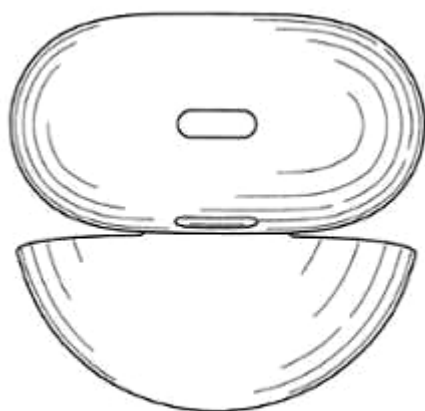

1.7



1.8

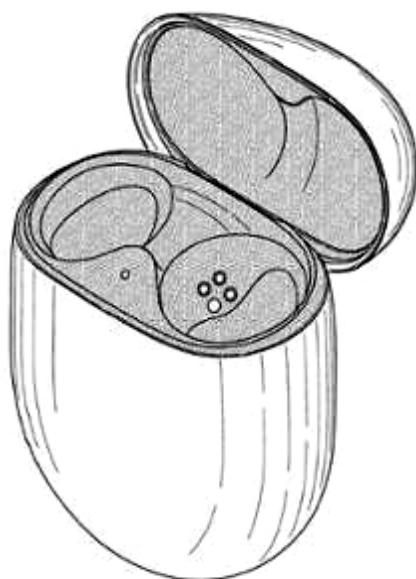

2.1

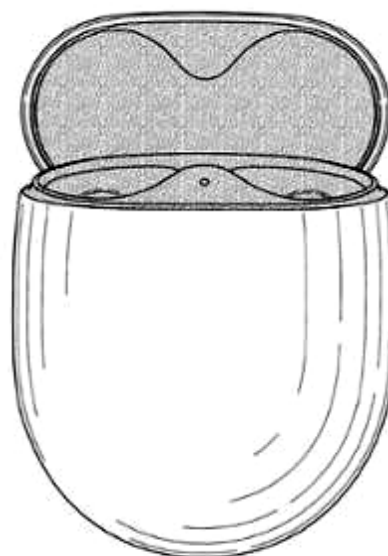

2.2



2.3

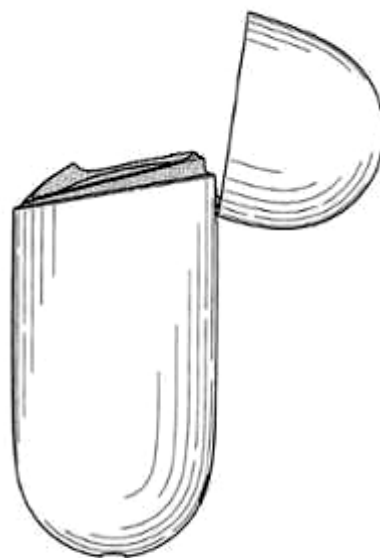

2.4



2.5

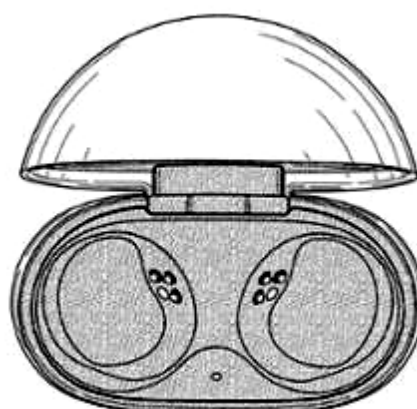

2.6

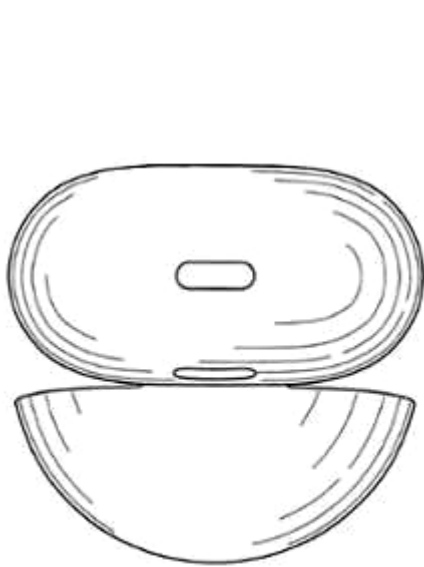

2.7

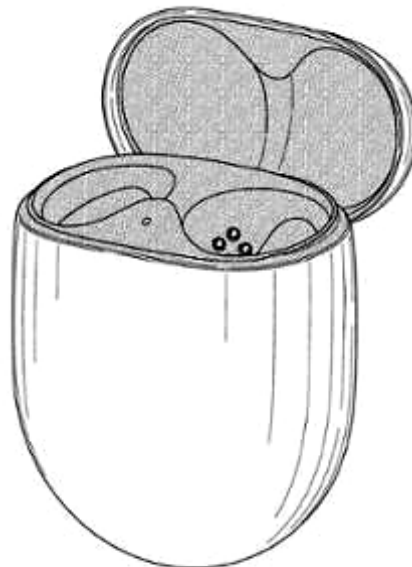

2.8



3.1



3.2



3.3



3.4



3.5

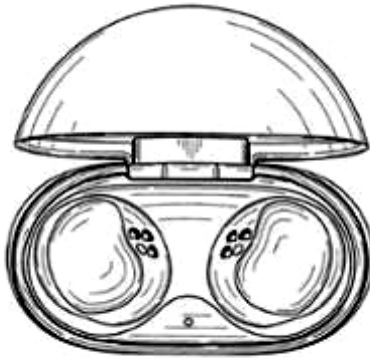

3.6



3.7

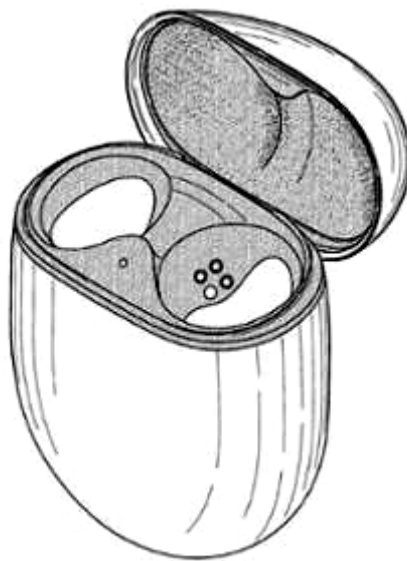

4.1



4.2



4.3

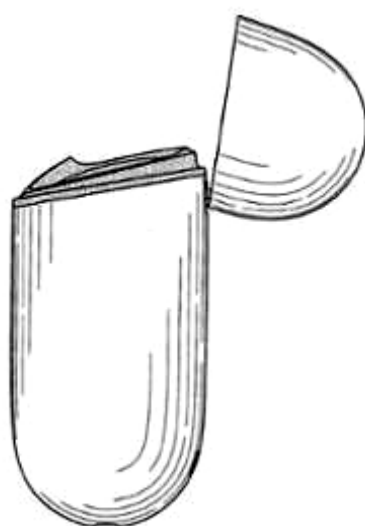

4.4



4.5



4.6

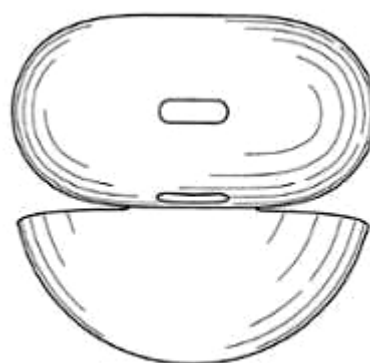

4.7

CÔNG BÁO SỞ HỮU CÔNG NGHIỆP SỐ 395 TẬP A – QUYỀN 2 (02.2021)

- (11) **41058**
- (21) 3-2020-00801 (28) 4
- (54) **HỘP SẠC TAI NGHE** (51) **13-02**
- (22) 10/04/2020 (43) 25/02/2021
- (30) 29/709,192 11/10/2019 US;
GOOGLE LLC (US)
- (73) 1600 Amphitheatre Parkway, Mountain View, California 94043, United States of America
1. REIMANN, GINA (GB)
2. MASTRANGELO, LUKE DAVID (US)
3. OLSSON, MAJ ISABELLE (SE)
4. GIRARD, IDIL (US)
- (72) 5. CAZALET, PETER MICHAEL (US)
6. CARROLL, BENJAMIN CALEB (US)
7. HAMEED, SHAMEEM (US)
8. WARAICH, SANDEEP SINGH (IN)
- (74) Công ty TNHH Sở hữu công nghiệp Sao Bắc Đẩu (SAO BAC DAU IP CO.,LTD)
- (55)



1.1



1.2



1.3



1.4

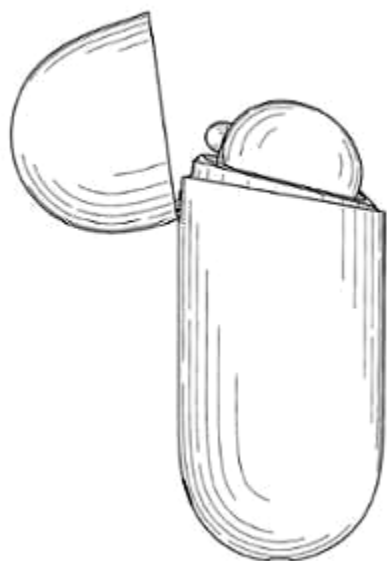

1.5

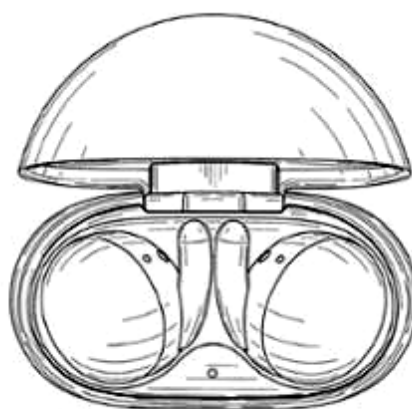

1.6



1.7



1.8

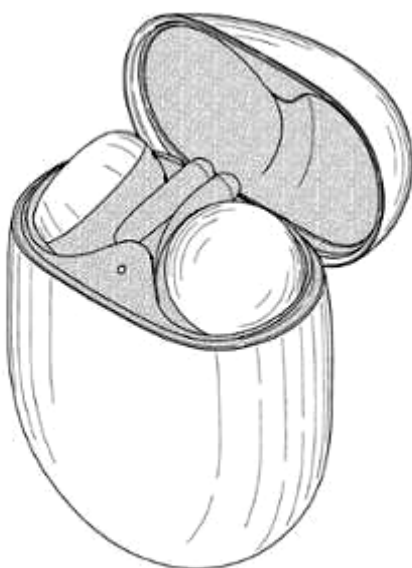

2.1

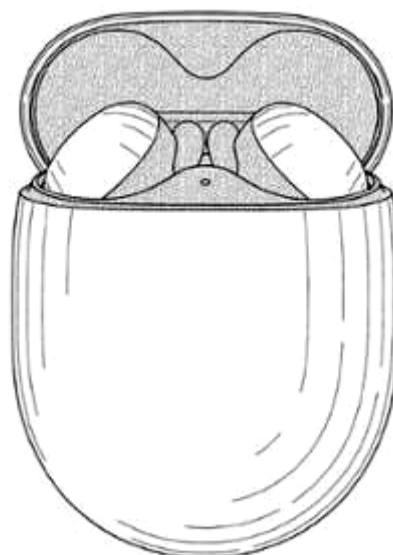

2.2



2.3

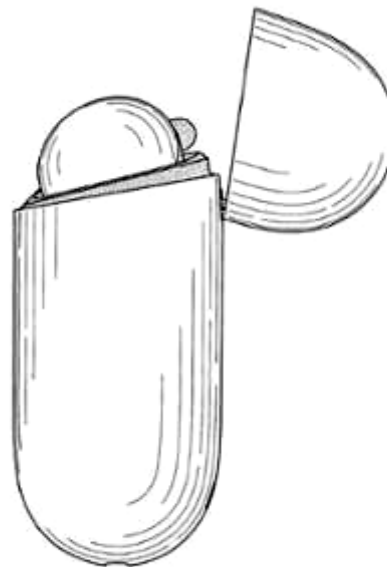

2.4

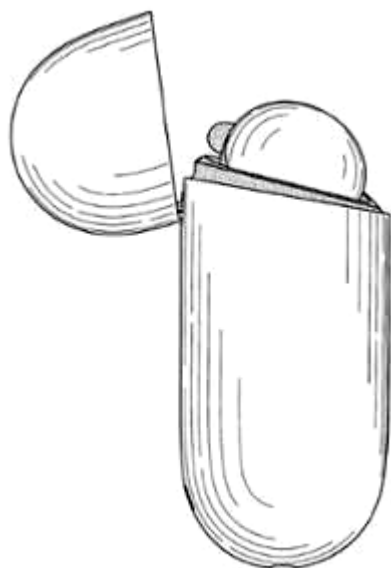

2.5

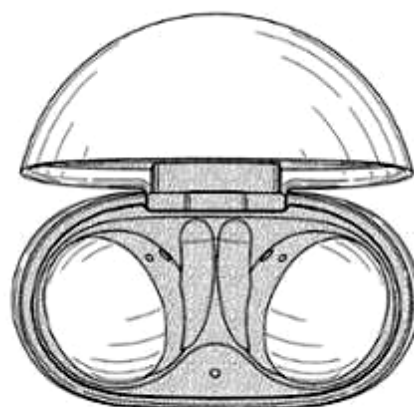

2.6



2.7

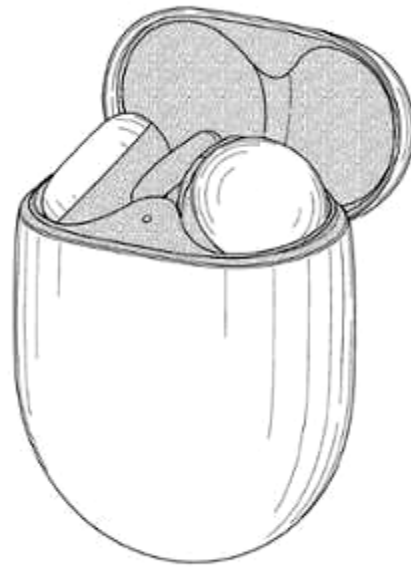

2.8



3.1



3.2



3.3



3.4

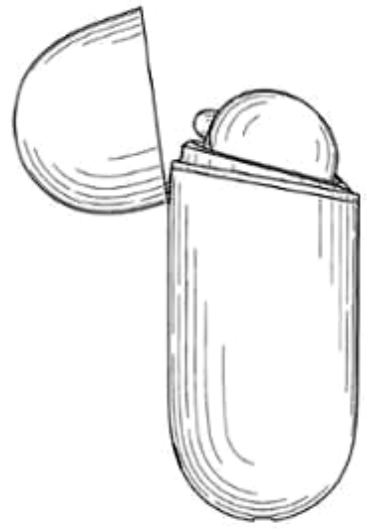

3.5

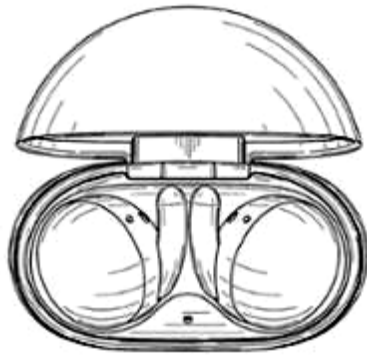

3.6



3.7

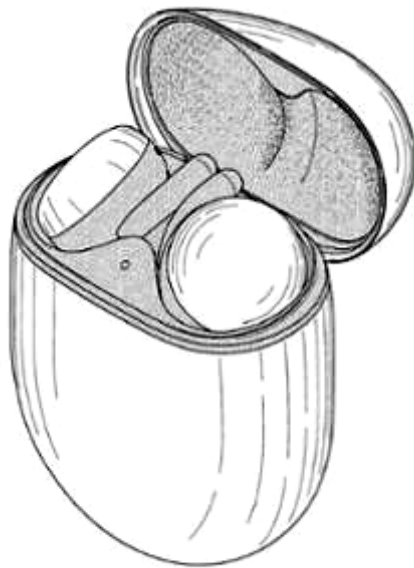

4.1

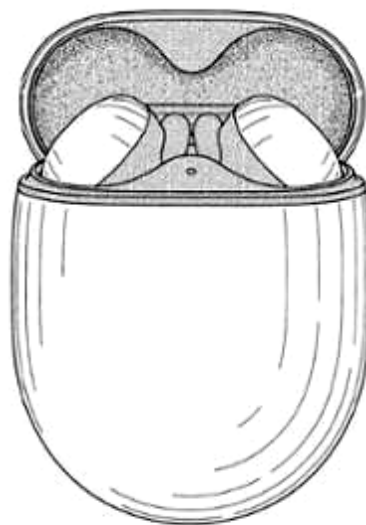

4.2



4.3

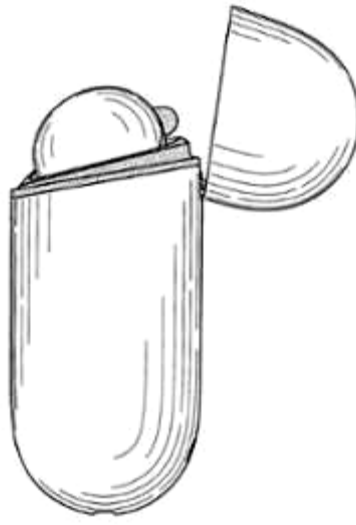

4.4

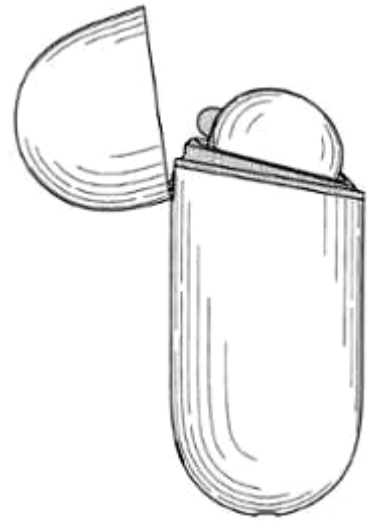

4.5

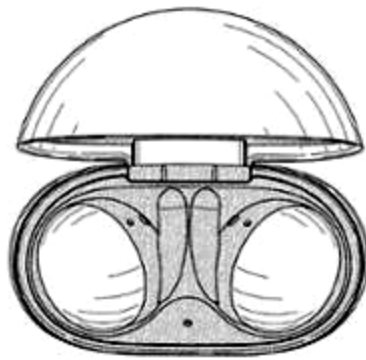

4.6



4.7

- (11) **41059**
(21) 3-2020-00800 (28) 3
(54) **HỘP SẠC TAI NGHE** (51) **13-02**
(22) 10/04/2020 (43) 25/02/2021
(30) 29/709,177 11/10/2019 US;
GOOGLE LLC (US)
(73) 1600 Amphitheatre Parkway, Mountain View, California 94043, United States of America
(72) 1. MASTRANGELO, LUKE DAVID (US)
2. OLSSON, MAJ ISABELLE (SE)
(74) Công ty TNHH Sở hữu công nghiệp Sao Bắc Đẩu (SAO BAC DAU IP CO.,LTD)
(55)

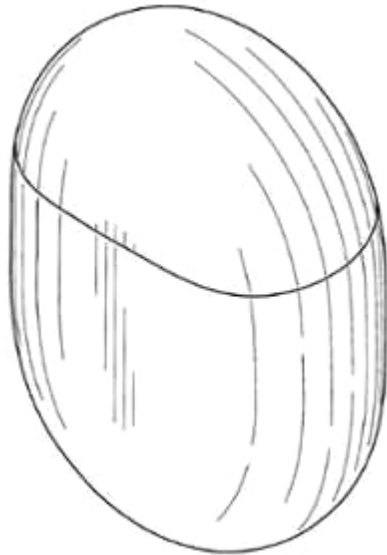

1.1

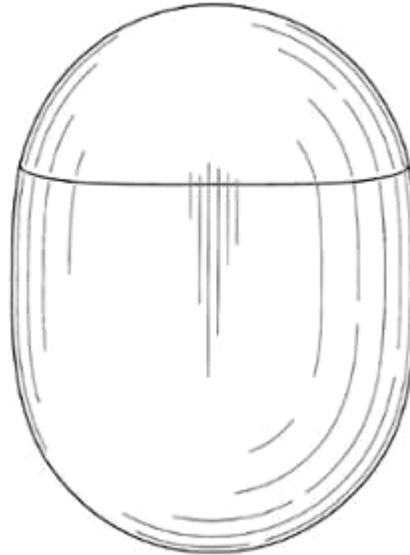

1.2

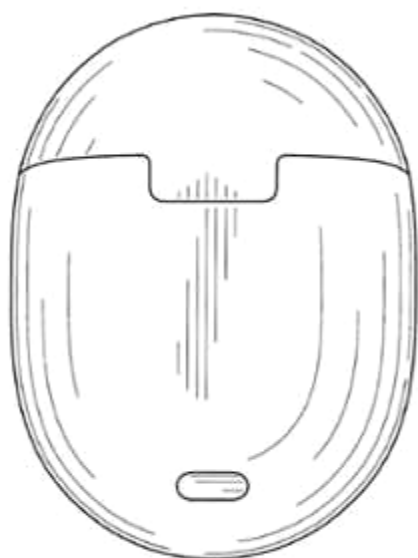

1.3

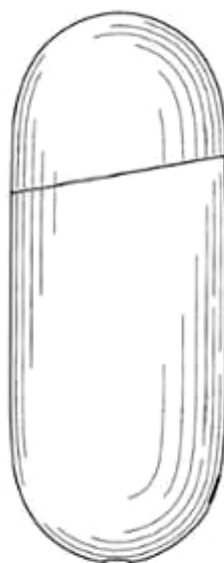

1.4

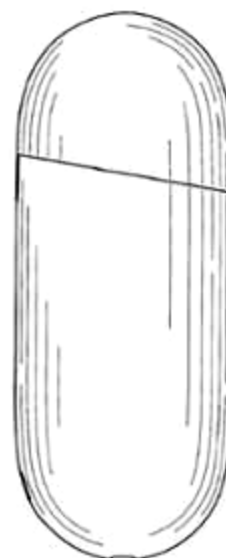

1.5



1.6



1.7

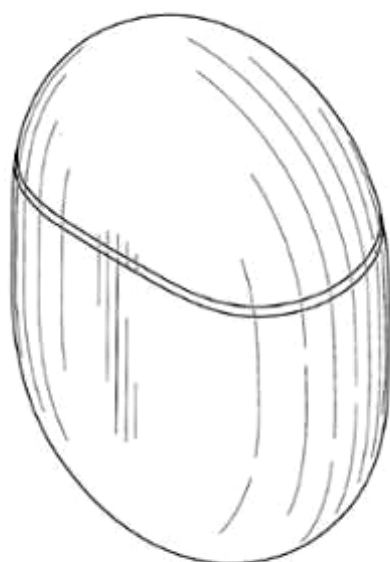

2.1

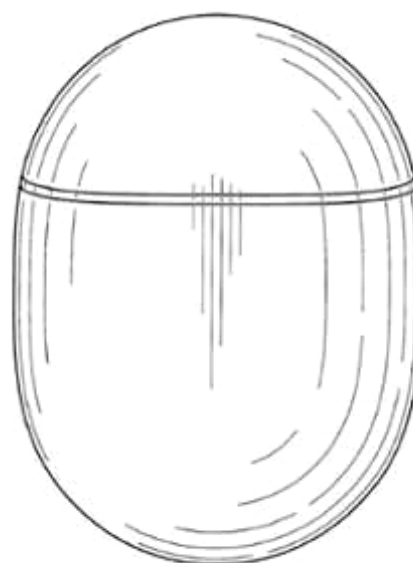

2.2

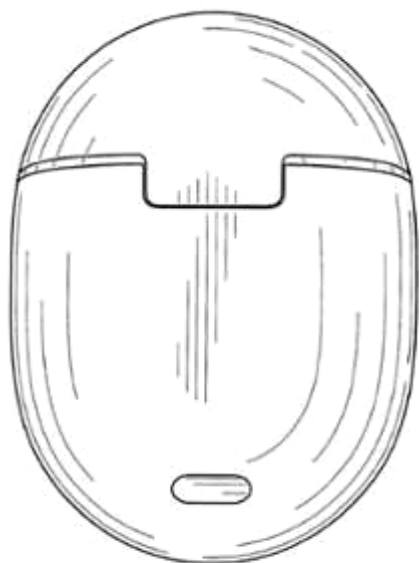

2.3



2.4

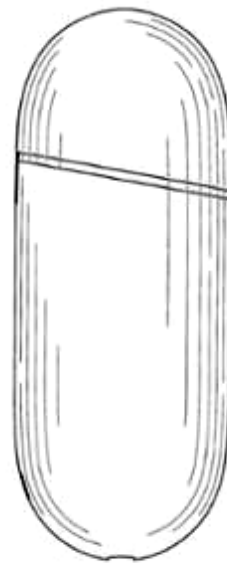

2.5



2.6



2.7

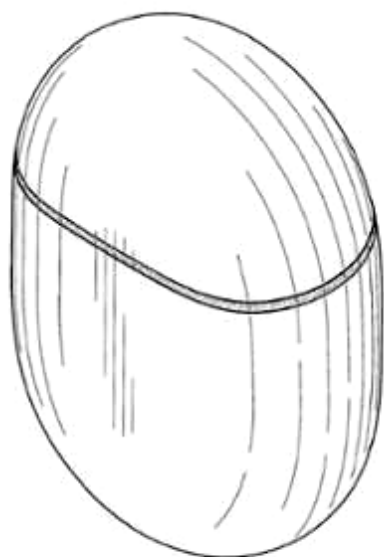

3.1

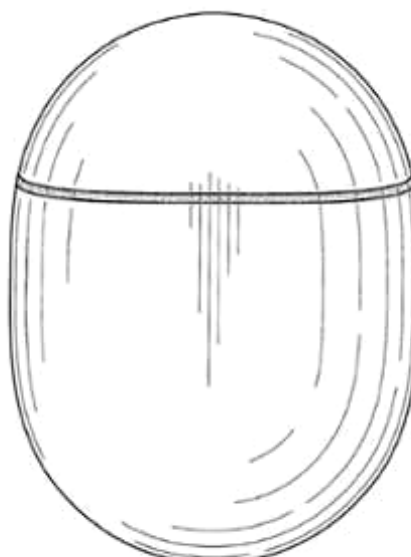

3.2

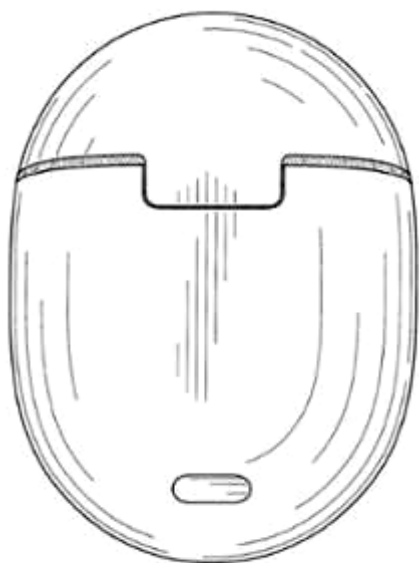

3.3



3.4



3.5



3.6



3.7

CÔNG BÁO SỞ HỮU CÔNG NGHIỆP SỐ 395 TẬP A – QUYỀN 2 (02.2021)

- (11) **41060**
- (21) 3-2020-00799 (28) 1
- (54) **TAI NGHE KHÔNG DÂY** (51) **14-01**
- (22) 10/04/2020 (43) 25/02/2021
- (30) 29/709,173 11/10/2019 US;
GOOGLE LLC (US)
- (73) 1600 Amphitheatre Parkway, Mountain View, California 94043, United States of America
1. REIMANN, GINA (GB)
 2. MASTRANGELO, LUKE DAVID (US)
 3. OLSSON, MAJ ISABELLE (SE)
 4. GIRARD, IDIL (US)
 5. CAZALET, PETER MICHAEL (US)
- (72) 6. CARROLL, BENJAMIN CALEB (US)
7. EDWARDS, TROY (US)
 8. ARANGUREN, MAURA (MX)
 9. DAYRINGER, ERIC (US)
 10. WARAICH, SANDEEP SINGH (IN)
 11. HAMEED, SHAMEEM (US)
- (74) Công ty TNHH Sở hữu công nghiệp Sao Bắc Đẩu (SAO BAC DAU IP CO.,LTD)
- (55)



1.1



1.2



1.3



1.4



1.5



1.6

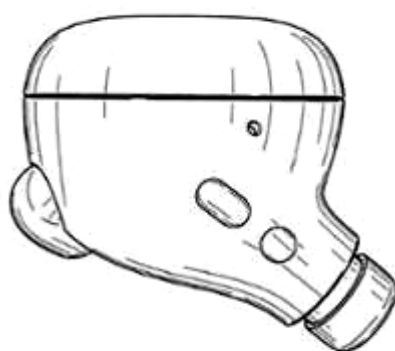

1.7

CÔNG BÁO SỞ HỮU CÔNG NGHIỆP SỐ 395 TẬP A – QUYỀN 2 (02.2021)

- (11) **41061**
- (21) 3-2020-00798 (28) 2
- (54) **TAI NGHE KHÔNG DÂY** (51) **14-01**
- (22) 10/04/2020 (43) 25/02/2021
- (30) 29/709,173 11/10/2019 US;
GOOGLE LLC (US)
- (73) 1600 Amphitheatre Parkway, Mountain View, California 94043, United States of America
1. REIMANN, GINA (GB)
 2. MASTRANGELO, LUKE DAVID (US)
 3. OLSSON, MAJ ISABELLE (SE)
 4. GIRARD, IDIL (US)
 5. CAZALET, PETER MICHAEL (US)
- (72) 6. CARROLL, BENJAMIN CALEB (US)
7. EDWARDS, TROY (US)
 8. ARANGUREN, MAURA (MX)
 9. DAYRINGER, ERIC (US)
 10. WARAICH, SANDEEP SINGH (IN)
 11. HAMEED, SHAMEEM (US)
- (74) Công ty TNHH Sở hữu công nghiệp Sao Bắc Đẩu (SAO BAC DAU IP CO.,LTD)
- (55)



1.1



1.2

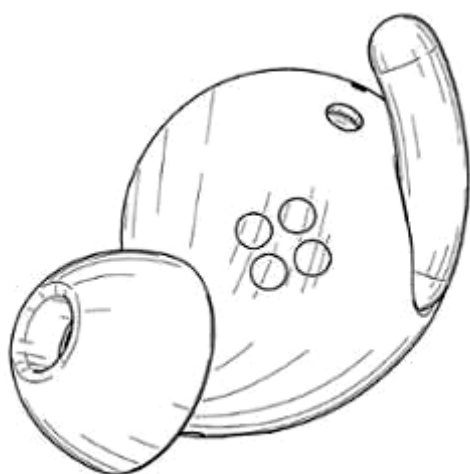

1.3

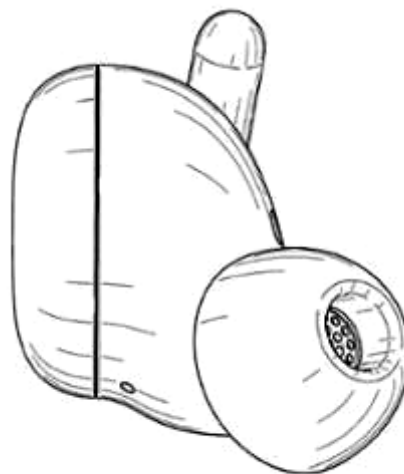

1.4



1.5



1.6

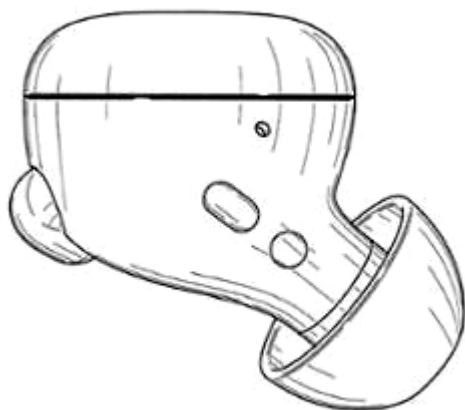

1.7

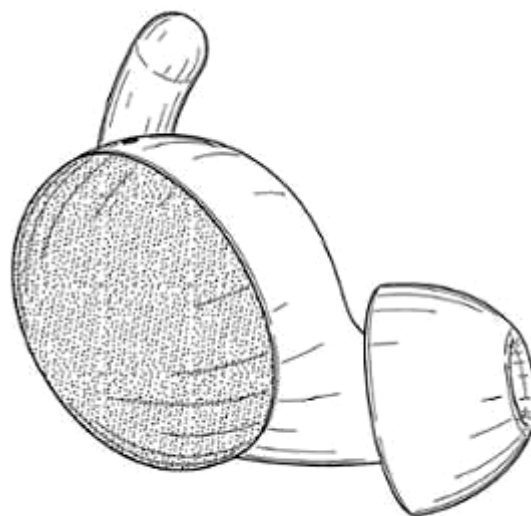

2.1

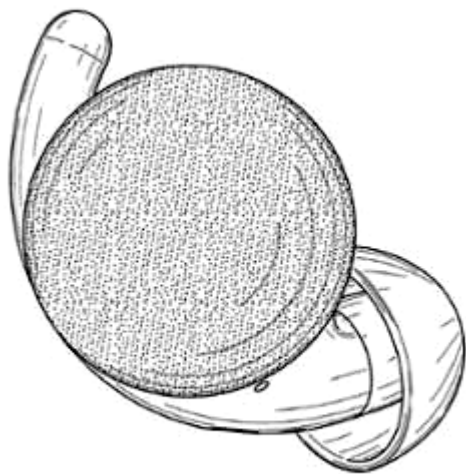

2.2



2.3

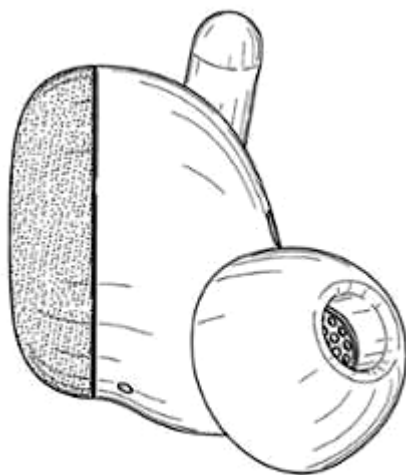

2.4

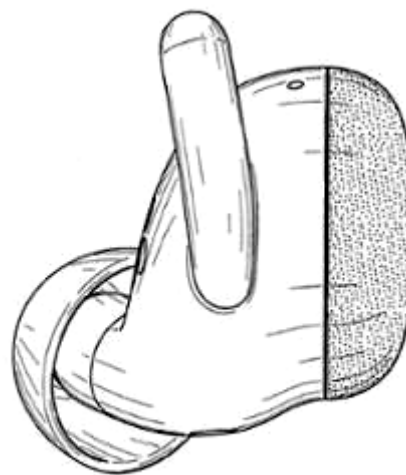

2.5

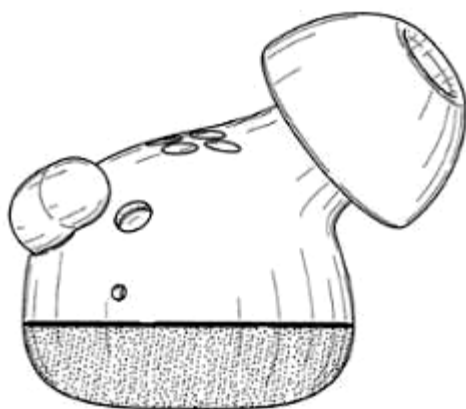

2.6

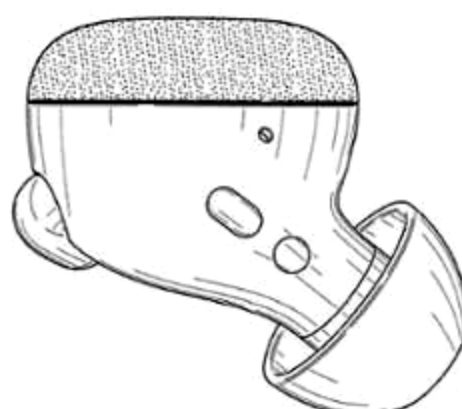

2.7

(11) **41062**

(21) 3-2020-00485

(28) 1

(54) **NAN CỬA**

(51) **25-01**

(22) 04/03/2020

(43) 25/02/2021

CÔNG TY CỔ PHẦN TÂN PHONG (VN)

(73) Số 9B, ngách 100/4, ngõ 100, đường Hoàng Quốc Việt, phường Nghĩa Đô, quận Cầu Giấy, thành phố Hà Nội

(72) Trần Văn Thiêm (VN)

(74) **CÔNG TY LUẬT TRÁCH NHIỆM HỮU HẠN AMBYS HÀ NỘI (AMBYS HANOI)**

(55)



1.1

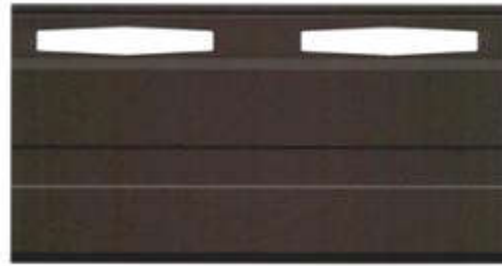

1.2



1.3



1.4



1.5



1.6



1.7

(11) **41063**

(21) 3-2020-00263

(28) 1

(54) **THANH ĐỊNH HÌNH**

(51) **25-01**

(22) 04/02/2020

(43) 25/02/2021

CÔNG TY TNHH CƠ KIM KHÍ QUANG MINH (VN)

(73) 275-NO-07-LK07-12 khu đất dịch vụ 1, phường Đồng Mai, quận Hà Đông, thành phố Hà Nội

(72) 1. TRỊNH TUẤN THẮNG (VN)

2. ĐÌNH ĐỨC ANH (VN)

(74) Công ty TNHH Trường Xuân (AGELESS CO.,LTD.)

(55)

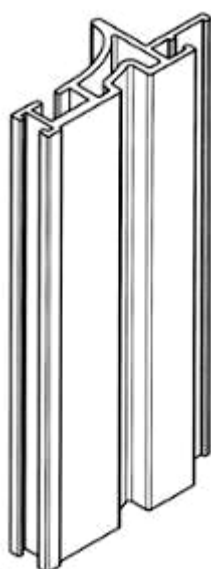

1.1

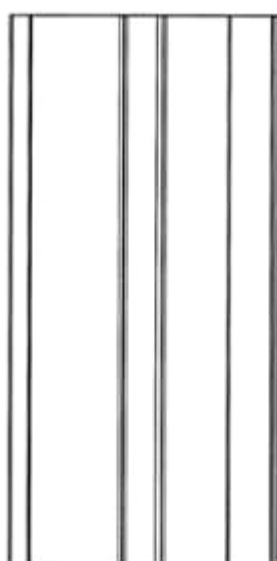

1.2

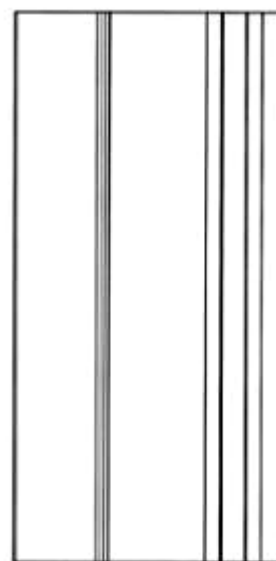

1.3



1.4



1.5



1.6



1.7

- (11) **41064**
(21) 3-2020-00242 (28) 2
(54) **ỐNG DỪNG CHO XÂY DỰNG** (51) **25-01**
(22) 31/01/2020 (43) 25/02/2021
MS PIPE CO., LTD. (KR)
(73) 65, Songdeok-ro 212beon-gil, Ocheon-eup, Nam-gu, Pohang-si, Gyeongsangbuk-do, Republic of Korea
(72) KIM, Jae Young (KR)
(74) Công ty TNHH Trường Xuân (AGELESS CO.,LTD.)
(55)

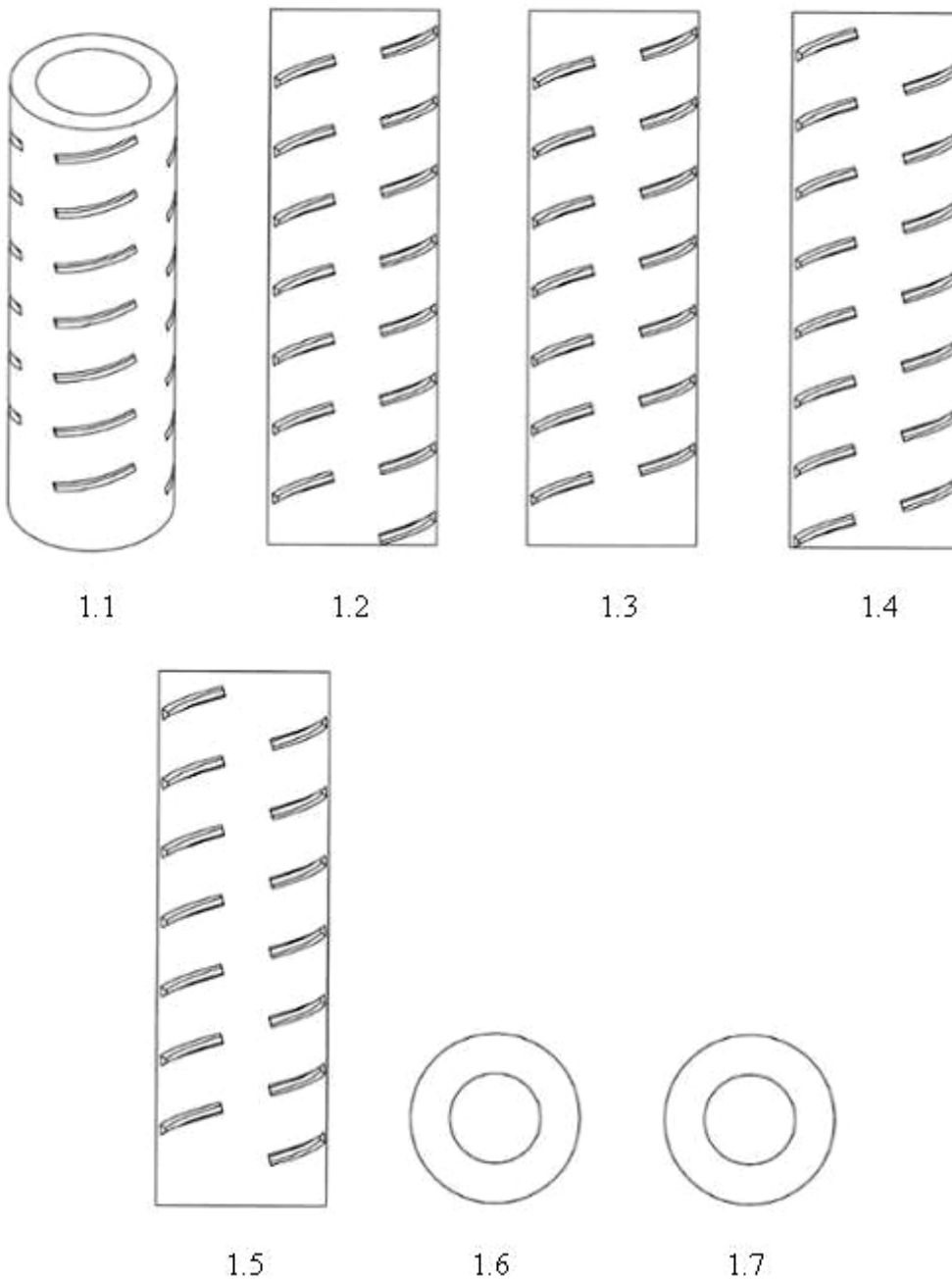



1.8

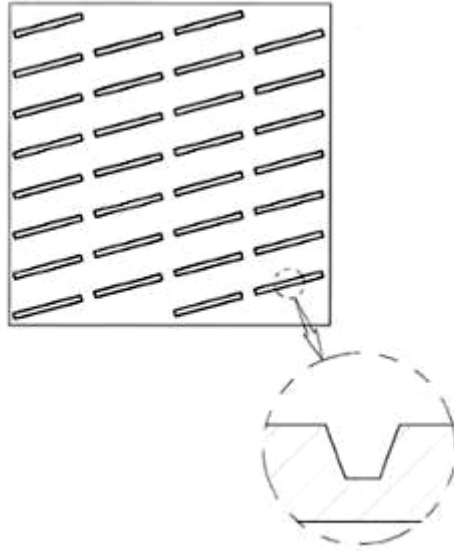

1.9



2.1

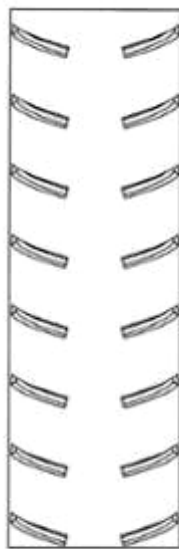

2.2



2.3



2.4



2.5

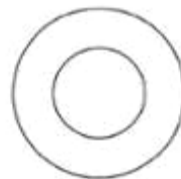

2.6



2.7



2.8



2.9

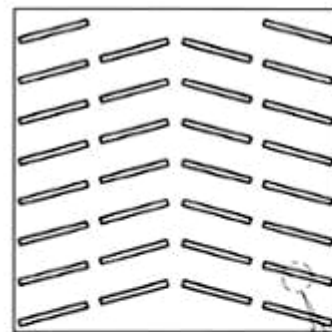

2.10

CÔNG BÁO SỞ HỮU CÔNG NGHIỆP SỐ 395 TẬP A – QUYỀN 2 (02.2021)

(11) **41065**

(21) 3-2020-00178

(28) 1

(54) **HỒ GA NGĂN MÙI**

(51) **25-02**

(22) 21/01/2020

(43) 25/02/2021

CÔNG TY CỔ PHẦN KHOA HỌC CÔNG NGHỆ VIỆT NAM (BUSADCO)

(73) (VN)

Số 6 đường 3 tháng 2, phường 8, thành phố Vũng Tàu, tỉnh Bà Rịa - Vũng Tàu

(72) Hoàng Đức Thảo (VN)

(55)

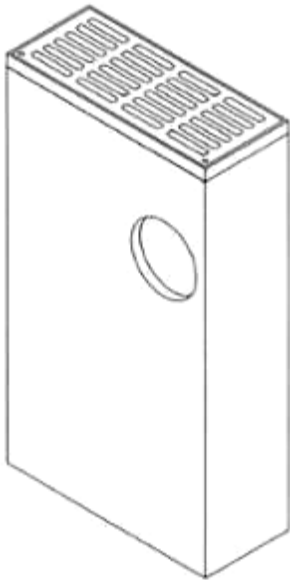

1.1

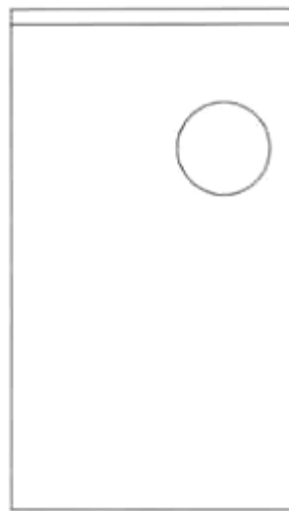

1.2



1.3



1.4



1.5

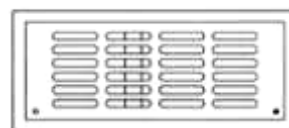

1.6



1.7

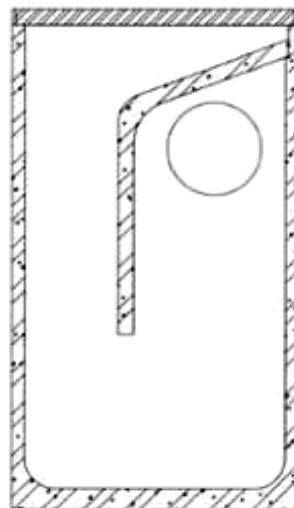

1.8

CÔNG BÁO SỞ HỮU CÔNG NGHIỆP SỐ 395 TẬP A – QUYỀN 2 (02.2021)

- (11) **41066**
(21) 3-2019-03463 (28) 1
(54) **GHẾ SÔ PHA** (51) **06-01**
(22) 27/12/2019 (43) 25/02/2021
(73) **HTL FURNITURE (CHINA) CO., LTD. (CN)**
Wu Yujiangnan Road, Kunshan Development Zone, Jiangsu Province, China
(72) PHUA YONG TAT (SG)
(74) Công ty Luật TNHH quốc tế BMVN (BMVN INTERNATIONAL LLC)
(55)



1.1



1.2



1.3



1.4



1.5



1.6



1.7



1.8

CÔNG BÁO SỞ HỮU CÔNG NGHIỆP SỐ 395 TẬP A – QUYỀN 2 (02.2021)

(11) **41067**

(21) 3-2019-03455

(28) 1

(54) **GHÉ**

(51) **06-01**

(22) 27/12/2019

(43) 25/02/2021

(73) **HTL FURNITURE (CHINA) CO., LTD. (CN)**

Wu Yujiangnan Road, Kunshan Development Zone, Jiangsu Province, China

(72) PHUA YONG TAT (SG)

(74) Công ty Luật TNHH quốc tế BMVN (BMVN INTERNATIONAL LLC)

(55)



1.1



1.2



1.3



1.4



1.5



1.6

CÔNG BÁO SỞ HỮU CÔNG NGHIỆP SỐ 395 TẬP A – QUYỀN 2 (02.2021)

(11) **41068**

(21) 3-2019-03451

(28) 1

(54) **GHÉ**

(51) **06-01**

(22) 27/12/2019

(43) 25/02/2021

(73) **HTL FURNITURE (CHINA) CO., LTD. (CN)**

Wu Yujiangnan Road, Kunshan Development Zone, Jiangsu Province, China

(72) PHUA YONG TAT (SG)

(74) Công ty Luật TNHH quốc tế BMVN (BMVN INTERNATIONAL LLC)

(55)



1.1



1.2



1.3



1.4



1.5



1.6

CÔNG BÁO SỞ HỮU CÔNG NGHIỆP SỐ 395 TẬP A – QUYỀN 2 (02.2021)

- (11) **41069**
(21) 3-2019-03450 (28) 1
(54) **GHẾ** (51) **06-01**
(22) 27/12/2019 (43) 25/02/2021
(73) **HTL FURNITURE (CHINA) CO., LTD. (CN)**
Wu Yujiangnan Road, Kunshan Development Zone, Jiangsu Province, China
(72) PHUA YONG TAT (SG)
(74) Công ty Luật TNHH quốc tế BMVN (BMVN INTERNATIONAL LLC)
(55)



1.1



1.2



1.3



1.4



1.5



1.6

CÔNG BÁO SỞ HỮU CÔNG NGHIỆP SỐ 395 TẬP A – QUYỀN 2 (02.2021)

- (11) **41070**
(21) 3-2019-03448 (28) 1
(54) **GHẾ** (51) **06-01**
(22) 27/12/2019 (43) 25/02/2021
(73) **HTL FURNITURE (CHINA) CO., LTD. (CN)**
Wu Yujiangnan Road, Kunshan Development Zone, Jiangsu Province, China
(72) PHUA YONG TAT (CN)
(74) Công ty Luật TNHH quốc tế BMVN (BMVN INTERNATIONAL LLC)
(55)



1.1



1.2



1.3



1.4



1.5



1.6

CÔNG BÁO SỞ HỮU CÔNG NGHIỆP SỐ 395 TẬP A – QUYỀN 2 (02.2021)

- (11) **41071**
(21) 3-2019-03426 (28) 1
(54) **GHẾ SÔ-PHA** (51) **06-01**
(22) 27/12/2019 (43) 25/02/2021
(73) **HTL FURNITURE (CHINA) CO., LTD. (CN)**
Wu Yujiangnan Road, Kunshan Development Zone, Jiangsu Province, China
(72) PHUA YONG TAT (SG)
(74) Công ty Luật TNHH quốc tế BMVN (BMVN INTERNATIONAL LLC)
(55)





1.6

CÔNG BÁO SỞ HỮU CÔNG NGHIỆP SỐ 395 TẬP A – QUYỀN 2 (02.2021)

(11) **41072**

(21) 3-2019-03278

(28) 1

(54) **GHẾ SÔ-PHA**

(51) **06-01**

(22) 13/12/2019

(43) 25/02/2021

(73) **HTL FURNITURE (CHINA) CO., LTD. (CN)**

Wu Yujiangnan Road, Kunshan Development Zone, Jiangsu Province, China

(72) PHUA YONG TAT (SG)

(74) Công ty Luật TNHH quốc tế BMVN (BMVN INTERNATIONAL LLC)

(55)



1.1



1.2



1.3



1.4



1.5

CÔNG BÁO SỞ HỮU CÔNG NGHIỆP SỐ 395 TẬP A – QUYỀN 2 (02.2021)

- (11) **41073**
(21) 3-2019-03245 (28) 1
(54) **GHẾ SÔ-PHA** (51) **06-01**
(22) 11/12/2019 (43) 25/02/2021
(73) **HTL FURNITURE (CHINA) CO., LTD. (CN)**
Wu Yujiangnan Road, Kunshan Development Zone, Jiangsu Province, China
(72) PHUA YONG TAT (SG)
(74) Công ty Luật TNHH quốc tế BMVN (BMVN INTERNATIONAL LLC)
(55)



1.1



1.2



1.3



1.4



1.5



1.6

CÔNG BÁO SỞ HỮU CÔNG NGHIỆP SỐ 395 TẬP A – QUYỀN 2 (02.2021)

(11) **41074**

(21) 3-2019-03244

(28) 1

(54) **GHẾ SÔ-PHA**

(51) **06-01**

(22) 11/12/2019

(43) 25/02/2021

(73) **HTL FURNITURE (CHINA) CO., LTD. (CN)**

Wu Yujiangnan Road, Kunshan Development Zone, Jiangsu Province, China

(72) PHUA YONG TAT (SG)

(74) Công ty Luật TNHH quốc tế BMVN (BMVN INTERNATIONAL LLC)

(55)



1.1



1.2



1.3



1.4



1.5



1.6

CÔNG BÁO SỞ HỮU CÔNG NGHIỆP SỐ 395 TẬP A – QUYỀN 2 (02.2021)

- (11) **41075**
(21) 3-2019-03148 (28) 2
(54) **Ổ KHÓA** (51) **08-06; 08-07**
(22) 05/12/2019 (43) 25/02/2021
(30) 201930292057.7 06/06/2019 CN;
BEIJING XIAOMI MOBILE SOFTWARE CO., LTD. (CN)
(73) No.018, Floor 8, Building 6, Yard 33, Middle Xierqi Road, Haidian District, Beijing 100085, China
(72) 1. JIANYU TANG (CN)
2. NINGNING LI (CN)
(74) Công ty TNHH Sở hữu trí tuệ Vàng (GINTASSET CO., LTD.)
(55)

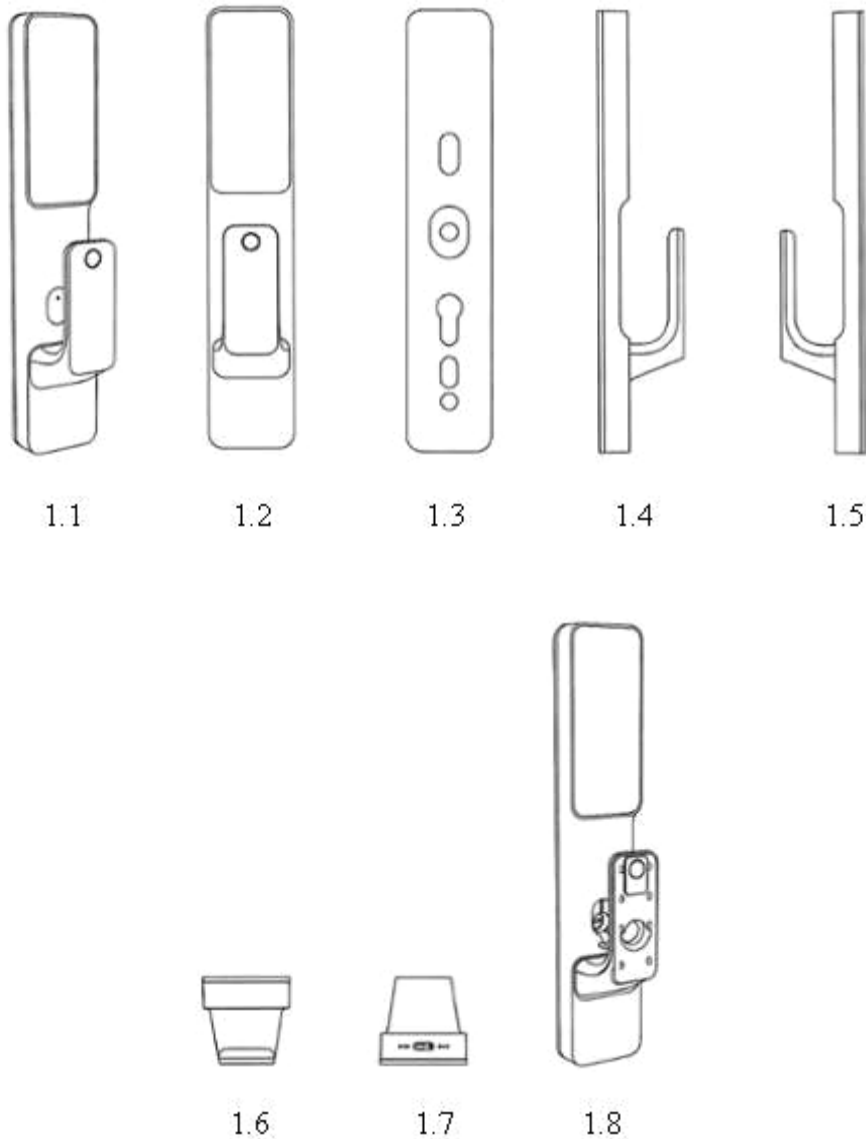

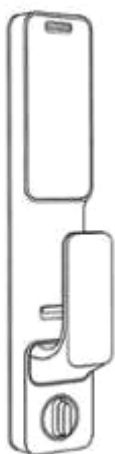

2.1



2.2



2.3



2.4



2.5



2.6



2.7



2.8

(11) **41076**

(21) 3-2019-02526

(28) 1

(54) **MIẾNG ỚP GÓC**

(51) **12-16**

(22) 03/10/2019

(43) 25/02/2021

CÔNG TY TNHH SẢN XUẤT - THƯƠNG MẠI - DỊCH VỤ Ô TÔ QUYỀN (VN)

(73) Lô 2A Đức Hòa Hạ, khu công nghiệp Tân Đức, xã Đức Hòa Hạ, huyện Đức Hòa, tỉnh Long An

(72) Hứa Duy Luân (VN)

(74) Công ty TNHH Tư vấn sở hữu trí tuệ Việt (VIET IP CO.,LTD.)

(55)

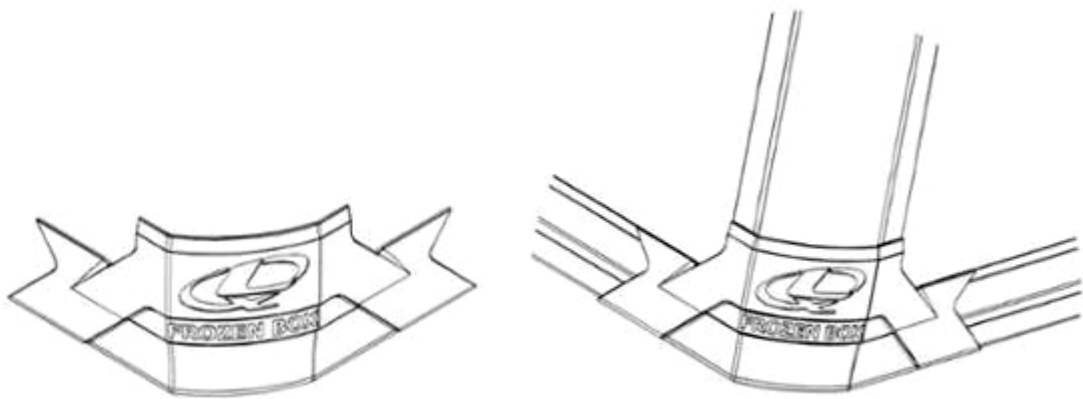

1.1

1.2

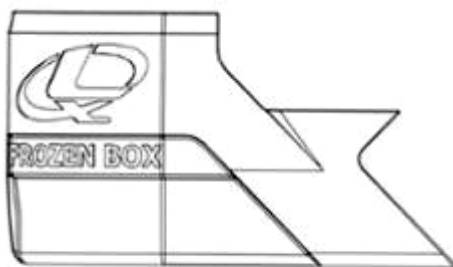

1.3

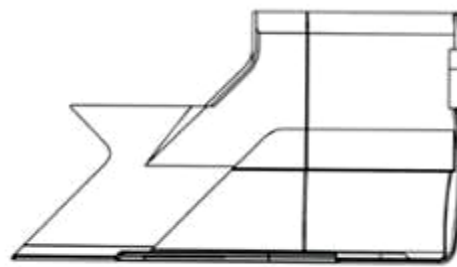

1.4

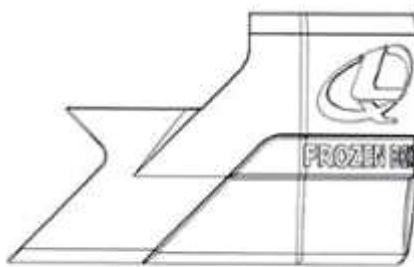

1.5

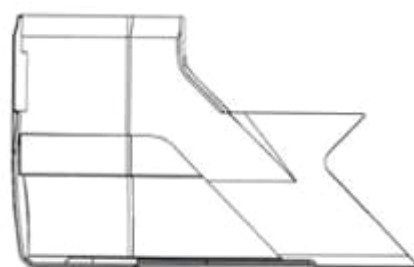

1.6

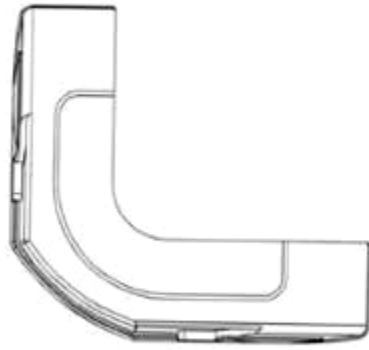

1.7



1.8

(11) **41077**

(21) 3-2019-02196

(28) 1

(54) **CÀU NÂNG**

(51) **12-05**

(22) 29/08/2019

(43) 25/02/2021

(73) **MING LURN PRECISION MACHINE CO., LTD. (TW)**

No. 66, Ln. 2, Sec. 2, Shatian Rd., Dadu Dist., Taichung City 432, Taiwan

(72) Tsung-Hsiang CHEN (TW)

(74) Văn phòng Luật sư Ân Nam (ANNAM IP & LAW)

(55)



1.1

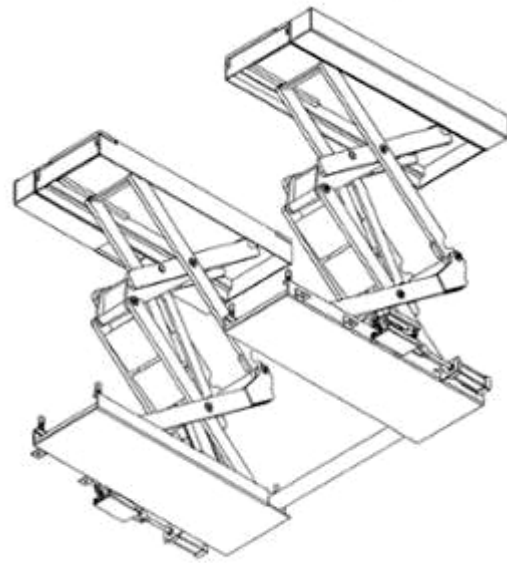

1.2

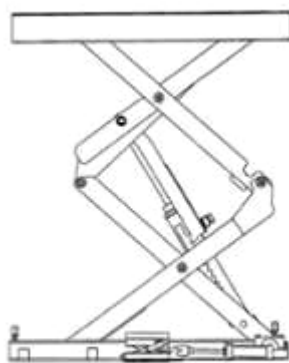

1.3

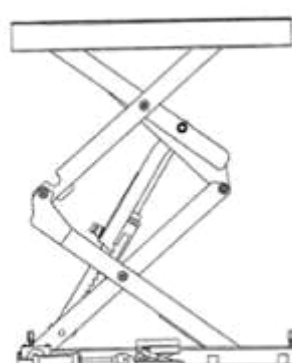

1.4

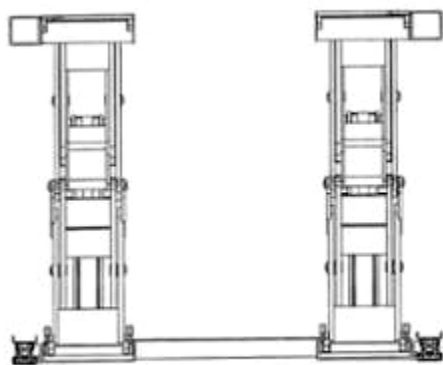

1.5

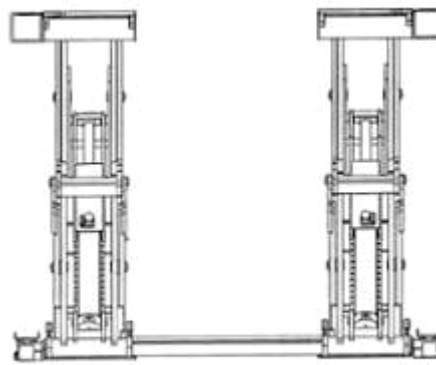

1.6

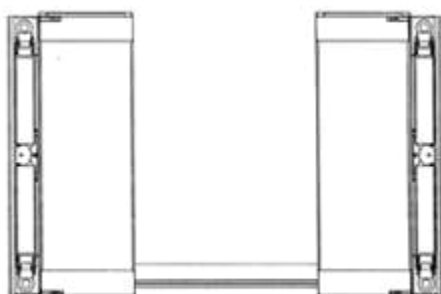

1.7

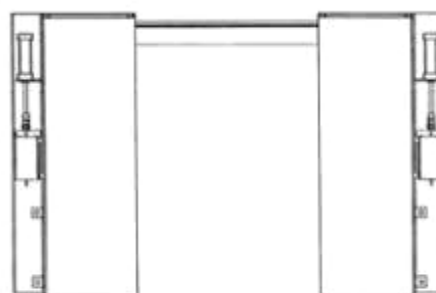

1.8

- (11) **41078**
(21) 3-2019-02086 (28) 2
(54) **RƠ LE BẢO VỆ ĐIỆN ÁP CAO VÀ THẤP KẾT NỐI KHÔI PHỤC TỰ ĐỘNG** (51) **13-03; 13-99**
(22) 19/08/2019 (43) 25/02/2021
(30) 201930081709.2 28/02/2019 CN;
PANASONIC INTELLECTUAL PROPERTY MANAGEMENT CO., LTD.
(73) (JP)
1-61, Shiromi 2-chome, Chuo-ku, Osaka-shi, Osaka 540-6207 Japan
1. XIANQING LUO (CN)
(72) 2. XIANG MAO (CN)
3. HATSUO MIZUNO (JP)
(74) Công ty Luật TNHH Phạm và Liên danh (PHAM & ASSOCIATES)
(55)

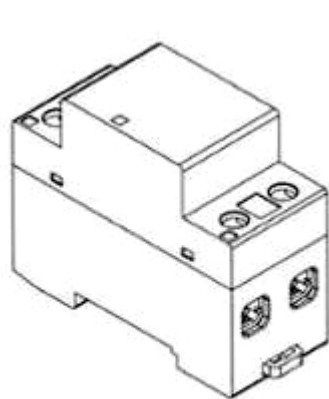

1.1

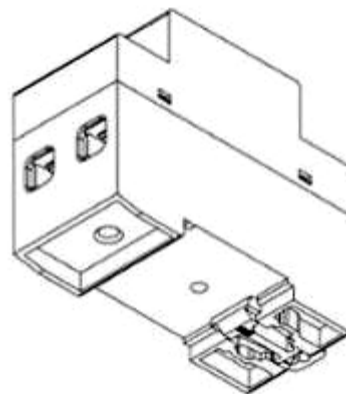

1.2

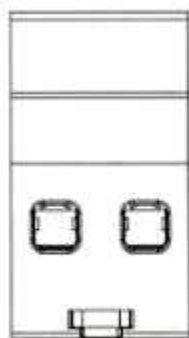

1.3

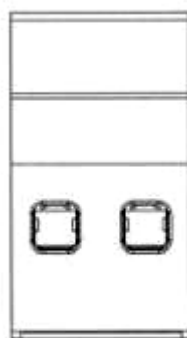

1.4

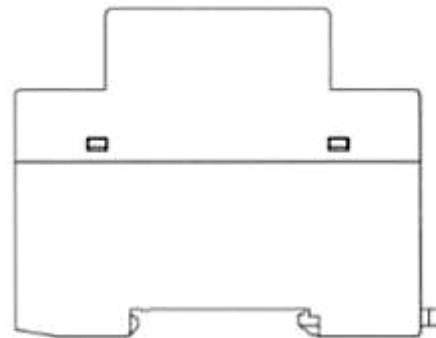

1.5

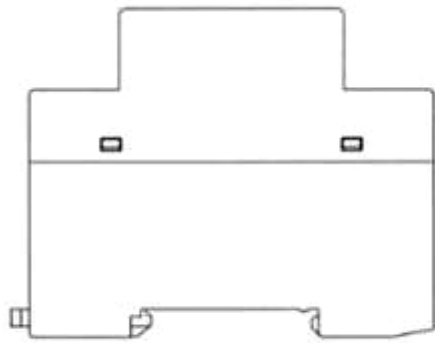

1.6



1.7

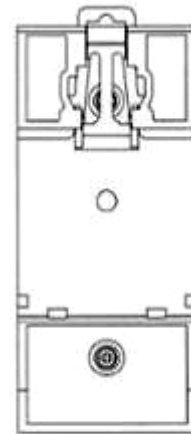

1.8

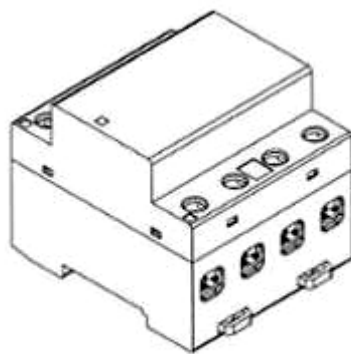

2.1

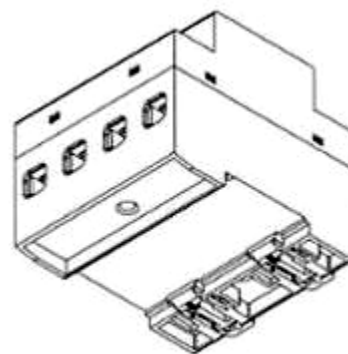

2.2

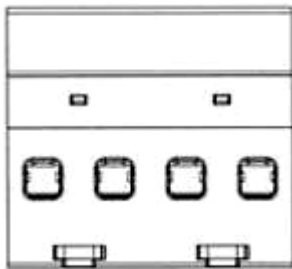

2.3

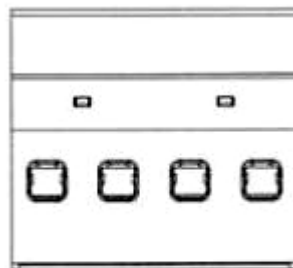

2.4

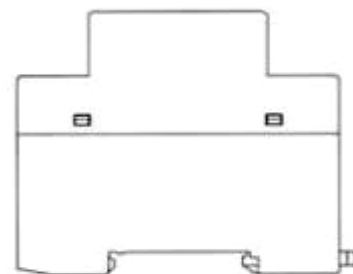

2.5

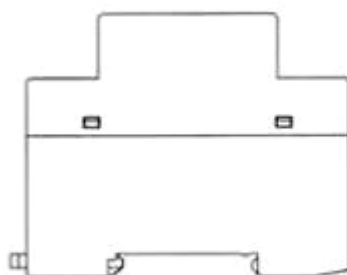

2.6

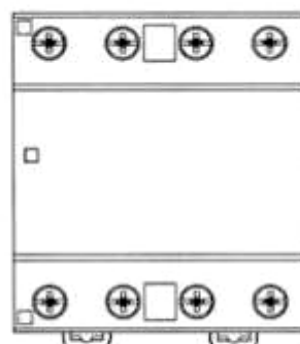

2.7

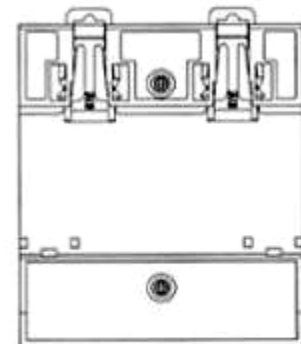

2.8

(11) **41079**

(21) 3-2019-01796

(28) 1

(54) **XE ĐẠP XÉP**

(51) **12-11**

(22) 17/07/2019

(43) 25/02/2021

(73) **TRẦN HƯƠNG BÌNH (VN)**

18/21A Trần Quang Diệu, phường 14, quận 3, thành phố Hồ Chí Minh

(72) Trần Hương Bình (VN)

(55)



1.1

1.2



1.3

1.4



1.5



1.6



1.7



1.8

CÔNG BÁO SỞ HỮU CÔNG NGHIỆP

Do Cục Sở hữu trí tuệ thuộc Bộ Khoa học và Công nghệ ấn hành theo Luật Sở hữu trí tuệ số 50/2005/QH11 được Quốc hội thông qua ngày 29 tháng 11 năm 2005 và được sửa đổi bằng Luật sửa đổi, bổ sung một số điều của Luật sở hữu trí tuệ số 50/2005/QH11 được Quốc hội thông qua ngày 19 tháng 6 năm 2009.

Địa chỉ liên hệ:

384-386 đường Nguyễn Trãi, quận Thanh Xuân,
thành phố Hà Nội, Việt Nam
ĐT: 024. 38583069
Fax: 024. 38588449